

POPULAR MECHANICS

MAGAZINE



WRITTEN SO YOU CAN UNDERSTAND IT

REGD. TRADE MARK GREAT BRITAIN NO. 40426

REG. U.S. PAT. OFF.

FEBRUARY
1946
25 CENTS
30c IN CANADA



SEE PAGE 40



...look **SHARP**.....
...feel **SHARP**.....
...be **SHARP**.....



use **Gillette**
Blue Blades

with the **SHARPEST** edges ever honed!

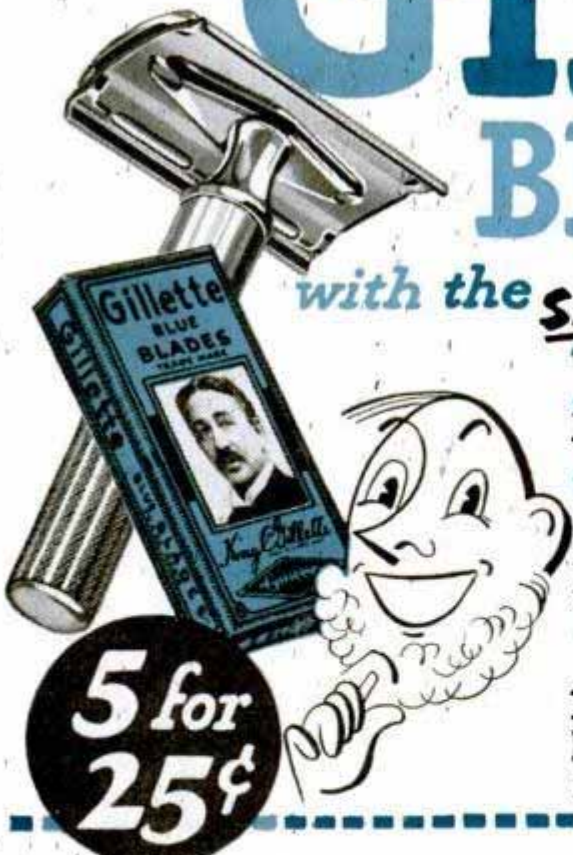

You look SHARP because you get the best-looking shaves any man ever had!

You feel SHARP because Gillette Blue Blades give you the quickest, most refreshing shaves of your life!

You are SHARP when you buy Gillette Blue Blades with the **SHARPEST** edges ever honed, because you get more shaves per blade and save money!

Copr. 1946 Gillette Safety Razor Co.

GILLETTE'S CAVALCADE OF SPORTS presents the major boxing event of the week every Friday night over American Broadcasting Company stations at 10 o'clock E.S.T.
Gillette Safety Razor Company, Boston 6, Mass.



Even at high speeds these new tires

OUTWEAR PREWAR TIRES

It's the new B. F. Goodrich tire for passenger cars

THE new B. F. Goodrich tire is made from synthetic rubber, but it is not a "wartime" tire. It has passed nearly 17 million miles of tests...on taxi fleets...on police cars (like the one above) and on the B. F. Goodrich test fleet.

Many of the tests required constant running, day and night, at sixty miles an hour. Few, if any, drivers are ever going to ask this kind of wear of a tire.

Yet the new B. F. Goodrich synthetics not only outlasted prewar tires—but they did better than new tires of natural rubber built

to prewar specifications!

These tires are made from a new kind of synthetic rubber that runs cooler, wears better, than other types. The tread is made wider and flatter so that the tread wear is distributed over more tire surface.

The tire body, or carcass, is stronger, too! By using a new kind of stronger cord—and by using more cords in each tire, B. F. Goodrich has perfected a stronger tire body.

B. F. Goodrich started making synthetic tires 18 months before Pearl Harbor, and offered tires containing synthetic rubber to Amer-

ican motorists three years ahead of any other tire manufacturer.

They were the first such tires ever sold in America. This extra experience is reflected in the best tire for your car today . . . B. F. Goodrich *Silvertown* that actually outwears prewar tires. *The B. F. Goodrich Company, Akron, Ohio.*



Here's why most Airlines specify Champion Spark Plugs

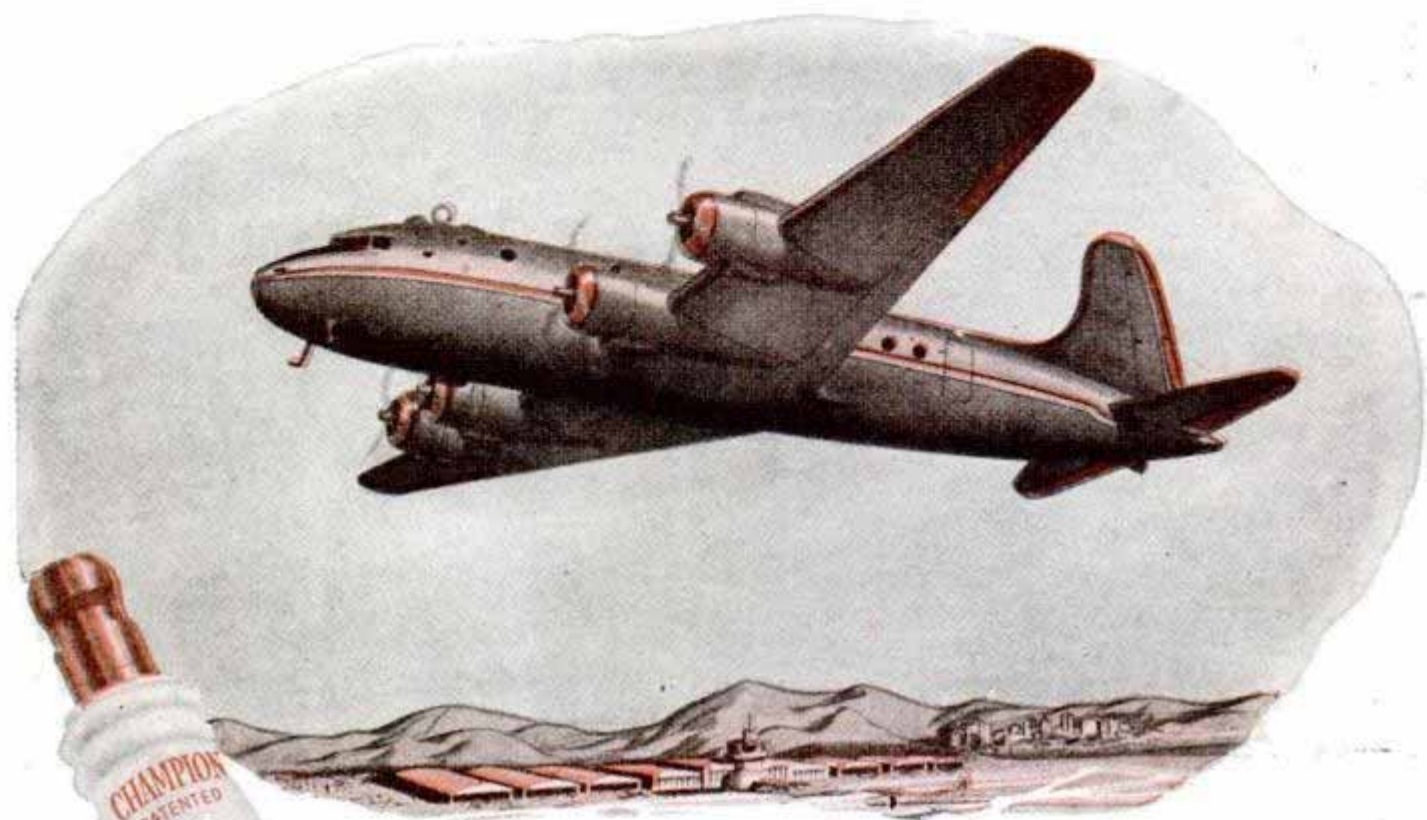

THEY'RE DEPENDABLE!

Your choice of Champion Spark Plugs is made easy and sure if you follow the judgment and experience of men who know spark plugs best—men to whom spark plugs are a vital factor in their business. Most airlines find in Champions those indispensable qualities of maximum performance and dependability so essential to the better performance of your car—your own motoring satisfaction. Champion Spark Plug Company, Toledo 1, Ohio.

FOLLOW THE EXPERTS . . . DEMAND DEPENDABLE CHAMPIONS FOR YOUR CAR

Popular Mechanics Magazine

Registered in U. S. Patent Office and Canada

H. H. WINDSOR, Founder

H. H. WINDSOR, Jr., Editor and Publisher



Lt. Col. Aubrey O. Cookman, recently released from the U. S. Army Air Forces after nearly five years of service, has joined the staff of Popular Mechanics as Aviation Editor.

Next Month

COSMIC rays are not, at the moment, for hire. But potentially they may pack more useful power than the atom, and scientists are busily trying to solve their mystery. They hit the edge of our universe with the energy of 15 billion volts, and can penetrate 1600 feet of rock. A March feature tells how the cosmic ray researchers are "Unlocking the Universe."

RAINBOW trout, bass or pan fish are very fastidious. They won't bite on any old bait you toss at them. With new tackle to be available soon, fishermen will find a handy guide to follow in "Tips on Tackle," appearing next month.

A GOOD house-painting job isn't just an accident. It's the result of using high-grade materials on a surface painstakingly prepared. An article in the March Craftsman Section tells how to do it right.

YANKEE ingenuity is nowhere more at home than on the farm. It always will be hard work to operate a farm, but between the ingenious farmer and the implement manufacturers the business of producing food is heading as rapidly as it can toward a push-button industry. "Mechanics Are Popular on the Farm," featured next month, is a report of progress.

FOUR tubes do the work of seven in the "Little Giant" A.C.-D.C. Super Broadcast Receiver described in the March Radio and Electronics Section.

Volume 85 FEBRUARY 1946 Number 2

Managing Editor.....Roderick M. Grant
Assistant Managing Editor.....Wayne Whittaker
Shop Notes and Crafts Editor.....James R. Ward
Radio and Electronics Editor.....Frank L. Britton
Art Director.....Frank Beatty
Aviation Editor.....Aubrey O. Cookman
Associate Editor.....John R. Kinsey
Western Editor.....Thomas E. Stimson, Jr.

In This Issue

Radar Cues the Navy Fighters	1
Two New Building Blocks	8
"Little David"	13
Artist With a Pocketknife	17
Running Water for Saipan	28
On Guard Against Death Rays	32
Science Pins Down the Weather	40
Maps for a Shrinking World	50
Fingerprinting Surfaces With Film	60
Plugging the Dikes of Holland	65
Will Malaria Strike at Home?	76
Fighting Flying Ice	82

For the Craftsman

Fencing Frames the House	88
Nutshell Novelties	98
Kitchen Desk and Breakfast Table	107
Kiltie—Model Racing Yacht	115
Multipurpose Voltage Regulators	133
Radio and Electronics	141

Other items, and manufacturers of available products described, are listed on pages 8A and 10A

Published monthly by POPULAR MECHANICS COMPANY, 200 East Ontario Street, Chicago 11, Ill. H. H. Windsor, Jr., president; Paul H. Dunakin, vice president and general manager; D. F. Windsor, vice president and secretary-treasurer; William Harrison Fetridge, assistant to the publisher; Clover L. Perkins, advertising manager; Alan M. Deyoe, circulation manager. Single copy in the United States, 25 cents; subscription rates in United States and possessions, and countries of the Pan-American Postal Union, 1 year, \$2.50; 2 years, \$4.50; 3 years, \$6.00. Single copy in Canada, 30 cents; subscription rates, 1 year, \$3.00; 2 years, \$5.50; 3 years, \$7.50. To all other countries add \$1.00 a year over United States prices for overseas postage. If you plan to move, notify us at least 60 days in advance so you will not miss an issue. Give both old and new addresses. Entered as Second Class Matter, September 15, 1903, at the Post Office at Chicago, Illinois, under Act of March 3, 1879. Entered as Second Class Matter at Post Office Dept., Canada. Copyright 1946, by Popular Mechanics Company. Copyright under International Copyright Union. All rights reserved under Pan-American Copyright Union. Printed in the United States of America.

Planes That Made History!

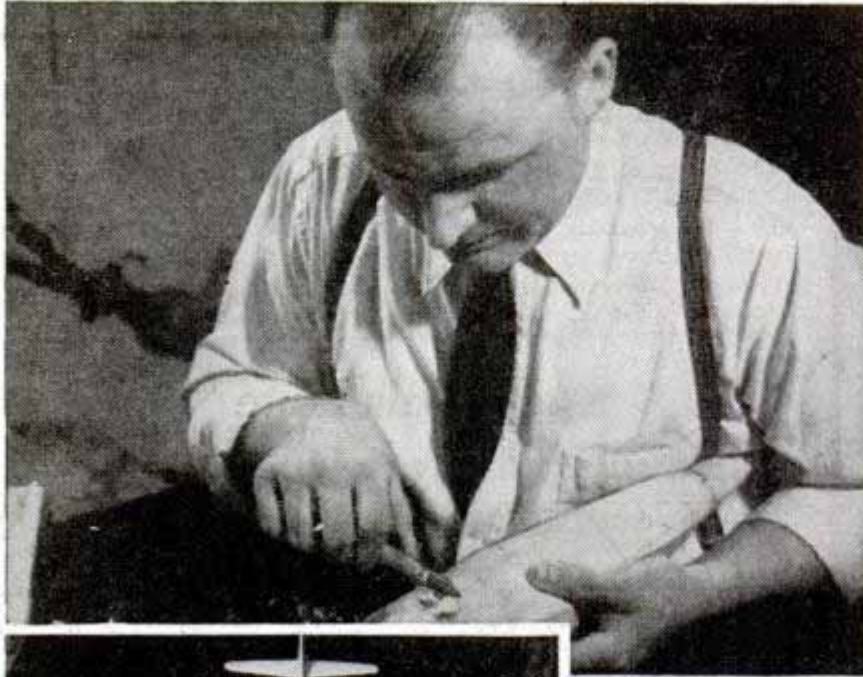

Above: Adolph Esbrandt of Baltimore carving a miniature Boeing Clipper.

Left: Esbrandt's scale models of the Wright Brothers' first plane; the first plane to fly across the English Channel; the famous B-29.

Baltimore Hobbycrafter Builds Scale Models of Famous Planes — With X-acto Knives

SAYS X-ACTO IS INDISPENSABLE

Not everybody who likes to build scale model planes can be as expert at it as Adolph Esbrandt. But you'll come a lot closer to it if you use the knife the experts choose . . . a super-sharp X-acto!

"I find X-acto indispensable," says Mr. Esbrandt. "With its variety of blades and handles, it's the perfect tool for every job from tiny braces to the big, solid fuselage section."

What's Your Hobby? Plane models? Whittling? Leather work? Photography? Get yourself an X-acto and you'll have a lot more fun. Easy to use as a pencil, keen as a surgeon's scalpel. It's the hobbycrafter's favorite knife for paper, wood or plastics.

Girls, Too? Sure thing! Plenty of girls make plane models . . . and use X-acto Knife kits. Send 10c for a copy of "How to Build Scale Model Planes," an illustrated, 32-page booklet that tells you just what to do.



x-acto
KNIVES & TOOLS

X-acto Knives & Knife Chests From 50c to \$5.00

* Buy where you see this sign. At better hardware, hobby and gift shops — or if not available write direct to X-acto Crescent Products Co., Inc., 440 Fourth Avenue, New York 16, N. Y.

*Reg. U. S. Pat. Off.

ONLY X-ACTO KNIVES HAVE ALL THESE IMPORTANT ADVANTAGES

FIRST CHOICE of experts in hobbycraft and art fields. Indispensable tool for modelmaker's workshop.

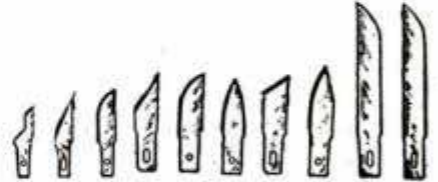

10 BLADE SHAPES, interchangeable. All of scalpel-sharp surgical steel. A blade for every type of cutting job.



3 HANDLE STYLES, of solid duraluminum construction. Designed for safety, firm grip, precise control.



INGENIOUS COLLET DEVICE locks in blades securely, so they can't fold under on curves or heavy cuts.



CHANGE BLADES in about 5 seconds. A twist, a twirl, and there! X-acto's always sharp, always ready.



X-ACTO TOOLS, TOO! Scientifically accurate, each perfect for its purpose. Sander, 50c; Balsa Stripper (without Knife), \$1; Planer, \$1. Drill Holder and Pin Vise, 75c; Hobbycrafter's Saw, \$1.25.

Read what Home Owners say about MODUFLOW*^{comfort}

ACTUAL EXCERPTS FROM USERS' LETTERS

(Names available on request)

- "Would not take a thousand dollars for mine if I could not get another."
- "This is the first winter season we have been able to enjoy our home."
- "Moduflow results have far exceeded the most extreme statements made in your advertising."
- "Since the installation of Moduflow, the temperature does not vary over one-half a degree."
- "In effect, Moduflow has added a room to our home during the heating season."
- "Next to the purchase of war bonds, I consider the purchase I made from you of a Moduflow control system as my best buy."
- "Since our new Moduflow system was installed, we have enjoyed a more comfortable home than we thought possible."
- "We are getting steady, even temperature at all times all over the house. It is the last word in house heating."
- "Since Moduflow has been installed the same floors are warm enough to allow the baby to play on them, and we are able to set our thermostat much lower."
- "I am delighted with Moduflow and take pleasure in recommending it as being the perfect heat control system."



During the past two years, Honeywell's remarkable new MODUFLOW Control System has been installed in thousands of homes. Hundreds of enthusiastic letters have poured in telling about the amazing improvement in heating comfort.

Here are some typical quotations taken from a few of these letters. They stamp Moduflow as the greatest advance in heating comfort since the invention of automatic controls.

FOR YOUR PRESENT HOME

Best news of all is that Moduflow can be easily and inexpensively installed in your present automatic heating plant. You don't have to wait until you remodel or build a new home.

FOR YOUR NEW HOME

If you are planning to build, make sure that your new home is *really modern* with a Moduflow Control System. Get the complete story of Moduflow without delay. Mail the coupon for your free copy of "Heating and Air Conditioning the Postwar Home".

* Moduflow is the name of Honeywell's newest heating control system for homes. It means heat *modulated* to just the right comfort temperature, with a uniform, continuous flow. Moduflow is a heating control system — not a complete heating plant. It can be installed in any type of automatic heating plant, whether warm air, hot water or steam.

SEND FOR THIS BOOK 

Minneapolis-Honeywell Reg. Co.
2749 Fourth Avenue South
Minneapolis 8, Minnesota
Please send my free copy of "Heating
and Air Conditioning the Postwar Home"

Name

Address

City State

Tomorrow's Apartment will have Personalized Heat Control . . . with Moduflow

By These Signs -----

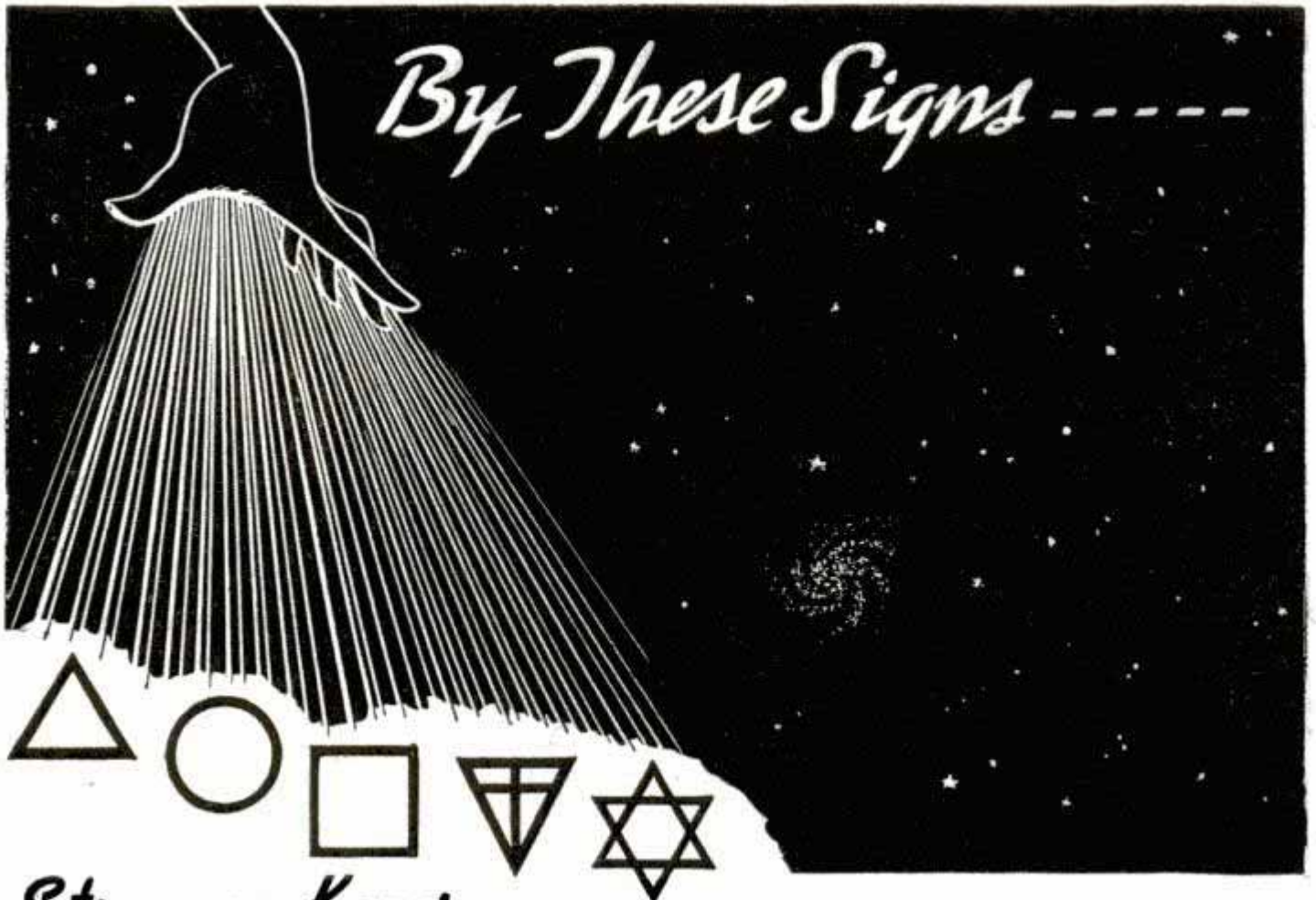

Strange Keys to the Powers of the Universe

"GOD GEOMETRIZES," said an ancient sage. Within the straight line, curve, and angle—and their combinations—exist the forces of creation. These *secret symbols* contain the mysterious laws of the universe. Upon their right use—or the neglect of them—the success or failure of every *human enterprise* depends.

Have you a desire, *something you wish to accomplish* in life? Put your finger on a dot. In whatever direction you move your finger from the dot, you have made a beginning. Thus a dot is the symbol of *one*—or a beginning. Your desire then is also symbolized by *one*. If you follow the *proper method* or way to accomplish what you want, you have arrived at point *two*. Whenever these two symbols are brought together—the idea and the right way—you produce point *three*—the success of your plan. Success, therefore, is symbolized by the three equal sides of a *triangle*.

In planning your personal affairs—business, domestic, or the welfare of your family—do you use a *Cosmic formula*? Do you determine whether your acts are in accord with Divine truths eternally expressed in symbols? Why does the circle represent completion? Why is it said that a man is on the square? These

symbols are used by astronomers and scientists to prove the physical laws of the universe—why don't you apply them to the problems of your everyday world? Learn what symbols, as powers and forces of nature, you can simply and intelligently use in directing the course of your life.

Let the Rosicrucians (not a religious organization), a world-wide brotherhood of learning, reveal to you *the symbolism of successful living*.

Let this GIFT BOOK Explain

If you want to prepare yourself through understanding for the greater rewards of life, write for the fascinating *free Sealed Book*. It explains how you may receive this age-old wisdom. Use the coupon below.

Scribe D. Z. W.
THE ROSICRUCIANS, AMORC
San Jose, California, U. S. A.

Please send me the Free, Sealed Book. I am interested in knowing how I may obtain the masterful Rosicrucian teachings.

Name.....

Address.....

.....



THE ROSICRUCIANS, AMORC - SAN JOSE, CALIFORNIA, U. S. A.



**Are YOU
doing
bookkeeping
"chores"?**

**CLIMB
HIGHER!**

**BECOME
an
ACCOUNTANT**

IF you are doing the "chore" work of accounting as a bookkeeper, ledger clerk, cost clerk, billing clerk, or in one of the other many record keeping jobs—

You should consider climbing higher—becoming an accountant.

Why be satisfied all your life with a small salary and an ordinary job when there is such a large future for the man or woman who understands accountancy in all its forms and phases?

One big difference between you and the successful accountant is that he doesn't do the chores. He bosses those who do the drudgery and he gets the money and prestige. And he does that because he knows the principles behind the records you keep—can plan those records and interpret them to management. He knows what you know—and a lot more.

There are two ways in which you can get this knowledge which will qualify you for an accountant's position.

First—the old way of day-by-day experience on the job. This is the long route—taking many, many years, sometimes a lifetime. Most people taking this way never get anywhere. Why sacrifice years of success—lose time and money—when there is a better and easier way?

Second, the LaSalle way of learning in your spare time—studying and preparing for the step ahead. You learn by doing—you study accounting principles and solve accounting problems. You cover accountancy from the basic principles right up through Accounting Systems and Income Tax Procedure—C.P.A. training if you so desire.

As you go along you absorb the principles of auditing, business law, statistical control, cost accounting, organization, management and finance, etc.

This way is not magic. It is not easy. It requires giving up certain spare time to serious study. How long will it take you to acquire

this accountancy training is strictly up to you—you can go as fast or as slowly as you choose. But after you have gone part way (you need not wait until you are clear through the training) you will find yourself stepping up to better positions.

And once you have mastered this fascinating profession—once you have become an accountant—then you will have the money and the standing to make your dreams come true. You will be a respected member of the best paying profession and equipped to go out into public accounting or to climb to a top management position.

Our free 48-page booklet, "Accountancy, the Profession That Pays," tells you what you must know to be an accountant and how you can prepare in your leisure time at moderate cost. The coupon below will bring this booklet quickly without cost or obligation. You already have a start in this field; now find out how you can go all the way. Do it today.

LASALLE EXTENSION UNIVERSITY
A Correspondence Institution

Dept. 264-H 417 S. Dearborn Street, Chicago 5, Illinois

I'd like to know more about your home study program to help me prepare for an accounting career. Please send me your free 48-page booklet, "Accountancy, the Profession That Pays."

Name . . .

This One

Present to . . .

Address . . .

City & Sta.



GBAB-43B-WNSU

WHERE-TO-BUY-IT INDEX

Manufacturer's name and address appear in parentheses directly after items believed by us to be commercially available

AVIATION

Planes land and take off on nylon rope.....	38
More deadly buzz bombs were on the way.....	49
Radar camera maps world air transport routes.....	59
Nazi ME-110 carried radar installation in nose.....	64
Handley Page Manx is tailless.....	64
XP-83 is longest ranged jet-propelled craft.....	64
British transport has 23 wheels.....	64
Ground test for airplane wings.....	70
Brabazon 1—largest British transport.....	72
Latest British four-engine bomber.....	74

HOUSE AND HOME

Vacuum cleaner saws, grinds, drills, polishes (Marshall Co., 6605 Second Ave., Detroit, Mich.).....	26
Laundry label ironed on (Iron-A-Label Co., Box 4068, Tulsa, Okla.).....	51
Electric oven has transparent walls.....	54
Portable washer (Menasco Mfg. Co., 805 S. San Fernando Blvd., Burbank, Calif.).....	56
Combination sink, dishwasher and washing machine (Hurley Machine, 2115 S. 54th Ave., Cicero 50, Ill.).....	56
Plastic block conditions refrigerator air (Plastex Corp., 653 N. Robertson Blvd., West Hollywood, Calif.).....	56
Combination locker (Tyler Fixture Corp., Niles, Mich.).....	56
Baseboard heating units (Burnham Boiler Corp., Balter St., Irvington, N. Y.).....	57
Vacuum cleaner purifies air (Landers, Frary & Clark, New Britain, Conn.).....	57
Portable washtubs (Noblitt-Sparks, Columbus, Ind.).....	57
Plastic clothesline (Dow Chemical Co., Midland, Mich.).....	57
Fire fighting valve shuts off gas (Kelly Safety Device Co., 2196 W. 65th St., Cleveland 2, Ohio).....	58
"Mirror" insulation reflects heat (Sisalkraft Co., 205 W. Wacker Dr., Chicago 6).....	81
Wax waterproofing (Socony-Vacuum, 26 Broadway, New York).....	148
Skirt hanger (M. S. Glover, 212 2d Natl. Bldg., Akron 8, Ohio).....	160

INDUSTRY

Electrified water salts eliminate corrosion (Stomac Engineering Co., 2000 W. 25th St., Cleveland 13, Ohio).....	26
Rotating work-holder (Garfield Eng. Co., Wichita 2, Kans.).....	31
Movable booth "mixes" sound for movies.....	31
Dial on inside calipers (B. C. Ames Co., Waltham, Mass.).....	36
Small rotary files spin at 100,000 r.p.m. (Lincoln Park Industries, Lincoln Park 25, Mich.).....	36
Finger flashlight (Universal Prod. Corp., Norristown, Pa.).....	36
Plug-in electric trucks (Elwell-Parker Electric Co., 4000 St. Clair Ave., Cleveland 14, Ohio).....	39
"Building set" makes frames without drilling or welding (Unistrut Products Co., 1013 W. Washington Blvd., Chicago 7).....	55
Portable conveyor (Food Machinery Corp., Riverside, Calif.).....	58
Magnetic vise (Lucas-Milhaupt Eng. Co., Cudahy, Wis.).....	71
Compressed air powers saw (Air-Speed Tool Co., 1028 W. Slauson Ave., Los Angeles 44, Calif.).....	71
Kriston plastic (Goodrich Chemical Co., Cleveland, Ohio).....	71
Jacks open pipe line flanges (T. G. Persson Co., 224 Glenwood Ave., Bloomfield, N. J.).....	71
Lead-headed hammer toughens with use (Nu Products Co., 1060 Broad St., Newark 2, N. J.).....	71
Electric "drill" cleans clogged drains (Spartan Tool Co., 6007 N. Lincoln Ave., Chicago 45).....	75
Precision gauge (Sheffield Corp., Dayton, Ohio).....	75
Gas "detectives" trace underground leaks.....	81
Plastic template (Timely Products, Box 206, Columbus, O.).....	81
Box lift hooks (Neilson Co., 207 E. Michigan St., Milwaukee 2).....	81
Portable metal-spraying gun (Alloy-Sprayer Co., 602 First National Bldg., Ann Arbor, Mich.).....	150
Hose connector (Punch-Lok Co., 321 N. Justine St., Chicago 7).....	150
Towline gripper (Safety Tow-Line Co., Milwaukee, Wis.).....	154
Grease gun (John W. Hobbs Corp., Springfield, Ill.).....	154
Acidproof coating for wood (Koppers Co., Orrville, Ohio).....	158
Conveyor tower extracts more oil from soybeans.....	158

RADIO

Radio program director uses "blister".....	74
Time indicator (Dixon Maps, 40 Eastgate, Winnipeg, Can.).....	75
Television receiver cabinet has disappearing screen (Allen B. DuMont Laboratories, Inc., 2 Main Ave., Passaic, N. J.).....	141
Kitchen radio set mounts on wall (Radio Craftsman, Inc., 1341 S. Michigan Ave., Chicago 5).....	144
Portable multiband receiver (Zenith Radio Corp., 6001 W. Dickens Ave., Chicago 39).....	144
Seven-tube chairside phono-radio (Electronic Corp. of America, 45 W. 18th St., New York 11).....	144
Portable set has "tuck-away" handle (Westinghouse Electric and Manufacturing Co., 2519 Wilkens Ave., Baltimore, Md.).....	144

MISCELLANEOUS

Radio laboratory on rails.....	24
Plastic oxygen tents (Bakelite Corp., 300 Madison, New York).....	27
Compressed air powers engine of miniature train.....	27
Fire fighting pump carried on back (Product Engineering Service, 227 Iron St., Detroit 7, Mich.).....	36
Subsoil plow (Oliver Corp., 400 W. Madison St., Chicago 6).....	37
Plane or scooter—which is it?.....	37
Seesaw respirator (E. D. Bullard Co., 275 8th St., San Francisco, Calif.).....	39
Diving helmet made from nose of B-29.....	48
"Bellows" for heavy trucks cushion the ride.....	54
Patients read book on ceiling with microfilm projector.....	58
Army's "two-faced" auto.....	59
Hedgehog and mousetrap.....	63
British try out captured V-2 rocket.....	70
Glass-plastic fracture bandage (Tower Co., Seattle, Wash.).....	154
Folding rack holds rubber boots for drying (Mitchell Advertising Agency, 301 Essex Bldg., Minneapolis, Minn.).....	160

(Continued to page 10A)

PYROIL STARTS...

are easy for you and your car

Because Pyroil W* keeps your cylinder walls covered with a film of lubricating oil, it is all set to function when you step on the starter. There is no breathless . . . "will it or won't it go" concern for you. There is no heavy battery drain . . . no metal-to-metal rub to cause extra wear. Pyroil prevents formation of carbon and sludge, too. Ask your service man to add Pyroil today.

(*Pyroil W is Winter grade of Pyroil B.)

Pyroil for Aircraft Engines

Use Aircraft Pyroil B for lubricating oil, Aircraft Pyroil A for gasoline.

Manufactured and Guaranteed by Pyroil Company, W. V. Kidder, Founder, 52 Pyroil Bldg., La Crosse, Wis.



PYROIL COMPANY

52 Pyroil Building
La Crosse, Wisconsin

I want my car to last and run properly. Please tell me more about Pyroil and how it can accomplish this for me.

Name.....

Address.....

City or Town..... State.....



Jerry, the talking dog, is entertaining hospitalized veterans, by courtesy of the PYROIL Company.

2635 M. E. ...



"When I had to leave school, I enrolled with I.C.S. The Course was excellent--and the beginning of an educational habit which has persisted through my life."

WALTER D. FULLER
President, The Curtis Publishing Company*

"To those who are denied the opportunity of a college education, I.C.S. offers a satisfying substitute. I know. I studied an I.C.S. Course myself."

JASPER McLEVY
Mayor of Bridgeport, Connecticut**

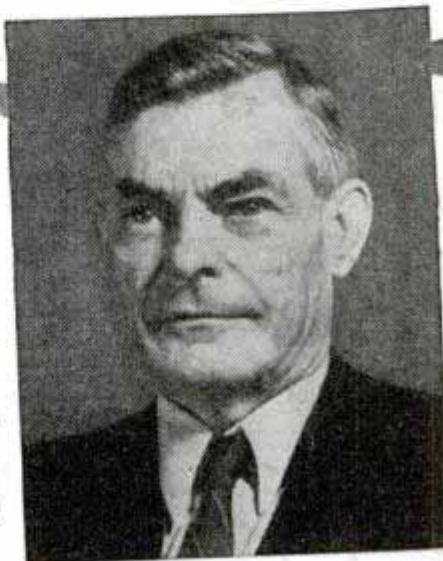

*Publishers of *The Saturday Evening Post*, *Ladies' Home Journal*, *Country Gentleman*, *Jack and Jill*.

**Now in his 12th consecutive year in this office.

INTERNATIONAL CORRESPONDENCE SCHOOLS



BOX 5569-K, SCRANTON 9, PENNA.

Without cost or obligation, please send me full particulars about the course *before* which I have marked X:

- | | | | |
|---|---|---|--|
| <p>Business and Academic Courses</p> <ul style="list-style-type: none"> <input type="checkbox"/> Accounting <input type="checkbox"/> Advertising <input type="checkbox"/> Arithmetic <input type="checkbox"/> Bookkeeping <input type="checkbox"/> Business Correspondence <input type="checkbox"/> Business Management <input type="checkbox"/> Certified Public Accounting <input type="checkbox"/> Commercial <input type="checkbox"/> Cost Accounting <input type="checkbox"/> Federal Tax <input type="checkbox"/> First Year College <input type="checkbox"/> Foremanship <input type="checkbox"/> French <input type="checkbox"/> Good English <input type="checkbox"/> High School <input type="checkbox"/> Higher Mathematics <input type="checkbox"/> Illustrating <input type="checkbox"/> Motor Traffic <input type="checkbox"/> Postal Service <input type="checkbox"/> Salesmanship <input type="checkbox"/> Secretarial <input type="checkbox"/> Sign Lettering <input type="checkbox"/> Spanish <input type="checkbox"/> Stenography <input type="checkbox"/> Traffic Management <p>Air Conditioning and Plumbing Courses</p> <ul style="list-style-type: none"> <input type="checkbox"/> Air Conditioning <input type="checkbox"/> Heating <input type="checkbox"/> Plumbing <input type="checkbox"/> Refrigeration <input type="checkbox"/> Steam Fitting | <p>Chemistry Courses</p> <ul style="list-style-type: none"> <input type="checkbox"/> Chemical Engineering <input type="checkbox"/> Chemistry, Analytical <input type="checkbox"/> Chemistry, Industrial <input type="checkbox"/> Chemistry, Mfg. Iron & Steel <input type="checkbox"/> Petroleum Refining <input type="checkbox"/> Plastics <input type="checkbox"/> Pulp and Paper Making <p>Civil Engineering, Architectural and Mining Courses</p> <ul style="list-style-type: none"> <input type="checkbox"/> Architectural Drafting <input type="checkbox"/> Architecture <input type="checkbox"/> Building Estimating <input type="checkbox"/> Civil Engineering <input type="checkbox"/> Coal Mining <input type="checkbox"/> Contracting and Building <input type="checkbox"/> Highway Engineering <input type="checkbox"/> Lumber Dealer <input type="checkbox"/> Reading Structural Blueprints <input type="checkbox"/> Sanitary Engineering <input type="checkbox"/> Structural Drafting <input type="checkbox"/> Structural Engineering <input type="checkbox"/> Surveying and Mapping <p>Communications Courses</p> <ul style="list-style-type: none"> <input type="checkbox"/> Electronics <input type="checkbox"/> Practical Telephony <input type="checkbox"/> Radio, General <input type="checkbox"/> Radio Operating | <ul style="list-style-type: none"> <input type="checkbox"/> Radio Servicing <input type="checkbox"/> Telegraph Engineering <p>Electrical Courses</p> <ul style="list-style-type: none"> <input type="checkbox"/> Electrical Drafting <input type="checkbox"/> Electrical Engineering <input type="checkbox"/> Electric Light and Power <input type="checkbox"/> Lighting Technician <input type="checkbox"/> Practical Electrician <input type="checkbox"/> Power House Electric <input type="checkbox"/> Ship Electrician <p>Internal Combustion Engines Courses</p> <ul style="list-style-type: none"> <input type="checkbox"/> Auto Technician <input type="checkbox"/> Aviation <input type="checkbox"/> Diesel-Electric <input type="checkbox"/> Diesel Engines <input type="checkbox"/> Gas Engines <p>Mechanical Courses</p> <ul style="list-style-type: none"> <input type="checkbox"/> Aeronautical Engineering <input type="checkbox"/> Aircraft Drafting <input type="checkbox"/> Flight Engineer <input type="checkbox"/> Forging <input type="checkbox"/> Foundry Work <input type="checkbox"/> Heat Treatment of Metals <input type="checkbox"/> Industrial Engineering <input type="checkbox"/> Industrial Metallurgy <input type="checkbox"/> Machine Shop <input type="checkbox"/> Machine Shop Insp. | <ul style="list-style-type: none"> <input type="checkbox"/> Mechanical Drafting <input type="checkbox"/> Mechanical Engineering <input type="checkbox"/> Mold-Loft Work <input type="checkbox"/> Patternmaking—Wood, Metal <input type="checkbox"/> Reading Shop Blueprints <input type="checkbox"/> Sheet-Metal Drafting <input type="checkbox"/> Sheet-Metal Worker <input type="checkbox"/> Ship Drafting <input type="checkbox"/> Ship Fitting <input type="checkbox"/> Tool Designing <input type="checkbox"/> Toolmaking <input type="checkbox"/> Welding—Gas and Electric <p>Railroad Courses</p> <ul style="list-style-type: none"> <input type="checkbox"/> Air Brake <input type="checkbox"/> Car Inspector <input type="checkbox"/> Diesel Locomotive <input type="checkbox"/> Locomotive Engineer <input type="checkbox"/> Locomotive Fireman <input type="checkbox"/> Railroad Section Foreman <input type="checkbox"/> Steam Engineering Courses <p>Boilermaking Courses</p> <ul style="list-style-type: none"> <input type="checkbox"/> Boilermaking <input type="checkbox"/> Combustion Engineering <input type="checkbox"/> Engine Running <input type="checkbox"/> Marine Engineering <input type="checkbox"/> Steam Electric <input type="checkbox"/> Steam Engines <p>Textile Courses</p> <ul style="list-style-type: none"> <input type="checkbox"/> Cotton Manufacturing <input type="checkbox"/> Rayon Weav'g <input type="checkbox"/> Textile Desig'ng <input type="checkbox"/> Woolen Manufacturing |
|---|---|---|--|

Name..... Age..... Home Address.....
 City..... State..... Present Position..... Working Hours..... A.M. to..... P.M.

Canadian residents send coupon to International Correspondence Schools Canadian, Ltd., Montreal, Canada.

British residents send coupon to I. C. S., 71 Kingsway, London, W. C. 2, England.

A DISCOUNT TO DISCHARGED VETERANS—SPECIAL TUITION RATES FOR MEMBERS OF THE ARMED FORCES

Craftsman and Shop Notes Index

ART AND ARTIST

- Method of drawing beam sections saves drafting time.....132
- Tray in lower arm of drafting machine holds instruments.....137
- Lettering pen improvised from ruling pen.....140

AUTOMOTIVE

- "Play pen" for small child in rear seat of auto.....96
- Washers keep battery clamp from sticking to terminal.....130
- Battery cable is repaired easily.....138

FARM

- Stretched screen-door spring joins rabbit-hutch partitions...102
- Tools stored in tub of oiled sand are kept clean.....129
- Poultry roosts held by sash hangers are easily removed.....140

HAND TOOLS

- Adjustable bench clamp holds small work for engraving.....113
- Disk will reface faucet seats.....114
- Repairing broken folding rules.....128
- Folding parallel rules have built-in scale.....132
- Handle will aid when sharpening spoke-shave blades.....137
- Metal fixture guides die when cutting threads.....137
- Inspection work speeded by coloring snap gauge.....138
- Increasing capacity of machinist's tool box.....138
- Screw wedge holds hammer head.....138
- C-clamps converted to snap gauge.....140

HOUSEHOLD

- Baffle helps refrigerator operation.....92
- Dicer for tenderizing steak.....92
- Marshmallows toasted in electric toaster.....92
- Solving home problems.....94
- Salt shaker is economical tooth powder dispenser.....102
- Copper tubing used to make drawer pulls.....103
- Postage stamp moistener applies white shoe cleaner.....106
- Lipstick holder wrapped with tape to keep cap on.....110
- Gauge measures warped windows to fit storm sash exactly.....114
- Canvas and clothesline make a durable bathinette cover.....119
- Match held in clothespin jaws for lighting oil heater.....120

OFFICE, STORE AND SHOP

- Posters attached to wall by concealed "stickers".....106
- Rotating stop permits removal of drawer without lifting.....120
- Crochet hook used to string shipping tags.....136
- Paper guard for typewriter.....138
- Postal card holder aids typist.....140

PHOTOGRAPHY

- Hairs aid in focusing enlarger.....124
- Powder puffs cushion photo trays.....124
- Focal plane shutter strap repaired with ribbon.....124
- Photo lamp is mounted on a gooseneck.....124
- Hooks substitute for clips when drying sheet film.....124
- Simple synchronizer for auxiliary lens mounting.....125
- Inscriptions on photoprints written with light.....125
- Window shade used as darkroom partition.....126
- Sticks and tin can make emergency tripod.....126
- Getting uniform margins on prints.....126
- Using small photoflood lamps in large reflector.....126

POWER TOOLS

- Boring-bar holder takes four tool sizes.....129
- Jig centers drill in end of rods.....130
- Cutting transmission belts for perfect joint.....132
- Collet made from drill chuck is used for small work.....136
- Burring tool for production work.....139

RADIO AND ELECTRONICS

- Disappearing video screen in television receiver cabinet.....141
- Three-tube short-wave super of advanced design.....142
- Portable and home sets for 1946.....144

TOYS AND NOVELTIES

- Embossing plastics with metal die.....92
- Striped heart is built of laminated plastic sheets.....97
- Garden hose makes tires for wagons and tricycles.....101
- Simple tricks to amaze your friends.....104
- Polishing plastic on a drill press.....106
- Brooch is made from a .30-caliber cartridge.....110

WOODWORKING

- Folding snack server occupies little space.....93
- Walnut candelabras decorate dinner table.....101
- Small work sanded on abrasive held on work bench top.....102
- Scrap wood is ideal for bric-a-brac cabinet.....103
- Adjustable hold-down for drill press.....110
- Carved desk set has decorative inlays.....111
- Spice chest holds coffee can containers.....113
- Guide assures equal spacing of cuts on circular saw.....120

MISCELLANEOUS

- Snap lock can be substituted for tumbler type device.....93
- Rough fountain pen clip smoothed with cellulose cement.....96
- Window latches used to hold trunk closed.....96
- Fish scaler improvised from bottle caps.....96
- Two sizes of tubing connected by using cork as bushing.....102
- Cups used as cash boxes at club socials.....110
- Zipper key purse holds fishhooks.....114
- Steam bath restores fishing flies.....114
- Clock wall outlet hidden from view.....119
- Soldering paste is kept in spool.....120
- Breakwater reduces impact of incoming waves.....130
- Glass tube in dispensing bottle permits free flow of contents.....130
- Safety reversing switch for shop motors.....131
- Hacksaw blade used as guide in trimming paint brushes.....132
- Bending edges of sheetmetal braces increases strength.....136
- Slotted tympan sheet permits adjusting guide on job press.....140

IMPORTANT NOTICE

It is the intention of this magazine to provide its readers with information regarding the latest developments in the mechanical arts. We take no responsibility as to whether the disclosures contained in our articles are covered by patents and advise readers to investigate this subject before making, using, or selling any of the products, machines, or processes described in order to avoid possible liability for patent infringement.



O. SOGLOW

AUDELS REFRIGERATION & AIR CONDITIONING GUIDE....\$4

New from Cover to Cover—1280 Pages, Fully Illus. Covering basic principles, servicing, operation & repair of household, commercial & industrial refrigeration & air conditioning. A gold mine of essential important facts for engineers, servicemen, users.

AUDELS CARPENTERS & BUILDERS GUIDES—4 Vols.\$6

A practical illustrated trade assistant on modern construction for carpenters, joiners, builders, mechanics and all woodworkers. 4 vols., 1600 pages, 3700 illustrations, flexible covers. Pocket size. Each volume sold separately \$1.59 a vol.

AUDELS AUTOMOBILE GUIDE....\$4

A practical quick ready reference book for auto mechanics, service men, operators & owners. Explains theory, construction & servicing of modern motor cars, trucks, buses & auto type Diesel engines. 1540 pages, fully illustrated. 55 chapters. Indexed. A standard book for mechanics. New fluid drive covered.

AUDELS DIESEL ENGINE MANUAL.\$2

A practical, concise treatise with questions and answers on the theory, operation and maintenance of modern diesel engines including General Motors 2 cycle Diesel. 384 pages, fully illus., flexible binding, pocket size. All details plainly brought out, this book is of extreme value to engineers, operators & students.

AUDELS WIRING DIAGRAMS.....\$1

210 Pages. Illustrated. Gives practical facts on wiring of electrical apparatus. It shows clearly how to wire apparatus for practically all fields of electricity. Each diagram is complete & self-explanatory. Highly Endorsed Pocket Companion.

AUDELS PLUMBERS & STEAMFITTERS GUIDES—4 Vols.\$6

A Practical Trade Assistant & Ready Reference. Explains in plain language & by clear illustrations, diagrams, charts, graphs, pictures principles of modern plumbing practice including Marine Pipe Fitting and Air Conditioning. 4 Vols.—1670 Pages—3642 Diagrams. Pocket size. Each Vol. Sold Separately \$1.50 a Vol.

AUDELS SHEETMETAL WORKERS HANDY BOOK.....\$1

Practical inside information. Fundamentals of Sheet Metal Work. 388 pages. Illustrated. 11 sections. Clearly written. Essential & important facts, figures, pointers in everyday language. Ref. Index.

AUDELS SHEETMETAL PATTERN LAYOUTS.....\$4

Developed by Experts for Sheet Metal Workers, Layout Men & Mechanics. A Practical Encyclopedia in 10 Sections, size 7 x 10 x 2—1125 Pages—350 Layouts—1600 Illustrations. 1001 Key Facts. Fully indexed for ready reference in answering your layout problems. Covers all phases of sheet metal work including Pattern Cutting, Pattern Development & Shop Procedure.

AUDELS ANSWERS ON BLUE PRINT READING.....\$2

For Mechanics & Builders. Covers all types of blue print reading including ship & airplane. 376 pages, fully illustrated.

AUDELS NEW MACHINIST & TOOLMAKERS HANDY BOOK....\$4

Covers modern machine shop practice in all its branches. 5 practical books in 1. New from cover to cover. Tells how to set up & operate lathes, screw and milling machines, shapers, drill presses and all other machine tools. 1600 pages, fully illustrated, 5 x 6 1/2 x 2. Indexed. 5 sections. 1—Modern Machine Shop Practice. 2—Blue Print Reading & How to Draw. 3—Calculations & Mathematics for Machinists. 4—Shop Physics. 5—How to Use the Slide Rule. 60 chapters. Easy to read and understand. A shop companion that answers your questions.

AUDELS MATHEMATICS & CALCULATIONS FOR MECHANICS \$2

Mathematics for home study or reference. 700 pages, 550 illus. Practical mathematics from beginning. How to figure correctly. Easy, correct methods covering a complete review. Ill. & Indexed.

AUDELS HANDY BOOK OF PRACTICAL ELECTRICITY.....\$4

For maintenance engineers, electricians & all electrical workers. 1440 Pages. 2600 illus. Covers important electrical information in handy form—including Marine Wiring, Radio Principles, Welding. Indexed. A Key to a practical understanding of electricity.

AUDELS RADIOMANS GUIDE.....\$4

A key to the practical understanding of radio including Frequency Modulation, Television, etc. Aircraft & Marine Radio. For radio engineers, servicemen, amateurs. 772 pages. 400 Illustrations & Diagrams. Photos. Review Questions & Answers, Reference Index. Authentic, clear, concise.

AUDELS ELECTRONIC DEVICES....\$2

Tells What You Want to Know About Electric Eye. Easily Understood. Covers photo-electric cells & their applications. Amplifiers, illumination, frequencies, voltage, photocells, tubes, Ohm's Law, wiring diagrams, etc.

AUDELS WELDERS GUIDE.....\$1

A concise, practical text on operation & maintenance of all welding machines for all mechanics. Over 400 pages, illustrated. Covers all methods of electric and acetylene welding including airplane work.

AUDEL, Publishers, 49 W. 23 St., N. Y. 10



AN AUDEL GUIDE IS A GOOD FRIEND!

Use the brains and experience of others in these Guides of the Trades. Save time and money with right methods, short cuts, labor saving ideas. CHECK NOW! You can look over any Audel Guide in your home. Start the Easy Payments if satisfied.

CUT HERE MAIL ORDER

THEO. AUDEL & CO., 49 W. 23 St., New York 10, N.Y.

Please mail me for 7 days' free examination the books marked (X) below. I agree to mail \$1 in 7 days on each book or set ordered, and to further mail \$1 a month on each book or set ordered until I have paid purchase price.

If I am not satisfied with Guides I will return them.

- Audels REFRIGERATION & Air Conditioning Guide . \$4.
- Audels POWER PLANT ENGINEERS GUIDE . 4.
- Audels PUMPS, HYDRAULICS & AIR COMPRESSORS . 4.
- Audels WELDERS GUIDE . 1.
- Audels BLUE PRINT READING . 2.
- Audels SHEET METAL WORKERS Handy Book . 1.
- Audels SHEET METAL PATTERN LAYOUTS . 4.
- Audels AIRCRAFT WORKER . 1.
- Audels MATHEMATICS and CALCULATIONS . 2.
- Audels MACHINISTS & TOOLMAKERS Handy Book . 4.
- Audels MECHANICAL Dictionary . 4.
- Audels AUTOMOBILE GUIDE . 4.
- Audels DIESEL ENGINE MANUAL . 2.
- Audels MARINE ENGINEERS Handy Book . 4.
- Audels SHIPFITTERS Handy Book . 1.
- Gueths MECHANICAL DRAWING COURSE . 1.
- Rogers DRAWING and DESIGN . 2.
- Audels MILLWRIGHTS and Mechanics Guide . 4.
- Audels CARPENTERS and Builders Guides (4 vols.) . 6.
- Audels PLUMBERS and Steamfitters Guides (4 vols.) . 6.
- Audels MASONS and Builders Guides (4 vols.) . 6.
- Master PAINTER and DECORATOR . 2.
- Audels GARDENERS & GROWERS GUIDES (4 vols.) . 6.
- Audels ENGINEERS and Mechanics Guides Nos. 1, 2, 3, 4, 5, 6, 7 and 8 complete . 12.
- Audels Answers on Practical ENGINEERING . 1.
- Hawkins Aids to ENGINEERS EXAMINATION . 2.
- Audels ELECTRICIANS EXAMINATIONS . 1.
- Audels WIRING DIAGRAMS . 1.
- Audels Handy Book of PRACTICAL ELECTRICITY . 4.
- Audels ELECTRICAL POWER CALCULATIONS . 2.
- Hawkins ELECTRICAL Guides at \$1. each . 10.
- Audels ELECTRONIC DEVICES . 2.
- Audels ELECTRIC Dictionary . 2.
- Audels RADIOMANS GUIDE . 4.
- Audels NEW ELECTRIC LIBRARY at \$1.50 a Volume Vols. I, II, III, IV, V, VI, VII, VIII, IX, X, XI, XII.

Name.....

Address.....

Occupation.....

Employed by..... PM



You build this A. M. SIGNAL GENERATOR to get valuable experience. Provides amplitude-modulated signals for test and experiment purposes.

(Left) Radio Servicing pays many good money for full time work. Many others make \$5, \$10 a week EXTRA fixing Radios in spare time.

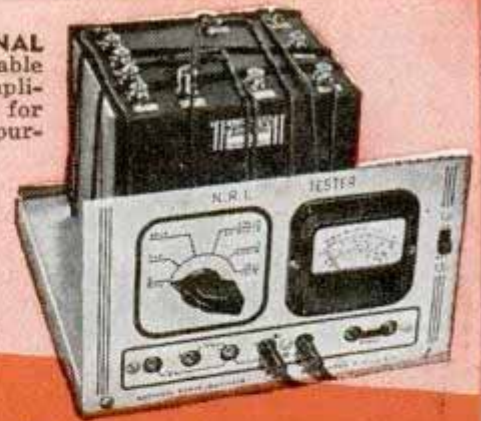

Learn RADIO

WITH THE 6 BIG KITS OF



J. E. SMITH, President
National Radio Institute
Our 32nd Year of Training Men
for Success in Radio

BE A SUCCESS IN RADIO

I Will Train You at Home

Here's a *practical* way to learn Radio at home in spare time—to train for a good Radio job, or to start your own spare time or full time Radio Service Business!

You get Radio EXPERIENCE building real Radio Circuits with kits of standard parts I send. You get solid KNOWLEDGE of Radio, Television, Electronic fundamentals from my easy-to-grasp lessons. You follow the same "50-50" method that helped hundreds of beginners make \$5, \$10 EXTRA a week in spare time while learning . . . and prepared them for full time Radio jobs at good pay.

Future for Trained Men Is Bright in Radio, Television, Electronics

The Radio Repair business is booming NOW. There is good money fixing Radios in your spare time or own full time business. And trained Radio Technicians also find wide-open opportunities in Police, Aviation and Marine Radio, in Broadcasting, Radio Manufacturing, Public Address work, etc. Think of the boom coming now that new Radios can be made! And think of even greater opportunities when Television and Electronics are available to the public! Get into Radio NOW.

MEN I TRAINED AT HOME Get Good Jobs Like These

Averages Over \$60 a Week



"Not long ago I was working 16 hours a day in a filling station at \$10 a week. Now I have my own radio business and average over \$60 a week. The N.R.I. course is fine."—ALBERT C. CHRISTENSEN, 1116-10th Avenue, Sidney, Neb.

Fixing Radios Profitable Hobby

"I am doing radio work in my spare time, and find it a profitable hobby. My extra earnings run about \$10 a week. I certainly am glad I took your N.R.I. Course."—FERDINAND ZIRBEL, Chaseley, North Dakota.



Has Good Job in Broadcasting

"The N.R.I. course gave me the strength to tackle jobs without fear of failure. At present I am a member of the engineering staff of a large broadcasting chain."—SERGE A. DESOMOV, 849 First Ave., New York, N. Y.



From Elevator Man to Supervisory Job

"Since taking your Course I have moved up from elevator operator to a supervisory job in our Electronics Division. My investment in N.R.I. training has been returned tenfold."—EARL D. HARRISON, 193 Galt Ave., Verdun, P. Q., Canada.



Runs Repair Shop for Sears Roebuck

"I was a barber and not working steadily. After about 30 lessons in your Course, I came with Sears Roebuck and now run their radio service shop here, at a nice steady income."—NORMAN P. FORNOFF, 1923 E. 13th St., Davenport, Iowa.



FIND OUT ABOUT THIS **TESTED WAY**

You build this **MEASURING INSTRUMENT** yourself early in the Course—use it for practical Radio work on neighborhood Radios to pick up **EXTRA** spare time money!

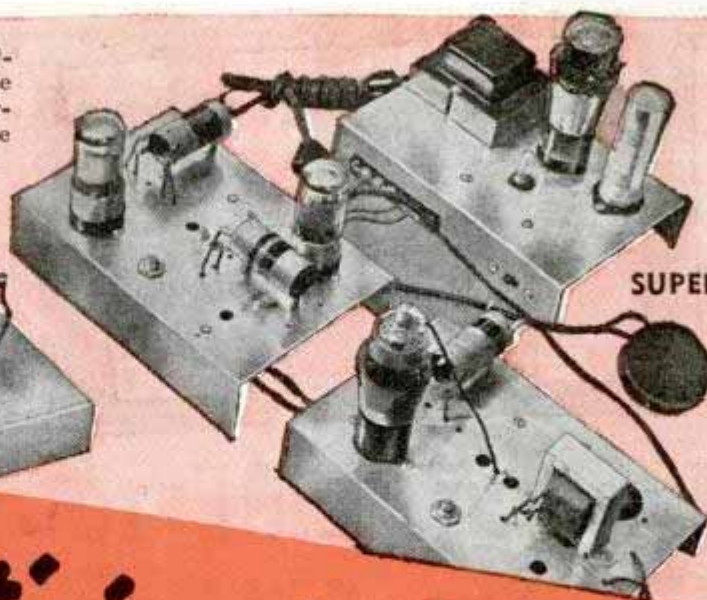
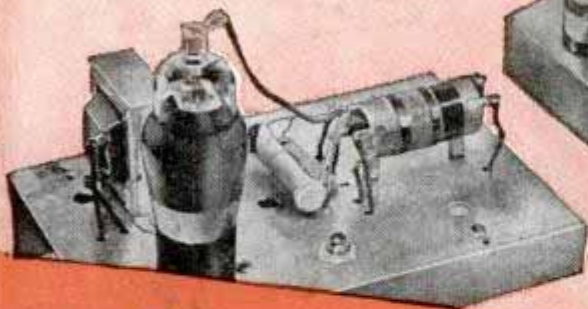

You build this **SUPERHETERODYNE CIRCUIT**

that brings in local and distant stations. You get *practical* experience putting this set through fascinating tests!

by Practicing in Spare Time

RADIO PARTS I SEND YOU

Many Beginners Soon Make \$5, \$10 a Week **EXTRA** in Spare Time

The day you enroll I start sending **EXTRA MONEY JOB SHEETS** to help you make **EXTRA** money fixing Radios in spare time while learning. You **LEARN** Radio principles from my easy-to-grasp Lessons—**PRACTICE** what you learn by building real Radio Circuits with the six kits of Radio parts I send—**USE** your knowledge to make **EXTRA** money while getting ready for a good full time Radio job.

MY RADIO COURSE INCLUDES
TELEVISION ★ ELECTRONICS
FREQUENCY MODULATION

Find Out What **N. R. I.** Can Do for **YOU**

MAIL COUPON for **FREE** 64-page book. It's packed with facts about opportunities for you. Read the details about my Course. Read letters from men I trained, telling what they are doing, earning. Just **MAIL COUPON** in an envelope or paste it on a penny postal.—**J. E. SMITH, President, Dept. 6BP, National Radio Institute, Pioneer Home Study Radio School, Washington 9, D. C.**

Sample Lesson
64 Page Book
BOTH FREE

FREE LESSON gives hints on Receiver Servicing, Locating Defects, Repair of Loudspeakers, I. F. Transformer, Gang Tuner Condenser, etc., 31 illustrations. Study it—keep it—use it—without obligation! Mail Coupon **NOW** for your copy!



GET BOTH 64 PAGE BOOK **FREE** SAMPLE LESSON

Mr. J. E. SMITH, President, Dept. 6BP NATIONAL RADIO INSTITUTE, Washington 9, D. C.

Mail me **FREE**, without obligation, Sample Lesson and 64-page book about how to win success in Radio and Television—Electronics. (No salesman will call. Please write plainly.)

Age.....

Name.....

Address.....

City..... State..... 4FR

(If you have a Post Office zone number please include it.)

TO GOOD PAY

INVENTOR

NOW IS THE TIME TO PATENT AND SELL YOUR INVENTION

Now, more than ever before, is the right time to patent and sell your invention. Why? Because manufacturers everywhere, in striving to keep ahead of competition, are looking for new inventions and buying up the patent rights thereon so that they will have better and more attractive items to make and sell. Hence, the wise thing for you to do is also to act at once. Protect your invention—and yourself—by applying for a patent now.

FREE "PATENT GUIDE" EXPLAINS WHAT TO DO

Our Free 48 page "Patent Guide for the Inventor", containing complete information about patent procedure and selling inventions, answers many important questions concerning Patents that inventors constantly ask. It tells what facts, details, drawings, sketches, etc., are necessary to apply for a Patent; how to protect your invention through dated and witnessed disclosure; how to do this at once to safeguard your rights; how Patent Office Records can be checked to determine whether the invention is probably patentable before filing fees need be paid; discusses costs involved and a practical way these can be paid as the application progresses. It tells how some inventors secured financial backing; how many simple inventions have proved large commercial successes; how Patents covering improvements also can be profitably utilized and marketed; and countless other facts that every inventor will want to know. And in addition, our "Patent Guide" contains illustrations of over 150 basic mechanical movements.

WHY YOU NEED EXPERT ASSISTANCE

The Patent Laws were enacted for your benefit—to give you protection for the features of your invention which are Patentable. But these features must be legally and concisely set forth in the form of "claims". This phase of the procedure is so complex that the U.S. Patent Office advises the Inventor to engage a competent Registered Patent Attorney. We maintain a large staff—carefully trained registered patent attorneys—expert draftsmen—experienced searchers—to serve you. We have been serving inventors for more than twenty years. Write for a free copy of our "Patent Guide for the Inventor" today. Clarence A. O'Brien & Harvey B. Jacobson, Registered Patent Attorneys, 61-B Adams Building 4, Washington, D. C.

**CLARENCE A. O'BRIEN
& HARVEY B. JACOBSON**

REGISTERED PATENT ATTORNEYS

*Free Book
for*

TORS

48

PAGES

*Over 150
Mechanical
Movements*

FREE

"RECORD OF INVENTION"

With our free "Patent Guide for the Inventor" you will receive also free a "Record of Invention" form. This "Record of Invention" enables you to conveniently make a proper, dated disclosure of your invention before you file your patent application, which will prove of great value to you, should the occasion for evidence arise.

TAKE FIRST STEP NOW

Remember, in Patent matters action is important. Delay can be costly. Therefore, take your first step now—toward protecting your invention. Send for your free copy of our "Patent Guide for the Inventor" containing complete information about patent procedure and selling inventions. At the same time, receive a free "Record of Invention" form with complete instructions for making a disclosure of your invention and establishing its date. This step costs you nothing—yet may be vital to your success. Mail the coupon in an envelope, or paste it on a penny postcard—now.



CLARENCE A. O'BRIEN & HARVEY B. JACOBSON

CLARENCE A. O'BRIEN & HARVEY B. JACOBSON
Registered Patent Attorneys before the United States Patent Office
61-B Adams Building, Washington 4, D. C.

Please send me your 48-Page "Patent Guide for the Inventor" and your specially prepared "Record of Invention" form FREE. This request does not obligate me.

Name.....

Address.....

City..... State.....

(Please write or print plainly.)

*Worthy of
Your Trust*

I'LL SHOW YOU HOW TO SUCCEED IN RADIO

Here's the right training for Big Post-War Pay!



F. L. Sprayberry, one of the country's foremost Radio Teachers.



A RADIO SERVICE BUSINESS OF YOUR OWN



A GOOD JOB IN RADIO & TELEVISION BROADCASTING



RADIO-ELECTRONIC SERVICE ENGINEER

BE A RADIO ELECTRONICIAN

NOW! YOU CAN PREPARE AT HOME IN SPARE TIME FOR AMAZING OPPORTUNITIES AHEAD IN **RADIO • ELECTRONICS • TELEVISION**



I SUPPLY A FULL RADIO SET for practical Easy LEARNING

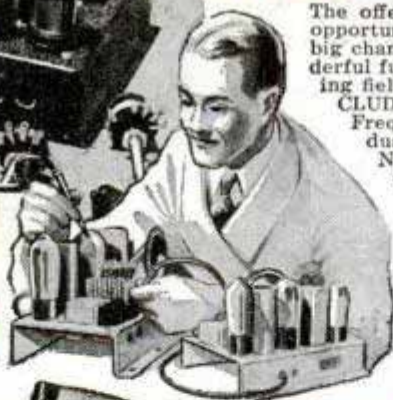

The offer I make you here is the opportunity of a lifetime. It's your big chance to get ready for a wonderful future in the swiftly expanding field of Radio-Electronics INCLUDING Radio, Television, Frequency Modulation and Industrial Electronics. Be wise! NOW'S the time to start. Opportunities ahead are tremendous! No previous experience is necessary. The Sprayberry Course starts right at the beginning of Radio. You can't get lost. It gets the various subjects across in such a clear, simple way that you understand and remember. And, you can master my

entire course in your spare time. It will not interfere in any way with your present duties. Along with your Training, you will receive my famous **BUSINESS BUILDERS** which will show you how to make some nice profits while learning.

Prepares You for a Business of Your Own or Good Radio Job

My training will give you the broad, fundamental principles so necessary as a background, no matter which branch of Radio you wish to specialize in. I make it easy for you to learn Radio Set Repair and Installation Work. I teach you how to install and repair Electronic Equipment. In fact, you'll be a fully qualified **RADIO-ELECTRONICIAN**, equipped with the skill and knowledge to perform efficiently and to make a wonderful success of yourself.

JUST OUT! FREE!

"How to Read Radio Diagrams and Symbols"

... a valuable new book explaining in simple English how to read and understand any Radio Set Diagram or circuit. Includes translations of all Radio symbols. Send for this FREE book now, and along with it I will send you another big FREE book describing my Radio-Electronic training.



GET FREE BOOKS

SPRAYBERRY ACADEMY OF RADIO

F. L. Sprayberry, President
Room 1026, Pueblo, Colorado.

Please rush my FREE copies of "How to MAKE MONEY in RADIO, ELECTRONICS and TELEVISION," and "HOW TO READ RADIO DIAGRAMS and SYMBOLS."

Name..... Age.....

Address.....

City..... State.....

(Mail in plain envelope or paste on penny postcard)

SPRAYBERRY TRAINING GIVES YOU BOTH TECHNICAL KNOWLEDGE—SKILLED HANDS

There's only one right way to learn Radio Electronics. You must get it through simplified lesson study combined with actual "shop" practice under the personal guidance of a qualified Radio Teacher. It's exactly this way that Sprayberry trains you... supplying real Radio parts for learn-by-doing experience right at home. Thus, you learn faster, your understanding is clear-cut, you acquire the practical "know how" essential to a good-paying Radio job or a Radio business of your own.

I'll Show You a New, Fast Way to Test Radio Sets Without Mfg. Equipment

The very same Radio Parts I supply with your Course for gaining pre-experience in Radio Repair work may be adapted through an exclusive Sprayberry wiring procedure to serve for complete, fast, accurate Radio Receiver trouble-shooting. Thus, under Sprayberry methods, you do not have one cent to outlay for manufactured

Test Equipment which is not only expensive but scarce.

DON'T PUT IT OFF!

Get the facts about my training—now! Take the first important step toward the money-making future of your dreams. All features are fully explained in my big, illustrated FREE Catalog which comes to you along with another valuable FREE book you'll be glad to own. Mail Coupon AT ONCE!

— ATTENTION VETERANS! —

The Sprayberry Radio-Electronics Home Study Course has been fully approved for Veterans Training under the G. I. Bill of Rights. This is important to you! It's your opportunity to get our complete Radio Training through Government grant. Find out about your eligibility AT ONCE!

How to Make YOUR Body Bring You **FAME**

... Instead of **SHAME!**

**ARE YOU
Skinny?
Weak?
Flabby?**

**Will You Let Me
Prove I Can Make You
a New Man?**

I KNOW what it means to have the kind of body that people pity! Of course, you wouldn't know it to look at me now, but I was once a skinny weakling who weighed only 97 lbs. I was ashamed to strip for sports or undress for a swim. I was such a poor specimen of physical development that I was constantly self-conscious and embarrassed. And I felt only HALF-AEIVE.

But later I discovered the secret that turned me into "The World's Most Perfectly Developed Man." And now I'd like to prove to you that the same system can make a NEW MAN of YOU!

What "Dynamic Tension" Will Do For You

I don't care how old or young you are or how ashamed of your present physical condition you may be. If you can simply raise your arm and flex it I can add SOLID MUSCLE to your biceps—yes, on each arm—in double-quick time! Only 15 minutes a day—right in your own home—is all the time I ask of you! And there's no cost if I fail.

I can broaden your shoulders, strengthen your back, develop your whole muscular system **INSIDE** and **OUTSIDE!** I can add inches to your chest, give you a viselike grip, make those legs of yours lithe and powerful. I can shoot new strength into your old backbone, exercise those inner organs, help you cram your body so full of pep, vigor and red-blooded vitality that you won't feel there's even "standing room" left for weakness and that lazy feeling! Before I get through with you I'll have your whole frame "measured" to a nice new, beautiful suit of muscle!

Only 15 Minutes A Day

No "ifs," "ands" or "maybes." Just tell me where you want handsome, powerful muscles. Are you fat and flabby? Or skinny and gawky? Are you short-winded, peppy? Do you hold back and let others walk off with the prettiest girls, best jobs, etc.? Then write for details about "Dynamic Tension" and learn how I can make you a healthy, confident, powerful HE-MAN.

"Dynamic Tension" is an entirely NATURAL method. Only 15 minutes of your spare time daily is enough to show amazing results—and it's actually fun. "Dynamic Tension" does the work.

"Dynamic Tension!" That's the ticket! The identical natural method that I myself developed to change my body from the scrawny, skinny chested weakling I was at 17 to my present super-man physique! Thousands of other fellows are becoming marvelous physical specimens—my way. I give you no gadgets or contraptions to fool with. When you have learned to develop your strength through "Dynamic Tension," you can laugh at artificial muscle-makers. You simply utilize the dormant muscle-power in your own body—watch it increase and multiply into real, solid LIVE MUSCLE.

My method—"Dynamic Tension"—will turn the trick for you. No theory—every exercise is practical. And, man, so easy! Spend only 15 minutes a day in your own home. From the very start you'll be using my method of "Dynamic Tension" almost unconsciously every minute of the day—walking, bending over, etc.—to BUILD MUSCLE and VITALITY!

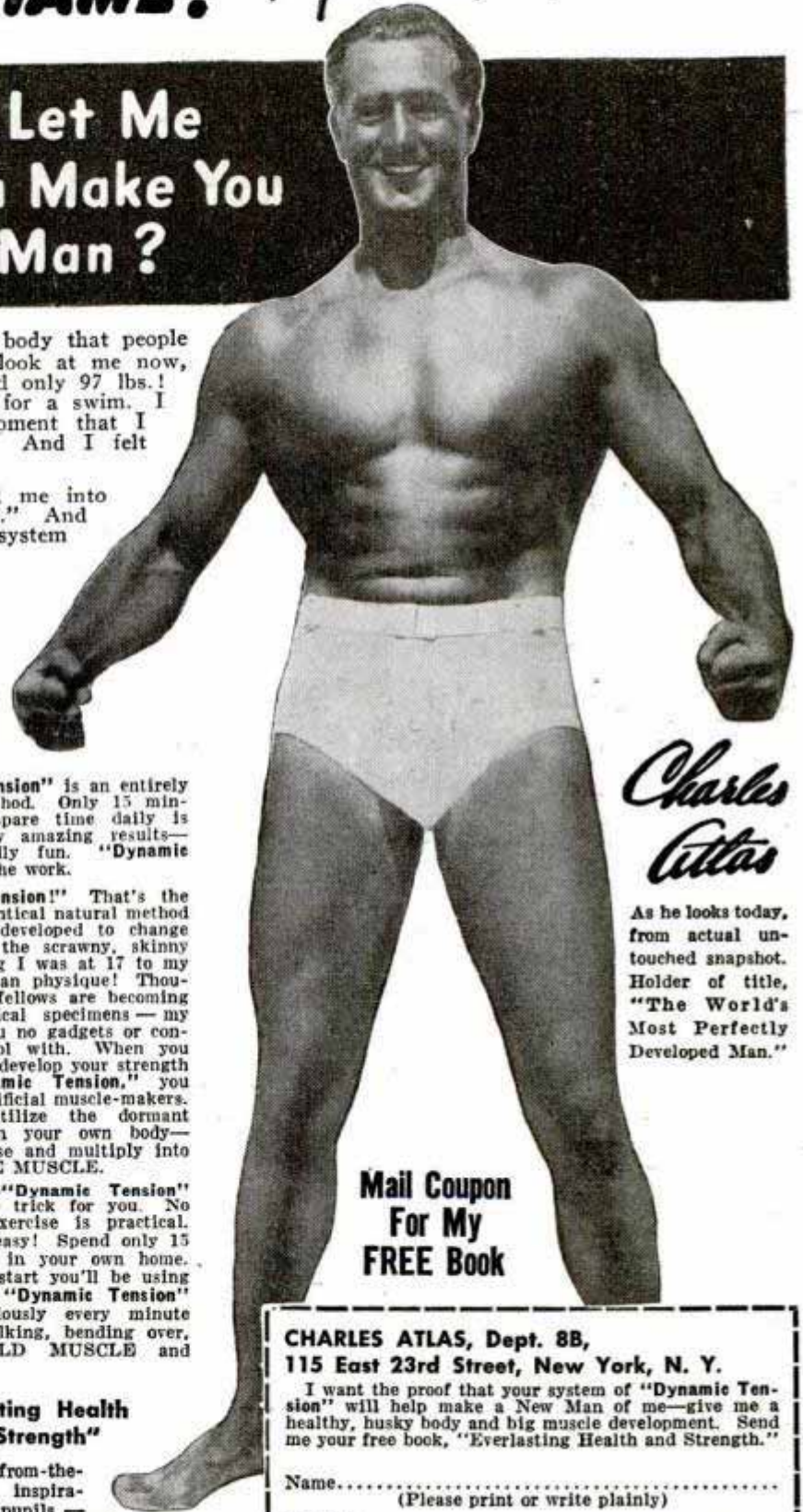

*Charles
Atlas*

As he looks today, from actual untouched snapshot. Holder of title, "The World's Most Perfectly Developed Man."

**Mail Coupon
For My
FREE Book**

**CHARLES ATLAS, Dept. 8B,
115 East 23rd Street, New York, N. Y.**

I want the proof that your system of "Dynamic Tension" will help make a New Man of me—give me a healthy, husky body and big muscle development. Send me your free book, "Everlasting Health and Strength."

Name.....
(Please print or write plainly)

Address.....

City..... State.....

Check here if under 16 for Booklet A.

FREE BOOK "Everlasting Health and Strength"

In it I talk to you in straight-from-the-shoulder language. Packed with inspirational pictures of myself and pupils—fellows who became NEW MEN in strength, my way. Let me show you what I helped THEM do. See what I can do for YOU! For a real thrill, send for this book today, AT ONCE. CHARLES ATLAS, Dept. 8B, 115 East 23rd Street, New York, N. Y.



INVENTORS

LEARN HOW TO
PROTECT and SELL
YOUR INVENTION

GET NEW **FREE BOOK**



FREE

Invention Record
Know How Successful
Inventors Protect and
Sell Their Inventions

Our new **FREE** Book is a book every inventor should have. Mail the coupon today for "How to Protect, Finance and Sell Your Invention" and learn . . .

- How to know if there is a prior U. S. patent on your invention.
- How to save steps in getting patent action.
- How to prepare your application for presentation to the Patent Office.
- How you may patent an improvement on something in use now.
- How to obtain funds to patent and promote your invention.
- How to find a buyer or backer for your invention.
- How to protect yourself in making royalty agreements.

MODERN BUSINESS WANTS INVENTIONS

Practical and novel inventions are in big demand today. The opportunity for quick money is enticing. Sales sources are many if your invention has merit. But, be *sure*—before you place your device in strange hands—that it is fully protected. A United States Patent gives you this protection. *The first step toward inventive success always is—and always has been—the application for a U. S. Patent. There is no other way to protect your invention in accordance with the laws of this country.*

MAKE THIS RECORD NOW If you have an invention, and wish to secure it for the future, act at once. Have it dated now and recorded in our office. We will send you this **FREE** Invention Record Form for the purpose. Fill out the Invention Record Form fully describing the nature of your invention. Make a sketch of its main features. Mail it to us and we will record the date it was received in our office. The earlier the date the better your chance of combating rival inventors who may lay claim to your idea later. *Don't delay a single minute in taking this important step. Your whole future may depend upon it. Mail the coupon for our FREE Invention Record Blank and New FREE Book today!*

HOW WE SERVE YOU AS REGISTERED PATENT ATTORNEYS

The U. S. Patent Office strongly recommends—unless the inventor is familiar with such matters—that he employ the services of a Registered Patent Attorney in the preparation of his Patent Application. We are Registered Patent Attorneys fully qualified to represent you at the Patent Office. We have had long experience in studying hundreds of types of inventions. This gives us the ability to judge your invention and to describe it accurately and convincingly in technical language. It gives us the perception to center arguments upon those details of your invention which, in our judgment, will be looked upon most favorably by the Patent Office Examiner.

Mail the coupon today for our new **FREE** Book, "How to Protect, Finance and Sell Your Invention," and our **FREE** Invention Record Form—maybe this step will pave the way to future security for you and your family. Act Today!

McMORROW & BERMAN

REGISTERED PATENT ATTORNEYS

135-L ATLANTIC BUILDING, WASHINGTON 4, D. C.

Send me your new **FREE** book, "How to Protect, Finance and Sell Your Invention"—and "Invention Record" form at once. I understand that this request does not obligate me.

NAME

ADDRESS

CITY..... STATE.....

(Write or print name clearly)

McMORROW & BERMAN

Registered Patent Attorneys

135-L Atlantic Building, Washington 4, D. C.

INTERNATIONAL CORRESPONDENCE SCHOOLS

OFFER YOU LOW-COST

SPECIAL TRAINING

FOR SUCCESS IN MODERN BUSINESS AND INDUSTRY

Air Conditioning and Plumbing Courses

Air Conditioning Heating Refrigeration Steam Fitting Plumbing

Chemistry Courses

Chemical Engineering Chemistry, Analytical Chemistry, Industrial Chemistry, Mfg. Iron and Steel Petroleum Refining Plastics Pulp and Paper Making

Civil Engineering, Architectural and Mining Courses

Architectural Drafting Architecture Bridge and Building Foreman Building Estimating Civil Engineering Coal Mining Contracting and Building Highway Engineering Lumber Dealer Reading Structural Blueprints Sanitary Engineering Structural Drafting Structural Engineering Surveying and Mapping

Communications Courses

Electronics Practical Telephony

Radio, General Radio Operating Radio Servicing Telegraph Engineering

Electrical Courses

Electrical Drafting Electrical Engineering Electric Light and Power Lighting Technician Practical Electrician

Internal Combustion Engines Courses

Auto Technician Aviation Diesel-Electric Diesel Engines Gas Engines

Mechanical Courses

Aeronautical Engineering Aircraft Drafting Flight Engineer Foundry Work Heat Treatment of Metals Industrial Engineering Industrial Metallurgy Machine Shop Mechanical Drafting Mechanical Engineering Mold-Loft Work Patternmaking—Wood, Metal Reading Shop Blueprints Sheet-Metal Drafting Sheet-Metal Worker Ship Drafting Ship Fitting Tool Designing Toolmaking Welding—Gas and Electric

Railroad Courses

Air Brake Car Inspector Diesel Locomotive Locomotive Engineer Locomotive Fireman Railroad Section Foreman

Steam Engineering Courses

Boilermaking Combustion Engineering Engine Running Marine Engineering Steam Electric Steam Engines

Textile Courses

Cotton Manufacturing Rayon Weaving Textile Designing Woolen Manufacturing

Business and Academic Courses

Accounting Advertising Arithmetic Bookkeeping Business Correspondence Business Management Certified Public Accounting Commercial Cost Accounting Federal Tax First Year College Foremanship French Good English High School Higher Mathematics Illustrating Motor Traffic Postal Service Salesmanship Secretarial Sign Lettering Spanish Stenography Traffic Management

If you can read and write, and are willing to study,

WE CAN TEACH YOU!

• Special service and attention are always given to the student who may need extra help in order to understand.

REASONABLE TERMS MAY BE ARRANGED



The successful man DOES today what the failure INTENDS to do tomorrow. Mail this coupon NOW!

INTERNATIONAL CORRESPONDENCE SCHOOLS
BOX 5570-K, SCRANTON 9, PENNA.

Please send complete information on following subject:

(Write above Technical, Business or General Educational Subject in which you are interested.)

Name _____ Age _____

Home Address _____

City _____ State _____

Present Position _____ Working Hours _____ A.M. _____ P.M.

Discount to Discharged Veterans—Special Tuition Rates for Members of the Armed Forces

GET READY FOR JOBS *like* THESE:

RADIO
MANUFACTURING

ELECTRONICS
TECHNICIAN

TELEVISION

RADIO
RECEIVERS

AUTO
RADIO

SOUND
SYSTEMS

F.M.
(FREQUENCY
MODULATION)

PUBLIC
ADDRESS

YOUR OWN
RADIO SHOP

Learn

RADIO

PREPARE IN A FEW SHORT WEEKS for BETTER PAY and a REAL FUTURE

YES, you can be doing work with the kind of future you want—not in a year, not in six months, but just a few short weeks from now! The vast field of Radio-Electronics and Television offers unlimited opportunities to men with practical training. That's what you get in my quick, streamlined Shop Course at COYNE.

Many Branches Open with My "All-Around Training"

Let other fellows stay in the "one-operation" job rut. Build YOUR career on "all-around" knowledge in Radio-Electronics and Television. Then you'll be ready for what-

ever good position offers itself. My training covers trouble-shooting, construction, F. M., television, auto radios, electronic controls. Also how to set up and operate YOUR OWN RADIO SHOP.

The Great COYNE Shops
Home of "Learn-by-Doing" Training



**47
YEARS
OF
SUCCESS**

Work on Real Apparatus

Coyne Training is based on my famous "Learn-by-Doing" method. You get practical instruction on real, full-size radio-electronics equipment—plus the necessary theory given in interesting lectures and demonstrations. No wonder you make such rapid strides. No wonder COYNE graduates are in such demand today.

Lifetime Job Service

I not only prepare you for a great future, I help you get the kind of job you want after you graduate. My Employment Service is FREE to all Coyne-Trained Men whenever you need it.

Age—Lack of Experience— Bars No One

Men as young as 16, and on up to 40, make good with Coyne training. It's not how old you are—it's what you know, that counts. Many of my students had no previous Radio experience. Others had experience in one or two branches but realized they needed all-around training for better jobs and advancement. Coyne Training can help YOU too!

VALUABLE RADIO JOB BOOK FREE..

with Real Shop Training
like **THIS:**

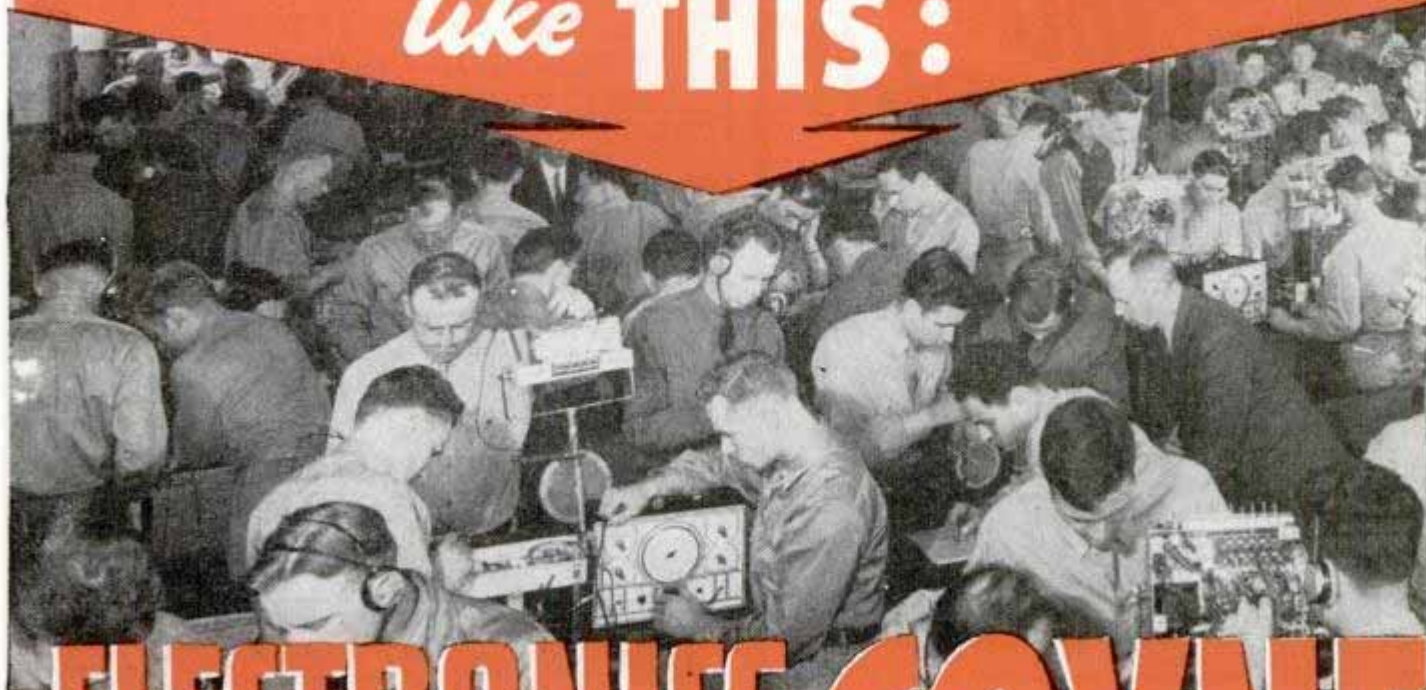

-ELECTRONICS COYNE *and Television..AT*

Student Finance Plan

I make it easy for you. If you don't have much cash, I'll arrange to finance most of your tuition and you can pay it in small monthly installments after you complete your training. We'll even help you get a part time job if you wish, so you can earn while learning. I have many plans to help you. Mail coupon now.

EARN WHILE LEARNING

If you need part-time work to help living expenses while at school, we will help you get it. Coyne graduates also receive a Life Membership with free technical service and review privileges.

VETERANS! Coyne is also equipped to train those who qualify for training under the G. I. Bill of Rights. Check coupon for special G. I. Bulletin.

Also facilities for men with physical disabilities, whether due to war or other causes. Check coupon for special information.

H. C. LEWIS, Pres.

Founded 1899

COYNE ELECTRICAL SCHOOL
RADIO-ELECTRONICS DIV.

500 S. PAULINA STREET, Dept. 26-3H, CHICAGO 12, ILLINOIS



EXTRA TRAINING
NO EXTRA COST

Industrial Electronics and Electrical Refrigeration
Extra training to help you get ready for the better jobs in these great fields... no additional tuition cost IF YOU ACT NOW!

THIS GIANT BOOK of RADIO FACTS—FREE

Packed with facts and pictures of students at work in my shops. Coupon will also bring details on how I'll finance most of your training... how I help you "Earn-While-Learning"... information on FREE EMPLOYMENT SERVICE... and other plans to help you. ACT NOW TO MAKE SURE YOU GET MY GENEROUS OFFER. Sending for this interesting free book can be your first big step to success. No obligation. No salesman will call. Mail coupon today.



FREE BOOK COUPON

H. C. Lewis Pres. Radio-Electronics Div. Coyne Electrical School, 500 S. Paulina, Dept. 26-3H, Chicago 12, Ill.

Dear Mr. Lewis: Send me your Big Free Radio-Electronics Book and all the facts... also full details of your "Student Finance" plan. If you are interested in information on the following, check also.

- Send special G.I. Bulletin.
- Physical disability.

NAME.....

ADDRESS.....

CITY..... STATE.....

MAIL THIS COUPON NOW

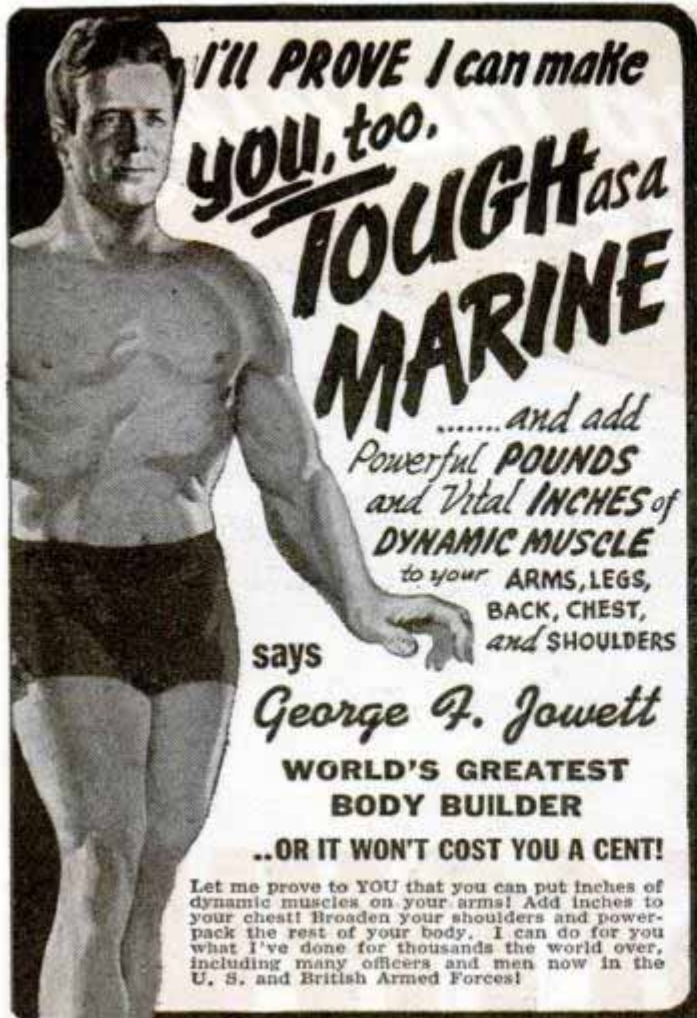

I'll PROVE I can make
you, too,
**TOUGH as a
MARINE**

.....and add
Powerful POUNDS
and Vital INCHES of
DYNAMIC MUSCLE
to your ARMS, LEGS,
BACK, CHEST,
and SHOULDERS

says
George F. Jowett

**WORLD'S GREATEST
BODY BUILDER**

..OR IT WON'T COST YOU A CENT!

Let me prove to YOU that you can put inches of dynamic muscles on your arms! Add inches to your chest! Broaden your shoulders and power-pack the rest of your body. I can do for you what I've done for thousands the world over, including many officers and men now in the U. S. and British Armed Forces!

GIVE ME 10 MINUTES A DAY!

I'll Show You My Secrets Of Body Building

I'll help you learn the "Progressive Power Method" through which I rebuilt myself from a physical wreck to the holder of more strength records than any other living athlete or teacher! No matter how skinny or flabby you are, you can learn my methods right in your own home. Through my proved secrets I show you how to develop your power, inside and out, until YOU are fully satisfied that you are the man you want to be. "The Jowett System," says E. F. Kelly, Physical Director of the YMCA, Atlantic City, "is the greatest in the world!"

If you want a physique that will inspire respect from men, and admiration from women... **ACT LIKE**

A HE-MAN! Decide at once! The famous book, "Nerves of Steel—Muscles Like Iron" will be included FREE! Priceless for the strength fan! Full of photos of marvelous power-bodied men who will show you what Jowett has done for them and how he can do the same for you. Reach out... Grasp this Special Offer today!

**PROVE TO YOURSELF
IN ONE NIGHT!**

Send only 25c for test Course, "Molding a Mighty Arm." Read it the evening it arrives—learn from experience the thrill you can give your muscles!

**SEND FOR THESE FIVE FAMOUS
COURSES IN BOOK FORM**

**ONLY 25c EACH
or ALL 5 for \$1.00**

Jowett Institute of Physical Culture
230 Fifth Avenue
Dept. 938-A
New York 1, N. Y.

*This
Book
Free!*



**BOOK WITH PHOTOS OF FAMOUS STRONG MEN
MAIL COUPON NOW FREE**



Jowett Institute of Physical Culture
230 Fifth Avenue, Dept. 938-A New York 1, N. Y.

George F. Jowett: Your proposition looks good to me. Send by return mail, prepaid, the courses checked below, for which I enclose (). Include FREE book of PHOTOS.

- George F. Jowett
Champion of Champions
- All 5 courses for... \$1
 - Molding a Mighty Arm 25c
 - Molding a Mighty Back 25c
 - Molding a Mighty Grip 25c
 - Molding a Mighty Chest 25c
 - Send all 5 C.O.D. (\$1 plus postage.) No orders less than \$1 sent C.O.D.

NAME Age.....
(Please print plainly. Include Zone Number.)

ADDRESS

**Do You Make
Mistakes in English?**

EVERY time you speak or write you show just what you are. Mistakes in English reveal you as a person who lacks education and refinement. Lack of language power prevents you from presenting your thoughts in the strongest possible way. No matter what you do, real command of English will help you to your goal. Stop making mistakes in spelling, punctuation, pronunciation. Increase your vocabulary.



WONDERFUL INVENTION

Only 15 minutes a day with Sherwin Cody's new invention—and you can actually SEE your English improve. It teaches by HABIT—makes it easier to do the RIGHT way. Wonderful self-correcting lessons include spelling, punctuation, grammar and expression.

FREE BOOK ON ENGLISH

Lack of language power may easily be costing you friendships, income every year. See what Mr. Cody can do for you: it costs nothing to find out. Mail a postal card or letter this very minute for free book, "How You Can Master Good English in 15 Minutes a Day." It will prove a revelation to you. WRITE NOW. Address:

Sherwin Cody School of English, 52 B & O Bldg., Rochester 4, N. Y.

ANY BOOK IN PRINT!

Delivered at your door. We pay postage. Standard authors, new books, popular editions, fiction, reference, medical, mechanical, children's books, etc.—all at guaranteed savings. Send card now for Clarkson's 1946 Catalog.



FREE Write for our great illustrated book catalog. A short course in literature. The buying guide of 300,000 book lovers. The answer to your gift problem. FREE if you write NOW—TODAY!

CLARKSON PUBLISHING COMPANY
Dept. PM46, 1253 S. Wabash Ave. Chicago 5, Ill.

Learn Penmanship

You can learn plain, rapid writing or fancy ornamental writing for social and business advancement, right in your own home during spare time by my Simplified Method. Write for my free book, "How to Become an Expert Penman," which shows what others have accomplished by taking my Courses. Send 10c for one of my favorite Pen Points and your name with a beautiful flourish hand written on a card. Write today. T. M. Tevis, Box 25K, Chillicothe, Mo.

**LEARN MONEY-
MAKING CARTOONING**

IN SPARE TIME — by Easy Picture Chart Method

Same Simplified Method that has helped train creators of "Terry & Pirates," "Freckles," "Out Our Way," "Winnie Winkle," "Regular Fellers," "Strange As It Seems," "The Neighbors," and many others. Earn while learning. Send 10c for Picture Chart (to test your ability), and full details. (State age.)



Landon School of Cartooning, Dpt 4602 Philadelphia (1) Pa.

**\$UCCESS for YOU... in
ADVERTISING**

Profitable • Fascinating • Many Opportunities

Easy to learn in short time from an Expert. NOT a "School"... A "Successful Adv. Executive."

Write for Free booklet *Success for You in Advertising*.

G. H. JENSSEN, A, 450 E. Ohio, Chicago 11.

FIX TYPEWRITERS

A Simplified Practical Homestudy Course. Many of our Students now have their own Business—Many Repair for others. Repair Shops Swamped. Health or Age no handicap.



WEBER TYPEWRITER MECHANICS SCHOOL
Box 269, Osborn, Ohio

MONEY for MEN ALL FREE

THE PLASTEX Industry needs manufacturers on small scale and for big production of Lamp and Clock Stands, Art Goods and Novelties in Plastex and Marble Imitation. Experience unnecessary. 1/2c material makes regular 10c store sellers. Rubber moulds furnished for speed production. Small investment brings good returns. Big chain store orders now being placed. Ambitious men have chance for real prosperity. Our Free booklet will interest and benefit you.

PLASTEX INDUSTRIES, Dept. P, 1085 Washington Ave., New York, N. Y.

WHICH OF THESE *Opportunities* INTERESTS *You* MOST?

Accounting & C. P. A.
Air Conditioning
Architecture & Building
Automotive Engineering
Aviation—Practical
Aviation Drafting & Design
Better Foremanship
Bookkeeping
Business Management
Contracting

Diesel Engineering
Drafting & Design
Electrical Engineering
Electricity—Practical
Electronics, Industrial
High School Courses
Machine Shop Operations
Mechanical Engineering
Plastics Engineering
Plumbing—Practical

Private Secretary
Radio Operating & Servicing
Railway Training
Refrigeration
Sheet Metal Pattern Drafting
Shop Management
Surveying & Topographical
Drafting
Tool Making

THINK! LOOK FORWARD!

Business is making big, new plans

Men and Women are preparing for the future

WHAT ARE YOU DOING ABOUT YOUR TOMORROWS?

● *Today*, choose the job you want—and prepare for it. Or if you are already engaged in the work you like best, start training *now* for quicker promotion. Acquire the knowledge that will help you to get ahead faster, make more money and have greater security.

Invest part of your spare time in more rapid progress. Start training now, in spare time in your own home. Be ready to grasp your opportunity and step out ahead of those who lack the ability you have attained.

American School, founded in 1897 as an educational institution *not for profit*, can help you to reach your goal just as it has helped others during the past forty-nine years. Give serious thought to the list above. Pick one or more subjects that interest you. Then check the coupon at right, add your name and address and mail it at once. The school will send you details on its training plan and outline of study prepared by specialists. There is no charge, no obligation, so send the coupon immediately.

PRACTICAL, EFFECTIVE HOME - STUDY TRAINING SINCE 1897

Take This First Easy Step

CHECK, CLIP AND MAIL COUPON NOW

AMERICAN SCHOOL, Dept. G245, Drexel at 58th, Chicago 37, Ill.
Without obligation, Please send FREE and postpaid, bulletin and details of the Subject checked.

- | | | |
|--|---|--|
| <input type="checkbox"/> PLASTICS ENG'R | <input type="checkbox"/> Accounting & C.P.A. | <input type="checkbox"/> Drafting and Design for Men and Women |
| <input type="checkbox"/> Refrigeration | <input type="checkbox"/> Electrical Engr. | <input type="checkbox"/> Radio |
| <input type="checkbox"/> Architecture and Building | <input type="checkbox"/> Electricity-Pract. | <input type="checkbox"/> High School |
| <input type="checkbox"/> Contracting | <input type="checkbox"/> Electronics, Industr. | <input type="checkbox"/> Air Conditioning |
| <input type="checkbox"/> Practical Plumbing | <input type="checkbox"/> Bookkeeping | <input type="checkbox"/> Mechanical Eng. |
| <input type="checkbox"/> Automotive Engineering | <input type="checkbox"/> Private Secretary | <input type="checkbox"/> Shop Management |
| <input type="checkbox"/> Aviation Drafting | <input type="checkbox"/> Diesel Engineering | <input type="checkbox"/> Tool Making |
| <input type="checkbox"/> Aviation | <input type="checkbox"/> Surveying & Topographical Drafting | <input type="checkbox"/> Better Foremanship |
| <input type="checkbox"/> Business Mgmt | <input type="checkbox"/> Sheet Metal Pattern Drafting | <input type="checkbox"/> Machine Shop Operations |
| <input type="checkbox"/> Railway Training | | |

Name..... Occupation.....
Address..... Age.....
City..... State.....

AMERICAN SCHOOL

Dept. G245, Drexel at 58th Street, Chicago 37

"YOU ARE UNDER ARREST!"



There's a Thrill in Bringing a Crook to Justice Through Scientific **CRIME DETECTION**

I have taught thousands of men and women this exciting, profitable, pleasant profession. Let me teach you, too, in your own home. Prepare yourself in your leisure time to fill a responsible, steady, well-paid position in a very short time and at very small cost. What others have done, you too, can do.

53% of All American Identification Bureaus

Employ students or graduates of I.A.S. This fascinating work is easy to learn and the training is inexpensive. You, too, can fit yourself to fill a responsible crime detection job with good pay and steady employment. But don't delay—get the details now. Let me show you how easily and completely I can prepare you for this fascinating work, during spare time, in your own home. You may pay as you learn. Write today for free Crime Book.

**Be A
FINGER
PRINT
Expert**

FREE! "THE BLUE BOOK OF CRIME"

It's a thriller. Tells about some of the most interesting crimes ever perpetrated and how they were solved through the very methods taught by I.A.S. Send now—be sure to state age.

INSTITUTE OF APPLIED SCIENCE
DEPT. 1352, 1920 SUNNYSIDE AVE., CHICAGO, ILLINOIS

AUDELS Carpenters and Builders Guides 4 vols. \$6



Inside Trade Information for Carpenters, Builders, Joiners, Building Mechanics and all Woodworkers. These Guides give you the short-cut instructions that you want—including new methods, ideas, solutions, plans, systems and money saving suggestions. An easy progressive course for the apprentice and student. A practical daily helper and Quick Reference for the master worker. Carpenters everywhere are using these Guides as a Helping Hand to Easier Work, Better Work and Better Pay. To get this assistance for yourself, simply fill in and mail the FREE COUPON below.

Inside Trade Information On:

How to use the steel square—How to file and set saws—How to build furniture—How to use a mitre box—How to use the chalk line—How to use rules and scales—How to make joints—Carpenters arithmetic—Solving mensuration problems—Estimating strength of timbers—How to set girders and sills—How to frame houses and roofs—How to estimate costs—How to build houses, barns, garages, bungalows, etc.—How to read and draw plans—Drawing up specifications—How to excavate—How to use settings 12, 13 and 17 on the steel square—How to build hoists and scaffolds—skylights—How to build stairs—How to put on interior trim—How to hang doors—How to lay floor—How to paint



THEO. AUDEL & CO., 49 W. 23rd St., New York City

Mail Audels Carpenters and Builders Guides, 4 vols., on 7 days' free trial. If O.K. I will remit \$1 in 7 days, and \$1 monthly until \$6 is paid. Otherwise I will return them. No obligation unless I am satisfied.

Name

Address

Occupation

Reference

HOME-STUDY BRINGS BIGGER PAY

Don't be caught napping when Opportunity knocks. Prepare for advancement and more money by training now for the job ahead. Free 48-Page Book *Tell How*. Write for the book on the business field you like—or mail us this ad with your name and address in the margin. Now, please.

- | | |
|--|--|
| <input type="checkbox"/> Higher Accountancy | <input type="checkbox"/> Business Management |
| <input type="checkbox"/> Traffic Management | <input type="checkbox"/> Business Corres. |
| <input type="checkbox"/> Law—Degree of LL.B. | <input type="checkbox"/> Salesmanship |
| <input type="checkbox"/> Commercial Law | <input type="checkbox"/> Modern Foremanship |
| <input type="checkbox"/> Industrial Management | <input type="checkbox"/> Expert Bookkeeping |
| <input type="checkbox"/> Stenotypy | <input type="checkbox"/> C. P. A. Coaching |

LASALLE EXTENSION UNIVERSITY

A Correspondence Institution

Dept. 264-R 417 So. Dearborn St. Chicago 5

LEARN WATCH REPAIRING



AT HOME. By our modern and original system of instruction you can learn every part of the **WATCH REPAIRING TRADE AT HOME.** Prepare yourself for a well-paying position or start in business after completing our course of instruction. Good watch repairers are in demand and generally earn very good salaries. For particulars apply to the **Wisconsin School of Watch Repairing** 759 North Milwaukee St., Milwaukee 2, Wis.

LEARN MEAT CUTTING

At Home—In Spare Time



Get into the vital meat industry. Concise, practical Home Training based on 25 years proven instruction methods used at National's famous resident school. Prepares you for bigger pay as Meat Cutter, Supervisor, market manager or more money in your own store. Go as rapidly as your spare time permits. Diploma. Start NOW to turn your spare hours into money. Send for FREE bulletin today. No obligation.

National School of Meat Cutting, Inc., Dept. U-66, Toledo 4, Ohio

Become a Doctor of PSYCHOLOGY

Win the degree of Ps.D. Teach the secret of contentment, happiness. Solve mental worries. Experience the revelation of truth. Chartered college. Individual help. Write for FREE book. **COLLEGE OF UNIVERSAL TRUTH, 5153-B North Clark St., Chicago.**

Good Handwriting

HELPS YOU WIN SUCCESS!

It's so important to write a good hand for business and social advancement. Poor illegible penmanship often causes costly errors and marks you for failure. Why write a poor hand? It's so easy to learn at home in spare time. Write for our new free booklet today. If you wish, send 10c for a penpoint suitable for shaded writing and your name beautifully written.

THE TAMBLYN SCHOOL OF PENMANSHIP
Business Since 1895 H-441 Ridge Bldg., Kansas City, Mo., U. S. A.

LEARN PORTRAIT PAINTING AT HOME



● Previous art training or talent NOT necessary. The Stuart System teaches you, in 11 easy-to-follow lessons, to (1) locate features *exactly* to

correspond to model's features, (2) outline head and face to correspond to model's outline, (3) make each feature a true portrait of that feature in the model, (4) produce shadows and shading that *exactly* correspond to that of model's face, (5) mix flesh paint tints that are like living flesh. Our students' portraits look alive. You, too, can make *exact* charcoal and oil likenesses. Send for free booklet today.

STUART STUDIOS,

121 Monument Circle, Room 626, Indianapolis 9, Ind.

Please send me free book and outline of lessons.

Name

Street

City

Now You can Use.



ALL OF THESE RADIO PARTS

to help You learn

RADIO

FASTER—EASIER AT HOME

YOU CAN BUILD **133** FASCINATING EXPERIMENTS.

At home—in your spare time—you get real Radio experience from these many interchangeable Radio parts and sub-assemblies. DeForest's handy "Block System" eliminates unnecessary mechanical work; the convenient spring clip connections save a great deal of time. You quickly build Radio circuits that work. You experiment with Photo-Electric Cell "Magic" . . . a 5 tube Superheterodyne Receiver . . . a Radio Telephone, and scores of other fascinating projects. Little wonder learning Radio at home is so practical . . . effective and real fun—with DeForest's modern "Home Laboratory."

YOU USE "LEARN-BY-SEEING" MOVIES!

Think of the pleasure, as well as help you get from the use of this DeVRY Motion Picture Projector and exciting "movie" TRAINING FILMS. You will be surprised how much faster . . . easier . . . Home Movies help you understand Radio-Electronic fundamentals. Here's a preferred training method of tomorrow—yours today. SEE the principles of what you're learning—in motion . . . ANIMATED! See circuit actions otherwise hidden from the eye. You get this big Radio home training advantage—exclusively with DeFOREST'S. So act now! Mail coupon for complete details.



VETERANS!

Big things are happening at DeForest's for veterans! See how we can prepare you WITHOUT COST for a GOOD JOB or a BUSINESS OF YOUR OWN in the vast Radio-Electronic opportunity field.

See how DeForest's fascinating SHOP METHOD Radio Training at home can help you toward a good start in the Billion Dollar Radio-Electronic Field. Write for DeForest's BIG FREE book, "VICTORY FOR YOU!" that has helped many to good pay jobs. You'll be surprised at the opportunities ahead in F.M. Radio, Aviation Radio, Broadcast Radio, a Profitable Business of Your Own, Motion Picture Sound Equipment, Electronics—plus the exciting future possibilities ahead of Television, Radar, etc.

You Get "ALL THREE" With DeFOREST'S

Where else can you get such a combination of PROVED MAJOR training features as—(A) modern loose-leaf lessons prepared under the supervision of Dr. Lee DeForest, often called the "Father of Radio;" (B) the use of "Learn by Seeing" home movie films and a genuine 16 mm. DeVRY

MOVIE PROJECTOR—and (C) eight big kits of "Home Laboratory" Radio parts to give you valuable practical Radio experience—at home.

You get an Effective Employment Service, too. Residential training in our Chicago laboratories also available.

DeFOREST'S TRAINING INCLUDES INSTRUCTION IN MOTION PICTURE SOUND EQUIPMENT, FM RADIO AND TELEVISION . . .



DeFOREST'S TRAINING, INC., Dept. PM-C2
2535-41 N. Ashland Ave., Chicago 14, Illinois, U.S.A.

Send—FREE and WITHOUT OBLIGATION—illustrated book, "VICTORY FOR YOU" and KIT SUPPLEMENT, showing how Home Movies and Home Laboratory can speed my preparation for a place in the Radio-Electronics industry.

Name _____ Age _____

Address _____

Name _____ Zone _____ State _____

If under 16, check here for special information.
 If a discharged veteran of World War II, check here.

DeFOREST'S

TRAINING, INC.
CHICAGO 14, ILLINOIS



SO IT NEEDS FIXING

By S. T. CHRISTENSEN
the "Fix-it Man"

WELL, I guess I'm the fellow to see, for I've repaired thousands of refrigerators (home and commercial both), vacuum cleaners, radios, washing machines, irons, fans, lamps, mangles, motors, etc. In fact, many of my customers call me their "electrical appliance doctor." And, "doctoring" I might add, has paid me a good substantial income for quite a few years. Funny, in a way, how I got started. Always liked to tinker and by experimenting around I found that most electrical appliances had many things in common. That, regardless of what the appliance was used for, or who the manufacturer was, the basic principles were much the same. From fixing my own appliances to fixing friends' and then for strangers at a fee, seems now to have been but a small step.

What to Charge?

At first, I let the owner decide the charge and, frankly, I was amazed at what I earned per hour. But then, when one figures what initial costs are involved in buying most electrical appliances, one can readily see that spending extra dollars for repairs is well worth while. Before long I was making more in my spare time repairing than from my regular job. The result . . . I went into business for myself. When war came, business boomed, for new appliances were not available.

For a while, repair parts (needed on some

jobs) were a little difficult to get. But that situation quickly adjusted itself and many repair parts were given the high priority rating of AA2. After all, we had to provide for the health and well-being of our civilian population.

The Future Offers

Friends ask me about my future. And, I think I've got a grand one. Age is no handicap in repairing. I have in my files enthusiastic letters from repairmen ranging in age from 18 to 79 years. Now the war is over we are certain to see hundreds of new products on the market . . . products that the average person never dreamt of. These new products and our old appliances are all going to need at some time or other "fixing." Well, I'll still be the fellow to do it. The field open for appliance repairmen is unlimited. I don't worry at all about too much competition.

If You Are Ambitious

To the contrary, I've prepared a complete course, chuck full of simple, easy to understand photos and drawings and written in the same non-technical language as this article. I know the course is good, because I have hundreds of men all over the country writing to me telling me how the course has helped swell their pockets with cash. If you too want to prepare now for your future, I suggest you read the next page and send me the handy coupon."

Advertisement



BIG MONEY INDEPENDENCE

A PROFITABLE LIFETIME BUSINESS OF YOUR OWN!

LEARN ELECTRICAL APPLIANCE REPAIRING

PREPARE NOW FOR THE FUTURE

If now employed, start your home appliance repair business NOW in your spare time and be set with a business of your own no matter what happens. You don't need elaborate fixtures or expensive equipment to be a successful repairman. Operate from your garage, basement, vacant store, etc. Work as many hours as you wish—the home appliance repairman is his own boss. It is a profitable occupation for on many types of repairs it is not unusual for a repairman to charge on the basis of \$5.00 to \$6.00 per hour. Don't gamble with your future—learn a trade that will always support you. Remember, as long as electrical appliances are used, there will be a need for electrical appliance repairmen.

If you are at all mechanically inclined—can hold and use tools—then you have all of the qualifications required for becoming a big money earning home appliance repairman. It does not matter if you have not had a great deal of schooling or had previous experience along these lines—**WE WILL TEACH YOU.** Age should be no barrier—nor should any minor physical handicap.

New Course Tells All

Profusely illustrated, our new course shows you in simple, easy to understand language and drawings how to make each repair on refrigerators, vacuum cleaners, washing machines, motors, etc. Explains and gives you a working knowledge of electricity, welding, nickel plating, etc. Shows you how to build the power tools you need and how to solicit and keep business coming to you. Not a theory course but an honest to goodness course written by and used by repairmen the country over. Price of course is so low that the savings on your own household appliance repairs will quickly pay for it. Act now! Mail the handy coupon below today.

Read What Our Students Say About Course

I really believe your course the best investment a mechanically minded man can make.—Claude E. Allen, Indianapolis, Ind.

I have received your Course in Appliance Repairing and I must say I am well pleased with same. I am only sorry I did not have said Course some years ago. I have learned so much more through this course I would not part with it.—Charles Schwarz, Hamilton, Ohio.

The Course in Appliance Servicing arrived a few days ago. Want to take out a few minutes of my valuable time to let you know that this is just what I have been looking for ever since I opened up my Fix-It shop. I must admit that you told the truth when you said that it contains quite a bit more information than I bargained for.—P. J. Bretl, Sebring, Ohio.

I am a mechanic for the Western Union Telegraph Co. Three days after receiving the lessons in refrigeration I earned the exact cost of the course.—Henry S. Lee, Washington, D. C.

I work day times at the shipyard and after 4:00 P.M. I operate from my cellar and garage. I average \$10.00 to \$15.00 clear every day.—Walter Hanhy, Brockton, Mass.

GET STARTED TODAY—MAIL THIS COUPON



CHRISTY SUPPLY CO.
2835 N. Central Ave., Dept. D-3003
Chicago 34, Illinois

Please send me free illustrated literature about America's Fastest Growing Industry — ELECTRICAL APPLIANCE REPAIRING.

Name.....

Address.....

City..... State.....

Do you want

- ➔ ..to go to College?
- ➔ ..or to enter a Profession?
- ➔ ..or get an Office Position?

(Such as Accounting, Architecture, Nursing, Dentistry, Teaching, Social Work, Osteopathy, Beauty Culture, Optometry, Embalming, Chiropractic, Law, Medicine, etc.)

To get anywhere, you practically **MUST** finish High School **FIRST**. You can complete our simplified High School Course in **SPARE** time at home, as **FAST** as your time and abilities permit. Equivalent to resident school work—prepares you for college, pre-professional examinations, business, industry. Standard texts furnished. Diploma. Credit for H. S. subjects already completed. Single subjects if desired. Low tuition, easy terms. American School, Chicago, est. 1897—endorsed by educators. Finish your high school education **NOW**, Write **TODAY!**

High School Course at Home

Many Finish in 2 Years

American School, Dept. H245, Drexel Ave. at 58th St., Chicago 37, Ill.

Gentlemen: Send me **FREE** information covering special training in subjects checked below. No obligation on my part.

- | | |
|--|--|
| <input type="checkbox"/> High School Course | <input type="checkbox"/> Diesel Engineering |
| <input type="checkbox"/> Architecture and Building | <input type="checkbox"/> Drafting and Design for Men & Women |
| <input type="checkbox"/> Automotive Engineering | <input type="checkbox"/> Plastics |
| <input type="checkbox"/> Business Management | <input type="checkbox"/> Private Secretary |
| <input type="checkbox"/> Electrical Engineering | <input type="checkbox"/> Mechanical Engineering |
| <input type="checkbox"/> Elec. and Gas Refrigeration | <input type="checkbox"/> Aviation |
| <input type="checkbox"/> Air Conditioning | <input type="checkbox"/> Salesmanship |
| <input type="checkbox"/> Railway Training | <input type="checkbox"/> Radio |
| <input type="checkbox"/> Electronics, Industrial | |

Name.....

Address.....

Learn this Profitable Profession



IN 90 DAYS AT HOME
Money-Making Career Open to Men and Women, 18 to 50

Hundreds of men and women between 18 and 50 make \$10 to \$20 in a single day giving scientific Swedish Massage and Hydro-Therapy treatments. There is big demand from doctors, hospitals, sanatoriums and clubs. Graduates earn large full time incomes from these or in private practice in their own offices. Others make good money from home treatments given in spare time. Learn this interesting, money-making profession in your own home, through our home study course. Same instructors as in our nationally known resident school. You can win independence and prepare for future security by qualifying for your Diploma. Course can be completed in 3 to 4 months. Many earn while they learn. Begin your training at once.



Anatomy Charts & Booklet FREE

Enroll now and we will include, at no extra cost, many needed supplies. Fit yourself to help meet growing demand for Scientific Swedish Massage. Send the coupon at once for complete details. Anatomy Charts and 32-Page Illustrated Booklet, **FREE**, postpaid.

THE COLLEGE OF SWEDISH MASSAGE
 Dept. 664-B, 100 East Ohio St., Chicago 11, Illinois

Please send me **FREE** and postpaid, Anatomy Charts, 32-page Booklet and complete details on Home Training.

Name.....

Address.....

City..... State.....



BE YOUR OWN BOSS!

MAKE MORE MONEY

\$1.00 VALUE
25¢
 68 PAGES
 40,000 WORDS

In "CASH IN" you get **ALL** the real money-makers—dozens of profitable tested mail order plans, confidential business secrets, dozens of practical tested formulas, successful tested schemes—actual experiences of men who have started on a shoestring—with less than \$10 capital.

25c a copy postpaid. Send U. S. stamps, money order, or coin.

MONEY BACK GUARANTEE

NATIONAL PLANS COMPANY

P. O. Box 26F, Station N, New York 23, N. Y.



Get ten big issues of America's Handwriting magazine for \$1.50. Free copy sent on request.
 THE EDUCATOR, 612 N. Park St., Columbus 8, Ohio

NEW WRITERS NEEDED

New writers needed to re-write ideas in newspapers, magazines and books. Splendid opportunity to "break-into" fascinating writing field. May bring you up to \$5.00 per hour spare time. Experience unnecessary. Write today for **FREE** details. **NO OBLIGATION**. Postcard will do.

FREE DETAILS

COMFORT WRITER'S SERVICE

200-T40 South Seventh (2)

St. Louis, Mo.

ANALYZE HANDWRITING

Qualify for Certified Grapho-Analyst Degree. New uncrowded, fascinating field of service. Gratifying earnings reported by graduates in Employment, Credit, Social Service, Police and Judicial, and Entertainment fields. Others have developed profitable private practice, full or spare time, as Personal Problem and Vocational Counselors. Send for 3000 word test lesson and Grapho-Analyst

FREE

ADDRESS A. I. G. A. Inc. 120 NOEL, MO.

Make BIG MONEY in Coming REAL ESTATE BOOM!



Get in the Swim NOW

PREPARE NOW for a big pay, permanent job or your own 6-Profit business in the predicted post-war real estate boom! Salaries up to **\$2,500.00 to \$10,000.00 a year** in property management, brokerage, appraisal, loans, insurance, building. Dignified, pleasant work. Many make fortunes in real estate. Thousands of trained men, women required yearly by real estate firms, insurance companies, banks, Federal agencies, etc. **Coming real estate boom** means even bigger demand for workers, greater earnings, larger profits. Rush post-card or coupon for **FREE 32-Page QUIZ BOOK** and full details on Modern Real Estate Practice—first and only complete, popular-priced home training and reference library in this entire field. **Hurry!**

JOB SEEKERS! REALTORS! OWNERS! BUILDERS! INVESTORS!

RUSH COUPON OR POST-CARD FOR 32-Page FREE BOOK!

LANE BOOKS, INC.
 100 E. Ohio St., Dept. B-2, Chicago 11, Ill.
 Send me **FREE, POSTPAID** and **WITHOUT OBLIGATION**, your 32-Page QUIZ BOOK and complete details on Modern Real Estate Practice.

Name.....
 Home Address.....

INVENTORS

HERE ARE 4 GOOD REASONS

Why you should send for these books *Immediately!*

1 MANUFACTURERS NEED YOUR INVENTIONS—*Your Opportunity*

War plants and critical materials have been released for civilian production! Manufacturers are looking for new products—new processes!

Who will supply these new products—these new processes? America's Inventors, of course. They always have!

Filing your application in the U. S. Patent Office for a patent may prove to be the door opener for you—manufacturers prefer to talk to inventors whose applications for patents are filed.

2 TIME WAITS FOR NO MAN— *Your Chance to Profit*

If you have an idea for a patentable invention—in your head or on your workbench—keeping it there won't do you any good. It won't pay royalties to you there.

While you're doing nothing about it—some other inventor may come up with the same idea and cash in. It has happened. Be first to apply for a patent—that's the way to benefit in case of controversy.

3 PATENTS MAKE JOBS— *A Challenge to You*

The postwar economy of the Nation calls for full employment for 60,000,000 workers. Wouldn't you like to feel that your invention gave employment to even a small percentage of that number . . . in addition to the possible financial rewards you'd receive?

VICTOR J. EVANS & CO. has helped inventors for nearly 50 years. They can help you. An experienced staff of draftsmen, specification writers and patent attorneys will take care of all details for you. All you have to do is send us a description of your invention. You can pay on our deferred payment plan. Remember—you can get a patent yourself, BUT—the U. S. Patent Office advises that unless an inventor is familiar with patent matters he should employ a competent registered patent attorney.

**HERE'S YOUR FIRST STEP—
MAIL THIS COUPON Today!**



4 THE BOOKS TELL YOU WHAT TO DO

Thousands of successful inventors have followed the advice found in these two books. They tell you, step by step, the procedures required by the U. S. Patent Office; they give you valuable suggestions on financing, selling a patent; they illustrate 115 mechanical movements that may help you complete your invention. And—THEY'RE FREE—in addition to important Evidence of Invention Form that will give you a record of the date of your disclosure. SEND FOR ALL THREE TODAY.

VICTOR J. EVANS & Co.

MERLIN M. EVANS
Registered Patent Attorneys

Main Office: 130-B Merlin Building
Washington 6, D. C.
Pittsburgh Office: 521-N Empire Building
Los Angeles Office: 738-N Security Building

Rush by return mail. Free copies of your books, "Patent Protection" and "When and How to Sell an Invention"—also important—"Evidence of Invention" form.

Name.....

Address.....

City and State.....

The set of books that makes



MASTER MACHINISTS and leads to bigger pay!

This big home-study and reference course gives you the practical facts on machines and methods you need to advance in machine shop work. Take advantage of the other man's experience as found in books, to solve your problems, increase your efficiency, with

The AMERICAN MACHINISTS' LIBRARY

6 volumes—2368 pages—2516 illustrations
(A combined home-study course and reference library)

This library of machine shop practice was written for practical men. It gives you the best methods for every kind of machine shop work. It fully explains lathes, drills, and other machine tools and their operation, automatic screw machines, speeds and feeds, gear design and production, jigs and fixtures, punch and die work, metal surfacing, etc., etc. Plainly written—completely illustrated—the best kind of help to the machine shop man who wants to advance himself.

No money down—special price—easy payments.

EXAMINATION COUPON

McGRAW-HILL BOOK CO., 330 W. 42nd St., N. Y. 18

Send me for ten days' examination the American Machinists' Library. If satisfactory I will send you \$1.50 in 10 days and \$3.00 monthly until the price of \$19.50 is paid. If not wanted, I will return the books postpaid. (To insure prompt shipment write plainly and fill in all lines.)

Name

Home Address

City and State

Company

Position

PM 2-46

Keep that "TICKING" Car

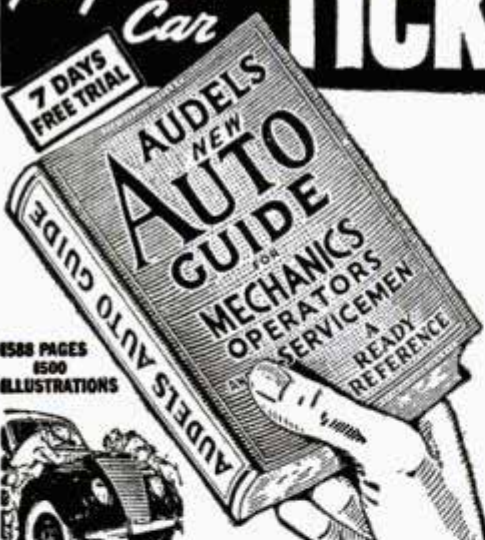

Every operator and mechanic needs AUDELS AUTO GUIDE.

This book saves time, money and worry. Highly endorsed. It presents the whole subject of auto mechanics:

- 1—Basic principles
- 2—Construction
- 3—Operation
- 4—Service
- 5—Repair

Handy Size. Easily understood.

NEW FLUID DRIVE, HYDRAULIC SHIFT AND DIESEL ENGINES FULLY COVERED

Over 1500 pages—1540 illustrations showing inside views of modern cars, trucks and buses with instructions for all service jobs.

\$4 ASK TO SEE IT!—To Get This Assistance for Yourself Simply Fill in and Mail Coupon Today.

4 COMPLETE • PAY ONLY \$1. A MONTH ←

AUDEL Publishers, 49 West 23rd St., New York

MAIL AUDELS NEW AUTO GUIDE for free examination. If O.K. I will send you \$1 in 7 days; then remit \$1 monthly until price of \$4 is paid. Otherwise I will return it.

Name

Address

Occupation

Employed by

PM

No Waiting to LEARN Start at Once to EARN!

This BIG BOOK SHOWS HOW

If it's Results you want, you can get action quickly with this practical book. Never before has a more helpful book been printed for those planning a business of their own. Gathered in this large illustrated volume are the formulas, recipes, facts and secrets that have contributed so largely to America's great industrial progress. Capitalize on this information for making most any conceivable product without experience, special equipment or previous knowledge of chemistry. Start at home, expand with profits—build for a profitable independence. The experts who compiled this book are authorities, and present this information in simple, understandable language. They also give you wholesale supply sources for needed material, short cuts and economy methods for the most profitable results. Hundreds of good paying businesses have been built on a product made from a simple recipe. Opportunities in this field exist everywhere. Choose from any of the 162,000 facts and 10,000 formulas of which the following are only a very few: Adhesives, Alloys, Anti-Freeze Solutions, Cosmetics, Beverages and Liqueurs, Candy, Gum, Casein, Celluloid, Ceramics, Cheese, Cleaning Preparations, Concrete, Copper, Cotton, Dentifrices, Dyes, Embalming Fluids, Enameling, Glass, Household Formulas, Inks, Insecticides, Iron, Jewellers' Formulas, Lacquers, Laundry Preparations, Leather, Linoleum, Lubricants, Manicure Preparations, Marble (artificial), Metals, Mirrors, Oils, Ointments, Paints, Paper, Perfumes, Photography, Poisons, Powders, Remedies for Man, Beast or Fowl, Rubber Products, Refrigerants, Seams, Solder and Soldering, Tooth Cements, Transfers, Transparencies, Varnishes and Thousands of others for making all sorts of profitable and practical things.

10,000 FORMULAS, RECIPES SECRET PROFIT IDEAS



924 Illustrated Big Pages
Especially recommended for ex-Servicemen and ex-War Workers planning a profitable business of their own. This comprehensive book is an accepted authority by chemists, schools, industry, etc. and is the largest and most comprehensive book of its kind ever issued. Nothing else like it in existence. A single formula has been worth a thousand times this book's small cost to countless owners. Crammed with money-making ideas, invaluable for reference. Ideal for Factory, Home, Farm, Office or Workshop. As necessary as the dictionary and more useful for manufacturers, chemists and salesmen who put up products for profit.

Prepare for "After-War-Business"

This Complete Book Only \$2.98 POST PAID Worth More

ALSO INCLUDED! Formulas for "D.D.T." insecticide. Also our New Book of Money Making Facts: "The More You Know the More You Can Earn—Easier and Quicker." Ambitious Polka Profit by this valuable information. Immediate Shipment—Safe Delivery Guaranteed, \$2.98 postpaid, Canada or Foreign, \$3.25 U. S. Funds. (C.O.D. shipments U. S. A. only.) ADAMS BROWN COMPANY Books of Applied Science Dept. 302, Chestnut Hill 67, Massachusetts, U. S. A.

DRAW CARTOONS BIG MONEY!



EASY . . . PLEASANT WORK!
Let CHAS. H. KUHN, with 25 years actual experience in drawing a daily newspaper cartoon, teach you how to create, draw and sell your work. 52 complete lessons—one sent each week. Professional criticism on every lesson. Write today.

KUHN SCHOOL OF CARTOONING
420 MURPHY BUILDING Dept. M INDIANAPOLIS 4, INDIANA

MAKE MAGIC your HOBBY



Entertain for Fun or Profit!
Everybody loves magic. Rush 25c for copy of "102 Magic Tricks." This amazing book tells how to do easy tricks with coins, cards, cigarettes, watches, mind-reading, etc. FREE—with your order, our catalog of low-priced professional magical apparatus.
D. ROBBINS & CO. Dept. PM2
152 W. 42nd St. New York 18, N. Y.

PRINT ANY PHOTO on Paper, Cloth, Leather or Wood

SIMPLE, EASY TO USE
Magic liquid takes only 2 minutes to reproduce any snapshot you have on to stationery, handkerchiefs, ties, scarfs, etc. Won't wash off. Won't hurt negative or fabric it's used on. Personalize your belongings! An ideal gift. Complete outfit enough to transfer 100 photos—only \$1.00 postpaid. Sent C.O.D. for \$1.21.
CHRISTY PHOTO SUPPLY, Dept. 2210
2835 N. Central, Chicago 34



NOTICE: Over 100,000 ambitious men have been helped to higher paying jobs with the aid of books listed on this page.



Which of these books can help you GET A BETTER JOB AND MAKE MORE MONEY

Here's how to beat job competition and insure yourself of a prosperous future. Gateway Books help you tackle those tough jobs you've always had your eye on... because they show you how to do the HARDEST jobs the EASIEST way in LESS time. Gateway Books are written by men who are experts in their particular field... men who have worked themselves up the hard way. Now you can take advantage of their knowledge the easy GATEWAY way.

hard way. Now you can take advantage of their knowledge the easy GATEWAY way. Our Money Back Guarantee and Special offer appear elsewhere on this page. Study this list of popular books now.

Order From This List

WOODWORKING

1. **CARPENTRY CRAFT PROBLEMS.** 302 pages explains and illustrates hundreds of practical solutions to all types of carpentry problems met by the amateur and professional woodworkers. Complete in every detail. \$2.50
2. **BUILDING—FORMS, STAIRS, ROOFS.** Latest information on how to build correctly, forms, staircases, roofs, etc. For carpenters and helpers. 250 pages, illus. \$2.50
3. **WOODEN BOAT AND SHIP BUILDING.** Solves every type of problem in building wooden boats and ships. 244 pp., illust. \$2.25
4. **HOW TO MAKE RUSTIC FURNITURE.** Hundreds of ideas and plans on making all types of rustic furniture for the home. Completely illust., thoroughly described. \$2.00
5. **WOOD TURNING.** An excellent book for every home craftsman. Tells and shows how to do the most artistic kind of work. Numerous photos and detailed drawings. \$2.50
6. **HOW TO WHITTLE AND CARVE.** Complete directions for all types of whittling and carving of toys, jewelry and novelties, etc. Illustrations make work simple. \$2.75

PAINTING

7. **CONCRETE DESIGN and CONSTRUCTION.** 508 pages. 251 illust. A new and large edition of "How-to-do-it" book covering all phases of concrete work. \$4.75
8. **HANDBOOK OF ORNAMENT.** For artists, designers, jewelers, architects, etc. Topics covered include: Elements of Decoration, Decorated Objects, and Ornaments applied to Features. 3,000 illus., 548 pages. \$5.00
9. **INTERIOR WALL DECORATION.** Practical working methods for plain and decorative wall finishes. 185 illus., 491 pages. \$3.00
10. **THE MIXING OF COLORS and PAINTS.** How to mix colors for interior decorating, arts, crafts, general mixing methods. A handy book for professional and amateur painters. 302 pages, fully illustrated. \$2.50
11. **SPRAY PAINTING.** Spraying technique and operating instructions on paints, materials, finishes. 125 fully illust. pages. \$2.00
12. **HOUSE PAINTING METHODS.** 400 pages and 150 illust. cover the subject of house painting (of any surface) thoroughly... time and money saver. \$2.50
13. **WOOD FINISHING.** Wood finishes and problems—tools—material. 353 illust. \$2.50
14. **CYCLOPEDIA of PAINTING and DECORATING.** Covers methods, tools and materials for the home and workshop, including every branch of painting and decorating. Any particular job is fully explained with illustrations to clarify the text. 350 pages. \$3.50

METAL WORKING

15. **WELDING.** Arc, spot, butt and electric welding, etc. 280 pages. \$2.00
16. **SHEET METAL WORKERS MANUAL.** Complete instructions and information on every phase of sheet metal working. Includes many tables. 532 pages, 375 illust. \$3.00
17. **METAL SPINNING.** A new art of proven popularity. Step-by-step descriptions of the various phases of the craft shows you how to make the most out of your metal work. Simple, concise. \$1.75
18. **METAL SPINNING PROJECTS.** Tells how to make bowls, lamps, serving dishes, book ends, candle sticks, etc. Complete patterns and instructions. \$2.75

REFRIGERATION - PLUMBING AIR CONDITIONING

19. **REFRIGERATION SERVICE MANUAL.** Domestic and commercial refrigeration used in markets, milk depots, soda fountains, etc., and in homes. 300 pages, illust. \$2.50
20. **PLUMBING INSTALLATION and REPAIR.** 236 page book on how to repair leaky faucets, clogged toilets, drains, traps, vents, sewers, etc. 153 illustrations. \$2.50
21. **HEATING-COOLING and AIR CONDITIONING.** Complete and authoritative. 706 fact filled pages on heating of all types, cooling, Air Conditioning, equipment, furnaces, controls, etc. 706 pages, 64 charts, 351 illustrations. \$4.50

ELECTRICITY

22. **PRACTICAL ELECTRICITY and HOUSE WIRING.** An ideal book for around the home because it debunks all the mysteries of electricity and shows you how you can save plenty by doing all of your own wiring. Plenty of illust. and diagrams. \$2.00
23. **ARMATURE and MAGNET WINDING.** The construction of armature and their repairs fully covered with illustrations. \$2.00

ART

24. **HANDBOOK of ADVERTISING LAYOUT.** Written and illustrated by one of the country's leading advertising men, it is practical and sound. \$3.00
25. **FIGURE DRAWING FROM LIFE.** \$1.00
26. **AMATEUR ARTIST.** \$1.50
27. **LETTERING AND DESIGN.** \$3.00
28. **SILK SCREEN METHODS.** How to make silk screens, materials needed. Complete, authoritative. Fully illustrated. \$3.00
29. **ART of CARICATURE.** \$2.50

SPECIAL If your purchase totals \$10.00 or more and remittance is enclosed with your order, we will send you any \$2.00 book you choose absolutely FREE.

SELF IMPROVEMENT

30. **PRINCIPLES of ACCOUNTING.** 740 pages that help make you a proficient accountant and show you how to keep your own books easily. Gives all details. \$3.75
31. **MATHEMATICS.** Includes all phases of mathematics to help reader solve all practical problems. 224 pages. \$2.25
32. **SLIDE RULE and LOGARITHMIC TABLES.** Uses and principles of slide rule and logarithmic tables fully covered. Includes even 10 place log tables. 200 pages. \$1.75
33. **101 WAYS to BE YOUR OWN BOSS.** Information gathered from over 600 successful business men tells you how to be your own boss in business. Complete... authoritative... leaves nothing to doubt... helpful. \$2.49

HOBBIES

34. **TIN CAN PROJECTS.** Tells how to turn tin cans into objects of beauty that command high prices. This handy book has all the patterns, designs, etc. \$1.50
35. **MODERN HOMECRAFT.** 240 pages of ideas for modern furniture... and how to make it... fully illustrated. \$3.50
36. **LEATHER WORKING.** Tells of tools, materials and equipment needed. Gives working drawings of key holders, book marks, coin purses, billfolds, belts, frames, etc. \$2.00

JUST RELEASED!
AUTOMOTIVE SERVICEMANUALS
 Just released as Civilian Editions published for U. S. Armed Forces Institute. They represent the most complete and authoritative information available. They cover all phases of repair and service and are specifically designed to be a source for training in the automotive repair and service fields. Books may be bought separately... or in the money saving sets. Order books and sets by specified number.

SET NO. 1

37. **VOL. 1: The service station, frames, wheels, suspension, steering and ride control, transmissions, clutches, universals, front and rear systems and brakes.** App. 550 pages. \$4.00
38. **VOL. 2: Power Plants, Oil and Cooling systems, Engine repair and Maintenance, Fuel and Ignition Systems, Automotive Electricity.** 600 pages. \$4.50
39. **Combination Price, the above 2 Vols.** \$8.00

SET NO. 2

- These books, bound in paper are app. 300 pages.
40. **The Engine** \$1.50
 41. **Cooling, lube and fuel systems.** \$1.50
 42. **Automotive Electricity** \$1.50
 43. **The Power Flow** \$1.50
 44. **Chassis Units** \$1.50
 45. **Combination Price, the above 5 vols.** \$6.75

CHECK, CLIP AND MAIL THIS COUPON NOW

THE GATEWAY BOOK CO., 32 N. State St., Dept. PM-14, Chicago 2, Illinois
 O.K. Send the books I've circled. If C.O.D., I'll pay postman cost of books plus a few cents postage and handling charge. If prepaid, Gateway pays all shipping charges. If any book is not entirely satisfactory, I will return it in 10 days and you will refund my money. No C.O.D.'s outside the U.S.

1 2 3 4 5 6 7 8 9 10 11 12 13 14 15 16 17 18 19 20 21 22 23
 24 25 26 27 28 29 30 31 32 33 34 35 36 37 38 39 40 41 42 43 44 45
 (Please print name clearly)

Name.....
 Address.....
 City.....Zone.....State.....

Guarantee

Gateway Books are guaranteed to be absolutely satisfactory in every respect, or your money will be cheerfully refunded. **The GATEWAY BOOK CO., Dept. PM-14 32 N. State — Chicago 2, Illinois**

"I'll show YOU how to make yourself COMMANDO-TOUGH

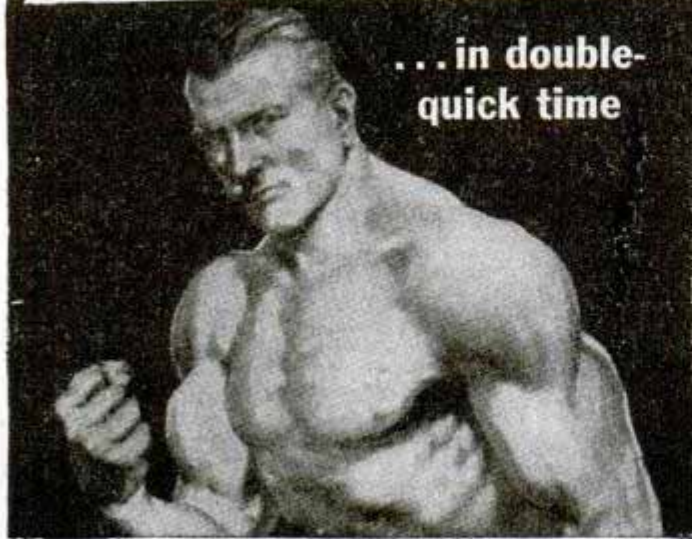

...in double-quick time

...OR IT WON'T COST YOU A CENT!"
says *George F. Jowett*

WORLD'S GREATEST BODY BUILDER

Let me prove to YOU that you can put inches of dynamic muscles on your arms! Add inches to your chest! Broaden your shoulders and power-pack the rest of your body. I can do for you what I've done for thousands the world over, including many officers and men now in the U. S. and British Armed Forces.

GIVE ME 10 MINUTES A DAY! I'll Show You My Secrets Of Body Building

I'll help you learn the "Progressive Power Method" through which I rebuilt myself from a physical wreck to the holder of more strength records than any other living athlete or teacher! No matter how skinny or flabby you are, you can learn my methods right in your own home. Through my proved secrets I show you how to develop your power, inside and out, until YOU are fully satisfied that you are the man you want to be. "The Jowett System," says R. F. Kelly, Physical Director of the YMCA, Atlantic City, "is the greatest in the world!"

PROVE TO YOURSELF IN ONE NIGHT!

Send only 25c for test Course, "Molding a Mighty Arm." Read it the evening it arrives—learn from experience the thrill you can give your muscles!

SEND FOR THESE FIVE FAMOUS COURSES IN BOOK FORM
ONLY 25c EACH
or ALL 5 for \$1.00

BOOK WITH PHOTOS OF FAMOUS STRONG MEN
MAIL COUPON NOW

FREE



George F. Jowett
Champion of
Champions

Jowett Institute of Physical Culture
230 Fifth Avenue, Dept. 938-B, New York 1, N. Y.
George F. Jowett: Your proposition looks good to me. Send by return mail, prepaid, the courses checked below, for which I enclose (). Include FREE book of PHOTOS.

- | | |
|--|---|
| <input type="checkbox"/> All 5 courses for . . . \$1 | <input type="checkbox"/> Molding Mighty Legs 25c |
| <input type="checkbox"/> Molding a Mighty Arm 25c | <input type="checkbox"/> Molding a Mighty Grip 25c |
| <input type="checkbox"/> Molding a Mighty Back 25c | <input type="checkbox"/> Molding a Mighty Chest 25c |
| <input type="checkbox"/> Send all 5 C.O.D. (\$1 plus postage.) No orders less than \$1 sent C.O.D. | |

NAME Age
(Print name)

ADDRESS

*This
Book
Free!*



BIG MONEY NOW IN LIQUID MARBLE

THREE wonderful new opportunities for your own big money-making business—regardless of your age, sex, or previous experience!

1. **LIQUID MARBLE.** Make beautiful artificial Marble Slabs. Pour from liquid state. Glazed or unglazed. This marble may be mottled, veined, multi-colored or left in original snow-white state. The color is actually a part of the marble! Does not fade or wear away. Liquid Marble is unsurpassed on kitchen or bathroom walls. Easy to make and install.

2. **PLASTIC FLOORING.** May be made in any color or combination of colors. Gives a lifetime of wear. Dustproof, Soundproof, Verminproof. Resilient to the tread. Lay out solid from wall to wall or in pattern design of various shaped blocks.

3. **FLEXIBLE MOLDS.** For plaster casting. Make your own moulds for few cents each. \$1.00 in raw materials will make up to \$25.00 worth of finished goods. We furnish names of buyers. Write now for FREE information about our BIG THREE money-making opportunities! Get in on busy season just starting. Send penny postcard or letter. No obligation.

COMPO-TEX, Box 786-SG, ST. LOUIS 1, MO.

Available Now! OFFICIAL PHOTOS OF NAVY SHIPS

Only \$1.20 per Set of 20 4" x 5" Glossy Prints

Taken by Official Navy Cameramen. Order sets by name: Battleships, Carriers, Escort Carriers, Destroyers, Cruisers, Auxiliary Ships, Navy Planes and many other exciting sets. OFFICIAL PHOTOS CO., Dept. A 1434 N. Western Av., Hollywood 27, Cal.

Write for Descriptive Circular



TRI-STATE COLLEGE

B. S. Degree in 27 Months

Distinguished for technical 2 1/2-year courses in Civil, Electrical, Mechanical, Chemical, Radio, Aeronautical Engineering; Business Administration, Accounting, and Secretarial Science.

VETERANS can complete work here in shortest possible time. Special Prep. Dep't. Also REFRESHER COURSES. 36-Week Courses in Surveying, Drafting. Low tuition. Low living costs. Cosmopolitan student body. 63rd year. Enter Sept., March, June, Jan. Catalog. 426 College Ave. ANGOLA, INDIANA



THERE'S MONEY IN CARTOONS!

RAYE BURNS will teach you HOW to CREATE ORIGINAL CARTOONS at home that you may SELL! Course contains 26 lessons and over 600 illustrations. All for Only \$2.85

Send name and address for free details.
RAYE BURNS SCHOOL, Dept. M, Box 3583, CLEVELAND, OHIO



STUDY AT HOME for PERSONAL SUCCESS and LARGER EARNINGS. 35 years expert instruction—over 108,000 students enrolled. LL.B. Degree awarded. All texts furnished. Easy payments. Send for FREE BOOK—"Law and Executive Guidance."

AMERICAN EXTENSION SCHOOL OF LAW
Dept. 62M, 646 N. Michigan Ave., Chicago 11, Ill.

YOU CAN ADVANCE IN PLASTICS!

Plastics can be the next great industry . . . expanding as swiftly and largely as the automotive, radio and aviation businesses. Already, it is an important industry and a growing one. With I. C. S. training, you can take advantage of the many opportunities in Plastics today. At the same time, you prepare for the vast possibilities of tomorrow. Write for the free booklet containing full information! Do it right now!

INTERNATIONAL CORRESPONDENCE SCHOOLS BOX 5571-K, SCRANTON 9, PENNA.

Send me full information on the following subject:

Name Age
Home Address
City State
Present Position Working Hours A.M. to P.M.

AVIATION *Career*

MAXIMUM TRAINING IN MINIMUM TIME

CAL-AERO TECH. TRAINING will ADD DOLLARS to YOUR pay check all the rest of YOUR life!

Your future EARNINGS depend upon your *training*. A wise investor always determines in advance what the return on his investment will be before he puts cash "on the line." You who plan to invest in a course of training, for a future career, **MUST** do the same. It is even more important to you, because your choice of training will determine **HOW MUCH MONEY YOU WILL MAKE THE REST OF YOUR LIFE**. Specializing in *Aeronautical Engineering* and *Master Aviation Mechanics* since 1929, Cal-Aero Technical Institute training is carefully designed to do just **ONE THING—MAKE MORE MONEY FOR YOU**. An alumni of over 6000 proves that **CAL-AERO TECHNICAL TRAINING** can get results and increase your pay check. **CAL-AERO** has provided its graduates with a profitable occupation, and secure future since it trained them in advance for the highest position they could ever expect to occupy. **IT CAN DO THE SAME FOR YOU.**

We invite your consideration, investigation and comparison. Send coupon **TODAY**.

VETERANS

Train in Sunny Southern California. Cal-Aero Technical Institute is on the list of approved schools on file with the Veterans' Administration, making discharged servicemen attending Cal-Aero eligible for the educational benefits, as provided under the "G. I. Bill of Rights."

Write us—we will be happy to help you with your future plans. Many ex-servicemen are now enrolling and taking advantage of these benefits here at Cal-Aero.

CAL-ACRO
TECHNICAL INSTITUTE

MAJOR C. C. MOSELEY

PRES. SINCE 1929

FORMERLY CURTISS-WRIGHT TECHNICAL INSTITUTE

**GRAND CENTRAL AIR TERMINAL
GLENDALE 1, CALIFORNIA**

LOS ANGELES COUNTY

"DON'T MISS THE BOAT" — MAIL THIS COUPON TODAY!

Cal-Aero Technical Institute, Grand Central Airport, Glendale 1, California
Please send full information and illustrated catalog on Aviation Training
FREE—without obligation. Dept. PM-2

NAME _____ BIRTH DATE _____

STREET _____

CITY _____ STATE _____

I PLAN TO ENROLL—Month _____ Year _____

AVIATION'S MOST DISTINGUISHED SCHOOL OF AERONAUTICS

Hear Better!



**THIS ONE UNIT
IS ALL YOU WEAR**
(with earpiece
and cord)

Beltone MONO-PAC

**No separate battery pack!
No battery wire!
About 1/2 the weight
of most hearing aids!**

New freedom, new comfort, and clear, rich hearing! That's what the compact little Beltone MONO-PAC offers you. It's a masterpiece of electronic research and precision construction . . . with batteries and transmitter combined into a *single streamlined case* so small that it fits in the palm of your hand. Thousands wear it . . . try it and compare it!

Write for free booklet.

Beltone Hearing Aid Co.

Dept. PM-2
1450 W. 19th St., Chicago 8, Ill.

STUDY AT HOME

With An Educational Institution

Men with specialized training win higher positions, insure larger earnings, and are bigger successes in business and public life. Opportunities NOW greater than ever before. Send for our Catalog.

ARTS and SCIENCES

Courses in Philosophy; Education; Letters; Public Health; Medical Jurisprudence; Psychology; Sociology; Physics; Chemistry; Plastics; Geology; Political Science; Theology; Business and Commerce; Accounting; Mathematics; Statistics; Agriculture.

ENGINEERING

Courses in Electrical, Civil, Mechanical, Drafting, Architectural, Steam, Aeronautical, Radio, Structural, Mining, Industrial, Petroleum, Marine, Chemical, Diesel, Automobile, Refrigeration, and Air Conditioning Engineering.

LAW

Complete Professional Law Course includes 20 Hornbook Series college grade textbooks. Courses also in Commercial Law, Patent Law and Medical Jurisprudence.
McKinley-Roosevelt Incorporated, 4610-K, Sheridan Rd., Chicago 40, Ill.

ENGINEERING DEGREE IN 27 MONTHS

**INDIANA
TECHNICAL
COLLEGE**

Aeronautical, Chemical, Civil, Electrical, Mechanical, and Radio Courses. B.S. degree, 1-yr. diploma in Electrical, Mechanical, and Radio Services; Drafting, Prep. courses. Gov't. approved for GI's. Low rate. Earn board. Large industrial center. Demand for graduates. Enter March, June, Sept., Dec. Catalogue, 526 E. Washington Blvd., Ft. Wayne 2, Ind.

Learn LANDSCAPE GARDENING!

Prepare for the giant postwar home-building program. A thorough, constructive, interesting home-training for those who wish to become LANDSCAPERS, DESIGNERS, GARDENERS, etc., for profit or pleasure. Write today for FREE INFORMATION, without obligation, to
NATIONAL LANDSCAPE INSTITUTE
Dept. P-2 756 So. Broadway Los Angeles 14, California



WONDERFUL INVENTION — Corrects poor penmanship in few hours. No failures. Helps one get better job. Write Ozment, 34, St. Louis, Mo.

JET PROPULSION

Experimenters! New principle to drive boats, bicycles, model helicopters. Circular on plans. Rush name. H. Maupin, Tipp City 12, Ohio.

HIGH SCHOOL AT HOME

Most well-paid positions demand high school training. Without it, or equivalent, you can't advance to the full extent of your abilities in any trade, business or profession. Whatever your age, however you're situated, IT ISN'T NECESSARY TO STRUGGLE UNDER THAT HANDICAP. I.C.S., famous for more than 50 years, enables you to start your own high school in your own home. You're in a class by yourself—study in your spare time—acquire a high school education at astonishingly low cost. Authoritative texts! Rapid Progress! Write today for free booklet.

INTERNATIONAL CORRESPONDENCE SCHOOLS BOX 5571-K, CRANTON 9, PENNA.

Send me full information on the following subject:

Name.....Age.....
Home Address.....
City.....State.....
Present Working
Position.....Hours.....A.M. to.....P.M.

GET INTO

RADIO

TELEVISION
ELECTRONICS
NOW!

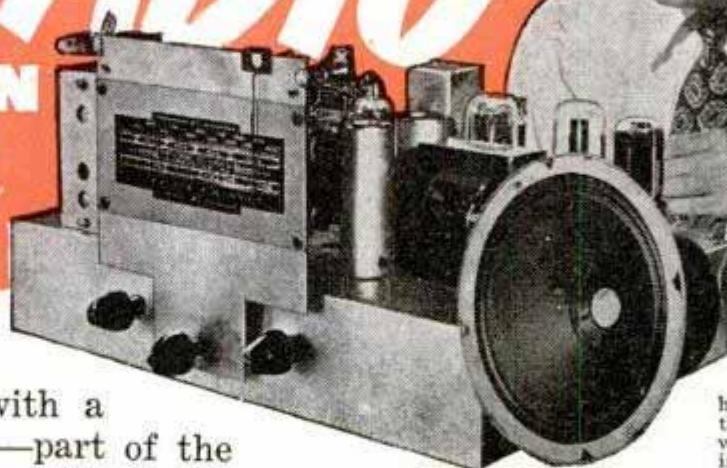

You build this complete, modern super-heterodyne receiver with the equipment that comes with your National Training at no extra cost.

This amazing new shop instruction system gives you actual experience with a Home Radio Laboratory—part of the

SHOP METHOD HOME TRAINING

FOR YOU—A REAL HOME LABORATORY IN MODERN RADIO

from one of the world's best established Oldest and Largest Technical Trade Schools



Your National Training Kits include equipment for hundreds of practical electronic experiments in your own home. You

have the genuine parts for this audio oscillator which you get to understand by building it yourself.

You learn modulation, beat frequencies, signal generation by actually building this small radio transmitter with your National shop parts.

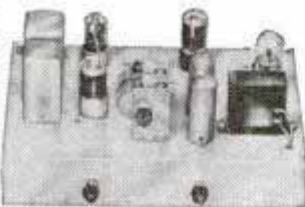

Your training outfits from National are made up of the most modern radionic equipment—much of it just out of the experimental laboratory. You learn new ways of handling equipment

by modern methods. Get the details by mailing the coupon.

Send the coupon below, immediately. Learn how this **sensationally improved**, practical speed-up training can fit you, in a short time, for the **GREAT BUSINESS OF RADIO**—for the **NEW AND RAPIDLY EXPANDING FIELD OF FREQUENCY MODULATION (F.M.), TELEVISION AND ELECTRONICS.**

This is the thoroughly proved, quick and easy speed-up method used so extensively in wartime training—endorsed by the **success of National men everywhere**—a system by which you study in spare time—off hours, even minutes right in your home and yet have the **ADVANTAGE OF REAL SHOP EXPERIENCE** to back you up.

Trained Radio Men Wanted

The man who really **knows modern Radio** is in greater demand today than ever before—not only in Radio proper but in **Television and Electronics**—in **Aviation, Transportation, Communications. Good jobs**

are wide open, **WAITING FOR YOU**, in the production, operation and maintenance of modern electronic equipment—in radio stations, in hundreds of industries—in homes, theatres and studios. Good, sound training in this important field is absolutely necessary. And now, National Schools brings such training to you **no matter where you live or what you may be doing**—not only the fundamental theory but the **actual experience that comes with knowing shop practice and working with real equipment**—demonstrating each step with first-hand knowledge. This is true **"learning by doing"**—direct from the great shops and laboratories of National Schools where new developments in methods, equipment and applications are constantly going forward.

Only National can offer you such practical training because only National has the plant to back it up. **Sample this training yourself. MAIL THE COUPON FOR A FREE LESSON.**

POSTWAR SUCCESS and SECURITY FOR YOU

Radio is a Big Sound Well-Established Business. **Television is just on the threshold of limitless expansion.** When you hang up your uniform—when your war job folds up, will you step out proudly into an essential established industry? Perhaps into a business of your own? Answer these questions by reading the catalog sent you **FREE** from National Schools. **Face realities now!** Fill out and mail the coupon today.

Check the Job You Now Have With These Opportunities in RADIO

1. Financial Security Radio has grown from \$100 million to \$5 billion in past few years.
 2. Limitless Future predicted by over 1,800 manufacturers of equipment.
 3. Television promises over half a million jobs alone—experts estimate.
 4. Electronics opens wide new fields in home and industrial use.
 5. Your Own Business with little or no capital.
- Get the details. Use the coupon!

FREE GET THESE 2 BIG BOOKS



NATIONAL SCHOOLS

LOS ANGELES 37, CALIFORNIA EST 1905



MAIL OPPORTUNITY COUPON FOR QUICK ACTION

National Schools, Dept. PM-2
4000 South Figueroa Street
Los Angeles 37, California

(Mail in envelope or paste on penny post card)

Mail me **FREE** the books mentioned in your ad including a sample lesson of your course. I understand no salesman will call on me.

NAME..... AGE.....

ADDRESS.....

CITY..... STATE.....

Include your zone number

NATIONAL TRAINING WINS BIG JOBS

You, too, can share the success of National graduates. Joseph Grumich, Lake Hiawatha, N. J., writes: "My latest offer was for \$5,800.00 as Radio Photo Engineer, but I am doing well where I am. I am deeply indebted to National."



While still a student of National training, I. Wilson of Vallejo, California, writes: "My pay has jumped from \$52.18 a week to \$72.65, and the end is not in sight. I am proud of my National Course."

Joseph Michel, Jr., Granite City, Illinois, writes: "I am enthused with National training. I am now earning \$225 a month as a radio operator and technician and \$20 a week more in my shop at home."

HERE ARE **3 Fine** Aviation Books



NOW READY FOR YOU!

Just off the press! A completely new book on the world's most popular airplane and new editions of two books that have been requested by hundreds of thousands of aviation enthusiasts. Here they are:

1. **Piper Cub Brochure.** Brand new! Beautiful full-color airplane illustrations, suitable for framing. Complete specifications of Piper Cubs.
2. **"How to Fly" Book.** Takes you on a typical flying lesson with 53 step-by-step photos and descriptions. Many other interesting facts.
3. **"What Your Town Needs" Book.** Will help you or your community plan an inexpensive landing area now.

Get these books from your Piper Cub Dealer now. Or, if you prefer, send us 10c per book or 25c for all three. Use stamps or coins. Specify which books you desire. Write Dept. PM26.

PIPER AIRCRAFT CORPORATION
LOCK HAVEN, PENNA.

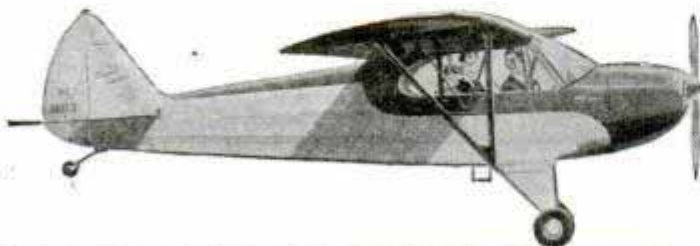

PIPER

THIS GREAT BOOK

HOW to BREAK and TRAIN HORSES

FREE!

Every farmer, every lover of horseflesh should have a copy of it. This amazing book tells how to know horses—how to break them—how to train them—how to make money as a master horseman. Write for it today—FREE, together with my special offer of a course in Animal Breeding. If you are interested in Gaiting and Riding the saddle horse check here Do it today—now. You'll never regret it.

BEERY SCHOOL OF HORSEMANSHIP
Dept. 1102D • Pleasant Hill, Ohio

Get Started in Radio

TEN "HOW-TO-DO-IT" BOOKS

Get a solid foundation in radio by means of these 10c timely text books. Each clearly written, profusely illustrated, contains over 15,000 words. You'll be amazed at the wealth of information packed into these handy books. Excellent for reference—ideal for technical library. Your money back if not satisfied.

5 Books for 50c - 10 Books for \$1
SENT TO YOU POSTPAID

RADIO for BEGINNERS

NO. 1—How To Make Four Doerle Short Wave Sets
NO. 2—How To Make The Most Popular All-Wave Tube Receivers
NO. 3—Alternating Current for Beginners
NO. 4—All About Aerials
NO. 5—Beginners' Radio Dictionary
NO. 6—How To Have Fun With Radio
NO. 7—How To Read Radio Diagrams
NO. 8—Radio for Beginners
NO. 9—Simple Electrical Experiments
NO. 10—Television

Remit by check or money order—register letter if you send cash or stamps.
RADIO PUBLICATIONS, 23F West Broadway, New York (7)

BOOKS FOUND FREE!

WHAT BOOKS DO YOU WANT?

We quote the lowest market prices. No charge for locating Hard-to-Find and Out-of-Print Books. All books, OLD or NEW, mailed POST-FREE.

SEARCHLIGHT BOOK CLUB, 22 East 17th St., New York City

Fix Your Own

ALARM CLOCKS

New, practical home course. Just out. Makes interesting hobby—profitable too. Save money by doing your own repairing at home. Easy if you know how. Price now only \$1.00. Details FREE. Send postcard.

THIES JEWELRY STORE, Genoa 3, Illinois

Learn Public Speaking

Learn theory and fundamentals at home—in spare time. Then acquire actual experience and practice. Send for FREE booklet "Power of Effective Speech."

North American School, Dept. 1352
1315 S. Michigan Ave., Chicago 5, Illinois

Learn to Write

Begin today. Write now for our Free Book, "How to Become a Good Penman." It contains specimens and tells how others learned to write in spare time. Enclose 10c for your name beautifully written and a pen point suitable for shaded writing. Write today.

THE TAMBLYN SCHOOL OF PENMANSHIP
N-441 Ridge Building, Kansas City, Mo.

A NEW BOOK ON

ANIMATED CARTOONING

A PREPARATORY COURSE FOR SCREEN AND TELEVISION

2 POST PAID

CARTOONIMATOR CO. DEPT S
5029 ILLINOIS AVE., N. W. WASHINGTON 11, D. C.

NAME.....
STREET.....
CITY..... ENCLOSE 10c "CHECK" OR "MONEY ORDER" STATE.....

TIE UP YOUR FUTURE with these
Growing Industries

**AIR CONDITIONING
and REFRIGERATION**

Air Conditioning and Refrigeration are among the great industries of today and tomorrow. Installations everywhere—in restaurants, shops, homes, etc., need service. Thousands of businesses are waiting for new installations. Today, more and more homes are being air conditioned. The Refrigeration and Air Conditioning industries are headed for greater prosperity and men who have the "know how" and experience should ride along.

TRAIN NOW Before the Expected Expansion Begins

Experts predict large demand for men to install and service Air Conditioning and Refrigeration equipment . . . Rise to the kind of job which requires a competent, trained man who can carry the responsibilities of installing costly equipment and maintaining it. If he knows the answer when he is called in for consultation, his reputation grows and his pay should grow also.

FOLLOW THIS WAY TO KNOWLEDGE

If over 17, and under 60, here's all it takes to get you ready for experience in this modern industry. Just invest a limited amount of your spare time—while you are still on your present job. Through our balanced training, you learn first through home study, how to handle Installation, Maintenance & Service Work on Refrigeration and Air Conditioning equipment. Then you can get practical training in our big shops under capable instructors—experienced men who'll take a personal interest in helping you learn. When you're through you should have knowledge that enables you to get started in this vast industry.

WANT YOUR OWN REPAIR SHOP?

UEI training is easily understood by mechanically inclined men. You gain experience when you complete your course. Equipment, tools and personal following can accumulate as you progress. Soon you may find it wise to set up your own shop.

Get Free Facts Right Now!

It costs you nothing to get all the facts about this great field. Simply mail the coupon below and we'll tell you, without obligation, the whole, sensational story of what's ahead in Refrigeration and Air Conditioning. Mail the FREE coupon now.

UTILITIES ENGINEERING INSTITUTE
1314 W. Belden Avenue, Dept. 126, Chicago 14, Ill.

Please send me the FREE FACTS about opportunities in Air Conditioning and Mechanical Refrigeration. I have marked the one that interests me most.

Air Conditioning Mechanical Refrigeration

NAME.....AGE.....

ADDRESS.....

CITY.....ZONE.....STATE.....

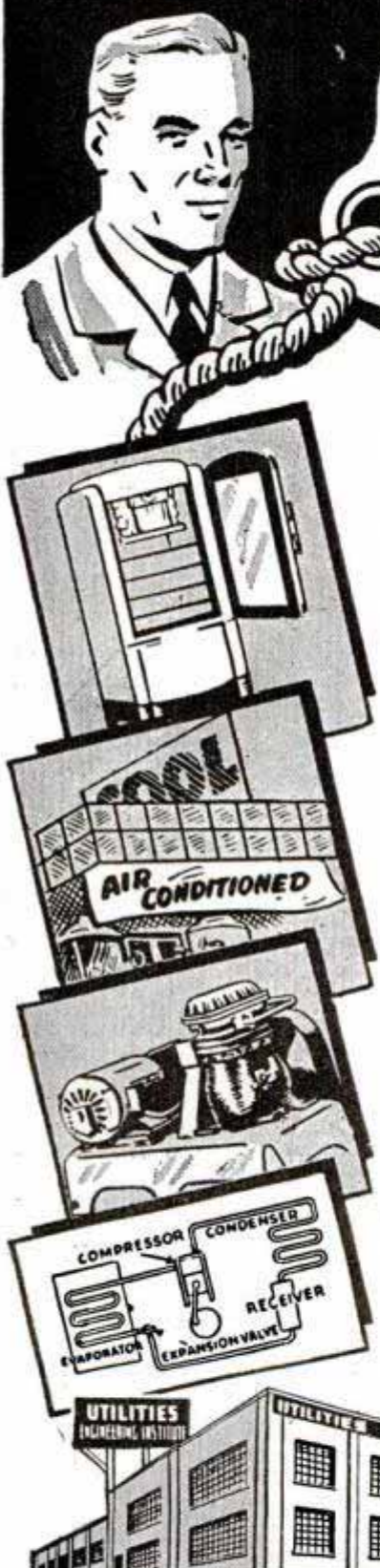

**REFRIGERATION
TRAINING
Since 1927**

**UTILITIES
ENGINEERING INSTITUTE**
1314 W. Belden Ave., Dept. 126, Chicago 14, Ill.



For Men Who are Trained in AUTO BODY & FENDER WORK

Men 18 to 60. Want a future with good pay perhaps a business of your own later? If you are mechanically inclined, start now to learn to become an auto body mechanic and fender repair man. This fast growing field has great possibilities for trained men with experience. U. E. I. spare time, home-study training combined with actual shop practice gives you sound, basic knowledge of latest best methods so you may get the experience which may bring you big pay. Capable instructors supervise your studies and actual practice on automobiles. Course includes acetylene welding, spray painting, use of hand and power tools.

THOROUGH, RELIABLE TRAINING

U. E. I. has trained men for new opportunity fields since 1927 and many students are now making good. Auto body and fender repairing is one of the best profit-makers in any garage or service station. Little capital required for mechanically inclined men to get into this business. Free employment placement service, or we will show you how to start your own shop. Get the facts FREE, without obligation. Write today.

UTILITIES ENGINEERING INSTITUTE

AUTO-CRAFTS DIVISION

1314 Belden Avenue, Dept. 126X, Chicago 14, Ill.

Gentlemen:—YES! I want to get into profitable Auto Body and Fender Repair Work. Please send me FREE FACTS at once. This inquiry does not obligate me in any way.

Name _____ Age _____

Address _____

City _____ Zone _____ State _____

AUDELS NEW MACHINISTS HANDY BOOK NOW READY!

Prepare!

A KEY TO SHOP PRACTICE
For Every Machinist, Toolmaker, Machine Operator, Draughtsman, Metal Worker, Mechanic or Student. Covers Shop Practice in All Branches.

A READY REFERENCE
Tells How to Operate and Set Up Lathes, Screw and Milling Machines, Shapers, Drill Presses and All Machine Tools.

5 PRACTICAL BOOKS IN ONE!
60 FULLY ILLUSTRATED CHAPTERS
Covering: 1—Modern Machine Shop Practice. 2—Blue Print Reading and How to Draw. 3—Calculations & Mathematics for Machinists. 4—Shop Physics. 5—How to Use Slide Rule.

Get This Information for Yourself. Mail Coupon Today. No Obligation Unless Satisfied ASK TO SEE IT.

1600 PAGES FULLY ILLUSTRATED \$4 COMPLETE • PAY ONLY \$1 MO.

THEO. AUDEL & CO., 49 WEST 23rd STREET, NEW YORK
Mail AUDELS MACHINISTS & TOOLMAKERS HANDY BOOK. Price \$4 on 7 Days Free Trial. If O. K. I will remit \$1 in 7 days and \$1 monthly until \$4 is paid. Otherwise I will return it.

Name _____
Address _____
Occupation _____
Reference _____ PM

SAY YOU SAW IT IN POPULAR MECHANICS

WE WILL PAY

\$100.00 to \$500.00

each for clever, original, practical, patentable

IDEAS FOR TOYS

which we consider worthy of manufacturing

Prefer pull toys or educational toys which can be made of wood, plastic or metal.

If accepted, and not already patented, we will defray cost of procuring same on assignment to us.

A working model, or workable drawing from which a model could be produced, should accompany each idea submitted.

In submitting any idea it will be understood that no obligation on the part of Play Hour Toys will be assumed or incurred in the event the submitted idea is refused for any cause.

PLAY HOUR TOYS

2021 Adams Street

Toledo 2, Ohio

What Every Mason Wants



We have important Masonic books for Blue Lodge, Chapter, Commandery, Scottish Rite, and Shrine.

Our Rituals Are Used the World Over. Send for free catalog of books and rituals for Masons, Odd Fellows, Knights of Pythias, Knights of Columbus, etc. EZRA A. COOK, Publisher, P. O. Box PF, Chicago 90, Ill.

IMPROVE YOUR PLAYING



PIANISTS—Send for FREE Booklet showing how you may greatly improve your technique, accuracy, memorizing, sightreading and playing thru Mental-Muscular Coordination. Quick results. Practice effort minimized. Used by famous pianists, organists, teachers and students. No obligation.

BROADWELL STUDIOS, Dept 156B, Covira, Calif.

NOW . . . ELECTROPLATING

Learn this profitable, interesting trade. Hobby or full time business. Chromium, Nickel, Gold, Silver, etc. Postcard brings full details, FREE.

PLATER HYDE, Dept. M, P.O. Box 176, National City, Calif.



Thrilling Work COLORING PHOTOS

Fascinating vocation learned at home by those with aptitude. Thrilling pastime. National method brings out life-like colors. Free booklet.

NATIONAL PHOTO COLORING SCHOOL
1315 S. Michigan, Dept. 1352, Chicago 5

RADIO, ELECTRONICS and YOU!

THERE are big rewards in the communications line for the Radio man who has the answers! Too, the equipment that has made Radio communication possible is functioning now in other rewarding fields. Electron tubes in industry promise a whole new World of Electronics. I. C. S. has a variety of Radio Courses and a great new standard Electronics Course. Write for booklet, pick your Course.

INTERNATIONAL CORRESPONDENCE SCHOOLS BOX 5571-K, SCRANTON 9, PENNA.

Send me full information on the following subject:

Name _____ Age _____
Home Address _____
City _____ State _____
Present Working Position _____ Hours _____ A.M. to _____ P.M.

**DO ANY JOB.. EASIER.. QUICKER
MAKE MORE MONEY in the
BIG OPPORTUNITY
FIELDS**

**Here's the Help You Need
For Best Paying Jobs
Right NOW!**

**FREE TRIAL
IN YOUR OWN HOME**

**Used by Army, Navy, Other Government
Depts., 200 Schools and Industrial Firms.**

SEND NO MONEY
Select the Books
YOU Need Now!
We Ship C.O.D.
Anywhere in U. S.
and Will Refund
Amount Paid if
Not Satisfactory.

Don't submit to tough, heartbreaking job competition, now that wartime jobs are over. Get into one of these big opportunity fields. Big money and many other advantages await you if you prepare now. Here is the help you need—**EASY—QUICK—AT LOW COST.** Thousands of men have already used these famous books. Beginners and experienced men alike have doubled and tripled their earnings with this help. You too, can now get the special knowledge you need for top pay, better jobs, or a business of your own. This is your **GOLDEN OPPORTUNITY.**

AIR CONDITIONING

Big air conditioning boom interrupted by war will be bigger than ever. It's ready to GO now! Get this non-technical book by international authority and be ready for your share of millions to be spent. Covers whole field. 450 pages. Illustrated. \$3.50.

AIRPLANE WELDING

All metal airplane building offers big peacetime opportunities

New 2nd edition of this famous book by J. B. Johnson, Materials Division, Wright Field. The authoritative and practical book on Airplane welding and materials brought right up to date. 420 pages, 193 pictures. \$3.50.

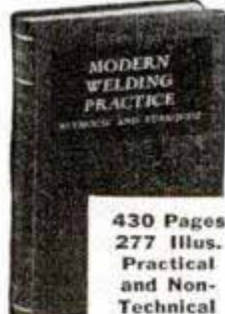

MODERN WELDING PRACTICE

Newest book on all types of welding and heat treatment of metals. Written by recognized specialists in training men for production jobs. **Practical and Non-Technical.** Covers

430 Pages
277 Illus.
Practical and Non-Technical

everything you need to know. Prepare for best pay jobs now. Price \$4.00.

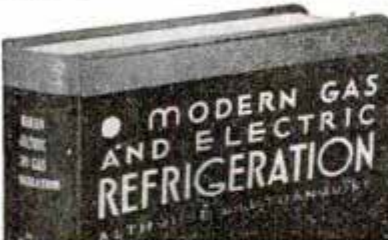

**REFRIGERATION—Book of the Hour!
Biggest Opportunity in Many Years!**

NEW PRINTING—ALMOST 1000 PAGES

408 Pictures—17 Diagrams in Colors Makes All Refrigerator Service Maintenance, Repairs Simple as A. B. C.

Thousands of Refrigerators need repairs! Owners will pay big for competent service which will be needed more and more. Get **MODERN GAS AND ELECTRIC REFRIGERATION**, the non-technical guide to all types of refrigerators and get your share of this new profit. Get a job or start your own service business. This book will help you make money anywhere. Price \$5.00.

BODY & FENDER REPAIR

Owners will spend big money to keep their good older cars looking like the new ones coming out. This is a practical money-making guide, ideal for shop owners and every man who wants a share of the millions to be spent in keeping



old cars looking new. Tells how to get a good job or start business of your own with small capital. 325 pages, 232 illustrations. \$3.00.

**DYKE'S FAMOUS
CARBURETOR BOOK**

This famous book has been the standard guide in the best paying auto work for a generation. It has helped thousands of men make money. New edition covers engine tune-up, compression, ignition, carburetion, fuel pump valves, etc. Use this book to specialize in this big field. 244 pages, 549 illustrations. \$3.00.

**HOUSE WIRING
NEW 1945 EDITION**

Get this new sixth edition of this standard and practical electrical wiring book. It gives complete practical instruction on every phase of house wiring in one handy volume. Goes further than most books on subject. Handbook style. Gives National Electric Code. 400 pages, 669 illustrations. Electrical work will reach a new high with millions of new homes to be built. Get started now. \$2.50.

**15 Million Refrigerators
Need Service and
Repairs**

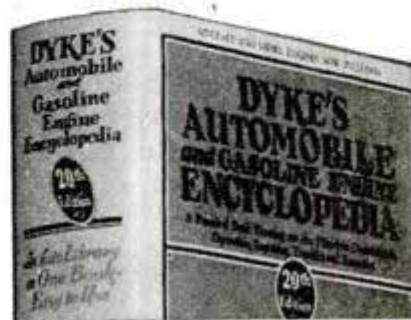

**NEW
20th
EDITION**
Leading
Auto
Book
for Over
32 Years

**World's
Greatest AUTO BOOK**

**New Material on Transmissions,
Trucks, Tractors, Diesels, Air-
craft and Auto Engines**

Now with millions of cars needing repairs and thousands of men needed to do the work, you need the famous DYKE Auto Book more than ever before. Brand new 20th Edition covers all principles, construction, repair, adjustments, testing, troubles and remedies of all cars. Over a half million copies of 20 editions of Dyke's have been sold. Gives specifications of old and newer cars. World's biggest book value, \$6.00. This big book, a complete auto library in one volume, has 1483 pages—4600 illustrations and diagrams—weighs 6 lbs.—equal to 4 ordinary books.

ENGINEERS HANDBOOK

World famous Bailey's handbook of universal questions and answers for Stationary, Marine and DIESEL engineers and firemen. Prepares for any license examination. This is the one book that men should have if they want to reach the top in installation, maintenance and operation of Diesel and steam plants. Pocket size, \$2.00.

Mail Coupon to

Goodheart-Willcox Co., Inc.
209 S. Michigan Ave., Dept. 12, Chicago 16, Ill.

SEND NO MONEY! Mail Coupon

GOODHEART-WILCOX CO.,

209 S. Michigan Ave., Dept. 12, Chicago 16, Ill.

Send books checked, C.O.D. I will pay postman, plus few cents charges. If not satisfactory I will return books in 5 days and you will refund money paid. (Outside U.S. or possessions remit with order.)

- | | |
|--|--|
| <input type="checkbox"/> Gas & Electric Refrigeration \$5.00 | <input type="checkbox"/> Sheet Metal Layout \$3.00 |
| <input type="checkbox"/> Dyke's Auto Book \$6.00 | <input type="checkbox"/> Air Conditioning \$3.50 |
| <input type="checkbox"/> Dyke's Carburetor Book . \$3.00 | <input type="checkbox"/> Engineers Handbook . . . \$2.00 |
| <input type="checkbox"/> Modern Welding \$4.00 | <input type="checkbox"/> Body and Fender Repair. \$3.00 |
| <input type="checkbox"/> Airplane Welding \$3.50 | <input type="checkbox"/> House Wiring \$2.50 |
| | <input type="checkbox"/> Shop Math. (2 vols.) . . . \$3.00 |

If remittance accompanies order we will pay all postage charges under same return privilege.

Name

Address

City State

Learn REFRIGERATION- AIR CONDITIONING

FOR GREATER EARNING POWER

Trained men are needed for big paying jobs. Get in on the ground floor by starting now with the only civilian trade school selected for Army Training Program in this big, new industry.



Learn by doing actual work, with tools, on real machines, in our shops or train at home. In a few months you'll be a qualified Refrigeration Service Engineer, ready for a big paying job or be your own boss.

FREE BIG 16 PAGE BOOK OF VALUABLE INFORMATION

Tells all about the opportunities that await . . . of the tremendous growth and development of this industry. You can get in on the ground floor if you ACT NOW. Write Today!

ALL
DETAILS
SENT
FREE

Send Coupon TODAY!

ACT NOW!

LEARN
IN YOUR
SPARE
TIME
AT HOME

Commercial Trades Institute, Dept. M-22
209 W. Jackson Blvd., Chicago 6, Ill.

Without obligation, please send me the facts. Let me judge for myself the opportunities and post-war security this training offers.

Check here if interested in GI training.

NAME

ADDRESS

CITY..... STATE.....



AUTO

BOOKS ON APPROVAL

SEND NO MONEY. Just mail the coupon for a complete set of Six Big Auto Books, 20th Edition. Whether you are a mechanic or helper, expert or apprentice, auto owner or driver, take immediate advantage of this FREE EXAMINATION OFFER.

MAKE GOOD MONEY NOW HOLD A PERMANENT JOB

America wants its automobiles kept in good repair. Men with "know how" are in demand, at big pay. These books will help you get and hold an important job, or give you a chance to go into business for yourself now or later. Any man who half tries to improve himself can learn auto servicing and repairing by this quick reference method. Use the JIFFY INDEX to find easily understood answer to any auto problem. These wonder books prepared by eleven of America's great automobile engineers. Many hundreds of valuable illustrations. Send the coupon TODAY.

[A year's consulting privileges with our engineers now given with these books without extra charge.]
Vocational Publishers Since 1898

CAN YOU FIX IT?

These wonder books tell step by step HOW to make difficult repairs and adjustments, how to keep a car at maximum efficiency, including latest improvements in car design and operation. Engine troubles and how to correct them well covered.

6 BIG VOLUMES

2800 pages, 2000 illustrations, wiring diagrams, etc., including Diesel engines. Beautiful modernistic, washable cloth binding.

AMERICAN TECHNICAL SOCIETY, Dept. A219
Drexel Ave., at 58th St., Chicago 37, Ill.

I would like to examine your Six-Volume Set of Auto Books. I will pay the delivery charges only, but if I choose I may return them express collect. If after 10 days' use I prefer to keep them, I will send you \$2 and pay the balance at the rate of only \$3 a month until \$24.80 has been paid. Please include consulting service as offered above.

Name

Address

City..... State.....

Please attach a letter stating your age, occupation, employer's name and address, and name and address of at least one business man as a reference. Men in service, also please give home address.

INTRODUCING-New Victory Model HANDIWELD ELECTRIC ARC WELDER

RETAILS
ONLY
\$1.95

FULLY
GUARANTEED



PLUGS into LIGHT SOCKET

VICTORY Model Handiweld Arc Welder operates from 110 volts, A.C. or D.C. current same as other arc welders higher priced; generates tremendous heat to weld all metals. Not a toy welder that uses carbons, but actually uses standard coated rods — sizes 1/16" and 3/32". Generous quantity of 1/16" and 3/32" rods supplied with the welder. Guaranteed not to burn out. Repairs fenders, auto bodies, radiators, machinery parts, etc. Take Victory Model Handiweld anywhere to job, operate right from light socket. You'll find a

thousand uses for this welder around your home, garage, workshop. Also in garages, factories, repair shops, tin shops; mechanics, inventors, plumbers, farmers, etc. Order a "VICTORY MODEL" HANDIWELD today!

SEND NO MONEY We'll rush one to you with rods, helmet, operating instructions, and all necessary parts with the exception of a large jar and small piece of extension cord; these most everyone has. Pay postman only \$1.95 plus few cents p's't'ge. If not delighted return Victory Model Handiweld in 5 days from receipt and money paid for it will be refunded promptly. Rush your order now. **KUMFY PRODUCTS, Dept. E-202, Cincinnati 25, Ohio**



MAGIC LIQUID Prints Photos

On Wood, Leather, Cloth, Cards Letterheads or almost any surface. Use any snapshot or other negative. Make hundreds of prints without harming negative. Won't wash off. Easy to use. Complete kit for 100 or more photos now only \$1.00 postpaid, or \$1.29 C.O.D. (Canada \$1.50 money order only; no C.O.D.'s). Satisfaction positively guaranteed. Rush order today for the original, big, complete Magic Photo Printing Outfit.

L & M MFG. CO.
Dept. 390-G, 229 W. Breckinridge, Louisville 3, Ky.

Correspondence Courses in RADIO and ELECTRICAL ENGINEERING

LOW AS
\$25

ELECTRICAL ENGINEERING. Get good grasp of wide electrical field. Modern. Very understandable. Theory made easy.
RADIO ENGINEERING. Extra fine course in radio, public address, photo-electric work. Training you to be super-service man, real vacuum tube technician. Tuition ONLY \$25, either course. Deferred payment plan. Servicemen needed badly.
FREE LINCOLN ENGINEERING SCHOOL, Box 931-P86, Lincoln, Nebr.

ARTISTS MAKE MONEY

Do you like to draw? Send name, address, age and occupation for **FREE ART TEST**, to find out your ability.

ART INSTRUCTION, Inc.

2136 ART INSTRUCTION BLDG., MINNEAPOLIS 15, MINN.

STAMMER?

GET THIS
FREE
BOOK!

This new 128-page book, "Stammering, Its Cause and Correction," describes the Bogue Unit Method for scientific correction of stammering and stuttering—successful for 45 years. Benj. N. Bogue, Dept. 1833, Circle Tower, Indianapolis 4, Ind.

LAW STUDY AT HOME

Legally trained men win higher positions and bigger success in business and public life. Greater opportunities now than ever before. Big corporations are headed by men with legal training.

More Ability: More Prestige: More Money

We guide you step by step. You can train at home during spare time. Degree of LL. B. Successful graduates in every section of the U. S. We furnish all text material, including 14-volume Law Library. Low cost, easy terms. Get our valuable 48-page "Law Training for Leadership" and "Evidence" books FREE. Send for them NOW.
**LASALLE EXTENSION UNIVERSITY, 417 South Dearborn Street
A Correspondence Institution Dept. 264-L Chicago 5, Ill.**

:: SAVE WASTE PAPER ::

The favorite hunting and fishing spots

of America's leading Rod & Gun Editors!

Complete
in the New

AMERICAN FISHERMAN AND HUNTER'S ANNUAL

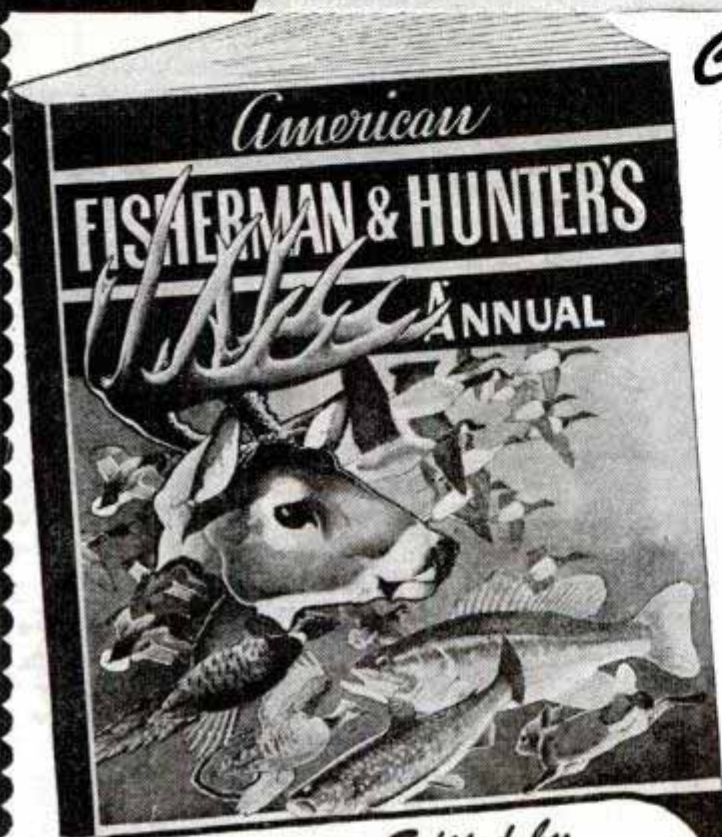

Edited by
DON STILLMAN

Don Stillman has been Rod and Gun Editor of the New York Herald-Tribune since 1930. He possesses that happy combination of the sportsman's skill and the writer's art. A born lover of the outdoors and a talented writer and editor, his background qualified him admirably for the task of producing this unusual Annual.



A **New AND VALUABLE SERVICE TO Every REAL SPORTSMAN**

The American Fisherman and Hunter's Annual is more than a book—it is a unique service. For here, at last, is the kind of "inside" information you've been looking for, a guide to the byways as well as the highways of better hunting and fishing; every fact presented by an on-the-spot expert! Don't miss this opportunity! Order your copy today. Lavishly illustrated.

PERIODICAL SALES CO., INC. DEPT. C
R.K.O. Bldg., Rockefeller Center 20, N. Y.

1946 EDITION
Now Ready
ONLY \$1

Choice Spots WHERE YOU'LL FIND BETTER HUNTING, KEENER FISHING

Here, at last, is a sportsman's annual for outdoorsmen who are not content to travel well-beaten paths . . . who wish to learn of those "hidden" places known to ace fishermen and hunters. Thus, the WHERE TO GO section of this Big Annual is not just a routine list, but a REMARKABLE guide to the hunting and fishing spots selected by a leading rod and gun writer in each of the 48 states, Canada, Mexico and Alaska. Every listing, state by state, contains complete information—where to go for better fishing and hunting, who to contact, guide information, type of accommodations, and many other facts that will make your next trip the best you've ever had!

NUMEROUS SIDELIGHTS AND HIGHLIGHTS ON HUNTING AND FISHING

In addition to its remarkably unique where-to-go section, The American Fisherman and Hunter's Annual contains a bonanza of feature and technical articles covering a wide variety of subjects close to the heart of the outdoorsman. Below is a brief list of these features—each written especially for this volume by a distinguished sportsman.

- "American Salt Water Angling" by S. Kip Farrington, Jr.
- "Hunting with the Camera" by Harold McCracken
- "Big Game Rifle" by Captain Charles Askins, Jr.
- "The Striped Bass" by Ray Camp
- "American Women Anglers" by Francesca La Monte
- "Florida and Bahamas Fishing" by Erl Roman
- "Western Duck Shooting" by H. L. Betten
- "Go Camping with Your Car" by Maurice H. Decker
- "Fishing Tackle" by Don Stillman
- "Trouble in the Woods" by Commander Eric H. Pattison
- "Selection of a Hunting Dog" by Nash Buckingham

The *Most Authoritative* Fishing and Hunting Information ever compiled for U. S., Canada, Mexico and Alaska!

PERIODICAL SALES CO., INC. DEPT. C
R.K.O. Bldg., Rockefeller Center, 20, N. Y.

I enclose \$1. Send me a copy of the 1946 edition of The American Fisherman and Hunter's Annual. It is understood that if I am not completely satisfied I may return the volume within 5 days and you will refund my money.

Name.....

Address.....

City..... Zone..... State.....

Electricity at your finger ends



Sold Singly
Price \$1.50
A Book
Pocket Size!

AUDELS NEW ELECTRIC LIBRARY—A progressive Home Study and Reference Course in applied electricity. Easy to understand. Questions and answers plainly written for a complete working knowledge of modern electrical practice, necessary to every electrician, engineer, mechanic and student.

LEARN THE AUDEL WAY! You ask the question—Audels New Electric Library gives the answer—9500 simplified outlines, graphic illustrations and precise explanations covering Construction, Operation and Machine Maintenance.

BOOK A MONTH PLAN—Order the volume that interests you—today! We will send that volume on 7 days' free trial. If the book helps you, send us \$1.50. If it does not help you, mail book back to us. On receipt of your first payment, we will send your second book. We allow 30 days to pay for this and for each following book until you complete the Series.

If you are not satisfied, you may cancel your subscription at any time.

FREE EXAMINATION COUPON

Theo. Audel & Co., 49 W. 23rd St., New York City
Mail Vol. I, Electric Library on 7 days' free trial. If O. K. I will remit \$1.50, otherwise I will return it. I also request you to mail one book each month on same terms. No obligation unless I am satisfied.

Name

Address

OccupationPM

8 BIG BUILDING BOOKS

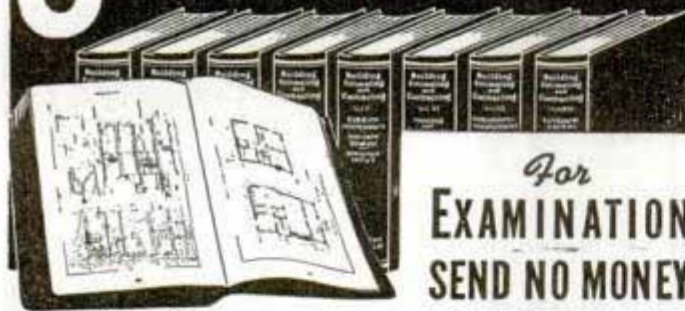

For
EXAMINATION
SEND NO MONEY

Learn to draw plans, estimate, be a live-wire builder, do remodeling, take contracting jobs. These 8 practical, profusely illustrated books cover subjects that will help you to get more work and make more money. Architectural design and drawing, estimating, steel square, roof framing, construction, painting and decorating, heating, air-conditioning, concrete forms and many other subjects are included.

BETTER JOBS — BETTER PAY UP-TO-DATE EDITION

Keep busy now at good pay, and be prepared for after-war building boom. Big opportunities are always for MEN WHO KNOW HOW. These books supply quick, easily understood training and handy, permanent reference information that helps solve building problems.

These books are the most up-to-date and complete we have ever published on these many subjects.

Coupon Brings Eight Big Books For Examination

AMERICAN TECHNICAL SOCIETY Vocational Publishers since 1898
Dept. G219 Drexel at 58th Street Chicago 37, Ill.

You may ship me the Up-to-Date edition of your eight big books, "Building, Estimating and Contracting," without any obligation to buy. I will pay the delivery charges only, and if fully satisfied in ten days, I will send you \$2.00, and after that only \$3.00 a month, until the total price of only \$34.80 is paid. I am not obligated in any way unless I keep the books.

Name

Address

City State

Please attach a letter stating your age, occupation, employer's name and address, and name and address of at least one business man as a reference. Men in service, also please give home address.

SAY YOU SAW IT IN POPULAR MECHANICS



SALESMEN FOR CITY AND COUNTY

Nationally Known Manufacturer

Build up a business of your own with Nationally Advertised Products bearing Underwriters' label. Sell to schools, factories, service stations, warehouses, hotels, restaurants, public institutions, truck and bus companies, grain elevators, house trailers, autos, farms, homes, etc. **Capable man can earn real money.** Established in 1916. Write letter with details, age, experience, etc.

THE FYR-FYTER CO.,

Dept. 90-14

Dayton 1, Ohio



CODE-SENDING-RECEIVING-SPEED

Learn to send and receive Radio Code with greater speed. Stop nervous tension. Have confidence. Be proficient. Same system used by radiotelegraph specialists. Thousands of operators needed. Rush name for FREE book.

CANDLER SYSTEM CO.

Dept. 5-B, Box 928, Denver 1, Colo., U. S. A.

DEVELOP THE POWERFUL INFLUENCE

FEUCHTINGER Method Guaranteed
IN YOUR VOICE

DO IT YOURSELF AT HOME

Write for the Voice Book - FREE

Sent only to those over 17 yrs of age

PERFECT VOICE INSTITUTE

Studio 9352

Kimball Hall Bldg., Chicago 4, Ill.

Inventions Wanted

Patented or Unpatented

Inventions can now be safely sold without patenting expense. If you have a practical, useful idea for sale, either unpatented or patented, write

INSTITUTE OF AMERICAN INVENTORS
Dept. 4, 1926 Eye St., N.W. Washington 6, D. C.



YOU CAN LEARN TO DRAW

Be An Artist—We Train You at Home—in Your Spare Time

Plan your future career now in a field where training pays. We teach Art from the beginning and interestingly train you step by step. Trained artists are capable of earning \$30-\$50-\$75 A WEEK!

COMMERCIAL ART CARTOONING ALL IN ONE COMPLETE COURSE DESIGNING

Many of our most successful graduates never studied Art before enrolling with W.S.A. Since 1914 our well known, practical method has been training men and women for successful Art Careers. 2 ART OUTFITS with course. FREE book—"Art for Pleasure and Profit" tells all about our step by step training, what graduates say and commercial opportunities for you in Art.

FREE BOOK gives details!

Washington School of Art, Studio 122C
1115—15th St., N.W., Washington 5, D. C.

Send me your free booklet and full particulars.

Name Age

Address

City State



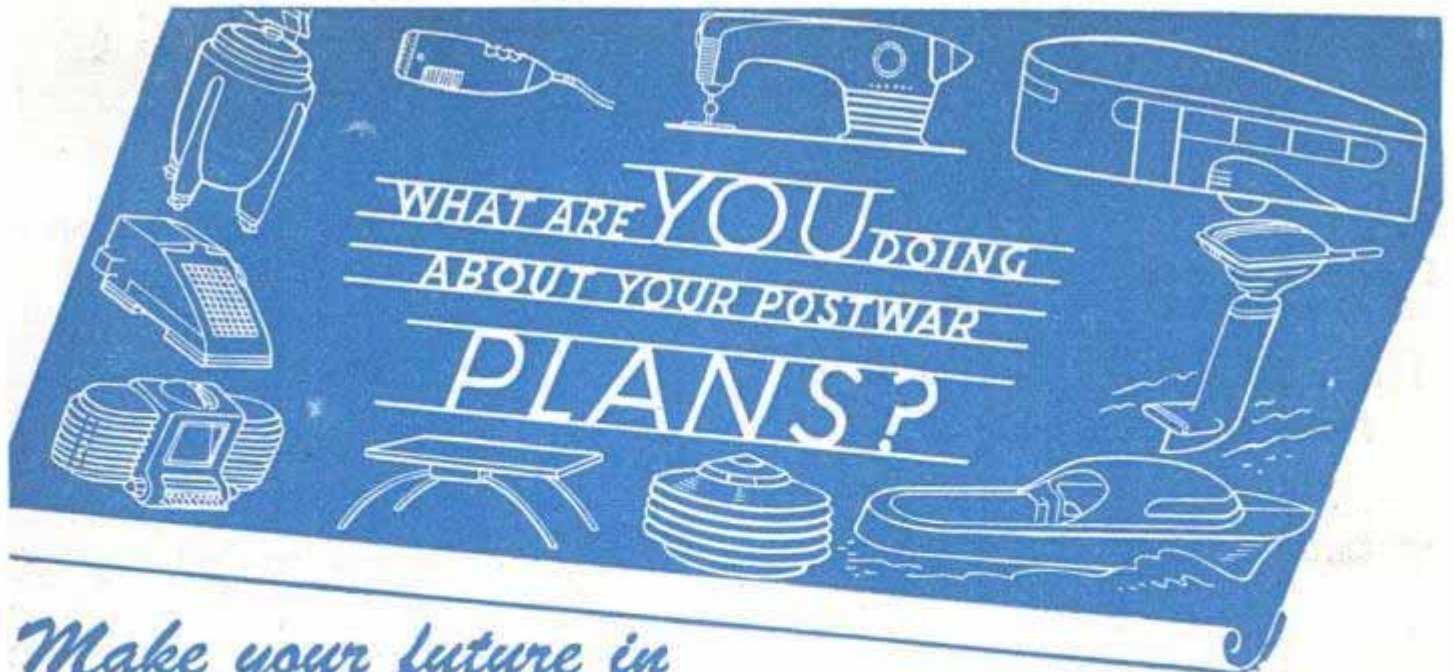

Make your future in **PLASTICS**

Every day you read of new and wonderful uses for plastics in this, our postwar world. The wide range of objects that can be made of plastics—from buildings to surgical appliances, from cars to textiles—challenges the imagination.

THE PLASTICS ERA IS HERE—Are you ready? Opportunities are opening in every branch of the plastics industry. Plastics know-how is necessary in practically every type of manufacturing. Are you capable of grasping these opportunities? If you want a choice position in this expanding plastics field, or a business of your own, act *now*—get in on the ground floor!

A COMPLETE COURSE—You learn the various phases of plastics from this course . . . materials, designing, molding, fabricating, laminating and testing. You acquire a basic knowledge of plastics that can be invaluable to you in acquiring the type of position you want in this great new industry.

YOU LEARN AT HOME—Your present work need not be interrupted, and this thorough, easy-to-understand course requires no previous technical experience.

EXCLUSIVELY PLASTICS—Plastics Institute is America's oldest and largest educational organization which devotes all of its facilities exclusively to plastics.

YOU MAKE THINGS—We supply materials. To give you practical experience in working with plastics, we supply handsome, colorful, rods, sheets and tubes of plastics from which you make useful, attractive creations. You saw, cement, buff, form, dye, decorate, cast and laminate various types of plastics. You also design your own plastics articles—develop your own ideas. You may earn money while learning.

START YOUR FUTURE TODAY—Mail the coupon below, now! You will get an interesting, illustrated, free booklet with valuable information about plastics. You will see how, at small cost you can prepare for a future in this important industry while carrying on your present work. Clip this coupon and mail it **TODAY!**

VETERANS ASK ABOUT G. I. TRAINING.

NEW YORK

Dept. PM6-2, 122 E. 42nd St.

CHICAGO

Dept. PM6-2, 221 N. LaSalle St.

LOS ANGELES

Dept. PM6-2, 1601 S. Western

SPECIAL RATES FOR SERVICE MEN

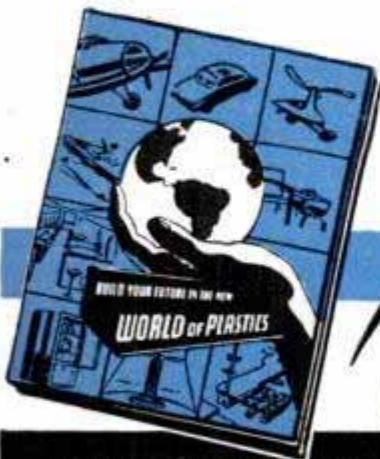

FREE BOOKLET
Send For It Today!

Plastics

INDUSTRIES TECHNICAL INSTITUTE

Plastics Industries Technical Institute,
221 N. La Salle St., Dept PM6-2 Chicago 1

Mail in Envelope or
paste on penny postcard

Gentlemen: Please send me the booklet "World of Plastics" and information on your training program. I understand there is absolutely no obligation.

Name.....Occupation.....

Street.....Age.....

City.....Zone.....State.....

Veterans: Check for special information. If under 18: Check for special booklet.

OFFERS LOW COST LIFE INSURANCE

Postal Life offers \$1724. in Protection for \$2.00 monthly (age 21). Other Ages in Proportion

THIS PREMIUM HALF PERMANENT RATE Policy Fully Paid-up in 30 years

NEW YORK, Saturday. Postal Life of New York, unique among important Old Line, Legal Reserve Life Insurance Companies, is again offering this special modified policy, already owned by thousands of American families. You pay half the permanent rate until the 6th year; \$2.00 monthly for substantial amounts of Protection, depending on age! \$2.00 monthly pays for \$1754. of life long protection at 20; \$1142. at 40; \$5.00 monthly buys \$3650. at 30, etc. Proportionate amounts at other ages. You pay no premiums after 30 years; policy fully paid-up and in force your entire life.

For your convenience we print below a coupon that can be clipped and sent to Postal Life. Full information, rates, etc., will be sent to you promptly. There is no obligation to buy but we advise immediate action. Life Insurance is vital to your future and your family's welfare. Postal Life Insurance Company, 511 Fifth Avenue, New York 17, N. Y.

Postal Life Insurance Company
511 Fifth Ave., Dept D-529, New York 17, N. Y.

Mail rates and full details about your "\$2.00-per-month", 30-Payment Life Policy at my age.

Name _____
Occupation _____ Date of Birth _____
Address _____

Include P. O. District Number, if any

AIR RIFLES BENJAMIN AIR PISTOLS
ORDERS NOW ACCEPTED
EARLIEST POSSIBLE DELIVERY REALLY ASSURED—ACT NOW!
ORDER Latest Models BENJAMIN AIR RIFLES & BENJAMIN AIR PISTOLS AT ONCE. Send for our FREE ILLUSTRATED FOLDER and complete Specifications TODAY. BOTH CALIBRE BENJAMIN H-C PELLETS ARE AVAILABLE NOW.
BENJAMIN AIR RIFLE CO., 812 MARION ST., ST. LOUIS 4, MO.

RADIO ENGINEERING. Broadcasting, Servicing, Electronics, Aviation, Marine & Police Radio taught thoroughly. 48 weeks' Engineering course equivalent to 3 years' college radio work. Approved Veteran Training. Co-educational. Catalog free.
VALPARAISO TECHNICAL INSTITUTE, Dept. D, Valparaiso, Ind.

HUNTING and FISHING
is a monthly magazine crammed full of hunting, fishing, camping, dog and boating stories and pictures, invaluable information about guns, fishing tackle, game law changes, best places to fish and hunt—countless ideas that will add more fun to your days afield.
Special Trial Offer
Send 25c in stamps or coin and we will send you Hunting & Fishing for six months.
HUNTING & FISHING MAGAZINE
251 Sportsmen's Bldg., Boston, Massachusetts



★ TRAIN for SUCCESS in the Poultry Business



Study at home in spare time. Earn extra while learning.

YOU CAN MAKE MONEY FROM POULTRY

Get ready now—the easy, scientific, inexpensive way! For 25 years, we've been helping thousands to greater success. During 25 years we have trained thousands of students, showing them how to establish poultry farms—how to avoid mistakes—how to cut losses—how to increase profits on established plants—how to have their own small profitable breeding plant and make a good living at it.



Proper management and "know-how" makes profits ANY season, for life. Our courses cover all phases of poultry raising, including plans for buildings, breeding, hatching, culling, sexing, caponizing, marketing, judging, exhibiting, and many others, etc., as planned by Harry M. Lamon, former Senior Poultryman for the United States Dept. of Agriculture. Endorsed by leading colleges, poultrymen everywhere. Write today for this Free Catalog "How to Raise Poultry for Profit." It fully describes courses, methods, service, opportunities, and easy payment plan.

National Poultry Institute
Dept. 50-G, Adams Center, N. Y.



YOU CAN SUCCEED... Send For this Book Today!

FLIGHT JACKET INSIGNIA
With your own first name... **50c** each
Come and get 'em, only... Postpaid

Dress up your sweater, blouse, or lumber jacket and look just like the men that fly our big bombers. Indicate selection by number and print carefully your first name, or your nick name. Mail with 50c today. Agents Make Money—Take orders. Sell for \$1.00. Illustrated book of all Army Insignia Emblems only 25c.

INSIGNIA MART
703 Broadway, Dept. P, New York 3, N. Y.



Learn BAKING At Home

Baking is one of America's high industries in wages. Nearly depression-proof. Thorough basic home course lays sound foundation. If you have aptitude, write for **FREE BOOKLET**, "Opportunities in Commercial Baking."
National Baking School, 1315 Mich. Ave., Dept. 1352, Chicago 5



WATCHES WANTED Broken or Usable
—all kinds, even Ingersolls. Highest prices paid for jewelry, rings, spectacles, gold teeth, etc. Cash mailed promptly. Write for Free Shipping Container.
LOWE'S, Holland Bldg., Dept. PM, St. Louis 1, Mo.

A SIMPLIFIED ART ANATOMY OF THE HUMAN FIGURE
ONLY 51c POSTPAID
by Charles Carlson. The book they're talking about! One of the most informative books of its kind for both student and professional artists. Charts, notes, and over 350 drawings show detailed studies of every part of the body, posed and in action.
HOUSE OF LITTLE BOOKS, 80-A E. 11 St., New York 3



WELDERS VETERANS—Ask about G. I. Training. WANTED!
Earn up to \$12 a day or start your own business. Learn Welding by actual shop work. America's leading school. Established 1902. 41,000 graduates. Write for "Welding Facts."
Greer Shop Training, Dept. 326, 460 S. State St., Chicago

FIBRE ARMS AND LEGS!
Light, correctly fitted, strong and comfortable. Natural appearance. Braces for all deformities. Scientific design. Fair Terms.
BUCHSTEIN-MEDCALF 610-3rd Av. S., Minneapolis, Minn.



★ **SAVE WASTE PAPER** ★

I Can Give You A SUPERBUILD

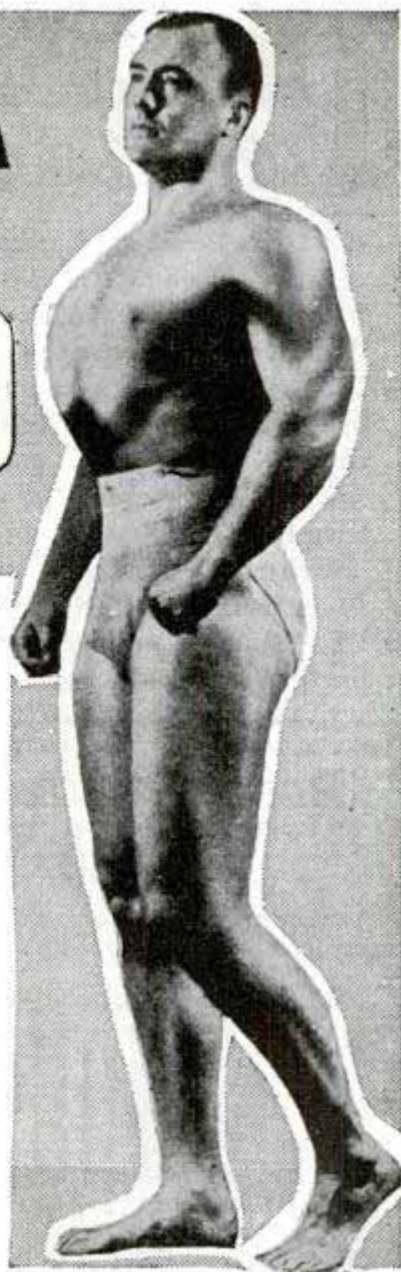

Have you ever wished you were as strong as Samson? Have the strength to tear down buildings...slay mighty armies single-handed. Well, Bob Hoffman can't perform these miracles but he can give you real SUPER-STRENGTH with the kind of muscles you see on real champion strong men. Bulging, mighty arms and a mid-section that will stand the hardest punches of your friends. Bob Hoffman has trained thousands of men and boys who were weaklings and developed them into real "he" men. Jules Bacon, the "Mr. America" of 1944... Steve Stanko, one of the world's strongest men... and Gord Venables, who can lift 275 pounds over his head 25 times are just three of the famous names who have trained with Bob Hoffman Instruction Course. You can have the same dynamic, forceful muscles of these men by just mailing the coupon below. Start today to be a real "he" man... one distinguished wherever he goes... one who will amaze people with feats of strength.

Just 5 of the Thousands I Have Helped

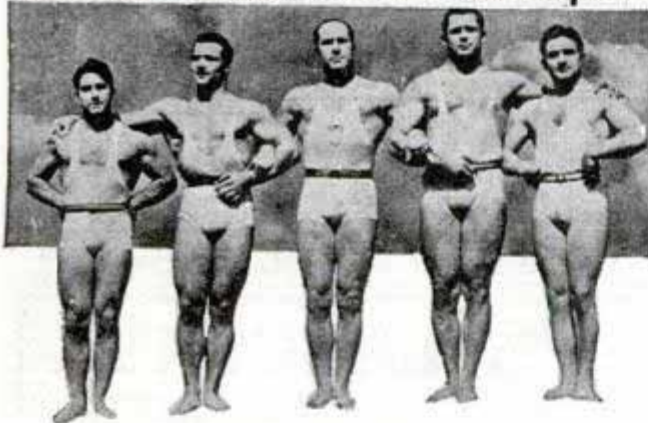

... and Gord Venables, who can lift 275 pounds over his head 25 times are just three of the famous names who have trained with Bob Hoffman Instruction Course. You can have the same dynamic, forceful muscles of these men by just mailing the coupon below. Start today to be a real "he" man... one distinguished wherever he goes... one who will amaze people with feats of strength.

MAKE YOURSELF THE MAN YOU WANT TO BE

It's time to start! Stop dreaming of building castles and do something about it! Write today for this complete muscle foundation course of Arm and Abdominal Instructions and begin building your body into a high-powered, potent muscular physique. The kind of figure that draws the admiration of everyone on the beach or street. Each course is a tried and proven successful method of training. Time?? ... no it doesn't take years... just a few minutes a day for a few months and even at the end of a few weeks you'll be noticing a difference. Cost?? ... only \$1.00 for the 2 complete courses.

IT COSTS YOU NOTHING UNLESS SATISFIED!

Bob Hoffman wants you to be a man or pay nothing. His Arm and Abdominal Instruction Course is now offered at a special low price of only \$1.00 complete. You can examine this course and try it for five days FREE! If at the end of that time you feel it will never help you then return it to Bob Hoffman and he will refund your \$1.00, a fair and square offer.

BOB HOFFMAN, Dept. 3602, York, Pa.



Special FREE

With Your Order



"ROAD TO SUPER-STRENGTH."

Bob Hoffman's own book showing you the results of others. Filled with pictures of the kind of man Bob Hoffman develops... men who were weaklings yesterday and today are pillars of strength. You'll want this book for your very own and here's your chance to receive it FREE!

BOB HOFFMAN, Dept. 3602 YORK, PA.

Dear Bob: Send me your illustrated Abdominal Course and the illustrated Arm Developing Course. Also include a free copy of "THE ROAD TO SUPER-STRENGTH". I enclose \$1.00. It is understood that all of this is mine to keep and there is nothing more to pay... If I am not satisfied, I may return within 5 days and you will refund my dollar.

NAME.....

ADDRESS.....

CITY & ZONE..... STATE.....

INVENTORS

Do Not Delay

Have you ever been startled by seeing a successful article on the market, and exclaimed—"Why, I invented THAT 5 years ago—I didn't think it valuable enough to Patent!"

The Patent Laws were intended for the Protection of the Inventor, and the Inventor who slumbers on his Rights may wake up to find someone else reaping the reward that could have been his.

Write NOW for Information and Record of Invention form FREE. RANDOLPH & BEAVERS, Registered Patent Attorneys, Columbian Bldg., Washington, D. C.

PERSONALIZED SERVICE — REGISTERED PATENT ATTORNEYS

RANDOLPH & BEAVERS

11-D Columbian Bldg., Washington, D. C.

Please send me full particulars on Patents, fees, etc., and "RECORD of INVENTION" form—FREE.

Name

Street

City State.....

"ART ANATOMY AND FIGURE DRAWING"

by George Hirsch



THE BOOK THEY'RE TALKING ABOUT!

\$1.00
NOW ONLY (Outside U.S. send \$1.25)

- Reveals Inner Secrets of Fine Drawing
- Detailed Study of Male and Female Figure, Posed and In Rhythm
- Over 350 Illustrations, Drawings, Charts, Notes

MAIL THIS COUPON AT ONCE!

MAJOR BOOK CO. Dept 16C
Forest Hills, New York

\$1.00 enclosed for book, ART ANATOMY.
(\$1.25 if delivered outside U. S.)

Name Age.....

Address.....

City & State..... Zone.....

TRAIN FOR KEY JOB OR BUSINESS OF YOUR OWN

REFRIGERATION and AIR CONDITIONING

Millions of Older Units Need Expert Service. Big After-the-War Expansion Will Create Even More Opportunities. Approved for Veterans "G. I." Training

A key job—a successful business of your own—you can have either in this vital, war-hit industry. A serious shortage of service-experts exists in every branch. Big post-war boom will open thousands of new opportunities. Get ready for your big chance. We'll give you the practical training you need—at home—and in our big Chicago shops, largest and most completely equipped in the country. No advanced schooling needed. Our unique methods make everything easy to grasp. We've trained thousands. Pay as you go. Quit when you want to. Get the full facts without obligation. Write TODAY.

INDUSTRIAL TRAINING INSTITUTE

2150 Lawrence Avenue, Dept. P-10 Chicago 25, Ill.



PATENTS

AND TRADE MARKS

C. A. SNOW & CO.

Registered Patent Attorneys Since 1875
Write for Free Book and "Certification of Invention" form
427 SNOW BUILDING, WASHINGTON 1, D. C.



PATENT YOUR IDEAS SEND FOR FREE BOOK

Written by Former Member Examining Corps (1922-24) U. S. Pat. Office.

CARL MILLER, Registered Patent Attorney
Former Member Examining Corps U. S. Patent Office

Woolworth Bldg., Dept. 26-A New York — Bond Bldg., Dept. 26-A Washington, D. C.

PATENTS

E. E. VROOMAN, Patent Lawyer
Registered Patent Attorney No. 5606
871 Woodward Building, Washington 5, D. C.

SAY YOU SAW IT IN POPULAR MECHANICS



LANGUAGE IS POWER

... Forge ahead, win special assignments, promotion, better job in global peace time opportunities through ability to speak a foreign language.

MASTER A NEW LANGUAGE quickly, easily, correctly by

LINGUAPHONE

The world-famous Linguaphone Conversational Method brings voices of native teachers INTO YOUR OWN HOME. You learn the new language by LISTENING. It's amazingly simple; thousands have succeeded.

HOME-STUDY COURSES IN 29 LANGUAGES

Send for FREE book—

LINGUAPHONE INSTITUTE

98 RCA Building, New York 20, N.Y. • Circle 7-0830

LINGUAPHONE INSTITUTE,
98 RCA Bldg., New York 20, N.Y.

Send me the FREE Linguaphone Book.

Name

Address..... City.....

Language Interested.....



DRAFTING



Here I am at work making good money as a draftsman. I'm glad I sent the coupon to Chicago Tech for that Free Trial Lesson and found out how easy it is to learn Drafting in spare time at home. Today I feel secure in my job because the draftsman's work comes first on any new project. And, in addition, draftsmen can't be replaced with machines. What's more, I feel I'm slated for promotion and more pay, because I see so many draftsmen advancing to high-pay jobs in Engineering.

Here's a tip: Mail the coupon or send a post card to Chicago Tech and find out about your opportunities in Drafting.

LEARN in Spare Time — at Home!

A few hours of pleasant home study every week—that's all. No interference with your present job. With Chicago Tech's help, you train yourself step by step. This tested method,—developed over 40 years of C.T.C. progress,—prepares men quickly for good positions in industry.

Building Industry Needs Trained Men

Great housing shortage has brought tremendous building boom to last for years. Men who can read blue prints, lay out and run building jobs, are in great demand. Prepare quickly at home with C.T.C. "Builders' Course."

Get Free Information — Send Coupon

Find out now how you can use your spare time to prepare, in your own home, for these opportunities by use of the Chicago Tech Plan. Same training methods as used in our Chicago school. Choose the line where you would like to work,—in Drafting, or in Building Construction. Mark and mail the coupon or send a post card. No obligation of course. Act today.



FREE TRIAL LESSON

To prove to you how easy it is to learn Drafting at home by the Chicago Tech method we will send you this FREE TRIAL LESSON. No charge for this Lesson, now or later. Fill out and mail Coupon, or send postcard today.

DRAWING OUTFIT INCLUDED with

Drafting Courses

All the tools you need including folding drawing table. With them you can put your ideas on paper quickly and with accuracy. With training you are all set to master Drafting in months — not years, —at home.

CHICAGO TECHNICAL COLLEGE

B-207 Tech Bldg., 2000 South Michigan Ave., Chicago 16, Ill.

Send INFORMATION PLEASE on Home-Study Training in:

- | | |
|---|--|
| <input type="checkbox"/> Machine Drafting | <input type="checkbox"/> Builders' Course |
| <input type="checkbox"/> Electrical Drafting | <input type="checkbox"/> Blue Print Reading—Building |
| <input type="checkbox"/> Architectural Drafting | <input type="checkbox"/> Estimating,—Buildings |

Name.....Age.....

Address.....

City.....Zone.....State.....

I Help Good Men Drive Ahead to Bigger SUCCESS



Outlined below are just a few of the tremendously fast-growing fields now offering New and Bigger Opportunities. Rush coupon for great **FREE SUCCESS-CATALOG** which advises you how to select a "coming" business, trade or profession. **GET IT RIGHT NOW!**



Watch and Clock Repairing
Excellent money-making trade now... basic training for the booming precision instrument field. Self-instruction course for beginners. Illustrated step-by-step lessons. Strictly up-to-date.



Practical Refrigeration
Grow up with this baby giant. Study the fundamentals of quick-freeze-units, food lockers, freon, air conditioning & ordinary automatic household and commercial refrigeration, both electric & gas.



AUTO MECHANICS
Amazing opportunities opening up in sales and service. Diesel included. Self-training lessons teach repairing, tune-up, etc., on all makes of cars. What to do... and how to do it. See coupon!



Locksmithing and Key Making
A profitable, steady business... the kind of work a practical man likes. Up-to-date course teaches how to pick locks, make master keys, de-code, service, etc. Hardware and fix-it shops, gunsmiths.



Practical Radio Servicing
Big-pay work now... and preparation for sensational electronic field. Fascinating self-instruction on repair, adjustment, troubleshooting, etc. With mathematics, questions and answers, problems.



Building and Estimating
There's great future in the building trades—if you have the "know how." Excellent course, teaches planning, remodeling houses, painting and decorating, and carpentry, stair building, roofing.

PICK YOUR OPPORTUNITY

PLASTICS
ELECTRONICS
DRAFTING
ACCOUNTING
TELEVISION
AVIATION

BE A SUCCESS

TAKE THIS FIRST STEP NOW

Send no money. Just fill out and mail this coupon TODAY for our world-famous illustrated Success-Catalog. It's FREE. Learn how you can take full advantage of any of the carefully selected HOME-STUDY COURSES.

NELSON COMPANY

321 SOUTH WABASH AVENUE
Dept. 3802 CHICAGO 4, ILL.

Now I'm Ready To Help YOU!

If you're ambitious—if you want to be one of the Leaders of Tomorrow—HERE'S YOUR GREAT OPPORTUNITY!

That Post-War era you dreamed of is here—ceilings are off salaries and wages—promotions are unlimited—prosperous businesses can be started with every chance of big success by the kind of men I have been helping for so many years.

If you're that kind of man, you don't need previous higher education—you don't need capital—all you need is the willingness to use a few spare-time hours to prepare for the new trades, new professions, new chances for Success and Big Money that are opening up all around you.

TAKE YOUR PICK!

I don't tie you down to one set routine. No! I offer you unlimited choice of fine careers for yourself. Hundreds of ways to be your own boss—to get a better job with more pay—to keep your income going UP in good times and bad—to prevent being laid off during reconversion... all these are at your disposal. All you have to do right now is send the coupon below for the great FREE Nelson Success-Catalog.

NO DRUDGERY...

You can get ready NOW to move ahead. Just a few weeks of fascinating spare-time study may make all the difference for you. You take your choice of sound, up-to-the-minute types of training, recently developed to "stream-line" the progress of ambitious men. Experience unnecessary—satisfaction GUARANTEED.

The Next 2 Minutes can be the turning point of your whole life

In the next two minutes you can fill out and mail us the coupon below—or you can just turn the page and forget all about it. If you mail the coupon, I can promise you one of the greatest thrills of your life, when you realize that my great, illustrated Success-Catalog coming to you FREE, can end doubt, insecurity and worry. If you mail coupon NOW you take the vital first step to qualify yourself for BIG EARNINGS SOON!

SPECIAL DIVISION TO HELP VETERANS AND FORMER WAR PLANT WORKERS TO GET BETTER JOBS, OR START THEIR OWN GOOD BUSINESSES

Check and Mail Coupon NOW

MAIL TODAY FOR GREAT FREE BOOK

NELSON COMPANY, Dept. 3802, 321 S. Wabash, Chicago 4, Ill.

Please rush me your FREE 100-page Illustrated Success-Catalog, telling me how I can get ahead in the world faster. Give me without cost or obligation all details of your special service for ambitious men. Don't send any salesman to bother me—just give me this great OPPORTUNITY and I'll do the rest.

NAME _____

ADDRESS _____

CITY _____ STATE _____

VETERAN EX-WAR WORKER



PREMIUMS. The Point-System premiums are worthwhile! Elbe albums and stock books, world atlases, stamps, etc. Send for Point-System foreign approvals and premium plan. Charles Horn, Santa Ana, Calif.

EXOTIC Pictorial collection, including Tahiti Spear Fishing, Melanesian Idol, Carib Archer, Malagasian Farmer and many other scarce stamps from strange countries. Everything only 5c. Imperial Stamp Co., Yonkers, N. Y.

MINT French Colony sets, Togo, Ivory Coast, Cameroun, etc. Four stamps per set. 10 sets 70c, 20 sets \$1.20 to approval applicants. Carskaddon, Box 1081, Newark, Calif.

BIG Opportunity. Includes Gold Coast, St. Vincent, Falklands (Shetlands), Morocco Agencies, Aden (Qu'aiti State), Chinese Famine stamps, Guatemala bisect, Armenia, Azerbaijan, etc. Everything 10c to approval applicants. Georgian Stamp Shop, Box 1913 Atlanta, Georgia.

NICARAGUA—Will Rogers Airmail mint set 10c with approvals. Wood, 5719 Wabash, Kansas City 4, Missouri.

POSITIVELY Greatest free offer—Latest Scott's International \$5.00 stamp album—covering entire world, contains 36,000 illustrated, descriptive spaces; Scott's 1946 Standard \$5.00 catalogues "Philately's Encyclopedia" — absolutely free to applicants for foreign approvals becoming customers. Plymouth, Bell, Calif.

AFRICANS, 100 Different 10/— Good value. Ten war and bargain list free to buyers. van Laun, Box 3642, Johannesburg, South Africa.

COMPARE These values! All different U. S., good and guaranteed. 155—50c, 210—\$1, 255—\$2. Beginners approvals. R. Cole, 43 Rinewalt, Williamsville, N. Y.

FREE! New Zealand war provisionals. Also British Empire packet. Approval applicants only! Auburn Stamp Co., Box-1, Auburn, Mass.

PENNY Approvals by country. M. H. Hoerning, 215, Farmington, Ark.

50 DIFFERENT Including scarce diamond-shaped airmail 3c to approval service applicants. Avalon Stamp Co., Dept. M, Springfield 8, Mass.

125 ALL Different U. S. \$1.00. Old, new issues—Comms., postage, dues, famous Americans, airmails, etc. Good condition. Lightly cancelled. Guaranteed to please. Try our foreign packets 10c each, 3 for 25c. 14 packets \$1.00. All different. Bargain. Approvals sent on request. Armour Stamp Co., St. Albans, N. Y.

WOW! \$10.00 Worth of fun only 10c. What a treasure hunt! Big package 500 foreign stamps—just as received from foreign missions other sources. Includes stamps from Africa, South America, Philippines, Dutch Indies, Cape Juby, Palestine, etc., including airmails, commemoratives, and stamps worth up to 50c and 75c. This amazing offer is given for 10c to serious approval applicants only. One to a customer, money back if not more than delighted. Jamestown Stamp Co., Dept. 22, Jamestown, New York. Stamps—valued up to 50c and 75c each.

75 COUNTRIES! Packet containing stamps from 75 countries to approval applicants sending 10c for mailing expenses. Quality Stamp Company, Department M, Box 202, Station F, Buffalo, New York.

77 DIFFERENT World—5c. Approvals. Utechs, 1143C, North Keeler, Chicago 51.

50 DIFFERENT Stamps from 50 different countries—airmails, commemoratives, pictorials! 5c to approval applicants. Thiem, 1100 1/2 St. Paul, Rochester, N. Y.

PITCAIRN Mutiny Islands, Pirate Map, Thailand, Ukraine, Mauritania, Ottoman, Hatay, Tobago, etc. with Camel, Kiwi, etc. All free with approvals for 3c postage. Star Co., 206 E. Terrace, Lakewood, New York.

19th CENTURY U. S. Commem., Civil War—Battleship revenues, \$5 and \$10 stamps free to U. S. approval applicants. Metropolitan Stamps, 198C Broadway, New York.

GREAT Values! United States, British, French, United Nations. Packet 500—\$1.00. Bob Stern, 130—25th St. S.E., Massillon, Ohio.

FOREIGN Pictorial approvals. Brandan, 1912 3rd Ave. South Minneapolis 4, Minn.

LOW Priced United States approvals. Steger, 1165 Downing, Denver 3, Colorado.

FIFTY British Colonies. Free to approval applicants. Pelican Stamp Co., 1609 S. W. 8th St., Miami, Fla.

U. S. Mixture. Guaranteed to contain \$1 Presidential. \$1 per bag, postpaid. Stamphouse, 7235-A Sheridan, Chicago 26.

5 HITLER Stamps 3c. with approvals. Lists. Gaydos, Kenosha, Wis.

BRITISH Colonies and South America on approval. Theo. Stevens, Box 3705, Kercheval Station, Detroit 15, Mich.

MOZAMBIQUE Triangles, unused. Set 10c with approvals. Vargo Stamps, 6044 South Fairfield, Chicago 29, Ill.

FINE Approvals, freshly mounted. Fast, personal service. Tell me what countries you prefer and I'll send their stamps. Skinner, 231 East Fourth, Long Beach 2, Calif.

OLD Scarce U. S. seconds. Approvals. Herrfield, 551 Clinton, Newark 8, N. J.

FREE! World wide packet. Approvals. Eagle, 2439 So. Fifth, Philadelphia 48, Pa.

500 DIFFERENT Stamps \$1.00, 1000 \$2.50. Ransom, 1333 Pontiac, Ann Arbor, Mich.

DANDY United States approvals. Write immediately. Sullivan, Endicott Building, St. Paul 1, Minn.

EASTERN Rumella set catalogs over 25c. Scarce "Dragon," Belgium Congo "Big Chief," and exotic "Mosquito" stamps. 5c with approvals. Jefferson Stamp Co., 1300 Jefferson St. N.W., Washington 11, D. C.

MAGAZINE—Chock-full stamp information, news and bargain ads! 15 issues 25c! "Stamp Post," Station A, Pasadena 3, Calif.

DOLLAR Each, 1500 foreign; 1200 better U. S. Seiden, 1331 Intervale, New York 59.

KOOKABURRA Stamp. Mozambique! Travancore! Tobago! Colombian "Midgets," others, 5c. Approvals. George Keating, Box 313, Miami Springs, Florida.

BECHUANALAND Protectorate, gorgeous Tonga, exotic Pitcairn Isle, beautiful French Colonies—Everything 3c with approvals! Saxons, Walden, New York.

LIBERAL Offer, thick packet with Seychelles, Fiji, U. S. commemoratives, Tete, Djibouti, Inini, Congo, Porto Rico, Philippines and multitude others. Everything only 10c to approval applicants. Burmaster, Box 1910 A, Los Angeles 53, Calif.

PENNY Approvals, that satisfy. Nell Gronberg, Box 5441-P, Philadelphia 43, Penna.

MINT Will Rogers set from Nicaragua 3c with approvals. Brown, Box 2024, Evansville 14, Ind.

GLOBAL Packet 40 stamps 10c. No approvals. Eclipse, Box 635, St. Louis 1, Mo.

43 MIXED Indian cents \$1.00—20 foreign coins from 15 different countries \$1.00—50 different foreign from 50 different countries \$5.00. Lists. Approvals. Delmonte, 40 West 18, New York 11.

SUPERFINE U. S. mixture, 8 oz. 40c; 2 lbs. \$1.25. Weatherby, Medina, Ohio.

ONE, Two, four, five dollar U. S. stamps free to approval applicants. United Stamp Service, Box 1789-M, Miami 10, Florida.

1000 GRABAGS 15c Each. Super bags 25c. Zandy, 630 Bingham, Reading, Pa.

30 BEAUTIFUL Airmails, 10c. Selected approvals. Louis Morrison, Milmont Park 1, Penna.

BOX Stamps containing hundreds all different, cataloging up to 25c each. Everything \$1.00. Longacre Shop, 108 West 42nd, New York City.

SCARCE "Pole to Pole" packet! Stamps from strange, mysterious countries only—Greenland (North Pole), Solomons, Spanish Morocco, Bhopal, Patiala, Siberia, Grahamsland (South Pole), Djibouti, Zanzibar, etc., and including stamps cataloging up to 25c each! Our price only 5c to approval applicants. Big dime packet list free! Methuen Stamp Service, Inc., Dept. 136, Lawrence, Mass.

TURKS, Caicos, Grenada, Brunel, Dominica, Caymans; everything 3c with approvals. Viking, 130(Z) Clinton St., Brooklyn, N. Y.

U. S. Price list. Send postage. State Stamp Service, 1225 Park Building, Pittsburgh 22, Penna.

FREE U. S. price list. Postage 3c. Mark Hanna, 335 - 5th Avenue, Pittsburgh 22, Penna.

The Best United States and Philippine Islands approvals. Largest varieties. America's lowest selling prices. Stamp Company, Albany 7, New York.

1000 WELL Mixed U. S. 25c. Monjar, 1750 Fairmount, Cincinnati, Ohio.

SPECIAL—Airmails, 19 different, including zeppelin, triangles, Latin-America, 5c with approvals. Continental Company, (Dept. B), Box 606, New Rochelle, New York.

EXCELLENT Pictorial approvals. Reasonably priced. Crown Stamp Company, Box 331, Toronto, Canada.

RICH Man's approvals, poor man's prices. Grand value packet containing five mint sets, free with approvals. Stoll Stamp Service, 2630B West Burnett, Louisville 10, Kentucky.

PACKET Scarce United States before 1910. Only 10c to approval applicants. E. J. Banks, 6635-16 Ave., Kenosha, Wis.

TRIANGLES—(Mozambique Co.) other beauties, 10c. Approvals. Reuter, 611-C West 40th, Los Angeles 37.

FREE Packet with attractive approvals that satisfy. Pearl Field, Derby, Maine.

25 DIFFERENT Guatemala 10c with 1/4, 1/2, 1c approvals. Carroll's, 4357A S. Hoover, Los Angeles 37, Calif.

U. S. Price list. Send postage. Stanley Gibbons, 38-P Park Row, New York.

FREE—Pick 25c worth of stamps from our first U. S. approval selection. Approximately 100 stamps to choose from. Excellent value. No obligation to buy. Lists illustrating the most popular U. S. stamps—at prices you can afford—will be included. Don't miss this opportunity! Write today. S. C. Engel Co., 38 Park Row, New York City.

114 DIFFERENT Stamps from far away countries including airmail and Free Fighting French to approval applicants for 10c. Reich Stamp Co., 4647 Kenmore, Chicago 40, Dept. M9.

COMPLETE "United States" catalog with 1000 illustrations! Send 10c for mailing. Harris & Co., 137 Transit Building, Boston, Mass.

SMOKY Mountain commemorative sheet, largest U. S. stamp issued, and 33 U. S. including commemoratives, airmail, revenues, etc. Catalogs 75c—To approval applicants for 5c. Curhan Stamp Company, Gloucester, Mass.

U. S. Collection fifty different mint un-issued commemoratives 1921-1939 only \$2.00 with your request for approvals. Orange Stamp Company, Albany 7, N. Y.

UNITED States approvals complete coverage, fine quality, attractive prices. Seminole Stamps, Box 436, Coconut Grove, Florida.

AMAZING Offer! Assortment each of giant stamps, midget stamps, flag stamps, airmail stamps, Free French Colonies, U. S. commemoratives and numerous others. Everything only 10c to approval applicants. Simon, Box 214, Iraan, Texas.

60 DIFFERENT U. S., 10c. Pricelist free. Seidenberg, Cassopolis, Mich.

FREE! Western Hemisphere packet. Postage 3c. Owens, 806 Welsh, Bay City, Michigan.

FREE! Pony Express set (facsimiles). Postage 3c. Roberts, 406 Building, Bay City, Michigan.

DEALERS—Wholesale list. Postage 3c. Frank, 5031 Queensberry, Baltimore 15, Md.

FREE! British Empire packet. Postage 3c. Williams, 606 Archer, Bay City, Mich.

FRESHLY Mounted approvals for collectors using Scott's International Junior album. Wlaschim, 55 Nagle Ave., New York 34.

SCARCE 1880 U. S.—Hussey local carrier stamp listed at 15c. Also Costa Rica No. 65 listed at 40c. Both sent free to approval buyers sending 3c postage. Pladon Stamps, 1717-M Idaho, Toledo 5, Ohio.

ZOWIE-E-E! A barrel of fun for only a dime. 500 United States—absolutely unpicked and unsorted—just as received from church missions. Many varieties, including large commemoratives, airmails, high denominations up to \$5.00! Stampdom's biggest package of fun—and you might find something really valuable! Price only 10c to serious approval service applicants. Money back if not delighted. Illustrated bargain lists with each order. Mystic Stamp Company, Department 80, Camden, New York.

WORLD'S Largest diamond and triangle stamps, free stamp magazine, stamps from fighting Free French, 20 stamps from 20 different countries, pictorials, airmails, big bargain 5c with approvals. Capital Stamps, Dept. 2, Little Rock, Ark.

118 DIFFERENT Stamps including commemoratives, charities, airmail sets, etc., only 3c to approval buyers. We buy collections. Badger Stamp Co., Milwaukee 3, Wis.

VICTORY Packet free—Includes stamps from Tanganyika, British Cayman Islands, animal, scarce babyhead, coronation, early Victorian, airmail, map stamps, with big catalogue—all free. Send 5c for postage. Gray Stamp Company, Dept. PM, Toronto, Canada.

FREE! Canadian sets, royal visit, George VI, George V, coronation, jubilee, others, to approval applicants. Ensign, Box 118-M, South Orange, N. J.

FREE! The Stamp Finder! Send today for the big new edition, fully illustrated, enabling you instantly to identify all difficult stamps! Also fine packet strange, fascinating stamps from Bosnia-Herzegovina, Monaco, Fatiala, Cyprus, etc., including maps, ships, animals and strange scenes. All free to approval applicants inclosing 3c postage. Garcelon Stamp Company, Box 900, Calais, Maine.

CANADA 100 Different 25c—approvals all countries. Lists. Victoria Stamp Co., London, 4, Canada.

GET Stamps you want without spending money. Write. Victory, Dept. P.26, Box 1501, Des Moines, Iowa.

STAMPS Wanted by thousands of our readers. Your ad in this space will bring you some nice orders. One advertiser sold 150,000 stamps. Write for positive proof. F. W. Johnson, Classified Advertising Manager, Room 301, 200 East Ontario St., Chicago.

HOBBIES AND COLLECTIONS

COLLECTING Hobbyists. Exchange duplicates. Swappers directory 10c. C. Bishop, Route 8, Kalamazoo 88, Michigan.

SECRET Messages—fun to de-code. Send 10c for information to Warner, Rt. 4, Box 2340, Bremerton, Washington.

SEND \$1.00 For lead and zinc specimens in its natural state from one of world's largest fields. Baldwin's, Box 402, Baxter Springs, Kansas.

MAKE That hobby earn money, full information \$1.00. Dun-Mar Co., 227 Hill, Dept. C, Memphis 7, Tenn.

HOW To make money with hobbies, see display ad page 178, Rieder.

NEW—15 Different match covers 10c. Box 202, Rochester 1, N. Y.

"HOW To Make Money With Hobbies." Easy, exciting, profitable. Cornell, Sandston, Va.

POSTCARD Collectors—12 beautiful Kodachrome postcard scenes of "outdoor" Wisconsin. 50c postpaid. Ray Almon, Box 175-M, Appleton, Wisconsin.

COLLECT Colorful Army patches. Pictures, prices and sample patch only 10c. Insignia Mart, 703 Broadway, N. Y.

FOREIGN Military insignias: Sample; prices. Send 15c. Hobbyguild, P35 West 32nd St., New York, N. Y.

WHITTLES—20 Patterns, instructions, X-acto knife, wood, \$1.00. "Old Whittler," 1402 Charles, LaCrosse, Wis.

FOREIGN Decoration ribbons, list, sample, 20c. Foreign insignia packet, booklet, \$1.00. Insigniacrafts, 236-28th Ave. N.W., Calgary, Canada.

UNUSED Match book covers. 100 all different \$1.00. 35 Royal Flash covers \$1.00. Free list. Charles Edelman, 1311C East 84, Cleveland 3, Ohio.

JEWELRY Stones removed from rings, etc., 100 assorted \$2.40; 50 large ones \$2.40. B. Lowe, Holland Bldg., St. Louis 1, Mo.

MINERALS AND PRECIOUS STONES

"GENUINE" Arizona "Rubies" (Garnets). Send quarter for packet. Mineral Specimens Company, Box 2651, Phoenix, Arizona.

CAMERAS AND PHOTO SUPPLIES

CAMERAS Available. Fresh films. Newest enlargers, printers, dryers, also paper, chemicals. 8/16mm films and equipment. Lowest prices. Free catalogs, specify item. Photo-Craft, Box 470-G, Jamaica, N. Y.

CAMERAS, Enlargers, lowest prices. Free catalog. Cavalier Camera, 1822 Center, Pittsburgh 19, Penna.

OIL Coloring photographs can be a fascinating hobby or profitable sideline for those with artistic talent. Learn at home. Easy simplified method. Send for free booklet. National Photo Coloring School, 1315 Michigan, Dept. 3432, Chicago 5, Ill.

FLASH Synchronizers, projectors, meters, film, flash bulbs. Advise your needs. Photoking Supply Shop, 6803 North Clark Street, Chicago 26, Illinois.

ENLARGERS—Build your own. Kit of parts, \$6.00. Free particulars. Krescent Engineering, Box 586-P, North Hollywood, Calif.

SNAPSHOT Films, 6 rolls; 127, \$1.75; 120 or 620, \$2.10; 116 or 616, \$2.40. Post paid. 8 high quality exposures each roll. Reliance Film, 354 W. 44 St., New York, N. Y.

CANDID Camera, takes 16 pictures, 2 rolls 127 film, \$3.98 postpaid. Cavalier, 1822 Center, Pittsburgh 19, Penna.

SOUTHWESTERN Slides. Yosemite, Grand Canyon, etc. 20 full frame mounted \$1.00. 5 samples 25c coin. Double or single mounts \$2.00 per hundred. Mounted slides from your pictures 20c each. Rogers Studio, Box 134, San Diego 5, Calif.

NEW: 8m Revere No. 85 500 watt projector \$89.50. New 8m Revere No. 88 F2.5 and case. Tax included \$63.42. 30x40 radiant tripod screen. Silver beaded, \$12.50. Conway Camera Company, 34 North Clark, Chicago 2, Illinois.

ARROW Films. Can be used for indoor and outdoor snapshots. Packages of 5 rolls. No. 127, \$1.45; No. 120 also No. 620, \$1.75; No. 116 also No. 616, \$2.00, postpaid. Empire Photos, Newark 8, New Jersey.

PHOTO-RING-KIT Makes 10 thermoplastic rings valued at \$10, \$1.10 postpaid. Beck Manufacturing, 13401 Cerise, Hawthorne, Calif.

CAN You make pictures? We can help you sell them. Free particulars. NeBen Photo Service, 407 E. 31st St., Balto 18, Md.

Adjustable Direct positive cameras for all size rolls. Ever ready focusing device. Hanson's Photo Lab, 3122 N. Clark St., Chicago 14.

PHOTOGRAPHY For pleasure or profit. Learn at home. Practical basic training. Long established school. Write for booklet. American School of Photography, 1315 Michigan, Dept. 3432, Chicago 5.

USED Camera Directory, Box 1031-M, Canton, Ohio—lists hundreds of war-bargain used cameras—35mm., Speed Graphics, Kodaks, Rolleiflex—many others. Send 25c for latest issue.

WAR Surplus Films 127 \$3.45 dozen; 120, 620, \$4.15; 116, 616, \$4.81 dozen postpaid. Cameras, meters. Cameraman, 542 Fifth Ave., New York 19, N. Y.

HANDSOME Jointless aluminum light, proof photographic paper storage box \$4.95. Box 171, Glendale, Calif.

BASS Says: War time proves Bass leadership. Amazing selection of finest still cameras—Leica, Contax, new and used still available. Write for quotations. Satisfaction guaranteed or your money refunded. Bass buys 'em, sells 'em, trades 'em. 35c postpaid for 100 page book "Military & News Photography" by Jack Price. Up to the minute information. Bass Camera Company, Dept. AG, 179 W. Madison St., Chicago, Illinois.

MAKE Copy-all. Photostamp printer. Instructions \$1 each. Tirekope (AA-1) Madeira, Ohio.

HAVE You a camera? Improve your hobby of photography and learn how to make better pictures. Write today for our latest book catalog and sample copy of American Photography, containing articles and pictures by the world's foremost writers and photographers. Camera House, 601, 353 Newbury St., Boston 15, Mass.

CASH! Spot cash for cameras, lenses, binoculars, movie or still, sound projectors. Send full description by mail, or wire for prompt cash offer. Over 30 years of dependability insures honorable dealings. 35c postpaid for 100 page book "Military & News Photography" by Jack Price. Up to the minute information. Bass Camera Company, 179 West Madison Street, Chicago, Illinois.

PHOTO FINISHING

8 VELOX Prints and two professional enlargements 25c. Send roll or negatives for trial offer. Young Photo Service, 405-C, Albany 2, N. Y.

2 BEAUTIFUL Hi-Gloss prints each good negative and enlarging coupon with each 6 or 8 exposure roll developed, 28c. Owl Photo Co., Weatherford, Okla.

ROLL, Developed, printed, 25c. Reprints 75—\$1.00. Howard's, 3760 Fremont, Chicago 13.

50 REPRINTS \$1.00. No limit. Studio, 1408-M Bond, Rockford, Ill.

ENLARGEMENTS—Deluxe quality only. Made on finest D.W. matt paper 5x7—25c. 8x10—45c. 11x14—\$1. Helio Photo Studio, P.O. Box 521, Church St., Station, New York 8, N. Y. Prompt service.

ENLARGEMENTS. Two 5x7 enlargements and one mount for \$1.00. Two 3x4 enlargements and one mount for 50c. Burgess Photo Shop, 106½ Forsyth St., N.W., Atlanta 3, Ga.

GLOSS Finish enlargements. 4 5x7 from negative 50c. 3 5x7 from photo 50c. Robert Renshaw, Jr., P.O. Box 478, Chester, Penna.

PROFESSIONAL Enlargements, two 8x10, \$1.00 postpaid. Work guaranteed. Send money and negative to Projectaprints, Box 114, Lansing, Michigan.

PHOTO Copies by experts. 5x7 50c. Any picture. Original returned. Beautiful enlargements, coloring. Any size or quantity. Free lists. Artcraft Studios, 906 E. 14th Street, Oakland 6, California.

BEAUTIFUL Enlargements. 4x6, 10c; 5x7, 15c; 8x10, 25c. Any size negative. Reprints 3c. Prompt service. Imperial Foto, 122 Sharon, Glendale, Ohio.

SLIDES, Black and white, made from your favorite snapshots, 6 for \$1 in standard 2x2, cardboard mounts. Excellent for family, club, church use. Send any photos under 8x10 (to be returned). No negatives. Jane Sherer, 16 Victory St., Waukegan, Ill.

PRINTING And developing done. Send 25c to Beauti-Craft, 92 Woodrow Ave., Dorchester 24, Mass.

CANADA Introductory special! Mail this ad with 10c in coin and 4 negatives and receive 4 beautiful panel-embossed snapshots in handy pocket album! Artisto, Dept. 131, Drawer 220, Regina, Saskatchewan.

PINER Photo finishing specials 25c. Eight exposure rolls developed with two prints each good negative or one enlarged print of each. Try today's quicker, finer Moen-Tone Enamel finish. Satisfaction since 1898. Moen Photo Service, 452 Moen Bldg., LaCrosse, Wis.

PHOTOGRAPHY For pleasure or profit. Learn at home. Practical basic training. Long established school. Write for booklet. American School of Photography, 1315 Michigan, Dept. 3451, Chicago 5.

MONEY Back guarantee, 16 sparkling double clear Nu-Art prints, also 2 enamel finish enlargements. All complete 25c. Rolls or negatives. Prompt, careful, guaranteed. Lifetone Studios, Department 139, Des Moines 8, Iowa.

BEAUTIFULLY Colored enlargements. 11x14 \$3.00. Haynescraft, 706 Eighth, Washington 1, D. C.

REPRINTS 3c Each. 5x7 enlargement 25c. Fred Cox, Palmer, Texas.

8 EXPOSURE Rolls 25c, over 8 exposure 40c, for one Velox print each and free enlargement coupon. Reprints 3c, minimum 25c. Fred D. Eastman, Bode, Iowa.

6-8 EXPOSURE Rolls developed and enlarged mammoth size 30c. Reprints 3c. Thrifty Photos, Box 46, South Gate, Calif.

CENTURY Delivers work and service that can't be beat. 8 exp. roll 25c with two professional enlargements free. Century Photo Service, LaCrosse, Wis.

ROLLS Developed and printed 25c. Reprints 2c; 5x7 enlargements, 15c; 8x10, 25c. Davis Studio, Guthrie, Okla.

TECHNIFINISH 35mm. 36 exposure rolls, fine grain developed and beautifully enlarged to 3"x4" high gloss prints only 90c; 18 exposure rolls 55c. Credit given for non-printing negatives. Reprints only 90c for 36, 55c for 18. Reprints of selected frames from uncut rolls 4c each. Reloads for your empty cartridges; 36 exposure reloads 35c, 18 exposure reloads 20c. Fresh stock. Technifinish color prints 8"x10" from your 35mm. Kodachromes or 35mm. area of larger transparencies only \$3.00 in distinctive mounts; \$1.50 for additional prints from the same transparency. Black-and-white positives from your 35mm. negatives for your projector; 36 exposure positives 50c, 18 exposure 35c. Write for free mailing bag, sample print and complete information. Technifinish, Dept. 112, Rochester 3, New York.

8 PRINTS, All enlarged to nearly postcard size, from your roll or negative, 25c. Willard Studios, Box 3535A, Cleveland 18, Ohio.

AT Last! Roll developed, all your snapshots hand-colored as beautiful as most actual colored photography 35c. Hand colored reprints 4c each—12 for 45c. National Photo Art Company, Janesville 26, Wis.

SENSATIONAL Introductory offer! Send snapshot or negative, this ad, and 3c. We'll send you a beautiful 7"x5" enlargement! Or, Kodak roll developed with 16 guaranteed deckled-edge velox fade-proof prints or 8 double-size prints, 25c! Special! From your negatives, 16 regular-size or 8 double-size reprints, 25c! Candid rolls—36 exp. 35mm. developed, vaporated, enlarged to 3x4. \$1.00! 18 exp. 50c. Reprints, 3x4, 3c each. We have new, perfect 35mm. film. Low prices. Free mailers, details on request. American Studios, Dept. 279, LaCrosse, Wis.

EVERY Picture an enlargement! 8 sparkling deckle-edge enlargements and roll developed 25c coin; 116 size or smaller; enlarge reprints 3c. Enlarge Photo, Box 791D, Boston, Mass.

BIGGEST \$1.00 Value in 35 mm. finishing today. 36 exposure fine grain 3 1/4 x 4 1/2 enlargements; deckled, embossed margin and date. Eighteen exposures 75c; 16 exposure splits 55c; 36 exposure reloads 50c. Special: return this ad with \$2.00 and we will send five 36 exposure reloads. Free mailers. 8 exposure rolls in beautiful, deckled contact finish with embossed wide margin, 25c. Mailbag Film Service, Box 5440A, Chicago 80.

BEAUTIFUL Double-size pictures 3 1/2 x 5 each, from 116 and 120 negatives, 3 1/4 x 4 1/2 from all other sizes. All work guaranteed. Overnight service. Roll developed and 8 pictures 30c. Roll 12 pictures 45c. Roll 16 pictures 60c. Enlargements on double weight portrait paper 5x7-30c, 8x10-50c. Copies made from any picture 75c. Pacific Photo Service, Box 666, San Francisco, Calif.

MOTION PICTURES AND SOUND EQUIPMENT

YOUR Own business showing talkies theatreless communities. No investment. We rent sound equipments, programs, reasonable. Remarkable possibilities. Earn \$50-\$200 weekly. 2200 RKO Building, Radio City, N. Y.

RENT 16 MM. sound films 50c reel. Large selection; free catalog. Film Service, 128 Chestnut Street, Roselle Park, N. J.

16MM. Sound projectors, film. Free catalog. Holmes, 3594 Main, Riverside, Calif.

EXTRAVAGANZA. Inspiring movies for every occasion, supplies, projectors, films. New 1946 catalog 25c refundable. A quarter well invested. Trans American Sales, Morristown, New Jersey.

ANYTHING Photographic. Lists. Specify. Thompsons, 2 Southeast Fifth, Evansville 9, Indiana.

I BUY. Sell, swap, rent s.o.f., 8 and 16mm. films. List free. Harvey Iris, Box 539, Brockton, Mass.

SAVE: Rent 16mm. silent films by the week. \$2.00 reel. Robert Salmon, 3558 So. 11th East, Salt Lake City, Utah.

PROJECTORS, Cameras, films. Home movie catalogs free. William Richardson, Wyoming, Penna.

GUARANTEED Fresh movie film! Three spools double 8mm. \$3.45! Six spools single 8mm. for Univex cameras \$3.50! Processing free! \$1.00 deposit C.O.D.'s. Give camera make. Eso-S, 4038 Broadway, Kansas City 2, Missouri.

AMOS 'N Andy cartoons, "Rasslin' Match," "Lion Tamer," theatre length, 8mm. \$5.50, 16mm. \$8.75, 16mm. sound \$17.50. Valuable gift included for remittance with order. Charlie Poorman, Dept. PM, Schuylkill Haven, Penna.

KODACHROME Slides, sample and lists, 35c. Home movies, sale, exchange. Galloway Films, 3008 Fifth Street S.E., Washington 20, D. C.

8MM.-16MM. Silent-sound film. Complete rental library. All latest subjects. Free catalogue. (Sample film 10c.) Garden Film, 317 West 50th, New York 19.

WORLD'S Greatest clock, 6000 pounds, 15,000 parts, 16m.p.m., silent, 125 feet \$4.50. Nu-Art Films, 145W, 45 St., New York City.

35MM. Silent films, projector, feature, shorts—cheap. Sanford Film Exchange, 74 Sanford St., Rochester, N. Y.

COMEDIES, Melodramas. 8-16mm.; 35mm.; sold, exchanged. Meginnis, 340-U West 29th, New York 1.

8MM.-16MM. Films. Free catalogue (sample film 10c). Parkway Exchange, 53 Rockaway Parkway, Brooklyn, N. Y.

16MM. And 8mm. sound and silent films bought, sold, exchanged. Film Exchange, 154 Nassau St., New York.

UNUSUAL Home movies—travel, adventure, sports, news, war films. Many film bargains. Big 1946 catalog and sample, dime. Audet, Box 6520-BG, Philadelphia 38, Penna.

8MM. Films for sale, exchange. List of popular subjects, sample, dime. Arnett, 820 Gordon, Piqua, Ohio.

MOVIE Projector 16mm. with 110v. motor-2" projection lens \$13.95 postpaid. Cavalier Camera, 1822 Center, Pittsburgh 19, Penna.

SALE 35mm. choice silent films. 7235 Guilford, Upper Darby, Pennsylvania.

NEW Revere cameras 2.5 lens \$52.50. Projectors, 500 watt light \$80.50. From-ader Genero, Davenport 7, Iowa.

16MM. Silent film exchange 40c-100'. Emerick's, Stumpf, Parma, Ohio.

8MM., 16mm., 35mm. films. Samples 10c. Lists free. Paramount Films, Monmouth, Illinois.

35MM. Silent sound film bargains: List. Victor Cromwell, Darien, Conn.

UNUSUAL 8-16 mm. Film subjects. Big catalog with sample film, 10c. National Film Exchange, Sta. E-Broadway, Toledo, Ohio.

16MM. Motor driven projectors \$13.50, hand cranked \$10.50. Send stamp for 16mm., 8 mm. catalogue. Sterling's, 679 Northampton, Easton, Pennsylvania.

NEW Catalogue 35mm. motion picture productions. Roadshow attractions. Westerns. Gangster. Medicals. Any type picture you want. Low prices. Catalogue 25c. Bussa Film Exchange, Friendship, Ohio.

16MM. Bell Howell, Victor, Ampro, sound projectors. Delivery now. Dime brings catalog. Movico, Box 482, Ithaca, N. Y.

RELIGIOUS New sound prints only. Screenart, 723 - 7th Ave., New York.

35MM. Sound features, projectors. A Savarese, Woodcliff Lake, New Jersey.

SENSATIONAL Full color movie subjects! 8mm., 16mm. Big catalog, 25c. Special! Projection length sample scenes (Kodachrome), "Waikiki Hula." \$1.00. Specify width. Iriscope kits, \$5.00. World in Color Productions, Box 392-F, Elmira, N. Y.

HOME Movie rentals, sales, exchange. 8-16mm. and sound. Latest releases—Money-saving rates. Details for stamp. Midland Film Exchange, Box 429, Oak Park 4, Illinois.

BEAUTIFUL Kodachrome slide and list, 25c. Art Slide Co., M-1, Canton, Ohio.

"THE World's Greatest Passion Play." all sizes sound and silent. Write Hemenway Film, 33-F Melrose St., Boston 16, Mass.

LEARN Movie projection, management. Free catalog. Theatre Institute, Elmira, N. Y.

MOVIE Camera films, 100' 16mm. \$2.50. 25' double 8mm. \$1.25. Free developing. Better Films, 742 NewLots, Brooklyn 7, N. Y.

MOVIE Projectors bought and sold. List 10c. United, 2309-A Lawrence, Toledo, O.

BASS Says: Leadership in the cine field is apparent in war times. Here ready—your choice of 8 mm. and 16 mm. apparatus. Write for quotations. Your old equipment is worth real money in trade—describe please. Or we buy for cash and pay immediately on receipt. Write to headquarters. Bass buys 'em, sells 'em, trades 'em. Satisfaction guaranteed or your money refunded. 35c postpaid for 100 page book "Military & News Photography" by Jack Price. Up to the minute information. Bass Camera Company, Dept. A, 179 W. Madison St., Chicago, Illinois.

SPECIAL Movie film, 8mm., 25 feet double-Weston 8, \$2.00. Super double X, Pan indoor 60 outdoor 100, 16 mm., \$6.50. Super X Pan indoor 24, outdoor 50, \$5.75. Pan Weston 12, \$5.00. 16 mm. 100 feet Weston 6, \$4.00. Free developing. Exhibitors Film Exchange, 630 9th Ave., New York 19, N. Y.

MUSIC AND MUSICAL INSTRUMENTS

GUITARISTS, Play professional. Modernistic set of runs, breaks, modulations, introductions, progressive futuristic rhythm chords, notes, diagrams, fingering. \$3.00. Nicosia, Box 596, Brooklyn 1, N. Y.

POPULAR Piano in 12 lessons, guaranteed. Beginners advanced. Kelly School, 1734 30th Ave., San Francisco 22, Calif.

POEMS Wanted! I'll compose special music. Send poem for free examination. Elliot Wright, Master Composer. Box 3861-Z, Portland 8, Oregon.

SONGWRITERS. Have your material completed by an honest, experienced arranger. Free analysis report. Tommy Kilbourne, Box 1253, Bakersfield, Calif.

SONGWRITERS: Collaborate with nationally famous composer of "Boots and Saddles." Send poems for free examination. Get free instructive booklet. Hollywood Harmony House, 126 South La Brea, Studio M-7, Los Angeles, California.

SONGS Remodeled. Write for information. Kuhlmanns, 403 East Main, Woodville, Ohio.

NOW Compose tunes to songs you write. New invention automatically creates melodies which you copy on manuscript paper furnished. You get "Compos-A-Tune," musical slide rule. How to Write Professional Songs and Rhyming Dictionary. \$3.00 complete. Order now. Music Writers Publishing, 535 Fifth Avenue, Studio 10, New York.

SONG Poems wanted, for musical settings. Send poem for free examination and outstanding offer. Write for free instructive booklet outlining opportunities. United Music, Salem 3, Indiana.

WANTED Songs for folios. Latest folio 50c. Melody Publishers, Davis, W. Va.

VOCALIST Pays well. Amazing home method. Details free. Vocalito, Madison Hotel, Box 132A, Atlantic City, N. J.

SONGS Wanted. Royalty proposition. Mercury Music, 1216 Park Row Building, New York, N. Y.

WRITE Music? Read The Songwriter's Review, magazine for songwriters. Songs published free. \$1, 12 issues. 111-M W. 48, New York.

SONGS Revised, arranged, published. Details, Rainbow Melodies, 1658 Broadway, New York City.

HARMONICAS C \$1.50, \$2. Guitars \$12 up. Free list. Musician's Shop, 2 E. Centre Street, Baltimore 2, Md.

ACCORDIONS: All sizes and makes. Wholesale prices. Free catalogue. American Accordion Center, 39 S. Kedzie, Chicago 2, Ill.

ADVERTISE In Musical Echoes Magazine. Copy 15c. Davis, W. Va.

ACCORDIONS—Special discount. Dealers prices. New or used. All sizes and makes. Free catalog. Metro Accordion Co., 31 So. Cicero, Chicago.

GUARANTEE To teach you to play Hawaiian or Spanish guitar in ten lessons, one dollar. Frank's Musicians Supply, 732 Jersey Ct., San Diego 8, Calif.

NEW Songs and lyrics wanted for popular radio program and professional promotion. Free examination. Transradio Music Inc., Dept. P., 1650 Broadway, New York.

SONG Poems wanted—All subjects. Send your best poems today for free examination, or write for free booklet "Getting Ahead in Songwriting." Song Service, 331-C West 46th, New York.

MUSIC Composed to song-poems. Address: Frank Wildt, Lancaster, Penna.

SONG Writer's attention! The amazing demand for phonograph records, accelerated by more than 300,000 juke boxes and the hits popularized warrants your immediate consideration. We are offering song-poem writers the rare opportunity of having established composers collaborate on appealing material received this month. Recola Records, Box 987P, Hollywood 28, Calif.

POEMS Wanted for immediate musical setting. Free examination; any subject. Well known music publisher in urgent need of original material. Send poems to: Composers' Guild of America, 545 Fifth Avenue, New York 17, N. Y.

LEARN To write music, words, arrangements and publishing. The Complete Songwriter tells how. Send \$2.00 M.O. postpaid to Puritan Publishing Co., Inc., 343 So. Dearborn St., Chicago 4, Ill.

SONG Selling suggestions 10c. Andy Toce, Box 187, Miami Beach, Fla.

PLAY Music without study. Money back if you are not pleased. Order "Play Music Without Study," \$1.00 postpaid. Dr. F. Wilson, P.O. Box 1205, Chicago 90.

SONGWRITERS! Outstanding, amazing offer. Hibbeler, C5, 2157 N. Avers, Chicago.

SONGWRITERS. A limited amount of musical compositions wanted for radio distribution. Tin Pan Alley Publications, 1587 Broadway, New York 19, N. Y.

POEMS Wanted for musical setting. Send poem for immediate consideration and free rhyming dictionary. Richard Brothers, 24 Woods Building, Chicago.

PHONOGRAPH Records: Send us \$2.00, we will ship you 10 used phonograph "juke box records"—all different. Satisfaction guaranteed! Automatic Sales, 56 E. Hennepin, Minneapolis 1, Minn.

SONGWRITERS—Send poems for immediate examination and free book. "Your Future in Songwriting." Radio City Music Academy, 1674 Broadway, New York City 19.

WANTED! Lyrics, melodies for songs. We arrange, publish, sell. Superior Song Studios, Passaic, N. J.

ACCORDIONS. New and used at wholesale prices. Save up to \$100.00. Buy direct from factory. Del Principe, 307 So. Wabash, Chicago.

BEFORE Sending your poem to be set to music, know your composer. Free folder. Al Moquin, 5333 La Cresta Court, Hollywood 38, Calif.

PLAY Swing piano! Send 10c for instruction bulletin. Christensen Studios, 751 Kimball Hall, Chicago 4, Ill.

POEMS Wanted for musical setting. Send poem for immediate consideration. Five Star Music Masters, 630 Beacon Building, Boston.

SONG Poems wanted. Free examination. McNeil, Master of Music, 510-PM South Alexandria, Los Angeles, Calif.

WRITE Songs. Big money and reputation. Write for information. J. Gordon Pub Co., 201 N. Hoyne Ave., Chicago.

RADIOS AND SUPPLIES

YOUR New free catalog is ready! Radionic's catalog lists hard-to-get radio parts and books. All available for immediate shipment. Send today to: Radionic Equipment Co., Dept. 2D; 170 Nassau St., New York 7, N. Y.

BE A radio service engineer. New, easy course. Details. Electronic Engineering Institute, Albuquerque, New Mexico.

BUILD Latest, extra-loud crystal set. Instructions, 20c. "All About Crystal Sets," booklet: 45c. Amorose Radio, R-4, Hungary Road, Richmond, Virginia.

ATTENTION—Amateur radiomen. Build your own midget radios. Diagrams and instructions 50c. Loofbourou, 2842 N.E. 47th Avenue, Portland 13, Oregon.

INSTANTANEOUS Revolving pocket size dial. Analyzes every face. Absolutely new. \$1.00 while they last. Voncrowe, 360 Wrexham Ave., Columbus 4, Ohio.

WORLD'S Smallest a.c. d.c. set. Built in loudspeaker operation. Uses one tube. Easily fits in ladies' handbag or briefcase. Plans, photos, instructions, 50c. Louis Toth, P.O. Box 110, Station H, New York 25, N. Y.

WAR Material release. Send your requirements, free list. Special neon electric tester, circuits, motors, radio, thirty-nine cents. John Barron, 662 - 85 St., Brooklyn, New York.

AMATEURS—New Cornell-Dubilier condensers. 4 mfd. 600 volt—list \$5.50—\$1.49. .45 ampere 2 to 18 volt Selenium rectifiers 79c. Guaranteed perfect. Other bargains. Richard Campbell, 3800 Kinzie Ave., Racine, Wisconsin.

GOVERNMENT Release new Western Electric type twenty six fixed crystal detector. Cost six dollars. Prepaid ninety-nine cents. Free list. Raid City Labs., 30 Church St., New York, New York.

FAMOUS "Allen" Midget Semi-Fixed Crystal Detector, set building plans and 100 late crystal set distance reports all for 50c postpaid. Allen, 427-P, Clinton, Mo.

REVISED Plans 18 long distance crystal sets, including "Radiobuilder"—25c. Laboratories, Box I-C, San Carlos, Calif.

MAKE Simple, tubeless, batteryless, distance-getting crystal radios. Crystal and illustrated instructions 25c postpaid. Allen, 427-P, Clinton, Missouri.

LEARN Radio easier—faster! "The Mystery of Radio (How It Works)" illustrates, explains radio principles, circuits, etc. Only \$1.00. Scientific Radio Service, Box 1285, Sioux City 7, Iowa.

BUILD Your own radio. Simple instructions. All kits complete including tubes. 4 tube T.R.F.—\$10.75. 5 tube Superheterodyne—\$17.95. National Radio Distributors, 140-M West 42nd Street, New York 18, N. Y.

FM Can now be heard on old radios! Very simple adaptor! Send postcard for free data! Topical Emprise Corporation, 1527 Highland, Box 42, Louisville 4, Ky.

BUILD Radio. Complete kit with tubes \$10.95. Details. Radio, 9418e Avenue "A," Brooklyn, N. Y.

RADIO Service men and experimenters send stamp for our giant radio catalogue. Save dollars. United Radio Co., (1000-V) Newark 1, N. J.

RADIO Service flat rate schedules solve pricing problems. Compiled from 20 years experience. Write for information. Radio Equipment Co., 1415 W. Franklin Ave., Minneapolis 5, Minn.

FAMOUS Razor blade radio! Illustrated plans 35c. New Radio, Lohrville, Iowa.

RADIO Technician and radio service courses. Training for federal licenses. American Radio Institute, 101 W. 63 St., New York City. Approved under G. I. Bill of Rights.

BUSINESS OPPORTUNITIES

ELECTRICAL Appliance repair. Open your own shop. Learn house wiring; electric motors, vacuum cleaners, washers, etc. Complete illustrated course shows how. Free booklet. Pacific Training School, Dept. AP-1, 7217 So. Broadway, Los Angeles 3, Calif.

START Your own business now. Little or no investment. Full or part time. Free booklet describing over 100 moneymaking plans. Anes-Hausen, Box 1643, New Orleans 11, Louisiana.

BUILD Mail order business of your own—anywhere! Free illustrated prospectus on "Modern Mail Merchandising." Write at once. Mail enterprises, Inc., 316-A Fox Building, Detroit 1, Michigan.

DISTINGUISH Your product by a good trade-mark. Find out if registerable in U. S. Patent Office. Any word or name searched for \$2.50. State kind of product. Address: Raymond L. Smith, 410-TM Bond Building, Washington 5, D. C.

BE Independent! Become associated with us in an essential proven profitable profession. Universal Exterminators, 950 Margate Terrace, Chicago 40, Ill.

HANDY Men—Earn money home operating Community "Fix-It" Shop. Write Stafford, 708 Rawlings, Carbondale, Ill.

MAKE Flexible Molds, Statuary, Art Goods, Novelties, Artificial Marble Flooring, Liquid Marble, Literature free. Kemico, Park Ridge (2-M), Ill.

GOING Into business? Illustrated book packed with complete practical plans. How to choose business, organize, finance, buy, sell, locate. Includes farming. Only \$1.00. Money back guarantee. Commercial Publishing, 8808PM So. Commercial, Chicago 17.

YOUR Own business. Big profits, very small capital. National organization teaches, helps, supplies everything. Interesting service business. Big demand everywhere. Americlean, 211 North 7th Street, St. Louis 1, Mo.

PREFABRICATED Door canopies. Install quickly. All material furnished ready cut. Earn \$10 per. Photos, news copy, scheme, etc. Send \$1. Muro Products, 18410 Rutherford, Detroit 19, Mich.

OPERATE Postage stamp vending machines. Legal! Steady profits! Free details! Adair Company, 6924 Roosevelt, Oak Park, Illinois.

OPERATE Your own credit-collection agency business; fulltime-lifetime vocation; many earn \$5,000-\$10,000 upwards annually; our comprehensive copyrighted course comprises 10 separately bound lessons; antique covers; over 35,000 words; altogether 224 subjects; mailing weight 30 ounces; shipped complete \$5.00 postpaid; descriptive folder free. Educational Extension Service, Department 101, Los Angeles 36.

MECHANICALLY Inclined men — Own and operate general appliance repair shop. Complete, illustrated course shows you how. Welding, refrigeration, motor repair, how to get business, etc., all phases covered. Free literature. Christy Supply, Dept. 161, 2835 N. Central Ave., Chicago.

THERE Is big money in collecting delinquent accounts for business firms and doctors. Write us for free details. Cole & Associates, Syracuse, N. Y.

MAKE Soap at home. No machinery. Profitable. Literature free. Kemico, Park Ridge (SM-2), Ill.

TRADE Magazine directory. See Books, Periodicals. Commercial Engraving Publishing Company.

INDEPENDENCE Obtained. Fascinating profession manufacturing picture projectors. Wonderful, professional machine, easy made \$1.50. Sells \$20.00. Projects any picture, photo, drawing—any screen. Guaranteed plans, manufacturing instructions—\$1.00. Gladwal Engineering Co., 61 Ashdale, Toronto, Canada.

MAIL Order beginners! "How to Build Your Own Mail Order Business." Noted specialist's 10,000-word treatise, shows—step by step—how to make it pay, on small-capital start. 25c, satisfaction guaranteed. Maupin & Maupin, LaFayette 3, Indiana.

QUARTER—Dollar—\$2.00 orders by mail. Amazing all profit plan. Capital practically unnecessary. Reliable firm starts you. United, 305-N West 8th, Los Angeles 14, Calif.

MAKE Your fortune in great new industry manufacturing and marketing products containing "DDT," Wonder-Working Insecticide. World-wide waiting market. My Ten Master DDT Formulas and simplified manufacturing and marketing instructions for starting on small capital. Rush request for full details, free. Howard Robinson, Ph.G., 1320 S. Ohio, Sedalia 10, Mo.

MAKE Strange new plastic—1c pound! Makes beautiful, durable floors, walls, roofs. Build for half! Bays Laboratory, Oklahoma City 9.

OPERATE Profitable home business on \$5 capital. Details free. Powell Service, 5713 Euclid, Cleveland 3, Ohio.

LIQUID Marble—Make in any color. Soundproof plastic flooring. Flexible molds. Cast novelties, plaques, statuary. Big money—your own business. Free catalog. Write—Bing Products, 88-AD Broad Street, Boston 10, Massachusetts.

LARGE Profits in spare time home business. Free details. Acme Distributor, 15 Park Row, New York.

LIQUID Rubber for making molds for plaster castings. Finest quality. Sample? Sure! Costs more, worth more. \$3.00 quart, \$10.00 gallon. W. Wooley, 115-A Donald, Peoria, Ill.

MAKE Liquid Marble, Plaster Plaques, Statuary. Instructions, formulas, \$1.00. Ideal Service, 179-M, Park Ridge, Ill.

GOT \$24,500 Using "schemes" from "Schemer" Magazine, Alliance, Ohio, 48th year, \$1.00; 4 samples, 30c.

EARN Money evenings, copying and duplicating comic cartoons for advertisers. Adservice, Argyle 1, Wisconsin.

MAKE Big money in window cleaning business. Be independent in a business of your own. Details free. Write P.O. Box 6, Springfield, Mass.

WORK For yourself. Average \$1.00 hourly. Absolutely no selling. Pleasant spare-time work. Convincing particulars free. American Business Service, Nescopeck, Pa.

RUBBER —Airlastex liquid, pre-war quality. "Makes molds overnight." Sample pint, instructions \$1.50. Gallon \$9.00. 20th Century Products, 3151-3 Southport, Chicago.

WANT To make \$100.00 weekly? History of World War II. Your opportunity; write today. Better still, send \$3.85 for sample history and order taking outfit. Wilkin & Co., 118½-PM E. Main, Hillsboro, Ohio.

HOMEWORKERS—Attention veterans! Castwood plastic gifts, novelties; material and instructions furnished. Sample quart with mold model, \$2.00. 20th Century Products, 3151-3 Southport, Chicago.

ESTABLISH Yourself in profitable mail order business of your own. Free descriptive literature. Church, 814 N. 24th St., Billings, Montana.

FOREIGN Employment Digest. (Best foreign job guide). Mail \$1.00 to Industrial Research, Ltd., 403 Bdwy. Bldg., San Diego 1, Calif., for 1946 Edition.

LEARN Shell jewelry manufacturing. Complete, simplified home instruction course, beautifully illustrated, shows 45 styles pins, earrings, brooches, sprays, hair ornaments. Includes pearlizing, dyeing, golding, glow-in-dark methods. No tools needed! Learn-earn within a week. Only \$1 postpaid, including wholesale prices of all raw materials. House Of Gifts, Box 4550-P8, Coral Gables, Fla.

PLASTIC—Intermix, makes ordinary casting plaster shatterproof. Pint develops 100 pounds, \$1.25 postpaid. Plastic Material Supply, 1416-N2 Fletcher, Chicago.

BECOME A used car salesman. Earn big money. My sales manual and advice will prepare you. Only \$2.00. Further particulars free. Barlow Used Cars, 89 State, Binghamton, N. Y.

OPERATE Profitable home mail order business. \$5.00 required. Details free. P. O. Schlott, 131-C Prospect St., Rockville, Conn.

FREE Booklet describes "Collection 137 Tested Plans"—full or spare time. Fully illustrated. Kakay & Co., Box 1032, Tampa 1, Florida.

1000% PROFITS Making \$1 scarce materials for building boom. \$1. Clanranald, 157 Golddale, Toronto 12, Canada.

DOLLARS Daily! Start home mailorder businesses. Details free. Duffy, M56, Covington, Ky.

ELITE Collection contains 137 practical money-making plans; local and mail order. New edition. Particulars free. Elite Co., 214 Grand St., New York 13.

5" POCKET Combs—144 for \$4.00. Sample free. P. Richardson, So. Lancaster, Massachusetts.

HOW To operate your own advertising agency profitably. New, different, copy-righted manual reveals all. Learn how to start in spare time, at home, with few dollars capital. No stock or equipment to buy. Earnings unlimited. Sincerely interested send stamp for special folder. P. Snyder, Box 4907-A, Philadelphia 19, Pa.

A GOLDEN Opportunity for men and women looking for a post war future. G. S. Bond, Mounds, Okla.

RUBBER-LATEX Molding liquid. "The real thing." Sample quart, directions \$2.95. Gallon \$9.50. Plastic Material Supply, 1416-N2 Fletcher, Chicago.

FORMULA Buyers and collectors join our New Formula Club just starting. Get hundreds of valuable formulas free. Write Alliance Chemical Co., Box 568, Alliance, Nebr.

PROFITABLE Plans, ideas. 10c. Spada Enterprises, Box 1075, Hartford 1, Conn.

METALLIZE Baby shoes! Learn from nationally recognized consultant. See Kushner ad on page 178.

START Own business, make big money selling welding flux. For information G. Fuller, 252 Lexington Ave., Cambridge 38, Mass.

PROFITABLE, Dignified mail order business conducted from home. Particulars free. Ives Mdse. System, Office 622, 1328 Chestnut St., Philadelphia 7, Penna.

MONEYMAKING Mailorder opportunities. Successfully operating 44 years. Little capital needed. Sure-fire profits. Consultation. Trial. Astonishing testimonials, particulars free. Raymond Dow, 2922 164th St., Flushing 30, N. Y.

MAKE Up to \$10,000 and more a year. Enter a new profitable professional business in 60 days. Small investment. Suite 844, Dept. G, 127 North Dearborn St., Chicago 2, Ill.

PRINTING Price list free. Fletcher, 639 Bushwick Ave., Brooklyn 6, N. Y.

BUSINESS Machine repairing. Self teaching course. First lessons teach how to make money in garage or basement. Office Machines Service School, University Station, Box 134, Seattle 5, Washington.

FAME, Independent, really profitable business too impossible? Why not investigate without risk? Airmail dollar (refundable) for mailorder lifetime plan, unusual opportunities. Limited. Zigzag Corporation, Box 101-W, Guatemala, Central-America.

WANT A government job! Commence \$125-\$220 month. Men-women. Prepare now at home, for 1946 examinations. Full particulars and list positions, free. Write today. Franklin Institute, Dept. M54, Rochester 4, N. Y.

IMPRESSIVE N. Y. mailing address. Only \$2.00 monthly. United, 141 Broadway.

1100 BUSINESSES With limited competition, \$1. Neutron Company, Box 1, Station C, New York 14, N. Y.

HARDWARE Business is one of the most interesting and profitable of them all. Be independent. You can start your own retail store with small investment and no previous experience. 15,000-word, copy-righted booklet tells you how. \$1.00 post-paid. C. R. Divan, P.O. Box 325, Santa Monica, Calif.

BE Your own boss. Start at home. Amazing profits. Literature free. Ace Sales, 920 A2 Cullom Ave., Chicago 13, Ill.

AT Home—Your own manufacturing business; making popular \$1.00 novelties. Cost you 3c to 15c. Everything supplied. Write SoLo Works, Dept. B-600, Cincinnati, Ohio.

OWN A mail-order paper products business. Sell envelopes, tags, bags, boxes by mail, wholesale. Tremendous demand. Steady profits. No capital necessary. Write Omaha Envelope Service, Dept. 129, 4721 California, Omaha 3, Nebr.

INDEPENDENCE—Wealth—in own business! Free information. Successful Income Builders, Hollywood 28, California.

BOOKKEEPERS. Be your own boss. Operate profitable bookkeeping service. Start small, grow big. Details free. Bourque, 3712 Fifth, Marrero 1, Louisiana.

TO Those concerned: I will represent you in St. Louis on business or personal assignments. \$1.00 per hour. Reliable service. John Shanahan, Box 4511, St. Louis, Mo.

ESTABLISH Home mailorder business. Write Smith, 72-A Southbourne, Boston 30, Mass.

HAVE Your own business, full or part time, selling Ramsay Simplified Book-keeping Systems. Practical, easily operated, moderately priced. Furnishes complete, accurate information required by government. Every business a prospect. Excellent opportunity for accountants and book-keepers to service clients. Liberal commissions paid daily. Write for details. Ramsay Systems, Inc., 192 Lexington Ave., New York 16, N. Y.

PLASTIC Inspection molding machines; hand powered; makes parts to 2 ounces experimental or production to one ounce; \$795.00; suitable for home shops; agents wanted. McNeil Molding Machine Company, 1352 North Western Avenue, Chicago, Illinois.

BE Independent. Start a business of your own and enjoy financial freedom. Little or no cash required. 3c stamp brings full details. W. M. Drexler, 258 Broad, Newark 4, N. J.

MAILORDER Directory Magazine, many business opportunities, start small, grow big. Mail 25c for copy or year's subscription \$1. Rieder, 93-20 71st Drive, Forest Hills, N. Y.

CAST Book ends, novelties. We furnish rubber molds. Liquid rubber for moldmaking. Free information. Mold Craft Industries, Box 324, Morris Plains, N. J.

HOME Mail order profits. Learn how. Free details. Hetrick, 514A West Mahoning Street, Punxsutawney, Penna.

EVERY User of the mails needs an envelope sealer. We manufacture a proven, practical sealer. Capacity forty per minute. Sells on demonstration. \$2.50, immediate deliveries. Kendale Sealer Company, East Jaffrey, New Hampshire.

YOUR Own mail order business at home. Large profit! Carry no stock. Unique plan. Start spare time now. Write: Dante A. Antonelli, 1301 Commonwealth Ave., Boston 34, Mass.

VENDING Machines—Be independent, earn a steady income. Operate a route of our new 1946 models of postage stamp, stationery, peanut or gum ball vending machines. Earnings run as high as \$10.00 weekly profit per machine. Machines cost as low as \$10.50 each. No car or experience necessary. Can be operated in your spare time or as a full time investment. Act now—write for our free illustrated catalogue. Parkway Machine Co., 3046Q Tioga, Baltimore 15, Maryland.

YOUR Own business—As little as \$100 starts you now! No training needed! See our ad on page 82A. American Photocopy Equipment Co., 2849 N. Clark St., Dept. GP26, Chicago, Ill.

BOOKKEEPERS — Operate your own "Dollar-A-Week" bookkeeping and tax service. Full or spare time. Details free. Ellis, Box 200, Cedar Grove, No. Carolina.

EARN Money with textile painting course. Free details. George Gundrum, LeRoy, Michigan.

SELL Books by mail. Spare time, home office. Start small, grow big. Grand opportunity to establish clean, legitimate mail order business. "How" booklet 10c. Kraft, 3114-S1 Walnut, Chicago 12, Ill.

MAIL Order business course shows you how to make money, spare or fulltime. Teaches professional mail order technique—not penny-snatching schemes. Fascinating 100-page illustrated success-catalog free! Write—Nelson Company, Dept. 4-02, Chicago 5.

START Profitable home business in spare time. Complete mail sales campaign literature supplied. Details free. A. Riegel, 1111 Harrison, Philadelphia 24, Penna.

SELL By mail. Particulars free. Write, Frank J. Artz, 1060 Harding Drive, Toledo 9, Ohio.

PLASTICS Guide-listing dealers in materials, molds, machines, supplies, equipment, accessories. \$1. Plastics Digest, 3937P Tracy, Kansas City 4, Mo.

SELL Cosmetics by mail. Women spend millions on beauty. You can make your share of this cosmetic money. Let us show you how. Details free. Frank J. Artz, 1060 Harding Drive, Toledo 9, O., Dept. A.

RUBBER Mold making liquid. Make gifts, novelties, pre-war quality. Free cast-wold plastic model with sample quart \$2.95; directions. Rubbercoat, 3873 California, San Diego, Calif.

JUST Released: Liquid rubber to make molds for plaques and statues. Plastic formulas and compounds. Apex Plastic Products, 1740 Estes Ave., Chicago 26.

SIX Leading mail order publications 25c. Full of articles, plans, schemes, wholesale offers. Kraft, 3114-S1 Walnut, Chicago 12, Illinois.

BECOME A finance man. Particulars free. George Lenhoff, Lincoln 8, Nebr.

EXPORT, Import, represent manufacturers. Deal with South America, Africa, China, Europe. War-peace time big business. Uncrowded fields. Unlimited opportunities. Deposit one dollar for two bulletins. Money refunded if unsatisfied. P. Benko, 246 Fifth Avenue, New York.

FREE Hot water the year 'round. First cost is last cost. Build your own solar water system. Average cost less than seventy dollars. Good business opportunity sell solars in your community—it's easy. Complete instructions and drawings send two dollars. Will produce hot water any locality. Miami Solar Water Co., P.O. Box 175, Coral Gables, Florida.

137 WAYS To make money, in home or office, business of your own. Full particulars free. Elite Co., 214 Grand St., New York 13.

CASH By mail. Either sex. 10c brings offers. Bargain. Specialty Company, Box 635BO, Modesto, California.

PLASTICS. Make your own at home. Formula and moulding instructions \$1.00. Box 84, Station K, Toronto, Canada.

PLASTIC Homes—build yourself! Re-surface old buildings! Wonderful building material. Marbleized Service, Edwardsville, Illinois.

TAILORED Homes—the modern plan book. Ad under heading Miscellaneous.

RAPID Marbleizing liquid—Colorful, glazed! Molded, brushed, sprayed! Composition floors. Rubberlastic molds. Particulars free. Marbleizing Service, Edwardsville, Illinois.

MANUFACTURE Nameplates, house numbers, electric signs. Box 221, Newport News 6, Virginia.

START A home business in spare time. Make extra money. Experience not essential. Literature free. Rolf S. Iverson, Box 916A, Grand Central Annex, New York 17, N. Y.

BUILD Miracle homes. Yours. Others. Chamberlain, Fitzsimons Building, Pittsburgh 22, Penna.

ASTOUNDING Modern mailorder plan brings quick profits. Darrah, Orono, Me.

FREE Literature. Hundred money-making ideas. Wolf's, 3240 Glenview Street, Philadelphia, Penna.

EARN More money. Hundreds of live business and manufacturing propositions. Free booklet. Charles Service, 117 East Second Street, Girard, Ohio.

LATEX For making flexible rubber moulds. Thoroughly tested. No shrinkage. Complete instructions with each order. Stoneham Rubber Co., Box 244, Stoneham 80, Mass.

\$5,000 YEARLY Possible, selling books by mail. Distributors proposition. Nichols Publishers, Box 831, Pine Bluff 1, Ark.

MEN — Women — "Everybody Likes Candy." Learn to manufacture professionally at home. (Our 35th year.) Ragsdale Candies, East Orange 2, N. J.

HIGH School seniors: Make good money selling our graduation name cards. Biggest commissions! Season starting. Hurry! Craftcards, Box 235(AL), Pittsburgh, Pa.

WANT More money—better job? Scientific way, using basic principles explains exactly how to get what you want. Details free. Kindig, 1629 Vine St., Philadelphia 3, Penna.

START Home business making statuary, plaques, novelties, garden furniture, artificial marble flooring, liquid marble. Make your own flexible molds. Amazing profits. Folder free. Creative Publishers, Box 236-L, Winnetka, Illinois.

WE Start you in business, at home, sparetime, earning \$10-\$30 weekly selling by mail. Stamp appreciated but not necessary. Driscoll Sales Service, Box 2771-A, Denver, Colo.

START Profitable home business now; capitalize spare time; free details. Manhattan House, 126 Lexington Avenue, New York 16.

FREE Valuable money-making self-help books. For particulars write, Mae Specialties Company, P.O. Box 23, Station L, New York 35, New York.

SPARE Time mail business earned \$1400 monthly. Copyrighted instructions \$1.00. Wm. Boyd, 331 Fourth, Pittsburgh 22, Pa.

INCORPORATE Your business. Delaware laws. Many advantages, free details. Tax Research Bureau, Inc., Delaware Trust Building, Wilmington, Delaware.

RUBBER Moulds for casting novelties. Latex for making moulds. Use thoroughly tested and approved products. Eastern Latex Laboratories, Box 153, Mattapan 26, Mass.

SELL Exclusive books of instruction by mail. Assorted subjects. Popular prices. 70% profit. Rush name for sample imprint circulars and full details. Financial Education, 404F, Mack Bldg., Denver 2, Colo.

SELL By mail with Elfco Ready Made Circular Service! Large profits! Catalog free! Elfco, 434 North Wells, Chicago 10.

AMAZE Others. Add columns instantly. Add faster than adding machine. Free details. Math Institute, Box 633, Mobile 4, Ala.

WORK For yourself. Your own business. Operate entirely by mail—direct from your home in spare time. Few dollars starts you. Literature free. Albert Wilcox, PM21, Nicholls, Georgia.

NEW Flexible mold material, casts catalin plastic, concrete, plaster, in same mold. Literature. Sanflex, Box M, Clyde, Ohio.

FLORIDA Opportunities—Pensacola offers exceptional opportunities for small industries, especially in the field of mahogany novelties and woodware, perfumes, soap, chemicals. Delightful year-round climate. Wonderful fishing, hunting, beach sports. For information write: Industrial Development Division, Municipal Advertising Board, Pensacola, Florida.

BUILD Own business mailing penny post cards; six profitable plans with information for starting. Gordian Publishers, Box 23, Pawtucket, R. I.

"HOW To Make Simple Molds and Plaster Plaques." Profitable business or hobby! Instructive booklet 25c. Plastercraft, 1406 East 43rd Street, Cleveland 3, Ohio.

"10,000 ALASKA Fishing jobs." Alaska's largest industry regularly employs thousands of men and women in seafoods production. Possible earnings up to \$5,000 in few weeks. Authentic 7,000-word copyrighted report gives job information, union requirements, sample application letter, names and addresses over 40 Alaska fisheries. Newest edition includes similar information on California, Oregon and Washington fisheries. Vital facts for immediate application in a permanent industry. \$1.00. 7-day refund privilege. Pacific Industrial Research Bureau, Dept. PM-9, 202 Studio Building, Portland 5, Oregon.

MAKE And mold genuine plastics. Forty illustrated work-sheets explain methods, processes. Authentic-simplified \$1. Free circular. Plastics Digest, 3937B Tracy, Kansas City 4, Mo.

START Profitable sideline business now! Complete free details and premium offer available. Write Sheboygan Publishing Co., Sheboygan, Wisconsin.

RECAST Old batteries into new. Latest achievements. Battery Laboratories, Minneapolis.

\$25 WEEKLY Working two hours daily. No canvassing. No manufacturing. Lycke, Box 2471, Cleveland 12, Ohio.

TYPEWRITER Repairing — Original course, simplified home study. Weber Typewriter Mechanics School, Box 269, Osborn, Ohio.

QUICK Money! "Repairing Car Batteries." At home. Easy too. Write Batteryman, 901 South Avenue, Grand Junction, Colo.

START Mailorder bookshop—Everything furnished; publisher cooperation. 25c brings booklet, exclusive setup, samples, exciting ideas. General Publications, Ossining, N. Y.

BECOME An "Attritionist Masseur." First improvement over Swedish massage in 100 years! Results unbelievable! Dr. Swearingen, 9123M, Station S, Los Angeles.

COLORGLAZED Concrete pottery made without molds. New, low cost, patented method. Cemetery products, novelties, tiles, floors, etc. Basement leaksealing. Other moneymaking projects. Booklet, details free. Men only. National Potteries Company, Fergus Falls, Minnesota.

BIG Money making Hollywood style pottery, bird baths, wishing-wells, benches, stucco-rock. New method. Clever designs. Color with chemicals, water-paints. Marbling, colored glaze effects. Dime brings samples, pictures, literature. Hollywood Cementcraft, 8527 Wonderland Ave., Hollywood 46, California.

HOW And where to obtain capital. Fully explained. Particulars free. Star Service, Wapakoneta, Ohio.

LIQUID Marble; snow-white, multi-colored. Glazed. Unglazed. Composition flooring. Lifetime wear. Any color. No priorities. Flexible molds. Plaster casting. Get into the big money now. Full information given free. Write Compo-Tex, Box 786-R, St. Louis, Mo.

BRUSH Plating outfits connect to a battery. No tanks necessary. Good paying business at home plating autoparts, bathroom fixtures, bicycles, reflectors, silvering mirrors. No shop or experience required. Outfits furnished. Free booklet. Gunmetal Co., Ave. H, Decatur, Ill.

AGENTS—To mail our literature. Good profits. Home business. Maywood, 1133 Broadway, New York.

RAISING Canaries pays good profits. Valuable bird book—"Its Care, Breeding and Training." Price \$1.00. American Canary, 2839 N. Halsted, Chicago.

EXPERT Shoe fitting learned quickly, inexpensively. Pleasant, profitable work. Details free. Mountain, Pisgah, Alabama.

MONEYMAKING OPPORTUNITIES

MECHANICALLY Inclined men — Own and operate general appliance repair shop. Complete, illustrated course shows you how. Welding, refrigeration, motor repair, how to get business, etc., all phases covered. Free literature. Christy Supply, Dept. 1161, 2835 N. Central Ave., Chicago.

PROFITABLE Mail order business. Small capital start. Over 135 successful plans. Stamp brings literature. Kessler National Service, Box 392-PMF, Indianapolis 6, Ind.

ENORMOUS Profit — making candied fruits and popcorn. 28 varieties. Formulas \$1.00. LaPlant, Menominee, Michigan.

WANT Financial independence? I've helped thousands. Dr. Tibolt, 61M, Philadelphia 20.

OPERATE Your own credit-collection agency business; many earn \$5,000-\$10,000 upwards annually; investigate Educational Extension Service advertisement under Business Opportunities.

NOVELTY Manufacturing offers splendid opportunity to start profitable business. Large market. Manufacture wall plaques, book ends, etc. Many started in garage or basement now have people working. No machinery or molds to buy, easily learned. Successful manufacturer tells how. Literature free. Plastex Products, 127 Clement, San Francisco 18, Calif.

WHAT Makes you think you couldn't sell by mail? We're doing it, happily! New! Different! Exclusive! Alive with money-making opportunity. Full particulars free. Investigate! Compare! The What-to-Do Shop, Box 1082, Tacoma, Wash.

START Your own business! Big money—manufacturing novelties, plaques, statuary. Free catalog. Write—Bing Products, 88-AE Broad Street, Boston 10, Mass.

BUSINESS Plans illustrated. Proven moneymakers for operators from coast to coast. Write for proof. Wilkin & Company, 118½-PM E. Main, Hillsboro, Ohio.

THOUSANDS Articles wholesale. "Supply Source Directory" 10c. Ideal Service, D-2, Park Ridge, Ill.

EARN Money at home by mail. Many opportunities, large magazine, 10c. Thomason, 857-m East Jessamine, Fort Worth 3, Texas.

BIG Jack-pot package, redhot mailorder plan, 25c. Baucom, 1411 So. First, San Jose, Calif.

MAKE \$5 To \$15 daily at home. 24 tested ideas 10c. Dickey's, 4304-A Maryland, St. Louis 8, Mo.

GET Rid of money worries. Instruction books, manufacturing formulas lead to moneymaking and a business of your own. Our free circulars G-16 will interest and benefit you. "The Guild," 2726 Holland Avenue, New York 67, N. Y.

FORTUNES Are started by mail and in homework by ordinary people without previous experience. Full or spare time, small initial investment. Free literature explains how you can start quickly, easily! Post-cards welcome. Upham and Son, 939 Ravine Drive, Cleveland 12, Ohio.

QUICK Returns. Sharpening razor blades. Custom and salvage resales. Equipment \$85 to \$200. Keil, 822 West Fourth, Erie, Penna.

10c INCLUDES Your name in numerous mailing lists for opportunities, moneymaking offers, magazines. New Age Enterprises, 578-A Prospect, New York City 55.

NAMES Of 150 new mothers, \$1. V. Matosh, 7653 Reuter, Dearborn, Michigan.

BUY Direct—Anything. Hundred different lines. Wholesalers. Dime brings catalog. Schuster, Box 3936, Cleveland 20, O.

WONDERFUL Opportunity, for success and greater earnings in a business of your own, in your own home. Small capital required. Write today for free illustrated literature. Joseph Russell, 79 Columbia Ave., Cedarhurst, N. Y.

I MAKE Plenty. Am my own boss. My booklet showing how sent for 25c. Cash in, too. Commonwealth, 5708-P2 Carothers, Cincinnati 27, Ohio.

FREE Literature upon request, describing many moneymaking plans. Island Mail Service, Box 162, Jamaica 4, New York.

MAKE Up to \$10,000 and more a year. Enter a new profitable professional business in 60 days. Small investment. Suite 844, Dept. H, 127 North Dearborn St., Chicago 2, Ill.

1,500,000 ARTICLES Wholesale! Free directory! Miceli, 412 Massachusetts, Buffalo 13, New York.

EARN Money at home! "Cash In" tells how. Copy, with latest mail order magazine, 25c. Mailmart "M," Box 403, Indianapolis 6, Indiana.

GREETING Cards, novelties, stationery, gift wrappings. 4154g Fifth Street, Philadelphia 40.

GREAT Moneymaking opportunities. Start mailorder business of your own, spare time, make money. Write no obligation. A. Rieder, 93-20 71st Drive, Forest Hills, N. Y.

I MADE \$1000 from 1000 tomato plants using my unique methods. Detailed instructions, \$1.00. Money back guarantee. Alfred Dinsmore, Marlborough, Mass.

FASCINATING Mailorder ideas, schemes. Plenty moneymaking opportunities. Warco, Freeland, Mich.

CO-PUBLISH Mail buyers directory for profit, prestige. Sample, details, 25c. Mailmart "M," Box 403, Indianapolis 6, Indiana.

300 MONEYMAKERS, 62 Pages, plans, formulas, 25c. F. Larson, Galeton, Penna.

"HOW To Sell By Mail" 25c. 40 mail-order subjects. A. Rieder, 93-20 71st Drive, Forest Hills, N. Y.

AMATEUR Or advanced cartoonists and artists, cash in on your ability. Write Hamilton, Box 4 KA, Woolsey Sta., Astoria, N. Y.

BOOKKEEPERS — Interested in more money spare time. Postwar opportunity. Journeay, 1003 Fourth, Orange, Texas.

READ "How to Go into Business for Yourself." 64 pages of eye-opening information. Rush one dime. George A. Simon, 6843 Jonathon, Dearborn, Mich.

"HOW To Make Money with Big Mails" booklet 25c. Frank J. Artz, 1060p Harding Drive, Toledo 9, Ohio.

MAKE Fast-selling novelties with colorful plastics! Free details. Beginner's jewelry kit and instructions, \$1 (refundable). Plastic Works, 712 Kimball, Danville 3, Illinois.

\$1 MATERIAL Brings \$20.00. Unlimited possibilities with concentrate cosmetics. 50c value sample 10c. Money back. Kohen, 506 W. 45th, Chicago 9.

FORTIFY The future! Start own business; home, office. Booklet describing "Collection of 137 Tested Plans" free. Elite Co., 214 Grand St., New York 13.

GIGANTIC Mails — trade magazines — name listed 25c. Jackson, Newfoundland 3, Kentucky.

MONEY Made office, home or room. 10c brings envelope opportunities. Bargain Specialty Company, Box 635C, Modesto, California.

10c BRINGS You lots of mail. Catalogs, magazines, money making ideas, samples. Gardenville Publishers, Gardenville 1, N. Y.

FREE Literature. 200 moneymaking ideas. No investment required. Send post-card now. Lynch, 402-PM Hazlett, Baltimore 29, Md.

LEARN Battery repairing, rebuilding. Engineer offers money making methods. Battery Bureau, 2225 North 44th St., Milwaukee, Wis.

EARNINGS \$2,000 Year easy; inventing simple items for special cash markets. Ideas only. No patents. Write, Hendrickson, Argyle 7, Wisconsin.

BIG Profits. Manufacture custom arch supports. Jul Corssen, 2638 Geyer, St. Louis 4, Missouri.

MAN, You'll like silvering mirrors, reflectors! Making sparkling chipped glass nameplates. Outfit prices. Sprinkle, Plat-er, V80, Marion, Indiana.

WHOLESALE Catalog, directory 10c. Hundreds of thousands articles. Stafford, Sunnyside-PM, Indianapolis 44, Ind.

YOUR Big mail order opportunity—No time has ever been as good as right now. Get your start right. Let me show you how, what to sell and who will buy. Big profits, easy work at home. Write: H. S. Smith, 3139A So. Mabbett Avenue, Milwaukee 7, Wisconsin.

PUBLISH Your own magazine. Hand-some 52 page format, well edited, illustrated. Cost low as \$1.00 month. Brings you prestige, profits, 25c brings sample. details. National. Ord. Nebr.

THOUSANDS Of alarm clocks need repairing. Jewelry stores swamped. Our simplified course teaches you how to repair these clocks. Necessary tools and supplies furnished with course. Alarm Clock Repair Service, Dept. B, P.O. Box 1983, Houston, Texas.

I MAKE Big money in the mail-order business. You can do the same at home with my copyrighted system. Write me. I'll tell you how. F. Little, Box 8, Glen-shaw P.O., Pittsburgh, Penna.

LEARN Metascience. Remarkable drug-less healing. No manipulation. No apparatus. Unbelievable simplicity and results. Inexpensive correspondence course. Write Metascience, De Land, Florida.

FORMULAS, PLANS, ETC.

AUTHENTIC Formulary. 924 page illustrated book. 10,000 scientific formulas, recipes, secrets, instructions for most any product. Countless profitable business opportunities, including D.D.T., new insecticide. And our new book: "The More You Know the More You Can Earn." \$2.98 postpaid (c.o.d. U.S. only). Foreign \$3.25 delivered. Adams Brown Company, Dept. 364, Chestnut Hill 67, Mass.

"LUMINOUS Paint," resilvering mirrors, 100 other formulas—50c. D.D.T., insecticide \$1.00. Soap making, (20 formulas) \$1.00. Ideal Service, 302 Park Ridge, Ill.

AUTHENTIC, scientific formulas. Large profit-bringing book. Rare bargain. Thousands of formulas. Reliable. Complete instructions for most any product. Free literature, or sent direct for \$1.49 postpaid. Foreign \$1.75. Ritt & Ritt, 112-A 9th Ave., South, Nashville 3, Tenn.

MANUFACTURE Fast-selling Products yourself. Bubble blowing liquid \$1.00. Formula catalog free. Kemico, Park Ridge (16), Ill.

BUBBLES, Bubbles, bubbles. That amazing liquid causing national sensation. Complete formula, and source of supply, \$5.00. Certified check or P.O. money order. Millions bottles sold. N. P. Woodward Co., New Castle, Penna.

FIFTY Formulae, recipes for one cent. Details free. Pauline, 924 Southern Blvd., New York City 59.

FORMULAS: 15 Proven moneymaking formulas \$1.00. (Not stock-formula catalogue stuff), real unusual offers. List free. Marvel Laboratories, 6629 No. Maplewood, Chicago.

10,000 AUTHENTIC Scientific formulas, secrets. 924 page illustrated book. Countless profitable, tested business opportunities. Latest discoveries! Genuine bargain! \$2.49 postpaid (C.O.D.—U.S.A.) Literature free. Continental Publications, 79-02m Woodside, Elmhurst, New York.

MONEY Making ideas and trade secrets. Over 900 pages of scientific formulas, recipes, moneymaking ideas and trade secrets. Thousands are using this book as a starter for new business. Find your fortunes in this, cloth bound, fully indexed book for only \$2.98 postpaid or C.O.D. Act now. Jordan's, 3116 N.W. 27th, Oklahoma City 7, Okla.

MANUFACTURE New products inexpensively. Free literature. Commercial Projects, St. John 2, N. B.

NEED Chemists? Formulas. Analyses. Ideas. Consulting Scientific Company, Swarthmore, Pennsylvania.

REAL Manufacturing formulas. Lists free. Cummings, Chemist, Gordon Ave., Syracuse, N. Y.

FORMULAS — Latest, best. Analysis. Literature free. Belfort, Engineering Building, Chicago.

PLASTICS

PLASTICS, Catalin, Plexiglas, Lucite, Bakelite and others. Dyes, cements, supplies, etc. Novelty shaped rods. Free project suggestions, illustrations and instructions with our price list only 10c. Send for yours now. Douglas Home Craftsman, Box 34B, Stamford, Conn.

PLASTIC Sheeting 90c yard, beauty capes, aprons. Beautiful free circular. 10,000 uses. Pernal, 12449 South State, Chicago 28.

PLEXIGLAS And Lucite Kit Assortments, including cement, working drawings, instructions. 1 pound \$1.25; 6 pounds \$5.00; 25 pounds \$18.75. Masked sheets 12x12— $\frac{1}{8}$ " \$2.50; $\frac{3}{16}$ " \$2.75; $\frac{1}{4}$ " \$3.00. Plexiglas rods: 24"— $\frac{1}{8}$ " \$c— $\frac{1}{4}$ " 15c. Lucite rods: 23"— $\frac{3}{8}$ " 40c; $\frac{1}{2}$ " 65c; $\frac{3}{4}$ " \$1.25; 1", \$2.25. Lucite tubes: 26"— $\frac{1}{2}$ " \$2.45; 2", \$2.95; 3 $\frac{1}{4}$ ", \$4.75. Six ounces Plasti-set fast-drying cement, \$1.00. Eight ounces red, blue, yellow, gold, green dye, \$1.00 each. Please remit with order. Add 10% to cover postage. Satisfaction guaranteed. Carmen-Bronson, 165 East Third, Mount Vernon, N. Y. Dept. 2-B.

ONE Hundred twenty eight page complete illustrated instruction book chock full of ideas and projects in all plastics now given with Kosto Plasti-Kit Number Three postpaid \$5.00 in U. S. Kit contains lucite, plexiglas, catalin, dyes, solvents, cements, polishing materials. Now ready. No waiting. Kosto Plasti-Kits, 3263 M Street, N.W., Washington 7, D. C. Dept. M2.

LUCITE, Sheets, rods, tubes, kits, tools, bearings, brazing wire, flux, drill rod, etc. Catalogue 10c. Metiplas Supply Co., 1420 So. 16th, Maywood, Ill.

COLOR Your lucite-plexiglas. Complete color range. Simply dip, rinse, wipe dry. Six bottles with instructions \$2.00. Quantity prices. Cardinal Chemical Co., 98 Olean, Rochester, N. Y.

ASSEMBLE Lucite gifts. Ideal home business or profitable side-line. No tools necessary! Everything furnished! Big demand. Illustrated catalog with list—25c. Plastic Products Co., Box 384H, Massillon, Ohio.

LUCITE—Complete supplies. Price list, instructions free. Lucite sample 35c. Maurice Lannon, Postoffice Box 686, North Hollywood, Calif.

CHEMISTRY

WINN'S New idea champion chemical-kits, apparatus-outfits and supplies for students home experimenting. (Established 1931.) Send 10c for catalog. John H. Winn, 124 W. 23rd St., Dept. 502, New York, N. Y.

CHEMICAL And apparatus catalog 5c. Arc Chemical Co., 1910 Arthur Ave., Bronx, N. Y.

APPARATUS, Chemicals, ounce quantities, catalog 5c. Fleischer's Laboratories, Everett 49, Mass.

SEMI-TECHNICAL Chemistry brochures. Literature free. Lankton, 310 Westmoreland, Lansing 15, Mich.

HANDBOOK For chemical experimenters, illustrated, hundreds of experiments, 50c. Experiment booklet 15c. 1946 chemistry catalog 5c. Reading Scientific Company, Reading, Penna.

FREE Catalog, Chemistry, mineralogy, biology, optics. Tracey Laboratories, Evanston, Illinois.

NEW 36 Page chemical apparatus order book. Complete line of chemical glassware, apparatus and chemicals. Send 10c for this book. Standard Science Supply Co., 1232 N. Paulina St., Chicago.

CHEMICALS And apparatus for industrial, analytical, and private laboratories. Complete supply service for correspondence school students. Send 3c for catalog. Dept. M-43, Biological Supply Co., 1176 Mt. Hope Ave., Rochester 7, New York.

SPECTROSCOPE For quick chemical analysis \$2.50. Kutting Sons, Campbell, California.

LABORATORY Supplies at wholesale prices: Chemistry, biology, physics. Catalogue 10c. National Scientific Co., 2304 W. North Ave., Chicago. Established 1908.

HELP WANTED

OPPORTUNITY Of lifetime supplying DDT and other profitable products to farmers. No experience or capital required. Must have auto and good references. Permanent. Write or wire McNess Company, Dept. 712, Freeport, Illinois.

WANTED: Experimenters to work with jet propulsion. Write for free literature. Shea, 374 Grant, San Lorenzo 11, Calif.

DO You want agents for your proposition? Your ad in this space will place your message before hundreds of men seeking fast-selling products. My folder "How to Secure Agents" is filled with proof. I'll gladly send you a copy free. F. W. Johnson, Manager Classified Advertising. Popular Mechanics Magazine, 200 E. Ontario St., Chicago.

AGENTS WANTED

EVERYDAY Cards. Earn big money. Take orders galore from friends. 21 French folders with tricky, appealing designs for \$1. Costs you as low as 50c per box. Also new beaded everyday boxes, birthdays, convalescent, everyday gift wraps. Send for samples on approval today. Sunshine Art Studios, 115 Fulton St., Dept. EE2, New York City.

\$1 STARTS You in business. Sell deluxe five fold ties. 100% wool interlining. Cost you only \$7 per dozen, you make \$5 dozen. Send \$1.00 for special introductory offer two five fold ties. Catalog complete line free. Phillip's Neckwear, 20 West 22nd St., Dept. K-24F, New York 10.

BUY Unpainted wall plaques. Decorate and sell locally. Good profits. Small cost. List free. Samples \$2.00. Pioneer Plastex Art Products, Austin, Minnesota.

SILVER Plating liquid. (NuSilver trade mark.) Apply with a cloth. Simply rub-on with a saturated cloth, dry-off and buff-up bright with a dry soft polishing cloth. All done in 1 minute. It cleans, silverplates and polishes from the one application. Easily done at home or in the office by anyone. NuSilver Plating Liquid is a more than 50% ($\frac{1}{2}$ plus) genuine U. S. government treasury department domestic silver solution, 1000 fine (pure silver), sterling. It renews all sterling and plated silverware. It also silverplates onto brass, copper, bronze, zinc, nickel-silver, german-silver, and some other composition metals. Over 100 uses listed to date. NuSilver is a permanent lasting finish. Won't wash off. Won't brush off. Won't boil off. Once applied as directed it is there to stay. NuSilver Plating Liquid is a widespread and intensive seller. Working sales distributors are wanted for areas not now being worked. Easily sold to merchants in dozen lots by a sales set-up which furnishes free printed guarantees, printed advertising leaflets and one store counter display card for each one dozen, any kind of a store or business place can sell NuSilver. Any kind of an average distributor-Salesman can sell NuSilver. You sell, deliver and collect your big cash profits as you work. Details by letter-mail. For U.S.A. territory only. Can sell both wholesale and retail, and to jobbers, or any way you like. NuProcess Products Laboratories, Dept. 206, Aurora, Ill.

FASCINATING Year 'round income building plan. Take easy orders from friends, fellow workers, church organizations for 10 fast selling greeting card assortments. Sell for \$1.00 each—cost you 50c up. Extra bonus. Experience unnecessary. Request foremost \$1.00 All Occasion box on approval, free Correspondence Notes samples. Special offer. Bluebird Studios, Dept. 16-D, Fitchburg, Mass.

CALL On friends with greeting card assortments; Easter, birthday, other occasions. Personal stationery; gift wrappings. Big profits. Experience unnecessary. Samples on approval. Wallace Brown, 226 Fifth Avenue, Dept. B-4, New York 10.

AGENTS Wanted for all states, sell new and original copyrighted business forms, cards and certificates. Large repeat business, liberal commission, no investment. Write Keirstead, 3541 North Meridian St., Indianapolis, Indiana.

JUST Out! History of World War II. Huge volume. Popular price. Authentic text. Official photographs. Big profits. Riverside Book Company, Iowa Falls, Iowa.

SELL Ultra-blue store stock signs. 35c sellers. Cost 5c-\$1.00 brings 15 samples postpaid. Lowy, 8 West Broadway, New York, Dept. 270.

PERSONALIZED Honor scrolls. Big profits. Free details. Ropicki, 5117 Roosevelt, Philadelphia 24.

STRANGE "Dry" window cleaner. Sells like wild. Replaces messy rags, liquids. Simply glide over glass. Samples sent on trial. Kristee 122, Akron, Ohio.

200 MONEY Making plans. Formulas. Schemes. Free folio. Formico Service, Box 572, Dayton, Ohio.

FREE Wholesale catalog hard to get merchandise. American Merchandising, PM-3, 703 Vandiver Building, Montgomery, Alabama.

90c PROFIT Each \$1 sale. Sell permanent mothproofing solution to housewives, stores, agents. Experience unnecessary. Postal brings details. Kinford, Wayne 3, Penna.

LANOLA Shampoo and other cosmetics. Large profits. Progress Products, 9465 Charest Ave., Detroit 12, Mich.

AGENTS, Distributors, wanted! Sell "Silverene," sterling silver plating liquid. Details. Rabiro Products, 228P, East 2nd Street, New York 9, N. Y.

NEW Year 'round extra money plan. Show friends exclusive greeting card assortments. Up to 100% profit. Request all occasion \$1.00 assortment on approval. Also show birthdays, social notes, gift wrappings. Free sample personalized stationery. Thomas Terry Studios, 29 Union Ave., Westfield, Mass.

SELL Greeting cards. Easy money showing gorgeous all occasion, birthday, religious, humorous, Valentine, Easter box assortments. Wrappings, stationery, correspondence notes. Special offers. Experience unnecessary. Quick service. Request \$1.00 everyday assortment on approval. Hedenkamp, 343 Broadway, Dept. PMF, New York 13, N. Y.

SCHOOL Seniors! A postal will bring you our Kwick-Sell Cardalog of graduation name cards. Hot selling everywhere! Big profits! Hurry! Craftcards, Box 235 (L), Pittsburgh 30, Pa.

WE Pay you \$25 for selling fifty \$1.00 assortments birthday, all occasion cards. Tremendous demand. Sell for \$1.00—your profit 50c. It costs nothing to try. Write for samples. Cheerful Card Co., 57 White Plains, N. Y.

SCHOOL Seniors! Sell classmates superb Craftcards for super profits. Write Craftcards, Box 235-AK, Pittsburgh, Penna.

AGENTS—Big money for men, women, boys, girls—selling gorgeous night-glowing orchids, gardenias; perfect imitation real flowers; last for years; all the rage for wear on hair or clothes. Write for wholesale prices. Marney's, Dept. M-1, P.O. Box 581, Ogden, Utah.

25 WAYS To make money with Luminous Paint (shines in dark). Rush 25c for profitable details. Lite-Saver, 97C, Saybrook, Connecticut.

MAKE Money at home by mail. Complete set-up. Send 25c—refundment. Business Plans Foundation, Box 56A, New York 10, N. Y.

SELL New-Used clothing from home, auto, store. Mens suits \$1.17. Leather Jackets 85c. Overcoats 62c. Dresses 17c. Ladies coats 38c. Other bargains. Catalog free. S & N, 565A Roosevelt, Chicago.

MEXICAN Feather pictures. Unusual novelty. 50c (stamps) bring \$2.00 worth samples, details. Refunded if unsatisfied. Aztec Art, Apartado 762, Mexico City.

UP To 100% profit selling friends sensational \$1.00 all occasion greeting card assortment. Costs you 50c up. Birthday, baby, gift wrapping, humorous, scripture boxes 35c up. Extra bonus. Request \$1.00 box on approval, free personal stationery portfolio. Special offer. Elmira Greeting Card Co., M-58, Elmira, N. Y.

AGENTS! Register your name, address with us and receive latest mail order propositions. Free listing. Mail-Way Agency, 10P-620 William Ave., Winnipeg, Manitoba, Canada.

NEW Offers. Write Box 61, Times Square Station, New York 18.

PEARL Earrings women prefer. Assortment popular sizes. Sterling silver mountings. \$1.00 retailers. Individually carded. 36 pairs \$10.00. Specialty Wholesale, 535 S. Franklin, Chicago.

BALLOONS Are made again. Millions kids, stores, night clubs waiting. Write Unger Novelties, 567 Harrison, Chicago, Ill.

INGERSOLL Dollar stropper — New available. The famous Ingersoll stropper with the barber's stroke. Two types, double edge and single edge. Sells for \$1.00 each. Samples of both with particulars to agents for \$1.00, postpaid. Ingersoll Stropper Co., Dept. C, Union City, New Jersey.

MAKE Quickmend solder 1c stick, sensational demonstrator, mends with match. Sample 25c. Manufacturing outfit \$25.00. Western Chemical, Salem, Oregon.

SELF Expansion men's wrist watch bracelets. Stainless steel. Sample \$1.50 c.o.d. United Watch Company, Saint Cloud 5, Minnesota.

HARMONICAS \$10.80 Doz. \$21 doz. Harmonica Wholesalers, 2 E. Centre Street, Baltimore 2, Md.

COSTS 4c, Sells 25c. Immediate demand. Big repeater hose preservative. Sample 25c. Details free. Lyle Products, 5 E. Spaulding, Willoughby, Ohio.

137 COMPLETE Plans for starting own business: local—mail order. Particulars free. Elite Co., 214 Grand St., New York 13.

SELL Spac-Saver clothes rack for closets. Fifty-two inches hanging space on twenty-two inches. H. and H. Products Co., Arkansas City, Kans.

BIG Profits, packaging, distributing amazing cleaner, Steady repeater. Everything furnished. Sample 25c. Linnell Co., Box 1720, Cleveland 5, Ohio.

LUMINOUS Pictures that glow in the dark. Large manufacturer wants factory representatives; wonderful new item; fast seller; free sample. Madison Mills, 303 Fourth Ave., New York City.

\$7.50 START Engraving jewelry, leather, glass, cuts wood, plastic, etc. A.C. current. Bonomo, 25 Park St., Brooklyn, N. Y.

WHOLESALE. Cigarette lighters, flashlights, leather billfolds, tobacco pouches, etc. Write for illustrated price list. National Sales Co., 1319 Stone St., Dept. 113, Flint 4, Michigan.

MAGIC Cleaner and laundry soap deal. Hotter than a firecracker. Big profits. Sample free. Bestco, 5007 Irving Park, Chicago.

\$3 FIRE Extinguisher; quick sales, wholesale or direct; liberal profits. "Fire-Killer," 109 N. Franklin, Syracuse 1, N. Y.

BEAUTIFUL. Red, white and blue, stars and stripes, welcome home pennant, size 15"x35". Send 25c for 2 pennants and wholesale prices. Welcome Home Pennant Co., 30 W. Harrison, Chicago.

GREAT New money maker—Non skid checker board. New invention sells on sight. Checker clubs, train and plane riders, invalids, everyone. Checkers can't slide, fall off or skid. Play on any angle, anywhere. Pocket or regulation size. Details, sample \$1.00 postpaid. Side Line Sales Company, 59PM Congress Street, Hartford 6, Conn.

NOW You enjoy double profits selling Rukgleen and Mothtex Concentrates to homes, hotels, rooming houses, etc. Send for new complete offer. Tremendous profits. Year round repeat business. Products used daily in every home. The Russell-Johnson Service, Clarksfield, Minnesota.

SIMPLE, Dramatic demonstrations insure easy sales. Sensational \$3.00 fire extinguisher. Liberal discounts. Other products. Molonite Company, 5713 Euclid, Cleveland 3, Ohio.

SCHOOL Seniors—Sell classmates America's most beautiful, distinctive graduation name cards. Positively highest commission. Largest selection. Lowest prices. Free cards and sample kit. Printcraft, 1423 East Elm Street, Scranton 5, Penna.

GOLD Lacquered window sign letters. New foils, styles, absolutely beautiful. Free samples. Atlas, 7941 Halsted, Chicago.

WAR Honor scroll: All branches of service represented. 12 by 16. Space provided for name and photograph. Truly beautiful. Agents make big money. Sample 25c. E. Condon, Dept. 6, Upper Darby, Penna.

SELL "Petite picture notes." Something really different in greeting cards. Sample free. Dunbar Cards, New Brunswick 20, N. J.

AGENTS: Stamping names on pocket-key protectors. Sample check with your name, address, 25c. Stamping outfits, Emblem checks, check-fobs, name plates. Hart Mfg. Co., 303 Degraw St., Brooklyn, N. Y.

AGENTS—Big line including food products. Fast selling premium and bargain deals. Low prices. Send card for big outfit offer with gift. Ho-Ro-Co, 2768 Dodier, St. Louis 7, Mo.

BIG Profits taking subscriptions for all magazines. Agents' confidential catalog listing over 2500 periodicals and complete starting supplies free. Pines Subscription Agency, Flushing, New York.

WHOLESALE Sources. 500,000 articles. Free directory. Maywood, 1133 Broadway, New York.

EXCELLENT Sideline for printing salesmen. Decalcomania name plates in small quantities. Also, make money applying initials on automobiles. Free samples. "Ralco," X-164, Boston (18), Mass.

PLATING Outfits for autoparts, reflectors. Connect to a battery. No tanks necessary. Free booklet and particulars. Gunmetal Co., Ave. N, Decatur, Ill.

FREE Water and our concentrates, makes flavors, lotions, shampoos. 72 products, labels, bottles furnished. Qualco, E-20030 Russell, Detroit.

AGENCIES WANTED

VETERAN Interested in investing savings in novelties, gifts, jewelry, mail order business. Prefer exclusive agency. Mr. Alfredo Mendez, No. 25 San Pablo St., Mayaguez, Puerto Rico.

DISTRIBUTORSHIP Or agency wanted. Write 861-Station Place, Berkeley 6, Calif.

MAINE Veteran wants outstanding specialties for home, store and office. Mail order, direct and distribution in northern New England. Only new products considered. Jack Holmes, P.O. Box 902, Portland, Maine.

HIGH GRADE SALESMEN

SALESMEN, Experienced. Would you like to make up to \$75 cash commission weekly? Address Schutt Co., 244 East Ohio St., Indianapolis 4, Ind.

AMAZING New zipper shoe sells on sight. Big profits for salesmen. Leads line 200 splendid styles. Territories open. Get free sample outfit. Write Consolidated Shoe, Dept. S-150, Chippewa Falls, Wis.

DELUXE Plastic match drums sell fast. Free details. Zone Co., Delray Beach, Fla.

SELL To dealers. America's finest line counter-carded novelties and necessities. We show you how to make profits very first day. Highlander, Dept. 4B, 4613 North Clark, Chicago 40, Ill.

START Your own business on our capital. Always your own boss. Hundreds average \$6,000 to \$25,000 annual sales year after year. We supply stocks, equipment on credit. 200 home necessities. Selling experience unnecessary to start. Wonderful opportunity to own pleasant, profitable business backed by world wide industry. Write Rawleigh Co., Dept. B-U-PPM, Freeport, Illinois.

SALESMEN In every town to sell—History of World War II. Salary or commission. Great chance. Part or full time. No deliveries. Box 421, State College, Penna.

MAKE Money as I do. Geo. S. Parker, New Brunswick, N. J.

FREE! Latest issue Opportunity Magazine. Salesman's Guide. Inspiring, constructive. Shows how to earn money selling for others or in your own business. Hundreds postwar opportunities. Send name and describe what you have sold or are selling. Illustrated copy sent free. Opportunity Magazine, 620 N. Michigan, Dept. 17, Chicago 11, Ill.

\$4.97 PUTS You in lifetime business. Write Midwest Drug Co., Dept. 4, Columbus 15, Ohio.

EDUCATIONAL AND INSTRUCTION

MAKE Up to \$25-\$35 week as a trained practical nurse! Learn quickly at home. Booklet free. Chicago School of Nursing, Dept. M-2, Chicago.

"HOW To Break and Train Horses"—A book every farmer and horseman should have. It is free; no obligation. Simply address Beery School of Horsemanship, Dept. 1102C, Pleasant Hill, Ohio.

GOOD Jobs and a sound, substantial future await you in hotel and institutional field. Men and women—all ages—needed for well-paid positions that offer color, excitement, ever-new and fascinating duties. Record-breaking travel means even greater opportunities for trained men and women in hotels, clubs and institutions. Lewis School receiving calls for managers, assistant managers, stewards, hostesses, purchasing agents and 55 other types of important positions! From coast to coast there are important positions that offer splendid opportunities for advancement in a business where you are not dropped because you are over 40. Previous experience proved unnecessary! No need to leave your job to qualify. A good grade school education, plus Lewis Training qualifies you at home, in spare time. Our national placement Bureau helps to place you—and our amazing Certified Job Plan—actually guarantees you will "make good" when placed. Write today for free book! This course is available under government auspices to discharged veterans, if qualified under the G.I. Bill. Lewis Hotel Training School, Room HB-368, Washington 7, D. C. (First and only school of its kind—now in its 30th year.)

LEARN To be a landscape architect. Hundreds now manage own businesses as successful landscapers. Steady income. Home study course—45 beautifully illus. lessons. Course can be completed in 8-12 months. 29th yr. Send for free bklet. American Landscape School, 6338 Grand Ave., Des Moines, Iowa.

HAVE An office of your own. Learn collection agency business by correspondence. Many earn \$5000-\$15,000 annually. Write for free bulletin. Franklin Publishing Company, Roanoke 7, Virginia, Dept. PM.

"KNOW How" books. Courses. Fiction. Free catalogue. Baker, 5509-B Winthrop, Chicago.

INVENTORS: Learn now—without obligation—how to protect and sell your invention. Write for free "Record of Invention" form and complete information for making disclosure and establishing date of your invention. We also send our new free "Patent Guide for the Inventor," containing complete information about patent procedure and how to sell inventions; giving illustrations of many successful inventions; over 150 basic mechanical movements. We assure you prompt, confidential service. Delays may be dangerous. Write today for your free "Patent Guide" and "Record of Invention" form. Clarence A. O'Brien & Harvey Jacobson, Registered Patent Attorneys, 61B-A, Adams Building, Washington, D. C.

PATENTS. Promptness assured. Wilfred E. Lawson, 1524 K Street, N.W., Washington 5, D. C.

PATENTS Obtained; selling service, information, recording forms free. Labiner, World Building, New York.

C. A. SNOW & Co., M-427 Snow Bldg., Washington 1, D. C. Registered patent attorneys. Established 1875. Literature mailed on request.

FOR INVENTORS

EX-WAR Plants want new patented products. E. Galvin, 20 N. Wacker, Chicago 6.

We have buyers for practical inventions. Details free. Inventors Exchange, Dept. 5B, Hartford 1, Conn.

MAKE Money with patents: We combine and develop consumer values and sound commercial construction with effective patent values. Ideas, inventions and products improved for service and protection: patents obtained. Development Co., Patent & Development Engineers, 30 years experience: fees reasonable. 132 Nassau St., New York City.

INVENTORS—Information on what to do first toward securing a patent on your invention is of vital importance. "Patent Protection" and "When and How to Sell Your Invention"—two valuable, richly illustrated books—explain fully what to do first, and a lot more. Get this information quickly, together with "Evidence of Invention" form. All three will be sent to you free. Write immediately to Victor J. Evans & Co., Registered Patent Attorneys, 132-B Merlin Building, Washington 6, D. C.

WHERE Can you sell your ideas? Have you a new idea, an improvement, a device of utility or novelty? Want to know where to sell it? Learn the facts first about its patentability. We have letters from manufacturers wanting new patented ideas. The present emergency market has created a big demand. Get our free book, "How to Protect, Finance and Sell Your Invention." Also free special form "Invention Record." No obligation. McMorro & Berman, Registered Patent Attorneys, 134-G Atlantic Building, Washington 4, D. C.

INVENTORS: Your idea designed at a minimum cost to you. Gadget Designer, 725 Walnut, Room 23, Philadelphia 6, Pa.

BUSINESS Outlook demands new gadgets and ideas previously withheld due to war. We develop and market. Consult us now! Pyramid Consulting Engineering Service, 14257 Gratiot Ave., Detroit 5, Michigan.

A PERSONAL Knowledge of the fundamentals of the development and patenting of inventions is the inventor's best guarantee of the maximum reward. Write for information about our course "Patent Law for Engineers and Inventors." C. B. Proudfoot, 142 Wade Lane, Oak Ridge, Tenn.

INVENTORS: Learn now—without obligation—how to protect and sell your invention. Write for free "Record of Invention" form and complete instructions for making disclosure and establishing date of your invention. We also send our new free "Patent Guide for the Inventor," containing complete information about patent procedure and how to sell inventions; giving illustrations of many successful inventions; over 150 basic mechanical movements. We assure you prompt, confidential service. Delays may be dangerous. Write today for your free "Patent Guide" and "Record of Invention" form. Clarence A. O'Brien & Harvey Jacobson, Registered Patent Attorneys, 61A-A Adams Building, Washington, D. C.

INVENTORS—We will help you if you have a good idea. We supply the finances to patent your idea in your own name. You own the patent. We also arrange profitable manufacturing connections for inventions. Write without obligation. Patent Financing Corporation, 209H Hospital Trust Building, Providence 3, R. I.

INVENTIONS Developed, designed, promoted; models constructed, patent advice; reasonable rates. Free consultation service and literature. Invention Development, Dept. C, 7127 Van Nuys Blvd., Van Nuys, Calif.

I'D Like to show you how I've sold my inventions. You too can sell your invention before spending money getting a patent. No obligation. G. W. Pearce, Box 6, Swampscott, Mass.

DEPENDABLE Patent searches—simple inventions \$5.00. Protection form free. Write Raymond L. Smith, Patent Searcher, 410-M Bond Building, Washington 5, D. C. (Former U. S. Patent Office employee.)

INVENTIONS Having profit possibilities in demand by specific manufacturers, cash or royalty. Free descriptive booklet, protective disclosure form, references, and how to safely disclose an invention for sale, upon request. Invention Reporter, 5A-11106 So. Longwood Dr., Chicago 43.

I SELL Patents. Established in 1900. Charles A. Scott, 773PM Garson Ave., Rochester, N. Y.

HAVE Your idea or model developed now at pre-war prices. Forty years experience in developing, designing. Tool and die work. Inventors Laboratory, Madisonville, La.

RANDOLPH & Beavers: Registered Patent Attorneys, 11-E Columbian Building, Washington, D. C. In order to protect your invention and reap the reward that should be yours, patent your invention without delay, and at the same time have rights to sell as manufacturers convert to civilian production. Write for information and record form today.

CASH For practical ideas and inventions. Mr. Ball, AB-9441 Pleasant, Chicago.

PATENTED And unpatented inventions promoted. M. Joyce Humphries, 1424 Land Title Bldg., Philadelphia 10, Penna.

INVENTIONS WANTED

SELL Your invention, or design, now. Patented, or unpatented. Cash, or royalty basis. John D. & Son, 140 Spruce St., Box 3213, Bridgeport 5, Conn.

QUICKER! Results! Protect your invention with "Certi-Proof." Then manufacturers pay patent expenses, cash, royalties. \$1.00 postpaid. Warner Company, 1413 Great Northern Building, Chicago.

WANTED—Patented, unpatented inventions having profit possibilities, all kinds. If will sell, reply immediately. Descriptive booklet, references, free. Invention Reporter, 5B-11106 So. Longwood Drive, Chicago 43.

INVENTORS: Have you a sound, practical invention for sale, patented or unpatented? If so, write Institute of American Inventors, Dept. 4-D, Washington.

CASH For plumbing specialty inventions. Chicago Specialty Mfg. Co., 2954 Lawrence, Chicago 25, Illinois.

MANUFACTURER Desires postwar products to make and sell through drug, hardware, department stores and mail order. Or will handle sales only. Reputable, nationally-known organization capable of promoting nationwide sales as well as manufacture of items. Prefer non-electrical products of metal, glass, plastics, etc. Write P.O. Box 1373, Indianapolis, Indiana.

INVENTORS! Have you good patentable idea? Write Mr. Metzler, 11 West 42nd, New York.

CASH For inventions, patented, unpatented. Mr. Ball, A-9441 Pleasant, Chicago.

MANUFACTURER Wants sensible mechanical device or idea with quick sales possibilities in low-priced field. Write Matt, 1412-D Great Northern Building, Chicago 4.

PATENTS FOR SALE

TUBULAR Crutch. More comfortable, convenient. John Wheeler, 1433 Birch Street, N. E., Camas, Wash.

EARTH Tamper. Pat. No. 2,266,204. Three sizes in one. Will sell good. P.O. Box 88, Mt. Healthy, Ohio.

PATENT Pending sanitary milk bottle jar covers. Bakelite. Four outstanding kitchen uses. Millions sales prospect. Reputable manufacturers only! Sale, cash royalty. Wormull, 2 New York Ave., Bergenfield, New Jersey.

WANT—Automatic electric mouse trap manufactured on royalty basis. Box 363, Farmland, Indiana.

MANUFACTURERS. New self using electric hair clipper. Patent for sale, or royalty. Write Harry King, International Falls, Minn.

MANUFACTURING

INDUSTRIAL Diamonds mounted \$1.50 models, small lot manufacturing metals etc. Specialty Machine, 2821 Mitchell, Racine, Wis.

PLASTIC Fabricating—any item or quantity. Quick service. Plastic Products Co., Dept. M, Box 384, Massillon, Ohio.

MODELS—Small lot manufacturing. Metals, plastics, etc. Milburn, Burlington, Kentucky.

MODELS AND MODEL SUPPLIES

ORDERS From our catalog of 1000 listings. 10c brings catalog and used item list if you state your gauge. Some new tinplate and diecast items available. Expert repairing in all gauges. Trilor Hobbyist, State Road, North Dartmouth, Mass.

MARINE Steam engine models. Cigar box size. Double expansion, reversible, 7/8 horse. Fascinating building. Need only small lathe. Castings and drawings—single expansion, \$10; double, \$12.50; triple, \$16. List drawings all type boats, free. Laboratory Press, Groton, Conn.

BUILD Model gasoline engine. Castings supplied. Circular 10c. Roger Tully, 71 Chelsea Avenue, Newark 6, N. J.

HIGH Speed model steam engines. Descriptive literature 10c. R. Looker, P.O. Box 105, Michigan City, Ind.

SHIP And yacht model fittings and blueprints. Hundreds of items to choose from. Send 25c for new illustrated catalog. A. J. Fisher, 1002 Etowah Ave., Dept. M, Royal Oak, Mich.

BRASS Gears and model supplies for the inventors. Send 10c for catalog. Pierce Model Works, Tinley Park, Ill.

LANDLOCKED Sailors! Here's a beautiful, richly illustrated, fully descriptive catalogue of famous model ships—whalers, slavers, corvettes, etc., authentic in every detail. Send for it today. Only 10c. Marine Model Company, Inc., Dept. C-9, Halesite, Huntington, N. Y.

MODEL Kits and supplies listing 10c. Badger Hobbycraft, 2945 S. 46th St., Milwaukee 7, Wis.

MODEL Engines, aircraft, ship, army vehicle models. Catalog free. Hobby Center, 3324 E. Tenth St., Indianapolis 1, Ind.

WIZZ Electric motor: Assembles in a jiffy. Operates on flashlight cell. All parts complete. Instructions. Send 25c, plus 5c postage. Eltro, Box 171B, Deer Park, N. Y.

MODEL Airplanes, gas models, solid models, gliders, gas engines, ship models, supplies, tools. Send 25c (includes refund coupon) for 68 page 8 1/2 x 11 illustrated master model airplane and gas model catalogue. General Modelcraft Company, Dept. M-2, 91-17 173rd Street, Jamaica 3, New York.

SHIP Models and yacht supplies complete. Large 64 page catalogue 25c. Bill Wild's, 510 East 11 St., New York City.

RAILWAY Models, complete line, informative catalog, HO and O Gauge, 79 pages, 25c. Walthers, 247 Erie, Milwaukee, Wisconsin.

MODEL Engine catalog, railroad supplies, 25c refunded. Simonsen, A-3054 Greenview, Chicago 13.

BIG Illustrated model engine catalog 10c. Active Products & Supply Co., 53 W. Jackson, Chicago 4.

STEAM Engines, boilers, castings, blueprints, circulars 10c. Anton Bohaboy, 2297 Price, Rahway, New Jersey.

MINIATURE Steam locomotives, 1/4", 1/2", 3/4" scales. Castings, parts, rail! Thorough drawings with instructions. Catalog 25c. Little Engines, Wilmington, Cal.

CATALOGS (Illustrated) for modellers! Airplanes, 60 page book on solids. Features construction data, specifications, camouflaging, 15c; railroads: 128 page "HO" guide. Equipment, accessories, fittings. 25c (includes refund coupon). Send coin or stamps for each profusely illustrated catalog desired. Polk's, "Nation's Leading Hobby House," 314-PM Fifth Ave., New York City 1.

SHIP Model kits and fittings. Complete line Fisher model yacht equipment. All Boucher, Fisher, Marine Model and Ideal kits, fittings and blueprints at standard prices. Most complete stock in New England. Send 10c for price list. James Bliss & Co., Inc., 220 State St., Boston, Mass.

BOAT Models. P.T., cabin cruiser, speedboat. Free circular. All Star, 2003 Lincoln Ave., Chicago 14.

Would you
pay me 2¢ if I
made you your
OWN BOSS!



“I'm offering you 250 Money-Making
Ideas for a business of your own”

Do you want to go into business for yourself? What type of business should you operate? How, When, Where should you start? Now—you have the chance to get the answers to questions like these.

OPPORTUNITIES TO SHARE

By A. C. CHAPMAN

At last! Here is your opportunity to get a practical, complete, inside guide that will equip you to act intelligently and confidently to become your own boss. Right from the start, point by point, this remarkable, easily understood handbook tells you how to avoid the pitfalls, gives all the do's and don'ts, questions and answers you must know to become independently successful. Tells you what decisions to make and how. Weighs your chance of success. Outlines how to start on limited capital and grow into a successful businessman. Gives stimulating ideas on businesses of the future. Chapter—“How to Finance a Business” alone . . . worth price of book.

TELLS HOW TO

- Finance a business
- Make money with a movie camera
- Market your inventions
- Make a success of the retail business
- Start on the proverbial shoestring
- Take advantage of G.I. Bill of Rights
- run many other businesses

Hundreds of POST-WAR Opportunities

Never before has such a concentration of tested, simple facts been offered to help the beginner start right, develop fast, and avoid common errors that cause 90% of business failure. It's helped hundreds and can help you. You haven't the time or experience to dig out information like this—expertly compiled, organized, dramatized “Opportunities to Share” is ready now to work for you—but YOU MUST ACT IMMEDIATELY!

5-Day Trial Examination Offer

SEND NO MONEY. Mail name and address on a penny postcard. On delivery, pay postman \$4.98, plus C. O. D. charges. If you send cash we pay postage. Read and examine the book for 5 days. If by then you are not completely satisfied that it is the best investment you've ever made, return it and get your money back! If it can't help you, we won't let you keep it! DON'T WAIT! ORDER NOW!

The INVENTORS GUILD
2 East 39th St., Dept. 12,
Kansas City 2, Mo.



The INVENTORS GUILD, Dept. 12,
2 East 39th St., Kansas City 2, Mo.

Please send me your 628-page book “OPPORTUNITIES TO SHARE” with the understanding that if not satisfactory, I can return it within 5 days of delivery and my money will be refunded.

Please send C. O. D. I enclose \$_____

NAME _____
ADDRESS _____
CITY AND STATE _____

EASY to
PLAY

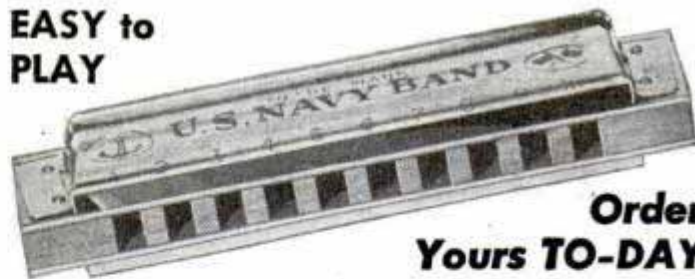

Order
Yours TO-DAY

The New Luellen HARMONICA

Most wonderful pocket instrument ever made is the harmonica. Easy to master, fun for Everyone. The Luellen has 10 holes, 20 notes. Key of C. Beautiful tone. Now ready. Postpaid Only..... **\$2.10**

INSTRUCTION BOOK. Simple for youngest child. No notes, scales nor exercises. Ten lesson charts show everything. Includes 75 popular songs. Price \$1.00. Here's our special introductory offer: The Instructor and the Harmonica, both postpaid, both for \$2.69. Send Check or Money Order Today.

JOHN LUELLEN & CO., 17034 Page Avenue, Dept. 203, Hazelcrest, Ill.



Selected Collection of WORLD FAMOUS MARCHES

FOR THE PIANO

Here is an outstanding collection of 20 world-famous marches, the kind you have always wanted, in ONE convenient volume arranged for about third grade. Among the stirring time-honored marches

included are "American Patrol," "Marine Hymn," "Under the Double Eagle," "American Legion March," etc. Send only 75c and this book of World Famous Marches will be sent postpaid. Satisfaction guaranteed or money back. Also send for . . .

FREE MUSIC CATALOG . . . containing over 1200 standard, classical and teaching pieces for piano, violin and voice.

McKINLEY PUBLISHERS, INC.
Dept. 3372, 425 S. Wabash Ave., Chicago 5, Ill.

WHEN YOU BUY FLASHLIGHT BATTERIES ASK FOR "EVEREADY" FRESH DATED BATTERIES

The word "Eveready" is the registered trade-mark of National Carbon Co., Inc.



Big Profit AUSTRALIAN WHITES

Sensational MONEY MAKING HYBRID. Customers report broilers 8 weeks, laying 4 1-2 mos. Disease resistant. **Hardy Layers.** 50,000 chicks weekly. Started pullets. Profit Sharing Plan. FREE Book. Write today. **GERRY BROS. FARMS, Box 582, ATCHISON, KANS.**



How to Make Money by Mail

Easy way to start new or expand present business. Expert, successful operating plan. No capital needed, no loans, sure cash profits. Facts and 44 years proofs. Particulars free. Write today.

HOWARD ST. HOUSE, Melrose 76-640, Mass.

Wonderful POULTRY BOOK

FREE LOW PRICES 48 varieties SEX-LINKED and PUREBREDS; BABY CHICKS, Pullets or Cockerels, also STARTED CHICKS, BABY TURKEYS, Mature Fowls and Hatching Eggs. **ALL FLOCKS BLOOD TESTED FOR BWD.** Write quick for this fine free book. **GREAT WESTERN HATCHERY, Box 15, Salina, Kans.**



52 BREEDS MRS. BERRY'S POULTRY BOOK

BERRY'S Champion-Mated, Hand-Picked CHICKS, also SEXED, STARTED. 52 Breeds. 7 HYBRIDS. All Iowa Inspected, BWD Tested. Over 400 Prizes—30 Shows! **LOW PRICES.** In Business nearly 50 years. Beautiful **POULTRY BOOK FREE,** stamps appreciated. **BERRY'S POULTRY FARM, Ex. 29, CLARINDA, IOWA**

See you saw it in Popular Mechanics!

USE THIS EASY, QUICK "BRUSH-UP" HELP

FREE TRIAL in Your Home.

Send No Money!

We Ship C.O.D. in U. S.
and Will Refund Money
if Not Satisfied.



ELECTRICITY AND HOUSE WIRING

Every type electric wiring job covered. Every material, equipment, code system fully explained. 227 illustrations show how to plan and make installations and alterations. Covers motors, motor winding and household appliance repairs. 200 pages. Book No. 1. \$1.50.

THE STEEL SQUARE

The only complete book on this basic tool. A practical and valuable guide in figuring carpentry. Over 300 illustrations. 500 pages. Book No. 2. \$2.00.



HELP YOURSELF TO TOP SUCCESS

YOUR PERSONALITY AND HOW TO IMPROVE IT

A practical and helpful book for men and women—for worker and employer. Developing your personality can be just as important to personal success as training your mind and learning skills with your hands. Making friends, getting along with people, influencing others pays off big. Get this helpful book by Dr. Lockhart and get the most out of your personality. Book No. 3. \$1.98.

DON'T BE AFRAID!

Learn how to get rid of the fears and emotions that hold you back. Learn how to banish personal worry and anxiety, fear and fatigue that can so easily keep you from being the success you want to be. Dr. Edward Cowles shows you how to do it in this practical self-helping book—how you can be happier, more successful—by following simple rules. Book No. 4. \$2.00.

RADIO SERVICING

New 6th edition (1945) of this famous Course Book. Teaches how to actually service all types of radio sets easily and quickly. Prepared by engineers and instructors of Radio Technical Institute. Paper covers, 8 1/2 x 10 3/4 inches. Get this book. 37 million radios to be serviced. Book No. 5. \$2.50.

REFRIGERATION SERVICE MANUAL

New 1945 book. Covers all types of household and commercial refrigeration with latest information on maintenance, trouble shooting and repair. Millions of refrigerators must be serviced. Make money with this book. 300 pages. Illustrated. Book No. 6. \$2.00.

MEASURING METHODS

To reach top pay jobs in all mechanical fields you must know methods of measurement. This book tells all. Packed with helpful pictures & tables. Mechanic's scale and protractor included—free. Book No. 7. \$1.98.

SIMPLIFIED RADIO SERVICING

Ideal for trouble-shooting, for home radio repair, or money-making radio servicing. Easily understood, yet comprehensive for the expert. Characteristic tables for all tubes. Profusely illustrated. Book No. 8. \$1.50.

PLUMBING

Installation and repair. Expert instruction enables inexperienced to plan and install simple plumbing and hot water systems according to good practice without violation of general regulations. 153 illustrations. 200 pages. Book No. 9. \$1.50.

BLUEPRINT READING

Part I, Instruction. Part II, Blueprints for reading, checking, testing. Separate answer key. Complete in 3 parts in portfolio. Best of all for self help and home study. Book No. 10. \$1.98.

Get Ready for BIGGER OPPORTUNITIES and BEST PAYING JOBS

Select from this list for best paying jobs in the top pay fields. Get the help you need from these proven books that thousands of successful men are using—that returning service men and others are depending on—to help them meet tough job competition. Men with some experience—beginners—you men who want to start your own business—this is your big opportunity. Act now. Order on coupon. Draw a circle in coupon around numbers of books you want. Money refunded if not satisfied.

SPRAY PAINTING

Industrial, Commercial. Easy-to-read, practical book teaches expert spraying technique for employment in industrial spray booths; interior, exterior decoration, sign shop, studio work. Book No. 11. \$1.50.

DIESEL ENGINES AND DIESEL ELECTRIC POWER

Complete, practical instruction on Diesel Engines and power equipment. Easy-to-understand language, illustrated by over 200 helpful illustrations of construction, operation, care, adjustment, etc. 308 pages. Book No. 12. \$2.50.

LIVING MATHEMATICS REVIEWED

Review of mathematics essential in business and shop work today—Arithmetic, Algebra, Plane and Global Geometry, Spherical and Military Trigonometry, complete exercises and answers. Book No. 13. \$2.50.

PRACTICAL PLANE TRIGONOMETRY

Quick reference for beginner and advanced student. Learn to apply trigonometry to everyday technical problems. Amaze others by your speed and accuracy. Book No. 14. \$2.00.

ARITHMETIC PRACTICE BOOK

New but proven method of reaching accuracy and speed in all arithmetic problems, now so essential for promotion and progress in all business and shop jobs. Separate answer book included. Book No. 15. 76 cents.

WEBSTER'S VEST POCKET DICTIONARY

New 1945 Edition. Contains over 25,000 words. Simulated leather binding. Size 3 x 5 3/4 inches. Improve your vocabulary and ability to spell as a sure help to success. Book No. 16. 75 cents.

WOOD FINISHING

Plain and decorative. Know how to handle all stains, colors, materials, mixing, brushing, rubbing, polishing, etc. Packed with proven formulas, best methods. 360 pages. Book No. 17. \$2.00.

SHEET METAL WORKER'S MANUAL

15 Comprehensive sections cover entire sheet metal industry from drafting to shop execution; welding processes, pattern making, etc. Metals and alloys, geometry. Useful tables. 552 pages. 375 illustrations. Book No. 18. \$2.00.

PLASTICS .. New Opportunities Everywhere!

Get "Plastic Problems and Processes" and get into this new big-money industry. Over 350 pages of practical and latest information on Plastics and how to use them. Covers design and tells how to make things that sell. Book No. 19. \$4.00.



ONE OF THE YEAR'S MOST HELPFUL BOOKS

SLIDE RULE Included

Don't wish you knew how to use a slide rule—get this book "The Slide Rule and How to Use It" and learn—quick and easy. Amazingly simplified. Anyone can master it in a few hours. Genuine Mannheim slide rule with magnifying indicator—will last a lifetime—included. Book has 200 pages, instructions, charts, work sheets, etc. Book No. 20. Book and slide rule, \$2.98.



MODERN HOMECRAFT

Modern furniture design, construction, finishing, complete. Detailed drawings simplify and insure expert workmanship. 240 pages. Best book for professional or home workshop use. Book No. 21. \$3.00.

CARPENTRY (CRAFT PROBLEMS)

More than 700 illustrations provide working knowledge on all building details. Expert's best methods for measuring, cutting, fitting—all materials. 300 pages Book No. 22. \$2.00.

MACHINISTS HANDBOOK

In simple technical form, a wealth of valuable money-making, time and error saving information. Now in 26th year and 14th up-to-date edition. Best book for all mechanics. Hundreds of illustrations, tables, diagrams. Book No. 23. \$2.00.

ENGINE LATHE OPERATION

Learn highly paid job operating lathe, milling, drilling, threading, boring machine. Beginner's authentic, easy "show how—tell how" book. Book No. 24. \$1.98.

FREE! New World Map

When you send your order for any of the Helpful Follett Books on this page, send also the names and addresses of three friends you think would like to know about our fine books. For this courtesy we will send you the new OCTOVUE ILLUSTRATED WORLD MAPS AND PICTURES. Printed in colors and showing for the first time in history, the entire world in correct size, shape and position. 51 authentic color paintings and 270 pen drawings included showing people, customs and places all over the world. Maps are 27 x 38 inches. Send names today. This offer may be withdrawn at any time.

Send No Money! MAIL THE COUPON NOW

WILCOX AND FOLLETT CO., Dept. 22, 1255 S. Wabash Ave., Chicago 5

Send books whose numbers I have encircled below. I will pay postman plus few cents charges. Any book not satisfactory will be returned in 5 days and you will refund money paid.

Check here if remittance is included with order. If so we pay all handling and postage charges and allow same return with refund privilege. (Amount enclosed \$.....)

Name.....

Address.....

City..... Zone..... State.....

LET'S TALK ABOUT *YOUR* FUTURE CAREER IN AVIATION



Is there a place for you in Aviation . . . in a steady, well-paid position? **Yes, there certainly is.** The Civil Aeronautics Authority recently estimated that 750,000 NEW jobs can open up in the next ten years. The tremendous growth of civilian air activities all over the world requires maintenance specialists and aeronautical engineers. You can be one of these fortunate men yourself.

Learn

AERONAUTICAL ENGINEERING

For men with imagination and ambition, Aeronautical Engineering opens the door to fascinating careers in Aviation. All the new planes and designs must come first from the designer and engineer. Where better can you learn engineering than at Northrop—an organization noted the world over for research and development—originator of a long series of outstanding aircraft.



Get Into

AIRLINES MAINTENANCE



Work on Giant Engines! Handle maintenance on transcontinental transports . . . Build your own business on your local airport. Interesting and well-paid positions are open to qualified Aircraft and Engine Mechanics . . . with airlines, aircraft builders, Civil Service, and service depots. Be a specialist in Airlines Maintenance through training at Northrop Aeronautical Institute.

NORTHROP AERONAUTICAL INSTITUTE

(A division of Northrop Aircraft, Inc.)

1525 E. Broadway, Hawthorne
Los Angeles County, California



In your training at Northrop you get the benefit of up-to-the-minute knowledge of the industry and its new developments. Now is the time to select your course.

SEND COUPON FOR BOOKLET

NORTHROP AERONAUTICAL INSTITUTE
1525 E. Broadway, Hawthorne, Calif.

Please send me your free, illustrated booklet and information, including starting dates and tuition rates, on the training courses checked below.

- Aeronautical Engineer Airplane Mechanic
 Master Airplane & Engine Mechanic (A&E) Engine Mechanic
 Home-Study Course Airplane & Engine Maintenance

NAME _____

ADDRESS _____

AGE _____

CITY _____

ZONE _____

STATE _____

Check one: Veteran; In Service; Civilian **PM-3**

SAY YOU SAW IT IN POPULAR MECHANICS

Have an **OFFICE** of YOUR OWN Learn at Home in 60 days

A new profitable profession in an uncrowded field. Many earn up to \$5,000-\$15,000 per year. Others make good money in their spare time. Little money needed to start. A business where your earnings begin sooner. Easy to learn. No selling or goods to buy. A course of action to guide you step by step as you earn. All 53 lessons sent at once to use as operating manuals! Tuition only \$25; terms \$5.00 month. Write for free bulletin now.

Franklin Pub. Co., Dept. 32, Roanoke 7, Va.



FENCING

EXCITING
FUN
HARMLESS

NEW—Clean—Healthful
Develops Strong Body—Alert Mind.
Become best swordsman in your neighborhood. **FREE BOOKLET** (with foils) teaches Quickly—Easily. **HARMLESS** because the 3 ft. Spring Steel Foils (swords) have safety rubber buttons. Complete outfit 2 Steel Foils (swords) and **FREE** Instructions. Now Only \$1.98 postpaid. **MAIL CHECK** or **M.O.** today. Add 28c for Foreign Postage.

LEE PRODUCTS CO., 1613E-First Ave., New York 28, N.Y.



JIU-JITSU

HOW TO BECOME EXPERT, Keep Health, Have Fun. Teaching 35 years. Free information. Write

MODERN SCHOOL JIU-JITSU, Dept. EE, 5 W. 52nd St., N.Y.C. 19



MUSIC LESSONS

LEARN . . . PROGRESS . . . EARN MORE . . . \$. . . SUCCEED . . . \$
Your own achievement, popularity, success through music. Learn in your home. Check course: Piano, Violin, Cornet, Saxophone, Clarinet, Guitar, Harmony, Arranging, History. If juvenile, parent's signature must accompany inquiry. Low cost. Easy Terms. **FREE** catalog. Suite U330 765 Oakwood Bl. Chicago 15

UNIVERSITY EXTENSION CONSERVATORY



WHY WEAR DIAMONDS

When diamond-dazzling Zircons from the mines of far-away mystic Siam are so effective and inexpensive! Thrilling beauty, stand acid, true backs, full of FIRE! Exquisite mountings. See before you buy. Write for **FREE** catalog.

National Zircon Co., Dept. 20
Wheeling, W.Va.

Catalog FREE!

RAFTER LENGTHS. A new vest pocket book for the carpenter, estimator. Gives lengths, Side cuts, Plumb cuts. Deductions. For all your rafters to fit any building from one inch wide to forty feet wide. Gives the numbers to cut on the square. Also gives degrees for same cuts for Radial Saws. All standard pitches from 1/4 to 3/4 are given. Just open book to pitch page and there in plain print are your lengths, side cuts, etc. Any one who knows what a jack rafter is can frame a roof correctly if he has this great book. Price one dollar, prepaid.

BUILDERS' TOPICS. Dept. M, Med. Arts Bldg., Seattle 1, Wash. Original teachers of the square in five easy lessons, by mail. Send for **FREE** list of plan books—Kamp Kitchens to Mansions.

RUPTURED?

Get Relief This Proven Way

Why try to worry along with trusses that gouge your flesh—press heavily on hips and spine—enlarge opening—fail to hold rupture? You need the Cluthe. No leg-straps or cutting belts. Automatic adjustable pad holds at real opening—follows every body movement with instant increased support in case of strain. Cannot slip whether at work or play. Light. Waterproof. Can be worn in bath. Send for amazing **FREE** book, "Advice To Ruptured," and details of liberal truthful 60-day trial offer. Also endorsements from grateful users in your neighborhood. Write: **CLUTHE SONS, Dept. 31, Bloomfield, New Jersey**



Learn by Mail to Mount Birds

Animals, Game-Heads, Fish, Pets, to Tan Skins

Men, Boys! Be a **Taxidermist**. Learn at home in spare time. Easily, quickly learned. Grand **Fun**. A wonderful, profitable hobby, for expert hunters, also for amateurs, even young boys. Mount wild-game, although wild-game is not necessary. Use common, domestic specimens, squirrels, pigeons, even frogs. This famous, reliable school in business more than 35 years. **More than 300,000** delighted students. Think of that!

Hunters Save Your Trophies — Have a Home-museum Be a Taxidermy Artist

You will be **THRILLED** and **DELIGHTED**. You learn **QUICKLY**, easily **AT HOME**. Your friends will be amazed. Hunters from near and far will bring their **TROPHIES** to be mounted. You can earn fine **profits in spare time**. Many students earn \$60 to \$100 a month, in season. **Rush the coupon today**, and learn all about wonderful taxidermy. **DO IT NOW!**

Save your own hunting trophies. Have a lifelong hobby. Have a home museum that you are proud of, and that makes you popular and well-known far and wide. **BOYS**, wild-game is **not** necessary. Use common specimens, squirrels, owls, domestic birds and animals. **It's wonderful**. Inquire today. **Kill fewer game-birds. Double your fun and pleasure.**

Fun — Fascination — Profit

And so easily learned in spare time. Wild-game is growing scarcer. Help preserve it. Shoot only a **FEW** fine ducks and other game-birds. **MOUNT THEM** for home and den, and have **MORE FUN** and **PLEASURE** than killing the legal limit every day. **Help preserve the wild-game.**

Remember you learn to mount expertly, **birds, animals, game-heads, fish, pets, to tan skins and furs**. Investigate! You will be delighted. Send for **free book today**. "Eat your trophies and have them too."

THE N. W. SCHOOL OF TAXIDERM, 3372 Elwood Bldg., Omaha 8, Nebr.

FREE BOOK!

Yes **FREE**, 44 pages, with 100 unique pictures of taxidermy work. No other book in the world like this. It will amaze and thrill you. **Ask today for your free copy. State your AGE.**

Send the Coupon!

Write name plainly in coupon or margin, or a **post card** will do. **Rush** your request, as **free books** may be exhausted quickly. Decide **now**. Don't wait a moment. **State your age.**

FREE BOOK

Northwestern School of Taxidermy, 3372 Elwood Bldg., Omaha, Neb. Send me your free illustrated book "How to Mount Game". Also tell me how I may learn this fascinating art easily and quickly by mail. No obligation. State your age.

Name _____ Age _____
Address _____



FIX ANY RADIO

Amazing New Invention

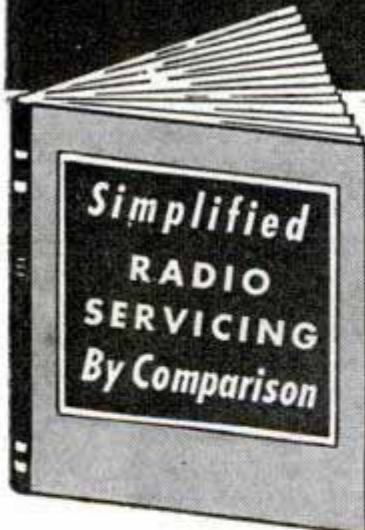

FOR BEGINNERS or EXPERTS

Learn quickly to repair radio sets. New revolutionary different **comparison** picture method quickly simplifies radio servicing. No previous radio knowledge required. Introductory training included. Find any fault with ease. Do expert radio work almost immediately. Repair radios in minutes instead of hours. Plan U. S. Copyrighted. Take advantage of this new invention. You can fix any radio after a few hours.

NO EQUIPMENT NEEDED

Most tests described require the use of only a screw driver, pliers and a piece of wire—no testers needed. Simple point-to-point picture suggestions tell you where to look for defects, how to test radio circuits and parts, and how to make the repair. You may try the plan for 10 days without any risk.

RADIO MADE EASY

Let this unique plan with its easy-to-understand diagrams, simplified illustrations, hints, job-sheets, and practical examples teach you basic radio facts. Learn important shortcuts in radio trouble-shooting. Make needed tests without testers, trace the signal, find all faults within the hour after receiving the plan. Follow the comparison tests given on large trouble-shooting diagram blueprints. Over 1,000 repair hints. Data on all tubes. Circuits and hints for many types of radios — new and old models.

10 DAYS "NO RISK" TRIAL

Examine and use **Simplified Radio Servicing** plan for 10 days in your own home. Apply this technique and repair one or more radios. Then decide to keep this greatest radio training bargain, or return the material and get your money refunded in full. You take no risk.



Complete plan, only **\$1.50**

In manual form, 8 1/2 x 11" Trouble-shooting charts. Data on 346 radio tubes. 63 large job-sheets. 1,000 time-saving hints. Covers many types of sets—new and old, FM, portables. Developed by **Beltman**, noted engineer, teacher, and author. Order today on 10-days no-risk trial →

REPAIR RADIOS IN MINUTES

Read the introductory job-sheets, follow the step-by-step picture blueprints, and fix any radio in a matter of minutes. Do radio work for fun and profit. The complete simplified training is yours for only \$1.50.

MORE HELP — IF NEEDED

Supplement your study, clear-up all hard problems, get ahead in Radio. A companion 19 lesson **Practical Radio** manual will give you added assistance, help you get ahead faster, presents important facts in greater detail. Include this large manual also in your trial order. See coupon →

No Risk TRIAL ORDER COUPON

SUPREME PUBLICATIONS, 9 S. KEDZIE AVE., CHICAGO 12, ILL. Ship the following manuals to me for 10 days' trial under your money-back guarantee. I am enclosing \$.....full price. Ship postpaid.

Simplified Radio Servicing @ \$1.50 Complete manual as described. **Practical Radio Manual @ \$2.95** Companion Volume, 19 lessons.

Name:PMF

Address:

NOW! Enjoy Learning to Speak

SPANISH AT HOME

FRENCH-GERMAN-ITALIAN

BIG opportunities and jobs waiting for those who can speak Spanish. Millions of dollars being invested in Mexico, Central and South America — business and travel increasing every day. Now the ability to speak Spanish will mean more to you than ever before.



Only 15 Minutes a Day

The **CORTINA METHOD**, famous for **OVER 60 YEARS**, teaches you to speak Spanish **LIKE A NATIVE**. Right in your own home, relaxed and at ease, you learn as easily as a child learns—**BY LISTENING** to native instructors on these 30 new, easy-to-understand **CORTINA** recordings. **EVERY WORD CLEAR AS A BELL.**



Sent on 5 Days Approval

THOUSANDS have learned Spanish, this quick, easy way for **PLEASURE** and **BUSINESS**. Why not you? Free, 32-page book, "The Cortina Short-Cut," describes this famous method fully and tells how you can try it in your own home for 5 days. **NO COST IF NOT DELIGHTED.** Mail coupon for free book now.



Write Today-NOW!

CORTINA Academy (Established in 1882)
Dept. 642, 105 W. 40th St., New York 18, N. Y.

Please send me—without obligation—your free book. I am interested in (check)

SPANISH French Italian German

Name.....

Address.....

City..... State.....

SHOW BUSINESS!

THE HIGHEST PAYING PROFESSION

is continually looking for new comedy talent. Experience unnecessary. Get the best in comedian's instruction, scripts, 'inside dope,' etc., in our latest handbook, **PERFORMER'S COLLECTION & MANUAL**. Tells everything you want to know:

- Top radio comedian's stylization and scripts
- How to balance your entertainment
- The 'talk a song technique'
- How to master dialects and their effective use
- Sources of comic makeup and costume
- How to get bookings, arranging for pay, etc.
- A theatrical mail address at no cost

Also a full year of professional advice at no cost. **COMPLETE COLLECTION ONLY.....**

\$1

SEND FOR FREE DETAILS!

J. & H. Kleinman, 25-31-B 30th Rd., Long Island City 2, N. Y. Here's my dollar. Rush the Manual including all comedy scripts. If I am not satisfied my money will be promptly refunded.

NAME.....

ADDRESS.....

Be Your Own Boss! LEARN MECHANICAL DENTISTRY



Big Paying Profession

The **BIG** post-war permanent demand for trained Dental Technicians is on! Start now! Learn this profitable profession—a Lifetime career for men and women. Individual instruction on practical work—day or night. Part time instructions also available.

Visit us or write for Free Booklet No. PM-2

NATIONAL SCHOOL OF MECHANICAL DENTISTRY
10 W. Jackson Blvd. Chicago 4, Ill.

COLOR BLIND? CORRECTION

in 90% of the cases

Make yourself eligible for railway jobs, merchant marine or any job requiring accurate color recognition. This proven method of color education may be the answer if color blindness is keeping you from the position you want. **NOW** by MAIL. Correction or No Pay. Write today **COLOR BLIND CORRECTIVE SCHOOL**, 603½ S. MARIPOSA, LOS ANGELES 5, CALIF.

Learn DRAFTING AT HOME

it's new! THE B-F WAY



Anyone can learn by the new **B-F** method. Learn to read blue-prints. Become a successful draftsman. Start any time. The **B-F** method is geared to your ability. Go slow or fast. Personal help by **EXPERT** instructors. Complete equipment furnished **FREE** when enrolled. Write for Information Circular at once. **B-F School of Drafting**, Box 58, Wilmette, Ill.

MAKE IT EASY,

Whether one-finger playing without study, or interpretations that baffle the experts! Harmonic and melodic tables, by P. Wilson. Structure of octave thoroughly clarified. 4ths and 7ths disentangled. Vague "tendencies" replaced by precise definitions. Logical notation and naming of half-tones. Crystalline, fluid, fixed just chromatic and spherical scales. \$1.00 ppd. Dr. P. Wilson, Box 1205, Chicago 90.

CARTOONING



CASH IN on Big Cartoon Market. **BECOME CARTOONISTS QUICKLY** with our **NEW, EASY METHOD**. No experience necessary. Prepared by successful cartoonists. Only \$2.85 postpaid. **SATISFACTION GUARANTEED**. Sample **LESSON PLATE** and interesting literature **FREE**.

NATIONAL ARTISTS BUREAU
Dept. A-3, Box 4248 DALLAS 8, TEXAS

SHORTHAND in 6 Weeks at Home

Famous Speedwriting system. No signs or symbols; uses ABC's. Easy to learn; easy to write and transcribe. Fast preparation for a job. Surprisingly low cost. 100,000 taught by mail. Used in leading offices and Civil Service. Write for free booklet. **SPEEDWRITING**, Dept. 1502-6, 55 West 42 St., N. Y. 18

Say you saw it in Popular Mechanics!

Now! NO AUTO REPAIR JOB IS TOO TOUGH FOR YOU!

Let this New Short-Cut Save You Time and Work!

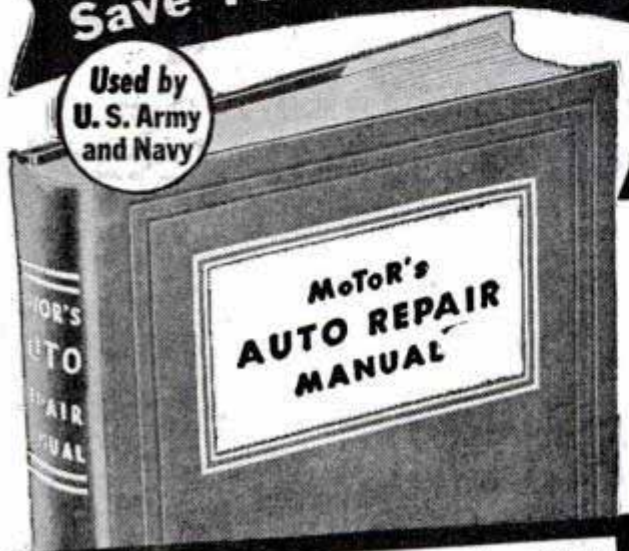

Whether you do auto repairs either as full-time or as part-time work, no service or repair job can "throw" you when you've got MoToR's AUTO REPAIR MANUAL! Just look up make, model, and the job in the streamlined index—and you're ready to lick ANY job from carburetor to rear end, faster, easier, better!

Try it **FREE** for 7 Days!

MoToR's AUTO REPAIR MANUAL Shows You How to Service and Repair ANY Part of ANY Car Built Since 1935!

Nearly 200,000 service and repair facts on all 30 makes. 640 big pages; including 50 pages of carburetor text, charts, illustrations, covering all models. Over 450 charts, tables; Tune-up Chart; Valve Measurements; Compression Pressure; Torque Wrench Reading; Starting Motor; Engine Clearances; Generator; Clutch & Brake Specifications; Front End Measurements, etc., Engines; Electric; Fuel, Cooling, Lubricating Systems; Transmissions; Universals; Front Ends; Wheels; Rear Ends, etc.

Covers All These Makes!

- | | | | |
|-----------|-----------|------------|--------------|
| American | Cord | La Salle | Packard |
| Bantam | De Soto | Lincoln | Pierce Arrow |
| Auburn | Dodge | Lincoln | Plymouth |
| Austin | Ford | Zephyr | Pontiac |
| Buick | Graham | Mercury | Reo |
| Cadillac | Hudson | Nash | Studebaker |
| Chevrolet | Hupmobile | Overland | Terraplane |
| Chrysler | Lafayette | Oldsmobile | Willys |

Try this great book for 7 days FREE! It's "headquarters" for 200,000 facts about service, repair, adjustment, replacement, and tune-up—on every car built from 1935 to 1945. The engineer-editors of MoToR Magazine built this Manual for YOU, by collecting and organizing all the vital information from 150 official factory shop manuals. Then they put ALL the facts into this ONE amazing workbook.

More Than 1,000 Pictures!

MoToR's AUTO REPAIR MANUAL not only TELLS you clearly what to do. It SHOWS you, too!—in over 1,000 cut-away photos, diagrams, drawings. 764 BIG pages (8½x11 inches) put the complete "know-how" right at your fingertips! And the Fabric binding is strong, built for years of day-in-day-out service!

No wonder it is used by the U. S.

Army, Navy, trade and technical schools, thousands of auto servicemen and handymen everywhere! No wonder we're willing to have YOU try it, FREE, for 7 days! Once you use it—and see for yourself how much valuable time and hard work it saves—you'll never again want to be without it!

SEND NO MONEY 7-Day Free Examination

Don't send any cash—unless you wish to do so in order to save postage charges! Simply mail coupon NOW. When postman brings your book, pay him nothing. First make the book show you what it does for you! Unless convinced it's the greatest time-saver and work-saver you've ever seen—return book in 7 days, pay nothing. Mail coupon NOW! Address: MoToR Book Dept., Desk 1-B, 572 Madison Avenue, New York 22, N. Y.

Same FREE 7-Day Offer Applies on New MoToR's TRUCK REPAIR MANUAL

For mechanics, truck specialists, service stations, fleet owners. Covers EVERY job on EVERY truck made since 1936! 1400 pictures, 900 pages, 300,000 facts. Used by Armed Forces.

All types Gasoline Engines, Diesels, Hesselman, Fuel Systems, Governors, Lubrication Systems, Ignition Systems, Starters, Generators, Clutches, Transmissions, Axles, Torque Dividers, Transfer Cases, Brakes, Steering, etc.

ALSO SERVICES many buses, farm and industrial tractors, contractor and road building equipment, stationary power machinery, etc. (on all parts described in Manual.) Check box in coupon at right.



Published by MoToR, The Leading Automotive Business Magazine. MoToR's manuals assure high standard repair work.

MAIL COUPON NOW FOR 7-DAY FREE TRIAL

MoToR Book Dept., Desk 1-B, 572 Madison Ave., New York 22
Rush to me at once: (check box opposite book you want).

- MoToR's AUTO REPAIR MANUAL. If O.K. I will remit \$1 in 7 days, \$1 monthly for 4 months, plus 35c delivery charge with final payment (\$5.35 in all). Otherwise I will return book postpaid in 7 days. (Foreign price, remit \$7 cash with order).
- MoToR's TRUCK REPAIR MANUAL. (Described at left.) If O.K., I will remit \$2 in 7 days, and \$2 monthly for 3 months, plus 35c delivery charges with final payment (\$8.35 in all). Otherwise I will return book postpaid in 7 days. (Foreign price, remit \$11 cash with order).

Print Name..... Age.....
 Print Address.....
 City..... Zone No..... State.....
 Occupation.....
 SAVE 35c! WE pay postage if you ENCLOSE full payment. (Check, M. O., postal note.) Same 7-day return-refund privilege.

START YOUR OWN BUSINESS

Here's your opportunity to learn a profitable, busy trade—**Watch and Clock Repairing**—at home. You probably know how busy jewelers and watchmakers have been. "Try to get your watch repaired quickly."

WATCH AND CLOCK REPAIRING



You can learn in your spare time at home . . .

Testimonials from well known authorities praise this instruction material on the science of modern watch repairing and adjusting. How completely and thoroughly the field is covered is shown by subjects discussed: Improvement of Ability and Higher Earnings for Watchmakers; The Efficient Use of Saws; Drills and Expert Drilling; Steel and Its Heat Treatment, etc. Decide today to get into this big opportunity field. No previous experience necessary. Low Price . . . Money Back Guarantee. Send coupon for free details.

Send coupon for free details.

INDUSTRIAL DIAMONDS

Learn more of this valuable trade. The material treats technically of machine methods of dividing diamonds and gem stones, cutting and polishing, boring, drilling, engraving, etc. Other subjects covered: Industrial Diamonds and their many uses in industry; Manufacture of Watch and Pivot Bearings. Fascinating. Authoritative treatment. Write today.

Send Coupon for Free Details

The Charles T. Powner Co.
P. O. Box 796, P.F., Chicago 90, Ill.
Please send me free illustrated folder describing the following fast-growing trades.
Watch and Clock Repairing Industrial Diamond Production
Name.....
Address.....Zone.....
City.....State.....

Learn How to Repair ELECTRICAL APPLIANCES

Nearly 3,000,000 additional American homes have been wired for electricity since 1940 . . . making the opportunity and demand for service mechanics in this field the greatest in history. Our practical, easy-to-learn home course teaches you, during your spare time, how to repair washing machines, vacuum cleaners, stoves, lamps, motors, irons, etc., and to do house wiring. Learn how to—

OPEN YOUR OWN REPAIR SHOP

Have a Secure, Permanent Future

WITH A BUSINESS OF YOUR OWN

You won't lose your job if another big depression comes along when you have your own shop. You can start a business of your own in your garage or basement with \$20.00 worth of tools. One good repair job can pay for the cost of the entire course. Write today for further information, without obligation.

USE
COUPON
BELOW

SEND FOR FREE BOOKLET TODAY!

Pacific Training School

7217 So. Broadway, Dept. P-2, Los Angeles 3, Calif.

Dear Sirs: Please send me, without obligation, your free catalog and full details.

Name.....
Address.....
City.....State.....

WHY DON'T YOU WRITE?

Writing short stories, articles on business, homemaking, hobbies, shop crafts, local and club activities, etc., will enable you to earn extra money. In your own home, on your own time, the New York Copy Desk Method teaches you how to write—the way newspaper men learn, by writing. Our unique "Writing Aptitude Test" tells whether you possess the fundamental qualities essential to successful writing. You'll enjoy this test. Write for it, without cost or obligation.

NEWSPAPER INSTITUTE OF AMERICA
SUITE 559-B, ONE PARK AVENUE, NEW YORK 16, N. Y.

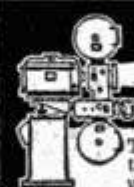

LEARN MOVIE PROJECTION THEATRE MANAGEMENT

The Motion Picture Theatre Business offers big opportunities for trained men. Get into a fascinating field with a post-war future. Train at home in spare time. Free Catalog. Established 18 years.

THEATRE INSTITUTE, 370 Washington St., Elmira, New York

"How to Make Money With Simple Cartoons"

A book everyone who likes to draw should have. It is free; no obligations. Simply address

CARTOONISTS' EXCHANGE

Dept. 92-D Pleasant Hill, Ohio

MAKE MONEY CASTING AT HOME FREE FACTS SENT



Make hundreds of Plaster Casts, quick, easy. Sell output to stores, novelty shops, etc. Enormous profits. No experience. Very little capital needed. Start in basement, garage or workshop. Complete, simple instructions anyone can follow. Start now while merchants are begging for merchandise to sell. Rush.

PLASTIC ARTS STUDIOS, R.R. 5, Dept. 29, Muncie, Ind.

Quick Answers to 250 Puzzling QUESTIONS on ROCKETS, DYNAMATORS, JET MOTORS



Written by A. L. Murphy, authority and consulting specialist in this field. 160 fact-filled pages. Accurately illustrated. Thoroughly indexed. Puts vital information at your fingertips. Answers on jet propulsion for land, sea, and air craft—applications, limitations, designs, fuels, etc. Amazingly complete. Valuable to amateur or engineer, model builder, or inventor.

Send for a copy today; mailed C.O.D. if you prefer.
WETZEL PUBLISHING CO., INC., Dept. P
524 So. Spring St. Los Angeles 13, Calif.

Learn TOOL DESIGN

Now, as never before, draftsmen and tool designers are needed to redesign for peacetime reconversion. Qualify quickly. Many making \$100 to \$150 per week. More qualified men needed than available. Good pay jobs waiting. Rush name and kind of job wanted today for full free facts. State age.

OHIO INSTITUTE OF TECHNOLOGY, Box 300, Greenville 1, Ohio

LAW

STUDY AT HOME for PERSONAL SUCCESS and LARGER EARNINGS. 35 years expert instruction—over 108,000 students enrolled. LL.B. Degree awarded. All texts furnished. Easy payments. Send for FREE BOOK—"Law and Executive Guidance."

AMERICAN EXTENSION SCHOOL OF LAW
Dept. 62M, 646 N. Michigan Ave., Chicago 11, Ill.

FREE PUBLICATIONS

"THE UNIVERSAL GUIDE TO FREE PUBLICATIONS" on science, nature, mechanics, homemaking, etc. Only \$2.50 for 26 issues. SAMPLE FREE ON REQUEST.

RESEARCH PUBLISHING COMPANY
Room 622-F, 1328 Chestnut St. Philadelphia 7, Pa.

YOU CAN MASTER MATHEMATICS

Key to the Electronic, Atomic age. Mathematicians in great demand. \$200 to \$500 per month. Literature free.

O-UNIVERSAL SCHOOL OF MATHEMATICS
623 Walter Story Bldg., So. Broadway, Los Angeles, Calif.

LEARN MASTER MACHINIST MECHANICAL DRAFTING

Expert training on Lathes, Milling Machines, Shapers, Grinders, etc. Allied shops are completely equipped and modern. Approved for G. I. Training. Days, Evenings.

ALLIED SCHOOL OF MECHANICAL TRADES
1330 South Michigan Avenue Chicago 5, Illinois

IMAGINE! MUSIC LESSONS

for less than 7¢ a day



Thousands have learned to play this quick, easy short-cut way, right at home—AND YOU CAN, TOO!



PLAYS FROM START. I can play my favorite instrument even though I'm only at the beginning. How can I ever express my joyful gratitude. *F.R.O., III.



PLAYS ON RADIO. As a proud student I can't keep from telling you that as a result of my course I have a good position playing from KTIS every morning. *J. S. Heavener, Okla.

IT'S grand fun learning music this amazing, home-study, "Print and Picture" way. Instead of tedious exercises, you learn to play real tunes by note, almost from the start. First printed instructions tell you how to play a tune. Next a picture shows you how. Then you play it yourself and hear how it sounds. You go from simple tunes to more advanced pieces. And sooner than you ever dared hope you're thrilled to find that you can play almost any popular number by note.

And just think! You can study any instrument you like for less than 7c a day.

That includes valuable sheet music, printed Instructions, diagrams, and our Personal Advisory Service.

If you really want to learn music . . . to win new popularity . . . get more fun out of life . . . send for our Free Illustrated Booklet and "Print and Picture" Sample. See how easy it is to learn this modern, short-cut money-saving way. Check instrument you want to play. Mail coupon now! U. S. School of Music, 72 Brunswick Bldg., New York 10, N. Y. Forty-eighth year. (Est. 1898.)



SIMPLE AS A-B-C

Yet it's from the famous "Merry Widow" Waltz.

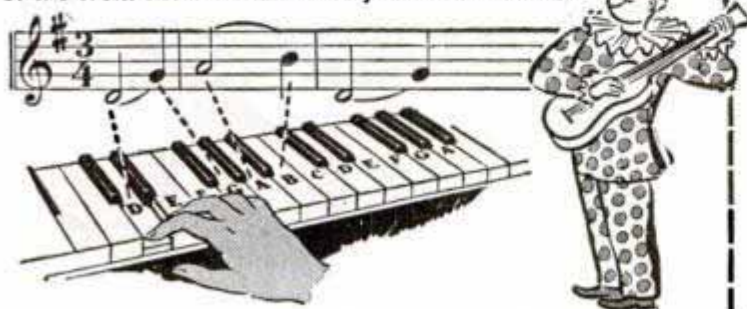

*Actual pupils' names on request. Pictures by professional models.

FREE! Print and Picture Sample

U. S. School of Music, 72 Brunswick Bldg., New York 10, N. Y.

Please send me Free Booklet and Print and Picture Sample. I would like to play instrument checked below.

(Do you have instrument?.....)

- | | | | |
|----------|-----------------|------------------|-------------|
| Piano | Guitar | Clarinet | Tenor Banjo |
| Violin | Piano Accordion | Mandolin | Modern |
| Hawaiian | Saxophone | Practical Finger | Elementary |
| Guitar | Trumpet, Cornet | Control | Harmony |

Name.....
(Please Print)

Street.....

City..... State.....

NOTE . . . If you are under 16 years of age parent must sign this coupon.

SAVE 2c — Stick coupon on penny postcard.

PLEASURE AND
PROFIT IN

Photography



IMPROVE YOUR
SKILL — STUDY
AT HOME

Whether you wish to make a career of photography or want to gain additional skill as an amateur, the American School of Photography offers practical basic training, which requires only spare time study.

With proper aptitude and application, this Course should provide you with a fundamental background which may open the door to valuable professional experience . . . or add fascination and zest to your hobby.

OLD ESTABLISHED SCHOOL. Backed by years of experience, our training covers every phase of Modern Photography through spare time study at home. Basic photographic principles are taught by inspiring "learn-by-doing" method, step-by-step, under the supervision of a qualified instructor.

GET FREE BOOKLET! Send coupon today for free booklet, "Opportunities in Modern Photography," and full particulars.

AMERICAN SCHOOL OF PHOTOGRAPHY
1315 S. Michigan Ave. Dept. 1352
Chicago 5, Illinois

AMERICAN SCHOOL OF PHOTOGRAPHY
1315 S. Michigan Ave., Dept. 1352, Chicago 5, Ill.

Please send me without obligation your free booklet, "Opportunities in Modern Photography," and full particulars.

NAME..... AGE.....

ADDRESS.....

CITY..... ZONE..... STATE.....

JET PROPULSION

Experimenters—New Principle to power model airplanes, boats, bicycles, helicopters. Circular on plans. Write Hudson Publishing Co., B4, 6112 Park Ave., West New York, NEW JERSEY.

Learn Newest **MONEY MAKING**
PROFESSION AT HOME
IN 90 DAYS!



MEN AND WOMEN! 18 TO 60

No High School or previous training necessary. Large incomes from Doctors

Become a Contact Lens Technician—Learn to fit the newly improved unbreakable Contact Lenses (invisible eye glasses). Diploma upon completion.

Many Technicians make \$75.00, \$100.00 a week, and more! Prepare for a permanent big money future in this fascinating work!

Today the demand for Contact Lens Technicians is great, tomorrow it will be greater! Tremendous advantages await you! Open your own office—be a Professional Man—gain the respect of your friends and community!

If you are ambitious to fit yourself in the higher money brackets—send for our **FREE BOOKLET NOW!!!**

ILLINOIS COLLEGE OF OPTICS
127 N. Dearborn St., Dept. E Chicago 2, Illinois

Tomorrow's MONEY MAKING OPPORTUNITY IS HERE Today

Returning Veterans! Office and factory workers. All Men looking to the FUTURE! Get set for life with one of America's greatest industries. Quick cash profits are yours demonstrating **AUTOFYRSTOP**, the remarkable new combination automatic and manual fire extinguisher and alarm that holds unequalled records. Sells fast to factories, schools, homes. Write for **FREE** facts. No experience necessary.

AUTOFYRSTOP CO., Dept. M-26
2035 Washington Ave. Philadelphia 46, Pa.

-KILLS FIRE BY ITSELF



MOTOR HISTORY OF AMERICA



REO

CLYMER, Dept. PM, 2125 W. Pico St., Los Angeles 6, Calif.

World's Wonder Book of Motor History. 416 pages, 100 illustrations. Authentic story of automotive industry since inception. Details careers of Ford, Willys, Dodge Bros., Haynes, Chrysler, Winton, Chalmers, Durant, Chapin, Nash, Olds, Flanders, Duryea, others. Lists over 1600 makes of cars. Contains "Scrapbook" supplement, with dozens original historical ads., by Floyd Clymer. Postpaid \$3.00; cloth-bound \$4.00.

PRINTING PAYS BIG

"Make your future secure. Prepare for a highly paid position or a print shop of your own. Students throughout the world are enthusiastic in their praise of our training program and the personal attention given each student. Rush name today for free literature and sample lesson. No salesman will call. Dept. M26.

COMPLETE COURSE ONLY

\$14.50 CASH

TERMS AVAILABLE

International School of Printing, Troy, O.

ANYONE CAN DO THIS IF

THEY HAVE OUR CHART

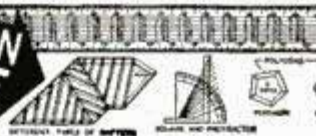

SPECIAL OFFER FOR AGENTS

Blue Print 27"x36" shows how to find length of any polygon 3 to 16 sides, find any angle in degrees, frame octagon scale, rafter tables and many other uses. Can be scaled down for model work as well as full scale framing. Also Chart changing pitches to degrees for use with Radial Saws. Send 50c in Coin or M. O. No Checks or Stamps. **MASON & PARRISH ENGINEERS, 2031-B N. Burdick St., Kalamazoo 81, Mich.**

HOW RUPTURE MISERY MAY DISAPPEAR

Don't go on day after day suffering the tortures of a clumsy truss that presses on your hips and back, gouches your flesh, slips and slides and leaves your rupture **DANGEROUSLY UNPROTECTED.**

Get the truth about rupture care and how the newly patented Vita-Pneumatic Nature-Ade (U.S. Reg.) appliance with its unique features can help your rupture, misery disappear. Write at once for **FREE** booklet containing much valuable information.

PNEUMATIC APPLIANCE, 103 PARK AVE., N. Y. 17, N. Y., DEPT. 45E

MAKE MONEY AT HOME

RUBBER MOLDS Low as **6¢ EA.**

Amazing rubber mold-making outfit makes perfect flexible molds of plaques, ash trays, bookends, etc. Molds cost 6c to 25c each. Each mold makes hundreds of novelties and gifts to sell for \$1.00 apiece and more! No experience necessary. Everything furnished. Quick and easy. Start profitable business in your home—sell to stores, gift shops, friends, resorts, road stands, by mail. Full or spare time. Write for complete **FREE** details and easy instructions.

SOLO WORKS, Dept. C-800, Loveland, Ohio



Always write your name and full address clearly when answering advertisements.

If You Are Doing Electrical Work of Any Kind You Need This 1946

ELECTRICIANS HANDBOOK

Let Me Send it to You to Examine For 7 DAYS FREE OF ANY COST You Send No Money! You Pay No C. O. D. Charges!

Here is the book every electrician needs. No matter what your work is, you will find this Handbook mighty valuable after you see it and see the information it contains. I am sure you wouldn't part with it for many times its small cost, and remember it won't cost you a cent to see it and examine it for 7 Days.

Every Electrician needs certain information at various times. No one can be expected to carry around in his head all the many formulas—latest code requirements, building codes, rules, tables, charts, test guides, size of wire to use on certain jobs, motors, current and hundreds of other things every electrician needs to refer to at various times.

NOT A TEXT BOOK!

This book is not a text book. Every subject is indexed and covered in just a few pages. You don't have to study the whole book to get the information you need on any subject—merely turn to the index—look up the subject you want and then you'll find this subject only is covered on the page you turn to. No wasted time or effort.

SEND NO MONEY!—See It FREE

I'm not asking you to send any money. No indeed. I know you need this book. I am so sure it's the book you want and need, I want to send it to you to examine for 7 days free trial. Then you look it over and you decide. If it isn't all I claim, then send it back and you owe nothing. If you are convinced it is worth many times its cost, then send \$2.75 at the end of 7 days and the book is yours. Send coupon now, while it's before you.

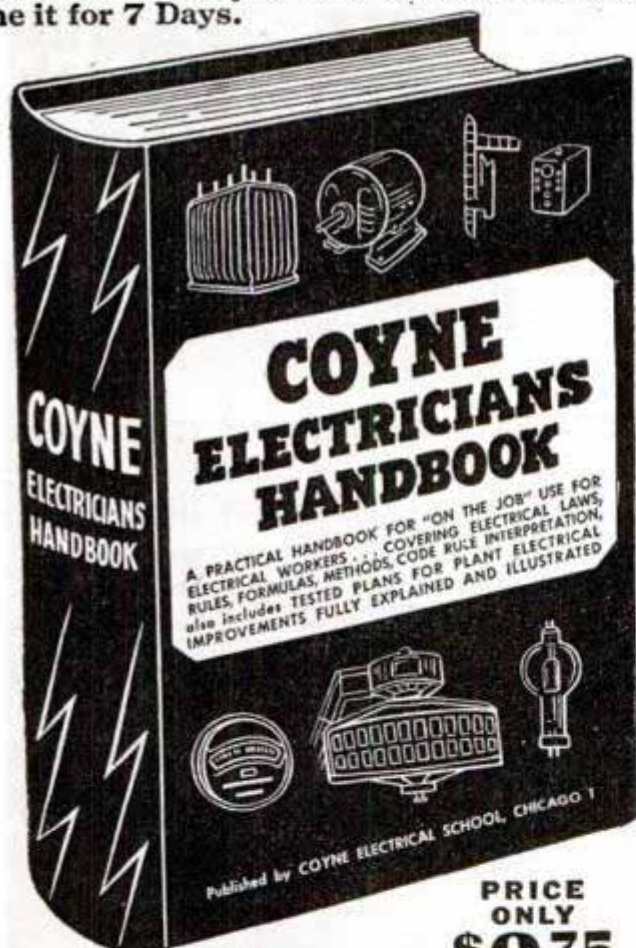

PRICE ONLY \$2.75

You can get the information on any of over 600 different subjects you want in five minutes. Then too, Electronics problems are also included in the book, just as all other electrical subjects are. MAIL COUPON. ALSO SEE COUPON FOR OTHER COYNE BOOKS!

FREE TRIAL COUPON

H. C. LEWIS, PRESIDENT
COYNE ELECTRICAL SCHOOL, Dept. 26-R6
500 S. Paulina St., Chicago 12, Ill.

Send me the 1946 COYNE ELECTRICIANS HANDBOOK for 7 days FREE examination. After 7 days I'll either return the book and owe nothing or I'll send you a check or money order for \$2.75.

HERE ARE OTHER COYNE BOOKS — I'LL SEND ANY or ALL on SAME 7 DAY FREE EXAMINATION OFFER

- COYNE PRACTICAL APPLIED ELECTRICITY—7 Volume Set, \$19.75 Cash or \$21.00 on time—\$3.00 after 7 Days and \$3.00 per month—1 year FREE Consultation Service and Technical Bulletins.
- COYNE ELECTRICAL & RADIO TROUBLE SHOOTING MANUAL—1 Volume, \$8.00 Cash—\$8.95 on time—\$3.00 after 7 Days and \$3.00 monthly—1 year Technical Bulletins Free.
- COYNE ELECTRONICS for RADIOMEN & ELECTRICIANS—1 Volume, \$4.95 after 7 Days examination—1 year Free Technical Bulletins.
- 150 DIAGRAMS & HOW TO READ THEM—1 Volume, \$1.95 after 7 Days.

NAME _____ Age _____

ADDRESS _____

TOWN _____ Zone _____ STATE _____

Where Employed? _____

If you prefer to pay postman (Cash price indicated above) when books arrive check here. Same 7 Day examination and money back guarantee of satisfaction.

COYNE ELECTRICAL SCHOOL
500 SOUTH PAULINA ST.
DEPT. 26-R6 CHICAGO, ILL.

Thanks, I can eat Steak again!

Fit-Rite
makes
FALSE
TEETH
tight!

Fit-Rite
TRADE MARK REG.

**REFITS and
RELINES
DENTAL PLATES!**



Makes
**False Teeth
TIGHT!**
Improved Newest
Plastic Reliner

LASTS FOR MONTHS!

FIT-RITE quickly makes loose, slipping, clattery dental plates fit snugly and comfortably. Eat, talk and laugh naturally and confidently!

FIT-RITE you apply — at Home

Simply squeeze FIT-RITE on your dental plates and put it in your mouth, where it hardens and makes false teeth feel and fit like new. No fuss, no muss—no heating. Not a paste or powder. Becomes a part of plate. You apply it yourself.

FIT-RITE IS 100% O.K. ON ANY DENTAL PLATE

FIT-RITE won't harm any denture or your gums. Tasteless odorless, sanitary—cleanses and sweetens the mouth and helps prevent gum soreness. It won't come off with scrubbing or washing. EVERY APPLICATION GUARANTEED TO LAST FOR MONTHS OR NO COST.

SEND NO MONEY Send for a tube today, for only \$1.00. Use coupon below. Enjoy teeth like new again. 100% satisfaction guaranteed or money back.

FREE TRIAL OFFER!

SPECIAL—generous package of dental plate cleanser included absolutely free. This instant, brushless cleanser WORKS LIKE MAGIC and will not harm any denture. Try Fit-Rite first.

FIT-RITE CO. 1573 MILWAUKEE AVENUE
Dept. 2-PM, Chicago 22, Ill.

Mail This COUPON -----

FIT-RITE COMPANY, Dept. 2-PM
1573 Milwaukee Ave., Chicago 22, Ill.
Send 1 tube of FIT-RITE Dental Plate Reliner that you guarantee to satisfy 100%—or it won't cost me a penny.

I will deposit \$1.00 plus postage with postman when package arrives.
 Enclosed is \$1.00—You pay postage.

NAME.....

ADDRESS.....

CITY..... STATE.....

P.S.: — RUSH THIS ORDER TODAY!

SCREWS NUTS, BOLTS,
RIVETS, SPRINGS,
WASHERS, Etc.



5 POUND ASSORTMENT

More than 1000 pieces. Great for mechanics, repairmen, hobbyists, experimenters. Worth double. Satisfaction guaranteed. Order now. Write for bargain list of fiber, bakelite, rubber, felt washers, pads; radio lugs, clips, connectors, etc.

HUDSON TRADING CORPORATION
F 1521 N. Wells Street Chicago 10, Illinois

\$1.98
Two for \$3.99

Be Your Own Boss...
GET INTO PLASTICS



LEARN
Plastics
Fabrication & Casting
For Financial Security

START AT HOME—SMALL CAPITAL NEEDED

Start your own Plastics business... with small capital... at home. Grow with this giant industry as you increase your "know-how" and skill. Plan now for your own business or prepare for exciting post-war Plastics jobs. Our revolutionary teaching plan covers production phases of fabrication, casting, cementing methods, mold making, compounding, dyeing, etc. You actually work with many types of Plastics materials. We supply everything. Check information desired. Home Training. Resident Course in Plastics Eng. Send this ad with your name and address in envelope or paste on 1c postcard to Dept. PM

VETERANS: Check here for special information
Plastics Tech. School of America, Inc.
5200 Euclid Avenue CLEVELAND 3, OHIO

Write your own Future
in Photography

Prepare now for a well-paid position today and a future that is different, fascinating and profitable. Photography offers ever-increasing opportunities. FREE book tells how N. Y. I. experts can quickly train you at home in leisure time through success-proved home study courses. Training includes ALL branches of black and white, motion picture and COLOR photography. Also resident instruction in our N. Y. studios. Write TODAY!

NEW YORK INSTITUTE OF PHOTOGRAPHY
Dept. 49 10 West 33 Street New York 1, N. Y.

Get Ready for Big After War Opportunities!

I Will Train You at Home Until You Get a GOOD PAY JOB in DRAFTING

Act now to get a better job with more pay and pleasant working conditions. Get into Drafting—the basic profession where all post war products will start. I will train you at home—give you experience—doing the same kind of jobs you will do with the best paying firms. I furnish instruments, drawing table and all equipment when you start. Write today for vital facts and FREE illustrated book. Give Age.

Engineer Dobe, Div. 12, Libertyville, Ill.



59c

COMB-A-TRIM
THE NEW QUICK TRIMMER

Something New! Trim your hair without any experience. It's easy! The excess hair comes off smoothly and easily by just pulling trimmer through hair like an ordinary comb. Also removes hair from legs—armpits. Save on hair-cut bills... Trim your own hair or the whole family's. Send 59c and your Comb-A-Trim will be sent at once.

SPECIAL OFFER
Send \$1.00 for 2 Comb-A-Trims and save 18c. **2 for \$1**

5 Extra Blades (Year's Supply) 25c
1734 Carew Tower Dept. R-3 **COMB-A-TRIM CO.** Cincinnati, O.

TRAIN NOW at home FOR RADIO-ELECTRONICS!

A Complete, 972-Page BASIC RADIO-ELECTRONIC EDUCATION

FOR BEGINNERS—36 COURSES IN ONE ONLY

\$5

More widely used for home study and by more Signal Corps, Navy and civilian schools and colleges than any other book or course of its kind.

Here is the big, 3 1/2 lb. profusely illustrated book that makes it easy for beginners to start in the fascinating fields of Radio - Electronics - Television. A. A. Ghirardi's 972-page RADIO PHYSICS COURSE book gives you exactly the basic training you need—ALL YOU NEED—easier, better, faster—FOR ONLY \$5 COMPLETE. Actually, this giant book is 36 different courses in one. If sold in lesson form as a course, you'd regard it as a bargain at \$50 or more!

You'll be surprised how easily RADIO PHYSICS COURSE helps you master subjects that other

courses make seem very complicated. You'll be delighted how quickly you will understand every phase of the subject. Step by step, it carries you from Basic Electricity through to the most modern Radio - Electronic - Television developments. Hundreds of users have completed it in a few weeks. All you need is a little reading time plus a desire to get started NOW for a better paying future in the fastest-growing industry in the world. Our 5-DAY UNRESERVED MONEY-BACK GUARANTEE is your absolute protection!

RADIO'S GREATEST TRAINING BUY!

ONLY \$5 EACH

The most and best Training for your money—You be the judge!

Get a better job—start a business of your own in fascinating Radio-Electronics!

THE ONLY COMPLETE BOOK ON MODERN RADIO REPAIR WORK

LEARN AT HOME—WITHOUT AN INSTRUCTOR

Ghirardi's MODERN RADIO SERVICING is the only inexpensive 1-vol. course that gives you a COMPLETE MODERN EDUCATION in radio test instruments, trouble-shooting and the truly PROFESSIONAL radio repair methods that will be your "Open Sesame!" to the big-money opportunities. It is a complete, professional servicing course from A to Z—easy to read, easy to understand. Not only will it help you handle radio repair jobs fast and profitably, but it will give you the kind of training to equip you for industrial electronic work.

GET A BETTER JOB—START A BUSINESS OF YOUR OWN

Gives complete data on all types of test instruments; how to use them; preliminary trouble checks, scientific circuit analysis; troubleshooting; parts repair, replacement, substitution; obscure troubles; aligning and neutralizing; color codes—and hundreds of other subjects including How to Start and Operate Your Own Radio-Electronic Service Business. Contains 1300 pages; 706 illustrations; 720 Self-Test Review questions. \$5 complete. SEE MONEY-SAVING COMBINATION OFFER IN COUPON!

EASY TO READ—EASY TO UNDERSTAND

An Exact GUIDE FOR LOCATING AND REPAIRING RADIO RECEIVER TROUBLES

Tells exactly WHAT to do—exactly HOW to do it . . . on over 4800 Radio Models

Like to repair radios for fun and profit? Then Ghirardi's big, 4 lb. RADIO TROUBLESHOOTER'S HANDBOOK is just the manual you need to show you how to do the work quickly without a lot of previous experience or costly test equipment. This 744-page HANDBOOK brings you specific repair data for common faults that account for almost 90 per cent of ALL troubles in practically every radio in use today. Simply look up the Make, Model and Trouble Symptom of the radio you want to repair. Clear instructions tell exactly what the trouble is likely to be, exactly how to fix it. Specific data covers over 4,800 home and auto radio receivers and automatic record changers of 202 manufacturers!

Also, the HANDBOOK includes over 300 pages of repair charts, tube charts, tuning alignments data, transformer trouble data, etc., etc.—all designed to help you repair any radio ever made better, faster, more profitably! Only \$5 complete. Sold on 5-DAY MONEY-BACK GUARANTEE.

Make Spare Time Money—Eliminate Useless Testing!

5-DAY MONEY-BACK GUARANTEE

MURRAY HILL BOOKS, INC., Dept. PM-26, 232 Madison Ave., New York 16, N. Y., U. S. A.

Enclosed find \$..... for books checked; or send C.O.D. (no foreign C.O.D.'s) for this amount plus postage. If not fully satisfied, I may return the books within 5 days for refund of my money.

- RADIO PHYSICS COURSE \$5 (\$5.50 foreign)
 RADIO TROUBLESHOOTER'S HANDBOOK, \$5 (\$5.50 foreign)

- MODERN RADIO SERVICING \$5 (\$5.50 foreign)

MONEY-SAVING COMBINATION: Modern Radio Servicing AND Troubleshooter's Handbook (BOTH BIG BOOKS) only \$9.50 (\$10.50 foreign).

Name.....

Address.....

City & Dist. No..... State.....

REPAIR ANY KIND OF RADIO EQUIPMENT



START

\$1506 to \$2650 YEAR

MEN—WOMEN

Veterans Get Special Preference!

Career Service Available

Mail Coupon Today—SURE

**Franklin Institute,
Dept. M46
ROCHESTER 4, N. Y.**

Gentlemen: Rush to me, FREE of charge, list of U. S. Government big pay jobs. Send me FREE 32-page book describing salaries, vacations, hours, work, and full particulars telling how to qualify for one of these jobs.

Name.....

Address..... Vet?.....

Learn REFRIGERATION and AIR-CONDITIONING

ARE YOU HANDY WITH TOOLS?

Exceptional opportunity for men of all ages up to 60. The demand for repair and service mechanics in both REFRIGERATION and AIR-CONDITIONING is acute and will continue. You can easily and quickly—

Learn to Be a Service Mechanic at Home or in Our Shops

Our practical, thorough course is easy to grasp and can be studied at home in your spare hours. No previous experience is needed. A common school education is enough. Learn how to start your own business with \$50.00 worth of tools in garage or basement. Open up your own shop or take a well paid job in this active field.

START YOUR OWN REPAIR SHOP

Write for free booklet today. No obligation whatever.

MAIL COUPON TODAY

Send for FREE BOOKLET!

Mechanics Training School

4701 W. Pico, Dept P-2, Los Angeles 6, Calif.

Dear Sirs: Please send me, without obligation, your free catalog and full details.

Name.....

Address.....

City..... State.....



Electrical TRAINING, RADIO AND ELECTRONICS

Fundamentals of Industrial Electrical Engineering

8 months intensive residence course prepares for technician, engineering aides in communications, power, business machines, sales and service.

Theory and extensive laboratory practice, drafting. Graduates hold responsible technical and engineering positions. Approved for veteran training. 53rd year. Enter Feb. 25, July 8. Write for catalog.

BLISS 132 Takoma Avenue, Washington 12, D. C.

ELECTRICAL SCHOOL



COLLECT U. S. ARMY Shoulder Patches

Fascinating hobby. Patches 1 1/2 to 1 3/4 each. Complete set of 258 for \$50. Official patches available for every major Army and Air Corps unit. Send \$1 for sample assortment of patches and illustrated patch catalogue.

SPRINGER'S
276 San Francisco St. EL PASO, TEXAS



GENUINE U.S. BARGAINS

Army O. D. Wool Blankets, 5 lbs. \$5.95
Army Pocket Knife, Scout Style..... \$2.50
Pup Tents, Poles and Pegs, Used..... \$4.85
Mess Kit—Knife, Fork and Spoon,
Used \$.50
Thousands of Other Bargains in Military, Outdoor & Sport Goods for Hunter, Farmer, Scout. Send 10c for 32-page catalog returned with first order.

A and N SUPPLY CO.
4720 LESTER ST. RICHMOND, VA.

EST. 1868

TOMBSTONES

DIRECT TO YOU \$9.95 up

Genuine Beautiful Rockdale Monuments, Markers. Satisfaction or MONEY BACK. Freight paid. Write for our FREE Catalog and compare prices.

EASY Terms

ROCKDALE MONUMENT CO.

Dept. 655

JOLIET, ILLINOIS



ANNOUNCING

Diamond Dust Mottoes
New-Different-Artistic-Salable
Best loved Scripture Verses, Artistically lettered-Radiant Colors. Big Values-Excellent profit. Send \$1.00 for \$2.00 Sample Outfit. Big Free Catalogs listing Stationery, Greeting Cards, Plaques, Books, Bibles.

GOLDEN RULE PUBLISHERS North Manchester 8, Ind.

CHICKS 30 Days Trial

guarantee. Money refunded on any chicks not true to breed. No need to take chances. You get 30 days to make sure chicks are as represented. Male or pullet chicks furnished. Low prices. All varieties. Mo. Approved. Blood Tested. Easy buying plan. Bargain Prices and Chick Manual Free. **MISSOURI STATE HATCHERY.** Box 289, BUTLER, MO.

SEXED

FOOT RELIEF

Don't worry—No matter how many ordinary arch supports, pads and braces have failed. CUSTOM MADE RESEARCH FOOT BALANCERS have relieved foot pains for 25 years. Write for FREE ANALYSIS FOOT CHART and interesting literature TODAY.

KINDSCHI FOOT APPLIANCE PRODUCTS
Dept. A2 321 W. Jefferson Dallas 8, Texas

Always write your name and full address clearly when answering advertisements.



PRACTICAL TECHNICAL TRAINING FOR YOU

Specialize in Electronics, Radio, Electricity, Air-Conditioning, Refrigeration, Welding. Prepare in six or twelve months for position as Technician—or in two more years secure B.S. Degree in Electrical Engineering. Write for complete information and FREE Booklet "Career Building." Mention course desired.

MILWAUKEE SCHOOL of ENGINEERING
Institute of Electrotechnics

P.M.—246 N. Broadway and E. State Milwaukee, Wisconsin

INVENTORS

WITH GOOD INVENTIONS

Should write us without delay for FREE BOOKLET, Protective Disclosure Form and facts about The Inventor's Most Logical Markets. Patented, Unpatented inventions, all kinds, Cash, Royalty, needed by specific manufacturers. If your invention is for sale, write today for full particulars. A Post-Card will do! Address:

THE INVENTION REPORTER
5C-11106 South Longwood Drive Chicago 43, Illinois

LOAN ME \$1 I'LL START YOU in a FOOD ROUTE



Make extra money in full or spare time. Big assortment. Actual full sized packages sent for own use and to show friends and neighbors. Take orders. Big profits. Complete facts rushed to you. Be first in your territory. Rush name on post card.

FOSTER BROTHERS CO.
Dept. 162, Decatur, Illinois



Balance 4" x 9" Base. With either \$6.00 Metric or Avoirdupois Weights ...

Catalog with 3000 Illustrations of laboratory Apparatus sent for 75 cents. Catalog listing 10,000 chemicals, drugs, minerals, etc., and 1700 scientific books sent for 25 cents. 100 scientific books 10 cents.

LABORATORY MATERIALS CO.
7321 Vincennes Ave. Chicago 21, Ill.

This 176-page

FREE BOOK

is also your

GUIDE for the FUTURE



● Prepare for peacetime competition. Let this free book help you. It is issued by an organization known throughout the world for thorough engineering training. The examination subjects listed below are only a few of those dealt with. Without obligation, write today to Canadian Institute of Science & Technology, 70 Chester Bldg., 219 Bay Street, Toronto 1, Canada.

- | | | |
|-------------------------------|---|---------------------------------|
| A.M.I. Mech. E.
Mechanical | A.M. Brit. I.R.E.
Radio and Telegraphy | A.M.I. Struct. E.
Structural |
| A.M.I. E.E.
Electrical | A.M.I. C.E.
Civil | Automobile |
| A.F.R. Ae. S.
Aeronautical | | Mining |
| | | London Matriculation |
| | | B.Sc. (Pure Science) |

Canadian Institute of Science & Technology Limited,
70 Chester Building,
219 Bay St., Toronto 1, Canada.

Please forward us free of cost or obligation of any kind your 176-page handbook, "ENGINEERING OPPORTUNITIES."

Name

Address AGE

Course interested in

FREE!

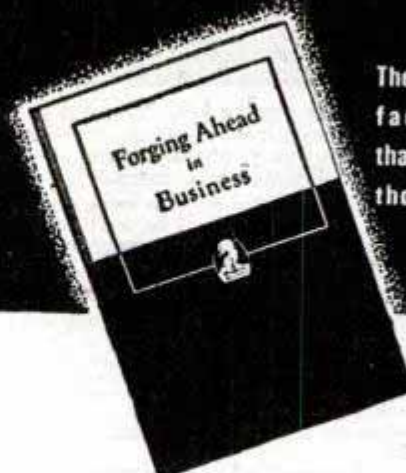

The famous 64-page, fact-packed book that has stimulated thousands of men!

"Forging Ahead in Business" is a practical, thoughtfully-written book with "punch" and common sense on every page. It carries a message of vital importance to every man who wants to make more money, get a better job and improve his station in life.

Partial Contents:

- Law of Success
- Highway of Achievement
- Forging a Career
- Making Decisions
- Organized Knowledge
- Failure and Success

Noted Contributors

Among the prominent men who have contributed to the Institute's training plan, which is described in "Forging Ahead in Business," are: Thomas J. Watson, President, International Business Machines Corp.; Clifton Slusser, Vice President, Goodyear Tire & Rubber Co.; Frederick W. Pickard, Vice President and Director, E. I. du Pont de Nemours & Co.

Simply return the coupon below, and your FREE copy of "Forging Ahead in Business" will be mailed to you.

MAIL COUPON TODAY

ALEXANDER HAMILTON INSTITUTE
Dept. 369, 71 West 23rd Street, New York 10, N. Y.
In Canada: 54 Wellington Street, West, Toronto 1, Ont.
Please mail me, without cost, a copy of the 64-page book—"FORGING AHEAD IN BUSINESS."

Name

Firm Name

Business Address

Position

Home Address

Say you saw it in Popular Mechanics!

Invitation to success!

We invite you to increase your chances of success in the electrical maintenance and repair field by studying these five books. Are you satisfied that you know all you can—to install all types of motors and generator units—make tests of switchboards—"trouble-shoot" on all kinds of electrical machinery?



The man who can tackle any wiring or motor problem can double-time march into a better paying job. You can get the "know-how" confidence you need from these experts—in five books thoroughly treating the very problems that may be worrying you now or that will come up tomorrow.

THE LIBRARY OF ELECTRICAL MAINTENANCE AND REPAIR

5 vols., 1826 pages, 1724 illustrations

These books were written by men who have been through practical shop stages of the game and have worked their way up to experts. They show you HOW—to install all types of motor and generator units—to inspect and repair motor starters and generators—to diagnose motor and generator troubles—to figure new windings for old cores—DC and AC windings—to test armature windings—test induction motors, etc., etc. One book is full of trouble-shooting charts that show quickly symptoms, causes, specific remedies, etc.

Help yourself to knowledge — Mail this coupon TODAY
No money down—special price—easy payments—FREE trial

McGraw-Hill Book Co., 330 W. 42 St., New York 18, N. Y.

Send me for ten days' free examination the Electrical Maintenance and Repair Library. If satisfactory I will send you \$1.00 in 10 days and \$2.00 monthly until the price of \$15.00 is paid. If not wanted I will return books postpaid. (To insure prompt shipment write plainly and fill in all lines.)

Name.....
Home Address.....
City and State.....
Company.....
Position..... PM-2-46



Your Own PHOTOCOPY Business!

No Training Needed

AS LITTLE As \$100
starts you in business for yourself

Start Right Out Making Money

Make photoexact copies of important papers, letters, drawings, photos, veterans' discharges, etc.—for local firms, lawyers, real estate men, accountants, advertising men, engineers, others. *Every business* is your prospect for error-proof, low-cost photocopies. New, amazingly simple method requires no lens, darkroom or training. For only \$100 you own your own business—with APECO, "America's Most Widely Used Photocopy Equipment." Easy to start... many prospects... quick results... pleasant work. A real money-making opportunity, good for a lifetime!

Get Full Information! MAIL COUPON NOW

AMERICAN PHOTOCOPY EQUIPMENT CO.
2849 N. Clark St., Dept. GF26, Chicago 14, Ill.

Please send me your illustrated book and details about the APECO business opportunity.

NAME.....
STREET.....
CITY & STATE.....

BOYS! GET THE THRILL OF YOUR LIFE Here's the Authentic FLARE PARACHUTE



A real flare parachute with nine shroud lines attached, made of parachute cloth. Used in actual combat operations. Simply attach parachute (in a folded position) under a trap door which will spring at a given time, allowing the parachute to open, bringing the plane safely back to earth without injury to your model. Can also be attached to other objects. Parachute is 128 inches in circumference, 21 inches long. Unusual value. Shipped prepaid in parachute sack on receipt of only..... **\$1**

Excellent parachute for aviation classes.

AVIATION PRODUCTS CO., 207-C East 43d St., N. Y. 17

Burpee Big Zinnias



Flowers up to 6 1/2 inches across!

75¢ PACKET for 10¢

Richer colors—apricot, rose, salmon, yellow, orange, scarlet. Some have curled petals like chrysanthemums. Sturdy 3-ft. plants, easy to grow. SPECIAL, for all to enjoy Burpee's Big Zinnias—75c Super Pkt. Seeds for 10¢—Send Dime Today!

W. ATLEE BURPEE CO.

505 Burpee Bldg. Philadelphia 32, Pa. OR 505 Burpee Bldg. Clinton, Iowa

MINK Easterns Labradors Yukons \$40.00 EACH

All shipments made subject to 5 days' inspection before acceptance.

The quality of my mink is indicated by the fact that I have netted an average of \$20.00 a pelt on all mink skins sold during the past 5 years.

WHITE, SILVERBLU, and BLACK CROSS MINK Priced on Request
WHITE FACE, PLATINUM SILVER, and PEARL PLATINUM FOX

BOOK "Domestic Mink" \$1.00

HARRY SAXTON'S MINK RANCH, Bemus Point, N. Y.



CLEANS WINDOWS WITHOUT WATER

NEW CHEMICAL MITT

Sensational! DRY Window Cleaner! Uses no water, no messy liquids. Chemically Treated. Simply glide over windows; leaves glass sparkling clear. No heating water, no heavy buckets to carry. No rags, powders, sponges, chemicals. No mess or fuss. No red chapped hands. Dust, dirt, grime, fog disappear like magic. Wonderful for auto windows, windshields!

SAMPLES FOR AGENTS Sample offer sent immediately to all who send name at once. A penny postal will do. SEND NO MONEY—just your name. KRISTEE CO., 652 Bar Street, AKRON, OHIO.

Train Your Own HORSES!

Colts • Stock Horses • Circus Horses
Gait Show Horses — Write for FREE BOOK
ANIMAL LOVERS' ASSOCIATION
Box KA-111, Tarzana, Calif.



Loose FALSE TEETH are a NUISANCE!

Now you can make your loose plate fit tight and snug with my new discovery. Easy to apply. Do it yourself. Perfect Fit Guaranteed. Write for Details. Dr. C. N. Reese, DENTIST, Box 268•A, Winnetka, Illinois

BARGAINS in WAR SURPLUS LENSES & PRISMS



VIEW
of
7 x 50
Binocular



All Items Finely Ground and Polished but Edges Slightly Chipped or Other Slight Imperfections which We Guarantee Will Not Interfere with Their Use. Come Neatly Packed and Marked.
You Can Easily Make Telescopes, Magnifiers, Photographic Gadgets and Hundreds of Experiments with these Low Cost Lenses.
To translate millimeter measurements: 25.4 mm. equals one inch.

NOW! MAKE YOUR OWN BINOCULARS!

Complete Set of LENSES and PRISMS from
Navy's 7 x 50 Model

SAVE UP TO \$150.00!

Here's an unusual opportunity to secure a fine set of Binoculars . . . at a tremendous saving of money. Build them yourself with all of the very same optics (no metal parts) contained in the Navy's 7 Power Glasses . . . the Binoculars which received such wide acclaim during the war. Depending on your choice, you may buy a perfect set of Lenses and Prisms for the Binocular construction job, or a set of seconds (exactly the same units, but Lenses are un cemented and have slight imperfections). If, however, you wish to construct a Monocular (1/2 a Binocular) you may do so, choosing either perfect components or seconds. The Monocular sets comprise 1/2 quantities of the same optics required for the Binocular. The full Binocular set comprises the following: 2 Cemented Achromatic Eye Piece Lenses, 17.5 mms. diam.; 2 Eye Field Lenses; 4 Porro Prisms; 2 Cemented Achromatic Objective Lenses, diam. 52 mms. Complete assembly directions included.

Stock # 5102-H Perfect Binocular Set. . . . \$25.00 Postpaid
Stock # 5103-H Perfect Monocular Set. . . . \$12.50 Postpaid
Stock # 5105-H Seconds for Binoculars. . . . \$11.00 Postpaid
Stock # 5104-H Seconds for Monocular. . . . \$ 5.50 Postpaid

REMARKABLE VALUE!

\$141.01 WORTH OF PERFECT LENSES FOR ONLY \$10.00

Complete System from Artillery Scope (5X) . . . 9 Lenses, low reflection coated, absolutely Perfect. Diameters range from 1-1/8 inches to 2-1/5 inches. Used for making Telescope and hundreds of other uses.

Stock # 5019-H. . . . \$10.00 Postpaid

16 MM PROJECTOR CONDENSING LENSES—Consists of two Condensing Lenses with combined F.L. of one inch.

Stock # 4026-H. . . . \$1.00 Postpaid

MAGNIFIER SET . . . 5 Magnifying Lenses . . . Powers from 1 to 10. Various diam. for many uses. Free Booklet on Home-made magnifiers included.

Stock # 1026-H. . . . \$2.00 Postpaid

OPTICS FROM 4-POWER PANORAMIC TELESCOPE—Excellent condition. Consists of Objective Prism, Dove Prism, Achromatic Objective Lens, Amici Roof Prism, Eye Lens Set (. . . a \$60.00 value).

Stock # 5016-H. . . . \$6.00 Postpaid

35 MM KODACHROME PROJECTING LENS SET—Consists of Achromatic Lens for projecting, plus a Condensing Lens and piece of Heat Absorbing Glass with directions.

Stock # 4025-H. . . . \$1.95 Postpaid

ALL THE LENSES YOU NEED TO MAKE YOUR OWN TELESCOPE! ALL ARE ACHROMATIC LENSES

GALILEAN TYPE—Simplest to make but has narrow field of view.

Stock # 5018-H 4 Power Telescope. . . . \$1.25 Postpaid

Stock # 5004-H Small 2 Power Pocket Scope. \$1.00 Postpaid

PRISM TELESCOPES—Uses Prism instead of Lenses to erect image. Have wide field of view.

Stock # 5010-H 6 Power Telescope \$3.00 Postpaid

Stock # 5012-H 20 Power Telescope \$7.25 Postpaid

SPECIALS IN LENS SETS

Big 10-Page Project and Idea Booklet with all sets.

Set #1-H "Our Advertising Special"—15 lenses for \$1.60 Postpaid. For making your own powerful telescopes, low power microscope, strong magnifiers, drawing projector, photo cells, telephoto lens, dummy focusing camera, Kodachrome viewer, stereoscopic viewer, ground glass and enlarging focusing aids. For experimental optics, portraits of babies and small pets, copying, ultra close-up shots, and many, many other uses.

New 50-Page Idea Book, "FUN WITH CHIPPED EDGE LENSES" Contains wide variety of projects and fully covers the fascinating uses of all Lenses in sets listed above . . . only \$1.00 Postpaid.

TELESCOPE EYE PIECE SET—Consists of perfect Eye Lens Set from a Govt. Telescope. Diam. 1 inch, Focal Length 1 inch.

Stock # 6144-H. . . . \$1.00 Postpaid

SPECTROSCOPE SET . . . These sets contain all Lenses and Prisms you need to make a Spectroscope plus FREE 15-page Instruction Booklet.

Stock # 1500-H Hand Type Spectroscope. . . . \$3.45 Postpaid

Stock # 1501-H Laboratory Type Spectroscope. \$6.50 Postpaid

CLEANING BRUSH SET—12" flexible hollow plastic handle, circular construction, 4 brushes to set, range stiff to soft.

Stock # 504-H. . . . Price \$1.00

RIGHT ANGLE PRISM—Flint Optical Glass, size 41 mm. by 91 mm by 64 mm. Use in front of camera lens to take pictures to right or left while pointing camera straight ahead. Also used in front of camera lens to reverse image in direct positive work. Two of these Prisms will make an erecting system for a Telescope.

Stock # 3076-H. . . . \$3.00 Postpaid

16 MM. PROJECTING LENS SET—Consists of 2 Fluoride coated cemented Achromatic Lenses, 1 inch diam. with combined F.L. of 2 inches.

Stock # 4024-H. . . . \$1.70 Postpaid

BIG DOUBLE CONVEX LENS—74 mm. diam., 99 mm. F.L. Weighs 9 oz. Made of borosilicate Crown Optical Glass. Used as spotlight Lens, Condensing Lens, etc.

Stock # 1048-H. . . . \$1.50 Postpaid

BIG DOUBLE CONCAVE LENS—74 mm. diam., 110 mm. F.L. Made of extra dense Flint. Used as reducing Lens, for trick photography, etc.

Stock # 1049-H. . . . \$1.00 Postpaid

MICROSCOPE SETS

Consisting of two Achromatic Lenses and two Convex Eye Piece Lenses which you can use to make a 40 Power Pocket Microscope, or 140 Power Regular Size Microscope. These color corrected Lenses will give you excellent definition.

Stock # 1052-H. . . . \$3.00 Postpaid

Consisting of Prism, Mirror and Condensing Lens. These used together with Stock #1052-H will make an excellent Microprojector enabling you to get screen magnification of 400 to 1000 Power according to screen distance.

Stock # 1038-H. . . . \$2.00 Postpaid

MISCELLANEOUS ITEMS

Stock No.	Item	Price
16-H	Level Vial, 48 mm. long.	\$.20 each
3016-H	Pentagon Prism75 each
2024-H	10 Pieces Circular A-1 Plate Glass (Diam. 31 mm.—for making Filter)25
523-H	Six Threaded Metal Reticle Cells.25
624-H	Neutral Ray Filter, size 4 3/4" x 2 1/2"25
22-H	Inclinometer—Aircraft type25 each
704-H	Lens Cleaning Tissue, one ream (480 sheets) size 7 1/2" x 11"	1.50
1030-H	2" Diam. Reducing Lens.25 each
1031-H	Perfect 6 Power Magnifier—Diam. 28 mm.25 each
2043-H	Crossline Reticle—Diam. 29 mm.50 each
1034-H	Burning Glass Lens25 each

(Minimum order on above—\$1.00)

TANK PERISCOPE

Complete Set Mounted Components

Rugged, strong, originally constructed for U.S. Tank Corps. Consists of 2 fine Periscope Mirrors mounted in metal and plastic. Perfect condition. Would normally retail at \$40 to \$50.
Stock # 700-H. \$2.00 Complete Set Postpaid

Order by Set or Stock No. • Satisfaction Guaranteed • Immediate Delivery

EDMUND SALVAGE COMPANY, P. O. AUDUBON, NEW JERSEY



WANT A GOVERNMENT JOB?

\$1,506 to \$2,650 Year to Start

Veterans Get Preference!

GET READY NOW FOR 1946 EXAMINATIONS

Railway Postal Clerks

Railway Postal Clerks get \$1,900 the first year regular, being paid on the first and fifteenth of each month. (\$79.17 each pay day.) Their pay is automatically increased yearly to \$3,000. Advance may be had to Chief Clerk at \$5,000 a year. (\$208.33 each pay day.) Age 18 to 35.

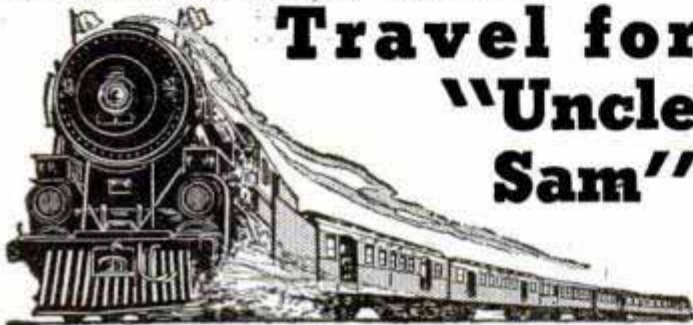

Travel for "Uncle Sam"

3 Days On — 3 Days Off — Full Pay

Railway Postal Clerks on long runs usually work 3 days and have 3 days off duty or in the same proportion. During this off duty their pay continues just as though they were working. They travel on a pass when on business. When they grow old, they are retired with a pension.

City Mail Carriers, Post Office Clerks

Clerks and Carriers now get \$1,700 (\$141.67 a month) the first year on regular and automatically increase \$100 a year to \$2,700 (\$225.00 a month) and \$3,000. Age 18 to 48.



Ass't Statistical Clerk

Open to Men — Women 18 to 50. Entrance salary \$1,902 year. Appointments as Clerks in the Departments at Washington, D. C., are made from this examination.

Many Other Positions

Many other positions are obtainable. Those wishing these positions should qualify at once.

Get Free List of Positions

Fill out the following coupon. Tear it off and mail it today—now, at once.

This small investment may result in your getting a big-paid government job.

FRANKLIN INSTITUTE, Dept. M51, Rochester 4, N. Y.

Rush to me, entirely free of charge (1) a full description of U. S. Government Jobs; (2) Free copy of illustrated 32-page book, "How to Get a U. S. Government Job"; (3) List of U. S. Government Jobs; (4) Tell me what to do to qualify for one of these.

Name.....

Address.....

Use This Coupon Before You Mislaid It. Write or Print Plainly

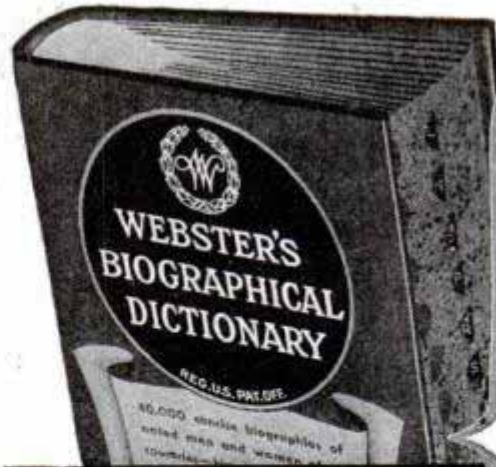

THE MERRIAM-WEBSTER Book of BIOGRAPHIES

An entirely new work by the famed editorial staff of *Webster's New International Dictionary, Second Edition*. Contains more than 40,000 concise biographies, with pronunciation of names and all essential facts. Includes scientists, statesmen, explorers, writers, painters, actors, radio personalities, eminent figures from every other field of activity. **WEBSTER'S BIOGRAPHICAL DICTIONARY** is an invaluable source of information for writers, speakers, and readers. 1,736 pages, thumb index. \$6.50. At your bookdealer, or from the publishers. **G. & C. MERRIAM COMPANY** 557 Federal St., Springfield 2, Mass.

At Your Finger-Tips—Essential Facts About **40,000 NOTED MEN AND WOMEN**

Historical and Contemporary — from Every Country and Every Field of Human Achievement!

Opportunity

FOR MAN WITH CAR

NO BOSSES—You'll be your own boss—go and come as you like.

NO LAYOFFS—You'll have a big pay job as long as you want it.

NO STRIKES—You'll be working for yourself in a pleasant, interesting, healthful job.

Use Your Car as McNESS STORE ON WHEELS-

Serve a rich trading area regularly with popular line of quality home and farm necessities. Easy to establish big volume, permanent business now. Make more money than ever before—We'll help you start. Write today for McNESS Dealer Book—Tells all about this wonderful opportunity—no obligation. Write today.

THE McNESS COMPANY
210 Adams St. Freeport, Ill.

A 3-year enlistment in the Regular Army now entitles American young men to a

FULL COLLEGE COURSE

or a Business or Trade School Education

By Act of Congress, benefits of the GI Bill of Rights are open to every qualified young man who enlists in the new Regular Army before October 6, 1946

Hundreds of thousands of intelligent young men finishing high school have been unable to afford a higher education. *Now they can have it.*

Greatest Educational Opportunity in History

Under the GI Bill of Rights every young man who enlists in the Regular Army before October 6, 1946, is entitled, after discharge, to education or training in the school or college of his selection at Government expense. *For a period based on the length of his service, the Government will pay his tuition, up to \$500 per ordinary school year, plus \$65 monthly for living expenses—\$90 if he is married. After a 3-year enlistment, for example, he may have 48 months of education, with a total of \$5120 paid by the Government!*

Original enlistments are open to men aged 17 to 34, and may be for 1½, 2 or 3 years.

The Army itself is one of the world's best schools. Thorough training in one or more of 200 skills, trades and technical subjects is open to every soldier.

If you are 17 or over, and mentally and physically fit, you can *earn while you learn* in the Army. You'll get good pay, food, clothing, quarters and medical care. You'll get a 30-day paid furlough each year. If you enlist for 3 years you can choose your branch of service and overseas theater in the Air, Ground or Service Forces.

Since the new peacetime Army will use the most modern scientific equipment, many technical grades will be open, with higher pay and rapid advancement.

PAY PER MONTH—ENLISTED MEN In Addition to Food, Lodging, Clothes and Medical Care

	Starting Base Pay Per Month	MONTHLY RETIREMENT INCOME AFTER:	
		20 Years' Service	30 Years' Service
Master Sergeant or First Sergeant	\$138.00	\$89.70	\$155.25
Technical Sergeant	114.00	74.10	128.25
Staff Sergeant	96.00	62.40	108.00
Sergeant	78.00	50.70	87.75
Corporal	66.00	42.90	74.25
Private First Class	54.00	35.10	60.75
Private	50.00	32.50	56.25

- (a)—Plus 20% Increase for Service Overseas.
- (b)—Plus 50% if Member of Flying Crews, Parachutist, etc.
- (c)—Plus 5% Increase in Pay for Each 3 Years of Service.

Get full particulars today at the nearest U. S. Army Recruiting Station. This is your opportunity to get the education you want and fit yourself for a successful career!

SEE THE JOB THROUGH

U. S. Army

BE A

"GUARDIAN OF VICTORY"

AIR FORCES • GROUND FORCES • SERVICE FORCES



HOBART

helps you get PROFITS out of your ARC WELDER

IDEAS GALORE! Hundreds of proven designs for your work "Practical Design for Arc Welding" is the book you need if you work in metal—are a designer, weldor, engineer, or have any redesign problems. Any of the ideas can easily be worth hundreds of dollars to you.

YOUR IDEAS ANALYZED

Opposite each design drawing there is an estimating chart that will convert your ideas into cold facts in regards to cost, production and sales angles. There is also a graph on which you can sketch your ideas.

EASY TO UNDERSTAND

There are no detailed explanations to confuse—the drawing is large and self-explanatory. Each drawing is marked by welding symbols to indicate type of weld desired. Often there are several alternative designs.

LARGE WELL-BOUND VOLUMES

Each volume of "Practical Design for Arc Welding" is rigidly cloth bound and measures 11 1/4" x 8 3/4". Each of the three volumes is completely different. Printed in 2 colors, it makes an attractive addition to your library. Use the coupon to get your books at once. All three volumes, only \$10.00. Single volume, \$3.50

HOBART BROS., Box M-26, TROY, OHIO
"One of the World's Largest Builders of Arc Welders"

Attend the HOBART Arc Welding SCHOOL

Welding is one of the most highly paid trades in industry today—and a few weeks' intensive training will qualify you as an expert weldor. Veteran instructors give individual attention, and each student has his own booth and machine. Veterans enroll under G. I. Bill. Write for free booklet and details.



Free!

"Welder's Vest Pocket Guide." Check the coupon.

Reach for Your Scissors!

HOBART BROTHERS CO., BOX M-26, TROY, OHIO
I'm interested in Welding redesign. Find \$ _____ attached for Vol. 1 Vol. 2 Vol. 3 "Practical Design for Arc Welding."

Also send items checked below, without obligation.
 FREE "Vest Pocket Welder's Guide" Hobart Welding School Details
 Catalog Complete Hobart Line

NAME _____

ADDRESS _____

SAVE WASTE PAPER

SILVERPLATE

Electrically by Brush!

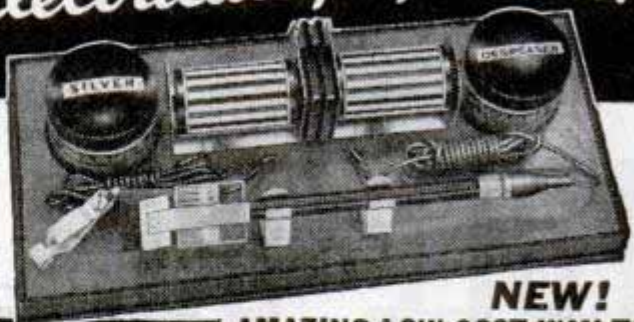

NEW!

AMAZING LOW COST WAY TO PLATE GENUINE SILVER ON Models, Projects, Worn Fixtures

Hundreds of uses for this complete Silverplating Outfit! New, patented electrified brush and concentrated compound of Atomic Silver work like magic. Easily and quickly, you can apply a heavy, permanent coat of Genuine Silver to any conductive surface . . . on models, projects, silverware, jewelry, etc. Outfit includes Degreaser, Atomic Silver Compound, Battery Power-Pack, Nylon-Lucite Electrolytic Brush, Solid Silver Anode, Leads, Connectors and simple Instructions in compact carrying case. All at amazing low cost! Small shipping charge collected on delivery. ORDER TODAY.

Homecrafters, Dept. E-5
360 North Michigan Ave.
Chicago 1, Illinois

ONLY \$12.50

The Tool of A 101 USES



JUST OUT! NEW FROM COVER TO COVER

AUDELS REFRIGERATION and AIR CONDITIONING GUIDE



4 Books in One! Covering:

- Basic principles, Servicing, Operation, Repair of
 - 1—Household Refrigeration
 - 2—Special Refrigeration Units
 - 3—Commercial & Industrial Refrigeration
 - 4—Air Conditioning Systems
- A gold mine of essential important facts for ENGINEERS, SERVICEMEN & USERS.
A Good Book is a Good Friend! Here you have at your fingers' ends a Complete Library in ONE VOLUME, the necessary data you have been looking for on: MODERN UNITS, SYSTEMS & MACHINES, REFRIGERANTS, including Freon, Lockers, Water Coolers, Quick Freezing & Air Conditioning Systems.
1280 Pages, 46 chapters all Fully Illustrated & indexed for Ready Reference.

ANSWERS YOUR QUESTIONS
Get This Information for Yourself. Mail Coupon Today. No Obligation Unless Satisfied. ASK TO SEE IT.

\$4 COMPLETE • PAY ONLY \$1. A MONTH

AUDELS, Publishers, 49 W. 23rd St., New York 10, N.Y.
MAIL AUDELS NEW REFRIGERATION GUIDE for free examination. If O.K. I will send you \$1 in 7 days; then remit \$1 monthly until price of \$4 is paid. Otherwise I will return it.

Name _____
Address _____
Occupation _____
Employed by _____ PM

Have Fun and Win Popularity THROUGH MUSIC!



Don't envy the fellow who plays an instrument... You, too, can be popular and have fun *making music!* You can entertain others... be the "life of the party." Playing a wind instrument is *easy...* and *it's a lot more fun than just listening!* Anyone who can whistle a tune can play a new Conn. The fingering is simple and the scale comes easily because of exclusive, patented Conn features and advanced design. *Get all the thrilling details.* See for yourself how you can have fun and win popularity through music. See your friendly Conn dealer, or write direct to Conn for FREE copies of the profusely illustrated, interesting books shown at right. Do it today.

C. G. CONN LTD., Elkhart, Indiana. 1914

Write... FOR FREE BOOKS

TEEN-AGERS—Ask for "Fun and Popularity Through Music." Ideas and examples of how you can enjoy advantages and opportunities which playing a wind instrument provides.

PARENTS—Ask for "Music, The Emotional Outlet for Youth." An important guide in rearing children that is widely acclaimed by authorities on youth problems.



C. G. CONN LTD.,
231 Conn Building, Elkhart, Indiana.
Without obligation, please send FREE Book checked below.

- "Fun and Popularity Through Music"
 "Music, The Emotional Outlet for Youth"

NAME _____
ADDRESS _____
CITY _____ ZONE _____ STATE _____



WORLD'S LARGEST MANUFACTURERS OF BAND INSTRUMENTS

Nothing
could
be finer!

Your first spin with a 1946 Evinrude
could be finer . . . and you'll find it to
from Evinrude's complete range of models.
of Evinrude's priceless performance features
exactly suits your requirements — in type.
Every model, from the lightest to the swiftest,
ing *sureness*, operating ease and rugged sturdiness.
Evinrude has developed through 36 years of building
There's matchless know how in every one! See your
dealer, and write for catalog of the complete Evinrude
EVINRUDE MOTORS, 5167 N. 27th St., Milwaukee



Nothing could be finer — for the fellow who takes fishing seriously — than a smart, powerful Evinrude "Zephyr" or "Lightfour" (both four cylinders and "smooth as silk").



Nothing could be finer for youngsters, (or for any grown-up who specially prizes lightness and handiness), than one of Evinrude's light models . . . "Ranger", "Sportsman", "Sportwin".



Nothing could be finer, for the skipper who wants thrilling speed, than an Evinrude high-powered model — the famed "Speeditwin", the "Speedifour" and the "Big Four".



EVINRUDE
OUTBOARD MOTORS

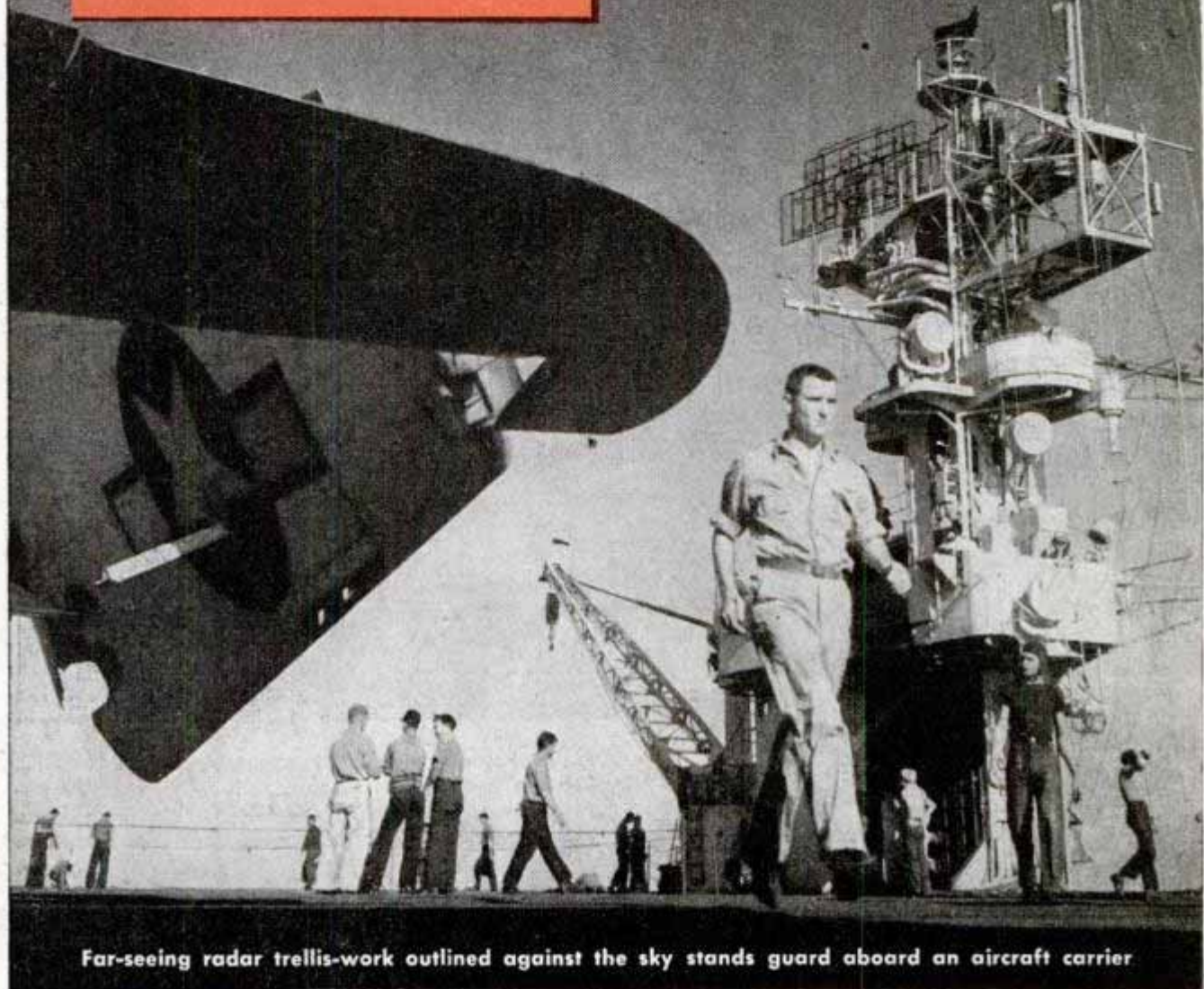

Far-seeing radar trellis-work outlined against the sky stands guard aboard an aircraft carrier

PART I

RADAR *Cues the Navy Fighters*

THINK of one of those model ships in a bottle, then stretch your imagination a bit. Picture, if you will, a city-block-long modern aircraft carrier, complete with a hundred planes, resting neatly in a huge bottle exactly like the ship model, except that this bottle is coated with lamp black making it impossible for you to see the ship.

Now place yourself in the position of the officer-of-the-deck, conning the carrier from the bridge—inside that bottle! Strain your

good weather eye; still you can scarcely make out the straightedge of the flight deck and certainly nothing past that.

This ship-in-a-black-bottle business is exactly how you feel on the black nights as you churn through Pacific waters, yet there is one big difference. Unfortunately you don't have a protective bottle around you, and somewhere in that black, forward, abeam and aft, are more ships—dozens, perhaps hundreds—making up the force. A miscalculation in

**By Lieut. Comdr. James S. Hunter, USNR
and Lieut. (j.g.) Max Hodge, USNR**

During the past 3½ years, Comdr. Hunter has been a fighter director officer of the Casablanca, the Wasp and the Hoggatt Bay. Lieut. Hodge spent 21 months in the same capacity in the Gilberts and the Marshalls

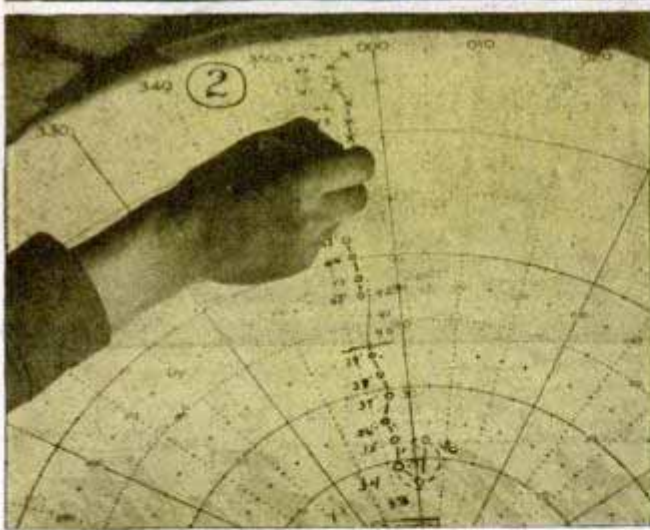

Four observers maintaining a surface plot in CIC. Left, raid plotter notes approach of a bogey, carefully recording time to the left of the track path. The small "o"s mark the course of a friendly plane

wheel against the reddish glow of the gyro-compass:

"Come right to one-six-zero."

The quartermaster nods: "Right to one-six-zero, sir!"

Ahead you note the far, dim straightedge of the flight deck tilt slightly to the left as the ship heels over to the new course. Below decks in the still, close air of the bunk-rooms a few hundred men stir slightly in their sleep.

You didn't see the guide ship closing. But down below in a compartment no larger than your dining room back home is the Combat Information Center. Here eyes were focused on a glass covered black disk, the size, shape and color of an ordinary phonograph record, with small dots or blobs of light moving over the black surface. Each blob of light is a ship in the formation. In your own Combat Information Center, or CIC, your drift was noted, and in the CICs on the guide ship and all the other ships of the group your drift off course was watched closely. For instance, a watch officer in CIC on the battleship off your bow has been watching the small

speed or compass check by you or any one of the officers-of-the-deck could bring one of those ships plowing into your carrier. Collision at sea is a constant nightmare, for you, as officer-of-the-deck, or OD, are responsible for the safe "steering" of the ship. How to avoid collision? Come to think of it, you do have a protective bottle:

"Bridge from combat," blares out from the squawkbox on the bulkhead.

You, as OD, reach over, flip a switch, and talk into the squawkbox: "Bridge, aye, aye."

"Guide has closed to one-double-o, sir!"

"Bridge, aye, aye."

You turn from the squawkbox to the quartermaster, faintly silhouetted at the

RADAR "EYES" ON AN ESSEX CLASS CARRIER

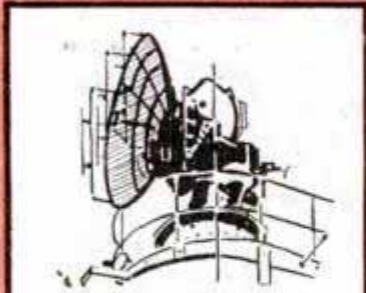

Air search radar, used to determine altitude, range and bearing of aircraft

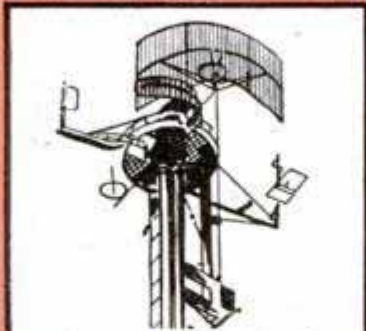

Surface search radar for navigational purposes and to detect surface vessels

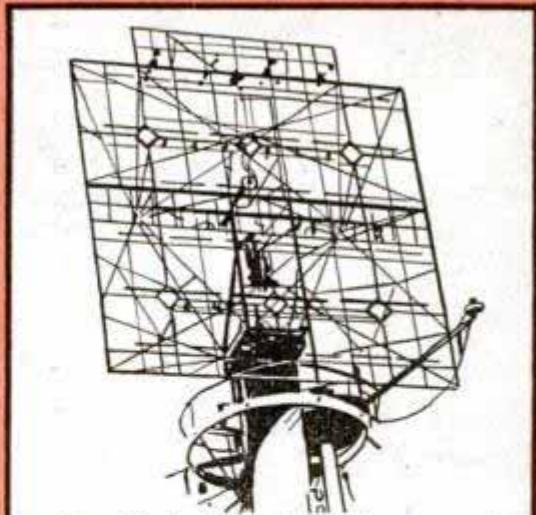

SK, or "bedspring," air search gear used to give warnings of enemy planes above 5000 feet and more than 100 miles away



Rear view of the gun firing control, used to elevate and train batteries on targets

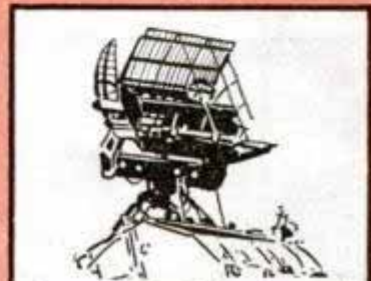

Front view of fire control unit, valuable in picking up targets in fog and darkness

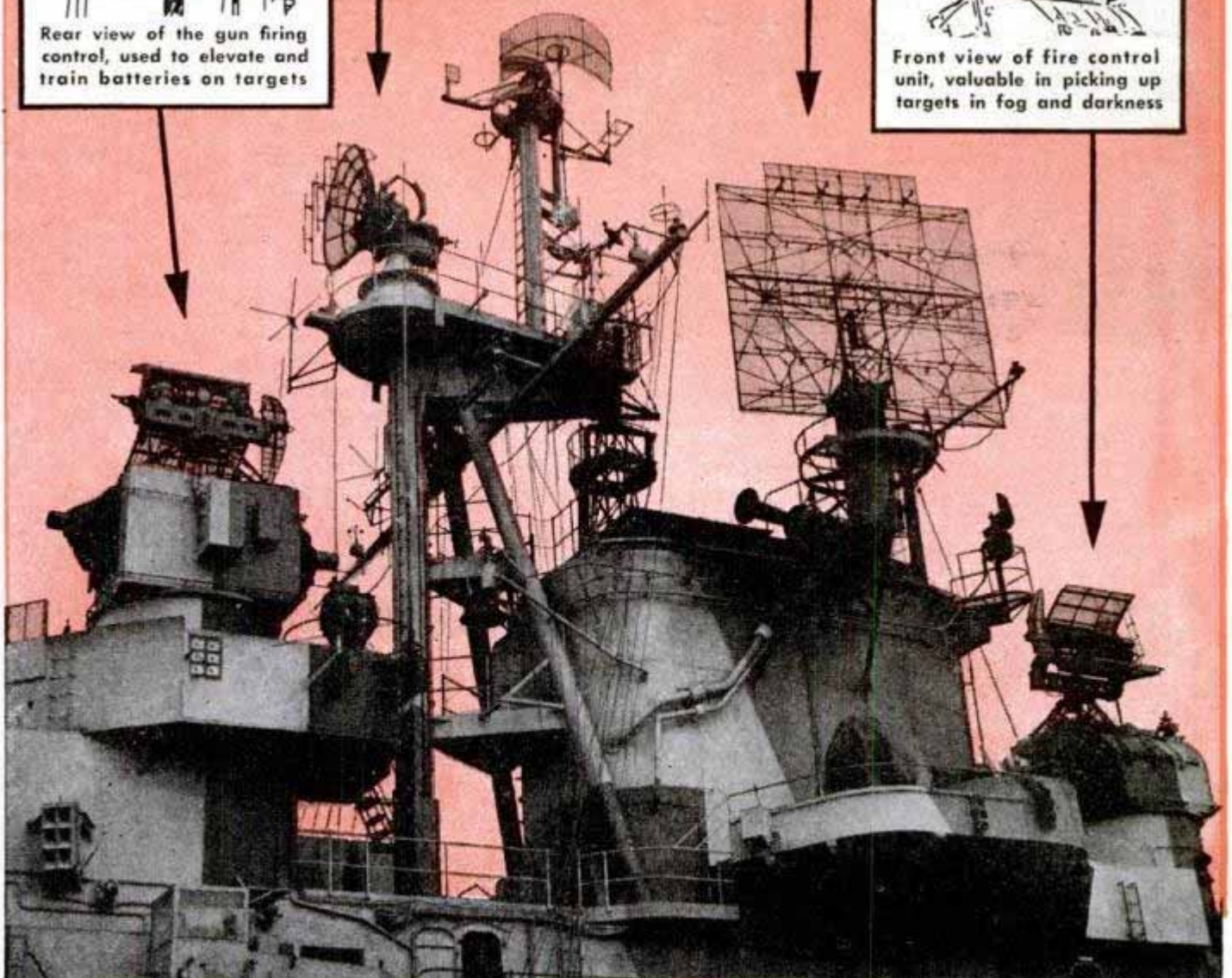



"CIC"
BRAINS OF A
FIGHTING SHIP

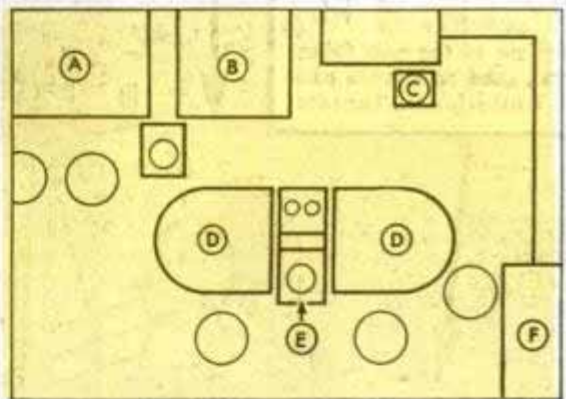

(A) Radar console. (B) Plexiglas plotting "window" shows positions of all planes as taken from radar scope. (C) "Squawkbox." (D) Plotting table. (E) Plan Position Indicator, or PPI, contains darkened disk on which planes appear as blobs of light. (F) Dead Reckoning Tracer, or DRT, automatically records ship's course

blob of light—your carrier—move slowly towards its rightful position among an ordered symmetry of blobs of light. He turns away from the disk, or PPI, to a petty officer bent over a plotting board on which are penciled symbols showing where every ship should be according to the cruising plans. The plotting board and this black disk with the blobs of light now match up.

"She's back on station, sir," the petty officer says, grinning.

The watch officer nods.
 Thus, reenacted, is a minor drama of radar—guide and guardian of today's ships and aircraft, potent right arm of the Fleet and the shore-based Navy. Certainly the atomic bomb is the greatest miracle of this war, but its entrance was made just a few moments before the final curtain was rung

down on World War II. The star of the show during the six-year run was radar and its tactical use.

Like television, radar has given rise to many a tall story. The facts themselves are genii's brew enough, as a matter of fact. Our purpose is to give a general idea of the role radar played in this war.

The explanation of what radar actually is—the physical laws which govern it, its eccentricities, limitations and complete capabilities—is a job for the physicist and the mathematician. As fighter director officers—FDOs in the Navy's nomenclature—our concern at sea and ashore has been with radar's function as a tactical weapon.

A word of explanation, however, will help. It is a new thing; the word itself is made of the initials of the phrase "Radio

Detection And Ranging." Actually the word "radio" is a misnomer. For radar is certainly no more than a thrice-removed cousin of what we ordinarily think of as radio. It has dials, tubes and circuits, true enough. But it is not a device of communication. It is a piece of apparatus—exceedingly complex and delicate—which projects a beam of electrical energy that permits the operator to determine the range, bearing and sometimes the altitude of distant objects.

Think of it this way. Suppose you toss an ordinary rubber ball against the wall and it bounces back into your hand. With a stop watch you could measure the time it takes for the ball to leave your hand and return. For instance, if it took one second, and you knew that the ball travels at the rate of 20 feet per second, you would know the wall is 10 feet away. The ball actually covered 20 feet in the round trip; therefore, to get the "range" this distance must be divided by two.

The beam of energy released by the radar acts in the same fashion. You know the beam travels 186,000 miles per second. Perhaps the most amazing thing about radar is the fact that it is possible actually to measure the time it takes for the electrical impulse to reach an object and "bounce back." Therefore, we know the distance from the object to ourselves.

The same principle, generally, applies in the computation of bearing, or direction. Our radar beam, projected toward the object, has characteristics of width and depth. Thus if your beam is narrow in the horizontal plane, you can determine the relative direction of that object from yourself. Put range and bearing together and you can say with certainty that an object is at a noted range and bearing from yourself.

With some sets an even more complete picture can be obtained—not only of distance and direction but also of the height of an object above the earth's surface. The importance of this information not only for the control of aircraft but for radar-directed antiaircraft fire is now so obvious that it is hard to imagine what the Navy did before radar came along.

There are other important characteristics of radar as a weapon. It can distinguish between friendly ships and aircraft and those of the enemy. It will supply a pretty accurate estimate of the size of a ship or the number of aircraft in a flight. Under some circumstances, it also can detect, in advance, changes in the weather, spotting cloud-clear areas or noting the advance of a rain squall. Its ability to pick up buoys, headlands and other landmarks is employed routinely in navigation of ships through crowded waters.

Bare to the eye, the outlines of the coast of Honshu or the islands of Bashi Channel lie before the navigator's eye—white irregularities of light which skilled observers can translate readily into the convolutions of bays, peninsulas and mountain peaks inland. Norfolk buoys, stretching on either side of the channel, are small dots of light sliding past on the face of the scope. Even the flight of a shell, arcing redly through the night toward an enemy target, can be noted and clocked!

Still, little has been told of one of radar's most fascinating tales—its use in the direct control of aircraft in the defense of the Fleet and those island bases—Tarawa, Kwajalein, Saipan, Iwo Jima, Okinawa—that we fought for so hard . . . and won. Yet of all of radar's uses none is perhaps more dramatic or, as far as the Navy is concerned, none exerted more influence on the ultimate outcome of battles than the employment of radar in fighter direction.

Readers of Milt Caniff's *Terry and the Pirates*, that mine of military lore and operations, are aware of the fact that the Army, Navy and Marines used fighter direction with the aid of radar to repel air raids. Small boys in a hundred American suburbs may be heard martially shrieking the jargon of Lieutenant Charles and the marine controllers charged with the defense of Mr. Pyzon's island:

"Roger, boy."

"Wilco, out."

"Trigger four, this is Copper base, over—"

Mr. Caniff's students know fighter direction for what it is: the control of aircraft from ground or ship by radio communication between the pilot and a ground controller whose information is derived principally from radar. What they have not known is the extent of the role fighter direction has played in World War II, involving thousands of Army, Navy and Marine officers, tens of thousands of enlisted radar operators, not to mention a half dozen high pressure training schools and experimental stations.

We—an ex-college professor and an ex-advertising man—were fighter directors, so it is understandable that in its essence the art or craft of fighter direction is quite simple. Keep in mind that radar is a kind of television and that it is possible through a special kind of gear known as IFF to distinguish between enemy and friendly aircraft. Remember your radar PPI scope or darkened disk shows your air contacts as small blobs of light. This disk is ruled off in degrees like an ordinary gyrocompass—360 degrees with a "bearing line" at every 10 degrees. The range is ruled off in circles representing 10 miles each. You may have eight to 10 range circles which means you

may pick up a contact 80 to 100 miles from your base or ship.

One small blob of light, looking exactly like a small, constantly glowing firefly, hovers within the 10-mile range. That is your CAP or Combat Air Patrol which the fighter director controls. Thus he has before him a picture of the territory for 80 to 100 miles around him, and he can see the exact location of his friendly planes and any enemy planes that come within 100 miles of the ship or ground base. Equip your fighter director with high-frequency radio with which he can talk to the pilot, and he can direct his CAP to "intercept" any enemy aircraft that shows up on the screen or disk, noting both the path of the enemy and his own planes so that he can order whatever changes in direction or altitude are necessary.

To get an idea of how fighter direction works and how it is employed, let us imagine that our carrier is operating off the coast of the Philippine Islands.

Come with us down into the CIC or Combat Information Center. Hatches are battened down to keep the room in semidarkness. As you enter, the first impression is one of confusion; in fact, in the parlance of the personnel, CIC stands for: "Cripes, I'm Confused." Here is a weird jungle of electronic gear, illuminated tables, shining dials and gadgets which, at first glance, makes Flash Gordon look like a piker and Buck Rogers an anachronism. Here are officers and enlisted personnel, most of them stripped down to their skivvie shirts, wearing earphones and talking strange jargon into microphones, telephones and

(Continued to page 168)

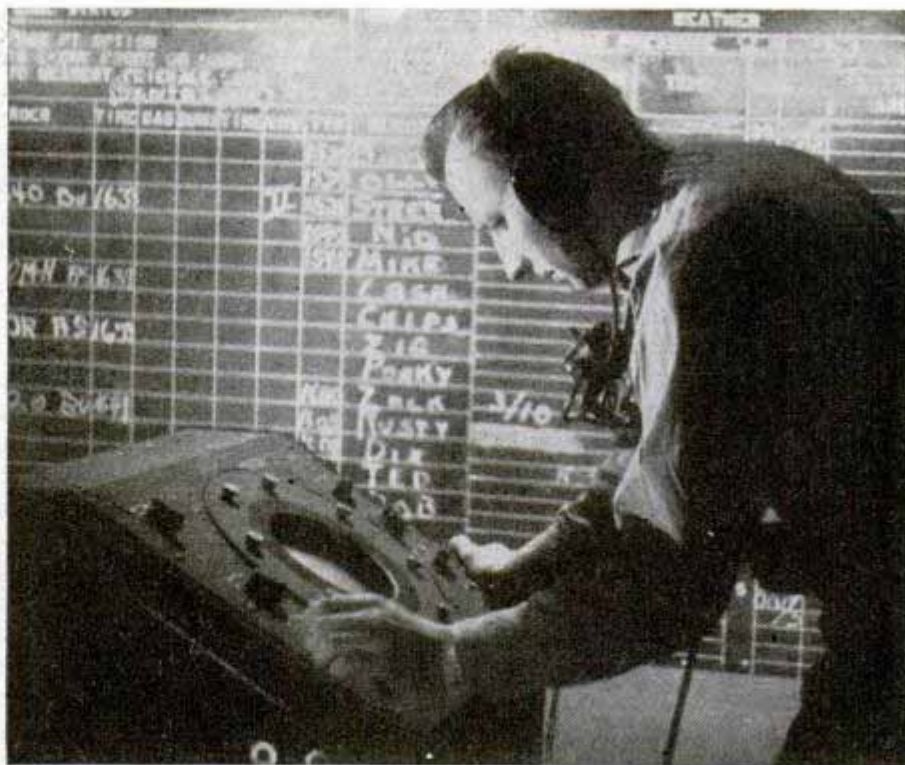

Interceptor officer scans his PPI scope. Status board at rear has takeoff times, raid numbers and other pertinent data. Below, view of PPI scope

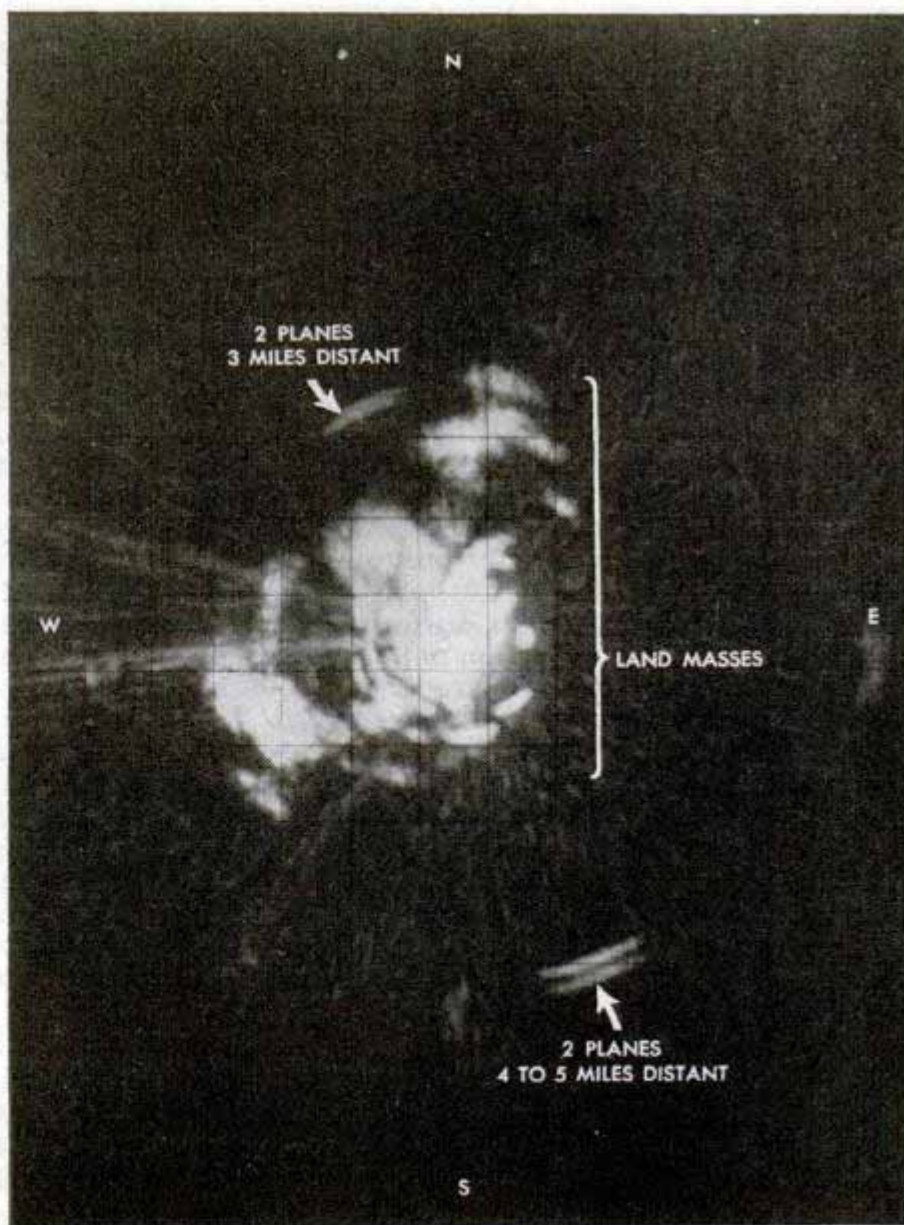

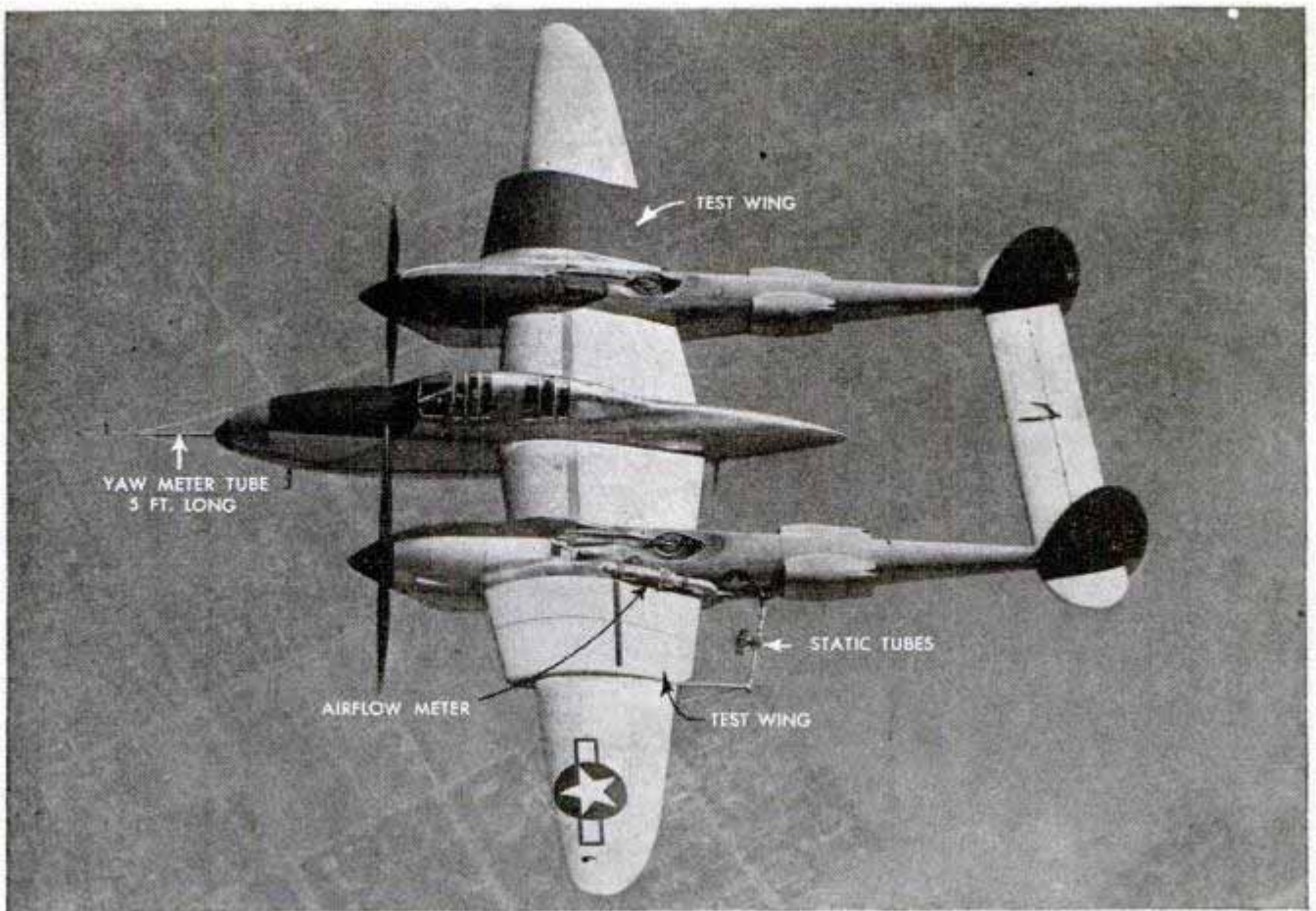

"Flying Wind Tunnel"

Removable "envelopes," or false wings, fitted over inner portions of the regular wings, enable the Lightning Swordfish to function as the world's fastest "flying wind tunnel." The plane, a modified version of the Lockheed P-38 fighter, is used to test wing designs of all sizes up to transport types and can gauge drag, lift and airflow characteristics of any airfoil under actual flying conditions. The false wings are constructed with contours in exact proportion to an experimental wing and in flight react

to the plane's special instruments exactly like a full scale model. Tests already have been made at dive speeds in excess of 525 miles an hour. A motion picture camera records the performance during flight to supplement the pilot's visual observations. Other distinguishing features of the Swordfish are a five-foot yaw meter, or "sword," that protrudes from its nose to indicate skidding or side slipping, an observer's station back of the pilot and rows of static tubes that trail the wings to measure airflow drag. Pressure distribution through small holes in the wing envelopes is used in calculating lift.

Four-Passenger Rear Seat Features the New Frazer Car

Flowing fender lines, increased visibility, room for four persons in the rear seat, and low height (64½ inches) are features of the new medium-priced Frazer automobile, produced by Graham-Paige Motors Corporation. A six-cylinder, 100-horsepower engine powers the car, which was designed by Howard A. Darrin, automobile stylist. The rear seat is located in front of the rear axle to provide smoother riding. Pillar posts are moved back from the conventional position, increasing front and side



visibility. Outside door handles, attached at both ends to eliminate clothes snagging, are operated by trigger-action at the touch of a finger. Inside recessed door controls are the push-button type.

Two New — — BUILDING BLOCKS

The smashing of the atom has turned up two unexpected by-products—elements 95 and 96—which may play a big role in harnessing of atoms

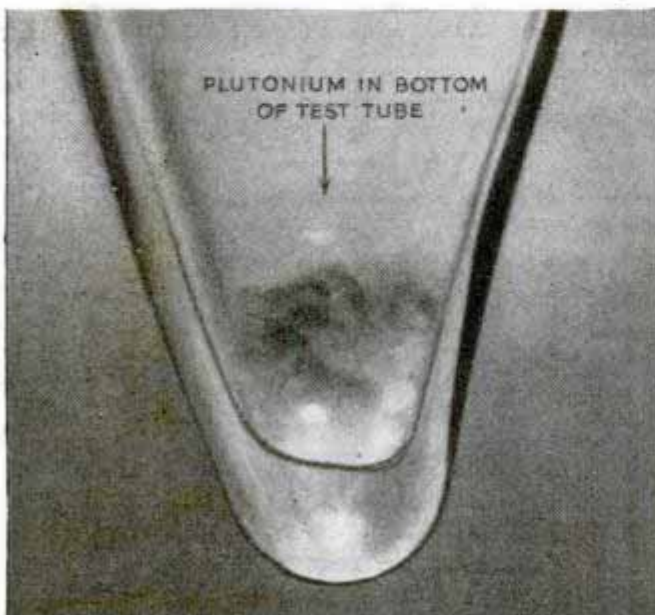

By Nathaniel Nitkin

WHEN Dr. Glenn T. Seaborg collaborated in creating plutonium, one of the elements used in the atom bomb manufacture, he had no idea he was on the threshold of other startling discoveries in the same line of atomic research. The results of his latest findings are, first, that both of the new elements, neptunium and plutonium, which had been unknown before 1939, exist in natural state though in small amounts; and second, the creation of two new unnamed elements to which he attached numbers 95 and 96. Plutonium is number 94 in the atomic scale.

Dr. Seaborg's researches may bring nearer the day when atomic energy will be harnessed to general use. According to present scientific knowledge, the higher the atomic number of an element, the less the force holding each individual atom together, and the easier it is to split.

The story of the elements goes back to 1869 when the Russian scientist, Dr. Dmitri Ivanovich Mendeleef, published his famous periodic classification table. But first consider what an element is. Oxygen, hydrogen, iron and gold are familiar examples, yet they are made of the same basic ingredients: protons, particles of positive electricity; electrons, bits of negative electricity; and neutrons, which are neutral particles. The chemical and physical properties of an element depend on how many protons there are in the atom's nucleus. And the number of protons is balanced by an equal number of electrons revolving around it. For instance, an atom of oxygen has eight protons in its nucleus, around which eight electrons revolve like a miniature solar system of one exceedingly small sun and eight large but featherweight satellites.

The proton has mass and weight while the electron's weight is negligible. On the other hand, oxygen has an atomic weight of 16, each proton having a weight unit of one. The answer is simply that eight more particles in the nucleus make up for the difference in weight, and these particles are neutrons.

Suppose we experiment with a hydrogen

Dr. Glenn T. Seaborg examines a specimen of plutonium after it has settled in bottom of a test tube

FORMING ELEMENTS 95 AND 96 BY BOMBARDING PLUTONIUM WITH HELIUM NUCLEI

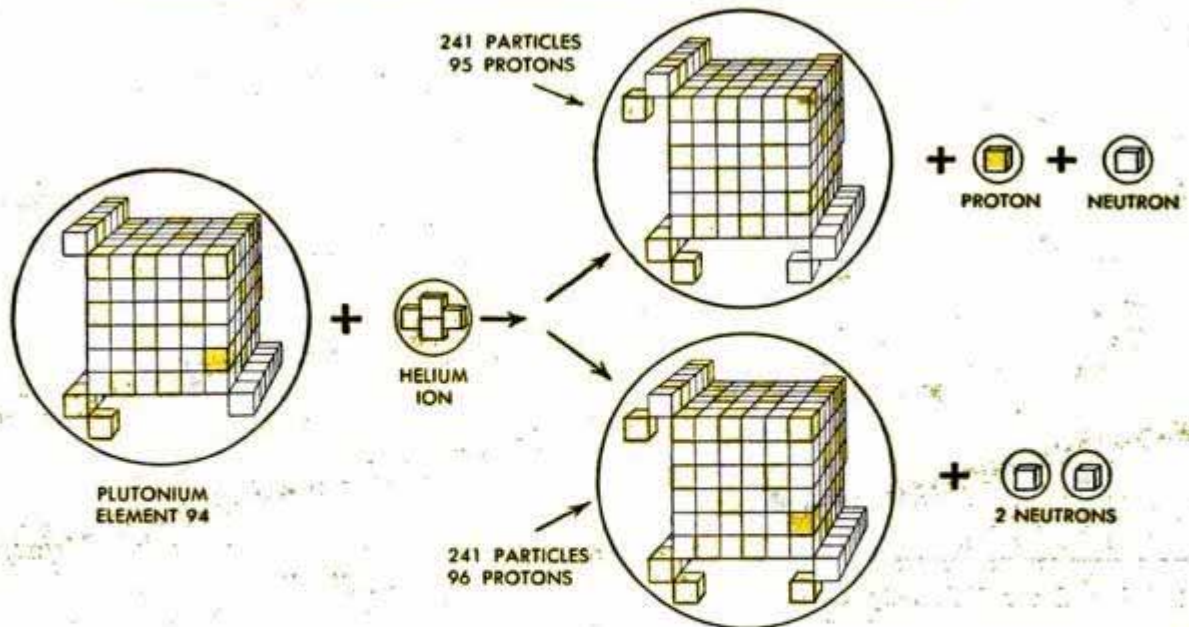

Artist's "building-block" conception of the forming of two new elements with complex atomic structure

atom, made of one proton with one electron revolving around it. If we add another proton to the hydrogen atom nucleus, we get a positive electrical charge of two instead of one; it has become the nucleus of a helium atom. The new nucleus would capture a free electron to counterbalance the added positive charge. Thus we have a helium atom but for one thing; helium has an atomic weight of four. The other two particles are simply neutrons.

In nature, the jump in weight is not so abrupt. Heavy hydrogen has an atomic weight of two; that is, a proton and a neutron in the nucleus, the revolving electron not counting for practical purposes. If we add still another neutron to the nucleus, we have triple-weight hydrogen. Ordinary helium has a weight of four, yet there is a

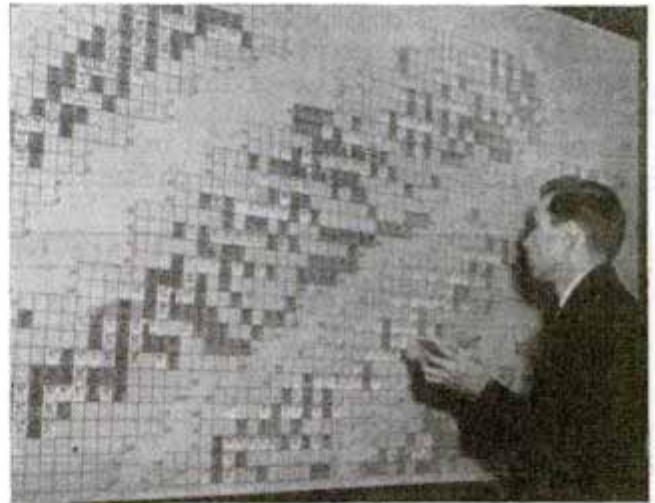

Dr. Seaborg takes notes from chart of isotopes. Below, a slight atomic change creates a new element

MODE OF FORMATION OF PLUTONIUM FROM URANIUM

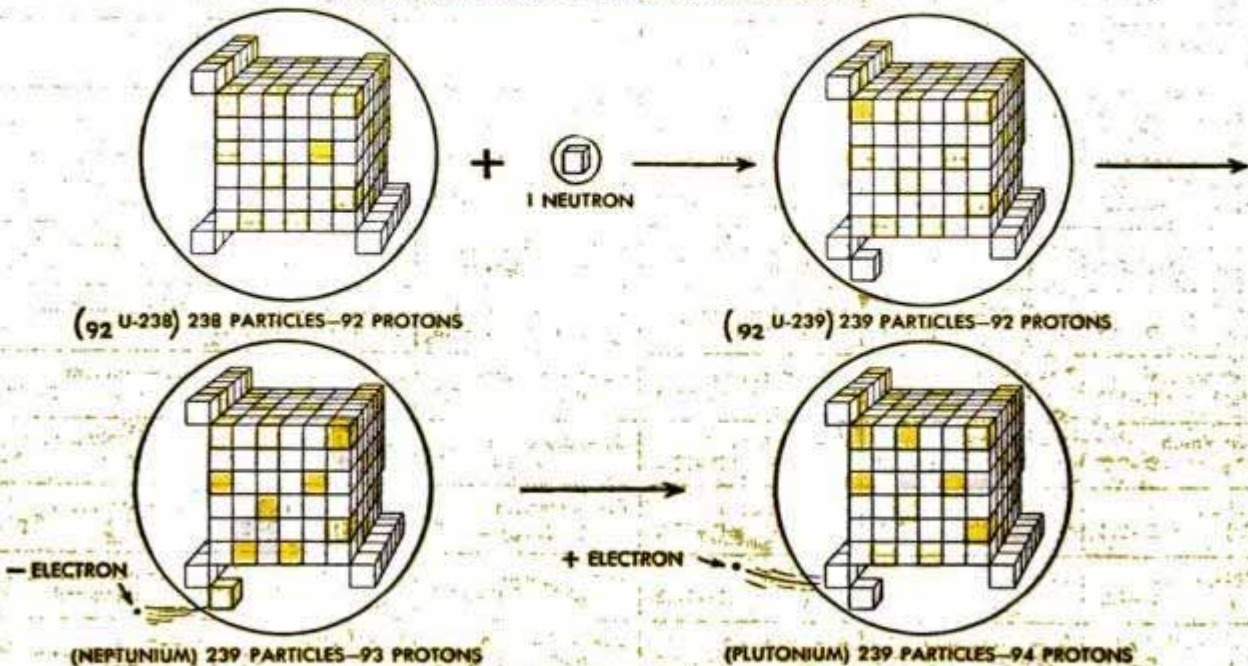

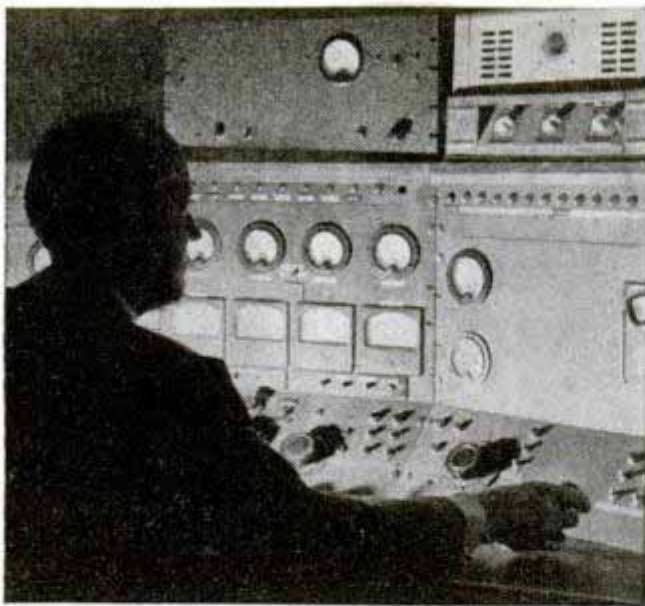

Control board for University of Chicago cyclotron

lightweight helium atom with one less neutron; that is, there is only one neutron instead of two in the nucleus of a lightweight helium atom. But triple-weight hydrogen has only one proton and one electron while lightweight helium, like ordinary helium, has two protons and two electrons. That makes a different element. Yet in the laboratories it has been found that the neutron

can change into a proton, and vice versa.

The change of hydrogen into helium is not theoretical. Astronomers believe the sun gets its energy by transmuting hydrogen into helium, using ordinary carbon as a catalyst. The power generated by this atomic change is infinitely greater than splitting uranium 235 and plutonium, as is done in our atom bombs.

The structure of the atom and theories of atomic change were unknown when Mendeleef published his periodic table. He showed that when all chemical elements were listed in order of their atomic weight, there were periodic recurrences of elements that are similar to each other. As an example, starting with lithium and counting eight elements down the list, we come to sodium. Counting another eight, we arrive at potassium. Lithium, sodium and potassium are soft, white metals which, when dropped into water, react violently.

Counting eight elements from carbon, we have silicon. Carbon and silicon are found in various forms, but think of carbon as a diamond. The silicon counterpart would be quartz, a very hard mineral.

Dr. Mendeleef listed 92 elements and there were many gaps in his chart. However, from his table he was able to foretell

TABLE OF ELEMENTS						D—Density
1—Hydrogen (H) D—.00009	17—Chlorine (Cl) D—.0032	33—Arsenic (As) D—5.7	49—Indium (In) D—7.3	65—Terbium (Tb) D—8.3	81—Thallium (Tl) D—12.0	
2—Helium (He) D—.00018	18—Argon (A) D—.0018	34—Selenium (Se) D—4.5	50—Tin (Sn) D—7.3	66—Dysprosium (Dy) D—8.56	82—Lead (Pb) D—11.3	
3—Lithium (Li) D—.5	19—Potassium (K) D—.9	35—Bromine (Br) D—3.1	51—Antimony (Sb) D—6.6	67—Holmium (Ho) D—8.76	83—Bismuth (Bi) D—9.7	
4—Beryllium (Be) D—1.8	20—Calcium (Ca) D—1.5	36—Krypton (Kr) D—.0037	52—Tellurium (Te) D—6.1	68—Erbium (Er) D—9.16	84—Polonium (Po) D—?	
5—Boron (B) D—2.5	21—Scandium (Sc) D—2.5	37—Rubidium (Rb) D—1.5	53—Iodine (I) D—4.9	69—Thulium (Tm) D—9.35	85—Element not isolated	
6—Carbon (C) D—2.2	22—Titanium (Ti) D—4.5	38—Strontium (Sr) D—2.5	54—Xenon (Xe) D—.0058	70—Ytterbium (Yb) D—7.0	86—Radon (Rn) D—.0099	
7—Nitrogen (N) D—.00125	23—Vanadium (V) D—5.8	39—Yttrium (Y) D—3.8	55—Caesium (Cs) D—1.9	71—Lutecium (Lu) D—9.74	87—Element not isolated	
8—Oxygen (O) D—.0014	24—Chromium (Cr) D—6.9	40—Zirconium (Zr) D—6.4	56—Barium (Ba) D—3.8	72—Hafnium (Hf) D—13.4	88—Radium (Ra) D—5.1	
9—Fluorine (F) D—.0017	25—Manganese (Mn) D—7.4	41—Columbium (Cb) D—8.4	57—Lanthanum (La) D—6.2	73—Tantalum (Ta) D—16.6	89—Actinium (Ac) D—?	
10—Neon (Ne) D—.0009	26—Iron (Fe) D—7.9	42—Molybdenum (Mo) D—9.0	58—Cerium (Ce) D—6.8	74—Tungsten (W) D—18.8	90—Thorium (Th) D—11.5	
11—Sodium (Na) D—1.0	27—Cobalt (Co) D—8.8	43—Element not isolated	59—Praseodymium (Pr) D—6.8	75—Rhenium (Re) D—21.5	91—Protoactinium (Pa) D—?	
12—Magnesium (Mg) D—1.7	28—Nickel (Ni) D—8.8	44—Ruthenium (Ru) D—12.0	60—Neodymium (Nd) D—7.0	76—Osmium (Os) D—22.5	92—Uranium (U) D—18.7	
13—Aluminum (Al) D—2.7	29—Copper (Cu) D—8.9	45—Rhodium (Rh) D—12.4	61—Rare earth	77—Iridium (Ir) D—22.4	93—Neptunium (Np) D—?	
14—Silicon (Si) D—2.4	30—Zinc (Zn) D—7.1	46—Palladium (Pd) D—12.2	62—Samarium (Sm) D—6.9	78—Platinum (Pt) D—21.4	94—Plutonium (Pu) D—?	
15—Phosphorus (P) D—2.2	31—Gallium (Ga) D—5.9	47—Silver (Ag) D—10.5	63—Europium (Eu) D—5.24	79—Gold (Au) D—19.3	95—Discovered but unnamed	
16—Sulphur (S) D—2.0	32—Germanium (Ge) D—5.5	48—Cadmium (Cd) D—8.6	64—Gadolinium (Gd) D—7.95	80—Mercury (Hg) D—13.6	96—Discovered but unnamed	

the properties of then unknown elements and when they were discovered his predictions were remarkably accurate.

Element 92 is uranium. In laboratories, physicists have added elements 93 and 94—neptunium and plutonium. Now Dr. Glenn T. Seaborg not only has discovered the existence of these in a natural state but also has developed elements 95 and 96.

This briefly is the story of the new elements. An uranium atom has 92 protons in its nucleus and 92 electrons in its orbits, no matter what its weight. Ordinary uranium has an atomic weight of 238, the rest of the mass in its nucleus being made up of neutrons. The nucleus of uranium 235 has three neutrons less than the ordinary kind and is unstable. When smashed by a free neutron, uranium 235 breaks into barium and krypton with a loss of matter in weight. The lost matter is changed into energy—as predicted long ago by Dr. Albert Einstein—and the release of energy is 200,000,000 electron volts per atom. An electron volt is the energy possessed by a hydrogen atom moving 600 miles per second.

When bombarded by a stream of neutrons, uranium 238 behaves differently. It captures a neutron, incorporates it into its nucleus and becomes uranium 239. But the latter is unstable. One neutron in the nucleus changes into a proton and we have a new element, neptunium—93 protons—number 93 in the periodic table.

A strange thing takes place at the same time. When a neutron changes into a proton, it throws off an electron. Conversely when a proton changes into a neutron, it ejects a particle of positive electricity—not a proton but a positron—the positive electrical opposite of the electron, each having negligible weights. Proton and neutron are counterparts, but a proton has a positive electrical charge, a neutron has none.

Neptunium is an unstable element and gives off an electron, which means another neutron in the nucleus has changed into a proton. Now we have 94 protons in the nucleus—a new element, plutonium—number 94 in the periodic table.

All the changes described are made under bombardment of a stream of neutrons slowed by a wall of paraffin or heavy water or anything rich in hydrogen. A fast stream of neutrons only passes through atoms. There are several methods of generating such a flow of neutrons. Dr. Seaborg used the cyclotron—a huge electromagnet which whirls particles with increasing speed to build up power before releasing them through a slit to the target.

Time will tell what value Dr. Seaborg's new elements have; but his work represents a long leap toward the eventual harnessing of atomic energy for general use.

200
Reading, Pa.
One-Ounce Eye Shield of Plastic

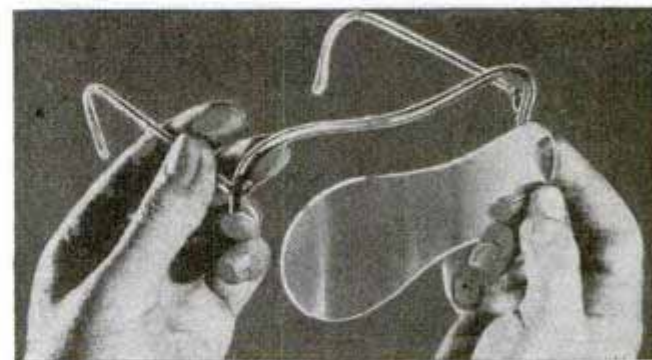

An eye shield weighing just one ounce is suitable for spot welding, light grinding and woodworking. The one-piece lens, or shield, is held tightly in a suspension-lock frame. If work requires shielding the eyes from glare, the lens may be removed quickly and a colored one substituted. The shield can be worn over regular glasses.

Buoys Radioed Warning of Subs

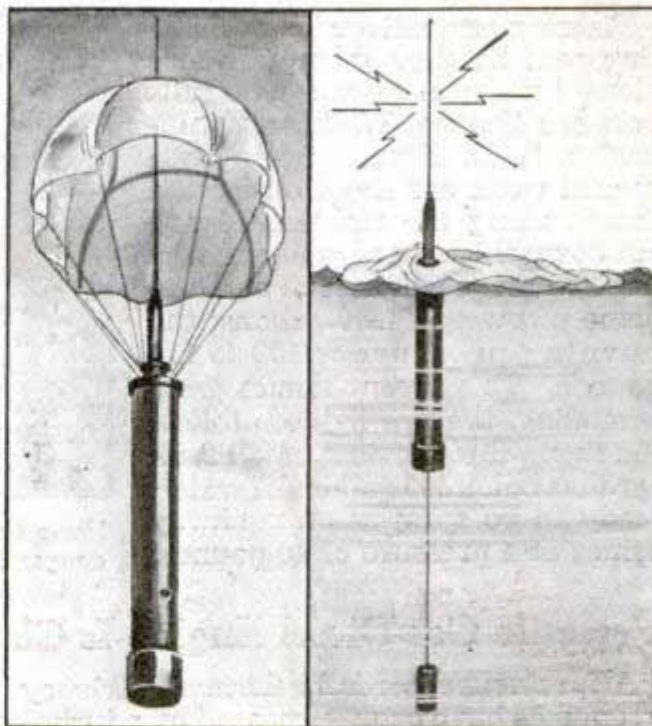

Parachuted into the ocean from U. S. planes, radio-equipped buoys served as "watch dogs" to broadcast the presence of Nazi submarines. The buoy had an antenna above water to send out a warning message when its hydrophone—24 feet under water—detected an enemy sub.

Rail-Riding Flame Throwers Kill Weeds Along Tracks

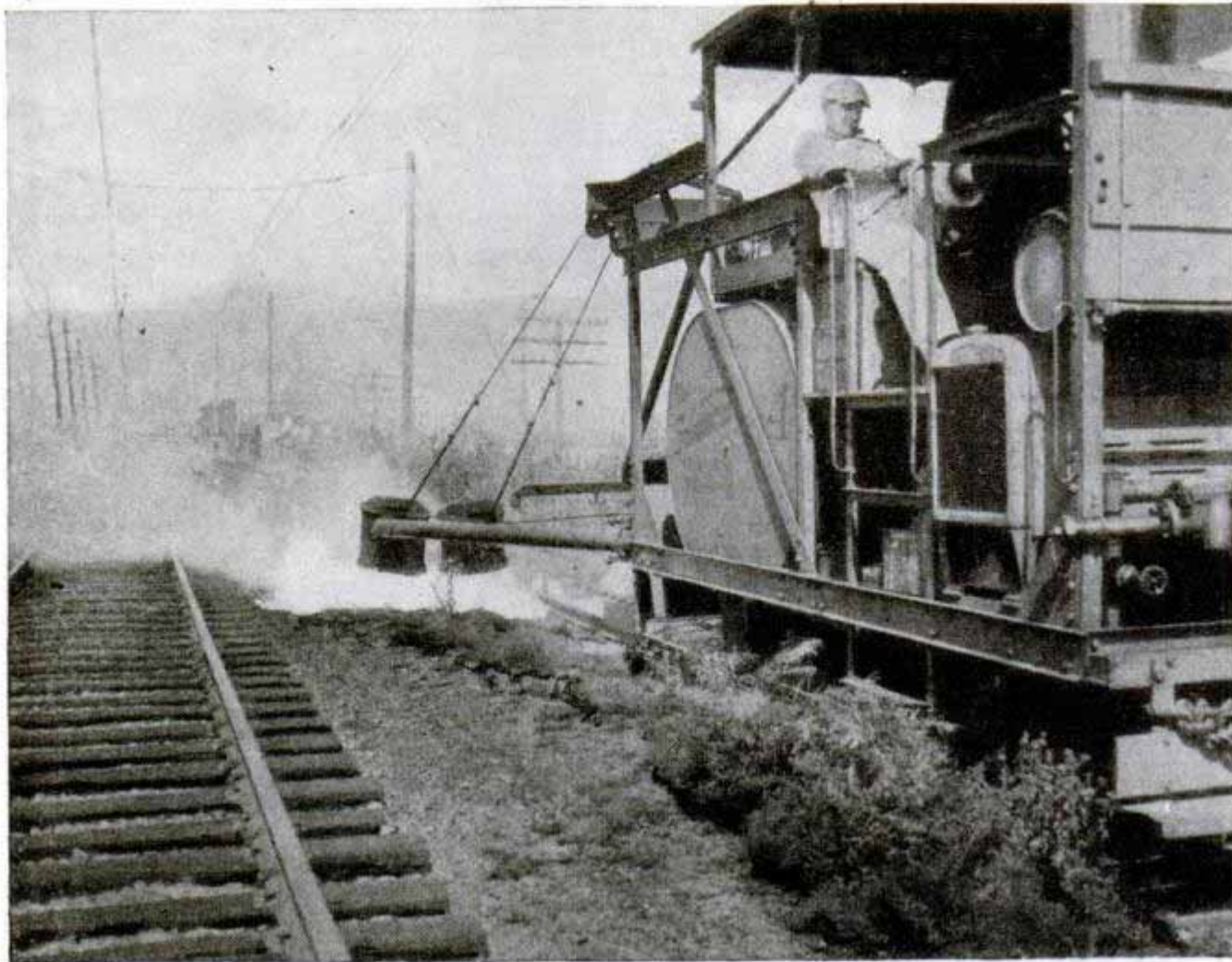

Firemen on a rail car follow flame throwers as they destroy weeds along hundreds of miles of rails between Seattle, Wash., and Mobridge, S. D. Five blowers on a special work car shoot oil-ignited flames along the right-of-way to cut down thick weeds that menace fast trains. Fuel capacity of the flame thrower is 1500 gallons; the burning pressure is 100 to 115 pounds. To prevent flames from spreading, the fire fighters follow the flame thrower in a small tank car that holds 500 gallons of water, ready to be sprayed on runaway flames at a pressure of 40 pounds.

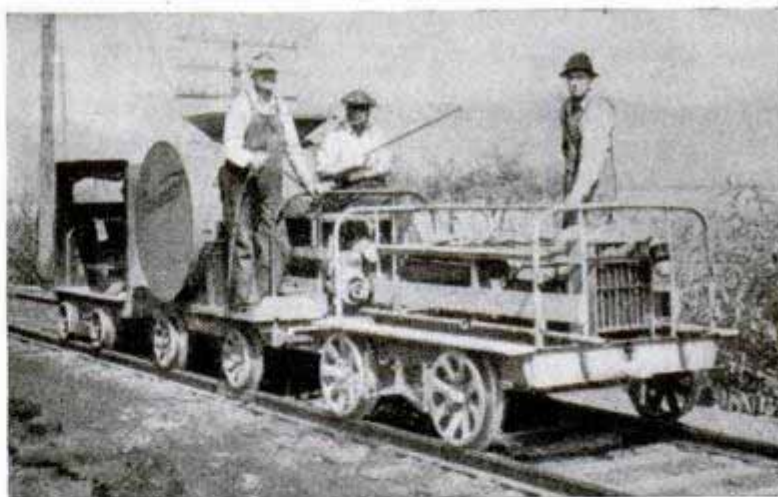

Flame throwers find postwar use in destroying weeds that endanger fast trains. Firemen extinguish flames from tank car

Versatile Gas-Diesel Engine Is Claimed the Most Efficient Ever Built

All previous records for thermal efficiency in engines have been surpassed by a turbo-charged gas-Diesel engine, according to the manufacturer. Thermal efficiency is the ratio of fuel consumed as compared with horsepower developed. The thermal efficiency of the engine was reported "in excess of 40 percent—higher than ever accomplished by any steam, gas, gasoline, gas

turbine or Diesel engine." The designer states that the engine's efficiency will cut fuel consumption of gas engines by 20 to 25 percent. Resulting from experiments begun in 1928, the engine is claimed to be so versatile that it can operate on a wide variety of fuels, including fuel oil, natural gas, manufactured and coke-oven gases, sewage gas and refinery by-products.

The Cooper-Bessemer Corp.

"LITTLE DAVID"

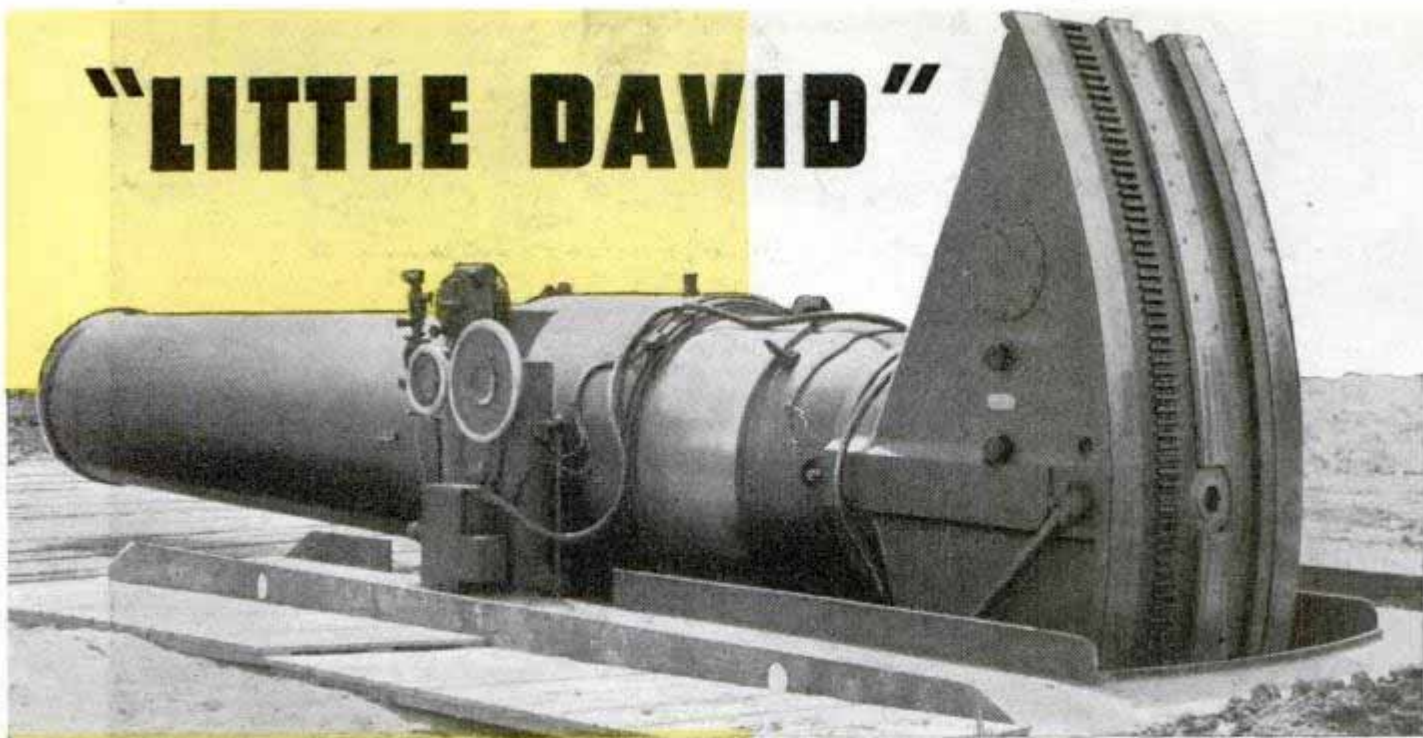

Above, "Little David's" 40-ton gun tube in position with 46½ tons of base assembly buried beneath. Below, mortar's shell slides into place when weapon is elevated

By Theodore H. Erbe

LARGEST and most destructive mortar ever built, "Little David" was developed by the Army for use in pulverizing the Japanese in the battle for the Jap homeland. Never used, it is still one of the world's most potent weapons.

Surpassing even the 31½-inch weapon built by the Germans, "Little David" hurls a 36-inch shell weighing nearly two tons a distance of six miles. The barrel, or tube, weighs 40 tons; the boxlike base upon which the barrel rests 46½ tons. Everything about the weapon is gigantic, even the 136-pound doughnut-shaped powder rings used to propel the shell.

Despite its immense proportions, the weapon is highly mobile. Two "Dragon Wagons," tremendous 40-ton-capacity vehicles designed to recover wounded tanks, carry the mortar. One supports the 22-foot tube, another the base box. A bulldozer and a crane with a bucket shovel are among the other vehicles used in transporting and emplacing the gun. Trained crews need only 12 hours to install the mass of steel in firing

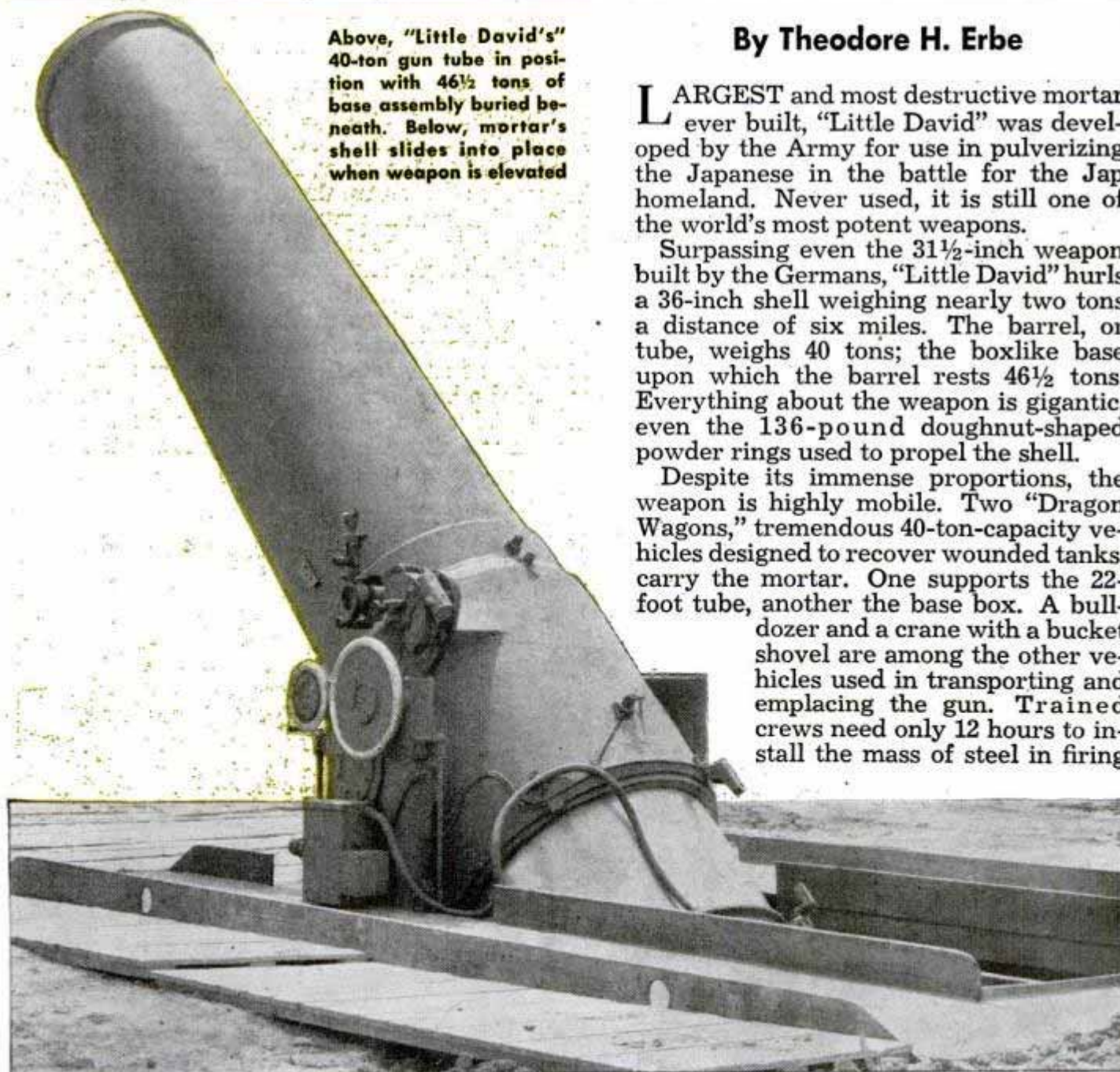

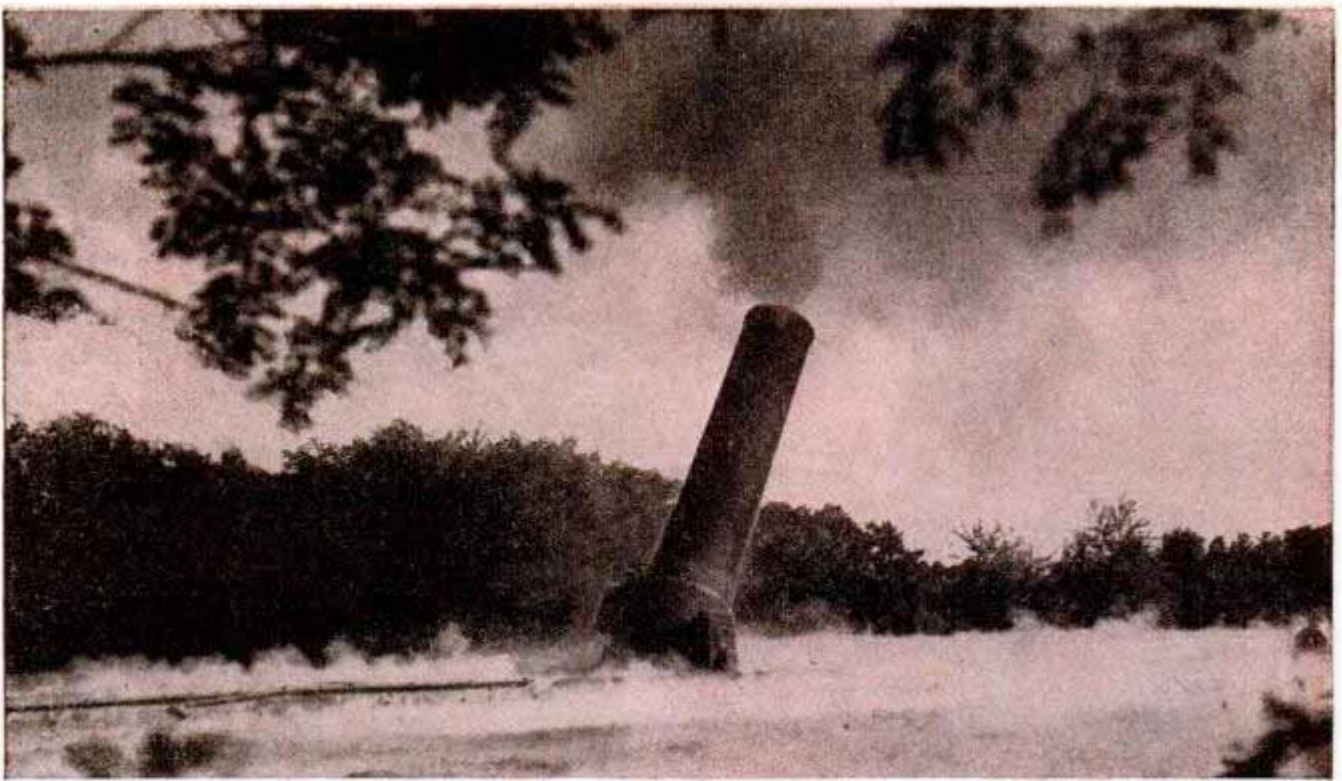

With an earthshaking roar "Little David" launches nearly two tons of explosives six miles through the air

position. The German "Dora," a slightly smaller mortar, used 25 railway cars as transportation, and required three weeks' work on the emplacement before a shot could be fired.

Biggest obstacle to overcome in emplacing the giant is installing the base box. This 93,000-pound unit containing all control mechanisms is 18 feet long, 9 feet wide and 10 feet high. Sinking it into the ground until the top is flush with the surface of the earth requires the movement of 1620 cubic feet of dirt. The job is done by bulldozing a large cut in the ground with a ramp at each end.

After the cut is prepared, the "Dragon

Wagon" carrying the base box is driven down one ramp into the hole. Six built-in hydraulic jacks then lower the base from the truck into the excavation. The "Dragon Wagon" is driven up the other ramp, electric cables from the generator are attached, drainage pipes are installed, and the truck-mounted crane and bulldozer fill in the trench, packing dirt around the firing base.

Similar ingenious methods are used to install the gun tube above the base. Crew members fasten steel runners across the top of the base box. The second "Dragon Wagon" hauls the 40-ton gun across the runners. Hydraulic jacks gently lower the

(Continued to page 166)



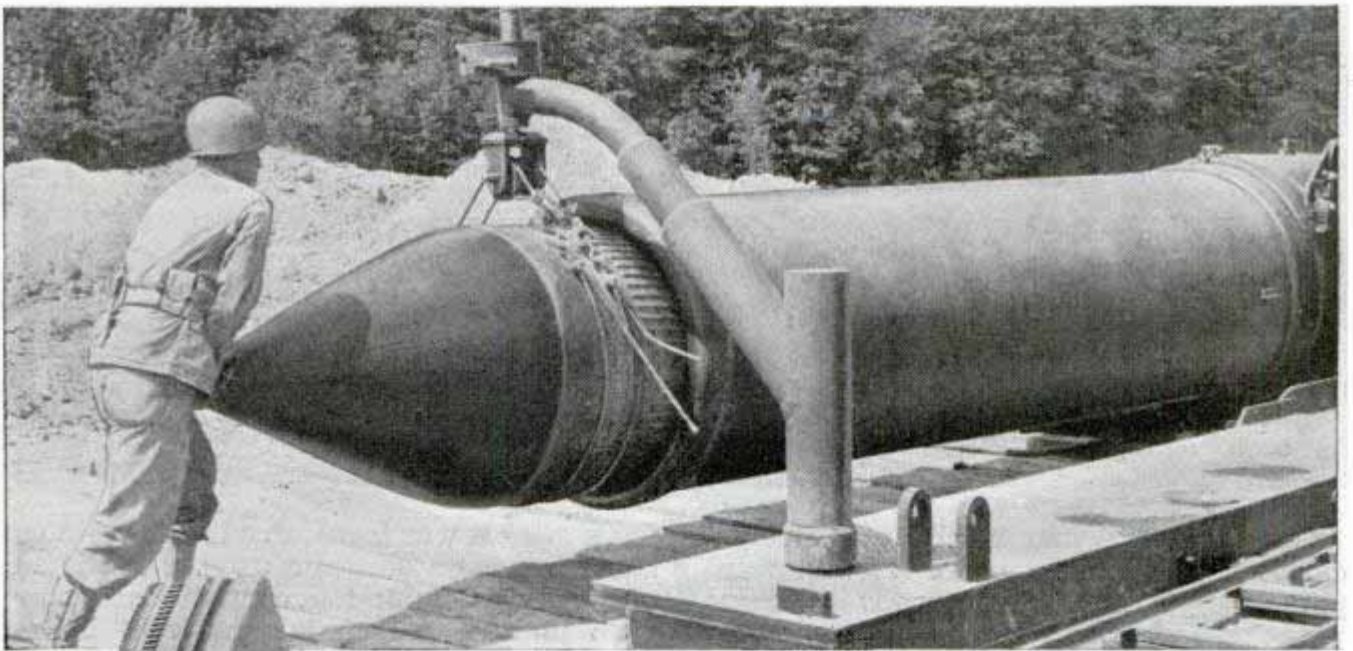
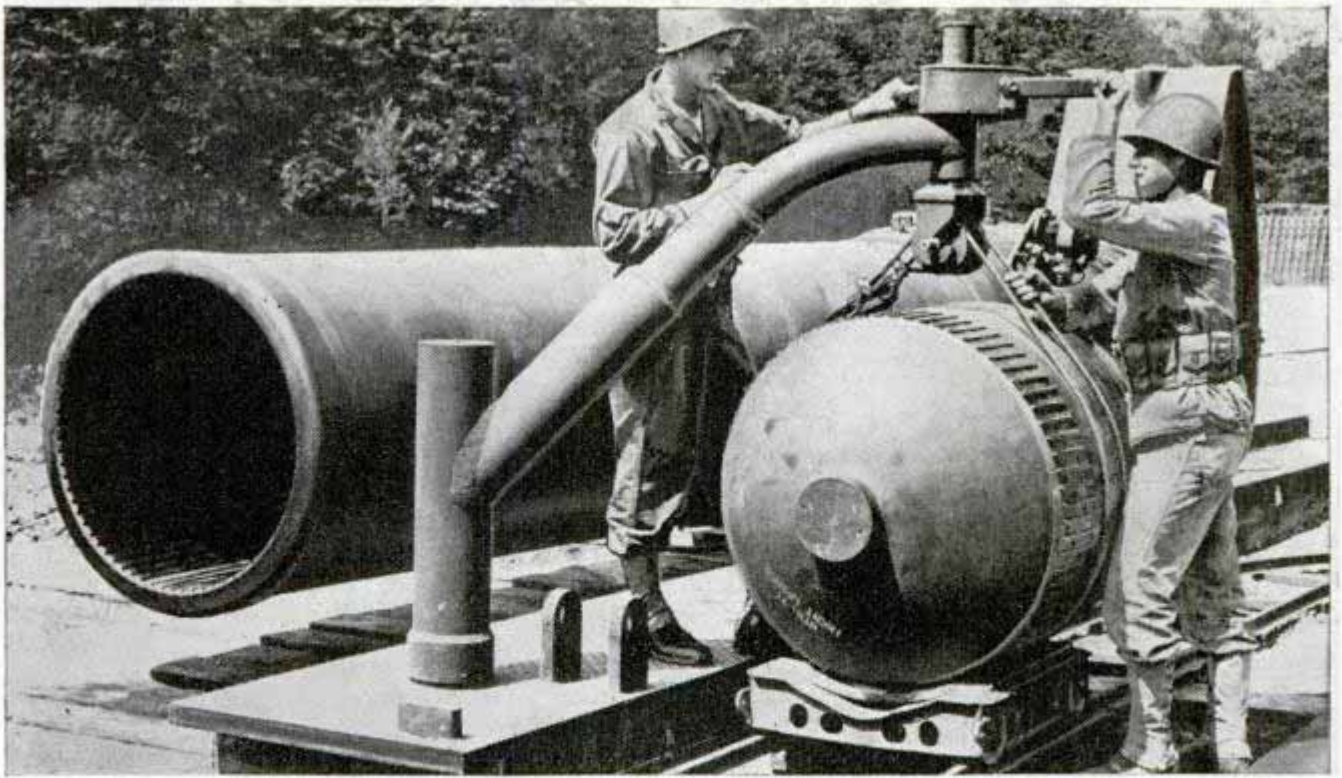

Signal Corps photo
Top, gigantic shell is lifted by davit from special trolley. Above, base of shell is pushed into muzzle until grooved band engages rifling. Below, "Dragon Wagon" hauls monster to gun emplacement. The 46½-ton base assembly is carried on a similar truck



Refrigerated Jeeps and Trains Carried Food in Burma

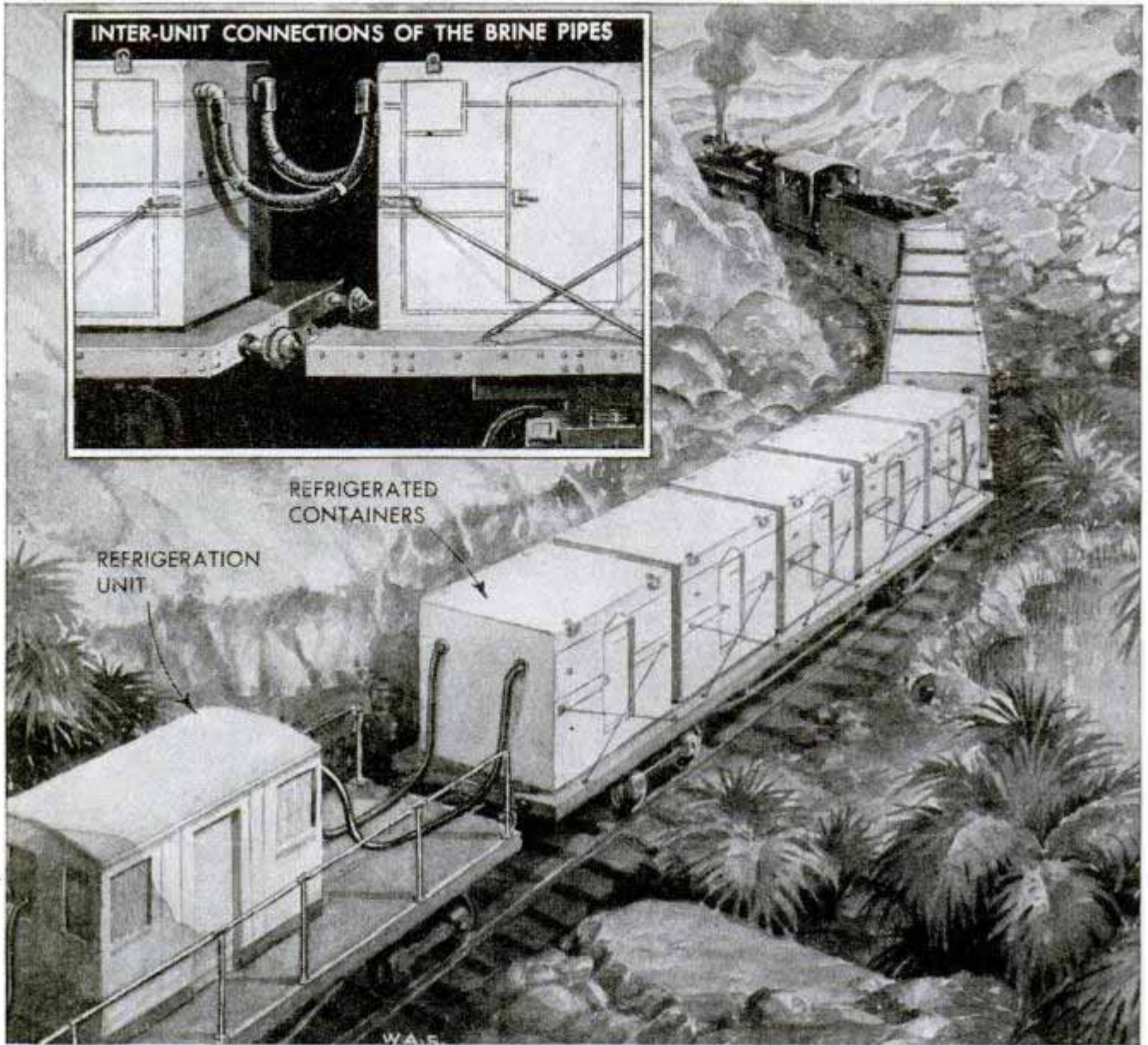

Specially designed refrigerated freight cars, jeeps and barges played an important part in supplying British troops in Burma with fresh meat and vegetables. Ammonia brine was used as the refrigerant, the brine being circulated through coils. Small refrigerators carried the food on mules or in

jeeps after it was transferred from train or boat. Refrigerated trains usually consisted of twenty 170-cubic-foot containers, five for each flatcar. All containers were interlocked to the refrigeration unit by flexible brine pipes to keep the cooling system operating during journeys of hundreds of miles.

Giant Trailer with 64 Pneumatic-Tired Wheels Hauls a 300-Ton Load

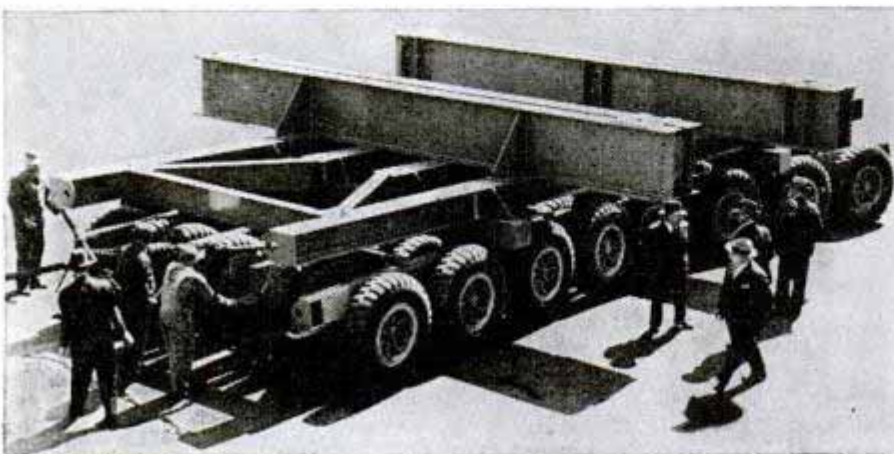

Three hundred tons of secret military equipment—heaviest load ever moved on pneumatic tires—were carried on a giant 64-wheeled trailer built by Rogers Brothers Corporation of Albion, Pa. The trailer was 39 feet long, 17 feet wide and weighed 73 tons. The 14.00-24-inch Goodrich synthetic rubber tires weighed 220 pounds each.

ARTIST WITH A POCKETKNIFE

Ernest Warther trims a bit of wood from one of his elaborate hand-carved canes. Below, he chats with his brother, Fred, at his workshop in Dover, Ohio



By Walter E. Burton

WHEN the roadside signs along the country pikes near Dover, Ohio, began disappearing one by one some 54 years ago, people wondered about it. Eventually they learned that any missing bit of wood could be traced to a youngster with a pocketknife—Ernest Warther, who was just beginning a lifetime of whittling.

His career of carving probably reached its zenith in a series of ivory, ebony, black walnut and pearl models recreating in miniature the history of the locomotive. The task took him 32 years, and between times he has whittled an amazing variety of objects of art, novelties and museum pieces. His wartime specialty was commando knives.





did this happen that the neighbors began to kid them about it. This kidding got under Warther's skin. He got some wood, whittled two 14-inch perch, dressed them up with penciled-on scales, and carried them, concealed under his shirt, out to the fishing spot. That afternoon there was no kidding, for he and his companion each toted through the streets a tasty-looking perch, dangling from a string. Arriving home, Warther tossed the fish into a tub of water in his yard, an action that almost earned him a spanking. His mother, seeing the perch, got out the frying pan and a knife, and discovered the ruse only when she picked up one of the fish with the intention of scaling it.

This "bush" is 511 pairs of interlocking pliers fashioned by this pocketknife artist from a walnut block similar to the one he holds in his right hand. He can carve a single pair of pliers in one minute

Warther's carving skill developed rapidly. He got a job in a local steel mill as a shear operator, a task not noted for its gentle treatment of hands, for it involved the handling of as much as 15 tons of steel a day; yet after a 10-hour shift he would go home and carve, often keeping at it until long past bedtime. Somewhere he heard that it is possible to make, with a keen, slender knife blade, a pair of wooden pliers that work like the real thing, yet being cut

Young Ernest's chief occupation, at the age of five, was convoying cows along the roads around his home town. That didn't keep his hands busy, so he acquired a pocketknife and started whittling.

Every day Ernest and a boy companion would trudge out to Sugar Creek to go fishing; and in the evening they would trudge back again, always empty-handed. So often

from one piece cannot be taken apart without breaking the wood. He could find no one who knew how to do this, so he decided to work out the process by himself. "I used up a lot of wood and time," he says, "but the pliers would split or break before I had succeeded in separating the halves at the joints. After dozens of trials, I finally made a pair that worked. Then I attempted to

Shaping a commando knife blade on a grinder. Right, measuring an ivory-toothed gear wheel for a locomotive

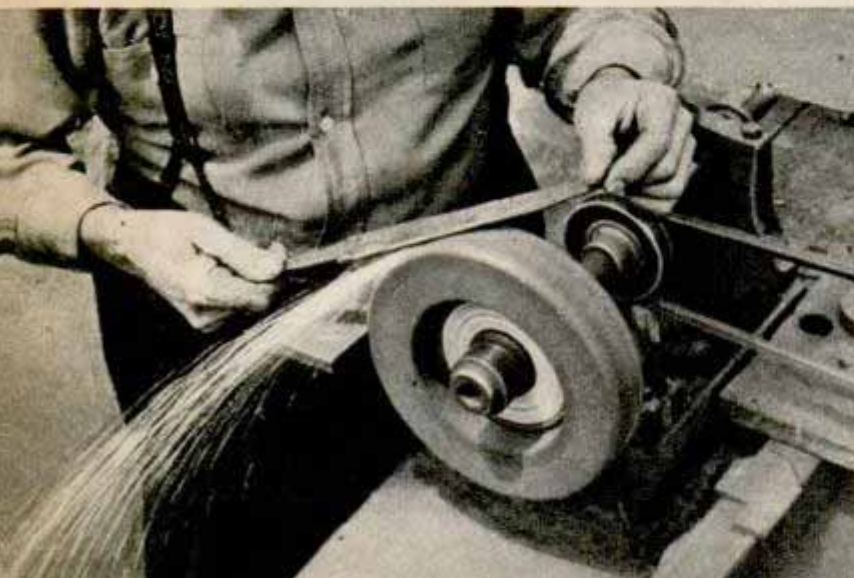

figure out why I had succeeded this time after so many failures, and I finally decided that it was because the wood had come from an old well bucket. Maybe the long soaking in water had something to do with it. So I started out to gather up wooden buckets."

Warther perfected the art of plier-carving, and then tackled group arrangements, in which several interlocking pairs of pliers are fashioned from a single block of wood. His ultimate triumph was the carving, from one piece, of 511 interlocking pairs. This tree-like cluster has been exhibited in museums and at world fairs, and now resides in his private collection. He still likes to amaze visitors by whittling a pair of pliers from a stick of white pine in one minute flat, but he declares he never will attempt again to fashion 511 pairs from a single block. The plier tree and other items of his home display are kept in his museum, at the rear of his home.

In 1913 Warther undertook a task that would make a less enthusiastic man hesitate for a lifetime: he started to carve a series of scale-model locomotives depicting the entire history of the iron horse. His principal tool was a carving knife of his own design and make, supplemented by micrometers for measuring to thousandths of an inch, and a drill press for forming holes. He used no lathe, even though each model contains dozens of wheels, shafts and other round parts. In the 32 years that have elapsed since he started the series, he has completed 34 locomotive models, each representing an outstanding step in the evolution of railroading. Starting the parade is a model of an engine designed by Hero at Alexandria, Egypt, in 250 B.C.; and ending it are models of the latest giants of the rails. There is one missing link, a locomotive said to have been designed or made by Leonardo da Vinci in the 15th century. Warther has been trying to locate the plans for this engine, but so far has

Museum has lock and key from ancient sailing ship



Elephant tusk provides ivory for tiny locomotive parts

not succeeded. He refuses to start work on a model until he has complete, reliable blueprints or other drawings. Most of his engines were built from full-scale blueprints furnished by the Baldwin Locomotive Works.

In 1923 Warther, in a specially fitted Pullman car, took 15 of his models on a 13,000-mile tour of the New York Central Lines. Attendants counted 786,000 visitors through that car. The models then were placed on display in Grand Central Station in New York City.

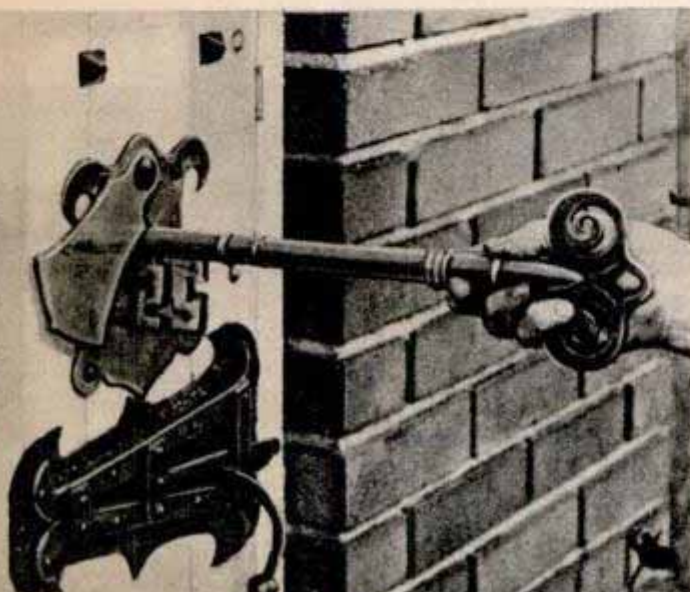

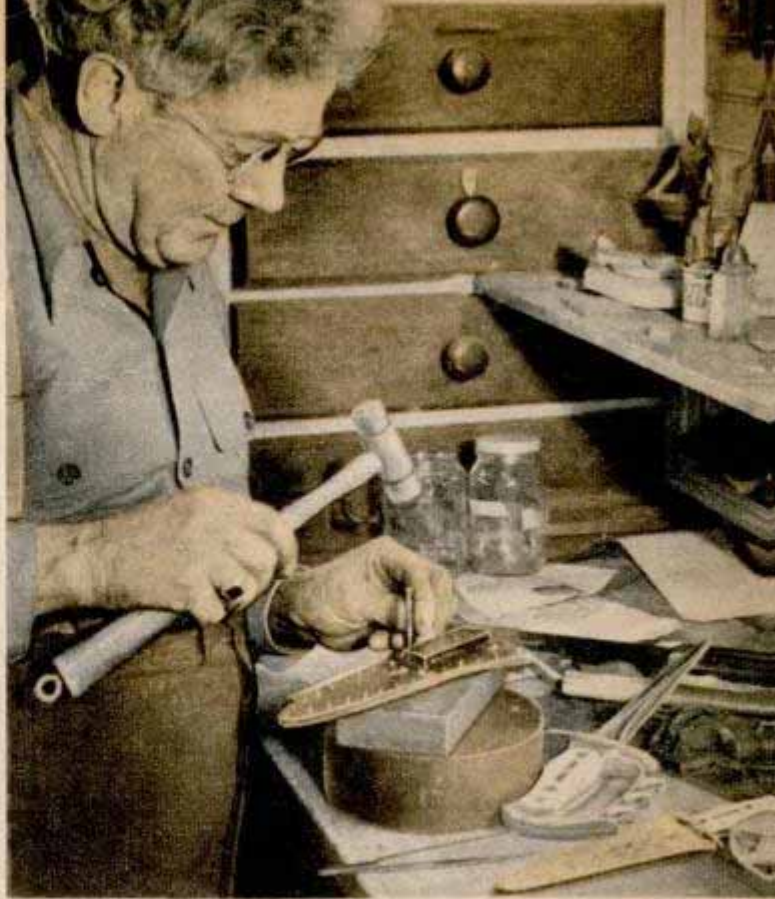

Warther rivets together sheath for commando knife

For the past 18 years Fred Warther, Ernest's brother, has piloted the Warther show truck around the United States, displaying 17 of the locomotive models, a working model of the steel mill in which Ernest toiled for more than two decades, and miscellaneous exhibits of arrowheads and other curios and commando knives.

The locomotives in the private museum, like those in the truck, all are running when exhibited. They start when the room lights are switched on. Electric motors drive the wheels, pistons and other moving parts at a rate of about 30 drive-wheel revolutions per minute. Each model is elevated enough above the track for the wheels to revolve freely; the model does not move around the track, but remains stationary.

Carved from one piece of wood, cane has two "cages" containing wooden balls. Below, ivory parts for trains



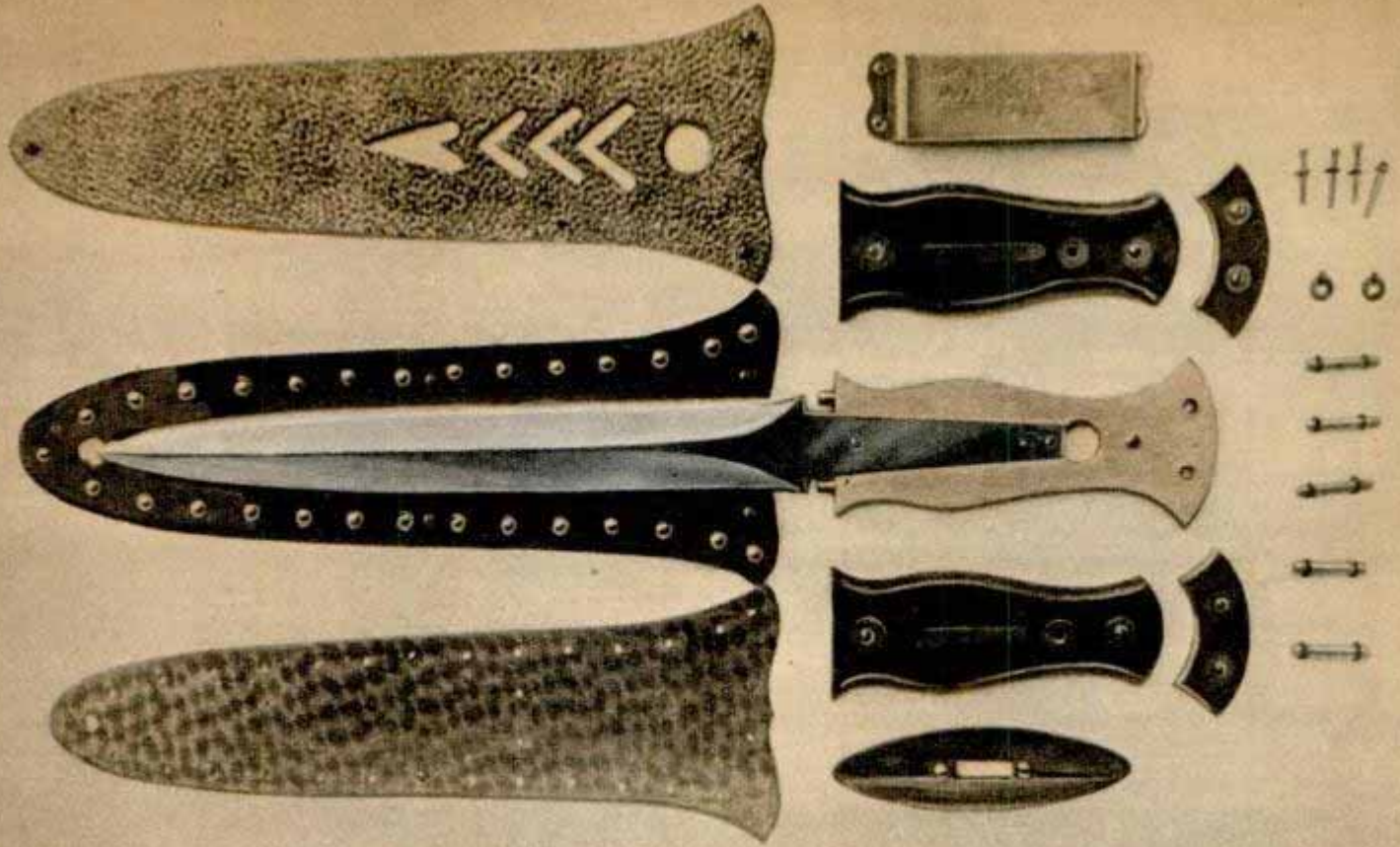

The 59 parts that make up one hand-made commando knife fashioned by the Ohio craftsman are pictured here

One of the models in the museum will serve as an example to illustrate the intricate work involved in building the locomotive series. This is a scale replica of the Great Northern mountain type locomotive built by the Baldwin Locomotive Works in 1930. The model of No. 2577 is 58 inches long and weighs 74 pounds. It took Warther 1600 hours of carving to create it, and the ivory, ebony, pearl and other materials cost \$302.50.

Like all the other locomotive models, everything is built to scale, and every moving part works as in the full-sized prototype—yet no metal parts are used. The ivory steam pipes are curved exactly like the original ones, yet ivory cannot be bent. Warther had to carve the pipes to their exact curves. On a locomotive equipped with a bell, the ivory bell rope is carved to

the exact curve of a real rope supported at both ends. Ivory bolts have nuts that screw on their threads and help hold the model together, yet Warther used no tools other than his carving knife and small files to produce these. Likewise, he carved the driving wheels to exact scale and roundness with micrometer accuracy, without the use of a lathe. The bearings in which the ivory shafts rotate are made of arguto wood, an imported material containing a natural lubricant that has found numerous applications in industry and war. Models that have been running for 20 years show no appreciable wear of shafts or bearings. An inspection of the Warther locomotives, and consideration of the hours of patient labor that went into each one, will explain why the collection is valued at more than \$500,000.

Equipped with ivory handle and fancy sheath, a deluxe commando knife made by Warther was priced at \$100



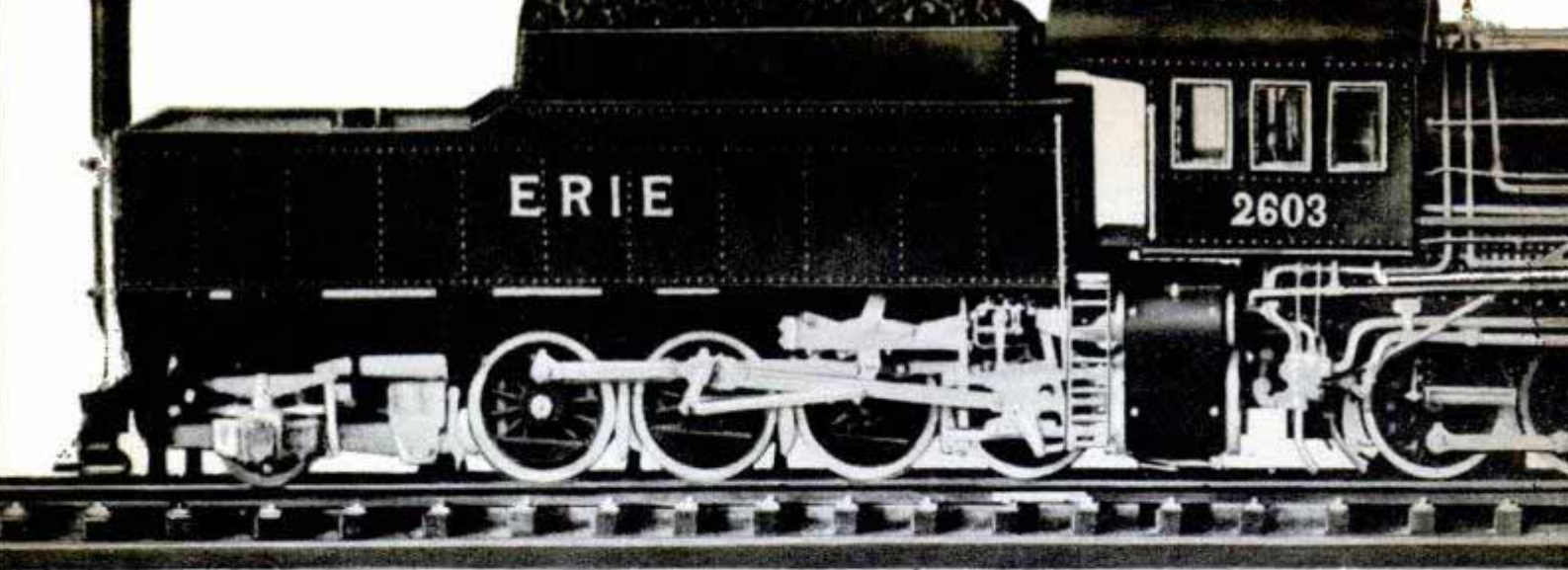

It took Warther 1½ years to build this model locomotive; it has 1004 ebony and ivory parts, weighs 78 pounds

The Warther brothers turned their attention during the war to making knives for servicemen. It all started shortly before Pearl Harbor when a Dover serviceman wrote from camp to his wife, asking whether Warther could make him a com-

mando knife. As a sideline, the Dover carver had been making various items of cutlery almost as long as he had been whittling. First of all, he has had to make all of his carving knives to get the kind he wants. Then, when tedious carving became

tiring, he developed the habit of pounding scrap pieces of steel into knife blades, the anvil work serving as a form of relaxation. More than one Dover housewife will attest to his skill as a knife-maker. In the museum is a well-worn paring knife that was in daily use for more than 20 years. Once he gave a similar knife to a woman as a wedding present, and a generation later she presented the same knife to her daughter as a wedding gift.

Warther didn't even know, when the request came, what a commando knife was. But he got out a piece of tool steel and some odds and ends of wood and metal, and set to work designing a knife

Model of George Stephenson's "Rocket" which pulled the world's first passenger train in 1829

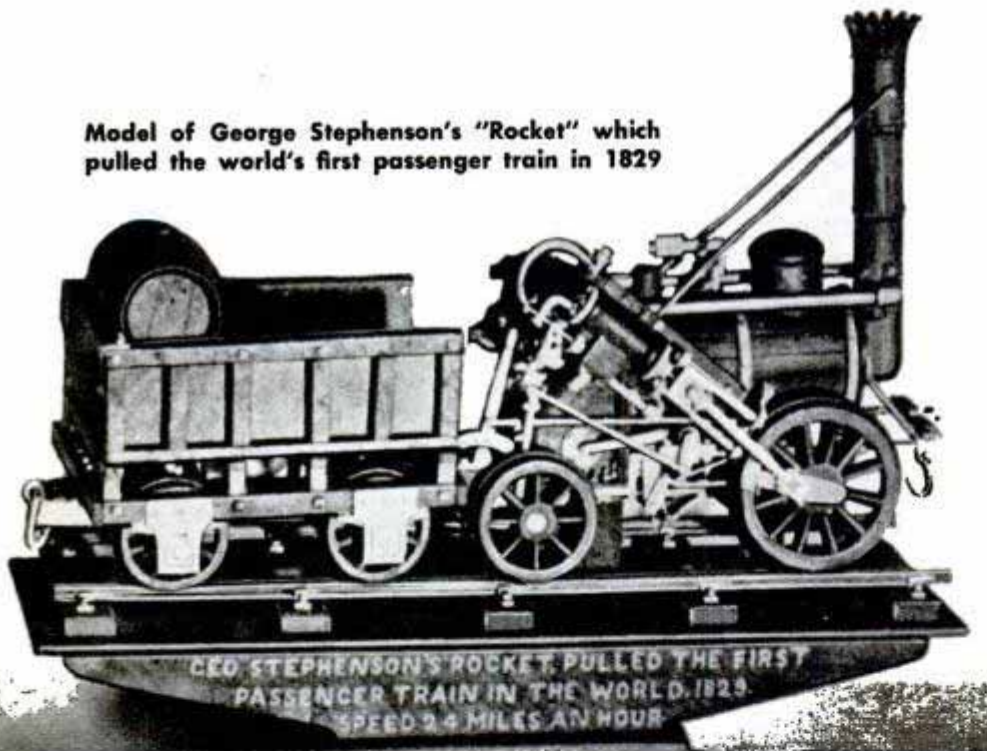

Representing 1600 hours of hand carving, this model of a mountain type locomotive weighs 74 pounds



Great Northern mountain type locomotive
Designed and built by the Baldwin
Locomotive works 1930

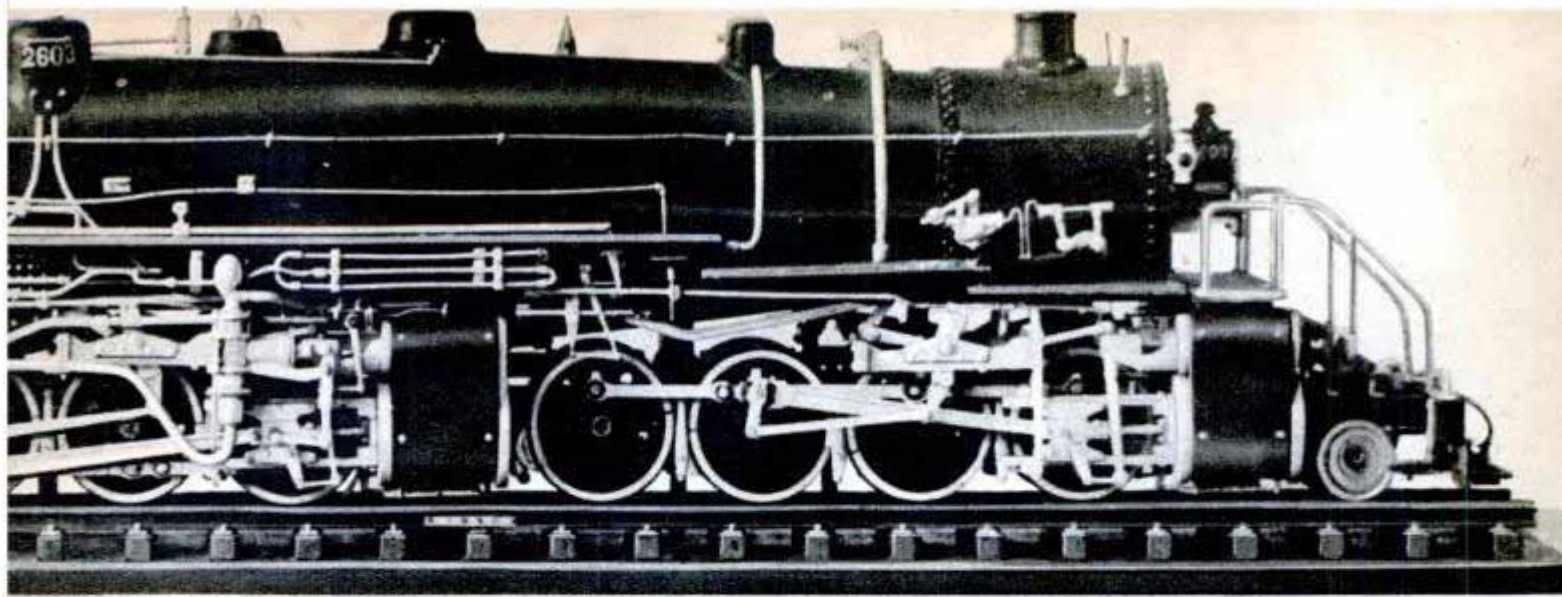

that, in his opinion, ought to be useful for combat carving. He turned the finished knife over to the soldier's wife, and she relayed it to camp. Back came a letter asking for eight more for the soldier's buddies.

From that day until the war ended Warther had more combat knives to make than time to make them. His knives were declared by many to be the most beautiful in the Army, Navy or any other fighting organization, as well as being highly useful when occasion demanded. The Warther line included several different grades, ranging from the basic 7-inch model and the 8-incher to a superdeluxe, ivory-handled stabber.

The blade of a commando knife was made from high-quality carbon or alloy tool steel. After forging the blade, Warther brought it to virtually final shape on an electric grinder he keeps under a box on a terrace of his garden. Grinding in the open prevents his tiny, chaletlike workshop from being filled with gritty particles. He hardened and tempered the blade by a process involving a secret quenching solution containing, among other things, sperm oil. "I guarantee that my knife cannot be broken on anything that walks, swims, flies or crawls," he tells his customers.

The blades were equipped with aluminum alloy guards, and handles were made of ebony, cocobolo wood or ivory. The higher-priced models were equipped with aluminum alloy knuckle guards. The ivory-handled ones had inlaid decorations whose elements were so shaped and inserted that they couldn't work loose. Inlaid in each handle were two metal plates, one for the owner's name, the other for his serial number. On the deluxe models, these plates were engraved by a jeweler.

Warther encased his knives in all-metal sheaths, made of surplus and scrap metals, that were highly decorative as well as useful. The back was stainless steel that was given a watch-case finish. The front was

(Continued to page 162)

Even the "wood" in one locomotive's tender is ivory



Warther's intricate carving is done with a small knife

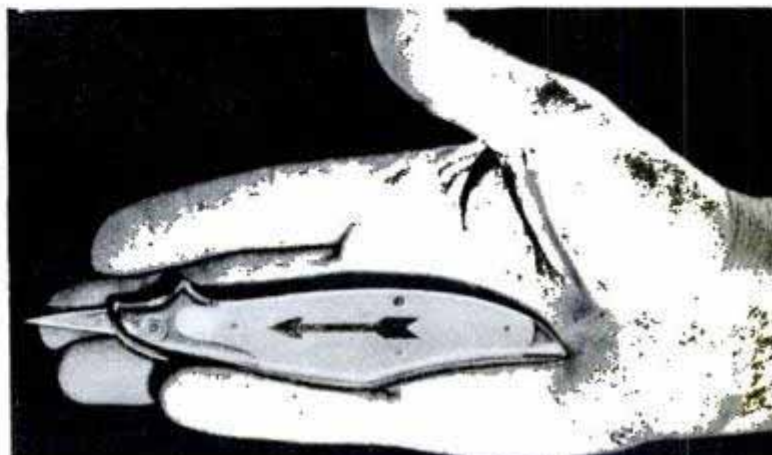

RADIO LAB ON RAILS

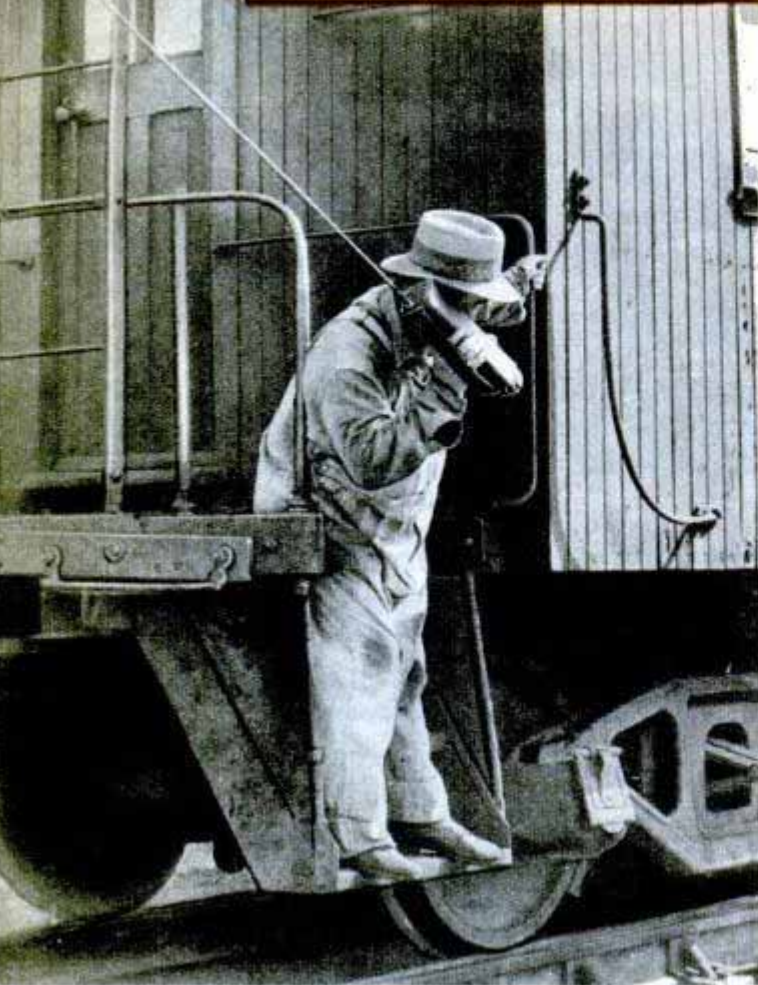

Galvin Mfg. Corp. photos
Trainman uses handie-talkie to facilitate switching. The set is one of many radio devices on laboratory car. Below, portable FM transmitter-receiver bridges gap in wires

The job that radio can perform for the railroads is being determined in a traveling electronic laboratory on the Rock Island railroad. It started life in a caboose, but moved into a Pullman car to keep pace with fast passenger trains and fast-moving developments in train communications. Cramped with radio apparatus for tests and emergency work, the car contains living quarters for a 13-man crew. At the front is a combination radio room and office with an FM transmitter-receiver. It is used for ordinary communication with the company's stations and operates while the car is in motion or standing still. In the center of the car is the bunk-living room with adjoining galley and shower. Back of this is the electronic laboratory proper with a complete assortment of instruments, meters and trouble-shooting equipment. On one table is a portable recorder that can be "patched" into any radio or telephone circuit. A telephone handset permits remote control of the radio equipment up front. A closet in the laboratory holds two handie-talkie and two FM walkie-talkie sets which take the place of hand and flare signals in emergencies and are otherwise useful in maintaining contact with the car. At the extreme end of the car is the power plant, a soundproof room containing a gasoline-driven generator which supplies electricity for the main radio equipment. Stored in this end compartment are two self-contained portable FM transmitter-receiver units which are set up to bridge gaps (up to about 35 miles) where wires are down. The units are "duplex" FM—that is, they can receive on one frequency and at the same time transmit on another. The car has three antennae. It is entirely air-conditioned and is equipped with fluorescent lights

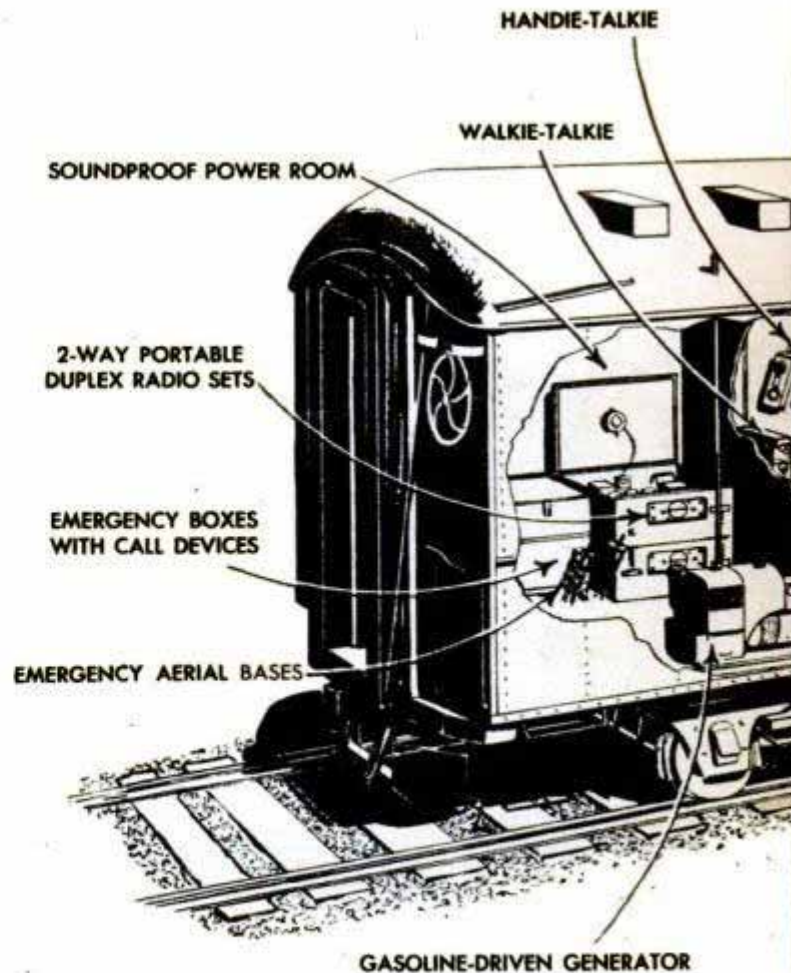
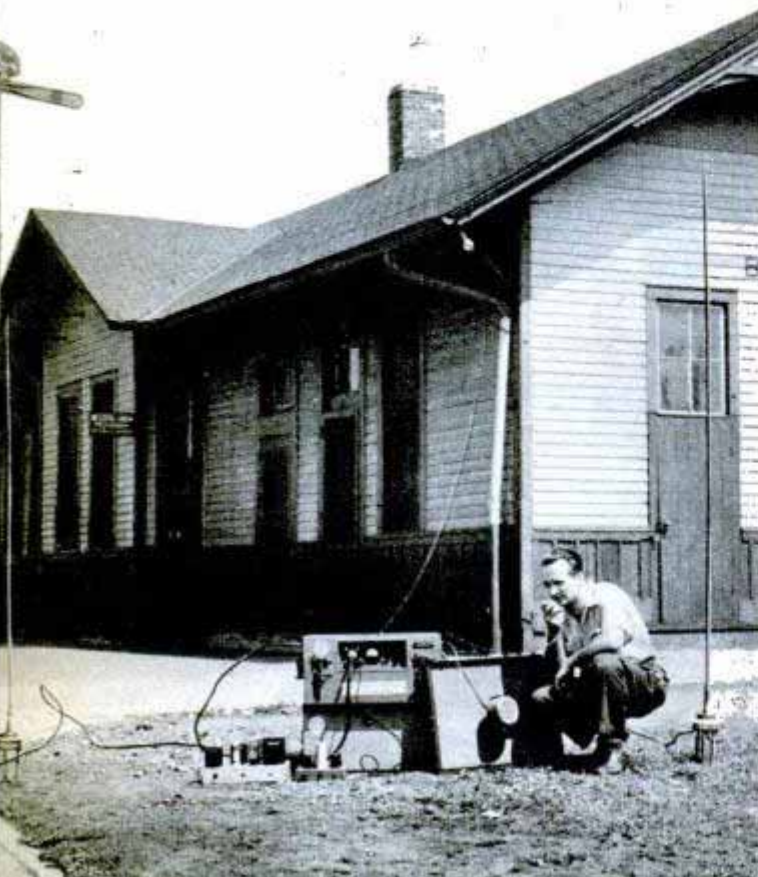



When lines are down, radio "patching" solves communication problem. Left, operator of portable transmitter-receiver spans gap in telephone line by putting signals on the air. At other end of gap similar unit receives message which is put back on wire. Right, testing walkie-talkie for use on handcar to keep repairmen informed of approaching trains. Below, cutaway drawing shows layout of Rock Island's rolling radio laboratory

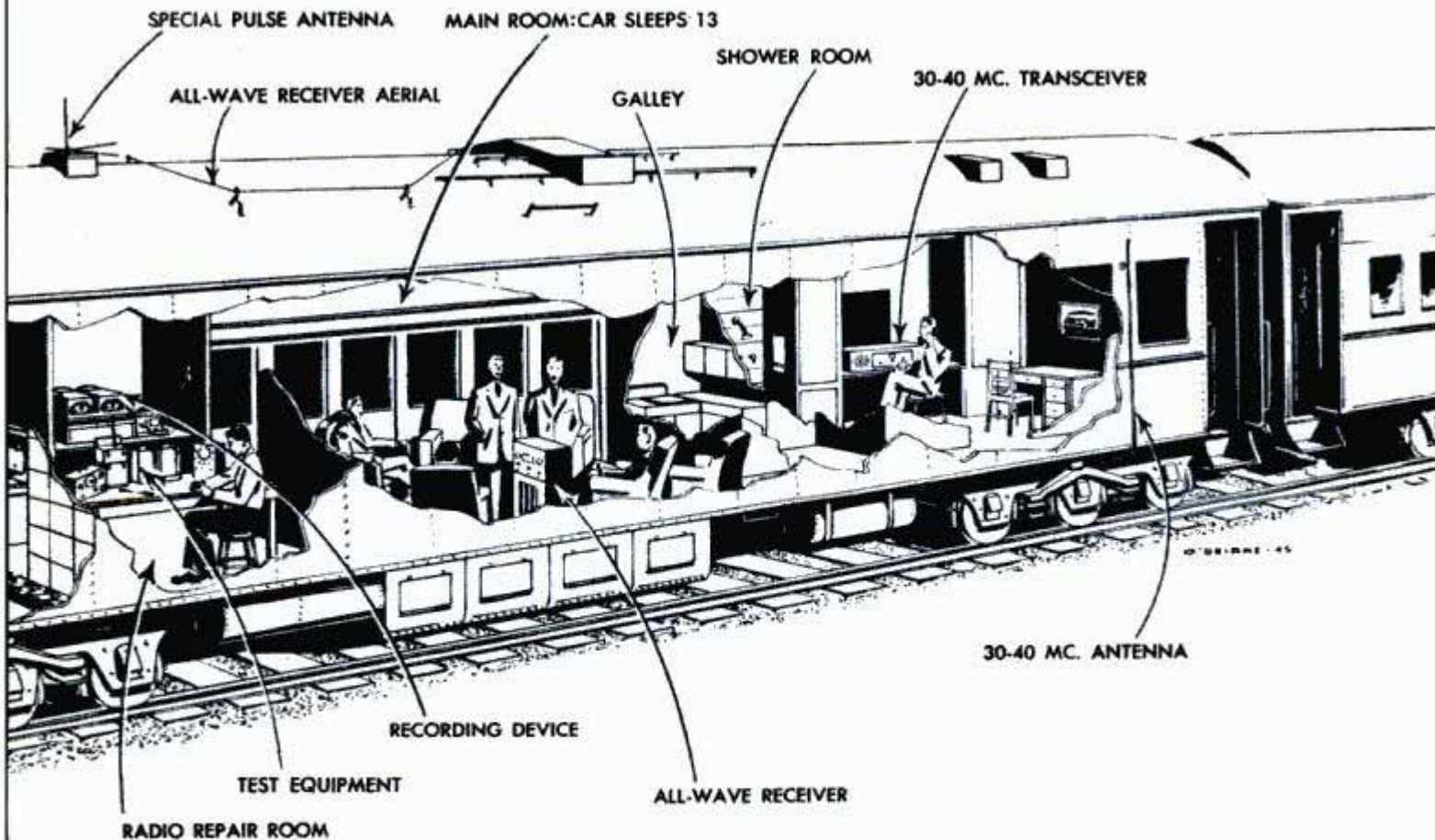

VACUUM CLEANER SAWS, GRINDS, DRILLS AND POLISHES

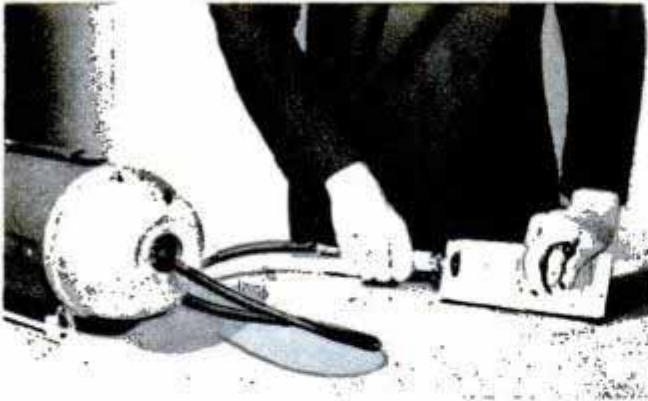

Circular saw at the end of vacuum cleaner's flexible shaft cuts wood, metal or plastic; below, grinding.

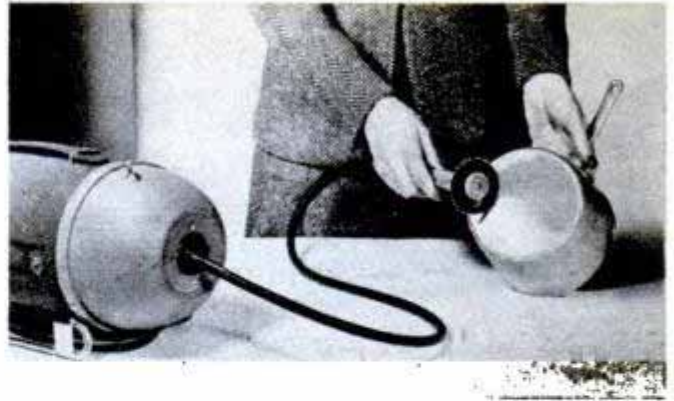

Buffers or steel brushes scour and polish utensils; below, drilling holes up to 1/4 inch in wood or metal

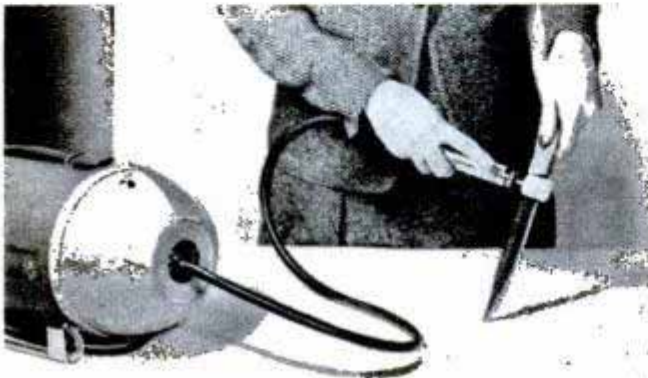

Sawing, grinding, drilling and polishing, as well as cleaning, can be done with a vacuum cleaner to be marketed soon. Designed as a portable power tool, the jack-of-all-trades cleaner can be plugged into any standard electric outlet. A hand grip holds accessories including circular saw blades, grinding and buffing disks, wire brushes, and drills up to 1/4 inch in diameter, in addition to the cleaner attachment.

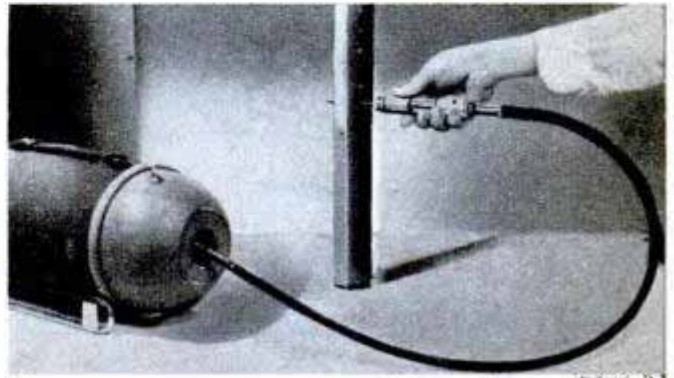

A clamp binds the hand grip to a bench when the cleaner is used for grinding or similar work. Brushes, either fixed or rotating, are unnecessary in the cleaner because of the high suction provided by the blower. A 1/2-horsepower motor provides speeds of 2500 or 15,000 r.p.m. regulated by snapping the flexible shaft into a worm reduction gear on the side or into the top-speed socket on the end of the cleaner.

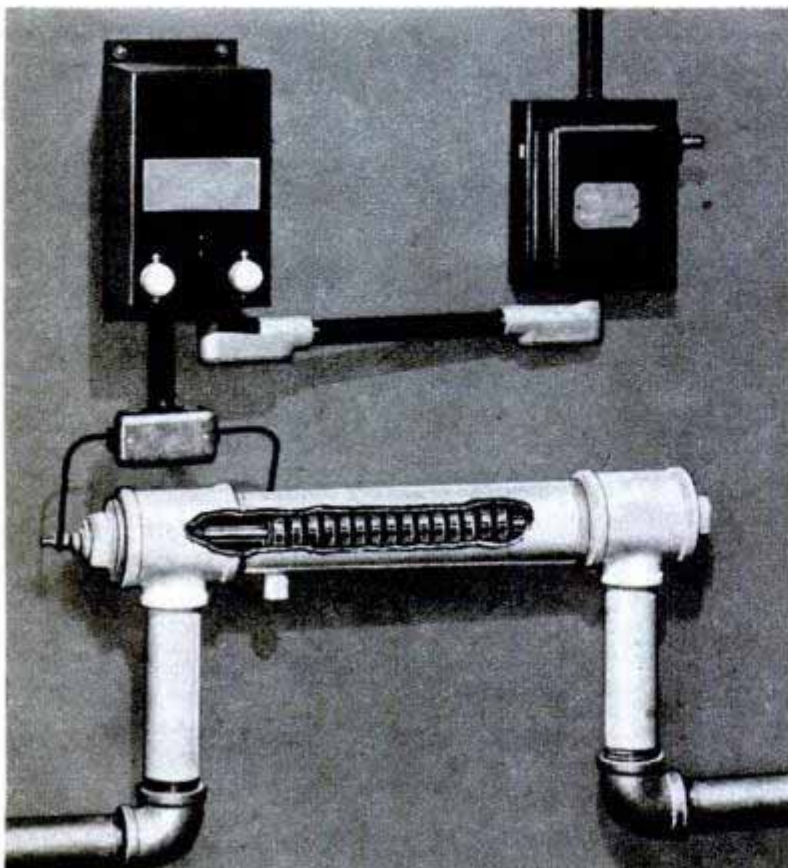

Electrified Water Salts Eliminate Corrosion

Salt particles in water are electrified in a water treatment system designed to reduce the huge bill American industry pays in cleaning boilers and replacing pipes corroded by "hard" water. When water is passed through an electrically charged cylinder, the salts pick up a charge which prevents their being attracted to hot boiler tubes. The process also prevents oxidizing and neutralizes acids and poisonous gases, according to the manufacturer, thus removing the causes of corrosion.

¶ All American countries now conform to the rule of driving on the right side of the road, Uruguay being the last to adopt the practice in September.

Compressed Air Powers Engine of Miniature Train

Puffing like a real steam engine, and equipped with cylinders, driving rods and drive wheels like its big brothers, a miniature railway locomotive in Cleveland's Euclid Beach Amusement Park eliminates cinders, dirt and delay in starting by using compressed air instead of steam power. As many as 50 children can ride at one time behind the engine. Compressed air is stored in the "tender" before each trip. Two air compressors power the train. One boosts pressure to 100 pounds per square inch. After the air has passed through an inter-cooler, the second compressor builds up the pressure to 350 pounds. One "load" of air in the tender will drive the train over its half-mile route.

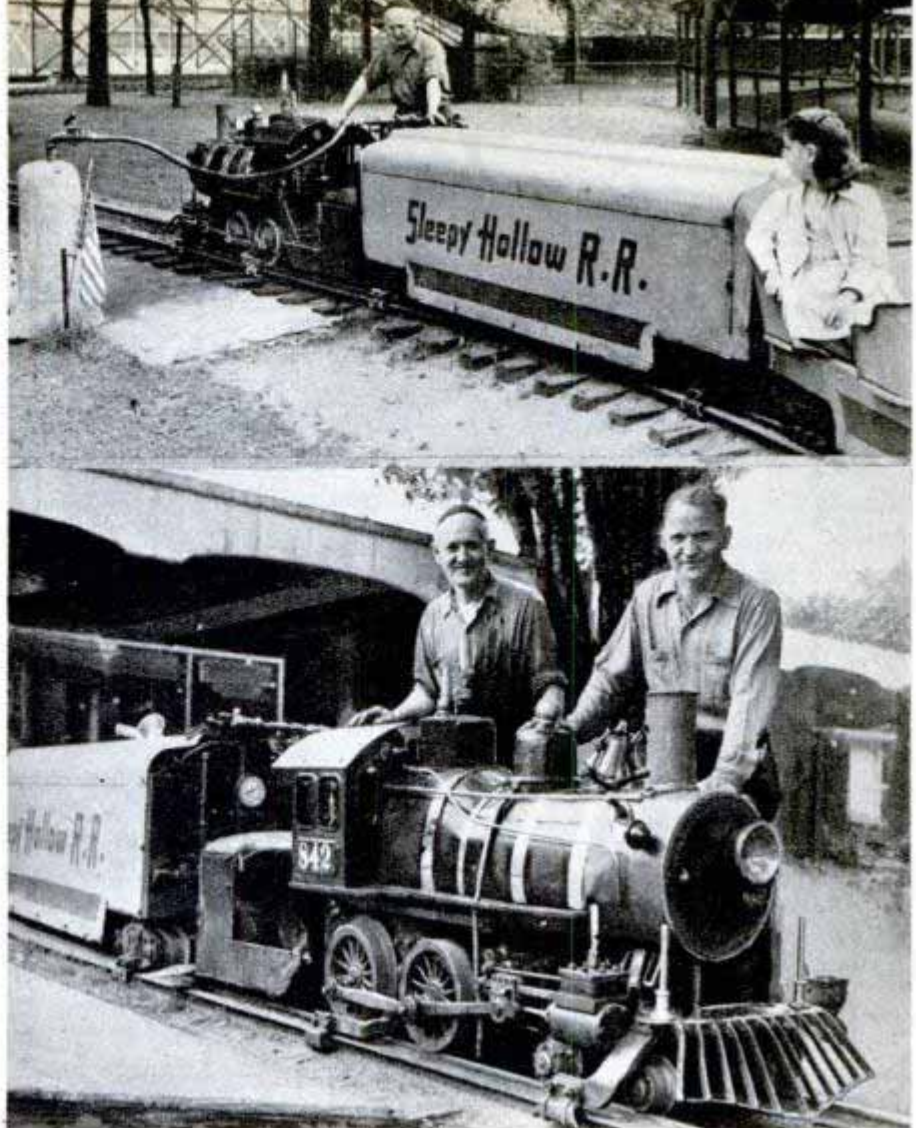

Oxygen Tents Are Made of Plastic

Oxygen tents, often the deciding factor in crucial medical cases, now are being made of Vinylite, a translucent plastic. Tents of this material will not crack easily or develop holes, and are lightweight, flexible and easily sterilized. A drawstring at the bottom holds the tent close to the waist of the patient. Oxygen enters from an aperture at the top. A transparent window of rigid plastic, sealed to the flexible film, allows the patient to see and be seen.

"Sand Blast" for Drilling Teeth Is Painless

Operating somewhat on the principle of a sand blast, a new dental instrument may replace the conventional drill. It applies an abrasive to a cavity with an almost pinpoint stream of compressed air. The "air-brasive," as it is called by the inventor, Dr. Robert B. Black of Corpus Christi, Tex., operates swiftly without pain or noise. No pressure is exerted against a tooth during the process. Tooth debris and the abrasive, aluminum oxide, are withdrawn from the cavity into a vacuum hood on the instrument by a secondary stream of air. Softer abrasives might be used for cleaning teeth.

Running Water for Saipan

Moses smote the rock and water gushed forth. Army and Navy engineers got the same results on Saipan in a modern way

SIX days after D-day at Saipan there were over 5000 Japanese fighting in the mountain wilderness of that island—Japanese soldiers, well-armed, who still firmly believed that their brothers were fighting in California. The hills of Saipan were far from safe, but men of the 101st Naval Construction Battalion joined with Marine Guards and went into the hills with construction equipment. Their job was to tap a stream of fresh water with which to augment Saipan's scanty water supply.

When the Seabees with their Marine escort reached Atchugo Spring they went to work, putting the mountain stream into a 200-foot tamperproof concrete vault to discourage thirsty Japanese who roamed the nearby hills.

At Donnay Springs, chief water source of Saipan's great Mount Tapotchau, the Army Engineers and engineers of the Second Marine Division took over Japanese installations. Donnay Springs, true to the Nipponese sense of beauty, was landscaped and provided with retaining walls, cisterns and pumps. The American engineers immediately improved the water source by

capping the open cisterns to discourage bacteria, adding larger pumps and establishing a high-capacity water treating plant. Today, almost two years after the invasion of Saipan, many Japanese water mains are still in use on the island.

Spring water on Saipan provides 2,200,000 gallons daily, but is only one fourth of the total water supply. Most spring water comes from four high-level artesian springs that come to the surface of their own accord. This water requires careful treatment.

But Saipan's spring water, God's gift to the thirsty, must be supplemented by artificial water sources. Along the seafont distillers transform the brackish water of swamps and shore streams into water for use only in laundries; engineers have drilled deep wells to tap subterranean water sources, and at various points on the island elaborate rainwater catch systems are in operation.

Naval base units throughout the Pacific war have been equipped with large batteries of distillers. At Saipan, distilled water was an important item to invasion and early garrison forces, but now is a minor source, hardly used at all for drinking or cooking.

When Saipan's naval base reached the semipermanent construction stage, a city of two-story steel Quonset Huts stretched from the sea-flats to the top of a tall hill. These round-domed huts were provided with eaves troughs, two-story-tall rain barrels and a maze of rainpipe to provide naval personnel with ample soft water for laundry purposes. Saipan's Naval Hospital catches its own water and purifies it for all hospital uses.

Most amazing of all Saipan water projects is an infiltration tunnel just above Tanapag Harbor. The 101st Seabees began this tunnel soon after water of fairly low salinity had been discovered in the vicinity, from which geologists inferred that there must be an underground source of fresh

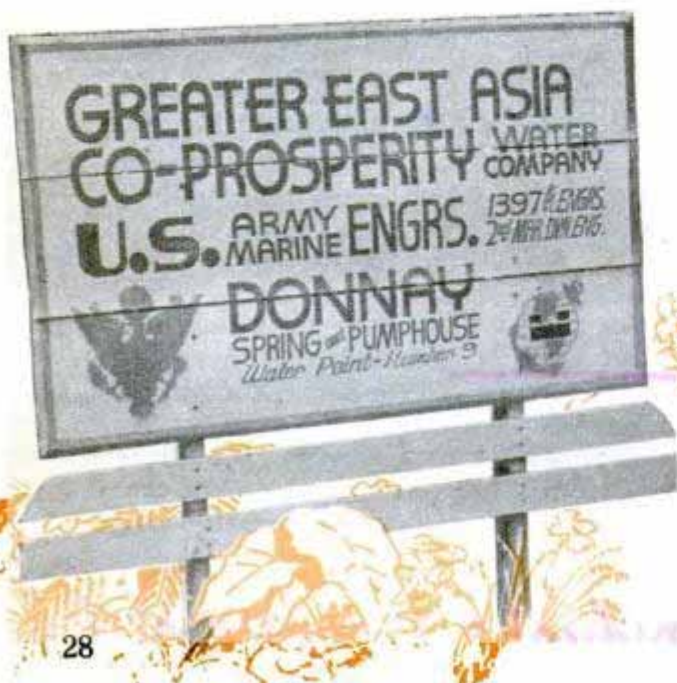



Infiltration tunnel was drilled through 800 feet of coral rock to tap underground water source. Three huge caverns were found

Giant rainbarrels catch water during tropic storms. Below right, tunnel workers drill holes for dynamite

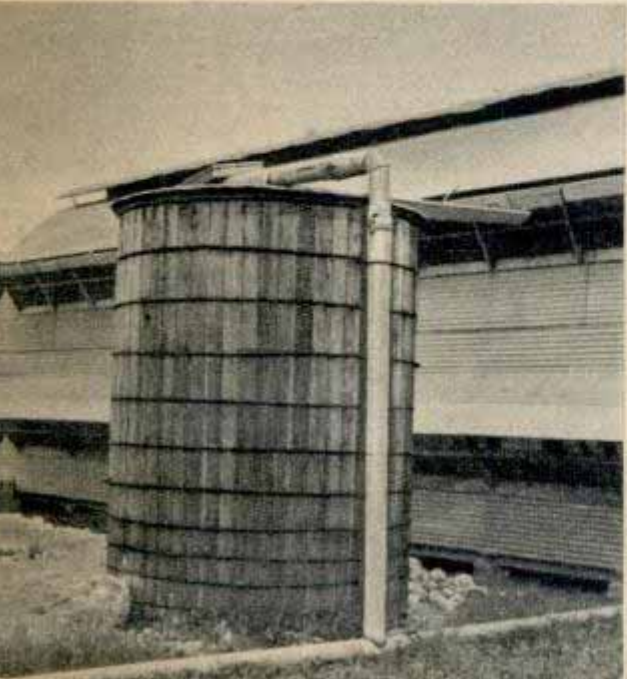



Seabees dig virtual mine in search of fresh water source. Japanese railway carries rock away. Below, "eavesdropper" tank collects water from hospital roof for the patients' use

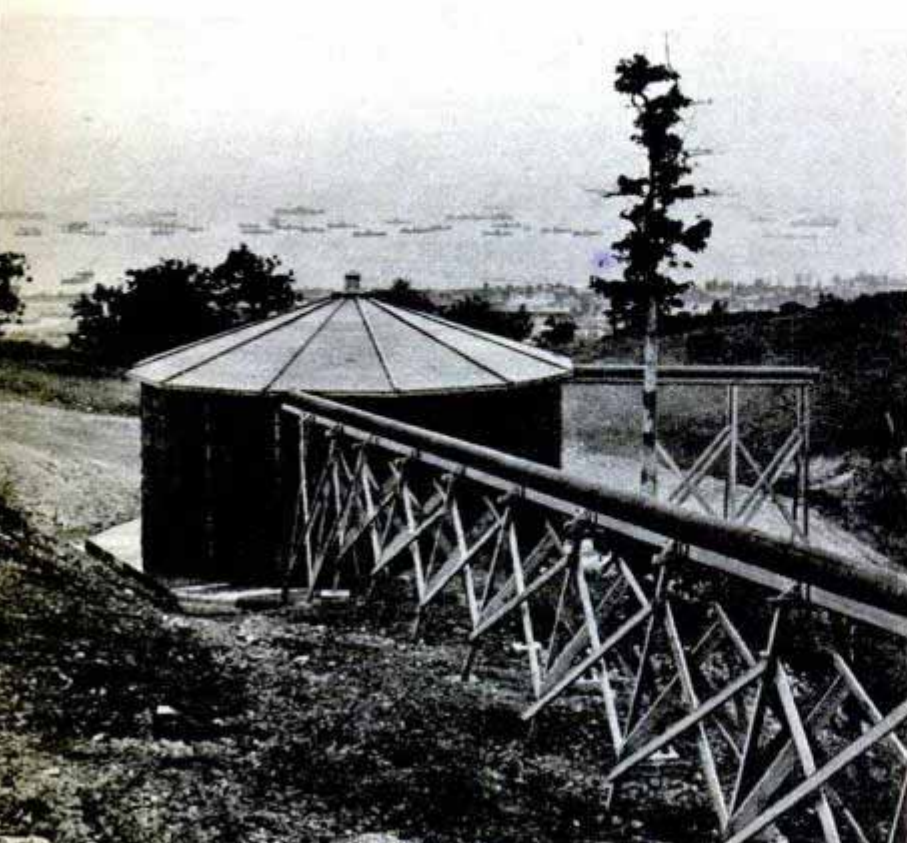

water nearby. The tunnel was drilled 800 feet through solid coral rock to follow the underground water to its unsalty source.

During the drilling three subterranean caves were entered. Within the caves are enormous stalactite and calcite structures. The caves are just above sea level. Salt water, by a sort of osmosis, comes up through porous rock into these caves at high tide. From their ceilings drips fresh water. One of these caverns has an immense room with reddish and white "icicles" of stone hanging from its ceiling. Its floor is covered with crystal clear cool water—excellent for lamplight swimming, say the water workers, the first human beings ever to set foot in these caves where the inner workings of the earth have been going on undisturbed for centuries.

Now the Tanapag tunnel project is in the hands of civilian employees of the U. S. Army Engineers who have worked the tunnel close to the main spring and will soon have it producing fresh water in quantity. The project often is referred to by Saipan GIs as the "New York Subway." A narrow-gauge railroad built from tracks salvaged from Saipan's cane-field railroads runs through the tunnel carrying air-compressors for drilling and cars for removing broken rock.

Instrumental in locating water sources on Saipan and in planning their development were three noted scientists and geologists. One of them who landed soon after the invasion was Dr. Harold Stearns, foremost Pacific geologist of the United States Coast and Geodetic Survey. From Honolulu came two experts at solving problems of island water supply, Dr. Chester K. Wentworth, senior geologist of the Honolulu Board of Water Supply, and Dr. Frederick Ohrt, manager and chief engineer of the Honolulu Water Supply.

Much of Saipan's water system is modeled after that of Honolulu and the Hawaiian island of Maui. On that island, a type of well was developed which now is known professionally as the Maui Well. Such wells are made by drilling an open shaft deep into the earth. At the bottom of the shaft tunnels are dug in all directions to tap all possible water sources. Saipan boasts one

(Continued to page 162)



Engineer has necessary controls at fingertips. Left, unit is mounted on truck

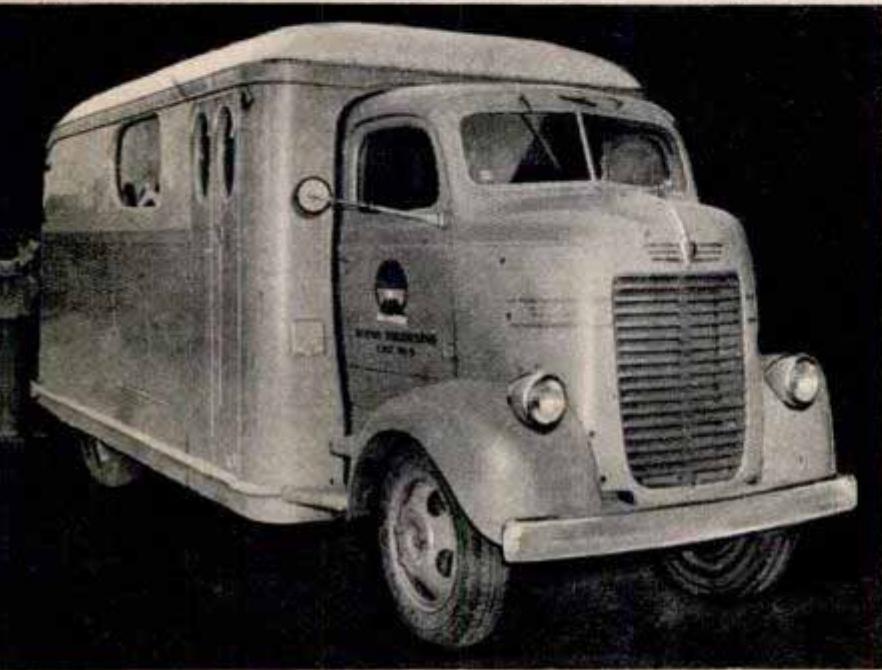

Movable Booth for "Mixing" Sound

Many difficulties formerly encountered in recording sound for motion pictures have been overcome by Paramount Pictures with the development of a mobile sound recording unit to take the place of a stationary "mixer's booth." Moved in a truck

from one stage to another and to field locations, the equipment enables the sound engineer to be on the scene of action rather than in a booth some distance away to which the sound previously was transmitted via lengthy cables. The new system helps the engineer to do a better job of controlling sound recording because he can see as well as hear. A short and simplified cable system "pipes" mixed sound into the truck to be recorded. There the engineer has all necessary controls within reach. As the sound is recorded on blank film, the motor which runs the film magazine in the truck is synchronized with those of the cameras.

Rotating Work-Holder for a Vise Clamps Parts in Convenient Positions

New versatility has been added to the old-fashioned vise. A hydraulic work-holder now on the market has a clamping fixture that can be rotated in a 90-degree arc from horizontal to vertical. This tool is especially useful for holding, in any desired position, such engine parts as carburetors, magnetos and fuel pumps for repair by garage mechanics. The largest model will support up to 225 pounds.

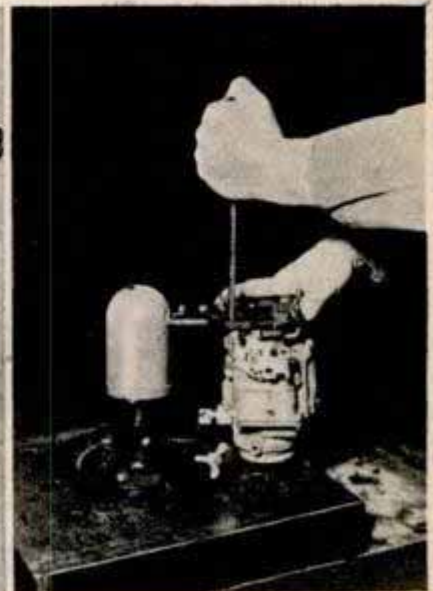



On Guard Against

University of California scientist adjusts oscillator tube that regulates the power to operate atom-smashing cyclotron

By Thomas E. Stimson, Jr.

THE CHANCES are that you never will drive an atomic automobile or fly in an airplane powered by nuclear energy. Scientists don't know when, if ever, those dreams will come true.

The difficulty is not a matter of dollars and cents, for the men closest to the picture believe that in our lifetimes it may become cheaper to "burn" uranium than coal.

The trouble is that atomic power packages radiate vast quantities of deadly, invisible rays. The emanations are destructive to living tissue and there is no human sense that can warn against them. Their presence can be detected only by special instruments.

Our only protection is to enclose radioactive substances in thick walls of insulat-



Atomic researcher reads meter which determines if he has absorbed a dangerous amount of radioactive rays

Death Rays

ing material, among the best of which are water, lead and concrete. Adequate insulation for an automobile's atomic engine would consist of concrete walls four to six feet thick, weighing in the neighborhood of 100 tons. Any such handicap makes an atomic automobile or passenger-carrying airplane an absurdity.

That deadweight, however, would not be much of an obstacle for an atomic locomotive. It will be no handicap in powering ocean liners. Steam plants and electric plants that use atomic heat will have built-in protection in their structural walls.

The deadly rays produced by radioactive materials consist of infinitesimally small fragments of energy and matter that are shot out at high speed in all directions. Neutrons, hard and soft gamma rays, alpha particles, and X-rays, depending on the type of activity, are among the rays produced. They cause deep burns comparable to X-ray burns or the burns suffered from overexposure to radium. Paralyzed bone marrow, nonclotting blood and a reduction in the blood cell count, all lumped together under the general term "X-ray poisoning," occur in addition to the burns. Depending on the degree of exposure, a radioactive source could destroy a person in a second or insidiously over a period of years.

That is not to say that even the slightest exposure is deadly. We all are being bombarded, all the time, by cosmic rays from outer space. The earth, water and air all contain small amounts of radioactive materials. Radium salts and other radioactive



Measuring radioactive "trace elements" fed to tomato plant to learn rate of food absorption. Below, cyclotron control is insulated by water and concrete

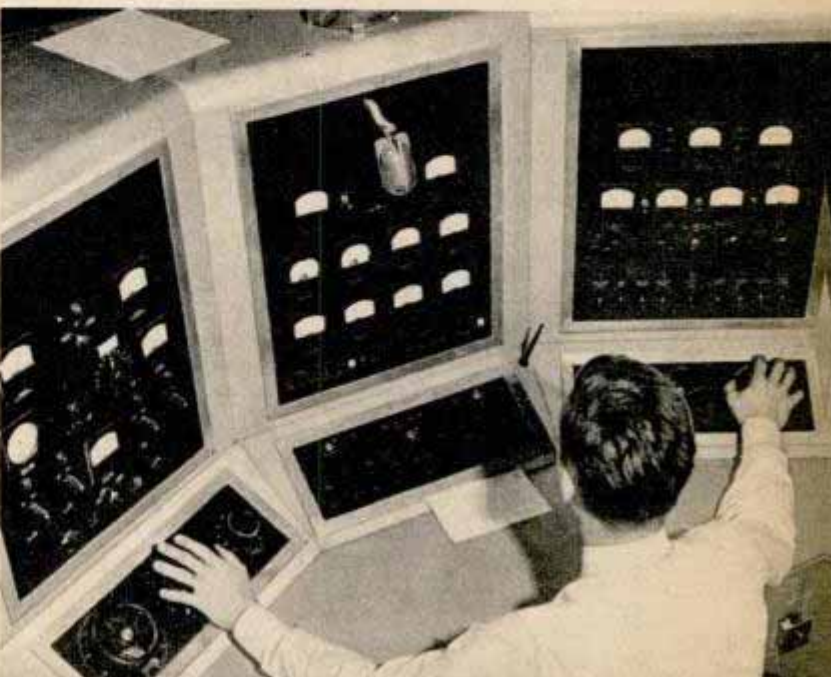

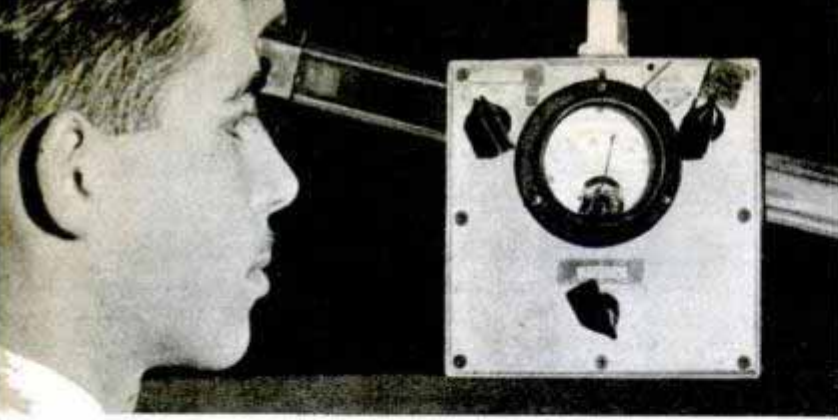

Measuring radiation from metal bar (held behind meter) which has been exposed to stream of neutrons

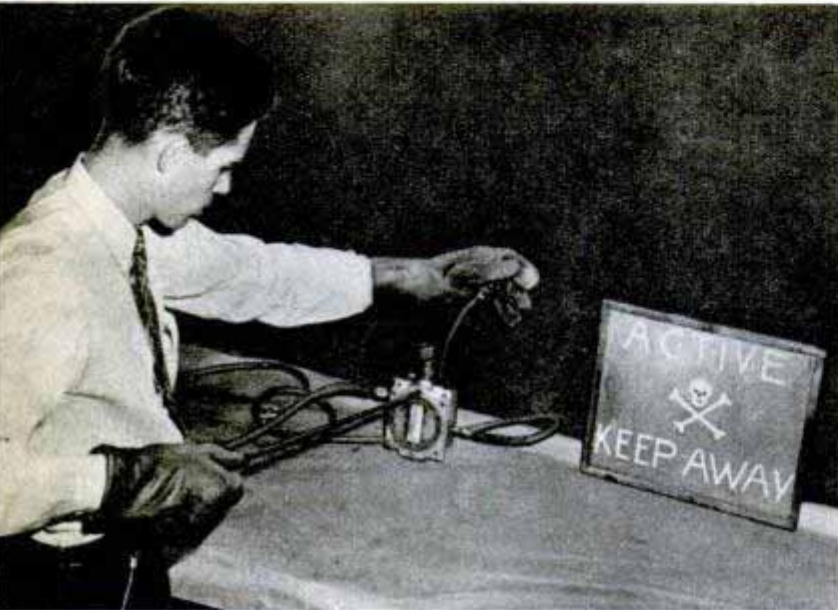

Heavy lead gloves and a long screwdriver protect physicist against rays from atom smasher equipment. Right, when scientist lifts barrier to enter cyclotron chamber a switch shuts off the power as a safety precaution

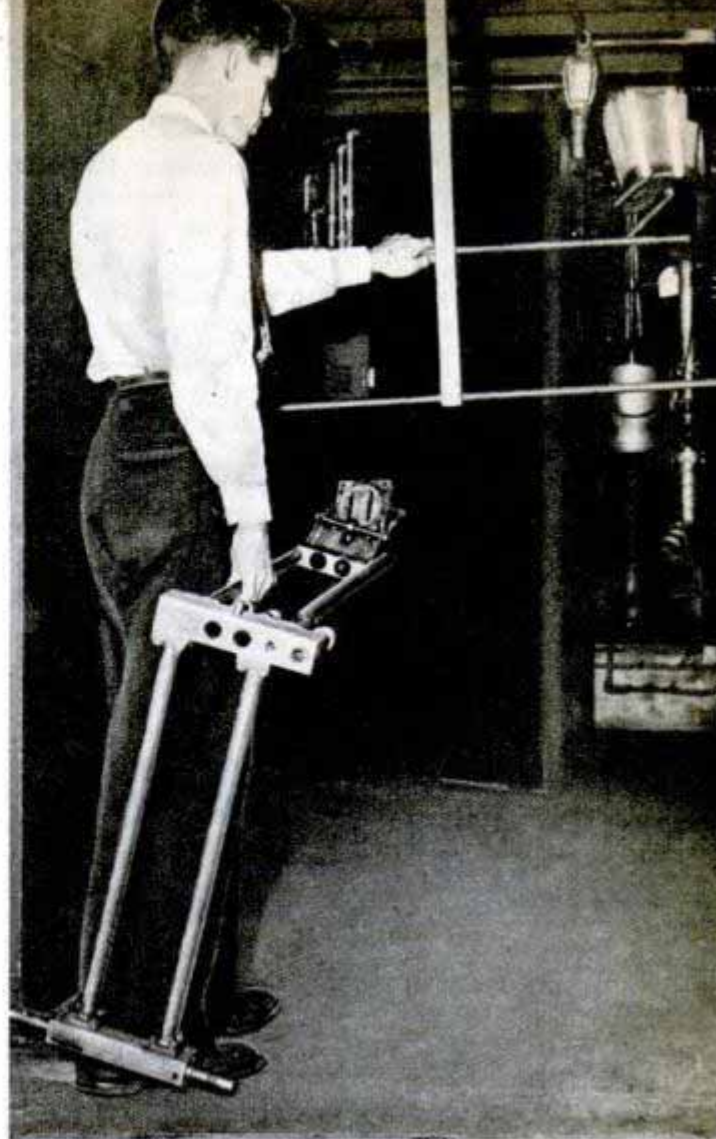

substances are used safely in the treatment of disease. The doses are controlled carefully to avoid any chance of overexposure. Slightly radioactive substances are used as "trace elements" in nutrition studies of plant life without hazard.

At the University of California where Dr. Ernest O. Lawrence and his staff of physicists are working with a 60-inch cyclotron, elaborate precautions are taken to avoid harm from the radiations that the machine gives off.

The Berkeley cyclotron was an important tool in the research that led to the atomic bomb. The new element plutonium was discovered with the aid of the cyclotron. Plutonium is created from hitherto useless uranium 238 and increases by about 100 times the atomic energy obtainable from a given amount of raw uranium.

In operation, the cyclotron produces a neutron radiation at its target that is equal to the radiation from several hundred pounds of pure radium mixed with beryllium. To appreciate what this means it should be understood that even a single gram of radium must be encased in a lead safe weighing several hundred pounds to

protect nearby persons from the effects of its radioactivity.

The cyclotron, accordingly, is surrounded by five-foot-thick walls of water contained in large movable steel tanks. This protection is increased to 10 feet of water plus two feet of concrete on the side directly exposed to the target. Water, instead of lead or concrete, is used as the principal protection because the tanks may be moved out of the way when major changes are to be made to the cyclotron. Overhead radiations are absorbed by four feet of water in tanks installed in the reinforced ceiling.

To make sure that no one can enter the cyclotron chamber while the instrument is in operation, the passageways leading to it contain barrier gates that must be swung upward for entrance, and this action throws a switch that turns off the power supply.

The cyclotron itself has become radioactive from use and precautions must be taken against this radioactivity in making changes or repairs to the instrument. Distance is an important factor in the degree of protection and so most work on the cyclotron is done with the aid of three-foot-long screwdrivers and wrenches. But

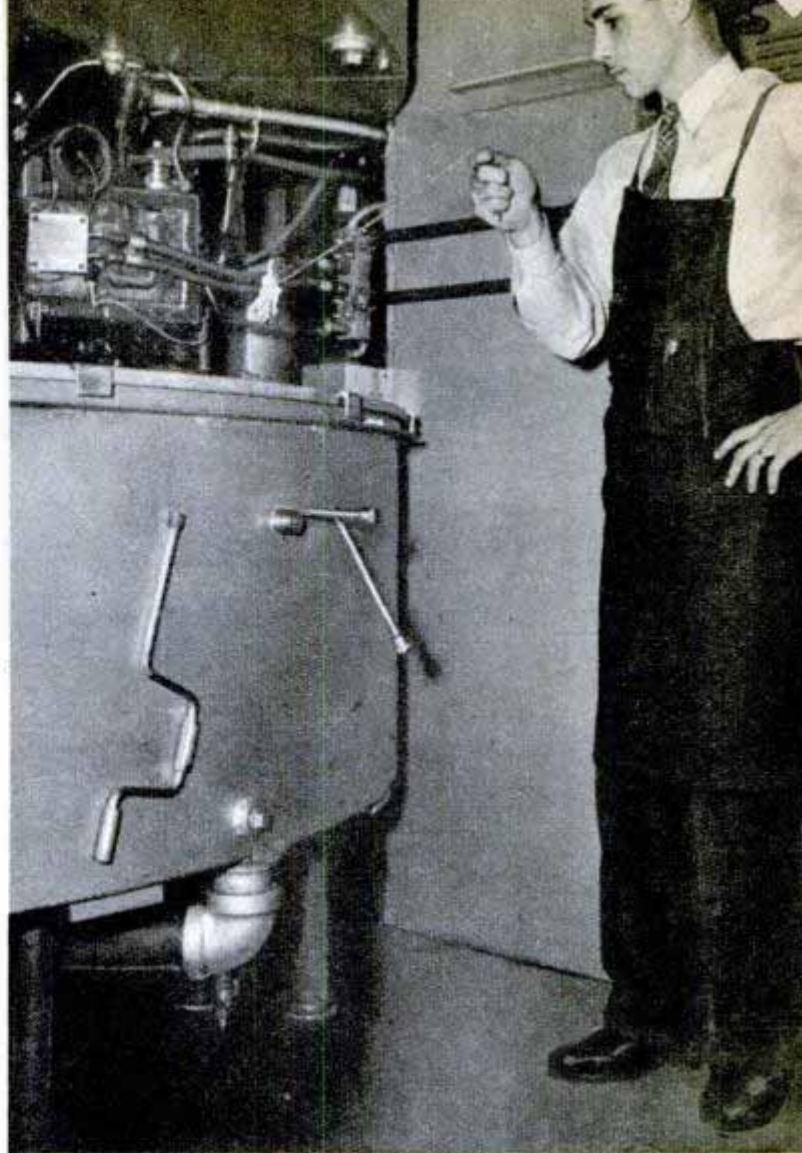

Lead and brick safe (left) stores radioactive materials. Powerful magnet (right) of cyclotron attracts key chain

no staff member is allowed to work on the instrument until he has measured the radioactivity of the actual part that is to be worked on. He uses a meter that shows whether an exposure of only a few seconds, a few minutes or an entire hour is safe.

Targets that have been bombarded by the cyclotron as well as other equipment that has become radioactive are stored in separate compartments of a lead-walled safe. Portions of the machine that have become worn out from use are buried, for safety, in a special burial ground.

As a final precaution, each member of the cyclotron staff wears on his clothing a badge that contains a strip of X-ray film. Worn for a week and then developed, the film shows, by its degree of darkening, the amount of radiation to which the worker has been exposed. Each member of the staff also carries a pocket ionization chamber resembling a thick lead pencil. In case of doubt while working close to the cyclotron the staff member can go outside and measure the amount of discharge of the ionization chamber. This tells him whether he safely can return to the dangerous area that day.

At the mammoth Hanford Engineer

Works, Richland, Wash., where atomic power has been harnessed for manufacturing the new element plutonium, comparable precautions on an even greater scale are taken to safeguard workers from the lethal rays. Designers of the safety features of the plant were extremely cautious because no one ever had dealt with such tremendous quantities of radioactivity before. No one could predict what the effects would be. As a result of the safety program, exposure to workers is negligible.

There are two main types of protection: elaborate physical safeguards to absorb the rays produced by radioactive materials, and multimethod checks on the workers and the surrounding area to make certain that no one can be harmed. In all, possibly \$50,000,000 was spent on protection at Richland although a considerable part of this money went into massive airtight concrete walls that serve for structural purposes as well.

Radioactive materials that are stored at Richland are planted in huge storage basins where they rest under many feet of water. Special railroad cars are used for transporting the materials around the plant.

(Continued to page 164)

Back-Toted Fire Fighting Pump

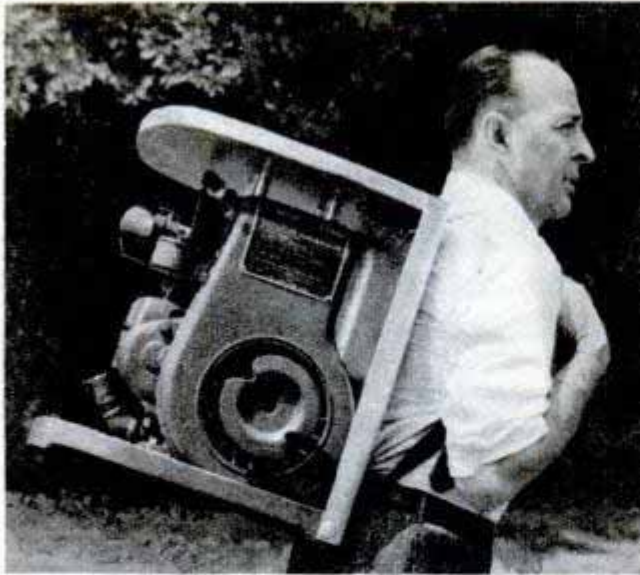

Small enough to be carried on a man's back, an 85-pound portable fire fighting pump can be rushed to the scene of a blaze to deliver 40 gallons of water a minute at 100-pound pressure. The power source is a compact one-cylinder engine. In combating forest fires one man carries the pump unit while another carries the fuel tank and hose. The tank holds 5½ gallons of gasoline, sufficient to operate the pump for about eight hours. Special rubber impellers enable the apparatus to pump dirty water as well as clean.

Dial Indicator on Inside Calipers

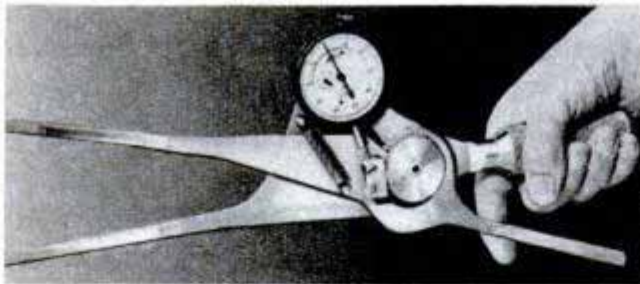

Inside diameters can be measured quickly and accurately—and registered on a dial—by using a caliper gauge recently placed on the market. Equipped with long jaws, the gauge can be thrust deep into tubes or other objects to provide inside diameter measurements at various depths. Gauges of this type are available to make measurements from 7/8 inch to 4 inches.

Protective Resin Coating on Food Wrapper Acts as Self-Sterilizer for Foods

Cheese, dried fruits and other foods may be protected in the future by a self-sterilizing wrapper with an inside coating of resin. This coating, developed at the California Institute of Technology, can be used on metal foil, plastic films or paper. It ster-

Tiny Files Spin at 100,000 R.P.M.

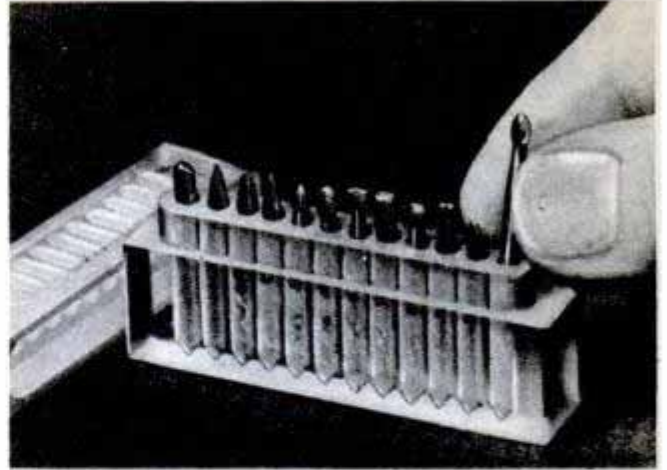

Lasting many times longer than steel files, a set of cemented-carbide rotary files is now available in midget form. Furnished in 12 assorted shapes, the files, measuring 1½ inches in length and 1/8 inch in diameter, are for use in power tools, taking the place of hand files and mounted grinding wheels. The tiny files are said to cut faster than grinding wheels as they are designed to operate at 65,000 to 100,000 r.p.m.

Finger Flashlight for Mechanics

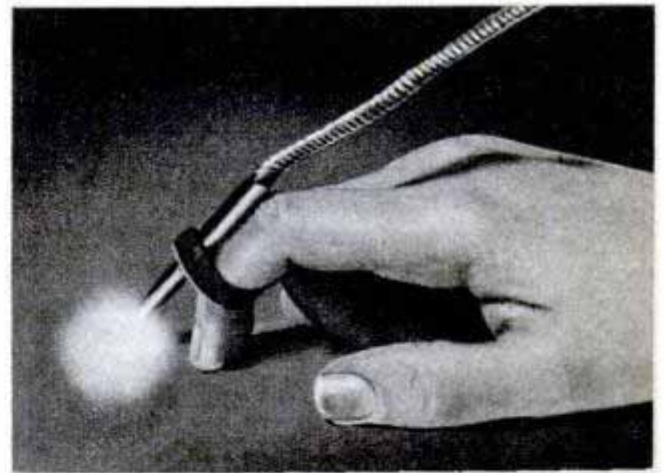

Mechanics probing for obscure troubles in airplane, locomotive or automobile engines are aided by a tiny flashlight that can be attached to a tool or clamped on the worker's finger. Equipped with an acorn-sized 2.5-volt bulb and a midget mirror, the light comes in two types, one operating from batteries and the other from standard lighting sockets.

Plane or Scooter— Which Is It?

When Guthrie Mitchell of Passaic, N. J., applied for a license for his latest invention, the State Motor Vehicle Commission was stumped. Several inspectors examined the vehicle to determine whether it moved forward or backward, in the air or on the ground. Mitchell, a Civil Air Patrol pilot, calls his midget car the Windjammer. It is driven by a pusher propeller powered by a two-cylinder engine that develops 12 horsepower. The frame was made from a cut-down Model A Ford and it has a shortened Ford steering gear. The Windjammer has neither clutch, transmission, differential or drive-shaft. A license was granted after the in-

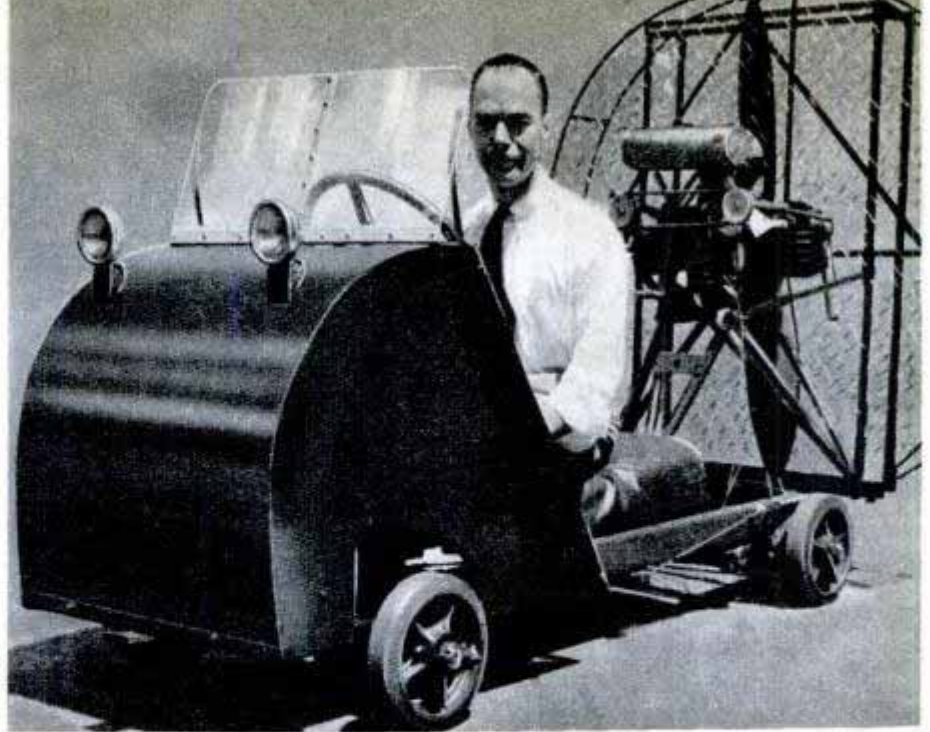

ventor attached a heavy propeller guard and four-wheel brakes. Mitchell, an engineer for a division of Raybestos-Manhattan, Inc., also has built a power scooter and a "snow jeep" for clearing walks.

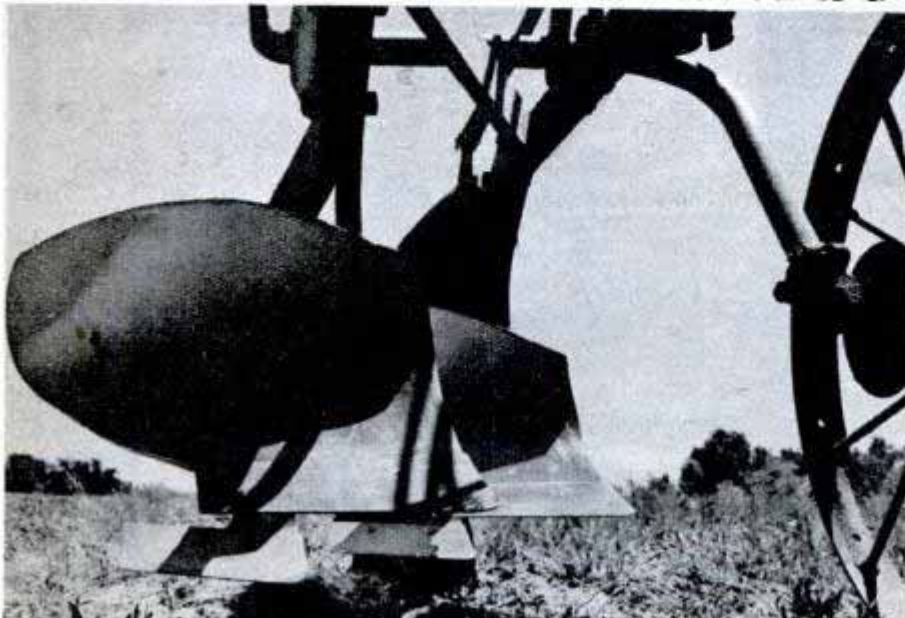

Plow Cuts Deeper With Extra Blades

Furrows four inches deeper than the usual cut are dug by a plow equipped with two additional knifelike blades which work below, behind and slightly to one side of the conventional plowshare. Thus the ground's hardpan is broken up, permitting plants to go deeper for food, minerals and water, and more air, light, water and warmth penetrate to the roots of the crops. Beside reducing the amount of harrowing and disking necessary in soil preparation, the extra-bladed plow protects the soil against erosion, according to the manufacturer. Subsoil that has become packed by years of ordinary plowing is restored to use, topsoil is rejuvenated and crops develop more vigorously. The plow already has undergone extensive tests at various university experimental farms.

Nylon Airport

Like tightrope walkers, light planes now hook-land and take off from a 500-foot steel cable equipped with nylon loops 65 feet above the ground. Called the Brodie system after its inventor, Captain James H. Brodie of the AAF, this "trolley wire" airport demonstrated its practicability aboard ships and on battlefields during the war. Now it is ready for possible use for landing aircraft atop buildings in the heart of big cities or in wooded sections and other areas where it is difficult to construct landing fields. Brodie predicts eventual handling of 7000-pound planes

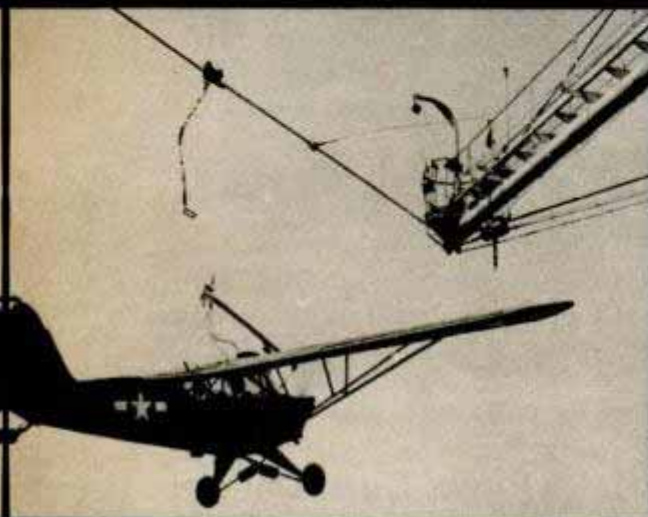
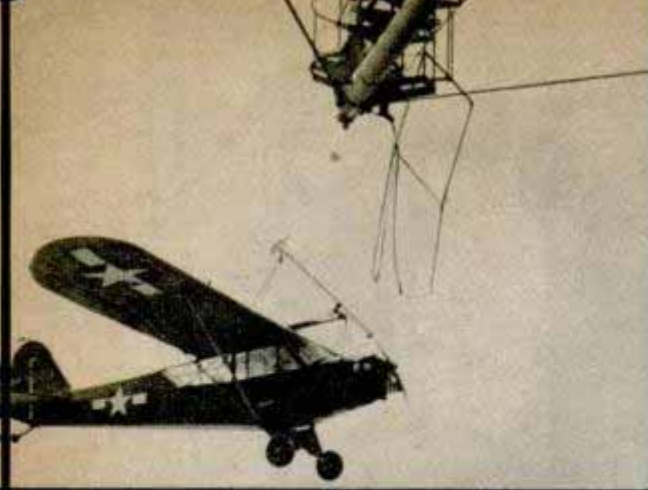

Its hook ready to snag a nylon loop, a plane (top) comes in for a landing. Take-off is demonstrated in other picture above. After the hook engages the loop (below), a braking system halts the plane which is lowered to ground (bottom) by derrick

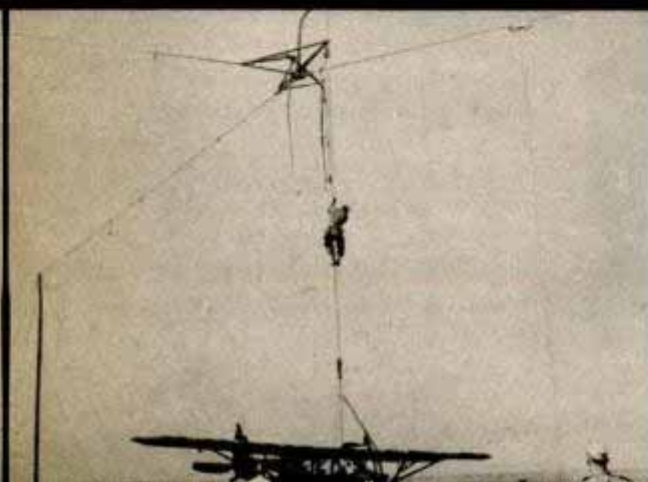
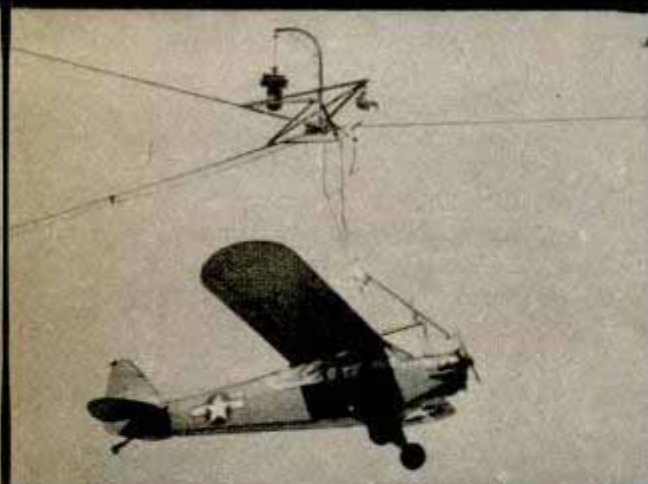

Navy photos

Getting ready for a takeoff (above), a hoisting bridle is attached to a plane to lift it to the steel cable "air strip." Below, Piper Cub gets a "shove" from a smoky catapult





CRASH TRUCK originally built to salvage wrecked bombers and fighter planes was put to work laying gasoline burner pipes along the edges of an airfield at Arcata, Calif., in connection with FIDO fog-lifting equipment

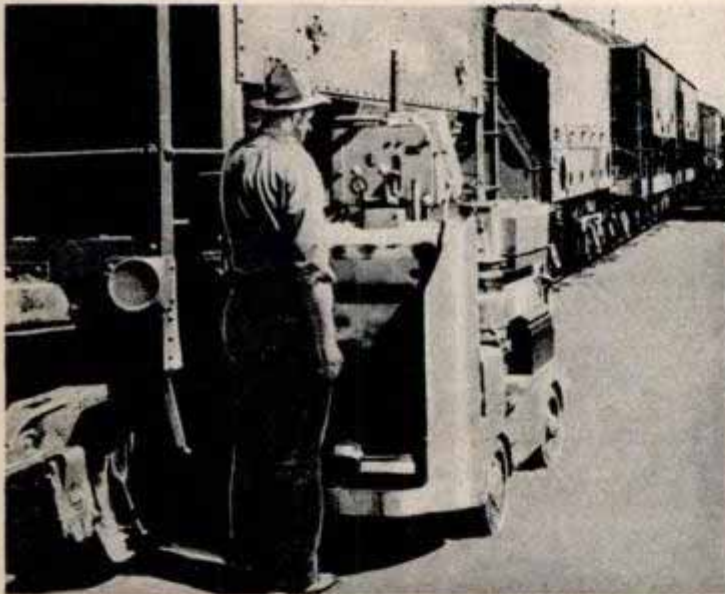

PLUG-IN ELECTRIC TRUCKS speed up the job of unloading hopper cars filled with iron ore. Powered by electricity from outlets along railroad docks, the trucks' motors turn four-foot-long wrenches which open and close bottom gates of hopper cars. One operator can do the job now in a fraction of the time previously required for two men to wield a 55-pound wrench. The truck has three-phase, 220-volt AC motor connected with a generator

SEESAW RESPIRATOR equipped with a simple attachment on a folding stretcher induces breathing by the "rocking chair" or seesaw method. The attachment supports the stretcher, converting it into a respirator in a few seconds. It is operated by gently rocking the patient back and forth. The motion restores breathing and aids circulation. This method of artificial respiration affords a quick, uninterrupted change from manual to mechanical means and is less tiring than the former method

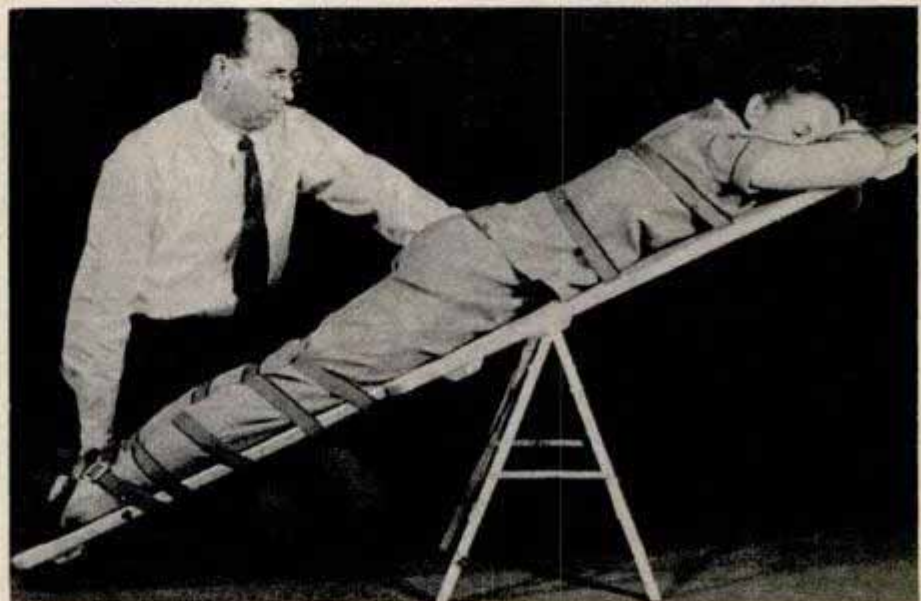

SCIENCE PINS DOWN THE WEATHER

At last we're doing something about it—wartime techniques of forecasting by radar and robot balloon are mapping the weather accurately on a worldwide scale

DOWN through history, weather has been winning victories for the admirals and generals. **By Andrew J. Hamilton**

Strong westerly winds wrecked the so-called "Invincible Armada" of Philip II of Spain in 1588 and halted the invasion of England. Napoleon failed to take into account the severity of winter snows in Russia and was forced to retreat from Moscow. Winston Churchill's daring Gallipoli adventure in 1915 proved a failure because of adverse weather conditions.

Weather played an even more important role in World War II and was a decisive factor in almost every

phase of the conflict. Hitler chose a long dry spell in September 1939 to drive his tanks onto the Polish plains. A pea-soup fog in the English Channel helped the British Army escape at Dunkirk. The Japs took advantage of a weather front to sneak into Pearl Harbor. General Eisenhower looked at a weather map before he gave his famous Normandy invasion order, "Let 'er rip!" Admiral Nimitz consulted his fleet aerologists before each task force raid and amphibious landing in the Pacific.

Weather knowledge was vital to victory—and, what is more important,

An aerologist at one of the U. S. Navy's shore stations climbs up to take a look at the weather

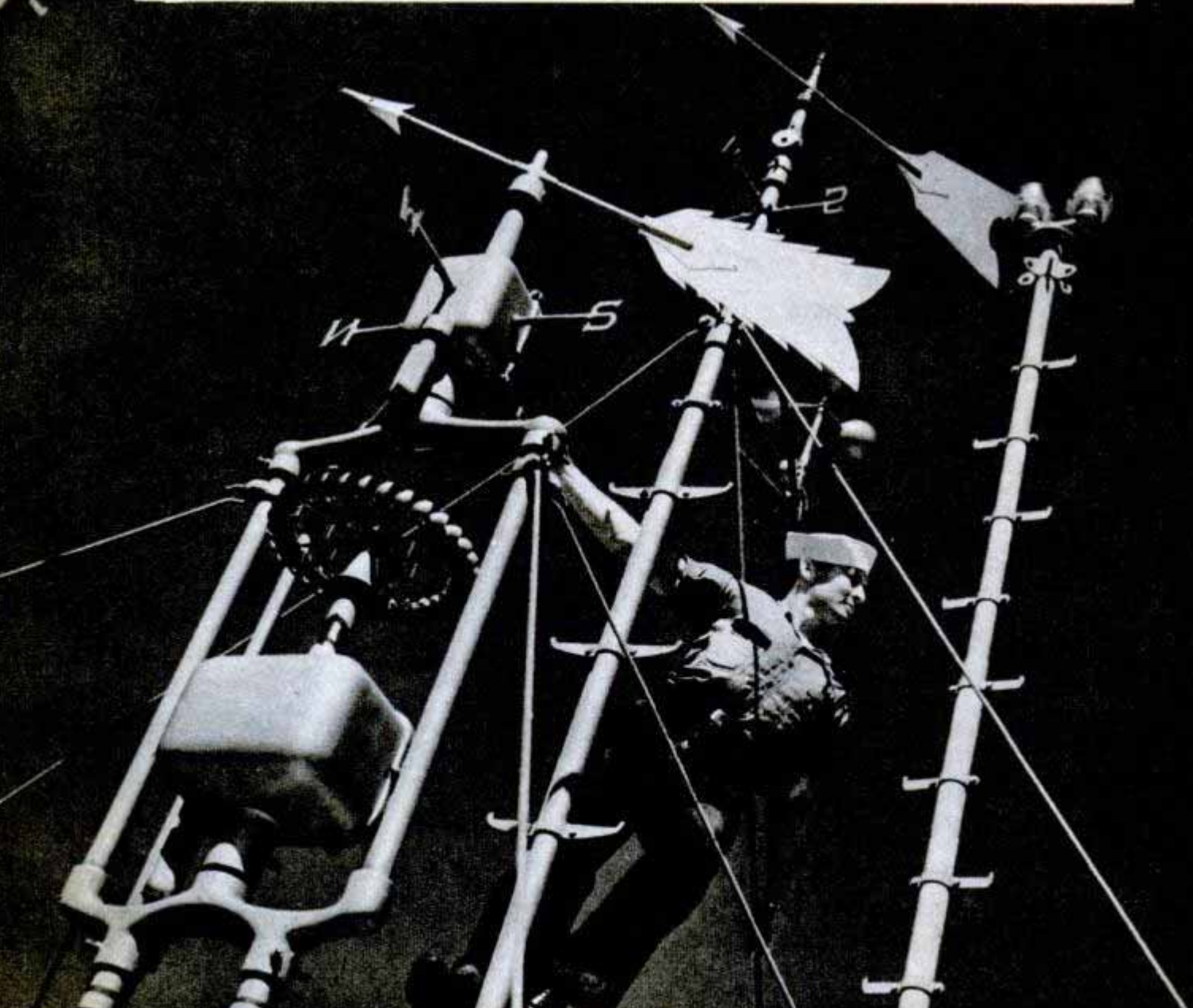



Army glider unit sets up airborne weather station; wind vane is at right, theodolite and balloon at left

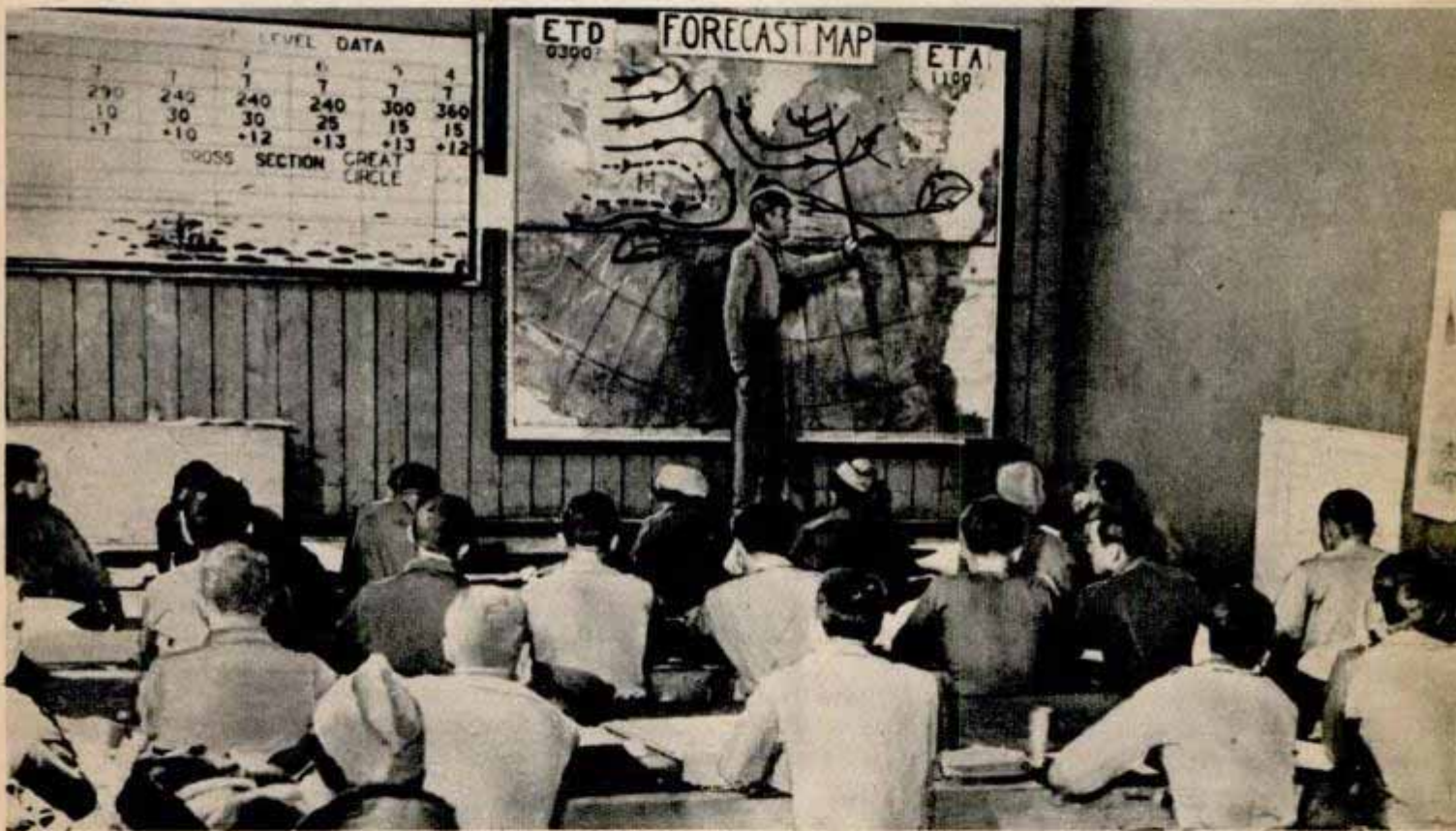

Pilots listen intently while AAF weather officer briefs them before transatlantic hop. Tail winds may cut ETA (estimated time of arrival). Below, sucking up tons of water, a waterspout moves across the Pacific

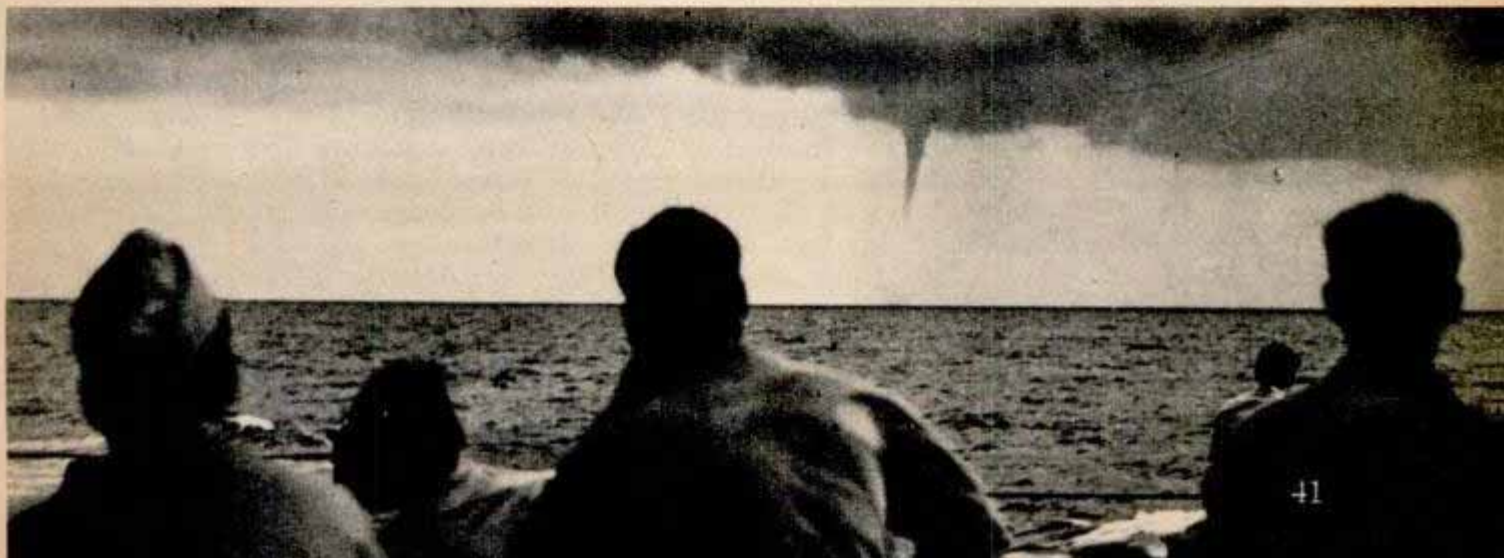

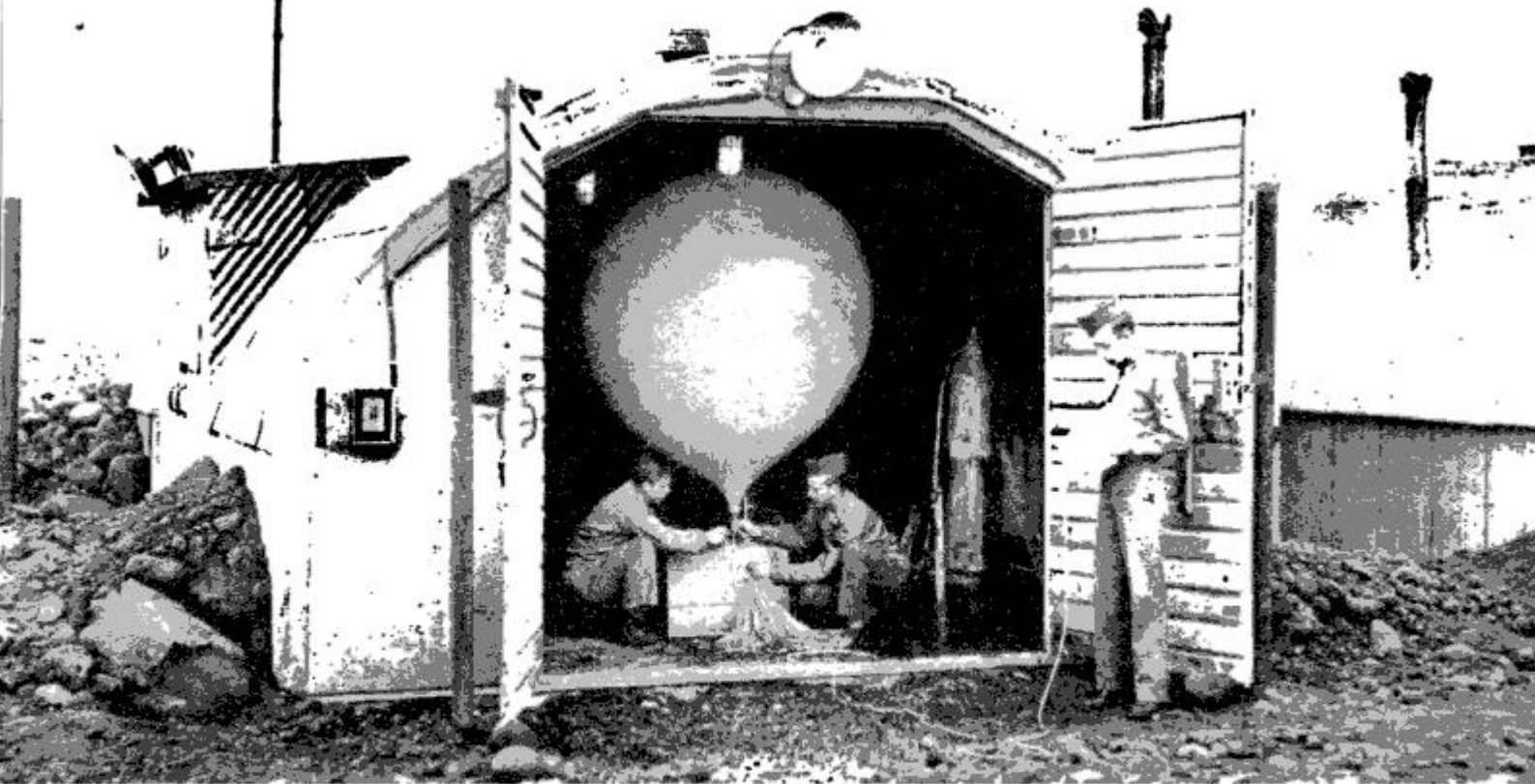

Air corpsmen inflate a balloon to carry aloft a radiosonde transmitter at Meeks Field, Kleflavik, Iceland

it now can be turned to peaceful pursuits.

In World War II, the United States suffered more than 1,000,000 of her young men killed, wounded or missing, and spent nearly \$300,000,000,000. This blood and treasure were not squandered in vain. German and Japanese militarism were crushed, and the by-products of scientific achievement will save millions of lives and billions of dollars in property in the future.

New techniques in weather forecasting, new scientific equipment and a trained force of nearly 10,000 weathermen will be of the greatest importance to air lines, railroads, steamship lines, farmers, forest rangers, telephone and telegraph companies, department stores, sports promoters and others whose lives and investments depend upon the vagaries of the weather.

Meteorology, in spite of its universally popular interest, was slow in emerging from the "old wives say" stage. It got its biggest shot in the arm during World War II, and the bill for meteorological services cost Uncle Sam a cool \$1,000,000,000. Today it is a recognized science, based upon known laws of physics and mathematics.

The Army Air Forces trained more than 5000 weathermen and stationed them all around the globe—from Adak to Australia, Greenland to Guadalcanal. The Artillery, the Chemical Warfare Service, General Headquarters and other Army activities used hundreds more. The Navy placed aerologists at all shore bases and aboard major ships. Army and Navy flyers acted as weather observers when they went aloft. Weather "commandos" were dropped behind enemy lines in China and France

to furnish valuable information. Never in history has there been a more complete observation of the world's winds, clouds, fogs, temperatures and storms.

Weather experts are confident that this vast web of weather stations and trained observers will be maintained during peace. Weather is not limited by national boundaries and global air travel is already with us. Proposals have been made to place weather stations and airway communications systems under international control—possibly the United Nations Organization. This would standardize weather forecasting procedures and insure adequate world-wide coverage. Each nation would pay for the service in proportion to the size of its foreign air operations.

This world-wide network of weather stations would be augmented in local areas with special "airspionage" groups—such as those developed during the war—to keep track of local disturbances.

The U. S. Weather Bureau for many years has maintained a Hurricane Warning Service. But in 1944 the Army Air Forces organized its own Hurricane Warning Service at Miami, Florida, to forewarn Army installations of the comings and goings of tropical storms. Special B-25 weather planes were sent aloft when a hurricane gathered to measure its strength and probable direction.

The great Atlantic hurricane of 1944 was "fixed" in its initial stages by the AAF's Hurricane Warning Service and its movements radioed all over the West Indies and South Atlantic seaboard. An estimated \$250,000,000 worth of property was saved.



Bomber crew in Marianas studies map showing tropical fronts. Chart in left background traces typhoon; curving arrows on other map indicate wind directions. Wooden observation tower (below) in China-Burma-India theater mounted antiaircraft guns behind sand bags. Aerograph being attached to plane "reads" atmosphere



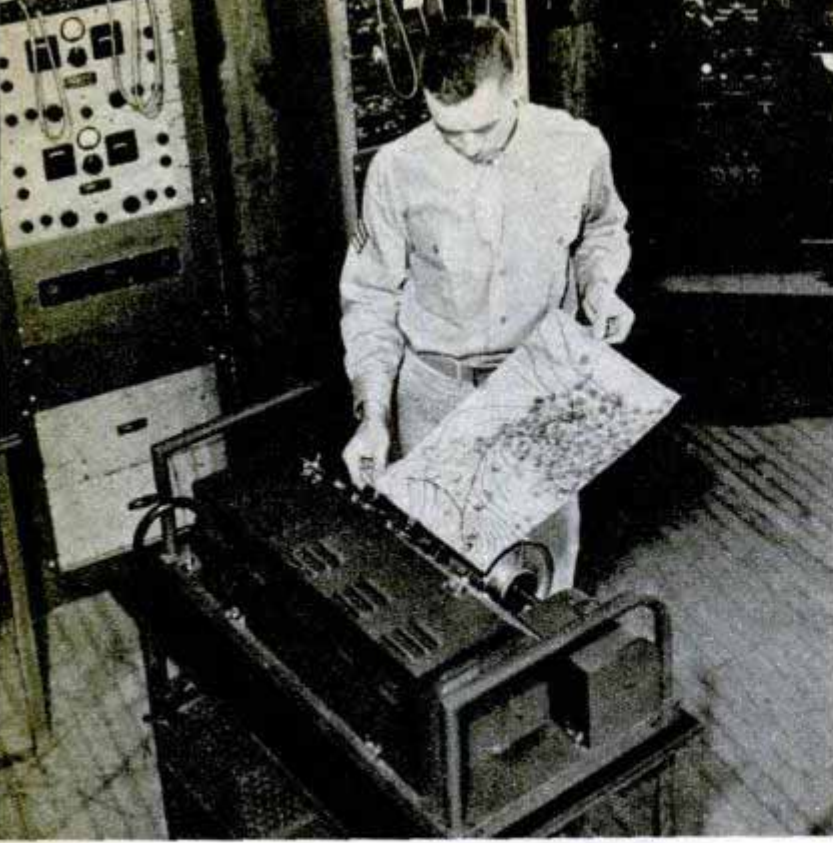

Facsimile transmission of analyzed weather maps has increased both the scope and speed of forecasting

A leading roofing material manufacturer recently took advantage of hurricane information in Texas to follow the storm and provide roofing materials to homeowners whose roofs had been blown away.

In the Middle West, Severe Storm Warning Nets were established by the Army Air Forces and the U. S. Weather Bureau, assisted by civilian volunteers. Thunderstorms and tornadoes were kept under constant observation. In other parts of the world, weather warning squadrons have been suggested to watch Western Pacific typhoons, violent Arctic storms and Afri-

can sandstorms. Such advance information would allow preparation to safeguard lives and property.

In 1941 the U. S. Weather Bureau made weather forecasts on schedules of 48 hours and five days. Some meteorologists, like Dr. Krick of the California Institute of Technology, ventured as much as two weeks ahead. The time range of forecasts has not been materially increased but weathermen say that today's forecasting is more accurate "than even the most optimistic meteorologist would have declared practical a few years ago."

Modern mechanical sorting machines have been employed in a new type of "analogue" weather forecasting, developed in the last few years. For example, a ground force commander in Europe would want information on what the weather would be like the following week. For a quick 20-minute forecast, weather maps for the past 40 years would be run through a sorting machine. The one that most closely resembled the map of that day's weather would indicate to a fair degree the type of weather to follow during the next week.

Such weather prognostication will be of special value to farmers. Advance notice on heavy rainfall, frosts or dust storms will allow them to harvest crops or protect their fields, orchards and barns before disaster strikes. Citrus orchardists in Florida and California rely heavily upon forecasts.

Improved weather forecasting also will aid the U. S. Forest Service in its year-round battle against forest and range fires. "Catch 'em young and treat 'em rough" is the slogan of the new program in which the Forest Service and the U. S. Weather Bureau cooperate.

Radar scope detects hurricane approaching station (white area at top) and, right, as it passes within 10 miles

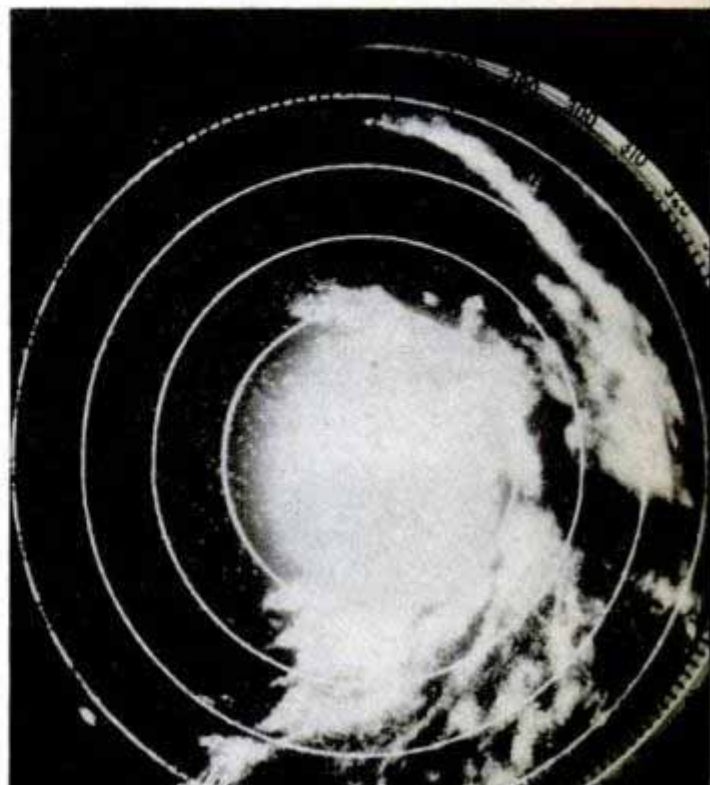
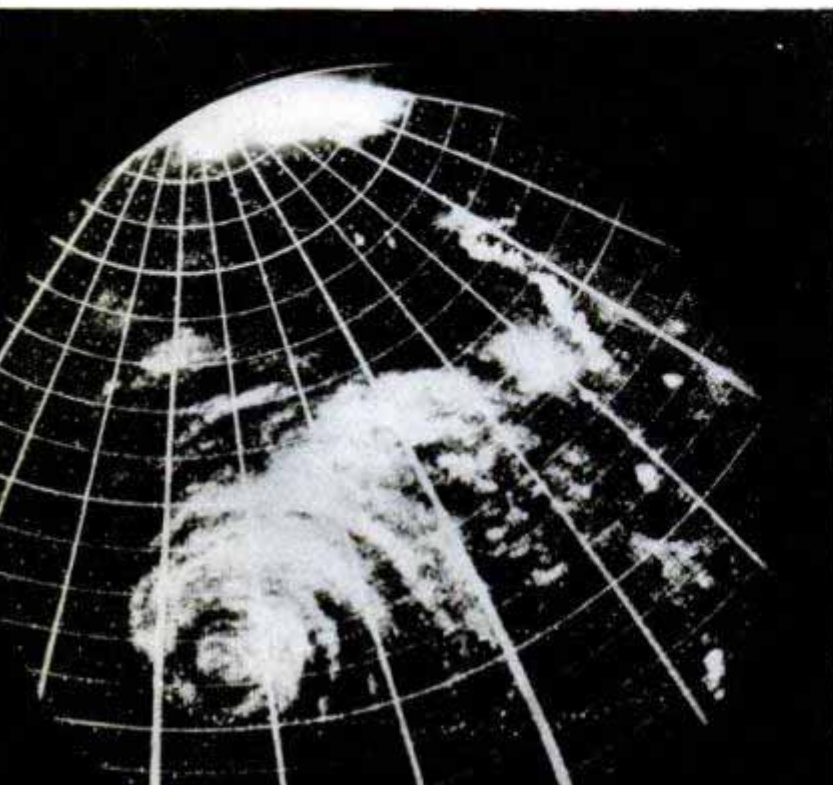

Fire weather forecasts are regarded by the Forest Service as one of its major weapons in preventing or suppressing fires in timber and brush watersheds. Advance news on probable wind velocity, humidity, visibility and temperature gives the Forest Service fire fighters a chance to plan their strategy. Turnabout, many ranger stations and forest lookouts act as weather observers and send reports to the Weather Bureau.

If forest fuels are dry and fire weather forecasts indicate that dangerous conditions will prevail the following day, road crews and other personnel are held in readiness. Trucks are stationed at convenient points to transport fire fighters and equipment. If the forecast indicates poor visibility, additional fire lookouts are manned at temporary stations and airplane spotters are sent aloft. If conditions become more critical, warnings are issued to logging operators to shut down.

Radar is expected to play an ever-increasingly important role in weather forecasting. The Air Technical Service Command at Wright Field recently revealed that radar reconnaissance planes gave prompt and accurate data on preflight weather in Europe for bombing flights.

A 450-pound piece of radar equipment that was originally developed for blind flying was adjusted to provide meteorological information as well as navigational data. With his set trained on the air around him instead of on the ground, the radar operator simply pushed a switch marked "weather" and received a picture of advance cloud formations on a specially designed detecting screen.

Tracking clouds instead of a target, the microwave screen indicated approaching storms 100 to 200 miles away. Even greater distance in forecasting storms has been achieved by triangulation of electrical disturbances in a storm area. Lightning



Aerographer using anemometer to check wind velocity aboard a carrier

flashes give off 200-kilowatt radio waves. Three thunderstorm locaters, equipped with radio direction finders coupled to cathode-ray tubes (similar to those used in television), can "fix" such flashes at distances of 1000 miles and more. The spread and direction of the storm can be followed hourly and new outbreaks detected. This technique is especially important in covering oceans and polar regions, where maintenance of weather stations is difficult.

Such advance information on rainstorms will be invaluable to promoters of outdoor sports events or community pageants. Large department store sales managers also

Navy weathermen plot a balloon sounding at Alameda, Calif., air station



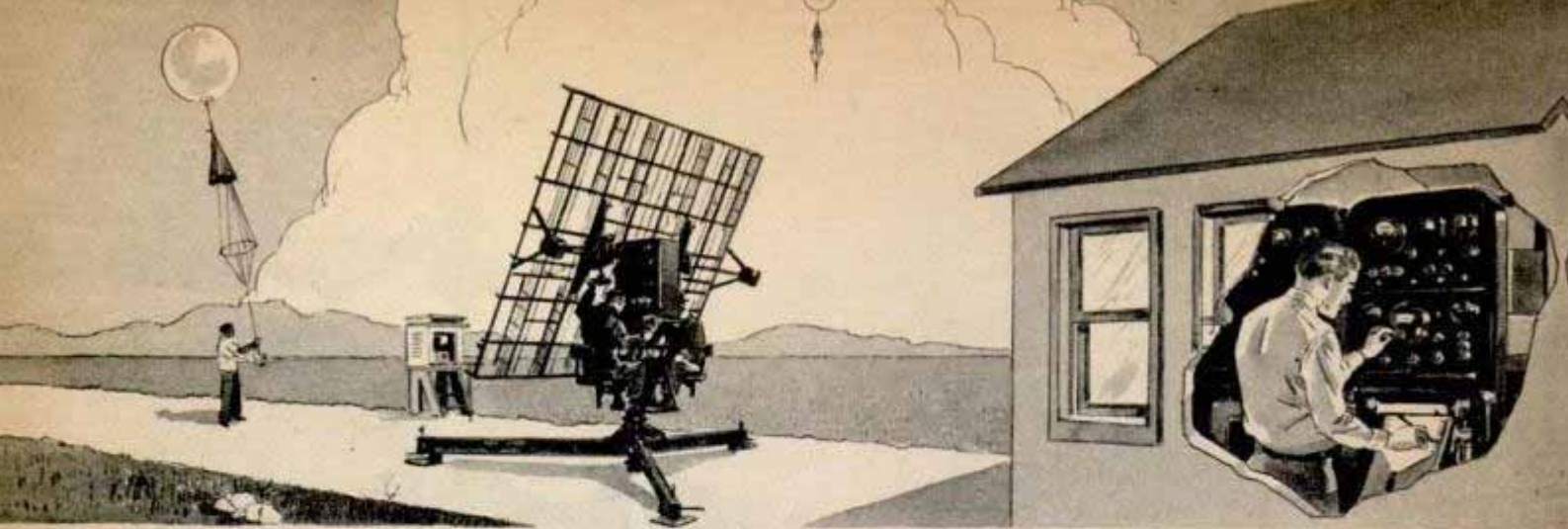

Radiosonde unit, with balloon, parachute and radiosonde at left, receiver set in center and recorder at right

will be able to consult the weatherman before planning a large clearance sale.

A national sunburn lotion manufacturer times his advertising according to weather forecasts. In the Middle West, a large construction company waited to pour concrete on a million-dollar job until the weatherman said O.K., saving hundreds of dollars.

Before the war, the weatherman's standard instruments for ground observation consisted of a thermometer, a barometer, a rain gauge, a psychrometer to measure moisture content of the air, the thermograph and barograph to record continuing

temperatures and atmospheric pressures, and an anemometer to measure wind speed. World War II provided many refinements of this equipment.

Radiosonde, a small lightweight radio sending set that transmits data on temperature, air pressure and humidity after being carried aloft by a balloon, was in use at the beginning of the war. New improvements have made it amazingly accurate.

One of these, called the "Weather Sleuth" and built by the Farnsworth Television and Radio Corporation, employs direction finding at the ground receiving station (shown

Radiosonde, left, transmits data on upper air conditions to the receiver unit, right, which tracks balloon
 Courtesy Farnsworth Television & Radio Corp.

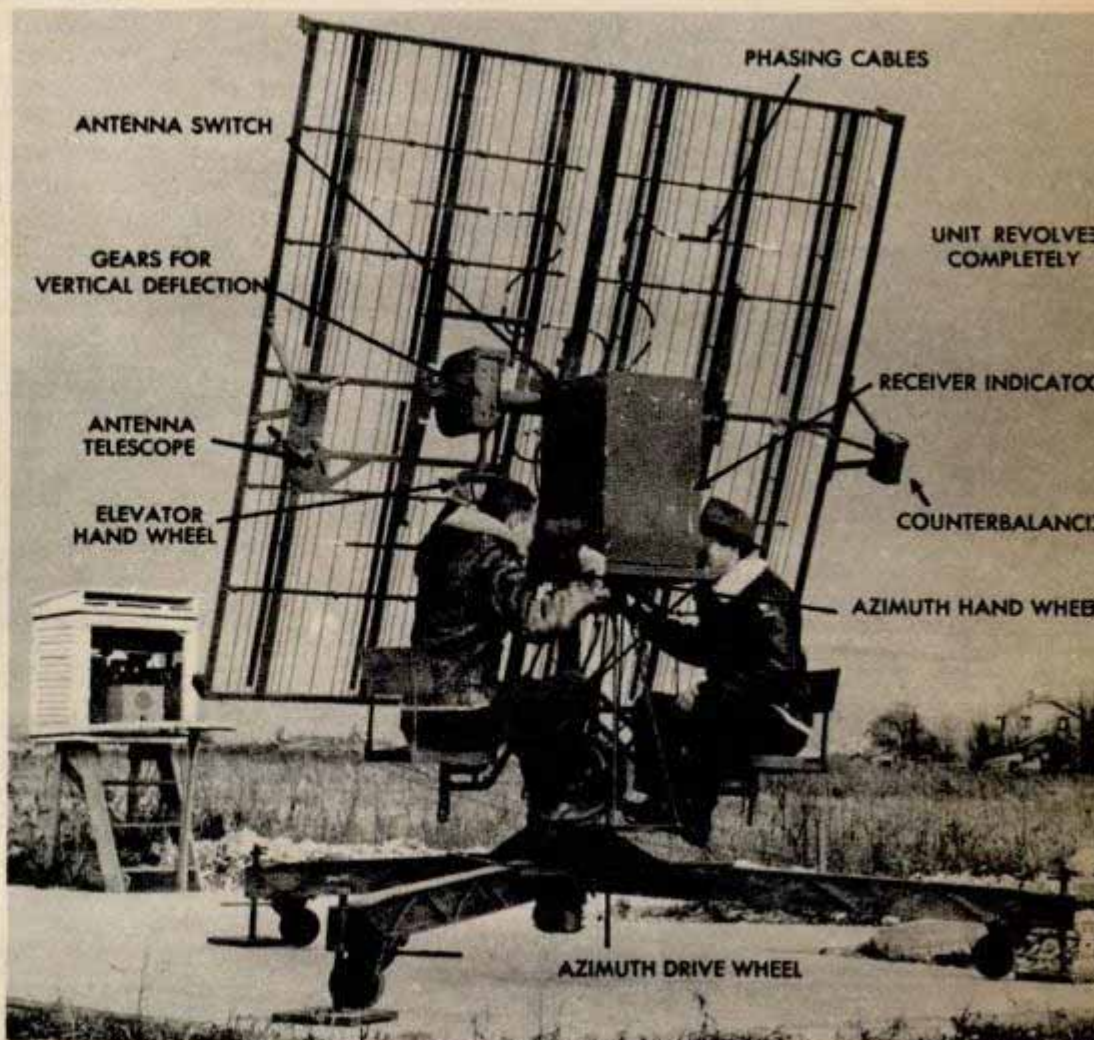
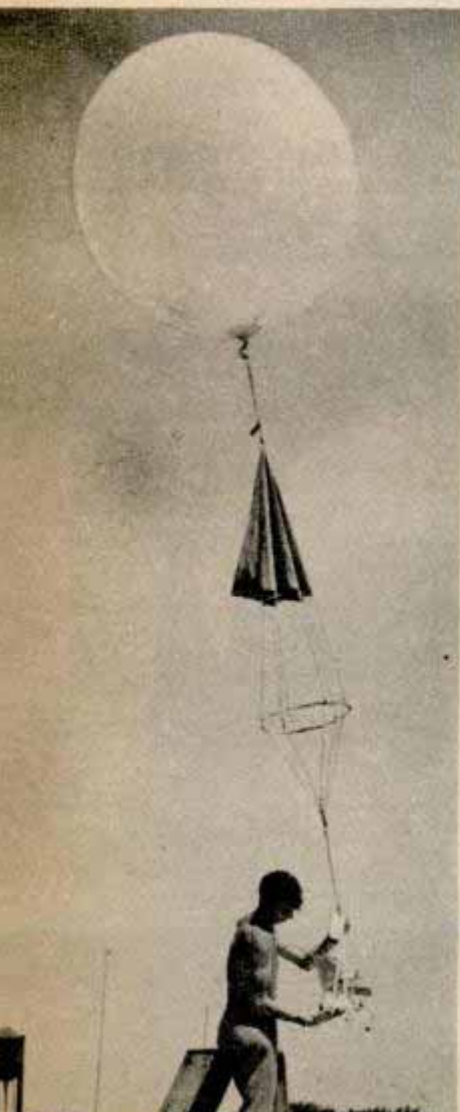

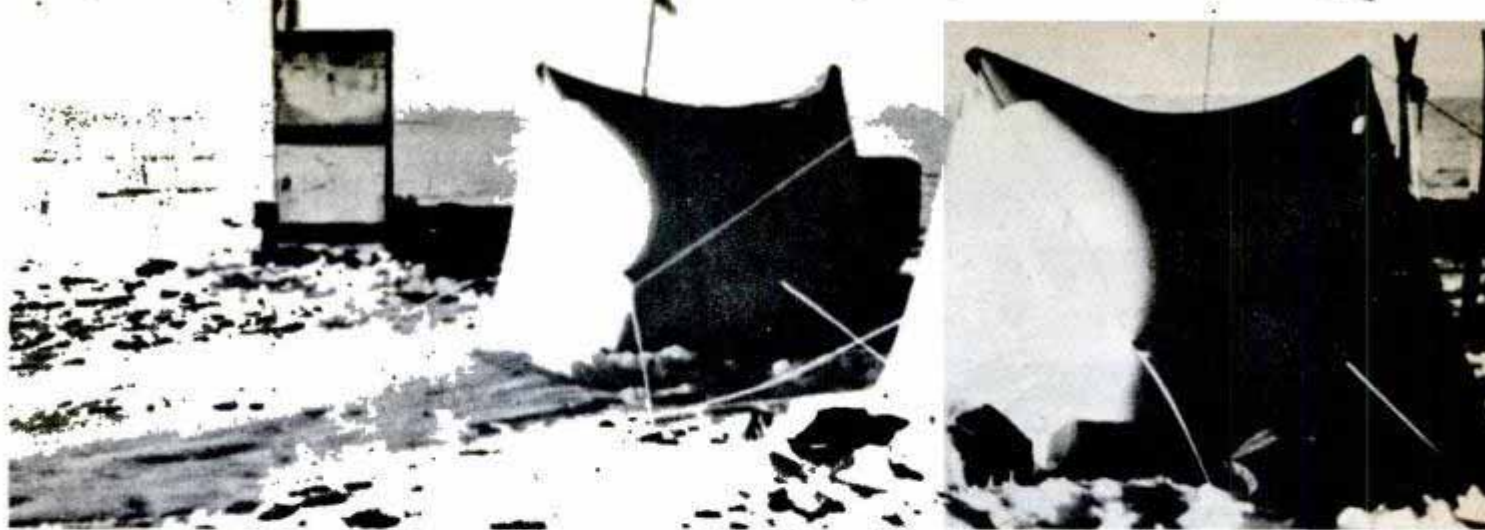

Arctic gales constantly beat down on the AAF's pioneer weather station on the crest of the Greenland Ice Cap

on the cover of this issue). Also, its radiosonde is equipped with a parachute, permitting the continued sending of reliable weather information after the balloon has burst at its usual ceiling of about 60,000 feet. This type equipment helps determine ahead of time the direction and velocity of the wind at various levels so that planes can fly with greater operational economy.

At the present time, the limit of radiosonde observation is about 20 miles. Experiments have been made by which meteorological instruments were carried by rockets. This gives a possible range of from

This unit graphically records data from radiosonde



20 to 500 miles in the upper atmosphere.

Techniques in weather-map making also have been improved. The world-wide spread of American military aviation during the war brought forth new three-dimensional weather maps. Such maps are made of weather at the ground and at heights of 5000 to 30,000 feet. With this knowledge, pilots not only can dodge storms and weather fronts but duck above or below them.

Facsimile map transmission—similar to newspaper wirephoto—enables weathermen to transmit weather information faster, more accurately and to more stations.

Mobile weather stations may find a place in the peacetime world for special aerology observation problems. During the early days of the war, "packaged" weather stations were mounted in the rear ends of jeeps and followed the troops into action. Later, improvements were made on this "weather-wagon" when equipment was installed in one-ton six-wheel trucks, known to the Army as "six-by-sixes."

Automatic "robot" weather stations—in reality small radio transmitting sets similar in construction to radiosonde—have been developed which can be placed in lonely Arctic, jungle or desert areas. Without human assistance, they relay valuable information on temperatures, humidity and barometric pressure. They need servicing only about every six months.

The last four years have shown how valuable world-wide weather observation can be—in war or peace. The Army and Navy both intend to maintain extensive meteorological services and continue a program of training new men. Private industry—air lines, agriculture, chain stores and governmental agencies—will require the services of weather experts.

Mark Twain remarked that "everybody talks about the weather, but nobody does anything about it." Well, Mark lived in the age of the steamboat—not the age of radar, globe-girdling planes and the atom bomb.

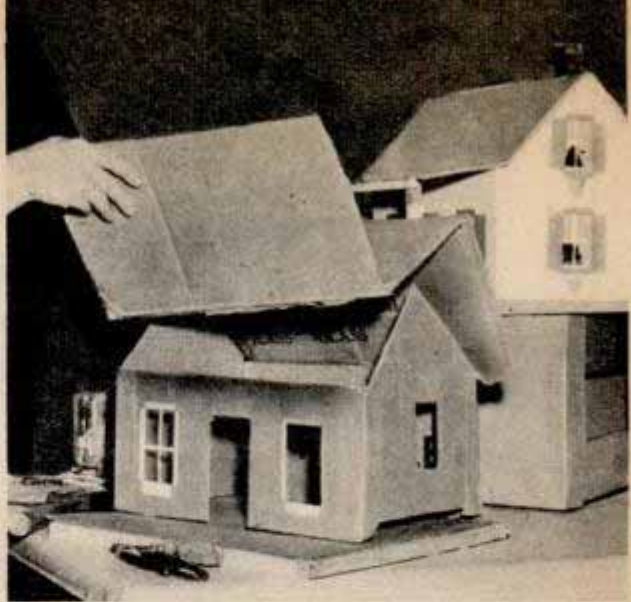

Doll Housing Shortage, Too?

Discarded cardboard packing cases and bits of glass, wallpaper and wood are utilized by Mrs. Frank E. Vanderhoof of Suitland, Md., to build colorful doll houses as presents for neighbor girls. For tools she uses scissors, glass cutter, pen-knife, small saw, hammer and pliers, and to add brightness to shutters, window boxes and other trim she employs paints of gay colors. Mrs. Vanderhoof started her hobby when illness forced her to stay in bed

40 - Cardboard House Building



Diving Helmet Made From Nose of B-17

Salvaged war equipment furnished the materials for a diving helmet made by Lieutenant Richard C. Walter of Akron, Ohio, while convalescing at Wakeman General Hospital, Camp Atterbury, Ind. The helmet itself was made of transparent plastic from the nose of a B-17, giving it 360-degree visibility. The air pump is a discarded DDT sprayer, and the air line was a hose for an acetylene torch. Six strands of combat telephone wire serve the communications system and spotlight, the latter taken from a B-29 along with throat and hand microphones. "It worked like a charm when we tried it in a swimming pool," Lieutenant Walter said.



Names and addresses of makers or sellers of commercial products described in this magazine are listed in the Where-to-Buy-It Index, page 8A. Write to them for additional information and be sure to say you saw it in Popular Mechanics.

More Deadly Buzz Bombs Were on the Way

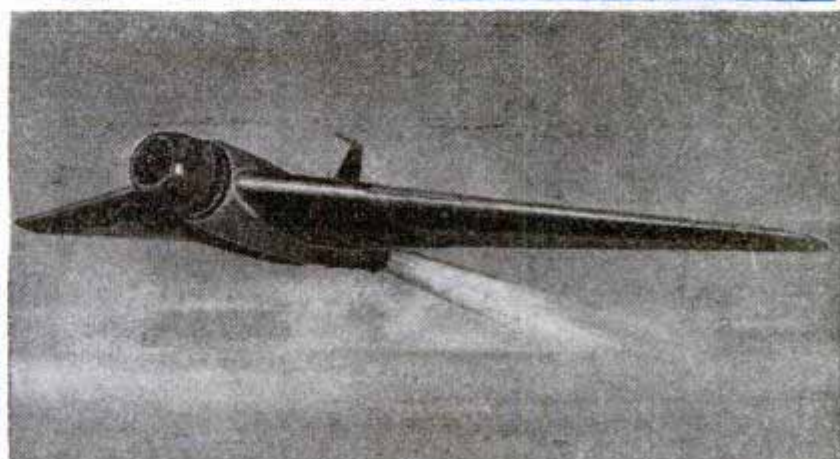
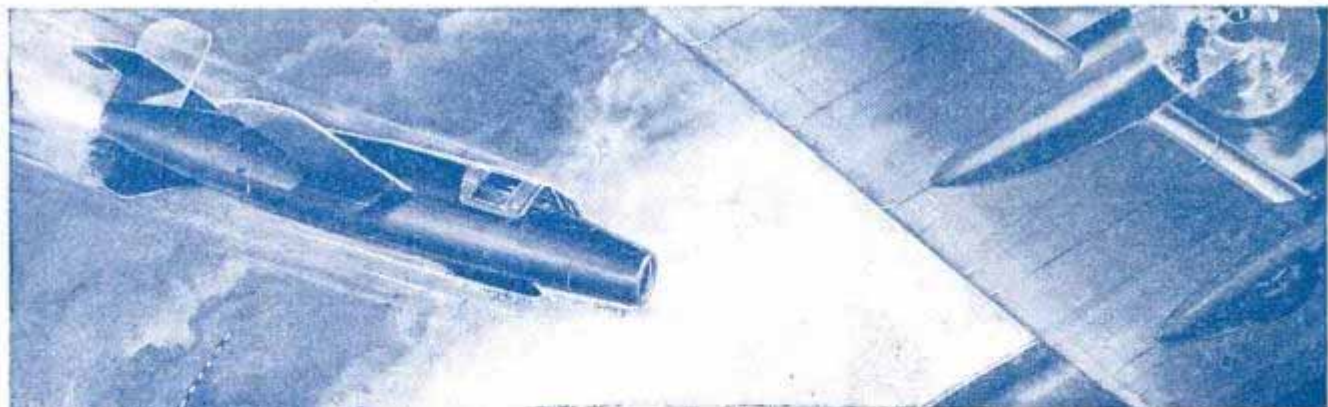

The U. S. Army's 7000-pound Northrop Flying Wing bomb in flight

The German Viper, a piloted missile built to attack Allied air opposition with either cannon or rockets or by ramming, is illustrated above. Its top speed is 620 miles an hour. The pilot ejects himself mechanically prior to the ramming attack. It is rocket-powered

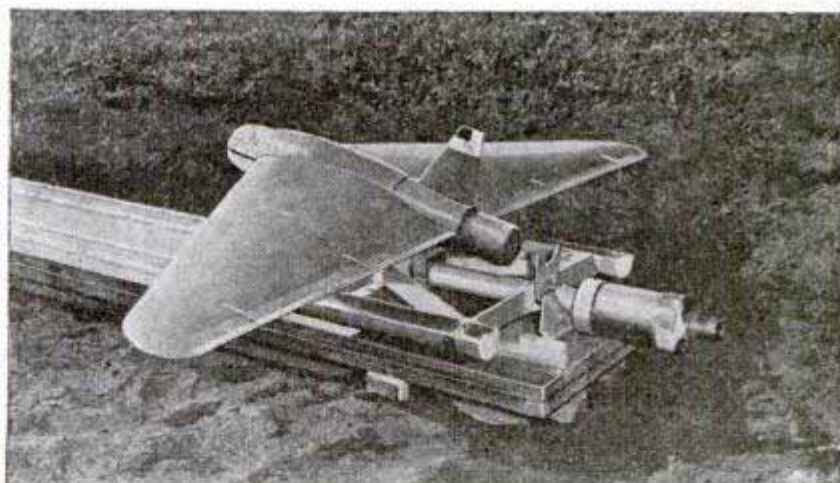

Wing model on new launching sled that cuts takeoff from 300 feet to 50. Below, the Nazi X-4 missile, equipped with a proximity fuse





Dr. Louis H. Powell, director of Science Museum at Saint Paul Institute, traces an air line route on the concave surface of a spherical map made for school use

- 1** Papier-mache hardened in plaster mix forms segments for a globe
- 2** Grooved edges of the two "hemispheres" assure a smooth fitting
- 3** After assembling the two halves, workmen point and paint globes
- 4** Numbered horizontal and perpendicular lines — grids — are added

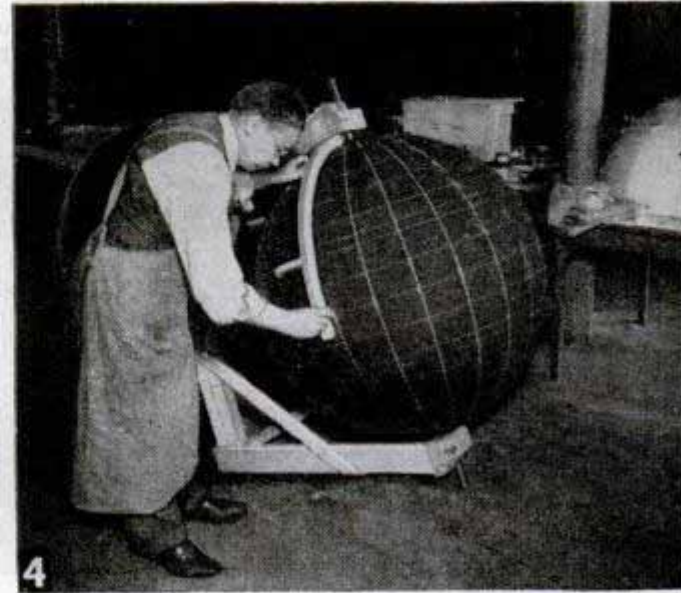
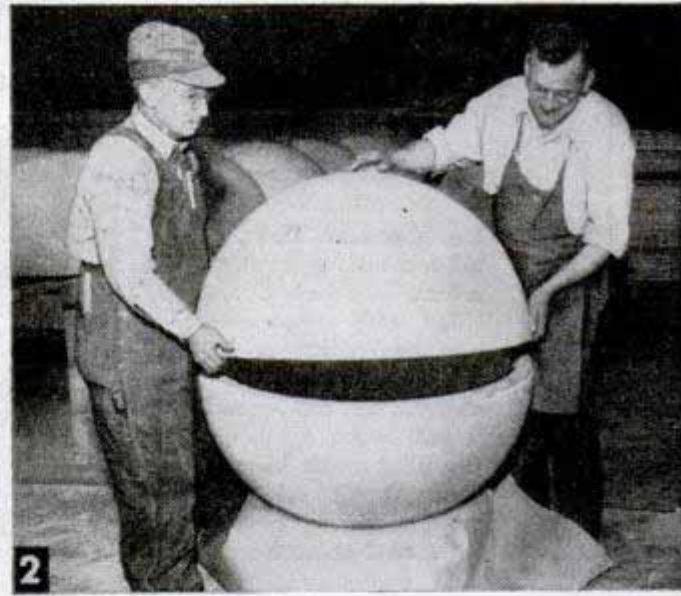

for a Shrinking World

TOO OFTEN in the past, geography bogged down in the classroom in an uninspiring recital of capitals, lakes and rivers or states bounded by this and that.

Things are different now. Faraway countries are brought almost next door as the world shrinks in the air age. Geographic knowledge is more essential than ever for tomorrow's citizens. Geography has become glamorous.

Contributing tremendously to today's keen interest in the subject are new advances in geographic tools—maps, charts and globes which unfold the world before eager eyes. Some of these ingenious mechanical and scientific developments already have appeared in the classroom and the response has been so enthusiastic that alert educators everywhere are adding them to their stock in trade.

Making great strides in the new approach to geography is the Science Museum of the Saint Paul Institute, St. Paul, Minn. In 1940, the museum displayed to the public an exhibit of various types of maps and their uses. The reaction was so favorable that in April 1941 another exhibit, using large spherical maps, answered a question uppermost in many minds then: "Can America be bombed?"

A nonprofit organization devoted to increasing interest in the sciences, and working closely with the St. Paul schools, the Science Museum has a workshop in which it prepares material for its various activities. Most of its exhibits are housed in the museum's own building, the mansion of a former governor of the state.

Construction of the large globes required for the air exhibit was a new venture for the workshop, but Dr. Louis H. Powell, museum director, and his staff put all their energies into the task, with surprising results. For instance, before long they found themselves producing a vast quantity of 40-inch blackboard surface globes for the Navy, which were used to train aerial navigators. The classroom demand for globes with a patented mechanical mount, which



Space-saving mechanical mount supports globe on a padded ring suspended on roller responding to touch

can be revolved by a fingertip and installed in recesses of a wall, became so great that a separate corporation had to be set up to handle the business. The mount and globes both were developed in the workshop.

Experimentation with concave spherical maps for use in the exhibits also had interesting results. Concave maps enable a per-

Curved three-arm protractor accurately measures bearings on spherical map

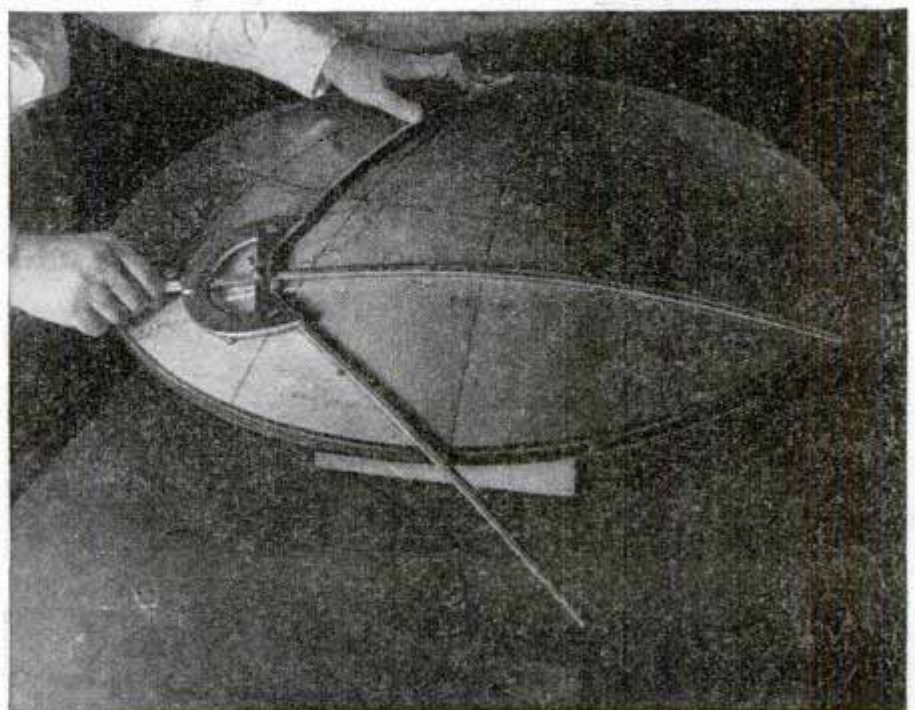

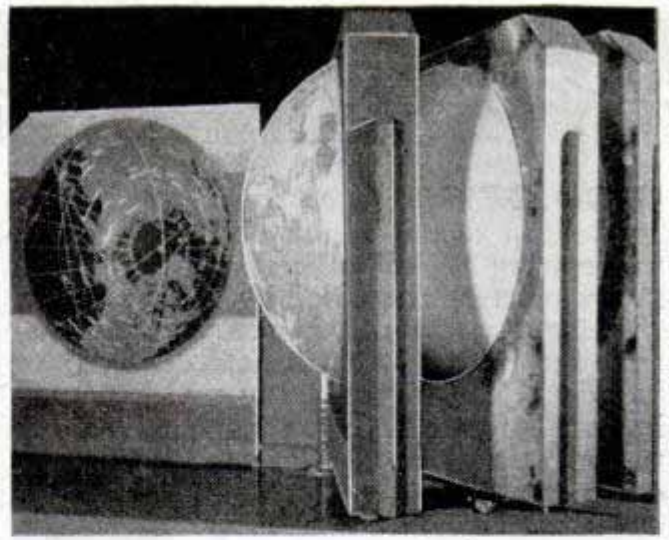

Student locates point on a globe. Right, spherical maps fit together in "book" containing world in segments

son to see any point on the surface clearly. With an ordinary globe, points at the far areas from center can't be seen unless you stand directly over them. Globes take up much room, too, so from this experimenting came an idea. Why not a nest of segments of concave and convex spheres, fitting into each other? The "Atlas of Spherical Maps" was the result. A desk unit already has been designed in which each leaf is 22 by 26 inches.

Wire model shows relationship between conic projection and globe built to same scale

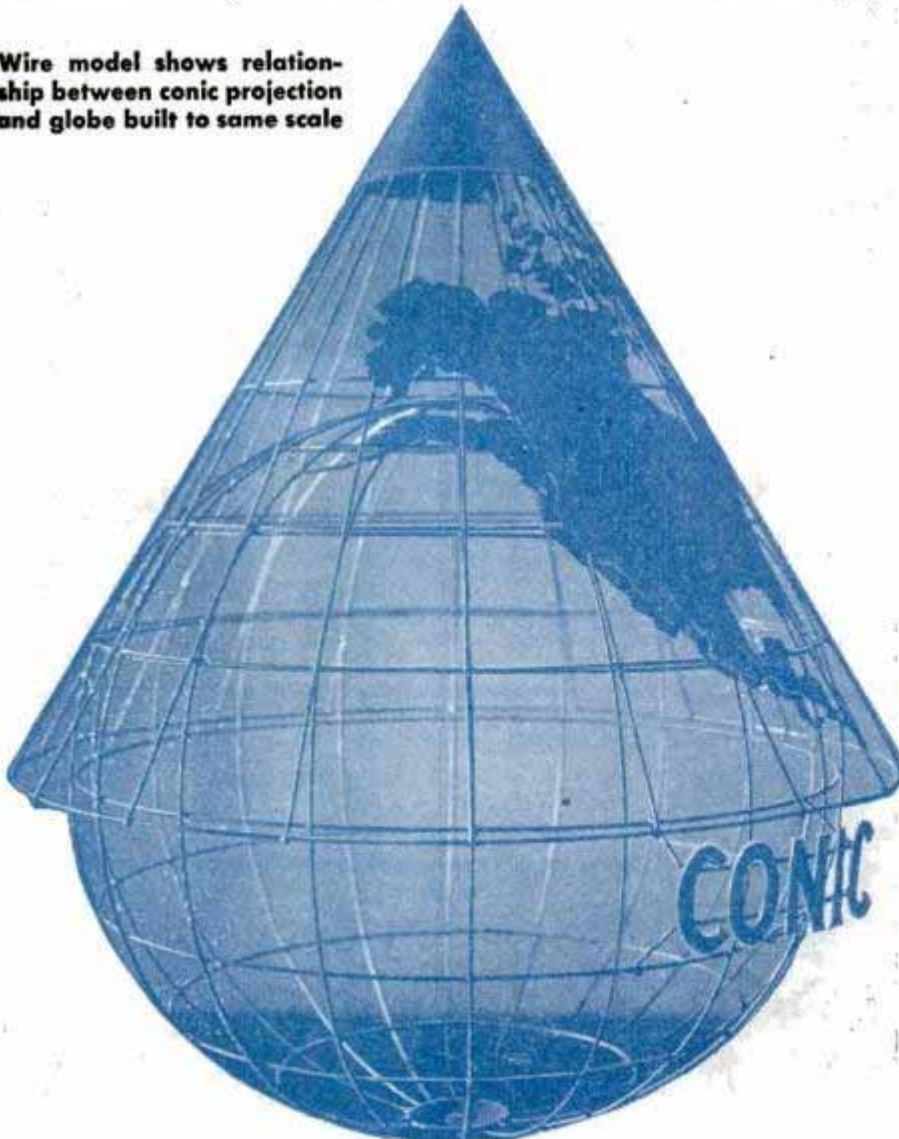

Main objective of the maps has been to abandon the old flat-plane methods, with their attendant distortions, and to substitute globes, global segments of large size, and the concave spherical maps. Globes for classroom purposes aren't dotted with thousands of finely printed names that can't be read at a distance. Instead, the lines of the continents and principal islands are outlined on the blackboard-finished surface. The pupils themselves insert national boundaries and other locations with chalk, or the instructor may write in data or draw air line routes between capitals of the world for all to see.

Use of large-size segments of a globe permits detailed attention to areas. Gores for these globes are prepared carefully in the museum workshop from best map sources, and accuracy is carried to a degree rarely touched before. Some segments of globes prepared in the workshop would require globes 10 feet in diameter if fully carried out.

Size of globes in use until the museum came along had been limited generally to the size of the doorway through which the globe had to pass. The museum staff developed a globe made up of two hemispheres which can be joined together easily, thereby doubling the size of globes which can be taken through an ordinary 32-inch doorway.

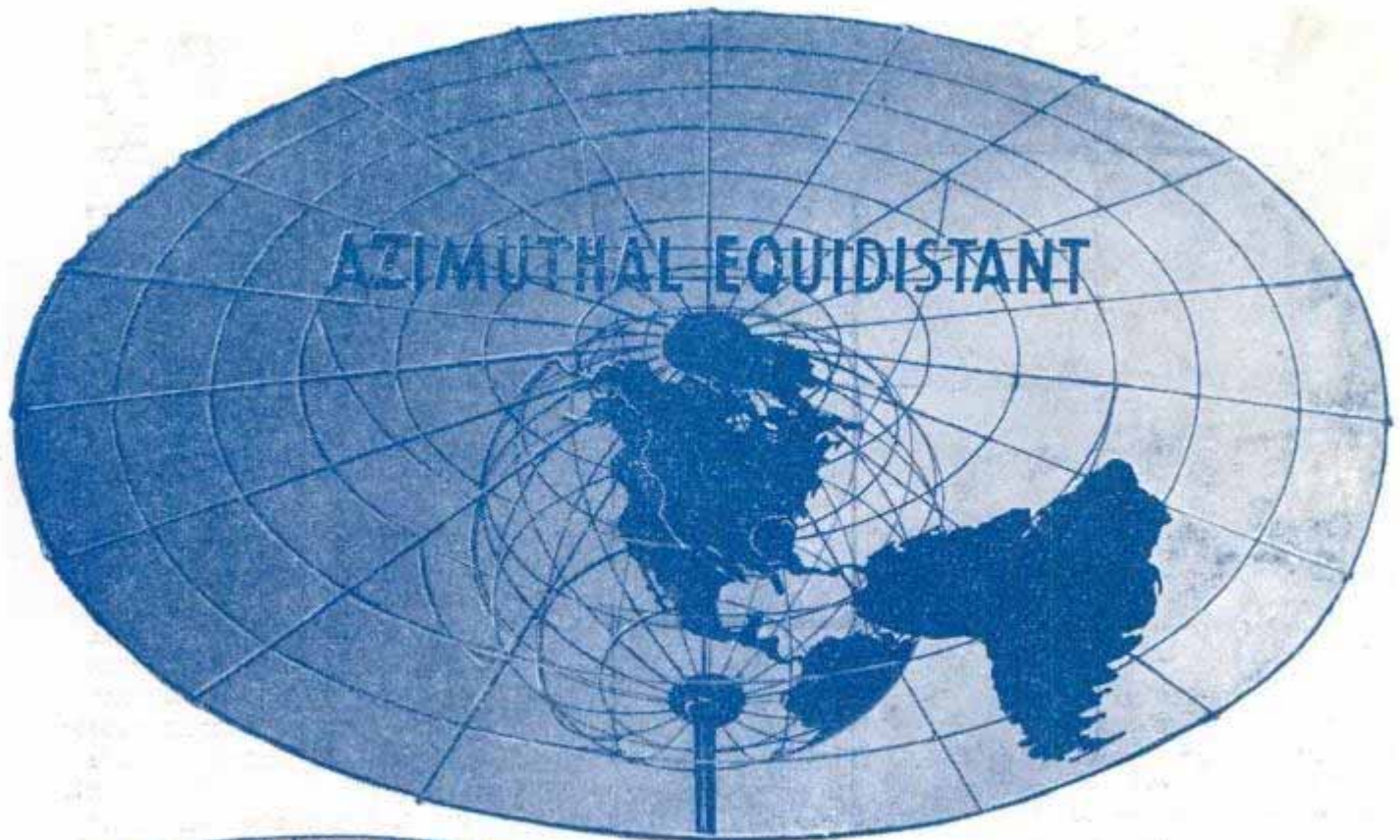

Relationship between azimuthal equidistant projection and a globe made to the same scale is demonstrated above. Similar comparison (left) between Mercator projection and a wire globe



Largest globes made in the workshop are 5.2 feet in diameter, split at the equator, and scaled 1:8,000,000.

The mechanical mount which abolishes the usual axis and ring of conventional globes consists of a ring base which revolves on four small rollers to provide motion from right to left or left to right. Four larger rollers mounted beneath the ring operate in pairs controlled by a hand lever and cam. Moving the lever raises one pair of large rollers to bear the weight of the globe and permit fingertip rotation of the sphere from top to bottom or bottom to top. Another shift of the lever raises the other large rollers for clockwise or counterclockwise horizontal motion of the globe.

Working principally with large globes, the museum workshop found it necessary to develop a material stronger than the usual cardboard of small globes or plaster of paris of larger globes. This problem was solved by creating a plaster-of-paris master form of extreme accuracy. Basin molds are prepared on the master form and from them are cast the large globes, segments and spherical maps.

Many compounds were tried before a satisfactory material was worked out for casting the globes. Best results were obtained with papier-mache built up of small squares of brown paper dipped in a dextrin-tempered plaster mix. A thin layer of the mix is brushed on the mold before laying the paper to assure a smooth outer surface.

Another development is a spherical protractor, designed by the museum to measure spherical map bearings directly and swiftly, and to measure great circle distances. This consists of two fixed arms, each curved to the great circle curvature of the

(Continued to page 156)

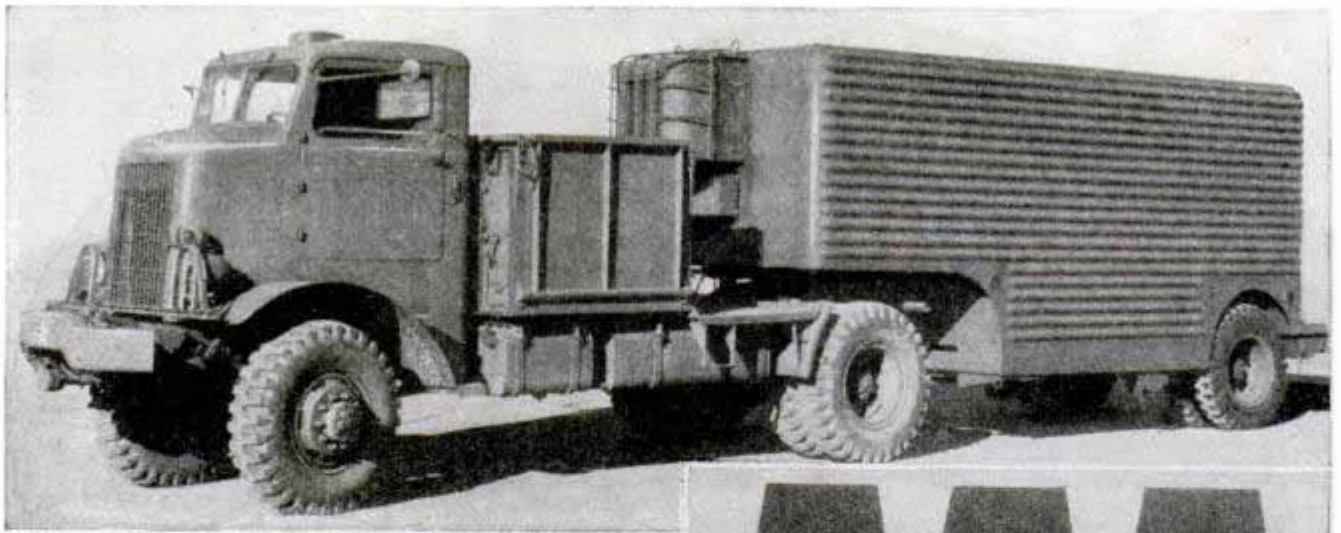

"Bellows" for Heavy Trucks Cushions the Ride

Smooth riding in heavy trucks is provided with an air spring suspension developed by the Firestone Tire & Rubber Company. Installed in a new Army refrigerated trailer built by Fairchild Aircraft, the novel shock absorption device consists of a rubberized fabric bellows inflated with air to carry the desired load. The air system communicates with an air reservoir through a valve which provides almost any type of shock absorption action desired. In a recent test over "torture roads" at Camp Lee, Va., an air spring equipped trailer carrying a 6000-pound load was reported to ride as smoothly as a passenger car.

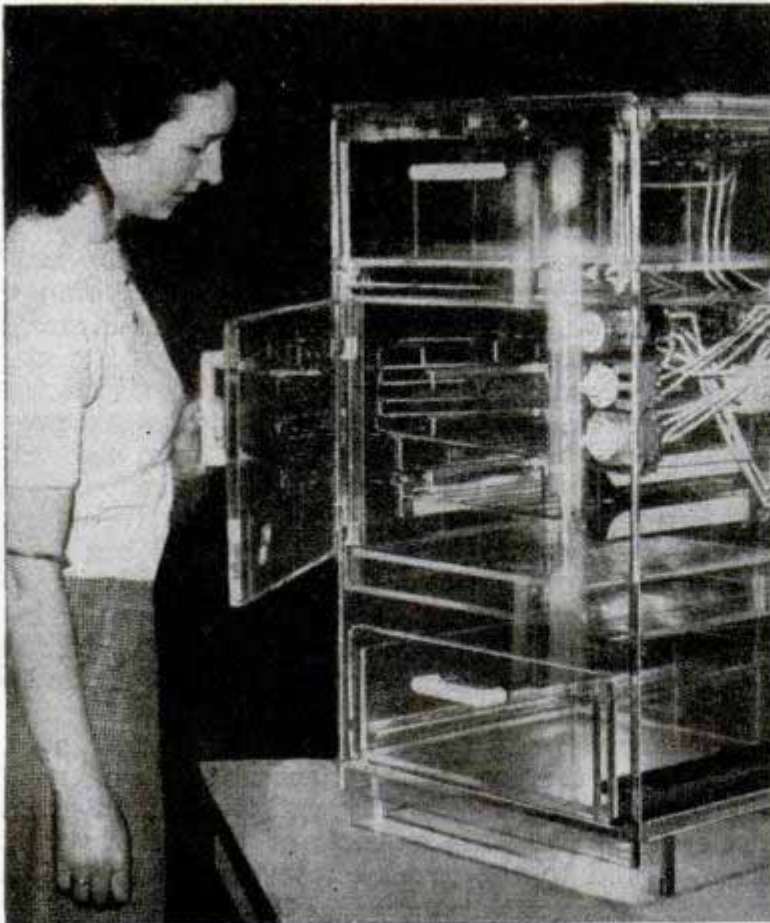
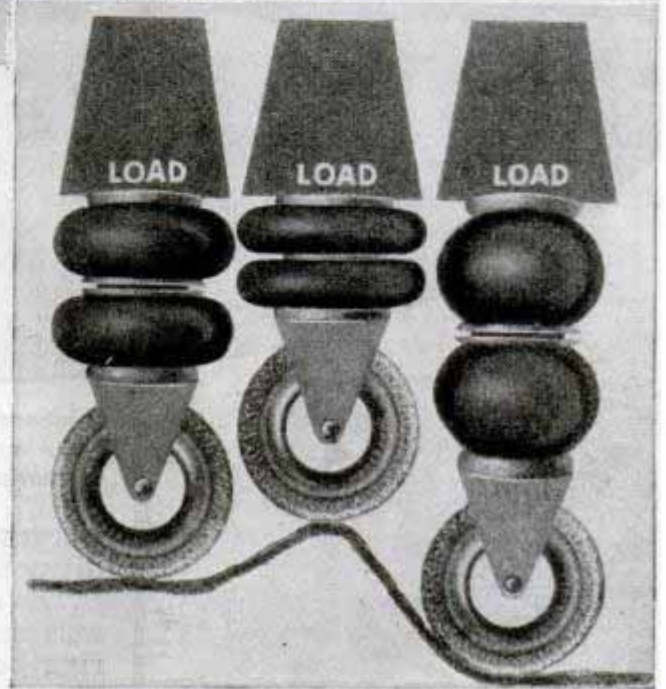

Transparent Oven Walls Give Cook 'X-Ray' View

Opening oven doors and pulling out hot baking pans to view or test their contents are eliminated by a new electric oven that has transparent plastic walls. Housewives look right through the walls to see that steaks, fish, fowl, cakes, bread and other foods reach exactly the right "doneness." The oven was displayed at an electrical exhibition at London.

Laundry Label Is "Set" With Hot Iron

Stamping names on clothing to avoid laundry loss no longer requires application of special inks. Labels are available that can be pressed into clothing with an ordinary iron. Manufacturers claim the label withstands laundering and dry cleaning. Names and addresses or telephone numbers can be stamped with the labels.

"Building set" bench holds heavy tools

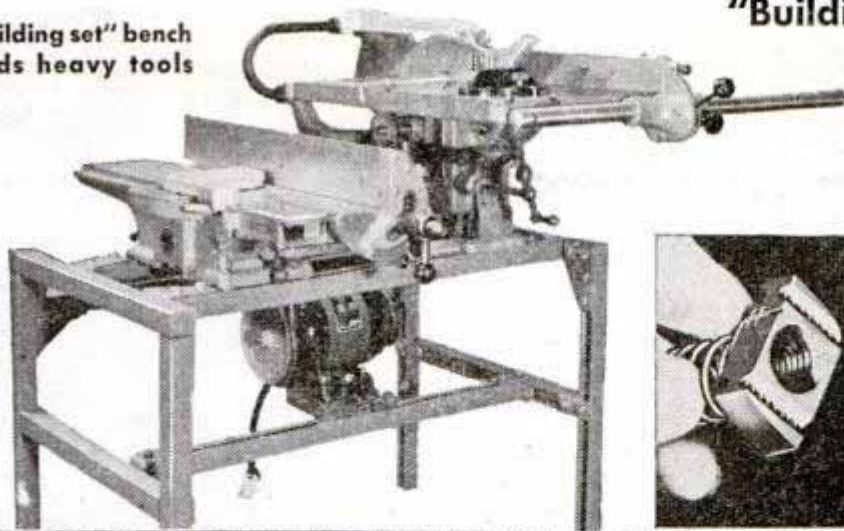

"Building Set" Makes Frames Without Drilling or Welding

Spring-held nut bites into ridged inner edge to hold frame securely

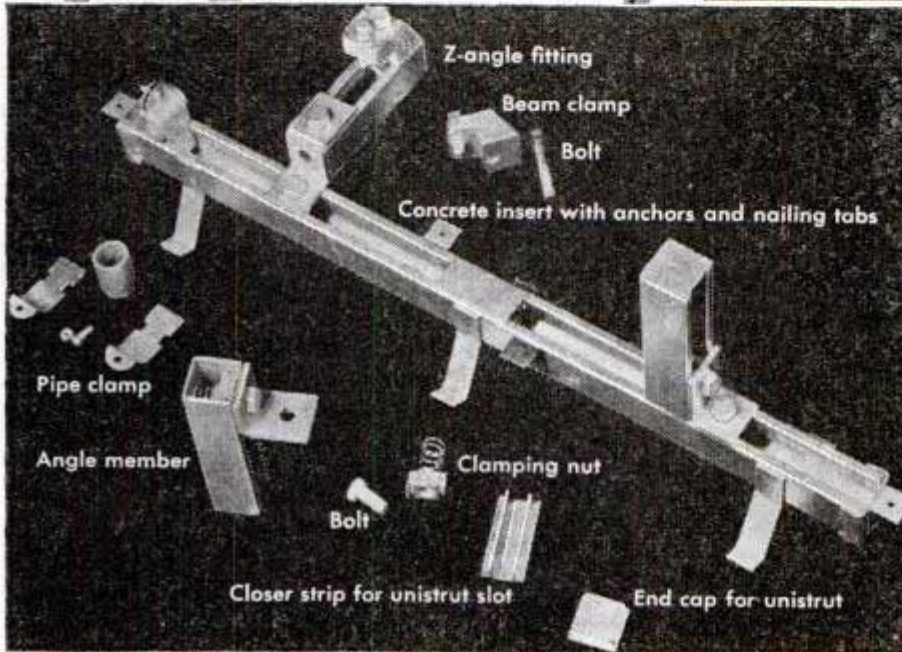
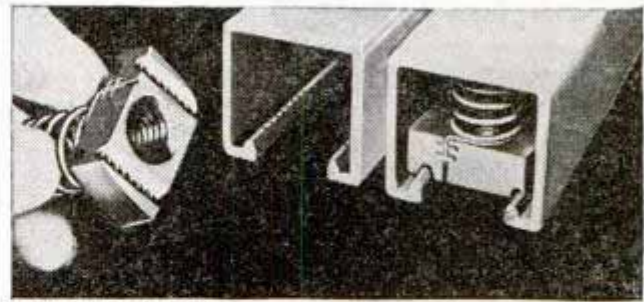

Metal frames to serve as racks or work benches can be constructed with a man-sized "building set." It eliminates drilling or punching holes and welding. Frame pieces come up to 20 feet long and can be reassembled for varied uses. There is no waste in rebuilding. Called Unistrut, the frame consists of a hollow square steel channel with one side open forming a slot. Inside edges of the slot are turned back to form "rails" which are notched to engage teeth of a spring-held nut attachment. This permits another part to be fastened at any point without drilling a hole. Parts can be cut to desired length with a hacksaw. A complete range of fittings is available with the set

FLOATING PIERS of wood and canvas developed by the British helped the Allies move equipment ashore along the coast of France. The GIs called the piers "Swiss Roll" and more than 2700 feet were used at one port

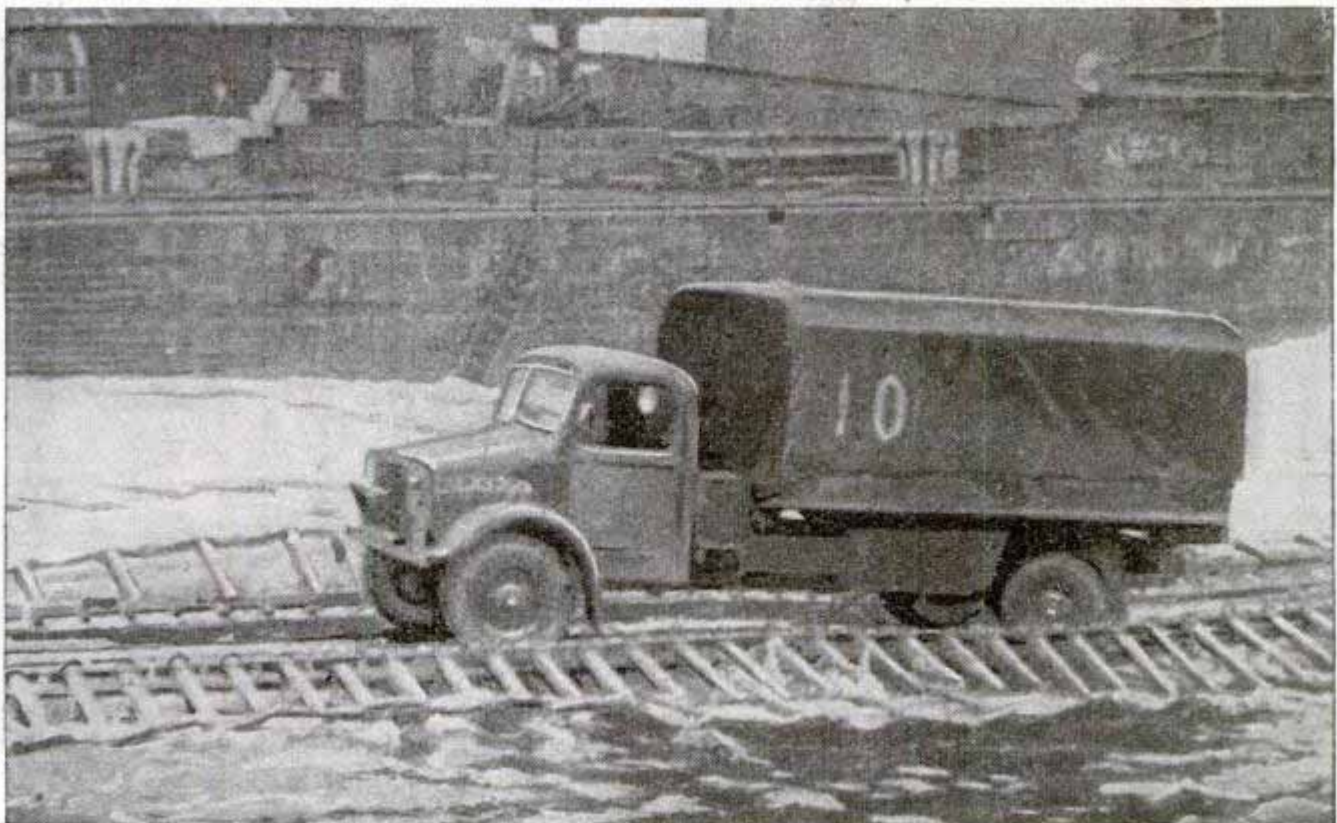

"Inside Stuff" For Your Home

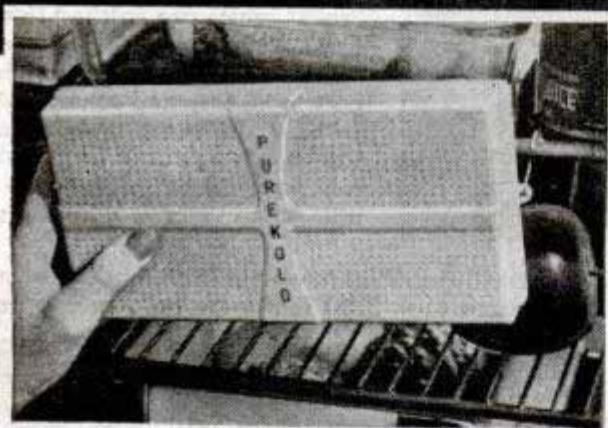
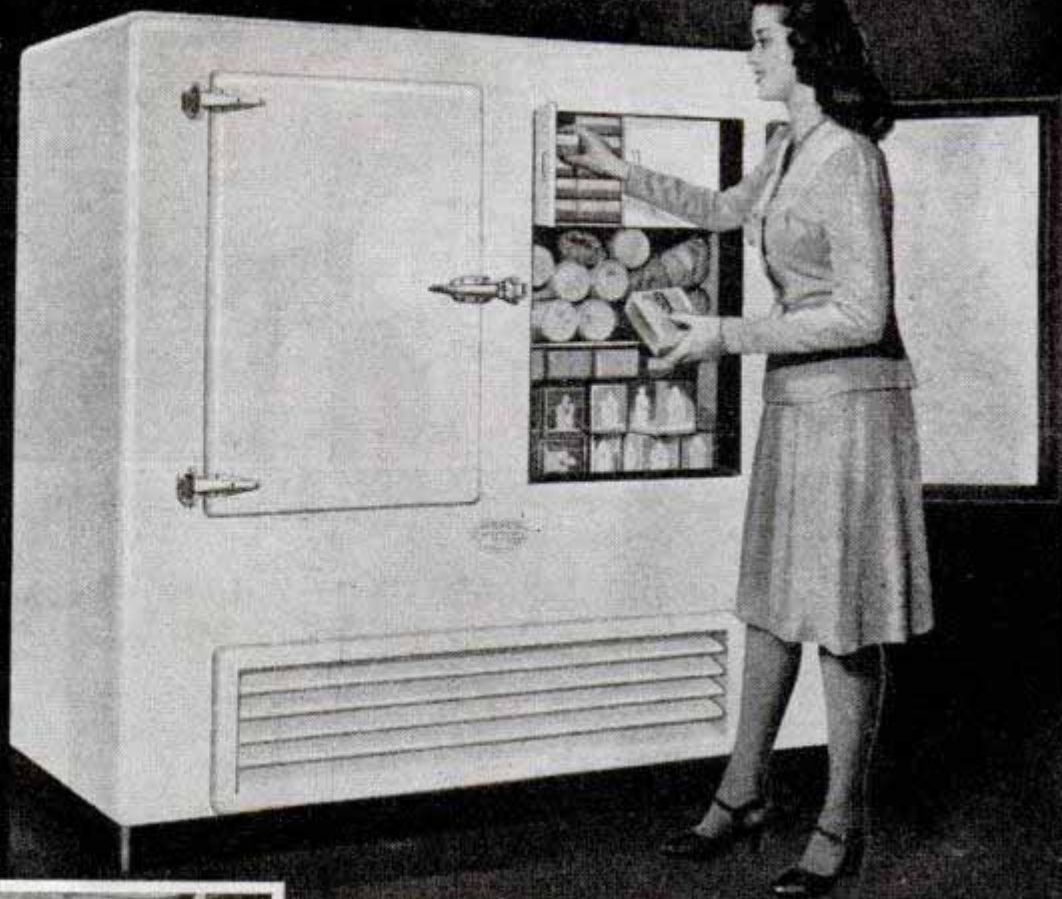

This 18-cubic-foot locker is made in two models. One is entirely for frozen food; the other is half for frozen food and half for normal temperature storage. Left, plastic block filled with chemicals prevents foods in refrigerator from drying out. It also eliminates odors



Sink, dishwasher and washing machine are combined in unit above. When the dishwasher is in use, the clothes washer is stored under the sink, and vice versa. Left, portable washer has motor in base



Waterproof clothesline of tinted plastic won't rust or rot and can be left up; soap and water clean it. Right, portable washing and rinsing tubs mounted on one frame have gravity drains

Vacuum cleaner purifies and removes dust from air in the room of a sick person. Same cleaner has a "tattle tale" light which flashes on to warn the user that the dust bag needs emptying

Invisible heating units for the home (not illustrated) resemble typical baseboards. Hot water flows through two pipelike channels of iron fixture. It can be painted to match the woodwork



Patients Read Book on Ceiling With Microfilm Projector



Text and pictures in magazines and books are reproduced on hospital ceilings by a microfilm projector for the benefit of bedridden patients. The patient can "turn the pages" by means of special switches that move the microfilmed material in the projector. Projected Books, Inc., of Ann Arbor, Mich., a nonprofit organization, was established to promote this new method of reading and distribute the projectors and films.

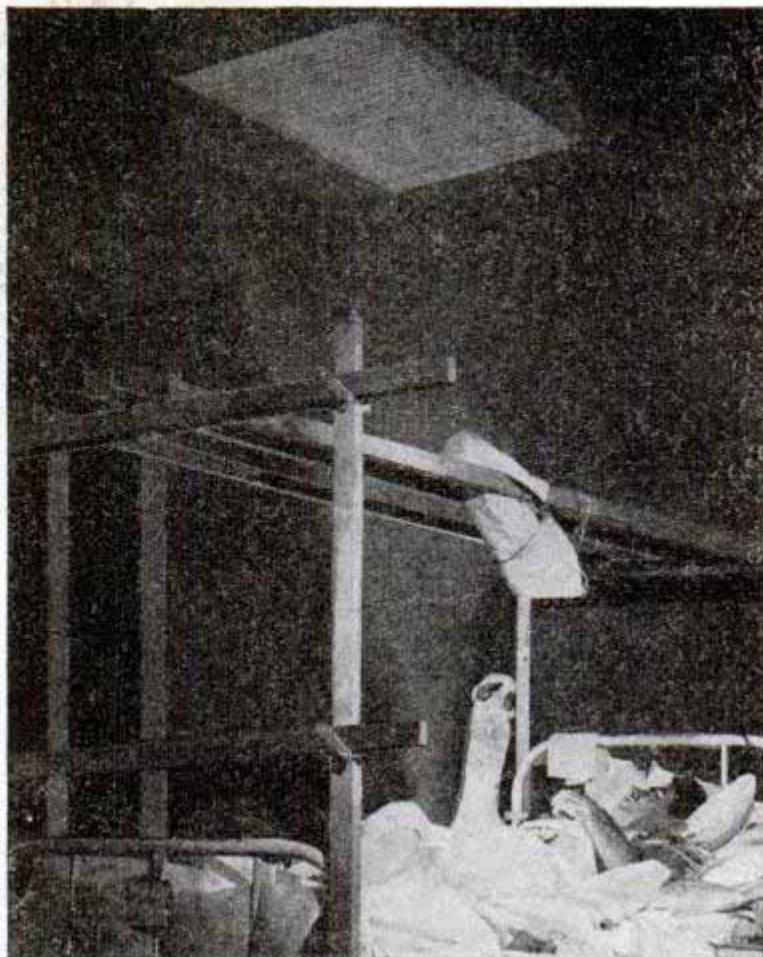

Portable 'Accordion' Conveyor Holds Package on 'S' Turn



Built like an accordion, a portable conveyor recently introduced has sections which can be compressed from 100-inch lengths to 21 inches. The legs, likewise, can be lengthened or shortened to provide various work heights. This lightweight system, which can be set up by one man, also is equipped with special "split" rollers which enable material to make "S" turns without falling off and without the need for siding. Because the conveyor can be set up and taken down quickly, it is suitable for such uses as transporting cartons of food from storage rooms to store shelves.

"Fire Fighting" Valve Shuts Off Gas

"Fire fighting" valves cut off the gas supply in burning homes and thus decrease explosion hazards. High temperature caused by fire moves a Vinylite plastic link in the safety valve, causing the valve stem to shut off the flow of gas instantly.

Radar Camera Built To Map World Air Transport Routes

It now is possible for a flier operating a radar scope to view a luminous picture of the terrain below at the same time that a camera photographs the scene on 35-millimeter motion picture film for a permanent record. An automatic radar recording camera makes this possible. Used with all types of airborne and shipboard radar, the unit consists of a camera, magazine, beam splitter, adapter casting and control box. The camera, equipped with an interchangeable magazine which holds 100 feet of film, can be operated at extreme temperatures and altitudes up to 35,000 feet. It has a range of 100 miles on a frame as compared with the standard aerial camera's usual range of five miles. Peacetime uses predicted for the camera include making radar maps of worldwide air line routes and as an aid in determining safe navigation paths.

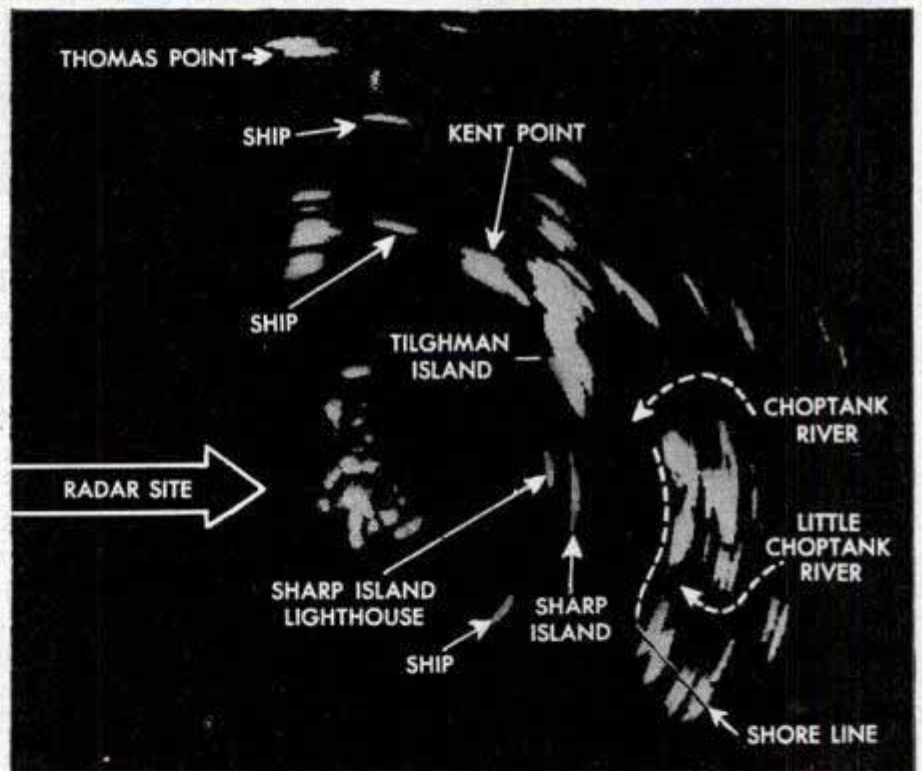

"Two-Faced" Auto Designed for Army

Experiments with a gun-carrying automobile that had steering wheels at both front and back were being conducted by engineers of the Studebaker Corporation when the war ended. In theory, the driver would dash into position, blast the enemy with a few

rounds of gunfire and then make a speedy getaway by hopping behind the duplicate steering wheel and controls facing the rear of the armored car. Another novelty that Studebaker experimented with was a tank trainer designed to instruct drivers early in 1942 when the vehicles themselves were just starting to roll from production lines. Mounted on a six-ton, 24-foot-long chassis, the trainer was equipped with an imitation tank cab, an engine control and a movie projector to give the illusion of a moving tank.

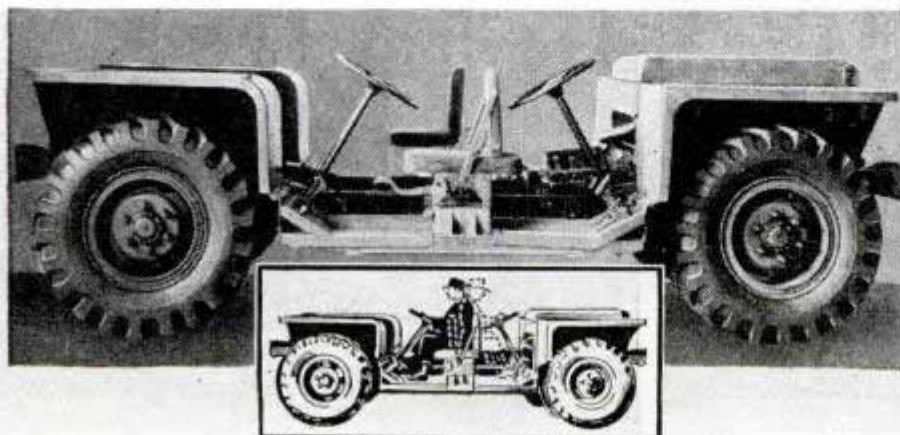

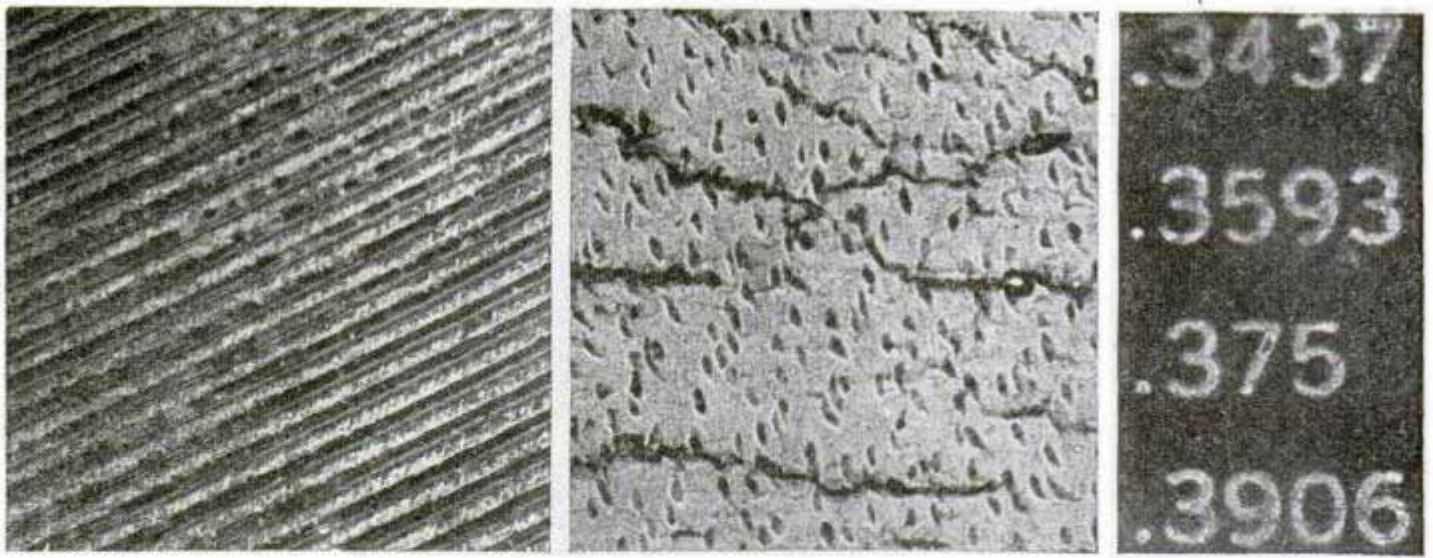

Magnified many times, these photographs reveal (left to right) the teeth of a file, surface of leather and figures engraved on a micrometer. Rex D. McDill (below), inventor, projects film showing magnified surface

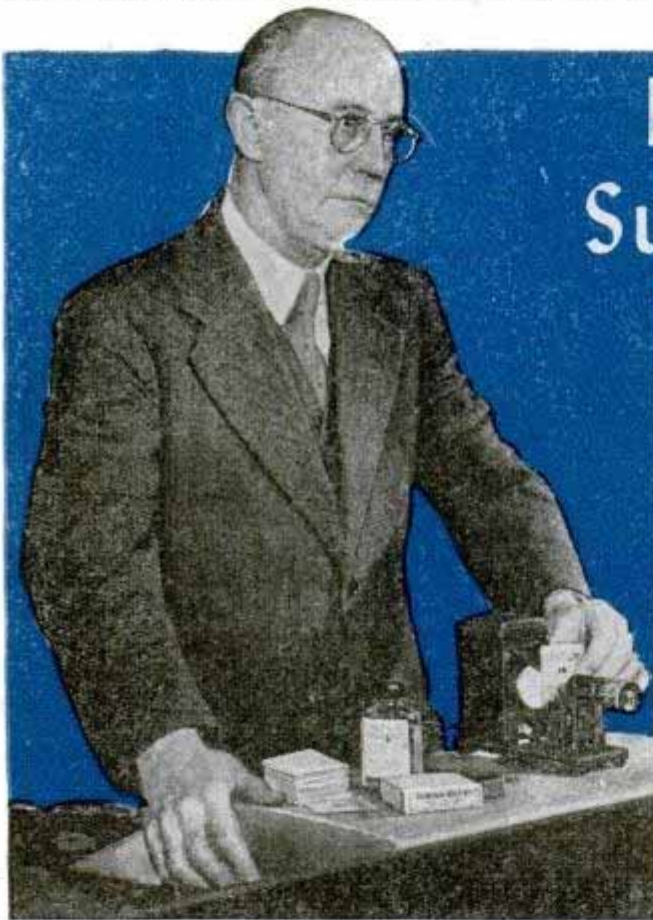

Fingerprinting Surfaces On Film

AN ENGINEER studying emulsion scratches along the sound track of motion-picture film was having trouble. He wanted to collect specimens of the scratches for transmission to other technicians, but he couldn't cut bits of the sound tracks from numerous films, and to make photomicrographs of dozens of specimens was out of the question.

One evening he visited a friend who was making records of metal surfaces with the aid of a simple embossing process that has been adopted widely by industry during the past two years. The engineer had a scrap of sound film in his pocket, and asked his friend to make a replica of it.

He found what he wanted—a way to pre-

To "fingerprint" a surface, solvent first is applied (left), then a strip of blank film is pressed on top (right)

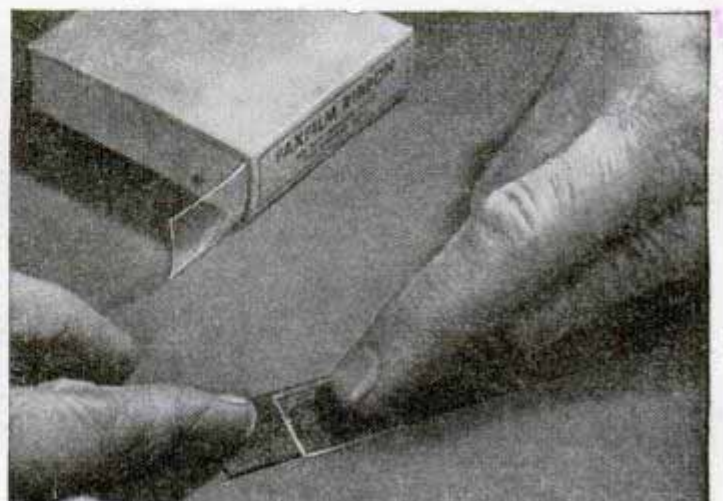
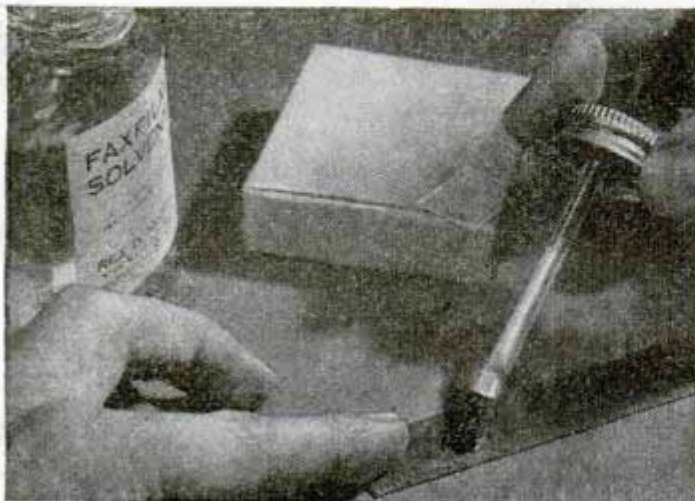

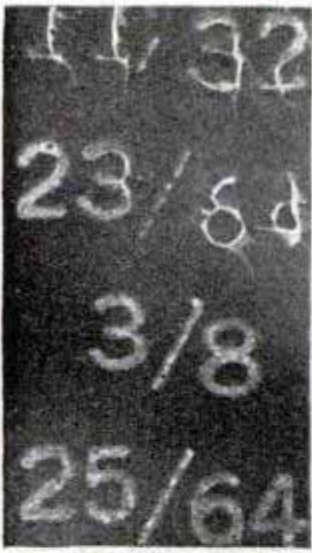

Resembling ripples in water, these circles are tool marks on metal faced on a lathe. Right, wrinkled enamel

serve surface scratches. All he had to do was apply a drop of liquid solvent to the sound-track emulsion, place over it a piece of clear plastic film, and hold it in contact for 20 seconds or so. When stripped off, the plastic carried the imprint of every scratch and other surface detail.

This simple method saved countless precious hours for wartime industry, and promises to be even more useful in peace. It has speeded up inspections. It has given engineers and scientists a cheap, quick way of making permanent records of metal and other surfaces. It offers a means of measuring surface smoothness quickly and accurately when no profilometer is at hand.

The film is the invention of Rex D. McDill, Cleveland, Ohio, engineer, holder of more than 40 patents on electronic equipment and other devices and processes. One of McDill's specialties is inspection equipment, and one day he ran into a problem that couldn't be solved by ordinary methods. It involved the structure of a metal surface. He got the idea that, if the surface details could be transferred to a transparent film which could be projected on a screen or examined on a microscope slide,

his troubles largely would be over. He knew that biologists sometimes flow liquid collodion over mother-of-pearl or other surface, let it dry, strip it off, and mount it on a slide for microscopic examination of details the collodion has picked up. But for industrial use, this is too messy and slow.

So, over a period of two years, McDill tested dozens of plastics and solvents until he finally worked out a combination that gives satisfactory results. McDill dubbed his discovery "Faxfilm," and assembled kits consisting of a roll of transparent film, bottle of solvent, two by two-inch cardboard mounts for the film specimens, a moistener for wetting the mount adhesive and a hand magnifier for viewing the film.

The blank film is a strip of clear plastic material .0055 inch thick and $\frac{3}{4}$ inch wide. The solvent softens one side of the film so it penetrates every scratch or other unevenness of the surface being recorded. After the replica is stripped off, the excess solvent evaporates, leaving the embossed details as permanent as the film itself. Usually about one inch of film is used for each record. This is mounted by sandwiching it between two 2-inch squares of card-

Film bearing the imprint of metal surface is removed (left) and placed over a $\frac{1}{2}$ -inch hole in cardboard

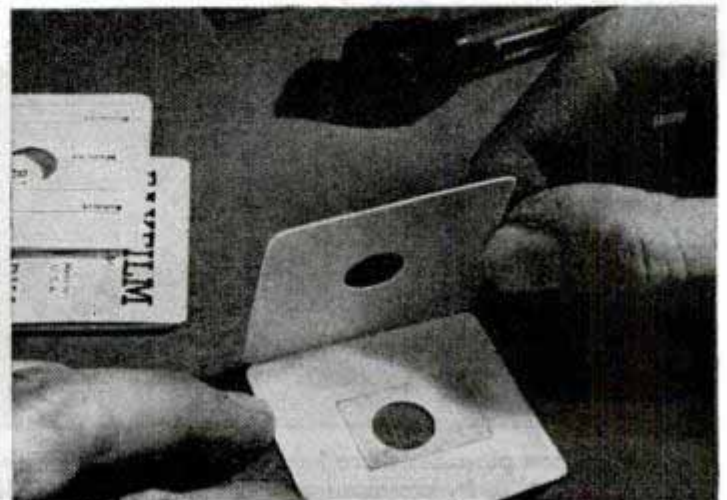
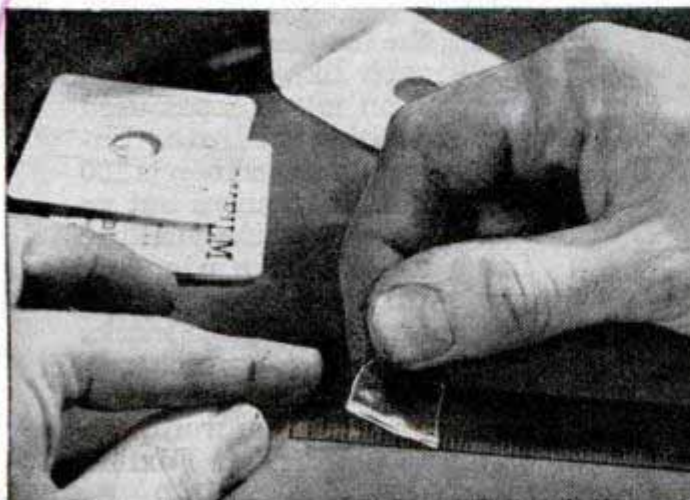

5199 Mansfield Road

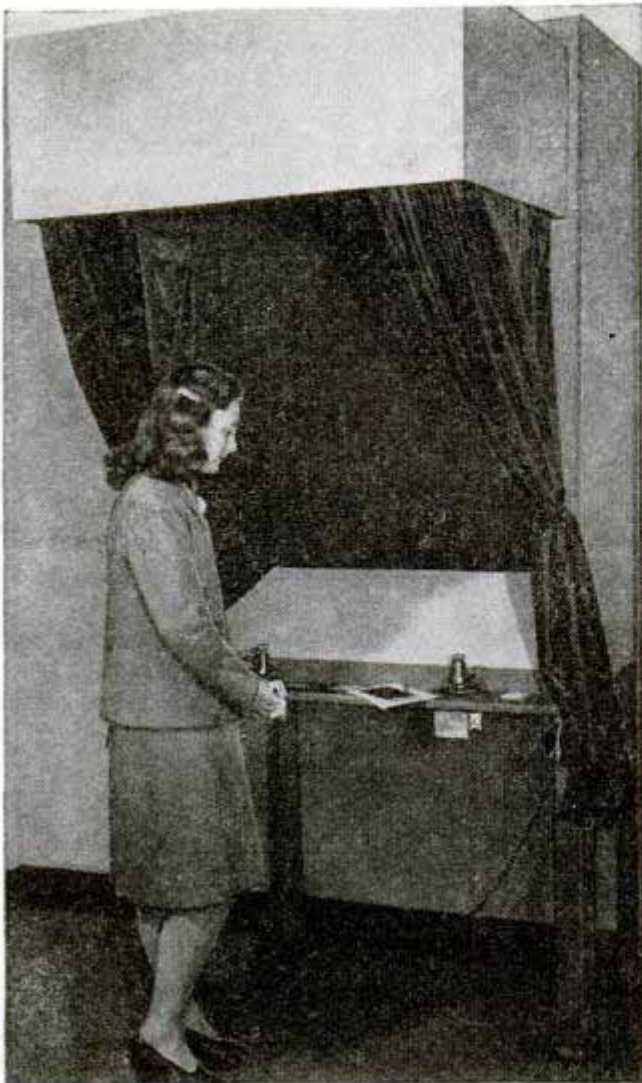

Finish of a machined part is compared with a master sample in this instrument of mirrors and projectors

board with half-inch holes in their centers. Data concerning the replica may be written on the mount. The two by two-inch size enables the specimen to be projected in an ordinary slide projector, as well as in special projectors McDill has designed. Ordinarily a magnification of 100 diameters on the screen is sufficient to reveal the desired details.

When a record is to be made of the sur-



For comparison purposes these images were flashed on the screen of the instrument. Left, corrosionproof coating. Right, halftone plate

face of a hard substance such as a metal specimen etched to reveal its grain structure, the solvent is applied first to the specimen. When the record is to be of something soft, like a rose petal or plant leaf, the solvent is applied to one surface of the film, and the specimen may be oiled lightly to prevent sticking.

The ways in which Faxfilm has been used have surprised even McDill. For example, it is helping solve an important problem in the operation of ocean-going ships. When the surfaces of turbine gear teeth develop undue roughness and wear, trouble is likely to result. One manufacturer of turbine equipment heard about McDill's film, and tests showed that it could be used to make periodic records of gear tooth wear. By studying such records, trouble can be detected and corrected early enough to prevent costly breakdowns. It is planned to equip ships with kits for making film replicas.

In one factory, unrest among workers began to develop because of a rumor that finish inspection standards were being upped. That is, work that seemed to be as well finished as in the past was being rejected. Company officials called union leaders together and had a piece of work produced in strict accordance with the blueprints. A film record was made of this work and compared with similar replicas of the finish on rejected pieces. It was obvious that the rejected work had an inferior finish. The union stewards passed this news on to the workmen, and everything settled back to normal.

The need for a quick way of comparing surface finishes with a standard led McDill to develop a comparator outfit. This is a curtained booth housing a rectangular screen, two optically flat mirrors and two film-slide projectors. The projector beams shoot upward, strike the mirrors, and are reflected downward on the screen in such

a way that the twenty by twenty-two-inch images are side by side. By adjusting the relative positions of the film slides, the images can be lined up — much like those in the comparison microscopes used for examining bullets. Enlargement on the screen is 100 diameters. It requires but an instant to determine whether finish marks on a piece of work are finer, coarser, or equivalent to the finish marks on a standard. A purchaser, in specifying finish requirements for a piece of work, can staple to the order a Faxfilm

(Continued to page 152)

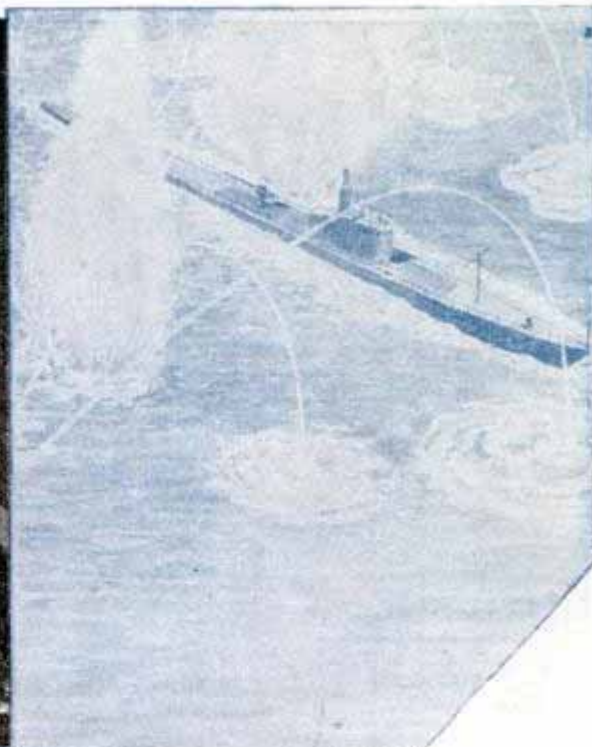

HEDGEHOG AND MOUSETRAP

Two rocket launchers used by the Navy in whipping the submarine menace were the Hedgehog, above, and the Mousetrap, below. Both are known as "ahead thrown" weapons because they are affixed to the bow of vessels, whereas depth charges are hurled or dropped off the stern or from projectors in that vicinity. The Hedgehog can be trained horizontally on a target and its 24 projectiles are propelled by a cartridge charge, while the Mousetrap is immobile and must be aimed by heading the ship on the proper bearing, and its eight rockets are self-propelled. Both lay their missiles in a pattern that covers the target area, where they sink immediately, exploding only on direct contact.

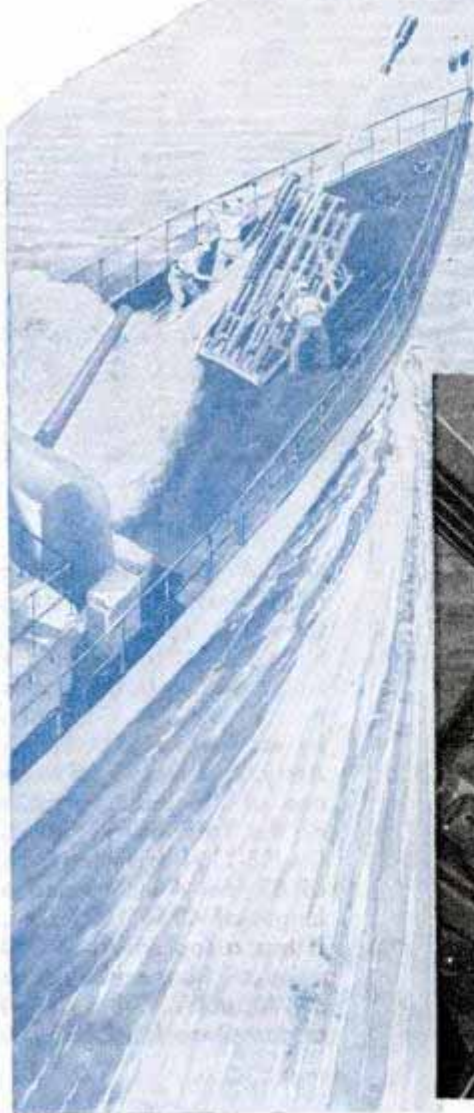

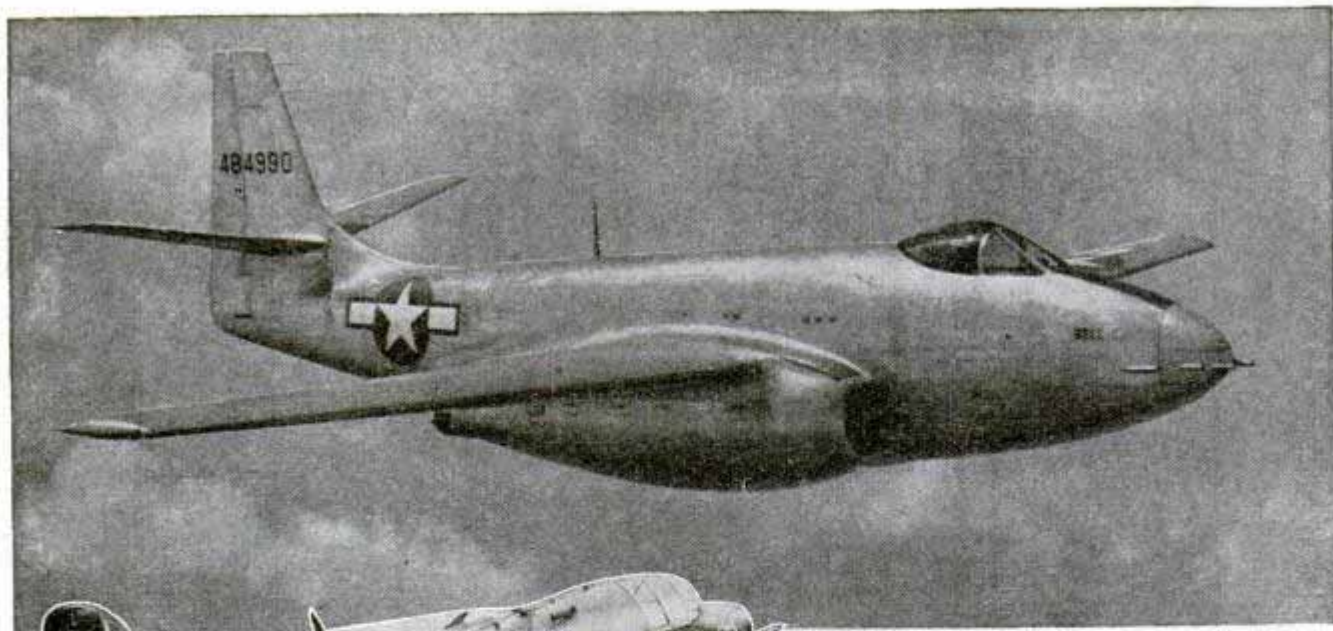

Above: Twin General Electric engines power the XP-83, built by Bell for the AAF and reported to be the longest ranged of the jet-propelled craft. Its top speed is "in excess of 500 miles an hour"



Like a Manx cat, the Handley Page Manx is tailless. The pusher type propellers are driven by twin de Havilland 140-hp. engines. Eighteen feet long with a wing span of 40 feet, the 4000-pound airplane cruises at a speed of 150 miles an hour



Right: Used for tank and gun-carrying assignments, the Arado 232-B, a British transport plane, has 23 wheels to ease the strain of moving its heavy loads

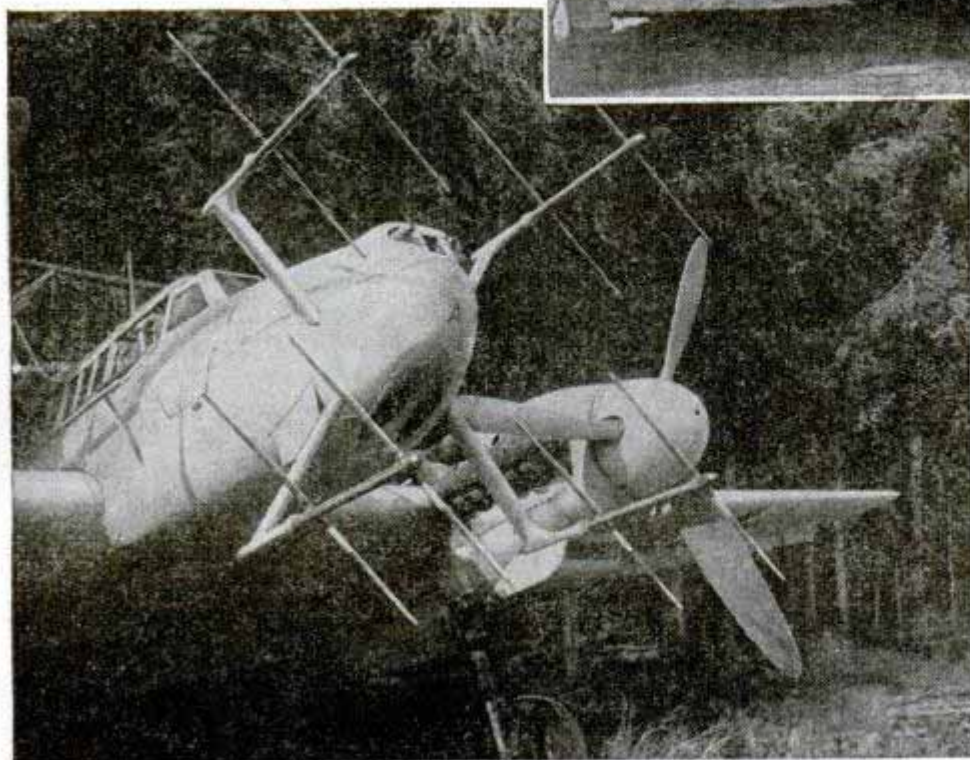

Left: A grotesque looking radar installation marks the nose section of this Nazi ME-110 night fighter found hidden in the woods near Unt Aching, Germany, by scouts of the U. S. 7th Army. Acknowledged to be one of the most versatile of the Luftwaffe's planes, the ME-110 has a wing span of 53 feet 4 inches and a length of 40 feet 4 inches. It has a top speed of 340 miles per hour and a range of 1300 miles. Gross weight of the plane is 22,100 lbs.

Plugging the Dikes of Holland

Framed by anchor, old barge closes breach in dike. Tons of clay filled the gap later

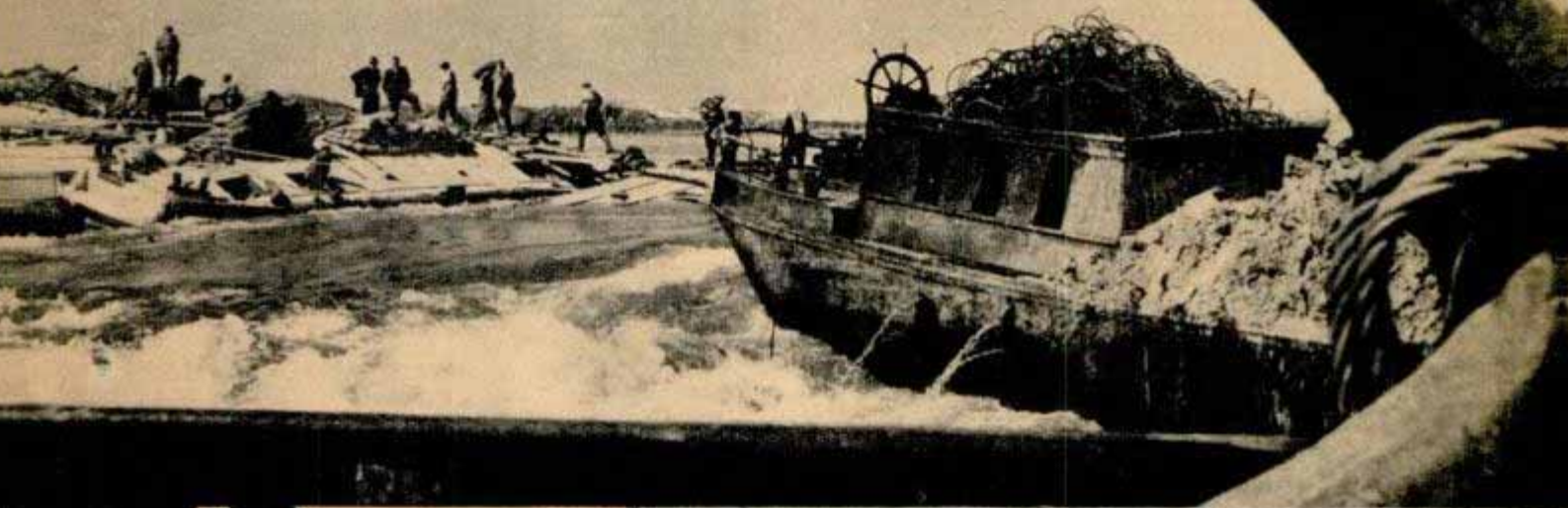

Paderborn
• Munster Kassel

DUTCH engineers are winning the greatest battle in the history of the Netherlands. Walcheren Island, flooded during the war, again has been lifted from the bottom of the North Sea.

Walcheren, "the fruit basket of Holland," disappeared in November 1944 when accurate RAF bombers breached four dikes surrounding the island. Walcheren was an important fortress in the German West Wall. The land previously had supplied Hollanders with a large share of their food. Last year its 50,000 farmers were homeless.

Time was a greater enemy than the sea during the great battle.

Frankfur

Mannhei

Metal hoops covered with rope are used as washers in joining huge sand pipes. Right, young engineer makes soundings to check possible sea damage to breach



All four of the breaches had to be sealed before the severe winter storms raged across the island. If the island had remained beneath the sea another winter, it would have disappeared forever. German mines, countless and uncharted, increased the hazards of the work.

Work began in December 1944, a month after the dikes were bombed. Engineers at Delft University near The Hague built models of the dikes, complete with rising tides and foaming water, to solve engineering problems. Broken ends of the four gaps were reinforced to prevent the restless sea from stealing more land. Allied officials promised supplies. These arrived in June.

Work to close the breaches actually started in July.

Foreign workers have tried and failed in building dikes. It is a craft, centuries old, passed from father to son. Modern engineering can produce few improvements. But the project became truly international. American "Ducks" carried workers through flood waters to the dikes. Navy barges and LCTs carried materials. Britain sent engineering equipment, clothing and a million sandbags. Royal Engineers carried out demolition assignments. Barracks for 2000 workers were built by the Swiss. Belgium gave a narrow gauge railway.

(Continued to page 69)

Workers sink concrete pontoons in position to close dike. Later a storm drove several of them out to sea



The first gap is filled. Three more had to be completed before winter storms. Below left, Dutch scientist solves engineering problem on scale model of dike



Stakes and sandbags insulate top of dike. Right, twigs and stones help hold back sea

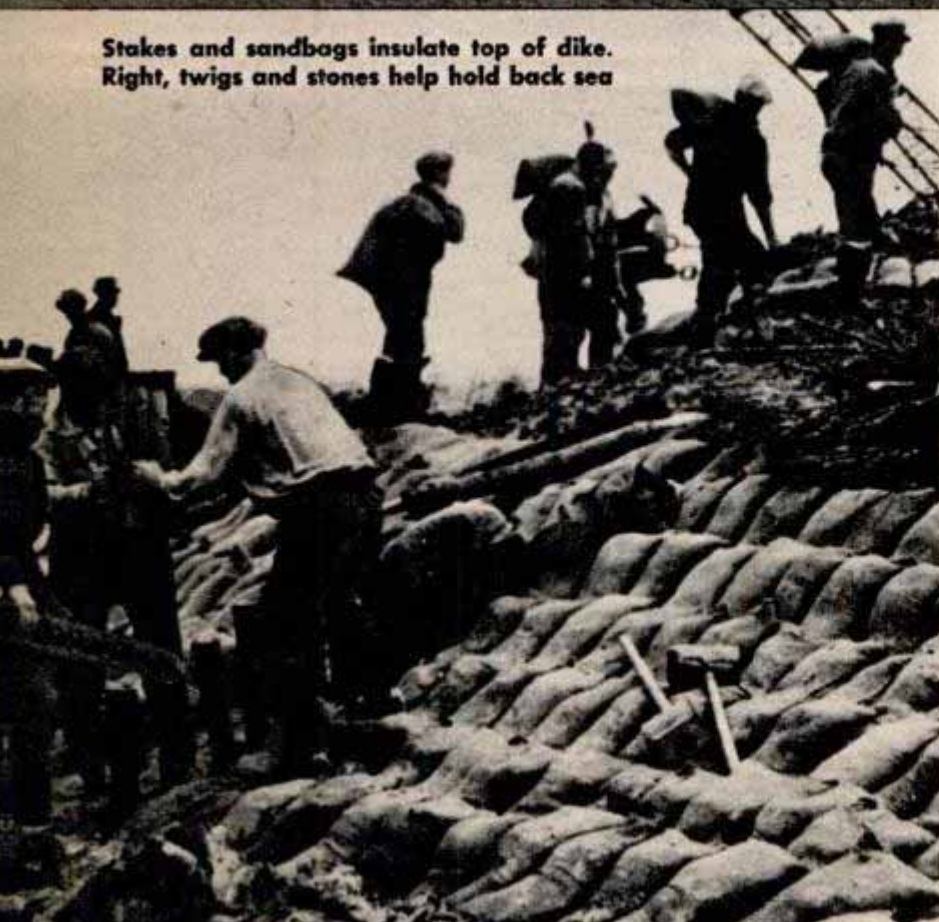



Above, a thousand tons of sand pour through giant pipe each hour to form core of dike. Left, huge dredge drops antisubmarine net and scrap into German barge that was sunk to seal final gap successfully



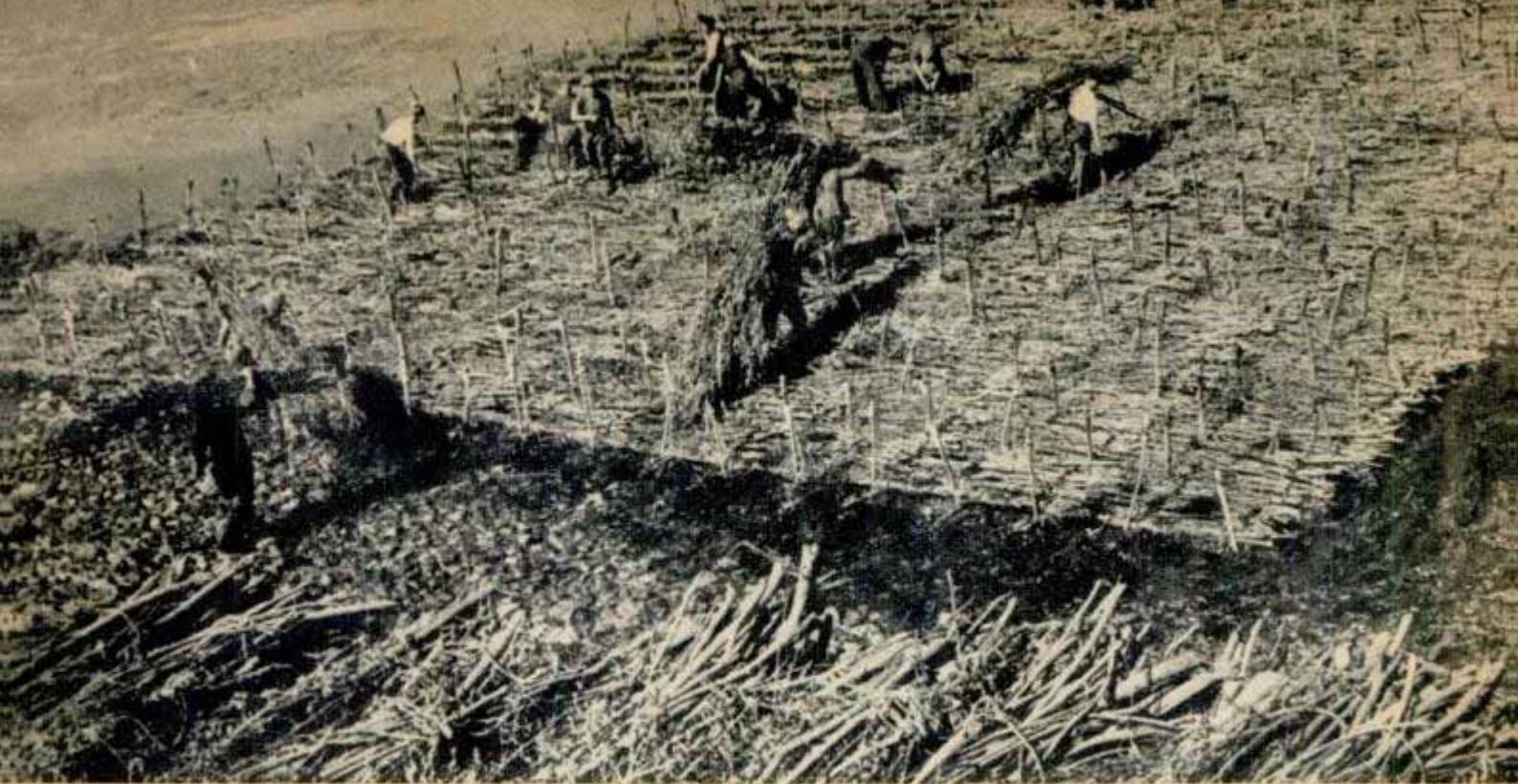

Black Star photos

Great willow mattresses patiently hand-woven by Dutch specialists prevent sea from carrying away sand

Engineers first worked to close a breach at de Nolle, on the west side of the island, where the seething North Sea was claiming more land. Great woven mattresses of willow twigs were threaded through the dike. A thousand tons of sand, pumped a mile and a half through a giant pipe, poured in each hour to form the core.

As the breach grew smaller it channeled the titanic force of the sea into a narrow hissing flood. "Beetles," concrete pontoons built by the British for the artificial harbor used in the invasion of Normandy, were towed into position across the gap. Before they could be sunk a sudden squall tore many loose and rushed them out to sea. A hundred feet of dike disappeared.

Again the heartbreaking work was started. A leaky German barge, filled with submarine nets and other scrap, was sunk in the channel. Water, rushing through port-holes and leaks, was dammed quickly. A

thousand workers packed black Belgian rock and blue Klundert clay against stakes across the top. It held. The battle for one breach had been won.

Tireless, the engineers turned to the three remaining breaches. As the shortening days passed, the breaches at Westkapelle, at Veere and Rammekens, were locked in the same manner. They were sealed just before the winter storms.

But time remains the enemy of Walcheren farmers. Six long months will be required to pump flood waters from inside the completed dikes. Normally crops could not push through the salt-scoured earth of the island for at least five years after it is lifted from the sea. However, Dutch engineers have discovered that gypsum will cleanse the soil, so fertility may return to the island's fields by 1947. Then the old Dutch motto will live again on Walcheren: "I fight and emerge."

The sea, once barred from Walcheren, laps roof of a farm home. Salt-laden soil must be treated to produce



British Try Out Captured V-2 In a vertical firing position and surrounded by fuel lorries, a 45-foot-long V-2 rocket captured from the Germans is prepared for a trial flight at Cuxhaven under supervision of the British



Straight up goes the 12-ton flying bomb for observation by English scientists. Carrying a ton of explosives, the V-2 is believed capable of reaching a height of 70 miles above the earth and a speed of 3600 miles an hour. In the tests, all explosives were removed

By "flying" new airplane wings on the ground, a vibration test machine used by Lockheed Aircraft Corporation compresses the stresses and strains of a 350-mile-an-hour transcontinental flight into a 20-minute period. Engineers observe and measure at first hand the effects of flight on internal wing structures as a shaker jig, using an off-center wheel, vibrates the

Ground Test for Airplane Wings

wing at 170 times per minute. Smaller devices spin at 1800 r.p.m. to simulate engine vibration. Lead weights up to 50 tons bend the wing 18 inches out of line to increase the strain. Electronic gauges at strategic points measure variations in ribs, spars, beams and skin surfaces. The machine also enables engineers to test methods of sealing leaks in wing fuel tanks

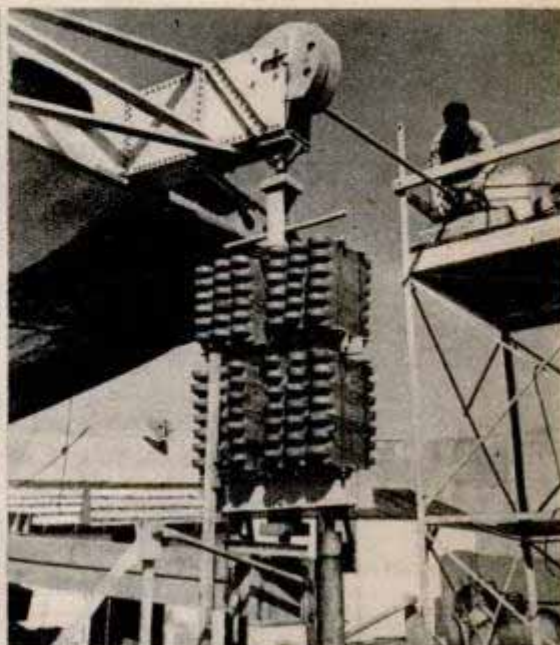
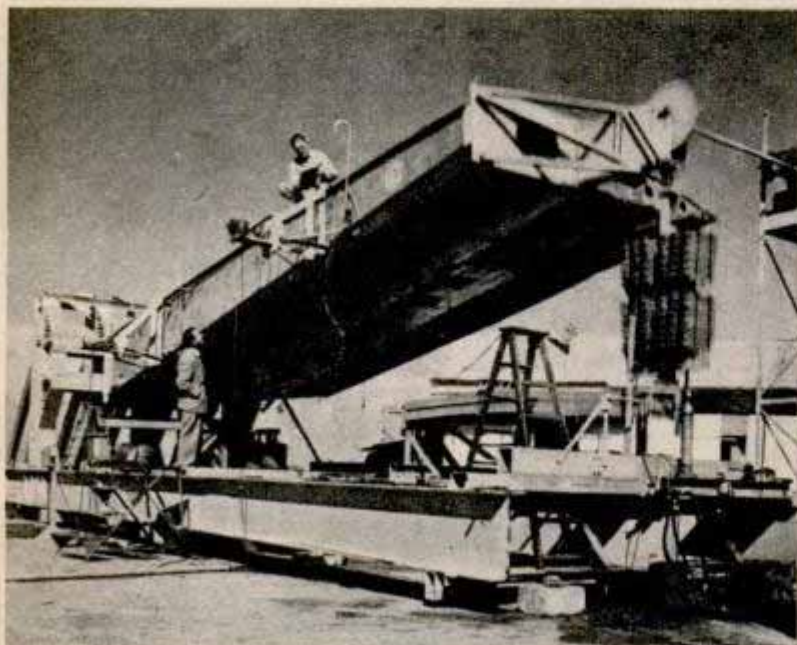

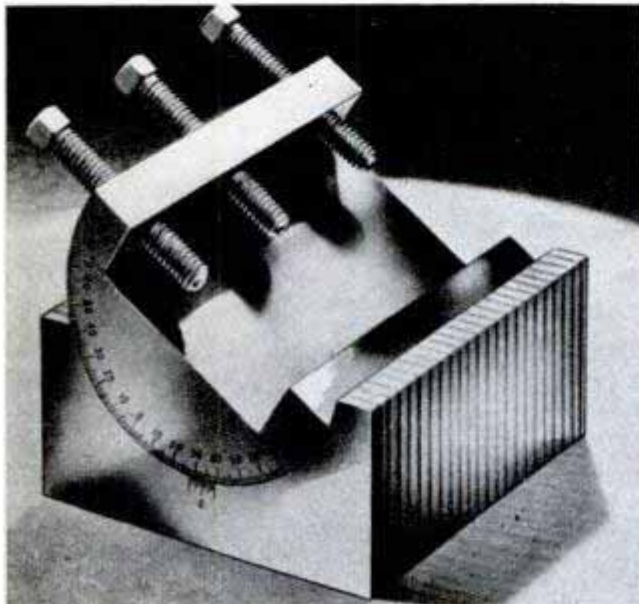
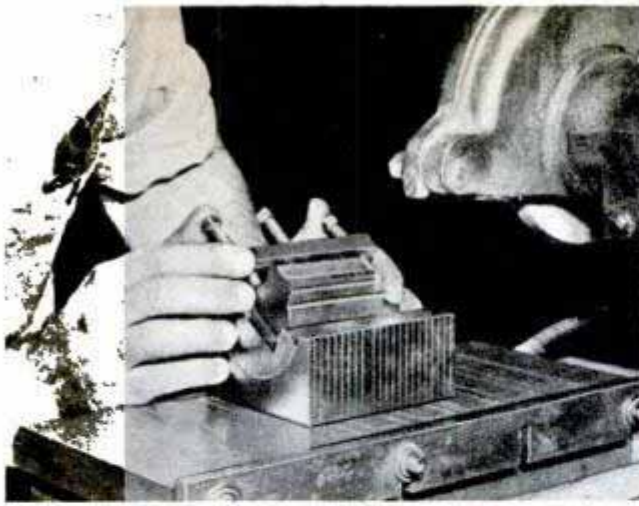

PARALLEL ANGLE VISE is held by magnetism in exact position for precise grinding operations. After the vise is set at the desired angle by calibrations, it is placed on a magnetic chuck and when current is applied the vise is set rigidly. Base of the vise consists of copper and steel laminations permanently fused into a solid unit in which a semicircular recess is machined to receive the rotating work holder

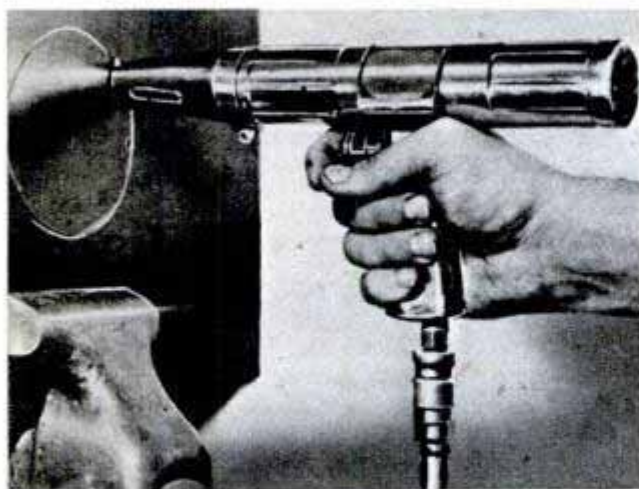

POWER SAW driven by compressed air facilitates sawing and filing in cramped quarters and also permits circular sawing of metals and wood as well as "dead end," keyhole or scroll work. The tool weighs 3½ pounds, has fingertip speed and power control and a cutting stroke adjustment from ¼ to 1¼ inches



LENSES FOR GLASSES, insulators and control knobs for electrical equipment and jewel-like pins for dresses are applications predicted for a plastic called Kriston. Its transparency and high refractive properties make it suitable for optical lenses, while its resistance to electricity makes it useful to the electrical industry. It can be made in translucent or opaque colorings for decorations in the fashion field

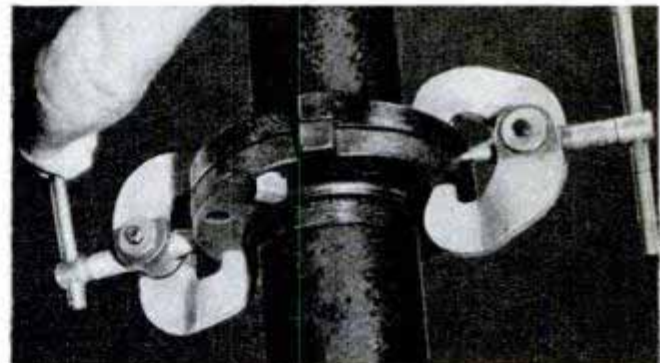

FLANGE JACKS simplify replacement of worn gaskets that cause leaks in flanged pipe lines. Used in pairs, the jacks gradually open the flanges without the use of hammer and chisel. Turning the handles forces the pointed tool to separate the flanges without disturbing the alignment of the bolt holes

HAMMER designed for use in aircraft plants has a head made of a special lead alloy that gets tougher the more it is used. It will not blemish metal surfaces and is said to eliminate danger from flying chips and splinters. The shaft is made of two steel rods with welded cross members to absorb shock. A serrated plastic handle assures a firm grip. The head weighs five pounds. The hammer has an overall length of 16 inches and is adaptable to many industries



The hammer has an overall length of 16 inches and is adaptable to many industries

"BRABAZON 1"

Flying Hotel

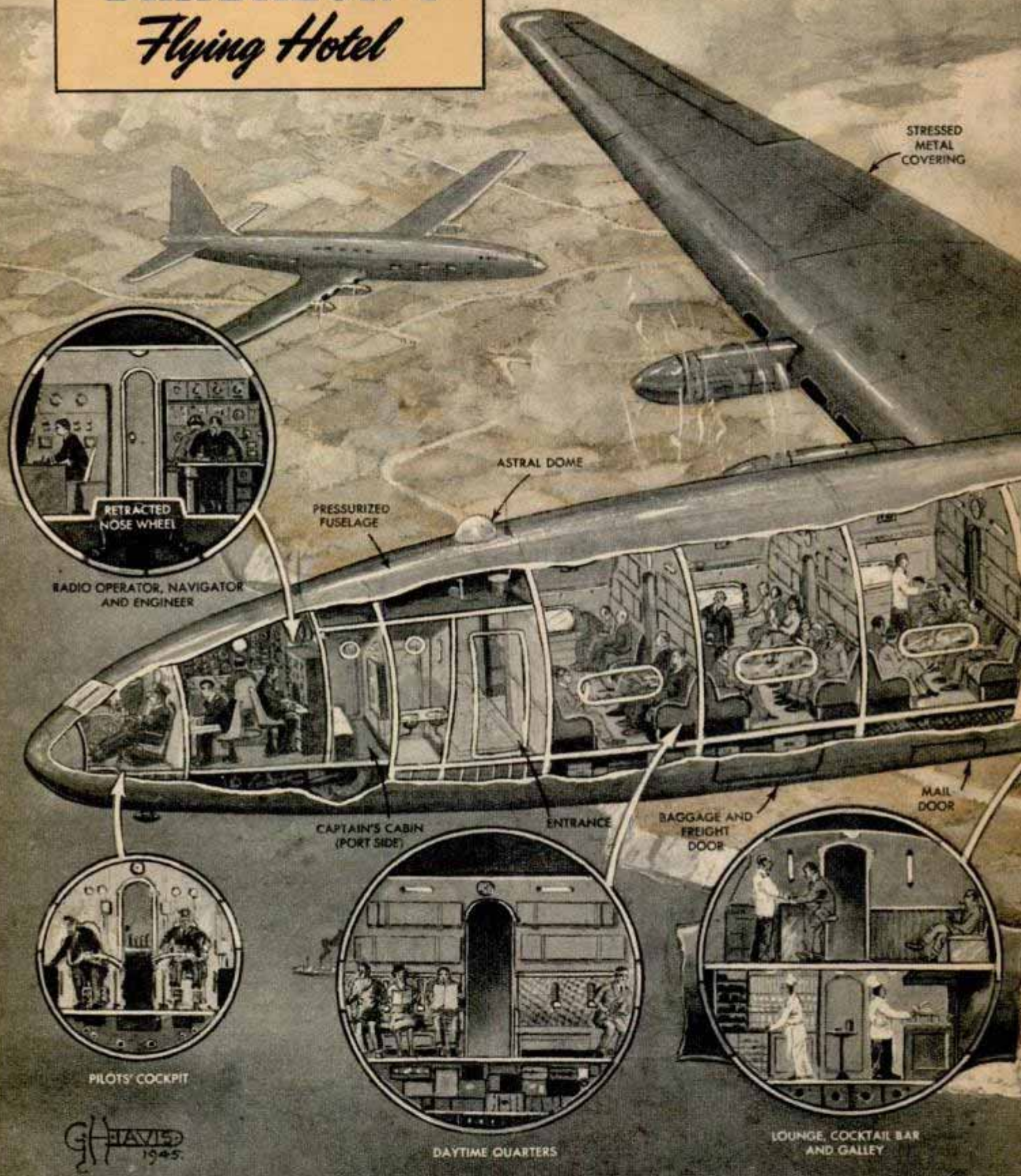

STRESSED METAL COVERING

ASTRAL DOME

PRESSURIZED FUSELAGE

RETRACTED NOSE WHEEL

RADIO OPERATOR, NAVIGATOR AND ENGINEER

CAPTAIN'S CABIN (PORT SIDE)

ENTRANCE

BAGGAGE AND FREIGHT DOOR

MAIL DOOR

PILOTS' COCKPIT

DAYTIME QUARTERS

LOUNGE, COCKTAIL BAR AND GALLEY

G. HAVIS
1945

Nearing completion at Bristol, England, is a plywood mockup of Great Britain's largest airliner, the 110-ton Brabazon 1. Although its dimensions have not been officially announced, the wing span is reported to be approximately 270 feet and the overall length nearly 160 feet. It is estimated that the four 2500-horsepower engines, with contrarotating propellers, will give the plane a range of 5000 miles at a 250-mile-an-hour cruising speed. Flights between Australia and England in 48 hours are expected for the plane. One hundred and thirty feet of the fuselage's length will be pressurized. A short-haul version of the Brabazon, named after

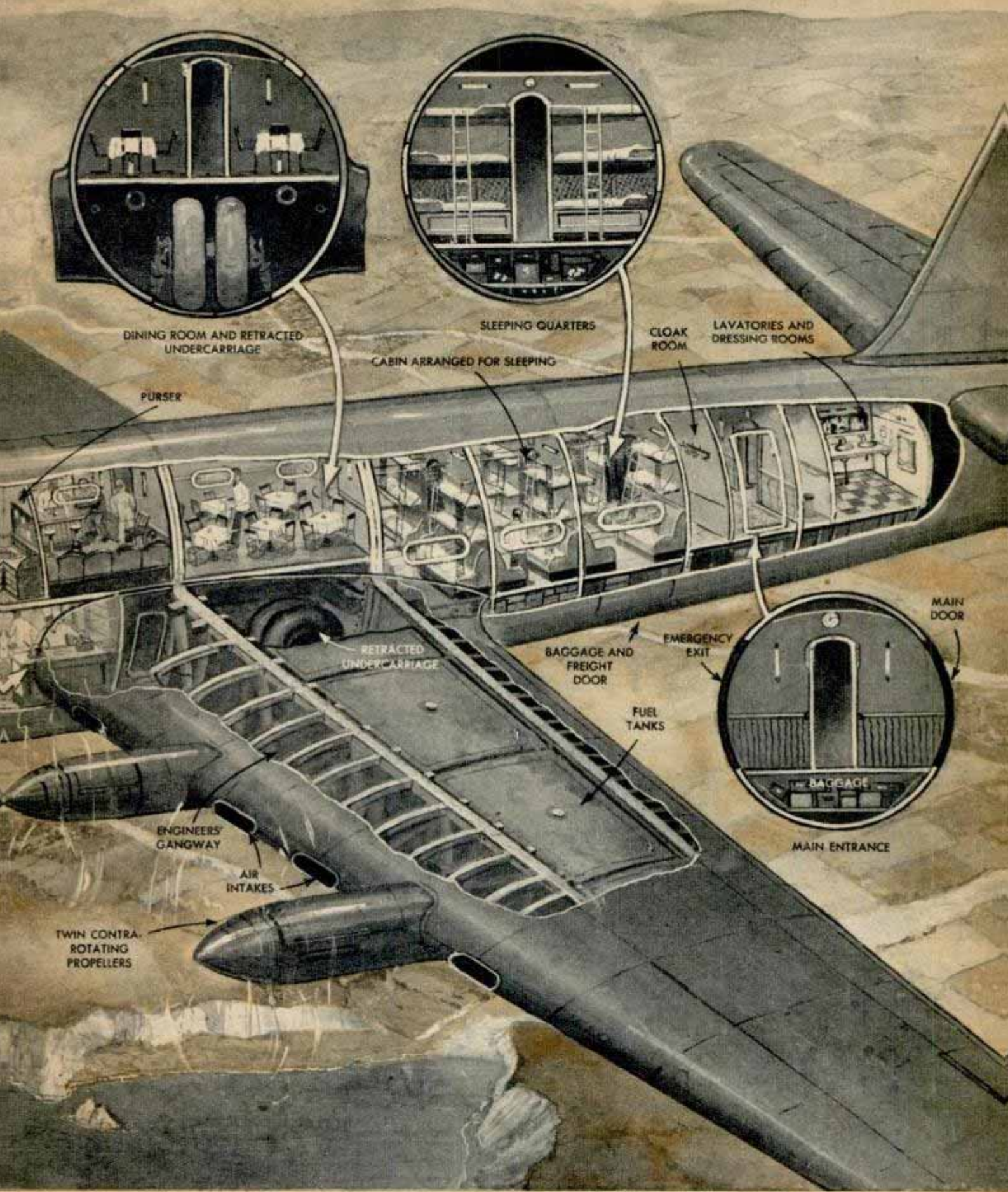

a pioneer English airman, Lord Brabazon, will carry 224 passengers. The long distance type illustrated above will sleep 72. There will be two main passenger salons, separated by a full-height double-deck section housing a cocktail and snack bar, lounge and dining room above and a galley, purser's office and part of the auxiliary gear below. Each main salon will be divided into three compartments, with seats accommodating three passengers facing forward and three to the rear on either side of the aisle. A triple-decker berth arrangement will take care of each compartment's 12 daytime occupants at night. The plane is expected to be ready in 1947

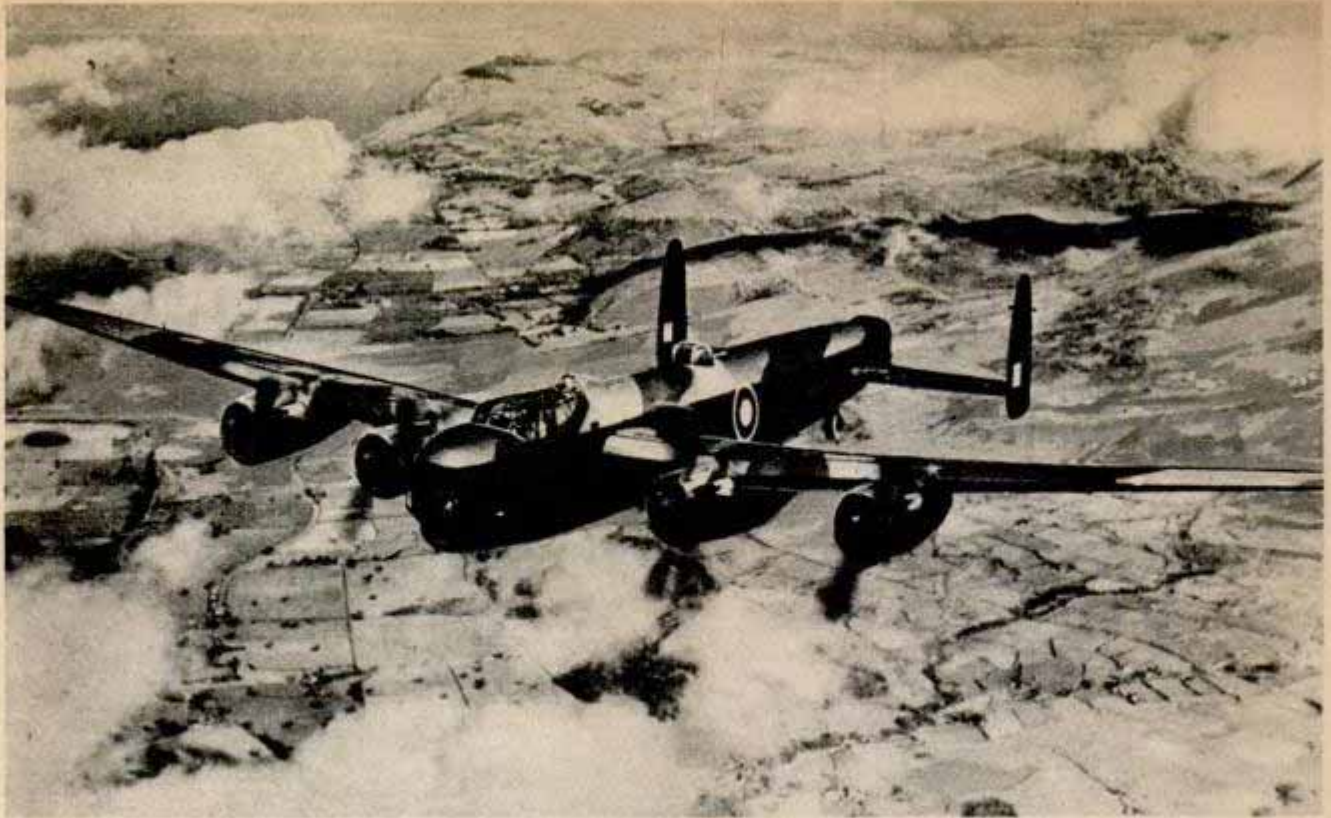

Shortly before the end of the war the British developed a new heavy bomber, the Lincoln, which was specially designed to drop 11-ton "de-penetration" bombs on Japan. The RAF plane, built by the makers of the famous Lancaster, carries a crew of seven men, has a wing span of 120 feet

Latest British 4-Engine Bomber Carries 11-Ton "Penetrator"

and is powered by four 1750-horsepower Rolls Royce Merlin engines. Its maximum

speed is approximately 320 miles per hour. Armament consists of .50-caliber machine guns—two in the nose turret, two in the mid-upper turret, two in the tail turret and one under the fuselage.



Radio Director Uses "Blister"

When the director of a radio show works from a control room at a distance from the stage, nearsighted actors have to wear glasses in order to follow him. This difficulty was solved at the Vanderbilt Theater in New York by building a glass-enclosed "blister" for the director in front of the stage. The actors, facing the theater audience during a broadcast, can see him with ease. At the same time he can communicate by telephone with the control room in the balcony.

Radio show director in soundproof glass "blister" can be seen by nearsighted actors and heard by man in control room

Electric "Drill" Cleans Clogged Drains With Cable That Turns Curve

Equipped with 110 feet of flexible steel shafting to which cutting tools are attached, an electrically driven device permits easy removal of obstructions in drain pipes. The driving mechanism resembles and operates like an electric drill. The cable automatically coils and uncoils as it is fed through the electric "drill." The flexible cable permits the cutting head to round "S" curves with ease to get at obstructions. The tool has attachments for cutting, scraping or polishing the insides of pipes and tubing.

Gauge Checks Fuel Injector To 10 Millionths of an Inch

When the Army Air Forces decided to use direct fuel injection for the aircraft engines, this equipment required supersensitive gauges to guarantee dimensional accuracies as fine as 10 millionths of an inch. If you could split a human hair lengthwise into 10,000 slices, each slice would be about 10 millionths of an inch "thin." The answer to this problem was a flow-type air gauge called the Precisionaire. Applicable for checking either internal or external dimensions, this gauge is so simple to operate that untrained inspectors learned in a few

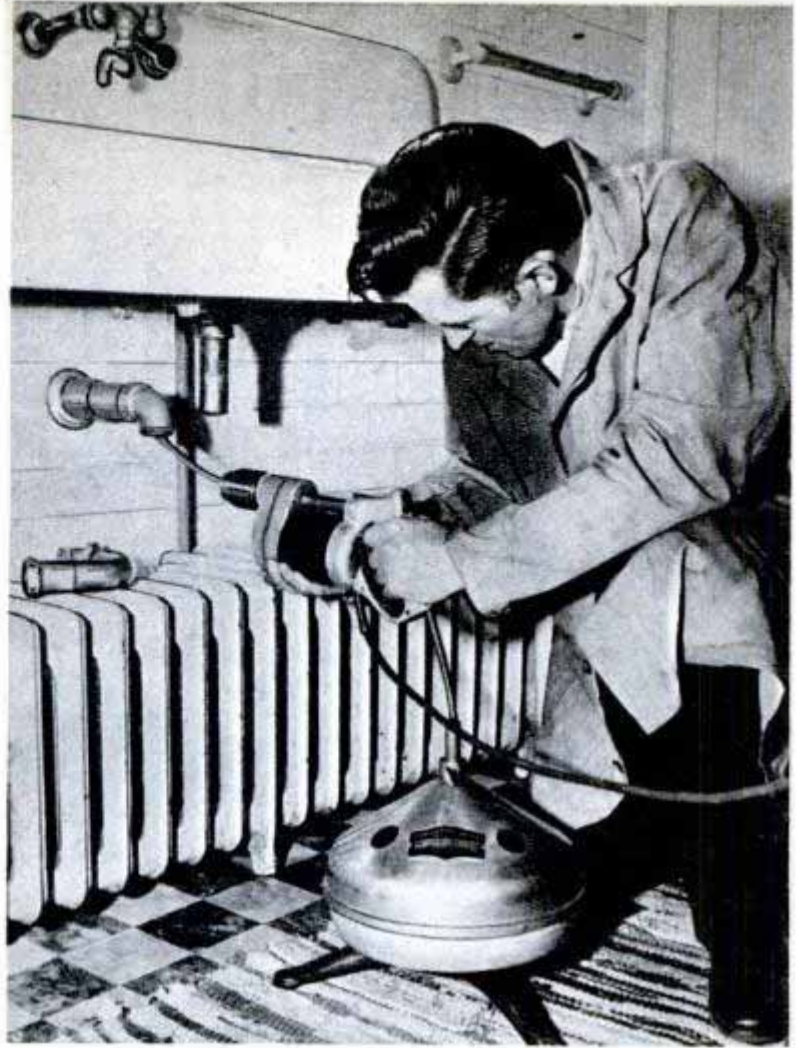

hours how to make accurate measurements in less than two seconds. Engineers predict the gauge will have extensive peacetime applications for precision inspection.



Indicator Tells Time Anywhere in World

Setting a disk at the time in your own zone will give you the correct time for any other part of the world on a cardboard indicator. The world is divided into halves on each side of the indicator, with the various times showing in circular openings along the round edges. The indicator has special value for short-wave radio enthusiasts who tune in broadcasts from all over the world.

☞ Test pilots at Willow Run flew 5,000,000 miles in four years without an accident.

Will Malaria Strike at Home?

Thousands of boys are returning from the tropics with the mosquito-borne disease. There is danger of its spreading—but our scientists back in 1940 began a fight to prevent an epidemic

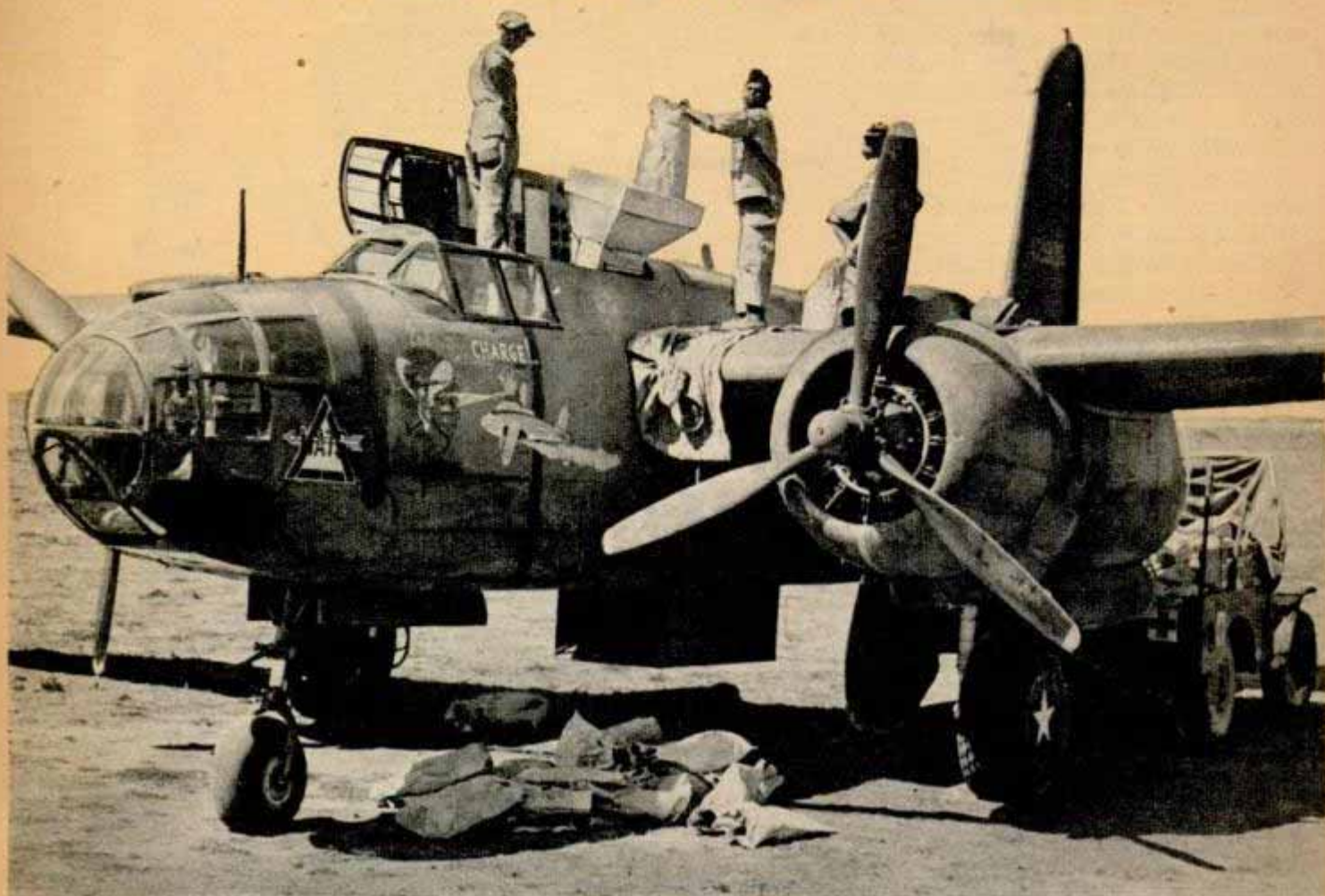

Antimalaria larvicide is loaded into an Army bomber and (below) dusted over a mosquito breeding area



As this goes to press word comes from Washington of a new synthetic drug, SN-7618, superior to quinine or atabrine. A second drug, still experimental, offers the promise of a positive cure for malaria



Officers volunteer as "guinea pigs" to learn whether bites of malarial mosquitos carry filar'asis infection

MALARIA is still, as it has been for some 2500 years, one of the most important diseases in the world. Today it is responsible for some three million deaths among three hundred million victims a year. Most of it occurs in areas where American soldiers fought in World War II—the Mediterranean, India, Burma, China, the Dutch East Indies and nearby islands in the Pacific.

It was inevitable, then, as the Army pointed out, that large numbers of our troops returned to this country would be infected with malaria. But responsible agencies, both civilian and military, were prepared to cope with an epidemic of malaria. In addition, all measures were taken to prevent such an epidemic.

The Surgeon General of the Army, for example, began as far back as 1940 to expand the Army's malaria control program, creating a new Commission on Tropical Diseases within the Board for Control of Epidemics. He obtained the best medical men of the country as consultants, organized a subcommittee on tropical diseases in

By **John L. Kent**

the National Research Council, established a research program on all phases of the disease, and set up a division of tropical disease control in the Preventive Medicine Service of the Surgeon General's Office. Lieutenant Colonel O. R. McCoy, chief of this division, says there is little danger of any serious epidemic of malaria in the United States traceable to returned soldiers.

Fear due to lack of information can cause more harm than malaria itself, reports Major General Norman T. Kirk, the Surgeon General of the Army. With the prospect of thousands of soldiers returning to this country from malarious regions, General Kirk made an appeal for a better understanding of the problem so the public will realize that, with a few simple precautions, malaria is not a disease that should give undue concern either to infected servicemen or to their families.

There are a number of types of malaria, but the two that concern American troops are benign tertian malaria, which is rarely a serious disease, and malignant tertian

TO GET RID OF MALARIA...



Decontaminating huts of natives in India by spraying DDT from a power sprayer mounted on an Army quarter-ton amphibious truck

Another preventive method shown at left is to mount a can over a mosquito-breeding ditch and let oil drip steadily upon the water

malaria, which without treatment may be fatal. The latter type is cured by atabrine so that it is not a problem when properly treated. Servicemen infected with benign tertian malaria continued their arduous combat duties as long as they took the necessary small doses of atabrine. Benign malaria, however, rarely is cured by atabrine, but the drug prevents the appearance of symptoms of malaria, or, as is more commonly said, suppresses the disease. When a man who has benign malaria stops taking atabrine, the usual symptoms—chills,

fever, headache and nausea—may return.

Contrary to what is generally supposed, the Army's experience reveals that relapses occur with the same frequency in the north as in the south.

General Kirk stressed the point that malaria can be spread only by the anopheles mosquito. Even if a man is infected, the anopheles mosquito cannot transmit the disease unless it has bitten the victim during a relapse and before medical treatment has been secured. In most parts of the United States there is little likelihood of

"Production line" of the portable plant which concentrates quinine from wet cinchona bark out in the field

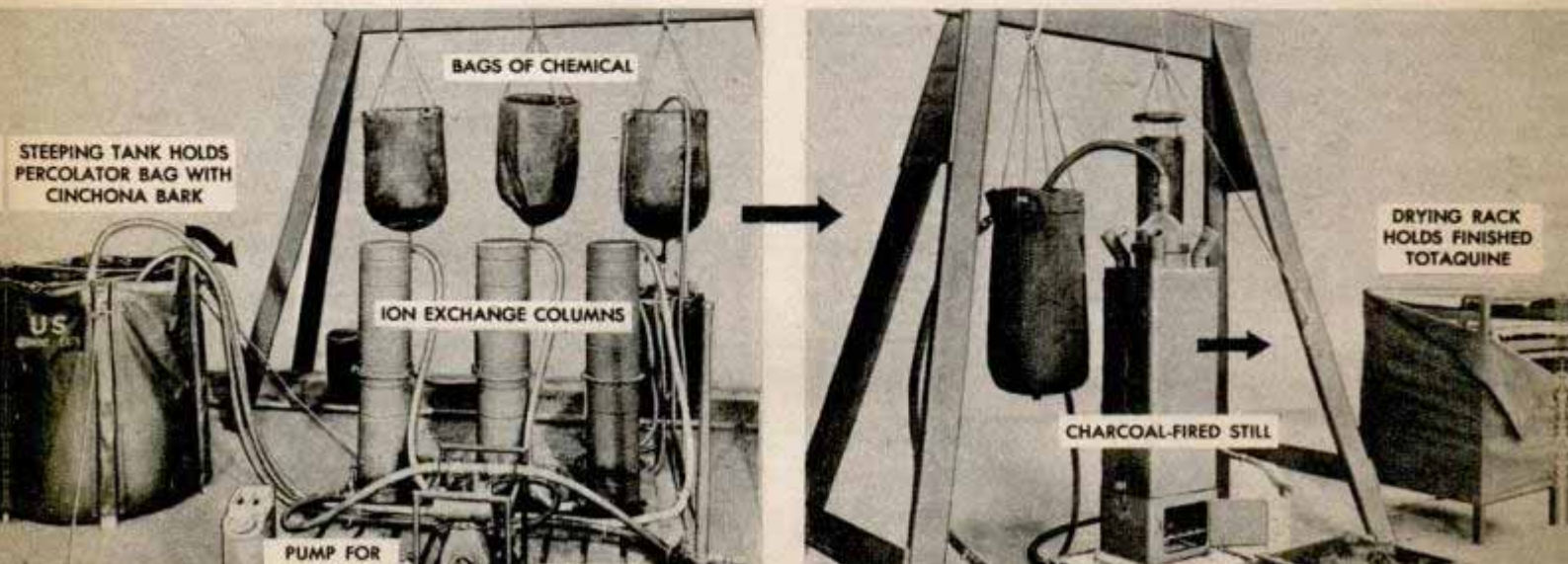

..GET RID OF MOSQUITOS

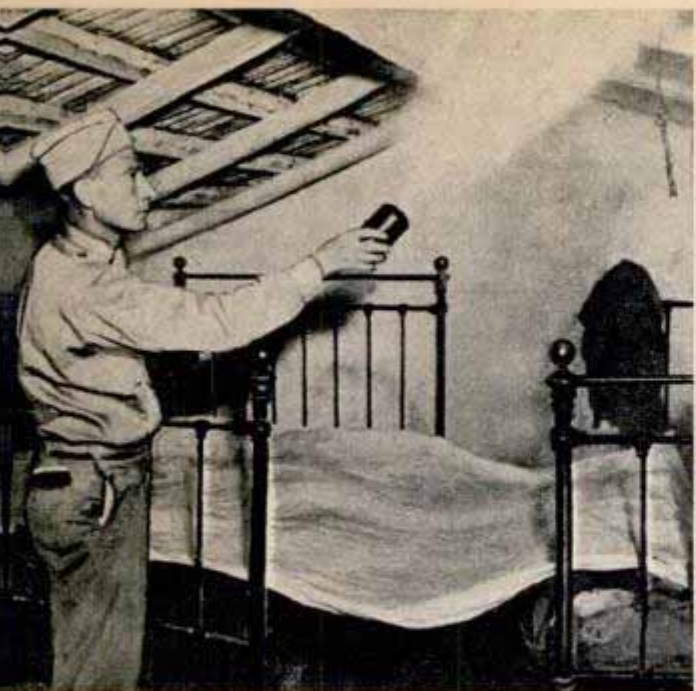

An Arab home in Algiers is rid of malarial mosquitos by an American soldier loosing an "aerosol" bomb to fill room with insecticide



At right, a Yankee uses a rotary duster to spread paris green on an Italian swamp, ridding area of the disease-bearing mosquito

this, since mosquito control is adequate. But it was not like this in the Pacific.

Protection of overseas troops in forward areas and in combat involved many difficulties. Mobility of troops, difficulties of supply and presence of the enemy made the use of permanent control measures impracticable. Reliance had to be placed largely upon the individual methods of protection, using repellents, nets, protective clothing and insecticidal sprays.

Early in the war, the Army and Navy used liquid sprays containing pyrethrum.

Model of a hand-operated quinine extraction unit

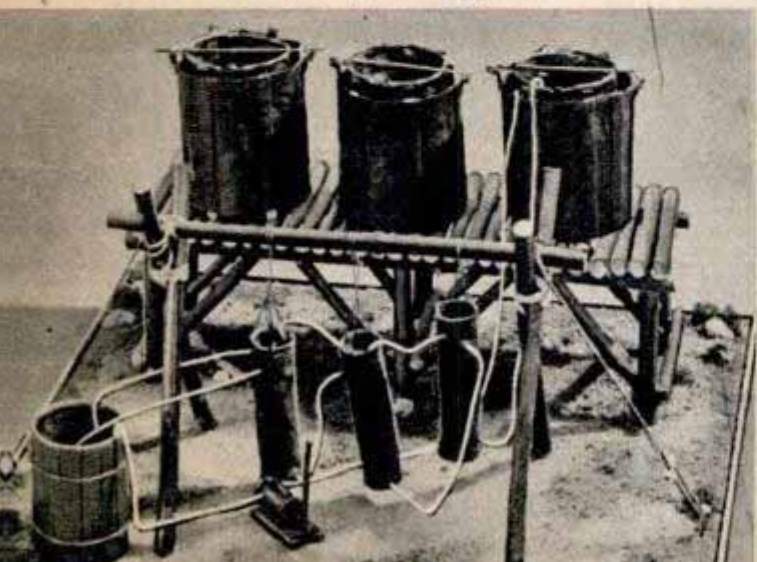

Such sprays were only moderately effective. In 1942 there was developed an aerosol method of distributing pyrethrum insecticide, using freon, an inert gas, to propel the material from a small container now known as the "mosquito bomb." It can be used in forward areas, and soldiers equipped with these "mosquito bombs" had a weapon with which they killed mosquitos in shelter tents, foxholes and dugouts, even under combat conditions.

An outstanding advance in control of mosquitos was made during the war with the discovery of the remarkable insecticidal properties of DDT. Sprayed on interior surfaces, DDT will kill insects alighting on the treated areas for several months. Mixed with oil, DDT was distributed from aircraft for large-scale control, and was so highly effective that on some islands in the Pacific where it was used visitors reported they did not observe any mosquitos at all.

Where the risk of malarial infection was substantial, atabrine and quinine were used to keep men on their feet during the campaigns. Although neither drug can prevent infection, they do suppress the recurrent chills and fever of malaria.

When war cut off the quinine supplies



Digging flume to drain malarial lagoon into ocean. Nearby is camp

from the East Indies and before the large-scale production of atabrine made a substitute available, the Army turned to South America as a possible source for quinine. In Colombia, Ecuador, Bolivia and Peru are many wild stands of cinchona trees from whose bark quinine is derived. But bringing the bark out of the jungle presented a transportation problem.

Dry bark had to be gathered, tied and transported by mule pack and oxen-drawn wagons over winding trails to the permanently located extraction plants.

But American science and mechanical ingenuity came to the rescue. Suited especially for use in South America, a new process of quinine extraction was developed, and a completely portable plant using this process to produce quinine at the

Lee Kaye of Newark, New Jersey, commanding officer of the Army's Cinchona Research Unit. In 1940, Major Kaye, then a civilian, began experimenting with acid extraction for quinine. After joining the Army, he was ordered to continue the research that finally resulted in the new process. The Army encouraged the development mainly for the purpose of providing a solution to the pressing problem of wartime cinchona procurement. Assistance to Latin American countries in their efforts to rid their countries of malaria was a secondary plan. To this end, three types of plant, involving two methods of extraction, have been developed.

Two of these plants use the ion exchange principle. Besides the engine-pumped model, which is designed to process from 500 to 1000 pounds of bark per day, there has been assembled a similar hand-pumped gravity-flow model. This plant operates in a manner identical with the engine-powered model, except for the gravity flow. Agitation of the bark mass is obtained by stirring with a paddle or other hand-operated device. Its capacity is about one half that of the engine-powered plant.

The third plant does not use the ion exchange principle. Instead, the alkaloids are precipitated from acid solution by the addition of strong alkali.

(Continued to page 166)

An assortment of Okinawa mosquitos is mounted for classification

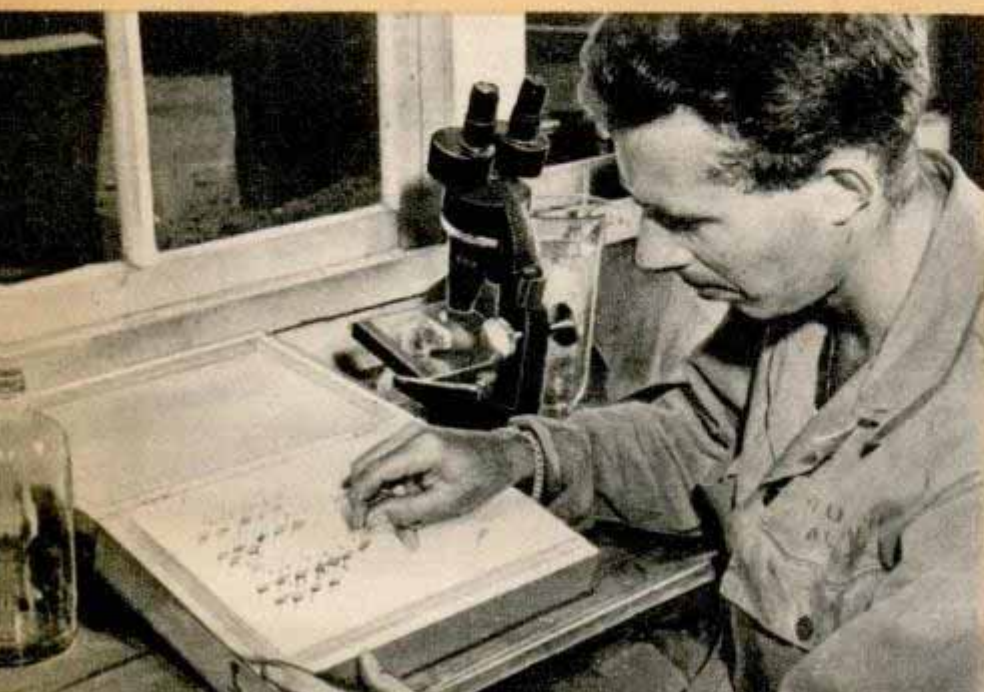

Gas "Detectives" Trace Underground Leaks

Gas companies often receive calls from excited customers saying they think gas is escaping from pipes beneath their yards, causing grass to wilt and threatening the lives of trees. Gas "detectives" dispatched to the scene quickly find out if escaping gas is the trouble maker. Using a bar to make a hole about one inch in diameter in the ground, the gas men insert a rubber tube and draw up a sample of underground atmosphere. The sample passes over a tiny electric wire in a special testing instrument which analyzes the atmosphere. If the sample contains gas, it burns and causes the wire to get hot. This change registers on a dial and tells the "detectives" positively if gas is escaping and in what quantities it is present.

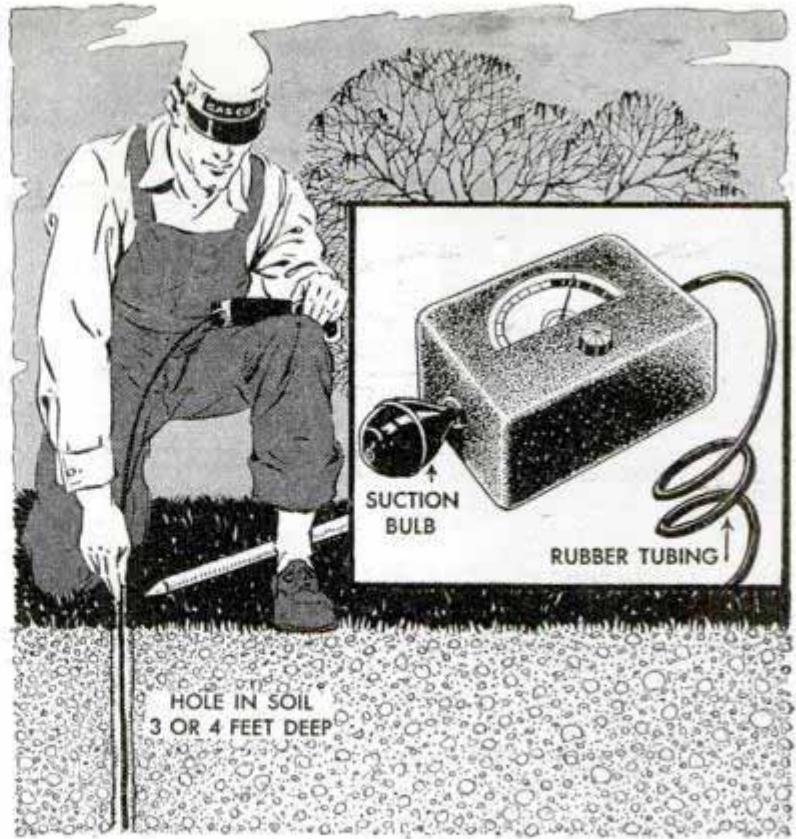

Plastic Cutouts Help In Drawing Plans

Professional or amateur architects drawing plans for new homes will find many uses for a house plan template made of clear plastic $5\frac{1}{4}$ by $6\frac{3}{4}$ inches. Containing cutouts for drawing various parts of home plans, the template is scaled $\frac{1}{4}$ inch to one foot. Of particular help to home planners are cutouts for often-repeated items such as electric outlets. The template also has roof pitch markings for use in laying out the correct pitch for new designs and in checking roof pitch on drawings.

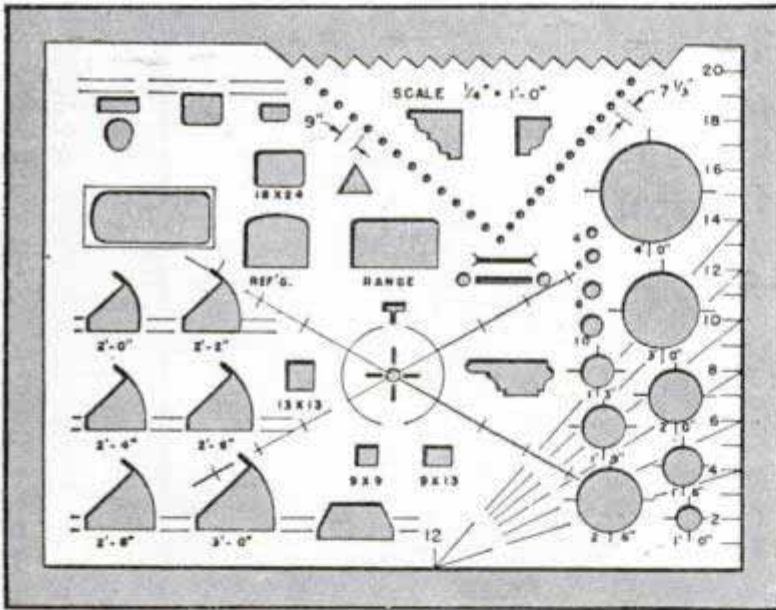

Lift Hooks Made as Part of Box

Loading of cargo for shipment to the Air Forces overseas was simplified by devising a box with lift hooks permanently installed on the four top corners. Capable of lifting 5000 pounds, the hooks fit snugly in frames flush with the top of the box when not being used for hoisting.

"Mirror" Insulation Fights Heat

Heat waves bounce from the mirrorlike surface of a new material now used to insulate homes. Consisting of cross-meshed fibers embedded in specially treated asphalt and sealed under heat and pressure between two sheets of "wet strength" paper, the material is installed in sidewalls and on the underside of roof rafters.

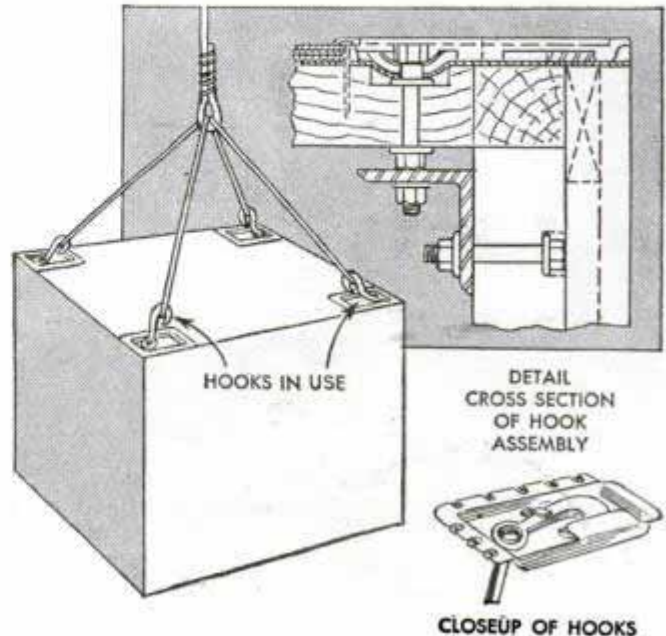

FIGHTING FLYING ICE



Inspector braves icy gale atop Mt. Washington, N. H., to get valuable data on rime formation on test wing. White rime ice forms rough deposits upsetting aerodynamics. It also plays havoc with radio towers (below) and forms "beads" which rotate on the cables

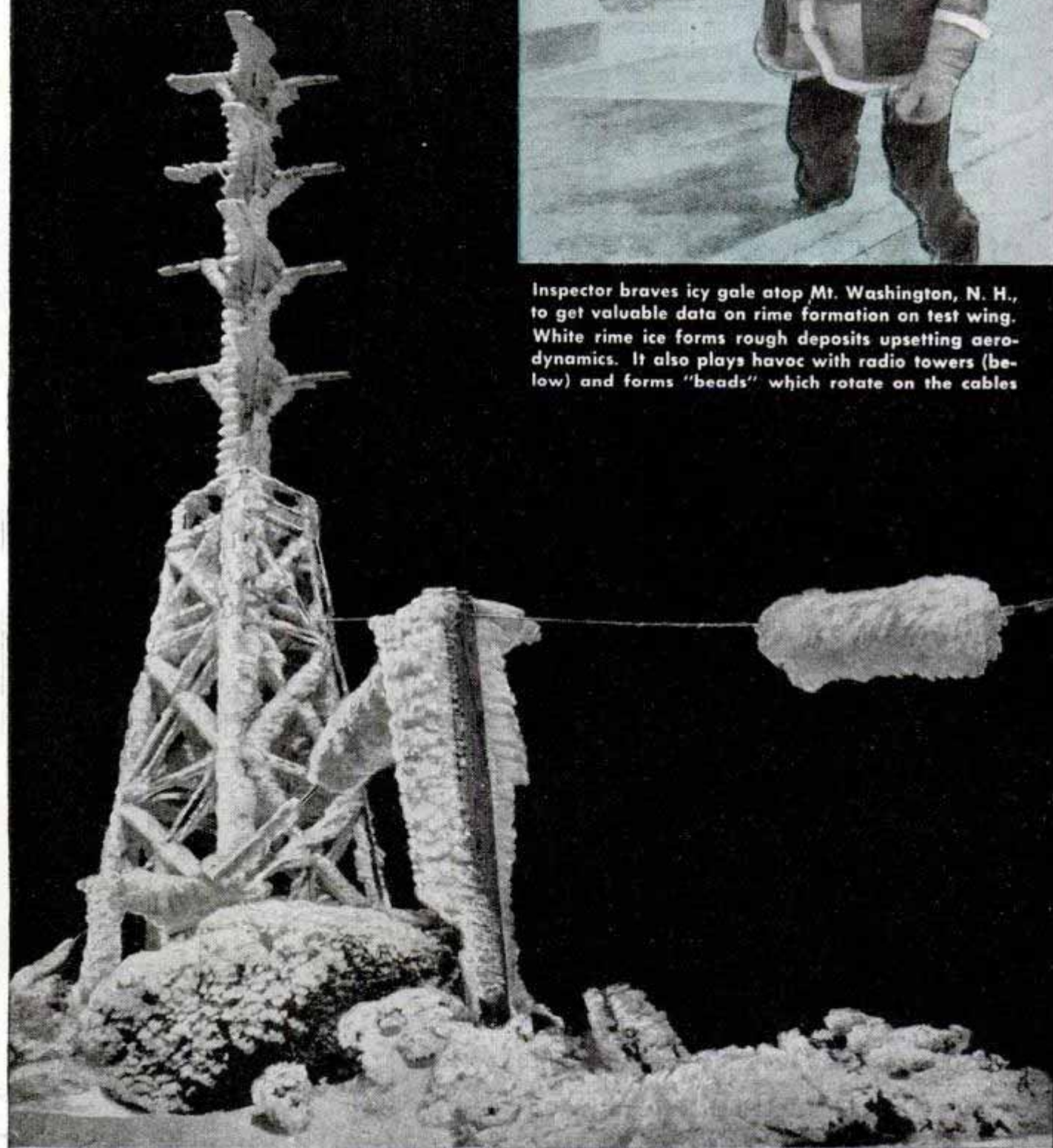

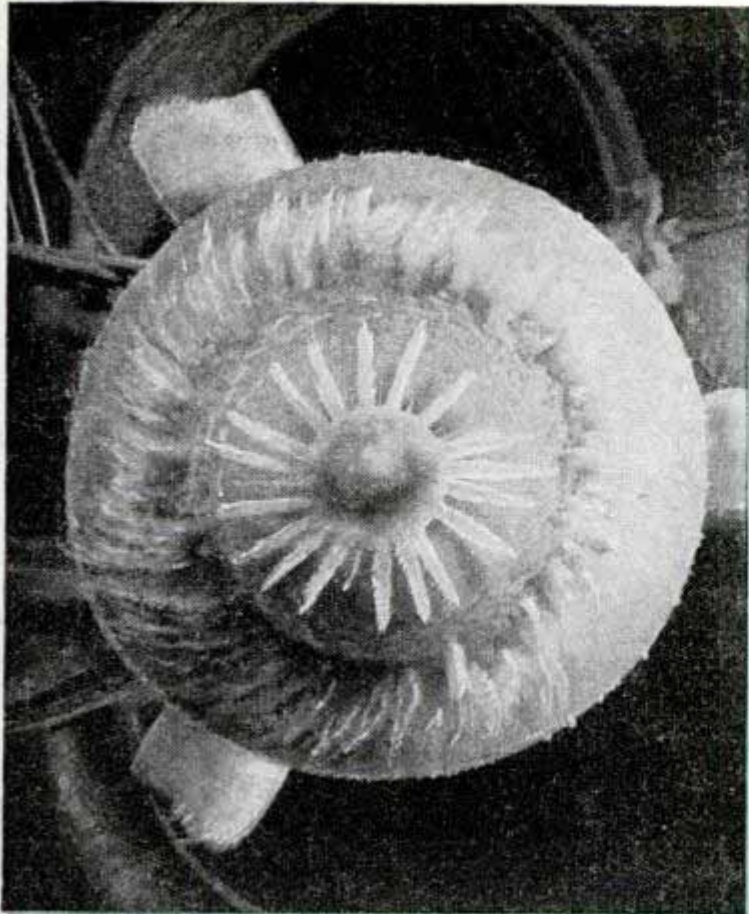

Refrigerated wind tunnel freezes ice formations on propeller spinner and stub blades

on sample airplane parts and De-Icer installations. Much was learned, but certain icing conditions encountered in actual flying could not be duplicated. An exhaustive study of natural icing and de-icing was needed.

So Dr. D. L. Loughborough, senior physicist of the research department, and his associates, Dr. E. G. Haas and H. E. Greene, started to work. Airplanes flying at high altitudes often encounter natural icing conditions severe enough to serve the purpose of research; but long and detailed observations by such flying would be costly and hazardous. So the trio set out in search of the world's worst ground weather that was not too far from the home base at Akron, Ohio.

They found it on top of 6293-foot-high Mount Washington, tallest peak of the White Mountain range in New Hampshire. There, from late September to May, the wind may blow 231 miles per hour, and the temperature slide to 46 degrees below zero, Fahrenheit. Ice-forming conditions may exist as many as 28 days a month.

Dr. Loughborough's crew took along a test section of airplane wing, fitted it with fins, mounted it like a wind vane atop an old water tower near a weather and radio station, and hooked it to control equipment housed in a shed nearby. Throughout the first winter Dr. Loughborough and Greene took turns fitting experimental De-Icers to the wing and observing their behavior in the severe weather.

At the end of the first winter the tangible results were mostly in the form of several square yards of facts and figures understandable only to a physicist. Ultimately this material will be translated into ice-fighting improvements that the ordinary air traveler can see and understand; but at this stage the results of the mountain-top studies are scientific data not yet available for general circulation.

To gather this information, the physicists watched various kinds of De-Icer units operating in the minus-36-degree and 200-m.p.h. weather encountered. They studied placement of the boots with respect to wing and weather. They tested boots with different surface treatments to reduce adhesion of ice. And they gathered some cold facts about ice itself—where it starts to form,

ON A MOUNTAIN top where the world's worst weather howls, a section of airplane wing pivots on its mount like a wind vane. By keeping its leading edge pointed into icy gales, it ferrets out facts that, added to those gathered in laboratories and in actual plane operation, promise safer flying of military and civilian aircraft.

Back in 1929 Dr. William C. Geer, commissioned by the Daniel Guggenheim Foundation to study flying problems encountered in ice-forming weather, conceived the idea of letting ice collect on an airplane, then cracking it so the air stream would carry the pieces away. B. F. Goodrich engineers converted the idea into a workable rubber installation that was named the De-Icer. A De-Icer system includes "shoes" of natural and synthetic rubber attached along the leading edges of wings, tail assemblies, radio antennae and other projections.

When ice begins to form on these shoes, tubes running through them are expanded with air and then deflated. The timed pulsations first crack and then lift the ice film, permitting the air stream to get beneath the ice and peel it off. The De-Icer, by performing this simple chore, has helped make possible year-round operation of both commercial air liners and warplanes.

To develop improvements in ice-fighting equipment, Goodrich built the first refrigerated wind tunnel in the United States. By mixing temperature, humidity and air velocity, researchers caused ice to form at will

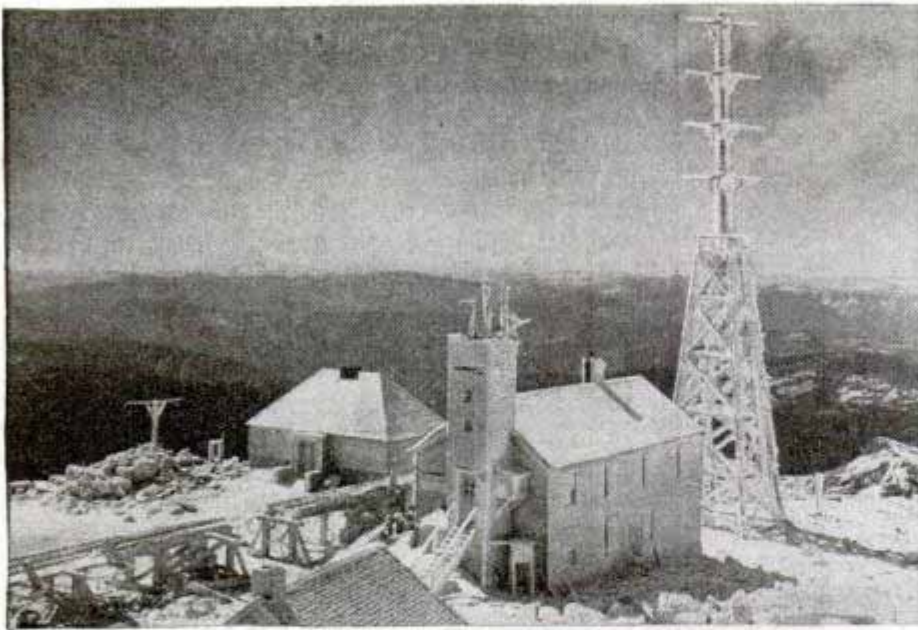

Ice-covered weather station and FM radio tower near the scene of the experiments. The end of the Mt. Washington cog railway also can be seen

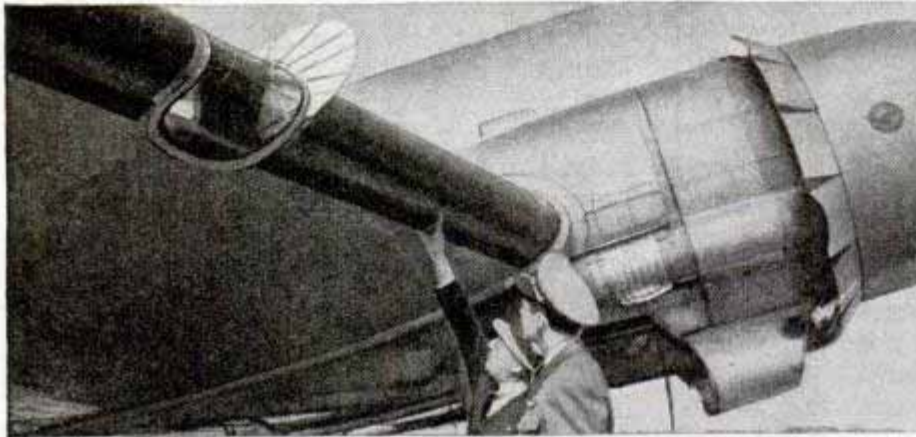

T.W.A. Airline photo
Inspection of De-Icers on wing of a commercial air line plane. Below, propeller equipped with feed shoes to distribute antifreeze over blades

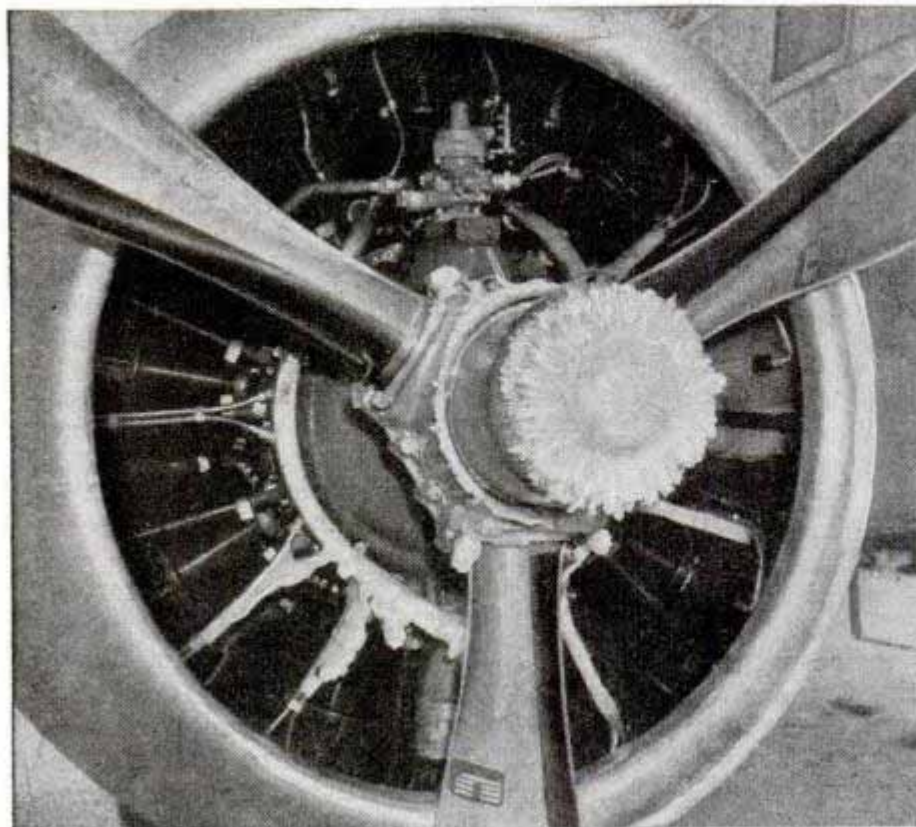

where it sticks most tightly and under what conditions it collects most rapidly.

Not long ago one of the most important advances in the fight against ice was discovered—the chemical treatment of a rubber surface so that ice will not stick to it readily. First step in the treatment is performed at the factory, the final step after the equipment has been installed on a plane. Occasionally the treatment may be renewed in order to maintain high efficiency. By treating part of a test De-Icer and leaving the other part untreated, the effectiveness of the process under different icing conditions is observed easily.

Experience has shown that ice is more hazardous on a propeller than on the leading edge of a wing, pitot mast or radio antenna. Propeller ice, by changing the aerodynamic shape of the blades, may seriously reduce efficiency. It can throw the prop so far out of balance that damaging vibration is set up in the engine and other parts. But perhaps worst of all

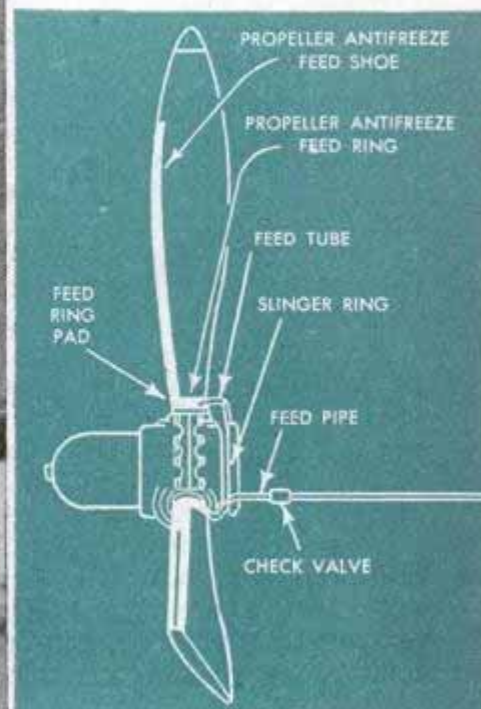

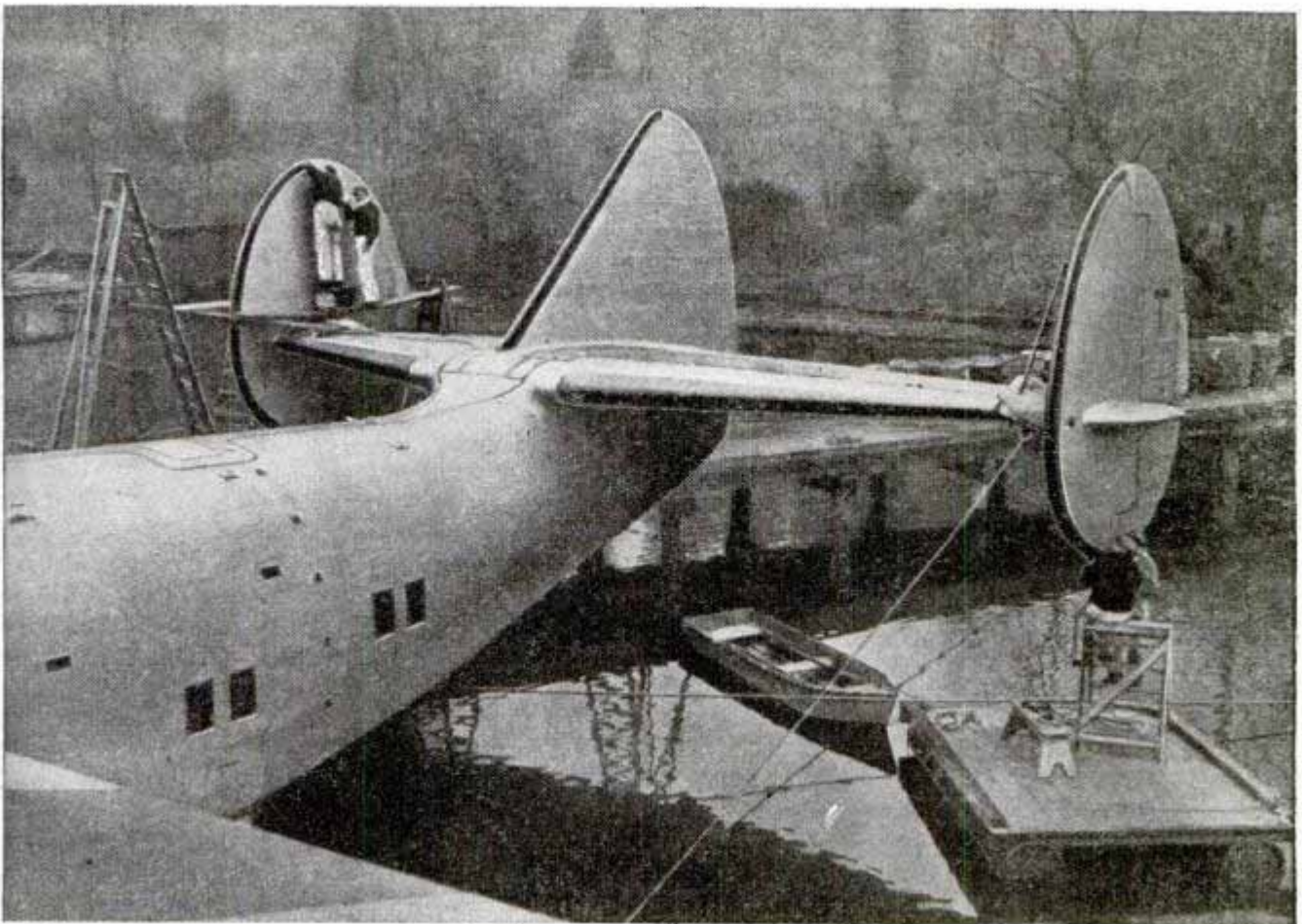

Applying De-Icers to tail assembly of Boeing Clipper. Rubber shoes crack ice off surface after it has formed

is the disturbance caused when accumulated ice suddenly breaks loose and is thrown off the spinning blades. The sudden unbalancing of the prop and the projectilelike action of the ice easily may prove disastrous.

While ice always is allowed to form on wing and tail before de-icing, it is not desirable to permit any to form on the pro-

PELLER blades. So methods of heating blades and of applying antifreeze solutions to them were developed. Ice fighters worked out a widely used method of feeding antifreeze through a rubber shoe cemented to the leading edge of each propeller blade. The fluid is fed into a rotating ring behind the propeller hub, then through tubes to the shoes. Grooves in the shoes distribute

Diagram in color shows complete assembly for de-icing propellers. Below, shoe and ring on propeller blade

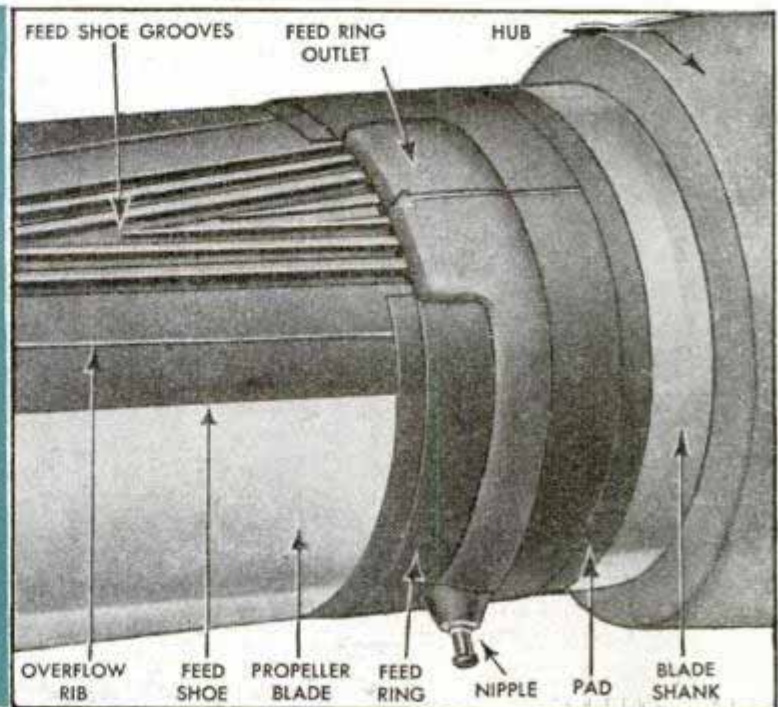
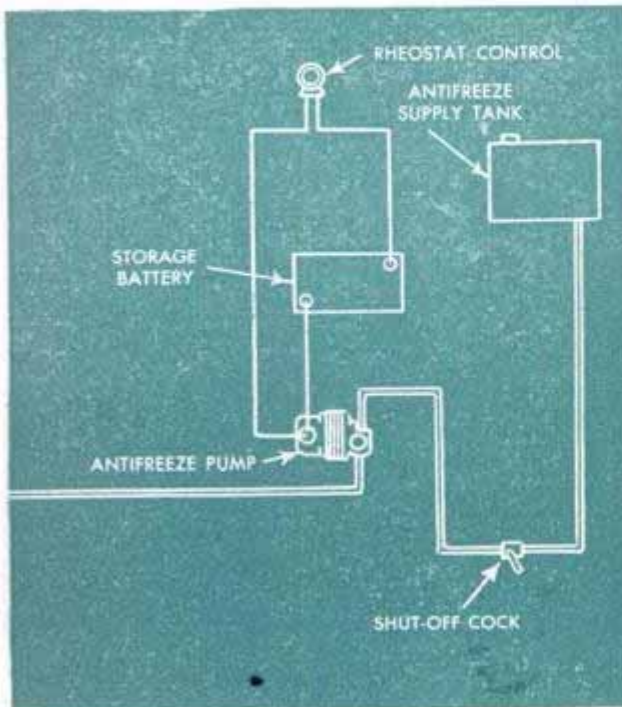

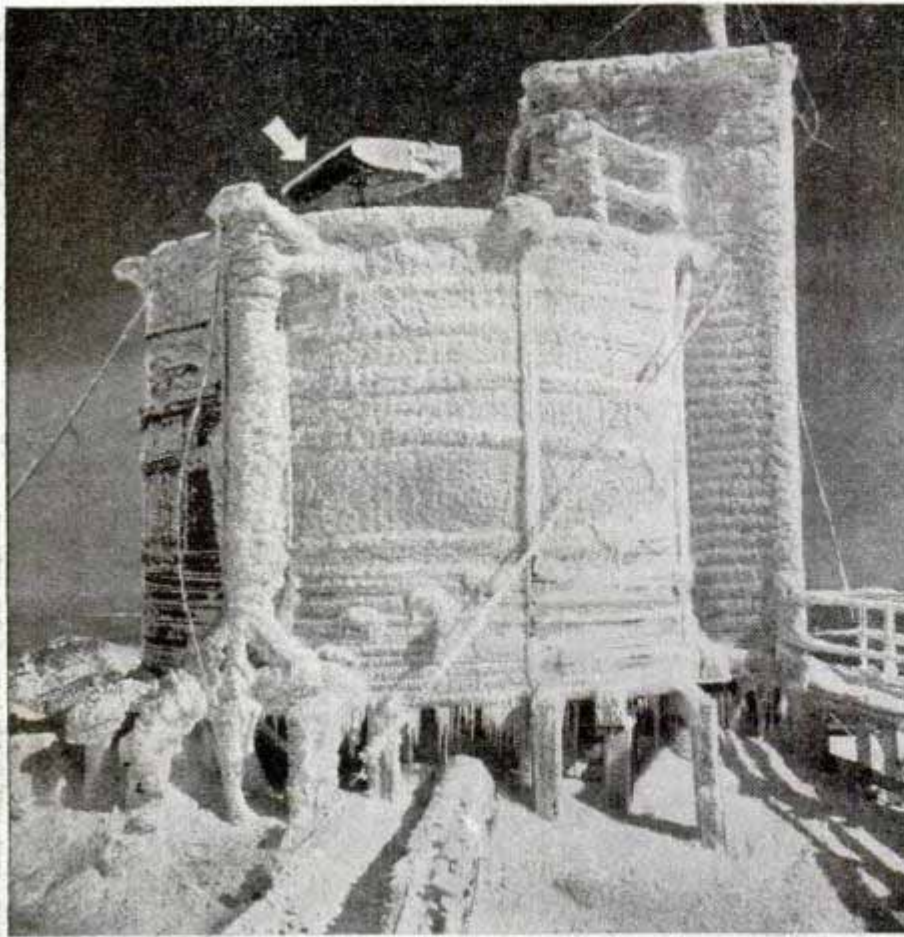

Test wing section mounted atop ice-bound water tower pivots with wind

the fluid over propeller blades for most effective ice prevention.

At the start of the battle against flying ice, knowledge of ice itself was believed to be fairly complete. But since then a lot of new facts have been added, and there still is much to learn.

In most cases, ice forms on aircraft when two conditions are properly related. First, temperature must be less than 34 degrees above zero, Fahrenheit. Second, there

Research staff member observes rime formations on wing of airplane model

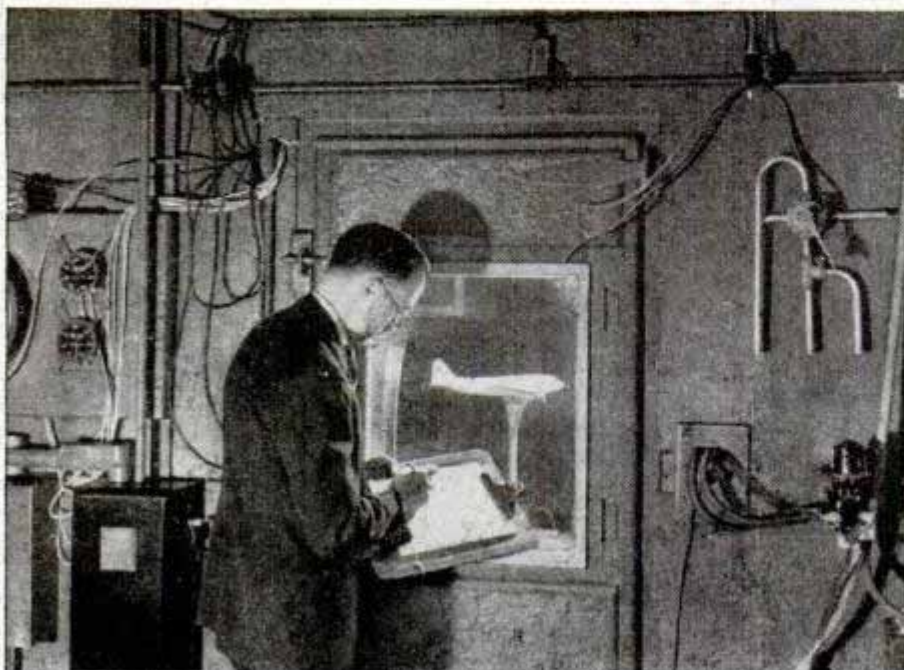

The rapidity with which ice can form on a plane sometimes is surprising. Ice may form rapidly when a plane is flying through a layer of cold air and there is, above it, a layer of warm air from which rain falls. The drops of water, striking the cold plane, freeze almost instantly.

When a plane that has been flying through air below freezing temperature suddenly enters a warm cloud, ice forms very quickly, but doesn't last long enough

to become more than a thin film. Warming of the plane by the higher temperature air melts the ice before long.

Most rapid icing occurs when the temperature is just below freezing and fog particles are large. The fastest accumulation observed during the mountain-top studies was at the rate of five inches per hour.

Ice often forms very rapidly on a thin collector such as a radio mast at right-angles to the direction of flight. For this reason radio antennae wires are strung in a direction parallel with the

(Continued to page 148)

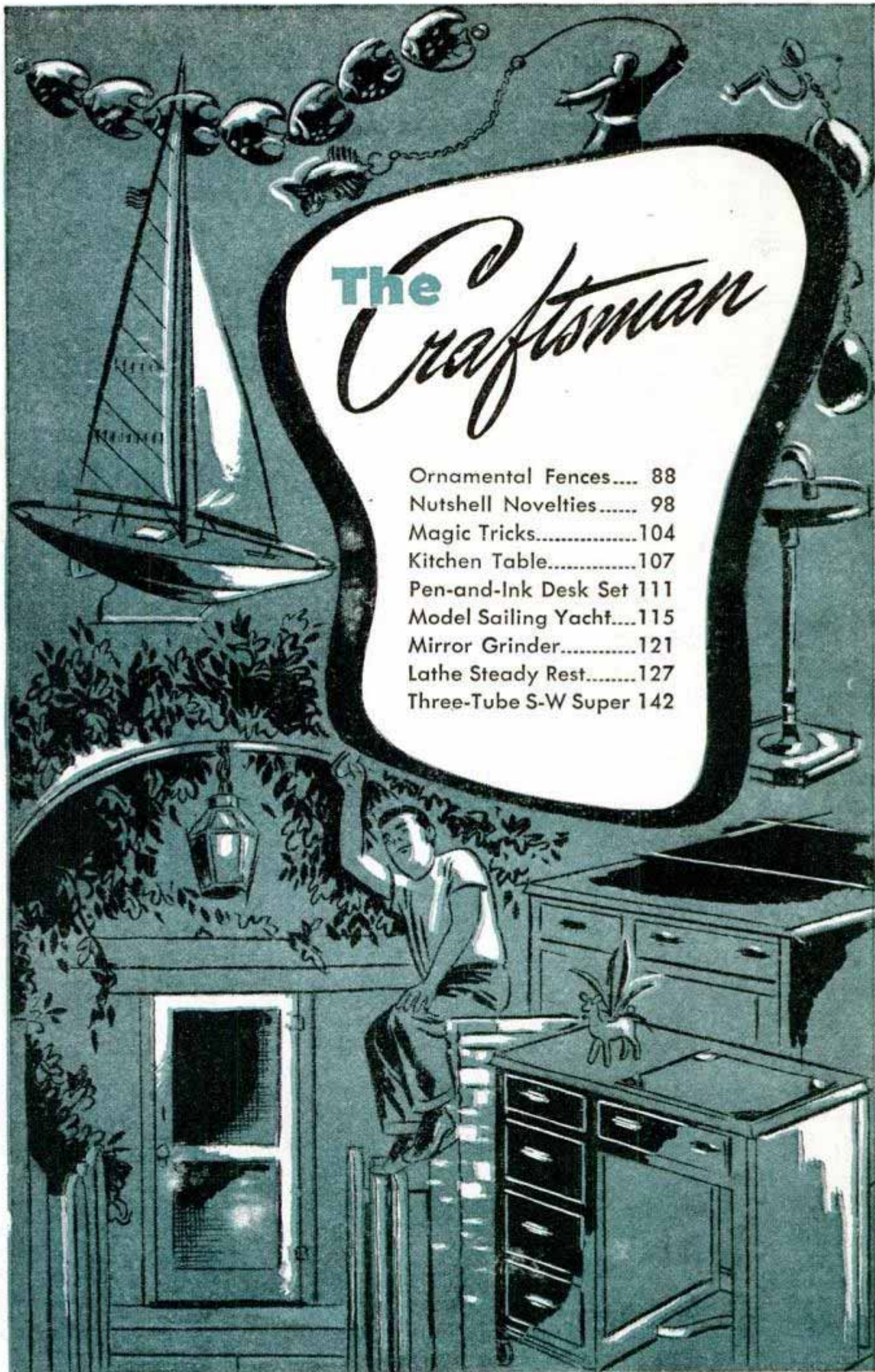

The Craftsman

Ornamental Fences.....	88
Nutshell Novelties.....	98
Magic Tricks.....	104
Kitchen Table.....	107
Pen-and-Ink Desk Set	111
Model Sailing Yacht....	115
Mirror Grinder.....	121
Lathe Steady Rest.....	127
Three-Tube S-W Super	142

FENCING FRAMES THE HOUSE

By Hi Sibley



Above, this "rail" fence is made of square stock with hewn or adzed edges. Below, a low X-brace design frames a small cottage effectively

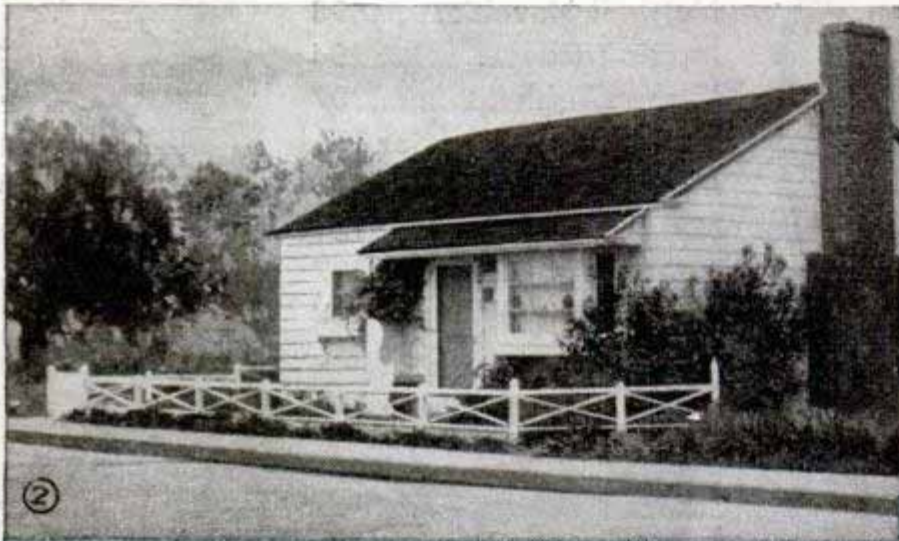

A FENCE does for the house what a frame does for a picture. It bounds the area, and just as a frame may add to or detract from a picture, so may the fence do much to improve or impair the appearance of a house. The style chosen should blend with the general architecture. To use extreme examples, a Georgian house would not look well with a split rail fence, nor would a log cabin appear natural surrounded by a brick wall. However, many of the styles shown here will blend with most types of architecture.

When building a fence, the posts should be spaced an even number of feet apart; 6, 8 or 10 feet, for example. The reason for this is that the 2 by 4-in. lumber that forms the top and bottom rails of most fences comes sawed in such lengths, or multiples of these dimensions, and can be cut without waste.

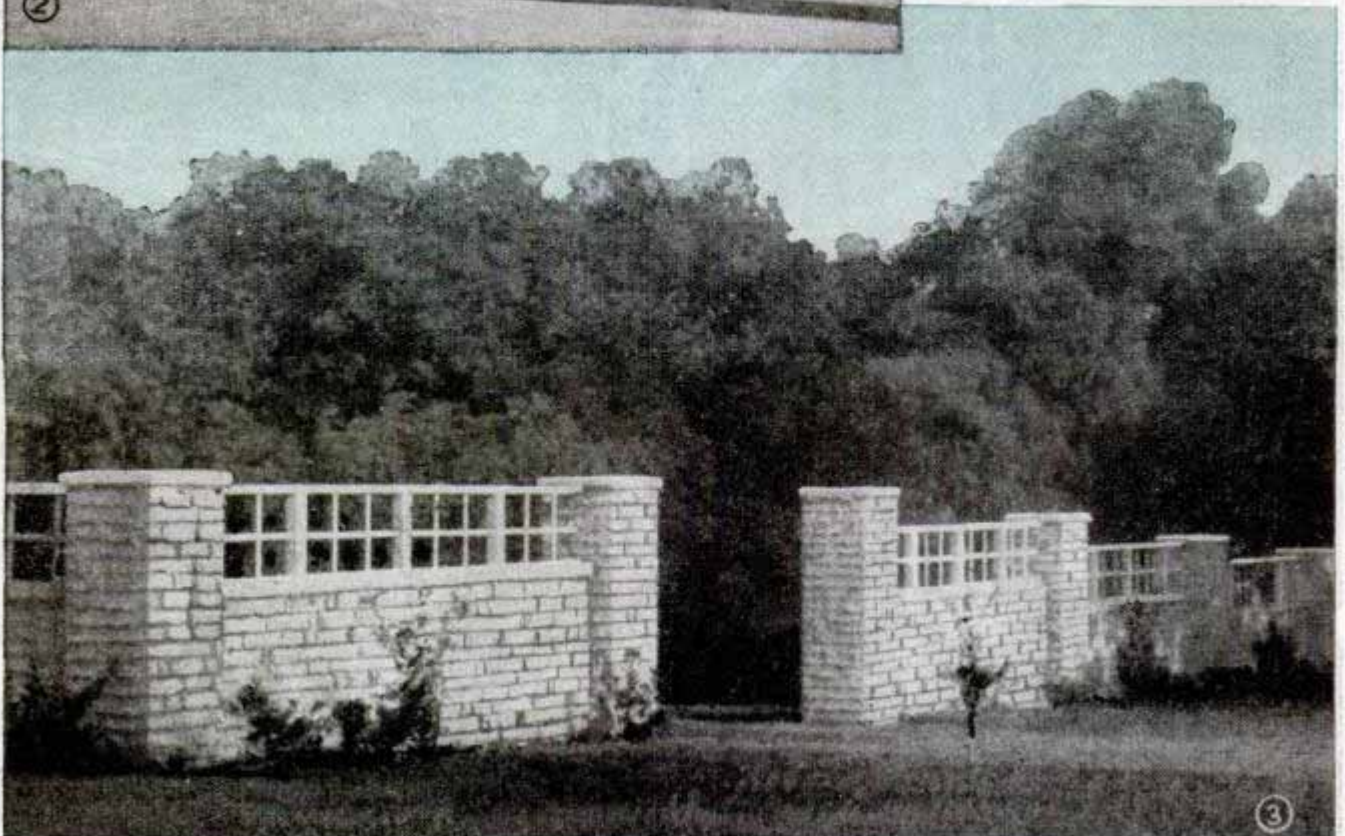

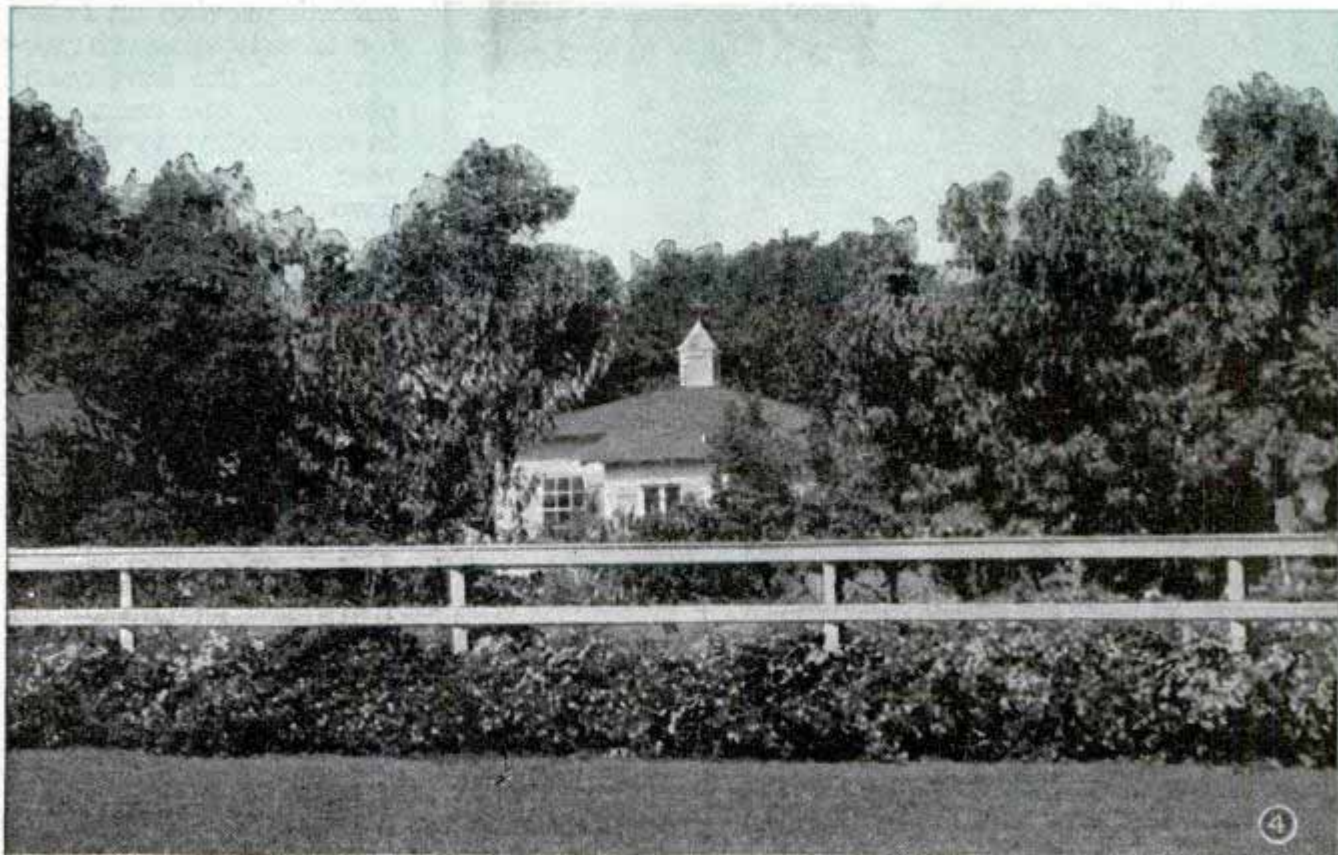

But if the design is best with the posts spaced an odd number of feet, as shown in the details of Fig. 7, a 7-ft. length can be cut from a 14-ft. piece and a 9-ft. span cut from 10-ft. stock without much waste due to the lap past the posts. Figs. 1, 2 and 3 show wide variations in the design of fencing which has been adapted to the setting. In Figs. 1 and 2 notice how the fence has been especially designed and located to complement structural details of the house in both cases. In Fig. 3 the heavy, massive architecture of the wall-and-fence combination borders a large landscaped area most effectively. In Fig. 4 the simple lines of the board fence unobtrusively supplement a landscape largely natural in its arrangement and add a foreground detail that is pleasing to the eye at any season. Moreover, the fence serves the additional dual purpose of defining the boundaries of the property and providing a backdrop detail for the low, flowering shrubs bordering the grassed area in the near foreground.

Fig. 5 shows how another fencing problem has been worked out with the architecture of the house and the boundaries of the property in mind. To break up the geometric pattern formed by the vertical and horizontal lines of both the picket

fence and the house, tops of the pickets have been cut and fitted on a radius and the regular curve thus formed is further accentuated by nailing a thin wood strip over the curved ends. The gate in this particular fence is so constructed that it forms part of the major curve, as you can see from the photo and the detail in Fig. 7. Thus the long sweep of the curved strip has the effect of lengthening the spans between the posts and makes the area enclosed appear larger and more spacious. Such a design is especially effective where the fence must be near the house, as on a small lot.

Other examples of the application of complementing designs are those shown in Figs. 6 and 8, both of these following to a certain degree the lines of the building. Both houses are of the rambling "ranch-

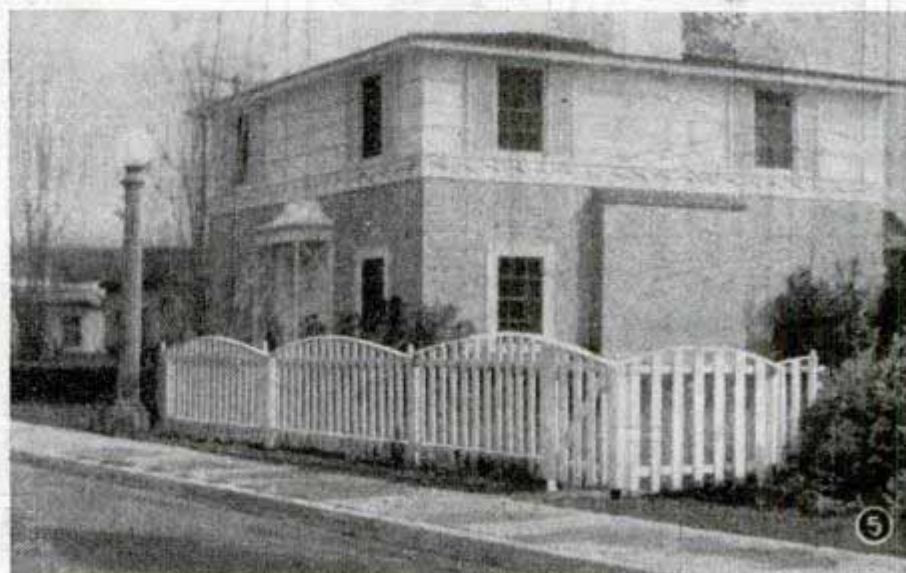

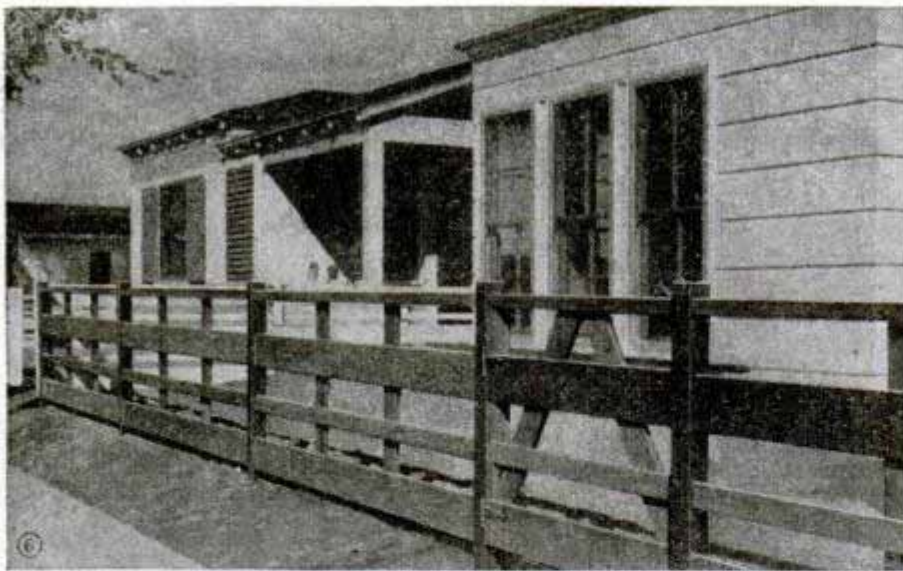

Long horizontal spans are broken up by adding the vertical lines of two uprights which are equally spaced between the main supporting posts

house" styling and in each case the character and nature of the property made it necessary or desirable to locate the fence near the building. In the first design, Fig. 6, note that the long horizontal spans are broken by the addition of two uprights equally spaced between the posts and that the gate is clearly defined by an inverted "V" formed by slanting uprights framed into the panel of the gate. There being no shrubbery nearby, the fence was stained with creosote to a weathered brown color which gives pleasing contrasts.

In Fig. 8 the fence is more nearly a part of the architectural plan, inasmuch as it serves only as a partial enclosure. The horizontal boards, of equal widths equally

spaced, provide an arbor for intertwining shrubbery and the long spans obviously are calculated to complement the low roof lines of the house. Two other designs, not pictured but detailed in Fig. 9, not only are of wide utilitarian application but are particularly effective when judiciously arranged with frame homes of the colonial or Cape Cod styling located on medium to large landscaped grounds.

Notice that the fence detailed in the lower view, Fig. 9, features a

wide board in the center between top and bottom boards of approximately half the width of the center member. The design detailed in the top view, Fig. 9, is of the popular X-brace style with a bottom board below the lower horizontal stretcher. This particular styling also is effective as a background for low, dense shrubbery due to the angular lines of the X-brace design, which give an open-panel effect.

In building fences of the types pictured and detailed the selection of suitable materials and fastenings is quite important. Posts should be of enduring woods such as red cedar or oak, and the boards, pickets and rails may be of cedar, white pine or cypress. Either rough-sawed or surfaced

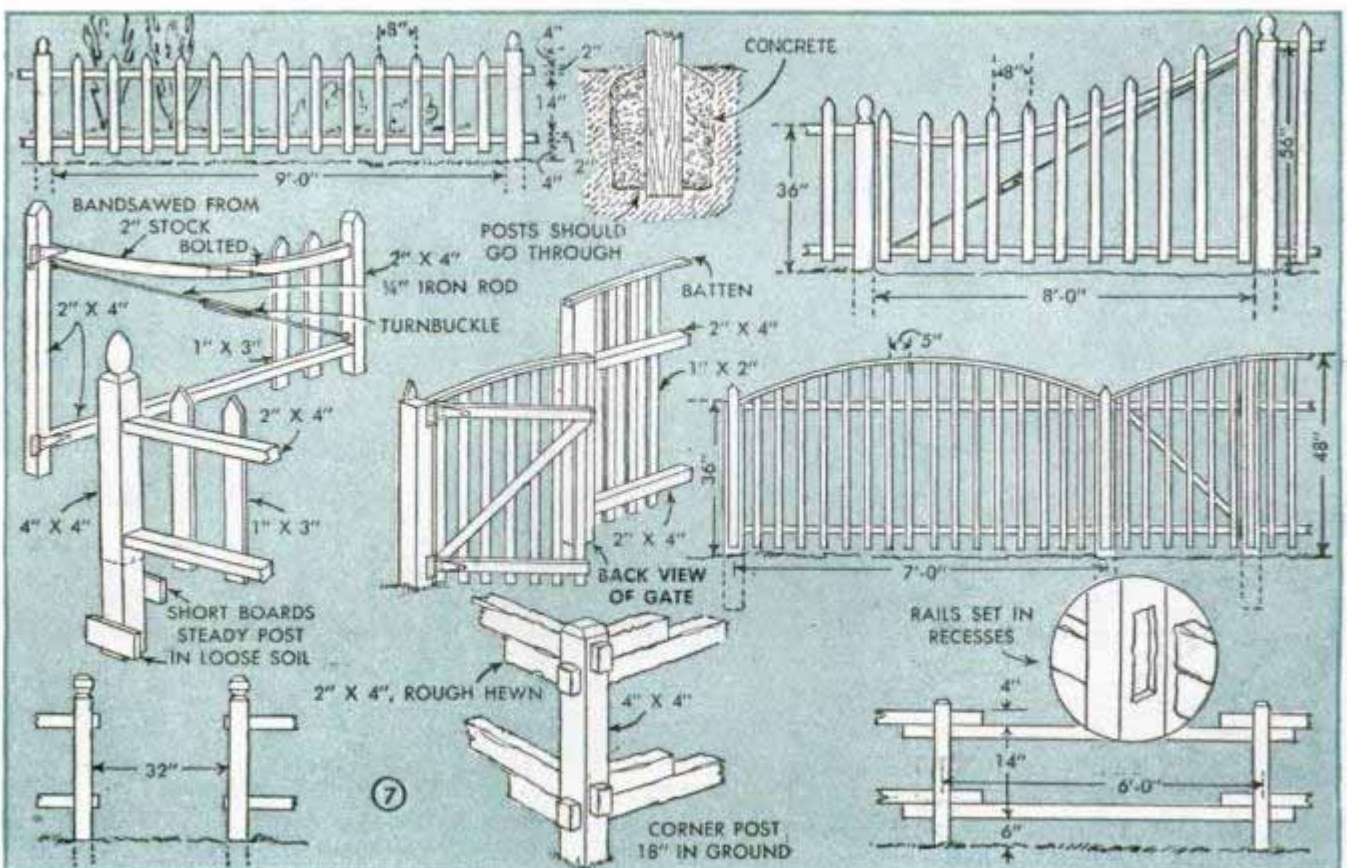



boards can be used, although those of the former grade are much more difficult to paint. In setting posts permanently first creosote the lower ends up to the ground line and then set in concrete, making sure that the lower ends project as shown in the upper center detail of Fig. 7. Fasteners, such as nails, screws, bolts, hinges and hooks, used in assembling any of the fences shown should be zinc-coated or otherwise made rust-resistant. In any case, always use coated nails as they not only resist rust for long periods but hold much better in soft woods. Unless colors are demanded by some special outdoor decorative scheme, fences are commonly painted white, using an outside lead-and-oil paint, or are stained with creosote which also acts as a preserva-

tive. The fence will be much more enduring if you take the time to apply paint to the surfaces of all joining parts. If you assemble the fence first and then paint it you leave a portion of the surfaces unprotected. Moisture works into the joints and is absorbed through the uncoated wood. This causes swelling, loosening of the nails and eventual checking and decay. The best way is to prime the wood and then apply one finish coat before assembly, but if you're in a hurry apply the priming coat to the joining surfaces as you assemble the parts. It's advisable to do this when finishing with either lead-and-oil paint or creosote. The primer should be thoroughly dry before applying a second coat, otherwise peeling is likely to result.

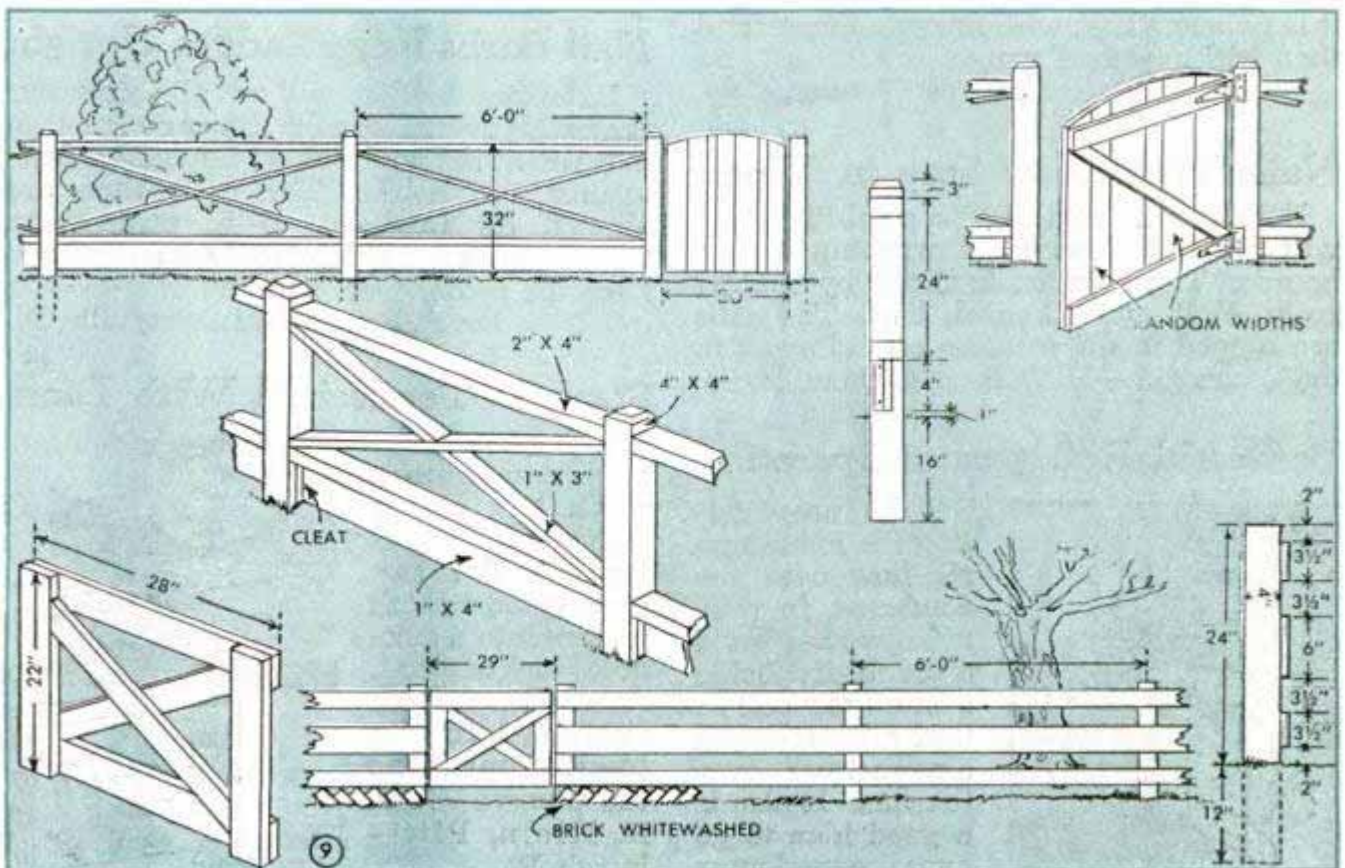

Embossed Metal Is Used as Die To Decorate Plastics

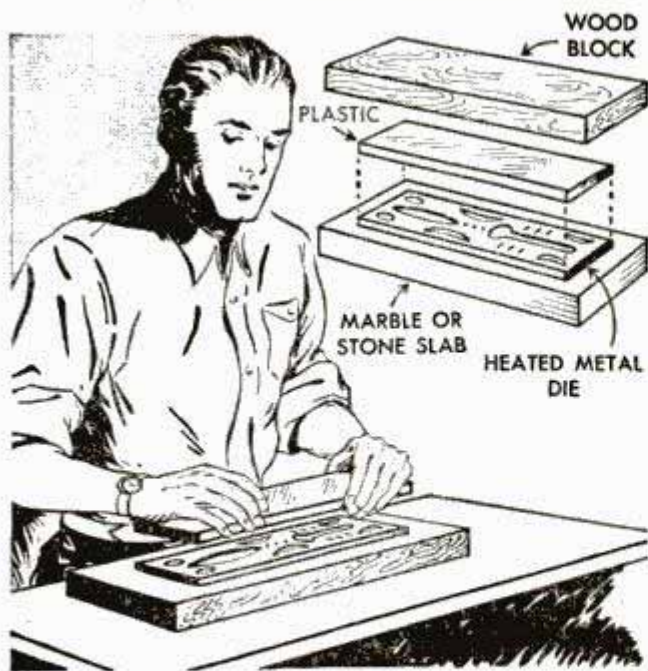

By heating a piece of metal having an embossed design and using it as a die, thermoplastics can be decorated for use as costume jewelry, vanity and cigarette boxes. The heated metal is placed on a marble or stone slab and the plastic is laid on it under a wooden block, which is tapped with a mallet to make the impression. When embossed, the plastic is filed to remove the ridges of material formed by the die, then the depressions are colored with nail polish and a second piece of plastic is cemented over the impression with acetone to cover the design. When the piece is cut to shape, it is polished first with fine sandpaper and then with jewelers' rouge.

Cpl. Walter Lessick, Denver, Colo.

Nails Treated to Stay in Wood

Nails can be coated with a solution that will prevent them from working out of boards. The solution is made by mixing rosin, ¼ lb., with benzol, 1 qt. The nails are dipped in the solution and allowed to dry overnight.—H. W. Swope, Danville, Pa.

Baffle Aids Refrigerator Operation

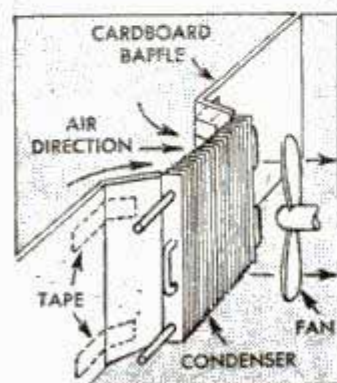

To be sure of getting the maximum air flow over the condenser in your refrigerator, build a cardboard baffle around the coil so that all entering air must pass over the fins. It also is a good idea to go over the condenser

occasionally with a small brush to remove dust or any other obstructions. Dust or dirt will act as insulation and retard the transfer of heat from the condenser to the air.—C. D. Bassett, Ypsilanti, Mich.

Patch for Holes in Linoleum

Holes in inlaid linoleum can be patched so that they are hardly noticeable. To do this, small chips or shavings are scraped from a scrap piece of linoleum of the same color and pressed tightly into the hole, a little waterproof household cement being used as a binder. After the cement is dry, the patch may be smoothed with fine sandpaper.—Ralph Mayer, Woodbridge, N. J.

Marshmallows "Done" in Toaster

An open-type bread toaster of the kind shown is excellent for preparing marshmallows indoors. Holders are made by fitting one end of a straight piece of wire with a drawer knob to serve as a handle. The free end is pointed with a file. Also, notches should be filed in the sides of the toaster frame to hold the wires so they can be rotated until the marshmallows are an even golden brown.

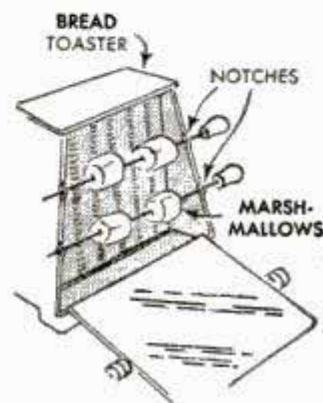

Nail Barbs Keep Ladder Upright

Extension ladders will not slip sideways if a nail is driven into the upper end of each side rail at the point where the ladder rests against the house. The nails then are clipped off to leave ½-in. projections. These are filed to a point and act as barbs to keep the ladder from slipping.

Dr. R. E. Sayers, Libertyville, Ill.

Steak Is Tenderized With Dicer

You can tenderize your own steak with the dicer shown here. It is made by driving corrugated metal joiners into a suitable block of wood. A wooden handle fastened to the block completes the utensil.—Mrs. R. Klein, Pittsburgh, Pa.

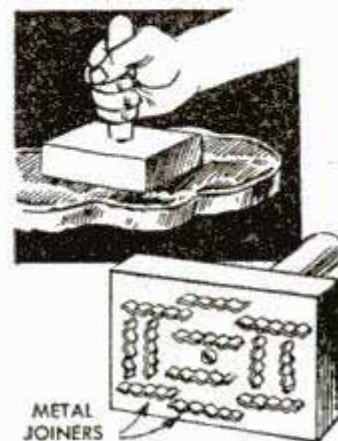

Snack Server Folds Into Small Storage Space

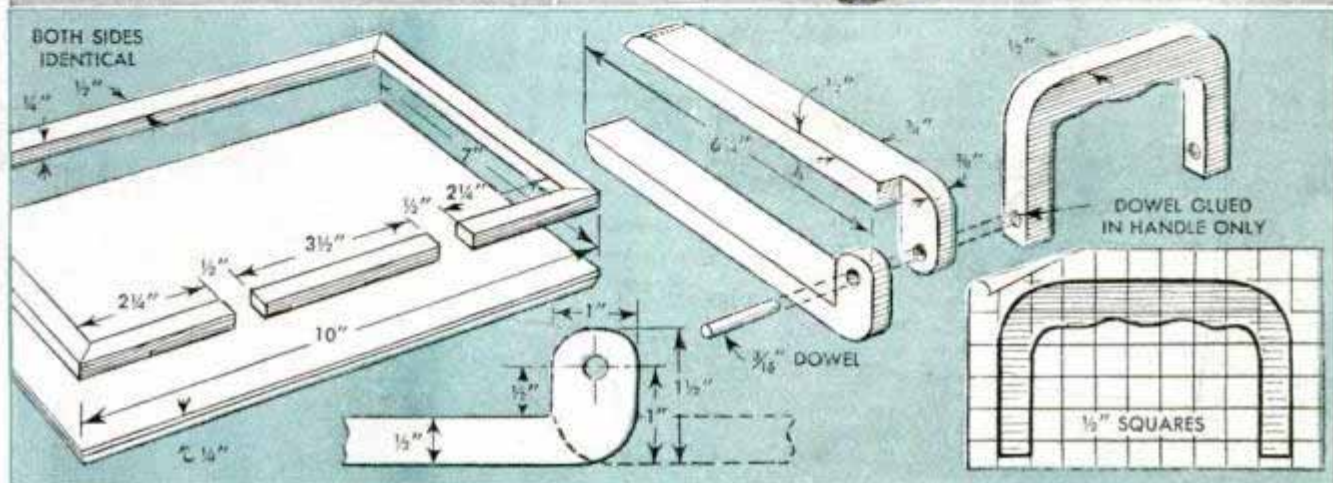
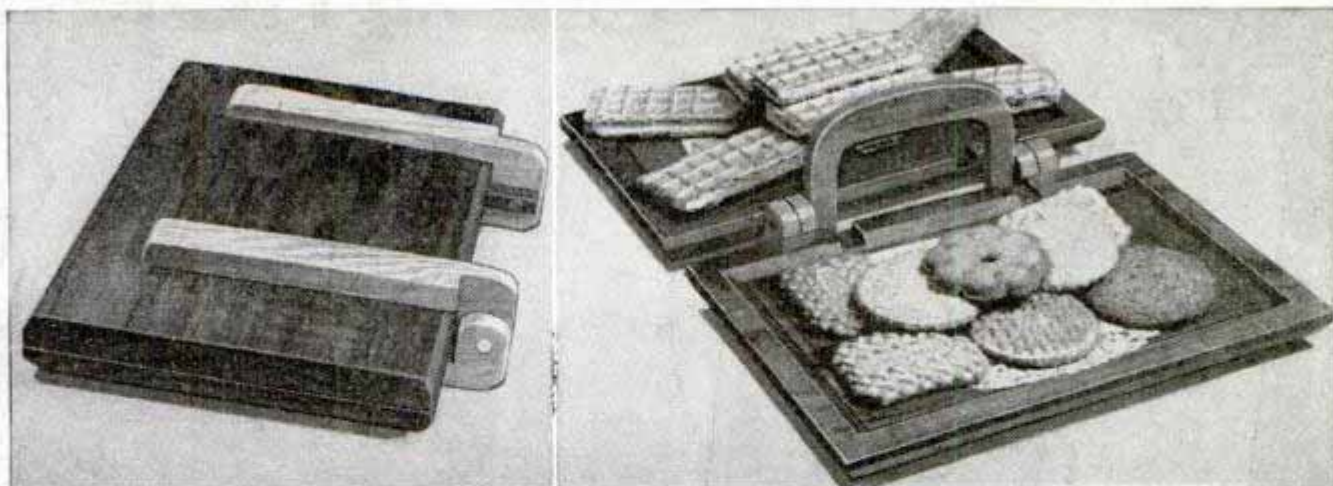

Built of maple and walnut, this snack server folds like a book and does not require the storage space that most trays do. The two halves of the tray are made of walnut which is cut to the dimensions shown on the left side of the detail. Construction of the maple hinges is indicated

in the center and the walnut handle is shown at the right. After assembling the hinges and the handle, glue the hinges to the halves of the tray, using casein glue. To finish the server attractively, apply several coats of shellac rubbed with steel wool and then wax.—Elma Waltner, Hurley, S. D.

Snap Lock Can Be Substituted for Tumbler Type Device

One traveler found this snap lock useful when staying in a room where the door did not have a tumbler type lock. It is cut from light sheet metal and bent to the dimensions shown in the detail. A pad of sponge rubber 1 3/4-in. square is glued to the underside of the longer arm. To use the lock, press the teeth against the jamb and close the door. The shorter arm will snap out and hold the door closed against the short lip of the lock. Pressing the two arms together will allow the door to be opened.

Joseph E. Sullivan, Jackson, Mich.

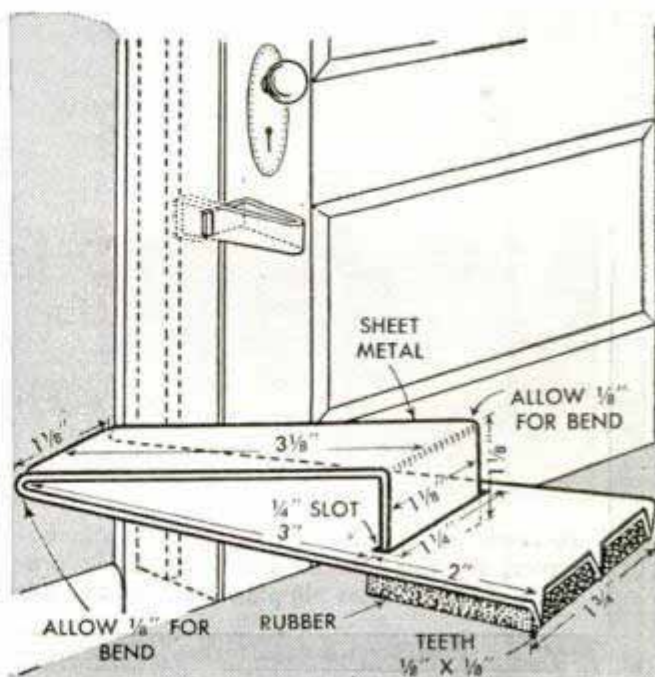

Lacquer Will Preserve Linoleum

If linoleum shows signs of wear, a coat or two of clear lacquer will help preserve the surface. If solid or liquid floor wax is applied over this finish, it will, in turn, act as a further preservative.

Solving HOME



Kept in the supply pipe of a kerosene stove, a screen door spring is worked in and out to clean the line. It is left in after the pipe is capped

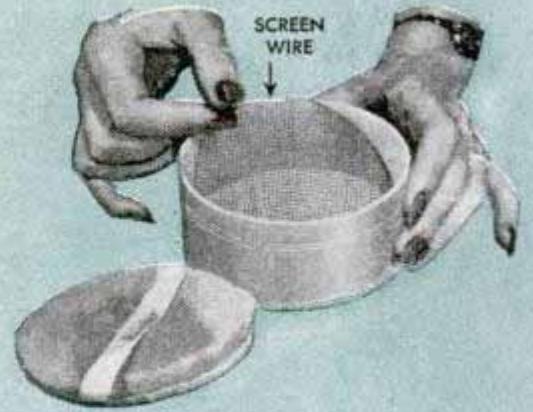

If screen wire is cut to fit inside a powder box and laid on top of the powder, only the proper amount will sift through when the powder puff is used

FLAT-TYPE CURTAIN ROD

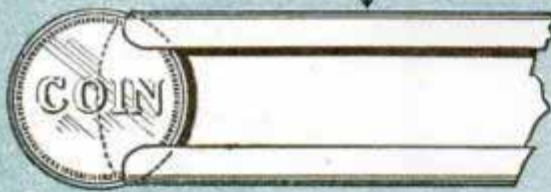

By wedging a coin into the edge of a flat-type curtain rod, curtains may be slipped onto the rod with a minimum of difficulty



One housewife uses an empty egg box for a spare sewing kit. Scissors and a pin cushion are secured to the lid with cellulose tape

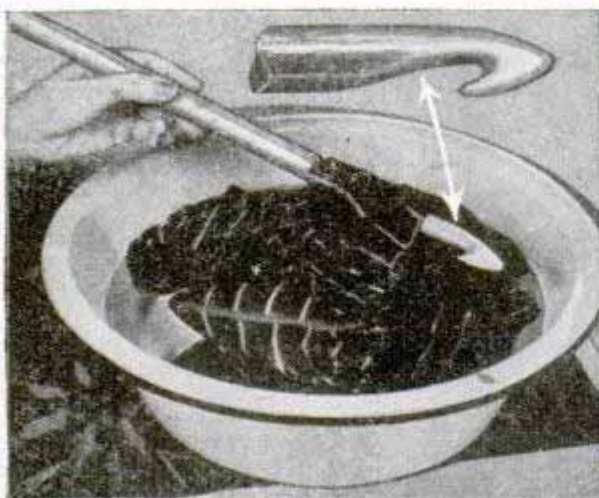

To avoid burns when handling clothes in hot water, try this hooked stick. The hook prevents clothing from slipping back in the tub

ADDITIONAL HOLES PUNCHED



A rubber nipple, punched with extra holes, can be slipped over the neck of a beverage bottle and then be used to sprinkle clothes

PROBLEMS

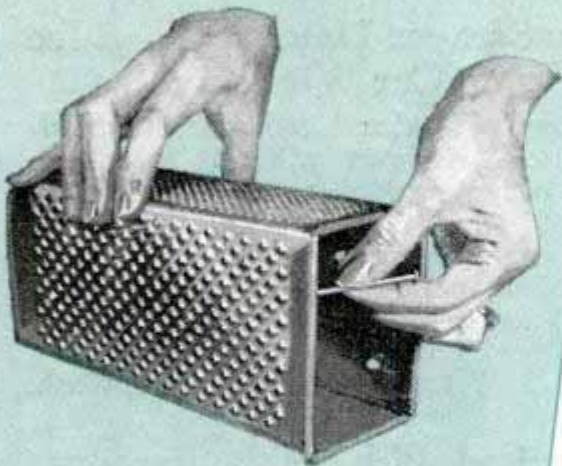

The perforations on a food grater may be so clogged the grater will not work well. It can be cleaned by forcing a sharp-pointed nail through the holes



Bib washers can replace worn rubber feet on electric toasters. If the rivets on the feet are driven out as illustrated here, they can be reused

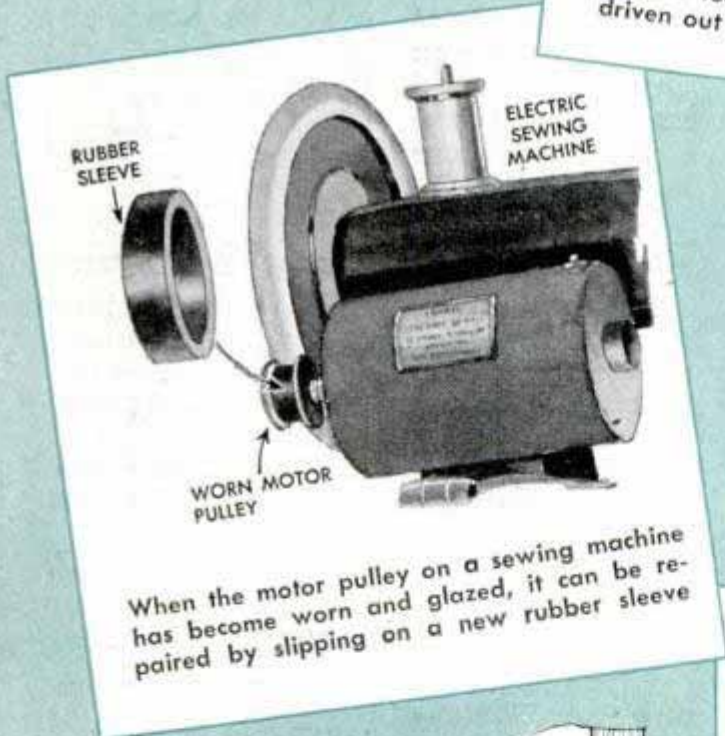

When the motor pulley on a sewing machine has become worn and glazed, it can be repaired by slipping on a new rubber sleeve

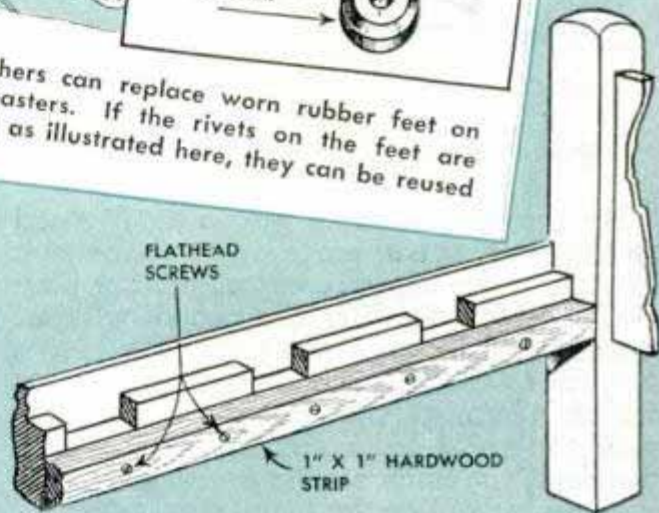

Hardwood strips screwed to the inside of bed rails will hold the slats in place. The strips should run the length of the rails

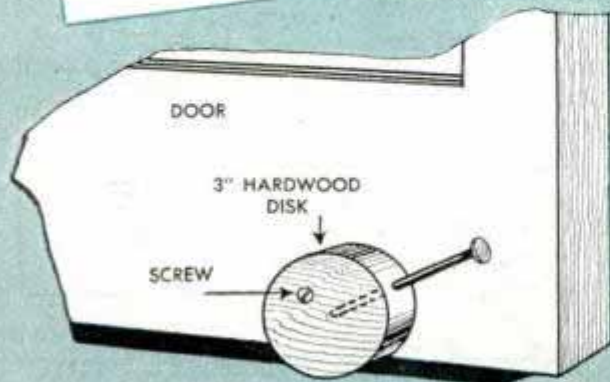

With this disk, a door can be held in any desired open position. The disk is made to fasten, off-center, to the bottom of the door



Grease spots can be removed from wallpaper by rubbing a cube of laundry starch over the soiled area and brushing to remove the starch

Wooden Partition in Rear of Auto Forms "Play Pen" for Child

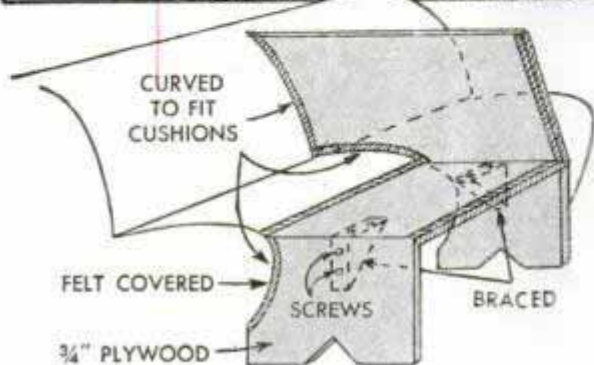
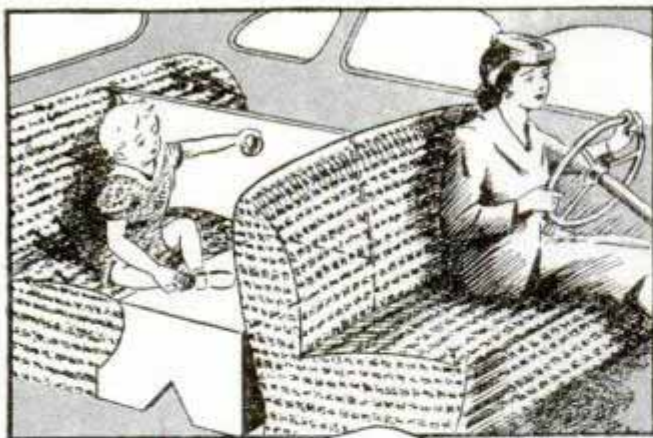

By assembling three pieces of plywood as shown, you can partition the back seat of your car to form a compartment or play pen in which a small child can sit without danger of falling off the seat. The pieces are cut to fit the cushions and are edged with felt to protect the upholstery. To prevent the child from accidentally opening the door, the latch can be reversed so that it opens by pulling the handle up instead of pressing it down.

How to Tell Age of Dressed Fowl

In selecting dressed chickens, you can tell whether a fowl is young by pressing the breastbone, which is pliable in chickens less than a year old. Another method of determining the age is to lift the wing so that the skin under it is stretched tightly. If the skin tears readily, the bird is young.

Ruth Peck McLeod, Knoxville, Tenn.

Fountain Pen Clip Is Smoothed With Cellulose Cement

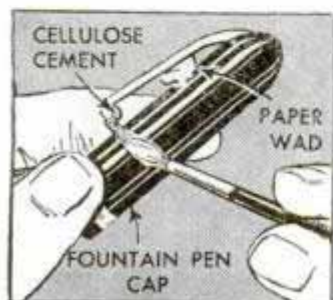

When the tip of the pocket clip on your fountain pen is sharp and tends to tear your pocket, you can remedy this condition by smoothing the rough edge with

cellulose cement. Wedge the clip away from the cap with a wad of paper and apply a drop of thick cement. This will dry and become a plastic ball in a few minutes.

Plastic Scraper Used to Clean Ice From Car Windshield

Removal of frost and ice from a car windshield and windows, after it has been parked out overnight, is made easier by using a sheet of flexible plastic. One side must be straight and the scraper should be six to eight inches wide for ease in handling. The plastic will not scratch windshields or windows.

J. W. Langham, Jr., Seattle, Wash.

Improvised Fish Scale Remover

If you are on a fishing trip, and have no scaler, one can be improvised from a wood block and four bottle caps. Just shape a handle on the block and screw or nail the caps to it.—Isadore M. Fenn, Chicago.

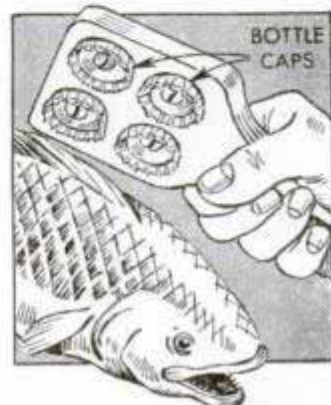

Rubber Fingers Save Manicure

Housewives who dislike wearing rubber gloves, but who wish to protect their manicure while washing dishes, can solve this problem by buying a pair of rubber gloves a size smaller than required and cutting off the finger tips. If the tips are slipped over the nails, the manicure will be protected while doing housework.

Ann-Marie K. Ortman, Somerville, N. J.

Latch Keeps Baggage Closed

Window latches make good fasteners for trunks when installed as shown. They are easily obtained and cost less than latches usually found on luggage.—R. Gordon, Seattle, Wash.

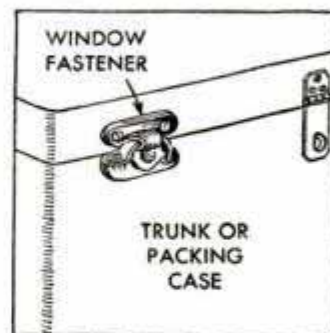

Toothbrush Is Fast Comb Cleaner

A comb can be cleaned in a hurry if a toothbrush with stiff bristles is worked between the teeth of the comb. This is faster than washing or soaking the comb.

F. Valenzuela, Durango, Mexico

Striped Heart Is Built of Laminated Plastic Sheets

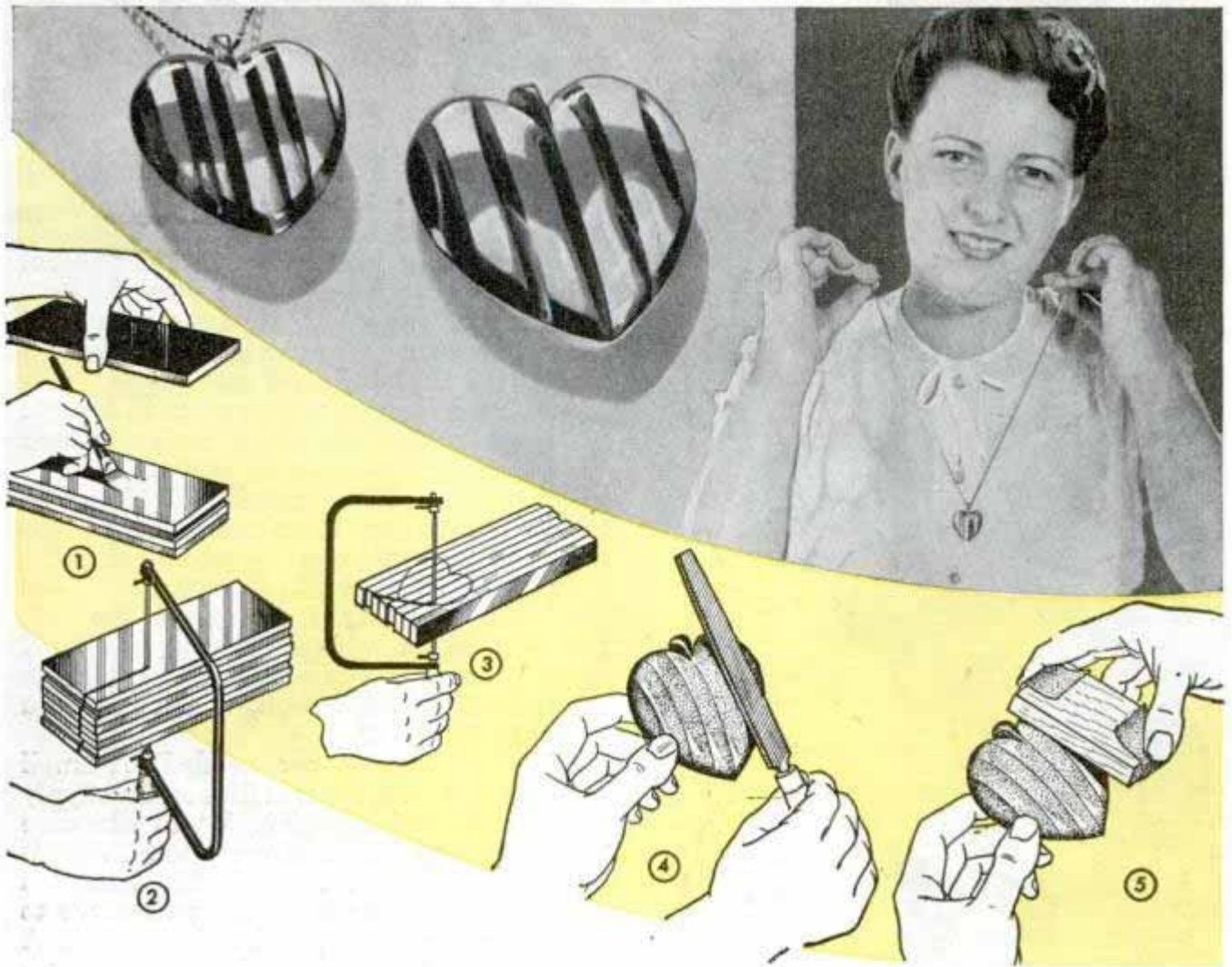

When viewed from the front, this plastic heart shows a few fine vertical lines of color which widen into stripes as it is rotated slowly, and when viewed from the side the heart appears to be a solid color. The blank from which the heart is cut is built up of laminations of transparent thermoplastic cemented together. The plastic sheets may be of the same thickness, or of varying thicknesses from $\frac{1}{4}$ to $\frac{1}{8}$ in. to provide different patterns. The plastic first is washed with acetone and then the surfaces to be joined are coated with colored fingernail polish. After the polish has dried, it should be sanded with No. 400 wet or dry sandpaper and wiped clean. When building up the laminations, use glacial acetic acid for a binder, Fig. 1, wiping off any air bubbles. Press the sheets together with the fingers when the surfaces become tacky, but do not use clamps as this will press the polish out from between the sheets, leaving a weak color or no color at all. Allow the block to set for at least 24 hours and then cut lengthwise strips, Fig. 2, about $\frac{3}{8}$ to $\frac{1}{2}$ in. thick. Using a template with the shape of a heart, saw the rough, Fig. 3, and round with a file, Fig. 4. If a few extra minutes are spent with the filing, it will

save much sanding time. Final sanding is done with No. 320 emery cloth, Fig. 5, followed by No. 400 wet-or-dry sandpaper. While any fine abrasive polish can be used, one made with a paste of tin oxide and water spread on a tightly stretched cloth works well. The heart is rubbed briskly over the cloth, rotating and turning it in the process. When the heart has the required polish, the hole for the chain is drilled with a No. 50 drill. This should be at an angle from both sides to avoid marring the polished surfaces. To complete the piece, polish the hole with a cotton string to which the abrasive has been applied.

Edward Lopkoff, Seattle, Wash.

Cretonne Pockets in Drawer

Cretonne pockets, thumbtacked to the inside of a dresser drawer, will make handy receptacles in which to keep bobby pins, costume jewelry and other odds and ends. The pockets may be sewed separately or in groups, similar to shoe bags.

Mrs. M. R. O'Connor, Washington, D. C.

☞ Nail polish remover will clean small daubs of paint from the hands.

Nutshell

By E. N. Moore

THE hobby of nutcrafting offers many new possibilities for craftsmen who like unusual novelties. Servicemen especially will find it an intriguing test of manual skill. Costume jewelry and other objects made from nutshells always are prized highly as gifts. In nutcrafting you're not limited to the hard and soft-shelled nuts alone. Plum stones, which grow in several different colors, including red, tan and brown; date stones, generally mottled in effect, and pits from cherries may be used. Shells from more than one variety often are used in working out designs for necklaces, such as shown in Figs. 6 and 9, and the bracelet in Fig. 7, as well as the belt, Fig. 4. An ensemble consisting of a lapel pin, bracelet and earrings, Fig. 1, can be made from coconut shell, which is sawed easily as in Fig. 13.

Only a few tools are needed. A small hand drill, Fig. 2, several files and a supply of fine-grit sandpaper, Fig. 5, will take care of most of the finishing operations. A special clamp, made from light flat iron and hacksaw blades as in Fig. 8, will serve to hold the nutshells in place while sawing. A coping saw with an assortment of fine-toothed blades is a necessity. The cross-hatched patterns such as that at the left of Fig. 2 and those just below Fig. 10 are included merely for the purpose of enabling you to trace the outlines and transfer these

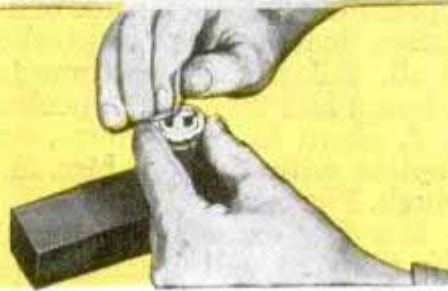
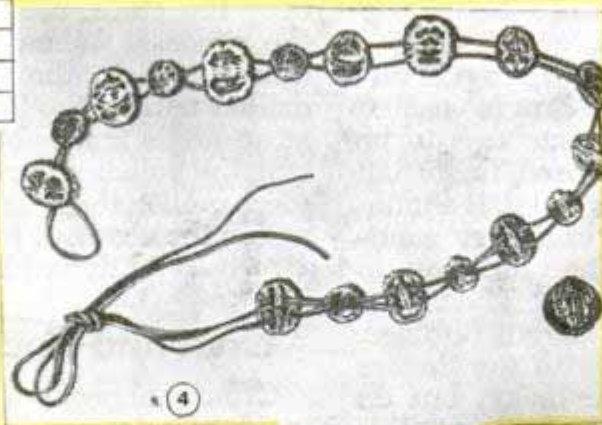
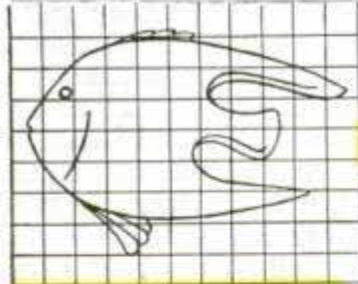
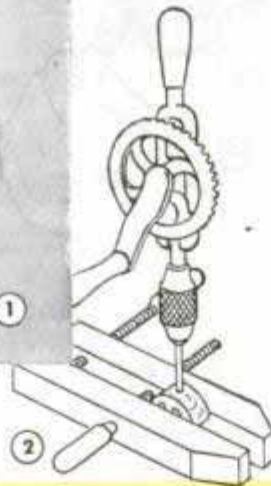
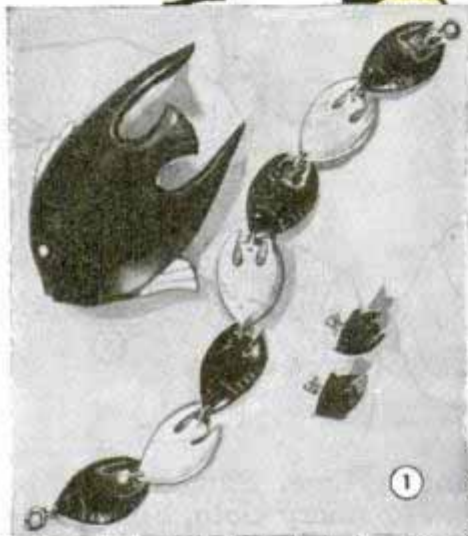

Novelties

to the surface of the work. The exact size or detail will be determined by the area of the shell or whatever design suits your fancy.

Small holes, either for stringing or for ornamentation, can be drilled through the "slices" or other parts of the shells as in Fig. 2, using a carpenter's wood clamp as shown. For stringing the finished parts of shells, use fine jewelry chain, leather thong or elastic cord.

If you use fine-toothed coping-saw blades in the slicing operations you won't have much trouble removing the saw marks from most shells. However, this must be done with care, for in nutcrafting the finish is the thing. The polished surfaces of most of the shells used in this work will take a beautiful finish even in the natural color, so it pays to do a thorough job. Producing a suitable surface on the flat-faced slices, such as those in the belt, Fig. 4, is simply a matter of persistence with file and sandpaper in successively finer grades, preferably of the "wet-or-dry" type. Sometimes the finishing operation can be speeded up by tacking a sheet of 8-0-grit paper to a flat surface such as a table top, then rubbing the slice back and forth on the abrasive. This will produce the desired smooth surface with uniform sharp edges.

Working down curved or convex surfaces can be made much easier if you take

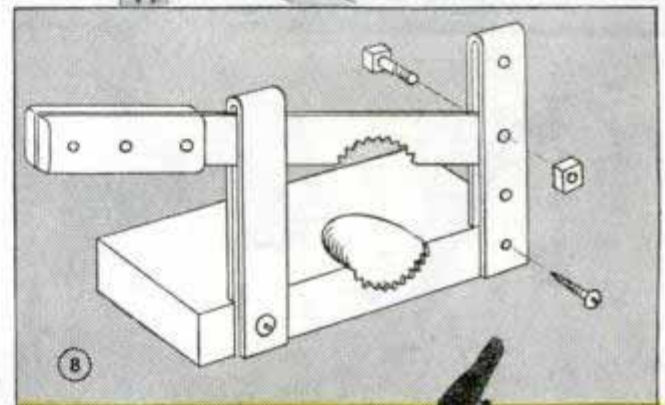
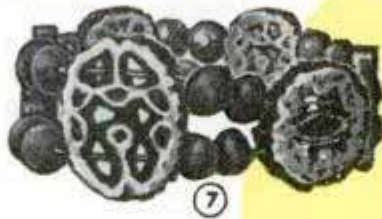



time to make the small fixture shown in Fig. 3. By pressing the edge of the nutshell against the heads of the nails you can work on any part of the curved surface clear down to the edges with either file or abrasive paper.

Carving nutshells is, of course, something else. However, if you have the skill and inclination, much can be done in the field of nutshell carving either by hand with a sharp pocket knife or with an electric grinder of the hand type, using wood-cutting burrs. Usually the final polishing is done with a very fine abrasive paper known as "granite" paper, and also with jeweler's rouge.

As a finishing material some nutcrafters work the oil out of the nut meats with a mortar and pestle and use this oil as a stain and polish, rubbing it on with the fingers to give the polished surfaces color and tone. Others use wax for a natural finish.

Other nutshell novelties are shown in Figs. 10, 11, 12 and 14. Those in Figs. 11 and 12 are salt shakers made from Brazil nut and English walnut shells. These are very popular items and are simple to make as the shells of both Brazil nut and English walnut work easily. In making shakers from English walnut shells care should be taken to break the halves apart without cracking. Then the inside of the shell is scraped and smoothed with a sharp knife or a wood-burring tool and the halves reassembled with a quick-setting adhesive. A

single large hole is drilled in the bottom to take a cork which serves as a base. With shakers made from irregularly shaped shells such as those of the Brazil nut, it is necessary to make a base from a shell of contrasting color. Fig. 14 shows an unusual novelty display made up by using a tree limb on which are hung several nutshell baskets made from various kinds of small shells, the principal feature being a flowerpot made from a coconut. Of course, other arrangements are possible.

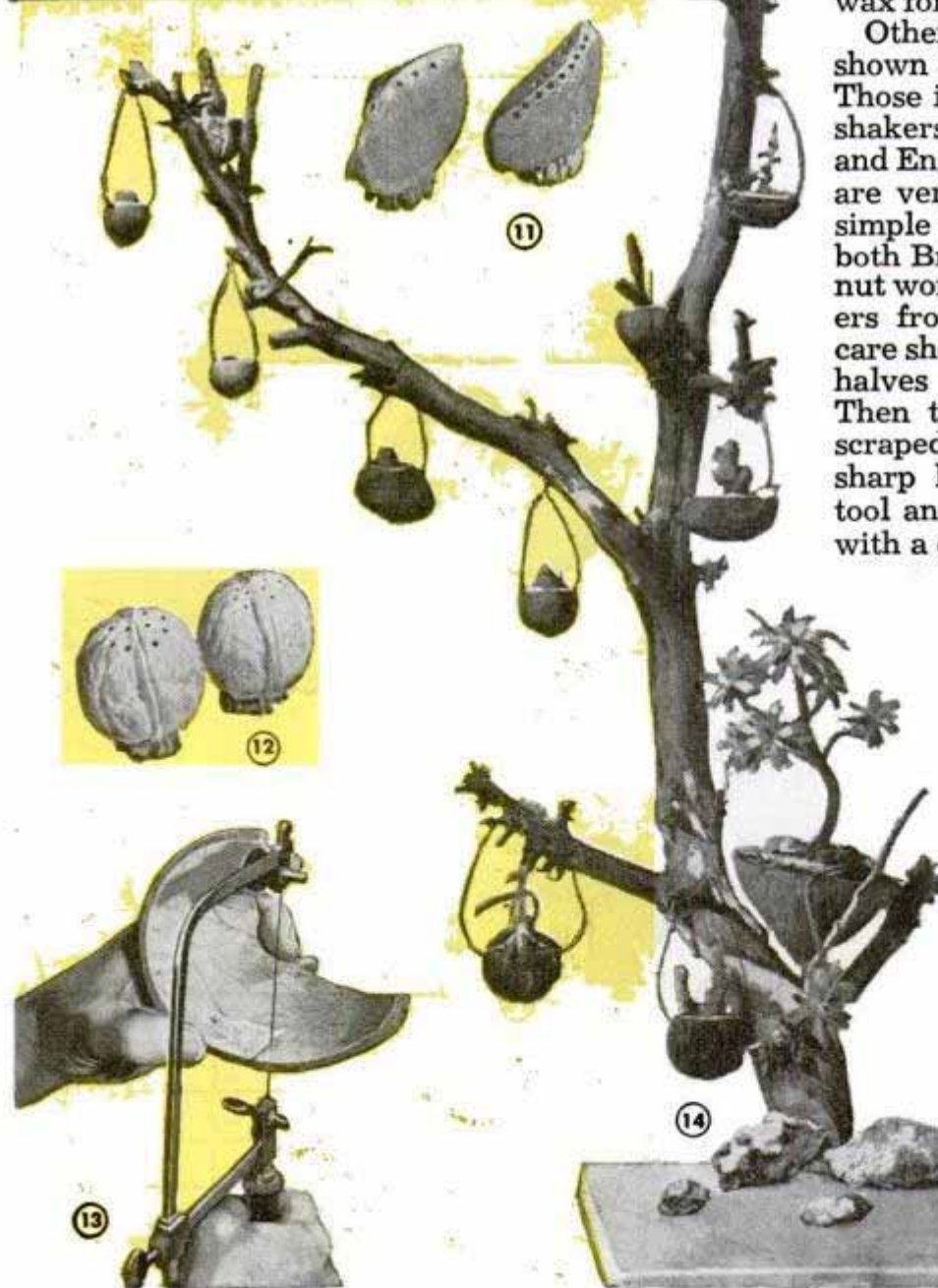

Walnut Candelabras Decorate Dinner Table

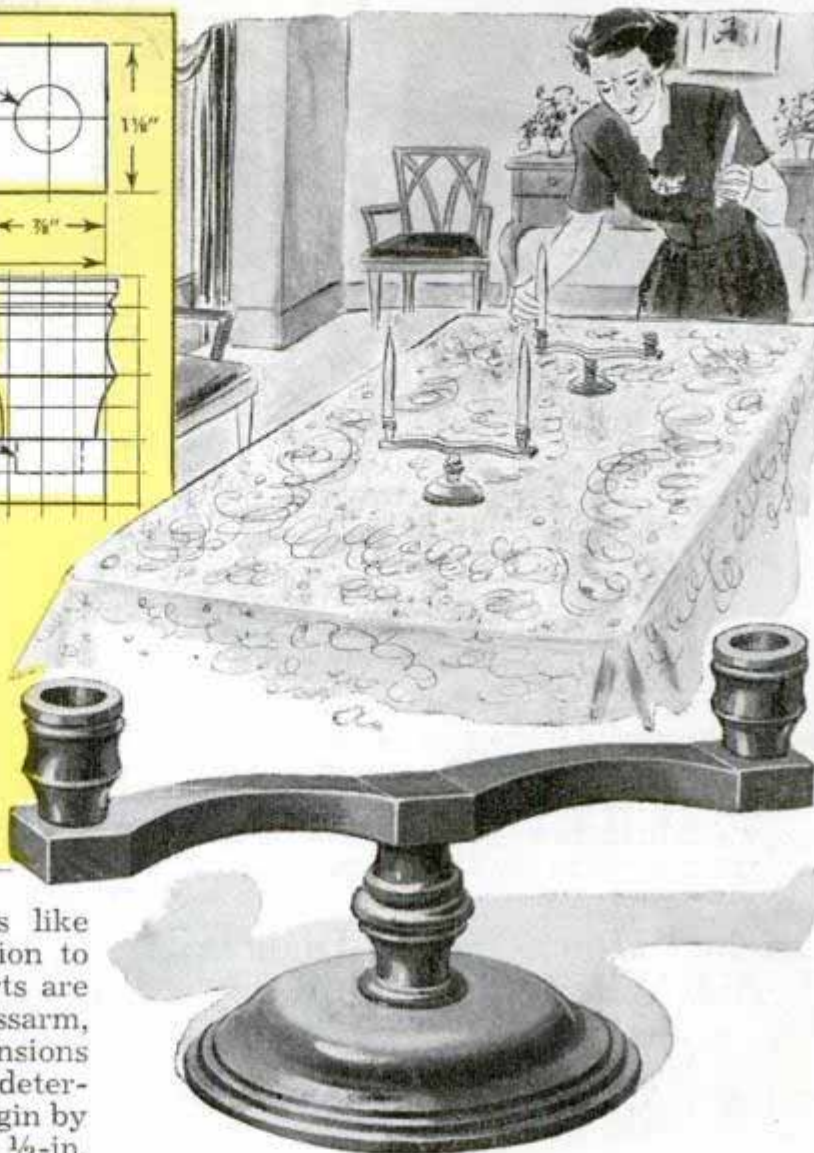
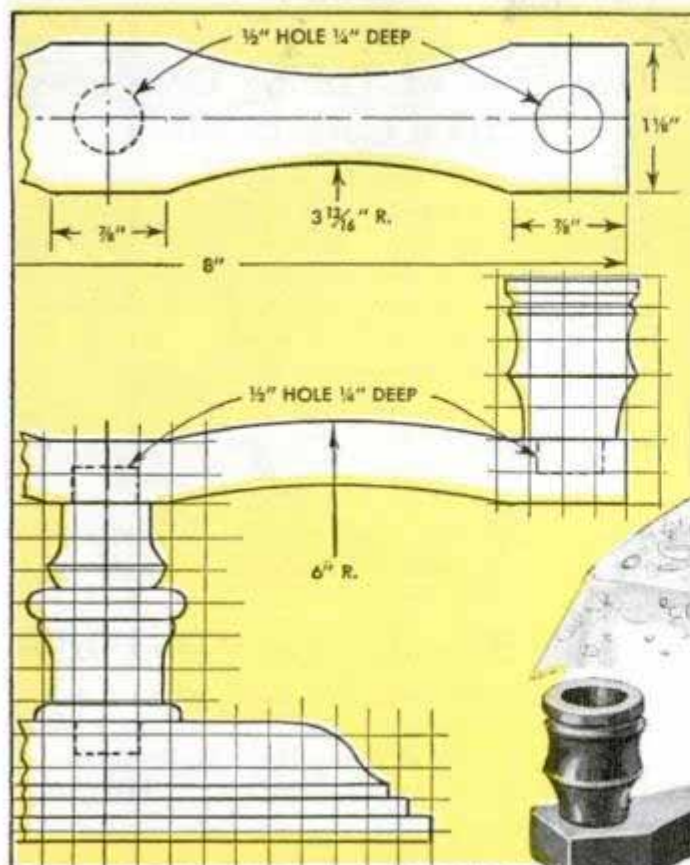

A pair of walnut candelabras like these will be an attractive addition to your dinner table. All of the parts are turned on a lathe except the crossarm, which can be bandsawed. Dimensions not given on the drawing can be determined from the 1/4-in. squares. Begin by turning the base and then bore a 1/2-in. hole 1/4 in. deep to hold the standard, which has a round tenon 1/2 in. in diameter and 1/4 in. long at each end to fit into the base and the crossarm. The cups also have a similar tenon to fit into the crossarm. To hold the candles, holes are drilled 1 in.

deep. After these parts have been turned, the crossarm is cut and all pieces are sanded and finished. The assembly then is glued together.

Wm. H. Freeman, Baldwin, N. Y.

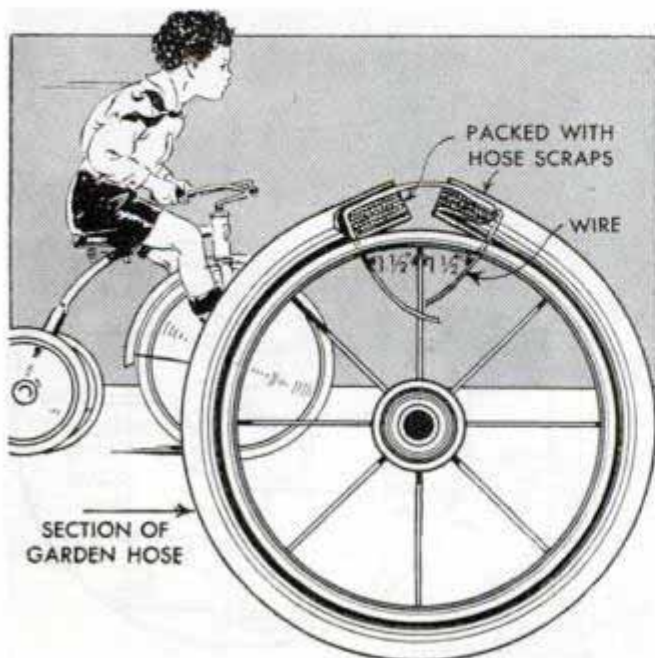

Garden Hose Makes Sturdy Tires For Wagons and Tricycles

Tires for wheels of children's wagons and tricycles can be made from lengths of garden hose. First drill two small holes in the rim equidistant from a spoke and fit the hose to the rim so the ends will meet. Then mark and cut holes in the hose corresponding with those in the rim. Finally, insert wire in the ends of the hose after the openings have been plugged with scraps, pull the wire through the holes in the hose and rim, and twist it to draw the tire tight.

Fred Pennoyer, Bremerton, Wash.

☞ Glass tumblers that have stuck together may be separated by putting cold water in the top one and setting the bottom one in warm water.

Sandpaper Held on Workbench For Finishing Small Parts



You can save time when sanding small parts by rubbing them over a piece of abrasive paper fastened to the top of a workbench. An ideal method of attaching the paper is to hold the ends with sticks pressed into grooves cut in the bench top.

Original House-Wiring Diagram Aids When Adding Outlets

When you build a new home, obtain a plan or diagram of the electric wiring installation. This will enable you to know the circuit layout later if you add outlets or extensions after the interior walls are finished. When adding extensions, it should be remembered that most branch circuits are No. 14 wire and that the maximum safe load is 1650 watts. Determine from the drawing how many outlets the branch circuit feeds and then add the wattage used at each outlet. Lights and appliances usually are rated in watts so the total load is determined easily. Generally, circuits should not carry more than 1200 watts.

Mrs. R. E. Berry, Decker, Ind.

Shaker Is Economical Dispenser

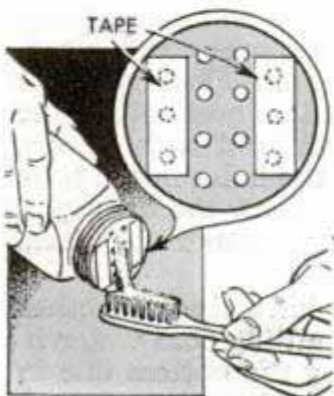

Users of tooth powder will find that a large salt shaker with a flat top will make an ideal dispenser. If two narrow strips of adhesive or cellulose tape are pasted over the top of the lid, leaving a double row

of holes exposed, the powder then can be sifted onto the toothbrush and there will be very little waste.

Two Sizes of Tubing Connected With a Cork Bushing

To connect two sizes of tubing, use a cork as a bushing. The cork should be a tight fit in the larger tube and is drilled to receive the smaller one. If the connection is subject to vibration or has too much play, an application of household cement will help to make the joint tight.

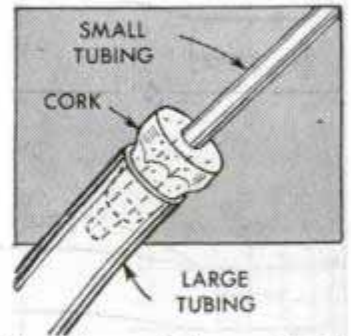

Dental Burrs Used as Wood Drills

Dental burrs can be chucked in a hand grinder and used for drilling wood or plastics. Such burrs may be obtained from dentists after they become too dull for a dentist to use.

Rabbit-Hutch Partitions Joined By Screen-Door Spring

When building or enlarging rabbit hutches you can use a screen-door spring to connect pieces of wire mesh for partitions. The spring is stretched into a loose spiral and then wound through two pieces of the mesh as indicated in the circular detail. By this means, wooden cleats and nails are unnecessary, and the partitions can be removed quickly whenever desired merely by unwinding the spring.

E. G. Pophal, St. Pauls, N. C.

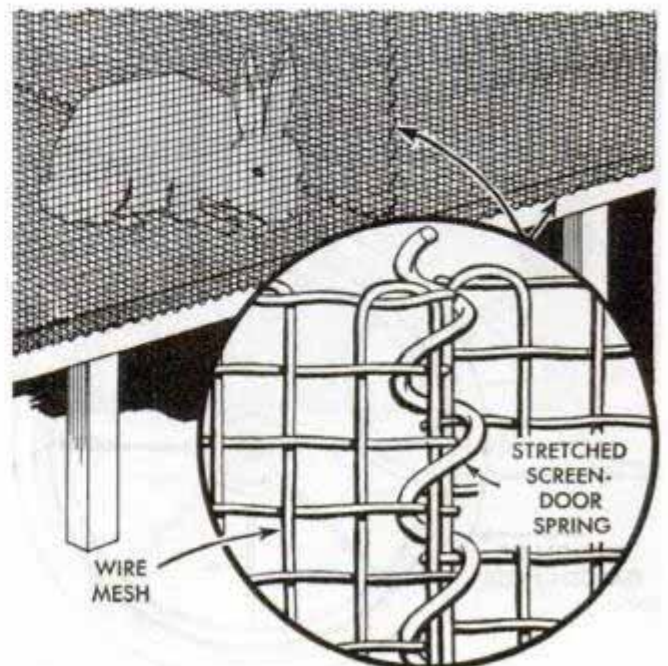

Bric-a-Brac Wall Cabinet Has Antique Design

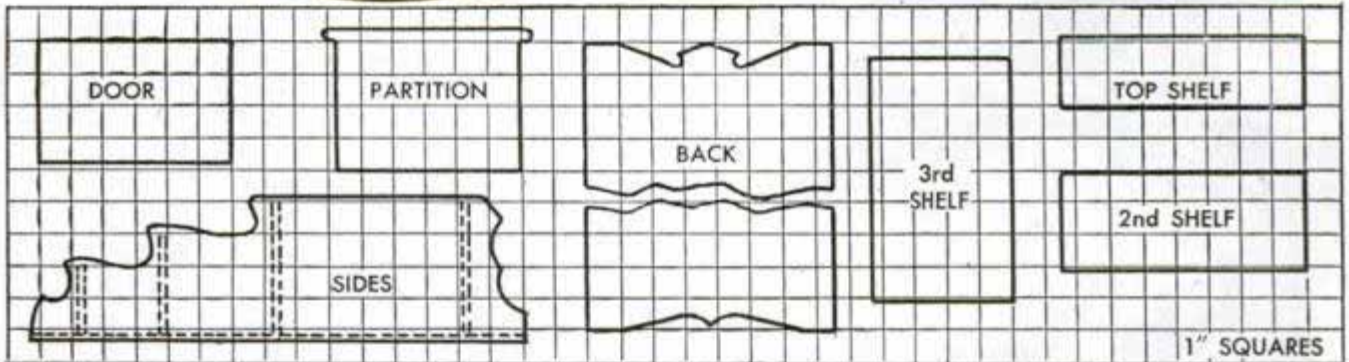
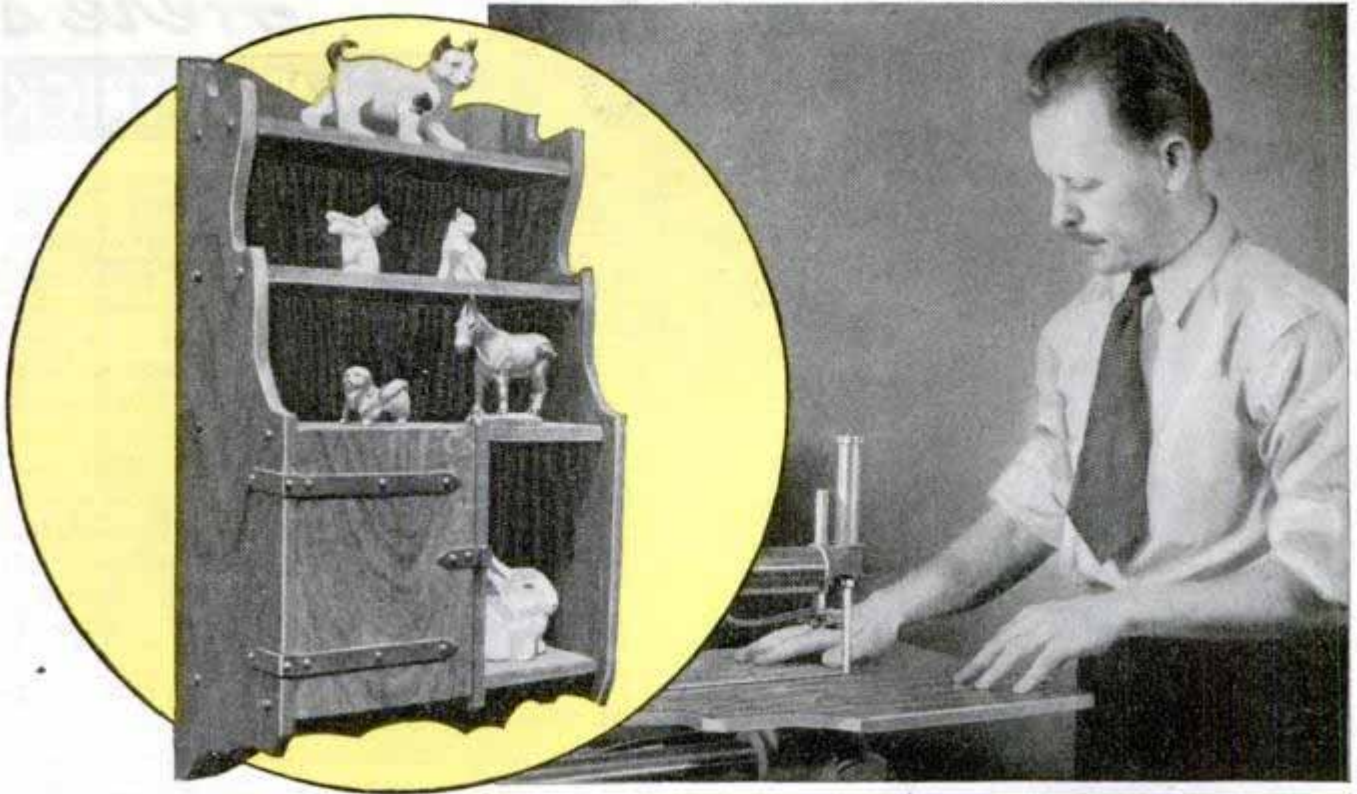

Scrap wood is just the material for a bric-a-brac cabinet like the one shown, which is trimmed with strips of hammered metal, and can be given an antique or weathered finish if desired. All pieces are $\frac{3}{8}$ -in. stock, planed and cut to the dimensions indicated in the cross-hatched detail. Although not shown on the drawing, the bottom shelf is the same size as the third shelf. The height of the back is $15\frac{1}{4}$ in. There is only one door, which swings on two butt hinges and

is closed by a hasp. This and the metal strips, which simulate ornamental strap hinges, can be formed from 22-ga. sheet copper indented with a ball-peen hammer, or strips cut from a sheet of tin will do. The metal should be polished with fine steel wool after hammering, then lacquered to prevent tarnishing or rusting. The cabinet is assembled with round-head wood screws and finished after assembly.

Dick Hutchinson, Ithaca, N. Y.

Drawer Pulls Fabricated From Copper Tubing and Wire

Neat drawer pulls can be made from $\frac{3}{8}$ -in. copper tubing polished with steel wool and formed around a large cylinder. The tubing is cut to length, the ends being cut at an angle to fit flat against the drawer. To attach a pull, a length of wire threaded at both ends and similarly formed is inserted through the tubing and through holes in the drawer. A nut and washer at each end holds it in place. The pulls should be lacquered to prevent tarnishing.

Pfc. Gordon P. Jones, Seattle, Wash.

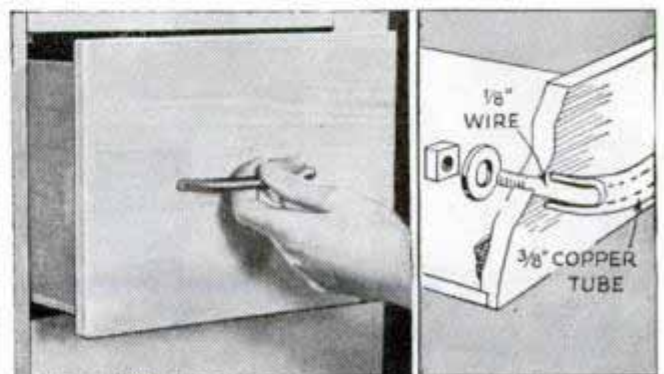

Here's SIMPLE TRICKS

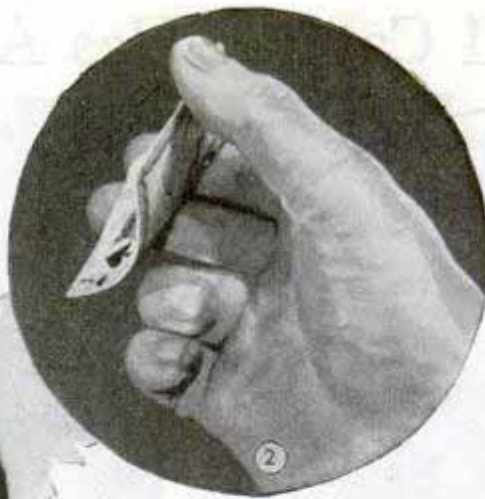

ALTHOUGH mystifying in effect, most magic tricks are easy to execute and depend mainly on the skill and dexterity of the performer for success. The illusions shown here do not require elaborate paraphernalia, but they should be well rehearsed before they are tried out. In addition to manual ability, a line of patter is considered a necessary accompaniment as it serves to distract the observer's attention as well as add to the amusement value of the occasion.

Effect: The first trick, Figs. 1 and 2, is card reading. The performer shuffles the deck and asks someone to select a card and place it on the bottom of the deck. Then, without looking at the card, he tells the audience what it is, in this case the jack of spades. As a variation, instead of putting the selected card on the bottom of the deck, it can be held in the left hand while the rest of the cards are held in the right hand. Then members of the audience can continue selecting cards from the deck which are read as the performer places them in his left hand, face toward the audience.

Method: The secret, of course, is the way in which the cards are held. If held as shown in Fig. 1 and tilted, Fig. 2, it is possible to see one corner of the face of the card while seeming to glance elsewhere.

Effect: Two paper matches of the kind that come in matchbooks are held between the thumb and forefinger, detail A of Fig. 3. A flip of the wrist and the matches, which had white sticks, now have black ones.

Method: The matches must be prepared beforehand. One side of each is blackened with a pencil. When they are shown to the audience as in detail A the white side is

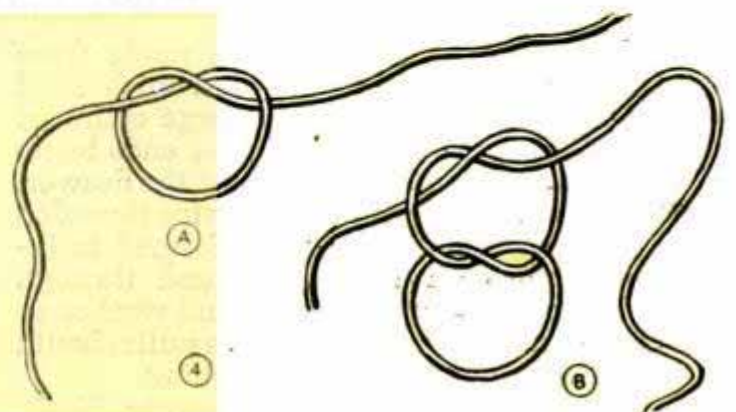
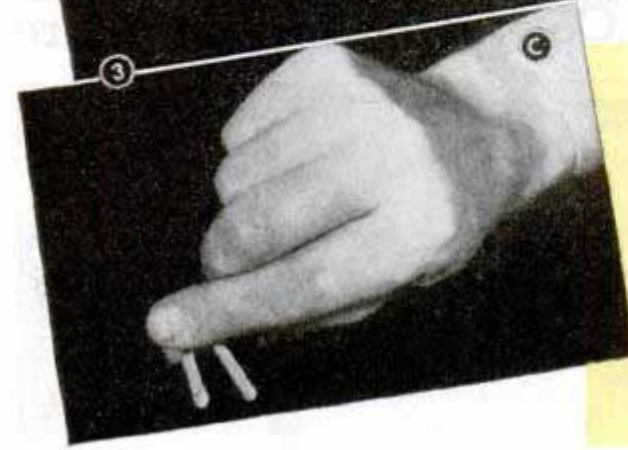
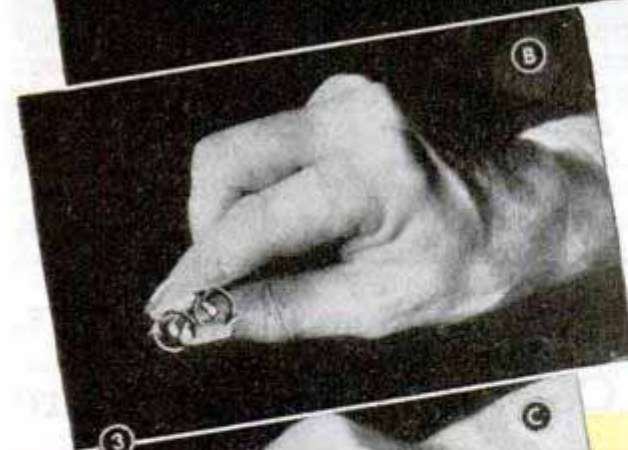

How It's Done

TO AMAZE YOUR FRIENDS

toward the observers. Then the hand is snapped down, details B and C, meanwhile rotating the matches, detail B, so that when the hand is returned to its original position, the black side is seen.

Effect: This is the knot that unties itself! Starting with an overhand knot, the magician proceeds to make the knot increasingly complex until, tiring of the whole procedure, he grasps the ends of the cord, pulls, and the knot unties itself.

Method: The manner in which the knot is made is given in details A, B, C and D of Fig. 4. Start with an overhand knot, and following, tie a square knot. Keep the knot loose so the additional figure eight shown in detail C may be made. When this is done the knot can be untied by pulling on the ends.

Effect: You can be "laughing up your sleeve" while blowing up your sleeve. In this trick a lighted wooden match is held in one hand and extinguished by blowing up the sleeve of the opposite hand, Fig. 5.

Method: Fig. 6 shows how the match must be held to accomplish the trick. When held between the two fingers with the thumbnail against the end of the match, it's easy to flick the match slightly, just enough to extinguish the flame, while pretending to blow up the opposite sleeve.

Effect: Take an apple with an unblemished skin and offer to bet that there is a coin inside. When sufficient interest is aroused the fruit is cut with a table knife to reveal a coin.

Method: The knife is prepared previously by fastening a coin to the blade near the handle with beeswax. This side of the knife is not seen. When cutting the apple, wedge the two halves apart and quickly slip the coin off the knife onto the apple. Then complete the cut and show the fruit and money.

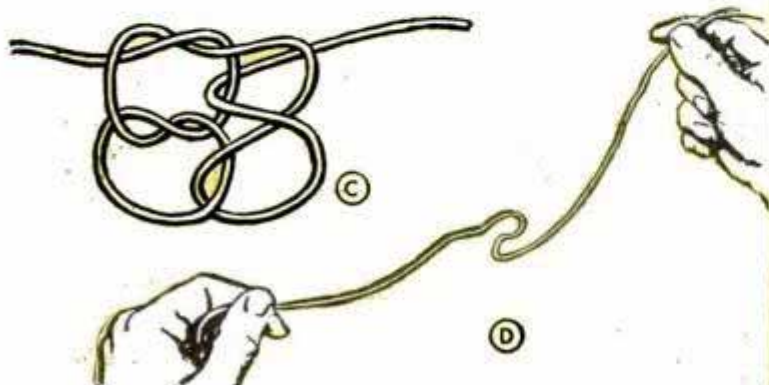

Plastics Can Be Polished on Drill Press With Sanding Disk

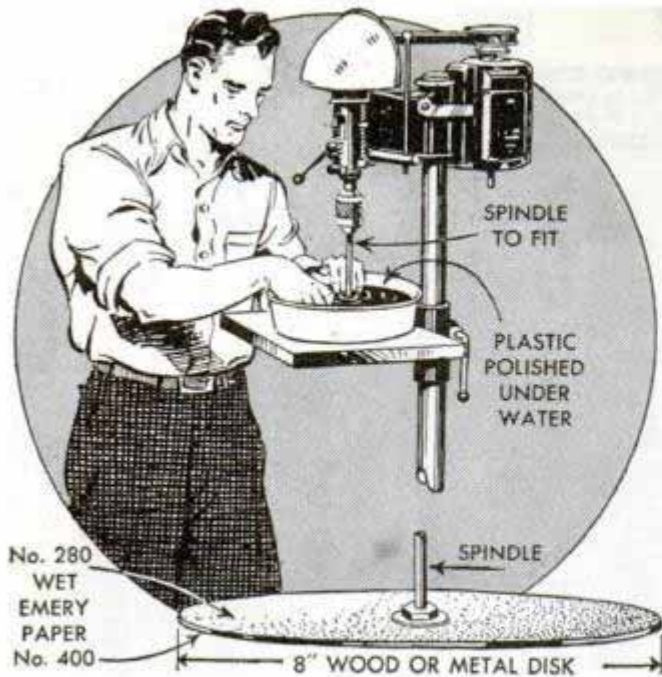

Plastics used for making novelties can be sanded with the aid of a drill press if no sander is available. An 8-in. disk of metal, or plywood of the type used in exterior construction, is drilled for a spindle, which can be a length of rod. One end of the rod is left-hand threaded to take two nuts and washers which lock the disk on the spindle. The disk is covered with No. 280-grit wet emery paper on one side, and on the other with paper of No. 400 grit, shellac being used as an adhesive. After the disk is mounted in the chuck, it is lowered into a pan of water set on the drill-press table and the plastic is rough-ground with the coarse paper. The disk then is removed and inverted on the spindle to polish the plastic with the fine-grit abrasive. A slow speed should be used for both the rough and the fine polishing.

Alfred T. Marles, Santa Monica, Calif.

Stamp Moistener Applies Cleaner To Two-Color Shoes

A postage-stamp moistener, consisting of a glass or plastic tube stoppered with a piece of sponge rubber, makes an excellent applicator for liquid white-shoe cleaner, especially for two-color shoes on which it



is difficult to apply a white cleaner without spreading it over the colored part of the shoe. The tube is filled with the cleaner and rubbed over the shoe so the flow is directed only where desired.—Allan Abramow, Rochester, N. Y.

Weights Will Straighten Records

When phonograph records become warped, they can be straightened by weighting them with books or other objects that cover the entire disk. Before attempting to straighten them, however, it should be made sure that they are at room temperature, since a cold record may crack. Add a few weights at a time at intervals of one hour. Usually it takes about 24 hours to straighten the records, but there is no harm in continuing the process longer.

Jean Brickman, Champaign, Ill.

☐ To remove chewing gum from clothing, place the garment in a refrigerator to chill and harden the gum thoroughly, and it can be scraped off easily with a knife.

Clothespins and Rubber Bands Hold Baby's Crib Covers

Instead of pinning a baby's crib covers to the mattress you can use spring-type clothespins over which rubber bands are slipped. These will stretch and allow the baby to turn freely, yet will hold the covers securely. When in use, a wide rubber band is slipped between the jaws of two clothespins, over the spring joints. One pin is clipped to the crib spring, while the other is fastened to the covers. Two sets of pins are used on each side of the crib.

James D. Callahan, Lincoln, Nebr.

Posters Attached to Bulletin Board By Concealed "Stickers"

It is easy to attach a poster to a bulletin board or wall with "stickers," or pieces of gummed-paper tape, so that these are not visible. The stickers are applied to the back of the poster, allowing half of each sticker to project beyond the edge. Then they are folded back, moistened and pressed against the wall or bulletin board.

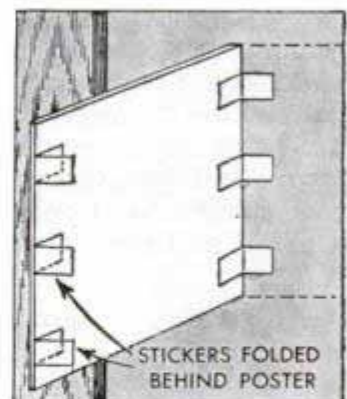

☐ Use a mixture of table salt and lemon juice for brightening copper vessels that have become blackened by contact with fire. Rinse them with tepid water.

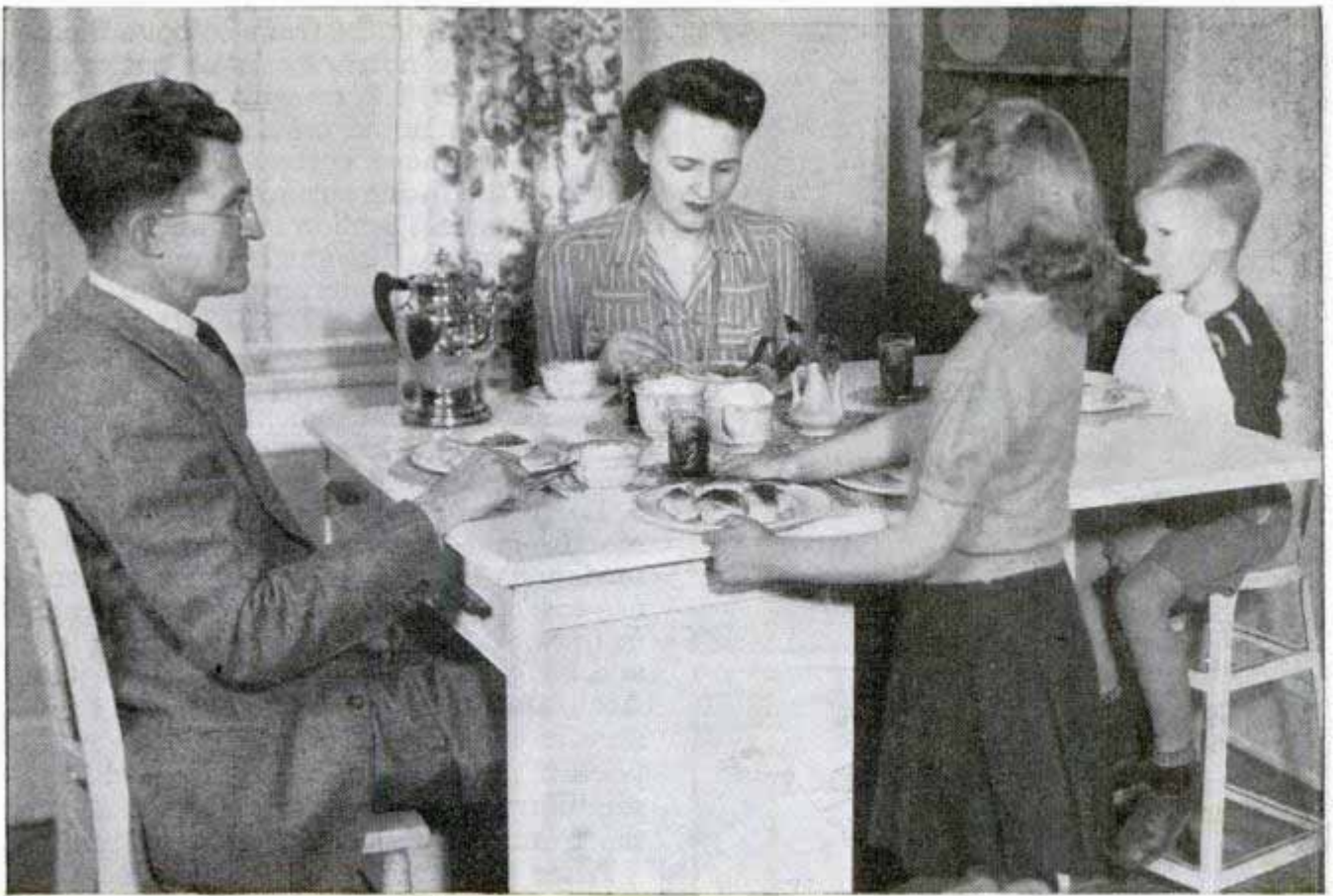

Kitchen Desk and Breakfast Table

By Charles E. Troutt

FINISHED in enamel or lacquer with brightly colored handles, this table adds a note of cheer to a room, and offers the utmost in utility and space saving. When used as a breakfast table it will seat four persons comfortably with ample space for coffee percolator, waffle iron, etc. By dropping the back leaf it becomes a kitchen desk, Fig. 7, and thereby folds to less than half its former size. The five drawers provide storage for kitchen linens and utensils. Fine cabinet woods are unnecessary, although the posts should be made of wood that can be turned satisfactorily.

Making the legs: Only the three front legs have feet turned on the lower ends.

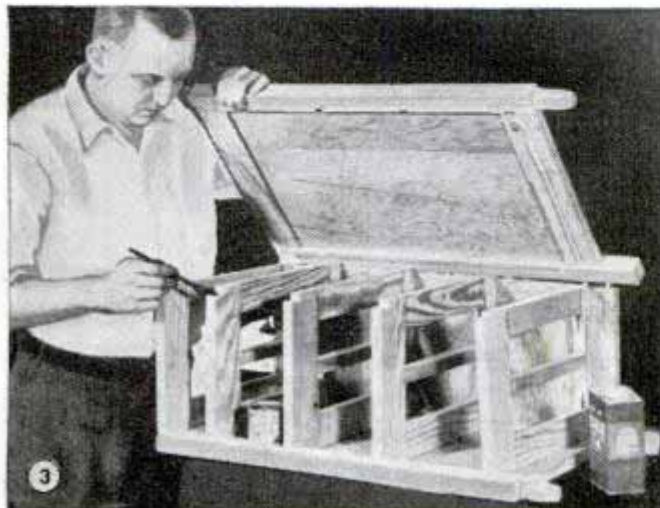

The back legs are square. Care should be taken to center exactly the legs that are to be turned, otherwise you will not be able to turn them to the dimensions given. Fig. 1 shows the bead being cut with a shaper cutter in a homemade holder. All legs are grooved $\frac{1}{4}$ by $\frac{5}{16}$ in. to receive the panels. The cuts should be stopped before reaching the turned feet and the ends of the grooves squared with a chisel. Also, all legs must be notched to receive the drawer

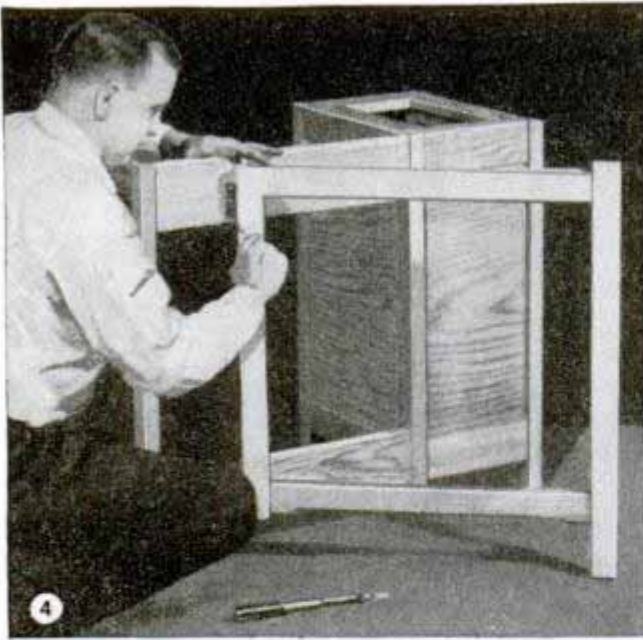

frames, including the frames above the top drawers. The notches can be cut with a router as in Fig. 2, or with a hand chisel. The legs are fluted on a shaper, using a 1/4-in. round-nose cutter. Note that the flutes on the inside surface of the legs next to the kneehole section stop before reaching the drawer. The single front rail at the bottom of the drawer section should have two flutes as shown in Fig. 6. It is necessary for the top back rails to be 4 3/4 in. wide to cover the back opening of the kneehole drawer. With the exception of the two back rails of the kneehole section, all rails are grooved on one side for 1/4-in. panels.

The drawer frames: These are of open mortise-and-tenon construction, 1/4 by 1/2-in. tenons being used. Before the frames are assembled, cut a notch 1/2 in. deep and 3/4 in. wide in the center edge of each front and back rail to receive the drawer guide. Accurate centering of the notch is necessary as any discrepancy would be multiplied if the rail ends were reversed in assembling. The molded shape on the edge of the front rail also is cut before assembly.

After the drawer frames are assembled and before the guides are glued in, notch each corner as indicated in the circular de-

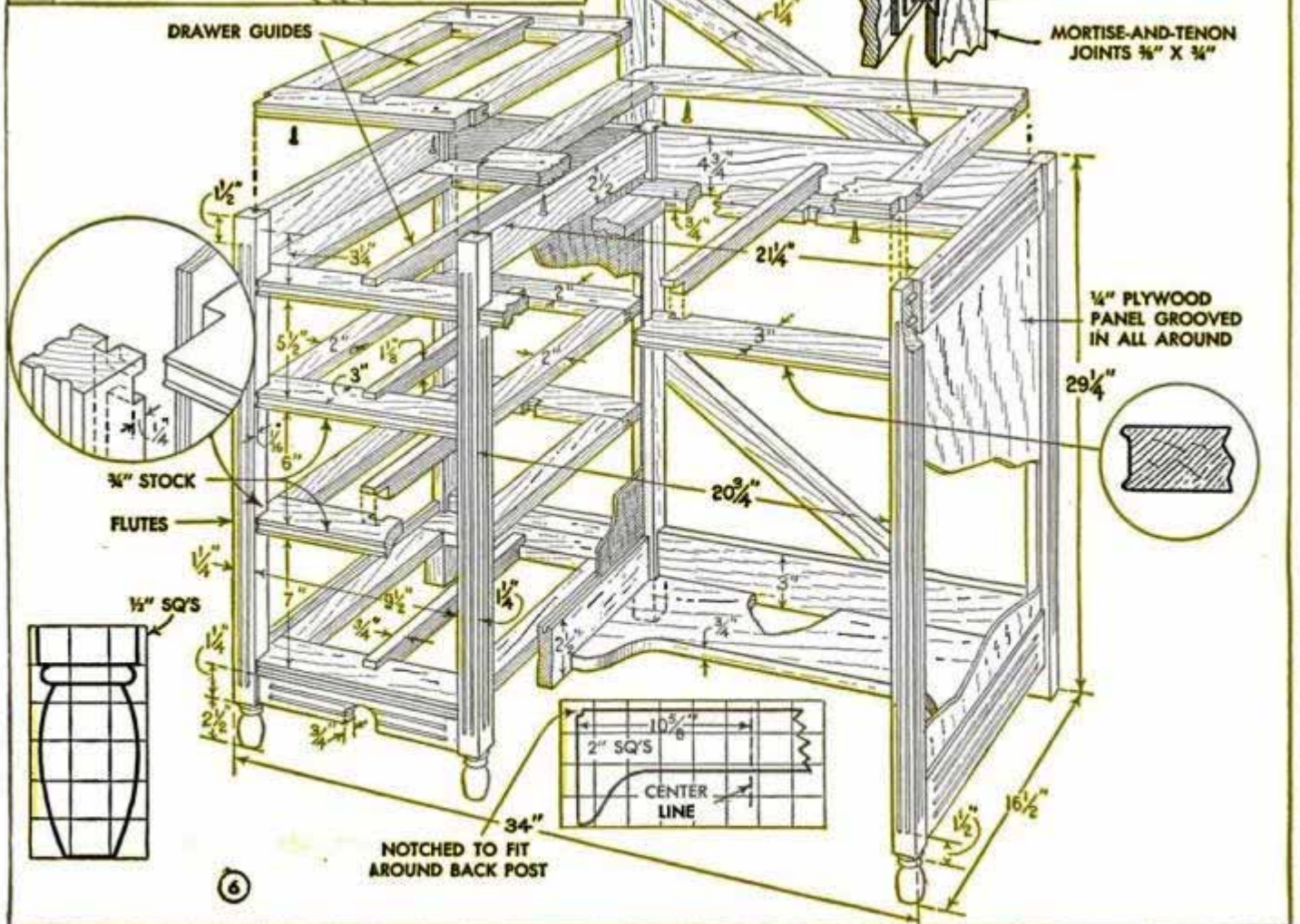
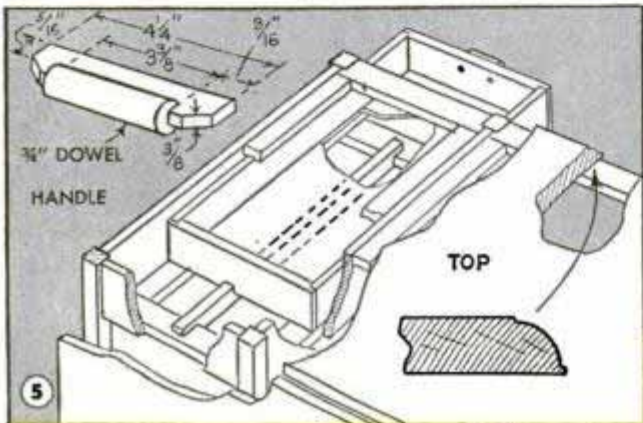

tail of Fig. 6. The drawer guides also will serve as drawer stops if they are notched to come within $\frac{7}{8}$ in. of the front edge of the front rail. Detail for the bottom knee-hole brace is given in the plan. The back corners are notched to fit around the legs.

The drop leaf and support: In making the support, note that the top rail is mortised into the outside stile $\frac{1}{2}$ in. down from the top, but that it is flush with the top of the inside stile, Figs. 4 and 8. These mortises are best cut with a hollow chisel on a drill press. In joining stock for the top, warping can be minimized by using pieces not over 4 in. wide and reversing the end grain in alternate pieces. To assure a close butt joint between the drop leaf and the desk top when the leaf is raised, it is necessary to cut a shallow recess for the hinge pin in both pieces. Mold all edges except those where the top and drop leaf are butted together.

Drawers and pulls: No exact dimensions are given for the drawers as the pieces vary with the type of joint used. Dovetail joints are preferred, although a simple rabbeted joint will serve the purpose. Regardless of the type of joint, the drawer bottoms should set up $\frac{1}{2}$ in. from the bottom edge, and there should be a notch $1\frac{3}{16}$ in. wide by $\frac{1}{2}$ in. deep cut in the bottom edge of the drawer back to fit over the guide. Fig. 5 shows how this notch fits over the drawer guide. Details for a simple and attractive drawer pull also are given. Holes for attachment screws should be drilled in the base before the pull is assembled. The top part of the pull is a $\frac{3}{4}$ -in. dowel grooved to fit over the base. After cutting the four panels you are ready for final assembly. Note that one panel must be sound on both sides. In the event plywood is not available, hard-pressed board can be substituted.

Final assembly: Sand as many of the pieces as possible before assembly. All rails are doweled to the legs. It is advisable to improvise a jig to hold the rails rigidly up-



right while drilling the dowel holes in the end grain.

Glue the two side panels and the center panel first, Fig. 3. The panel that is good on both sides goes between the right-hand legs. The drop-leaf support and the drawer frames should be glued at this time. Be sure to drill the dowel holes for the back rails, as well as the dowel holes for the bottom knee-hole-section brace, before this gluing operation. Since the top is screwed in place, the holes should be drilled and countersunk on the bottom side of the top drawer frames. These two frames are doweled to the side rails for extra strength.

The drop-leaf support is hinged to the back rails, and filler blocks must be used under the hinges to align the support with the posts. Attach the top, leaving a $\frac{3}{4}$ -in. overhang on the front and sides. A block should be screwed to the underside of the drop leaf to stop the support when it swings out to the center of the leaf. Sufficient sanding with the proper grit of paper is necessary for a good finish. Use a very fine grit for the final sanding and slightly round the corners of the legs. Follow with a sealer to prevent the grain from raising and showing through the finishing coats. Apply lacquer or enamel as it comes from the can and be careful that it does not sag on the vertical surfaces. Use a quick-drying enamel.

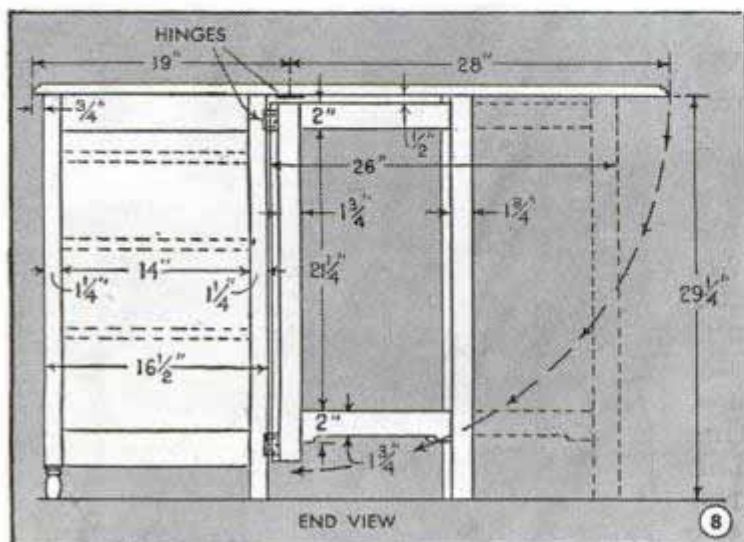

Novel Brooch Is Cut From Bullet And Cartridge Case

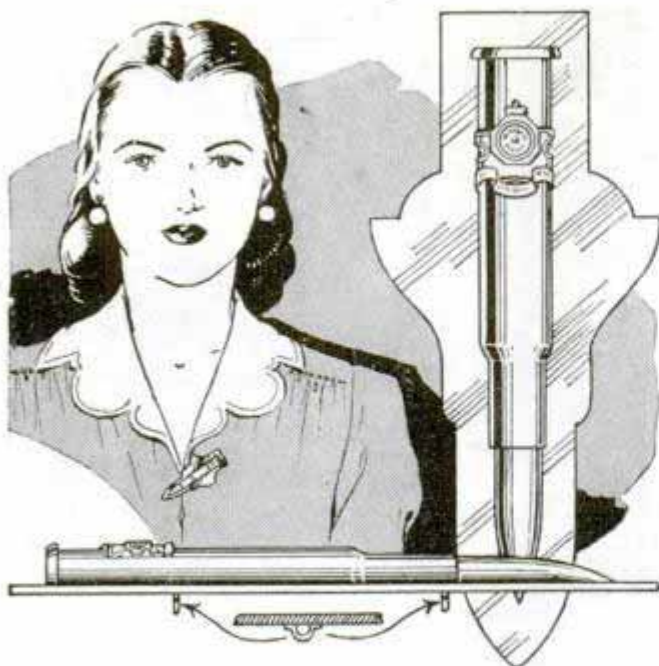

Decorative and attractive, this novel brooch is made from a .30-caliber cartridge case and bullet. The case can be either the rim or rimless type, but be sure that both powder charge and primer have been removed from the case before sawing or otherwise altering it. Don't remove either the powder charge or the primer from a "live" cartridge unless you are thoroughly familiar with this operation. Both the empty case and the bullet are sawed in half longitudinally and the rough edges are smoothed on a sheet of emery cloth laid on a flat surface. Then one half of each piece is soldered to a strip of brass filed and finished to the shape shown. If desired, the brooch can be decorated with an emblem shaped from thin brass and soldered in place. Polished surfaces should be coated with clear lacquer to prevent tarnishing. Two wire loops on the back of the brooch are for small safety pins used to attach it to the wearer's clothing.

Peter B. Horsley, Pembroke, Ont., Can.

Adjustable Wooden Hold-down

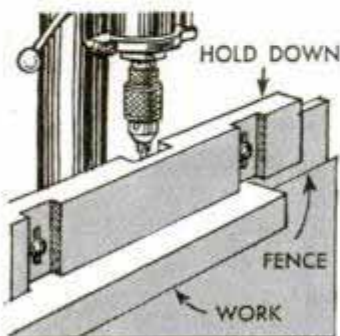

To hold work flat while being surfaced with a drill-press shaping tool, an adjustable wooden hold-down bolted to the fence will assure smooth, even cutting with no danger of gouging the work. The hold-down, which is made from a length of 2 by 4-in. stock or similar material, is recessed in the center to fit around the cutter-

head, and near each end for bolts inserted through slots that allow adjustment of the hold-down. The lower edge is rubbed with paraffin to permit work to slide freely.

E. West, Berkeley, Calif.

Cups Serve as "Cash Boxes"

When serving as cashier at a club social, if no cash register is available you will find that cups are better than biscuit tins or cigar boxes for holding coins. The rounded bottoms of ordinary coffee cups make it easy to remove the coins. Since the cups occupy little space in a table drawer, one can be used for each denomination.

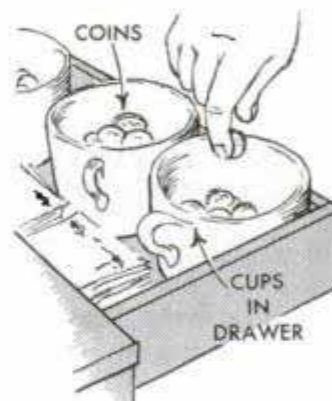

Lard Cleans Tar from Cloth

Tar usually can be removed from washable fabrics by rubbing lard over the spot and scraping it off as it becomes discolored. More lard is added and scraped off until the tar is out. After this, the cloth is washed in heavy suds to cleanse it of lard.

Joseph G. Cleveland, Minneapolis, Minn.

Cellulose Tape on Lipstick Holder Prevents Cap from Falling Off

If the cap on a lipstick holder is so loose that it drops off, this annoyance can be overcome by wrapping a piece of cellulose tape around the holder at the edge. The tape is hardly noticeable, and will pad the holder enough to keep the cap secure.

Benjamin Nielsen, Aurora, Nebr.

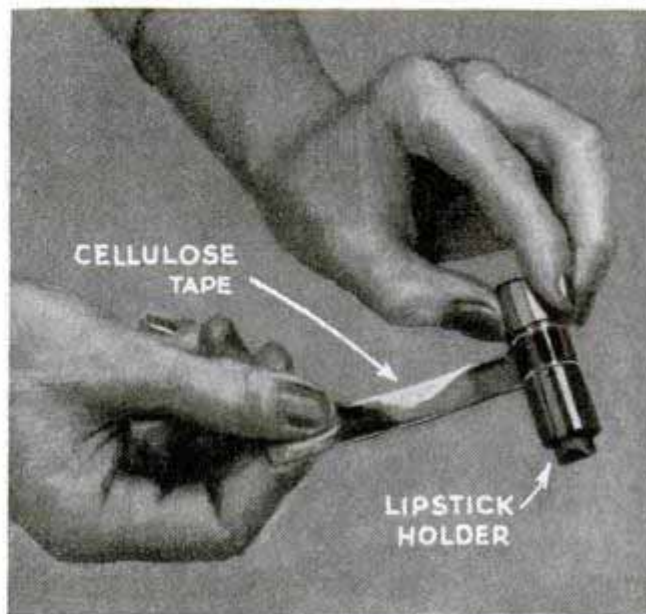

CARVED DESK SET

Decorative Inlays



By Carmen J. Gentile

WITH the exception of a few small items, such as the ivory used for initials, this desk set is built of either holly or birch and inlaid with walnut. Although carving the panel that forms the back-ground may seem difficult, if done with care the result will be satisfactory. The back panel, which can be a starting point, is inlaid and sawed to shape. Fig. 1 shows the panel being routed to the dimensions indicated in Fig. 4. The inlay for the carved part is $\frac{1}{2}$ in. thick, while the smaller inlays are $\frac{1}{8}$ in. for both panel and base.

After the walnut has been glued in and the panel cut to the dimensions indicated in Fig. 4, plane and sand the surfaces and chamfer the edges. In the same

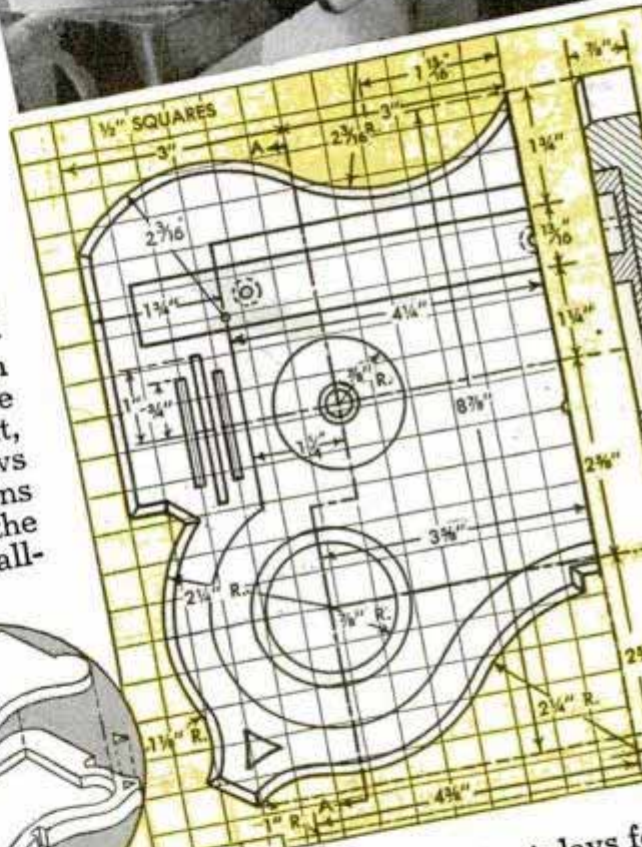
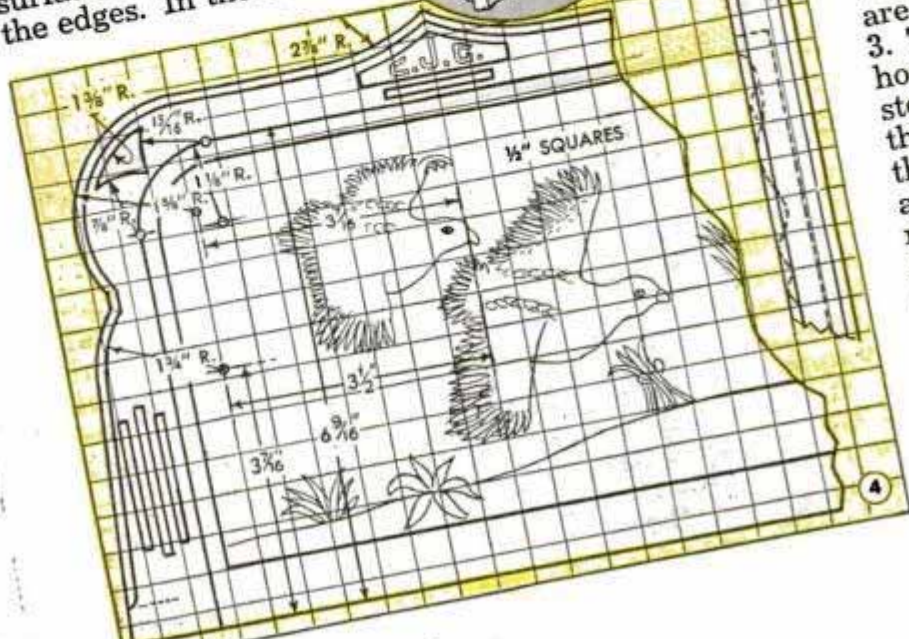
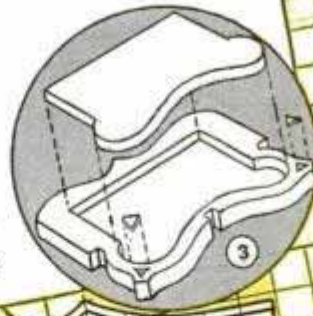

manner, the inlays are cut and finished. 3. The larger inlay, however, is only $\frac{3}{8}$ in. thick, as in the panel. Referring to the recesses for the inlays, they are $\frac{1}{4}$ in. deep, as is the recess for the back panel. The inlays are drilled and finished in the same manner as detail A, for the inlays in the panel. The inlays are approximately $\frac{1}{2}$ in. deep.





cessed and glued into each cap. To hold the caps when ink is being used, a wire ring, Fig. 8, is bent as being used, a wire ring, The birds carved on the sign base on paper and transfer a carbon paper. Then cut a gouge or small inlay can be cut from the piece of walnut. Just before assembly, give the holders and collars a coat of shellac rubbed down with fine steel wool. Assemble the holders as shown in Fig. 6 and glue and clamp them to the base. The panel then is glued and screwed to the base, after which the covers for the ink bottles has glued and clamped. When the adhesive with fine sandpaper, except for the carving which can be high lighted with steel wool. To finish the set, apply a coat of boiled linseed oil to the walnut parts, masking off

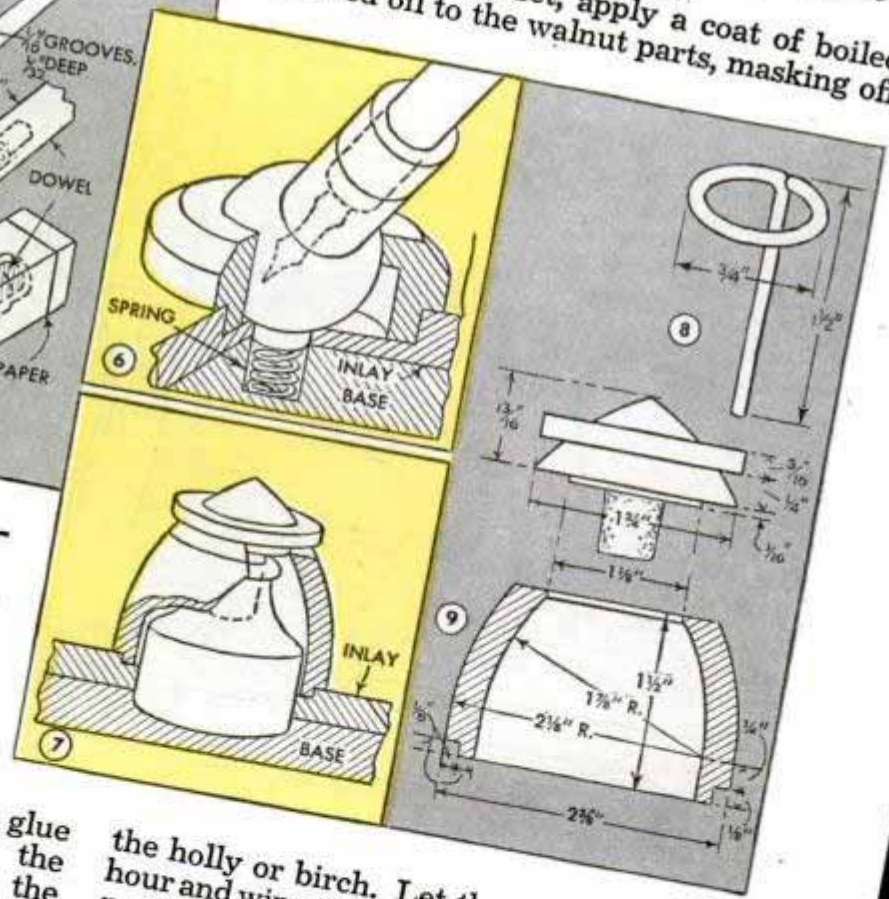
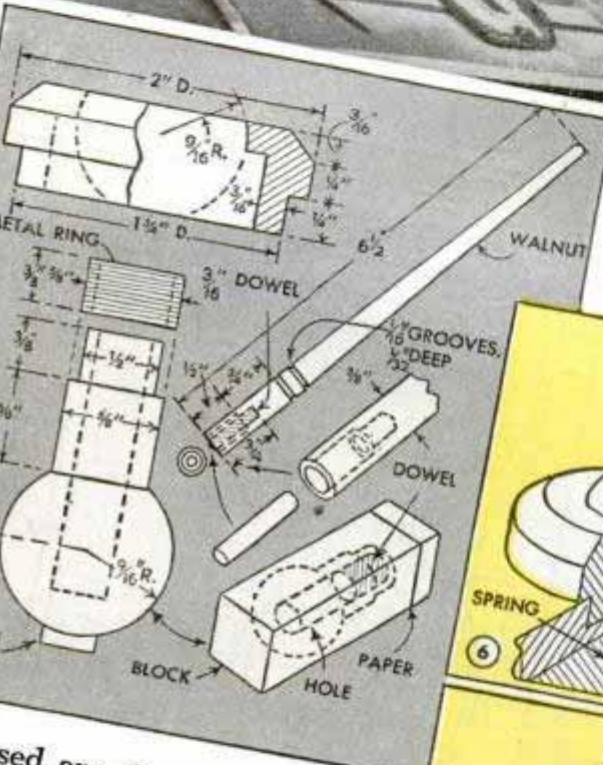

ed are those which con- ink. nut collars for the pen- upper left-hand detail of turned on a lathe, using to check the curvature into which the balls fit. ng the holly-ball pen- t drill 3/8-in. holes for g them with dowels and glue ck with paper between the d. Then turn the ball to the dicated in the lower details complete assembly is shown buttons on which the balls Fig. 5. Shown in the upper il of Fig. 5, the pens are diameter sanded down to The ink-bottle covers and 9, are built of walnut and 9, respectively. A cork is re-

the holly or birch. Let the oil stand for 1/2 hour and wipe with a cloth dampened in turpentine. Then, using thin shellac, brush all surfaces except the inside of the carved panel. Rub down the shellac with fine steel wool and apply a light second coat of linseed oil to the panel, working it in well. Let the set dry for about 24 hours and finish with two coats of furniture wax. To prevent scratching the desk, felt should be glued to the base. The metal ring or ferrule for the penholder and the wire cork holder are added after the set is finished.

CARVED DESK SET

Has Decorative Inlays

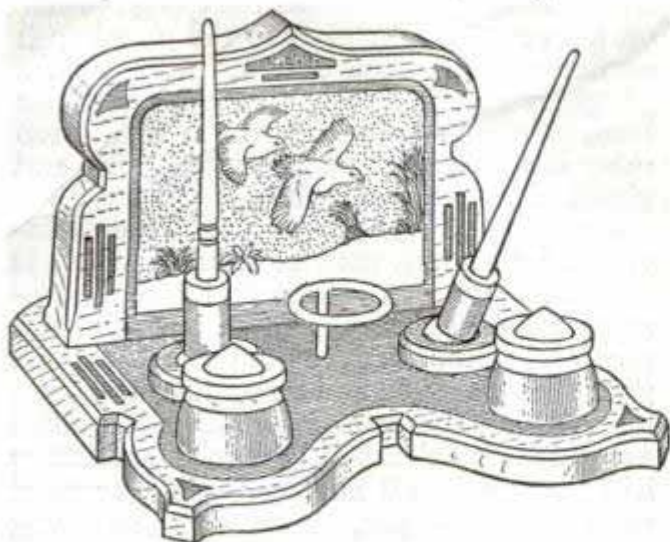

By Carmen J. Gentile

WITH the exception of a few small items, such as the ivory used for initials, this desk set is built of either holly or birch and inlaid with walnut. Although carving the panel that forms the background may seem difficult, if done with care the result will be satisfactory. The back panel, which can be a starting point, is inlaid and sawed to shape. Fig. 1 shows the panel being routed to the dimensions indicated in Fig. 4. The inlay for the carved part is $\frac{1}{2}$ in. thick, while the smaller inlays are $\frac{1}{8}$ in. for both panel and base.

After the walnut has been glued in and the panel cut to the dimensions indicated in Fig. 4, plane and sand the surfaces and chamfer the edges. In the same

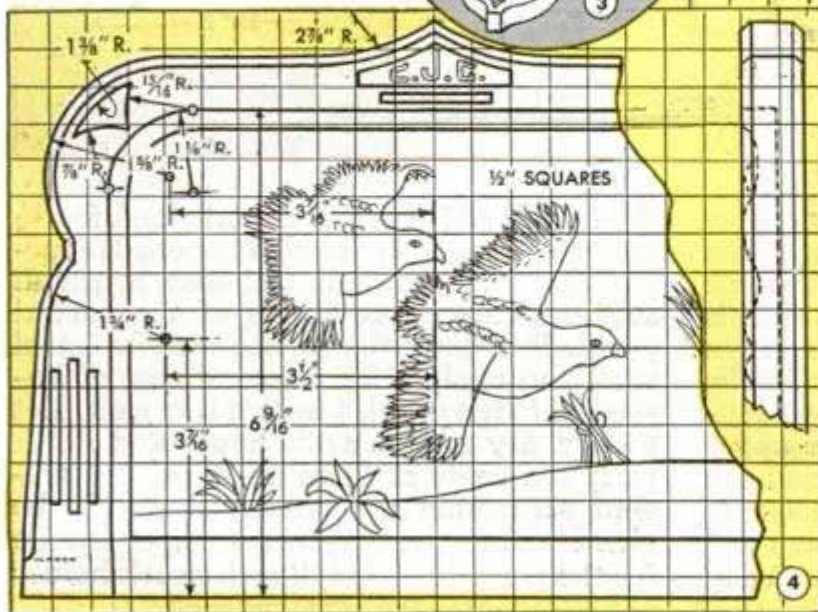
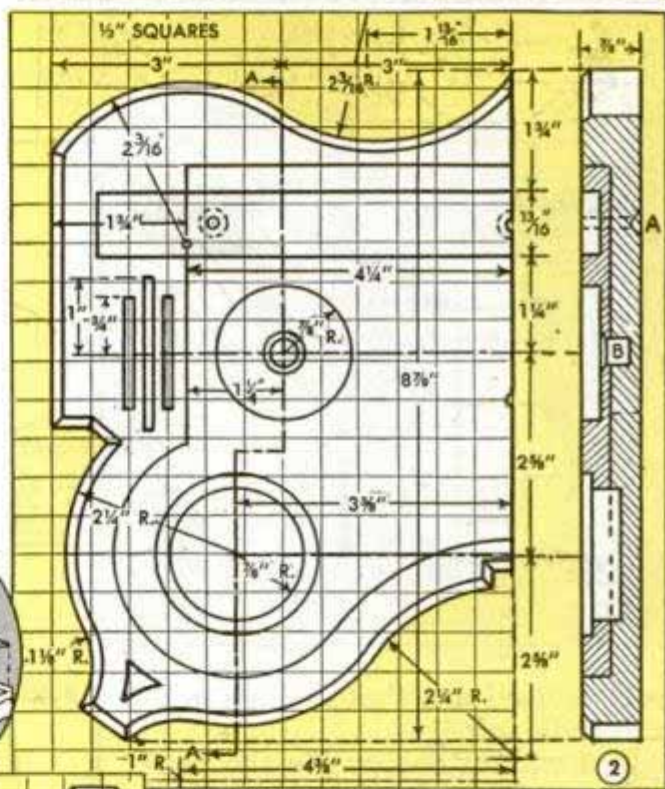
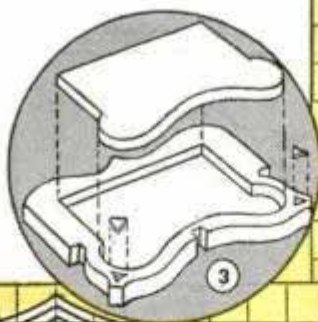

manner, the inlays for the base are cut and finished, Figs. 2 and 3. The larger inlay for the base, however, is only $\frac{3}{8}$ in. thick instead of $\frac{1}{2}$ in. as in the case of the panel. Referring to Fig. 2, the recesses for the penholders are $\frac{1}{4}$ in., as is the groove that receives the back panel. Holes are drilled and countersunk, detail A, for three No. 12, 1-in. flathead wood screws to hold the panel. The spring compartments, detail B and Fig. 6, are approximately $\frac{3}{4}$ in. deep and the recesses for the inkwells $\frac{1}{2}$ in. deep. Note that the ink

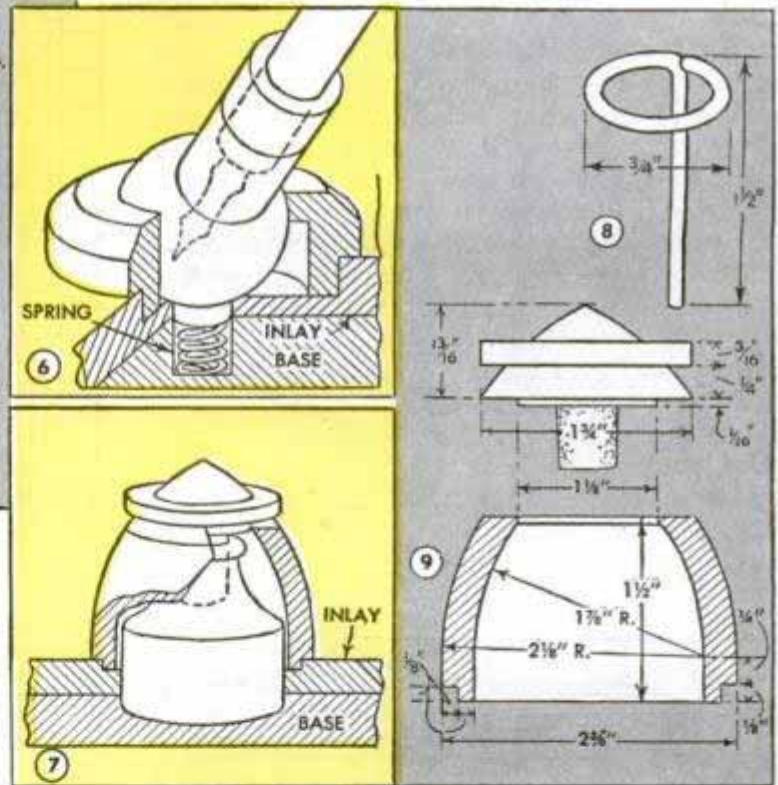
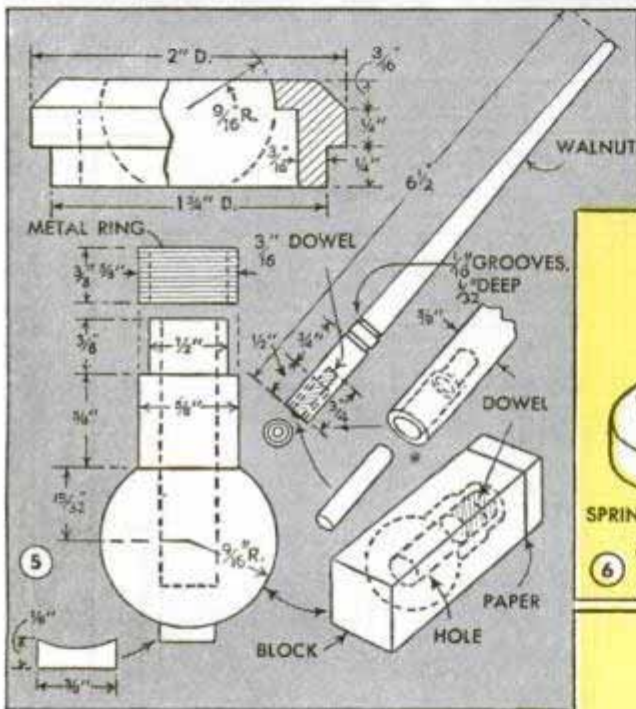
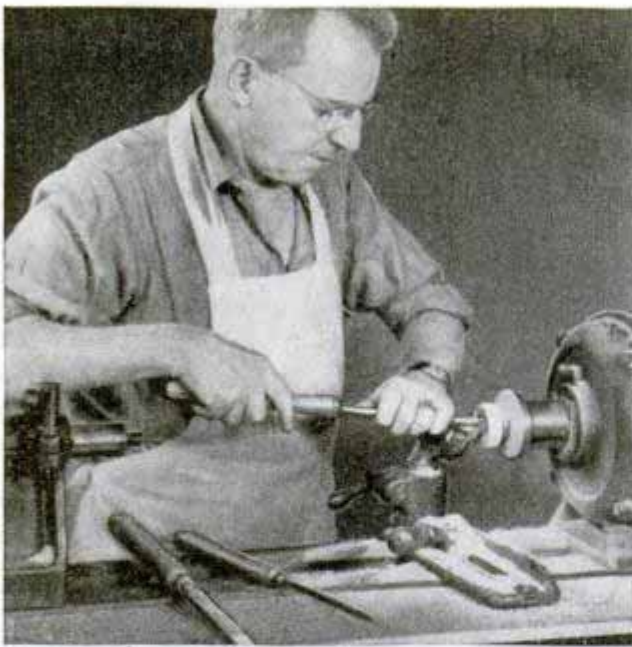

bottles used are those which contain India ink.

The walnut collars for the penholders, upper left-hand detail of Fig. 5, are turned on a lathe, using a template to check the curvature of the rings into which the balls fit. When making the holly-ball penholders, first drill $\frac{3}{8}$ -in. holes for the pens, plug them with dowels and glue on waste stock with paper between the pieces of wood. Then turn the ball to the dimensions indicated in the lower details of Fig. 5. The complete assembly is shown in Fig. 6. The buttons on which the balls ride also are dimensioned in the lower left-hand detail of Fig. 5. Shown in the upper right-hand detail of Fig. 5, the pens are about $\frac{3}{8}$ in. in diameter sanded down to fit the holders. The ink-bottle covers and caps, Figs. 7 and 9, are built of walnut and holly or birch respectively. A cork is re-

cessed and glued into each cap. To hold the caps when ink is being used, a wire ring, Fig. 8, is bent as shown to set in the base.

The birds carved on the back panel are bobwhites in flight. Draw the design to size on paper and transfer it to the panel with carbon paper. Then cut the relief with a gouge or small chisel. After the panel has been carved, the initials shown in the top inlay can be cut from a strip of ivory and glued in the piece of walnut.

Just before assembly, give the penholders and collars a coat of shellac which is rubbed down with fine steel wool. Assemble the holders as shown in Fig. 6 and glue and clamp them to the base. The back panel then is glued and screwed to the base, after which the covers for the ink bottles are glued and clamped. When the adhesive has hardened, all surfaces are smoothed with fine sandpaper, except for the carving which can be high lighted with steel wool to give an antiqued effect.

To finish the set, apply a coat of boiled linseed oil to the walnut parts, masking off

the holly or birch. Let the oil stand for $\frac{1}{2}$ hour and wipe with a cloth dampened in turpentine. Then, using thin shellac, brush all surfaces except the inside of the carved panel. Rub down the shellac with fine steel wool and apply a light second coat of linseed oil to the panel, working it in well. Let the set dry for about 24 hours and finish with two coats of furniture wax. To prevent scratching the desk, felt should be glued to the base. The metal ring or ferrule for the penholder and the wire cork holder are added after the set is finished.

This Spice Chest Holds Coffee-Can Containers

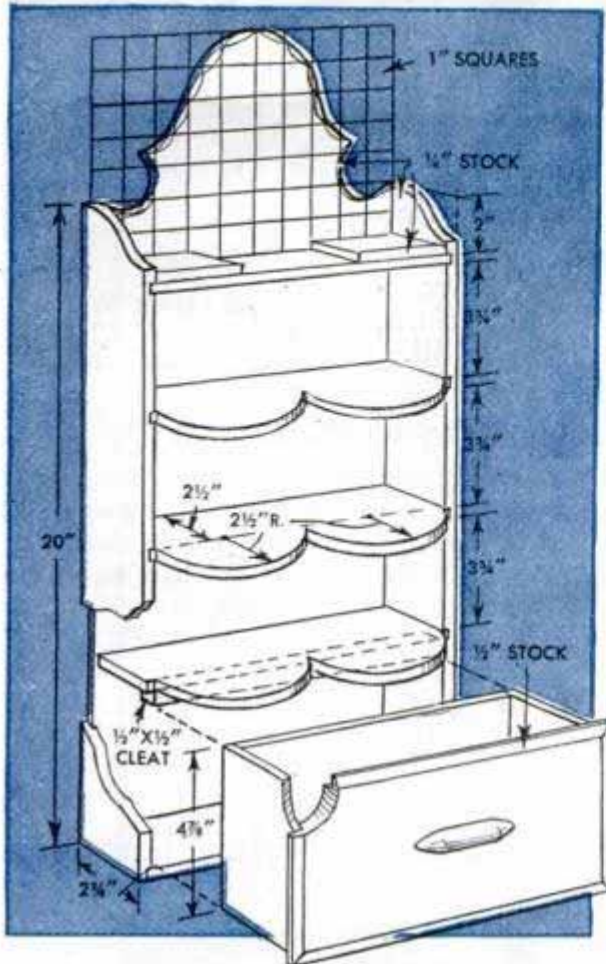

This step-saving spice chest provides storage for all the food-seasoning ingredients right within arm's reach of the kitchen range or work table. Shelves are so arranged that each one supports two coffee cans of the 1-lb. size side by side. These serve as containers for coffee, raisins, powdered sugar and other items. Two aluminum shakers for salt and pepper occupy the top shelf and the small drawer at the bottom easily holds five or six spice containers. All parts are cut from 1/4-in. plywood except the drawer front which is 1/2-in. stock.

Before you cut any material, save six coffee cans of uniform size and figure the dimensions from these. Note that the cans overhang the shelves slightly and that the edges are cut to the contour of the cans. Groove the side pieces about 1/8 by 1/4 in. to take the shelves, which are glued in. The drawer is of ordinary construction, sides being joined to the front with rabbeted joints. Enamel the chest to harmonize with the kitchen cabinetwork and decorate with colored transfers to suit your taste.

L. H. Young, Pismo Beach, Calif.



100 W.P. Adjustable Fixture Clamps Work For Fine Engraving

Small work such as wood blocks and signet rings that are to be engraved can be held firmly in an adjustable fixture like the one that is shown here. The fixture, which can be made of any convenient size to fit the work, consists of a 3/4-in. hardwood frame screwed to a sheet-metal base, several spacers and two wedges, also of hardwood. Screws are driven through holes countersunk in the base into the underside of the frame to form a tray for the spacers. In use, the spacers are positioned on either side of the work and the wedges are driven in to clamp the latter securely.

Samuel Bergman, New Rochelle, N. Y.

Gauge Measures Warped Frame To Fit Storm Sash Exactly

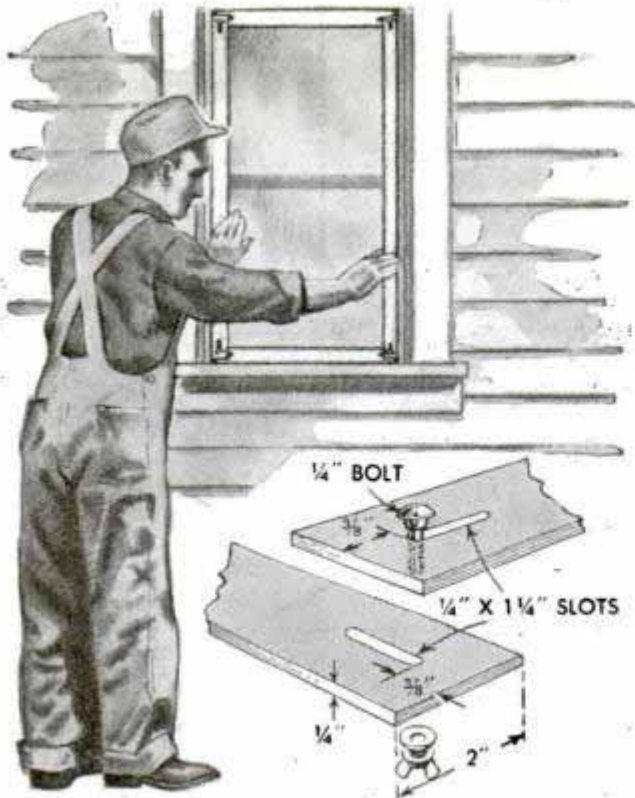

With an adjustable gauge made of light wood, storm windows can be fitted exactly into old sash frames that are out of square. The gauge consists of four strips of $\frac{1}{4}$ by 2-in. stock cut $\frac{1}{4}$ in. shorter than the dimensions of the largest window to be fitted. The strips are assembled to form a frame that fits into the window, a slot being cut near the end of each strip to take a bolt, which is held by a washer and wing nut. The gauge is fitted to the sash frame and used as a pattern for the storm sash which is cut to fit exactly. After using the gauge on the largest window, the strips are shortened to fit loosely into the next largest window frame and so on until all windows have been fitted.

E. V. Briceland, Toronto, Ont., Can.

Disk Will Reface Faucet Seats

If a nonrenewable faucet seat becomes rough or corroded so a new washer will not stop the leak, it can be refaced with this tool. Backing up an abrasive disk are a faucet washer and a steel washer. The

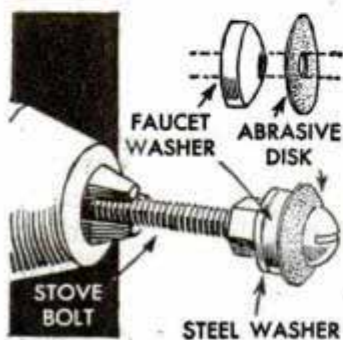

whole assembly is tightened on the bolt with a nut and the jig is ready for action. Used in a hand drill, a few hundred revolutions will serve to reface the seat.—William G. Campbell, Duluth, Minn.

Steam Bath Restores Fishing Flies

If your favorite fishing flies are matted and bedraggled, you can restore their fluffiness by steaming them. This is done by holding the fly over a teakettle spout with tweezers.—D. E. Horn, River Forest, Ill.

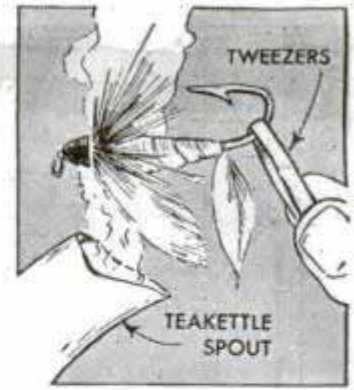

Easy Way to Rehang a Door

When rehangng a door that has been taken down for repairs, you will be able to slip in the upper hinge pin more easily if you first loosen the screws holding half the lower hinge on the door jamb, then join the parts and insert the pin. Loosening half the lower hinge permits the door to be tilted slightly to align the halves of the upper hinge for inserting the pin.

E. L. Reynolds, Bronxville, N. Y.

Zipper Key Purse Holds Fishhooks



One fisherman found that a very serviceable fishhook container can be made from a key purse. The key clips are removed and three small holes are punched in the leather lining for each hook.

A. M. Wettach, Mt. Pleasant, Iowa.

☛ An easy way to stop the blowing of a car horn that is stuck is to strike the relay a sharp blow with a hammer or wrench to separate the contacts.

Kiltie Model RACING YACHT Of the Wee Six Class

By John Black

Ex-President International Model Yacht Racing Union

KILTIE was built to a scale of $1\frac{3}{8}$ in. to the foot. The Wee Six, as this class is called, ranges in size from 36 to 40 in. on the waterline with overall lengths between 56 and 65 in. The minimum displacement varies from 19 lbs. on a 36-in. waterline to 25.5 lbs. on a 40-in. waterline, and the sail area varies between 1150 and 1300 sq. in.

To begin construction, make a full-size drawing of the lift plan in Fig. 2, in the center of a 24 by 72-in. building board. Extend each of the station lines across the width of the board and number them. The other side of the board is used to lay out the profile view, in Fig. 2. Transfer the fore-and-aft centerline, station No. 5 and the curve of the various lifts to $\frac{1}{8}$ -in. plywood from which templates are cut. Only one side of the lift need be made as the same template can be used on either side of the fore-and-aft centerline.

As the greatest beam of Kiltie is $11\frac{1}{4}$ in. use stock $\frac{13}{16}$ in. thick and 12 in. wide. Start by laying out lift No. 1. Lifts 1, 2 and 3 should be cut to extreme beam. Tumble-

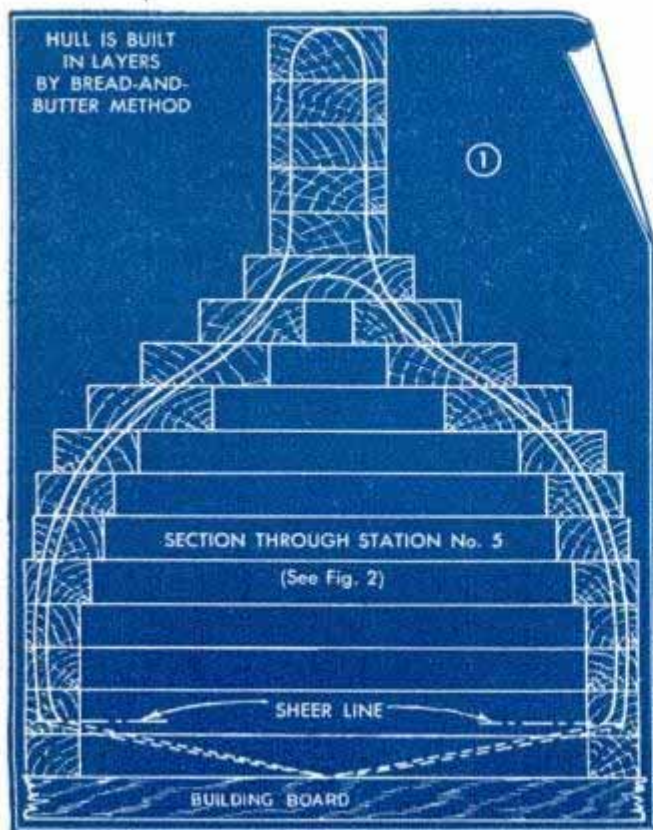
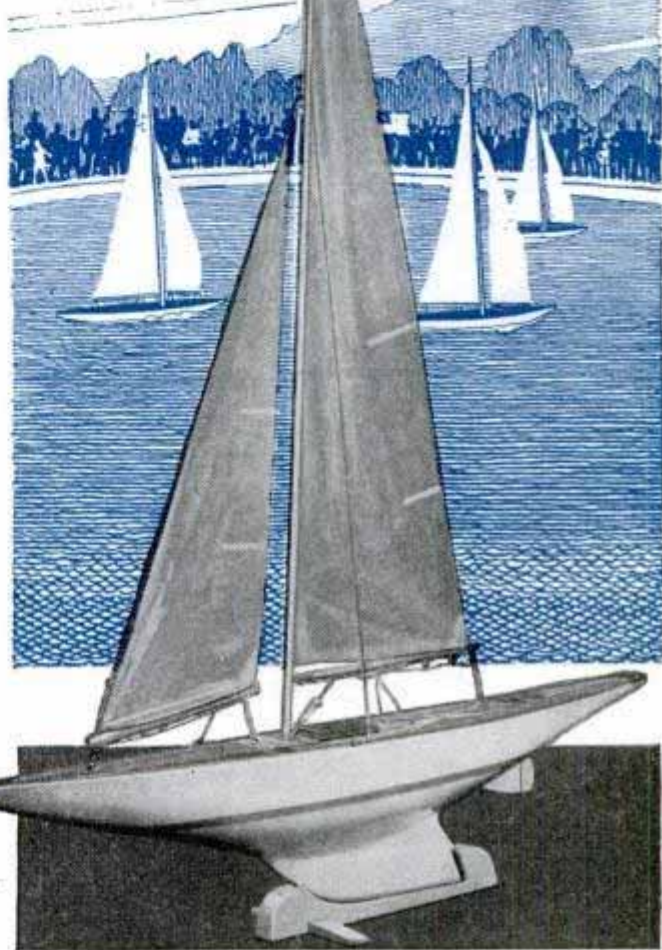

home is shaped later. On each side of a fore-and-aft centerline make a sharp pencil line along the curve of the template. Mark station No. 5 and the bow end as in Fig. 3 on the first seven lifts. To find the cutout line on lift No. 6, take template No. 7, using the fore-and-aft centerline and station No. 5 as locating points and draw a line on the board. Then move template No. 7 back from the line about $\frac{3}{4}$ in. and make another line. Repeat this operation on the other side of the fore-and-aft centerline. The third line will be the cutout line. See lower left-hand detail of Fig. 2. Cut on a jigsaw as in Fig. 5. The remaining lifts can be made from stock cut out of the first seven lifts. Cutouts should be made in all the lifts up to No. 10.

When all lifts have been cut you are ready to start gluing. Use waterproof glue and prime each coat. Glue the first three lifts, clamp at both sides of station No. 5, then apply more clamps progressively fore and aft. After the glue dries, apply the next two lifts and repeat the procedure. Check

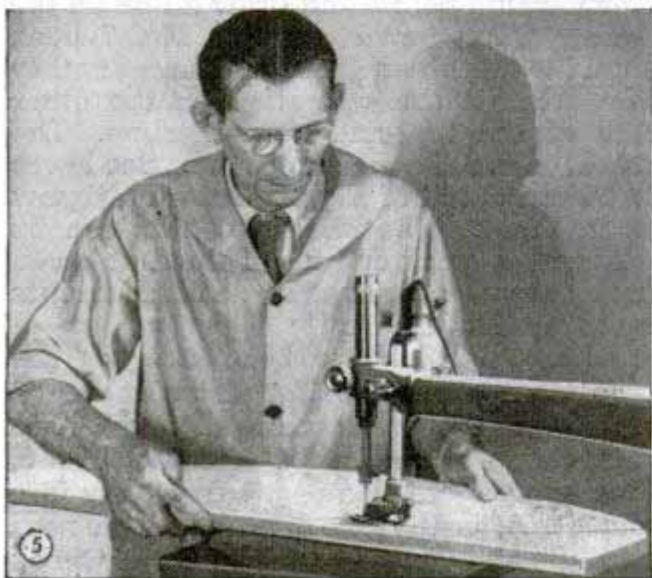
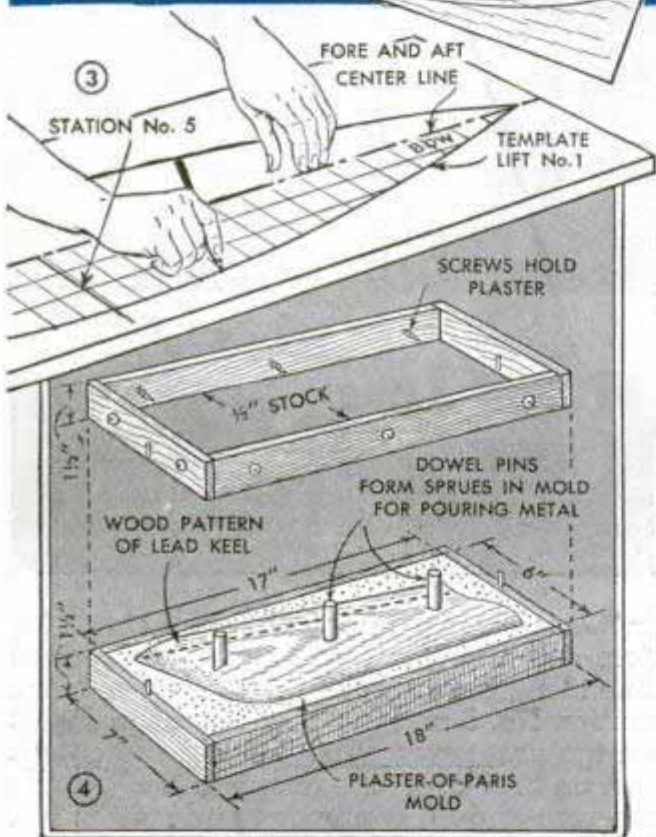
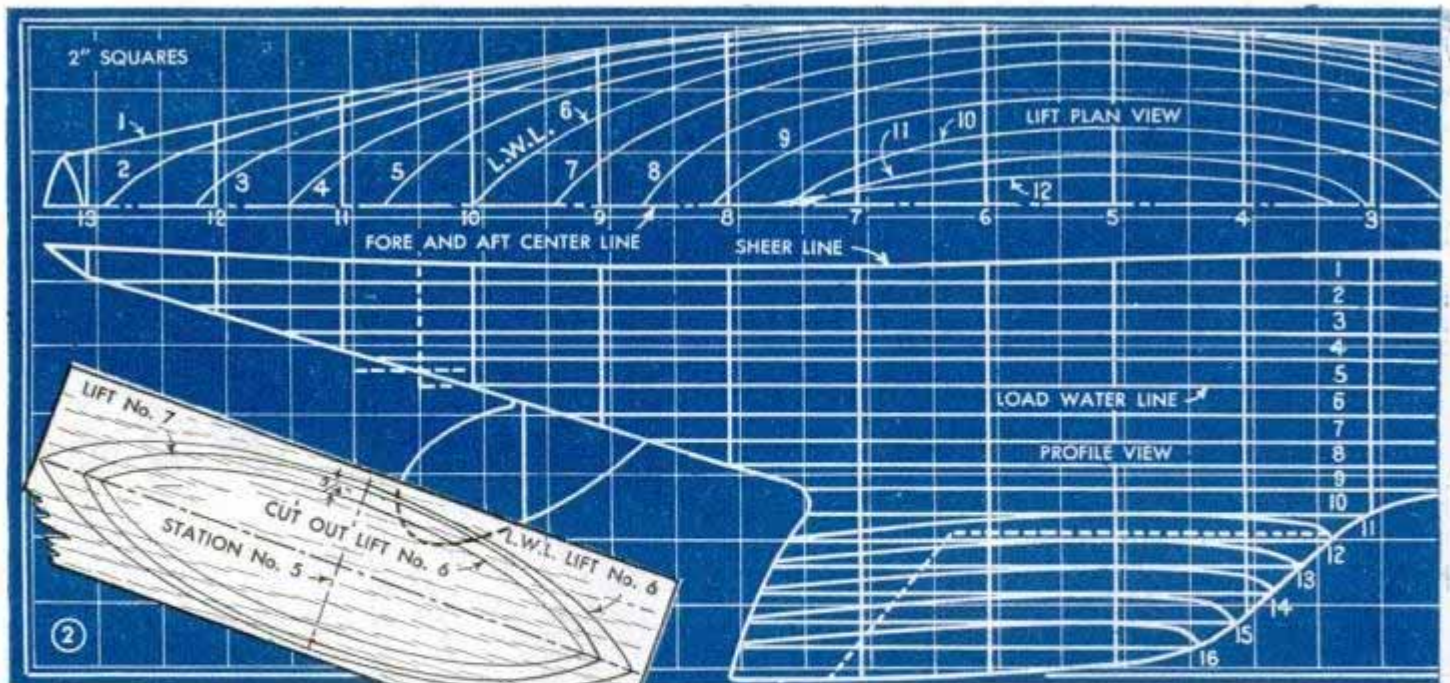

center lines carefully. Two short lifts $\frac{3}{4}$ in. wide and about 25 in. long are added to the forward end of lift No. 1 at each side. From the profile drawing on the building board, measure the distance from one of the water-lines to the sheer line at each station point and transfer to the hull. Draw the sheer line on each side of the hull through all these points and plane down to shape. To obtain the proper tumblehome, a true check line must be transferred to the top of the hull. The best method of doing this is to measure the distance between the vertical centerline and the deck-line points of each station from a full-size drawing of Fig. 8 made on cardboard. Then measure off and mark these distances on their corresponding station lines of the lift plan. Draw a curve connecting all these points and make a template from this curve to mark the deck line on the top side of the hull. The next step will be to cut away the bow and stern lifts. Make two templates from the profile drawing, one for the forward profile from station No. 5 to the tip of the bow, and one for the after profile from station No. 5 to the stern. Mark the load water line and station No. 5 on each template. Then cut away the corners of the forward lifts. Colored chalk rubbed on the edge of the template will locate the high spots. Repeat this operation on the after profile. Check to see that both the fore-and-aft load water lines on the templates line up with the corresponding lift line on the hull. Draw a centerline on the hull from the tip of the bow over the edge of the rudder and down to the stern or transom. The hull now is ready for rough shaping. Cut away the corners of the lifts to within $\frac{1}{8}$ in. of the glued joint at each lift. Then mount the hull on the building board in line with the drawing of the lift plan view with L.W.L. parallel with the sur-

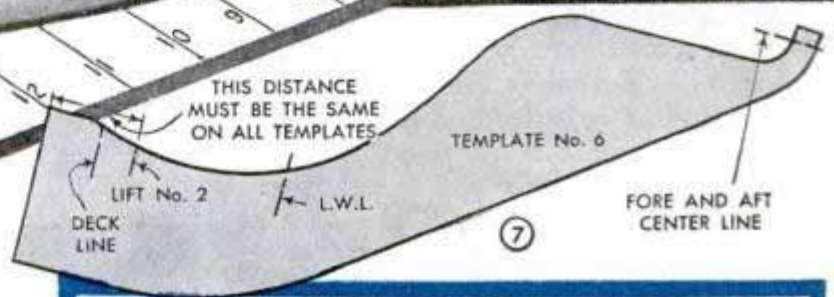
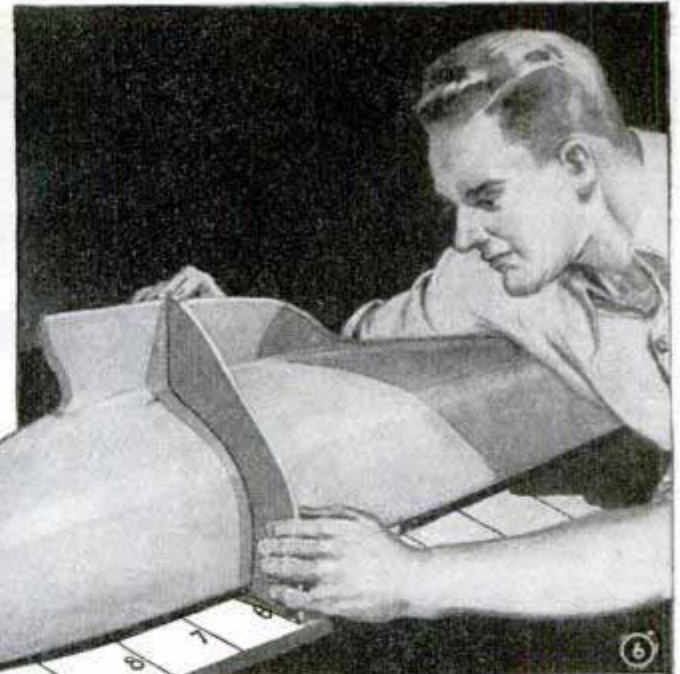
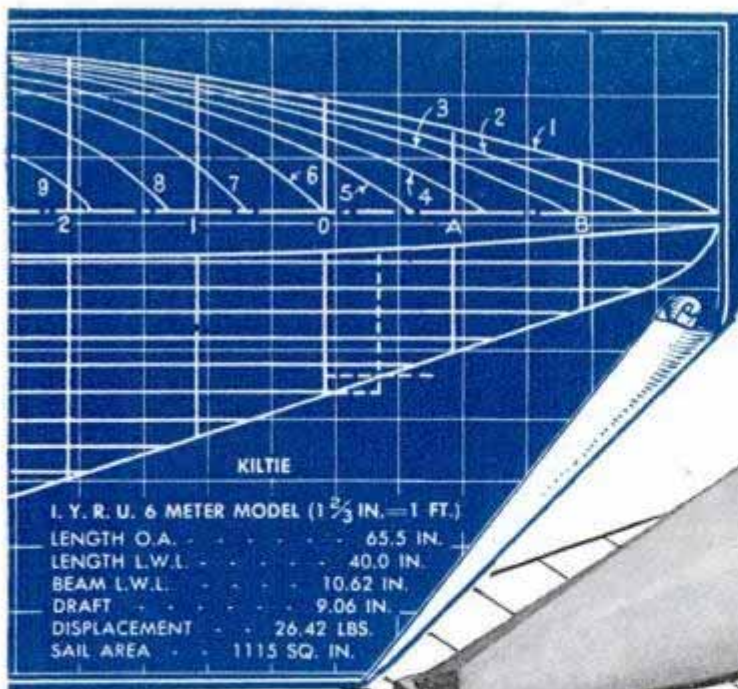

face of the building board. Now make a complete set of templates from the full-size drawing in Fig. 8 and mark these as shown on template 6 of Fig. 7. The distance from the line of lift No. 2 to the end of the template can be measured from the hull. Begin shaping the hull by fitting No. 5 template. Use a block plane and locate the high spots with colored chalk on the template. Proceed to fit the other templates as in Fig. 6 then sand off remaining high spots. Use a rolling motion when smoothing with fine sandpaper. The hull then is hollowed out to a wall thickness of $\frac{3}{16}$ in. as in Fig. 1. Note that the wall widens to $\frac{1}{2}$ in. at the sheer line. Mark and saw off the pattern to be used in casting the lead keel, but leave the line on the hull as a guide in fitting the casting. Nail two $\frac{1}{2}$ -in. pieces of wood to the pattern as in Fig. 10 to compensate for shrinkage. Shellac the pattern to keep out moisture when forming the plaster-of-paris mold, Fig. 4. Be sure the mold is dry before pouring the lead.

The after edge of the lead keel should be beveled slightly and fitted to the hull. Locate and drill the holes for the keel bolts and counterbore on the bottom edge for the nuts. Two floor timbers, Fig. 9, are fitted in the hull directly above the keel bolts, which pass through the floor timbers. Use white lead in all joints of the hull, keel and floor timbers. Flow solder over the coun-

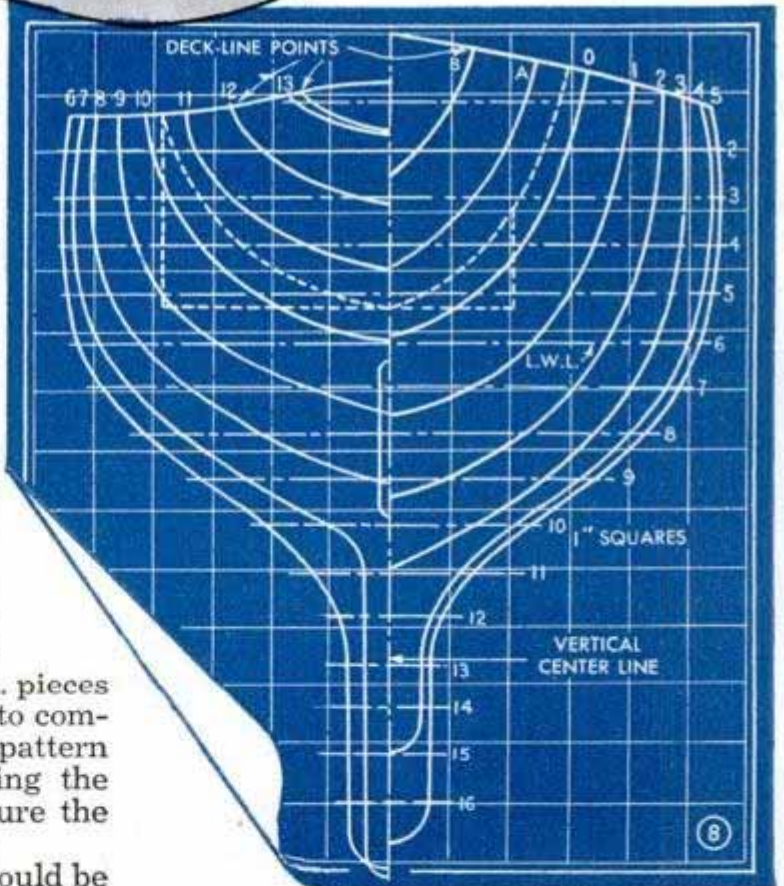

tersunk nuts and smooth with a file. Next make the cradle or stand detailed in Fig. 11.

Eight deck beams laid out from the template at the lower left-hand corner of Fig. 9 and spaced as shown in the hull drawing, are jointed and glued in the hull. Lengthwise supports are set in the deck beams



pine or basswood. Before laying the deck, the supports, deck beams and the sheer-line edge of the hull should be trued and checked with a template for the proper camber. Lay the deck on the hull, then mark and drill a hole for the rudder tube and fasten the deck to the bow and each side amidships with a $\frac{3}{8}$ -in. No. 10 screw. Mark the shape of the deck, remove from the hull and saw just outside the line. Then fasten temporarily to the hull and trim flush. Mark the location of the hatch opening which should be cut flush with deck beams 4 and 5. To mark the imitation planking, remove the deck and score lines with a marking gauge as in Fig. 9. When all lines have been cut darken them with a chisel-pointed pencil and apply white shellac. Before attaching the deck, give the inside of the hull and underside of the deck three coats of paint or varnish. Then apply a light coat of white lead to the edge of the hull and

flush with the top. The support directly above the forward keel bolt is $\frac{1}{2}$ in. thick and is braced laterally with dowels. The support between beam No. 7 and the transom is fitted now, but not glued in until the skag and rudder are in place. The latter are made of mahogany patterned from the full-size profile drawing. Care should be taken to fit the rudder tube and skag in the exact center position. The skag should join the hull with a tight, flat joint. Apply white lead to the underside of the rudder-tube plate before fastening permanently. The rudder is screwed to a $\frac{1}{4}$ -in. brass rod with two brass screws which are countersunk, soldered and filed flush. The rudder should be tapered so the after edge is $\frac{1}{8}$ in. thick. Material for the deck may be $\frac{1}{8}$ -in.

flush with the top. The support directly above the forward keel bolt is $\frac{1}{2}$ in. thick and is braced laterally with dowels. The support between beam No. 7 and the transom is fitted now, but not glued in until the skag and rudder are in place. The latter are made of mahogany patterned from the full-size profile drawing. Care should be taken to fit the rudder tube and skag in the exact center position. The skag should join the hull with a tight, flat joint. Apply white lead to the underside of the rudder-tube plate before fastening permanently. The rudder is screwed to a $\frac{1}{4}$ -in. brass rod with two brass screws which are countersunk, soldered and filed flush. The rudder should be tapered so the after edge is $\frac{1}{8}$ in. thick. Material for the deck may be $\frac{1}{8}$ -in.

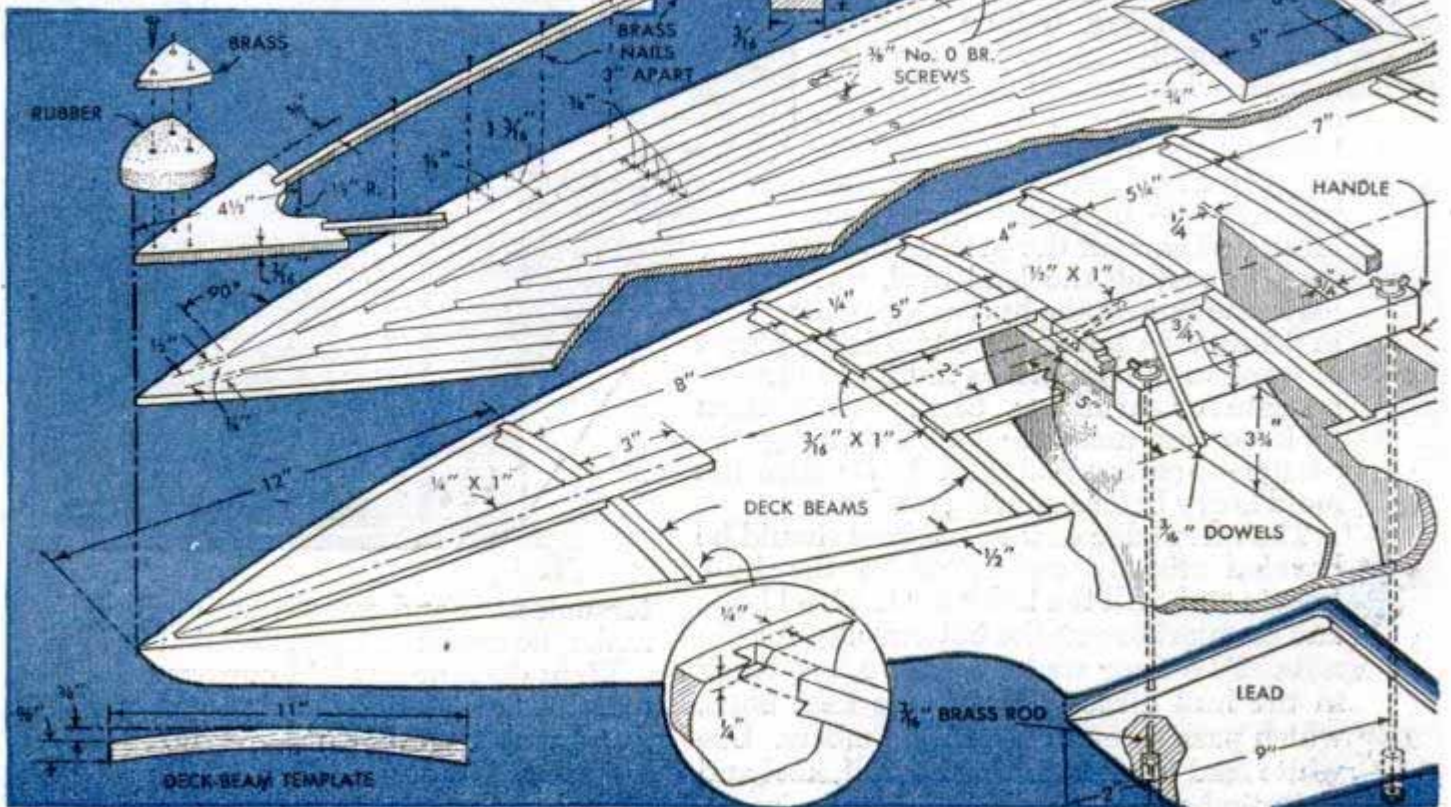

screw the deck securely in place.

Make and fit the mahogany bow and stern plates and small deck rail. As the top of the deck outside the rail is painted the same color as the hull, mark a line along the deck at the edge of the rail then remove the plates and rail.

Apply three coats of gray enamel on the topsides and bottom with a $\frac{3}{4}$ -in. bright red stripe, called a boot-top, at the waterline. Smoothness of the surface will depend upon the time spent in sanding and puttying the first coat. Allow two or more days for the second coat to dry. Sand with wet-or-dry 6-0 sandpaper, rubbing lightly until the surface is smooth. The third and last coat should be allowed to dry for several days before rubbing down with sandpaper and steel wool. For a glass-smooth finish and also a semigloss, rub the



hull with powdered rottenstone. The bow and stern plates and rail are given a coat of boiled linseed oil to darken the mahogany and add contrast to the natural finish of the deck. Wipe off all surplus oil.

Finally, make the hatch cover and frame of mahogany and fit them to the curvature of the deck. Before gluing, scrape the shellac from the deck where the frame is located. Brass screws may be used to fasten each corner of the frame. The inside frame of the hatch cover should fit snugly into the deck frame. Rub with linseed oil and when dry give the deck, rails, hatch and end plates three coats of spar varnish. The rubber bumper and brass plate, although not absolutely necessary, will serve to protect the sharp point of the bow.

(To be continued)

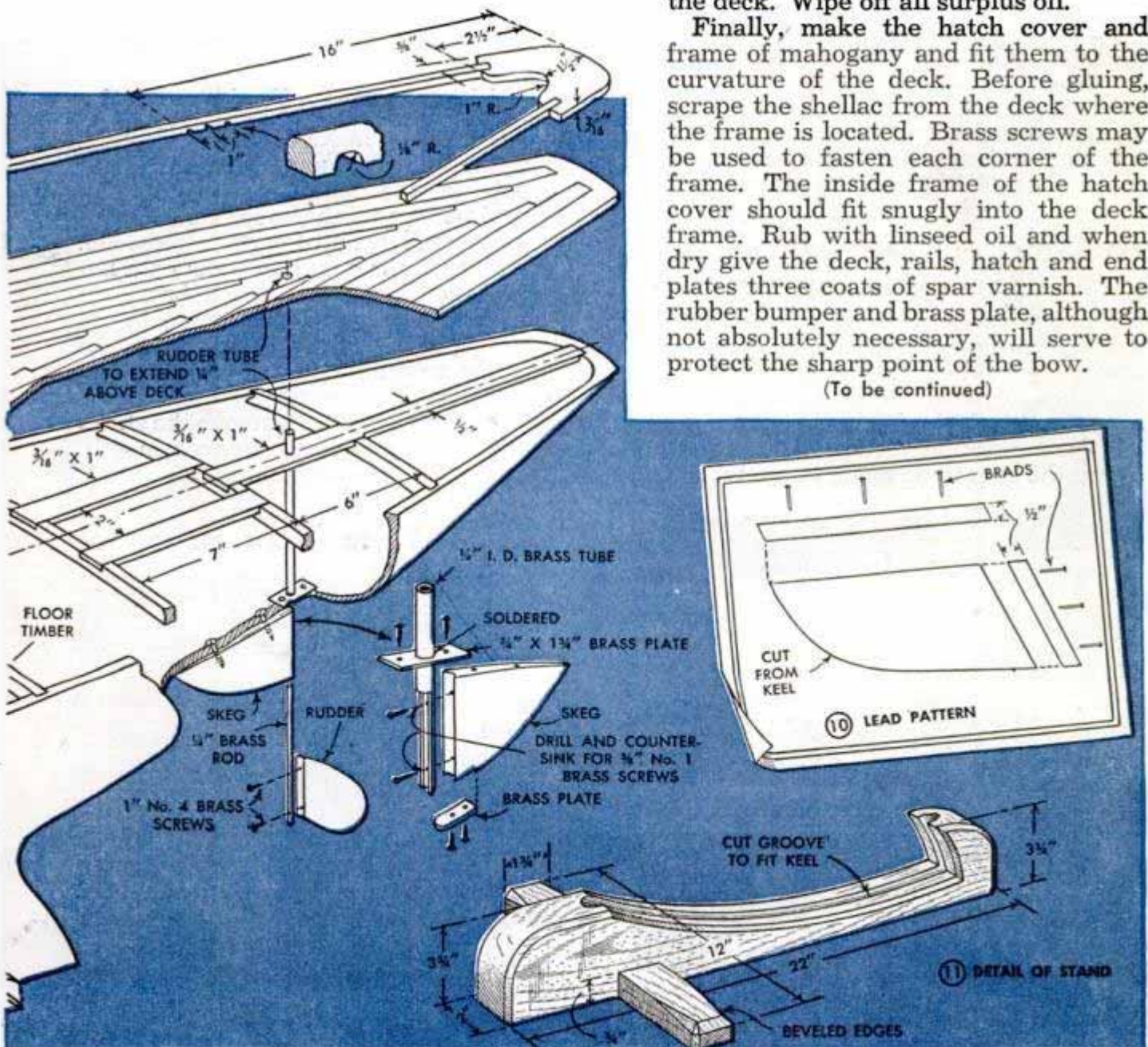

Match Held in Clothespin Jaws For Lighting Oil Heater

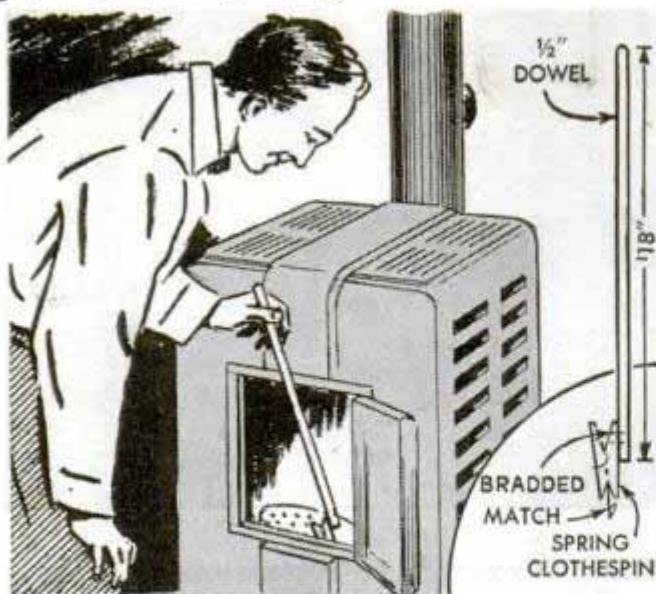

Instead of using a wad of twisted paper for a torch when lighting an oil heater, you can hold a match in the jaws of a spring-type clothespin that is bradded to a length of dowel. This method is especially useful for heaters that are lighted through an opening in the top, as it eliminates ashes and charred paper that otherwise would drop to the bottom of the heater.

T. E. Fallin, Sunnymead, Calif.

Backstop on Saw Miter Gauge Spaces Cuts Equally

When you have to make a series of equally spaced cuts along the edge of a board, try this method. Screw an auxiliary backstop to the miter gauge of a circular saw, then push the backstop over the cutter. Now mark off the spacing desired between the cuts to be made in the work and

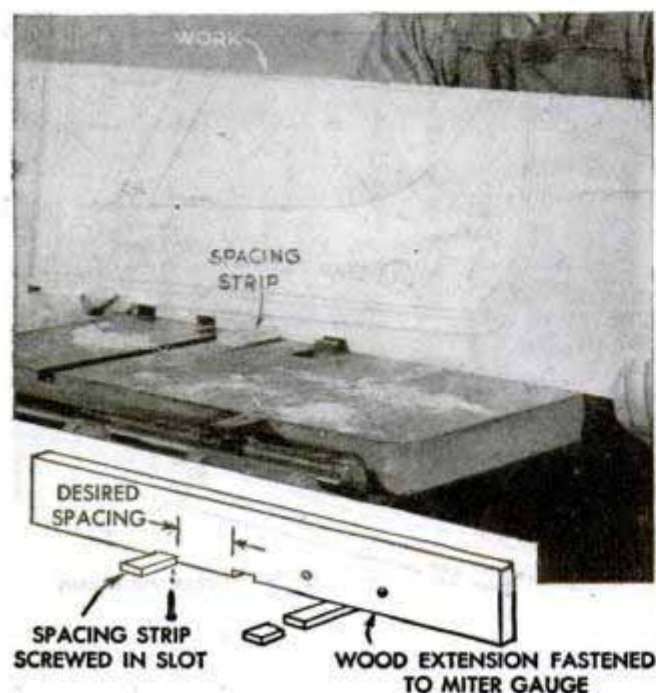

cut a slot at the mark. A wood spacing strip screwed into this slot will serve as a stop to position work on the saw table, each cut in the work being fitted over the spacing strip to set the work for the next cut.

Drawer Fitted with Rotating Stop Is Removed Without Lifting

Screwed to the underside of a table or desk, a drawer stop like the one illustrated rotates to permit removal of the drawer without raising the front end. The stop is a block of hardwood shaped as shown in the detail. A notch is cut in the rear panel of the drawer to pass the stop when the latter is turned parallel with the drawer sides.

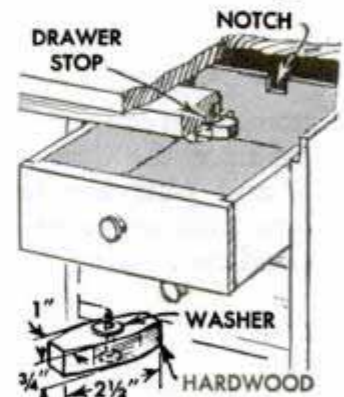

George Sperry, Detroit, Mich.

Easy Way to Make Buffing Sticks

If you want to make your own buffing sticks, you can do so by using the following materials in the stated proportions by weight: 4 parts naphtha soap, 1 part beeswax, 2 parts tallow and 4 parts rottenstone. First melt the tallow and beeswax on a hot plate and add the soap, which has been shaved into fine particles. Then stir in the rottenstone, being sure that all parts are thoroughly mixed. Pour the ingredients into molds made of cardboard and allow them to cool. When hard, remove the sticks from the molds and cut to desired length.

G. J. Issakoff, Sioux City, Iowa.

Soldering Paste Kept in Spool

Soldering paste can be kept in the core of a spool around which wire solder is wound. To do this, close one end of the spool with a wooden plug and cork the other end to retain the paste.

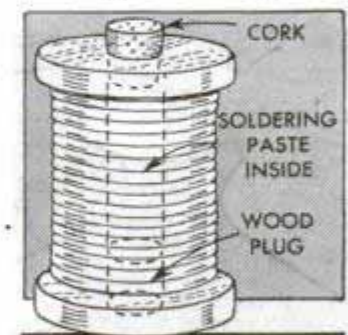

With this arrangement, the wire and paste are in the same container and either is easily accessible.

When adhesive tape or plaster will not adhere because of cold or because it has dried out with age, just heat it for a few seconds to renew its adhesiveness.

POWER GRINDER

for telescope mirrors

FOR the amateur astronomer who would like to build a telescope, but dislikes the work of hand grinding and polishing a large concave mirror, this power grinder will solve the problem. It also is an excellent group project for an astronomical society as it can be moved to the workshops of the various members.

The machine automatically carries out the three correlated movements of hand grinding; namely, the back-and-forth motion, the slight turn of the upper disk at the end of each stroke and the short step around the barrel or pedestal every few strokes as is necessary in hand grinding.

As shown in Fig. 7, the frame or base of the machine consists of 2 by 4-in. stock bolted together with a short length of 2 by 12-in. plank across one end to support the turntable. A 1-in. board is bolted to one side of the other end to mount the motor. Straight, seasoned lumber should be used.

Use a 1/4-hp. motor of 1750 r.p.m. Two four-step pulleys of 4 1/2, 3 3/4, 3 and 2 1/4 in. dia. steps are used as the first stage in the speed reduction. Further reduction is accomplished by using two 14-in. pulleys and two 2-in. pulleys arranged as shown. For the fine polishing operation, reduce the speed to about 27 r.p.m.

at the crank drive shaft. All rotating and sliding shafts are mounted in 1/2 and 3/4-in. pillow-block bearings. The motor and pulley-shaft assemblies can be bolted in position after the belts are in place. This will assure proper belt tension.

The crank arm, shown in the lower right-hand detail of Fig. 7, is made of

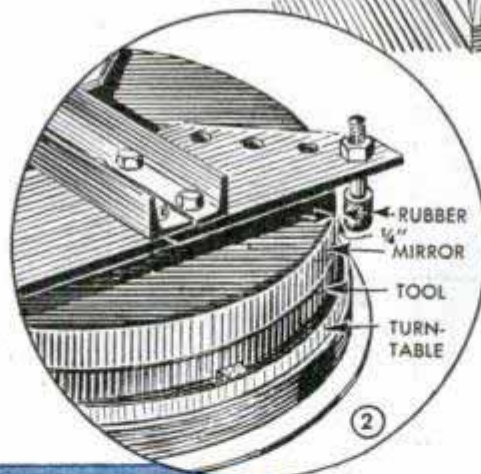
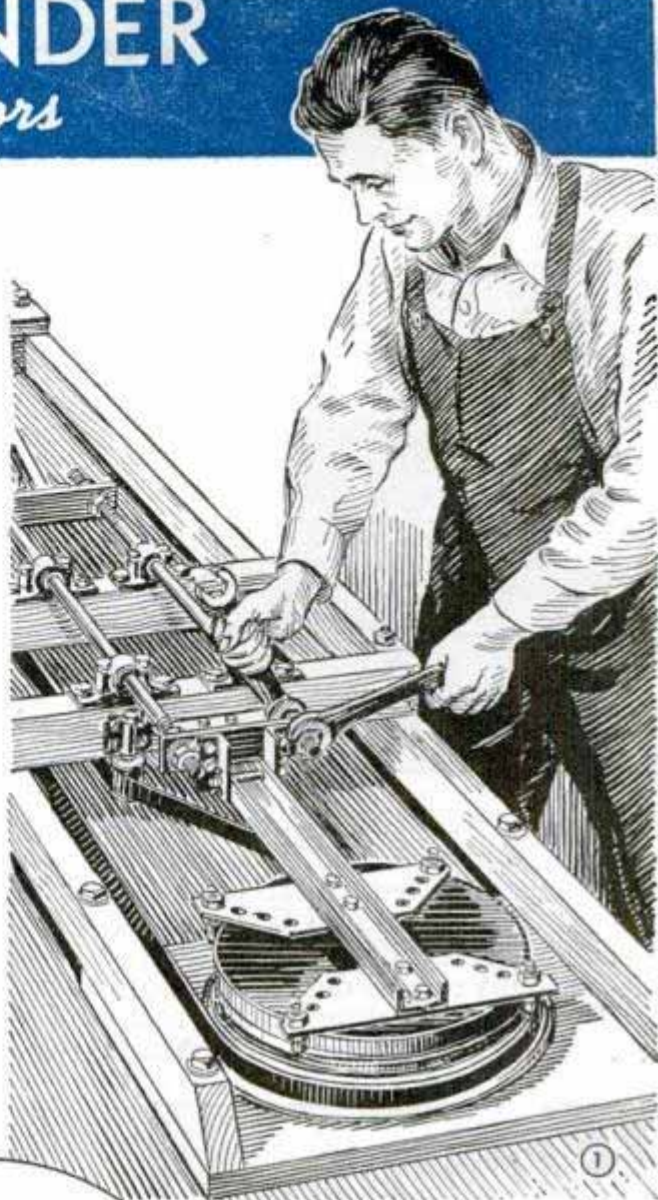

steel-bar stock, drilled and tapped as indicated. Two 1/2-in.-13 tapped holes provide for changing the length of the stroke. The long stroke, which is used for rough grinding, will move the center of the upper disk from one edge almost to the other of the lower disk. The short stroke is used for fine grinding and polishing and

will give the required 1/3 stroke for the particular size mirror to be made. A pin secures the crank arm on the shaft and permits easy removal when changing arms for mirrors of different sizes.

The connecting rod, Fig. 7, is drilled and reamed on one end to take a bronze bushing 1/32 in. longer than the width of the rod. This provides a clearance between the rod and the brass washers. The other end of the rod pivots on a 3/8-in. pin, which is attached to one end plate of the horizontal slide. The slide

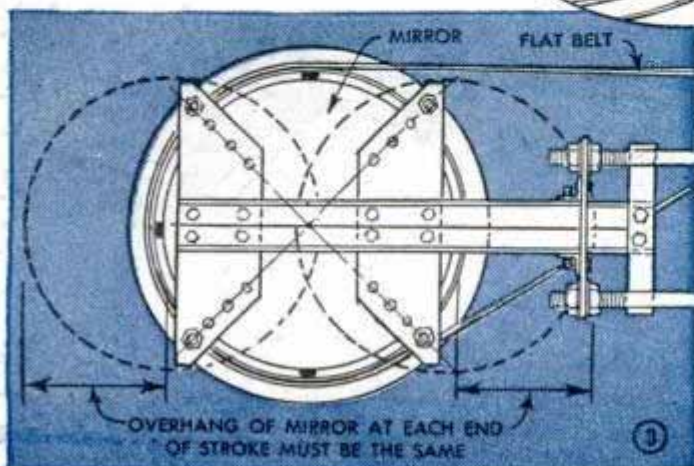



consists of two pieces of $\frac{3}{4}$ -in. shafting threaded on each end, and two flat-iron end plates drilled to accommodate the shafts. Care should be taken to keep the center-to-center distance the same on both pieces. This can be done as shown in Fig. 6. When constructing the turntable, detailed in Fig. 8, you will find that the $1\frac{1}{4}$ -in.

pipe will have to be dressed down to slip into the $1\frac{1}{2}$ -in. pipe. Surfaces of the pipe floor flanges that bear against the brass ring also should be finished smooth.

The turntable pan is made from a piece of 20-gauge sheet metal, 14 in. in dia., onto which a band $1\frac{1}{4}$ in. wide is soldered to make it watertight. The pan is mounted on the $1\frac{1}{4}$ -in. pipe flange with flat-head bolts. The rubber gasket material used on the bottom of the pan is cut in four parts resembling pieces of pie, with space between the pieces. This cushions the tool and provides a place for the water to drain off the tool. A hole drilled in the center of the pan provides a drain for water and sludge. When mounting the $1\frac{1}{2}$ -in. pipe and flange in the frame, care should be taken to have the center exactly in line with the center of the slide. A flat belt driven by a $1\frac{1}{2}$ -in. pulley on the crank drive shaft rotates the turntable. Two idler pulleys on a $\frac{1}{2}$ -in. shaft are fastened on the frame as shown in the upper left-hand detail of Fig. 7. Another idler pulley, to guide the belt, is mounted vertically on the front crosspiece. The grinding arm, Fig. 5, is hinged to the end plate of the slide as indicated in Fig. 7. Holes, $\frac{1}{2}$ in. in dia., are drilled in the $\frac{1}{4}$ -in. plates of the grinding arm to take four studs, long enough to extend about $\frac{3}{4}$ in. below the top surface of the mirror. A piece of heavy rubber tubing is slipped on the lower end of each stud in order to pro-

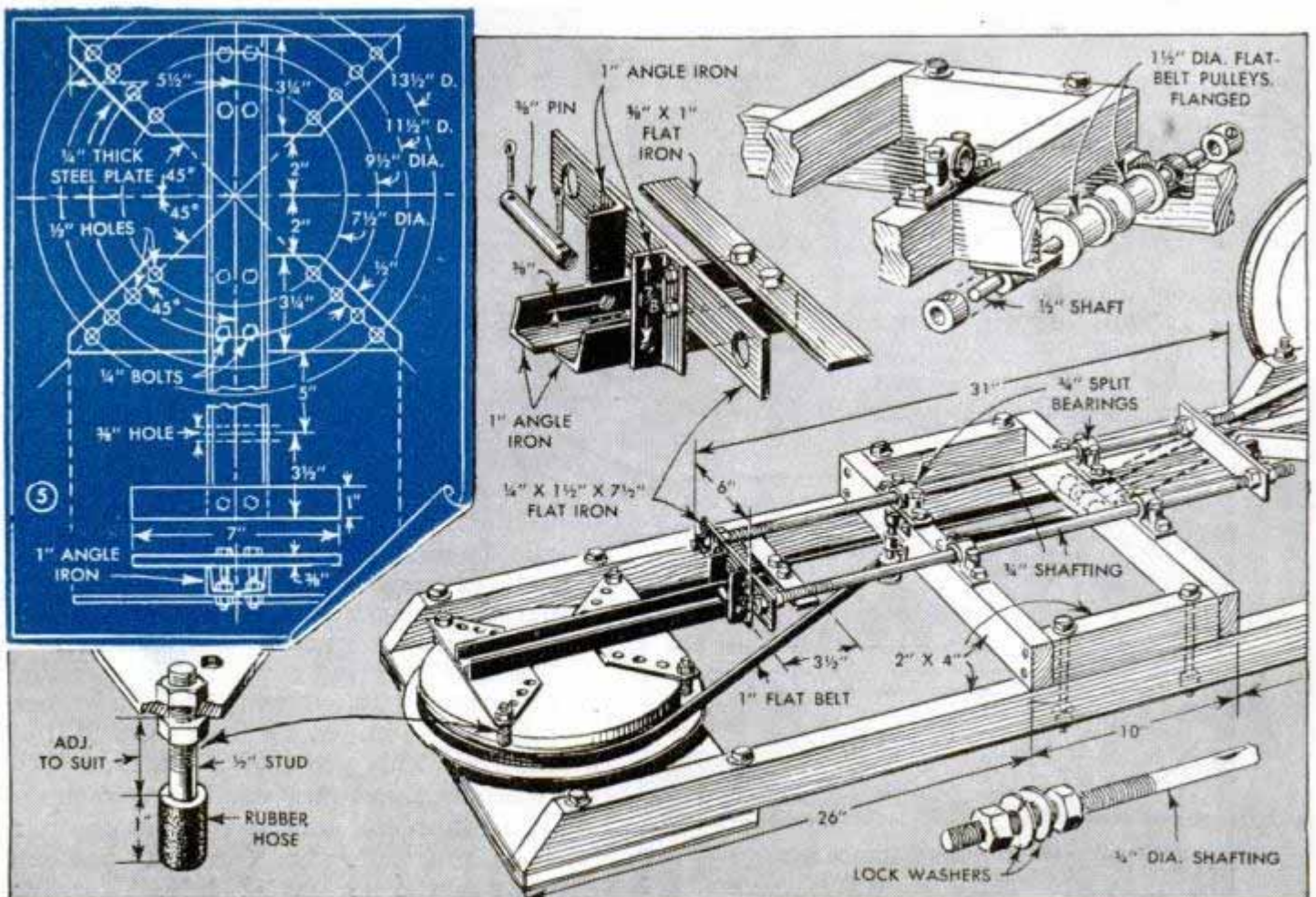

vide a better grip on the edge of the mirror.

The $\frac{1}{2}$ -in. holes in the $\frac{1}{4}$ -in. plates of the grinding arm are located so that a 6, 8, 10 or 12-in. mirror may be ground merely by changing the four studs to the proper set of holes. When the studs are adjusted and tightened in place there should be about $\frac{1}{4}$ in. clearance between the mirror and the rubber hose on each stud. See Fig. 2. Glass to be used as the tool is placed in the turntable and four small pieces of rubber are inserted between the turntable band and the tool to center it and hold it tightly in place. If the mirror to be ground is less than 12 in. in dia., use blocks of soft wood. Place the mirror glass on top of the tool and lower the grinding arm, which then is adjusted until the overhang of the mirror is exactly the same at each end of the stroke, as in Fig. 3. This can be done by turning the machine slowly by hand and adjusting the nuts, Fig. 1, that hold the end plate. As an added precaution, place a small table against the frame in front of the turntable to prevent the mirror from dropping to the floor when adjusting the overhang. If everything is working properly, the arm moves the mirror back and forth across the tool, while the turntable revolves slowly. At the end of each stroke the moving turntable will rotate the mirror approximately 1 in. because of the clearance allowed between the rubber-covered studs and the mirror. This causes the mirror to cross the



tool in a different position on each stroke. The speeds of the tools and mirror are not important; it is important only that their relative speeds are different. When changing sizes of grit, remove the belt and take the entire turntable, tool and mirror to a drain and wash thoroughly, using a stiff brush. Then rinse as in Fig. 4, using a hose with low water pressure.

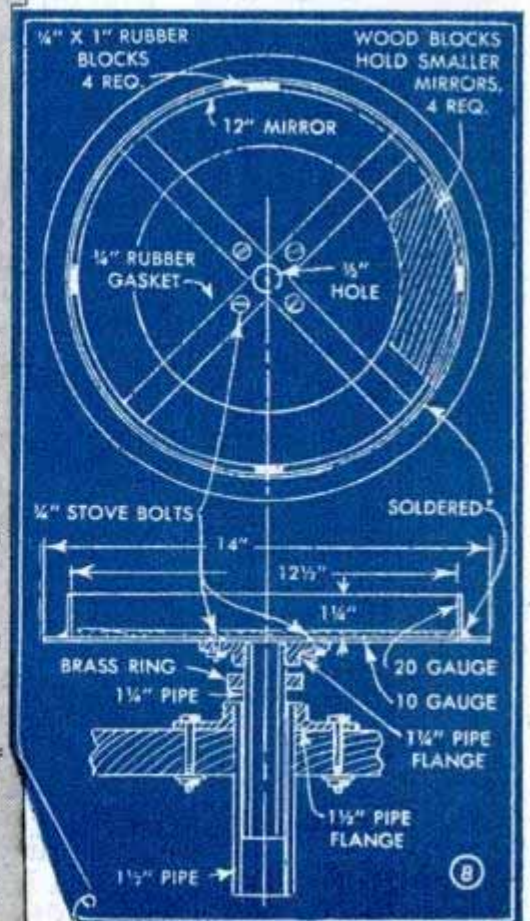
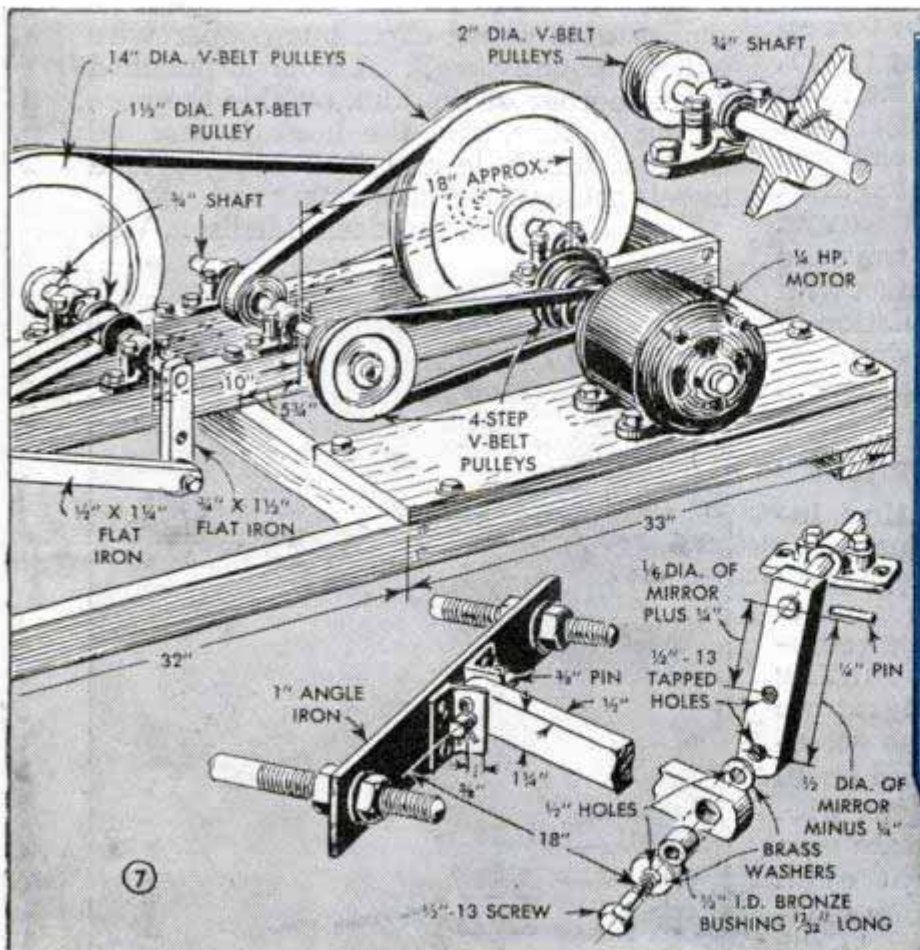

Hairs Aid in Bringing Enlarger To Sharp Focus



As a help in focusing dense negatives sharply in his enlarger, one photographer replaces the negative with a few hairs in the negative carrier. The hairs make it easy to obtain sharp focus, after which they are removed and the negative placed in the carrier again.

Powder Puffs Cushion Trays



Powder puffs placed between developing trays, when nesting them for storage, will prevent chipping and thus lengthen the life of the trays. Since the trays are not in contact with each other, there is a better circulation of air to dry them and prevent corrosion.

H. Klein, Pittsburgh, Pa.

Lamp Mounted on Gooseneck

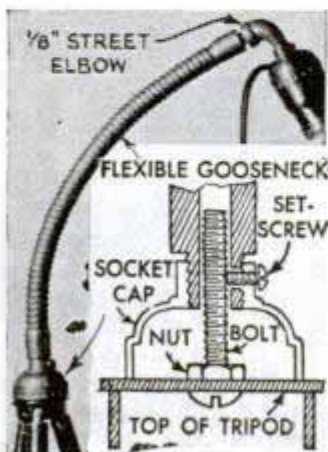

Permitting instant adjustment which "stays put," a flexible gooseneck makes a serviceable mounting for photographic lamps. The gooseneck should be 10 or 12 in. long with a $\frac{1}{8}$ -in. male pipe thread at each end. A lamp socket is fitted to the

gooseneck with a street elbow, running wire direct from the socket to an outlet, or through a hole drilled in the street elbow. A neat mounting on a lightweight tripod is made by using part of a light socket, as shown in the detail.

Shutter Repaired With Ribbon

If the fabric straps on a focal plane shutter wear through, they can be repaired by using a piece of satin ribbon. The ribbon is placed over the worn part of the old strap and the two then can be sewed together.—Sidney Pott, Victoria, B. C., Can.

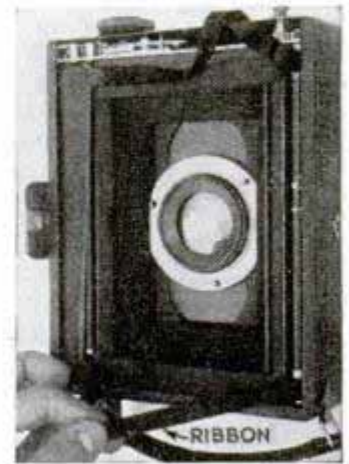

Shaving Brush Cleans Lenses

A shaving brush that has been softened by use makes a good dusting brush for camera lenses. Before it is used, the bristles should be trimmed to a uniform length.

Wire Hooks Substitute for Clips

Film clips are unnecessary when drying sheet film if a few short pieces of wire and a paper punch are available. One photographer uses paper clips, but copper wire will do equally well. A hole is punched in one corner of the film, outside the area of the picture, and the hook is inserted through this hole and then hung over a towel rack or other supporting rod.

George T. Lundeen, Madison, Wis.

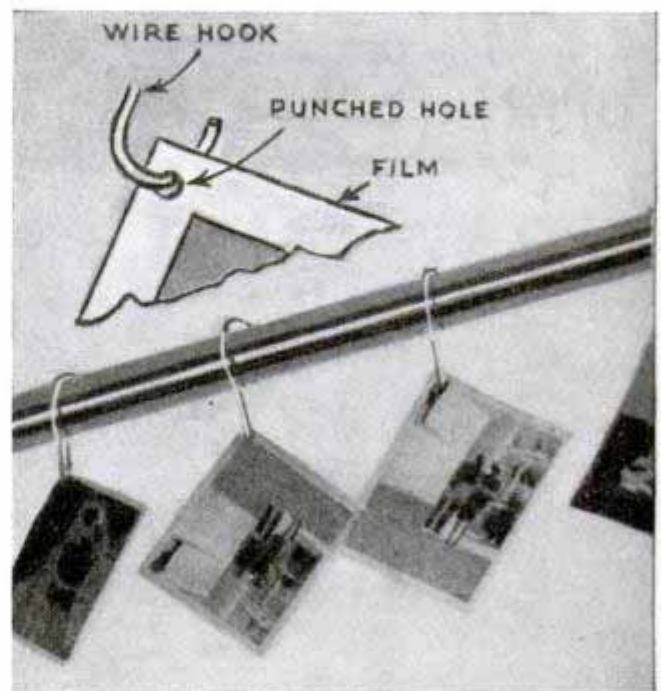

Simple Synchronizer for Auxiliary Lens Mount

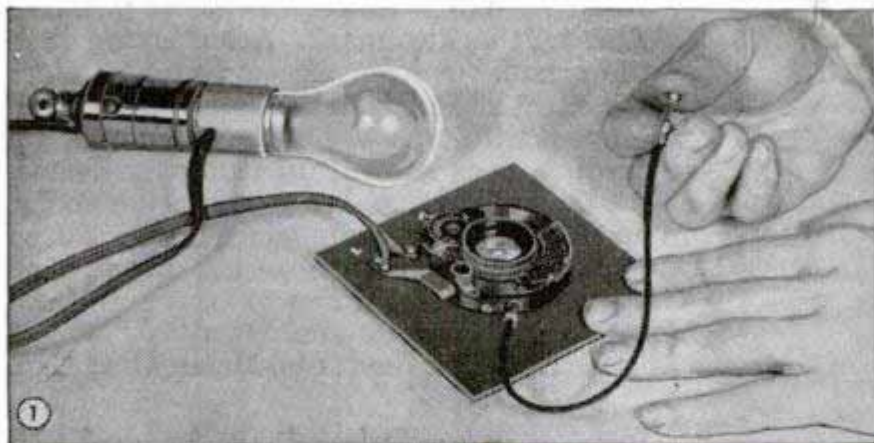

Auxiliary lens equipment with the cocking type shutter can be synchronized for flash bulb photography by using the cocking lever of the shutter as a contact switch. Two strips of brass about $\frac{5}{16}$ in. wide make up the switch, as can be seen in Figs. 2 and 4.

The shorter piece is clipped under the timing scale, or some other part of the shutter body, while the longer piece, which is fastened to the lens board, is bent and fitted so the cocking lever will brush over it and make contact when the shutter is operated. Wires from the switch terminate at an extension socket on the flash gun. A hole is drilled through the insulation and shell of the socket, permitting the wires to be soldered in place, as indicated in the wiring diagram, Fig. 2. Adjustment of the switch must be set so the cocking arm closes the electrical circuit and flashes the bulb at the same instant that the shutter diaphragm opens.

This is easily checked by making a tester using a 15-watt bulb in the socket which is screwed into another socket connected to the house current, Fig. 1. To avoid a shock when the lever brushes the spring during cocking, do not connect the socket to the outlet until this operation is complete. By watching the shutter, or by looking through the lens, it is easy to determine when the switch arm is properly located. The bulb should light when the shutter is open. The finished setup with a camera is shown in Fig. 3, the extension socket fitting into any standard type of flash gun. Good results are obtained with this switch up to a speed of $\frac{1}{25}$ second. For this reason, fast-action pictures cannot be secured. At faster speeds, it is not wholly reliable since the contact is so momentary that the bulb sometimes fails to go off. Do not put the bulb in the socket until the shutter is cocked as the lever touches the

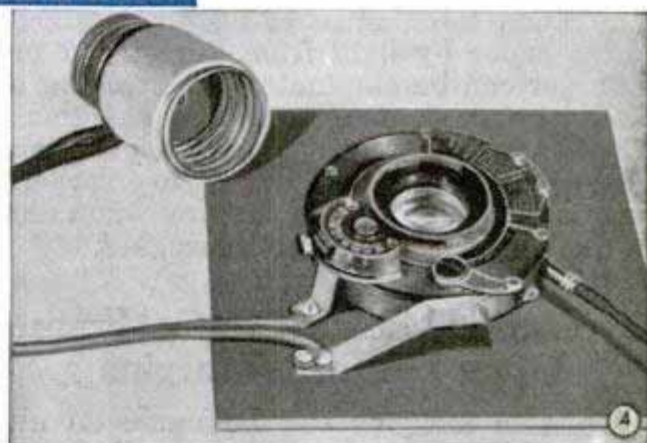
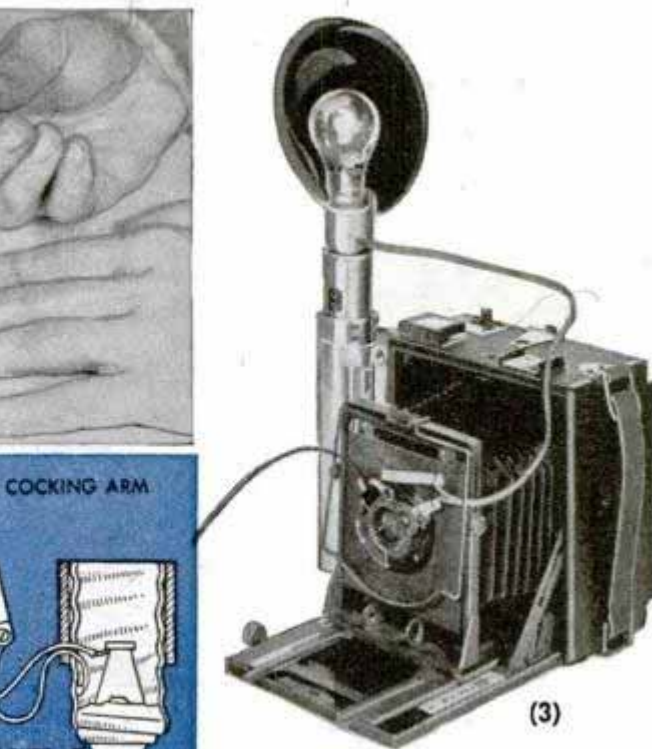
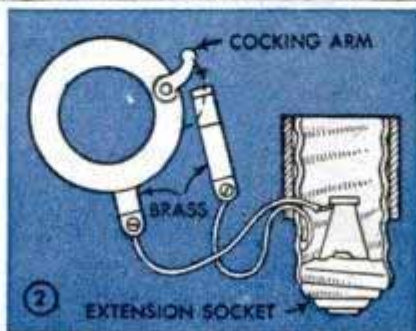

switch arm during this operation and completes the circuit. This would flash the bulb when the shutter was closed.

Sam Brown, Marion, Ohio

Flashlight "Writes" on Photoprint

When making photoprints, it's easy to write your name with light on the print so that the inscription is developed with the picture. To do this, fit a tapered piece of Lucite into the end of a fountain-pen flashlight and opaque the plastic with red nail polish. Then sand the color from the tip so that light will shine through, and use the flashlight as a pen. The writing should be done on a light portion of the print. —Michael Donner, New York.

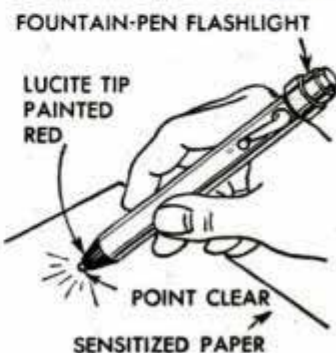

Window Shade Serves as Partition Between Enlarger and Paper

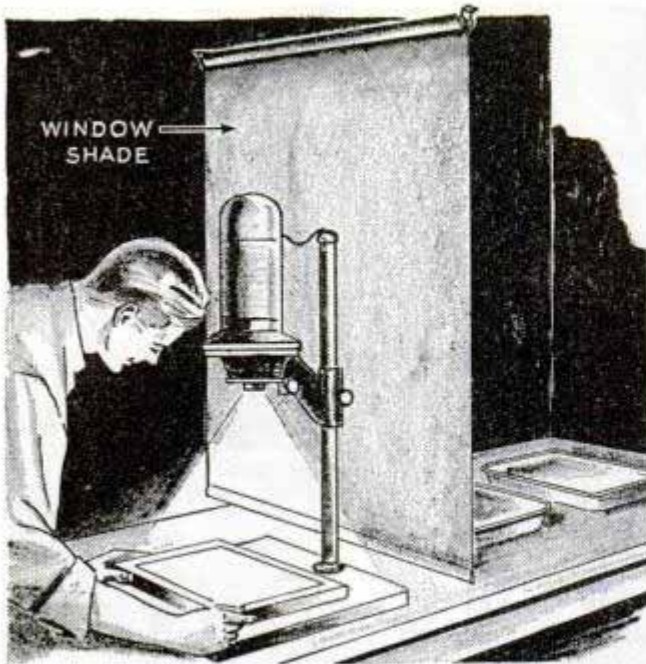

Where enlarging, printing and developing are done at the same time in a small darkroom, the chance of fogging unfixed photo paper by light from the printer or enlarger can be eliminated by attaching a dark window shade to the ceiling as shown. The shade is lowered to form a partition that will stop stray light from the enlarger, and can be raised out of the way when not in use.—Ken Murray, Baltimore, Md.

Cardboard Mask in Contact Frame Gives Uniform Margins

Uniform margins can be made on all prints of the same size without setting any easel guide strips, which are difficult to adjust in the dim light of a darkroom. All you need is a printing frame of the desired size, a piece of heavy cardboard and a sheet of opaque paper, both of which are cut to fit snugly within the frame. First remove the

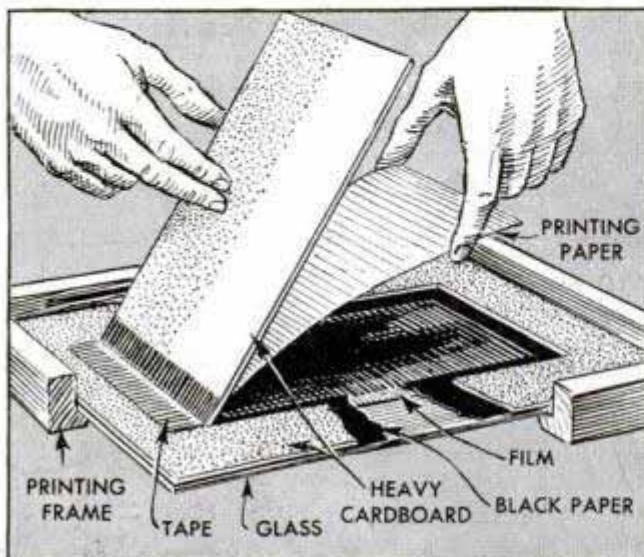

hinged back of the frame, then cut a rectangular opening in the opaque paper slightly smaller than the negative you use. This will be the mask. After laying it in the frame, cut from the cardboard a piece the exact size of your sensitized paper and hinge it with tape within the opening in the cardboard as shown. In using the frame, lift the hinged flap, lay the negative on the mask emulsion-side up, place the sensitized paper over it emulsion-side down, and press on the hinged flap to assure uniform contact of the paper and negative.

D. H. Jones, Sault Ste. Marie, Ont., Can.

Emergency Tripod Is Assembled From Sticks and Tin Can

Wishing to take some time exposures of his camp, and having no tripod to hold the camera, one sportsman solved the problem by using three sapling sticks and a tin can, assembled as indicated. Of course, with

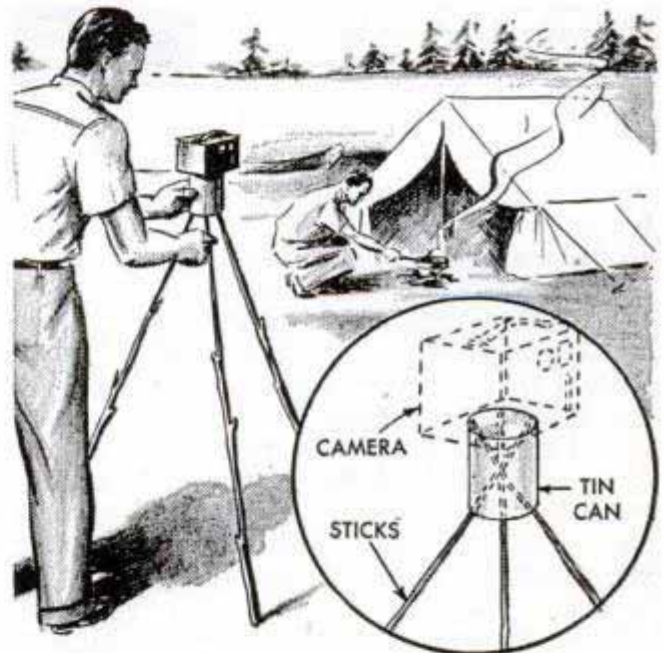

this arrangement the camera is not secured to the can, so it should be held to prevent it from falling.

G. E. Hendrickson, Argyle, Wis.

Effective Use of Small Bulb

If occasionally you have to use a small photoflood bulb in a deep reflector, you can get better light distribution by setting the bulb forward in the reflector. To do this, use two or three inexpensive extension sockets.

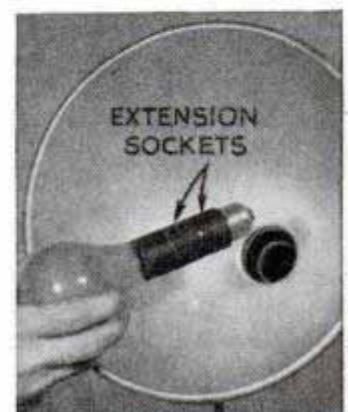

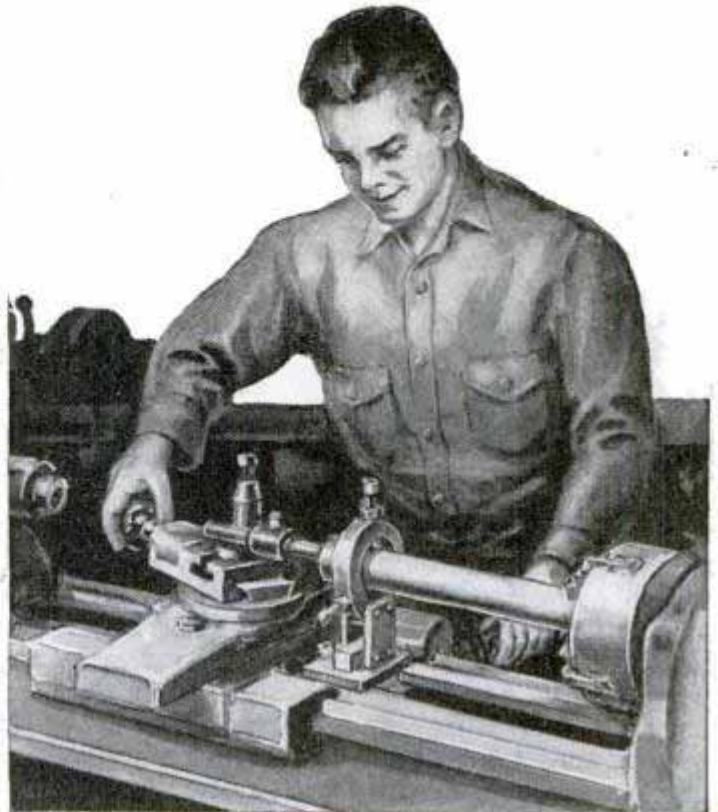

Make Your Own Steady Rest

By Gary Moore

WHEN turning long shafts of small diameter and when boring or threading spindles it usually is necessary to support the work in a steady rest. Where the lathe is not equipped with this accessory one can be made easily from small pieces of standard cold-rolled stock.

Only general dimensions are given in Fig. 1 as the rest must be dimensioned to fit the lathe on which it is to be used. Sizes of the parts are determined largely by the swing of the lathe, the type of lathe-bed ways and the nature of the work. The particular rest shown was designed for a 10-in. lathe with flat ways. The work support consists of a steel ring fitted with socket-head setscrews, located 120 degrees apart and provided with locknuts. Ends of the setscrews are built up by brazing on a bearing surface with bronze welding rod as in Figs. 1 and 2. The ring is chucked as indicated in Fig. 3 and turned, faced, bored and indexed in the chuck. It then is drilled and tapped for the setscrews and also for two $\frac{1}{4}$ -in. rivets, Fig. 7. These latter holes must be located carefully so that when the rest is assembled the ring will be positioned with one setscrew at the top. Assembly of the rest is shown in Fig. 1. The base is built up from pieces of flat steel stock cut to the sizes required. The upright members which support the ring are riveted to a square of steel attached

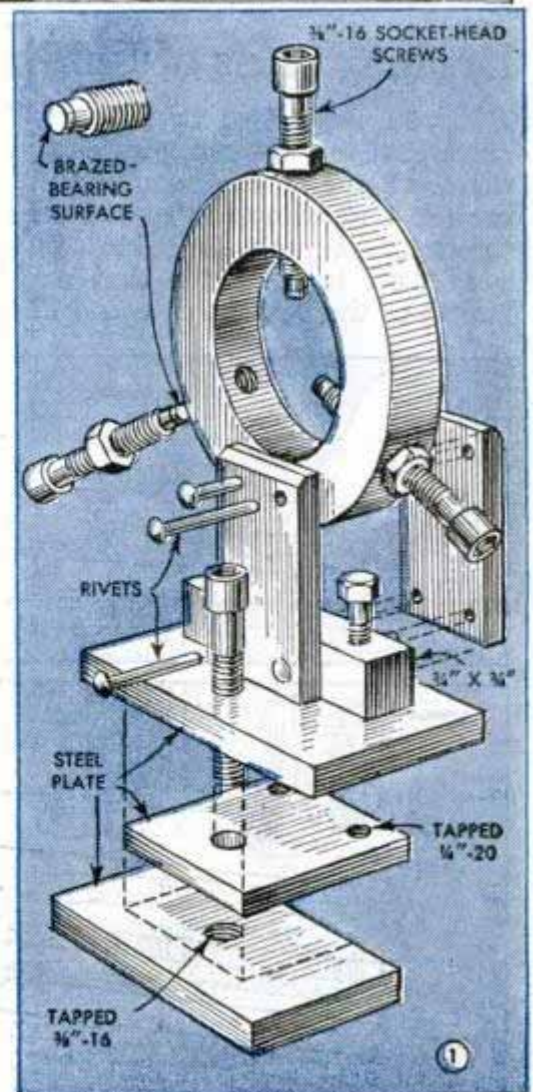

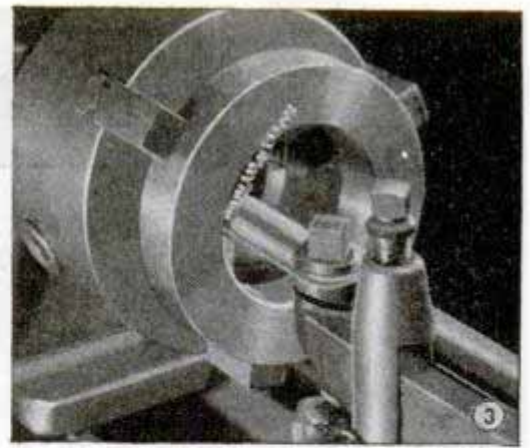

Principal part of this steady rest is a steel ring machined all over as shown above. Dimensions of the ring depend on swing of lathe and size of work

to the top part of the base with cap screws as indicated. The smaller of the two parts which comprise the clamp must be a free sliding fit between the lathe ways and must be located carefully so that the rest sets perpendicular to the lathe centers when the clamping bolt is tightened. Ends of the set-screws that bear against the work should be rounded over slightly with a fine file and

finished smooth with emery cloth. After the long tube or shaft has been set up in the rest ready for machining, place a few drops of light machine oil on the work at the point where the screws contact the surface. During prolonged turning operations, particularly on thin-walled tubing or shafting, check frequently to see that the work does not heat and bind in the rest.

Broken Ends of Folding Rules Are Joined to Make Repair

If you have two or more 6-ft. folding rules that are broken, you can join two of them to make one complete rule. The broken end of one is sawed off square at the nearest inch line, and the other is sawed off to a length that added to the length of the other will equal 72 in., allow-

ing for a 4-in. overlap. For example, if one rule is broken between the 47 and 54-in. marks, it is cut off 47 in. long. A second rule is sawed at the 29-in. mark and lapped under the other a distance of 4 in. In this way the end of the top rule meets the other at the 25-in. mark to total 72 in. Two holes are drilled through the overlapping sections for pins, and the paint is scraped from adjacent surfaces of the lapped sections so that they may be glued. While the glue is drying, the rules should be clamped together firmly. Care should be taken in making repairs of this kind to glue one rule to the other so that the sections may be folded normally.

George B. Taylor, Jacksonville, Fla.

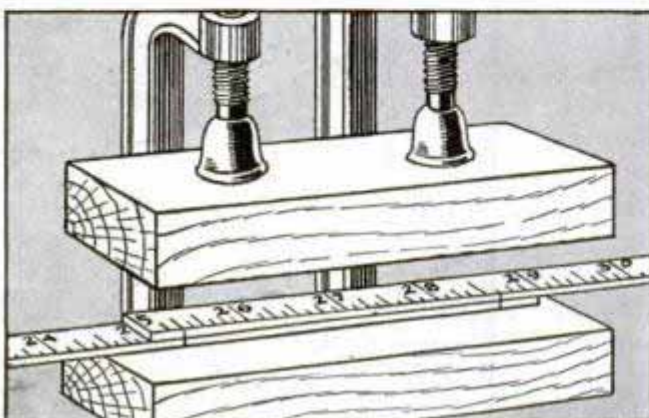
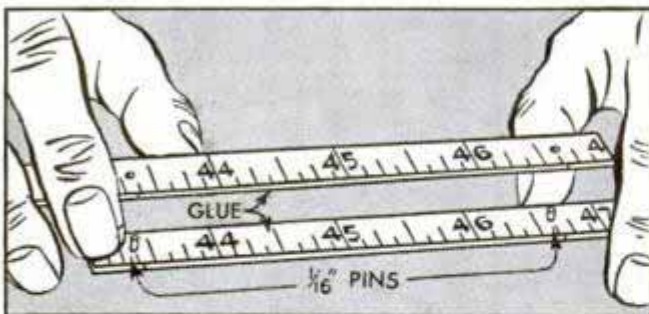

Work Is Rotated in Drill Press To Keep Holes True

When drilling in metal, one machinist found that, because of a slight tilt in the table of the drill press, the holes were from .002 to .010 in. out of round. This he remedied by rotating the work as the drilling progressed, turning the work at regular intervals so that when the drilling was completed the work had been turned around once.

John Eichberger, Franklin Park, Ill.

Boring-Bar Holder Adjustable to Four Tool Sizes

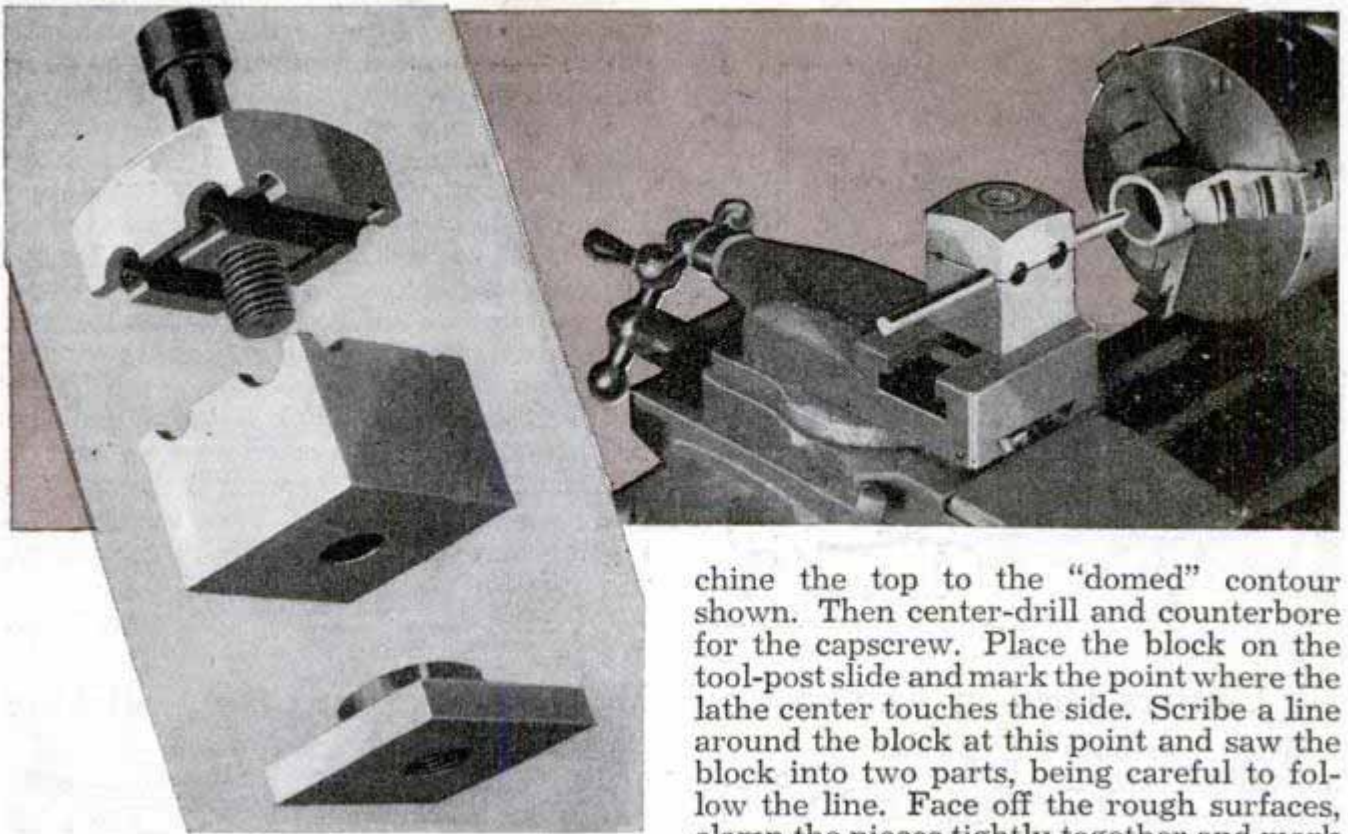

Simplicity and rigidity are the features of this boring-bar holder which can be made to fit almost any lathe and take bars of four different diameters. It consists of a two-part square of steel which bolts to the tool-post slide. The first step in making it is to measure the distance from the top of the lathe carriage at the tool-post slot to the center of the spindle. Then add for the thickness of the bar-holder cap to get the overall height. Square the block and ma-

chine the top to the "domed" contour shown. Then center-drill and counterbore for the capscrew. Place the block on the tool-post slide and mark the point where the lathe center touches the side. Scribe a line around the block at this point and saw the block into two parts, being careful to follow the line. Face off the rough surfaces, clamp the pieces tightly together and mark the centers of the boring-bar holes, centering these a distance from the nearest edge equal to the diameter of the largest hole. The hole size should correspond to the diameters of the boring bars. Care must be taken in drilling the first hole so that the drill bit does not "run." After the first hole has been drilled you can use a short steel rod as a key. Finally, mount each half of the holder separately in the chuck and take off a light facing cut, about 0.010 in., to provide clamping clearance.

Farm Tools Stored in Oiled Sand to Prevent Rusting

To keep his spades, pitchforks and other tools clean and free from rust, one farmer sets them in a container of sand, where they always are ready for use. This also prevents the possibility of accidentally tripping over or stepping on tools left standing against a wall. A large basket, box or cut-down oil drum will do for the container, which is filled with sand mixed with a small amount of waste crankcase oil. The sand not only prevents rust, but also cleans the tools after use.

Caulking Cotton Seals Windows

When windows of the casement type fail to keep out drafts during cold weather, try sealing them for the season with marine caulking cotton. The same treatment can be applied around the edges of doors.

A. S. Goodwin, Port Stanley, Ont., Can.



Glass Tube Inserted in Bottle Permits Free Flow of Liquids



Laboratory workers who use distilled water or other liquid from a large bottle which is supported in an inverted position will find that a glass tube inserted through the stopper to project above the liquid will allow the latter to flow freely. A rubber cork or stopper with two holes is needed. In one of these a short piece of curved glass tubing is inserted and fitted with a length of hose, which can be held by a hook screwed into an adjacent wall when it is not being used. A tube long enough to extend to within 1 in. of the bottom of the bottle is inserted in the other hole. When the bottle is filled and inverted over a stand or platform, air enters through the long tube and rises to the top of the bottle. By raising the hose above the level of the water, the flow will be stopped.

Jim Beaber, Denver, Colo.

Jig Centers Drill in End of Rod

When you have a number of rods to be end-drilled in the center, a jig like the one shown will position the drill properly. The jig is made from a short length of cold-rolled steel or similar stock. First a hole to serve as a drill guide is made through the steel, after which the hole is counterbored about halfway through to slip over the work. The edges of both ends of the hole then are chamfered slightly.

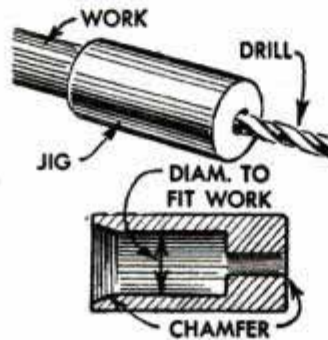

Washers Prevent Clamp Sticking

If fiber washers are inserted between the nut and clamp when connecting the cable to a battery terminal, the cable will be easier to remove later. Corrosion tends to make the nut stick to the clamp but the washers will prevent this. When the battery is removed, the washers are pried outward to loosen the clamp. It may be necessary to use a longer bolt and acid resistant washers.

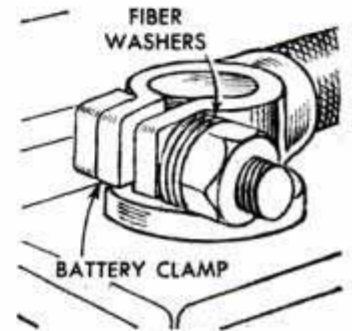

Breakwater Has Curved Face to Minimize Pounding Effect

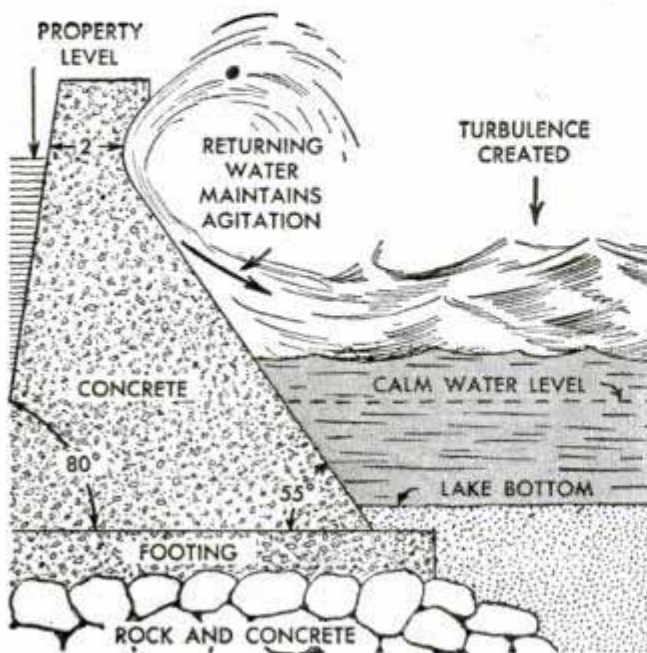

By making the design of a concrete breakwater such that it breaks up the impact of waves, lake-front property owners can prevent damage to their land and save money otherwise spent in repairs. The walls of the breakwater are sloped as indicated to give maximum support and to dissipate the pounding of the water. A curvature at the top returns the water and sets up a secondary turbulence that lessens the impact of onrushing waves.

L. Meehan, Toronto, Ont., Can.

Wet Chalk Will Mark Oily Surface

In marking rough cuts for acetylene burning, one welder found that wet chalk will leave a mark on oily sheet-metal plate while dry chalk will not. Using wet chalk saves time that otherwise would be wasted wiping oil off the plate.

W.T.M. Concrete

SAFETY REVERSING SWITCH

For Shop Motors

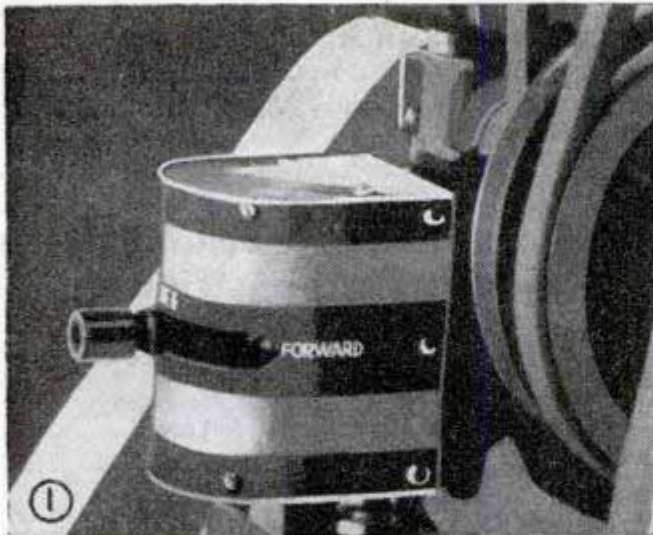

IF YOU use a split phase or capacitor type motor in your workshop, you can make a safety reversing switch, Fig. 1, that will enable you to change the rotation of your lathe or drill press without crossing the belt, and in addition you have the protection of an enclosed switch. The unit is made from a t.p.d.t. switch which is cut down to make it more compact. Since the dimensions of switches as manufactured vary, no measurements are given and assembly will have to be by the cut-and-try method. The blades and contacts are removed from the original base and the blades are shortened by cutting them, Fig. 2. To secure the blades to the crossbar, fillister-head screws are slotted and soldered to each blade as shown in the lower detail of Fig. 3. Holes are drilled in the fiber-board crossbar to receive the screws, and the handle is attached by fastening it to a strip of metal which, in turn, is mounted on the crossbar bridging the center blade. The base also is made of fiber board grooved to fit the contacts. These should be spaced as closely as possible, but not so closely that there would be possibility of a short circuit. Also, keep in mind that the location of the contacts must fit the throw of the switch. Top and bottom are of wood curved so the crossbar has clearance to swing within the cover and rabbeted as indicated in the lower detail of Fig. 3. For a cover, sheet metal lined with paper for insulation is used. The slot for the handle is made by drilling a hole at each end and completing the cut with tin shears. When the unit is assembled, label the two closed positions of the switch "Forward" and "Reverse," with the open position marked "Off." Do not change rotation without allowing the motor to stop. The switch can be given the finish as shown so that it is easily seen. A wiring diagram is shown in the upper detail of Fig. 3.

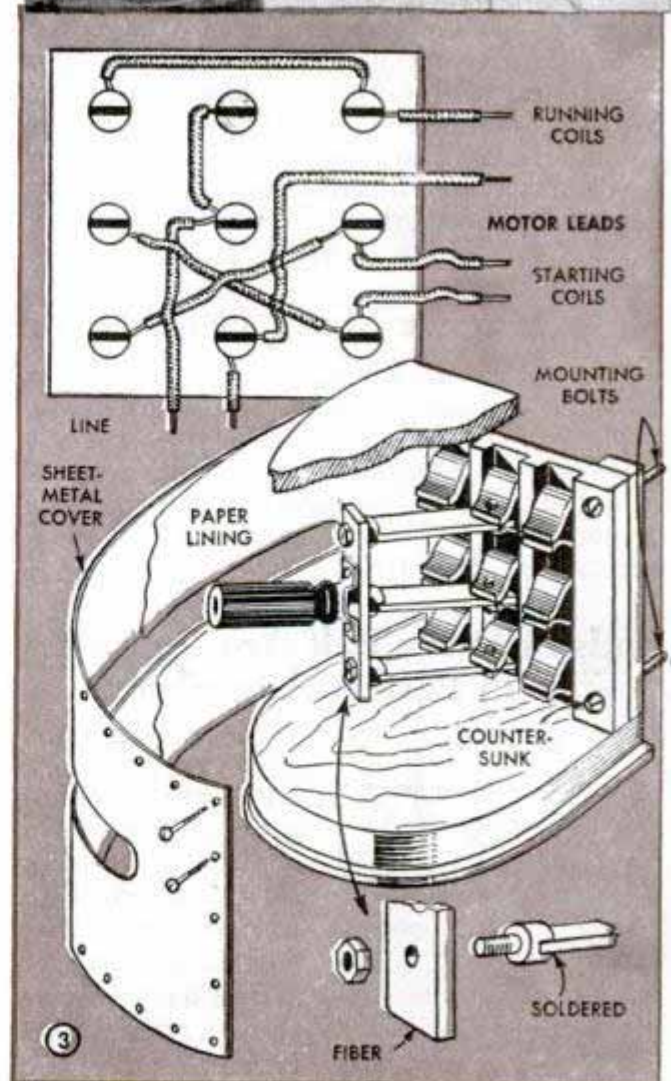

Folding Parallel Rules Are Set With Aid of Built-on Scale

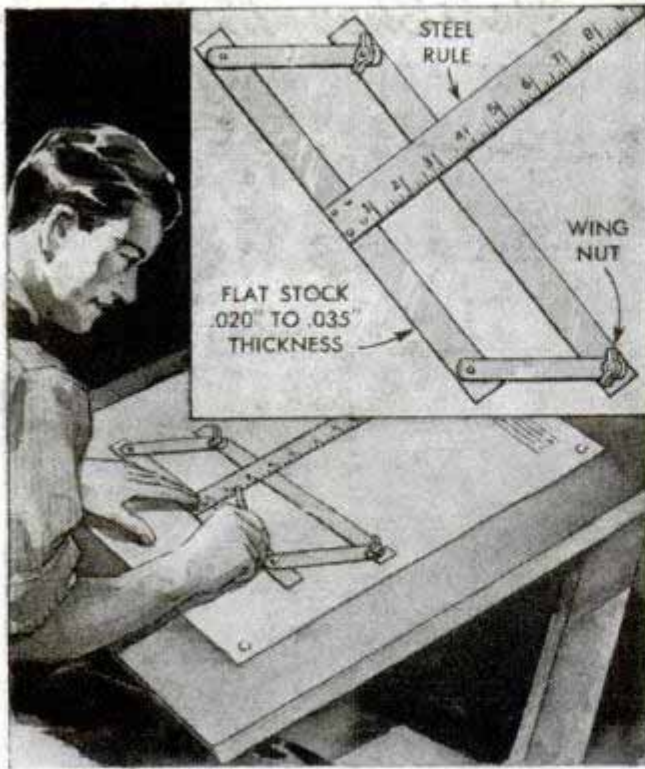

Layout work on a drafting board or workbench is easier if folding parallel rules like these, which are made of flat iron, have an attached steel rule to set the distance between parallel lines. Holes are drilled and countersunk in one of the rules for rivets, and in the other for bolts, the holes being spaced the same distance from the ends of each. The rules then are joined by two arms, also of flat iron, and tightened by wing nuts screwed on the bolts.

Hugh A. Wells, Parkville, Md.

Shop Magnet Made From a File

A worn rattail file can be magnetized to draw chips, screws, bolts and small metal objects from holes and otherwise inaccessible places. The teeth first are ground off to smooth the surface, and after this the file is magnetized. This tool will hold its magnetization a long time.

Ends of Drive Belt Are Cut to Fit With Perfect Alignment

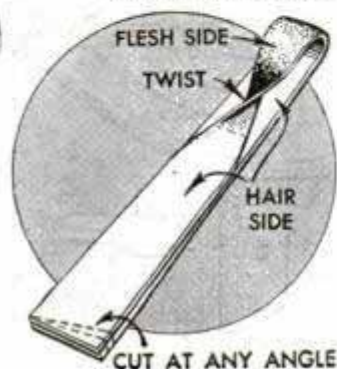

Drive belt ends need not be square with the sides in order to fit exactly if they are cut as illustrated. The belt first is twisted and laid with the sides aligned as shown, after which the ends may be

cut square or at any other angle. The cuts must be straight, however, so that when the belt is untwisted and the ends are joined they will align. Although it is best to cut the ends square, this system will prevent possible errors in marking and cutting and will result in a joint that will have perfect alignment.

W. E. Schaphorst, Newark, N. J.

Method of Drawing Beam Sections Saves Drafting Time

When drawing detailed sections of standard channels and I-beams, the time required to detail the beveled edges of the work can be greatly shortened by cutting the inside of a triangle to the correct bevel.—Michael Vidos, Inglewood, Calif.

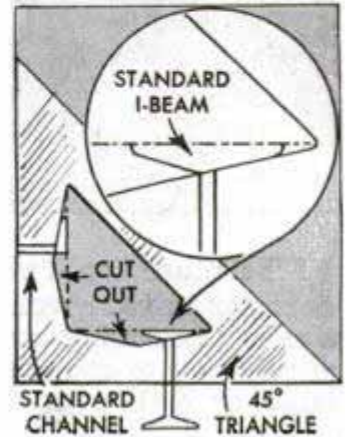

Locating Opening for Wall Outlet

To install electrical wall outlets, drive a brad through the plaster to locate the space between laths. When the space is located, the box is centered over the hole made by the brad and the outline of the box is scribed on the wall. An opening cut along the scribed lines will locate the box so that the screw tabs will project over strips of lath, where screws can be driven to hold the box securely.

Hacksaw Blade Serves as Guide In Trimming Paint Brushes

If the outside bristles of paint brushes become frayed and worn, they can be trimmed by using a hacksaw blade as a guide. Insert the blade between the worn and the good bristles and trim with shears or snips, as shown. Be sure to press the blade firmly against the base of the brush.—Jack Bronte, Grass Valley, Calif.

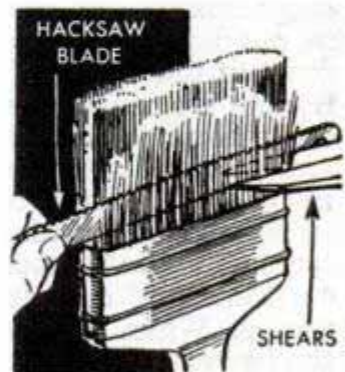

ⓘ Since hard composition boards dull circular saws quickly due to the abrasive substances they contain, it is well for this purpose to use an old saw or to use your best saw as sparingly as possible.

Variable VOLTAGE REGULATOR *has many uses*

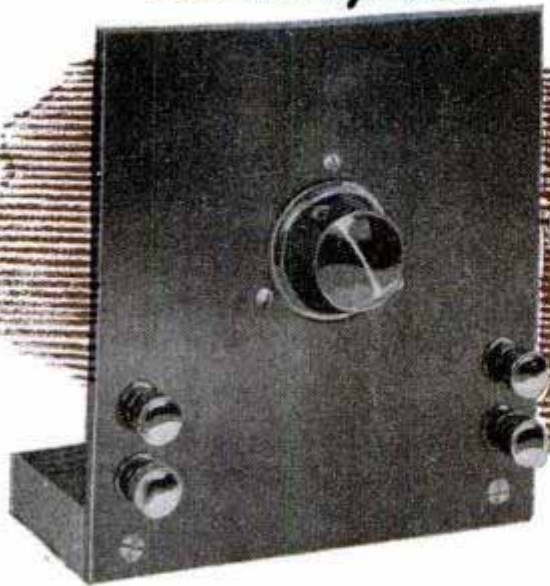

By Alexander Maxwell

THIS A.C. current regulator gives a smooth and continuous voltage control from zero to maximum and can be used as either a step-up or step-down transformer to increase or reduce voltage. The transformer is of the "doughnut" type, mounted on a panel, and is designed to carry a 100-watt load continuously, but easily is constructed for higher voltages by increasing the transformer core and wire sizes proportionately. The panel is fitted with two sets of binding posts, Fig. 6, those marked "high" connecting to the two ends of the coil, while those marked "low" connect to the slide and one end of the coil. When used as a step-down transformer, the electrical source is connected to the "high" terminals and the slide is adjusted to get the desired voltage. If the regulator is used as a step-up transformer, the electrical source is connected to the "low" terminals. It's best not to build up the voltage to more than twice that of the input, because of the loss by heating.

In making the regulator you begin with the transformer core which is wound on a wooden mandrel in the lathe as in Fig. 3, using transformer iron of the "ribbon" type. Start the winding by cutting a shallow groove lengthwise in the mandrel. Then bend a hook in one end of the iron ribbon and insert in the groove. Run the lathe at the lowest speed with the back gears engaged. It's advisable to wind and unwind the ribbon several times to soften the metal so it will bend easily and fit snugly. When the winding is finished the core should be about 4 in. in diameter. It then is fitted with a compression band of the same material, as shown in Fig. 10. This band should reduce the diameter of the core to about $3\frac{3}{4}$ in. The band is left in place under the windings as it holds the core securely and reduces the

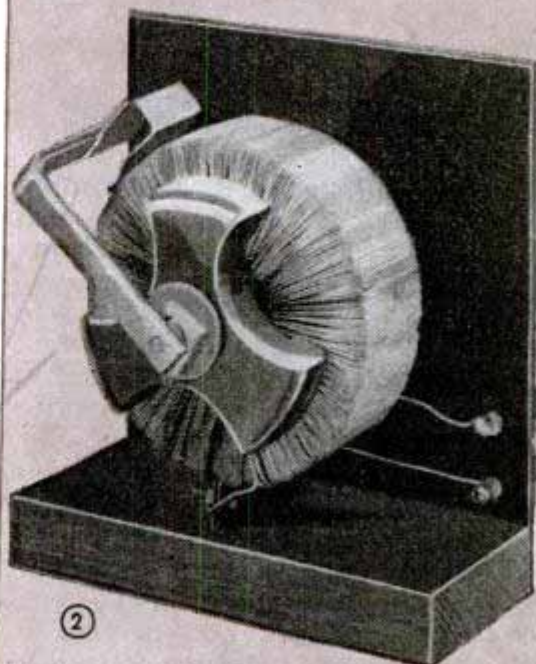
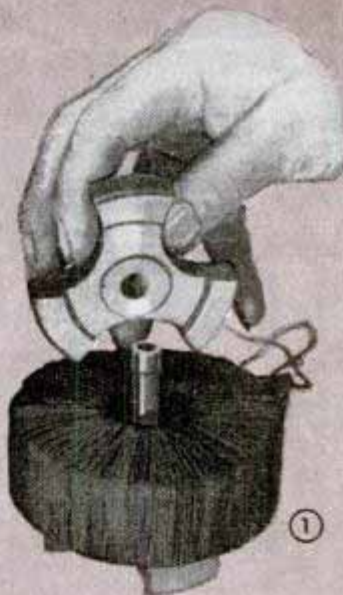

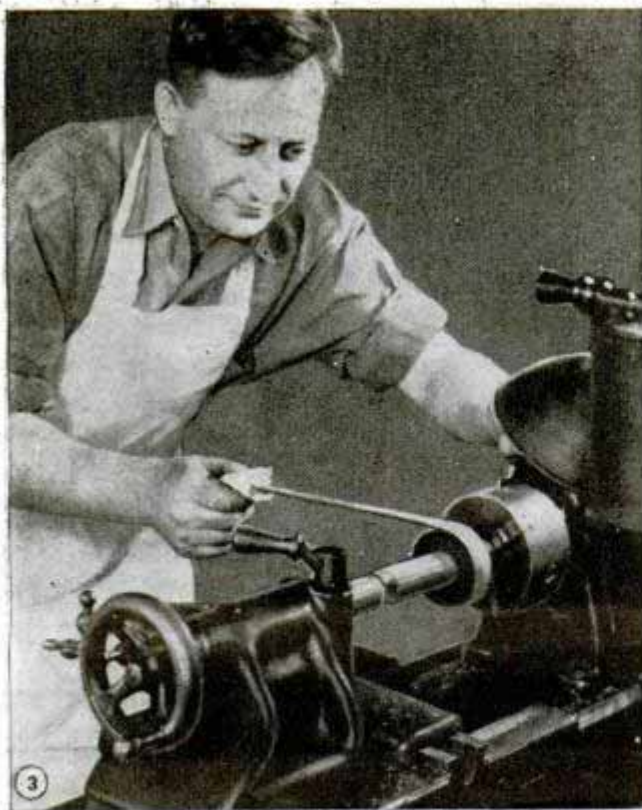

wire also can be bared with a fine scratch wheel as in Fig. 7.

The finished coil is mounted on the panel as in Figs. 1, 2 and 6, the latter showing in detail how the mounting is assembled. First turn two hardwood end plates to the dimensions given in Fig. 11 and mount the coil and end plates on a sleeve made from brass tubing as in Fig. 6. Be sure that the coil is centered on the sleeve, then draw up the nut to grip the coil between the end plates and hold it securely in place. Next, the $\frac{1}{4}$ by 4-in. steel shaft carrying the slide is cut to length and turned down to $\frac{3}{16}$ in. in diameter at one end to take the slide arm as indicated. The slide and arm are made as in the upper right-hand detail of Fig. 6, and are soldered to the shouldered end of the shaft against a collar as shown in Fig. 2. The slide must be adjusted carefully at the point of contact so that it touches only one wire at a time, as indicated in the upper left-hand detail of Fig. 10. An adjusting knob completes this assembly. The bake-

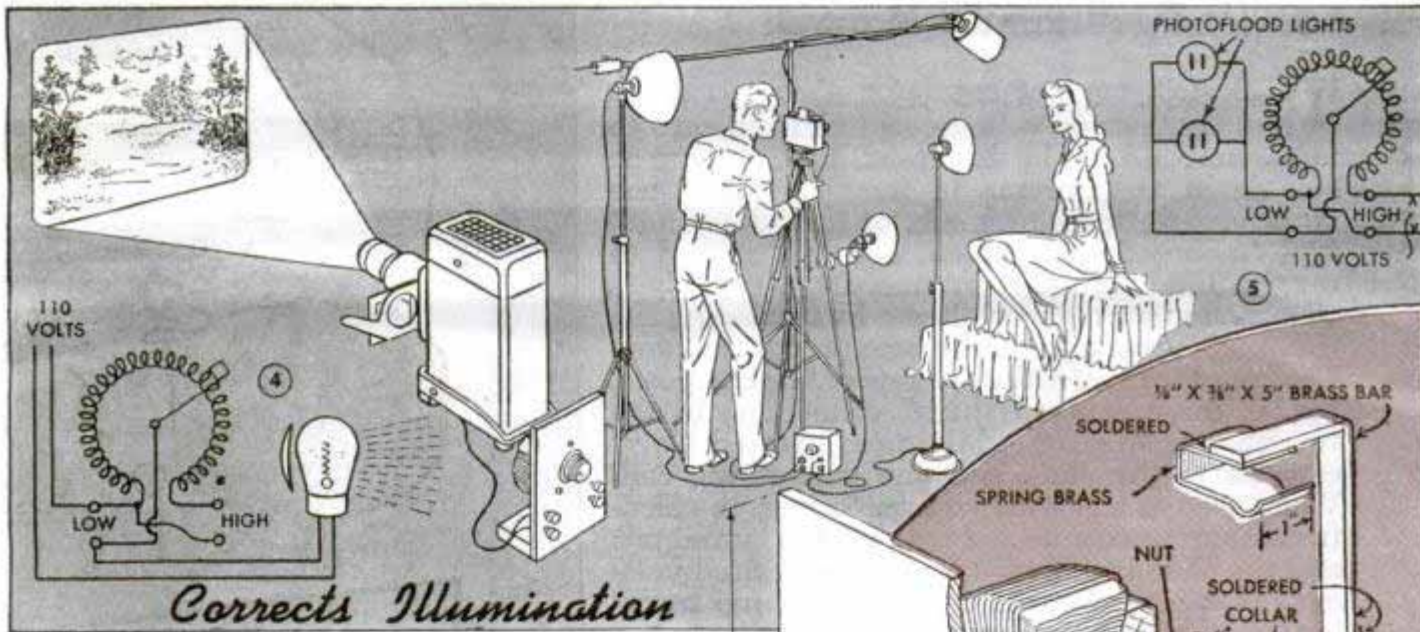

tendency of the regulator to create a hum.

The load-carrying capacity of this type transformer is primarily determined by the amount of iron in the core and the size of the wire used in the coil. This one is wound with 400 turns of No. 14 enameled antenna wire, the windings being in one layer at the circumference of the core, three or more layers at the center opening of the core. The winding is done with an improvised "shuttle" as in Fig. 12. Care should be taken to keep the wire under uniform tension and to wind the turns tightly together side by side. When the winding is finished coat with a baking enamel and dry in an oven. To bare the wire for the slide contact, use fine emery cloth and be very careful not to damage the insulation between the windings. The

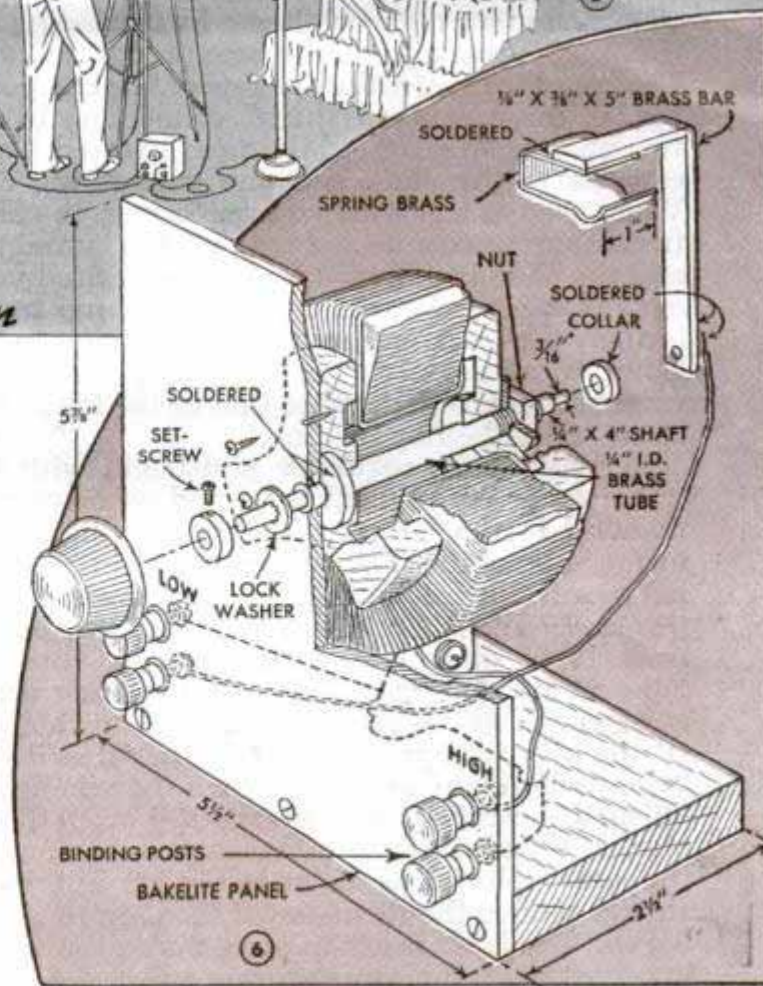

lite panel is screwed to a hardwood base and, after fitting and wiring the high and low terminals, the unit is ready for use.

Figs. 4, 5, 8 and 9 suggest a number of uses and give the wiring diagrams for each application. For these particular purposes a smooth, positive change from one voltage to another is especially desirable. For example, regulating the output of a projection bulb as in Fig. 4, or controlling the brilliancy and illumination factors of photo lights as in Fig. 5, are common applications of this type of voltage regulator. In both instances the light intensities can be varied to emphasize delicate detail on the screen or on the subject to be photographed. And, of course, by cutting down the voltage when posing the subject for an indoor shot as in Fig. 5 you prolong the life of high-intensity bulbs as the lights can be raised to full brilliancy for the short interval of the exposure and then immediately decreased in brightness. Be sure that the combined wattage of the lights does not

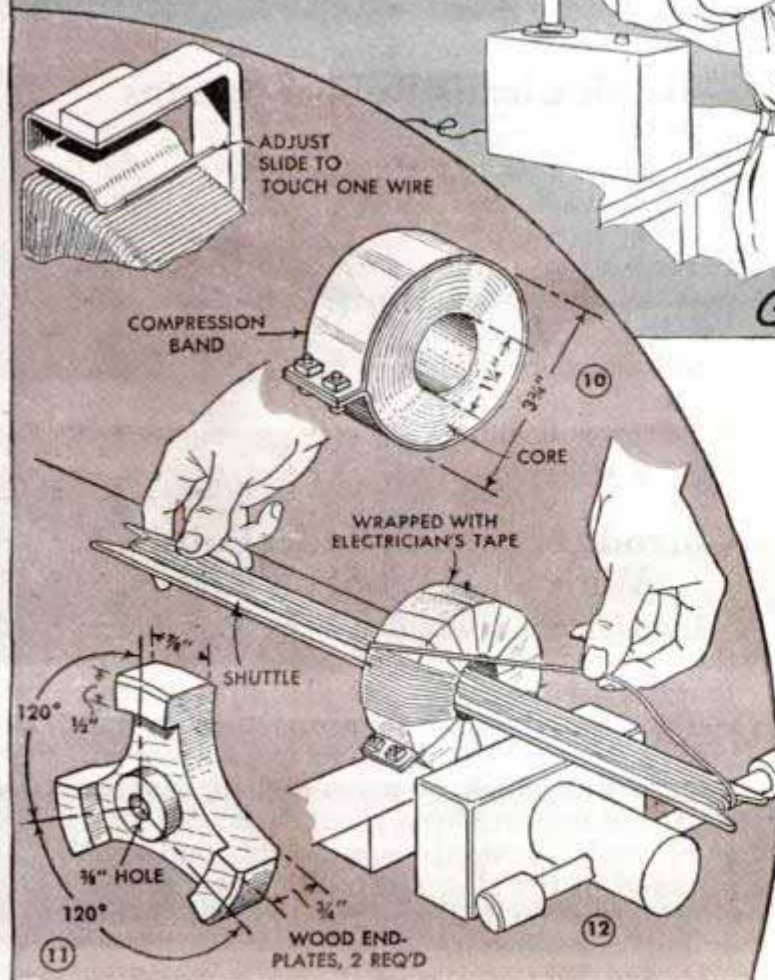
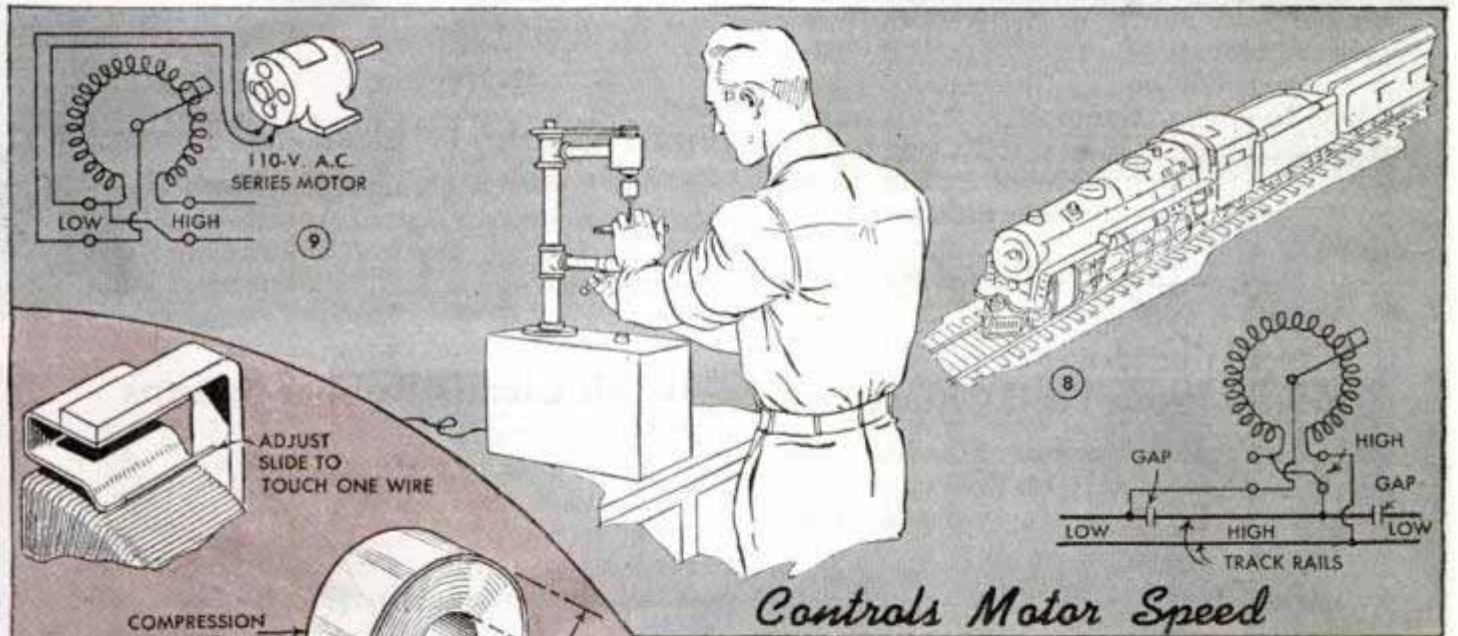

exceed the capacity of the transformer.

The regulator also can be used to control a small series motor through a range of speeds without the current loss due to heat, as is the case where a rheostat is used. Often, on large model railway layouts, there is a portion of track where a number of factors combine to slow the speed of the train. This portion of the track can be insulated from the rest and the regulator used as a step-up transformer to feed it. Current for the regulator is taken from the section just ahead. As the train enters the "slow" section the regulator slide is advanced until the train maintains the desired speed. When the train reaches the end of the section the locomotive again receives power from the regular source.

Shipping Tags Strung Quickly By Using a Crochet Hook

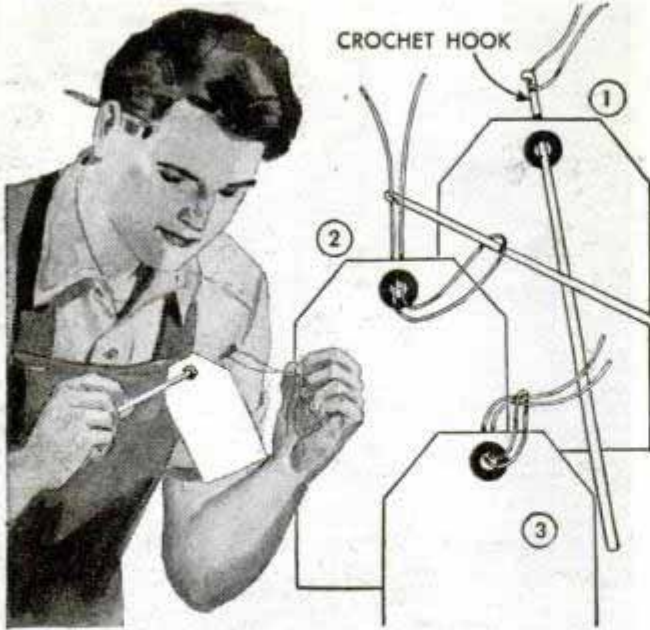

Shipping tags of the type having strings inserted through holes in the tags can be strung quickly and easily if an ordinary crochet hook is used. The string is doubled and the crochet hook is inserted through the hole to engage the loop, which is pulled through the hole as in Fig. 1. The hook then is advanced to catch the strands, Fig. 2, and pulled back, bringing these through the loop as in Fig. 3.

Leo A. Chartier, Danielson, Conn.

Lathe Collet for Small Work Made From Drill Chuck

Lacking a collet attachment for his lathe, one machinist used a 1/2-in. drill chuck and altered it to take stock of any diameter up

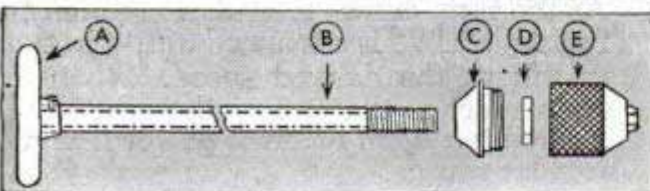
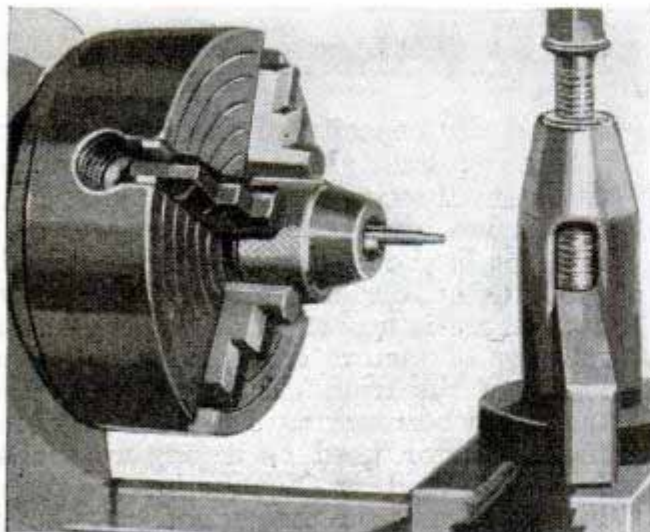

to 3/8 in. One advantage of this chuck is that once it has been centered in the lathe, any number of pieces can be machined without further centering. When making the attachment, drill a 3/8-in. hole in disk D to allow long work to pass through the chuck E. One end of tubing B then is threaded to fit piece C of the chuck and the other end is threaded for handwheel A.

Gerald S. Seidel, Norristown, Pa.

Sheet Metal Braces Strengthened By Forming Channels

A flat sheet-metal brace can be made more rigid by hammering down the free edges so they are at right angles to the brace. In effect, this forms a channel that will be much stronger than the flat piece of metal.

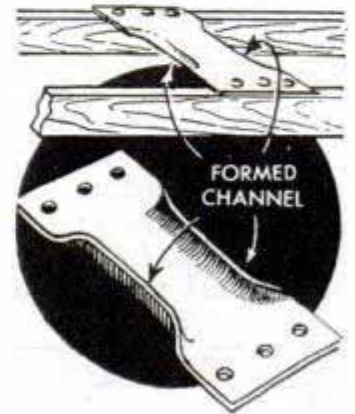

Small Bottle Is Used as Trowel

When laying a cement floor in a basement, you can use a small round bottle instead of a trowel. The bottle is used to form neat concave corners where the floor joins the wall.

Brush Cleans Rubber Stamps

Rubber stamps can be freed of thickened ink and other clogging material by being passed lightly over the bristles of a small scrub brush screwed to a workbench or wall within easy reach.



Corroded Brake Cylinder Polished With Steel Wool on Rod

If no hone is available for dressing down the interior of a hydraulic-brake cylinder that has become corroded, a length of metal rod and a wad of fine steel wool will do the work. The rod should be of a diameter to fit into the chuck of a hand drill, and is slotted at one end for a short distance. The steel wool is wrapped around this end and engaged in the slot, after which the rod is chucked in the drill and rotated inside the cylinder to polish it.

Cpl. Wm. R. Biglin, Cape Charles, Va.

Metal Fixture Guides Die When Cutting Threads

When cutting threads, this guide can be clamped on a die stock to start the die properly so that clean, straight threads will result. It is made from a strip of $\frac{5}{8}$ -inch-wide flat iron formed with right angle bends. To be sure that the guide will not slip when clamped to the handle, the two ears are curved for a better fit. The hole in the fixture should have the same diameter as the rod or pipe which is being threaded. As the illustration indicates, C-clamps are used to fasten the guide to the handles of the die stock.—Geo. Tee Boon, Rochester, N. Y.

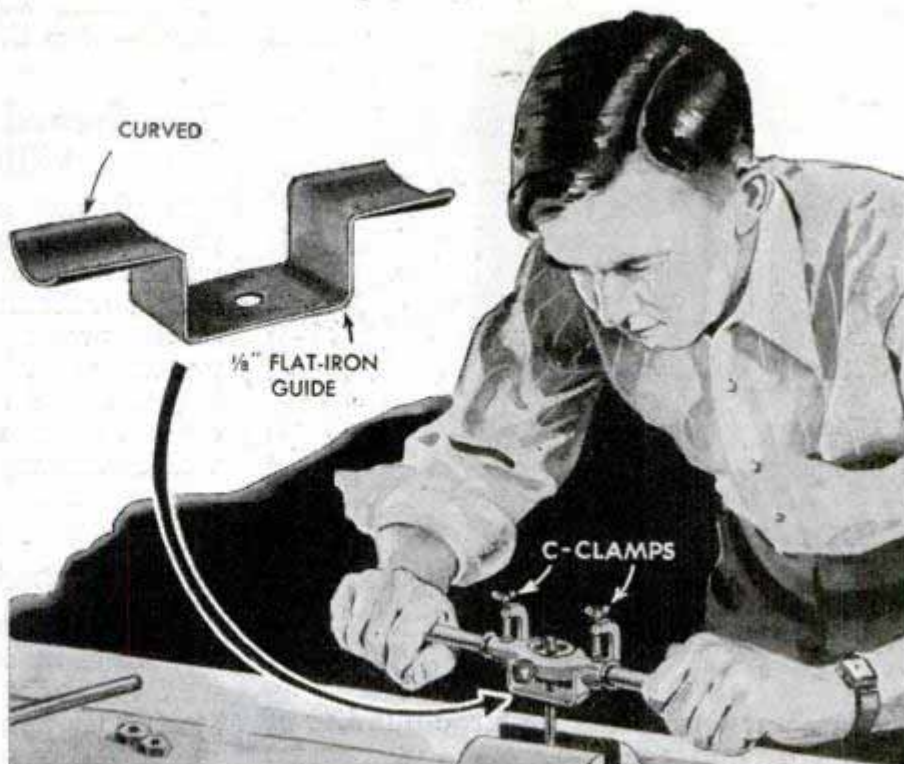

Lower Arm of Drafting Machine Holds Instrument Tray

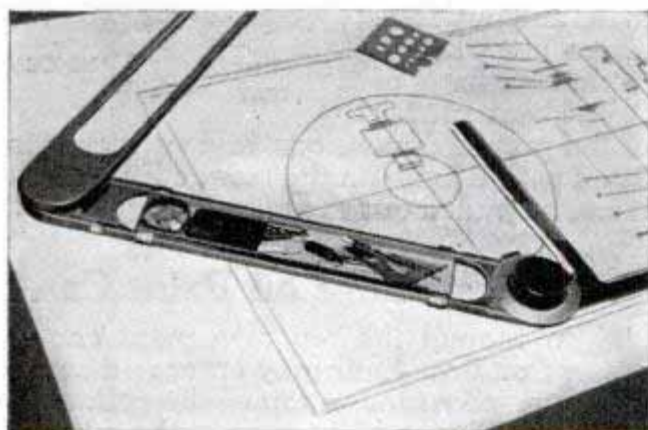

If you use a drafting machine of the type that is illustrated here, you can fashion a tray for your instruments that will be an integral part of the machine and thus avoid sweeping tools off the table when moving the arms. As can be seen, the tray fits between two rods that comprise the lower arm. It is cut from stiff cardboard to fit between the rods. The length of the tray is immaterial as long as it does not interfere with the action of the machine. The cardboard is held in place with drafting tape.

G. L. Dillon, Tecumseh, Ont., Can.

Removable Handle Will Position Spoke-Shave Blade for Sharpening

To obtain the proper angle when sharpening spoke-shave blades, one carpenter made the handle shown here so he could hold the blade more easily. The handle can be of steel stock $\frac{3}{8}$ in. thick and $\frac{3}{4}$ in. wide by 6 in. long. If such heavy material is not available, a lighter steel can be substituted. A hole is drilled for a round-head stove bolt to hold the blade to the handle.

C. C. Pickering, Montreal, Que., Can.

Smoked Blade Aids Saw Filer

Saw filing is greatly facilitated if the blade is coated by passing it through the flame of a candle or other open flame. After this is done, each fresh file cut will show up plainly, eliminating guesswork as to which teeth have been filed.

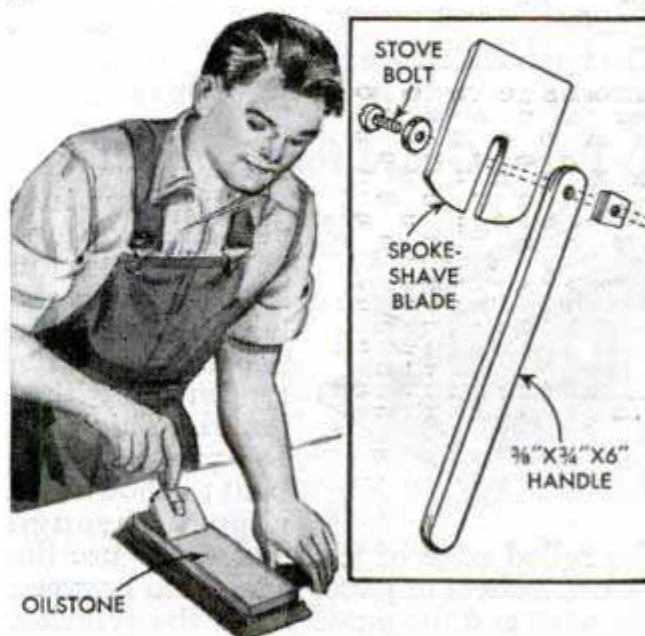

Keys Can Be Selected Quickly When Spaced on Chain

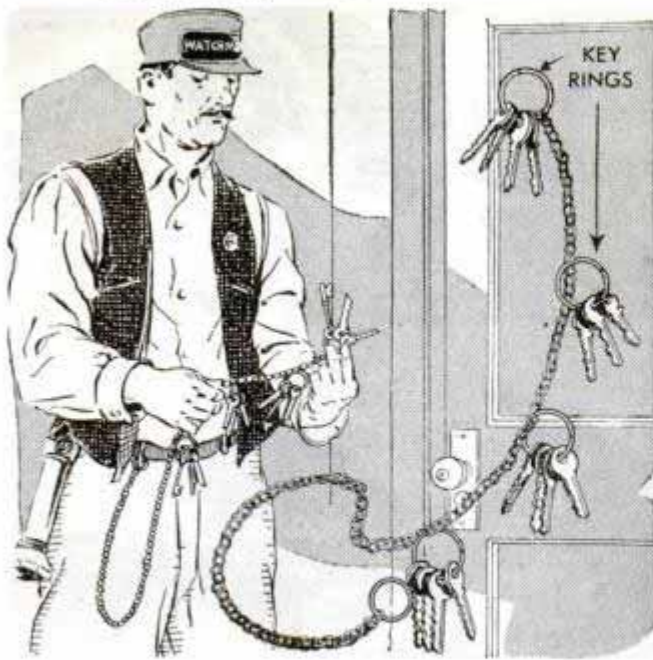

Watchmen who carry a large number of keys will find that any one key can be selected more easily if the keys are separated into groups according to the location of the locks on the route of inspection. Each group of keys is held by a ring and the rings are spaced along a chain attached to the trouser belt.

Wedge Fastens Handle to Head



A serviceable wedge to hold a hammer or hatchet head on its handle can be made from an ordinary wood screw. Before being driven into the handle, the screw is flattened so that it has a triangular shape.

The teeth which are formed by the flattened threads serve to hold the wedge in place.

Paper Guard for Typewriter

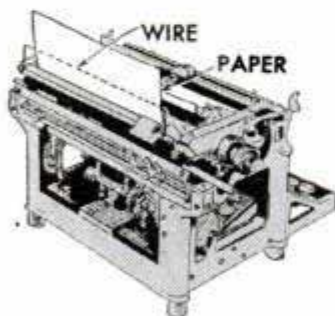

When typing, you can prevent the paper from falling over the keys by fitting the paper guide of the typewriter with a guard. This is a length of wire bent as shown and slipped through

the rolled edge of the guides. To use the guard, a sheet of paper is inserted between the wire and the guide under the cylinder.

After about $\frac{1}{3}$ of the paper has been typed, the top of the sheet is slipped under the wire. This will keep it from falling forward.—Don C. Higbee, Downey, Calif.

Roughened Surface of Photostat Will Take Writing

Draftsmen and others who work with photostats frequently find it necessary to make corrections on the photostat. Usually this is difficult to do because the surface of the paper is glossy and will not take pencil or ink. If the area on which the writing is to be done is roughened with an eraser, it then will take pencil or ink as well as tracing paper does.

Bernard Sachs, New York

Toolbox Capacity Increased

The space at the bottom of machinist's toolbox for storing the removable front cover is an excellent place for keeping small tools such as taps, drills and punches. These are placed in shallow trays of light sheet metal

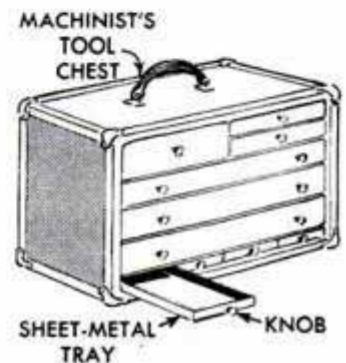

of the proper dimensions, and each tray is fitted with a knob on the front edge so that it can be pulled out easily.

Wax Seals Edge on Paint Can

Even though the top of a paint can is pressed on firmly, air may enter and cause formation of a film on top of the paint. To prevent this, one painter seals the edge of the lid with candle wax. This is done by holding a lighted candle at an angle so the drippings fall on the seam between the lid and the can.

F. F. Walden, St. Petersburg, Fla.

Colors Identify Ends of Gauge

To save time in checking parts with a "go no-go" gauge in a production shop, one foreman painted two bands of color on the gauge to distinguish the "go" end from the "no-go" end. A red band was painted on the "no-go" end and a green one on the "go" to correspond to the "stop-and-go" system of colors used in traffic lights.—Emil Wittmann, Philadelphia, Pa.

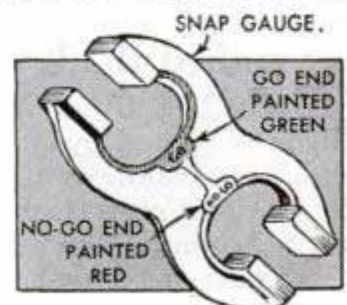

Blades of Ruling Pen Are Ground To Form a Lettering Pen

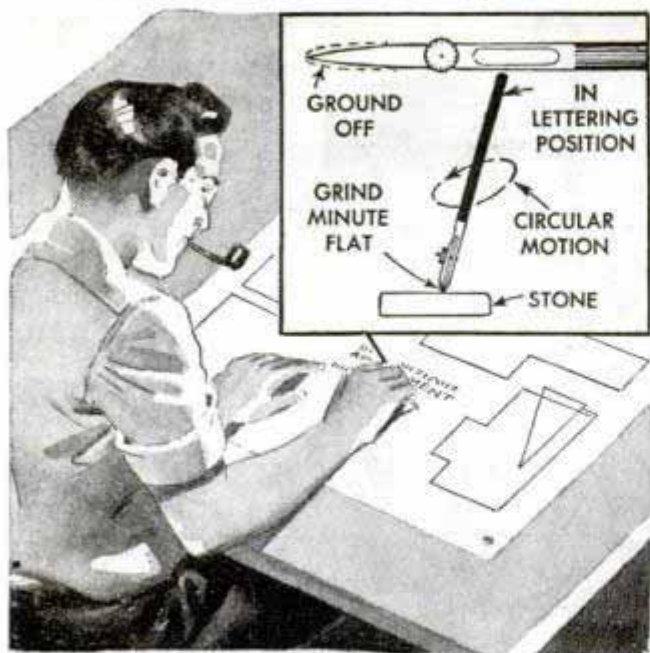

A lettering pen that will hold a large quantity of ink and produce letters of uniform density can be improvised from a ruling pen. The blades are ground to a gradual taper having a circular cross section. Then burrs are removed on an oilstone and a minute flat is ground on the extreme tip of the pen. This is done by holding the pen in a nearly vertical position and rubbing the tip against the stone with a circular motion. For best results when using the pen, it should be held almost perpendicular, with the nibs adjusted for a smooth flow of ink to make lines of the desired thickness.

Henry Zave, Chicago

Lack of Fluid Reduces Gas Mileage

In cars equipped with fluid drive, one cause of low gasoline mileage which can be overlooked easily is slippage in the coupling due to an insufficient amount of the fluid. This should be checked at regular intervals, but only after the car has cooled, since the fluid expands under heat.

Hal Geihm, Aurora, Ill.

Snap Gauge Built From C-Clamp

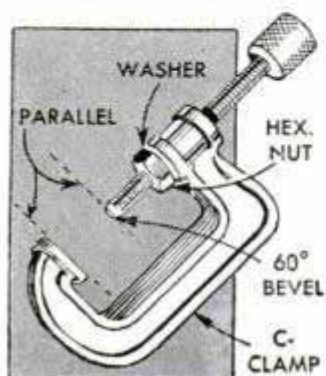

To speed inspection of identical metal parts in a production shop, a "go no-go" snap gauge can be made from a C-clamp. This can be adjusted for testing work of various sizes and will gauge tolerances

as close as .001 in., being more accurate than spring calipers for this purpose. To make the gauge, remove the tip from the clamp screw so that the screw can be chucked in a lathe. Turn the end square and chamfer it slightly. The screw then is reassembled on the frame and a flat steel washer and hex nut are added to complete the assembly. When set at the required distance, the screw is held at this setting by tightening the nut against the clamp.

Slot in Tympan Sheet Saves Time In Setting Guides on Job Press

When printing cards of various sizes on a job press, time is saved in adjusting the side guide by slotting the tympan sheet. This allows the guide to be set at various distances without making a new slot for each size of stock to be printed.

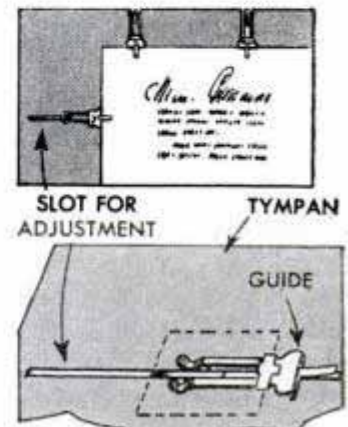

Engine-Driven Pump Is Portable

Used to draw water from lakes and streams, this portable pump is powered by a small gasoline engine through a V-belt drive. The pump, which is a positive displacement type, is supported by two up-rights that rest on the lower base and the engine is mounted on top of the pump.

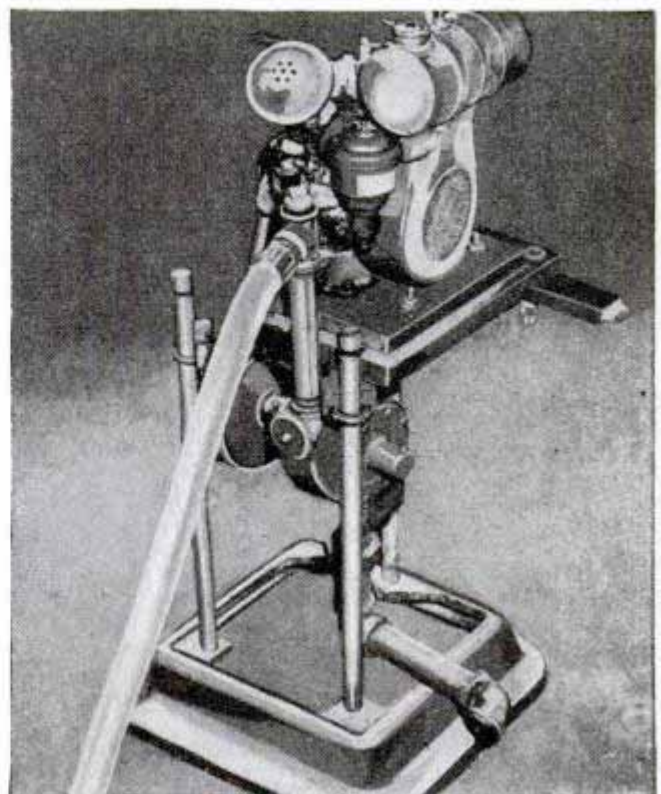



Disappearing Video Screen in "Teleset" Cabinet

ALTHOUGH this modern styled cabinet is only 24 inches deep, it houses a 20-inch direct-view television receiver, FM, standard broadcast and phonograph equipment. In the center is an ingenious disappearing screen which can be tilted back into the cabinet automatically merely by pressing a push-button control which starts a small silent motor. The record player and storage space for phonograph albums are at the left in photo A; beneath the screen is housed the mechanism of the set. At the right are the controls for the television, FM and AM receivers and their associated speakers. Photo B shows the cabinet completely closed when not in use.

Sketch Fig. 1 illustrates the space-saving mechanism which permits the use of a 20-inch cathode-ray tube which has greater length than the cabinet depth. Heavy lines show the screen in the viewing position. Dotted lines indicate the position of the video screen in the concealed position to which it is retracted mechanically when the television set is not in use. When activated by the push-button the motor-operated mechanism brings the tube into the viewing position in 10 seconds while the set is warming up. The tube is retracted by pressing the push-button a second time.

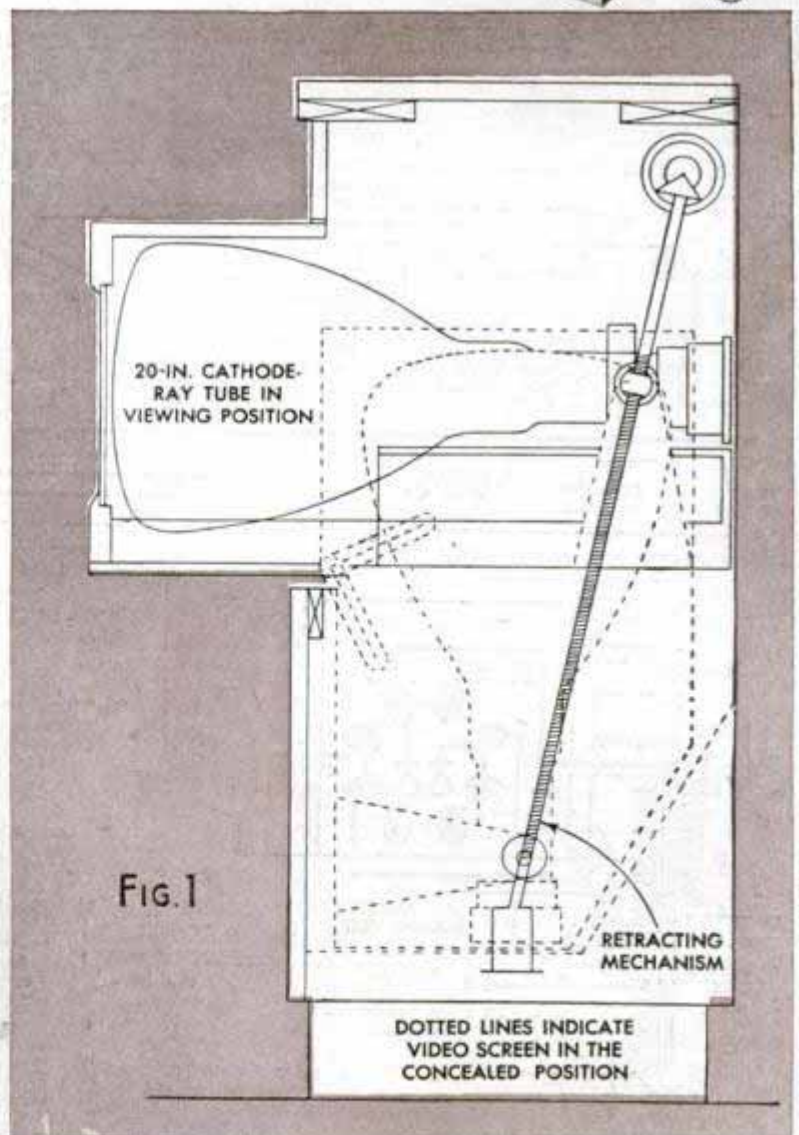
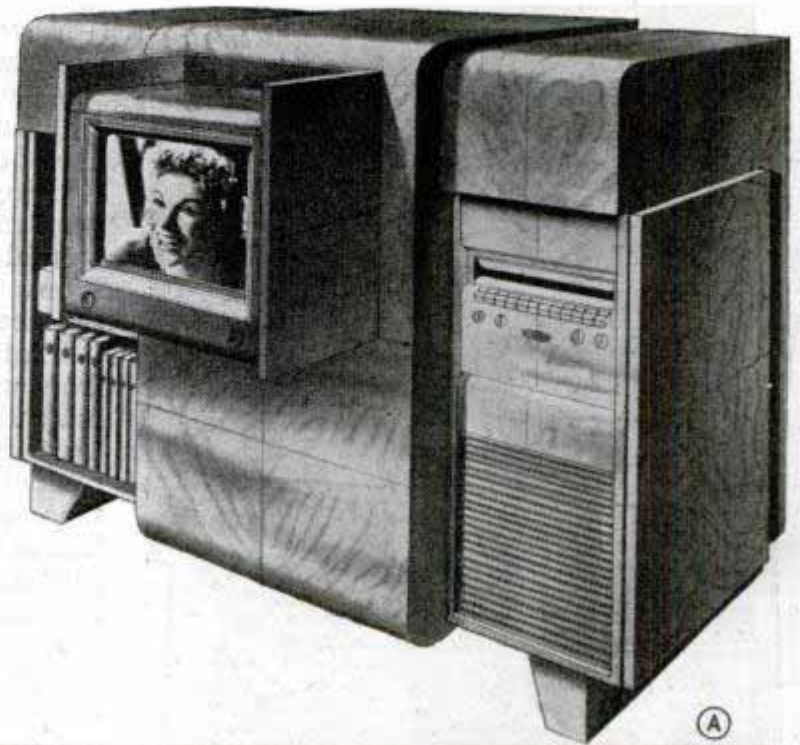

THREE-TUBE SHORT-WAVE

By C. H. Trapp

SOMETHING new has been added to a favorite circuit of many amateurs and experimenters. Originally a two-tube short-wave super, it has been improved by doubling the volume and providing for the use of crystal headphones.

Using a 25-ft. antenna and no external ground, Australian and African stations were logged without effort in the Middle West. The power supply section may be replaced with batteries if desired.

Photos A, B and C show top, bottom and front views. The schematic circuit diagram is Fig. 1 and pictorial wiring diagram Fig. 3. Two R.F. coils cover the complete frequency range from 5400 to 14,500 kilocycles. One oscillator coil covers the entire range. These coils are wound on standard 4-prong plug-in coil forms. Windings L2 on the R.F. coils and winding L4 on the oscillator coil consist of seven close-wound turns of No. 24 enameled wire. Winding L1 on R.F. coil No. 1 consists of 18 turns of No. 22 enameled wire space-wound over a length of 1½ in. L1 on R.F. coil No. 2

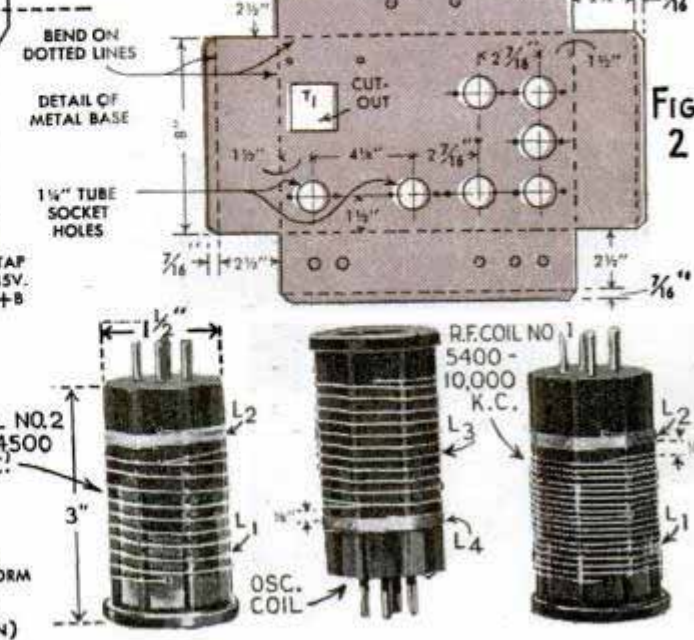
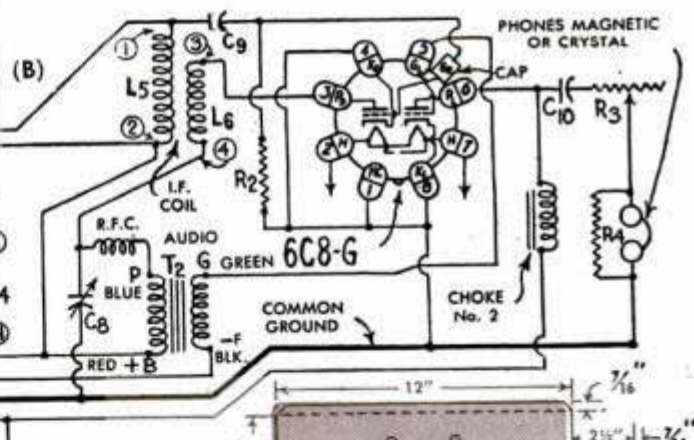
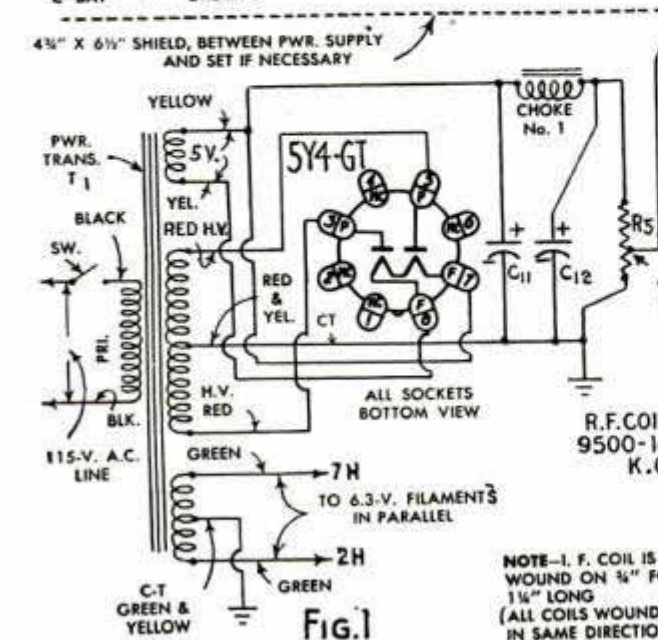
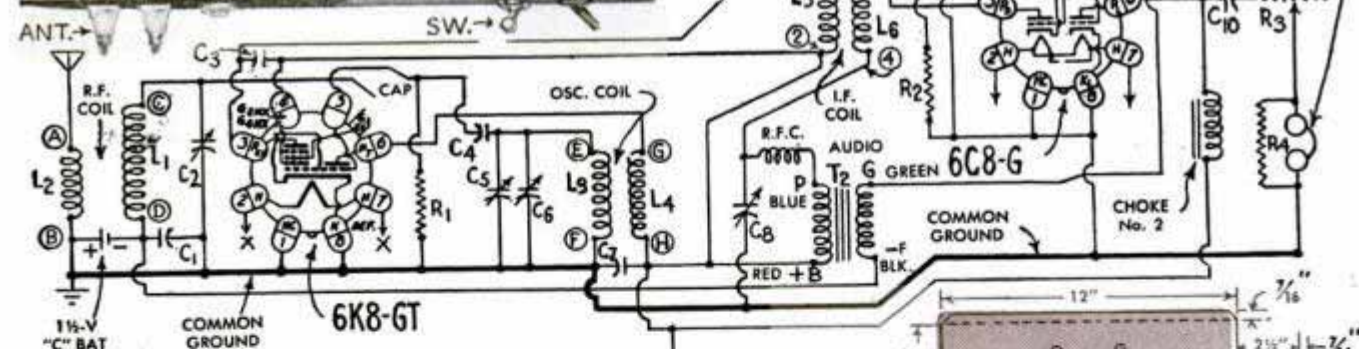
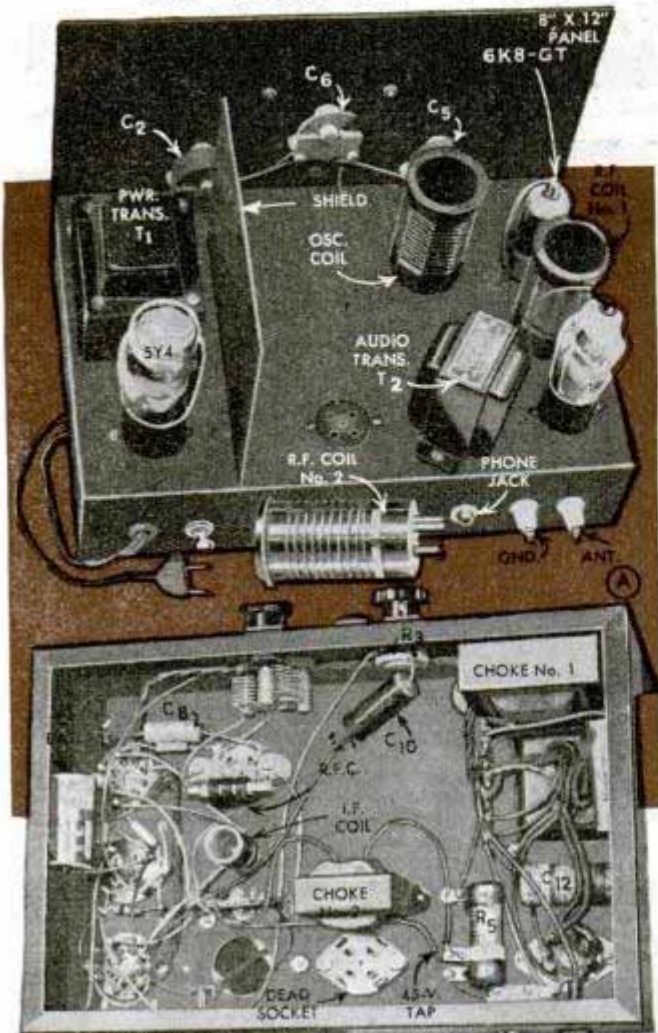

NOTE—I. F. COIL IS WOUND ON ¼" FORM 1½" LONG (ALL COILS WOUND IN SAME DIRECTION)

SUPER of ADVANCED DESIGN

10 turns of the same size enameled wire space-wound to a length of $1\frac{1}{2}$ in. Winding L3 on the oscillator coil consists of 12 turns of No. 22 enameled wire also spaced to a length of $1\frac{1}{2}$ in. Make sure that all coil ends in prongs go to the proper socket terminals.

The I.F. coil, mounted under the base, is wound on $\frac{3}{4}$ -in. plastic or Bakelite tubing $1\frac{1}{4}$ in. long. Winding L5 consists of 55 turns of No. 28 enameled wire close-wound; winding L6 is 18 turns of the same wire close-wound. The total length of wire required to wind L5 is 130 in.; 43 in. are required for L6; spacing between L5 and L6 is $\frac{1}{8}$ in. The power transformer T1 may be any small receiver type. Audio transformer T2 is a 3-to-1 ratio shielded type mounted at a 45-degree angle to the power transformer. To operate the receiver, set C2 at about half scale; now turn C5 slowly until a signal is heard. Next adjust C2 and C8 for maximum volume; once set for maximum sensitivity C8 may be left alone.

Potentiometer R3 controls tone if crystal phones are used. Detailed student material list R-341 is available if desired.

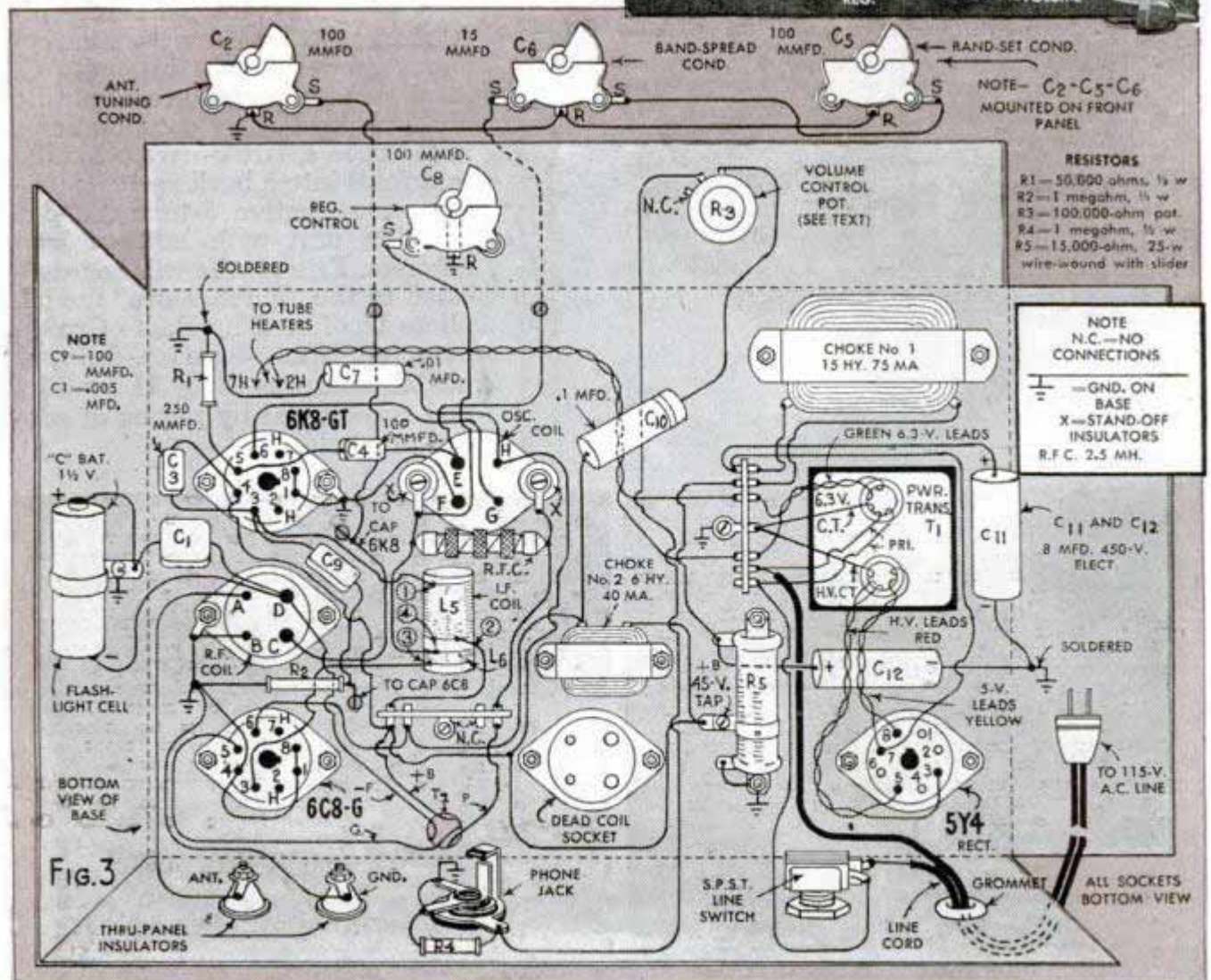
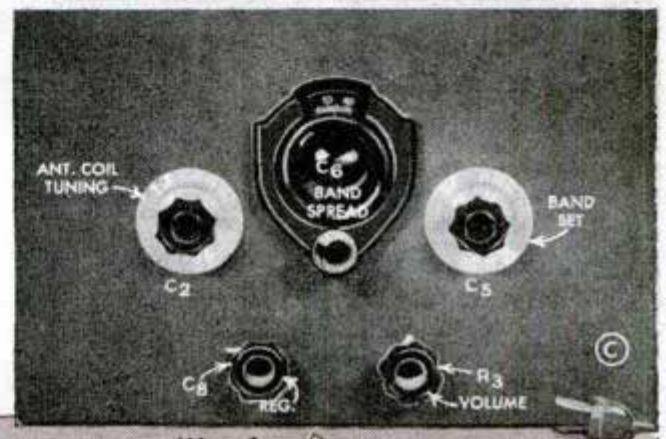

1946 Portable and General Purpose Home Sets



ACCENTUATING practical applications, and including many improvements in design gained by wartime manufacturing experience, the new receivers reaching the market should satisfy pent-up civilian demands and needs.

Outdoor enthusiasts will find portables of several types that will outperform anything they used in prewar days. The "three-way" battery or line-powered compact unit shown in photo A covers standard broadcasts and short waves with band-spread tuning on five foreign broadcast bands. It features the Zenith detachable loop antenna and also has a rod antenna that "pops up" at a touch of the finger. The 7-tube chairside radio-phonograph combination in photo B, built by Electronic Corporation of America, includes a record changer and provision for convenient servicing through the top of the set. The full vision illuminated slide-rule dial is equipped with a "bomb sight" indicator.

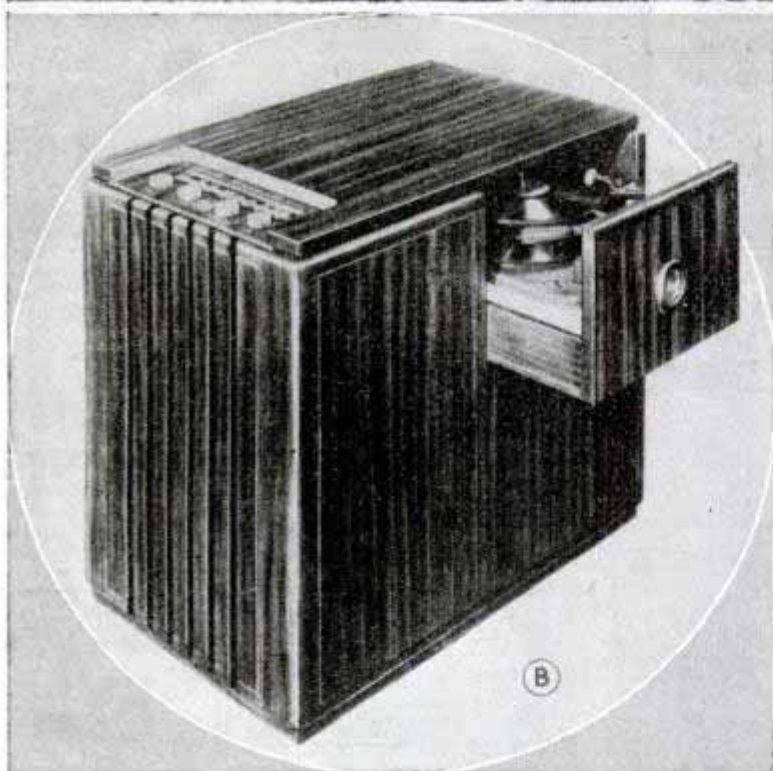

Westinghouse introduces the ultramodern 6 by 6 by 9-in. carry-about model shown in photo C. Available in pastel green plastic and gold and ivory combinations, it features a tuck-away handle that folds into a back recess, making an attractive 5-tube a.c.-d.c. portable unit with built-in loop antenna. Friend wife will be interested in the "Kitchenaire" model, photo D, offered by Radio Craftsmen, Inc. This 5-tube a.c.-d.c. wall model measures 22 by 11 by 6 in. and is mounted by means of special brackets.

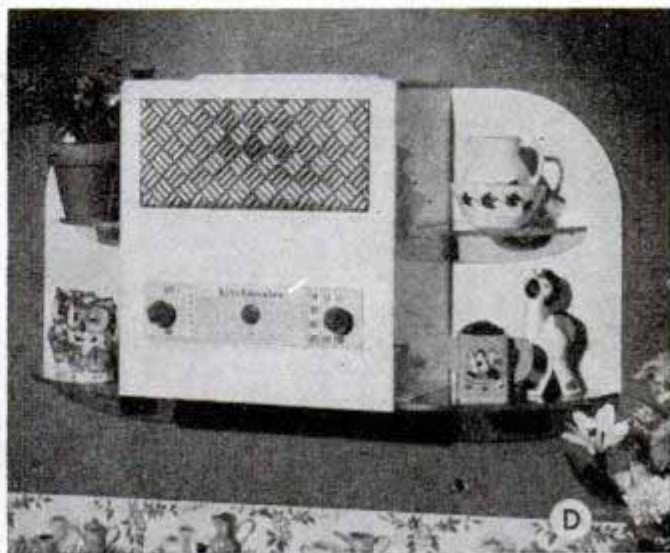



“Gee, Dad, you sure need new Sealed Power Rings!”

SMOKE from the exhaust always means oil burning, inefficient combustion, an engine that's growing old too fast. It's a sure sign of worn piston rings. Get your favorite repairman to install new Sealed Power Piston Rings now—restore original power, lengthen engine life, save oil, save gas.

Sealed Power Individually Engineered Ring Sets are selected from twenty-six basic designs of piston rings. Whatever the make, model, and cylinder-wear condition of your engine, there's a Sealed Power Set specifically engineered to do the best possible job in it. Sealed Power Piston Rings have been the choice of major engine builders for 34 years, a record of which Sealed Power workers are extremely proud. For maximum power, say “Sealed Power.” Sealed Power Corporation, Muskegon, Michigan and Windsor, Ontario.

KEEP YOUR WAR BONDS! GET \$4 FOR \$3!

© 1946, Sealed Power Corp.

For better results 26 Basic Ring Designs

No one piston ring design can meet all replacement needs. Sealed Power Individually Engineered Ring Sets are made up from twenty-six (26) basic ring designs, which permit each set to be specifically engineered to do the best possible job in a particular make of engine.

These ring sets are engineered to save gas without sacrifice of oil economy, to save oil without inducing friction and cylinder wear. Each set gives *balanced* performance in a particular engine.

*Piston Rings
Pistons
Cylinder Sleeves
Valves
Water Pumps
Chassis Parts*



SEALED POWER PISTON RINGS

BEST IN NEW CARS! ★ BEST IN OLD CARS!

Ingenious New Technical Methods

To Help You with Your Reconversion
Problems

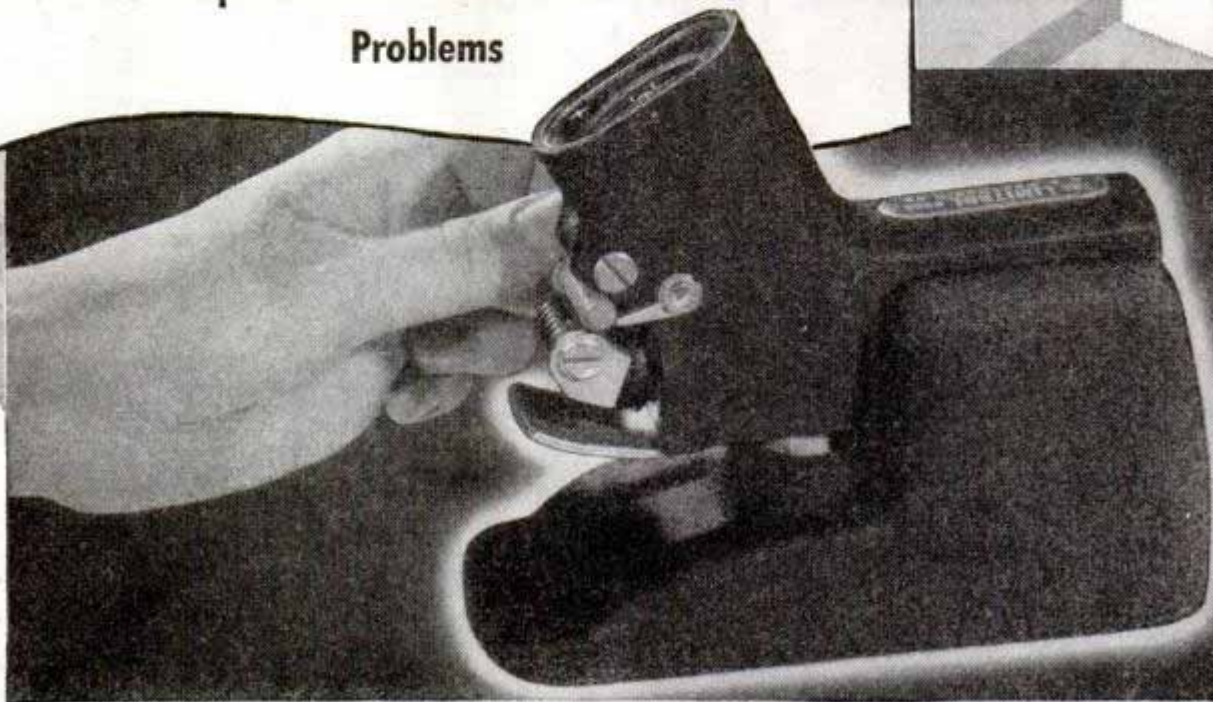

New Comparator Gage Saves Time— Gives 6 Inspections in One!

Even the most inexperienced operator can obtain accurate inspection of externally threaded parts, with the Limitrol Comparator Gage—in many instances, increasing the rate of inspection as much as 400%! The Limitrol, proved in hundreds of war plants, permits 6 visual checks in one: pitch diameter, lead, taper, out-of-roundness, angle, and straightness. Its use reduces inspection and production costs, cuts scrap waste while increasing speeds of operation. If a part passes the Limitrol, it will assemble accurately.

Graduated dials are furnished as standard equipment. These dials are graduated in increments which approximate .0005 inch when the magnification is 250 to 1, and serve as a guide in determining just how far over or under the limits the part might be.

Another "help on the job" is chewing gum. Chewing seems to make work go easier, time go faster. Good chewing gum is available, but there's still a shortage. That's why we at Wrigley wish we could make Wrigley's Spearmint now, to help increase the available supply. You may be sure we will, just as soon as sugar restrictions are lifted. Meanwhile, chew any good available brand, because it's the chewing that really does you good.

*You can get complete information from
N. A. Woodworth Co., Sales Division, 1300 E. Nine Mile Road
Detroit 20, Michigan*

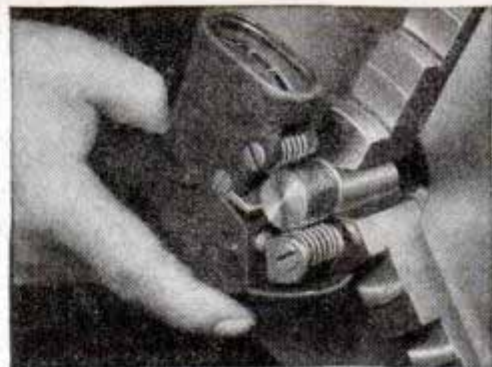

Hand Model used for "in process" gaging



AA-54



IT'S A GRAND FEELING
TO GET
A PERFECT FIT...

IT'S A GRAND FEELING, TOO,
WHEN YOUR CAR IS
CUSHIONED WITH MARFAK
CHASSIS LUBRICATION



With ordinary grease . . . you're taking the road shocks again after a few hundred miles.



Marfak stays on the job hundreds of miles longer — means more velvet smooth riding.

MARFAK Chassis Lubrication gives your car that "cushiony" feeling and for more miles. And here's why:

Marfak is scientifically designed for the job — is given special cohesive and adhesive qualities that resist washout, jar-out and squeeze-out. Because it clings to bearing surfaces, it seals out dirt and grime. In addition, *Marfak* is unusually resistant to heat.

Yes, it's a grand feeling when your car is cushioned with *Marfak* Chassis Lubricant. See your Texaco Man and say: "*Marfak*, please."

You're welcome at

TEXACO DEALERS



**FIRE-CHIEF
GASOLINE**



**SKY CHIEF
GASOLINE**



**HAVOLINE AND TEXACO
MOTOR OILS**

Let us
MARFAK
your car

**MARFAK
LUBRICATION**



**THE
TEXAS
COMPANY**

Tune in the TEXACO STAR THEATRE with JAMES MELTON Sunday Nights ★ METROPOLITAN OPERA BROADCASTS Saturday Afternoons

KNOW your handsaw files



*The right file for the job is the file whose width, or flat side, is equal to a little more than twice the depth of the saw tooth.

SAW FILING is an "art." And half the art lies in the ability to select *The right file for the job**—plus the resolve to use none but the tops in quality.

There are nearly forty shapes and sizes of triangular files for sharpening or reshaping worn teeth of handsaws and other saws having 60-degree or wider tooth angle. Taper, Blunt and Double Ender are the groups of shapes—with the first mentioned by far the most widely used. They are usually single cut, with corners, as well as sides, cut to deepen the gullets between the saw teeth.

Make Nicholson or Black Diamond files your choice. They're the products of the world's foremost file maker and are sold under the sweeping manufacturer guarantee of *Twelve perfect files in every dozen.*

FREE BOOK, "FILE PHILOSOPHY." Contains useful information on saw filing, plus 44 additional pages on kinds, use and care of files.

NICHOLSON FILE CO., 22 Acorn St., Providence 1, R. I.
(In Canada, Port Hope, Ont.)

NICHOLSON FILES

FOR EVERY
PURPOSE

NICHOLSON
U.S.A.
MADE IN U.S.A.

Fighting Flying Ice

(Continued from page 86)

normal movement of the plane in flight.

Research engineers found all three principal kinds of ice that are encountered in flying in their Mount Washington studies. Clear or glaze ice, which easily is produced in a refrigerated wind tunnel, forms a transparent, glasslike sheet. It is encountered in flying through freezing rain or when large water drops are suspended in air at freezing temperature. Such ice, being smooth and dense, does not appreciably change the aerodynamic properties of a plane, but covers large areas and is likely to increase the plane's weight rapidly.

Ice encountered in flight is most likely to be the type known as "rime," and is formed when water particles are of average size and supercooled, or when glaze ice is diluted with sleet or snow. Rime ice, because it is porous, is an opaque white. It forms rough, often fantastically shaped deposits and causes loss of stability and lift by upsetting the aerodynamic characteristics of a plane.

Rime frost, or simply frost, is not of great importance in flying except in the landing of a plane. It develops when water particles are minute and the temperature very low. It is porous like rime, usually smoother and whiter, and on a wing it often forms a deposit that tapers forward to a point.

Observers encountered many problems in their Mount Washington studies. Freezing temperatures and 120-mile winds drove them into the control shed to record observations of their test wing. Making photographs to record their experiments was difficult. Camera shutters froze within a few minutes. Lens filters accumulated ice.

But engineers are winning the mountain-top battle against ice. Tests today will provide safer flying tomorrow.

Wax Emulsion in Family Wash Makes Clothes Waterproof

When a wax emulsion developed for the armed services goes on the market, anything in the family washing can be made water resistant. The milky liquid, neither poisonous nor inflammable, is merely added to the rinse water or can be used with starch. It consists of small particles of paraffin wax in a solution of an aluminum salt and water. The invisible wax does not fill the spaces between fibers, thus retaining the porous qualities of clothing. Treated garments are less likely to wrinkle and spot. The emulsion also can be used on awnings, window shades, draperies and other fabrics.

Your Hardware Dealer Knows . . .

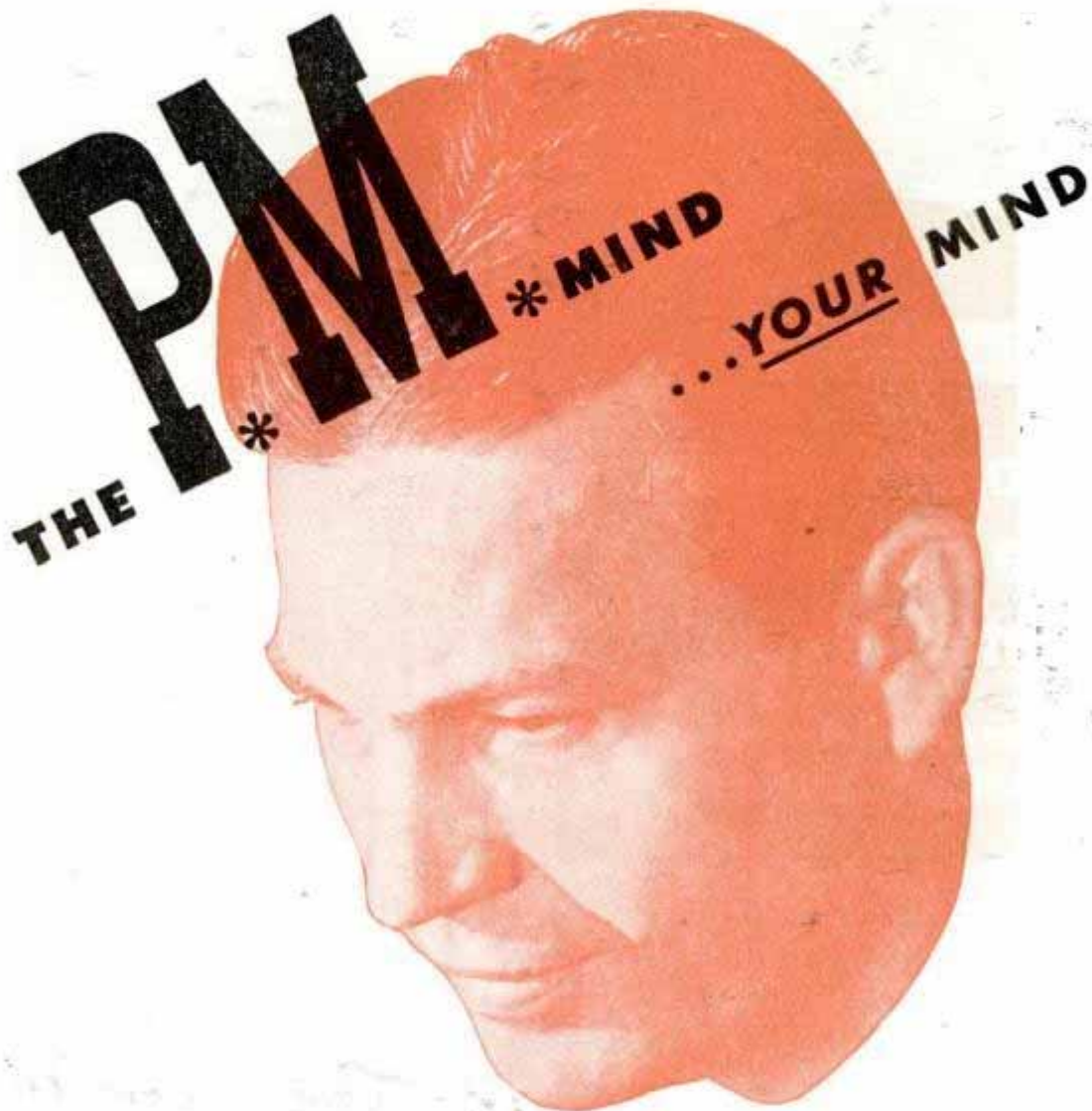

YOUR hardware dealer especially likes to serve you.

Why? Well, for one thing, readers of **POPULAR MECHANICS** *know* tools... they *know* hardware... they recognize quality. Readers of **POPULAR MECHANICS** have "the P. M. Mind" . . . the inquisitive, exploring, enthusiastic mind that is always active, alert to new ideas, and always doing something about them.

Your hardware dealer likes to serve you . . . whether you need a handful of brads or a home workshop lathe. He carries 40,000 to 60,000 items for men who like to do things . . . men just like you.

So depend on your hardware dealer. Consult him. He will help you with your home projects and home repair jobs. From his knowledge and from his huge stocks he can come up with the answer to almost any problem you have.

Visit your hardware dealer. He'll be especially glad to see *you* . . . because he has "the P. M. Mind," too!

**POPULAR
MECHANICS**



SIMONIZ



Simoniz Protects the Finish for Winter Driving!

Saves your Car's Beauty and Trade-in Value.

Until you have that new car... be proud of your old one. SIMONIZ it for protection against winter weather... against slush, mud and freezing cold. Saves car trade-in value, too. Simoniz Kleener, liquid or paste, restores dull finishes to shiny newness... SIMONIZ keeps it sparkling, eliminates frequent washings. Easy to use... gives beauty and protection months longer. Don't let winter ruin your car's finish... SIMONIZ today!

THE SIMONIZ COMPANY, CHICAGO 16, ILL.

Sold by grocery, hardware, drug, paint 5¢ to \$1, auto accessory, department stores, garages and service stations.



MOTORISTS WISE

SIMONIZ

HOUSEWIVES DO LIKEWISE

Tool Connects Hose to Pipe Line

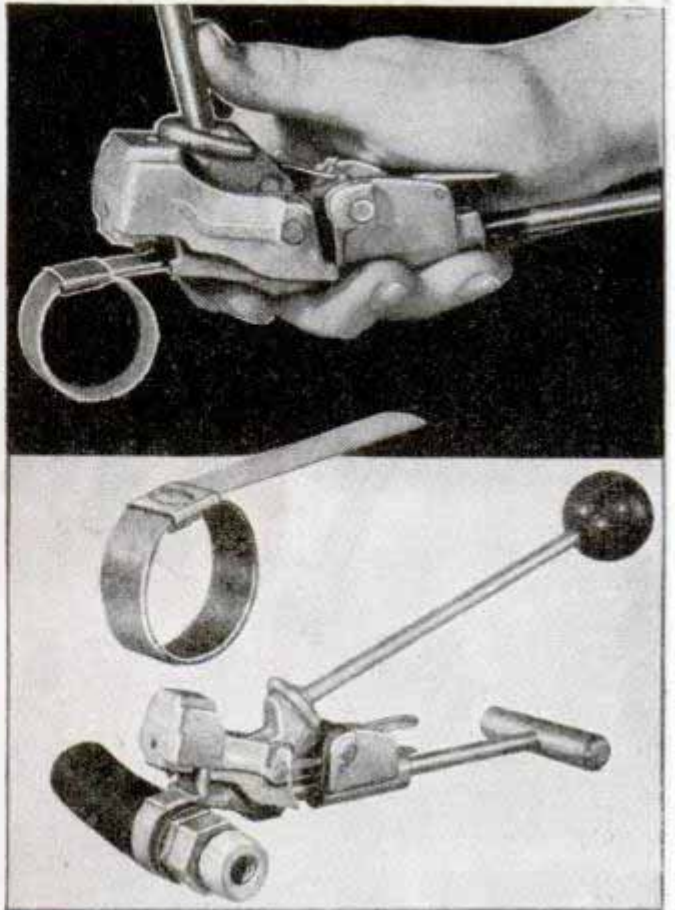

Flexible hose can be attached to rigid pipe lines with a special clamping tool. Galvanized steel bands are wrapped twice around the joint and clamped tight under high pressure. The clamping tool locks a clip into place. This tool also can be used to connect various types of fittings, to splice electric welding cables and to stop leaks in steam and water lines.

Portable Gun for Spraying Metal

Compact and easy to use, a portable sprayer for low temperature metals and alloys can be plugged into any electrical outlet and connected to an air line or to bottled air or nitrogen. It operates on pressures of 20 to 60 pounds. Metals and alloys are melted at 100 to 600 degrees F., and the spray can be adjusted to fine, coarse or pour. In pouring, no air pressure is needed and the metal flows like solder. A thermostat controls the pot.

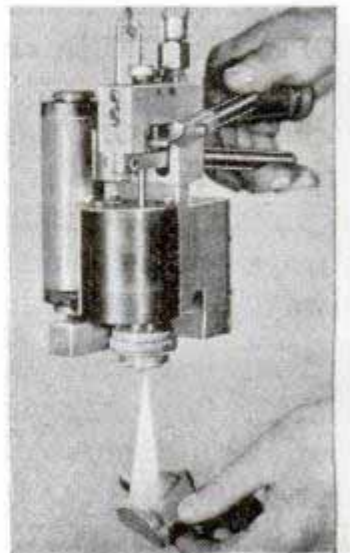

Alloy-Sprayer Co. 602 First National Bldg. Ann Arbor Mich. Punch-Lok Co. 321 N. Justine St.

RIDE A NEW HARLEY-DAVIDSON



HAPPY TOURING AND FUN DAYS AHEAD

The new Harley-Davidsons are rolling off the production line — ready to thrill more and more riders who want the power, rugged dependability and proved performance of "The World's Champion Motorcycles." Get set for fullest enjoyment of glorious, fun-

packed days ahead — as you ride *your own* Harley-Davidson on pleasure-filled tours and exciting endurance runs, or take in race meets, hillclimbs and other motorcycling good times. Get your order in early — see your Harley-Davidson dealer NOW!

HARLEY-DAVIDSON *Motorcycles*

HARLEY-DAVIDSON MOTOR COMPANY, Dept. P, Milwaukee 1, Wis.

Please send at once free copy of 24-page "Enthusiast" Magazine, filled with motorcycle action pictures and thrilling stories.

Name.....

Address.....

City..... State.....



NEXT TIME SAY BRIGHT STAR

and you will get a
FLASHLIGHT & BATTERIES
famous since 1909
for **QUALITY,**
STYLE and
SERVICE



BRIGHT STAR BATTERY CO. CLIFTON N. J.

Fingerprinting Surfaces on Film

(Continued from page 62)

record of the finish he desires, and this replica can be used for checking the finish on the completed work.

An engine manufacturer uses the film to make porosity checks of the chromium plating inside cylinder liners, and finds it quicker and easier than the visual observations and photomicrographs formerly employed. Some critical parts for B-29 bombers were rejected because of "scratches" eight inches down inside a cylinder. A check with Faxfilm showed that the marks were not scratches but were a succession of tiny pits, and indicated that the parts might be salvaged.

Even dentistry has found a use for the new film. A dentist doing research work on extracted teeth found that he could use the film to reveal fibrils pulled out of the tubules of dentine.

Students of biology are finding various applications for McDill's film. The surface of mother-of-pearl exhibits an interesting microscopic structure, but is difficult to observe directly. A film replica, being a transparency, is easily projected on a screen or studied with a microscope. The outer surfaces of sea shells and various other hard materials may be similarly studied. In a matter of seconds, permanent film records may be made of plant leaves, petals and stems, of insect wings and other body parts, and of textile fibers. The replicas often reveal as much detail as permanent specimen mounts requiring days of preparation. It is not a very easy matter to focus a microscope on a human hair in such a way that the scaly structure of the surface is seen clearly. But if the hair is pressed against the solvent-softened surface of a piece of Faxfilm, it will leave a faithful imprint of its surface structure. The film may be studied like any transparent microscope slide at magnifications up to several hundred diameters.

Powerful Rat Poison Harmless to Humans

One pound of Antu, a new rat poison, could kill 300,000 rats but is not dangerous to humans. The name stands for alpha-naphthyl thiourea, the chemicals in the potent rodent killer. A fine gray powder with little odor or taste, the poison can be mixed with ground corn or wheat, sprayed or dusted on fruits, vegetables, floors and runways, blown into rat holes or placed in water where rats drink. Antu was discovered by Dr. Curt P. Richter of the Phipps Psychiatric Clinic at Johns Hopkins Hospital when using rats in an experiment.

SEE WHAT YOU CAN DO WITH A CASCO POWER TOOL KIT

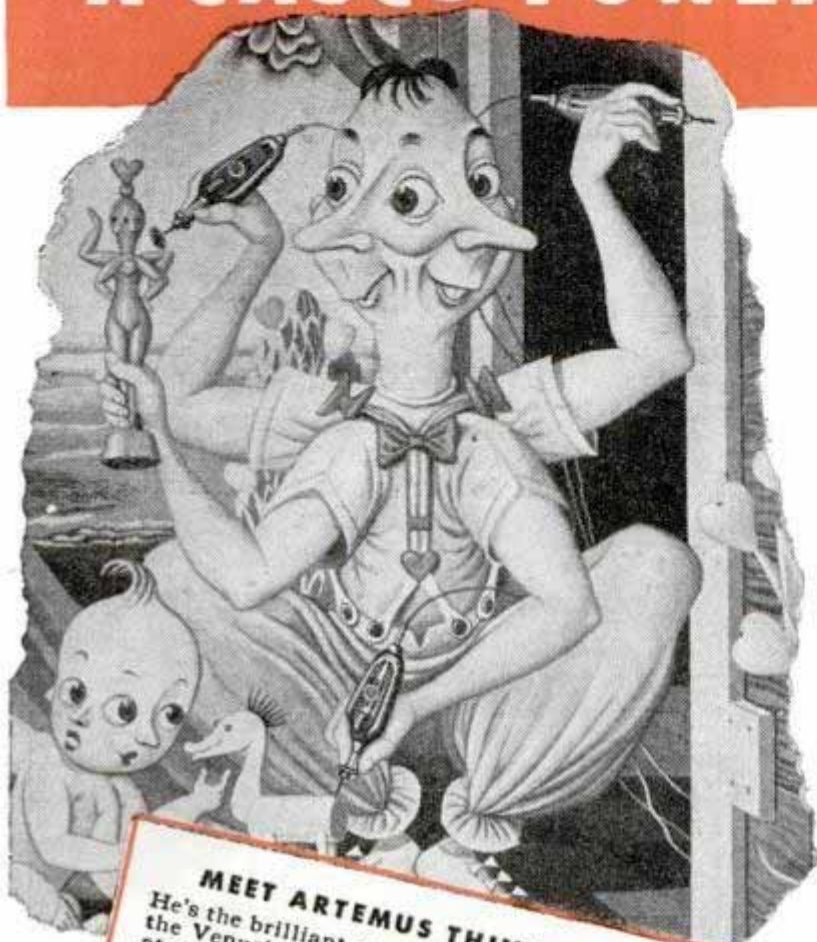

MEET ARTEMUS THINKLE OF VENUS

He's the brilliant concept of artist Boris Artzybasheff—the Venusian you'll meet and like as soon as the new atom-drive space ship is completed. Mr. Thinkle's four hands (notice they're all right hands) give him a slight edge—but you can do everything he's doing with a Casco Power Tool Kit—and more!

35 ATTACHMENTS DO ALL THESE JOBS BETTER AND FASTER

- Sanding
- Carving
- Sawing
- Finishing
- Drilling
- Engraving
- Grinding
- Sharpening
- Burring
- Burnishing
- Inlaying
- Cleaning
- Polishing
- Routing
- Dressing
- Cutting
- Rasping
- Brushing
- Touching Up
- Mortising

... and many other machine and hobby uses

watch

CASCO

for new and unusual contributions to better living

- **It's hand-sized—handles as easily as a fountain pen!**
- **Gets into small places—does fine detail work**
- **Works on metal, glass, wood or plastic**
- **Acts as both a repair and a hobby tool**



The Casco **ELECTRI-CRAFT** Power Tool Kit—now in production, available soon! Casco Products Corp., Bridgeport 2, Conn.

MILLERS FALLS TOOLS

SINCE
1868

One thing in common — QUALITY!

There are hundreds of Millers Falls Tools for thousands of jobs. . . . From the simplest screw driver to the finest precision tool, they have one thing in common — **QUALITY**. Experienced craftsmen of the past took pride in the unvarying quality of Millers Falls tools. Countless thousands of new craftsmen now depend upon them. Your dealer's supply of Millers Falls Tools is increasing in size and variety. Ask him or write for complete details.

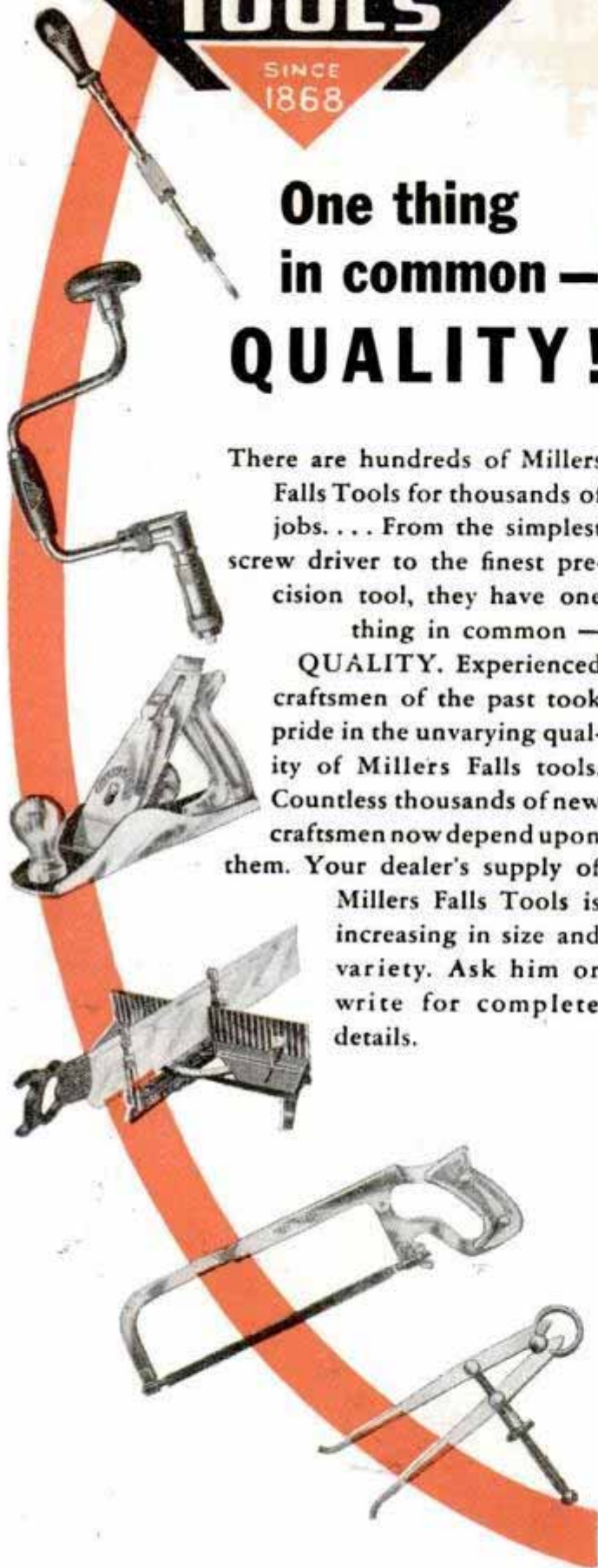

MILLERS FALLS COMPANY
Greenfield • Massachusetts

Grease Gun Gives 5-Ton Pressure



Plugging into any electric outlet, a seven-pound grease gun delivers approximately 10,000 pounds pressure. Shooting 40,000 tiny shots of grease per minute, one filling of the gun is sufficient to lubricate from three to five automobiles.

Towline Gripper Eliminates Knot

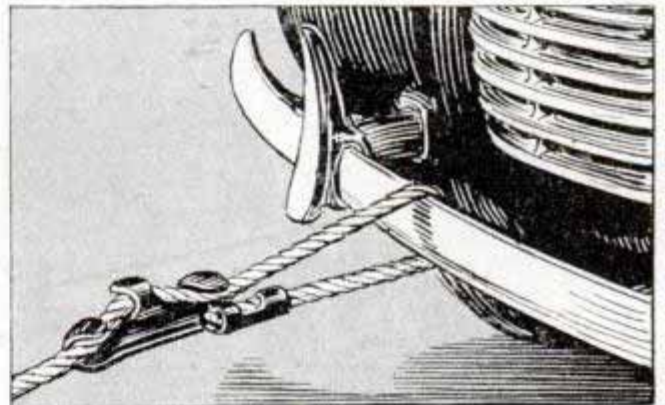

Capable of pulling up to 4900 pounds, a knotless towline has been developed for towing automobiles and for use as a boat line, tent rope, clothesline and hammock rope. Taking the place of a knot is a metal fastener equipped with prongs through which the rope is looped. The fastener is so devised that the "grip" of a $\frac{3}{4}$ -inch rope becomes tighter as more and more pull is exerted. The rope is unfastened easily.

Glass-Plastic Fracture Bandage

Lightweight bandages of Fiberglas and plastic are being substituted for heavy, bulky plaster-of-paris casts in the treatment of hospital patients. Weighing one sixth as much as a plaster cast, the knitted glass-plastic bandage is flexible, permits X-ray examination, is cool to wear and does not absorb water, thus enabling the patient to bathe while wearing his cast.

JITTERBUG

Irresistible at Night!



*Arthur Koss
of Detroit and
some of his
fishing party*

"I Cast Eight Times and Caught Five Bass!"

"Dear Fred:

"We got these largemouth black bass in two nights from Carp Lake with your red and white Jitterbug. They were caught at night in shallow water, casting among the weeds. One night I cast eight times and caught five bass inside of 10 minutes with my Jitterbug. I certainly intend to try some of your Hawaiian Wigglers, too, when I get a chance to buy them."

— *Arthur Koss, Detroit, Mich.*

Fascinates Fish and Fishermen

Jitterbug makes a loud, gurgling, paddling noise, especially noticeable to bass on calm days or nights. It is as fascinating to fishermen as it is to fish, for being on the surface makes it possible to hear and see the strike as it's made. Write for free catalog on Jitterbugs and Hawaiian Wigglers.



\$1.21 ea.

FRED ARBOGAST & CO., 1622 North St., Akron 3, Ohio

Choice of 6 colors

"DUSTLESS" SWEEPING SIMPLE AS THIS



Fill the Dustless brush reservoir with Arbitrin

sweeping fluid. In the process of sweeping, this fluid filtering through the tufts makes sweeping compound out of dust on



The result:



Germ culture after ordinary sweeping



Germ culture after "Dustless" sweeping

the floor. The result: You eliminate up to 97% of the dust in the air between sweepings. You also have cleaner floors and out sweeping costs. Thousands of factories, shops, stores, and schools now use "Dustless"

sweeping. Write for complete facts today.



- Dustless
- Speed Sweep
- Speed Wash brushes

MILWAUKEE DUSTLESS BRUSH COMPANY

528 N. 22nd Street - Milwaukee 3, Wisconsin

Maps for a Shrinking World

(Continued from page 53)

spherical map and calibrated out from a thrust pin at their intersection in nautical miles to the scale of the map. Pivoting about the pin is a swinging arm, moving between the fixed arms. A bearing is found by placing the thrust pin on the point of the map at which the bearing is to be read and adjusting one of the fixed arms in a north-south position. Moving the swinging arm over the desired point for which the bearing is sought gives the bearing on the calibrated scale at the thrust pin base.

Many new advances in map making have been made during the war, of course, not the least of these being clothing almanacs prepared by the Office of the Quartermaster General. These were designed to show the soldier at a glance what clothing he required month by month for any region all over the world. The clothing maps now can help travelers decide on what to pack for vacation or business trips anywhere on the globe.

New paper for maps developed by the Army Map Service retains all its strength when wet or greasy. It can be folded many times without tearing, and when wet can be written upon with pencil or grease crayon. Of minimum weight, the paper is virtually shrinkproof and stretchproof. Folding strength specifications call for a minimum of 700 double folds, 700 percent higher than before.

Another valuable map developed by the Army Map Service is the fluorescent map, which glows under "black light" but is not visible to the enemy. This was made by printing map paper with an overall coating of weak reacting fluorescent ink and a strong fluorescent ink in the body, with regular lithograph inks over all. The light source was a small ultraviolet light attached inside the plane or worn on the airman's forehead.

Cloth maps to guide flyers forced down on missions were made of calendered acetate rayon taffeta, which could be folded into a packet with no more bulk than a handkerchief.

In fact, the war brought Italy something she never had before, thanks to the Army Map Service and its British associates. That is a complete, accurate map of every inch of Italian terrain. These maps were prepared six months before the Italian invasion.

Three-dimensional movie effects are achieved by a Russian inventor by projecting a double row of images on a screen made of 2000 matched pieces of mirror glass.

TURN YOUR SPARE TIME INTO PROFITS!

**NO EXPERIENCE REQUIRED • LIGHT, CLEAN WORK
STEADY, PROFITABLE INCOME
BE YOUR OWN BOSS
WORK RIGHT IN YOUR OWN HOME**

Here's the way to make big profits in your own business! Clean, easy work that pays *all* the profits to you. Without any experience, you can quickly learn to operate the Ideal Lawnmower Sharpener right in your own home, or as a sideline in your shop or garage. Automatic operation assures a perfect job every time. Just place mower in sharpener, make a few simple adjustments and the machine does the rest!

The Ideal Sharpener takes any make or size hand lawnmower. Every community needs this service. Work as long as you like . . . you're the boss, running your own business. Make those evenings at home pay cash profits now. Write today for complete information, without obligation.

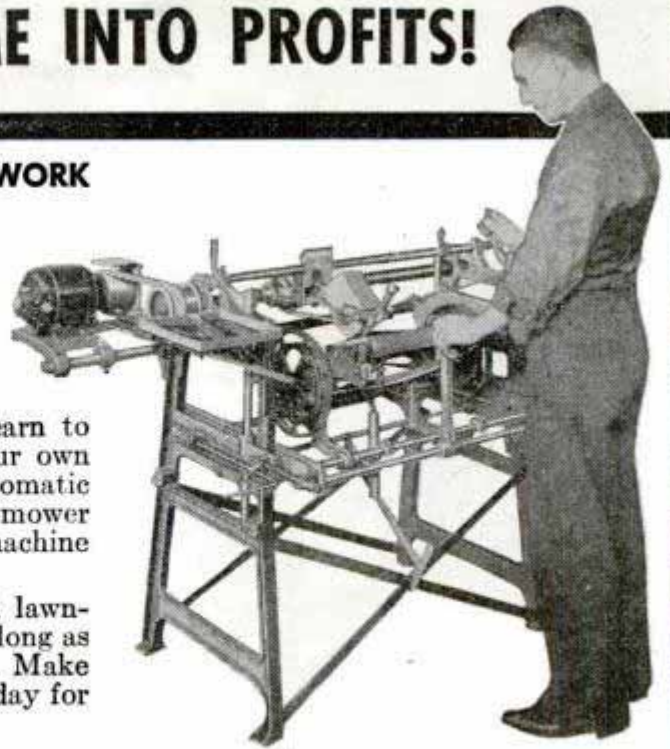

THE FATE-ROOT-HEATH CO. • 1246 BELL ST., PLYMOUTH, OHIO

SEND FOR THIS FREE BOOK!

**"HOW TO BUILD
A PROFITABLE BUSINESS
OF YOUR OWN"**

MAKE MORE MONEY

Applying or Selling **ROOF COATING**
Lasting

Extra profitable, easy to apply. Exclusive new formula makes this America's best roof coating for felt, composition, steel, slag, iron, gravel, concrete and metal roofs. Definitely superior in all climates, at all temperatures. Act at once!

DEALERS & AGENTS WANTED
Write for Details of Our Proposition



LASTING PRODUCTS COMPANY
MANUFACTURERS OF PAINTS, PUTTIES, PLASTICS
FRANKLINTOWN ROAD PLANT, BALTIMORE 23, MARYLAND

Larson **HAND-CRAFTS**
HEADQUARTERS!

Make Belts, Moccasins, Purses,
Gloves and other useful things
for profit

We have a fairly well balanced stock
of leather, tools and accessories.

Send 10c for catalog

J. C. LARSON & CO.

180 No. Wacker Drive, Dept. D
Chicago 6, Ill.



Say you saw it in Popular Mechanics!

**Useful
TOOLS**



**SET
T-52
Deluxe
Electrical
Ignition
and
Radio Set**

All For \$13.00
List Price

See your dealer or write us

SPINTITE SET
A Positive Need in Every RADIO,
HOME and ELECTRICAL SHOP.

Contains Chuck Type Handle, Reamawl, 3 Screw Drivers,
2 Pliers, 7 SPINTITES and Insulated, **WALDEN**
Neutralizing Alignment Wrench.



STEVENS WALDEN, INC.

WORCESTER 4, MASSACHUSETTS

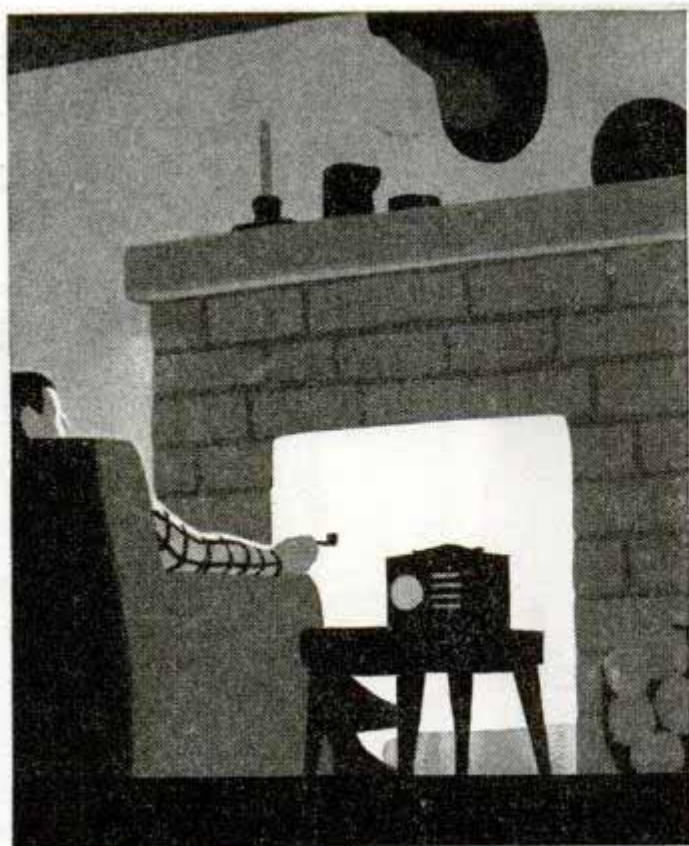

Soybeans Ride Conveyor Tower In Oil Extraction Process

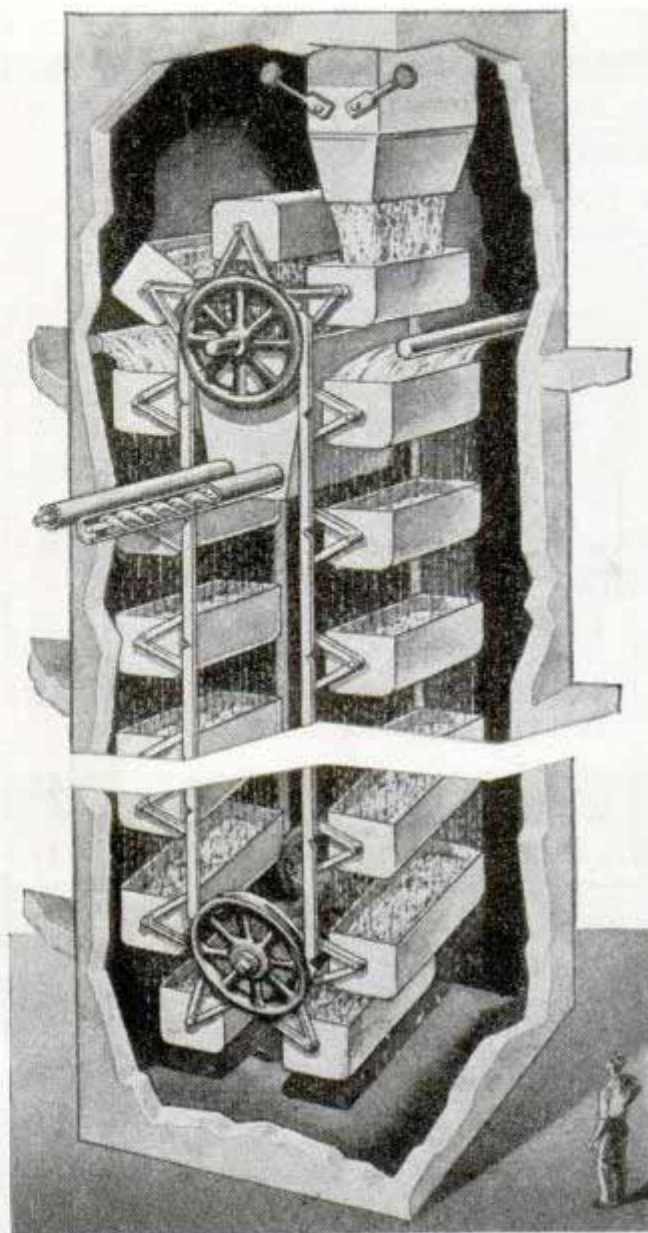

Soybeans are taken for a ride to remove their oil content in a new \$2,000,000 extraction mill at Decatur, Ill. The cracked and flaked beans are placed in baskets on a conveyor tower, and as each basket reaches the top it is flooded with a solvent. This removes all but about one percent of the oil in the meal and drains through the perforated bottom of each basket to the one below. The oil-laden solvent collects at the bottom. Solvent and oil are separated by a special process and the oil is carried away for refining or shipment as crude oil. Engineers at the A. E. Staley Manufacturing Company report that the solvent extraction process produces three percent more oil than with other methods.

Yellow pine planks covered with a layer of special plastic-impregnated wood remain sound and firm after 18 months in a solution of sulphuric acid at 180 degrees F.

FOR
YOUR RADIO

BURGESS BATTERIES

RECOGNIZED BY THEIR
STRIPES • REMEMBERED
BY THEIR SERVICE

Big Demand for Wood! Prices Never as High! QUICK PROFITS with OTTAWA

Log Saw of
the Future
TODAY!



OTTAWA 6 H-P LOG SAW

FELLS TREES • SAWS LOGS Buzzes Up Poles and Limbs

Unbeatable combination! 3 in 1 machine. Does everything you need fast and easy. You can turn wood lot into cash quickly and profit by present high prices.

USE ENGINE FOR BELT JOBS—When not sawing wood, use the engine to grind feed, pump water, etc. Pulley furnished.

THOUSANDS IN USE EVERYWHERE

Speed Up Production!

Thousands NOW making more money with an OTTAWA LOG SAW. You can beat the labor shortage with this powerful machine. Saws the human way, only many times faster. Starts easy in any weather.

350 Saw Strokes per Minute

Air cooled motor—a blessing in winter. No shut-downs or strikes. Many exclusive OTTAWA features. Uncle Sam needs you to help relieve the nation wide fuel shortage. No priority needed when you buy an OTTAWA. Plan to get yours at once!

What Users Say "My 6 H-P Ottawa is a mighty magnet of power and energy. It is always ready to work in any kind of weather and makes log sawing a pleasure. It is easy to operate profitably and economically."—Edward Androus, California.

FREE Big Catalog Write today for your FREE copy of the Ottawa Catalog. Contains complete information of the "6" and other Ottawa Saws.

OTTAWA MANUFACTURING COMPANY, 227 PINE STREET, OTTAWA, KANSAS

SOON THE WORLD'S SAFEST ELECTRIC JIG SAWS will again carry the name

SYNGRO

SYNGRO DEVICES, INC.
Ferndale 20, Michigan

Electrically Welded Endless

Paramount

BAND SAW BLADES

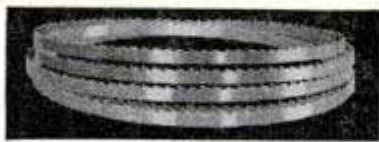

Made in widths from 1/8" to 1 3/4"

Make your band saw do more work for you. The proper width of blade will extend the scope of this important machine. Burrill's Paramount Blades are made from tough Nickel Alloy Steel properly tempered. Teeth accurately set and filed, and all saws carefully straightened. Send order and check today. Delivery will be made as promptly as war conditions permit, from a few days to a week or two. You can obtain these saws at the following prices:

1/2"-3/16"-1/4"-3/8" wide, 5'6" long.....	\$.90 each
1/2"-3/16"-1/2"-3/8" wide, 6'6" long.....	.95 each
1/2"-3/16"-1/2"-3/8" wide, 7'6" long.....	1.10 each

Other sizes at proportional prices

Your satisfaction is guaranteed
BURRILL SAW & TOOL WORKS
407 E. Main St., Ilion, N.Y.

AMMCO 7" SHAPER

"A Precision Machine of a Thousand Uses"

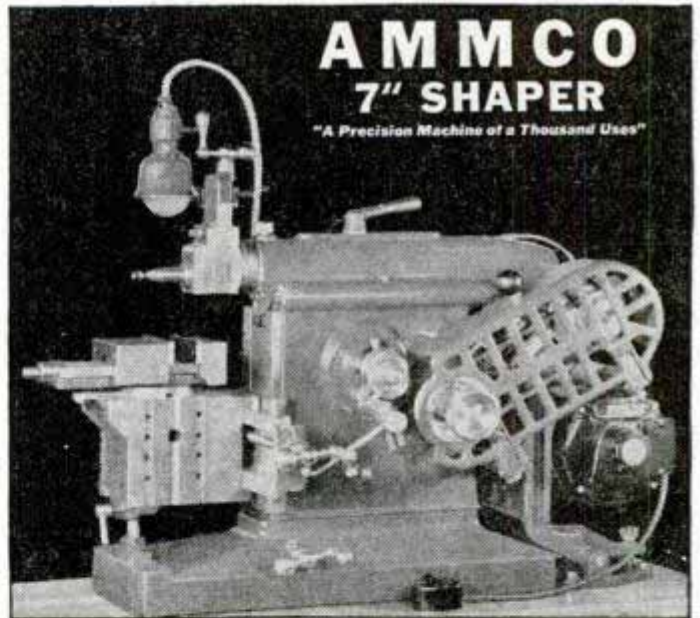

A wide variety of jobs can be done accurately, quickly, easily, and economically on the AMMCO Shaper (7" stroke). Construction incorporates many features you would expect to find only in larger, more expensive machines... For example: WAYS of ram, tool head, and front face of the main frame are of the "VEE" type, hand scraped to insure accuracy and long life. Available for stationary installation or as portable unit.

Write today for specifications and prices

AMMCO

2140 Commonwealth Ave. North Chicago, Ill.

*Quick! Permanent!
Sticks to all surfaces!*

CASCO

FLEXIBLE CEMENT

the best news to homecrafters in years!



Just look at what this new product does!

1. Bonds a wide variety of materials, such as:

WOOD		METAL
WALLBOARD		PLASTICS
PLASTER		GLASS
FABRIC	TO	ENAMEL
LEATHER		FOIL
FELT		LINOLEUM
CANVAS		SHEET RUBBER
PAPER		ETC.

2. Can't Crack Loose: Casco keeps joints flexible—absorbs shocks and expansions.

3. Resists Moisture: Makes heat- and moisture-resisting joints in bathrooms, kitchens, etc.

4. Convenient to use: Does not stain or discolor surfaces. It's white! Non-inflammable, too! No heating necessary. Easy to work with.

Get a large (2-oz.) 25¢ tube at local hardware, paint, or building supply dealer's.

CASCO

FLEXIBLE CEMENT

Also 1/2-pint, pint, quart, and gallon sizes.

CASEIN COMPANY OF AMERICA
(Division of The Borden Co.)

Dept. PM-26, 350 Madison Avenue
New York 17, N. Y.



Hanger for Skirts Is Adjustable



Slipping over a regular wire clothes hanger, a simple new skirt hanger can be adjusted to the proper width by sliding its ends along the wire. The skirt hanger consists of two curved pieces of metal with an interlocking fastener on each that holds the device firmly in place once it has been set in the desired position.

Folding Rack Holds Rubber Boots

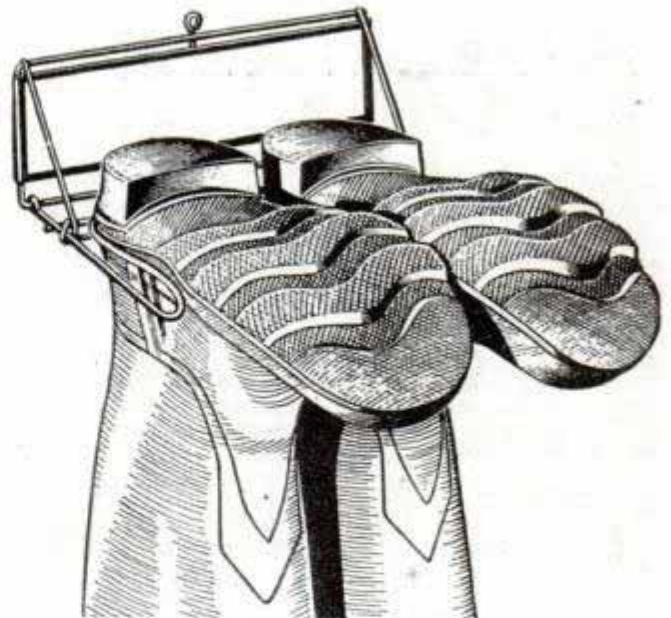

Boots, overshoes and high shoes are kept dry by a metal rack that holds them with tops pointed downward and thus permits warm air to rise into the boots while the cool, damp air flows out. The folding hanger can be carried in a hunter's pocket and attached to the wall of his cabin.

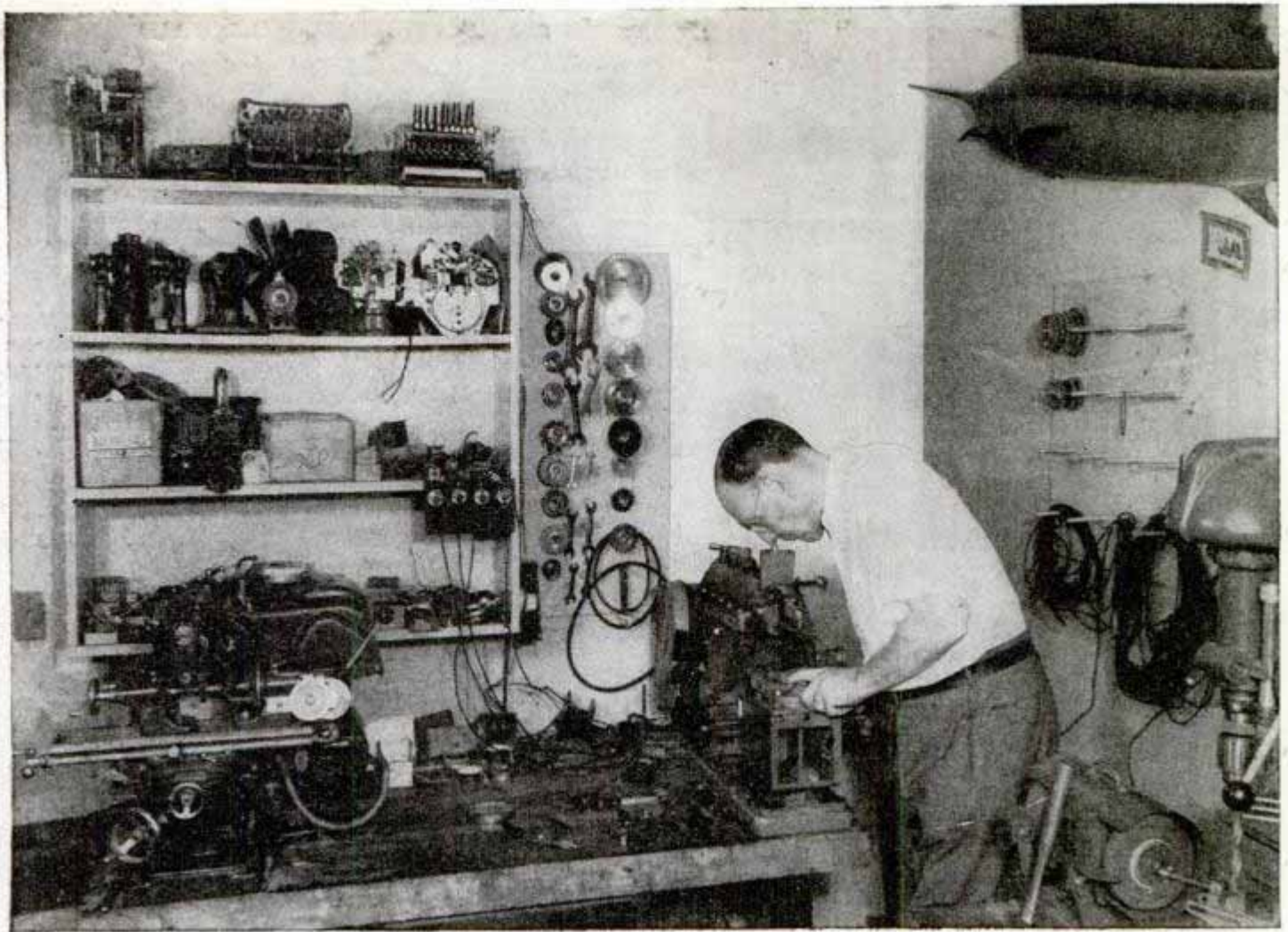

WORKSHOP in the SKY

One never knows, in this great mechanized nation of ours, where you'll find men who love to work with tools.

Who would imagine, for example, that Basil Ruysdale, famous opera star and Lucky Strike announcer had a shop like this! Yet here he is, happily at work in his New York skyscraper home with the Atlas tools he has used to make important contributions to the science of electronics.

Any man is fortunate who has such a fascinating and practical hobby. Atlas tools, with their engineered pre-

cision and rugged construction, will help you make the most of your mechanical skill and ability.

Atlas' industrial reconversion orders are rapidly being filled. Ask your distributor to let you know when you can see and operate Atlas tools in his showroom.



SEND FOR FREE CATALOG

You can begin making your shop equipment plans now with this 64-page profusely illustrated catalog. Send for your copy today. Atlas Press Company, 243 North Pitcher St., Kalamazoo 13D, Mich.

Atlas 4 TOOL TEAM

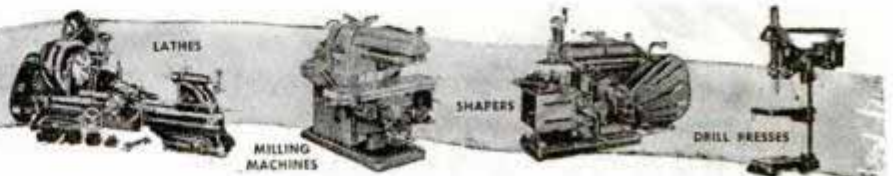

meet the watch that
runs **without** winding!



**Croton Aquamatic . . .
the Waterproof Watch
that winds itself!**

This wonderful 17-jewel watch seems specially designed for busy people. You never have to wind a Croton Aquamatic. It keeps going just by the natural motions of your wrist. Revolutionary? Yes! And practical besides! Recently, in a 30-day wearing test, 3 Aquamatics proved to be 13.5% more accurate than the average of 9 other famous hand-wound watches.

It's CERTIFIED Waterproof!

You can leave the Aquamatic on when you wash your hands, bathe or swim—even in hot, cold, fresh or salt water. This 17-jewel Croton is sturdy and dustproof. It resists shocks, doesn't tarnish and the crystal can't break. Other features:—sweep-second hand, radium dial, waterproof strap. The ideal man's gift for only \$49.50!

P. S. If not now available at your dealer, write for Free Booklet.
Croton Watch Co., 48 W. 48th St., N. Y. 19

Croton

WATERPROOF AQUAMATIC

Artist With a Pocketknife

(Continued from page 23)

of hammered brass. The spacer between these parts was made of aluminum alloy, and the assembly was held together by brass rivets.

Although Ernest and Fred used jigs and patterns for shaping and drilling parts, the knives were by no means production-line items. Each one was carefully put together and finished and was decidedly hand-made.

People who view Warther's work are often curious about his sources of materials, particularly ivory. He buys whole elephant tusks, and uses many other articles made of ivory, such as piano keys, billiard balls and old ivory-backed brushes. From admirers of his work he receives many gifts of ivory articles.

When Warther was married in 1910, he made a windmill for the garden. "We'll see which runs longer, it or I," he told his wife. Both are still going strong. "But," the carver adds, "both the windmill and I have had to have some repairs." The windmill has bearings of arguto wood and a shaft of Monel metal.

Warther put aside a half-finished commando knife the minute the war ended and put it in his museum. Now he is building a model of a Pennsylvania locomotive.

Running Water for Saipan

(Continued from page 30)

of the finest and most productive Maui wells in existence. It is in the center of a basic water table that lies 97 feet in the earth. From the well, water is boosted 100 feet into a renovated Japanese reservoir. The reservoir holds one million gallons. When the new well goes into full operation the reservoir will be filled and emptied daily.

Producing water has been a major problem on Saipan, but almost as complicated is the system used to distribute it. Because of Saipan's rugged terrain and many hills and mountains the water must pass through an arterial system of pumps, sumps, stage tanks and gravity tanks.

Water ships run day and night carrying Saipan's fresh water to ships in port. Some large warships take almost half a million gallons in one load. Water from the springs and wells of Saipan played an important part in the invasion of Okinawa.

Fresh water baths and drinking fountains at every turn of the road are no longer idle dreams at America's Pacific fortress of Saipan. Every hour of the waking day, GIs on Saipan drink a toast to the water engineers—with water!

*Brakes to trust
... quick and quiet!*

The big 1946 Ford is the smartest ever built. It offers increased power, too—with more economy . . . New oversize hydraulic brakes assure quick and quiet stops . . . New slow-action springs provide a ride that's smooth and gentle . . . Inside you'll find new richness. Colorful fabrics are smartly tailored to the broad, deep seats . . . There's a choice of engines—both with new thrift features. The V-8, stepped up from 90 to 100 horsepower—the 90 horsepower Six . . . See your Ford dealer now!

FORD MOTOR COMPANY

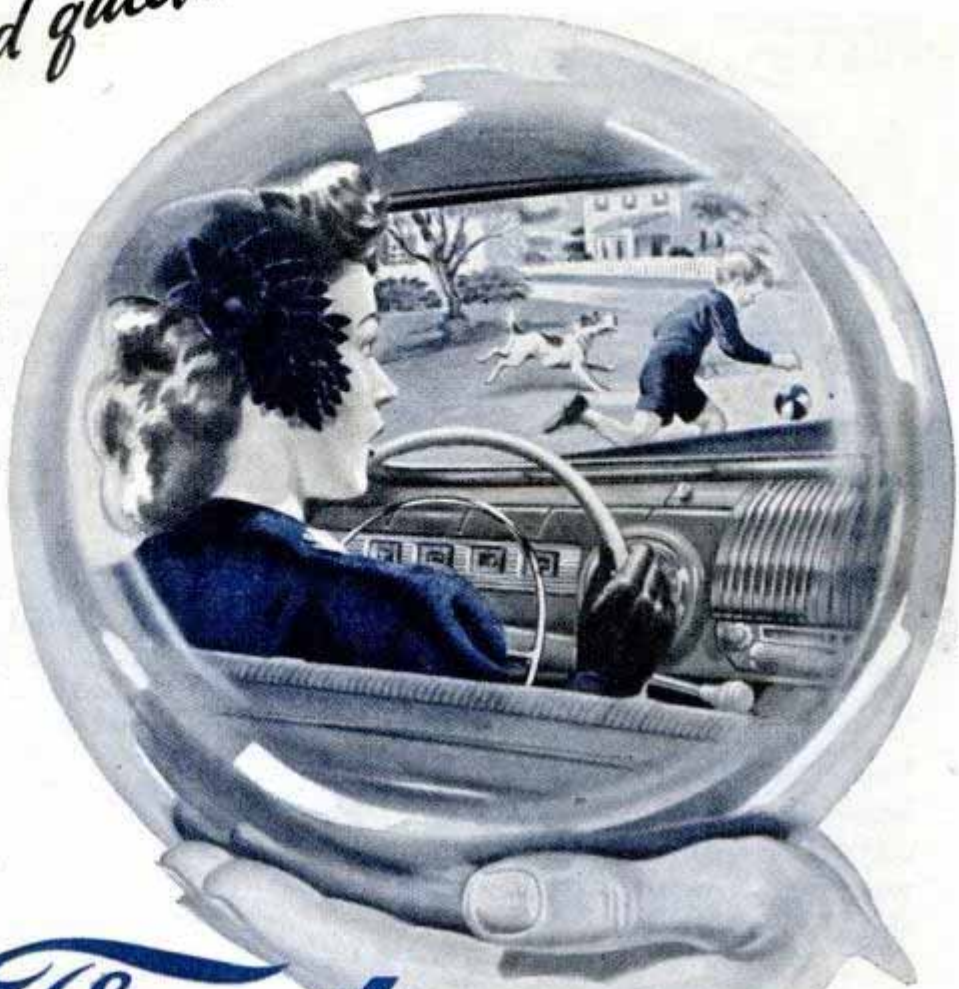

There's a Ford in your future!



TUNE IN...THE FORD SHOW...CBS, Tuesdays, 10-10:30 P.M., E. S.T. THE FORD SUNDAY EVENING HOUR...ABC, Sundays, 8-9 P.M., E. S.T.

ANCO RAIN-MASTER

"Dead-Locker"

WINDSHIELD WIPER ARMS and BLADES

BLADE SNAPS ON...
STAYS PUT

FINGER-
TIP
RELEASE

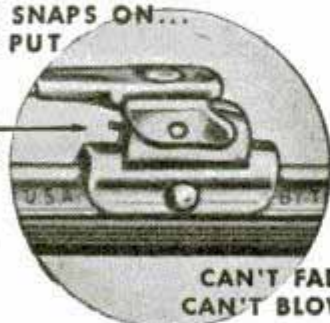

(A war-born invention—by ANCO—first)
for military aircraft—now for your car.)

DON'T SHOOT YOUR GAS-PUMP MAN!

He's doing the best he can. Sure, he knows how dangerous it is for you to drive your car... in stormy weather... with your dull old windshield wipers that smear and smear. He'd gladly put on for you quickly a pair of keen new ANCO RAIN-MASTER Wiper Blades and Arms. He has them—Newest Models! But he forgets to remind you? Too busy? You can't shoot him for that!



After all, it's *your* car to protect. So *you* remind *him*. Get RAIN-MASTERS... patented features... original equipment on many makes of high grade cars and trucks... used in war—on our fighting tanks and trucks and ships and bombers too... because ANCO RAIN-MASTERS clean quicker, clean cleaner... last longer. May save you a costly smashup.

Ask for RAIN-MASTER Windshield Wiper Arms and Blades next time you buy gas.

THE ANDERSON COMPANY
Established 1918
GARY, INDIANA

On Guard Against Death Rays

(Continued from page 35)

Cranes lift materials into and out of the cars, eliminating the need for workers to approach too closely.

There are no doors or entrances to the parts of the plant that are most highly radioactive. Routine operations in these regions are done by remote control. Certain maintenance work, however, must be performed periodically in some of these dangerous areas, work that ordinarily would be done by hand. The plant designers had to invent mechanical robots that could move around, unaffected by the penetrating rays, and unthread pipe connections, remove and replace lengths of pipe, remove screws, change electrical fixtures and install new pieces of apparatus.

The robots include special cranes whose long booms reach through a slot in the thick concrete wall around the area which no human may enter. Electrically operated wrenches and tools are attached to the end of the boom or to its cables.

Each worker at Richland carries two electroscope "pencils" in his clothing, one to check the accuracy of the other. Each worker receives a periodic health check with special reference to his blood cell count. A final precaution is an automatic bell over each of the plant's exit gates. The bell sounds an alarm if anyone with an "overdose" of radioactivity approaches.

As part of the precautionary program the amount of contamination to laboratory coats is measured after they have been worn and again after they have been laundered. Smoke from the plant's stacks has been investigated for possible toxic gases and materials, and surveys are made of adjacent wells and streams for possible increases in their natural radioactivity.

This description of the precautions that must be taken when working with atomic power suggests that future power plants will be confined to large stationary installations. Nor is there much hope, scientists say, of materially reducing the bulk and weight of the insulation that must be placed around such a plant. Neutrons, for instance, must actually collide with other matter before they are stopped, and to a neutron a quarter-inch-thick shield of lead or concrete has as many open spaces as the solar system. Only when the wall is of massive thickness is there certainty of insulation.

That is not to say, of course, that atomic power never will be used indirectly for powering light vehicles. Power transmission by radio, long talked about but never practical in the past, may be possible when large central atomic power plants are built.



THERE IS
NO SUBSTITUTE
FOR
EXPERIENCE

THE
1946

SEA-HORSE

in
Sea-Green

This is the motor that *experience* built—the finest in Johnson history. Sparkling in performance, **DEPENDABLE** in operation and more beautiful than ever in appearance! Shipments to dealers are being made now. *Full* production schedules should be reached soon. Look for the name of your Johnson Dealer under Outboard Motors in your classified phone book. See him. In the meantime write for a copy of the new Sea-Horse Handy Chart, with illustrations, features and specifications.

JOHNSON MOTORS
400 Pershing Road, Waukegan, Illinois

FIVE GREAT MODELS

- Small Alternate Firing Twin . 2.5 H.P.
- Medium Alternate Firing Twin . 5 H.P.
- Large Alternate Firing Twin . 9.8 H.P.
- Super Alternate Firing Twin . 16 H.P.
- Heavy Duty Opposed Twin . 22 H.P.

All H.P. ratings are O.B.C. Certified Brake Horsepower at 4000 r. p. m.

MAKE AND SELL FOR PROFIT

Plastic **JEWELRY AND NOVELTIES!**

There's fun and profit in making plastic jewelry, novelties, and furnishings, in your home workshop! We have every material you need — Plexiglas, Lucite, Bakelite, Lignolite, Tenite II, Lumarith, in a large variety of sheets, rods, tubes, and special shapes. Also dyes, cements and other plastics supplies and accessories. Send 10 cents today for complete catalog. Address Dept. 2-B.

CARMEN-BRONSON CO.

165 EAST 3RD ST., MT. VERNON, N. Y.

War Improved ★
FOR EVERY OIL NEED

FIENDOIL

Fiendoil is your three-handed helper—thanks to a wartime discovery, Fiendoil is the **ONE** oil for lubricating, preventing rust, removing rust. Protects machines and equipment under toughest conditions. Resists extreme heat, flows in cold to 50° below. In handy, 3-oz. spout cans. See your dealer today.



It's Smart to Use a
SHERRILL
Magnetic "DIRECTOR"
AUTO COMPASS



Deluxe—\$5.50

Finger-Tip Control

For Touring or Daily Driving!

Deluxe-illuminated and standard models! Accurate. Durable. Finger-tip control. No tools are required. Molded plastic construction. Every motorist should have one. Sold at Drug, Dept., Hdw., Chain Stores.

For Boats and Planes • \$40.00

SHERRILL INSTRUMENT COMPANY, PERU, IND.

THE TRUTH ABOUT SHAVING



For PERFECT SHAVES use

- ① A Good Razor and Blade
- ② A Good Beard Softener
- ③ The Best Sharpener—to Strop Blades Before You Shave



See how TWINPLEX fits the hand—holds and flexes blade at proper angle and pressure—gives a barber-smooth edge! Genuine strop-leather rollers. Just turn the crank for smoother, cleaner shaves. No skill required. Only \$2. See your dealer for a demonstration today.

TWINPLEX MANUFACTURING CO., CHICAGO

OWNERS BRAG ABOUT

Twinplex

BLADE STROPPER

USED BY MILLIONS SINCE 1915

Will Malaria Strike at Home?

(Continued from page 80)

Alkali precipitation is not well adapted to commercial operation, since, even under laboratory controls, some 25 percent of the alkaloids remain in solution and are lost. Since none of the chemicals used is recoverable, no advantage in transportation requirements is realized. However, the method is peculiarly adapted for small scale operation, since it can be carried on with the very simplest sort of equipment and a minimum of technical knowledge.

In line with our country's efforts to maintain a strategic supply of quinine within the American hemisphere, the War Department has cooperated with the Foreign Economic Administration in establishing a cinchona plantation in Costa Rica. This plantation is being developed from seed of high grade cinchona trees which produce bark running over 10 percent in quinine alkaloid content. These seeds were produced in the Philippines and flown out while the Japanese were occupying the islands.

Quinine and atabrine are still the most important suppressives for malaria. More than 8000 medical compounds have been tested by American research laboratories in the aggressive hunt for a drug that will either prevent malaria or cure it. As Brigadier General James S. Simmons, Chief of the Preventive Medicine Service of the U. S. Army, and president of the National Malaria Society, said:

"We are now armed with exact knowledge about malaria. We know its cause, its local vectors, and we have proven methods for its control under the conditions that exist in the United States.

"It is my belief that under the leadership of Public Health Service and the various state and private facilities organized to wage war on malaria, it may be possible not only to prevent the spread of this ancient enemy of mankind, but ultimately to banish it completely from our country."

"Little David"

(Continued from page 14)

gigantic tube into position. Crews make a few simple attachments and "Little David" is ready to work—a half-day after installation was started.

The 3650-pound shell is hauled to the gun site by a bomb service truck. There it is lifted with a monorail device and swung to a dolly. Crew members push the dolly along a two-rail trolley until it is beside the gun's muzzle. Meanwhile, huge doughnut-

(Continued to page 168)

Thompson BEATS the World on BOATS



Better Built Lower Prices

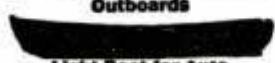
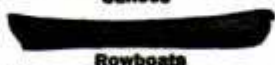

Safe Boats With Full Length Spray Rails
Keep passengers perfectly dry—even at high speeds. Catalog also shows two new models of "Take-Along" Boats. Two big factories—save you freight.
CATALOG FREE
Write for your copy. State kind of boat in which you are interested.
THOMPSON BROS. BOAT MFG. CO. (151)
213 Ann St. (Write to either place) 113 Elm St.
PESHTIGO, Wis. CORTLAND, N.Y.



BENCH SAWS

WOOD LATHES

JIG SAWS

DRILL PRESSES

BAND SAWS

BELT AND DISC SANDERS

JOINTER PLANERS

SPINDLE SHAPERS

POWER KING TOOLS ARE BACK!

with AMAZING NEW VALUES for YOU

TABLE SAWS, JIG SAWS, WOOD LATHES, DRILL PRESSES, BAND SAWS, BELT and DISC SANDERS, JOINTER PLANERS, SHAPERS — all the great Power King Tools are back again with scores of new improvements to double your workshop fun and save you hours of time on your woodworking projects. You'll be surprised at their sensational values. They are up-to-the-minute in modern design, ruggedly built for smooth and accurate operation, and priced so reasonably you can completely equip your shop at an amazingly low cost.

SEND FOR ILLUSTRATED SPECIFICATION SHEETS

Write today for new descriptive literature to help you make your power tool shop plans. Keep in touch with your Power King dealer to see the new tools when they arrive.

POWER KING TOOL CORPORATION
220 Cleveland Street WARSAW, IND.



LOOK FOR THIS TRADE MARK



Carhartt

OVERALLS

... A Clear Track Favorite
On Any Job

● Carhartt Master Cloth overalls have been a big favorite with railroad men the country over for more than half a century—a great tribute to the better wear and fit of these famous work clothes—and to the traditions of the Carhartt family for building the best work garments money can buy. You'll find that, regardless of your work, Carhartt's give you those "extras" that make them a better buy on every count.

At the Better Dealers Everywhere.

THE HAMILTON CARHARTT OVERALL CO.

Established 1889

Detroit
Atlanta

Dallas
Carhartt Park



KEEP YOURSELF UP-TO-DATE ON
WOOD VENEERS
LUMBER & SUPPLIES

with
CONSTANTINE'S
MASTER MANUAL

Published by the leading suppliers to woodworkers, the most complete book ever offered. More than a catalog, contains valuable information on lumber inlays, veneers, wood finishing, etc. 83 inlay border designs in full color, 6 pages of full color inlays plus a wood identification chart showing over 60 rare woods in natural color. Send only 25c today and we will include FREE a year's subscription to our publication, Chips & Chats.

ALBERT CONSTANTINE & SON, INC.
791 F. E. 135th Street, New York 54, N. Y.

with A YEAR'S
SUBSCRIPTION TO
Chips & Chats

shaped bags of powder are shoved into the tube, the number of powder charges varying with the range at which the gun is to be fired. Using a davit, the crew lifts the bomb from the dolly and lowers it into the muzzle until it engages the rifling, or spirals, inside the tube, which spin the shell to improve accuracy when the gun is fired. The tube then is elevated, the shell sliding the rest of the way to the bottom of the tube in about 20 seconds.

Several electric switches operate a maze of motors and power equipment to elevate and traverse the gun. The mortar can sweep an arc of 13 degrees horizontally and will elevate to plus 65 degrees. A simple lanyard fires the mammoth weapon. The shell leaves the gun in an earthshaking explosion, traveling at 1250 feet per second.

Effects of the exploding shell are gargantuan. Upon striking the ground, the 1550-pound picratol charge blasts a hole 38 feet in diameter and 14 feet deep, a crater big enough to conceal a large Army truck. The shell can break up concrete seven feet thick. It can finish off a strong pillbox or bunker with a single shot. Trained crews fire six shells an hour, a rapid rate for such a herculean gun.

"Little David" is not a freak weapon, according to ordnance experts. Rigidly tested, it has shown itself capable of producing a tremendous effect against the most resistant targets.

Radar Cues the Navy Fighters

(Continued from page 6)

squawkboxes that seem to be flashing red lights constantly. Here is the nerve center of the ship, as important to today's operations as the bridge or the engines.

"We have a bogey, captain—" one officer is saying into the squawkbox on the overhead.

"Red One airborne," says an enlisted status board keeper who prints RED ONE—0934—on the luminous Plexiglas board.

"'nother bogey—two-seven-five," says a towhead sitting beside a round "plotting table" with a frosted glass top lighted from underneath. He makes a small cross on the board and taps the board with his pencil. An officer bends over the board. "Ten-twelve planes in that raid," the towhead says as he prints on the glass top table: 10-12p.

Everyone's lips seem to be moving—talking to unseen people listening in on the other end of the "line" . . . talking to lookouts standing exposed topside who are straining to see what CIC personnel "see"

(Continued to page 170)



MOTO-TOOL ★ THE "POCKET-SIZE" MACHINE SHOP

PUT THIS "WAR VETERAN" TO WORK *Approximately 27,000 R.P.M.*

READ MOTO-TOOL'S RECORD

Long before Pearl Harbor Dremel Moto-Tools had won their spurs in tool rooms, machine shops, home workshops. Now they have the respect of every branch of the armed forces. And thousands of them helped establish production records at General Electric, Westinghouse, Remington Arms, Ford, Nash-Kelvinator, Consolidated Aircraft, Douglas and others.



MOTO-TOOL KIT

Kit No. 2 with 23 high grade accessories and Model 2 Moto-Tool, in hardwood case. \$23.50
Model 2 Moto-Tool, with 1 accessory. \$16.50

Now that priorities have been lifted, Moto-Tool can work for you. Moto-Tool owners daily discover new jobs that can be done more expertly in less time. In fact, new purchasers find dozens of uses in addition to those they had in mind. So great is the saving of time and labor with Moto-Tools, thousands of mechanics and craftsmen would find it difficult to get along without their "mighty little midgets."

ONLY MOTO-TOOLS HAVE ALL THESE FEATURES

A Model 2 Moto-Tool develops a speed of approximately 27,000 rpm. Weighs only 13 oz. Shaped to fit the hand. Sturdily built with shock-proof bakelite housing. Balanced for vibrationless operation. Uses 110-120 AC or DC current.

10 DAY TRIAL—MONEY BACK GUARANTEE

Ask your dealer today about Dremel Moto-Tools and Accessories. If he does not handle them, order direct from factory on 10 day trial. We ship post-paid if cash in full accompanies order. If you prefer to send only \$2.00, Moto-Tool will be shipped C. O. D. for balance plus postage. Catalog sent FREE.



Model 2 Illustrated

A FEW OF THE JOBS THAT MOTO-TOOL CAN DO FOR YOU

- | | | |
|--------------------------------------|-------------------------------------|-----------------------------------|
| <input type="checkbox"/> Sharpening | <input type="checkbox"/> Burring | <input type="checkbox"/> Cleaning |
| <input type="checkbox"/> Finishing | <input type="checkbox"/> Grinding | <input type="checkbox"/> Routing |
| <input type="checkbox"/> Touching Up | <input type="checkbox"/> Polishing | <input type="checkbox"/> Cutting |
| <input type="checkbox"/> Sanding | <input type="checkbox"/> Burnishing | <input type="checkbox"/> Rasping |
| <input type="checkbox"/> Drilling | <input type="checkbox"/> Inlaying | <input type="checkbox"/> Carving |
| <input type="checkbox"/> Mortising | <input type="checkbox"/> Sawing | <input type="checkbox"/> Brushing |
| <input type="checkbox"/> Engraving | <input type="checkbox"/> Scoring | <input type="checkbox"/> Dressing |

WATCH FOR THE RETURN OF MOTO-SAW

Dremel Moto-Saw . . . the sensational electric scroll saw . . . will be back as soon as materials are available.

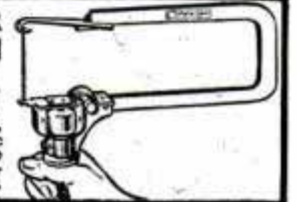

DREMEL MFG. CO. 116-B RACINE, WIS. U.S.A.



HUNTER'S COMPASS

Hunting Case, Watch Type, All Metal, Jeweled **\$3.50**

Engineers All Metal Army Type Hand-Sighting

LEVELS

\$1.50



PUBLIC SPORT SHOPS

13 S. 16th St., Phila. 2, Pa.

No COD's

120 MILES PER GALLON

Complete motor ready to mount on ordinary balloon-tired bicycle. No mechanical skill required to install. No alteration of bike necessary. Easy to operate.



Can be pedalled by merely releasing clutch. Speed 5 to 40 M.P.H. Shipped pre-paid complete with 4 cycle, 2½ H.P. motor, all attachments and heavy duty stand. Get complete facts about this low-cost, convenient transportation. . .

Write today for descriptive illustrated literature.

WHIZZER MOTOR SALES CO.

Dept. A, 3132 E. Washington, Los Angeles 23, California

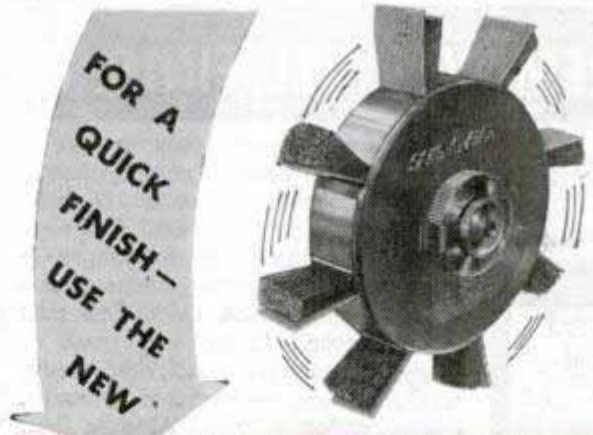

SAND-O-FLEX ALL-PURPOSE SANDER

Here is a low-cost sander that really reaches into recesses, around edges, and handles all those tedious jobs that were formerly done only by hand. Eight bristle brushes "cushion" the abrasive cloth and force it "down in" or "evenly over" all wood and metal surfaces. The central magazine houses the strip abrasive which is fed out as needed. Refill abrasive cartridges are supplied in various grits for all types of work. Loads in less than a minute. Weight 2¾ pounds. Diameter 8", including brushes. Slips onto your motor shaft and produces miracle finishes on curves and contours. See your dealer or write for catalog today.

SAND-O-FLEX CORPORATION

4373 Melrose Avenue • Los Angeles 27, Calif.

Many Unusual Features in famous MYERS WATER SYSTEMS

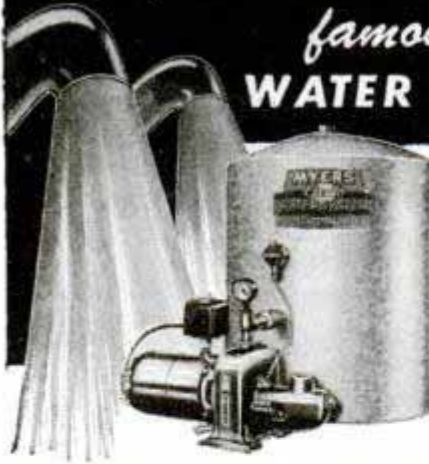

Convertible
for either
deep or shallow
wells.



The advanced design and construction of Myers Water Systems gives you the utmost performance, quality and reliability. Popular new "H" Series Ejecto has high-efficiency pump—only one moving part. Quiet, vibrationless. Delivers large quantities of water per horsepower. Never needs repriming. Has positive air control. See the wide range of Ejecto and reciprocating models.

MAIL COUPON
for FREE BOOK



THE F. E. MYERS & BRO. CO.
Dept. D-81, Ashland, Ohio

Send your new water system book.

Name _____
Address _____

REMOVES ALL FINISHES



NO BENZOL-ACID-CAUSTIC-ALKALI-
SAFER TO USE

New type semi-paste remover quickly lifts off paint, enamel, varnish, shellac, lacquer, bakelite and other synthetic resin finishes. (Removes emulsified resin water paints, too.) Stays wet longer — stays put on upright or overhead surfaces — strips clean, quick. One coat usually enough (apply with brush or spray). Contains no benzol, acid, caustic, alkali, or wax — harmless to hands, bristles, surface stripped. All sizes (pint 65c) at paint and hardware stores.

FREE CIRCULAR

"How to Remove Paints, Varnishes, Lacquers, etc." Also describes other Savogran Products: Heavy Duty Cleaner, Crack Filler, Wood Putty, Remover & Bleacher (renews floors), Paint Brush Cleaner, Coldfoam Soapless Soap Powder.

It's Orange!



THE SAVOGRAN CO.
DEPT. 26, BOSTON 10, MASS.

SAVOGRAN STRYPEEZE

IN EVERY WELL-EQUIPPED HOME WORKSHOP

so well in the small compartment in the bowels of the ship . . . talking to the captain on the bridge . . . talking to the gunnery officers who are ready to open fire when the word is passed . . . talking to the destroyers that screen the carrier . . . talking to the pilots in the planes over the ship.

A six-foot circular Plexiglas "window" dominates the compartment. It is marked out with bearing lines, radiating from the center of the board, and range circles, exactly as the PPI scope or disk; in fact, this is an enlargement of the picture seen on the radar screen or disk except instead of blobs of light to indicate planes, symbols are being plotted by men stationed behind the board. These symbols, due to special side lighting, show up exactly like small neon figures and can be seen from any position in the compartment. In the center of this—tagged by everyone else on the ship as the "madhouse"—sits the fighter director officer on a raised platform. In front of him is his own PPI scope. At his fingertips are pushbuttons and controls that make it possible for him to listen and talk to every key post on the ship and to other ships.

As you entered the CIC, you heard one plotter report, "bogey, two-seven-five." A bogey is an unidentified airplane or planes. Immediately after a bogey contact is picked up by the radar it is plotted and evaluated in CIC. Within minutes—seconds even—the word goes out, first to the admiral and captain, then over the task group radio nets to the other ships:

"Hello, Columbine. This is Babyface. We show bogey two-seven-five, fifty, over—"

"This is Columbine. We concur. Looks like ten to twelve. Out."

"This is Bridget. We concur."

"This is Blueboy. We concur."

Swiftly the task force fighter director officer, representing the admiral, begins to deploy his forces. Certain ships are assigned to follow the raid with their radars. Others are directed to continue their complete 360-degree sweep to detect, as is often the case, whether other raiders are coming in from another direction.

Now you are caught in CIC for General Quarters. More men pour into the compartment to take battle stations. On all ships of the force bugles sound through bull horns: "Torpedo Defense" or "General Quarters"—the brazen throats of alarm bells (and bosun's mates) summon all hands to battle stations. AA guns point skyward in the direction of the raid. Deep inside the hulls steel doors slam shut as the ships button up for action.

In our carrier CIC here, which is the flagship, the fighter director officer speaks to

(Continued to page 172)

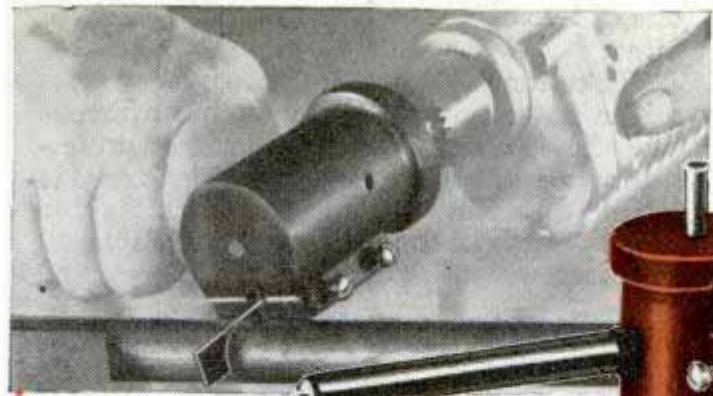

1 ROTO-VERT **\$12.50**
 PAT. PEND.
 Makes a reciprocating saw or filing machine out of your drill. Will saw irregular shapes in wood or metal.

All three tools operate in 1/4" electric drills with speeds of 1600-2500 rpm. Illustrations shown are 1/3 actual size. Weight 2 lbs. each.

Standard files and hack saw blades may be used with the ROTO-VERT. Various accessories, chisels, star drill and adaptor, center punch, available at \$1.00 each for the ROTO-PEIN.

3 ROTO-PEIN **\$12.50**
 PAT. PEND.
 For peining small aluminum, copper and brass rivets. Also for chipping, chiseling and gouging wood; bumping metal; and drilling 1/4" holes in brick, concrete, etc.



K-JAX 1-DESIGNING
 2-ENGINEERING
 3-MANUFACTURING
 P. O. BOX 3044 DALLAS, TEXAS

**YOUR ELECTRIC DRILL HAS
 100 Other Uses
 WHEN USED WITH K-JAX 1-2-3 LINE**

**FOR MECHANICS, MAINTENANCE MEN,
 TOOL AND DIE MAKERS, CRAFTSMEN,
 RADIO REPAIR SHOPS, HOBBYISTS, Etc.**

Each tool has only TWO MOVING PARTS, NO GEARS, assuring long life.

The 1-2-3 TOOLS pay for themselves on one small job.

Each tool, made of the finest materials, is guaranteed.

2 ROTO-SNIP **\$18.75**
 PAT. PEND.
 For shearing all metals 20 gauge and lighter. Cuts radii down to 1 1/2".

**Wherever a Drill Is Used . . .
 These Tools Are Needed**

These tools were designed by a nationally known mechanical engineer, to do jobs that are in hard to get to places. Being used today by electricians, plumbers, heating and ventilating men, neon sign makers, automotive shops and all types of commercial, industrial and fabricating plants.

SEE YOUR JOBBER, LOCAL HARDWARE DEALER OR MAIL COUPON

K-JAX, Dept. 2
 P.O. Box 3044, Dallas, Texas

Enclosed find \$..... money order or check. Send me the following immediately:

- 1-Roto-Vert **\$12.50** 2-Roto-Snip **\$18.75**
 3-Roto-Pein **\$12.50**

Name.....
 Address.....
 City..... State.....

RED-ITCHY SKIN?

watch out—it's often

ECZEMA

**'Invisible'
Liquid
Promptly
Relieves
Torture!**



First applications of wonderful soothing Zemo—a Doctor's highly medicated *invisible* liquid—quickly relieve intense itching burning of Eczema, Psoriasis and similar annoying skin and scalp irritations due to external cause. Zemo also aids healing. Amazingly successful for over 35 years! Apply any time—doesn't show on skin. First trial of clean, stainless *liquid* Zemo convinces! Buy Extra Strength Zemo for mean cases. At all drugstores.

ZEMO

HAUCK FLAME
GUN

KILLS WEEDS



2000° F controlled heat quickly, easily destroys seeds, roots, brush, poison ivy, wild morning glory, Canada thistle, other unwanted growths. Many uses: splitting rocks, burning stumps, sterilizing poultry houses. Burns kerosene. Does the work of 4 men. Safe, easy to use. 10 day trial. Satisfaction guaranteed. Free catalog.

HAUCK MFG. CO.

121 Tenth St.

Brooklyn 15, N. Y.

MAKE MORE MONEY REPAIRING MOTORS!

with Modern IDEAL Motor Repair
and Maintenance Equipment

Get ready for repair and servicing work on the millions of motors that have been working overtime during the war.

Install the latest type IDEAL Coil Winding and Motor Maintenance Equipment. For winding coils and armatures:—IDEAL COIL WINDER DRIVE AND COIL WINDER HEADS. For servicing Commutators and Slip Rings:—IDEAL RESURFACERS, PRECISION GRINDERS, MICA UNDERCUTTERS.

This work is easy if you have the proper equipment—and profitable!

Write for FREE Motor Maintenance Handbook.

IDEAL Sycamore

IDEAL COMMUTATOR DRESSER CO.
5136 Park Ave. Sycamore, Ill.

one of two officers who sit on either side of him:

"Take the raid—use Babyface 1."

The intercept officer nods his affirmative. He is a lieutenant, perhaps, or an ensign who has been specially trained for this job of directing the Navy's crack fighter plane patrols in the defense of the ship and the force.

On the PPI scope the intercept officer notes the position of the raid—the small blob of light 50 miles due west, altitude 10,000 feet. Overhead, at 12,000 feet, he knows there are two divisions of Combat Air Patrol, eight planes, flying a three-mile orbit around the task force. They are Babyface 1 and 2 and are joined to each other. He speaks into his microphone to the senior division leader of the CAP overhead:

"Hello, Babyface 1. This is Babyface. We have a customer for you. Vector two-seven-zero, buster, angels twelve, over."

From 12,000 feet above the ship, the senior division leader replies for all eight pilots: "Wilco vector two-seven-zero, buster, angels twelve, out!"

At 240 knots (buster speed) on a due west course at 12,000 feet (angels twelve), the eight planes swing to their course, arrowing out in the direction of the raid.

Below, the intercept officer concentrates on his scope. He notes the two blobs of light, one the enemy, the other his fighters, slowly approaching each other almost head on. He looks up at the six-foot Plexiglas board where plotters are charting the course of the fighters and the enemy, carefully and methodically noting course, speed, number.

"Bogey ahead forty . . . appears to be ten to twelve planes, over—" the intercept officer says into the microphone.

"Roger, out," comes from the senior division leader in the air.

The two blobs of light are moving toward each other.

" . . . estimate altitude of bogey 10,000—" blares out from the speaker on the bulkhead. That was Columbine reporting. Columbine is code for another Essex-type carrier just off the starboard beam.

" . . . concur—" Blueboy speaking over the intership communication.

An officer in our CIC is talking into the squawkbox to the captain: ". . . bogey is closing on course zero-nine-zero, speed two-eighty. Babyface 1 and 2 have been vectored out for the interception—"

Look up at the large Plexiglas board. The raid is heading directly towards the center of the board and our planes are go-

(Continued to page 174)

Mows and Trims Lawns



In One Simple
Easy Operation

8 1/4 Lbs.

Save Time
and Labor with a
MONTAMOWER

New model. New type metal handle has special device to adjust cutting height. Drive shaft now mounted on free rolling, factory lubricated, and sealed ball bearings. No tired backs or aching arms. 8 1/4 lbs. of live precision made mechanism that first gathers, then cuts smoothly a clean 16" swath through grass, dandelions, spike grass and weeds. No noise or clatter. As modern and efficient as your electric razor. Cuts right up to walls, fences, trees or posts; leaves no fringes to be trimmed by hand. Cutters are self-sharpening. Built to last many years. Many thousands in use. Sold direct from factory. Costs little. Write at once for guarantee information and literature.

MONTAMOWER DISTRIBUTING CO.

820 Keeler Bldg. GRAND RAPIDS 2, MICHIGAN

LEPAGE'S GLUE

LEPAGE'S MODEL AEROPLANE GLUE
LEPAGE'S LIQUID SOLDER



DRILL-INDEX A compact container for indexing and filing twist drills. Eliminates search. Made entirely of steel in nine sizes. See your dealer or write to

HUOT MFG. CO.

Foot Schultz Bldg. St. Paul 1, Minn.

2 Bushels of Ripe TOMATOES from ONE VINE



2 or 3 vines will produce enough tomatoes for the average family..

**New BURGESS CLIMBING
TRIP-L-CROP**

TOMATO rapidly grows to a height of 10 to 18 feet. Grow on trellis, side of house or barn or as a bush in garden. Beautiful crimson, solid, meaty fruits of best quality, some weighing over 2 lbs. each. The most productive of all tomatoes. Trial packet 10c—3 for 25c, postpaid.

CASH PRIZE CONTEST

Send for FREE Garden Book giving full details about CASH PRIZES to growers of this wonderful tomato.

**BURGESS SEED & PLANT CO.
217 C.T., GALESBURG, MICH.**

RIGHT NOW is
the right time
to . . .



That dripping pipe . . . that crack in the furnace . . . those loose door hinges . . . casters and handles that fall out . . . all those little repair jobs—get after them NOW with Smooth-On No. 1 Iron Repair Cement, famous since 1895 for stopping leaks, sealing cracks, tightening loose parts.

Easy to use—no heat required—applied like putty. Smooth-On repairs are inexpensive, too—cost vastly less than a repair man's bill . . . and are lasting. Get Smooth-On No. 1 in 1 3/4-oz., 7-oz. or larger size at your neighborhood hardware store. If they haven't it, write us.

**GET THIS 40-PAGE
REPAIR HANDBOOK FREE**

Clear, simple, practical directions. 170 diagrams. Pocket size. Dozens of short-cut repairs. Just send the coupon.

—Sign and Mail NOW—

**SMOOTH-ON
CEMENTS**



For the
Motor Car and Boat,
Home, Factory and
Power Plant

Smooth-On Mfg. Co., Dept. 37,
570 Communipaw Ave., Jersey City 4, N. J.

Please send me a Smooth-On Handbook.

Name.....

Address.....

2-46.....

Do it with **SMOOTH-ON**
The Iron Repair Cement of 1000 Uses



Navy men always choose AUTHENTICAST models of their ships. They use them in Recognition Training and they know AUTHENTICAST models are the finest ever built! . . . super-detailed to the Navy's precision specifications.

Build your own waterline models of famous American ships from AUTHENTICAST easy-to-build complete assembly kits: Aircraft Carrier *Enterprise*; Battleships *Missouri* (Iowa Class) and *North Carolina* Class; Cruisers *Baltimore* Class and *Cleveland* Class; Destroyer *Sims* Class; *DE-51* (Buckley Class) — priced \$7.00 to \$11.00 at hobby shops. Official scale: 1 inch to 500 inches. See them all in the exciting 32-page AUTHENTICAST catalog — send 35c in coin for yours!



MAKE MORE MONEY

APPLYING OR SELLING

CORKSTONE PLASTIC FLOORING

EASY TO APPLY

Here's your opportunity to get into business for yourself applying or selling Corkstone, the economical, top-grade plastic flooring. Plenty of profit. Act without delay!



Dealers & Agents Wanted

WRITE FOR DETAILS OF OUR PROPOSITION

We believe in teamwork and cooperation. We'll help you get started. No cost, no obligation. Act today!

LASTING PRODUCTS COMPANY

MANUFACTURERS OF PAINTS, PUTTIES, PLASTICS
FRANKLINTOWN ROAD PLANT, BALTIMORE 23, MARYLAND

ing out from the center. Thirty miles apart now.

"Bogey ahead thirty . . . enemy height 10,000," the intercept officer tells the division leader in the air.

"Roger, out," is the reply.

High in the blue, clear air the pilots in the eight fighter planes are peering ahead, searching for the enemy planes, each realizing that today he might become an ace.

On the scope in the CIC the two blobs of light creep closer and on the big Plexiglas plotting board the symbols draw toward each other. Then suddenly through the intercept officer's earphones, sounding above the high crackle of static:

"Tallyho! One o'clock, ten miles, eight fish, down—"

The intercept officer throws a thumb up toward the fighter director officer, who has been supervising the whole operation from his perch at the desk, and "rogers" the pilot's message.

Now the information is being printed on the Plexiglas board and the status board. A slight murmur goes up:

"Eight fish—"

"Eight fish—"

Everyone seems to be muttering this information to himself. Eight fish—that's eight torpedo planes. If one gets through—?

"Splash one fish," one of the pilots up there calls in over the very-high-frequency radio.

One down, seven to go.

"Splash a fish," that's the division leader calling. Another bandit in the drink! But it only takes one of those enemy planes to get through to sink a ship. Minutes creep by. One of our planes is in trouble, which shows up on our radar screen. Everyone is noting carefully the position of the stricken plane in case it goes down so that a destroyer or destroyer escort can be dispatched to pick up the pilot.

"Splash two fish," the report comes in.

Only one blob of light on the screen now—that one blob representing our planes and the enemy at the same range and bearing from the ship—that one blob of light constantly closing on the ship.

Over the phones, a lookout reports to CIC that he can see the sky battle.

Guns are trained in the direction of the planes—everyone alert for the possibility of an enemy plane breaking through.

Then, finally, the most welcome call from the division leader in the air: "Grand slam!"

That's it. All enemy planes downed. Our pilots can return to their CAP position over the ship.

(Continued next month)

Production Again!

SHAW and "PEPPY-PAL" TRACTORS

GARDEN and ALL-PURPOSE
Direct from FACTORY
to YOU!

Cultivate, Mow...
Do Belt Jobs of All Kinds

Yes! . . . SHAW "Peppy Pal" and "Du-All" Tractors are again coming off the production line! Now that the war is over, our facilities are again in full force producing these famous money-making, work-saving machines. Now you can get the small tractors so ideal for little farms, orchards, truck gardens, poultry ranches, estates, parks, cemeteries . . . wherever dependable, economical power is needed. Get all the facts now . . . and you'll want a SHAW!



LOW COST — LOW UPKEEP



RIDING TRACTOR



"PEPPY-PAL" with CUTTER BAR

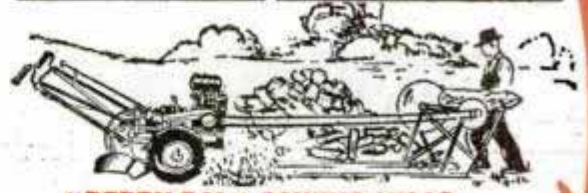

"PEPPY-PAL" SAWING WOOD

A SIZE TO FIT YOUR NEEDS — 1 to 9 H.P.

You'll find a SHAW "Peppy Pal" or "Du-All" Tractor ruggedly built and properly powered for practically every type of farm, garden, estate or cemetery job. It will do a good job of plowing, cultivating, discing, mowing, seeding, harvesting and spraying. Does things big tractors can't. Quick change from one piece of equipment to another.

RUNS BELT MACHINERY, TOO!

Runs feed grinders, saws and other belt machinery. Pumps water and pulls wagons or trailers. It's a versatile tractor . . . always ready and willing on power jobs. Operating costs are remarkably low! Easy to operate.

GET ALL THE FACTS — NOW!

Find out about the different models. Get the facts on the SHAW Tractor that will quickly and easily do the jobs that you want done on your place. Fill out and mail coupon for FREE Descriptive Literature.

FREE DESCRIPTIVE FOLDER

Just fill out and mail the coupon for folder that illustrates and describes various models of Shaw Tractors, Prices, etc.



MAIL COUPON NOW!

SHAW MANUFACTURING CO.

4502P Front St.
668GP North 4th St.

Galesburg, Kansas
Columbus, Ohio

Send me Free and Postpaid Descriptive Literature on SHAW "Du-All" and "Peppy Pal" Tractors.

Name

Street

Town..... State.....

SHAW MANUFACTURING COMPANY
4502P Front Street
668GP North 4th Street
GALESBURG, KANSAS
COLUMBUS, OHIO

3 OUTSTANDING, TIME-TESTED DRILL PRESS ACCESSORIES

THE BARRON ROTARY SURFACE SANDER

\$5.95
COMPLETE



Note these Special

Features—Made of Alcoa aluminum. Machined and balanced for smooth operation in drill press chuck. For surface sanding woods, plastics or polishing metal surfaces. Complete with 20 instantly removable sanding cup discs. No messy glueing needed. Leaves an agate smooth, absolutely true surface finish. Does not leave waves, ripples, steps or striations in work piece. The only tool of its kind. Shipped prepaid on 10 DAY MONEY BACK GUARANTEE for \$5.95.



The IMPROVED Barron Multi-Purpose Drill Press Planer.. \$7.50

Not only surface planes toughest woods and plastics to precision limits—but rabbets, routs, tenons, panels, grooves, beads. Will cut rabbets, tenons, panels, etc. to a depth of 1" with special Barron extra long hi-speed cutter blades. Thousands now in use. Made of Alcoa aluminum, machine finished thru-out. Vibrationless. Fits any drill press. Shipped prepaid on 10 DAY MONEY BACK GUARANTEE on receipt of cash, money order or C.O.D. for \$7.50.

Baron ALL-METAL Auxiliary DRILL PRESS Table.. \$8.85



Hard Alcoa aluminum die casting heavily ribbed—machined both sides. Has 234 sq. inch extra large working surface. Equipped with Barron Steel Planer Fence. Can also be used for shaper operations, innumerable other drill press uses. A real buy at \$8.85, express collect.

See Your DEALER . . . Or Write For CATALOG

BARRON TOOL CO., INCORPORATED
369 Architects Bldg. Detroit 1, Mich.

BARRON PRECISION WORK SHOP TOOLS



GERSTNER Tool Chests
Genuine Gerstner Chests are made better. They serve longer. Free catalog for Tool, Die and Pattern Makers.
GERSTNER TOOL CHESTS
446 Columbia St. Dayton 7, Ohio

YOU NEED THESE CRAFTSMAN'S TOOLS

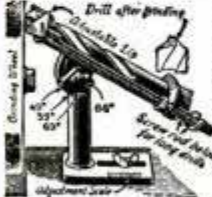

Sharpens round shank drills from 3/32" to 1 1/16" diameter. Grinds Old Drills like new in 4 different drill point angles. Grinds Short, Medium and Long Twist Drills from 1/4" up to 1 1/2" long, for hand or power grinding wheels.

70,000 NOW IN USE!

Grinds your drills like factory in 25 seconds. Gives perfect center and clearance. Saves drills, time and money. No shop should be without the Super Drill Grinder. Guaranteed to do the work or money back. The Grinder that gives a round point!

Only
\$2.95

SUPER ARBOR

(PATENT PENDING)
A combination drilling or grinding wheel attachment. For 3/4" motor shafts. Will take grinding wheel with 1" hole on shaft and 3/4" hole on small end. Extension can be used for rag or wire wheel, or 3/4", 24-thread drill chuck which holds drills from No. 60 to 3/4" in diameter. Right hand thread only.

Price Only
\$1.50

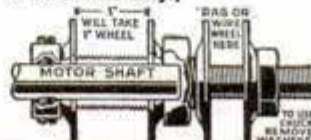

SUPER HACKSAW

AND FLAT DIE FILE HOLDER



The tool with 100 uses! Holds broken hacksaw blades—used by mechanics, electricians, plumbers, auto mechanics, hobbyists and repairmen. Perfect for all round household needs; ideal for difficult close-quarter work. Nothing like it for tool and die men. Price, without saw blade.

Only
95c

At Your Dealer's or Postpaid
CRANDALL MFG. CO.
1512 West Slauson, Dept. FA-2
Los Angeles 44, Calif.

IF YOU DO ask for

LIGHT
or HEAVY

INSIST ON 3-IN-ONE

...The finest household oil for over 50 years. Sold everywhere!



3-IN-ONE Oil

MULTIWELD "150" A. C. ARC WELDER



HEAVY DUTY, with heavy transformer and four large coils—continuously wound without splices, without solder. Over 200 different heats at hairline control. 110 or 220 volts A-C. Uses any A-C electrode, 1/16, 3/32, 1/4, 5/32 and 3/16. Economical to operate. All steel welded construction. Wide heat range permits overhead, vertical, horizontal or flat welding.

\$82.50

F. O. B. CHICAGO

TWO YEAR GUARANTEE

Not a toy—but a sturdy piece of equipment built so that we can offer a two year guarantee. It will outlive this guarantee period many times. Ten day trial with privilege of return. It's a HEAVY DUTY piece of equipment to serve you under all conditions.

PHILLIP WILSON, 309 E. Bridge St., Streator, Ill.

AMAZING MYSTERY BUTTON

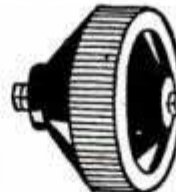

Startles Everybody. With this *Electronic Button* you can make your own Telephone—Amplifier—Detector. Attach this button to piece of cardboard—transmit conversation to another room. Music also transmitted to distant places. Most interesting, electrical apparatus ever discovered. Enables you to perform hundreds of experiments. So tiny it can be concealed in dozens of places. A Pre-War Product. Electronic Button including 5000 word instruction booklet with 50 illustrated experiments postpaid only \$1.00.

Electronic Products Company, Saint Charles, Ill.

NEW OTTAWA Wood Saw



FOR TRACTORS Makes wood sawing fast; easy. Cuts enough wood to pay for itself quickly. Easily moved while attached. Big blade; send for FREE details. **OTTAWA MFG. CO., W227 Oak Ave., Ottawa, Kans.**

LOW
PRICE



NOW!
**"MORE VERSATILE
 THAN EVER"**

BURGESS vibro-tool
ADDS POWER TO YOUR CRAFT SKILL

This improved model Vibro-Tool makes it easier than ever before to get "hand work" results in your craft work, yet with unusual speed, and employing every possible short cut.

Having the Vibro-Tool is literally having craft magic at your finger tips. Being light in weight and easy to grip, even youngsters find it a simple matter to become proficient with the Vibro-Tool. Thousands of craft workers and home workshop enthusiasts say that it is indispensable.



Engraves names, designs... decorates glass and glass objects.



Incises or secures embossed effects in wood carving.

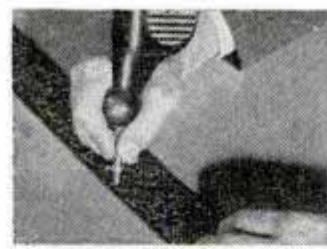

Tools leather belts and leather projects of all kinds.

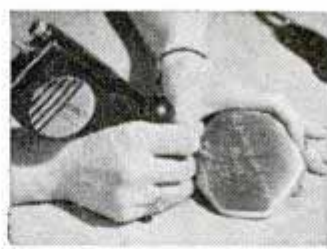

Engraves on jewelry almost as easily as writing with a pencil.



Marks names or identifications on tools and personal belongings.

The Vibro-Tool attachments are all interchangeable... easily inserted into universal chuck to give you fast, precise performance on all types of jobs.

Operates by vibration, 120 strokes per sec.; 110 V, 60 cycles, AC.

The Vibro-Tool complete with engraving needle \$7.50; with all attachments \$10.90.

SEE YOUR DEALER TODAY

Or Order Direct
 HANDICRAFT DIVISION

BURGESS BATTERY COMPANY
 166 N. WABASH AVE. • CHICAGO 1, ILL.



NEW KIND OF POWER SAW

**Easy to Handle!
Triples Production!
Low Cost Upkeep!**

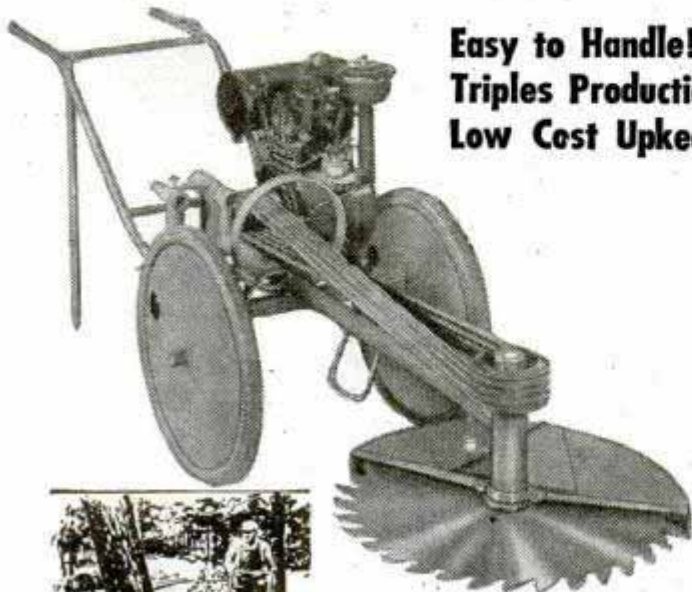

FELLING TREES

30" Oak felled in two minutes and fifty-two seconds with the Lowther C-Saw—11" Pine in fifteen seconds.



CUTTING LOGS

Cutting 10 to 20 cords of wood a day—on only 3 gallons of gasoline.



CLEARING LAND

Transforms brush covered wasteland into valuable pasture—Quickly and Easily.



HARRY A. LOWTHER COMPANY

141 West Jackson Boulevard Chicago 4, Illinois
Send Me Circular No. 311

Name

Address

NOW! A LOW-COST PRECISION MILL FOR PRODUCTION, EXPERIMENTAL AND HOME USE

Diamond

MODEL B-12

Net weight - 450 lbs.

Ideally suited to needs of experimenters, home craftsmen and precision manufacturers. Powerful, sturdy, for all precision milling. Beautifully finished. 6 spindle speeds - non-slipping, double vee belt drive - tapered roller bearings - 12" table travel - 6" transverse and 9" vertical table movements. Immediate delivery. All types accessories available. Price only \$372.00 f.o.b. Los Angeles, less motor. Distributors in principal cities. Write for folder! Dept. I. Other Diamond models available.

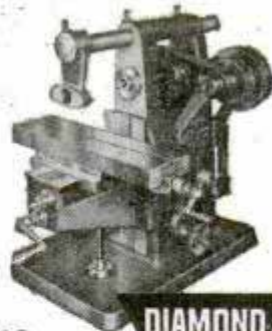

DIAMOND MACHINE TOOL CO.
3429 E Olympic Blvd., Los Angeles 23, Calif.

DIAMOND
DTCO

Manufacturers of the DIAMOND Line
of Precision Milling Machines and Accessories

Build These Cleveland Model Super-Values

★ ★ ★ ★
Famous U. S. BLACK WIDOW

Big 36" model of the super night fighter that has all the world agog. This is another of the C-D popular Industrial Training Models. Build them all. C-D Kit T-155..... **\$150**

Biggest \$1.00 Model in U.S. 84" Super Condor Searer. Soars for hours. Kit E-5019. **\$100**

SEE YOUR DEALER FIRST. In ordering direct, add 20c extra for packing-postage.

36" PIPER CUB



CATALOG 5c (Circular free) The civilian plane that went to war, and did a darn good job. Rubber or gas, tether or free flight. C-D Kit T-94..... **\$150**

CLEVELAND MODEL & SUPPLY CO.
4508 F 15 Lorain Ave. ★ ★ ★ Cleveland 2, Ohio, U. S. A.

"HOW TO MAKE MONEY WITH HOBBIES" \$1 HOBBIES DO PAY

Exciting Money-Making Homecraft Plans, THRILLING IDEAS and Experiences. Provides incentive and inspiration. Makes your HOBBY pay real dividends.

GET THIS BOOK YOU SHOULD HAVE
Just mail a dollar bill or write for free particulars to

A. H. RIEDER

Dept. PM-82, 93-20 71st Drive

Forest Hills, N. Y.

THE GEM MAKER



Amateurs or professionals... hobbyists or jewelers... Polish your own gems with a B&I Gem Maker. You will find this a profitable adventure. All necessary lapidary equipment is furnished, including a super-charged diamond blade for sawing, and all wheels for grinding, shaping and polishing, also complete instructions. The complete equipment as shown, less motor and belt, for only \$29.50, f.o.b., Burlington, Wis. Write today for information and literature on the Gem Maker and accessories. **B&I MFG. CO., Dept. S, Burlington, Wis.**

METALLIZE BABY SHOES

Learn this easy, money making business from nationally recognized consultant. Small investment; perpetual market. For free details write Joseph B. Kushner, B.S. Ch.E., Metal Finishing Consultant, Stroudsburg, Pennsylvania, R.D. 3A.

BURN YOUR NAME ON TOOLS WITH THE ARKOGRAF

PROTECT YOUR TOOLS FROM THEFT
Write with electricity any name or design on the hardest and finest tools and instruments or any metal, like writing on paper with pen or pencil. Thousands used by mechanics, garages, machine shops. **Complete Outfit \$3.50—Prepaid Anywhere** Interesting illustrated circular free. Write today. **ARKOGRAF PEN CO., 3927 S.E. Stark, Portland 15, Ore.**

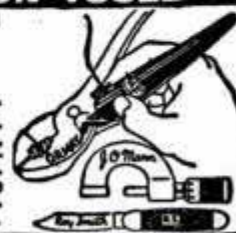

SAY YOU SAW IT IN POPULAR MECHANICS

Can You Equal This Home for **1575**

Shipped Direct from Our Mill



Save 30% to 40% on Your New Home..

WE PAY FREIGHT

Don't pay several hundred dollars more than necessary when you build a home! Buy it direct from our mill at our low factory price. We ship you the materials—lumber cut-to-fit, ready to erect. Paint, glass, hardware, nails, etc., all included in the price—no extra charges. We pay the freight. Plans furnished—also complete building instructions. No wonder our customers write us that we saved them 30% to 40%, compared with builders' prices. Easy terms—monthly payments.

Send for **FREE BOOK** of Liberty Homes

Handsome Big **FREE CATALOGUE**

Pictures wonderful homes in colors at money-saving prices. Designs to suit everyone. Write for your catalogue today. **LEWIS MANUFACTURING CO.** 1262 Lafayette Ave. Bay City, Michigan

FIND UNDERGROUND MINERALS and METALS with M-SCOPE

Employs same principle as Army Mine Detector. Unsurpassed in Efficiency. Write for Free 16 page booklet.

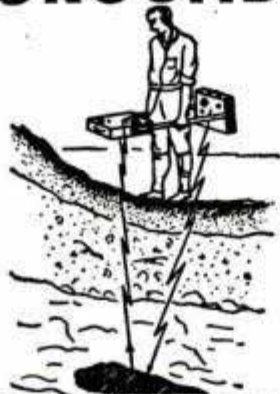

FISHER RESEARCH LABORATORY PALO ALTO CALIFORNIA

BUILD this GAS ENGINE

No Castings! No Special Tools.

All you need is a lathe and some scrap shunting. Speed and power for midget cars, boats, etc. Two cycle, 3/4" bore, 3/4" stroke. With our unique construction methods you can also design other engines incorporating your own ideas. No casting or pattern worries. Order complete plans and step-by-step instructions NOW—satisfaction guaranteed. Engine Plans, \$1.75. Carburetor plans, 75c. Mailed postpaid on receipt of remittance. **R. W. Rowe, Engineering, 8889 Appoline, Detroit 27, Mich.**

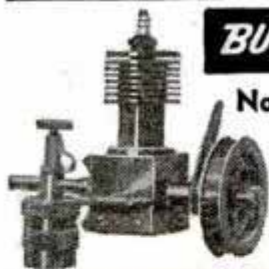

KEEP WARM! SAVE FUEL!

Mortite

Seal your home against drafts and cold, stop expensive heat leaks! It's easy with **MORTITE**, the pliable, plastic tape which goes on quickly, is effective immediately. You need no tools to apply. Simply press into place around windows, doors, baseboards, etc. **MORTITE** also keeps out dust and dirt, fills cracks, etc. Roll, about 80 ft., is enough for 5 windows. At hardware, paint, dept. stores, lumberyards.



\$1.25

Higher cost of Rockies & Canada

ASK FOR FREE **J. W. MORTELL CO.** **MORTITE CIRCULAR** 522 Burch St., Kankakee, Ill.



pipe-smoking in king frederick's day...

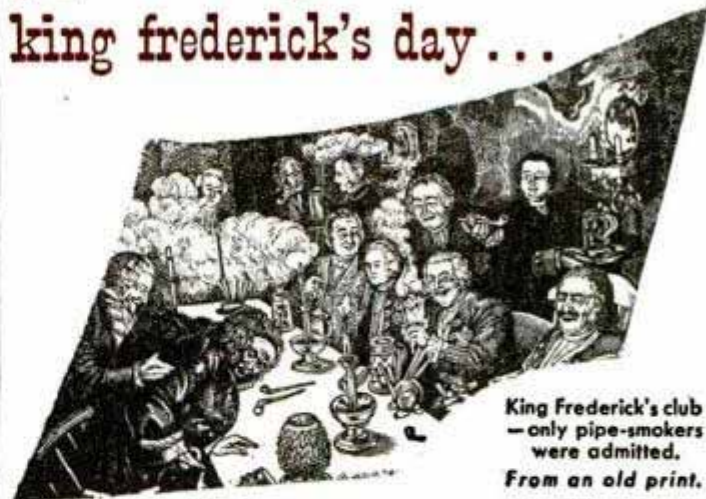

King Frederick's club — only pipe-smokers were admitted. From an old print.

... but then not even a king could have an

LHS STERNCREST STERLING

No, not even a king in those days could enjoy the sweet smoke of an LHS, made of rare imported briar. A good pipe is an investment in daily pleasure.



Other LHS Pipes

LHS Sterncrest Ultra-fine . \$10.00
LHS Sterncrest 14K . . . 7.50
LHS Certified Purex . . . 3.50
LHS Purex Superfine (Domestic Briar) 1.50

at good dealers everywhere.

\$5

Model No. 14. Others—plain or antique finish.



IMPORTED BRIAR

STERLING SILVER BAND

FREE. Write for "Pipes — for a World of Pleasure"

L & H STERN, INC., Stern Bldg., 56 Pearl St., Bklyn 1, N.Y.

for that Professional
FINISH...

use **PLASTIC WOOD**

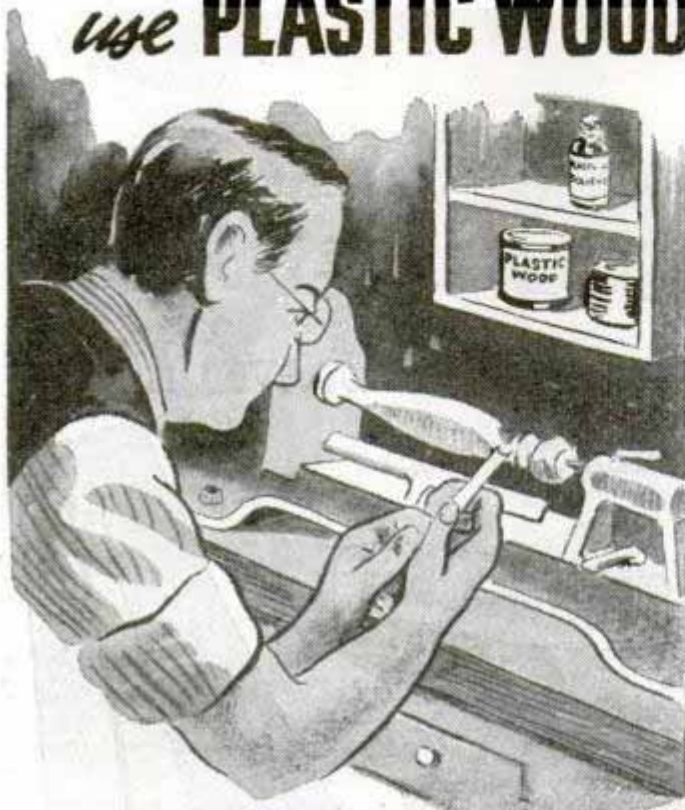

in your **HOME WORKSHOP!**

- **PLASTIC WOOD** is the most versatile material for the wood working hobbyist... Not only can you do many things with **PLASTIC WOOD**, such as special moldings, decorative effects in relief, and strengthened joints, but you can cover any mistakes or fill in knot holes for a perfect surface.
- **PLASTIC WOOD** can be carved, sanded, planed, sawed, drilled, or nailed... and it won't split, crack or chip.

PLASTIC WOOD is an all purpose material for any wood working shop. Sold in cans or tubes in all hardware, paint, and 10¢ stores.

Did you ever use **PLASTIC WOOD** for dowel pins?

PLASTIC WOOD

A CELLULOSE FIBRE FILLER



Test-O-Lite the MODERN
TROUBLE SHOOTER



← **THE NEON GLOW**

... LOCATES TROUBLE INSTANTLY in electric circuits, fuses, cut-outs, motors, radios, appliances. Tests everything electrical from 100 to 550 volts. Indicates hot or grounded wires. Tells AC from DC. Far superior to ordinary clumsy test bulb.

↑ **PUTS "FINGER" ON THE TROUBLE SPOT -- QUICKLY**

Saves precious time. Indispensable in shop or home. Has patented safety features. Vest pocket size with clip. Lifetime guarantee. List \$1.50. Purchase through regular electrical dealers.

L. S. BRACH MFG. CORP.

55 Dickerson St. Newark, N. J.



FUSES



MOTORS



OUTLETS

FREE! 40 Page
Hobby Catalog

Over 1000 Items — Over 300 Photos

Our new 40-page catalog—just off the press—is the "bible" of wide-awake modelers. Practically every nationally advertised model is listed and many, many hard-to-get items. Planes, engines, boats, gliders, supplies, etc. America's Hobby Center, Dept. B26, 156 W. 22 St., N. Y. 11, N. Y.

OTTAWA TRACTOR SAW



FREE BOOK
and
Price List

350 CUTS PER MINUTE

Make money sawing wood. Use Ottawa—fastest cutting. Cuts large, small logs easiest way. Fells trees. One man operates. Thousands in use. Built to last with heavy, stiff saw blade. Positive safety clutch control: uses power take-off any tractor.

OTTAWA MFG. CO., D-227 Forest Ave., Ottawa, Kan.



G E A R S

In Stock - Immediate Delivery

Gears, speed reducers, sprockets, thrust bearings, flexible couplings, pulleys, etc. A complete line is carried in our Chicago stock. Can also quote on special gears of any kind. Send us your blueprints and inquiries.

Send for Complete Catalog No. 10

CHICAGO GEAR WORKS

440-50 N. Oakley Blvd., CHICAGO 12, ILL.

NEW CHEAP OIL BURNER

FOR COOKING & HEATING STOVES-FURNACES
HEAT YOUR HOME, COOK YOUR MEALS
WITH CHEAP FURNACE OIL



NO MORE SHOVELING COAL OR ASHES. New Fuelizer Starter Vaporizing System turns Cheap 130 Flash Furnace Oil into Oil Gas heat without clogging up. **LIFE-TIME GUARANTEE** against defects. \$1.00-BONUS OFFER FOR TESTING. We will let you try it in your own stove or furnace for one month. Get Yours for introducing. Big profits. Be first. Send in your name today.



NORTHWEST MFG. CO. 561-B 5th Ave. Mitchell, So. Dak.

Lubricated-for-life Ball Bearings...

—double-sealed against
harmful shop dust...

—an advanced
engineering feature that
assures greater operating
satisfaction from your

Delta
MILWAUKEE
REG. U.S. PAT. OFF.
Power Tools

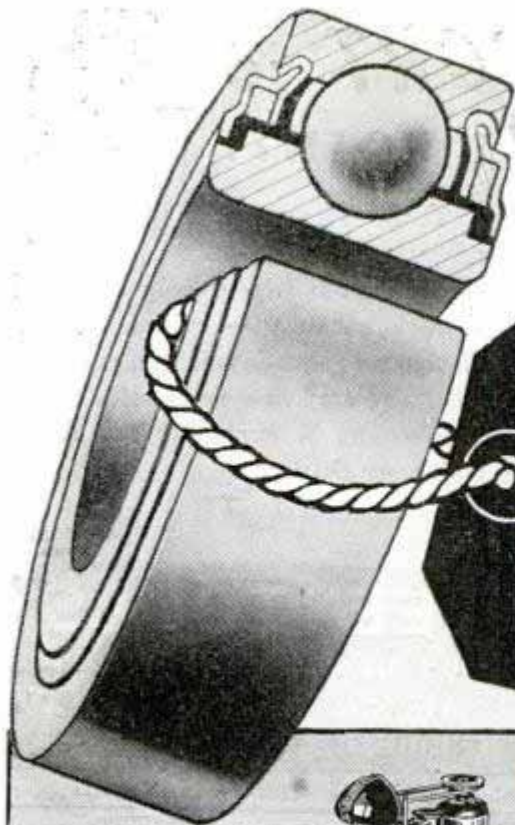

Other Delta features include:

✓ **Pre-loaded Bearings.** This is the result of an extra manufacturing operation that reduces the "play" in the bearings, to help you enjoy long-time operating efficiency and accuracy.

✓ **Precision-bored Bearing Seats.** These bearing seats help keep all parts lined up properly, so that you have greater assurance of producing finished pieces exactly according to dimensions.

✓ **Precision-ground Shafts.** These are shafts built to run without any "wobbling" which might throw off your measurements.

✓ **Dynamically-balanced Pulleys.** The pulleys which transmit the power from your motor to your power tool are balanced to help eliminate annoying, damaging vibration.

IN YOUR favorite store, Delta-Milwaukee Power Tools don't look much different from most other makes of power tools. But — see Delta tools in action. Actually use them. Then you can tell there is a difference.

Delta's advanced engineering features make this difference. You can't always see them with your eyes. For they are "hidden values" in construction. But the trouble-free performance and safety of Delta-Milwaukee Power Tools tell you that *they're there*.

The accuracy and precision built into Delta tools largely replace the manual skill of the old-time hand craftsman. Once you set a tool for the job, it takes care of keeping the work true and straight... helps you know the thrill of producing attractive, professional-looking work.

It's because *quality* is so important to satisfactory results that Delta-Milwaukee Power Tools are used by happy woodworking hobbyists everywhere.

There's a store near you — perhaps right in your own neighborhood — that carries Delta tools. The people there are looking forward to giving you the complete Delta story. Drop in to see them soon.



FREE!

"Happiness Herald"

—an illustrated tabloid newspaper that gives interesting facts about woodworking, a fascinating hobby. Tells about woodworking as an aid to mental health and happiness. Pictures typical shops and projects. Shows how the hobby can pay its way. Enjoy its inspiration and ideas. Send coupon for your free copy now.

Tear out coupon and mail today!

THE DELTA MANUFACTURING CO.
681B E. Vienna Ave., Milwaukee 1, Wis.

Please send me my free copy
of the "Happiness Herald."

Name.....

Address.....

City.....

(...) State.....

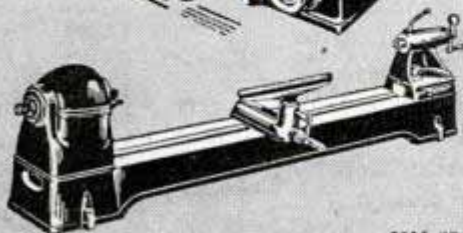
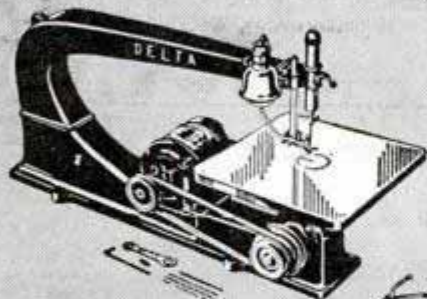
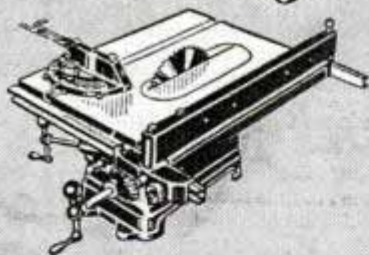
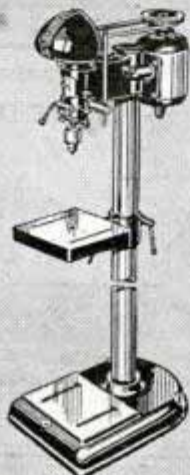

HM-33

SWIVEL-HEAD

FLASHLIGHT

nothing else like it!

**HEAD TURNS
LIGHT AT
ANY ANGLE**



Greatest advance in flashlight design in a generation. Turn powerful pre-focused beam where you want it . . . stand it up . . . clip it on . . . both hands are free. A handsome, durable, all-purpose flashlight for everyone. Ask your dealer.

**\$2 LESS
BATTERIES**



No. SW-22
Patented

No. 75 Heavy-Duty Dated Cell. Fresh Lasts longer. 10c

Flashlights & Batteries

If dealer cannot supply, send \$2.00 to Dept. P UNITED STATES ELECTRIC MFG. CORP., New York 11, N. Y.

*USA LITE Red-Head Safety Flashlight—a "MUST" for the motorist.

Say you saw it in Popular Mechanics



RIGHT TO THE POINT!



Every "Yankee" spiral screw driver is right to the point. Every part is ingeniously designed to speed work, cut down man-hours. Pains-taking design and simple strength are typical of all "Yankee" fine mechanics' tools . . . whether Tap Wrenches, Vises, Automatic Drills, or Bit Braces.

"YANKEE" SPIRAL SCREW DRIVER No. 130A
A Size for Every Purpose

"YANKEE" TOOLS

make good mechanics better

North Bros. Mfg. Co., Phila. 33, U. S. A.
Established 1880

Makers, also, of "Yankee-Handyman" Tools

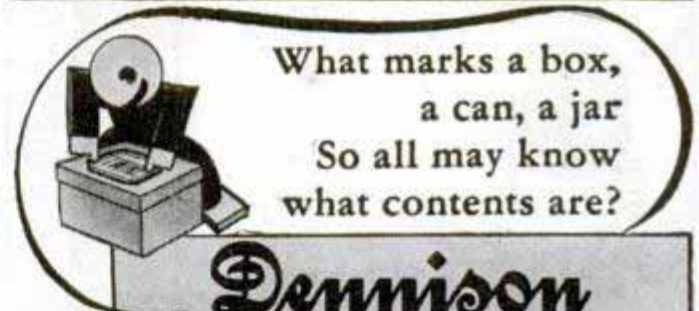

What marks a box,
a can, a jar
So all may know
what contents are?

**Dennison
GUMMED LABELS**

At Stationery Departments Everywhere

SANDING "HANDEE RUBLOK" POLISHING
USED BY BIG MANUFACTURERS . . . NOW AVAILABLE FOR
WORKSHOP, HOME AND SHOP USE

Rub wood, metal surfaces to a smooth factory finish . . . quickly, easily. Fine for paint work, waxing, polishing . . . gives even pressure over entire surface . . . gets into corners, irregular shapes. Special rubber cushion relieves hand fatigue. 6" x 2" rubbing surface. Complete with 6 durable, quick change covers only \$1.00 C.O.D.; postpaid if cash with order. Established dealers and agents invited.



FITS
THE HAND
FITS THE JOB

FEILD ENGINEERING CORP., DEPT. HB132, 12264 WASHBURN, DETROIT 4, MICH.

WRITE FOR YOUR FREE COPY OF THE NEW KRW HYDRAULIC PRESS BOOK

Describes all manner of Production and Shop Work on KRW Hydraulic and Bench Type Arbor Presses. 32 pages illustrating the new KRW Hand-operated, Electric-operated and Air-operated Hydraulic Presses.

Write for your copy today.

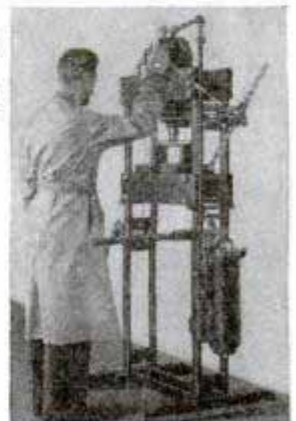

K. R. WILSON, DEPT. 17, 215 MAIN ST., BUFFALO 3, N. Y.

Builders of Shop Equipment for Ford Dealers Since 1916

... FOR MEN WHO REALLY KNOW PIPES



\$150

Selected Briar



MOUTHPIECE TUBE
prevents backflow
of moisture

CONDENSING CHAMBER
traps and holds bitter
juices and sediment

BOWL GUARD
keeps shank
and bowl dry

REMOVABLE SECTION
eases thorough cleaning

CHAMBER GUARD
bars tobacco fragments
from bit
Patented

Royalton
CROWN

YOU ARE EVERLASTINGLY SAFE from unsavory juices and bitter slugs when your pipe is a Royalton Crown. Because of its patented condensing well and other unique features harsh impurities can't curtail your pipe contentment . . . For cool, dry smoking continuously—no pipe quite equals a Royalton Crown. HENRY LEONARD & THOMAS, Inc., Ozone Park 17, N. Y.



When you want to fix things fast . . . remember Weldwood Glue. It's quick to mix . . . easy to use . . . tremendously strong . . . stain-free . . . rot-proof . . . and permanent. At hardware stores, lumber yards, chain stores.



WELDWOOD
PLASTIC RESIN
WATERPROOF GLUE

UNITED STATES PLYWOOD CORPORATION, New York 18, N. Y.

*It sidetracks
MOISTURE*



Pat. No.
2,166,537

SMOKE passes
thru aluminum
tube, slotted
at the bottom.

A pipe cleaner,
folded in half, and
inserted under the
slot of the tube,
absorbs all moisture
as fast as it forms.

Smoke always has a clean
passage—is not drawn
through tobacco juices.

Light up a Smokemaster and see what a difference this exclusive feature makes in smoking enjoyment. Note how much more fragrant, sweet-tasting and mellow the smoke is when it is not contaminated by rank, biting juices . . . Smokemaster, Custom-made \$1.50 . . . Smokemaster, Standard \$1.00.

At leading dealers, in a full range of models.

Briarcraft, Inc., 347 Fifth Ave., New York 16, N.Y.

**Briarcraft
Smokemaster**

THE PIPE-CLEANER PIPE

Attention! HAMS
... FINISH YOUR OWN CRYSTALS

**NEW... Complete
Crystal Finishing Set**

Meet F. C. C. regulations for frequency control with Quartz Crystals. Finish your own crystals to meet your individual requirements. It's fun—it's easy—it's economical. Kit contains 4 AT or BT low drift Quartz Crystals cut to U.S. Signal Corps war-time specification. Complete accessories including a holder with stainless steel hand lapped electrodes and special device for making limited frequency adjustments—flat glass grinding plates—coarse and fine special grinding abrasives—cleaning brush and syntex beads and complete instructions. Be sure to specify frequency desired so we can send blanks within easy grinding range. All at amazing low cost. Send money order, check or cash for your kit today.

only
\$4.95
postpaid

COMMERCIAL EQUIPMENT CO.

Dept. D

1416 McGee St., Kansas City 6, Mo.

**FREE
INSTRUCTION**

Sensational Value
PORTABLE TROUBLE LAMP



\$2.50
POST PAID

Sturdily constructed with all rubber safety handle and Heavy Duty Steel Reflector Guard. Rubber plug and 25 feet of No. 18-Gauge Rubber Cord. Will accommodate up to 100 watt lamp.

HURSEY SALES CO.
1763 W. Ogden Ave.
Chicago 12, Illinois

SIMPLIFY HOME WOODWORKING!

LOCATE DOWEL HOLES EASILY...

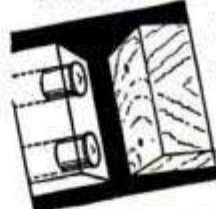

KENKRAFT Metal Dowel Centers leave clear, accurate impressions on mating piece. Mating holes easily drilled to accurate fit. Made for 1/2", 3/8" and 1/4" dowels. Two of each size prepaid \$1.00

KENKRAFT
BOX 516 - MANHATTAN BEACH, CALIF.

DO YOU

WANT a permanent business profession of your own? Then **BECOME A FOOT CORRECTIONIST**. Earnings in this greatly needed profession run as high as \$50-\$100 weekly after a few weeks home training—not medical or chiropody—no further capital needed, no goods to buy. 50th year. Write for free booklet.

Stephenson System of Foot Correction

28 Back Bay,

Boston, Mass.

**NEW AIR-SPEED SAW and FILE cuts TIME
cuts COST cuts PERFECTLY**



Air-Speed for difficult sawing or filing jobs!

Dependable pneumatic power saw and file—Weight: 3 1/2 pounds—Operating speed and cutting stroke easily adjustable—Nothing like it for key hole, dead-end and scroll cutting in iron, steel, aluminum, copper, plastics, brass, wood, hard fibre and other materials—File can be inserted in chuck, instead of saw blade, for all filing operations—Only two moving parts guarantee long life—Fully warranted—Retail for \$39.50—Immediate deliveries—See your Dealer.

COMPLETE LITERATURE AVAILABLE

AIR-SPEED TOOL COMPANY

1028 W. Slauson Ave., Los Angeles 44, Cal.

Dept. PM-2

ELECTRICITY FOR ANY JOB ANYWHERE



Reliable, economical electric service anywhere, anytime, with an Onan Electric Generating Plant. Driven by Onan built, 4-cycle, gasoline engines, these power plants are of single-unit, compact design and sturdy construction. Suitable for all types of service.

Models range from 350 to 35,000 watts. A.C. types from 115 to 660 volts; 50, 60, 180 cycles, single or three-phase; 400, 500 and 800 cycle, single phase; also special frequencies. D.C. types range from 6 to 4000 volts. Dual voltage types available. Write for engineering assistance or detailed literature.

ONAN
D.W. ONAN & SONS, 2514 Royalston Ave., Minneapolis 5, Minn.

A TOOL—
NOT A
BRUSH



PAINTERS' STRIPING

TOOL

ONLY
\$1.00
POST
PAID

As easy to use as a pencil! Draws parallel lines, straights, curves, circles with paint, enamel, lacquer. Use to stripe autos, furniture, toys, bikes, model planes, signs, bulletin boards, linoleum. (Makes wall board look like tile.) Every painter and craftsman should own one! Type "S" MASTER Painters' Striping Tool with instructions, adj. guide, 1/16" tip, complete only \$1.00. C. O. D. 25c extra. Order Today! PAINT DEALERS! WRITE FOR LITERATURE, ETC.

WENDELL MFG. CO., 4234-B, Lincoln Ave., Chicago 18, Ill.

MARCOT KEY MACHINE

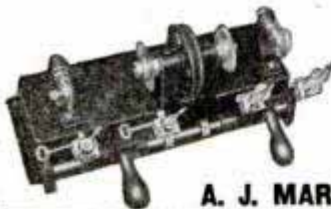

Marcot No. 8 Key Machine
Mounted on Cabinet.....\$ 75.00
Book on Modern Locksmithing 3.95
Auto Code Book and Depth
Keys 12.50
2592 Assorted Key Blanks. 77.76
Set Key Files, Tools, Pins,
Springs, Thimble 10.50

\$179.71

A. J. MARCOTTE CO., 1200 N. Kedzie Ave. CHICAGO 51, ILL.

Ask Directions WITHOUT STOPPING

A glance at your HULL AUTOMOBILE COMPASS shows true direction of travel. Saves time, anxiety, increases driving pleasure. Insist on HULL established quality. Circular free. At your dealer's. Price \$3.50.

HULL MFG. CO.

P. O. BOX 246-D3

WARREN, OHIO



AMAZING SELLS LIKE LIGHTNING!

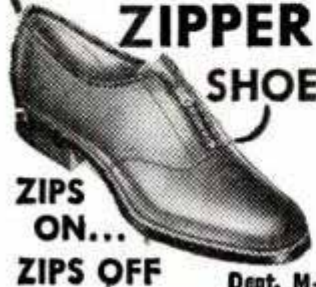

ZIPS
ON...
ZIPS OFF

● Here's your chance to start a fine, solid, profitable business right among your friends and neighbors. Tie up with the LEADER in the direct-to-wearer shoe industry, established 42 years. Just rush postcard NOW for FREE SAMPLE OUTFIT, Free 10-Second Air Cushion Demonstrator, Free Automatic Selling Plan. Learn how you can start making money very FIRST DAY with over 200 fast-selling Feature Style and Comfort Shoes.

Mason Shoe Mfg. Co.
Dept. M-330, Chippewa Falls, Wis.

A TOOLSHOP IN YOUR HAND!

● GRIND ● DRILL
● POLISH ● ROUT
● ENGRAVE ● CUT
● CARVE ● SAND
● SAW, etc.

HANDEE TOOL OF 1001 USES

The first small portable tool and today's finest. Smooth, steady power at your fingertips. You'll be amazed at what you can do with your Handee—turn out professional looking projects for pleasure or profit—ship, plane or train models, costume jewelry, wood carvings, puppets, initialed tumblers, etc.

Uses 300 different accessories. AC or DC. 25,000 r.p.m. Weight 12 ounces.

With 7 accessories, postpaid.....\$18.50

MAKE THINGS FROM
WOOD ● PLASTICS
METALS ● GLASS
LINOLEUM
LEATHER ● ALLOYS
HORN ● STONE
BONE, etc.



Get a Good Start

Get the HANDEE KIT

HANDEE Tool and 45 most popular accessories, in handsome, com-

compact, steel carrying case! Set includes steel cutter, drills, bristle brushes, polishing wheels and points, rubber disc, drum sander and bands, mounted wheels, Speed Oil, sandpaper discs. You'll be amazed at what you can accomplish! Complete, postpaid. . . .

\$25.00

FOR YOURSELF OR A FRIEND...
THE GIFT OF A LIFETIME!



ORDER NOW!
USE THIS COUPON

FREE
64-PAGE
Catalog

CHICAGO WHEEL & MFG. CO.
1101 W. Monroe St., Dept. PM
Chicago 7, Ill.

Send me HANDEE TOOL HANDEE KIT
 Remittance enclosed. Send C.O.D.
 Send 64-page Catalog.

Name

Address

BUILD the COMET INTERCEPTOR!

DE-THERMALIZER DEVICE

AUTOMATIC RETRACTABLE LANDING GEAR

\$2.95

Kit No. T-14

The GAS MODEL with the SENSATIONAL POST-WAR FEATURES!

Sensational GAS MODEL designed by CARL GOLDBERG! Offers amazing De-Thermalizer—which brings your model down out of rising air currents—prevents flying away! Foolproof automatic retractable landing gear; steep climb—graceful glide! Kit contains plans and materials to complete either Class "A" or "B" model.

Many other Comet Kits at your dealer

COMET MODEL AIRPLANE & SUPPLY CO. INC.,

129 W. 29th STREET, CHICAGO 16, ILL.

1170 BROADWAY, NEW YORK 1, NEW YORK

BUILD ARC WELDER PLANS 35¢

We Show You How to build this new powerful welder without rewinding. For light or heavy work. Uses coils taken from old auto generators. Works on 110 or 220 volts A. C. Has 20 different heats. Send 35¢ for complete PLANS and valuable Catalog. Write today. LEJAY MFG. CO., 1347 LeJay Bldg., Minneapolis 8, Minn.



READY CUT HOMES

Order Now

Homes \$1182 and up, freight paid. Orders filled in order received. Post war delivery. Save at least \$500 on modern production method homes. Much more compared with builders' prices. Anyone can assemble with simple plans furnished. Complete, including paint, hardware, roofing, glass, nails, etc. Send 25¢ in coin for full color catalog showing 56 modern low-priced homes and floor plans. Complete building plans ready for filing at low cost.

Dept. P.M.26
INTERNATIONAL MILL
& TIMBER CO.
Bay City,
Mich.

NEW COLOR CATALOG
FOR ONLY
25¢



DEXTER UNIVERSAL LATHE CHUCK well-made, accurate, strong, serviceable



New Backless design requires no adapter
2"—\$10; 3"—\$15; 4"—\$19;
5"—\$24; 6"—\$28

Includes inside and outside jaws
State spindle size and threads per inch
Distributors Wanted

**THE LEAVITT MACHINE COMPANY
ORANGE MASSACHUSETTS**

"For the SPARK that NEVER Falls"

INSIST ON



RUMIN FLINTS
Gold Coated
and LIGHTER FLUID

All drug
and cigar
stores, PX
and Ship's
Service.

ROCK FLINT CO., 123 Doughty Blvd., Far Rockaway, N.Y.

NOW AVAILABLE

Red Latex Molding Compound

Make your own molds for plaster objects
Write for information and prices

COLUMBUS GLOVE MFG. CO.

474 Lilley Avenue

Columbus 5, Ohio

CRESCENT TOOLS

Give Wings to Work

ASK YOUR
HARDWARE
DEALER

SAY YOU SAW IT IN POPULAR MECHANICS

SHARPEN YOUR DRILLS WITH THE E-Z DRILL SHARPENER

ONLY
\$2.80

Complete
with
Protractor

This precision fixture was developed for factory use by aircraft tool engineers. Real shop size and not a toy. Sturdily built, attaches to bench or grinder frame. Has new PROTRACTOR FEATURE which enables you to adjust quickly for different drill angles. Thousands now in use—home and repair shops, garages, factories, farm shops—wherever accurate holes are drilled. E-Z is simple to operate. Gives faster drilling, perfect hole centers and clearance. Guaranteed to do the work or money back.

SHARPENS ALL ROUND SHANK DRILLS FROM THE SHORTEST TO 11" LONG—3/32" TO 1 1/16" DIAMETER

SAVE MONEY WITH E-Z. Comes complete with instructions, ready to sharpen your dull drills as good as new. Low price of \$2.80 because of our volume business on this wanted precision tool. The E-Z protractor gives you proper angles for cutting extra hard material, ordinary use, for soft material, wood, Plexiglas, Lucite, Plastics. Send check or money order for \$2.80. WE PAY POSTAGE AND SHIP IMMEDIATELY.

FRED F. TEN EYCK,

Dept. P-10, 758 S. Irolo St.
LOS ANGELES 5, CALIF.



STOKER EMPTIES OWN ASH!

A remarkable stoker already used by thousands of home owners—fits into any furnace or boiler. Manufactured since 1934. So automatic it takes the coal from your present coal bin through a pipe to the furnace, going around corners if necessary. Keeps house at even temperature, empties its own ash in sealed containers, no coal to shovel, no clinkers to dig, only bituminous stoker of its kind on the market. Send for full information NOW!

POCAHONTAS FUEL COMPANY INCORPORATED
344 EAST 131st STREET • CLEVELAND 8, OHIO

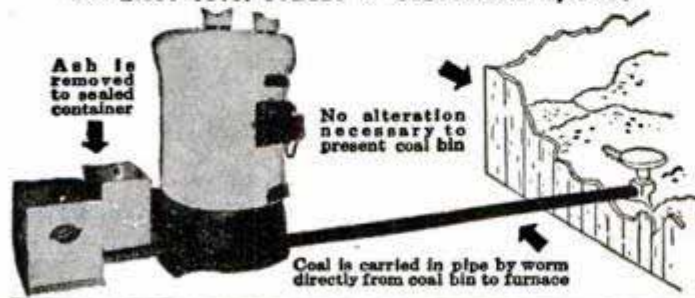



WELD

ANYTHING ANYWHERE ANYTIME

ALL PURPOSE ARC WELDER
9 Models . . . 32 Volt D.C., 110 to 440 A.C.

A complete workshop in itself! Weld, cut, braze or solder any type metal; iron, castings, aluminum, steel, bronze . . . in any gauge or weight, with equal ease. Compact, complete, as sturdy as the Rockies. Formed steel and cast aluminum case, welded steel base, 4" cast wheels. Built with voltage control. Better on R.E.A. lines. Completely equipped. No instructions needed. Sold throughout the world. Several dealer territories open. Write;

FORNEY MFG. CO.
FORT COLLINS 2, COLORADO



PRESTO!

MASTER GLAZE

ANYONE CAN



LEAVES HARD GLASS-LIKE FINISH

EASY TO APPLY

PROTECTS THE SURFACE

NO SMEAR OR STREAKS AS WITH WAX

LASTS SIX MONTHS TO A YEAR

SEALS THE PORES OF THE SURFACE

WILL NOT FINGER-MARK

NO GILY FILM AS WITH POLISH

SAVES YOU MONEY

Car Owners! Meet Master Glaze—the sensationally different luster for new and used cars! Not a wax—not an oil polish—not a paint!—nothing that “smears” over the surface.

MASTER GLAZE is a unique discovery—a creamy liquid—quick and easy to apply! Gives a hard, glass-like surface. Even gasoline cannot dull it! Lasts six months to a year! Amazing luster—beautiful, sparkling clean and brilliant! Doesn't finger-mark—doesn't smear! A match box full glazes an entire car. Seals the pores—protects! **NOTHING LIKE IT!**

FREE SAMPLE
Just send your name and address today to
MASTER GLAZE CO., 7720-532 W. Harwood Ave., Milwaukee, Wis.

AGENTS
An unusual opportunity!
Quick, flashy demonstrator.
Big profits.
Good territory.
Write today!

You'll like this famous **RIGID** PIPE WRENCH

UNCONDITIONAL GUARANTEE
If this Housing ever
Breaks or Distorts we
will replace it Free
COPY. 1937
THE RIDGE TOOL CO.
ELYRIA, O.



*with this guarantee that
saves you all wrench
housing repairs*

● No other pipe wrench offers you the freedom from wrench housing troubles and expense guaranteed to you by the **RIGID**. For the **RIGID** housing doesn't break or warp—so it's seldom off duty for any kind of repair, you need fewer spares. Full-floating hookjaw and adjusting nut always work easily. And you'll enjoy the non-slip jaws, the handy pipe scale on hookjaw, the comfort-grip I-beam handle. Ask for **RIGID** at your Hardware Store or Supply House.

THE RIDGE TOOL CO • ELYRIA, OHIO, U.S.A.



HOW TO OBTAIN SHOP TOOLS

at the earliest possible moment and
**PAY FOR THEM OUT OF
PATRIOTIC SAVINGS
IN WAR BONDS**

Own versatile, low-cost, sturdy

Boice-Crane
Band Saws - Saw Jointers
Jig Saws - Spindle Shapers
Belt Sanders - Spindle Sanders
Drill Presses - Lathes
Thickness Planers

Write today for folder on the

*Boice
Crane*

**PURCHASE
PRIORITY
PLAN**

a safe, convenient plan for forward-look-
ing shop men and home craftsmen.

True, government priority restrictions
are removed, but civilian power tool
delivery delays will continue to exist
for many months. You can avoid pro-
longed waiting for your tools, or the
necessity of buying something less satis-
factory, by reserving a preferred de-
livery position now. Use this convenient
coupon to get details.

BOICE-CRANE CO.
943 Central Ave., Toledo, Ohio

Please send, without obligation or cost, details of the
Boice-Crane Purchase Priority Plan, together with a
copy of your catalog on shop tools.

NAME _____
STREET _____
CITY _____



All Steel TRUCK

Order Monday—Get Friday—\$12.95
for 1...\$35.85 for 3. "Handee" nat. adv.
Thousands in use. 5x2 rub. trd. whls.
600 lb. cap. 44" ht. 14" nose width.
Easy handling. Wt. 28 lbs. For all
purp. 1% 10da. Return express collect
if not 100% satis. FOB. Order from
HANDEES CO., Dept. 230A1, Bloomington, Ill.

IT'S EASY!

IT'S FUN!

*Build
Your Own*

• Transmitter Kits • Photo Amplifier
Kits • Antenna Kits • Crystal Sets
and many others.

**FREE NEW 52 PAGE
PARTS CATALOG**

SEND FOR YOUR COPY TODAY!

Write for these exclusive items:

Tube and Circuit Book..... 10c

Giant Radio Reference Map..... 15c

Handy Tube-Base Calculator..... 25c

Address PM-2,
Council Bluffs,
Iowa



Wholesale
RADIO LABORATORIES

ROLL FILM

No limit at present

Size	Price	Made to exacting U. S. Government stand- ards, this fine tested war surplus film has just been released. Panchromatic high speed. 8 exposures. Orders filled by return mail.
127	• 27c	Please order a minimum of 4 rolls. Include 18¢ to cover postage and handling. No C.O.D.'s please. Refund on request. We sug- gest you send us your order today.
120	• 33c	
620	• 33c	
116	• 38c	
616	• 38c	

Howard West, 3 W. 42 St., New York 18, N. Y. Dept. C2

PLASTAKIT

Make your own ornaments, decorations and jewelry de-
signs out of plastic. Box of 60 pieces including such
pieces as boats, anchors, hearts, pilots' wheels, flower
baskets, also 2 plastic bases to make your own brooches.
All complete, including earclips, glue and pins. Now the
latest rage. Send \$2... box sent postpaid. No C.O.D.'s.

WASHINGTON EMBLEM CO.

Dept. S

Box 1067

Providence, R. I.

EXPERIMENT WITH LUMINOUS PAINT



Complete kit of luminous paints
in colors. Paint artificial flowers,
lapel ornaments, novelties, house
numbers, light switches, etc. Kit of
one oz. each of 3 lasting colors, bright
blue, gardenia and charrtruse, one ounce
sealer. Guaranteed best quality.

**COMPLETE KIT
WITH 3 COLORS
AND SEALER**
**\$4.25 POST
PAID**

BLACK LIGHT PRODUCTS • 450 E. Ohio St. • Chicago 11, Illinois

SAY YOU SAW IT IN POPULAR MECHANICS

Marvelous New 3 WHEEL ROLLER SKATE

• **Faster, Smoother, Easier Skating** •



\$4.25 pair

Plus 35c for Postage
& Handling. Give Size.
Higher in Canada.

SALES... SALES... EVERYWHERE... No matter where these outstanding 3 Wheel
Roller Skates are shown they win instant approval... Lighter in weight makes for Easier
Skating... The Streamlined principle gives more SPEED and Smoother Skating... For
Rink, Figure and Sidewalk Skating... Fully Chrome Plated. **EXCLUSIVE FEATURE:**
Has a Brake for quick stopping.

Sales Are Tremendous!

This is an unusual opportunity for **QUICK, BIG VOLUME SALES**
and we want wide-a-wake Distributors and Local Agents to take care of this business in
their territory... The interesting part of this BEB Skate is... it is interchangeable
to Ice Skating in a few minutes... Ice Skate Attachment \$1.90 extra.

DISTRIBUTORS... AGENTS WANTED EVERYWHERE

We want every territory covered... Dealers are enthusiastic and order in large quantities
... We want Go-Getters to supply this demand and offer a **BIG MONEY-MAKING**
Proposition.

BEB SKATE CO., Dept. P, 4529 Ravenswood Ave., CHICAGO 40, ILLINOIS



**CHANGEABLE
FROM ROLLER
TO ICE SKATES**

**THREE BALL BEAR-
ING WHEELS in line
gives MORE SPEED
with LESS EFFORT**
... Simply raise the
toe to **STOP QUICK.**

Want to Ski Better?



Buy...

NORTHLAND SKIS

Fine skis *do* make a difference! That's why champion skiers use Northlands. Balanced perfectly, you have more control . . . more confidence . . . you *ski better* on Northlands.

STUDY HELPFUL SKIING MANUAL

★ Expert advice on ski-technique. Write for FREE copy of Northland Ski Manual. 48 pages. 82 illustrations. (Offer does not apply in Canada.)

NORTHLAND SKI MFG. COMPANY

World's Largest Ski Manufacturers

95 MERRIAM PARK • SAINT PAUL 4, MINNESOTA



BUILD Boucher MODELS

CLIPPER TANKER FREIGHTER
Everything for the Model Ship Builder Since 1905

34 DIFFERENT
MODEL KITS
\$5 to \$35

Send 35c for 96
PAGE ILLUSTRATED
CATALOGUE

BOUCHER SHIP MODELS 36 EAST 12TH ST. NEW YORK, 3, N.Y.

Color-
book for
1 year.

LOOK HOT WATER IN 5 MINUTES

Can't
Heat—
Chrome
plated.



Just drop the Elden Electric Water Heater into water, plug into any light socket and you will have steaming hot water in 5 minutes!

Ideal for shaving, baby's bath, boiling water or sterilizing instruments. Thousands in use in homes, cottages, trailers, hunting lodges, refreshment stands, barber shops, dentist's offices and on the farm.

Comes complete with 6 ft. waterproof insulated all rubber cord and plug. Send check or money order today.

\$6.50

ELDEN PRODUCTS CO. DEPT. A, 7310 WOODWARD AVE. DETROIT 2, MICHIGAN



NOW AVAILABLE!

Crosman Silent Rifles—America's favorite compressed air rifles for indoor and outdoor shooting are back again! Available in 22 cal. single shot and Magazine Loading Types. At your dealer—or order direct. Ask for Crosman SUPER-PELLS too—the better ammunition for all compressed air rifles. .177 Cal.—\$1.80 per M. .22 Cal.—\$2.00 per M.

CROSMAN ARMS CO., INC. • Rochester 7, N. Y.

DIE-LESS DUPLICATING

Many small parts can be formed without dies, to duplicated accuracy of .001" with DI-ACRO Precision Machines,—Benders, Brakes, Shears. Save die expense and time delay. Ideal for experimental and research work, making samples, models, etc., as well as regular production runs. Write for descriptive literature.

O'Neil-Irwin Mfg. Company
341 8th Ave. South
Minneapolis 15, Minn.



Chungking Calling

MAIN STREET

And you'll get the call if you own a National all-wave radio like the NC-2-40C, even though the signal is only one-millionth of a volt.

It takes a special-constructed receiver and one with extreme sensitivity to bring in consistently and clearly radio waves broadcast from world capitals. You and your family will want to hear them in this new era when the whole world is our neighbor and

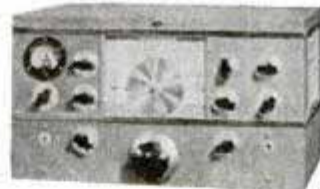

NC-2-40C

when so many fathers and sons are sharing in the pleasures of amateur radio, one of the world's most educational hobbies.

For many years, National has been building such radios for amateurs, for government and for others, to whom long-range reception is both requirement and enjoyment. See your local dealer about the NC-2-40C, the NC-46, and other National models.



NATIONAL COMPANY

EST.  1914

MALDEN, MASS.

THE MOST DISTINCTIVE NAME IN RADIO COMMUNICATIONS

Army-Navy Type HEADPHONES

TYPE HS-23



Save up to 70% on genuine U.S. Signal Corps headphones. These are the better \$10.00 headphones for only \$2.95. Leather-covered headband, detachable rubber cushions, lightweight construction, impedance 8000 ohms. Ea. \$2.95

Signal Corps TELEGRAPH KEY

Genuine U.S. Signal Corps key with switch to close contacts, polished durable enameled metal base mounting on a bakelite base, key lever is nickel-plated brass, silver contacts; packed in new original boxes. Shipping wt., 1 lb. Ea. 95c

Write for our illustrated literature featuring all types of radio parts. Plus shipping charges.

Arrow Radio Co., Dept. G, 2205 W. Division St., Chicago 22, Ill.

New Designs in FRANZITE GRIPS

Modernize Your Gun! Improve Your Score! Most durable grips made. Positively unbreakable! For Colt, Smith & Wesson, Hi-Standard, Ortgies, Luger & Mausers in a wide choice of beautiful designs in ivory, pearl, walnut, onyx, etc. Low prices. FREE CATALOG. Dealers Wanted.

SPORTS, INC., (Mfrs.) 5501 Broadway, Dept. P-2, Chicago 40, Ill.

WOOD WORKERS

LUMBER—PLYWOOD AVAILABLE

Harold Hunt wants to send revised No. 14 catalog. 124 pages of woodworking ideas. UNEQUALED BARGAINS in imported and American woods, supplies. Those already holding this catalog—send for revised sheets.

CRAFTSMAN WOOD SERVICE CO.
2729 S. Mary St., Dept. A-66 Chicago 8, Ill.

only 10¢

"WONDER" ELECTRIC BUTTON

Most interesting electrical apparatus ever discovered. Make your own Telephone-Amplifier Detertophone. Transmit your voice or music to distant rooms. Perform hundreds of fascinating experiments. So tiny it can be concealed in dozens of places. Send \$1 now for button and free 5,000 word instruction booklet with 50 illustrated experiments. SPECIAL OFFER 6 buttons and booklets sent post-paid for \$3.

BUCK MFG. COMPANY, Box A-26, No. Aurora, Ill.

LAWN ORNAMENT-NOVELTY PATTERNS

28 Lawn Ornament Patterns, 25c. Other patterns: 15-20" high; Dutch Girl, Dutch Boy, Pirate, Bull Terrier, Mexican Girl, Mexican Boy, Dwarf, Penguin, Flower Girl, 10c each. 25 Novelty Patterns, 30c. All 62 Full Size Patterns, \$1.00 Postpaid.

Strother Pattern Service, Dept. C-8, Box 383, Belington, W. Va.

MOTORISTS NOW SAVE MONEY ON GASOLINE!

Now you can get up to 30% extra gasoline mileage with a Vacu-matic on your car. Quicker pick-up, smoother running, added power and precious gasoline savings guaranteed.

Automatic Supercharge Principle
Vacu-matic is entirely different! Operates on the Supercharge principle. Saves gas. Automatically provides a better gas mixture. Guaranteed to give up to 30% extra gas mileage, more power and better performance.

FITS ALL CARS
Constructed of six parts, fused into a single unit. Adjusted and sealed at the factory. Very quickly installed by anyone.

AGENTS TRIAL OFFER
Every car, truck, tractor a prospect. Send name, address on postcard for big money making offer and how you get yours for introducing.

VACU-MATIC CO., 7617-1263 W. State St., Wauwatosa 13, Wis.



SELF-WINDING

THE LAMONT ULTRAMATIC

Everything you could want in a watch—fully automatic.

- compensamatic
- shockproof
- waterproof
- sweep second hand
- unbreakable crystal
- anti-magnetic
- self winding
- 17 jewels
- radium dial
- fully guaranteed

All Stainless Steel, Fed. Tax Incl. \$43.95
14K Gold, Fed. Tax Incl. 95.40
Ladies' Self-Winding — without sweep second hand. Stainless Steel, Fed. Tax Incl. \$49.50

Mail orders promptly filled. Postage prepaid. Write for Free illustrated booklet.

LAMONT
INTERNATIONALLY FAMOUS WATCHES
Fifth Avenue
ROOM 1005 • 597 FIFTH AVENUE
NEW YORK 17, N. Y.

Now for EVERY WORK SHOP!

NEW Invention Electroplates by BRUSH



Easy to Plate CHROMIUM GOLD, SILVER, NICKEL, COPPER . . . For Pleasure and Profit!

If you have a workshop—at home or in business—you need this new Warner Electroplater. At the stroke of an electrified brush, you can electroplate models and projects—you can replate worn articles, faucets, tools, fixtures, silverware, etc. with a durable, sparkling coat of metal . . . Gold, Silver, Chromium, Nickel, Copper or Cadmium. Method is easy, simple, quick. Everything furnished—equipment complete, ready for use. By doing a bit of work for others, your machine can pay for itself within a week. So make your shop complete by getting a Warner Electroplater right away. Send today for FREE SAMPLE and illustrated literature. ACT AT ONCE! Mail Coupon.

WARNER ELECTRIC CO., DEPT. G-8
663 North Wells, Chicago 10, Illinois

FREE Details & Sample!

WARNER ELECTRIC CO., 663 North Wells, Chicago 10, Dept. G-8
Gentlemen: Send Free Sample and Details to:

Name _____
Address _____
City _____ State _____

They're Here!
**ROLLER
 DERBY
 Skates**

\$2.95 plus 25c shipping and wrapping charge. Total \$3.20

Double Row Ball Bearings! Gleaming Finish!

ORDER NOW

Now available! New postwar roller skates with **PROFESSIONAL** features—built like a bridge for longer, harder wear! Hard steel wheels! Heavy rubber cushions! Greater speed! Order today—send check or Money Order to:

Western Skate Co., 4444 Broadway, Chicago 40, Ill.

MADE FROM IMPORTED BRIAR



\$3.50 to \$10

Enjoy unmatched sweet smoking quality, outstanding fine grains, in modern designs, \$3.50 to \$10. At leading tobacconists everywhere.

Write for **FREE** illustrated booklet.

C. B. WEBER & CO., 141 Cator Ave., Jersey City 5, N. J.

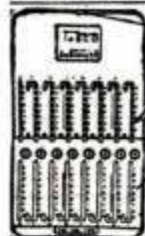

POCKET ADDING MACHINE

STURDY STEEL construction for lifetime use. Adds, subtracts, aids multiplication. Capacity 999,999.99. A real machine—guaranteed 5 years. Thousands of satisfied users. Send name and address. We ship immediately. On delivery, pay postman \$2.50 (plus C.O.D. and postage charges). If you send \$2.50 with order, we pay postage. Leatherette case 25c additional. Your money back after 10 days trial if not satisfied.

Free Trial \$2.50

Send no money

TAVELLA SALES CO., 19-BA West Broadway, New York 7, N. Y.



The Pond Speedex Model C Garden Tractor saves many hours of time and reduces back-breaking work in the garden and on the small farm. Easy to

operate, economical and dependable . . . its attachments make it ideal for plowing, discing, harrowing, furrowing, cultivating and mowing. Works close to fence lines.

Price, \$116.50 with cultivator, gauge wheel and 5.00-20 pneumatic tires, at the factory. Write for full information.

POND GARDEN TRACTOR COMPANY
 Los Angeles, Calif. RAVENNA, OHIO Seattle 8, Wash.
 4276 E. Olympic Blvd. Box 216-B 5821 First Ave. So.

WOODWORKING IS FUN

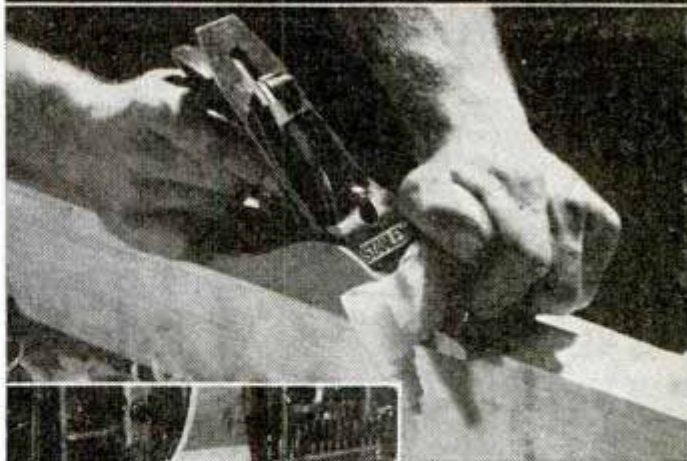

...when
 you have a
**GOOD
 PLANE**

A proper assortment of fine tools chosen from the Stanley line will put real fun into making things in your postwar home workshop. For example, the Stanley "Bailey" Plane—one of Stanley's 64 types of planes—will lend even your first efforts the touch of the expert. Like other Stanley Tools, this plane is better designed and balanced. It takes and holds a keener edge. And it is made to last!

Expert Help in Selecting Tools

Stanley has a free booklet for you, "The Joy of Accomplishment." Crammed full of helpful suggestions, it contains: a primary list of tools, a list of tools to be added as needed, and a list of project plans. You'll also find the big Stanley textbook, "How to Work with Tools and Wood," mighty useful. It's yours for only \$1.00. Mail the coupon today.

STANLEY THE TOOL BOX OF THE WORLD
 TRADE MARK

MAIL NOW

The Stanley Works
 126 Elm St., New Britain, Conn.

Please send by return mail —

- FREE booklet: "The Joy of Accomplishment"
- The 188-page book: "How to Work with Tools and Wood". \$1 enclosed.

(In Canada: Send order to Stanley Tool Co. of Canada, Ltd., Roxton Pond, Quebec.)

Name.....

Address.....

City..... State.....



**YOU
CAN
NOW
BUY**

a real
JET ENGINE!

\$35.00
PLUS TAX

IF YOUR DEALER
CANNOT SUPPLY
SEND CHECK OR
MONEY ORDER
MINIJET MOTORS
9012 Wilshire Boulevard
Beverly Hills, Calif.

THIS is the real thing—a miniature of the famous V-1 buzz bomb engine. The MINIJET is 27" long, 2" in diam., weighs 16 oz. Build it right into your model plane, burns gasoline—2 oz. per minute. Develops in excess of 2 lb. thrust. Get into the new class of model plane builders—Build a Jet Job!

GET REAL SPEED!

The MINIJET is a highly engineered, precision-built engine. It is the lightest engine in existence for the power it develops. It can be used as the fuselage of a Model plane with surfaces attached directly to the engine body.

Ask your dealer for a —

minijet MINIATURE
JET ENGINE

(REG. U. S. PAT. OFFICE)

**Start a
SAW REPAIR
BUSINESS!**

MAKE A GOOD LIVING IN YOUR OWN BUSINESS—sharpening saws with the Foley Automatic Saw Filer. It makes old saws cut like new again. All hand saws, also hand saws and cross-cut circular saws can be filed on this ONE machine.

THERE ARE HUNDREDS OF SAWS TO BE FILED in your own neighborhood, used by farmers, carpenters, homes, schools, factories, etc. W. L. Tarrant writes: "I left my old job last September and in 10 months have filed 2,159 saws. We have a lovely business worked up and cannot keep up with the work."

SEND FOR FREE PLAN Shows how to start this steady cash business. No experience needed, no eyestrain, no canvassing. Send coupon today.



FOLEY Automatic SAW FILER

FOLEY MANUFACTURING CO.
216-G Foley Bldg., Minneapolis 13, Minnesota
Send Free Plan on Saw Filing business, no obligation

Name _____

Address _____

**REPAIR ANY RADIO
QUICKLY-EASILY
WITH THE HELP OF
Feiler Signal Tracer TS-1**

Locates causes of dead or weak sets, noise, hum, poor sensitivity. Locates speaker defects, short tuned or open coupling condensers, open or shorted antenna coils, loops or transformers. Checks faults due to faulty condensers or resistors. Simple instructions explain procedure for point-to-point signal tracing and how to recognize cause of trouble. An important time saver for service men.



Model TS-1 Complete with Tube, But Less \$985
Batteries and Phones.....

B-4794 Headphones for Above..... \$1.45

B-4745 Batteries for Above..... \$.79

WRITE FOR FREE 1946 PARTS CATALOG

R-L Electronic Corp.

731 W. WASHINGTON BL., DEPT. P., CHICAGO 6, ILL.



IDENTIFICATION BRACELET only \$1.95, Heavy silver plated, name engraved without extra charge. Orders shipped same day. We also make these with a STERLING SILVER tag, heavy weight, with nickel silver chain, each boxed, \$2.95. We pay tax and postage.

MONT PETIT MFG. CO.
15 E. Pearson St., Dept. S Chicago, Ill.

BURNED OUT or BROKEN ELECTRIC

HEATING ELEMENTS REPAIRED
WITH NEW AMAZING NICHROCITE
Simply overlap ends, apply Nichrocite Paste and turn on current. Used by large utility companies. Trial order, \$1.00; 4 oz., \$2.50; 1 pound, \$8.00.
Armstrong Mfg. Co., Box 861-C, Minneapolis, Minn.



NEW BIG MONEY FIELD

Make Any Article

GLOW IN THE DARK

with

Magic New Discovery!

SERVICE FLAGS

LIGHT SWITCH

DECORATIONS

JEWELRY

CLOCKS

Make **BIG** money in your own business! Tremendous profits being made now by making articles **GLOW IN THE DARK!** With our complete outfit and confidential instructions—all for only \$1.00—it's easy! A stroke of the brush—any article glows in the dark like magic! Absolutely harmless. Hundreds of uses. Use on statuettes, jewelry, house numbers, flowers, toys, etc. Order **NOW!** Supply Limited. Money-back guarantee.

\$1.00
Send No Money

Complete Lite-Glo Kit, \$1.00. Send name, address, pay postman \$1.00 plus postal charges. Send cash, we pay postage.

LITE-GLO, Dept. 123-LB, Topeka, Kan.

The basic "know how" for the metal-cutting lathe operator



Not a "shop kinks" book but an easy-to-read, easy-to-understand textbook that starts at the beginning and goes thru each standard lathe operation.



"The Care and Operation of a Lathe" (2nd edition) is a book every home craftsman should have. Over 100 pages, 224 illustrations and charts. Bound in enduring dark blue fabricoid. 75c postpaid. Send for your copy today.

SHELDON MACHINE CO., INC.
4266 N. Knox Ave. Chicago 41, U.S.A.

GET YOURS NOW!



Use them as TRUCKS TRACTORS RUNABOUTS STATION-WAGONS

Mech. Guar. Like NEW CAR

YOU NEED JEEPS—BERG SELLS JEEPS

Completely overhauled Army JEEPS. NOW YOU CAN BE FIRST TO OWN ONE! Built powerfully for rugged combat use. Speedy! Tough! Highly maneuverable. Standard 600x16 tires; 16.25 HP motor; hydraulic brakes; 2-speed aux. trans.; about 25 miles per gal. of gas; climbs 65° grade; for farming, hauling, touring, towing. Can be financed. Send NOW for complete information, prices, terms.

BERG TRUCK & PARTS COMPANY
1608 So. Wabash Ave. Chicago 16, Illinois

WRITE For FREE Literature

BUILD YOUR OWN POWER LAWN MOWER

WHY BREAK YOUR BACK MOWING FIELD OR LAWN?

Now anyone can save time and effort mowing field or lawn, by building their own whirl type power mower.

We furnish complete information, and whirl type blade attachment. Write today.



T & H Mfg. Co.

811 E. 31, Dept. B-1, Kans. City 3, Mo.

THE RITE-WAY MOWER ATTACHMENT

WINDOW SIGN LETTERS

For Store Fronts and Office Windows. Anyone can put them on. Samples furnished. Genuine Gold and Silver. METALLIC LETTER CO., 430 N. Clark St., Chicago 10

BUILD YOUR OWN FAST FREEZER

PLANS \$1.00

It's easy to build this household appliance and profitable to use. Save up to 75%. Operates on 110 or 32 volts. Plans show 5 sizes and are easy to follow. ENJOY MAKING ONE OF these freezers from new or used parts. No expert knowledge needed. Mail \$1.00 bill or check for complete plans and catalog.

LEJAY MFG., 447 LeJay Bldg., Minneapolis 8, Minn.



5 sizes 8 to 40 cu. ft.

\$75,000 for boy MODEL BUILDERS

8 UNIVERSITY SCHOLARSHIPS

588 CASH AWARDS

36 CONVENTION TRIPS

Here's the biggest news you've read in a long time. You are eligible to try for these awards in the TWO competitions listed below—if you reside in the United States and are between the ages of 12 and 19 inclusive.

1. NAPOLEONIC COACH COMPETITION—316 awards, including two \$5,000 and two \$3,000 scholarships. In this, you build a miniature model Napoleonic Coach to plans we furnish you.

2. MODEL CAR DESIGN COMPETITION—316 awards, including two \$4,000 and two \$2,000 scholarships. All you do is make a solid model automobile embodying your own ideas of motorcar design.

Rules are simple and fair

In both competitions the following regulations will prevail. Boys 12 years old, or older, but not yet 16 by September 1, 1945, compete in the Junior Division. Boys 16 years old, or older, and not yet 20 on September 1, 1945, compete in the Senior Division. All boys within these age limits are eligible to Guild Membership. There are no dues or entrance fees of any kind. Each member shall receive, without charge, an official Guild membership card and button, and a full set of Guild drawings and instructions. Both competitions close July 15, 1946, and are open to all boys within the age limits, including the sons of General Motors employees. In all cases where the son of a General Motors employe qualifies for an award, duplicate awards will be made.

FISHER BODY CRAFTSMAN'S GUILD

An educational foundation sponsored by Fisher Body Division of General Motors

General Motors Bldg., Detroit 2, Michigan
Gentlemen: Please enroll me in the Fisher Body Craftsman's Guild for 1946, in the

- Napoleonic Coach Competition
- Model Car Design Competition

Send me full instructions without charge

Name _____

Address _____

City _____ Zone _____ State _____

I was born on the _____ day of _____ 19____

Name of parent or guardian _____

Dept. 49

THE NEW AIR-COOLED

3 3/4 H.P.

Sheppard DIESEL

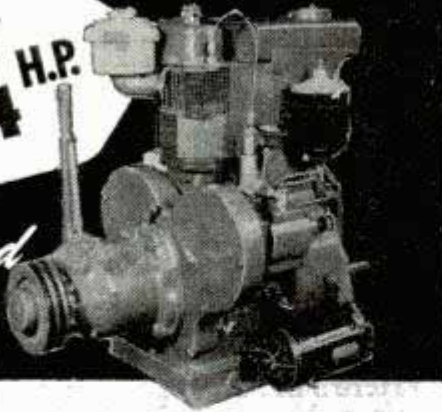

For the first time, Diesel economy and dependability are available in a small engine. The new Model 14 Sheppard Diesel is not only the smallest Diesel ever built for commercial use . . . but it's also the only stationary Diesel that is air-cooled.

Overall the engine stands 28 1/2" high, 20 3/4" wide, 22 1/2" long with crank removed. It is a single cylinder, 4-cycle Diesel . . . developing 3 3/4 continuous horsepower at 1800 R.P.M.

The Model 14 is ideal for powering communication systems, auxiliary or standby lighting plants, pumps, conveyors and other power-driven equipment.

If you need a small engine you can install and forget—the new air-cooled Sheppard Diesel is the one to remember. Write for complete information about this revolutionary new engine.

R. H. SHEPPARD COMPANY
48 Middle St., Hanover, Pa.
OTHER POWER UNITS, 3/4 to 56 HP
GENERATING SETS, 2 to 36 KW

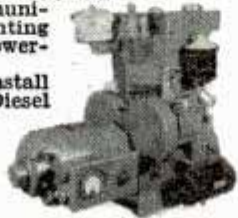

Available direct-connected to a 2 KW generator

DIESEL'S THE POWER—

Sheppard's

THE DIESEL!

AUTO ENGINE SPEED CONTROL GOVERNORS (REGULADORES)



Without Pulley
In place

Give constant or changeable speed to any auto or truck engine, when used for power. Guaranteed. Instructions. Oil ring bearing, \$12.50. Full ball bearing, \$19.00. Postage west of Miss., 50c; east of Miss., 85c. Sent COD or—Pulleys to 3", \$1.00, wt. 1 lb.; to 6", \$1.50, wt. 1 1/2 lb. Governor speed 1400 to 2400 rpm. Figure your pulley size.

Agents Wanted: Parts and Implement Dealers, Garages, Welders Wreckers, Catalog and Mailing List Houses, etc.



Used where carburetors have outside attachments.

State size of opening and distance between bolt holes.

1", \$3.75; 1 1/4", \$5.25; 1 1/2", \$6.50; 1 3/4", \$7.50; V8, \$7.00. Mailing weight, 3 lbs. If remitting, enclose for postage. You may order from this ad, or we will send circulars. Stocks carried: In Montreal 15, Canada: 7546 Wiseman St. In Latin America: East Asiatic Co. In Auburn, N. Y.: 3 Seminary Ave., Auburn Welding Supply.

CANDEE, Dept. 1, 2641 S. Hill, Los Angeles 7, Calif.

Say you saw it in Popular Mechanics

Fuse Puller—Circuit Tester

For Home or Factory

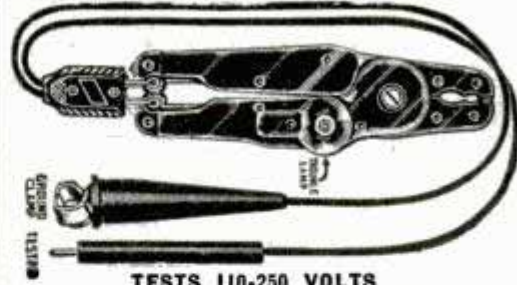

TESTS 110-250 VOLTS

When motors stop and lights go out, this tool quickly **LOCATES DEAD CIRCUITS** and safely removes blown Fuse. The Star Test Pocket Plier is made of a Transparent Plastic having in one of the legs a small lamp in series with a resistance and can be used to test 110 to 250 volts circuit. The Plier will pull fuses from 10 to 100 Amperes. Thousands of Electricians find this tool handler than Test Lamps. Price \$2.75 each without Leads, \$1.50 additional for Leads, plus 10c postage. Can be obtained from General Electric or Westinghouse Stores or directly from us. Order NOW. **STAR PLIER CO., 233 Canal St., New York 13, N. Y.**

BUILD YOUR OWN MACHINE TOOLS!

Blueprints \$1.00 - Catalog FREE

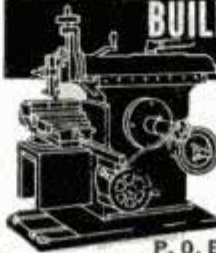

Detail construction Blueprints on 6 Lewis metal and wood-working tools postpaid for \$1.00. Includes prints for Lewis 10" Shaper, Milling Machine, Drill Press, Vice, 16" Band Saw, 6" Janter, Plain or semi-finished castings available for these tools save up to 80% of comparable new tool cost.

Illustrated 22-page Catalog—sent free with Blueprint Order—describes 20 Lewis tools. WRITE TODAY!

LEWIS MACHINE TOOL CO.

P. O. Box 116, Sta. A, Dept. M-26, Los Angeles 31, Calif.

ONLY \$9.95 ENGINES IN STOCK



The G. H. Q. miniature gasoline engine that really operates is available. Over 100,000 sold to date. 1/5 H. P. Complete with coil and condenser and full illustrated instructions for only \$9.95. Fully bench tested and ready to run. Power for all models. Send only \$1.00—Shipped Collect C.O.D. same day. Send for free illustrated Catalog of hundreds of hobby items.

GHQ MOTORS, Dept. BX26, P.O. Box 193, Station O, N.Y. 11, N.Y.

TRAIN Your VOICE!

Results **GUARANTEED**

We build, strengthen the vocal organs—not with singing lessons—but by sound, scientifically correct silent and vocal exercises and absolutely guarantee complete satisfaction with results. Write for Voice Book, FREE. Sent to no one under 17 years old unless signed by parent.

Perfect Voice Institute, Studio 1352, Kimball Hall Bldg., Chicago 4, Ill.

JET PROPULSION

Speedier autos, boats, bicycles, models, aeroc. Experimental power circular free.

MAC BOSS, 2265 Warren St., Toledo 10, O.

NEW WAYS CUT BUILDING



cost of houses, garages, poultry and farm buildings, cabins and stores. Make wall-high, insulated blocks with inside and outside finish with simple, homemade equipment. Composition roofs and floors. Ten formulas. Cement panels, blocks and tiles in color. Stream-lined roof, walls and gutters. Several ways to use cheap wood with cement makes strong buildings. Wallboard of sawdust. Save hundreds of dollars. 100 money and labor saving ideas. Mixer and buzz saw easily made from an old auto. 40 proved ways to earn \$10 to \$15 a day. Guaranteed illustrated booklets, \$1.00.

MAKE FURNITURE OF COMPOSITION cement, sawdust, asbestos, paper. Some part scrap wood and metal. Illustrated instructions to make tables, cabinets, chests, racks, shelves, inclosed sinks, lawn novelties and toys, 500 per cent profit. 50c.

HOW TO MAKE ACCURATE SHOP MACHINES: Band, jig, and circular saws, electric drills, sanding wheels, forge, tools, electric weed cutters and many other things from old auto parts and washing machine motors. Illustrated, 50c.

HOME MFG. ENTERPRISES, 50 selected home shop projects, illus., 50c. Special: All five booklets described above, \$2.00 postpaid. No C.O.D. **HOME INDUSTRIES, 1318 So. 30th Ave., Dept. PM, Omaha 5, Nebr.**

NEW! TWO AMAZING TOOLS TO USE ON YOUR DRILL PRESS

Berry Rotary Disc Sander! Produces controlled, uniform surfaces. Duplicates parts without variation. Finished work has a smooth, satin finish. Patented **FLEX-TOP** "gives" if surface is irregular. Complete with sanding discs, postpaid or C.O.D.\$9.95



Berry Rotary Planer! Planes, panels, tenons, rabbets and routs. Patented angle-set (not vertical) hollow-ground blades cut beneath surface, insuring a smooth, shearing cut. No tearing of wood! Planes, parallels and finishes an 8" x 24" board in 30 seconds. Complete, postpaid or C.O.D.\$7.50

5-day trial offer. Free literature. **ACT TODAY!**
H. J. BERRY MFG. CO., 2297 Scott St., Detroit 7, Mich.

Sand Casting—Forging—Heat Treating—Case Hardening
BRONZE FOUNDRY



is again available in limited quantity without priority. Orders filled in sequence as received. **INVENTORS—SCHOOLS—CRAFTSMEN** use **FOUNDRYETTE** for making castings quickly for new inventions, for instruction, and general purpose. Order now for early delivery. Three sizes are available capable of making bronze castings of 1½, 3, and 6 pounds weight, aluminum, copper, brass, etc., \$17.50, \$24.00, \$34.50, f.o.b. Kansas City. Domestic gas supply and 110 volt AC or DC energy required for operation. Write for circular.

KANSAS CITY SPECIALTIES CO.
Box 6022, Dept. P-63 Kansas City, Mo.

Big Money for Workers In Home or Shop



Licensed Concrete Specialists wanted. No experience needed. Make *Colorglazed* concrete pottery without molds. New, low cost, patented method. Cemetery products, novelties, tiles, etc. Basement leaksealing. Other big pay projects. Booklet, details free. Men only.

NATIONAL POTTERIES COMPANY
542 Lincoln Avenue Fergus Falls, Minnesota

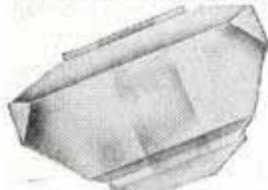

AMICI (ROOF) PRISMS

90° double inversion. Accuracy 2-sec. arc. 2 sizes: 1.6" x .83" and 2.6" x 1.4"

	Small	Large
Grade A (perfect)	\$6.00	\$8.00
Grade B (slight defects)	\$4.00	\$5.00

PRINTS SENT ON REQUEST
Satisfaction Guaranteed—Sent Prepaid on Receipt of Check or Money Order

INDUSTRIAL SERVICE

302 LUMBER EXCHANGE BLDG., MINNEAPOLIS, MINN.

Maule's Giant Asters



Wilt-Resistant! Five best colors—**Red, White, Blue, Pink, and Purple**—a 10c-Packet of seeds of each, all 5 Packets post-paid to you, for only 10c. **5 pkts. 10c**

Send dime today!
Maule's Seed Book FREE
Tested, guaranteed seeds for prize vegetables and flowers. Have a garden—help raise food.



Wm. Henry Maule, 155 Maule Bldg., Phila. 32, Pa.
(in the west) 155 Maule Bldg., Clinton, Iowa

ONE-MAN SAWMILL LESS THAN \$110.00
Easy To Turn Trees Into Money

Makes Lumber, ties, shingles, crates, lath, studding, siding.



BELSAW MODELS

in to 24 feet sawing lengths. Patented Mechanical Feed, accurate set works and positive dogs. Use tractor or old auto engine for low cost power. Thousands used for commercial sawing. Pays for itself quickly. Send postcard today for FREE booklet, "How To Make Lumber" & Catalog of Woodworking Equipment.

BELSAW MACHINERY COMPANY
Dept. 1811-W 3542 Main Street, Kansas City 2, Mo.

EXPECT Action WITH WILLIAMS TOOL HOLDERS

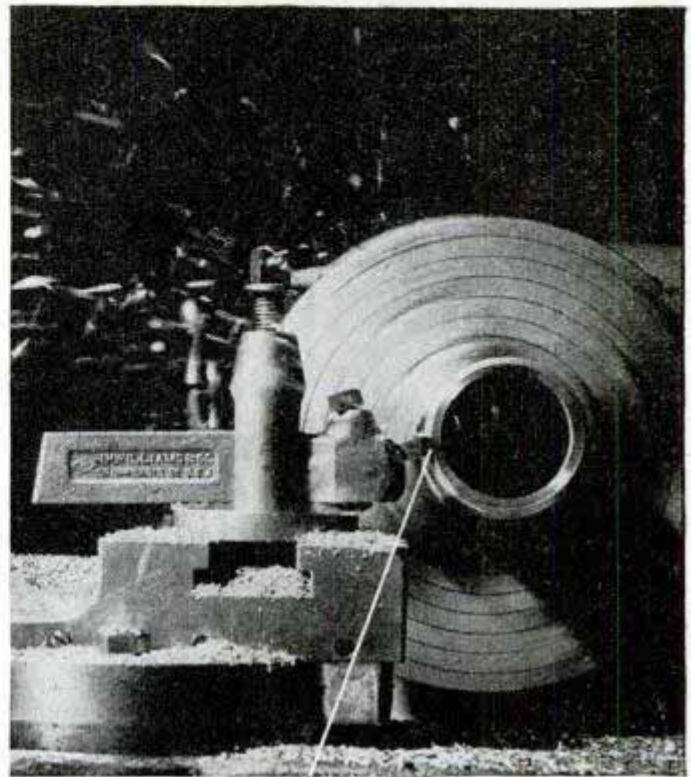

● There's a Williams Holder for every regular operation on lathe, planer and shaper—each functionally designed for super performance—all built to withstand the rigors of continuous high production.

For fast, chatter-proof, clean-cutting service, specify Williams High-Speed Steel or Carbide Holders. Write Dept. M-26 for free Tool Holder Data Sheets.

J. H. WILLIAMS & CO.
BUFFALO 7, NEW YORK



DROP FORGINGS AND DROP-FORGED TOOLS

GUM GRIPPER

**TIGHTENS
FALSE TEETH**

**OR NO
COST**

**Amazing
NEW
Plastic
Reliner**

LASTS FROM 4 to 6 MONTHS



NOW—in a jiffy—you can make loose, slipping dental plates fit snug and comfortable. Eat, talk in comfort, laugh freely—for "Gum Gripper" enables you to enjoy that feeling of almost having your own teeth again!

● APPLY IT YOURSELF — AT HOME

"GUM GRIPPER" amazing plastic Reliner tightens dental plates quickly, makes them hold firmly and fit like new! Just squeeze from tube, spread evenly, put plate in mouth, wear it while "Gum Gripper" sets in few minutes. No heating necessary.

● USE ON ANY DENTAL PLATE

"Gum Gripper" will not harm denture or irritate gums. Sanitary, tasteless, odorless. Keeps mouth sweet and clean, prevents sore spots. Application of plastic "Gum Gripper" is guaranteed to last 4 to 6 months—or no cost. Can be scrubbed or washed. Rev. A. J. Wigley, Pittsburgh, Pa., writes: "Best material I ever used. I have not relined my lower teeth for 2 months."

SEND NO MONEY—Order a tube today—it's only \$1.00. Fill out and mail coupon below. You'll be delighted! Satisfaction guaranteed or your money back.

FREE Generous size package Dental Plate cleaner included free of extra cost. Cleanses dental plates without brushing. Will not harm denture.

GUM GRIPPER 127 N. Dearborn St., Dept. 71-H, CHICAGO

GUM GRIPPER, Dept. 71-H,
127 N. Dearborn St., Chicago 2, Ill.

Send me a tube of "Gum Gripper." You guarantee it to satisfy—or it will not cost me a penny.

I will deposit \$1.00 plus postage with postman when package arrives.

Enclosed is \$1.00—You pay postage.

NAME.....

ADDRESS.....

CITY..... STATE.....

ARC-WELDERS, 110 Volt, \$29

This welder has proved a great local success. Now we offer it nationally. Try it for 15 days. Your money will be promptly returned if you don't wish to keep it. Welds light and heavy steel.

PAUL MORRIS, 1850 State St., Schenectady 4, N. Y.



**BUILD
THIS
TUG
BOAT**

KIT

\$7.50

Every landlocked sailor will enjoy building this tough SEA GOING TUGBOAT for game room or study. Authentically detailed—14" long, 7" high. Completely shaped hull—simple to build. Add 25c for packing and shipping. Big catalogue only—10c. Address Dept. 9.

MARINE MODEL CO., INC., Halesite, Huntington, N. Y.

**SEND FOR THIS
TIME SAVING OHMITE
Ohm's Law Calculator**



**Figures Ohms,
Watts, Amperes
Volts... Quickly!**
Any Ohm's Law
Problem solved
with one setting

of slide. All values direct reading. (4 1/8" x 9")
Send only 10c in coin to cover cost of handling.
OHMITE MFG. CO., 4931 Flournoy St., Chicago 44, Ill.

MACHINE SHOP EQUIPMENT



Every man who owns a workshop should have a copy of this new, authentic catalog of Machine Shop Equipment... the latest tools made by the biggest manufacturers in the United States. Replete with illustrations, descriptions, prices. Prompt delivery on most tools listed in this catalog. Available at the cost of printing—50c a copy—Get yours today! Price of Catalog Refunded on First Order over \$5.00. Send check or Money Order to

CENTER TOOL CO.
154 Centre St., New York 13, N. Y.

LENSES 500,000 OF THEM

Buy them for a fraction of their original cost.
U.S. ARMY & NAVY surplus lenses and prisms.
HOBBYIST LENS SET—Magnifiers, reducing lenses, positives, negatives, etc. 10 lens set.....ea. \$ 1.00
5X TANK TELESCOPE (M71) BRAND NEW complete...ea. 22.50
ACHROMATIC SYMMETRICAL EYE PIECE SET.....ea. 2.00
METAL PARTS FOR TELESCOPE (25 Pt. Ass't.) cells,
tubes, rings, spacers, housings, etc.....ea. 4.95
ACHROMAT OBJECTIVE 2" Dia. 7" F. L. coated.....ea. 3.00

Send Money Order or Check—3 cent stamp for list
A. JAEGER, 120-14P 115th AVE. SO. OZONE PARK 20, N. Y.



**CAPE COD CHAIRS
TRELLISES**

Arbors Fence Pickets

Chairs styles B-C-A Plans
50c ea. All 3 only \$1.00.
12 different trellis designs.
Plan of all 12 only 50c.
Beautiful 31-family Mt.

Vernon martin house. Large, fully detailed plan \$1.00.
Four fine lawn figure patterns: Dutch Boy, Tulip Girl, Holland Pair and Sunbonnet Girl—all four patterns only \$1.00.
Send 10c for beautiful catalog illustrating many fine home and garden projects, plans, knockdown kits and completed projects.
CRAFTSMAN'S MODEL CO., Dept. P88, 2030 No. 41st St., Milwaukee 8, Wis.

**FACTORY TO YOU
KITSELMAN FENCE**

Buy Farm, Poultry, Hog Fence, Steel Posts, Barbed Wire at **FACTORY PRICES!** Save too on quality Paints, Roofing, Hay Tools, Hog Feeders, Founts, Poultry Supplies and other farm needs! **WE PAY FREIGHT.**
Write today for **FREE** Catalog!
KITSELMAN BROTHERS
Dept. 94 Muncie, Indiana.

BRUSH PLATING OUTFITS

for re-plating articles in the home and shop. No tanks necessary. Free particulars.
GUNMETAL CO., AVE. M, DECATUR, ILLINOIS

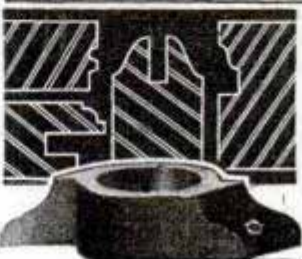

SHAPER & SASH CUTTERS

Saw Blades, Mortise Chisels, Boring Tools, Jointer, Planer Moulding Knives, Dovetail Cutters, Countersinks, Dowels, Vises, Arbors, Complete Line of Wood Shop Equipment. New 40 page large catalogue No. 102. Postpaid 10 cents allowed on first order.
WOODWORKERS TOOL WORKS
Quincy & Jefferson Sts. Chicago 8, Ill.

Your LAUNDRY Troubles are Over

New Type, High-Speed WASHER

Washes in Half the Time
—One-tenth the Effort

Now, for the small amount of one week's laundry bill, you can own a THRIF-TEE Washer . . . enjoy having all the clean sheets, towels and clothes you want. Washes anything from daintiest lingerie, to heaviest work clothes! Wonderful for baby's daily wash or any hurry-up job. Simply toss washing into sudsy water, drop the rotar on the clothes and get a tubful of snow white washing in 10 minutes or less. Oscillating action swishes the wash exactly like an expensive power washer. So easy a child can wash with the THRIF-TEE! Light, portable; wash anywhere.

Direct from
Factory, Only
\$4.95



Whirling-Suction Washes Like Magic

TWO WEEKS' TRIAL At Our Risk

TRY IT FOR 2 WEEKS, then keep it or get your money back. Send \$1 with order, balance \$3.95 plus express, C.O.D. Or send \$4.95 and we ship prepaid. Money back if not delighted. Illustrated Folder Free if you write, gives you full details.

THRIF-TEE WASHER CO., 915 Valley St., Dept. 142, Dayton 4, Ohio

Build Low Cost TELESCOPES Booklet 10 Cents

Booklet of ideas, plans, and materials for building inexpensive, tremendously powerful, telescopes. Hundreds of types and sizes possible. Complete, easy instructions so simple a boy can follow them. Plus list of outstanding optical values. Join the thousands who enjoy this fascinating hobby. Telescopes are NOT expensive to build. 10c brings booklet.

BEELERSCOPE, Box 235PMB, North Hollywood, Calif.

Now You Can Own OFFICIAL COMBAT PHOTOS

Only \$1.20 per Set of 20 4" x 5" Glossy Prints

Action shots by Official Army, Navy, Air Corps, Marine Corps and Coast Guard on-the-spot photographers include: Japan Bombed, Tarawa Operation, Iwo Jima Operation, Battles of Coral Sea and Santa Cruz, Normandy Landing, Okinawa Landing, Air Action over Germany, German Atrocities, Sicily and many other exciting sets.

OFFICIAL PHOTOS CO., Dept. A-1 1434 N. Western Av., Holly'wd 27, Cal.

Write for Descriptive Circular

TRIG SLIDE RULE

Patent Pending

● Fits the pocket. Quickly solves radio, trigonometry and electricity problems. Simply move the easy-to-use indicators and read the answers for all three sides and angles of a triangle. Gives degrees, sines, cosines and tangents of angles simultaneously. Easy instructions included. PRICE NOW \$1.00. Postage prepaid. Resale and wholesale orders taken.

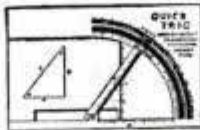

REED MFG. CO., 124 W. 4th St., Los Angeles 13, Calif.

TRAILER AXLES, HITCHES, AND PARTS

● If you are interested in purchasing trailer axles, hitches, and other trailer parts, contact us promptly. Complete house trailer blue prints, \$1.00. Write for free literature.

HAMMER BLOW TOOL COMPANY, Dept. 102, WAUSAU, WIS.

NEW! Ideal Gift for Your Service Man!

Heavy 10K Solid Gold Souvenir Service Ring of World War II. A beautiful and authentic ring that your service man will be proud to wear and cherish forever. It plainly shows that he is a Veteran of our Armed Forces of World War II. Available in all sizes. We pay postage and Fed. Tax. No. 1214 10K Solid Gold \$18.00 Solid Sterling Silver - - - - \$6.00

Send for Circular of Service Jewelry EDWIN W. LANE CO., Dept. PM, 32 W. Randolph St., Chicago 1.



SAY YOU SAW IT IN POPULAR MECHANICS



ARC WELD

your way to SUCCESS with

HOBART

Simplified Welding

A Profitable Business

It's easier now than ever to open your own job welding shop and become your own boss while enjoying the big income of an expert welder—especially with a "Simplified" Arc Welder. Everyone needs arc welding for either construction or repair—and they'll bring this profitable work to you!

Hobart Welds Easy

There's nothing complicated about arc welding with a "Simplified" Hobart. By turning two dials you get a choice of 1000 volt-amp combinations that will give you the exact welding heat for all types of metal. The Hobart delivers a steady arc that deposits perfect beads—easily and quickly. The exclusive Hobart Remote Control feature lets you adjust welding heat, at the work, no matter how far it is from machine.

Built for You

Regardless of the type welder you have in mind—portable, electric, gasoline drive, AC—you'll find it in the complete Hobart line. Every one is efficient and long-lived—for steady, big profits.

HOBART BROTHERS CO., Box M-261 TROY, OHIO

"One of the World's Largest Builders of Arc Welders"

HOBART Exclusive REMOTE CONTROL . . . an advantage that will profit you



SAVE \$150 to \$300 Build Your Own HOBART Arc Welder This generator and old auto parts does the trick—use coupon for details.



Free!

This handy "Welder's Vest Pocket Guide." Check coupon for your copy.

Reach for Your Scissors!

HOBART BROTHERS CO., BOX M-261 TROY, OHIO

I'm interested in starting my own arc welding business. Please send items I've checked below:

- Complete Hobart Catalog "How to Build Your Own Welder"
- FREE "Vest Pocket Guide"

Name _____

Address _____

MILL IT ON YOUR LATHE



WITH A **PALMGREN**

MILLING ATTACHMENT

Now — you can do milling, slotting, grinding, grooving, squaring shafts, sawing at angles, and many other important operations on your lathe. PALMGREN MILLING ATTACHMENT is a necessary fixture for small shops, schools and emergency work in large plants. Fits South Bend, Atlas, Craftsman, Logan, Sheldon and all other makes. It has 360° graduation for rotary angle adjustments, also graduated feed and adjustment screw. Easily mounted by straddling lathe's regular tool post. Try one — it will quickly pay for itself.

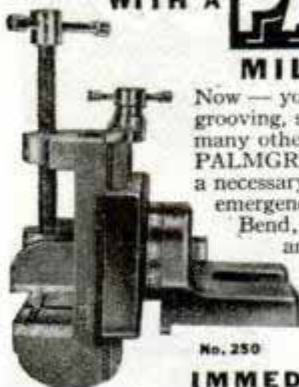

No. 250

IMMEDIATE DELIVERY

No.	Width Jaws	Depth Jaws	Jaws Open	Weight Pounds	Base Opening	Price F. O. B. Factory
150	1 1/2"	1"	1 3/4"	6 1/2	1"	\$18.75
250	2 1/2"	1 3/4"	2 1/4"	11	1 1/4"	24.75
400	4"	1 1/2"	4"	25	2"	39.75

Order from your dealer or jobber. Write for circular No. 349

CHICAGO TOOL AND ENGINEERING CO.

Mfrs. of PALMGREN PRODUCTS for Over 25 Years

8365 South Chicago Avenue • Chicago 17, Illinois

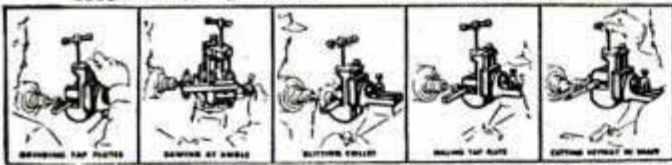

BIG MONEY IN FLOOR SURFACING



Get into something for yourself—no time clock to punch, no seasonal layoffs, no special schooling, no big investment—and be your own boss.

There's big money in floor surfacing with American Sanders. Write today for "tell-all" booklet entitled "Opportunities in Floor Surfacing." Use coupon below and enclose 25¢ in coin or stamps to cover handling.

AMERICAN FLOOR SURFACING MACHINE CO.

535 So. St. Clair St. • Toledo 3, Ohio

Gentlemen: Enclosed find 25c in stamps or coin for booklet "Opportunities in Floor Surfacing," telling me how I can start my own floor sanding business.

Name _____
Street _____
City _____ State _____

SAY YOU SAW IT IN POPULAR MECHANICS

SEND FOR THESE VALUABLE BOOKS AND CALCULATORS... NOW!

Radio Formulas & Data Book No. 37-752. 10c
Dictionary of Radio Terms No. 37-751. 10c
Radio Circuit Handbook No. 37-753. 10c
Radio Builders' Handbook No. 37-750. 10c
Simplified Radio Servicing No. 37-755. 10c
Radio Data Handbook No. 37-754. 25c
ALL SIX BOOKS No. 37-799. 75c

R. F. Resonance and Coil Winding Calculator. No. 37-955. 25c
Parallel Resistance and Series Capacitance Calculator. No. X37-960. 25c

ALLIED RADIO CORP.

833 W. Jackson, Dept. 5-B-6, Chicago 7



ALLIED RADIO

EVERYTHING IN RADIO AND ELECTRONICS

SILVER SOLDER KITS! For Silver Soldering ALL METALS



All welding, brazing and general repair shops, garages, makers of tools, machine and engineering establishments, etc., welcome this convenient silver solder kit.

KIT INCLUDES

One 3 oz. Tube XCEL-FLUX "SS" Silver Solder Paste
Nine 5 inch lengths of Silver Brazing Alloy
(TOTAL OF 45 INCHES of wire)
1/16" and 1/8" SIL-FOS wire
1/16" and 3/32" EASY-FLO wire
.005" x 1" EASY-FLO strip

ONLY
\$1.00
Postpaid

Economy size with 100 inches of Silver Solder Wire for \$2.00 postpaid.

AMERICAN PRODUCTS CORPORATION
422 S. DEARBORN ST. CHICAGO, ILL.

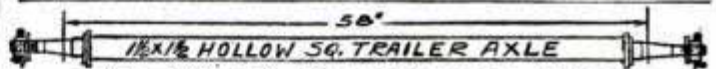

CAP.—2000 LBS.—\$6.75 EACH F.O.B. DETROIT

STRONG MACHINE & AXLE COMPANY

9710 Lumpkin Hamtramck 12, Michigan

1,471 WAYS TO EARN MONEY!

Year 1944. 500,000 persons made \$10,000. to \$25,000. each. New Copyrighted book No. 359,007 has 1,293 DRAWINGS, 1,471 PATENT NUMBERS. Shows how you can make what 1,471 Successful men and women made, as toys, gadgets, devices, compositions, etc. How you can obtain Patents, Designs, Trade-Marks and Copyrights. Book 8 by 11 has 110 pages. \$1. Postpaid. Satisfaction or money back. Free Particular.

S. L. Centofanti, PM-PUB. 25 S. Pearl St., Youngstown 6, Ohio.

RADIO PARTS GRAB BAG!!

\$25 original value assortment of Coils, Condensers, Transformers, Resistors, Controls, etc. An experimenter's dream. While they last, only.....

\$3.98

MARKO SUPPLY, Dept. P.M. 2

2924 Logan Blvd. Chicago 47, Ill.

COLOR CONCRETE WITH CHEMICALS

A business of your own. Big money making Hollywood style pottery and birdbaths without moulds. Washing-wells, stucco-rock, benches. Marbling and cement water-paints. 10c brings sample, literature, pictures. Hollywood Cement Craft, 8529 Wonderland Ave., Hollywood 46, California

HOW TO FIX ZIPPERS

Why discard clothing, leather goods, etc.? Fix the zipper yourself. Step by step instructions, 39 sketches. Be prepared for zipper trouble, mail \$1.00 now.

MOREHELP, A26, Box 140

LAKEWOOD, N. J.



My Copyrighted Treatise

"KEEPING RABBITS FOR PROFIT"

Postpaid \$1.00

28th Year

KIT C. VICKREY

JOPLIN 1, MISSOURI

Wonder-Shave BRUSHLESS SHAVING AT IT'S BEST

All over the country, men are hailing this new, different shave cream. Contains ALL FIVE essentials for clean, comfortable shaving. You too, can enjoy cool, zippy shaves. Send 15c for trial size—you'll like it. ROYAL-JAY PRODUCTS CO. Box 337-A Mamaroneck, N. Y.

SIGNS EASILY AND EXPERTLY PAINTED WITH LETTER PATTERNS AND SHOWCARDS

MANY SIZES & STYLES
WRITE FOR FOLDER!

JOHN F. RAHN
1830-31 N. Central Ave.
CHICAGO 51, ILL.

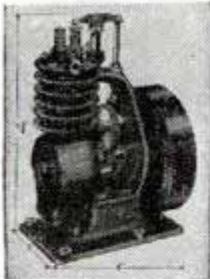

MODEL: Gasoline Engine Ready to Run

A precision built and engineered single cylinder FOUR-CYCLE model gasoline engine. Bench tested and ready to run. Available with stationary or marine engine base. Full instructions. Lots of fun. Engine \$27.50. Coil and condenser \$2.75. Immediate delivery.

The THOMPSON ENGINEERING COMPANY

7 3/4" high — 3" wide 206 Winchester Place, Grand Rapids, Mich.

BROWNSCOPE

RESUMES CIVILIAN BUSINESS
After 3 years devoted exclusively
to the winning of the war
TELESCOPES, MICROSCOPES,
BINOCULARS, LENSES,
LENS KITS,
PRISMS,
ETC.



Also
used instruments
bought and sold.

Send for free price list.

BROWNSCOPE CO., 369 Lexington Ave. (Suite 602A) N. Y. 17, N. Y.

get 'FM' like Reception...
From any radio... Old or New!

SATISFACTION GUARANTEED
Now you can get crystal clear radio reception all the time... just like new "FM"... with our amazing Patent applied for discovery. Easily installed by anyone in few seconds. Your money promptly returned if not more than pleased.

Special discounts to radio dealers.

\$4.50 Postpaid	----- SEND TODAY -----	\$4.75 C.O.D.
FREDERICKS SALES—Dept. PM-2 32 N. State - Chicago 2, Ill.		

LAW STUDY AT HOME for PERSONAL SUCCESS and LARGER EARNINGS. 35 years expert instruction—over 108,000 students enrolled. LL.B. Degree awarded. All texts furnished. Easy payments. Send for FREE BOOK—"Law and Executive Guidance."

AMERICAN EXTENSION SCHOOL OF LAW
Dept. 62M, 646 N. Michigan Ave., Chicago 11, Ill.

FEET HURT? Try Dr. BARRON'S New Foot Cushion

Many with tired, aching feet have found happy relief! So comfortable—LIKE WALKING ON A PILLOW! Made of fine, soft spongy material, leatherette covered. So light, flexible—cushions and helps relieve your feet from heel to toes. If you suffer from metatarsal callouses, corns, foot pains or fallen arches, try Dr. Barron's Foot Cushion. Wear in any shoes—helps make walking a pleasure. Doctor says: "I recommend Foot Cushions to foot sufferers." Send only \$1.98 for A PAIR—or will ship C. O. D., plus postage. STATE SHOE SIZE AND IF MAN OR WOMAN, 30 DAY TRIAL GUARANTEE. Money back if you don't get blessed relief! ORTHO CO., 111 W. 83rd St., Dept. 49-B, New York City 24

6 Tools in One

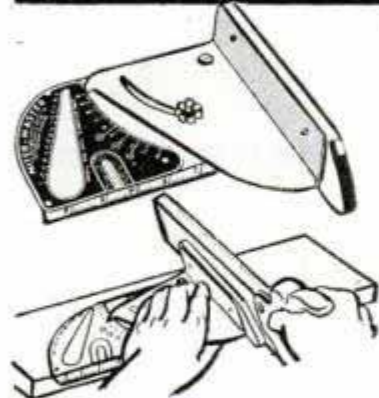

MITER-MASTER

- Mitering Guide
- Diameter Gauge
- Accurate Square
- Marking Gauge
- Center Finder
- Handy Ruler

For mitering, set at desired angle. Place material against bench stop. Hold saw firmly against Miter-Master guide board. It's that simple!

Miter-Master takes the place of an expensive miter box accurately set to any angle. Sturdy steel construction. Set any point from 45-90°. Scale marked for mitering 5, 6, 8 sided frames. Satisfaction guaranteed or your money back. Ask your dealer or order direct.

\$1.50
POSTPAID

MASTER SPECIALTY CO.
3018 E. Lake St., Minneapolis 6, Minn.

Enclosed is \$1.50 for Miter-Master, postpaid in U.S.A. (Foreign \$1.75)

NAME.....
(Print address in margin)

DOES

Gray Hair Handicap YOU?



• M. HERBOLD, A.B., M.S., the Hollywood Chemist, creator of Herbold Pomade, who says: "I have such confidence in my pomade that I want it sold only on the basis of complete satisfaction or money back."

WHEN ONE'S HAIR looks faded, dry and streaked with gray, one may be severely handicapped. It may even threaten a man's position in trade or business. And, in the past, most correction methods have required so much bother, mess and waste of time!

Now, however, the Hollywood chemist, M. Herbold, has developed an answer to this problem. His preparation, *Herbold Pomade*, adds deep, rich color to faded, gray-streaked hair, and does it easily, without muss or bother! Once each day take a little of this clean, fragrant *Herbold Pomade* on your finger tips and massage it into your hair. It is as easy as that! That is all you do. Yet, this simple process adds color from hair root to hair end... lustrous color you will be proud of!

IMPARTS COLOR GRADUALLY

Furthermore, *Herbold Pomade* imparts color so gradually that usually not even close associates will suspect. In fact, it largely appears to others that one is simply using an excellent daily hair dressing, which is literally true, because *Herbold Pomade* counteracts dryness, and grooms the hair and helps keep it in good form, while adding lustrous color at the same time.

It will not rub off or stain one's pillow or clothing, and can be used in less than a minute a day in the privacy of your bathroom. So get *Herbold Pomade* and take pride in the lustrous color and splendid grooming it will impart to your dry, faded or gray-streaked hair.



MONEY - BACK GUARANTEE

USE HERBOLD POMADE exactly as directed on package. If, for any reason, you are not completely satisfied after using the entire contents, simply return the empty jar to us and your total purchase price of \$1.00 plus tax and postage will be refunded. HERBOLD LABORATORY, HOLLYWOOD, CALIFORNIA.

HERBOLD LABORATORY, INC., Dept. 333
7212 Melrose Ave., Hollywood 46, Calif.

For the enclosed \$1.25 send me a jar of HERBOLD POMADE as guaranteed above. (\$1.00 for the pomade plus 25c tax and postage, total \$1.25).

Name _____

Address _____

City _____ Zone _____ State _____

SAY YOU SAW IT IN POPULAR MECHANICS

TUFFY

Power-Arm Driver

LOOSENS!

TIGHTENS!

DRIVES!

Now with the new Tuffy power-arm driver you can loosen those rusted-over screws the ordinary screw driver can't budge . . . for tightening, Tuffy gives you that extra quarter-turn pressure to make screws stay put. Tuffy's durable aluminum power-arm does the hard work for you—allows full hand and body pressure without slipping or gashing screw head—puts that extra leverage where it counts. The power-arm folds up when not in use, making Tuffy a regular screw driver.

Tuffy is available in 3 sizes: 1/4" dia. 5" blade \$1.95; 5/16" dia. 6" blade \$2.25; 3/8" dia. 8" blade \$2.65. Complete set of 3 sizes specially packaged in attractive kit box, \$6.85. If your dealer can't supply you, send check or money order direct. Shipped postpaid. Satisfaction guaranteed.

SWALLOW AIRPLANE CO., INC.

903 LINCOLN AVENUE, WICHITA 1, KANSAS

Cushman
MOTOR SCOOTER

Side Car
Carries
**200
LBS.**

I GET 75
MILES TO
THE GALLON!



**LOW COST TRANSPORTATION
AND DELIVERY SERVICE**

Want to get there fast, at Amazingly Low Cost? Want to carry an extra passenger or a 200-lb. load? Then, pick the New 1946 CUSHMAN! 10 times faster than walking! 400 miles on \$1 worth of gas! Built for long, hard use—comfortable riding! Thousands gave rigorous service in war plants during the last few years.

POWERFUL, 4 H. P. ENGINE. New low and high gear supplies power for steepest hill. Floating Drive applies power smoothly. **Smooth Riding:** Special springing, long wheel base, balloon tires. **Safe:** Low center of gravity, heavy brakes. Durably constructed.

2-wheel and 3-wheel models with 200-lb. and 300-lb. capacity package-boxes. Prompt delivery.

WRITE for free folder describing all models if your dealer does not handle. Send Today!

CUSHMAN MOTOR WORKS, Dept. P-72, Lincoln, Nebr.

SAY YOU SAW IT IN POPULAR MECHANICS

Your Rust Troubles are Over CORODEX Rust Remover

is the war-time miracle liquid which cleaned millions of parts during war effort. CORODEX positively removes RUST and CORROSION regardless of depth, from iron, steel, brass, bronze, copper, chromium and nickel. Cleans tools, hardware, sports equipment, household utensils, etc., for a few cents a piece. No RUBBING or hard work.

CORODEX IS UNCONDITIONALLY GUARANTEED TO REMOVE RUST WHEN DIRECTIONS ARE FOLLOWED. Valuable Manual of Rust Control free with order.

At Sears Chicago, Suburban and Gary stores, 50c and \$1.00. Mail orders QUART SIZE ONLY \$1.00 Money Order or Check F.O.B. Chicago Express to:

SEARS, ROEBUCK AND CO.
403 SO. STATE STREET, DEPT. 8500-9, CHICAGO 5, ILLINOIS
(CorOdeX is made by Allied Products Co., Chicago)



**VETERANS-SERVICEMEN! Wear a
"SHOULDER PATCH" PIN**

Show your pride in your old outfit by wearing a full color enamel lapel pin. Available in ALL divisions of the Air Force and Army. Finely made with safety catches for lifetime wear. Just send name of your outfit and \$1.00. We deliver at once, postpaid. (No C.O.D. or stamps, please).

ZEV SALES CO.

153 Hart St. (Dept. PM 1) B'klyn 6, N. Y.



LIQUID MARBLE

Different! Marvelous! Color-glazed. Brush, spray; mold tiles, table-tops, ornaments! **SANITARY COMPO** Flooring—Dustless, noiseless; put on like plaster, plain or tile design; yielding as cork, lasting as stone. **RUBBERLASTICK Mold Compound**—For plaster casting, novelties, statuary, toys, plaques, dolls. **COLORLED POTTERY**—Birds, baskets, garden furniture, vases. **TILEX ROOFING**—Tile-like colors. Illustrated literature and Free Catalog Other Compositions of cement, sawdust, asbestos, paper, etc. **MARBLEIZING SERVICE, Dept. 10-A, Edwardsville, Illinois**

RADIO-ELECTRONICS

Communications experts in demand. Prepare now for unequalled opportunities. Send for free booklet "Lifetime Careers in Radio Communications."

APPROVED FOR VETERANS
WESTERN RADIO COMMUNICATIONS INSTITUTE
106 W. Third Street (O) Los Angeles, Calif.

Stop Groping -- Make it

GLOW IN THE DARK!

End fumbling for light switches, keyholes, pull chains, drawer handles, etc. **MAGI-GLO**—the wonder liquid—makes anything glow in the darkest room. Has 101 different uses. Ideal for light switches, clock dials, house numbers, toys, ornaments, jewelry, dash boards, photo dark room equipment, fish files, camp equipment, gun sights, flowers, ties, etc. Easily applied to any surface with a brush. Magi-Glo dries quickly, lasts indefinitely, will glow all night. Non-toxic, safe for children and pets. Makes novel bridge and bunco prizes.

SEND NO MONEY
Order your Magi-Glo kit today. Send only name and address and kit will be sent promptly. Pay postman \$1.29, plus postal charges. Or send cash, check or money order for \$1.29 and we'll send your Magi-Glo kit, postpaid. Either way, satisfaction guaranteed or money back.

MAGI-GLO 32 W. Randolph St. Dept. 100, Chicago, Ill.

do you WORRY?

Why worry and suffer any longer if we can help you? Try a Brooks Patented Air Cushion. This marvelous appliance for most forms of reducible rupture is **GUARANTEED** to bring YOU heavenly comfort and security—day and night—at work and play—or it costs you **NOTHING**. Thousands happy. Light, neat-fitting. No hard pads or springs. For men, women, and children. Durable, cheap. **Sent on trial** to prove it. Not sold in stores. Beware of imitations. Write for Free Book on Rupture, no-risk trial order plan, and proof of results. All Correspondence Confidential.



Brooks Company, 359 State St., Marshall, Mich.

POPULAR MECHANICS

PRINT-O-MATIC POST CARD SIZE STENCIL DUPLICATOR

COMPLETE
WITH SUPPLIES

\$9⁵⁰

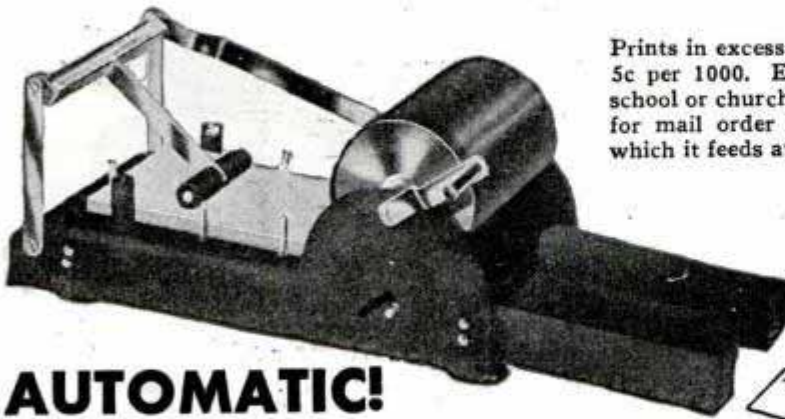

Prints in excess of 3000 clear legible cards per hour at an average cost of 5c per 1000. Easy to operate and entirely automatic. Ideal for clubs, school or church announcements, special bulletins, sale notices, etc. Ideal for mail order business. Permanently adjusted for U. S. post cards, which it feeds automatically. The price includes

- 1 lb. Can Special Formula Ink. 1 Writing Plate.
- 1 Stylus. 1 Bottle Correction Fluid.
- 1 Inking Brush. 1 Cloth Pad.
- 4 Special Quality Cellulose Print-O-Matic Stencils.

AUTOMATIC! SELF-FEEDING! PRINT TYPE AND ILLUSTRATIONS

You can print typewritten matter, handwriting or illustrations or a combination of all three. No plates or engravings necessary! You type, draw or trace your own stencils, then print! Quick, easy, economical. Thousands in satisfactory use daily.

PRUITT Dept. A-1, 437 N. LaSalle St.
CHICAGO 10, U. S. A.



PRUITT OFFICE MACHINE CO. (Est. over 25 years)

425 N. La Salle St., Dept. A-1, Chicago, Ill.
Gentlemen: Enclosed find my remittance for \$..... Ship at once
the Print-O-Matic Duplicator complete as advertised.

Name.....
Please Print

St. or RFD.....

City.....Zone.....State.....
 Send FREE Money Saving Catalog.



CARBIDE SCRIBER NON-MAGNETIC

FOR HARDEST STEEL, GLASS, ETC.

Tungsten Carbide — the hardest metal made by man — carefully ground on diamond laps, brazed into stainless steel 6" handle for marking steel and other metals — for etching, marking, cutting glass. Cuts all directions. Easy to follow any contour. In plastic case with pocket clip.

LUCAS-MILHAUPT ENGINEERING COMPANY 5049 S. LAKE DRIVE
CUDAHY, WISCONSIN



\$2.00

PRICE POST PAID

**Sensational!
New!**

ARC-MELT SOLDERING UNIT

THE RADICALLY NEW UNIT THAT HANDLES ALL TYPES OF INTRICATE WORK!

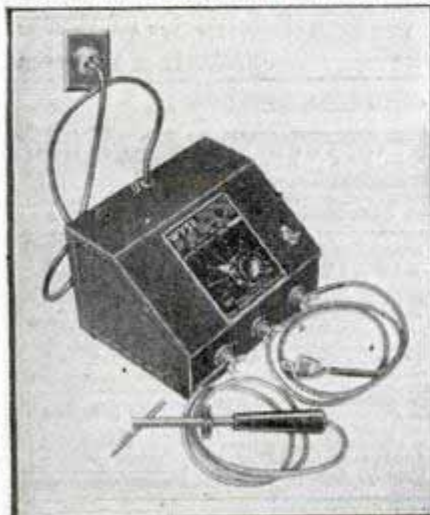

• This machine was developed to meet an exacting need for speed and accuracy on the most intricate work. The tip (copper-plated carbon rod) gets 'way down into smallest spaces. It may be resharpened repeatedly.

Heat is concentrated only at TIP... which becomes red-hot on contact. No current drain!

Fully tested, perfected and PROVEN in thousands of actual jobs! TWENTY-FOUR heat temperatures instantly! Use with flux, same as ordinary soldering iron. Excellent for etching on metal. Maximum secondary output 5 volts. Complete, compact, efficient... fully guaranteed for one year. Orders filled promptly. Order now, or request circular.

WYSE LABORATORIES
211 S. Ludlow St., Dayton 2, Ohio

• A precision machine for smallest to heavy-duty work. Shipping weight 32 lbs. Shipped F.O.B. Dayton, send check or specify C.O.D. **\$39.85**

Adjustable wire-stripper adapter also available. Ask for information.

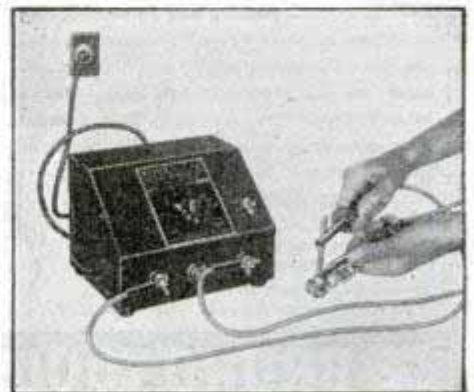

RENEW VALUABLE EQUIPMENT WITH
CITIES SERVICE PRODUCTS

CITIES SERVICE RUST REMOVER

Quickly and easily cleans rust or corrosion from steel, iron, chromium, copper, aluminum and nickel. Cleans enamel and porcelain as well. It is non-inflammable, contains no dangerous acids. Four years' test proves it tops for tools and equipment. Buy it NOW at these amazingly low prices. Send coupon today.

16 oz. — 65c
1 gal. — \$2.80



We Pay Postage

Send In Your Order Now for
CITIES SERVICE ANTI-CORRODE



Get rid of rust and corrosion AND KEEP THEM AWAY! Cities Service Anti-Corrode forms a thin, soft, transparent film on a metal surface, making it impervious to moisture from either fresh or salt water. Has exceptional lasting qualities. Ideal for tools and equipment. Dip, brush or spray. This is your opportunity!

1 gal. — \$1.75

CITIES SERVICE SOLVENT No. 26

A new product that quickly and safely cleans oil, grease, paint, varnish, carbon deposits, etc., from metals, porcelain, stone or wood. Also removes oxides from copper, zinc and zinc alloys. Saves time, labor, expense. Non-corrosive. Harmless. Rub, dip, brush or spray.

1 gal. \$2.72



FILL IN AND MAIL THIS COUPON
YOUR ORDER WILL BE SHIPPED POSTAGE PAID

Cities Service Oil Co., 403 New York Ave., Trenton, N. J.

I enclose check or money order for \$..... Please send

NAME.....

ADDRESS.....

PM

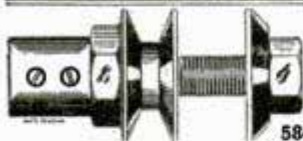

Build your own grinder with this combination pulley and arbor. Fits 1/2" shafts. **75c** Postpaid U.S.A.

AGENTS INVITED
F. ROESCH
584 Communipaw Ave., Jersey City, N. J.

SAY YOU SAW IT IN POPULAR MECHANICS

CUT Any SIZE* HOLE TO Any DEPTH IN WOOD

Something new in wood-boring tools! Bruno Expansive Bit works like a lathe ... requires less pressure ... actually pulls itself through. Positive lock with patented triangle blade. Diamond grind on lead screw prevents splitting. Wide throat for chip clearance. Easy-to-read scale. All cutting surfaces of high grade tool steel. Replaceable blades.

***Wide Cutting Range!**

No. 200-B cuts 1/4" to 1 1/4" Diameter.
No. 201-B cuts 1 1/2" to 3 1/2" Diameter.
Each comes with 1 long, 1 short cutter.

Money Back Guarantee.
At All Hardware Stores or Write Dept. PM2



NO. 200-B
\$2.95
COMPLETE



BRUNO TOOLS

Beverly Hills California

Now!
A Better Soldering Tool...

THE VANATTA

KWIKHEAT

THERMOSTATIC SOLDERING IRON

Has Built-in Thermostat Control!



HOT, READY FOR USE ONLY 90 SECONDS after plugging in! Kwikheat is the only soldering iron with a thermostat built into the tool itself*—maintaining the proper level of heat for most efficient, economical operation. **SAFE!** ... Cannot overheat—**ECONOMICAL!** ... Lasts longer—saves tips and requires less retinning. **POWERFUL!**—225 watts—yet exceptionally light weight (14 oz.). Well-balanced with cool protecting plastic handle. Modern streamlined design. Six interchangeable tip styles adapt one Kwikheat iron to all your soldering jobs. You will be proud to own America's finest and most versatile soldering tool... from tip to plug Kwikheat is in a class by itself. Ask your dealer to demonstrate the quick-heating feature now!

6 TIP STYLES

- #0—\$1.25
- #1—\$1.25
- #2—\$1.25
- #3—\$1.25
- #4—\$1.75

#5—Melting Pot for tinning—\$1.25

Kwikheat iron with choice of #0, 1, 2, 3, or 5 tips. \$11.00
Set of 5 Tips, consisting of #0, 2, 3, 4, and 5.... \$6.00

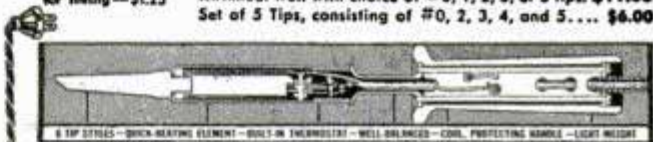

Dept. PM-2, Kwikheat Division of
SOUND EQUIPMENT CORP., 3903 San Fernando Rd., Glendale, 4 Calif.

EXPERIMENT WITH **BLACK LIGHT!**

FUN! THRILLS! PROFITS! See seven page article on this fascinating science in June 1945 issue of Popular Mechanics. We furnish all supplies. Trial Kit of 8 lacquers only \$6.25. Black bulb for testing, \$2.00. Lamps, lacquers, crayons, fabrics, etc. Write for descriptive list and full details today!

BLACK LIGHT PRODUCTS, 450 East Ohio Street Chicago 11, Illinois

King of **ELECTRIC SWITCHES**

Versatile Switch of a Thousand Uses
Millions in Post War Applications



Floodlights your porch when the door is opened—sounds alarm when window is opened—signals arrival of mail—controls heating of furnace—filling of water tank, these and many other services are performed by this versatile switch. Shipped with instruction sheet showing numerous illustrated uses for this device at the low price of \$1.00 postpaid.

KING PRODUCTS COMPANY

BATAVIA 2, ILLINOIS

ENSHRINE THEIR MEMORIES WITH
U.S. MONUMENTS \$14. UP
Freight Paid



There is none better. Our free catalog is ready for you. Write today. A-18 U. S. Marble & Granite Co., Gneco, Fla.

HAIR CAN BE SAVED
"GIVE YOUR HAIR A CHANCE"

Is the amazing book by J. W. KING, Sc. B. on dandruff, baldness, thinning and graying hair. Much usable information.—Ohio State Medical Journal, Best Investment.—Science Education, Debunks hair fads.—Scientific American, Scientific fact.—Sunset Magazine, Without commercial bias.—Teaching Biologist, Book of a scientist.—Homes Across, Enormous assistance.—Pictorial Review, Practical.—Science News Letter, Send only \$2.00 today for postpaid copy of this authentic instruction, on how to save your hair, 6th printing. Prompt refund if not helped.
BRADNER PUBLISHING CO. (EST. 1933) Dept. 27, Cambridge 42, Mass.

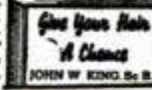

Say you saw it in Popular Mechanics



J.S. Govt. BOLO KNIFE

Extra heavy. For farm, home or jungle use. Blade of Gov't. formula cutlery steel. Walnut riveted handle. 3 1/2 inch hilt. 10 1/2 inch blade. You'll find hundreds of uses for a Bolo knife. Blade will take and hold a keen cutting edge. Wt., 2 lbs.

- A112—with Army Sheath..... **\$4.95**
- A212—Leather Sheath, extra..... **\$1.50**



PUP TENTS

Regulation Army Pup Tents of durable, brown canvas. Used, but in good condition. Fine for campers, outdoorsmen, boy scouts, etc. Grand Xmas gift for children.

- A1—Tent Only... **\$4.95**
- A110—Tent, new... **\$7.95**
- A101—Ropes, wooden poles and stakes for above. Per set..... **\$1.00**



BIG SHIPS BELLS

Purchased from U. S. Maritime Comm. Measures 10 inches high, 9 3/4 inch flare. Big 6 inch clapper. Weight 15 lbs. Fine for farms, clubs, estates, etc. All new. Ship. wt. 10 lbs.

- A541—ONLY..... **\$9.85**

PROF. TELEGRAPH KEY

Purchased from the gov't. Finest design and construction. Base measures 3x4 1/2 inches. Original value \$2.50. All parts of instrument brass. Adjustable.



- A147—Each..... **98c**

MEDICAL STERILIZER



Consists of alcohol burner and sterilizing tray in hinged metal case 1 7/8 x 1 1/4 x 2 3/4 inches. Burner may be used separately. Bright nickel finish. All brand new.

- A125—Each..... **98c**

MESS KITS



Regulation Army Mess Kits. Ideal for campers, boy scouts, etc. Slightly used but guaranteed perfect. Two pieces. Folding handle.

- A-116—Each..... **69c**



Regular U. S. Gov't issue canteens. Plastic screw top cap chained to body. Slightly used.

- A117—METAL BODY. Each... **69c**
- A118—PLASTIC BODY. Each..... **69c**
- A109—Canteen Covers. New. Each..... **69c**
- A119—Canteen Covers. Used. Each..... **35c**
- A120—Canteen Cups. Used. Each..... **25c**

WAR SURPLUS AND HUNDREDS OF OTHER BARGAINS

McCLELLAN SADDLE

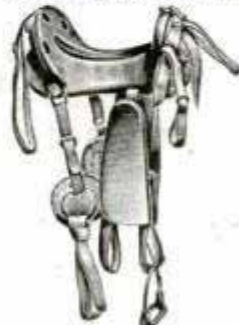

Brand new! McClellan model saddles. Top grade cowhide with hair perth, fender and 12 inch seat. Has straps for blanket roll and knapsack. Buckles, girths and sabre loops. A splendid value.

- A-145—Each..... **\$13.95**

27 LENSES, ALL NEW, PERFECT

For experimental work in optics. Consists of 27 precision ground and polished prisms and lens elements in assorted diameters and focal lengths. Big variety, positives, negatives, etc. Actual value over \$100.00.

- A519—27 PIECES..... **\$7.95**

50 LENSES, SEMI-FINISHED

Lenes similar to above but not polished. All are blanked and formed ready for polishing. Negatives, positives, and prisms in Crown and Flint glass. Worth many times this low price.

- A520—50 LENSES. ONLY..... **\$1.95**



GI POCKET BELTS

Of heavy canvas. Adjustable waist size. Each with 5 pockets and metal recoil fitting. Brand new. Fine for hunters, boy scouts, etc.

- A107..... **98c**



MICROPHONE BUTTON

Brand new! For experiments in radio, electronics and other electrical apparatus. Used in telephone, amplifier and detectaphone work. Diameter 2 1/2 inches. New.

- A512—EACH..... **98c**

AMMUNITION BOX

Fine for storing valuables, carrying lunches, etc. Of heavy gauge 7 1/2 x 11 x 4 inches. Fireproof. Hinged lid with folding handle. Olive drab finish. Used, but perfect. Shipping wt. 4 lbs.

- A525—EACH..... **25c**



RADIO HEADPHONES

Extremely sensitive with 4000 ohms resistance. Brand new and fully guaranteed. With moisture-proof cord and phone plug. A splendid value for the radio serviceman and experimenter.

- A106—PAIR..... **\$2.95**
- A108—Pair..... **\$5.95**



SADDLE BAGS

Made of finest top grain leather. Rivet reinforced seams. Bottom and side gussets. Each canvas lined bag measures 12x13 inches. Fine for motorcyclists. May be separated to make two duffel bags. Used, but perfect.

- A151—Each..... **\$7.95**



MARINE KNIFE

Fine for boy scouts. Blades include knife, bottle opener, screw driver and reamer. All metal handle 3 3/4 in. long. Weight 1 lb.

- Stock No. 107—Each..... **\$1.95**

WATCH COMPASS

Officer's type. Brand new gov't surplus. Army Navy model. Single jewel mounted needle. Silver colored dial. A splendid value. Weight 1 1/2 lb.

- Stock No. A-174—Each..... **\$2.35**



7-LB. RADIO PARTS ASSORTMENT

A "gold mine" for the radio serviceman. Hundreds of valuable radio parts, new radar and electronic parts and sub-assemblies, coils, resistors, trimming condensers—worth many times this low price.

- A130R—7 LBS. **\$1.79**



PLASTICS—LUCITE AND PLEXIGLAS

In sheet form. Good workable sizes. Transparent. For costume jewelry, etc. Easy to work and polish.

- A280—5 LB. ASST..... **\$4.75**

CATALAN—ASST. COLORS

Extruded shapes, rounds, half rounds, etc. Easy to machine. Furnished in assorted colors, shapes and lengths.

- A281—5 LB. ASST..... **\$4.75**

LIFE PRESERVER BELTS



Right for the invasion beaches. Consists of two air chambers. May be inflated automatically with "sparklet" cartridges or manually by attached hose. Adjustable in waist size. One air chamber guaranteed air tight—other may need a tire patch. All belts are used and slightly soiled but a bargain at this low price.

- No. 1261 Each..... **\$1.00**



ARMY BANDOLIERS

Of fine heavy khaki. Big roomy pockets with snap button fasteners. Fine for hunters, campers, boy scouts, etc., also for shop work in carrying small parts, etc. Material alone is worth this price.

- 11 Pocket Type No. 129 Each.... **49c**
- 5 Pocket Type No. 110 Each.... **29c**

ORDER DIRECT FROM THIS AD

Values galore! Hundreds of hard-to-find items for home, shop and outdoors. Make remittances by money-order, bank draft or personal check. Send 25% deposit on C.O.D. orders. No C.O.D.'s on orders for less than \$5.00. Include sufficient postage on parcel-post orders—any overage will be promptly refunded. All quotations F.O.B. Chicago. Used items and materials are guaranteed serviceable and as described. Your money back if not more than satisfied.

BIG ILLUSTRATED CATALOG FREE

STARK'S Dept. PM246
509 So. State St.
CHICAGO 5, ILL.



STILLS

Distill your own water with one of these fine portable stills. Purchased from the Gov't. Completely self contained. Has 1 gallon capacity; output 1 1/2 gal. per hour. Fitted with genuine Coleman double burner stove. Operates 5 to 7 hrs. on one filling. Heat output 20,000 BTU's. Stove alone is worth this price. All new and guaranteed. Instr. included. Weight 109 lbs.

- No. 206 Each... **\$59.50**

IF FALSE TEETH SLIP OR DROP



USE REFIT MAGIC PLASTI-LINER

MAKES ALL PLATES FIT PERFECTLY OR MONEY BACK PERMANENTLY

ONE APPLICATION LASTS FOR LIFE OF PLATE

PLASTI-LINER is a professionally developed re-liner for home use that ends forever the mess and bother of temporary applications that last for only a few hours or a few months. It is NOT a paste, nor a powder; but a strip of genuine dental plastic!

SAFE AND EASY TO USE

PLASTI-LINER is non-toxic, pure, non-irritating, harmless, odorless, tasteless, smooth, molds to mouth. No heat necessary. Just 3 easy steps.

"Excellent Results" say users

"I bought your product over a year ago. Have had no trouble with my plates since. I have told my friends and now all of us with false teeth use PLASTI-LINER. It really works." Mrs. E. S., Brooklyn, N. Y.

FREE! Our competent staff dentist will answer all your plate problems.

SEND NO MONEY — ORDER TODAY

PLASTI-LINER CO. Dept. 36
617-619 Main St., Buffalo 3, N. Y.

Rush PLASTI-LINER with complete directions. I will pay Postman \$_____ plus postage charges. I may return package for refund if I am not satisfied.

\$1 for UPPER or LOWER \$2 for Both

Name _____

Address _____

City _____ Zone _____ State _____

You Save Postage by Enclosing Money



A genuine steel pack muffler WITH A BEAUTIFUL MOTORBOAT TONE. Sandee Mufflers feature improvements far in the lead, years ahead of competition. Increases mileage and power, reduces back pressure and gives better performance. Savings in gasoline will pay for a Sandee Muffler.

V-8 FORD AND MERCURY DUALS \$17.50
SINGLES—FIT IN PLACE OF REGULAR MUFFLER
Chev., V-8 Ford, Plym., \$3.00 Chrys., Olds., Buick, etc., \$7.00
These mufflers will outlast two regular stock replacements.

Dealers Wanted

SANDEE MUFFLER CO.
7523 S. WESTERN AVE., LOS ANGELES 44, CALIF.

KILLS RATS

OR YOUR MONEY BACK!

Easy, safe, and cheap to use. New, improved K-R-O Ready-Mixed in Bis-Kit form kills rats or your money back.

Nothing to mix. No mess. No bother. Mr. N. P., Hudson, N. H., says, "... in one night I got 10 rats. We think it (K-R-O) is a wonder."

Not a poison. K-R-O (Kills Rats Only) is made of red squill. Relatively harmless to humans and domestic animals.

Small cost. Only 35c and \$1. Also K-R-O Red Squill Powder, 75c. At most drug, feed, and seed stores. Get K-R-O, today!

FREE "Rat Proofing Buildings and Premises," by U. S. Dept. of Interior. Send for your copy, now. The K-R-O Company, Springfield, Ohio, Dept. 00.

K-R-O KILLS RATS ONLY



Pat. Pend.

LOCATES TROUBLE INSTANTLY IN ALL ELECTRICAL DEVICES

HANLAN APPLIANCE TESTER

In this single unit are combined all the necessary tests for examining every appliance. Checks thermostats under actual working conditions. Tells instant it opens or closes. Controls the heat on soldering irons. Prevents over-heating. Tests continuity, open circuits, etc. Checks automatic irons, vacuum cleaners, motors, shavers, bulbs, appliances with 3-way switches, etc. Great time, effort and money saver! **ONLY \$9.50 COMPLETE.**

FREE with each Tester. New, Complete Practical Course in electrical appliance repairing. **WRITE FOR CIRCULAR.**

HANLAN CO., 1419-A, West Jefferson, Los Angeles 7, Calif.

Now Repair your own ELECTRICAL APPLIANCES

with CHANITE Self-Welding ELECTRICAL HEATING ELEMENT flux. Generous amount, instructions enclosed \$1.00 post-paid. Guaranteed nothing like it. Stick Form 25c ea., \$2.00 dozen. CHANITE SALES COMPANY, 914 So. Main, Fort Worth 4, Tex.

HOUSE PLAN BOOKS...

Do Your Selecting and Planning Now. Build Later.



- America's Best Low-Cost Homes — Fine selection of 1, 2 story homes. Cost \$1,200 to \$6,100. \$1.00
- De Luxe Small Homes — 210 popular designs, cost \$1,100 to \$10,000. 1.00
- New American Homes — 88 high class designs. \$3,900 to \$15,000. 1.00
- New Brick Homes — 4 to 7 rooms. \$3,600 to \$7,400. .50
- New Small Homes — 62 designs. \$2,300 to \$6,700. .50
- Artistic Homes — Selected for unusual features. \$2,600 to \$9,000. .50
- Colonial Homes — 48 designs. .50
- Low Budget Homes — Small, medium size, \$2,100 to \$6,000. .50
- Spanish and Western Homes. .50
- Sunshine Homes — For warm climates. \$1,900 to \$7,600. .50
- New Duplex Book. .50

Send Your Order to **POPULAR MECHANICS PRESS** Dept. 613 Chicago 11, Ill.

LOW COST!

Make Power Tools from Auto Parts

Send today for new edition, featuring tools you can make of wood. Build your own lathe, drill press, sander, circular, scroll and band saw and other power tools you have always wanted, from discarded parts, at low cost. Simplified instructions, hundreds of pictures and diagrams make building easy. Order today. Only \$1.25. Money back if not satisfied.



POPULAR MECHANICS PRESS, Dept. 614, 200 E. Ontario St., Chicago, 11

Build Things WORTH WHILE!



The **LEJAY MANUAL** has a Special Appeal for the Amateur Who Likes to Make Things that Work

FOR ONLY
\$1.50
WORTH
\$12.35

Making practical things that work and save money is always fascinating, especially when you can do it in spare time and with spare equipment you may have in your own garage or workshop. If you need a welder, you can make that, too. In fact, the 50 basic plans in the LeJay Manual contain instructions that will enable you to make 100 or more individual items. Think of the money you can earn making and repairing things for other people.

THESE SIMPLE PLANS AND A FEW TOOLS ARE ALL YOU NEED

These plans are made for YOU and others like you, who are not in any sense electrical experts or mechanics. They are simple, yet efficient, and do not need a lot of expensive equipment to carry them out. Thousands of amateurs are having fun or making profits with the many things these plans helped them to build. The illustrations shown are only a few of the many things you can make.

SENT C. O. D. ON 3 DAYS TRIAL BUT YOU CAN SAVE WITH CASH

If you will fill in and mail the attached coupon, we will send you the LeJay Manual C.O.D. on three days trial, guaranteeing to return your \$1.50 if you return the manual. However, you can save C.O.D. fees by sending the cash in the first place; the same 3 day return privilege applies if you don't care to keep the manual. In Canada, send \$1.75.

SHOWS YOU HOW TO BUILD

200 Amp. Generator Welder
Workshop Spot Welder
Large Transformer Welder
Gunsmith's Carbon Welder
6, 12, 32, 110-Volt Motors
Electric Outboard Motor
Wind-Driven Light Plant
Electric Fencers
Electric Drills
Bench Grinders
Armature Rewinding
Electric Scooter
Insect Electrocutors
Electric Bicycle Pusher
and Many Other Things.

LEJAY MFG. CO.,
47 LeJay Bldg., Minneapolis 8, Minn.

Gentlemen: Please send me C.O.D. your big 1946 LeJay Manual, on the understanding that if, after 3 days trial, I should return the manual, you guarantee to return the \$1.50 purchase price. (Canada \$1.75)

enclose \$1.50 for the above manual, same guarantee.....

Name.....
Address.....
City..... State.....

MAIL THIS COUPON TODAY

LEJAY MFG. CO.

47 LEJAY BUILDING

MINNEAPOLIS 8, MINNESOTA.

WORLD'S

LOWEST PRICED ADDING MACHINE

VEST POCKET SIZE

MAKES IDEAL GIFT

Baby Calculator makes an ideal gift—for every Gift occasion. Birthday—Graduation—Christmas—Anniversaries. For men, women, children—teachers, business people, home or shop use. **COMES PACKED READY FOR GIFT WRAPPING.**

TEN DAY TRIAL

Money Back Guarantee

Because we know that our machine is the very best Calculator to be obtained at this low price, we make this 10 Day Trial offer on a positive money back guarantee!! Don't buy ANY Calculator without this guarantee! Send only name and address, pay postman \$2.50 plus postage (if cash is sent, we pay postage—you save up to 40c). (Send full cash if outside U.S.) Money back within 10 days if not delighted.



IDEAL for INCOME TAX

Fits vest pocket or purse. Guaranteed Accurate. Operated as easily, and as reliable, as machines costing many times as much. **NOT A TOY or GADGET.** Substantially made of 28-gauge steel—guaranteed for life against defects in construction. Beautiful looking, modernized design. Finished in Black, Silver and Red. You positively can't buy a Calculator of equal quality for as little money. **ACCEPTED AS THE FINEST LOW PRICED CALCULATOR FOR OVER 30 YEARS!** Operates with a flick of your finger. Adds, subtracts, multiplies, divides—counts up to ten million. Pays for itself over and over in mistakes avoided, and time saved.

CALCULATOR Machine Co. (Mfrs.)

DEPT. 175, P. O. BOX 248, GLENVIEW, ILLINOIS

USE COUPON

CALCULATOR MACHINE CO. (Mfrs.)

P. O. Box 248, Dept. 175, Glenview, Ill.

Your Calculator is just what I've been looking for. Send one at once (C.O.D.) or (I am enclosing \$2.50).

Name.....

Address.....

City..... State.....

FREE TRIAL

ONLY

\$2⁵⁰

TOTAL COST

SEND NO MONEY

AGENTS WANTED

FREE!!

Each Baby Calculator enclosed in beautiful rich-looking Leatherette Case—at no extra cost.



6-Power Aluminum TELESCOPE \$1.97



Here's what you have been waiting for... a really fine, 3 section, Army type telescope, at an amazingly low price. It's precision built, handsomely finished, all aluminum construction, waterproof, dustproof, and moistureproof. Has scientifically ground 40mm. lens, easy to focus; clear, powerful vision. Length closed 8 inches, open 15 inches. Send \$1.97 and we'll pay postage. Try for 10 days. Return for refund if not completely satisfied. Rush Order—Supply Limited.

UTICA MAIL ORDER CO., 923 Eagle St., Utica 3, New York

RADIO PARTS KITS

For Immediate Delivery! —

NOW YOU CAN get what you want, and get it quickly! **CONCORD** has complete stocks of all standard radio parts required for **POPULAR MECHANICS KITS** in addition to the well known line of Concord Kits! Also every kind of radio part and electronic equipment... standard lines, dependable quality, exceptional values. Order from former Catalogs No. 94 and No. 345. And write for special **VICTORY CLEARANCE FLYER**, offering thousands of items at money-saving prices. Mail coupon for **FREE COPY**.

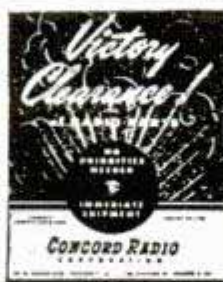

CONCORD RADIO CORP.

LAFAYETTE RADIO CORPORATION

CHICAGO 7, ILL. 901 W. Jackson Blvd. • 265 Peachtree St. ATLANTA 3, GA.

CONCORD RADIO CORPORATION, Dept. P-26

901 W. Jackson Blvd., Chicago 7, Ill.

Please RUSH FREE Concord's Victory Clearance Flyer.

Name.....

Address.....

City..... State.....

Get Into The FOOD BUSINESS For Yourself

ANYONE CAN START MAKING REAL CHILI Quick

AND MAKE BIG MONEY JUST DELIVERING TO STORES, RESTAURANTS ETC... WITH

CHILIPEP

NEW FLAVOR SENSATION Makes FINEST CHILI YOU EVER TASTED

Only \$5 BRINGS YOU OUR PERSONAL PRICELESS 20-Yr TESTED RECIPE, PLUS CHILIPEP TO MAKE 50 lbs BEST CHILI PLUS ADVERTISING AND PACKAGING MATERIALS. PLUS INSTRUCTIONS ON HOW TO START MAKING MONEY AT ONCE IN THIS EASY, PLEASANT AND VERY HIGHLY PROFITABLE BUSINESS

TEST IT OUT

SEE WHAT YOU CAN DO!

WRITE US TODAY

CHILI RESEARCH INDUSTRIES
304 E 5th, HUTCHINSON KANSAS

IDEAL FOR Auto-Home Appliance and Farm REPAIRS

Now A DYNAMIC HEAVY DUTY INDUSTRIAL WELDER

Available Now Without Priorities!

Designed to Do High-Grade Welding *Inexpensively*

Maintenance men, farmers, mechanics, machine shops, foundries, auto, general repair and job welding shops using the DYNAMIC WELDER find it so indispensable and useful that they cannot afford to be without it. If inexperienced you can easily learn to do a variety of high-grade welding jobs by following the practical, simplified operating and welding instructions furnished.

WORKS ON IRON, STEEL, BRASS, BRONZE and OTHER METALS

Has eight metallic and carbon arc welding heat stages. Does work you would think only possible with a larger, more expensive machine.

READ WHAT USERS SAY...

Repair Shop Owner says, "It will do more than you say"

"I want to say I operate a repair garage and am more than satisfied with the welder. It will do more than you say." C. P., Butler, Ohio

It's the Greatest Portable Outfit

"Now I am equipped for all kinds of welding and I must say it's the greatest portable outfit for welding any man could ever wish to own. I wouldn't sell mine for the cost of plenty welders I have seen which were very high in cost but not in convenience. You may put me on file as a booster of your wonderful welding product." W. J. B., St. John, N. B., Canada

Better Than I Expected

"I have done quite a little welding with my welder and will say it is better than I expected. The price, convenience, and variety of work that can be done with the Dynamic are the attractive points." W. R. P., Portland, Ore.

EASY TO OPERATE!

DYNAMIC SUPERCHARGED WELDER

GET DETAILS ON OUR 10-DAY TRIAL OFFER!

Once you see a DYNAMIC in operation you won't want to be without it. Its simplicity will amaze you. In a year the DYNAMIC only costs you about 6c a day. Comes complete, ready to operate, with helmet, rods, cables, electrode holder and operating instructions, etc. Nothing else to buy. Write today for Free particulars. Act now and get details on our amazingly low priced Dynamic Welder and 10 day trial offer.

DYNAMIC WELDER CO.

13 East 23rd Street—FB

CHICAGO 16, ILLINOIS

FOR ONLY
\$23⁵⁰

COMPLETE

AMAZINGLY SIMPLE TO OPERATE!

This portable Dynamic Welder, easily carried right to the job, can be operated from any convenient, properly wired 110 Volt 60 cycle line. Can also be supplied for 220 Volt 60 cycle operation and for other voltages and cycles at slight additional cost.



FARM IMPLEMENTS



BICYCLE REPAIRS



HOME APPLIANCES



SHOP MAINTENANCE



AUTOMOBILE REPAIRS



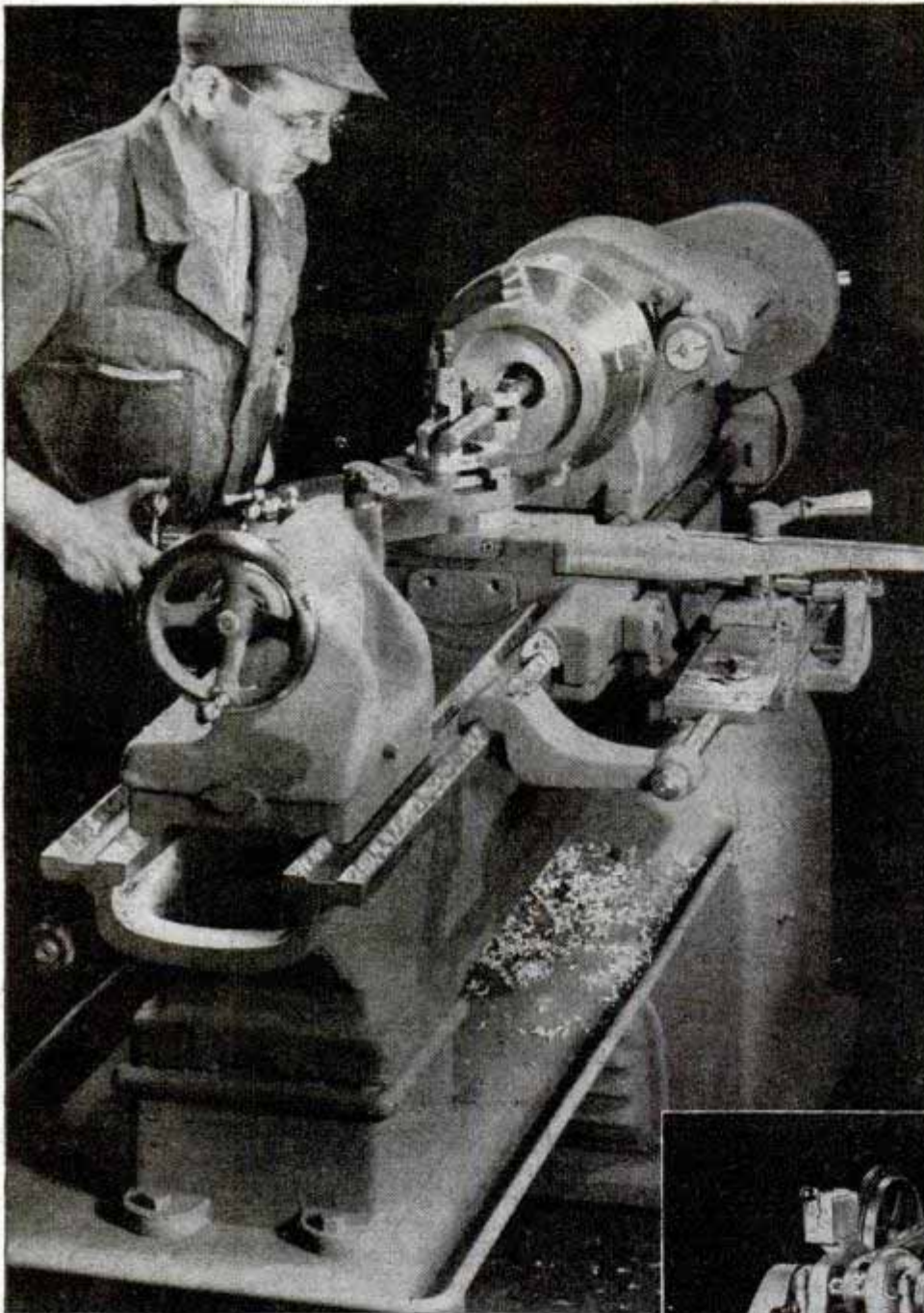

ABOVE—16" x 6' South Bend Toolroom Lathe
 RIGHT—9" x 3' Model A, 12 Speed Bench Lathe

SOUTH BEND LATHES

PRICES

(Less Elec. Equip., F.O.B. Factory)

BENCH LATHES

(Bench Not Included in Prices)

9" x 3' Model C, 6 Speed . . .	\$110.50
9" x 3' Model A, 12 Speed . . .	239.50
10" x 3' Quick Change Lathe . . .	558.00
10" x 3' Toolroom Lathe . . .	787.00

FLOOR LATHES

(Enclosed Underneath Motor Drive)

13" x 5' Quick Change Lathe . \$	909.00
13" x 5' Toolroom Lathe . . .	1202.00
14½" x 5' Quick Change Lathe	1095.00
14½" x 5' Toolroom Lathe . . .	1410.00
16" x 6' Quick Change Lathe . .	1251.00
16" x 6' Toolroom Lathe . . .	1803.00

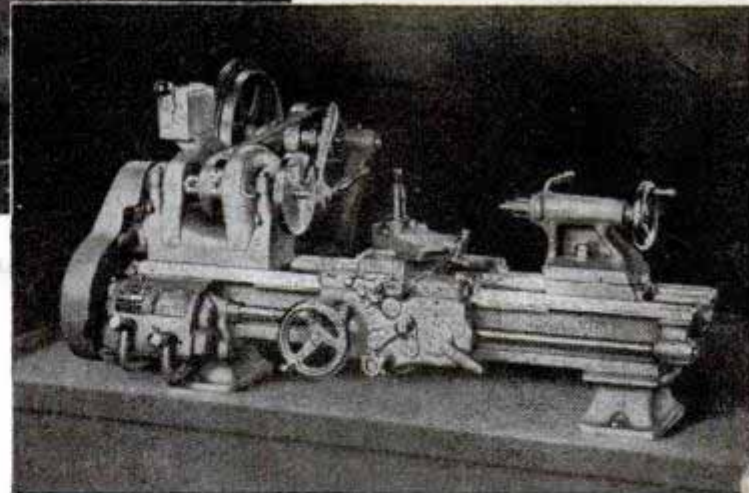

Among men who know machine tools best, South Bend Lathes hold an unchallenged reputation for fine performance on difficult jobs in the laboratory, toolroom, and production shop. Accurate, versatile, powerful, they handle close tolerance work with speed and efficiency. They have a wide range of speeds and feeds which make them practical for machining all classes of materials from plastics to the toughest tool steels. Their built-in safety features, ease of operation, and ruggedness recommend them for manufacturing, repair, maintenance, and experimental work. Made with 9" to 16" swings and bed lengths to 12', prices start at \$110.50, f.o.b. factory.



Write for FREE catalog which illustrates South Bend Lathes in full color and gives detailed specifications. No obligation! Please state size of lathe in which interested.



Lathe Builders Since 1906
SOUTH BEND LATHE WORKS

455 EAST MADISON STREET • SOUTH BEND 22, INDIANA

Printed by Popular Mechanics Company, Chicago, Ill., U. S. A.

**FAST STARTING
HORSEPOWER
FOR ALL CARS**



CASITE

**GUARANTEES QUICK STARTING
IN WINTER WEATHER
OR DOUBLE-YOUR-MONEY-BACK**

Now you can step on the starter and *start*, no matter how cold the weather. Casite guarantees it! Casite retards congealing of oil . . . lets your motor spin over rapidly . . . saves your battery and your temper, too. Put a pint of Casite in the crankcase *now* and every time the oil is changed. Sold by service stations, garages and car dealers.

THE CASITE CORPORATION • HASTINGS, MICHIGAN

CASITE Gives Better and Smoother Performance All-Year-Round

WE GUARANTEE that any motor capable of being started in a warm room will start promptly in the coldest weather when Casite is added to the crankcase according to instructions. If your car fails to start quickly, you get double-your-money-back by filling out guarantee certificate and mailing it to The Casite Corporation, Hastings, Michigan. Maximum refund is \$1.30 per pint, twice the advertised price of Casite.



**65¢
A PINT**

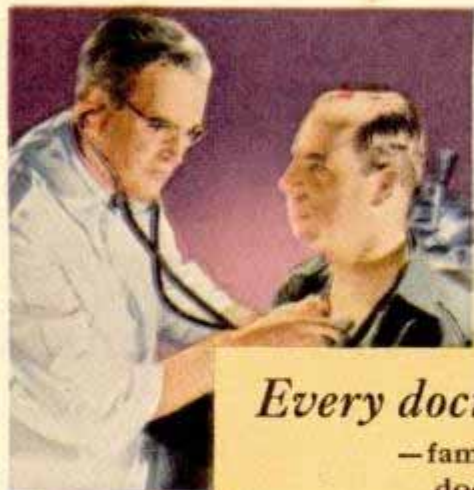

*Every doctor in private practice was asked:
—family physicians, surgeons, specialists...
doctors in every branch of medicine—
“What cigarette do you smoke?”*

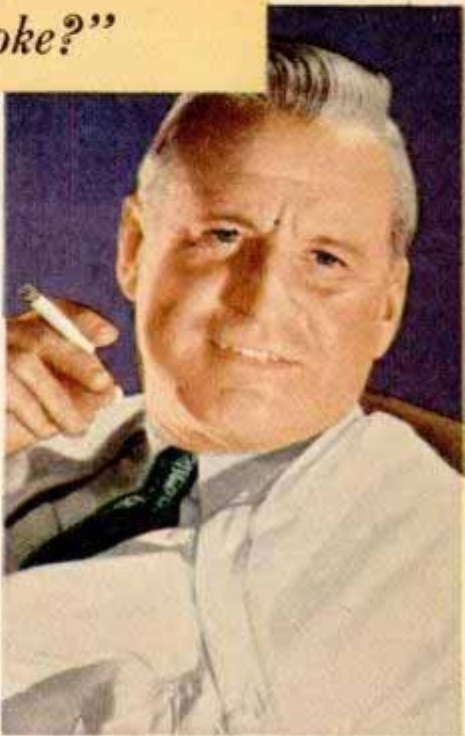

According to a recent Nationwide survey:

More Doctors Smoke Camels

than any other cigarette!

Not a guess, not just a trend... but an actual fact based on the statements of doctors themselves to 3 nationally known independent research organizations.

THE
“T-ZONE” TEST
WILL
TELL YOU



The “T-Zone”—T for taste and T for throat—is your own laboratory, your proving ground, for any cigarette. For only your taste and your throat can decide which cigarette tastes best to *you*... and how it affects your throat.



R. J. Reynolds Tob. Co.
Winston-Salem, N.C.

YES, your doctor was asked... along with thousands and thousands of other doctors from Maine to California. And they've named their choice—the brand that more doctors named as their smoke is *Camel!* Three nationally known independent research organizations found this to be a fact.

Doctors smoke for pleasure just like the rest of us. They appreciate mildness... they too enjoy the full, rich flavor of expertly blended costlier tobaccos. Next time you buy cigarettes, try Camels.