

A detailed illustration of a steam locomotive pulling a train through a snowy mountain landscape. The locomotive is a dark brown color and is emitting a large plume of white steam from its smokestack. The train consists of several passenger cars and a large cylindrical tank car. The background shows snow-covered mountains and a small, bare tree on the right side. The overall scene is set in a winter environment.

POPULAR MECHANICS



MAGAZINE

SO YOU CAN UNDERSTAND IT

REG. U.S. PAT. OFF.

JANUARY
1946
25 CENTS
30c IN CANADA

SEE PAGE 8



THE FLASHLIGHT BATTERY THAT
Stays Fresh
FOR WHEN YOU NEED IT -
EVEN FOR YEARS AND YEARS

Proven by our fighters - First choice for YOU

SEALED IN STEEL

It's LEAKPROOF 2 Ways..

- 1 Power is sealed in—your flashlight works when you need it, even for years and years.
- 2 Ingredients are sealed in—your flashlight is protected against ruinous corrosion and swelling of cells (see guarantee on battery).

RAY-O-VAC 10¢
Leakproof
FLASHLIGHT BATTERIES
COST NO MORE THAN ORDINARY BATTERIES

RAY-O-VAC COMPANY, MADISON 4, WISCONSIN

OTHER FACTORIES AT CLINTON, MASS., LANCASTER, OHIO, SIOUX CITY, IOWA, FOND DU LAC, WIS., MILWAUKEE, WIS., KANSAS CITY, MO.

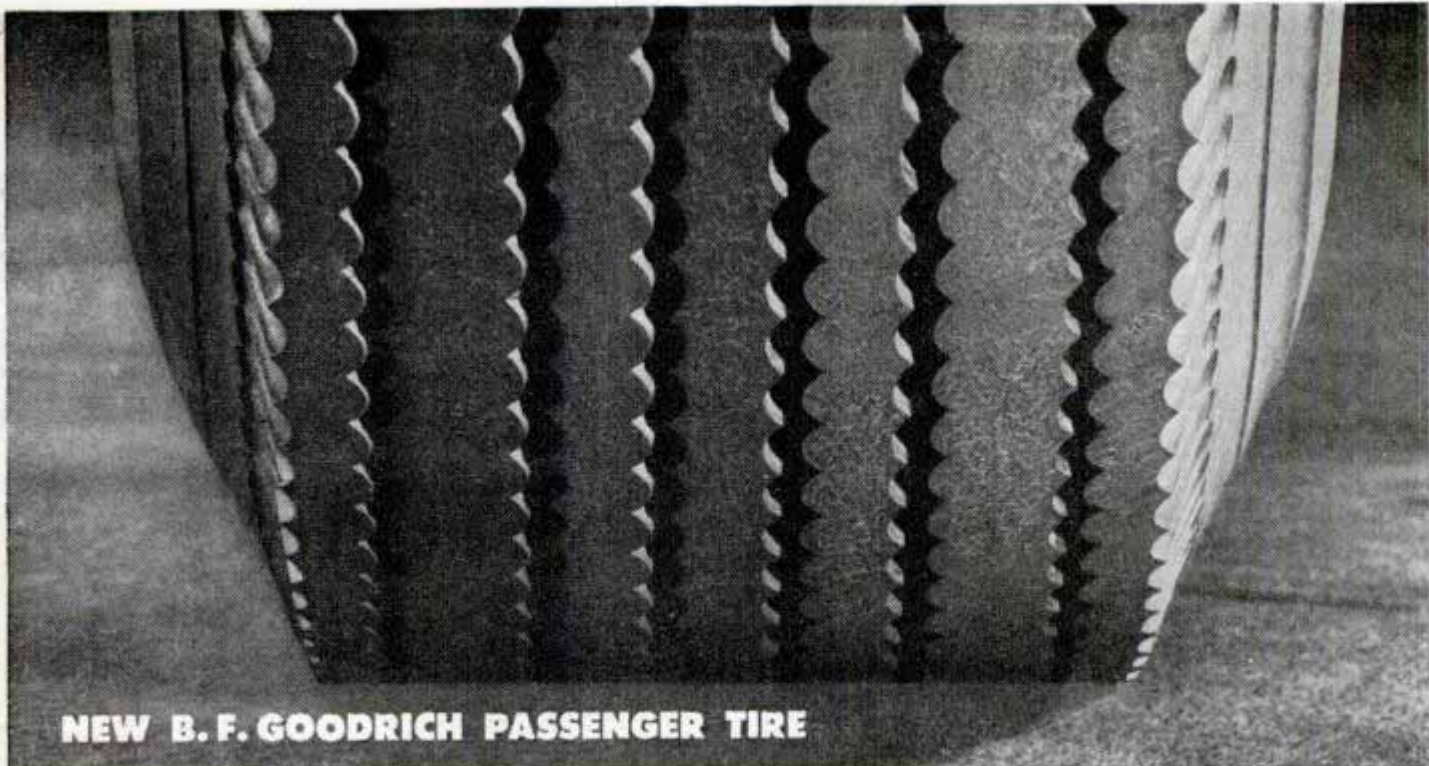

NEW B. F. GOODRICH PASSENGER TIRE

New B. F. Goodrich synthetic TIRE THAT OUTWEARS PREWAR TIRES!

"A MIRACLE," some have called it! Few believed that a tire could ever be made of synthetic rubber that would actually outdistance those made of prewar natural rubber. Yet here it is, the new B. F. Goodrich Silvertown. And here are some of the reasons for its longer-than-prewar mileage:

New, better rubber

A new rubber, so superior that for a long time it was a closely guarded military secret, was developed by B. F. Goodrich. Tires made with this rubber wear longer, run cooler. They have greater resistance to cracking—actually are more resistant to bruising and damage from accidents. But rubber is only one reason why the new B. F. Goodrich Silvertown outwears prewar tires.

New road-level tread

In the picture above, note how the tread is flatter—puts more rubber on the road. This means that

more rubber shares the wear, spreads it evenly over the whole tread surface. No more worn-out-in-the-middle treads. The result: more mileage, better traction, more skid-resistance and greater safety.

The tire body is more rugged, too. B. F. Goodrich developed a stronger cotton cord for this tire. And more cords are used than in prewar tires. Another feature that means more miles, greater safety for you.

Nearly 17 million test miles

Over 2,000 tests have been made with this new tire. Taxi fleets, state police cars, and the B. F. Goodrich test fleet have rolled up nearly 17 million miles under all kinds of driving conditions. The new B. F. Goodrich Silvertown gives longer tread wear . . . actually outdistances prewar tires.

3 years' EXTRA experience

The first B. F. Goodrich tires containing synthetic rubber were

sold to American motorists 18 months *before* Pearl Harbor. That was three full years before any other tire manufacturer . . . three years during which B. F. Goodrich has been piling up extra synthetic rubber tire experience. This three-year head start is another reason why you can count on extra mileage . . . extra safety . . . extra value from the new B. F. Goodrich Silvertown. Supplies are still limited, of course, but we hope to have much larger quantities in the hands of most dealers within the next few months. *The B. F. Goodrich Co., Akron, O.*

More miles with
B.F. Goodrich
FIRST IN RUBBER

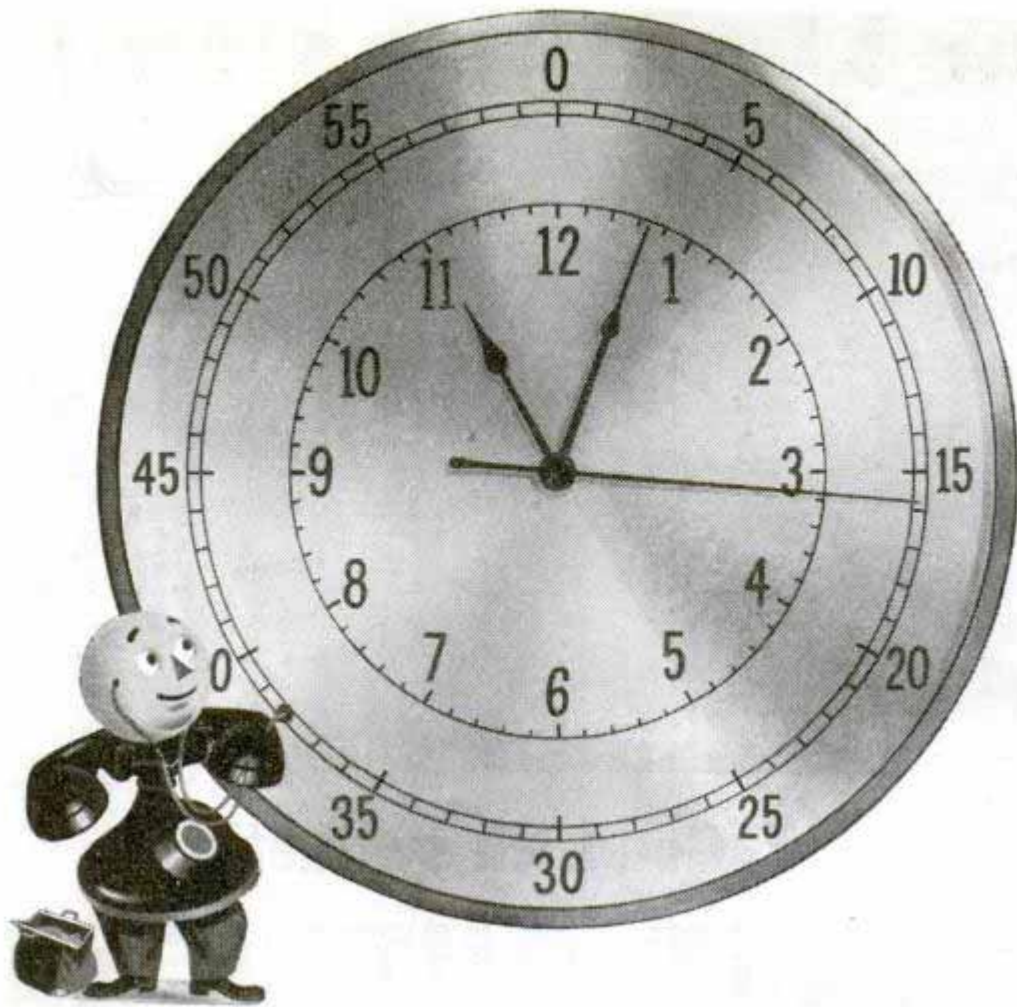

Clocks with tiny crystal hearts that beat 100,000 times a second

CRYSTAL HEARTS beat time in Bell Telephone Laboratories, and serve as standards in its electronics research. Four crystal clocks, without pendulums or escapements, throb their cycles without varying by as much as a second a year.

Precise time measurements may seem a far cry from Bell System telephone research, but time is a measure of frequency, and frequency is the foundation of modern communication, whether transmission is by land lines, cable, or radio.

These clocks are electronic devices developed by Bell Laboratories, and refined over years of research. Their energy is supplied through vacuum tubes, but the accurate timing, the controlling heart of

the clock, is provided by a quartz crystal plate about the size of a postage stamp.

These plates vibrate 100,000 times a second, but their contraction and expansion is less than a hundred-thousandth of an inch. They are in sealed boxes to avoid their variation in atmospheric pressure, and temperatures are controlled to a limit as small as a hundredth of a degree.

Bell Laboratories was one of the first to explore the possibilities of quartz in electrical communication, and its researches over many years enabled it to meet the need for precise crystals when war came. The same character of research is helping to bring ever better and more economical telephone service to the American people.



BELL TELEPHONE LABORATORIES *Exploring and inventing, devising and perfecting for continued improvements and economies in telephone service.*

Popular Mechanics Magazine

Registered in U. S. Patent Office and Canada

H. H. WINDSOR, Founder

H. H. WINDSOR, Jr., Editor and Publisher

Next Month

Scores of radar articles have been written since censorship was lifted, but the best of them all is told by two Navy officers "who were there." One served as fighter direction officer on the Wasp; the other in the Gilberts and Marshalls. Their story—as filled with adventure as Terry and the Pirates and as clear as ABC—tells how the Navy directed its fighters in fog and darkness. The first installment of "Radar Cues the Navy Fighters" is in the February issue.

ERNEST WARTHER of Dover, Ohio, can take an old water bucket or an elephant's tusk and create something that museums fight over. This "Artist With a Pocket Knife," featured next month, has a collection which includes the history of the locomotive done in ivory, ebony, black walnut and pearl. His collection is valued at a half million dollars.

THE destiny of nations has hinged on a whim of weather. Uncle Sam spent a billion dollars during the war on rain-or-shine research and service. A February article reveals new techniques in forecasting the weather.

NUTCRAFT may not be in the dictionary, but you'll find an article about how to do it in the February issue. Necklaces, belts, and unique curios can be made in the home workshop.

SHORT-WAVE listeners and radio amateurs will want to build the three-tube short-wave super described next month. It covers many "ham" bands and foreign broadcasts.

JUST like a picture, a house requires the proper "frame" in the form of an ornamental fence. A variety of pleasing designs is presented in the Craftsman section in February.

Volume 85	JANUARY 1946	Number 1
Managing Editor.....	Roderick M. Grant	
Assistant Managing Editor.....	Wayne Whittaker	
Shop Notes and Crafts Editor.....	James R. Ward	
Radio and Electronics Editor.....	Frank L. Brittin	
Art Director.....	Frank Beatty	
Associate Editor.....	John R. Kinsey	
Western Editor.....	Thomas E. Stimson, Jr.	

In This Issue

Long Distance by Short Wave	1
FIDO Fights Fog	12
Flying Freight	20
Sweeping Up Sudden Death	28
Homes to Fit the Family	36
It's Time to Open the Shutters	43
Sinews of Wire	50
Navigation for the Sky Tourist	58
They Police California's Rain	65
Modeling With Nuts and Bolts	76
China's Underground Arsenal	82
Aussie "Glidea Pool"	86

For the Craftsman

Cacti—All-Season House Plants	99
Fun With a Jackknife	108
18-In. Model of Overland Stagecoach	115
Single-Negative Design Photos	122
Tractor Scoops From Scrap Materials	133
Radio and Electronics	141

Other items, and manufacturers of available products described, are listed on pages 8A and 10A

Published monthly by POPULAR MECHANICS COMPANY, 200 East Ontario Street, Chicago 11, Ill. H. H. Windsor, Jr., president; Paul H. Dunakin, vice president and general manager; D. F. Windsor, vice president and secretary-treasurer; William Harrison Fettridge, assistant to the publisher; Clover L. Perkins, advertising manager; Alan M. Deyoe, circulation manager. Single copy in the United States, 25 cents; subscription rates in United States and possessions, and countries of the Pan-American Postal Union, 1 year, \$2.50; 2 years, \$4.50; 3 years, \$6.00. Single copy in Canada, 30 cents; subscription rates, 1 year, \$3.00; 2 years, \$5.50; 3 years, \$7.50. To all other countries add \$1.00 a year over United States prices for overseas postage. If you plan to move, notify us at least 60 days in advance so you will not miss an issue. Give both old and new addresses. Entered as Second Class Matter, September 15, 1903, at the Post Office at Chicago, Illinois, under Act of March 3, 1879. Entered as Second Class Matter at Post Office Dept., Canada. Copyright 1946, by Popular Mechanics Company, Copyright under International Copyright Union. All rights reserved under Pan-American Copyright Union. Printed in the United States of America.

The Camera that went to Harvard

HARVARD COLLEGE OBSERVATORY
 FREMONT PASS STATION
 CLIMAX, COLORADO

12 October 1945

Universal Camera Corporation
 28 West 23rd Street
 New York 10, New York

Gentlemen:

I thought you might like to have a report on the Mercury Camera Shutter that your firm supplied to us in 1940 for use in our automatic motion picture camera for study of phenomena of the sun.

PERFORMED
 AMAZINGLY

The shutter has performed amazingly and is still in operation after having exposed frame by frame, over 7000 feet of 16mm. motion picture film at 16 frames per foot, or over 112,000 exposures.

STILL IN OPERATION
 AFTER 112,000
 EXPOSURES

The Mercury shutter has proved extremely satisfactory under very trying conditions. We have been bothered considerably by extremely low temperatures at which the equipment must operate, but the shutter has gone on taking thousands of pictures, one after the other, with clock-like precision and no indication of change with age or temperature. The conditions of use have been very severe with zero and sub-zero weather common from October through April.

EXTREMELY SATISFACTORY
 UNDER VERY TRYING
 CONDITIONS

PICKED AFTER CAREFUL
 COMPARATIVE TESTS

You may also be interested to know that the Mercury Shutter was picked after careful comparative tests of a number of different shutters, including the [redacted] and [redacted] and that we found the comparative performance for our application to be very much in favor of the Mercury.

CLOCK-LIKE
 PRECISION

COMPARATIVE PERFORMANCE
 VERY MUCH IN FAVOR OF THE
 MERCURY

It occurs to me that you might want to use the information for advertising purposes. If you wish to contact me, I shall be glad to supply any further details you may wish to have about this application of the Mercury shutter.

Very sincerely yours,

Walter Orr Roberts
 Walter Orr Roberts

WOR/hos.

*Cameras selling at 2 1/2
 and 4 times the price
 of the Mercury II.

it's the MERCURY II

by UNIVERSAL

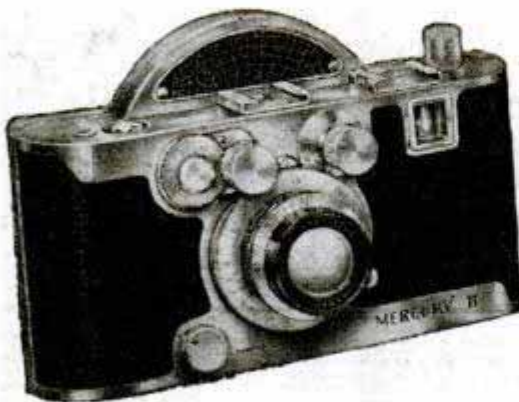

SUPER-SPEED! SUPER-PRECISION! ESPECIALLY DESIGNED FOR COLOR!

The 1/1000 second shutter combined with other advanced Universal features makes the Mercury II the camera that takes pictures practically by itself. Candid, action, portrait or still-life shots are all perfectly captured in a wink of the Mercury II eye. Color shots are clear and true right out to the edges, sharp in both background and foreground. Film economy too—Mercury II gives you 32 negatives on an 18 exposure standard 35 mm. color or black and white film cartridge.

LOOK FOR IT AT YOUR DEALER'S!

UNIVERSAL CAMERA CORPORATION

NEW YORK

CHICAGO

HOLLYWOOD

When it's an Exide... you start



You can usually expect more for your dollars in service as well as merchandise when you deal with the man who sells brands of KNOWN high quality.

THE ELECTRIC STORAGE BATTERY COMPANY

Philadelphia 32

Exide Batteries of Canada, Limited, Toronto

BUY TO LAST

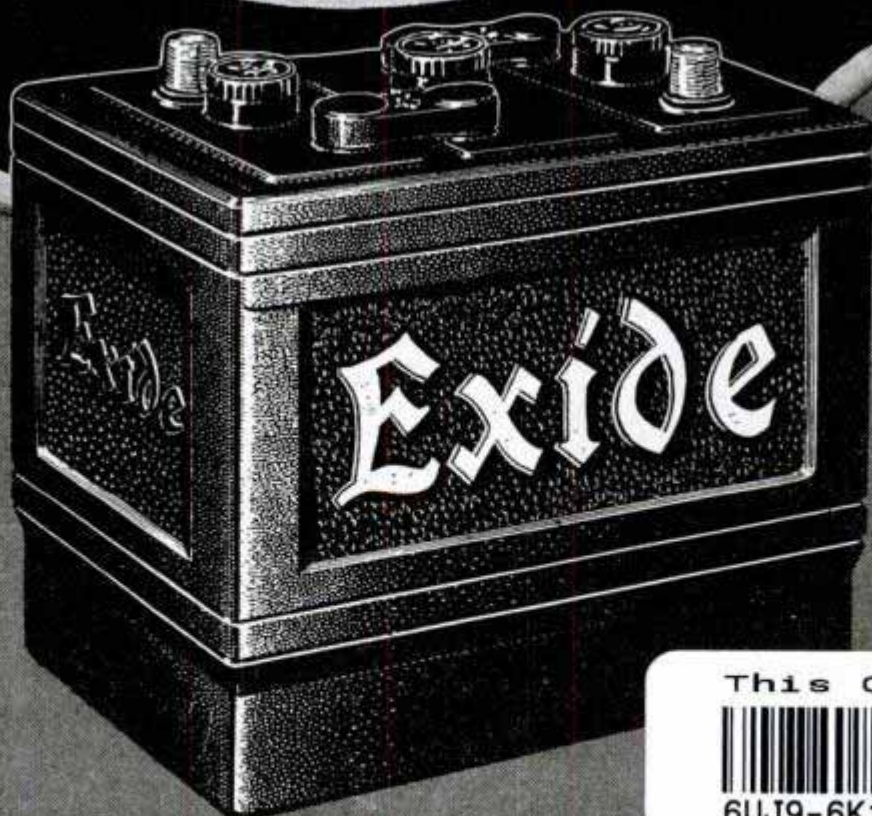

This One



6UJ9-6K1-AF9E

Depend on the Exide dealer for good products, good service.

MAN-*The Mortal God*

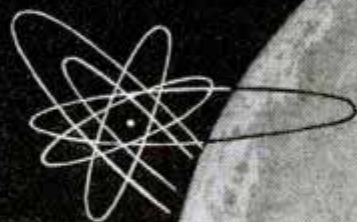
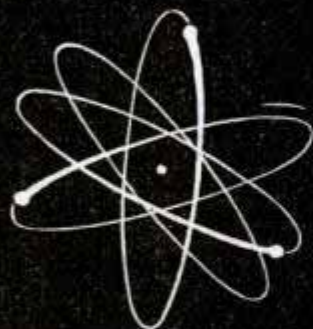

Unseen Worlds At *Your* Command!

Possibly there are universes beyond this one to be realized. Perhaps within the nucleus of each atom is the energy of a thousand dynamos — awaiting man's command. But for all of this outward conquest, are you still at the mercy of mysterious *indwelling forces*? No man is a master who has not explored self — to whom the worlds of *inspiration, mental creating, and intuition* remain dark continents of the mind. Would you like to shatter the illusions of time and space — know what is real and what are the oppressing limitations in life? Would you like to *know* the true purpose of your conscious existence — and experience the Cosmic forces which influences it?

ACCEPT THIS *Free* BOOK

Now is the time to discard obsolete, traditional thought. We are on the horizon of a new era. Learn how nature was intended to obey your commands. Write the Rosicrucians, a world-wide fraternity (not a religion), for their fascinating free book, "The Mastery of Life." It will throw new and searching *light* upon you and your universe.

Address SCRIBE: H. T. V.

THE ROSICRUCIANS (A. M. O. R. C.)

SAN JOSE, CALIFORNIA, U. S. A.

**"What's he got
that I haven't got?"**



LOOK at the successful men you know. "What have they got" that you haven't?

Very little, probably. In most ways these men are no brighter or naturally more capable than average. Many of them probably have no more formal education or better natural aptitudes than you.

But that little extra they have is important. They have the special knowledge and ability for which business is glad to pay well—they know the what, why and how of business. They have also the confidence and aggressiveness which come from knowing that they know and can apply their knowledge.

You may add that extra—may get that same profitable knowledge and ability—that same confidence and aggressiveness—if you are willing to pay the price in earnest, necessary study. For LaSalle has spent 37 years developing, testing and proving, with over a million student members, spare-time success training in certain specialized business fields. What scores of thousands of men and women—many just like you—have done, you should be able to do.

You need not leave your home or interrupt your job; you need pay comparatively little money. But you must be ambitious and willing to study seriously. And soon after you start training, the results will begin to show up in your own confidence and in your work. For what you learn at home tonight is so practical that often you can apply it on the job tomorrow.

How much do you want success—more money, a promotion or a new job, prestige and responsibility? If you really want it, you will use the coupon below to find out what LaSalle training can do for you. It costs only a postage stamp, but a coupon like it has been the starting point to real success for scores of thousands—and can be for you.

LA SALLE Extension University
A Correspondence Institution

Dept. 164-R • 417 S. Dearborn • Chicago 5, Ill.

I want to know how LaSalle can help me win success in the field I have checked below. Please send me your free 48-page booklet about that field and your success training in it.

- | | |
|--|--|
| <input type="checkbox"/> Accountancy | <input type="checkbox"/> Salesmanship |
| <input type="checkbox"/> Bookkeeping | <input type="checkbox"/> Effective Speaking |
| <input type="checkbox"/> C.P.A. Coaching | <input type="checkbox"/> Executive Management |
| <input type="checkbox"/> Business English | <input type="checkbox"/> Industrial Management |
| <input type="checkbox"/> Law: LL.B. degree | <input type="checkbox"/> Traffic Management |
| <input type="checkbox"/> Foremanship | <input type="checkbox"/> Stenotypy |

Name.....Age.....

Position.....

Address.....

City, Zone and State.....

LA SALLE EXTENSION UNIVERSITY
A Correspondence Institution

for easy STARTING start using...



The time to condition your car for easy cold weather starting is while you are running it. If you have Pyroil B or W in your lubricating system, a constant self lubricating surface is maintained on bearing surfaces. (Pyroil W is the Winter Grade of Pyroil B.) This surface is maintained even after you stop . . . it does not run off. When you start again . . . it is a lubricated start. No wearing metal to metal contact. No heavy battery drain. Protect your car with Pyroil B or W . . . simply ask your gas station service man.

Manufactured and Guaranteed by Pyroil Company, W. V. Kidder, Founder, 51 Pyroil Bldg., La Crosse, Wisconsin.

PYROIL COMPANY

51 Pyroil Bldg., La Crosse, Wisconsin

I want my car to last and run properly. Please tell me more about Pyroil and how it can accomplish this for me.

Name.....

Address.....

City or Town.....State.....



Jerry, the talking dog is entertaining hospitalized veterans, by courtesy of the PYROIL Company

WHERE-TO-BUY-IT INDEX

Manufacturer's name and address appear in parentheses directly after items believed by us to be commercially available

AVIATION	
Fighter planes that missed the war.....	7
New bomber-transport has propellers in rear.....	10
Signs replace lung power in aircraft plant.....	17
Most powerful aircraft engine develops 5500 horsepower.....	70
Vampire is newest British jet-propelled plane.....	71
Portable airfield floats in the sea.....	74
Metal "fish" scoops water for blimp's ballast.....	85
FARM	
Glass-lined silo (A. O. Smith Corp., Milwaukee, Wis.).....	6
Jeep tows corn binder and furnishes power.....	10
Cyclone duster sprays insect-killing chemical (Niagara Sprayer & Chemical Co., 3343 Niagara St., Middleport, N. Y.).....	19
Cranberry picker (A. V. Anderson, Grayland, Wash.).....	19
Heating element prevents ice from forming in water tanks (General Electric Co., Schenectady, N. Y.).....	55
Hand-operated garden tractor (Ellinwood Industries, 150 W. Slauson Ave., Los Angeles 3, Calif.).....	55
Irrigation revives fur trapping.....	56
HOME IMPROVEMENTS	
Fuel saver for oil heaters (Beachhead Mfg. Co., 1906 S. Keisel St., Bay City, Mich.).....	6
89-pound oil burner has no exposed parts (Torridheat Division, Cleveland Steel Products Corp., Cleveland 2, Ohio).....	18
Faucet washer easy to install (Durst Mfg. Co., Inc., 462 Broadway, New York 13).....	35
Folding electric ironer (Electric Utilities Corp., 2115 S. 54th St., Cicero, Ill.).....	40
Electric ironer has knee control (Nineteen Hundred Corp., St. Joseph, Mich.).....	40
Electric dishwasher shuts itself off (Westinghouse Electric Corp., Mansfield, Ohio).....	40
Jan opener attaches to shelf (Aircraftsman Co., 223 Hindry Ave., Inglewood, Calif.).....	40
Cordless electric iron (Eureka Vacuum Cleaner Co., 574 W. Randolph St., Chicago).....	41
Table lamp uses fluorescent tube (Chicago Lighting Institute, 72 W. Adams St., Chicago).....	41
Ash tray has safety edge (Aircraftsman Co., 223 Hindry Ave., Inglewood, Calif.).....	41
Garage light waits three minutes before going out (T. J. Mudon Co., 1240 Merchandise Mart, Chicago).....	41
Garage doors open and close automatically (Purdy Door-Operator Co., 342 Madison Ave., New York).....	64
Bottle holder feeds baby (Feederette Co., 7207 Myron Ave., Cleveland, Ohio).....	70
Vacuum unit keeps steam radiators working (Leiman Bros., Inc., 127 Christie St., Newark 5, N. J.).....	81
Shutters in glass window open like Venetian blind (Nu-Air-Wa Co., 601 S. Vermont Ave., Los Angeles 5, Calif.).....	88
Indoor clothes drier fastened to wall (Wm. P. Horn, 1355 Market St., San Francisco, Calif.).....	88
Handle feeds cleaning fluid into brush (Rivet-O Mfg. Co., 195 Main St., Orange, Mass.).....	88
INDUSTRY	
Glove drier protects welders.....	35
Bulldozer-crane on tractor (Hyster Co., Portland, Ore.).....	39
Film sprayed on glass peels off when dirty.....	39
Two-color spray gun (Sherwin Williams Co., 101 Prospect Ave., N.W., Cleveland, Ohio).....	55
Air cleaner blows soot out of boiler tubes (Compressed Air Institute, Rm. 1111, Terminal Tower, Cleveland, Ohio).....	70
Monster and midget drills aided war production.....	72
Multiple drill head has movable spindles (Commander Mfg. Co., 4235 W. Kinzie St., Chicago 24).....	81
Resin toughens plaster of paris (Furane Plastics & Chemicals Co., 233 W. San Fernando Rd., Los Angeles 26, Calif.).....	81
Plastic treatment for wood (Koppers Co., Orrville, Ohio).....	85
MILITARY	
Ultra-high-frequency radio mine detector.....	11
Mine scenting jeep locates buried explosives.....	15
Electric torpedoes leave no telltale wake.....	18
British battleship refuels two destroyers simultaneously.....	71
China's underground arsenals provided tools of war.....	82
TRANSPORTATION	
Rotary snowplow throws snow 125 feet.....	8
Home mechanics build three-wheeled "junkmobiles".....	11
British try plastic rail car with special spring body.....	19
Hinged cab for motor truck makes engine accessible.....	35
Ice truck lifts own body to top of rail car.....	42
Jet engine modeled after buzz-bomb has no rotating parts (G. M. Giannini & Co., 161 E. California St., Pasadena, Calif.).....	64
Divan for railroad car converts into sleeping unit.....	70
Truck rides wooden rails over Quebec swamp-land.....	71
MISCELLANEOUS	
Book cover folds into upright holder (Robert W. Brown, 1731 F St., N. W., Washington, D. C.).....	16
Light beam matches automobile paints (Acme White Lead & Color Works, Detroit, Mich.).....	39
Magnet "freezes" footprint in ball bearings.....	42
Hobbyist makes tiny horses of balsa wood and calfskin.....	49
Firemen carry their own "fresh air" (Scott Aviation Corp., Lancaster, N. Y.).....	55
Watertight camera takes pictures under water.....	57
New X-ray machine may unlock atomic secrets.....	63
Pocket-size check perforator (Esquire Products Co., 2948 E. Walnut St., Pasadena 8, Calif.).....	63
Map of U. S. made of stamps.....	70
"Beer barrel" boat to cross Atlantic.....	70
Air pictures guide rebuilding of bombed-out Britain.....	75
Robot golf "pro" teaches duffers (Dave Bauer, 3748 Chatwin Ave., Long Beach 8, Calif.).....	75
Telephoto camera films horse race from start to finish.....	85
Pocket radio receiver is a 5-tube super (Belmont Radio Corp., 5921 W. Dickens Street, Chicago).....	141

(Continued to page 10A)

HOW'S YOUR POST-WAR PROGRESS?



• Remember when you were going to prepare for the period of post-war opportunities? *This is it!* New industries are coming into being, established industries are expanding . . . and there are rewarding openings for *trained* men in all lines.

• If you failed to get ready for them, it still isn't too late to do something about it! You don't have to slip back . . . you don't have to content yourself with merely hanging to the same old job. The famous International Correspondence Schools can help you to catch up with the procession.

• But don't delay again . . . or it may be too late. Mail the coupon today for full information on I. C. S. training in the field of your interests. Thousands of leaders in American business and industry started up the ladder of success in just that way. It can be the beginning of your climb to higher pay and a more responsible position.

INTERNATIONAL CORRESPONDENCE SCHOOLS



BOX 5566-K, SCRANTON 9, PENNA.

Without cost or obligation, please send me full particulars about the course *before* which I have marked X:

Air Conditioning and Plumbing Courses

- Air Conditioning
- Heating Plumbing
- Refrigeration Steam Fitting

Chemistry Courses

- Chemical Engineering
- Chemistry, Analytical
- Chemistry, Industrial
- Chemistry, Mfg. Iron & Steel
- Petroleum Refining Plastics
- Pulp and Paper Making

Civil Engineering, Architectural and Mining Courses

- Architectural Drafting
- Architecture
- Bridge and Building Foreman
- Building Estimating
- Civil Engineering
- Coal Mining
- Contracting and Building
- Highway Engineering
- Lumber Dealer
- Reading Structural Blueprints
- Sanitary Engineering
- Structural Drafting

- Structural Engineering
- Surveying and Mapping

Communications Courses

- Electronics
- Practical Telephony
- Radio, General
- Radio Operating
- Radio Servicing
- Telegraph Engineering

Electrical Courses

- Electrical Drafting
- Electrical Engineering
- Electric Light and Power
- Lighting Technician
- Practical Electrician

Internal Combustion Engines Courses

- Auto Technician Aviation
- Diesel-Electric
- Diesel Engines Gas Engines

Mechanical Courses

- Aeronautical Engineering
- Aircraft Drafting
- Flight Engineer
- Foundry Work
- Heat Treatment of Metals

- Industrial Engineering
- Industrial Metallurgy
- Machine Shop
- Mechanical Drafting
- Mechanical Engineering
- Mold-Loft Work
- Patternmaking—Wood, Metal
- Reading Shop Blueprints
- Sheet-Metal Drafting
- Sheet-Metal Worker
- Ship Drafting Ship Fitting
- Tool Designing
- Toolmaking
- Welding—Gas and Electric

Railroad Courses

- Air Brake Car Inspector
- Diesel Locomotive
- Locomotive Engineer
- Locomotive Fireman
- Railroad Section Foreman

Steam Engineering Courses

- Boilermaking
- Combustion Engineering
- Engine Running
- Marine Engineering
- Steam Electric Steam Engines

Textile Courses

- Cotton Manufacturing
- Rayon Weaving
- Textile Designing
- Woolen Manufacturing

Business and Academic Courses

- Accounting Advertising
- Arithmetic Bookkeeping
- Business Correspondence
- Business Management
- Certified Public Accounting
- Commercial
- Cost Accounting
- Federal Tax
- First Year College
- Foremanship French
- Good English High School
- Higher Mathematics
- Illustrating Motor Traffic
- Postal Service
- Salesmanship Secretarial
- Sign Lettering
- Spanish Stenography
- Traffic Management

Name..... Age..... Home Address.....
 City..... State..... Present Position..... Working Hours..... A.M. to..... P.M.

Canadian residents send coupon to International Correspondence Schools Canadian, Ltd., Montreal, Canada.
 British residents send coupon to I. C. S., 71 Kingsway, London, W. C. 2, England.

A DISCOUNT TO DISCHARGED VETERANS—SPECIAL TUITION RATES FOR MEMBERS OF THE ARMED FORCES



REFRIGERATION AIR CONDITIONING

Air Conditioning and Refrigeration are among the great industries of today and tomorrow. Installations everywhere—in restaurants, shops, homes, etc., need service. Thousands of businesses are waiting for new installations. Today, more and more homes are being air conditioned. The Refrigeration and Air Conditioning industries are headed for greater prosperity and men who have the "know how" and experience should ride along.

Train Now Before the Expected EXPANSION Begins



Experts predict large demand for men to install and service Air Conditioning and Refrigeration equipment. . . Rise to the kind of job which requires a competent, trained man who can carry the responsibilities of installing costly equipment and maintaining it. If he knows the answer when he is called in for consultation, his reputation grows and his pay should grow also.

Follow This Way to Knowledge

If over 17, and under 60, here's all it takes to get you ready for experience in this modern industry. Just invest a limited amount of your spare time—while you are still on your present job. Through our balanced training, you learn first through home study, how to handle Installation, Maintenance & Service Work on Refrigeration and Air Conditioning equipment. Then you can get practical training in our big shops under capable instructors—experienced men who'll take a personal interest in helping you learn. When you're through you should have knowledge that enables you to get started in this vast industry.

WANT YOUR OWN REPAIR SHOP?

UEI training is easily understood by mechanically inclined men. You gain experience when you complete your course. Equipment, tools and personal following can accumulate as you progress. Soon you may find it wise to set up your own shop.

GET FREE FACTS RIGHT NOW!

It costs you nothing to get all the facts about this great field. Simply mail the coupon below and we'll tell you, without obligation the whole, sensational story of what's ahead in Refrigeration and Air Conditioning. Mail the FREE coupon now.

REFRIGERATION
TRAINING
Since 1927

UTILITIES ENGINEERING INSTITUTE
1314 W. Belden Avenue, Dept. 116, Chicago 14, Ill.

Please send me the FREE FACTS about opportunities in Air Conditioning and Mechanical Refrigeration. I have marked the one that interests me most.

Air Conditioning Mechanical Refrigeration

NAME _____ AGE _____

ADDRESS _____

CITY _____ ZONE _____ STATE _____

(Continued from page 8A)

Craftsman and Shop Notes Index

ART AND ARTIST	
Copying drawings simplified by using ruled glass.....	96
Masking tape holds cards for spraying.....	98
Guide tabs minimize eyestrain in drawing parallel lines.....	140
AUTOMOTIVE	
Leather strips form pockets in glove compartment.....	112
Plumb bob indicates uneven loading of truck.....	126
Adjustable engine positioner has many uses.....	129
Panel across garage doors conserves heat in winter.....	132
Drop-leaf tailboard on truck facilitates sorting loads.....	137
FARM	
Hook locks grain-blower piping.....	92
Roofing tar prevents fence posts from decaying.....	98
Chart computes number of acres in rectangular tract of land.....	112
Stock cars used for corn crib and overhead granary.....	138
Feed cooker made from oil drum.....	139
Olive oil stored in ax handle prevents drying of hands.....	140
HOME IMPROVEMENTS	
Glass jar replaces lamp bowl.....	92
Sliding roof on dog house permits easy cleaning.....	92
Solving home problems.....	94
Gate latch has no moving parts.....	103
Washing machine improved by adding extra paddles.....	104
Repairing broken alarm-clock spring.....	104
Adhesive tape will muffle doorbell.....	106
Cabinet attached to door provides closet space.....	113
Pipe and fan in fireplace warm room by circulating air.....	120
Broken andiron repaired with pipe.....	120
OFFICE	
Gummed-paper tape used to make index tabs.....	96
Carbon paper creased diagonally to prevent curling.....	106
Markers and holder save time in locating files.....	114
Tab frees gummed-tape roll when end is stuck.....	120
Typist's copyholder improvised from writing board.....	128
Pins aid lining up original page with carbon copy.....	140
PHOTOGRAPHY	
Two types of improvised darkroom safelights.....	121
Extra-long lens hood permits taking photos against sun.....	121
Perforated board used as easel for copying photographs.....	124
Cut-film hanger holds many sheets.....	124
Hose used to control photo-tank temperature.....	124
Plug-in lamps illuminate projector when changing reels.....	124
RADIO AND ELECTRONICS	
Five-tube superheterodyne receiver fits in pocket.....	141
"Sound" amplifier for converted 16-mm. home movie projector.....	142
Comparison chart for common radio and industrial symbols.....	144
Clearing radio switches and volume controls.....	144
How to add a directional reflector to an FM dipole antenna.....	144
Simplest practical tone control for small set.....	144
Fuse puller removes "hot" metal tubes.....	144
Table dolly handy for moving test sets on workbench.....	144
Locating loose connections that cause crackling noises.....	144
SPORTS	
Bamboo poles and auto casings become pole-vault standards.....	92
Lipstick case encloses bowler's crayon.....	96
Blocks permit walking on skate runners.....	104
STORE AND SHOP	
"Absence indicator" made from cardboard and cord.....	107
Four-operator grid unit for welding machines.....	125
Air compressor operates without moving parts.....	127
Stranded wire wound on reels with electric drill.....	128
Wood sheath protects soapstone stick.....	132
Pans converted to stock bins provide additional space.....	138
Showcase lock protects wares.....	138
TOOLS	
Handle for chisel held by U-bolt.....	98
Holder bolted to lathe housing keeps chuck wrench handy.....	128
Tool holder simplifies convex turning.....	130
Counter improvised from compass to aid printers.....	132
Chucks and face plates repaired with ring inserts.....	132
Attachment extends use of wrench.....	137
How to improve a soldering iron.....	138
Lathe backstop supports thin work for facing.....	139
TOYS AND NOVELTIES	
Toy houseboat will amuse young sailors.....	91
Whistle made from fountain pen cap.....	96
Four-place coaster has positive brake.....	97
Lacquered capsules make colorful beads.....	104
Star stamp cut from bottle cork.....	104
Cigarette lighter made from .50-cal. cartridge case.....	107
Remote-control switch for model railways.....	111
Strips over slot in child's bank prevent removal of coins.....	114
WOODWORKING	
Duncan Phyfe lyre table.....	89
Four-part trinket box scrollsawed in one operation.....	93
Cabinet fitted to circular saw serves as sawdust catcher.....	98
Magazine rack has sides made of woven splints.....	105
Glued column work is clamped by cord in hand-screw jaws.....	106
Drill-press attachment shapes masts for model ships.....	106
Clamping arrangement holds work for hand mortising.....	120
MISCELLANEOUS	
Mucilage applied to scrapbook clippings with oilcan.....	93
Refilling small spouted cans from bottle.....	106
Dating stamp for concrete work uses old license plates.....	112
Hot plate made from tin can and heat-lamp element.....	114
Bracing protects record album when being shipped.....	114
Leather strip on edge of helmet protects welder's neck.....	132
Ice pick is used to bend glass tubing.....	132
Control operates overhead stop cocks.....	140

IMPORTANT NOTICE

It is the intention of this magazine to provide its readers with information regarding the latest developments in the mechanical arts. We take no responsibility as to whether the disclosures contained in our articles are covered by patents and advise readers to investigate this subject before making, using, or selling any of the products, machines, or processes described in order to avoid possible liability for patent infringement.

AUDELS REFRIGERATION & AIR CONDITIONING GUIDE.....\$4

New from Cover to Cover—1280 Pages, Fully Illus. Covering basic principles, servicing, operation & repair of household, commercial & industrial refrigeration & air conditioning. A gold mine of essential important facts for engineers, servicemen, users.

AUDELS CARPENTERS & BUILDERS GUIDES—4 Vols.\$6

A practical illustrated trade assistant on modern construction for carpenters, joiners, builders, mechanics and all woodworkers. 4 vols., 1600 pages, 3700 illustrations, flexible covers. Pocket size. Each volume sold separately \$1.50 a vol.

AUDELS AUTOMOBILE GUIDE.....\$4

A practical quick ready reference book for auto mechanics, service men, operators & owners. Explains theory, construction & servicing of modern motor cars, trucks, buses & auto type Diesel engines. 1540 pages, fully illustrated. 53 chapters. Indexed. A standard book for mechanics. New fluid drive covered.

AUDELS DIESEL ENGINE MANUAL.\$2

A practical, concise treatise with questions and answers on the theory, operation and maintenance of modern diesel engines including General Motors 2 cycle Diesel. 384 pages, fully illus., flexible binding, pocket size. All details plainly brought out, this book is of extreme value to engineers, operators & students.

AUDELS WIRING DIAGRAMS.....\$1

210 Pages. Illustrated. Gives practical facts on wiring of electrical apparatus. It shows clearly how to wire apparatus for practically all fields of electricity. Each diagram is complete & self-explanatory. Highly Endorsed Pocket Companion.

AUDELS PLUMBERS & STEAMFITTERS GUIDES—4 Vols.\$6

A Practical Trade Assistant & Ready Reference. Explains in plain language & by clear illustrations, diagrams, charts, graphs, pictures principles of modern plumbing practice including Marine Pipe Fitting and Air Conditioning. 4 Vols.—1670 Pages—3642 Diagrams. Pocket size. Each Vol. Sold Separately \$1.50 a Vol.

AUDELS SHEETMETAL WORKERS HANDY BOOK.....\$1

Practical inside information. Fundamentals of Sheet Metal Work. 388 pages. Illustrated. 11 sections. Clearly written. Essential & important facts, figures, pointers in everyday language. Ref. Index.

AUDELS SHEETMETAL PATTERN LAYOUTS.....\$4

Developed by Experts for Sheet Metal Workers, Layout Men & Mechanics. A Practical Encyclopedia in 10 Sections, size 7 x 10 x 2—1125 Pages—350 Layouts—1600 Illustrations. 1001 Key Facts. Fully indexed for ready reference in answering your layout problems. Covers all phases of sheet metal work including Pattern Cutting, Pattern Development & Shop Procedure.

AUDELS ANSWERS ON BLUE PRINT READING.....\$2

For Mechanics & Builders. Covers all types of blue print reading including ship & airplane. 376 pages, fully illustrated.

AUDELS NEW MACHINIST & TOOLMAKERS HANDY BOOK...\$4

Covers modern machine shop practice in all its branches. 5 practical books in 1. New from cover to cover. Tells how to set up & operate lathes, screw and milling machines, shapers, drill presses and all other machine tools. 1600 pages, fully illustrated, 5 x 6 1/2 x 2. Indexed. 5 sections. 1—Modern Machine Shop Practice. 2—Blue Print Reading & How to Draw. 3—Calculations & Mathematics for Machinists. 4—Shop Physics. 5—How to Use the Slide Rule. 60 chapters. Easy to read and understand. A shop companion that answers your questions.

AUDELS MATHEMATICS & CALCULATIONS FOR MECHANICS \$2

Mathematics for home study or reference. 700 pages, 550 illus. Practical mathematics from beginning. How to figure correctly. Easy, correct methods covering a complete review. Ill. & Indexed.

AUDELS HANDY BOOK OF PRACTICAL ELECTRICITY.....\$4

For maintenance engineers, electricians & all electrical workers. 1440 Pages, 2600 Illus. Covers important electrical information in handy form—including Marine Wiring, Radio Principles, Welding. Indexed. A Key to a practical understanding of electricity.

AUDELS RADIOMANS GUIDE.....\$4

A key to the practical understanding of radio including Frequency Modulation, Television, etc., Aircraft & Marine Radio. For radio engineers, servicemen, amateurs. 773 pages. 400 Illustrations & Diagrams. Photos. Review Questions & Answers, Reference Index. Authentic, clear, concise.

AUDELS ELECTRONIC DEVICES...\$2

Tells What You Want to Know About Electric Eye. Easily Understood. Covers photo-electric cells & their applications. Amplifiers, illumination, frequencies, voltage, photocell, tubes, Ohm's Law, wiring diagrams, etc.

AUDELS WELDERS GUIDE.....\$1

A concise, practical text on operation & maintenance of all welding machines for all mechanics. Over 400 pages, illustrated. Covers all methods of electric and acetylene welding including airplane work.

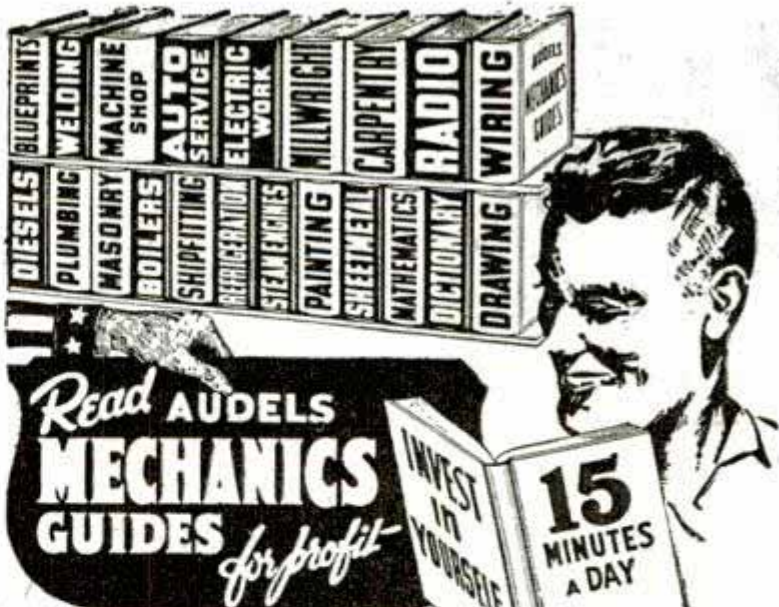

AN AUDEL GUIDE IS A GOOD FRIEND!

Use the brains and experience of others in these Guides of the Trades. Save time and money with right methods, short cuts, labor saving ideas. CHECK NOW! You can look over any Audel Guide in your home. Start the Easy Payments if satisfied.

CUT HERE MAIL ORDER

THEO. AUDEL & CO., 49 W. 23 St., New York 10, N.Y.

Please mail me for 7 days' free examination the books marked (X) below. I agree to mail \$1 in 7 days on each book or set ordered, and to further mail \$1 a month on each book or set ordered until I have paid purchase price. If I am not satisfied with Guides I will return them.

- Audels REFRIGERATION & Air Conditioning Guide . \$4.
- Audels POWER PLANT ENGINEERS GUIDE . 4.
- Audels PUMPS, HYDRAULICS & AIR COMPRESSORS . 4.
- Audels WELDERS GUIDE . 1.
- Audels BLUE PRINT READING . 2.
- Audels SHEET METAL WORKERS Handy Book . 1.
- Audels SHEET METAL PATTERN LAYOUTS . 4.
- Audels AIRCRAFT WORKER . 1.
- Audels MATHEMATICS and CALCULATIONS . 2.
- Audels MACHINISTS & TOOLMAKERS Handy Book . 4.
- Audels MECHANICAL Dictionary . 4.
- Audels AUTOMOBILE GUIDE . 4.
- Audels DIESEL ENGINE MANUAL . 2.
- Audels MARINE ENGINEERS Handy Book . 4.
- Audels SHIPFITTERS Handy Book . 1.
- Gueths MECHANICAL DRAWING COURSE . 1.
- Rogers DRAWING and DESIGN . 2.
- Audels MILLWRIGHTS and Mechanics Guide . 4.
- Audels CARPENTERS and Builders Guides (4 vols.) . 6.
- Audels PLUMBERS and Steamfitters Guides (4 vols.) . 6.
- Audels MASONS and Builders Guides (4 vols.) . 6.
- Master PAINTER and DECORATOR . 2.
- Audels GARDENERS & GROWERS GUIDES (4 vols.) . 6.
- Audels ENGINEERS and Mechanics Guides Nos. 1, 2, 3, 4, 5, 6, 7 and 8 complete . 12.
- Audels Answers on Practical ENGINEERING . 1.
- Hawkins Aids to ENGINEERS EXAMINATION . 2.
- Audels ELECTRICIANS EXAMINATIONS . 1.
- Audels WIRING DIAGRAMS . 1.
- Audels Handy Book of PRACTICAL ELECTRICITY . 4.
- Audels ELECTRICAL POWER CALCULATIONS . 2.
- Hawkins ELECTRICAL Guides at \$1. each . 10.
- Audels ELECTRONIC DEVICES . 2.
- Audels ELECTRIC Dictionary . 2.
- Audels RADIOMANS GUIDE . 4.
- Audels NEW ELECTRIC LIBRARY at \$1.50 a Volume Vols. I, II, III, IV, V, VI, VII, VIII, IX, X, XI, XII.

Name.....
 Address.....
 Occupation.....
 Employed by..... PM

AUDEL, Publishers, 49 W. 23 St., N. Y. 10

I Will
Show You
How to

Learn RADIO

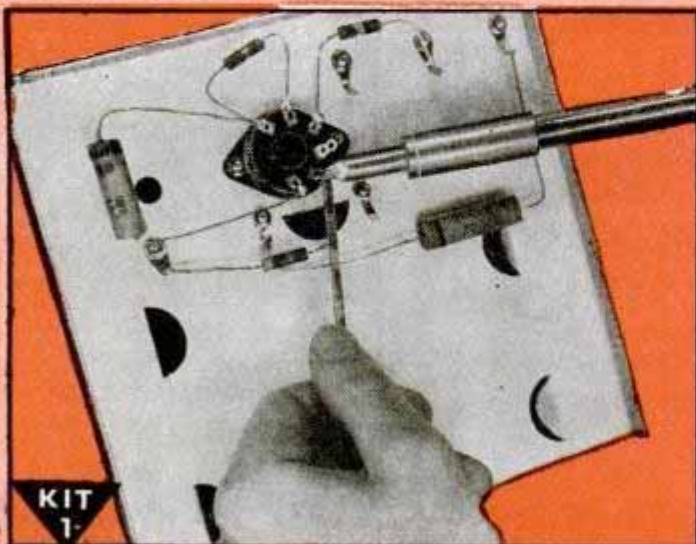

I send you Soldering Equipment and Radio parts; show you how to do Radio soldering; how to mount and connect Radio parts; give you practical experience.



Early in my course I show you how to build this N.R.I. Tester with parts I send. It soon helps you fix neighborhood Radios and earn EXTRA money in spare time.

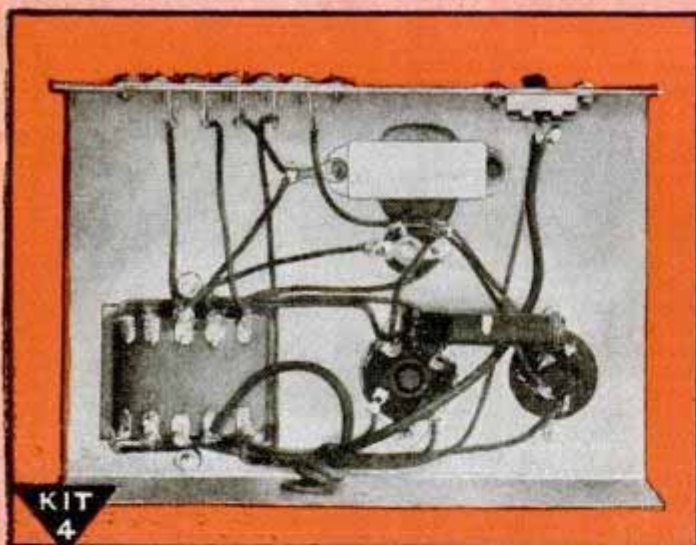

You get parts to build this Vacuum Tube Power Pack; make changes which give you experience with packs of many kinds; learn to correct power pack troubles.

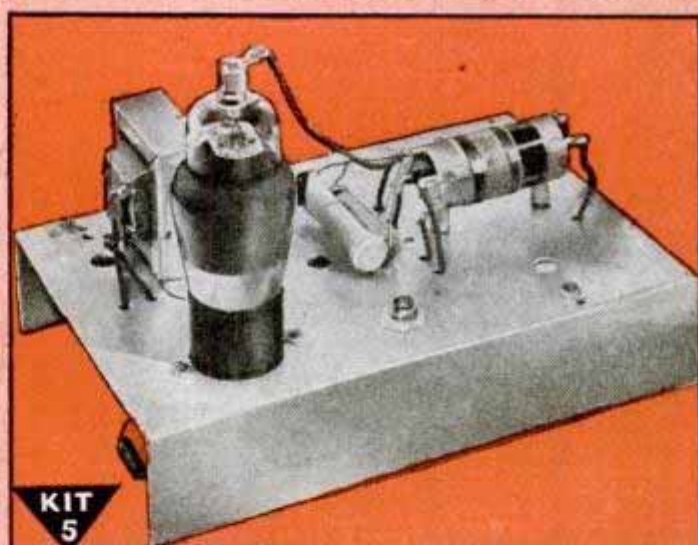

Building this A. M. Signal Generator gives you more valuable experience. It provides amplitude-modulated signals for many tests and experiments.

MEN I TRAIN AT HOME GET GOOD JOBS LIKE THESE

\$250 a month
in own shop

"I am now operating a radio shop for myself and own all my equipment. Right now I only repair radios, because there are none to sell, but I average \$250 a month."—J. M. SCRIVENER, JR., Aberdeen, Miss.



Fixing Radios
Profitable Hobby

"I am doing radio work in my spare time, and find it a profitable hobby. My extra earnings run about \$10 a week. I certainly am glad I took your N.R.I. Course."—FERDINAND ZIRBEL, Chaseley, North Dakota.



Chief Engineer
Station KWLM

"Am now Chief Engineer of Station KWLM and in charge of maintenance of Police Station KRIN, County Highway Dept. Also have my own business. Mighty glad to be in radio."—LLOYD V. STENBERG, 516 Litchfield Ave., W., Willmar, Minn.



Still Climbing in
Air-craft Radio

"I am still climbing as a result of my N.R.I. training. I now do aircraft radio work at Greenwood Army Air Field, and operate a radio shop in my spare time."—JAMES L. BOYETT, P.O. Box 218, Greenwood, Miss.



by Practicing in Spare Time

**I Send You
6 Big Kits
of Radio Parts**

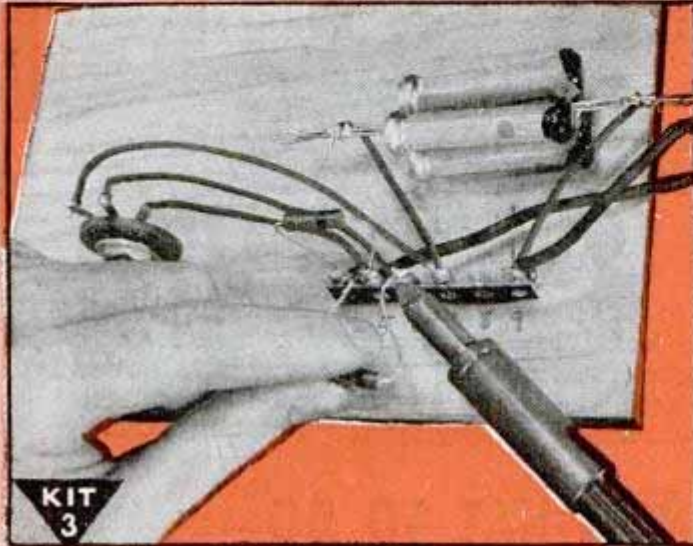

**KIT
3**

You get parts to build Radio Circuits; then test them; see how they work; learn how to design special circuits; how to locate and repair circuit defects.

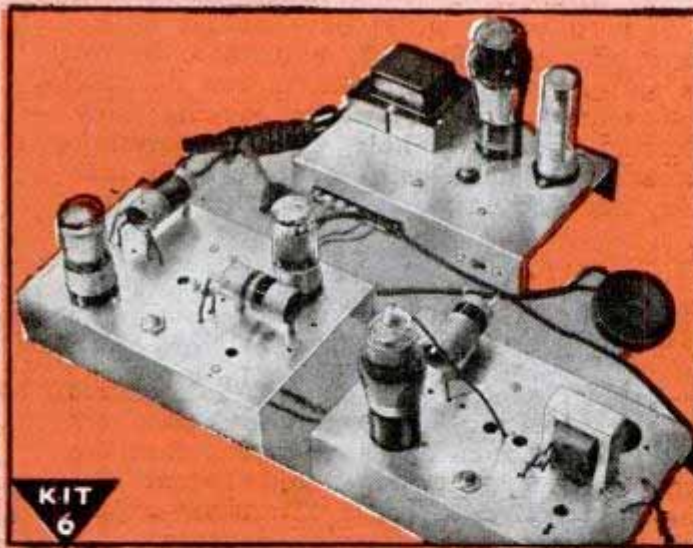

**KIT
6**

You build this Superheterodyne Receiver which brings in local and distant stations—and gives you more experience to help you win success in Radio.

SAMPLE LESSON FREE

Gives hints on Receiver Servicing, Locating Defects, Repair of Loudspeaker, I. F. Transformer, Gang Tuner, Condenser, etc. Mail Coupon.



**My Radio Course Includes
TELEVISION • ELECTRONICS
FREQUENCY MODULATION**

KNOW RADIO *Win Success* I Will Train You at Home

Send coupon for FREE Sample Lesson, "Getting Acquainted with Receiver Servicing," and FREE 64-page book, "Win Rich Rewards in Radio." See how N.R.I. trains you at home. Read how you practice building, testing, repairing Radios with SIX BIG KITS of Radio parts I send you.

Future for Trained Men Is Bright in Radio, Television, Electronics

The Radio Repair business is booming NOW. Fixing Radios pays good money as a spare time or full time business. Trained Radio Technicians also find wide-open opportunities in Police, Aviation, Marine Radio, in Broadcasting, Radio Manufacturing, Public Address work, etc. Think of the boom coming now that new Radios can be made! Think of even greater opportunities when Television and Electronics are available to the public!

Many Beginners Soon Make \$5, \$10 a week EXTRA in Spare Time

The day you enroll I start sending EXTRA MONEY JOB SHEETS to help you make EXTRA money fixing Radios in spare time while learning. MAIL COUPON for sample lesson and 64-page book FREE. It's packed with facts about opportunities for you. Read about my Course. Read letters from men I trained, telling what they are doing, earning. MAIL COUPON in envelope or paste on penny postal. J. E. Smith, President, Dept. 6AP, National Radio Institute, Pioneer Home Study Radio School, Washington 9, D. C.

OUR 31st YEAR of TRAINING MEN for SUCCESS in RADIO

MAIL NOW!

MR. J. E. SMITH, President, Dept. 6AP
National Radio Institute,
Washington 9, D. C.

Mail me FREE, your sample lesson and 64-page book. (No salesman will call. Please write plainly.)

Age

Name

Address

City State 4FR

(Please include Post Office Zone Number)



INVENTOR

NOW IS THE TIME TO PATENT AND SELL YOUR INVENTION

Now, more than ever before, is the right time to patent and sell your invention. Why? Because manufacturers everywhere, in striving to keep ahead of competition, are looking for new inventions and buying up the patent rights thereon so that they will have better and more attractive items to make and sell. Hence, the wise thing for you to do is also to act at once. Protect your invention—and yourself—by applying for a patent now.

FREE "PATENT GUIDE" EXPLAINS WHAT TO DO

Our Free 48 page "Patent Guide for the Inventor", containing complete information about patent procedure and selling inventions, answers many important questions concerning Patents that inventors constantly ask. It tells what facts, details, drawings, sketches, etc., are necessary to apply for a Patent; how to protect your invention through dated and witnessed disclosure; how to do this at once to safeguard your rights; how Patent Office Records can be checked to determine whether the invention is probably patentable before filing fees need be paid; discusses costs involved and a practical way these can be paid as the application progresses. It tells how some inventors secured financial backing; how many simple inventions have proved large commercial successes; how Patents covering improvements also can be profitably utilized and marketed; and countless other facts that every inventor will want to know. And in addition, our "Patent Guide" contains illustrations of over 150 basic mechanical movements.

WHY YOU NEED EXPERT ASSISTANCE

The Patent Laws were enacted for your benefit—to give you protection for the features of your invention which are Patentable. But these features must be legally and concisely set forth in the form of "claims". This phase of the procedure is so complex that the U.S. Patent Office advises the Inventor to engage a competent Registered Patent Attorney. We maintain a large staff—carefully trained registered patent attorneys—expert draftsmen—experienced searchers—to serve you. We have been serving inventors for more than twenty years. Write for a free copy of our "Patent Guide for the Inventor" today. Clarence A. O'Brien & Harvey B. Jacobson, Registered Patent Attorneys, 61-A Adams Building 4, Washington, D. C.

**CLARENCE A. O'BRIEN
& HARVEY B. JACOBSON**
REGISTERED PATENT ATTORNEYS

Free Book
for

TORS

48
PAGES
Over 150
Mechanical
Movements

FREE "RECORD OF INVENTION"

With our free "Patent Guide for the Inventor" you will receive also free a "Record of Invention" form. This "Record of Invention" enables you to conveniently make a proper, dated disclosure of your invention before you file your patent application, which will prove of great value to you, should the occasion for evidence arise.

TAKE FIRST STEP NOW

Remember, in Patent matters action is important. Delay can be costly. Therefore, take your first step now—toward protecting your invention. Send for your free copy of our "Patent Guide for the Inventor" containing complete information about patent procedure and selling inventions. At the same time, receive a free "Record of Invention" form with complete instructions for making a disclosure of your invention and establishing its date. This step costs you nothing—yet may be vital to your success. Mail the coupon in an envelope, or paste it on a penny postcard—now.



CLARENCE A. O'BRIEN & HARVEY B. JACOBSON

CLARENCE A. O'BRIEN & HARVEY B. JACOBSON
Registered Patent Attorneys before the United States Patent Office
61-A Adams Building, Washington 4, D. C.

Please send me your 48-Page "Patent Guide for the Inventor", and your specially prepared "Record of Invention" form FREE. This request does not obligate me.

Name.....

Address.....

City..... State.....

(Please write or print plainly.)

*Worthy of
Your Trust*

I'LL SHOW YOU HOW TO SUCCEED IN RADIO

Here's the right training for Big Post-War Pay!



F. L. Sprayberry, one of the country's foremost Radio Teachers.



A RADIO SERVICE BUSINESS OF YOUR OWN



A GOOD JOB IN RADIO & TELEVISION BROADCASTING



RADIO-ELECTRONIC SERVICE ENGINEER

BE A RADIO-ELECTRONICIAN

NOW! YOU CAN PREPARE AT HOME IN SPARE TIME FOR AMAZING OPPORTUNITIES AHEAD IN **RADIO • ELECTRONICS • TELEVISION**

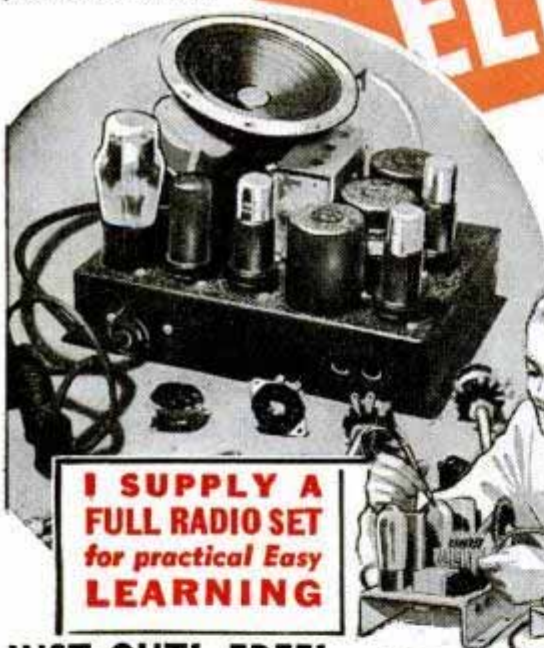

I SUPPLY A FULL RADIO SET for practical Easy LEARNING



The offer I make you here is the opportunity of a lifetime. It's your big chance to get ready for a wonderful future in the swiftly expanding field of Radio-Electronics INCLUDING Radio, Television, Frequency Modulation and Industrial Electronics. Be wise! NOW'S the time to start. Opportunities ahead are tremendous! No previous experience is necessary. The Sprayberry Course starts right at the beginning of Radio. You can't get lost. It gets the various subjects across in such a clear, simple way that you understand and remember. And, you can master my

entire course in your spare time. It will not interfere in any way with your present duties. Along with your Training, you will receive my famous **BUSINESS BUILDERS** which will show you how to make some nice profits while learning.

Prepares You for a Business of Your Own or Good Radio Job
My training will give you the broad, fundamental principles so necessary as a background, no matter which branch of Radio you wish to specialize in. I make it easy for you to learn Radio Set Repair and Installation Work. I teach you how to install and repair Electronic Equipment. In fact, you'll be a fully qualified **RADIO-ELECTRONICIAN**, equipped with the skill and knowledge to perform efficiently and to make a wonderful success of yourself.

JUST OUT! FREE!

"How to Read Radio Diagrams and Symbols"

... a valuable new book explaining in simple English how to read and understand any Radio Set Diagram or circuit. Includes translations of all Radio symbols. Send for this FREE book now, and along with it I will send you another big FREE book describing my Radio-Electronic training.



GET FREE BOOKS

SPRAYBERRY ACADEMY OF RADIO

F. L. Sprayberry, President
Room 1016, Pueblo, Colorado.
Please rush my FREE copies of "How to MAKE MONEY in RADIO, ELECTRONICS and TELEVISION," and "HOW TO READ RADIO DIAGRAMS and SYMBOLS."

Name..... Age.....
Address.....
City..... State.....
(Mail in plain envelope or paste on penny postcard)

SPRAYBERRY TRAINING GIVES YOU BOTH TECHNICAL KNOWLEDGE—SKILLED HANDS

There's only one right way to learn Radio Electronics. You must get it through simplified lesson study combined with actual "shop" practice under the personal guidance of a qualified Radio Teacher. It's exactly this way that Sprayberry trains you... supplying real Radio parts for learn-by-doing experience right at home. Thus, you learn faster, your understanding is clear-cut, you acquire the practical "know how" essential to a good-paying Radio job or a Radio business of your own.

I'll Show You a New, Fast Way to Test Radio Sets Without Mfg. Equipment

The very same Radio Parts I supply with your Course for gaining pre-experience in Radio Repair work may be adapted through an exclusive Sprayberry wiring procedure to serve for complete, fast, accurate Radio Receiver trouble-shooting. Thus, under Sprayberry methods, you do not have one cent to outlay for manufactured

Test Equipment which is not only expensive but scarce.

DON'T PUT IT OFF!

Get the facts about my training—now! Take the first important step toward the money-making future of your dreams. All features are fully explained in my big, illustrated FREE Catalog which comes to you along with another valuable FREE book you'll be glad to own. Mail Coupon AT ONCE!

ATTENTION VETERANS!

The Sprayberry Radio-Electronics Home Study Course has been fully approved for Veterans Training under the G. I. Bill of Rights. This is important to you! It's your opportunity to get our complete Radio Training through Government grant. Find out about your eligibility AT ONCE!

HOW "JACK THE WEAKLING" SLAUGHTERED THE "DANCE-FLOOR HOG"!

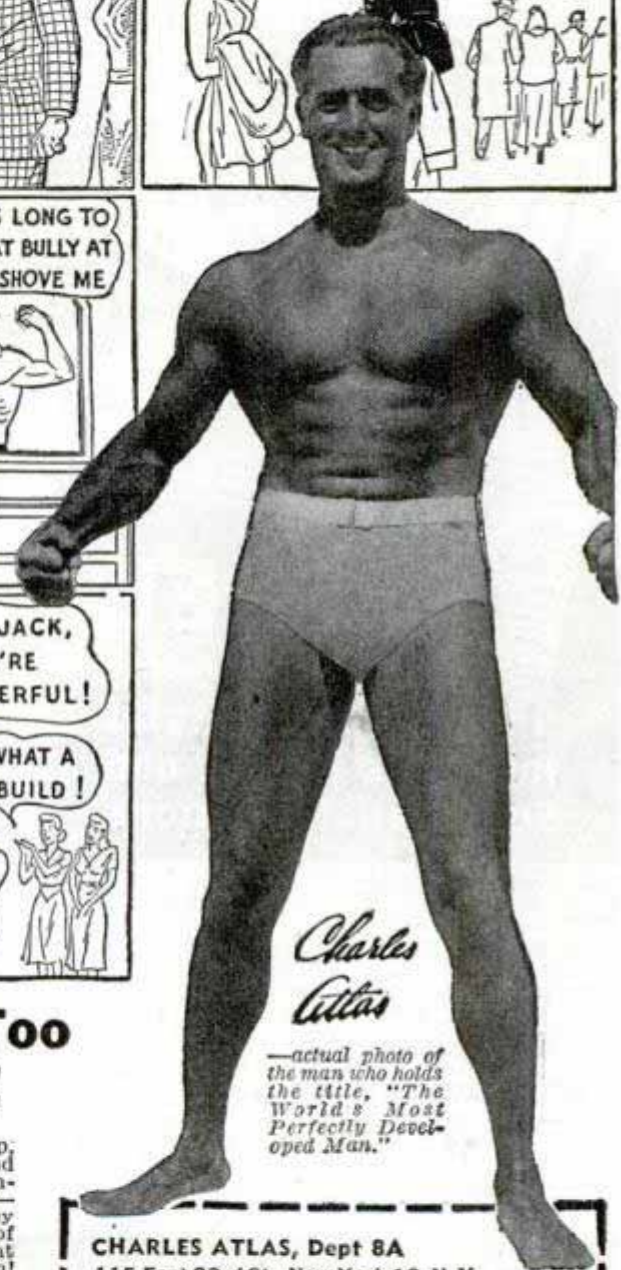
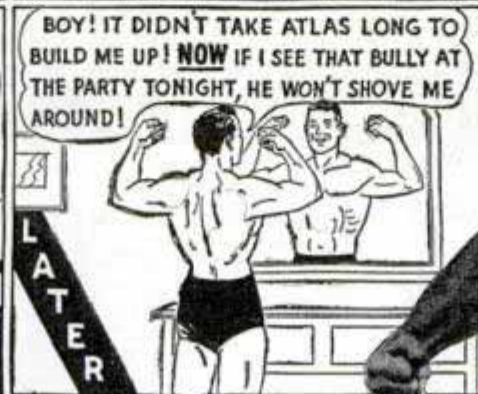
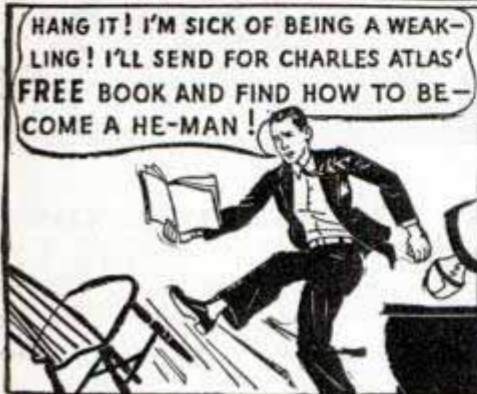

Charles Atlas

—actual photo of the man who holds the title, "The World's Most Perfectly Developed Man."

I Can Make YOU a New Man, Too —in Only 15 Minutes a Day!

HAVE YOU ever felt like Jack—absolutely fed up with having bigger, huskier fellows "push you around"? If you have, then give me just 15 minutes a day! I'll PROVE you can have a body you'll be proud of, packed with red-blooded vitality!

"Dynamic Tension." That's the secret! That's how I changed myself from a scrawny, 97-pound weakling to winner of the title, "World's Most Perfectly Developed Man."

"Dynamic Tension" Does It!

Using "Dynamic Tension" only 15 minutes a day, in the privacy of your own room, you quickly begin to put on muscle, increase your chest measurements, broaden your back, fill out your arms and legs. This easy, NATURAL method will make you a finer specimen of REAL MANHOOD than you ever dreamed you could be!

You Get Results FAST

Almost before you realize it, you will notice a general "toning up" of your en-

tire system! You will have more pep, bright eyes, clear head, real spring and zip in your step! You get sledge-hammer fists, a battering-ram punch—chest and back muscles so big they almost split your coat seams—ridges of solid stomach muscle—mighty legs that never get tired. You're a New Man!

FREE BOOK

Thousands of fellows have used my marvelous system. Read what they say—see how they looked before and after—in my book, "Everlasting Health and Strength."

Send NOW for this book—FREE. It tells all about "Dynamic Tension," shows you actual photos of men I've turned from puny weaklings into Atlas Champions. It tells how I can do the same for YOU. Don't put it off! Address me personally:

Charles Atlas, Dept. 8A,
115 East 23rd St., New York 10, N. Y.



CHARLES ATLAS, Dept 8A
115 East 23rd St., New York 10, N. Y.

I want the proof that your system of "Dynamic Tension" will help make a New Man of me—give me a healthy, husky body and big muscular development. Send me your free book, "Everlasting Health and Strength."

Name.....
(Please print or write plainly)

Address.....

City.....State.....

Check here if under 16 for Booklet A

INVENTORS

LEARN HOW TO
**PROTECT and SELL
YOUR INVENTION**

GET NEW FREE BOOK



FREE

**Invention Record
Know How Successful
Inventors Protect and
Sell Their Inventions**

Our new FREE Book is a book every inventor should have. Mail the coupon today for "How to Protect, Finance and Sell Your Invention" and learn . . .

- How to know if there is a prior U. S. patent on your invention.
- How to save steps in getting patent action.
- How to prepare your application for presentation to the Patent Office.
- How you may patent an improvement on something in use now.
- How to obtain funds to patent and promote your invention.
- How to find a buyer or backer for your invention.
- How to protect yourself in making royalty agreements.

MODERN BUSINESS WANTS INVENTIONS
Practical and novel inventions are in big demand today. The opportunity for quick money is enticing. Sales sources are many if your invention has merit. But, be *sure*—before you place your device in strange hands—that it is fully protected. A United States Patent gives you this protection. *The first step toward inventive success always is—and always has been—the application for a U. S. Patent. There is no other way to protect your invention in accordance with the laws of this country.*

MAKE THIS RECORD NOW If you have an invention, and wish to secure it for the future, act at once. Have it dated now and recorded in our office. We will send you this FREE Invention Record Form for the purpose. Fill out the Invention Record Form fully describing the nature of your invention. Make a sketch of its main features. Mail it to us and we will record the date it was received in our office. **The earlier the date the better your chance of combating rival inventors who may lay claim to your idea later. Don't delay a single minute in taking this important step. Your whole future may depend upon it. Mail the coupon for our FREE Invention Record Blank and New FREE Book today!**

HOW WE SERVE YOU AS REGISTERED PATENT ATTORNEYS

The U. S. Patent Office strongly recommends—unless the inventor is familiar with such matters—that he employ the services of a Registered Patent Attorney in the preparation of his Patent Application. We are Registered Patent Attorneys fully qualified to represent you at the Patent Office. We have had long experience in studying hundreds of types of inventions. This gives us the ability to judge your invention and to describe it accurately and convincingly in technical language. It gives us the perception to center arguments upon those details of your invention which, in our judgment, will be looked upon most favorably by the Patent Office Examiner.

Mail the coupon today for our new FREE Book, "How to Protect, Finance and Sell Your Invention," and our FREE Invention Record Form—maybe this step will pave the way to future security for you and your family. Act Today!

McMORROW & BERMAN

REGISTERED PATENT ATTORNEYS

135-K ATLANTIC BUILDING, WASHINGTON 4, D. C.

Send me your new FREE book, "How to Protect, Finance and Sell Your Invention"—and "Invention Record" form at once, I understand that this request does not obligate me.

NAME

ADDRESS

CITY STATE

(Write or print name clearly)

McMORROW & BERMAN
Registered Patent Attorneys

135-K Atlantic Building, Washington 4, D. C.

THERE is a definite I.C.S. type. The records of 100,000 current students . . . more than 5 million students since 1891 . . . supply the outlines. Here's how the typical enrollee shapes up at the time of beginning his studies:

He is an adult. In good times or bad times, he is an employed man. Circumstances have prevented his attending a college but he is ambitious, intelligent, determined to acquire the specialized training that will help him in his present job and prepare him for a better one.

Does the description fit *you*? Then you'll be interested in what I.C.S. helps these students to achieve. In a single 30-day period we have received as many as 635 student letters reporting advancement in salary and position. In a period of 120 days we have received 1,920 such reports.

Graduates include the presidents, board chairmen, chief engineers or chief chemists of some of the largest steel, airplane, chemical, railroad and electrical equipment companies in the country. Thousands of others have registered substantial successes in their chosen fields. Here's the kind of coupon they signed and mailed.

**are you the
I. C. S.
type of man?**



INTERNATIONAL CORRESPONDENCE SCHOOLS



BOX 5567-K, SCRANTON 9, PENNA.

Without cost or obligation, please send me full particulars about the course *before* which I have marked X:

- | | | | |
|--|---|---|--|
| <p>Air Conditioning and Plumbing Courses</p> <p><input type="checkbox"/> Air Conditioning
<input type="checkbox"/> Heating <input type="checkbox"/> Plumbing
<input type="checkbox"/> Refrigeration <input type="checkbox"/> Steam Fitting</p> <p>Chemistry Courses</p> <p><input type="checkbox"/> Chemical Engineering
<input type="checkbox"/> Chemistry, Analytical
<input type="checkbox"/> Chemistry, Industrial
<input type="checkbox"/> Chemistry, Mfg. Iron & Steel
<input type="checkbox"/> Petroleum Refining <input type="checkbox"/> Plastics
<input type="checkbox"/> Pulp and Paper Making</p> <p>Civil Engineering, Architectural and Mining Courses</p> <p><input type="checkbox"/> Architectural Drafting
<input type="checkbox"/> Architecture
<input type="checkbox"/> Bridge and Building Foreman
<input type="checkbox"/> Building Estimating
<input type="checkbox"/> Civil Engineering
<input type="checkbox"/> Coal Mining
<input type="checkbox"/> Contracting and Building
<input type="checkbox"/> Highway Engineering
<input type="checkbox"/> Lumber Dealer
<input type="checkbox"/> Reading Structural Blueprints
<input type="checkbox"/> Sanitary Engineering
<input type="checkbox"/> Structural Drafting</p> | <p><input type="checkbox"/> Structural Engineering
<input type="checkbox"/> Surveying and Mapping</p> <p>Communications Courses</p> <p><input type="checkbox"/> Electronics
<input type="checkbox"/> Practical Telephony
<input type="checkbox"/> Radio, General
<input type="checkbox"/> Radio Operating
<input type="checkbox"/> Radio Servicing
<input type="checkbox"/> Telegraph Engineering</p> <p>Electrical Courses</p> <p><input type="checkbox"/> Electrical Drafting
<input type="checkbox"/> Electrical Engineering
<input type="checkbox"/> Electric Light and Power
<input type="checkbox"/> Lighting Technician
<input type="checkbox"/> Practical Electrician</p> <p>Internal Combustion Engines Courses</p> <p><input type="checkbox"/> Auto Technician <input type="checkbox"/> Aviation
<input type="checkbox"/> Diesel-Electric
<input type="checkbox"/> Diesel Engines <input type="checkbox"/> Gas Engines</p> <p>Mechanical Courses</p> <p><input type="checkbox"/> Aeronautical Engineering
<input type="checkbox"/> Aircraft Drafting
<input type="checkbox"/> Flight Engineer
<input type="checkbox"/> Foundry Work
<input type="checkbox"/> Heat Treatment of Metals</p> | <p><input type="checkbox"/> Industrial Engineering
<input type="checkbox"/> Industrial Metallurgy
<input type="checkbox"/> Machine Shop
<input type="checkbox"/> Mechanical Drafting
<input type="checkbox"/> Mechanical Engineering
<input type="checkbox"/> Mold-Loft Work
<input type="checkbox"/> Patternmaking—Wood, Metal
<input type="checkbox"/> Reading Shop Blueprints
<input type="checkbox"/> Sheet-Metal Drafting
<input type="checkbox"/> Sheet-Metal Worker
<input type="checkbox"/> Ship Drafting <input type="checkbox"/> Ship Fitting
<input type="checkbox"/> Tool Designing
<input type="checkbox"/> Toolmaking
<input type="checkbox"/> Welding—Gas and Electric</p> <p>Railroad Courses</p> <p><input type="checkbox"/> Air Brake <input type="checkbox"/> Car Inspector
<input type="checkbox"/> Diesel Locomotive
<input type="checkbox"/> Locomotive Engineer
<input type="checkbox"/> Locomotive Fireman
<input type="checkbox"/> Railroad Section Foreman</p> <p>Steam Engineering Courses</p> <p><input type="checkbox"/> Boilermaking
<input type="checkbox"/> Combustion Engineering
<input type="checkbox"/> Engine Running
<input type="checkbox"/> Marine Engineering
<input type="checkbox"/> Steam Electric <input type="checkbox"/> Steam Engines</p> | <p>Textile Courses</p> <p><input type="checkbox"/> Cotton Manufacturing
<input type="checkbox"/> Rayon Weaving
<input type="checkbox"/> Textile Designing
<input type="checkbox"/> Woolen Manufacturing</p> <p>Business and Academic Courses</p> <p><input type="checkbox"/> Accounting <input type="checkbox"/> Advertising
<input type="checkbox"/> Arithmetic <input type="checkbox"/> Bookkeeping
<input type="checkbox"/> Business Correspondence
<input type="checkbox"/> Business Management
<input type="checkbox"/> Certified Public Accounting
<input type="checkbox"/> Commercial
<input type="checkbox"/> Cost Accounting
<input type="checkbox"/> Federal Tax
<input type="checkbox"/> First Year College
<input type="checkbox"/> Foremanship <input type="checkbox"/> French
<input type="checkbox"/> Good English <input type="checkbox"/> High School
<input type="checkbox"/> Higher Mathematics
<input type="checkbox"/> Illustrating <input type="checkbox"/> Motor Traffic
<input type="checkbox"/> Postal Service
<input type="checkbox"/> Salesmanship <input type="checkbox"/> Secretarial
<input type="checkbox"/> Sign Lettering
<input type="checkbox"/> Spanish <input type="checkbox"/> Stenography
<input type="checkbox"/> Traffic Management</p> |
|--|---|---|--|

Name..... Age..... Address.....

City..... State..... Present Position..... Working Hours..... A.M. to..... P.M.

Canadian residents send coupon to International Correspondence Schools Canadian, Ltd., Montreal, Canada.

British residents send coupon to I. C. S., 71 Kingsway, London, W. C. 2, England.

A DISCOUNT TO DISCHARGED VETERANS—SPECIAL TUITION RATES FOR MEMBERS OF THE ARMED FORCES

4 WAYS To Be Your Own Boss!

NOW, more than ever before, is the **right** time to start a small profitable business of your own... or train yourself for a practical money-making trade in which you can be **independent**. TODAY take your first step, without cost or obligation. Just mail coupon—and by return mail you will get full information on the courses listed here.

watch and clock repairing



Learn at Home—In Your Spare Time

Prepare for a happy future of prosperity, security... and get a big-pay job now. Fascinating, high-grade occupation. You can **EARN WHILE YOU LEARN**. Excellent field for part-time work at home.

Practical Course in HOROLOGY

Thorough self-instruction training in American and Swiss watches, clocks. Special sections on alarm clock repairs. Interesting. **LEARN-BY-DOING** instruction method. Learn **QUICKLY**, easily. No previous experience necessary. **BASIC TRAINING FOR AIRCRAFT** and other scientific precision jobs.

Essential WATCHMAKING IS INSTRUMENT WORK and other scientific precision jobs.

Amazing Low Price! • Money-Back Guarantee! Get into this fast-growing field NOW... big opportunity... don't delay. Mail coupon below for **FREE** information. No obligation.

locksmithing and key making

PRACTICAL UP-TO-DATE COURSE

How to pick locks, de-code, make master-keys, repair, install service, etc. New, self-instruction lessons for every handy man, home-owner, carpenter, mechanic, service station operator, fix-it shop, hardware dealer, gunsmith.

53 Easy Illustrated Lessons

Low Price! Satisfaction guaranteed or money back. Write now... no obligation!

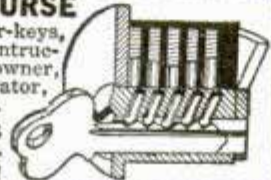

practical RADIO servicing



SELF-INSTRUCTION COURSE

Teaches you the **practical** side of radio... repair, adjustment, operation, alteration, trouble-shooting. No previous knowledge necessary. Large clear illustrations, diagrams, charts, etc. **INTERESTING STEADY WORK!** Set up a radio repair shop of your own—or prepare for booming industrial electronics. This useful, how-to-do-it course brings you all the fundamentals, including mathematics, review questions, problems, answers. Strictly up-to-date. Low price. Coupon below will bring you full information you want immediately. Mail it in today!

MAIL ORDER BUSINESS

Your Big Opportunity!

34-lesson course on proved, tested, up-to-date, **profitable** methods. Amazing treasure-house of the best mail order plans and practices. How to start your mail order business on a small one-man scale... how to keep it growing more and more profitable month after month. Money-making **FACTS**. **WRITE FOR COMPLETE DETAILS ON ANY OF THESE COURSES. Send Coupon for World-Famous Copyrighted Success-Catalog—IT'S FREE!**



NELSON CO., Dept. 3A02, 1139 S. Wabash Ave., Chicago 5, Ill.

FREE details... mail coupon!

NELSON CO., Dept. 3A02, 1139 S. Wabash Ave., Chicago 5, Ill.

Please send me—**FREE** and without obligation—illustrated Success-Catalog containing information about the course (or courses) I have checked below. No salesman will call.

- Watch and Clock Repairing. Locksmithing and Key Making.
 Practical Radio Servicing. Mail Order Business.

NAME _____
 ADDRESS _____
 CITY _____ STATE _____

SAVE WASTE PAPER

STUDY AT HOME

With An Educational Institution

Men with specialized training win higher positions, insure larger earnings, and are bigger successes in business and public life. Opportunities **NOW** greater than ever before. Send for our Catalog.

ARTS and SCIENCES

Courses in Philosophy; Education; Letters; Public Health; Medical Jurisprudence; Psychology; Sociology; Physics; Chemistry; Plastics; Geology; Political Science; Theology; Business and Commerce; Accounting; Mathematics; Statistics; Agriculture.

ENGINEERING

Courses in Electrical, Civil, Mechanical, Drafting, Architectural, Steam, Aeronautical, Radio, Structural, Mining, Industrial, Petroleum, Marine, Chemical, Diesel, Automobile, Refrigeration, and Air Conditioning Engineering.

LAW

Complete Professional Law Course includes 20 Hornbook Series college grade textbooks. Courses also in Commercial Law, Patent Law and Medical Jurisprudence.
 McKinley-Roosevelt Incorporated, 4610-K, Sheridan Rd., Chicago 40, Ill.

Write your own Future in Photography

Prepare now for a well-paid position today and a career that is sound and substantial as well as different, fascinating and profitable. Photography offers ever-increasing opportunities for both men and women. **FREE** book tells how N. Y. I. experts can quickly train you at home or thru resident, day or evening instruction in our up-to-the-minute N. Y. studios. **ALL** branches of black and white, motion picture and **COLOR** photography. Write **TODAY!**

NEW YORK INSTITUTE OF PHOTOGRAPHY
 Dept. 49 10 West 33 Street New York 1, N. Y.

Learn Penmanship

You can learn plain, rapid writing or fancy ornamental writing for social and business advancement, right in your own home during spare time by my Simplified Method. Write for my free book, "How to Become an Expert Penman," which shows what others have accomplished by taking my Courses. Send 10c for one of my favorite Pen Points and your name with a beautiful flourished bird written on a card. Write today. T. M. Tevis, Box 25K, Chillicothe, Mo.

LEARN MONEY-MAKING CARTOONING

IN SPARE TIME — by Easy Picture Chart Method
 Same Simplified Method that has helped train creators of "Terry & Pirates," "Freckles," "Out Our Way," "Winnie Winkle," "Regular Fellers," "Strange As It Seems," "The Neighbors," and many others. Earn while learning. Send 10c for Picture Chart (to test your ability), and full details. (State age.)
 Landon School of Cartooning, Dept. 4601 Philadelphia 11 Pa.



PRINT ANY PHOTO on Paper, Cloth, Leather or Wood

SIMPLE, EASY TO USE
 Magic liquid takes only 2 minutes to reproduce any snapshot you have on to stationery, handkerchiefs, ties, scarfs, etc. Won't wash off. Won't hurt negative or fabric it's used on. Personalize your belongings! An ideal gift. Complete outfit enough to transfer 100 photos—only \$1.00 postpaid. Sent C.O.D. for \$1.21.



CHRISTY PHOTO SUPPLY, Dept. 2110
 2835 N. Central, Chicago 34

MEN! Whether You're 16 or ^{up} to 40.. *Learn* ELECTRICITY



A partial view of one of the Training Departments at Coyne

I'll Finance Your Training

Let me show you how to prepare for a **GOOD JOB NOW**—Get Ready **QUICKLY** for the field that offers **STEADY WORK** and a **REAL FUTURE**

Learn By Doing in 90 Days

Start now to prepare for a **Lifetime of Success**. Get into Electricity, the essential field that will continue to offer good pay and a real future all through the years. Coyne trains you, **NOT** by correspondence, but by actual shop work right on real electrical machinery. Then on my "STUDENT FINANCE" PLAN YOU CAN PAY MOST OF YOUR TUITION IN EASY MONTHLY PAYMENTS AFTER YOUR TRAINING PERIOD IS OVER.

In the Big Coyne Shops you get practical "all-around" training by actual work—not by correspondence. No advanced education or previous electrical experience needed. Many of my students had no previous experience. Others had experience in one or two branches but realized they needed all-around training for the better jobs and advancement.

Earn While Learning

If you are short of money and need part-time work to help pay for your room and board while training, my Employment Department will help you get a part-time job. When you have graduated, they will give you Lifetime Employment Service.

Learn by Doing

You get practical "Learn-by-Doing" training . . . wiring, installing, operating, testing, repairing and servicing various types of Electrical and Electronic equipment . . . you work on real armatures, motors, generators, refrigerators, electronic controls, etc.



PREPARE FOR PERMANENT JOBS LIKE THESE

Light and Power Wiring
Power Plant Work
Armature Winding
Substation Operator
Maintenance Electrician
Electrical Testing and Repair
Signal Maintenance
Industrial Electronics
Electric Refrigeration
and many others
Our Employment Bureau for graduates gives FREE lifetime employment service.

Industrial Electronics and Electric Refrigeration — Included at No Extra Cost

Extra training in these two great fields now can be yours without extra charge, with my Electrical Course. Industrial Electronics and Electric Refrigeration offer big opportunities. Get BOTH at Coyne!



MEN WITH PHYSICAL DISABILITIES —

We also have facilities for men with physical disabilities whether due to war or other causes. Check coupon for particulars if you have a physical disability of any nature.

GET THE FACTS

Don't let lack of money keep you from sending in the Coupon now. My Big FREE Book is full of facts and photographs which tell you about Coyne training. It also gives you the details of my "Student Finance" Plan, Part Time Employment Plan, Graduate Employment Service, Lifetime Membership, etc.

MY GRADUATE EMPLOYMENT SERVICE HAS LETTERS FROM DOZENS OF FIRMS ASKING FOR COYNE TRAINED MEN FOR GOOD JOBS WITH A REAL PEACE-TIME FUTURE.



This modern fireproof building is occupied entirely by the Coyne Electrical School.

VETERANS

Coyne is also equipped to train those who qualify for training under the G. I. Bill of Rights. Check coupon for special G.I. Bulletin

EXTRA TRAINING IN INDUSTRIAL ELECTRONICS AND ELECTRIC REFRIGERATION Now Included! No Extra Cost!

Send Today for this FREE Book!

H. C. LEWIS, President, COYNE ELECTRICAL SCHOOL, 500 S. Paulina St., Dept. 16-72, Chicago 12, Ill.

Without obligation send big free illustrated book with facts about Coyne and details of "Student Finance" Plan and extra training in Industrial Electronics and Electrical Refrigeration you are now including.

- Send special G. I. Bulletin.
- Send physical disability details.

Name.....

Address.....

City.....State.....

COYNE H. C. LEWIS, Pres.
ELECTRICAL SCHOOL
500 S. Paulina St., Dept. 16-72, Chicago, 12



HOW YOU CAN BUILD A MIGHTY BODY

Quickly! Easily! Pleasantly
—in 10 minutes a day in your own home

"The World's greatest molder of men"—at last reveals to you in these five complete book-courses (value \$5 each)

1. How YOU Can Build a Mighty ARM!



A. PASSAMONT
First prize for physical perfection.

house of energy. Ferris writes, "I want to add my sincere gratitude to that of thousands of pupils for wonderful results from your course. Your course is by far the best." If you have a narrow, sunken chest I can improve it so that you will be proud to show it off.

Complete Arm Course

25c

2. How YOU Can Build a Mighty CHEST!

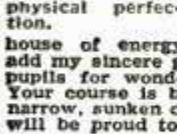

REX FERRIS
Champion of South Africa, says, "I owe everything to Jowett Methods."

Look at the Heroic Chest of this Jowett Pupil. A power-ferris writes, "I want to add my sincere gratitude to that of thousands of pupils for wonderful results from your course. Your course is by far the best." If you have a narrow, sunken chest I can improve it so that you will be proud to show it off.

Complete Chest Course

25c

3. How YOU Can Build a Mighty BACK!



CHAS. SCHAFER
an amazing Jowett product. Once a puny weakling. Now versatile athlete.

Look at his rock-like Back now! He says, "You have worked wonders for me. You are head and shoulders above the rest in your profession." Let me help YOU, TOO, build a back of power. Square shoulders with enviable military spread. A spine as strong as a steel shaft.

Complete Back Course

25c

4. How YOU Can Build a Mighty GRIP!

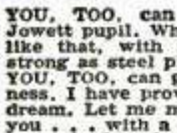

W. BURNS
A Jowett-made Olympic Strength Champion.

YOU, TOO, can have a Manly Grip like this Jowett pupil. What would you give for a forearm like that, with its bone-crushing grip? Fingers strong as steel pincers. A hand like an iron vise. YOU, TOO, can get these symbols of real manliness. I have proved to thousands this is no mere dream. Let me mold a pair of arms like this for you... with a grip of might, a handshake that will win friends—success.

Complete Grip Course

25c

5. How YOU Can Build Mighty LEGS



BOB MITCHELL
A Jowett Champion—not in words but by ACTUAL RECORDS.

What would you give to have the all-round he-man strength of Bob Mitchell? It's reasonable to assume that what I have done for thousands, I can do for you. I myself increased my thighs by 8 inches, my calves by 8 inches, by this simple, unbeatable method. I'll help you build legs that are real props of leaping, tireless power!

Complete Leg Course

25c

Last Chance! Get All 5 Picture Courses for \$1.00

Send for them now and learn the "World's Greatest Secrets of Body Building." FREE! Marvelous Photo Book of Famous Strong Men, "Nerves of Steel—Muscles like Iron".

RUSH COUPON NOW

BOOK WITH PHOTOS OF FAMOUS STRONG MEN
MAIL COUPON NOW FREE

Jowett Institute of Physical Culture
230 Fifth Avenue, Dept 931-A, New York 1, N. Y.
George F. Jowett: Your proposition looks good to me. Send by return mail, prepaid, the courses checked below, for which I enclose (). Include FREE book of PHOTOS.
 All 5 courses for . . . \$1 Molding Mighty Legs 25c
 Molding a Mighty Arm 25c Molding a Mighty Grip 25c
 Molding a Mighty Back 25c Molding a Mighty Chest 25c
 Send all 5 C.O.D. (\$1 plus postage.) No orders less than \$1 sent C.O.D.

NAME Age
(Please print plainly. Include Zone Number.)

ADDRESS

SAY YOU SAW IT IN POPULAR MECHANICS

BECOME A SERVICE EXPERT

REFRIGERATION and AIR CONDITIONING

Millions of Older Units Need Expert Service. Big After-the-War Expansion Will Create Even More Opportunities

Approved for Veterans "G.I." Training

Now, not "next week," is the time to start training for a top-pay job in this vital field. A drastic shortage of trained service experts exists. Many thousands more will be needed for big post-war expansion caused by new industrial uses. Train NOW to get your pick of best jobs. We will give you the practical training you need. For 2 years we trained men and women for the Army and Navy only, in fine-precision aircraft instrument work. So our methods must be right. Common schooling is all you need. Our unique system makes everything easy to grasp. You can train at home and in our big Chicago shops. Write for full facts TODAY, without obligation.

INDUSTRIAL TRAINING INSTITUTE

2150 Lawrence Avenue, Dept. PIN, Chicago 25, Illinois

Trains MAGAZINE

The illustrated monthly about railroads

Travel America in your armchair with TRAINS, the magazine which tells what the railroads do and how they do it. Fine maps, photos and explanatory diagrams. Read now about the new streamliners you'll soon be riding... Ask your newsdealer or send 25 cents for a copy.

TRAINS MAGAZINE, Dept. M, Milwaukee, 3, Wis.



PLAY GUITAR LIKE THE COWBOYS DO... 8 1/3 A LESSON

Just out—very latest guaranteed, simple, easy method. Play cowboy songs the Western way in a few minutes by ear. Surprise and amaze your friends. In big demand at parties, camps, public entertainments, on the radio, etc. 12 Complete Lessons. SEND NO MONEY. Pay postman only \$1.00 plus postage and C.O.D. charges, or send \$1.00 and get EXTRA SONGS all postpaid. (Canada, \$1.25 money order only.) Nothing else to buy. Positive money back guarantee. Rush order today. WESTERN RANGER STUDIOS, Dept. 151, Hutchinson, Kans.

TRI-STATE COLLEGE

B. S. Degree in 27 Months

Distinguished for technical 2 1/4-year courses in Civil, Electrical, Mechanical, Chemical, Radio, Aeronautical Engineering; Business Administration, Accounting, and Secretarial Science. EX-SERVICE MEN can complete work here in shortest possible time. Special Prep. Dep't. Also REFRESHER COURSES. 36-Week Courses in Surveying, Drafting. Low tuition. Low living costs. Cosmopolitan student body. 62nd year. Enter Sept., Jan., March, June. Catalog. 416 College Ave. ANGOLA, INDIANA

LEARN PORTRAIT PAINTING AT HOME

● Previous art training or talent NOT necessary. The Stuart System teaches you, in 11 easy-to-follow lessons, to (1) locate features exactly to correspond to model's features, (2) outline head and face to correspond to model's outline, (3) make each feature a true portrait of that feature in the model, (4) produce shadows and shading that exactly correspond to that of model's face, (5) mix flesh paint tints that are like living flesh. Our students' portraits look alive. You, too, can make exact charcoal and oil likenesses. Send for free booklet today.

STUART STUDIOS,

121 Monument Circle, Room 616, Indianapolis 9, Ind.

Please send me free book and outline of lessons.

Name _____

Street _____

City _____ State _____

POPULAR MECHANICS

WHICH OF THESE *Opportunities* INTERESTS *You* MOST?

Accounting & C. P. A.
Air Conditioning
Architecture & Building
Automotive Engineering
Aviation—Practical
Aviation Drafting & Design
Better Foremanship
Bookkeeping
Business Management
Contracting

Diesel Engineering
Drafting & Design
Electrical Engineering
Electricity—Practical
Electronics, Industrial
High School Courses
Machine Shop Operations
Mechanical Engineering
Plastics Engineering
Plumbing—Practical

Private Secretary
Radio Operating & Servicing
Railway Training
Refrigeration
Sheet Metal Pattern Drafting
Shop Management
Surveying & Topographical
Drafting
Tool Making

THINK! LOOK FORWARD!

Business is making Post-war plans

Men and Women are preparing for the future

WHAT ARE YOU DOING ABOUT YOUR TOMORROWS?

● *Today*, choose the job you want—and prepare for it. Or if you are already engaged in the work you like best, start training *now* for quicker promotion. Acquire the knowledge that will help you to get ahead faster, make more money and have greater security.

Invest part of your spare time in more rapid progress. Start training now, in spare time in your own home. Be ready to grasp your opportunity and step out ahead of those who lack the ability you have attained.

American School, founded in 1897 as an educational institution *not for profit*, can help you to reach your goal just as it has helped others during the past forty-eight years. Give serious thought to the list above. Pick one or more subjects that interest you. Then check the coupon at right, add your name and address and mail it at once. The school will send you details on its training plan and outline of study prepared by specialists. There is no charge, no obligation, so send the coupon immediately.

PRACTICAL, EFFECTIVE HOME - STUDY TRAINING SINCE 1897

Take This First Easy Step

CHECK, CLIP AND MAIL COUPON NOW

AMERICAN SCHOOL, Dept. G145, Drexel at 58th, Chicago 37, Ill.
Without obligation, Please send FREE and postpaid, bulletin and details of the Subject checked.

- | | | |
|--|---|--|
| <input type="checkbox"/> PLASTICS ENG'R | <input type="checkbox"/> Accounting & C.P.A. | <input type="checkbox"/> Drafting and Design for Men and Women |
| <input type="checkbox"/> Refrigeration | <input type="checkbox"/> Bookkeeping | <input type="checkbox"/> Radio |
| <input type="checkbox"/> Architecture and Building | <input type="checkbox"/> Private Secretary | <input type="checkbox"/> High School |
| <input type="checkbox"/> Contracting | <input type="checkbox"/> Diesel Engineering | <input type="checkbox"/> Air Conditioning |
| <input type="checkbox"/> Practical Plumbing | <input type="checkbox"/> Surveying & Topographical Drafting | <input type="checkbox"/> Mechanical Eng. |
| <input type="checkbox"/> Automotive Engineering | <input type="checkbox"/> Sheet Metal Pattern Drafting | <input type="checkbox"/> Shop Management |
| <input type="checkbox"/> Aviation Drafting | <input type="checkbox"/> Electrical Engr. | <input type="checkbox"/> Tool Making |
| <input type="checkbox"/> Aviation | <input type="checkbox"/> Electricity-Pract. | <input type="checkbox"/> Better Foremanship |
| <input type="checkbox"/> Business Mgmt | <input type="checkbox"/> Electronics, Industr. | <input type="checkbox"/> Machine Shop Operations |
| <input type="checkbox"/> Railway Training | | |

Name..... Occupation.....

Address..... Age.....

City..... State.....

AMERICAN SCHOOL

Dept. G145, Drexel at 58th Street, Chicago 37

BE READY FOR
A BETTER JOB
AT BIGGER PAY



PREPARE *Now*
FOR POST-WAR
BUILDING
BOOM

Thousands of
Trained Men
Will Be Needed

Now that war has ended, new homes and other structures to be built will provide a tremendous number of well-paid jobs. Men trained in Architecture, Drafting, Contracting, Carpentry and related building trades will cash in BIG on their knowledge and skill. YOU can train in spare time at home, at low cost, for a big-pay job in this rich field. American School can help you to succeed just as it has helped others during its 49 years. Check, fill in and mail coupon NOW for FREE information.

AMERICAN SCHOOL, Dept. B145, Drexel Ave. at 58th St., Chicago 37, Ill.

Send me FREE information about your special training plan covering subjects checked below.

- | | |
|--|--|
| <input type="checkbox"/> Architecture and Building | <input type="checkbox"/> Automotive Engineering |
| <input type="checkbox"/> Drafting and Design | <input type="checkbox"/> Diesel Engineering |
| <input type="checkbox"/> Contracting | <input type="checkbox"/> Mechanical Engineering |
| <input type="checkbox"/> Practical Plumbing | <input type="checkbox"/> Plastics Engineering |
| <input type="checkbox"/> Air Conditioning | <input type="checkbox"/> Aviation <input type="checkbox"/> Radio |
| <input type="checkbox"/> Refrigeration | <input type="checkbox"/> Business Management |
| <input type="checkbox"/> Electrical Engineering | <input type="checkbox"/> High School Courses |

Name.....

Address.....

Keep that "TICKING"
Car



Every operator and mechanic needs AUDELS AUTO GUIDE.

This book saves time, money and worry. Highly endorsed. It presents the whole subject of auto mechanics:

- 1—Basic principles
 - 2—Construction
 - 3—Operation
 - 4—Service
 - 5—Repair
- Handy Size, Easily understood.

588 PAGES
4500 ILLUSTRATIONS



NEW FLUID DRIVE, HYDRAULIC SHIFT AND DIESEL ENGINES FULLY COVERED

Over 1500 pages—1540 illustrations showing inside views of modern cars, trucks and buses with instructions for all service jobs.

ASK TO SEE IT!—To Get This Assistance for Yourself Simply Fill in and Mail Coupon Today.

4 COMPLETE • PAY ONLY \$1. A MONTH ←

AUDEL Publishers, 49 West 23rd St., New York
MAIL AUDELS NEW AUTO GUIDE for free examination. If O.K. I will send you \$1 in 7 days; then remit \$1 monthly until price of \$4 is paid. Otherwise I will return it.

Name.....
Address.....
Occupation.....
Employed by..... PM

Do You Make Mistakes in English?

EVERY time you speak or write you show just what you are. Misrefinement in English reveals you as a person who lacks education and refinement. Lack of language power prevents you from presenting your thoughts in the strongest possible way. No matter what you do, real command of English will help you to your goal. Stop making mistakes in spelling, punctuation, pronunciation. Increase your vocabulary.



WONDERFUL INVENTION

Only 15 minutes a day with Sherwin Cody's new invention—and you can actually SEE your English improve. It teaches by HABIT—makes it easier to do the RIGHT way. Wonderful self-correcting lessons include spelling, punctuation, grammar and expression.

FREE BOOK ON ENGLISH Lack of language power may easily be costing you friendships, income every year. See what Mr. Cody can do for you; it costs nothing to find out. Mail a postal card or letter this very minute for free book, "How You Can Master Good English in 15 Minutes a Day." It will prove a revelation to you. WRITE NOW. Address:

Sherwin Cody School of English, 51 B & O Bldg., Rochester 4, N. Y.

LAW...

STUDY AT HOME Legally trained men win higher positions and bigger success in business and public life. Greater opportunities now than ever before.

More Ability: More Prestige: More Money We guide you step by step. You can train at home during spare time. Degree of LL.B. We furnish all text material, including 14-volume Law Library. Low cost, easy terms. Get our valuable 48-page "Law Training for Leadership" and "Evidence" books FREE. Send for them NOW.
LASALLE EXTENSION UNIVERSITY, 417 South Dearborn Street
A Correspondence Institution Dept. 184-L Chicago 5, Ill.

FREE Music Catalog

OVER 1300 STANDARD, CLASSICAL & TEACHING PIECES for piano, violin and voice in World Famous McKinley Sheet Music and Book Editions—the teachers' standard for nearly 50 years. Splendid arrangements. Write today enclosing 5 cent stamp for return postage. Dept. 3371.
McKINLEY PUBLISHERS, Inc., 425 S. Wabash, Chicago 5

THERE'S MONEY IN CARTOONS!

RAYE BURNS will teach you HOW to CREATE ORIGINAL CARTOONS at home that you may SELL! Course contains 26 lessons and over 600 illustrations. All for Only..... **\$2.85**

Send name and address for free details.
RAYE BURNS SCHOOL, Dept. M, Box 3583, CLEVELAND, OHIO



Begin today. Write now for our Free Book, "How to Become a Good Penman." It contains specimens and tells how others learned to write in spare time. Enclose 10c for your name beautifully written and a pen point suitable for shaded writing. Write today.
THE TAMBLYN SCHOOL OF PENMANSHIP
N-441 Ridge Building, Kansas City, Mo.

IDEAS and INVENTIONS... WANTED...

Cash in on your new ideas, inventions and methods now! Responsible buyers reach you quickly and easily through the Nation-Wide Bureau of Ideas. This free service costs you absolutely nothing, offers complete protection. Write for all details today.
MORTON MANUFACTURING COMPANY,
353 North Leamington Avenue, Chicago 44, Illinois.

Photography for



PLEASURE or PROFIT

Learn at home. Spare time. Practical basic training. Long-established school. Many have earned while learning. Send coupon below for free booklet, "Opportunities in Modern Photography" and full particulars.

AMERICAN SCHOOL OF PHOTOGRAPHY
1315 Michigan Avenue Dept. 1351 Chicago 5, Illinois
Send booklet, "Opportunities in Modern Photography," full particulars and requirements.
Name..... Age.....
Address.....
City..... Zone..... State.....

See how readily YOU can train at home for BIGGER EARNINGS in RADIO ELECTRONICS



FREE KIT PACKET SHOWS HOW YOU CAN GET LOTS OF "LEARN-BY-DOING" RADIO EXPERIENCE AT HOME FROM DeFOREST'S THRILLING RADIO "Home Laboratory"

133 EXPERIMENTS

DeForest's Kit Packets show how you can get real Radio experience from the many standard Radio parts furnished you with DeForest's Training. See how you may quickly build Radio Circuits that work... how you may experiment with Photo Electric Cell "Magic"... a 5-Tube Superheterodyne Receiver... a Radio Telephone and scores of other fascinating projects. See how you get actual "shop training" at home to give you the practical Radio experience you need.

VETERANS!

Big things are happening at De Forest's for veterans! See how we may prepare you without cost for a GOOD JOB or BUSINESS OF YOUR OWN in the vast Radio-Electronic opportunity field.

DeFOREST'S PROVIDES ALL 3 HOME TRAINING AIDS

- A** DeVry Movie Projector and Learn-By-Seeing Movie Film
- B** Actual Radio Parts for working out 133 experiments
- C** 90 lessons prepared under the supervision of Dr. Lee DeForest—the "Father of Radio."



Now—you can see for yourself why DeForest's Training does such a grand job of preparing men for a bright future in one of America's most promising opportunity fields—Radio and Electronics. Send the coupon below for your free "Kit Packet" plus the big free book, "Victory For You!" that has helped so many to good pay jobs. You'll be surprised at the opportunities ahead of FM Radio, Aviation Radio, Broadcast Radio, a profitable Business of Your Own, Motion Picture Sound Equipment, and Electronics—plus the exciting future possibilities ahead of Television, Radar, etc. You can train in your spare time at home—or you may get all of your training in our Chicago laboratories.

You Also Get EFFECTIVE EMPLOYMENT SERVICE

Upon completing your training, you get the full benefit of DeForest's Employment Service that has helped so many men to get started in the Radio-Electronic field.



DeFOREST'S TRAINING INCLUDES INSTRUCTION IN MOTION PICTURE SOUND EQUIPMENT, FM RADIO AND TELEVISION... RESIDENTIAL TRAINING IN OUR MODERN CHICAGO LABORATORIES ALSO AVAILABLE —ASK US FOR INFORMATION!

E. B. DeVry, President
DeFOREST'S TRAINING, INC.
2535-41 North Ashland Ave., Dept. PM-CI
Chicago 14, Illinois, U.S.A.

Send FREE RADIO KIT PACKET and "VICTORY FOR YOU!" BOOK.



Name _____ Age _____
Address _____
City _____ Zone _____ State _____
 If under 16, check here for special information. If a discharged Veteran of World War II, check here.

DeFOREST'S TRAINING, INC.
CHICAGO 14, ILLINOIS



SO IT NEEDS FIXING

By S. T. CHRISTENSEN
the "Fix-it Man"

WELL, I guess I'm the fellow to see, for I've repaired thousands of refrigerators (home and commercial both), vacuum cleaners, radios, washing machines, irons, fans, lamps, mangles, motors, etc. In fact, many of my customers call me their "electrical appliance doctor." And, "doctoring," I might add, has paid me a good substantial income for quite a few years. Funny, in a way, how I got started. Always liked to tinker and by experimenting around I found that most electrical appliances had many things in common. That, regardless of what the appliance was used for, or who the manufacturer was, the basic principles were much the same. From fixing my own appliances to fixing friends' and then for strangers at a fee, seems now to have been but a small step.

What to Charge?

At first, I let the owner decide the charge and, frankly, I was amazed at what I earned per hour. But then, when one figures what initial costs are involved in buying most electrical appliances, one can readily see that spending extra dollars for repairs is well worth while. Before long I was making more in my spare time repairing than from my regular job. The result . . . I went into business for myself. When war came, business boomed, for new appliances were not available.

For a while, repair parts (needed on some

jobs) were a little difficult to get. But that situation seems to have adjusted itself for many repair parts have today the high priority rating of AA2. After all, we must provide for the health and well-being of our civilian population.

The Future Offers

Friends ask me about my future. And, I think I've got a grand one. Age is no handicap in repairing. I have in my files enthusiastic letters from repairmen ranging in age from 18 to 79 years. After the war, we're bound to see hundreds of new products on the market . . . products that the average person never dreamt of. These new products and our old appliances are all going to need at some time or other "fixing." Well, I'll still be the fellow to do it. The field open for appliance repairmen is unlimited. I don't worry at all about too much competition.

If You Are Ambitious

To the contrary, I've prepared a complete course, chuck full of simple, easy to understand photos and drawings and written in the same non-technical language as this article. I know the course is good, because I have hundreds of men all over the country writing to me telling me how the course has helped swell their pockets with cash. If you too want to prepare now for your future, I suggest you read the next page and send me the handy coupon."

Advertisement



**BIG MONEY
INDEPENDENCE**

*A PROFITABLE
LIFETIME
BUSINESS
OF
YOUR OWN!*

LEARN ELECTRICAL APPLIANCE REPAIRING

PREPARE NOW FOR THE FUTURE

If now in war work, start your home appliance repair business NOW in your spare time and be set with a business of your own when the war is over. You don't need elaborate fixtures or expensive equipment to be a successful repairman. Operate from your garage, basement, vacant store, etc. Work as many hours as you wish—the home appliance repairman is his own boss. It is a profitable occupation for on many types of repairs it is not unusual for a repairman to charge on the basis of \$5.00 to \$6.00 per hour. Don't gamble with your future—learn a trade that will always support you. Remember, as long as electrical appliances are used, there will be a need for electrical appliance repairmen.

If you are at all mechanically inclined—can hold and use tools—then you have all of the qualifications required for becoming a big money earning home appliance repairman. It does not matter if you have not had a great deal of schooling or had previous experience along these lines—WE WILL TEACH YOU. Age should be no barrier—nor should any minor physical handicap.

New Course Tells All

Profusely illustrated, our new course shows you in simple, easy to understand language and drawings how to make each repair on refrigerators, vacuum cleaners, washing machines, motors, etc. Explains and gives you a working knowledge of electricity, welding, nickel plating, etc. Shows you how to build the power tools you need and how to solicit and keep business coming to you. Not a theory course but an honest to goodness course written by and used by repairmen the country over. Price of course is so low that the savings on your own household appliance repairs will quickly pay for it. Act now! Mail the handy coupon below today.

-----Read What Our Students Say About Course-----

I really believe your course the best investment a mechanically minded man can make.—Claude E. Allen, Indianapolis, Ind.

I have received your Course in Appliance Repairing and I must say I am well pleased with same. I am only sorry I did not have said Course some years ago. I have learned so much more through this course I would not part with it.—Charles Schwarz, Hamilton, Ohio.

The Course in Appliance Servicing arrived a few days ago. Want to take out a few minutes of my valuable time to let you know that this is just what I have been looking for ever since I opened up my Fix-It shop. I must admit that you told the truth when you said that it contains quite a bit more information than I bargained for.—P. J. Bretl, Sebring, Ohio.

I am a mechanic for the Western Union Telegraph Co. Three days after receiving the lessons in refrigeration I earned the exact cost of the course.—Henry S. Lee, Washington, D. C.

I work day times at the shipyard and after 4:00 P.M. I operate from my cellar and garage. I average \$10.00 to \$15.00 clear every day.—Walter Hanhy, Brockton, Mass.

GET STARTED TODAY—MAIL THIS COUPON

CHRISTY SUPPLY CO.
2835 N. Central Ave., Dept. D-2903
Chicago 34, Illinois

Please send me free illustrated literature about America's Fastest Growing Industry — ELECTRICAL APPLIANCE REPAIRING.

Name.....

Address.....

City..... State.....



HAVE THIS

Staff of Specialists

PATENT YOUR



PROFIT BY THE EXPERIENCE

NO MATTER HOW GOOD . . . how original or practical your invention may be, the commercial value of your patent protecting that invention depends almost entirely upon the careful, capable preparation of specifications and strong claims covering it. You assume a risk if you entrust your patent application to anyone who is not thoroughly experienced and entirely familiar with all intricate phases of patent procedure.

SEND AT ONCE FOR THESE BOOKS . . . THEY'RE FREE

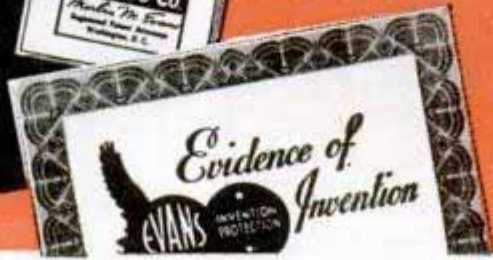
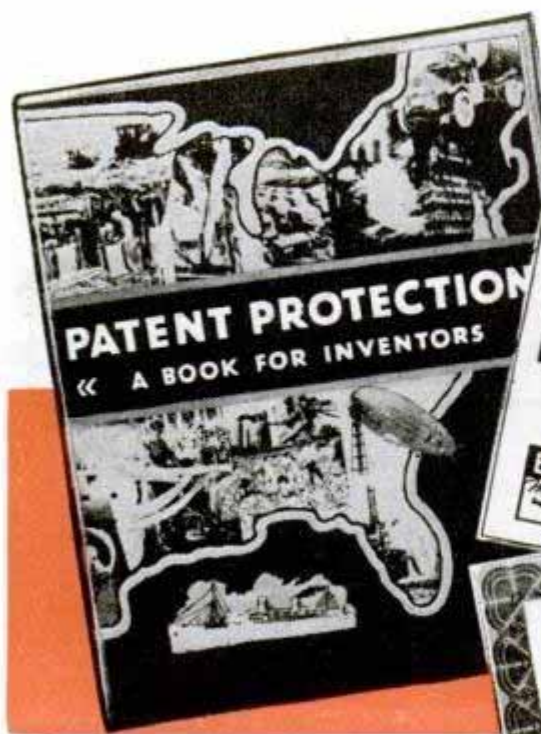

Here are two plainly written books which this thoroughly experienced, dependable firm will be glad to send you absolutely free. "Patent Protection" tells you, step by step, how to safeguard your invention . . . tells you about pertinent Patent Laws . . . illustrates 115 mechanical movements that may help you develop, complete or improve your invention. "When and How to Sell Your Invention" gives you valuable ideas on how to commercialize your patent . . . discusses royalties, infringements . . . tells you how to approach a manufacturer. Sent with books is free "Evidence of Invention" form which may help establish the date of your disclosure to us . . . an important date should another inventor file application for a patent on the same invention.

GET THE COUPON INTO THE MAIL AT ONCE.

64 FACT-PACKED PAGES

OF INFORMATION FOR INVENTORS AND THE IMPORTANT "EVIDENCE OF INVENTION" FORM

HELP YOU

INVENTION!



OF OTHERS

HERE'S EXPERIENCE . . . Victor J. Evans & Co. has helped and wisely advised individual inventors for almost half a century. Our staff is made up of specialists . . . men who are intimately familiar with patent application procedure. They are skilled in the preparation and presentation of patent drawings, specifications and claims. Their knowledge will save you time, trouble and money. Their object is to secure for Evans clients the strongest possible patents which their inventions warrant.

READ THESE QUOTATIONS FROM TYPICAL LETTERS DRAWN FROM OUR FILES *

" . . . I wish to thank you for your kind cooperation, and assure you that if I or any of my associates are in need of a patent lawyer in Washington, we will certainly recommend your services . . ." D. C. M.
" . . . I wish to thank you for the Patent Papers just received, and wish to say that my dealings with you have been satisfactory, and very pleasant. And, that the time may not be too far away when I may employ your services again. . ." F. T. F.
" . . . I wish to express my appreciation for your services and congratulate you upon the successful prosecution of this application. . ." J. R. J.

* Names and addresses upon request.

PRESENT DEMAND FOR NEW PRODUCTS A GOLDEN OPPORTUNITY FOR INVENTORS

Today, the opportunities for inventors are almost unlimited. Manufacturers everywhere are crying for new, practical ideas and improvements on products and processes of manufacturing. But—to be in the best position to talk to manufacturers you should file your application for a patent **FIRST** . . . manufacturers prefer it that way. **You should act quickly.** Remember . . . your patent will give you 17 years "exclusive right to make, use and sell."

VICTOR J. EVANS & Co.

Merlin M. Evans
Registered Patent Attorney

Main Office: 130-A Merlin Building
Washington 6, D. C.
Pittsburgh Office: 521-N Empire Building
Los Angeles Office: 738-N Security Building
Rush by return mail free copies of your books, "Patent Protection" and "When and How to Sell an Invention"—also important—"Evidence of Invention" form.
Name.....
Address.....
City and State.....

Coupon
BRINGS YOU THESE 2 BOOKS
Free!

The Steady Pay Profession Good Times or Bad!

SCIENTIFIC CRIME DETECTION

FOLLOW
THIS MAN

Operator
No. 38



It Is Easy to Learn!

I will teach you this fascinating science during your spare time at home. It pays to be an expert in Finger Printing, Firearms Identification, Police Photography and Secret Service Methods. I have trained hundreds of men and women now successfully serving in identification bureaus throughout America. You, too, may quickly prepare yourself to become a well-paid valued officer of the law, often sharing in the generous rewards offered for wanted criminals.

FREE! 53 PER CENT

"BLUE BOOK OF CRIME"

This book is full of exciting information on scientific crimedetection. It will show how You can get started in a grand career. Now, at amazingly low cost. Clip coupon now... Mail it today.

of all Identification Bureaus in the U. S. employ students and graduates of I. A. S. A majority of these men are heads of Bureaus. Many of them knew nothing about crime detection before training with me. Now they have steady jobs, good salaries and a fine future. Write today for full particulars and free book. Give age.

INSTITUTE OF APPLIED SCIENCE

1920 Sunnyside Ave., Dept. 1351 Chicago 40, Ill.

INSTITUTE OF APPLIED SCIENCE
1920 Sunnyside Ave., Dept. 1351, Chicago 40

Gentlemen: Without any obligation on my part, send me the "Blue Book of Crime," and complete list of Identification Bureaus employing your students or graduates, together with your low prices and Easy Terms Offer. (Literature will be sent ONLY to persons stating their age.)

Name.....

Address.....

Age.....

AUDELS Carpenters and Builders Guides 4 vols. \$6

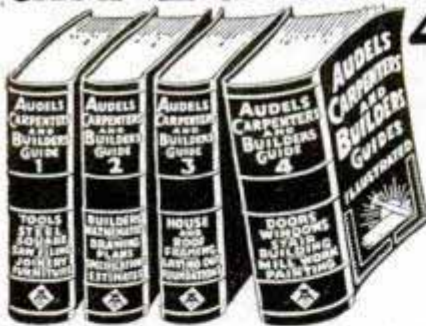

Inside Trade Information for Carpenters, Builders, Joiners, Building Mechanics and all Woodworkers. These Guides give you the short-cut instructions that you want—including new methods, ideas, solutions, plans, systems and money saving suggestions. An easy progressive course for the apprentice and student. A practical daily helper and Quick Reference for the master worker. Carpenters everywhere are using these Guides as a Helping Hand to Easier Work, Better Work and Better Pay. To get this assistance for yourself, simply fill in and mail the FREE COUPON below.

Inside Trade Information On:

How to use the steel square—How to file and set saws—How to build furniture—How to use a mitre box—How to use the chalk line—How to use rules and scales—How to make joints—Carpenters arithmetic—Solving mensuration problems—Estimating strength of timbers—How to set girders and sills—How to frame houses and roofs—How to estimate costs—How to build houses, barns, garages, bungalows, etc.—How to read and draw plans—Drawing up specifications—How to excavate—How to use settings 12, 13 and 17 on the steel square—How to build hoists and scaffolds—skylights—How to build stairs—How to put on interior trim—How to hang doors—How to lay floors—How to paint



THEO. AUDEL & CO., 49 W. 23rd St., New York City

Mail Audels Carpenters and Builders Guides, 4 vols., on 7 days' free trial. If O.K. I will remit \$1 in 7 days, and \$1 monthly until \$6 is paid. Otherwise I will return them. No obligation unless I am satisfied.

Name.....

Address.....

Occupation.....

Reference..... PM

INTRODUCING-New Victory Model HANDIWELD ELECTRIC

ARC WELDER

RETAILS
ONLY
\$1.95

FULLY
GUARANTEED



PLUGS INTO LIGHT SOCKET

Victory Model Handiweld Arc Welder operates from 110 volts, A.C. or D.C. current same as other arc welders higher priced; generates tremendous heat to weld all metals. Not a toy welder that uses carbon, but actually uses standard coated rods—sizes 1/16" and 3/32". However, due to Priorities a generous supply of 1/16" rods only are supplied with the welder. Guaranteed not to burn out. Repairs fenders, auto bodies, radiators, machinery parts, etc. Take Victory Model Handiweld anywhere to job, operate right from light socket. You'll find a thousand uses for this welder around

your home, garage, workshop. Also in garages, factories, repair shops, tin shops; mechanics, inventors, plumbers, farmers, etc. Order a "Victory Model" Handiweld now.

SEND NO MONEY We'll rush one to you with rods, helmet, operating instructions, and all necessary parts with the exception of a large jar and a small piece of extension cord; these most everyone has. Pay postman only \$1.95 plus a few cents postage. If not delighted return Victory Model Handiweld in 5 days from receipt and money paid for it will be refunded promptly. Rush your order now.

KUMFY PRODUCTS, Dept. D-202, CINCINNATI 26, OHIO



DRAW CARTOONS

BIG MONEY!

EASY . . . PLEASANT WORK!

Let CHAS. H. KUHN, with 25 years actual experience in drawing a daily newspaper cartoon, teach you how to create, draw and sell your work. 52 complete lessons—one sent each week. Professional criticism on every lesson. Write today.

Complete Course
Only \$15.00

KUHN SCHOOL OF CARTOONING

420 MURPHY BUILDING Dept. M INDIANAPOLIS 4, INDIANA

Inventions Wanted Patented or Unpatented

Inventions can now be safely sold without patenting expense. If you have a practical, useful idea for sale, either unpatented or patented, write

INSTITUTE OF AMERICAN INVENTORS
Dept. 4, 1926 Eye St., N.W. Washington 6, D. C.

HIGH SCHOOL AT HOME

Most well-paid positions demand high school training. Without it, or equivalent, you can't advance to the full extent of your abilities in any trade, business or profession. Whatever your age, however you're situated, IT ISN'T NECESSARY TO STRUGGLE UNDER THAT HANDICAP. I.C.S., famous for more than 50 years, enables you to start your own high school in your own home. You're in a class by yourself—study in your spare time—acquire a high school education at astonishingly low cost. Authoritative text! Rapid Progress! Write today for free booklet.

INTERNATIONAL CORRESPONDENCE SCHOOLS BOX 5568-K, SCRANTON 9, PENNA.

Send me full information on the following subject:

Name.....Age.....

Home Address.....

City.....State.....

Present Position.....Working.....

Hours.....A.M. to.....P.M.

GET INTO RADIO ELECTRONICS & TELEVISION NOW!

Hundreds of Industries Need Radio and Television Men Now and for Great Future Demands

The man trained in electronics is wanted not only in Aviation, Transportation, Communications, ... in the designing, engineering and operation of hundreds of industries today and for years to come. Learn how great the field is for YOU... How you may GET INTO BUSINESS FOR YOURSELF. Mail the coupon now.



Send for FREE Lesson and Prove to Yourself How Quick and Easy You Get Ahead in Radio by the NEW

SHOP METHOD HOME TRAINING OF THIS GREAT, ESTABLISHED RESIDENT SCHOOL



Learn by Doing!
Use real Radio Equipment Furnished with your Course

Experience is the best teacher and you learn by experience with the National Shop Method of Home Training. You build a long distance, high fidelity, superheterodyne receiver—build many other circuits and conduct experiments with the big kits of standard radio parts included with your training at no extra cost.

Here is the kind of training that gives you a first hand knowledge advanced and approved means and methods. Not only do you understand the basic principles of the industry but you become expert with practical experience. Send the coupon for detailed information on all the different departments of this course of training.

CHOOSE YOUR FUTURE

1. Radio is a \$6-billion business. Radar, just starting, already does \$2-billion a year.
2. Thousands of men needed for stations and communication companies—for operation and maintenance.
3. Half million jobs in Television right at start is the opinion of industrial leaders.
4. Limitless future in Electronics—in the home and industry.

Get ready for Television and FM. Get your share of the Radio Service Business. Take your place in industry as an Electronics expert. Here is a sensationally improved way for you to get the right training. Study in spare time—odd hours, even minutes—and have the advantage of actual shop experience behind you.

This exclusive shop method of home training comes to you right from one of the world's greatest vocational educational centers—the resident training shops and experimental laboratories of the great NATIONAL SCHOOLS. It is sound, based on the actual experience of qualified instructors, engineers and technicians—men who are right in the industry.

National Schools has been training men for higher pay and greater opportunity for more than a third of a century. Fill out and mail the coupon below for details.

Shop Method Training Wins Good Jobs



Joseph Grumich, Lake Hiawatha, New Jersey.

"My latest offer was \$5,800.00 as Radio Photo Engineer... but I'm doing well where I am now engaged. I am deeply indebted to National."

"Due to my training at National I was selected to instruct in the laboratory work of Navy and Marines."—R. R. Wright, Blackfoot, Idaho.



Read what hundreds of other enthusiastic students have written about National Training. Send in your coupon today.



"I believe National offers the best course to be had. Keep up the good work."—O. K. Ivey, Washington, D. C.

Grasp This Opportunity

Experts agree that Radio, Electronics and Television is right at the start of the greatest boom in history. Right now is the time to prepare yourself for BIG SUCCESS and LIFE-TIME SECURITY. Take part in the great expansion. The field is wide open.

You need no previous experience—no electrical or mechanical knowledge. National Shop Method Home Training is complete in itself—up-to-date.

Make use of your free time NOW to build yourself a great future. See how quickly you progress—how easy it is to get a firm, practical understanding of Electronics in all branches.

See for Yourself

Take the first step now. Fill out, and mail the coupon below. Be among the first to get into the big money—to win a position of importance—to have a BUSINESS OF YOUR OWN.

The industry is crying for trained men everywhere. It holds out rich rewards—a prosperous future. Well trained men ONLY are wanted.

Examine the National Shop Method of Home Training carefully in the quiet of your own

home. Make up your own mind. No salesman from National will call on you. Fill out and mail the coupon today.



GET THESE 2 BIG BOOKS FREE!

Learn for yourself just how easy this SHOP METHOD HOME TRAINING gives you the practical, down-to-earth experience you can never get from theory alone.

NATIONAL SCHOOLS

LOS ANGELES 37, CALIFORNIA EST. 1905

MAIL OPPORTUNITY COUPON FOR QUICK ACTION

National Schools, dept. PM-1
4000 South Figueroa Street,
Los Angeles 37, California

(Mail this in an envelope or paste on a postcard.)

Send me FREE the two books mentioned in your ad including a sample lesson of your course. I understand no salesman will call on me.

NAME AGE

ADDRESS

CITY STATE

Include your zone number

Worth hundreds of dollars to YOU...

tells you how to redesign
for **ARC WELDING**

Estimating charts and work
page opposite every design
increases practical value.

OVER 300 suggested basic designs

If you work in metal—are a Designer, Engineer, or have any redesign problem—"Practical Design for Arc Welding" is the book that will show you plenty of ideas to help solve your difficulties. Estimating charts help you analyze your redesigning plans in terms of cost, production, sales advantages, and leaves nothing to doubt.

Convert Ideas Into Cold Facts

After going through "Practical Design for Arc Welding" you'll discover hundreds of applications that cut costs, add strength and improve your production through arc welding. You'll save hours and dollars with these books.

Available in 3 Vol.
Each volume is complete in every respect. Only \$3.50 per volume, or all 3 for \$10.00. A real bargain to help improve your post-war position. Mail coupon today!

HOBART
BROTHERS CO.
Box M-16, TROY, O.
"One of the World's
Largest Builders of
Arc Welders"

FREE!

"Vest Pocket
Guide for
Arc Welders."

REACH FOR YOUR SCISSORS

Send me detailed information on Hobart Arc Welders, together with books I've checked.

- Welding School
 Attached find \$_____ for _____ volumes
 "Vest Pocket Guide" of "Practical Design for Arc Welding."

HOBART BROS. CO., Box M-16, TROY, OHIO

NAME _____

FIRM _____

ADDRESS _____

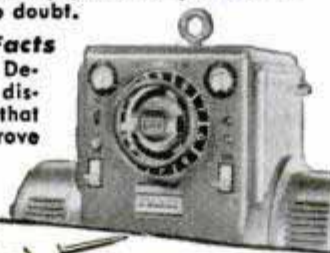

HOBART Arc Welding School

Trains you for a profitable future as an expert welder. You get individual attention from veteran instructors. In this short and intensive course you also get the advantage of individual machines and booths, and training with the latest equipment. If a veteran, you can enroll under G. I. bill. Write for free booklet and details.

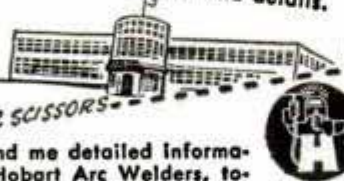

No Waiting to LEARN - Start at Once to EARN!

This BIG BOOK SHOWS HOW

If it's Results you want, you can get action quickly with this practical book. Never before has a more helpful book been printed for those planning a business of their own. Gathered in this large illustrated volume are the formulas, recipes, facts and secrets that have contributed so largely to America's great industrial progress. Capitalize on this information for making most any conceivable product without experience, special equipment or previous knowledge of chemistry. Start at home, expand with profits—build for a profitable independence.

The experts who compiled this book are authorities, and present this information in simple, understandable language. They also give you wholesale supply sources for needed material, short cuts and economy methods for the most profitable results. Hundreds of good paying businesses have been built on a product made from a simple recipe. Opportunities in this field exist everywhere. Choose from any of the 162,000 facts and 10,000 formulas of which the following are only a very few: Adhesives, Alloys, Anti-Freeze Solutions, Cosmetics, Beverages and Liquors, Candy, Gum, Casein, Celluloid, Ceramics, Cheese, Cleaning Preparations, Concrete, Copper, Cotton, Dentifrices, Depilatories, Dyes, Embalming Fluids, Enameling, Glass, Glazes, Household Formulas, Inks, Insecticides, Iron, Jewelers' Formulas, Lacquers, Laundry Preparations, Leather, Linoleum, Lubricants, Manicure Preparations, Marble (artificial), Metals, Mirrors, Oils, Ointments, Paints, Paper, Perfumes, Photography, Polishes, Powders, Remedies for Man, Beast or Fowl, Rubber Products, Refrigerants, Soaps, Solder and Soldering, Tooth Cements, Transfers, Transparencies, Varnishes and Thousands of others for making all sorts of profitable and practical things.

10,000 FORMULAS, RECIPES SECRET PROFIT IDEAS



924 Illustrated
Big
Pages

Cloth Bound
Size 5 1/2" x
8 5/8" x 2 1/4"

Prepare for "After-War-Business"
Especially recommended for Servicemen and War Workers planning a profitable business of their own. This comprehensive book is an accepted authority by chemists, schools, industry, etc. and is the largest and most comprehensive book of its kind ever issued. Nothing else like it in existence. A single formula has been worth a thousand times this book's small cost to countless owners. Crammed with money-making ideas. Invaluable for reference. Ideal for Factory, Home, Farm, Office or Workshop. As necessary as the dictionary and more useful for manufacturers, chemists and salesmen who put up products for profit.

This
Complete
Book Only
\$2.98
POST PAID

Worth More

ALSO INCLUDED! Complete plans: "D.D.T." Insecticide. Also our New Book of Money Making Facts: "The More You Know the More You Can Earn—Easier and Quicker."

Immediate Shipment—Safe Delivery Guaranteed, \$2.98 postpaid, Canada or Foreign, \$3.25 U. S. Funds. (C.O.D. shipments U. S. A. only.)

ADAMS BROWN COMPANY Books of Applied Science
Dept. 301, Chestnut Hill 67, Massachusetts, U. S. A.

LEARN WATCH REPAIRING



AT HOME. By our modern and original system of instruction you can learn every part of the **WATCH REPAIRING TRADE AT HOME.** Prepare yourself for a well-paying position or start in business after completing our course of instruction. Good watch repairers are in demand and generally earn very good salaries. For particulars apply to the **Wisconsin School of Watch Repairing** 759 North Milwaukee St., Milwaukee 2, Wis.

LEARN MEAT CUTTING At Home—In Spare Time



Get into the vital meat industry. Concise, practical Home Training based on 25 years proven instruction methods used at National's famous resident school. Prepares you for bigger pay as Meat Cutter, Supervisor, market manager or more money in your own store. Go as rapidly as your spare time permits. Diploma. Start NOW to turn your spare hours into money. Send for FREE bulletin today. No obligation.

National School of Meat Cutting, Inc., Dept. U-65, Toledo 4, Ohio

RADIO, ELECTRONICS and YOU!

THERE are big rewards in the communications line for the Radio man who has the answers! Too, the equipment that has made Radio communication possible is functioning now in other rewarding fields. Electron tubes in industry promise a whole new World of Electronics. I. C. S. has a variety of Radio Courses and a great new standard Electronics Course. Write for booklet, pick your Course.

INTERNATIONAL CORRESPONDENCE SCHOOLS BOX 5568-K, SCRANTON 9, PENNA.

Send me full information on the following subject:

Name.....Age.....

Home Address.....

City.....State.....

Present Position.....Working Hours.....A.M. to.....P.M.

AVIATION *Career*

MAXIMUM TRAINING IN MINIMUM TIME

**CAL-AERO TECH. TRAINING will ADD DOLLARS
to YOUR pay check all the rest of YOUR life!**

Your future EARNINGS depend upon your *training*. A wise investor always determines in advance what the return on his investment will be before he puts cash "on the line." You who plan to invest in a course of training, for a future career, **MUST** do the same. It is even more important to you, because your choice of training will determine **HOW MUCH MONEY YOU WILL MAKE THE REST OF YOUR LIFE**. Specializing in *Aeronautical Engineering* and *Master Aviation Mechanics* since 1929, Cal-Aero Technical Institute training is carefully designed to do just **ONE THING—MAKE MORE MONEY FOR YOU**. An alumni of over 6000 proves that **CAL-AERO TECHNICAL TRAINING** can get results and increase your pay check. **CAL-AERO** has provided its graduates with a profitable occupation, and secure future since it trained them in advance for the highest position they could ever expect to occupy. **IT CAN DO THE SAME FOR YOU.**

We invite your consideration, investigation and comparison. Send coupon **TODAY**.

VETERANS

Train in Sunny Southern California. Cal-Aero Technical Institute is on the list of approved schools on file with the Veterans' Administration, making discharged servicemen attending Cal-Aero eligible for the educational benefits, as provided under the "G. I. Bill of Rights."

Write us—we will be happy to help you with your future plans. Many ex-servicemen are now enrolling and taking advantage of these benefits here at Cal-Aero.

CAL - TECHNICAL  **AERO INSTITUTE**
MAJOR C. C. MOSELEY PRES. SINCE 1929
FORMERLY CURTISS-WRIGHT TECHNICAL INSTITUTE

**GRAND CENTRAL AIR TERMINAL
GLENDALE 1, CALIFORNIA
LOS ANGELES COUNTY**

"DON'T MISS THE BOAT" — MAIL THIS COUPON TODAY!

Cal-Aero Technical Institute, Grand Central Airport, Glendale 1, California
Please send full information and illustrated catalog on Aviation Training
FREE—without obligation. Dept. PM-1

NAME _____ BIRTH DATE _____

STREET _____

CITY _____ STATE _____

I PLAN TO ENROLL—Month _____ Year _____

AVIATION'S MOST DISTINGUISHED SCHOOL OF AERONAUTICS

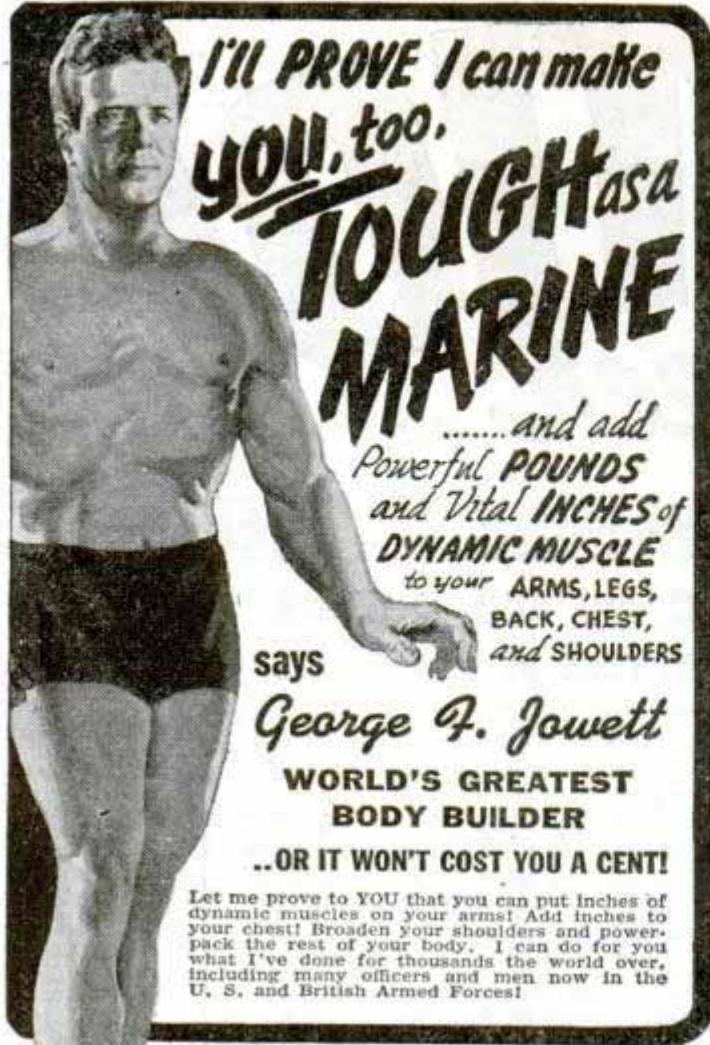

I'll PROVE I can make
you, too.
**TOUGH as a
MARINE**

.....and add
Powerful **POUNDS**
and Vital **INCHES** of
DYNAMIC MUSCLE
to your **ARMS, LEGS,**
BACK, CHEST,
and **SHOULDERS**

says
George F. Jowett

**WORLD'S GREATEST
BODY BUILDER**

..OR IT WON'T COST YOU A CENT!

Let me prove to YOU that you can put inches of dynamic muscles on your arms! Add inches to your chest! Broaden your shoulders and power-pack the rest of your body. I can do for you what I've done for thousands the world over, including many officers and men now in the U. S. and British Armed Forces!

GIVE ME 10 MINUTES A DAY!

I'll Show You My Secrets Of Body Building

I'll help you learn the "Progressive Power Method" through which I rebuilt myself from a physical wreck to the holder of more strength records than any other living athlete or teacher! No matter how skinny or flabby you are, you can learn my methods right in your own home. Through my proved secrets I show you how to develop your power, inside and out, until YOU are fully satisfied that you are the man you want to be. "The Jowett System," says R. F. Kelly, Physical Director of the YMCA, Atlantic City, "is the greatest in the world!"

If you want a physique that will inspire respect from men, and admiration from women... **ACT LIKE**

A HE-MAN! Decide at once! The famous book, "Nerves of Steel—Muscles Like Iron" will be included FREE! Priceless for the strength fan! Full of photos of marvelous power-bodied men who will show you what Jowett has done for them and how he can do the same for you. Reach out... Grasp this Special Offer today!

**PROVE TO YOURSELF
IN ONE NIGHT!**

Send only 25c for test Course, "Molding a Mighty Arm." Read it the evening it arrives—learn the experience the thrill you can give your muscles!

**SEND FOR THESE FIVE FAMOUS
COURSES IN BOOK FORM
ONLY 25c EACH
or ALL 5 for \$1.00**

Jowett Institute of Physical
Culture
230 Fifth Avenue
Dept. 931-R.
New York 1, N. Y.

*This
Book
Free!*



**BOOK WITH PHOTOS OF FAMOUS STRONG MEN
MAIL COUPON NOW**

FREE



Jowett Institute of Physical Culture
230 Fifth Avenue, Dept. 931-B, New York 1, N. Y.
George F. Jowett: Your proposition looks good to me. Send by return mail, prepaid, the courses checked below, for which I enclose (). Include FREE book of PHOTOS.

- George F. Jowett Champion of Champions
- All 5 courses for... \$1
 - Molding a Mighty Arm 25c
 - Molding a Mighty Back 25c
 - Molding a Mighty Grip 25c
 - Molding a Mighty Chest 25c
 - Molding a Mighty Leg 25c
 - Send all 5 C.O.D. (\$1 plus postage.) No orders less than \$1 sent C.O.D.

NAME.....Age.....
(Please print plainly. Include Zone Number.)

ADDRESS.....

SAY YOU SAW IT IN POPULAR MECHANICS

Inventors
**DEVELOP
YOUR IDEAS**

We will protect and secure your patents for you or further develop any patented or patents pending inventions for manufacture. We build working models and offer you an expert engineering service for developing your ideas from plans to finished products. Complete manufacturing facilities for volume production.

Write for full information—no obligation.

**ACCURATE
TOOL & ENGINEERING CO**
640 10TH AVE. SAN DIEGO, CALIF.

IMPROVE YOUR PLAYING



PIANISTS—Send for FREE Booklet showing how you may greatly improve your technique, accuracy, memorizing, sightreading and playing thru Mental-Muscular Coordination. Quick results. Practice effort minimized. Used by famous pianists, organists, teachers and students. No obligation.
BROADWELL STUDIOS, Dept. 156A, Covina, Calif.



**Get Started in Radio
TEN "HOW-TO-DO-IT" BOOKS**

Get a solid foundation in radio by means of these 10c timely text books. Each clearly written, profusely illustrated, contains over 15,000 words. You'll be amazed at the wealth of information packed into these handy books. Excellent for reference—ideal for technical library. Your money back if not satisfied.

5 Books for 50c—10 Books for \$1
SENT TO YOU POSTPAID

- No. 1—How To Make Four Doerle Short Wave Sets
 - No. 2—How To Make The Most Popular All-Wave 1 and 2 Tube Receivers
 - No. 3—Alternating Current for Beginners
 - No. 4—All About Aerials
 - No. 5—Beginners' Radio Dictionary
 - No. 6—How To Have Fun With Radio
 - No. 7—How To Read Radio Diagrams
 - No. 8—Radio for Beginners
 - No. 9—Simple Electrical Experiments
 - No. 10—Television
- Remit by check or money order—register letter if you send cash or stamps.
RADIO PUBLICATIONS, 231 West Broadway, New York (7)

**\$5, \$10, \$15
FOR ONE
DRAWING**

Be an ARTIST!

—Train at Home in Your Spare Time
The fascinating field of Art offers commercial opportunities to men and women. **COMMERCIAL ART, CARTOONING, DESIGNING** all in one complete course. **TWO ART OUTFITS** furnished. Learn to draw step-by-step. Trained Artists are capable of earning \$30, \$50, \$75 a week. Write today for full information in FREE BOOK, "Art for Pleasure and Profit." Mail coupon now.

FREE BOOK gives details

Washington School of Art, Studio 121C
1115—15th St., N. W., Washington 5, D. C.
Name.....Age.....
Address.....
City.....State.....

**LEARN
AT HOME**

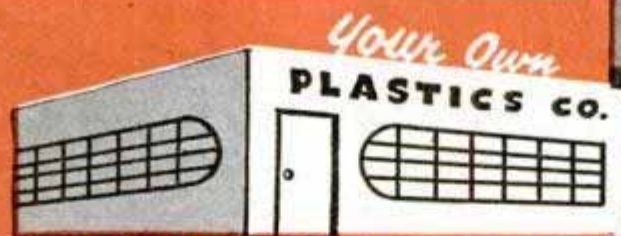

START YOUR OWN BUSINESS

PLASTICS

FABRICATION

New - Profitable Industry!



**MAKE PRODUCTS
LIKE THESE**

YOU'LL really enjoy learning plastics this new, interesting way! For you'll actually make beautiful, useful plastics articles during your home study training with Plastics Industries Technical Institute.

NOW'S YOUR OPPORTUNITY—Yes, the exciting age of plastics is here! Demands of war have caused phenomenal growth in the plastics industry—creating exceptional opportunities for those who know plastics. If you are a person with an eye to the future, you won't remain on the outside looking in—you'll want a choice position in the growing, expanding plastics field—or a plastics business of your own.

WE SUPPLY MATERIALS—For your interesting and practical work with plastics, we supply handsome, colorful, transparent rods, sheets and tubes of plastics from which you make useful, attractive creations. You saw, cement, machine, buff, form, dye, decorate, cast and laminate various types of plastics.

You also design your own plastics articles—develop your own ideas—express your originality. Earn money while learning.

A COMPLETE COURSE—This practical training in plastics fabrication is only one part of the Plastics Institute home study course. In addition, you learn about the many types of plastics, their manufacture, characteristics, properties and uses—intensive coverage of molding and mold design—testing and cost analysis—everything to help prepare you for your place in plastics.

START YOUR FUTURE TODAY—Mail the coupon below now! We will send you an interesting, illustrated free booklet with valuable information about plastics. We'll tell you how, at small cost, you can prepare for a future in this important industry while carrying on your present work. Don't put it off. Clip the coupon and mail it today!

VETERANS: ASK ABOUT G.I. TRAINING



NEW YORK
Dept. PM6-1, 122 E. 42nd St.

CHICAGO
Dept. PM6-1, 221 N. La Salle St.

LOS ANGELES
Dept. PM6-1, 1601 S. Western

SPECIAL RATES FOR SERVICE MEN

Plastics
INDUSTRIES TECHNICAL INSTITUTE

Plastics Industries Technical Institute
221 N. La Salle St., Dept. PM6-1, Chicago 1

Mail in Envelope or
paste on penny postcard

Gentlemen: Please send me the booklet "World of Plastics" and information on your training program. I understand there is absolutely no obligation.

Name.....Occupation.....
Street.....Age.....
City.....Zone.....State.....

Veterans: Check for special information. If under 18: Check for special booklet.

FREE BOOKLET
Send For It Today!

The set of
books
that makes



MASTER MACHINISTS and leads to bigger pay!

This big home-study and reference course gives you the practical facts on machines and methods you need to advance in machine shop work. Take advantage of the other man's experience as found in books, to solve your problems, increase your efficiency, with

The AMERICAN MACHINISTS' LIBRARY

6 volumes—2368 pages—2516 illustrations
(A combined home-study course and reference library)

This library of machine shop practice was written for practical men. It gives you the best methods for every kind of machine shop work. It fully explains lathes, drills, and other machine tools and their operation, automatic screw machines, speeds and feeds, gear design and production, jigs and fixtures, punch and die work, metal surfacing, etc., etc. Plainly written—completely illustrated—the best kind of help to the machine shop man who wants to advance himself.

No money down—special price—easy payments.

EXAMINATION COUPON

McGraw-Hill Book Co., 330 W. 42nd St., N. Y. 18

Send me for ten days' examination the American Machinists' Library. If satisfactory I will send you \$1.50 in 10 days and \$3.00 monthly until the price of \$10.50 is paid. If not wanted, I will return the books postpaid. (To insure prompt shipment write plainly and fill in all lines.)

Name.....
Home Address.....
City and State.....
Company.....
Position..... PM-1-48

Do you want

- ..to go to College?
- ..or to enter a Profession?
(Such as Accounting, Architecture, Nursing, Dentistry; Teaching, Social Work, Osteopathy, Beauty Culture, Optometry, Embalming, Chiropractic, Law, Medicine, etc.)
- ..or get an Office Position?

To get anywhere, you practically MUST finish High School FIRST. You can complete our simplified High School Course in SPARE time at home, as FAST as your time and abilities permit. Equivalent to resident school work—prepares you for college, pre-professional examinations, business, industry. Standard texts furnished. Diploma. Credit for H. S. subjects already completed. Single subjects if desired. Low tuition, easy terms. American School, Chicago, est. 1897—endorsed by educators. Finish your high school education NOW. Write TODAY!

High School Course at Home Many Finish in 2 Years

American School, Dept. H145, Drexel Ave. at 58th St., Chicago 37, Ill.

Gentlemen: Send me FREE information covering special training in subjects checked below. No obligation on my part.

- | | |
|--|--|
| <input type="checkbox"/> High School Course | <input type="checkbox"/> Diesel Engineering |
| <input type="checkbox"/> Architecture and Building | <input type="checkbox"/> Drafting and Design for Men & Women |
| <input type="checkbox"/> Automotive Engineering | <input type="checkbox"/> Plastics |
| <input type="checkbox"/> Business Management | <input type="checkbox"/> Private Secretary |
| <input type="checkbox"/> Electrical Engineering | <input type="checkbox"/> Mechanical Engineering |
| <input type="checkbox"/> Elec. and Gas Refrigeration | <input type="checkbox"/> Aviation |
| <input type="checkbox"/> Air Conditioning | <input type="checkbox"/> Salesmanship |
| <input type="checkbox"/> Railway Training | <input type="checkbox"/> Radio |
| <input type="checkbox"/> Electronics, Industrial | |

Name.....

Address.....

SAY YOU SAW IT IN POPULAR MECHANICS

THIS AMAZING BOOK

FREE

CARTOONING



Contains money-making tips, ways of getting ideas, a list of cartoon buyers. Cartooning, Commercial Art and Portrait Painting may open up a vast new future for you. You can now enjoy the thrill of a cartoonist's popularity while earning. Our exclusive, revolutionary new inventions simplify and shorten students' training time. Look at these sensational features that you get: LAUGH FINDER—COMIC CHARACTER CREATOR—MAGIC MARIONETTE, a sensational, yet simple device that will amuse you—also our new PORTRAIT COURSE just out—all at NO EXTRA COST. No previous art experience needed. 24 big lessons. Profusely illustrated. So simple even a sixth grade pupil can start learning first day.

FREE Send no money, just name. Get booklet. "How to Make Money With Simple Cartoons". Fascinating facts on your future in cartooning. Rush.

CARTOONISTS' EXCHANGE
Dept. 31-D, Pleasant Hill, Ohio

TRAIN



Your VOICE!

Results GUARANTEED

We build, strengthen the vocal organs—not with singing lessons—but by sound, scientifically correct silent and vocal exercises and absolutely guarantee complete satisfaction with results. Write for Voice Book, FREE. Sent to no one under 17 years old unless signed by parent.

Perfect Voice Institute, Studio 1351, Kimball Hall Bldg., Chicago 4, Ill.

What Every Mason Wants



We have important Masonic books for Blue Lodge, Chapter, Commandery, Scottish Rite, and Shrine.

Our Rituals Are Used the World Over. Send for free catalog of books and rituals for Masons, Odd Fellows, Knights of Pythias, Knights of Columbus, etc. EZRA A. COOK, Publisher, P. O. Box PJY, Chicago 90, Ill.

LEARN MOVIE PROJECTION THEATRE MANAGEMENT



The Motion Picture Theatre Business offers big opportunities for trained men. Get into a fascinating field with a post-war future. Train at home in spare time. Free Catalog. Established 18 years.

THEATRE INSTITUTE, 370 Washington St., Elmira, New York

FENCING

EXCITING
FUN
HARMLESS



NEW—Clean—Healthful
Develops Strong Body—Alert Mind. Become best swordsman in your neighborhood. FREE BOOKLET (with foil) teaches Quickly—Easily. HARMLESS because the 3 ft. Spring Steel Foils (swords) have safety rubber buttons. Complete outfit 2 Steel Foils (swords) and FREE Instructions. Now Only \$1.98 postpaid. MAIL CHECK or M.O. today. Add 28c for Foreign Postage.



LEE PRODUCTS CO., 1613H-First Ave., New York 28, N. Y.

LAW

STUDY AT HOME FOR PERSONAL SUCCESS and LARGER EARNINGS. 35 years expert instruction—over 108,000 students enrolled. LL.B. Degree awarded. All texts furnished. Easy payments. Send for FREE BOOK—"Law and Executive Guidance."

AMERICAN EXTENSION SCHOOL OF LAW
Dept. 61 M, 646 N. Michigan Ave., Chicago 11, Ill.

WELDERS VETERANS—Ask about G. I. Training. WANTED!

Earn up to \$12 a day or start your own business. Learn Welding by actual shop work. America's leading school. Established 1902. 41,000 graduates. Write for "Welding Facts."

Greer Shop Training, Dept. 316, 460 S. State St., Chicago

Learn Public Speaking

Learn theory and fundamentals at home—in spare time. Then acquire actual experience and practice. Send for FREE booklet "Power of Effective Speech."

North American School, Dept. 1351
1315 S. Michigan Ave., Chicago 5, Illinois

NEW ELECTRICAL & ELECTRONIC BOOKS



Guaranteed to Earn You 5 Times their Cost

I know what these books will do for you and so to prove my faith I guarantee that the books you order will earn you five times their cost within a year. You take no risk whatever. You may even see the books you want 7 days FREE for examination and you may return them without owing a penny if you don't wish to keep them.

SEND NO MONEY!

You do not have to send a single penny to see these books for 7 days FREE in your own home or shop. Just check the books you want on the coupon and mail it to me. SEND NO MONEY. If you decide you don't want them send them back within 7 days and you owe nothing. If you keep them you pay on the terms indicated and accept my *Money-Back Guarantee* that the books will help you earn 5 TIMES THEIR COST within a year after you own them or you get your money back. Rush coupon Now.

These authentic Coyne Books are so packed with important, on-the-job helps, valuable diagrams, easy-to-follow tables, etc., that I am willing to send you any or all of them with my GUARANTEE that they will help you earn at least 5 times their cost within a year after you own them—or I'll refund every penny you paid.

You would easily understand why I can make this amazing offer if you could see the hundreds of letters we get praising these books because they have helped men to success—brought pay raises—earned new, important jobs for men who want to succeed. These are not just books to be read—but volumes of facts you will refer to every day—information you can sell—advice you can use to get things done better and faster.

YOU'RE THE JUDGE

The books are right up-to-the-minute, prepared and published by the great 45 year old Coyne School. They are written by electrical men who are familiar with every day problems in electrical construction, house-wiring, installation and servicing. The pages are so packed with such practical pay-raising information that a single suggestion could easily bring you many times the cost of the book.

These books bring valuable information on Motors and Controls, Refrigeration, Air Conditioning, Radio, Batteries and Diesels. Simple explanations of modern Electronics, Trouble Shooting, Generators, Electrical Circuits, new electrical ideas, modern methods, up-to-date data—a veritable gold mine of easy-to-follow rules, tables, charts.

Every formula is tested—every diagram is proved—every table is authentic. *And each book is written so you can understand it*—so you can get the facts you want in a hurry. Thousands of old-timers and beginners are using these books right now to help them do better work, get bigger pay, earn promotions and jobs of authority.



GUARANTEED EARNINGS OFFER

H.C. Lewis, Pres., Coyne Electrical School, Dept. 16-R6
500 S. PAULINA STREET, CHICAGO 12, ILL.

Send me books checked below. I'll either return them in 7 days and owe you nothing or pay for them according to the plan I select as outlined below. You agree to refund price paid if I don't earn 5 times cost in one year.

- Coyne Applied Practical Electricity:** 7 volumes, includes 1 yr. free consultation service & bulletins. Price complete \$19.75 Cash, or \$21 on time, payable \$3 after 7 day free examination & \$3 monthly.
- Coyne Electrical and Radio Trouble Shooting Manuals:** one volume—610 pages—500 large wiring diagrams—4 books in one. Price \$8.00 Cash—or \$8.95 on time, payable \$3.00 after 7 days and \$3.00 monthly. One year consultation and bulletins FREE.
- Coyne Electricians' Handbook:** 1 vol.—400 pgs.—latest electrical laws, rules, formulas, methods—book every electrical worker should have. Price \$2.75 payable after 7-day FREE examination.
- Electronics for Radio Men and Electricians:** 1 volume—400 pages. Newest facts, diagrams and development—includes 1 year FREE technical bulletins. Price \$4.95 after 7-day FREE trial.
- 150 Shop Prints & Diagrams:** 1 vol.—150 large size electrical wiring diagrams—a real buy. Price \$1.95 after 7-day free trial.

NAME _____

ADDRESS _____

TOWN _____ Zone _____ STATE _____

COYNE ELECTRICAL SCHOOL
500 SOUTH PAULINA ST.
DEPT. 16-R6 CHICAGO, ILL.

JUST OUT! NEW FROM COVER TO COVER

AUDELS REFRIGERATION and AIR CONDITIONING GUIDE

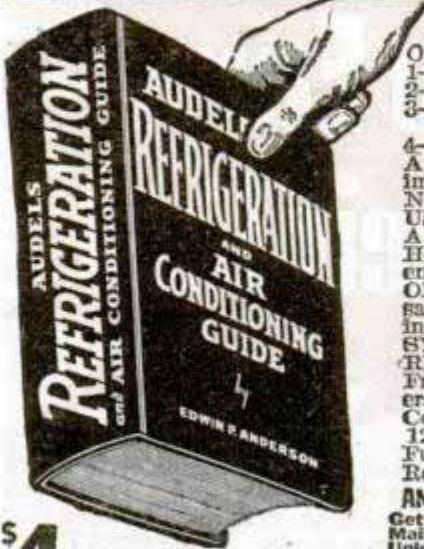

4 Books in One! Covering:
 Basic principles, Servicing, Operation, Repair of
 1—Household Refrigeration
 2—Special Refrigeration Units
 3—Commercial & Industrial Refrigeration
 4—Air Conditioning Systems
 A gold mine of essential important facts for ENGINEERS, SERVICEMEN & USERS.
 A Good Book is a Good Friend! Here you have at your fingers' ends a Complete Library in ONE VOLUME, the necessary data you have been looking for on: MODERN UNITS, SYSTEMS & MACHINES, REFRIGERANTS, including Freon, Lockers, Water Coolers, Quick Freezing & Air Conditioning Systems.
 1280 Pages, 46 chapters all Fully Illustrated & indexed for Ready Reference.

ANSWERS YOUR QUESTIONS
 Get This Information for Yourself. Mail Coupon Today. No Obligation Unless Satisfied. ASK TO SEE IT.

\$4 COMPLETE • PAY ONLY \$1. A MONTH ←

AUDEL, Publishers, 49 W. 23rd St., New York 10, N.Y.
 MAIL AUDELS NEW REFRIGERATION GUIDE for free examination. If O.K. I will send you \$1 in 7 days; then remit \$1 monthly until price of \$4 is paid. Otherwise I will return it.

Name.....
 Address.....
 Occupation.....
 Employed by..... PM

Learn this Profitable Profession



**IN 90 DAYS
AT HOME**

Money-Making Career Open to Men and Women, 18 to 50

Hundreds of men and women between 18 and 50 make \$10 to \$20 in a single day giving scientific Swedish Massage and Hydro-Therapy treatments. There is big demand from doctors, hospitals, sanatoriums and clubs. Graduates earn large full time incomes from these or in private practice in their own offices. Others make good money from home treatments given in spare time. Learn this interesting, money-making profession in your own home, through our home study course. Same instructors as in our nationally known resident school. You can win independence and prepare for future security by qualifying for your Diploma. Course can be completed in 3 to 4 months. Many earn while they learn. Begin your training at once.



Anatomy Charts & Booklet FREE

Enroll now and we will include, at no extra cost, many needed supplies. Fit yourself to help meet growing demand for Scientific Swedish Massage. Send the coupon at once for complete details. Anatomy Charts and 32-Page Illustrated Booklet, FREE, postpaid.

THE COLLEGE OF SWEDISH MASSAGE
 Dept. 664-A, 100 East Ohio St., Chicago 11, Illinois

Please send me FREE and postpaid, Anatomy Charts, 32-page Booklet and complete details on Home Training.

Name.....
 Address.....
 City..... State.....

THIS GREAT BOOK

**HOW TO
BREAK
and
TRAIN
HORSES**

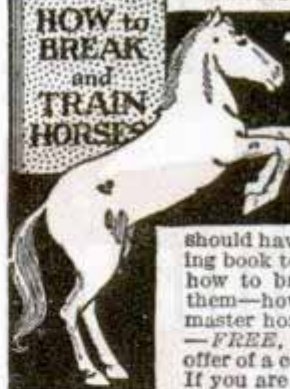

FREE!

Every farmer, every lover of horseflesh should have a copy of it. This amazing book tells how to know horses—how to break them—how to train them—how to make money as a master horseman. Write for it today—FREE, together with my special offer of a course in Animal Breeding. If you are interested in Gaiting and Riding the saddle horse check

here Do it today—now. You'll never regret it.
BEERY SCHOOL OF HORSEMANSHIP
 Dept. 1101D - Pleasant Hill, Ohio

ANALYZE HANDWRITING

Qualify for Certified Grapho-Analyst Degree. New uncrowded, fascinating field of service. Gratifying earnings reported by graduates in Employment, Credit, Social Service, Police and Judicial, and Entertainment fields. Others have developed profitable private practice, full or spare time, as Personal Problem and Vocational Counselors. Send for 3000 word test lesson and Grapho-Analyst

FREE

ADDRESS: A. I. G. A. Inc. 120 NOEL, MO.

Learn LANDSCAPE GARDENING!

Prepare for the giant postwar home-building program. A thorough, constructive, interesting home-training for those who wish to become LANDSCAPERS, DESIGNERS, GARDENERS, etc., for profit or pleasure. Write today for FREE INFORMATION, without obligation, to

NATIONAL LANDSCAPE INSTITUTE
 Dept. P-1 756 So. Broadway Los Angeles 14, California

INVENTORS

WITH GOOD INVENTIONS

Should write us without delay for FREE BOOKLET, Protective Disclosure Form and facts about The Inventor's Most Logical Markets. Patented, Unpatented inventions, all kinds, Cash, Royalty, needed by specific manufacturers. If your invention is for sale, write today for full particulars. A Post-Card will do! Address:

THE INVENTION REPORTER
 5C-11106 South Longwood Drive Chicago 43, Illinois

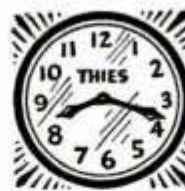

Fix Your Own

ALARM CLOCKS

New, practical home course. Just out. Makes interesting hobby—profitable too. Save money by doing your own repairing at home. Easy if you know how. Price now only \$1.00. Details FREE. Send postcard.

THIES JEWELRY STORE, Genoa 3, Illinois

ELECTRICITY MEN NEEDED

GOOD JOBS • GOOD PAY • GOOD FUTURE

Through spare time home study you can qualify for a starting job in electrical work and prepare for bigger pay promotions. Or if now employed in this field you can acquire know-how which can win you a bigger, better job. It's not difficult to master principles of equipment used in generating, transmission and use of electricity. Begin now. Send name and address today for FREE information.

AMERICAN SCHOOL, Dept. EE145, Drexel Ave. at 58th St. Chicago 37

Name.....
 Street.....
 City, State.....

NOTICE: Over 100,000 ambitious men have been helped to higher paying jobs with the aid of books listed on this page.



Which of these books can help you GET A BETTER JOB AND MAKE MORE MONEY

Here's how to beat job competition and insure yourself of a prosperous future. Gateway Books help you tackle those tough jobs you've always had your eye on . . . because they show you how to do the HARDEST jobs the EASIEST way in LESS time. Gateway Books are written by men who are experts in their particular field . . . men who have worked themselves up the hard way. Now you can take advantage of their knowledge the easy GATEWAY way.

Our Money Back Guarantee and Special offer appear elsewhere on this page. Study this list of popular books now.

Order From This List

WOODWORKING

1. **CARPENTRY CRAFT PROBLEMS.** 302 pages explains and illustrates hundreds of practical solutions to all types of carpentry problems met by the amateur and professional woodworkers. Complete in every detail. \$2.50
2. **BUILDING—FORMS, STAIRS, ROOFS.** Latest information on how to build correctly, forms, staircases, roofs, etc. For carpenters and helpers. 250 pages, illus. \$2.50
3. **WOODEN BOAT AND SHIP BUILDING.** Solves every type of problem in building wooden boats and ships. 244 pp., illust. \$2.25
4. **HOW TO MAKE RUSTIC FURNITURE.** Hundreds of ideas and plans on making all types of rustic furniture for the home. Completely illust., thoroughly described. \$2.00
5. **WOOD TURNING.** An excellent book for every home craftsman. Tells and shows how to do the most artistic kind of work. Numerous photos and detailed drawings. \$2.50
6. **HOW TO WHITTLE AND CARVE.** Complete directions for all types of whittling and carving of toys, jewelry and novelties, etc. Illustrations make work simple. \$2.75
7. **HOME REMODELING.** A book that tells the home owner or carpenter what to do and how to do it. Over 500 pages and 300 illust. provides hundreds of useful ideas. \$4.75

PAINTING

8. **HANDBOOK OF ORNAMENT.** For artists, designers, jewelers, architects, etc. Topics covered include: Elements of Decoration, Decorated Objects, and Ornaments applied to Features. 3,000 illus., 548 pages. \$5.00
9. **INTERIOR WALL DECORATION.** Practical working methods for plain and decorative wall finishes. 185 illus., 491 pages. \$3.00
10. **THE MIXING OF COLORS AND PAINTS.** How to mix colors for interior decorating, arts, crafts, general mixing methods. A handy book for professional and amateur painters. 302 pages, fully illustrated. \$2.50
11. **SPRAY PAINTING.** Spraying technique and operating instructions on paints, materials, finishes. 125 fully illust. pages. \$2.00
12. **HOUSE PAINTING METHODS.** 400 pages and 150 illust. cover the subject of house painting (of any surface) thoroughly . . . time and money saver. \$2.50
13. **WOOD FINISHING.** Wood finishes and problems—tools—material. 353 illust. \$2.50
14. **CYCLOPEDIA OF PAINTING AND DECORATING.** Covers methods, tools and materials for the home and workshop, including every branch of painting and decorating. Any particular job is fully explained with illustrations to clarify the text. 350 pages. \$3.50

Guarantee

Gateway Books are guaranteed to be absolutely satisfactory in every respect, or your money will be cheerfully refunded. The GATEWAY BOOK CO., Dept. PM-13 32 N. State — Chicago 2, Illinois

METAL WORKING

15. **WELDING.** Arc, spot, butt and electric welding, etc. 280 pages. \$2.00
16. **SHEET METAL WORKERS MANUAL.** Complete instructions and information on every phase of sheet metal working. Includes many tables. 552 pages, 375 illust. \$3.00
17. **SHEET METAL LAYOUT SHEETS.** Makes sheet metal work so simple that anyone can learn. Thousands of men badly needed for this big pay work. 143 jobs worked out in detail. Fully illustrated. \$3.00
18. **METAL SPINNING.** A new art of proven popularity. Step-by-step descriptions of the various phases of the craft shows you how to make the most out of your metal work. Simple, concise. \$1.75
19. **METAL SPINNING PROJECTS.** Tells how to make bowls, lamps, serving dishes, book ends, candle sticks, etc. Complete patterns and instructions. \$2.75

REFRIGERATION - PLUMBING AIR CONDITIONING

20. **REFRIGERATION SERVICE MANUAL.** Domestic and commercial refrigeration used in markets, milk depots, soda fountains, etc., and in homes. 300 pages, illust. \$2.50
21. **PLUMBING INSTALLATION AND REPAIR.** 236 page book on how to repair leaky faucets, clogged toilets, drains, traps, vents, sewers, etc. 153 illustrations. \$2.50
22. **HEATING-COOLING and AIR CONDITIONING.** New book shows you how you can make more money in heating . . . refrigeration and Air Conditioning fields. Complete and authoritative . . . four big books in one. 706 fact filled pages on heating of all types, cooling, Air Conditioning, equipment, furnaces, controls, etc. 706 pages, 64 charts, 351 illustrations. \$4.50

ELECTRICITY

23. **PRACTICAL ELECTRICITY AND HOUSE WIRING.** An ideal book for around the home because it debunks all the mysteries of electricity and shows you how you can save plenty by doing all of your own wiring. Plenty of illust. and diagrams. \$2.00
24. **ARMATURE AND MAGNET WINDING.** The construction of armature and their repairs fully covered with illustrations. \$2.00
25. **TELEVISION.** A great new book that tells everything about this great high paying—good future field. Talks in understandable language for the amateur. \$3.50

SPECIAL If your purchase totals \$10.00 or more and remittance is enclosed with your order, we will send you any \$2.00 book you choose absolutely FREE.

ART

26. **HANDBOOK OF ADVERTISING LAYOUT.** Written and illustrated by one of the country's leading advertising men, it is practical and sound. \$3.00
27. **FIGURE DRAWING FROM LIFE.** \$1.00
28. **AMATEUR ARTIST.** \$1.50
29. **LETTERING AND DESIGN.** \$3.00
30. **SILK SCREEN METHODS.** How to make silk screens, materials needed. Complete, authoritative. Fully illustrated. \$3.03
31. **DRAW FUNNY PICTURES.** \$2.50
32. **ART OF CARICATURE.** \$2.50
33. **PRACT. COLOR MANAGEMENT.** \$2.50
34. **MODERN ILLUSTRATIONS.** \$2.00

SELF IMPROVEMENT

35. **HOW TO INCREASE YOUR VOCABULARY.** For the ambitious who wishes to acquire a powerful vocabulary that amazes friends. Pronunciation, definitions and tests show you how in shortest possible time. \$3.75
36. **BETTER SPEECH FOR YOU.** Avoid mispronunciation of 2,000 troublesome words and 400 of the commonest errors. Makes you envied by friends who wish they could talk as clear and perfectly as you. \$2.00
37. **PRINCIPLES OF ACCOUNTING.** 740 pages that help make you a proficient accountant and show you how to keep your own books easily. Gives all details . . . leaves nothing to chance, complete. \$3.75
38. **MATHEMATICS.** Includes all phases of mathematics to help reader solve all practical problems. 224 pages. \$2.25
39. **SLIDE RULE AND LOGARITHMIC TABLES.** Uses and principles of slide rule and logarithmic tables fully covered. Includes even 10 place log tables. 200 pages. \$1.75
40. **101 WAYS TO BE YOUR OWN BOSS.** Information gathered from over 600 successful business men tells you how to be your own boss in business. Complete . . . authoritative . . . leaves nothing to doubt. \$2.49

HOBBIES

41. **TIN CAN PROJECTS.** Tells how to turn tin cans into objects of beauty that command high prices. This handy book has all the patterns, designs, etc. \$1.50
42. **MODERN HOMECRAFT.** 240 pages of ideas for modern furniture . . . and how to make it . . . fully illustrated. \$3.50
43. **LEATHER WORKING.** Tells of tools, materials and equipment needed. Gives working drawings of key holders, book marks, coin purses, billfolds, belts, frames, etc. \$2.00

CHECK, CLIP AND MAIL THIS COUPON NOW

THE GATEWAY BOOK CO., 32 N. State St., Dept. P.M.-13, Chicago 2, Illinois
O.K. Send the books I've circled. If C.O.D., I'll pay postman cost of books plus a few cents postage and handling charge. If prepaid, Gateway pays all shipping charges. If any book is not entirely satisfactory, I will return it in 10 days and you will refund my money. No C.O.D.'s outside the U.S.

1 2 3 4 5 6 7 8 9 10 11 12 13 14 15 16 17 18 19 20 21 22
23 24 25 26 27 28 29 30 31 32 33 34 35 36 37 38 39 40 41 42 43
(Please print name clearly)

Name

Address

City Zone State

NOW! Enjoy Learning to Speak

SPANISH AT HOME

FRENCH-GERMAN-ITALIAN

BIG opportunities and jobs waiting for those who can speak Spanish. Millions of dollars being invested in Mexico, Central and South America — business and travel increasing every day. Now the ability to speak Spanish will mean more to you than ever before.

Only 15 Minutes a Day

The **CORTINA METHOD**, famous for **OVER 60 YEARS**, teaches you to speak Spanish **LIKE A NATIVE**. Right in your own home, relaxed and at ease, you learn as easily as a child learns—**BY LISTENING** to native instructors on these 30 new, easy-to-understand **CORTINA** recordings. **EVERY WORD CLEAR AS A BELL.**

Sent on 5 Days Approval

THOUSANDS have learned Spanish, this quick, easy way for **PLEASURE** and **BUSINESS**. Why not you? Free, 32-page book, "The Cortina Short-Cut," describes this famous

method fully and tells how you can try it in your own home for 5 days. **NO COST IF NOT DELIGHTED.** Mail coupon for free book now.



Write Today-NOW!



★ TRAIN for SUCCESS in the Poultry Business



Study at home in spare time. Earn extra while learning.

YOU CAN MAKE MONEY FROM POULTRY

Get ready now—the easy, scientific, inexpensive way! For 25 years, we've been helping thousands to greater success. During 25 years we have trained thousands of students, showing them how to establish poultry farms—how to avoid mistakes—how to cut losses—how to increase profits on established plants—how to have their own small profitable breeding plant and make a good living at it.



Proper management and "know-how" makes profits ANY season, for life. Our courses cover all phases of poultry raising, including plans for buildings, breeding, hatching, culling, sexing, caponizing, marketing, judging, exhibiting, and many others, etc., as planned by Harry M. Lamon, former Senior Poultryman for the United States Dept. of Agriculture. Endorsed by leading colleges, poultrymen everywhere. Write today for this Free Catalog "How to Raise Poultry for Profit." It fully describes courses, methods, service, opportunities, and easy payment plan.

National Poultry Institute
Dept. 50-F, Adams Center, N. Y.



YOU CAN SUCCEED... Send For this Book Today!

Get Ready for Big After War Opportunities!

I Will Train You at Home Until You Get a GOOD PAY JOB in

DRAFTING

Act now to get a better job with more pay and pleasant working conditions. Get into Drafting—the basic profession where all post war products will start. I will train you at home—give you experience—doing the same kind of jobs you will do with the best paying firms. I furnish instruments, drawing table and all equipment when you start. Write today for vital facts and FREE illustrated book. Give Age.

Engineer Dobe, Div. 11, Libertyville, Ill.

HAIR CAN BE SAVED "GIVE YOUR HAIR A CHANCE"

is the amazing book by J. W. KING, Sc. B. on dandruff, baldness, thinning and graying hair. Much usable information.—Ohio State Medical Journal. Best investment.—Science Education. Debunks hair fads.—Scientific American. Scientific fact.—Sunset Magazine. Without commercial bias.—Teaching Biologist. Book of a scientist.—Home Acres. Enormous assistance.—Pictorial Review. Practical.—Science News Letter. Send only \$2.00 today for postpaid copy of this authentic instruction, on how to save your hair. 6th printing. Prompt refund if not helped. BRADNER PUBLISHING CO. (EST. 1933) Dept. 28, Cambridge 42, Mass.



CORTINA Academy (Established in 1882)
Dept. 641, 105 W. 40th St., New York 18, N. Y.

Please send me—without obligation—your free book. I am interested in (check)

SPANISH French Italian German

Name

Address

City State

Electrical Training at Bliss

NOW OPEN TO VETERANS AND CIVILIANS AFTER 3 YEARS OF WAR TRAINING

BLISS

Intensive 8 months residence course in fundamentals of industrial electrical engineering, including radio and electronics. Extensive laboratory practice in electrical measurements; testing power equipment; circuit tracing; wiring techniques; radio and industrial electronics; use of machine tools; motor construction; drafting. Basic training meets industry's requirements for engi-

neering aides, laboratory assistants; operating, production and maintenance technicians; customers' engineers; draftsmen.

Graduates hold responsible technical and executive positions in communications, power, manufacturing. Modern buildings, dormitories, dining hall, campus. Moderate cost. Enter Feb. 25, July 8. 53rd year. Catalog. 131 Takoma Ave., Washington 12, D. C.

ELECTRICAL SCHOOL
A TECHNICAL INSTITUTE



HUNTERS! LEARN NOW AT HOME to MOUNT BIRDS



Animals, Game-heads, Fish, Pets and to Tan Skins. Save your valuable trophies. Kill only a FEW game birds but **DOUBLE** your interest and pleasure in hunting.

MEN, BOYS! Be an expert taxidermist! Learn quickly **BY MAIL**, from our simple lessons. A wonderful, profitable hobby for expert hunters and **ALSO FOR BOYS and YOUTHS** on farm or in city.

FUN • FASCINATION • PROFIT

Have a Home Museum

SPORTSMEN, YOUNG AND OLD. Here is the grandest hobby in the world for Hunters, Anglers. If you **EVER** hunt or fish, even seldom, **YOU** will be delighted with **taxidermy**. Save those wonderful trophies; mount them just like life, and create a **home museum** that will amaze family and friends and make you **well known and popular**.

Help Save the Game

Shoot fewer specimens, **yet double your fun**. Help save the disappearing wild-game. Join "**DUCKS UNLIMITED**" in wild-game preservation. Shoot only a **FEW** wild-ducks, mount them for your den or home and have **MORE PLEASURE** than you ever had by killing the bag limit. Help keep wild-game forever. "**Eat your trophy and have it too.**"

WHAT YOU LEARN

Our simple lessons teach you **QUICKLY**, right in your own home in your spare time, to **MOUNT—beautifully and permanently, BIRDS, ANIMALS, GAME-HEADS, FISH**, just like museum exhibits. You will also learn the wonderful **KROME-TANNING**. You can then **TAN** fine furs for garments, also skins into real leather. Write today.

LESSONS WORTH \$1,000.00

E. J. Riordan says: "I am more than delighted. My friends are amazed and urge me to mount their specimens. I think your course is worth a thousand dollars, yes it is **priceless to sportsmen**. I am known everywhere as a "**taxidermist**," and earn fine profits in my spare time mounting for other sportsmen. All thanks to your great school."

HE AND PARTNER SUCCEED

John H. Sizis writes: "I and Bob, my partner, who is only 14 years of age have mounted more than 50 specimens. I shall send you a picture of our "**museum**" which is becoming famous. We learned quickly from your simple lessons, in spare time. Your great school is doing a wonderful job. All sportsmen should join it."

MEN, BOYS, Send Today! Don't delay. Obtain **YOUR** copy of the **FREE BOOK** before the supply is exhausted... nothing like it in the entire world. **Write Now. A Postal will do.**

NORTHWESTERN SCHOOL OF TAXIDERMY
3371 Elwood Bldg. Omaha 8, Nebraska

300,000 STUDENTS

This vast number of **MEN, BOYS AND WOMEN** are delighted members of the famous, reliable 25 year old sportsmen's school. Think of that! They are located all over the world. **YOU are invited to join this grand throng. Send for the FREE BOOK this very minute.**

Sportsmen, Boys

All hunters **OF COURSE** save their trophies now-a-days. The school **INVITES THE BOYS TOO!** boys as young as 12 or 13 years succeed in Taxidermy. **Get the FREE BOOK, join the school.**

BIG, EASY PROFITS

Mount and Tan for others. Work comes from far and near. Many students earn fine **PROFITS** from spare time. **SO CAN YOU. RUSH THE COUPON.**

Wild-Game Not Needed

Mount squirrels, rabbits, pigeons, frogs, chicks, crows, hawks. Make craft-work: book-ends, door-stops, gun-racks hundreds of valuable and delightful creations. **What a Hobby for you!**

FREE BOOK!

Yes, **FREE**, 44 pages, with 100 unique pictures of taxidermy work. No other book in the world like this. It will thrill and amaze you. **Ask today for your free copy. State your AGE.**

Send the Coupon!

Write name plainly in coupon or margin, or a post card will do. **Rush** your request, as **free books** may be exhausted quickly. **Decide now.** Don't wait a moment. **State your age.**

FREE BOOK

Northwestern School of Taxidermy, 3371 Elwood Bldg., Omaha, Neb. Send me your free illustrated book, "**How to Mount Game**". Also tell me how I may learn this fascinating art easily and quickly by mail. No obligation. **State your age.**

Name _____ Age _____

Address _____



THIS EASY WAY TEACHES PIANO Without Music!

NO LONG HOURS
PRACTICING SCALES
OR EXERCISES...
**PLAY SONGS
FIRST DAY**



**You May Play Any Song
in 10 Days without being
Able to Read a Note . . .**

If you want to quickly learn how to play the piano... if you want to play song hits, waltzes, marches, hymns, two steps, red hot numbers and western songs, like "Don't Fence Me In" . . . here's amazing news. Now at last Mr. Dave Minor has perfected a wonderfully easy play-by-ear piano course that must teach you piano playing in only ten quick days or no cost. No scales, no long exercises. You start playing songs from the first lesson, and so soon it's amazing you're playing the piano surprisingly well. Mr. Minor's course is complete. It contains all the pictures, all the instruction, everything you need. The complete course sent for your inspection, trial and approval.



SEND NO MONEY—Make This Conclusive 10 Day Test. Just send your name and address today. On arrival deposit \$1.49 plus postage through postman. There is nothing more to pay. Inspect course carefully, see how simple yet thorough it is. Follow it for 10 days. Then if you aren't actually playing the piano and playing it well, if you aren't entirely satisfied and delighted with your discovery, return the course and get your money back. Piano playing is more popular than ever. **DON'T WAIT BUT WRITE TODAY!** If you act now you will receive without extra cost the wonderful, big 72-page Dave Minor piano song book of 50 songs. You quickly learn to play the songs the Dave Minor method or money back. Get in on this 2 FOR 1 offer NOW.

2 for 1 OFFER
\$**1.49**
ONLY
COMPLETE

DAVE MINOR, Room 49-A, 230 E. Ohio St., Chicago 11, Ill.

**AIR
RIFLES**

BENJAMIN

**AIR
PISTOLS**

ORDERS NOW ACCEPTED

EARLIEST POSSIBLE DELIVERY REALLY ASSURED—ACT NOW!
ORDER Latest Models BENJAMIN AIR RIFLES & BENJAMIN AIR PISTOLS AT ONCE. Send for our FREE ILLUSTRATED FOLDER and complete Specifications TODAY. BOTH CALIBRE BENJAMIN H-C PELLETS ARE AVAILABLE NOW.
BENJAMIN AIR RIFLE CO., 812 MARION ST., ST. LOUIS 4, MO.

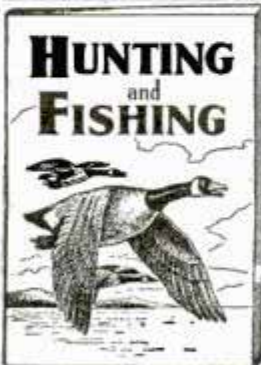

HUNTING and FISHING

is a monthly magazine crammed full of hunting, fishing, camping, dog and boating stories and pictures, invaluable information about guns, fishing tackle, game law changes, best places to fish and hunt—countless ideas that will add more fun to your days afield.

Special Trial Offer

Send 25c in stamps or coin and we will send you Hunting & Fishing for six months.

**HUNTING & FISHING
MAGAZINE**

251 Sportsmen's Bldg., Boston, Massachusetts

★ **SAVE WASTE PAPER** ★

BIG MONEY NOW IN LIQUID MARBLE

THREE wonderful new opportunities for your own big money-making business—regardless of your age, sex, or previous experience!

- 1. LIQUID MARBLE.** Make beautiful artificial Marble Slabs. Pour from liquid state. Glazed or unglazed. This marble may be mottled, veined, multi-colored or left in original snow-white state. The color is actually a part of the marble! Does not fade or wear away. Liquid Marble is unsurpassed on kitchen or bathroom walls. Easy to make and install.
- 2. PLASTIC FLOORING.** May be made in any color or combination of colors. Gives a lifetime of wear. Dustproof, Soundproof, Verminproof. Resilient to the tread. Lay out solid from wall to wall or in pattern design of various shaped blocks.
- 3. FLEXIBLE MOLDS.** For plaster casting. Make your own moulds for few cents each. \$1.00 in raw materials will make up to \$25.00 worth of finished goods. We furnish names of buyers. Write now for FREE information about our **BIG THREE** money-making opportunities! Get in on busy season just starting. Send penny postcard or letter. No obligation.

COMPO-TEX, Box 786-SG, ST. LOUIS 1, MO.

CARTOONING



MAKE BIG MONEY
CASH IN on Big Cartoon Market. BECOME CARTOONISTS QUICKLY with our NEW, EASY METHOD. No experience necessary. Prepared by successful cartoonists. Only \$2.85 postpaid. **SATISFACTION GUARANTEED.** Sample LESSON PLATE and interesting literature FREE.

**NATIONAL ARTISTS BUREAU
Dept. A-3, Box 4248 DALLAS 8, TEXAS**

You Can Write Well

Get ten big issues of America's Handwriting magazine for \$1.50. Free copy sent on request.
THE EDUCATOR, 612 N. Park St., Columbus 8, Ohio

NEW WRITERS NEEDED

New writers needed to re-write ideas in newspapers, magazines and books. Splendid opportunity to "break-into" fascinating writing field. May bring you up to \$5.00 per hour spare time. Experience unnecessary. Write today for FREE details. **NO OBLIGATION.** Postcard will do.

**FREE
DETAILS**

COMFORT WRITER'S SERVICE

200-T40 South Seventh (2)

St. Louis, Mo.

Correspondence Courses in **RADIO and ELECTRICAL ENGINEERING** **LOW AS \$25**

ELECTRICAL ENGINEERING. Get good grasp of wide electrical field. Modern. Very understandable. Theory made easy.
RADIO ENGINEERING. Extra fine course in radio, public address, photo-electric work. Trains you to be super-service man, real vacuum tube technician. Tuition ONLY \$25, either course. Deferred payment plan. Servicemen need badly.

FREE LINCOLN ENGINEERING SCHOOL, Box 931-P85, Lincoln, Nebr.

YOU CAN MASTER MATHEMATICS

Key to the Electronic, Atomic age. Mathematicians in great demand. \$200 to \$500 per month. Literature free.
**O-UNIVERSAL SCHOOL OF MATHEMATICS
623 Walter Story Bldg., So. Broadway, Los Angeles, Calif.**

GET THIS FINE SUIT NO MONEY TO PAY!



BIG CASH EARNINGS, TOO! Big news! This fine tailored suit yours without paying one cent—and big cash earnings, too! It's easy! Just take a few orders for famous Gibson Tailoring. Earn up to \$10 in a day and get your own suit as extra bonus. Dozens of rich new fabrics, superbly tailored in latest styles, at low prices produce orders on sight. Money back guarantee. **FREE SAMPLES!** Write today giving name, address, age, etc., for big complete outfit of actual samples and details of amazing new Bonus Suit and money-making plan—All Sent Free! No experience. **SEND NO MONEY!** W. Z. GIBSON, Inc., 500 S. Throop St., Dept. A-516, Chicago 7, Ill.

DO ANY JOB.. EASIER.. QUICKER
MAKE MORE MONEY *in the*
BIG OPPORTUNITY
FIELDS

SEND NO MONEY
 Select the Books
 YOU Need Now!
 We Ship C.O.D.
 Anywhere in U. S.
 and Will Refund
 Amount Paid if
 Not Satisfactory.

Here's the Help You Need
For Best Paying Jobs
Right NOW!

FREE TRIAL
IN YOUR OWN HOME

Used by Army, Navy, Other Government
 Depts., 200 Schools and Industrial Firms.

Don't submit to tough, heartbreaking job competition, now that wartime jobs are over. Get into one of these big opportunity fields. Big money and many other advantages await you if you prepare now. Here is the help you need—EASY—QUICK—AT LOW COST. Thousands of men have already used these famous books. Beginners and experienced men alike have doubled and tripled their earnings with this help. You too, can now get the special knowledge you need for top pay, better jobs, or a business of your own. This is your GOLDEN OPPORTUNITY.

AIR CONDITIONING

Big air conditioning boom interrupted by war will be bigger than ever. It's ready to GO now! Get this non-technical book by international authority and be ready for your share of millions to be spent. Covers whole field. 450 pages. Illustrated. \$3.50.

AIRPLANE WELDING

All metal airplane building offers big peacetime opportunities

New 2nd edition of this famous book by J. B. Johnson, Materials Division, Wright Field. The authoritative and practical book on Airplane welding and materials brought right up to date. 420 pages, 193 pictures. \$3.50.

MODERN WELDING PRACTICE

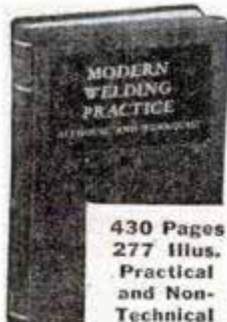

430 Pages
 277 Illus.
 Practical and Non-Technical

Newest book on all types of welding and heat treatment of metals. Written by recognized specialists in training men for production jobs. **Practical and Non-Technical.** Covers everything you need to know. Prepare for best pay jobs now. Price \$4.00.

BODY & FENDER REPAIR

Owners will spend big money to keep their good older cars looking like the new ones coming out. This is a practical money-making guide, ideal for shop owners and every man who wants a share of the millions to be spent in keeping old cars looking new. Tells how to get a good job or start business of your own with small capital. 325 pages, 232 illustrations. \$3.00.



DYKE'S FAMOUS CARBURETOR BOOK

This famous book has been the standard guide in the best paying auto work for a generation. It has helped thousands of men make money. New edition covers engine tune-up, compression, ignition, carburetion, fuel pump valves, etc. Use this book to specialize in this big field. 244 pages, 549 illustrations. \$3.00.

HOUSE WIRING NEW 1945 EDITION

Get this new sixth edition of this standard and practical electrical wiring book. It gives complete practical instruction on every phase of house wiring in one handy volume. Goes further than most books on subject. Hand-book style. Gives National Electric Code. 400 pages, 669 illustrations. Electrical work will reach a new high with millions of new homes to be built. Get started now. \$2.50.

15 Million Refrigerators
 Need Service and Repairs

REFRIGERATION—Book of the Hour!
Biggest Opportunity in Many Years!

NEW PRINTING—ALMOST 1000 PAGES

408 Pictures—17 Diagrams in Colors Makes All Refrigerator Service Maintenance, Repairs Simple as A. B. C.

Thousands of Refrigerators need repairs! Owners will pay big for competent service which will be needed more and more. Get MODERN GAS AND ELECTRIC REFRIGERATION, the non-technical guide to all types of refrigerators and get your share of this new profit. Get a job or start your own service business. This book will help you make money anywhere. Price \$5.00.



NEW 20th EDITION
Leading Auto Book for Over 32 Years

World's Greatest AUTO BOOK
New Material on Transmissions, Trucks, Tractors, Diesels, Aircraft and Auto Engines

Now with millions of cars needing repairs and thousands of men needed to do the work, you need the famous DYKE Auto Book more than ever before. Brand new 20th Edition covers all principles, construction, repair, adjustments, testing, troubles and remedies of all cars. Over a half million copies of 20 editions of Dyke's have been sold. Gives specifications of old and newer cars. World's biggest book value, \$6.00. This big book, a complete auto library in one volume, has 1483 pages—4600 illustrations and diagrams—weighs 6 lbs.—equal to 4 ordinary books.

ENGINEERS HANDBOOK

World famous Bailey's handbook of universal questions and answers for Stationary, Marine and DIESEL engineers and firemen. Prepares for any license examination. This is the one book that men should have if they want to reach the top in installation, maintenance and operation of Diesel and steam plants. Pocket size, \$2.00.

Mail Coupon to
Goodheart-Willcox Co., Inc.
 2009 S. Michigan Ave., Dept. 11, Chicago 16, Ill.

SEND NO MONEY! Mail Coupon

GOODHEART-WILCOX CO.,
 2009 S. Michigan Ave., Dept. 11, Chicago 16, Ill.
 Send books checked, C.O.D. I will pay postman, plus few cents charges. If not satisfactory, I will return books in 5 days and you will refund money paid. (Outside U.S. or possessions remit with order.)

- | | |
|--|--|
| <input type="checkbox"/> Gas & Electric Refrigeration \$5.00 | <input type="checkbox"/> Sheet Metal Layout \$3.00 |
| <input type="checkbox"/> Dyke's Auto Book \$6.00 | <input type="checkbox"/> Air Conditioning \$3.50 |
| <input type="checkbox"/> Dyke's Carburetor Book \$3.00 | <input type="checkbox"/> Engineers Handbook \$2.00 |
| <input type="checkbox"/> Modern Welding \$4.00 | <input type="checkbox"/> Body and Fender Repair \$3.00 |
| <input type="checkbox"/> Airplane Welding \$3.50 | <input type="checkbox"/> House Wiring \$2.50 |
| | <input type="checkbox"/> Shop Math. (2 vols.) \$3.00 |

If remittance accompanies order we will pay all postage charges under same return privilege.

Name

Address

City State

DRAFTSMEN NEEDED



PREPARE NOW for a BETTER JOB AND GREATER OPPORTUNITIES

If you are ambitious to hold a better job, make more money and have greater opportunities to get ahead, start now to become a draftsman. Or if you are now employed in routine drafting work and want a better job—as a real draftsman, on more important work, at bigger pay, start now to qualify for that job.

Learn at Home in Spare Time

American School has helped thousands to reach higher goals, and can help you. Our practical, up-to-date training plan can provide the know-how that fits men for responsible jobs and opens opportunities. Begin draftsman training now. Check, fill in and mail the coupon below for FREE information—today.

AMERICAN SCHOOL, Dept. DD145, Drexel Ave. at 58th St., Chicago 37, Ill.

Gentlemen: Send me FREE information covering special training in subjects checked below. No obligation on my part.

- | | |
|--|---|
| <input type="checkbox"/> Drafting and Design for Men and Women | <input type="checkbox"/> Electrical Engineering |
| <input type="checkbox"/> Architecture and Building | <input type="checkbox"/> Diesel Engineering |
| <input type="checkbox"/> Automotive Engineering | <input type="checkbox"/> High School Course |
| <input type="checkbox"/> Business Management | <input type="checkbox"/> Plastics |
| <input type="checkbox"/> Railway Training | <input type="checkbox"/> Mechanical Engineering |
| <input type="checkbox"/> Electronics, Industrial | <input type="checkbox"/> Aviation |
| | <input type="checkbox"/> Radio |

Name.....

Address.....

Learn REFRIGERATION and AIR CONDITIONING

Get in on the ground floor by starting now with the only civilian trade school selected for Army Training Program in this big, new industry.

LEARN—DOING WORK ON REAL MACHINES

Train at home or in our big shops. Work with tools on actual machines. Simple to master by our special training methods. Big opportunities now waiting. In a few short months you can be a qualified REFRIGERATION SERVICE ENGINEER, ready to move into a big paying job or be your own boss with your own business.

FREE BIG 16 PAGE BOOK OF VALUABLE INFORMATION

This big free book tells you all about the opportunities that await. Read the fascinating story of the tremendous growth and development of this industry—how you can get in on the ground floor if you ACT NOW. Write today!



Send Coupon TODAY!

ACT NOW!
LEARN IN YOUR SPARE TIME AT HOME

Commercial Trades Institute, Dept. M-21
209 W. Jackson Blvd., Chicago 6, Ill.
200 S. 20th St., Birmingham, Ala.

Without obligation, please send me the facts. Let me judge for myself the opportunities and post-war security this training offers.

Check here if interested in GI training.

NAME.....

ADDRESS.....

CITY..... STATE.....

SAY YOU SAW IT IN POPULAR MECHANICS

Get into Good Paying AUTO BODY and FENDER WORK



Men 18 to 60. If you are mechanically inclined, start now to learn to become an auto body mechanic and fender repair man. U. E. I. spare time, home-study training combined with actual shop practice gives you sound, basic knowledge of practical methods so you may get the experience which may bring you big pay. Course includes acetylene welding, spray painting, use of hand and power tools.

THOROUGH, RELIABLE TRAINING

Auto body and fender repairing is one of the best profit-makers in any garage or service station. Employment placement service included, or we'll show you how to go about to get started in your own shop. Get the facts FREE today!

WRITE FOR FACTS

AUTO-CRAFTS DIVISION • UTILITIES ENGINEERING INSTITUTE
3134 BELDEN AVENUE, DEPT. 116X, CHICAGO 14, ILLINOIS

MAKE MONEY CASTING AT HOME FREE FACTS SENT



Make hundreds of Plaster Casts, quick, easy. Sell output to stores, novelty shops, etc. Enormous profits. No experience. Very little capital needed. Start in basement, garage or workshop. Complete, simple instructions anyone can follow. Start now while merchants are begging for merchandise to sell. Rush.

PLASTIC ARTS STUDIOS, R.R. 5, Dept. 29, Muncie, Ind.

HOW TO GET A BIG PAY JOB IN Real Estate

Write for FREE BOOK!

Tremendous real estate boom predicted. Big pay, permanent jobs or your own 6-profit business. Salaries up to \$2,500 to \$10,000 a year in property management. brokerage, appraisal, loans, insurance, building. Many make fortunes selling real estate. Thousands of trained men, women, required yearly by real estate firms, insurance companies, banks, Federal agencies. Rush post-card for 32-page QUIZ BOOK—mailed FREE with full details on new and only 5-volume library. MODERN REAL ESTATE PRACTICE! Lane Books, Dept. B-1, 100 East Ohio St., Chicago 11, Illinois.

ENGINEERING DEGREE IN 27 MONTHS

INDIANA TECHNICAL COLLEGE

Aeronautical, Chemical, Civil, Electrical, Mechanical, and Radio Courses. B.S. degree. 1-yr. diploma in Electrical, Mechanical, and Radio Service; Drafting. Prep. courses. Gov't. approved for GI's. Low rate. Earn board. Large industrial center. Demand for graduates. Enter—Merch. June, Sept., Dec. Catalogue 516 E. Washington Blvd., Ft. Wayne 2, Ind.



WONDERFUL INVENTION—Corrects poor penmanship in few hours. No failures. Helps one get better job. Complete outline Free. Write Ozment, 34, St. Louis, Mo.



CARTOON TO SUCCESS!

Learn to cartoon! Big pay! Easy, enjoyable work! Cartoon course, gag course, anatomy course and business course full of plans, markets, ideas. Drawing set and criticisms. All one low price! Rush card for details! HARTMAN SCHOOL, 2438 W ST., LINCOLN 3, NEBRASKA

JET PROPULSION

Experimenters! New principle to drive boats, bicycles, model helicopters. Circular on plans. Rush name. Houston Maupin, Tipp City 12, Ohio.



FLIGHT JACKET INSIGNIA

With your own first name Come and get 'em, only... 50¢ each Postpaid

Dress up your sweater, blouse, or lumber jacket and look just like the men that fly our big bombers. Indicate selection by number and print carefully your first name, or your nick name. Mail with 50c today. Agents Make Money—Take orders. Sell for \$1.00. Illustrated book of all Army Insignia Emblems only 25c.

INSIGNIA MART
703 Broadway, Dept. P, New York 3, N.Y.

Learn RADIO- ELECTRONICS- TELEVISION



ELECTRONIC CIRCUIT TESTING — Instructor showing students use of large Cathode Ray Oscilloscope.



RADIO TESTING AND SERVICING—Students learning to locate troubles with modern radio analyzers.

**TRAIN FOR A GOOD
JOB NOW** one that
offers **STEADY WORK**
with a **REAL FUTURE**

Don't be caught napping. Prepare for a good job now that will still be a good job with a real future when conditions change. If you are not a trained man you may have to compete with millions of other untrained men. Get into a field that offers real opportunities in good-times and bad-times. Tremendous expansion in **Frequency Modulation and Television** is predicted because of war time discoveries now being re-converted to civilian use. **Radio-Electronics** trained men are needed today—they will be needed in the years ahead!

Real Opportunities for the Radio Trained Man

Prepare for jobs as assembler, inspector and tester—Radio sales or service and installation work, electronics, television, sound work, aircraft-radio, auto-radio, etc. Many opportunities in the vast **Radio-Electronics** field.

GET MY BIG NEW BOOK

It tells all about my big Chicago shops and my plans to help you get ahead. Packed with facts and pictures of students at work in my shops. **Mail coupon for this Big New Book** now! Coupon will also bring details on how I'll **Finance Your Training** . . . facts on how I help you "Earn-While-Learning" . . . information on **FREE EMPLOYMENT SERVICE FOR LIFE** . . . and other plans to help you. **ACT NOW TO MAKE SURE YOU GET MY GENEROUS OFFER.** Sending for this interesting free book can be your **first big step to success.** No obligation. No salesman will call. **Mail coupon today.**



H. C. Lewis

H. C. LEWIS, Pres., Radio-Electronics Div.,
COYNE ELECTRICAL SCHOOL
500 S. Paulina St., Dept. 16-3H,
Chicago 12, Ill.

Dear Mr. Lewis: Send me your Big Free Radio-Electronics Book and all the facts . . . also full details of your "Student Finance" plan. Send special G.I. Bulletin.
 Send physical disability details.

NAME.....

ADDRESS.....

CITY.....STATE.....

"Learn by Doing"

RIGHT HERE in the SHOPS of COYNE—12 Weeks Training
Student Finance Plan

We train you on real Radio, Television and Sound equipment—**RIGHT HERE IN THE COYNE SHOPS IN CHICAGO.** Whether or not you have had Radio experience you need Coyne all-around Radio Electronics training. Many of my students had no previous experience. Others had experience in one or two branches but realized they needed all-around training for better jobs and advancement.

EARN WHILE LEARNING

If you need part-time work to help pay living expenses while at school, we will help you get it. Coyne graduates also receive a **Life Membership** with **Lifetime Employment Service**, free technical service and privilege of review without additional tuition charge.

MEN WITH PHYSICAL DISABILITIES—whether due to war or other causes—we also have facilities for you. Check coupon for particulars if you have a physical disability of any nature.

H. C. Lewis, Pres.

Founded 1899

COYNE ELECTRICAL SCHOOL
RADIO-ELECTRONICS DIV.

500 So. Paulina Street Dept. 16-3H CHICAGO 12, ILLINOIS

PREPARE FOR JOBS LIKE THESE

Frequency Modulation (FM)
Radio Manufacturing
Radio Set Serviceman
Television Servicing
Electronics Maintenance
Public Address Systems, etc.
Your Own Radio Shop

**EXTRA
TRAINING**
NO EXTRA COST

Industrial Electronics
and **Electric Refrigeration**
Extra training to help you get ready for the better jobs in these great fields . . . no additional tuition cost **IF YOU ACT NOW!**

THE HOME OF
COYNE



VETERANS!
Coyne is also equipped to train those who qualify for training under the **G. I. Bill of Rights**. Check coupon for special **G. I. Bulletin**.

INVENTORS

Do Not Delay

Have you ever been startled by seeing a successful article on the market, and exclaimed—"Why, I invented THAT 5 years ago—I didn't think it valuable enough to Patent!"

The Patent Laws were intended for the Protection of the Inventor, and the Inventor who slumbers on his Rights may wake up to find someone else reaping the reward that could have been his.

Write NOW for Information and Record of Invention form FREE. RANDOLPH & BEAVERS, Registered Patent Attorneys, Columbian Bldg., Washington, D. C.

PERSONALIZED SERVICE — REGISTERED PATENT ATTORNEYS

RANDOLPH & BEAVERS

11-D Columbian Bldg., Washington, D. C.

Please send me full particulars on Patents, fees, etc., and "RECORD of INVENTION" form—FREE.

Name

Street

City State

Learn REFRIGERATION and AIR-CONDITIONING

ARE YOU HANDY WITH TOOLS?

Exceptional opportunity for men of all ages up to 60. The demand for repair and service mechanics in both REFRIGERATION and AIR-CONDITIONING is acute and will continue. You can easily and quickly—

Learn to Be a Service Mechanic at Home or in Our Shops

Our practical, thorough course is easy to grasp and can be studied at home in your spare hours. No previous experience is needed. A common school education is enough. Learn how to start your own business with \$50.00 worth of tools in garage or basement. Open up your own shop or take a well paid job in this active field.

START YOUR OWN REPAIR SHOP

Write for free booklet today. No obligation whatever.

MAIL COUPON TODAY



Send for FREE BOOKLET!

Mechanics Training School

4701 W. Pico, Dept P-1, Los Angeles 6, Calif.

Dear Sirs: Please send me, without obligation, your free catalog and full details.

Name

Address

City State

PATENTS AND TRADE MARKS

C. A. SNOW & CO.

Registered Patent Attorneys Since 1875
Write for Free Book and "Certification of Invention" form
427 SNOW BUILDING, WASHINGTON 1, D. C.

PATENTS

E. E. VROOMAN, Patent Lawyer
Registered Patent Attorney No. 5606
871 Woodward Building, Washington 5, D. C.

PATENT YOUR IDEAS

SEND FOR FREE BOOK → HOW TO OBTAIN A PATENT

Written by Former Member Examining Corps (1923-24) U. S. Pat. Office.
CARL MILLER, Registered Patent Attorney
Former Member Examining Corps U. S. Patent Office
Woolworth Bldg., Dept. 16-A New York — Bond Bldg., Dept. 16-A Washington, D. C.

END COLOR BLINDNESS

Over 90% of cases can be corrected. Don't spend your life in a world of gray—with the coming of the air age, color blindness assumes new importance. Most cases report all tests passed easily. New method makes scientific correction available BY MAIL. NO CORRECTION—NO PAY. Write today.

COLOR BLIND CORRECTIVE SCHOOL
603½ S. Mariposa, Los Angeles 5, Calif.

CODE SPEED SHORT CUT

Be an expert. Learn to be a Telegraph or Radio Operator. Thousands of men needed. Intensely interesting work—good pay. Learn at home or wherever you are, quickly, easily with the famous Candler Speed System. Book of particulars Free. CANDLER SYSTEM CO., Dept. 5-A, Box 928, Denver 1, Colo., U.S.A.

FIX TYPEWRITERS

A Simplified Practical Homestudy Course. Many of our Students now have their own Business—Many Repair for others. Repair Shops Swamped. Health or Age no handicap.
WEBER TYPEWRITER MECHANICS SCHOOL
Box 269, Osborn, Ohio

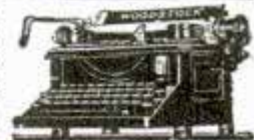

FREE 32-PAGE BOOKLET ABOUT

MODEL RAILROADING

THE WORLD'S MOST FASCINATING HOBBY



FREE 32-PAGE BOOKLET tells all about this absorbing hobby for skilled tradesmen, business and professional men. Give yourself hours of satisfaction and relaxation building your own scale model railroad which performs and looks like the real thing. It's easy and relatively inexpensive. Get started now. Send at once for our free booklet "Your Model Railroad."

MODEL RAILROADER MAGAZINE
DEPT. MR MILWAUKEE 3, WISCONSIN

MONEY for MEN ALL DATA FREE

THE PLASTEX Industry needs manufacturers on small scale and for big production of Lamp and Clock Stands, Art Goods and Novelties in Plastex and Marble imitation. Experience unnecessary. Lgc material makes regular 10c store sellers. Rubber moulds furnished for speed production. Small investment brings good returns. Big chain store orders now being placed. Ambitious men have chance for real prosperity. Our Free booklet will interest and benefit you.

PLASTEX INDUSTRIES, Dept. P, 1085 Washington Ave., New York, N.Y.



DRAFTING

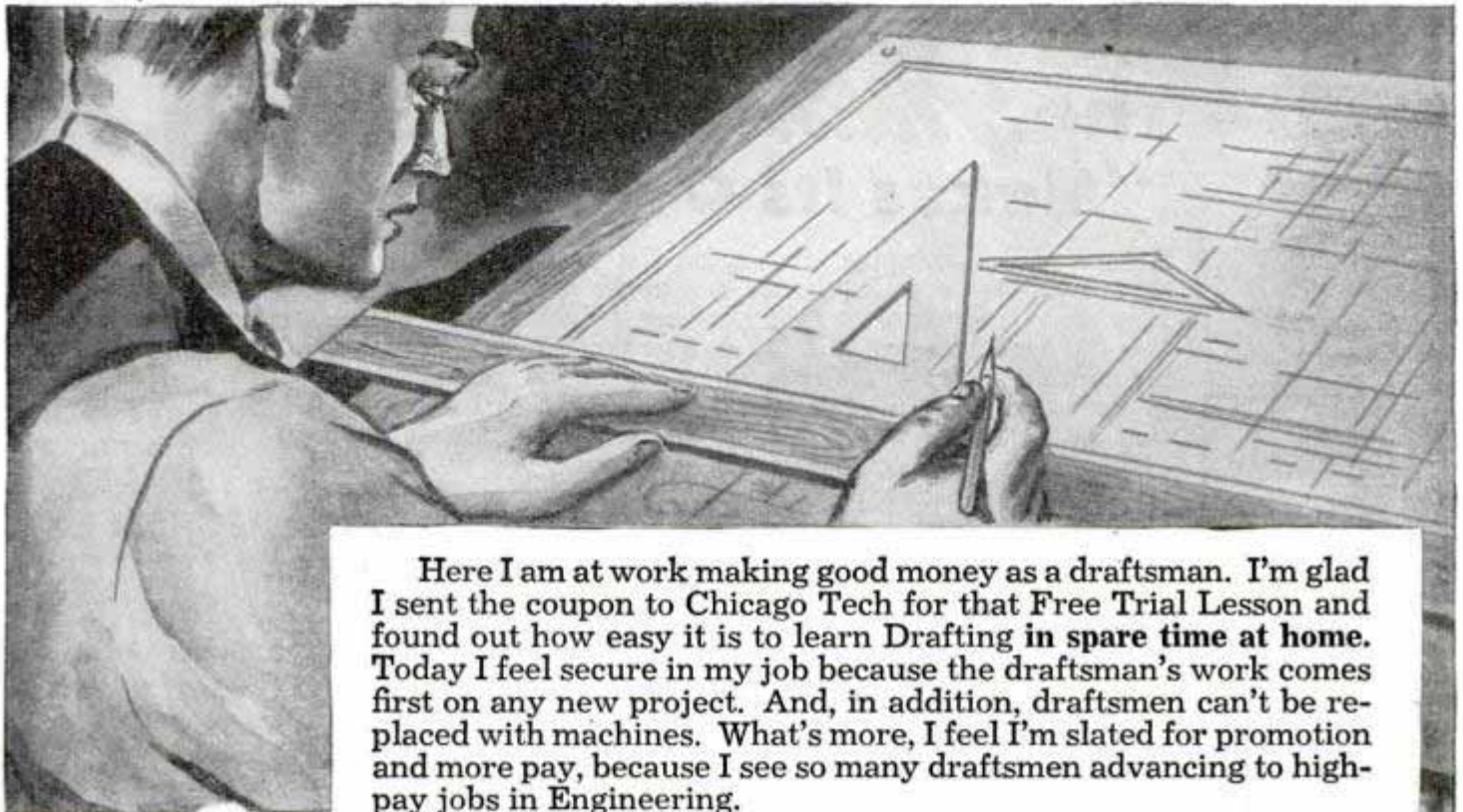

Here I am at work making good money as a draftsman. I'm glad I sent the coupon to Chicago Tech for that Free Trial Lesson and found out how easy it is to learn Drafting in spare time at home. Today I feel secure in my job because the draftsman's work comes first on any new project. And, in addition, draftsmen can't be replaced with machines. What's more, I feel I'm slated for promotion and more pay, because I see so many draftsmen advancing to high-pay jobs in Engineering.

Here's a tip: Mail the coupon or send a post card to Chicago Tech and find out about your opportunities in Drafting.

LEARN in Spare Time—at Home!

(Or at the College in Chicago)

A few hours of pleasant home study every week—that's all. No interference with your present job. With Chicago Tech's help, you train yourself step by step. This tested method,—developed over 40 years of C.T.C. progress,—prepares men quickly for good positions in industry.

Get Free Information — Send Coupon

Find out now how you can use your spare time to prepare, in your own home, for these job opportunities by use of the Chicago Tech Plan. Same training methods as used in our Chicago school. **Choose the line where you would like to work,—in Drafting, Building Construction, Refrigeration or Air Conditioning.** Mark and mail the coupon or send a post card. No obligation of course. Act today.



FREE TRIAL LESSON

To prove to you how easy it is to learn Drafting at home by the Chicago Tech method we will send you this FREE TRIAL LESSON. No charge for this Lesson, now or later. Fill out and mail Coupon, or send postcard today.

DRAWING OUTFIT INCLUDED with Drafting Courses

All the tools you need including folding drawing table. With them you can put your ideas on paper quickly and with accuracy. With training you are all set to master Drafting in months — not years, —at home.

CHICAGO TECHNICAL COLLEGE

A-207 Tech Bldg., 2000 South Michigan Ave., Chicago 16, Ill.

Send INFORMATION PLEASE on Home-Study Training in:

- | | |
|---|--|
| <input type="checkbox"/> Architectural Drafting | <input type="checkbox"/> Builders' Course |
| <input type="checkbox"/> Machine Drafting | <input type="checkbox"/> Blue Print Reading—Building |
| <input type="checkbox"/> Electrical Drafting | <input type="checkbox"/> Estimating,—Buildings |
| <input type="checkbox"/> Structural Drafting | <input type="checkbox"/> Refrigeration, Air Conditioning |

Name.....Age.....

Address.....

City.....Zone.....State.....

NOW You Will Never Run Out of Ink!



"Now I Need Never Worry About Ink"

The Yanks Write:

"Best pen I ever had."
 "Should have been made long ago."
 "Wouldn't be without one."
 "I wouldn't take a hundred dollars for it."
 "Wonderful, ink wherever there is water."
 A Blackhawk Div. Vet. writes: "Next to my rifle, the Ink-maker is my best friend."

FILLS ITSELF
 Simple Isn't It!



JUST PLAIN WATER

Just place Pen in water. Fills instantly. Has no complicated filling mechanism. As trouble-free as a jeep.

The Inkmaker Pen "Makes Its Own Ink"

Returning war veterans are singing the praises of the pen that never *needs an ink bottle, yet never runs out of ink!* Now you, too, can own this war-born INKMAKER Pen that "MAKES its own ink"! Yes, now you can enjoy having continuous fresh, lustrous, quick-drying ink generated in your pen from a concentrated ink battery—a battery that lasts months without replacement. You just add plain water. And, no matter where you are, you never run out of ink, because the INKMAKER Pen carries its own spare battery!

No More Bottle-Feeding!

Stacks of unsolicited letters from GI's, from officers, from all points of the globe, laud the pen that is not bottle-fed . . . needs no ink-bottle nursing. Once you own an INKMAKER

Pen, you would not part with it at twice its cost if you could not get another. It's the "extra pen" you want on a trip, for all you need is water . . . write anytime, anywhere!

BACKED BY 100 YEARS OF FINE PEN CRAFTSMANSHIP

The INKMAKER Pen is the result of eighteen years of intensive laboratory research by pen engineers backed by a century old tradition of fine pen craftsmanship. There is no perishable rubber sac to deteriorate, no ink-filling

levers or push buttons to wear out; no metals to corrode. This absence of complicated mechanisms really justifies the strong "Guarantee of Lifelong Service" packed with every INKMAKER Pen.

Exquisitely Styled and Streamlined

Precision built of durable materials, yet feather-light for effortless writing. A 14-K gold point, tipped with costly iridium for smooth writing. Every INKMAKER Pen is equipped with the exclusive patented Ink-"O"-Guard that prevents leaking even at high altitudes and under all climatic conditions.

The IDEAL GIFT

to yourself, to your friends, to your loved ones in the service. With each INKMAKER Pen you receive 4 Ink Batteries, 2 in pen and 2 extra. Refills always available, 2 for 25c.

When Ordering: Use the coupon order form. Specify point: Fine, Medium, Heavy. Specify color: (Give also second choice) Jet Black, Burgundy, Navy Blue. Enclose \$1.00 per pen with order and pay postman balance \$7.75 per pen plus C.O.D. charges. Or enclose full \$8.75 per pen and we will ship prepaid.

INKMAKER PENS, 40 So. Clinton St.
 Dept. 11, Chicago 6, Ill.

INKMAKER PENS, 40 S. Clinton St., Dept. 11, Chicago 6, Ill.

Please ship.....

- I enclose.....in full. Ship prepaid.
- I enclose \$1.00 per pen and will pay postman balance \$7.75 per pen plus C.O.D. charges.

Name.....Address.....
 City.....Zone.....State.....

The World's Most Practical Pen

NOTE: No gelatin or other ink substitute—actually makes highest quality, quick-drying, smooth-writing, blue-black ink.

Thousands In Use The World Over

SPARE BATTERY
 You never will run out of ink!

Concentrated INK-BATTERY
 In Use. Lasts months

INK GAUGE
 Tells when To Refill

Patented INK-"O"-GUARD
 Protects Against Leaking in Any Climate, Any Altitude.



14K Gold Point Iridium Tip

A WHOLE "BARREL OF INK"

Guaranteed FOR LIFELONG SERVICE

1000 GRABAGS 15c Each. Super bags 25c. Zandy, 630 Bingaman, Reading, Pa.

20 DIFFERENT Mexico—3c with approvals. Premiums with purchases. Brandwein Stamp Company, Box 92, Bayonne 2, N. J.

30 BEAUTIFUL Airmails, 10c. Selected approvals. Louis Morrison, Milmont Park 1, Penna.

1000 MIXED U. S. on paper 25c. Jem Stamps, Port Jefferson, N. Y.

25 DIFFERENT New Zealand, 10c to applicants for my quality foreign or U. S. approvals. Karr Ross, DeRidder, La.

BOX Stamps containing hundreds all different, cataloging up to 25c each. Everything \$1.00. Longacre Shop, 108 West 42nd, New York City.

CASH Waiting for collections and accumulations. Richard Groman, 306M East Hamilton, Allentown, Penna.

NOTICE! Mixed foreign, off paper, better than average condition, 25c per 100, \$1.00 per 500. Satisfaction guaranteed. Karr Ross, DeRidder, Louisiana.

SCARCE "Pole to Pole" packet! Stamps from strange, mysterious countries only—Greenland (North Pole), Solomons, Spanish Morocco, Bhopal, Patiala, Siberia, Grahamsland (South Pole), Djibouti, Zanzibar, etc., and including stamps cataloging up to 25c each! Our price only 5c to approval applicants. Big dime packet list free! Methuen Stamp Service, Inc., Dept. 136, Lawrence, Mass.

100 DIFFERENT 10c With approvals. Jacobsen, 59 Nagle Ave., New York 34, New York.

TURKS, Caicos, Grenada, Brunel, Dominica, Caymans; everything 3c with approvals. Viking, 130(Z) Clinton St., Brooklyn, N. Y.

U. S. Price list. Send postage. State Stamp Service, 1225 Park Building, Pittsburgh 22, Penna.

FREE U. S. price list. Postage 3c. Mark Hanna, 335 - 5th Avenue, Pittsburgh 22, Penna.

THE Best United States and Philippine Islands approvals. Largest varieties. America's lowest selling prices. Stamp Company, Albany 7, New York.

1000 WELL Mixed U. S. 25c. Monjar, 1750 Fairmount, Cincinnati, Ohio.

PENNY Approvals by country. M. H. Hoerning, 115, Farmington, Ark.

EXOTIC Pictorial collection: Tahiti spearfishing, Melanesian idol, Carib archer, Columbo harbor, Reunion produce, Yugoslavia, Philippines, Porto Rico, Malagasy farmer, Dutch Indies, South Africa, Roman's charity, Martinique settlement, Newfoundland codfish, Djibouti locomotive, Victoria. Everything only 5c. Imperial Stamp Co., Yonkers 1, N. Y.

SPECIAL—Airmails, 19 different, including zeppelin, triangles, Latin-America, 5c with approvals. Continental Company, (Dept. B), Box 606, New Rochelle, New York.

APPROVAL Sheets. Frederick B. Driver, 401 Finance Building, Philadelphia 2, Pa.

EXCELLENT Pictorial approvals. Reasonably priced. Crown Stamp Company, Box 331, Toronto, Canada.

RICH Man's approvals, poor man's prices. Grand value packet containing five mint sets, free with approvals. Stoll Stamp Service, 2630B West Burnett, Louisville 10, Kentucky.

PACKET Scarce United States before 1910. Only 10c to approval applicants. E. J. Banks, 6635-16 Ave., Kenosha, Wis.

TRIANGLES—(Mozambique Co.) other beauties, 10c. Approvals. Reuter, 611-C West 40th, Los Angeles 37.

FREE Packet with attractive approvals that satisfy. Pearl Field, Derby, Maine.

25 DIFFERENT Guatemala 10c with 1/4, 1/2, 1c approvals. Carrroll's, 4357A S. Hoover, Los Angeles 37, Calif.

U. S. Price list. Send postage. Stanley Gibbons, 38-P Park Row, New York.

FREE—Pick 25c worth of stamps from our first U. S. approval selection. Approximately 100 stamps to choose from. Excellent value. No obligation to buy. Lists illustrating the most popular U. S. stamps—at prices you can afford—will be included. Don't miss this opportunity! Write today. S. C. Engel Co., 38 Park Row, New York City.

114 DIFFERENT Stamps from far away countries including airmail and Free Fighting French to approval applicants for 10c. Reich Stamp Co., 4647 Kenmore, Chicago 40, Dept. M9.

COMPLETE "United States" catalog with 1000 illustrations! Send 10c for mailing. Harris & Co., 137 Transit Building,

SMOKY Mountain commemorative sheet, largest U. S. stamp issued, and 33 U. S. including commemoratives, airmail, revenues, etc. Catalogs 75c—To approval applicants for 5c. Curhan Stamp Company, Gloucester, Mass.

U. S. Collection fifty different mint un-hinged commemoratives 1921-1939 only \$2.00 with your request for approvals. Orange Stamp Company, Albany 7, N. Y.

UNITED States approvals complete coverage, fine quality, attractive prices. Seminole Stamps, Box 436, Coconut Grove, Florida.

AMAZING Offer! Assortment each of giant stamps, midget stamps, flag stamps, airmail stamps, Free French Colonies, U. S. commemoratives and numerous others. Everything only 10c to approval applicants. Simon, Box 214, Iraan, Texas.

60 DIFFERENT U. S., 10c. Pricelist free. Seidenberg, Cassopolis, Mich.

FREE! Western Hemisphere packet. Postage 3c. Owens, 806 Welsh, Bay City, Michigan.

FREE! Pony Express set (facsimiles). Postage 3c. Roberts, 406 Building, Bay City, Michigan.

DEALERS—Wholesale list. Postage 3c. Frank, 5031 Queensberry, Baltimore 15, Md.

FREE! British Empire packet. Postage 3c. Williams, 606 Archer, Bay City, Mich.

FRESHLY Mounted approvals for collectors using Scott's International Junior album. Wiaschim, 55 Nagle Ave., New York 34.

SCARCE 1880 U. S.—Hussey local carrier stamp listed at 15c. Also Costa Rica No. 65 listed at 40c. Both sent free to approval buyers sending 3c postage. Pladon Stamps, 1717-M Idaho, Toledo 5, Ohio.

ZOWIE-E-E! A barrel of fun for only a dime. 500 United States—absolutely unpicked and unsorted—just as received from church missions. Many varieties, including large commemoratives, airmails, high denominations up to \$5.00! Stampdom's biggest package of fun—and you might find something really valuable! Price only 10c to serious approval service applicants. Money back if not delighted. Illustrated bargain lists with each order. Mystic Stamp Company, Department 80, Camden, New York.

WORLD'S Largest diamond and triangle stamps, free stamp magazine, stamps from fighting Free French, 20 stamps from 20 different countries, pictorials, airmails, big bargain 5c with approvals. Capital Stamps, Dept. 2, Little Rock, Ark.

118 DIFFERENT Stamps including commemoratives, charities, airmail sets, etc., only 3c to approval buyers. We buy collections. Badger Stamp Co., Milwaukee 3, Wis.

FREE! Canadian sets, royal visit, George VI, George V, coronation, jubilee, others, to approval applicants. Ensign, Box 118-M, South Orange, N. J.

FREE! The Stamp Finder! Send today for the big new edition, fully illustrated, enabling you instantly to identify all difficult stamps! Also fine packet strange, fascinating stamps from Bosnia-Herzegovina, Monaco, Patiala, Cyprus, etc., including maps, ships, animals and strange scenes. All free to approval applicants enclosing 3c postage. Garcelon Stamp Company, Box 900, Calais, Maine.

CANADA 100 Different 25c—approvals all countries. Lists. Victoria Stamp Co., London, 4, Canada.

FREE! Leeward Is., Cayman Is., Turks and Caicos plus 60 different mint Geo. VI coronation poster stamps, to approval service applicants sending 3c postage. Tatham Stampco, Springfield-30, Mass.

VICTORY Packet free—Includes stamps from Tanganyika, British Cayman Islands, animal, scarce babyhead, coronation, early Victorian, airmail, map stamps, with big catalogue—all free. Send 5c for postage. Gray Stamp Company, Dept. PM, Toronto, Canada.

EXCHANGE Duplicates, details 3c. Clarence Schultz, 1304 19th, Two Rivers, Wisconsin.

HOBBIES AND COLLECTIONS

MILITARY Ornaments. American, German, Japanese, political buttons, badges, all descriptions. Relics bought, sold. S. Hoffman, 929 Locust St., Philadelphia, Pa.

WANTED: Old cigarette cards. Write Charles Bray, East Bangor, Penna.

POSTCARD Collectors—12 beautiful Kodachrome postcard scenes of "outdoor" Wisconsin. 50c postpaid. Ray Almon, Box

"GEM Cutting" profitable, interesting hobby. Instructive illustrated booklet. Dollar. Mineral Specimens Company, Box 1191, Santa Monica, California.

COLLECT Colorful Army patches. Pictures, prices and sample patch only 10c. Insignia Mart, 703 Broadway, N. Y.

EARN Cash in spare time collecting plants for me. Details free. G. Elbert, P.O. Box 414-Y, VanDyke, Mich.

REPRINTED Abraham Lincoln liquor license, only \$1.00 for two copies. Yes, Lincoln operated a tavern in 1833. Proof and many interesting facts shown on this antique document. Send for it—today. Charles Sales Company, Preuss Sta., Box 56, Los Angeles 35, Calif.

HOBBYISTS—Bird lovers. Make any bird, life size, complete body, correct colors. Robin size costs dime. No molds or special equipment needed. Pictures, plans, instructions, one dollar. Birds, Box 1575, Medford, Oregon.

FOOL'S Gold—From famous gold camp, 10c per sample. Also mineral specimens from famous local mines. Martin's Snap Shop, 506 Harrison Ave., Leadville, Colo.

FOREIGN Military insignias: Sample; prices. Send 15c. Hobbyguild, P35 West 32nd St., New York, N. Y.

COLLECTING Hobbyists. Exchange duplicates. List free. C. Bishop, Route 8, Kalamazoo 88, Michigan.

WHITTAKER'S—20 Patterns, instructions, X-acto knife, wood, \$1.00. "Old Whittler," 1402 Charles, LaCrosse, Wis.

FOREIGN Decoration ribbons, list, sample, 20c. Foreign insignia packet, booklet, \$1.00. Insigniacrafts, 236-28th Ave. N.W., Calgary, Canada.

EXCHANGE Duplicates. Swappers everywhere. List free. Box 2166, Denver 1, Colorado.

UNUSED Match book covers. 100 all different \$1.00. 35 Royal Flash covers \$1.00. Free list. Charles Edelman, 13110 East 84, Cleveland 3, Ohio.

JEWELRY Stones removed from rings, etc., 100 assorted \$2.40; 50 large ones \$2.40. B. Lowe, Holland Bldg., St. Louis 1, Mo.

MINERALS AND PRECIOUS STONES

OPALS, Polished, rough, also meteorites. Robinson, Box 36, San Pablo, Calif.

CAMERAS AND PHOTO SUPPLIES

LEARN Professional negative retouching quickly, easily. Complete course and deluxe professional retouching stand only \$10.00 express prepaid. Set of "Victory" film clips (6) (a new kind—makes no holes in film) and drying hanger only \$1.50 postpaid. The H. K. Williams Co., Dept. 32-A, Moline, Ill.

WE Would like to give you an idea of the range of photo-goods and cameras we have in store for you this coming year. Likely that everything you may select may not be available at this moment, but this you may be sure, however, and that is, new merchandise is arriving daily—and that you are next whatever your buying is. We buy and trade. Conway Camera Co., 34 N. Clark, Chicago 2, Ill.

PHOTOGRAPHIC Supplies. Lowest prices. Free catalog. Cavalier Camera, 1822 Center, Pittsburgh 19, Penna.

PHOTOGRAPHY For pleasure or profit. Learn at home. Practical basic training. Long established school. Write for booklet. American School of Photography, 1315 Michigan, Dept. 3432, Chicago 5.

FILM! Army surplus. 5 rolls, 8 exposures, including postage: No. 127—\$1.50, 120—\$1.75, 620—\$1.75, 116—\$2.00, 616—\$2.00. Payment with order. Artex, Union, New Jersey.

USED Camera Directory, Box 1031-M, Canton, Ohio—lists hundreds of war-bargain used cameras—35mm., Speed Graphics, Kodaks, Rolleiflex—many others. Send 25c for latest issue.

100 "POISON" Gummed labels, 20c. Ultra, 264 Ninth, Paterson 4, N. J.

WAR Surplus Films 127 \$3.45 dozen; 120, 620, \$4.15; 116, 616, \$4.81 dozen postpaid. Cameras, meters. Cameron, 542 Fifth Ave., New York 19, N. Y.

AVAILABLE Film, flash bulbs, paper, equipment. Photoking Supply Shop, 6803 North Clark Street, Chicago 26, Illinois.

HANDSOME Jointless aluminum light, proof photographic paper storage box \$4.95. Box 171, Glendale, Calif.

BASS Says: War time proves Bass leadership. Amazing selection of finest still cameras—Leica, Contax, new and used still available. Write for quotations. Satisfaction guaranteed or your money refunded. Bass buys 'em, sells 'em, trades 'em. 35c postpaid for 100 page book "Military & News Photography" by Jack Price. Up to the minute information. Bass Camera Company, Dept. AG, 179 W. Madison St., Chicago, Illinois.

GREATEST Value ever offered—14 handbooks, journalistic photography, illustrated. \$7.95 prepaid. Darkroom, studio equipment. Cameras, lenses, trades accepted, bought. Mogul's, 68-P West 48th St., New York 19.

MAKE Copy-all. Photostamp printer. Instructions \$1 each. Tirekopo (AA-1) Madeira, Ohio.

FILMS. Standard brand, 127 each 25c. 120, 620, each 30c. 116, 616, each 35c. Add 10c per order for postage. Limit dozen rolls. Ask our lowest prices on other films, equipment, darkroom supplies. Free literature. Photo-craft, 470 Jamaica, New York.

ENLARGERS—Build your own. Kit of parts, \$6.00. Free particulars. Crescent Engineering, Box 251-P, South Pasadena, California.

HAVE You a camera? Improve your hobby of photography and learn how to make better pictures. Write today for our latest book catalog and sample copy of American Photography, containing articles and pictures by the world's foremost writers and photographers. Camera House, 601, 353 Newbury St., Boston 15, Mass.

OIL Coloring photographs can be a fascinating hobby or profitable sideline for those with artistic talent. Learn at home. Easy simplified method. Send for free booklet. National Photo Coloring School, 1315 Michigan, Dept. 3431, Chicago 5, Ill.

CASH! Spot cash for cameras, lenses, binoculars, movie or still, sound projectors. Send full description by mail, or wire for prompt cash offer. Over 30 years of dependability insures honorable dealings. 35c postpaid for 100 page book "Military & News Photography" by Jack Price. Up to the minute information. Bass Camera Company, 179 West Madison Street, Chicago, Illinois.

PHOTO FINISHING

CANADA Introductory special! Mail this ad with 10c in coin and 4 negatives and receive 4 beautiful panel-embossed snapshots in handy pocket album! Artisto, Dept. 131, Drawer 220, Regina, Saskatchewan.

SIX Or eight exposure roll film developed and 6 or 8 prints with 5x7 double weight glossy enlargement 30 cents silver. 12 or 16 exposure, 12 or 16 prints, no large film packs 50c with large 5x7. Our customers send roll after roll. Dover Photo Service, 22 Dover-Foxcroft, Maine.

CENTURY Delivers work and service that can't be beat. 8 exp. roll 25c with two professional enlargements free. Century Photo Service, LaCrosse, Wis.

FINER Photo finishing specials 25c. Eight exposure rolls developed with two prints each good negative or one enlarged print of each. Try today's quicker, finer Moen-Tone Enamel finish. Satisfaction since 1898. Moen Photo Service, 452 Moen Bldg., LaCrosse, Wis.

GLOSSY Contact prints 3c each from any size roll film negative except 35mm. Photo Prints, 136 Maple Ave., Haddonfield, N. J.

PHOTOGRAPHY For pleasure or profit. Learn at home. Practical basic training. Long established school. Write for booklet. American School of Photography, 1315 Michigan, Dept. 3451, Chicago 5.

MONEY Back guarantee. 16 sparkling double clear Nu-Art prints, also 2 enamel finish enlargements. All complete 25c. Rolls or negatives. Prompt, careful, guaranteed. Lifetone Studios, Department 139, Des Moines 8, Iowa.

PHOTO Enlargements hand painted. Particulars. Fregoe, 28 Park, Massena, N. Y.

NOW! Glossy photo finishing in gorgeous colors. Any 6-8 exposure roll 35c (coin). Colorcraft, Avoca, N. Y.

BEAUTIFULLY Colored enlargements. 11x14 \$3.00. Haynescraft, 706 Eighth, Washington 1, D. C.

CUSTOM Finishing at popular prices. All negatives fine grain developed and enlarged. Eight exposure roll, 50c. 36 exposure roll \$2.00. MacDonald's, Box 28, Congress Park, Illinois.

35MM. Enlarging 5x7's, 3 \$1.00. 8x10's, 3 \$1.75. Premier Photo, 1316 Park Road, Washington 10, D. C.

QUALITY Enlargements, 8x10, 60c; oil colored \$1.50. From photo 75c extra. Statuette, \$1.30; colored, \$1.80. Photo Services, Inc., 580 Market Street, San Francisco 4, Calif.

REPRINTS 3c Each. 5x7 enlargement 25c. Fred Cox, Palmer, Texas.

BEAUTIFUL Oil hand tinted by expert. Enlargements from any favorite photograph, finest quality double weight paper, in mount to match. 5x7 inch \$1.50; 8x10 inch \$2.00. State colors. Original returned. Reprints 3c each. Home Studio, Wadsworth, Kans.

18 BEAUTIFUL Deckledge Christmas cards made from your negatives \$1.00 including envelopes. Kodak films developed two deckledge prints of each negative 25c. Velox deckledge guaranteed reprints 2c each. Summers Studio, Unionville, Mo.

8 EXPOSURE Rolls 25c, over 8 exposure 40c, for one Velox print each and free enlargement coupon. Reprints 3c, minimum 25c. Fred D. Eastman, Bode, Iowa.

6-8 EXPOSURE Rolls developed and enlarged mammoth size 30c. Reprints 3c. Thrifty Photos, Box 46, South Gate, Calif.

CENTURY Delivers work and service that can't be beat. 8 exp. roll 25c with two professional enlargements free. Century Photo Service, LaCrosse, Wis.

ROLLS Developed and printed 25c. Reprints 2c; 5x7 enlargements, 15c; 8x10, 25c. Davis Studio, Guthrie, Okla.

SPECIAL—25 Reprints 50c. Suburban Studio, 1408-M Bond, Rockford, Illinois.

TECHNIFINISH 35mm. 36 exposure rolls, fine grain developed and beautifully enlarged to 3"x4" high gloss prints only 90c; 18 exposure rolls 55c. Credit given for non-printing negatives. Reprints only 90c for 36, 55c for 18. Reprints of selected frames from uncut rolls 4c each. Reloads for your empty cartridges: 36 exposure reloads 35c, 18 exposure reloads 20c. Fresh stock. Technifinish color prints 8"x10" from your 35mm. Kodachromes or 35mm. area of larger transparencies only \$3.00 in distinctive mounts; \$1.50 for additional prints from the same transparency. Black-and-white positives from your 35mm. negatives for your projector: 36 exposure positives 50c, 18 exposure 35c. Write for free mailing bag, sample print and complete information. Technifinish, Dept. 112, Rochester 3, New York.

8 PRINTS, All enlarged to nearly postcard size, from your roll or negative, 25c. Willard Studios, Box 3535A, Cleveland 18, Ohio.

AT Last! Roll developed, all your snapshots hand-colored as beautiful as most actual colored photography 35c. Hand colored reprints 4c each—12 for 45c. National Photo Art Company, Janesville 26, Wis.

SENSATIONAL Introductory offer! Send snapshot or negative, this ad, and 3c. We'll send you a beautiful 7"x5" enlargement! Or, Kodak roll developed with 16 guaranteed deckled-edge velox fade-proof prints or 8 double-size prints, 25c! Special! From your negatives, 16 regular-size or 8 double-size reprints, 25c! Candid rolls—36 exp. 35mm. developed, vaporated, enlarged to 3x4, \$1.00! 18 exp. 50c. Reprints, 3x4, 3c each. We have new, perfect 35mm. film. Low prices. Free mailers, details on request. American Studios, Dept. 279, LaCrosse, Wis.

BIGGEST \$1.00 Value in 35 mm. finishing today. 36 exposure fine grain 3 1/2"x4 1/2" enlargements; deckled, embossed margin and date. Eighteen exposures 75c; 16 exposure splits 55c; 36 exposure reloads 50c. Special: return this ad with \$2.00 and we will send five 36 exposure reloads. Free mailers. 8 exposure rolls in beautiful, deckled contact finish with embossed wide margin. 25c. Mailbag Film Service, Box 5440A, Chicago 80.

BEAUTIFUL Double-size pictures 3 1/2x5 1/2 each, from 116 and 120 negatives, 3 1/2x4 1/2 from all other sizes. All work guaranteed. Overnight service. Roll developed and 8 pictures 30c. Roll 12 pictures 45c. Roll 16 pictures 60c. Enlargements on double weight portrait paper 5x7—30c, 8x10—50c. Copies made from any picture 75c. Pacific Photo Service, Box 666, San Francisco, Calif.

EVERY Picture an enlargement! 8 sparkling deckle-edge enlargements and roll developed 25c coin; 116 size or smaller; enlarge reprints 3c. Enlarge Photo, Box 791D, Boston, Mass.

PHOTO Enlargers—Four types you can make. Illustrated instruction book 25c. Popular Mechanics Press, (C-43), 200 E. Ontario, Chicago.

MOTION PICTURES AND SOUND EQUIPMENT

ATTENTION Home movie fans! Send for our free illustrated catalog of camera film, subjects, supplies, rental library, lowest prices! Solar, 4247 South Kedzie, Chicago 32, Illinois.

35 MILLIMETER Sound films for sale. Will trade for 16 millimeter sound film and machines. Mertz's Films, Springfield, Ill.

LEARN Professional motion picture technique at home. Free catalog. Motion Picture Institute, Birmingham 4, Mich.

BRAND New, latest style, 16 mm. sound projector, factory guaranteed; also one slightly used, cheap. Box 875, Reading, Penna.

FREE, 1946 Movie Catalog; samples 10c. Roll film, enlargers, etc. Goodwill Company, Jackson, Tennessee.

UNUSUAL 8-16 mm. Film subjects. Big catalog with sample film, 10c. National Film Exchange, Sta. E-Broadway, Toledo, Ohio.

16MM. Motor driven projectors \$13.50, hand cranked \$10.50. Send stamp for 16mm., 8 mm. catalogue. Sterling's, 679 Northampton, Easton, Pennsylvania.

WANT Mary Pickford films, 16 or 35mm. Roy, 1600 So. Vermont, Los Angeles 6, California.

UNUSUAL Home movies: travel, comedy, adventure, sports, news war film. Many film bargains. Big 1946 catalog and sample, dime. Audet, Box 6520-BG, Philadelphia 38, Penna.

MOVIE Films, 100' outdoor 16mm. \$2.25; three 70' rolls \$6.00; 100' indoor film \$4.25. Ambassador, 479-A, Quincy Street, Brooklyn, N. Y.

MOVIE—Sonja Henie, 100 feet 16mm. \$3.50; 8mm., 50 feet \$1.75. (Free with every purchase Rudolph Valentino photo, 40 page synopsis "Son of the Shiek," fire-side booklet.) Fireside Films, 145 W. 45th St., New York City.

SCREENS, new, 52"x72" "Raven" beaded, metal case, tripod, \$32.50. Charlie Poorman, Dept. PM, Schuylkill Haven, Penna.

FREE Membership—Movie Film Rental Library. 8-16-35mm. sound, silent projectors, cameras. Movie film 8mm. \$2.25; 16mm. \$2.45. Movie films exchanged; catalogs. Trades accepted. Mogul's, 68-T West 48th St., New York 19.

NEW Catalogue 35mm. motion picture productions. Roadshow attractions. Westerns. Gangster. Medicals. Any type picture you want. Low prices. Catalogue 25c. Bussa Film Exchange, Friendship, Ohio.

NEW Film, equipment, subjects. All sizes. Free list. State wants. Thompsons, 2 Southeast Fifth, Evansville 9, Indiana.

16MM. Bell Howell, Victor, Ampro, sound projectors. Delivery now. Dime brings catalog. Movico, Box 482, Ithaca, N. Y.

RELIGIOUS New sound prints only. Screenart, 723 - 7th Ave., New York.

FILM; Free processing, 25 ft. Double 88 Weston 6, \$1.35; Weston 24, \$1.89; Weston 64, \$1.99. 100 ft. 16mm. Weston 6, \$2.50; Weston 24, \$4.85; Weston 64, \$4.95. Write for circular. Fromader Genera, Davenport 7, Iowa.

35MM. Sound features, projectors. A Savarese, Woodcliff Lake, New Jersey.

SENSATIONAL Full color movie subjects! 8mm., 16mm. Big catalog, 25c. Special! Projection length sample scenes (Kodachrome), "Waikiki Hula," \$1.00. Specify width. Iriscope kits, \$5.00. World in Color Productions, Box 392-F, Elmira, N. Y.

HOME Movie rentals, sales, exchange. 8-16mm. and sound. Latest releases—Money-saving rates. Details for stamp. Midland Film Exchange, Box 429, Oak Park 4, Illinois.

BEAUTIFUL Kodachrome slide and list. 25c. Art Slide Co., M-1, Canton, Ohio.

"THE World's Greatest Passion Play" all sizes sound and silent. Write Hemenway Film, 33-F Melrose St., Boston 16, Mass.

LEARN Movie projection, management. Free catalog. Theatre Institute, Elmira, N. Y.

BUY, Sell, trade 35mm., 16mm., 8mm. Samples 10c. Lists free. Paramount Films, Monmouth, Illinois.

GUARANTEED Fresh movie film! Three spools double 8mm. \$3.45! Six spools single 8mm. for Univex cameras, \$3.50! (Limit six spools each type.) Processing free! Will ship C.O.D. on \$1.00 deposit. State make of camera. Eso-S, 4038 Broadway, Kansas City 2, Missouri.

MOVIE Camera films, 100' 16mm. \$2.50. 25' double 8mm. \$1.25. Free developing. Better Films, 742 New Lots, Brooklyn 7, N. Y.

MOVIE Projectors bought and sold. List 10c. United, 2309-A Lawrence, Toledo, O.

BASS Says: Leadership in the cine field is apparent in war times. Here ready—your choice of 8 mm. and 16 mm. apparatus. Write for quotations. Your old equipment is worth real money in trade—describe please. Or we buy for cash and pay immediately on receipt. Write to headquarters. Bass buys 'em, sells 'em, trades 'em. Satisfaction guaranteed or your money refunded. 35c postpaid for 100 page book "Military & News Photography" by Jack Price. Up to the minute information. Bass Camera Company, Dept. A, 179 W. Madison St., Chicago, Illinois.

SPECIAL Movie film, 8mm., 25 feet double-Weston 8, \$2.00. Super double X, Pan indoor 60, outdoor 100, 16 mm.—\$6.50. Super X Pan indoor 24, outdoor 50, \$5.75. Pan Weston 12, \$5.00. 16 mm. 100 feet Weston 6, \$4.00. Free developing. Exhibitors Film Exchange, 630 9th Ave., New York 19, N. Y.

CAMERA Film! Guaranteed satisfaction. Weston 12 double 8mm. \$2.19, 16mm. 100' \$4.39. Free processing. Other film bargains. Write Variety, Palatine, Illinois.

MUSIC AND MUSICAL INSTRUMENTS

GUITARISTS. Play professional, modernistic set, runs, breaks introductions, modulations, \$2.00, notes, diagrams. Nicossia, Box 596, Brooklyn 1, New York.

PIANISTS—Quickly improve technique, sightreading, accuracy, memorizing, playing through mental-muscular coordination. Free booklet. Broadwell Studios, Dept. 46-A, Covina, Calif.

ACCORDIONS—Special discount. Dealers prices. New or used. All sizes and makes. Free catalog. Metro Accordion Co., 31 So. Cicero, Chicago.

GUARANTEE To teach you to play Hawaiian or Spanish guitar in ten lessons, one dollar. Frank's Musicians Supply, 732 Jersey Ct., San Diego 8, Calif.

NEW Songs and lyrics wanted for popular radio program and professional promotion. Free examination. Transradio Music Inc., Dept. P., 1650 Broadway, New York.

SONGS Recorded. Radio staff artists. \$6.50 up. Write for details. George Hunt, 2739 Wilma, Wichita, Kansas.

SONG Poems wanted—All subjects. Send your best poems today for free examination, or write for free booklet "Getting Ahead in Songwriting." Song Service, 331-C West 46th, New York.

MUSIC Composed to song-poems. Address: Frank Wildt, Lancaster, Penna.

SONG Writer's attention! The amazing demand for phonograph records, accelerated by more than 300,000 juke boxes and the hits popularized warrants your immediate consideration. We are offering song-poem writers the rare opportunity of having established composers collaborate on appealing material received this month. Recola Records, Box 987F, Hollywood 28, Calif.

SONGWRITERS: Collaborate with nationally famous composer of "Boots and Saddles." Send poems for free examination. Get free instructive booklet. Hollywood Harmony House, 126 South La Brea, Studio M-6, Los Angeles, California.

POEMS Wanted for immediate musical setting. Free examination; any subject. Well known music publisher in urgent need of original material. Send poems to: Composers' Guild of America, 545 Fifth Avenue, New York 17, N. Y.

LEARN To write music, words, arrangements and publishing. The Complete Songwriter tells how. Send \$2.00 M.O. postpaid to Puritan Publishing Co., Inc., 343 So. Dearborn St., Chicago 4, Ill.

WE Offer the services of a noted Hollywood motion picture composer and arranger. Recordings made by NBC singer. Send your poem on any subject today for consideration and our liberal offer. Hollywood Melodies, P.O. Box 2168PM, Hollywood 28, Calif.

SONG Selling suggestions 10c. Andy Tocco, Box 187, Miami Beach, Fla.

ATTENTION! Song writers. "Let your song ideas make your dreams come true." Expert arranging. Free information. Grant MacGregor (Hollywood Composer), 5079 Lemon Grove Ave., Hollywood 27, California.

PLAY Music without study. Money back if you are not pleased. Order "Play Music Without Study." \$1.00 postpaid. Dr. P. Wilson, P.O. Box 1205, Chicago 90.

SONGS Published. Music free. National songwriters, 1587 Broadway, New York.

HAWAIIAN Guitarists. Write for list of supplies. Ameri-Conn, Branford, Conn.

HAWAIIAN Guitar orchestrations. List on request. Complete course \$1.50. Hula folio 50c. Golden Gate Publications, 5472 Foothill, Oakland 1, California.

SONGWRITERS! Outstanding, amazing offer. Hibbeler, C5, 2157 N. Avers, Chicago.

SONGWRITERS. A limited amount of musical compositions wanted for radio distribution. Tin Pan Alley Publications, 1587 Broadway, New York 19, N. Y.

POEMS Wanted for musical setting. Send poem for immediate consideration and free rhyming dictionary. Richard Brothers, 24 Woods Building, Chicago.

POEMS Wanted! I'll compose special music. Send poem for free examination. Eliot Wright, Box 3861-Z, Portland 8, Ore.

PHONOGRAPH Records: Send us \$2.00, we will ship you 10 used phonograph "juke box records"—all different. Satisfaction guaranteed! Automatic Sales, 56 E. Hennepin, Minneapolis 1, Minn.

HAWAIIAN Guitar chord chart \$1.00. Over 650 chords in A Major—C Sharp Minor E-7th and B-11th tuning. Arranged by Sol Hoopii and Dick McIntire in note and diagram. Fator's, 935 W. Santa Barbara Ave., Los Angeles 37, Calif.

SONGS Arranged and scored. Melodies composed for lyrics. Workmanship guaranteed. Write for particulars. Tommy Kilbourne, Box 1253, Bakersfield, Calif.

POPULAR Piano in 12 lessons. Positively guaranteed, beginners or advanced. Get copies of hit parade tunes free with the course. Kelly School, 1734 30th Ave., San Francisco 22, Calif.

SONGWRITERS—Send poems for immediate examination and free book, "Your Future in Songwriting." Radio City Music Academy, 1674 Broadway, New York City 19.

WANTED! Lyrics, melodies for songs. We arrange, publish, sell. Superior Song Studios, Passaic, N. J.

ACCORDIONS. New and used at wholesale prices. Save up to \$100.00. Buy direct from factory. Del Principe, 307 So. Wabash, Chicago.

BEFORE Sending your poem to be set to music, know your composer. Free folder. Al. Moquin, 5333 La Cresta Court, Hollywood 38, Calif.

PLAY Swing piano! Send 10c for instruction bulletin. Christensen Studios, 751 Kimball Hall, Chicago 4, Ill.

POEMS Wanted for musical setting. Send poem for immediate consideration. Five Star Music Masters, 630 Beacon Building, Boston.

SONG Poems wanted. Free examination. McNeil, Master of Music, 510-PM South Alexandria, Los Angeles, Calif.

WRITE Songs. Big money and reputation. Write for information. J. Gordon Pub Co., 201 N. Hoyne Ave., Chicago.

RADIOS AND SUPPLIES

FAMOUS "Allen" Midget Semi-Fixed Crystal Detector, set building plans and 100 late crystal set distance reports all for 50c postpaid. Allen, 427-P, Clinton, Mo.

YOUR New free catalog is ready! Radionic's Catalog lists hard-to-get radio parts and books. All available for immediate shipment. Send today to: Radionic Equipment Co., Dept. 1D; 170 Nassau St., New York 7, N. Y.

CRYSTAL Set fans! Build latest, extra-loud set. Instructions, 20c. Booklet: "All About Crystal Sets," 45c. Many crystal circuits, supplies available. Amorose, R-4, Hungary Road, Richmond, Virginia.

REVISED Plans 18 long distance crystal sets, including "Radiobuilder"—25c. Laboratories, Box I-C, San Carlos, Calif.

MAKE Simple, tubeless, batteryless, distance-getting crystal radios. Crystal and illustrated instructions 25c postpaid. Allen, 427-P, Clinton, Missouri.

5 AMPERE A charger, eliminator, complete kit \$9.35, 9003 tubes \$1.25, list, dime. Milton Bursma, R5, Grand Rapids, Mich.

LEARN Radio easier—faster! "The Mystery of Radio (How It Works)" illustrates, explains radio principles, circuits, etc. Only \$1.00. Scientific Radio Service, Box 1285, Sioux City 7, Iowa.

TRANSFORMERS—700 v.ct 90ma, 6.3V 3.5A, 5V 3A Sec, 115V Pri tested. Quantity limited. Send \$1.00. Balance \$2.95, plus postage C.O.D. C. O. Halland, 822 Eastwood, Chicago, Ill.

BE A radio service engineer. New, easy course. Details. Electronic Engineering Institute, Albuquerque, New Mexico.

RADIOS: New or used, bought and sold. Hagedorn, 2250 North 27th, Milwaukee, Wisconsin.

BUILD This world's smallest a.c. d.c. set. Loudspeaker operation. Uses one tube. Easily fits in ladies' handbag or briefcase. Send 50c for plans, photos, instructions. Louis Toth, 111 W. 103rd St., New York 25, N. Y.

TELEVISION: Send 50 cents coin/stamps for complete list including diagrams for television sets RCA, GE, DuMont, Andrea. Free with order \$5.00 or more. RCA 5BP4 Cathode Ray tube, factory sealed, \$18.00, many others. Electronics Service & Supply, 264 West Fortieth, New York.

WESTERN Electric new war material blueprint 168707. Rectifier, fixed crystal detector, other uses. Every home experimenter should buy several quick. Cost originally six dollars. Rare buy at ninety-nine cents prepaid. Send name for other buys. Radio City Labs, 30 Church St., New York, New York.

HEAD Phones; latest type, light weight, finest quality, adaptable for use in making crystal sets. Slightly used sets without head bands \$1.25. With leather covered adjustable head bands \$2.50. New sets without head bands \$1.75. New sets with leather covered adjustable head bands and rubber covers \$3.75. Add 25c for mailing, send check or money order—quantity limited. Department C, Nico Supply Co., 540 N. 17th St., Philadelphia 30, Penna.

BUILD Your own radio. Simple instructions. All kits complete including tubes. 4 tube T.R.F.—\$10.75. 5 tube Superheterodyne—\$17.95. National Radio Distributors, 140-M West 42nd Street, New York 18, N. Y.

FM Can now be heard on old radios! Very simple adaptor! Send postcard for free data! Topical Emprise Corporation, 1527 Highland, Box 42, Louisville 4, Ky.

CRYSTAL Frequency control units. All kinds, including 1000 kc. calibrating crystals. Also blanks. High quality. Low price. Prompt delivery. Standard Piezo Company, Box 164, Carlisle, Penna.

BUILD Radio. Complete kit with tubes \$10.95. Details. Radio, 9418e Avenue "A," Brooklyn, N. Y.

RADIO Tubes, parts, condensers. Free bargain lists. Potter, 1314 McGee, Kansas City, Mo.

RADIO Service men and experimenters send stamp for our giant radio catalogue. Save dollars. United Radio Co., (1000-V) Newark 1, N. J.

RADIO Service flat rate schedules solve pricing problems. Compiled from 20 years experience. Write for information. Radio Equipment Co., 1415 W. Franklin Ave., Minneapolis 5, Minn.

FAMOUS Razor blade radio! Illustrated plans 35c. New Radio, Lohrville, Iowa.

RADIO Technician and radio service courses. Training for federal licenses. American Radio Institute, 101 W. 63 St., New York City. Approved under G. I. Bill of Rights.

BUSINESS OPPORTUNITIES

LEARN Shell jewelry manufacturing. Complete, simplified home instruction course, beautifully illustrated, shows 45 style pins, earrings, brooches, sprays, hair ornaments. Includes pearlizing, dyeing, golding, glow-in-dark methods. No tools needed! Learn-earn within a week. Only \$1 postpaid, including wholesale prices of all raw materials. House Of Gifts, Box 4550-PP6, Coral Gables, Fla.

OWN A going business—Four big issues reputable national magazine packed with money-making merchandise and equipment offers. Rush 25c. 1107-C Times Star Tower, Cincinnati 2, Ohio.

NOW Operate mail business successfully. Write Baker, 5509 Winthrop, Chicago.

BOOKKEEPERS—Operate your own "Dollar-A-Week" bookkeeping and tax service. Full or spare time. Details free. Ellis, Box 200, Cedar Grove, No. Carolina.

PROFITABLE Business right at home. Be our agent for leading magazines taking subscriptions in your spare time. Send card for supplies. American Readers Service, Gwynedd, Penna.

BUILD Mail Order business of your own—anywhere! Free illustrated prospectus on "Modern Mail Merchandising." Write at once. Mail Enterprises, Inc., 316-A Fox Building, Detroit 1, Michigan.

MAKE Flexible Molds. Statuary, Art Goods. Novelties, Artificial Marble Flooring, Liquid Marble. Literature free. Kemico, Park Ridge (I-M), Ill.

EARN Money with textile painting course. Free details. George Gundrum, LeRoy, Michigan.

INDUSTRIAL X-Ray a vast new post-war profession. Find out how to qualify. Rush name for facts. Ohio Institute of Technology, Box X-278, Greenville, Ohio.

BOOKKEEPERS: General ledger and tax report experience. Operate permanent, profitable accounting service for the smaller business. Part or full time. Simplified method. Write now! L. A. Bell, 1404 West 25th Street, Cleveland 13, Ohio.

BE Your own boss. Start at home. Amazing profits. Literature free. Ace Sales, 920A1 Cullom Ave., Chicago 13, Ill.

JUMBO Abalone sea shells, make, sell novelty lamps, information, prices, stamp. S. Kelley, 2302 Ontario St., Ft. Wayne 6, Indiana.

SELL Books by mail. Spare time, home office. Start small, grow big. Grand opportunity to establish clean, legitimate mail order business. "How" booklet 10c. Kraft, 3114-S1 Walnut, Chicago 12, Ill.

ELECTRICAL Appliance repair. Open your own shop. Learn house wiring; electric motors, vacuum cleaners, washers, etc. Complete illustrated course shows how. Free booklet. Pacific Training School, Dept. AP-1, 4703 West Pico, Los Angeles 6, Calif.

MECHANICALLY Inclined men—Own and operate general appliance repair shop. Complete, illustrated course shows you how. Welding, refrigeration, motor repair, how to get business, etc., all phases covered. Free literature. Christy Supply, Dept. 160, 2835 N. Central Ave., Chicago.

START Advertising and letter shop. Complete low cost home training shows how. Free booklet. Pacific School, 1-B, 7217 South Broadway, Los Angeles 3, Calif.

MAILORDER Business opportunities. Details—postal. Smith, 72-E Southbourne, Boston 30, Mass.

TRADE Magazines—Classified directory 3343 business, vocational and diversion publications with addresses and subscription rates. \$1.00 postpaid. Commercial Engraving Publishing Co., 34CC North Ritter, Indianapolis 1, Indiana.

MAIL Order business course shows you how to make money, spare or fulltime. Teaches professional mail order technique—not penny-snatching schemes. Fascinating 100-page illustrated success-catalog free! Write—Nelson Company, Dept. 4-02, Chicago 5.

TREASURE Finders. See Goldak advertisement in Miscellaneous section.

WANT To sell by mail? If it's information you desire, get the facts, avoid needless risks. Absolute necessity if planning to sell by mail. Write Elco Service, 3338 Monterey, Detroit 6, Mich.

START Profitable home business in spare time. Complete mail sales campaign literature supplied. Details free. A. Riegel, 1111 Harrison, Philadelphia 24, Penna.

SELL By mail. Particulars free. Write, Frank J. Artz, 1060 Harding Drive, Toledo 9, Ohio.

POSTWAR Security! The greatest legitimate scheme ever devised to secure a big mailing list and a stream of dimes. Free particulars. Jack Killion, 7922 South Vermont Ave., Los Angeles 44, California.

MAKE Soap at home. No machinery. Profitable. Literature free. Kemico, Park Ridge (SM-1), Ill.

\$24,500 RICHER! Used schemes from "Schemer" Magazine. Alliance, Ohio, 48th year, \$1.00. 4 samples, 30c.

PLASTICS Guide-listing dealers in materials, molds, machines, supplies, equipment, accessories. \$1. Plastics Digest, 3937P Tracy, Kansas City 4, Mo.

LIQUID Rubber for making molds for plaster castings. Finest quality. Sample. Sure costs more worth more. \$3.00 qt. \$10.00 gallon. W. Wooley, 115-B, Donald, Peoria, Ill.

HUGE Profits, new food specialties! 5,000 word course \$2.00. Trekop, Box N-1, Madeira, Ohio.

OPPORTUNITIES—Foreign countries. Thousands of job opportunities in many fields. Information explaining where and how to apply. Lists of hundreds of firms with foreign interests \$1.00. Industrial Trade Surveys, Dept. A-11, P.O. Box 4151, Los Angeles 24, Calif.

SELL Cosmetics by mail. Women spend millions on beauty. You can make your share of this cosmetic money. Let us show you how. Details free. Frank J. Artz, 1060 Harding Drive, Toledo 9, O., Dept. A.

MAKE Strange new plastic 1c pound. Makes charming, durable floors, walls, roofs. Bays Laboratory, Oklahoma City 9.

QUICK Independence and fame. Money unnecessary. Thousands strangely richer. Fascinating, easy, desirable work. Airmail dollar. Results or refund. Zigzag Corporation, Box 101, Guatemala, Central America.

EARN Steady income using table and few hand tools. Easy, pleasant work, exclusive product and rich market. Full or spare time. Industrial development service, 3006 Ridge Avenue, Philadelphia 21, Penna.

LIQUID Marble—make in any color. Soundproof plastic flooring. Flexible molds. Cast novelties, plaques, statuary. Big money—your own business. Free information. Write—Bing Products, 621-AB Tremont Street, Boston 18, Massachusetts.

RUBBER Mold making liquid make gifts, novelties, pre-war quality. Free cast-wood plastic model with sample quart \$2.95; directions. Rubbercoat, 3873 California, San Diego, Calif.

WANT To make \$100 weekly? No foolin'. Details and valuable tested business secrets, success plans, moneymaking information, 25c postpaid. Refund coupon. Rush. Wilkin, 118½-PM E. Main, Hillsboro, Ohio.

JUST Released: Liquid rubber to make molds for plaques and statues. Plastic formulas and compounds. Apex Plastic Products, 1740 Estes Ave., Chicago 26.

FOREIGN And domestic jobs, all kinds. Latest accurate information on jobs, firms and projects in U. S. and foreign countries. Mail \$2.00 to Industrial Research, Ltd., 403 Broadway Bldg., San Diego 1, Calif., for the 1946 edition of the Foreign Employment Digest. Lists the actual projects with application blanks. Costs more, worth more. 7 day refund privilege.

PANNING Gold—Vacation expenses—Occupation. New 160 page beginners book and three large blueprints—modern equipment \$3.00. Free literature. Old Prospector, Box 21S80, Dutch Flat, Calif.

BUILD Your own independent, fascinating and very profitable business at home, spare or full time. \$50.00 and up weekly easily possible decorating beautiful imitation marble novelties and religious figures. Fast sellers by you, through agents, stores. Quickly learned and few dollars starts you making real money. We tell you how, as manufacturers, and furnish everything. Be our representative in your territory. Write for full information at once. Inghram Company, 2845 Sixth Street, Detroit 1, Michigan.

BECOME A finance man. Particulars free. George Lenhoff, Lincoln 8, Nebr.

MAKE Your fortune in great new industry manufacturing and marketing products containing "DDT." Wonder-Working Insecticide. World-wide waiting market. My Ten Master DDT Formulas and simplified manufacturing and marketing instructions for starting on small capital. Rush request for full details, free. Howard Robinson, Ph.G., 1318 S. Ohio, Sedalia 10, Mo.

SIX Leading mail order publications 25c. Full of articles, plans, schemes, wholesale offers. Kraft, 3114-S1 Walnut, Chicago 12, Illinois.

BECOME A columnist. Author of textbook offers correspondence course to limited number. Circular free. Ben Arid, Box 4, Station D, Los Angeles.

PERFUME, Brilliantine, manufacturing business, little capital, good profits. Particulars free. Bob Celaya, 907 Adams, Brownsville, Texas.

START Profitable home mail order business. \$5.00 required. Details free. Powell Service, 5713 Euclid, Cleveland 3, Ohio.

FREE Hot water the year 'round. First cost is last cost. Build your own solar water system. Average cost less than seventy dollars. Good business opportunity sell solar in your community—it's easy. Complete instructions and drawings send two dollars. Will produce hot water any locality. Miami Solar Water Co., P.O. Box 175, Coral Gables, Florida.

137 WAYS To make money, in home or office, business of your own. Full particulars free. Elite Co., 214 Grand St., New York 13.

PUBLISH—An amusement magazine in your community. No investment. Interesting and profitable opportunity. Complete instructions together with sample copy of successful magazine—\$1.00. Publisher, Box 151, Grand Rapids, Mich.

1100 BUSINESSES With limited competition, \$1. Box 1, Station C, New York.

BOOKKEEPERS Earn additional income posting at home. Barnhart & Kennedy, Public Accountants, Memorial Square, Chambersburg, Penna.

EXPORT, Import, represent manufacturers. Deal with South America, Africa, China, Europe. War-peace time big business. Uncrowded fields. Unlimited opportunities. Deposit one dollar for two bulletins. Money refunded if unsatisfied. P. Benko, 246 Fifth Avenue, New York.

METALLIZE Baby shoes! Learn from nationally recognized consultant. See Kushner ad on page 178.

MILLIONS Want start own business; be independent! Cash paid you for helping us reach them. Co-Operative Service, Box 253, Niagara Square Station, Buffalo, N. Y.

CASH By mail. Either sex. 10c brings offers. Bargain. Specialty Company, Box 635BO, Modesto, California.

PLASTICS, Make your own at home. Formula and moulding instructions \$1.00. Box 84, Station K, Toronto, Canada.

PLASTIC Homes—build yourself! Resurface old buildings! Wonderful building material. Marbleized Service, Edwardsville, Illinois.

GIANT Chinchilla rabbits. Valuable fur. Delicious meat. Easily raised. Pleasant pastime. Tremendous demand. Small investment. Large profit. Willow Farm, R15, Sellersville, Penna.

TAILORED Homes—the modern plan book. Ad under heading Miscellaneous.

LEARN Plastic fabrication at home. Instruction sheet with easy to make projects by well known Homecraft writer. 2 pounds of Lucite, Plexiglass and B-29 scrap laminate plastic in large pieces with generous supply of solvent cement included each kit. \$1.49 postage prepaid. No C.O.D.'s. Keith Vining, 615 Broadway, Daytona Beach, Fla.

CASH in on bubble craze. New miracle liquid sells like wild. Instructions, formula and source of supply of bottles, wands, labels, \$2.00 check or m.o. Benco Distributors, 276 Morris Ave., Elizabeth, New Jersey.

PROFITABLE, Dignified mail order business conducted from home. Particulars free. Ives Mdse. System, Office 622, 1328 Chestnut St., Philadelphia, Penna.

RAPID Marbleizing liquid—Colorful, glazed! Molded, brushed, sprayed! Composition floors. Rubberlastic molds. Particulars free. Marbleizing Service, Edwardsville, Illinois.

MANUFACTURE Nameplates, house numbers, electric signs. Box 221, Newport News 6, Virginia.

START A home business in spare time. Make extra money. Experience not essential. Literature free. Rolf S. Iverson, Box 916A, Grand Central Annex, New York 17, N. Y.

BUILD Miracle homes. Yours. Others. Chamberlain, Fitzsimons Building, Pittsburgh 22, Penna.

ASTOUNDING Modern mailorder plan brings quick profits. Darrah, Orono, Me.

OWN A mail-order paper products business. Sell envelopes, tags, bags, boxes by mail, wholesale. Tremendous demand. Steady profits. No capital necessary. Write Omaha Envelope Service, Dept. 124, 4721 California, Omaha 3, Nebr.

SOMETHING New in small business plans. Created by a business counselor. They're tops! Particulars 3c stamp. E. Reese, 915A 30th South, Seattle.

HANDY Men—Earn money home operating community "Fix-It" shop. Write Stafford, 708 Rawlings, Carbondale, Ill.

FREE Literature. Hundred money-making ideas. Wolf's, 3240 Glenview Street, Philadelphia, Penna.

PROFITABLE, Mail opportunities, pleasant, interesting. Particulars free. Reichert's, 1838 Van Buren, Cleveland 12, Ohio.

MONEY-MAKING Opportunity. Free literature. Readers' Service, 651 Peoples Building, Charleston, S. C.

HEDDEN Metal-detectors. Materials now available! We have the latest in circuit and mechanical design plus The Know How! Write for literature. Hedden Metal Detectors, Box 6892, N.S. Pittsburgh, Pa.

EARN More money. Hundreds of live business and manufacturing propositions. Free booklet. Charles Service, 117 East Second Street, Girard, Ohio.

LATEX For making flexible rubber moulds. Thoroughly tested. No shrinkage. Complete instructions with each order. Stoneham Rubber Co., Box 244, Stoneham 80, Mass.

\$5,000 YEARLY Possible, selling books by mail. Distributors proposition. Nichols Publishers, Box 831, Pine Bluff 1, Ark.

MEN - Women - "Everybody Likes Candy." Learn to manufacture professionally at home. (Our 35th year.) Ragsdale Candies, East Orange 2, N. J.

HIGH School seniors: Make good money selling our graduation name cards. Biggest commissions! Season starting. Hurry! Craftcards, Box 235(Al), Pittsburgh, Pa.

SHARPEN Scissors for doctors, barbers, housewives. Mail \$1.00 for complete instructions to Sterling Service, 1301 Porter Street, Richmond, Virginia.

HAVE An office of your own. Learn collection agency business by correspondence. Many earn \$5000-\$15,000 annually. Write for free bulletin. Franklin Publishing Company, Roanoke 7, Virginia, Dept. PM.

39,147 FOREIGN Patents, now available for manufacture. 25,000 royalty-free. 290 classifications. Information free. Patent Service Company, St. Cloud 14, Minnesota.

WANT More money—better job? Scientific way, using basic principles explains exactly how to get what you want. Details free. Kindig, 1629 Vine St., Philadelphia 3, Penna.

START Home business making statuary, plaques, novelties, garden furniture, artificial marble flooring, liquid marble. Make your own flexible molds. Amazing profits. Folder free. Creative Publishers, Box 236-L, Winnetka, Illinois.

WE Start you in business, at home, sparetime, earning \$10-\$30 weekly selling by mail. Stamp appreciated but not necessary. Driscoll Sales Service, Box 2771-A, Denver, Colo.

START Profitable home business now; capitalize spare time; free details. Manhattan House, 126 Lexington Avenue, New York 16.

IDEAS For starting to choose your own business, write to Dranichak & King, P.O. Box 310, Binghamton, New York.

FREE Valuable money-making self-help books. For particulars write, Mae Specialties Company, P.O. Box 23, Station L, New York 35, New York.

PREPARE Now to start own business making Venetian blinds. Splendid prospects. Illustrated instruction book \$1.00. Elwert, 6900 North Ashland, Chicago 26.

IF You'd like to make \$5,000 annually or better, in an easily learned office business of your own, send for free details immediately. G. H. Cole, Pres., Syracuse 2, N. Y.

HOW To start your own business. Write Successful Income Builders, Hollywood 28, California.

SELL Folios by mail. Small capital starts you. Send \$1.00 for sample and complete set up. Gulf Coast Industries, 209 West Keys, Tampa 3, Fla.

UNPAINTED Wall plaques 2½¢ up. Illustrated list free. Oman, 642 Broadway, St. Paul 1, Minnesota.

RUBBER Moulds for casting novelties. Latex for making moulds. Use thoroughly tested and approved products. Eastern Latex Laboratories, Box 153, Mattapan 26, Mass.

TREMENDOUS Profits mailing our literature. Generalprint, Cottage Place, East Orange, N. J.

FORMULAS, Opportunity plans, bargain guide, literature free. Beejay's, 518 South 30th, Lafayette, Indiana.

HOW To operate your own advertising agency profitably, brand new copyrighted manual reveals all. Learn how you can start from home, spare time with few dollars capital. No stock or equipment to buy. Earnings unlimited. Sincere folks get free details. P. Snyder, Box 4907-A, Philadelphia 19, Penna.

SPARE Time mail business earned \$1400 monthly. Copyrighted instructions \$1.00. Wm. Boyd, 331 Fourth, Pittsburgh 22, Pa.

300 TESTED Moneymakers, 62 pages, 40,000 words. Business plans, secrets, formulas, mail order plans. Wholesale suppliers. Now, you get—not just one plan—but all for only 25¢ postpaid. Start now, no waiting for free details costing \$1 to \$15. Money returned if dissatisfied. F. Larson, Galeton, Penna.

INCORPORATE Your business. Delaware laws. Many advantages, free details. Tax Research Bureau, Inc., Delaware Trust Building, Wilmington, Delaware.

SELL Exclusive books of instruction by mail. Assorted subjects. Popular prices. 70% profit. Rush name for sample imprint circulars and full details. Financial Education, 404F, Mack Bldg., Denver 2, Colo.

AMAZING New liquid rubber for making molds. Foolproof. Highly flexible. Gives positive results. Perfect reproduction of fine, intricate lines. Simple to use. Economical. No waste. \$3.50 quart, \$6.25 one-half gallon, \$11.45 gallon. No samples. Money-back guarantee. Write for free circular. Compo-Tex, Box 786-A, St. Louis, Mo.

SELL By mail with Elfo Ready Made Circular Service! Large profits! Catalog free! Elfo, 434 North Wells, Chicago 10.

AMAZE Others. Add columns instantly. Add faster than adding machine. Free details. Math Institute, Box 633, Mobile 4, Ala.

WORK For yourself. Your own business. Operate entirely by mail—direct from your home in spare time. Few dollars starts you. Literature free. Albert Wilcox, PM21, Nicholls, Georgia.

NEW Flexible mold material, casts cat-alin plastic, concrete, plaster, in same mold. Literature. Sanflex, Box M, Clyde, Ohio.

LEARN Profitable credit-collection agency business; earn \$5,000-\$10,000 upwards annually; sparetime opportunities excellent; postcard brings interesting literature free. Write: Educational Extension Service, Department 101, Los Angeles 36.

START Big money business on shoestring. New, successful cleaning service. Big demand everywhere. Easy, quick profits. Write for details. Americlean, 211 N. 7th St., St. Louis 1, Mo.

MAIL Order beginner's "Business Development Plan," "Profitable Mail Selling Idea," "Pointers Along the Mail Order Trail" show how to make mail order business pay! All three, in 10,000-word treatise, postpaid quarter. Satisfaction guaranteed. Maupin & Maupin, LaFayette 3, Indiana.

FLORIDA Opportunities—Pensacola offers exceptional opportunities for small industries, especially in the field of mahogany novelties and woodware, perfumes, soap, chemicals. Delightful year-round climate. Wonderful fishing, hunting, beach sports. For information write: Industrial Development Division, Municipal Advertising Board, Pensacola, Florida.

BUILD Own business mailing penny post cards; six profitable plans with information for starting. Gordin Publishers, Box 23, Pawtucket, R. I.

"HOW To Finance Any Business, Obtain Capital." Research, Aitkin 5, Minn.

"HOW To Make Simple Molds and Plaster Plaques." Profitable business or hobby! Instructive booklet 25¢. Plastercraft, 1406 East 43rd Street, Cleveland 3, Ohio.

"10,000 ALASKA Fishing jobs." Alaska's largest industry regularly employs thousands of men and women in seafoods production. Possible earnings up to \$5,000 in few weeks. Authentic 7,000-word copyrighted report gives job information, union requirements, sample application letter, names and addresses over 40 Alaska fisheries. Newest edition includes similar information on California, Oregon and Washington fisheries. Vital facts for immediate application in a permanent industry. \$1.00. 7-day refund privilege. Pacific Industrial Research Bureau, Dept. PM-9, 202 Studio Building, Portland 5, Oregon.

MAKE And mold genuine plastics. Forty illustrated work-sheets explain methods, processes. Authentic-simplified \$1. Free circular. Plastics Digest, 3937B Tracy, Kansas City 4, Mo.

START Profitable sideline business now! Complete free details and premium offer available. Write Sheboygan Publishing Co., Sheboygan, Wisconsin.

RECAST Old batteries into new. Latest achievements. Battery Laboratories, Minneapolis.

\$25 WEEKLY Working two hours daily. No canvassing. No manufacturing. Lycke, Box 2471, Cleveland 12, Ohio.

TYPEWRITER Repairing — Original course, simplified home study. Weber Typewriter Mechanics School, Box 269, Osborn, Ohio.

QUICK Money! "Repairing Car Batteries." At home. Easy too. Write Batteryman, 901 South Avenue, Grand Junction, Colo.

START Mailorder bookshop—Everything furnished; publisher cooperation. 25¢ brings booklet, exclusive setup, samples, exciting ideas. General Publications, Ossining, N. Y.

BECOME An "Attritionist Masseur." First improvement over Swedish massage in 100 years! Results unbelievable! Dr. Swearingen, 9128M, Station 5, Los Angeles.

COLORGLAZEL Concrete pottery made without molds. New, low cost, patented method. Cemetery products, novelties, tiles, floors, etc. Basement leaksealing. Other moneymaking projects. Booklet, details free. Men only. National Potteries Company, Fergus Falls, Minnesota.

BIG Money making Hollywood style pottery, bird baths, wishing-wells, benches, stucco-rock. New method. Clever designs. Color with chemicals, water-paints. Marbling, colored glaze effects. Dime brings samples, pictures, literature. Hollywood Cementcraft, 8527 Wonderland Ave., Hollywood 46, California.

\$-RAISE Giant Chinchilla rabbits. Willow Farm, R 15A, Sellersville, Penna.

HOW And where to obtain capital. Fully explained. Particulars free. Star Service, Wapakoneta, Ohio.

AGENTS—To mail our literature. Good profits. Home business. Maywood, 1133 Broadway, New York.

RAISING Canaries pays good profits. Valuable bird book—"Its Care, Breeding and Training." Price \$1.00. American Canary, 2839 N. Halsted, Chicago.

LIQUID Marble; snow-white, multi-colored. Glazed. Unglazed. Composition flooring. Lifetime wear. Any color. No priorities. Flexible molds. Plaster casting. Get into the big money now. Full information given free. Write Compo-Tex, Box 786-R, St. Louis, Mo.

BRUSH Plating outfits connect to a battery. No tanks necessary. Good paying business at home plating autoparts, bathroom fixtures, bicycles, reflectors, silvering mirrors. No shop or experience required. Outfits furnished. Free booklet. Gunmetal Co., Ave. H, Decatur, Ill.

YOUR Own business—As little as \$100 starts you now! No training needed! See our ad on page 180. American Photocopy Equipment Co., 2849 N. Clark St., Dept. GF16, Chicago, Ill.

MONEYMAKING OPPORTUNITIES

MECHANICALLY Inclined men — Own and operate general appliance repair shop. Complete, illustrated course shows you how. Welding, refrigeration, motor repair, how to get business, etc., all phases covered. Free literature. Christy Supply, Dept. 1160, 2835 N. Central Ave., Chicago.

BOOKKEEPERS — Interested in more money spare time. Postwar opportunity. Journey, 1003 Fourth, Orange, Texas.

READ "How to Go into Business for Yourself." 64 pages of eye-opening information. Rush one dime. George A. Simon, 6843 Jonathon, Dearborn, Mich.

"HOW To Make Money with Big Mails" booklet 25¢. Frank J. Artz, 1060p Harding Drive, Toledo 8, Ohio.

EARN Money at home! 64 page "How" book—25¢. Money-making propositions, home work offers—free. Random Company, Box 2688K, Los Angeles 28.

EXTRAORDINARY Mail order ideas and opportunities, 10¢. Thomason, 857M East Jessamine, Fort Worth 3, Texas.

MAKE Liquid Marble, Plaster Plaques, Statuary. Instructions, formulas, \$1.00. Ideal Service, 179-M, Park Ridge, Ill.

TREASURE Finders. See Goldak advertisement in Miscellaneous section.

FASCINATING Mailorder legitimate plans, schemes. Nearly all profit. Particulars, stamp. Warco, Freeland, Mich.

HOW To make and sell novelty barometer ornaments. \$1.00 postpaid. Gerald McNeely, 3044 Jackson Blvd., Chicago 12, Illinois.

MAKE Fast-selling novelties with colorful plastics! Free details. Beginner's jewelry kit and instructions, \$1 (refundable). Plastic Works, 712 Kimball, Danville 3, Illinois.

GET Into Moneymaking business. New, used Army, Navy wearing apparel, equipment. Big demands—big profits. Famous Jobbing Company, 566 W. Roosevelt Road, Chicago 7, Illinois.

NOVELTY Manufacturing offers splendid opportunity to start highly profitable business. No expensive equipment, orders waiting, big profits, easily learned. Definite post war future. Plastex Products, 127 Clement St., San Francisco 18, Calif.

START Your own business! Big money manufacturing novelties, plaques, statuary. Details free. Write—Bing Products, 621-AC Tremont Street, Boston 18, Mass.

\$1 MATERIAL Brings \$20.00. Unlimited possibilities with concentrate cosmetics. 50¢ value sample 10¢. Money back. Kohlen, 506 W. 45th, Chicago 9.

WIN Financial independence. I'm helping thousands. Dr. Tibolt, 41M, Phila. 20.

THOUSANDS Articles wholesale. "Supply Source Directory" 10c. Ideal Service, D-1, Park Ridge, Ill.

ONLY \$1.00 For complete illustrated instruction book to make shell jewelry with materials for pins. Free catalog of supplies on request. All shells 10c pkg. except Miss. gars, Baby Conch 15c. Collectors specimens. Woods Shellcraft, Box 306, Bradenton, Florida.

FORTIFY The future! Start own business; home, office. Booklet describing "Collection of 137 Tested Plans" free. Elite Co., 214 Grand St., New York 13.

GIGANTIC Mails—trade magazines—name listed 25c. Jackson, Newfoundland 3, Kentucky.

MONEY Made office, home or room. 10c brings envelope opportunities. Bargain Specialty Company, Box 635C, Modesto, California.

WE Sold thousands, so can you. Practical plastic novelties. Proven designs, blueprints, instructions \$1.00. Freeman, 41 Locust St., Yonkers, N. Y.

10c BRINGS You lots of mail. Catalogs, magazines, money making ideas, samples. Gardenville Publishers, Gardenville 1, N. Y.

START Mimeograph shop. Send \$1.00 for 70-page book, illustrated Mimeographing Technique and Equipment plus catalog of supplies and machines. Schubert, 2614 Sunset, Los Angeles 26.

MAKE Money at home. Do it with anything you have! Capital unnecessary. Let a successful man with 44 years experience tell you how. Write postcard today! Carter, Box 8-DB2B, Station A, New York 12.

SELL By mail from home, office; make big money. Booklet describing "127 Tested Plans" free. Wilson, Box 2654 Gravois Station, St. Louis 16, Missouri.

MAKE Money by mail at home. Send stamp for our special after-Xmas offers! Gravely Enterprises, Box 1654, Baltimore 3, Md.

PROFITABLE Mail order (local) business in your home. Stamp brings literature describing 125 proven plans. Kessler National Service, Box 392-PMJ, Indianapolis 6, Ind.

FREE Literature. 200 moneymaking ideas. No investment required. Send postcard now. Lynch, 402-PM Hazlett, Baltimore 29, Md.

LEARN Battery repairing, rebuilding. Engineer offers money making methods. Battery Bureau, 2225 North 44th St., Milwaukee, Wis.

EARNINGS \$2,000 Year easy; inventing simple items for special cash markets. Ideas only. No patents. Write, Hendrickson, Argyle 7, Wisconsin.

EARN Money evenings, copying and duplicating comic cartoons for advertisers. Adservice, Argyle 1, Wisconsin.

OUR List of names and addresses of 800 ladies who delight in beautiful homes and lovely flower gardens using mail order since October 1945 will make you money. Price \$5.00. Sheigin Mailing Agency, Athens, Texas.

BIG Profits. Manufacture custom arch supports. Jul Corssen, 2638 Geyer, St. Louis 4, Missouri.

RECEIVE Giant mails, latest moneymaking home work offers, opportunities, magazines. Your name listed 10c. New Age Enterprises, 578-A Prospect, New York City 55.

MAN, You'll like silvering mirrors, reflectors! Making sparkling chipped glass nameplates. Outfit prices. Sprinkle, Plaster, V60, Marion, Indiana.

WHOLESALE Catalog, directory 10c. Hundreds of thousands articles. Stafford, Sunnyside-PM, Indianapolis 44, Ind.

YOUR Big mail order opportunity—No time has ever been as good as right now. Get your start right. Let me show you how, what to sell and who will buy. Big profits, easy work at home. Write: H. S. Smith, 3139A So. Mabbett Avenue, Milwaukee 7, Wisconsin.

MONEYMAKING Books. Free list. Journalism booklet, 25c. Underhill, Beebe, Arkansas.

THOUSANDS Of alarm clocks need repairing. Jewelry stores swamped. Our simplified course teaches you how to repair these clocks. Necessary tools and supplies furnished with course. Alarm Clock Repair Service, Dept. B, P.O. Box 1983, Houston, Texas.

START Profitable collection agency business; office; home; sparetime. Earn \$5,000-\$10,000 upwards annually. Investigate Educational Extension Service advertisement under Business Opportunities.

PUBLISH Your own magazine. Hand-some 52 page format, well edited, illustrated. Cost low as \$1.00 month. Brings you prestige, profits. 25c brings sample, details. National, Ord, Nebr.

—RAISE Giant Chinchilla rabbits. Willow Farm, R 15B, Sellersville, Penna.

I MAKE Big money in the mail-order business. You can do the same at home with my copyrighted system. Write me, I'll tell you how. F. Little, Box 8, Glen-shaw P.O., Pittsburg, Penna.

LEARN Metascience. Remarkable drug-less healing. No manipulation. No apparatus. Unbelievable simplicity and results. Inexpensive correspondence course. Write Metascience, De Land, Florida.

EARN Money at home! Thousands do! "Home Worker Magazine" tells how. Sample, 25c. Sizemore, Box 7, 4917 North Kostner, Chicago.

FORMULAS, PLANS, ETC.

MAKE Bleach water, formula \$1.00. We also sell coloring for bleach water. Capete-ste, 1707 Cranston St., Cranston 9, R. I.

GASOLINE Gas machines, 30c rates, plans \$1.00. Ideal Specialties, Lakewood 5, Rhode Island.

MANUFACTURE Paints. No equipment capital needed. Complete instructions, formulas, \$2.00. Industrial Chemist, 1826-Y 60th, Kenosha, Wis.

MANUFACTURE Fast-selling Products yourself. Bubble, blowing liquid \$1.00. Formula catalog free. Kemico, Park Ridge (16), Ill.

MANUFACTURE New products inexpensively. Free literature. Commercial Projects, St. John 2, N. B.

AUTHENTIC Formulary. 924 page illustrated book, 10,000 scientific formulas, recipes, secrets, instructions for most any product. Countless profitable business opportunities, including D.D.T. new insecticide. And our new book: "The More You Know the More You Can Earn." \$2.98 postpaid (c.o.d. U. S. only). Foreign \$3.25 delivered. Adams Brown Company, Dept. 363, Chestnut Hill 67, Mass.

NEED Chemists? Formulas, Analyses. Ideas. Consulting Scientific Company, Swarthmore, Pennsylvania.

FORMULAS—Silvering mirrors, artificial coal, 22 other moneymakers, 25c. Our latest list and two samples—free. Random, Box 2688J, Los Angeles 28.

"LUMINOUS Paint," 100 other formulas—50c. D.D.T. insecticide \$1.00. Soap making, (20 formulas) \$1.00. Resilvering mirrors 25c. Ideal Service, 301 Park Ridge, Ill.

MAKE Money! Profitable lifetime business. Exclusive washing fluid formula now revealed. Guaranteed bleach. \$1.00 value 25c. Ruch Research, 136 S. Crescent St., Rome, N. Y.

WEED Killer. Make it yourself for 3c pound. Formula and information \$1.00. D. Burnette, P.O. Box 92, Hartford, Mich.

10,000 AUTHENTIC, Scientific, formulas, secrets. 924 page illustrated giant book. Countless profitable opportunities. Latest discoveries! Genuine bargain \$2.49 postpaid. Free literature will benefit you. Continental Publications, 79-02m, Wood-side, Elmhurst, New York.

FORMULAS For cosmetics, insecticides, inks, auto polish, soaps, spot removers, and scores of others contained in new directory, 25c. Toledo Laboratories, 2671 Algonquin, Toledo, Ohio.

TIRE Carcasses everywhere, from these reclaim rubber to make molds, tire plastic, etc. Details for stamp. Betke, Box 699, Berger, Texas.

REAL Manufacturing formulas. Lists free. Cummings, Chemist, Gordon Ave., Syracuse, N. Y.

FORMULAS—Latest, best, Analysis. Literature free. Belfort, Engineering Building, Chicago.

PLASTICS

PROFITS In plastics! Use factory like methods. Details for stamp. Craft Co-op, 3928 Dumaine, New Orleans, La.

GOOD-Rubber-make moulds. \$1.50 pint. Burgermaier, 15 Carl St., Dayton 3, Ohio.

MOLD New plastic at home. Complete instructions \$1.00. Tirekop, Box E-1, Madeira, Ohio.

PLEXIGLAS And Lucite Kit Assortments, including cement, working drawings, instructions. 1 pound \$1.25; 6 pounds \$5.00; 25 pounds \$18.75. Masked sheets 12x12— $\frac{1}{8}$ ", \$2.50; $\frac{3}{16}$ ", \$2.75; $\frac{1}{4}$ ", \$3.00. Plexiglas rods: 24"— $\frac{1}{8}$ ", 8c— $\frac{3}{16}$ ", 15c. Lucite rods: 23"— $\frac{3}{8}$ ", 40c; $\frac{1}{2}$ ", 65c; $\frac{3}{4}$ ", \$1.25; 1"—\$2.25. Lucite tubes: 26"— $1\frac{1}{2}$ ", \$2.45; 2"—\$2.95; $3\frac{1}{4}$ ", \$4.75. Six ounces Plasti-set fast-drying cement, \$1.00. Eight ounces red, blue, yellow, gold, green dye, \$1.00 each. Please remit with order. Add 10% to cover postage. Satisfaction guaranteed. Carmen-Bronson, 165 East Third, Mount Vernon, N. Y.

PLASTICS, Lucite, Plexiglas—masked—not strips. Workable pieces \$1.15 per pound prepaid. Noval Te Plastic, P.O. Box 106, Brooklyn 19, New York.

PLASTICS And plastic supplies. Lucite, Catalin, Bakelite, Plexiglas, dyes, cements, cleaners, etc. Complete list only 10c. Douglas Home Craftsman, Box 34 H, Stamford, Connecticut.

CONSULTING Plastics chemist and engineer on plastics, adhesives, and related problems. Reasonable fee. M. L., 239 Birr Street, Rochester 13, N. Y.

PLEXIGLAS, Phenolite in sheets, rods, tubes and kits. Tools, screws, bearings. Hundreds of items for craftsmen. Catalogue 10c. Metiplas Supply Co., 1420 So. 16th, Maywood, Ill.

ASSEMBLE Lucite gifts. Ideal home business or profitable side-line. No tools necessary! Everything furnished! Big demand. Illustrated catalog with list—25c. Plastic Products Co., Box 384H, Massillon, Ohio.

PLASTIC, Transparent, 3/16" thick, each piece over 90 square inches, $\frac{1}{8}$ " thick, each piece over 110 square inches, 6 pieces for \$5.00, sent prepaid. Plastic Supply Co., 2618 St. Louis Ave., St. Louis 6, Mo.

LUCITE—Complete supplies. Price list, instructions free. Lucite sample 35c. Maurice Lannon, Postoffice Box 686, North Hollywood, Calif.

CHEMISTRY

\$50.00 OFFERED For home research! Free copy "Science Quest," Box 73D, Memphis 1, Tennessee.

WINN'S New idea champion chemical-kits, apparatus-outfits and supplies for students home experimenting. (Established 1931.) Send 10c for catalog. John H. Winn, 124 W. 23rd St., Dept. 501, New York, N. Y.

50 "POISON" Gummed labels, 10c. Ultra, 264 Ninth, Paterson 4, N. J.

SEMI-TECHNICAL Chemistry brochures, literature free. Lankton, 310 Westmoreland, Lansing 15, Mich.

CHEMICALS, Ounce quantities, apparatus. Catalog 5c. Fleischer's Laboratories, Everett 49, Mass.

HANDBOOK For chemical experimenters, illustrated, hundreds of experiments, 50c. Experiment booklet 15c. 1946 chemistry catalog 5c. Reading Scientific Company, Reading, Penna.

FREE Catalog, Chemistry, mineralogy, biology, optics. Tracey Laboratories, Evanston, Illinois.

NEW 36 Page chemical apparatus order book. Complete line of chemical glassware, apparatus and chemicals. Send 10c for this book. Standard Science Supply Co., 1232 N. Paulina St., Chicago.

CHEMICALS And apparatus for industrial, analytical, and private laboratories. Complete supply service for correspondence school students. Send 3c for catalog. Dept. M-43, Biological Supply Co., 1176 Mt. Hope Ave., Rochester 7, New York.

SPECTROSCOPE For quick chemical analysis \$2.50. Kutting Sons, Campbell, California.

LABORATORY Supplies at wholesale prices: Chemistry, biology, physics. Catalogue 10c. National Scientific Co., 2204 W. North Ave., Chicago. Established 1908.

HELP WANTED

ENGINEERS—Mechanical and Aeronautical for development and test projects. Recent engineering graduates as well as experienced men required. Apply or write to Wright Aeronautical Corporation, Dept. 182, Paterson, N. J.

DRAFTSMEN—Detailers and Checkers. Excellent opportunities. Apply or write to Wright Aeronautical Corporation, Dept. 182, Paterson 3, N. J.

WANTED: Experimenters to work with jet propulsion. Write for free literature. Shea, 374 Grant, San Lorenzo 11, Calif.

AGENTS WANTED

CALL On friends with greeting card assortments; Easter, birthday, other occasions. Personal stationery; gift wrappings. Big profits. Experience unnecessary. Samples on approval. Wallace Brown, 225 Fifth Avenue, Dept. A-4, New York 10.

WONDER Rat boards. A new type trap made of special glue. No poisons, no disagreeable odors. "Like catching flies on flypaper." Cost \$4.00 dozen, \$45.00 gross. Resell at \$9.00 dozen, \$100.00 gross. Star Exterminating Co., 2958 Nostrand Ave., Brooklyn 29, New York City.

25 WAYS To make money with luminous paint (shines in dark.) Rush only 25c for details and luminous sample. Address, Lite-Saver, 97C, Saybrook, Connecticut.

DISTRIBUTORS Extra dollars for you in selling our newest lighter. Sample \$4.00 and full details. Johnson, 1842 McGilvra Blvd., Seattle 2.

SILVER Plating liquid. Simply rub-on with a cloth. Cleans, silverplates, polishes, one rubbing. Puts on genuine 1000 fine silverplate. Renews silverplated ware like new. Silverplates onto brass, copper, bronze, etc. Lasting finish, won't come off. Sales representatives wanted. Details free. NuProcess Products, Dept. 202, Aurora, Ill.

EARN Big money. Full or part time. Take orders for lifetime reproduction in plastic of any picture or negative. Simply beautiful. Sells itself. World wide field. Men or women. Write immediately. Plastic-Craft, Dept. 146, P.O. Box 1221, Philadelphia 5, Penna.

\$1 STARTS You in business. Sell deluxe five fold ties. 100% wool interlining. Cost you only \$7 per dozen, you make \$5 dozen. Send \$1.00 for special introductory offer two five fold ties. Catalog complete line free. Philip's Neckwear, 20 West 22nd St., Dept. K-24E, New York 10.

LUMINOUS Pictures that glow in the dark. Large manufacturer wants factory representatives; wonderful new item; fast seller; free sample. Madison Mills, 303 Fourth Ave., New York City.

EVERYDAY Cards. Earn big money. Take orders galore from friends. 21 French folders with tricky, appealing designs for \$1. Costs you as low as 50c per box. Also new beaded everyday boxes, birthdays, convalescent, everyday gift wraps. Send for samples on approval today. Sunshine Art Studios, 115 Fulton St., Dept. EE1, New York City.

STRANGE "Dry" window cleaner. Sells like wild. Replaces messy rags, liquids. Simply glide over glass. Samples sent on trial. Kristee, 121, Akron, Ohio.

EVERY Motorist needs our four specialties, 50% commission. Kay's Manufacturing Co., Stimson Bldg., Los Angeles 13, Calif.

BEAUTIFUL Colored pictures. (Unframed prints.) Lists free. Curtis, Box 1916A, Denver 1, Colo.

RARE Premium book deal. Free details. Gene McLean, Eureka, Calif.

137 COMPLETE Plans for starting own business: local—mail order. Particulars free. Elite Co., 214 Grand St., New York 13.

MR. MAGIC Is back! Big profits packaging, distributing this amazing cleaner. Steady repeater. Everything furnished. Sample 25c. Linnell Co., Box 1720, Cleveland 5, Ohio.

PLASTONE; Amazing new polish for floors, furniture, autos. Beautifully packaged. Low priced. Whirlwind seller to stores, gas stations, homes. Fast repeater. Unconditional moneyback guarantee. Write for "free sample kit offer." Plastone Co., 2207-P West Chicago Ave., Chicago 22, Ill.

AUTHENTIC Reproduction Japanese surrender document. Homes, stores, professional offices everywhere will buy, frame, and display this memorable document. 300% to 500% profit. 25 for \$5; 50, \$9; 100, \$13; 250, \$25; 500 and over, 8c each. Sample 50c. Box 1033, Philadelphia 5, Penna.

\$7.50 START Engraving jewelry, leather, glass, cuts wood, plastic, etc. A.C. current. Bonomo, 25 Park St., Brooklyn, N. Y.

WANT Immediate coverage, all U. S. towns. New item. Sells everywhere. Details. E. Reese, 915M—30th South, Seattle.

WHOLESALE. Cigarette lighters, flashlights, leather billfolds, tobacco pouches, etc. Write for illustrated price list. National Sales Co., 1319 Stone St., Dept. 113, Flint 4, Michigan.

AGENTS Wanted for all year around household commodities used daily in every home. Big profits—repeat business. Send \$1.00 for sample, catalogue. Marshall Sanitary Products, 5535 N. Clark, Chicago 40.

SALESMEN Calling on farmers, garage, 100 of leads, protected territory. Eagle Welding, 5085 Broadway, Chicago 40, Ill.

SELL Individualized belts, buckles. Over thousand emblems to choose. Fast money maker. Repeat business. Write today special outfit offer. Hook-Fast Specialties, Box 1425, Providence, Rhode Island.

MAGIC Cleaner and laundry soap deal. Hotter than a firecracker. Big profits. Sample free. Bestco, 5007 Irving Park, Chicago.

BEAUTIFUL, Red, white and blue, stars and stripes, welcome home pennant, size 15" x 35". Send 25c for 2 pennants and wholesale prices. Welcome Home Pennant Co., 30 W. Harrison, Chicago.

\$3 FIRE Extinguisher; quick sales, wholesale or direct; liberal profits. "Fire-Killer," 109 N. Franklin, Syracuse 1, N. Y.

DISTRIBUTORS, Canned pecans, shrimp (dried), herring (24 pkgs. per card). Cards cost you \$1.40 each, retail at \$2.40 each. You sell at \$1.85 ea. Freight prepaid. Mercier Distributing Co., 2363—37th Ave., San Francisco 16, Calif.

DOUBLE Profits selling "Genamoth" and "Rugafom" concentrates. Big profits assured! Year around business! General Products, 246P—5th Avenue, New York 1, N. Y.

DISTRIBUTORS, Agents, wanted! Sell "Silverene," silver plating fluid. Write: Rabiro, 228P East 2nd Street, New York 9, N. Y.

EASY To sell beautiful rock necktie slides. Sample 50c. V. Fish, 437 W. 56th St., Los Angeles 37, Calif.

EARN \$5-\$15 Day with veteran's beautiful service mementos. Sample 25c. Starlite, 4305 Franklin Blvd., Cleveland 13, Ohio.

200 MONEY Making plans, schemes, formulas. Formico Service, Box 572, Dayton, Ohio.

UNUSUAL Opportunity for wide-awake dealers selling household or consumer items. Here's your golden opportunity to make big, steady money throughout the year. Easy-Mend quickly repairs rips, tears, snags, holes, burns, etc. on all linens and wearing apparel. Repairs stand repeated washing and dry-cleaning. Easy-Mend makes strong, neat fabric repairs in a few seconds with a flat-iron without sewing or darning. Sold on a money-back guarantee. This marvelous invention does away with mending the weekly wash and darning socks. Our unique selling plan makes sales in three minutes. Start the new year right. Write for full particulars now to Plastic Products Company, 2307 Payne Ave., Cleveland 14, Ohio.

WE Pay you \$25 for selling fifty \$1.00 assortments birthday, all occasion cards. Tremendous demand. Sell for \$1.00—your profit 50c. It costs nothing to try. Write for samples. Cheerful Card Co., 36 White Plains, N. Y.

SENSATIONAL Seller. Excellent profits. Particulars free. Readers' Service, 653 Peoples Building, Charleston, S. C.

SCHOOL Seniors: Sell classmates superb Craftcards for super profits. Write Craftcards, Box 235(AK), Pittsburgh, Penna.

RAZOR Blades thousand \$5.75. Dolls dozen \$12.00. Pencils gross \$1.95. 1728 bobby hairpins \$3.60. Send payment. Catalogs free. Mills Sales Co., 801 Broadway, New York 3.

GREAT New money maker—Non skid checker board. New invention sells on sight. Checker clubs, train and plane riders, invalids, everyone. Checkers can't slide, fall off or skid. Play on any angle, anywhere. Pocket or regulation size. Details, sample \$1.00 postpaid. Side Line Sales Company, 59PM Congress Street, Hartford 6, Conn.

SCHOOL Seniors! A postal will bring you our Kwick-sell Cardalog of graduation name cards. Hot selling everywhere! Big profits! Hurry! Craftcards, Box 235-L, Pittsburgh 30, Penna.

NOW You enjoy double profits selling Ruggleen and Mohtext Concentrates to homes, hotels, rooming houses, etc. Send for new complete offer. Tremendous profits. Year round repeat business. Products used daily in every home. The Russell-Johnson Service, Clarksfield, Minnesota.

SIMPLE, Dramatic demonstrations insure easy sales. Sensational \$3.00 fire extinguisher. Liberal discounts. Other products. Molonite Company, 5713 Euclid, Cleveland 3, Ohio.

SCHOOL Seniors—Sell classmates America's most beautiful, distinctive graduation name cards. Positively highest commission. Largest selection. Lowest prices. Free cards and sample kit. Printcraft, 1423 East Elm Street, Scranton 5, Penna.

GOLD Lacquered window sign letters. New foils, styles, absolutely beautiful. Free samples. Atlas, 7941 Halsted, Chicago.

WAR Honor scroll: All branches of service represented. 12 by 16. Space provided for name and photograph. Truly beautiful. Agents make big money. Sample 25c. E. Condon, Dept. 6, Upper Darby, Penna.

SELL "Petite picture notes."—Something really different in greeting cards. Sample free. Dunbar Cards, New Brunswick 20, N. J.

AGENTS: Stamping names on pocket-key protectors. Sample check with your name, address, 25c. Stamping outfits. Emblem checks, check-fobs, name plates. Hart Mfg. Co., 303 Degraw St., Brooklyn, N. Y.

AGENTS—Big line including food products. Fast selling premium and bargain deals. Low prices. Send card for big outfit offer with gift. Ho-Ro-Co, 2768 Dodier, St. Louis 7, Mo.

BIG Profits taking subscriptions for all magazines. Agents' confidential catalog listing over 2500 periodicals and complete starting supplies free. Pines Subscription Agency, Flushing, New York.

WHOLESALE Sources. 500,000 articles. Free directory. Maywoode, 1133 Broadway, New York.

EXCELLENT Sideline for printing salesmen. Decalcomania name plates in small quantities. Also, make money applying initials on automobiles. Free samples. "Ralco," X-164, Boston (18), Mass.

PLATING Outfits for autoparts, reflectors. Connect to a battery. No tanks necessary. Free booklet and particulars. Gunmetal Co., Ave. N. Decatur, Ill.

FREE Water and our concentrates, makes flavors, lotions, shampoos. 72 products, labels, bottles furnished. Qualco, E-20030 Russell, Detroit.

DO You want agents for your proposition? Your ad in this space will place your message before hundreds of men seeking fast-selling products. My folder "How to Secure Agents," is filled with proof. I'll gladly send you a copy free. P. W. Johnson, Manager Classified Advertising, Popular Mechanics Magazine, 200 E. Ontario St., Chicago.

AGENCIES WANTED

MIAMI Distributorships wanted. Personal calls also made. 228-B Republic Building.

HIGH-GRADE SALESMEN

AMAZING New zipper shoe sells on sight. Big profits for salesmen. Leads line 200 splendid styles. Territories open. Get free sample outfit. Write Consolidated Shoe, Dept. S-149, Chippewa Falls, Wis.

LOOK Here! Wanted—Men and women to start in business on our capital. Sell some 200 farm-home products. Thousands our dealers now make quick sales, big profits. For particulars write Rawleigh Co., Dept. A-U-PPM, Freeport, Ill.

FANS, Fans, fans. Salesmen will be cleaning up in 1946 on our line of electric fans. Write Universal Fan Company, Peru, Indiana, Dept. 2.

SALESMEN Experienced, who would like to make up to \$75 commission weekly. Write Schutt Co., 244 East Ohio St., Indianapolis 4, Indiana.

SALESMEN—Executive type. Sell surplus listings business men only. Up to \$100 day. Wire-write quick. War Surplus Reporter, 20 E. Jackson, Dept. 1, Chicago.

JUMBO Hershey deal on 2 1/2c board. Leave us face it. Candy is scarce. Hersheys are scarcity—if salesboards are allowed in your territory. Write Jay Wico Products, Logansport, Ind.

MAKE Money as I do. Geo. S. Parker, New Brunswick, N. J.

FREE! Latest issue Opportunity Magazine. Salesman's Guide. Inspiring, constructive. Shows how to earn money selling for others or in your own business. Hundreds postwar opportunities. Send name and describe what you have sold or are selling. Illustrated copy sent free. Opportunity Magazine, 620 N. Michigan, Dept. 17, Chicago 11, Ill.

\$4.97 PUTS You in lifetime business. Write Midwest Drug Co., Dept. 4, Columbus 15, Ohio.

FREE—"Amazing New Book"—"Profits From Classified Advertising." Tells how and what to advertise. Be sure to read this book before you invest one cent in advertising. Remember—it's free! Write for your copy now. P. W. Johnson, Classified Advertising Manager, 200 East Ontario Street, Chicago 11, Illinois.

EDUCATIONAL AND INSTRUCTION

WHY Don't you write? Writing short stories, articles, etc., will enable you to earn extra money. In your spare time we teach you to write the way newspaper men learn—by writing. Free "Writing Aptitude Test" tells whether you possess the fundamental qualities essential to successful writing. Write today! Newspaper Institute of America, Suite 570-A, One Park Avenue, New York 16, N. Y.

GOOD Jobs and a sound, substantial future await you in hotel and institutional field. Men and women—all ages—needed for well-paid positions that offer color, excitement, ever-new and fascinating duties. Record-breaking travel means even greater opportunities for trained men and women in hotels, clubs and institutions. Lewis School receiving calls for managers, assistant managers, stewards, hostesses, purchasing agents and 55 other types of important positions! From coast to coast there are important positions that offer splendid opportunities for advancement in a business where you are not dropped because you are over 40. Previous experience proved unnecessary! No need to leave your job to qualify. A good grade school education, plus Lewis Training qualifies you at home, in spare time. Our national placement Bureau helps to place you—and our amazing Certified Job Plan—actually guarantees you will "make good" when placed. Write today for free book! This course is available under government auspices to discharged veterans, if qualified under the G.I. Bill. Lewis Hotel Training School, Room HA-368, Washington 7, D. C. (First and only school of its kind—now in its 30th year.)

"HOW To Break and Train Horses"—A book every farmer and horseman should have. It is free; no obligation. Simply address Beery School of Horsemanship, Dept. 1101C, Pleasant Hill, Ohio.

MAKE Up to \$25-\$35 week as a trained practical nurse! Learn quickly at home. Booklet free. Chicago School of Nursing, Dept. M-1, Chicago.

29 LANGUAGES By Linguaphone. Russian, Spanish, Portuguese—Direct conversational method for mastering any language quickly, easily, correctly at home. Send for free book. Linguaphone Institute, 83 RCA Bldg., New York.

GET Government Job: Good salaries, permanent. Service men given preference. Low priced home study practice lessons help you make good grade. Write, Ozment's School, 75, St. Louis, Mo.

UNISCRIP.T. Rapid, legible, improved shorthand, 25c. Jesse L. Cook, Bartow, Florida.

FREE. Send for 1946 catalogue. Baker, 5509 Winthrop, Chicago 40, Ill.

HOME Study. Write for bulletin R, real estate course; bulletin V, vocational courses; or bulletin B, business course on starting, operating any small business. DeVoto Schools, 35 Vicente, San Francisco 16, Calif.

WRITE Short stories at home for pleasure and profit. Fame, riches and happiness of achievement are rewards to be realized by students who acquire tested technique. Get free booklet from home study school with 50 years experience. Write today! Blackstone-Sprague, Dept. 11, 307 North Michigan, Chicago 1.

GOOD "Used" self-instruction educational books on all subjects bought, sold, rented, exchanged. Satisfaction guaranteed. Complete information and 100-page illustrated bargain catalog free! Write—Nelson Company, Chicago 5.

AMAZE With Super Memory! Facts, figures, names stick like burrs! Write A13, Thor Books, Box 1210, Chicago.

WELDING—Electric arc. Learn profitable trade quickly through actual practice. Individual welder instructions at bare cost of materials. Full particulars free. Valuable welding lessons book 50c. Hobart Welding School, Box M-162, Troy, Ohio.

"HOW To Make Words Work For You." Short, clear and concise home study course lessons that make your work easier and more enjoyable. Send \$1.00 to Lee Harway, 2815 W. 154th St., Gardena, Calif.

QUALIFY For new type radio work! Write Topical Emprise Corporation, 1527 Highland, Box 42X, Louisville 4, Ky.

HOME Bible course. Simple, helpful, instructive. Total cost \$3.00 includes textbooks, examinations, certificate. \$1.00 starts you, or simply request prospectus. The Bible Study School, 382 Van Houten Street, Paterson 1, N. J.

BECOME A Doctor of Psychology and Metaphysics. Teach secret of contentment, happiness. Win degree of Ps.D. or Ms.D. Solve mental worries. Free book. College of Universal Truth, 5153-B North Clark, Chicago.

DARE To be somebody and get somewhere! See adv. under Miscellaneous heading. Personal Psychology, Inc., 1008-1009 Washington Bldg., Louisville 2, Ky.

INCREASE Your mental powers; integrate your personality. "The Secret Sanctum" explains. \$1.00 prepaid. The Time-Binder Press, 628 South Bixel, Los Angeles 14, Calif.

ABSOLUTELY Free, new \$10 Home Bible Institute course. Box 382-A, Santa Ana, California.

HOW You can win new friends and success with personal publicity. Easy instructions. Write: John B. Martin, 1101 West State Street, Jacksonsville, Illinois.

BECOME An interesting, sparkling conversationalist and public speaker! Complete course \$1.00. "The Secret of Memory Improvement" included free! Lafayette Institute, Box 1764-CS, Toledo, Ohio.

DISCOVER Your best abilities through scientific aptitude tests. Information 10c. Testing Service, 507-X Electric Building, Rockford, Illinois.

FREE Facts with tested plan to raise your child's arithmetic grade. Riddle Game Co., Box 1741, Louisville, Kentucky.

LEARN To be a landscape architect. Hundreds now manage own businesses as successful landscapers. Steady income. Home study course—45 beautifully illus. lessons. Course can be completed in 8-12 months. 29th yr. Send for free bklt. American Landscape School, 6337 Grand Ave., Des Moines, Iowa.

NEW Streamlined basic accounting course. Personalized instruction. Low tuition. Western Home Study Institute, Box 2506, San Francisco 26, Calif.

TEACH-YOURSELF! Illustrated magazine. Free! Learn trade! Profession! Own business! Warner Company, 1085 Monadnock Bldg., San Francisco 5.

1946 GOVERNMENT Jobs! Commence \$125-\$220 month, men-women. Prepare now at home, for examinations. Full particulars and list positions. Free. Write today. Franklin Institute, Dept. L48, Rochester 4, N. Y.

GET Rid of money worries. Self-instruction books lead to bigger pay and a business of your own. Our free circulars G-15 will interest and benefit you. "The Guild," 2726 Holland Avenue, New York 67, N. Y.

MATHEMATICS, Arithmetic, algebra, geometry, trigonometry, physics, drafting, architectural, mechanical, electrical, structural, building estimating. Coach licenses: Professional engineer, architect, surveyor, electrician, plumber, stationary, refrigeration. Mondell Institute, 230 W. 41st, New York.

LEARN Chalk talk. Can make an interesting speaker of anyone. Command attention. Details free. Arthur E. Ryde, P.O. Box 1071, Springfield, Mass.

NEW, Used, home-study books; catalogs, dime. Westway Educational Service, Box 58-C, Los Angeles 35, Calif.

ANALYZE Handwriting. Unlimited opportunities in uncrowded profession. Complete course including free handwriting analysis \$1.00. Mayer, 681-P Market, San Francisco 5, California.

SCHOLARSHIPS. University training at home for business and social success. Planned to meet your need. Give education and occupation. University Foundation, PM, St. Augustine, Florida.

USED Educational and technical books bought, sold, rented. Catalog free. Educational Exchange, Henagar, Ala.

SEND 25c For Stereopix Navigation book. Addison-Wesley, Cambridge 42, Mass.

ROOFS, Hoppers, bays, polygons, segments. All lengths, cuts, safe loads, instantly. Vestpocket tables, \$1.00. Morgan, Box 1414, Great Falls, Montana.

LEARN Photo-engraving at home or in oldest, largest school in America. Work for newspaper or establish own profitable business. New Tasope Photo-Engraving equipment available soon. Write for information. Veterans ask about G.I. training. The Aurora School of Photo-Engraving, Tasope Bldg., Aurora, Mo.

LEARN Fascinating credit-collection agency business; office; sparetime. Investigate Educational Extension Service advertisement under Business Opportunities.

INVESTIGATOR Training. Phillips Secret Service, 1917B North Kenneth, Chicago 39, Illinois.

29 LANGUAGES By Linguaphone. Russian, Spanish, Portuguese—Direct conversational method for mastering any language quickly, easily, correctly at home. Send for free book. Linguaphone Institute, 83 RCA Bldg., New York.

LOCKSMITH Course. Lock picking, key fitting, etc. \$1.00 prepaid. Locksmith, Canadian, Texas.

MEDICAL Laboratory technicians in great demand. We train you in your spare time, in your own home. You can practice while studying. Write for free catalogue. Imperial Technical Institute, Box 973-E, Austin, Texas.

SECRET Investigation. Experience unnecessary. Investigators particulars free George Wagner, M 125 West 86th, New York.

HORSEMEN—Learn to train and gait Teach tricks. Free book. Animal Lovers Association, K-111, Tarzana, Calif.

USED Educational books on all subjects sold, rented, also bought and exchanged. Moneyback guarantee. Write today for free catalog and details. Lee Mountain, Pisgah, Alabama.

PLAYS, STORIES, MANUSCRIPTS

NEW Writers needed to rewrite ideas in newspapers, magazines and books. Splendid opportunity to "break into" fascinating writing field. May bring you up to \$5.00 per hour spare time. Experience unnecessary. Write today for free details. No obligation. Postcard will do. Comfort Press, Inc., 210-P South Seventh St., St. Louis 2, Missouri.

COMPLETE Assistance for writers. Inquire National Writers Club, 1837 Champa, Denver 2, Colorado.

MANUSCRIPTS Edited, typed. 228-B Republic Building, Miami.

BIG Money writing "Information Folios." Instructions, samples \$1. Mackormack (AA3), Madeira, Ohio.

IMMEDIATE Income for writers, beginners or advanced. My plan reveals how. Sell short personalized stories, waiting market, prompt remittance. Profitable and pleasant. I'll prove it. P. Snyder, Box 4907-W, Philadelphia 19, Penna.

I WANT New writers to cash hundreds of checks for \$1 to \$100, offered each month. The easiest way to write for pay. No previous experience necessary. Send for free details. No obligation. Saunders M. Cummings, Box 609-M, Colorado Springs, Colo.

SHOWCARDING, COMMERCIAL ART, SHOPPING WRITING, SIGN PAINTING

"HOW To Make Money With Simple Cartoons"—A book everyone who likes to draw should have. It is free; no obligation. Simply address Cartoonists' Exchange, Dept. 91-C, Pleasant Hill, Ohio.

LEARN Showcard writing at home in spare time. Fascinating, lifetime business of your own. No special skill needed. Free information. Sherwood Publishing Co., Box 8, Dept. 64, Irvington, N. J.

CARTOON Drawn, your idea. 7x9 inches, \$2.00. Verret, Raceland, Louisiana.

PAINT Signs with spray gun. Adhesive stencils. Samples and details 10c. Wm. Beaman, Oregon, Ill.

CARTOONISTS! Idea suggestions with gags; twelve for two dollars. James Jacobs, Box 421, General Post Office, New York 1.

WE Print student's cartoons. Free literature. School of Cartoons, P.O. Box 3291, San Francisco 19, Calif.

MAKE Signs, letters, stencils. 9 complete alphabet pattern sets, 3 complete numeral pattern sets and catalog \$1.00. Sign Letter Distributors, P.O. Box 101, Mineola, N. Y.

CHALK Talks. Laugh producing program, \$1.00. Catalog 10c. Balda The Cartoonist, Oshkosh, Wisconsin.

CARTOON Course—22 easy lessons. 200 figure sketches. 25c coin postpaid. Snack-Pack Co., 32 E. Georgia, Indianapolis 4.

ADVERTISING AGENCIES, LETTER WRITERS, FOR ADVERTISERS

ADVERTISE Profitably: \$20.00 reaches 5,000,000 Sunday newspaper readers with 24-word ad. Newspaper, magazine, mailing-list ratebook free. Chicago Advertising Agency, 20-PA W. Jackson, Chicago 4.

ADVERTISE: 24 Words, 40 newspapers \$3.50. List free. Advertising Bureau, 4515-C Cottage Grove, Chicago 15.

ADVERTISE Continuously for results in Mail Order World. Sample 25c. Free details. Martin's, Box 2414P, Bridgeport 8, Conn.

20 WORDS, 30 Newspapers \$2.00. Good-all, 37 Gardner, Vallejo, California.

FRESH Names! 100 new mothers 50c. 100 mimeographed letters, 300 words, \$1.50. Swivel, 909 Sherman, Plainfield, N. J.

SELL Abroad. 50,000,000 prospects! Advertising instructions \$1.00. Tirekop, Box J-1, Madeira, Ohio.

ADVERTISERS Service—For men going in business. Put our experience in merchandising and advertising back of your products. Write Van De Mark, Times Star Bldg., Cincinnati 2.

24 WORDS In 64 weeklies \$4.96. H. J. Darnell, 730 Hays, Jackson, Tenn.

EFFECTIVE Sales letters and literature written, \$5 page. Dudley Bunn, 126 Lexington Avenue, New York 16.

ADVERTISERS! 6,000,000 Circulation 25 Sunday national key newspapers. 18 words, \$39.25. "Terrific pullers" 20 popular newspapers \$8. "Free booklet." Newmarks Advertising Agency, 217-7th Ave., New York.

INCH Display adv. 50 magazines yr. \$24. Wood's Popular Services, Atlantic City, (N. J.)

ADS Placed in out of town newspapers and magazines. Low rates. Catalogue free. Ideas that pay. Baker Advertising Agency, Successors Ankrum Agency, 189 W. Madison, Chicago 2.

FREE—New Advertisers Rate Guide. 44 pages. Includes everything. Lowest rates. E. H. Brown Advertising Agency, Merchandise Mart, Chicago.

BUSINESS SERVICE

\$2.00 MONTHLY Maintains Washington, D. C., office address. Your business, personal mail reforwarded when wanted. Hawkins, (Established 1917), 1300 Taylor (102).

BALTIMORE, Md. Mail forwarding, confidential. Letter, 10c. Inquiries answered. Box 765, Baltimore 3, Md.

RECEIVING And re-forwarding mail. For further particulars write to Dunn Mail System, 216 West 69th Street, Box 42, New York 23, N. Y.

TO Whom it may concern: We will represent you in the principal cities of California; Florida; Illinois; Louisiana; Massachusetts; Michigan; Missouri; New York; Ohio; Pennsylvania; Texas; Washington; also Alaska, Canada and Mexico. Personal or business assignments \$1 per hour. James W. Farley, Citizens Bldg., Cleveland 14, Ohio. Note: Would appreciate hearing from someone who wishes to enter this business in your city.

BUSINESS Representation. Mail forwarded, \$15.00 yearly. United Business Service, 137 Cordova, San Francisco, Calif.

MAILING Address, business section. Nation's Capital, \$5.00 monthly. Service, 2131 Penna. Ave., Washington.

MIAMI Office operated under your name. \$2.00 month. 228-B Republic Building.

NEW YORK City, office address, \$2.00 monthly. Goldman, 59 Montgomery St.

SEATTLE And Bremerton: Reliable business or personal representation. Assignments \$1 per hr. H. Washington, Bx. 1741, Sta. A, Bremerton, Wash.

SPECIAL SERVICES

READ American Trade Service. Contents: Products review; new things on market; FTC items, complaints, etc.; trademark lists; consumers publications with product ratings as "best buys," "acceptable," "not acceptable," "recommended"; "intermediate"; not recommended"; sources, other data. Copy 50c. Chaffee, 308 Washington, Chicago 6.

MAIL Forwarding service. Letters composed on any subject. Personal Service Bureau, 1224 National Bank Building, Lima, Ohio.

MAIL Forwarded from Santa Barbara, California, 25 cents. Confidential Service, 1215 Anacapa.

GOOD "Used" self-instruction educational books on all subjects bought, sold, rented, exchanged. Satisfaction guaranteed. Complete information and 100-page illustrated bargain catalog free! Write—Nelson Company, Chicago 5.

SALES Consultant for new or ailing businesses. John Morris, Box 5411, Philadelphia. "Since 1913."

LETTERS Written for every purpose. Sales, business, personal, collection, etc. 17% direct orders from one letter mailed to ten thousand prospects. Hastings Letter Service, P.O. Box 467, San Francisco, Cal.

DRAWINGS—Blueprints made. Tools, small homes designed. Send details for estimate. Lasky, 1414 West 85, Cleveland, Ohio.

YOUR Name, address stamped on key check, 25c. Smalley Sales Co., 3742 Albury St., Long Beach 8, Calif.

HOLLYWOOD Or Los Angeles address for business or personal prestige, \$1.50 mo. Hollywood Personal Services, Suite 218, 1154 N. Western Ave., Hollywood 28, Calif.

TYPEWRITERS, DUPLICATORS, OFFICE DEVICES

USED Typewriters, mimeograph, multi-graph, presses, supplies, appliances. Dixie-Graph, King, N. Car.

PRINT Your own postal cards, paper, or anything on "Printomatic Self-feeding Rotary Postal Card Stencil Duplicator." Only \$9.50 with \$2.35 worth of supplies, stencils, ink, etc. Literature free. Pittsburgh Typewriter Supply, 336-RB Fourth Ave., Pittsburgh 22, Penna.

USED Mimeograph \$25. All makes office machines bought and sold. Catalog free. Schubert, Box 9818, Los Angeles 27.

RUBBER STAMPS, OFFICE SUPPLIES

ANY 3 Lines 65c. Literature. Lee-Vall Press, Box 1242, Indianapolis 6, Indiana.

3 LINES 35c. Signature \$1.50, pad 25c. Stamprite, Wauwatosa, Wis.

YOUR Name and address on a three line, cushioned, indexed rubber stamp with knob handle \$1.00. Extra lines 25c each. Ideal Rubber Stamp Company, Detroit 8, Mich.

RUBBER Stamps, all kinds. Send for catalog. Excello, Box 500, Shreveport, La.

PRINTING, MULTIGRAPHING, MIMEOGRAPHING, GUMMED LABELS

LETTERHEADS, Envelopes, statements, personalized stationery. Best quality. Attractively printed. Details. Samples. Joseph Grimes, Bloomsburg, Pennsylvania.

PRINTING: Special—49c for 50 letterheads 5 1/2" x 8 1/2" and envelopes, (Hammermill). Postpaid. Benson, Box 1849-A, Chicago 90.

FREE—Samples patriotic stationery, armed forces stationery. Name and address stickers, patriotic stickers, view cards and big mail. Victor Burkhardt, 1228 St. Ferdinand, New Orleans 17, La.

8 1/2 x 11 LETTERHEADS; 6 3/4 Envelopes; statements; billheads; adcards; each 200—\$1.00. Benneville, 907 West Roosevelt, Philadelphia 40, Penna.

5000 ELEGANT Envelope slips, \$5.00 postpaid; circulars, folders, imitation letters at low prices. Goodprint, Harrisonburg, Virginia.

250 IMPRINTED Approval sheets—\$1.00. Schultco, Box 41, Irwin, Penna.

MIMEOGRAPHING—Multigraphing. High quality, reasonable. Free lists. Letter Company, 109 East Ninth, Fort Worth, Texas.

SEND 10c Now, for our 36-page 1946 pricelist—refunded first order. McCall Press, 1326 South 27th, Omaha, Nebraska.

GUMMED Labels, personal stationery. List free. Box PM-135, Spiro, Okla.

400 5 1/2 x 8 1/2 LETTERHEADS \$1.25. Mango, 555A South 20th, Newark 3, N. J.

100 8 1/2 x 11 LETTERS Mimeographed (like typewriting) \$1.50; additional 100s, 50c. Speedy service, Multico, Boston 8.

PENCILS Stamped with any imprint up to 40 letters. Dozen 50c, 3 doz. \$1.00, gross \$3.50 postpaid. James Virtue, 5301 Atlantic Ave., Ventnor, N. J.

CUTS—Make real halftones, line cuts yourself. Samples 25c. Particulars free. Rapido Service, Edwardsville, Illinois.

1000 BUSINESS Cards, neatly printed, 2-color, \$2.00 postpaid. Globe Print Shop, Box 1062, High Point, N. C.

LETTERHEADS, Envelopes. List free. Sam Wilson, 5423 No. Artesian Ave., Chicago 25, Ill.

200 SHEETS 5 1/2 x 8 1/2, 100 Envelopes, Hammermill bond, \$2.00 postpaid. Samoset Press, Plymouth, Mass.

INVEST In planned, result-producing printing. Ace Printing, Brentwood, Md.

500 BUSINESS Cards \$2.50 postpaid. Zampino, 2022 West Ninth, Brooklyn 23.

GET Our printing prices first. Crane, 3024 White, Kansas City, Missouri.

BOND Letterheads, 8 1/2 x 11, envelopes 6 3/4, or mixed. 200—\$1.00, 1000—\$3.90 postpaid. Barnes, 6439 Hamilton Ave., Chicago 45, Illinois.

MIMEOGRAPHING Done quickly, economically, any copy. Schubert, 2614 Sunset, Los Angeles 26.

150 LETTERHEADS And envelopes \$2.00 postpaid. Going Print Shop, P1544, Muskogee, Oklahoma.

PRINTING? Lowest prices, samples free. Churchill, 172 Pond, Randolph, Mass.

FIRST Class printing. Samples free. Walker Printing Service, Box 1298, Amarillo, Texas.

STRATHMORE Bond letterheads, envelopes 500 \$3.45. L. Spada, 10 Lexington, Wethersfield 9, Conn.

QUALITY Printing prepaid: Business, personal stationery. Letterheads, envelopes, statements. Prices reasonable. Samples. Mero Products, Box 344, Punxsutawney, Penna.

BETTER Grade printing reasonable. Estimates on anything. Economic Press, Leonia, N. J.

MIMEOGRAPHING—Any copy. Reasonable. Mailers Service, Box 606-A, Chicago 90, Ill.

500 3/4 x 2 1/4 FOUR Line gummed stickers, 25c. Moritz Printery, Saginaw, Mich.

MIMEOGRAPHING—Letters, pricelists, formulas, instructions. Lowest prices. Lem's Letter Shop, 5710 Stanton, Detroit 8.

PRINTING OUTFITS AND SUPPLIES

PRINTERS—Real money making ideas. Send \$1. Box 333, South Pasadena, Calif.

LINOTYPE Typesetting (6-24 pt.) Information—5c. Miller Printshop, Lawrence, Kansas.

MAKE Printing press, mimeograph cuts! Entire instructions \$1.00. Tirekop, Box A-1, Madeira, Ohio.

PRESSES, Type, cabinets, supplies. List for stamp. Lincoln Press, 220-Z Hartwell, Fall River, Mass.

PRINTING Equipment, type and supplies. Send stamp for details or dime for complete illustrated supply book. Kelsey Inc., X-11, Meriden, Conn.

PRINT At home—Send 10c for catalogue—presses, type, supplies. Barnhard Co., 6 Columbia St., Newark 5, N. J.

INEXPENSIVE Home-made printing press. Details free. Novelty Shop, Downs-ville, Louisiana.

PATENT ATTORNEYS

INVENTORS: Learn now—without obligation—how to protect and sell your invention. Write for free "Record of Invention" form and complete information for making disclosure and establishing date of your invention. We also send our new free "Patent Guide for the Inventor," containing complete information about patent procedure and how to sell inventions; giving illustrations of many successful inventions; over 150 basic mechanical movements. We assure you prompt, confidential service. Delays may be dangerous. Write today for your free "Patent Guide" and "Record of Invention" form. Clarence A. O'Brien & Harvey Jacobson, Registered Patent Attorneys, 61B-A, Adams Building, Washington, D. C.

INVENTORS—First things come first. Your first move toward securing a patent on your invention is acquiring full information on what to do. Our two books "Patent Protection" and "When and How to Sell Your Invention" contain this information and other helpful data. Get them immediately, together with our "Evidence of Invention" form. They cost you nothing, you assume no obligation. Write now to Victor J. Evans & Co., Registered Patent Attorneys, 131-A Merlin Building, Washington 6, D. C.

WHERE Can you sell your ideas? Have you a new idea, an improvement, a device of utility or novelty? Want to know where to sell it? Learn the facts first about its patentability. We have letters from manufacturers wanting new patented ideas. The present emergency market has created a big demand. Get our free book, "How to Protect, Finance and Sell Your Invention." Also free special form "Invention Record." No obligation. McMorro & Berman, Registered Patent Attorneys, 134-E Atlantic Building, Washington 4, D. C.

PATENTS. E. E. Vrooman, Patent Lawyer, Registered Patent Attorney No. 5606. 871 Woodward Building, Washington 5, D. C.

FRANK Ledermann, 154 Nassau St., New York 7, N. Y. Registered Patent Attorney since 1918.

I SELL Patented and patent pending inventions. Have calls for all types of inventions from manufacturers. Leslie Buford Stratton, Patent Broker, Quincy, Calif.

ROBERT Daley, Registered Patent Attorney, 19 South LaSalle St., Chicago.

PATENTS—Trade marks. Irving L. McCathran, 315 McLachlan Bldg., Washington 1, D. C. Registered Patent Attorney.

PATENTS. Promptness assured. Wilfred E. Lawson, 1524 K Street, N.W., Washington 5, D. C.

PATENTS Obtained; selling service. Information, recording forms free. Labiner, World Building, New York.

INVENTORS—Before disclosing your invention to anyone send for form "Evidence of Conception"; Schedule of Government and Attorneys' Fees and instructions. Sent free. Lancaster, Allwine & Rommel, Registered Patent Attorneys, 411 Bowen Building, Washington 5, D. C.

PATENT Protection. Write for information. Fees. Record of invention. Free. Randolph & Beavers, 21-C Columbian Bldg., Washington, D. C.

C. A. SNOW & Co., M-427 Snow Bldg., Washington 1, D. C. Registered patent attorneys. Established 1875. Literature mailed on request.

FOR INVENTORS

INVENTORS—Information on what to do first toward securing a patent on your invention is of vital importance. "Patent Protection" and "When and How to Sell Your Invention"—two valuable, richly illustrated books—explain fully what to do first, and a lot more. Get this information quickly, together with "Evidence of Invention" form. All three will be sent to you free. Write immediately to Victor J. Evans & Co., Registered Patent Attorneys, 132-A Merlin Building, Washington 6, D. C.

WHERE Can you sell your ideas? Have you a new idea, an improvement, a device of utility or novelty? Want to know where to sell it? Learn the facts first about its patentability. We have letters from manufacturers wanting new patented ideas. The present emergency market has created a big demand. Get our free book, "How to Protect, Finance and Sell Your Invention." Also free special form "Invention Record." No obligation. McMorrow & Berman, Registered Patent Attorneys, 134-D Atlantic Building, Washington 4, D. C.

INVENTORS: Learn now—without obligation—how to protect and sell your invention. Write for free "Record of Invention" form and complete instructions for making disclosure and establishing date of your invention. We also send our new free "Patent Guide for the Inventor," containing complete information about patent procedure and how to sell inventions; giving illustrations of many successful inventions; over 150 basic mechanical movements. We assure you prompt, confidential service. Delays may be dangerous. Write today for your free "Patent Guide" and "Record of Invention" form. Clarence A. O'Brien & Harvey Jacobson, Registered Patent Attorneys, 61A-A Adams Building, Washington, D. C.

TECHNICAL Design service! Patent and working drawings prepared, ready for manufacturing, for your ideas. Consult us on all your problems. Modern Technical Book Co., Dept. IMMC, 55 West 42nd St., New York 18.

DEPENDABLE Patent searches—simple inventions \$5.00. Protection form free. Write Raymond L. Smith, Patent Searcher, 410-M Bond Building, Washington 5, D. C. (Former U. S. Patent Office employee.)

INVENTIONS Having profit possibilities in demand by specific manufacturers, cash or royalty. Free descriptive booklet, protective disclosure form, references, and how to safely disclose an invention for sale, upon request. Invention Reporter, 5A-11106 So. Longwood Dr., Chicago 43.

APPRAISE Your own invention way manufacturers do. Authentic directions show how success; failure is estimated. How manufacturers compute royalties; prices. Information free. Industrial Management, Seven-A, Randolph Place, Washington 1, D. C.

100 PROFITABLE Military inventions needed. List 50c. Military Research Bureau, Box 116, East Pasadena, Calif.

EXHIBIT And perhaps sell your invention at World's Invention Exposition, April 11-22, 1946, Chicago, Illinois, at Chicago Arena. Thousands of manufacturers will attend to inspect new devices. Inventors need not come in person, since demonstrators will be on hand. Small rates for displaying new invention. Write for free folder. Offices, World's Invention Exposition, 155 N. Clark Street, Chicago 1, Illinois.

YOUR Genius and bright idea plus our long experience in development, production and marketing brings profits to you. Write us now. Pyramid Consulting Engineering Service, 14257 Gratiot, Detroit 5, Michigan.

WANTED. New products for midwest manufacturers. E. Galvin, 20 N. Wacker, Chicago 6.

INVENTORS Make money when merchandise value is combined with invention by commercial construction. We give sound aid to inventors to do this and prepare the patent application for best patent protection. Development Co., Patent Engineers, 30 years experience, 132 Nassau Street, New York.

PRODUCT Ideas wanted. Have you any ideas for postwar products? If they can utilize light metals our engineers will be glad to help you develop them. We are looking for new items to manufacture and are not soliciting fees for advisory service. We are also in a position to finance ideas of merit. No obligation. Write Box No. 39, Powerad Co., Advertising Agency, 79 Madison Avenue, New York City.

1 SELL Patents. Established in 1900. Charles A. Scott, 773PM Garson Ave., Rochester, N. Y.

INVENTORS—Selling your ideas is our business. Write for details. Inventors Sales Service, Box 3005, Euclid Branch, Cleveland 17, Ohio.

PATENTED And unpatented inventions promoted. M. Joyce Humphries, 1424 Land Title Bldg., Philadelphia 10, Penna.

INVENTORS—We will help you if you have a good idea. We supply the finances to patent your idea in your own name. You own the patent. We also arrange profitable manufacturing connections for inventions. Write without obligation. Patent Financing Corporation, 209H Hospital Trust Building, Providence 3, R. I.

HAVE Your idea or model developed now at pre-war prices. Forty years experience in developing, designing. Tool and die work. Inventors Laboratory, Madisonville, La.

RANDOLPH & Beavers: Registered Patent Attorneys, 11-E Columbian Building, Washington, D. C. In order to protect your invention and reap the reward that should be yours, patent your invention without delay, and at the same time have rights to sell as manufacturers convert to civilian production. Write for information and record form today.

CASH For practical ideas and inventions. Mr. Ball, AB-9441 Pleasant, Chicago.

INVENTIONS WANTED

INVENTORS Attention! Have you an invention patented or patentable of a novel electrical or mechanical device? Are you the owner of dies you wish to dispose of? If you have either or both give full particulars. We are a highly rated manufacturing concern with a nation-wide distributing organization. Your rights will be scrupulously respected. Lion Manufacturing Corp., Dept. B R, 2640 Belmont Ave., Chicago 18, Illinois.

MANUFACTURERS Desire practical inventions and designs. Patented or unpatented. Cash or royalty basis. John D. & Son, 140-A Spruce St., Bridgeport 5, Conn.

WANTED—Patented, unpatented inventions having profit possibilities, all kinds. If will sell, reply immediately. Descriptive booklet, references, free. Invention Reporter, 5B-11106 So. Longwood Drive, Chicago 43.

\$1.00 CERTI-PROOF Protects unpatented inventions. Manufacturers pay patent expenses, cash, royalties. Free particulars. Warner Company, 715 Baltimore Bldg., Chicago.

INVENTORS: Have you a sound, practical invention for sale, patented or unpatented? If so, write Institute of American Inventors, Dept. 4-D, Washington.

CASH For plumbing specialty inventions. Chicago Specialty Mfg. Co., 2954 Lawrence, Chicago 25, Illinois.

MANUFACTURER Desires postwar products to make and sell through drug, hardware, department stores and mail order. Or will handle sales only. Reputable, nationally-known organization capable of promoting nationwide sales as well as manufacture of items. Prefer non-electrical products of metal, glass, plastics, etc. Write P.O. Box 1373, Indianapolis, Indiana.

INVENTORS! Have you good patentable idea? Write Mr. Metzler, 11 West 42nd, New York.

CASH For inventions, patented, unpatented. Mr. Ball, A-9441 Pleasant, Chicago.

MANUFACTURER Wants sensible mechanical device or idea with quick sales possibilities in low-priced field. Write Matt, 1412-D Great Northern Building, Chicago 4.

WANTED: Practical inventions. Inventors Patent Exchange, Research Division-B4, Hartford 1, Connecticut.

PATENTS FOR SALE

PATENTED—Pencil and pen holder. Philip J. Bona, Chehalis, Wash.

5 IMPROVED Inventions lunch kit, cigarette case, pipe, logrip, and pliergrip, wrenches. Tobie Jenkins, 924 E. 24 Ave., Denver, Colo.

SELL Your patent through a small classified ad in Popular Mechanics. Many inventors have found buyers in this way. Ask me for proof—I'll gladly send it to you. F. W. Johnson, Manager Classified Advertising, 200 E. Ontario St., Chicago.

MANUFACTURING

MODELS—Small lot manufacturing. Metals, plastics, etc. Milburn, Burlington, Kentucky.

WOODWORKING Power tools—Make them yourself from old auto parts, pipe fittings, scraps. Sanders, drill presses, lathes, saws, etc. Complete details on 40 tools in 96-page book \$1.25. Popular Mechanics Press, (C-43), 200 E. Ontario, Chicago.

MODELS AND MODEL SUPPLIES

RAILWAY Models, complete line, informative catalog, HO and O Gauge, 79 pages, 25c. Walthers, 247 Erie, Milwaukee, Wisconsin.

B29 SUPERFORTRESS, \$1.00. Free, hobby catalog. Earl Schlotzhauer, Shenandoah, Virginia.

LANDLOCKED Sailors! Here's a beautiful, richly illustrated, fully descriptive catalogue of famous model ships—whalers, slavers, corvettes, etc., authentic in every detail. Send for it today. Only 10c. Marine Model Company, Inc., Dept. C-7, Halesite, Huntington, N. Y.

JET Propulsion! Experimenters! New plans to drive boats, bicycles, model planes. Rush postcard for circular. Phil Hopkins, Union 5, N. Y.

MODEL Engine catalog, railroad supplies, 25c refunded. Simonsen, A-3054 Greenview, Chicago 13.

WORLD'S Largest selection miniature engine castings and drawings. Illustrated catalogue 10c. Wayne Miller, Engineering Bldg., Chicago 6.

1001 ITEMS—for model builders. Air, land, sea! Catalog 15c. International Models, 879 8th Ave., New York 19.

MODEL Builders and hobbyists. Send 25c (includes refund coupon) for 68 page 8 1/2 x 11 master model airplane and gas model catalogue. General Modelcraft Co., MI, 91-17 173rd Street, Jamaica 3, N. Y.

BIG Illustrated model engine catalog 10c. Active Products & Supply Co., 53 W. Jackson, Chicago 4.

STEAM Engines, boilers, castings, blueprints, circulars 10c. Anton Bohaboy, 2297 Price, Rahway, New Jersey.

MINIATURE Steam locomotives, 1/4", 1/2", 3/4" scales. Castings, parts, rail! Thorough drawings with instructions. Catalog 25c. Little Engines, Wilmington, Cal.

CATALOGS (Illustrated) for modellers! Airplanes, 60 page book on solids. Features construction data, specifications, camouflage, 15c; railroads, 128 page "HO" guide. Equipment, accessories, fittings, 25c (includes refund coupon). Send coin or stamps for each professional illustrated catalog desired. Polk's "Nation's Leading Hobby House," 31-33 Fifth Ave., New York City 1.

SHIP And yacht model fittings and blueprints. Hundreds of items to choose from. Send for our war time supplement. A. J. Fisher, 1002 Etowah Ave., Dept. WM, Royal Oak, Mich.

SHIP Model kits and fittings. Complete line Fisher model yacht equipment. All Boucher, Fisher, Marine Model and Ideal kits, fittings and blueprints at standard prices. Most complete stock in New England. Send 10c for price list. James Bliss & Co., Inc., 220 State St., Boston, Mass.

BOAT Models. P.T., cabin cruiser, speedboat. Free circular. All Star, 2003 Lincoln Ave., Chicago 14.

MONEY-MAKING Ideas. Latest books. Catalog free. Popular Mechanics Press, (C-43), 200 E. Ontario, Chicago.

HOME CRAFTSMEN

LEARN Shell jewelry manufacturing. Complete, simplified home instruction course, beautifully illustrated, shows 45 styles pins, earrings, brooches, sprays, hair ornaments. Includes pearlizing, dyeing, gilding, glow-in-the-dark methods. No tools needed! Learn-earn within a week. Only \$1 postpaid, including wholesale prices of all raw materials. House of Gifts, Box 4550-P7, Coral Gables, Florida.

PLASTICS—Plexiglas, Lucite, Bakelite, Lignolite, Lumarith, Tenite. Sheets, tubes, rods, and special shapes. Complete range of sizes. Also cements, dyes and other supplies. Complete catalog 10c. Carmen-Bronson, 165 East Third, Mount Vernon, N. Y.

LUCITE Plexiglas kit, including dye, cement, polishing compound, instructions. \$2.00 postpaid. Homecrafters, 75 Erskine, Toronto, Canada.

TOY Patterns, table and chairs, doll stroller, Colonial cradle, circus group \$1.00. List 10c. Modern Woodcraft, Saginaw, Michigan.

PLYWOOD—Deluxe woods for paneling and cabinet work. Bird's eye maple, curly birch, havello, mahogany, walnut. Thickness 1/16" through 1"; large, small sheets. Complete catalog 10c. Carmen-Bronson, 165 East Third, Mount Vernon, N. Y.

LUCITE—Complete stock, all sizes. Sheets, rods. Free listings. Craft-Plastics, Box 129-M, Somerville, New Jersey.

BUILD Garages, chicken houses, etc., under \$25 for nonrationed materials. Also, make a durable substitute for barn paint under 25c gallon. Beautifier, preserver. Instructions 25c. Unique Information Service, P.O. Box 2250, Winston-Salem, N. C.

WANTED Experimenters to work with jet propulsion. Circular on plans. Rush name. John P. Seery, North Conway 3, N. H.

"LUCITE" Beautiful creations in kits. All machined and cut ready for assembly. Materials, directions supplied \$1.00 and \$3.00 specials. A & M Special Plastic Products, 898 River Road, Edgewater, N. J.

HOBBY Craft plywood, all thicknesses. Pieces average 34 sq. inches. Bargain assortments, 30 sq. feet \$2.00, 65 ft. \$4.00. White pine assortment 40 lbs. \$2.00, shipped express collect. Edwards Lumber Co., Dept. 511, 1784 Linden, Des Plaines, Ill.

CRAFTSMEN! Manufacture "Waldo, the Waddling Duck" in full color without painting! Free set of the new 1946 full color plates that eliminate toy painting sent with your order of "Waldo" and his three pals. All full size action toy patterns. Excellent toys for Easter and year 'round. Send only \$1.00—we pay postage. Scully-Hall 92-46 220th Street, AA6, Queens Village 8, New York.

MANUFACTURE Fastest selling wall plaque in America today. Appeals to millions. Free literature. Fritz Foundry, 622 N. Fulton, Allentown, Pa.

MAKE Plaster paris novelties. Rubber mold catalog free. Sample ash tray mold \$3.50. Irons, 204½ Maple, Terre Haute, Indiana.

PANTOGRAPHs. Precision instruments. \$2.50 postpaid. Enlarges workshop drawings automatically, twenty-five ratios including eight times original size. Eliminates using graph-squares. Immediate shipment. Money-back guarantee. Details dime. Pantographs, Munising 2, Michigan.

JEWELRY Supplies. Shell metal and plastic parts for manufacturing. Free illustrated catalogue and detailed instructions on shell jewelry. Florida Supply House, 415 12th Street, Bradenton, Fla.

CRAFTSMEN—Professional plastic projects. 1000 desk set, 32 sketches, dye sample, application instructions. All \$1.00. Glassite, 225 Atlantic, Monterey Park, Calif.

1000 TELUHOW Plans for homemakers. List 10c. Charles King, E. Kingston, N. H.

MAKE Shell jewelry—For gifts, as a hobby or start a business. Free catalogue and price list. Complete illustrated book of instructions 75c. Florida Shellcraft Company, Box 1840, Sarasota, Florida.

BULLDOZER, Power shovel, earthmover. Prints and specifications of above original toy designs in wood \$1.00. Others available. Earthmover Toys, East Lansing, Mich.

SPARKLING Colors for Lucite, Plexiglas with ingredients available drug stores. Two tested formulas, complete mixing and dyeing instructions. \$1.00. Kenson Plastic Products, 954 South LaBrea, Los Angeles 36, California.

PATENTED Metal article, made easy, big demand, licensed territory. Write Arthur Thompson, Marysville, Calif.

TOYS Easily made from scrap wood. 15 patterns 25c, 25 novelty patterns 25c. 15 lawn ornament patterns 25c. Complete Plexiglas construction kit only \$1.25 postpaid. Lynds, Medway, Mass.

DYES For lucite, plexiglas, etc. 15 colors. Just dip to color. Trial combination, red, blue, yellow, \$1.25 postpaid. G. Baker Co., 685 Center Ave., River Edge, New Jersey.

CRAFTSMEN—Fast selling, make childrens and adults lawn chairs. Plans and instructions \$1.00. Summercraft Studio, 42 Vernon St., Newton 58, Mass.

CATALOG: Patterns plywood novelty furniture, letters, numerals, plaques, frames, weathervanes, silhouettes, lawn ornaments, 100 books and booklets on crafts and hobbies, picture frame mouldings, tools, large line decal transfers. Other lines. Hundreds articles finely illustrated. Write Wo-Met Shop, Ashburn, Ga.

TOY Patterns. Circus wagons, trucks, carts, pull toys, etc. 35 patterns \$1.00. Continental Products, 907 Birch, Eau Claire, Wisconsin.

WHITTLES—20 Patterns. Instructions, X-acto knife, wood \$1.00. "Old Whittler," 1402 Charles, LaCrosse, Wis.

CRAFTMEN—Build and sell lawn chairs. Detail plans \$1.00. We tell you how we build, how and where we sell. The Woodcraft Shop, Danby, Vermont.

PATTERNS—Full size for rocking horse, swan rocker, doll stroller, cradle and boy's wheelbarrow. \$1.00 postpaid. Lincoln's Craft Shop, Farmington, Conn.

FUN And profit for home craftsmen. Over 600 projects. Everything from book ends to fireplaces described in set of four What to Make books. Per set, cloth edition \$5.00; paper \$2.00. Popular Mechanics Press, (C-43), 200 E. Ontario, Chicago.

MAKE IT YOURSELF

FLUORESCENT Lights. How to make your own 20 watt lights for less than \$1.00 each. Materials available. Complete, guaranteed, detailed instructions \$1.00 cash or money order. Checks \$1.10. Specialty Sales, Box 1086, Muncie, Indiana.

"ELECTRO-MATIC" Furnace for home or office. Convert now. Blueprint and instructions how to build \$1.00. Electro-Matic, Box 734, Portland 7, Oregon.

DELICIOUS Wieners in 2 minutes! Build amazing electric roaster from scrap materials. Plans 50c. Emco Sales, Box 116, Cambridge 38, Mass.

MAKE Home freezer from household refrigerator. Drawings, instructions \$1.00. Payne, Box 176, Wilbraham, Mass.

NEW Formulas, instructions for making valuable products, your own or profitable sales. Book 630 pages \$2.00. Home owners handbook \$1. DeLancey, Lefferts, Box 121, Brooklyn 25, N. Y.

INEXPERIENCED? Build your home yourself. Your labor saves up to 60%. Valuable circular for beginners 25c. William Jackson, A.B., 1713 Howard, Port Huron, Michigan.

BUILD It yourself. Backyard foundry for making castings up to 65 lbs. Easy available materials. Plans \$1.00. Sylvester Kruse, 1504 Madison St., Madison, Wis.

WHEELS For your own construction of wagon, scooter, racer, wheelbarrow, and bicycle trailer. Drawings, 25c each. 8x12" and 10x1.75" all-metal wheels with puncture-proof tires and ball bearings \$2.25 per 8" wheel. \$3.25 per 10" wheel. Send orders to Jim Brown's Toy Company, 868 East Tallmadge Avenue, Akron, Ohio.

SHELLWORKERS. Send for new wholesale illustrated catalog. Metal and plastic jewelry parts, seashells and supplies. Shell Novelty Co., Box 1664, Fort Myers, Florida.

CONCRETE Mixer, efficient hand power, inexpensive. For oil drum. Plans \$2.00. A. Mitkos, 8802 Corwin, Jennings 21, Mo.

COMPLETE Plans and instructions for building eight-foot bobsled, speedy skied, and sporty toboggan. All three \$1.00. Universal, 2671 Algonquin, Toledo, Ohio.

BUILD Concrete block machine. Easy, inexpensive. Sell blocks, build home, garage, barn at low cost. Free details. Horne, 206 West Wilder, Tampa 3, Fla.

WATCHES, OLD GOLD, JEWELRY, ETC.

BIG Money in watchmaking, repairs, adjustments. Learn this profitable trade at home! New, complete "practical course" for beginners, professionals. Fully illustrated, only \$2.95 postpaid. Money back guarantee. Tools, materials supplied. Modern Technical Book Co., Dept. 2MMC, 55 West 42nd St., New York 18.

WATCH and clock repairing—complete practical course in modern horology. 66 illustrated self-instruction lessons. Just out! Low price. Fascinating 100-page illustrated catalog free! Write—Nelson Company, Dept. 8-02, Chicago 5.

"JEWELRY, Gem Cutting, Metalcraft." Fascinating designs for hobbies and moneymaking opportunities. New, complete illustrated book covers cutting, polishing, mounting gems, metal, jewelry work, etc. 287 pages, \$2.95 postpaid. Money back guarantee. Tools, materials supplied. Modern Technical Book Co., 55 West 42nd St., Dept. 3MMC, New York 18.

WANTED—Old or broken jewelry. Cash paid immediately. Mail your watches, gold teeth, rings, silverware, diamonds, spectacles, cigarette cases. Satisfaction guaranteed or merchandise returned. Information free. Rose Smelting-Refining Co., 29 East Madison, Chicago, Dept. A.

BURGESS Vibro-tool engraves jewelry, cuts and emboss \$7.50. A.C. current. Bonomo, 25 Park St., Brooklyn, N. Y.

CASH. Highest prices paid for old gold, no matter what condition. Small amounts acceptable. Old gold teeth, bridges, bracelets, watch chains bring many cash dollars. Payment goes out by return mail. Licensed-bonded dealer. J. Tropp, 15 Park Row, New York 7, N. Y.

GUARANTEED Watch repairing. Swiss and American. 8-10 day service. Mail yours to Rite-Time, 1318 W. 95th St., Chicago, Ill.

WATCH Repairing: Complete course. Every part of watch fully explained. Many large pictures and drawings. Tools, material. Where to buy. \$2.75 money back guarantee. Park Place Supply Co., P.O. Box 1140A, Houston 1, Texas.

GOLD \$35.00 Ounce—Mail old gold teeth, diamonds, jewelry, watches—receive cash by return mail. Satisfaction guaranteed. Free information. Dr. Weisberg's Gold Refining Company, 1500-Q Hennepin, Minneapolis, Minn.

GEMS, Precious and semi-precious, all genuine, from world wide sources. Deal direct, no overhead, save money. Catalog 10c. Hill Co., Route 7, Salem, Oregon.

WATCH Repairing easy learned by our home study course. Watch repairers are in demand and are among the highest paid craftsmen today. Write for free information. Houston Chronometer & Watch Co., P.O. Box 5367C, Houston 12, Texas.

RAZORS, BLADES, SHARPENING

HAIR And animal clipper. Blades re-sharpened 50 cents. Repair service. Factory experience. Clipper Electric Service, New Bloomfield, Pennsylvania.

100 DOUBLE Edge or 80 single edge blades—\$2.00 prepaid. Wholesale accounts invited. Ace Company, 3518 32nd Street, Union City, N. J.

TOBACCO, SMOKER SUPPLIES

SMOKING Pipes repaired. Send for price list. The Humidor, 8129 Euclid, Cleveland, Ohio.

HOLLYWOOD Harempipe, streamlined oriental water pipe, beautiful glazed porcelain, variegated colors. Smokes cigarette or tobacco. \$5.00 postpaid U.S.A. Walker, 3367 Hill St., Huntington Park, California.

IMPORTED From Mexico! Cigarette case. Hand tooled, laced, genuine leather. Aztec design. \$2.00 postpaid. Chicago Trading Co., Box 5672A, Chicago 80.

50 MILD Cigars prepaid \$3.15. \$4, \$5.50. Continental Cigars, Corning, New York.

CIGARETTES—All popular brands, order shipped same day received; minimum order 3 cartons. New low price! \$1.35 per carton, including postage. No other costs. Perfect delivery guaranteed. Send check or money order to Ace Mail Order Co., East Orange 84, N. J.

CIGARETTE Cases, calfskin. Handmade by veteran. \$2.00 cash-stamps. 505 Rossiter, Baltimore 12, Md.

SMOKING Pipes repaired, price list. Steg. 413 City Bank Bldg., Syracuse 2, N. Y.

FOR THE HOME

HOUSEWIVES, Parchment dish rags. Will not absorb grease or dirt. Send dime. Satisfaction guaranteed. F. De Franco, 16404 Biltmore, Cleveland 20, Ohio.

25 SHELVES You Can Make. Booklet describing everything from wall shelf for dishes to knickknack shelf of white enameled wire and blue glass. 25c. Popular Mechanics Press, (C-43), 200 E. Ontario, Chicago.

ARMY Goods (used). Raincoats \$1, bolo knives \$3.75, jeep hats and caps 10c, oversea caps 10c, dungarees 95c, tool boxes \$1, gun mask bags 50c, steel helmets \$1, gun slings 75c, holsters 75c, canteens 50c, cups 15c, mess kits 35c, leggings 25c, cartridge belts 50c, sheepskin coats or pants \$6.00, rubber parka suits \$2.50, rubber wading boots \$2.95, rubber life suits complete \$4.95, portable spark coil set \$3.00, buzzer phone \$2.00, rubber 25c lb. Minimum shipment \$1. No C.O.D. N. Y. Salvage, 144 Chambers St., New York City.

MAGIC Bubble liquid, wave, blow, 16 oz. \$1.25 postpaid. Barry Products, 3107 George St., Chicago 18, Illinois.

"SUPERFORT" Surplus, aircraft alloy assortment. Bolts, fibrolok nuts, etc. Ideal for mechanics, handy man. 3 lbs. \$1.48, 5 lbs. \$1.98, 10 lbs. \$3.48. Plastic hose. Heat, oil proof. Amazingly tough, light. With garden hose fittings, 25' \$2.98, 45' \$4.98. Satisfaction guaranteed. Cagle, 425, 7121 Holly Pk. Dr., Seattle 8, Wash.

CHANGE Making machine for sale. Few parts. Easy to operate, accurate, inexpensive. With slug rejector. U. S. patent pending. D. M. Dion, Riceburg, Quebec, Can.

SELF-WINDING Extension reels equipped with 16 feet No. 18 electric cord. Suitable for factory or garage. These reels manufactured by Vacuum Cleaner Corporation of America on special order. Closing out at \$2.25 each postpaid. Radio Reel Co., 1116 Rust Building, Tacoma 2, Wash.

CUTTERS, Dental burs assorted, reclaimed job-lot, \$1.90 per gross. Wolf, 1924 E. Hartlane, Philadelphia, Penna.

WANTED MISCELLANEOUS

WOOD Model houses. Wood carved action animals and people. H. P. Jones, 486 Brandeis Bldg., Omaha, Nebraska.

MERCURY (Quicksilver). Write for quotation stating quantity. Metallurgical Products Co., 35th and Moore Sts., Philadelphia, Penna.

MAINE Veteran wishes to contact manufacturers of specialties, electrical or otherwise, suitable for garages, taverns, service stations, restaurants, hotels. Also above-the-average advertising specialty. Jack Holmes, P.O. Box 902, Portland, Me.

IF You want to swap, buy or sell anything, send 25c for The National Swappers Guide. It's chock full of swappers, sellers and buyers from coast to coast and opportunities to swap, buy and sell almost anything under the sun. National Swappers Guide, 610 St. Joseph, Evansville 12, Ind.

PERSONAL

POOR Penmanship corrected—few hours. New-way. Ozment, 9, St. Louis, Mo.

DISCHARGE Certificates copied. Highest photographic quality, handy billfold size. Two copies \$1.00. Electro Photo, LaCrosse, Wisconsin.

SWAP: Trade Information. Write: "Swappers' Gazette," 2836-P Slevin, Louisville 12, Ky.

NOISESTOPPERS Insure quality sleeping, improve health. Write Raymond Dow, 15 Park Row (A1215), New York 7. Get free illustrated health secrets.

TREASURE Finders. See Goldak advertisement in Miscellaneous section.

LEGAL Matters in Mexico. Fred Morales, Box 449, Tijuana, Mexico.

SHAVINGMASTER — 100 Smoothest shaves from every blade. Easy. Guaranteed. 10c. Raymond Dow, 15 Park Row (A1215), New York 7.

CONSULTING Psychologist. Confidential correspondence. Dr. Haynes, 706 8th, Washington 1, D. C.

MOVIE Stars latest, beautiful, interesting actual photos, guaranteed. 20 for \$1.00, samples 25c. O. P. Meyers, Box 246, Glendale, California.

EXCITING! Mail friends postcards from Florida. Send 10c with return stamped envelope. Letters mailed 15c. Souvenirs 25c. Grossman, Box 1126, Miami Beach, Florida.

MIDGET Bible. Size of postage stamp, three for 25c. Kaybee, Crescent Beach, B.C., Canada.

LIVE Longer, feel better, enjoy life. Free information. Fairchild Company, Mt. Vernon, Ohio.

KNOW How to promote yourself—how to get a better job—or more pay in your present job. Details free. Machado (Consultant), 339-P, East 111th Street, Los Angeles 3, Calif.

NERVOUS? Bashful? "Fears?" Free, encouraging information. Jno. Englund, Ironwood, Michigan.

MEXICAN Law practice. A. B. Flota, Box 236, El Paso, Texas.

BOOK Bargains. Illustrated catalogs free. Rialto, 349-B, Sackett, Brooklyn, N. Y.

HAIR Falling? Dandruff? Write Trichologist, 137 Lewis St., Phillipsburg, N. J.

COSMETIC Formulas. Make own hand lotions, cold creams, rouge, etc. Instruction booklet 25c. Popular Mechanics Press, (C-43), 200 E. Ontario, Chicago.

MISCELLANEOUS

TREASURE Finders. New powerful Goldak electronic locaters now ready. Amazing sensitivity. At last the war time developments in electronics can be yours for finding minerals and metals. Radically new type. New circuits; new principle of operation. Money back guaranteed locate gold, silver or any metal at greater depth than any other device. Write for full details. Send stamp. The Goldak Co., 1544 W. Glenoaks, Glendale 1, Calif.

NEW Hand painted wall plaques and figurines, five cents and up. Sample assortment, one dollar, worth much more. Paris Novelty Co., 611 West 7th St., St. Paul 2, Minn.

CARPENTERS—Fast! Accurate! Calculator. Simplifies everything. Postcard brings particulars. Box 1414, Great Falls, Montana.

BEAUTIFUL Shrine set in miniature rock garden; crucifix finished in polished wood and metal. Only \$2.00 postpaid. Box 51, Madison Square Sta., New York City.

YOUR Name in silver on 100 matchbooks \$1.25. Brookside Press, Antrim, N. H.

REFRIGERATION — Understand how kitchen, commercial, frosted food refrigerators work. Information that will save you money. Only \$2.00. Refrigeration Exchange, 389 Hickory St., Arlington, N. J.

CUBAN Maracas carved, handpainted multicolors. Artistic pair \$1.00. M. Rodriguez, Box 2497, Havana, Cuba.

FEET Hurt arch supports. Custom made to impression \$4.50 pair. Booklet free. Archcraft Co., 600 West 164th St., New York City 32, New York.

"RECEIVE Mail." Moneymaking offers, opportunities, catalogs. Name listed 10c. Ideal Service, 101, Park Ridge, Ill.

WRITE Souvenir post cards from New York. We send fifteen cards for \$1.00. You address, stamp, return for mailing here. Morton, 4367 Webster Ave., New York 66, N. Y.

PERSONALIZED Pencils. Individual or firm name. Doz. 50c, 3 doz. \$1.00. Gross \$3.60. Cash. Delivered. Pencil Market, 611—15th St., Knoxville 16, Tenn.

NOVELTIES, Books, jewelry, greeting cards, stationery, movie star photos. Free list. Helen White, Route 3, Middletown, New York.

GOOD "Used" self-instruction educational books on all subjects bought, sold, rented, exchanged. Satisfaction guaranteed. Complete information and 100-page illustrated bargain catalog free! Write—Nelson Company, Chicago 5.

OPEN, Test locks—5 pass keys \$1.00. National Service, 322A Union Ave., Brooklyn 11, N. Y.

GIGANTIC Malls, magazines, samples, listing 10c, three times 25c. Waddell's Directory, 341 East 76th, New York 21.

SOUTH-AMERICAN Opportunities. Profitable employment. Fertile lands free. Mailorder selling. Interesting information, 25c (refundable). Vallesp, 395 Broadway, New York 13.

LUCK Rabbit's foot with key and tie chain; send \$1 for 12; sell 15c each. Chas. Brand, 156 West 27th, New York.

ATTENTION Carpenters. How to straighten any warped door. Write for details. J. E. Conway, 2711 Chestnut St., Tampa, Fla.

LET Yourself go! Dare to be somebody and get somewhere. Smash your fears and inhibitions. Gain peace of mind, self-confidence and creative ability. Achieve better health, greater influence and usefulness, earn more. We guarantee our personality-developing plan to get results for you or money back. Rates low. Write for full details today. No obligation. School of Personal Psychology, 1008-1009 Washington Bldg., Fourth at Market, Louisville 2, Ky.

TAILORED Homes plan book. Sixty floor plans, one-story houses with your selection of Colonial, English, Spanish, Moderne exteriors, making hundreds of combinations! Price \$1.00. Distributors wanted. H. P. Jones, 486K Brandeis Bldg., Omaha 2, Nebr.

SECRET Writing! Learn to use codes and invisible inks. Twelve lesson course \$1.00. Circular free. Far-Go Co., Box 1546, Uniontown, Penna.

BE Lucky. Ten genuine Indian lucky stones \$1. Resell them 25c each. Wiener Co., Box 509, Tucson, Ariz.

MIDGET Bible. 200 pages. 35c. Ropicki, 5117 Roosevelt, Philadelphia 24.

METALLIZERS! New baby shoe bases. Write Frank's, 744 Laurel, St. Paul, Minn.

WONDER-SHAVE—Brushless shaving at its best. New, different, you'll like it. Full 6 oz., 40c, postpaid. Royal-Jay, Box 337, Mamaroneck, N. Y.

MOTHER Would like this: 36 "copy-righted" quilt block designs. 25c "coin." E. C. Stapp, 215 H St., Chula Vista, Calif.

BE A good conversationalist! Our practical course teaches you how! Details free. Nankers Company, Box 1222, Colorado Springs, Colorado.

MEXICAN Feathered bird pictures. Samples 25c. Large framed picture \$1.00. Price list free. Foley's, 217 Grafton St., Brockton 6, Mass.

AMAZING New toy. Automatic hand grenade, and nylon parachute. Opens when thrown into air. 75c postpaid. Bernard Pine, 507 Fifth Ave., New York (M-1).

HEATING 6 Rooms \$25.00 yearly! Circulans 10c. Rosenzweig, RR10 E3, Cincinnati.

PHOTOCELLS. Make your own. Material and instructions \$1.00. Details free. Hill Laboratories, Box 83, Glen Rock, N. J.

BIGGEST Money in tattooing now! No experience required. Complete instructions with outfits. Send for free literature. Tatuco, 651 South State, Chicago.

ARE You interested in life, travel, adventure in the tropics? Free copy of magazine when published. Write, Tropical World, Suite 410 Bond Bldg., Washington, D. C.

SEEK Buried treasure. Methods, mysteries, devices explained. Circulans free. Century Press, Box 151-B, Glen Ellyn, Ill.

LATEST Mail order propositions from many companies, sent steadily one year, 25c. Geo. Pfeiffer, Hackensack, N. J.

RECEIVE Malls, samples, moneymaking opportunities, literature. Your name in several mailing lists, 10c. Rogowski, 3415 Broadway, New York 13.

FEET Hurt Arch supports made to order \$4.50 pair. Unbelievable comfort. Booklet free. Archcraft Company, 600 West 164 St., New York City 32, N. Y.

NERVOUS? Bashful? "Fears?" Free, encouraging information. Jno. Englund, Ironwood, Michigan.

"BIBLE Studies" 70 lessons 25c. Bulletin, Box 87, Station H, New York 25.

MEDICAL Laboratory technicians in great demand. We train you in your spare time, in your own home. You can practice while studying. Write for free catalogue. Imperial Technical Institute, Box 973-J, Austin, Texas.

BEAUTIFUL Bronze grave markers, signs, reasonable. Berg, Box 3162, Bridgeport, Conn.

MEXICAN-AZTEC Featherwork tropical bird picture cards. Samples 25c. Bulletin free. Mexican Products Co., 126 No. Main, Tulsa 3, Okla.

LUMINOUS Paint. Best quality. Glows bright blue in dark. 1 oz. each paint and sealer only \$1.39 postpaid. Black Light Products, 450 E. Ohio St., Chicago 11, Ill.

SQUARE Dance instructions, calls, 25 sets, \$1.00. Rayburn, Lonsdale, Arkansas.

METAL, Mineral locaters latest 1946 electronic type ready for immediate shipment. Fisher Research Laboratory manufactured 2 million dollars worth of electronic equipment for the U. S. Army, including some of the finest metal-locaters. Experience gained is yours in the best metal, mineral locator. Free 16 page booklet upon request. Fisher Research Laboratory, Palo Alto, California.

STAMPS Wanted by thousands of our readers. Your ad in this space will bring you some nice orders. One advertiser sold 150,000 stamps. Write for positive proof. F. W. Johnson, Classified Advertising Manager, Room 301, 200 East Ontario St., Chicago.



H. T. ARMSTRONG
General Manager

**START YOUR OWN
APPLIANCE REPAIR SHOP
Be Independent!**



**YOUR JOB IS SAFE
IF YOU HAVE
YOUR OWN SHOP**

No new-fangled machine can ever take your place in this work . . . for it takes hands to fix appliances. So you will never be out of a job. Further, everyone needs a repair man from time to time . . . so everyone is literally a potential customer. Yes, and everyone respects and admires a man who can fix things . . . so there is a lot of satisfaction being in this business. But there's even more satisfaction in knowing you and your family will never be out on a limb . . . because you will never be out of a job. Let's talk it over by mail.

**NEW BOOK
"HOW TO START YOUR
OWN BUSINESS"**

**Sent at No Extra Cost
If You Act Promptly**

This valuable book covers locating your shop, contains drawings of how to build and wire work-benches, where and how to advertise, what to charge, how to hire solicitors, etc. Let's hear from you, TODAY.

**FREE BOOKLET
MAIL THIS COUPON
TODAY**

Learn at HOME in
Your Spare Time
**How To REPAIR & SERVICE
ELECTRICAL
APPLIANCES**

Our practical, thorough course teaches you this interesting, good-paying business AT HOME, DURING YOUR SPARE TIME. A grade school education is all you need. We teach repairing electrical appliances, motors and house wiring. And from long, daily experience we know how to make our lessons understandable and easy to grasp . . . and how to give you the answers to the questions you'll want to ask. For the man who is handy with tools, and likes to work with his hands as well as his head, there is a WIDE OPEN OPPORTUNITY today, in this great growing field.

**YOU CAN PAY FOR YOUR TRAINING
WITH JUST ONE GOOD REPAIR JOB**

It's a fact! One good repair job can more than pay the cost of the entire course of training. And here's a business you can start as small as you like, in your basement or garage . . . work when you want to . . . and grow as big as you like. Or, you can take a well paid job most anywhere, to start . . . as the need for service mechanics is tremendous in this field and will grow bigger as more and more appliances are released.

AN INDUSTRY WITH A FUTURE

Just think! Despite war, shortages, priorities and restrictions, nearly 3,000,000 more U. S. homes were wired for electricity for the first time . . . since 1940. It's almost like discovering a new continent filled with customers . . . added to the millions already here. And electrification is in for a big boom with government projects in plan for all over the nation.

H. T. ARMSTRONG, General Manager,
**PACIFIC TRAINING SCHOOL, Dept. P-1,
7217 So. Broadway, Los Angeles 3, Cal.**

Dear Sirs: Please send me, without obligation, your FREE BOOK-LET, and full details.

Name

Address

City State

Hear Better!



THIS ONE UNIT IS ALL YOU WEAR

(with earpiece and cord)

Beltone MONO-PAC

No separate battery pack!

No battery wire!

About 1/2 the weight of most hearing aids!

New freedom, new comfort, and clear, rich hearing! That's what the compact little Beltone MONO-PAC offers you. It's a masterpiece of electronic research and precision construction . . . with batteries and transmitter combined into a *single streamlined case* so small that it fits in the palm of your hand. Thousands wear it . . . try it and compare it!

Write for free booklet.

Beltone Hearing Aid Co.

1450 W. 19th St., Chicago 8, Ill.

HOW MACHINES WORK?

This is an age of machines. It is not difficult to operate or understand a machine. This remarkable, compact encyclopedia, **FUNDAMENTALS OF MECHANICS**, is crammed full with the "how" and "why" of machinery. . . . **FIRST**, it describes and explains by pictures and words such basic elements and ideas as:—atoms, matter, motion, liquids, gases, solids, density, energy, force, gravity, measurement, friction, gage, gears, heat, inertia, mass, momentum, tensile strength, temperature, volume, weight, etc.—**THEN**, it shows you just how machines of different kinds work, such as:—Automobile, Diesel Engine, Steam Engine, Pumps, Bombs, Hydraulic Press, Jet Force, Levers, Pulley, Screw, Wedge, Wheel, Movers, Pendulum, Rocket Ship, Thermostat, Block & Tackle, etc., etc. . . . This book lifts up the hood, and shows you simply, just what happens! **40 CHAPTERS—188 PAGES—HUNDREDS OF ILLUSTRATIONS AND DIAGRAMS**, plus formulas, tables and charts—to inform the beginner—and for the technician! It is a reference book of value. **THIS MATERIAL** was used by army personnel in training its mechanics. Never before has such valuable data been available at such a low price. Send only 50c (check, coin or stamps)—no o.o.d.'s at this low price—and **MONEY BACK** if not satisfied!

HOBBY BOOK MART, 150 Nassau St., Dept. F-11, New York 7, N. Y.

Stamp Collections Bought



"STAMP COLLECTORS"

SEND 15c FOR THESE "6" U.S. AIRMAILS As Illustrated.

"Stanley The Stamp Man"

3120 So. Adams Ave., Milwaukee 7, Wis.

Attractive Approvals Included

MAKE MORE MONEY ON YOUR OWN JOB

If you are engaged in any mechanical or production work we can help you. There is an easier and better way of doing any job. Ideas on how to cut corners and cut production costs make for advancement and bring you more money. Our training, featuring short cuts in production used by big industry, will enable you to make improvements in your own job and increase your value to your employer. Write today for detailed information, giving us your name and occupation. **Methods Training Consultants, 124 Montford Avenue, Asheville, North Carolina.**

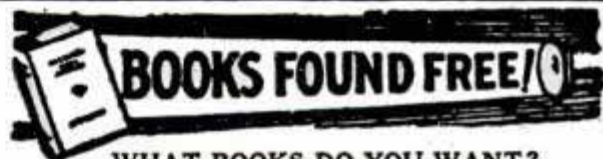

WHAT BOOKS DO YOU WANT?

We quote the lowest market prices. No charge for locating Hard-to-Find and Out-of-Print Books. All books, OLD or NEW, mailed **POST-FREE**. **SEARCHLIGHT BOOK CLUB, 22 East 17th St., New York City**

MAIL OLD GOLD teeth

diamonds, jewelry, watches—and get cash by return mail. Gold is now worth \$35 an ounce. Satisfaction guaranteed. Free Information. **PARAMOUNT GOLD REFINING CO.**
1500P Hennepin Ave. Minneapolis, Minn.

BRUSH PLATING OUTFITS

for re-plating articles in the home and shop. No tanks necessary. Free particulars. **GUNMETAL CO., AVE. M, DECATUR, ILLINOIS**

NEW! DIFFERENT! THRILL YOUR FRIENDS WITH

LIQUID LIGHT

Trade Mark
CHEMISTRY BRINGS YOU

100 AMAZING EXPERIMENTS, TRICKS AND GAMES! All colors of the rainbow! Write with fire. Form whirlpools of light. Make "Neon Tubes" of light. And 97 others—with fluids that glow in the dark. 12 items in each **LIQUID LIGHT KIT**. **SEND NO MONEY!** Pay postman \$2.98 plus postage. Or send cash and we pay postage. **MONEY BACK IF NOT SATISFIED!** FREE 45-page Booklet—"100 Experiments, Tricks and Games" with each Kit. **FREE**

MAIL NOW PELHAM SCIENTIFIC PROJECTS, Dept. B-2, 1 Wolf's Lane, Pelham 65, New York
Send me **LIQUID LIGHT KITS.**
 I enclose \$2.98 for each Kit. I will pay on delivery.
Name
Street
City State

USE THIS EASY, QUICK "BRUSH-UP" HELP

FREE TRIAL in Your Home.
Send No Money!
We Ship C.O.D. in U. S.
and Will Refund Money
if Not Satisfied.



ELECTRICITY AND HOUSE WIRING

Every type electric wiring job covered. Every material, equipment, code system fully explained. 227 illustrations show how to plan and make installations and alterations. Covers motors, motor winding and household appliance repairs. 200 pages. Book No. 1. \$1.50.

THE STEEL SQUARE

The only complete book on this basic tool. A practical and valuable guide in figuring carpentry. Over 300 illustrations. 500 pages. Book No. 2. \$1.79.



HELP YOURSELF TO TOP SUCCESS

YOUR PERSONALITY AND HOW TO IMPROVE IT

A practical and helpful book for men and women—for worker and employer. Developing your personality can be just as important to personal success as training your mind and learning skills with your hands. Making friends, getting along with people, influencing others pays off big. Get this helpful book by Dr. Lockhart and get the most out of your personality. Book No. 3. \$1.98.

DON'T BE AFRAID!

Learn how to get rid of the fears and emotions that hold you back. Learn how to banish personal worry and anxiety, fear and fatigue that can so easily keep you from being the success you want to be. Dr. Edward Cowles shows you how to do it in this practical self-helping book—how you can be happier, more successful—by following simple rules. Book No. 4. \$2.00.

RADIO SERVICING

New 6th edition (1945) of this famous Course Book. Teaches how to actually service all types of radio sets easily and quickly. Prepared by engineers and instructors of Radio Technical Institute. Paper covers. 8 1/2 x 10 3/4 inches. Get this book. 37 million radios to be serviced. Book No. 5. \$2.50.

REFRIGERATION SERVICE MANUAL

New 1945 book. Covers all types of household and commercial refrigeration with latest information on maintenance, trouble shooting and repair. Millions of refrigerators must be serviced. Make money with this book. 300 pages. Illustrated. Book No. 6. \$2.50.

MEASURING METHODS

To reach top pay jobs in all mechanical fields you must know methods of measurement. This book tells all. Packed with helpful pictures & tables. Mechanic's scale and protractor included—free. Book No. 7. \$1.98.

SIMPLIFIED RADIO SERVICING

Ideal for trouble-shooting, for home radio repair, or money-making radio servicing. Easily understood, yet comprehensive for the expert. Characteristic tables for all tubes. Profusely illustrated. Book No. 8. \$1.50.

PLUMBING

Installation and repair. Expert instruction enables inexperienced to plan and install simple plumbing and hot water systems according to good practice without violation of general regulations. 153 illustrations. 200 pages. Book No. 9. \$1.50.

BLUEPRINT READING

Part I, Instruction. Part II, Blueprints for reading, checking, testing. Separate answer key. Complete in 3 parts in portfolio. Best of all for self help and home study. Book No. 10. \$1.98.

Get Ready for BIGGER OPPORTUNITIES and BEST PAYING JOBS

Select from this list for best paying jobs in the top pay fields. Get the help you need from these proven books that thousands of successful men are using—that returning service men and others are depending on—to help them meet tough job competition. Men with some experience—beginners—you men who want to start your own business—this is your big opportunity. Act now. Order on coupon. Draw a circle in coupon around numbers of books you want. Money refunded if not satisfied.

SPRAY PAINTING

Industrial, Commercial. Easy-to-read, practical book teaches expert spraying technique for employment in industrial spray booths; interior, exterior decoration, sign shop, studio work. Book No. 11. \$1.50.

DIESEL ENGINES AND DIESEL ELECTRIC POWER

Complete, practical instruction on Diesel Engines and power equipment. Easy-to-understand language, illustrated by over 200 helpful illustrations of construction, operation, care, adjustment, etc. 308 pages. Book No. 12. \$2.50.

LIVING MATHEMATICS REVIEWED

Review of mathematics essential in business and shop work today—Arithmetic, Algebra, Plane and Global Geometry, Spherical and Military Trigonometry, complete exercises and answers. Book No. 13. \$2.50.

PRACTICAL PLANE TRIGONOMETRY

Quick reference for beginner and advanced student. Learn to apply trigonometry to everyday technical problems. Amaze others by your speed and accuracy. Book No. 14. \$2.00.

ARITHMETIC PRACTICE BOOK

New but proven method of teaching accuracy and speed in all arithmetic problems, now so essential for promotion and progress in all business and shop jobs. Separate answer book included. Book No. 15. 76 cents.

WEBSTER'S VEST POCKET DICTIONARY

New 1945 Edition. Contains over 25,000 words. Simulated leather binding. Size 3 x 5 3/4 inches. Improve your vocabulary and ability to spell as a sure help to success. Book No. 16. 75 cents.

WOOD FINISHING

Plain and decorative. Know how to handle all stains, colors, materials, mixing, brushing, rubbing, polishing, etc. Packed with proven formulas, best methods. 360 pages. Book No. 17. \$2.00.

SHEET METAL WORKER'S MANUAL

15 Comprehensive sections cover entire sheet metal industry from drafting to shop execution; welding processes, pattern making, etc. Metals and alloys, geometry. Useful tables. 552 pages. 375 illustrations. Book No. 18. \$2.00.

PLASTICS .. New Opportunities Everywhere!

Get "Plastic Problems and Processes" and get into this new big-money industry. Over 350 pages of practical and latest information on Plastics and how to use them. Covers design and tells how to make things that sell. Book No. 19. \$3.00.

ONE OF THE YEAR'S MOST HELPFUL BOOKS

SLIDE RULE Included

Don't wish you knew how to use a slide rule—get this book "The Slide Rule and How to Use It" and learn—quick and easy. Amazingly simplified. Anyone can master it in a few hours. Genuine Mannheim slide rule with magnifying indicator—will last a lifetime—included. Book has 200 pages, instructions, charts, work sheets, etc. Book No. 20. Book and slide rule, \$2.98.

MODERN HOMECRAFT

Modern furniture design, construction, finishing, complete. Detailed drawings simplify and insure expert workmanship. 240 pages. Best book for professional or home workshop use. Book No. 21. \$3.00.

CARPENTRY (CRAFT PROBLEMS)

More than 700 illustrations provide working knowledge on all building details. Expert's best methods for measuring, cutting, fitting—all materials. 300 pages. Book No. 22. \$2.00.

MACHINISTS HANDBOOK

In simple technical form, a wealth of valuable money-making, time and error saving information. Now in 29th year and 14th up-to-date edition. Best book for all mechanics. Hundreds of illustrations, tables, diagrams. Book No. 23. \$2.00.

ENGINE LATHE OPERATION

Learn highly paid job operating lathe, milling, drilling, threading, boring machine. Beginner's authentic, easy "show how—tell how" book. Book No. 24. \$1.98.

FREE! New World Map

When you send your order for any of the Helpful Follett Books on this page, send also the names and addresses of three friends you think would like to know about our fine books. For this courtesy we will send you the new OCTOUBE ILLUSTRATED WORLD MAPS AND PICTURES. Printed in colors and showing for the first time in history, the entire world in correct size, shape and position. 51 authentic color paintings and 270 pen drawings included showing people, customs and places all over the world. Maps are 27 x 38 inches. Send names today. This offer may be withdrawn at any time.

Send No Money! MAIL THE COUPON NOW

WILCOX AND FOLLETT CO., Dept. 21, 1255 S. Wabash Ave., Chicago 5

Send books whose numbers I have encircled below. I will pay postman plus few cents charges. Any book not satisfactory will be returned in 5 days and you will refund money paid.

Check here if remittance is included with order. If so we pay all handling and postage charges and allow same return with refund privilege. (Amount enclosed \$.....)

Name.....
Address.....
City..... Zone..... State.....



AUTO

BOOKS ON APPROVAL

SEND NO MONEY. Just mail the coupon for a complete set of Six Big Auto Books. 20th Edition. Whether you are a mechanic or helper, expert or apprentice, auto owner or driver, take immediate advantage of this FREE EXAMINATION OFFER.

MAKE GOOD MONEY NOW HOLD A PERMANENT JOB

America's autos must be kept in service, now and after the war. Men with "know how" are in demand, at big pay. These books will help you get and hold an important job, or give you a chance to go into business for yourself now or later. Any man who half tries to improve himself can learn auto servicing and repairing by this quick reference method. Use the JIPFY INDEX to find easily understood answer to any auto problem. These wonder books prepared by eleven of America's great automobile engineers. Many hundreds of valuable illustrations. Send the coupon TODAY.

[A year's consulting privileges with our engineers now given with these books without extra charge.]
Vocational Publishers Since 1898



CAN YOU FIX IT?

These wonder books tell step by step HOW to make difficult repairs and adjustments, how to keep a car at maximum efficiency, including latest improvements in car design and operation. Engine troubles and how to correct them well covered.

6 BIG VOLUMES
 2800 pages, 2000 illustrations, wiring diagrams, etc., including Diesel engines. Beautiful modernistic, washable cloth binding.

AMERICAN TECHNICAL SOCIETY, Dept. A119
 Drexel Ave. at 98th St., Chicago 37, Ill.

I would like to examine your Six-Volume Set of Auto Books. I will pay the delivery charges only, but if I choose I may return them express collect. If after 10 days' use I prefer to keep them, I will send you \$2 and pay the balance at the rate of only \$3 a month until \$24.80 has been paid. Please include consulting service as offered above.

Name

Address

City..... State.....

Please attach a letter stating your age, occupation, employer's name and address, and name and address of at least one business man as a reference. Men in service, also please give home address.

WORK FOR THE



GOVERNMENT JOBS

START \$1506 to \$2650 YEAR MEN—WOMEN

- Customs Guard
- Accountants
- Railway Postal Clerks
- Postoffice Clerks — Carriers
- Stenographers — Clerks

Many Other Positions

VETERANS GET PREFERENCE

Over 20,000 Appointments Monthly to Veterans. Thousands Each Year.

Mail Coupon TODAY, SURE

COUPON

Name

Address..... Vet?.....

FRANKLIN INSTITUTE

Dept. L51

ROCHESTER 4, N. Y.

Gentlemen: Rush to me, FREE of charge, list of U. S. Government big pay jobs. Send FREE 32-page book describing salaries, vacations, hours, work, etc. Tell me how to qualify for one of these jobs. (Use at once)



MUSIC LESSONS

COMPLETE CONSERVATORY HOME STUDY COURSES

40 years of successful training in Piano, Violin, Cornet, Trumpet, Saxophone, Clarinet, Guitar, Mandolin—Voice, Ear Training and Sight Singing, Choral Conducting, Public School Music—History of Music, Harmony, Advanced Composition, Arranging. The only home study school teaching all courses leading to degree, Bachelor of Music.

MAIL COUPON NOW

UNIVERSITY EXTENSION CONSERVATORY 765 Oakwood Blvd., Suite U322 Chicago 15, Ill.

Send catalogue and illustrated lesson for course.

Name

Street.....

City, State.....

Give experience..... Age.....

BUILD 100 POWER TELESCOPE IN ONE EVENING

See Saturn's Rings, Moon Craters, Comets, Satellites, and Hundreds of Interesting Earth Sights!

TELESCOPE LENS KIT ONLY \$3.95!

Kit includes all optical parts needed to build this powerful 6 1/2 ft. refractor showing erect image. A 3" dia. 75" F.L. high quality objective lens; 3 assembled brass eyepieces of 50X and 100X for astronomy and 75X for earth-viewing; color filter; diaphragms; and building plan. New, perfect lenses. Builds neatly into inexpensive stove-pipe. Money back guarantee. Thousands already in use.

EDUCATIONAL — SIMPLE TO BUILD

Send \$3.95 U.S. cash, check, or m.o. We pay postage. Foreign 5% extra.

BEELERSCOPE, BOX 235PMA, NO. HOLLYWOOD, CALIF.

Send 10c for booklet on amateur telescope building.

FLOYD CLYMER'S MOTOR SCRAPBOOK



Early cars, motorcycles, illustrated, described. Historical, educational. "A MUST," says TIME Magazine. Read about Ford, Hup, Dodge, Metz, EMF, Maxwell, Stutz, Reo, 250 others. No. 1, 2, and 3 books, each different, \$1.50 each. 100% STEAM CAR EDITION, with steamer history, list of 125 makes, photos, \$2.00. All books postpaid. Cloth-bound \$1.00 extra. Motor-book catalog, 10c.

REO
CLYMER, Dept. PM, 2125 W. Pico St., Los Angeles 6, Calif.

So You Think You're Living?

Yes, you're going through the motion, all right—eating, sleeping, working and all that. But are you really LIVING? And how do you KNOW you are living? To find out read "Life Unlimited," a message for immortals. Your copy mailed free on request.

LIFE UNLIMITED, Dept. PM-1

3227 Indiana Ave. St. Louis 18, Mo.



Thrilling Work COLORING PHOTOS

Fascinating vocation learned at home by those with aptitude. Thrilling pastime. National method brings out life-like colors. Free booklet.

NATIONAL PHOTO COLORING SCHOOL
 1315 S. Michigan, Dept. 1351, Chicago 5

STAMMER?

This new 128-page book, "Stammering, Its Cause and Correction," describes the Bogue Unit Method for scientific correction of stammering and stuttering—successful for 45 years. Benj. N. Bogue, Dept. 1832, Circle Tower, Indianapolis 4, Ind.

GET THIS FREE BOOK!

LEARN MASTER MACHINIST MECHANICAL DRAFTING

Expert training on Lathes, Milling Machines, Shapers, Grinders, etc. Allied shops are completely equipped and modern. Approved for G. I. Training. Days, Evenings.

ALLIED SCHOOL OF MECHANICAL TRADES
 1330 South Michigan Avenue Chicago 5, Illinois

NOW ELECTROPLATING

Learn this profitable, interesting trade. Hobby or full time business. Chromium, Nickel, Gold, Silver, etc. Postcard brings full details, FREE.

PLATER HYDE, Dept. M, P.O. Box 176, National City, Calif.

Learn BAKING At Home

Baking is one of America's high industries in wages. Nearly depression-proof. Thorough basic home course lays sound foundation. If you have aptitude, write for FREE BOOKLET, "Opportunities in Commercial Baking." National Baking School, 1315 Mich. Ave., Dept. 1351, Chicago 5



SAY YOU SAW IT IN POPULAR MECHANICS

Aviation's Urgent Need For Trained Men

LED TO THE ESTABLISHMENT OF

NORTHROP AERONAUTICAL INSTITUTE

(Division of Northrop Aircraft, Inc.)

Responsible, well-paid positions in civilian aviation are today seeking *qualified* men. The end of the war started a tremendous expansion in civilian air activities—air bases, repair stations, airline routes, and the production of peacetime aircraft. Aeronautical engineers, airline maintenance men, and aviation mechanics are *urgently needed*. But to qualify for these positions, you must have comprehensive, up-to-date training in the design, building, or servicing of the new *civilian aircraft types*.

This Modern Training Available

—To supply comprehensive training in civilian aviation, Northrop established the Northrop Aeronautical Institute—a new school dedicated to the training and advancement of men for careers in aviation. As a Northrop student, you have *exceptional* advantages. You are located right on the mile-long Northrop air field, in new, especially designed buildings. You become an *actual part* of the Northrop organization, a great aircraft-engineering plant, with world-famous *research, engineering, and production* facilities.

Learn New Aircraft Designs

Designer and builder of the deadly Black Widow P-61 night fighter, Northrop is a leader in aircraft de-

sign—jet propulsion, gas-turbine aircraft engines, and advanced air-frame types. In your aviation training, you get the benefit of this up-to-the-minute knowledge.

Progressive Educational Methods

—Northrop educational programs have already been proved through the training of thousands of Air Forces personnel and Northrop employees. In your training, you get the benefit of tested methods designed to train you thoroughly yet rapidly for the aviation career you choose. Your success in that career will depend, to a great extent, upon *how soon you start*. You now stand at the beginning of a great new era in the history of aviation... *a time of opportunity for men who plan a successful career.*



The Airplane and Engine Mechanic (A & E) is expert on service of all types of aircraft.



The Aeronautical Engineer plans the aircraft of the future.



The Engine Mechanic keeps commercial aircraft engines safe for flight.

"Dedicated to the Training and Advancement of Men for Careers in Aviation."

750,000 New Jobs...

Civil Aviation in the U.S. can provide more than 750,000 new jobs in the next ten years, according to the Civil Aeronautics Administration. The government agency also forecasts that more than 400,000 private planes will be in use in the U.S. by 1955.

Reported by Associated Press.



Northrop Aeronautical Institute

Division of Northrop Aircraft, Inc.

1527 E. Broadway, Hawthorne, California

SEND COUPON FOR FULL INFORMATION

NORTHROP AERONAUTICAL INSTITUTE
1527 E. Broadway
Hawthorne, California

Please send me your free, illustrated booklet and information, including starting dates and tuition rates, on the training courses checked at right.

NAME _____ AGE _____

ADDRESS _____

CITY _____ ZONE _____ STATE _____

Check one: Veteran In Service Civilian

- Aeronautical Engineer
- Airplane Mechanic
- Engine Mechanic
- Master Airplane and Engine Mechanic (A & E)
- Home-Study Course Airplane & Engine Maintenance PM-2

How to Make Money by Mail

Down-to-earth facts, directions (illustrated) for running business profitably, using expertly for your good fortune the employees, trains, planes which Gov't places at your disposal **CHEAP**. Get orders by mail, ship by express or freight or mail, **get out of the kindergarten**... 3rd printing of this book now selling. It's **YOUR** winner.

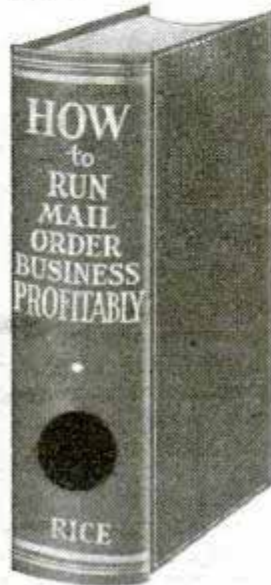

THE EASY WAY to start new or expand your present occupation. **Do it NOW.**

Extraordinary plain, simple skill, know-how. No theory. Fact story of rich experience of author E. Rice day-by-day. How many times have we heard: "I wish I had some money, this patent would earn me a fortune," or "why can't my crop pay better?" or "I wish I knew how to sell this gadget myself," or "why should my boss alone do this when I know too how the money is made?"... **Listen, you do not need money** to start this Rice way. His method **automatically** pays all bills same day rendered, no bank loans, pay as you go, no borrowing from relatives or friends, no usurers. Also no worry, quickly a home of your own all paid for. **Rice paid off \$5000 in mortgages a year** after using this idea.

44 Years of PROOF

Sounds fishy? Sure, but this has been done steadily for 44 years, depression or no depression, by the author; that is why he wrote this book to pass the good word along. **Make it go with anything you have** which is salable. Rice made his plan work when living in one room in a city lodging house. **Turn your city or country home, your work, your hobby, into money.** How to get orders at cost of **only \$4** for each \$100 taken in. The popular error to avoid in trying for sales. Business won **free** while others have to pay for it. How to conceive the money-getting advertisement... Profitable changes from ordinary ideas and methods. Not usual cut-dried pattern, 60 adventures, a dictated book in **everyday talk**, no dictionary writing.

Take a chance on this book being worth a fortune to you and yours and send **\$2.50**. Book mailed same day order is received. Or ask two friends to chip in **83 cents** each with your **84c** to get this book. Hundreds of buyers whose letters we show you declare emphatically its superlative goodness. Follow its easy pattern for success. Cloth-bound, 512 pp., 8 1/4 by 5 1/4. Best seller, 3rd edition now selling. Cut out the **\$2.50 HOW BOX** here, pin or stick it to sheet of paper bearing your name and address, mail in envelope with money order or check for **\$2.50** to



HOWARD ST. HOUSE, Melrose 76d, Massachusetts



LANGUAGE IS POWER

... Forge ahead, win special assignments, promotion, better job in global peace time opportunities through ability to speak a foreign language.

MASTER A NEW LANGUAGE quickly, easily, correctly by

LINGUAPHONE

The world-famous Linguaphone Conversational Method brings voices of native teachers INTO YOUR OWN HOME. You learn the new language by LISTENING. It's amazingly simple; thousands have succeeded.

HOME-STUDY COURSES IN 29 LANGUAGES

Send for **FREE** book—

LINGUAPHONE INSTITUTE

98 RCA Building, New York 20, N.Y. • Circle 7-0830

LINGUAPHONE INSTITUTE,
98 RCA Bldg., New York 20, N.Y.

Send me the **FREE** Linguaphone Book.

Name
Address City.....
Language Interested.....

Be Your Own Boss... GET INTO PLASTICS



LEARN
Plastics
Fabrication & Casting
For Financial Security

START AT HOME-SMALL CAPITAL NEEDED

Start your own Plastics business... with small capital... at home. Grow with this giant industry as you increase your "know-how" and skill. Plan now for your own business or prepare for exciting post-war Plastics jobs. Our revolutionary teaching plan covers production phases of fabrication, casting, cementing methods, mold making, compounding, dyeing, etc. You actually work with many types of Plastics materials. We supply everything. Check information desired. Home Training. Resident Course in Plastics Eng. Send this ad with your name and address in envelope or paste on 1c postcard to Dept. PM

VETERANS: Check here for special information

Plastics Tech. School of America, Inc.
5200 Euclid Avenue CLEVELAND 3, OHIO

PRACTICAL TECHNICAL TRAINING FOR YOU

Specialize in Electricity, Radio and Electronics, Air Conditioning—Refrigeration—Welding. Prepare in six or twelve months for position as **TECHNICIAN**—or in two more years secure B.S. Degree in Electrical Engineering. Write for complete information and mention course desired.

MILWAUKEE SCHOOL OF ENGINEERING
P.M.-146 N. Broadway and E. State Milwaukee, Wisconsin



MAGIC LIQUID Prints Photos

On Wood, Leather, Cloth, Cards Letterheads or almost any surface. Use any snapshot or other negative. Make hundreds of prints without harming negative. Won't wash off. Easy to use. Complete kit for 100 or more photos now only \$1.00 postpaid, or \$1.29 C.O.D. (Canada \$1.50 money order only; no C.O.D.'s). Satisfaction positively guaranteed. Rush order today for the original, big, complete Magic Photo Printing Outfit, L & M MFG. CO.

Dept. 390-F, 229 W. Breckinridge, Louisville 3, Ky.

ARTISTS MAKE MONEY

Find out your ability. Send name, age, occupation and address for Free Vocational Art Test.

ART INSTRUCTION, INC. (Formerly Federal Schools)
1136 Art Instruction Building, Minneapolis, Minnesota

DRAFTING SPRINGBOARD TO SUCCESS!

Increased salary, larger responsibilities, a real career instead of just a job—these are to be had by the trained draftsman. I.C.S. makes the way to thorough, practical training open to you. Check up and you'll find that nearly every "big name" American in engineering and production acquired experience at the drafting board. Many of them started by writing for the I.C.S. free booklet. Send for it today! It can be the most important act of your life.

INTERNATIONAL CORRESPONDENCE SCHOOLS
BOX 5568-K, SCRANTON 9, PENNA.

Send me full information on the following subject:

Name.....Age.....
Home Address.....
City.....State.....
Present Working
Position.....Hours.....A.M. to.....P.M.

Say you saw it in
POPULAR MECHANICS



IT'S FUN! BE YOUR OWN MUSIC TEACHER!

YES, it's a great pastime learning music this short-cut. Print and Picture way, right at home. You learn to play by playing real tunes by note with the very first lesson.

No boring exercises. No lengthy, baffling explanations. Instead of hard work, learning to play becomes a genuine pleasure. You start with simple melodies. As you improve, you take up more difficult pieces. And soon you're amazed to find that you can pick up many popular tunes and play them right off.

And that's not all. You can take up any instrument this easy, home-study way for only 7c a day. That covers everything, valuable sheet music, printed instructions, diagrams, and our Personal Advisory Service.

If interested, send for our Free Booklet and Print and Picture Sample which explain all. U. S. School of Music, 71 Brunswick Bldg., New York 10, N. Y.

*Actual name on request. Picture by professional model.



It's easy as A-B-C!

Yet it's from that stirring favorite of the South, "Dixie"

PLAYS ON RADIO . . .

"As a proud student I can't keep from telling you that as a result of my course I have a good position playing from KTHS every morning."

* J. S. Heavener, Okla.

Diagrams like this explain everything

Follow the dotted lines from the notes to the piano keyboard and before you know it you're playing the famous "Dixie".

FREE! Print and Picture Sample

U. S. School of Music, 71 Brunswick Bldg., N. Y. 10, N. Y. I am interested in music study, particularly in the instrument indicated below. Please send me your free booklet "How to Learn Music at Home" and your Print and Picture Sample. (Do you have instrument.....)

Piano	Piano Accordion	Reed Organ	Clarinet
Guitar	Saxophone	Tenor Banjo	Trombone
Violin	Trumpet, Cornet	Ukulele	Other Instruments

Name..... PLEASE PRINT

Street.....

City..... State.....

Check here if under 16 years of age.
SAVE 2c—Stick coupon on penny postcard

FIX ANY RADIO

Amazing New Invention



FOR BEGINNERS or EXPERTS

Learn quickly to repair radio sets. New revolutionary different comparison picture-method quickly simplifies radio servicing. No previous radio knowledge required. Introductory training included. Find any fault with ease. Do expert radio work almost immediately. Repair radios in minutes instead of hours. Plan U. S. Copyrighted. Take advantage of this new invention.

NO EQUIPMENT NEEDED

Most tests described require the use of only a screw driver, pliers and a piece of wire—no testers needed. Simple point-to-point picture suggestions tell you where to look for defects, how to test radio circuits and parts, and how to make the repair. You may try the plan for 10 days without any risk.

RADIO MADE EASY

Let this unique plan with its easy-to-understand diagrams, simplified illustrations, hints, job-sheets, and practical examples teach you basic radio facts. Learn important short-cuts in radio trouble-shooting. Make needed tests without testers, trace the signal, measure voltage, within the hour after receiving the plan. Follow the comparison tests given on large trouble-shooting diagram blueprints. Over 1,000 repair hints. Data on all tubes. Circuits and hints for many types of radios—new and old models.



10 DAYS "NO RISK" TRIAL

Examine and use Simplified Radio Servicing plan for 10 days in your own home. Apply this technique and repair one or more radios. Then decide to keep this greatest radio training bargain, or return the material and get your money refunded in full. You take no risk.

Complete plan, only **\$1.50**

In manual form, 8 1/2 x 11" Trouble-shooting charts. Data on 346 radio tubes. 76 large job-sheets. 1,000 time-saving hints. Covers many types of sets—new and old, FM, portables. Developed by Beitman, noted engineer, teacher, and author. Order today, use plan this week. →

REPAIR RADIOS IN MINUTES

Read the introductory job-sheets, follow the step-by-step picture blueprints, and fix any radio in a matter of minutes. Do radio work for fun and profit. The complete simplified training is yours for only \$1.50, postpaid, 10 days no risk trial.

MORE HELP — IF NEEDED

Supplement your study, clear-up all hard problems, get ahead in Radio. A companion 19 lesson Practical Radio manual will give you added assistance, help you get ahead faster, present important facts in greater detail. Include this large manual also in your trial order. See coupon. →

No Risk TRIAL ORDER COUPON

SUPREME PUBLICATIONS, 9 S. KEDZIE AVE., CHICAGO 12, ILL.

Ship the following manuals to me for 10 days' trial under your money-back guarantee. I am enclosing \$.....full price. Ship postpaid.

Simplified Radio Servicing @ \$1.50 Complete manual as described. Practical Radio Manual @ \$2.95 Companion Volume, 19 lessons.

Name:PMJ

Address:.....

Increasing your hold on your job and giving yourself a chance for advancement

Few men deliberately plan to work persistently on self-improvement. If progress comes naturally, they're happy; if it doesn't, they worry or ignore the situation. Yet it is possible to pay attention to self-improvement with considerable hope of success. A noticeable degree of advancement is practically assured any one who will make an intelligent and persistent effort. Thousands of men have proved this for themselves, with:



The Croft Library of Practical Electricity

The Croft Library is a complete electrical educator. It is founded on practice—on 20 years of shirt-sleeve experience—on work as it is actually done. It is jammed from cover to cover with the kind of hard-headed facts you want. Written so that the beginner can easily understand it, yet so sound, so thorough, that it is the daily guide of 50,000 highly paid electrical workers and engineers. Croft tells you the things you need to know about motors, generators, armatures, commutators, transformers, circuits, switchboards, distribution systems—electrical machinery of every type—wiring for light and power—wiring of finished buildings—underwriters and municipal requirements—illumination in its every phase—the most improved methods of lighting lamps—and lamp effects, etc.—how to do a complete job, from planning it, to completion.

No money down—easy payments

Fill in and mail the coupon attached and we will send you the entire set of seven volumes for ten days' examination on approval. We take all the risk—you assume no obligation. If you decide to keep the books, send \$3.00 in ten days and the balance at the rate of \$3.00 a month. Send the coupon NOW and see the books for yourself.

McGraw-Hill Book Co., 330 W. 42nd St., New York 18, N. Y.
Send me for ten days' examination on approval the Croft Library of Practical Electricity, 7 vols. If satisfactory I will send you \$3.00 in 10 days and \$3.00 monthly until the price of \$18.00 is paid. If not wanted, I will return the books postpaid. (To insure prompt shipment write plainly and fill in all lines.)

Name.....
Home Address.....
City and State.....
Company.....
Position..... PM-1-46

AN INFANT INDUSTRY ... SUDDENLY MATURED PLASTICS

Get In at the Start—and Grow

Plastics is a new industry which the nation's war needs is forcing to quick maturity. Already Plastics are indispensable in practically every branch of the Service—Aircraft, Ordnance, Chemical, Marine, Signal Corps, etc. Opportunities? Nearly everything, from homes to clothing, from gadgets to tools, will be affected by Plastics.

Spare Time Training Now Ready

The time to get started is now. You can prepare at home, in your spare time, to take your place in an infant industry that even now is leaping into prominence. A new, practical training plan is now ready to help you realize your ambitions and build your future security. Act now. Don't delay. Mail this coupon today.

AMERICAN SCHOOL, Dept. P145
Drexel Ave. at 58th St., Chicago 37, Ill.

Send me FREE information covering special training in subjects checked below. No obligation on my part.

- | | |
|---|--|
| <input type="checkbox"/> Plastics | <input type="checkbox"/> Radio |
| <input type="checkbox"/> Electrical Engineering | <input type="checkbox"/> Automotive Engineering |
| <input type="checkbox"/> Drafting and Design | <input type="checkbox"/> Architecture & Building |
| <input type="checkbox"/> for Men and Women | <input type="checkbox"/> Business Management |
| <input type="checkbox"/> Diesel Engineering | <input type="checkbox"/> High School Course |
| <input type="checkbox"/> Mechanical Engineering | <input type="checkbox"/> Railway Training |
| <input type="checkbox"/> Aviation | <input type="checkbox"/> Electronics, Industrial |

Name.....
Address.....



An astonishing formula for wealth and success different from anything ever published has been devised by a man who made four fortunes, two for other people and two for himself. This extraordinary formula is easily followed in any honest trade or profession. It points out how other persons found it easy to make a fortune in spite of themselves. Truly, it is amazingly right, so simple, practical, and workable.

Send No Money

Just write a penny post card with your name and address and the book will be sent to you C.O.D. Upon arrival pay the postman \$1.00 plus postage and C.O.D. charges or you may remit with order and save the postal fees. Keep the book for three weeks and if at the end of this time it hasn't stirred your imagination and inspired you to get out of a rut and make real money, return the book and your money will be promptly refunded. Order today. Get rich in spite of yourself. Address Grafe & Grafe, Dept. 35, 434 N. Vista St., Los Angeles 36, Calif.

MAKE IT EASY,

Whether one-finger playing without study, or interpretations that baffle the experts!

Harmonic and melodic tables, by F. Wilson. Structure of octave thoroughly clarified. 4ths and 7ths disentangled. Vague "tendencies" replaced by precise definitions. Logical notation and naming of half-tones. Crystalline, fluid, fixed just chromatic and spherical scales. \$1.00 ppd. Dr. P. Wilson, Box 1205, Chicago 90.

PRINTING PAYS BIG

"Make your future secure. Prepare for a highly paid position or a print shop of your own. Students throughout the world are enthusiastic in their praise of our training program and the personal attention given each student. Rush name today for free literature and sample lesson. No salesman will call. Dept. M16.

COMPLETE COURSE ONLY \$14.50 CASH
TERMS AVAILABLE

International School of Printing, Troy, O.

A SIMPLIFIED ART ANATOMY OF THE HUMAN FIGURE

ONLY 51 POSTPAID

by Charles Carlson. The book they're talking about! One of the most informative books of its kind for both student and professional artists. Charts, notes, and over 350 drawings show detailed studies of every part of the body, posed and in action. HOUSE OF LITTLE BOOKS, 80-A E. 11 St., New York 3

LAW

STUDY AT HOME for PERSONAL SUCCESS and LARGER EARNINGS. 35 years expert instruction—over 108,000 students enrolled. LL.B. Degree awarded. All texts furnished. Easy payments. Send for FREE BOOK—"Law and Executive Guidance."

AMERICAN EXTENSION SCHOOL OF LAW
Dept. 61M, 646 N. Michigan Ave., Chicago 11, Ill.

SIGNS EASILY AND EXPERTLY PAINTED WITH LETTER PATTERNS

AND SHOWGARDS

MANY SIZES & STYLES WRITE FOR FOLDER!

JOHN F. RAHN
1380-31 N. Central Ave.
CHICAGO 51, ILL.

:: SAVE WASTE PAPER ::

The Taller Person Has The Advantages In Life

DID YOU KNOW that while the average height of their forebears in Japan was only 5 feet 2 inches "a cross section of Hawaii's American Japanese community provided a better type of soldier than Japan was getting and that MANY WERE ALMOST SIX FEET TALL"?—(Vide "New York Times," April 4, 1943. Report of a statement by General Emmons, Commander, Hawaiian Dept. U. S. Army.) Read

"BUILDING HUMAN STATURE

A Complete Study"

to learn why, and to what scientists attribute the increased height of these men with hereditary small stature. Read what, according to authorities, made them and others GROW SO MUCH TALLER than their forefathers.

This book, compiled by a Doctor of Science who was once a famous Champion Athlete and Editor, contains the research results, the opinions, and the ADVICE of the world's greatest authorities, physiologists, physicians, anthropologists, biologists, and physical culture experts, on this most significant matter of increasing human height.

What made the average New Zealander FIVE AND A HALF INCHES TALLER than the Indian? This book, "BUILDING HUMAN STATURE—A Complete Study," tells you. It is a

Most Important and Amazing Book

The average person grows, or has the possibility of growing, until he or she is between 21 and 24 years of age. However, Bob Hoffman, Editor of "Strength & Health," wrote: "Some people have recorded an increase in height after reaching their thirties." Gerling, whose book "Short Stature and Height Increase" has been acclaimed by numerous medical journals, wrote: "even after the period of growth is past (after about 21-24 years of age) though the response to growth stimulating factors will no longer be as great it is still possible to have them yield some gratifying results."

The writer of this book, "BUILDING HUMAN STATURE—A Complete Study," urges that what are considered to be height stimulating factors should be adopted at the earliest possible age in order to expect the best results.

Captain Juan Cano, Commander of the Health Service, Spanish Loyalist Army Volunteer Divisions, writes: "There is no doubt in my mind that if a young man inclined towards shortness of stature apply himself to the recommendations in this book it should make considerable difference in his ultimate height and figure."

If you are within the growing age you have a particular interest in getting a copy of "BUILDING HUMAN STATURE—A Complete Study." It is loaded with information, and has FULL AND EASILY FOLLOWED DESCRIPTIONS AND DIRECTIONS FOR MAKING THE STRETCHING AND SUSPENSION APPARATUS for using which some have claimed remarkable results.

Every parent who wishes his children to achieve fine stature should possess this book.

On the dance floor, and in social life, girls usually prefer taller men and choose them for favors.



FATHER and SON
Son exceeds father's height by nearly a head. This young man grew almost 6 inches during a year that he used a Suspension Apparatus.

Read This Partial List of Contents

of 22 wonderful chapters, 100,000 enjoyable words, over 300 pages, and numerous illustrations with photos, sketches and diagrams:—

Foreword, by Capt. Juan Cano.—Huge Funds Subscribed for Stature Building Research.—Age Limits.—Bernard College Head Expects Height Record for Students.—The Truth About Heredity in Height Increase. Not a Completely Contrary Factor.—Height a Variable Factor.—Hereditary Complications.—Food for Stature Building.—What Sir John Orr Advises.—Tryptophane Essential to Full Growth.—Vitamins for Stature Building.—A "New Growth Spur" Found in Vitamin.—Dr. Ehrmann's Basic Nutrition.—U. S. Surgeon General's Dietary Advice.—How Food Has Affected Stature the World Over.—Bone Development.—"Response of Bones to Stimuli."—Natural and Artificial Bone Growth.—How the Ductless Glands Affect Stature.—"Gains in Height Varying From 1½ to 6 Inches From Gland Treatment.—Tracking Down the Growth Principle.—Some Very Tall Human Specimens.—A Famous Dwarf. Doubled His Height at 39.—Building the Japanese Stature.—How Some Japanese Have Developed Almost 6 Feet Stature.—Increasing Stature in the Soviet Union.—How Russian-Jewish Children in U. S. Grew 5 Inches Taller Than Their Parents.—What Professor Delehanty Outlined as Factors Which Increase Height.—Dr. Fishbein, Head of American Medical Association, Advised Exercise for Metabolism and Stimulation of Growth.—Advice of U. S. Director of Physical Fitness.—Dr. Greulich, of Yale, Using X-Rays, Praises Height Increasing Benefits.—Stature Gaining Factors According to Dr. Krogman, Noted Anthropologist.—Dr. George Crile's Physics of Growth.—8 Ft. Watussl and 3 Ft. Bushmen in Africa; Why?—Some Suggestions For An Exercise System.—Suggested Free Exercises.—Exercises With Two Chairs.—Advanced Chair Exercises.—Exercises on Home-made Trapeze and Rings.—Specialized Use of Weights for Pronounced Stretching.—Increased His Height 6 Inches in 16 Months.—Body Suspension.—Clear Simple Instructions for Making Suspension Apparatus.—Use of Suspension Apparatus.—High Pay Jobs as Instructors.

In business a commanding presence is advantageous in almost any department of making a living.

Send NOW for this extremely valuable book. Send check, money order or cash for \$3.75 and your copy will be delivered to you postpaid in plain wrapper. Your money will be cheerfully refunded if you are not overwhelmed with satisfaction. Cut out and mail this coupon NOW.

CARILLON BOOKS, Dept. 11, Boerne, Texas

Please send at once "BUILDING HUMAN STATURE—A Complete Study." I enclose \$3.75.

Name

Address

SILVERPLATE

Electrically by Brush!

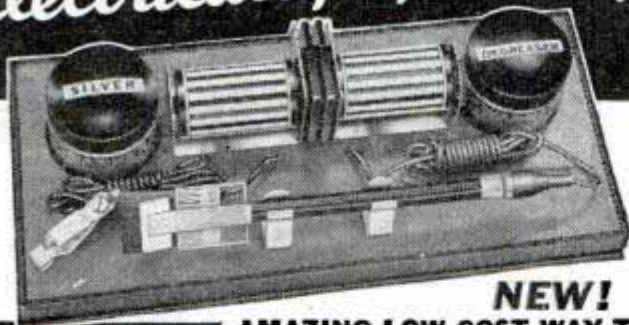

NEW!

The Tool of a 101 USES

AMAZING LOW COST WAY TO PLATE GENUINE SILVER ON Models, Projects, Worn Fixtures

Hundreds of uses for this complete Silverplating Outfit! New, patented electrified brush and concentrated compound of Atomic Silver work like magic. Easily and quickly, you can apply a heavy, permanent coat of Genuine Silver to any conductive surface . . . on models, projects, silverware, jewelry, etc. Outfit includes Degreaser, Atomic Silver Compound, Battery Power-Pack, Nylon-Lucite Electrolytic Brush, Solid Silver Anode, Leads, Connectors and simple Instructions in compact carrying case. All at amazing low cost! Small shipping charge collected on delivery. ORDER TODAY.

Homecrafters, Dept. E-4
360 NORTH MICHIGAN AVE.
CHICAGO 1, ILLINOIS

ONLY \$12.50



AUDELS NEW MACHINISTS HANDYBOOK NOW READY!

Prepare!

A KEY TO SHOP PRACTICE
For Every Machinist, Tool-maker, Machine Operator, Draughtsman, Metal Worker, Mechanic or Student. Covers Shop Practice in All Branches.

A READY REFERENCE
Tells How to Operate and Set Up Lathes, Screw and Milling Machines, Shapers, Drill Presses and All Machine Tools.

5 PRACTICAL BOOKS IN ONE!
60 FULLY ILLUSTRATED CHAPTERS
Covering: 1—Modern Machine Shop Practice. 2—Blue Print Reading and How to Draw. 3—Calculations & Mathematics for Machinists. 4—Shop Physics. 5—How to Use Slide Rule.

Get This Information for Yourself. Mail Coupon Today. No Obligation Unless Satisfied. ASK TO SEE IT.

1600 PAGES FULLY ILLUSTRATED \$4 COMPLETE • PAY ONLY \$1 MO.

THEO. AUDEL & CO., 49 WEST 23rd STREET, NEW YORK
Mail AUDELS MACHINISTS & TOOLMAKERS HANDY BOOK. Price \$4 on 7 Days Free Trial. If O. K. I will remit \$1 in 7 days and \$1 monthly until \$4 is paid. Otherwise I will return it.

Name.....
Address.....
Occupation.....
Reference..... PM

START YOUR OWN BUSINESS

Here's your opportunity to learn a profitable, busy trade —Watch and Clock Repairing—at home. You probably know how busy Jewelers and Watchmakers have been. "Try to get your watch repaired quickly."

WATCH AND CLOCK REPAIRING



You can learn in your spare time at home . . .

Testimonials from well known authorities praise this instruction material on the science of modern watch repairing and adjusting. How completely and thoroughly the field is covered is shown by subjects discussed: Improvement of Ability and Higher Earnings for Watchmakers; The Efficient Use of Saws; Drills and Expert Drilling; Steel and Its Heat Treatment, etc. Decide today to get into this big opportunity field. No previous experience necessary. Low Price . . . Money Back Guarantee. Send coupon for free details.

Money Back Guarantee. Send coupon for free details.

INDUSTRIAL DIAMONDS

Learn more of this valuable trade. The material treats technically of machine methods of dividing diamonds and gem stones, cutting and polishing, boring, drilling, engraving, etc. Other subjects covered: Industrial Diamonds and their many uses in industry; Manufacture of Watch and Pivot Bearings. Fascinating. Authoritative treatment. Write today.

Send Coupon for Free Details

The Charles T. Powner Co.
P. O. Box 796, Chicago 90, Ill.
Please send me free illustrated folder describing the following fast-growing trades.
Watch and Clock Repairing Industrial Diamond Production

Name.....
Address.....Zone.....
City.....State.....

8 BIG BUILDING BOOKS

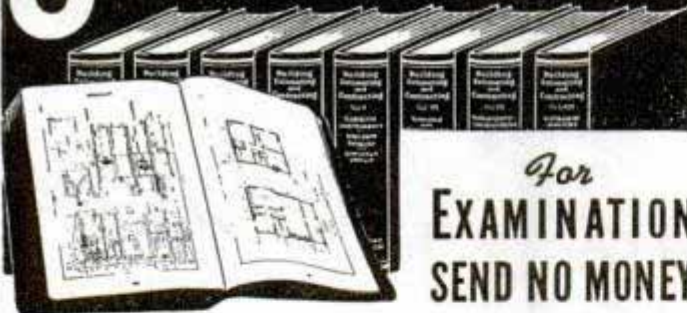

For
EXAMINATION
SEND NO MONEY

Learn to draw plans, estimate, be a live-wire builder, do remodeling, take contracting jobs. These 8 practical, profusely illustrated books cover subjects that will help you to get more work and make more money. Architectural design and drawing, estimating, steel square, roof framing, construction, painting and decorating, heating, air-conditioning, concrete forms and many other subjects are included.

BETTER JOBS — BETTER PAY

Keep busy now at good pay, and be prepared for after-war building boom. Big opportunities are always for MEN WHO KNOW HOW. These books supply quick, easily understood training and handy, permanent reference information that helps solve building problems.

UP-TO-DATE EDITION

These books are the most up-to-date and complete we have ever published on these many subjects.

Coupon Brings Eight Big Books For Examination

AMERICAN TECHNICAL SOCIETY Vocational Publishers since 1898
Dept. G119 Drexel at 58th Street Chicago 37, Ill.

You may ship me the Up-to-Date edition of your eight big books, "Building, Estimating and Contracting," without any obligation to buy. I will pay the delivery charges only, and if fully satisfied in ten days, I will send you \$2.00, and after that only \$3.00 a month, until the total price of only \$34.50 is paid. I am not obligated in any way unless I keep the books.

Name.....
Address.....
City.....State.....
Please attach a letter stating your age, occupation, employer's name and address, and name and address of at least one business man as a reference. Men in service, also please give home address.



SALESMEN FOR CITY AND COUNTY

Nationally Known Manufacturer

Build up a business of your own with Nationally Advertised Products bearing Underwriters' label. Sell to schools, factories, service stations, warehouses, hotels, restaurants, public institutions, truck and bus companies, grain elevators, house trailers, autos, farms, homes, etc. Capable man can earn real money. Established in 1916. Write letter with details, age, experience, etc.

THE FYR-FYTER CO.,

Dept. 90-13

Dayton 1, Ohio

"The Book They're Talking About"

Contains over 350 illustrations, charts and notes.



ART ANATOMY OF THE HUMAN FIGURE

For the amateur and professional artist and sculptor. Giving detailed study of every part of the body. Male and Female, Posed and in Action. Outside U.S.A. Send \$1.25

ONLY \$1.00

MAJOR BOOK CO., Dept. 3514-A, FOREST HILLS, N. Y.

BE YOUR OWN BOSS! BIG PAYING PROFESSION MECHANICAL DENTISTRY

G. I. APPROVED

Big post war demands for trained Dental Technicians! Start Now! Learn this profitable profession.

Visit Us or Write for Free Booklet "P.M.-1"

National School of Mechanical Dentistry

10 W. Jackson Blvd., Chicago 4, Illinois

IF YOU ARE A MANUFACTURER

write now for our Prospectus; we will also represent individuals in personal or business activities.

LIAISON SERVICE BUREAU

A national cooperative association of Manufacturers' Agents
HOME OFFICE — 4509 WASHINGTON — EVANSVILLE, IND.

JIU-JITSU HOW TO BECOME EXPERT, Keep Health, Have Fun. Teaching 35 years. Free information. Write

MODERN SCHOOL JIU-JITSU, Dept. EE, 5 W. 52nd St., N.Y.C. 19

Learn TOOL DESIGN

Now, as never before, draftsmen and tool designers are needed to redesign for peacetime reconversion. Quality quickly. Many making \$100 to \$150 per week. More qualified men needed than available. Good pay jobs waiting. Rush name and kind of job wanted today for full free facts. State age.

OHIO INSTITUTE OF TECHNOLOGY, Box 281, Greenville, Ohio

JET PROPULSION

Real experiments. New power principle for boats, bicycles, autos, scooters, models, aeros. Free circular.
MAC BOSS, 2265 Warren, Toledo 10, Ohio

WATCHES WANTED Broken or Usable

—all kinds, even Ingersolls. Highest prices paid for jewelry, rings, spectacles, gold teeth, etc. Cash mailed promptly. Write for Free Shipping Container.

LOWE'S, Holland Bldg., Dept. PM, St. Louis 1, Mo.

Train Your Own HORSES!

Colts - Stock Horses - Circus Horses
Gait Show Horses — Write for FREE BOOK
ANIMAL LOVERS' ASSOCIATION
Box KA-111, Tarzana, Calif.



RADIO ENGINEERING, Broadcasting, Servicing, Electronics, Aviation, Marine & Police Radio taught thoroughly. 48 weeks' Engineering course equivalent to 3 years' college radio work. Approved Veteran Training. Co-educational. Catalog free.

VALPARAISO TECHNICAL INSTITUTE, Dept. D, Valparaiso, Ind.

Now Any AUTO REPAIR JOB Can Be a "Push-Over" for You!

**IN LESS TIME —
WITH LESS WORK —
AND MORE PROFITS!**

MoToR's new AUTO REPAIR MANUAL shows you how to service and repair ANY part of ANY car! Now you can lick even the toughest jobs when you have this amazing Manual to make your work easier!

Every job on every car built since 1935 is explained as simply as A-B-C. Clear, illustrated instructions lead you step by step. NOW you can tackle ANY job from carburetor to rear end—and do it quick, easy, right, the FIRST time! Just look up make, model, and the job in the quick index of MoToR's AUTO REPAIR MANUAL—and go to work!

ONLY Manual of Its Kind

No wonder this manual is used by the U. S. Army, Navy, trade and technical schools everywhere, and thousands of successful auto servicemen!

To make this great book possible, the engineer-editors of MoToR Magazine condensed all the meat from 150 official factory manuals for you. They dug out all the information you need; made sure every word is crystal-clear; and put "the whole works" into this one great, handy book!

MoToR's AUTO REPAIR MANUAL is a big book: 764 large pages, 8½ x 11 inches, bound in sturdy covers. Nearly 200,000 ser-

vice, repair, adjustment, replacement, tune-up facts on every car built from 1935 to 1945!

Over 1,000 Pictures!

More than 1,000 cutaway photos, diagrams, drawings, charts, SHOW you what the clear text TELLS you! No wonder thousands of men call this amazing book their Auto Repair "Bible"! No wonder it will save YOU countless hours of work—and help you make MORE MONEY from auto repairs!

See for yourself—without cost!—what a work-saver, time-saver, and "life-saver" MoToR's AUTO REPAIR MANUAL will be for you! TRY it FREE—for 7 days. Learn first-hand how it can pay for itself the first few times you use it!



Clear, Pictured Facts on Every Job on Every Car Built Since 1935!

Nearly 200,000 service and repair facts on all these makes:

American	Crosley	La Salle	Packard
Bantam	De Soto	Lincoln	Pierce
Auburn	Dodge	Lincoln	Arrow
Austin	Ford	Zephyr	Plymouth
Buick	Graham	Mercury	Pontiac
Cadillac	Hudson	Nash	Reo
Chevrolet	Hupmobile	Oldsmobile	Studebaker
Chrysler	Lafayette	Overland	Terraplane
Cord			Willys

764 big pages; including 50 pages of carburetor text, charts, illustrations covering all models. Over 500 charts, tables: Tune-up Chart; Valve Measurements; Compression Pressure; Torque Wrench Reading; Starting Motor; Engine Clearances; Generator; Clutch & Brake Specifications; Front End Measurements, etc.; Engines; Electric, Fuel, Cooling, Lubricating Systems; Transmissions; Universals; Front Ends; Wheels; Rear Ends, etc.



Just mail coupon below—without money! When the postman brings your book, examine it thoroughly. Make it show you what it's got! Unless you agree this is the greatest time-saver and work-saver you've ever seen—return book in 7 days and pay nothing. Mail coupon today! Address: MoToR Book Department, Desk 1A, 572 Madison Ave., New York 22, New York.

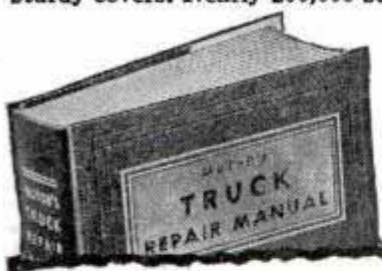

Same FREE 7-Day Offer Applies on MoToR's Truck Repair Manual

For mechanics, truck specialists, service stations, fleet owners. Covers EVERY job on EVERY truck made since 1936! 1400 pictures, 914 pages, 300,000 facts. Used by Armed Forces. Warranted to contain every essential fact you need to know. Strong binding, size 8½x11.

Covers all types Gasoline Engines; Diesels and Hesselmans. Fuel Systems, Governors, Lubrication Systems, Ignition Systems, Starters, Generators, Clutches, Transmissions, Axles, Torque Dividers, Transfer Cases,

Brakes, Steering, etc., etc. Also services buses, farm and industrial tractors, contractor and road building equipment, stationary power machinery, etc. (on all parts described in Manual.)

Offered on same FREE 7-Day examination as Auto Repair Manual. Check box in coupon at right.



Published by MoToR, The Leading Automotive Business Magazine. MoToR's manuals assure high standards of repair work.



Used by U.S. Army and Navy

MoToR Book Dept., Desk 1A, 572 Madison Ave., N. Y. 22

Rush to me at once: (Check box opposite book you want)

MoToR's AUTO REPAIR MANUAL. If O.K. I will remit \$1 in 7 days, and \$1 monthly for 4 months, plus 35c delivery charge with final payment (\$5.35 in all). Otherwise I will return book postpaid in 7 days. (Foreign price, remit \$7 cash with order.)

MoToR's TRUCK REPAIR MANUAL. (Described at left.) If O.K. I will remit \$2 in 7 days, and \$2 monthly for 3 months, plus 35c delivery charge with final payment (\$8.35 in all). Otherwise I will return book postpaid in 7 days. (Foreign price, remit \$11 cash with order.)

Print Name..... Age.....

Print Address

City..... Zone No. (if any).....

State..... Occupation.....

SAVE 35c SHIPPING CHARGE! ENCLOSE full payment (check, money order, or postal note) and we pay postage. Same 7-day return-refund privilege.

BARGAINS in WAR SURPLUS LENSES & PRISMS



TANK PRISMS

In order that the tank driver shall not get shot in the face, 2 of these Silvered Prisms are used to make a Periscope. We have secured a number of these, 90-45-45 degree Prisms of huge size—5 3/4" long, 2 1/8" wide, finely ground and polished. Used to build a Periscope, camera stereo attachment, range finder, etc. Excellent also for experiments, classroom demonstrations. Prism easily converted into desk name plate by affixing gold letters, 100 gold letters supplied at only 10c.

(Order Stock #3008-H.) Normally these Prisms would retail from \$24 to \$30 each.

- SILVERED TANK PRISM**
 Stock # 3004-H.....\$2.00 each Postpaid
- PLAIN TANK PRISM**
 Stock # 3005-H.....\$2.00 each Postpaid
- FOUR TANK PRISMS—Special—\$7.00 Postpaid** . . . The most sensational bargain we have ever been able to offer.

REMARKABLE VALUE!

\$141.01 WORTH OF PERFECT LENSES FOR ONLY \$10.00

Complete System from Artillery Scope (5X) . . . 9 Lenses, low reflection coated, absolutely Perfect. Diameters range from 1-1/3 inches to 2-1/5 inches. Used for making Telescope and hundreds of other uses.

- Stock # 5019-H.....\$10.00 Postpaid
- 16 MM PROJECTOR CONDENSING LENSES**—Consists of two Condensing Lenses with combined F.L. of one inch.
 Stock # 4026-H.....\$1.00 Postpaid
- CLEANING BRUSH SET**—12" flexible hollow plastic handle, circular construction, 4 brushes to set, range stiff to soft.
 Stock # 504-H.....Price \$1.00
- MAGNIFIER SET** . . . 5 Magnifying Lenses . . . Powers from 1 to 10. Various diam. for many uses. Free Booklet on Home-made magnifiers included.
 Stock # 1026-H.....\$2.00 Postpaid
- OPTICS FROM 4-POWER PANORAMIC TELESCOPE**—Excellent condition. Consists of Objective Prism, Dove Prism, Achromatic Objective Lens, Amici Roof Prism, Eye Lens Set (. . . a \$60.00 value).
 Stock # 5016-H.....\$6.00 Postpaid
- 35 MM KODACHROME PROJECTING LENS SET**—Consists of Achromatic Lens for projecting, plus a Condensing Lens and piece of Heat Absorbing Glass with directions.
 Stock # 4025-H.....\$1.95 Postpaid

ALL THE LENSES YOU NEED TO MAKE YOUR OWN TELESCOPE! ALL ARE ACHROMATIC LENSES

- GALILEAN TYPE**—Simplest to make but has narrow field of view.
 Stock # 5018-H 4 Power Telescope.....\$1.25 Postpaid
 Stock # 5004-H Small 2 Power Pocket Scope. \$1.00 Postpaid
- TERRESTRIAL TYPE**—Have much wider field of view than Galilean Type.
 Stock # 5007-H 11 Power Telescope.....\$3.20 Postpaid
 Stock # 5008-H 20 Power Telescope.....\$3.45 Postpaid
- PRISM TELESCOPES**—Uses Prism instead of Lenses to erect image and are much shorter than Terrestrial Type. Have wide field of view.
 Stock # 5010-H 6 Power Telescope.....\$3.00 Postpaid
 Stock # 5011-H 11 Power Telescope.....\$3.25 Postpaid
 Stock # 5012-H 20 Power Telescope.....\$7.25 Postpaid

Order by Set or Stock No. • Satisfaction Guaranteed • Immediate Delivery

EDMUND SALVAGE COMPANY, P. O. AUDUBON, NEW JERSEY

All Items Finely Ground and Polished but Edges Slightly Chipped or Other Slight Imperfections which We Guarantee Will Not Interfere with Their Use. Come Neatly Packed and Marked.

You Can Easily Make Telescopes, Magnifiers, Photographic Gadgets and Hundreds of Experiments with these Low Cost Lenses.

To translate millimeter measurements: 25.4 mm. equals one inch.

SPECIALS IN LENS SETS

Big 10-Page Project and Idea Booklet with all sets.

Set #1-H "Our Advertising Special"—15 lenses for \$1.60 Postpaid. For making your own powerful telescopes, low power microscope, strong magnifiers, drawing projector, photo cells, telephoto lens, dummy focusing camera, Kodachrome viewer, stereoscopic viewer, ground glass and enlarging focusing aids. For experimental optics, portraits of babies and small pets, copying, ultra close-up shots, and many, many other uses.

New 50-Page Idea Book, "FUN WITH CHIPPED EDGE LENSES" Contains wide variety of projects and fully covers the fascinating uses of all Lenses in sets listed above . . . only \$1.00 Postpaid.

14 POWER COLOR CORRECTED MAGNIFIER SET—Consists of two Achromatic Lenses and section of metal tubing for mount.
 Stock # 1044-H.....\$1.55 Postpaid

MONOCULAR SET OF LENSES AND PRISMS . . . from Navy's 7 x 50 Binocular. All the optics you need to make a 7 Power Monocular. Buy 2 sets to make a Binocular.
 Stock # 5100-H.....\$5.00 Postpaid

38 PAGE DIRECTION BOOK "HOMEBUILT BINOCULARS" . . . 50c Postpaid.

TELESCOPE EYE PIECE SET—Consists of perfect Eye Lens Set from a Govt. Telescope. Diam. 1 inch, Focal Length 1 inch.
 Stock # 6144-H.....\$1.00 Postpaid

SPECTROSCOPE SET . . . These sets contain all Lenses and Prisms you need to make a Spectroscope plus FREE 15-page Instruction Booklet.
 Stock # 1500-H Hand Type Spectroscope.....\$3.45 Postpaid
 Stock # 1501-H Laboratory Type Spectroscope, \$6.50 Postpaid

MICROSCOPE SETS

Consisting of 4 Achromatic Lenses for making a 40 Power Pocket Microscope or 140 Power regular size Microscope. These color corrected Lenses will give you excellent definition and may be used for Micro-photography.

- Stock # 1037-H.....\$3.00 Postpaid
- Consisting of Prism, Mirror and Condensing Lens. These used together with Stock # 1037-H will make an excellent Micro-projector enabling you to get screen magnification of 400 to 1000 Power according to screen distance.
 Stock # 1038-H.....\$2.00 Postpaid

MISCELLANEOUS ITEMS

Stock No.	Item	Price
3016-H	Pentagon Prism	\$.75 each
2024-H	10 Pieces Circular A-1 Plate Glass (Diam. 31 mm.—for making Filter)	.25
4009-H	Heat Absorbing Glass 4" x 5"	.35 each
523-H	Six Threaded Metal Reticle Cells	.25
26-H	First Surface Aluminized Mirror, Diam. 1 1/4"	.25 each
624-H	Neutral Ray Filter, size 4 3/4" x 2 1/2"	.25
22-H	Inclinometer—Aircraft type	.25 each
704-H	Lens Cleaning Tissue, one ream (480 sheets) size 7 1/2" x 11"	1.50
1030-H	2" Diam. Reducing Lens	.25 each
1031-H	Perfect 6 Power Magnifier—Diam. 28 mm.	.25 each
2043-H	Crossline Recticle—Diam. 29 mm.	.50 each
1034-H	Burning Glass Lens	.25 each

(Minimum order on above—\$1.00)

TANK PERISCOPE

Complete Set Mounted Components

Have fun! Make a real Periscope. Use it to see over the heads of crowds, to see under water, to see out windows without yourself being seen, and many other uses where observation by "remote control" is required. Originally constructed for U. S. Army Tanks, set consists of 2 fine Periscope mirrors mounted in metal and plastic. Perfect condition. Only plywood body frame is required to finish this exceptional Periscope. Set weighs 2 3/4 lbs. Overall length 6 1/8", width 2 1/8". Would normally retail at \$40 to \$50.

Stock # 700-H.....\$3.00 Complete Set Postpaid (Two Sets (four units).....Special \$5.50 Postpaid)



To the man who wants
an **ACCOUNTANT'S**

to enjoy
CAREER



IF you're that man, here's something that will interest you.

Not a magic formula—not a get-rich-quick scheme—but something more substantial, more practical.

Of course, you need something more than just the desire to be an accountant. You've got to pay the price—be willing to study earnestly, thoroughly.

Still, wouldn't it be worth your while to sacrifice some of your leisure in favor of interesting home study—over a comparatively brief period in your life? Always provided that the rewards were good—a salary of \$2,000 to \$10,000?

An accountant's duties are interesting, varied and of real worth to his employers. He has *standing!*

Do you feel that such things aren't for you? Well, don't be too sure. Very possibly they *can* be!

Why not, like so many before you, investigate LaSalle's modern Problem Method of training for an accountancy position?

Just suppose you were permitted to work in a large accounting house under the personal supervision of an expert accountant. Suppose, with his aid, you studied accounting principles and solved problems day by day—easy ones at first—then the more difficult ones. If you could do this—and if you could turn to him for advice as the problems became complex—soon you'd master them all.

That's the training you follow in principle under the LaSalle Problem Method.

You cover accountancy from the basic Principles right up through Accountancy Systems and Income Tax Procedure. Then you add C. P. A. Training and prepare for the C. P. A. examinations.

As you go along, you absorb the principles of Auditing, Cost Accounting, Business Law, Statistical Control, Organization, Management and Finance.

Your progress is as speedy as you care to make it—depending on your own eagerness to learn and the time you spend in study.

Will recognition come? The only answer, as you know, is that success *does* come to the man who is really *trained*. It's possible your employers will notice your improvement in a very few weeks or months. Indeed, many LaSalle graduates have paid for their training—with increased earnings—before they have completed it! For accountants, who are trained in organization and management, are the executives of the future.

Write For This Free Book

For your own good, don't put off investigation of *all* the facts. Write for our free 48-page book, "Accountancy, The Profession That Pays." It'll prove that accountancy offers brilliant futures to those who aren't afraid of serious home study. Send us the coupon *now*.

Over 2200 Certified
Public Accountants among
LaSalle alumni

LASALLE EXTENSION UNIVERSITY A CORRESPONDENCE INSTITUTION

417 South Dearborn Street, Dept. 164-H Chicago 5, Illinois

I want to be an accountant. Send me, without cost or obligation, the 48-page book, "Accountancy, The Profession That Pays," and full information about your accountancy training program.

Name.....

Address..... City.....

Position..... Age.....



January 31

THE LAST DAY

for men now in the Army
to retain their present
grades by reenlisting . . .



Men now in the Army who reenlist before February 1 will be reenlisted in their present grade. Men honorably discharged can reenlist within 20 days after discharge in the grade they held at the time of discharge, provided they reenlist before February 1, 1946.

There's a long list of attractive reenlistment privileges in the new Armed Forces Voluntary Recruitment Act of 1945. The ability to keep your present grade is only one of them, but this privilege expires on January 31.

There are plenty of other reasons why many thousands of men have enlisted, and more thousands are enlisting every day. You'll certainly want to know all of the opportunities open to you. If you'll read them carefully, you'll know why a job in the new peacetime Regular Army is being regarded today as "The Best Job in the World."

PAY PER MONTH—ENLISTED MEN

In Addition to Food, Lodging, Clothes and Medical Care

	Starting Base Pay Per Month	MONTHLY RETIREMENT INCOME AFTER:	
		20 Years' Service	30 Years' Service
Master Sergeant or First Sergeant	\$138.00	\$89.70	\$155.25
Technical Sergeant	114.00	74.10	128.25
Staff Sergeant	96.00	62.40	108.00
Sergeant	78.00	50.70	87.75
Corporal	66.00	42.90	74.25
Private First Class	54.00	35.10	60.75
Private	50.00	32.50	56.25

- (a)—Plus 20% Increase for Service Overseas.
- (b)—Plus 50% if Member of Flying Crews, Parachutist, etc.
- (c)—Plus 5% Increase in Pay for Each 3 Years of Service.

HIGHLIGHTS OF THE NEW ENLISTMENT PROGRAM

1. Enlistments for 1½, 2 or 3 years. (1-year enlistments permitted for men now in the Army with 6 months' service.)
2. Enlistment age from 17 to 34 years inclusive, except for men now in Army, who may reenlist at any age.
3. Men reenlisting retain their present grades, if they reenlist within 20 days after discharge and before February 1, 1946.
4. The best pay scale, medical care, food, quarters and clothing in Army history.
5. An increase in the reenlistment bonus to \$50 for each year of active service since such bonus was last paid, or since last entry into service.
6. Up to 90 days' paid furlough, depending on length of service, with furlough travel

- paid to home and return, for men now in Army who enlist.
7. A 30-day furlough every year at full pay.
8. Mustering-out pay (based upon length of service) to all men who are discharged to reenlist.
9. Option to retire at half pay for life after 20 years' service—or ¾ pay after 30 years' service. All previous active federal military service counts toward retirement.
10. Benefits under the GI Bill of Rights.
11. Family allowances for the term of enlistment for dependents of men who enlist before July 1, 1946.
12. Opportunity to learn one of 200 skills and trades.
13. Choice of branch of service and overseas theater in the Air, Ground or Service Forces on 3-year enlistments.

Reenlist now at your nearest U. S. Army Recruiting Station

SEE THE JOB THROUGH
U. S. Army
BE A
"GUARDIAN OF VICTORY"
AIR FORCES • GROUND FORCES • SERVICE FORCES

Popular Mechanics Magazine

Registered in U. S. Patent Office and Canada

WRITTEN SO YOU CAN UNDERSTAND IT

Vol. 85

JANUARY 1946

No. 1

Long Distance by Short Wave

By Wayne Whittaker

MILLIONS of words have been printed about the war-developed wonders that are going to revolutionize our lives. Radar. The smashed atom. Jet propulsion.

However, few persons in their everyday life actu-

Huge reflectors atop Bell Telephone building in New York direct radio beam carrying eight phone conversations



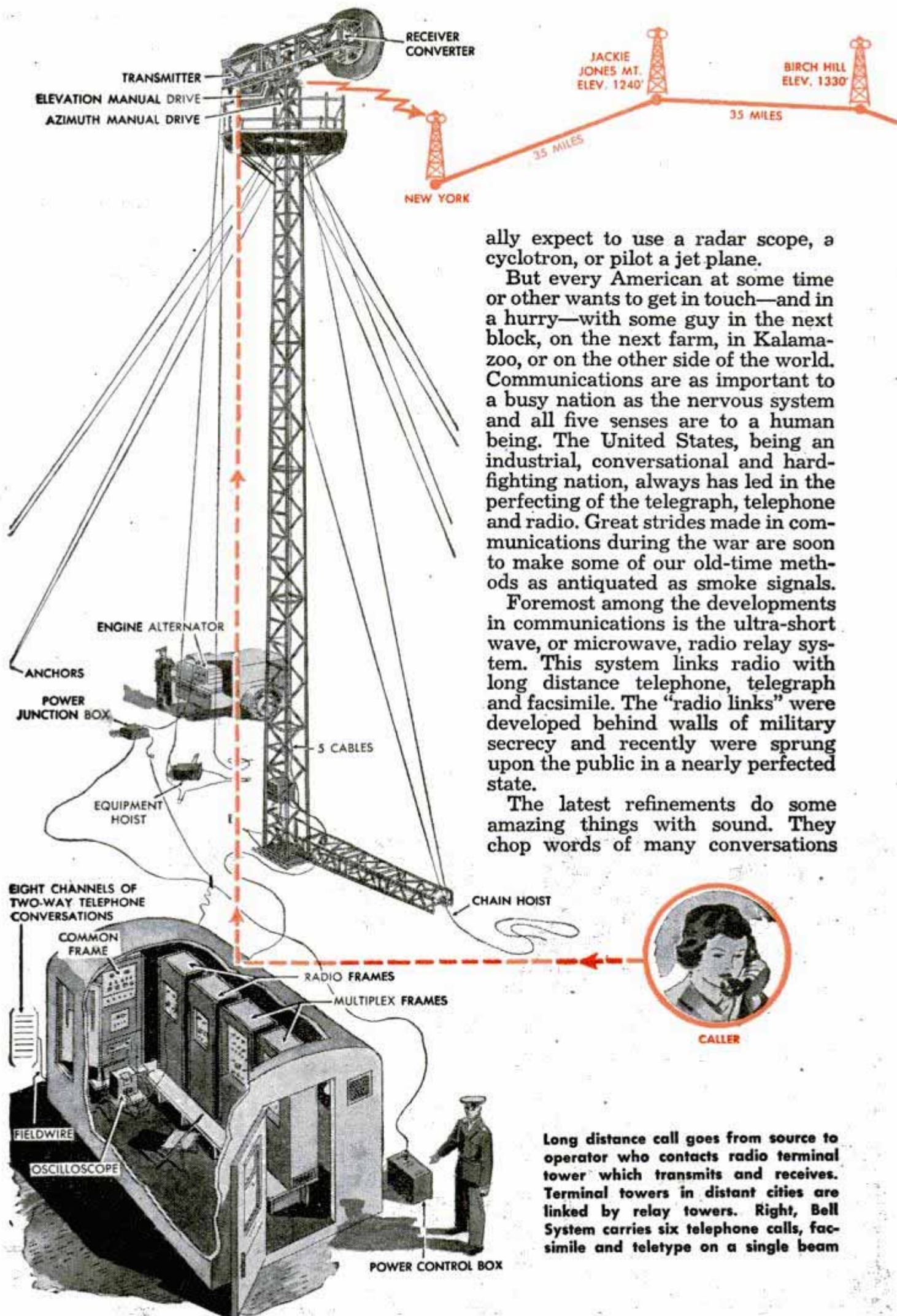

ally expect to use a radar scope, a cyclotron, or pilot a jet plane.

But every American at some time or other wants to get in touch—and in a hurry—with some guy in the next block, on the next farm, in Kalamazoo, or on the other side of the world. Communications are as important to a busy nation as the nervous system and all five senses are to a human being. The United States, being an industrial, conversational and hard-fighting nation, always has led in the perfecting of the telegraph, telephone and radio. Great strides made in communications during the war are soon to make some of our old-time methods as antiquated as smoke signals.

Foremost among the developments in communications is the ultra-short wave, or microwave, radio relay system. This system links radio with long distance telephone, telegraph and facsimile. The "radio links" were developed behind walls of military secrecy and recently were sprung upon the public in a nearly perfected state.

The latest refinements do some amazing things with sound. They chop words of many conversations

Long distance call goes from source to operator who contacts radio terminal tower which transmits and receives. Terminal towers in distant cities are linked by relay towers. Right, Bell System carries six telephone calls, facsimile and teletype on a single beam

Line-of-sight relay towers carry signal to terminal where it again goes on wire

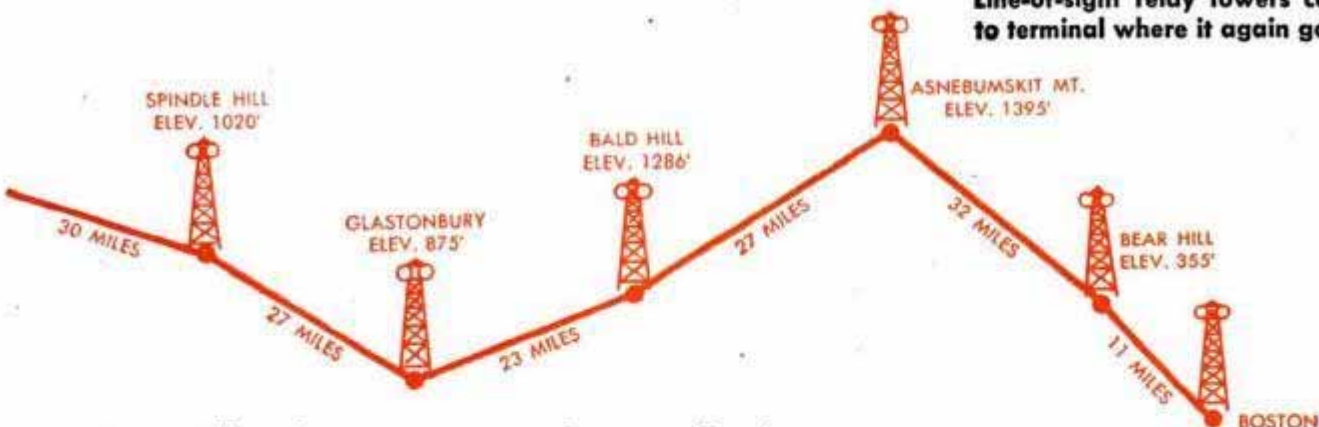

into millionth parts per second, scramble them on a single radio channel, and then unscramble them into the original "That you, Joe?" or "This is San Diego calling."

Radio links mean far more than an eventual farewell to the familiar telephone and telegraph poles. They mean the hurling of messages through space with the speed of light; it will take more than floods, hurricanes or ice storms to break the communication chain. They mean that one radio transmitter may be able to broadcast the entire output of several stations at the same time. They mean the linking of isolated regions, particularly in China, Russia, Canada, Alaska and our own West, with the rest of the world.

Maintenance costs will be reduced drastically. Consider, for example, the miles of wire and number of poles in Western Union's vast 2,300,000-mile network. When various types of communications leave the wires for the air waves, their cost may be so small few persons will bother with an old-fashioned letter.

If you prefer the personal touch, a letter can be sent by facsimile in seconds. It will be reproduced faithfully, mistakes and all. Also, you may include a radiophoto of that big one you caught at Lake Oogibogie, or a floor plan of your new home. The radio

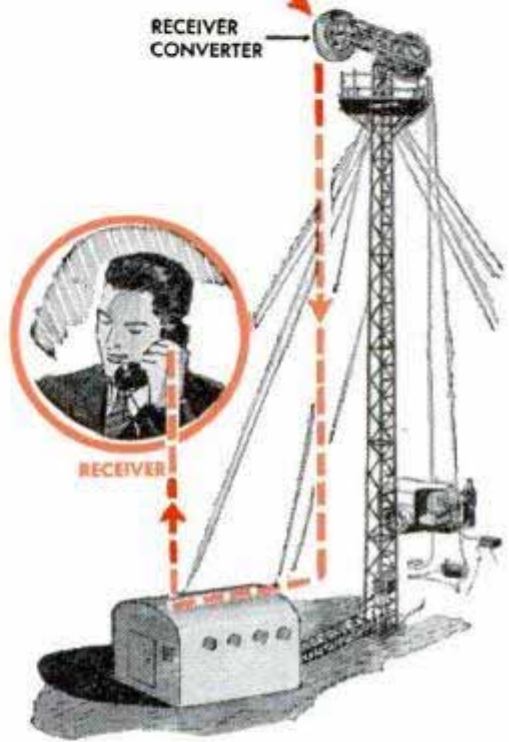

MULTIPLE TELEPHONE CALLS

FACSIMILE

TELETYPE



relay system also accommodates television and teletype, and can be used to operate business machines by remote control.

Radio relay operates like a relay race with runners stationed at set intervals. The runners carry a short stick which they pass along to the next man in the relay chain. This stick might be compared with the message that is "handed" on from one radio tower to the next, and finally to the terminal tower where it is transferred to the wires that lead to the telephone in your home or office.

More than one runner is used in the relay race because one man's breath would not hold out for the long distance. More than one radio relay tower is used because the radio microwave runs out of "breath" when it reaches the horizon and shoots off into space. These radio frequencies behave like television beams and travel in a straight line instead of following the curve of the earth like ordinary radio waves.

The Bell Telephone Company is building its first radio relay route from New York to Boston. This experimental project consists of two terminals and seven relay stations. The 50 to 70-foot relay towers are located on hills about 30 miles apart and ranging in elevation from 335 to 1395 feet. Terminals are atop the Long Lines Building in New York and the Bowdoin Square Building in Boston.

The sites were selected carefully to allow for line-of-sight transmission of the sharp beams from station to station. The microwaves are about a hundred times higher in frequency (or shorter in wave length) than very-high-frequency waves.

At these extreme frequencies, reception is immune from disturbances of lightning, static or electrical interference which might be caused by anything from a streetcar to a power line. Reflectors point the beam directly toward the receiving antenna. The beam is so sharp that speech is entirely lost if the receiver is turned two or three degrees to one side or the other. Maximum distance for satisfactory performance between any two relay stations is about 100 miles.

As far as John Q. Public is concerned, the placing of a long distance call via radio links will be done in the conventional way. The revolutionary procedure starts when the long distance operator puts his call on a field wire which carries it to the proper radio terminal. Here his voice will be chopped up and its channel placed with a group of others for transmission. The entire group of channels is called a "frame." The Bell system provides for eight two-way conversations.

This system of transmission, which differs radically from ordinary radio, is known as pulse-position modulation. This simply means that the signal is broken down into various time periods. The time-division signal starts with a "reference" pulse of energy followed by eight time periods—one for each channel. These time periods, accurately controlled by engineering genius, are shorter than the human mind can conceive. Speech is transmitted in millionth-second bits.

The frame of eight channels of chopped up sound is received at a terminal tower. There the different pulses are switched to eight different receiving circuits. The magic of electronic gateway arrangements makes sure that a particular channel pulse always enters its own circuit. Instead of being garbled or distorted, as logically might be expected, the resulting speech or other sound is unusually clear. The electronic tubes which accomplish these wonders are said to do the work of more than 50 ordinary vacuum tubes. An electron beam inside of them can be made to rotate 8000 to 30,000 times a second.

The Bell system also is introducing other aids to communication. One in the field of radio is telephone service between

(Continued to page 162)

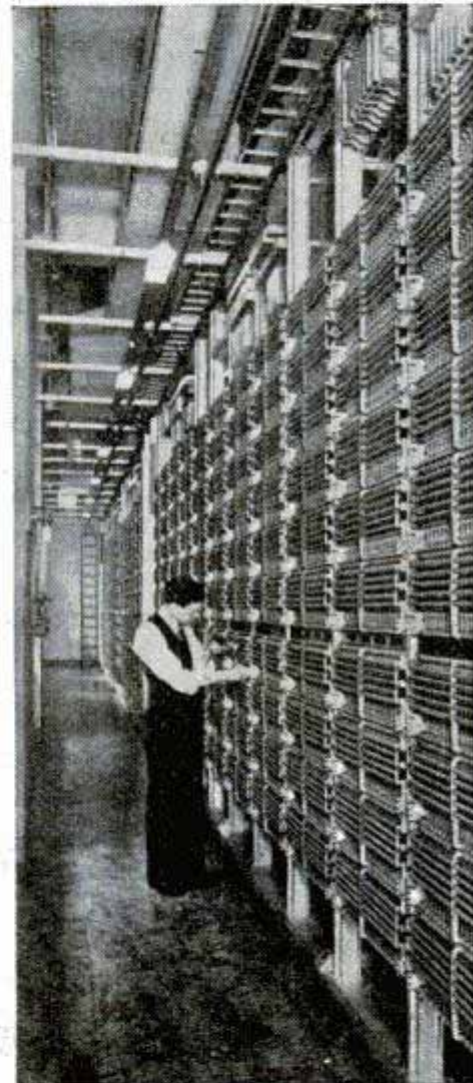

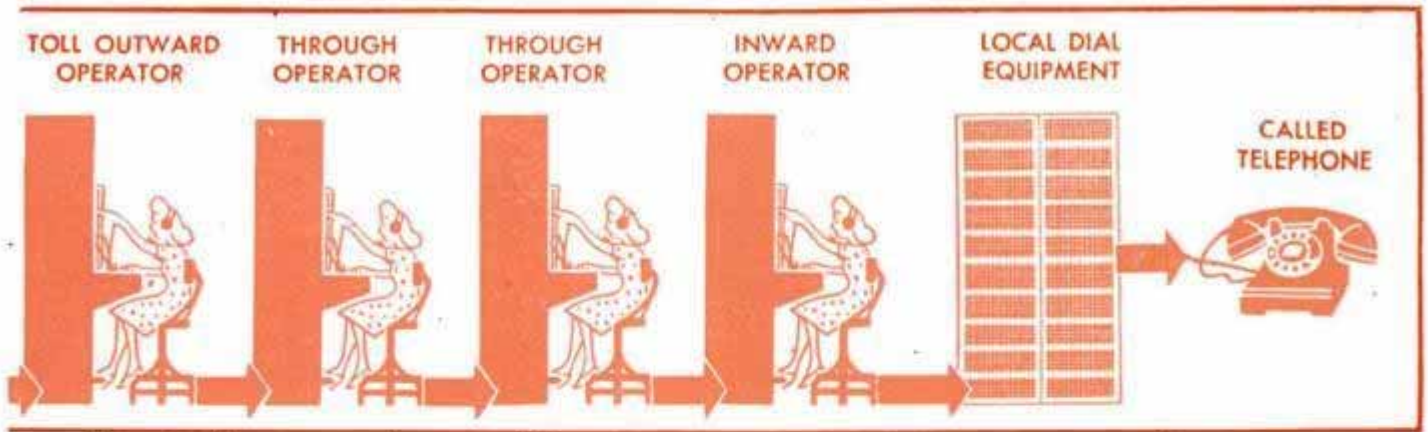

Present toll system requires several long distance operators; new dial system is shown at bottom of page

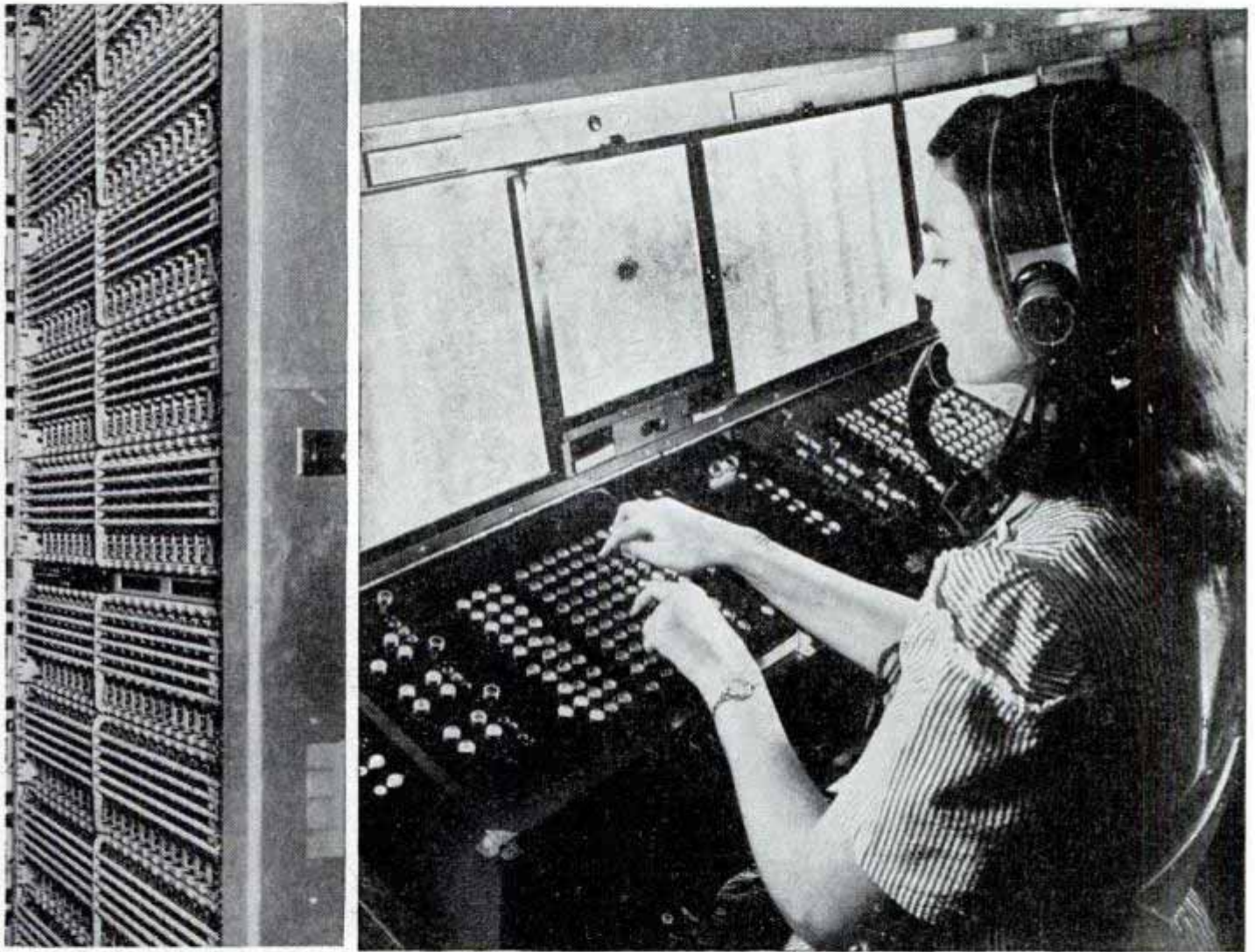

Bell Telephone System photos
 Crossbar switches (left) link the long distance dial system so that the operator above can put a call through directly to a telephone in a home or office thousands of miles away. The operator sets up the call on keys which list special codes and routes. Her position in the long distance circuit is indicated in the sketch below

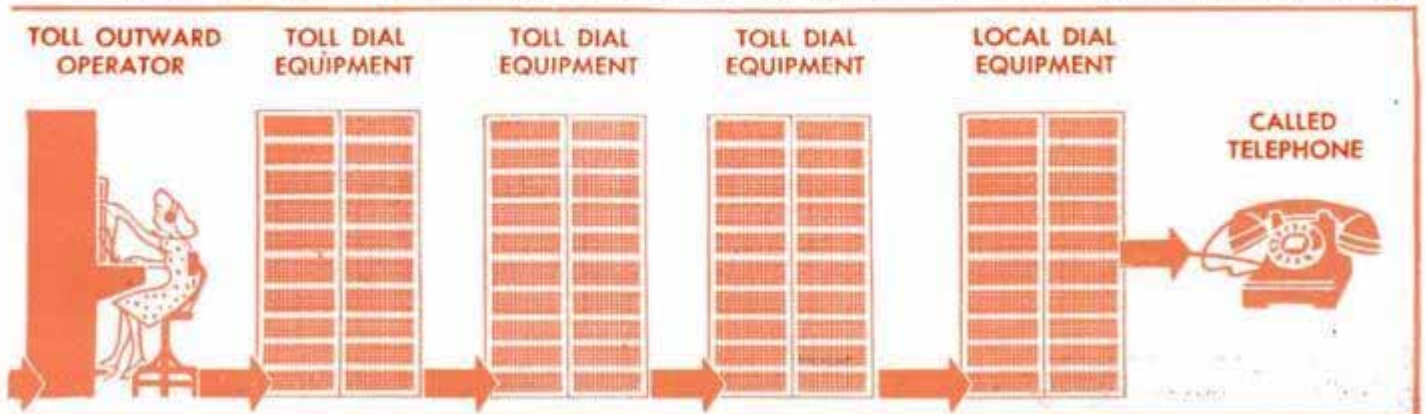

Fuel Saver Fits in Heating Stove to Burn Oil Efficiently

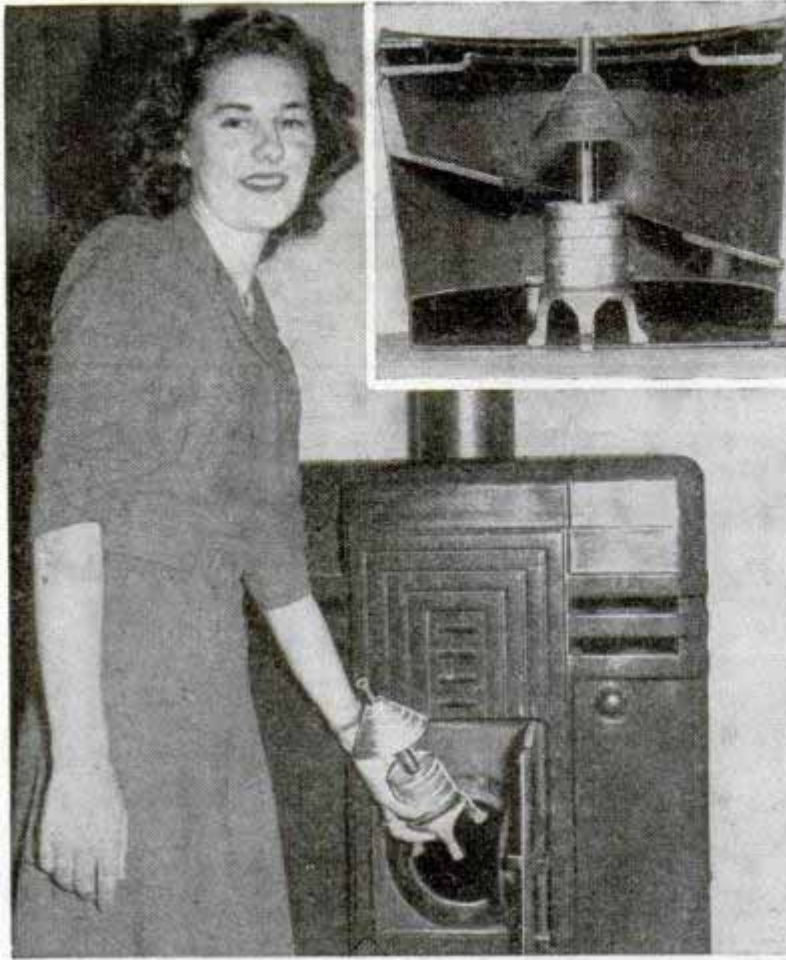

Fuel savings up to 35 percent were recorded in laboratory tests with a small cast iron decarbonizer that fits into the firepot of most heating stoves. Resembling a small table lamp, the bottom of the fuel saver contains a metallic cartridge which, when heated, emits oxide gas. This gas rises into a canopy above the base of the device where it mixes with low combustible gases from the fuel, which then are diverted to the sides of the firepot and consumed. It is claimed that use of the fuel saver results in complete combustion of the fuel oil and virtually eliminates formation of soot and carbon.

Manufacturers of commercially available products described in Popular Mechanics are listed in the Where-to-Buy-It Index, page 8A. Should you desire additional information on other articles in this magazine, a letter to our Bureau of Information will bring a prompt response with whatever knowledge we have that may prove helpful.

Silo Made of Glass and Steel Has an Automatic Unloader

Coated inside and out with glass, an experimental steel silo near Beloit, Wis., erected after consultation with University of Wisconsin agricultural engineers, is reported to keep silage fresh in much the same manner that glass jars preserve food. The structure, being airtight, prevents the formation of molds by keeping out oxygen. In addition, the silo has two labor-saving features in its automatic unloader, which does away with climbing to the top of the silo and pitching the silage down by hand, and its built-in filler pipe. The unloading mechanism, installed at the bottom, operates on the principle of a furnace stoker and utilizes an agitator mast to loosen the silage and a feed screw to deliver it into a wagon or wheelbarrow. A six-horsepower engine furnishes power for the unloader. The built-in filler pipe eliminates the labor of erecting and dismantling usually necessary each season. The exterior, of dark blue glass, requires no painting.

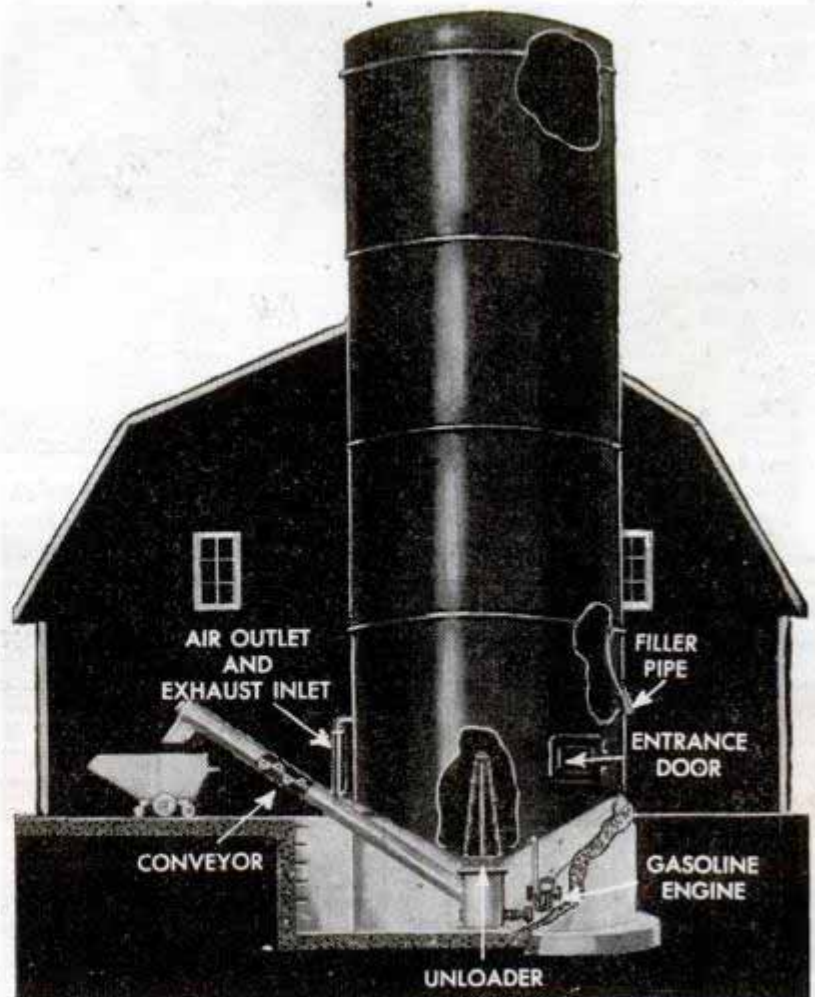

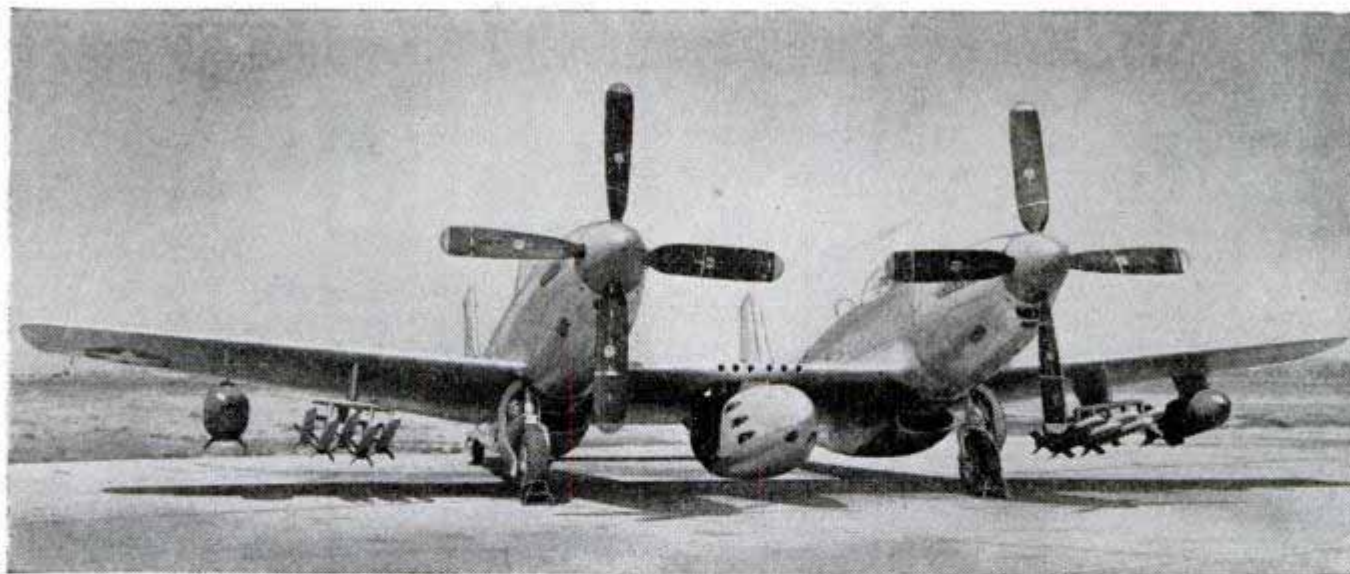

Fighter Planes That Missed The War

Too late for World War II are the P-82 Twin Mustang (top and center) and the XF8B-1 (bottom). The 475-mile-an-hour twin-fuselaged P-82, built by North American Aviation, consists of two modified P-51 Mustangs joined by a common wing, elevator and stabilizer. The pilot flies in the left-hand cockpit and the co-pilot in the right. It can carry radar for night fighting. The single-engine XF8B-1, built for the Navy by Boeing Aircraft, serves as a fighter, torpedo plane, bomber, or attack plane. After dropping a 6400-pound bomb load, it can travel over 450 miles per hour. It has contrarotating propellers driven by a

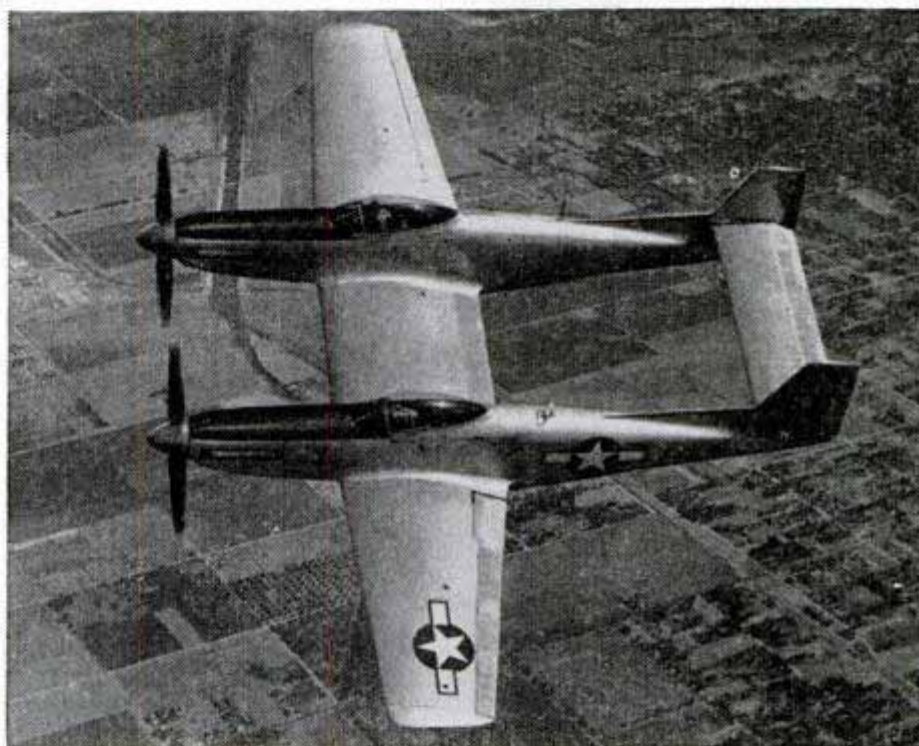

Pratt and Whitney engine which develops 3600 horsepower. Armament consists of six 20-mm. cannon mounted in the wings and sighted by remote control.

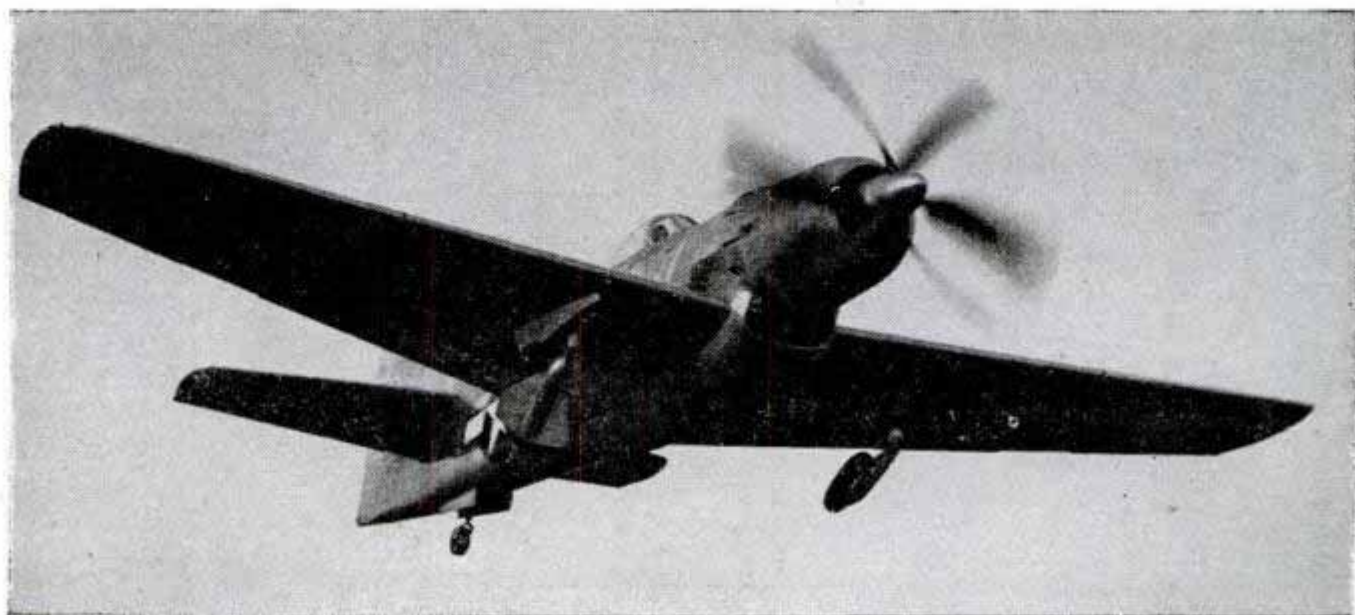



Beneath the cab of the snowplow is an ice scarifier (seen in closeup below) which is lowered to the rail to cut away ice and snow on either side.

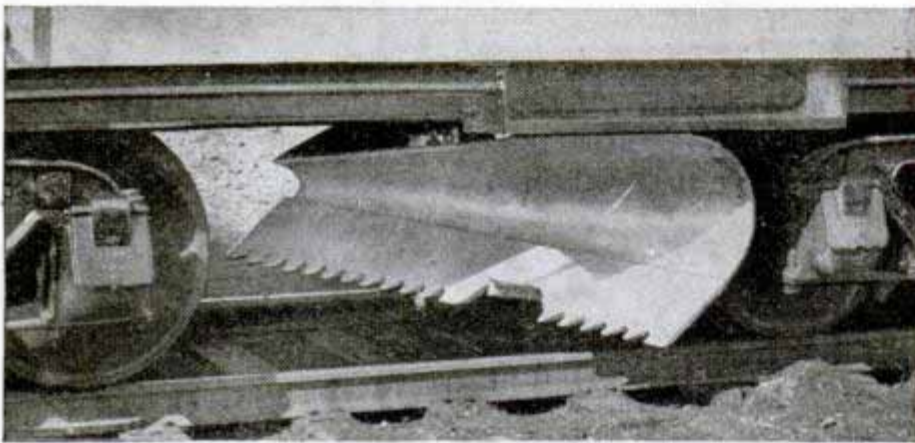

Brother of the rail plow, the highway model eating into a deep drift below can fling a plume of snow 125 feet. Many were built for the Army.

SNOW EATER



Sno-Flyr tosses snow beyond right-of-way or loads it into car on next track. Navy used road plow at bottom to clear airports

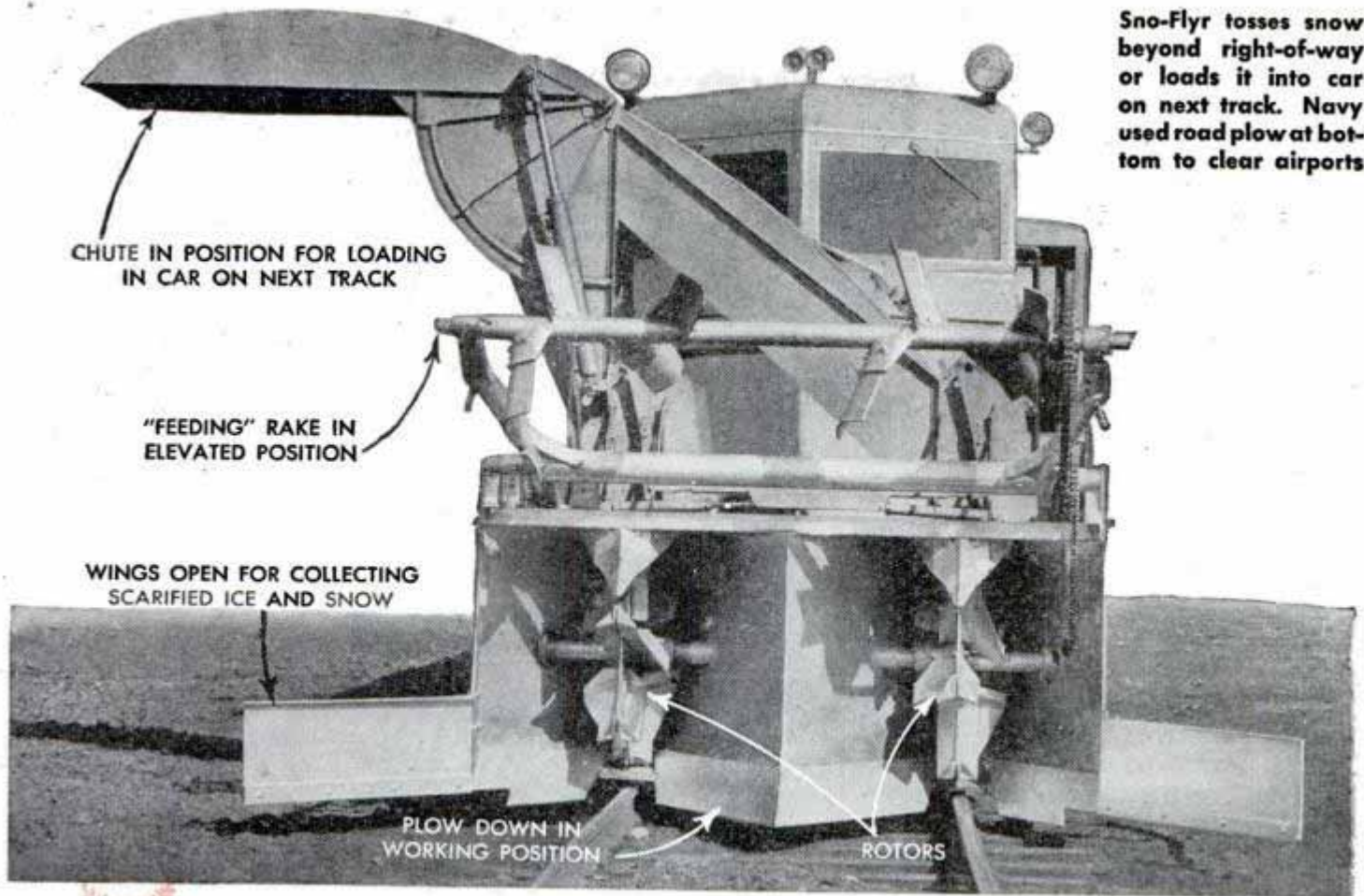

LAST winter 18,000 railroad cars carrying vital war material and perishable goods to the East Coast were tied up for weeks in the "snow belt" of northern New York State. Thousands of hours and dollars were lost. To fight this white menace to railroad traffic, a new snowplow has been developed that moves tons of the stuff per minute and can do the work of battalions of men.

The Sno-Flyr rotary plow, built by the William Bros Boiler & Manufacturing Co. of Minneapolis, is mounted on a car with two 100-horsepower gasoline engines and an enclosed two-man cab. The engines drive two multiple-vane rotors on the front. These rotors throw snow and loosened ice, conducted to them by the nose-type plow and gathering side wings, as far as 125 feet. Snow from both rotors can be conducted through a removable metal chute to deposit the icy cargo on flat cars or clear of the tracks.

An outstanding feature of the Sno-Flyr is a rail ice cutter, or scarifier-flanger, a wedge-shaped device mounted midway between the car trucks. It

forces steel teeth into the ice between the rails and over the ties, moving loosened ice outside the railroad ties. When the plow, which is pushed by a Diesel or steam locomotive, is backed up and again brought forward, this loosened ice is collected by the side wings on the front of the plow. Another feature is a rotating feeding rake that extends forward to break up chunks of snow and ice. A highway model can be attached to a truck for clearing roads or airports.



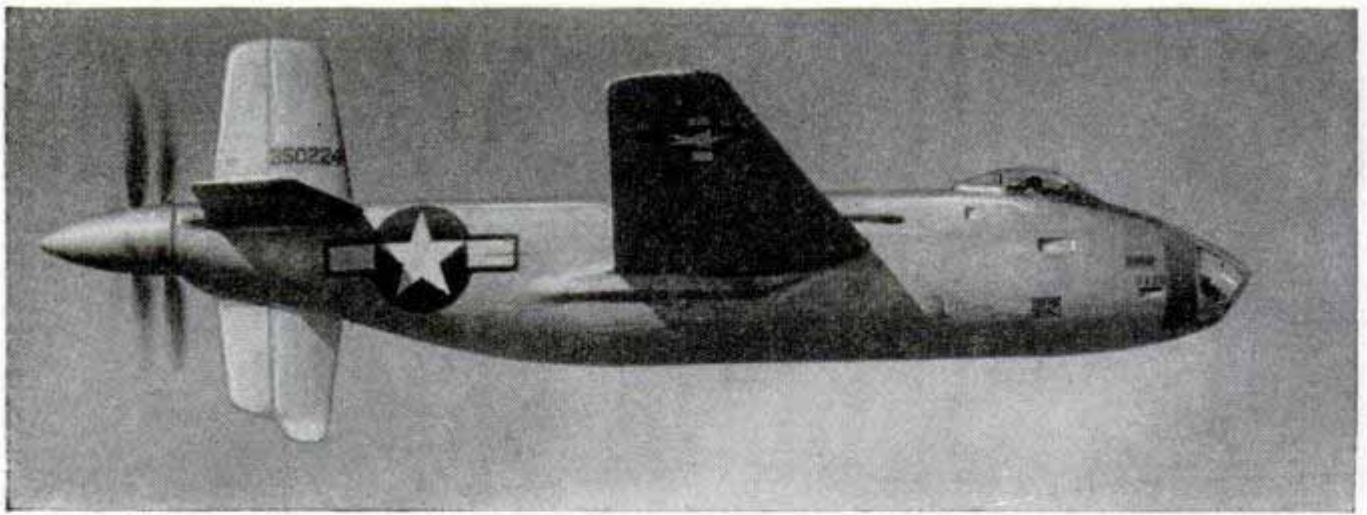

400-M.P.H. "Mixmaster"

On the AAF top secret list for two years, the Douglas XB-42 bomber will be known as the DC-8 in its transport version. This two-engine plane, which has unconventional contrarotating co-axial propellers in the rear, is the postwar successor to the familiar DC-3 known as the "work horse of the air lines." The Army version was said to be the first bomber in the 400-mile-an-hour class, and the DC-8 offers a 50-percent increase in cruising speed over the DC-3. It will carry twice the pay load. The DC-8's Allison liquid-cooled engines have a takeoff rating of 1820 horsepower with water injection. The engines are buried in the fuselage aft of the cockpit. The propellers are driven independently and either can be feathered in flight

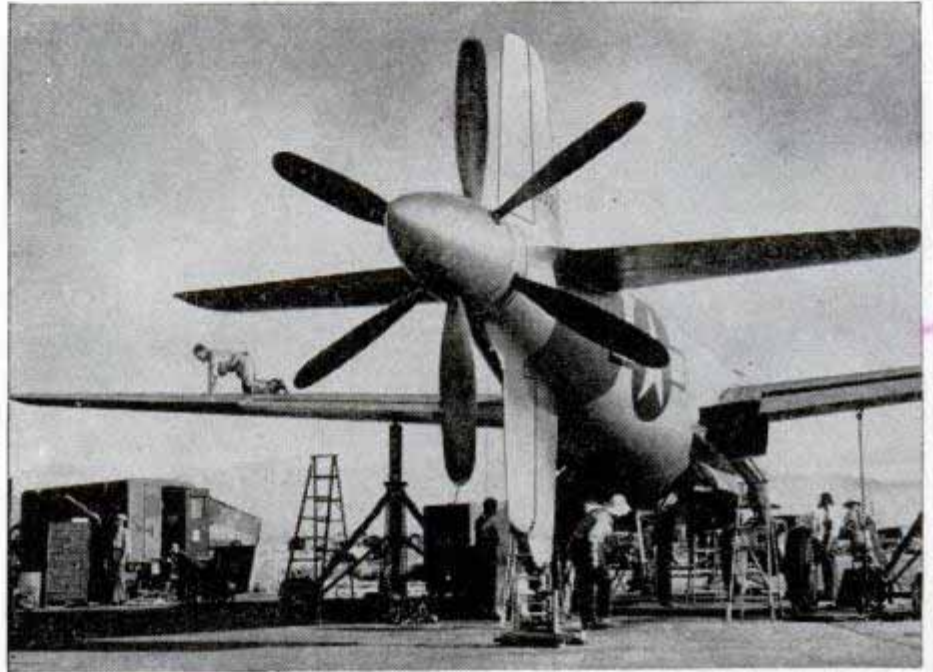

while the engine is repaired. Elimination of engines, nacelles and propellers from the wings not only reduces drag but adds to the comfort of the passengers. The DC-8 has a wing span of 110 feet 2 inches, is 25 feet 9.5 inches high and 77 feet 10 inches long. It weighs 39,500 pounds at takeoff.

Versatile Farm Jeep Tows Corn Binder With Motor Providing Power



Although the military jeep has seen "Paree" and served all the way from Tokyo to Berlin, this Army choreboy has settled down on the farm to perform scores of duties. It serves as tractor, light truck, passenger car and, with a special power takeoff, as an independent power unit. On an Illinois farm, it was used to tow a one-row corn binder with the motor furnishing power to run the binder.

Home Mechanics Build 3-Wheeled "Junkmobiles"

Parts from a washing machine, wheelbarrow, bicycle and windmill were used by V. G. Clements of Elmwood, Neb., to build the "tricycle" shown at right, top. The half-horsepower engine was from a washing machine; front wheel from a wheelbarrow; back wheels from a bicycle, and control rods from a wrecked windmill. The "junk-cycle" gets from 60 to 70 miles on a gallon of gasoline and scoots up hills at 10 miles an hour.

The homemade automobile at the right (in which the builder, Robert E. Taylor of Bridgeport, Conn., is seated), is a three-wheeled motor scooter. Powered by a four-horsepower engine, the car has a top speed of 30 miles per hour and carries two persons. Its electric starter is from a standard automobile and the steering wheel once served a motor boat.

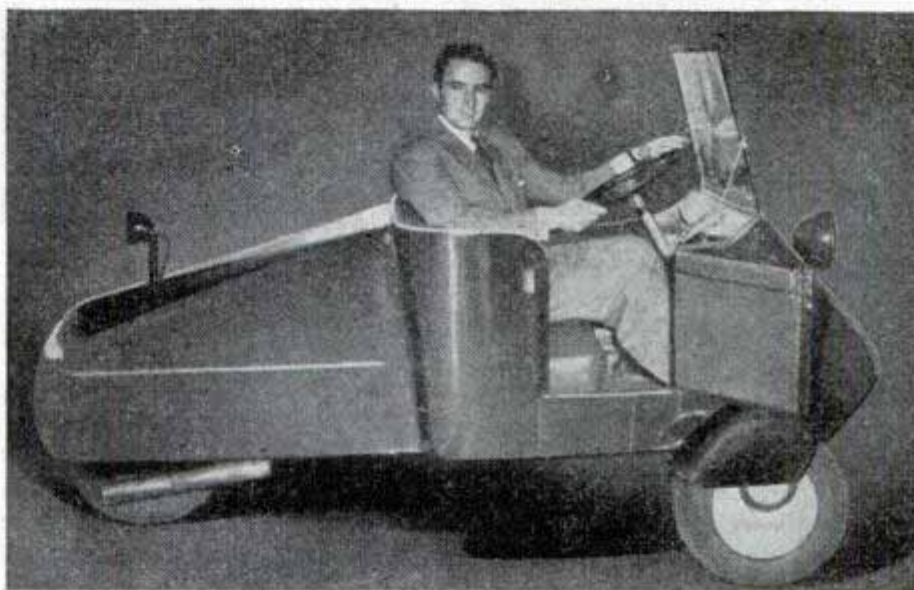
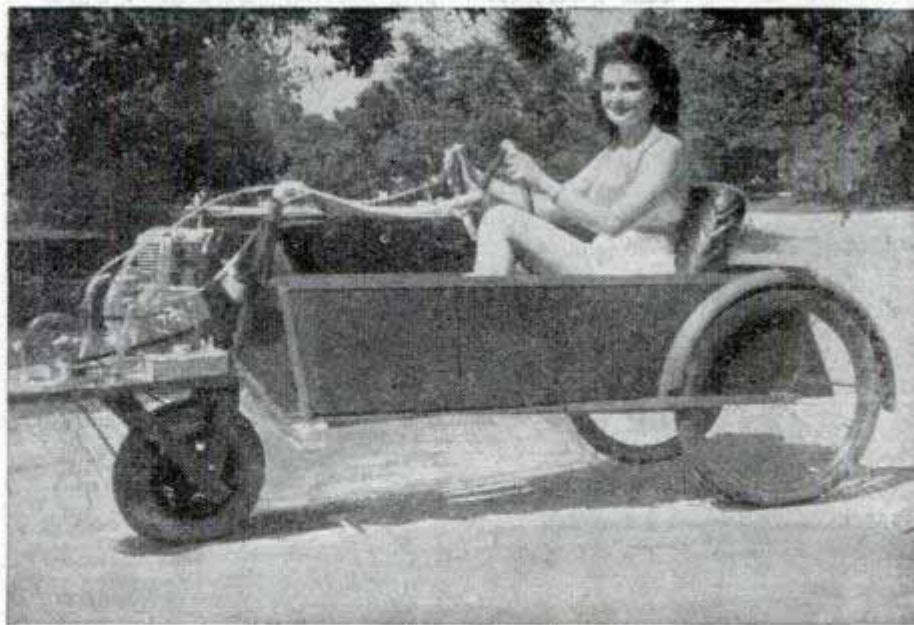

540 Fairfield Ave.



Lightweight Radio Mine Detector Unearths Hidden Explosives

Ultra-high-frequency radio wave transmitters developed near the close of the war by the Radio Corporation of America made it possible for our soldiers and Marines to detect both metallic and nonmetallic mines. The transmitters were installed in 20-pound portable detectors which were operated with a sweeping motion two or three inches above the ground to reveal—by a buzzing noise and dial alarm—the presence of mines.

Submersible Storage Battery

Total submersion in several feet of salt water has no effect on operation of a storage battery developed for use on motor vehicles. The system is based on the principle of the diving bell which allows sea water to enter a compression dome or a bell housing a breather standpipe. Relative volume and height of the standpipe are adjusted to the size of the battery and the maximum depth of submersion.

FIDO FIGHTS FOG

Burning holes in California fog to bring the planes down safely was an idea borrowed from Britain—lend-lease in reverse! We're also shaking the fog down with horns and fans and fountains



Dispatchers watch fog disappear after FIDO burner is turned on to clear the way for the plane below to make a safe landing on the now visible landing strip

By Thomas E. Stimson, Jr.

ZERO-ZERO weather, the pea-soup kind that cancels all air operations, has yielded to a mechanical hot-foot.

On one recent morning the whole northern coast of California lay under a solid fog blanket 1500 feet thick. At Arcata the flight dispatcher at the Navy's Landing Aids Experiment Station couldn't see even a portion of his runway. Ground operations were at a standstill.

Then, in his earphones, the dispatcher caught a message from an inbound plane. "Turn on your FIDO, I'm coming in!"

Promptly he twisted several switches and punched a few buttons on a control panel, then watched while two long lines of flame began to outline the landing runway. The dense fog slowly thinned and lifted. Within 10 minutes the sun broke through and there was blue sky overhead. The oncoming plane burst out of the fogbank to the east, settled in, and landed normally.

Ten minutes later, with the plane in its hangar and the FIDO installation turned off, the field again was shrouded in fog.

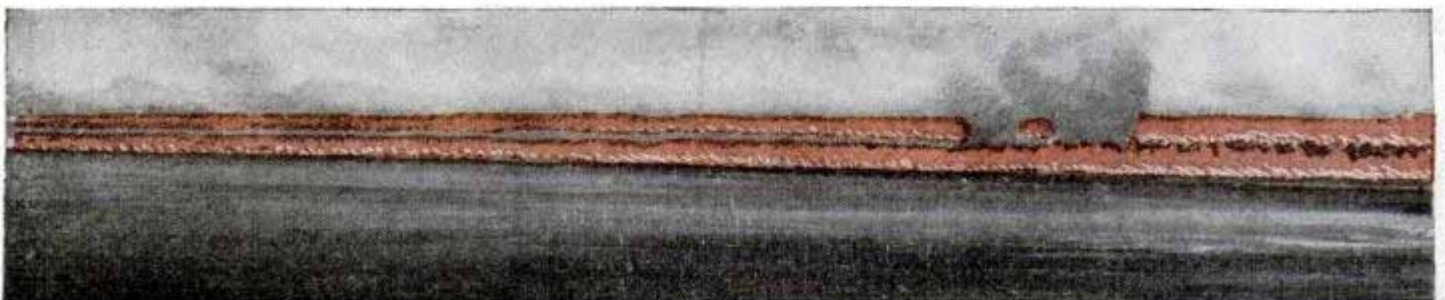

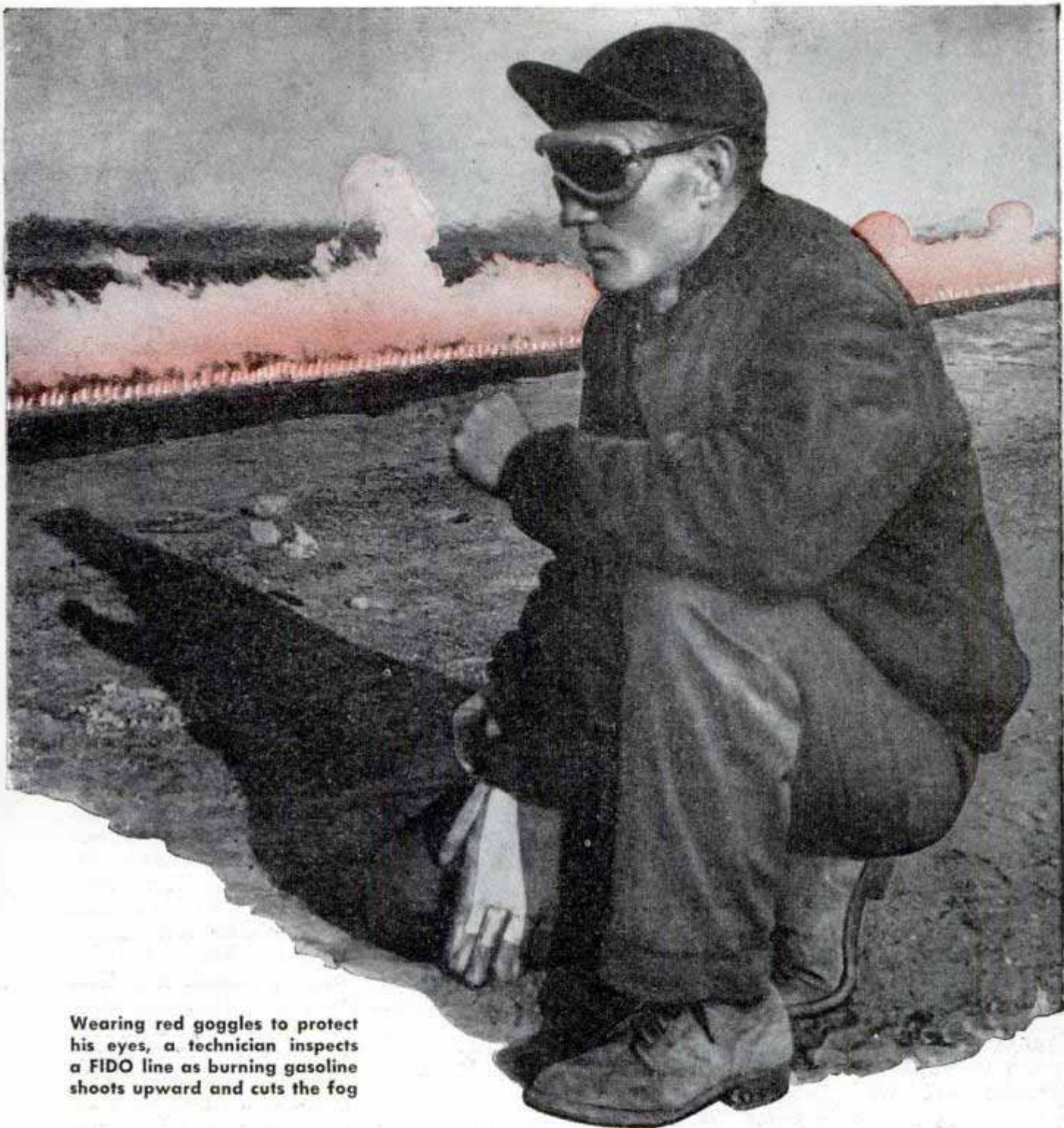

Wearing red goggles to protect his eyes, a technician inspects a FIDO line as burning gasoline shoots upward and cuts the fog

FIDO, which can be interpreted as "Fog, Intensive, Disposal of" or "Fog Investigation Dispersal Operation" depending on whether you live in America or England, was born in Great Britain out of the desperate need for some emergency way to land heavy bombers after sudden fogs had settled over their landing fields. Evapo-

rating the fog by the heat from vast amounts of burning gasoline was the one idea that worked, although the first experimental installation consumed 200,000 gallons of aviation gasoline per hour at a fuel cost of about \$4000 per airplane landed. But that emergency method saved 187 bombers and their crews on one night alone

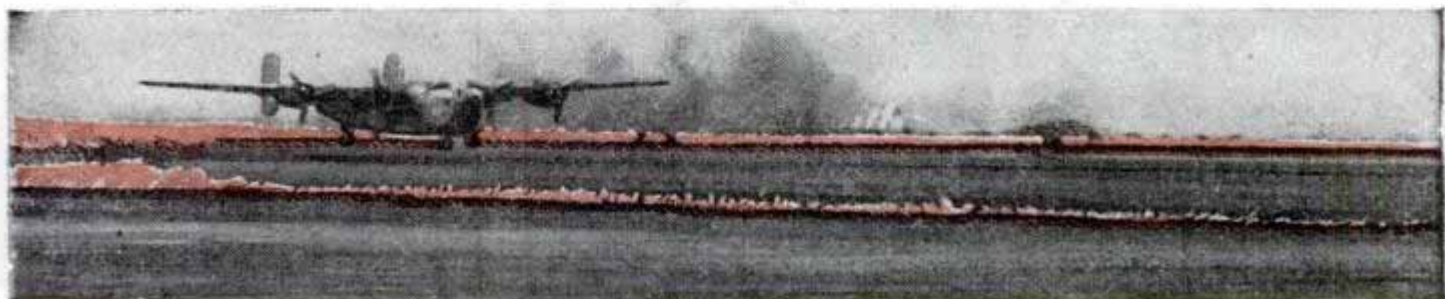

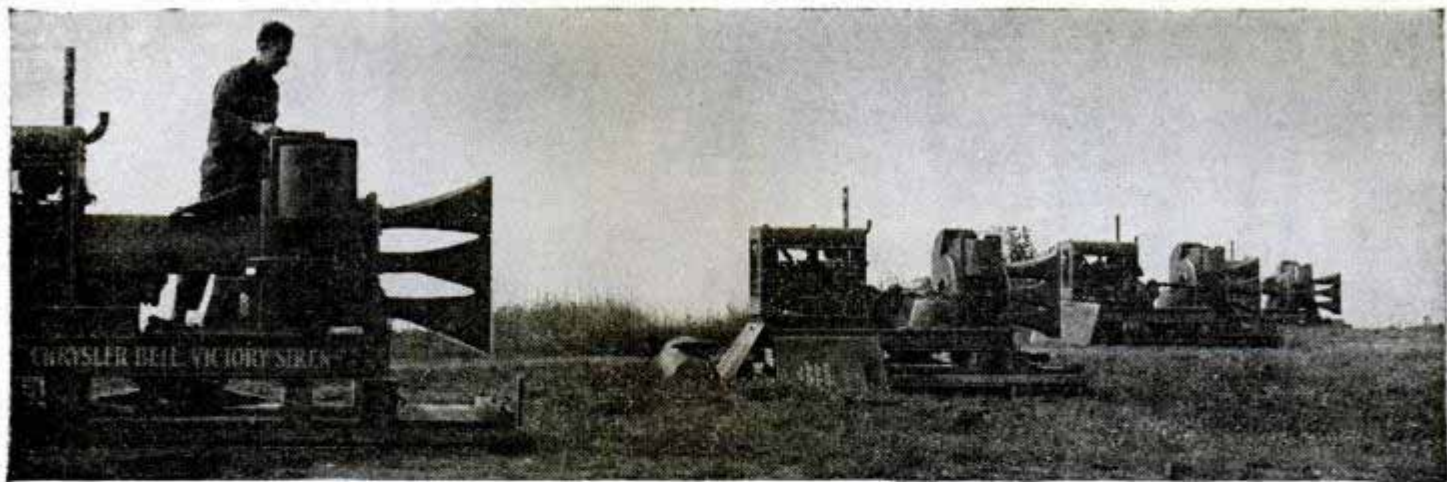

The roar of these horns—called sonic generators—bumps fog particles together, creates rain and lifts fog



Pipe lines to carry gasoline are installed in trenches like this in FIDO installations. Below, close-up of a six-siren sonic generator which creates a noise heard many miles from Arcata, Calif., scene of the fog tests

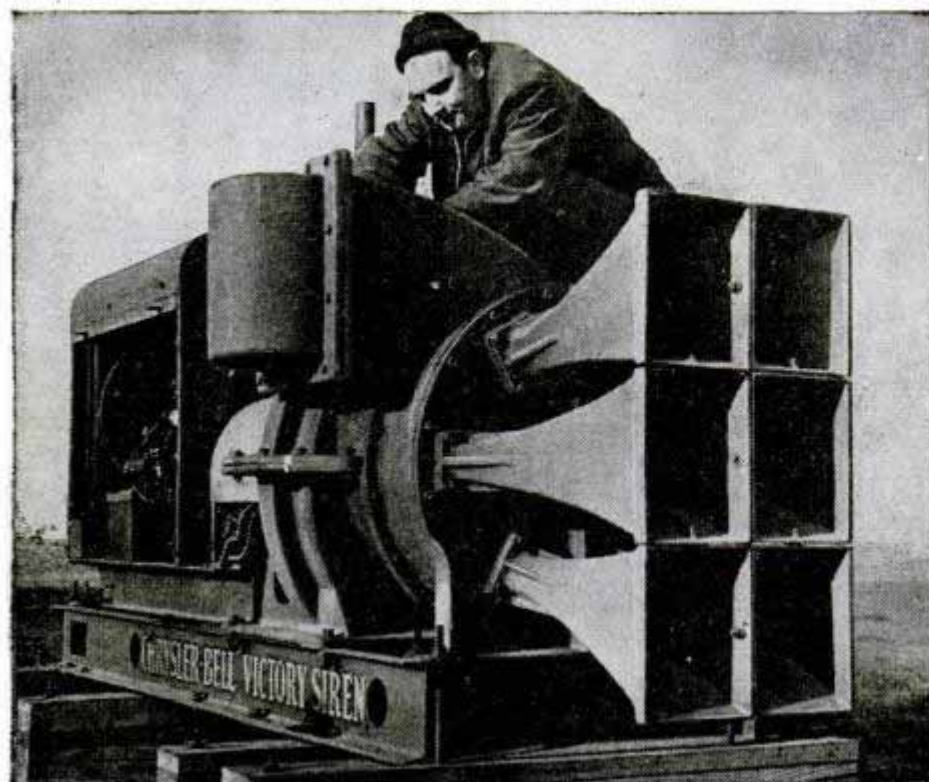

after an unpredicted fog had blanked out the whole island.

Improvements in the efficiency of the apparatus made it feasible to install FIDO at 15 fields, allowing mass takeoffs and landings in weather so bad that German meteorologists couldn't understand how Allied bombers dared leave their bases. Portable FIDOs later were installed in France during the push into Germany.

Using British-designed burners with some modifications, the U. S. Navy installed a FIDO system at Amchitka in the Aleutians in 1944, and FIDO helped launch and land antisubmarine patrols through fogs and fog-drizzles that were sometimes a mile thick. Two parallel burner lines on one side of the field and one burner line on the other were installed at

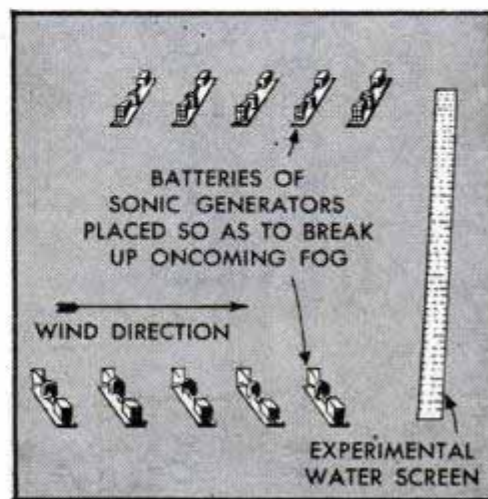

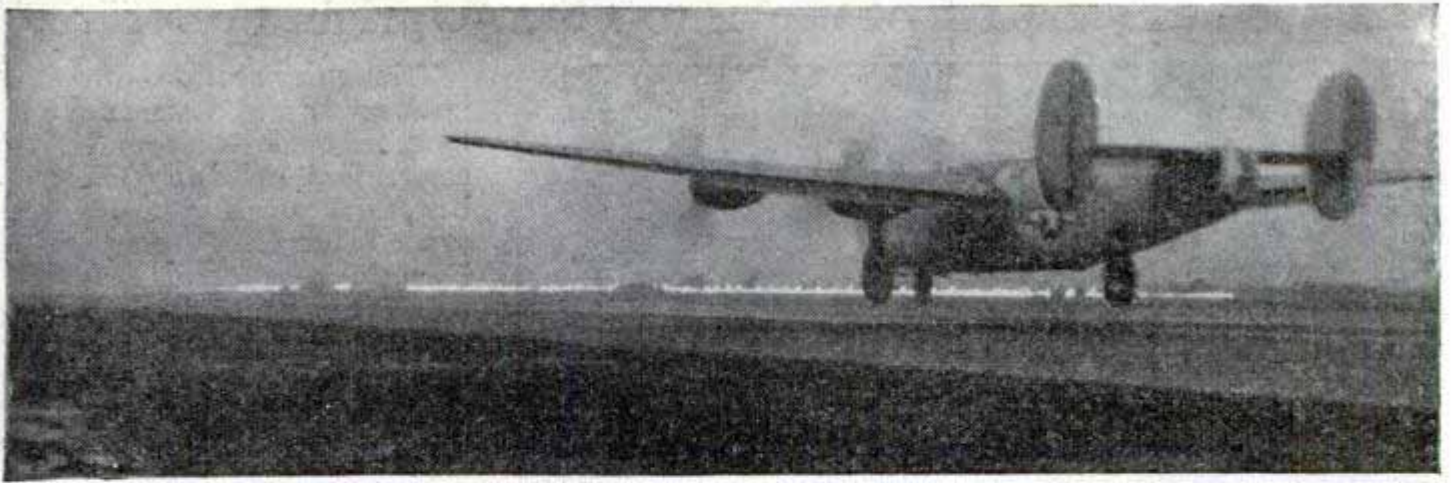

While gasoline-burning FIDO lines lift the fog and increase visibility, a plane comes in for a safe landing

Amchitka to insure visibility in spite of winds up to 15 knots. In moderate weather one burner line sometimes was enough; in unusually thick weather with a rapidly drifting fog all three lines were burned.

Pilots in the sunlight overhead reported that they were able to locate the man-made hole in the fog as far as 15 miles away. The orange tint of the flames was reflected from the edges of the hole both night and day.

Coming down to land, the pilots made standard instrument approaches through the fog and broke out into the clear over the marker burners at about 150 feet altitude. The hot air near the runway was turbulent and created a floating effect but the pilots made normal landings easily.

It's possible, of course, for a highly trained pilot to land blind without the help of FIDO. Instrument approaches plus radio "talk down," localizer and glide path radio beams, and radar landing systems are three methods by which pilots can land in spite of bad weather. Any such landing assist-

ance will line a pilot up with the field and bring him in over the approaches at about 150 feet in the air. From then on it's up to him. None of these systems can substitute for the accuracy and judgment of human eyes in the last few critical seconds of a landing operation. In the words of one officer, "A completely blind landing is con-

sidered to be more of a stunt than a normal operating procedure with acceptable risk. Visual check of the runway is necessary for a safe landing at the present time."

With this in mind the Navy selected Arcata, its foggiest continental air station, as the site for an experimental field at which all kinds of efforts

to control the weather or to operate in spite of it could be tested. Radio and radar systems, improved types of FIDO, wind curtains, water screens, desiccants, and other ideas will be tried and evaluated there.

Preliminary studies on some of these subjects were made during the war by the Universities of Illinois, Iowa and California,

(Continued to page 158)

A \$200 machine that sprays out a chemical may become a potent weapon to combat fog. Developed by Clellan Ross Pleasants, of San Francisco, the "Nofog" device is said to lift fog by changing the humidity of the surrounding area. The atmosphere absorbs fog and sheds the excess as rain. Army and Weather Bureau officials recently watched a demonstration of "Nofog" machines clearing fog from an area in the San Francisco Golden Gate channel

Drawing of airfield equipped with FIDO fog fighting equipment and sonic generators (shown on opposite page)

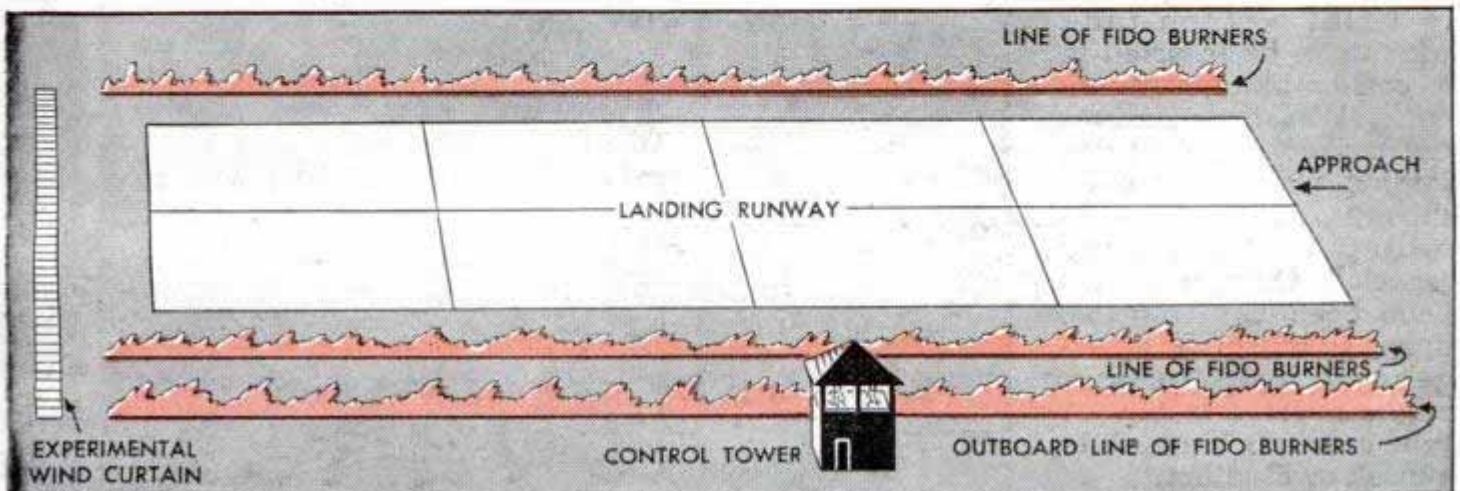

Book Rest Folds Out of Cover to Form Upright Support



Triangular sections of a book cover fold down and lock in back to form a convenient holder. The built-in book rest, invented by H. P. Botts, New York artist, supports a book in an upright position for reading or reference. It is handy for students or office workers and can be used with notebooks and looseleaf ledgers. Bed-ridden convalescents will find the holder useful since it holds a book so it can be read easily from a reclining position.

Army's "Mine Scenting" Jeep Locates Buried Explosives

Like a hound sniffing the trail of game, a "mine scenting" jeep has been developed by Army engineers to locate metallic explosives buried beneath the ground. In action, the mine detection device is lowered in front of the jeep on a seven-foot boom as the vehicle creeps along at four miles an hour. The instant a mine is encountered, the jeep automatically goes out of gear, puts on its brakes and comes to a dead stop. When not in use the boom is raised to an upright position and the jeep proceeds in a normal manner.



Oxygen Tank Gives Parachutist Air

Among recent patents is a flat oxygen tank which can be inserted in a cushionlike parachute pack. This tank reduces the peril of a high altitude jump in the thin air of the substratosphere by providing a respiratory "snack." Oxygen bottles have been used for this purpose, but in an emergency a built-in tank might avert disaster. A tube connects the tank to a mask or breather.



FLIGHT LINE TALK

When a man makes a throat cutting gesture or holds his nose on the flight line at the Glenn L. Martin plant near Baltimore, nobody bats an eye. It saves shouting. Right, signal to set up fuel pressure is acknowledged by the pilot



"CUT ENGINES"



CALL INSPECTOR

It takes more than leather lungs or ultra-short-wave radio to solve the communications problem on a flight line where noisy engines are being ground tested. Lung power failed and radio was abandoned after a fair trial due to too much interference. Resorting to 10 nimble fingers and two good hands, mechanics worked out a sign language of their own that is functioning perfectly. Around the "clock" here are some of the most useful signals. The man pounding his fist isn't angry, he's calling an inspector. The fellow below him isn't thumbing a ride but signaling that he is ready for ship to move. And that easy thumb's-down gesture below saves lots of breath and engines



"ELECTRICIAN NEEDED"



"CHOCKS OUT"



"DECREASE GYRO VACUUM GRADUALLY"



"SEND RADIOMAN WITH EARPHONES"

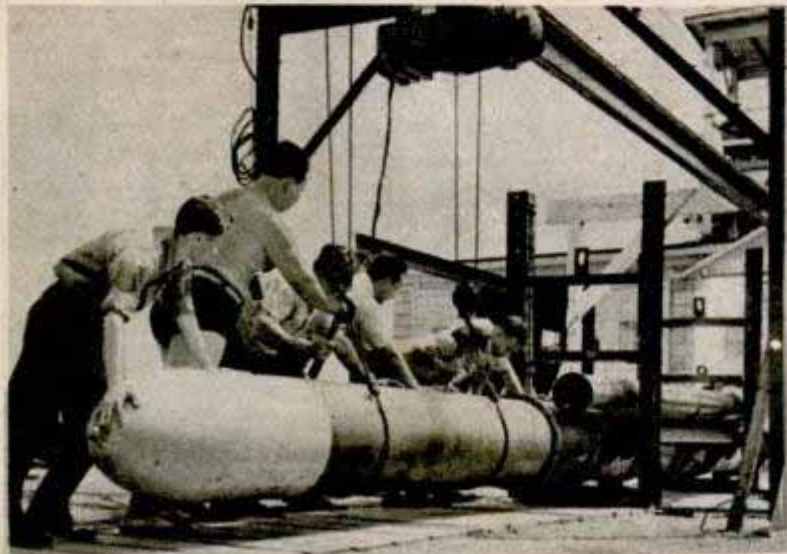

Electric torpedoes are unloaded and backed into a firing tube for tests in Lake Pymatuning, Pa. Above, coils placed in motor

Electric Torpedo Fired by Sub Leaves No Telltale Wake

Electrically propelled torpedoes fired from U. S. submarines and leaving no telltale trail of bubbles sank 372 Japanese vessels for a total of 1,858,200 tons of shipping. The targets ranged from a 42,500-ton battleship to cargo-carrying merchant ships and naval auxiliaries of 500 tons. Amidst great secrecy, the Westinghouse Electric Corporation designed and built the electrically driven torpedoes. A major design problem was the development of a light-

weight power plant to drive the torpedo. The answer was a 275-pound motor combined with a high capacity battery developed by the Electric Storage Battery Company. Another problem was to find a substitute for solder to bind

coils to the commutator since solder would melt under the intense heat of the enclosed high speed motor. A new system of brazing the coils, plus baking in synthetic resin under infrared lamps for 18 hours, provided the solution. Gases generated within the torpedo were disposed of by a tiny electric wire in the battery compartment, thus preventing any visible wake in the water from escaping gas. Nazi submarines demonstrated early in the war that electric torpedoes were more potent than the old type torpedoes driven by compressed air which left a trail of bubbles.

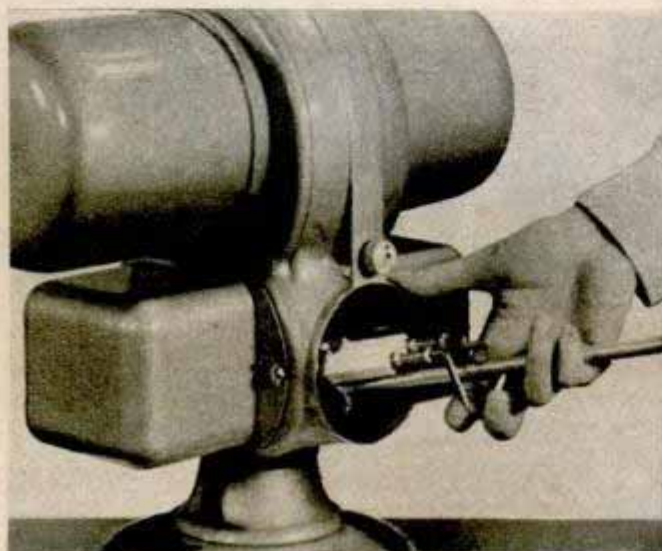

Compact 89-Pound Oil Burner Has No Exposed Parts

Weighing only 89 pounds, a streamlined oil burner with no exposed working parts is now being manufactured. The unit, said to fit into any heating plant, is so designed that its vital parts can be removed easily for adjustment. The complete electrode assembly and tube to nozzle can be removed through the back of the burner. The air control is mounted on the outside and can be adjusted to provide the most economic atomization of the oil fuel.



INSECT-KILLING CHEMICAL DUST is blown on crops and fruit trees with 185-mile-an-hour cyclonic force by a "cyclone duster." Equipped with a 24-nozzle boom that covers eight rows of crops, the bug killer is mounted on the front of a tractor and operated by the driver. With a capacity of 150 to 200 pounds of chemical dust, the machine has a four-cylinder motor which revolves a steel bladed fan at 3600 revolutions per minute to create the man-made wind that distributes the powdered chemical evenly. One duster can cover 100 acres in a day. Various combinations of nozzles and hoses are available for different crops and for fruit trees

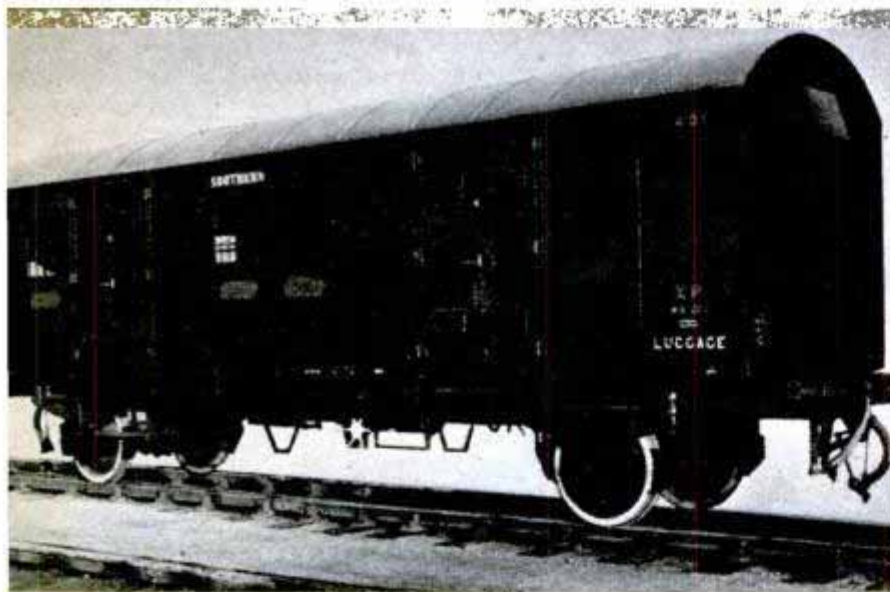

PLASTIC PANELS give strength and light weight to bodies of passenger-baggage cars being built by the Southern Railway of England. Novel body-cushioning devices also are employed to safeguard the cargo. Somewhat smaller than conventional cars, the plastic cars are regularly employed in high-speed service. The panel plastic is reinforced with woven high-tensile steel wire and cotton to reduce brittleness. It weighs only 11½ ounces per square foot, a fourth of the weight of steel or wooden panels, and is fastened to the steel framing by screws fitted into furred strips in channel sections. The body is independent of the main frame, with cushioning springs of steel coils and rubber, permitting longitudinal movement up to 11 inches

A MECHANICAL CRANBERRY PICKER that operates like a giant vacuum cleaner is credited by its inventor with duplicating the speed of 50 persons picking by hand. A. V. Anderson of Grayland, Wash., who developed the device in conjunction with U. S. Rubber Company engineers, says the big rubber hose not only sucks up cranberries rapidly but also cleans them by drawing off weeds, dust and leaves. The machine does not disturb the buds, Anderson explains, and thus will increase the cranberry yield

Every day new products for homes and workshops, farms and factories, are appearing on the nation's markets, and every month you'll find them described in Popular Mechanics. For additional information, write to the manufacturers listed on page 8A in our Where-to-Buy-It Index

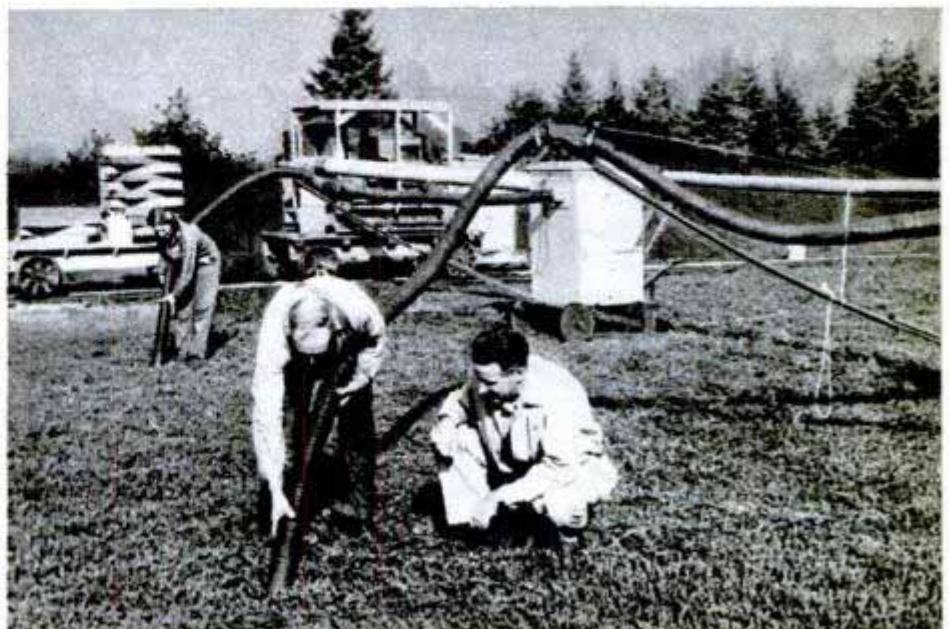

FLYING FREIGHT



By John L. Kent

ONE THURSDAY several months ago, Cleveland housewives served strawberries, tomatoes and lettuce which 48 hours before were still growing in California sunshine—2400 miles away. A huge four-engine airfreighter brought the 18,500-pound load of fruits and vegetables from Salinas, Calif. It was the largest shipment of its kind ever flown by a commercial air cargo plane in the history of the nation's air transportation.

The experimental plane, built and owned by Consolidated-Vultee Aircraft Corporation, is known as Convair Model 39 and is operated by American Airlines. Arrival of the airfreighter marked the inaugural flight in a special three-month research program

Two jeeps parked side by side are drop-in-the-bucket cargo for C-74 Globemaster which carries 30 tons

Douglas Globemaster raises jeep into cargo compartment with own elevator which can lift eight tons

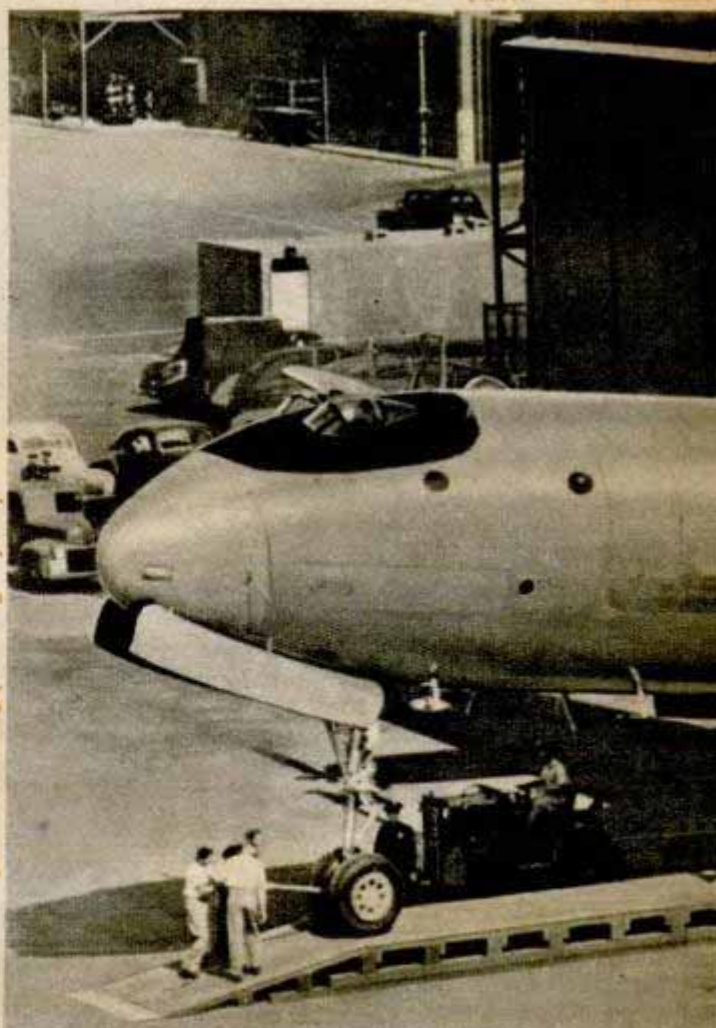

in large-scale transcontinental transport of perishables to determine whether such flights are practical.

The experimental nature of the operation has made it possible for American Airlines to charge the shipper approximately 15 cents per ton-mile as compared with the lowest commercial rate now offered of 26 cents. At first glance, the high weight and low value of fruits and vegetables would rule out any consideration of transporting them by air—the most expensive transportation of all. The transportation charges, you would think, would so increase the cost that the consumer might refuse to pay the high prices. Results of the experiment should show whether the public is willing to pay the extra costs of getting vine and tree-ripened fruit and crisper lettuce. Of more importance, however, is the fact that the



"Bug eyes" of C-74 Globemaster provide pilots with unobstructed vision

future of all domestic air transport hinges to a greater extent upon a large and continuous volume of perishable products than upon any other source of pay load. All experts agree on this. Why?

The answer is simply that fresh fruits and vegetables hold a key to the profitable operation of transport planes on their west-to-east and south-to-north flights. High-

Overall view shows Globemaster's wing is almost amidships; black paint around "bug eyes" prevents glare

DIMENSIONS
SPAN—173 FEET 3 INCHES
LENGTH—124 FEET 1 1/2 INCHES
HEIGHT—43 FEET 9 INCHES
PROPELLER DIAMETER—19 FEET



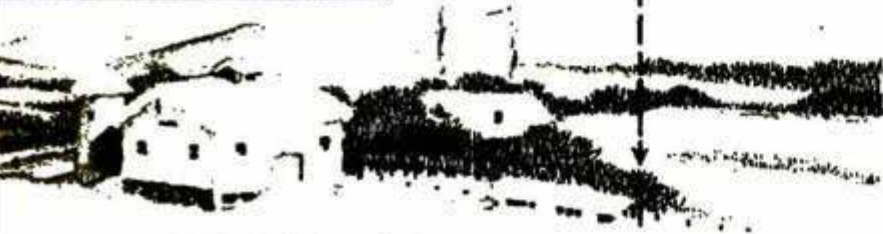
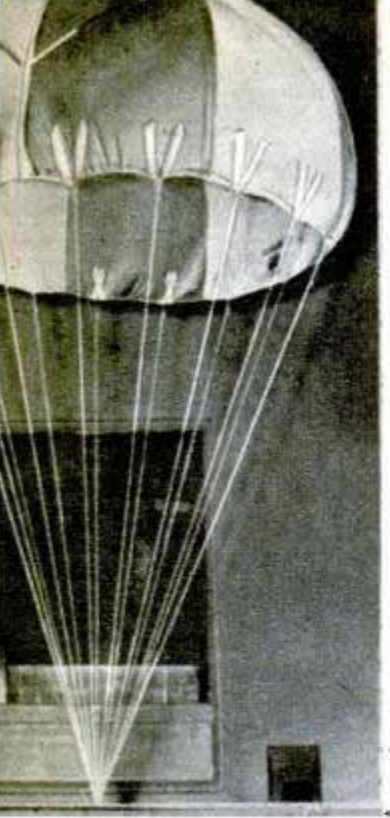

General Textile Mills, Inc., photo

"Baseball" type parachute is nonoscillating and slow inflation minimizes opening shock. Below, rotary wing cargo chute

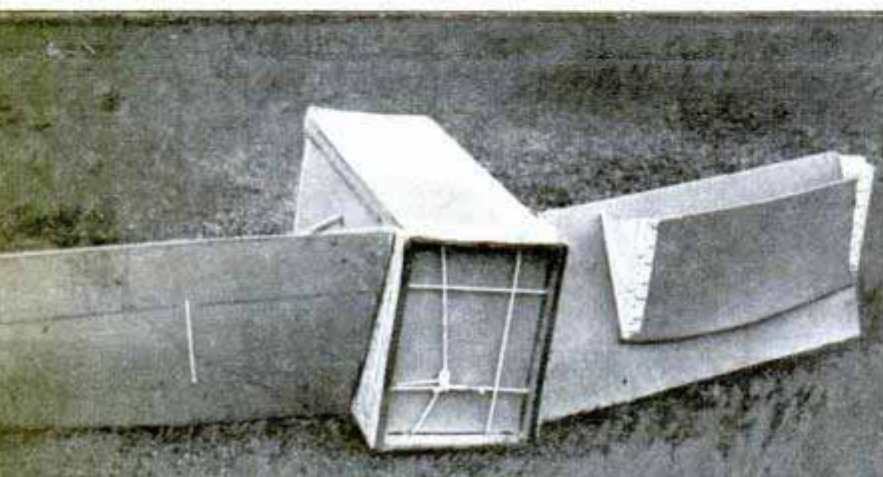
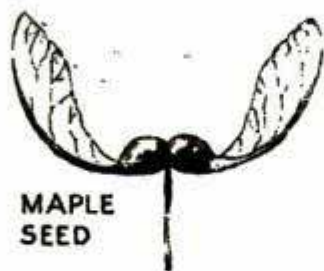
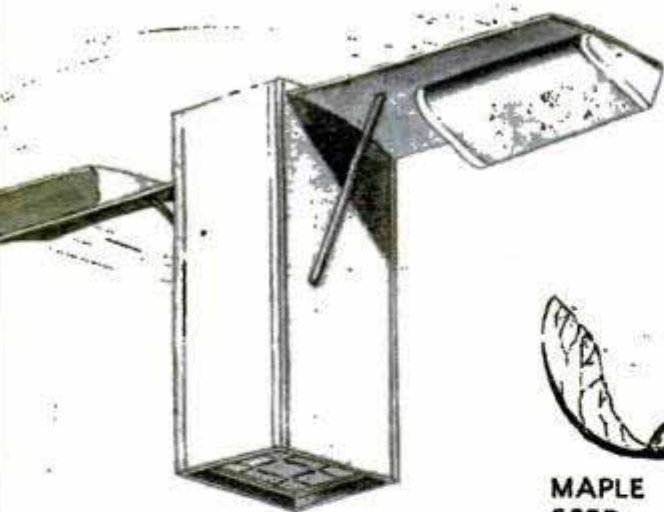

value-low-weight manufactured goods can be found in plenty in our northern and eastern cities to make profitable east-to-west and north-to-south traffic at reasonable air rates. It is on the flights north and east that the airlines find it hard to fill planes. In order to be commercially successful, planes must be loaded almost to capacity on both flights. Thus, on its return flight, the airfreighter carried 18,500 pounds of gas ranges from Chicago to Burbank, Calif.

During the past four years transport prophets have been gazing into the postwar future and emerging with predictions about the great future of transport aviation. Now the postwar is here—and the prophets suddenly are silent. In their place the great airlines of the nation have started on the practical possibilities of air cargo transport—to find out by experiment just how much air cargo there is.

Many self-appointed prophets saw a great cargo fleet resulting from Army cargo and bomber planes. But the commercial operators are not convinced of the ultimate economy of converting Army C-47 or C-54 transport planes to domestic freight hauling any more than most people are convinced that discarded Army jeeps ever can substitute for the family sedan.

"It's all a question of the equipment's suitability for the job it is intended to perform in civilian life," said Claude N. Palmer of the United Fresh Fruit & Vegetable Association, speaking before the Air Transport Users Conference in Washington. "The main factor is: Can it do the job as economically, or more economically, than a plane of more modern design? The military demanded the latest in equipment. By the same reasoning, industrial competition will demand the latest and best of equipment to counteract wartime handicaps and restrictions."

Planes for air cargo, therefore, fall into two classes: Surplus war cargo carriers and new cargo carriers. Since all effort by aviation companies has been on military cargo planes, the peacetime cargo carriers still are in the de-

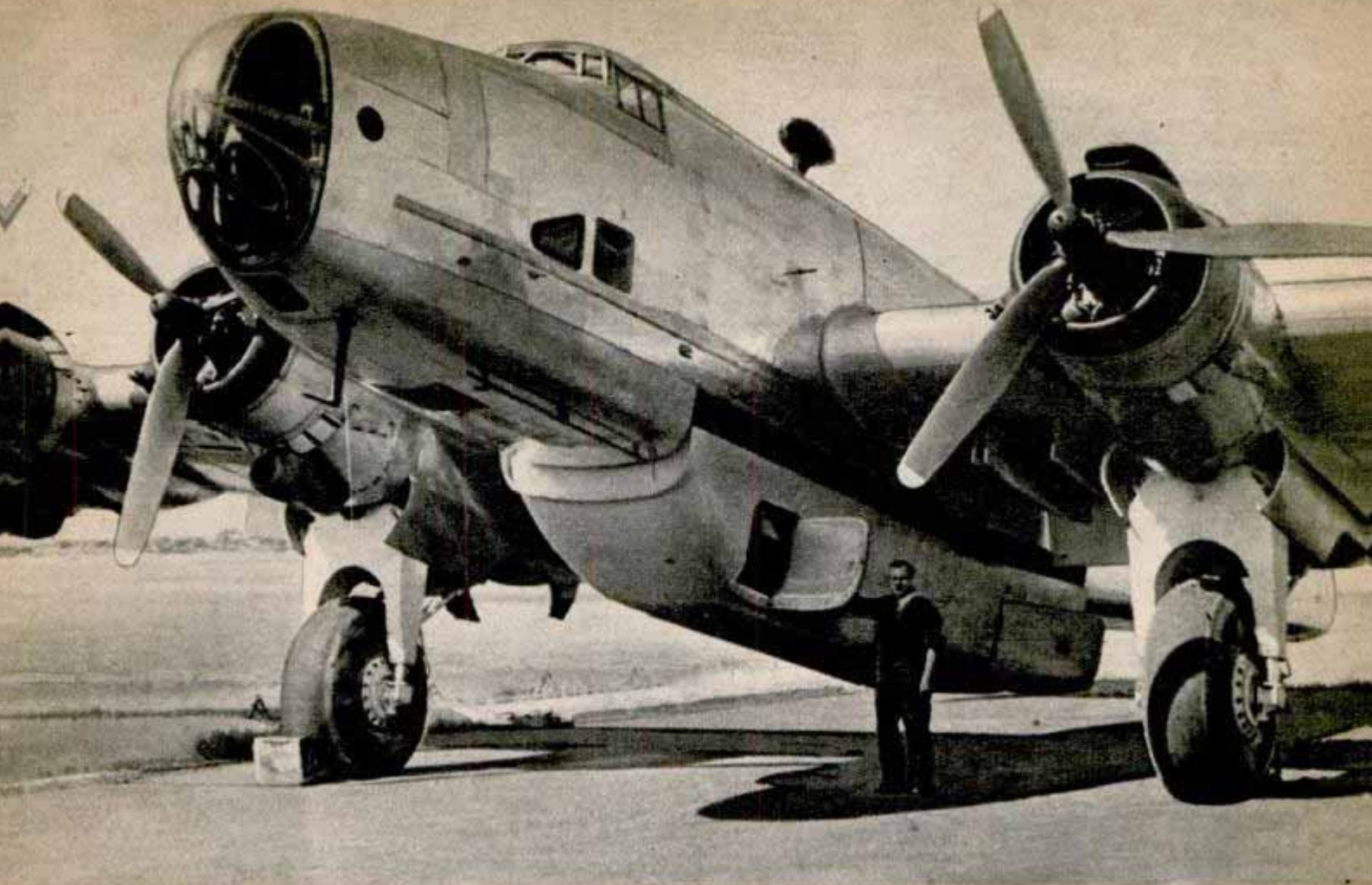

sign stages. However, there are several different types of military planes available for commercial cargo service.

Among these is the Douglas DC-3 type, the military versions being known as C-47 and C-53. American Airlines already has converted a standard DC-3 transport into an airfreighter. The interior of the airplane has been completely redesigned and all windows and other features of the passenger airliner have been removed. The converted ship features a thermostat temperature control for transportation of perishables and seven cargo bins each capable of holding up to 750 pounds. The new plane is the first of 20 such airfreighters which the line intends to put into domestic service.

Another possible cargo conversion is the C-54 or DC-4 type. It has proved its worth in military service. The Douglas C-74 Globemaster is the military cargo version of the DC-7, big brother of the C-54. This four-engine aerial giant has a wing span of 173 feet and three inches—32 feet wider than the B-29—

Converted British Halifax bomber has detachable freight compartment in place of bomb bay. Below, first commercial aerial shipment of heavy goods arrives in Los Angeles from Chicago



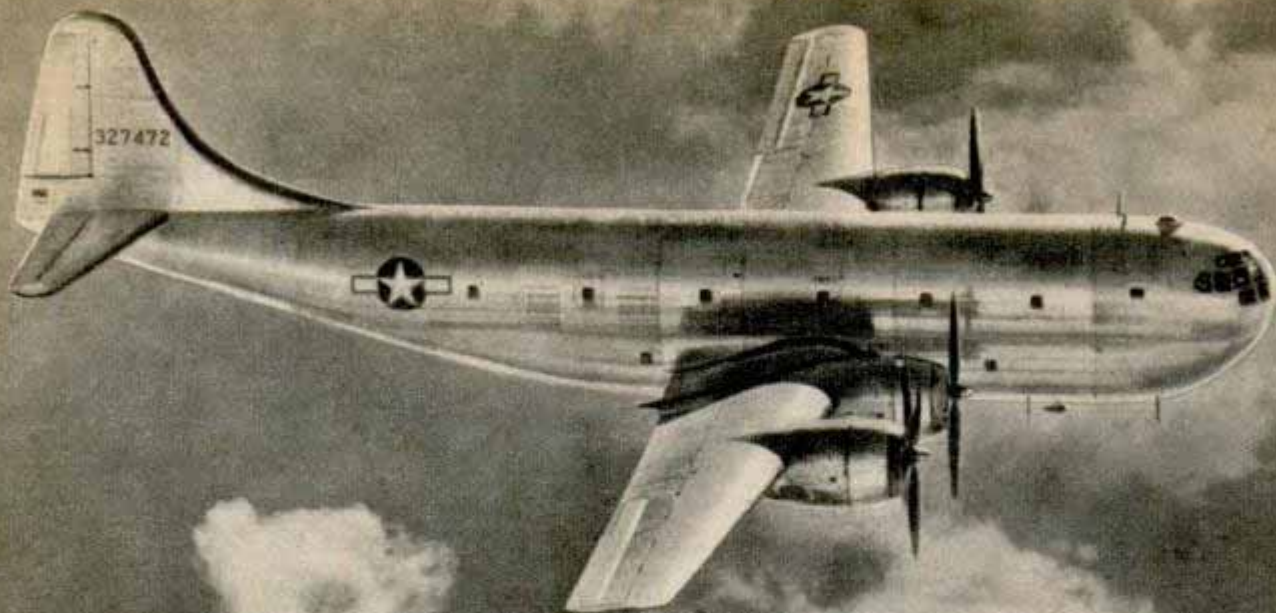

Boeing C-97 has two decks and usable cargo space almost equal to that of two average railway boxcars

and carries a pay load of 30 tons. Built for transoceanic service, the Globemaster will fly nonstop more than 7500 miles. It carries its own crane, hoists and cargo elevator for loading and unloading.

Other postwar aerial freight possibilities are the Lockheed Lodestar types, among which are the C-37, C-56 and C-60. To this group may be added the twin-engine Curtiss Wright Commando, or C-46.

Among the four-engine Army transports there are the C-87 Consolidated Liberator-Express and the Lockheed Constellation, or C-69.

One of the newest entrants is a transport counterpart of the Boeing B-29 Superfortress—the C-97. A commercial version

There's room for standard bowling alley and 15 feet to spare in main compartment of C-97, transport version of Superfortress

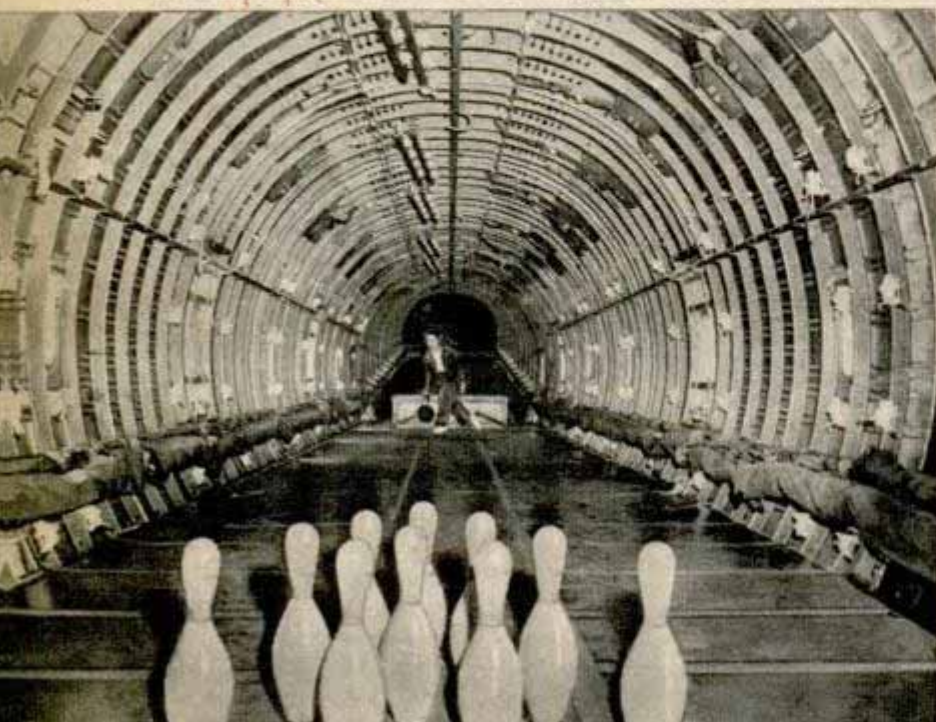

of the plane, to be known as the Boeing Stratocruiser and capable of carrying up to 100 persons, has been announced. The C-97 has wings, tail surfaces and landing gear identical to those of the B-29, but the volume—10,000 cubic feet—is more than twice that of the B-29. It has usable cargo space almost equal to that of two average railway boxcars. A unique feature of the C-97 is a pair of great loading doors which open under the rear of the fuselage, with a drive-up ramp which is let down from within. The ramp is self-contained in the plane and is retracted by an electrically powered cargo hoist so that no special equipment is necessary.

One of the newcomers to the Army cargo plane ranks is the Fairchild C-82, nicknamed the Packet. As a cargo carrier, the "flying boxcar" can carry a maximum pay load of nine tons on flights up to 500 miles, and six and one-half tons for 1500 miles. The Packet's immense cargo compartment, with 93 percent as much cubic capacity as a railroad boxcar, is long and square-sided. It loads from the rear end, eliminating the usual cumbersome methods used in loading heavy cargo.

Huge double doors in the rear of the fuselage open like a clam-shell to the full width of the cargo compartment. There is plenty of room under the high twin-boom tail for a large truck to back up and unload cargo directly into the

plane. Transfer of cargo is facilitated by the fact that the Packet's floor is level at truckbed height. There also is a side loading door at the forward end of the cargo compartment.

These quick, convenient loading features, combined with a comparatively low direct operating cost per ton-mile (estimated at less than seven cents for trips under 500 miles) are expected to give the Packet a competitive advantage as a commercial air-freighter on short runs.

Since the prime advantage of shipping cargo by air is speed, the scope of air cargo service is limited when the final destination is not served by air lines. At the present time there are only about 350 points in the United States served by commercial air liners. However, to bring the advantages of air transport to other communities, air lines are experimenting with parachute dropping of cargo. The idea is not new; our Army has been using it for several years, and emergency air delivery at isolated spots has been made by commercial carriers on many occasions by parachute. Many new types of parachutes and dropping containers are being tried out. One of these is a combination parachute and container, which when dropped from a plane sprouts wings or rotors. These wings limit the rate of fall and drift. The container can drop 50 pounds safely.

Another type of parachute immune to oscillation in descent, which is common to ordinary parachutes, has been tried by the Army. It has been nicknamed the "baseball parachute" because it is constructed in hemispherical shape through the sewing together of material cut in the form of a figure eight in the manner of a baseball cover. Dishes, phonograph records and glassware are among the fragile items successfully parachuted from cargo planes.

American air line companies also expect gains in overseas air cargo as a result of several planes nearing completion. Chief among these is the Mars type flying boat, several of which are on order with the Glenn L. Martin Company for the Navy Transport Service. It is patterned after a converted patrol bomber, the Mars, which carried



Manhattan Storage and Warehouse Co. photos
Veneer box for cargo chute test contains radio and 12 tubes

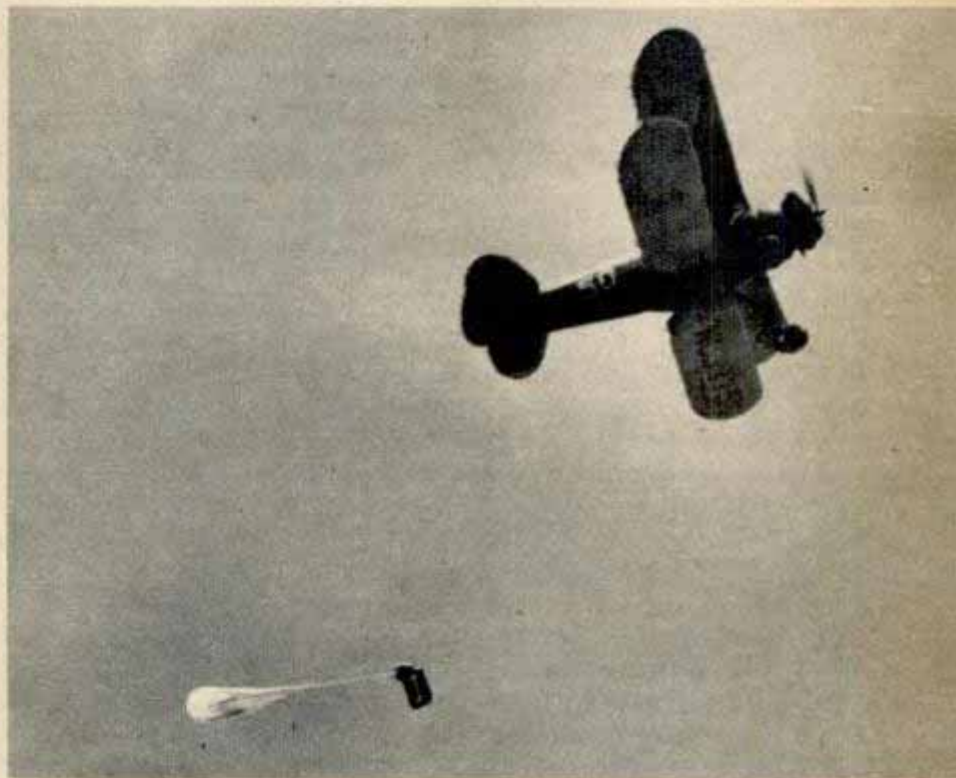

Swinging from special parachute is fiberboard carton containing phonograph records. Below, records landed without scratch



an average pay load of 22,000 pounds for a distance of 2400 miles between Alameda, Calif., and Pearl Harbor. The new type Mars weighs 72 tons and will carry the same load for an increased distance of 3550 miles. The postwar model, with engines throttled to two thirds power, will carry as much as 50,000 pounds of pay load for 2000 miles at a speed in excess of 200 miles an hour. On this commercial model the four present engines, totaling 9000 horsepower, will be replaced with four Pratt & Whitney Wasp Majors, raising the rated horsepower to 12,000 plus.

Another commercial overseas possibility is the C-99, world's largest land-based troop carrier plane nearing completion at San Diego by Consolidated-Vultee Aircraft Corporation. It was intended as a troop transport and is the military counterpart of the recently announced Model 37, a 204-passenger luxury liner ordered by Pan American World Airways for transoceanic service.

Because of its capacity it is readily convertible to cargo operation and will carry a pay load of 100,000 pounds over a distance of 1500 miles. Loaded with 19,000 gallons of fuel, it will have a range with a reduced pay load of approximately 8000 miles. The "99" has a wing span of 230 feet and is powered by six pusher-type engines. The 183-foot aluminum fuselage is completely double-decked with two large ramps in the bottom section for loading. Equipment includes monorails and electrical hoists.

Some experts feel that overseas air lines have a better chance at cargo operation than domestic operators. The coming battle is going to be played at the home field. Can air cargo seriously compete with the railroads, the trucking industry and other

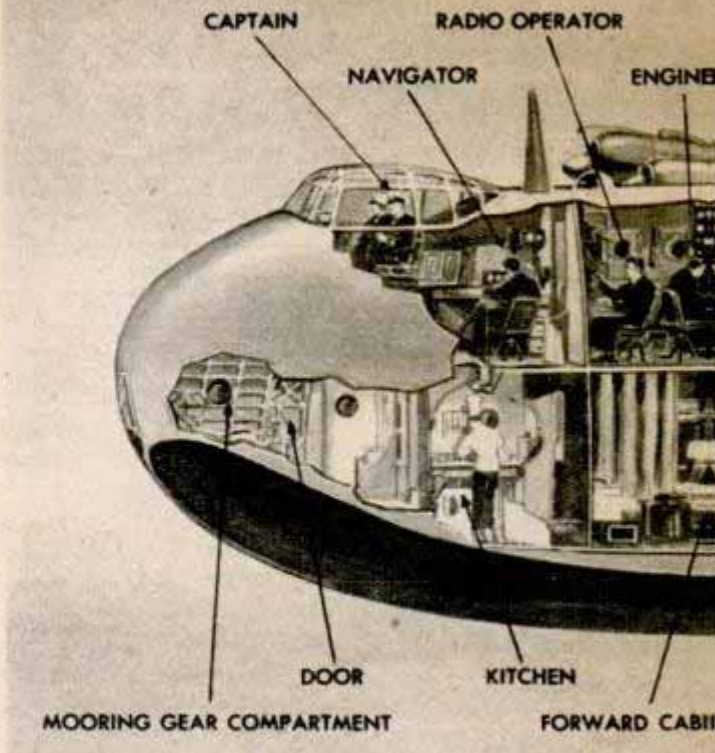

forms of surface transportation? Can air cargo ever get its rates low enough to attract the large volume traffic it must have to become one of our major systems for the transportation of goods? Here's one side of the picture—the dark side:

Cargo loading costs run between \$10 and \$15 per ton at airports, but only 50 to 75 cents per ton at rail and truck terminals. The rail freight rate per pound from New York to Chicago is 2 cents, by rail express under 5 cents, but by air freight 15 cents.

But here's the other side: Do you remember the receding tracks and roadbed as you

Mars type flying boat carries 22,000 pounds of freight; below, interior view and loading scene at dock
Glenn L. Martin Co. drawings

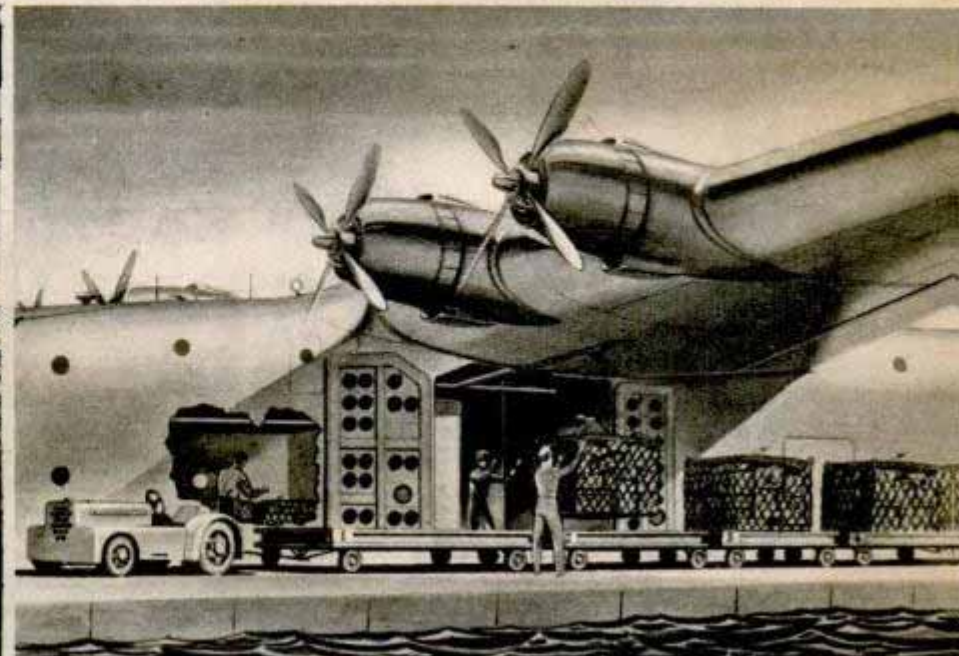

ENGINES—FOUR BRISTOL 18-CYLINDER
 OVER 2500 B.H.P. EACH
 DIMENSIONS—SPAN—150 FEET
 LENGTH OVER-ALL—107 FEET
 WEIGHT—130,000 POUNDS
 ACCOMMODATION—UP TO 70 PASSENGERS

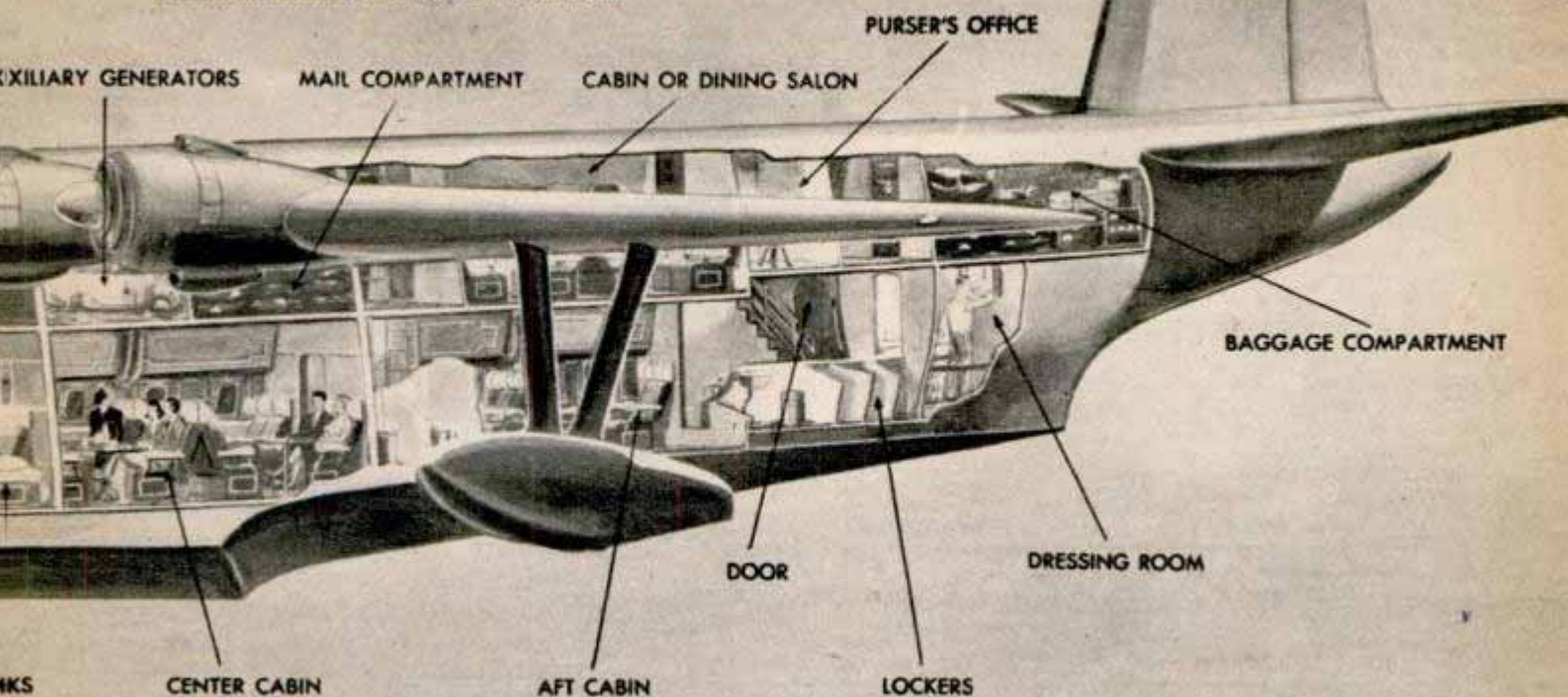

The Shetland flying boat is Britain's largest plane; it can fly nonstop from London to Bombay—4650 miles

and serviced regularly. Rails and ties must be replaced when they wear out. The road-bed must be replaced or rebuilt on occasion because of accidents, washouts and storms. Capital was borrowed originally to build or replace those facilities and equipment—and interest must be paid on that capital, year after year.

watched out of the rear observation car on your last train trip? The rails were resting on tie plates and spikes fastened them to the ties. The ties were spaced about 20 inches apart—and there were thousands upon thousands. Then there was the ballast of crushed stone or cinders. Every so often you would pass a turnout switch or a frog, a ground signal or overhead semaphores. At intervals you would rumble over bridges and then ride through tunnels.

But air cargo has the free, unobstructed and boundless roadway of the air that requires no servicing, no maintenance, no replacements and no interest charges.

All this equipment must be inspected

Trailer truck unloads directly into cargo compartment of Fairchild Packet by backing under twin-boom tail

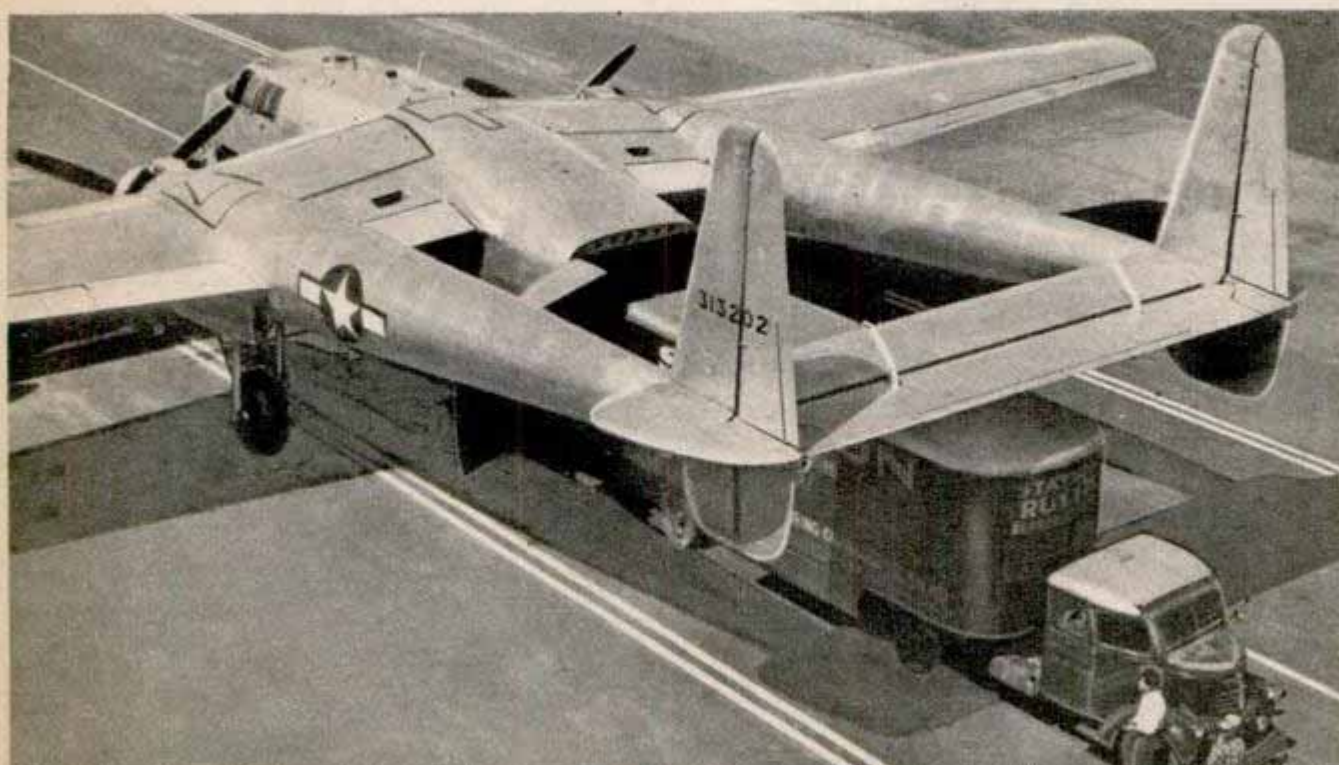

SWEEPING UP SUDDEN DEATH

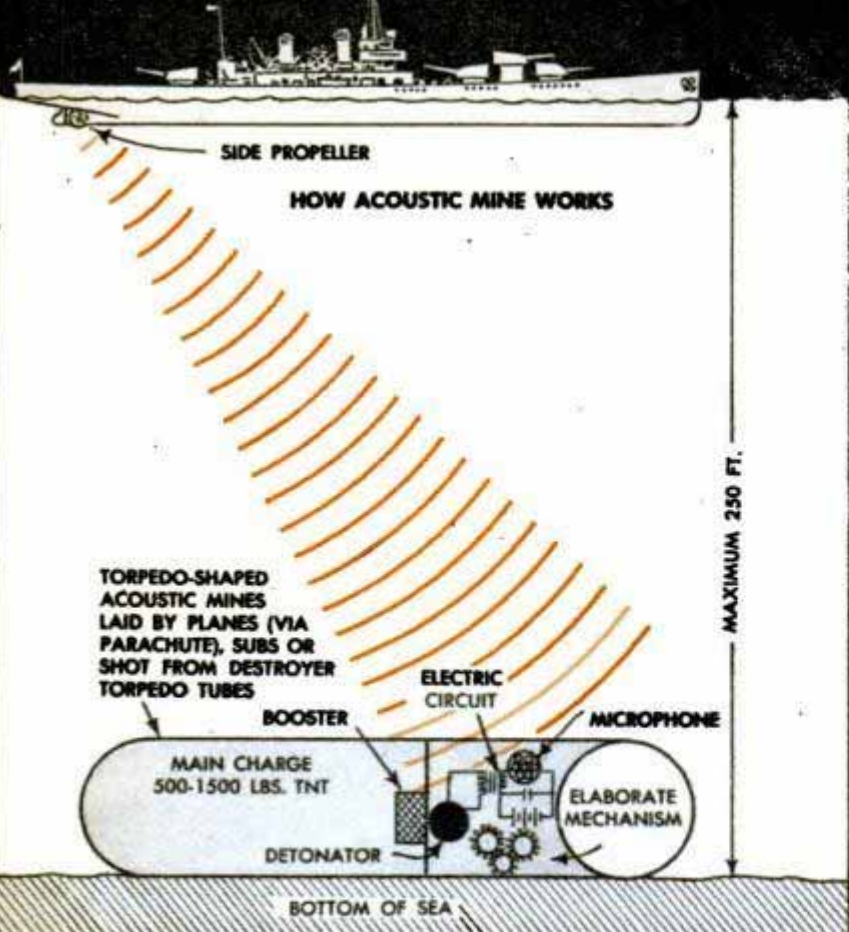

THE BLOODIEST war in history is at an end. But a hardy little fleet of United States ships and men is still in daily contact with Japanese destruction and death.

They are the Navy's minesweepers and the rugged young men who sail them. "First in—last out" is their motto. Having spearheaded amphibious landings in Europe and the Pacific, minesweepers now are engaged in the dangerous duty of clearing unexploded mines from waters around Japan, Korea, the China Coast, Formosa, the Dutch East Indies and Malaya.

Jap minesweepers, men and equipment are being used as much as possible, but because most of the Jap ships were sunk, the United States and British navies also must pitch in and help. It is a slow and difficult job that may take several years.

United States minesweepers in 1942 and 1943 cleared 62 mines from the Atlantic seaboard that were laid by German submarines. They swept 1933 mines from the Mediterranean and North Sea. It is estimated that the Far East will be the biggest job of all—with perhaps as many as 15,000

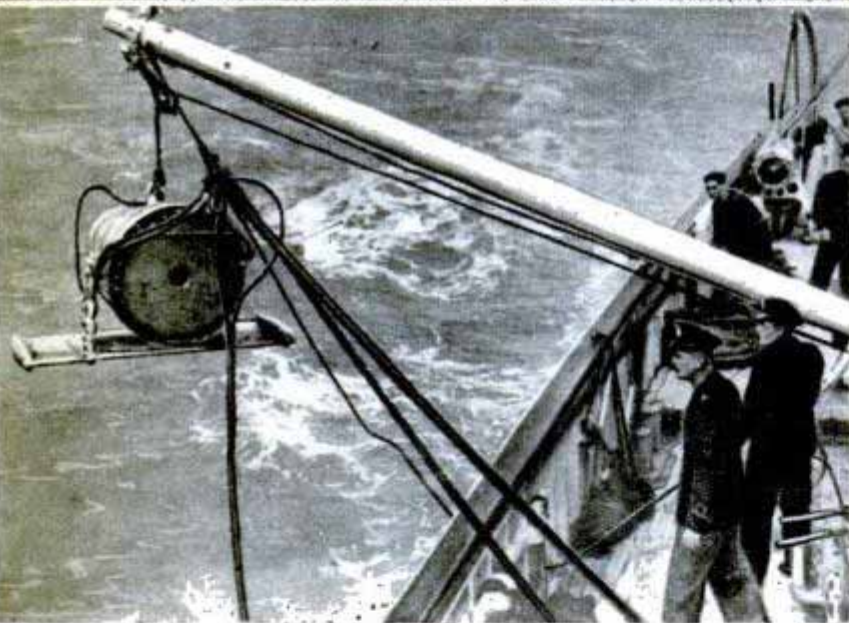

←Lowering a noisemaker over side of British minesweeper to explode acoustic mines in European waters

"NOISEMAKER" OR HAMMER BOX, BUILT LIKE PNEUMATIC HAMMER SENDS SOUND AHEAD OF SHIP TO EXPLODE MINE

HOW SWEEPER EXPLODES ACOUSTIC MINE

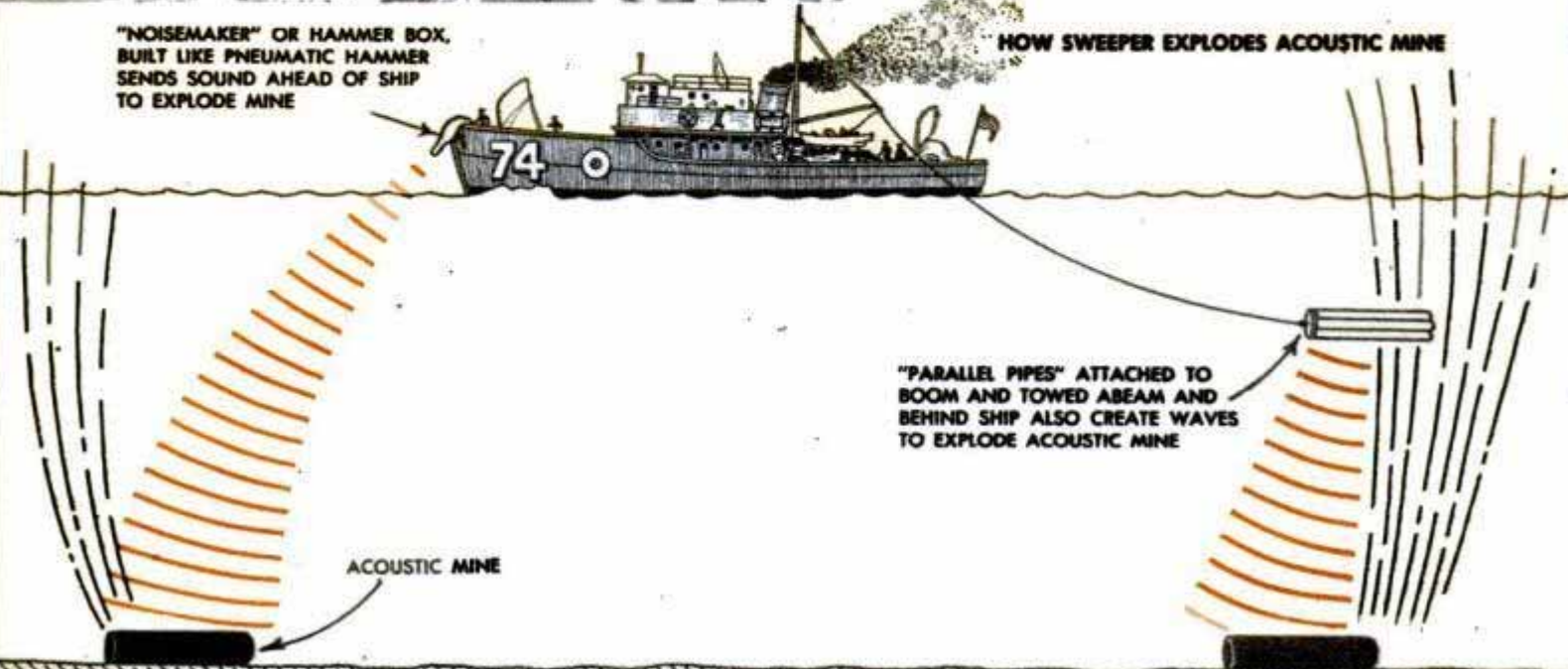

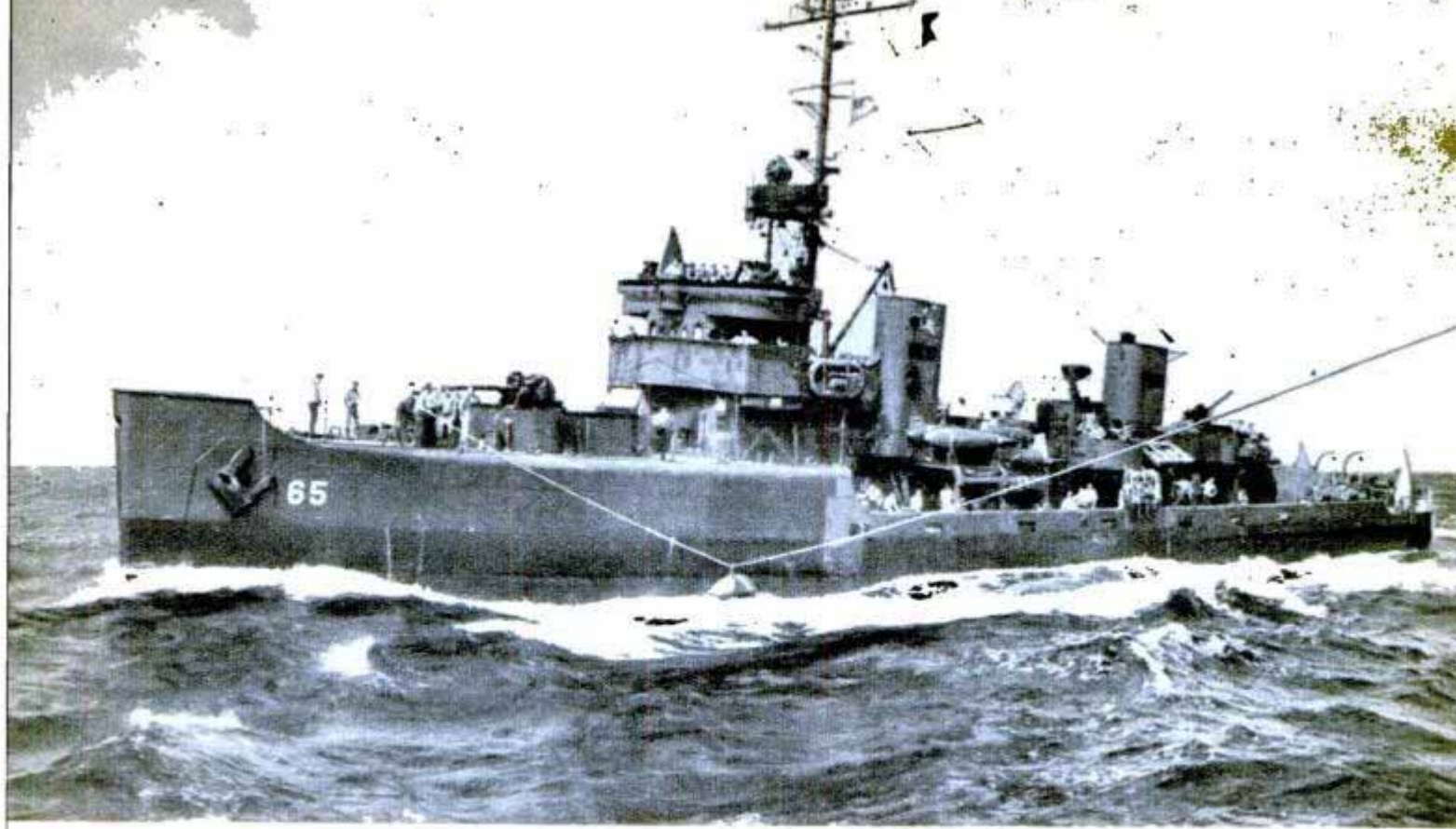

USS Swallow, one of Fleet's "scrubwomen," takes time out to pass mail with heaving line to another ship

mines to be found and rendered harmless.

The Japs laid down extensive minefields to protect bays, harbors and rivers around their home islands and Far Eastern naval bases. In the final weeks of the war, B-29s and Navy land-based planes sowed so many aerial mines (12,000) that the battered remnants of the Imperial Navy couldn't budge, and became sitting ducks for Admiral Halsey's mighty Third Fleet.

As soon as the shooting stopped, the minesweepers went to work, carrying out a job as important as it was dangerous. The men of the minesweepers knew that unless mines were swept up and exploded, the lives of Army garrison troops on transports, sailors with the Navy and merchant seamen aboard tankers and freighters would be endangered.

Minesweeping rates second only to submarine duty in the Navy as a hazardous occupation. Crews are highly trained specialists in the man-killing art of mine disposal as well as skillful seamen and navigators. They wear special insignia on their uniforms and are fiercely proud of their ugly little ships.

Minesweepers are affectionately — and sometimes not so affectionately — called "sweepers of the sea," "scrubwomen," "charwomen of the fleet." They range in size from tiny, 100-ton tuna fishing boats to 1190-ton World War I flush-deck destroyers which have been converted into high-speed minesweepers.

At the present time the Navy has several

hundred minesweepers, divided into four categories: (1) motor minesweepers, (2) coastal minesweepers, (3) fleet minesweepers and (4) high-speed minesweepers.

Mines are round or torpedo-shaped and carry a charge of TNT varying from 250 to 1600 pounds. They are anchored by cable or lie on the ocean bottom and can be planted as deep as 3000 feet below water-surface and at varying depths to intercept surface craft or submarines. Free-floating mines, prohibited by international law, are of doubtful value because they are hazardous to friend as well as foe and can be spotted easily.

The contact mine is the simplest and perhaps the most widely used. When a ship strikes one of the contact points, or "horns," which protrude from the mine's side, an explosion takes place. Magnetic mines were used with success by the Germans in the early part of the war and took a serious toll of Allied shipping. They are set off by electrical impulses created by a ship's metal hull. Acoustic mines work on the same principle except that they are set off by underwater sound waves.

Aerial mining first was attempted by the Germans in an effort to blockade British shipping in the Thames and channel ports. But the Germans did not have enough planes or mines. Later, joint United States Army-Navy efforts in dropping aerial mines by parachute in Japanese waters proved extremely successful.

To explode contact mines, minesweepers

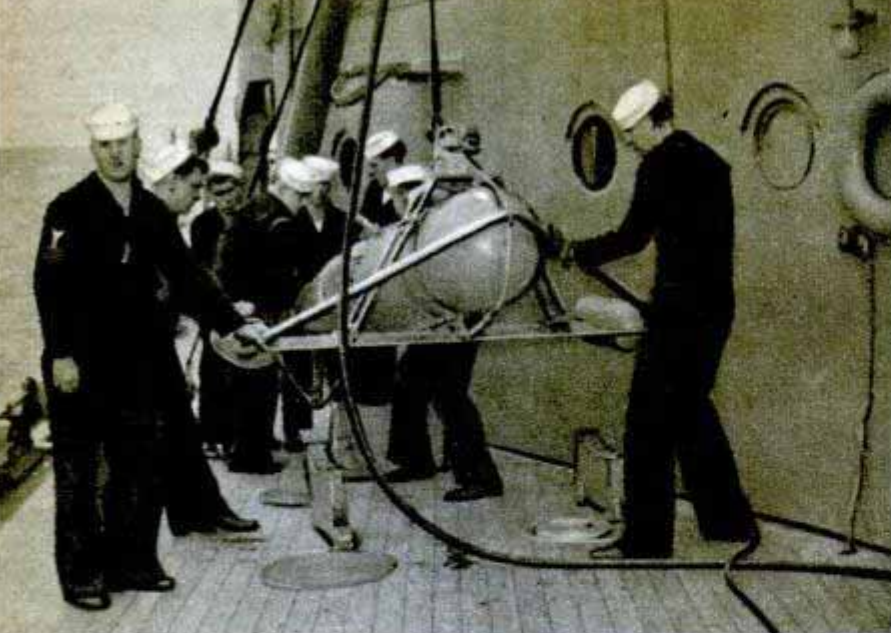

Paravane which holds steel cable towed by minesweeper is handled like a baby by sailors hoisting it aboard. This delicate mechanism holds cable at proper depth and angle

When a ship passes over a magnetic mine (right) the electric field created by its steel hull swings needle mechanism in mine. This activates the detonator which in turn sets off the booster charge of granulated TNT and the main charge of cast TNT. When minesweeper (below) approaches a magnetic mine it is protected by De-Gaussing cable. Flotation cable towed behind is electrically charged so that magnetic field between long and short leads explodes mine

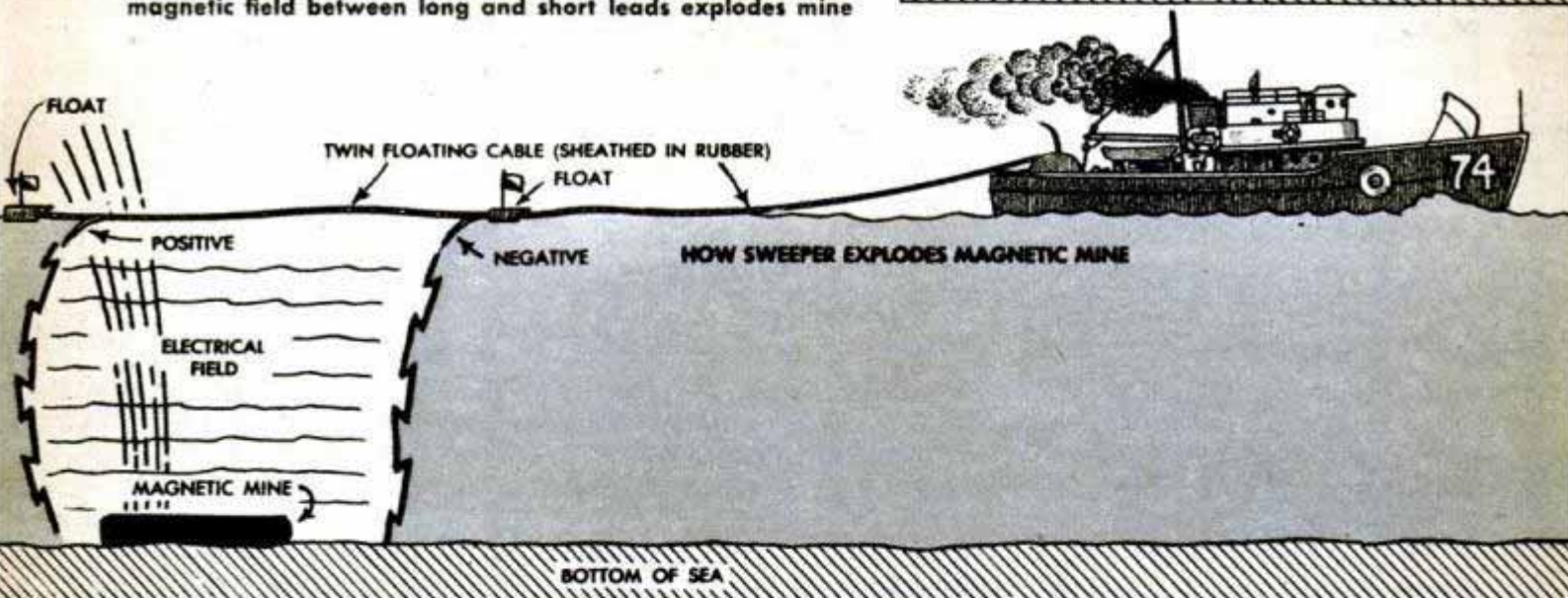
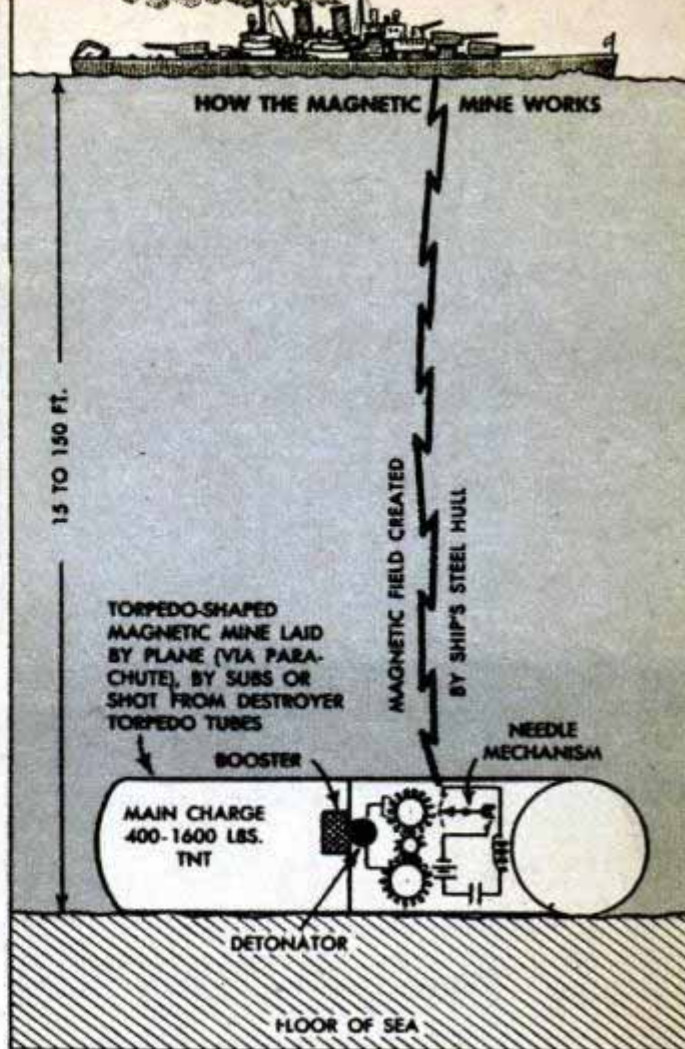

tow long steel cables which are held by paravanes at an angle from the ship and at the required depth below the surface. When the cable connecting the mine to its anchor is caught by the ship's cables, it slides along toward the paravane, where it is cut by sharp knives. The mine then bobs to the surface and is exploded by gunfire.

Magnetic mines are destroyed by electrically charged cables towed behind minesweepers. Acoustic mines are detonated by special devices known as "noisemakers" which send out underwater sound waves.

Come aboard a "sweeper of the sea" as it begins operations. The ship is one of a

squadron assigned to sweep a certain designated area. The skipper gives the orders: "All hands to sweeping stations."

The men move quietly and efficiently. Trained under battle conditions where the slightest sound might betray the presence of the ship to the enemy, the skipper gives his commands by telephone:

"Out sweep."

Over the stern goes the float. Its little flag trails almost out of sight in the milky green-white wake of the ship. Then the paravane slips off its launching tray and the sweep wire begins to play out. The man at the winch reports when it has reached

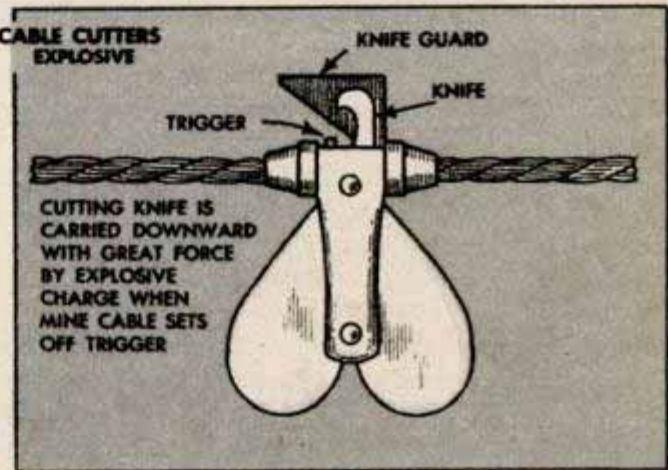
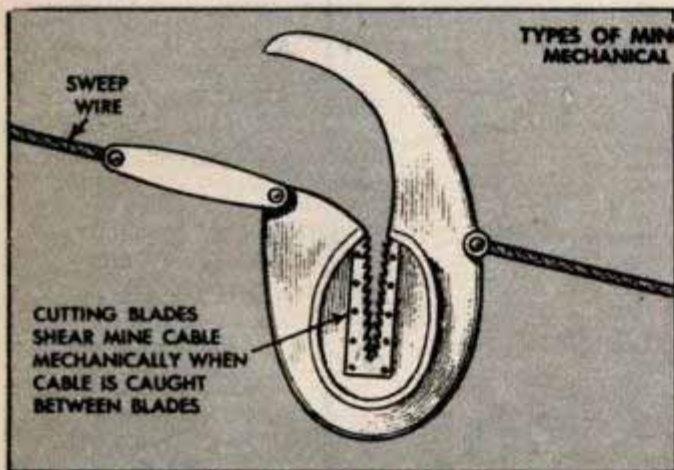
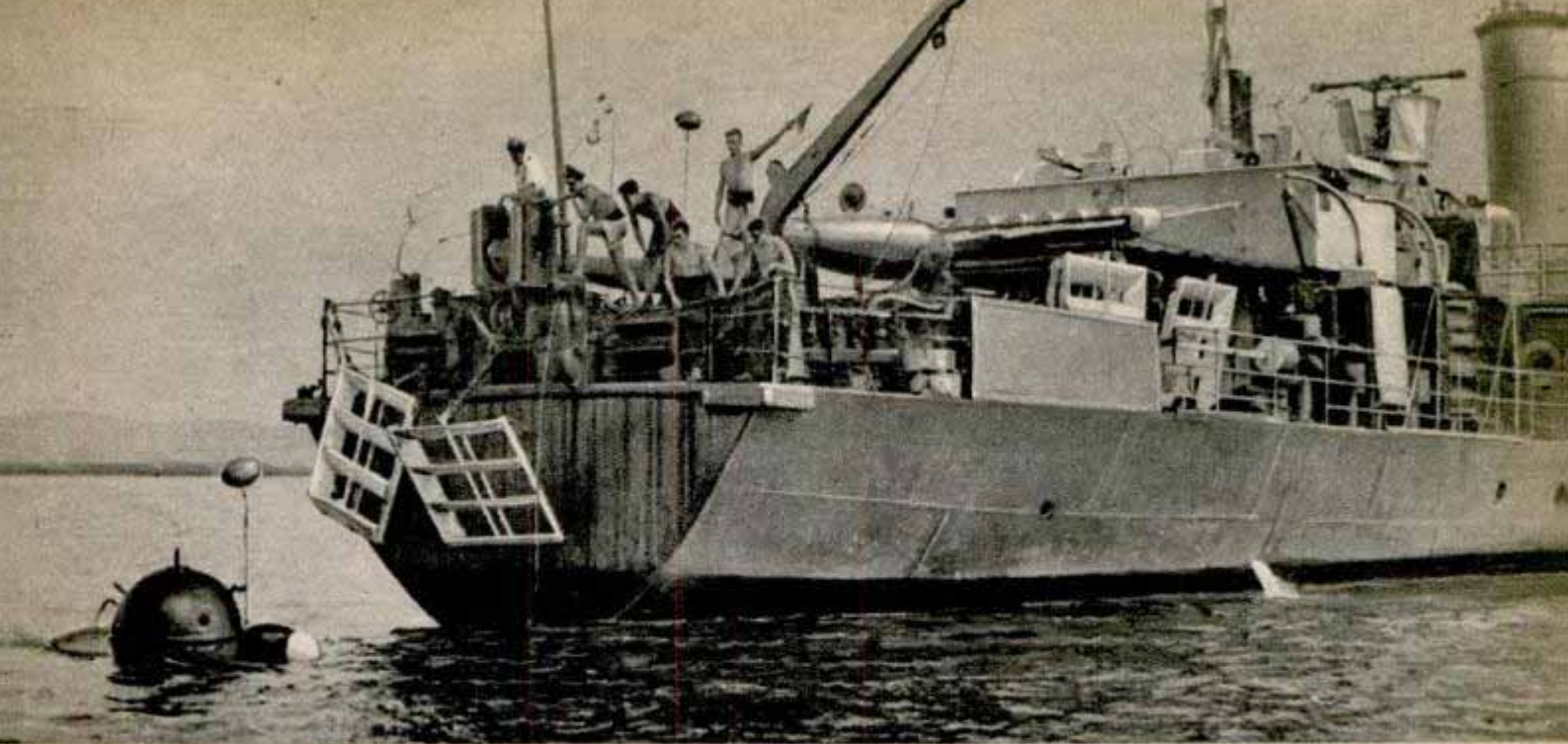

a depth of the required number of fathoms.

Everything is quiet except for the steady thrum of the ship's engines. Everyone is nervous—waiting for the blast that will indicate sweeping of the first mine.

Suddenly the sweep wire becomes taut. A black, wicked-looking mine bobs to the surface and the ship's 3-inch gun cracks. Then there is a rumbling sound and the explosion pressure breaks the surface with an ear-shattering "whoomph." A tower of white water rises high into the air and the little ship tosses to the concussion of the blast. The first mine has been destroyed.

The original tenseness subsides as the men buckle down to their work. One mine after another is exploded and the area finally is pronounced cleared. The job is over and the skipper winds it up with:

"In sweeps!"

Mine warfare is not a modern development. In fact, it is more than 350 years old. It came into being in 1585 when the Dutch destroyed 800 Spaniards during the siege of Antwerp by using an "explosive vessel" fitted with a clockwork mechanism. During the 17th century the English produced

Crew inspects "catch" (top) as cut mine is drawn in close to British minesweeper. Drawings show cutters. Below, gunfire explodes mine brought to the surface



THE DE-GAUSSING CABLE

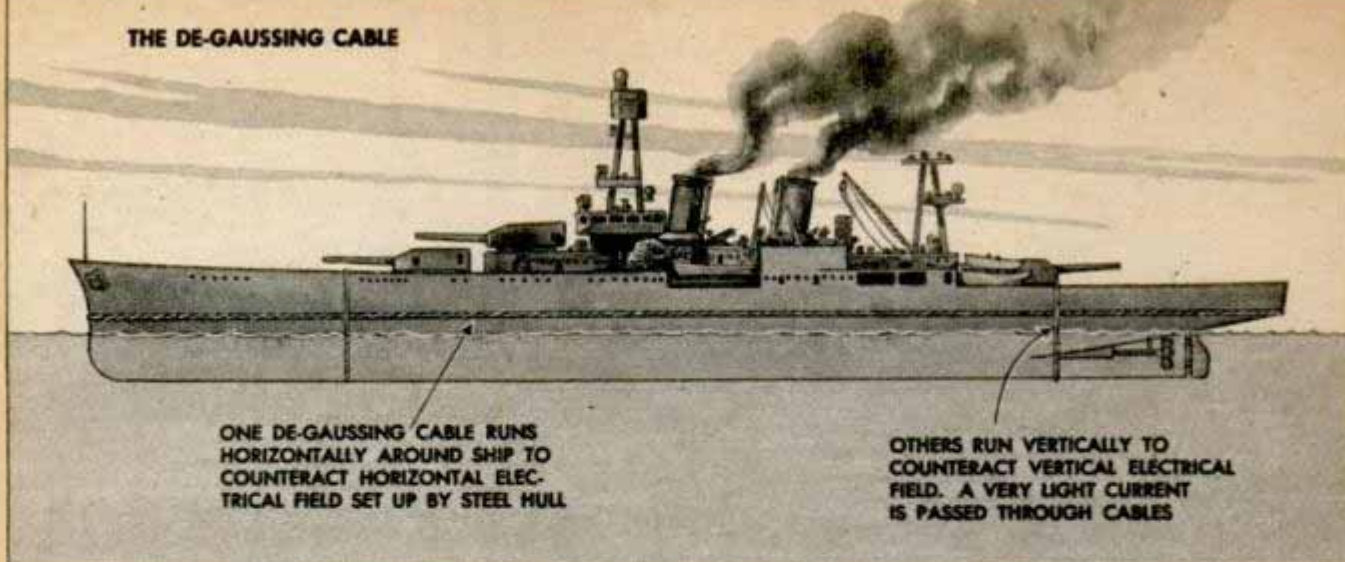

Greatest boon to the minesweeper is the De-Gaussing cable that protects it from the deadly magnetic mine

similar devices which were attached to a ship's hull by a diver.

It was David Bushnell, the American inventor, who finally conceived the idea of detonating mines by contact. Twenty years after Bushnell, Robert Fulton began experiments of the same nature. And in 1804, after failing to interest the French, Fulton turned his ideas over to the British.

During the Civil War, the Confederates made extensive use of mines and it was Admiral David Glasgow Farragut who issued the famous command: "Damn the torpedoes, full speed ahead." Actually he used the word torpedo to describe the heavy mine field which the Confederates had planted to guard Mobile Bay. One of the mines had sunk his leading ship as the Union fleet attacked that port.

Many other nations began to make use of mine warfare both offensively and defensively. By the time of World War I it had become an important factor in naval strategy. With World War II came further improvements—notably the magnetic mine,

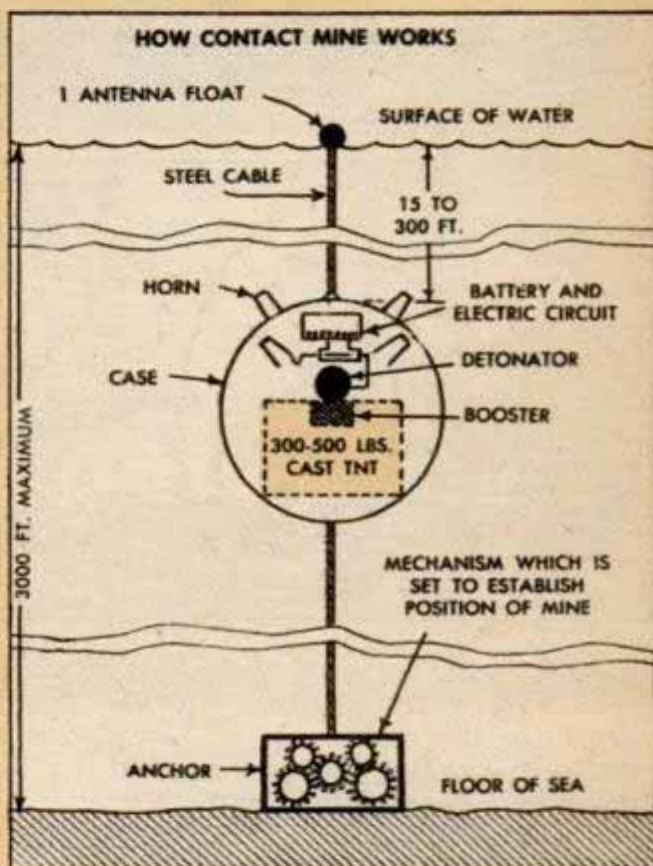

HOW CONTACT MINES ARE SWEEPED

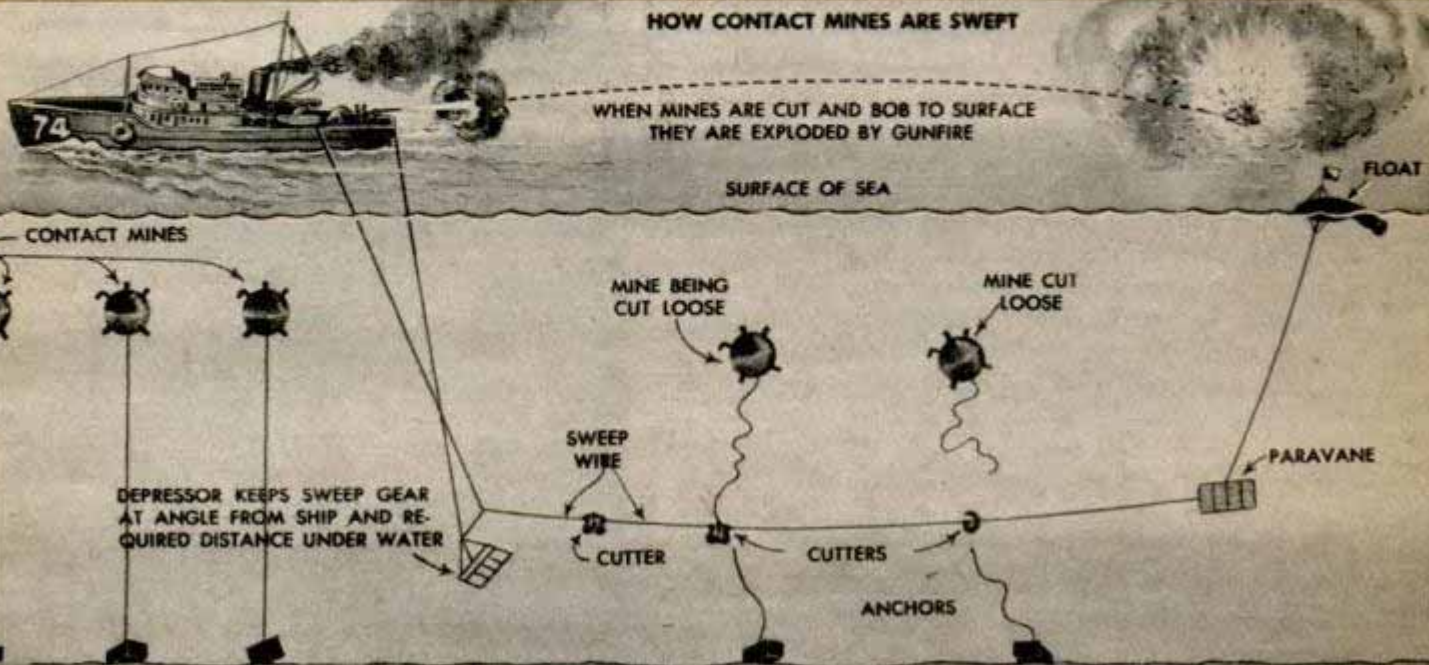

acoustic mine and aerial mine.

Minesweepers were developed as a counterweapon to the mine. In World War II, which saw so many amphibious landings by Allied troops, the minesweeper played a vital role.

Several hours before assault troops hit the Normandy beach on D-day, the minesweepers were close inshore. Gear splashed into the Seine and the minesweeping squadron began its run back and forth in front of the landing strips where infantry would go ashore.

"The enemy on shore could see us," said one of the skippers, "but he was so busy dodging bombs from our aircraft that he couldn't do much about it."

The squadron completed the task of clearing a channel for supporting cruisers and destroyers only a few minutes before the men-of-war opened their barrage.

"We got out of the way then," said the minesweeping officer, "and enjoyed a box office view of the shelling which made up for all our earlier efforts."

At Iwo Jima a squadron of 136-foot motor minesweepers swept back and forth under enemy guns on Mt. Suribachi two days before the Marines fought their way up the beaches of the Jap-held island.

The minecraft worked under cross-fire from Jap batteries on shore while the shells of the United States battleships and cruisers thundered overhead. The little ships went within a half mile of shore, and later were reported by the Jap radio as an "invasion fleet" which was "repulsed."

In addition to sweeping, the "charwomen of the fleet" have been used to guard shipping lanes, ride herd on convoys, perform antisubmarine work, and as tugs, traffic control vessels, rescue craft and patrol vessels. Most of their operations are dull, dirty and dangerous, but occasionally they have had the chance to perform deeds of valor usually reserved for their more glamorous sister ships.

In the critical days of antisubmarine warfare in 1943, many fleet minesweepers escorted convoys to British and Mediterranean ports. One of them rescued 100 sailors from a torpedoed French tanker. Pulled aboard, wiped clean of oil and given hot coffee, the French-

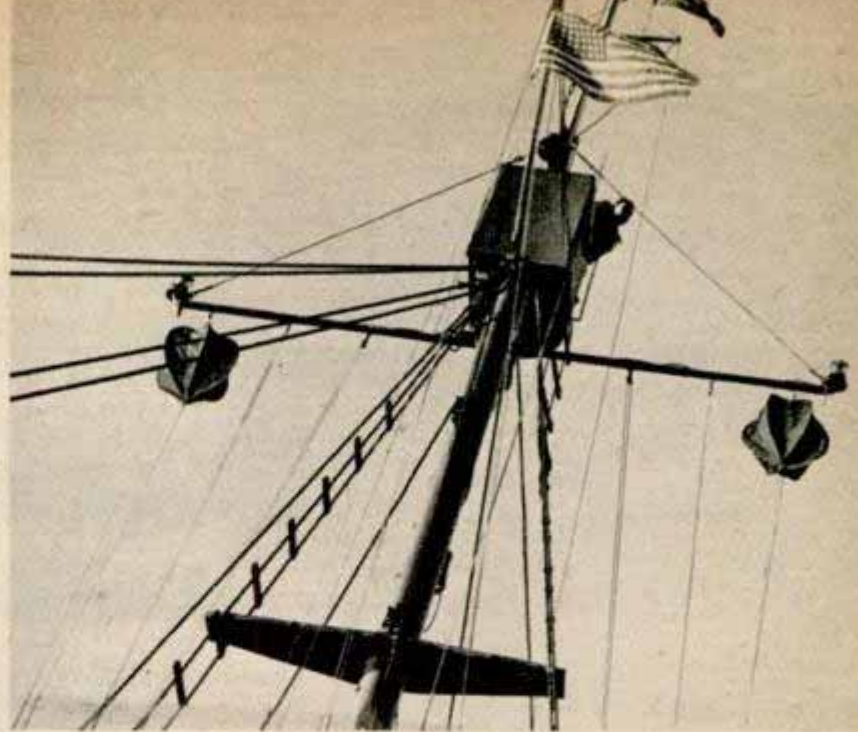

High in the crow's nest, a minesweeper bluejacket watches

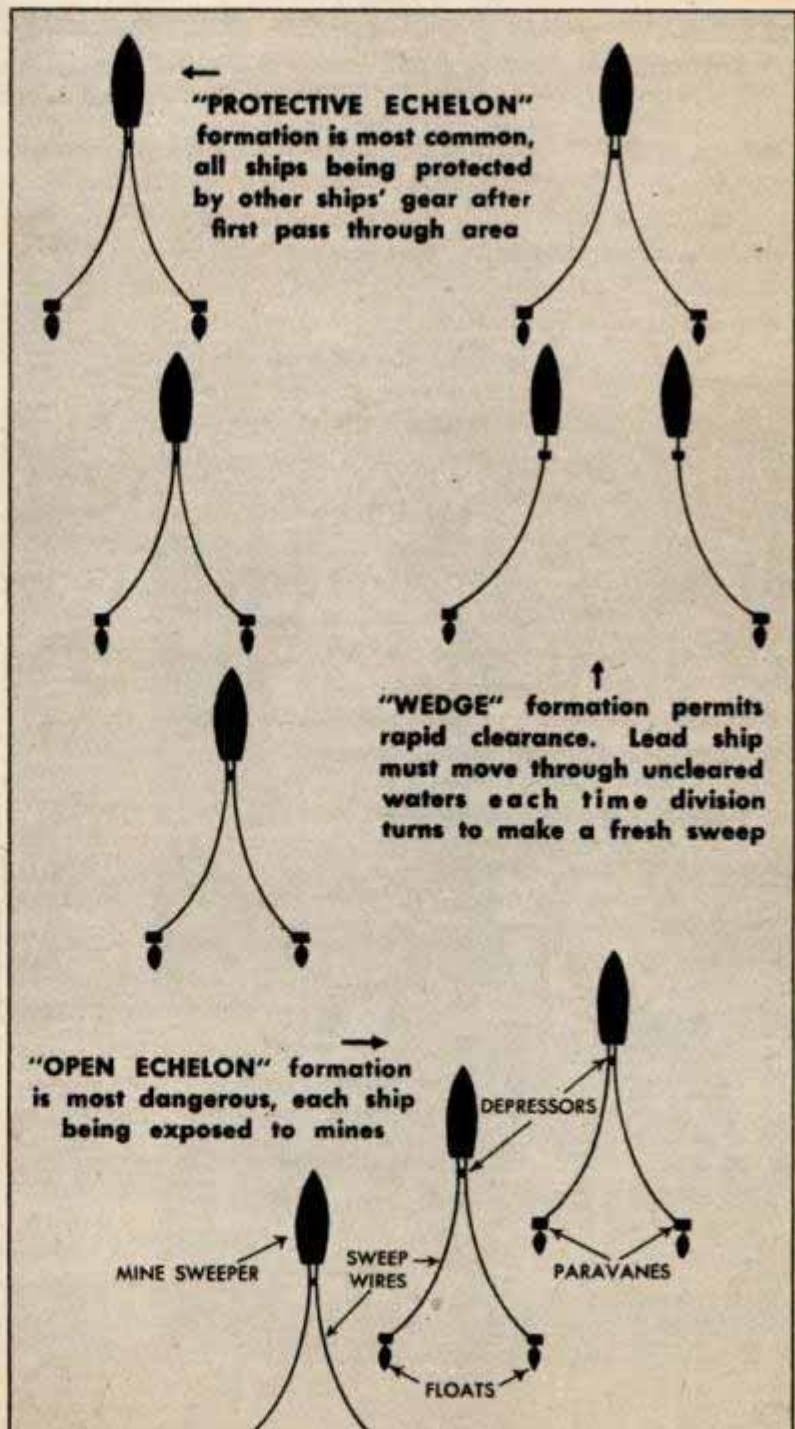



Magnetic field of flotation cables behind two British minesweepers explodes magnetic mines in 10-acre area. Below, sailors haul in heavy cable which helped explode scores of magnetic mines laid in European waters

men promptly sang the "Marseillaise" in honor of the minesweeper's crew.

Minesweepers that swept a channel off Sicily before the landings engaged in a running fight with shore batteries. At least two batteries were put out of commission, but none of the valiant minecraft was hit.

In the Pacific, minesweepers had to venture into uncharted waters, risking the hazards of reefs and coral heads as well as mines. And at night the Japs came over to

drop bombs to add a third hazard to minesweeping duty.

In spite of their dangerous role, only a score of minecraft was lost in World War II. Most of the sinkings were due to enemy mines, but there were also losses caused by bombing, collision and hurricanes.

The sinking of the YMS-39 is an example of the hazards connected with minesweeping. The little ship was cruising back and forth off Balikpapan, Borneo, when it struck a Jap mine.

"Everything went boom!" said the commanding officer. "The explosion struck amidships and cut us squarely in two. The sweeping gear activated two other mines and the triple explosion blew the ship out of the water and rolled her over. She sank in 10 seconds."

So the war is not yet over for men of the Navy's minesweepers. Sweeping sudden death from the waters of the Far East will continue until the last Jap and United States mine is removed and navigation once again becomes safe.



Baseball Grenade Sprays Tear Gas

Built like a baseball, a new grenade has been adopted by the Army's Chemical Warfare Service for use with a new type tear gas. The grenade is grasped with thumb or index finger over a projecting plug. Pulling a safety pin, the soldier throws the grenade exactly as he would a baseball. A two-second fuse explodes a small bursting charge that scatters tear gas in a fine spray.

Glove Drier Protects Welders



Welders in a Detroit automobile plant are protected from electrical shocks by a glove drier. Perspiration contains salt and the combination with water is an especially good conductor of electricity. Operating on the principle of an auto heater, the unit consists of a drier, fan and spouts over which gloves are draped. Hot air forced through the spouts provides speedy drying.

Faucet Washer Easy to Install

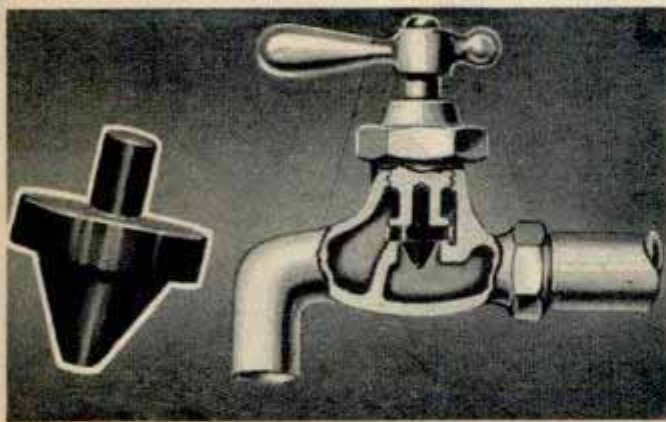

Leaky, noisy faucets can be repaired quickly with an improved washer which is fitted into place with the fingers. The washer has a permanent seat with a positive grip and rotating disk action, assuring long service and eliminating pipe vibration, according to the manufacturer. It comes in three sizes for every faucet need.

Hinged Cab for Motor Truck

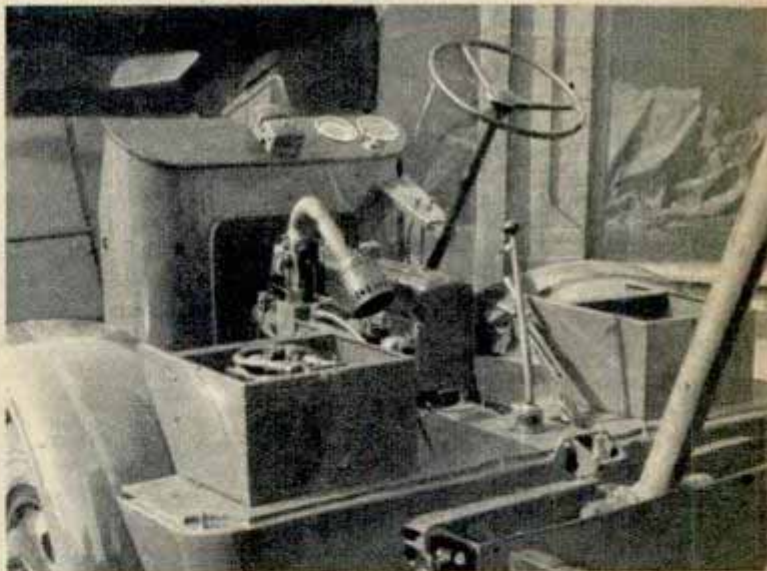
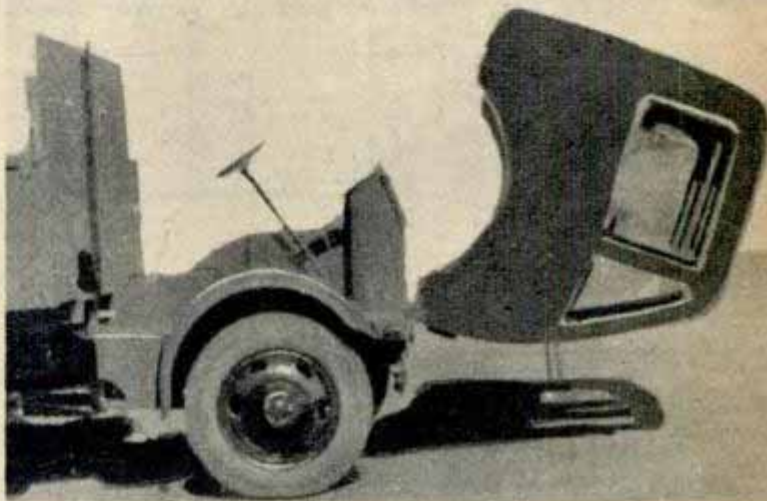
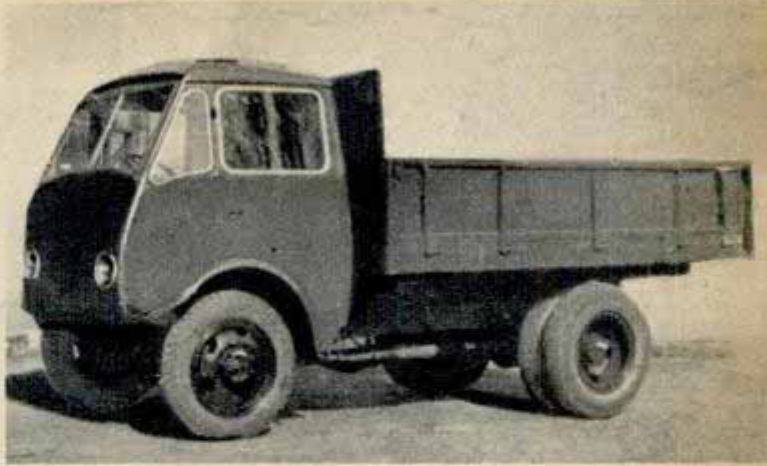

Built in two parts, a hinged cab for trucks is tipped forward to uncover the engine. The lower part consists of the floor, engine cover and fenders and the upper part is the cab proper. The parts are mounted with a hinged joint in front of the radiator. When the top is swung forward it rests on a pair of legs which in normal position are flush with the windshield. The cab, designed by G. E. Neville & Son, Mansfield, England, makes the engine easily accessible, usually a problem on space-saving trucks of the cab-over-engine type.

HOMES TO FIT

EVERY 25 minutes a home soon will be rolling off the production line in a factory at New Albany, Ind. Not a house all put together and standing up, of course, but sturdy floors, walls, ceilings and roofs—in section form—all ready to be put together by the time you can change your address.

On that shaded lot of yours, workmen can erect this home in one day. Fixtures are installed, porches added, and the place is ready to live in a week later.

This result of science and mass production is not only a well built, rugged, efficiently planned structure but a livable home with charm and distinction.

Available in eight sizes, prefabricated homes built by Gunnison Homes, Inc. (a subsidiary of United States Steel Corporation) range in price from around \$3500 to \$9000. When its new \$1,000,000 plant is completed by the middle of this year, Gunnison will increase its capacity

Gunnison prefabricated homes are available in eight sizes; these are typical plans

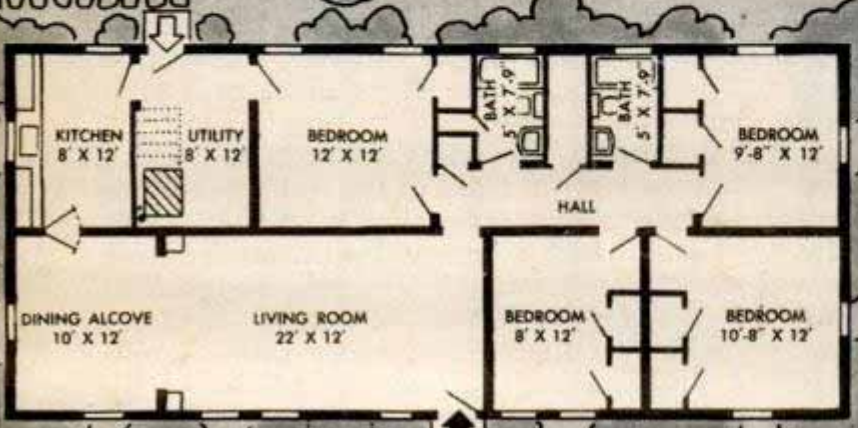
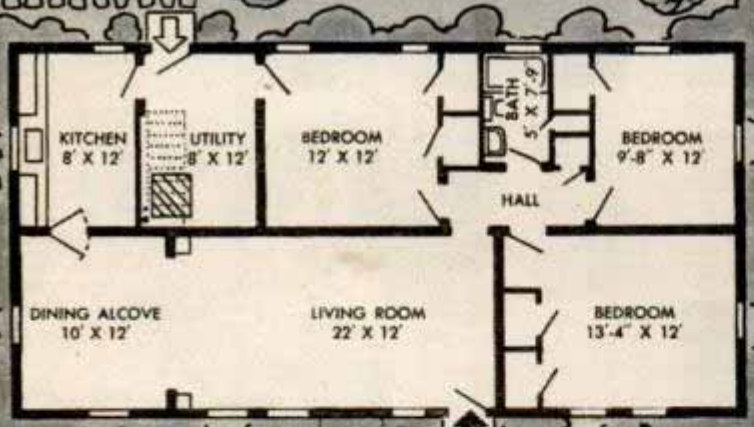
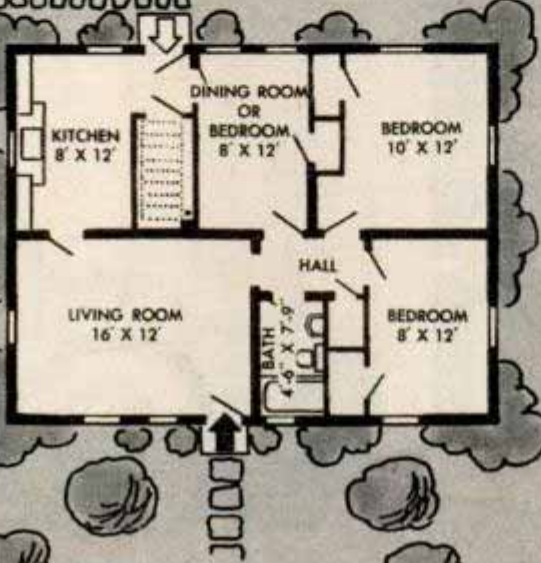
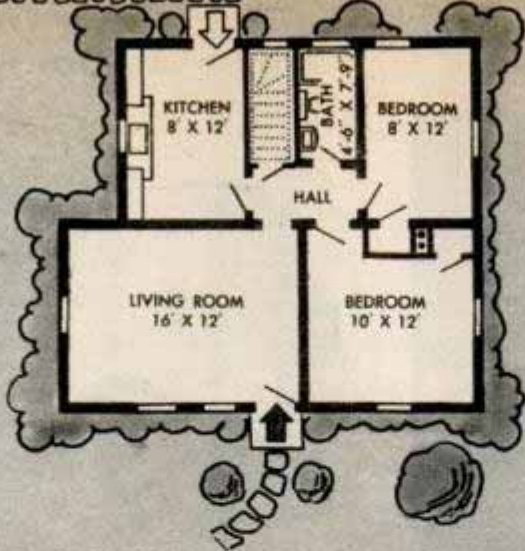

THE FAMILY

1650 houses a year, on an 8-hour production basis, or 3200 on a double-turn schedule.

The Gunnison home is assembled from interchangeable hardwood panels, built up in layers and with a sheet of thermosetting phenolic resin placed between each layer before the whole panel undergoes a chemical conversion process in hot-plate presses. The final result is a combination of wood and plastics which Gunnison engineers report is stronger for its weight than steel. It is waterproof, more resistant than metals to heat and cold, and inert to acids, corrosion and bacteria. All panels, including floors, exterior walls, ceiling and partition panels, have chemically treated rock wool bat insulation sealed within them.

Doors and windows, also assembled at the factory, reach the home site all set in special panels, with no cutting or trimming required. Two coats of white paint are applied to the exterior at the plant and a third coat is added after the house is assembled.



Screened-in porch, gay shutters and window boxes add charm to a factory-built home. Below, interior walls paneled in hardwood



Wall panels at left, with space for windows, are mass-produced at New Albany, Ind. Small home (below) sells for about \$3500

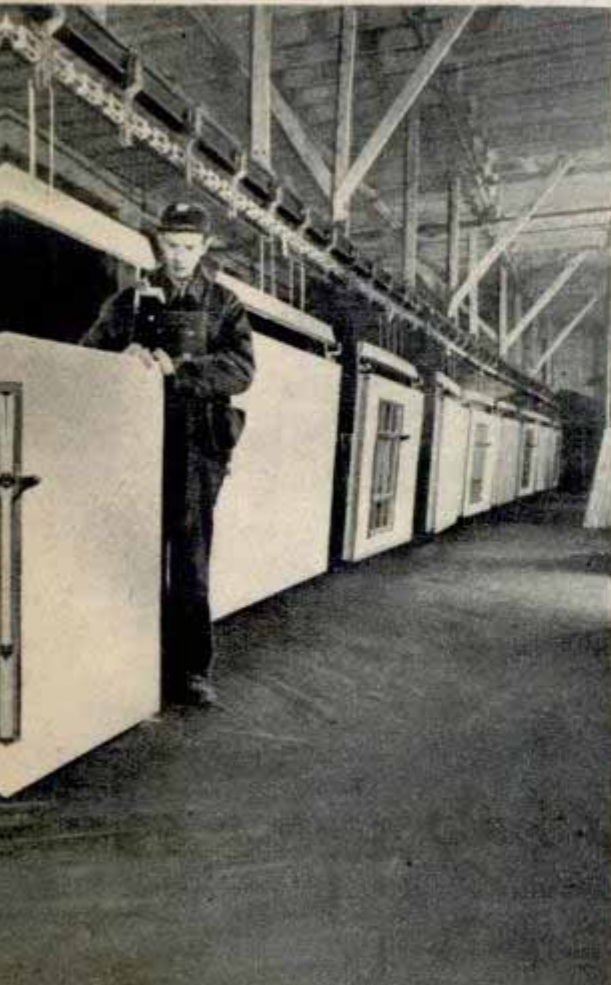



Kitchens have washable waterproof white walls which may be tinted any color. Standard equipment includes steel-trimmed wall and sink cabinets

The Gunnison house definitely is not drab-looking. It bears no resemblance to those "look-alike" dwellings so often crammed into an emergency housing project. Almost unlimited variety in appearance may be achieved in several ways.

For example, every home plan is available in either left-hand or right-hand design. That is, the same general plan can be

had with the kitchen and dining alcove at either the extreme left or right.

Then there are many standardized accessories and trimmings that can be added: porches, window boxes, wrought iron rails, shutters, arcades and garages. Roofing, window boxes and shutters come in maroon, green or blue.

Interior walls are paneled in hardwood—walnut in living rooms and dining alcoves, light mahogany in master bedrooms and gum in other bedrooms. Kitchen, bathroom and utility room walls are white and may be tinted any

color. All walls are waterproof and may be washed with soap and water, although wiping with a waxed rag is sufficient.

House plans range from 4-room dwellings 28 feet by 24 feet to 7-room structures 56 feet by 24 feet. All are for one-story houses. However, the designs are flexible enough to permit prospective home owners to have certain rooms enlarged.

Nestling among trees, a rambling Gunnison prefabricated home provides livability and low maintenance costs

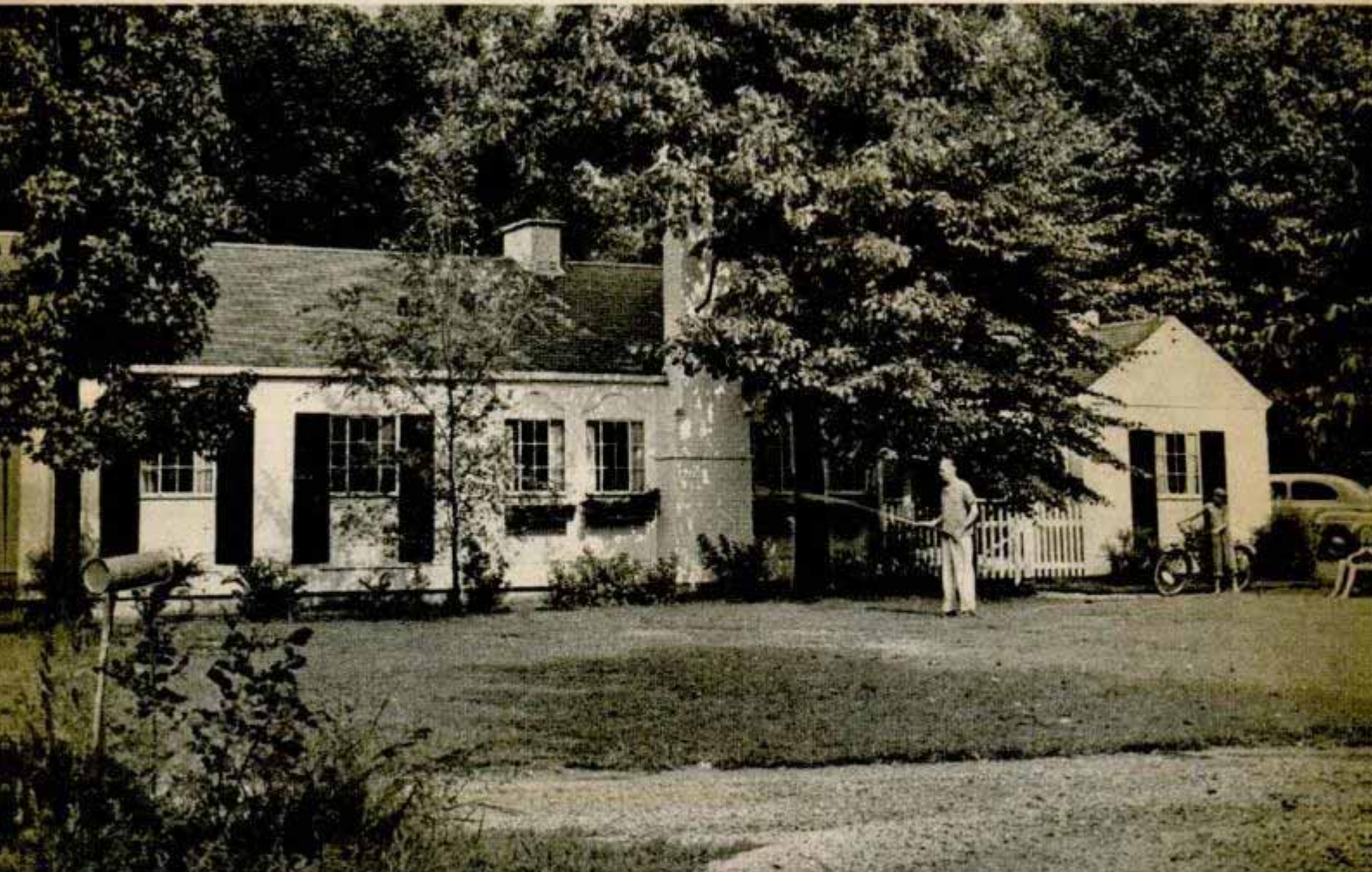

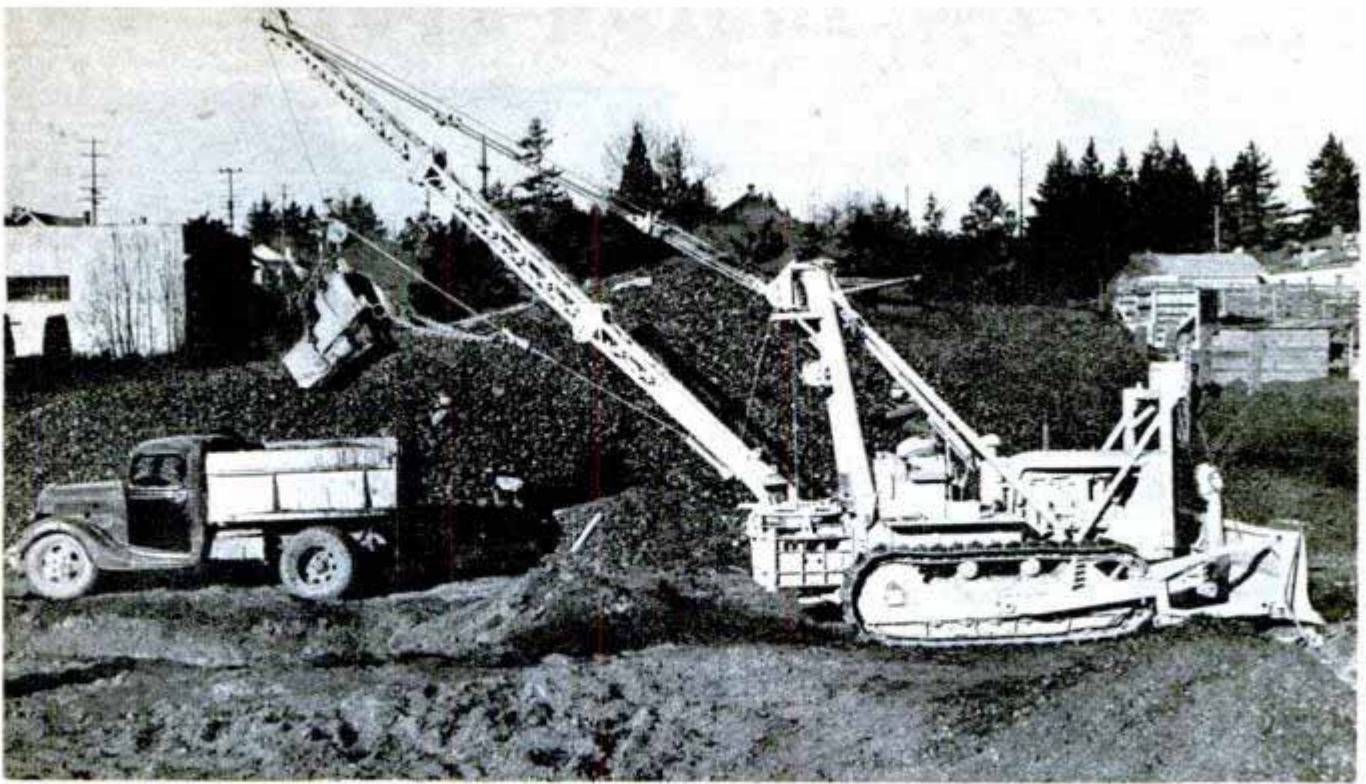

Bulldozer-Crane on Tractor

Bulldozer, dragline, clamshell and crane are combined in a unit that can be mounted on a tractor in two hours and removed in less than one. Partial use of the bulldozer

is possible without removing the dragline and crane unit. Movement of the crawler-type tractor is not impeded by the unit. The outfit can be transported by dump trucks or flat-bed trucks from one job to another and has even been carried by plane.

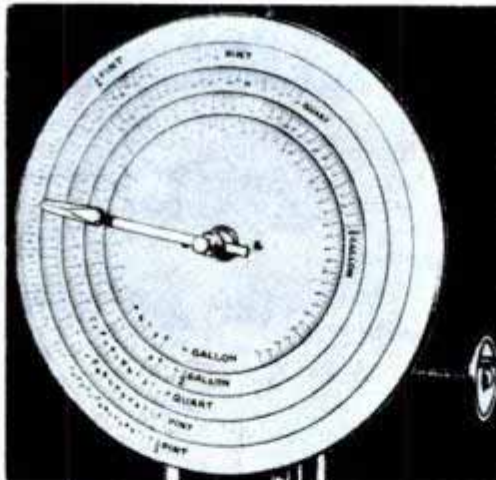

Light Beam Matches Automobile Paints

As little as four ounces of paint for any automobile job can be matched with a "color eye" now on the market. By setting a dial according to a color formula, the amounts of various paints or lacquers required to produce a certain color are indicated on the dial.

Film on Glass Peels When Dirty

Glass panels over lights in paint booths at a Douglas Aircraft plant are cleaned by a novel method. The panels are sprayed with a film which is peeled off when the light becomes obscured. Then a new coating is applied. Formerly the panels had to be cleaned with paint thinner and steel wool.

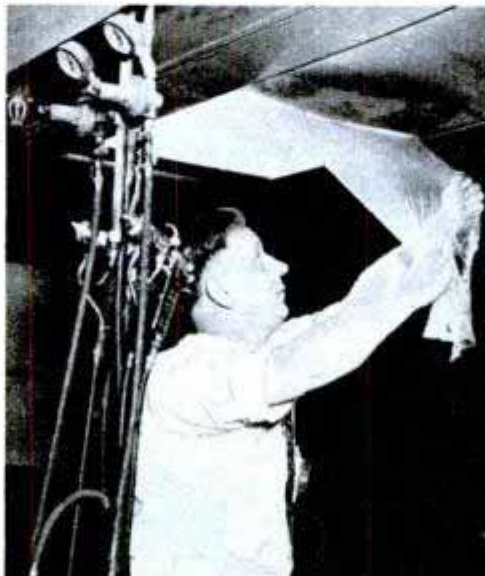

"INSIDE STUFF" FOR



This Thor electric ironer folds up to occupy only 1 $\frac{3}{4}$ square feet of storage space. The ironing mechanism is counterbalanced on a tubular steel stand. Below, Whirlpool ironer has knee control to leave hands free to direct materials, also has four-arm rack to hold ironed, folded garments



Westinghouse photo
Electric dishwasher sprays, washes and rinses dishes twice in 12 minutes, cleans and drains itself and automatically shuts off. The dishwasher fits into a work surface next to a sink and holds 28 large dishes, 12 cups, 12 saucers, 12 glasses and a basket of silverware. Below, jar opener, attached to under surface of a kitchen shelf, works on any jar



YOUR HOME

Another postwar appliance is the cordless electric iron which gets its heat from an electrically heated base. With no dangling cord, the user thus has freedom of motion. Various temperatures can be dialed

Westinghouse automatic washers are installed in self-service laundries where women pay 25 cents for 30 minutes' use. The housewife puts clothes in, adds soap, and the washer does everything except iron



Tired of getting out of your car to turn out the garage light? A new switch waits three minutes after being flipped to douse the lights

no cut

*Fashion Group 170 Ave
729 Milwaukee Ave
Chicago*

New table lamp has a 32-watt "circline" fluorescent tube and 100-watt conventional bulb to provide ample illumination. This combination is said to avoid sharp contrasts in lighting effects and at the same time provide warmth of color
Chicago Lighting Institute photo



Ash tray has safety edge to catch burning cigarettes that fall outward. The entire tray is stamped from a piece of heavy aluminum and the outer edge is wide for safety



Boston, Mass.

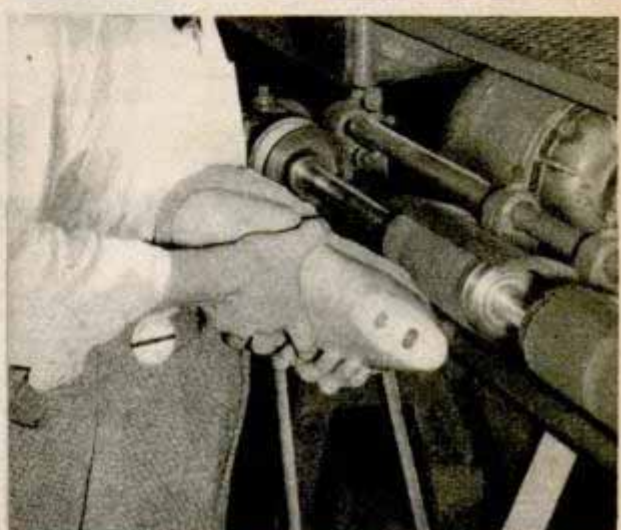
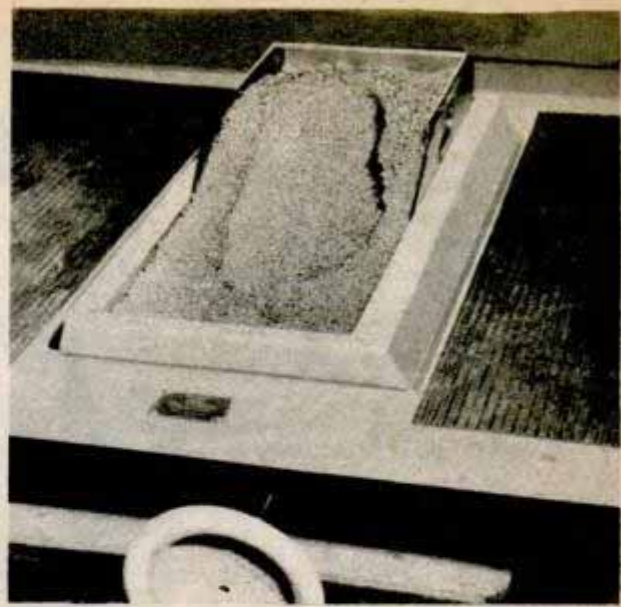

Tiny ball bearings and an electromagnet team up to aid wounded war veterans in finding corrective shoes that compensate for foot injuries or missing toes. Designed by an eastern machine maker in conjunction with the Army Quartermaster Corps, a foot measuring device employs the ball bearings—each $\frac{1}{16}$ inch in diameter—for

Magnet "Freezes" Footprint

taking foot impressions. After the soldier stands on his injured foot in the bed of steel balls, electric current is passed through the impression. This "freezes" the foot mark and provides a perfect pattern for making a plaster cast and later the orthopedic shoe. Cork parts are built into the shoe to take the place of missing members.



Ice Truck Lifts Body To Top of Rail Cars

Icing of refrigerated freight cars is made easy with a high-lift body on a truck owned by a Louisville ice company. The lift boosts the body, containing up to 36 blocks of ice weighing 300 pounds each, to the roof level of the refrigerated car. Operators slide the ice off and drop it into compartments with little difficulty. The same type of truck may be adapted to loading cargo planes.

This aerial camera was made rugged to insure steadiness when pictures are made from an open airplane by photographers of Douglas Aircraft

IT'S TIME TO OPEN THE SHUTTERS



Starvation is over for the millions of camera fans who have been standing in line for film and waiting for new cameras that didn't exist. Take a look at what's coming to the photographic counters. The signs point to fun ahead for film fans!

HOW WOULD you like to have your camera films developed at the corner drugstore in five minutes, while you wait?

Research in the diazo "dry photography" field suggests this possibility within the next few years. A diazo emulsion contains light-sensitive dyes that reproduce a photographic image after a few seconds of exposure to ammonia fumes, doing away with the wet baths and lengthy processing that are

necessary in standard photography.

The diazo process is widely used today for the rapid copying of photographs and sketches. So far its use is limited to contact prints, but research is being conducted by the Ozalid Division of General Aniline & Film Corporation in the expectation of widely increasing its versatility. The rapid processing of film that you can use in your camera, converting the exposed film into photoprints within a few min-

utes is one promising possibility.

Aside from the new cameras and improved films and papers that are coming on the market, a whole host of new developments are in the offing. Here are a few of them:

Lightweight optical plastics that can be used to create large lens elements that are now impractical because of weight and cost; a new color process by which ordinary black and white negatives produce movies or still pictures in true natural colors, and a new 16-pound portable speed lamp that you can carry under your arm. It is powered by a small rechargeable wet battery and provides plenty of

*Megard Corp
1461 S. Beverly
Los Angeles, Cal.*



Courtesy Grover Photo Products
Plastic hanger with locking grips holds film during processing. Left, X-ray base used as camera stand

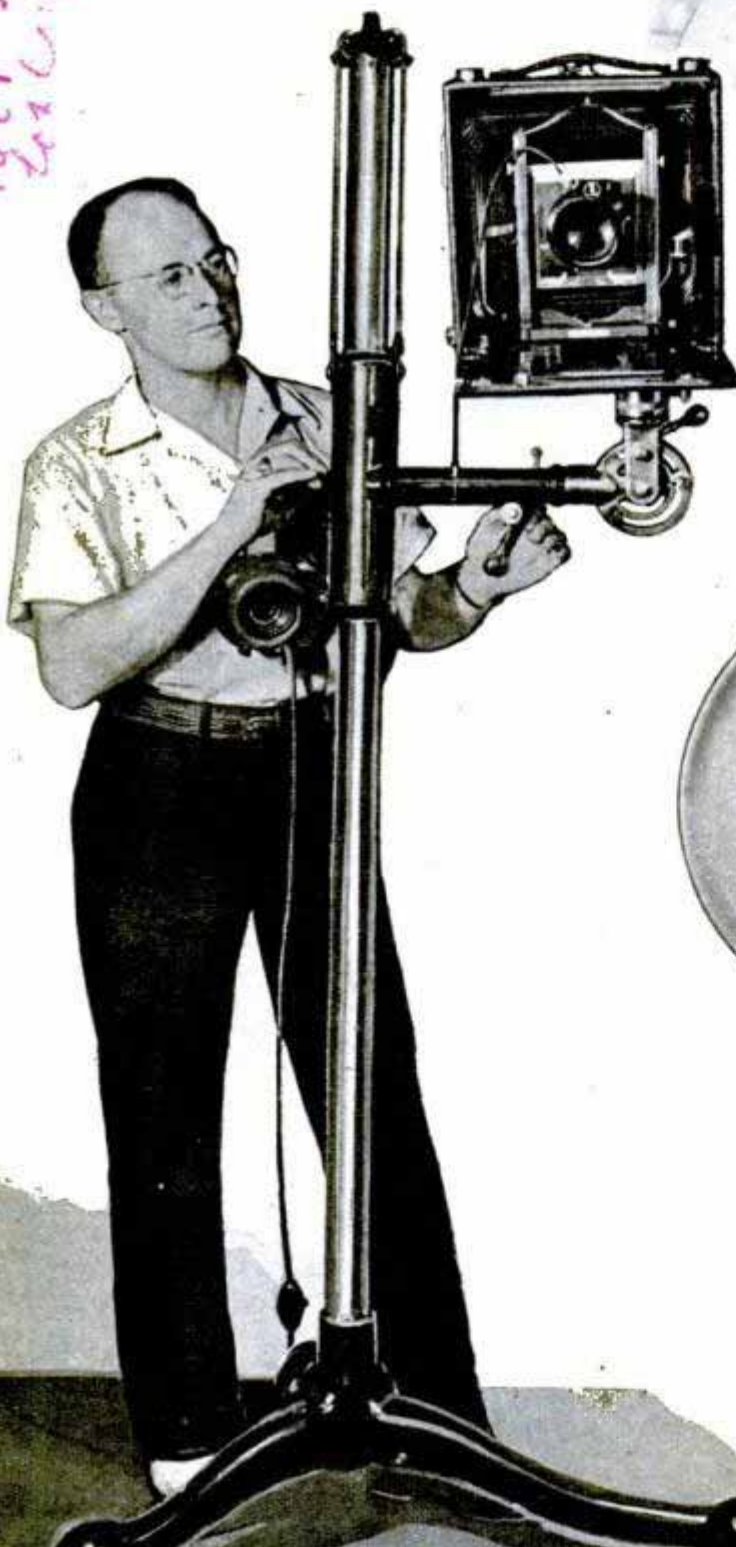

light for stopping action at even 1/10,000 second.

Also in preparation is a short-wave radio flash outfit by which commercial photographers can set off any number of flash bulbs at a distance, synchronized with the opening of the camera shutter.

A synchronized flash outfit, attached to the camera, that uses no batteries and derives its current from a small dynamo

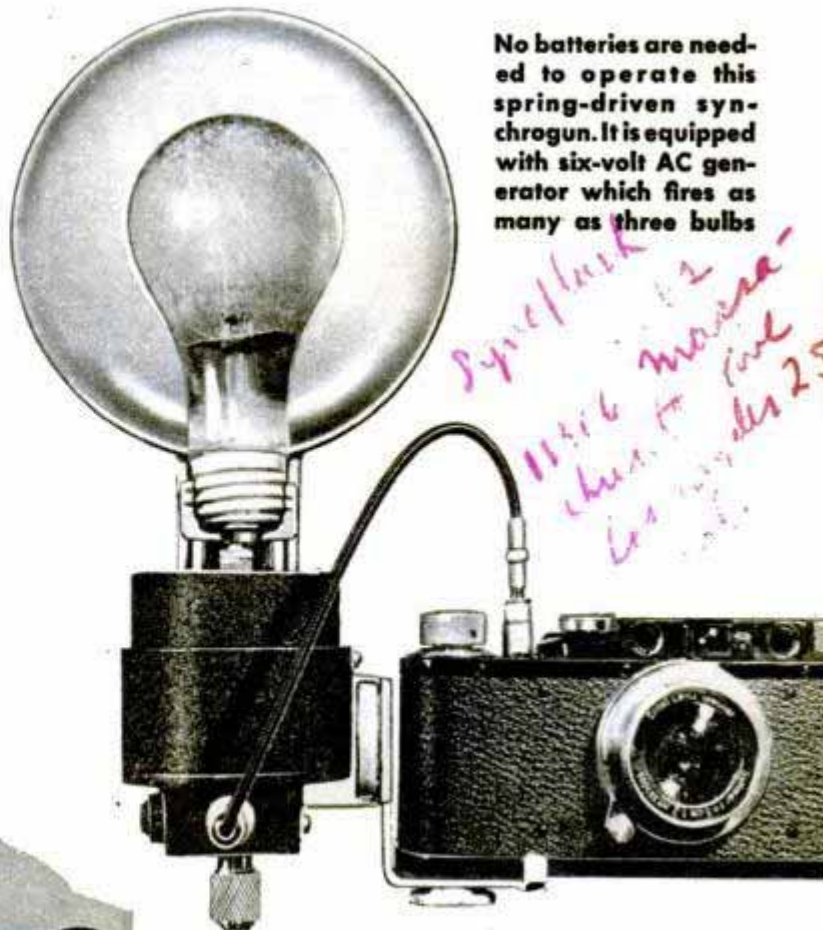

No batteries are needed to operate this spring-driven synchrogun. It is equipped with six-volt AC generator which fires as many as three bulbs

*Synchrogun
11.516 m.w. source -
check for coil
Los Angeles 2.5*

Photo Page

*Erwin Blumenfeld
542
Los Angeles, Cal.*



contained in its base is still another development. One turn of a winding knob sets up spring pressure that spins the dynamo when the shutter is tripped, flashing any standard flash bulb in synchronization with the shutter. The outfit can be adapted to any camera, cannot get out of "sync," and weighs one pound two ounces. It generates enough current for use with extension flashes.

New and improved developing tanks for color films and papers, new types of hangers in which negatives are locked so they can't fall out during development, a new optical system for enlarging that avoids hot spots, and a transformer that steps up any standard household bulb to photoflood intensity are a few other items that will be available shortly. The step-up transformer produces light that has a color temperature in the neighborhood of 3200 degrees Kelvin, making it ideal for color photography. Average life of a bulb at the stepped-up voltage is 10 hours.

Plastic photographic lenses are in use although plastics may never compete with glass for most photographic purposes. The manufacture of optical elements from these transparent resins is still somewhat restricted and the first commercial applications probably will be in providing heat-resistant condensers for photo enlargers, large-field upright-image view finders, and portrait lenses of large aperture and long focal length. At present it appears that plastic lenses enjoy little if any price saving over glass.

Movies in full natural colors from black and white film are achieved by a new optical system that eventually will be available for all movie cameras. Developed by

Ordinary light bulbs are stepped up to photoflood intensity by special transformer. Spiral tube (below) replaces flash lamp in reflector for fast shots
Megard Corp. photo



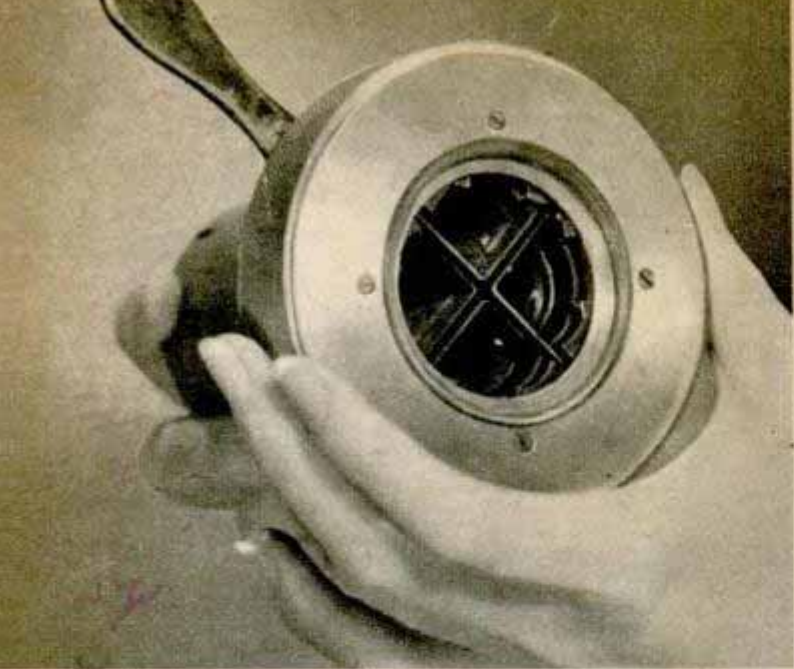

Motion picture camera (right) equipped with Thomas-color lens takes natural color pictures on black and white film. Projection lens (left) converts black and white images back into natural color when shown on a screen

Richard Thomas Enterprises, Inc., Hollywood, the system consists of a special lens assembly that is interchangeable with the ordinary lens used for black and white motion picture photography. The lens barrel is divided into quadrants, each of which has its own lens. Light that passes through one of these lenses goes to the view finder, while light that passes through each of the others travels through a special filter before being recorded as a separate frame on ordinary film. Each frame of film is thus divided into four parts, three of which record the same scene as seen through different filters.

When a print from this negative is projected through a Thomas-color projection lens the three images again pass through their respective color filters, pick up the colors that were filtered out during exposure, and are superimposed on the screen as one picture in natural color. Lens parallax is adjustable for any length of projection. Special lighting is not required, speeds of up to 1/1000 second may be used, and processing is the same as for any other black and white film. The company at present is building commercial sizes of motion picture lenses and foresees the time when news reels in color will be standard.

Similar lens arrangements will be made for still cameras: a three-lens system for still pictures that are to be printed by the wash-off relief method, and a four-lens system for negatives from which color printing plates are to be made.

Coated lenses that transmit more light to the film and reduce flare and fog, making cleaner, sharper negatives, are standard on many post-war cameras. A coated lens has a layer of fluoride or some other compound only a few millionths of an inch thick on each surface. They must be cleaned with care

*Spindler + Luppé
2201 Beverly Blvd
L. A. Cal.*

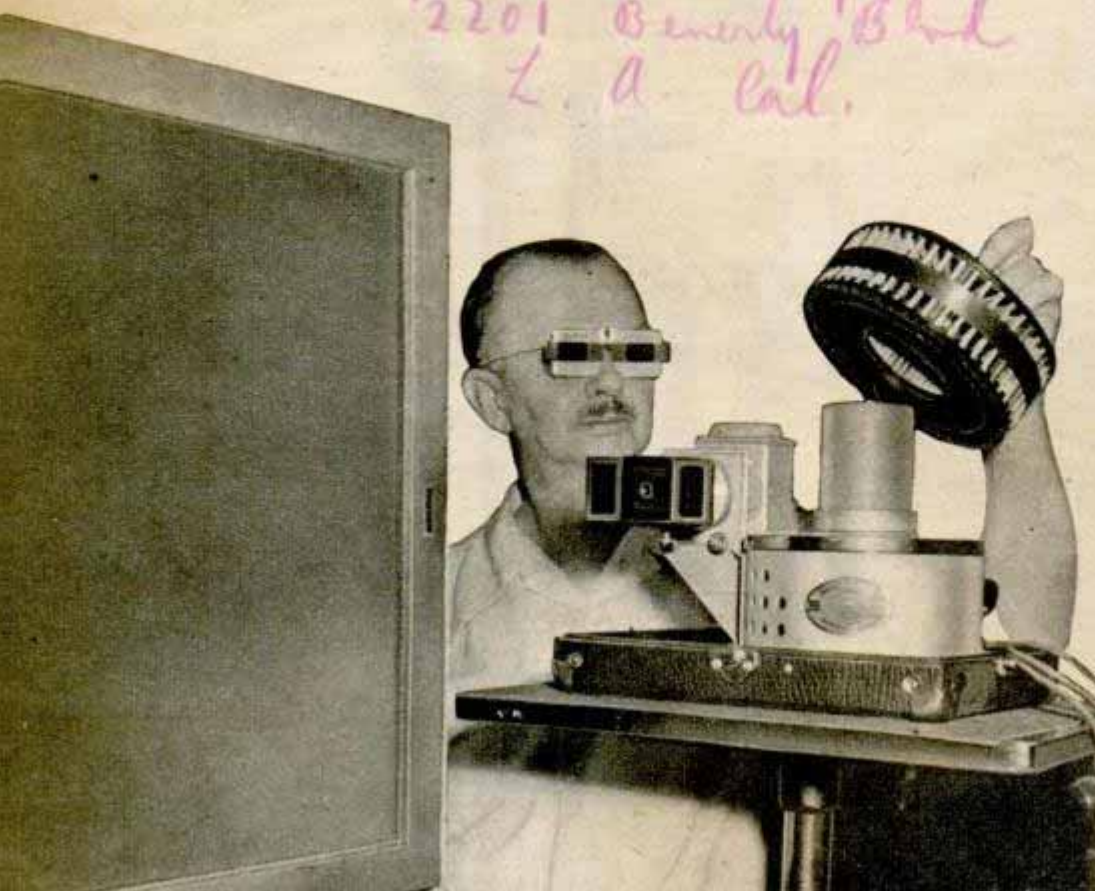

"Selectorslide" projection apparatus shows color transparencies in three dimensions. Spectators wear polaroid spectacles

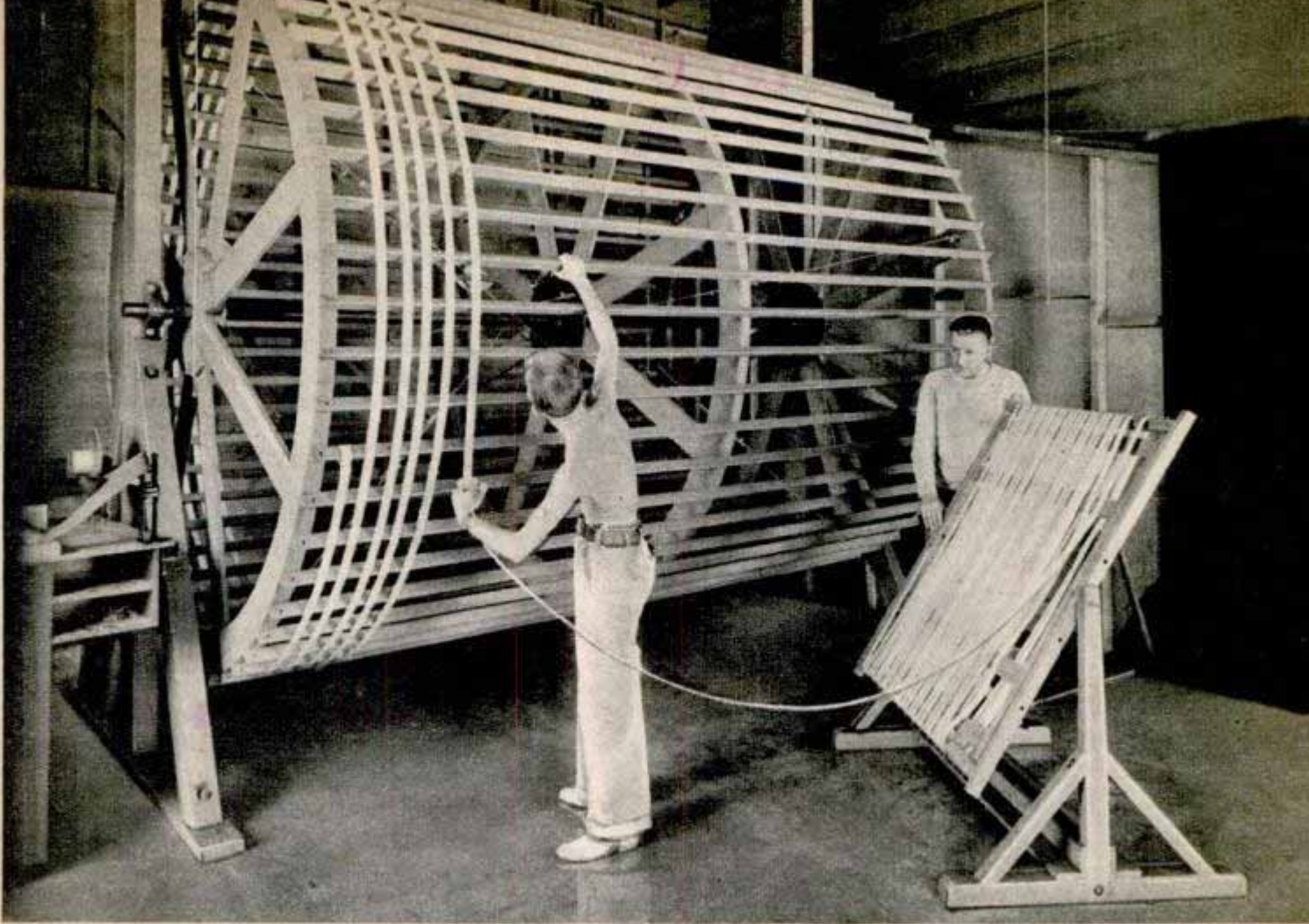

to avoid scratches. Present optical elements for cameras, enlargers and projectors can be coated at a cost of \$2.50 per surface and up.

A preview of the trend in cameras is provided by the combat model of the 4x5 Graphic used during the war. This camera has a sturdy permanent hood that protects the extended bellows. It has both front and back shutters and the shutters are interlocked to insure that the one not in use remains open. It is equipped with a built-in flash synchronizer and the batteries that operate the flash are carried inside the body of the camera. The camera is much more dustproof and weatherproof than prewar cameras.

One of the most amazing of all photographic effects is the projection of natural color transparencies in three dimensions. Stereoscopic attachments that are placed over the lens of a miniature camera are available for shooting three-dimensional pictures, which then are observed by means of a stereoscopic viewer. A new "Selectorslide" projector incorporates this feature together with polaroid filters and achieves three-dimensional effects on a translucent projection screen. The projector has a rotary magazine which holds 48 color transparencies. Close-up pictures projected from this apparatus often have the startling appearance of reaching out

Drying black and white film on which Thomas-color natural color pictures have been photographed. Below, new rotary film and paper processing tank for color shots





Motion picture camera powered by a battery-driven motor with chain and sprocket wheel. Below, photo printer places wording on the margin of photographs

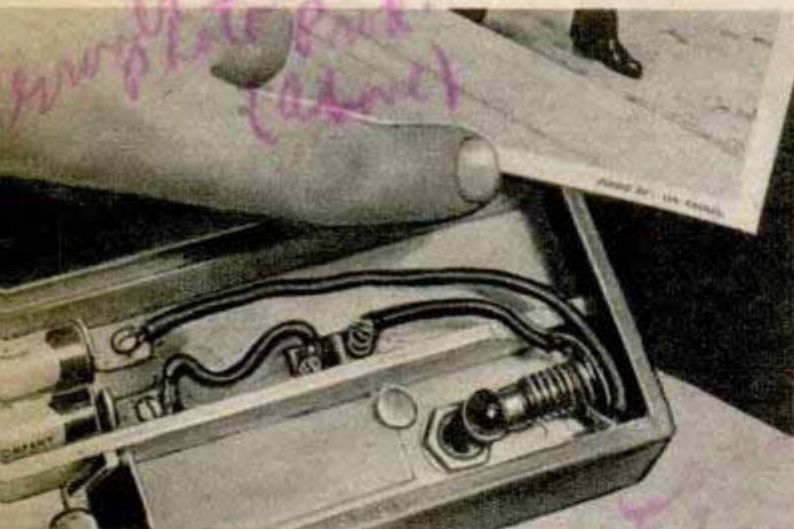

With this film splicer and flexible "tongue" it's easy to thread film on movie reel, saving time and tempers

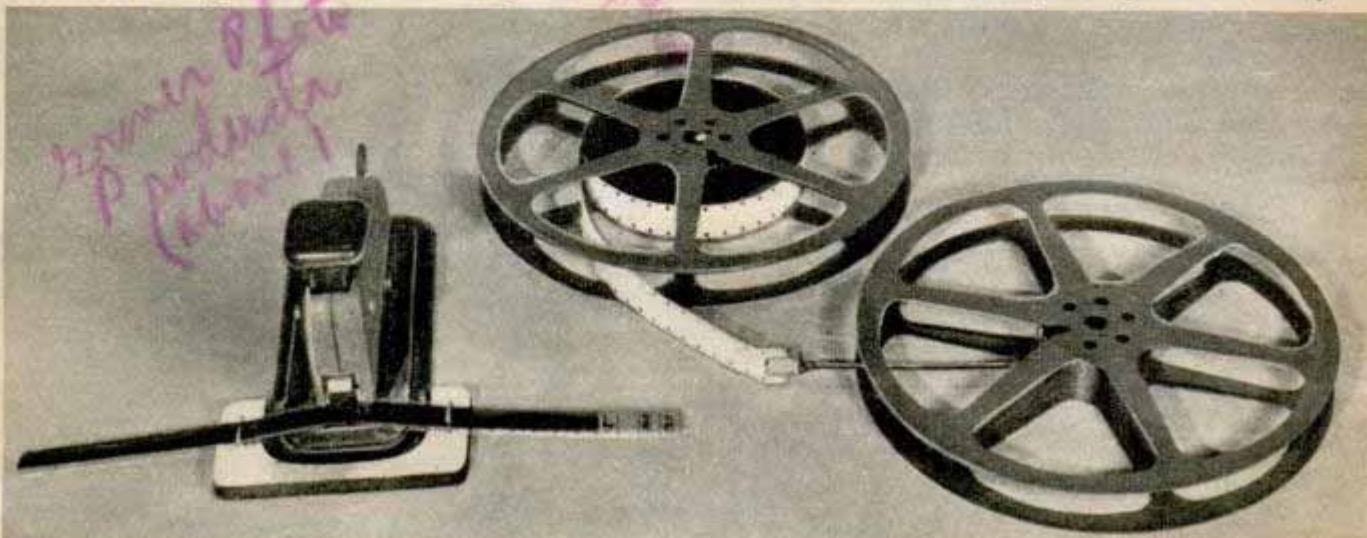

toward you. Polaroid goggles are worn in viewing the screen.

Another device which creates three-dimensional effects is an "optical balance" lens invented by Stephen E. Garutso Hollywood. It is reported to give great depth of field from 40 inches to infinity. The lens is so small that it fits into the objective barrel of any photographic camera making stills or motion pictures.

Threading movie film on a reel has always been a nuisance and this job is made easier by use of a flexible strip of metal, one end of which is attached permanently to the hub of the reel. The free end of this "tongue" projects out beyond the reel and contains a clip to which the film is easily secured. The flexible metal strip and the film itself then are wound up on the reel in the usual manner.

A film splicer for movie film works on the principle of a stapling device and "welds" the film ends together with transparent tape that is coated with a special adhesive.

For amateurs who wish to process their own home movie film a simplified five-compartment developing tank has been perfected in which from 50 to 1600 feet of 16-mm. negative film may be processed at one time. Film leader is first wound up and down over a series of power-driven rollers, then the compartmented processing tank is raised up into place, submerging the length of leader material. One end of the leader is attached to the end of the exposed reel of film. The tank is light-trapped so that lights may be turned on in the room after the processing has started. The leader and film travel progressively through a developing solution, a short stop, hypo and two wash tanks, after which the film moves through a drying compartment and is finally wound up on a reel, completely processed. The machine is driven by a 1/20-horsepower motor, the speed of which can be adjusted to the particular developing solution used.

(Continued to page 154)



Hobbyist Makes Tiny Horses of Balsa Wood and Calfskin

With the lightweight balsa wood from which boys make model airplanes, an Oregon hobbyist carves miniature horses. The wood is covered with plastic wood to get the proper curves and smoothness. When the form has hardened it is covered with calfskin for a surprisingly realistic effect. Mane and tail are added to conform with the coloring and breed of horse. Two favorite subjects are a mare and her young colt. Saddles, bridles, packs and blankets all are handmade. The horses are made by Fannie Branson of Agate Beach, Oregon, who has spent most of her life on a ranch. She took up the hobby several years ago after being crippled by a fall from a horse.

After applying plastic wood and calfskin to a balsa frame, Mrs. Branson adds saddle and other accoutrements. At right, she looks over part of her "herd"



Three Guns Behind Plane Propeller Fired by Electric Synchronizer

Firing of three .50-caliber aircraft machine guns through a three-bladed propeller rotating at 800-1500 r.p.m. is provided by an electric gun synchronizer developed by the Fairchild Camera & Instrument Corporation. The system consists of a timer

unit, control box and three motors, one for each gun. The control box transmits firing impulses to the motors. The trigger-motor armature, weighing only 2¼ ounces, exerts a 55-pound punch and takes a 110-pound recoil 72 times a second.

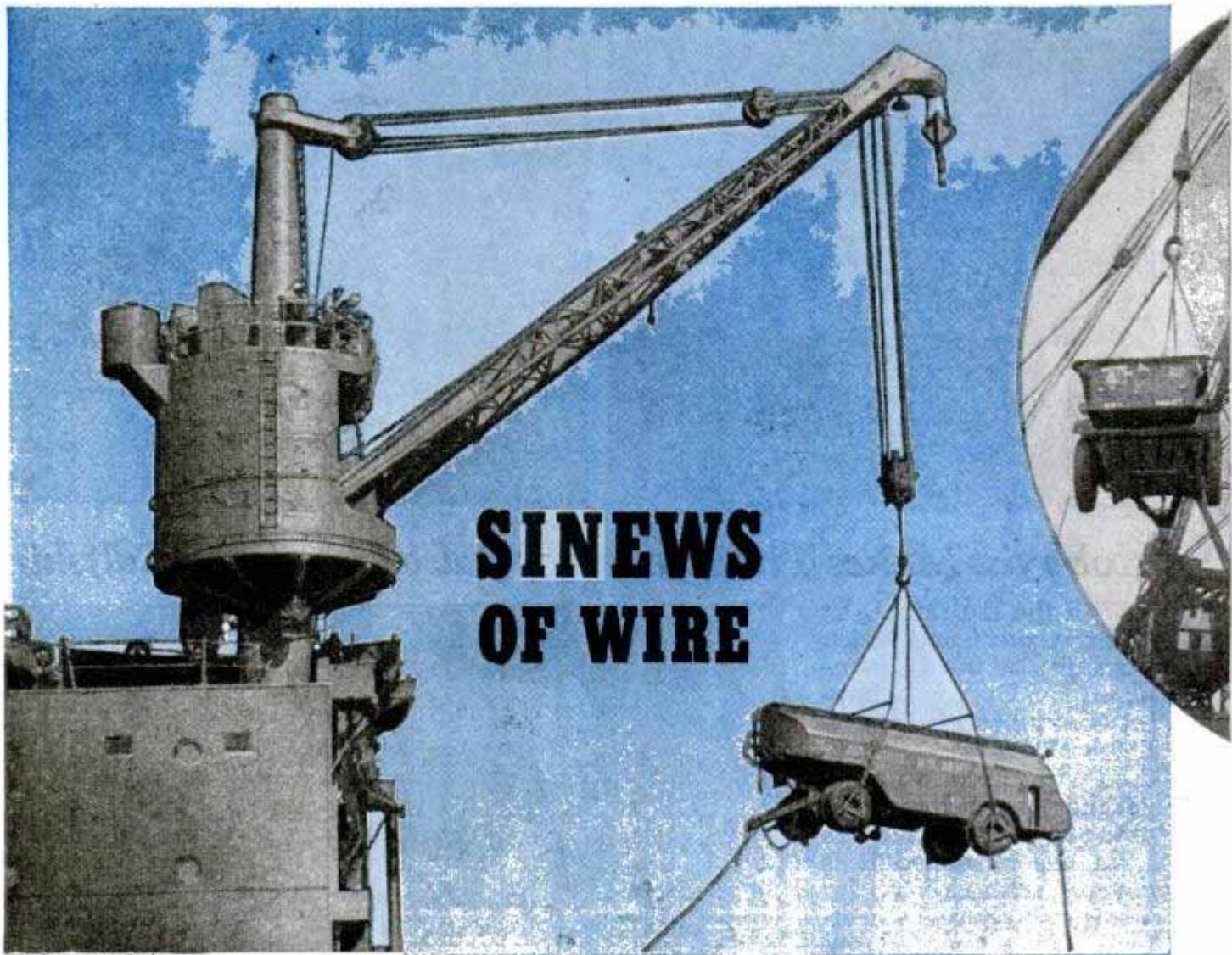

SINEWS OF WIRE

U. S. Navy photo

Derrick equipped with strong steel cable lowers a tank trailer to the deck of the USS Curtiss at Pearl Harbor

FOR two hours guns on naval ships poured shells into space at unseen targets, and as the night mist broke into cold rain anxious men on these ships looked at their wrist watches.

H-hour! Landing barges dropped down at ends of thin steel threads and pulled away from the ships. They hit the beach and the ramps dropped down. Tanks, trucks and jeeps with motors roaring streamed out. The beach was not all sand—some of it was soft and muddy. Coming off the ramp a jeep sank sideways and both front and rear wheels on one side quickly disappeared into the soft ooze. The driver and two helmeted figures abandoned the vehicle, and struck out for more solid ground. Behind the jeep, two more jeeps with trailers were helpless—and useless—since the way was blocked.

But the beachmasters—the special engineer ship-to-shore troops—were ready for just such delays. A bulldozer tractor was backed up close to the edge of the muddy spot, a hook at the end of a wire cable was extended and fastened to the bumper of the jeep. The tractor treads dug into the

By Staff Sgt. John L. Kent

sand and the jeep dragged a furrow in the muddy sand as it was pulled out. This thin, many-ply steel strand saved the day for the three jeeps and their crews.

If a friend of yours who works in a wire rope factory came to you and said: "Bill, the reason we won the war is because of wire rope," you would think him prejudiced and attaching undue importance to his job. Yet here's what he could tell you that wire rope did in the war:

Every Allied ship was loaded by derricks, ship cranes and hoists, all using wire rope. The "on-deck" cargo on the thousands of ships used during the invasion of every Pacific island was lashed to the deck hold-down rings with wire rope. On D-day, wire rope tethered the myriads of barrage balloons which swayed above the ships anchored off the Normandy coastline and prevented dive bombers from scoring direct hits. Boxes of ammunition and supplies, trucks and tanks and the hundreds of small landing craft were lifted from the decks and holds of the invasion flotilla with wire rope hoists. The ammunition used by the guns of the naval vessels during the

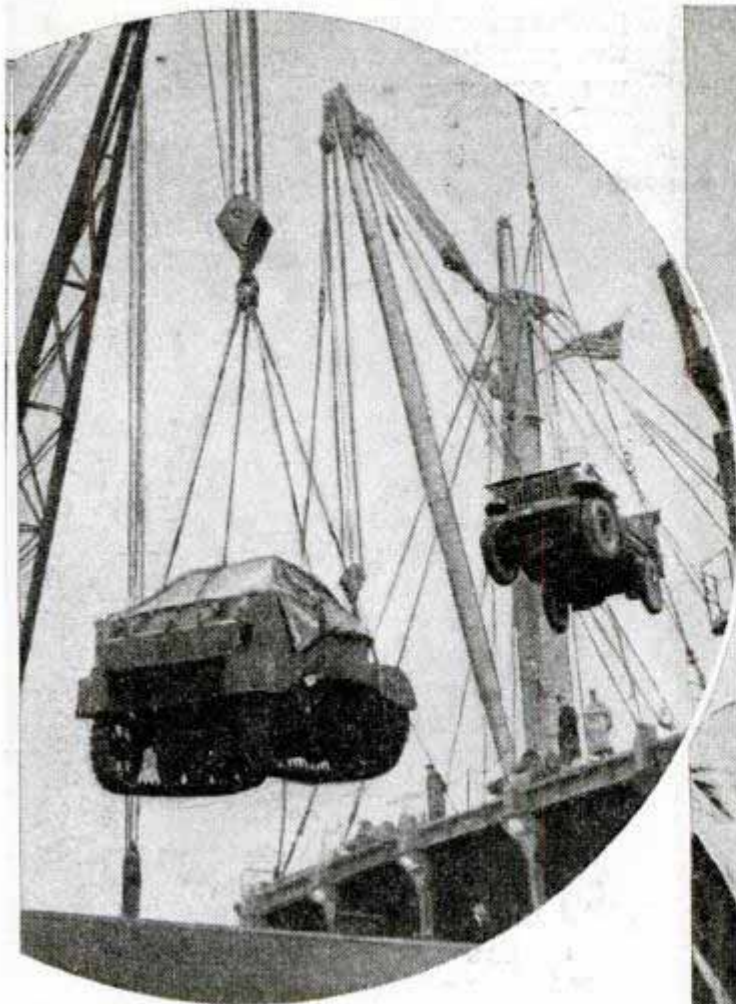

↑ Supported by steel cable lowered from a derrick, a tank and a jeep are loaded aboard a ship bound for overseas

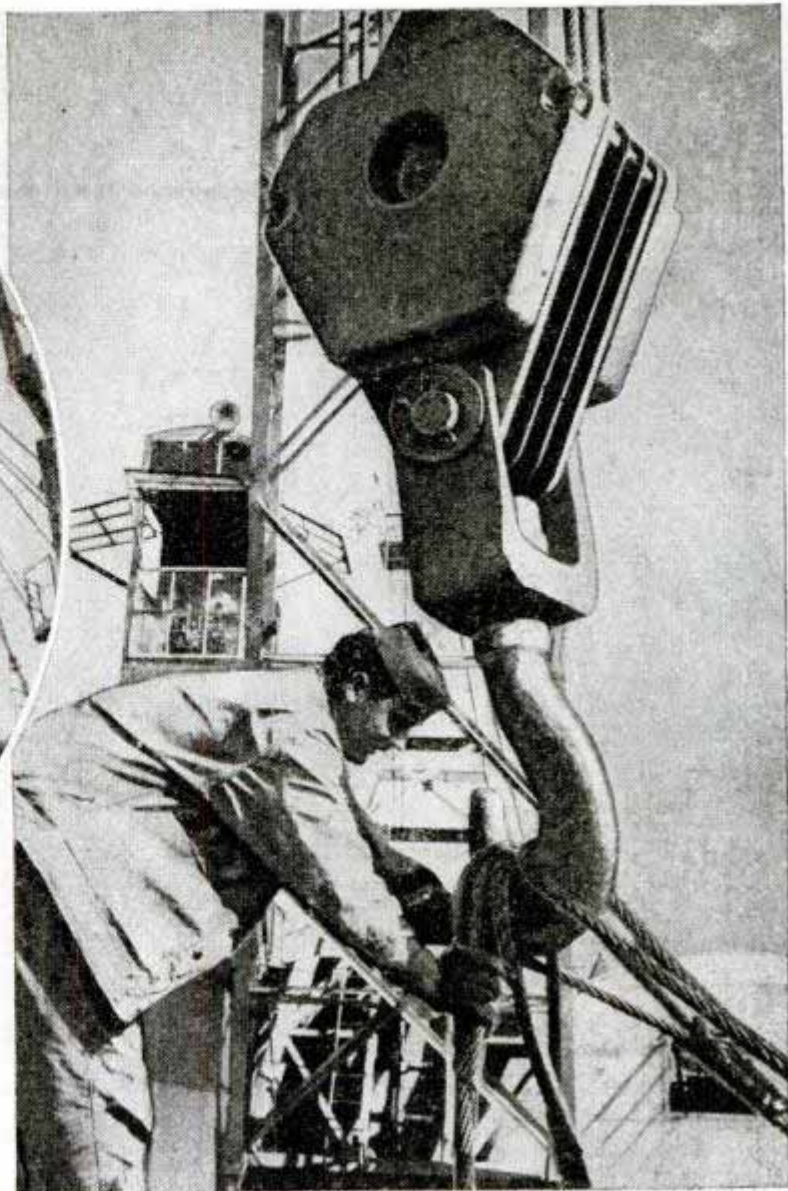

↑ A soldier makes sure that wire rope wrapped around a load of war equipment is fastened securely to a big traveling block

A crane swings a steel span into place as 1st Army engineers make short work of bridging the Vire River in France
Signal Corps photo

↓

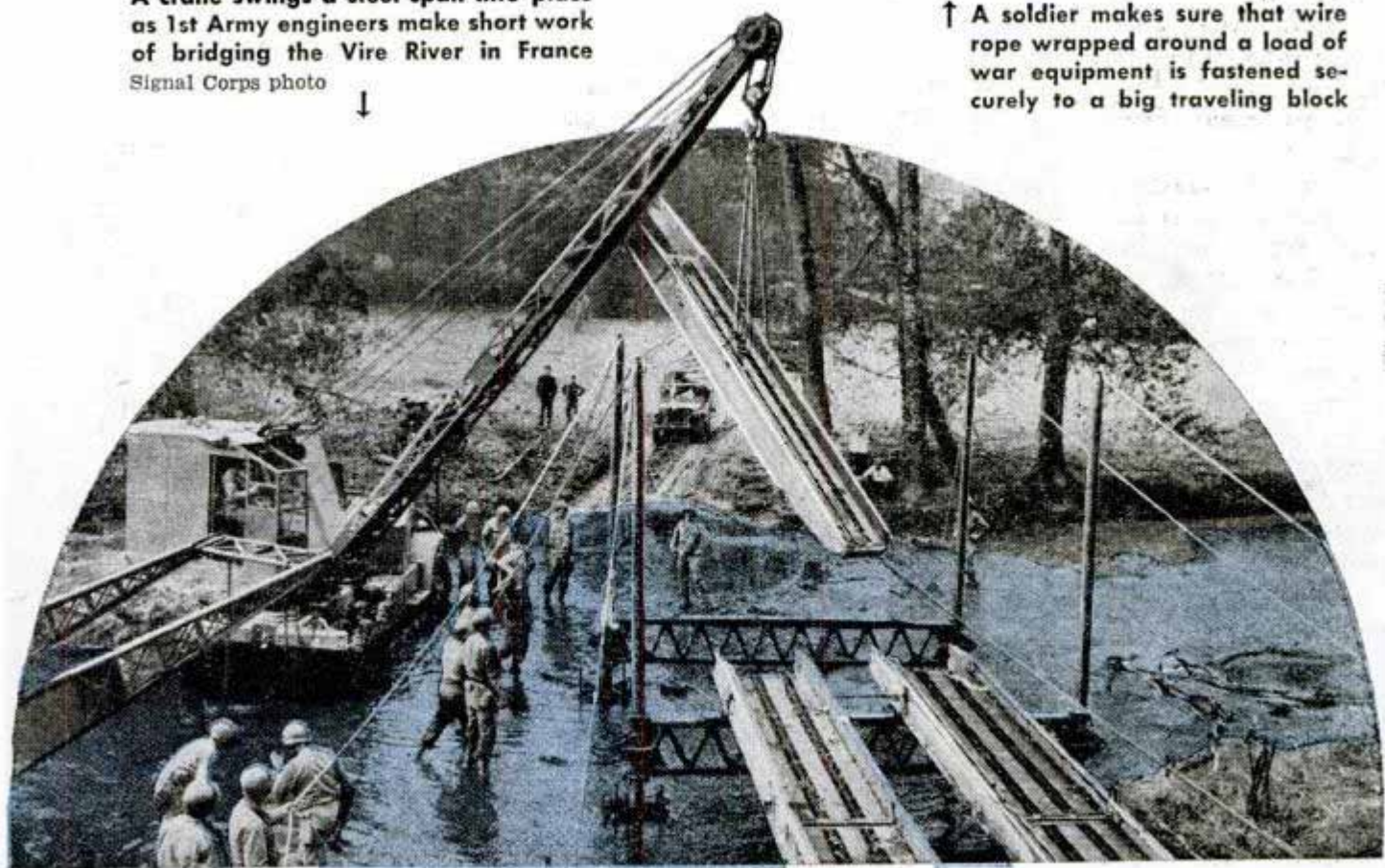

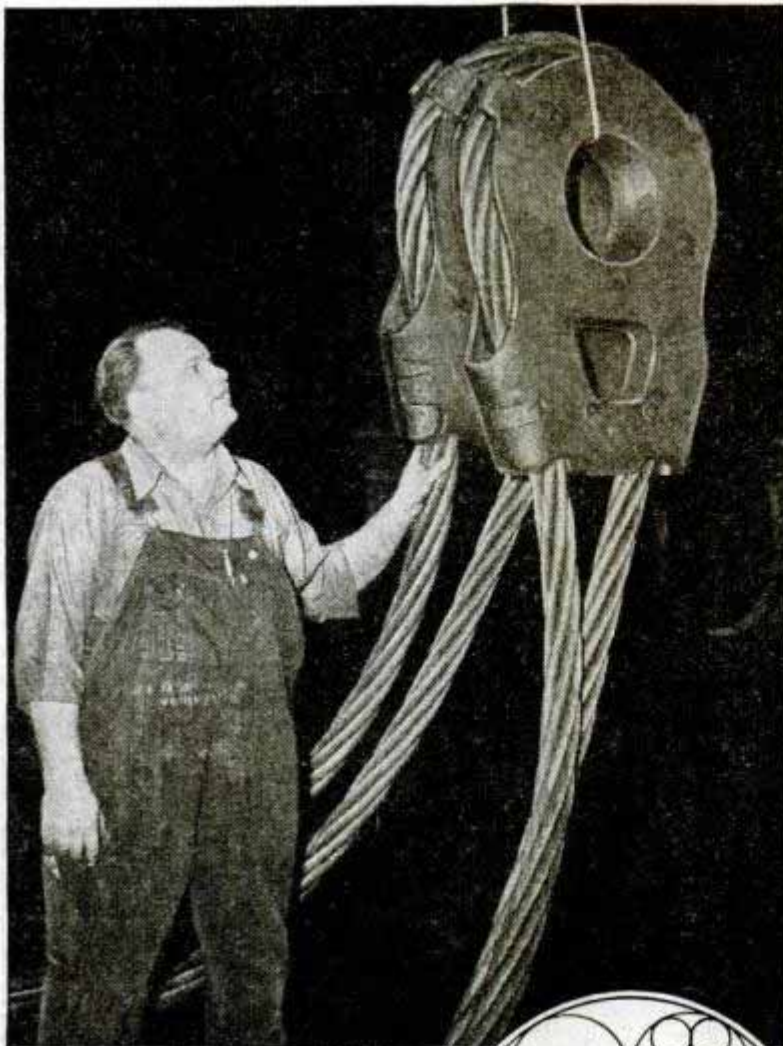

Courtesy
John A. Roebling's Sons Co.
Wire rope sling to handle
big Navy guns. Right,
cross section of hemp
center wire rope. Below,
fouled sub net of wire
is hoisted for cleaning

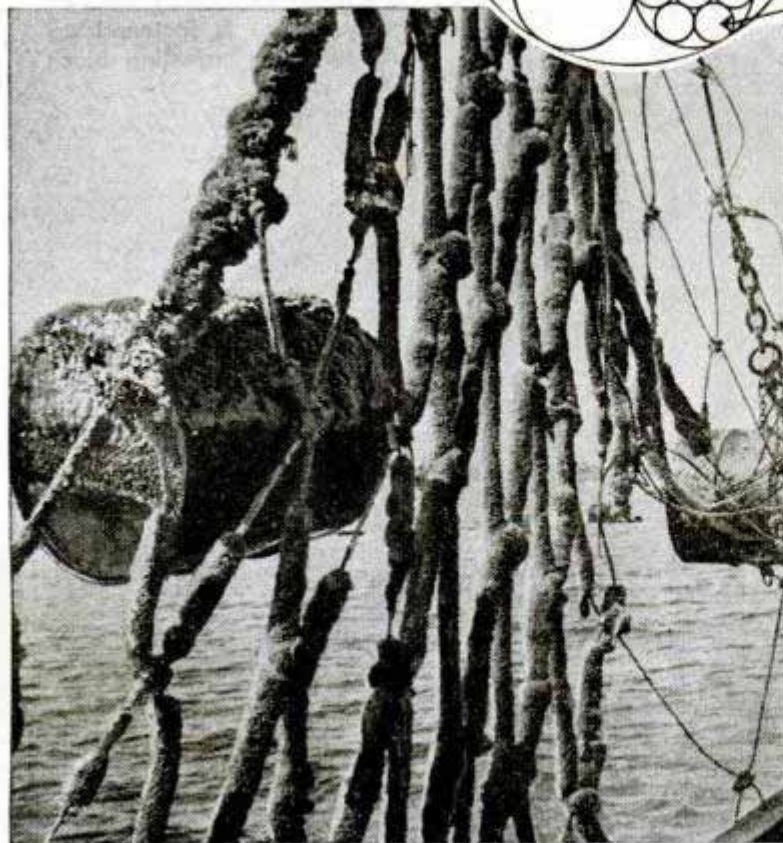
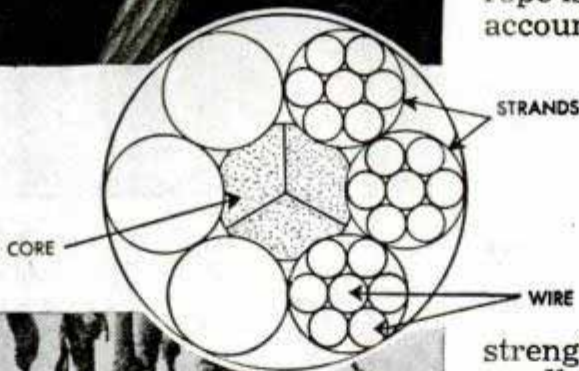

preinvasion barrage was hoisted to the gun turrets by wire rope or wire drawn elevators.

The ship's rigging, the masts holding the booms of the derricks, and winches of all kinds use steel cable—over two miles of it for a typical cargo ship. A combat cargo ship loaded for invasion takes almost $6\frac{1}{2}$ miles of steel wire of all sizes from $\frac{1}{4}$ inch to $2\frac{1}{2}$ inches. There are over a hundred different uses of wire rope directly involved in operation of ships, military vehicles, machines and devices. At sea, all naval ships use wire rope, from the speedy PT boat whose controls are cable-operated to the giant aircraft carrier whose arrestor ropes stop planes on the flight deck. Military aviation depends on wire rope, for every plane, be it fighter, bomber or cargo, has cable-operated controls. The Air Forces use wire rope in torpedo lifts and bomb hoists, bomb release controls, remote controls for guns and sea-plane hoists.

Experience has shown that wire rope is extremely adaptable, which accounts for its wide use. It is more

than three times as strong as the best manila rope of the same diameter and, of course, more wear resistant. In a strength lifting comparison, a $\frac{3}{4}$ -inch wire rope is equal to a 1-inch chain or a 3-inch manila rope. Wire rope gets its

strength from the combination of small wires of which it is made. Steel cable is built up. A certain number of wires are twisted together to form strands. These strands in turn are twisted together around a common center—the core, which is usually manila rope or hemp, or sometimes a single steel wire. These strands form the completed wire rope. If a flexible wire rope is required, such as one that moves over many small pulleys, the center is made of hemp, as this is more flexible than steel wire, and there also will be a great number of thin wires in each of the strands. The strands also will be more numerous. While flexibility of wire rope is a good thing, making the wire smaller to get this flexibility makes it wear down sooner as there is greater area in contact with pulleys and cable drums. A compromise usually is decided on.

The 6 x 19 and 6 x 7 are two common wire rope constructions. The 6 x 19 is used on cranes and derricks and construction equipment such as power shovels and draglines. Its designation identifies it as having six strands of 19 wires each. The 6 x 7 also has six strands, but each strand has only seven wires, which makes this wire less flexible. However, it lasts longer as there is less contact area for abrasion over wheels and pulleys. The 6 x 7 is used on long cableways and hoists where there are no small pulleys.

Because wire rope must be cut and various hooks and attachment devices fitted, research has developed a "preformed" wire rope which makes simple the time consuming and often dangerous task of cutting and binding wire cable. Ordinary wire rope has to be "seized" at the end when cut from the reel, as it tends to spread, the wires being more or less springlike and under constant tension to break away from the center core. In preformed wire rope, the internal stress has been eliminated and the rope is "at rest." Preforming makes the individual wires and strands lie down to fit the rope. When individual wires are pulled away from a preformed cable, they hold the wavy shape into which they have been preset during manufacture. Field experience has proved that one of the greatest advantages of preformed wire, next to being easy to cut, is the increased bending-life property of the cable. The results of preforming are amazing. A gravel plant using 500 feet of 7 x 19, 1 1/4-inch diameter preformed wire rope on its carrier line excavated over 50,000 cubic yards of

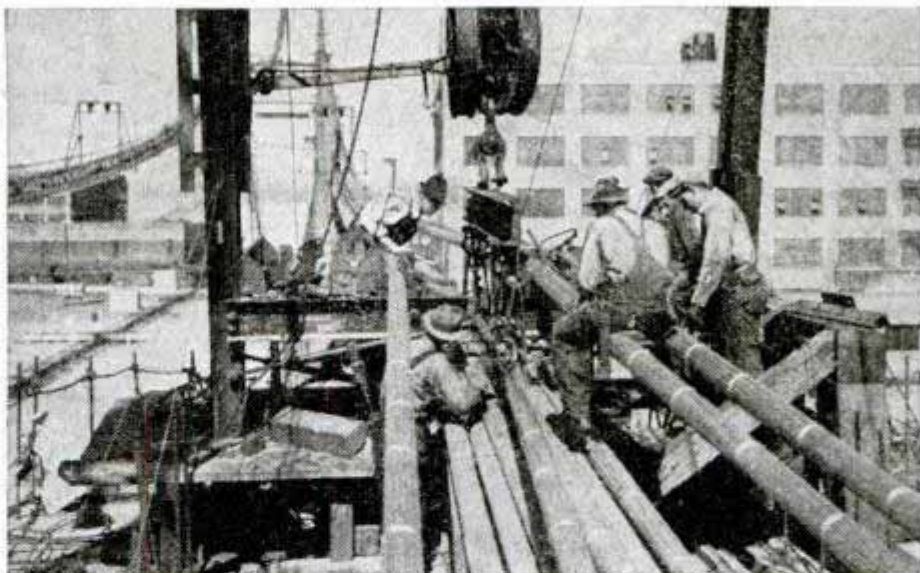

Workmen set a strand in position in main cable while building San Francisco-Oakland Bay bridge. Below, the completed bridge viewed from the center line. The main cables of the bridge are 29 inches in diameter



Below, using wire rope cables as guides, soldiers float jeep across Mogaung River on their way to Kamaing, Burma, to join other Allied forces
Signal Corps photo

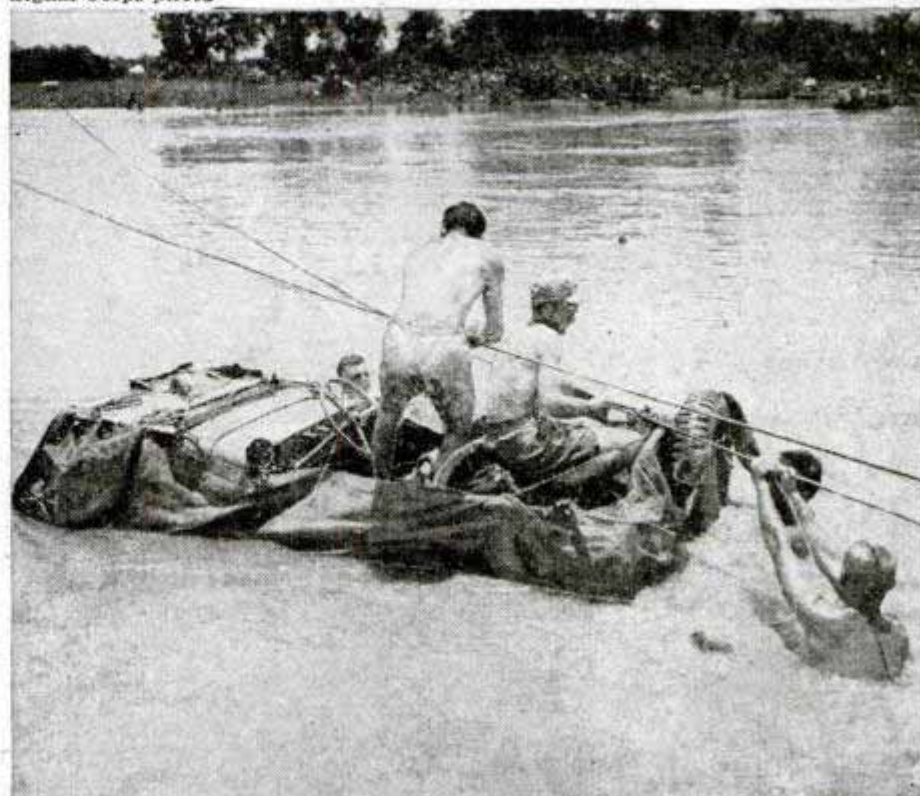

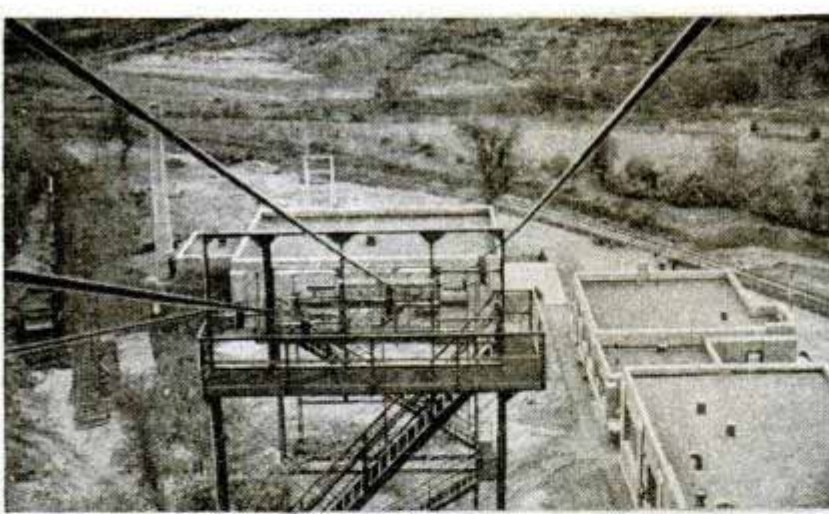

Inland Steel Co. photo

Up these sturdy cables ride "skips" filled with ore on its way to be dumped into railroad cars or trucks

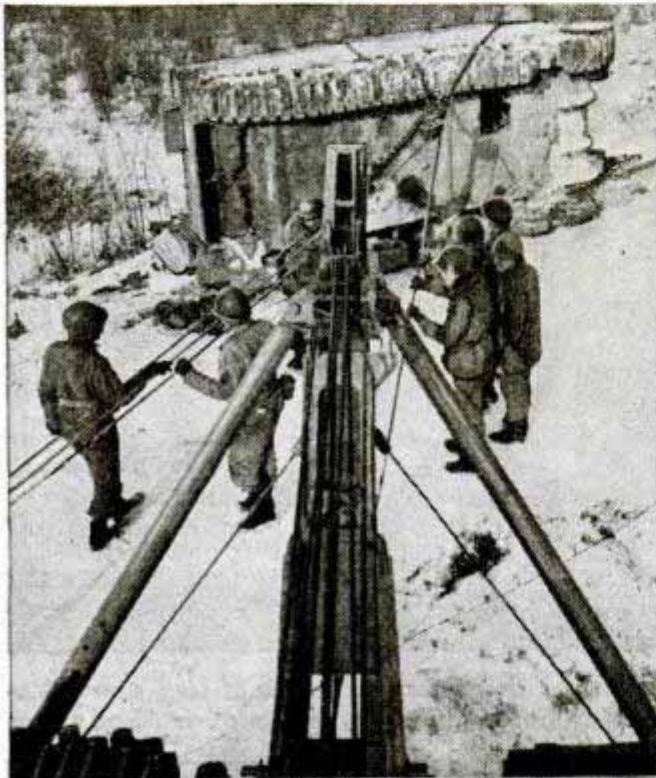

Ordnance men equipped with derrick and wire rope go to rescue of medium tank disabled by land mine. Below, steel cables lower boom to unload crushed rock

Wickwire Spencer Steel Co. photo



gravel, while with ordinary wire rope the output was only seven to eight thousand cubic yards before the cable had to be replaced.

Because wire rope does not part instantly, like a chain, for instance, but gives warning of failure far enough in advance, it is ideal for hoisting wires and sling cables.

Wire rope, like a machine, is a built-up device and requires attention. Also, it must be oiled. Oiling wire rope prolongs wear and prevents rusting. Periodic

examination usually reveals when a wire rope no longer is safe. Sometimes, however, ropes fail without any apparent cause. Some months ago 16 miners were killed in Canada because a wire cable failed. The cable broke near the hoist drum while the cage carrying the miners was at the 1000-foot level of a 2500-foot shaft. Undetected internal corrosion of rope strands caused the rope failure. The external portion of the rope was well lubricated and did not indicate that internal corrosion existed. When the rope was tested at the Wire Rope Laboratory of the Ontario Bureau of Mines, it revealed a 61 percent reduction in ultimate strength at the point of failure.

Many new uses constantly are being found for wire rope. It now is being used instead of cord or fabric in making of transmission belts. The steel cables are encased in an envelope of non-load-carrying fabric and molded in the rubber of the belt. The cables consist of a specially twisted, finely stranded, high tensile wire. Half the cables in a belt are twisted to the left and half to the right to insure a neutralized, true-running belt. The belts are described as being virtually unbreakable, because the

cables are imbedded in rubber and encased in a fabric envelope and for that reason receive no external, strength reducing wear.

Almost every industry in the U. S. will benefit, either directly or indirectly, from war-tested improvements which have resulted in stronger, safer and more versatile wire rope. There are no more H-hours with landing barges to be lowered over the sides of ships; but the greatest peacetime cargoes in history are awaiting safe transport; the longest and strongest bridges are yet to be built, and the largest air liner with cable-operated controls has yet to span an ocean.

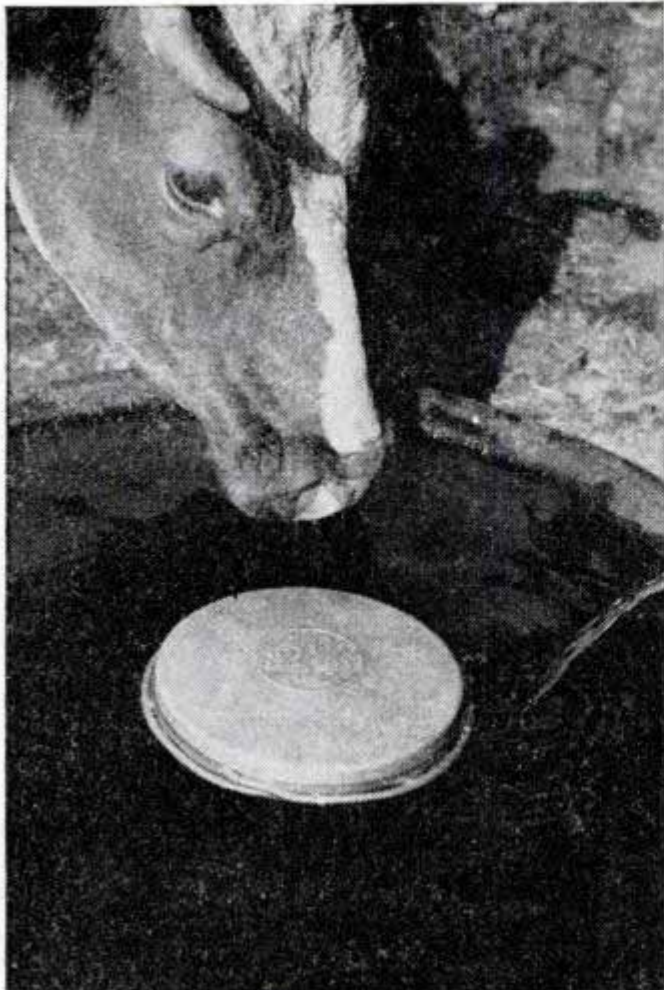

De-icer equipped with a heating element prevents ice from forming in water tanks even at 22 degrees below zero. Below, compressed "fresh air" is supplied to firemen from small tanks carried on their backs



Hand-operated motor tractor simplifies gardening. Below, two-color spray gun has an extra fluid inlet to supply an additional color of paint sprayed through the same nozzle. "Spatter" finishes are possible

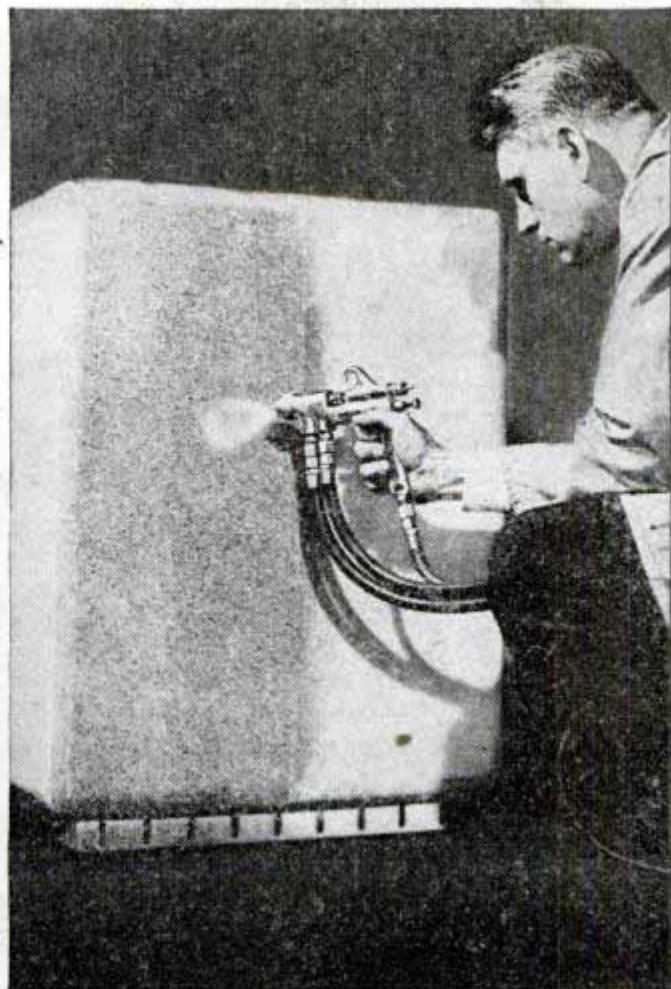

Irrigation Revives Fur Trapping

Fur trapping is staging a comeback in Manitoba, Canada, after nearly dying out when droughts dried up most of the game-producing marshlands. In one month 1600 trappers bagged 445,000 muskrats whose pelts netted approximately \$900,000.

The revival of the fur trapping industry is the story of government engineers bringing irrigation to 134,000 acres of arid land in Manitoba. A network of dams, ditches, dikes and canals impounded and distributed flood waters from adjoining rivers. At first no trapping was permitted so that muskrats could have a chance to build houses. In one year the muskrat houses in the huge preserve grew from 60 to 800, in three years to 32,800 housing an estimated 165,000 muskrats.

After five years 400 men were permitted to trap the area during a three-week period, with a limit of 300 muskrats for each trapper. The muskrats they caught brought \$162,000 at auction in Winnipeg. After the Manitoba government took a percentage to pay for part of the irrigation costs, each trapper was given \$100, plus \$20 a month for 10 months.

Other sections of Canada are now being rehabilitated. Manitoba is applying strict conservation rules to protect fur trapping. Trappers are registered and permitted to trap only in certain areas, and trapping that kills off breeding stock is discouraged.



Muskrat skins are placed on stretchers to dry. Below, a trapper carefully sets his trap in a muskrat house in Manitoba



Fur trappers travel to Canadian marshland in tractor-drawn sled



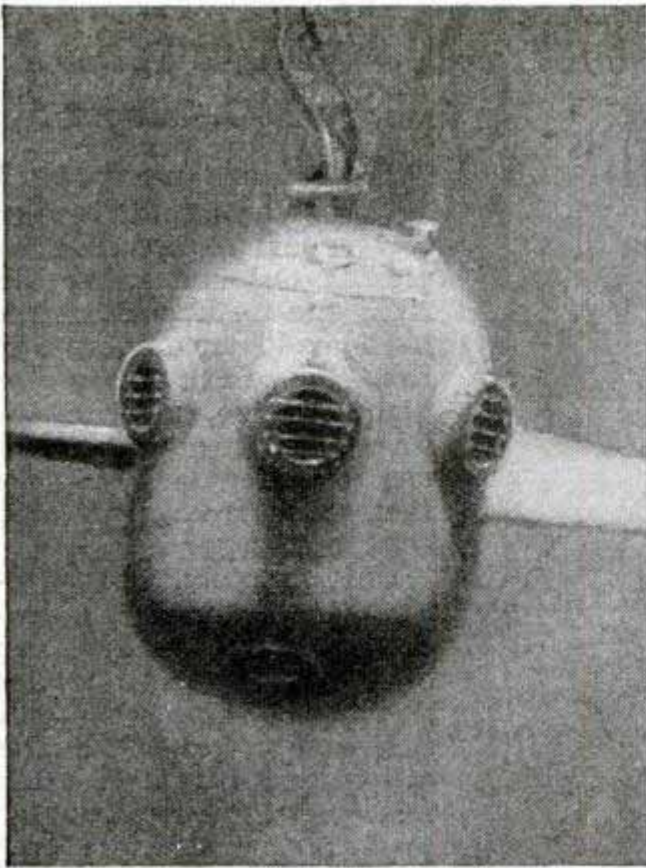

Snapshots on the Ocean Floor

A pressureproof, watertight camera is being built for taking pictures 300 feet under water to provide "blueprints" for deep-sea divers searching for valuable cargo in sunken vessels.

The camera, details of which still are secret, was designed specifically for Navy mine disposal work. It also was used to study damage to sunken warships and to inspect antitorpedo and anti-submarine nets.

Developed by Photo Utilities, Inc., and Graflex, Inc., the camera uses standard film, filters and flash bulbs and is operated from the surface by electric controls or carried under water by a diver.

The automatic motor and film transport mechanism of the K-25 aircraft camera is utilized in the underwater model, plus the 90-millimeter Graflex optar lens in a synchronized shutter designed for press cameras. Other standard equipment includes an aluminum pressure case with pressure type controls for lens, diaphragm and shutter. Waterproof socket reflectors developed by the Mines Equipment Company make it possible to change bulbs under water.

Assembly for underwater photography, above right, provides shots such as the one below of diver examining antitorpedo net

Underwater camera catches Navy mine observer in towed sub-surface glider and, right, diver attaching firing cable to mine

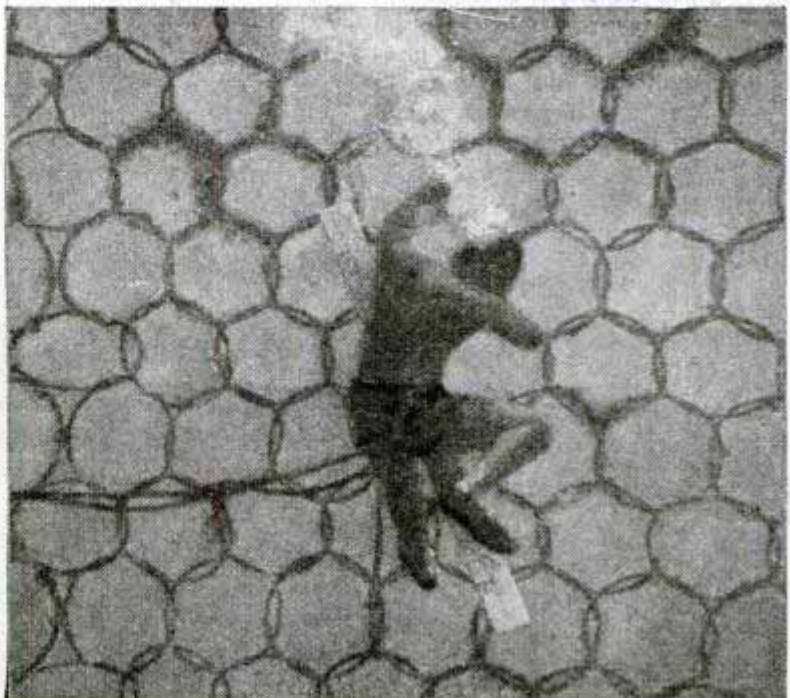
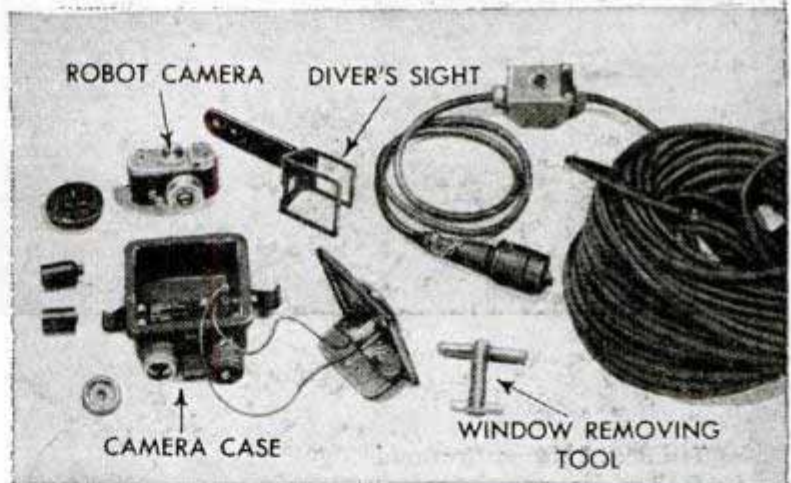

NAVIGATION FOR THE SKY TOURIST

By S. G. Cooper



THERE are many land highways, and the car driver has no trouble in picking out and using the right one to take him from his home to any city, near or far. There are many sky highways, too, and the airlines tune in on them and use them regularly to take their planes from city to city, safely and surely.

Unfortunately, the average private plane has no radio to tune in on them, nor do the radio ranges always go where he wants to go. It has been suggested that the country be dotted with markers visible from the air to help the pleasure flyer travel about easily, but if you intend to fly your own plane you had better learn the art of pilot navigation. You'll get more fun out of flying and you'll be much safer.

Pilot navigation is the navigation of an airplane by the man who is flying it. Almost always, it is contact flying, within sight of the ground. The pilot of a Superfortress doesn't have to worry about navigation; he has an expertly trained navigator

Ted Sills, Chicago flyer and CAP major, unreels antenna (shown below) so he can use his radio as a navigational aid to tune in on "sky highways" when he is flying to other cities





Landmark symbols (left) help in following air map. At right, pilot figures navigation problem with computer

who does the job for him, using all the tools that modern science can invent and the government can buy. The private pilot, on the other hand, is doing two jobs at once. He can't draw on a chart, because he has to fly the plane at the same time. He hasn't many instruments, because he can't afford to buy them, and wouldn't have the skill to use them if he did have the money. Under these circumstances, pilot navigation must be a simple affair—and it is, if it is learned correctly and used the same way.

The first requirement is to fly accurately,

and that isn't as easy as it sounds. Big aircraft have automatic pilots and gyroscopic instruments for the job, both of which are beyond the means of most private pilots. Remember that when you drive a car you can turn only to left or right, and even then if you aren't very experienced the car may wander all over the highway; in a plane you can go up or down as well. The magnetic compass generally used to keep an airplane headed straight in one direction is very sensitive to turns and changes in speed—and each time you gain

Under direction of CAA, 100,000 air markers are being installed throughout the nation to guide private planes

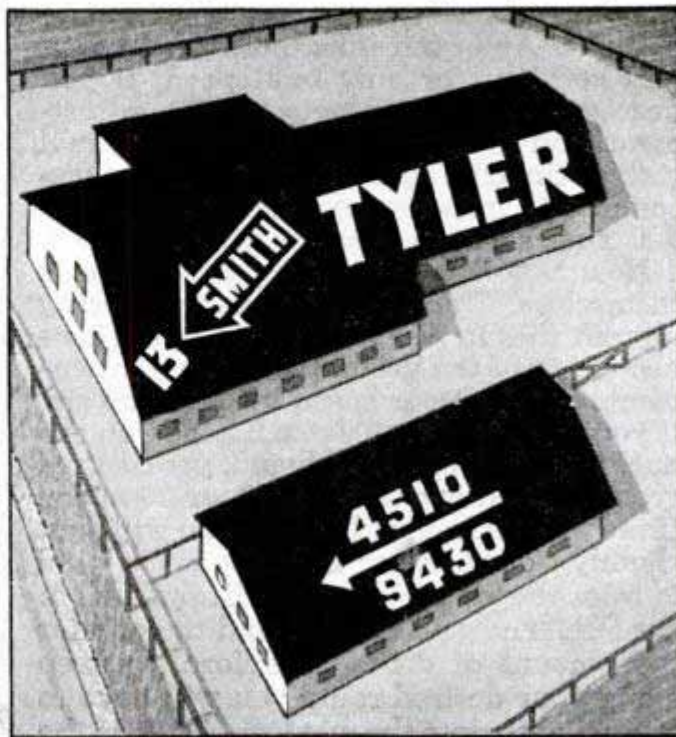

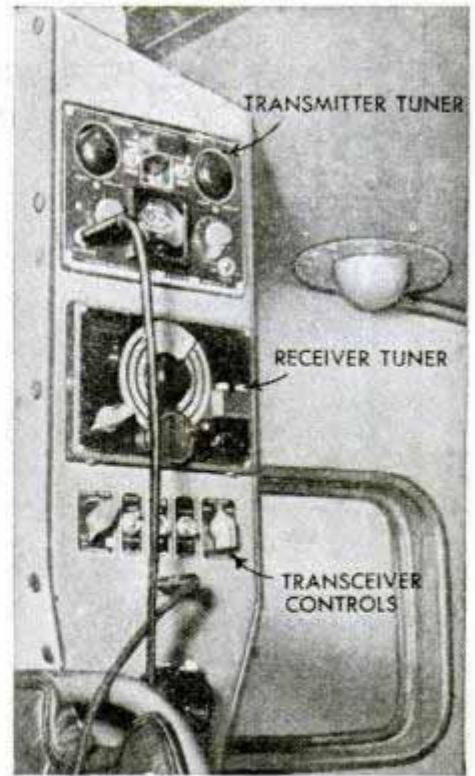

To get his bearings a flyer in a Grumman Widgeon tunes in his Lear radio. Right, closeup of the equipment

or lose a few feet of altitude your speed changes, just as it does when you go up or down a hill in an automobile without changing the pressure of your foot on the gas pedal.

Modern planes are equipped with little movable surfaces called trim tabs that can be adjusted to make the plane fly straight and level. In most light planes only the elevator tab is controlled from the pilot's position; tabs on the rudder and ailerons are just thin pieces of metal which can be bent as desired, when on the ground. This puts you at the mercy of the airframe mechanic; if he makes a mistake you're going to have to maintain a steady and tiring pressure on the rudder bar and stick to fly straight. And even if he did a good job, it will be right for only one speed; if you decrease or increase velocity the adjustment won't work. So if you're wise you'll look at the trim tabs and save a lot of discomfort by insisting on a controllable rudder trim as well as elevator trim.

Now as to the pilot navigation methods themselves. You must remember that an aircraft flies in air, and has no actual connection with the ground. All your instruments show is your speed through the air; if your air speed is 100 m.p.h., and you are bucking a 20 m.p.h. headwind, your actual ground speed is only 100—20, or 80 m.p.h. If the wind is from either side you will drift slightly sideways; for example, if the wind is from the right side you will drift off to the left. The greater the wind the greater the amount of drift. Therefore, to keep along your desired route you will have to steer slightly into the wind, or a little to the

right of the direction which you want to go.

Let's assume that you are going to fly from point "A" to point "B." Before you get into the air, you should obtain the meteorological report, which tells you the weather situation and what the wind is likely to be. With this information, and your knowledge of the height and the air speed at which you intend to fly, you work out just what heading you will have to follow and what your ground speed will be. With one of the simple computers now on the market the average problem can be worked out in less than a minute.

Glide angle indicator developed by CAA throws out light showing correct vertical approach for landing

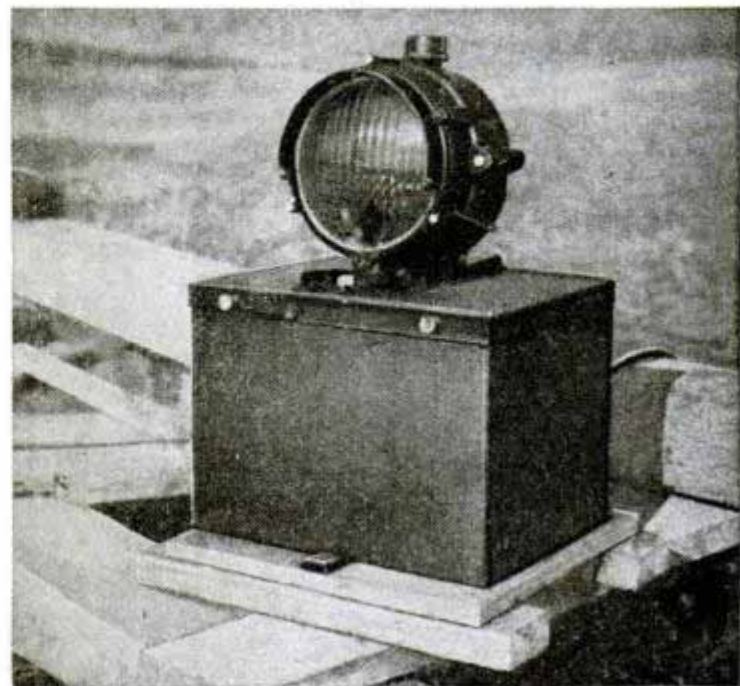

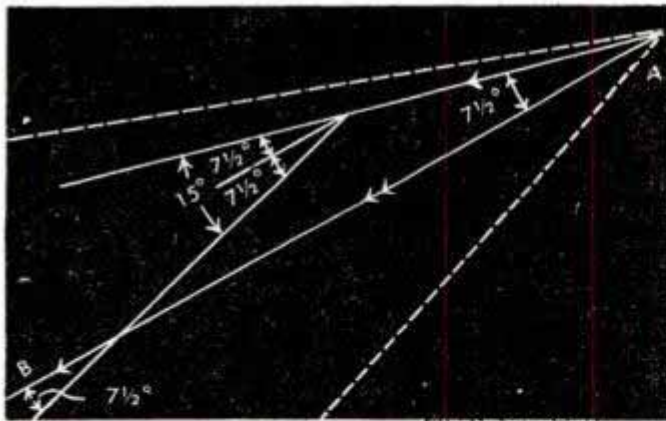

Off course by $7\frac{1}{2}$ degrees, pilot must make 15-degree correction to regain course, then turn $7\frac{1}{2}$ degrees again into true heading. (Angles are drawn twice size.) At right, plane is heading slightly into wind to correct for side drift

Now, if the forecast were absolutely correct, and you flew accurately the heading which you had figured out, you would arrive at point "B," and at the exact time you had calculated (this is your E.T.A., estimated time of arrival). Unfortunately, no weather report ever is that accurate, and so you must provide for being off course. There are several ways of doing this.

Draw a line on the map between "A" and "B" (your course) and from both "A" and "B" add the "10-degree lines"; that is, draw lines 10 degrees off the required course, and on both sides of it. Then draw in the "five-minute intervals," short lines at right angles to the course, spaced apart an amount equal to the distance that you calculated you would cover in five minutes.

Say that after 12 minutes of flying you manage to pinpoint yourself—that is, identify the position directly below you on the ground with a point on the map. This point, you find, is to the right of your proposed course, about three quarters of the way between that line and the 10-degree line. This means that you are off by about $7\frac{1}{2}$ degrees (the approach error), possibly because the wind was stronger than you anticipated. Therefore, if you alter your heading $7\frac{1}{2}$ degrees to the left, you will fly parallel with your course. This isn't good enough to get you to your destination, so now you look for the closing line—the

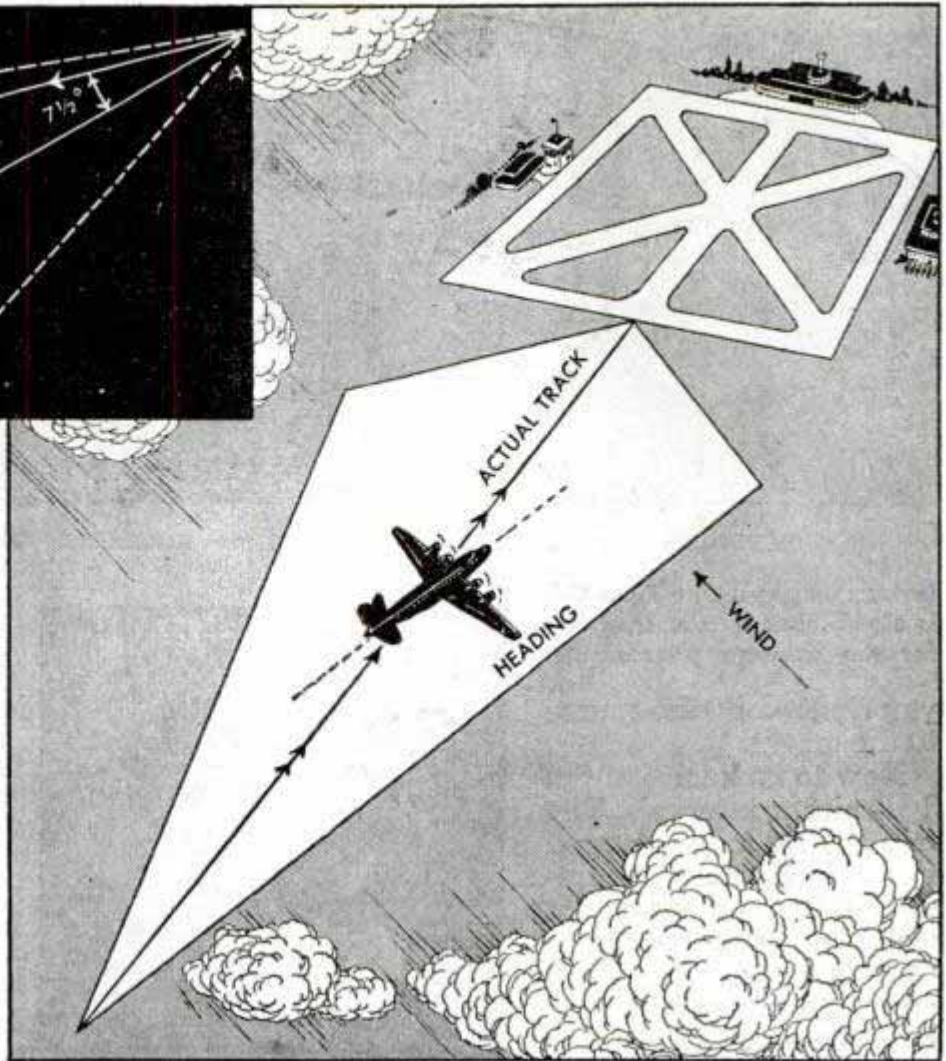

10-degree line from point "B." If you find that you're about half way between course and 10-degree line, which means that your closing error is 5 degrees. Therefore, if you alter your heading $7\frac{1}{2}$ plus 5 or $12\frac{1}{2}$ degrees to the left, you will come right in on your destination.

A second method, which is more commonly used, requires the drawing of only one set of 10-degree lines—the ones from the starting point. As before, you are $7\frac{1}{2}$ degrees in error, so if you alter your heading double the course error you will get back on course in exactly the same time as you took to get off it ($7\frac{1}{2}$ degrees to parallel course; $7\frac{1}{2}$ degrees more to get back on it). Remember, you have turned off 15 degrees to the left. Once you are back on course you then turn $7\frac{1}{2}$ degrees to the right (leaving you $7\frac{1}{2}$ degrees to the left of the original heading) which will bring

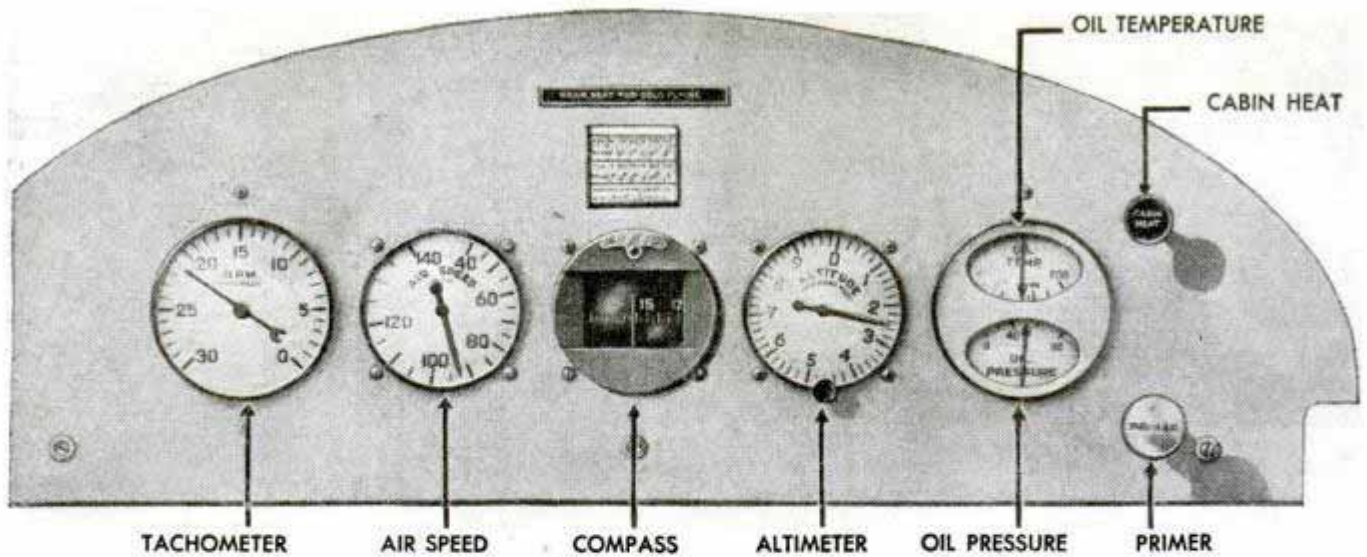

Instrument panel on a Piper Cub is simple, but it tells essentials for the average private pilot

you right along the course to the target.

Now to make use of the five-minute intervals. The trip as originally planned would have taken 37 minutes; the pinpoint you got was about the 14-minute time interval, although only 12 minutes had gone by since setting course over point "A." This puts you two minutes ahead in 14; in 37 you will therefore be about five minutes ahead. That is, your revised E.T.A. will be five minutes earlier than you planned; if course was set at 15 minutes past 10, the

This is one of the ingenious, handy plotters for determining a plane's bearing and position



new E.T.A. will be 10:47, instead of 10:52. This knowledge helps a lot to keep you from sailing right past point "B" without noticing it.

Most important in all navigation is a complete familiarity with the maps you use. The ones employed most often in the United States are the Sectional Aeronautical Charts issued by the U. S. Coast and Geodetic Survey, with a scale of 1:500,000, which is approximately eight miles to the inch. In reading maps, you must remember that the map is not a picture of the ground over which you are flying; at best it is a two-dimensional and therefore distorted representation of it. If the middle ages had been correct in their belief that the world was flat, it would have been much simpler for the cartographers and for everyone interested in navigation.

There is another reason why maps are distorted. A three-lane highway, which is an excellent landmark from the air, may be only about 36 feet wide. On a map with scale of eight miles to the inch, this would correspond to a line less than a thousandth of an inch wide. For seeing and printing purposes, the road must be represented

(Continued to page 150)

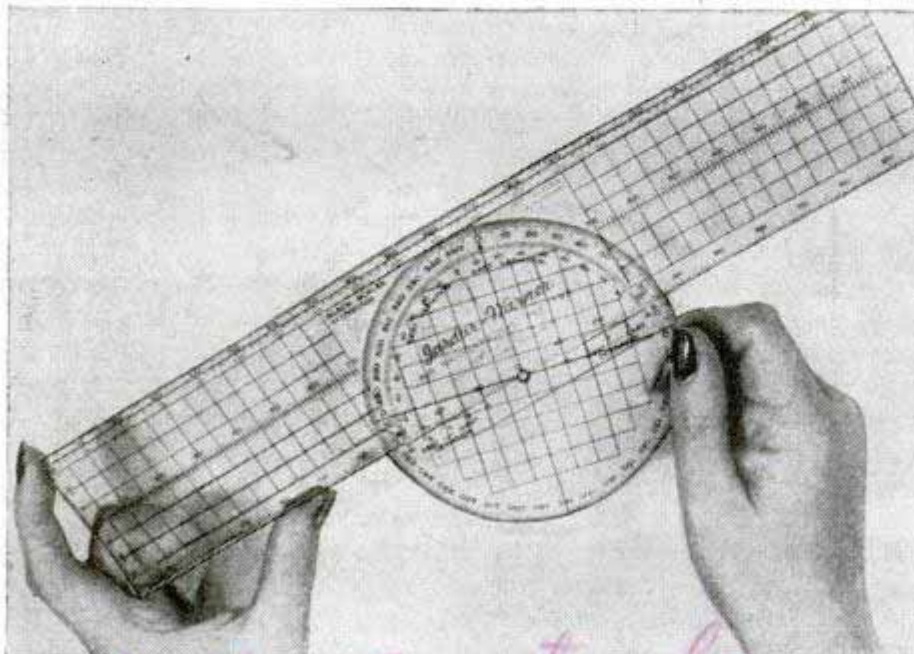

Gardner Aviation Co

Atomic Secrets May Be Unlocked By X-Ray Machine

Great strides in the use of X-rays and other types of electrical radiations in atomic research, medical therapy and industry are predicted with the revelation of details about the war-secret 100,000,000-volt electron accelerator, or betatron, built by the General Electric research laboratory. The new machine produces the most powerful X-rays ever created—so powerful they will penetrate thicknesses of metal greater than the 12 inches of steel that can be pierced by 2,000,000-volt industrial X-ray units. Even more exciting to scientists, however, is the fact that with the electron accelerator, radiations formerly present only in cosmic rays now can be generated in laboratories. The principal part of the machine is a huge electromagnet made of 130 tons of laminated silicon steel. In a rectangular opening passing through the magnet are pole faces, 76 inches in diameter, surrounded by large coils of insulated one-inch copper conductor. The heart of the machine is a doughnut-shaped glass vacuum tube from which is projected an elec-

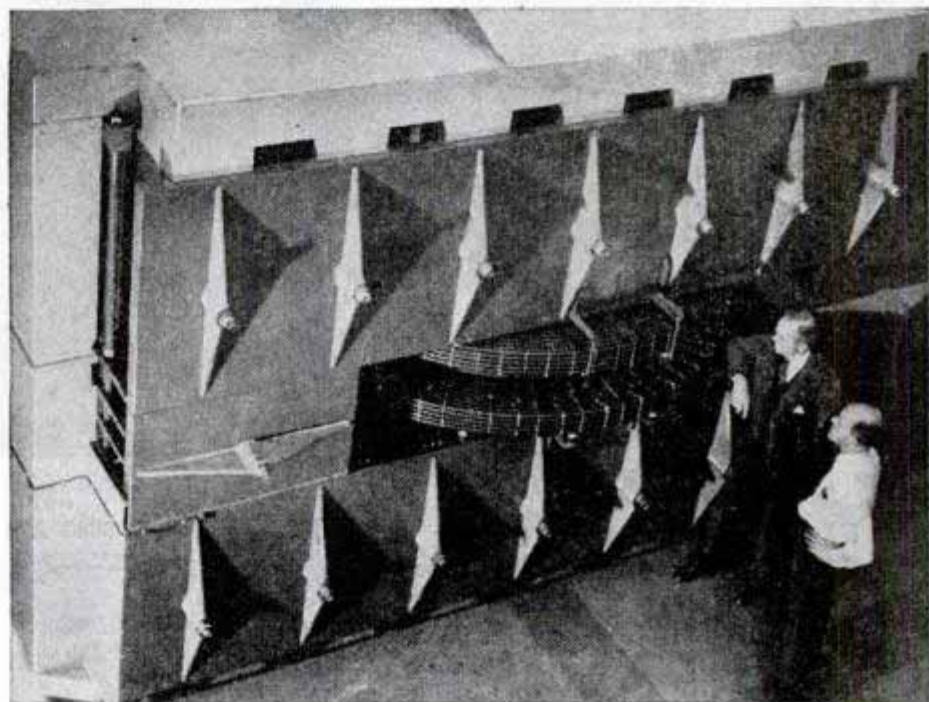
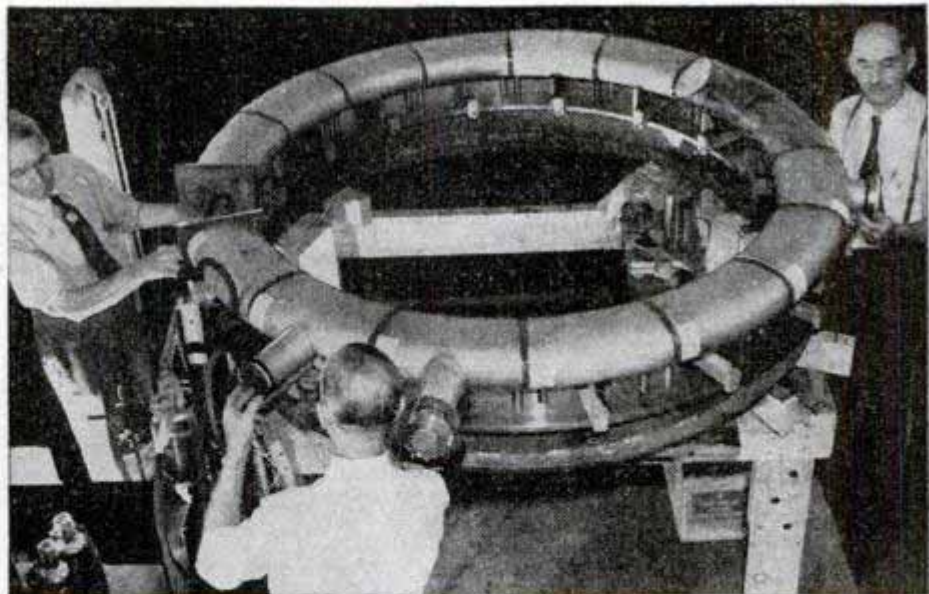

tron gun equipped with a heated filament. In operation, the ray maker accelerates electrons until they reach approximately the speed of light—186,000 miles a second.

Pocket-Size Check Perforator

Richard I. Heller, a Pasadena, Calif., salesman, wrote a check for \$80. A forger "raised" it to \$800. So, to protect himself against any such recurrence, Heller invented a pocket-size check protector, a perforating device through which he pulls checks to make tiny ridges on their surface and thus prevent any tampering. Heller designed a combination check holder, wallet and perforator that takes no more space than an ordinary wallet.

IF YOU WANT TO BUY IT—

Write to the manufacturer or distributor listed in the Where-to-Buy-It Index to learn more about commercially available products described in this magazine. Say you saw it in Popular Mechanics.



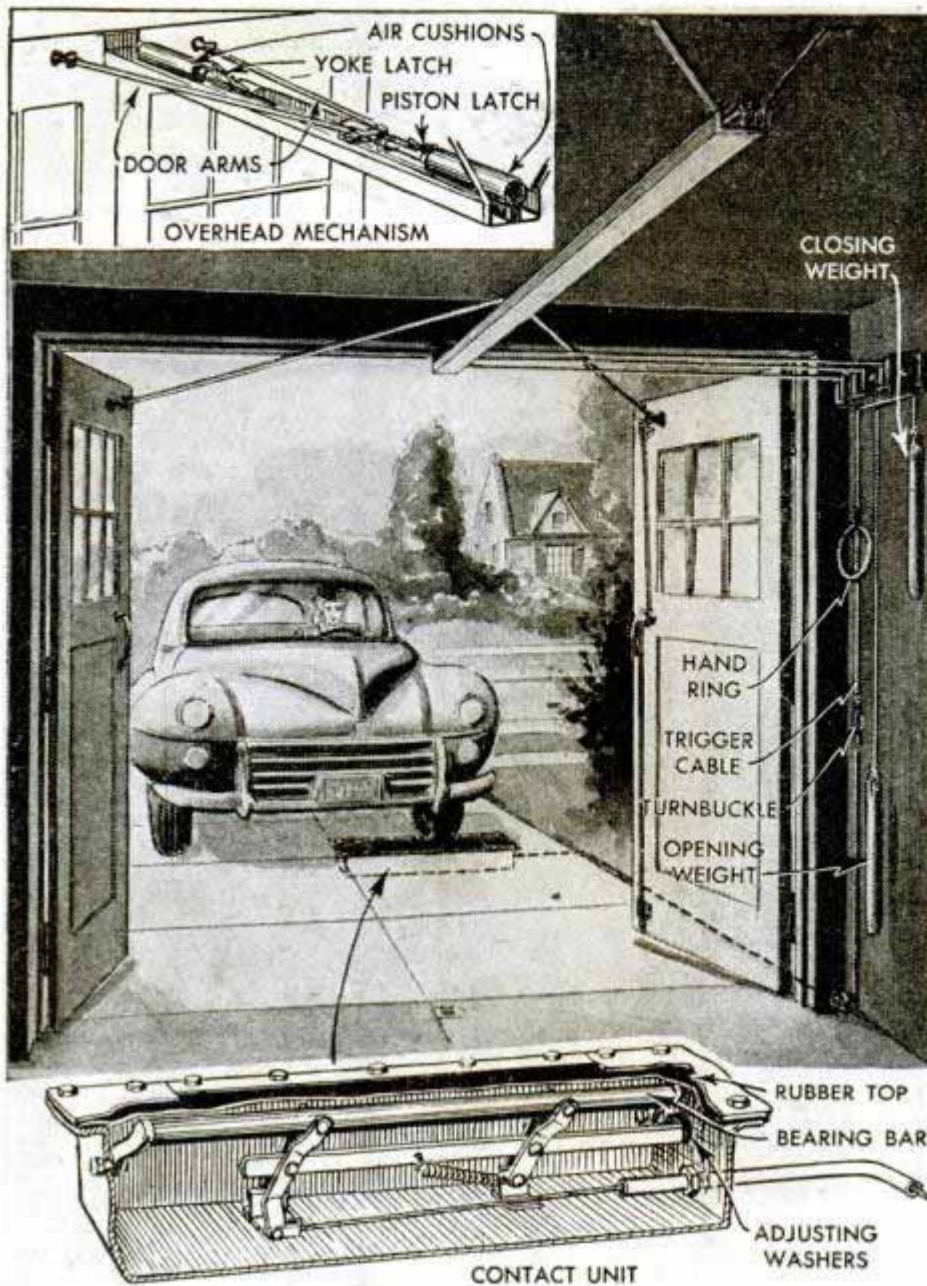

Garage Doors Open When Car Crosses Control

Garage doors are opened and closed by an automatic door operator whose motive power is derived from weights mounted on the wall. A wheel of the automobile touches a contact unit in the driveway, actuating a cable pull that releases the door-closing weight when doors are open, and the door-opening weight when doors are closed. Slamming is prevented by cushioned parts in the overhead unit. In getting the car out of the garage, the driver opens the doors by hand as usual. They close as the car goes over the contact unit. On returning, the unit opens the doors, and the driver closes them by hand. No electricity or other power is used in the operation. The contact unit is watertight, weathertight and dirtproof, and will operate satisfactorily under light snow.

Jet Engine Modeled After V-1 Has No Rotating Parts

Powered by gasoline or kerosene, a jet engine designed by West Coast engineers has no rotating parts and operates on the buzz-bomb principle rather than that of conventional jet engines. The engine consists of a stainless steel tube, part of which serves as the combustion chamber, plus a streamlined tube containing a fuel metering device and a spring type flutter valve. Air and fuel pass through the valve and are ignited in the combustion chamber. The back pressure resulting from the explosion seals the valve and thus creates the forward thrust. The engine has a firing rate of approximately 250 explosions per minute. A model of this design two inches in diameter, two feet long

and weighing five ounces exclusive of fuel tank produced two pounds of thrust, or enough to provide one G of acceleration in vertical flight in a one-pound model airplane. Called the "autoflight," the engine is started by introducing an air blast through the front opening.

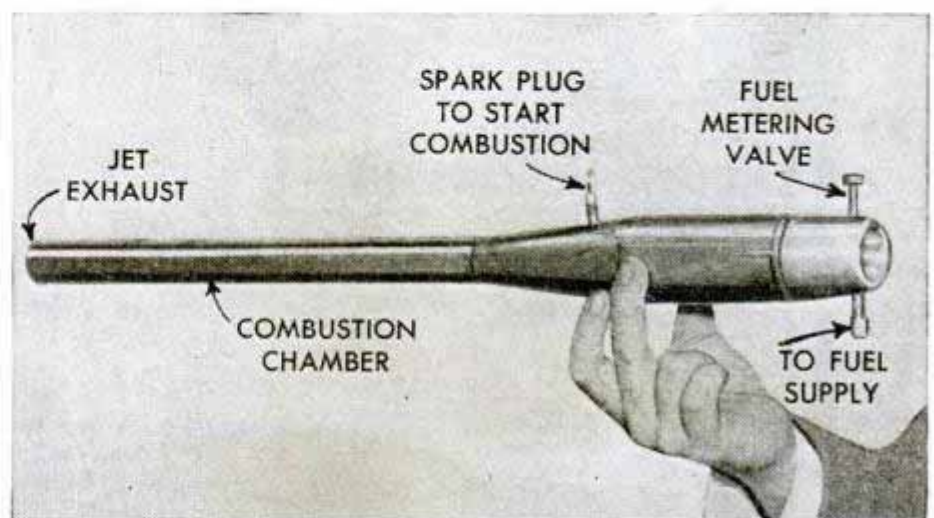

THEY POLICE CALIFORNIA'S RAIN

CALIFORNIA doesn't have an official rainmaker on its state payroll but it does have the next best thing—a state division of water resources that takes charge of the rain after it has fallen.

The experts of this division measure the rain and snow, forecast and partly control the flow to the sea, and help put the water to work in half a dozen different ways en route.

One result is that the owners of three million acres of rich land can learn ahead of time how much irrigation water from melted mountain snow will be available for them during the dry summer growing season. They select their crops and schedule their planting to make best use of the water they will receive.

Another result is that utility companies know which of their hydroelectric plants will receive the most water and which plants must store water for use later on, and thus are able to draw power from different stations so as to make best use of the water.

A third benefit is that warnings of floods are broadcast well in advance and it is possible to control and confine the excess water so that damage is minimized.

Flood warnings are especially important in the lower Sacramento River area because this river system contains a number of wide by-pass channels, normally devoted to agriculture, into which flood waters may have to be diverted to prevent breaching of levees along the river's main channel. The by-passes contain 80,000 acres on which beans, rice, asparagus and other crops are grown. Adequate warnings when the by-passes must be flooded give the inhabitants time to move their livestock, equipment and valuables to safety.

Flood forecasts are based on up-



Meteorologist inspects a current flow meter used to measure the rate at which rivers discharge water during big floods

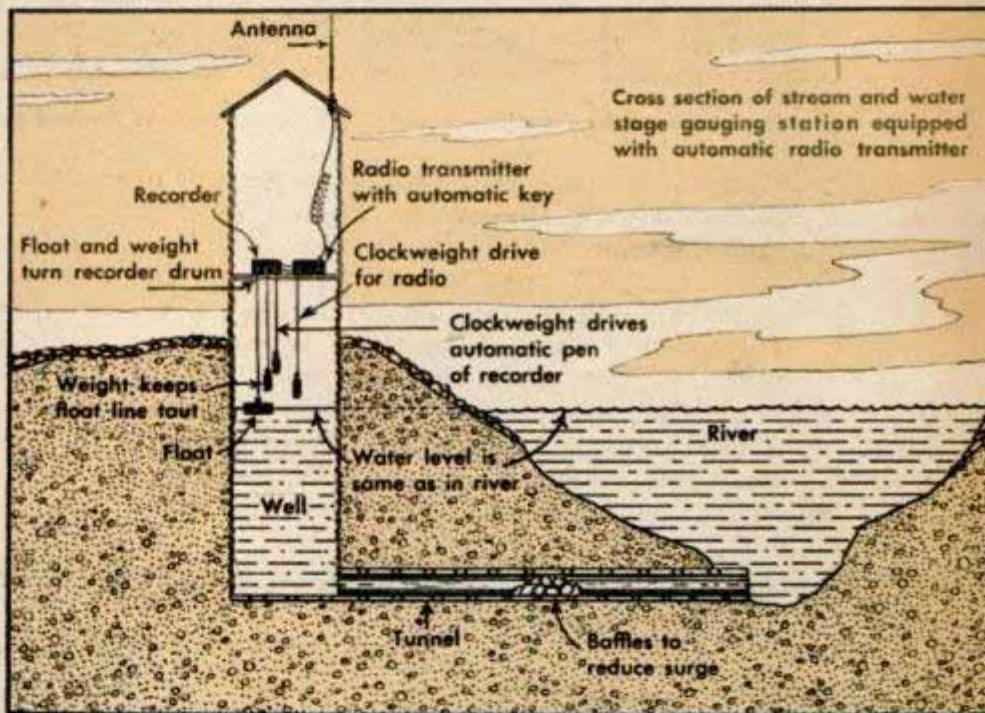

Drawing illustrates operations of water stage gauging station shown below, where height of a stream is recorded by inspector





Radioman at Sacramento records high water reports flashed by automatic measurers and radio transmitters

stream measurements of high water and in particular on the water depths at key gauging stations that are untended but that automatically report their readings by radio to the Sacramento headquarters. The automatic radio transmitters are used to make certain that the information will reach Sacramento even during storms that may disrupt telephone and telegraph circuits. Gerald H. Jones, the supervising hydraulic engineer, translates the radio

measurements into forecasts on the height of the flood and the time at which its peak will reach the populated areas in the lowlands. His forecasts are accurate to within one foot, three days ahead of time, and he refines these predictions to within one or two inches of the actual crest about eight hours before the peak arrives.

An automatic gauging and radio transmitting station consists of a small shelter placed on top of a well that is dug into the bank adjacent to a river. River water may be too turbulent for measurements in the open stream and so the height of the river is obtained by measuring the height of the water in the well, the bottom of which is connected to the river itself by means of a lateral tunnel. The measuring device consists of a float that rests on top of the water, with a thin flexible line that leads up to the instrument shelter. Here the line is wound around the drum of the automatic recorder, with its free end held taut by a weight. Raising or lowering of the

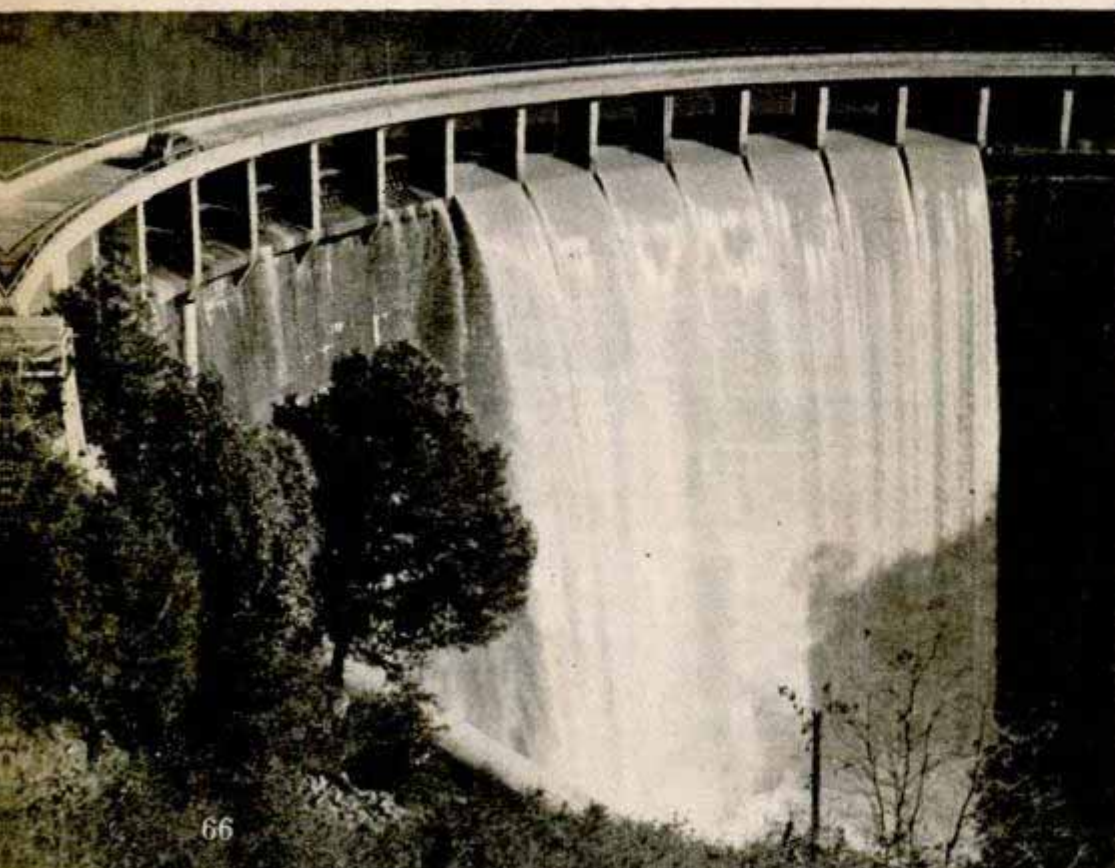

Spring run-off water pours over spillway of a California dam

water level thus rotates the drum. An automatic pen, driven by clockweights, makes a record of the drum's movements.

The companion automatic radio transmitter consists of a battery-powered 5-watt set that is turned on at hourly intervals by a clockwork mechanism driven by clockweights suspended in the well. The keying device is connected by a gear train to the drum of the automatic recorder so that it transmits dots and dashes that are based on the drum's position. Each of the automatic transmitters signs off with its own station call letters. These stations are serviced and their clockweights are reset once a month.

Too much water for short periods is not unusual during a California winter and yet, literally speaking, it doesn't rain in the state's central agricultural region at all during the rest of the year. Summer agriculture would be impractical except for the 33 million acre-feet of water, more or less, that fall in the form of snow each winter in the Sierra Nevada mountain range. The snow covers an area of 17,000 square miles and begins to contribute water to streams and irrigation ditches at about the time of the last spring rains.

A heavy snow pack in the mountains means that water will be available all summer long for vast agricultural tracts, while sparse winter snow means that little or no water will be available in some districts after the spring run-off.

To discover ahead of time what the summer water "crop" will amount to, federal and private agencies cooperate with the state in measuring the mountain snows each spring. As many as 150 experienced mountaineers participate in the snow survey under the direction of Fred H. Paget, state associate hydraulic engineer. Carrying equipment on their backs and usually traveling on skis, the men climb as high as 11,000 feet to measure the snowfall in 24 different watershed areas.



Snow packed in aluminum measuring tube is weighed to learn the amount of flood water it will produce

Food-stocked cabins in which the men sleep on these trips have heavy bars across their windows to keep out bears. Cabins located in regions of excessive snowfall are equipped with a low tower on the roof, with a trap door on top of the tower and another at the tower bottom, opening through the roof and leading to a ladder inside the cabin itself. Such a cabin may be completely buried when the survey party approaches it. The men remove the door from the top of the tower, let themselves down to the roof and through the second trap

Left, snow measurer arrives at cabin he will occupy. Right, ranger checks weather recordings in national park
National Parks Service photo





Severity of approaching floods is forecast by checking a river chart that compares river heights in Sacramento area

tube which also cores the snow as it is forced down. After removal, the tube and its snow load are weighed on a special scale and the water content of the snow is determined. Fresh snow contains an inch of water per 10 inches of snow; after it has settled for several months it may hold up to six inches of water per foot.

These snow measurements are compared by Paget with the survey figures of past years and form the basis of a water forecast that he issues early in April. The first forecast is accurate to within 10 percent and is followed by supplementary reports at 30-day intervals showing the rate at which the snow is melting, a figure that varies with high or low spring temperature.

This run-off information is based on the readings at the stream gauging stations, both radio and visual recording types. The run-off is plotted in a curve, day by day, and this shows when the peak of the run-off is reached in each district. Hydroelectric plants close their dam gates at this point and begin to store water, power meanwhile being produced at other plants on rivers that still are high.

Predictions based on the snow surveys have safeguarded agriculture during both extremely dry and extremely wet years. When a snow sur-

door, and then descend into the cabin.

Snow may pile up in drifts 100 feet deep in some Sierra valleys. Snow surveys, however, are made on level areas that are free of drifts, on sites marked by tall poles. Depth of the snow at one of the survey points rarely exceeds 17 feet. The depth is measured by means of a hollow aluminum

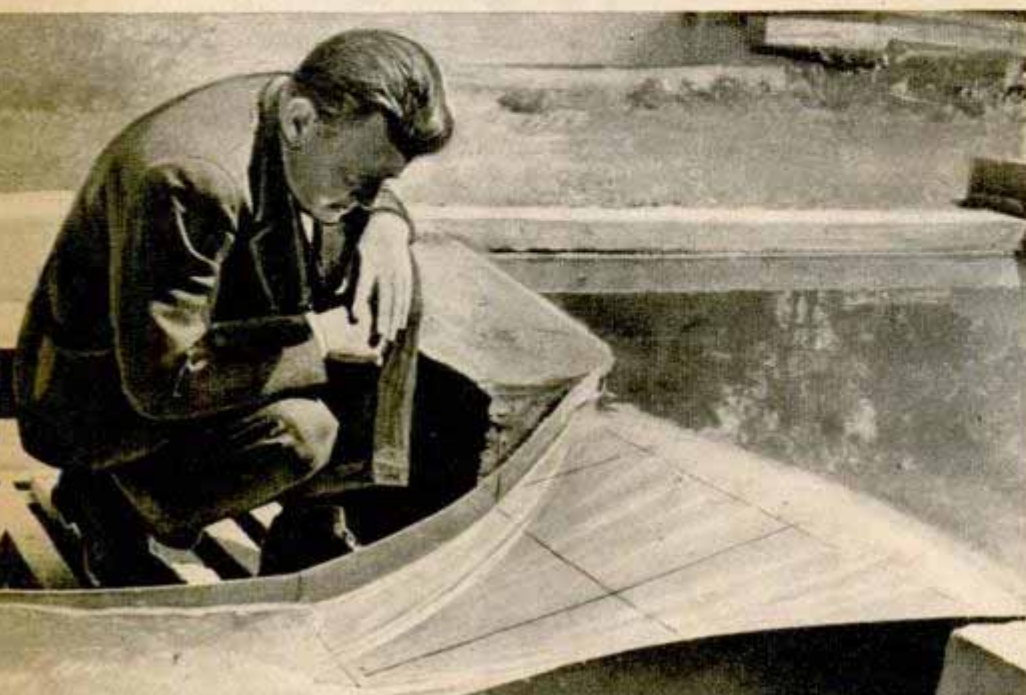

Spillway model at California Institute of Technology aids study of water in designing of waterworks systems

vey forecasts a serious shortage of summer water, farmers are advised to plant crops requiring a minimum of water. Men who had planned to plant rice, for instance, are able to shift to "dry" crops that will mature with the small amount of water available.

On the other hand, if the snow survey indicates a tremendous run-off with a threat of inundating thousands of acres of farm lands, the water in storage reservoirs is immediately reduced so as to provide storage space for the coming floods. Levee systems are inspected at the same time and weak points are strengthened.

There are some two dozen major dams in California in addition to scores of smaller structures. These control only a fraction of all the run-off water in the state. Additional dams eventually will end the threat of floods, provide more power, more water for agricultural areas, and will allow additional untilled tracts to be brought under cultivation.

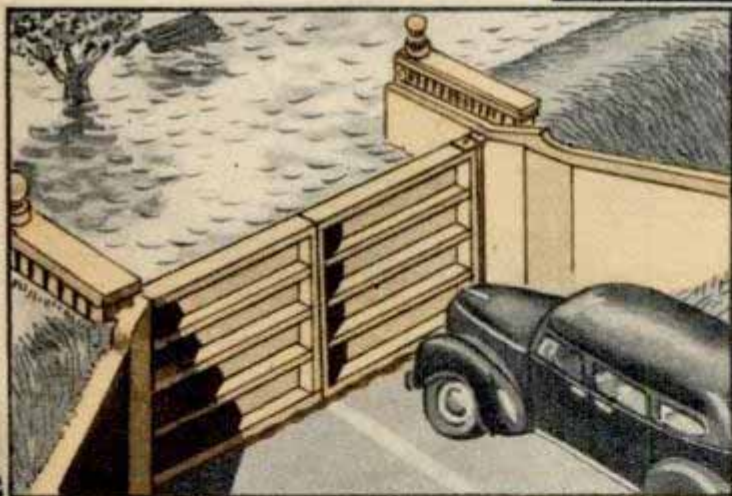

Above, skiing weather man takes time out from measuring snow to get a drink. Left, heavy iron gates block California highway and stop flood water from crossing levee. Below, when there is no high water, gates are kept open to permit automobile traffic to move on concrete road through the levee section

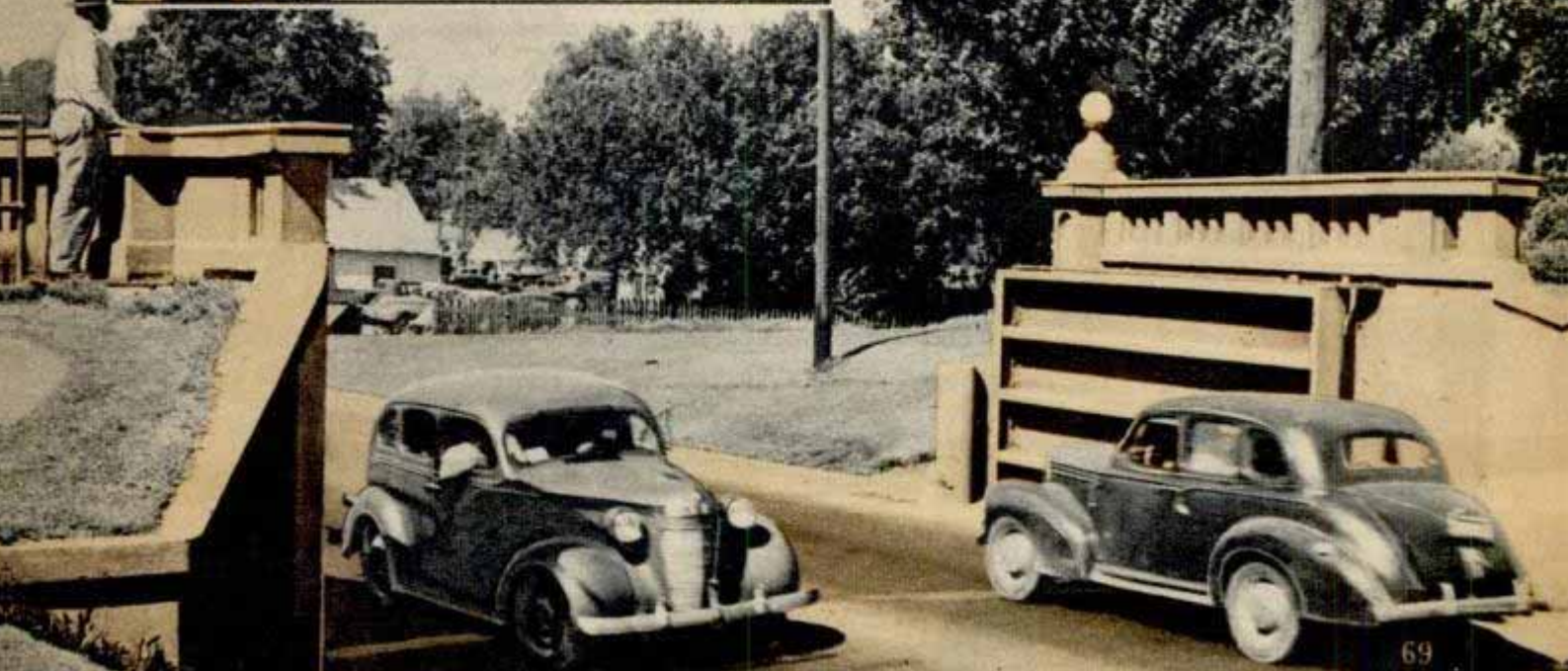



Just push a button and this luxurious club divan for railroad cars is converted into a sleeping unit. Designed by Nathaniel D. Arnot of Baltimore, Md., the sleeper will make bed-making easier for the porters

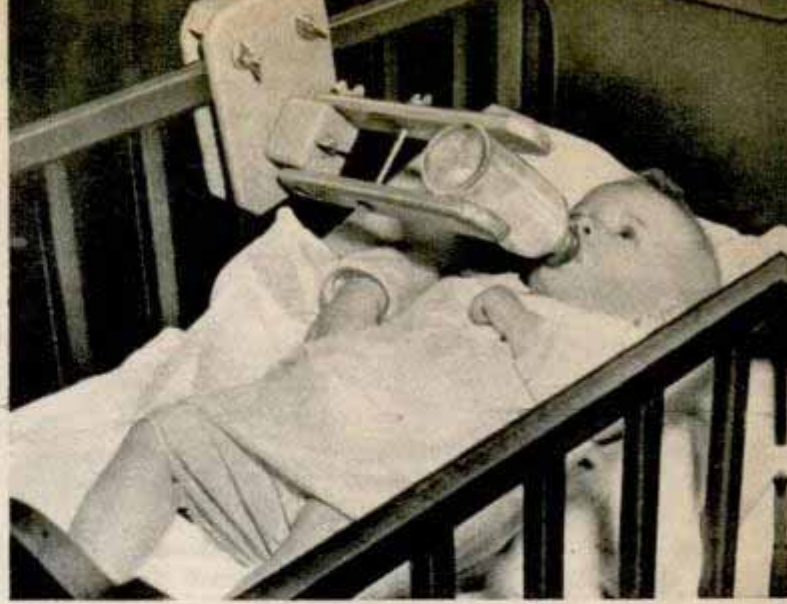

Clamped to a bed, this bottle holder saves mothers the time and trouble of standing over their babies during the feeding. When the milk is gone and baby moves its head, the holder moves the bottle away



These hardy men expect to sail from Sidney, Nova Scotia, to England in 80 days in this "beer barrel" boat equipped with a keel, two vanes and a rudder

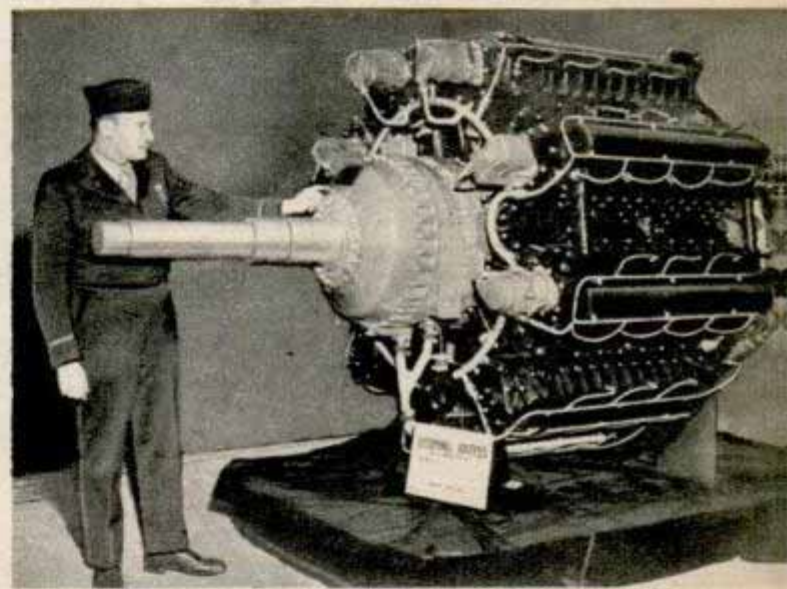

Most powerful engine developed for the AAF by the Power Plant Laboratory at Wright Field, this 5500-pound giant has 36 cylinders and develops 5000 h.p.

Coal soot lodged in boiler tubes is blown out with a compressed air cleaner made from a shovel handle, pipe, chain release and a metal disk on the pipe end

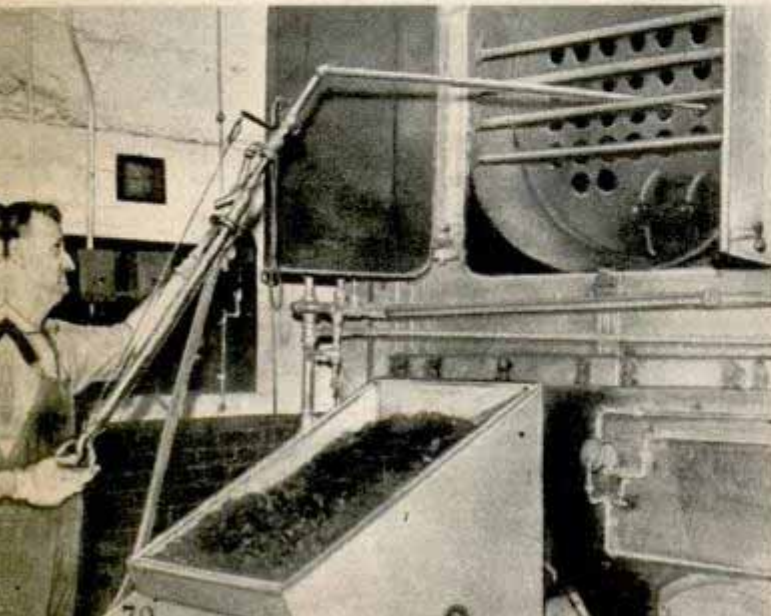

Irving Amstadter of Chicago used stamps to make this U. S. map. Stamps were placed in the home states of the persons pictured, Abraham Lincoln in Illinois, etc.





THE VAMPIRE, Great Britain's latest jet-propelled aircraft, is a single-seater fighter plane with a top speed of over 500 miles per hour. It is powered by a single Goblin gas turbine engine. This mid-wing monoplane has a span of 40 feet, is 30 feet 6 inches long, 9 feet 9 inches high, has a wing area of 258 square feet and is armed with four 20-millimeter cannon in the nose. The ship's central nacelle carries the pilot and the engine while twin booms from the wings hold the tail, twin fins and rudders. The third jet-propelled aircraft developed by Britain, the Vampire is of all metal construction. The plane is fitted for a pressure cabin

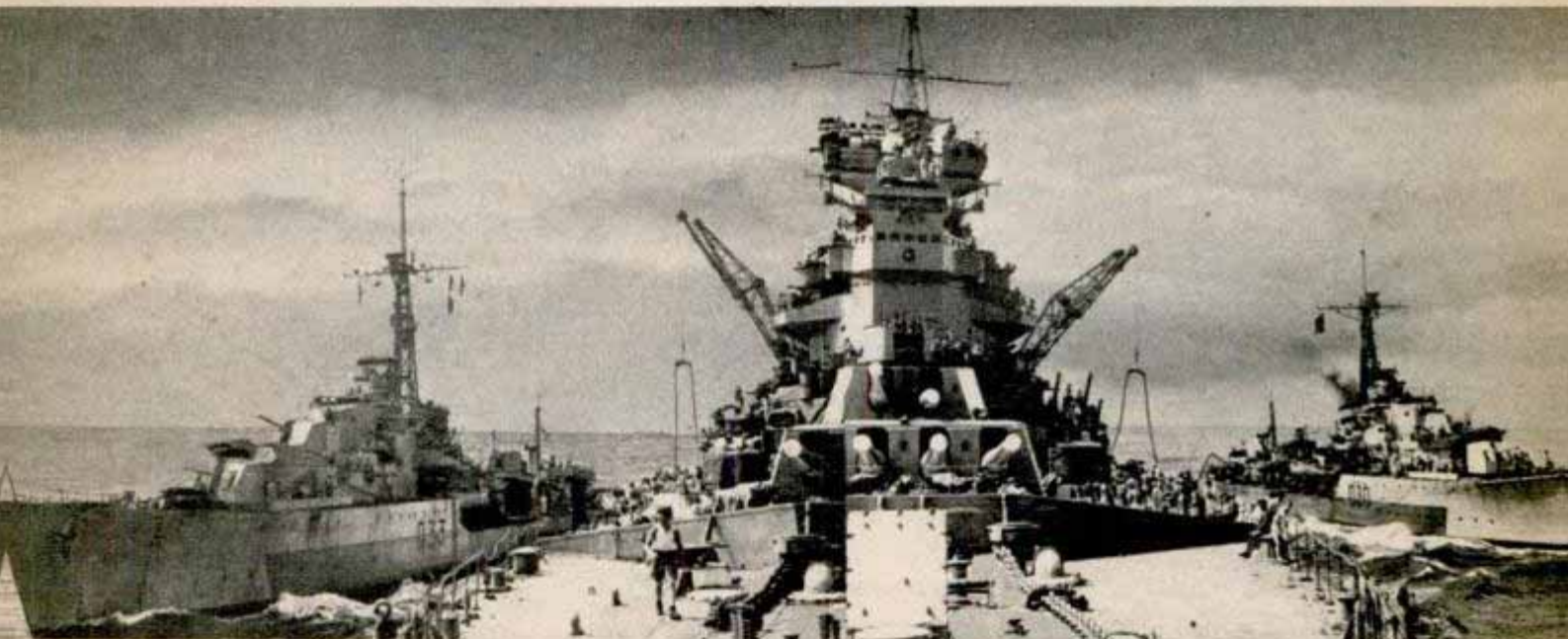
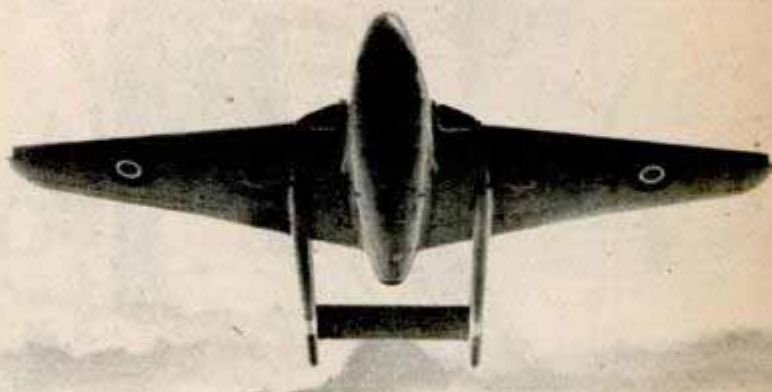

GREAT BRITAIN'S 35,000-ton battleship, the Duke of York, refuels simultaneously two British destroyers at sea

AN OLD TRUCK fitted with special rims rides wooden rails to carry men and machinery seven miles over swamplands to a gold mine in western Quebec, then turns around on a crude turntable fashioned out of pipes





Mesta Machine Co. photo
 Drill being inspected makes gun bores in 155-millimeter cannon. Below, shankless and conventional drills compared

SHANKLESS ROLL-FORGED HIGH SPEED DRILL



USABLE FLUTE

CONVENTIONAL TAPER SHANK HIGH SPEED DRILL



SPINNING faster than a whirling dervish in countless factories and assembly plants are the drills that never get to display their precision on the parade ground. It takes a lot of holes to put mechanized equipment together, and it takes a lot of drills to do the job, from the needle-sized $\frac{1}{64}$ -inch baby to the $5\frac{3}{8}$ -inch monster that drills 155-millimeter gun bores.

The small drill for years was made only in Germany and Switzerland and in peacetime was used mostly in watchmaking and similar fine work. During the war it was found useful for puncturing atomizer sprays and fuel jets for thousands of Diesel engines, and for making tiny holes in precision aircraft and electronic equipment. The atomizer nozzles of Diesel engines require very small holes to feed the fuel to the cylinders in the proper amounts and spray pat-

Diminutive $\frac{1}{64}$ -inch drill (top one of the two held between fingers at the left) is shown in comparison with an ordinary paper clip

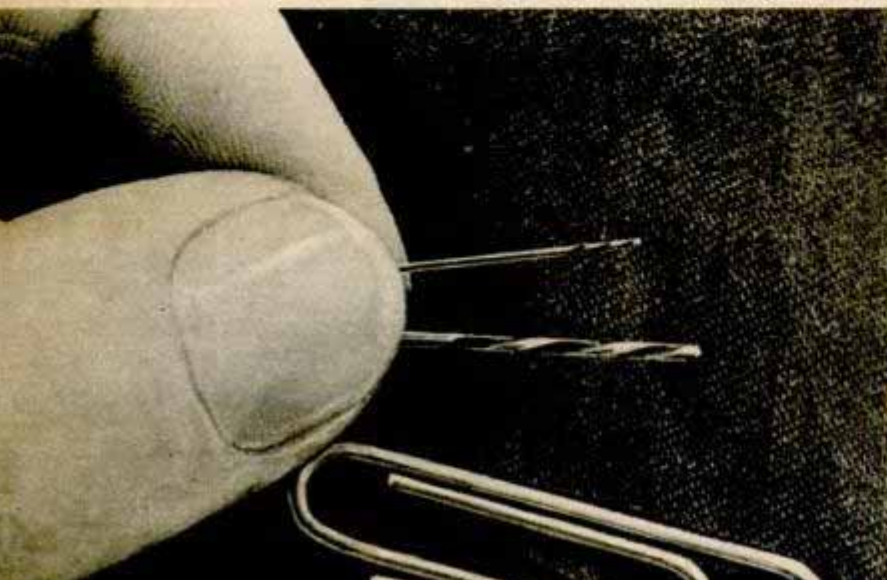

MIDGET DRILLS

The granddaddy of the line bores the famous 155-millimeter "Long Tom"; the baby, as fine as a needle, drills tiny holes for fuel jets and atomizers in Diesel engines

terns. These holes are made by the step drilling process, which means that the drill is moved up and down automatically during the operation in order to free the chips and allow lubricant to be applied.

The large drill was designed for a military purpose only, and so far has found no postwar demand.

A brand new drill industry sprang into being with the war, when demand for the tools led to mass production of the shankless drill. Invented years ago by an automobile executive, the shankless drill was not perfected and used until about six years ago, just before the patent expired. Organized only four years ago, a Chicago company has turned out more than 100,000,000 drills since then, most of them shankless. The plant was designed specifically for women workers, who constitute a majority of the firm's employees.

Conventional drills are made by milling flutes, with their cutting edges, in a bar of steel. The shank which fits into the operating tool is an integral part of the drill. The shankless drill is made from a bar of high speed steel with a groove on either side, as supplied by the steel mill. This bar is roll forged to add the cutting edge, and twisted while hot. The single process is simpler, quicker and less costly.

Shankless drills must be used with an adapter, which fits over the end and is inserted in the operating tool. The design permits a 25 to 40 percent increase in the usable portion of the cutting edges, as compared with a conventional drill of similar size. The shankless drills come in 135 sizes, from 1/4 inch to 2 inches in diameter. Only seven sizes of adapters are required for these drills. Smaller and larger drills are made by the process of milling the flutes.

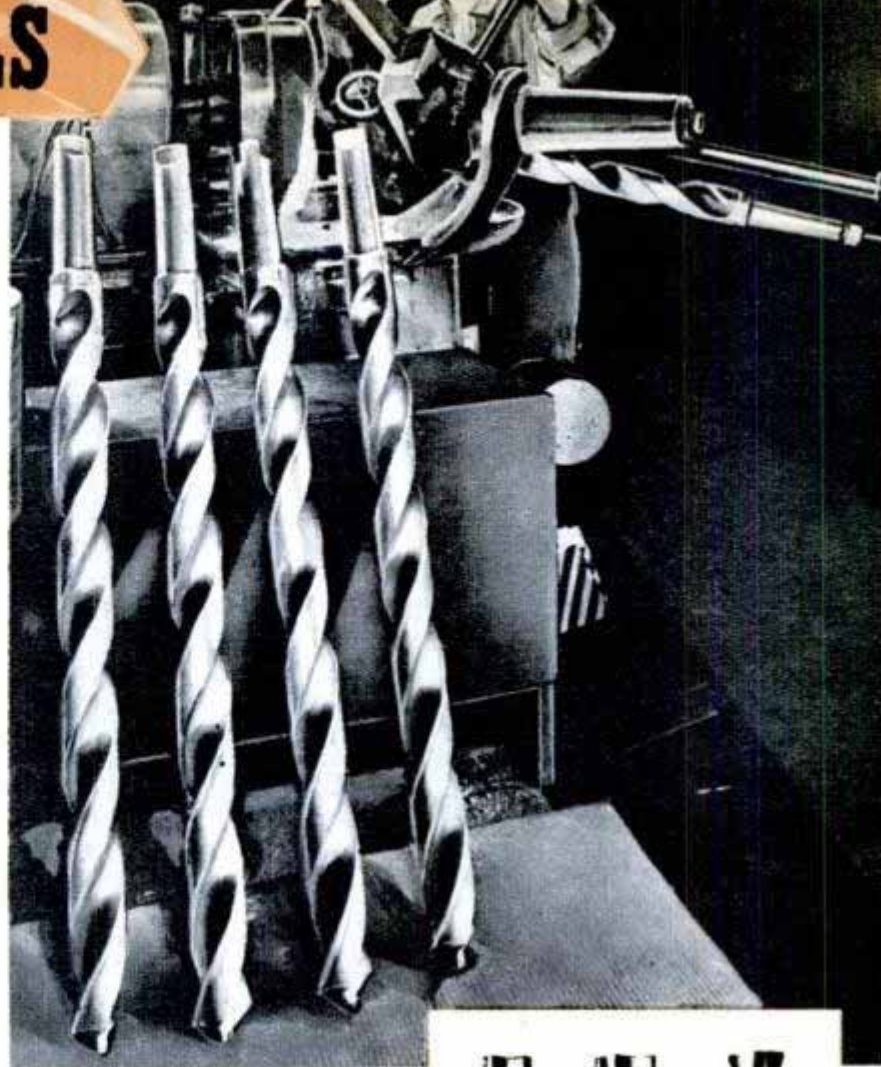

Four drills, 3½ inches in diameter, await inspection after having been milled on machine pictured in background

Republic Drill & Tool Co. photo
Three-stage drawing, right, illustrates the steps required to make a shankless drill by first roll forging, then hot twisting

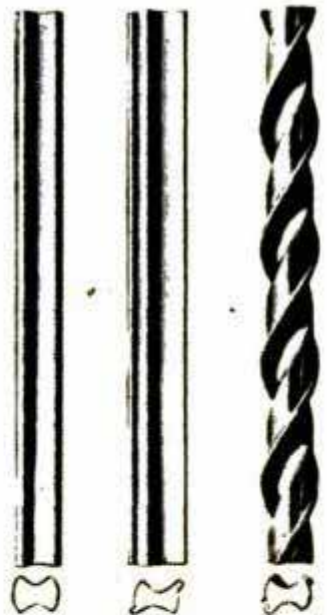

Shown in action below is monstrous drill measuring 5½ inches in diameter, used to make bore in "Long Tom" gun

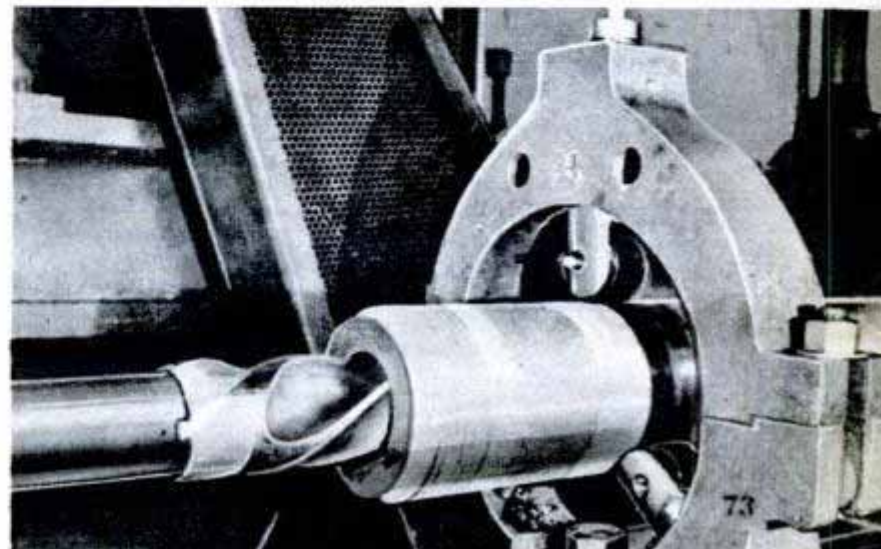

Floating "Honeycomb" Airport



Plane lands on British floating airstrip as big as carrier's deck



SEADROME UNDULATES WITH SWELL OF SEA

ARRESTER WIRES

FORE END BUOYANCY CHAMBER (FOR INCREASED STABILITY)

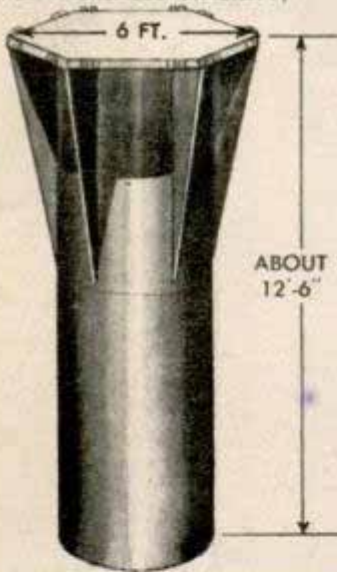

Rear section of seadrome is made of hollow steel chambers (right) that are bolted loosely to permit rolling with the waves. Forward chambers (left) of steel "honeycomb" are six sided on top, round at bottom, and deeper

MAIN TYPE BUOYANCY CHAMBER

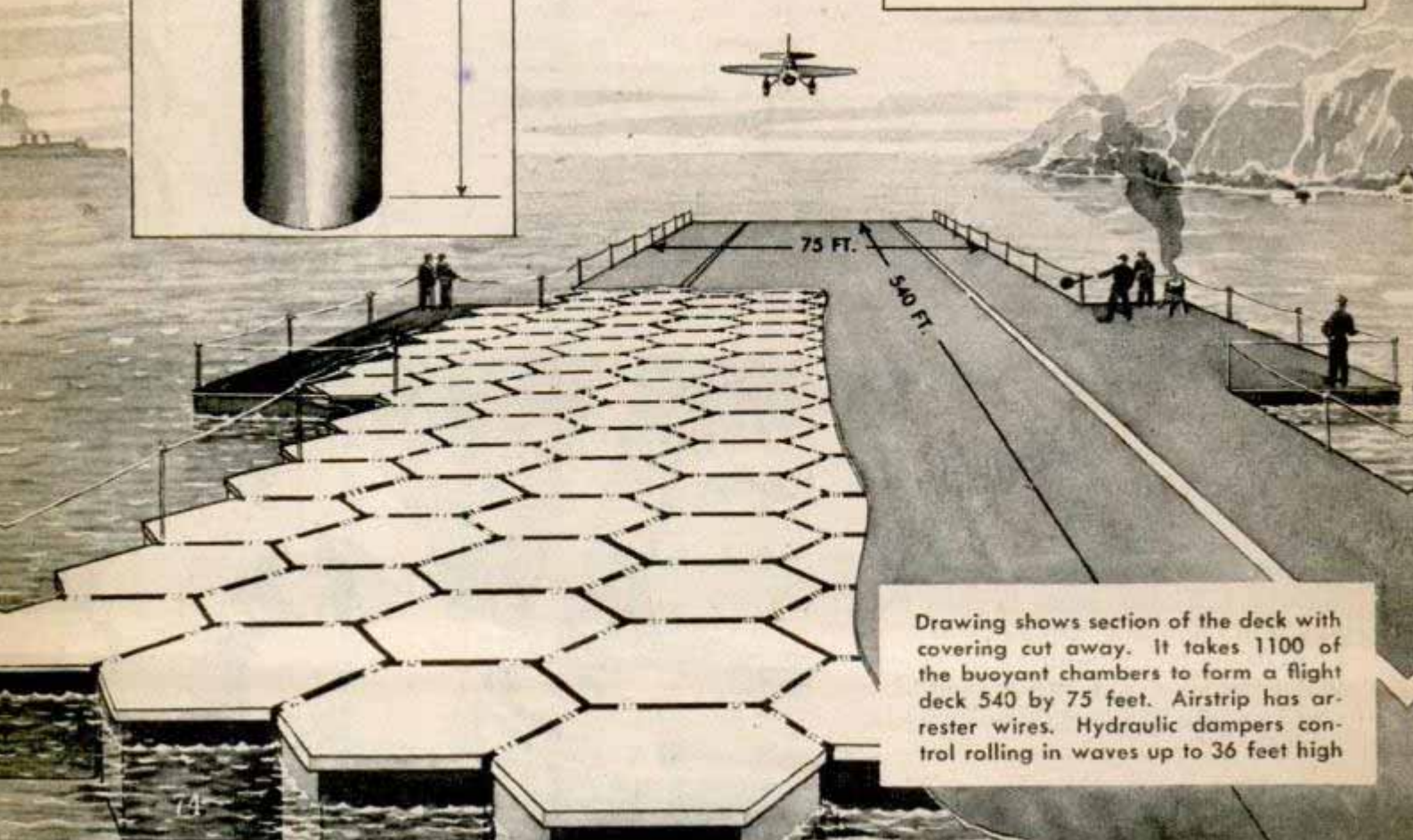
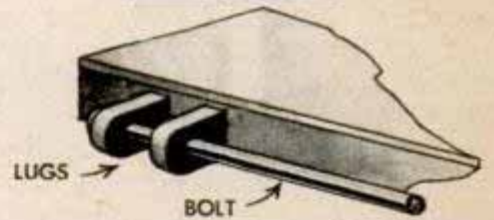
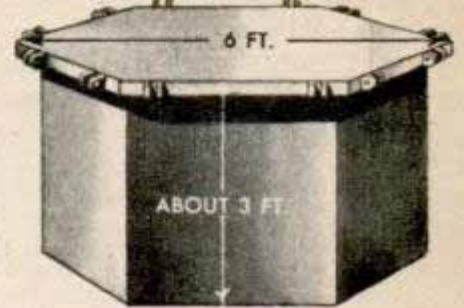

Drawing shows section of the deck with covering cut away. It takes 1100 of the buoyant chambers to form a flight deck 540 by 75 feet. Airstrip has arrester wires. Hydraulic dampers control rolling in waves up to 36 feet high

Air Pictures Guide British Rebuilding

Royal Air Force flying photographers who used to dodge flak when taking pictures over enemy territory now make photographs of smashed cities and towns in England to help the Ministry of Town and Country Planning replace bombed-out homes, buildings, streets and parks. Many war-developed techniques are being used to simulate cities and countryside in model form. For example, aerial photographs are translated into synthetic rubber models that show exactly what structures were knocked out.

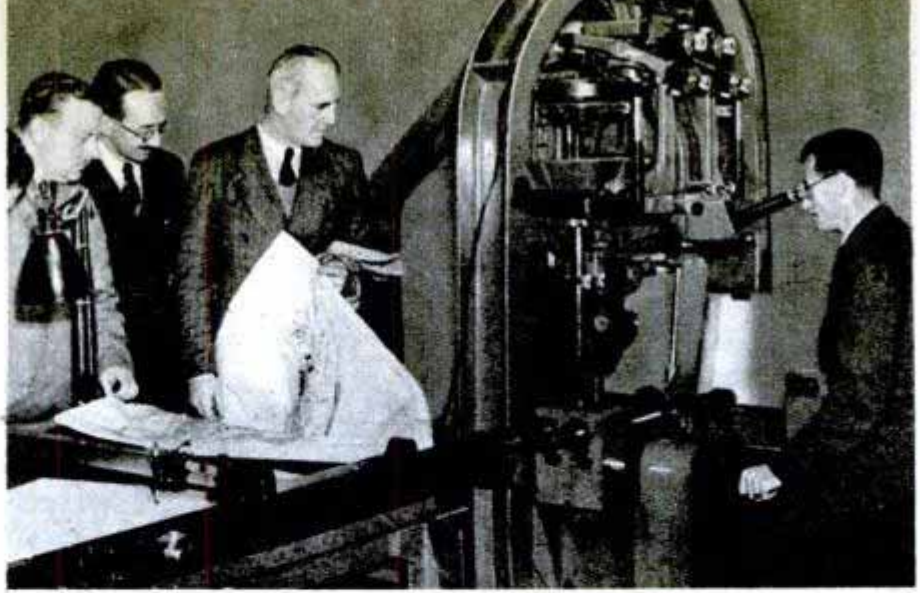

British Official photos
Photographs of enemy territory made by RAF flyers were transformed into maps by a machine and later studied by Allied military strategists

Robot Golf "Pro" Teaches Duffers

Keep your right heel down and you'll get a good drive, the golf professionals tell right-handed golfers. And now there's a practice machine that almost forces you to keep that right heel flat. Patented by Dave Bauer, a "pro" at Long Beach, Calif., the device has a small pedal on which duffers place their right heel. As long as the pedal is pushed down, it engages a lever that tees up a golf ball, all ready to

hit. If, however, the golfer raises his right heel—which probably would produce a poor shot—the pedal comes up and the teed-up ball goes down almost out of sight.

If you stand properly this device tees up a golf ball for you, but if you lift your heel the ball d'sappears

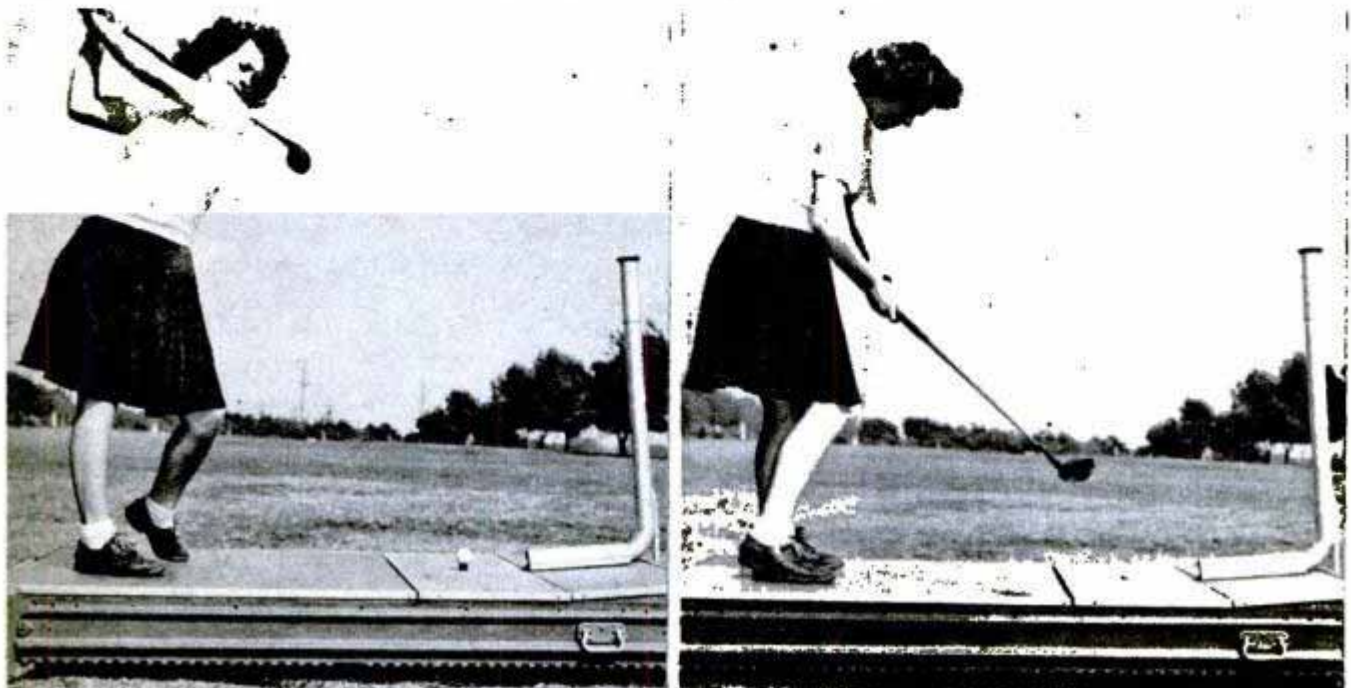

MODELING WITH NUTS AND BOLTS

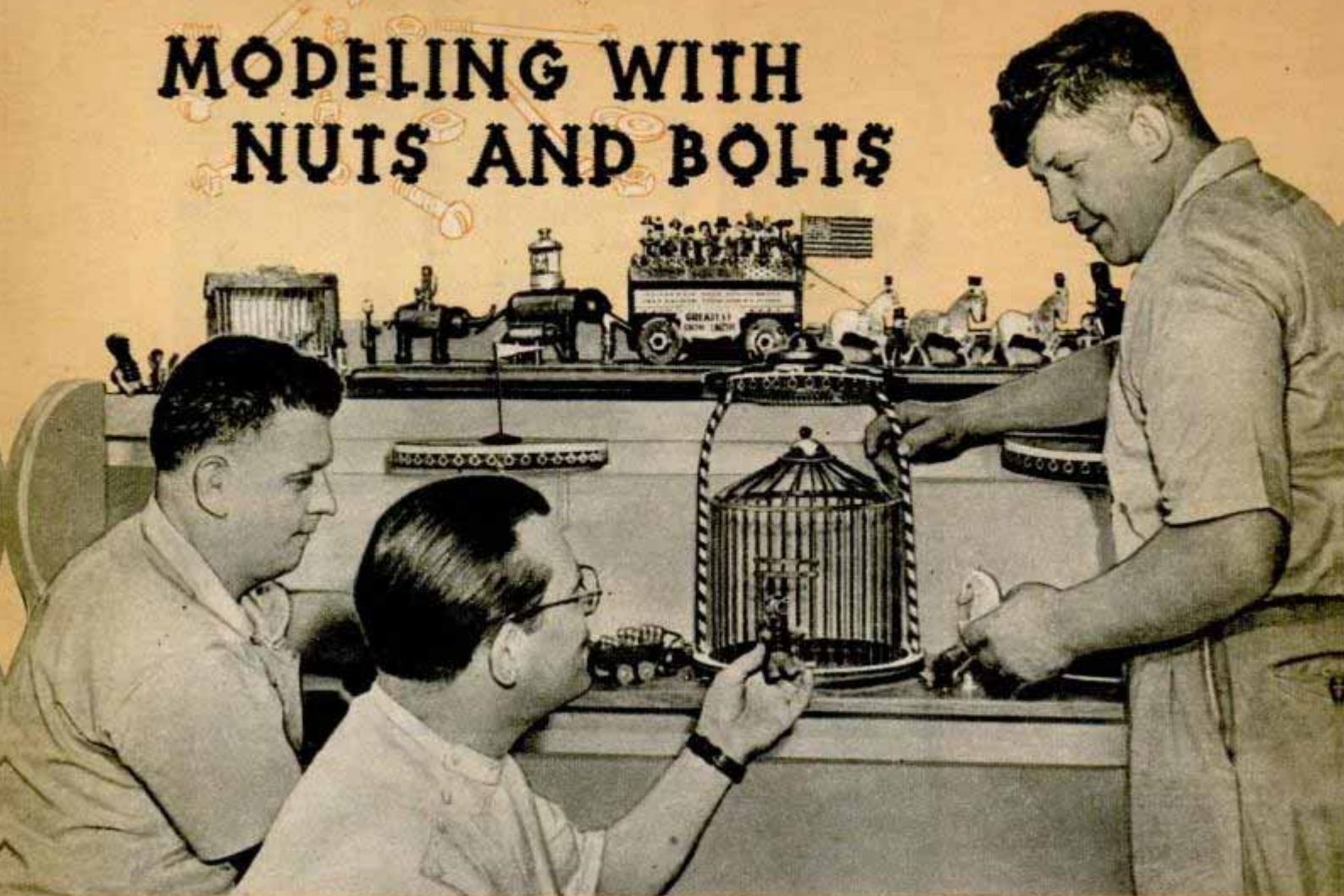

Dr. Bernard H. Cooper (center) and helpers apply finishing touches to the world's most unusual circus

THE craftsman's scrap box is the inspiration of a unique hobby originated by a Cleveland dental surgeon. He has found endless and exciting possibilities in modeling with nuts and bolts and scraps of metal.

Slice the threaded portion of a bolt with a hacksaw and you have an excellent Stalin moustache. Cartridge cases are the arms or legs for small metal figures. With a little imagination an old bevel gear becomes a skirt for a native gal. Slotted boltheads make realistic eyes—even cat's eyes if the slots are placed vertically.

"In half an hour I can teach anyone how to turn junk pieces into models of persons or animals," says Dr. Bernard H. Cooper. "The main thing is to learn to see the possibilities in each item. Every piece of metal that has been machined, cast, or otherwise worked is a part that can be linked by the imagination with some everyday form, or can be combined with other forms to suggest something familiar."

Dr. Cooper, whose suite of dental offices is lined with his artistic efforts, has been an enthusiastic hobbyist for 15 years. He first became interested in masks of aboriginal Africans, and made scores of them. He carved bas-relief heads and figures in wood. He painted pictures. He created

By **Walter E. Burton**

plaques, masks and figures in plaster and clay. He turned out beautiful plaques and masks of hammered copper. He worked in plastics, and in 1941 won first place in a national plastics show.

His enthusiasm for making copper plaques ran into a snag in the form of war-created shortages: no copper, no more amusing caricatures of Joe Louis or stern likenesses of Maxim Gorky. He looked around for a new outlet for his excess energy. He found it in the scrap box. With bolts and nuts, wood screws, chips from metal-cutting lathes, worn steel balls from coal pulverizers, cotter pins, old gears and other odd bits of metal, he created amusing or significant figures, groups, and even a complete circus. So successful has he been in this new field that his scrap box creations are sought by museums for permanent collections. They even have been shipped, on request, to Russia for use in teaching the art in hospitals and schools.

Dr. Cooper has been assisted in developing his new hobby by George and Steve Jencso. Besides contributing their skill to the working of metals and the making of special tools, these brothers have done much to accumulate the amazing collection of scrap parts that furnishes Dr. Cooper

his raw material. Patients, hearing of the work, often bring boxes or bags of bolts, pipe fittings, and other metal items. Glass jars filled with these things overflow one of the doctor's workrooms; other bits of raw material hang on nails and hooks. A door marked "X-Ray Room" leads to a chamber where circus models and other large displays are put together. Visitors rounding a corner in the hallway are surprised by a workbench supporting a drill press, heavy vise, tools, an assortment of parts and half completed figures.

Dr. Cooper is convinced that his new hobby will become popular all over the world because it gives even the most unskilled person a chance to create something original and unique. Besides, the work is easy and fun.

The actual assembling of a figure is simple and often surprising in its results. An example he often shows prospective "junketeers" is the making of an African damsel from an old bevel gear, a rejected 37-mm. cannon projectile, two empty .50-caliber machine-gun cartridges and a short piece of thick-walled steel tubing. Dr. Cooper is especially fond of making aboriginal figures and fetishes, and has made a study of this form of art.

The bevel gear, placed with the teeth sloping downward, suggests a native skirt, so it becomes the base of the figure's torso. By setting the short piece of tubing on the

gear, he completes the body. When the 37-mm. projectile is held with its nose downward, its base resembles the hair-do popular among some African women. A few wads of modeling clay, a little work with a dental tool, and the shell has acquired temporary eyes, nose and mouth. More clay is used to hold the nose of the shell in the end of the tubing and to secure the two cartridge cases to the body.

The mockup now is complete, and can be examined for possible ways to improve it.



Saluting robot at left was made mostly from bolts and nuts. Before trio of microphones is caricature of Joseph Goebbels

Odd pieces from scrap box present dramatic scene of Red Cross stretcher-bearer group. Right, assembling queer African idol

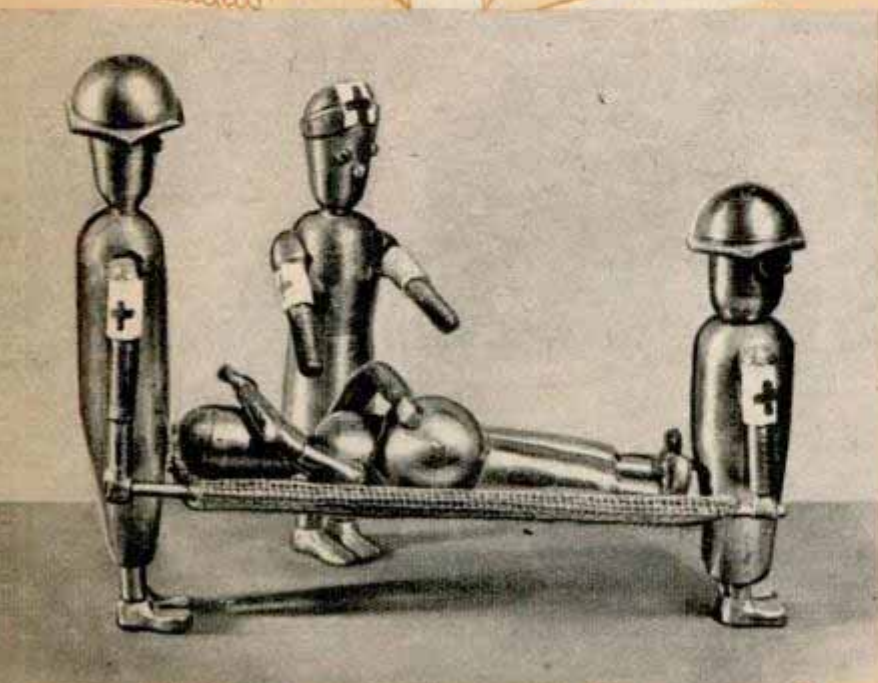



This is Dr. Cooper's self portrait which amuses his visitors. Below, sailors ride waves of lathe chips

The hole in the base of the cannon shell suggested a candle socket, so Dr. Cooper plans to assemble two such figures to make a pair of candle sticks. After he is satisfied with such a mockup, he proceeds with final assembly. This consists mostly of replacing the modeling clay with permanent materials. By pushing a scribe through the center of each eye, he marks the points where holes are to be drilled and tapped to receive bolts whose heads will become the permanent eyes. In a similar way he marks the positions of mouth, ears and nose. Bolts, solder and rivets are used to fasten together the various parts of the figure.

This is essentially how junketeering is done. The craftsman simply assembles various items to resemble a face, figure, animal or other object. Often the result is amusing as well as artistic; sometimes the theme is sobering. Individual figures can be assembled into groups to tell a story, examples being Dr. Cooper's Coastguard boat, Red Cross stretcher-bearer group and model circus.

Much of the fun results from discovering how a certain piece may become an eye, ear or other bit of anatomy. Dr. Cooper and the Jencso brothers are continually finding new ways of using odd bits and pieces. They have a few "standard" practices, such as using boltheads for eyes, that anyone can employ. The slots can be positioned to suggest normal or oriental eyes, or to give a drowsy expression to the face. Phillips-head bolts produce staring eyes. Larger boltheads, with the slots horizontal, make excellent mouths. Ears may be bolts with knurled heads, the ring ends of cotter pins, or screw eyes. Half-round threaded sections of bolts may be used as feet. Whole bolts become arms and legs. Screw eyes serve as oarlocks on rowboats, ears of figures and decorative trim around circus merry-go-rounds.

Heads of figurines may be anything round or cylindrical—cannon shells, large



iron balls, drawer pulls. In general, Dr. Cooper tries to keep his figures on a scale of one half inch to the foot. Sometimes, when he cannot find the right shape in the junk collection, he resorts to filing and other forming operations. But most of the fun of the pastime is the combining of ready-made shapes. It is not necessary to reproduce all the details of the figure to be represented. Often a mere suggestion is enough. Thus, in a group of sailors in a boat, the men have no ears, yet this omission is seldom noticed.

Lathe chips, particularly the long, coil-spring type, have many uses. Dr. Cooper stretches them in wire frames, paints them appropriate colors, and produces realistic United States flags. Flat, broken chips produced by heavy cuts make excellent waves for an ocean scene. Curly chips may be used for the hair of certain types of damsels or become the elements of a grass skirt.

One of the most successful model groups produced by Dr. Cooper and Steve and George Jencso is a miniature circus that includes a parade procession and complete sideshow. There are elephants made from pipe fittings, bolts and iron balls once used in coal crushers. Horses pulling the bandwagon were made by assembling flat sections sawed from heavy sheet brass. The main part of a lion is a copper thermostat bellows. An open coil spring forms the body of the human skeleton. Inside the circus cages are various rare and wholly imaginary animals, including vicious-looking reptiles having lathe-chip bodies and hexagon-nut heads. This circus, together with some grotesque fetishes, graceful candlesticks, and other examples of the junketeer's art, won an armful of prizes at the 1945 May Show at the Cleveland Museum of Art. Dr. Cooper intends to present the circus to the museum for permanent display, but first he is scheduled to exhibit it at various hospitals, along with other models.

The possibilities of the new hobby in hastening recuperation among hospital patients are so promising that Dr.



Ingenious scrap metal circus includes wagon train with caged animals and sideshow. It was exhibited at Cleveland Museum of Art

Cooper hopes to devote his full time eventually to the teaching of such occupational therapy. So simple and easily obtained are the materials and equipment needed that the hobby can be pursued in almost any hospital. He expects to see this done on a nationwide scale among civilian institutions. Officials of military hospitals are studying the possibilities. Not long ago the Russian government heard about Dr. Cooper's work and requested some models. He has sent 35 items to Moscow, and has more in preparation. He has been informed that the project is being adopted in Russian

"Big City" is made of steel blocks, cartridge, brass pieces and nuts

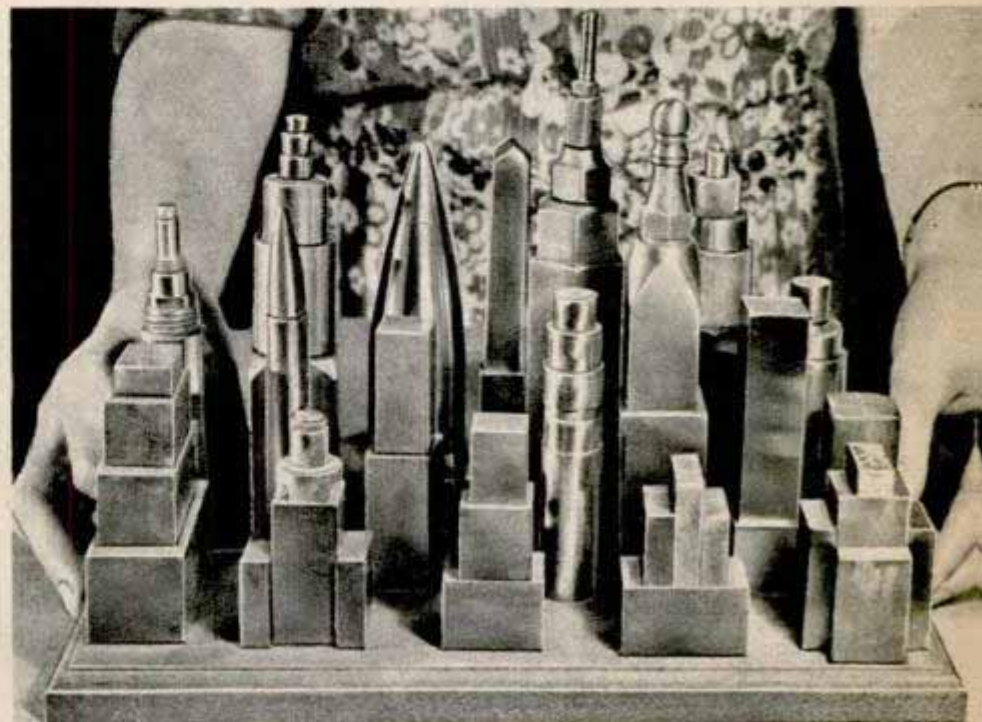

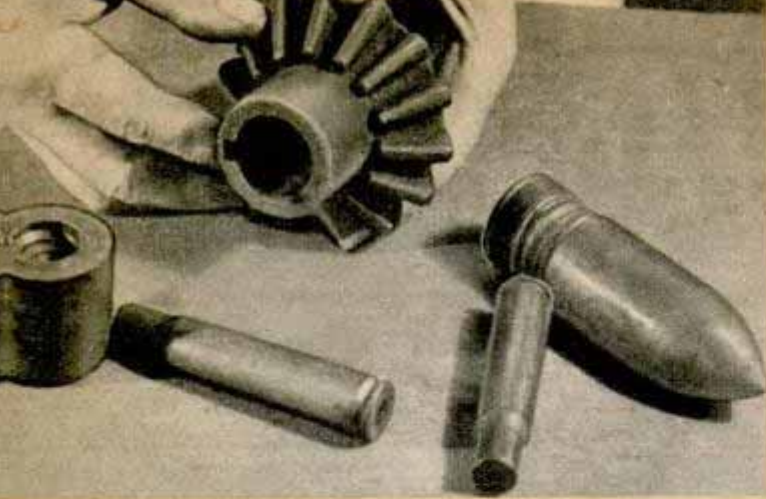

Series from top to bottom shows how to make native figure at right. Sloping teeth of old bevel gear form skirt and steel tube completes torso. Other parts are cannon projectile and cartridges

hospitals. The various standard hobbies, employed widely to occupy the minds and hands of patients, do not always stir their imagination, and sometimes lack masculine dignity. A man patient may benefit greatly from knitting or crocheting, but he is reluctant to show his work to others. But Dr. Cooper has found his model-building to be sufficiently mechanical and virile to satisfy any masculine standard. So, before long, instead of taking flowers to a hospital patient you may make him happier by taking a bagful of assorted bolts and nuts.

The assembling of scrap box parts into models is an excellent way to develop mechanical skill and steadiness of eye, nerve and muscle, as well as imagination. Dr. Cooper expects junketeering to be adopted as a school activity, perhaps in connection with art and vocational education courses. Here, again, availability of materials and simplicity of equipment are important.

Dr. Cooper and his two associate craftsmen have refused to capitalize on their hobby. They will accept donations of scrap parts, but no money. They feel that they have been amply rewarded in the fun they have had and in the making of life easier for hospital patients and others.

So if you want to assemble the sweepings from a machine-shop floor into a figure of Paul Revere, go right ahead; you have Dr. Cooper's blessing and his hope that you will become a confirmed junketeer.

"How old do you think I am?" Dr. Cooper asked as he worked on a display he is building to show life in the Gay Nineties.

"Oh, in the forties somewhere."

"I'm 57," he said, laughing. "When people say I don't look my age, I tell them it's because I always have had some creative hobby to occupy my spare time. And of all the hobbies I've tried, I think this one is the most interesting."



Adjustable Drill Follows Pattern

Six holes can be drilled in any pattern by a universally adjustable, multiple drilling attachment which can be installed on most types of drill presses. It consists of a driving head with six movable spindles, each located by an individual radially adjustable arm. The attachment permits the positioning of drills up to $\frac{17}{64}$ inch diameter in any hole pattern, including a straight line, within a five-inch diameter circle with minimum distance of $\frac{11}{16}$ inch between centers. The housing for drive gears and the supporting frame and adapters are made of strong aluminum alloy. The attachment weighs 13 pounds. It can be installed on most types of drill presses.

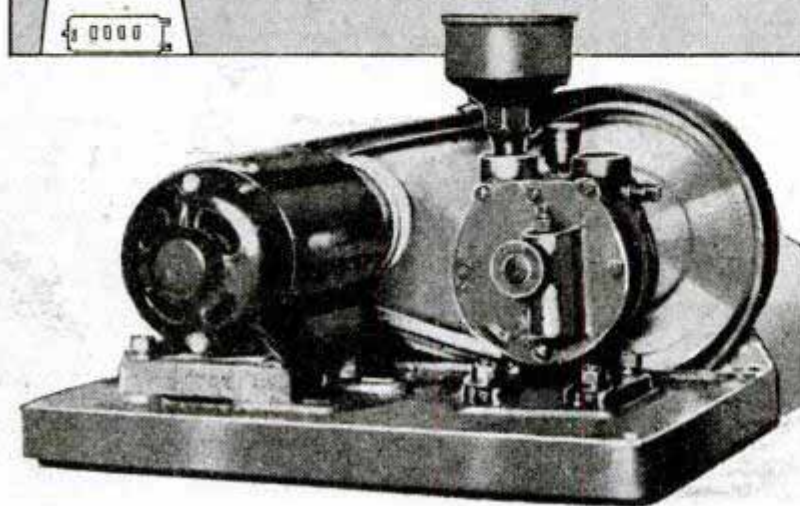
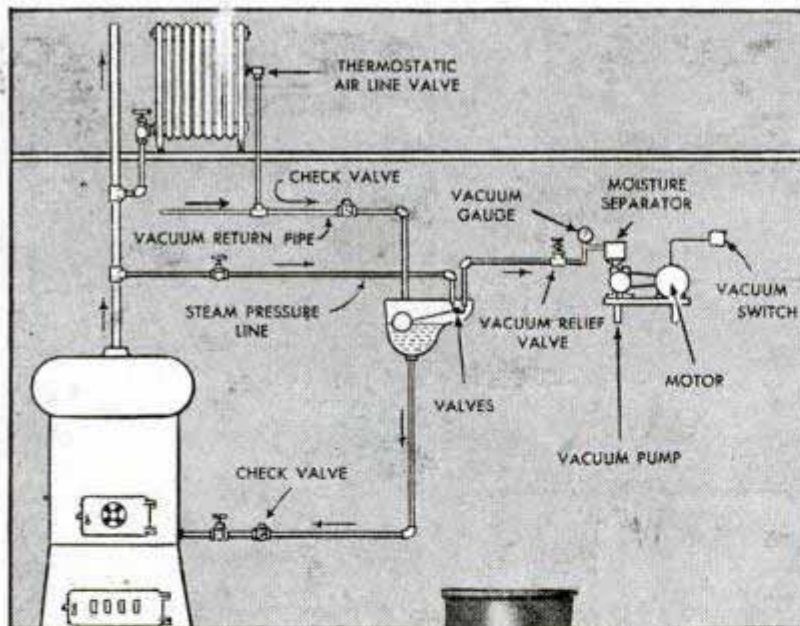
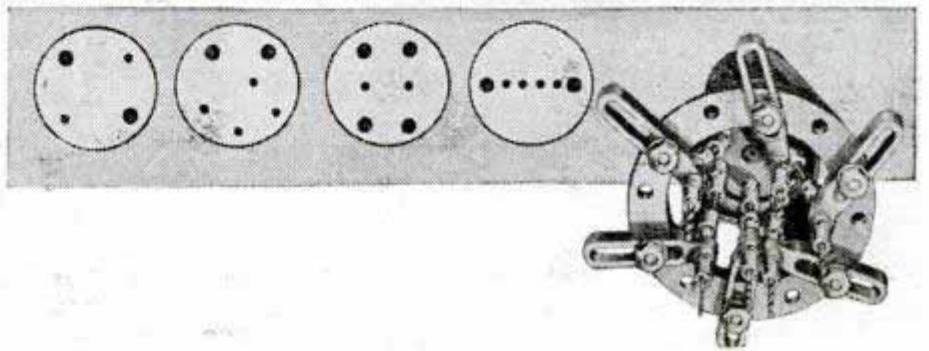
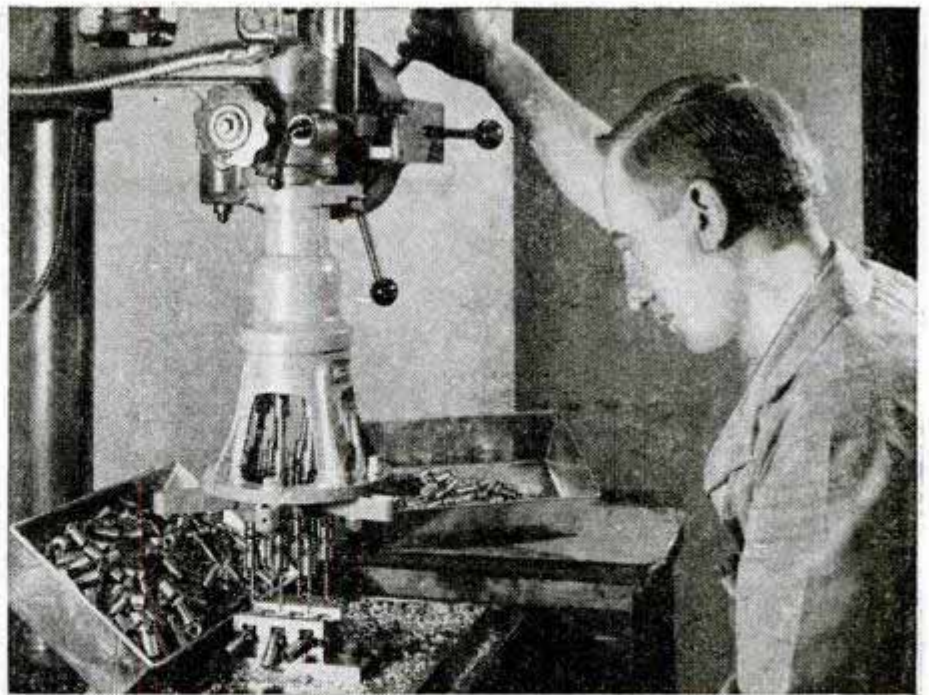

Vacuum "Spurs" Radiator To Give Even Heat

Acting as a kind of troubleshooter, an automatic vacuum unit is designed to operate only when a steam radiator stops giving heat. The unit stands by idly until a radiator fails to get its share of steam or starts acting up. As soon as the vacuum gets the radiator working again, it returns to inactive duty. The unit is simple in construction and operation and can be fitted to any steam heating plant. It will act on any radiator of a heating system or on several at the same time if necessary. It is said to save fuel by providing an even distribution of heat in all radiators.

Liquid Resin Toughens Plaster of Paris Casts

Plaster of paris forms take on a bonelike hardness when dipped in a liquid resin impregnant and cured in an oven. The treatment makes figurines, dies and core boxes more resistant to high temperatures, water and chemicals.

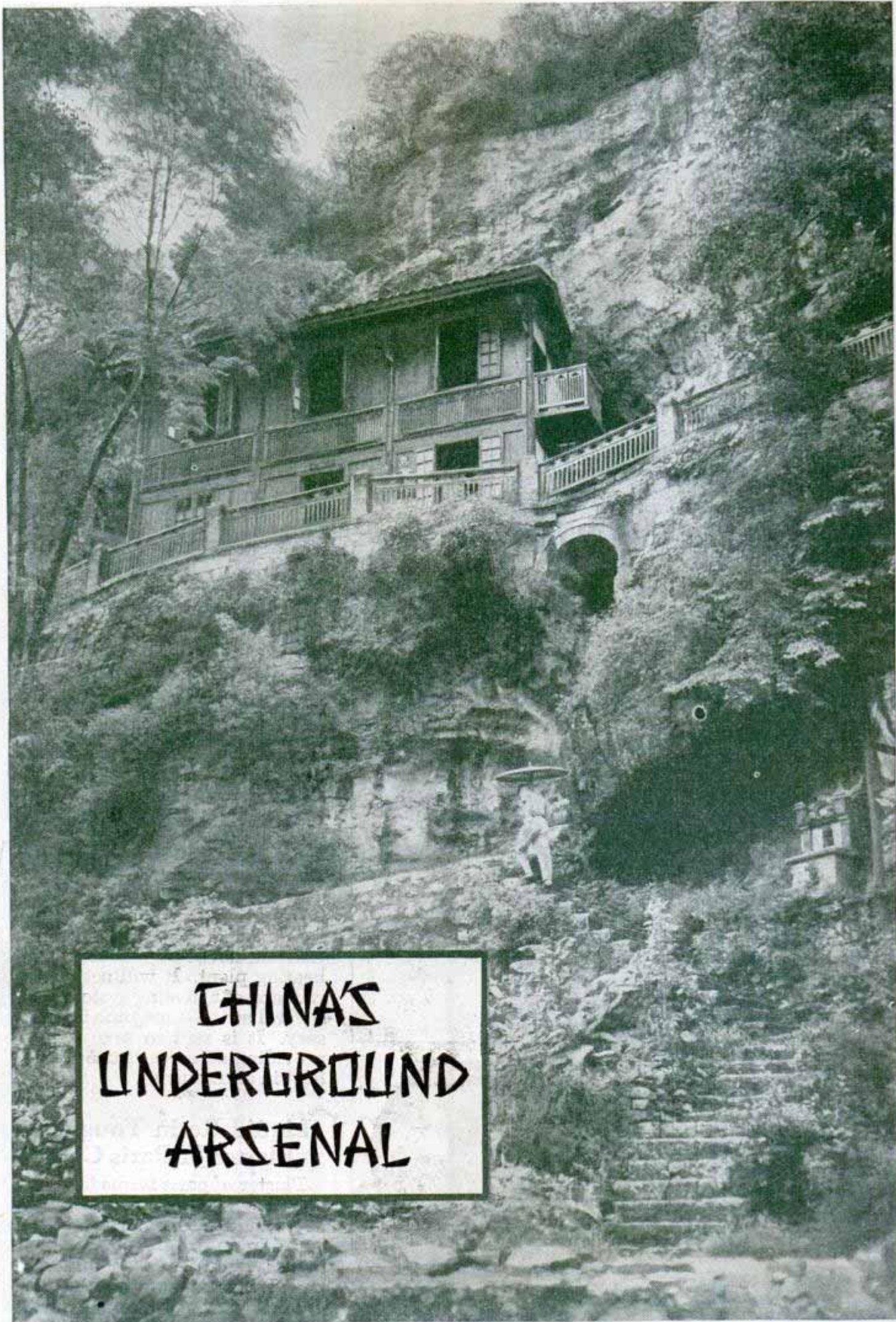

**CHINA'S
UNDERGROUND
ARSENAL**

SHORTLY before the war ended, a U. S. Army officer was on a secret mission in a remote section of China. Suddenly his guide, a Chinese officer, stopped before a hill and clapped his hands. An enormous door opened in the side of the hill.

Inside they found an Arabian-nights-like world. Here was a huge underground arsenal carved out of a mountain of rock. In the blacksmith shop, workers labored with cold chisels forged out of the finest medium carbon steel. Not far away another group of special workers could be seen removing red-hot steel bars from annealing ovens. Later the bars were put in hydraulic presses and made into projectiles for 75-millimeter ammunition.

The guide explained there were about a dozen of these underground arsenals in China located at strategic points close to the major battle zones. Each cave contained many large shops and a Diesel-electric generator to supply power for machines.

Each secret arsenal had its own plants for making most of the shells, machine guns and basic weapons. Both American-style bullets and projectiles and Chinese "ammo" were manufactured and loaded. Of special help were machines that crimped the bullets to the cartridges. This type of machine, like many other pieces of arsenal equipment, was of German manufacture—acquired legitimately or otherwise. All manner

Below, testing machine gun in underground arsenal where it was made

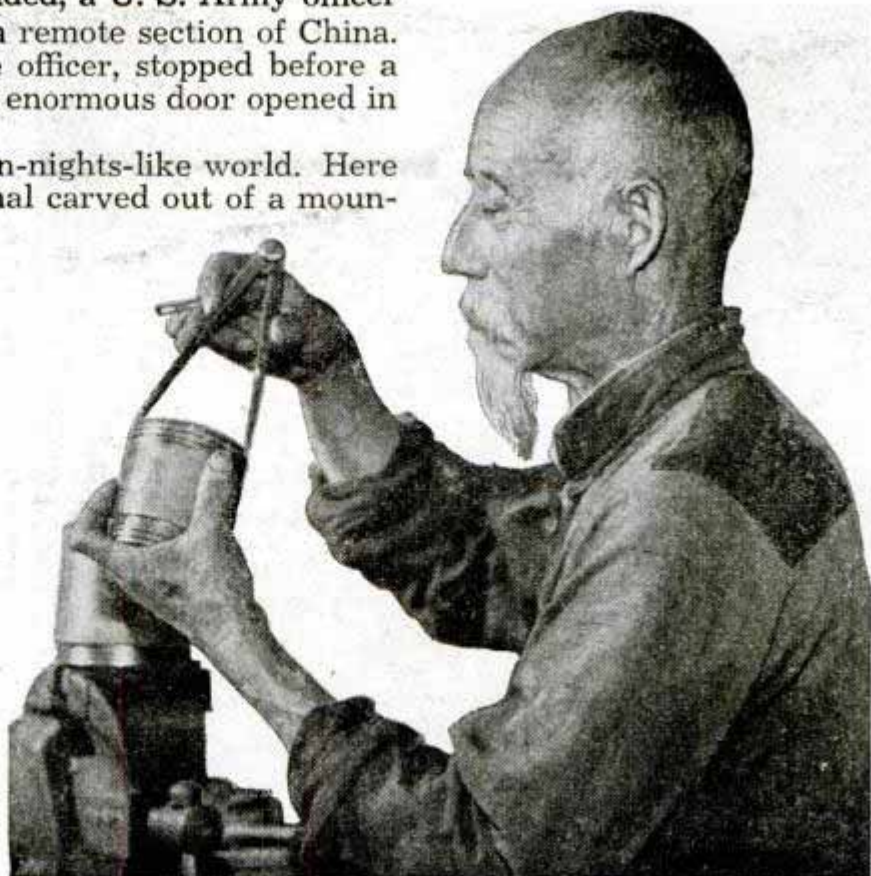

Aged Chinese craftsman checks a bushing for lathe in tool making shop of cave arsenal. Below, making 75-mm. "ammo" from hot steel

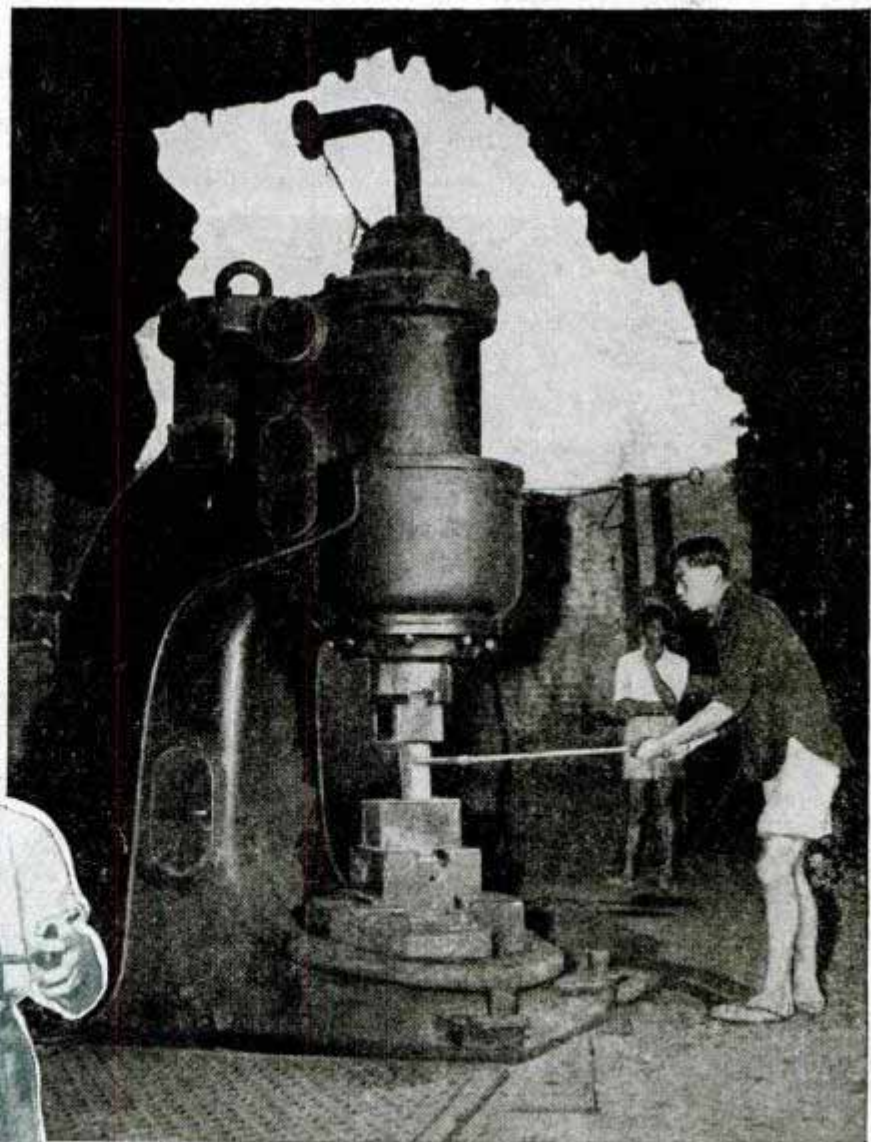



Left, GIs watch Chinese worker check bolt of machine gun. Right, loading steel bar into hydraulic press

of steel projectiles were made in the cave arsenals, although emphasis was on the 75-millimeter projectile, often hailed as the No. 1 weapon in the Sino-Jap war.

Chinese of all ages worked in the arsenals. They operated bandsaws used to cut wood for hand grenade boxes, packaged ammunition, and cast molten brass

into molds. Crucibles were made of rock cut by hand. All metal shavings were melted down and used again. The rolling mills made steel bars into six-foot lengths. Then they were cast into slugs and pounded into cartridges.

These hidden arsenals were China's bulwark in the dark days before victory.

In foundry at hidden arsenal deep in China, workmen prepare to melt brass in one of the many furnaces



Telephoto Corp. 6 1/2 x 7 1/2 inch. 11/10/46

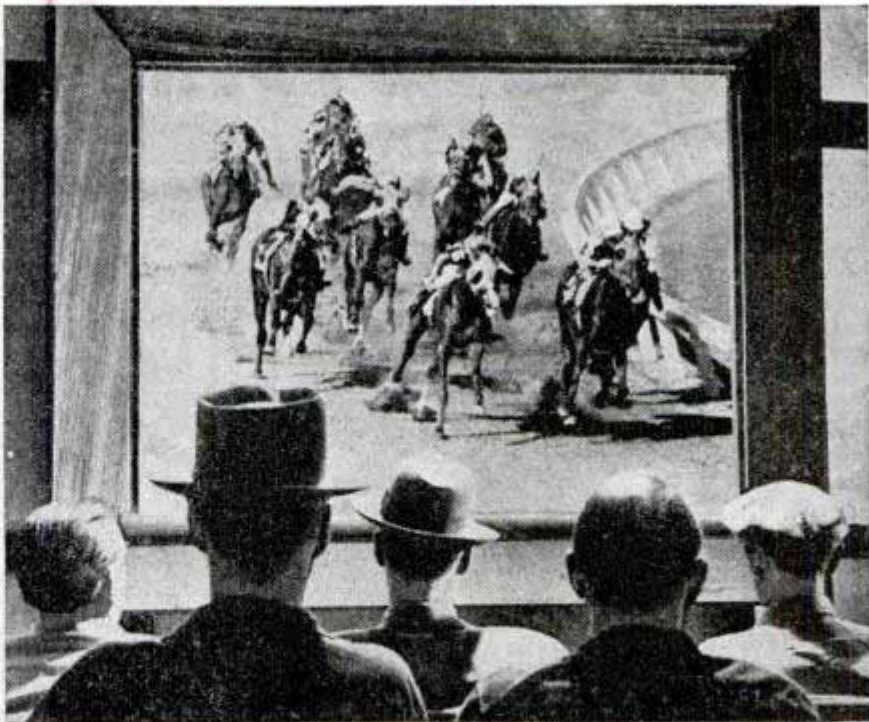
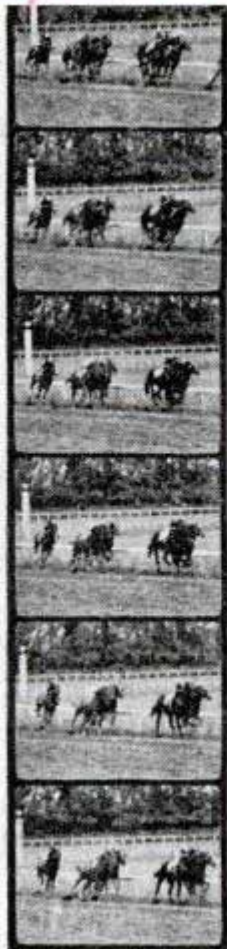

TELEPHOTO CAMERA at a California racetrack goes a step farther than the photo finish and provides a complete motion picture record of every foot of the race. The 16-millimeter camera is mounted on a 40-foot tower. Seven minutes after the race the movie can be run off for the benefit of stewards and judges. It insures accurate decisions on foul claims or any questionable action on the part of a jockey

Metal "Fish" Scoops Water For Navy Blimp Ballast

Towed by a blimp flying just above the surface of water, a torpedolike scoop is being tried out by the Navy to pick up water ballast. All lighter-than-air craft lose weight as they consume fuel, and various methods have been developed to counterbalance this loss. In the Navy's latest tests in Lake Erie a small electric pump was placed in a fishlike container with an opening at one end. The metal "fish" was towed behind a low-flying blimp to scoop up water that was pumped through the hose towline to the airship. The towline also served as a conduit for the electric wires that supplied power for the motor-driven pump.

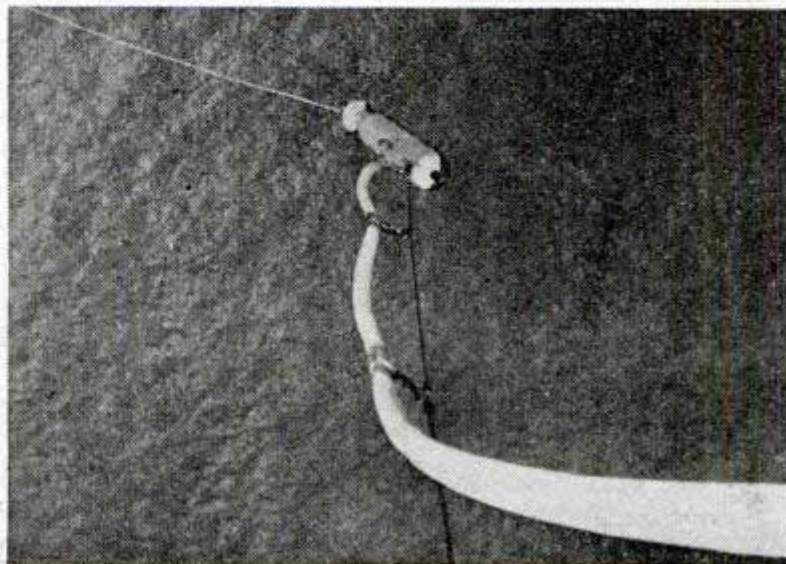
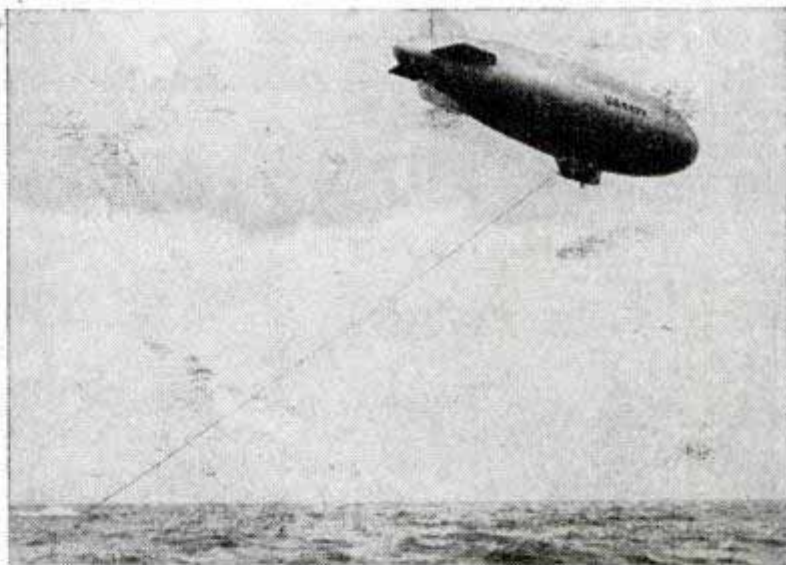

Plastic Treatment Hardens Wood

Wood impregnated with a plastic called Asidbar has increased weight and hardness, greater resistance against abrasion, water, chemicals and acid fumes, and acquires a black finish that need not be painted. The treated wood is suitable for flooring on platforms, in railroad cars and in structures subject to rough use.

AUSSIE "GIDEA POOL"



Auger attached to tractor gearbox digs postholes for Aussies

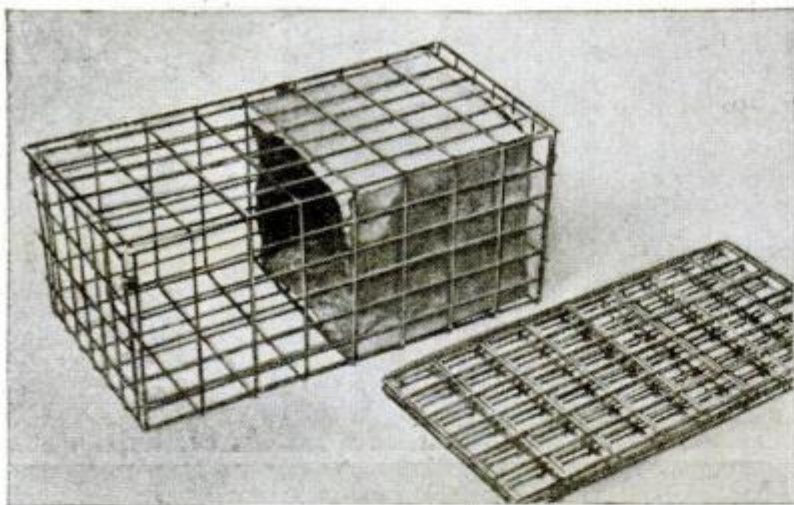

Among ideas offered to the Australian Army Inventions Directorate were the collapsible package container, above, and the "Storpedo," below, shockproof carrier for parachuting supplies

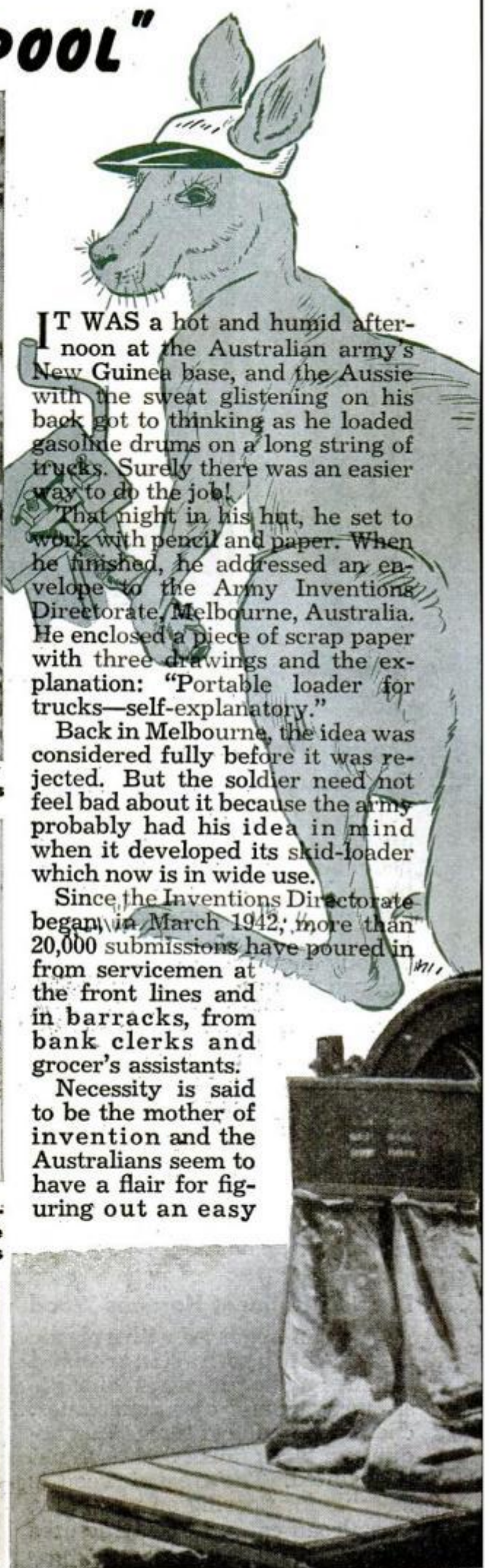
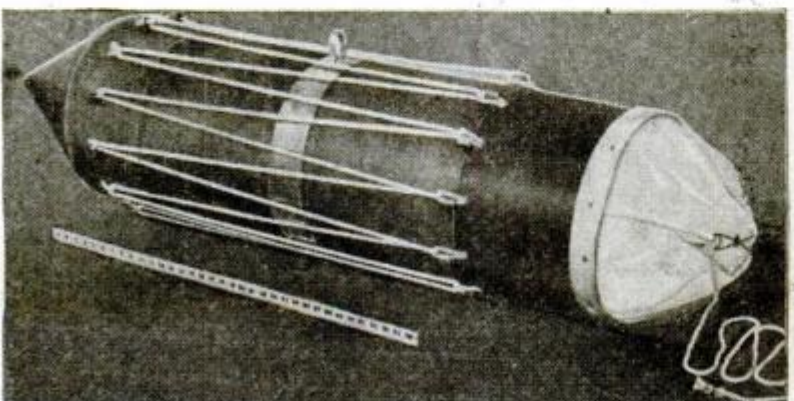

IT WAS a hot and humid afternoon at the Australian army's New Guinea base, and the Aussie with the sweat glistening on his back got to thinking as he loaded gasoline drums on a long string of trucks. Surely there was an easier way to do the job!

That night in his hut, he set to work with pencil and paper. When he finished, he addressed an envelope to the Army Inventions Directorate, Melbourne, Australia. He enclosed a piece of scrap paper with three drawings and the explanation: "Portable loader for trucks—self-explanatory."

Back in Melbourne, the idea was considered fully before it was rejected. But the soldier need not feel bad about it because the army probably had his idea in mind when it developed its skid-loader which now is in wide use.

Since the Inventions Directorate began in March 1942, more than 20,000 submissions have poured in from servicemen at the front lines and in barracks, from bank clerks and grocer's assistants.

Necessity is said to be the mother of invention and the Australians seem to have a flair for figuring out an easy

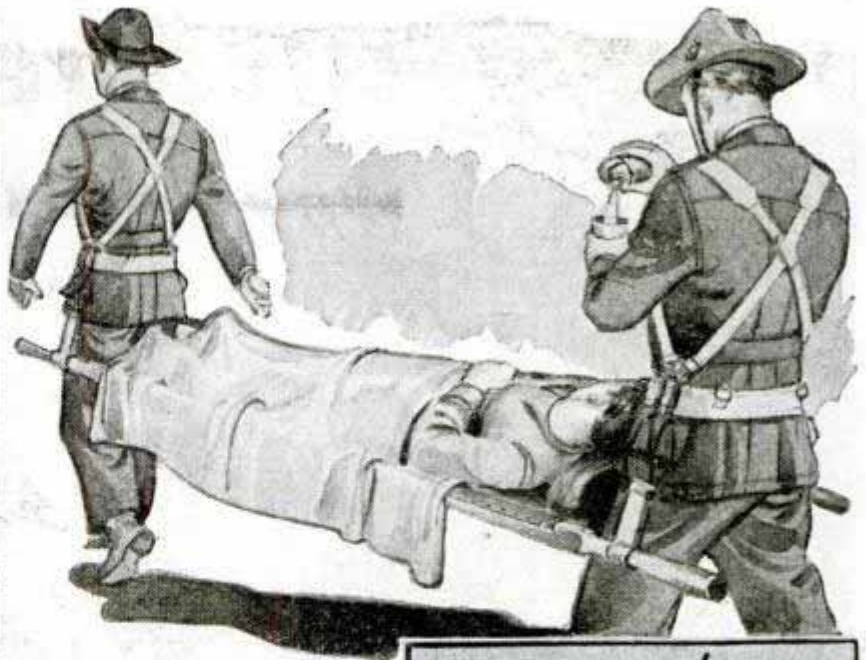

Stretcher bearer's harness leaves both hands free for climbing or clearing trail

way to do things. Take the stretcher bearer's harness which was developed during fighting in New Guinea. Soldiers, with heavy packs on their backs, found it tough enough to push their way through the tangled jungle growth in their chase after the Japanese. But stretcher bearers carrying the wounded out found the going almost impossible. They could not free a hand to push the vines and branches aside. That's how the harness was invented. Now the stretcher poles are inserted in loops in a harness hanging from the medical aid's shoulders. Both his hands are free.

An Australian sergeant noticed scraps of steel mesh

(Continued to page 148)

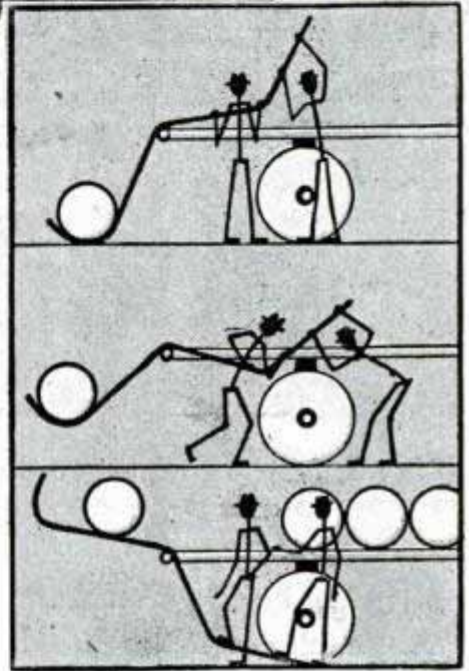

At right, soldier's idea of lever to load oil kegs on truck. Below, a potato digger and bagger developed by Aussie invention pool

Photos from Australian News and Information Bureau

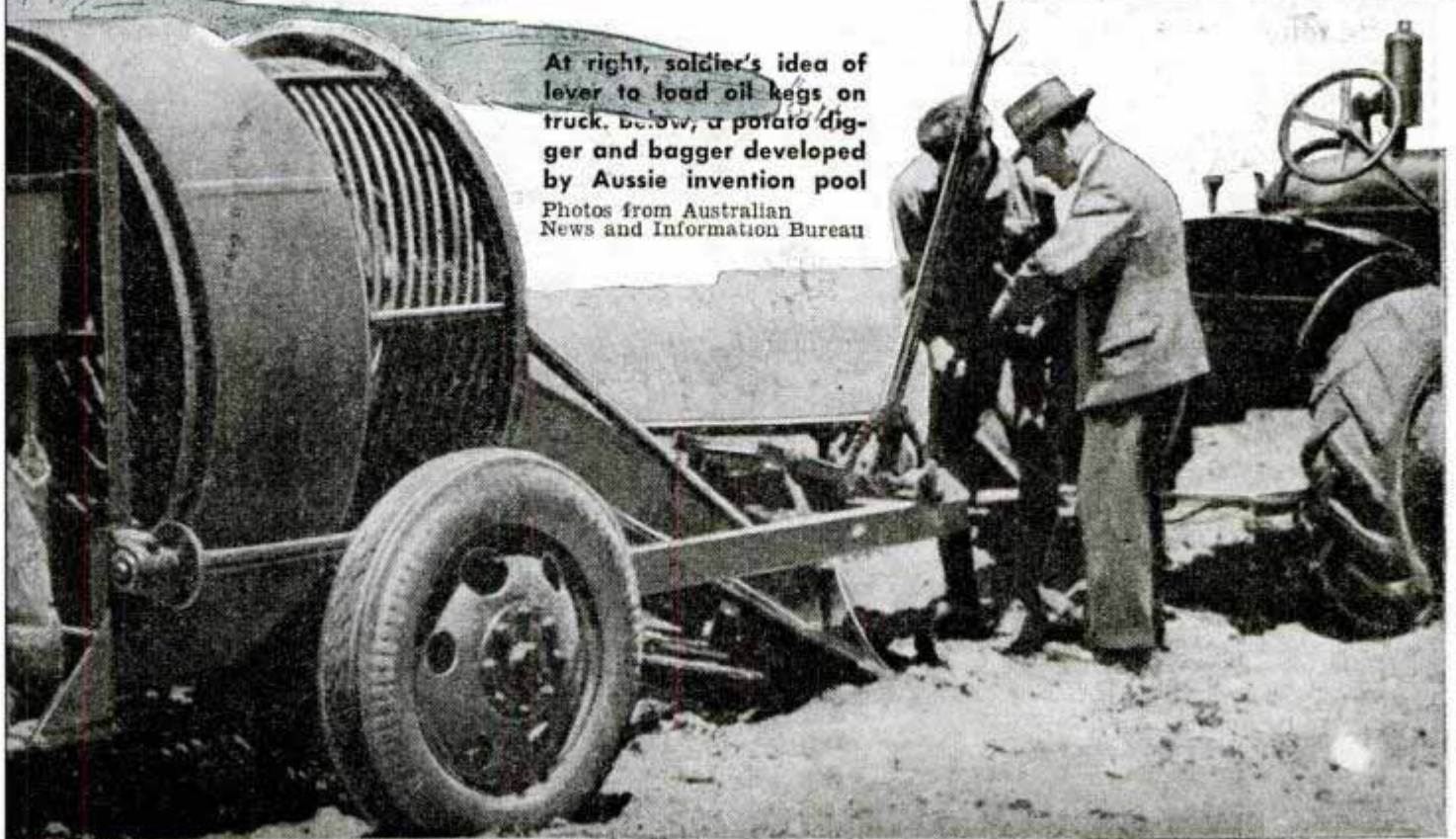



Shutters in Glass Window Open Like Venetian Blind

Windows resembling Venetian blinds, with louvers of plate glass that open horizontally for maximum ventilation, have been designed for postwar homes. When horizontal, the louvers open 90 percent of the window area for maximum ventilation. They can be tilted to any position to provide the desired ventilation while preventing draft. When closed the louvers overlap slightly, creating a watertight seal. The window is manufactured complete, ready to install in place of the usual sash. The louvers are available for both windows and doors and are made up in frosted glass for bathrooms, in tinted shades, and half clear, half frosted decorative designs.

The housewife is often the "popular mechanic" of the home—electrician, carpenter, photographer, plasterer in emergencies. Now that the postwar markets are brightening up with new appliances, the mechanics of running the household are a little less arduous. Keep abreast of what's new for the home by writing for information to the firms listed in the Where-to-Buy-It Index on page 8A, and say you saw it in Popular Mechanics.

Handle Feeds Cleaner Into Brush

A combination shoebrush and bottle of cleaner now on the market makes that last-minute touch-up of your shoes the work of a moment. The brush cleans suede, fabric and buckskin shoes, and the handle acts as an attached dispensing bottle that feeds a cleaning fluid into the brush for removing spots and stains from kid and other smooth-finish shoes. A fingertip button on top of the brush controls the fluid, and the bottle handle is refillable.

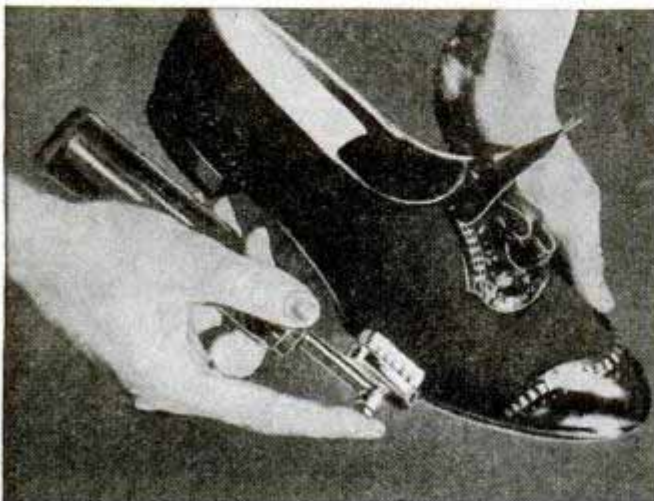

Indoor Drier Fastens to the Wall



Ninety feet of drying space is provided by an adjustable indoor clothes drier that will hold more than 100 pounds of wet wash. Fastened to the wall by four hooks, the drier is out of the way when not in use. It is adjustable for one piece or an entire washing and has a suspension of 18 feet. Clothes hang over 24 adjustable wooden bars, without use of clothespins. When packed, the device measures 3 by 30 inches.



Duncan Phyfe Lyre Table

By Norbert Engels

BUILT of solid mahogany with a matched grain, veneered top, this attractive occasional table is fashioned from an original designed by a famous craftsman. Distinctive features are the oval design of the top with offsets and the adaptation of the lyre as a basis for the pedestal construction.

Figs. 1, 2 and 4 detail the top. Because of the exposed edges, solid mahogany is used as a core under the four-way matched veneer. Edge-glue flat stock to produce a panel having a width and length slightly greater than the finished size. Then cut four pieces of mahogany veneer, preferably of the quality known as "ribbon" grained, and plane the edges true by clamping the pieces between two strips of waste stock. Make a trial fit of the four pieces to be sure the joints are tight, then join the four pieces with tape so that the grain matches in a diamond pattern. Finally glue the veneer to the mahogany core. After the glue is thoroughly dry, bandsaw the top to the pattern in Fig. 4 and run the molding on a

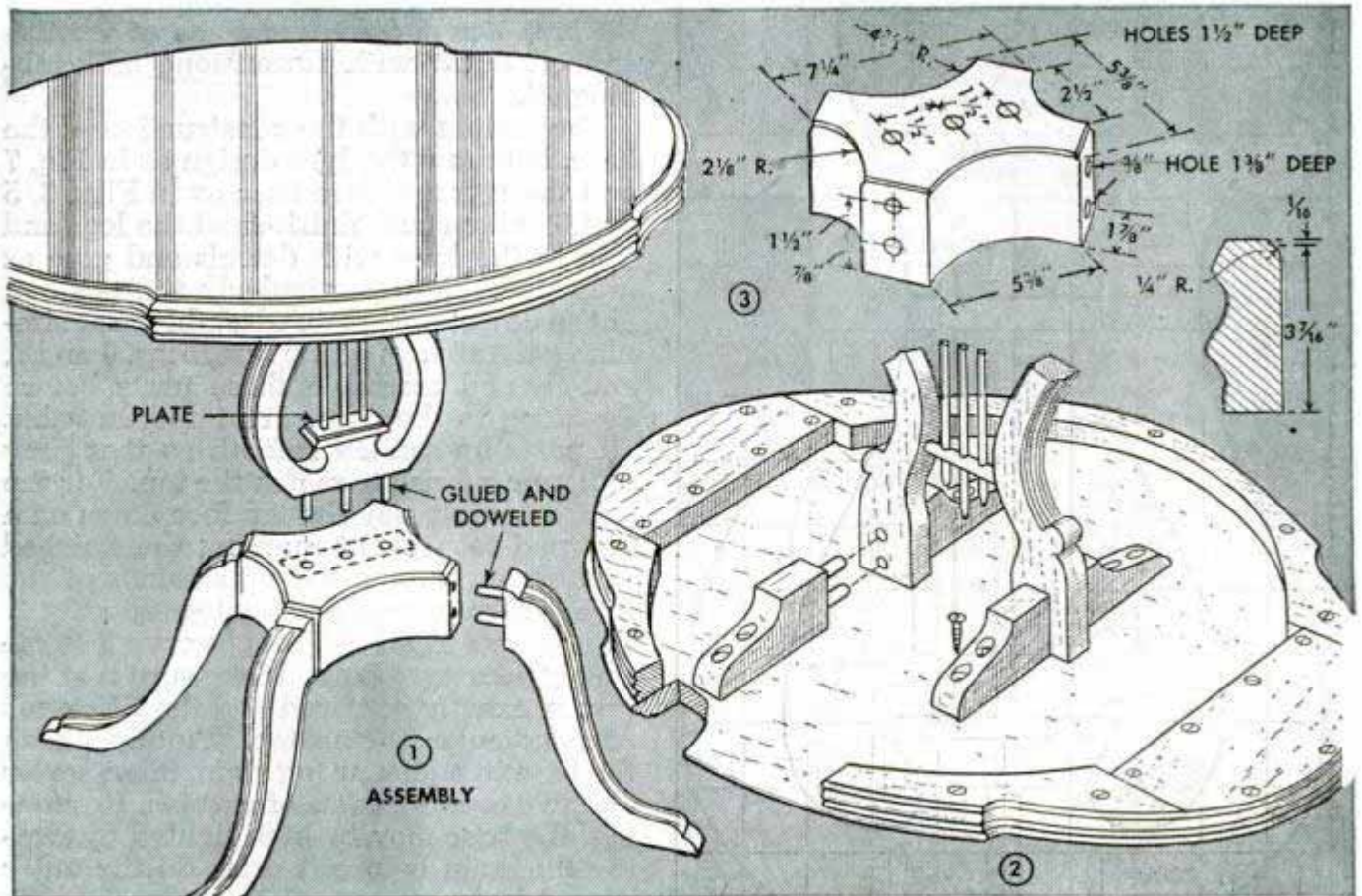

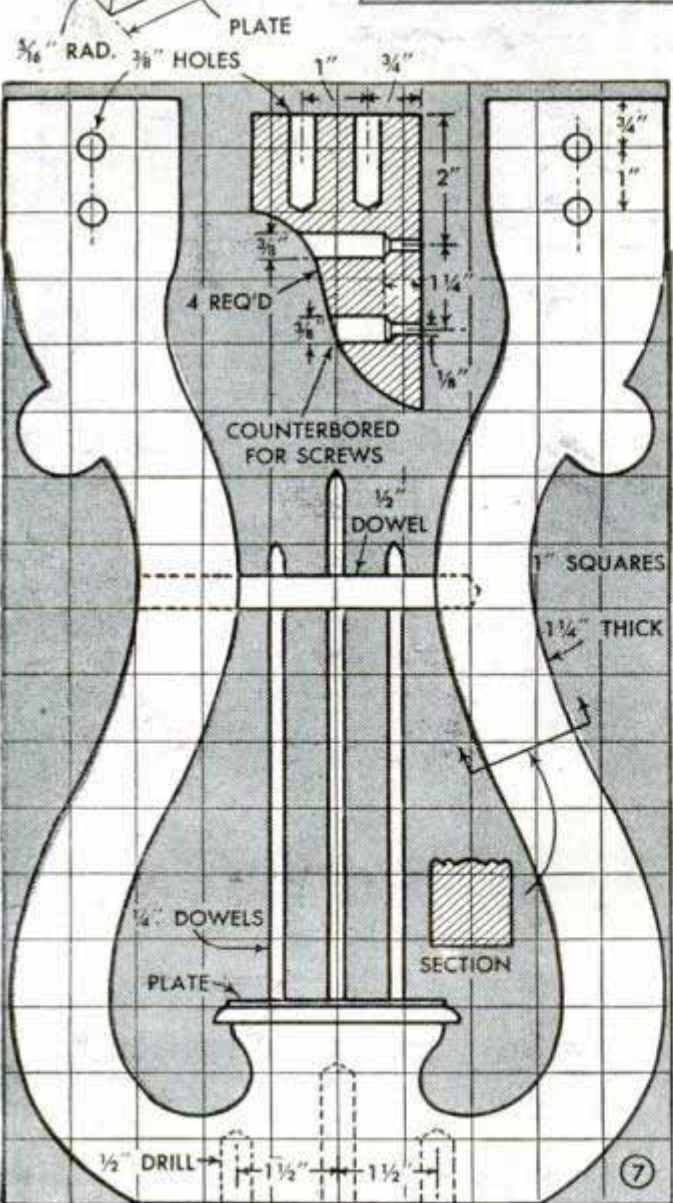
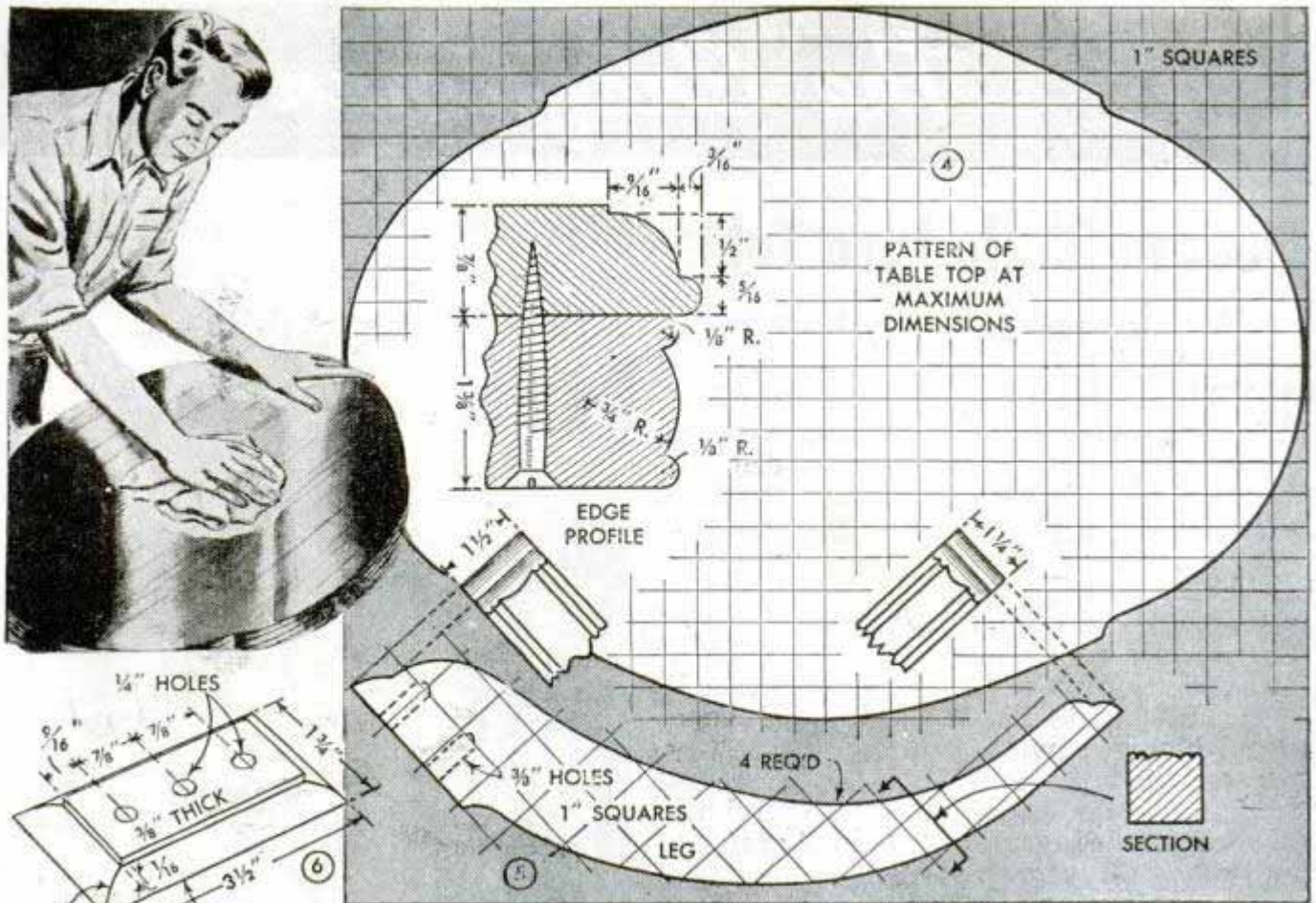

shaper. Next build up the apron as in Fig. 2, shaping the edges as in the sectional view, Fig. 4. Note that the top overhangs the apron slightly as in Figs. 2 and 4, and that it is bandsawed to the same pattern and glued and screwed to the underside of the top. Finish the top in the regular way by sanding smooth and applying stain, filler, sealer and several coats of varnish rubbed down with rottenstone and rubbing oil.

Proceeding with the construction of the base, bandsaw the lyre design as in Fig. 7 and the legs and lyre base as in Figs. 3, 5 and 6. Shape and finish-sand the legs and join to the base with dowels and glue as indicated. Note particularly the position of the dowel-and-plate assembly that simulates the strings of the lyre, Figs. 6 and 7, and fit and assemble these parts before doweling to the base. It's important that all parts be sanded smooth so that they will take a finish to match the top. For the final assembly, lay the top face down on a soft pad to prevent marring the finished surface and attach the upper ends of the lyre to the underside of the top as in Fig. 2. To assure a rigid assembly very close fitting is necessary here. Make sure that the lyre is exactly centered and that it stands perpendicular to the top. Finally, finish the base to match, using stain, filler, sealer and two or more coats of varnish. In staining, the base may be high lighted by wiping the stain before it dries on the outer exposed edges.

This Toy Houseboat Will Amuse Young Sailors

Designed for very young tots, this toy houseboat is simple in construction yet sturdy enough to stand the hard use it will receive. Because it has a removable roof, the boat can be used to store other small playthings besides being a toy itself. The deck is cut to the shape shown, and $\frac{1}{2}$ -in. holes $\frac{1}{4}$ in. deep are drilled for all dowel posts, except the hole for the one in the bow which is cut all the way through. The bow post is 3 in. long and the others are $1\frac{1}{4}$ in. long; all are rounded at the top and have holes for the cord. When the sides and ends of the cabin have been sawed and portholes drilled in the ends, the structure is assembled and nailed to the deck. Built of three sections, the roof is bradded together and the chimney is glued

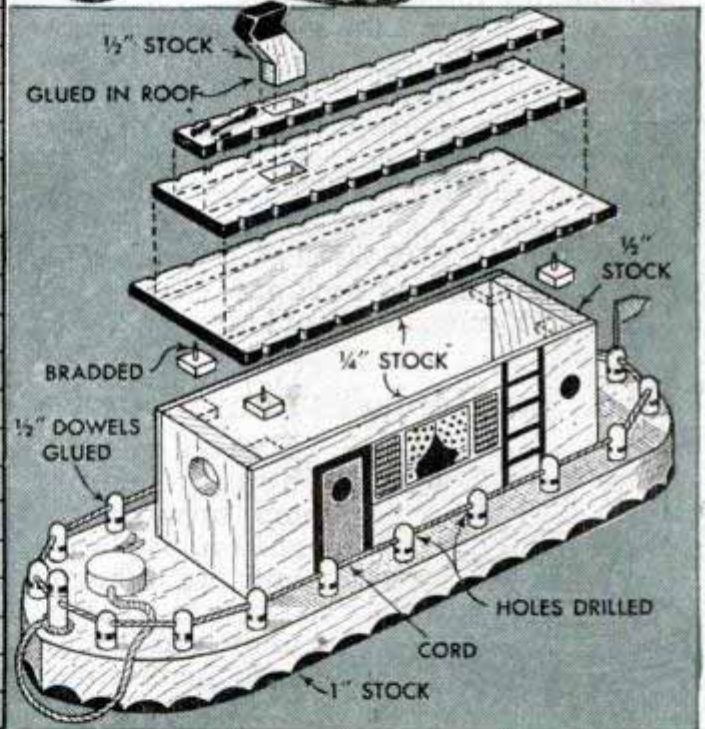
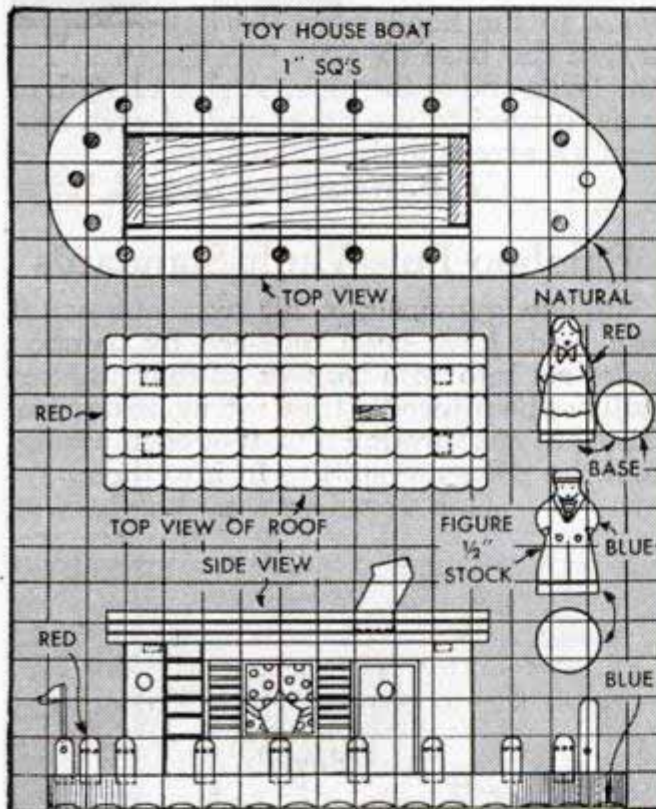

in the hole provided for it. There are four stops on the underside of the roof to hold it in place. For finish, the roof, chimney, railing posts and curtains are painted red and the outlines are black. To suggest waves, blue scallops are painted around

the bottom and the shutters also are blue. The suit and hat of the man are blue and the woman wears a red dress with a white apron. For the sake of simplicity, the rest of the boat is left in natural finish.

Roberta L. Fairall, La Crescenta, Calif.

Abrasive Strips for Model Work Can Be Made From Cellulose Tape

Handy and efficient abrasive strips for finishing or touching up model parts can be made by sifting emery on the adhesive side of a strip of cellulose tape. Cut off a suitable length and fold over the end for finger grips. If an old salt or pepper shaker is available, it can be used to apply the emery uniformly. An abrasive wheel for a

small motor is made by turning a wooden wheel and attaching cellulose to it sticky side out. Abrasive then is sprinkled on the surface.—W. C. Wilhite, Carlinville, Ill.

☐ Ordinary paper bags filled with shavings, sawdust or small scraps of wood make excellent fuel for starting a furnace fire.

Dog House Has a Sliding Roof To Permit Easy Cleaning



By making the roof of a dog house movable, you can clean the house more easily and change bedding chips without the inconvenience of pushing them through the doorway. The house can be built of any scrap lumber, but redwood is best as it repels parasitic insects. The roof slides on two runners, and is held on them by cleats. For ventilation, a hole should be drilled through the gable at each end.

J. Martin Young, Jr., Santa Monica, Calif.

Glass Jar Replaces Lamp Bowl

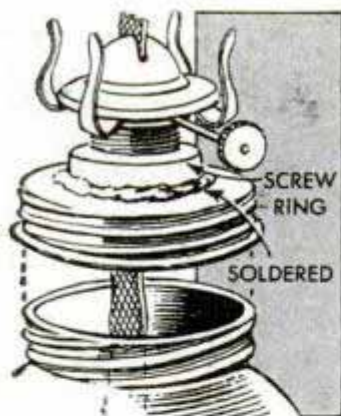

Frequently, when kerosene lamp bowls are broken, replacements are difficult to secure. But a sturdy substitute can be made from a glass jar by soldering the burner and screw ring to the jar lid. A hole is cut in the lid for the lamp wick to

drop down into the kerosene. For tall jars, a longer wick is required.

Jack Bronte, Grass Valley, Calif.

Testing Telescope Objective Lens

Sometimes when inspecting a telescope, binoculars, or other optical instruments, it is desirable to know whether the lens is a single one or the better grade cemented doublet. A simple test for this is to hold the instrument under an electric bulb so that the light shines on the lens. A plain piece of glass will show one large image

of the bulb; a single lens will show one large and one small image and a cemented doublet will show one large and two small images. Accuracy of the centering of a doublet can be noted by observing whether the three images form a straight line as the lens is manipulated under the light.

Hook Locks Grain-Blower Piping

Grain-blower pipe can be assembled easily and locked securely with the hook arrangement shown here. Hooks for this purpose can be obtained from a car or tractor. Using the fittings which held the hook to the hood, fasten the base to the large end of the pipe. A short length of pipe, brazed to the other end of each section, receives the tip of the hook.

J. B. Weisensee, Larned, Kans.

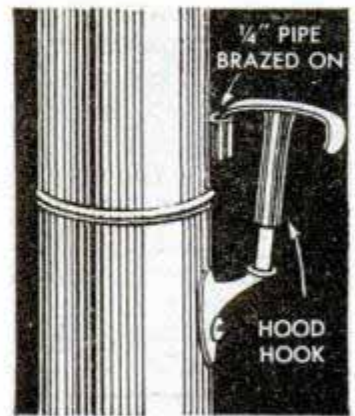

Bamboo Pole-Vault Standards

In one gymnasium, all iron pole-vault standards have been replaced by bamboo poles set into auto casings, so that athletes will not be injured if they fall against them. Slits are cut through a wall of each casing, and the poles are split to fit into them.

G. E. Hendrickson, Argyle, Wis.

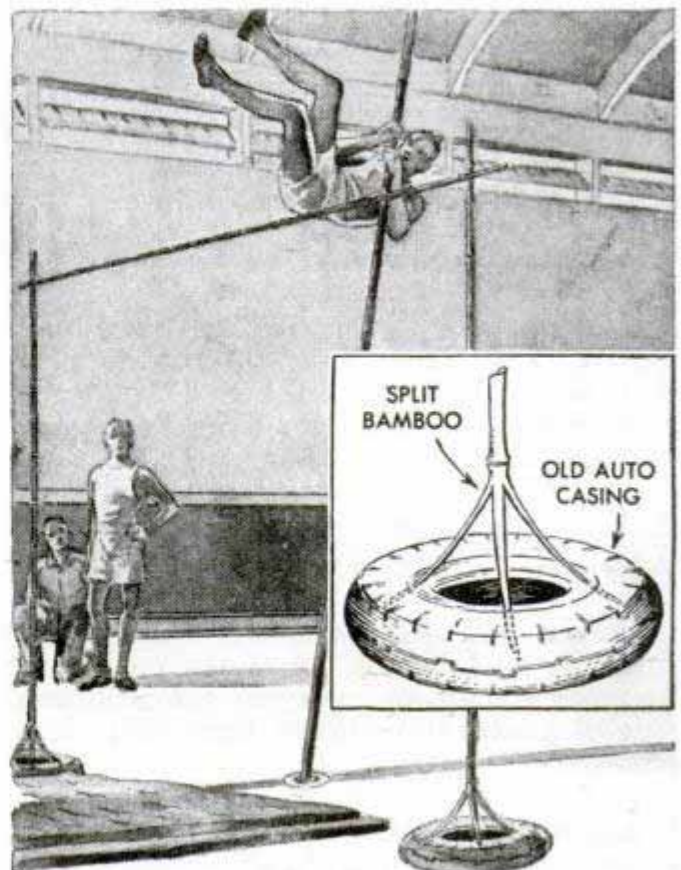

Flower-Shaped Trinket Box Is Cut on Scrollsaw

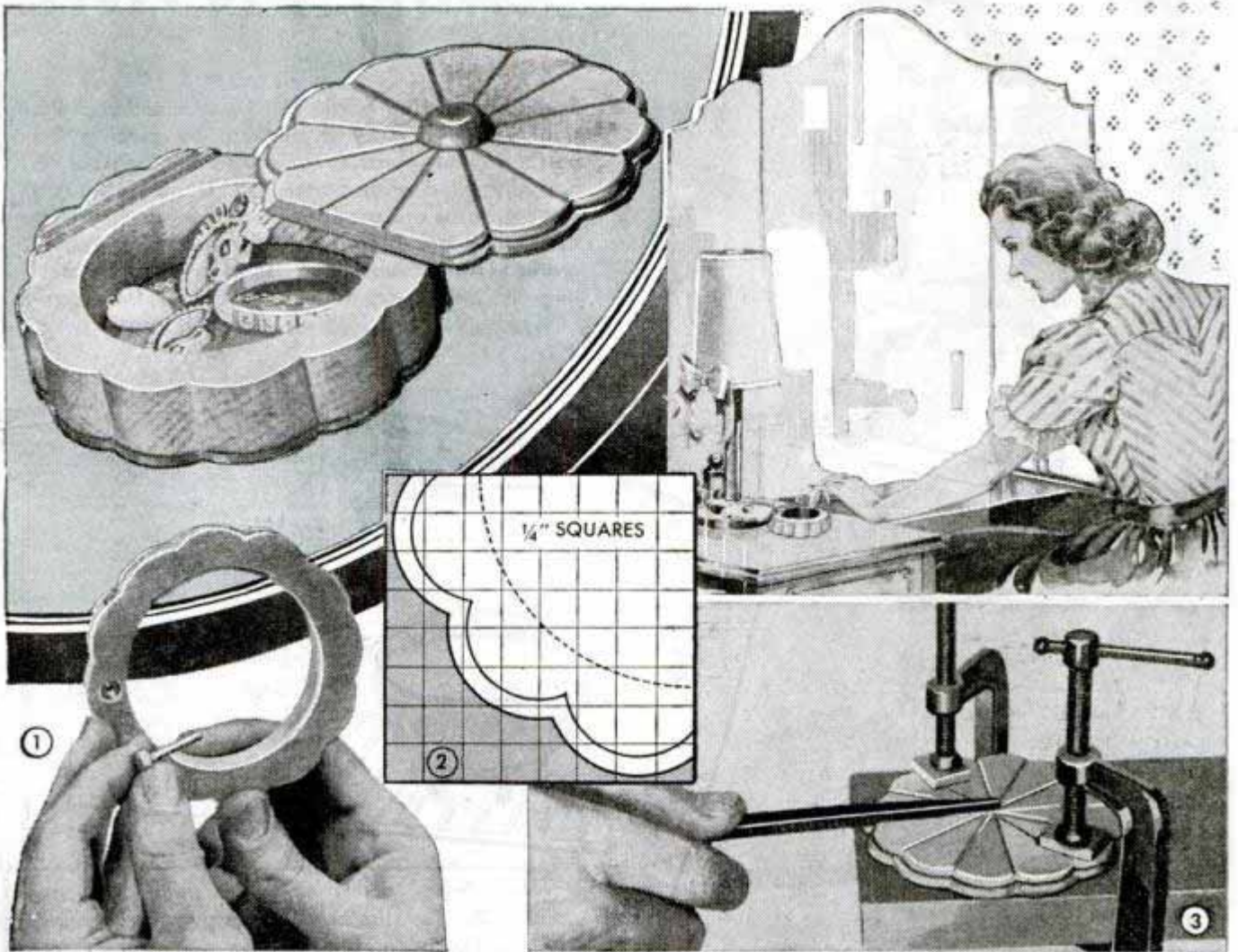

Made from four pieces of scrap hardwood, this attractive trinket box provides suitable storage for costume jewelry. Two pieces of $\frac{1}{8}$ -in. stock are used for the top and bottom and a third piece is planed to $\frac{5}{8}$ -in. thickness for the body. The three pieces then are glued together, sandwich-fashion, with heavy paper in the joints so that they later can be separated. After scrollsawing to the scalloped outline, Fig. 2, the edges are sanded and the parts are separated by running a sharp knife around the joints. Then the circular opening is scrollsawed in the center piece, Figs. 1

and 2, and an overlay of $\frac{1}{8}$ -in. stock is cut to the pattern indicated and glued to the lid, Fig. 3. The latter is then grooved with shallow saw cuts which are widened to V-cuts with a three-cornered file. As will be seen, the lid, or cover, is pivoted on a pin made from a short length of dowel, the pin being glued in a hole drilled in the lid, but turning freely in a counterbore through the body. After assembling the box by gluing on the bottom, a small section of the lid is cut away and glued to the body to act as a stop. Lastly, glue a screw-hole "button" to the center of the cover.

Mucilage Applied to Scrapbook Clippings Through Spout of Oilcan

Mucilage can be applied easily and neatly through an oilcan spout along the edges of clippings that are to be entered in a scrapbook. This method prevents smearing the work table and eliminates the need of backing paper under the clippings to catch excess mucilage. When not in use, the oilcan spout should be kept tightly covered with a cork to prevent hardening of the mucilage.

☐ Pieces cut from old felt hats provide good inner soles for house slippers.



Solving HOME

1. Baby's nursing bottle can be warmed rapidly, right in the nursery if desired, by placing the bottle in an electric coffee percolator that is partially filled with water. 2. If bowls having narrow bases are used for storing food, they may tip if they are placed on the shelf of a refrigerator. This trouble can be prevented by setting the bowls on tin-can covers or beverage-glass coasters laid on the shelf grating

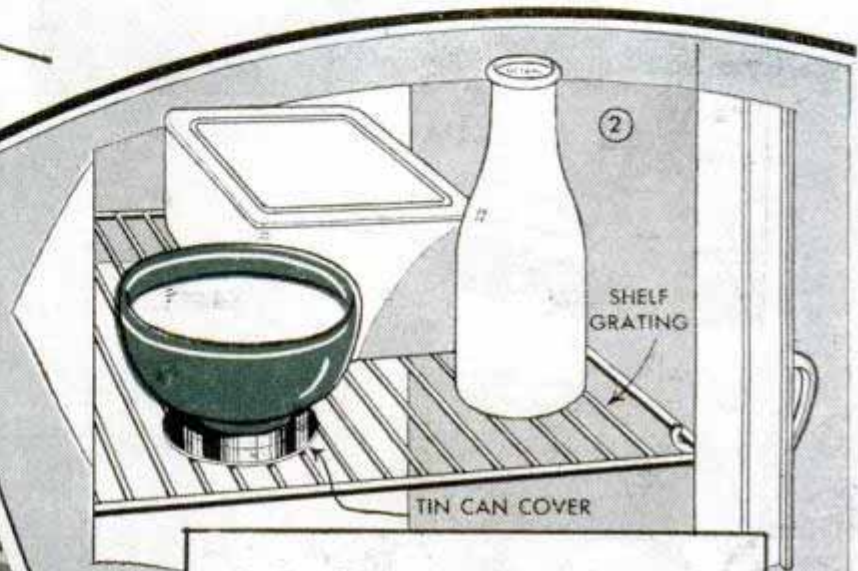
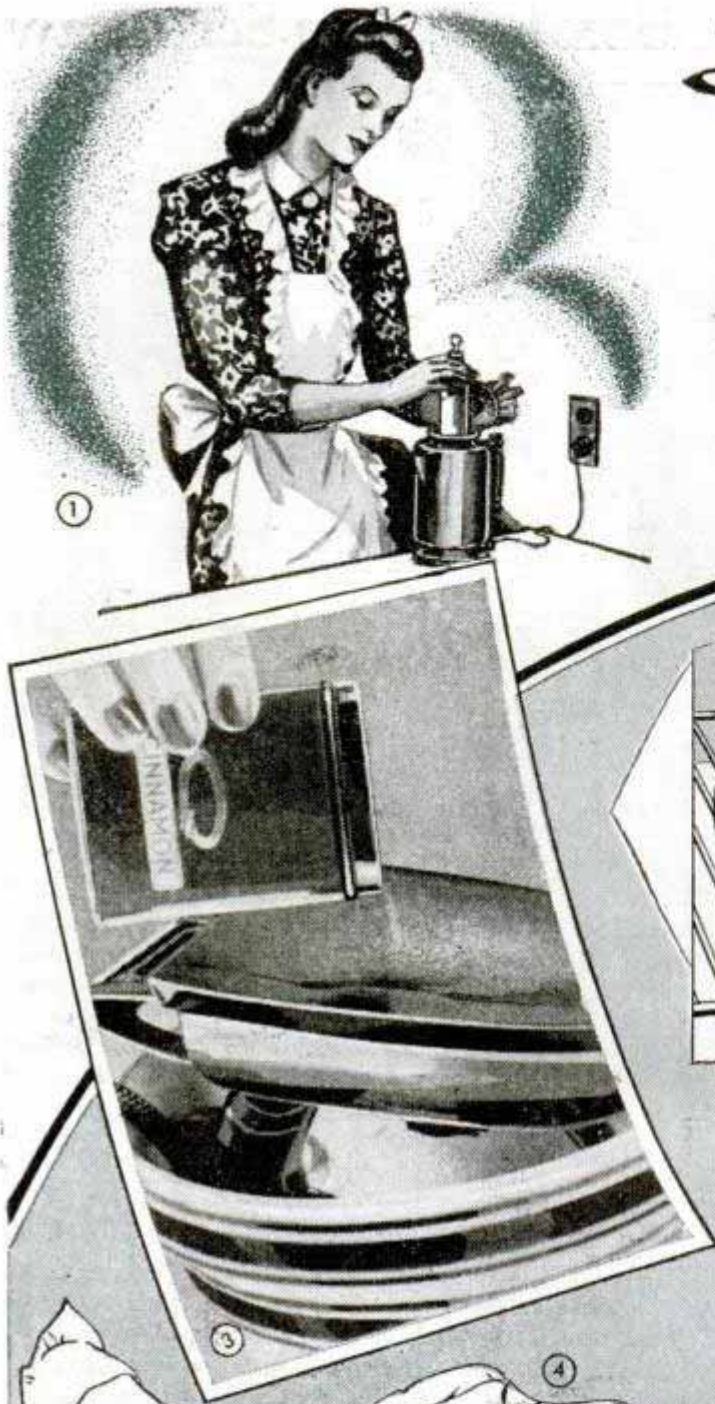

3. To eliminate cooking odors, sprinkle ground cinnamon or nutmeg on an electric iron that is set bottom up in a bowl, then plug in the iron for heating. 4. Rubbing shirt or blouse buttons with an ink eraser is a good way of removing discolorations sometimes left on them by laundering

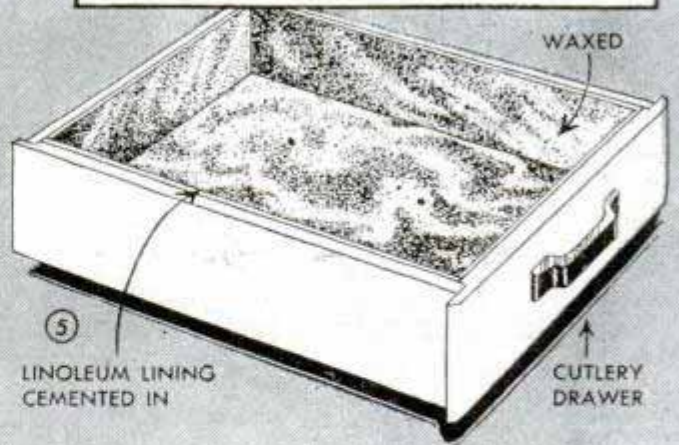
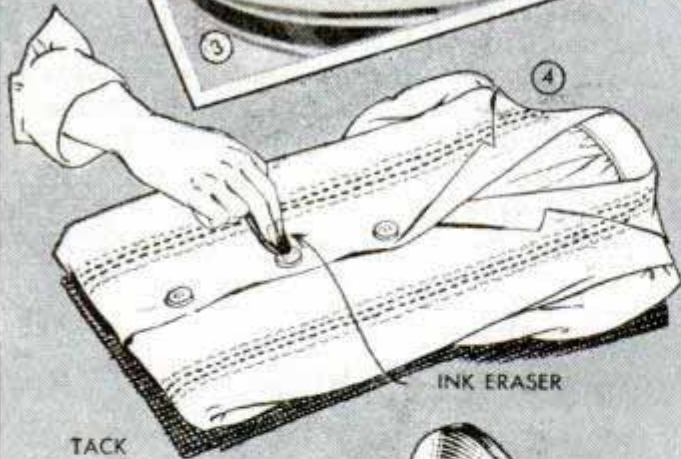

5. By cementing pieces of linoleum to the sides and bottom of a cutlery drawer, you can keep the drawer clean more easily, especially if the linoleum is waxed so that it may be wiped with a damp cloth. 6. A spool of thread will not roll far when it accidentally is dropped to the floor if you take the precaution of pressing a round-head upholsterer's tack or a thumbtack into one edge

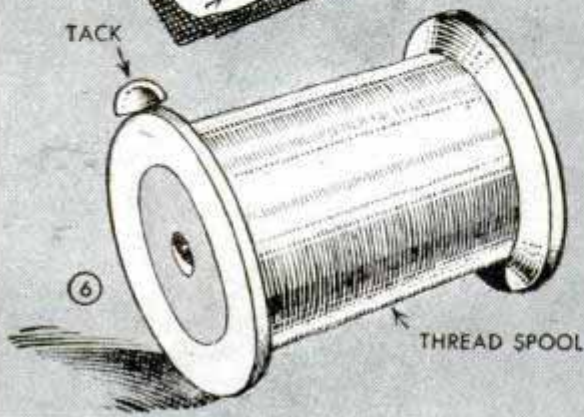

PROBLEMS

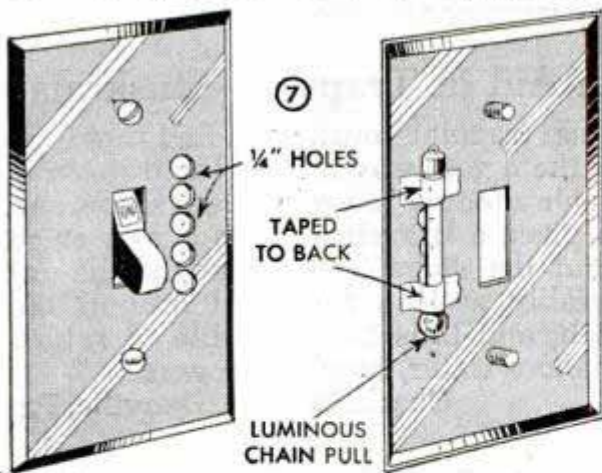

7. To help in locating a toggle switch on the wall in the dark, drill a series of holes in the switch plate and tape a luminous chain pull to it directly in line with the holes. 8. A hand-operated clothes washer, suitable for a baby's garments or for other light laundering, can be made from a large covered can or pail and a T-shaped plunger reinforced with flat iron as shown. Funnels with the necks shortened are bolted to the plunger arm

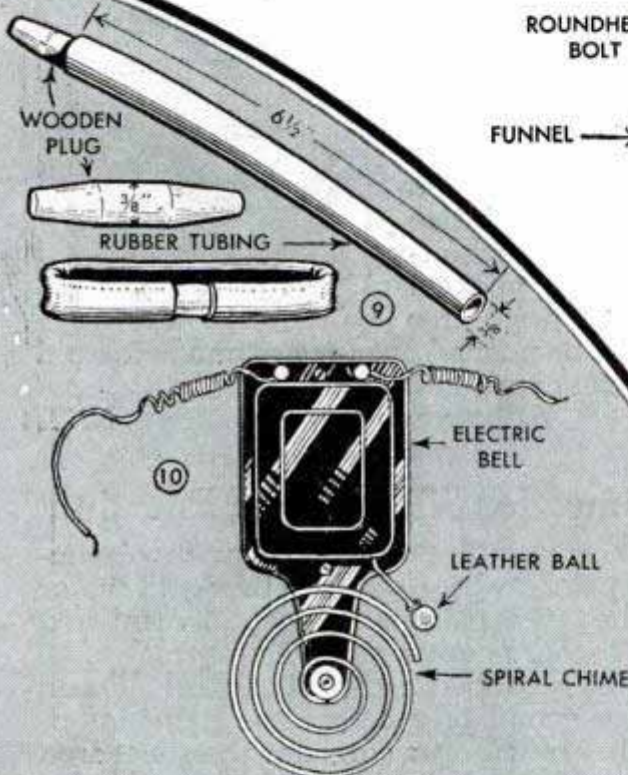

9. Hair curlers that can be worn without discomfort when you sleep are made from lengths of rubber tubing and wooden plugs. The hair is wound tightly on the tubing, the ends of which are bent inward and held by being slipped over the plug. 10. By removing the gong from a doorbell and substituting a spiral chime taken from an old mantel clock you will have a soft-toned door signal instead of a harsh bell

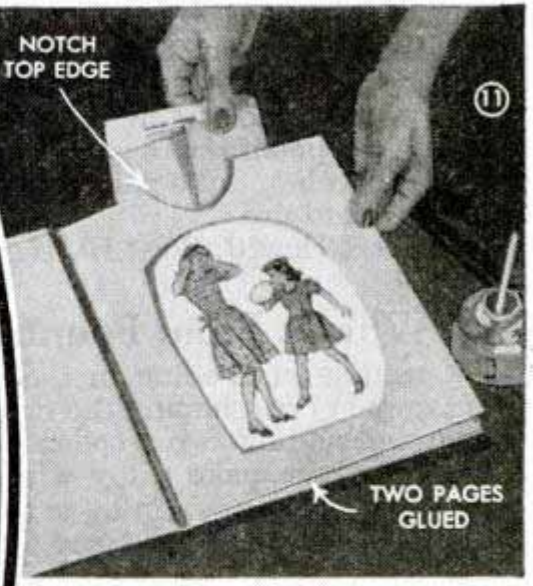
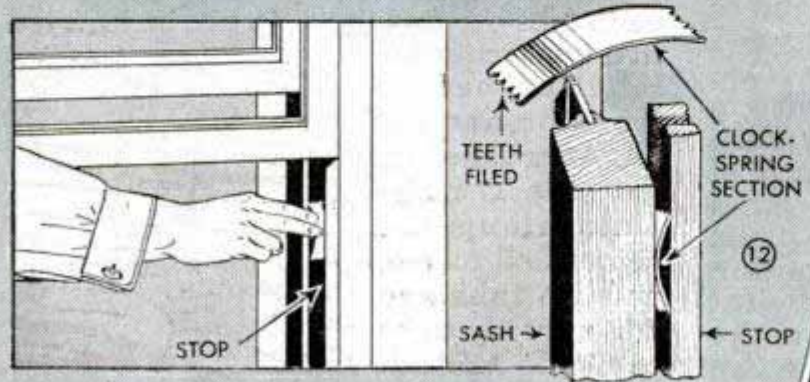

11. Scrapbook pages glued in pairs form pockets to hold sewing patterns. A picture on the pocket identifies the pattern. 12. Sections of clock spring between sash and stop prevent rattling of windows

Copying Drawings Is Simplified By Using Ruled Glass

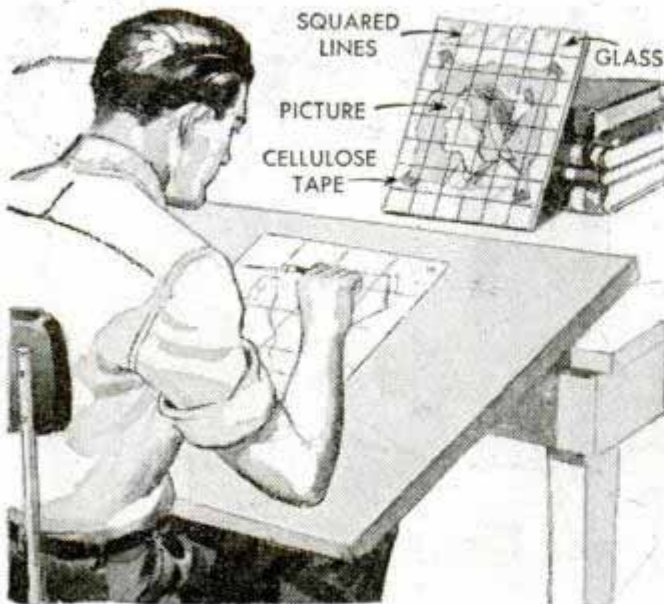

When copying a picture or drawing, artists and draftsmen will find that a sheet of glass, or a similar transparent material, on which squares have been ruled will make their work more accurate. The lines are drawn on the glass with waterproof ink. To use the guide, fasten the work to the underside of the glass with cellulose tape. The squares will locate the various parts of the drawing so it can be copied on paper ruled with similar squares.

Michael Ligocki, Gary, Ind.

Water Soluble Paints Restored With Baking Soda

Some water soluble paints, if exposed to air and later stored, will become rancid in time. If this happens, the paint can be restored by straining it through a clean piece of cheesecloth and adding a small amount (about a teaspoonful to a gallon) of baking soda. Stir well and the paint will be ready for immediate use.

Robert Hewitt, West Hartford, Conn.

Toy Whistle From Fountain Pen

By cutting an opening in the side of a fountain pen cap, shaping the open end as shown and adding two wooden plugs and a ball, you can make a toy whistle.

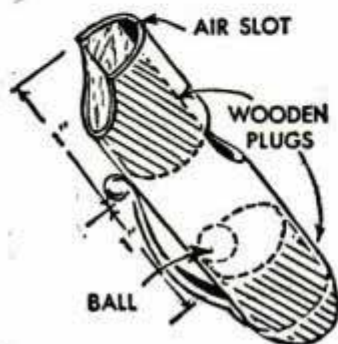

One plug is rounded to fit snugly within the closed end of the cap and pressed into place. Then a wooden ball somewhat larger than the cutout in the cap is dropped in, and the other plug is

added. This has a flat cut on one side for an air slot. The clip on the cap is used to hold the whistle in a pocket or on a trouser belt.—Albert E. Fenn, Chicago.

An Aid in Trapping Muskrats

When trapping muskrats I find that fewer of them get away if I set the trap stake in water a foot or more from the shore, and then place a branch or limb a foot or so beyond the stake. When caught the rat invariably swims out and around the branch, and thus being unable to return to shallow water, quickly drowns.

Charles Swope, Danville, Pa.

Bowler's Crayon in Lipstick Case Does Not Soil Pockets

Bowlers who like to keep a piece of crayon in their pockets for marking scores can prevent the crayon from soiling their pockets by enclosing it in a lipstick case. The crayon can be pushed out for use and retracted into the case as required.



William Swallow, Brooklyn, N. Y.

Primer for Sheet-Metal Painting

When painting sheet iron with plastic-base paints, whitewash or other cold-water finishes, the paint is less apt to run and will be more permanent if the surface to be painted is rubbed with vinegar and allowed to dry completely before the paint is applied. The vinegar corrodes the sheet iron just enough to provide a rough surface to which the paint will adhere readily.

E. P. Barnhart, Whittier, Calif.

Tape Index Tabs for Magazines

Index tabs cut from a strip of gummed-paper tape for use as markers on pages of a magazine are in some cases preferable to cloth tabs because the strip can be inserted

in a typewriter for labeling before the tabs are cut off. After labeling, the strip is moistened along the center and folded, and the tabs are cut off ready to be applied.—A. Stewart, Kansas City, Mo.

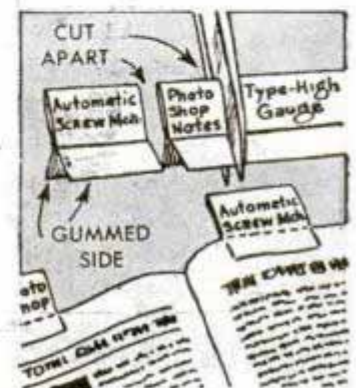

4-PLACE COASTER

has positive brake

Equipped with a direct-action brake, this coaster is sturdy enough to carry four passengers who straddle a long seat bicycle fashion. The chassis is rounded in front and covered with linoleum to simulate an auto grille, and is notched at the sides to shorten the turning radius. The wheels are kept from rubbing against the chassis by stop blocks. A brake lever pivoted to the chassis has a handle for ease in raising it. This forces the wooden "brake shoe" against the pavement to stop the coaster.

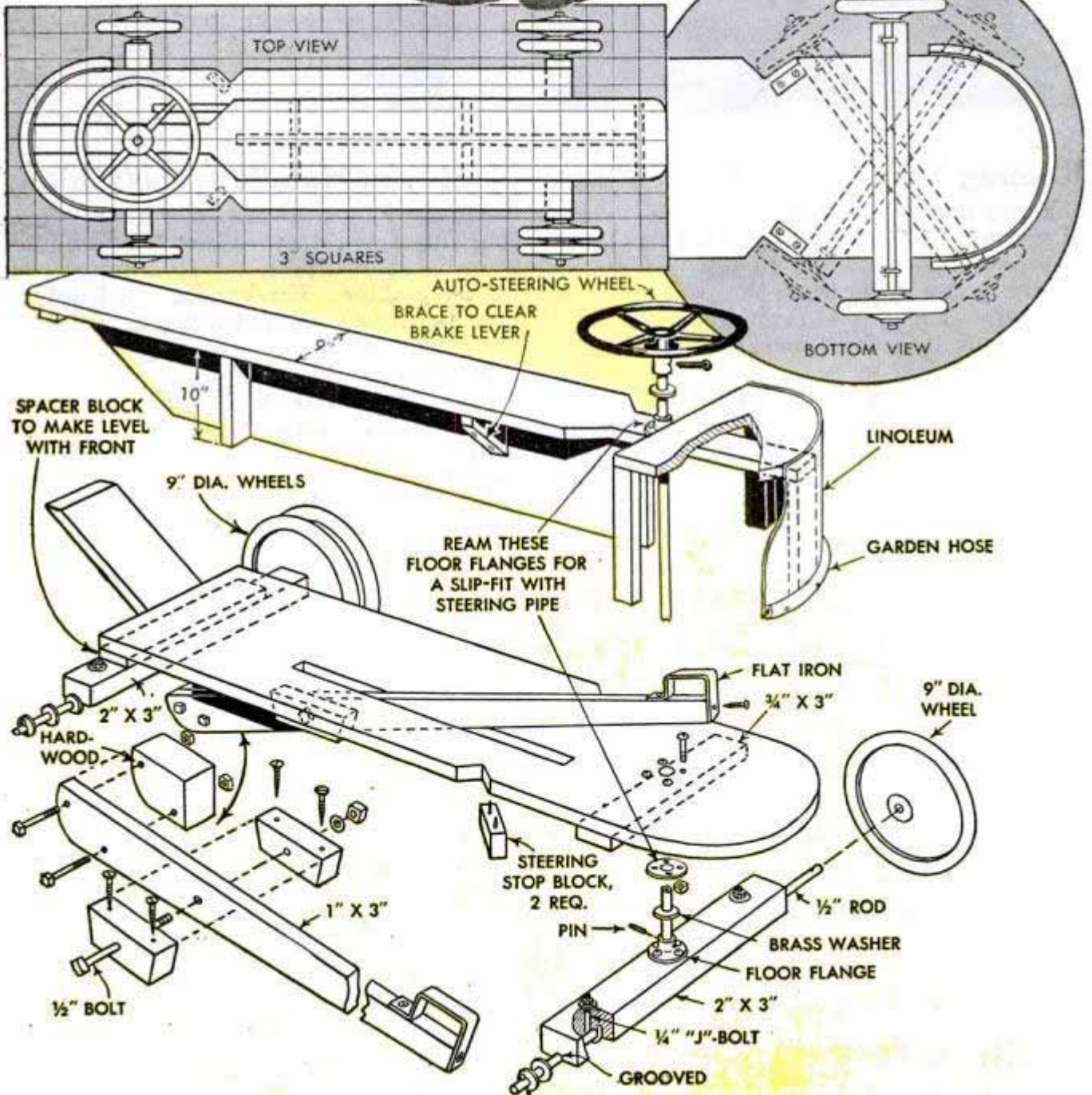
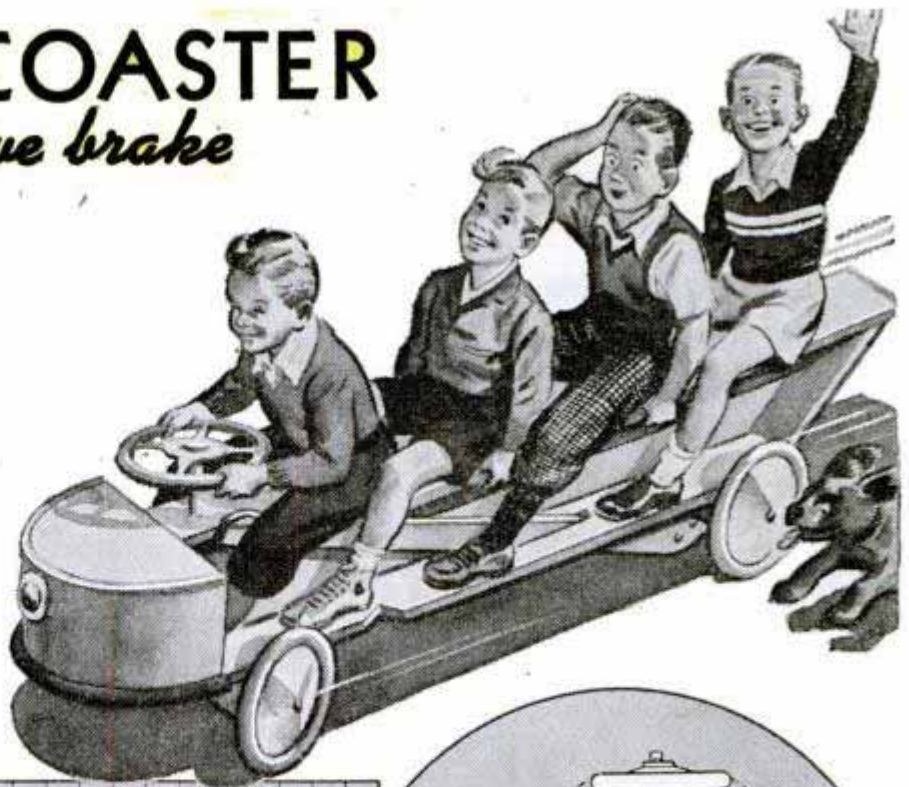

Drawer in Cabinet Collects Sawdust

Instead of tying a burlap sack over the spout of a circular saw to collect sawdust, or allowing it to spill onto the floor, one craftsman fitted his saw with a cabinet containing a drawer from which the sawdust could be removed. Use of the cabinet thus saves the work of retying a sack after emptying it and helps keep the room clean. The cabinet is built of plywood nailed to a light frame, or a wooden packing case can be used. A chute attached over an opening cut in the cabinet fits on the saw spout to direct sawdust into the cabinet.—W. F. Messenger, Ballston Spa, N. Y.

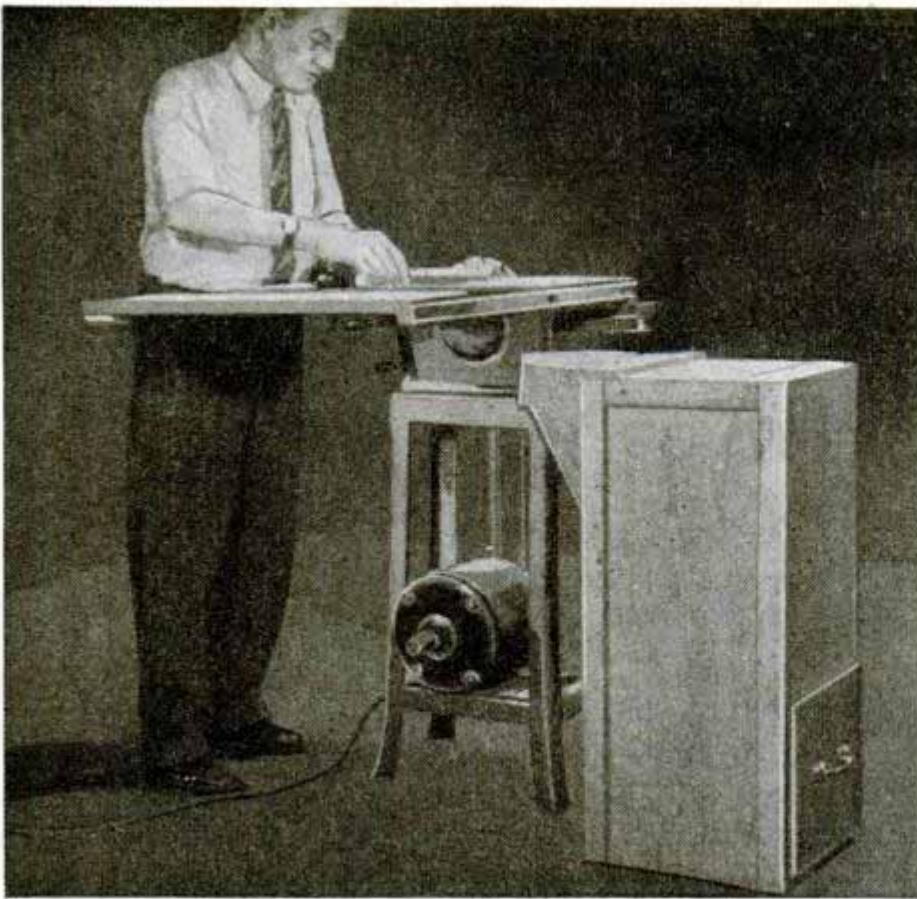

Roofing Tar Protects Fence Posts

Fence posts that are set in concrete are likely to decay rapidly at ground level unless a seal is provided to prevent water from seeping in between the post and the concrete. A good seal is made by applying roofing tar at the juncture of post and base. The tar should be poured into a beveled



recess at the edge of the concrete around the post as indicated. The recess can be made easily after newly poured concrete has been allowed to set for about 20 min.—Mrs. T. F. Watts, Charlotte, N. C.

Cards to Be Sprayed Are Held By Masking Tape

Small cards can be held for all-over spraying by using masking tape. A length of the tape is tacked to a board with the gummed side facing out. Then the cards are stuck to the tape as shown. The setup can be used repeatedly.

☐ When streets and sidewalks are icy, stick a strip of adhesive tape crosswise on the sole of each shoe to keep from slipping.

Flat-Iron Handle Holds Chisel

Attached by a U-bolt, this handle for a cold chisel will prevent a worker's fingers from being injured if the hammer glances from the chisel. The handle is a length of light flat iron looped at one end for a grip and bent to a right angle at the other. This is slipped into the U-bolt and held by a cross-piece that is tightened against it by nuts. By loosening these, the bolt may be adjusted to hold the handle at any position.—J. Burton, Pattonsburg, Mo.

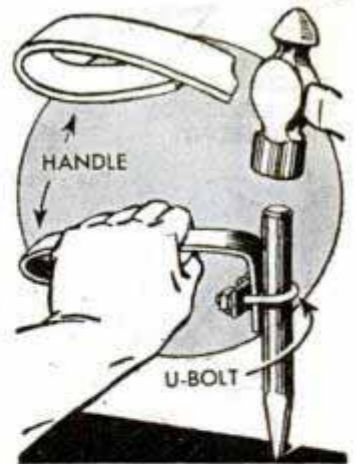



CACTI

All-season house plants

By Alexander Maxwell

BECAUSE there are so many varieties and shapes, raising cactus is a kind of indoor gardening that will not easily become monotonous. In shape, some plants are globular, some cylindrical and some columnar, while others are flattened, or ribbed like a cantaloupe. Several species, including the prickly pear, are edible, and others serve as forage for cattle, while still others are cultivated solely for their showy, delicately colored flowers.

Possessed with a camel-like ability to store water in their fleshy protuberances, cacti are plants that not only survive in the desert but in some instances attain unusual size. The giant cactus of Arizona and other southwestern states, for example, attains a height of 40 to 70 ft. with a diameter of about 2 ft. However, there are many smaller varieties that are suitable for cultivation in the home conservatory. Some of these are shown in Figs. 5 to 10, and 12 to 15.

Such plants usually can be purchased from nurseries and florists. Wild cacti sel-

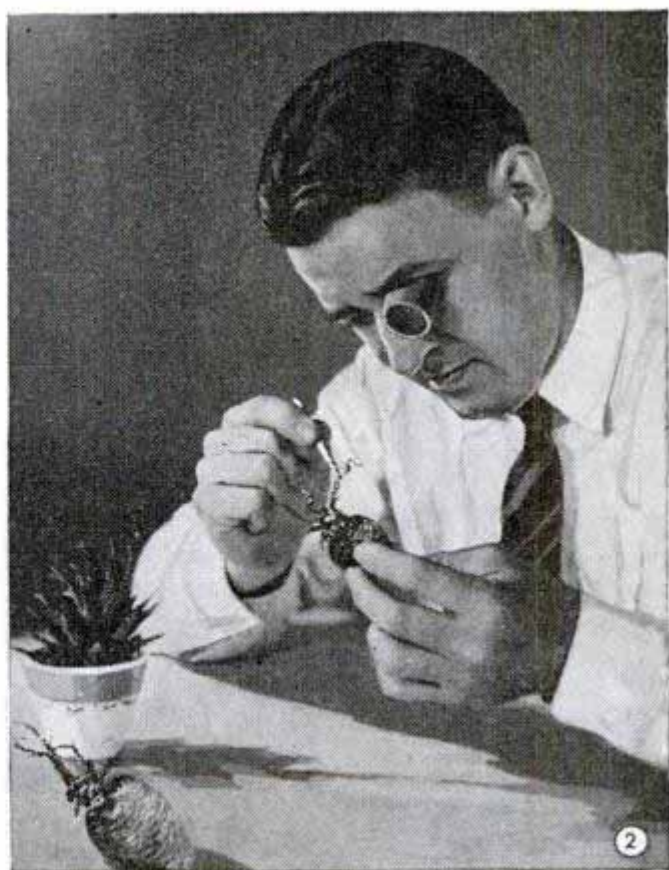

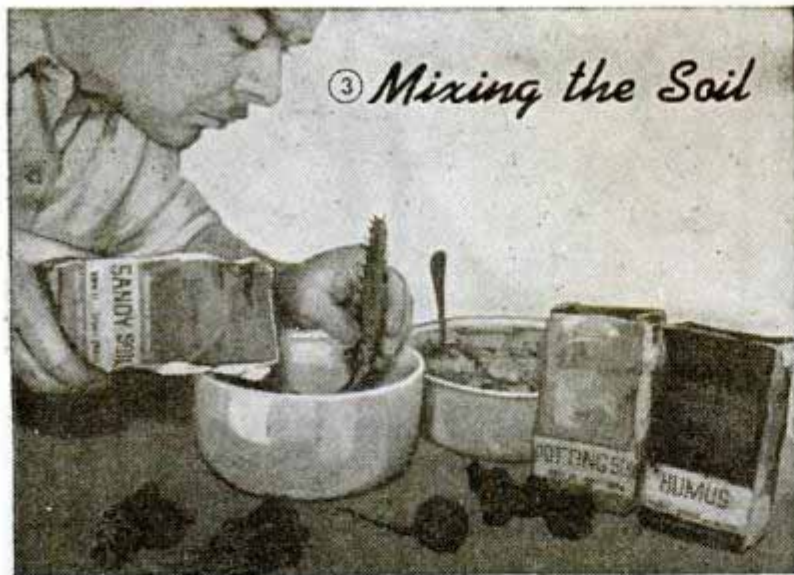

③ *Mixing the Soil*

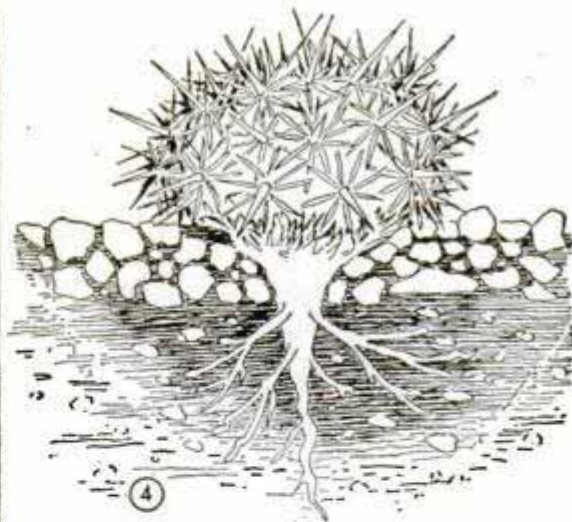

dom survive the artificial atmosphere of a house and generally are infested with insect pests. The

best plants for home culture, therefore, are those grown for this purpose from selected seeds nurtured under ideal conditions. These usually are well formed, healthy and free from pests.

When the plants arrive, unpack them carefully. If they are shipped in pots, wash away the soil using a hose connected to a faucet, Fig. 1, to avoid injuring the plants by pulling them up. Then snip off all roots that are dried or broken, and inspect the plants for pests such as spiders, scale and insect eggs. When looking for parasites, also note any bruises, Fig. 2, that may have been caused by rough handling. If the plants are in good condition, roll the roots in clean sand and repot as soon as they are dry.

Cacti are delicate, in spite of their bristly appearance, and are easily bruised. When this happens, decomposition sets in and the plant will die if not treated. If there are signs of damage, the injured tissue must be cut away carefully with a sharp knife, Fig. 19, and the plant laid with the cut portion uppermost until a scab forms. Then it can be planted temporarily in pure sand and heated frequently with an infrared lamp. While healing, it should be watered often and not replanted until it shows definite



Types of Cacti

⑤ **CORYPHANTHA PALMERI**
Sharp, curved thorns like cat claws

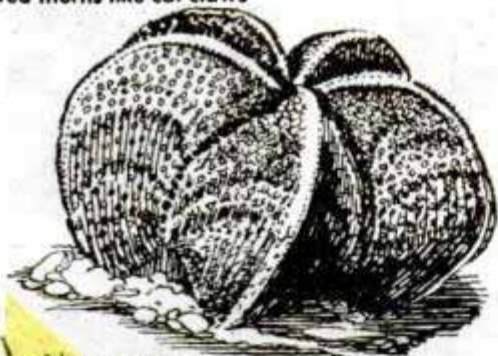

⑥ **ASTROPHYTUM MYRIOSTIGMA POTOSINA**
"The Bishop's cap"

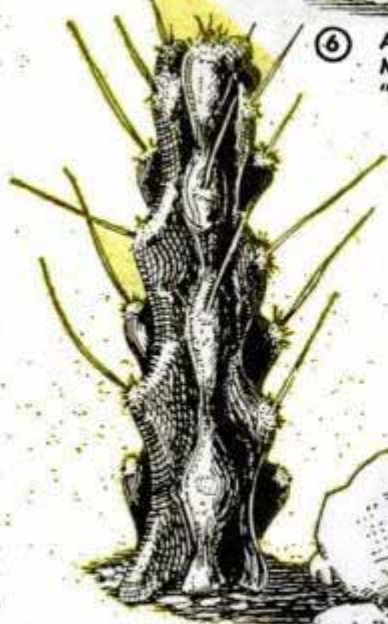

⑦ **ERIOCREUS MARTINII**
Green, purple and lumpy

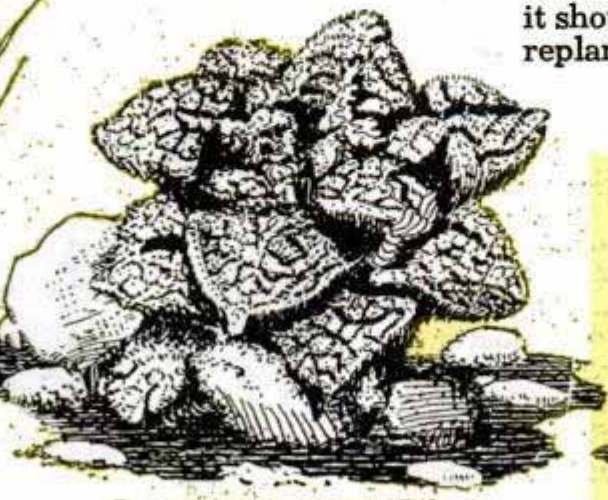

⑧ **ARIOCARPUS FISSURATUS**
"The living rock"

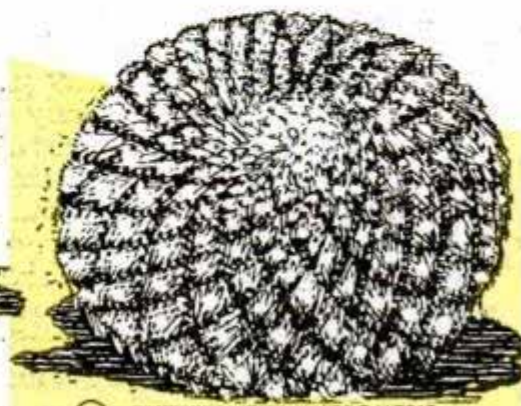

⑨ **EPITHELANTHA MICROMERIS**
Looks like a lost button

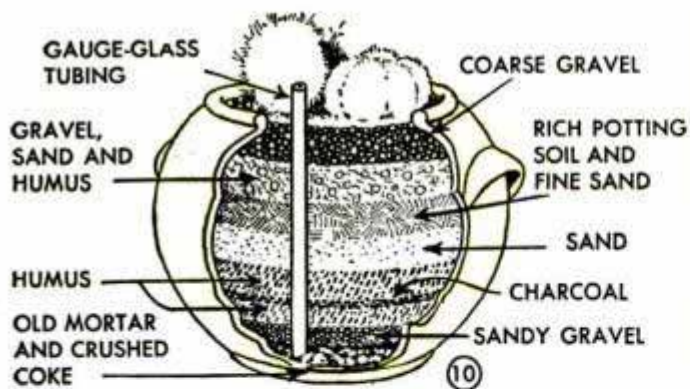

signs of recovery. The period of convalescence may be two or three months.

Growing cacti in the house is not a very difficult job; however, the right kind of container is important. Terra cotta flower-pots are not desirable because they absorb too much water, causing the soil to pack. This in turn will cause the roots to dry out and die. Also, as water evaporates from the outside of the pot, a cooling effect is obtained which may chill the roots. Wooden tubs are the best containers, but glazed pottery or porcelain will be most ornamental. Bean pots, mixing bowls and Mexican cooking ware add a touch of color to a living room and are entirely suitable to the needs of cacti.

Soil, too, is important. No cactus will thrive in sand alone, even though many species grow in the desert. Desert soil is light and fluffy, rich with wind-blown leaf dust and other nutrient elements, and there is enough moisture—enough for the cactus. Therefore, when growing cacti at home, these conditions must be duplicated as closely as possible. The soil can be made to order by mixing easily obtained ingredients: humus (decomposed leaves and other vegetation), potting soil (a composite of black, sandy loam and humus), gravel, old plaster, charcoal and crushed coke. These are placed in layers in the pot, Fig. 10, so the soil will be loose and porous as it is in the desert. The roots of cacti must have air.

Under no conditions must the soil be more than slightly damp. To determine the moisture content, press a length of glass tub-

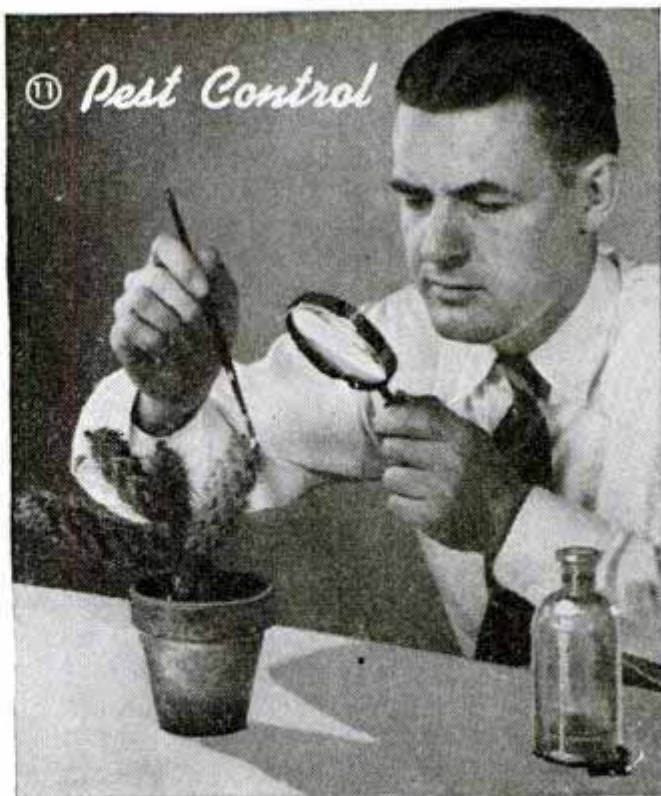

11 Pest Control



12 ECHINOCEREUS REICHENBACHI
Delicate white spines intermeshed like dainty lace

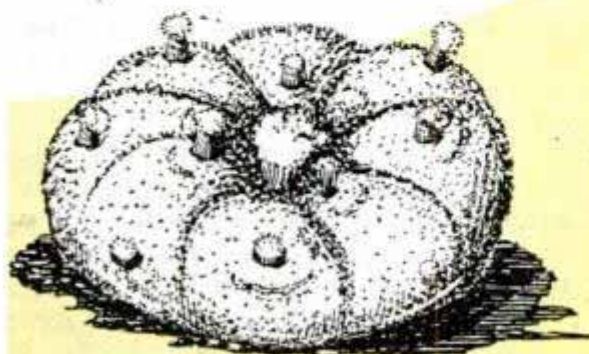

13 LOPHOPHORA WILLIAMSII
Mescal, or dumpling cactus



14 CEPHALOCEREUS SENILIS
The "Old Man" Cactus

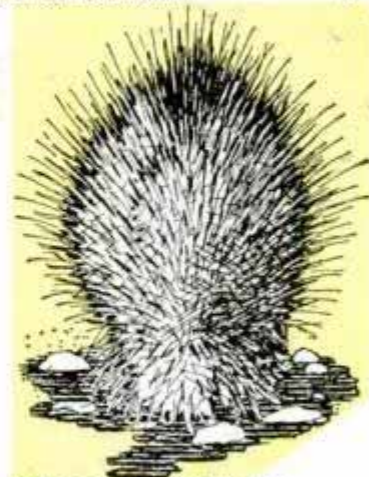

15 NOTOCACTUS SCOPE
A living red-and-silver Christmas-tree ornament



ing down through the soil, Fig. 10, and insert a water-color brush in the tube. If the brush is damp when withdrawn, the soil is too wet. Another function of the tube is to act as a vent or breather tube for the roots.

To set plants in filled pots, scoop out a depression for the root and, holding the plant erect, pack a cushion of gravel under it as in Fig. 4. The gravel will keep the plant dry and free from mildew. Usually four or five plants can be set together in one pot at the beginning, but, as they grow, some may have to be transplanted to avoid crowding. Since some species grow quite large while others mature and die when they reach the size of a man's thumb, it is best before planting to determine which types to group. The table under Fig. 17 will guide you.

The growth pattern for the different species varies widely. For example, the *Astrophytum* shown in Fig. 6 develops very slowly; a spine will start in the center of first one, then another, of the five lobes and gradually advance toward the edge, but there is little evidence of growth from month to month. Growth of *Echinocereus*, Fig. 12, starts as a tuft of soft down and slowly develops into a crown. In selecting types of cacti, it is best not to mix jungle varieties with the desert types such as the large growing species shown in the table. As a general rule, jungle cacti bloom quite frequently, but so-called fancy types rarely do, except when growing in their natural state.

From time to time the plants should be inspected under a magnifying glass. Soot and dust collect in the deep creases and under the spines to hide the sleek shine of a healthy plant. The best means of removing this accumulation is a long-haired showcard brush, Fig. 11. This is also an effective tool for exterminating insect pests which, if allowed to feed and multi-

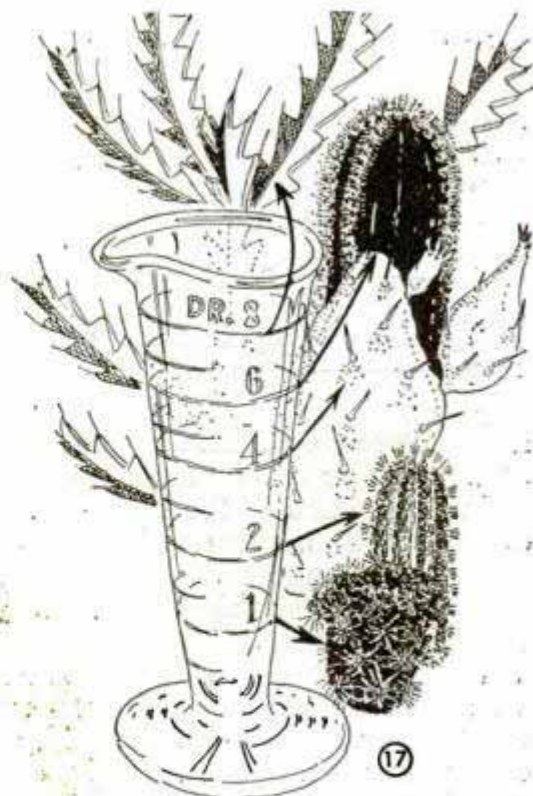

General classification of Cacti which may be grown in the home			
Large Growing	Jungle	Tiny Plants	Fancy Cacti
<i>Echinocactus</i>	<i>Echinopsis</i>	<i>Astrophytum</i>	<i>Cephalocereus</i>
<i>Carnegiea</i>	<i>Epiphyllum</i>	<i>Echinocereus</i>	<i>Coryphantha</i>
<i>Cleistocactus</i>	<i>Eriocereus</i>	<i>Epithelantha</i>	<i>Espostoa</i>
<i>Ferocactus</i>	<i>Heliocereus</i>	<i>Frailia</i>	<i>Hamatocactus</i>
<i>Gymnocalycium</i>	<i>Hylocereus</i>	<i>Lobivia</i>	<i>Leuchtenbergia</i>
<i>Lemaireocereus</i>	<i>Monvillea</i>	<i>Mamillaria</i>	<i>Notocactus</i>
<i>Melocactus</i>	<i>Nyctocereus</i>	<i>Rebutia</i>	<i>Periskia</i>
<i>Opuntia</i>	<i>Peniocereus</i>		<i>Stenocactus</i>
<i>Oreocereus</i>	<i>Rhipsalis</i>		
<i>Rathbunia</i>	<i>Selenicereus</i>		
<i>Trichocereus</i>	<i>Zygocactus</i>		

ply, will in time devour an entire plant. To kill such pests, dip the brush in alcohol and apply it under the spines and along the crevices that show signs of parasitic destruction.

In watering plants, the schematic guide shown in Fig. 17 indicates their widely varying needs. For small plants, one dram usually will be sufficient, while larger ones will need 8 drams, or one-half oz. The water is poured gently along the edge of the pot, Fig. 16, and allowed to soak into the soil. Water should never be poured directly on the cactus because a wet, soggy plant molds rapidly. For this reason, too little water is preferable to too much. Cactus will store up a year's supply of moisture and water should be added only to replace that consumed.

Strong light can be harmful; contrary to popular belief, cacti do not thrive in hot sunlight but prefer shady areas or locations where the sun will strike them only for part of the day. Jungle cacti, as the name implies, grow almost entirely in deep shade. Too much light, like too much water, destroys the color and leaves a bleached, drab-looking plant. However, in the house, a northern exposure is not likely

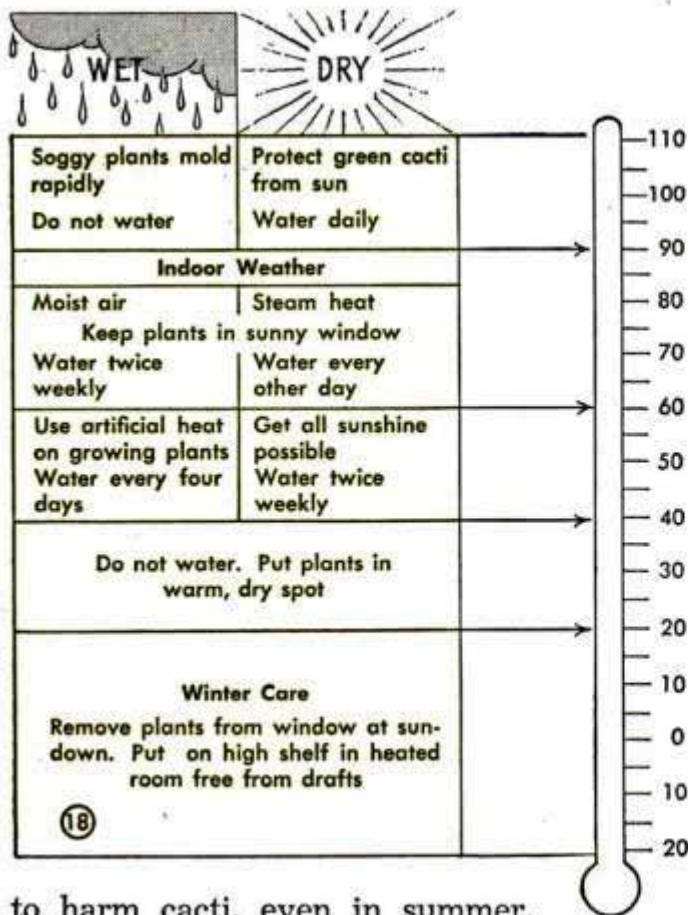

to harm cacti, even in summer.

In regard to growing temperatures, heat is preferable to cold. If chilled, the plant will stop growing and the buds will wither. A temperature of 100 deg. for an hour or two a day will speed the growing process. High humidity is dangerous because it promotes the development of

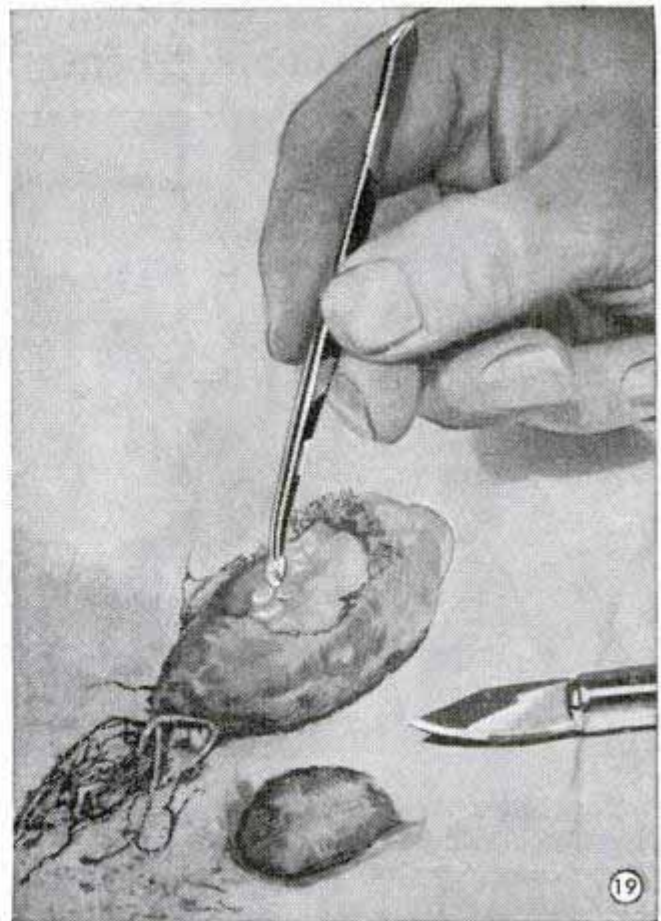

fungi. When the weather is damp or chilly, an infrared heat lamp can be directed at the plants, or they can be placed on a shelf near a hot-water tank or boiler. The chart, Fig. 18, will serve as a guide for wet and dry weather at various temperatures.

Gate Is Held by Latches That Have No Moving Parts

No springs or levers are needed on this gate as it has two latches that serve not only to keep it closed but also to help support its weight. The latches are made by bolting two strips of flat iron to the gate so as to project slightly. The ends of the strips are held in notched fittings attached to the gate post. Sides of the fittings are sloped upward toward the center as shown to guide the strips into the notches. The gate is lifted slightly to open or close it, a handle being screwed to the gate pickets for this purpose.

A. M. Wettach, Mt. Pleasant, Iowa.

Corks Are Used for Cleaning Jobs

Rather than throw away old corks, save them for cleaning purposes. For example, a cork dipped in kerosene or gasoline will take spots off linoleum or windows when other methods may fail. And a cork rubbed in soap or dipped in cleansing powder will do a good job of cleaning kitchen knives. You also can dip a cork in paraffin and use it to clean the tiles of a fireplace hearth.

Frank G. Harris, Flint, Mich.

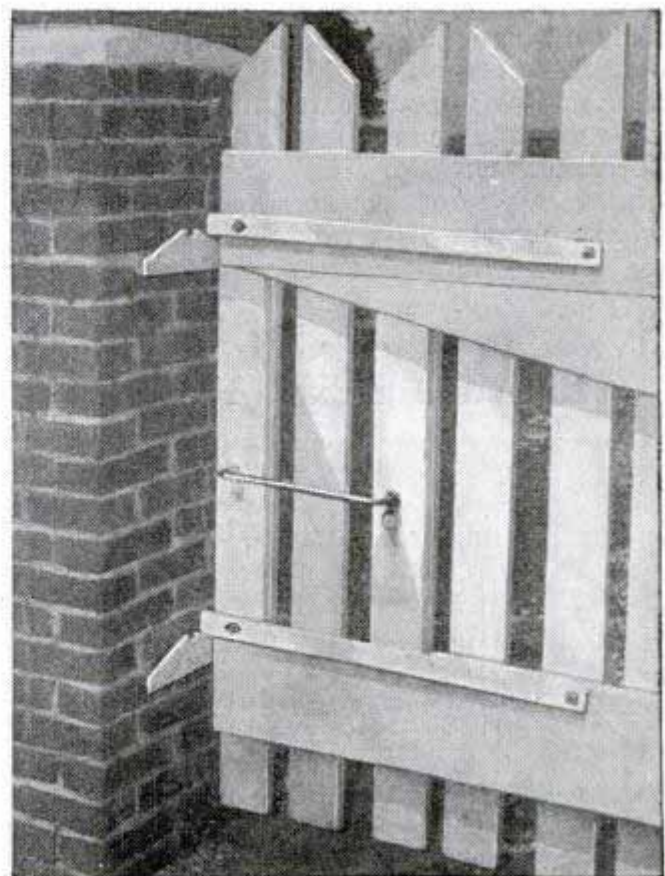

Blocks Strapped to Skate Runners Permit Walking on Them

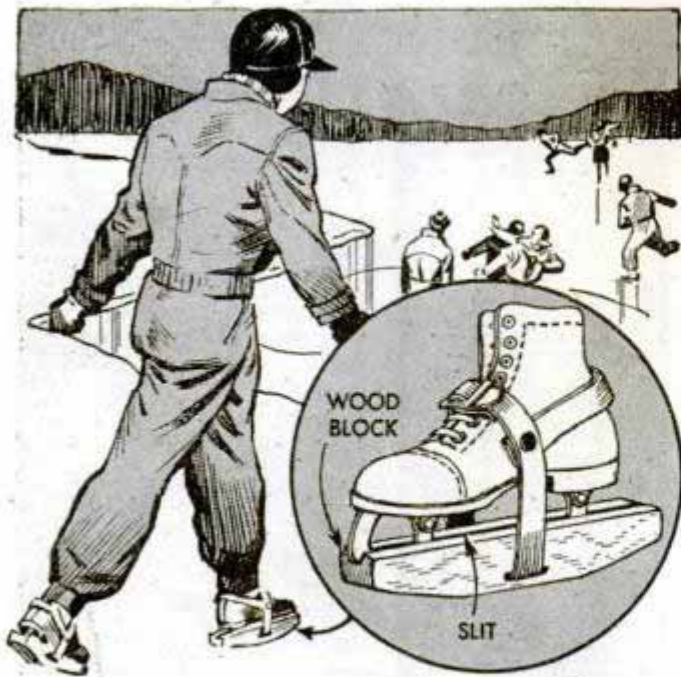

There's no need to wait until you reach the ice pond before you put on your skates if you have a set of wooden blocks like the ones shown for protecting the runners. The blocks are beveled at both ends to make walking easy. They are grooved for the runners and slotted for 1-in. webbing. This has a buckle at one end and a strap riveted to fit over the shoe.

C. H. Brown, Bel Air, Md.

Concealing Duplicate Auto Keys

To make sure that a set of duplicate keys is available if you lock one set in a car, it should be wrapped in a container and concealed on the outside of the car. Cellulose makes a good container to keep the keys clean, or a small metal tube corked at both ends will do. The container is taped under a fender or in some other place where prowlers are not likely to search.

Dorothy Norris, Geneva, N. Y.

Washing Machine Is Improved By Adding Extra Paddles

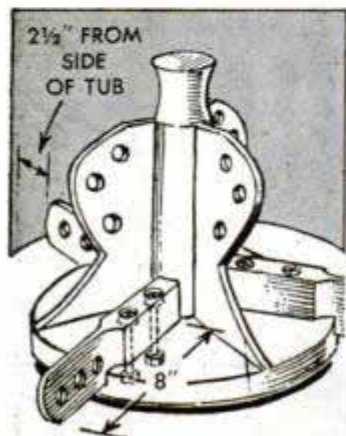

Three pieces of hardwood bolted to the gyrator of a washing machine to serve as auxiliary paddles not only will agitate the laundry more thoroughly when the tub is full, but will make it possible to wash just a few garments when the tub is

only partially filled with water. The paddles should be shellacked and varnished, and when attached to the gyrator they should extend to within $2\frac{1}{2}$ in. of the sides of the tub.—Robert F. Fry, Flora, Ill.

Repairing a Broken Clock Spring

Alarm clocks that are sometimes thrown away because of a broken main-spring can be repaired easily if the break has occurred fairly close to the shaft end of the spring. Anneal the spring at the broken end and form a hook on it to slip over the catch on the shaft. After reinstalling the spring, wind it slowly so that it will take its shape properly. The clock should now operate in a normal manner.

Wayne Sheppelman, West LaFayette, Ind.

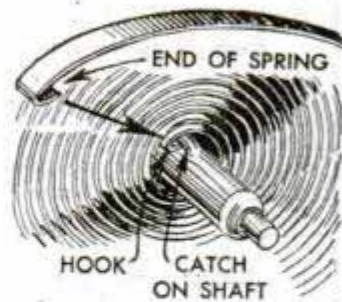

Capsules Make Colorful Beads

Empty medicine capsules, obtainable at your local drugstore, can be lacquered with nail polish to make a novel string of beads. First puncture the ends of the capsules with a large sewing needle and then string them on a strong thread. Apply an even coat of polish to the capsules and allow them to dry. If desired, alternate capsules may be lacquered with contrasting shades. Also, large and small capsules may be strung alternately.—Frank Shore, New York.

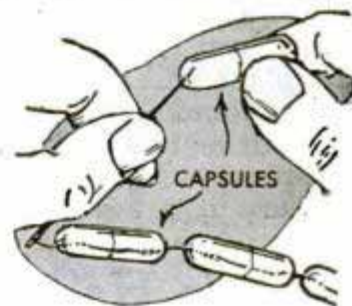

Star Stamp Cut From Bottle Cork

Children will enjoy this star stamp which can be made from an ink-bottle cork. The design is cut by first pasting a piece of paper on the end of the cork, then drawing the star on the paper and cutting around the outline with a razor blade. If the paper will not come off without pulling out pieces of cork, soak it in hot water. Designs other than the one shown can be made to build up a set of stamps.—J. J. Gold, Brooklyn, N. Y.

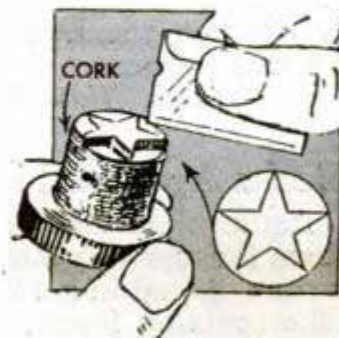

MAGAZINE RACK

Has Splint Sides

WITH a rope-wound handgrip and sides formed of splints, this rack for magazines is exceptionally pleasing in appearance, yet easy to make. It can be any size, with ends and bottom of $\frac{3}{4}$ -in. stock and a partition of $\frac{1}{4}$ -in. material. The partition is glued into grooves cut in the ends, which are dadoed to fit over the bottom where they are glued. Two strips of wood are set into rabbets at the upper corners of the ends and bradded in place to support the splints. The inner edges of the end pieces also are rabbeted to take the sides, as indicated in Fig. 4. The sides are made by attaching splints horizontally with lengths of molding to the edge of one of the end pieces, then weaving other splints across and through them as in Fig. 1. If desired, some of the splints may be stained and interwoven with others that are not stained, as shown in the illustration. When the splints have been woven, they are trimmed to fit and molding is applied over them along the other end of the rack and across the top and bottom edges. The handgrip is shaped as in Fig. 3 and wound with rope as in Fig. 2. The rope should be wound from the center toward the ends to prevent loosening, and the ends of the rope are hidden by being pulled through the coils with a bent wire.

Charles and Bertram Brownold.

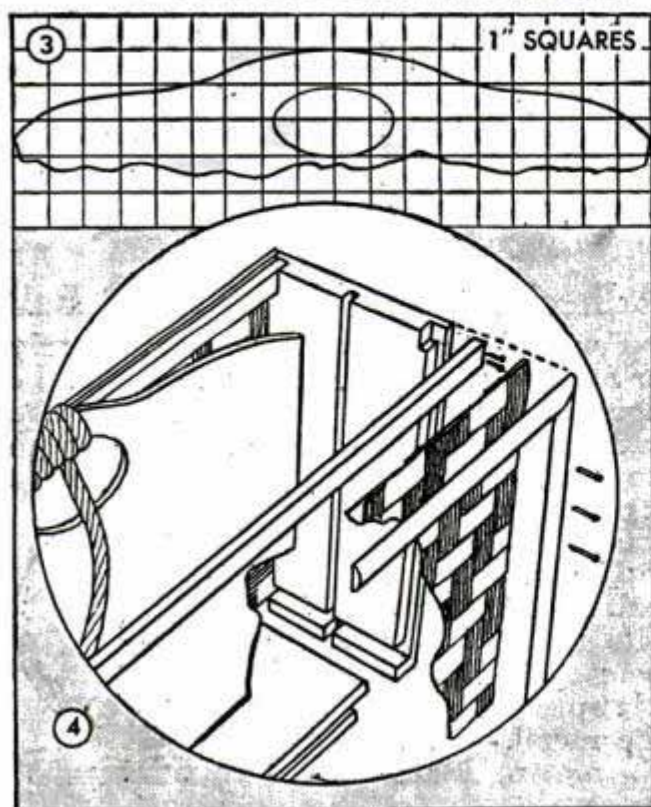
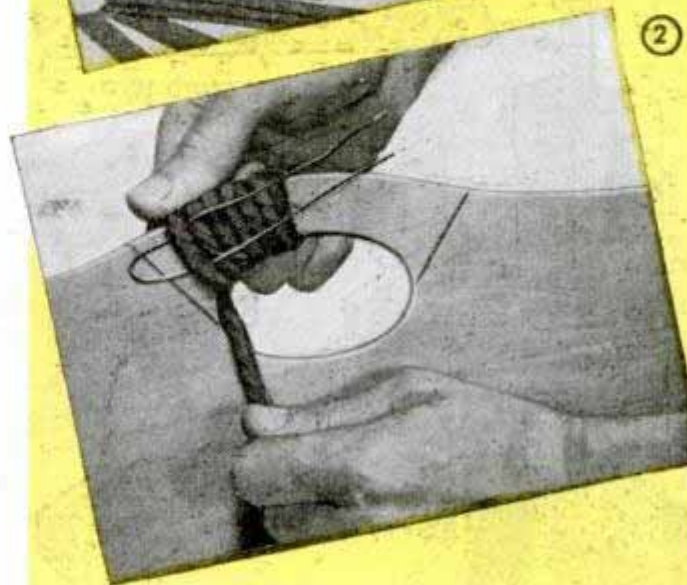
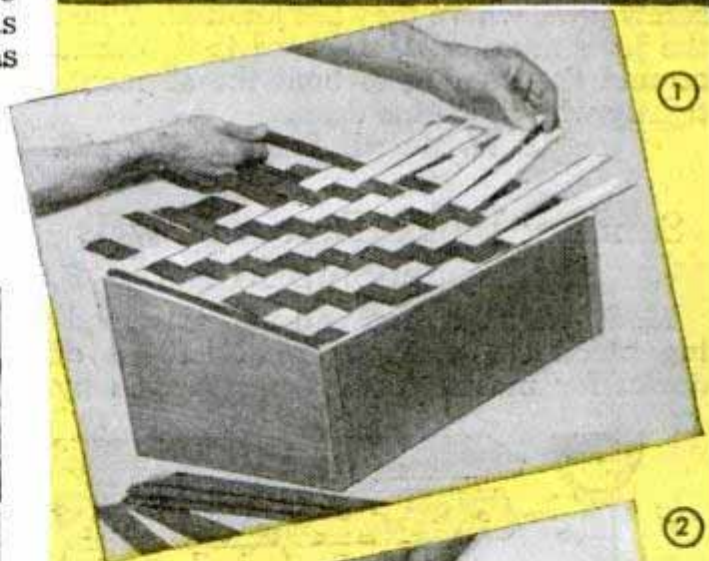

Glued Column Work Is Clamped By Cord in Hand-Screw Jaws

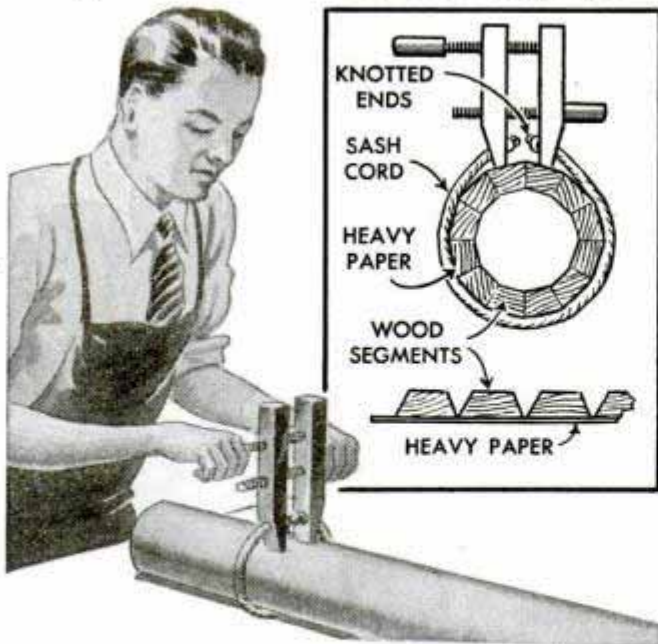

Columns composed of wood segments may be clamped for gluing by using an ordinary hand screw and a length of sash cord. Glue is applied to the sides of the segments, which then are aligned carefully on a strip of heavy paper and assembled into a column. The sash cord is looped over the column and the ends of the cord are inserted through holes drilled in the hand-screw jaws, where they are knotted. When the jaws are closed, the cord is tightened around the column to hold the segments tightly while the glue dries.

E. H. Merrill, San Rafael, Calif.

Sanding Block Tapers Dowels For Model-Ship Masts

Model-ship builders will find this sanding block useful in tapering lengths of dowel for masts. The block is made by

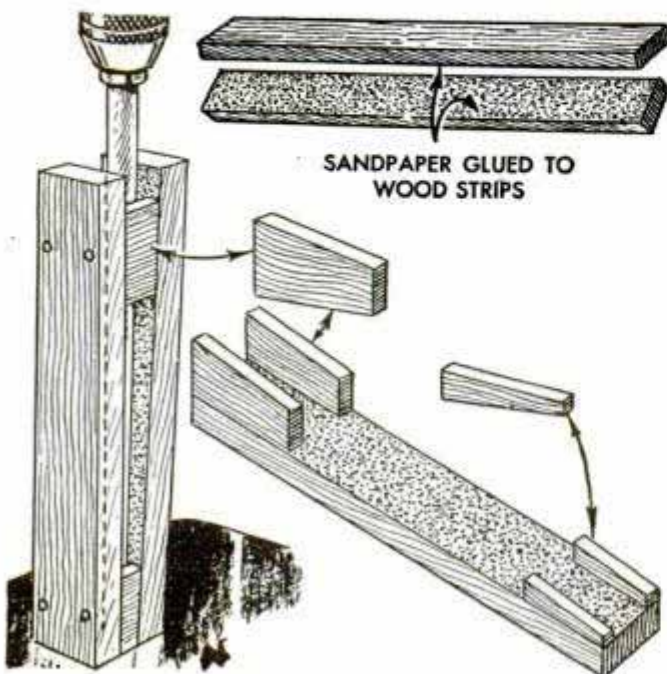

gluing sandpaper to two wooden strips, which then are nailed to four tapered spacing blocks. These are shaped to produce the desired taper on the masts. In operation, a dowel is chucked in a drill press and lowered into the guide gradually while being rotated. If no drill press is available, the work may be rotated in a hand drill, or by twirling it between the palms of the hands.—A. H. Waychoff, Phoenix, Ariz.

Refilling Small Spouted Cans From Glass Containers

Small containers that have spouts, such as those used for lighter fluid, can be refilled from bottles by using a cork that has been bored for the spout. The latter is pressed tightly into the cork, after which bottle and container are inverted. By pressing on the sides of the container, air will be forced out and fluid will be drawn in.

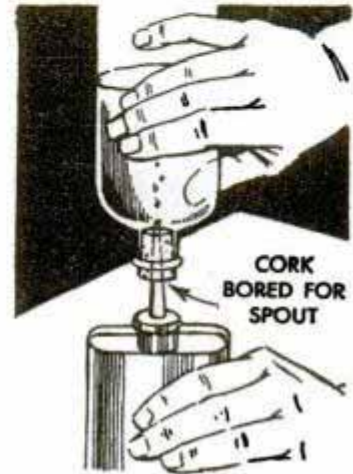

James F. Curtis, Aberdeen, Md.

Carbon Paper Creased Diagonally To Prevent Curling

Carbon paper will not curl when used in a typewriter if it first is creased from opposite corners as shown. The creases will not appear on the copies. — Tom McKitch, Vancouver, B. C.

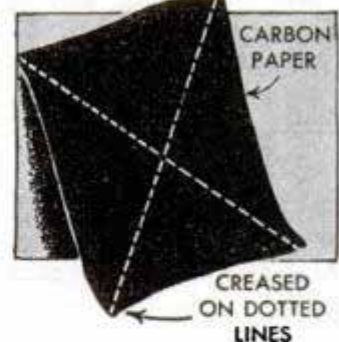

Adhesive Tape Will Muffle Bell

For the benefit of those who retire early or for any other reason wish to muffle the noise of a doorbell, this solution should be satisfactory. Paste a piece of adhesive tape on the gong so the clapper will strike the tape and not the metal. When the full tone of the bell is desired, rotate the bell to a point where the clapper will hit the metal. — J. F. Faimann, Baltimore, Md.



Cigarette Lighter Made From .50-Cal. Cartridge

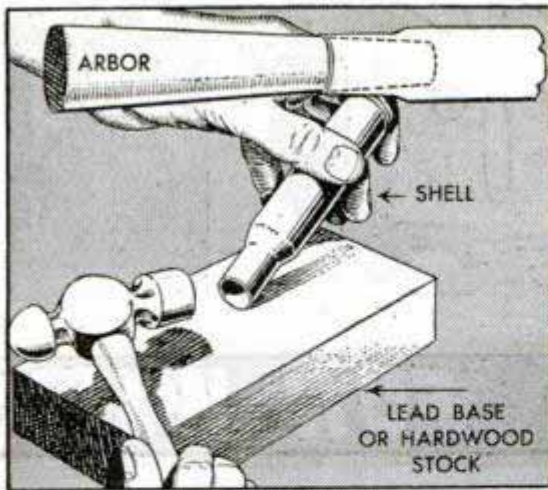

Empty .50-cal. cartridge cases—only those which have been fired—can be converted into attractive cigarette lighters. First, the empty case is annealed and an arbor, made by tapering a length of steel rod, is forced carefully into the neck of the case to expand it sufficiently to take a small lighter of the type having a bullet-shaped cap. After fitting the lighter, the case is held in the position indicated in the lower left-hand detail and the edges of the neck are tapped lightly with a hammer to turn them inward sufficiently to grip the lighter and hold it firmly in place. The case is weighted with lead as shown by dotted lines. To obtain a

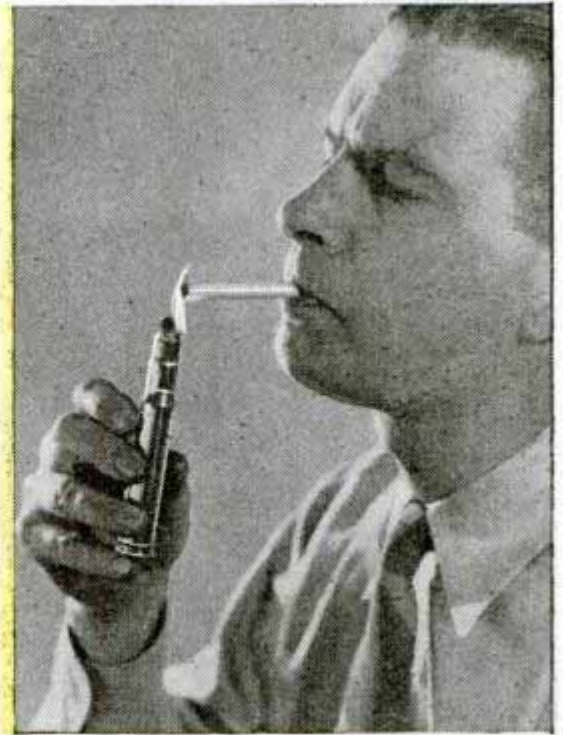

brilliant finish the case is brightened with fine emery paper, rubbed with pumice or silver polish and coated with clear nail polish or lacquer. Where the assembled lighter is used only as a smoking-table accessory the lower tip of the lighter case is cut off and a longer wick is used in the cartridge case, which is filled with cotton saturated with lighter fluid as indicated in the center detail.

Movable Pointer on Board Used as "Absence Indicator"

Shopkeepers and others who work alone can hang up an "absence indicator" like the one shown and thus save themselves the trouble of writing notes to explain their whereabouts. The indicator consists of a piece of stiff cardboard, a length of cord and a pointer. Two holes are punched in the cardboard, one near each end at one side, to take the cord. The pointer is made by threading the cord through the holes of a large button and over a narrow piece of wood, such as a matchstick, so that the button will slide. The ends of the cord then are inserted through the holes in the cardboard and knotted, and announcements are lettered on the board.

H. T. Gunderman, New York.

Easy Way to Open Oyster Shells

Oysters are removed from their shells easily if they are first immersed in carbonated water. The carbon dioxide in the water relaxes the muscles of the oyster and after about 5 min. the shell can be opened.



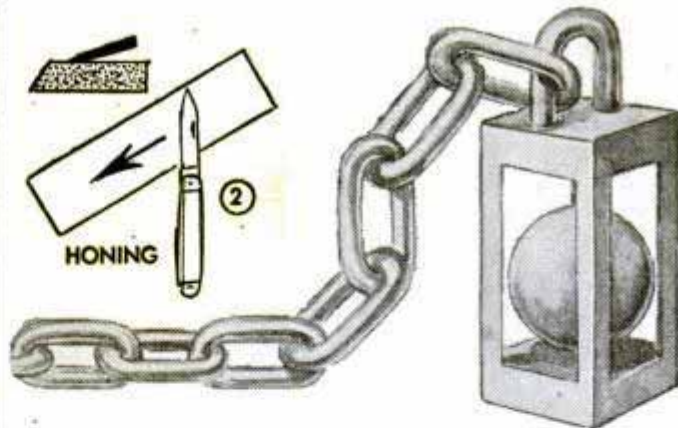
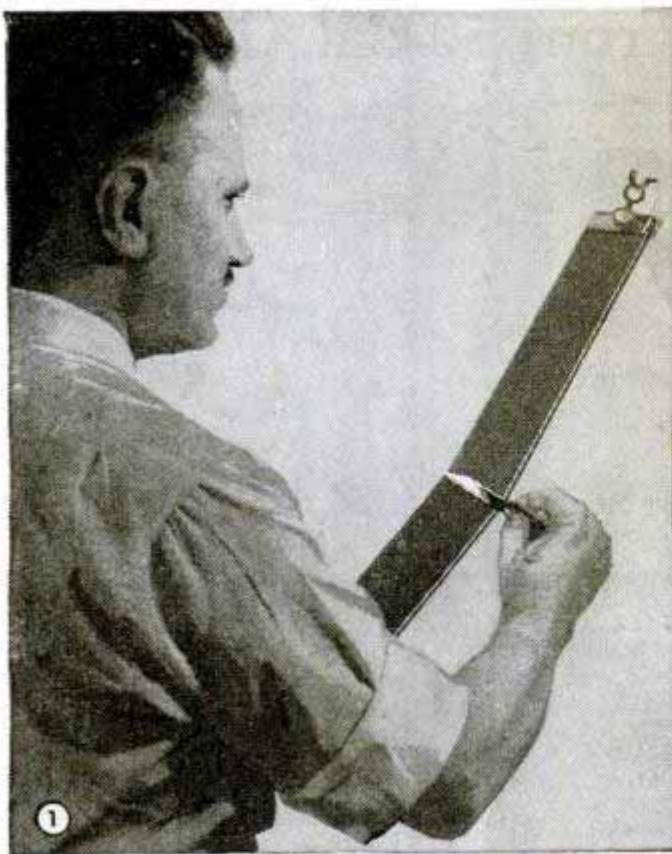

FUN WITH

YOU can have a lot of fun whittling chains, caged balls, scissors and many other objects that seem difficult but are really quite simple if you have a keen-edged jackknife. The secret of good whittling is to keep your knife sharp enough to make clean cuts without breaking the wood. When honing a knife, it's best to use two grades of oilstone, medium and fine. Both sides of the blade are drawn diagonally across the surface of the medium stone with the back edge raised slightly as in Fig. 2. Do not use a circular, grinding motion. Then the blade is similarly sharpened on the fine stone. The "wire edge" which is a result of this honing can be removed by stropping as in Fig. 1 and the knife is ready to go to work.

To make the chain, Fig. 3, select a length of $\frac{3}{4}$ -in. square, straight-grained basswood or sugar pine, both of which are soft and do not split easily. First cut a $\frac{1}{4}$ -in. strip from each corner as indicated in the upper detail. Then check the accuracy of the piece by making a template of sheet metal which has the same shape as the end section. This is slipped along the wood and used as a "go" and "no-go" gauge. Notches are cut to make the links, which then are formed and rounded as in the center detail, Fig. 3. They are smoothed with a piece of sandpaper glued around a

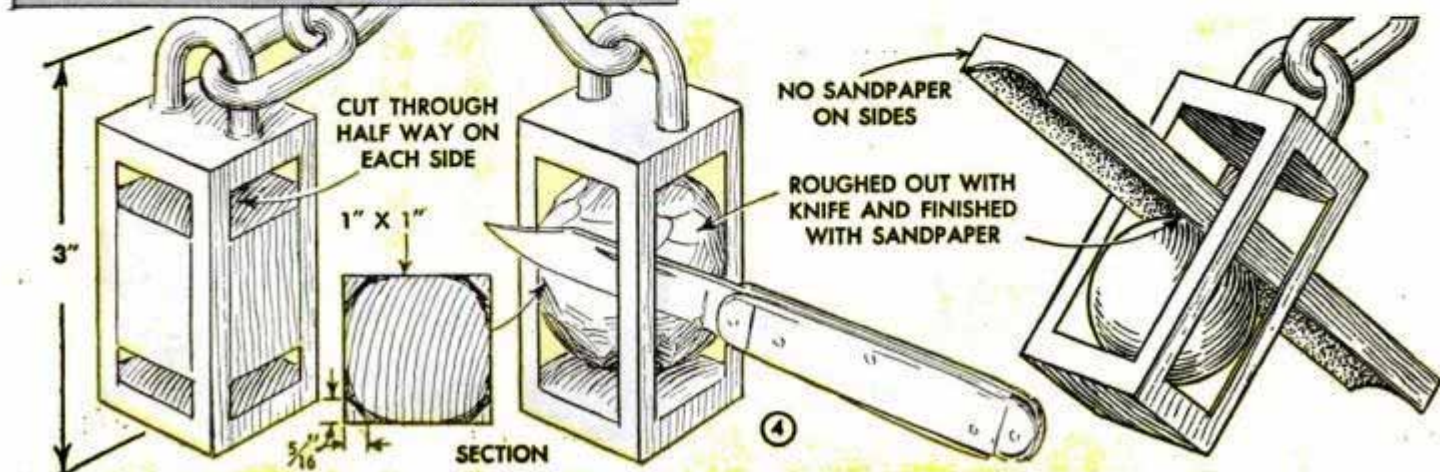
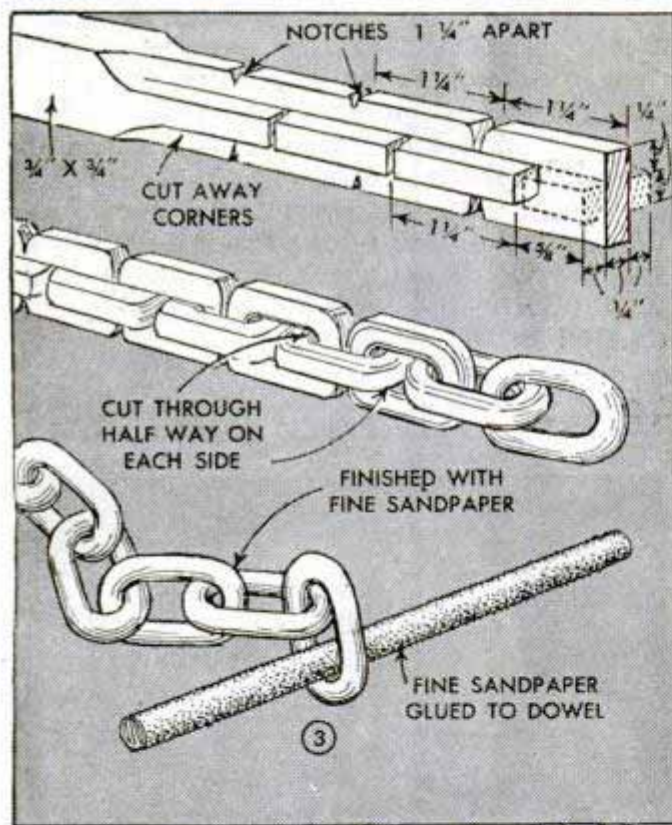



A JACKKNIFE

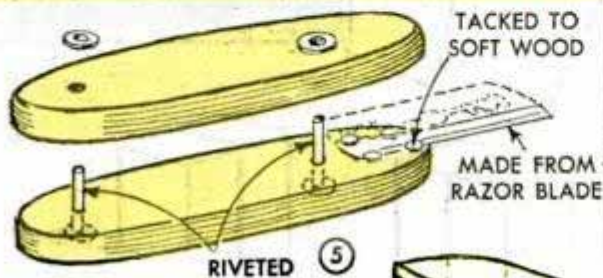

short length of dowel as indicated in the lower detail.

The ball-in-a-cage is made as shown in Fig. 4.

First the corner posts are cut and the ball is roughed out. It must be left as large as possible so that it will remain within the cage. After cutting the ball free, round it with sandpaper glued to a strip of wood having a concave face to fit the contour of the ball. The ball-in-a-cage can be combined with the chain as another project.

For the scissors, Fig. 6, an auxiliary cutting tool will be needed because of the intricate method of jointing. This is made from a piece of razor blade held between two halves of a wooden handle as in Fig. 5. Preferably this should be one of the thicker safety-razor blades. Dimensions of the scissors are shown in Fig. 8, the joint or fulcrum being detailed in Fig. 7. When made carefully, no pivot pin is needed. Opening and closing action of the joint is similar to that of the pliers, Figs. 10 and 11.

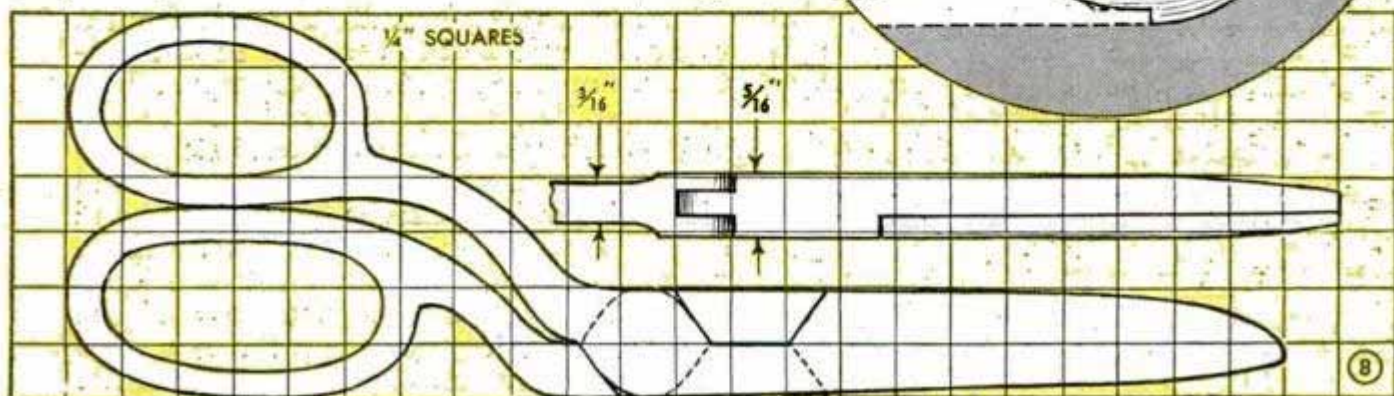
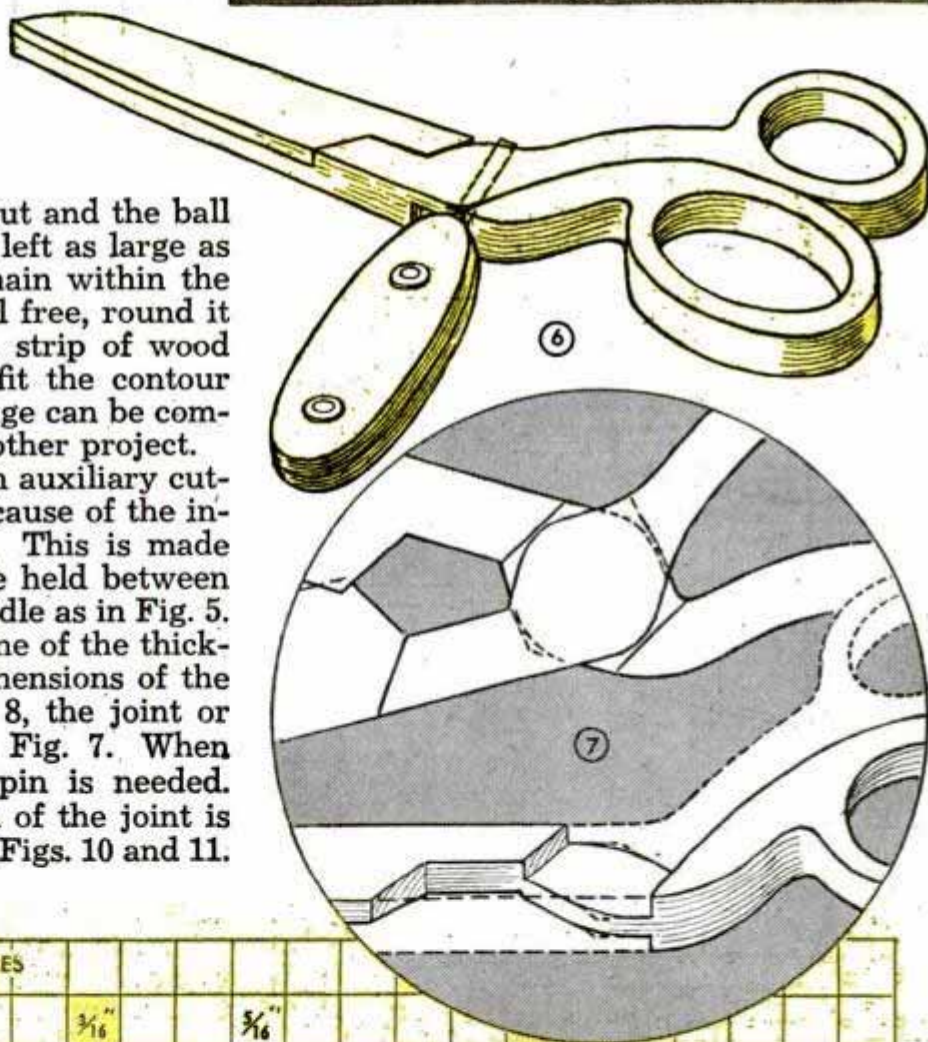

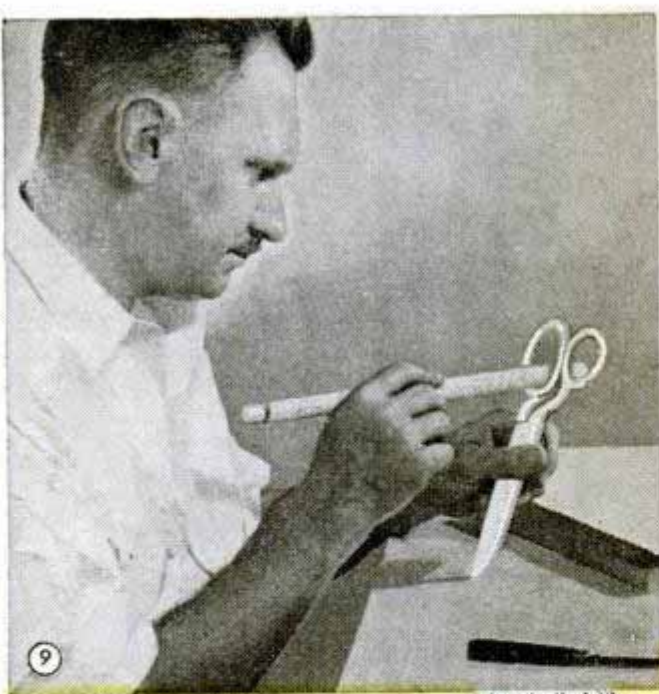

CUT THROUGH CAREFULLY AT A, B, C AND D

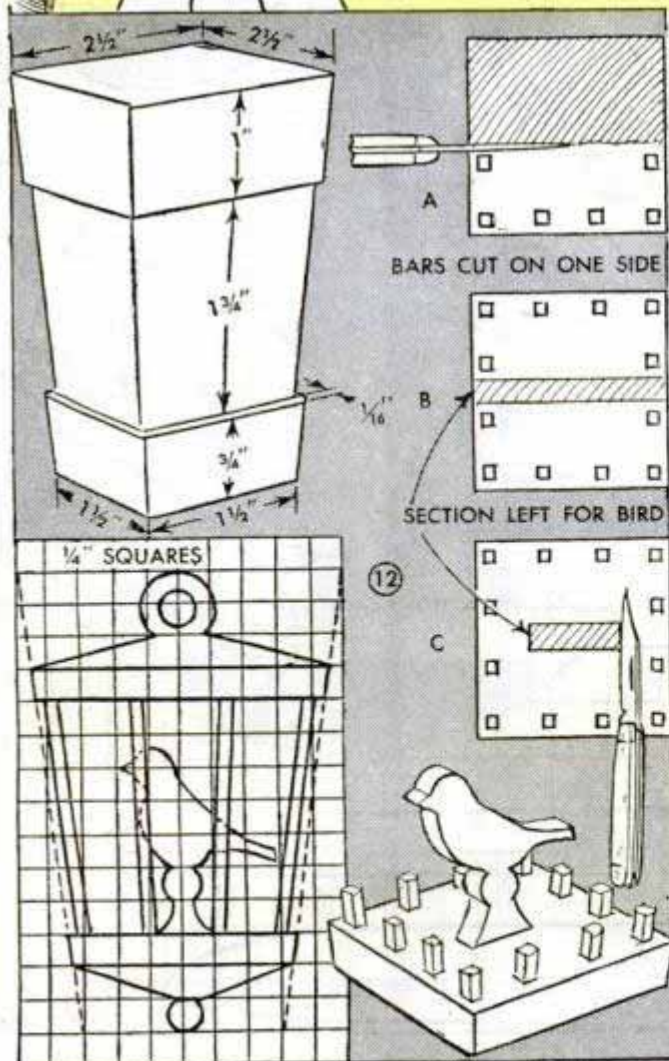
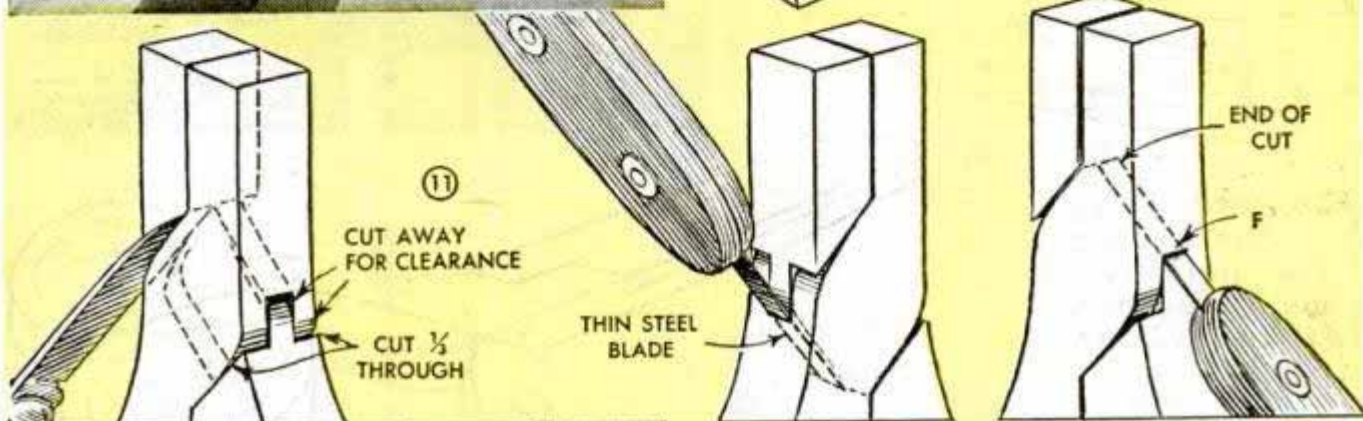
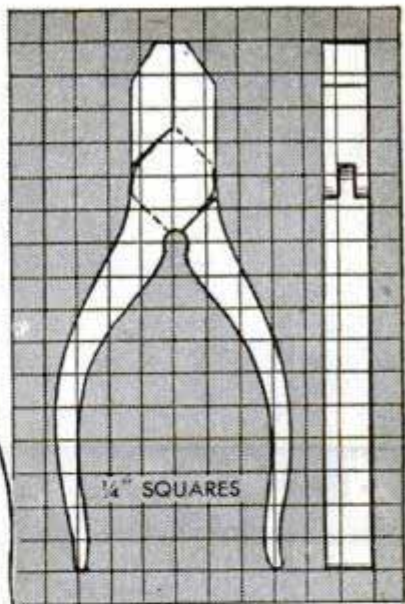
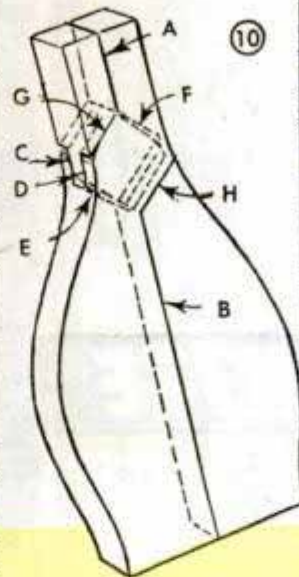

To make the pliers, carve them to the shape shown in the cross-hatched pattern, Fig. 10, and make cuts A, B, C and D all the way through. Then cut E to B and F to A, using the tip of the tool as in the center and right-hand details of Fig. 11. Cuts G and H are made about one third of the way through on both sides to leave a narrow strip joining the jaw with the handles. To prevent splitting the wood, cut but a little at a time. All diagrams must be followed exactly, as some of the cuts go only part way through the wood and, if continued, would spoil the piece. If the parts do not open readily, all cuts should be gone over again to ease the action. When the cutting is finished, the pieces can be sanded as in Fig. 9.

The bird cage, Fig. 12, is made from a tapered block that is recessed in the center portion as indicated in the upper left-hand detail. Bars are marked on all sides with pencil and then cut on each side leaving the central portion. The bird is carved to the shape shown in the lower right-hand detail. Cutting the bird will take some time as this must be done with the knife blade inserted between the bars of the cage. For variety, you can make a cage with five bars to a side, or you can whittle several animals in the cage.

REMOTE-CONTROL SWITCH for model railways

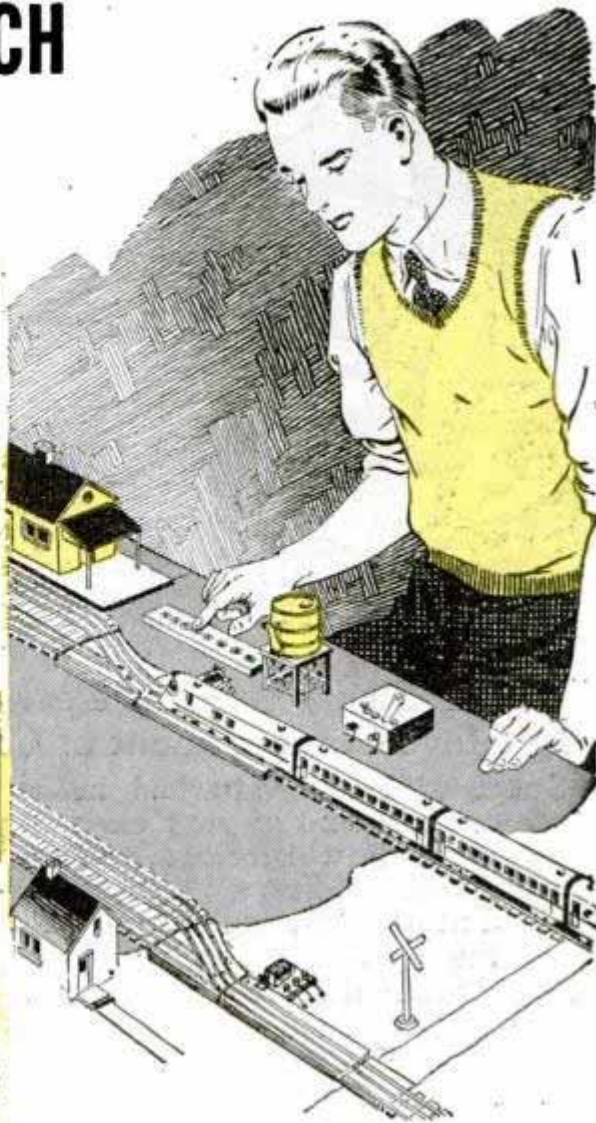
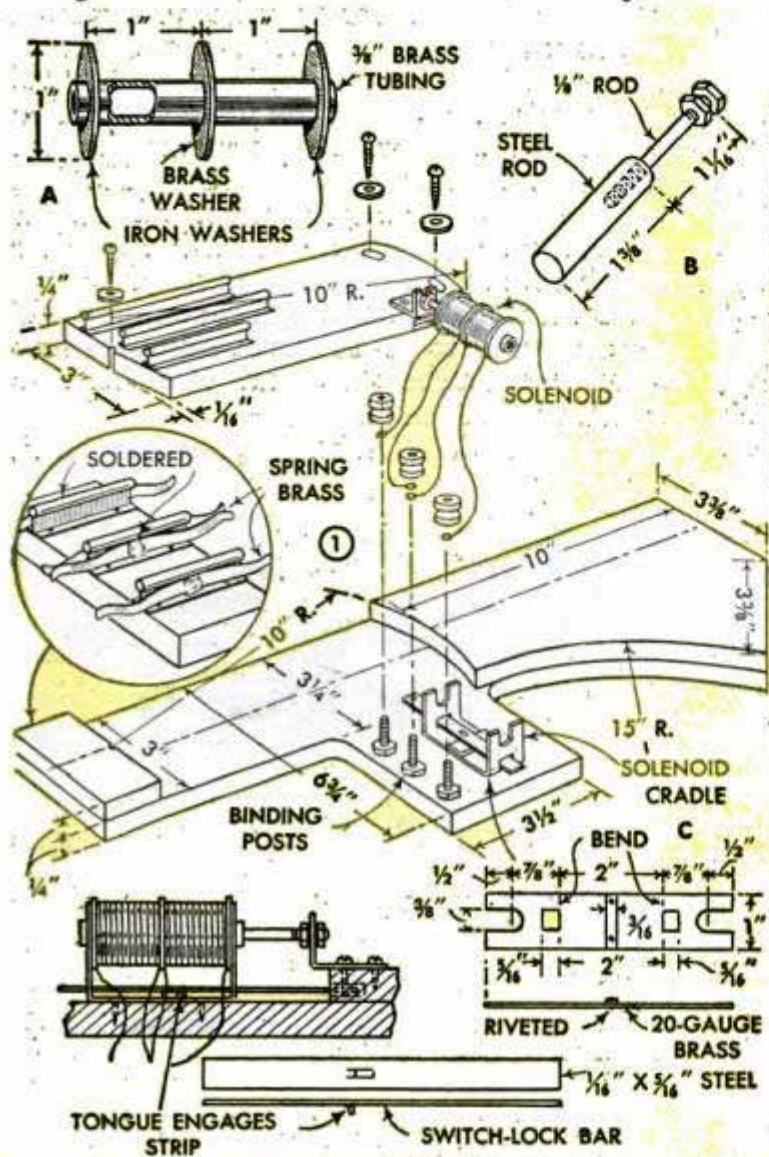

or to dry batteries, which will give more silent operation. The switch is moved by pressing push buttons, Fig. 2, one painted red to throw the switch for the side track, and a green one for main-line traffic.

The spool of the solenoid, detail A of Fig. 1, is a piece of brass tubing to which washers are attached. It is wound almost full with 25-ga. wire, and a plunger, detail B, is made to fit the tubing. The solenoid is held in a brass cradle, detail C. When power is applied, a magnetic field is created to move the plunger—which is attached to a track section—and lift the locking bar over the raised strip at the center of the cradle. When the current is shut off,

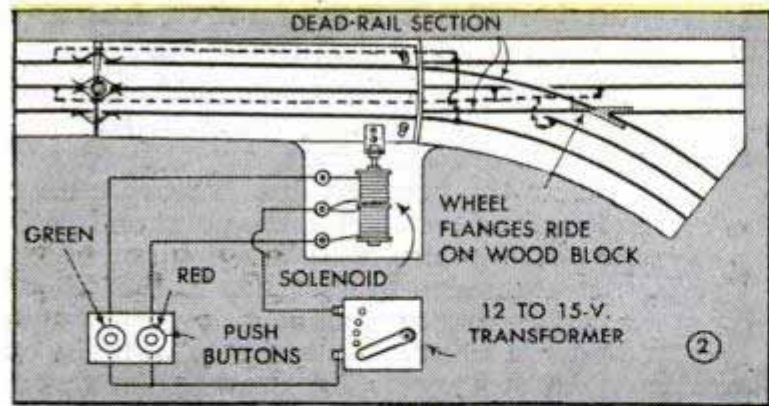

UNLIKE most switches for model electric railway tracks, this one, which is remotely controlled, moves a section of straight track to meet the switch. It has no sliding metal plates, no frogs and no parts that clatter when a train passes over it. The switch is operated without auxiliary levers by a double-acting solenoid, the electric current being supplied independently of the train circuit. For instance, the solenoid can be wired to the posts of the circuit transformer, to a separate transformer,

the bar drops down with its tongue on the other side of the strip. The track is bradded to pieces of plywood cut as shown in the center detail, Fig. 1. These are attached to a plywood base, the switch section being pivoted on a wood screw located at one end of the center rail. Spring clips soldered to the rails as indicated in the circular detail carry the current across the joint while permitting free action of the switch. The clips on the center rail encircle the pivot screw.—Chas. Franklin, Los Angeles, Calif.



Dating Stamp for Concrete Work Utilizes Old License Plates

When laying sidewalks, driveways or platforms, you can print the date of completion in the concrete with this stamp, which utilizes outdated auto-license plates of the kind that have raised numerals. The numbers are cut from the plate and nailed to a wood block with the reverse side up. White-lead putty is used for filleting around the outer edge of the numbers. As an alternative, house numbers or any other numbers that have been pressed out of sheet steel can be used. These stamps could also be used to press street numbers into sidewalks, curbstones and elsewhere to furnish identification.

John A. Benke, Buffalo, N. Y.

Leather Strips Used as Pockets In Glove Compartment of Car

Strips of leather attached inside the glove compartment of your car will provide pockets in which maps, pencils, bottles of lotion and first-aid medications can be held neatly. The pockets not only will keep the articles where they may be reached without searching, but will hold bottles upright and prevent them from spilling. The strips are wired in place, holes being drilled in the walls for the wire. If desired, a large hole can be cut in one of the walls to take paper drinking cups.

Thos. E. Stimson, Jr., Los Angeles, Calif.

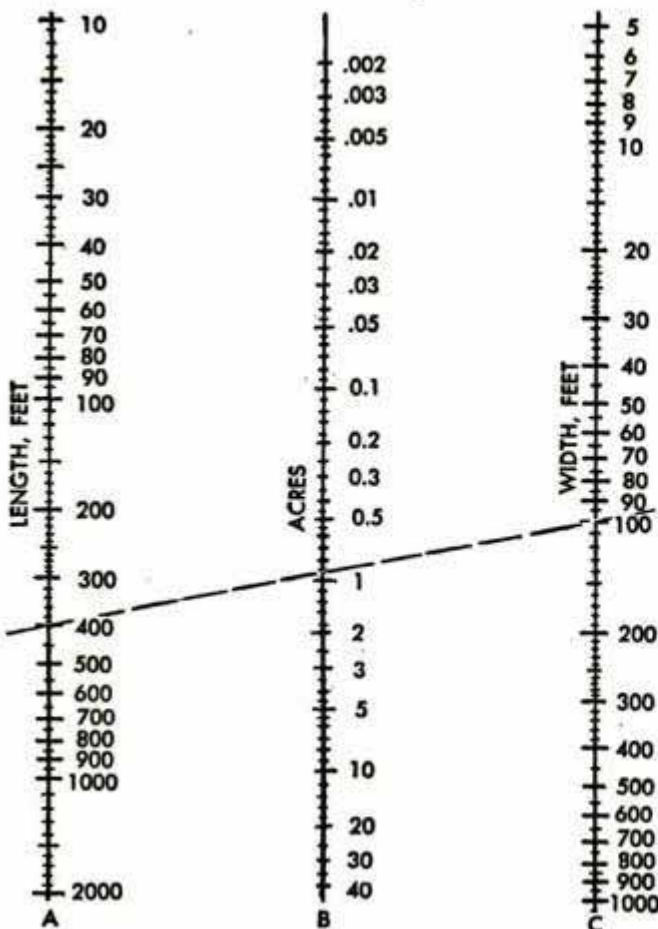
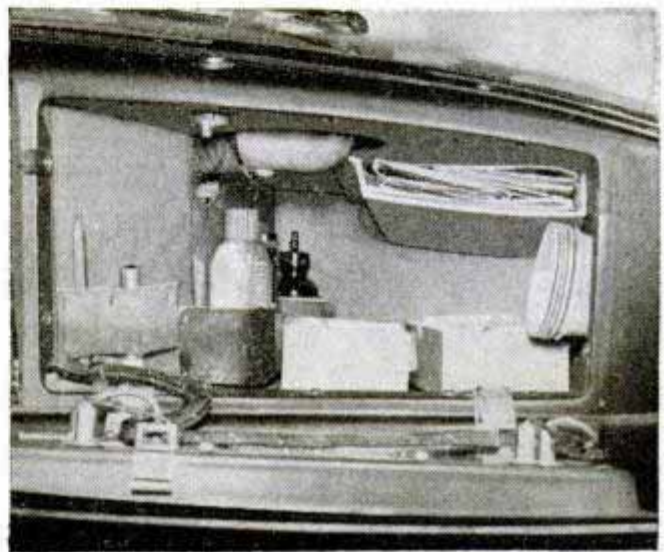

Chart Computes Number of Acres In Rectangular Tract of Land

With this chart you can tell the approximate acreage of any rectangular tract of land if the length and width in feet are known. To use the chart, a straightedge is laid from the point on line A representing the length of the tract to the point on line C representing the width. The point at which the straightedge crosses line B will show the approximate number of acres contained. In the example shown, a piece of land 400 ft. long by 100 ft. wide contains a little over 0.9 acres, or about 0.92 acres. For areas over 2000 ft. long, length measurements can be expressed in terms of hundreds of feet instead of thousands, and the figure found for the acreage multiplied by ten. An area 4000 ft. long by 100 ft. wide will contain about 9.2 acres. Similarly, if the tract is 4000 ft. by 1000 ft., the figure in line B is multiplied by 100 so as to read 92 acres, the decimal point being moved to the right as many places as there are ciphers added in lines A and C.

W. F. Schaphorst, Newark, N. J.

ON-A-DOOR CABINET

Saves Space

FOR those who live in small apartments, this clothes cabinet, which is attached to the inner side of a door, will increase storage space and permit shoes, ties, linens and similar articles to be stored neatly within easy reach. The cabinet frame is made of $\frac{1}{2}$ -in. stock cut to fit a door, and is grooved for shelves and a partition as shown. Staggered holes are drilled in the side members of the frame to take lengths of dowel, which form shoe racks, and the ends of the members are rabbeted for top and bottom pieces. Flush doors of $\frac{1}{4}$ -in. plywood are provided with friction catches and glass knobs. A wooden disk and a spacer made by cutting a spool in half are screwed into the underside of the top to hold ties, nails being driven into the edge of the disk for this purpose. When assembled and finished as desired, the cabinet is attached to the door with angle brackets screwed to top and bottom pieces.

Newell D. Hartley, Devon, Conn.

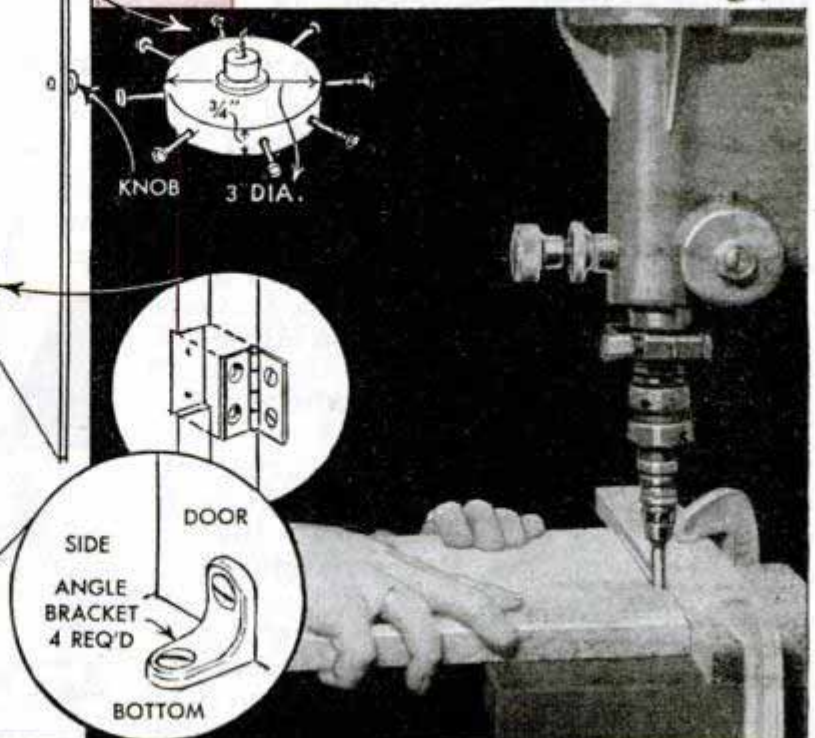
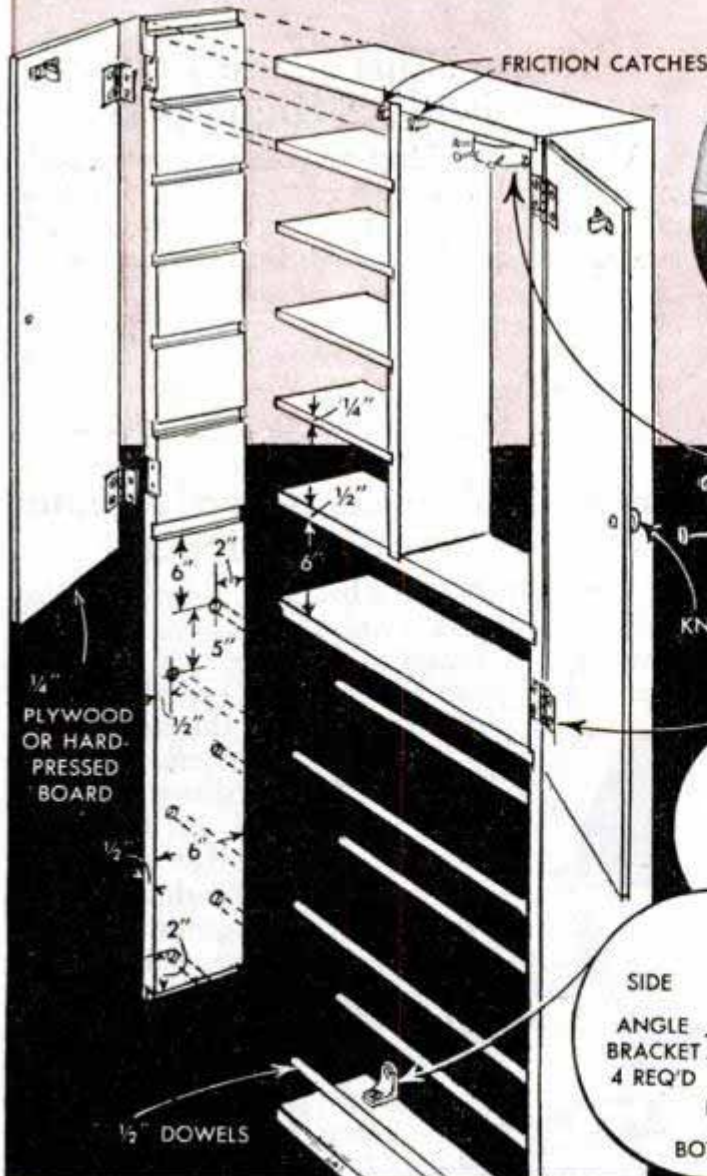

Markers and Holder Save Time In Locating Papers



When a file has been removed from a filing case, time frequently is lost replacing the folder in its proper place. As an aid in locating the place for the "out" file these markers are used. They can be cut out of cardboard, a little longer than the height of the file, and labeled with the name of the person who is using the file. A holder such as the one shown can be made of plywood.

Tape Secures Cork in Bottle

When packing your bag for traveling, one way to make sure cosmetic bottles will not spill is to put a strip of adhesive tape over each cork or stopper and run it an inch or more down each side. After that the bottles will take any amount of jarring without danger of spilling.

Vincent A. Otto, Baltimore, Md.

Hot Plate Is Made From Tin Can And Heat-Lamp Element

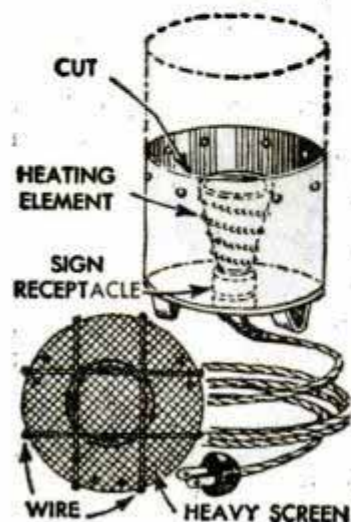

Using the element from a heating lamp, you can improvise a hot plate in a short time almost entirely from scrap materials. The heating element is screwed into a sign receptacle to which a cord and plug are attached, and the receptacle is fitted over a hole in the bottom of a

large tin can. This is cut down so that its edge extends for a short distance above the top of the element, and holes, spaced as shown, are punched in the edge of the can for lengths of heavy wire that support a grate. Strong screen wire or mesh, cut to fit inside the can, is used for this purpose. For legs, electric-cable straps are attached to the can with bolts.

Kenneth C. Colby, San Francisco, Calif.

Strips Over Slot in Child's Bank Prevent Removal of Coins

Fastened on the underside of the cover of a child's wooden bank, strips of rubber will prevent coins from falling out when the bank is inverted and shaken. Strips of inner-tube rubber or canning-jar rings are nailed on the cover so that they overlap the coin slot.

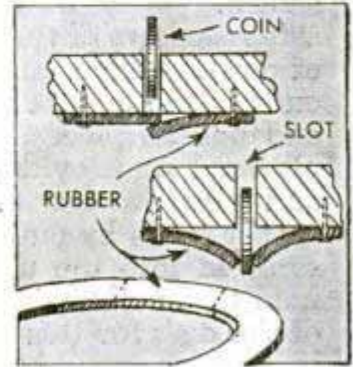

Philip C. Birnbach, Jr., Brooklyn, N. Y.

Wringer Rolls Made Efficient By Sanding High Spots

Usually, washing-machine wringer rolls will wear down most in the center because that part receives the hardest usage. Almost new efficiency can be secured by removing the rolls and sanding the high spots on each end with coarse sandpaper. To check the alignment for maximum contact, rotate the rolls against a straightedge.

Floyd Bushnell, Berkeley, Calif.

Bracing Protects Record Album While Being Shipped

With a little extra bracing, record albums can be shipped without damage. A small dowel is trimmed to fit the center hole and extend beyond the records on both ends.

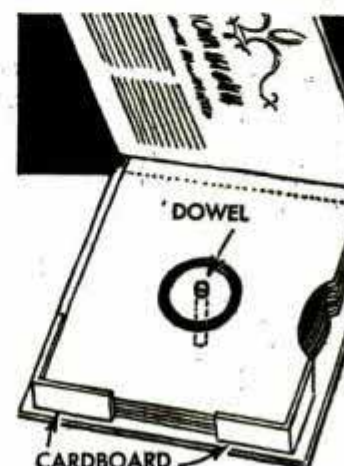

For the unprotected corners, corrugated cardboard is cut the same width as the length of the dowel, bent at right angles and inserted between the covers. The album then can be wrapped and shipped.—Lt. (j.g.) Frank L. McKibbin, Key West, Fla.

X437A



By Hi Sibley

HANDSOME in a rugged way, with bright yellow running gear, red coach body decorated with gilt striping and outdoor scenes painted in oil on the door panels, the prototype of this coach model weighed a ton and a quarter empty and cost nearly \$2500. Noteworthy features of these old overland coaches were the exceptionally heavy running gear and the unique method of springing the body as shown in Figs. 7 and 9. This particular coach was one of several owned by the "Overland Stage Line" which followed the pony express route between St. Joseph, Mo., and Sacramento, Calif., a service that was operated on regular schedules until the completion of the first transcontinental railway. Ben Holliday, whose name appears on the door panel of the old coach, was a division superintendent of the Overland Line.

Figs. 1, 2 and 6 will give you a good idea of the general appearance of the finished model. Construction begins with the body, component parts of which are shown in Fig. 3. The overall size of the body is easily determined by laying out full-sized patterns from the crosshatched views in Figs.

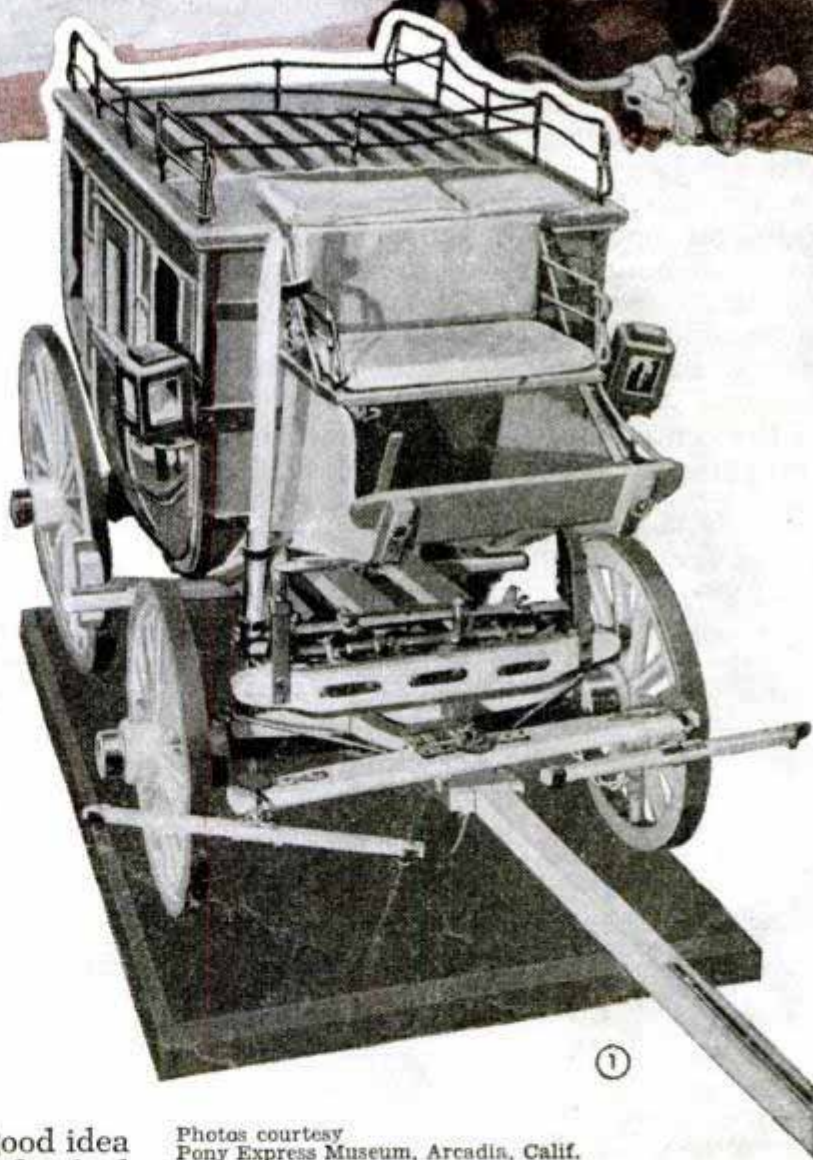

Photos courtesy
Pony Express Museum, Arcadia, Calif.

4 and 5. Before beginning work, notice the position of the parts A-A, right and left, and the bottom, B, in Fig. 3. Also note in Fig. 5 that the sides of the body do not slant inward at the top. Sides, front and

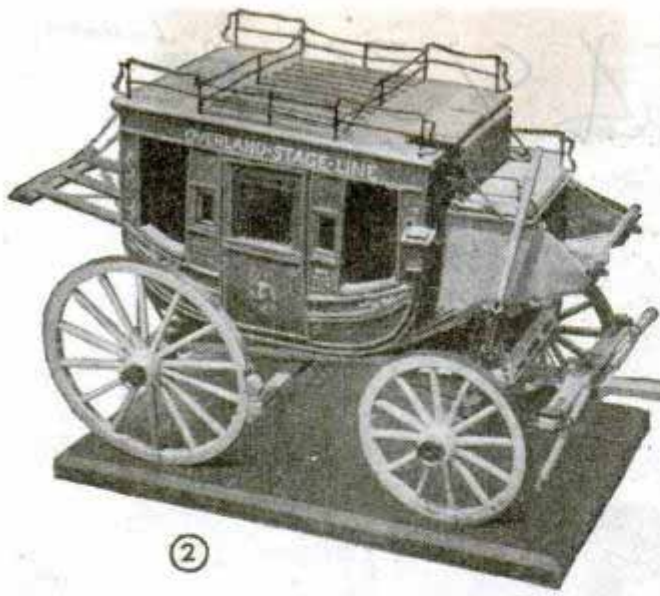

seats are carved from balsa wood or white pine and glued to the sides and bottom of the body as shown in the cross section, Fig. 3. Then the top is glued on and shaped to the curves indicated. Assembly of the luggage racks, top and rear, and the fitting of the driver's seat and "boot" finish the body ready for the final sanding and application of the trim molding.

back parts of the body should be cut from $\frac{1}{8}$ -in. plywood, preferably a close-grained wood such as birch. Window openings are cut as indicated, and the doors are outlined with a molding made by sandpapering thin strips of balsa wood or rattan to a half-round section and gluing in place. Note that the doors each have a single sash, partially lowered and fitted with a celluloid light. The sash frame is glued to the inside of the body panel. The two small windows, one on each side of the door, have celluloid lights but no frames, while the large windows on both sides are merely openings curtained with khaki cloth rolled up as indicated and secured with thin leather straps. In assembling, begin with the bottom and glue the curved side pieces A-A to the center piece B, Fig. 3, and then fit and glue the sides and ends in place. Inside

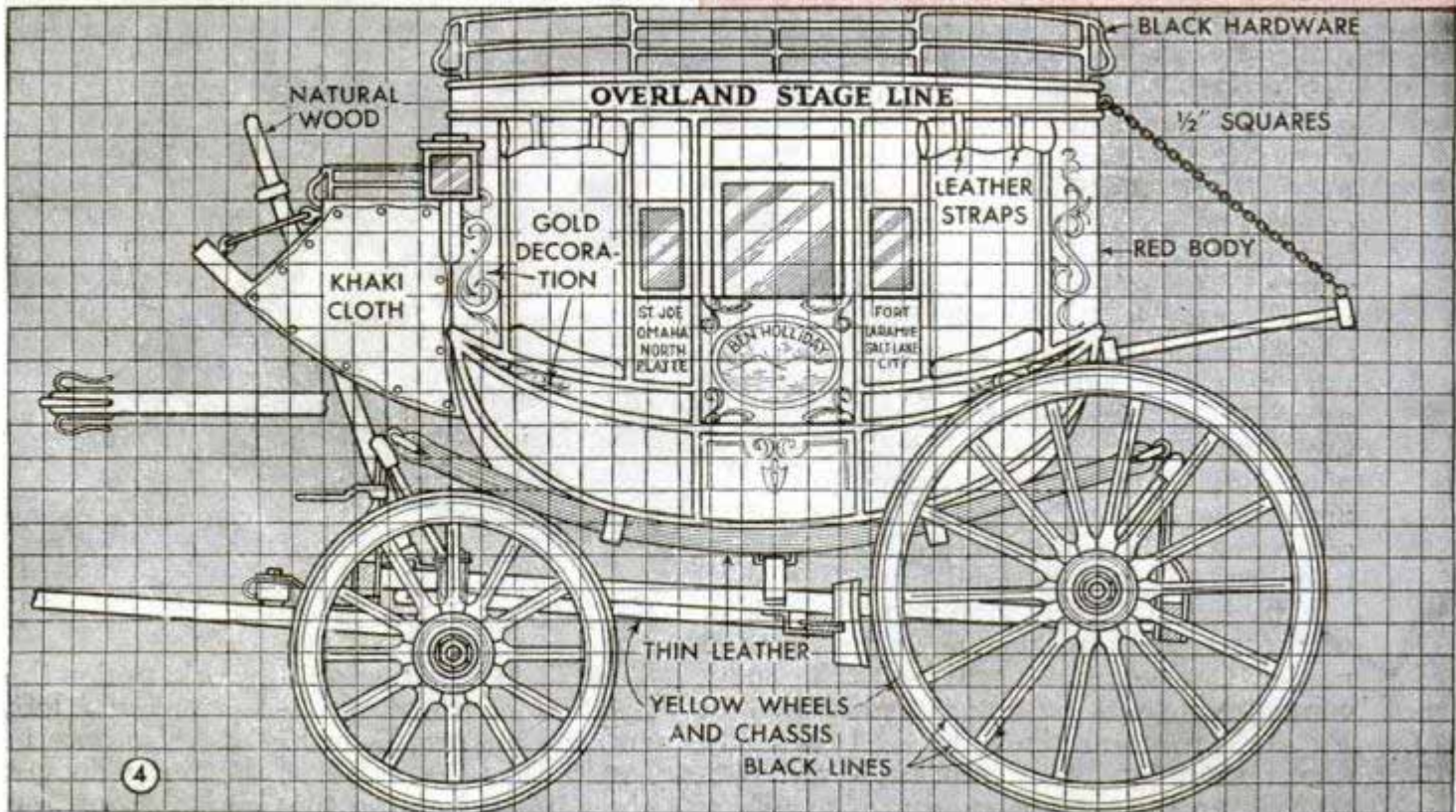
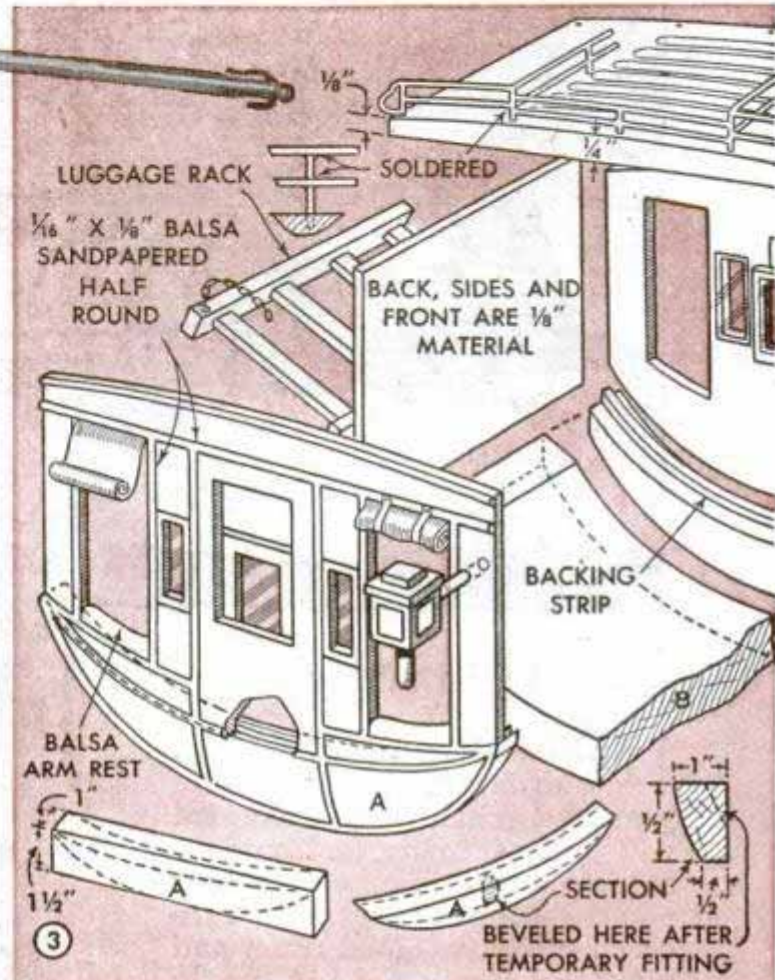

Next comes the running gear, the frame being detailed in Figs. 8 and 9 and the wheels in Fig. 10. The latter are the trickiest of all to make as close duplication of a number of parts is required. First, make the longeron, or spring unit, which consists of three lengthwise members mortised through end pieces as in Fig. 9. Note that the longerons slant to the rear, making the

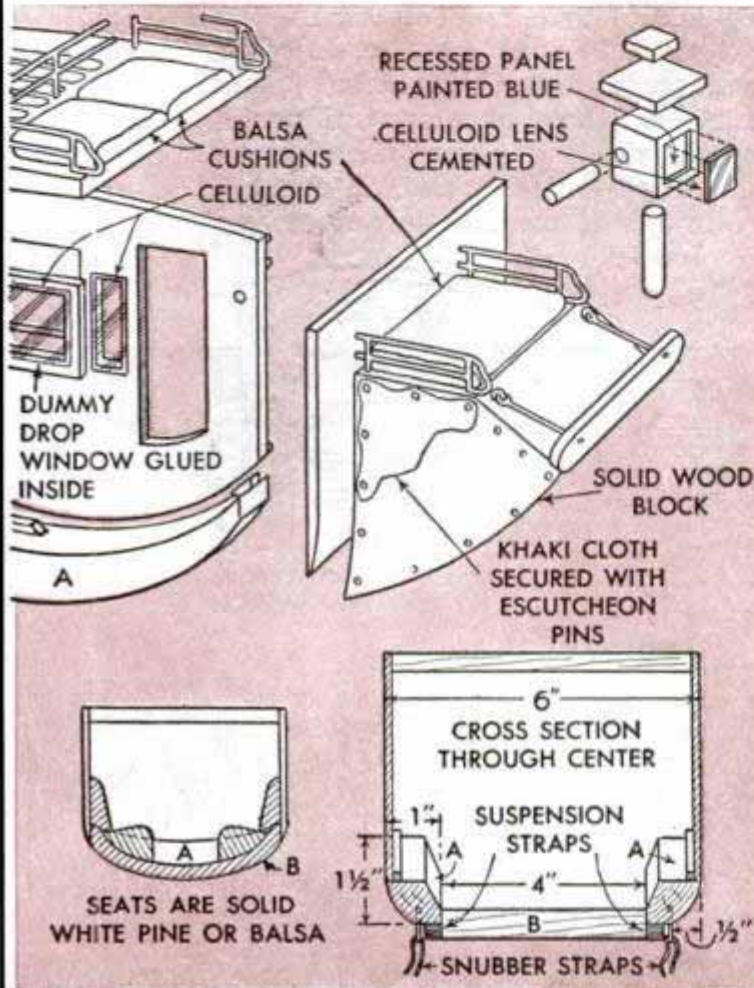

front axle the "overhung" type while the rear axle is of the conventional "underslung" construction. Use maple for all the wood parts. Sheet metal of 16-ga. thickness and wire of approximately the same diameter will serve in making most of the "hardware." Some of the "ironing" can be simulated by merely coating the area with black paint as in detail A, Fig. 9. Follow through with the construction as detailed in Figs. 8 and 9 up to the whippetrees and tongue, which can be left until later.

To make the wheel rims glue two pieces of $\frac{3}{16}$ -in. hardwood together with the grain

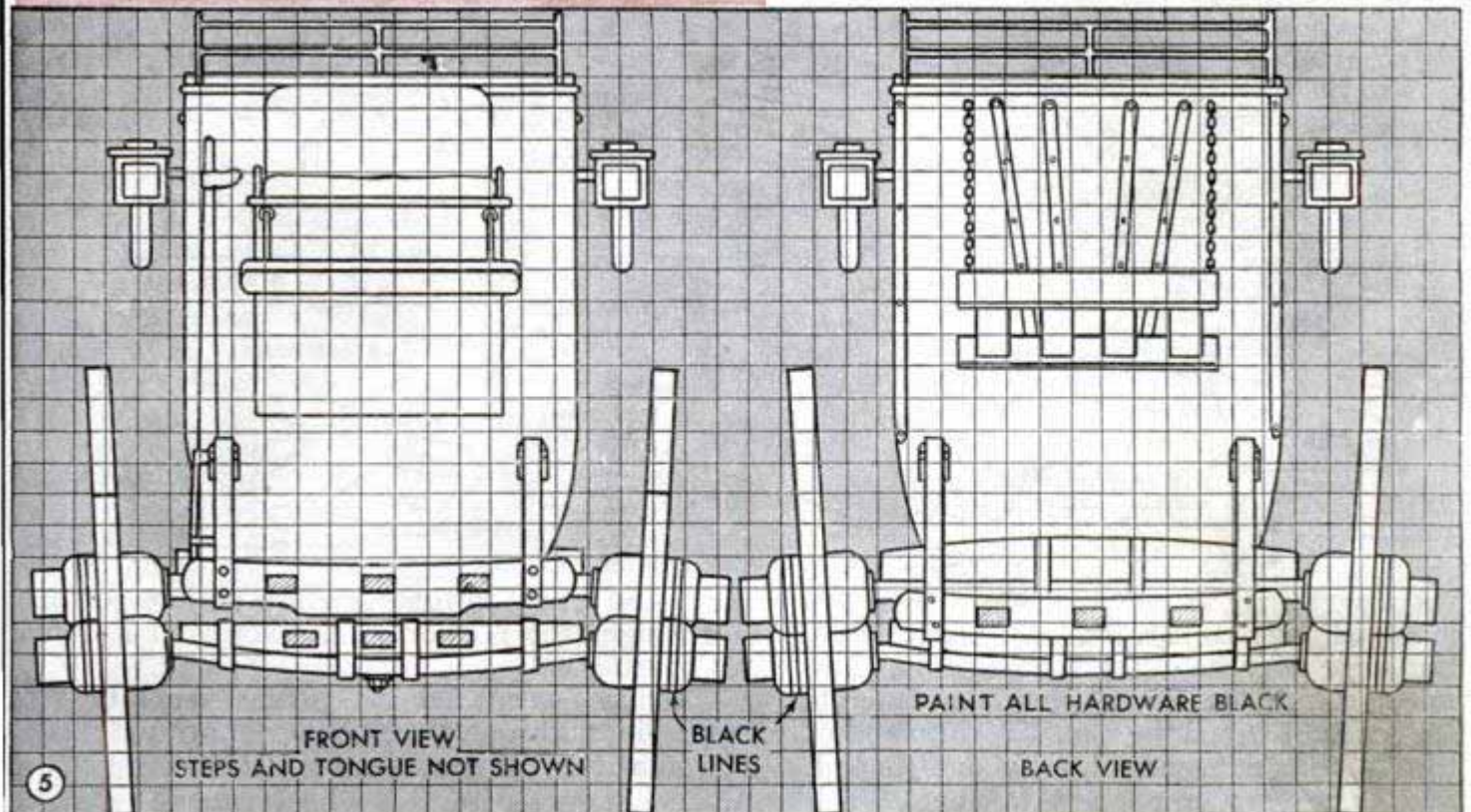

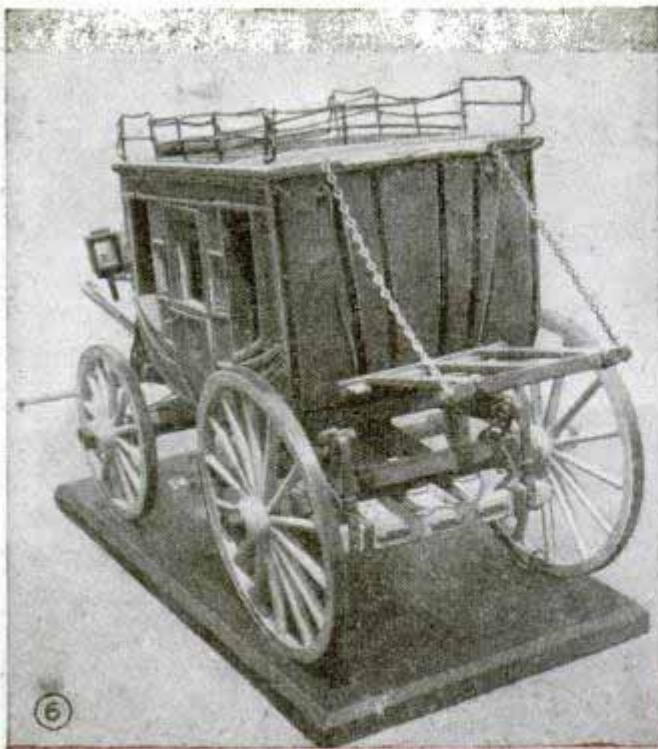

spoke with a template to assure uniformity. Blanks for the spokes should be cut slightly oversize and about $\frac{1}{8}$ in. longer than the finished length. After shaping, they are cut to exact length. Wheel hubs are turned to the dimensions given and fitted with a metal ferrule, after which a hole is drilled in the small end of each spoke to take a single brad. Before gluing the spokes into the hub a trial assembly is made of each wheel. With correct fit assured, glue the spokes into the hubs, trial-fit the wheel rims and glue and brad these in place. Make sure that the spokes are uniformly spaced on the rim and, before the glue dries, slip the wheel on the axle and check for true running. If the rim is out at any point,

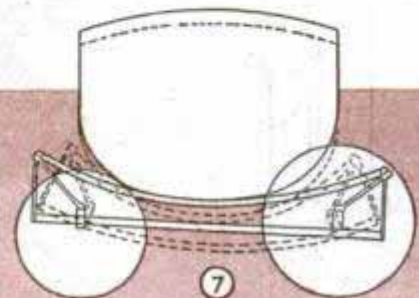

EXAGGERATED DIAGRAM ILLUSTRATING SPRING ACTION

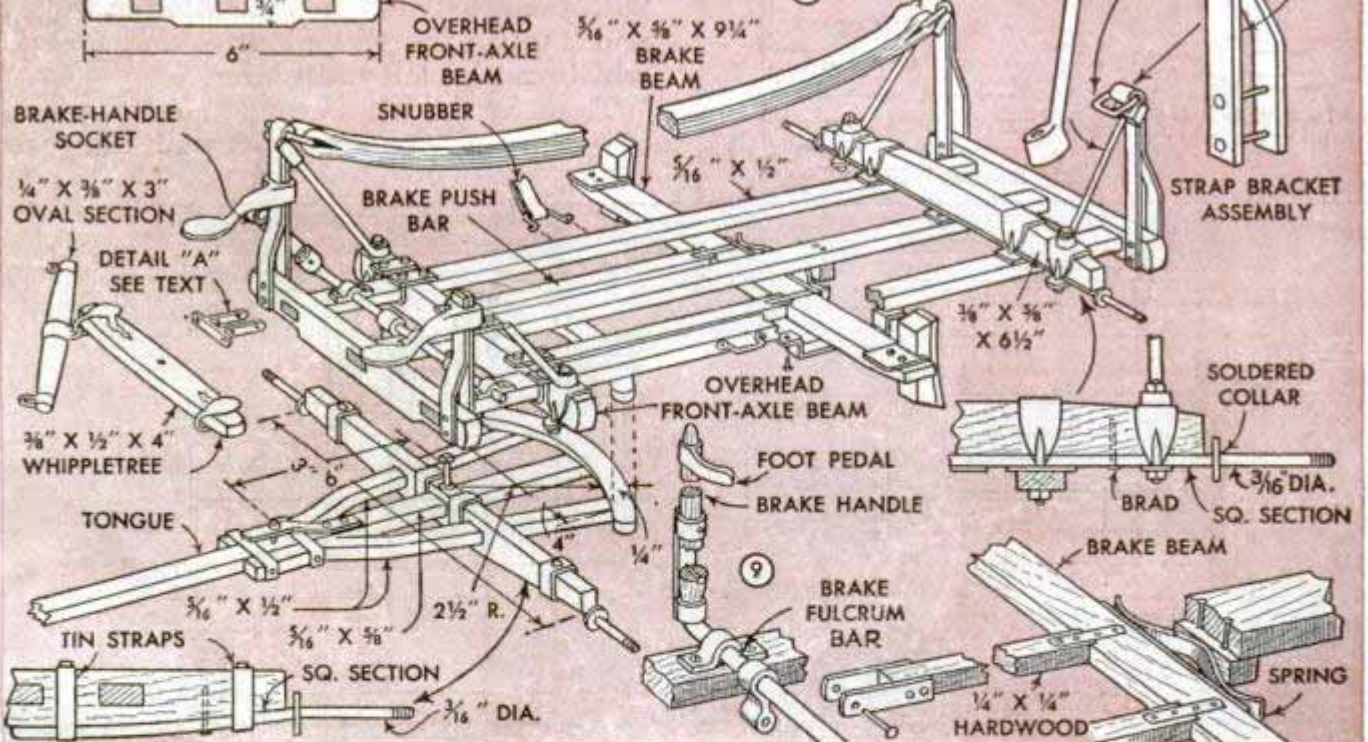
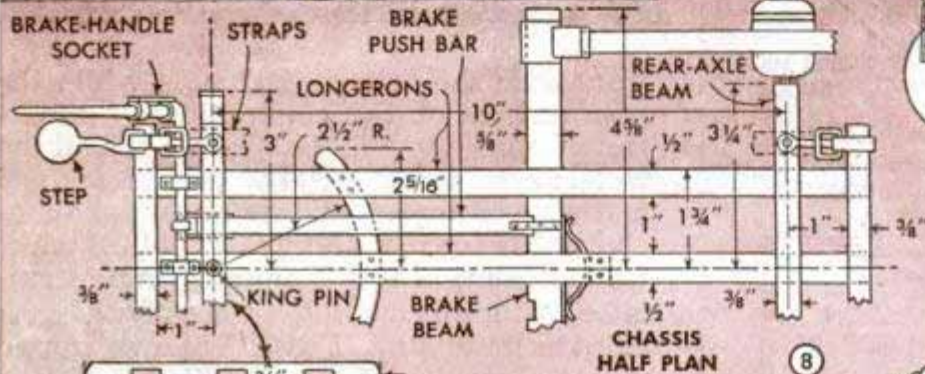

running at right angles. Scroll saw the rims to finish size, or, if a lathe is available, the rims may be turned accurately. The wheel spokes are of oval section and slightly tapered toward the rim. The hub end of the spoke is flat tapered, or wedge-shaped, and it is very important to check each

clamp the wheel to the edge of a table top and weight the portion of the rim that is out of true.

The tires are cut from 16-ga. sheet metal to a $\frac{3}{8}$ -in. width and are bent cold around a circular form of the same diameter as the outside diameter of the wheel rim. The

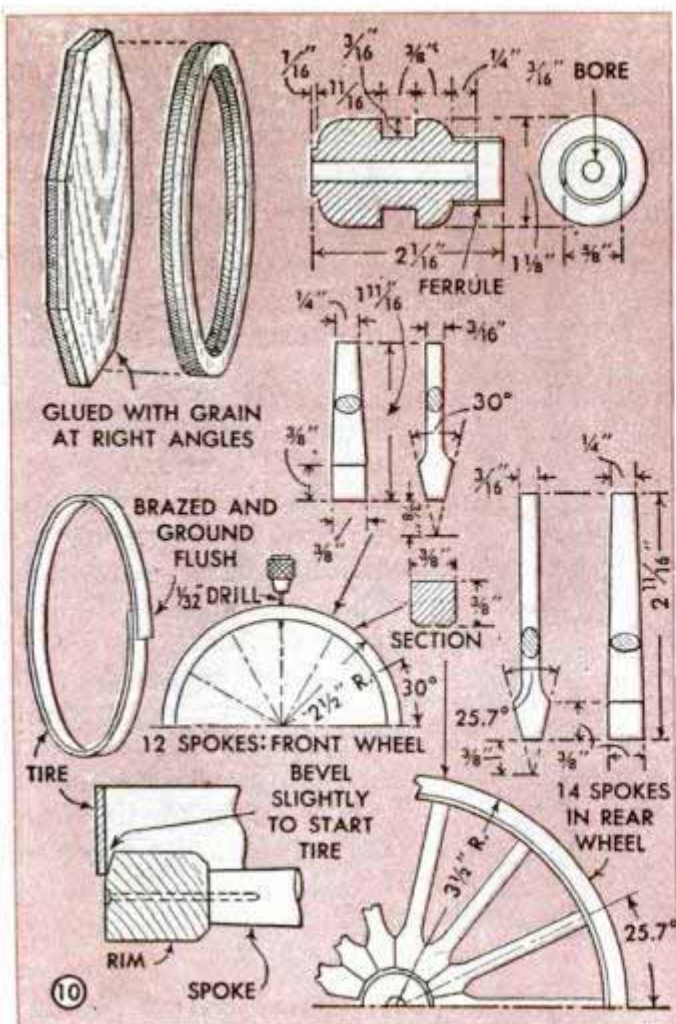

paint. Of course, on this particular job it is not practical to disassemble the body for dip-painting. Follow Figs. 3 and 4 and use colors ground in oil or sign-painters' colors and apply with small round brushes, taking great care on the flat surfaces to lay on a thin uniform coating. Seats and interior are painted a medium brown to simulate khaki-colored upholstery and body lining. Pick up any excess paint in the corners and at the edges with an extra dry brush and carefully smooth out any laps or sags that may develop on the vertical surfaces. Allow each coat plenty of time to dry thoroughly, and before painting any parts on which an acid-soldering flux has been used, Fig. 11, neutralize the acid by washing the parts in hot water.

After the last coat of paint has had time to dry assemble the running gear and mount the body. Then make and fit the lamps, Fig. 3, and the tongue and whipple-trees. Dip these parts in paint successively in the same manner as described and allow to dry before fastening them permanently in place. If you do not feel equal to the lettering and the fine-line striping on the wheels it's a good idea to obtain the services of a sign painter. However, the landscapes on the door panels can be cut from duplicate colored illustrations and pasted on.

The model should be mounted on a base as shown in Figs. 1 and 2. The base adds considerably to the attractiveness of the model and helps to safeguard it from damage. Attach the model permanently to the base with small metal clips bent to the shape of the wheel rims and fastened to the base with small screws. Stain and finish the base with spar varnish.

ends of the tire are overlapped $\frac{1}{2}$ in. and the joint is brazed and ground flush. Edges of the tire are then rounded slightly with a file and smoothed with fine emery cloth. Before shrinking the tire on the wheel rim see that the latter is smooth and true and beveled slightly on the inside edge. Then heat the tire at several points and force it carefully over the rim. If necessary use several small C-clamps equally spaced about the rim.

Paint the running gear before assembling the body and gear. A neat job of painting always emphasizes fine workmanship and on work of this kind most model-makers use tinting colors ground in oil for the primer. Some craftsmen even go so far as to assemble the job completely for trial fit of all parts, then disassemble and paint each part separately. This method assures a paint job of professional quality. Most of the easily detached hardware and the smaller wooden parts of the running gear can be dipped in the paint and hung to dry on a wire or separate hooks. In any case continue dipping the parts until three coats of paint have been applied in this manner. For dipping, the paint should be thinned to a priming-coat consistency. Allow the excess paint to drain back into the container before hanging the part to dry. Be sure that you use a prepared thinner recommended by the manufacturer of the

Stovepipe and Fan in Fireplace Warm Room by Circulating Air

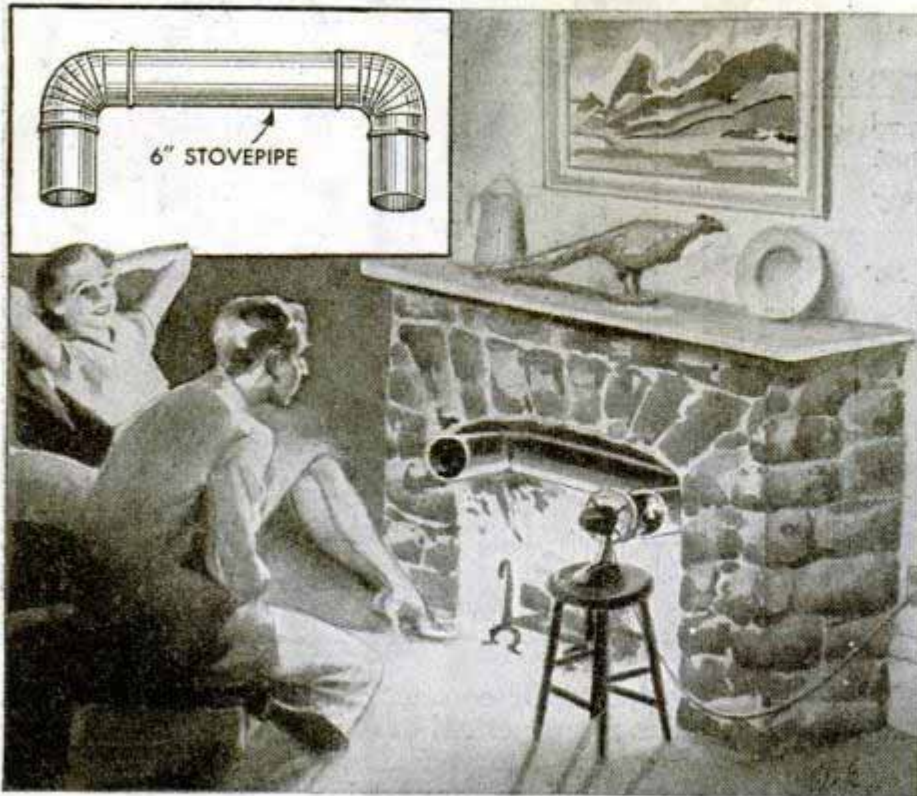

By installing a few lengths of 6-in. stovepipe in a fireplace and setting an electric fan to circulate air through it, an entire room of a cottage will be heated uniformly. Such an arrangement is ideal in cottages that are occupied only a part of the year, as it replaces a stove. Also, this method of warming a room will save fuel because it utilizes the heat of the fire before it is drawn up the chimney. The stovepipe is assembled as indicated in the detail and is located so that the flames will pass behind and in front of it. The fan is supported on a metal chair or stool and blows the air through the pipe into the room.—R. O. Leavenworth, M.D., St. Paul, Minn.

Clamping Fixture Holds Work For Hand Mortising

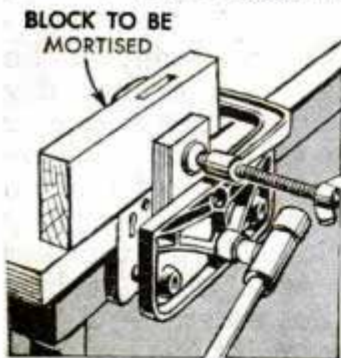

Damage to wood which is being mortised by hand can be reduced if the work is placed on top of the bench and clamped to a piece of wood held in a vise. The mortise is cut halfway through the wood,

and the piece then is turned over to complete the cut.

W. R. Ellis, Kendall, Australia.

Pipe Repairs Broken Andiron

If the horizontal member of an andiron is broken, it can be repaired with a length of pipe. Select pipe that will slip over the broken ends with as little clearance as possible between the inside of the pipe and the andiron. To add rigidity to the joint, wedge nails into the ends of the pipe.—Allan S. Binns, Vancouver, B. C., Can.

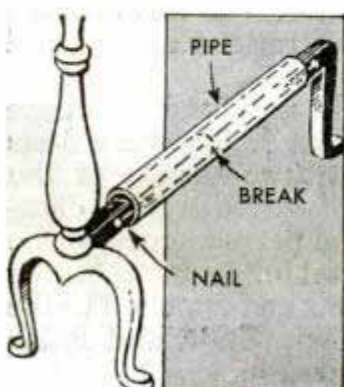

broken ends with as little clearance as possible between the inside of the pipe and the andiron. To add rigidity to the joint, wedge nails into the ends of the pipe.—Allan S. Binns, Vancouver, B. C., Can.

Tab Frees Gummed-Tape Roll When End Is Stuck

To prevent gummed tape from unrolling, it is an ordinary practice to stick the free end to the roll. However, this is not always satisfactory, since it is hard to free the tape, and cutting it may damage several thicknesses. One solution is to tear off a short piece and stick the gummed side of it to the gummed side of the roll a short distance from the end, then stick the free end to the roll. To loosen, pull the tab.

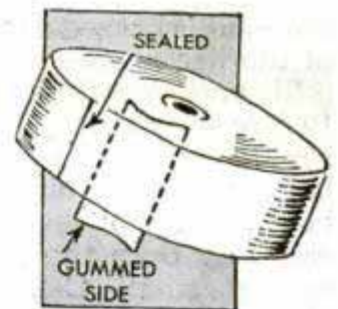

Pfc. Andrew Vena, New York.

Spare Parts Carried in Pen Cap

A fountain-pen cap with a hollowed out cork cover can be used to carry spare bicycle parts such as valve stems. It can be wedged into the seat post.—Rev. V. D. Elliot, Barsi, Sholapur Dist., India.

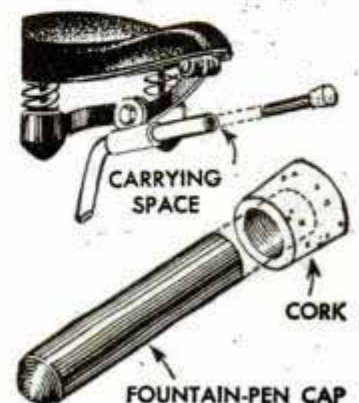

Two Types of Improvised Darkroom Safelights

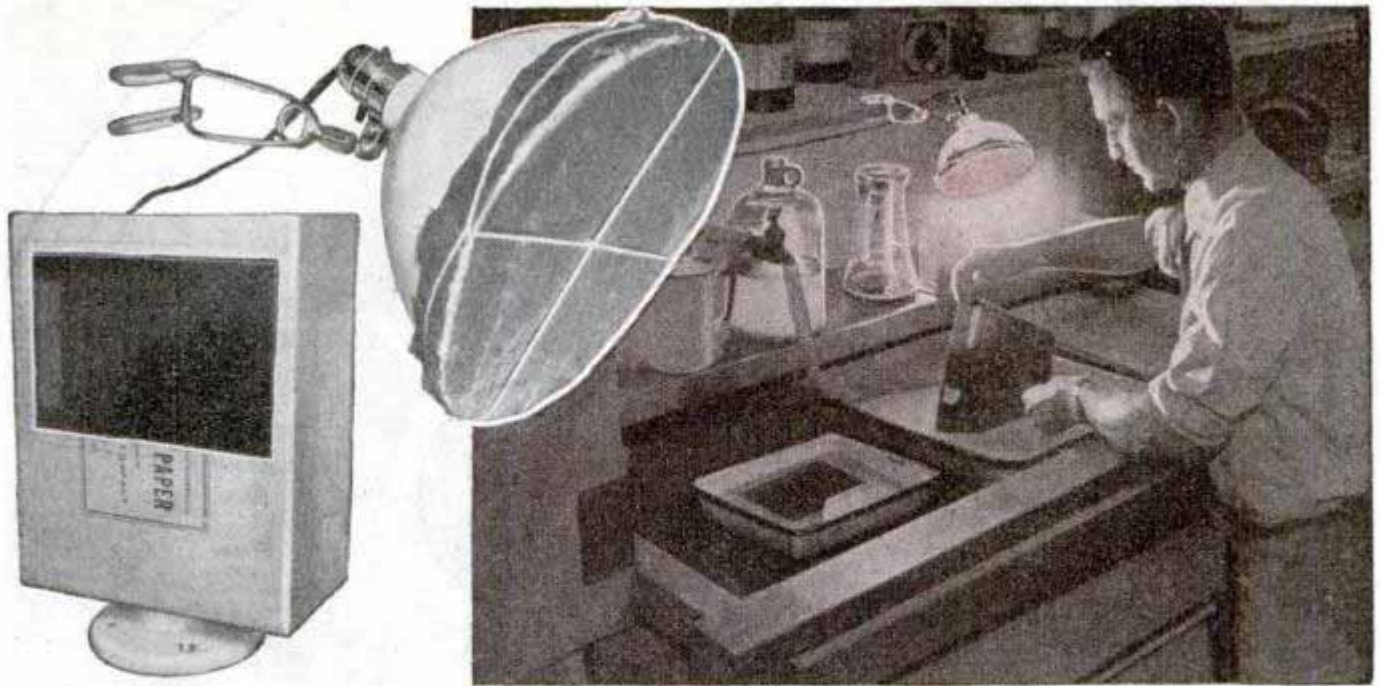

Using only a 10 or 25-watt amber or red electric lamp, a cardboard box and a porcelain socket with a base, you can improvise a safelight for your darkroom. A box like that in which photographic paper is sold will be suitable. Two openings are cut in the box, a large one in a side for emitting light, and another in one end just large enough to fit snugly over the socket. No paper need be pasted over the large opening if this is cut so as to leave enough of the side remaining to shield the lamp, as indicated in the left-hand detail. After

wiring the socket, the base is added and the "safelight" may be screwed to the work table or under a shelf.

Another method of improvising a safelight is to substitute a similar lamp for the photoflood lamp in a reflector of the type having a pivoted clamp. Red or amber-colored paper is spread over the reflector and tied securely with cord across the front and around the reflector bowl. This safelight, being adjustable, may be clamped anywhere and tilted over the work.

N. H. Berlin, Rosemead, Calif.

Extra-Long Lens Hood Permits Taking Photos Against Sun

Of lighter weight than most metal lens hoods, this one, which is made of cardboard, extends far enough beyond the lens to allow the camera to be pointed almost directly into the sun if necessary. The hood is a composite of three smaller hoods, each consisting of two cardboard rings glued together with a strip of two-ply Bristol board attached around them for a rim, as shown in the detail. The first hood fits the lens mount, the second is glued over the rim of the first, and the third over the rim of the second. After the cardboard rings have been glued, they can be sandpapered for a more accurate fit, sanding the ring that fits over the lens only enough to make it snug. Feather the edges of the Bristol board where they meet to form a smooth joint. As reinforcement, an extra strip of two-ply board is glued around the edge of the leading rim. The completed hood is then painted flat black to prevent light reflecting into the lens.

R. M. Roland, Chicago.

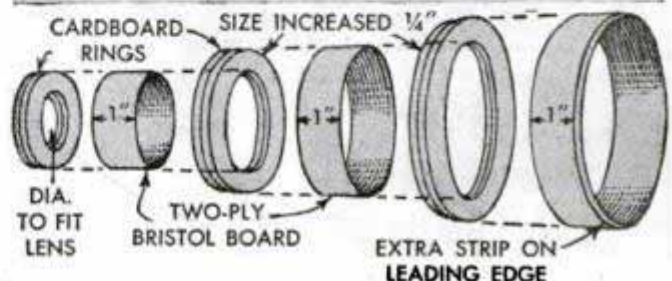
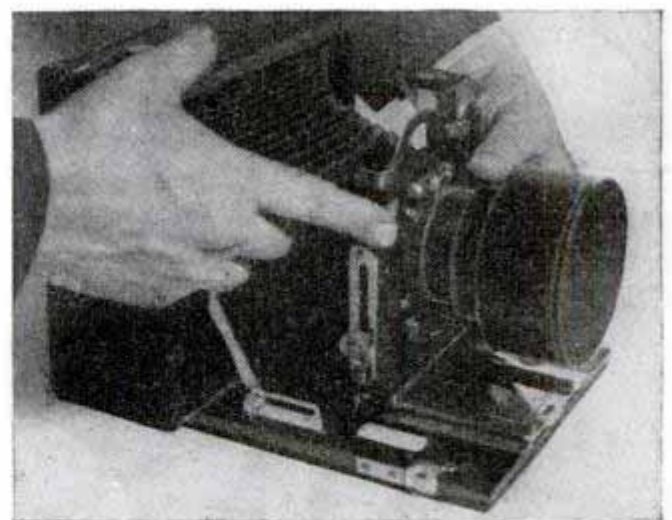

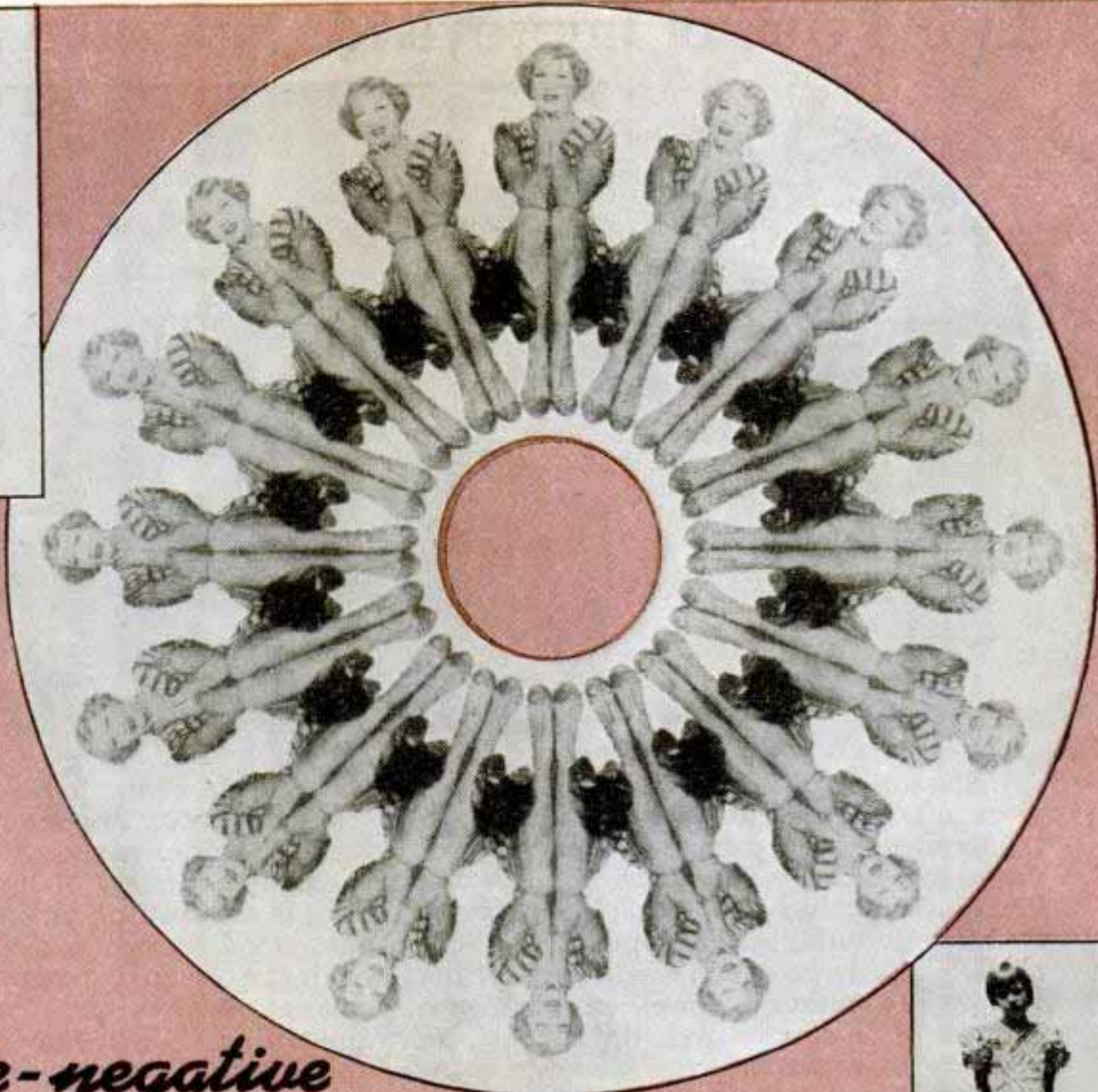

Single-negative

DESIGN PHOTOS

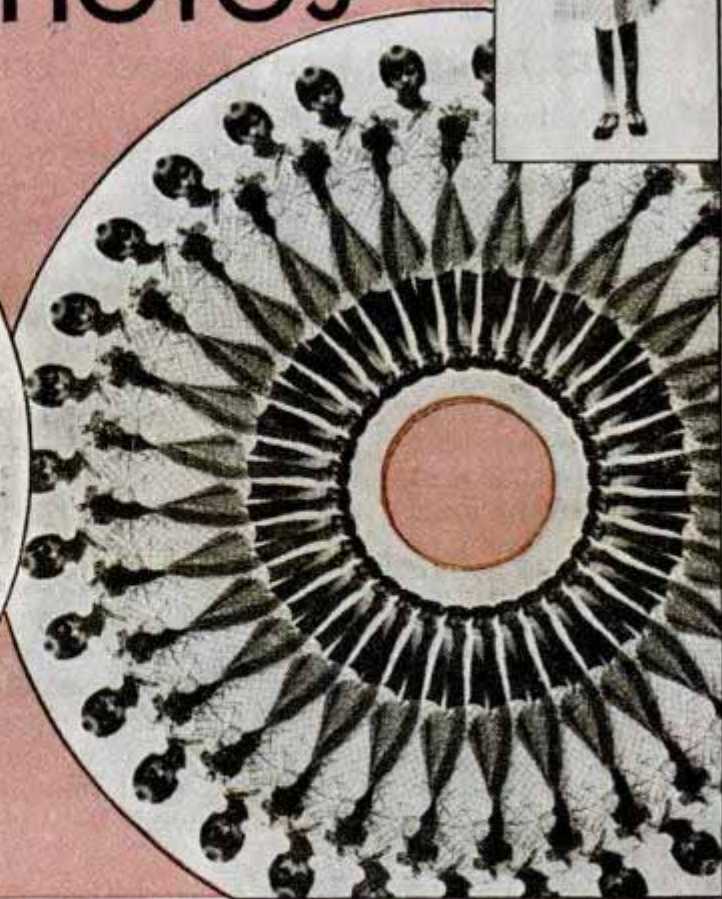
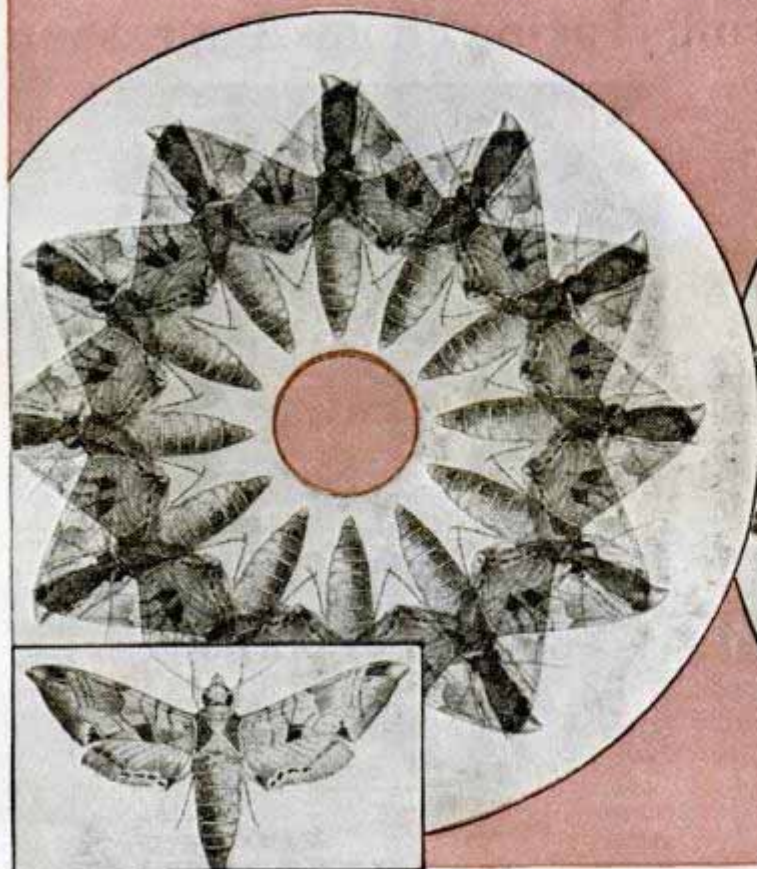

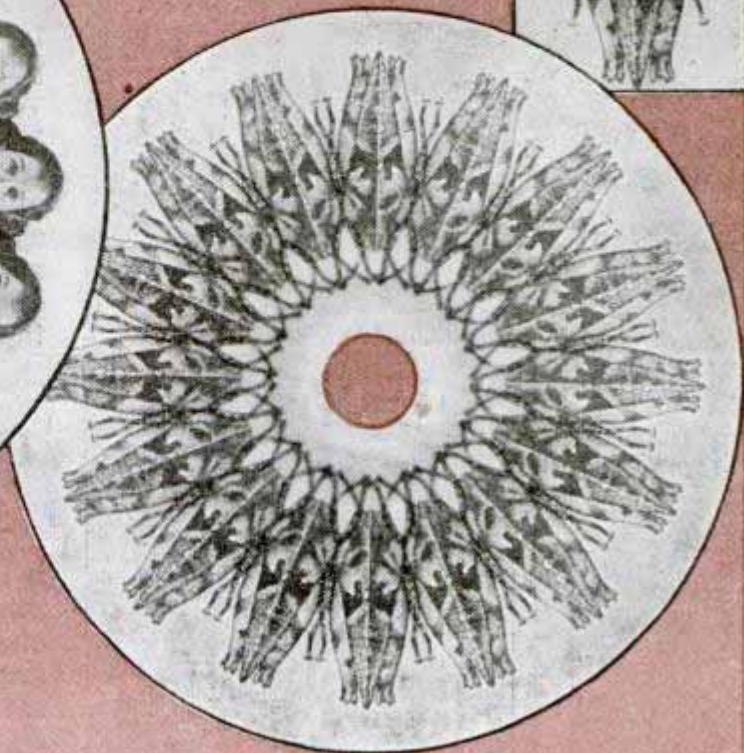
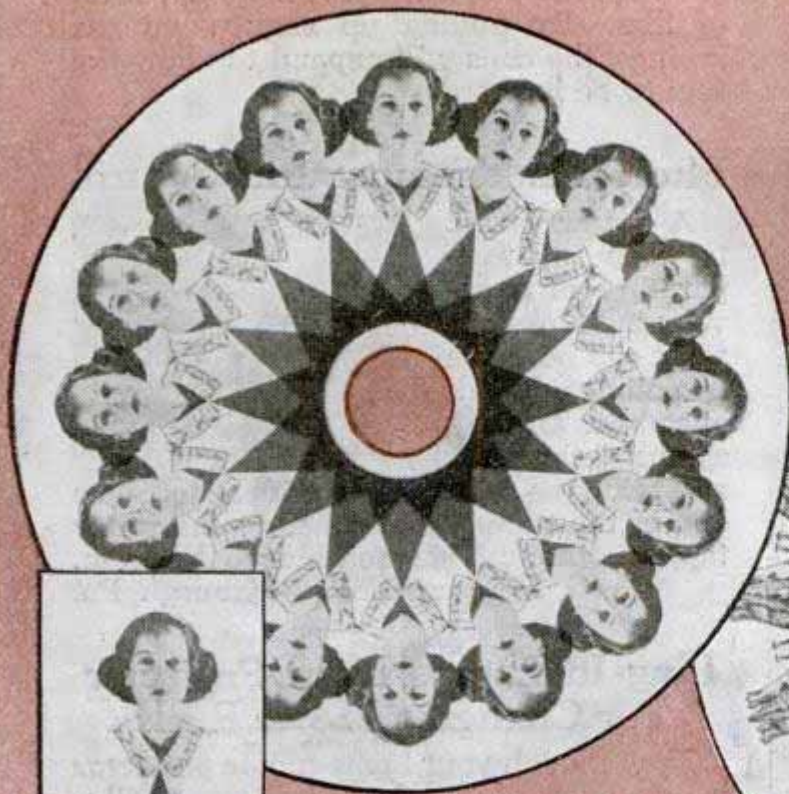

REPEATED exposures of a single negative on a squared sheet of sensitized paper gave the novel geometric patterns you see here. As the first step, the hinged back is removed from a standard contact-printing frame and a simple "indexing head" is fitted in its place. This consists of two parts, a fixture of $\frac{3}{4}$ -in. stock squared to fit the printing frame and a movable disk of the same material and thickness which fits in a hole scroll sawed in the wood fixture. The latter is indexed in twelve or more equal divisions. Sensitized paper is mounted emulsion-side up on the disk with art corners as shown. Then

an opening slightly smaller than the negative is cut in a sheet of opaque paper which is pasted on the printing-frame glass in the position indicated. Finally the negative is located off center and taped emulsion-side up on the opaque-paper mask. The first exposure is made with the index marks at the first graduation. Then the disk is rotated to the next mark for the second exposure, after which the process is repeated until the full number of exposures has been made. The negative should contain a single symmetrical figure and the exposures must be equally timed.—F. P. Roullard, Fresno, Calif.

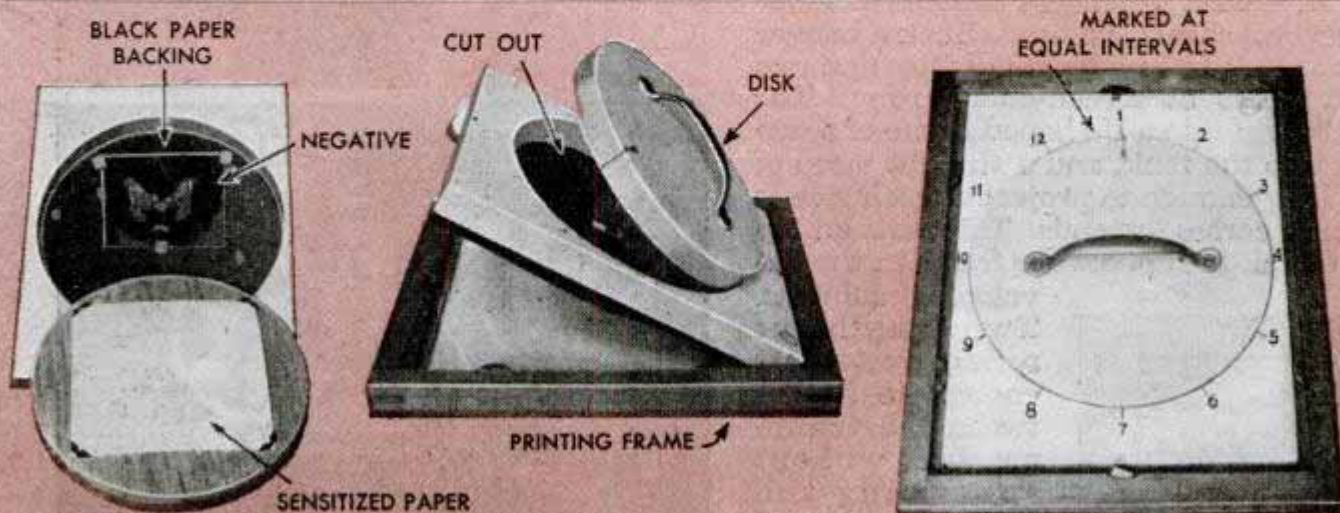

Perforated Board Serves as Easel For Copying Photographs

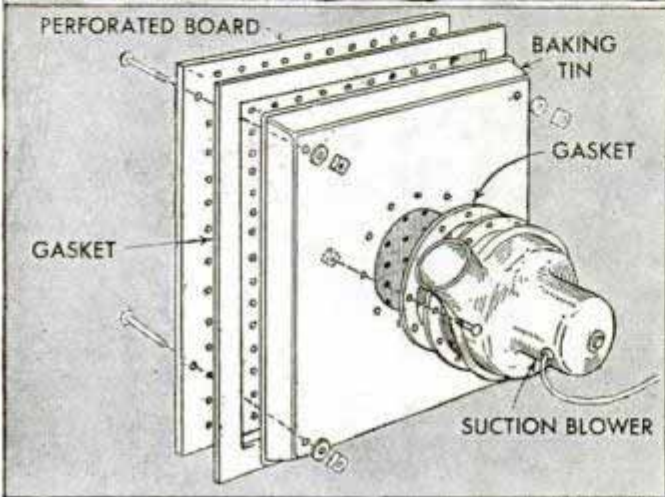
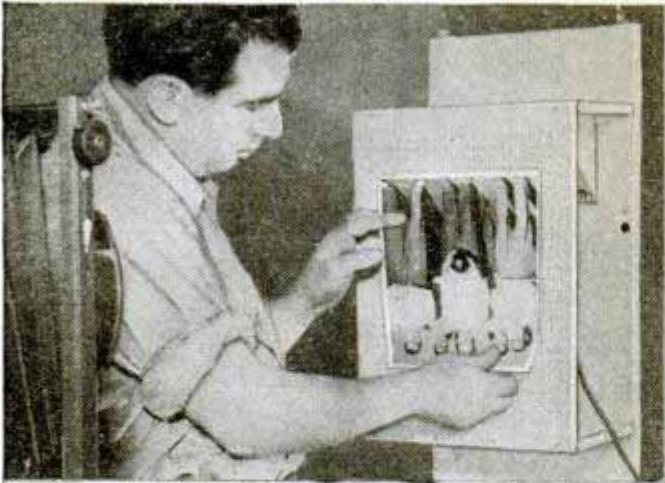

In copying work, one photographer supports prints on a perforated board where they are held by suction of air from a blower of the type used in vacuum sweepers. The blower is bolted to the bottom of a baking tin attached to the board and a cork or rubber gasket seals the edges of the tin.

Lyn Grover, Los Angeles, Calif.

Many Sheets of Pack or Cut Film Held in Wire Hanger

More than the usual dozen sheets of pack or cut film can be developed at the same time in a tank if hangers capable of holding several sheets are used. Such a hanger can be made from a length of wire and two short pieces of screen-door spring. The wire is bent into a U-shaped frame of a size to fit into the tank, and a straight piece of wire long enough to project at each side is soldered across the ends. This rests on top of the tank to support the frame in the developing solution.

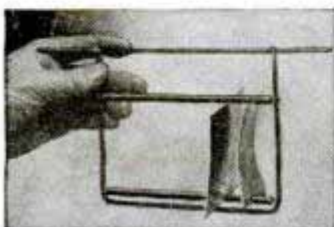

Two lengths of spring, just short enough to fit between the frame members without spreading the coils, are soldered

the required distance apart to hold a sheet of film. By pulling up slightly on the springs, the coils will expand to allow the film to be inserted.

Photo-Tank Temperature Control

A water jacket to keep the temperature of a developing tank constant can be made by coiling a length of rubber tubing around the tank and tying the coil together with string. One end of the tubing is attached to the water tap; the other directs the water to the drain.

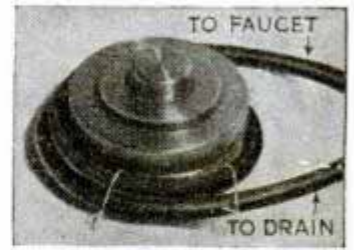

Herman Klein, Pittsburgh, Pa.

Plug-In Lamps Light Projector For Changing Movie Reels

Even though your home-movie projector is not equipped with built-in lights to illuminate the threading mechanism when you change reels, there's no need for groping around in the dark for the wall switch. Just set the projector on a board of suitable size on which a three-receptacle plastic outlet is attached as shown, and insert a cord from a wall outlet through a hole in the board to the receptacle connections. The auxiliary outlets will take the projector cord and two 7-watt snap-switch night lights, which will provide enough illumination on the projector for threading the reel.

L. H. Georger, Buffalo, N. Y.

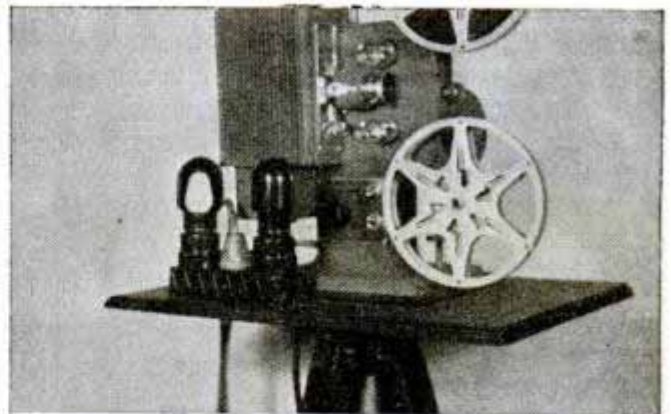



WELDING-MACHINE RESISTOR *Has four electrode-holder outlets*

By William R. Lewis

WELDING job shops, welding schools and other operators having occasional need for a number of machines in simultaneous operation have found that this four-lead grid unit pays for itself in a short time by making purchase of additional machines unnecessary. The unit was developed for use in conjunction with a 400-ampere welding machine and will permit up to four welders to work independently of one another within a range of 90 to 180 amperes.

Two rows of cast-iron resistance grids held together by long studs, which are insulated from the grids with mica tubing and washers, are mounted horizontally one above the other and enclosed in a heavy sheet-metal housing as shown in Fig. 1. Resistance in each row is arranged in steps of approximately $\frac{1}{4}$ to slightly over $\frac{1}{2}$ ohm to provide the various welding heats diagrammed in Fig. 2. Copper strips $\frac{1}{8}$ by 1 in. are used to connect the grids to the female part of electrode lead connectors mounted in the housing panel. Number 6 grids are used on the 90-ampere stage and number 3 grids for the other stages. These are heavy enough to stand the load without excessive heating. A center or common connector then is mounted

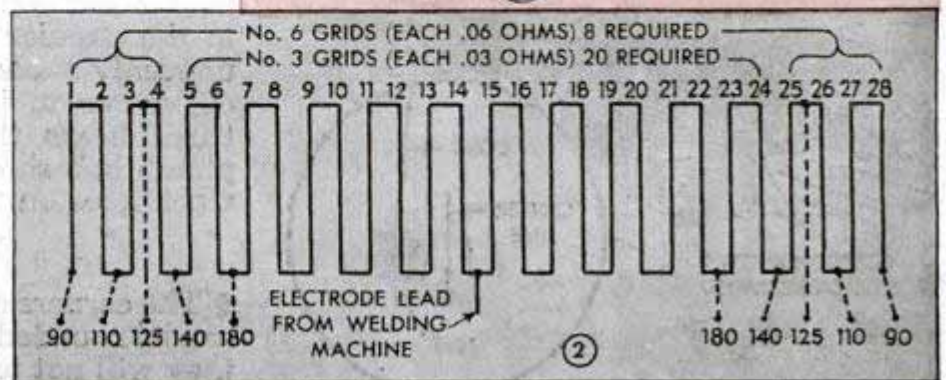
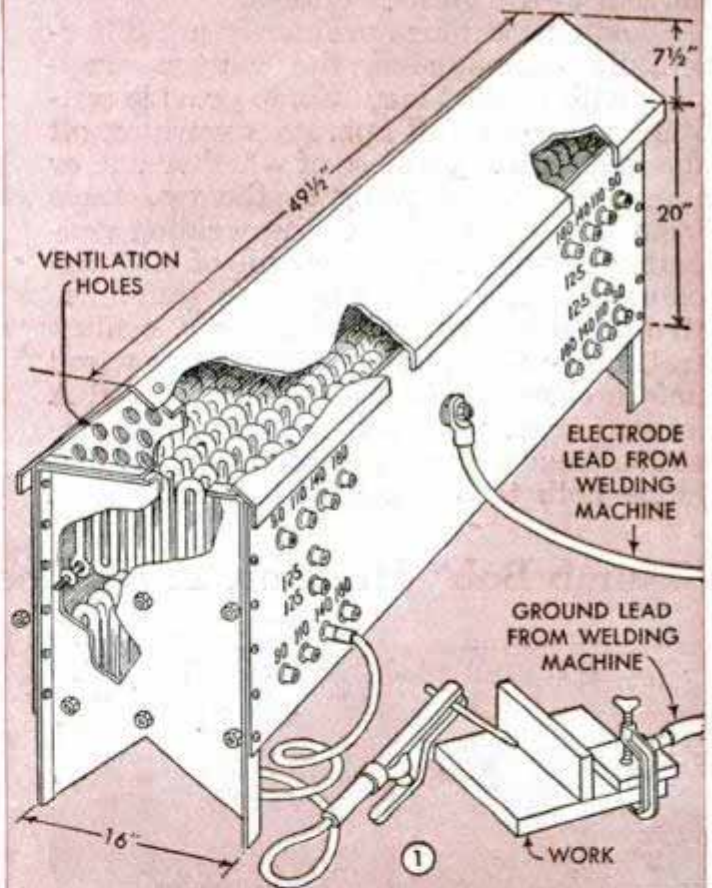

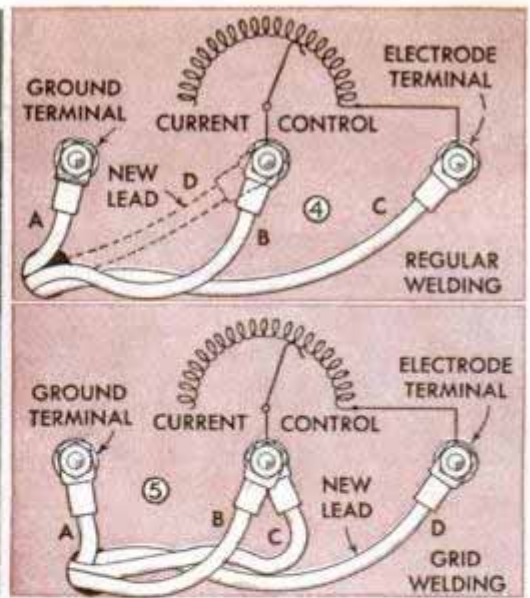
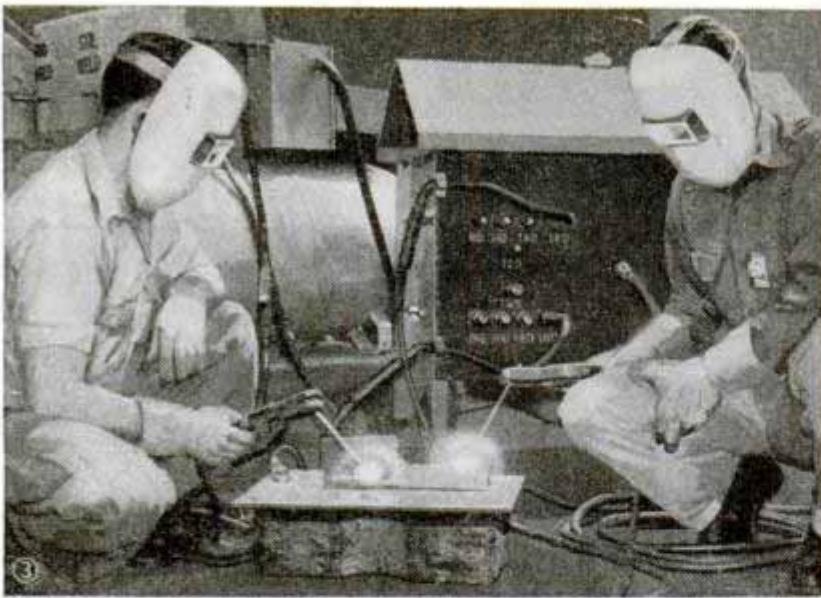

in the unit panel and hooked up with a copper strip to grids 14 and 15 in each row. In use, the ground lead is run directly from the welding machine to the work to be welded in the customary manner. The electrode lead from the machine is run to the center plug and the current then is carried to the various outlets.

Welding machines ordinarily are differentially compounded, the voltage dropping with applied load. So, to provide constant voltage to all operators working off the grid unit regardless of whether one or four welders are using it, the two leads from the series fields of the welding generator to the current control of the machine are reversed, resulting in accumulative or "over" compounding. Fig. 4 illustrates how the welding generator is wired before changing to grid welding. Lead A is connected to brushes within the machine. Lead B is connected within the machine both to one end of the series field

circuit and to one end of the interpole circuit. Lead C is connected to the other end of the series field circuit within the machine. To rewire for grid welding, lead B is disconnected from the series field within the machine but not from the interpoles. A new lead D is then connected to the end of the series field taken from B and brought through the case and connected to the same stud as B. With the new lead D in position as shown in Fig. 4 the machine still may be used for regular welding. To convert to grid welding merely interchange leads C and D as in Fig. 5. The current control then is adjusted to the point where voltage remains practically constant at all loads. It is not used thereafter for grid welding. Various heats for each of the four electrode holders are obtained by plugging in at the different taps in the panel.

A 100-ampere, double-pole, double-throw switch may be used to speed the change from regular to grid welding.

"Plumb Bob" Hung on Truck Door Will Indicate Uneven Loading

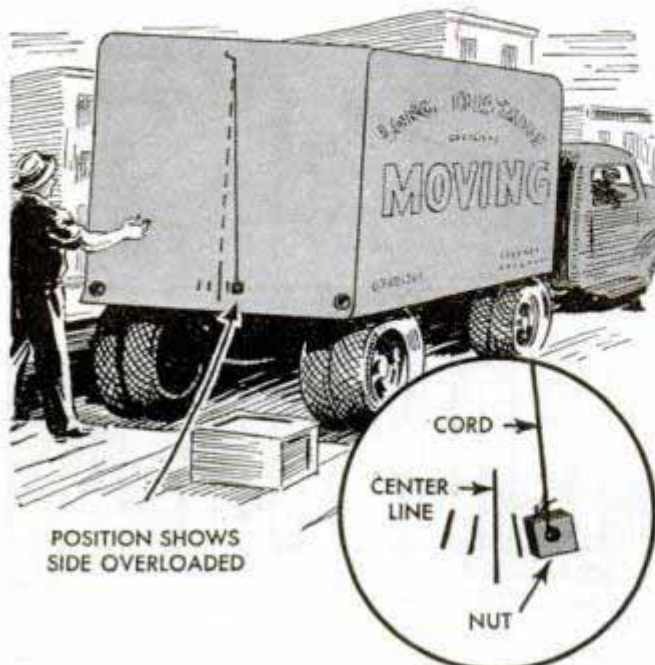

One fleet operator can tell at a glance whether any of his trucks are loaded more heavily on one side than on the other, a condition which may cause excessive wear on tires on the overloaded side. He screws a hook to the center of the rear door, and to it attaches a cord on which a nut or other weight is tied to act as a plumb bob. Then he marks the door at the center, as shown in the circular detail. When the truck is unevenly loaded, the weighted line shifts off center to indicate which side of the truck bears the excessive weight. The plumb bob should be removed before the truck goes on the highway.

Opie Read, Jr., Chicago.

☐ The corners of a notebook or writing pad can be rounded on a disk or belt sander so they will not tear pockets.

Air Compressor Operates Without Moving Parts

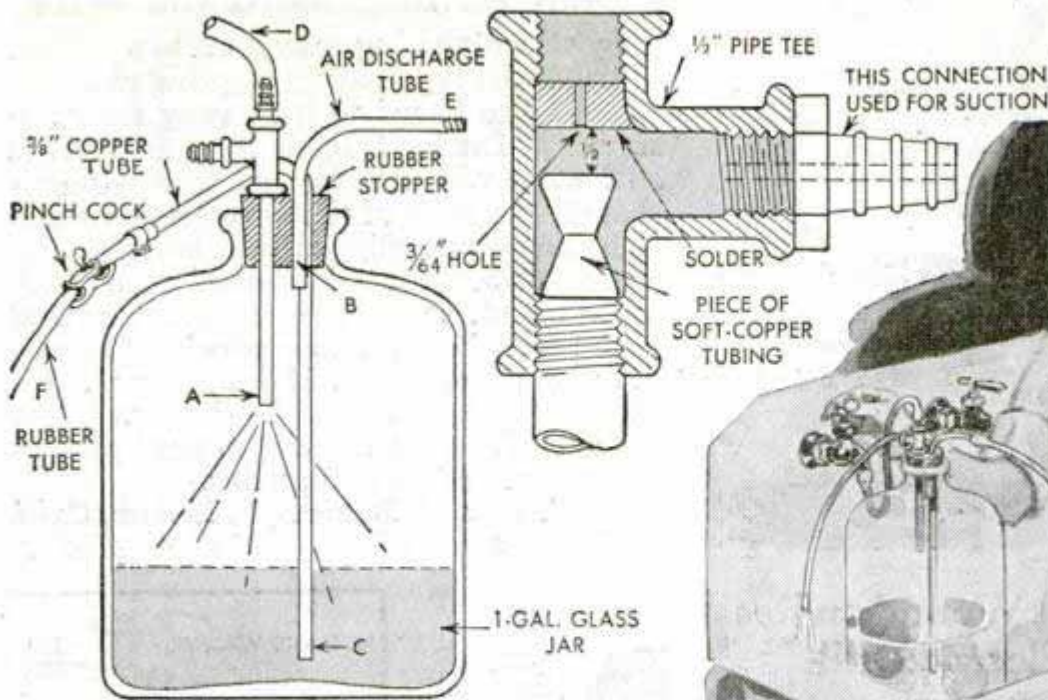

Laboratory workers, glass blowers and others who use Bunsen burners can easily make this air-compressor unit, which operates without any moving parts and delivers a steady supply of clean, washed air at a moderate pressure. The only part of the compressor to be made is the aspirator, which is fitted on a large glass jar or bottle, preferably one having a narrow mouth. The aspirator consists of a $\frac{1}{2}$ -in. pipe tee into which a nipple, A, and two hose connections are screwed. The connection in the center opening of the tee may be used for aspirating, or sucking, liquids, as well as for drawing air into the bottle. The tee is plugged with solder near one end just below the threads, after which a $\frac{3}{64}$ -in. hole is drilled in the center of the plug. A short piece of soft copper tubing just long enough to extend from the nipple to within $\frac{1}{2}$ in. of the plug is flared at both ends to an hour-glass shape and soldered to the end of the nipple. This is inserted through a rubber stopper that has three holes in it. A rubber hose leading from a water faucet is fitted to the upper hose connection as at D. Then a length of copper tubing is inserted through the stopper to within a short distance of the bottom of the bottle as at C, and the projecting end is bent downward and fitted with a rubber tube, F, which is equipped with a pinchcock, petcock or needle valve for controlling the flow of water out of the bottle. An air-discharge tube then is put in the third hole of the stopper to project slightly below it as at B, and a hose, joined to the tube at E, is connected to the burner. In operation, when water is introduced into the bottle it sucks in air through the center connection of the tee.

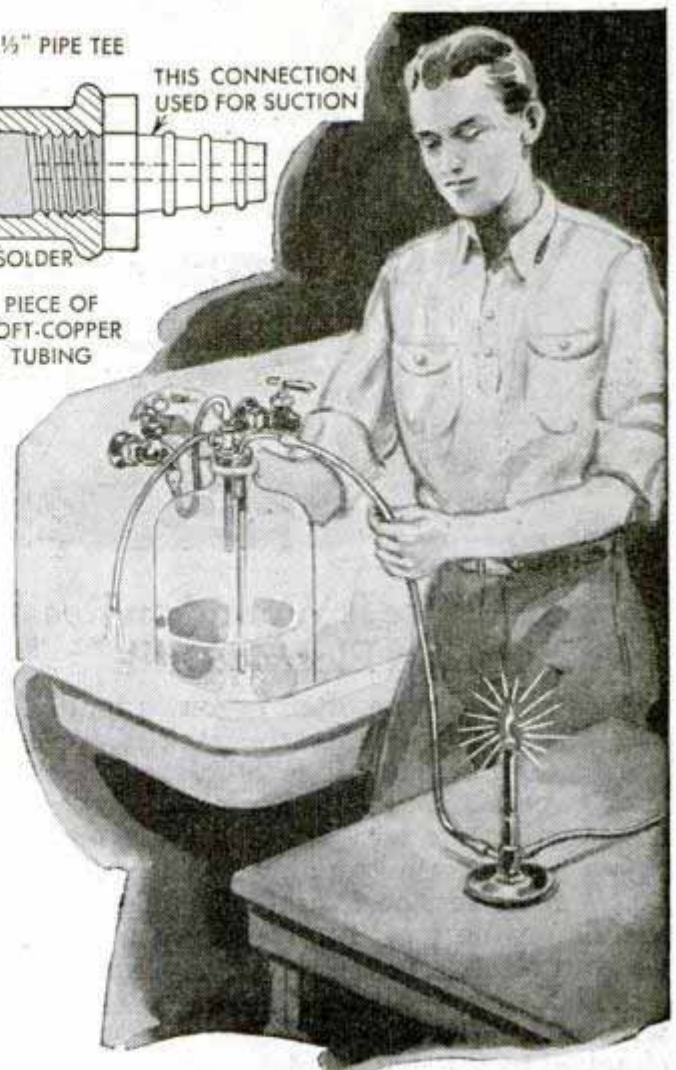

The water then is forced out from the bottom of the bottle through the valve and the rubber-tube outlet, and the air trapped above the water escapes through the discharge tube.—E. J. Hennessy, Chicago.

Lathe Compound Set at an Angle For Precision Turning

When working to close tolerances on a lathe on which both the cross-feed and compound-rest screws are graduated in thousandths, you can avoid some of the difficulty of setting the cutting tool to take a cut of less than .001 in. by lengthening its travel, thereby reducing its advance into the work. This is done by setting the compound rest at an angle to the lathe-center line. When the compound is set at an angle of 30 deg., advancing the screw .001 in. will move the tool less than this distance into the work. Similarly, the movement of the tool will be hardly noticeable if the compound is set at an angle of 6 deg.

E. E. Modes, Chicago.

☐To assure freedom from buckling, new floors in a house should be laid only when the temperature is right, 70 deg. in summer and 65 deg. in winter.

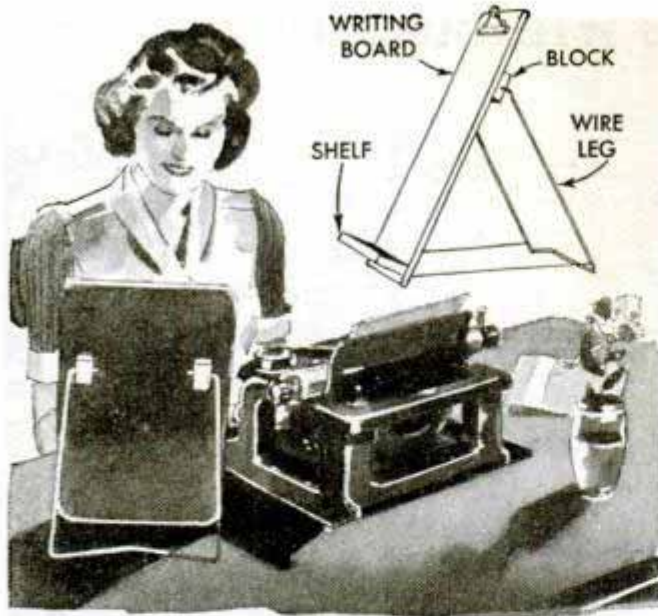

Typist's Copyholder Improvised From Writing Board and Wire

By attaching a leg or support to a writing board of the type having a spring clip, you can use the board to hold copy for transcribing. The leg is made from a length of stiff wire, which is formed to a wide U-shape. The ends of the wire are bent at a right angle and slipped into holes drilled in two blocks of wood bradded to the back of the board. Two pieces of string attached to the board with thumbtacks hold the leg at the required angle. If desired, a narrow shelf may be glued and bradded near the bottom edge of the board to hold pencils, erasers and other accessories.

Edwin M. Roberts, Palo Alto, Calif.

Stranded Wire Is Wound on Reels With an Electric Drill

As stranded wire often becomes tangled and difficult to handle when taken out of the boxes in which it is delivered, much time can be saved in production shops by transferring the wire to reels, from which it can be unwound quickly for use. Small metal reels are best, as they are easy to handle on the job. To wind the wire on a reel, an electric drill is used. A stud is inserted through the reel core and secured with a washer and nut, then the stud is chucked in the drill, which is gripped in a vise. The wire is attached to the core and the drill is operated to wind the wire quickly.—F. C. Zuiker, Chicago.

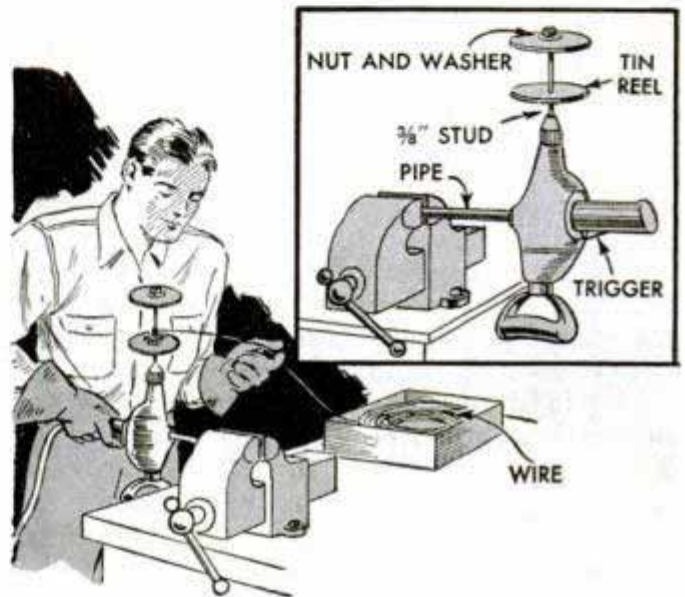

Holder Bolted to Lathe Housing Keeps Chuck Wrench Handy

Set in a holder bolted to the headstock bearing of a lathe, a chuck wrench will always be in position for immediate use. The holder is a length of flat iron bent as illustrated. A hole is drilled in each end, one hole for a bolt by which the holder is attached, the other to hold the wrench directly over the chuck-jaw adjustment screws. A coil spring raises the wrench out of the way when not in use.

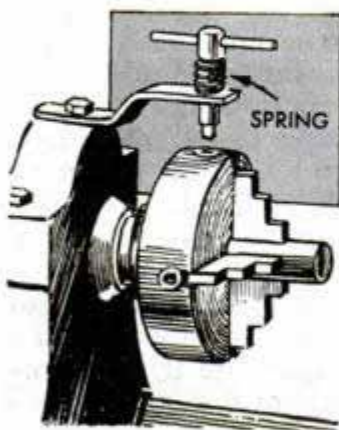

A hole is drilled in each end, one hole for a bolt by which the holder is attached, the other to hold the wrench directly over the chuck-jaw adjustment screws. A coil spring raises the wrench out of the way when not in use.

Nail Started in High Work By Using Hammer Claws

When nailing braces across the uprights of a high scaffold, one carpenter found that he could not reach high enough to hold a nail so that it could be struck, as no ladder was available. To avoid having to go after one, the nail was placed point out between the claws of a hammer, as shown, and started in the wood. Then the hammer was disengaged and the nail was driven in.

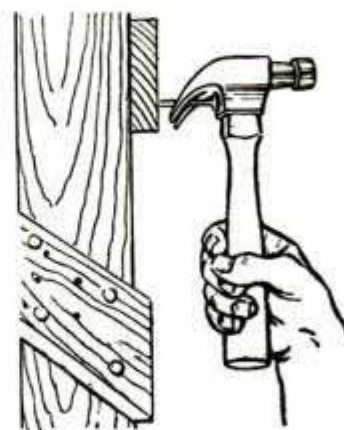

Then the hammer was disengaged and the nail was driven in.—Sgt. Malcolm Hunter, New York.

☐ Since preserving the natural shade is the most satisfactory way to refinish antique wood, nondyeing oils are preferable to stains or varnishes for this purpose.

☐ When tools are used outdoors they can be seen more easily, and are less apt to become lost or be left lying around, if they are painted a bright color, such as orange.

Adjustable

ENGINE POSITIONER

has many uses

CONSIDERABLE time can be saved when repairing or rebuilding automobile motors by using this adjustable engine cradle. Although ideally suited for garages specializing in one particular type of car, the cradle can be provided with different motor-mounting brackets as needed. The details below clearly illustrate its construction. The tilting mechanism is made from auto-starter gears, the pinion shaft rotating in two short lengths of pipe welded to a plate, which is bolted to the frame to obtain proper clearance between the gears. The auto-engine flywheel with its ring gear is welded to the tilting frame that turns in two bearings made as shown. To hold the engine at the desired angle a metal disk and crank handle are welded to the end of the small gear shaft. Holes in the disk receive the plunger of the locking device.—Capt. Edw. H. Klein, New York, N. Y.

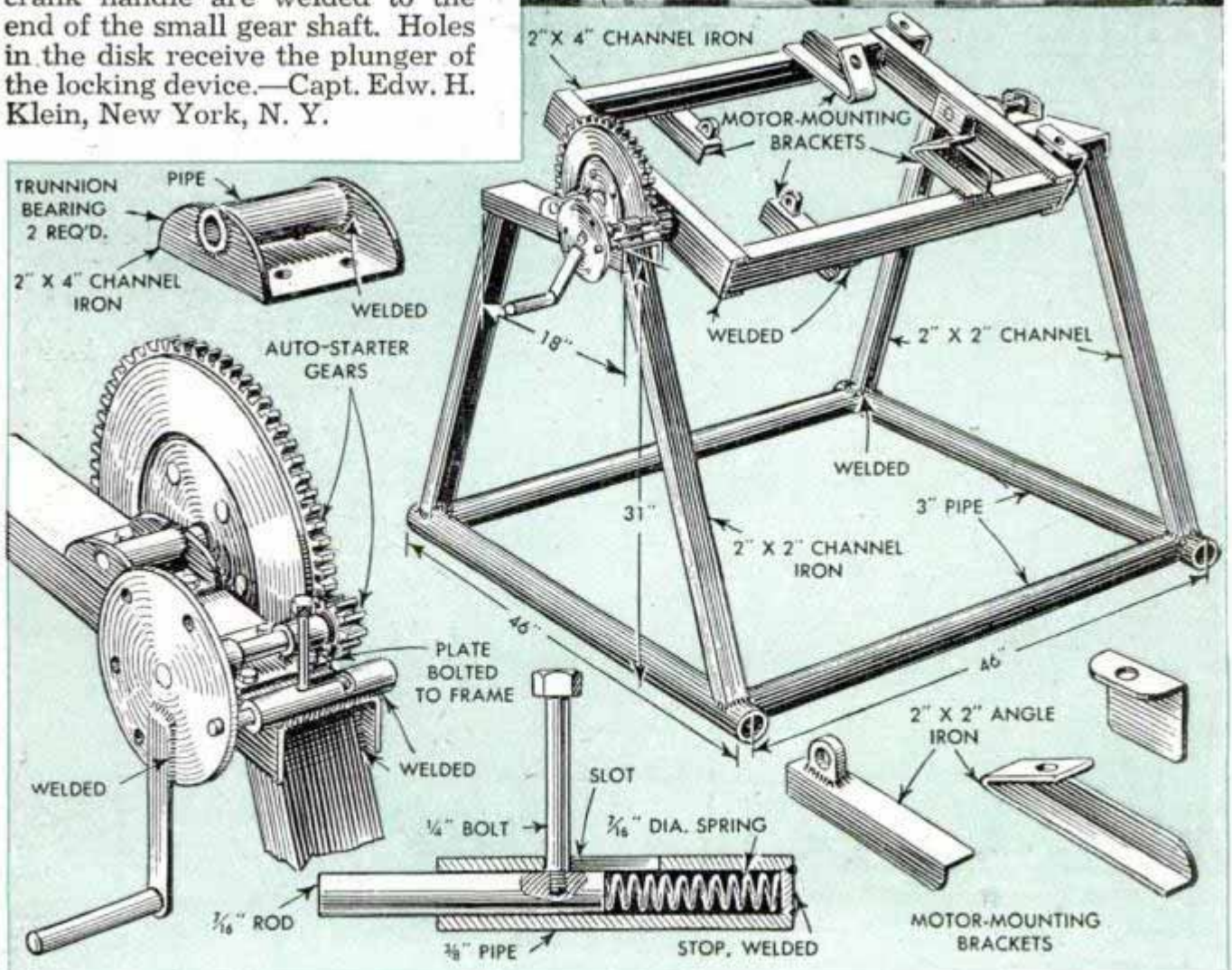
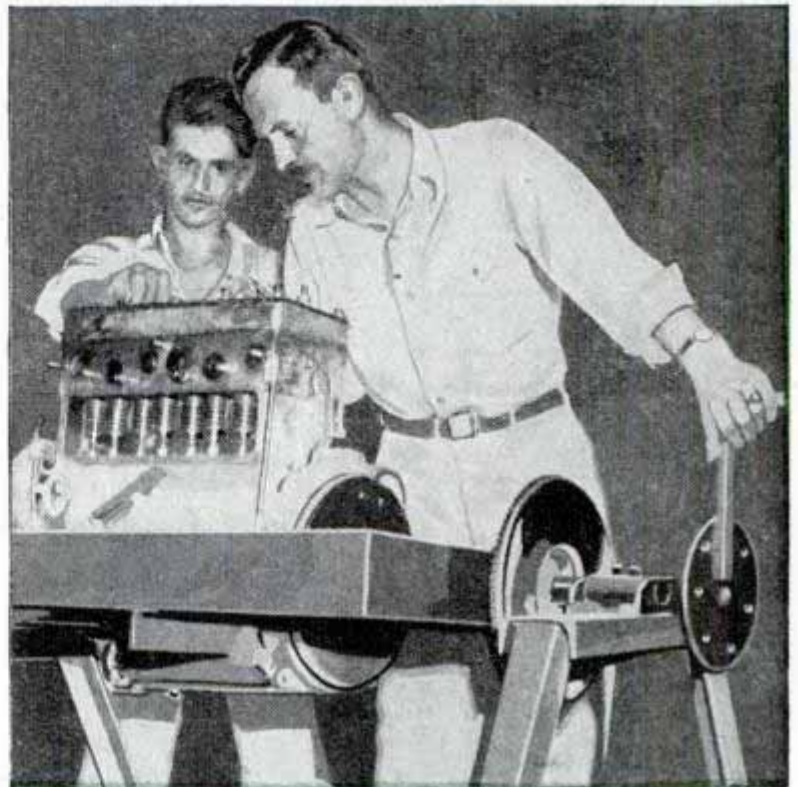

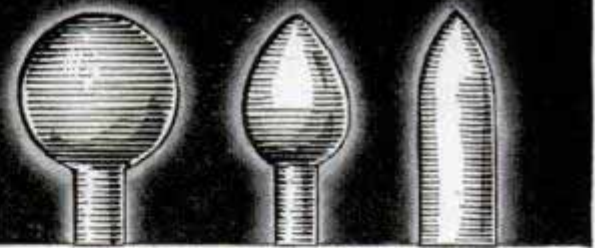

Tool Holder CONVEX

By W. T. Warde

MOUNTED on the lathe compound, this tool holder, or slide, makes it easy to turn a true spherical shape up to $2\frac{3}{4}$ -in. in diameter in a small metal-working lathe. The provision for adjustment makes it possible to turn a number of other shapes as shown above. In addition, the tool can be used effectively for straight turning. As dimensioned in Figs. 2, 3 and 4, the slide fits a 10-in. lathe, but on lathes of greater or lesser swing and of varying design it may be necessary to alter sizes of the parts to suit. The base of the slide, Figs. 3 and 4, can be made either of cold-rolled steel or diemetal, the latter being perhaps the easiest to machine in the ordinary lathe milling attachment.

The end view, Fig. 3, gives the general shape and indicates the machining to be done. Due to the limitations of some milling-attachment vises it may be necessary to face-mill the base to size and then end-mill the top steps, Fig. 6. By milling the steps as the second operation, it is possible to hold the work in the milling vise while making the dovetail cut, Fig. 7. Next the base is drilled and tapped for screws to hold the end plate, which then is screwed in place and a dovetail cut made through it, using an angular mill $\frac{1}{8}$ in. less in diameter than that used for making the dovetail

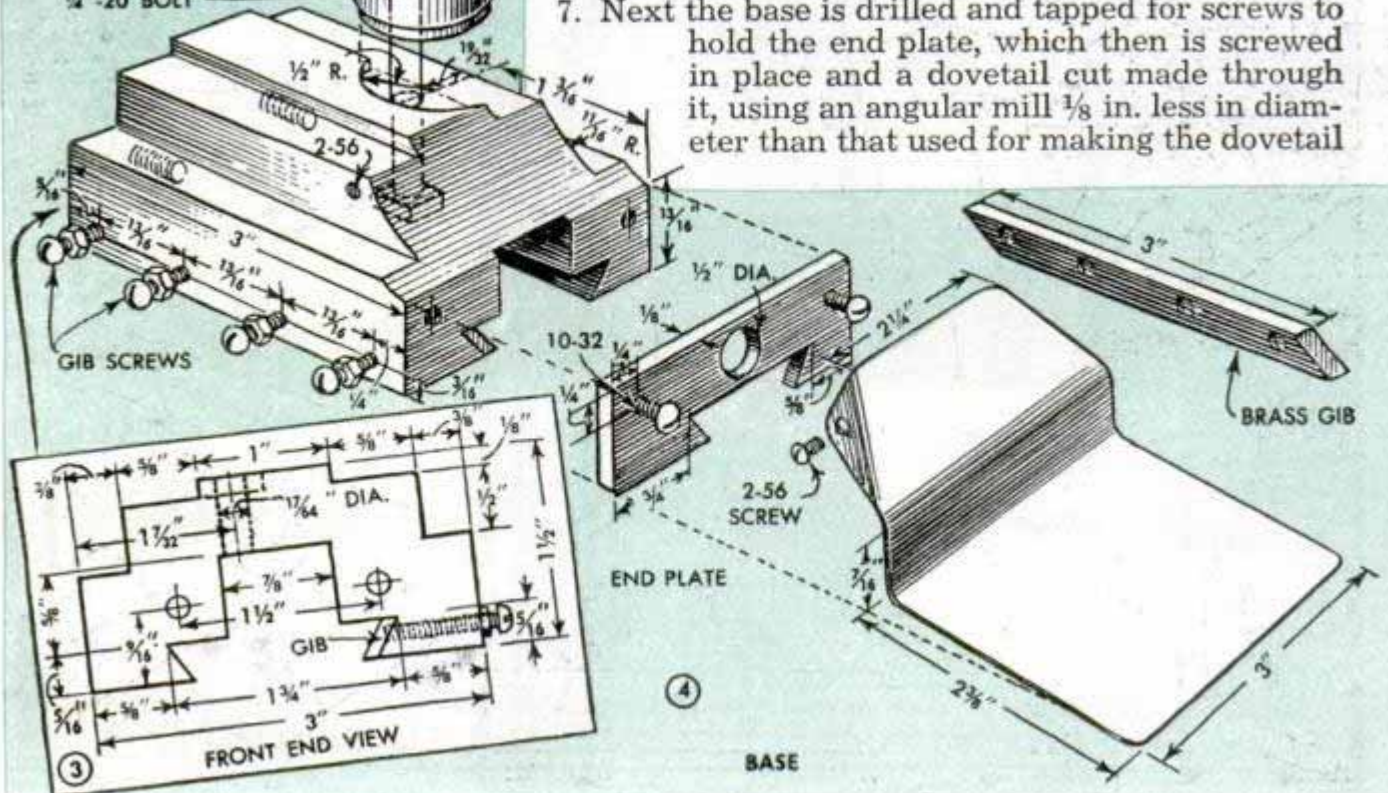
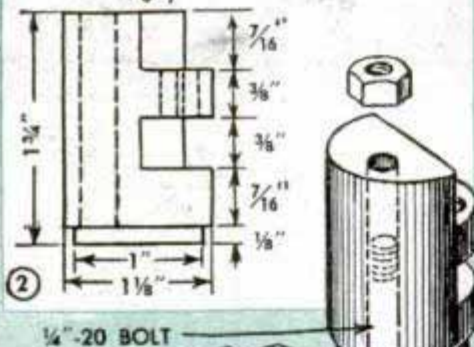



Simplifies **TURNING**

cut in the base. In this way, the end plate acts as a stop for the gib. Then the end plate is removed and the $\frac{7}{8}$ -in. groove for the feed screw is cut. The curved bevel cut across the upper half of the front can be made with a half-round file to a radius sufficiently accurate for practical purposes. The circular cut in the top of the base for the tool post is made on a drill press, using a 1-in. diameter Woodruff cutter. One side of the base is drilled and tapped for four gib screws carrying lock nuts as indicated. The gib is cut from $\frac{1}{8}$ -in. brass or mild steel and dressed to a sliding fit on the compound slide with the screws loosened. The tool post, Fig. 2, is a simple milling job on $1\frac{1}{8}$ -in. round stock and the feed-screw guard, Figs. 1 and 4, can be made from light sheet metal and attached with a machine screw as indicated.

To assemble and mount the finished job, Fig. 5, the compound rest is removed from the lathe, leaving the feed screw in place. The base is slid onto the ways and the feed-screw assembly attached. Next the cutter bit is shimmed up to exact center and the compound is loosened until it swings with a slight drag. Then, with a piece of metal in the chuck, the lathe is started and by simultaneous movement of the cross feed and the compound the point of exact center of the tool is located and a light line is scratched on the cross-slide way to indicate this position so that the slide may always be returned to the same location.

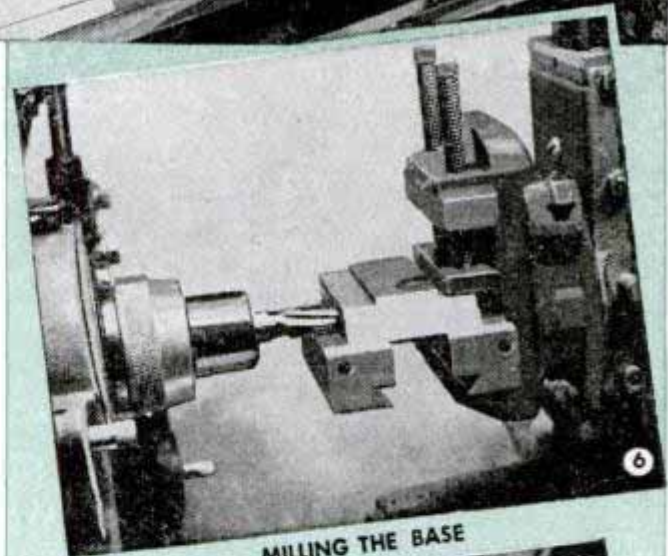
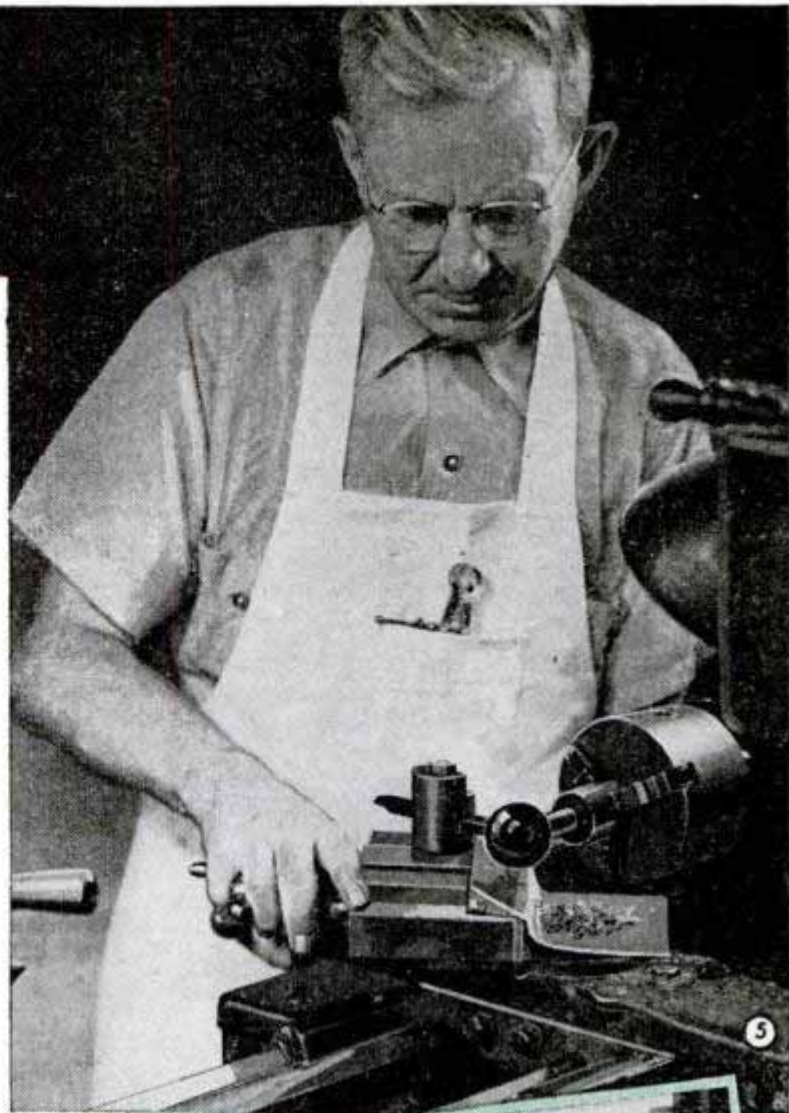

MILLING THE BASE

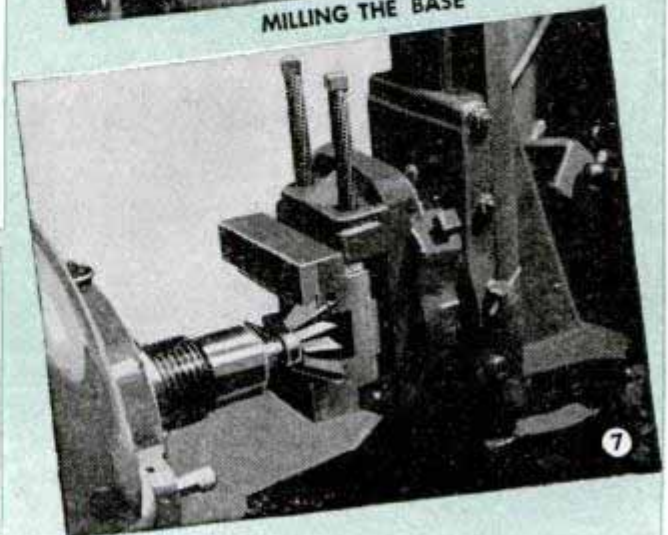

STEPS IN TURNING A BALL

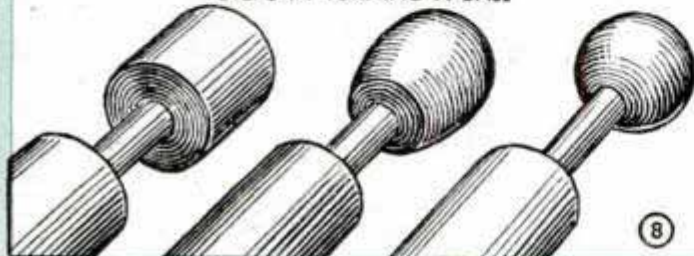

Leather Strip on Edge of Helmet Protects Welder's Neck

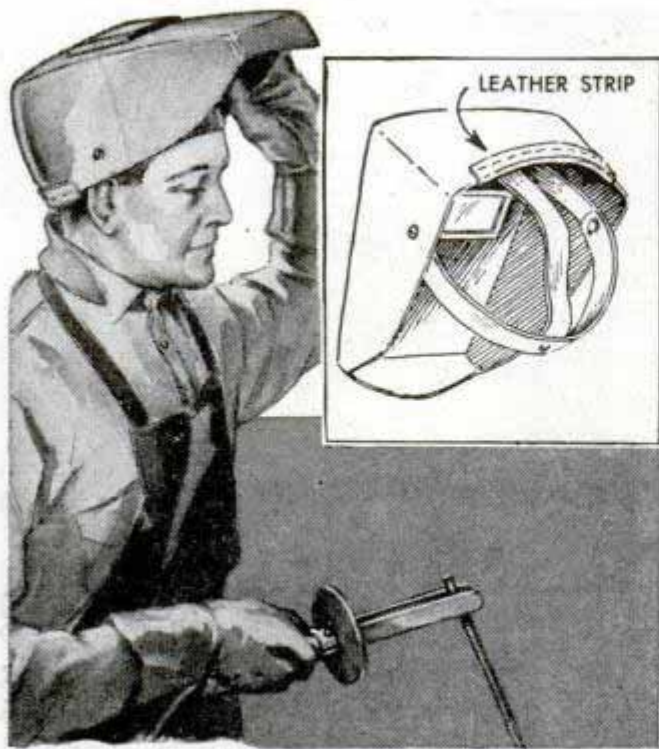

One welder found that a strip of leather, when sewed to the top edge of his helmet, will prevent it from digging into his neck when the helmet is raised. The leather is cut from the uppers of a pair of shoes and then sewed after holes have been punched in the helmet. As an alternative, split rivets can be used to fasten the strip.

John Krill, Youngstown, Ohio.

Ice Pick Is Used to Bend Tubing

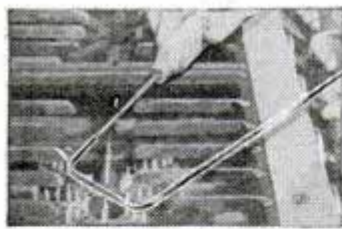

If glass tubing is to be bent on a short radius, an ice pick inserted in the tube can be used as a lever to make the bend. When pliers are used they may break the tube, and bending by hand often results in burning one's fingers.

Counter Made From Compass Is an Aid to Printers



Printers and stationers who need a pad counter in their work can make one from an adjustable compass and divider of the kind having hollow legs. After removing the divider point and

pencil, both legs should be flattened at the ends and filed to an oval shape. When doing this, make one of the legs shorter than the other. By using the adjusting nut, any size pad desired can be made.

Albert Stewart, Kansas City, Mo.

Wood Sheath for Soapstone

Soapstone sticks, such as used for marking steel and similar surfaces, are brittle and break easily. To prevent this, I encase the $\frac{1}{4}$ by $\frac{1}{4}$ by 6-in. stick in a $\frac{3}{4}$ by $\frac{3}{4}$ by 6-in. piece of white pine to

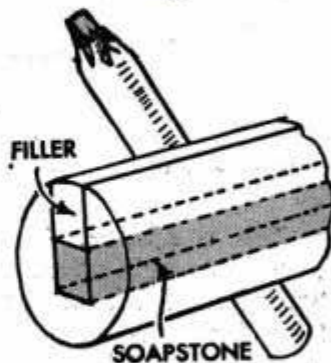

make a pencil. This is done by cutting a $\frac{1}{4}$ by $\frac{1}{2}$ -in. groove in the wood, gluing the soapstone in the groove and filling with a $\frac{1}{4}$ -in. square of pine. When the glue is dry, the pencil can be rounded and sharpened for use.—Conrad F. Sohn, Jr., Towson, Md.

Panel Across Top of Garage Door Prevents Escape of Heat

A plywood panel hung across the doors of a garage will help conserve heat by preventing escape of warm air, which, of course, is always near the ceiling. In garages where trucks are not serviced, the panel can be screwed to the door frame, allowing only room enough for cars to pass through. The panel can be made removable by drilling it for pins on which it is suspended.—Hal Geihm, Aurora, Ill.



TRACTOR SCOOPS

built from scrap materials



Photos and certain detail drawings courtesy State College of Washington

WITH a few salvaged auto parts, several lengths of 3 and 4-in. channel irons, angles and other odds and ends you can build an efficient tractor scoop that will increase the working capacity of one man a hundredfold. In Fig. 1 is pictured a lifting mechanism made from an auto transmission and rear axle, while Fig. 2 details the lifting assembly mounted on the rear axle of the tractor. The auto differential is locked with a weld, or by other means, and

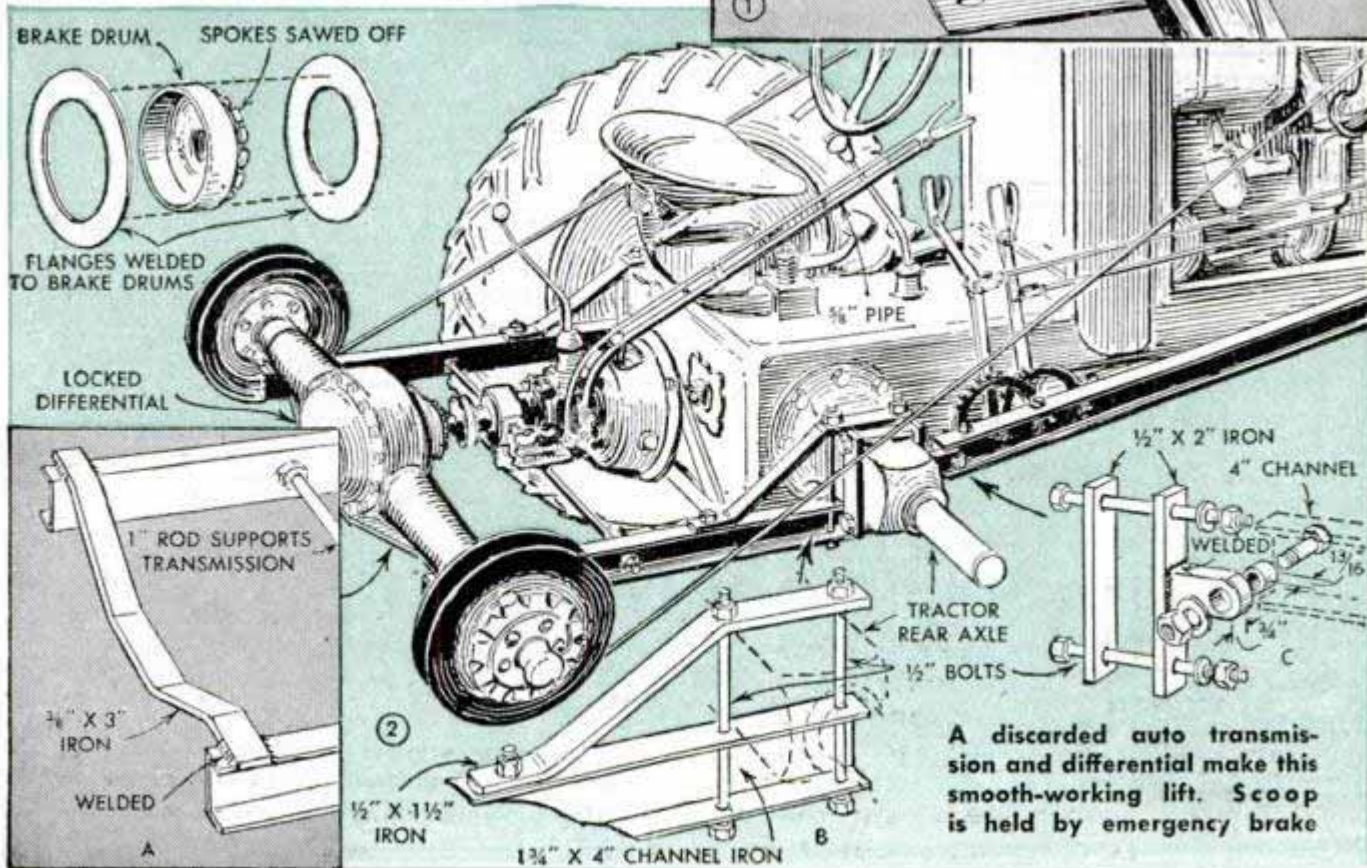
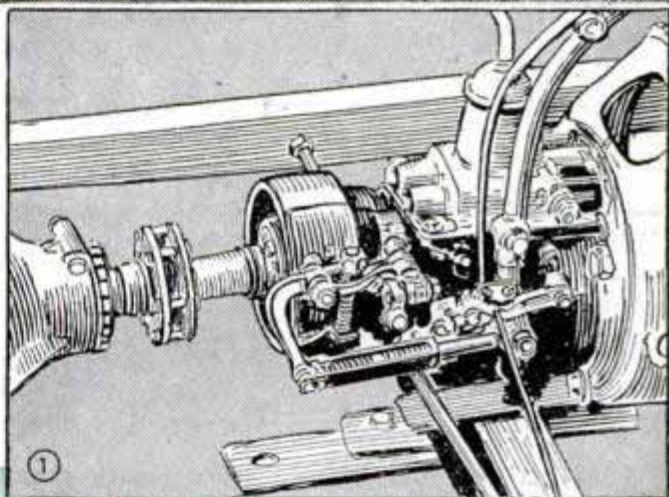

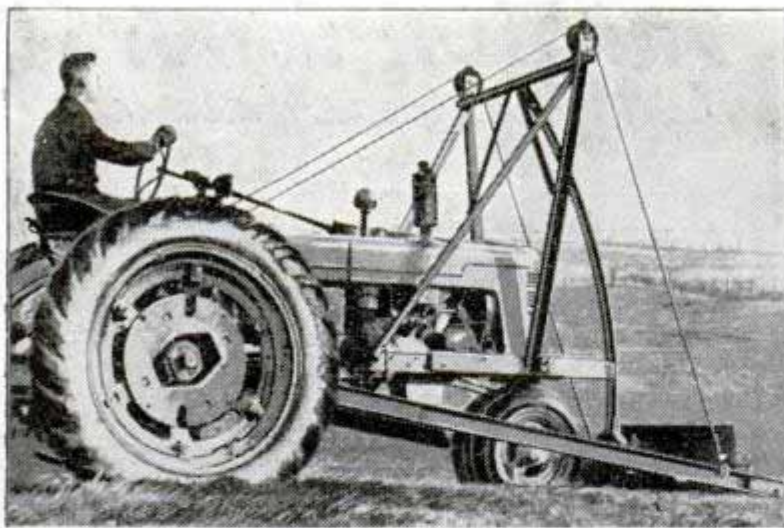

mounted on a frame, details A and B of Fig. 2; then bolted to the tractor-axle housing as in details B and C of Fig. 2. After the wheels have been removed from the auto axle, weld flanges on the brake drums to serve as winding drums for the lifting cables. Then the axle is bolted to the extending channels through the spring pads, or welded if the pads won't serve this purpose.

After the transmission has been mounted on the frame as shown, it is connected to the tractor power take-off and to the auto rear axle through a short shaft and universal coupling. The transmission

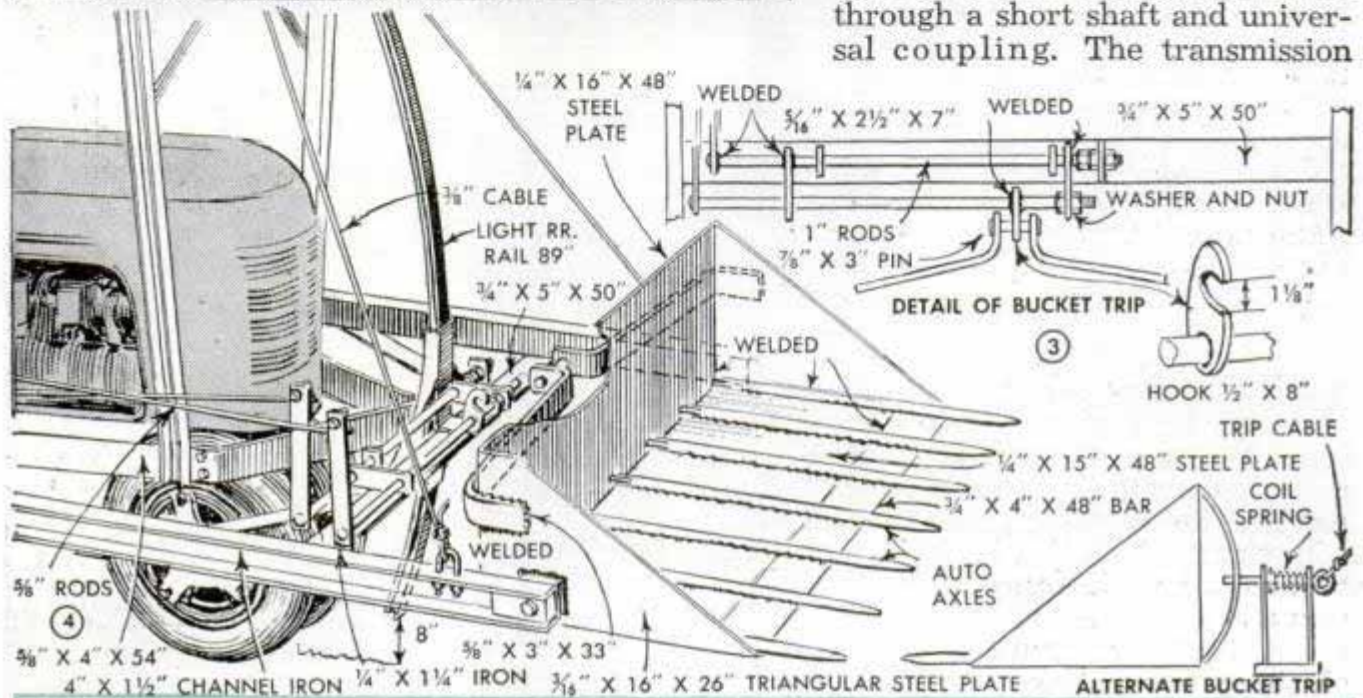

The curved guide made from a small industrial-type railroad rail keeps scoop from swinging sidewise. Radius of the curved portion of the rail can be determined after lift is in position

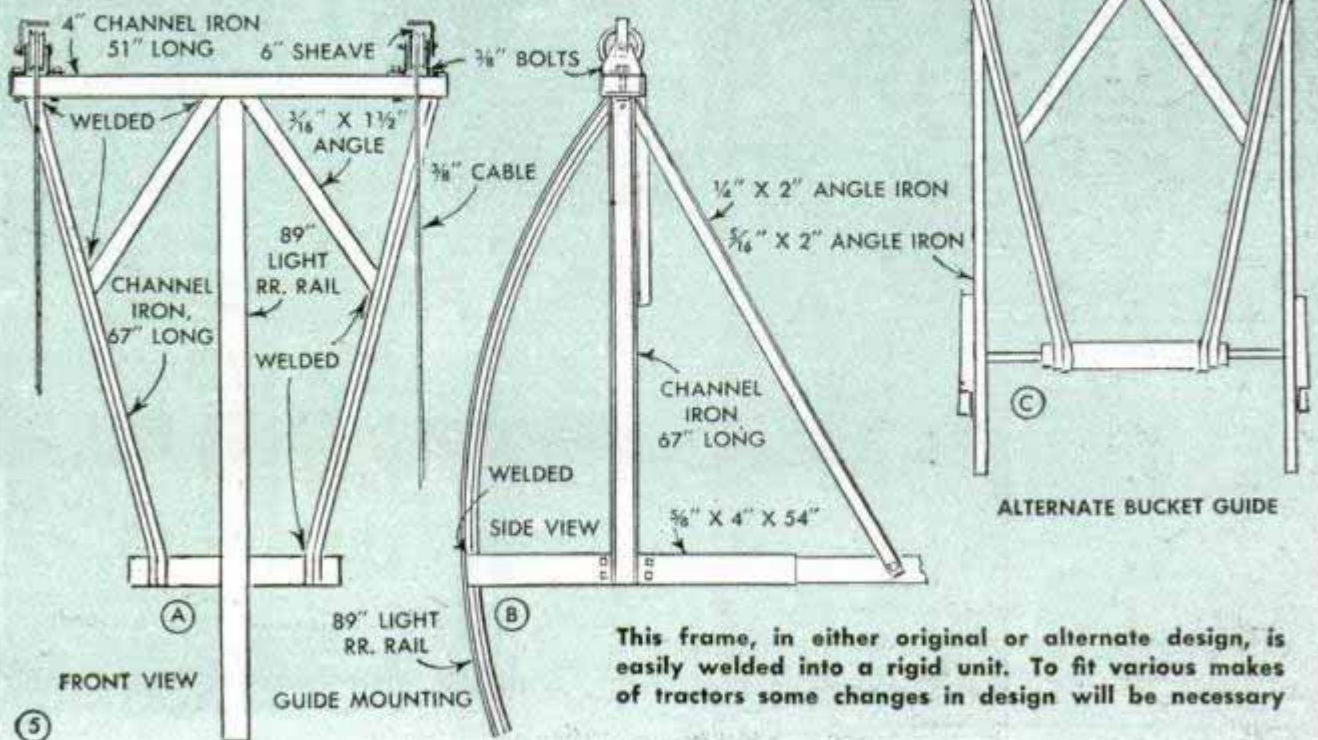

This frame, in either original or alternate design, is easily welded into a rigid unit. To fit various makes of tractors some changes in design will be necessary

must be of the type having an emergency brake at the rear of the housing. To make the brake lever easily accessible, lengths of pipe are welded to the lever and control rod and then bent forward toward the driver's seat. Applying the brake holds the scoop in the raised position.

Further details of the scoop, latch and lifting frame assembly that is mounted on the front of the tractor are found in Figs. 3, 4 and 5. The curved guide, Figs. 4 and 5, A and B, can be made from the industrial-type railroad rail specified or from a length of T-shaped steel wide enough across the flat side for a short "shoe" of 3 or 4-in. channel steel to ride on it smoothly. After the front frame is in place with the scoop arms attached, the radius of the guide can be determined.

Two methods of tripping the scoop are provided. One is detailed in Fig. 3, and a simple alternate arrangement, where dumping is accomplished by pulling a cord, is shown in Fig. 4. In the first arrangement, one of the pair of levers shown in Fig. 2 releases the trip

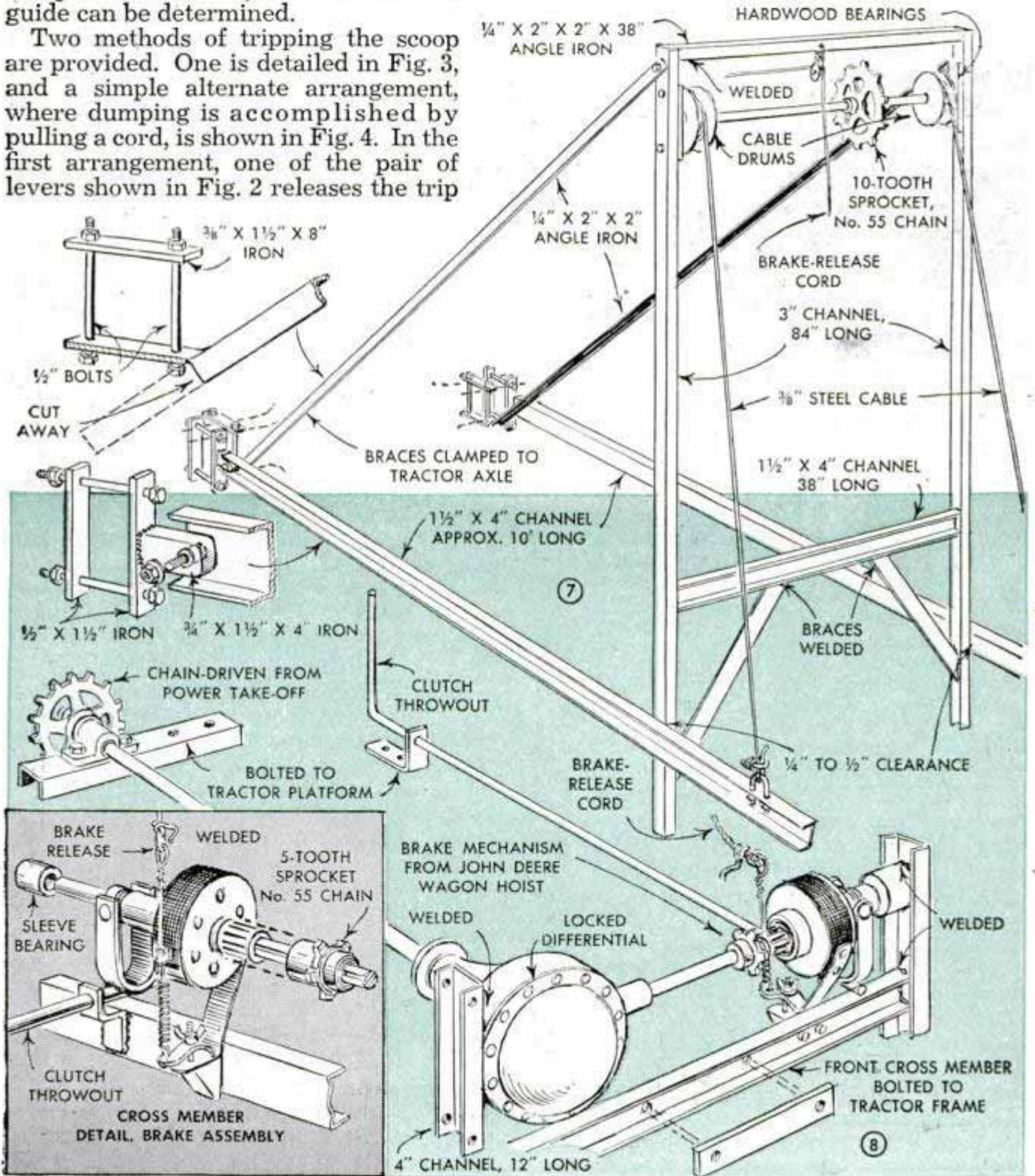
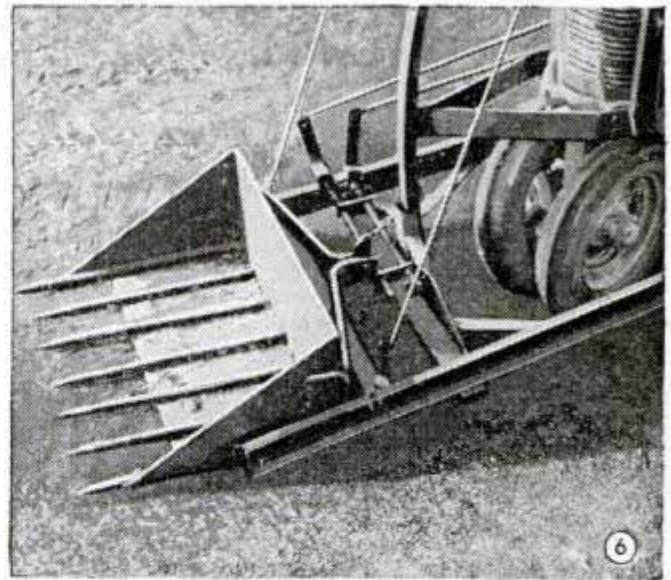

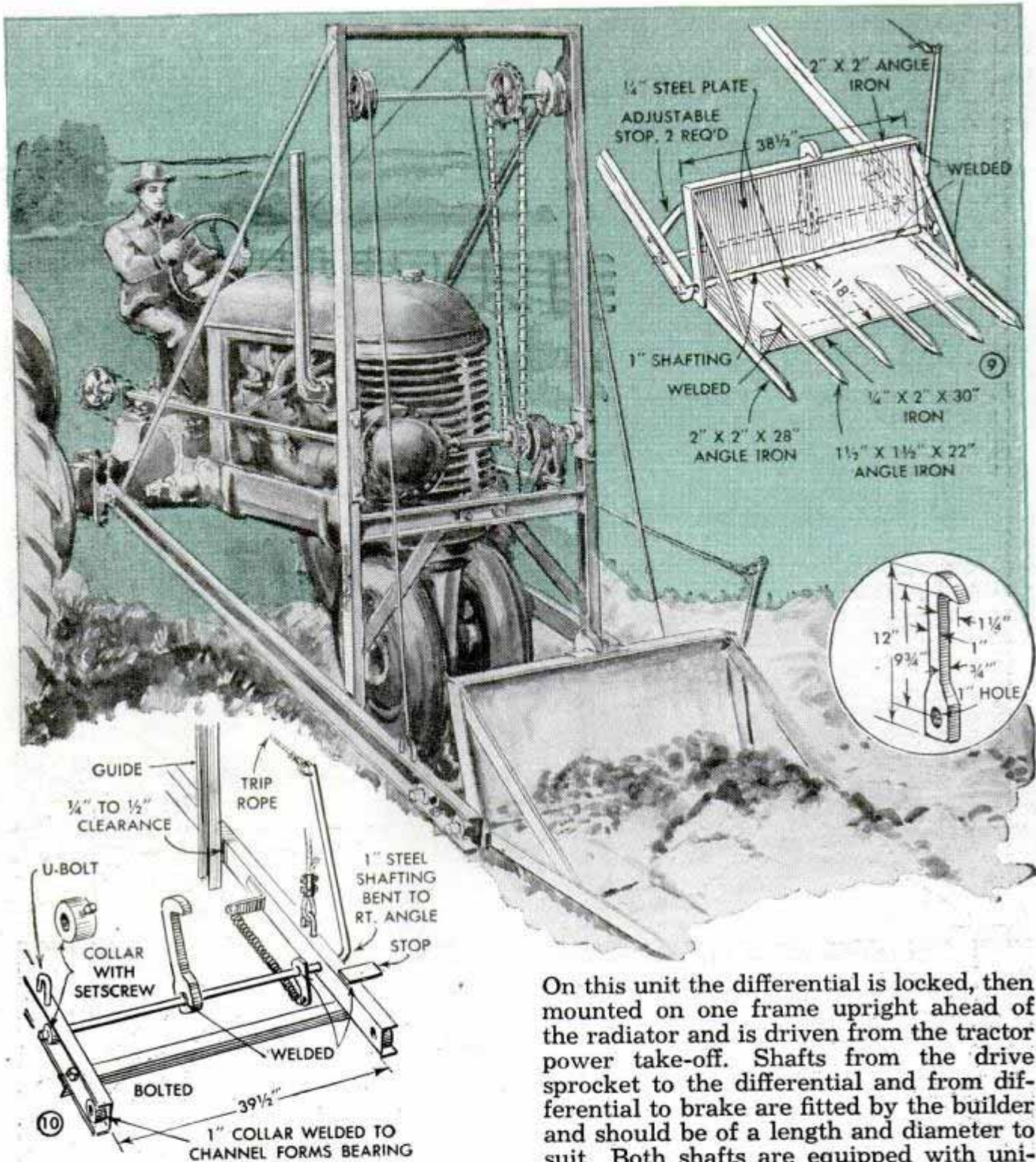

and the other levels the scoop. An alternate type of lifting frame is shown in detail C of Fig. 5 where side uprights, instead of the curved rail, serve as guides for the arms that lift the scoop. In Fig. 6 the finished assembly is pictured ready for work.

Differing from the scoop just described, Figs. 7 and 8 present a type that has a lift employing an auto differential with the axle shafts removed and the housings cut away. Here the bucket is held in the raised position and released for lowering by means of a wagon-hoist brake driven by a jaw clutch, as in Fig. 8 and the detail at the left. The clutch and brake are stock parts and are purchased as a unit. However, the U-shaped throwout and the long shaft and throwout lever are made-to-fit, see Fig. 8.

On this unit the differential is locked, then mounted on one frame upright ahead of the radiator and is driven from the tractor power take-off. Shafts from the drive sprocket to the differential and from differential to brake are fitted by the builder and should be of a length and diameter to suit. Both shafts are equipped with universals at one end to compensate for any misalignment of the frame which would cause the shafts to bind. Shafting $\frac{7}{8}$ or $1\frac{1}{4}$ in. in diameter is amply heavy for this drive, and stock sprockets and other slip-on parts usually fit one or the other of these dimensions. On this type scoop, there are two winding drums and a 10-tooth sprocket on the upper shaft, which rotates in bearings made from blocks of hardwood provided with some means of lubrication. Figs. 9 and 10 show the scoop construction and the bucket release assembly. Of course, scoops can be made in many forms to suit special purposes and by either of the methods shown in Figs. 4 and 9.

Tractors of different makes vary in width of frame, type of frame, wheelbase, height

and wheel diameters. Because of these variations, only a few general dimensions can be given on the frame parts of the scoops. Nearly all parts of either one must be made to suit the tractor on which the unit is mounted. As a general practice, it is usually better to mount the front frame first, before cutting any other materials. With this part of the lift in position, it's an easy matter to determine the dimensions of other parts by direct measurement. In some instances, due to the design of the tractor frame, it will be necessary to fit braces and supports in a manner different from that indicated in the details. Also, it is possible to substitute hardwood for many of the frame parts. As an example, the lifting arms and the frame uprights can be of 4 by 4-in. oak or maple. However, a frame built of welded steel channels and angles gives longer and more satisfactory service due to its greater strength, rigidity and ease of assembly.

Chucks and Face Plates Repaired With Ring Inserts

After extended use, spindle threads on lathes become worn and are not sufficiently rigid for heavy chuck and face-plate work. Rather than rethread the spindle, a simple remedy is to turn the threads off the nose for a short distance and provide the chuck or face plate with a ring insert that will slip over the turned portion without side play. To bore for the ring insert, place a spacer thicker than the turned portion of the spindle back of the chuck and cut the latter for the insert. After pressing the ring in place, it can be bored for a perfect fit on the spindle nose.—Pvt. Laurence H. Seibert, Camp Crowder, Mo.

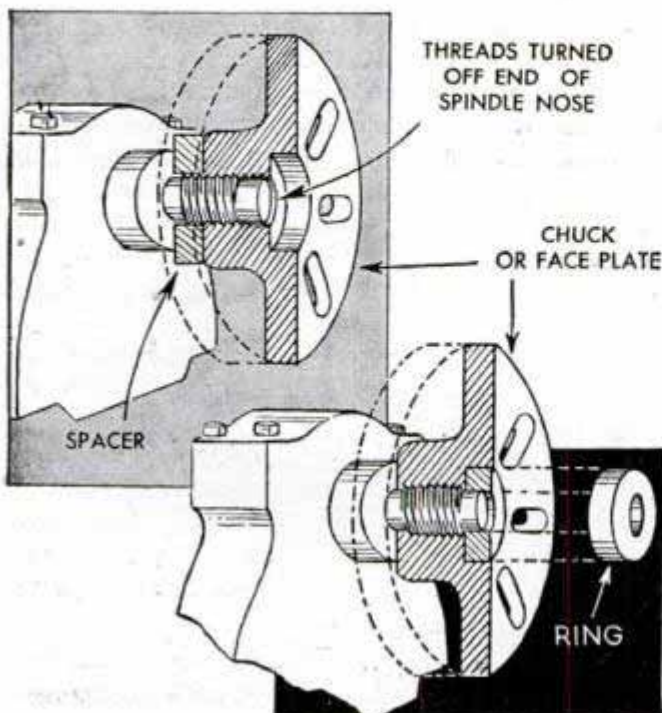

Drop-Leaf Tailboard on a Truck Facilitates Sorting Loads

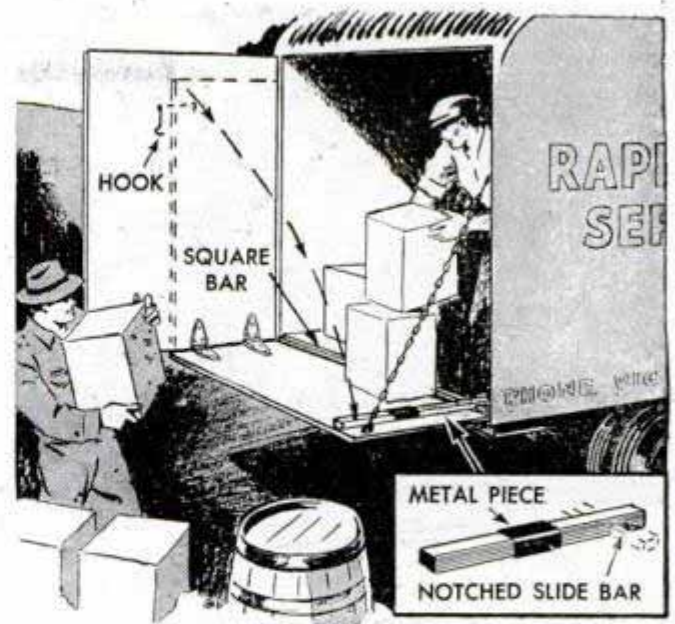

To provide a small loading or sorting platform at the rear of trucks and vans that have one rear door, a tailboard can be hinged to the inside of the door at the lower edge. In use, the tailboard is supported by a length of chain attached to the inside of the truck body, and by a sliding bar that is notched at one end to engage a cleat, or square bar, on the truck floor. The bar slides in a metal sleeve screwed to the tailboard. When not in use, the tailboard is raised and hooked to the door.

Adapter Extends Use of Wrench

The function of a ratchet wrench can be extended to include using it as a socket-head wrench with this attachment. It is made from a hexagon-shaped bar of a size to fit the wrench, with the part fitting into the socket filed down to the proper dimensions. Sets can be built for many sizes of socket-head screws and fittings.—Bruce Watkins, Osceola, Ind.

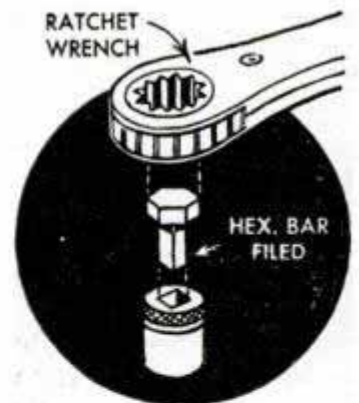

Magnetized Blade Picks Up Pins

By using a knife with a magnetized blade, modelmakers will save much of the time spent in picking up steel pins used to hold glued parts for drying. The blade can be magnetized by stroking it over a magnet or by holding it in the center of a coil connected to two dry cells wired in series.

Harold Weesner, Newburg, Ore.

Pans Converted Into Stock Bins Provide Additional Space

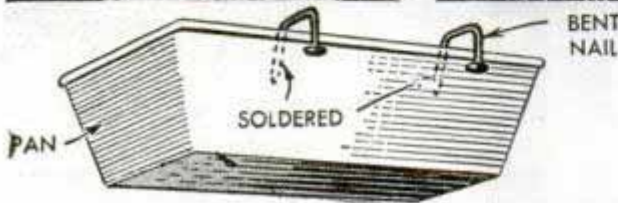
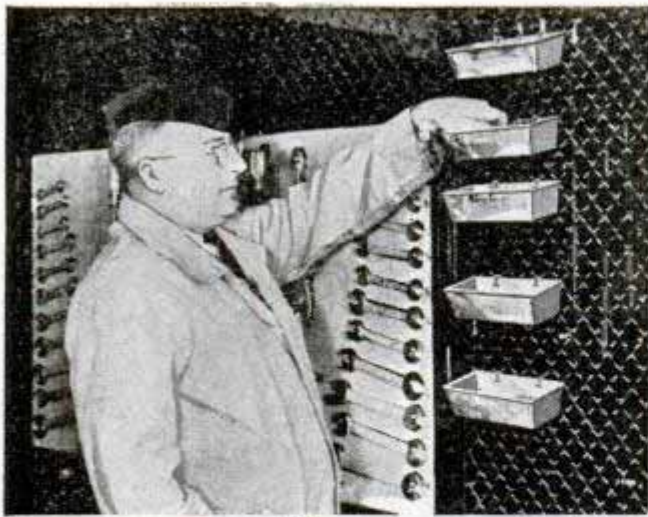

A stock-room man in one shop found that bin space could be increased by hanging bread pans on the wire cage walls of the room, as shown. Hooks for hanging the pans were made by bending nails and soldering them to the inside surface of the pans. Spacing of the hooks should be such that each will rest on the bottom of a "V" in the wire netting.—C. E. Packer, Chicago.

Solution Shows Flaws in Metal

Invisible cracks in metal parts can be detected by the following method: Clean the part thoroughly with kerosene or gasoline, after which it is wiped dry and warmed slightly to assure complete dryness. Then dip it into a solution of kerosene and a small amount of oil. Dry the part and spray it with any quick-drying mixture that will leave a white coating, such as a thin emulsion of zinc oxide powder in pure wood alcohol. After the part has dried for a few minutes, flaws will show up as brown lines on the white surface.

How to Improve a Soldering Iron

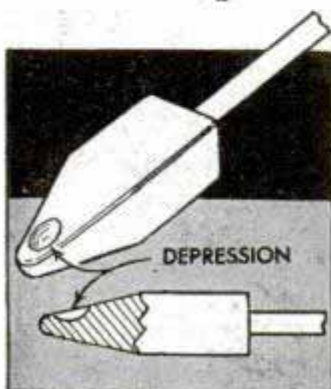

The seemingly difficult task of soldering from the underside of the work, and keeping the solder on the upper side of the iron, is a trick known to many tinsmiths. For this work, it is better to shape the iron

like a chisel, drawn narrower at the point than at the shoulder of the bit. Then, on the upper surface near the tip, cut a small depression just large enough to hold a drop of solder. Tin only the upper side of the iron, being sure that the other three sides do not retain solder.

John C. Sommer, Saginaw, Mich.

Drill Rod Kept From Oxidizing When Heated for Hardening

When you have occasion to harden a short length of drill rod, place it in a small metal container and cover it with brazing flux. When this melts, it seals the rod from air to prevent oxidation in the heat. When the work is quenched after heating, the flux will crack off, leaving the rod as clean as it was before hardening.

E. J. Murawski, Baltimore, Md.

Showcase Lock Protects Wares

A simple showcase lock can be made by using a hasp, a carriage bolt and a padlock. Where the sliding sections of the case overlap, drill a hole large enough for the bolt and fasten the hasp over the bolt so it will cover all exposed screws when closed. The padlock is fastened through the staple.

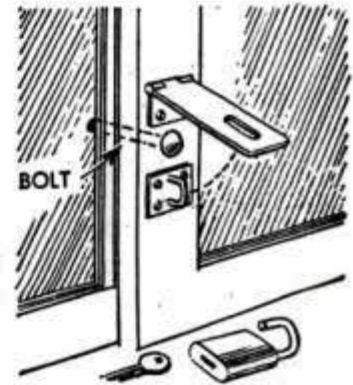

Helen M. Douglas, Commerce, Tex.

Stock Cars Used for Corn Crib And Overhead Granary

One farmer solved a building problem by using two railroad stock cars in the construction of a double corn crib and overhead granary. The cars were set on a concrete base for use as corn cribs and the space under the roof served as a granary.

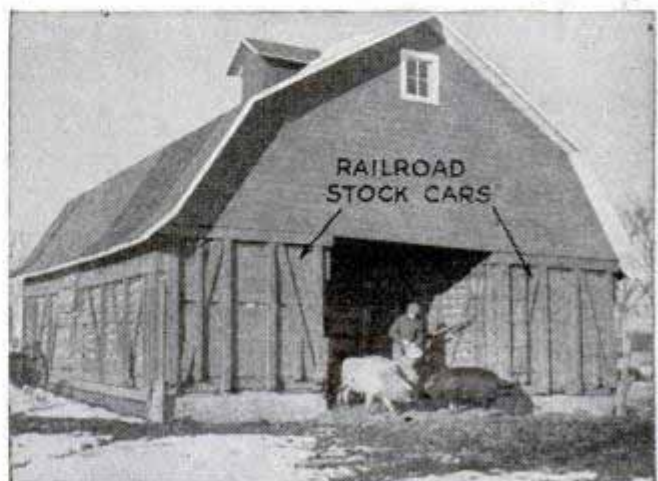

Chuck Backstop Supports Thin Metal Disks

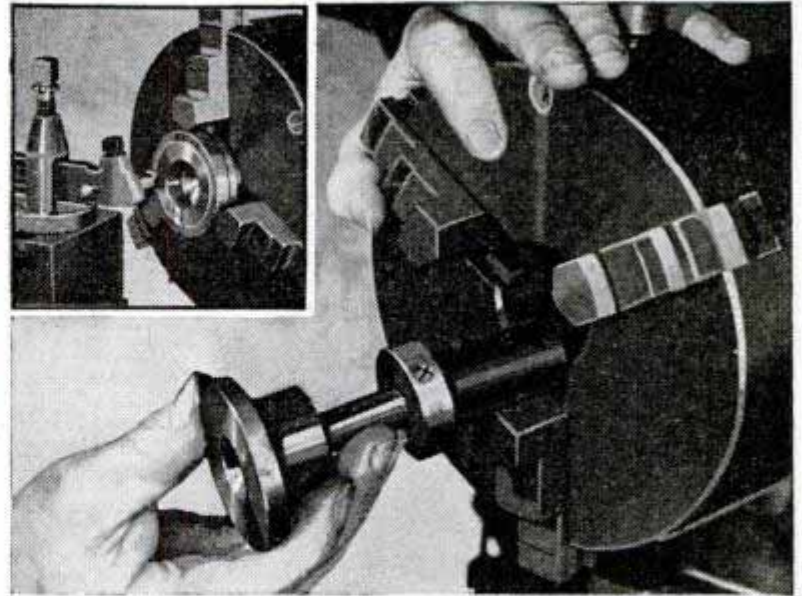
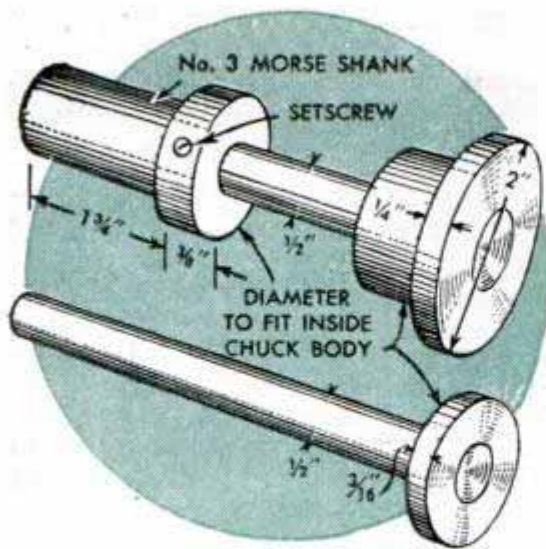

This backstop unit disposes of the problem of mounting thin metal disks in a three-jaw chuck. It's adjustable in or out to suit varying thicknesses and can be locked in any position for facing and boring operations on duplicate parts. The Morse-taper shank, cut from a broken carbon-steel drill, is fitted with a turned collar and setscrew, and is center-drilled to take the spindle of the stop or "pad." The shouldered portion of the stop is turned down to the same diameter as the collar on the tapered sleeve

so that it slips inside the chuck body. The stop spindle should be finish-ground to a close sliding fit and the stop face must be trued with the unit mounted in the taper shank. For handling work of smaller diameters a second stop can be made as in the lower left-hand detail, the head of the stop being turned down to a diameter that will allow it to slide inside the chuck body. This makes the stop unit more nearly universal. Before mounting work be sure that the surfaces are clean and free from chips.

Kettle Set in Oil Drum Is Used as an Outdoor Feed Cooker

By setting an iron cooking kettle into an oil drum from which the top has been removed, and fitting the drum with a door and stovepipe, you can improvise a sturdy outdoor cooker for use when preparing feed. A stove or furnace door is riveted over an opening cut in one side of the drum, and a length of stovepipe is fitted over a hole cut in the opposite side. A fuel tank mounted on an adjoining support such as a fence post holds waste crankcase oil. This is piped into the drum, a valve being installed to control the flow of oil. Bricks can be laid in the drum to catch the oil and serve as a grate, or cement can be laid to build up a firepot if no brick is available.

Typing on Adhesive Tape

To type on adhesive tape that is to be used for labels, place it lightly and smoothly on a sheet of photographic film. This will roll easily into the typewriter carriage and support the tape. When the typing has been completed, the tape can be stripped off the film. To keep the surface of the labels clean after they have been typed, coat them with colorless nail polish.

H. L. Thompson, Sarnia, Ont., Can.

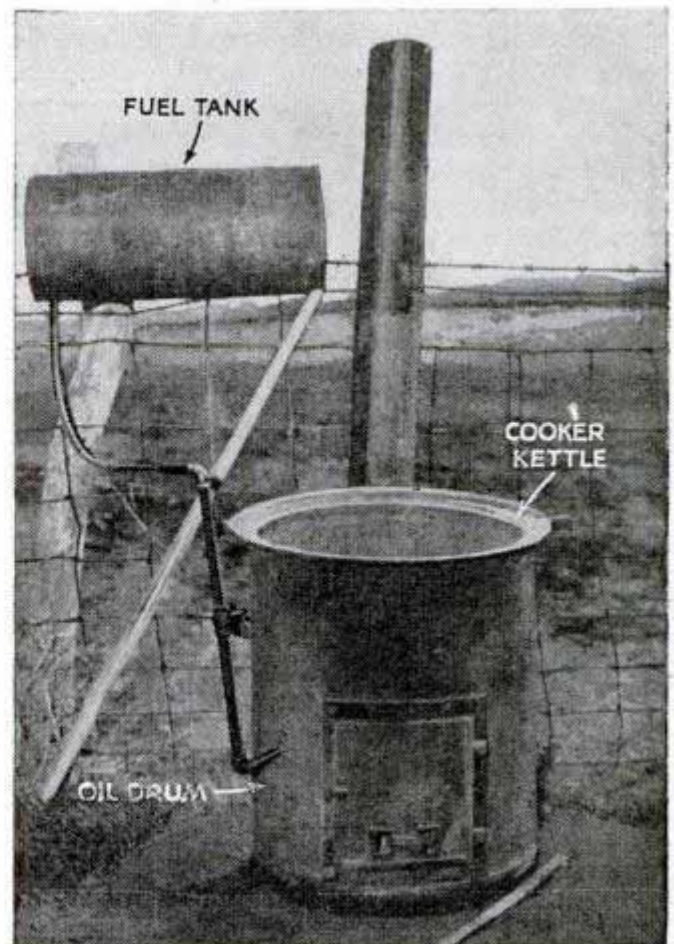

Guide Tabs Minimize Eyestrain When Drawing Parallel Lines

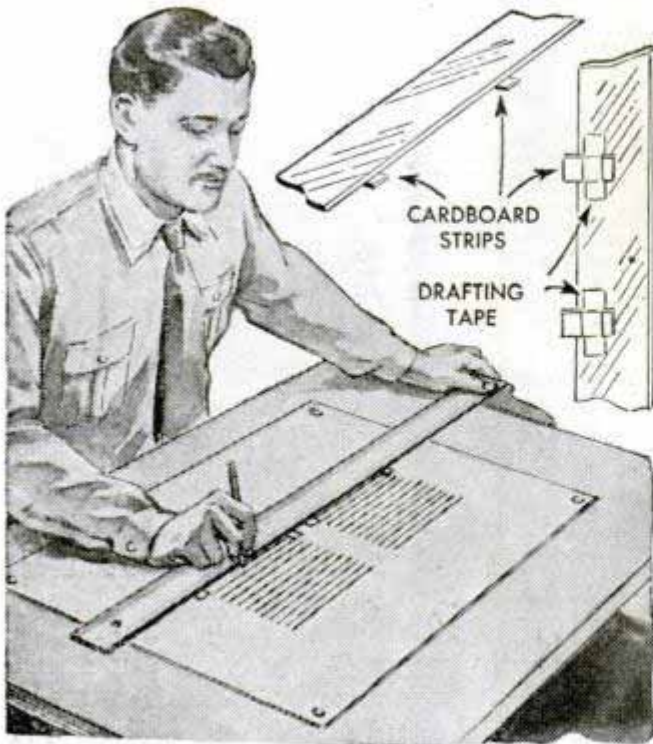

When a number of parallel horizontal lines of the same length are to be drawn, guide tabs attached to the underside of a T-square, as shown, will speed the operation. Addition of tabs, which are strips of cardboard held by drafting tape, also will minimize eyestrain for the draftsman.

Two Mechanical Brake Troubles That Are Easily Cured

When mechanical brake troubles are difficult to locate, the cause may be either a shifting of the axle due to a broken spring bolt or "frozen" anchor pins or bushings. Replacing the broken bolt and tightening all the parts involved will cure the first difficulty, and in the case of frozen parts, these should be freed and cleaned, after which the brakes should operate properly.

Olive Oil Stored in Ax Handle Prevents Drying of Hands

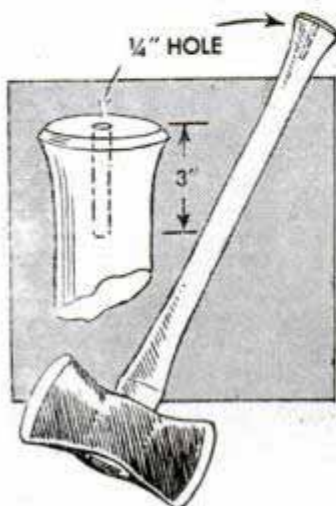

Lumbermen find that when they do much chopping during warm weather the skin of their hands becomes dry and cracked. To prevent this, one workman drilled a $\frac{1}{4}$ -in. hole 3 in. deep in the end of his ax handle, filled the hole with olive oil and then

plugged it. The oil gradually works through the ax handle and lubricates it so that the hands do not become dry.

Arthur L. Dufour, Queens Co., N. B.

Pins Aid Lining Up Original Page With Carbon Copy

Sometimes in typing it is necessary to make an addition to what has been written after the work has been taken out of the machine. If there is a carbon copy, it is difficult to align this with the original when putting the work

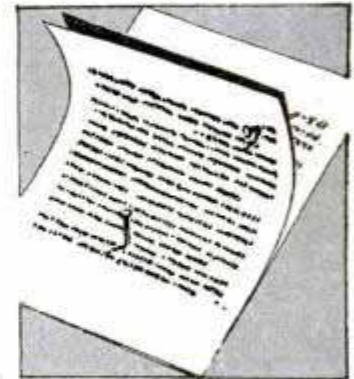

back in the typewriter. To line up several sheets of paper, insert pins through two widely spaced periods on the original and stick the pins through the carbon paper into the same periods on the copy. When aligned, the papers are held and reinserted for typing.—Mallory Trent, New York.

Drilling Overlapping Holes

In drilling a series of overlapping holes, as when removing the central portion of a die, mark off all the centers so that the holes will overlap slightly and then drill every other hole only. Force into each of the holes plugs cut from round stock of the proper size for a tight fit. After this, the overlapping holes can be drilled more easily without causing the drill to slip or break, and the uncut material can be removed easily.

Federico Strasser, Santiago, Chile.

Control Will Operate Stop Cocks

Opening and closing overhead stop cocks that are too high to be reached without a ladder can be simplified by attaching a wire-operated lever to the handle. Drill a hole in the handle for a length of rod, which is driven in and bent at right angles as indicated.

File a groove at each end to hold the wire, then bring the wires over the pipe and allow them to hang down on the other side. The cock is opened or closed by pulling one of the wires.

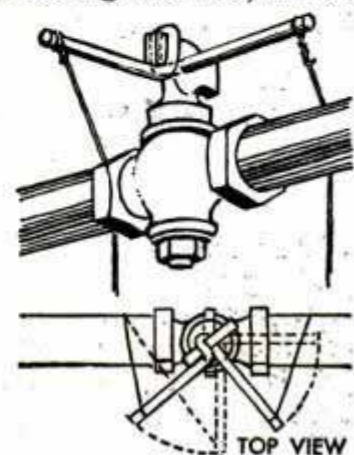



Five-Tube Super Pocket Radio

SUBMINIATURE tubes that made possible radar proximity VT-fuses in the noses of 5-in. shells which exploded automatically when they came within 70 feet of suicide plane and "buzz bomb" targets are now doing an excellent peacetime job in this ultracompact pocket receiver. About the size of a modern hearing aid, this pocket set is only 3 in. wide, $\frac{3}{4}$ in. thick and $5\frac{1}{4}$ in. high, and, believe it or not, all batteries are included in the case.

The five tiny Raytheon plug-in tubes employed in the set have a total weight of about a half ounce, yet they perform all the functions of normal size tubes found in conventional 5-tube supers. They are slightly over 1 inch long, as indicated in Fig. 1; all elements and construction details are shown in Fig. 2. Of the five tubes used, two are r.f. amplifiers, one is a frequency converter, one a detector amplifier and the fifth an output pentode.

Designed to fit the pocket or purse, as illustrated in photos A and C, the set will be available in gold, silver and leather-covered cases. Retail prices will start at approximately \$30.00. The earphone is a small and inconspicuous "hearing aid" type; the antenna is combined with the phone cord appearing in photos B and C.

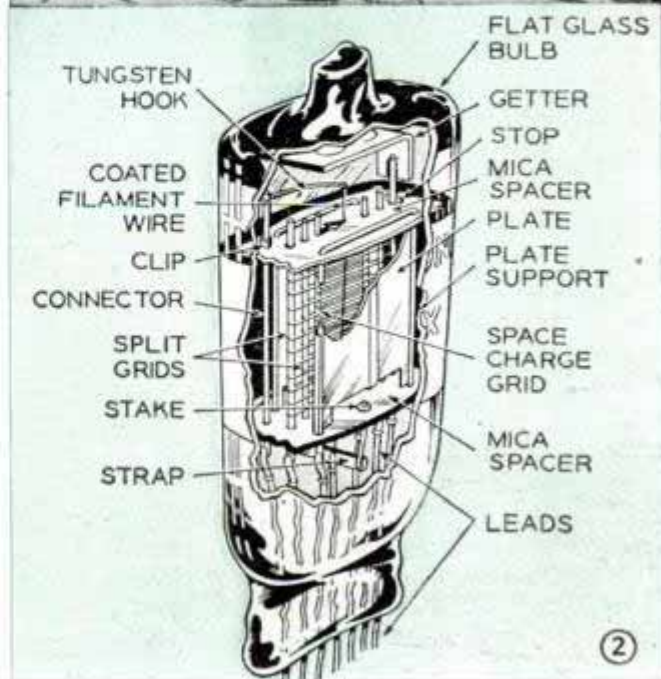
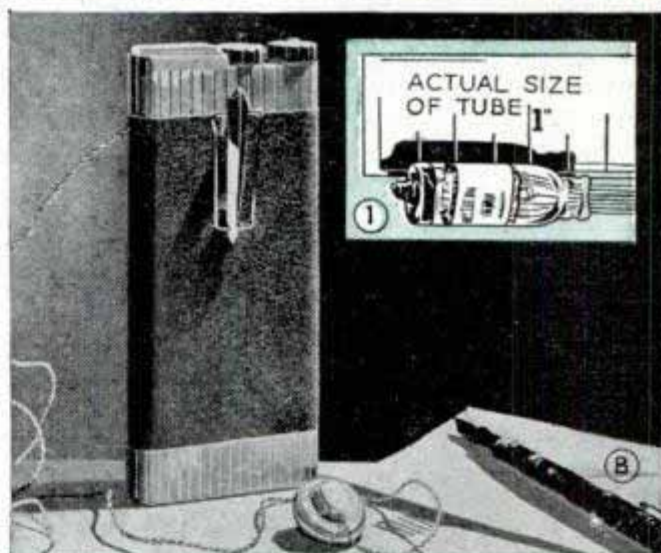

GENERAL PURPOSE "SOUND" AMPLIFIER FOR

By A. H. Ketzler

PART II

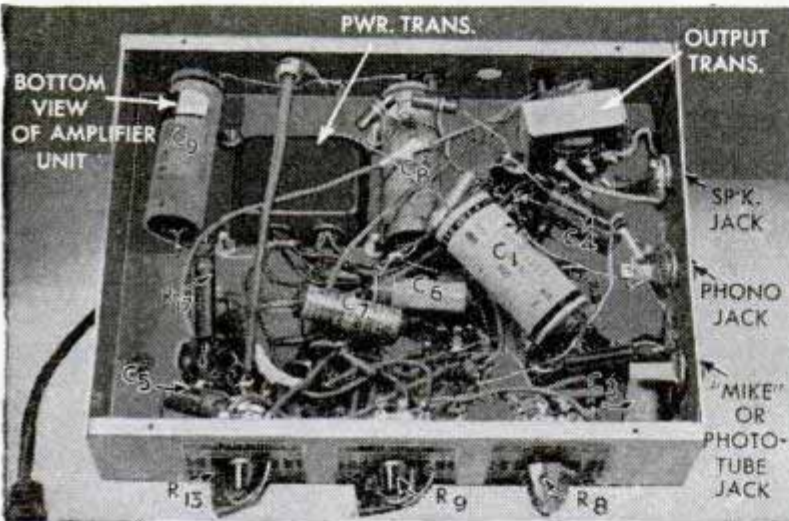
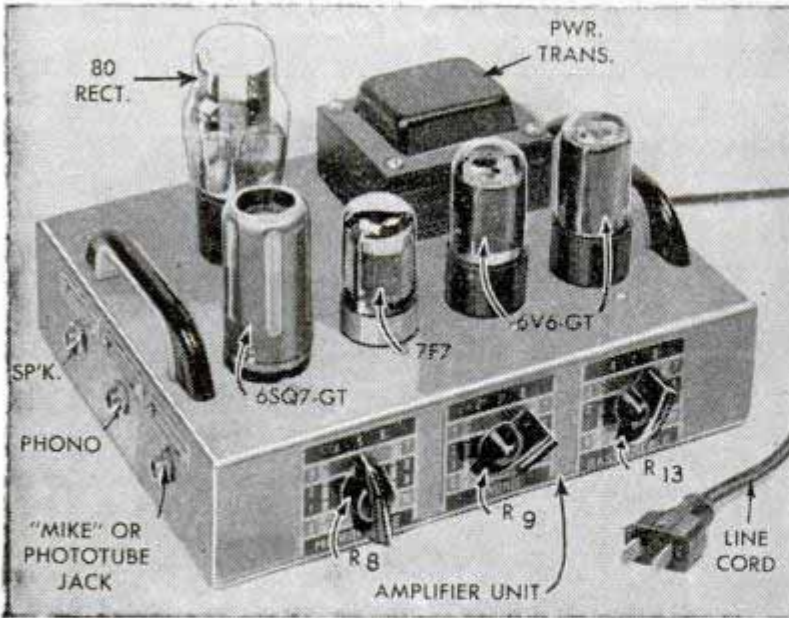

ALTHOUGH this audio amplifier originally was designed for use with the homemade sound head, described in the December issue, for converting an old silent home movie projector for sound, it also is ideal for other useful applications. It may be employed to amplify the output of a record player, and also provides a small public address system, as a microphone may be plugged into the phototube input jack when the operator wishes to address his audience for special announcements.

The amplifier is assembled on a sheet metal base 2 in. high, 7 in. wide and 9 1/4 in. long. A front and top view of the completed unit appears in the photo at upper left; please note carefully the location of the various parts. The midget jacks for the input channels and

RESISTORS

R1 = 1 megohm 1/2 watt	R11 = 50,000 ohms 1/2 watt
R2 = 100,000 ohms 1 watt	R12 = 250,000 ohms 1/2 watt
R3 = 100,000 ohms 1 watt	R13 = 250,000-ohm pot.
R4 = 5 megohms 1/2 watt	R14 = 500,000 ohms 1/2 watt
R5 = 150,000 ohms 1 watt	R15 = 500,000 ohms 1/2 watt
R6 = 250,000 ohms 1/2 watt	R16 = 100,000 ohms 1/2 watt
R7 = 100,000 ohms 1/2 watt	R17 = 250 ohms 2 watts
R8 = 1-megohm pot.	R18 = 20,000 ohms 1/2 watt
R9 = 1-megohm pot.	R19 = 5 megohms 1/2 watt
R10 = 1500 ohms 1/2 watt	R20 = 5 megohms 1/2 watt

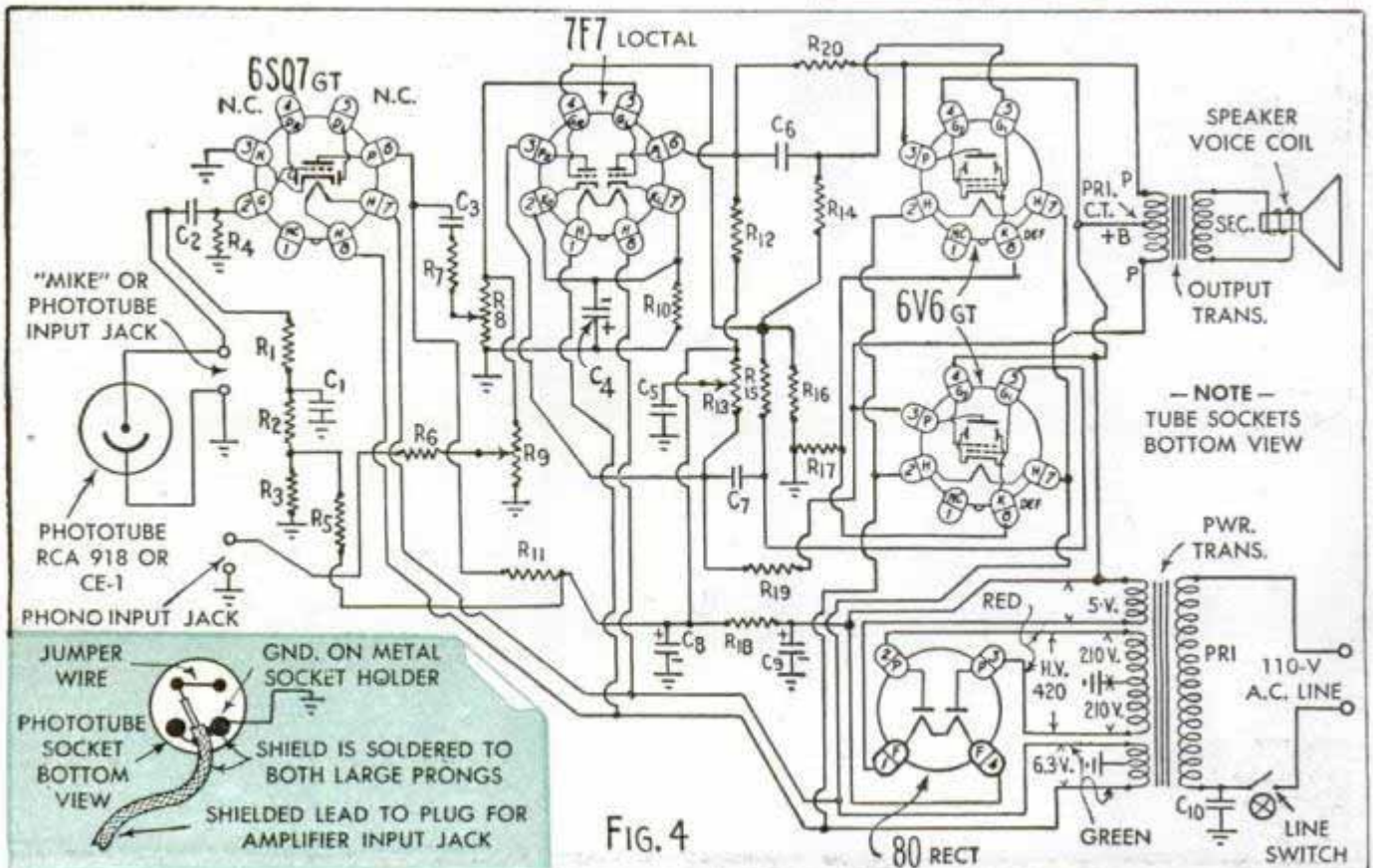

FIG. 4

CONVERTED 16 MM. SILENT MOVIE PROJECTOR

separate speaker are lined up along the left-hand side of the chassis base. Volume controls R8 and R9 control each input channel separately; R13 is a combination tone control and line switch. A shield is used on the type 6SQ7-GT tube. The carrying handles, which are optional, come from the 10-cent store and are bright red plastic to match the control knobs.

A complete schematic circuit diagram for the "sound" amplifier appears in Fig. 4; the detailed pictorial wiring diagram is given in Fig. 5. This is an underside view of the base with the sides flattened out to show all parts in their relative positions. Referring to Fig. 2 in Part 1 it will be noted that the phototube socket is a 4-prong shielded Amphenol or similar type, provided with a mounting flange that is a part of the metal housing. The shielded lead comes out of the rear of the housing and terminates in the amplifier plug. All phototube socket connections are detailed in the bottom view at lower left in Fig. 4; the wire shield is soldered to both of the large prongs and grounded with a short wire to a machine screw in the metal socket holder.

(Continued to page 154)

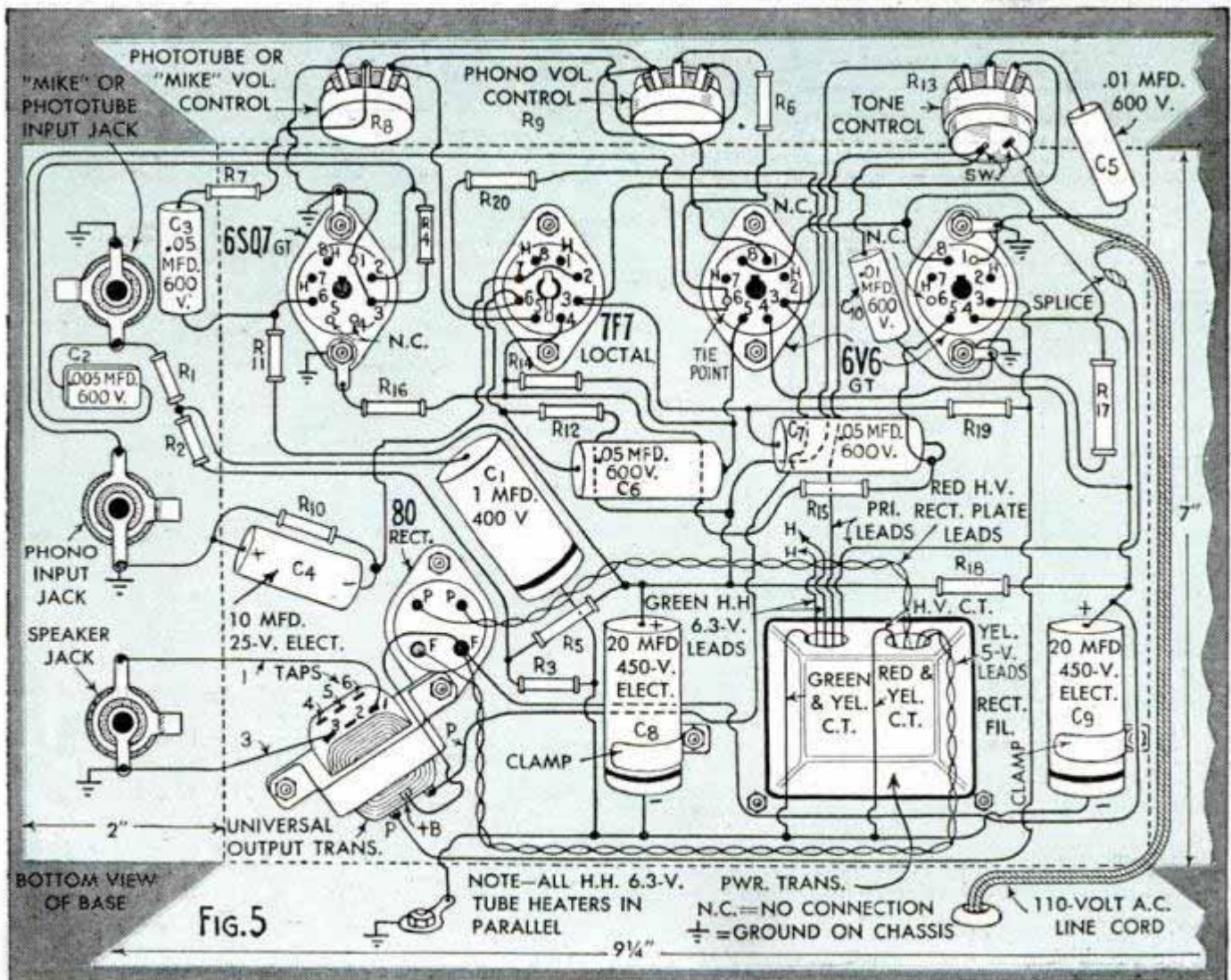
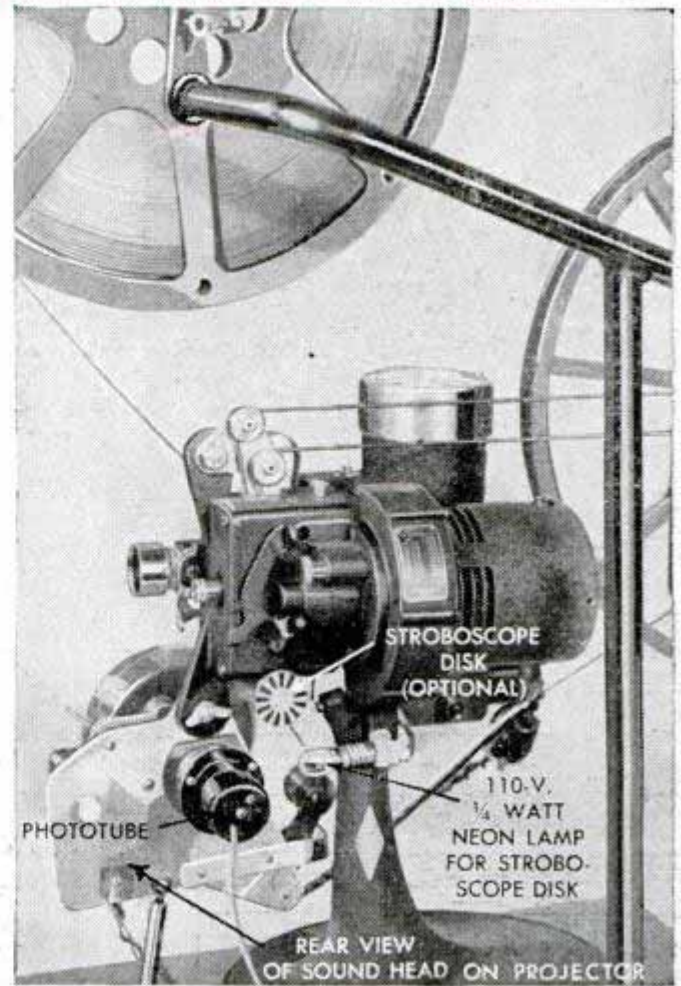



Helpful RADIO HINTS

(A) Comparison chart for industrial electronic service men working with timing circuits, alarm systems and similar installations in which radio symbols are used in diagrams. (C) Simplest practical tone control circuit that may be connected between the plate of an audio amplifier tube and ground. Condenser C1 may be either .01, .002 or .005 mfd.; switch at position 2 increases bass response when desired

PART REPRESENTED	COMMONLY USED CIRCUIT DIAGRAM SYMBOLS	
	RADIO DIAGRAM SYMBOL	INDUSTRIAL SYMBOL
CONDENSER (fixed)		
RESISTOR (fixed)		
POTENTIOMETER		
FUSE		
IRON CORE CHOKE		
IRON CORE TRANSFORMER		
RELAY CONTACTS (open)		
RELAY CONTACTS (closed)		

(B) To clean switch contacts and wire-wound controls, some radio workers use Hoppe's gunpowder solvent, others carbon tetrachloride

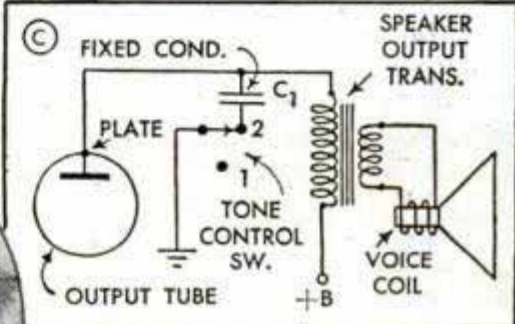
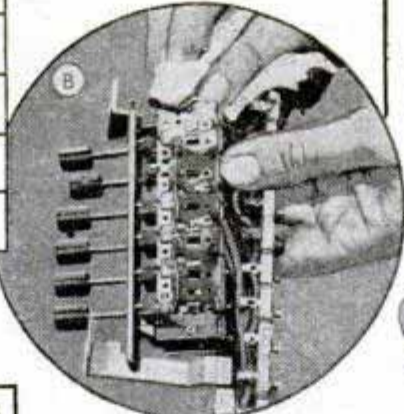

(D) FM dipole antenna may be made to operate in one direction by using a reflector parallel with its length

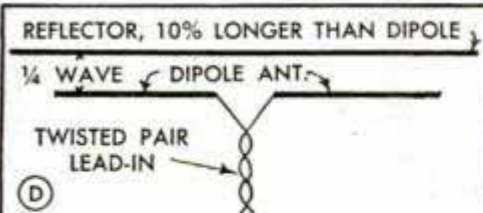

(E) "Hot" metal tubes easily removed with an electrician's cartridge fuse puller. (F) Crackling noises in set may be caused by crossed antenna and ground wires

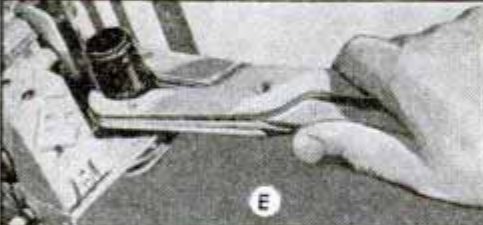
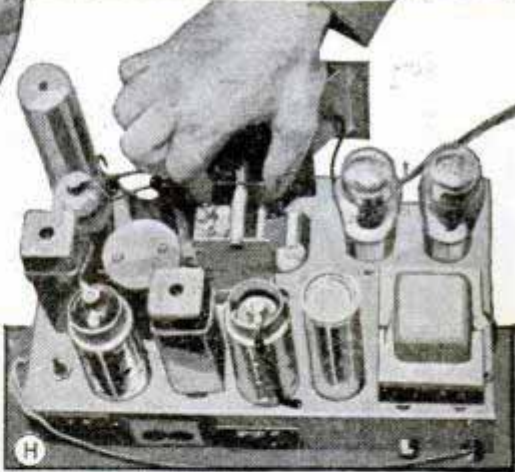

(H) Loose connections often are detected by moving variable condenser slightly

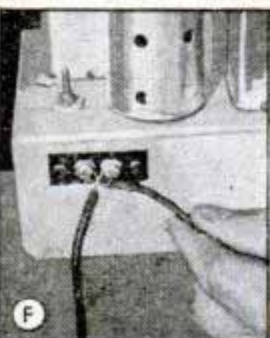

(G) Speaker plug always must be in socket before turning on set. (I) Table dolly is handy for bench test set



Tough *but oh so gentle*

When you install new piston rings, it will pay you to get Hastings rings. They *stop* oil-pumping, *check* cylinder wear, *restore* engine performance. Ask your motor specialist.

HASTINGS MANUFACTURING COMPANY
HASTINGS, MICHIGAN

Hastings Ltd., Toronto

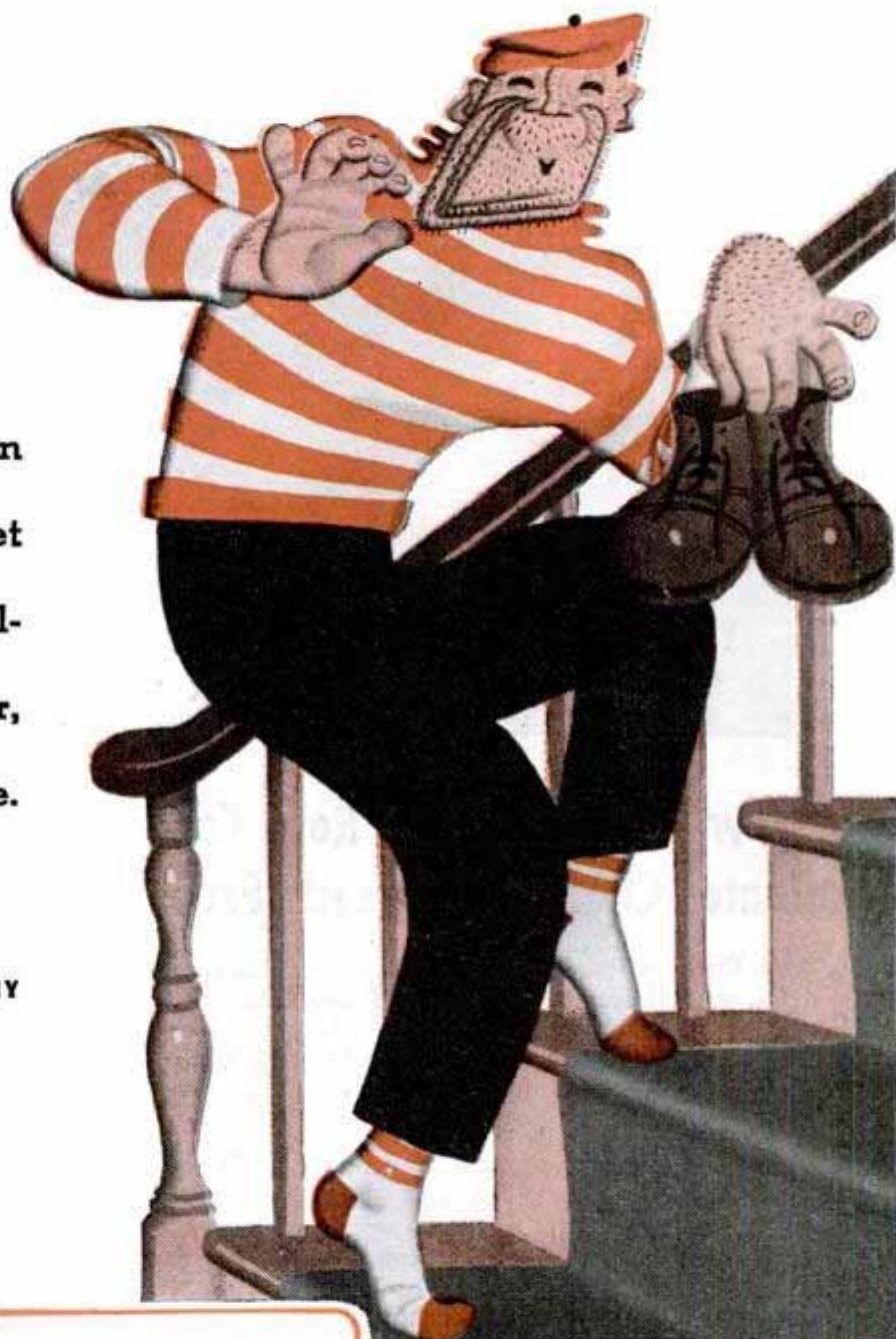

HASTINGS STEEL-VENT PISTON RINGS



TOUGH ON OIL-PUMPING GENTLE ON CYLINDER WALLS

Ingenious New Technical Methods

To Help You with Your Reconversion
Problems

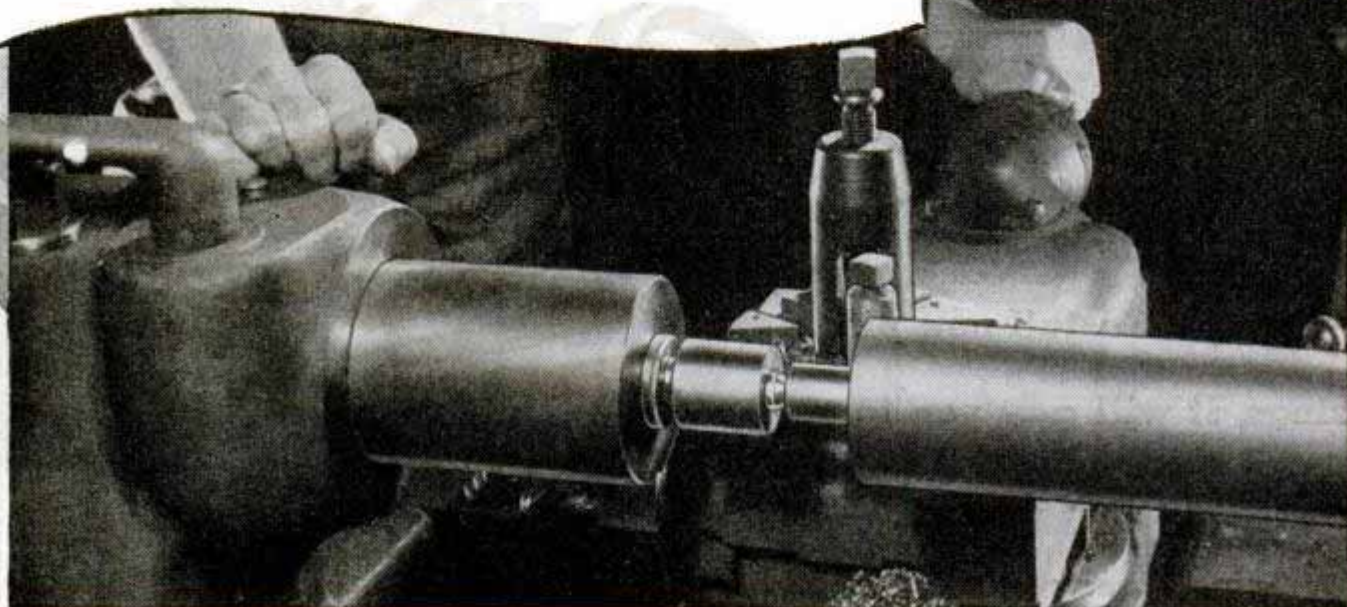

New Precision Built Roto Center Eliminates Chatter...Speeds Production!

Now You Can replace dead centers on lathe and grinder tailstocks, with this new Keene live Roto Center—to increase production—to eliminate all radial play and possibility of chatter! Low in cost, the Roto Center is a high capacity unit, featuring many innovations to speed and improve quality of work!

Matched roller bearings preloaded, are packed with high grade anti-friction grease at assembly. No attention is required for long periods. After assembly, runout is kept to absolute minimum—guaranteed less than .0002. Rear of center is tapped to receive standard hydraulic fitting. Chips, dust and cutting oil cannot reach bearings!

More and more peacetime "helps on the job" are returning to industry. One of these days, famous, flavorful Wrigley's Spearmint Gum will also be back to help you "on the job"—but only when we can assure Wrigley's Spearmint manufacture in *quantity* and *quality* for all. Today, we ask you to remember the famous Wrigley's Spearmint wrapper. Tomorrow, you may again enjoy Wrigley's Spearmint Gum quality and flavor while you are at work.

You can get complete information from
Keene Electrical Machinery Co., 549 W. Washington Blvd., Chicago 6, Ill.

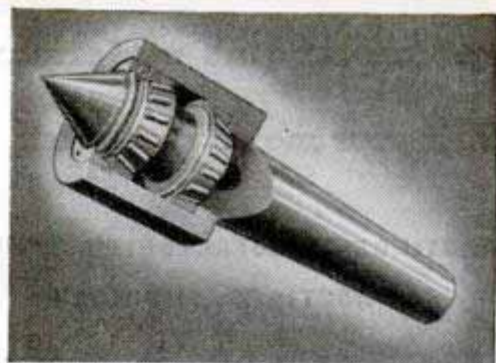

The Keene Roto Center



Remember this wrapper

Z-97

LIONEL

TRAINS ARE BACK AGAIN

The New 1946 Lionel 4-car Freight Set is on the market in limited quantities. But MORE are on the way! Set features Brand New Electro Magnetic Real Railroad Knuckle Couplers, solid steel wheels, and die cast trucks. It is a beauty! Yet this is only a pre-view of the sensational surprises coming from LIONEL in 1946. (Insert shows new truck and coupler assembly.) Suggest you write for the two books below.

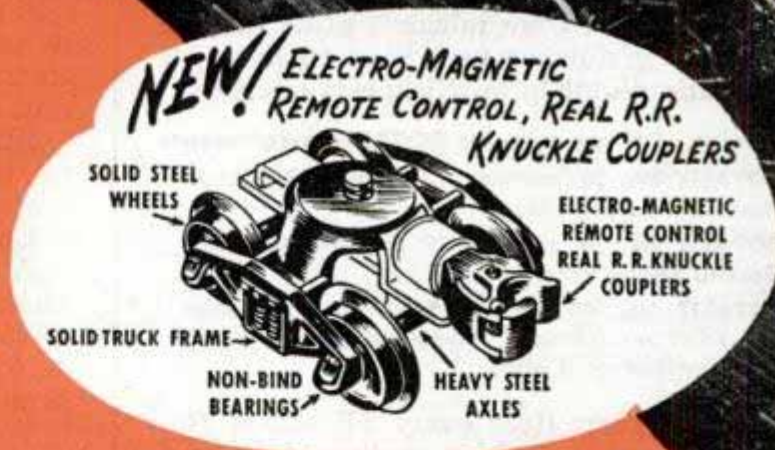

BOTH BOOKS FREE CLIP AND MAIL THIS COUPON NOW!



The Lionel Corporation
Dept. No. MB
15 East 26th Street, New York 10, N. Y.
Please rush my Two Big FREE Booklets!

Name.....

Address.....

City..... Zone No..... State.....

ROTAKIT

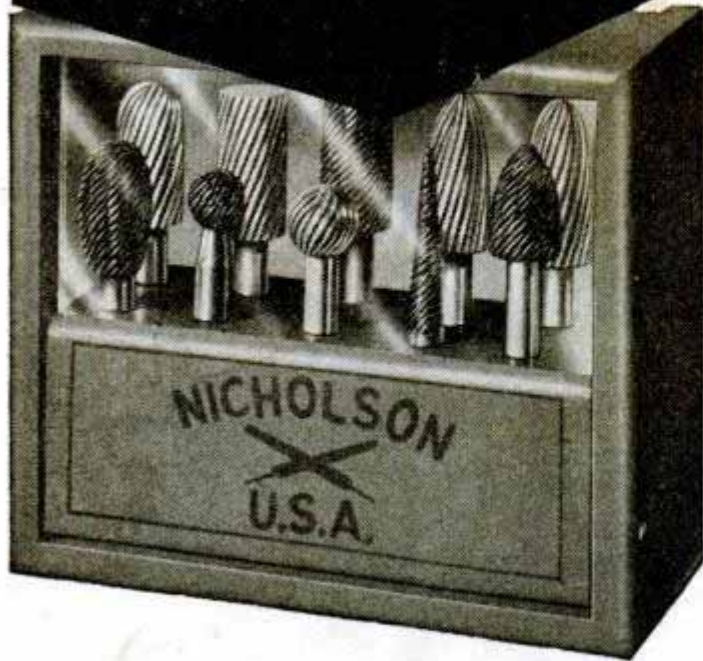

PRIDE OF THE INDUSTRIAL OR HOME CRAFTSMAN

TEN popular shapes of Nicholson Rotary Files in an attractive glass-front, hinged-stand case! The Nicholson ROTAKIT is a logical

sequence to the widening use of rotary files or "burs." And from inherent pride in good tools, every diligent user likes to have his rotary files in kit form. Nicholson offers—

A choice of three popular ROTAKIT assortments

ROTAKIT No. 20 contains 10 assorted Nicholson Hand Cut Rotary Files.

ROTAKIT No. 30 contains 10 assorted Nicholson Ground Rotary Files.

ROTAKIT No. 40 contains 5 assorted Nicholson Hand Cut and 5 assorted Nicholson Ground Rotary Files (as illustrated above).

Nicholson guarantees every Nicholson Rotary File made from high-quality, high-speed steel; keen, accurate cut; true-centered shaft and perfect radius at all cutting circumferences.

For ROTAKIT, or any individual assortments, contact your mill-supply house or leading hardware dealer.

NICHOLSON FILE CO., 22 ACORN ST., PROVIDENCE 1, R. I.
(In Canada, Port Hope, Ont.)

NICHOLSON
ROTARY FILES
(Hand Cut and Ground)
FOR EVERY PURPOSE

NICHOLSON
U.S.A.

Aussie "Glide Pool"

(Continued from page 87)

lying around his camp. He made a container with a hinged lid in an hour and told the Inventions Directorate about it. They redesigned it as collapsible and reusable and it became a standard army package.

The Army Inventions Directorate was asked to devise a way of dropping packages so that they would land exactly where required. One line of inquiry developed a container attached to a lopsided revolving vane, on the principle of the sycamore seed. That was good for weights of 40 pounds. But to drop accurately 200-pound packages, a new idea was tried—the "Storpedo." Shaped roughly like a torpedo, it is made of compressed paper with a shock-absorbing percussion head at one end and a parachute pack at the other.

There have been dozens of other ideas that paid off. One was for a nonpoisonous dye to camouflage faces and hands of Australian infantrymen in jungle fighting. It had to be made in large quantities; it had to be nontoxic and in a waterproof container; it had to be readily soluble in cold water, yet adhesive enough to stick to the skin despite continual sweating. The Inventions Directorate got it.

Here are a few of the valuable nonsecret items sponsored by the Directorate and accepted by the Services:

A time-service chronograph which makes it possible to synchronize time signals throughout the Australian Commonwealth and Australian combat zones.

Sliding clasp fasteners which can be made to hold materials so that they are watertight and airtight.

Colored smoke signals.

A device composed of two mirrors to enable distressed persons to focus a flash of sunlight on a friendly ship or plane.

Nonslip boot fittings for walking on wet, sloping logs and up slippery banks.

Waterproof maps.

Model Builders Attention!



	V	V-2	V-3
Hex	1/2"	3/8"	5/16"
Thread	3/8"-24	1/4"-32	1/4"-32
Thread Length	7/32	7/32	5/32
Weight, Grams	8	3 1/2	2 1/2

Actual Size V-Plug

Champion spark plugs for model gas engines give the same dependable performance as regular Champions. Sillment sealed. Sillimanite insulator. Alloy needlepoint electrodes for easy starting. One piece construction.

CHAMPION

SPARK PLUG COMPANY • TOLEDO 1, OHIO

Type of 6-engine Clipper Pan American World Airways will place in service in the future.



New Horizons...

IN SPARK PLUG PERFORMANCE!

Wartime necessity produced technological advances in Champion Spark Plugs which were outstandingly evident in the performance of the most advanced aircraft engines. Equally great strides were made in Champion Spark Plugs for other engines.

Today, there are new horizons in spark plug performance for your present car, if you insist on dependable Champion Spark Plugs. The unequalled manufacturing facilities and experience exclusive to Champion are back of every Champion Spark Plug. That's why it will pay you to insist on Champions—the automotive spark plugs with aircraft prestige and efficiency. Champion Spark Plug Company, Toledo 1, Ohio.

DEPENDABLE

CHAMPION SPARK PLUGS



ANCO RAIN-MASTER

"Dead-Locker"

WINDSHIELD WIPER ARMS and BLADES

BLADE SNAPS ON...
STAYS PUT

FINGER-
TIP
RELEASE

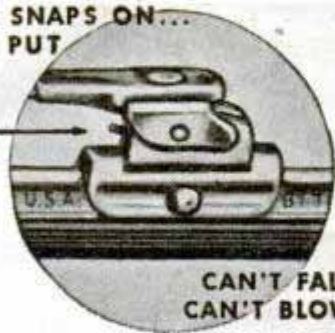

CAN'T FALL OFF
CAN'T BLOW OFF

(A war-born invention—by ANCO—first)
for military aircraft—now for your car.)

DON'T SHOOT YOUR GAS-PUMP MAN!

He's doing the best he can. Sure, he knows how dangerous it is for you to drive your car... in stormy weather... with your dull old windshield wipers that smear and smear. He'd gladly put on for you quickly a pair of keen new ANCO RAIN-MASTER Wiper Blades and Arms. He has them—Newest Models! But he forgets to remind you? Too busy? You can't shoot him for that!



After all, it's *your* car to protect. So *you* remind *him*. Get RAIN-MASTERS...patented features...original equipment on many makes of high grade cars and trucks... used in war—on our fighting tanks and trucks and ships and bombers too...because ANCO RAIN-MASTERS clean quicker, clean cleaner... last longer. May save you a costly smashup.

Ask for RAIN-MASTER Windshield Wiper Arms and Blades next time you buy gas.

THE ANDERSON COMPANY

Established 1918

GARY, INDIANA

Navigation for the Sky Tourist

(Continued from page 62)

by a much wider line. For reasons such as these, aerial navigation maps are designed so that certain features which are useful for navigation are accentuated, and other and less useful details omitted. For example, on the great plains, unpaved section roads are spaced one mile apart; there would be no point to putting these roads on a map (eight of them to each inch) and thus obscuring far more important landmarks, such as rivers and paved highways. Maps, therefore, use conventional symbols to represent ground objects such as railroads, rivers, power lines and towns, and before you can understand what you are doing in contact navigation you must have a very good knowledge of these symbols.

To read a map easily, it must be oriented correctly. That is, it must be lined up so that everything to the right of your course on the map is to the right of you on the ground. To do this you align the course with the fore and aft axis of the plane, and this insures that you will see the ground detail exactly as you see it on the map.

There is a definite map reading sequence—watch, map, ground. You must not, if possible, read from the ground to your map, because if you do your mind will try to fit a map detail to one you saw on the ground, whether or not it matches. For example, if you see a crossroad involving two paved highways just below you, and start looking for it on the map, you may see several road crossings which look as if they might fit—and you can be sure that your subconscious mind will pick out the one closest to the point where you want to be, instead of where you really are.

Instead you first look at your watch, then at the map. The five-minute intervals will tell you just where you should be, so that you can look around this point on the map and pick out details that you may expect to see before you on the ground, either now or in a few minutes. You next decide on just what the map details will actually look like. Then you look ahead of you, and to either side, and try to pick out some of these landmarks. Remember, to either side, because you are very likely to be a few miles off course, either to right or left.

Time markings are very useful. If you didn't have them you would have to watch map and ground all the time when flying over unfamiliar territory for fear of missing one of the few pinpoints available, and that would make flying drudgery, instead of the fun it really is. With the five-minute inter-

(Continued to page 152)



DEATH IN THE AIR. Many a Jap pilot, spinning down in flames from high over an American warship, quite literally never knew what hit him. Neither did enemy intelligence, bewildered by the accuracy of Allied gunnery.



FIVE-TUBE RADIO transmitter and receiver, in the fuse of the shell, is the brain of the secret weapon. In flight, the transmitter broadcasts a continuous radio wave. Reflected back from the target, this wave explodes the shell at exactly the right moment!

THE SHELL WITH A "RADIO BRAIN"

Army, Navy lift censorship on mystery weapon that licked V-Bomb, Kamikaze attacks



TYPICAL of "Eveready" "Mini-Max" power is this 15-volt *hearing-aid* battery. Small, light, economical, it makes possible lighter, easier-to-wear hearing aids. It is now available.

"CIGARETTE - CASE" RADIOS, small enough to wear, are made possible with this "Mini-Max" Battery. It packs 22½ volts into a package smaller than a standard box of safety matches!

NOT EVEN the Atomic Bomb was more "hush-hush" than the "Variable Time Radio Proximity Fuse"—a fuse mechanism that decides for itself when to explode; requires no advance setting.

Transmitter, receiver, and detonating mechanism all draw power from a tiny "Eveready" "Mini-Max" battery: a "powerhouse" rugged enough to withstand the shock of the gun's discharge: a force 20,000 times that of gravity!



The registered trade-marks "Eveready" and "Mini-Max" distinguish products of National Carbon Company, Inc.

The Man Who Wouldn't Stay Licked



*So inconspicuous

... and so, Bill, I'm back on top again. Yet, only a year ago, I thought I was licked because my hearing had gone bad.

It must have been failing for years but I wouldn't admit it. Then came the day when I said "no" on a big deal when I should have said "yes."

After that, I went to an ear specialist. He recommended a hearing aid. Fortunately, I tried a new Zenith.

So, now I'm sitting pretty, hitting on all eight cylinders. Yep, Bill, I can hear again, and the world's my oyster...

* * *

If you want to start friends or relatives who are hard of hearing back on the road to happiness—suggest that they visit a Zenith dispenser and try a new Zenith Radionic Hearing Aid. You owe it to them. They want to hear you but it's embarrassing when you shout.

Their own ears will decide—no one will ask them to buy. And the new Neutral-Color Earphone and Cord is so *inconspicuous*. Remember—Zenith has always stood for quality.

Choice of Amplifier Colors at no Extra Cost.

Super-powered Model A-3-A \$50

Model B-3-A (Bone Conduction) \$50

Standard Model A-2-A \$40

THE NEW
ZENITH
RADIONIC
HEARING AID

BY THE MAKERS OF ZENITH RADIOS



PASTE ON PENNY POSTCARD AND MAIL

ZENITH RADIO CORPORATION, Dept. PM-1B
6001 Dickens Avenue, Chicago 39, Illinois

Please send me FREE booklet about the Zenith Radionic Hearing Aid.

Name.....

Address.....

City..... State.....

COPYRIGHT 1946, ZENITH RADIO CORPORATION

vals you can forget about map reading for reasonable lengths of time, knowing that when you consult your map again the intervals will tell you just about where you are—providing, of course, that your flying has been accurate.

In spite of all these contact navigation aids, every so often you will get lost. Providing that you know what to do, this is nothing to worry about. The procedure is simple. Go back on your map to the last pinpoint of which you were sure, and work out how far you have gone from there and in what direction, knowing your air speed and approximate ground speed and course. You can estimate, knowing how well you have been flying and whether there has been any noticeable wind shift, just about how many miles you could be out, and this gives the radius of your circle of uncertainty—that is, you must be somewhere in the circle drawn with your calculated position as center, and possible error as radius. Then you fly on until you reach any landmark which, although unfamiliar, could be recognized on the map. Remember that your circle of uncertainty has moved as you continued to fly on the original heading. Now fly a square around the landmark (not a circle, because it is impossible to orient a map unless you fly in a straight line) as high as the visibility and cloud base will permit. Eliminate carefully the possible locations on the map within the circle of uncertainty until you find the one it must be. This can be checked by continuing on your original heading and making sure that the subsequent landmarks are consistent with the pinpoint that you have decided is correct. If, during your search, you couldn't identify the landmark, then fly on to the next one and start over again. In time, you are sure to find your position.

There are, of course, many other procedures for use when lost, but this is probably the best. But keep that "in time" in your mind. The average light plane can sit down in almost any fair-sized field; if you are thoroughly lost pick a good one, land, and ask the nearest farmer. Don't let your gasoline supply get low while you desperately try to locate yourself; pick a landing ground while you still have enough fuel to choose, and your precautionary landing will be both safe and sensible.

Estimated to be 80,000 times as bright as the sun, a new star which is 8300 light years (49,000,000,000,000 miles) from the earth was discovered recently in the constellation of Aquila by the Dominion Observatory at Victoria, B. C.

Get Michigan Limit of Largemouth with JITTERBUGS

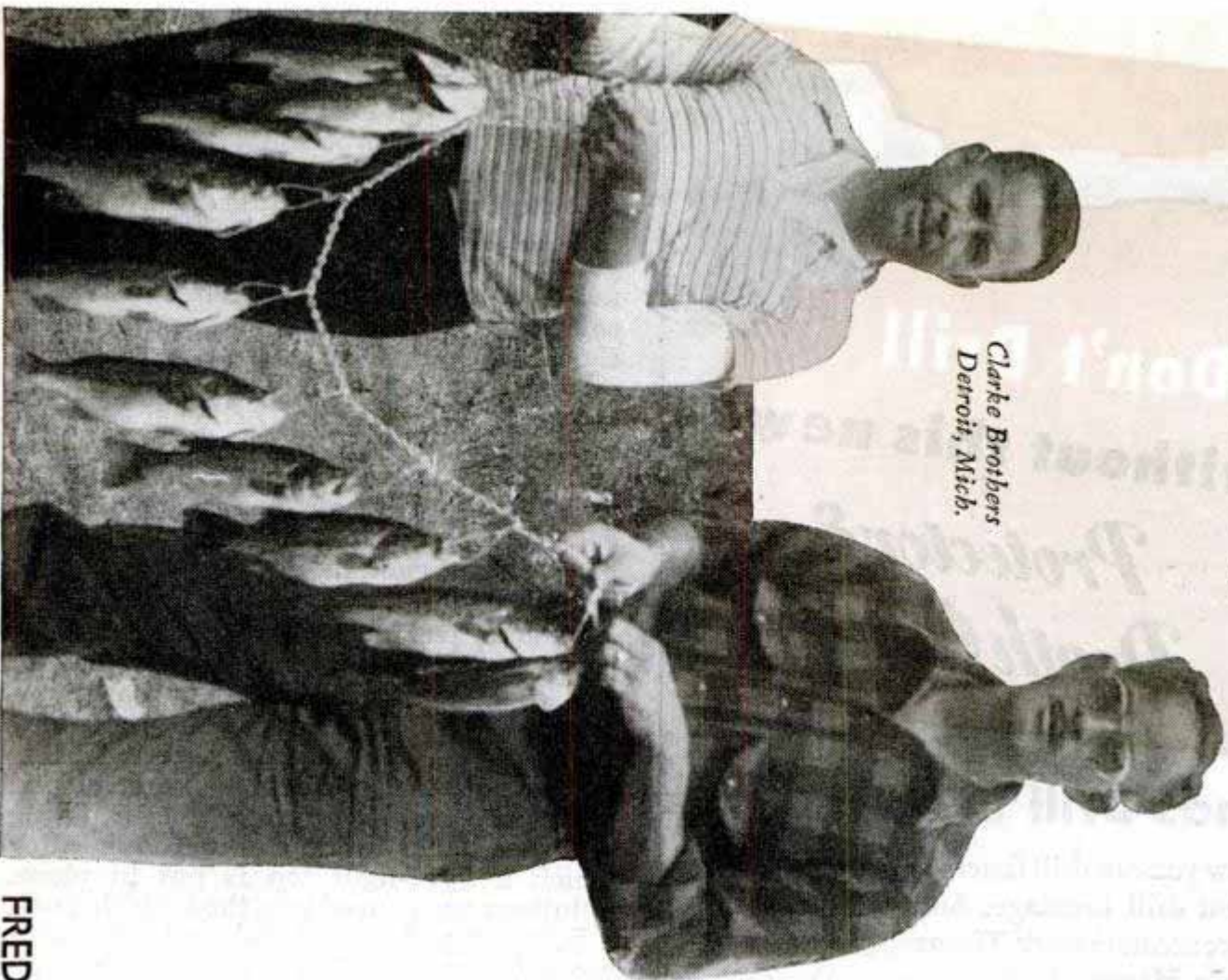

*Clarke Brothers
Detroit, Mich.*

"Dear Fred—I was using a frog finish Jitterbug and my brother a scale finish Jitterbug when we caught this limit of Michigan largemouths from Power Dam Lake on the Betsie River in Benzonia County. Thought you would like to know that my gang are now all 'Jitterbuggers'."—*Dr. Maurice W. Clarke, Detroit, Mich.*

SEND FOR FREE CATALOG

Gives all the latest information on Jitterbug, my famous surface bait, plus my family of Hawaiian Wigglers.



\$1.21

FRED ARBOGAST & CO., 1621 W. North St., Akron 3, Ohio



Don't Drill
without this new
*Protector &
 Depth Gauge*

Ends Drill Breakage

Now you can drill faster—and not worry about drill breakage. And you can do more accurate work. The new, precision-made Hartwell Protector & Depth Gauge reinforces drills, prevents them from bending or breaking. It is also a *depth gauge* and *stop* . . . can be used to measure depth of holes or to limit travel of your drill when you are drilling through thin material. It is available in 15 selected sizes, 1/16 through "F", and fits standard drill chucks.

HARTWELL Engineering Company

Designers • Manufacturers • Distributors
 3417 Crenshaw Boulevard • Los Angeles 16, Calif.

FREE: "Home Drilling Guide" for users of breast and portable power-driven drills. Write to above address.

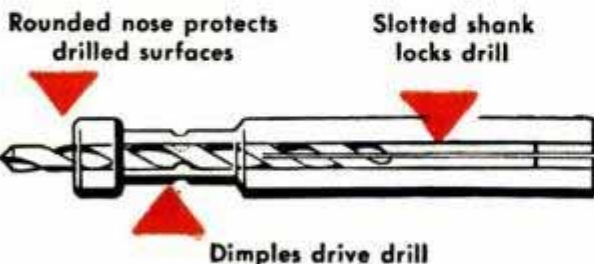

GET IT AT YOUR HARDWARE STORE

It's Time to Open the Shutters

(Continued from page 48)

Here is a stunt for making color prints in half the usual processing time, if your camera uses cut film. Cut a piece of color printing paper to size in the darkroom and load it in a holder, then expose it just as if you were using regular film. The exposure needs to be several times more than with color film so you should make several test shots, recording the data for each, to determine the proper exposure. Color papers are designed for use with artificial light and so if you photograph an out-of-doors scene you should use a correction filter of the type required when exposing "indoor" color film outside. After exposing the color paper in the camera, develop it according to the standard directions for its type.

The new techniques that are required for processing color materials are leading to the designing of much new darkroom equipment, one item of which is a rotary development tank for color papers. In this machine the color sheets to be developed are locked onto the perimeter of a plastic reel that hangs inside a round tank, after which a light-tight top is put in place. Solutions are poured into the tank through a light-trapped funnel and drained with a hose. A motor outside the tank rotates the reel, providing even, positive movement of the color material through the liquid bath. The tank permits use of minimum amounts of solutions. Its interior is rubberized to avoid contaminating the solutions.

General Purpose "Sound" Amplifier

(Continued from page 143)

The single insulated conductor then is soldered to the small socket prongs which are connected by means of a jumper wire. The shielded lead to the amplifier plug should be no longer than necessary, as the amplifier is placed near the projector. A 25-ft. two-conductor rubber insulated cable is used to connect the speaker, which is housed in a standard speaker cabinet that may be placed either at the side or directly behind the movie screen. Any good 6 or 8-inch permanent-magnet speaker may be used; the push-pull output transformer in the amplifier is a universal tapped type.

Solder all connections carefully, especially the ground connections made on the chassis base. The green 6.3-volt heater leads H and H go to the socket terminals marked H to connect the tubes in parallel just as shown in Fig. 4. The power trans-

(Continued to page 156)

...look **SHARP**.....
...feel **SHARP**.....
...be **SHARP**.....

use **Gillette**

**Blue
Blades**

with the
SHARPEST
edges
ever honed!



Copr. 1946 Gillette Safety Razor Co.

GILLETTE'S CAVALCADE OF SPORTS presents the major boxing event of the week every Friday night over American Broadcasting Company stations at 10 o'clock E.S.T.

Gillette Safety Razor Company, Boston 6, Mass.

NO NEED OF THIS . . .



This gentleman is the inventor of the "inside-outside" pipe. (From an old print)

**WHEN YOU'VE GOT
A SWEET SMOKING**

**LHS
STERNCREST
STERLING**

There are no tricks nor hocus pocus in pipe-making. All you need are the finest materials, a style sense, and pipe "know how". LHS has them all. You can own an LHS from \$1 to \$10. At your dealer's.



\$5

Model No. 46.
Plain Finish.
Dozens of
other hands
some model-
in Plain or An-
tique Finish.

**IMPORTED
BRIAR
STERLING
SILVER
BAND
BUY VICTORY BONDS**

- Other LHS Pipes
- LHS Sterncrest Ultra-fine . . . \$10.00
 - LHS Sterncrest 14K . . . 7.50
 - LHS Certified Purex . . . 3.50
 - LHS Purex Superfine (Domestic Briar) . . . 1.50



Write for "Pipes
—for a world of pleasure" FREE.

L & H STERN, INC., 56 Pearl Street, Brooklyn 1, N. Y.

former is a half-shell type having a 420-volt center-tapped H.V. (high-voltage) secondary winding, a 6.3-volt 3.5-amp. tube heater winding and a 5-volt 3-amp. winding for the rectifier tube. Do not use a power transformer with higher voltage than the 420 volts specified in this type of circuit. In other words, do not exceed 210 volts each side of the center tap. This is a comparatively inexpensive type of audio amplifier but the results were highly satisfactory and the volume is sufficient for the average size room where home movies are shown.

A small stroboscope disk which appears on the projector in the photo at upper right on page 143 is entirely optional, but it provides a means by which the operator can adjust the speed of the motor so that segments appear to be stationary when the film travels through the projector at exactly 24 frames per second. The disk is 1 1/8 in. in diameter and is made of white cardboard glued to a thin metal disk which is mounted on the end of sprocket shaft E. The black and white segments are equal in number. In this case there were 13 of each and the film speed is slightly less than 24. Actually there should be 12 of each to obtain a more accurate speed reading in this particular case. There is a perforation hole for every frame, and sound film travels 24 frames per second, therefore 24 multiplied by 60 equals 1440 frames per minute. Sprocket E has 5 teeth, therefore 1440 divided by 5 equals 288 r.p.m. A small neon lamp operating on the 110-volt 60-cycle line is mounted on the projector frame in front of the disk. As the number of light flashes are 60 per second there will be 3600 flashes per minute; this divided by the r.p.m. (288) indicates 12 segments. Detailed student material list R-340, including both the sound head and amplifier components, is available from Popular Mechanics radio and electronics department upon receipt of ordinary letter postage.

Wall Plug Serves as Night Light

A new wall plug serves as a combination safety pilot or night light, convenience outlet and appliance cord cap. A tiny bulb inside the plug emits



a soft glow through the front of the unit for convenience in locating the receptacle in dark locations. The plug can be adapted as a cap for the end of a cord to an electrical device.

Most makes of power tools look alike — but . . .
advanced engineering features of
DELTA-MILWAUKEE POWER TOOLS
mean greater operating satisfaction

1 Lubricated-for-life Ball Bearings. You don't have to worry about oiling these bearings — they're *lubricated for life* when they leave the factory. And they are *double-sealed* against harmful dust, to assure you of longer bearing life.

2 Pre-loaded Bearings. This is the result of an extra manufacturing operation that reduces the "play" in the bearings, to help you enjoy long-time operating efficiency and accuracy.

3 Precision-bored Bearing Seats. These bearing seats help keep all parts lined up properly, so that you have greater assurance of producing finished pieces exactly according to dimensions.

4 Precision-ground Shafts. These are shafts built to run without any "wobbling" which might throw off your measurements.

5 Dynamically-balanced Pulleys. The pulleys which transmit the power from your motor to your power tool are balanced to help eliminate annoying, damaging vibration.

Ask your Delta dealer to let you know when he receives his first shipment of these famous power tools. Then, see how they are built to help assure you of accuracy, dependability, safety, economy. Or place your order with your dealer now, so that you can be among those to receive delivery at the earliest moment.

**A Whole Year of Woodworking
 Fun, Projects, and Ideas**

for only **50¢**

. . . in THE *Deltagram*

**. . . the popular, plan-packed
 homecrafters' magazine**



Delivered to your home six times a year. Page after page of fascinating, shop-tested plans and projects helpful in producing beautiful objects your friends admire. Ideas, news, shop tips on performing woodworking operations more easily, more quickly, more safely. Crystal-clear, step-by-step instructions in



words and pictures.

The new subscription year for The Deltagram has just started. By subscribing right now, you're still in time to receive the first new issue. Fill out the coupon below and mail it today with coin, postal note, or money order. Only 50¢ for all six exciting issues!



TEAR OUT COUPON AND MAIL TODAY!

THE DELTA MANUFACTURING COMPANY
 681 A E. Vienna Avenue, Milwaukee 1, Wisconsin

Enclosed is 50c in payment for a full year's subscription to The Deltagram.

Name.....
 Address.....
 City..... (.....) State.....

NEXT TIME SAY BRIGHT STAR

and you will get a
FLASHLIGHT & BATTERIES
famous since 1909
for QUALITY,
STYLE and
SERVICE



BRIGHT STAR BATTERY CO. CLIFTON N. J.

FIDO Fights Fog

(Continued from page 15)

and by the Massachusetts Institute of Technology and Columbia University. The final tests are being made by a staff of experts under the direction of Lieutenant Robert L. Champion, Navy fog dispersion authority. One possibility is the finding of a way to clear the air over the deck and to the lee of a carrier that is running in dense fog. Another possibility is the perfection of an inexpensive method of fog dispersion suitable for use at air line terminals.

Using sonic generators to turn fog into rain to increase visibility is one thing being done at Arcata that disputes Mark Twain's remark that everybody talks about the weather but nobody does anything about it.

Sonic generators are immense sirens that produce a tremendous roar. Such sirens with giant wooden horns were audible 90 miles away when mounted on a California mountain top in one series of tests. A person's eardrums would be broken if he walked in front of one of these sirens. Birds are knocked out of the air a block away. The noise tingles the soles of your feet when standing beside the machines.

Tests so far show that the sonic method can create almost 100 per cent increase in visibility; that is, visibility of 100 yards is increased to 200 yards after the generators are turned on. The intense vibration bumps fog particles together, forming rain and decreasing the amount of fog in the air. At Arcata, six sonic generators are banked at each side of the runway at the windward end and will be tested for fog dissipation and for preventing the encroachment of fog on the runway. Not at all comparable in efficiency with heat at present, the sonic generators are objectionable for commercial installation because of their noise.

Ejecting a long thin wind curtain of hot air up from the ground to evaporate fog as it drifts toward the field is another idea that Lieutenant Champion and his staff will try out. Somewhat similar will be a water curtain in the form of a vertical sheet of spray that is shot 100 feet into the air to absorb fog particles as they are brought in by the wind. As much as 50,000 gallons of water per minute may be sprayed into the air experimentally, an amount that might create drainage problems at some fields but that probably would be no problem for most marine installations.

Powdered drying agents also will be sprayed into the air to observe their effect on fog. Some of the desiccants are known

(Continued to page 160)

VanRoy

with the new

Ajustomatic STEM

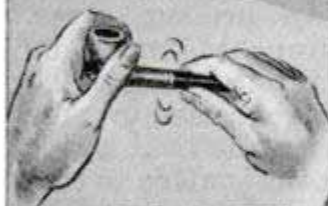

FREE-TURNING



SELF-ALIGNING

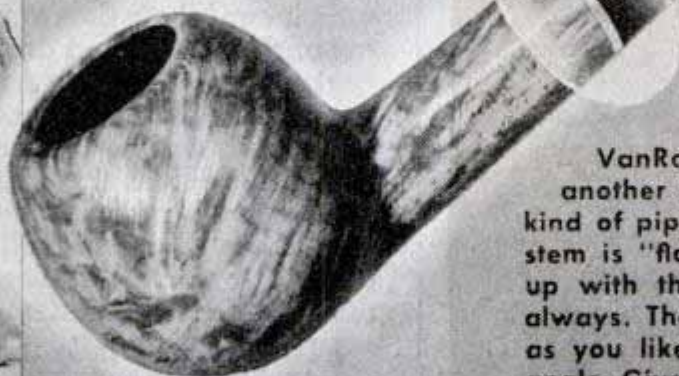

*The one and only
Pipe of its Kind*

VanRoy Ajustomatic is more than just another screw-stem. It is a totally new kind of pipe. New—because the patented stem is "float-mounted"—accurately lines up with the bowl as straight as a die, always. The stem can be turned as often as you like—it will never lock at an off angle. Give yourself, or another, the proud satisfaction of owning this latest—and greatest—achievement in VanRoy pipes.



SIGNET OF QUALITY IN PIPES

VANROY COMPANY, INC., Empire State Building, New York 1



Useful
TOOLS

SET
T-52
**Deluxe
Electrical
Ignition
and
Radio Set**

All For \$13.00
List Price

See your dealer or write us

SPINTITE SET

A Positive Need in Every RADIO, HOME and ELECTRICAL SHOP.

Contains Chuck Type Handle, Reamawl, 3 Screw Drivers, 2 Pliers, 7 SPINTITES and Insulated, Neutralizing Alignment Wrench.



STEVENS WALDEN, INC.

WORCESTER 4, MASSACHUSETTS

**MORE VERSATILE
THAN EVER**

**BURGESS
vibro-tool**
Trade Mark Reg. U. S. Pat. Off.

Gives power to your craft skill in embossing, tooling, carving, slicing, engraving, and a host of other craft and shop jobs where "hand work" quality is desirable.

Operates by vibration, 120 strokes per sec.; 110 V AC, 60 cycles.

The Vibro-Tool, complete with engraving needle \$7.50; with all attachments \$10.90.

SEE YOUR DEALER TODAY
Or Order Direct
HANDICRAFT DIVISION
BURGESS BATTERY COMPANY
166 N. Wabash Ave. • Chicago 1, Ill.



STOP DUST

It is no longer necessary to put up with a dirty room every time you sweep the floor. By sweeping with a Dustless brush, which makes its own sweeping compound as it sweeps, you can eliminate up to 97% of germ laden dust in the air between sweepings. You can also do away with costly sweeping compound and cut labor costs. Thousands of factories, shops, offices, schools, and stores now use Dustless sweeping. Get complete facts about this better method of dust control. Write today.



- Dustless
- Speed Sweep
- Speed Wash brushes

Dustless
DOES MORE FOR LESS

MILWAUKEE DUSTLESS BRUSH COMPANY

528 N. 22nd Street • Milwaukee 3, Wisconsin

to be effective although some also are extremely corrosive to aircraft metals. High-intensity lights are to receive a thorough testing for their fog-penetration qualities. All these ideas will be tried separately and in combination with each other and with the FIDO installation. The field also is one of the main test stations for new types of radio and radar landing aids.

The FIDO apparatus at Arcata consists of test lengths of different designs of burners, some of which are high-pressure types, some carried in open trenches, and some which emit their flames through slots in the ground. One slotted design is used to cross taxi runways leading from the field and is provided with quick shut-off valves so that the flames can be turned off when a plane is taxiing across the flame line. Each unit of burner length has its own electrical ignition and each is controlled from the field's control tower. A typical burner line creates a solid bank of flames two feet high.

FIDO burns a hole through several hundred feet of fog in five minutes and requires about 20 minutes to open up a large hole through 2000 feet of fog during a high wind. High winds, however, are not often associated with dense foggy conditions, nor is an unlimited ceiling necessary for normal visual landings after the heat has created a down-wind visibility of several miles with a ceiling of several hundred feet.

The cost of operating FIDO still amounts to several hundred dollars for landing one airplane, but Arcata is testing a new high pressure burner that uses Diesel fuel oil. Developed by Babcock & Wilcox Company, the Diesel oil burner may reduce fuel costs to \$150 per plane and possibly twice that amount for keeping a field open long enough to bring in a number of planes.

Atomizing the fuel instead of vaporizing it, the Diesel fuel installation operates at pressures up to 1500 pounds per square inch and produces an intense bushy flame with a minimum of smoke under adverse wind conditions. The nozzles, small steel tubes, are buried almost flush with the ground and require only simple bar guards for protection.

Air terminal and air line officials are interested in this development. A FIDO installation that burns inexpensive fuel oil instead of high priced gasoline may make it possible to operate air liners steadily on schedule in any weather.

At least 96 percent of all American colleges and universities now recognize aeronautics as an elective science, and about half the schools accept it as a laboratory science for entrance requirements.

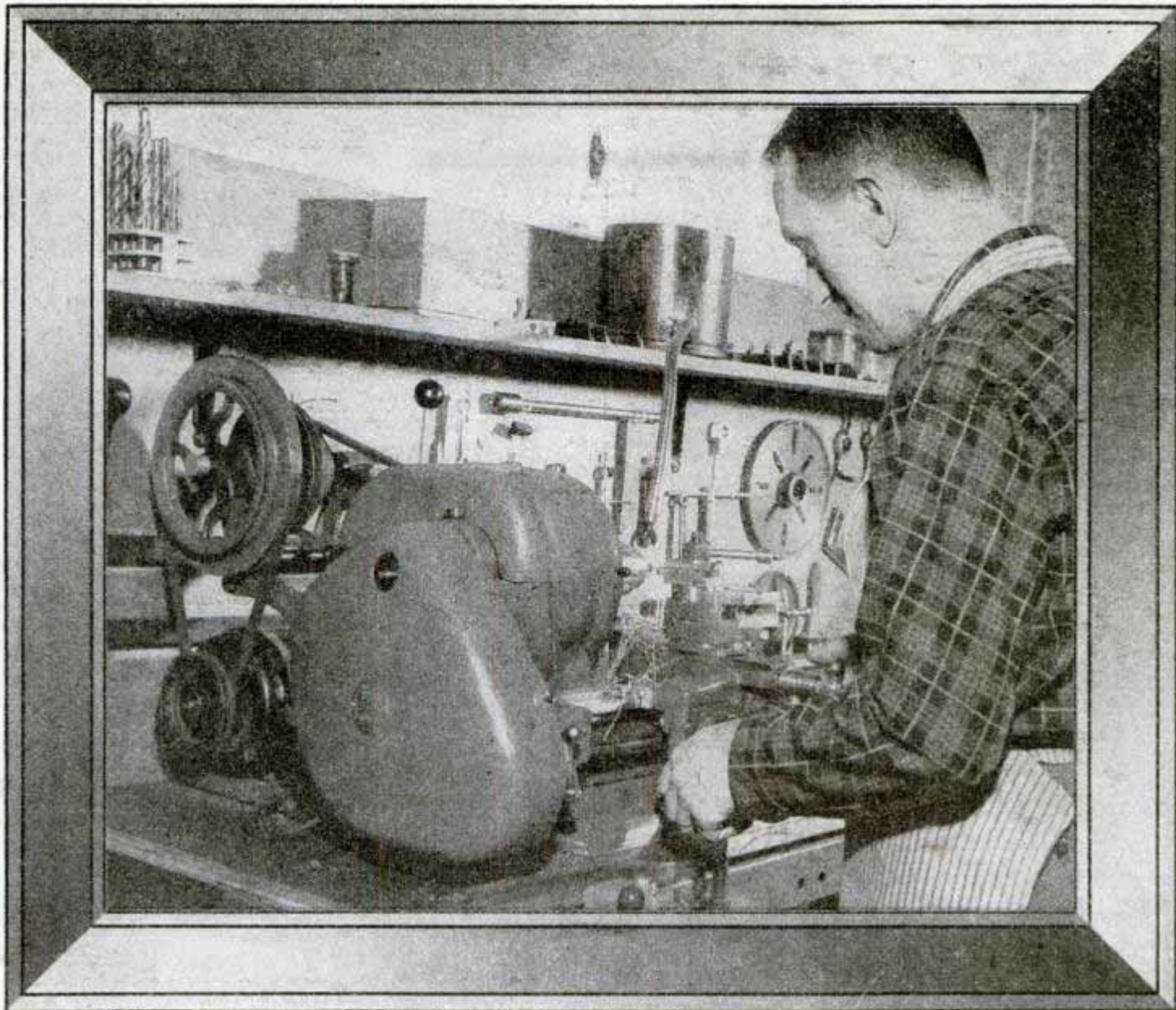

Portrait of a **HAPPY MAN!**

Relaxation and recreation to the hum of busy tools . . . making useful things for home or business . . . making quick repairs to home equipment — you're lucky if you have such a practical hobby!

Atlas tools will be available soon to help you equip your shop — at exceptionally low cost — for every project you want to undertake. They will give you the precision you need for close tolerance work — the strength required for heavy cuts. They are tools designed in every way to help you make the

most of your mechanical skill and ability on useful home projects.

Ask your distributor to let you know when you can see and operate Atlas tools in his showroom.



SEND FOR FREE CATALOG

You can get a preview of what to expect by sending for this new 64-page Atlas catalog. Hundreds of illustrations of special tools and operating views. Write for your copy today. Atlas Press Company, 143 N. Pitcher St., Kalamazoo 13D, Michigan.

Atlas 4 TOOL TEAM

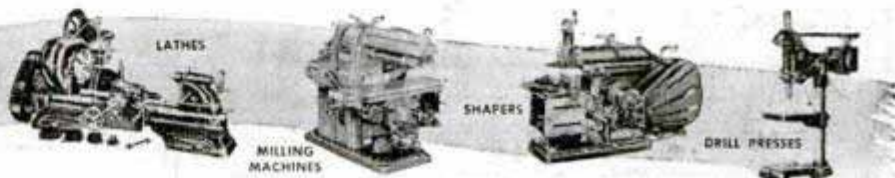

4-WAY ACCURACY

with a
Streamline
rule...



**CALIPER
SCRIBER
HEIGHT GAUGE
INSIDE MEASURING**

With the **MASTER Streamline Steel Tape Rule** you get **FOUR** accurate measuring instruments in one. The flat bottom case with the positive lock, and the six or eight-foot steel rule with markings on both sides, makes this precision tool the ideal for all-round shop or drafting room work. The extra long "claw" on the tip anchors the rule when making out-of-reach measurements.

All first-class hardware dealers carry the **STREAMLINE**. Or you can order direct from **MASTER** by using the coupon.

MASTER

WOOD AND TAPE RULES

TRADE MARK

MASTER RULE MFG. CO., INC.
815 E. 136th St., New York 54, N. Y., Dept. F1
Branch: P.O. Box 1587, Oakland, Cal.
Enclosed find \$2.65 for the new 6 ft. "Streamline" complete with spare blade.

NAME _____
ADDRESS _____
CITY _____ STATE _____

Long Distance by Short Wave

(Continued from page 4)

automobiles and stationary phones. The conversation travels part of the way by low-powered radio sets and part by telephone wire. Another development, which does not involve radio, is a long distance dialing system which speeds service. The operator who takes your call can dial directly a telephone in a distant city without assistance of other long distance operators.

With their far-reaching experiments in the transmission of sound, Bell engineers have succeeded in making pictures of sounds. This "visible speech," heralded as an aid to the deaf, uses a cathode ray tube and screen. Sound pictures forming words appear in wavy patterns. The graph for the word "sure," for example, resembles an airplane in a dive. After a period of training, a deaf person can carry on a rapid telephone conversation by reading the phonetic graph. This innovation is the result of research spurred by the war and is therefore a distant cousin of radio relay.

The International Telephone and Telegraph Corporation, pioneer in radiotelephony, has developed a relay system which permits 24 two-way conversations at the same time on a single radio-frequency carrier wave. The wave is beamed by giant eight-foot "saucers," or parabolic reflectors, mounted on towers or high buildings. With relay towers placed at 30-mile intervals, a single circuit can cover thousands of miles. I. T. & T. engineers report successful application of their system to broadcasting of sound-color-television programs.

A feature of the radio relay system devised by the Radio Corporation of America is an automatic relay tower. It turns on and off automatically to transmit and receive every signal and requires no attendants at relay stations. This system will be used by the Western Union Telegraph Company in a 62 million dollar relay system which will link major U. S. cities. Experimental networks between New York, Washington, Pittsburgh and Philadelphia would permit the removal of 2500 miles of pole lines carrying 54,000 miles of wire, and 180 miles of aerial and underground cables. High-frequency radio beams can carry many more messages than the wires they will replace—1080 messages at one time.

Although radio relay is still experimental for domestic use, it is far from experimental as far as the Army and Navy are concerned. Its military designation, AN/TRC, means Army Navy Transportable Radio Communication.

(Continued to page 164)

*And its styling
will stay smart!*

Fresh, eager, youthful—the new 1946 Ford is the smartest Ford ever built. From bright, massive grille to colorful, two-tone interiors—it's every inch a beauty . . . Advanced in style—and in comfort, performance and economy, too. Here's a car with new multi-leaf springing for a smooth, level ride. A car with new hydraulic brakes—extra-large and self-centering—for quick, smooth, quiet stops. And here's a car with new stepped-up power—plus new over-all economy. Two great engines to choose from: the V-8, now increased from 90 to 100 horsepower—the 90 horsepower Six . . . See this smart new 1946 Ford at your dealer's now.

FORD MOTOR COMPANY

Tune in . . . THE FORD SHOW . . . CBS, Tuesdays,
10-10:30 P. M., E. S. T. THE FORD SUNDAY EVENING
HOUR . . . ABC, Sundays, 8-9 P. M., E. S. T.

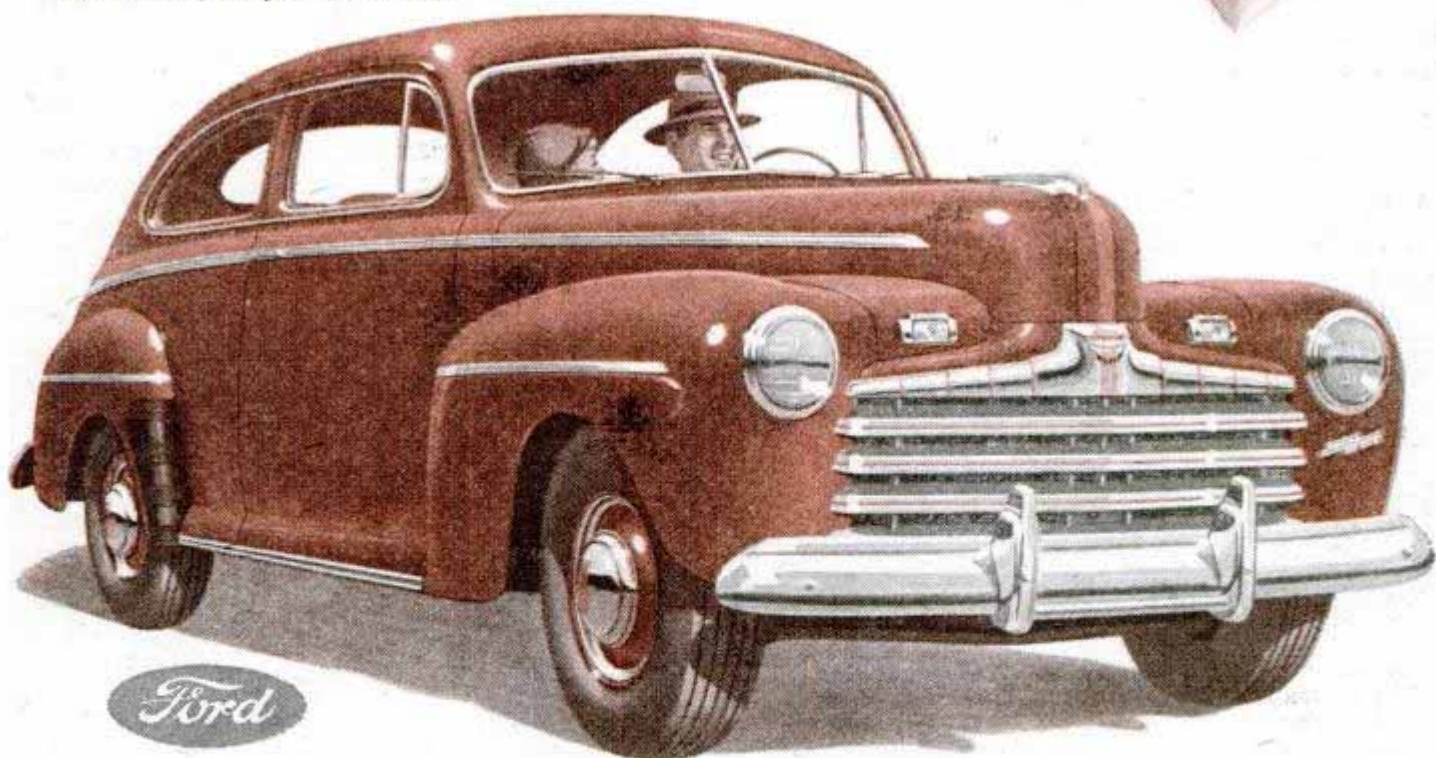

There's a Ford in your future!

YOU'RE NATURALLY
MORE

Confident



WHEN YOU LOOK YOUR BEST

You know how people talk about the fellow with the "porcupine" hair. Be careful this never happens to you! Now it's so easy to keep your hair smartly and neatly well-groomed *all day long* with Glover's Imperial Hair Dress. Try the one-minute massage tomorrow morning with Glover's Hair Dress and see the difference in more *natural-looking* softness that makes you feel sure of yourself. NON-ALCOHOLIC to avoid scalp dryness... ANTISEPTIC for clean, *protected* scalp! Ask for Glover's at any Drug Store or Drug Counter—or mail the Coupon today!

GLOVER'S *Imperial* HAIR DRESS

FREE
TRIAL SIZE



Send Coupon for Free Trial Size
—with easy instructions for the
famous Glover's 3-Way Medicinal
Treatment and FREE booklet,
"The Scientific Care of the Hair."

MAIL COUPON

Glover's, 101 W. 31st St.,
Dept. 1A1, New York 1, N. Y.

Send Free Trial Application package in plain wrapper by return mail, containing Glover's Imperial Hair Dress, GLO-VER Shampoo, and Glover's Mange Medicine in hermetically-sealed bottles, with informative FREE booklet. I enclose 10¢ to cover cost of packaging and postage.

Name _____

Address _____

City _____ Zone _____ State _____

Radio relay first was used by the Signal Corps in April 1943 to connect headquarters in Algiers with Tunisian combat areas. In Sicily, the radio links were invaluable because the enemy had destroyed all the line-wire circuits on the island. The first multichannel radio sets were introduced during the invasion of Normandy. They carried four simultaneous voice circuits, any one of which could be used to transmit four teletype signals.

When General Patton's Third Army swept across France there was no time for laying wires, and ordinary single channel radio, which naturally offered no additional facilities for telegraph, teletype and facsimile, could not do the job. The answer was portable radio relay stations which spanned rivers and desolate countryside.

"Our rapid drive across France was dependent upon a shoestring," said General Omar Bradley recently. "That shoestring was radio link."

The relay station network that began in France followed the armies over the Siegfried Line, made it possible to establish communications across the Rhine after the Remagen bridge break-through, and even maintained contact with our troops trapped in the famous Battle of the Bulge.

Radio relay played an equally important military role in the Pacific. It linked fighting units of soldiers, marines and sailors all the way from Guadalcanal to Tokyo. Telephone messages, teletype, photos and maps were flashed by radio beams over tropic jungles where wire communication was impracticable. The craftiest Jap in the jungle couldn't sever a radio beam.

At H-hour plus 2, an LCM landed radio relay equipment on the beach of Leyte Island. A half hour later, communication had been established with a Command Post Fleet (ships converted into communication centers). At H-hour plus 5 General MacArthur came ashore and broadcast his "I have returned" address over radio relay which was picked up and rebroadcast to the Philippines. Later in the Luzon campaign, radio relay sets carried 75 percent of the military telephone and teletype traffic.

The men whose lives depended on radio links during the war freely predict that the folks at home will find it just as useful as they did—and in the near future.

☞ Baby chicks are kept warm in brooders with an electrical rubber pad developed by the U. S. Rubber Company. The pad, which is made to conduct electricity by the addition of chemical compounds, diffuses heat evenly to all parts of the brooder, and a thermostat keeps the temperature uniform.

MAKE MORE MONEY

APPLYING OR SELLING

CORKSTONE PLASTIC FLOORING

EASY TO APPLY

Here's your opportunity to get into business for



yourself applying or selling Corkstone, the economical, top-grade plastic flooring. Plenty of profit. Act without delay!

Dealers & Agents Wanted

WRITE FOR DETAILS OF OUR PROPOSITION

We believe in teamwork and cooperation. We'll help you get started. No cost; no obligation. Act today!

LASTING PRODUCTS COMPANY

MANUFACTURERS OF PAINTS, PUTTIES, PLASTICS
FRANKLINTOWN ROAD PLANT, BALTIMORE 23, MARYLAND

This Complete Home Workshop

\$34⁹⁵

5 LATHE
DRILL
PRESS
CIRCULAR SAW
EMERY WHEEL
SANDER

Durable! Powerful! Heavily Built!
Five power tools in one compact unit. Fabricated steel construction with high quality bronze bearings. Lathe 37" between centers. 6" or 8" circular saw. Drill press pulls 1/2" drill in steel. Uses 1/4 H.P. motor. Designed to handle all types of home woodworking jobs. Get the facts now before prices advance. Write Today!

EMRICK MACHINE CO.
1602 FULFORD ST.
KALAMAZOO, MICHIGAN

Write — FOR LITERATURE



WEEKLY WORLD FLIGHTS INAUGURATED BY ATC

Utmost Reliability Again Demonstrated by
ATC Globesters and AC Spark Plugs



In the record-breaking time of 149 hours and 44 minutes, the Globesters of the Air Transport Command raced 23,279 miles, to chart the world's first regularly scheduled 'round-the-world' air service, September 28 to October 4, 1945.

AC Aircraft Spark Plugs played an important part in that history-making flight, just as they did in the Constellation, Stratocruiser, and the 4 Japan-to-Washington B-29's.

Ceramic Aircraft Spark Plugs were originated and built, solely by AC, for the Liberty Engines of World War I. They were the outgrowth of AC Ceramic Spark Plugs for automotive use. These automotive plugs have been factory equipment on 2 of every 4 new cars and trucks since 1932.

AC's are everywhere chosen for *utmost reliability*. So,—especially since better gasoline and normal driving require a change in plugs,—follow this lead for greatest spark plug satisfaction.

AC SPARK PLUG DIVISION
GENERAL MOTORS CORPORATION



Aircraft Spark Plug



Automotive Spark Plug

AC

SPARK PLUGS

HELP FIGHT INFLATION—BUY VICTORY BONDS



Build
a profitable
business
quickly with...

HOBART "Simplified" arc welding

They Bring in the Big Pay
Jobs to Hobart Owners
You're equipped to do all kinds
of jobs when you have a Hobart
welder — you're not limited to
just a few types of work. Used
by the U. S. Army and Navy. If
you were in Service you'll un-

derstand why. With Hobart you'll be able to demand higher
prices because it's really easy to get both speed and quality
with Hobart "Simplified" Arc Welding. Some reasons are:

DUAL CONTROL. Gives choice of 1000 combinations of voltage
and amperage, offering you the exact welding heat for every
type repair or construction job. Guarantees superior weld!

REMOTE CONTROL. Another exclusive Hobart feature that lets
you control the welding heat at the work—no matter how far
away it may be from the welder. Speeds up welding!

IT'S SIMPLIFIED! It's surprising how quickly one can learn to
obtain professional welds with
Hobart "Simplified" Arc Weld-
ing. Nothing is complicated to
do or understand—another
reason for the big success of
Hobart Welders. Clip coupon
now. Let us tell you about it.

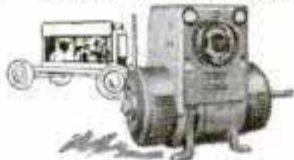

**YES, YOU CAN "BUILD YOUR OWN" Hobart Gas
Engine Drive Arc Welder**

With a Hobart generator and
easily-obtained auto parts you
can build your own gas drive
arc welder that lets you go out
after every welding job right
in the field—and save hundreds
of dollars, or you may purchase
a complete factory-built unit.
Clip coupon for the details.

HOBART BROTHERS CO.
BOX M-161, TROY, OHIO
"One of the World's Largest
Builders of Arc Welders"



Free!
Valuable "Vest
Pocket Guide"
Mail coupon.

REACH FOR YOUR SCISSORS
HOBART BROS. CO., BOX M-161, TROY, O.

Send me information on
the Hobart "Simplified"

Arc Welder—without obligation. Also items I've checked.

Vest Pocket Guide Booklet Info on Welding School
 Info on "How to Build Your Own"

NAME _____

ADDRESS _____

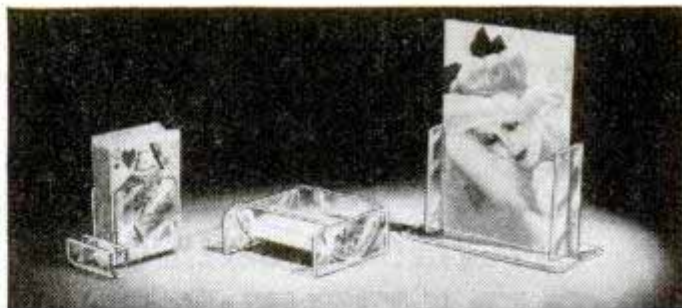

PLASTIGS Assembly SET \$3.95

Earn Big Profits at Home NOW!

Learn to manufacture fabricated Plastic Items!

Our sets and simple instructions open the
doors to this new *Big Earnings* field. **Get
in on the ground floor! Earn while you
learn! Make beautiful gifts with our sets!**

A complete package of plastic materials—
jigs—instructions to go with each set.
Special introductory offer postpaid, \$3.95
each set.

OTHER COUNTRIES, \$4.60

THERMO-PLAST CO.

Dept. C

737 Venice Blvd., Los Angeles 15, Calif.

KEEP WARM! SAVE FUEL!

Mortite



Seal your home against drafts and cold, stop
those expensive heat leaks! It's easy with
MORTITE, the pliable, plastic tape which
goes on quickly, is effective immediately.
You need no tools to apply. Simply press
MORTITE into place around windows, doors,
baseboards, etc. You'll be surprised at the dif-
ference it makes. MORTITE also keeps out
dust and dirt, fills cracks, etc. Roll, about 80
ft., is enough for 5 windows.

\$1.25

Higher cost of
Rockies & Canada

Get MORTITE at hardware, paint,
dept. stores and lumberyards.

ASK FOR FREE J. W. MORTELL CO.
MORTITE CIRCULAR 522 Burch St., Kankakee, Ill.

SIMPLIFY HOME WOODWORKING!

LOCATE DOWEL HOLES EASILY...

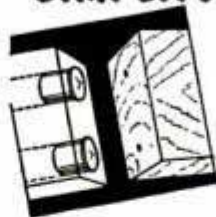

KENKRAFT Metal Dowel Centers leave clear,
accurate impressions on mating piece. Mating holes
easily drilled to accurate
fit. Made for 1/4", 3/8"
and 1/2" dowels. Two of
each size prepaid \$1.00

KENKRAFT
808 5th - MANHATTAN BEACH, CALIF.



NEW "CHATHAM"
EXTRA EARLY TOMATO

Best of
all early toma-
toes, big, rich, firm
fruits. **EXTRA EARLY**
for outdoor planting in
short season climates.
The Chatham is a wonder. Try
it this year.

15¢
PKT

**WILL'S PIONEER HOME
GARDEN**
Everything you want for
your garden—and lots
of it. Will's own hardy,
heavy yielding Beans,
Peas, Beets, Cabbage,
Radishes, Sweet Corn
and 12 more you'll be
proud to show! A \$2.20
Value At Special Price—
18 BIG \$1.50
PKTS. POST PAID

**FREE WILL'S 1946
SEED BOOK**

Wonderful Big, New 1946 Catalog. Pic-
tures in colors, rotogravure, etc. 63rd
YEAR. WILL'S hardy Northern Grown
Flowers, Fruits, Vegetables, Trees, Nurs-
ery Stock and Farm Seed. Many new
novelties—all the good old ones, too.
Write today—It's FREE.

OSCAR H. WILL & CO.
Box 645 Bismarck, No. Dak.

FROM $\frac{5}{8}$ TO 2,200
HORSEPOWER

CONTINENTAL *Red Seal Engines*



Here's Tiny Tim, Mighty Atom of the Red Seal Family. Gives Light and Power wherever you go — Farm, Camp, Wilderness. Light in weight, easily carried. A self-starting portable electric generator always at your service. It's $\frac{5}{8}$ H. P. Two-quart self-contained gasoline tank holds enough to run engine eight hours.

And here's the C-75-85 (horsepower) Aircraft Engine which powers most light planes. Dependable, economical—4-cylinder. It's the improved 1946 model of famous Red Seal "A" Engines which made flying possible for thousands. Other engines in the Continental family range up to the I-1430 aircraft engine of 2,200 horsepower.

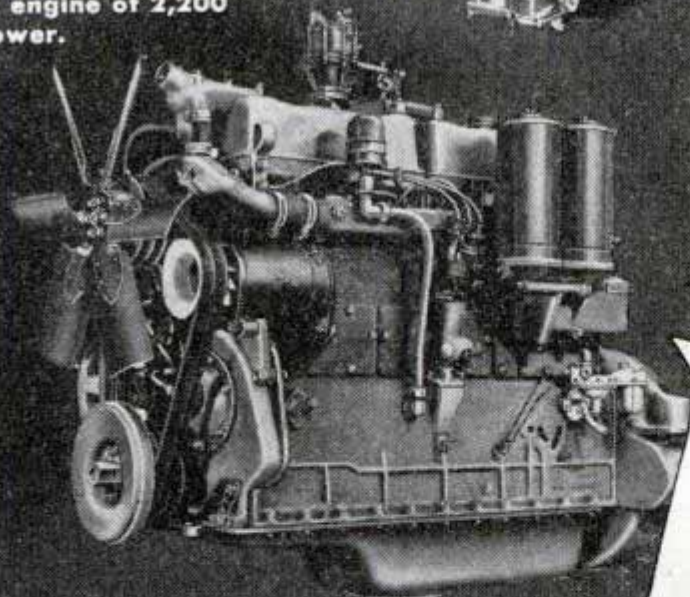
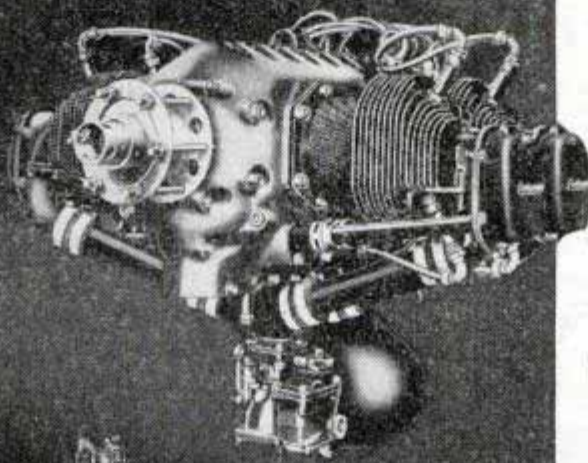

Or if you are looking for a rugged "workhorse" engine for powering trucks, buses, earth movers, compressors, cranes, air conditioning or refrigeration units, this 140 H.P. R-600 Red Seal engine will do your job reliably and economically.

Continental Motors Corporation
MUSKEGON, MICHIGAN



Adaptability! Another great Red Seal characteristic — Continental powered Flight Deck crash cranes that hauled crippled War Birds out of danger's way aboard Aircraft Carriers.

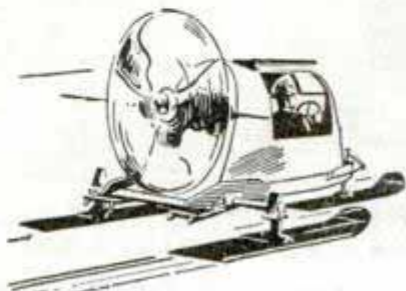

For the thrill of a winter-time, this Snow-mobile glides swiftly over the white horizon, with Red Seal powering the airplane propeller at rear.



To the rescue in an Army-Navy Swamp Glider . . . Just another call on Continental versatility . . . and a Red Seal Engine, plus airplane propeller, gets this speedy craft in and out of difficult waters.

POWER BY

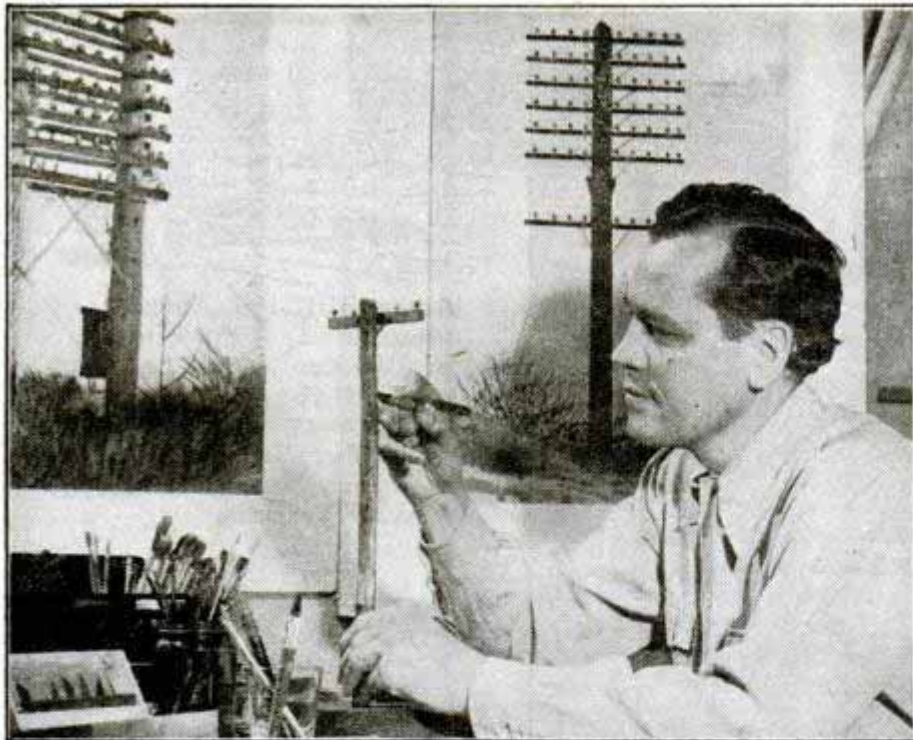
Red Seal
Engines
CONTINENTAL



"IT'S A SWELL LITTLE KIT!"
says Saturday Evening Post cover artist

*Dohanos Uses X-acto Knives
for His Work and for His Hobby*

Of course you, and several million other Americans know and admire the handsome covers which Stevan Dohanos does for the Saturday Evening Post. But we bet not many of you knew before that lots of those scenes Mr. Dohanos paints are constructed in miniature first with the aid of his trusty X-acto Knife!

Mr. Dohanos has a talent for seeing beauty in the commonplace things around him. His special hobby is glorifying such simple objects as fire-plugs, telephone poles, and other characteristic ingredients of the American landscape.

Often (note the photograph above) Mr. Dohanos' hand-carved miniatures serve as subjects for his easel paintings. And this is where his X-acto Knives come in so handy, he says. They're sharp and easy-cutting, with

plenty of just-right blades for intricate detail work.

"I've used X-acto for years," says Stevan Dohanos, "for work and for fun. It's a swell little kit!"

Make Your Own Fun
These Booklets Tell You How



It's fun to make things yourself. And so easy with scalpel-sharp X-acto. Send for these two helpful booklets and enjoy the long winter evenings at home!

(1) How to Make Scale Model Planes

(2) Whittler's Handbook with patterns



Profusely illustrated. 32 pages. 10¢ each. Write direct to X-acto, at the address given below.

ONLY X-ACTO KNIVES
HAVE ALL THESE
IMPORTANT
ADVANTAGES

FIRST CHOICE of experts in hobbycraft and art fields. Indispensable tool for modelmaker's workshop.

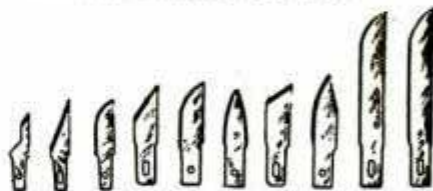

10 BLADE SHAPES, interchangeable. All of scalpel-sharp surgical steel. A blade for every type of cutting job.



3 HANDLE STYLES, of solid duraluminum construction. Designed for safety, firm grip, precise control.



INGENIOUS COLLET DEVICE locks in blades securely, so they can't fold under on curves or heavy cuts.



CHANGE BLADES in about 5 seconds. A twist, a twirl, and there! X-acto's always sharp, always ready.



KNIFE OF MYRIAD USES. Cuts paper, leather, wood or plastics easily. Ideal for modelmakers, artists, photographers, wood carvers, taxidermists. New uses every day.



X-acto * **KNIVES & TOOLS**

X-acto Knives & Knife Chests From 50c to \$5.00

Buy where you see this sign. At better hardware, hobby and gift shops

— or if not available write direct to

X-acto Crescent Products Co., Inc., 440 Fourth Avenue, New York 16, N. Y.

*Reg. U.S. Pat. Off.

READY CUT HOMES

Order Now

Homes \$1182 and up, freight paid. Orders filled in order received. Post war delivery. Save at least \$500 on modern production method homes. Much more compared with builders' prices. Anyone can assemble with simple plans furnished. Complete, including paint, hardware, roofing, glass, nails, etc. Send 25c in coin for full color catalog showing 56 modern low-priced homes and floor plans. Complete building plans ready for filing at low cost.



NEW COLOR CATALOG FOR ONLY 25c

Dept. P.M. 16
INTERNATIONAL MILL & TIMBER CO.
Bay City, Mich.



\$75,000

for boy

MODEL BUILDERS

8 UNIVERSITY SCHOLARSHIPS

588 CASH AWARDS

36 CONVENTION TRIPS

Here's the biggest news you've read in a long time. You are eligible to try for these awards in the TWO competitions listed below—if you reside in the United States and are between the ages of 12 and 19 inclusive.

1. **NAPOLEONIC COACH COMPETITION**—316 awards, including two \$5,000 and two \$3,000 scholarships. In this, you build a miniature model Napoleonic Coach to plans we furnish you.

2. **MODEL CAR DESIGN COMPETITION**—316 awards, including two \$4,000 and two \$2,000 scholarships. All you do is make a solid model automobile embodying your own ideas of motorcar design.

Rules are simple and fair

In both competitions the following regulations will prevail. Boys 12 years old, or older, but not yet 16 by September 1, 1945, compete in the Junior Division. Boys 16 years old, or older, and not yet 20 on September 1, 1945, compete in the Senior Division. All boys within these age limits are eligible to Guild Membership. There are no dues or entrance fees of any kind. Each member shall receive, without charge, an official Guild membership card and button, and a full set of Guild drawings and instructions. Both competitions close July 15, 1946, and are open to all boys within the age limits, including the sons of General Motors employees. In all cases where the son of a General Motors employe qualifies for an award, duplicate awards will be made.

HOLD-E-ZEE

AUTOMATIC GRIP SCREWDRIVERS

MORE WORK IN LESS TIME!



UPSON BROS., INC.,
86 Exchange St.,
Rochester 4, N.Y.

Hold-E-Zees do the job better, faster. They excel wherever screwdrivers are used. Gripper instantly released by spring action, sliding up out of way when not in use. All materials highest quality.

AT LEADING DEALERS EVERYWHERE

BUILD YOUR OWN RADIOS



Kits of all sizes, ready to assemble. Complete with instructions.

FREE RADIO PARTS CATALOG

Send for your copy today!
Write for these exclusive items:
Tube and Circuit Book.....10c
Giant Radio Reference Map 15c
Handy Tube-Base Calculator 25c
Address Leo, W9GFQ
Dept. PM-1, Council Bluffs, Ia.

Wholesale RADIO LABORATORIES

CUT ANY SIZE HOLE IN METAL·WOOD·PLASTICS



Bruno Adjustable Hole Cutter for home users, mechanics, farmers, technicians! High speed steel blade cuts clean holes quickly. Fits drill press, portable drill or hand brace. Money back guarantee! At all hardware stores or write direct, Dept. PM1

Model No.	Shank Size	Cutter Expansion Capacity	User's Price
100	1/4" straight shank	3/8" - 1 1/2"	\$2.95
100-B	Square Bit Stock	3/8" - 1 1/2"	\$2.95
101	3/8" straight shank	1" - 2 1/2"	\$4.95
101-B	Square Bit Stock	1" - 2 1/2"	\$4.95

BRUNO TOOLS Beverly Hills California

FISHER BODY CRAFTSMAN'S GUILD

An educational foundation sponsored by Fisher Body Division of General Motors

General Motors Bldg., Detroit 2, Michigan
Gentlemen: Please enroll me in the Fisher Body Craftsman's Guild for 1946, in the

- Napoleonic Coach Competition
- Model Car Design Competition

Send me full instructions without charge

Name _____

Address _____

City _____ Zone _____ State _____

I was born on the _____ day of _____ 19____

Name of parent or guardian _____

Dept. 42

SAY YOU SAW IT IN POPULAR MECHANICS



To-night... pick up your pipe

A load of Christian Peper Pouch Mixture will help you forget the problems of the day as you settle back and relax with this friendly smoke.

There's down-to-earth satisfaction in the honest fragrance, the just-right mildness of "Peper's Pouch," superb blend of fine imported and domestic tobaccos.

POCKET-SIZE PACKAGE
AT TOBACCO COUNTERS **25c**

Christian Peper · St. Louis
Fine Tobaccos Since 1852

Now - you can "Do it yourself" with the **CENTURY GAS GUN**



Here's the trigger-quick way to do your own soldering and brazing at home. To repair electric appliances, kitchen utensils, plumbing, radios, refrigerators, gardening equipment, household tools, etc. "go gunning" with the magic Century Gas Gun. Self-lighting! Self-extinguishing! Pull the trigger and it lights. Release the trigger and it shuts off. Saves gas, saves time! Send \$19.50 today for immediate delivery.

*If you want the regulator, hose, clamps and extension nozzle, send \$17.50 additional. Your local gas distributor can supply acetylene tank. If you are not thoroughly satisfied after 10 days' trial, money back! Send your order to—

CENTURY AIRCRAFT COMPANY · Gas Gun Division
5611 W. CENTURY BOULEVARD · LOS ANGELES 43

Fuse Puller — Circuit Tester

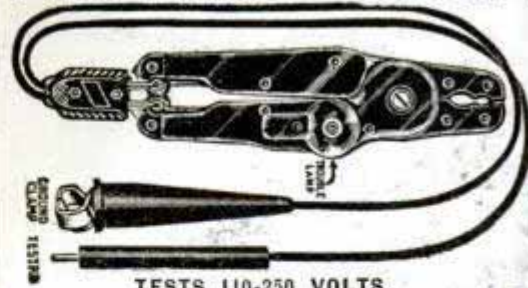

For
Home
or
Factory

TESTS 110-250 VOLTS

When motors stop and lights go out, this tool quickly **LOCATES DEAD CIRCUITS** and safely removes blown Fuse. The Star Test Pocket Plier is made of a Transparent Plastic having in one of the legs a small lamp in series with a resistance and can be used to test 110 to 250 volts circuit. The Plier will pull fuses from 10 to 100 Amperes. Thousands of Electricians find this tool handler than Test Lamps. Price \$2.75 each without Leads, \$1.50 additional for Leads, plus 10c postage. Can be obtained from General Electric or Westinghouse Stores or directly from us. Order NOW. **STAR PLIER CO.**, 233 Canal St., New York 13, N. Y.

KEEP YOURSELF UP-TO-DATE ON **WOOD** LUMBER & SUPPLIES

with **CONSTANTINE'S MASTER MANUAL**

Published by the leading suppliers to woodworkers, the most complete book ever offered. More than a catalog, contains valuable information on lumber inlays, veneers, wood finishing, etc. 83 inlay border designs in full color, 6 pages of full color inlays plus a wood identification chart showing over 60 rare woods in natural color. Send only 25c today and we will include FREE a year's subscription to our publication, *Chips & Chats*.

ALBERT CONSTANTINE & SON, INC.
791 E. 135th Street, New York 54, N. Y.



Sand Casting—Forging—Heat Treating—Case Hardening **BRONZE FOUNDRY**



is again available in limited quantity without priority. Orders filled in sequence as received. **INVENTORS—SCHOOLS—CRAFTSMEN** use **FOUNDRYETTE** for making castings quickly for new inventions, for instruction, and general purpose. Order now for early delivery. Three sizes are available capable of making bronze castings of 1½, 3, and 6 pounds weight, aluminum, copper, brass, etc., \$17.50, \$24.00, \$34.50, f.o.b. Kansas City. Domestic gas supply and 110 volt AC or DC energy required for operation. Write for circular.

KANSAS CITY SPECIALTIES CO.

Box 6022, Dept. P-62

Kansas City, Mo.

120 MILES PER GALLON

Complete motor ready to mount on ordinary balloon-tired bicycle. No mechanical skill required to install. No alteration of bike necessary. Easy to operate.



Can be pedalled by merely releasing clutch. Speed 5 to 40 M.P.H. Shipped pre-paid complete with 4 cycle, 2½ H.P. motor, all attachments and heavy duty stand. Get complete facts about this low-cost, convenient transportation. . .

Write today for descriptive illustrated literature.

WHIZZER MOTOR SALES CO.
Dept. A, 3132 E. Washington, Los Angeles 23, California



IT'S
A *Snap-on*

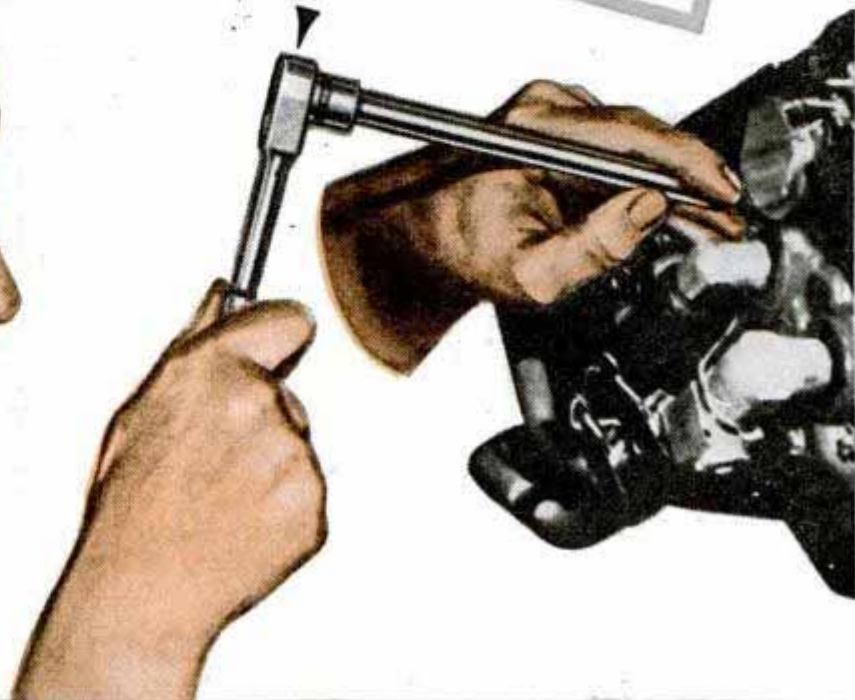

-THE NAME THAT

SAYS "QUALITY"

ON 3,000

TOOLS

To a vast army of skilled mechanics the brief phrase, "It's a Snap-on", sums up all they care to know of tool quality. Better tools mean added earning power, and they know that the Snap-on name on any tool pays off in speed and accuracy, in dependability and durability. Not only are Snap-on tools "the choice of better mechanics", but they are the choice of industry, widely used in every phase of production, assembly and maintenance. Write for catalog of 3,000 Snap-on tools.

THIS UNIQUE, NATION-WIDE ORGANIZATION
SERVES TOOL USERS EVERYWHERE

Snap-on's own distributing organization provides direct, personal service to tool users throughout America. Snap-on's branch offices and warehouses in 38 principal cities cover all major industrial areas. From factory branches a force of trained tool specialists bring Snap-on tools and service right to the work bench in shops and factories. The helpfulness and efficiency of this 25-year old service have won the endorsement of tool users everywhere. Write today for catalog and address of nearest factory branch.

SNAP-ON TOOLS CORPORATION
8062-A 28th Avenue Kenosha, Wisconsin

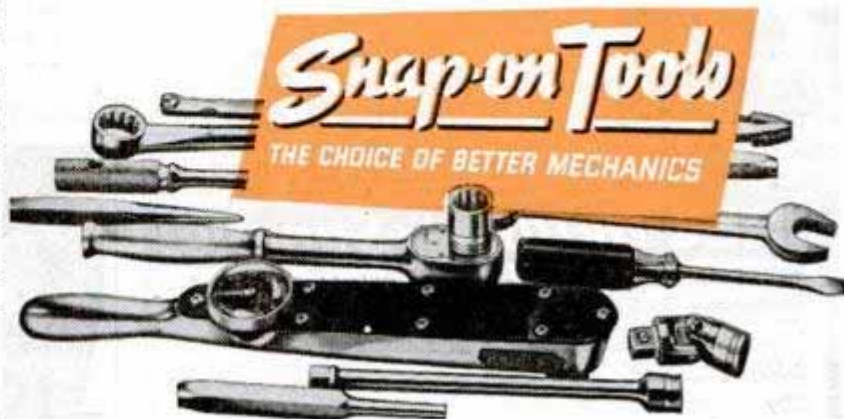

Quick Change Gear Box for Atlas, Logan and Craftsman Lathes

Cut threads from
4 to 224 per inch

Approximately .0003 feed
for fine turning

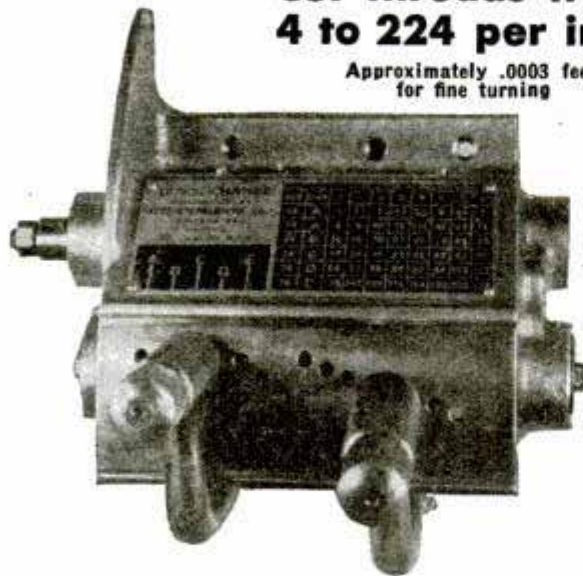

Only
\$75.00

F.O.B.
Chicago

Sold on
money-back
guarantee
if not
satisfied.

This gear box is constructed of all-steel gears in aluminum casting with bronze bearings throughout. Easy to install. Full instructions with shipment. Speedy production; maintained accuracy. Easy to set. Prompt delivery.

THE O'BRIEN MACHINE CO.
Dept. PMI 1620 Highland Ave. Chicago 26, Ill.

Now
for **EVERY WORK SHOP!**

**NEW
Invention** **Electroplates
by BRUSH**



**Easy to Plate CHROMIUM
GOLD, SILVER, NICKEL, COPPER
... For Pleasure and Profit!**

If you have a workshop—at home or in business—you need this new Warner Electroplater. At the stroke of an electrified brush, you can electroplate models and projects—you can replate worn articles, faucets, tools, fixtures, silverware, etc. with a durable, sparkling coat of metal . . . Gold, Silver, Chromium, Nickel, Copper or Cadmium. Method is easy, simple, quick. Everything furnished—equipment complete, ready for use. *By doing a bit of work for others, your machine can pay for itself within a week.* So make your shop complete by getting a Warner Electroplater right away. Send today for **FREE SAMPLE** and illustrated literature. **ACT AT ONCE! Mail Coupon.**

**WARNER ELECTRIC CO., DEPT. G-7
663 North Wells, Chicago 10, Illinois**

FREE Details & Sample!

WARNER ELECTRIC CO., 663 North Wells, Chicago 10, Dept. G-7

Gentlemen: Send Free Sample and Details to:

Name _____

Address _____

City _____ State _____



USE OUR
CAPITAL

NO SALES EXPERIENCE NEEDED

The biggest opportunity ever, to quickly establish a money-making, lifetime business, now awaits you as a McNESS Dealer. Sell things farmers need and use up. Serve same families year after year. Pleasant work--no bosses--easy to do. We supply capital to work on. Also provide offers--advertising--premiums and trade secrets that bring sales.

First to apply get best trading areas. Don't wait--write us today for McNESS proposition. Tell us county and state you want to serve. Ask for free McNESS Book.

THE McNESS CO., 150 Adams St., Freeport, Ill.

**EVERY SHIP MODEL ENTHUSIAST SHOULD
OWN THIS BOOK!**



**"SHIP MODELS
ILLUSTRATED"**

**\$2
POSTPAID**

The ace of all ship model books. Pictures all types from Clippers to Corvettes. A guide to modeling. Close-up photos and detailed drawings. Actual plans—and a glossary of nautical terms. Catalogue of kits and supplies included. Catalogue only—10c.

Address Dept. 7

MARINE MODEL CO., INC., 29 W. 15th St., N. Y. C.

ROLL FILM

No limit at present

Size	Price	Made to exacting U. S. Government standards, this fine tested war surplus film has just been released. Panchromatic high speed. 8 exposures. Orders filled by return mail. Please order a minimum of 4 rolls. Include 18¢ to cover postage and handling. No C.O.D.'s please. Refund on request. We suggest you send us your order today.
127	27c	
120	33c	
620	33c	
116	38c	
616	38c	

Howard West, 3 W. 42 St., New York 18, N. Y. Dept. C1



MACHINE SHOP EQUIPMENT

Every man who owns a workshop should have a copy of this new, authentic catalog of Machine Shop Equipment . . . the latest tools made by the biggest manufacturers in the United States. Replete with illustrations, descriptions, prices. Prompt delivery on most tools listed in this catalog. Available at the cost of printing—50¢ a copy—Get yours today! Price of Catalog Refunded on First Order over \$5.00. Send check or Money Order to

CENTER TOOL CO.

154 Centre St., New York 13, N. Y.



MOTO-TOOL ★ THE "POCKET-SIZE" MACHINE SHOP

PUT THIS "WAR VETERAN" TO WORK *Approximately 27,000 R.P.M.*

READ MOTO-TOOL'S RECORD

Long before Pearl Harbor Dremel Moto-Tools had won their spurs in tool rooms, machine shops, home workshops. Now they have the respect of every branch of the armed forces. And thousands of them helped establish production records at General Electric, Westinghouse, Remington Arms, Ford, Nash-Kelvinator, Consolidated Aircraft, Douglas and others.



MOTO-TOOL KIT

Kit No. 2 with 23 high grade accessories and Model 2 Moto-Tool, in hardwood case. \$23.50
Model 2 Moto-Tool, with 1 accessory. \$16.50

Now that priorities have been lifted, Moto-Tool can work for you. Moto-Tool owners daily discover new jobs that can be done more expertly in less time. In fact, new purchasers find dozens of uses in addition to those they had in mind. So great is the time and labor that Moto-Tools save, thousands of mechanics and craftsmen would find it difficult to get along without these mighty little midgets.

ONLY MOTO-TOOLS HAVE ALL THESE FEATURES

A Model 2 Moto-Tool develops a speed of approximately 27,000 rpm. Weighs only 13 oz. Shaped to fit the hand. Sturdily built with shock-proof bakelite housing. Balanced for vibrationless operation. Uses 110-120 AC or DC current.

10 DAY TRIAL—MONEY BACK GUARANTEE

Ask your dealer today about Dremel Moto-Tools and Accessories. If he does not handle them, order direct from factory on 10 day trial. We ship post-paid if cash in full accompanies order. If you prefer to send only \$2.00, Moto-Tool will be shipped C. O. D. for balance plus postage. Catalog sent FREE.



Model 2 Illustrated

A FEW OF THE JOBS THAT MOTO-TOOL CAN DO FOR YOU

- | | | |
|--------------------------------------|-------------------------------------|-----------------------------------|
| <input type="checkbox"/> Sharpening | <input type="checkbox"/> Burring | <input type="checkbox"/> Cleaning |
| <input type="checkbox"/> Finishing | <input type="checkbox"/> Grinding | <input type="checkbox"/> Routing |
| <input type="checkbox"/> Touching Up | <input type="checkbox"/> Polishing | <input type="checkbox"/> Cutting |
| <input type="checkbox"/> Sanding | <input type="checkbox"/> Burnishing | <input type="checkbox"/> Rasping |
| <input type="checkbox"/> Drilling | <input type="checkbox"/> Inlaying | <input type="checkbox"/> Carving |
| <input type="checkbox"/> Mortising | <input type="checkbox"/> Sawing | <input type="checkbox"/> Brushing |
| <input type="checkbox"/> Engraving | <input type="checkbox"/> Scoring | <input type="checkbox"/> Dressing |



DREMEL MFG. CO. 116-A RACINE, WIS. U.S.A.

WATCH FOR THE RETURN OF MOTO-SAW

Dremel Moto-Saw . . . the sensational electric scroll saw . . . will be back as soon as materials are available.

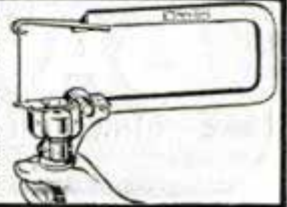

MAKE MORE MONEY

Applying or Selling *Lasting* ROOF COATING

Extra profitable, easy to apply. Exclusive new formula makes this America's best roof coating for felt, composition, steel, slag, iron, gravel, concrete and metal roofs. Definitely superior in all climates, at all temperatures. Act at once!

DEALERS & AGENTS WANTED
Write for Details of Our Proposition



LASTING PRODUCTS COMPANY
MANUFACTURERS OF PAINTS, PUTTIES, PLASTICS
FRANKLINTOWN ROAD PLANT, BALTIMORE 23, MARYLAND

REFRESHING SHAVES FOR "SMART" MEN!

HOSPITAL
MADE IN U.S.A.
Concave-homed
HOSPITAL
BRAND
RAZOR BLADES
NEWARK 7, NEW JERSEY

AMMCO 7" SHAPER

"A Precision Machine of a Thousand Uses"

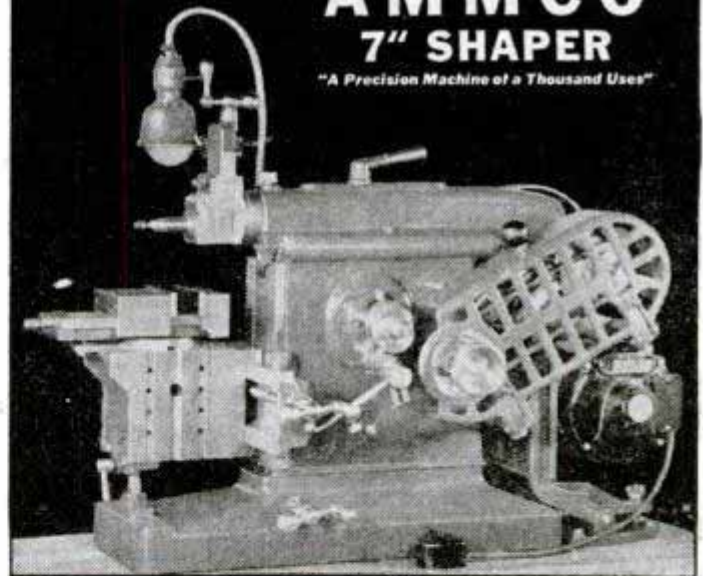

A wide variety of jobs can be done accurately, quickly, easily, and economically on the AMMCO Shaper (7" stroke). Construction incorporates many features you would expect to find only in larger, more expensive machines . . . For example: WAYS of ram, tool head, and front face of the main frame are of the "VEE" type, hand scraped to insure accuracy and long life. Available for stationary installation or as portable unit.

Write today for specifications and prices

AMMCO

2140 Commonwealth Ave. North Chicago, Ill.

Quick, Easy, Lasting REPAIRS!



Cracks, holes, dents in wood, plaster, concrete, metal, etc. — loose handles, rungs, knobs, screws — mistakes in carpentry, etc. — fix them all with Savogran Crack Filler (hard as stone) or Savogran Wood Putty (easily tooled). Just mix with water, press into place. Stays put, hardens quickly, will not shrink! Can be painted, pre-colored. Ideal for models, inlays, etc. Patented! Big 1-lb. can only 30c at hardware and paint stores.

FREE CIRCULAR

Describes these and other Savogran Products: Heavy Duty Cleaner, Remover & Bleacher (renews floors), Paint Brush Cleaner, Stryp-eeze (removes all finishes), Coldfoam Soapless Soap Powder.

THE SAVOGRAN CO.
Dept. 24, Boston 10, Mass.



SAVOGRAN

CRACK FILLER · WOOD PUTTY

IN EVERY WELL-EQUIPPED HOME WORKSHOP

GET BIG PROFITS from
SMALL INVESTMENT

OTTAWA

6 H-P LOG SAW



Log Saw of the
Future TODAY!

Buzzes
Up
Small
Limbs

FELLS TREES...
SAWS LOGS Fast, Easy

Demand for wood increases! Prices are higher than ever before. You can make real money sawing wood, if you have an Ottawa. Equipped with an easy to start, air-cooled 6 H-P engine. Designed for easy handling. Complete one-man machine with safety Saw Guide and other exclusive Ottawa features for fast sawing.

USE FOR OTHER JOBS — when not sawing wood, use engine for any belt job. Thousands in use. **FREE BOOK** and price list. Write today.

OTTAWA MFG. CO., 127 Pine Street, Ottawa, Kans.

ELECTRIC SOLDERING IRON

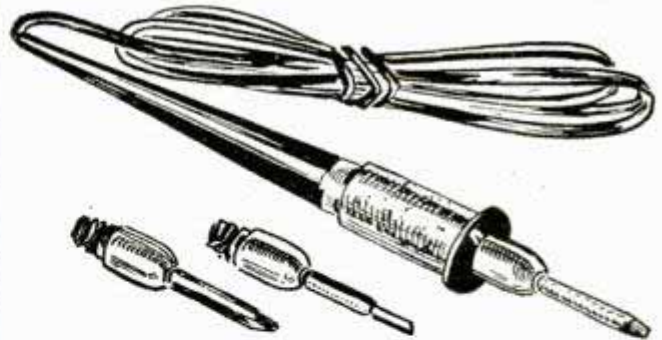

Light weight. Compact. Heats almost at once. Three different size interchangeable tips make soldering easy even in tightest places. Sold on money-back guarantee. Send cash with order. We ship postpaid.

\$2.95

R-L Electronic Corp.

731 W. WASHINGTON BL., DEPT. P., CHICAGO 6, ILL.

FREE!! 40 PAGE HOBBY CATALOG

Over 1000 Items — Over 300 Photos

Our new 40 page catalog is the "bible" of wide-awake modelers. Hundreds of models to choose from! Planes, engines, boats, jeeps, tanks, gliders, supplies, etc. Send for yours today!

AMERICA'S HOBBY CENTER, Dept. B16, 156 W. 22 St. N. Y. 11, N. Y.

BUILD DUTCH WINDMILLS

LIGHTHOUSES, LAWN FIGURES, LAWN CHAIRS, TRELLISES, ETC., BEAUTIFY YOUR GARDEN

Model B-30 Windmill 24" high. Wings operate farmer at bucksaw. Blueprint.....50c
Model B-10 Windmill hexagon style, 40" high overall. A beautiful model. Blueprint.....75c

Model H-10 Lighthouse, 40" high. Blueprint.....75c
Comfortable, Sturdy Cape Cod Lawn Chair. Blueprint.50c
12 Artistic Trellises. Blueprint all 12 only...50c

Special All Blueprints mentioned above for only \$2.00. (Over 35,000 Satisfied Customers) Send 10c for Illustrated Catalog.

CRAFTSMAN'S MODEL CO.
2030 N. 41st St., Dept. P-87, Milwaukee, Wis.



HOME INDUSTRY OPPORTUNITIES

Make Good Door Mats from Old Tires with simple homemade cutting and hole punching equipment powered with a 1/4 HP motor. Illustrated instructions, 50c.
Profitable Toy Making. From scrap wood, paper, metal, rubber, linoleum, cloth, plaster, etc., 25c.
Liquid Rubber from Old Tires. Make molds, door mats and rubber articles. Ten formulas and processes, 50c.
How to Make 30 Useful Articles of Wire and Sheet Metal with homemade jigs. Illustrated, 50c.
Rubber Mold Making. Marbling, glazing, etc., 25c.
Security in a Small Farm. Twenty ways describes, 25c.
10 Local Business Plans net up to \$200 a month, 25c.
Collection of 100 Selected Formulas, 25c.

All 8 of the Above List of Booklets and Formulas, \$2.00. No C.O.D.



NEW WAYS CUT BUILDING

cost of houses, garages, poultry and farm buildings, cabins and stores. Make wall-high, insulated blocks with inside and outside finish with simple, homemade equipment. Composition roofs and floors. Ten formulas. Cement panels and tiles. Stream-lined roof, walls and gutters. Several ways to use cheap wood with cement makes strong buildings. Wallboard of sawdust. Save hundreds of dollars. 100 money and labor saving ideas. Mixer and buzz saw easily made from an old motor. 40 proved ways to earn \$10.00 to \$15.00 a day. Guaranteed illustrated booklets, \$1.00.

MAKE FURNITURE OF COMPOSITION cement, sawdust, asbestos, paper. Some part scrap wood and metal. Illustrated instructions to make tables, cabinets, chests, racks, shelves, inclosed sinks, lawn novelties and toys, 500 per cent profit. 50c.

HOW TO MAKE ACCURATE SHOP MACHINES: Band, jig and circular saws, electric drills, sanding wheels, forge, tools, electric weed cutters and many other things from old auto parts and washing machine motors. Illustrated, 50c.

HOME MFG. ENTERPRISES, 50 selected home shop projects. Illustrated, 50c. Special: All five booklets described above, \$2.00 postpaid. No C.O.D.

HOME INDUSTRIES, 1318 So. 30th Ave., Dept. PM, Omaha 5, Nebr.

Enclosed find \$..... for which mail booklets as checked.

NAME.....

ADDRESS.....

CITY.....STATE.....

ROYALTON CROWN KEEPS A MAN PIPE-HAPPY. Why not! His smoking pleasure stays keen—never dulled by harsh juices and slugs. These gremlins are ruthlessly detoured from the mouthpiece by protective features found only in a Royalton Crown. With this matchless pipe, the first and last puff of the day taste equally cool... dry... satisfying.

Royalton CROWN

FOR MEN WHO

REALLY KNOW PIPES



MOUTHPIECE TUBE prevents backflow of moisture

CONDENSING CHAMBER traps and holds bitter juices and sediment

BOWL GUARD keeps shank and bowl dry

REMOVABLE SECTION eases thorough cleaning

CHAMBER GUARD bars tobacco fragments from bit

\$ 1.50

Selected Briar

Patented

HENRY LEONARD & THOMAS, INC., OZONE PARK 17, N.Y.

BLACK on WHITE for BETTER SIGHT

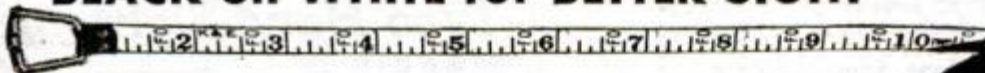

WYTEFACE Steel Tapes have black graduations on a crack-proof white surface. Easy to read in any light, from any angle. Faster measurements with fewer errors. Designed for hard service. Resists abrasion from rails, pipe, rocks, concrete. Protected against rust.



WYTEFACE
TRADEMARK
STEEL MEASURING TAPES

KEUFFEL & ESSER CO.
EST. 1867

NEW YORK • HOBOKEN, N. J.
CHICAGO • DETROIT • ST. LOUIS
SAN FRANCISCO • LOS ANGELES
MONTREAL



Drafting
Reproduction
Surveying Equipment
and Materials
Slide Rules
Measuring Tapes

YOU NEED THESE CRAFTSMAN'S TOOLS

SUPER DRILL GRINDER



Sharpens round shank drills from 3/32" to 1 1/16" diameter. Grinds Old Drills like new in 4 different drill point angles. Grinds Short, Medium and Long Twist Drills from 1 1/2" up to 11" long, for hand or power grinding wheels.

70,000 NOW IN USE!

Grinds your drills like factory in 25 seconds. Gives perfect center and clearance. Saves drills, time and money. No shop should be without the Super Drill Grinder. Guaranteed to do the work or money back. The Grinder that gives a round point!

Only \$2.95

SUPER ARBOR

(PATENT PENDING)

A combination drilling or grinding wheel attachment. For 1/2" motor shafts. Will take grinding wheel with 1" hole on shaft and 3/8" hole on small end. Extension can be used for rag or wire wheel, or 3/4", 24-thread drill chuck which holds drills from No. 60 to 3/8" in diameter. Right hand thread only.

Price Only \$1.50

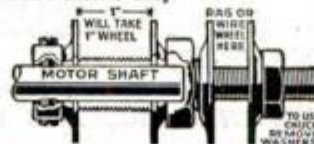

SUPER HACKSAW

AND FLAT DIE FILE HOLDER



The tool with 100 uses! Holds broken hacksaw blades—used by mechanics, electricians, plumbers, auto mechanics, hobbyists and repairmen. Perfect for all-round household needs; ideal for difficult close-quarter work. Nothing like it for tool and die men. Price, without saw blade.

Only 95c

At Your Dealer's or Postpaid
CRANDALL MFG. CO.
1512 West Slauson, Dept. FA-1
Los Angeles 44, Calif.

3 OUTSTANDING, TIME-TESTED DRILL PRESS ACCESSORIES

THE BARRON ROTARY SURFACE SANDER

\$5.95
COMPLETE



Note these Special

Features—Made of Alcoa aluminum. Machined and balanced for smooth operation in drill press chuck. For surface sanding woods, plastics or polishing metal surfaces. Complete with 20 instantly removable sanding cup discs. No messy glueing needed. Leaves an agate smooth, absolutely true surface finish. Does not leave waves, ripples, steps or striations in work piece. The only tool of its kind. Shipped prepaid on 10 DAY MONEY BACK GUARANTEE for \$5.95.



The IMPROVED Barron Multi-Purpose Drill Press Planer.. \$7.50

Not only surface planes toughest woods and plastics to precision limits—but rabbets, routs, tenons, panels, grooves, beads. Will cut rabbets, tenons, panels, etc. to a depth of 1" with special Barron extra long hi-speed cutter blades. Thousands now in use. Made of Alcoa aluminum, machine finished thru-out. Vibrationless. Fits any drill press. Shipped prepaid on 10 DAY MONEY BACK GUARANTEE on receipt of cash, money order or C.O.D. for \$7.50.

Baron ALL-METAL Auxiliary DRILL PRESS Table.. \$8.85



Hard Alcoa aluminum die casting heavily ribbed—machined both sides. Has 234 sq. inch extra large working surface. Equipped with Barron Steel Planer Fence. Can also be used for shaper operations, innumerable other drill press uses. A real buy at \$8.85, express collect.

See Your DEALER . . . Or Write For CATALOG

BARRON TOOL CO., INCORPORATED
369 Architects Bldg. Detroit 1, Mich.

BARRON PRECISION WORK SHOP TOOLS

LEPAGE'S PAPERHANGER'S PASTE

LEPAGE'S GLUE

LEPAGE'S PAPERHANGER'S WALL SIZE

● SAVE WASTE PAPER ●

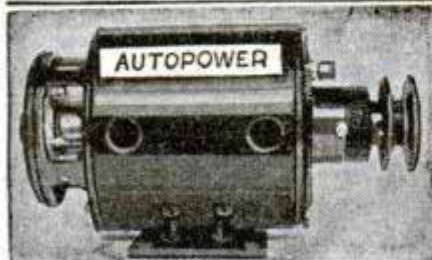

TURN SCRAP INTO MONEY

AUTOPOWER tells you how in plain, easy, simple, and illustrated instructions that anyone can follow. Change auto generators into useful, practical AC and DC generators and motors with voltage from 2 to 1,000 volts, for power, light, welding, radio, sound, etc. No previous experience nor special tools needed. Generators can be driven by wind, water, fan belt, etc. Already used and endorsed by thousands. Send for your copy of "AUTOPOWER." Only \$1.00 postpaid.

AUTOPOWER INC., 2118 Pine St., St. Louis 3, Mo.



SOLDERING Simplified

with this revolutionary gun-type iron.

INSTANT HEATING—Fast Handling



The streamlined BAKER Flash will do the work of several ordinary type irons—faster, easier, more economically. Instant heating, high or low heat as desired, by control of your "trigger finger." Hot only when actually soldering. Non-tiring, protected gun grip and perfect balance for easy, steady application. Unexcelled for work in close places. Operates from standard storage battery or plug-in with 110-volt transformer. AT YOUR DEALER or \$4.75 Postpaid. With HT Transformer \$9.95. Remit with order unless C.O.D.

BAKER-PHILLIPS CO., 3051 Lyndale S., Minneapolis 8, Minn.

1 New - Improved
OIL FOR ALL ---
HOUSEHOLD - SPORTSMAN - MECHANIC
Lubricates - Prevents Rust - Cleans Metal



FIENDOIL



HUNTER'S COMPASS

Hunting Case,
Watch Type, All Metal, Jeweled **\$3.75**

Engineers All Metal Army
Type Hand-Sighting

LEVELS \$1.50



PUBLIC SPORT SHOPS

13 S. 16th St., Phila. 2, Pa.

No COD's

New Designs in FRANZITE GRIPS



Modernize Your Gun! Improve Your Score!

Most durable grips made. Positively unbreakable! For Colt, Smith & Wesson, Hi-Standard, Ortgies, Luger & Mausers in a wide choice of beautiful designs in ivory, pearl, walnut, onyx, etc. Low prices. FREE CATALOG. Dealers Wanted.

SPORTS, INC., (Mrs.) 5501 Broadway, Dept. P-1, Chicago 40, ILL.

DO YOU

WANT a permanent business profession of your own? Then BECOME A FOOT CORRECTIONIST.

Earnings in this greatly needed profession run as high as \$50-\$100 weekly after a few weeks home training—not medical or chiropody—no further capital needed, no goods to buy. 50th year. Write for free booklet.

Stephenson System of Foot Correction

28 Back Bay,

Boston, Mass.

*Coming
your way -*

Steady on the course and heading right for you . . . *new Evinrudes* sparkling with the promise of more fun in '46! Again, a *complete line* of models — smart singles and twin cylinder motors — and three superb "fours"! All exactly as you would expect them . . . reflecting 37 years of priceless outboard *know how* . . . *the finest Evinrudes ever!* See your Evinrude dealer soon — and send for free catalog of the complete Evinrude line. Write for it today. EVINRUDE MOTORS, 5140 N. 27th Street, Milwaukee 9, Wisconsin.

FINEST
EVINRUDES
EVER

EVINRUDE
OUTBOARD MOTORS

"I'VE WORN
Carhartt
OVERALLS
FOR OVER 50 YEARS"



• Carhartt work clothes guarantee the easy fit, comfort and fine wearing qualities that only come with years of experience in building better overalls. Railroad men, the country over, have worn Carhartt's for more than 50 years—a great tribute to the wear and fit of Carhartt Master Cloth Overalls.

Better tailoring and workmanship, experienced design, stronger reinforcing and stouter lockstitching make Carhartt's America's outstanding work garment value. Count on Carhartt to give you the best that money can buy—backed by a 50 year money back guarantee.

Carhartt washable work caps are skillfully tailored, full cut for lasting wear, are neat in appearance, insure comfort fit.



On Sale at Your Local Dealers

HAMILTON CARHARTT OVERALL CO.

Established 1889

Detroit, Mich.
Atlanta, Ga.

Carhartt Park, Ky.
Dallas, Texas



Save Fingers
with
Steel-Grip Finger Guards

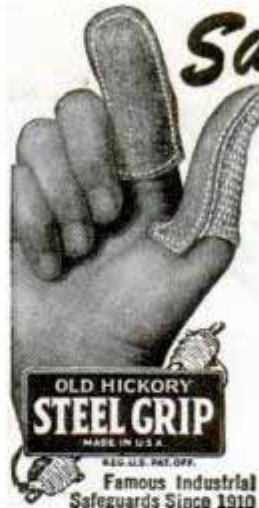

Hundreds of factories are saving time and injuries by protecting workers with Steel-Grip Finger Guards. Used for handling rough or sharp articles, for buffing, grinding, sanding, polishing, punch press work and hundreds of other jobs. Protect fingers or thumb, front or back, from cuts, abrasions or blisters. Made of durable leather with elastic web back for snug, cool, comfortable fit. Easy on and off. One size fits all, men or women. Send 10c each for samples or trial order box of 50 at \$4.25 less 10%.

OLD HICKORY
STEEL GRIP
MADE IN U.S.A.

REG. U.S. PAT. OFF.
Famous Industrial
Safeguards Since 1910

Catalog of Steel-Grip Safety
Apparel free on request

INDUSTRIAL GLOVES CO.
646 Garfield Blvd., Danville, Ill.
Canada: Safety Supply Co., Toronto

**HARLEY-DAVIDSON DAYS
ARE HERE AGAIN!**



More and more Harley-Davidsons are now going to dealers to meet demands of thousands of riders wanting the rugged dependability of "The World's Champion Motorcycles." For fullest enjoyment of exciting motorcycling events — get set to own a Harley-Davidson by seeing your dealer at once. Write today for FREE copy of "ENTHUSIAST" Magazine filled with thrilling motorcycle pictures and stories.

HARLEY-DAVIDSON MOTOR CO., Dept. IP, Milwaukee 1, Wis.

METALLIZE BABY SHOES

Learn this easy, money making business from nationally recognized consultant. Small investment; perpetual market. For free details write Joseph B. Kushner, B.S. Ch.E., Metal Finishing Consultant, Stroudsburg, Pennsylvania, R.D. 3A.



**NEW! Sell Popular
ALL WOOL
Buffalo Check Shirt -**

**BIG PROFITS
FOR YOU!**



Every Outdoor man a prospect. Smartest color and style combined with warm snug comfort. Genuine ALL WOOL Buffalo Check Shirts. Full cut, patented storm cuffs. Amazingly low priced, with generous profit for you.

COMPLETE LINE—Leather and wool jackets, raincoats, 200 fast selling shoe styles for men and women. Our salesmen making biggest profits in this field, using Actual Samples we furnish FREE. Write today for FREE SAMPLE OUTFIT.

MASON SHOE MFG. CO., Dept. M-329, Chippewa Falls, Wis.

BUILD-ARC WELDER FROM OLD GENERATOR

For Light or Heavy Work. 75-200 amperes. Complete PLANS 35c. Send today and we'll include FREE our Big NEW Catalog.

LEJAY MANUFACTURING CO.
1347 LeJay Bldg., Minneapolis, Minn.



SAY YOU SAW IT IN POPULAR MECHANICS

WRITE FOR YOUR **FREE** COPY OF THE NEW
KRW HYDRAULIC PRESS BOOK

Describes all manner of Production and Shop Work on KRW Hydraulic and Bench Type Arbor Presses. 32 pages illustrating the new KRW Hand-operated, Electric-operated and Air-operated Hydraulic Presses.
Write for your copy today.



K. R. WILSON, DEPT. 17, 215 MAIN ST., BUFFALO 3, N. Y.
Builders of Shop Equipment for Ford Dealers Since 1916

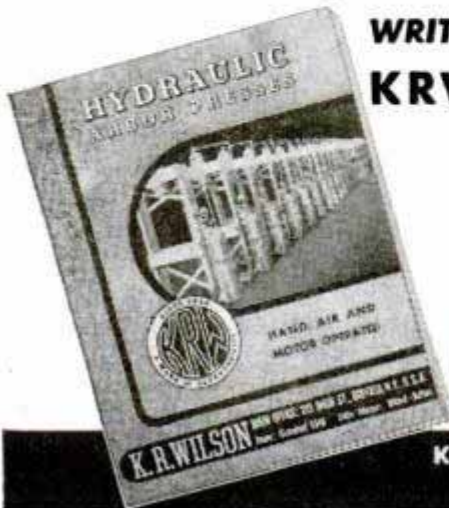
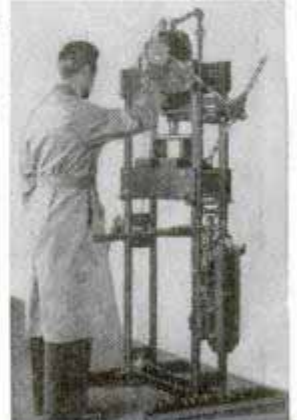

THE "Best Sellers"

ARE BACK FOR GOOD!

AT last, we are rid of War. And with it, rid of our obligation to build the tools of War. Now, happily we can build the tools of Peace once more. Yes, we are glad to say that Crescent "BEST SELLERS" . . . Crescent and "Crestoloy" Wrenches, Pliers, Screw Drivers, Snips and other tools . . . are coming back for good.

From now on, they will be showing up . . . in ever-increasing quantity . . . on the counters and display boards of America's better hardware stores. To the thousands of loyal dealers and users who have waited patiently for their Crescent Tools, we can now safely say: "Thank you, they're on their way."

CRESCENT TOOL COMPANY
Jamestown, New York



CRESCENT TOOLS

Give Wings to Work

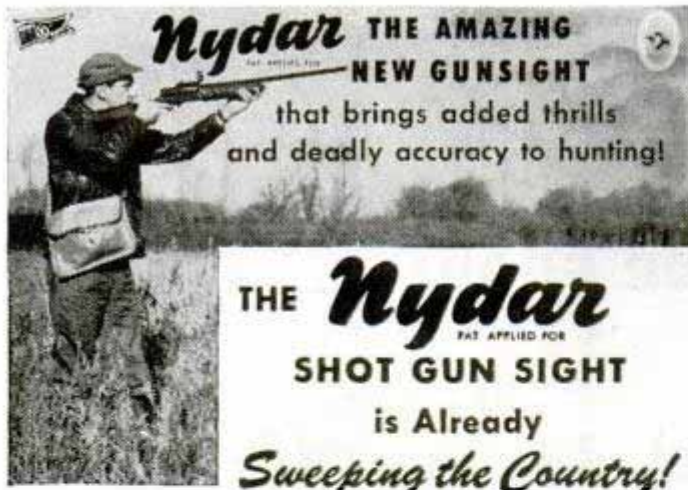

Nydar THE AMAZING
NEW GUNSIGHT
that brings added thrills
and deadly accuracy to hunting!

THE **Nydar**
SHOT GUN SIGHT
is Already
Sweeping the Country!

Out of amazing war-time developments has come this peace-time gunsight, built around precision optics... making it possible for every hunter to bag his quota of game in a minimum of time and with a minimum waste of ammunition. In demonstration after demonstration, experts and amateurs alike have been swept off their feet with results from the use of the Nydar gunsight.

Projecting an illusionary but definite ring and dot floating in space, Nydar permits quick and accurate aiming without squinting... makes for greater accuracy in lead shooting and enables the hunter to correctly gauge range.

Nydar can be quickly installed on your favorite shotgun. \$27.45 plus installation at your dealer's, or write for interesting circular.

SWAIN NELSON CO. 2390 GLENVIEW ROAD
GLENVIEW, ILLINOIS

Your OWN Business!



**As little as \$100
Starts You NOW!**

No Training Needed

Make good money by making photo-exact copies of important papers, letters, drawings, photos, veterans' discharges, etc.—for local firms, lawyers, real estate men, accountants, advertising men, engineers, architects, others. *Every business* is your prospect for error-proof, low-cost photocopies. New, amazingly simple

method requires no lens, darkroom, or training! A table-top with only \$100 worth of APÉCO equipment puts you in business for yourself! Easy to start... many prospects... quick results... pleasant work—here's a combination that's a real money-making opportunity—good for a lifetime!

Get Full Information! MAIL COUPON NOW!

AMERICAN PHOTOCOPY EQUIPMENT CO.
2849 N. Clark St., Dept. GF16,
Chicago 14, Ill.

Please send me your illustrated book and details about the APÉCO business opportunity.

NAME.....

STREET.....

CITY..... STATE.....

**MAKE MORE MONEY
REPAIRING MOTORS!**



with Modern IDEAL Motor Repair and Maintenance Equipment

Get ready for repair and servicing work on the millions of motors that have been working overtime during the war.

Install the latest type IDEAL Coil Winding and Motor Maintenance Equipment. For winding coils and armatures:—IDEAL COIL WINDER DRIVE AND COIL WINDER HEADS. For servicing Commutators and Slip Rings:—IDEAL RESURFACERS, PRECISION GRINDERS, MICA UNDERCUTTERS.

This work is easy if you have the proper equipment—and profitable!

Write for FREE Motor Maintenance Handbook.

IDEAL Sycamore

IDEAL COMMUTATOR DRESSER CO.
5136 Park Ave. Sycamore, Ill.

EXPERIMENT WITH LUMINOUS PAINT

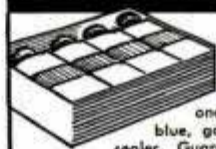

Complete kit of luminous paints in colors. Paint artificial flowers, lapel ornaments, novelties, house numbers, light switches, etc. Kit of one oz. each of 3 lasting colors, bright blue, gardenia and chartreuse, one ounce sealer. Guaranteed best quality.

**COMPLETE KIT
WITH 3 COLORS
AND SEALER**
\$4.25 POST PAID

BLACK LIGHT PRODUCTS • 450 E. Ohio St. • Chicago 11, Illinois

REPAIR YOUR OWN ELECTRIC APPLIANCES

WITH NEW AMAZING NICHROCITE



Simply overlap ends, apply Nichrocite paste and turn on the current—a perfect weld results. Used by big utility companies and repair shops. Just the thing for that broken or burned out heating element in your electric iron, stove, toaster or heater. Does the job in a jiffy. Trial order, \$1; 4 ozs., \$2.50; 1 lb., \$8.00.



Handy for Home or Industrial Use

ARMSTRONG ELECTRIC CO., Box 861-MP, Minneapolis, Minn.

NEVERSLIP PULLEY

Transmits more power with less belt wear; unaffected by weather. No pulley covering, no belt dressing required. Replace troublesome pulleys with NEVERSLIPS. All sizes. Money-back guarantee. Ask for NEVERSLIP Pulleys on ALL power machinery you buy. Write for folder and prices.



ROSENTHAL CORN HUSKER CO.
Box 16-146 Milwaukee, Wisconsin

MAKE MONEY AT HOME

RUBBER MOLDS Low as **6¢** EA.

Amazing rubber mold-making outfit makes perfect flexible molds of plaques, ash trays, bookends, etc. Molds cost 6¢ to 25¢ each. Each mold makes hundreds of novelties and gifts to sell for \$1.00 apiece and more! No experience necessary. Everything furnished. Quick and easy. Start profitable business in your home—sell to stores, gift shops, friends, resorts, road stands, by mail. Full or spare time. Write for complete FREE details and easy instructions.

SOLO WORKS, Dept. B-800, Loveland, Ohio



YOU WERE WRONG

**THE TIME YOU BROKE
YOUR NEW YEAR'S RESOLUTION**

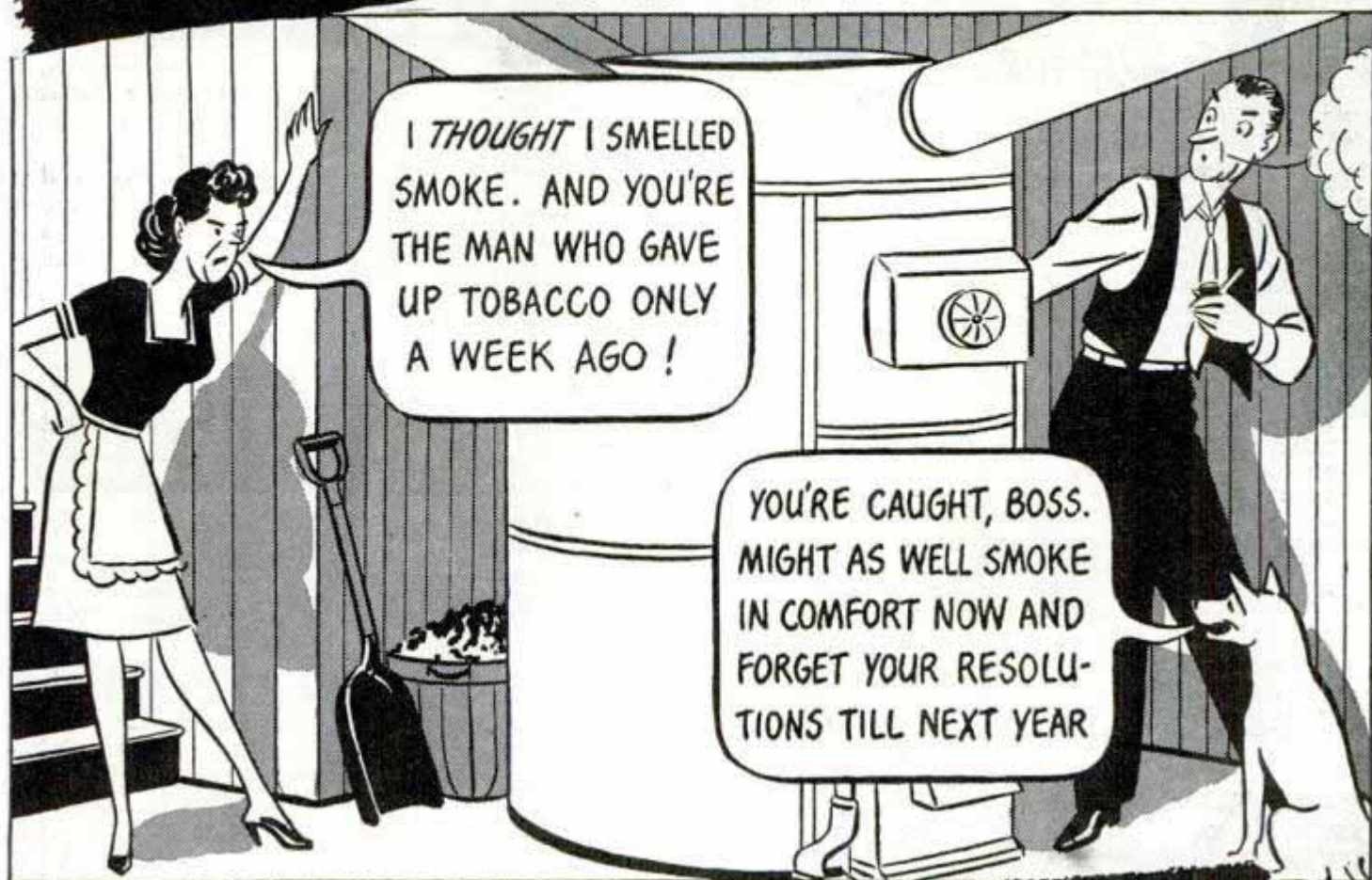

Sure! Broken New Year's resolutions are as common as worn-out spark plug wires. But when you use Packard Four-Forty ignition cable to replace worn-out wires, you're *right*—this year, next year, and for a long time to come.

No other high-tension cable can equal Packard Four-Forty for efficiency and endurance. That's because a tough protective sheath shields it against heat, cold, oil, moisture, corona and abrasion. And that means you get more miles per replacement . . . with peak perform-

**But... YOU'RE RIGHT
with
PACKARD CABLE!**

ance regardless of weather conditions! Packard Four-Forty ignition cable is the original-equipment choice on most cars—the replacement choice of most service stations and garages. Make it *your* first choice—and be right!

**PACKARD
CERTIFIED RE-WIRING SERVICE**

This sign means cable service at its best—the right Packard cable and the right methods. Thousands of dealers provide better electrical service as a result of the Packard Certified Re-Wiring Program.



Packard
REG. U.S. PAT. OFF.
TRADEMARK

PACKARD ELECTRIC DIVISION
GENERAL MOTORS CORPORATION
WARREN, OHIO



FOREMOST BUILDER OF AUTOMOTIVE AND AVIATION WIRING

WONDER PEN is Back

Complete **ELECTRIC Woodburning Outfit** — **BURN BEAUTIFUL DESIGNS** in WOOD

Again available! The real thing! Finest quality electrically heated pen and all materials. Burn and etch deeply on wood in rich shades of brown. Achieve gorgeous effects by applying colors, Sandpaper and varnish to a fine finish. It's fascinating fun! Decorate your room or home. Make good money selling your own handiwork.

Only Pen With Guarantee — 800 Working Hours

Long life point and heating coils. Comfortable, cool cork grip. Standard 4½ ft. cord and plug.

Decorate Cork, Leather,

Etc. Too—Make coasters, trays, high-ball jackets. Decorate belts, fobs, monograms. Create your own art pieces.

EASY TO LEARN — Full instructions. Use all-purpose point for lining, etching, shading.

ALL MATERIALS COMPLETE:

- | | |
|--------------------------------|-----------------|
| Guaranteed Electric Wonder Pen | 2 Paint Brushes |
| 2 Plaques 6½x4½ | 6 Colors Paint |
| 4 Pc. Bookends 5x4 | Pkg. Nails |
| 3 Plaques Approx. 4½x4 | 2 Sandpapers |
| 4 Plaques Approx. 3x4 | Bottle Varnish |

Ask for **WONDER PEN** at stores

or write

AMERICAN Toy & Furniture Co.
727 S. LaSalle
Chicago 5

Special!
New assortment of 8 different size plywood plaques, design imprinted. In box. Complete. \$1.25 postpaid.....



ONLY
\$3
FOR
OUTFIT
COMPLETE
& POSTPAID

Do a Better Job WITH ONE OF THESE EMPIRE LEVELS

Smallest, most handy and accurate Level made. "Cigar-shaped"—no sharp corners to tear pocket. Aluminum stock. Only 3 oz. wgt. 9" long. Has Level, Plumb, 45° Vials. No. 26.....

EMPIRE TORPEDO LEVEL



Aluminum stock. Only 3 oz. wgt. 9" long. Has Level, Plumb, 45° Vials. No. 26.....\$1.75



ALUMINUM LEVEL — No. 151

Cast and Machined, a Beautiful Tool, with Patented, Removable Level and Vial.

With 2 Plumb, 2 Levels, 2 — 45° Vials. 18".....\$5.00
24".....\$5.50 28".....\$6.25

Order **EMPIRE LEVELS** from your local dealer.

Write direct for literature.

EMPIRE LEVEL MFG. CO.

717 S. 6th St. Dept. P-238 Milwaukee 4, Wis.

LENSES 500,000 OF THEM

Buy them for a fraction of their original cost. U.S. ARMY & NAVY surplus lenses and prisms. Send 3 cent stamp for list. **HOBBYIST LENS SET-MAGNIFIERS**, reducing lenses, positives, negatives, etc. 10 lens set, ea. 1.00
5X **ACHROMATIC Telescope Set**.....ea. 1.50
BINOCULAR PRISM Erecting Set.....ea. 2.00
ACHROMATIC OBJECTIVE, 1½" Dia., 5" F.L......ea. 1.50
EYE PIECE SET, 1" Dia......ea. 1.50
5 lbs. **OPTICAL GLASS (Lens Blanks)**, Index plainly marked on each piece.....4.75

Send Money Order or Check (No C.O.D. Orders)

A. JAEGER'S, 120-14P 115th AVE. SO. OZON PARK 20, N. Y.

HANDY ELECTRIC TEST-LITE

Instantly Tells if Circuit is Broken!

Electric trouble shooter with hundreds of uses. Locates blown fuses, tests appliances, motors, spark plugs, electric fences, grounded lines, cables, etc. Neon indicator glows on voltages from 60 volts AC to 550 volts AC or DC. A necessity for experimenting. Complete instructions—easy to use. Satisfaction guaranteed. Available from dealers or 50¢ postpaid by return mail. Address—Dept. B.

Ne-O-Lite Mfg. Co., Rockford, Ill., U.S.A.

PICNIC STOVE and TRASH BURNER

Tree stump of durable reinforced Haydite concrete with grill, charcoal pan, grate. Burns trash safely.

Only \$29.45

Freight prepaid east of Rockies

For descriptive circular write to

W. O. JOHNSON CO. Omaha 6, Neb.



BUILD YOUR OWN MACHINE TOOLS!

Blueprints \$1.00 - Catalog FREE

Detail construction Blueprints on 6 Lewis metal and wood-working tools postpaid for \$1.00. Includes prints for Lewis 10" Shaper, Milling Machine, Drill Press, Vice, 16" Band Saw, 6" Jointer. Plain or semi-finished castings available for these tools save up to 80% of comparable new tool cost.

Illustrated 32-page Catalog—sent free with Blueprint Order—describes 20 Lewis tools. WRITE TODAY!

LEWIS MACHINE TOOL CO.

P. O. Box 116, Sta. A. Dept. M-25, Los Angeles 31, Calif.



WHY WEAR DIAMONDS

When diamond-gazing Zircons from the mines of far-away mystic Siam are so effective and inexpensive! Thrilling beauty, stand acid, true backs, full of FIRE! Exquisite mountings. See before you buy. Write for FREE catalog.

National Zircon Co., Dept. 20
Wheeling, W. Va.

Catalog FREE!

NEW! FOR ALL THOSE PIPE REPAIR JOBS
NO MESS — NO WASTE

Handy—
Easy to Use



PIPE-TITE-STIK
PIPE JOINT COMPOUND - HANDY AS A PENCIL
TRADE MARK PAT. APP. FOR

FEATURES!
• Withstands gasoline, oil, butane, propane, Freon, air, water, steam, acid, gas, brine.
• Lubricates and completely seals pipe joint threads, nuts, bolts, gaskets, turnbuckles, etc.
• Contains no lead. Contains no injurious ingredients.

Just rub 3 or 4 strokes across pipe threads. It spreads and fills threads when turned.

AT MOST GOOD HARDWARE COUNTERS—DEALERS INVITED
©Lake Chemical Co., Dept. P.M., 624 N. Western Ave., Chicago 12, Ill.

Adjustable Work Stop

NEW!

simplifies chucking of small parts... machining to accurate lengths

— for lathes, milling machines, dividing heads, etc.

\$3.75

POSTPAID anywhere U. S. A.

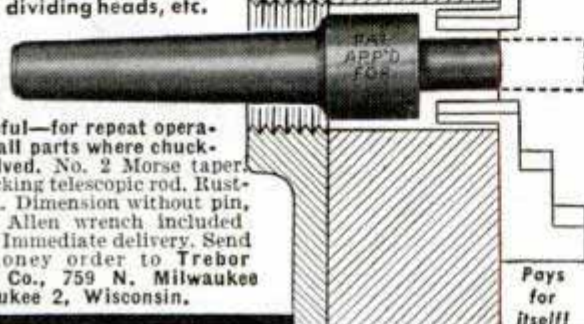

A time-saver!

Pays for itself!

Handy, useful—for repeat operations on small parts where chucking is involved. No. 2 Morse taper. Positive-locking telescopic rod. Rust-proof finish. Dimension without pin, 4" x 1". Allen wrench included. Order now. Immediate delivery. Send coin or money order to Trebor Machinery Co., 759 N. Milwaukee St., Milwaukee 2, Wisconsin.

SICKNESS or ACCIDENT can't rob me of my savings



I'VE A FAMILY MUTUAL HOSPITALIZATION POLICY

Costs **3¢** A DAY • EACH ADULT
only **1½¢** A DAY • EACH CHILD

Benefits begin the day you enter a hospital	
FOR SICKNESS OR ACCIDENT	
Hospital Expenses paid, up to (beginning with the first day)	\$540.00
FOR ACCIDENT	
Doctor Expense paid, up to	\$135.00
Loss of Wages reimbursed up to	\$300.00
Loss of Life by Accident	\$1000.00
WAR COVERAGE AND EXTRA BENEFITS	
Childbirth Expense paid, up to	\$75.00

Sickness or accident can easily wipe out, in a few weeks, savings it may have taken years to accumulate. Don't let this happen to you. With a Family Mutual Hospitalization policy you'll be able to pay your hospital bills. In case of accident, you will be reimbursed for your doctor expenses and for loss of time from work. You may choose any hospital in the United States and your own family doctor may attend you. Benefits applying to children are 50% of those paid adults.

MAIL COUPON TODAY—No Agent Will Bother You

FAMILY MUTUAL LIFE INSURANCE CO., WILMINGTON 99, DEL.

Family Mutual Life Insurance Co. PM-11
601 Shipley St., Wilmington 99, Del.
Please send me, without obligation, complete information on your Economical Hospitalization Plan.

NAME _____
ADDRESS _____
CITY _____ STATE _____



SHE'S "RARIN'" TO GO... WITH NEW BURD PISTON RINGS-

● You won't have to *baby* your car after a re-ring job with Burd "Graf-Flox" Piston Rings. You can hit normal speeds the first mile without danger of rings scoring, scuffing or seizing. What's more, you'll be pleased with the gas and oil saving, and pleased with your engine's new pep and power. The secret of Burd's superiority lies in the fact that the piston ring castings are made of electric furnace iron which insures uniform quality and ring tension, and long service. Then, Burd's accurate machining, plus the exclusive "Graf-Flox" finishing process, eliminates "run-in" period, without penalty. This combination of advantages assures you an economical, efficient re-ring job. Use the coupon to get a free copy of "Servicemen's Handy Handbook" and vest-pocket car expense record.

BURD PISTON RING CO., Dept. PM, Rockford, Ill.



THIS COUPON BRINGS FREE BOOKS

BURD PISTON RING CO., DEPT. PM, Rockford, Illinois

Gentlemen:

I'd like a FREE copy of your "Handy Handbook" which tells how to keep my car in good working order. Also send a "Car Economy Record Book."

Name.....
Address.....
City.....State.....



Thanks, I can eat Steak again!

- Fit-Rite
- makes
- FALSE
- TEETH
- tight!



REFITS and RELINES DENTAL PLATES!



Makes **False Teeth TIGHT!**
Improved Newest Plastic Reliner

LASTS FOR MONTHS!

FIT-RITE quickly makes loose, slipping, clattery dental plates fit snugly and comfortably. Eat, talk and laugh naturally and confidently!

FIT-RITE you apply — at Home

Simply squeeze FIT-RITE on your dental plates and put it in your mouth, where it hardens and makes false teeth feel and fit like new. No fuss, no muss—no heating. Not a paste or powder. Becomes a part of plate. You apply it yourself.

FIT-RITE IS 100% O.K. ON ANY DENTAL PLATE

FIT-RITE won't harm any denture or your gums. Tasteless, odorless, sanitary—cleanses and sweetens the mouth and helps prevent gum soreness. It won't come off with scrubbing or washing. **EVERY APPLICATION GUARANTEED TO LAST FOR MONTHS OR NO COST.**

SEND NO MONEY Send for a tube today, for only \$1.00. Use coupon below. Enjoy teeth like new again. 100% satisfaction guaranteed or money back.

FREE TRIAL OFFER!

SPECIAL—generous package of dental plate cleanser included absolutely free. This instant, brushless cleanser **WORKS LIKE MAGIC** and will not harm any denture. Try Fit-Rite first.

FIT-RITE CO. 1573 MILWAUKEE AVENUE
Dept. 1-PM, Chicago 22, Ill.

Mail This **COUPON** -----

FIT-RITE COMPANY, Dept. 1-PM
1573 Milwaukee Ave., Chicago 22, Ill.

Send 1 tube of FIT-RITE Dental Plate Reliner that you guarantee to satisfy 100%—or it won't cost me a penny.
 I will deposit \$1.00 plus postage with postman when package arrives.
 Enclosed is \$1.00—You pay postage.

NAME.....
ADDRESS.....
CITY..... STATE.....

P.S.: — RUSH THIS ORDER TODAY!

UTICA TOOLS

ALL TYPES FOR MORE TOOL MILEAGE

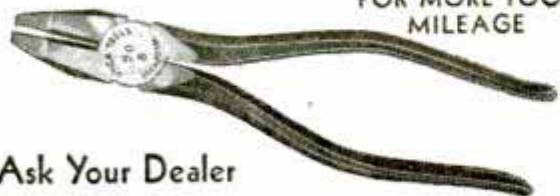

Ask Your Dealer



UTICA DROP FORGE & TOOL CORP.
★ UTICA, N. Y. ★

Larson **HAND-CRAFTS**
HEADQUARTERS!

Make Belts, Moccasins, Purses, Gloves and other useful things for profit

We have a fairly well balanced stock of leather, tools and accessories.

Send 10c for catalog

J. C. LARSON & CO.

180 No. Wacker Drive, Dept. D
Chicago 6, Ill.

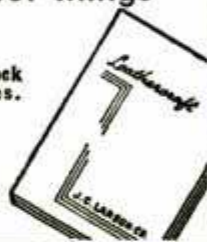

AMAZING ELECTRIC SWITCH

ELECTRIC SWITCH OF A THOUSAND USES
MILLIONS NOW IN USE



Turn on your porch light when you open the door—sound an alarm when the mail is put in the box—shut off the water when the tank gets full, these and many other services are performed with this amazing switch. Shipped with an instruction sheet showing more than 40 illustrated uses for this device, at the bargain price of \$1.00 postpaid.

ELECTRONIC PRODUCTS CO.

St. Charles 10, Illinois

WOOD WORKERS

LUMBER—PLYWOOD AVAILABLE

Harold Hunt wants to send revised No. 14 catalog, 124 pages of woodworking ideas. **UNEQUALED BARGAINS** in imported and American woods, supplies. Those already holding this catalog—send for revised sheets.

CRAFTSMAN WOOD SERVICE CO.
2729 S. Mary St., Dept. A-65 Chicago 8, Ill.



Maule's Giant Asters



Will-Resistant! Five best colors—Red, White, Blue, Pink, and Purple—a 10c-Packet of seeds of each, all 5 Packets postpaid to you, for only 10c. *Send dime today!*
Maule's Seed Book FREE
Tested, guaranteed seeds for prize vegetables and flowers. Have a garden—help raise food.

5 pkts. **10¢**
Maule's SEED BOOK FREE

Wm. Henry Maule, 155 Maule Bldg., Phila. 32, Pa.
(in the west) 155 Maule Bldg., Clinton, Iowa

TRAILER AXLES, HITCHES, AND PARTS

• If you are interested in purchasing trailer axles, hitches, and other trailer parts, contact us promptly. Complete house trailer blue prints, \$1.00. **Write for free literature.**



HAMMER BLOW TOOL COMPANY, Dept. 101, WAUSAU, WIS.

LAWN ORNAMENT-NOVELTY PATTERNS

28 Lawn Ornament Patterns, 25c. Other patterns; 15-20" high; Dutch Girl, Dutch Boy, Pirate, Bull Terrier, Mexican Girl, Mexican Boy, Dwarf, Penguin, Flower Girl, 10c each. 25 Novelty Patterns, 30c. All 62 Full Size Patterns, \$1.00 Postpaid. Strother Pattern Service, Dept. B-8, Box 383, Belington, W. Va.

Now Repair your own **ELECTRICAL APPLIANCES**

with **CHANITE** Self-Welding **ELECTRICAL HEATING** ELEMENT flux. Generous amount, instructions enclosed \$1.00 postpaid. Guaranteed nothing like it. Stick Form 25c ea., \$2.00 dozen. **CHANITE SALES COMPANY, 914 So. Main, Fort Worth 4, Tex.**

Now You Can be **TALLER** than "SHE" is!

Adler Elevator Shoes make you almost 2 INCHES TALLER, "Confidentially", and comfortably, the instant you put them on. Worn and praised by thousands. Look like any other stylish shoes—no high heels! Write for amazing catalog, mailed in plain wrapper. Adler, 122 E. 42nd St., New York 17, N. Y., Dept PM-5.

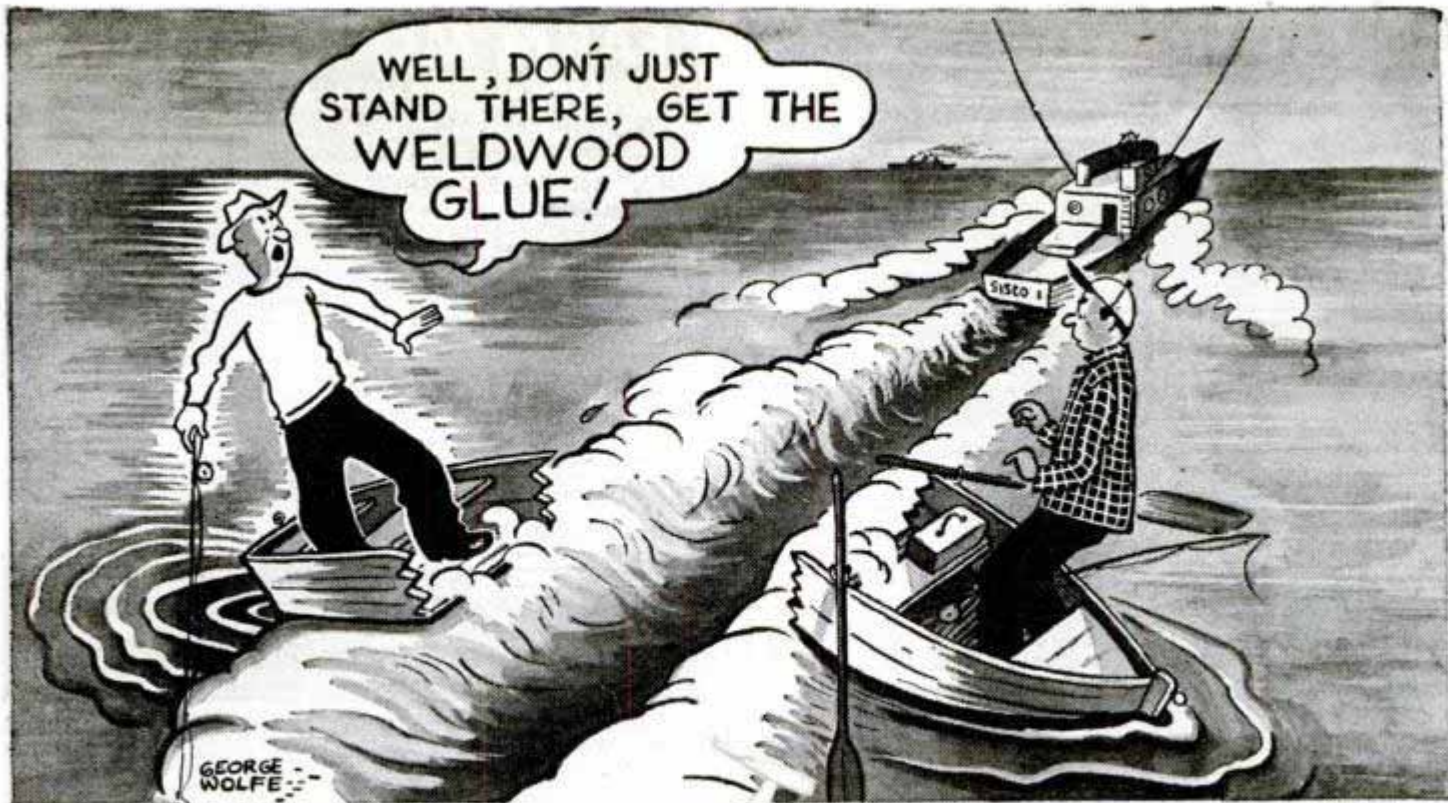

When you want to fix things fast . . . remember Weldwood Glue. It's quick to mix . . . easy to use . . . tremendously strong . . . stain-free . . . rot-proof . . . and permanent. At hardware stores, lumber yards, chain stores.



WELDWOOD PLASTIC RESIN WATERPROOF GLUE

UNITED STATES PLYWOOD CORPORATION, New York 18, N. Y.

HULL AUTO COMPASS

Security of direction makes driving enjoyable. HULL STREAM-LINE AUTO COMPASS keeps you headed right. No wrong turns. Accurate. Sturdy. Write for literature. Price \$3.50.

HULL MFG. CO.

P.O. Box 246-D2

Warren, Ohio



WORLD'S BEST KNIFE



HAND MADE AND HAND TEMPERED. 4½" BLADE \$8.00, WITH SCABBARD—6½" BLADE \$10.00, WITH SCABBARD. Money refunded immediately if not satisfied.

EAGLE MFG. CO. Box 243 San Antonio, Texas

CARRY YOUR HEAT RIGHT WITH YOU!

Sports Heater

\$4.75

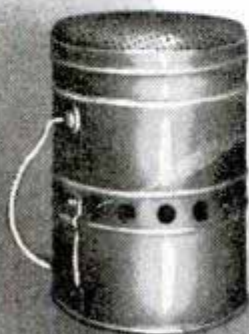

Something New!
Something Needed!
Ideal for Duck-Hunters!
For Spectator Hockey and Football! Skiing! Skating!

Handy light-weight portable heater you can carry with you like a lunch-box! Takes one minute to light! Perfect for unheated cabins, camps and trailers!

● FIRE PROOF! ● WIND PROOF ● FOOL PROOF

Money Back Guarantee! Send Check or Money Order to

SPORTS HEATER CO.

Denver 10, Colo.

DEALERS WANTED!



IT'S SMALL!

COMPACT!

MEASURED
IN INCHES!



SUCCESS!

How to Get Along in this World

Here, gathered together for the first time, are 5000 gems of worldly wisdom on how to live joyously, successfully . . . how to handle people, make money, be happy. Written out of **actual experience** by the best brains of mankind . . . during the past four thousand years! To-the-point, **workable** instructions on getting ahead. Only \$1. Included are lessons on **how to use** these quotations in your daily life. Clip and mail coupon below for **FREE** details today.

Short-Cut Mathematics

COMBINED WITH

Practical Mechanics Simplified

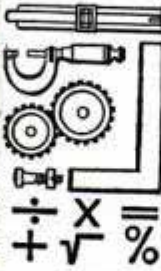

Be a "master mind." Learn how to juggle figures, do baffling tricks with numbers. Add long columns of figures this lightning-quick, short-cut way. Multiply 4 figures by 4 figures without old-fashioned multiplication. Here are speedy, simplified systems used by stage "wizards," expert accountants, engineers. Only \$1. Course includes illustrations, problems, answers. Mail coupon below!



SUPER JU JITSU

Now.. get tough **DOUBLE-quick!**

Fear no man. The bigger they come the harder they fall. Super Ju Jitsu is easy to learn. Big illustrated self-instruction course shows you how to disarm, disable and capture an armed attacker—**with only your bare hands!** Get amazing details at once—mail coupon below.

MAGIC AND CARD TRICKS



HOW to PERFORM for FUN and MONEY
Mystifying stunts made easy. **Secrets of magic** revealed in new illustrated course. Teaches tricks with coins, handkerchiefs, balls, ropes, etc. Shows you how to protect yourself from card sharks . . . **their card manipulations exposed!** Get the "inside" information on baffling stage performances. Learn how to be a magician and entertain friends. Mail coupon for **FREE** details.

CARTOONING MADE EASY

New Self-Instruction Course
Learn how to draw funny pictures for **money**—caricature, comic strip, gag-cartoon, political and editorial cartoon, etc. Practical **simplified** method takes out all the mystery. Step-by-step lessons for home-study. Excellent **SPARE-TIME** training for pleasure and profit. **FREE** interesting details on request. Just send name and address on coupon below.



how to write better letters

Make **your** letters **CLICK!** Learn to put warmth and sparkle into business and social correspondence. Practical **brass-tacks** instruction on writing successful job-getting application letters, exciting keen-witted friendly letters, etc. **ACTUAL EXAMPLES** show tested ways of packing your letters with vitamins. Fascinating details on request . . . **FREE.** Just mail coupon below today!

NELSON CO., Dept. 5A02, 1139 S. Wabash Ave., Chicago 5, Ill.
Write today for complete details on any of these **SELF-INSTRUCTION COURSES.** Send coupon below for the world-famous copyrighted Success-Catalog—It's **FREE**, on request.

FREE details . . . mail coupon!

NELSON CO., Dept. 5A02, 1139 S. Wabash Ave., Chicago 5, Ill.
Please send me—**FREE** and without obligation—illustrated Success-Catalog containing information about the course (or courses) I have checked below. No salesman will call.

- | | |
|--|--|
| <input type="checkbox"/> Success! | <input type="checkbox"/> Magic and Card Tricks |
| <input type="checkbox"/> Short-Cut Mathematics | <input type="checkbox"/> Cartooning Made Easy |
| <input type="checkbox"/> Super Ju Jitsu | <input type="checkbox"/> How to Write Better Letters |

NAME _____
ADDRESS _____
CITY _____ STATE _____

EARN MORE MONEY

GRINDING LAWN MOWERS

"THE UNIVERSAL WAY"

FULL OR SPARE TIME

Build a Business of Your Own in Your basement or garage and earn \$135 a month. Mr. Felber of Ind., writes, "My **UNIVERSAL GRINDER** is faster and more accurate than any other grinder. Its efficiency enabled me to sharpen 450 mowers in 4½ months." More than paid for itself the first month. Every customer satisfied. **Only on the UNIVERSAL** can the inside face and edge of stationary blade, as well as the edge of the reel blades, be ground to proper clearance **ALL IN ONE SET-UP** without removing any blade from the mower. Tool Grinding Rest included.

"The Universal Way is the Modern Way"
Write for Free Folder
Rogers Mfg. Co., Dept. 12-A, Lindsey, Ohio



RE-RING YOUR OWN CAR

Complete sets of Simplex Piston Rings are engineered and packaged so that any handyman can easily recondition his own car.

Rings are unbreakable and each packed in separate envelopes and marked for the groove in which it is to be placed. Complete detailed installations with each set.

Ask in your local store for "Rings made by Simplex"—they last longer.



BUY WAR BONDS AND KEEP THEM

SIMPLEX PISTON RINGS

SIMPLEX PRODUCTS CORP., Cleveland, O.

FOOT RELIEF

Don't worry—No matter how many ordinary arch supports, pads and braces have failed. **CUSTOM MADE RESEARCH FOOT BALANCERS** have relieved foot pains for 25 years. Write for **FREE ANALYSIS FOOT CHART** and interesting literature **TODAY.**

KINDSCHI FOOT APPLIANCE PRODUCTS
Dept. A2 321 W. Jefferson Dallas 8, Texas



IT'S A KNOCK-OUT!

Handsome 20-Year Monel Metal, Hand-Made, Hand-Engraved Carved Shoe Mother of Pearl inlaid **HORSESHOE RING**
Sent C.O.D. for \$2.95, plus tax and postage. Order NOW! State Size. **Satisfaction Guaranteed!**
National Jewelry Co., Dept. 204-H
Wheeling, West Virginia



Balance 4" x 9" Base. With either **56.00** Metric or Avoirdupois Weights . . .

Catalog with 3000 Illustrations of Laboratory Apparatus sent for 75 cents. Catalog listing 10,000 chemicals, drugs, minerals, etc., and 1700 scientific books sent for 25 cents. 100 scientific books, 10 cents.
LABORATORY MATERIALS CO.
7321 Vincennes Ave. Chicago 21, Ill.

Big Money for Workers In Home or Shop



Licensed Concrete Specialists wanted. No experience needed. Make **Colorglazed** concrete pottery without molds. New, low cost, patented method. Cemetery products, novelties, tiles, etc. Basement leaksealing. Other big pay projects. Booklet, details free. Men only.

NATIONAL POTTERIES COMPANY
542 Lincoln Avenue Fergus Falls, Minnesota

MILL IT
ON YOUR LATHE



WITH A **PALMGREN**

MILLING ATTACHMENT

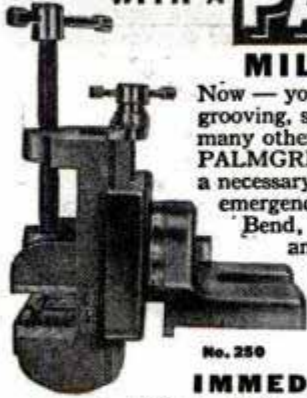

Now — you can do milling, slotting, grinding, grooving, squaring shafts, sawing at angles, and many other important operations on your lathe. **PALMGREN MILLING ATTACHMENT** is a necessary fixture for small shops, schools and emergency work in large plants. Fits South Bend, Atlas, Craftsman, Logan, Sheldon and all other makes. It has 360° graduation for rotary angle adjustments, also graduated feed and adjustment screw. Easily mounted by straddling lathe's regular tool post. Try one—it will quickly pay for itself.

No. 250

IMMEDIATE DELIVERY

No.	Width Jaws	Depth Jaws	Jaws Open	Weight Pounds	Base Opening	Price F. O. B. Factory
150	1½"	1"	1½"	6½	1"	\$18.75
250	2½"	1½"	2½"	11	1½"	24.75
400	4"	2"	4"	25	2"	39.75

Order from your dealer or jobber. Write for circular No. 349

CHICAGO TOOL AND ENGINEERING CO.
Mfrs. of PALMGREN PRODUCTS for Over 25 Years
8365 South Chicago Avenue Chicago 17, Illinois



RAFTER LENGTHS. A new vest pocket book for the carpenter, estimator. Gives lengths, Side cuts, Plumb cuts, Deductions. For all your rafters to fit any building from one inch wide to forty feet wide. Gives the numbers to cut on the square. Also gives degrees for same cuts for Radial Saws. All standard pitches from ¼ to ¾ are given. Just open book to pitch page and there in plain print are your lengths, side cuts, etc. Any one who knows what a jack rafter is can frame a roof correctly if he has this great book. Price one dollar, prepaid.

BUILDERS' TOPICS. Dept. M, Med. Arts Bldg., Seattle 1, Wash. Original teachers of the square in five easy lessons, by mail. Send for FREE list of plan books—Kamp Kabinos to Mansions.

MARCOT KEY MACHINE

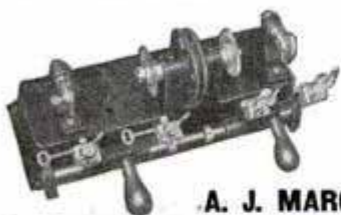

- Marcot No. 8 Key Machine Mounted on Cabinet..... \$ 75.00
- Book on Modern Locksmithing 3.95
- Auto Code Book and Depth Keys 12.50
- 2592 Assorted Key Blanks. 77.76
- Set Key Files, Tools, Pins, Springs, Thimble 10.50

A. J. MARCOTTE CO., 1200 N. Kedzie Ave. CHICAGO 51, ILL. \$179.71

PLASTIC STOCK & KITS

PLEXIGLAS SHEETS: New, per square foot, following thicknesses; 1/16" \$1.60; 1/8" \$2.00; 3/16" \$2.25; 1/4" \$2.75; 3/8" \$3.75; 1/2" \$4.75; 3/4" \$7.50; 1" \$9.50. 5% discount on orders over 5 square feet and 10% over 10 square feet. Other Plastic Supplies. **PLASTIC KITS:** \$2, \$5 and \$10 each. We pay shipping charges. Send Money Order to—**PLASTIC SUPPLY CO.,** 2618 St. Louis Ave., St. Louis 6, Mo.

TOMBSTONES

DIRECT TO YOU \$9.95 up
Genuine Beautiful Rockdale Monuments, Markers. Satisfaction or MONEY BACK. Freight paid. Write for our FREE Catalog and compare prices. **EASY Terms**



ROCKDALE MONUMENT CO. JOLIET, ILLINOIS

Dept. 654

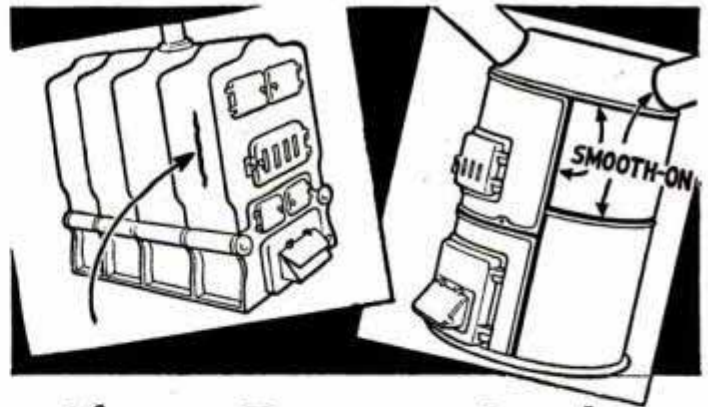

Those Furnace Leaks Waste Fuel...

Stop Yours with

SMOOTH-ON



STOP up leaks and cracks in your heating equipment and save precious coal or oil—prevent the discomforts of a furnace breakdown in winter weather.

Seal leaks in boiler, tank, piping and radiators with handy Smooth-On No. 1 Iron Repair Cement. No experience needed, no heat required. Smooth-On handles like putty, hardens durably. Besides stopping leaks and sealing cracks, Smooth-On tightens loose handles, knobs, casters—does countless home repair jobs.

Keep a can of Smooth-On handy—get it at your neighborhood hardware store in 1¾-oz.; 7-oz. or larger sizes. Inexpensive—does not deteriorate . . . and be sure to mail us the coupon TODAY for the—

FREE Home Repair Handbook

showing, with pictures and simplified descriptions, all sorts of repairs any householder can make. 40 pages. 170 diagrams. Pocket size. Handy index. Send coupon for your copy.

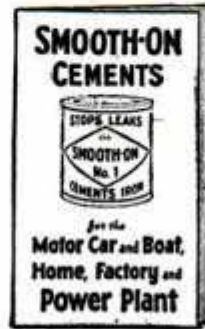

MAIL THIS TODAY

Smooth-On Mfg. Co., Dept. 37
570 Communipaw Avenue, Jersey City 4, N. J.
Yes—please mail me my Smooth-On Handbook.

Name.....

Address.....

1-46.....

Do it with **SMOOTH-ON**

NO OTHER TOOL IN THE WORLD LIKE THIS

*Holds Tighter — Cuts Better
Doubles the Power of Your Grip*



THESE EXCLUSIVE ADVANTAGES

1. Jaws remain always parallel, close like a vise.
2. Cutting jaws on outside of head, convenient to use.
3. Compound leverage action more than doubles the power of your grip.

Indispensable in every household and on every home workbench. Ask your hardware dealer for BERNARD parallel action pliers... Send for illustrated booklet of many BERNARD ingenious hand tools.

BERNARD

WM. SCHOLLHORN COMPANY

"Quality Tools Since 1870"

7501 Chapel Street, New Haven 9, Conn.



A SNAP TO START

"O.K." SUPER '60' ENGINE

FOR MODEL AIRPLANES
FOR FREE FLIGHT
OR CONTROL-LINE

DESIGN FEATURES

CYLINDER—1 piece
CRANKCASE—aluminum-alloy
PISTON—machined from steel, hardened and lapped to cylinder
BALL-BEARING—Radial and thrust
BORE .900, **STROKE** .950, **DISPL.** .604, **WGHT.** 12 ozs.

"OK" Super "60" is palm-size power plant! Gives consistent flying power to model airplanes! A snap to start! Many exclusive design features including **PATENTED PORTING** for complete instantaneous scavenging. **TOP SPEED** (to 9000 RPM) Super "60" with coil, spark-plug, gas tank, condenser \$24.00 at all model hobby shops.

FREE! Descriptive Brochure and Installation diagram. (Send stamped and addressed envelope)

HERKIMER TOOL & MODEL WORKS
HERKIMER (Dept. PM) NEW YORK

V-8 DUALS AND SINGLES



A genuine steel pack muffler WITH A BEAUTIFUL MOTORBOAT TONE. Sandee Mufflers feature improvements far in the lead, years ahead of competition. Increases mileage and power, reduces back pressure and gives better performance. Savings in gasoline will pay for a Sandee Muffler.

V-8 FORD AND MERCURY DUALS **\$17.50**

SINGLES—FIT IN PLACE OF REGULAR MUFFLER

Chev., V-8 Ford, Plym., \$5.00 Chrys., Olds., Buick, etc., \$7.00

These mufflers will outlast two regular stock replacements.

Dealers Wanted

SANDEE MUFFLER CO.

7523 S. WESTERN AVE., LOS ANGELES 44, CALIF.



AMICI (ROOF) PRISMS

90° double inversion. Accuracy 2-sec. arc. 2 sizes: 1.6" x.83" and 2.6" x1.4"

	Small	Large
Grade A (perfect)	\$6.00	\$8.00
Grade B (slight defects)	\$4.00	\$5.00
Grade C (chipped roofs)	\$2.00	\$3.00

Satisfaction Guaranteed—Sent Prepaid on Receipt of Check or Money Order

INDUSTRIAL SERVICE

302 LUMBER EXCHANGE BLDG., MINNEAPOLIS, MINN.

BUILD Boucher MODELS

CLIPPER TANKER FREIGHTER
Everything for the Model Ship Builder Since 1905

34 DIFFERENT MODEL KITS \$5 to \$35

Send 35c for 96 PAGE ILLUSTRATED CATALOGUE

BOUCHER SHIP MODELS 36 EAST 12th ST. NEW YORK, N.Y.



GEARS

In Stock - Immediate Delivery

Gears, speed reducers, sprockets, thrust bearings, flexible couplings, pulleys, etc. A complete line is carried in our Chicago stock. Can also quote on special gears of any kind. Send us your blueprints and inquiries.

Send for Complete Catalog No.10

CHICAGO GEAR WORKS
440-48 N. Oakley Blvd., CHICAGO 12, ILL.

FALSE TEETH FIT TIGHT with Dentyte



Soften DENTYTE by warming—spread it on your plate—put in mouth and bite to make a perfect impression. Remove plate—and allow few minutes to "set." You get an absolutely perfect fit. Sore gums vanish—no more slipping or loose teeth. DENTYTE is firm but resilient. For both Uppers and Lower. Each lining lasts for months. Immediately removable with fingers. Full size jar—(a year's undreamed of comfort per plate), postpaid only \$1. Send dollar bill at our risk. Easy to order. Easy to use. Unconditionally Guaranteed.

Dental Products Corp. Dept. PM-54, Manheim, Pa.

QUICK WARMTH
FOR ROOMS WITH THE
CHILLS



WITTIE
PORTABLE
ELECTRIC *Steam* HEATER



Equipped with safety automatic shut-off, Thermo Electric Control and other advantages.



Now you can bring *real steam heat* into any room! WITTIE Electric *Steam* Heater is a new revolutionary heater that provides quick, uniform warmth wherever and whenever you need it. Luggage-light, good-looking as a piece of furniture, and so economical to operate! Safer, too, because WITTIE is steam heat—no glowing coils. You'll want to see the WITTIE Portable Heater, so send coupon right away!

Weights only 37 lbs.; baked Hammerloid mahogany color; 110 volts AC

WITTIE MFG. & SALES COMPANY

1414 S. Wabash Ave., Dept. 17, Chicago 5, Ill.

Please tell me where and when I can see the new Wittie Portable Electric Steam Heater.

Name.....
Address.....
City..... State.....

READY! THE WAR'S GREATEST PHOTOS
ON LAND • ON SEA • IN THE AIR



MARK NUMBER OF SETS WANTED

U. S. NAVY SETS

- 100. Pearl Harbor
- 103. Carriers in Action
- 104. Battles of Coral Sea and Santa Cruz
- 105. Warship Damage
- 106. Battleships (BB)
- 107. Second Battle of the Philippines
- 108. LST's in Action
- 110. France and Italy Action
- 111. Carriers (CV)
- 112. Carriers Escort (CVE)
- 113. Leyte and S. Philippines
- 114. Manila and Manila Bay
- 115. Luzon
- 116. Destroyers (DD)
- 117. Cruisers (CA & CL)
- 118. Cruisers (CL)
- 119. Navy Planes
- 120. Auxiliary Ships
- 121. Palau Action
- 122. Iwo Jima Action
- 123. Solomons Action
- 124. Formosa and China Sea Strikes
- 125. Japan Bombed
- 126. Okinawa Action
- 127. Borneo and New Guinea Action
- 128. Central Pacific Action
- 130. Marianas Action
- 131. Carrier Activities
- 135. Japanese Surrender
- 138. U. S. Prisoners in Pacific
- 139. U. S. Prisoners in Pacific
- 140. Philippine Area Action

U. S. MARINE CORPS SETS

- 1. Saipan Operation
- 2. Saipan Operation
- 3. Guadalcanal Operation
- 4. Cape Gloucester Operation
- 5. Tarawa Operation
- 6. Tarawa Operation
- 7. Guam Operations
- 8. Kwajalein Operation
- 9. Eniwetok Operation
- 10. Tinian Operation
- 11. New Georgia Operation
- 12. Peleliu Operation
- 13. Peleliu Operation
- 14. Bougainville Operation
- 15. Iwo Jima Operation
- 16. Okinawa Operation
- 17. Okinawa Operation
- 18. Air Activities
- 19. Combat Engineers
- 20. Tanks in Action
- 21. Amtracs in Action
- 22. Marine Cemeteries
- 23. Communications in Action
- 24. Women's Reserve Activities

U. S. COAST GUARD SETS

- 200. Central Pacific
- 201. Philippine Landings
- 207. Southwest Pacific
- 211. Okinawa Landing
- 215. Iwo Jima Landing
- 218. Mediterranean Landings
- 220. Normandy Landings
- 222. Marianas Landings

Army and Air Force sets also available. Write for free descriptive circular.

Official
WAR PHOTOS
ONLY \$1.20 PER SET OF
20, 4x5" GLOSSY PRINTS

Prepare your own personal album of the War's greatest combat photos

Every fan, as well as veterans of World War II, will want a collection of these great photos—taken on the spot by official U. S. Army, Air Corps, Navy, Marine Corps and Coast Guard photographers. Scenes of street battles . . . landings . . . surrenders . . . atrocities . . . sinkings . . . air strikes . . . Kamikaze attacks, etc. Ideal for service men's personal albums and as gifts to friends and relatives. Order today, using attached coupon. Remit \$1.20 per set.

Official Photos Company
1434 NORTH WESTERN AVENUE,
HOLLYWOOD 27, CALIFORNIA

OFFICIAL PHOTOS COMPANY
1434 N. Western Ave., Dept. A-1, Hollywood 27, Calif.
Please send me postpaid () sets of your official war photos as per above list attached, for which I enclose.....

NAME.....
ADDRESS.....
CITY and ZONE..... STATE.....
PRINT PLAINLY

FLYING SUITS \$7.95

AIR CORPS (Type F-1)

Delivered anywhere in U.S.A.

All wool with extra inter wool lining. Zipper in front, on legs, sleeves, and pocket. Elastic wool collar, wrist and leg bottoms.

These suits are dry cleaned as they were slightly used. However, they are perfect in every respect.

Electrically wired for use on 24 volts DC. PLENTY WARM WHEN WORN WITHOUT ELECTRICAL ATTACHMENT.

Color, sky blue. Ideal for pilots, truck drivers, motorcyclists, hunters, ranchers, mechanics, skiers, or any sport to keep warm. Sizes small, medium, large.

Sold with money-back guarantee. \$7.95 delivered anywhere in U.S.A., prepaid. Send check or money order.

S & C

Equipment Company

1915 S. State St., Dept. P-1
Chicago 16, Illinois



This is the way to Make Money!

MACHINE SAW FILING with the Foley Automatic Saw Filer is the modern way to recondition saws. Anyone can do the work—no experience needed—no eye-strain. Start in spare time—Foley-filed saws cut so smooth and fast, they will advertise for you, bring you new customers and a steady repeat cash business.

The Foley is the ONLY machine that files all hand saws, also band and cross-cut circular saws—enables you to handle work from schools, shops and factories as well as farmers, carpenters, etc.

Send for FREE PLAN

Shows how to start—no canvassing. Send coupon today.

"I bought a Foley Saw Filer, one year later had all debts paid and also \$400 on a new home. Many days I earn as much as \$16," says J. H. Kellogg.

W. L. Tarrant writes: "I left my old job last September and in 10 months have filed 2,159 saws. We have a lovely business worked up and cannot keep up with the work."

Thor Nedribe, Iowa, says: "I have filed 550 saws, made \$350. As I'm a carpenter, I just file saws in spare time—have more than I can take care of."



FOLEY Automatic SAW FILER

FOLEY MANUFACTURING CO.
116-6 Foley Bldg., Minneapolis 13, Minnesota
Send Free Plan on Saw Filing business, no obligation

Name _____

Address _____

ELECTRICITY FOR ANY JOB ANYWHERE



Reliable, economical electric service anywhere, anytime, with an Onan Electric Generating Plant. Driven by Onan built, 4-cycle, gasoline engines, these power plants are of single-unit, compact design and sturdy construction. Suitable for all types of service.

Models range from 350 to 35,000 watts. A.C. types from 115 to 660 volts; 50, 60, 180 cycles, single or three-phase; 400, 500 and 800 cycle, single phase; also special frequencies. D.C. types range from 6 to 4000 volts. Dual voltage types available. Write for engineering assistance or detailed literature.

ONAN

D. W. ONAN & SONS, 2513 Royalston Ave., Minneapolis 5, Minn.

TRIG SLIDE RULE

Patent Pending

Fits the pocket. Quickly solves radio, trigonometry and electricity problems. Simply move the easy-to-use indicators and read the answers for all three sides and angles of a triangle. Gives degrees, sines, cosines and tangents of angles simultaneously. Easy instructions included. PRICE NOW \$1.00. Postage prepaid. Resale and wholesale orders taken.

REED MFG. CO., 124 W. 4th St., Los Angeles 13, Calif.

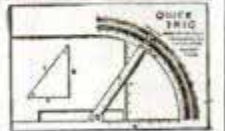

LOCATES TROUBLE INSTANTLY IN ALL ELECTRICAL DEVICES



HANLAN APPLIANCE TESTER

In this single unit are combined all the necessary tests for examining every appliance. Checks thermostats under actual working conditions. Tells instant it opens or closes. Controls the heat on soldering irons. Prevents over-heating. Tests continuity, open circuits, etc. Checks automatic irons, vacuum cleaners, motors, shavers, bulbs, appliances with 3-way switches, etc. Great time, effort and money saver! ONLY \$9.50 COMPLETE.

FREE with each Tester. New, Complete Practical Course in electrical appliance repairing. WRITE FOR CIRCULAR.

HANLAN CO., 1419-A, West Jefferson, Los Angeles 7, Calif.

DRILL PRESS OWNERS . . .



Convert your drill press into a multi-purpose machine with the new NOBUR ANGLE ADAPTOR. Write for literature.

NOBUR MANUFACTURING CO., Dept. M
910 N. Orange Dr., Los Angeles 38

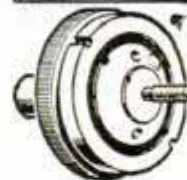

"WONDER" ELECTRIC BUTTON

Most interesting electrical apparatus ever discovered. Make your own Telephone-Amplifier Detectors. Transmit your voice or music to distant rooms. Perform hundreds of fascinating experiments. So tiny it can be concealed in dozens of places. Send \$1 now for button and

free 5,000 word instruction booklet with 50 illustrated experiments. SPECIAL OFFER 6 buttons and booklets sent post-paid for \$5.

BUCK MFG. COMPANY, Box A-28, No. Aurora, Ill.

FALSE TEETH

KLUTCH holds them tighter

KLUTCH forms a comfort cushion; holds dental plates so much firmer and snugger that one can eat and talk with greater comfort and security; in many cases almost as well as with natural teeth. Klutch lessens the constant fear of a dropping, rocking, chafing plate. 25c and 50c at druggists . . . If your druggist hasn't it, don't waste money on substitutes, but send us 10c and we will mail you a generous trial box.

KLUTCH CO.,

Box 4693-A,

I. P. INC.
ELMIRA, N. Y.

TURN YOUR SPARE TIME INTO PROFITS!

**NO EXPERIENCE REQUIRED • LIGHT, CLEAN WORK
STEADY, PROFITABLE INCOME
BE YOUR OWN BOSS
WORK RIGHT IN YOUR OWN HOME**

Here's the way to make big profits in your own business! Clean, easy work that pays *all* the profits to you. Without any experience, you can quickly learn to operate the Ideal Lawnmower Sharpener right in your own home, or as a sideline in your shop or garage. Automatic operation assures a perfect job every time. Just place mower in sharpener, make a few simple adjustments and the machine does the rest!

The Ideal Sharpener takes any make or size hand lawnmower. Every community needs this service. Work as long as you like . . . you're the boss, running your own business. Make those evenings at home pay cash profits now. Write today for complete information, without obligation.

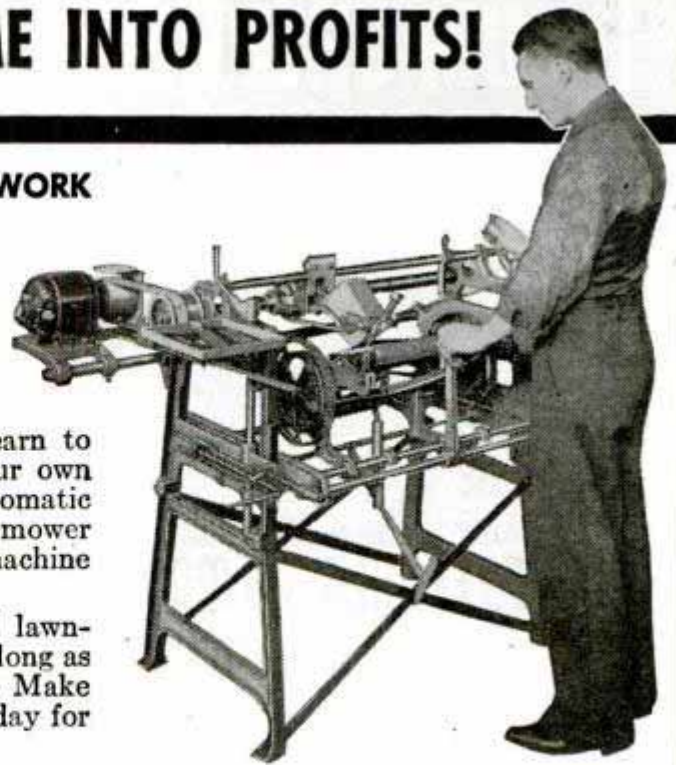

THE FATE-ROOT-HEATH CO. • 1146 BELL ST., PLYMOUTH, OHIO

SEND FOR THIS FREE BOOK!

**"HOW TO BUILD
A PROFITABLE BUSINESS
OF YOUR OWN"**

MODEL AIRPLANES

NEW BIG MONEY FIELD!
Make ANY Article
GLOW IN THE DARK
with Magic New Discovery!

STATUES

\$1.00

Undreamed of profits **RIGHT NOW** in this wonderful new business. One man sold over 200,000 glowing Statues of Christ for \$1.00 each. Another sold 25,000 glowing Crucifixes for \$1.00 each. Others have sold hundreds of thousands of glowing jewelry, glowing flowers, glowing pictures—at **BIG PRICES** and **BIG PROFITS!** This new Glow-in-the-Dark craze is sweeping the country. We show you how to get in this profitable business **QUICKLY** at a cost of only \$1.00! We show you how to take advantage of today's unequalled money-making opportunities. But you'll have to act **FAST**. Our supply is limited.

HUNDREDS OF USES! With Lite-Glo, anyone—even ten year old boys and girls—can make unlimited number of glow-in-the-dark articles. Here are a few: Model airplanes, orchids, gardenias, service flags, earrings, flowers, neckties, switches, religious statues, house numbers, furniture, pictures, clocks, stairs, holiday ornaments, etc. In addition, for safety purposes you can "light" medicine cabinets, knobs on radios, medicine bottles, doors, furniture, dark corners, etc. You can also originate "glowing" greeting cards, photographs, games, stationery, etc. Many wonderful uses. We give you hundreds of suggested money-making uses.

SEND NO MONEY! For quick delivery send coupon or penny postcard. Then pay postman \$1.00, \$2.00 or \$5.00 plus postage and handling charges. If you send cash with order, **WE** pay all postage and handling. But be sure to order **NOW!** Supply limited.

LITE-GLO COMPANY, Dept. 115-LA, Topeka, Kansas

FREE!

With your order for our largest Kit—Go-Into-Business-Size for only \$5.00—we include **FIVE** attractive composition religious figures

which, when made to Glow-in-the-Dark should retail for \$5.00—or the cost of the kit!

THREE DIFFERENT SIZE KITS!

Take your choice! Money-back guarantee on **ALL** kits!
(1) Complete introductory size kit. (2) Senior Kit, \$2.00. This kit contains three times as much material as the \$1.00 Kit. Also two colors, blue and purple.
(3) Go-into-business Kit, \$5.00. This contains **FOUR** times as much material as \$2.00 Kit, also two colors. In addition, on this limited offer, you get **FIVE** composition religious figures **FREE** with \$5.00 Kit!

CLIP AND MAIL COUPON NOW!

LITE-GLO CO., Dept. 115-LA, Topeka, Kans.

Please send me Lite-Glo Kits as marked below. With \$5.00 order be sure to send the Five **FREE** composition religious figures.

\$1.00 Kit **\$2.00 Kit** **\$5.00 Kit**
I am enclosing \$..... Send C.O.D.

Name.....

Address.....

City.....State.....

- LIGHT SWITCH
- FLOWERS
- JEWELRY
- PULL CORDS
- CLOCKS
- COSTUMES
- FURNITURE
- FUSE BOX
- KNOBS & KEYHOLES
- TELEPHONE
- SIGNS

GUM GRIPPER

TIGHTENS FALSE TEETH

OR NO COST

Amazing NEW Plastic Reliner

LASTS FROM 4 to 6 MONTHS

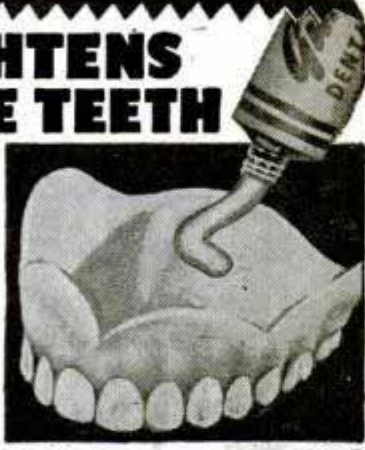

NOW—in a jiffy—you can make loose, slipping dental plates fit snug and comfortable. Eat, talk in comfort, laugh freely—for "Gum Gripper" enables you to enjoy that feeling of almost having your own teeth again!

● APPLY IT YOURSELF — AT HOME

"GUM GRIPPER" amazing plastic Reliner tightens dental plates quickly, makes them hold firmly and fit like new! Just squeeze from tube, spread evenly, put plate in mouth, wear it while "Gum Gripper" sets in few minutes. No heating necessary.

● USE ON ANY DENTAL PLATE

"Gum Gripper" will not harm denture or irritate gums. Sanitary, tasteless, odorless. Keeps mouth sweet and clean, prevents sore spots. Application of plastic "Gum Gripper" is guaranteed to last 4 to 6 months—or no cost. Can be scrubbed or washed. Rev. A. J. Wigley, Pittsburgh, Pa., writes: "Best material I ever used. I have not relined my lower teeth for 2 months."

"Best I've Ever Used"

SEND NO MONEY—Order a tube today—it's only \$1.00. Fill out and mail coupon below. You'll be delighted! Satisfaction guaranteed or your money back.

FREE Generous size package Dental Plate cleaner included free of extra cost. Cleanses dental plates without brushing. Will not harm denture.

GUM GRIPPER 127 N. Dearborn St., Dept. 71-G. CHICAGO

GUM GRIPPER, Dept. 71-G,
127 N. Dearborn St., Chicago 2, Ill.

Send me a tube of "Gum Gripper." You guarantee it to satisfy—or it will not cost me a penny.

I will deposit \$1.00 plus postage with postman when package arrives.

Enclosed is \$1.00—You pay postage.

NAME.....

ADDRESS.....

CITY..... STATE.....



Burpee's GIANT ZINNIAS

5 PACKETS **10¢**

BEST COLORS

Scarlet, Lavender, Yellow, Rose and White—75c Value!

Giant 5-in. blooms, Dahlia-flowered. Sturdy 3-ft. plants, easy to grow. All five 15c-Pkts., 1 of each color, postpaid for 10¢! Send dime today.

Write for Burpee's Seed Catalog FREE.

W. ATLEE BURPEE CO.

504 Burpee Bldg., Philadelphia 32, Pa. (or) Clinton, Iowa

Send 5 Pkts. Giant Zinnia Seeds (No. 7588). Enclosed is 10c.

SEED CATALOG FREE

Name.....

St. or R.D.

P.O. & State.....

Send Burpee's Seed Catalog FREE.

THOMPSON INBOARD MARINE ENGINE

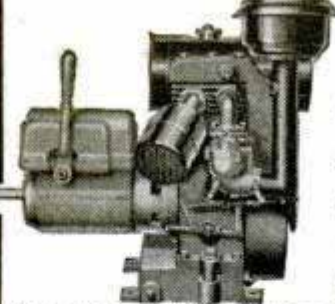

Flexi-Drive TRANSMISSION \$127.50

2-HP, 3-HP and 6-HP Models
4-Cycle — Air-Cooled
H.D. Magneto and Carburetor
Full Ball Bearing Drive and Reverse Gear
Quick Starting, Economical

2 H.P. Model, \$127.50
3 H.P. Model, 175.00
6 H.P. Model, 210.00

For Detailed Scale Drawings of WORK or PLEASURE BOATS, suitable for above engines, send \$2.50 (F.O.B. Grand Rapids, Mich., U.S.A.)

THOMPSON ENGINEERING CO. 212 Winchester Place, N. E. Grand Rapids 2, Mich., USA

Make Your Own ODORLESS PAINT



Use Ridsmel as thousands of professional painters do. Paint indoors any time of the year. A few drops of Ridsmel do the trick—in any casein or oil paint. No odors during painting. No lingering after odors.

Send \$1 today for trial bottle of Ridsmel—enough to deodorize 20 gallons of paint. Money back if not fully satisfied.

HAROLD MARSHALL CO., 9 E. 46 ST., N. Y. 17, N. Y.
Hardware, Paint Stores, distributors—write for details.

LAW

STUDY AT HOME FOR PERSONAL SUCCESS and LARGER EARNINGS. 35 years expert instruction—over 108,000 students enrolled. L.L.B. Degree awarded. All texts furnished. Easy payments. Send for FREE BOOK—"Law and Executive Guidance."

AMERICAN EXTENSION SCHOOL OF LAW
Dept. 61M, 646 N. Michigan Ave., Chicago 11, Ill.

OTTAWA TRACTOR SAW



350 CUTS PER MINUTE

Make money sawing wood. Use Ottawa—fastest cutting. Cuts large, small logs easiest way. Fells trees. One man operates. Thousands in use. Built to last with heavy, stiff saw blade. Positive safety clutch control: uses power take-off any tractor.

OTTAWA MFG. CO., D-127 Forest Ave., Ottawa, Kan.

FREE BOOK and Price List

RUPTURED?

Get Relief This Proven Way

Why try to worry along with trusses that gouge your flesh—press heavily on hips and spine—enlarge opening—fail to hold rupture? You need the Cluthe. No leg-straps or cutting belts. Automatic adjustable pad holds at real opening—follows every body movement with instant increased support in case of strain. Cannot slip whether at work or play. Light. Waterproof. Can be worn in bath. Send for amazing FREE book, "Advice To Ruptured," and details of liberal truthful 60-day trial offer. Also endorsements from grateful users in your neighborhood. Write:

CLUTHE SONS, Dept. 31, Bloomfield, New Jersey

Build These Cleveland Model Super-Values



★ ★ ★ Famous U. S. BLACK WIDOW

Big 36" model of the super night fighter that has all the world agog. **\$150**
This is another of the C-D popular Industrial Training Models. Build them all. C-D Kit T-155.....

Biggest \$1.00 Model in U.S. 84" Super Condor Soarer, Soars for hours. Kit E-5019. **\$100**

"Build the Models the Men in the Air Forces Build"

SEE YOUR DEALER FIRST. In ordering direct, add 20c extra for packing-postage.

36" PIPER CUB



The civilian plane that went to war, and did a darn good job. Rubber or gas, tether or free flight. C-D Kit T-94..... **\$150**

CATALOG 5c (Circular free)

CLEVELAND MODEL & SUPPLY CO.
4508F5 Lorain Ave. ★ ★ ★ Cleveland 2, Ohio, U. S. A.

ELECTRIC TESTER INDICATES VOLTAGE
AUTOMATICALLY TELLS WHETHER VOLTAGE IS: 110, 220, OR 440 VOLTS
CHECKS whether AC or DC, if 25 or 60 cycles, if open line, if grounded.
LOCATES TROUBLE---from 85 to 550 volts
in all appliances, fuses, plugs, radios, motors, spark plugs \$1.25 complete—Same but without voltage reading 1 neon-glow bulb 50c—With 110-220 volt reading—95c. Quantity price for dealers.
American Standard Labs., 1924 E. Hart Lane, Philadelphia 34, Pa.

THE GEM MAKER
Amateurs or professionals . . . hobbyists or jewelers . . . Polish your own gems with a B&I Gem Maker. You will find this a profitable adventure. All necessary lapidary equipment is furnished, including a super-charged diamond blade for sawing, and all wheels for grinding, shaping and polishing, also complete instructions. The complete equipment as shown, less motor and belt, for only \$29.50, f.o.b., Burlington, Wis. Write today for information and literature on the Gem Maker and accessories.
B&I MFG. CO., Dept. S, Burlington, Wis.

NOW AVAILABLE!

Crosman Silent Rifles—America's favorite compressed air rifles for indoor and outdoor shooting are back again! Available in 22 cal. single shot and Magazine Loading Types. At your dealer—or order direct. Ask for Crosman SUPER-PELLS too—the better ammunition for all compressed air rifles. .177 Cal.—\$1.80 per M. .22 Cal.—\$2.00 per M.

CROSMAN ARMS CO., INC. • Rochester 7, N. Y.

50" **1 1/2" HOLLOW SQ. TRAILER AXLE**
CAP.—2000 LBS.—\$6.75 EACH F.O.B. DETROIT
STRONG MACHINE & AXLE COMPANY
9710 Lumpkin Hamtramck 12, Michigan

Monuments Freight Paid Anywhere in U.S.A.
\$13.69 Up. Guaranteed Genuine Marble & Granite. Deal direct with Us by mail. Save. Write for Free catalog today.
U. S. MARBLE & GRANITE CO. Oneco, Fla. A-18.

ARMY RADIO PHONES only \$7.95
Made to U. S. Army Specifications, passed by Signal Corps Inspectors. Dynamic Microphone and dynamic receiver of finest quality—Water, shock, weather and altitude proof, used on tank and aircraft (B19) intercom systems. For recording, for battery-less telephone, talk through your radio set or use earphones for pocket-size set loud speaker.
Complete two receiver, cord set, head band, and dynamic hand microphone. Less than regular cost of dynamic mic.
Electronic Products Co., St. Charles, Ill.

:: SAVE WASTE PAPER ::



"I'm offering you 250 Money-Making Ideas for a business of your own"

Do you want to go into business for yourself? What type of business should you operate? How, When, Where should you start? Now—you have the chance to get the answers to questions like these.

OPPORTUNITIES TO SHARE
By A. C. CHAPMAN

At last! Here is your opportunity to get a practical, complete, inside guide that will equip you to act intelligently and confidently to become your own boss. Right from the start, point by point, this remarkable, easily understood handbook tells you how to avoid the pitfalls, gives all the do's and don'ts, questions and answers you must know to become independently successful. Tells you what decisions to make and how. Weighs your chance of success. Outlines how to start on limited capital and grow into a successful businessman. Gives stimulating ideas on businesses of the future. Chapter—"How to Finance a Business" alone . . . worth price of book.

- TELLS HOW TO**
- Finance a business
 - Make money with a movie camera
 - Market your inventions
 - Make a success of the retail business
 - Start on the proverbial shoestring
 - Take advantage of G. I. Bill of Rights
 - run many other businesses

Hundreds of POST-WAR Opportunities

Never before has such a concentration of tested, simple facts been offered to help the beginner start right, develop fast, and avoid common errors that cause 90% of business failure. It's helped hundreds and can help you. You haven't the time or experience to dig out information like this—expertly compiled, organized, dramatized. "Opportunities to Share" is ready now to work for you—but YOU MUST ACT IMMEDIATELY!

5-Day Trial Examination Offer
SEND NO MONEY. Mail name and address on a penny postcard. On delivery, pay postman \$4.98, plus C. O. D. charges. If you send cash we pay postage. Read and examine the book for 5 days. If by then you are not completely satisfied that it is the best investment you've ever made, return it and get your money back! If it can't help you, we won't let you keep it! **DON'T WAIT! ORDER NOW!**
The INVENTORS GUILD
2 East 39th St., Dept. 10, Kansas City 2, Mo.

The INVENTORS GUILD, Dept. 10
2 East 39th St., Kansas City 2, Mo.
Please send me your 628-page book "OPPORTUNITIES TO SHARE" with the understanding that if not satisfactory, I can return it within 5 days of delivery and my money will be refunded.
 Please send C. O. D. I enclose \$_____

NAME _____
ADDRESS _____
CITY AND STATE _____



Be the authority on accuracy in your shop!

A man's work is only as good as his measurement. You can be the "accuracy man" in your shop. Learn to work with genuine Ford "Jo-Blocks," guaranteed accurate to within 4 or 8 millionths of an inch, plus or minus. For as little as \$23 list price, you can own a fine working set of Jo-Blocks—keep your mikes and gages at millionth-inch precision. There is only ONE true American-made Jo-Block, made only by—

WRITE FOR THESE FREE BOOKLETS!

An absorbing story of the search for precision. A new De Luxe Catalog of Ford Jo-Blocks and Accessories.

FORD MOTOR COMPANY
Johansson Division
Dept. 101, Dearborn, Michigan



Johansson
GAGE BLOCKS

THERE'S Profit IN YOUR POWER BILL!

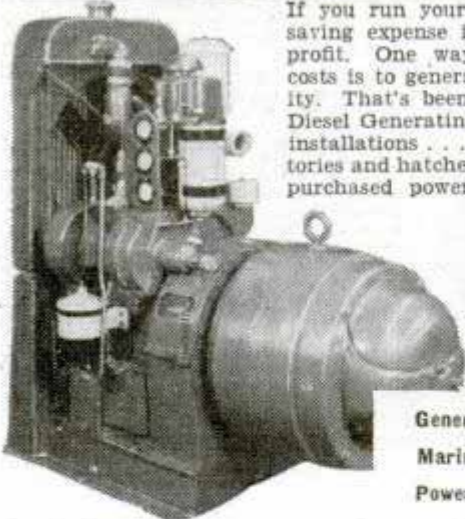

If you run your own small business, saving expense is just like making a profit. One way to lower operating costs is to generate your own electricity. That's been proved by Sheppard Diesel Generating Sets in hundreds of installations . . . on farms . . . in factories and hatcheries. It's cheaper than purchased power . . . it eliminates standby charges. Anyone who can press the starter button can operate it. There's a model to suit your requirements . . . investigate today.

Generating Sets—2 to 36 KW
Marine Engines—8 to 62 HP
Power Units—3¼ to 56 HP

R. H. SHEPPARD CO., 3448 Middle St., Hanover, Pa.

Sheppard ALL AMERICAN **DIESELS**

WELD ANYTHING ANYWHERE ANYTIME

ALL PURPOSE ARC WELDER
9 Models . . . 32 Volt D.C., 110 to 440 A.C.
A complete workshop in itself! Weld, cut, braze or solder any type metal; iron, castings, aluminum, steel, bronze . . . in any gauge or weight, with equal ease. Compact, complete, as sturdy as the Rockies. Formed steel and cast aluminum case, welded steel base, 4" cast wheels. Built with voltage control. Better on R.E.A. lines. Completely equipped. No instructions needed. Sold throughout the world. Several dealer territories open. Write:

FORNEY MFG. CO.
FORT COLLINS 2, COLORADO

BURN YOUR NAME ON TOOLS WITH THE ARKOGRAF

PROTECT YOUR TOOLS FROM THEFT
Write with electricity any name or design on the hardest and finest tools and instruments or any metal, like writing on paper with pen or pencil. Thousands used by mechanics, garages, machine shops. **Complete Outfit \$3.50—Prepaid Anywhere** Interesting illustrated circular free. Write today. **ARKOGRAF PEN CO., 3927 S.E. Stark, Portland 15, Ore.**

GENUINE U.S. BARGAINS

Army O. D. Wool Blankets, 5 lbs. . . . \$5.95
Army Pocket Knife, Scout Style . . . \$2.50
Pup Tents, Poles and Pegs, Used . . . \$4.85
Mess Kit—Knife, Fork and Spoon, Used . . . \$.50
Thousands of Other Bargains in Military, Outdoor & Sport Goods for Hunter, Farmer, Scout. — Send 10c for 32-page catalog returned with first order.

A and N SUPPLY CO.
4720 LESTER ST. RICHMOND, VA.
EST. 1868

DEXTER UNIVERSAL LATHE CHUCK
well-made, accurate, strong, serviceable

New Backless design requires no adapter
2" — \$10; 3" — \$15; 4" — \$19;
5" — \$24; 6" — \$28
Includes inside and outside jaws
State spindle size and threads per inch
Distributors Wanted

THE LEAVITT MACHINE COMPANY
ORANGE MASSACHUSETTS

Loose FALSE TEETH are a NUISANCE!

Now you can make your loose plate fit tight and snug with my new discovery. Easy to apply. Do it yourself. **Perfect Fit Guaranteed.** Write for Details. Dr. C. N. Reese, DENTIST, Box 268 • A, Winnetka, Illinois

Cut NEW TEETH in 3 Min.
With **FOLEY RETOOTHER**

For All HAND SAWS

No need to grind off old teeth—cut new ones over them. Fast, accurate, no eye-strain. Cuts filing time in half.

Cuts 20 sizes of teeth from 4 to 16 points per inch.

FOLEY MFG. CO. 139-6 Foley Bldg. Minneapolis 13, Minn.
Send full details on Foley Retooter.
Name
Address

Your Rust Troubles are Over CORODEX Rust Remover

is the war-time miracle liquid which cleaned millions of parts during war effort. CORODEX positively removes RUST and CORROSION regardless of depth, from iron, steel, brass, bronze, copper, chromium and nickel. Cleans tools, hardware, sports equipment, household utensils, etc., for a few cents a piece. No RUBBING or hard work.

CORODEX IS UNCONDITIONALLY GUARANTEED TO REMOVE RUST WHEN DIRECTIONS ARE FOLLOWED. Valuable Manual of Rust Control free with order.

At Sears Chicago and Gary stores, 50c and \$1.00 or send \$1.00 for full quart F.O.B. Chicago (express) to

SEARS, ROEBUCK AND CO.
403 SO. STATE STREET, DEPT. 8500-9, CHICAGO 5, ILLINOIS
(CorOdex is made by Allied Products Co., Chicago)

MAKE AND SELL FOR PROFIT

Plastic JEWELRY AND NOVELTIES!

There's fun and profit in making plastic jewelry, novelties, and furnishings, in your home workshop! We have every material you need — Plexiglas, Lucite, Bakelite, Lignolite, Tenite II, Lumarith, in a large variety of sheets, rods, tubes, and special shapes. Also dyes, cements and other plastics supplies and accessories. Send 10 cents today for complete catalog. Address Dept. I-B.

CARMEN-BRONSON CO.

165. EAST 3RD ST., MT. VERNON, N. Y.



Build your own grinder with this combination pulley and arbor. Fits 1/2" shafts.

75c
Postpaid
U.S.A.

AGENTS INVITED

F. ROESCH

584 Communipaw Ave., Jersey City, N. J.



FEET HURT? Try Dr. BARRON'S New Foot Cushion

Many with tired, aching feet have found happy relief! So comfortable—LIKE WALKING ON A PILLOW! Made of fine soft, spongy material, leather covered. So light, flexible—cushions and helps relieve your feet from heel to toes. If you suffer from metatarsal callouses, corns, foot palms or fallen arches, try Dr. Barron's Foot Cushion. Wear in any shoes—helps make walking a pleasure. Doctor says: "I recommend Foot Cushions to foot sufferers." Send only \$1.98 for A PAIR—or will ship C. O. D., plus postage. **STATE SHOE SIZE AND IF MAN OR WOMAN, 30 DAY TRIAL GUARANTEE.** Money back if you don't get blessed relief! **ORTHO CO., 111 W. 83rd St., Dept. 49-A, New York City 24**

:: SAVE WASTE PAPER ::

6 handy tools in ONE!

- 1 MITERING GUIDE
- 2 DIAMETER GAGE
- 3 ACCURATE SQUARE MARKING GAGE
- 4 CENTER FINDER
- 5 CONVENIENT RULER
- 6

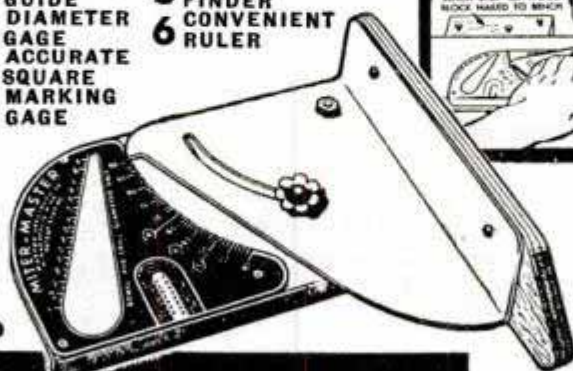

Miter Master takes the place of an expensive miter box accurately set to any angle. Scale marked for mitering 5, 6, and 8-sided frames. Steel construction. Built to last a lifetime. If your dealer can't supply you we will send it postpaid anywhere in the U. S. for \$1.50. Unconditional guarantee. If not satisfied within ten days for any reason whatsoever, your money will be refunded.

MITER-MASTER

\$1.50
POSTPAID

MASTER SPECIALTY COMPANY

5700 CEDAR AVENUE MINNEAPOLIS 7, MINN.

SWIVEL-HEAD FLASHLIGHT

nothing else like it!

**HEAD TURNS
LIGHT AT
ANY ANGLE**



Greatest advance in flashlight design in a generation. Turn powerful pre-focused beam where you want it . . . stand it up . . . clip it on . . . both hands are free. A handsome, durable, all-purpose flashlight for everyone. Ask your dealer.



\$2 LESS BATTERIES



No. SW-22
Patented

No. 75 Heavy-Duty Dated Cell. Fresh Lasts longer. 10c

Flashlights & Batteries

If dealer cannot supply, send \$2.00 to Dept. P UNITED STATES ELECTRIC MFG. CORP., New York 11, N. Y.

*USALITE Red-Head Safety Flashlight—a "MUST" for the motorist.

BUILD the COMET INTERCEPTOR!

DE-THERMALIZER DEVICE

AUTOMATIC RETRACTABLE LANDING GEAR

\$2.95

Kit No. T-14

The GAS MODEL with the SENSATIONAL POST-WAR FEATURES!

Sensational GAS MODEL designed by CARL GOLDBERG! Offers amazing De-Thermalizer—which brings your model down out of rising air currents—prevents flying away! Foolproof automatic retractable landing gear; steep climb—graceful glide! Kit contains plans and materials to complete either Class "A" or "B" model.

Many other Comet Kits at your dealer

COMET MODEL AIRPLANE & SUPPLY CO. INC.,

129 W. 30th STREET, CHICAGO 16, ILL.

1170 BROADWAY, NEW YORK 1, NEW YORK

ARMSTRONG TOOL HOLDERS

enabled American industry to change to war production "over night." For they are the permanent, multi-purpose tools used by 96 per cent of the machine shops and tool rooms, on lathes, planers and shapers—the tools used to make dies and jigs, to build production machines. They are the tools you will want for your own shop—ARMSTRONG TOOL HOLDERS for industry, ACE Tool Holders for home work shops.

ARMSTRONG BROS. TOOL CO.

"The Tool Holder People"

368 N. Francisco Ave., Chicago 12, U.S.A.

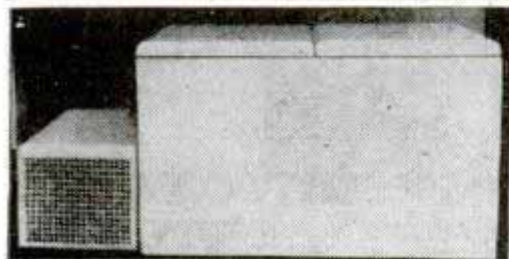

FOOD FREEZERS... BUILD YOUR OWN

Complete stock of all component parts now available for immediate delivery, including drawing, assembly instructions and list of materials. Save 30% to 40% of retail price. Build your own food freezer—it's easy. Free information—No obligations. Write:—

HASKRIS REFRIGERATION ENGINEERING CO.

6406 North Washtenaw Avenue

Chicago 45, Illinois

WISE-GRIP WRENCH

Gives Your Hand a TON-GRIP

Does more things, easier and quicker, than any other tool! Remains locked to the work with hands removed. Holds anything, any shape, with a Ton-Grip that never slips. Built with strength to back up its power. Is actually Hand-Vise, Clamp, Super-Plier, Adjustable End-Wrench, Pipe-Wrench, Locking Wrench and Toggle-Press—ALL IN ONE! Light, trim, handsome. Made of fine alloy steel. Zinc plated. 2 sizes.

Sold through Tool Jobbers and Dealers
PETERSEN MFG. CO., Dept. P-16, DeWitt, Nebr.



AGENTS

SALES-MEN

FOR IMMEDIATE DELIVERY

\$2.40 Doz.

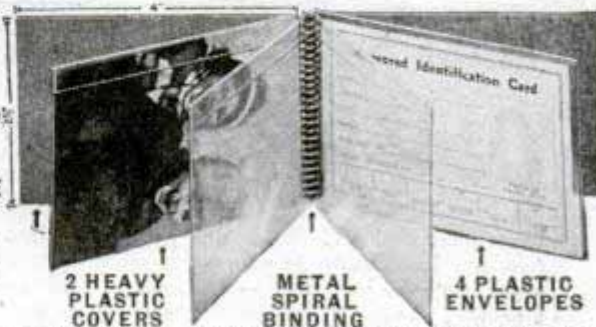

Timely fast selling Specialty—easy to carry. Everybody buys our Clear View Identico Case. The perfect Wallet Insert—fits into wallet, vest or blouse pocket and Ladies' purse. Sells like "Hot Cakes." Price 50c ea. Cost you \$2.40 Doz. Postpaid. Order trial Dozen today. GUARANTEE Sale of 1st order or money refunded for unsold portion. FREE 3 color display card, sample attached, with 1st order.

BEACON SALES CORP. Dept. PM-1, 37 S. Wabash, Chicago 3

EXPERIMENT WITH BLACK LIGHT!

FUN! THRILLS! PROFITS! See seven page article on this fascinating science in June 1945 issue of Popular Mechanics. We furnish all supplies. Trial Kit of 8 lacquers only \$6.25. Black bulb for testing, \$2.00. Lamps, lacquers, crayons, fabrics, etc. Write for descriptive list and full details today!

BLACK LIGHT PRODUCTS, 450 East Ohio Street Chicago 11, Illinois

FIBRE ARMS AND LEGS!

Light, correctly fitted, strong and comfortable. Natural appearance. Braces for all deformities. Scientific design. Fair Terms.

BUCHSTEIN-MEDCALF 610-3rd Av. S., Minneapolis, Minn.

HOW TO FIX ZIPPERS

Why discard clothing, leather goods, etc.? Fix the zipper yourself. Step by step instructions, 39 sketches. Be prepared for zipper trouble, mail \$1.00 now.

MOREHELP, A16, Box 140 LAKEWOOD, N. J.

COLOR CONCRETE WITH CHEMICALS

A business of your own. Big money making Hollywood style pottery and birdbaths without moulds. Washing-wells, stucco-rock, benches. Marbling and cement water-paints, 10c brings sample, literature, pictures. Hollywood CementCraft, 8529 Wonderland Ave., Hollywood 46, California

PEPSI-COLA HITS THE SPOT

SEE WHAT YOU CAN DO WITH A CASCO POWER TOOL KIT

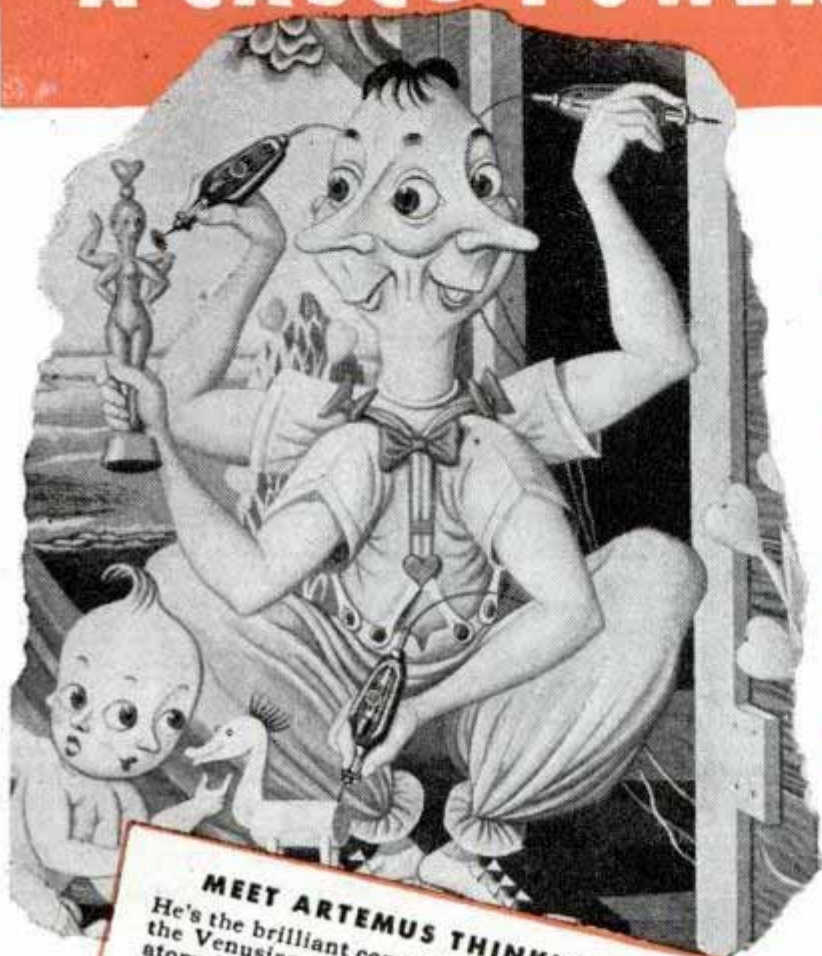

MEET ARTEMUS THINKLE OF VENUS
He's the brilliant concept of artist Boris Artzybasheff—the Venusian you'll meet and like as soon as the new atom-drive space ship is completed. Mr. Thinkle's four hands (notice they're all right hands) give him a slight edge—but you can do everything he's doing with a Casco Power Tool Kit—and more!

- **It's hand-sized—handles as easily as a fountain pen!**
- **Gets into small places—does fine detail work**
- **Works on metal, glass, wood or plastic**
- **Acts as both a repair and a hobby tool**

35 ATTACHMENTS DO ALL THESE JOBS BETTER AND FASTER

- | | | |
|-------------|--------------|---------------|
| ● Sanding | ● Sharpening | ● Dressing |
| ● Carving | ● Burring | ● Cutting |
| ● Sawing | ● Burnishing | ● Rasping |
| ● Finishing | ● Inlaying | ● Brushing |
| ● Drilling | ● Cleaning | ● Touching Up |
| ● Engraving | ● Polishing | ● Mortising |
| ● Grinding | ● Routing | |

... and many other machine and hobby uses

watch

CASCO

for new and unusual contributions to better living

The Casco **ELECTRI-CRAFT** Power Tool Kit—now in production, available soon! Casco Products Corp., Bridgeport 2, Conn.





ORDER NOW!

NEW

ECHOPHONE EC-1A RADIO RECEIVER

Be one of the first to own this popular set for short-wave and regular broadcast reception. Order now for earliest delivery. Many new features! Covers entire tuning range from 550 Kc. to 30 Mc. (550 to 9.85 meters) in 3 bands. For 110-125 volts AC-DC. Automatic noise limiter. Built-in PM speaker. Complete with tubes. **\$2950**

ALLIED RADIO CORP.
833 W Jackson Blvd., Dept. 5-AA-6, Chicago 7, Ill.
 Ship ECHOPHONE EC-1A at earliest moment.
 Enclosed \$ _____ Full Payment
 Part Payment. Balance C.O.D.
 Send additional information on Echophone EC-1A.
 Send information on other Communications Receivers and Time Payment Plan, without obligation.

Name _____
Address _____
City _____ Zone _____ State _____

Cushman
MOTOR SCOOTER
NOW I GET THERE QUICKER, CHEAPER



OVER 75 MILES PER GAL.

IT'S A HONEY! . . . this new 1946 CUSHMAN—greatly improved by its years of rigorous war-time service! Now has surprising Speed, Comfort and Economy!
Thousands find it the ideal way to get to and from work, run errands, make light deliveries. Also available with side car or tandem seat to carry an extra passenger.
So much FASTER and EASIER than walking—up to 35 miles an hour! So much CHEAPER than using an auto—about 400 miles on \$1 worth of gas!
POWERFUL 4 HP. ENGINE. Floating drive. Applies power as smoothly as Fluid Drive. New low and high gear gives power for steepest hills. Longer wheel base, improved spring action, big balloon tires, give new riding comfort. Durable electrically-welded all-steel frame.
OTHER MODELS: Paratrooper model for the sports rider. 3-wheel Package-Kar has front package-box that carries up to 300 lbs.—ideal for delivery service.
WRITE See your dealer who handles the CUSHMAN, or send for full details, photos and low prices on all 3 models. Send your name and address NOW!
CUSHMAN MOTOR WORKS, Dept. P-71, Lincoln, Nebr.

SAY YOU SAW IT IN POPULAR MECHANICS



Seeland
Since 1837
Chronograph
THE FIVE-IN-ONE WATCH

Telemeter • Tachometer
Stop Watch • Time Keeper
Time Out Stop Watch

AT BETTER JEWELERS EVERYWHERE

AMAZING MYSTERY BUTTON

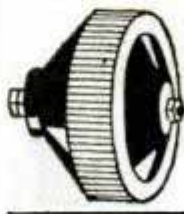

Startles Everybody. With this *Electronic Button* you can make your own Telephone—Amplifier—Detectophone. Attach this button to piece of cardboard—transmit conversation to another room. Music also transmitted to distant places. Most interesting, electrical apparatus ever discovered. Enables you to perform hundreds of experiments. So tiny it can be concealed in dozens of places. A Pre-War Product. *Electronic Button* including 5000 word instruction booklet with 50 illustrated experiments postpaid only \$1.00.
Electronic Products Company, Saint Charles, Ill.

ONE-MAN SAWMILL LESS THAN \$110.00
Easy To Turn Trees Into Money

Makes Lumber, ties, shingles, crates, lath, studding, siding.



BELSAW MODELS
In to 24 feet sawing lengths. Patented Mechanical Feed, accurate set works and positive dogs. Use tractor or old auto engine for low cost power. Thousands used for commercial sawing. Pays for itself quickly. Send postcard today for FREE booklet, "How To Make Lumber" & Catalog of Woodworking Equipment.
BELSAW MACHINERY COMPANY
Dept. 1811-V 3542 Main Street, Kansas City 2, Mo.

CAMERAMEN!

NEW HANDY LAB DIAL GIVES **UNIVERSAL DEVELOPER FORMULAS**

as recommended by the leading producers of film and paper, given instantly and correctly. Simply turn dial to film or paper desired and read formula. All standard brands of film and paper represented. It's palm-sized, richly colored with a fine, varnish finish. AT OUR RISK send for yours today. If not completely delighted, return within 10 days for immediate refund. Price Now 35c. Postage prepaid.
REED MFG. CO., 124 W. 4th St., Los Angeles 13, Calif.



Big Profit AUSTRA-WHITES

Sensational MONEY MAKING HYBRID. Customers report broilers 8 weeks, laying 4 1-2 mos. Disease resistant. **Hardy Layers**. 60,000 chicks weekly. Started pullets. Profit Sharing Plan. FREE Book. Write today.
BERRY BROS. FARMS, Box 582, ATCHISON, KANS.

WINDOW SIGN LETTERS

For Store Fronts and Office Windows. Anyone can put them on. Samples furnished. Genuine Gold and Silver.
METALLIC LETTER CO., 430 N. Clark St., Chicago 10

CHICKS ON 30 Days Trial

guarantee. Money refunded on any chicks not true to breed. No need to take chances. You get 30 days to make sure chicks are as represented. Male or pullet chicks furnished. Low prices. All varieties. Mo. Approved. Blood Tested. Easy buying plan. Bargain Prices and Chick Manual Free.
MISSOURI STATE HATCHERY, Box 189, BUTLER, MO.



MRS. BERRY'S POULTRY BOOK

BERRY'S Champion-Mated, Hand-Picked CHICKS, also SEXED, STARTED, 52 Breeds, 7 HYBRIDS. All Iowa Inspected, BWD Tested. Over 400 Prizes—30 Shows! **LOW PRICES.** In Business nearly 50 years. Beautiful **POULTRY BOOK FREE,** stamps appreciated.
BERRY'S POULTRY FARM, Box 29, CLARINDA, IOWA

Wonderful POULTRY BOOK

FREE LOW PRICES 48 varieties **SEX-LINKED** and **PUREBREDS; BABY CHICKS, Pullets or Cockerels, also STARTED CHICKS, BABY TURKEYS, Mature Fowls and Hatching Eggs. ALL FLOCKS BLOOD TESTED FOR BWD.** Write quick for this free book.
GREAT WESTERN HATCHERY, Box 15, Salina, Kans.



A TOOL—
NOT A
BRUSH

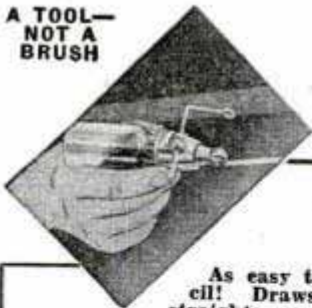

PAINTERS' STRIPING

TOOL

ONLY
\$1.00
POST
PAID

As easy to use as a pencil! Draws parallel lines, straights, curves, circles with paint, enamel, lacquer. Use to stripe autos, furniture, toys, bikes, model planes, signs, bulletin boards, linoleum. (Makes wall board look like tile.) Every painter and craftsman should own one! Type "S" MASTER Painters' Striping Tool with instructions, adj. guide, 1/16" tip, complete only \$1.00. C. O. D. 25c extra. Order Today! PAINT DEALERS! WRITE FOR LITERATURE, ETC.

WENDELL MFG. CO., 4234-X, Lincoln Ave., Chicago 18, Ill.



COMB-A-TRIM THE NEW QUICK TRIMMER

Something New! Trim your hair without any experience. It's easy! The excess hair comes off smoothly and easily by just pulling trimmer through hair like an ordinary comb. Also removes hair from legs—armpits. Save on hair-cut bills . . . Trim your own hair or the whole family's. Send 59c and your Comb-A-Trim will be sent at once.

59c



SPECIAL OFFER

Send \$1.00 for 2
Comb-A-Trims
and save 18c. **2 for \$1**

5 Extra Blades
(Year's Supply) 25c

COMB-A-TRIM CO.

1734 Carew Tower

Dept. R-2

Cincinnati, O.

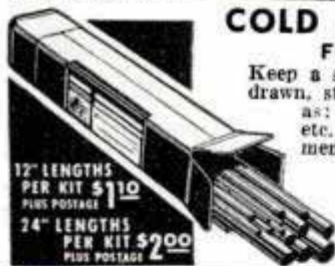

COLD ROLLED STEEL RODS FOR HOME WORK SHOPS

Keep a supply of these free machining, cold drawn, steel rods on hand for many uses such as: studs, pins, special screws, spacers, etc. Each kit contains a complete assortment of sizes, by sixteenths, from 3/16" to 3/4" inclusive. Furnished either in 12" or 24" (approx.) lengths. Weight, small kit 7 lbs., large 14 lbs.

Order today from
GENERAL METALS SUPPLY CO.
742 Park Ave. River Forest, Ill.

12" LENGTHS
PER KIT \$1.10
PLUS POSTAGE

24" LENGTHS
PER KIT \$2.00
PLUS POSTAGE

DEVELOP THE POWERFUL INFLUENCE



FEUCHTINGER Method Guaranteed
IN YOUR VOICE

DO IT YOURSELF AT HOME

Write for the Voice Book - FREE

Sent only to those over 17 yrs of age

PERFECT VOICE INSTITUTE

Studio 9351

Kimball Hall Bldg., Chicago 4, Ill.

RADIO PARTS GRAB BAG!!

\$25 value assortment of Coils, Condensers, Transformers, Resistors, Controls, etc. An experimenter's dream. While they last, only . . .

\$3.98

MARKO SUPPLY, Dept. P.M. 1

2924 Logan Blvd.

Chicago 47, Ill.

Burn Your Name On Tools Electro Name Etcher

Only

PROTECT valuable tools from thieves and tool borrowers! Electro Etcher BURNS your name, any design, permanently on tools, instruments, dog collars, any metal. Easy! Simple as writing with pen or pencil. Rush order today—supply limited—no more when these are gone! SEND NO MONEY! Pay postman \$1.00 plus few cents postage on delivery. Use 5 days—money back if not delighted. Electro Etcher, Dept. C-600, Strader Ave., Cincinnati, O.



A TOOLSHOP IN YOUR HAND!

- GRIND • DRILL
- POLISH • ROUT
- ENGRAVE • CUT
- CARVE • SAND
- SAW, etc.

HANDEE TOOL OF 1001 USES

The first small portable tool and today's finest. Smooth, steady power at your fingertips. You'll be amazed at what you can do with your Handee—turn out professional looking projects for pleasure or profit—ship, plane or train models, custom built jewelry, wood carvings, puppets, initialed tumblers, etc. Uses 300 different accessories. AC or DC. 25,000 r.p.m. Weight 12 ounces.

MAKE THINGS FROM
WOOD • PLASTICS
METALS • GLASS
LINOLEUM
LEATHER • ALLOYS
HORN • STONE
BONE, etc.

With 7 accessories, postpaid.....\$18.50

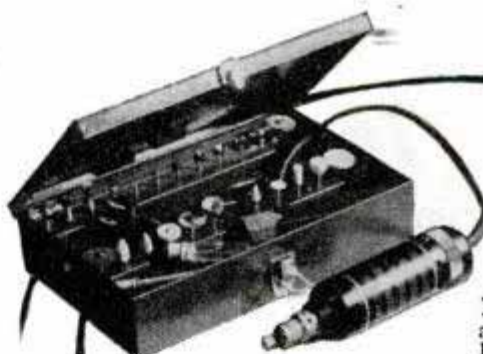

Get a Good Start

Get the HANDEE KIT

HANDEE Tool and 45 most popular accessories, in handsome, compact, steel carrying case!

Set includes steel cutter, drills, bristle brushes, polishing wheels and points, rubber disc, drum sander and bands, mounted wheels, Speed Oil, sandpaper discs. You'll be amazed at what you can accomplish! Complete, postpaid. . . .

\$25.00

FOR YOURSELF OR A FRIEND...
THE GIFT OF A LIFETIME!



ORDER NOW!
USE THIS COUPON

FREE
64-PAGE
Catalog

CHICAGO WHEEL & MFG. CO.
1101 W. Monroe St., Dept. PM
Chicago 7, Ill.

Send me HANDEE TOOL HANDEE KIT
 Remittance enclosed.
 Send C.O.D. Send Catalog.

Name.....

Address.....

YOU CAN'T BEAT this to relieve itching of SKIN and SCALP IRRITATIONS

So
Many
Druggists
Say!



Here's a Doctor's formula — Zemo — a stainless liquid which appears invisible on the skin—yet so highly medicated and soothing that the first applications promptly relieve itching, burning of Eczema, Psoriasis and similar skin and scalp irritations—due to external cause. Zemo ALSO aids healing.

Apply clean, stainless, invisible Zemo any time. It won't show on skin. Buy Extra Strength Zemo for mean cases.

ZEMO

The STANLEY TOOL GUIDE

Get this big book describing care and use of hand tools. Over 200 illustrations. Only 25¢ postpaid. Stanley Tools, 116 Elm Street, New Britain, Connecticut.



OUR THANKS

TO THE READERS OF

Popular Mechanics

THE AMP Solderless Electrical Repair Kit has been bought by the thousands for quick, easy electrical wiring repair of household appliances, cars, trucks, boats, tractors, model railroads, motors, etc.

Among the users of AMP Solderless Wiring Kits are doctors, auto mechanics, hobbyists, housewives, dentists, lawyers—in fact, the AMP Repair Kit is doing a good job for people in every walk of life—at home and at work.

They learned that one Kit does the whole job. \$5.95 complete. Why bother with solder?

All you need for sound electrical connections is an AMP Electrical Repair Kit! Nothing else to buy—simple as A, B, C. A—Strip insulation from wire with all-purpose tool. B—Place proper terminal on stripped wire. C—Attach terminal with all-purpose tool.

Send cash, check
or money order to



AIRCRAFT MARINE PRODUCTS INC.
1527-33 N. FOURTH STREET, HARRISBURG, PA.

FOOT PAINS STOPPED or Your MONEY BACK



Air-Cooled ARCH-HEELERS

Get Quick Lasting Relief

Wear Guaranteed Proved ARCH-HEELERS in any shoes for aching feet, metatarsal pains, burning callouses, corns, weak arches. Must please you or Your Money Back. Made of selected leather, specially shaped with soft cushions to gently lift bone joints, release nerve pressure, free blood circulation, align entire foot. Springy. Air cooled. Comfortable, even in tight fitting shoes. Users praise them. "I wouldn't take \$5 for mine!" says one. Pair only \$1.

Send No Money Send name, address and shoe size. Pay postman \$1 plus C.O.D. charge. Or save C.O.D. by sending price with order. Money back if not pleased after 30 days. Send Today.

ARCH HEELER CO., Dept. 6-Q-1 COUNCIL BLUFFS, IOWA



DECORATIVE DECALCOMANIA

TRANSFERS Imported Designs of all Sizes & Types—Flowers, Fruits, Figures, Silhouettes, Birds, Dogs, Horse Heads, Ships, Juvenile, Tropical, Chinese, Peasant, Colonial, Patriotic, Inlay, Borders, Initials, etc., for Furniture, Doors, Walls, Trays and what not. Catalog with 800 illustrations in color sent for 25¢. Deductible on first order of \$1.00 up. L. C. WELLS, Dept. PM-61, 25 E. 26th St., New York, 10.

KING OF ELECTRIC SWITCHES

VERSATILE SWITCH OF A THOUSAND USES
MILLIONS IN POSTWAR APPLICATIONS



Floodlights your porch when the door is opened—sounds alarm when window is opened—signals arrival of mail—controls heating of furnace, filling of water tank, these and many other services are performed by this versatile switch. Shipped with instruction sheet showing numerous illustrated uses for this device at the low price of \$1.00 postpaid.

KING PRODUCTS COMPANY Batavia 2, Illinois

ONLY \$9.95 ENGINES IN STOCK



The G. H. Q. miniature gasoline engine that really operates is now available. Over 100,000 sold to date. 1/5 H.P. Complete with coil and condenser and fully illustrated instructions for only \$9.95. Fully bench tested and ready to run. Power for all models. Send only \$1.00—Shipped Collect C.O.D. same day. Send for free illustrated Catalog of hundreds of hobby items.

GHQ MOTORS, Dept. BX16, Box 193, Sta. O, N. Y. 11, N. Y.

do you WORRY?

Why worry and suffer any longer if we can help you? Try a Brooks Patented Air Cushion. This marvelous appliance for most forms of reducible rupture is GUARANTEED to bring YOU heavenly comfort and security—day and night—at work and play—or it costs you NOTHING. Thousands happy. Light, neat-fitting. No hard pads or springs. For men, women, and children. Durable, cheap. Sent on trial to prove it. Not sold in stores. Beware of imitations. Write for Free Book on Rupture, no-risk trial order plan, and proof of results. All Correspondence Confidential.



Brooks Company, 359 State St., Marshall, Mich.

Always write your name and full address clearly when answering advertisements.

WAR SURPLUS BARGAINS

SENSATIONAL VALUES FOR QUICK LIQUIDATION

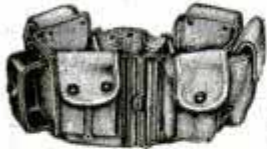

GI BELTS
Of heavy canvas webbing. Adjustable. Eyelets all around. Used, but guaranteed. **98c**
A107—Each.....



BANDOLEERS
Army Bandoleers of heavy khaki. Used by hunters, boy scouts, etc. Well made, serviceable, guaranteed new. **49c**
A129—11 POCKET, EACH.....



Mess Kits
Regulation Army Mess Kits. Ideal for campers, boy scouts, etc. Slightly used but guaranteed perfect. Two pieces. Folding handle. **69c**
A116—EACH.....



Regular U. S. Gov't issue canteens. Plastic screw top cap chained to body. Slightly used.
A117—METAL BODY, Each..... 69c
A118—PLASTIC BODY, Each..... 69c
A109—Canteen Covers, new, Ea. 69c
A119—Canteen Covers, used, Ea. 35c
A120—Canteen Cups, used, Ea. 25c



U.S. Govt. BOLO KNIFE

Extra heavy. For farm, home or jungle use. Blade of Gov't. Formula cutlery steel. Walnut riveted handle. 3 1/2 inch hilt, 10 1/2 inch blade. You'll find hundreds of uses for a Bolo knife. Blade will take and hold a keen cutting edge. Wt., 2 lbs.
A112—with Army Sheath..... \$4.95
A212—Leather Sheath, extra..... \$1.50



PUP TENTS

Regulation Army Pup Tents of durable, brown canvas. Used, but in good condition. Fine for campers, outdoorsmen, boy scouts, etc. Grand Xmas gift for children.
A100—Tent Only..... \$4.95
A110—Tent, new .. \$7.95
A101—Ropes, wooden poles and stakes for above. Per set..... \$1.00



SHIPS BELLS

Purchased from U.S. Maritime Comm. Measures 10 inches high, 9 3/4 inch flare. Big 6 inch clapper. Weight 15 lbs. Fine for farms, clubs, estates, etc. All new.
A541, ONLY... \$9.85

PROF. TELEGRAPH KEY

Purchased from the gov't. Finest design and construction. Base measures 3x4 3/4 inches. Original value \$2.50. All parts of instrument brass. Adjustable.
A147—EACH..... 98c



SADDLE BAGS

Made of finest top grain leather. Rivet reinforced seams. Bottom and side gussets. Each canvas lined bag measures 12x13 inches. Fine for motorcyclists. May be separated to make two duffle bags. Used, but perfect.
A151—EACH..... \$7.95

HOLD-E-ZEE SCREW DRIVER

Holds the screw for easy starting. Measures 4 1/2 inches long. Plastic handle.
A140, EACH..... 23c



CATHODE RAY TUBE

Purchased from U.S. Gov't. for experimenters in electronics, radar, etc. Slightly used for test work. Guaranteed perfect. Tubes are standard No. 5BP1 or 5BP4 with 5 inch screen. Each tube tested before shipment. Specify number when ordering. Tube list on request.
EACH, express collect..... \$12.00



MICROPHONE BUTTON

Brand new! For experiments in radio, electronics and other electrical apparatus. Used in telephone, amplifier and detectaphone work. Diameter 2 1/2 inches. New.
A512—EACH..... 98c



RADIO HEAD PHONES

Extremely sensitive with 4000 ohms resistance. Brand new and fully guaranteed. With moisture-proof cord and phone plug. A splendid value for the radio serviceman and experimenter.
A106—PAIR..... \$2.95
A108—New super sensitive phone, Pair..... \$5.95

7-LB. RADIO PARTS ASSORTMENT

A "gold mine" for the radio serviceman. Hundreds of valuable radio, radar and electronic parts, including individual parts, sub-assemblies, etc. Worth many times this low price.
A130R—7 LBS. \$1.79



AMMUNITION BOX

Fine for storing valuables, carrying lunches, etc. Of heavy gauge metal 7 1/2 x 11 x 4 inches. Fire-proof. Hinged lid with folding handle. Olive drab finish. Used, but perfect. A splendid value.
A525—EACH..... 25c



McCLELLAN SADDLE



Brand new! McClellan model saddles. Top grade cowhide with hair girth tender and 12 inch seat. Has straps for blanket roll and knapsack. Buckles, gunboot and sabre loops. A splendid value.
A145—EACH..... \$13.95

27 LENSES, ALL NEW, PERFECT

For experimental work in optics. Consists of 27 precision ground and polished prisms and lens elements in assorted diameters and focal lengths. Big variety, positive, negatives, etc. Actual value over \$100.00.
A519—27 PIECES..... \$7.95



MODEL CLAY



Made in England. Used by artists, designers, sculptors, etc. for modeling. In 1 lb. packages.
A105—Pound, EACH..... 25c

Made in England. Used by artists, designers, sculptors, etc. for modeling. In 1 lb. packages. **25c**

COMB. AIR PILLOW-LIFE BELT



Every outdoorsman, hiker, camper, boy scout, etc., should have one. Made of air tight, waterproofed, rubberized khaki 10 x 40 inches when deflated. Swimmers, boatsmen, etc., use them as life-belt or beach raft. Quickly inflated or deflated. Folds compactly for storage. Used, but guaranteed perfect.
A127—EACH..... 98c

OXYGEN GAUGE



Oxygen pressure gauge. Calibrated 0 to 2500 lbs. per sq. in. pressure. 2 1/4 inch dial, 3/4 inch threaded shank.
A144—EACH..... 98c



OFFICERS WATCH COMPASS

Brand new gov't. surplus. Army-Navy model. Single jewel mounted needle. Silver colored dial. A splendid value.
A174—EACH..... \$3.35



AVIATORS GOGGLES

U. S. Aviator Goggles. Over-size design with sponge rubber shock lining. Curved lenses. elastic head band. Fine for industrial use, motorcyclists, etc. Hinged nose arch. Slightly used, guaranteed perfect.
A159—PAIR..... \$5.95

MEDICAL STERILIZER



Consists of alcohol burner and sterilizing tray in hinged metal case 1 3/4 x 1 1/8 x 2 5/8 inches. Burner may be used separately. Bright nickel finish. All brand new.
A125—EACH..... 98c

ORDER DIRECT FROM THIS AD

Values galore! Hundreds of hard-to-find items for home, shop and outdoor use. Make remittances by money-order, bank draft or personal check. Send 25% deposit on C.O.D. orders. No C.O.D.'s on orders for less than \$5.00. Include sufficient postage on parcel-post orders—any overage will be promptly refunded. All quotations F.O.B. Chicago. Used items and materials are guaranteed serviceable and as described. Your money back if not more than satisfied.

BIG ILLUSTRATED CATALOG FREE

STARK'S

Dept. PM146
509 So. State St.
CHICAGO 5, ILL.



NAVY SWEATERS

Genuine U. S. Navy 100% wool sweater. Full over turtle neck style. Rib knit cuffs, waist and neck. Sizes 34 to 44. A ample warmth with medium weight.
A137—EACH..... \$4.95



Extra heavy machettes. Has curved 15 in. blade, bone handle, 20 inches overall. Finest steel.
A171—EACH..... \$5.95

MADE IN U.S.A.



\$5.50

WILLIAMS AUTOMATIC LIGHTER

Built like a watch. This sturdy man's wind-proof lighter is streamlined and made of finest mirror finished aluminum. **NO EXPOSED PARTS.** Built in screwdriver for adjusting and removing flint. Permanent asbestos wick.

See your dealer or mail coupon.



A. J. MACHINERY COMPANY
117 W. Harrison St., Chicago 5, Ill.

Ship.....Lighters.
Enclosed \$.....
Name.....
Address.....
City.....State.....

THE O'BRIEN Auto Jack

The O'Brien Machine Co., Mfr.
*Newest, Finest Engineered,
Most Powerful, Hydraulic,
All-Steel Bumper Jack
on the Market*

Built to Lift 2 Tons

Here is a jack built to take the headache out of flats. It's all steel construction with large solid steel

\$12.50

F.O.B. Chicago

base to avoid "tipping." Four telescoping steel tube columns quadruple its strength. The adjustable self-locking hook is shaped to accommodate any type of bumper. **FINGER PRESSURE** hydraulic stroke. No parts to rust. Life time guarantee. If your dealer cannot supply you, send \$12.50 and we will ship immediately. Money cheerfully refunded if not fully satisfied.

Distributors and Dealers:
Write for information.

AUTO PRODUCTS CO.

Sole Distributor
1620 HIGHLAND AVENUE
CHICAGO 26, ILL.

SEND FOR THIS TIME SAVING **OHMITE**
Ohm's Law Calculator



Figures Ohms, Watts, Amperes Volts... Quickly! Any Ohm's Law Problem solved with one setting

of slide. All values direct reading. (4 1/8" x 9")

Send only 10c in coin to cover cost of handling.

OHMITE MFG. CO., 4930 Flournoy St., Chicago 44, Ill

SANDING "HANDEE RUBLOK" POLISHING
USED BY BIG MANUFACTURERS... NOW AVAILABLE FOR WORKSHOP, HOME AND SHOP USE

Rub wood, metal surfaces to a smooth factory finish... quickly, easily. Fine for paint work, waxing, polishing... gives even pressure over entire surface... gets into corners, irregular shapes. Special rubber cushion relieves hand fatigue. 6" x 2" rubbing surface. Complete with 6 durable, quick-change covers only \$1.00 C.O.D.; postpaid if cash with order. Established dealers and agents invited.



FIELD ENGINEERING CORP., DEPT. HB132, 12264 WASHBURN, DETROIT 4, MICH.

"HOW TO MAKE MONEY WITH HOBBIES" \$1
HOBBIES DO PAY

Exciting Money-Making Homecraft Plans, THRILLING IDEAS and Experiences. Provides incentive and inspiration. Makes your HOBBY pay real dividends.

GET THIS BOOK YOU SHOULD HAVE
Just mail a dollar bill to

A. H. RIEDER

Dept. PM-81, 93-20 71st Drive

Forest Hills, N. Y.

YOUR OWN BUSINESS!



MAKE MONEY in your own home, spare room, basement, garage! Manufacture popular "Plastex" novelties. Be materials make \$1.00 sellers! Start in spare time. Pleasant business—small capital—BIG profits—Write for FREE folder, "Profits in Plastex Manufacturing"—**PLASTEX, 46-P King St., Dorchester, Mass.**



GERSTNER Tool Chests

Modern in design and most attractive in finish. Free Catalog for Machinists and Toolmakers.

H. GERSTNER & SONS

446 Columbia St. Dayton 7, Ohio



DRILL-INDEX A compact container for indexing and filing twist drills. Eliminates search. Made entirely of steel in nine sizes. See your dealer or write to

HUOT MFG. CO.

Foot Schultz Bldg.

St. Paul 1, Minn.

New **OTTAWA WOOD SAW**

For Tractors

—Makes wood sawing fast and easy. Can cut enough wood to pay for itself quickly. Easily moved while attached. Big heavy blade. FREE details.



LOW PRICE

OTTAWA MFG. CO.

W127 Oak Ave., Ottawa, Kans.

NEW CHEAP OIL BURNER

FOR COOKING & HEATING STOVES-FURNACES
HEAT YOUR HOME, COOK YOUR MEALS
WITH CHEAP FURNACE OIL



NO MORE SHOVELING COAL OR ASHES. New Fuelizer Starter Vaporizing System turns Cheap 130 Flash Furnace Oil into Oil Gas heat without clogging up. **LIFE-TIME GUARANTEE** against defects. \$1.00-BONUS OFFER FOR TESTING. We will let you try it in your own stove or furnace for one month. Get Yours for introducing. Big profits. Be first. Send in your name today.

NORTHWEST MFG. CO.

561-A 5th Ave.

Mitchell, So. Dak.

TAKE A TIP

from the
CHAMPS...



USE NORTHLAND SKIS

Champions choose Northlands because they bring out the best in a skier. Precision-balanced for extra control . . . extra confidence. Look for the Deerhead trademark.

★ FREE! Northland's helpful 48 page ski manual, 82 illustrations. (Offer does not apply in Canada)

NORTHLAND SKI MFG. COMPANY

95 Merriam Park

St. Paul 4, Minn.

World's Largest Ski Manufacturers

Fine

PLYWOOD

CAN ADD BEAUTY AND VALUE TO YOUR WORK!

People will double their admiration of your work when you give it the beauty advantage of Carmen-Bronson fine plywoods—Mahogany, Walnut, Curly Birch, Bird's Eye Maple, Havello! We offer a large selection of cabinet and paneling plywood in thicknesses from 1/32" to 1" in many standard and popular panel sizes. Also wide assortment of thin Aircraft bending stock and wood items and supplies for your workshop. Send 10c today for our complete catalog. Address Dept. I-B.

CARMEN-BRONSON CO.

165 EAST 3RD ST., MT. VERNON, N. Y.

RADIO PARTS KITS

For Immediate Delivery! —

NOW YOU CAN get what you want, and get it quickly! **CONCORD** has complete stocks of all standard radio parts required for POPULAR MECHANICS KITS in addition to the well known line of Concord Kits! Also every kind of radio part and electronic equipment . . . standard lines, dependable quality, exceptional values. Order from former Catalogs No. 94 and No. 345. And write for special VICTORY CLEARANCE FLYER, offering thousands of items at money-saving prices. Mail coupon for FREE COPY.



CONCORD RADIO CORP.

LAFAYETTE RADIO CORPORATION

CHICAGO 7, ILL. 901 W. Jackson Blvd. • 265 Peachtree St. ATLANTA 3, GA.

CONCORD RADIO CORPORATION, Dept. P-16
901 W. Jackson Blvd., Chicago 7, Ill.

Please RUSH FREE Concord's Victory Clearance Flyer.

Name

Address

City

State

This is a

STICK-UP!

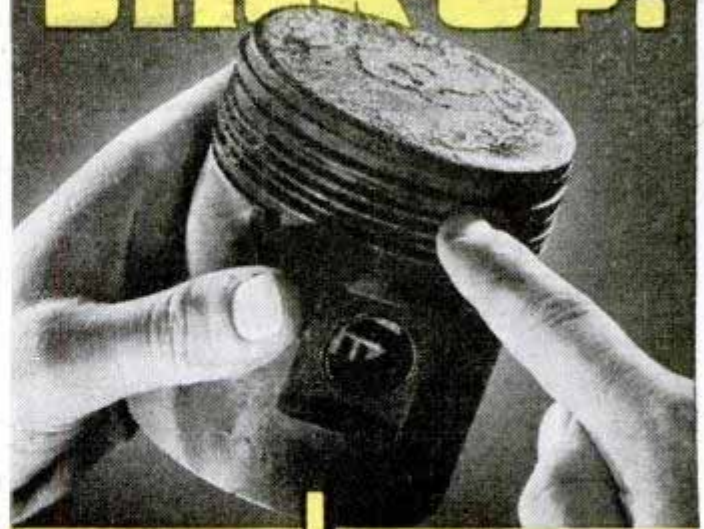

It's a "stick-up"—and you're the loser—when dirty oil circulates through your engine. Have your oil tested—*free*—by the AC method. If your oil contains grit, dirt or carbon, it stands out clearly on the clean white AC Test Pad.

Dirty oil clogs piston rings and slots—makes valves stick—wears out moving parts—wastes fuel and oil—robs engines of power.

You can prevent that "highway robbery" by installing an AC Oil Filter or Element. Why not do it today?

Free oil tests with AC Test Pads, as well as AC Oil Filters and Elements, are available where you see the yellow-and-black sign illustrated below.

AC SPARK PLUG DIVISION
GENERAL MOTORS CORPORATION

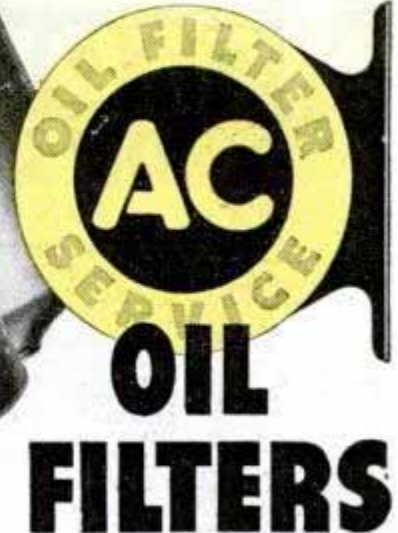
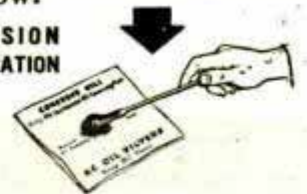

HELP FIGHT INFLATION — BUY VICTORY BONDS

IF FALSE TEETH SLIP OR DROP

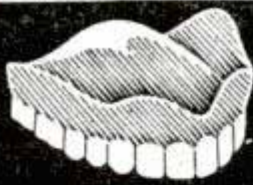

USE REFIT MAGIC PLASTI-LINER

MAKES ALL PLATES FIT PERFECTLY PERMANENTLY OR MONEY BACK

ONE APPLICATION LASTS FOR LIFE OF PLATE

PLASTI-LINER is a professionally developed re-liner for home use that ends forever the mess and bother of temporary applications that last for only a few hours or a few months. It is NOT a paste, nor a powder; but a strip of genuine dental plastic!

SAFE AND EASY TO USE

PLASTI-LINER is non-toxic, pure, non-irritating, harmless, odorless, tasteless, smooth, molds to mouth. No heat necessary. Just 3 easy steps.

"Excellent Results" say users

"I bought your product over a year ago. Have had no trouble with my plates since. I have told my friends and now all of us with false teeth use PLASTI-LINER. It really works." Mrs. E. S., Brooklyn, N. Y.

FREE! Our competent staff dentist will answer all your plate problems.

SEND NO MONEY — ORDER TODAY

PLASTI-LINER CO. Dept. 34
617-619 Main St., Buffalo 3, N. Y.

Rush PLASTI-LINER with complete directions. I will pay Postman \$_____ plus postage charges. I may return package for refund if I am not satisfied.

\$1 for UPPER or LOWER \$2 for Both

Name _____

Address _____

City _____ Zone _____ State _____

You Save Postage by Enclosing Money

MOTORISTS

NOW SAVE MONEY ON GASOLINE!

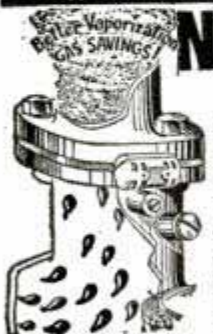

Now you can get up to 30% extra gasoline mileage with a Vacu-matic on your car. Quicker pick-up, smoother running, added power and precious gasoline savings guaranteed.

Automatic Supercharge Principle
Vacu-matic is entirely different! Operates on the Supercharge principle. Saves gas. Automatically provides a better gas mixture. Guaranteed to give up to 30% extra gas mileage, more power and better performance.

FITS ALL CARS AGENTS TRIAL OFFER

Constructed of six parts, fused into a single unit. Adjusted and sealed at the factory. Very quickly installed by anyone.
Every car, truck, tractor a prospect. Send name, address on postcard for big money making offer and how you get yours for introducing.
VACU-MATIC CO., 7617-1262 W. State St., Wauwatosa 13, Wis.

Do Your Own SURVEYING

No previous Experience Necessary

It is easy with a BURT TRIANGLE TRANSIT to run lines for roads, buildings, fields, fences, ditches and tiling... This new, simple, accurate, patented surveying instrument, invented by a Surveyor and developed by Industrial Research Engineers, is attracting country-wide attention. . . . Sold by direct mail only. Instructions include simple method for making a tripod. However, instrument can be used on post or box without tripod. Prices include postage and instructions—



With leveling base for two direct horizontal and up to 60° vertical sighting. . . . \$5.00
With Universal instrument holder for all horizontal and vertical sighting, or both at once. \$10.00
With Universal holder and tripod. . . . \$12.75

Mfd. and Guaranteed by FENTON CRAFTS, Fenton, Mich.

MINK Easterns Labradors Yukons \$40.00 EACH

All shipments made subject to 5 days' inspection before acceptance.

The quality of my mink is indicated by the fact that I have netted an average of \$20.00 a pelt on all mink skins sold during the past 5 years.

WHITE, SILVERBLU, and BLACK CROSS MINK
WHITE FACE, PLATINUM SILVER, and PEARL PLATINUM FOX

BOOK "Domestic Mink" \$1.00

HARRY SAXTON'S MINK RANCH, Bemus Point, N. Y.

New HOSPITAL and SURGICAL POLICY

Protects Whole Family

Costs Only 3c a Day for Adults Only 1½c a Day for Children

IT'S HERE! The new Family Hospital and Surgical Policy that insures whole family—mother, father, children, anyone now in good health, age 3 months to 65 years. Provides CASH to help pay for these bills: for hospital room and board up to 90 days for each Insured person in any one year; for other hospital expenses, such as medicines, X-ray, operating room, etc.; for doctor's fee for operations. Money Paid Direct to you—you select your own doctor and hospital. This special-value Policy issued at family group rates by Sterling Insurance Company, the reliable company with over \$2,000,000 surplus for policy holders. Investigate! Send no money, but mail the coupon below quick for 10-day Trial offer. No agent will call on you. NO OBLIGATION. ACT TODAY!

STERLING INSURANCE CO.
A-4866 STERLING BLDG., CHICAGO 11, ILL.

Send me 10-Day Trial Offer of LOW-COST Family Group Plan for Hospital and Surgical Insurance.

Name _____

Address _____

City _____ State _____

Let LEJAY Show You the Way to REAL FUN and PROFIT

GET THIS
BOOK of OVER
100 ITEMS
Only \$1.50



SIMPLE PLANS for PRACTICAL PROJECTS

You will have no trouble in working out the plans detailed in the LeJay Manual and you will get a lot of enjoyment from them. Whether or not you are mechanically inclined, the projects in these plans will appeal to you for their usefulness and practicability. They will save you money and make money for you, too, in jobs and repairs for neighbors and friends, because the plans embody all kinds of electrical devices.

NO EXPENSIVE TOOLS REQUIRED

The tools you have around the house are all you need for these projects and most of the necessary material can be found around workshops, garages and scrap yards. Being able to make your own welder helps a lot in doing other jobs, and the LeJay Manual shows you how easy it is to do this; also, how to make over 100 different items. . . . Sent on three days trial—money back if not satisfied. Only \$1.50, Canada, \$1.75.

FREEZE and SAVE PERISHABLE FOOD IN A HOME-BUILT LEJAY FAST FREEZER

ENJOY BUILDING THIS HANDY FREEZER

When you consider how necessary such equipment is to the modern household, you will realize what these complete plans mean to men, like yourself, who enjoy making such things, and get a big kick out of saving money in doing so. Its sturdy simplicity and ease of construction appeal to all handy men and amateurs.

NO KNOWLEDGE OF REFRIGERATION REQUIRED

Plans are easy to follow and you may have much of the material at hand. FAST FREEZERS made from these plans have been in use since 1938.

MILK COOLER PLANS, TOO

are included at no extra cost. Send only \$1.00 for the FAST FREEZER plans—or save 25c and send \$2.25 for both these plans and the LeJay Manual.

MAIL THE COUPON TODAY — AND SAVE 25c

LEJAY MFG. CO.

PLANS ONLY
\$1.00



FROZEN STORAGE from 5° above to 10° below zero

For Fish, Meat, Game, Fruit etc.
5 Sizes
8-40 Cu.Ft. capacity

HOW TO BUILD



WELDING GENERATORS
TRANSFORMER WELDERS



ARMATURE WINDING



ELECTRIC OUTBOARD

POWER TOOLS



WIND PLANTS

ELECT. GO-BIKE



MOTORS

INSECT KILLERS



ELECTRIC SCOOTER

ELECTRIC FENCERS

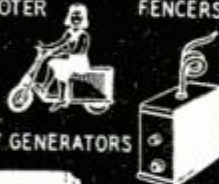

LIGHT GENERATORS



TRACTOR LIGHTS



LEJAY MFG. CO.

47 LeJay Building
MINNEAPOLIS 8, MINN.

BOTH ONLY
\$2.25

SAVE ON THIS COMBINATION OFFER

LeJay Manufacturing Co.,

447 LeJay Building, Minneapolis 8, Minn.

Gentlemen: Please send me both the LeJay Manual for 1946 (\$1.50) and the plans for your new Fast Freezer (\$1.00), for which I enclose \$2.25 in Cash Check (plus 5c exchange) Money order Canada, 25c additional.

I need only the LeJay Manual and enclose \$1.50

I need only the Fast Freezer plans and enclose \$1.00

NAME.....

ADDRESS.....

CITY.....STATE.....

WORLD'S LOWEST PRICED ADDING MACHINE

VEST POCKET SIZE

MAKES IDEAL GIFT

Baby Calculator makes an ideal gift—for every Gift occasion. Birthday—Graduation—Christmas—Anniversaries. For men, women, children—teachers, business people, home or shop use. **COMES PACKED READY FOR GIFT WRAPPING.**

TEN DAY TRIAL

Money Back Guarantee

Because we know that our machine is the very best Calculator to be obtained at this low price, we make this 10 Day Trial offer on a positive money back guarantee!! Don't buy ANY Calculator without this guarantee! Send only name and address, pay postman \$2.50 plus postage (if cash is sent, we pay postage—you save up to 40c). (Send full cash if outside U.S.) Money back within 10 days if not delighted.



IDEAL for INCOME TAX

Fits vest pocket or purse. Guaranteed Accurate. Operated as easily, and as reliable, as machines costing many times as much. NOT A TOY or GADGET. Substantially made of 28-gauge steel—guaranteed for life against defects in construction. Beautiful looking, modernized design. Finished in Black, Silver and Red. You positively can't buy a Calculator of equal quality for as little money. **ACCEPTED AS THE FINEST LOW PRICED CALCULATOR FOR OVER 30 YEARS!** Operates with a flick of your finger. Adds, subtracts, multiplies, divides—counts up to ten million. Pays for itself over and over in mistakes avoided, and time saved.

FREE TRIAL

ONLY

\$2.50
TOTAL COST

SEND NO MONEY

AGENTS WANTED

FREE!!

Each Baby Calculator enclosed in beautiful rich-looking Leatherette Case—at no extra cost.



CALCULATOR Machine Co. (Mfrs.)

DEPT. 174, P. O. BOX 1118, CHICAGO, ILLINOIS

USE COUPON

CALCULATOR MACHINE CO. (Mfrs.)

P. O. Box 1118, Dept. 174, Chicago, Ill.

Your Calculator is just what I've been looking for. Send one at once (C.O.D.) or (I am enclosing \$2.50).

Name.....

Address.....

City..... State.....

AUTO ENGINE SPEED CONTROL GOVERNORS

(REGULADORES)

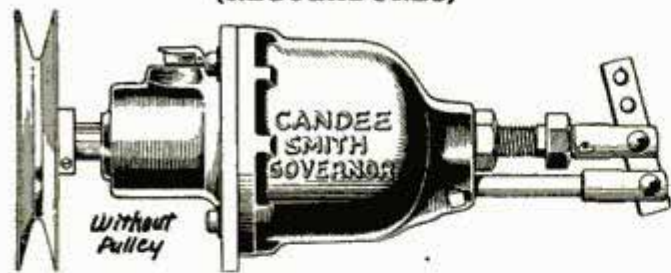

Give constant or changeable speed to any auto or truck engine, when used for power. Guaranteed. Instructions. Oil ring bearing, \$12.50. Full ball bearing, \$19.00. Postage west of the Mississippi, 50c; east of Mississippi, 85c. Pulleys to 3", \$1.00, wt. 1 lb.; to 5", \$1.50, wt. 1 1/2 lb. Governor speed 1800 r.p.m. Figure your pulley size.

Agents Wanted: Parts Dealers, Garages, Wreckers, Implement Dealers. General Merchants, etc. Free circulars.



State size of opening and distance between bolt holes.

1", \$3.75; 1 1/4", \$5.25; 1 1/2", \$6.50; 1 3/4", \$7.50; V8, \$7.00.

Mailing weight, 3 lbs. If remitting, enclose for postage.

You may order from this ad, or we will send circulars.

Stocks carried: In Montreal 15, Canada: 7546 Wiseman St. In Latin America: East Asiatic Co. In Auburn, N. Y.: 3 Seminary Ave., Auburn Welding Supply.

CANDEE, Dept. 1, 2641 S. Hill, Los Angeles 7, Calif.

FIND UNDERGROUND MINERALS and METALS with M-SCOPE

Employs same principle as Army Mine Detector. Unsurpassed in Efficiency. Write for Free 16 page booklet.



FISHER RESEARCH LABORATORY
PALO ALTO CALIFORNIA

SHAW and "Peppy-Pal" GARDEN TRACTORS

1 to 9 H.P. Circulars on request. Building more now. We supply repairs for all SHAW Tractors sold in our 42 years in business.

BUILD YOUR OWN RIDING TRACTOR—"WAR HORSE"

using old auto parts, powered by 2 H.P. or larger air-cooled engine; or walking type Garden Tractor 1/2 to 3 H.P. or convert truck or auto into Farm Tractor. Each with steel or rubber tires; will plow, cultivate. Plans for building, in few hours, any one of above, postpaid for \$1.00 (state which wanted) or all 3 for \$2.00. Money Back Guaranteed!

SHAW MFG. CO., 4501 Front St.
Galesburg, Kansas
608Q North 4th St., Columbus, Ohio



IDEAL FOR Auto-Home Appliance and Farm REPAIRS

Now A DYNAMIC HEAVY DUTY INDUSTRIAL WELDER

Available Now Without Priorities!

Designed to Do High-Grade Welding *Inexpensively*

Maintenance men, farmers, mechanics, machine shops, foundries, auto, general repair and job welding shops using the DYNAMIC WELDER find it so indispensable and useful that they cannot afford to be without it. If inexperienced you can easily learn to do a variety of high-grade welding jobs by following the practical, simplified operating and welding instructions furnished.

WORKS ON IRON, STEEL, BRASS, BRONZE and OTHER METALS

Has eight metallic and carbon arc welding heat stages. Does work you would think only possible with a larger, more expensive machine.

READ WHAT USERS SAY...

Repair Shop Owner says, "It will do more than you say!"

"I want to say I operate a repair garage and am more than satisfied with the welder. It will do more than you say." C. P., Butler, Ohio

It's the Greatest Portable Outfit

"Now I am equipped for all kinds of welding and I must say it's the greatest portable outfit for welding any man could ever wish to own. I wouldn't sell mine for the cost of plenty welders I have seen which were very high in cost but not in convenience. You may put me on file as a booster of your wonderful welding product." W. J. B., St. John, N. B., Canada

Better Than I Expected

"I have done quite a little welding with my welder and will say it is better than I expected. The price, convenience, and variety of work that can be done with the Dynamic are the attractive points." W. R. P., Portland, Ore.

EASY TO OPERATE!

DYNAMIC SUPERCHARGED WELDER

GET DETAILS ON OUR 10-DAY TRIAL OFFER!

Once you see a DYNAMIC in operation you won't want to be without it. Its simplicity will amaze you. In a year the DYNAMIC only costs you about 6c a day. Comes complete, ready to operate, with helmet, rods, cables, electrode holder and operating instructions, etc. Nothing else to buy. Write today for Free particulars. Act now and get details on our amazingly low priced Dynamic Welder and 10 day trial offer.

DYNAMIC WELDER CO.

13 East 23rd Street—FA

CHICAGO 16, ILLINOIS

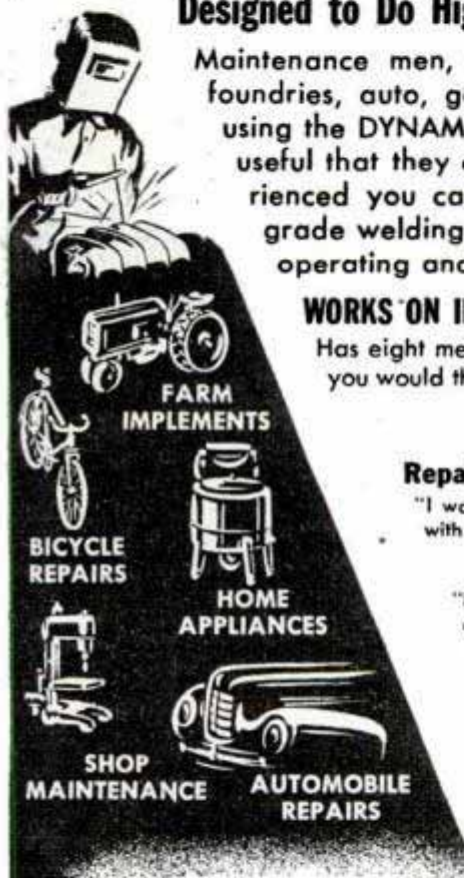

FOR ONLY
\$23⁵⁰
COMPLETE

AMAZINGLY SIMPLE TO OPERATE!

This portable Dynamic Welder, easily carried right to the job, can be operated from any convenient, properly wired 110 Volt 60 cycle line. Can also be supplied for 220 Volt 60 cycle operation and for other voltages and cycles at slight additional cost.



Get This New Catalog

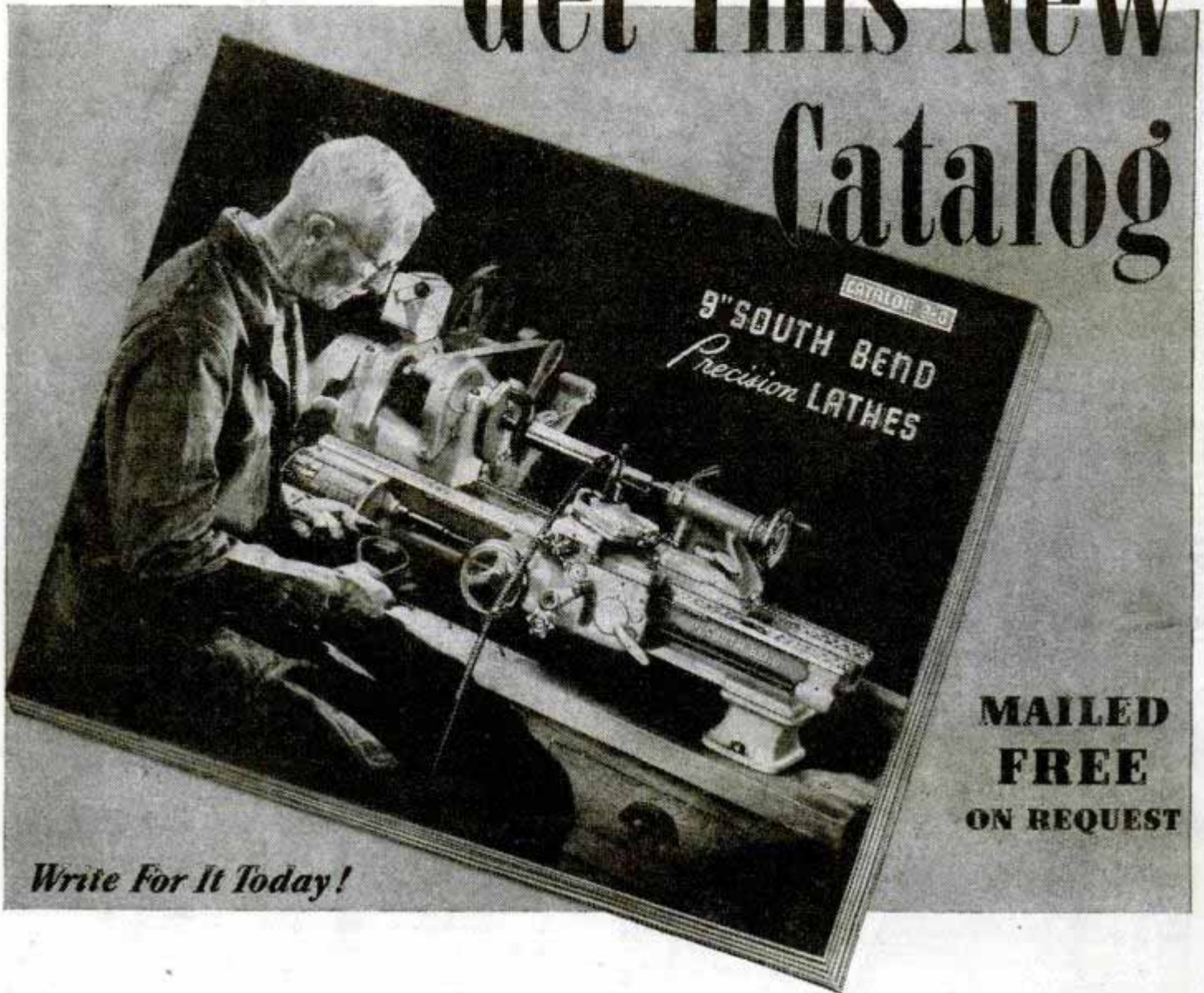

**MAILED
FREE
ON REQUEST**

Write For It Today!

If you own a shop, or are planning one, you'll want this new thirty-six page catalog which illustrates the complete line of South Bend 9-inch Precision Lathes in full color. Each lathe shown in this catalog is a precision tool capable of machining metals, plastics, compositions, and other machinable

materials, to exacting tolerances and is ideal for use in experimental, model, laboratory, machine and repair shops, and for toolroom and production work. Prices start at \$110.50, less electrical equipment and bench, f.o.b. factory. Complete specifications, including capacities, speeds, feeds, and weights are listed, and attachments and accessories are also shown, in this catalog. Write for your free copy today!

LARGER SIZES OF SOUTH BEND LATHES

South Bend Engine Lathes and Toolroom Lathes also are available with 10", 13", 14½", and 16" swings. Precision Turret Lathes are made with ½" and 1" collet capacities. Information supplied on request. Please specify size of lathe in which you are interested when you request your catalog.



SOUTH BEND LATHE WORKS

LATHE BUILDERS SINCE 1906

455 EAST MADISON STREET • SOUTH BEND 22, INDIANA



Printed by Popular Mechanics Company, Chicago, Ill., U. S. A.

with a **POND** *SPEEDDEX*
GARDEN TRACTOR

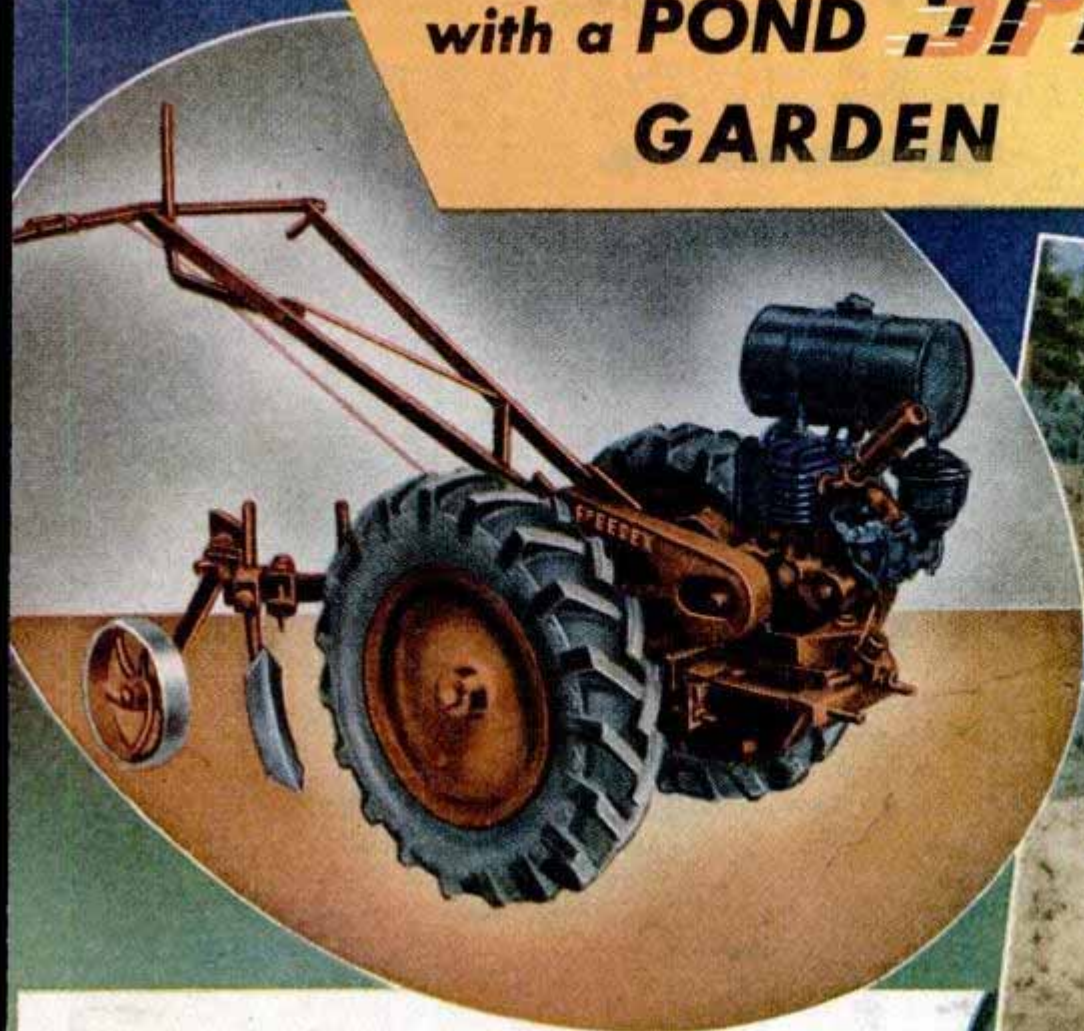

The greatest all-round time-and-work saver for small farmers, fruit growers, gardeners, florists, nursery men, poultry men, and estate owners. All you do is walk. The Speedex does the rest.

Speedex Model C Garden Tractor can be furnished with attachments for doing six jobs. Will work close to fence lines and in other cramped quarters. With its 1½ H. P. engine, the Speedex now gives stepped-up performance along with inexpensive operation . . . Gives years of honest, trouble-free, and satisfactory work — at a low, first cost.

Plan now for more and easier hours next spring and summer. Let Pond's Speedex Garden Tractor do the work for you. Write nearest office today for further information and low prices.



**PLOWING
DISCING
HARROWING
FURROWING
CULTIVATING
MOWING**

POND GARDEN TRACTOR COMPANY

it's radio!
 it's theatre!
 it's screen!
it's television!

And Loretta A. Brophy,
 one of television's
 leading program directors,
 will tell you that with her
 Camels are always in the picture



It's a song-and-dance team she's rehearsing here. Tomorrow it may be anything from a quiz program to grand opera. But to Director Loretta Brophy, of WABD-Dumont (seated above), it's all "fast, exciting, fun!"



"This is a take!" From her control room, Director Brophy (at left) gives the signal that telecasts the scene to you. And when she calls "Cut," that means the show is over ... But Camels are still in order (see right).



"The grand flavor and mildness of the tobaccos in Camels suit my 'T-Zone' to a 'T'!"

IF YOU'RE a Camel smoker you'll appreciate the words of Director Loretta Brophy when she tells of her experience during the late cigarette shortage.

"When I couldn't get Camels, I smoked anything I could get," Miss Brophy says. "That's when I learned really to appreciate Camels."

Now that Camels are again easier to get, more people than ever want Camels.

The "T-ZONE" Test Will Tell You

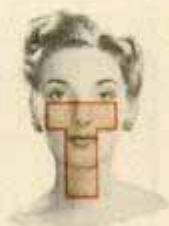

The "T-Zone" — T for taste and T for throat — is your own laboratory, your proving ground, for any cigarette. For only your taste and your throat can decide which cigarette tastes best to you ... and how it affects your throat.

Costlier tobaccos

Camels