



POPULAR MECHANICS

MAGAZINE

WRITTEN SO YOU CAN UNDERSTAND IT

DECEMBER
25 CENTS
30c IN CANADA

SEE PAGE 12





Will Your Flashlight **WORK**
When You Need Light?

It will with
RAY-O-VAC
LEAKPROOF
FLASHLIGHT
BATTERIES!

THEY *Stay Fresh*
FOR YEARS AND YEARS



RAY-O-VAC COMPANY
MADISON 4, WISCONSIN

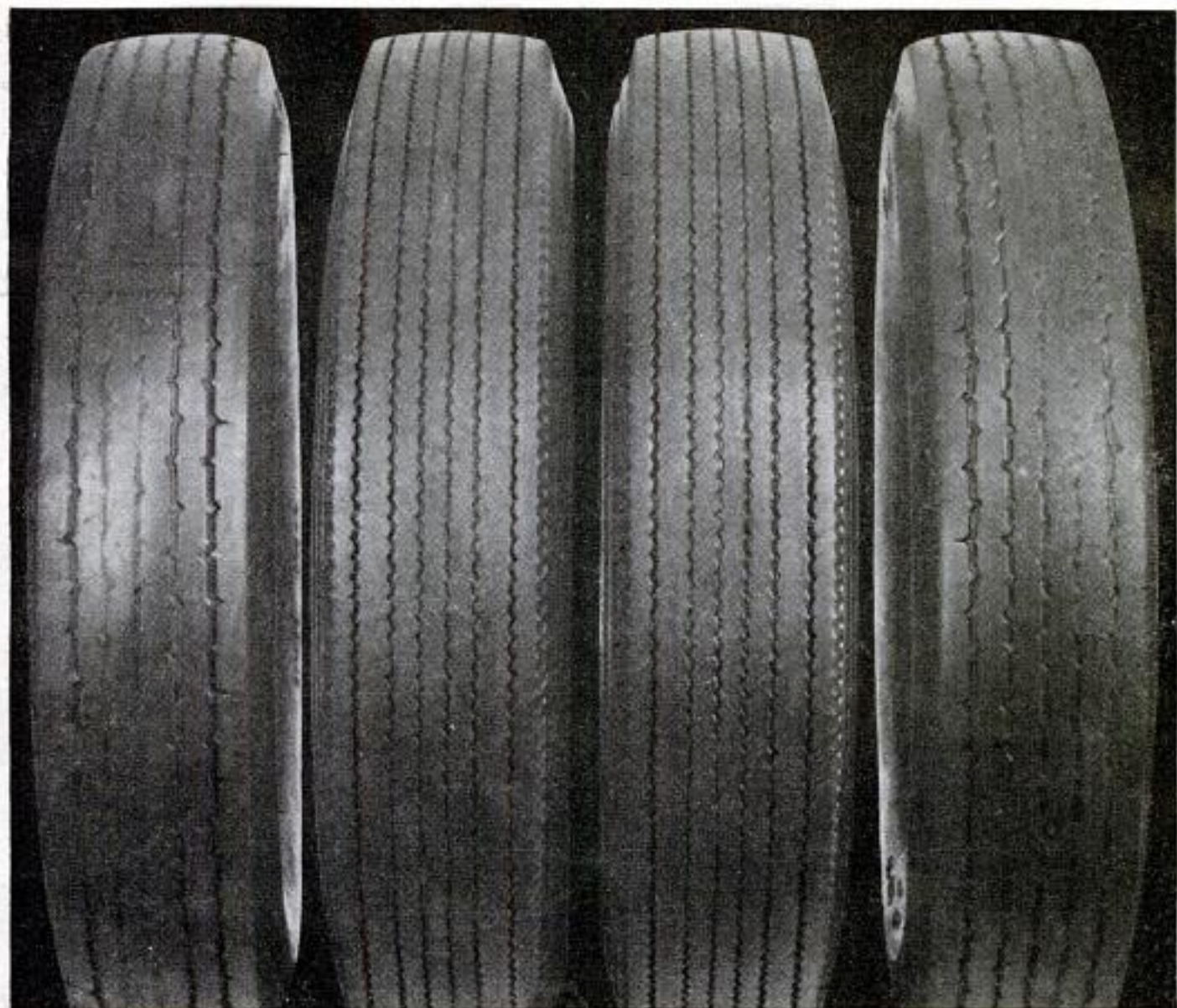

New synthetic tire will **OUTWEAR PREWAR TIRES**

B. F. Goodrich passenger car tire coming soon

BEFORE these tires had their pictures taken, they went thousands of miles on a test car. They were carefully rotated so all got equal wear. The unretouched picture shows exactly how they looked after the test.

The two outside tires were made of natural rubber with prewar treads—equal in every way to new prewar tires. Note that they were run until nearly smooth. Then observe the still effective tread on the middle tires... the new B. F. Goodrich synthetic-rubber Silvertowns. This was one of many tests that have proved the new tires give better-

than-prewar mileage.

These tires are newly designed for passenger cars. B. F. Goodrich builds them of a new, better synthetic rubber—different from the ordinary synthetic in general use by the tire industry. This rubber was also a B. F. Goodrich development. The tire body is stronger, too, with a new, stronger kind of cord reinforcement. The tread is slightly wider and flatter.

The tires have had more than 2,000 tests and nearly 17,000,000 miles of all-weather, all-road driving by taxicab fleets, state police departments, and the B. F. Good-

rich test fleet.

When can you get them? We hope to have them in the hands of nearly all dealers and ration-free by the end of the year. If you make your tires last as long as possible, you may be able to get these new, better tires by the time you have to buy. *The B. F. Goodrich Co., Akron, O.*

Coming soon...from

B.F. Goodrich

FIRST IN RUBBER

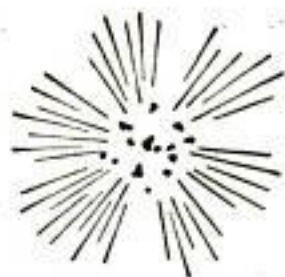

Target practice with Relays and Keys

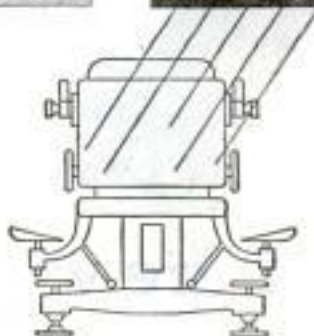

(Left to right) The operator punches the problem data on tape, which is fed into the computer. The solution emerges in the teletype receiver. Relays which figure out the problem look like your dial telephone system.

In designing the gun-control systems which shot down enemy planes, Army ballistic experts were faced by long hours of mathematical calculations.

So Bell Laboratories developed an electrical relay computer. It solved complicated problems more accurately and swiftly than 40 calculators working in shifts around the clock.

Resembling your dial telephone system, which seeks out and calls a telephone number, this brain-like machine selects and energizes electric circuits to correspond with the numbers fed in. Then it juggles the circuits through scores of combinations. It will even solve triangles and consult mathematical tables. The operator hands

it a series of problems with the tips of her fingers—next morning the correct answers are neatly typed. Ballistic experts used this calculator to compute the performance of experimental gun directors.

In battle action, Electrical Gun Directors are instantaneous. Such a director helped to make Antwerp available to our advancing troops by directing the guns which shot down more than 90% of the thousands of buzz bombs.

Every day, your Bell System telephone calls are speeded by calculators which use electric currents to do sums. Lessons learned are being applied to the extension of dialing over toll lines.



BELL TELEPHONE LABORATORIES EXPLORING AND INVENTING, DEVISING AND PERFECTING FOR CONTINUED IMPROVEMENTS AND ECONOMIES IN TELEPHONE SERVICE

Popular Mechanics Magazine

Registered in U. S. Patent Office and Canada

H. H. WINDSOR, Founder

H. H. WINDSOR, Jr., Editor and Publisher

Next Month

PHOTOGRAPHY fans may soon get their films developed at the drugstore in the time it takes to eat a sundae. At least that's what the researchers in diazo (dry photography) predict. Other wonders in store include color movies from black and white film, a short-wave radio flash outfit, and lightweight optical plastics. If you're not a camera fan already you will be after reading "It's Time to Open the Shutters" in the January issue.

MUCH of the Old West can be made to live again in a skillfully crafted model of the horse-drawn stage coaches of gold-rush days. How to build a model of the famous Ben Holliday coach is fully told in the next issue.

FRESH tomatoes and electric stoves are sprouting wings. And if you accept the confident prophecies of air-minded shippers, everything from azaleas to zebras will be carried in the fast air freighters of a future that starts right now. "Flying Freight," a January feature, depicts the giant cargo planes being readied for the air freight age, and the "bull's-eye" parachutes for delivering parcels on the route of the flying boxcars.

THERE'S an old one about "using your head to save your back"—and no one knows the truth of it better than a farmer. That's why he likes to sit on the tractor seat and "let the engine do it." The tractor scoop described next month increases the working capacity of one man a hundredfold.

MONTHS of dangerous work are ahead for our Navy men clearing unexploded mines from Asiatic waters. An article next month, "Sweeping Up Sudden Death," is illustrated by graphic drawings showing the mechanics of clearing the mine fields.

Volume 84	DECEMBER 1945	Number 6
Managing Editor.....	Roderick M. Grant	
Assistant Managing Editor.....	Wayne Whittaker	
Shop Notes and Crafts Editor.....	James R. Ward	
Radio and Electronics Editor.....	Frank L. Brittin	
Art Director.....	Frank Beatty	
Associate Editor.....	John R. Kinsey	
Western Editor.....	Thomas E. Stimson, Jr.	

In This Issue

Super Fuels for Your Car	1
\$200,000,000 Gateway to Europe	12
"Shore Duty" on a Battlewagon	17
"Incubator Babies" of the Plant World	28
Proving Ground for Inventions	34
Meet the Silicone Family	40
Hundred Billion Dollar Scrap Pile	44
More Fish Per Kilowatt	51
Two Million Car Garage	59
Meet the Model Man	65
Green Grow the Atolls	76
Message From the Jungle: Snafu	82

For the Craftsman

End Table Matches Most Furniture	89
Building Your Own Telescope	97
Make Your Own Gifts for Christmas	106
Stop It With Flash	118
Lathe Attachments Used Efficiently	130
Radio and Electronics	141

Other items, and manufacturers of available products described, are listed on pages 8A and 10A

Published monthly by POPULAR MECHANICS COMPANY, 200 East Ontario Street, Chicago 11, Ill. H. H. Windsor, Jr., president; Paul H. Dunakin, vice-president and general manager; D. F. Windsor, vice-president and secretary-treasurer; William Harrison Pettridge, assistant to the publisher; Clover L. Perkins, advertising manager; Alan M. Deyne, circulation manager. Single copy in the United States, 25 cents; subscription rates in United States and possessions, and countries of the Pan-American Postal Union, 1 year, \$2.50; 2 years, \$4.50; 3 years, \$6.00. Single copy in Canada, 30 cents; subscription rates, 1 year, \$3.00; 2 years, \$5.50; 3 years, \$7.50. To all other countries add \$1.00 a year over United States prices for overseas postage. If you plan to move, notify us at least 60 days in advance so you will not miss an issue. Give both old and new address. Entered as Second Class Matter, September 15, 1903, at the Post Office at Chicago, Illinois, under Act of March 3, 1879. Entered as Second Class Matter at Post Office Dept., Canada. Copyright 1945, by Popular Mechanics Company. Copyright under International Copyright Union. All rights reserved under Pan American Copyright Union. Printed in the United States of America.

Ingenious New Technical Methods

To Help You with Your Reconversion
Problems

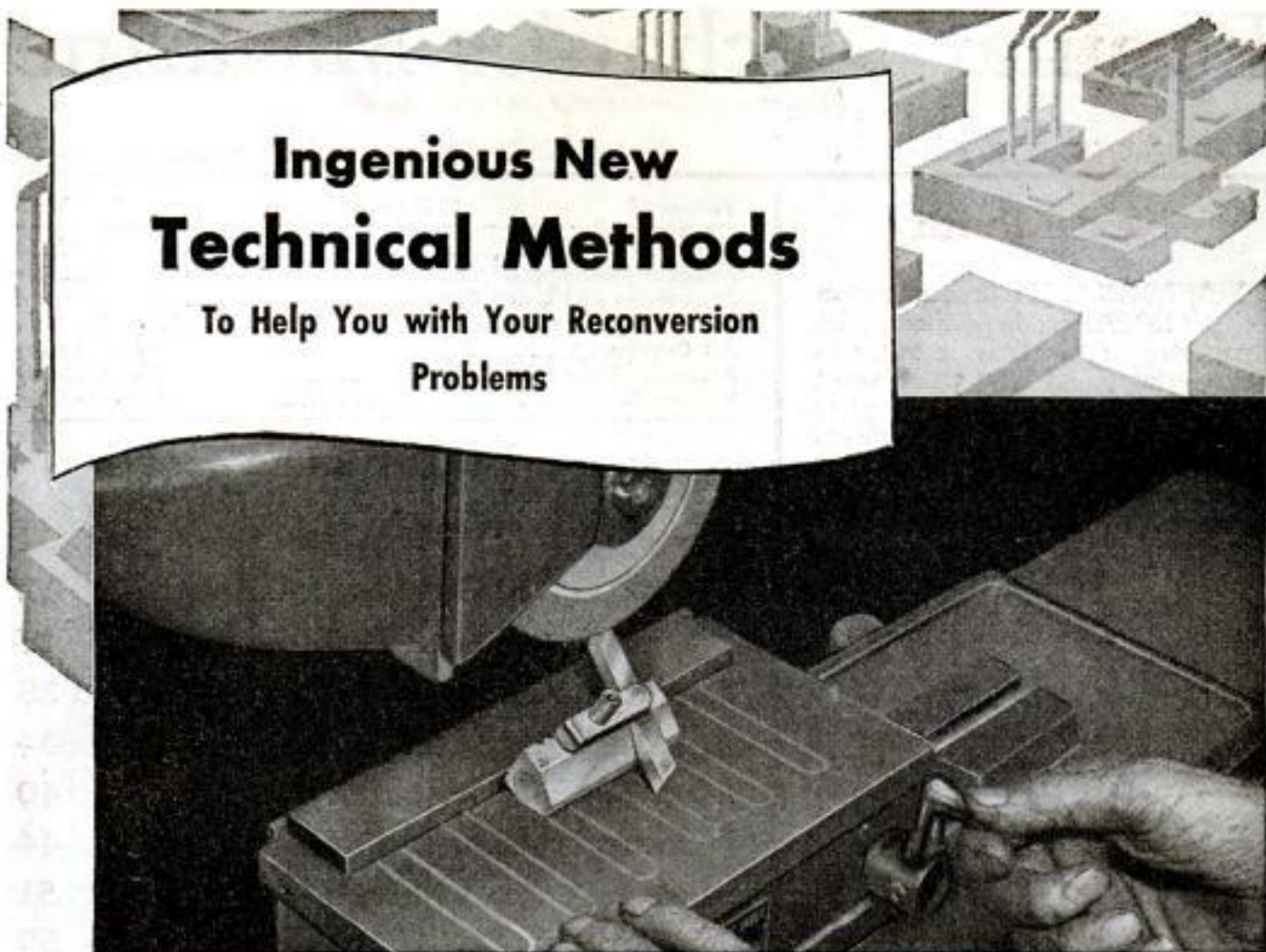

Now Anyone Can Grind Threading Tools!—with Master Grinding Gauge!

Until the advent of the Acro Master Grinding Gauge, only a skilled mechanic could grind thread-cutting tools to the required degree of accuracy. Now anyone can do it—in less time, with less waste, with even greater precision!

The cutting tool is simply placed in slot of the Master Grinding Gauge, and thumb screws hold it tightly in place, at the proper angle, while being ground on any type of surface grinder! The Gauge is made of hardened tool steel. There are no delicate or moving parts to get out of order. Milled slots at top and bottom provide correct grinding angles. A small set screw at end, eliminates any lateral motion. There is nothing special to learn—anyone can use it!

Anyone can be "helped on the job" by Wrigley's Spearmint Gum, too, once this quality product again becomes available. Just now, no Wrigley's Spearmint Gum is being made, and until conditions permit its manufacture in quality and quantity for everyone, we again urge you, please, to "Remember the Wrigley's Spearmint wrapper." It is our pledge to you, of the finest quality and flavor in chewing gum—that *will* be back!

*You can get complete information from:
Acro Tool and Die Works, 4554 Broadway, Chicago 40, Ill.*

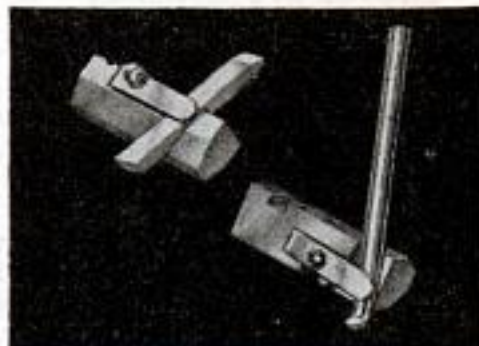

Acro Master Grinding Gauge



Remember this wrapper

Z-93



Back at last!

No doubt you've read our ads before
And sighed at our excuses
That Texcel Tape was not around
Because of its war uses.

Well, here's good news! It's back at last!
The tape you've waited for!
Though there's not much in stock just yet
Say "Texcel" at your store.



For Texcel wraps, protects and seals,
It holds with just a "stick."
At home and work, in stores and plants
It always does the trick.

And Texcel is an improved tape
Whose "stickum's" bonded on.
It won't come off, it won't dry out,
Before the judgment dawn.

So ask for Texcel at your store
And if there's none today,
Be patient, please, and bear in mind
That more is on the way.



CELLOPHANE TAPE —
STICKS WITH A TOUCH

Texcel Tape

REG. U. S. PAT. OFF.

INDUSTRIAL TAPE CORPORATION • NEW BRUNSWICK, N. J.

THE GREATEST
POWER ON
EARTH!



The Magic of Mind

WERE the great personages of the past victims of a stupendous hoax? Could such eminent men of the ancient world as Socrates, Pericles, and Alexander the Great have been deluded and cast under the spell of witchcraft—or did the oracles whom they consulted actually possess a *mysterious faculty of foresight*? That *the human mind can truly exert an influence over things and conditions* was not a credulous belief of the ancients, but a known and demonstrable fact to them. That there exists a wealth of infinite knowledge just beyond the border of our daily thoughts, which can be aroused and commanded at will, was not a fantasy of these sages of antiquity, but a dependable aid to which they turned in time of need.

It is time you realized that the rites, rituals and practices of the ancients were not superstitions, but subterfuges to conceal the marvelous workings of natural law from those who would have misused them. Telepathy, projection of thought, the materializing of ideas into helpful realities, are no longer thought by intelligent persons to be impossible practices, but instead, *demonstrable sciences*, by which a greater life of happiness may be had.

One of America's foremost psychologists and university instructors, says of his experiments with thought transference and the powers of mind—"The successes were much too numerous to be merely

lucky hits and one can see no way for guessing to have accounted for the results." *Have you that open-minded attitude of today which warrants a clear, positive revelation of the facts of mind which intolerance and bigotry have suppressed for years? Advance with the times; learn the truth about your inherited powers.*

Let this free book explain

The Rosicrucians (NOT a religious organization) have been leaders in introducing the ancient wisdom of mental phenomena. Established throughout the world for centuries, they have for ages expounded these truths to those thinking men and women who sought to make the utmost of their natural faculties. Use the coupon below—avail yourself of a pleasing book of interesting information which explains how you may acquire this most *unusual and helpful knowledge*.

The ROSICRUCIANS (AMORC)

USE THIS COUPON

Scribe O.M.S.
The Rosicrucians, AMORC,
San Jose, California.

I am sincerely interested in knowing more about this unseen, vital power which can be used in acquiring the fullness and happiness of life. Please send me, without cost, the book, "THE MASTERY OF LIFE," which tells me how to receive this information.

Name _____

Address _____

State _____



Your **ACCOUNTANCY-** *future*
may be inside these pages!

THAT suggestion, in past years, has prompted thousands of men and women, uncertain how to plan their futures and safeguard their business success, to investigate the career possibilities in Accounting. Having investigated, they went further: took LaSalle training in their spare time; qualified for well-paid positions; and in so doing solved their progress problems successfully.

Among those thousands were more than 2,200 who are now Certified Public Accountants—nearly 10 per cent of all the C.P.A.'s in the country.

What ARE My Opportunities?

Frankly, they are important ones—and numerous. Beginning opportunities as book-keeper, cost clerk, billing clerk, time clerk. Advanced opportunities to serve in big and small business firms; advising on finance, analyzing costs, helping to shape policies. Opportunities to qualify in the Governmental accounting jobs

that are opening up more and more. Opportunities in private practice, as a cost consultant or C.P.A.

One has only to study the statistical side of the news about business expansions, new lines of manufacture and marketing, to see that wherever business is busy accountants are busy. For remember: this is the profession back of the financial success and progress of *all other enterprises*. And accountancy incomes of \$2,000 to \$10,000, or more, yearly, certainly aren't earnings to be dismissed lightly!

The Best Answer of All

These are only a few facts in passing. Facts, however, that certainly invite your very thorough further investigation as to what LaSalle Training for this profession of many opportunities has in store for you.

Complete information—a survey covering this subject from differ-

ent angles—is what you should have now, before making any final decision. You'll find it in this 48-page book. And it is aptly titled "The Profession That Pays" . . . for, as the official *Journal of Accountancy* has pointed out: "If there be a profession in which the average compensation is higher, it is not known to us." So, if you really are in earnest—and willing to study seriously—fill in and mail the coupon for your copy today. *Your future* may lie inside its pages!

LASALLE
EXTENSION UNIVERSITY
A Correspondence Institution

Dept 1264-H • 417 S. Dearborn • Chicago 5, Ill.

I want to see what Accountancy offers for my future. Please send me your FREE 48-page booklet, "Accountancy, the Profession that Pays," and full information about your economical, spare time Training.

Name.....Age....

Street and No.....City.....

State.....Present Position.....

use PYROIL



NEXT TIME you say . . .
 "fill 'er up" tell your gas station attendant to add Pyroil to clean your motor and keep it clean . . . to provide a clinging surface of lubrication to your cylinder walls . . . to provide easy winter starting. Two ounces of Pyroil A in your gas tank for each 5 gallons of gasoline . . . two ounces of Pyroil B for each quart of oil in your crankcase does it.

Manufactured and Guaranteed by
Pyroil Company, W. V. Kidder, Founder,
 512 Pyroil Bldg., La Crosse, Wisconsin.

PYROIL COMPANY
 512 Pyroil Bldg., La Crosse, Wisconsin

I want my car to last and run properly. Please tell me more about Pyroil and how it can accomplish this for me.

Name.....

Address.....

City or Town..... State.....



Jerry, the talking dog is on tour entertaining hospitalized veterans, by courtesy of the PYROIL Company

WHERE-TO-BUY-IT INDEX

Manufacturer's name and address appear in parentheses directly after items believed by us to be commercially available

AUTOMOTIVE	
Gas streamline smashed-up jeep.....	6
Three-wheel auto goes 100 miles per hour.....	7
Coming up—the all-hydraulic car.....	8
Sound movie tests auto drivers.....	27
Direct-reading gauge shows antifreeze protection (Lacey-Webber Co., Kalamazoo 2, Mich.).....	27
Gasoline dispensing unit (Bowser, Inc., Fort Wayne 5, Ind.).....	39
Trailer lock sets off siren when tampered with.....	49
Stationary test for cars (Clayton Mfg. Co., Alhambra, Calif.).....	58
Dial tells when to shift truck gears (White Motor Co., E. 79th St. and Wallace Ave., Cleveland, Ohio).....	64
Hydraulic pump straightens bent auto frames.....	70
AVIATION	
Aerial "roadster" has 500-mile range (All American Aircraft, Inc., Long Beach, Calif.).....	11
"Balancing" sidewalls hold up roof of hangar.....	26
"Atom" planes used new fuel system for quick getaway.....	31
British plane has main wing behind.....	31
Propjet engine drives propeller, boosts with jet propulsion.....	33
"Bird bath" for airplane parts.....	39
Shortage of oxygen lights lamp in plane warning system.....	42
Robot planes fly as targets for antiaircraft gunners.....	42
Electronic "swallow counters" test flyers at high altitudes.....	49
"Wash line" for engine parts follows maze of tanks.....	50
Periscope gusset on A-26 Invader.....	63
Stratosphere brought to earth in bell jar test chamber.....	63
Section of metal landing strip acts as ramp.....	70
Push-button bomb control panel.....	70
Cover for B-29 sighting blister jettisoned after takeoff.....	71
"Picket fence" brakes on P-61 extend from wings.....	74
Cargo "wing" carries 3½ tons and 24 passengers (Canadian Car & Foundry Co., 621 W. Craig St., Montreal, Can.).....	74
Flying boat carries rescue platform.....	87
BOATS	
Speedboat built from fuel tanks.....	6
LCI dons "civies" to haul supplies for lumber camps.....	6
Paddle-wheel boat made from junked parts.....	6
British midget submarines scored many hits.....	7
Giant outboard motors are self-elevating (Murray & Tregurtha, Inc., 56 Hancock St., Quincy 71, Mass.).....	43
Aluminum canoe weighs 38 pounds.....	43
Air-boat skims over mud flats covered with inch of water.....	58
Barges serve as ambulances for crippled planes.....	71
HOUSEHOLD	
Burnproof ironing board cover (Textile Mills, 3948 Roosevelt Rd., Chicago 24).....	16
Leakproof garden hose coupling (E. B. Wiggins Oil Tool Co., Inc., 3424 E. Olympic Blvd., Los Angeles 23, Calif.).....	16
Salt shaker drier (Giffords, Inc., 135 Roosevelt Ave., Flushing, N. Y.).....	16
Combination washing machine and dishwasher (Electric Household Utilities Corp., 2113 S. 34th St., Cicero, Ill.).....	16
Shopping for furniture? (R. H. Macy & Co., Herald Sq., New York).....	75
Store-on-wheels will bring food to housewife's door (Associated Food Distributors, Inc., San Francisco, Calif.).....	81
Fluorescent lights for Christmas tree (Sylvania Electric Products, Inc., Ipswich, Mass.).....	81
INDUSTRY	
Drilling operations combined in one tool (Aircraft Tools, Inc., 750 E. Gage Ave., Los Angeles 1, Calif.).....	9
Rootlike horizontal drills boost oil output.....	10
Toolboxes swing out of rack and go back automatically.....	10
Leftover aluminum tubing makes bases for hobby horses.....	38
Ball bearing plug gauge (Taft Pierce Mfg. Co., Woonsocket, R. I.).....	39
Self-leveling sling (MacWhyte Co., Kenosha, Wis.).....	49
Borescope looks inside gun barrel or cylinder (Polan Industries, Huntington 19, W. Va.).....	50
Coupling seals pipe ends when disconnected (Thompson Products, Inc., Cleveland 3, Ohio).....	56
"Shot treatment" toughens steel (American Foundry Equipment Co., Mishawaka, Ind.).....	56
Air lift hoists 1000-pound drums.....	70
Attachment converts drill press into abrasive belt grinder (Stuart Industries, Inc., 75 Bellevue St., Newton 58, Mass.).....	81
Wheatblasting cleans with less abrasion than sandblasting.....	86
MILITARY	
Mapping Japan for the bombers.....	24
Army "cans" aircraft engines for shipment overseas.....	37
Revolving gasoline can cleaner removes rust and sediment.....	33
Clever, These Yankees!.....	72
Duck tires inflated while vehicle is in motion.....	79
RADIO AND ELECTRICAL	
Electric "Long Tom" toy cannon (Electronic Laboratories, Inc., 122 W. New York St., Indianapolis, Ind.).....	9
Compact soldering unit reaches difficult places (Wyse Laboratories, Dayton 2, Ohio).....	38
Electronic "mathematician" locates radio towers.....	39
Flickerless fluorescent lights work on 25-cycle current (Electronic Laboratories, Indianapolis, Ind.).....	50
Blind inspect roller bearings with electronic sound gauge.....	64
Electrocoating fibers creates new fabrics.....	87
Portable receiver and play-back unit (Fairchild Camera and Instrument Corp., 88-06 Van Wyke Blvd., Jamaica, N. Y.).....	141
Ultra-high-frequency receiver of advanced design (National Co., 61 Sherman St., Malden, Mass.).....	141
Magnetic wire recorder has automatic timing device (Radio-technic Laboratory, 1328 Sherman Ave., Evanston, Ill.).....	141
Automatic record changer attachment (Admiral Corp., 3800 Courtland St., Chicago 47).....	141
Electronic stethoscope (Maico Co., Inc., Minneapolis, Minn.).....	141
Automatic program timer is built into set (Warren Telechron Co., Ashland, Mass.).....	141
VHF kit receiver includes new FM band (Concord Radio Corp., 901 W. Jackson Blvd., Chicago).....	144

(Continued to page 10A)

INTERNATIONAL CORRESPONDENCE SCHOOLS

OFFER YOU LOW-COST

SPECIAL TRAINING

FOR SUCCESS IN MODERN BUSINESS AND INDUSTRY

Air Conditioning and Plumbing Courses

Air Conditioning
Heating Plumbing
Refrigeration
Steam Fitting

Chemistry Courses

Chemical Engineering
Chemistry, Analytical
Chemistry, Industrial
Chemistry, Manufacturing Iron and Steel
Petroleum Refining
Plastics
Pulp and Paper Making

Civil Engineering, Architectural and Mining Courses

Architectural Drafting
Architecture
Bridge and Building Foreman
Building Estimating
Civil Engineering
Coal Mining
Contracting and Building
Highway Engineering
Lumber Dealer
Reading Structural Blueprints
Sanitary Engineering
Structural Drafting
Structural Engineering
Surveying and Mapping

Electrical Courses

Electrical Drafting
Electrical Engineering
Power House Electric

Practical Electrician
Practical Telephony
Telegraph Engineering

Internal Combustion Engines Courses

Auto Technician
Aviation
Diesel-Electric
Diesel Engines
Gas Engines

Mechanical Courses

Aeronautical Engineering
Airplane Drafting
Flight Engineer
Foundry Work
Heat Treatment of Metals
Industrial Engineering
Industrial Metallurgy
Mechanical Drafting
Mechanical Engineering
Mold-Lore Work
Patternmaking
Reading Shop Blueprints
Sheet-Metal Drafting
Sheet-Metal Worker
Ship Drafting
Ship Fitting
Shop Practice
Steel Mill Workers
Tool Designing
Welding, Gas and Electric

Radio Courses

Electronics
Radio, General
Radio Operating
Radio Servicing

Railroad Courses

Air Brake Car Inspector

Locomotive Engineer
Locomotive Fireman
Railroad Section Foreman

Steam Engineering Courses

Boilermaking
Combustion Engineering
Engine Running
Marine Engineering
Steam-Electric
Steam Engines

Textile Courses

Cotton Manufacturing
Rayon Weaving
Textile Designing
Woolen Manufacturing

Business and Academic Courses

Accounting Advertising
Arithmetic

Bookkeeping
Business Correspondence
Business Management
Certified Public Accounting
College Preparatory
Commercial
Cost Accounting
Federal Tax
First Year College
Foremanship
French
Good English
High School
Higher Mathematics
Illustrating
Motor Traffic
Postal Service
Salesmanship
Secretarial
Sign Lettering
Spanish
Stenography
Traffic Management

If you can read and write,
and are willing to study,

WE CAN TEACH YOU!

• Special service and attention are always given to the student who may need extra help in order to understand.

**REASONABLE TERMS
MAY BE ARRANGED**



The successful man DOES today what the failure INTENDS to do tomorrow. Mail this coupon NOW!

INTERNATIONAL CORRESPONDENCE SCHOOLS
BOX 5562-K, SCRANTON 9, PENNA.

Please send complete information on following subject:

(Write above Technical, Business or General Educational Subject in which you are interested.)

Name _____ Age _____

Home Address _____

City _____ State _____

Present Position _____ Working Hours _____ A.M. _____ P.M.

Discount to Discharged Veterans—Special Tuition Rates for Members of the Armed Forces



Get Your Copy of This NEW EDITION of Piper's Famous "How to Fly" Booklet!

More colorful, interesting and instructive than ever! "How to Fly a Piper Cub" takes you on a typical flight lesson with over 50 photographs and descriptions. Written by a certificated flight instructor. Includes many other features and full-color pictures of Piper Cub planes. For booklet send 10c in stamps or coin for postage-handling. Piper Aircraft Corporation, Dept. PM125, Lock Haven, Pennsylvania.



(Continued from page 8A)

MISCELLANEOUS

Spiral art gallery has $\frac{3}{4}$ -mile ramp.....	11
Pumping station rides on barge.....	31
"Third hand" for phone leaves hands free (E. B. Windsor Co., 922 N. Fourth St., Milwaukee 3, Wis.).....	33
Boy crosses gully on homemade cable car.....	38
Oranges breathe into machine for moisture measurement.....	49
Grindstone on bicycle sharpens cutlery.....	54
De-icer sprays train "shoes" to clear freezing rails.....	64
Electric eel lights 48 small bulbs.....	70
Plastic irrigation tubes (Cozad Implement Co., Cozad, Nebr.).....	79
"Suntan" prevention may improve germ-killing lamps.....	79
Snow train on runners for park sightseers.....	86
"Bubble bath" keeps ice away from ducks' winter home.....	88

Craftsman and Shop Notes Index

AUTOMOTIVE

Emergency bed in sedan formed by arranging seat cushions..	92
Reel for extension cord made from metal spool.....	126
Rubber bushing forced into auto-spring eye by draw bolt.....	127
Half an oil drum holds sand for checking fires.....	138

FARM

Hose for bucket-ball grip is slit spirally.....	102
Pump handle shielded to protect hands on frosty mornings..	113
Tree saw made from power mower.....	127
Hog waterer made from boiler and auto frame.....	128
Hinge holds barn door open.....	128
Thermostatic buzzer warns of low brooder temperatures.....	140

HAND TOOLS

Sleeve prevents breakage of small drills.....	126
Hooked scraper removes burrs from sheared aluminum.....	126
Flashlight on screw driver for use in dark places.....	136
Holes punched in hacksaw blade by nail set and guide.....	140

HOME IMPROVEMENTS

Hot-air heating plant for small home made from oil stove...	91
Wall shingle slipped under insulator without removing it...	92
Frozen water pipes in wall thawed by hot air.....	93
Removing siding without splitting wood.....	93
Solving home problems.....	94
Taking up old flooring without splitting it.....	96
Flushing hot-water coil in furnace.....	104
Painted air vents cool food storage cellar.....	113
Spring clothespin on door casing holds memos for callers...	116
Baby-carriage wheels kept clean by inner-tube "galoshes"...	116
Key guide useful in dark vestibule.....	116

OUTDOOR SPORTS

Making "Eskimo" snow goggles.....	96
Engine head makes scraper for ice on skating pond.....	102
Bouncing bobsled has auto-spring body.....	101
Wet cloth cools fishing guide when soldering it to rod.....	116

PAINT AND PAINTING

Sheepskin buckled on wrist aids in washing ceilings.....	102
Stippling brush coated on screen roller.....	138
Striping brushes improvised from scrap material.....	138

PHOTOGRAPHY

Spacer adapts large plate holder to take smaller films.....	117
Slit hose holds light-reflecting sheet on picture molding.....	121
Camera focusing cloth replaced by an old bellows.....	122
Flood lamp clamps directly to movie camera.....	122
Printing your signature on photos.....	122
Crayon marks help identify darkroom trays.....	122

POWER TOOLS

Small work held in drill chuck for drilling or machining...	104
Small fixtures for toolmakers.....	123
Drip pan for lathe saves cutting oil.....	123
Reamer floated in holder if lathe centers are sprung.....	125
Broken drill helps to align parts for drilling.....	128
Measuring wedge gives fine adjustment on small saw.....	129
Slotted nut grips threaded work in lathe dog.....	136
Knurling tool adjusts to light or heavy work.....	137

RADIO AND ELECTRONICS

Equipment suggestions for 1946.....	141
How to convert a silent 16-mm. movie projector for sound...	142
10-tube FM-AM kit receiver for very high frequencies.....	144

WOODWORKING

Plywood disk templates for laying out corners.....	102
Fence pickets pointed with aid of jig.....	104
All-wood fireplace, bookcase and mantel.....	114
Photo frame made of dowels and wood strips.....	117
Clogged sanding belts renewed by cleaning on buffer.....	136

MISCELLANEOUS

Scissors and bulb test cells in flashlight.....	92
Key ring held safely by clip on trouser belt.....	96
Stops prevent discovery of secret compartment in drawer...	96
Twisted tissue paper substitutes for pipe filter.....	96
Tape under staples reinforces magazine binding.....	102
Leather laces cut by hacksaw blade in wooden holder.....	104
Renailing loose boards in docks.....	104
Table-top Christmas tree made of paper disks.....	104
Moistener for tobacco humidifier made from plaster cylinder...	116
Cigarette box holds pencils and pens in shirt pocket.....	116
Corn pad on microscope protects spectacles.....	126
Two methods of joining pipe without a union.....	128
Torn tracings mended with banana oil.....	136
Magnetized rod locates hidden hairpins.....	136
"Sanding block" shapes edges of insulating board.....	138
Corner bead leveled with chalk line.....	138
Four simple aids that printers find useful.....	139
Foundation lines marked off with layout square.....	139
Glove removed for writing is held by buckle on sleeve.....	140
Brush with retractable bristles made from package handle...	140

IMPORTANT NOTICE

It is the intention of this magazine to provide its readers with information regarding the latest developments in the mechanical arts. We take no responsibility as to whether the disclosures contained in our articles are covered by patents and advise readers to investigate this subject before making, using, or selling any of the products, machines, or processes described in order to avoid possible liability for patent infringement.

AUDELS REFRIGERATION & AIR CONDITIONING GUIDE.....\$4

New from Cover to Cover—1250 Pages, Fully Illus. Covering basic principles, servicing, operation & repair of household, commercial & industrial refrigeration & air conditioning. A gold mine of essential important facts for engineers, servicemen, users.

AUDELS CARPENTERS & BUILDERS GUIDES—4 Vols.\$6

A practical illustrated trade assistant on modern construction for carpenters, joiners, builders, mechanics and all woodworkers. 4 vols., 1600 pages, 3700 illustrations, flexible covers. Pocket size. Each volume sold separately \$1.50 a vol.

AUDELS AUTOMOBILE GUIDE.....\$4

A practical quick ready reference book for auto mechanics, service men, operators & owners. Explains theory, construction & servicing of modern motor cars, trucks, buses & auto type Diesel engines. 1540 pages, fully illustrated, 55 chapters, Indexed. A standard book for mechanics. New fluid drive covered.

AUDELS DIESEL ENGINE MANUAL.\$2

A practical, concise treatise with questions and answers on the theory, operation and maintenance of modern diesel engines including General Motors 2 cycle Diesel, 384 pages, fully illus., flexible binding, pocket size. All details plainly brought out, this book is of extreme value to engineers, operators & students.

AUDELS WIRING DIAGRAMS.....\$1

210 Pages, Illustrated. Gives practical facts on wiring of electrical apparatus. It shows clearly how to wire apparatus for practically all fields of electricity. Each diagram is complete & self-explanatory. Highly Endorsed Pocket Companion.

AUDELS PLUMBERS & STEAMFITTERS GUIDES—4 Vols.\$6

A Practical Trade Assistant & Ready Reference. Explains in plain language & by clear illustrations, diagrams, charts, graphs, pictures principles of modern plumbing practice including Marine Pipe Fitting and Air Conditioning. 4 Vols.—1670 Pages—3642 Diagrams. Pocket size. Each Vol. Sold Separately \$1.50 a Vol.

AUDELS SHEETMETAL WORKERS HANDY BOOK.....\$1

Practical inside information. Fundamentals of Sheet Metal Work. 388 pages, Illustrated. 11 sections. Clearly written. Essential & important facts, figures, pointers in everyday language. Ref. Index.

AUDELS SHEETMETAL PATTERN LAYOUTS.....\$4

Developed by Experts for Sheet Metal Workers, Layout Men & Mechanics. A Practical Encyclopedia in 10 Sections, size 7 x 10 x 2—1125 Pages—350 Layouts—1600 Illustrations, 1001 Key Facts. Fully Indexed for ready reference in answering your layout problems. Covers all phases of sheet metal work including Pattern Cutting, Pattern Development & Shop Procedure.

AUDELS ANSWERS ON BLUE PRINT READING.....\$2

For Mechanics & Builders. Covers all types of blue print reading including ship & airplane. 376 pages, fully illustrated.

AUDELS NEW MACHINIST & TOOLMAKERS HANDY BOOK...\$4

Covers modern machine shop practice in all its branches. 5 practical books in 1. New from cover to cover. Tells how to set up & operate lathes, arbor and milling machines, shapers, drill presses and all other machine tools. 1600 pages, fully illustrated, 5 x 8 1/2 x 2. Indexed. 5 sections. 1—Modern Machine Shop Practice. 2—Blue Print Reading & How to Draw. 3—Calculations & Mathematics for Machinists. 4—Shop Physics. 5—How to Use the Slide Rule. 60 chapters. Easy to read and understand. A shop companion that answers your questions.

AUDELS MATHEMATICS & CALCULATIONS FOR MECHANICS \$2

Mathematics for home study or reference. 700 pages, 550 illus. Practical mathematics from beginning. How to figure correctly. Easy, correct methods covering a complete review. Ill. & Indexed.

AUDELS HANDY BOOK OF PRACTICAL ELECTRICITY.....\$4

For maintenance engineers, electricians & all electrical workers. 1440 Pages, 2600 Illus. Covers important electrical information in handy form—including Marine Wiring, Radio Principles, Welding, Indexed. A Key to a practical understanding of electricity.

AUDELS RADIOMANS GUIDE.....\$4

A key to the practical understanding of radio including Frequency Modulation, Television, etc., Aircraft & Marine Radio. For radio engineers, servicemen, amateurs. 772 pages, 400 Illustrations & Diagrams, Photos, Review Questions & Answers, Reference Index. Authentic, clear, concise.

AUDELS ELECTRONIC DEVICES.....\$2

Tells What You Want to Know About Electric Eye. Easily Understood. Covers photo-electric cells & their applications. Amplifiers, illumination, frequencies, voltage, photocell, tubes, Ohm's Law, wiring diagrams, etc.

AUDELS WELDERS GUIDE.....\$1

A concise, practical text on operation & maintenance of all welding machines for all mechanics. Over 400 pages, illustrated. Covers all methods of electric and acetylene welding including airplane work.

AUDEL, Publishers, 49 W. 23 St., N. Y. 10



AN AUDEL GUIDE IS A GOOD FRIEND!

Use the brains and experience of others in these Guides of the Trades. Save time and money with right methods, short cuts, labor saving ideas. CHECK NOW! You can look over any Audel Guide in your home. Start the Easy Payments if satisfied.

CUT HERE MAIL ORDER

THEO. AUDEL & CO., 49 W. 23 St., New York 10, N.Y.

Please mail me for 7 days' free examination the books marked (X) below. I agree to mail \$1 in 7 days on each book or set ordered, and to further mail \$1 a month on each book or set ordered until I have paid purchase price.

If I am not satisfied with Guides I will return them.

- Audels REFRIGERATION & Air Conditioning Guide . \$4.
- Audels POWER PLANT ENGINEERS GUIDE . 4.
- Audels PUMPS, HYDRAULICS & AIR COMPRESSORS . 4.
- Audels WELDERS GUIDE . 1.
- Audels BLUE PRINT READING . 2.
- Audels SHEET METAL WORKERS Handy Book . 1.
- Audels SHEET METAL PATTERN LAYOUTS . 4.
- Audels AIRCRAFT WORKER . 1.
- Audels MATHEMATICS and CALCULATIONS . 2.
- Audels MACHINISTS & TOOLMAKERS Handy Book . 4.
- Audels MECHANICAL Dictionary . 4.
- Audels AUTOMOBILE GUIDE . 4.
- Audels DIESEL ENGINE MANUAL . 2.
- Audels MARINE ENGINEERS Handy Book . 4.
- Audels SHIPFITTERS Handy Book . 1.
- Gueths MECHANICAL DRAWING COURSE . 1.
- Rogers DRAWING and DESIGN . 2.
- Audels MILLWRIGHTS and Mechanics Guide . 4.
- Audels CARPENTERS and Builders Guides (4 vols.) . 6.
- Audels PLUMBERS and Steamfitters Guides (4 vols.) . 6.
- Audels MASONS and Builders Guides (4 vols.) . 6.
- Master PAINTER and DECORATOR . 2.
- Audels GARDENERS & GROWERS GUIDES (4 vols.) . 6.
- Audels ENGINEERS and Mechanics Guides Nos. 1, 2, 3, 4, 5, 6, 7 and 8 complete . 12.
- Audels Answers on Practical ENGINEERING . 1.
- Hawkins Aids to ENGINEERS EXAMINATION . 2.
- Audels ELECTRICIANS EXAMINATIONS . 1.
- Audels WIRING DIAGRAMS . 1.
- Audels Handy Book of PRACTICAL ELECTRICITY . 4.
- Audels ELECTRICAL POWER CALCULATIONS . 2.
- Hawkins ELECTRICAL Guides at \$1. each . 10.
- Audels ELECTRONIC DEVICES . 2.
- Audels ELECTRIC Dictionary . 2.
- Audels RADIOMANS GUIDE . 4.
- Audels NEW ELECTRIC LIBRARY at \$1.50 a Volume Vols. I, II, III, IV, V, VI, VII, VIII, IX, X, XI, XII.

Name.....
 Address.....
 Occupation.....
 Employed by..... PM



J. E. SMITH, President National Radio Institute
The man who has directed the Home Study Training of more men for the Radio Industry than any other man in America.

BE YOUR

*I will show you how to start
a Radio Service Business
Full Time or Spare Time without capital*

I Trained These Men



\$35 - \$45 A Week In Own Shop

"Previous to enrolling for your Radio training I made \$12 per week in a hardware store. Now I operate my own repair shop, and often clear \$35 to \$45 a week."—**FREDERICK BELL**, 75 Golf Ave., St. Johns, Newfoundland.



\$250 A Month In Own Shop

"I am now operating a Radio shop for myself and own all my equipment. Right now I only repair Radios, because there are none to sell, but I average \$250 a month."—**J. M. SCRIVENER, JR.**, Aberdeen, Miss.



Averages Over \$60 A Week

"Not long ago I was working 16 hours a day in a filling station at \$10 a week. Now I have my own Radio business and average over \$60 a week. The N. R. I. course is fine."—**ALBERT C. CHRISTENSEN**, 1116 Tenth Ave., Sidney, Neb.

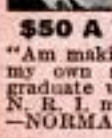

\$50 A Week From Own Shop

"Am making over \$50 a week profit from my own shop. Have another N. R. I. graduate working for me. I like to hire N. R. I. men because they know Radio."—**NORMAN MILLER**, Hebron, Neb.



\$50 A Month In Spare Time

"I have a spare time Radio and Electrical business of my own which has been very profitable, due to the efficient training I received from your Course. Last year I averaged over \$50 a month."—**FRED H. GRIFFIE**, Rt. 3, Newville, Pa.



Fixing Radios Profitable Hobby

"I am doing Radio work in my spare time and find it a profitable hobby. My extra earnings run about \$10 a week. I certainly am glad I took your N. R. I. Course."—**FERDINAND ZIRBEL**, Chaseley, N. Dak.



SAMPLE LESSON FREE SEE OPPOSITE PAGE

Let me show you facts about rich opportunities in Radio. See how knowing Radio can give you security, a prosperous future, and let you name *your own* hours as *your own* boss in *your own* Radio business. Send the coupon for FREE 64-page book, "Win Rich Rewards in Radio." Read how you practice building, testing, repairing Radios with SIX BIG KITS OF PARTS I send you.

Future For Trained Men Is Bright In Radio, Television, Electronics

The Radio Repair business is booming NOW. In your own spare time or full time Radio business you'll make good money fixing Radios, plus a good profit on Radio parts, and put yourself in line for more profits selling new Radios now that they can be made.

Trained Radio Technicians also find wide-open opportunities in Police, Aviation, Marine Radio, in Broadcasting, Radio Manufacturing, Public Address Systems, etc. And greater opportunities are coming when Television and Electronics are available to the public. Send for free book now!

Many Beginners Soon Make \$5, \$10 A Week EXTRA In Spare Time

The day you enroll I start sending EXTRA MONEY JOB SHEETS to help you make EXTRA money fixing Radios in spare time while learning. You LEARN Radio principles from my easy-to-grasp lessons—PRACTICE what you learn by building real Radio Circuits, with Radio parts I send—USE your knowledge to make EXTRA money in spare time.

Mail Coupon for Free Copy of Lesson and 64-Page Illustrated Book

I will send you FREE a sample lesson, "Getting Acquainted with Receiver Servicing," to show you how practical it is to train for Radio in spare time. With it I'll send my 64-page, illustrated book, "Win Rich Rewards in Radio." Just mail coupon in an envelope or paste it on a penny postal. **J. E. SMITH, President, Dept. 5NP, National Radio Institute, Pioneer Home Study Radio School, Washington 9, D. C.**

MY COURSE INCLUDES
**TELEVISION
ELECTRONICS**
FREQUENCY MODULATION

A TESTED WAY

OWN BOSS

**LEARN RADIO BY PRACTICING IN SPARE TIME
with 6 Big Kits of Radio Parts I Send You!**

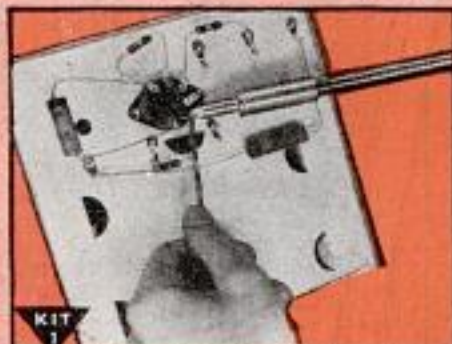

KIT 1
I send you Soldering Equipment and Radio Parts; show you how to do Radio soldering; how to mount and connect Radio parts; give you practical experience.



KIT 2
Early in my Course I show you how to build this N.R.I. Tester with parts I send. It soon helps you fix neighborhood Radios and earn EXTRA money in spare time.

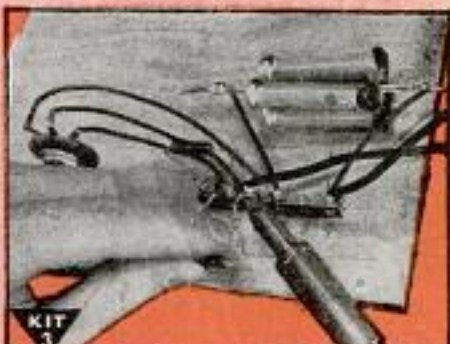

KIT 3
You get parts to build Radio Circuits; then test them; see how they work; learn how to design special circuits; how to locate and repair circuit defects.

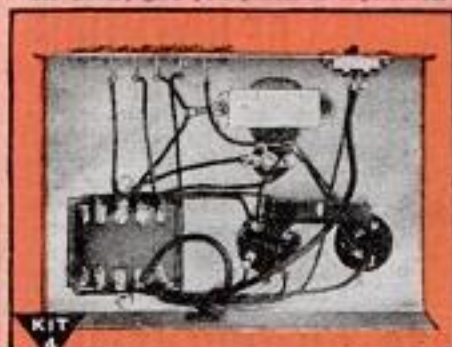

KIT 4
You get parts to build this Vacuum Tube Power Pack; make changes which give you experience with packs of many kinds; learn to correct power pack troubles.



KIT 5
Building this A. M. Signal Generator gives you more valuable experience. It provides amplitude-modulated signals for many tests and experiments.



KIT 6
You build this Superheterodyne Receiver which brings in local and distant stations—and gives you more experience to help you win success in Radio.

**SAMPLE LESSON
FREE**

I will send you a FREE Lesson, "Getting Acquainted with Receiver Servicing," to show you how practical it is to train for Radio at home in spare time. It's a valuable lesson. Study it—keep it—use it—without obligation! Tells how Superheterodyne Circuits work, gives hints on Receiver Servicing, Locating Defects, Repair of Loudspeaker, I.F. Transformer, Gang Tuning, Condenser, etc. Thirty-one illustrations.



**MAIL COUPON FOR FREE LESSON
AND 64-PAGE BOOK**

Good for Both FREE

MR. J. E. SMITH, President, Dept. 5NP
National Radio Institute, Washington 9, D. C.
Mail me FREE, without obligation,
Sample Lesson and 64-page book, "Win
Rich Rewards in Radio." (No salesman
will call. Please write plainly.)

Age.....

Name.....

Address.....

City..... State..... APR

(If you have a Post Office zone number please include it)



TO GOOD PAY

NEW BOOK *for*

PATENT GUIDE FOR THE INVENTOR

CLARENCE A. O'BRIEN
& HARVEY B. JACOBSON
REGISTERED PATENT ATTORNEYS
WASHINGTON, D. C.



FREE RECORD OF INVENTION

This FREE Record of Invention form enables you to conveniently make a sketch of your invention and have it witnessed in a manner of value to you, should the occasion for evidence arise.

48
PAGES
Over 150
Mechanical
Movements

LATEST FACTS ON INVENTIONS

Is your invention something for the home, the farm, the factory, the store? Would you like to know whether anything like it has ever been invented, and if not, how to protect your invention? Our new 48-page book "Patent Guide for the Inventor" will show you how to proceed with your invention. You'll get a good idea of whether you "have something" or not. Would you like to know how you may judge the marketability of your invention? This book gives you several important tests prepared by authorities. Read of the experiences of Bell, Edison, Westinghouse, and other outstanding, successful inventors who patented and thereby protected their inventions. This book not only tells you how to obtain a patent, it also explains the steps that must be taken afterward to promote the success of your invention. MAIL THE COUPON TODAY to Clarence A. O'Brien & Harvey B. Jacobson, Registered Patent Attorneys, 51-M, Adams Building, Washington 4, D. C.

**CLARENCE A. O'BRIEN
& HARVEY B. JACOBSON**
REGISTERED PATENT ATTORNEYS

INVENTORS

NOW Is the Time to PATENT and SELL Your Invention

Now, more than ever before, is the right time to patent your invention. Why? Because manufacturers everywhere presently engaged in war production are looking ahead to the future by buying up patent rights now, so they will have new and attractive items to make and sell for civilian consumption as soon as the war is over. This is what happened during and after the last war. Hence, the smart thing for you to do is to look ahead to the future too. Protect your invention and yourself by applying for a patent now.

Patent Guide Shows What To Do

Our "Patent Guide for the Inventor" answers many important questions concerning Patents that inventors constantly ask. It tells what facts, details, drawings, sketches, etc. are necessary to apply for a Patent; how to protect your invention through dated and witnessed disclosure; how to do this AT ONCE to safeguard your rights; how Patent Office Records can be checked to determine whether the invention is probably patentable before filing fees need be paid; discusses costs involved and a practical way these can be paid as the application progresses. It tells how some inventors secured financial backing; how many simple inventions have proved large commercial successes; how Patents covering improvements also can be profitably utilized and marketed; tells countless other facts of interest.

Why You Need Expert Assistance

The Patent Laws were enacted for your benefit—to give you protection for the features of your invention which are Patentable. But these features must be legally and concisely set forth in the form of "claims." This phase of the procedure is so complex that the Patent Office advises the Inventor to engage a competent Registered Patent Attorney. We maintain a large staff—carefully trained registered patent attorneys—expert draftsmen—experienced searchers—to serve you. We have been serving inventors for more than 20 years.

Take First Step Now

With the Patent Guide you will receive also Free a "Record of Invention" form which will enable you at once to establish the date of your invention, before you file your Patent application. This step costs you nothing yet may be vital to your success. Remember—in Patent Matters, ACTION is IMPORTANT. Delay can be costly. Mail the coupon in an envelope, or paste it on a penny postcard NOW.

*Worthy of
Your Trust*

Get

**FREE
COPY**

*Mail
Coupon
Today*

CLARENCE A. O'BRIEN & HARVEY B. JACOBSON

CLARENCE A. O'BRIEN & HARVEY B. JACOBSON

Registered Patent Attorneys before the United States Patent Office
51-M Adams Building, Washington 4, D. C.

Please send me your 48-Page "Patent Guide for the Inventor" and your specially prepared "Record of Invention" form FREE. This request does not obligate me.

Name.....

Address.....

City..... State.....

(Please write or print plainly.)

The HEARING AID

WITH A Truly Unique FEATURE



Beltone

Using a number of different types of plug-in tubes in numerous combinations, Beltone can fit practically any type of deafness from mild to severe. Beltone especially invites hard-to-fit cases.

As your hearing changes, your Beltone dealer can change the tubes in your instrument to compensate—while you wait! It is not necessary to buy a new instrument. Convenient, economical!

MAIL THIS COUPON Today!

BELTONE HEARING AID CO.
Dept. PM12, 1450 W. 19th St., Chicago 8, Ill.
Please send FREE booklet on BELTONE

NAME _____

ADDRESS _____

CITY & STATE _____

"YOU ARE UNDER ARREST!"



There's a Thrill in Bringing a Crook to Justice Through Scientific **CRIME DETECTION!**

I have taught thousands this profitable, pleasant profession. Let me teach you, too, in your own home. Learn Finger Printing and Secret Service Methods thoroughly, quickly and at small cost.

53% of All American Bureaus of Identification employ students or graduates of I. A. S. You, too, can fit yourself to fill a responsible crime detection job with good pay and steady employment. Get details now. Let me show you how I can prepare you for this fascinating work, during spare time, in your own home. You may pay as you learn. Write today . . . Now . . . Be sure to state age.

Be A **FINGER PRINT Expert**

FREE!!!
Send for Thrilling "BLUE BOOK OF CRIME"

INSTITUTE OF APPLIED SCIENCE
1920 Sunnyside Ave., Dept. 1359, Chicago 40, Ill.

TRAIN FOR KEY JOB OR BUSINESS OF YOUR OWN

REFRIGERATION and AIR CONDITIONING

Millions of Older Units Need Expert Service. Big After-the-War Expansion Will Create Even More Opportunities. Approved for Veterans "G. I." Training

A key job—a successful business of your own—you can have either in this vital, war-hit industry. A serious shortage of service-experts exists in every branch. Big post-war boom will open thousands of new opportunities. Get ready for your big chance. We'll give you the practical training you need—at home—and in our big Chicago shops, largest and most completely equipped in the country. No advanced schooling needed. Our unique methods make everything easy to grasp. We've trained thousands. Pay as you go. Quit when you want to. Get the full facts without obligation. Write TODAY.

INDUSTRIAL TRAINING INSTITUTE

2150 Lawrence Avenue, Dept. P1N, Chicago 25, Ill.

Keep that "Car" TICKING

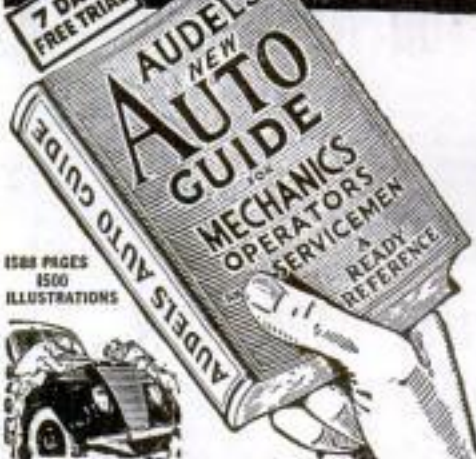

Every operator and mechanic needs AUDELS AUTO GUIDE.

This book saves time, money and worry. Highly endorsed. It presents the whole subject of auto mechanics:

- 1—Basic principles
 - 2—Construction
 - 3—Operation
 - 4—Service
 - 5—Repair
- Handy Size, Easily understood.

NEW FLUID DRIVE, HYDRAULIC SHIFT AND DIESEL ENGINES FULLY COVERED

Over 1500 pages—1540 illustrations showing inside views of modern cars, trucks and buses with instructions for all service jobs.

4 COMPLETE • PAY ONLY \$1. A MONTH

ASK TO SEE IT!—To Get This Assistance for Yourself Simply Fill in and Mail Coupon Today.
AUDEL Publishers, 49 West 23rd St., New York
MAIL AUDELS NEW AUTO GUIDE for free examination. If O.K. I will send you \$1 in 7 days; then remit \$1 monthly until price of \$4 is paid. Otherwise I will return it.

Name _____

Address _____

Occupation _____

Employed by _____ PM

What's My Job?—I Manufacture Weaklings into MEN!

Charles Atlas

Actual Photograph of the man who holds the title "The World's Most Perfectly Developed Man."

GIVE ME a skinny, pepleless, second-rate body—and I'll cram it so full of handsome, bulging new muscle that your friends will grow bug-eyed! . . . I'll wake up that sleeping energy of yours and make it hum like a high-powered motor! Man, you'll *feel* and *look* different! You'll begin to *LIVE!*



Let Me Make YOU a NEW MAN —IN JUST 15 MINUTES A DAY!

You wouldn't believe it, but I myself used to be a 97-lb. weakling. Fellows called me "Skinny." Girls sneekered and made fun of me behind my back. I was a flop. THEN I discovered my marvelous new muscle-building system—"Dynamic Tension." And it turned me into such a complete specimen of MANHOOD that today I hold the title "THE WORLD'S MOST PERFECTLY DEVELOPED MAN."

That's how I traded in my "bag of bones" for a barrel of muscle! And I felt so much better, so much on top of the world in my big, new, husky body, that I decided to devote my whole life to helping other fellows change themselves into "perfectly developed men."

What Is "Dynamic Tension"?

How Does It Work?

When you look in the mirror and see a healthy, husky, strapping fellow smiling back at you—then you'll be astounded at how short a time it takes "Dynamic Tension" to GET RESULTS!

"Dynamic Tension" is the easy, NATURAL method you can practice in the privacy of your own room—JUST 15 MINUTES EACH DAY—while your scrawny shoulder muscles begin to swell, ripple . . . those spindly arms and legs of yours bulge . . . and your whole body starts to feel "alive," full of zip and go!

One Postage Stamp

May Change Your Whole Life!

As I've pictured up above, I'm steadily building broad-shouldered, dynamic MEN—day by day—the country over.

2,000,000 fellows, young and old, have already gambled a postage stamp to ask for my FREE book. They wanted to read and see for themselves how I'm building up scrawny bodies, and how I'm paring down fat, flabby ones—how I'm turning them into breath-taking human dynamos of pure MANPOWER.

Take just a few seconds NOW to fill in and mail the coupon at right, and you will receive at once my FREE book—"Everlasting Health and Strength" that PROVES with actual snap-shots what "Dynamic Tension" has done for others—what it can do for YOU! Address: CHARLES ATLAS, Dept. 812, 115 East 23rd St., New York 10, N. Y.

FREE

Mail the coupon below right now for my FREE illustrated book, "Everlasting Health and Strength." Tells all about "Dynamic Tension" methods. Cramped with pictures, facted with photos, facted. Address me personally: CHARLES ATLAS, Dept. 812, 115 E. 23rd St., New York 10, N. Y.



CHARLES ATLAS, Dept. 812
115 East 23rd St., New York 10, N. Y.

I want the proof that your system of "Dynamic Tension" will help make a New Man of me—give me a healthy, husky body and big muscular development. Send me your free book, "Everlasting Health and Strength."

Name _____
(Please print or write plainly)

Address _____

City _____ Zone No. _____
(if any) State _____

Check here if under 16 for Booklet A.

INVENTORS

LEARN HOW TO
PROTECT and SELL
YOUR INVENTION

GET NEW **FREE BOOK**



FREE

Invention Record
Know How Successful
Inventors Protect and
Sell Their Inventions

Our new **FREE** Book is a book every inventor should have. Mail the coupon today for "How to Protect, Finance and Sell Your Invention" and learn . . .

How to know if there is a prior U. S. patent on your invention.

How to save steps in getting patent action.

How to prepare your application for presentation to the Patent Office.

How you may patent an improvement on something in use now.

How to obtain funds to patent and promote your invention.

How to find a buyer or backer for your invention.

How to protect yourself in making royalty agreements.

MODERN BUSINESS WANTS INVENTIONS

Practical and novel inventions are in big demand today. The opportunity for quick money is enticing. Sales sources are many if your invention has merit. But, be *sure*—before you place your device in strange hands—that it is fully protected. A United States Patent gives you this protection. *The first step toward inventive success always is—and always has been—the application for a U. S. Patent. There is no other way to protect your invention in accordance with the laws of this country.*

MAKE THIS RECORD NOW

If you have an invention, and wish to secure it for the future, act at once. Have it dated now and recorded in our office. We will send you this **FREE** Invention Record Form for the purpose. Fill out the Invention Record Form fully describing the nature of your invention. Make a sketch of its main features. Mail it to us and we will record the date it was received in our office. The earlier the date the better your chance of combating rival inventors who may lay claim to your idea later. *Don't delay a single minute in taking this important step. Your whole future may depend upon it. Mail the coupon for our FREE Invention Record Blank and New FREE Book today!*

HOW WE SERVE YOU AS REGISTERED PATENT ATTORNEYS

The U. S. Patent Office strongly recommends—unless the inventor is familiar with such matters—that he employ the services of a Registered Patent Attorney in the preparation of his Patent Application. We are Registered Patent Attorneys fully qualified to represent you at the Patent Office. We have had long experience in studying hundreds of types of inventions. This gives us the ability to judge your invention and to describe it accurately and convincingly in technical language. It gives us the perception to center arguments upon those details of your invention which, in our judgment, will be looked upon most favorably by the Patent Office Examiner.

Mail the coupon today for our new **FREE** Book, "How to Protect, Finance and Sell Your Invention," and our **FREE** Invention Record Form—maybe this step will pave the way to future security for you and your family. Act Today!

McMORROW & BERMAN
Registered Patent Attorneys

135-H Atlantic Building, Washington 4, D. C.

McMORROW & BERMAN

REGISTERED PATENT ATTORNEYS

135-H ATLANTIC BUILDING, WASHINGTON 4, D. C.

Send me your new **FREE** book, "How to Protect, Finance and Sell Your Invention"—and "Invention Record" form at once. I understand that this request does not obligate me.

NAME

ADDRESS

CITY STATE

(Write or print name clearly)

Training is essential to advancement in any field—and it's important to have it on record.

International Correspondence Schools' sound and practical training goes on record—and counts in the record. I. C. S. regularly reports the progress of its students to their employers, regularly receives letters expressing appreciation for this service.

A typical employer communication notes: "I have every I. C. S. report on my men filed with their personal records, the records which help to determine any action taken in regard to those men."*

YOU want your record to show you have *trained* for promotion. **YOU** want your employer to know that you have *prepared* yourself for larger responsibilities. Then *act* now to obtain that training. I. C. S. Courses cover more than 400 business and technical subjects. The coupon brings full information.

*Name furnished on request



INTERNATIONAL CORRESPONDENCE SCHOOLS



BOX 5563-K SCRANTON 9, PENNA.

Without cost or obligation, please send me full particulars about the course *before* which I have marked X:

- | | | | |
|---|--|--|--|
| <ul style="list-style-type: none"> <input type="checkbox"/> Air Conditioning and Plumbing Courses <input type="checkbox"/> Air Conditioning <input type="checkbox"/> Heating <input type="checkbox"/> Plumbing <input type="checkbox"/> Refrigeration <input type="checkbox"/> Steam Fitting Chemistry Courses <input type="checkbox"/> Chemical Engineering <input type="checkbox"/> Chemistry, Analytical <input type="checkbox"/> Chemistry, Industrial <input type="checkbox"/> Chemistry, Mfg. Iron & Steel <input type="checkbox"/> Petroleum Refining <input type="checkbox"/> Plastics <input type="checkbox"/> Pulp and Paper Making Civil Engineering, Architectural and Mining Courses <input type="checkbox"/> Architectural Drafting <input type="checkbox"/> Architecture <input type="checkbox"/> Bridge and Building Foreman <input type="checkbox"/> Building Estimating <input type="checkbox"/> Civil Engineering <input type="checkbox"/> Coal Mining <input type="checkbox"/> Contracting and Building <input type="checkbox"/> Highway Engineering <input type="checkbox"/> Lumber Dealer <input type="checkbox"/> Reading Structural Blueprints <input type="checkbox"/> Sanitary Engineering <input type="checkbox"/> Structural Drafting <input type="checkbox"/> Structural Engineering <input type="checkbox"/> Surveying and Mapping | <ul style="list-style-type: none"> Electrical Courses <input type="checkbox"/> Electrical Drafting <input type="checkbox"/> Electrical Engineering <input type="checkbox"/> Power House Electric <input type="checkbox"/> Practical Electrician <input type="checkbox"/> Practical Telephony <input type="checkbox"/> Telegraph Engineering Internal Combustion Engines Courses <input type="checkbox"/> Auto Technician <input type="checkbox"/> Aviation <input type="checkbox"/> Diesel-Electric <input type="checkbox"/> Diesel Engines <input type="checkbox"/> Gas Engines Mechanical Courses <input type="checkbox"/> Aeronautical Engineering <input type="checkbox"/> Airplane Drafting <input type="checkbox"/> Flight Engineer <input type="checkbox"/> Foundry Work <input type="checkbox"/> Heat Treatment of Metals <input type="checkbox"/> Industrial Engineering <input type="checkbox"/> Industrial Metallurgy <input type="checkbox"/> Mechanical Drafting <input type="checkbox"/> Mechanical Engineering <input type="checkbox"/> Mold-Loft Work <input type="checkbox"/> Patternmaking <input type="checkbox"/> Reading Shop Blueprints <input type="checkbox"/> Sheet-Metal Drafting <input type="checkbox"/> Sheet-Metal Worker | <ul style="list-style-type: none"> <input type="checkbox"/> Ship Drafting <input type="checkbox"/> Ship Fitting <input type="checkbox"/> Shop Practice <input type="checkbox"/> Steel Mill Workers <input type="checkbox"/> Tool Designing <input type="checkbox"/> Welding, Gas and Electric Radio Courses <input type="checkbox"/> Electronics <input type="checkbox"/> Radio, General <input type="checkbox"/> Radio Operating <input type="checkbox"/> Radio Servicing Railroad Courses <input type="checkbox"/> Air Brake <input type="checkbox"/> Car Inspector <input type="checkbox"/> Locomotive Engineer <input type="checkbox"/> Locomotive Fireman <input type="checkbox"/> Railroad Section Foreman Steam Engineering Courses <input type="checkbox"/> Boilermaking <input type="checkbox"/> Combustion Engineering <input type="checkbox"/> Engine Running <input type="checkbox"/> Marine Engineering <input type="checkbox"/> Steam Electric <input type="checkbox"/> Steam Engines Textile Courses <input type="checkbox"/> Cotton Manufacturing <input type="checkbox"/> Rayon Weaving | <ul style="list-style-type: none"> <input type="checkbox"/> Textile Designing <input type="checkbox"/> Woolen Manufacturing Business and Academic Courses <input type="checkbox"/> Accounting <input type="checkbox"/> Advertising <input type="checkbox"/> Arithmetic <input type="checkbox"/> Bookkeeping <input type="checkbox"/> Business Correspondence <input type="checkbox"/> Business Management <input type="checkbox"/> Certified Public Accounting <input type="checkbox"/> College Preparatory <input type="checkbox"/> Commercial <input type="checkbox"/> Cost Accounting <input type="checkbox"/> Federal Tax <input type="checkbox"/> First Year College <input type="checkbox"/> Foremanship <input type="checkbox"/> French <input type="checkbox"/> Good English <input type="checkbox"/> High School <input type="checkbox"/> Higher Mathematics <input type="checkbox"/> Illustrating <input type="checkbox"/> Motor Traffic <input type="checkbox"/> Postal Service <input type="checkbox"/> Salesmanship <input type="checkbox"/> Secretarial <input type="checkbox"/> Sign Lettering <input type="checkbox"/> Spanish <input type="checkbox"/> Stenography <input type="checkbox"/> Traffic Management |
|---|--|--|--|

Name..... Age..... Home Address..... Working Hours..... A.M. to..... P.M.

City..... State..... Present Position.....

Canadian residents send coupon to International Correspondence Schools Canadian, Ltd., Montreal, Canada.

British residents send coupon to I. C. S., 71 Kingsway, London, W. O. 2, England.

DISCOUNT TO DISCHARGED VETERANS—SPECIAL TUITION RATES FOR MEMBERS OF THE ARMED FORCES

**VETERANS!
EX-WAR WORKERS!
UNSKILLED MEN!**

Where do **YOU** Fit



**COYNE offers
Quick, Practical
Shop Training
to Help You —**

*Prepare in a Few
Short weeks for Good
Pay, Steady Work and
a Real Future!*

**LEARN
EITHER**

ELECTRICITY OR



Get Out of the "ONE-OPERATION" JOB RUT!

Today's better jobs demand men who know, not just one branch of one line of work, but the principles and methods of **MANY BRANCHES**. In other words — **"ALL AROUND KNOWLEDGE."** This takes **TRAINING**.

If you've missed such training by being in uniform or in war work, **NOW'S THE TIME TO GET IT**. Prepare in Chicago at **COYNE**. In amazingly short time you'll have the practical understanding for a real future in your chosen field of opportunity — **ELECTRICITY** or **RADIO**.

JOBS IN ELECTRICITY

Coyne Electrical Course leads to jobs such as Armature Expert, Motor Maintenance, Wiring Contractor, Aviation or Automotive Electrician, Signal and Alarm Work, Power Plants, etc. See my big **FREE** Electrical book.

JOBS IN RADIO-ELECTRONICS

Coyne Radio-Electronics Course covers branches such as Radio Manufacturing, Public Address and Sound Systems, Television, Frequency Modulation (FM), and your own Radio Business. See my big **FREE** Radio book.

Lifetime Employment Service

First we help you prepare for a good job and future, then assist you in getting located. Many big firms give Coyne men preference — this will be important to you during slack times. As a Coyne graduate you can use this service whenever you need it, without charge.

Men with Physical Disabilities

We have facilities for men with physical disabilities whether caused by war or other causes. If you have a physical disability of any kind check the coupon for information.

VETERANS

This great training is also available to you under G. I. Bill of Rights. Check coupon if you want information

in the *POSTWAR* World 

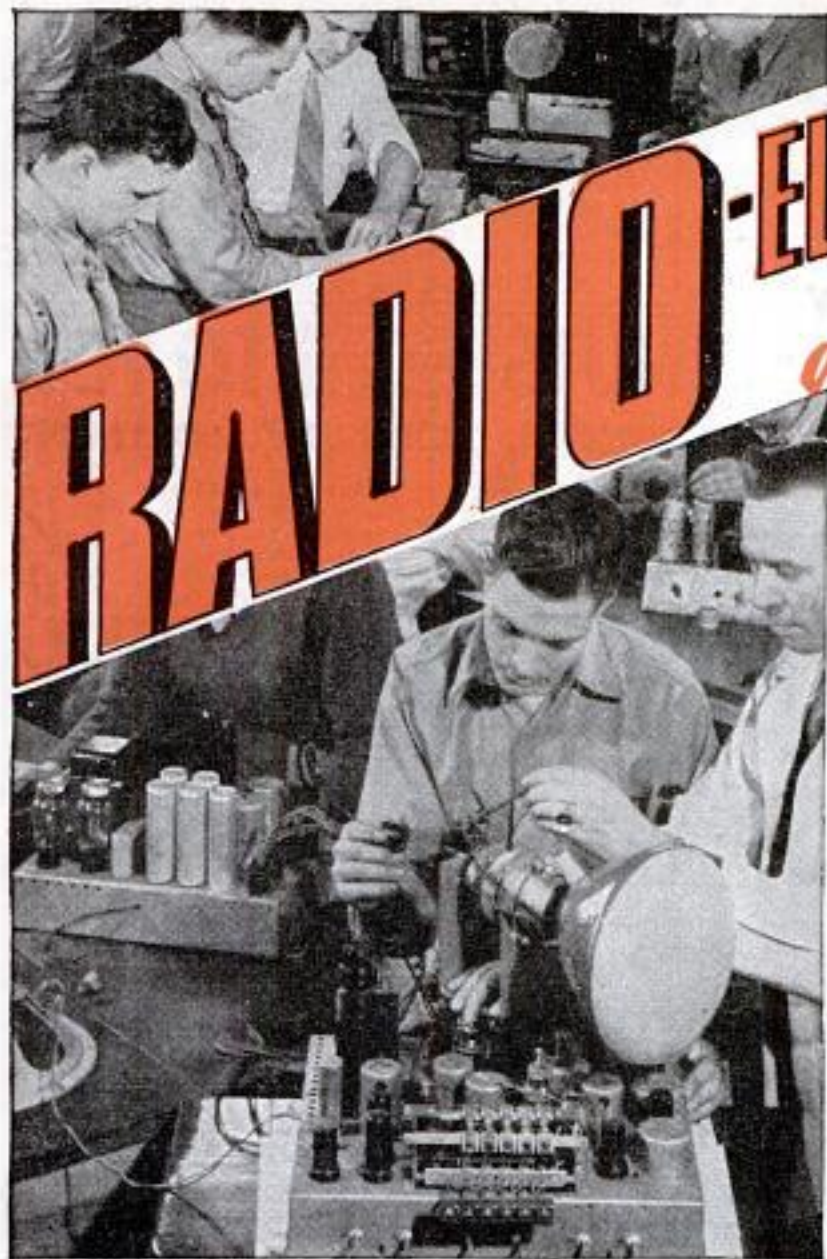

RADIO-ELECTRONICS and TELEVISION

"Learn by Doing"

**ON FULL SIZE EQUIPMENT
IN MY BIG CHICAGO SHOPS**

At Coyne you first get the basic principles, then apply your knowledge on real Electrical or Radio-Electronic apparatus. You are shown each step, then do it yourself. Expert instructors take personal interest in you. This way, you make rapid progress. A few short weeks and you are ready for your field, confident of your ability as a Coyne-trained man.

**INDUSTRIAL ELECTRONICS and
REFRIGERATION—with Either Course**

Two big extra opportunities for the Electrical or Radio Man. Right now I include special shop training in both INDUSTRIAL ELECTRONICS and ELECTRIC REFRIGERATION at no extra tuition cost.

Student Finance Plan

If you are short of money I'll arrange to finance most of your tuition and you can pay it back in easy monthly payments after you graduate. We'll help you get a part-time job if you wish, so you can earn while learning. I have many plans to help you. Send coupon for complete details. No salesman will call. You are the sole judge. Don't delay. You need Coyne training NOW.

Pick RADIO or ELECTRICITY—Get FREE BOOK NOW



You make no mistake choosing either Electricity or Radio-Electronics. They're both wonderful postwar fields. My big FREE BOOK on each field has dozens of pictures, latest facts about jobs. Check coupon for your selection and MAIL TODAY.



MAIL THIS COUPON TODAY

H. C. Lewis, Pres.
Coyne Electrical School
500 S. Paulina Street, Dept. 95-72H, Chicago 12, Ill.

Send me your BIG FREE BOOK—for the course checked below. Also full details of your "Pay-after-Graduation" plan.

() ELECTRICITY () Send special
 () RADIO-ELECTRONICS () G. I. Bulletin
 () Physical disability

NAME.....

ADDRESS.....

CITY..... STATE.....

COYNE ELECTRICAL SCHOOL
H. C. LEWIS, President Dept. 95-72H
500 S. Paulina Street, CHICAGO 12, ILLINOIS

The set of
books
that makes



MASTER MACHINISTS and leads to bigger pay!

This big home-study and reference course gives you the practical facts on machines and methods you need to advance in machine shop work. Take advantage of the other man's experience as found in books, to solve your problems, increase your efficiency, with

The AMERICAN MACHINISTS' LIBRARY

6 volumes—2368 pages—2516 illustrations
(A combined home-study course and reference library)

This library of machine shop practice was written for practical men. It gives you the best methods for every kind of machine shop work. It fully explains lathes, drills, and other machine tools and their operation, automatic screw machines, speeds and feeds, gear design and production, jigs and fixtures, punch and die work, metal surfacing, etc., etc. Plainly written—completely illustrated—the best kind of help to the machine shop man who wants to advance himself.

No money down—special price—easy payments.

EXAMINATION COUPON

McGraw-Hill Book Co., 330 W. 42nd St., N. Y. 18

Send me for ten days' examination the American Machinists' Library. If satisfactory I will send you \$1.50 in 10 days and \$3.00 monthly until the price of \$19.50 is paid. If not wanted, I will return the books postpaid. (To insure prompt shipment write plainly and fill in all lines.)

Name.....
Home Address.....
City and State.....
Company.....
Position..... PM-12-45

Learn this Profitable Profession



IN 90 DAYS
AT HOME

Money-Making Career Open to Men and Women, 18 to 50

Hundreds of men and women between 18 and 50 make \$10 to \$20 in a single day giving scientific Swedish Massage and Hydro-Therapy treatments. There is big demand from doctors, hospitals, sanatoriums and clubs. Graduates earn large full time incomes from these or in private practice in their own offices. Others make good money from home treatments given in spare time. Learn this interesting, money-making profession in your own home, through our home study course. Same instructors as in our nationally known resident school. You can win independence and prepare for future security by qualifying for your Diploma. Course can be completed in 3 to 4 months. Many earn while they learn. Begin your training at once.

Anatomy Charts & Booklet FREE

Enroll now and we will include, at no extra cost, many needed supplies. Fit yourself to help meet growing demand for massage now and after the war. Send the coupon at once for complete details, Anatomy Charts and 32-Page Illustrated Booklet, FREE, postpaid.



THE COLLEGE OF SWEDISH MASSAGE
Dept. 564-R, 100 East Ohio St., Chicago 11, Illinois

Please send me FREE and postpaid, Anatomy Charts, 32-page Booklet and complete details on Home Training.

Name.....
Address.....
City..... State.....

★ SAVE WASTE PAPER ★

YOUR FUTURE IN

AVIATION

Edited by
J. Fred Henry

• The Air Age of Tomorrow is HERE... TODAY... NOW! THIS is the time to get in on the ground floor of one of the world's biggest industries—AVIATION. Where do you fit in? What can you do? Where are the jobs and how can you find one? YOUR FUTURE IN AVIATION is the sensational new book that answers these questions for you—the smart way. It's the road map to your future, charted by 300 top-flight aviation experts—FOR YOU. MAINTENANCE AND REPAIR, TRAFFIC CONTROL, AIRPORT OPERATION AND SERVICE and DOZENS OF OTHER OPPORTUNITIES—RICH FIELDS ARE COVERED FROM A TO Z in this amazing book.

Don't delay. Order your copy of YOUR FUTURE IN AVIATION and get started on the highways to aviation success—NOW!

\$3.00

PRENTICE-HALL, INC., Dept. MA, 70 Fifth Ave., N. Y. 11

NUTS AND SCREWS, BOLTS, RIVETS, WASHERS, Etc. TO YOU

BIG 5 LB. ASSORTMENT



More than 1000 pieces. Great for mechanics, repairmen, hobbyists, experimenters. Worth double. Satisfaction guaranteed. Order now. Write for bargain list of fiber, bakelite, rubber, felt washers, pads; radio lugs, clips, connectors, etc.

\$1.98
2 for \$3.69

HUDSON TRADING CORPORATION

D1521 W. Hubbard Street Chicago 10, Illinois

LEARN MONEY- MAKING CARTOONING

IN SPARE TIME — by Easy Picture Chart Method

Same Simplified Method that has helped train creators of "Terry & Pirates," "Freckles," "Out Our Way," "Winnie Winkle," "Regular Fellers," "Strange As It Seems," "The Neighbors," and many others. Earn while learning! Send 1.00 for Picture Chart (to test your ability), and full details. (State age.)

Landon School of Cartooning, Dept. 4512 Philadelphia 31, Pa.



MECHANICAL ENGINEERING PAYS!

This is the machine age. And back of every machine—every part—are the engineers who designed it, the trained mechanics who built it. No wonder there's high pay... many opportunities to advance... for these indispensable men. Be one of them! Don't stick in a rut! Let I.C.S. show you the way to success! These Schools, famous for more than 50 years, offer authoritative, practical Courses to meet the needs of almost any man in mechanical trades. Mechanical Engineering... Drafting... Mechanical Drawing... Shop Practice. Write today for free booklet.

International Correspondence Schools, Box 5565-K, Scranton 9, Pa.

PHOTOGRAPHY

For Today's & Tomorrow's

BIGGEST
OPPORTUNITIES

Nationwide opportunities for trained photographers. N.Y.I. graduates winning success from coast to coast. Start now. Resident or home study. Write today for FREE catalog.

NEW YORK INSTITUTE OF PHOTOGRAPHY
Dept. 49 10 West 33 St. New York 1, N. Y.

FENCING

EXCITING—
FUN
HARMLESS



NEW—Clean—Healthful. Develops Strong Body—Alert Mind. Become best swordsman in your neighborhood. FREE BOOKLET (with foils) teaches Quickly—Easily. HARMLESS because the 3 ft. Spring Steel Foils (swords) have safety rubber buttons. Complete outfit 2 Steel Foils (swords) and FREE Instructions.

Now Only \$1.98 postpaid. MAIL CHECK or MONEY ORDER Today.

LEE PRODUCTS CO., 1613B-First Ave., New York 28, N. Y.



POPULAR MECHANICS

WHICH OF THESE *Opportunities* INTERESTS *You* MOST?

Accounting & C. P. A.
Air Conditioning
Architecture & Building
Automotive Engineering
Aviation—Practical
Aviation Drafting & Design
Better Foremanship
Bookkeeping
Business Management

Diesel Engineering
Drafting & Design
Electrical Engineering
Electricity—Practical
Electronics, Industrial
High School Courses
Machine Shop Operations
Mechanical Engineering
Plastics Engineering
Plumbing—Practical

Private Secretary
Radio Operating & Servicing
Railway Training
Refrigeration
Sheet Metal Pattern Drafting
Shop Management
Surveying & Topographical
Drafting
Tool Making

THINK! LOOK FORWARD!

Business is making Post-war plans

Men and Women are preparing for the future

WHAT ARE YOU DOING ABOUT YOUR TOMORROWS?

● *Today*, choose the job you want—and prepare for it. Or if you are already engaged in the work you like best, start training *now* for quicker promotion. Acquire the knowledge that will help you to get ahead faster, make more money and have greater security.

Invest part of your spare time in more rapid progress. Start training now, in spare time in your own home. Be ready to grasp your opportunity and step out ahead of those who lack the ability you have attained.

American School, founded in 1897 as an educational institution *not for profit*, can help you to reach your goal just as it has helped others during the past forty-eight years. Give serious thought to the list above. Pick one or more subjects that interest you. Then check the coupon at right, add your name and address and mail it at once. The school will send you details on its training plan and outline of study prepared by specialists. There is no charge, no obligation, so send the coupon immediately.

PRACTICAL, EFFECTIVE HOME - STUDY TRAINING SINCE 1897

Take This First Easy Step

CHECK, CLIP AND MAIL COUPON NOW

AMERICAN SCHOOL, Dept. G945, Drexel at 58th, Chicago 37, Ill.
Without obligation, Please send FREE and postpaid, bulletin and details of the Subject checked.

- | | | |
|--|---|--|
| <input type="checkbox"/> PLASTICS ENG'R | <input type="checkbox"/> Accounting and C. P. A. | <input type="checkbox"/> Drafting and Design for Men and Women |
| <input type="checkbox"/> Refrigeration | <input type="checkbox"/> Bookkeeping | <input type="checkbox"/> Radio |
| <input type="checkbox"/> Architecture and Building | <input type="checkbox"/> Private Secretary | <input type="checkbox"/> High School |
| <input type="checkbox"/> Practical Plumbing | <input type="checkbox"/> Diesel Engineering | <input type="checkbox"/> Air Conditioning |
| <input type="checkbox"/> Automotive Engineering | <input type="checkbox"/> Surveying & Topographical Drafting | <input type="checkbox"/> Mechanical Eng. |
| <input type="checkbox"/> Aviation Drafting | <input type="checkbox"/> Sheet Metal Pattern Drafting | <input type="checkbox"/> Shop Management |
| <input type="checkbox"/> Aviation | <input type="checkbox"/> Electrical Engineering | <input type="checkbox"/> Tool Making |
| <input type="checkbox"/> Business Mgmt | <input type="checkbox"/> Electronics, Industr. | <input type="checkbox"/> Better Foremanship |
| <input type="checkbox"/> Railway Training | | <input type="checkbox"/> Machine Shop Operations |

Name..... Occupation.....
Address..... Age.....
City..... State.....

AMERICAN SCHOOL

Dept. G945, Drexel at 58th Street, Chicago 37

**I'll PROVE I can make
you, too,
TOUGH as a
MARINE**

.....and add
**Powerful POUNDS
and Vital INCHES of
DYNAMIC MUSCLE**
to your **ARMS, LEGS,
BACK, CHEST,
and SHOULDERS**

says
George F. Jowett
**WORLD'S GREATEST
BODY BUILDER**
..OR IT WON'T COST YOU A CENT!

Let me prove to YOU that you can put inches of dynamic muscles on your arms! Add inches to your chest! Broaden your shoulders and power-pack the rest of your body. I can do for you what I've done for thousands the world over, including many officers and men now in the U. S. and British Armed Forces!

**GIVE ME 10 MINUTES A DAY!
I'll Show You My Secrets Of Body Building**

I'll help you learn the "Progressive Power Method" through which I rebuilt myself from a physical wreck to the holder of more strength records than any other living athlete or teacher! No matter how skinny or flabby you are, you can learn my methods right in your own home. Through my proved secrets I show you how to develop your power, inside and out, until YOU are fully satisfied that you are the man you want to be. "The Jowett System," says R. F. Kelly, Physical Director of the YMCA, Atlantic City, "is the greatest in the world!" if you want a physique that will inspire respect from men, and admiration from women . . . **ACT LIKE**

A HE-MAN! Decide at once! The famous book, "Nerves of Steel—Muscles Like Iron" will be included FREE! Priceless for the strength fan! Full of photos of marvelous power-bodied men who will show you what Jowett has done for them and how he can do the same for you. Reach out . . . Grasp this Special Offer today!

**PROVE TO YOURSELF
IN ONE NIGHT!**

Send only 25c for test Course, "Molding a Mighty Arm." Read it the evening it arrives—learn from experience the thrill you can give your muscles!

**SEND FOR THESE FIVE FAMOUS
COURSES IN BOOK FORM
ONLY 25c EACH
or ALL 5 for \$1.00**

Jowett Institute of Physical Culture
230 Fifth Avenue
Dept. 911-A,
New York 1, N. Y.

*This
Book
Free!*



**BOOK WITH PHOTOS OF FAMOUS STRONG MEN
MAIL COUPON NOW FREE**



Jowett Institute of Physical Culture
230 Fifth Avenue, Dept. 911-A, New York 1, N. Y.
George F. Jowett: Your proposition looks good to me. Send by return mail, prepaid, the courses checked below, for which I enclose (). Include FREE book of PHOTOS.

- George F. Jowett
Champion of Champions
- All 5 courses for . . . \$1
 - Molding a Mighty Arm 25c
 - Molding a Mighty Grip 25c
 - Molding a Mighty Back 25c
 - Molding a Mighty Chest 25c
 - Send all 5 C.O.D. (\$1 plus postage.) No orders less than \$1 sent C.O.D.

NAME _____ Age _____
(Please print plainly. Include Zone Number.)
ADDRESS _____

STUDY AT HOME

With A Chartered Educational Institution
Men with specialized training win higher positions, insure larger earnings, and are bigger successes in business and public life. Opportunities NOW greater than ever before. Send for our Catalog.

ARTS and SCIENCES

Courses in Philosophy; Education; Letters; Public Health; Medical Jurisprudence; Psychology; Sociology; Physics; Chemistry; Plastics; Geology; Political Science; Theology; Business and Commerce; Accounting; Mathematics; Statistics; Agriculture.

ENGINEERING

Courses in Electrical, Civil, Mechanical, Drafting, Architectural, Steam, Aeronautical, Radio, Structural, Mining, Industrial, Petroleum, Marine, Chemical, Diesel, Automobile, and Air Conditioning Engineering.

LAW

Complete Professional Law Course includes 20 Hornbook Series college grade textbooks. Courses also in Commercial Law, Patent Law and Medical Jurisprudence.
McKinley-Roosevelt Incorporated, 4610-K, Sheridan Rd., Chicago 40, Ill.

CARTOON Your Way to POPULARITY and PROFIT

FREE BOOK

**Shows How To Make Money
With Simple Cartoons**



Cartooning, Commercial Art and Portrait Painting may open up a vast new future for you. You can now enjoy the thrill of a cartoonist's popularity while earning.

Our exclusive, revolutionary new inventions simplify and shorten students' training time. Look at these sensational features that you get: LAUGH FINDER—COMIC CHARACTER CREATOR—MAGIC MABIONETTE, a sensational, yet simple device that will amaze you—also our new PORTRAIT COURSE just out—all at NO EXTRA COST. No previous art experience needed. 34 big lessons. Profusely illustrated. So simple even a sixth grade pupil can start learning first day.

FREE Send no money, just name. Get booklet, "How to Make Money With Simple Cartoons." Fascinating facts on your future in cartooning. Rush.

CARTOONISTS' EXCHANGE, Dept. 912-D, Pleasant Hill, Ohio

MAKE MONEY CASTING AT HOME FREE FACTS SENT



Make hundreds of Plaster Casts, quick, easy. Sell output to stores, novelty shops, etc. Enormous profits. No experience. Very little capital needed. Start in basement, garage or workshop. Complete, simple instructions anyone can follow. Start now while merchants are begging for merchandise to sell. Rush.

PLASTIC ARTS STUDIOS, R.R. 5, Dept. 29, Muncie, Ind.

HAIR CAN BE SAVED "GIVE YOUR HAIR A CHANCE"

is the amazing book by J. W. KING, Sc. D., on dandruff, baldness, thinning and graying hair. Much valuable information.—Ohio State Medical Journal, Best investment.—Science Education, Debunks hair fads.—Scientific American, Scientific fact.—Sawed Magazine, Without commercial bias.—Teaching Biologist, Book of a scientist.—Home Across Enormous assistance.—Fictorial Review, Practical.—Science News Letter. Send only \$2.00 today for postpaid copy of this authentic instruction, on how to save your hair, 6th printing. Prompt refund if not helped.
BRADNER PUBLISHING CO. (EST. 1933) Dept. 28, Cambridge 42, Mass.



LAW STUDY AT HOME

Legally trained men win higher positions and bigger success in business and public life. Greater opportunities now than ever before. Big corporations are headed by men with legal training.
More Ability: More Prestige: More Money
We guide you step by step. You can train at home during spare time. Degree of LL. B. Successful graduates in every section of the U. S. We furnish all text material, including 14-volume Law Library. Low cost, easy terms. Get our valuable 48-page "Law Training for Leadership" and "Evidence" books FREE. Send for them NOW.
LASALLE EXTENSION UNIVERSITY, 417 South Dearborn Street
A Correspondence Institution Dept. 1264-L Chicago 5, Ill.

Now You can Use.



ALL OF THESE RADIO PARTS

to help You learn

RADIO

FASTER—EASIER AT HOME

YOU CAN BUILD **133**
FASCINATING EXPERIMENTS.

At home—in your spare time—you get real Radio experience from these many interchangeable Radio parts and sub-assemblies. DeForest's handy "Block System" eliminates unnecessary mechanical work; the convenient spring clip connections save a great deal of time. You quickly build Radio circuits that work. You experiment with Photo-Electric Cell "Magic" . . . a 5 tube Superheterodyne Receiver . . . a Radio Telephone, and scores of other fascinating projects. Little wonder learning Radio at home is so practical . . . effective and real fun—with DeForest's modern "Home Laboratory."

YOU USE "LEARN-BY-SEEING"
MOVIES!

Think of the pleasure, as well as help you get from the use of this DeVRY Motion Picture Projector and exciting "movie" TRAINING FILMS. You will be surprised how much faster . . . easier . . . Home Movies help you understand Radio-Electronic fundamentals. Here's a preferred training method of tomorrow—yours today. SEE the principles of what you're learning—in motion . . . ANIMATED! See circuit actions otherwise hidden from the eye. You get this big Radio home training advantage—exclusively with DeFOREST'S. So act now! Mail coupon for complete details.



VETERANS!

Big things are happening at DeForest's for veterans! See how we can prepare you WITHOUT COST for a GOOD JOB or a BUSINESS OF YOUR OWN in the vast Radio-Electronic opportunity field.

See how DeForest's fascinating SHOP METHOD Radio Training at home can help you toward a good start in the Billion Dollar Radio-Electronic Field. Write for DeForest's BIG FREE book, "VICTORY FOR YOU!" that has helped many to good pay jobs. You'll be surprised at the opportunities ahead in F.M. Radio, Aviation Radio, Broadcast Radio, a Profitable Business of Your Own, Motion Picture Sound Equipment, Electronics—plus the exciting future possibilities ahead of Television, Radar, etc.

You Get "ALL THREE" With DeFOREST'S

Where else can you get such a combination of PROVED MAJOR training features as—(A) modern loose-leaf lessons prepared under the supervision of Dr. Lee DeForest, often called the "Father of Radio;" (B) the use of "Learn by Seeing" home movie films and a genuine 16 mm. DeVRY

MOVIE PROJECTOR—and (C) eight big kits of "Home Laboratory" Radio parts to give you valuable practical Radio experience—at home.

You get an Effective Employment Service, too. Residential training in our Chicago laboratories also available.

DEFOREST'S TRAINING INCLUDES INSTRUCTION IN MOTION PICTURE SOUND EQUIPMENT, FM RADIO AND TELEVISION . . .



DeFOREST'S TRAINING, INC., Dept. PM312
2535-41 N. Ashland Ave., Chicago 14, Illinois, U.S.A.

Send—FREE and WITHOUT OBLIGATION—illustrated book, "VICTORY FOR YOU" and KIT SUPPLEMENT, showing how Home Movies and Home Laboratory can speed my preparation for a place in the Radio-Electronics industry.

Name _____ Age _____

Address _____

Name _____ Zone _____ State _____

If under 16, check here for special information.
 If a discharged veteran of World War II, check here.

DeFOREST'S

TRAINING, INC.
CHICAGO 14, ILLINOIS



SO IT NEEDS FIXING

By S. T. CHRISTENSEN
the "Fix-it Man"

WELL, I guess I'm the fellow to see, for I've repaired thousands of refrigerators (home and commercial both), vacuum cleaners, radios, washing machines, irons, fans, lamps, mangles, motors, etc. In fact, many of my customers call me their "electrical appliance doctor." And, "doctoring," I might add, has paid me a good substantial income for quite a few years. Funny, in a way, how I got started. Always liked to tinker and by experimenting around I found that most electrical appliances had many things in common. That, regardless of what the appliance was used for, or who the manufacturer was, the basic principles were much the same. From fixing my own appliances to fixing friends' and then for strangers at a fee, seems now to have been but a small step.

What to Charge?

At first, I let the owner decide the charge and, frankly, I was amazed at what I earned per hour. But then, when one figures what initial costs are involved in buying most electrical appliances, one can readily see that spending extra dollars for repairs is well worth while. Before long I was making more in my spare time repairing than from my regular job. The result . . . I went into business for myself. When war came, business boomed, for new appliances were not available.

For a while, repair parts (needed on some

jobs) were a little difficult to get. But that situation seems to have adjusted itself for many repair parts have today the high priority rating of AA2. After all, we must provide for the health and well-being of our civilian population.

The Future Offers

Friends ask me about my future. And, I think I've got a grand one. Age is no handicap in repairing. I have in my files enthusiastic letters from repairmen ranging in age from 18 to 79 years. After the war, we're bound to see hundreds of new products on the market . . . products that the average person never dreamt of. These new products and our old appliances are all going to need at some time or other "fixing." Well, I'll still be the fellow to do it. The field open for appliance repairmen is unlimited. I don't worry at all about too much competition.

If You Are Ambitious

To the contrary, I've prepared a complete course, chuck full of simple, easy to understand photos and drawings and written in the same non-technical language as this article. I know the course is good, because I have hundreds of men all over the country writing to me telling me how the course has helped swell their pockets with cash. If you too want to prepare now for your future, I suggest you read the next page and send me the handy coupon."

Advertisement



**BIG MONEY
INDEPENDENCE**

*A PROFITABLE
LIFETIME
BUSINESS
OF
YOUR OWN!*

LEARN ELECTRICAL APPLIANCE REPAIRING

PREPARE NOW FOR THE FUTURE

If now in war work, start your home appliance repair business NOW in your spare time and be set with a business of your own when the war is over. You don't need elaborate fixtures or expensive equipment to be a successful repairman. Operate from your garage, basement, vacant store, etc. Work as many hours as you wish—the home appliance repairman is his own boss. It is a profitable occupation for on many types of repairs it is not unusual for a repairman to charge on the basis of \$5.00 to \$6.00 per hour. Don't gamble with your future—learn a trade that will always support you. Remember, as long as electrical appliances are used, there will be a need for electrical appliance repairmen.

If you are at all mechanically inclined—can hold and use tools—then you have all of the qualifications required for becoming a big money earning home appliance repairman. It does not matter if you have not had a great deal of schooling or had previous experience along these lines—WE WILL TEACH YOU. Age should be no barrier—nor should any minor physical handicap.

New Course Tells All

Profusely illustrated, our new course shows you in simple, easy to understand language and drawings how to make each repair on refrigerators, vacuum cleaners, washing machines, motors, etc. Explains and gives you a working knowledge of electricity, welding, nickel plating, etc. Shows you how to build the power tools you need and how to solicit and keep business coming to you. Not a theory course but an honest to goodness course written by and used by repairmen the country over. Price of course is so low that the savings on your own household appliance repairs will quickly pay for it. Act now! Mail the handy coupon below today.

----- Read What Our Students Say About Course -----

I really believe your course the best investment a mechanically minded man can make.—Claude E. Allen, Indianapolis, Ind.

I have received your Course in Appliance Repairing and I must say I am well pleased with same. I am only sorry I did not have said Course some years ago. I have learned so much more through this course I would not part with it.—Charles Schwarz, Hamilton, Ohio.

The Course in Appliance Servicing arrived a few days ago. Want to take out a few minutes of my valuable time to let you know that this is just what I have been looking for ever since I opened up my Fix-It shop. I must admit that you told the truth when you said that it contains quite a bit more information than I bargained for.—P. J. Bretl, Sebring, Ohio.

I am a mechanic for the Western Union Telegraph Co. Three days after receiving the lessons in refrigeration I earned the exact cost of the course.—Henry S. Lee, Washington, D. C.

I work day times at the shipyard and after 4:00 P.M. I operate from my cellar and garage. I average \$10.00 to \$15.00 clear every day.—Walter Hanby, Brockton, Mass.

GET STARTED TODAY—MAIL THIS COUPON

CHRISTY SUPPLY CO.
2835 N. Central Ave., Dept. D-2803
Chicago 34, Illinois

Please send me free illustrated literature about America's Fastest Growing Industry—ELECTRICAL APPLIANCE REPAIRING.

Name.....

Address.....

City..... State.....

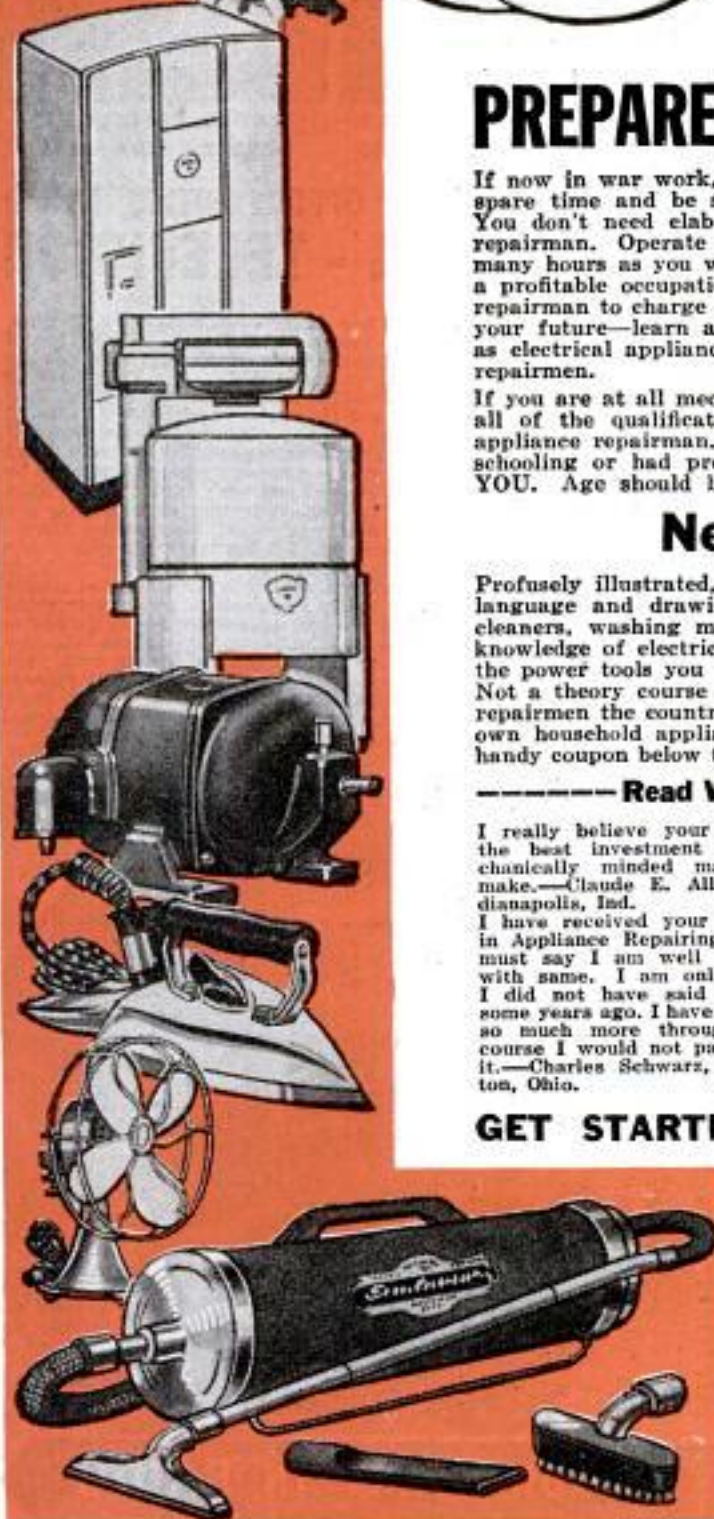

**I'LL SHOW YOU
HOW TO SUCCEED
IN RADIO**

BE A RADIO

**Here's the right
training for
Big Post-War
Pay!**



**A RADIO SERVICE
BUSINESS OF YOUR OWN.**



**A GOOD JOB IN RADIO &
TELEVISION BROADCASTING**



**RADIO-ELECTRONIC
SERVICE ENGINEER.**



**I'LL PREPARE YOU FOR THE AMAZING OPPORTUNITIES AHEAD
in RADIO - ELECTRONICS - TELEVISION**

The offer I make you here is the opportunity of a lifetime. It's your chance to become a RADIO-ELECTRONICIAN . . . the kind of Technical Expert who'll cash in on the big developments ahead in the swiftly expanding field of Radio-Electronics INCLUDING Radio, Television, Frequency Modulation and Industrial Electronics. Be wise! NOW'S the time to start. Opportunities are tremendous! Just show me that you're determined to get ahead and I'll do the rest. I'll give you exactly what you need to be able to roll up your sleeves and with expert hands, do a workmanlike job installing, operating or repairing any piece of Radio-Electronic equipment. No previous knowledge of Radio is necessary. The Sprayberry Course starts right at the beginning of Radio. You can't get lost. It gets the various subjects across in such a clear, simple way that you learn easily and fast . . . you understand and remember. And you can master my entire Course in your spare time . . . right at home. It will not interfere in any way with your present duties. Along with your Training, you will receive my famous BUSINESS BUILDERS which will show you how to make plenty of nice spare time profits while learning.

**YOU DO PRACTICAL EXPERIMENTS
GET REAL "SHOP" EXPERIENCE...**

**I SUPPLY A FULL
RADIO SET
for EASY LEARNING**

There's only one right way to learn Radio-Electronics. You must get it through simplified lesson study combined with actual "shop practice" and backing this up, you must have the personal guidance of a qualified Radio-Electronics Teacher. This is EXACTLY how Sprayberry teaches you. All Sprayberry lesson text is written in plain, simple English anyone can readily understand. Technical details are reduced to simplest terms and there are plenty of illustrations, charts and tables to make it all the easier. But most important of all, you get a full and complete set of real RADIO PARTS and components . . . everything you need to build a fine, modern Radio Receiving Set which you can sell later on at a nice profit. But while you're in training, these parts will serve a valuable purpose in experimental work.

Radio Breakdowns Occur Right Before Your Eyes

You'll be shown how to perform a whole series of interesting tests and experiments which will give you the real low-down on basic Radio. You will see Radio break-

downs occur before your very eyes. You will learn the very latest methods for trouble-shooting, for making speedy, efficient repairs. You'll come to understand all about Radio parts, their uses, why and how a Radio works. You'll get the finest kind of LEARN-BY-DOING experience right at home and it's this sort of preconditioning that will make you into a real Radio man. Put Sprayberry Training to any test and you'll find that every phase of it is designed for clear-cut understanding. You'll see that it's the one Training Course that gives the Student the practical know-how essential to a good-paying Radio job or a Radio Business of his own.

I'll Show You a New, Fast Way to Test Radio Sets Without Mfg. Equipment

The very same Radio parts I supply with your Course for gaining pre-experience in Radio Repair work may be adapted through an exclusive Sprayberry wiring procedure to serve for complete, fast, accurate Radio Receiver trouble-shooting. Thus, under Sprayberry methods, you do not have one cent of outlay for manufactured Test Equipment.



NOW IS THE TIME TO MAKE YOUR START IN RADIO

ELECTRONICIAN

SPRAYBERRY RADIO TRAINING

Gives you Both



It's a matter of practical common sense that the quality and thoroughness of your Radio Training will have a big influence on your future in Radio. We don't believe in trick schemes to teach you Radio. We don't rely on gadgets or anything of the sort. What we do employ is a hard-hitting, straight line, thoroughly proved method of PRACTICAL instruction that really gets RESULTS and gets them quickest and surest for the Student. Far more than an ordinary "theory" Course, Sprayberry Training is a full scale, broad gauge Radio Training which places equal stress on training your hands as well as your head. Not only will it fix the knowledge you need clearly in your mind . . . but it will develop the skill of your hands to give that knowledge full and useful expression. It means you get the stuff you need to make fast progress in Radio. It means you're prepared in the right way to step into any one of many varied and interesting Radio Jobs with a good salary and the assurance of regular increases. It means you will have the confidence and ability to hold down the kind

of job you'll be proud to tell your friends about. If that's the kind of SOLID RADIO TRAINING you think would appeal to you, then look no farther. SPRAYBERRY HAS EXACTLY WHAT YOU WANT!

PREPARES YOU FOR A BUSINESS OF YOUR OWN OR GOOD RADIO JOB

My Training will give you the broad, fundamental principles so necessary as a background, no matter which branch of Radio you wish to specialize in. I make it easy for you to learn Radio Set Repair and Installation Work. I teach you how to install and repair Electronic Equipment. In fact, you'll be a fully qualified RADIO-ELECTRONICIAN, equipped with the skill and knowledge to perform efficiently and to make a wonderful success of yourself.

DON'T PUT IT OFF!

Get the facts about my Training—now! Take the first important step toward the money-making future of your dreams. All features are fully explained in my big, illustrated FREE Catalog which comes to you along with another valuable FREE book you'll be glad to own. Mail Coupon AT ONCE!



F. L. Sprayberry, one of the country's foremost Radio Teachers.

Get Your FREE BOOKS JUST OFF THE PRESS

"How to Read Radio Diagrams and Symbols" . . . a valuable new book which explains in simple English how to read and understand any Radio Set diagram or circuit. Includes translations of all Radio symbols and many other useful facts and data. Send for this FREE book now and along with it, I will send you another big FREE book, completely describing my Radio-Electronic Training.

MAIL COUPON

Don't miss this Offer!

Read These Letters From Men I Trained:

Harold C. Schor writes: "While I was taking your Course, I made more than enough to pay for the Training by repairing Radio sets. Shortly after I completed the Course, I obtained a position managing the Radio Service Department of a large electrical dealer. In the past four months I have earned nearly \$600.00. Your Training has meant so much to me that it would take a great many pages to tell you just how much I have really benefited from it."

Stephen Skovran writes: "Since taking your Training, I have made in my spare time an average of about \$60.00 a week. I have paid all my outstanding bills and have a stock of Radio tubes and parts amounting to \$150.00 which is all paid for. I have a list of about 350 customers and it's still growing. For this, I have you and your School to thank and believe me, it's highly appreciated."

Adrien Benjamin writes: "Since last week, I fixed 7 Radios, all good-paying jobs and right now I am working on an amplifier system. This job alone will net me about \$20.00. I have only one word to say, and that is 'Thanks to my Sprayberry Training.' I am not afraid to boast about it."



SPRAYBERRY ACADEMY OF RADIO

F. L. Sprayberry, President
Room 10125 Pueblo, Colorado

Please rush my FREE copies of "How to MAKE MONEY in RADIO, ELECTRONICS and TELEVISION" and "How to READ RADIO DIAGRAMS and SYMBOLS."

Name..... Age.....

Address.....

City..... State.....

(Tear off, paste on penny postcard or mail in envelope)

INVEN

...THE TIME IS



HERE'S THE FIRST THING
TO DO...SEND FOR THESE
TWO FREE BOOKS

These **TWO FREE BOOKS** contain information that will guide you . . . tell you about pertinent Patent Laws and how they protect inventors like you . . . tell you about royalties, sale of patents, infringements...show you the procedure required by the United States Patent Office . . . illustrate 115 basic mechanical movements that may help you develop, improve or complete your invention. And they're yours for the asking. With the books we send "Evidence of Invention" form which may help establish the date of your disclosure to us in the event of another inventor filing application for the same invention.



TORS

RIPE FOR *Action!*

You men . . . you women . . . with ideas for patentable inventions . . . OPPORTUNITY IS KNOCKING! American industry WANTS your ideas for new products . . . new processes, time-and-labor-saving devices to offer to a public with money to buy such products. You see evidence of this every day in the newspapers . . . MANUFACTURERS ACTUALLY ARE ADVERTISING FOR IDEAS! And they want them NOW!

Don't wait! Get going now! Have your patent applications prepared and prosecuted just as quickly as you can. Remember—most manufacturers will consider an invention ONLY if you have taken steps to protect it with a patent.

HOW WE HELP INVENTORS

For nearly 50 years, Victor J. Evans & Co. has helped inventors secure strong patents. Our experienced staff of Registered Patent Attorneys, searchers, draftsmen, specification writers . . . does all the work for you . . . makes the search, prepares the drawings for submission to the United States Patent Office, prepares all necessary papers, pushes the prosecution of your claim to a conclusion.

Sure, you can do it yourself. But think of the lost time, the travel expense, the lost motion. Many successful inventors use . . . and recommend the services of an experi-

enced patent attorney. Even the United States Patent Office in Rule 17 of "Rules of Practice in the United States Patent Office" states in part . . . "An applicant or assignee of the entire interest may prosecute his own case, but he is advised, unless familiar with such matters, to employ a competent registered attorney or registered agent as the value of patents depends largely upon the skillful preparation of the specifications and claims . . ."

You can't go wrong when you select Victor J. Evans & Co. . . . a firm that has helped inventors for nearly 50 years . . . to handle your patent application for you.

READ THESE COMMENTS FROM TYPICAL INVENTORS*

"...I wish to thank you for your kind cooperation, and assure you that if I or any of my associates are in need of a patent lawyer in Washington, we will cer-

tainly recommend your services . . ." D.C.M.

"...I wish to thank you for the Patent Papers just received, and wish to say that my

dealings with you have been satisfactory, and very pleasant. And, that the time may not be too far away when I may employ your services again . . ." P.T.F.

"...I wish to express my appreciation for your services and congratulate you upon the successful prosecution of this application . . ." J.R.H.

* Names and addresses upon request.

MAIL THIS COUPON
For Quick Action

VICTOR J. EVANS & Co.

Merlin M. Evans

Registered Patent Attorney

Main Office: 930-F Merlin Building
Washington 6, D. C.

Pittsburgh Office: 521-N Empire Building
Los Angeles Office: 128-N Security Building

Rush by return mail free copies of your books, "Patent Protection" and "When and How to Sell an Invention"—also important—"Evidence of Invention" form.

Name.....

Address.....

City and State.....

AUDELS POWER PLANT ENGINEERS GUIDE

WITH QUESTIONS AND ANSWERS



NEW FROM COVER TO COVER!

JUST PUBLISHED—For All Engineers, Firemen, Water Tenders, Oilers, Operators, Repair Men and Applicants for Engineers' License Examinations. A Complete Steam Engineers' Library in One Book! 1500 PAGES—65 CHAPTERS 1700 ILLUSTRATIONS.FULL INDEX

1001 FACTS AT YOUR FINGER ENDS!

PRACTICAL INFORMATION IN HANDY FORM FEATURING—

Basic principles of Steam Engineering, including Boiler Construction, Operation and Repairs. Gives practical information on: Boiler Calculations, fuels, feed

pumps, water heaters, economizers, water treatment, injectors, traps, draught, safety valves, oil burners, stokers, condensers, ejectors, cooling towers, evaporators, steam and hot water heating, pipe fitting & tubing. Contains complete data on all types of Steam Engines and Turbines, Indicators, Valve gear, Valve setting, Air Compressors, Hoists, Gas and Diesel Engine Operation, Lubrication.

\$4

COMPLETE PAY \$1 A MONTH. ONLY 1 MO. Get this information for yourself—ASK TO SEE IT—Mail coupon today!

AUDEL, Publishers; 49 W. 23 St., New York 10, N.Y.

Mail AUDELS Power Plant Engineers Guide (Price \$4) on 7 days free trial. If O.K. I will remit \$1 in 7 days and \$1 monthly until \$4 is paid. Otherwise, I will return it.

Name _____
Address _____
Occupation _____
Employed by _____ PM

Don't Let SICKNESS or ACCIDENT Rob You of Your Savings . . . Provide Hospital Care for Yourself and Your Family

Costs only **3c** A DAY • EACH ADULT
1½c A DAY • EACH CHILD

FOR SICKNESS OR ACCIDENT
Hospital Expenses paid (beginning with the first day), up to . . . \$540.00

FOR ACCIDENT
Doctor Expense paid, up to \$135.00 Loss of Wages reimbursed up to \$300.00
Loss of Life by Accident \$1000.00

WAR COVERAGE and EXTRA BENEFITS
Childbirth Expense paid, up to \$60.00

Sickness or accident can easily wipe out, in a few weeks, savings it may have taken years to accumulate. Don't let this happen to you. With a Family Mutual Hospitalization policy, you'll be able to pay your hospital bills. In case of accident, you will be reimbursed for your doctor expenses and for loss of time from work. You may choose any hospital in the United States and your own family doctor may attend you. Benefits applying to children are 50% of those paid adults.

MAIL COUPON TODAY — No Agent Will Bother You

FAMILY MUTUAL LIFE INSURANCE CO., WILMINGTON 99, DEL.

Family Mutual Life Insurance Co., PM-10
601 Shipley St., Wilmington 99, Del.
Please send me without obligation, complete information on your Economical Hospitalization Plan.

NAME _____
ADDRESS _____
CITY _____ STATE _____

SAY YOU SAW IT IN POPULAR MECHANICS

INTRODUCING-New Victory Model HANDIWELED ELECTRIC ARC WELDER



RETAILS ONLY
\$1.95

FULLY GUARANTEED

PLUGS INTO LIGHT SOCKET

Victory Model Handiweld Arc Welder operates from 110 volts, A.C. or D.C. current same as other arc welders higher priced; generates tremendous heat to weld all metals. Not a toy welder that uses carbon, but actually uses standard coated rods—sizes 1/16" and 3/32". However, due to Priorities a generous supply of 1/16" rods only are supplied with the welder. Guaranteed not to burn out. Repairs fenders, auto bodies, radiators, machinery parts, etc. Take Victory Model Handiweld anywhere to job, operate right from light socket. You'll find a thousand uses for this welder around your home, garage, workshop. Also in garages, factories, repair shops, tin shops; mechanics, inventors, plumbers, farmers, etc. Order a "Victory Model" Handiweld now.

SEND NO MONEY We'll rush one to you with rods, helmet, operating instructions, and all necessary parts with the exception of a large jar and a small piece of extension cord; these most everyone has. Pay postman only \$1.95 plus a few cents postage. If not delighted return Victory Model Handiweld in 5 days from receipt and money paid for it will be refunded promptly. Rush your order now.

KUMFY PRODUCTS, Dept. C-202, CINCINNATI 26, OHIO

A SIMPLIFIED ART ANATOMY OF THE HUMAN FIGURE
ONLY \$1 POSTPAID
by Charles Carlson. The book they're talking about! One of the most informative books of its kind for both student and professional artists. Charts, notes, and over 350 drawings show detailed studies of every part of the body, posed and in action.
HOUSE OF LITTLE BOOKS, 80-A E. 11 St., New York 2

Available Now! OFFICIAL PHOTOS OF NAVY SHIPS

Only \$1.20 per Set of 20 4" x 5" Glossy Prints
Taken by Official Navy Cameramen. Order sets by name: Battleships, Carriers, Escort Carriers, Destroyers, Cruisers, Auxiliary Ships, Navy Planes and many other exciting sets.
OFFICIAL PHOTOS CO., Dept. A 1434 N. Western Av., Hollyw'd 27, Cal.

Write for Descriptive Circular

Learn LANDSCAPE GARDENING!

Prepare for the giant postwar home-building program. A thorough, constructive, interesting home-training for those who wish to become **LANDSCAPERS, DESIGNERS, GARDENERS, etc.**, for profit or pleasure. Write today for **FREE INFORMATION**, without obligation, to **NATIONAL LANDSCAPE INSTITUTE**
Dept. P-12 756 So. Broadway Los Angeles 14, California

ELECTRICITY MEN NEEDED

GOOD JOBS • GOOD PAY • GOOD FUTURE
Through spare time home study you can qualify for a starting job in electrical work and prepare for bigger pay promotions. Or if now employed in this field you can acquire know-how which can win you a bigger, better job. It's not difficult to master principles of equipment used in generating, transmission and use of electricity. Begin now. Send name and address today for **FREE** information.

AMERICAN SCHOOL, Dept. EE945, Drexel Ave. at 58th St. Chicago 37
Name _____
Street _____
City, State _____



what will YOU be doing one year from TODAY?



YOU'RE too smart to stay in the same old job rut! You know that you have one life — that's all. So you've thought about *doing* something that would advance you in your work, increase your income.

The time to get started is *now*. And you can take the first step toward Personal Success this very minute! Just look over the coupon below and mark the I. C. S. Course in your field of interest. Then mail it — *today!*

We'll send you complete information on the International Correspondence Schools, and how they can give you the training you need to get ahead faster. Cost is low, texts are easy to understand, and every student gets *personal service*. The time to "take steps" is RIGHT NOW!

INTERNATIONAL CORRESPONDENCE SCHOOLS



BOX 5564-K, SCRANTON 9, PENNA.

Without cost or obligation, please send me full particulars about the course *before* which I have marked X:

- | | | | |
|---|--|--|--|
| <ul style="list-style-type: none"> <input type="checkbox"/> Air Conditioning and Plumbing Courses <input type="checkbox"/> Air Conditioning <input type="checkbox"/> Heating <input type="checkbox"/> Plumbing <input type="checkbox"/> Refrigeration <input type="checkbox"/> Steam Fitting Chemistry Courses <input type="checkbox"/> Chemical Engineering <input type="checkbox"/> Chemistry, Analytical <input type="checkbox"/> Chemistry, Industrial <input type="checkbox"/> Chemistry, Mfg. Iron & Steel <input type="checkbox"/> Petroleum Refining <input type="checkbox"/> Plastics <input type="checkbox"/> Pulp and Paper Making Civil Engineering, Architectural and Mining Courses <input type="checkbox"/> Architectural Drafting <input type="checkbox"/> Architecture <input type="checkbox"/> Bridge and Building Foreman <input type="checkbox"/> Building Estimating <input type="checkbox"/> Civil Engineering <input type="checkbox"/> Coal Mining <input type="checkbox"/> Contracting and Building <input type="checkbox"/> Highway Engineering <input type="checkbox"/> Lumber Dealer <input type="checkbox"/> Reading Structural Blueprints <input type="checkbox"/> Sanitary Engineering <input type="checkbox"/> Structural Drafting <input type="checkbox"/> Structural Engineering <input type="checkbox"/> Surveying and Mapping | <ul style="list-style-type: none"> Electrical Courses <input type="checkbox"/> Electrical Drafting <input type="checkbox"/> Electrical Engineering <input type="checkbox"/> Power House Electric <input type="checkbox"/> Practical Electrician <input type="checkbox"/> Practical Telephony <input type="checkbox"/> Telegraph Engineering Internal Combustion Engines Courses <input type="checkbox"/> Auto Technician <input type="checkbox"/> Aviation <input type="checkbox"/> Diesel-Electric <input type="checkbox"/> Diesel Engines <input type="checkbox"/> Gas Engines Mechanical Courses <input type="checkbox"/> Aeronautical Engineering <input type="checkbox"/> Airplane Drafting <input type="checkbox"/> Flight Engineer <input type="checkbox"/> Foundry Work <input type="checkbox"/> Heat Treatment of Metals <input type="checkbox"/> Industrial Engineering <input type="checkbox"/> Industrial Metallurgy <input type="checkbox"/> Mechanical Drafting <input type="checkbox"/> Mechanical Engineering <input type="checkbox"/> Mold-Loft Work <input type="checkbox"/> Patternmaking <input type="checkbox"/> Reading Shop Blueprints <input type="checkbox"/> Sheet-Metal Drafting <input type="checkbox"/> Sheet-Metal Worker | <ul style="list-style-type: none"> <input type="checkbox"/> Ship Drafting <input type="checkbox"/> Ship Fitting <input type="checkbox"/> Shop Practice <input type="checkbox"/> Steel Mill Workers <input type="checkbox"/> Tool Designing <input type="checkbox"/> Welding, Gas and Electric Radio Courses <input type="checkbox"/> Electronics <input type="checkbox"/> Radio, General <input type="checkbox"/> Radio Operating <input type="checkbox"/> Radio Servicing Railroad Courses <input type="checkbox"/> Air Brake <input type="checkbox"/> Car-Inspector <input type="checkbox"/> Locomotive Engineer <input type="checkbox"/> Locomotive Fireman <input type="checkbox"/> Railroad Section Foreman Steam Engineering Courses <input type="checkbox"/> Boilermaking <input type="checkbox"/> Combustion Engineering <input type="checkbox"/> Engine Running <input type="checkbox"/> Marine Engineering <input type="checkbox"/> Steam Electric <input type="checkbox"/> Steam Engines Textile Courses <input type="checkbox"/> Cotton Manufacturing <input type="checkbox"/> Rayon Weaving | <ul style="list-style-type: none"> <input type="checkbox"/> Textile Designing <input type="checkbox"/> Woolen Manufacturing Business and Academic Courses <input type="checkbox"/> Accounting <input type="checkbox"/> Advertising <input type="checkbox"/> Arithmetic <input type="checkbox"/> Bookkeeping <input type="checkbox"/> Business Correspondence <input type="checkbox"/> Business Management <input type="checkbox"/> Certified Public Accounting <input type="checkbox"/> College Preparatory <input type="checkbox"/> Commercial <input type="checkbox"/> Cost Accounting <input type="checkbox"/> Federal Tax <input type="checkbox"/> First Year College <input type="checkbox"/> Foremanship <input type="checkbox"/> French <input type="checkbox"/> Good English <input type="checkbox"/> High School <input type="checkbox"/> Higher Mathematics <input type="checkbox"/> Illustrating <input type="checkbox"/> Motor Traffic <input type="checkbox"/> Postal Service <input type="checkbox"/> Salesmanship <input type="checkbox"/> Secretarial <input type="checkbox"/> Sign Lettering <input type="checkbox"/> Spanish <input type="checkbox"/> Stenography <input type="checkbox"/> Traffic Management |
|---|--|--|--|

Name..... Age..... Home Address.....

City..... State..... Present Position..... Working Hours..... A.M. to..... P.M.

Canadian residents send coupon to International Correspondence Schools Canadian, Ltd., Montreal, Canada.

British residents send coupon to I. C. S., 71 Kingsway, London, W. O. 2, England.

DISCOUNT TO DISCHARGED VETERANS—SPECIAL TUITION RATES FOR MEMBERS OF THE ARMED FORCES



REFRIGERATION AIR CONDITIONING

Air Conditioning and Refrigeration are among the great industries of today and tomorrow. Installations everywhere—in restaurants, shops, homes, etc., need service. Thousands of businesses are waiting for new installations. Today, more and more homes are being air conditioned. The Refrigeration and Air Conditioning industries are headed for greater prosperity and men who have the "know how" and experience should ride along.

Train Now Before the Expected EXPANSION Begins



Experts predict large demand for men to install and service Air Conditioning and Refrigeration equipment. . . Rise to the kind of job which requires a competent, trained man who can carry the responsibilities of installing costly equipment and maintaining it. If he knows the answer when he is called in for consultation, his reputation grows and his pay should grow also.

Follow This Way to Knowledge

If over 17, and under 69, here's all it takes to get you ready for experience in this modern industry. Just invest a limited amount of your spare time—while you are still on your present job. Through our balanced training, you learn first through home study, how to handle installation, maintenance & service work on Refrigeration and Air Conditioning equipment. Then you can get practical training in our big shops under capable instructors—experienced men who'll take a personal interest in helping you learn. When you're through you should have knowledge that enables you to get started in this vast industry.

WANT YOUR OWN REPAIR SHOP?

UEI training is easily understood by mechanically inclined men. You gain experience when you complete your course. Equipment, tools and personal following can accumulate as you progress. Soon you may find it wise to set up your own shop.

GET FREE FACTS RIGHT NOW!

It costs you nothing to get all the facts about this great field. Simply mail the coupon below and we'll tell you, without obligation the whole, sensational story of what's ahead in Refrigeration and Air Conditioning. Mail the FREE coupon now.

REFRIGERATION
TRAINING
Since 1927

UTILITIES ENGINEERING INSTITUTE

1314 W. Belden Avenue, Dept. 1125, Chicago 14, Ill.

Please send me the FREE FACTS about opportunities in Air Conditioning and Mechanical Refrigeration. I have marked the one that interests me most.

Air Conditioning Mechanical Refrigeration

NAME _____ AGE _____

ADDRESS _____

CITY _____ ZONE _____ STATE _____



Returning Veterans . . . office and factory workers . . . others! If you want to enjoy a FINE INCOME NOW, with even greater opportunities after the War ends, write us today! We are a nationally known manufacturer of Fire Fighting equipment . . . including "AUTOFYRSTOP," the amazing combination fire extinguisher and alarm that holds unequalled records. Our products sell FAST and in QUANTITIES to factories, schools, stores, homes. NO EXPERIENCE NEEDED. Write for FREE FACTS! Autofyrstop Co., Dept. M-125, 2035 Washington Ave., Philadelphia 46, Pa.

YOU CAN ADVANCE IN PLASTICS!

Plastics can be the next great industry . . . expanding as swiftly and largely as the automotive, radio and aviation businesses. Already, it is an important industry and a growing one. With I. C. S. training, you can take advantage of the many opportunities in Plastics today. At the same time, you prepare for the vast possibilities of tomorrow. Write for the free booklet containing full information! Do it right now! International Correspondence Schools, Box 5565-K, Scranton 9, Pa.

ENGINEERING DEGREE IN 27 MONTHS

INDIANA
TECHNICAL
COLLEGE

Aeronautical, Chemical, Civil, Electrical, Mechanical, and Radio Courses, B.S. degree, 1-yr. diploma in Electrical, Mechanical, and Radio Service; Drafting, Prep. courses, Gov't. approved for GI's. Low rate. Earn board. Large industrial center. Demand for graduates. Enter Dec., March, June, Sept. Catalogue. 5125 E. Washington Blvd., Ft. Wayne 2, Ind.

Learn Public Speaking

Learn theory and fundamentals at home—in spare time. Then acquire actual experience and practice. Send for FREE booklet "Power of Effective Speech."

North American School, Dept. 1359, 1315 S. Michigan Ave., Chicago 5, Illinois

LAW

STUDY AT HOME for PERSONAL SUCCESS and LARGER EARNINGS. 35-year expert instruction—over 108,000 students enrolled. LL.B. Degree awarded. All texts furnished. Easy payments. Send for FREE BOOK—"Law and Executive Guidance."

AMERICAN EXTENSION SCHOOL OF LAW, Dept. 60M, 646 N. Michigan Ave., Chicago 11, Ill.



LEARN PORTRAIT PAINTING AT HOME

● Previous art training or talent NOT necessary. The Stuart System teaches you, in 11 easy-to-follow lessons, to (1) locate features *exactly* to correspond to model's features, (2) outline head and face to correspond to model's outline, (3) make each feature a true portrait of that feature in the model, (4) produce shadows and shading that *exactly* correspond to that of model's face, (5) mix flesh paint tints that are like living flesh. Our students' portraits look alive. You, too, can make *exact* charcoal and oil likenesses. Send for free booklet today.

STUART STUDIOS,

121 Monument Circle, Room 6125, Indianapolis 9, Ind.

Please send me free book and outline of lessons.

Name _____

Street _____

City _____ State _____

GET INTO RADIO ELECTRONICS & TELEVISION NOW!

Hundreds of Industries Need Radio and Television Men Now and for Great Future Demands

The man trained in electronics is wanted not only in Radio and Television, but in Aviation, Transportation, Communications, ... in the designing, engineering and operation of hundreds of industries today and for years to come. Learn how great the field is for YOU...How you may GET INTO BUSINESS FOR YOURSELF. Mail the coupon now.



Send for FREE Lesson and Prove to Yourself How Quick and Easy You Get Ahead in Radio by the NEW

SHOP METHOD HOME TRAINING OF THIS GREAT, ESTABLISHED RESIDENT SCHOOL



Learn by Doing!
Use real Radio Equipment Furnished with your Course

Experience is the best teacher and you learn by experience with the National Shop Method of Home Training. You build a long distance, high fidelity, superheterodyne receiver—build many other circuits and conduct experiments with the big kits of standard radio parts included with your training at no extra cost.

Here is the kind of training that gives you a first hand knowledge advanced and approved means and methods. Not only do you understand the basic principles of the industry but you become expert with practical experience.

Send the coupon for detailed information on all the different departments of this course of training.

CHOOSE YOUR FUTURE

1. Radio is a \$6-billion business. Radar, just starting, already does \$2-billion a year.
2. Thousands of men needed for stations and communication companies—for operation and maintenance.
3. Half million jobs in Television right at start is the opinion of industrial leaders.
4. Limitless future in Electronics—in the home and industry.

Get ready for Television and FM. Get your share of the Radio Service Business. Take your place in industry as an Electronics expert. Here is a sensationally improved way for you to get the right training. Study in spare time—odd hours, even minutes—and have the advantage of actual shop experience behind you.

This exclusive shop method of home training comes to you right from one of the world's greatest vocational educational centers—the resident training shops and experimental laboratories of the great NATIONAL SCHOOLS. It is sound, based on the actual experience of qualified instructors, engineers and technicians—men who are right in the industry.

National Schools has been training men for higher pay and greater opportunity for more than a third of a century. Fill out and mail the coupon below for details.

Shop Method Training Wins Good Jobs



Joseph Gramlich, Lake Hiawatha, New Jersey.

"My latest offer was \$5,800.00 as Radio Photo Engineer... but I'm doing well where I am now engaged. I am deeply indebted to National."

"Due to my training at National I was selected to instruct in the laboratory work of Navy and Marines."—R. R. Wright, Blackfoot, Idaho.



Read what hundreds of other enthusiastic students have written about National Training. Send in your coupon today.

"I believe National offers the best course to be had... Keep up the good work."—O. K. Ivey, Washington, D. C.

Grasp This Opportunity

Experts agree that Radio, Electronics and Television is right at the start of the greatest boom in history. Right now is the time to prepare yourself for BIG SUCCESS and LIFE-TIME SECURITY. Take part in the great expansion. The field is wide open.

You need no previous experience—no electrical or mechanical knowledge. National Shop Method Home Training is complete in itself—up-to-date.

Make use of your free time NOW to build yourself a great future. See how quickly you progress—low cost it is to get a firm, practical understanding of Electronics in all branches.

See for Yourself

Take the first step now. Fill out, and mail the coupon below. Be among the first to get into the big money—to win a position of importance—to have a BUSINESS OF YOUR OWN.

The industry is crying for trained men everywhere. It holds out rich rewards—a prosperous future. Well trained men ONLY are wanted.

Examine the National Shop Method of Home Training carefully in the quiet of your own

home. Make up your own mind. No salesman from National will call on you. Fill out and mail the coupon today.



GET THESE 2 BIG BOOKS FREE!

Learn for yourself just how easy this SHOP METHOD HOME TRAINING gives you the practical, down-to-earth experience you can never get from theory alone.

NATIONAL SCHOOLS

LOS ANGELES 37, CALIFORNIA EST. 1905

MAIL OPPORTUNITY COUPON FOR QUICK ACTION

National Schools, dept. 12-PM
4000 South Figueroa Street,
Los Angeles 37, California

(Mail this in an envelope or paste on a postcard.)

Send me FREE the two books mentioned in your ad (including a sample lesson of your course. I understand no salesman will call on me.)

NAME AGE

ADDRESS

CITY STATE

Include your zone number

It's YOUR future—Make the most of it!



Start now to earn the bigger pay in electrical repair

WAS there ever such an opportunity to get started in electrical maintenance and repair—and at top-notch wages? Are you ready—with experience and ability—to cash in on it? Others are getting just the sort of background needed—quick! practical!—to handle the great variety of electrical maintenance and repair work TODAY—from this well-known electrical library. You can too!

THE LIBRARY OF ELECTRICAL MAINTENANCE AND REPAIR

5 vols., 1826 pages, 1724 illustrations

Gives you the "know-how" to tackle any wiring or motor job. Five books show you HOW—to install all types of motor and generator units—to inspect and repair motor starters and generators—to diagnose motor and generator troubles—to figure new windings for old cores—DC and AC windings—to test armature windings—test induction motors, etc., etc. One book is full of trouble-shooting charts that show quickly symptoms, causes, specific remedies, etc.

Take the first step toward improving YOUR future—Mail this coupon TODAY

No money down—special price—easy payments—FREE trial

McGraw-Hill Book Co., 330 W. 42 St., New York 18, N. Y.
 Send me for ten days' free examination the Electrical Maintenance and Repair Library. If satisfactory I will send you \$1.00 in 10 days and \$2.00 monthly until the price of \$15.00 is paid. If not wanted I will return books postpaid. (To insure prompt shipment write plainly and fill in all lines.)

Name
 Home Address
 City and State
 Company
 Position PM-12-45

AN INFANT INDUSTRY ... SUDDENLY MATURED PLASTICS

Get In at the Start—and Grow

Plastics is a new industry which the nation's war needs is forcing to quick maturity. Already Plastics are indispensable in practically every branch of the Service—Aircraft, Ordnance, Chemical, Marine, Signal Corps, etc. Opportunities? Nearly everything, from homes to clothing, from gadgets to tools, will be affected by Plastics.

Spare Time Training Now Ready

The time to get started is now. You can prepare at home, in your spare time, to take your place in an infant industry that even now is leaping into prominence. A new, practical training plan is now ready to help you realize your ambitions and build your future security. Act now. Don't delay. Mail this coupon today.

AMERICAN SCHOOL, Dept. P845
 Drexel Ave. at 58th St., Chicago 37, Ill.

Send me FREE information covering special training in subjects checked below. No obligation on my part.

<input type="checkbox"/> Plastics	<input type="checkbox"/> Radio
<input type="checkbox"/> Electrical Engineering	<input type="checkbox"/> Automotive Engineering
<input type="checkbox"/> Drafting and Design for Men and Women	<input type="checkbox"/> Architecture & Building
<input type="checkbox"/> Diesel Engineering	<input type="checkbox"/> Business Management
<input type="checkbox"/> Mechanical Engineering	<input type="checkbox"/> High School Course
<input type="checkbox"/> Aviation	<input type="checkbox"/> Railway Training
	<input type="checkbox"/> Electronics, Industrial

Name.....
 Address.....

TRI-STATE COLLEGE

Degree in 2 1/4 years

B. S. Degree in Civil-Electrical, Mechanical, Chemical, Radio, Aeronautical, Engineering; Business Administration, Accounting, Secretarial Science. Short diploma courses, (36 weeks) in Surveying, Drafting. VETERANS under the G.I. Bill or Public Law 16 can complete work here in shortest possible time. Special Prep. Dept. Also Refresher Courses. 62nd year. Tuition, living costs low. Enter Jan., March, June, Sept. Catalog. 4125 College Avenue, Angola, Ind.



ENGINEERING

CHEMISTRY IS OPPORTUNITY!

There's no limit to the chemist's chances for advancement in salary... in importance. Experiments develop laboratories. I.C.S. training... practical... thorough... opens this great field to you. Instruction papers specially written by noted chemical engineers, consulting chemists, metallurgists. And these big experts are EASY TO UNDERSTAND. Our editors have explained all technical terms simply, clearly. Any person of ordinary intelligence can learn and make rapid progress. You have ambition. We have the training you need. Send now for free booklet! International Correspondence Schools, Box 565-K, Scranton 9, Pa.



LEARN MEAT CUTTING At Home—In Spare Time

Get into the vital meat industry. Concise, practical Home Training based on 25 years proven instruction methods used at National's famous resident school. Prepares you for bigger pay as Meat Cutter, Supervisor, market manager or more money in your own store. Go as rapidly as your spare time permits. Diploma. Start NOW to turn your spare hours into money. Send for FREE bulletin today. No obligation.

National School of Meat Cutting, Inc., Dept. U-64, Toledo 4, Ohio

Good Handwriting HELPS YOU WIN SUCCESS!

It's so important to write a good hand for business and social advancement. Poor illegible penmanship often causes costly errors and marks you for failure. Why write a poor hand? It's so easy to learn at home in spare time. Write for our new free booklet today. If you wish, send 10c for a postpaid sample for shaded writing and your name beautifully written.

Business Since 1905 THE TAMRLYN SCHOOL OF PENMANSHIP H-441 Ridge Bldg., Kansas City, Mo., U. S. A.

YOU CAN LEARN TO DRAW

Be An Artist—We Train You at Home—in Your Spare Time Plan your future career now in a field where training pays. We teach Art from the beginning and prepare you for a commercial art career. Trained artists are capable of earning \$30-\$50-\$75 A WEEK!

COMMERCIAL ART CARTOONING ALL IN ONE COMPLETE COURSE DESIGNING

Many of our most successful graduates never studied Art before enrolling with W.S.A. Since 1914 our proven, practical method has been training men and women for successful Art Careers. 2 ART OUTFITS with course. FREE book—"Art for Pleasure and Profit" tells all about our step by step training, what graduates say and commercial opportunities for you in Art.

FREE BOOK gives details!

Washington School of Art, Studio 1212P
 1115—15th St., N.W., Washington 5, D. C.
 Send me your free booklet and full particulars.

Name..... Age.....
 Address.....
 City..... State.....



Learn

PLASTICS FABRICATION

New - Profitable Industry!

**START YOUR
OWN BUSINESS**

YOU'LL really enjoy learning plastics this new, interesting way! For you'll actually make beautiful, useful plastics articles during your home study training with Plastics Industries Technical Institute.

NOW'S YOUR OPPORTUNITY—Yes, the exciting age of plastics is here! Demands of war have caused phenomenal growth in the plastics industry—creating exceptional opportunities for those who know plastics. If you are a person with an eye to the future, you won't remain on the outside looking in—you'll want a choice position in the growing, expanding plastics field—or a plastics business of your own.

WE SUPPLY MATERIALS—For your interesting and practical work with plastics, we supply handsome, colorful, transparent rods, sheets and tubes of plastics from which you make useful, attractive creations. You saw, cement, machine, buff, form, dye, decorate, cast and laminate various types of plastics. You also design

your own plastics articles—develop your own ideas—express your originality. Earn money while learning.

A COMPLETE COURSE—This practical training in plastics fabrication is only *one* part of the Plastics Institute home study course. In addition, you learn about the many types of plastics, their manufacture, characteristics, properties and uses—intensive coverage of molding and mold design—testing and cost analysis—everything to prepare you for your place in plastics.

START YOUR FUTURE TODAY—Mail the coupon below now! We will send you an interesting, illustrated free booklet with valuable information about plastics. We'll tell you how, at small cost, you can prepare for a future in this important industry while carrying on your present work. Don't put it off. Clip the coupon and mail it today!

VETERANS: ASK ABOUT G.I. TRAINING

NEW YORK

CHICAGO

LOS ANGELES

Dept. PM5-12, 122 E. 42nd St.

Dept. PM5-12, 221 N. La Salle St.

Dept. PM5-12, 1601 S. Western

SPECIAL RATES FOR SERVICE MEN

Plastics

INDUSTRIES TECHNICAL INSTITUTE

Plastics Industries Technical Institute
221 N. La Salle St., Dept. PM5-12, Chicago 1

Mail in Envelope or
paste on penny postcard

Gentlemen: Please send me the booklet "World of Plastics" and information on your training program. I understand there is absolutely no obligation.

Name.....Occupation.....

Street.....Age.....

City.....Zone.....State.....

- Veterans: Check here for special information.
- If under 18: Check here for special booklet.



FREE BOOKLET
Send For It Today!

Do you want

- ➔ ..to go to College?
- ➔ ..or to enter a Profession?
- ➔ ..or get an Office Position?

(Such as Accounting, Architecture, Nursing, Dentistry, Teaching, Social Work, Osteopathy, Beauty Culture, Optometry, Embalming, Chiropractic, Law, Medicine, etc.)

To get anywhere, you practically MUST finish High School FIRST. You can complete our simplified High School Course in SPARE time at home, as FAST as your time and abilities permit. Equivalent to resident school work—prepares you for college, pre-professional examinations, business, industry. Standard texts furnished. Diploma. Credit for H. S. subjects already completed. Single subjects if desired. Low tuition, easy terms. American School, Chicago, est. 1897—endorsed by educators. Finish your high school education NOW. Write TODAY!

High School Course at Home

Many Finish in 2 Years

American School, Dept. H945, Drexel Ave. at 58th St., Chicago 37, Ill.

Gentlemen: Send me FREE information covering special training in subjects checked below. No obligation on my part.

- | | |
|--|--|
| <input type="checkbox"/> High School Course | <input type="checkbox"/> Diesel Engineering |
| <input type="checkbox"/> Architecture and Building | <input type="checkbox"/> Drafting and Design for Men & Women |
| <input type="checkbox"/> Automotive Engineering | <input type="checkbox"/> Plastics |
| <input type="checkbox"/> Business Management | <input type="checkbox"/> Private Secretary |
| <input type="checkbox"/> Electrical Engineering | <input type="checkbox"/> Mechanical Engineering |
| <input type="checkbox"/> Elec. and Gas Refrigeration | <input type="checkbox"/> Aviation |
| <input type="checkbox"/> Air Conditioning | <input type="checkbox"/> Salesmanship |
| <input type="checkbox"/> Railway Training | <input type="checkbox"/> Radio |
| <input type="checkbox"/> Electronics, Industrial | |

Name.....

Address.....

Your OWN Business!



As little as \$100 Starts You NOW!

No Training Needed

Make good money by making photo-exact copies of important papers, letters, drawings, photos, veterans' discharges, etc.—for local firms, lawyers, real estate men, accountants, advertising men, engineers, architects, others. Every business is your prospect for error-proof, low-cost photocopies. New, amazingly simple

method requires no lens, darkroom, or training! A table-top with only \$100 worth of APÉCO equipment puts you in business for yourself! Easy to start... many prospects... quick results... pleasant work—here's a combination that's a real money-making opportunity—good for a lifetime!

Get Full Information! MAIL COUPON NOW!

AMERICAN PHOTOCOPY EQUIPMENT CO.
2849 N. Clark St., Dept. GF125,
Chicago 14, Ill.

Please send me your illustrated book and details about the APÉCO business opportunity.

NAME.....

STREET.....

CITY..... STATE.....

Help Yourself to More Money

This Book Tells How!

Increase Your Earning Power. KNOW what you are worth—and WHY! Uncover your hidden talents. Develop your capacity to accomplish—achieve—DO THINGS! Fit yourself for something better,—more important work—more responsible position. Go forward—Progress. Don't drift—COMMAND! This Book tells HOW you can develop and direct your inherent capabilities—qualities you ALREADY POSSESS! It has helped thousands—and can HELP YOU. The Opportunity is YOURS. Grasp it NOW! Don't wait. Send TODAY! Mailed postpaid anywhere in U.S. for \$2.00. Money back if not satisfied in 5 days. Address—



Jessie D. Reed, Secy., 196 Lexington Ave., New York 16, N. Y.

Learn Penmanship

You can learn plain, rapid writing or fancy ornamental writing for social and business advancement, right in your own home during spare time by my Simplified Method. Write for my free book, "How to Become an Expert Penman," which shows what others have accomplished by taking my Courses. Send 10c for one of my favorite Pen Points and your name with a beautiful scrawled bird written on a card. Write today. T. M. Tevis, Box 254, Chillicothe, Mo.

BUILD AND FLY

your own motorcycle powered monoplane, at home. Easy to build, short run take offs, and a sweet plane to fly. No special tools needed. Cheap. Tested plans, guaranteed, \$1.00. Just the plane you have been waiting for. ORDER TODAY. NOW. AEROTECH, DEPT. 50, DEARBORN, MICHIGAN.



CARTOONING



MAKE BIG MONEY
CASH IN on Big Cartoon Market. BECOME CARTOONISTS QUICKLY with our NEW, EASY METHOD. No experience necessary. Prepared by successful cartoonists. Only \$2.85 postpaid. SATISFACTION GUARANTEED. Sample LESSON PLATE and interesting literature FREE.
NATIONAL ARTISTS BUREAU
Dept. A-3, Box 4248 DALLAS 8, TEXAS

HIGH SCHOOL AT HOME

Most well-paid positions demand high school training. Without it, or equivalent, you can't advance to the full extent of your abilities in any trade, business or profession. Whatever your age, however you're situated, IT ISN'T NECESSARY TO STRUGGLE UNDER THAT HANDICAP. I.C.S.S., famous for more than 50 years, enables you to start your own high school in your own home. You're in a class by yourself—study in your spare time—acquire a high school education at astonishingly low cost. Authoritative text! Rapid Progress! Write today for free booklet. International Correspondence Schools, Box 5565-K, Scranton 9, Pa.

CONTEST

YOU CAN WIN \$25.00 Monthly Prize for best true life story! Any subject! Any length! Send penny postcard for fair-and-square contest rules—TODAY! Truth Publishing Co., Dept. A-10 136 Liberty St. New York 6, N. Y.

MONEY MEN ALL FREE

THE PLASTEX Industry needs manufacturers on small scale and for big production of Lamp and Clock Stands, Art Goods and Novelties in Plastex and Marble imitation. Experience unnecessary. 1-20 material makes regular 10c store sellers. Rubber moulds furnished for speed production. Small investment brings good returns. Big chain store orders now being placed. Ambitious men have chance for real prosperity. Our Free booklet will interest and benefit you.
PLASTEX INDUSTRIES, Dept. P, 1035 Washington Ave., New York, N. Y.

**MEN! Here's
a Chance to
Earn Money**



**Which of these books can
help you GET A BETTER JOB
AND MAKE MORE MONEY**

Here's how to beat job competition and insure yourself of a prosperous future. Gateway Books help you tackle those tough jobs you've always had your eye on... because they show you how to do the HARDEST jobs the EASIEST way in LESS time.

Gateway Books are written by men who are experts in their particular field... men who have worked themselves up

the hard way. Now you can take advantage of their knowledge the easy GATEWAY way. Our Money Back Guarantee and Special offer appear elsewhere on this page. Study this list of popular books now.

Order From This List

WOODWORKING

1. **CARPENTRY CRAFT PROBLEMS.** 302 pages and over 700 illustrations explaining carpentry craft problems in detail...\$2.50
2. **BUILDING—FORMS, STAIRS, ROOFS.** Latest information on forms, staircases and roof building. For carpenters or helpers. 219 pages, 495 illustrations...\$2.50
3. **QUICK CONSTRUCTION.** Temporary buildings, roof and platform problems, special uses of tools, shingles, cornices and hundreds of useful subjects for the amateur or professional. 250 pages, 670 illustrations...\$2.00
4. **WOODEN BOAT and SHIP BUILDING.** Solves every problem of building wooden ships and boats. 244 pages...\$2.00
5. **HOW TO MAKE RUSTIC FURNITURE.** Hundreds of ideas and plans on making all types of rustic furniture. Completely illustrated, thoroughly described...\$2.00
6. **WOOD TURNING.** An excellent book for every home craftsman. Tells and shows how to do the most artistic kinds of work. Numerous photos and drawings...\$2.50
7. **HOW TO WHITTLE and CARVE.** Complete directions for all types of whittling and carving of toys, jewelry, and novelties, etc. Illustrations make work simple...\$2.75

PAINTING

8. **HANDBOOK OF ORNAMENT.** For artists, designers, jewelers, architects, etc. Topics covered include: Elements of Decoration, Decorated Objects, and Ornaments applied to Features. 3,000 illus., 518 pp...\$5.00
9. **INTERIOR WALL DECORATION.** Practical working methods for plain and decorative wall finishes. 185 illus., 491 pages...\$3.00
10. **THE MIXING OF COLORS and PAINTS.** How to mix colors for interior decorating, arts, crafts, general mixing methods. A handy book for professional and amateur painters. 302 pages fully illustrated...\$2.00
11. **SPRAY PAINTING.** Spraying technique and operating instructions on paints, materials, finishes, 125 fully illust. pages...\$1.50
12. **HOUSE PAINTING METHODS.** 400 pages and 150 illust. cover the subject of house painting (of any surface) thoroughly... time and money saver...\$2.00
13. **WOOD FINISHING.** Wood finishes and problems...tools...material...353 illust...\$2.00
14. **CYCLOPEDIA of PAINTING and DECORATING.** Covers methods, tools and materials for the home and workshop, including every branch of painting and decorating. Any particular job is fully explained with illustrations to clarify the text. 350 pages...\$3.00

Guarantee

Gateway Books are guaranteed to be absolutely satisfactory in every respect, or your money will be cheerfully refunded.

THE GATEWAY BOOK CO., Dept. PM-12
32 N. State—Chicago 2, Illinois

METAL WORKING

15. **WELDING.** Arc, spot, butt and electric welding, etc. 250 pages...\$1.50
16. **SHEET METAL WORKERS MANUAL.** Complete instructions and information on every phase of sheet metal working. Includes many tables. 552 pages, 375 illust...\$3.00
17. **SHEET METAL LAYOUT SHEETS.** Makes sheet metal work so simple that anyone can learn. Thousands of men badly needed for this big pay work. 143 jobs worked out in detail. Fully illustrated...\$3.00
18. **METAL SPINNING.** A new art of proven popularity. Step-by-step descriptions of the various phases of the craft shows you how to make the most out of your metal work. Simple, concise...\$1.75
19. **METAL SPINNING PROJECTS.** Tells how to make bowls, lamps, serving dishes, book ends, candle sticks, etc. Complete patterns and instructions...\$2.75

**REFRIGERATION - PLUMBING
AIR CONDITIONING**

20. **REFRIGERATION SERVICE MANUAL.** Domestic and commercial refrigeration used in markets, milk depots, soda fountains, etc., and in homes. 300 pages, illust...\$2.50
21. **PLUMBING INSTALLATION and REPAIR.** 226 page book on how to repair leaky faucets, clogged toilets, drains, traps, vents, sewers, etc. 153 illust...\$2.50
22. **HEATING-COOLING and AIR CONDITIONING.** New book shows you how you can make more money in heating... refrigeration and Air Conditioning fields. Complete and authoritative... four big books in one. 706 fact filled pages on heating of all types, cooling, Air Conditioning, equipment, furnaces, controls, etc. 706 pages, 64 charts, 351 illustrations...\$4.50



SPECIAL

If your purchase totals \$10.00 or more, we will send you any \$2.00 book you choose absolutely FREE. Group your purchase with a friend to take advantage of this special offer.

ELECTRICITY

23. **PRACTICAL ELECTRICITY and HOUSE WIRING.** Excellent for home repair work. 200 pages, 227 illustrations...\$2.00
24. **HOUSE WIRING MADE EASY.** Layout and plans for all phases of house wiring...\$1.50
25. **ARMATURE and MAGNET WINDING.** The construction of armatures and their repairs, fully covered with illustrations...\$1.50

ART

26. **HANDBOOK OF ORNAMENT** see No. 8.
27. **HANDBOOK OF ADVERTISING LAYOUT.** Written and illustrated by one of the country's leading advertising men, it is practical and sound...\$3.00
28. **FIGURE DRAWING FROM LIFE** \$1.00
29. **AMATEUR ARTIST**...\$1.50
30. **STUDIO HANDBOOK—LETTER AND DESIGN**...\$3.00
31. **SILK SCREEN METHODS.** How to make silk screens, materials needed. Complete, authoritative. Fully illustrated...\$3.00
32. **MODERN LETTERING AND DESIGN**...\$1.00
33. **HOW TO DRAW FUNNY PICTURES**...\$2.00
34. **ART OF CARICATURE**...\$2.00
35. **PRACTICAL COLOR MANAGEMENT**...\$2.00
36. **MODERN ILLUSTRATIONS**...\$2.00

SELF IMPROVEMENT

37. **PRINCIPLES OF ACCOUNTING.** 140 pages that help make you a proficient accountant and show you how to keep your own books easily. Gives all details... leaves nothing to chance, complete...\$3.75
38. **MATHEMATICS.** Includes all phases of mathematics to help reader solve all practical problems. 224 pages...\$2.00
39. **SLIDE RULE and LOGARITHMIC TABLES.** Uses and principles of slide rule and logarithmic tables fully covered. Includes even 10 place log tables. 200 pages...\$1.50
40. **101 WAYS TO BE YOUR OWN BOSS.** Information gathered from over 600 successful business men tells you how to be your own boss in business. Complete... authoritative... leaves nothing to doubt... helpful...\$2.49

HOBBIES

41. **TIN CAN PROJECTS.** Tells how to turn tin cans into objects of beauty that command high prices. This handy book has all the patterns, designs, etc...\$1.50
42. **MODERN HOMECRAFT.** 240 pages of ideas for modern furniture... and how to make it... fully illustrated...\$3.00
43. **WHITTILING** see No. 7.
44. **LEATHER WORKING.** Tells of tools, materials and equipment needed. Gives working drawings of key holders, book marks, coin purses, billfolds, belts, frames, etc...\$2.00

CHECK, CLIP AND MAIL THIS COUPON NOW

THE GATEWAY BOOK CO., 32 N. State St., Dept. P.M.-12, Chicago 2, Ill. O.K. Send the books I've circled. If C.O.D., I'll pay postman cost of books plus a few cents postage and handling charge. If prepaid, Gateway pays all shipping charges. If any book is not entirely satisfactory, I will return it in 10 days and you will refund my money. No C.O.D.'s outside the U.S.

1 2 3 4 5 6 7 8 9 10 11 12 13 14 15 16 17 18 19 20 21 22
23 24 25 26 27 28 29 30 31 32 33 34 35 36 37 38 39 40 41 42 43 44
(Please print name clearly)

Name.....
Address.....
City.....Zone.....State.....

"I'll show YOU how to make yourself COMMANDO-TOUGH



... in double-
quick time

...OR IT WON'T COST YOU A CENT!"

says *George F. Jowett*

WORLD'S GREATEST BODY BUILDER

Let me prove to YOU that you can put inches of dynamic muscles on your arms! Add inches to your chest! Broaden your shoulders and power-pack the rest of your body. I can do for you what I've done for thousands the world over, including many officers and men now in the U. S. and British Armed Forces.

GIVE ME 10 MINUTES A DAY!

I'll Show You My Secrets Of Body Building

I'll help you learn the "Progressive Power Method" through which I rebuilt myself from a physical wreck to the holder of more strength records than any other living athlete or teacher! No matter how skinny or flabby you are, you can learn my methods right in your own home. Through my proved secrets I show you how to develop your power, inside and out, until YOU are fully satisfied that you are the man you want to be. "The Jowett System," says R. F. Kelly, Physical Director of the YMCA, Atlantic City, "is the greatest in the world!"

If you want a physique that will inspire respect from men, and admiration from women... ACT LIKE A HE-MAN! Decide at once! The famous book, "Nerves of Steel—Muscles Like Iron" will be included FREE! Priceless for the strength fan! Full of photos of marvelous power-bodied men who will show you what Jowett has done for them and how he can do the same for you. Reach out... Grasp this Special Offer today!

Jowett Institute of Physical Culture
230 Fifth Avenue
Dept. 9118
New York 1, N. Y.

**PROVE TO YOURSELF
IN ONE NIGHT!**

Send only 25c for test Course, "Molding a Mighty Arm." Read it the evening it arrives—learn from experience the thrill you can give your muscles!

**SEND FOR THESE FIVE FAMOUS
COURSES IN BOOK FORM**

**ONLY 25c EACH
or ALL 5 for \$1.00**

*This
Book
Free!*



**BOOK WITH PHOTOS OF FAMOUS STRONG MEN
MAIL COUPON NOW**

FREE



Jowett Institute of Physical Culture
230 Fifth Avenue, Dept. 9118, New York 1, N. Y.

George F. Jowett: Your proposition looks good to me. Send by return mail, prepaid, the courses checked below, for which I enclose (). Include FREE book of PHOTOS.

- George F. Jowett
Champion of Champions
- All 5 courses for... \$1 Molding Mighty Legs 25c
 Molding a Mighty Arm 25c Molding a Mighty Grip 25c
 Molding a Mighty Back 25c Molding a Mighty Chest 25c
 Send all 5 C.O.D. (\$1 plus postage.) No orders less than \$1 sent C.O.D.

NAME..... Age.....
(Print name)

ADDRESS.....

THIS GREAT BOOK

HOW to BREAK and TRAIN HORSES

FREE!

Every farmer, every lover of horseflesh should have a copy of it. This amazing book tells how to know horses—how to break them—how to train them—how to make money as a master horseman. Write for it today—FREE, together with my special offer of a course in Animal Breeding. If you are interested in Galting and Riding the saddle horse check here Do it today—now. You'll never regret it.

BEERY SCHOOL OF HORSEMANSHIP
Dept. 11612D - - Pleasant Hill, Ohio

LEARN WATCH REPAIRING



AT HOME. By our modern and original system of instruction you can learn every part of the **WATCH REPAIRING TRADE AT HOME.** Prepare yourself for a well-paying position or start in business after completing our course of instruction. Good watch repairers are in demand and generally earn very good salaries. For particulars apply to the Wisconsin School of Watch Repairing 759 North Milwaukee St., Milwaukee 2, Wis.

ELECTRICAL TRAINING

8 months intensive residence course in fundamentals of industrial electrical engineering, including radio, electronics. Prepares for technician, engineering aides. Approved for veteran training. Classes begin Feb. 25, July 8. Catalog.

BLISS ELECTRICAL SCHOOL
122 Takoma Ave., Wash. 12, D. C.

FREE BARGAIN CATALOG of BOOKS

25,000 books of all publishers listed in our 51st Annual Bargain Catalog of 320 pages. Old-time favorites—latest "best sellers." Reference, Fiction, Juvenile, History, Scientific, etc. Supplying schools, colleges, libraries and thousands of individual customers. Send postcard today for our new 1946 catalog, "Bargains in Books."

THE BOOK SUPPLY COMPANY, Dept. 133
564-566 West Monroe Street Chicago 6, Illinois

DRAFTING SPRINGBOARD TO SUCCESS!

Increased salary, larger responsibilities, a real career instead of just a job—these are to be had by the trained draftsman. I.C.S. makes the way to thorough, practical training open to you. Check up and you'll find that nearly every "big name" American in engineering and production acquired experience at the drafting board. Many of them started by writing for the I.C.S. free booklet. Send for it today! It can be the most important act of your life.

International Correspondence Schools, Box 5565-K, Scranton 9, Pa.

"The Book They're Talking About"

ART ANATOMY & FIGURE DRAWING

For the amateur and professional artist. Containing over 350 illustrations, charts and notes, giving detailed study of every part of the body. **POSED \$1 and IN ACTION.** Outside U.S.A. send \$1.25. Price Only

MAJOR BOOK CO., Dept. 16A
72-04 Juno St., Forest Hills, New York

NEW ELECTRICAL & ELECTRONIC BOOKS

Guaranteed to Earn You 5 Times their Cost



These authentic Coyne Books are so packed with important, on-the-job helps, valuable diagrams, easy-to-follow tables, etc., that I am willing to send you any or all of them with my **GUARANTEE** that they will help you earn at least 5 times their cost within a year after you own them—or I'll refund every penny you paid.

You would easily understand why I can make this amazing offer if you could see the hundreds of letters we get praising these books because they have helped men to success—brought pay raises—earned new, important jobs for men who want to succeed. These are not just books to be read—but volumes of facts you will refer to every day—information you can sell—advice you can use to get things done better and faster.

YOU'RE THE JUDGE

The books are right up-to-the-minute, prepared and published by the great 45 year old Coyne School. They are written by electrical men who are familiar with every day problems in electrical construction, house-wiring, installation and servicing. The pages are so packed with such practical pay-raising information that a single suggestion could easily bring you many times the cost of the book.

These books bring valuable information on Motors and Controls, Refrigeration, Air Conditioning, Radio, Batteries and Diesels. Simple explanations of modern Electronics, Trouble Shooting, Generators, Electrical Circuits, new electrical ideas, modern methods, up-to-date data—a veritable gold mine of easy-to-follow rules, tables, charts.

Every formula is tested—every diagram is proved—every table is authentic. *And each book is written so you can understand it*—so you can get the facts you want in a hurry. Thousands of old-timers and beginners are using these books right now to help them do better work, get bigger pay, earn promotions and jobs of authority.

I know what these books will do for you and so to prove my faith I guarantee that the books you order will earn you five times their cost within a year. You take no risk whatever. You may even see the books you want 7 days **FREE** for examination and you may return them without owing a penny if you don't wish to keep them.

SEND NO MONEY!

You do not have to send a single penny to see these books for 7 days **FREE** in your own home or shop. Just check the books you want on the coupon and mail it to me. **SEND NO MONEY.** If you decide you don't want them send them back within 7 days and you owe nothing. If you keep them you pay on the terms indicated and accept my *Money-Back Guarantee* that the books will help you earn 5 **TIMES THEIR COST** within a year after you own them or you get your money back. Rush coupon Now.



GUARANTEED EARNINGS OFFER

H. C. Lewis, Pres., Coyne Electrical School, Dept. 95-R6
500 S. PAULINA STREET, CHICAGO 12, ILL.

Send me books checked below. I'll either return them in 7 days and owe you nothing or pay for them according to the plan I select as outlined below. You agree to refund price paid if I don't earn 5 times cost in one year.

Coyne Applied Practical Electricity: 7 volumes, includes 1 yr. free consultation service & bulletins. Price complete \$19.75 Cash, or \$21 on time, payable \$3 after 7 day free examination & \$3 monthly.

Coyne Electrical and Radio Trouble Shooting Manual: one volume—610 pages—500 large wiring diagrams—4 books in one. Price \$8.00 Cash—or \$8.95 on time, payable \$1.00 after 7 days and \$3.00 monthly. One year consultation and bulletins **FREE.**

Coyne Electricians' Handbook: 1 vol.—400 pgs.—latest electrical laws, rules, formulas, methods—book every electrical worker should have. Price \$2.75 payable after 7-day **FREE** examination.

Electronics for Radio Men and Electricians: 1 volume—400 pages. Newest facts, diagrams and development—includes 1 year **FREE** technical bulletins. Price \$4.95 after 7-day **FREE** trial.

150 Shop Prints & Diagrams: 1 vol.—150 large size electrical wiring diagrams—a real buy. Price \$1.95 after 7-day free trial.

NAME _____

ADDRESS _____

TOWN _____ Zone _____ STATE _____

COYNE ELECTRICAL SCHOOL
500 SOUTH PAULINA ST.
DEPT. 95-R6 CHICAGO, ILL.

**BE READY FOR
A BETTER JOB
AT BIGGER PAY**



**PREPARE *Now*
FOR POST-WAR
BUILDING
BOOM**

**Thousands of
Trained Men
Will Be Needed**

● New homes and other structures to be built after peace returns will provide a tremendous number of well-paid jobs. Men trained in Architecture, Drafting, Contracting, Carpentry and related building trades will cash in BIG on their knowledge and skill. YOU can train in spare time at home, at low cost, for a big-pay job in this rich field. American School can help you to succeed just as it has helped others during its 48 years. Check, fill in and mail coupon NOW for FREE information.

AMERICAN SCHOOL, Dept. B945, Drexel Ave. at 58th St., Chicago 37, Ill.

Send me FREE information about your special training plan covering subjects checked below.

- | | |
|--|--|
| <input type="checkbox"/> Architecture and Building | <input type="checkbox"/> Automotive Engineering |
| <input type="checkbox"/> Drafting and Design | <input type="checkbox"/> Diesel Engineering |
| <input type="checkbox"/> Contracting | <input type="checkbox"/> Mechanical Engineering |
| <input type="checkbox"/> Practical Plumbing | <input type="checkbox"/> Plastics Engineering |
| <input type="checkbox"/> Air Conditioning | <input type="checkbox"/> Aviation <input type="checkbox"/> Radio |
| <input type="checkbox"/> Refrigeration | <input type="checkbox"/> Business Management |
| <input type="checkbox"/> Electrical Engineering | <input type="checkbox"/> High School Courses |

Name.....

Address.....

AVIATION *Career*

MAXIMUM TRAINING IN MINIMUM TIME

CAL-AERO TECH TRAINING will add dollars to your pay check all the rest of your life. Specializing in AERONAUTICAL ENGINEERING and MASTER AVIATION MECHANICS since 1929, Cal-Aero Tech training is carefully designed for just one thing—TO MAKE MORE MONEY FOR YOU. An alumni of over 6000 successful graduates proves our career training is unsurpassed.

VETERANS —Write us about Aviation Training, as provided under "G.I. Bill of Rights."



**CAL - AERO
TECHNICAL INSTITUTE**
MAJOR C. C. MOSELEY PRES. SINCE 1929
FOUNDED BY THE NATIONAL TECHNICAL INSTITUTE

GRAND CENTRAL AIR TERMINAL
GLENDALE 1, CALIFORNIA
LOS ANGELES COUNTY

MAIL THIS COUPON TODAY!

Cal-Aero Technical Institute, Grand Central Airport, Glendale 1, California
Please send full information on Aviation Training FREE—without obligation, Dept. PM-12

Name..... Birth Date.....

Street.....

City..... State.....

TELEVISION

The Eyes of Tomorrow

By CAPTAIN WILLIAM C. EDDY • At last—the inside story on television, told to you straight. TELEVISION—The Eyes of Tomorrow is sensationally NEW, COMPLETE and AUTHORITATIVE. Here are detailed, scientific answers to every question you have on the history, nature and future of television—the modern miracle.

It's all here—lighting, visual effects, color, camera techniques, transmission, receiving production methods, and every other problem, discussed and explained by a man who's been in television from its pioneering days to the present.

Orders for this fascinating new book are piling up fast. Don't delay. Order your own copy NOW! \$3.75

PRENTICE-HALL, Inc., Dept. MT, 70 Fifth Ave., N. Y. 11

DEVELOP THE POWERFUL INFLUENCE



**FEUCHTINGER Method Guaranteed
IN YOUR VOICE**

DO IT YOURSELF AT HOME

Write for the Voice Book—FREE!

Sent only to those over 17 yrs of age

PERFECT VOICE INSTITUTE

Studio 9359

Kimball Hall Bldg., Chicago 4, Ill.

THERE'S MONEY IN CARTOONS!

RAYE BURNS will teach you HOW to CREATE ORIGINAL CARTOONS at home that you may SELL! Course contains 26 lessons and over 600 illustrations. All for Only.....

\$2.85

Send name and address for free details.

RAYE BURNS SCHOOL, Dept. M, Box 3583, CLEVELAND, OHIO

Learn PHOTOGRAPHY at Home

Splendid opportunities. Prepare in spare time. Practical basic training. Long-established school. Send for free book, "Opportunities in Photography." No obligation.

American School of Photography, 1315 S. Michigan Ave., Dept. 1359, Chicago 5, Ill.



LANGUAGE IS POWER

... Forge ahead, win special assignments, promotion, better job in global peace time opportunities through ability to speak a foreign language.

MASTER A NEW LANGUAGE quickly, easily, correctly by

LINGUAPHONE

The world-famous Linguaphone Conversational Method brings voices of native teachers INTO YOUR OWN HOME. You learn the new language by LISTENING. It's amazingly simple; thousands have succeeded.

HOME-STUDY COURSES IN 29 LANGUAGES

Send for FREE book—

LINGUAPHONE INSTITUTE

98 RCA Building, New York 20, N.Y. • Circle 7-0830

LINGUAPHONE INSTITUTE,
98 RCA Bldg., New York 20, N.Y.

Send me the FREE Linguaphone Book.

Name.....

Address..... City.....

Language Interested.....

DO ANY JOB .. EASIER .. QUICKER
MAKE MORE MONEY *in the*
BIG OPPORTUNITY
FIELDS

Here's the Help You Need
For Best Paying Jobs
Right NOW!

FREE TRIAL
IN YOUR OWN HOME

Used by Army, Navy, Other Government
 Depts., 200 Schools and Industrial Firms.

SEND NO MONEY
 Select the Books
YOU Need Now!
 We Ship **C.O.D.**
 Anywhere in U. S.
 and Will Refund
 Amount Paid if
 Not Satisfactory.

Don't submit to tough, heartbreaking job competition, now that wartime jobs are over. Get into one of these big opportunity fields. Big money and many other advantages await you if you prepare now. Here is the help you need—EASY—QUICK—AT LOW COST. Thousands of men have already used these famous books. Beginners and experienced men alike have doubled and tripled their earnings with this help. You too, can now get the special knowledge you need for top pay, better jobs, or a business of your own. This is your GOLDEN OPPORTUNITY.

AIR CONDITIONING

Big air conditioning boom interrupted by war will be bigger than ever. It's ready to GO now! Get this non-technical book by international authority and be ready for your share of millions to be spent. Covers whole field. 450 pages. Illustrated. \$3.50.

AIRPLANE WELDING

All metal airplane building offers big peacetime opportunities.

New 2nd edition of this famous book by J. B. Johnson, Materials Division, Wright Field. The authoritative and practical book on Airplane welding and materials brought right up to date. 420 pages, 193 pictures. \$3.50.



MODERN WELDING PRACTICE

Newest book on all types of welding and heat treatment of metals. Written by recognized specialists in training men for production and non-technical jobs. Practical and Non-Technical. Covers

everything you need to know. Prepare for best pay jobs now. Price \$4.00.

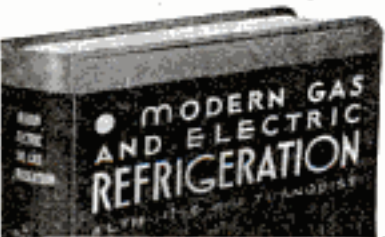

REFRIGERATION—Book of the Hour!
Biggest Opportunity in Many Years!

NEW PRINTING—ALMOST 1000 PAGES

408 Pictures—17 Diagrams in Colors Makes All Refrigerator Service Maintenance, Repairs Simple as A. B. C.

Thousands of Refrigerators need repairs! Owners will pay big for competent service which will be needed more and more. Get MODERN GAS AND ELECTRIC REFRIGERATION, the non-technical guide to all types of refrigerators and get your share of this new profit. Get a job or start your own service business. This book will help you make money anywhere. Price \$5.00.

BODY & FENDER REPAIR

Owners will spend big money to keep their good older cars looking like the new ones coming out. This is a practical money-making guide, ideal for shop owners and every man who wants a share of the millions to be spent in keeping



old cars looking new. Tells how to get a good job or start business of your own with small capital. 325 pages, 232 illustrations. \$3.00.

DYKE'S FAMOUS CARBURETOR BOOK

This famous book has been the standard guide in the best paying auto work for a generation. It has helped thousands of men make money. New edition covers engine tune-up, compression, ignition, carburetion, fuel pump valves, etc. Use this book to specialize in this big field. 244 pages, 549 illustrations. \$3.00.

HOUSE WIRING
NEW 1945 EDITION

Get this new sixth edition of this standard and practical electrical wiring book. It gives complete practical instruction on every phase of house wiring in one handy volume. Goes further than most books on subject. Hand-book style. Gives National Electric Code. 400 pages, 669 illustrations. Electrical work will reach a new high with millions of new homes to be built. Get started now. \$2.50.

15 Million Refrigerators
Need Service and Repairs



NEW 20th EDITION
Leading Auto Book for Over 32 Years

World's Greatest AUTO BOOK

New Material on Transmissions, Trucks, Tractors, Diesels, Aircraft and Auto Engines

Now with millions of cars needing repairs and thousands of men needed to do the work, you need the famous DYKE Auto Book more than ever before. Brand new 20th Edition covers all principles, construction, repair, adjustments, testing, troubles and remedies of all cars. Over a half million copies of 20 editions of Dyke's have been sold. Gives specifications of old and newer cars. World's biggest book value, \$6.00. This big book, a complete auto library in one volume, has 1483 pages—4600 illustrations and diagrams—weight 6 lbs.—equal to 4 ordinary books.

ENGINEERS HANDBOOK

World famous Bailey's handbook of universal questions and answers for Stationary, Marine and DIESEL engineers and firemen. Prepares for any license examination. This is the one book that men should have if they want to reach the top in installation, maintenance and operation of Diesel and steam plants. Pocket size, \$2.00.

Mail Coupon to

Goodheart-Willcox Co., Inc.
 2009 S. Michigan Ave., Dept. 112, Chicago 16, Ill.

SEND NO MONEY! Mail Coupon

GOODHEART-WILCOX CO.,

2009 S. Michigan Ave., Dept. 112, Chicago 16, Ill.

Send books checked, C.O.D. I will pay postman, plus few cents charges. If not satisfactory I will return books in 8 days and you will refund money paid. (Outside U.S. or possessions remit with order.)

- Gas & Electric Refrigeration \$5.00
- Dyke's Auto Book \$6.00
- Dyke's Carburetor Book \$3.00
- Modern Welding \$4.00
- Airplane Welding \$3.50
- Sheet Metal Layout \$3.00
- Air Conditioning \$3.50
- Engineers Handbook \$2.00
- Body and Fender Repair \$3.00
- House Wiring \$2.50
- Shop Math. (2 vols.) \$3.00

If remittance accompanies order we will pay all postage charges under same return privilege.

Name

Address

City

ELECTRICAL BOOKS

shipped for
EXAMINATION



SEND NO MONEY
**MODERN
ELECTRICITY
INCLUDING RADIO
AND REFRIGERATION**

Here's great news for anyone interested in Electricity. NEW, up-to-date 19th Edition of Applied Electricity with new subjects fully covered, including blueprint reading, electronics, F. M. radio, fluorescent lighting, 8 Big Books sent for examination!

**NEW Edition for
Beginners and
Experts**

Over 3700 pages, 2700 illustrations and 134 tables in most complete electrical work we have published. Dynamos, motors, diesel plants, power stations, transmission—everything explained for easy understanding.

**BIG FIELD! Big Demand!
Big Pay!**

Men who understand electricity are needed now in all kinds of industries, and will be needed when war production has ended. Practically every business depends on electrical knowledge, and men who know this subject make big money. Learn easily with these new, interesting books. Send coupon for a set of books on approval. See how they will help you to get ahead faster.

**SEND
NOW**

[A year's consulting privileges with our engineers now given to all buyers of this famous Cyclopaedia of Electricity.]

AMERICAN TECHNICAL SOCIETY
Vocational Publishers Since 1898

American Technical Society, Dept. E919, Drexel at 59th St., Chicago 37
Send for 10 days' free use, 8 volume set of New 19th Edition, Applied Electricity, including a certificate entitling me to consulting privileges for one year. I will pay the delivery charges only on the books. If I wish I may return them in 10 days and owe you nothing, but if I keep them, I will send \$2.00 after 10 days, then \$3.00 a month until the total price of only \$34.90 is paid.

NAME

ADDRESS

CITY

STATE

Please attach letter stating age, occupation and name and address of employer and have at least one business man as reference. Men in service, also please give home address.



OPPORTUNITIES AHEAD

For Men Who are Trained in AUTO BODY & FENDER WORK

Men 18 to 60. Want a future with good pay, perhaps a business of your own later? If you are mechanically inclined, start now to learn to become an auto body mechanic and fender repair man. This fast growing field has great possibilities for trained men with experience. U. E. I. spare time, home-study training combined with actual shop practice gives you sound, basic knowledge of latest, best methods so you may get the experience which may bring you big pay. Capable instructors supervise your studies and actual practice on automobiles. Course includes acetylene welding, spray painting, use of hand and power tools.

THOROUGH, RELIABLE TRAINING

U. E. I. has trained men for new opportunity fields since 1927 and many students are now making good. Auto body and fender repairing is one of the best profit-makers in any garage or service station. Little capital required for mechanically inclined men to get into this business. Free employment placement service, or we will show you how to start your own shop. Get the facts FREE, without obligation. Write today.

UTILITIES ENGINEERING INSTITUTE

AUTO-CRAFTS DIVISION
1314 Bolden Avenue, Dept. 1125X, Chicago 14, Ill.

Gentlemen:—YES! I want to get into profitable Auto Body and Fender Repair Work. Please send me FREE FACTS at once. This inquiry does not obligate me in any way.

Name Age

Address

City Zone State

SILVERPLATE

Electrically by Brush!



NEW!

**AMAZING LOW COST WAY TO
PLATE GENUINE SILVER ON
Models, Projects, Worn Fixtures**

Hundreds of uses for this complete Silverplating Outfit! New, patented electrolyzed brush and concentrated compound of Atomic Silver work like magic. Easily and quickly, you can apply a heavy, permanent coat of Genuine Silver to any conductive surface . . . on models, projects, silverware, jewelry, etc. Outfit includes Degreaser, Atomic Silver Compound, Battery's Power-Pack, Nylon-Lucite Electrolytic Brush, Solid Silver Anode, Leads, Connectors and simple instructions in compact carrying case. All at amazing low cost! Small shipping charge collected on delivery. ORDER TODAY.

Homecrafters, Dept. D-3
360 North Michigan Ave.
Chicago 1, Illinois

**ONLY
\$12.50**

The Tool of A
101 USES



AUDELS Carpenters and Builders Guides 4 vols. \$6



Inside Trade Information for Carpenters, Builders, Joiners, Building Mechanics and all Woodworkers. These Guides give you the short-cut instructions that you need— including new methods, ideas, solutions, plans, systems and money saving suggestions. An easy progressive course for the apprentice and student. A practical daily helper and Quick Reference for the master worker! Carpenters everywhere are using these Guides as a Helping Hand to Enter Work, Better Work and Better Pay. Get this satisfaction for yourself, simply fill in and mail the FREE COUPON below.

Inside Trade Information On:

How to use the steel square—How to file and set saws—How to build furniture—How to use a mitre box—How to use the chalk line—How to use rules and scales—How to make joints—Carpenters arithmetic—Solving measurement problems—Estimating strength of timbers—How to set girders and sills—How to frame houses and roofs—How to estimate costs—How to build houses, barns, garages, bungalows, etc.—How to read and draw plans—Drawing up specifications—How to excavate—How to use settings 12, 13 and 17 on the steel square—How to build hoists and scaffolds—skylights—How to build stairs—How to put on interior trim—How to hang doors—How to lath—lay floors—How to paint



THEO. AUDEL & CO., 49 W. 23rd St., New York City

Mail Audels Carpenters and Builders Guides, 4 vols., on 7 days' free trial. If O.K. I will remit \$1 in 7 days, and \$1 monthly until \$6 is paid. Otherwise I will return them. No obligation unless I am satisfied.

Name

Address

Occupation

Reference

Say Fred, be sure to get this Taxidermy book. You will surely be interested. It's now sent free.

LEARN TO MOUNT BIRDS & ANIMALS - BE A TAXIDERMIST

1 THAT WAS A GREAT HUNTING TRIP, BILL, ALL THE DUCKS WE WANT. BUT IT SEEMS A SHAME TO THROW AWAY THIS BEAUTIFUL PLUMAGE.

THAT'S JUST WHAT I'VE BEEN THINKING—JIM, I'M GOING TO WRITE TO THE NORTHWESTERN SCHOOL OF TAXIDERMY AND SEE IF I CAN'T LEARN TO MOUNT MY BEST TROPHIES.

WELL, I SEE YOU REALLY ARE TAKING UP TAXIDERMY IN EARNEST, BILL.

THAT'S RIGHT, JIM—AND I'VE NEVER HAD SO MUCH FUN IN MY LIFE. I'VE ACTUALLY DOUBLED THE PLEASURE I GET FROM MY HUNTING AND REALLY HAVE SOMETHING TO SHOW FOR IT. COME IN THE HOUSE AND I'LL SHOW YOU SOME OF MY WORK.

2 LATER

I'VE SOLD MANY BOOK-ENDS, LAMPS, ASH-TRAYS, PIPE RACKS, AND SO ON TO SPORTSMEN FOR THEIR DENS — I'VE LEARNED TO TAN FURS FOR CAPS, SCARFS AND RUGS, AND — BEST OF ALL — INSTEAD OF THROWING AWAY THOSE COW-HIDES, I TAN THEM INTO LEATHER FOR BELTS, HARNESS AND STRAPS.

BUT WASN'T TAXIDERMY HARD TO LEARN, BILL?

HARD? NOT A BIT, AFTER YOU GET THE HANG OF IT. WHY JIM, TO ME TAXIDERMY IS THE GRAND-EST HOBBY IN THE WORLD. I'VE MADE AS HIGH AS \$75 PER MONTH IN MY SPARE TIME, MOUNTING TROPHIES FOR HUNTERS. WHY DON'T YOU TAKE IT UP?

I'M SURE GOING TO — WHAT'S THAT ADDRESS? I HAD NO IDEA WHAT I'VE BEEN MISSING.

Amazing Pleasure and Profits in This Art

YOU LEARN IT EASILY, QUICKLY, BY MAIL IN SPARE TIME

Men, boys, women,—Study Taxidermy. Taught by Experts. ALL SECRETS revealed. It will amaze and delight you.



Hunters - Fisherman

Save your game trophies. They are **Valuable**. Mount them for home and den. Have a **Museum**. Win fame as a Taxidermist. Make undreamed-of money in spare time . . . You learn to mount (stuff) **expertly, Birds, Animals, Fish, Game-Heads**, just like life. That is Taxidermy. You can be a Taxidermist. Will you? Surely you are interested. Mail **Coupon** right now for the astonishing **Free Book**.

Our Students Succeed

This old reliable school has graduated 250,000 students with uniform **satisfaction**. If we have taught this VAST number, you **MUST** agree that we can teach YOU also. We offer you with **PRIDE** our success in teaching this vast number. We **KNOW** you will be delighted. So **SEND COUPON TODAY FOR FREE BOOK**.

Mail Coupon

Or a postcard will do. No obligation on your part. The beautiful **Book**, with hundreds of entrancing **Pictures** is **Free**. Do not miss this wonderful opportunity to obtain the marvelous and valuable book, **FREE** and **POST-PAID**. Write today. State your **Age**.

Wild Game Not Needed

You can use common animals and birds; squirrels, rabbits, little chicks, puppies, kittens, pigeons, even frogs. Mount them in human and humorous groups. Real **Fun**; and profitable, too. This is known as **Craft and Novelty taxidermy**; it's included in our unique lessons. It's **Marvelous**. Write the school this minute!

Is Taxidermy Profitable?

We believe that **NO OTHER BUSINESS** offers such large spare-time profits. Many students earn \$40 to \$100 a month from **SPARE TIME ALONE**. They sell their mounts, they mount for others. **INVESTIGATE** this WONDERFUL spare-time money-maker.

Learn Tanning

Tan fine harness, sole and chrome leathers; also furs with the hair on. **Expert Methods**, easily learned. **Save Money** making your own leathers; **Make Money** tanning for others. **Quick Sure Profits**. The **Free Book** tells about it. Send coupon.

NORTHWESTERN SCHOOL OF TAXIDERMY
3379 Elwood Bldg., Omaha, Neb.

FREE BOOK

Northwestern School of Taxidermy,
3379 - Elwood Bldg., Omaha, Neb.
Send me your free illustrated book, "How to Mount Game." Also tell me how I may learn this fascinating art easily and quickly by mail. No obligation. State your age.

Name Age

Address



SEND COUPON TODAY FOR WONDERFUL FREE BOOK

INVENTORS

Do Not Delay

Have you ever been startled by seeing a successful article on the market, and exclaimed—"Why, I invented THAT 5 years ago—I didn't think it valuable enough to Patent!"

The Patent Laws were intended for the Protection of the Inventor, and the Inventor who slumbers on his Rights may wake up to find someone else reaping the reward that could have been his.

Write NOW for Information and Record of Invention form FREE. RANDOLPH & BEAVERS, Registered Patent Attorneys, Columbian Bldg., Washington, D. C.

PERSONALIZED SERVICE — REGISTERED PATENT ATTORNEYS

RANDOLPH & BEAVERS

11-D Columbian Bldg., Washington, D. C.

Please send me full particulars on Patents, fees, etc., and "RECORD OF INVENTION" form—FREE.

Name

Street

City State

HUNTING and FISHING



HUNTING and FISHING

is a monthly magazine crammed full of hunting, fishing, camping, dog and boating stories and pictures, invaluable information about guns, fishing tackle, game law changes, best places to fish and hunt—countless ideas that will add more fun to your days afield.

Special Trial Offer

Send 25c in stamps or coin and we will send you Hunting & Fishing for six months.

HUNTING & FISHING MAGAZINE

251 Sportsmen's Bldg., Boston, Massachusetts



Begin today. Write now for our Free Book, "How to Become a Good Penman." It contains specimens and tells how others learned to write in spare time. Enclose 10c for your name beautifully written and a pen point suitable for shaded writing. Write today.

THE TAMBLYN SCHOOL OF PENMANSHIP
N-441 Ridge Building, Kansas City, Mo.

PATENTS AND TRADE MARKS

C. A. SNOW & CO.

Registered Patent Attorneys Since 1875
Write for Free Book and "Certification of Invention" form
427 SNOW BUILDING, WASHINGTON 1, D. C.

PATENT YOUR IDEAS

SEND FOR FREE BOOK

Written by Former Member Examining Corps (1922-24) T. B. PAT. OFFICE

CARL MILLER, Registered Patent Attorney
Former Member Examining Corps U. S. Patent Office
Woodworth Bldg., Dept. 125-A New York — Bond Bldg., Dept. 125-A Washington, D. C.

PATENTS Protect Your Idea: By securing FREE my "PROOF OF INVENTION" folder. Exceptional Personal Service, Excellent References. Established 1906.
E. E. VROOMAN, 571 Woodward Bldg., WASH., D. C.



Wonderful, new device, guides your hand; corrects your writing in a few days. Big improvement in three hours. No failures. Complete outline FREE. Write C. J. Ozment, Dept. 34, St. Louis, Mo.

STAMMER?

This new 128-page book, "Stammering, Its Cause and Correction," describes the Bogue Unit Method for scientific correction of stammering and stuttering—successful for 34 years. Benj. N. Bogue, Dept. 1831, Circle Tower, Indianapolis 4, Ind.



Thrilling Work COLORING PHOTOS

EASY TO LEARN

Fascinating vocation learned at home by those with aptitude. Thrilling pastime. Koolhaas method brings out life-like colors. Free booklet.
NATIONAL PHOTO COLORING SCHOOL
1315 S. Michigan, Dept. 1359, Chicago 5

ARTISTS MAKE MONEY

Find out your ability. Send name, age, occupation and address for Free Vocational Art Test.

ART INSTRUCTION, INC. (Formerly Federal Schools)
12135 Art Instruction Building, Minneapolis, Minnesota

SUIT YOURS AS A BONUS

And Big Money in Spare Time, Too

We want you to wear this fine made-to-measure suit. Make it yours by sending a few orders, and earn BIG CASH PROFITS in spare time. Your suit will help you get more orders with accuracy, quality fabrics, tailored-to-measure to newest styles. Also Ladies Tailored Suits—complete line. Write today for FREE SAMPLES. No experience, no money needed. For quick action tell us about yourself.

J. C. FIELD & SON, Harrison and Throop Sts., Dept. Z-1716, Chicago, Ill.



Get Into the MONEY via "Simplified" Arc Welding



You'd be surprised at the number of returning servicemen that are starting job welding shops, after doing their bit for Uncle Sam. Sure, some were welders before the war, some learned while in the service and others, well, they just saw the value of welding and made up their minds it's a "must" for a profitable business. They learned a lot about building and maintaining equipment and what an important part welding plays in this game. Better get started today!



HOBART BROTHERS COMPANY
BOX M-125 TROY, OHIO



Ask for Your Copy of Pocket Size Arc Welder's Guide. It's FREE!

HOBART
"Simplified" Arc Welders

"One of the World's Largest Builders of Electric Arc Welders."

Here I Am At WORK

Making

GOOD MONEY

in

DRAFTING



I'm glad I sent the coupon to Chicago Tech for that Free Trial Lesson and found out how easy it is to learn Drafting in spare time at home. Today I feel secure in my job because the draftsman's work comes first on any new project. And, in addition, draftsmen can't be replaced with machines. What's more, I feel I'm slated for promotion and more pay, because I see so many draftsmen advancing to high-pay jobs in Engineering.

Yes, this Free Lesson proved that drafting is easy, mighty interesting work . . . convinced me I didn't need special talent to get into this well-paid profession . . . proved beyond a doubt that Drafting by the fascinating C.T.C. method can be mastered easily At Home In Spare Time. Here's a tip: Mail the coupon or drop a card for the Free Trial Lesson. Do this today—and find out about your opportunities in Drafting.

LEARN in Spare Time — at Home!

(Or at the College in Chicago)

A few hours of pleasant home study every week—that's all. No interference with your present job. With Chicago Tech's help, you train yourself step by step. This tested method,—developed over 40 years of C.T.C. progress,—prepares men quickly for good positions in industry.

Get Free Information — Send Coupon

Find out now how you can use your spare time to prepare, in your own home, for these job opportunities by use of the Chicago Tech Plan. Same training methods as used in our Chicago school. Choose the line where you would like to work,—in Drafting, Building Construction, Refrigeration or Air Conditioning. Mark and mail the coupon or send a post card. No obligation of course. Act today.



FREE TRIAL LESSON

To prove to you how easy it is to learn Drafting at home by the Chicago Tech method we will send you this FREE TRIAL LESSON. No charge for this Lesson, now or later. Fill out and mail Coupon, or send post card today.

DRAWING OUTFIT INCLUDED with Drafting Courses

All the tools you need including folding drawing table. With them you can put your ideas on paper quickly and with accuracy. With training, you are all set to master Drafting in months — not years, —at home.

CHICAGO TECHNICAL COLLEGE

S-206 Tech Bldg., 2000 South Michigan Ave., Chicago 16, Ill.

Send INFORMATION PLEASE on Home-Study Training in:

- | | |
|---|--|
| <input type="checkbox"/> Architectural Drafting | <input type="checkbox"/> Builders' Course |
| <input type="checkbox"/> Machine Drafting | <input type="checkbox"/> Blue Print Reading—Building |
| <input type="checkbox"/> Electrical Drafting | <input type="checkbox"/> Estimating,—Buildings |
| <input type="checkbox"/> Structural Drafting | <input type="checkbox"/> Refrigeration, Air Conditioning |

Name..... Age.....

Address.....

City..... Zone..... State.....

Calling All Camera Fans!

Genuine Photo Master CANDID CAMERA

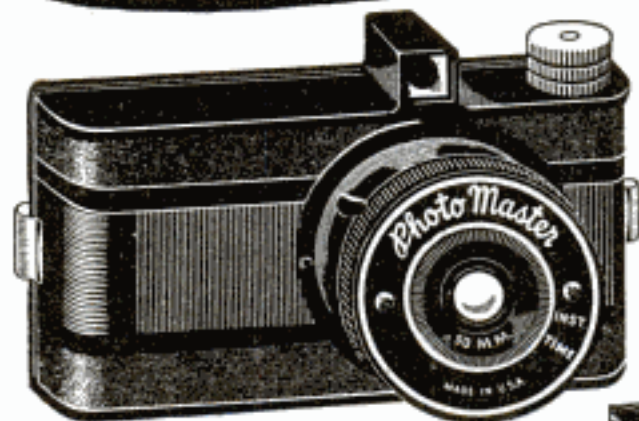

The Ideal Gift
For Mother, Dad, Son
or Brother

\$3.98

POST PAID

TAKE PICTURES YOU WILL TREASURE!

Imagine getting a genuine Photo Master with a ground and pitch polished lens in the face of one of the most drastic camera shortages in our history! A camera designed to take pictures in full color as well as black and white! A camera that will enable you to graphically record the events and people of the present for you to enjoy in the future. Yes, start today to take pictures of things as they happen. It's a real thrill that will bring you reflected pleasures for years to come. So order your Photo Master now! And if after the postman delivers it you don't think the \$3.98 you paid for it is the best \$3.98 you've ever spent—return it within 10 days and we'll refund your money cheerfully—and quick as a flash!

Sold on a "Examine At Our Risk"
GUARANTEE OF SATISFACTION

Look At These Features

- ★ Genuine Simpson Ground Pitch Polished Lens
- ★ Extremely Simple, Foolproof Operation
- ★ Takes 16 Pictures on any Standard No. 127 Film
- ★ Also Takes Excellent Pictures in Full Color
- ★ Level View Finder

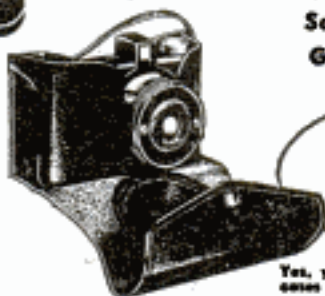

This Made-To-Measure
CARRYING CASE
only **2c** with purchase
of Camera

Yes, you can have one of these made-to-measure carrying cases worth 75c for only 2c with every camera ordered.

Biggest Smokers' Value Ever!

WINDPROOF LIGHTER and CIGARETTE CASE

Both For Only . . .

\$2.98

POST PAID
TAX FREE

For Your Smoking Pleasure A THRILL BY THEMSELVES...

. . . A TRIUMPH TOGETHER

Take the lighter, for instance! It's a genuine "Feather Lite," cased in gleaming heat resistant black plastic. Famed for the instant, positive action it's the favorite "flame" of smokers the nation over. Just a twirl of your thumb lights it—and its wind guard keeps it lit. And if you want the joy of a firm packed cigarette all the time, your answer is the matching featherweight cigarette case with its patented grooves that protect each and every cigarette until you're ready to smoke it. They're a peach of a pair, both yours to own for only \$2.98—a price you'd gladly pay for either one. Seeing is believing! and if you don't think you've bought a double value after seeing your thrilling twosome—we'll refund your money cheerfully! And that's a promise!

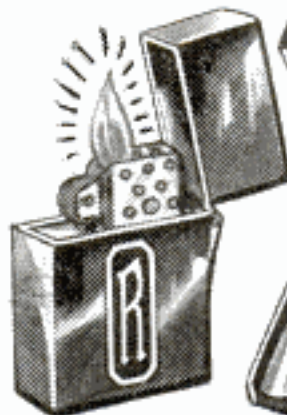

A Matched Set
You'll Be Proud To
Give or Get

Both Personalized

With a Rich Silver on Black
MONOGRAMMED INITIAL
of your own choice

MAIL THIS COUPON FOR SMOKER SET

NATIONAL NOVELTIES—Dept. R95
608 So. Dearborn St.—Chicago 5, Ill.

PRINT INITIAL
IN THIS BOX

Please rush Feather Lite Windproof Lighter and Matching Cigarette Case personalized with initial printed in box above.

CHECK ONE

- I am enclosing \$2.98. Send My Personalized Smoker Set Postpaid.
- Send my Personalized Smoker Set C.O.D. I will pay postman \$2.98 plus postage.

Name _____
Please Print Clearly.
Address _____
City _____ Zone _____ State _____

MAIL THIS COUPON FOR CAMERA

NATIONAL NOVELTIES—Dept. PC153
608 South Dearborn St.—Chicago 5, Ill.

Rush Photometer at \$3.98 with Carrying Case for only 2c extra. Satisfaction guaranteed or money back if returned within 10 days.

CHECK ONE

- I am enclosing \$4 for payment in full. Send Camera and Case Postpaid.
- Send Camera and Case C.O.D. I will pay postman \$4 plus postage costs. If you want 3 rolls of No. 127 Film (enough for 48 pictures) for only 81c plus 15c postage and handling costs CHECK BELOW.
- I am enclosing \$4.96 for payment in full. Include 3 rolls of Film postpaid.
- Include 3 rolls of Film C.O.D. I will pay postman \$4.96 plus postage.

Name _____
Please Print Clearly.
Address _____
City _____ Zone _____ State _____

**WORLD'S
BEST
WANT AD
MEDIUM**

CLASSIFIED Advertisements



Advertisements in this section 50 cents per word, each insertion, minimum 10 words, payable in advance
To be inserted under proper classification in January issue, copy should be in our office December 4th

January issue on sale January 1st

F. W. Johnson, Manager, Classified Advertising
Popular Mechanics Magazine, 200 East Ontario Street, Chicago 11, Illinois

YOU'LL PROFIT

By reading and answering the classified ads in this section. Hundreds of opportunities to make and save money.

Popular Mechanics Magazine, Chicago, Ill.

Gentlemen: I have your letter relative to my ad running in your Sept. issue and wish to say that the reason we have not continued the ad is because we are swamped with replies from all parts of the U. S. and Canada and have more business than we can attend to at this time until we can increase production. However just as soon as we can take care of more salesmen you will hear from us again.

(Original letter on file in our office)

Yours very truly,

GEO. MILLER AGENCY.

1143 CLASSIFIED ADVERTISEMENTS 1143 OPPORTUNITIES FOR YOU

AUTOMOBILES, MIDGET CARS

BUILD Authentic midget two-passenger "Jeep"! Large working plans, specifications, construction information, \$1.00. Universal, 2671 Algonquin, Toledo, Ohio.

WANTED: Stoddard-Dayton automobile and pertinent literature. Lohr, 1401 Ridge Avenue, Evanston, Illinois.

1946 **IGNITION** Supercharger \$5.50. Pep, mileage, fast starting. EG Mfg. Co., 355a E. 149th St., New York.

MASTER Ignition power booster \$3.00. Mileage; pep; easier starting. Satisfaction guaranteed. Master Co., 1702 E. Geneva, Milwaukee 11, Wisconsin.

FLOYD Clymer's popular motor books! Mercedes-Benz Book just out. Describes Grand Prix racing, 100 illustrations, photos world's fastest cars, drivers \$2.00, cloth-bound \$3.00. — Power and Speed, 200 illustrations, world's most famous racing book \$2.50. — Ab Jenkins (world's distance record holder) book "Speed on Sale" \$1.50, cloth-bound \$2.50. — Saga Roaring Road, historical book early day American automobile racing \$2.50. — Speed "How to Obtain It" \$1.50. — Motorcycling Manual, wonderful book, dozens motorcycles described, illustrated, \$2.00. (See our ad under Motorcycles). — Motorcycles "How to Manage Them" \$2.00. — English Motorcycle Service Manual, all about servicing various foreign motorcycles \$1.50. — Motor History of America "World's Wonder Book of Automotive Industry," all about Ford, Chrysler, Durant, Willys, Olds, Buick, others, 416 pages, lists 1600 different makes American automobiles \$3.00, cloth-bound \$4.00. — Floyd Clymer's Historical "Motor Scrapbooks"—the book Time Magazine called a "must" . . . specifications, illustrations, photographs hundreds early automobiles and motorcycles. No. 1 and No. 2 now ready, entirely different, \$1.50 each, cloth-bound \$2.50 each. — Clymer's Steam Automobile Scrapbook . . . Historical, illustrated review, early and late Steam Cars \$2.00, cloth-bound \$3.00. — Modern Steam Car, different book \$2.00. — All books postpaid. Sent overseas without request. We pay postage, guarantee delivery. Send dime for America's most complete Motor-book catalog. Clymers, 2125 W. Pico, Los Angeles 6, Calif. (See our ads under Motorcycles.)

PROFESSIONAL Midget racer, motor-scooter, midget car and midget motorcycle. Plans, specifications, for all four contained in illustrated handbook, 25c. Big list used motors, motorscooters, Servicycles, etc., included free! Midwest, 3839 Drummond, Toledo, Ohio.

CUSTOMIZE Your automobile. Illustrated, new restyling ideas, instructions, suggestions, specific model changes by simple methods. \$1. Speed Wheel, Box 723-E, Arcadia, California.

GARAGE Doors, all types, controlled from dashboard. Complete "Build Yourself" plans \$1.00, refundable. Free particulars. Kaytor Laboratories, Lynwood, Cal.

STEAM Car Scrapbook. Compiled by Floyd Clymer. Historical, authentic, amusing. Ads, photos, descriptions 250 early steam cars, with fascinating story by one-time world's youngest auto dealer. Postpaid \$2.00. Deluxe cloth-bound \$3.00. Clymers, 2125 W. Pico, Los Angeles 6, Cal.

BUILD Midget racer from castoff parts! Plans, specifications, construction information, \$1.00. Motor Supply, Box 1682-CS, Toledo, Ohio.

INTERESTING. Educational, illustrated English "Motor" magazine on foreign automobiles. 50c postpaid. Clymers, 2125 W. Pico, Los Angeles 6, Calif.

1945 **IGNITION** Supercharger. \$4.00. Pep, mileage, fast starting. EG Mfg. Co., 355a E. 149 St., New York.

REPAIR Your car. Motor parts for all engines, chassis parts, ignition and carburetor parts, etc. New replacement parts. Genuine and highest quality at manufacturers' retail parts. F.O.B. Chicago. No body parts. B & N Engineering Co., Box 3454 Merchandise Mart P.O., Chicago 54, Illinois.

AUTOMOBILE Racing book, fifth edition, well illustrated. Instructions on building bodies, frames, engines, Ford A and B conversions. Plans, AAA rules, specifications. Roadster racing, Indianapolis cars. \$1.00 postpaid, \$1.30 C.O.D. Ray Kuns, Dept. 47, Madisonville, Cincinnati 27, Ohio.

AUTO SUPPLIES AND EQUIPMENT

HAVING Car trouble? New, used, guaranteed auto, truck parts save money. Transmission specialists. Describe needs; immediate reply. Victory, 2930 1/2 Northwestern, Chicago 18.

WHIRLOAS Turbinator, \$3 carburetor amplifier, guarantees increased mileage and power by proven tests of universities. Users report savings high as 40%. Wrench installs 15 minutes. Give auto make, year. John Hanley, 5719 Loraine, Detroit 8, Mich.

AUTO Parts for all autos and trucks. Trans., motors, differentials, fenders, carburetors. Also body parts. Security Auto and Truck Parts, Box 1265BJ, Chicago 90.

CARBURETOR Repair kits for most popular cars and tractors. Free lists. Carburetor Service, 600 LaPrairie, Ferndale, Mich.

GASOLINE Saving device. Chevrolet, Ford 1932-1942, Dodge, Plymouth, 1933-1938. Walert Company, 3429 North 10th Street, Milwaukee 6, Wisconsin.

OIL Pumping motors—Brought back to normal without ring job. Write for particulars. Joe Mullner, Box 3102, St. Paul 1, Minn.

ANALYZE Your car costs. Know when to trade your car, what it costs per mile, how depreciation affects costs. Complete record and graphical analysis. No calculations needed. Send \$1.00. Garwood, 6034 Eastern St., Los Angeles 22, Calif.

DOLL Up your car. Sealed beam headlights, fog lights, aerials, and other parts. Behnke's Auto Supplies, 5303 Giddings St., Chicago, Ill.

POWER Booster—New Aqua-Charger, a scientific device designed by aircraft engineers applies to your car or truck the famous water-injection that has given aircraft extra speed and power. Aqua-Charger reduces carbon formation. Kills ping even under heavy load on steep grades. Has effect of raising octane rating of any gasoline. Increases gasoline mileage. Aqua-Charger \$17.95 postpaid. Give auto make, year. Associated Machine and Engineering Company, 40 George St., Torrington, Conn.

1000 MOTORISTS Needed to make gas saving test. Up to 30% savings. For trial test offer write Vacu-matic Carburetor Co., 7617-1260 W. State Street, Wauwatosa, Wis.

"PEPPY" Gas engine governors make automobile motors power units. \$9.50 up, circulars. Harris Machinery, Minneapolis, Minn.

MOTORISTS: For fresh air without draft, install Noblo, clear, plastic, patented, wind-deflector that clips in one minute in rear of driver's window. To eliminate those annoying motoring drafts and find new driving comfort, write today for information or send year, make, model, body style and \$3.95 check or money-order. Noblo Sales, Box 1214, San Diego, Calif.

ANTI-FREEZE. Noncorrosive, inexpensive—manufacture yourself. Send stamp. Box 699, Borger, Texas.

PLATING Outfits for auto parts. Connect to a battery. No tanks used. Free particulars and proofs. Gunmetal Co., Ave. J, Decatur, Ill.

AUTO TRAILERS

BUILD Streamlined trailer coach. Has everything. Build now for next summer. Large manual full of working drawings, instruction, floor plans \$1.00. Large blueprints \$3.00. Illustrated circular free. Craftsmann Books, Box 1153-P3, Milwaukee 1, Wisconsin.

BUILD Your own trailer! Save money! Have every feature you want! Plans for house, sport, camp and utility trailers. Catalog describing 9 models 10c. 15c in Canada and overseas. Jim Dandy, Box 125-A, Wausau, Wisconsin.

MOTORCYCLES, BICYCLES, MOTOR-SCOOTERS AND SUPPLIES

"MODERN Motorcycle Mechanics" enlarged, revised, second edition, 560 pages, 300 illustrations. The most up-to-date and complete motorcycle book published. Extensively covers design, operating and servicing Harley-Davidson, Indian and English makes. An ideal Christmas gift for motorcyclist friends. Price \$3.00 postpaid. Nicholson Bros., Motorcycle Engineers, Saskatoon, Canada.

MOTORBIKE Manual. Contains motorbike, scooter plans. Helpful hints and catalog section, also a small motor tuneup leaflet \$1.00. Variety Enterprise Co., Post Office Box 124, Evansville, Ind.

BICYCLE Book, how to buy, rebuild, sell used bicycles 50c. John Collett, Handley, Texas.

1942 CUSHMAN Motorscooter \$60; Briggs-Stratton motorbike \$45; midgelet car \$30; Briggs-Stratton motor \$10, other motors \$3.50 up; plenty of tires for motor-scooters and small cars at factory prices. (Mailorder only.) Send 25c for Big War-Bargain catalogue Number Ten, just out. (35c by first class mail.) Midget Motors Directory, Athens, Ohio.

BICYCLES, Brand new, boys and girls, also accessories. Send dime for list. Century Cycle Company, 3447 Lawrence Ave., Chicago 25, Ill.

PARTS, Accessories, pistons, chain Harley Davidson motorcycles, George's, P.O. Box 114, El Paso, Texas.

LARGE Stock Indian parts. Expert motor rebuilding. Indian Motorcycle Sales, Kansas City 1, Mo.

FLOYD Clymer's Motorcycling Manual, 120 illustrations. Information, specifications, descriptions dozens motorcycles. Engines, transmissions, carburetors, square four, two piston singles, overhead camshafts, spring frames, hydraulic forks, sidecars, riding instructions. Two cycle engines and power bicycles described, illustrated. \$2.00 postpaid. Clymers, 2125 W. Pico, Los Angeles 6, Calif.

BUILD America's lowest priced motor-scooter speedster! Complete plans, specifications, \$1.00. Big list used motors, etc., included free! Motor Supply, Box 1682-CS, Toledo, Ohio.

DEPENDABLE Bicycle generators \$2.85 prepaid. Ten day trial, L. Kimley, Highland, Williamsville, N. Y.

FLOYD Clymer's popular motorcycle, automobile books. See advertisement under Automobiles! Clymers, 2125 W. Pico, Los Angeles 6, Calif.

TIRES, Tubes, wheels, for industrial trucks, carts, wheelbarrows, scooters, midgelet cars, coaster wagons. Nationally known makes, first-line quality. Sizes 8" to 18" o.d. in 2, 4, and 6 ply tires, separate inner tubes, heavy duty demountable wheels. Also caster forks, straight and swivel types. Free illustrated circular and prices. Jahant Co., 628 East Exchange Street, Akron 6, Ohio.

ENGLISH "Motorcycling" Magazine. Interesting, educational, foreign motorcycles. Racing, new-old models, advertisements. 50c sample copy. Clymers, 2125 W. Pico, Los Angeles 6, Calif.

PLANS, Scale drawings, specifications, illustrations for building attractive motor scooter complete \$2.00; plans electrically driven bicycle \$1.50. Postpaid. Clymers, 2125 W. Pico, Los Angeles 6, Calif.

SEND 25c For complete motorbike plans and parts list. Motorbike Service, 1304 Indiana, New Albany, Ind.

HARLEY Davidson parts, accessories, supplies, expert service. Send \$2.25 for army motorcycle instruction book and bulletins or 10c for bulletins only. Knuth's, 2491 Fondulac Ave., Milwaukee 6, Wis.

TIRES And industrial wheels, suitable for scooters, wheelbarrows, farm equipment, etc. All sizes. Bicycles and accessories. Largest assortment in America. Send dime for list. Cycle Transport Company, 1241 So. Michigan Ave., Chicago 5, Illinois.

ELECTRIC Motorbike built from your bicycle. \$1.00 brings instructions-specifications. Mowery, Box 994, Lancaster, Pa.

BUILD Scooters, trailers, midgelets, conversions. Large manual \$1.00. Illustrated circulars dime. Craftsmann Books, Box 1153-P2, Milwaukee 1, Wis.

SPEEDY Motorscooter run by gas engine of washing machine type. Complete constructional details 25c. Popular Mechanics Press, (C-43), 200 E. Ontario, Chicago.

AVIATION

PROPELLERS For airplanes, ice-snow sleds, air boats, etc. Literature 5c. Banks Propellers, R.P.D. 7, Ft. Worth, Texas.

PROPELLERS—2 or 3 blade, fit any motor, ice, snow sleds, boats, planes, defrosters. Lists free. Ford motor conversion diagrams 50c. Quick delivery. Standard Aircraft, Ft. Worth, Texas.

LIGHTPLANE! How to build them. Illustrated circular 20c. Craftsmann Book, Box 1153-P1, Milwaukee 1, Wis.

ACTUAL Airplane photographs: Packets, each containing 20 genuine glossy prints: B-29 Superforts, Flying Fortresses, Naval aircraft, Army fighters, Army trainers. 25c each packet; all 5 for \$1, postpaid. Lloyds, 1411-PD Northwest 17th, Oklahoma City 6, Oklahoma.

SEND 25c For big War-Bargain catalogue of airplanes and gliders, located everywhere, some probably near you. (35c by first class mail). Used Aircraft Directory, Athens, Ohio.

WAR Bargains for hobby boys. Crash damaged fuel ratio dual meters and cell, convertible into d.c. combination milliamper-volt meter; \$2.95 c.o.d. add postage charges. Root, 2139 Addison, Houston 5, Texas.

AIRCRAFT Altimeters 8000 meters \$1.95. Pitch and bank indicators electrically illuminated \$2.95. Beach hand cranking magnetos worth \$50.00, sacrificed \$4.95. Liquid rubber 60% latex, mends everything in rubber, 3 cans \$1.00. 6-8 volt d.c. airplane generators, worth \$75.00 sacrificed \$2.95. Air Transport Co., Mineola, N. Y.

LUSCOMBE \$65, Cub \$300. New catalog 25c, lists thousands of sensational bargains in airplanes, motors, parts, parachutes, supplies. Aviation "Business Opportunity" section included free! National, Box 1682-CS, Toledo, Ohio.

JET Propulsion experiments. New principle to drive boats, bicycles, model helicopters. Circular on plans. Rush name. Houston Maupin, Tipp City 53, Ohio.

BATTERIES, GENERATORS, ETC.

PROTEC Battery terminals—From corrosion—Patented, guaranteed, instructions furnished. 50c per set. Include a friend. Battery Specialists, 1111 Windsor St., Salt Lake City, Utah.

EDISON Batteries. Light, Power. Fifteen year life. Unconditionally guaranteed. Complete lighting plants. Free literature. See-Jay Company, 321 Yonkers Avenue, Yonkers, New York.

ELECTRICAL SUPPLIES, EQUIPMENT

ASK Ted Riseman about parts for complete electric fan assembly. Assemble your own fans. 427 East Jefferson, Springfield, Illinois.

ELECTRICAL Appliance repair. Open your own shop. Learn house wiring; electric motors, vacuum cleaners, washers, etc. Complete illustrated course shows how. Free booklet. Pacific Training School, Dept. PA-12, 4703 West Pico, Los Angeles 6.

110 VOLT a.c. welders, \$15 to \$35. Growlers \$5, saw mandrels \$2.50 up, magnet wire, supplies. Catalog dime. Box 5086, San Francisco 1.

RECTIFIERS — Halfwave, 5 amperes, \$4.50; 2.2 amperes, \$2.25; 1.5 amperes, \$1.85. Fullwave, 1 ampere, \$2.50; .5 ampere, \$1.85. Maximum 18 volts input. List free. Milton Bursma, Route 5, Grand Rapids, Mich.

HEDDEN Metal detectors—Materials now available! We have the latest in circuit and mechanical design plus The Know How! Let us build yours. Write for literature. Metal Detectors, Box 6892, N. S. Pittsburgh, Penna.

ELECTRIC Irons \$10.50. Elements \$1.50. Aesco, P.O. Box 415, Austin 3, Texas.

MODEL Builders, experimental shops, manufacturers — 1500 assorted useful standard parts, 130 different items, all items marked; none are mixed. Total cost only \$9.00. Send 10c for detailed list. Albert A. Lohley, Dept. E, Mt. Prospect, Ill.

NOW—Repair your own electrical appliances with Chanite Self-welding Electrical Heating Element Flux. Instructions delivered, price \$1.00. Stick form 25c ea., \$2.00 doz. Chanite Sales Company, 914 South Main, Fort Worth, Texas.

BROKEN—Burned out electrical heating elements quickly repaired. Use new amazing Nichrome Paste, simply overlap ends and turn on current. Family size \$1.00 bill. Satisfaction guaranteed. Armstrong Mfg., 861-X, Minneapolis, Minn.

ELECTRIC Automobile heaters! Starts cold motors quickly. Saves gasoline, operates from light current. Postpaid \$1.95. Harris Machinery, Minneapolis, Minn.

ELECTRIC Pencil: Writes-engraves all metals \$1.00 postpaid. Beyer Mfg., 4515-H Cottage Grove, Chicago 15.

WELDING, SOLDERING, PLATING

BUILD D.C. arcwelder without rewinding armature. Plans \$1.00 each. 25 to 600 amperes from automotive d.c. motors, light plant generators, automobile starter-generators. Welders Club, AB-3432, Chicago 54.

ARC Welders wanted by the thousands. Learn with 516 page lessons manual. Over 500 how-to-do-it photos. \$2.00 copy. Money-back guarantee. Hobartweld, Box M-1234, Troy, Ohio.

WELD "Pot metals," braze aluminum easily with Commando. Directions furnished. Trial package \$1.00. Dealers wanted. J. M. Ragle Industries, 4029 Indiana, Kansas City 4, Mo.

NEW Model electric welder 110 volt a.c.-d.c.; will weld all metals; easy to use; full directions. Complete with power unit, flame and metallic arc attachments, carbons, fluxes, rods, mask; all for \$19.95. Used by the navy. Magic Welder Mfg. Co., 239-MP12 Canal St., New York City.

HEAVY Duty a.c. arc welder. Build at home from junk parts. Complete plans \$1.00. Senti Engr. Service, 1921 Higley Ave., Cedar Rapids, Iowa.

WHATEVER You need for welding, we have it. Gas or electric generator, 150 to 400 amp. transformer, 100-600 amp. gas torches, regulators, hose, wire, goggles, etc., cable. Welding Headquarters, 3425 Milwaukee Ave., Chicago, Ill. 47.

WELDING, Cutting, aircraft welding and soldering equipment. Electric arc welders. Superior Oxy-Acetylene Co., Hamilton, Ohio.

SLIGHTLY Used arc welders. Recommended by R.E.A. Guaranteed. Forney Mfg. Co., Fort Collins, Colo.

MACHINERY, TOOLS AND SUPPLIES

INTERESTED In making your own power drill press, if so—don't miss sending for these plans—easy to make—Low cost, sturdy, illustrations, and price list for special parts included. Send 25 cents. Allankraft, Box 366, Fond du Lac, Wis.

EMPIRE Precision live centers have interchangeable points for various operations. Used by industry throughout nation, these live centers multiply the usefulness of lathes and other metal-working machinery. Write today for literature—no obligation. Atlantic Supply, 71 Spring St., New York City 12.

GEARS For inventors, experimenters, model makers, schools, work shops, laboratories, etc. Government surplus made of brass, bronze, dural, steel and stainless steel. 12 matched pairs; 24 gears, bevel, spur and ratchet. List price \$12.00, our price \$2.50. 25 matched pairs; 50 gears, includes larger gears, also sets of worm gears. List price \$30.00, our price \$5.00. 50 matched pairs; 100 gears better assortment, including internal set and worm sets. List price \$75.00, our price \$10.00. Limited quantity. Order now. Write for our ball bearing catalog. Met Exchange, 323 Canal Street, New York.

PLAN Your postwar workshop now around Lewis mills, shapers, drill presses and other metal and woodworking tools—and save up to 80% of usual cost by completing them yourself. Plain or semi-finished castings furnished with all materials and construction blueprints. Send 10c to cover cost of mailing catalog describing 23 items. Lewis Machine Tool Co., P.O. Box 116, Station A, Dept. M-59, Los Angeles 31, California.

EXPERIMENTERS, Craftsmen, repairmen—400 valuable new springs, 75 kinds, numerous sizes, 10,000 uses, \$2.00. Deluxe assortment, \$3.00. Jumbo, \$5.00. Guaranteed. Technico, Box 248-A, West Hartford, Conn.

SERVICE Men. Gas and oil burner conversion jobs offer you a better paying business. Write Peerless, 4323 Sheridan, Lincoln 6, Neb.

MAKE Circular saw yourself. Prints, information, 25c. L. Bazain, Grand Rapids 3, Mich.

DRILL Grinder for twist drills \$2.95. See ad page 172.

MODEL Builders, experimental shops, manufacturers — 1500 assorted useful standard parts, 130 different items, all items marked; none are mixed. Total cost only \$9.00. Send 10c for detailed list. Albert A. Lohley, Dept. T, Mt. Prospect, Ill.

HIGH Speed drills, taps, milling cutters, end mills, tungsten carbide tipped tool and lathe bits, etc. Reasonable prices. Send for price list. Box 213, Milwaukee 9, Wis.

"SLIP ON" screwdriver handle. Power leverage, thrust, in setting sheet metal or wood screws. Send dollar bill to "Mechanic's Specialty Service," 2101 N. Union Ave., Portland, Ore.

MAIL \$1.98 And we ship parcel post prepaid E. Z. Drill Grinding Attachment for sharpening drills to factory accuracy. De Luxe model with protractor \$2.80. Instant two speed friction clutch counter shaft 300 to 1200 or fast reverse for Logan, Atlas and similar lathes \$49.50. E. Z. Manufacturing Co., Dept. 1, 1709 West Eighth St., Los Angeles 14, California.

BALL Bearing saw or grinding arbor, 3/4 shaft, \$10.00 prepaid. Poly Products, 405 E. Chester Court No. 1, Pasadena 3, California.

BUILD Quickchange gear box for 12" Craftsman, 10" Atlas lathes. Complete drawings, instructions \$3.00. No castings. Stevens Engineering, 2604 Military, Los Angeles 34, Calif.

METALS, Plastics, bearings, machine screws, tools, etc. Everything for machine builders. Catalogue 10c. Metiplas Supply Co., 1420 So. 16th Ave., Maywood, Ill.

ROTARY Vacuum pumps \$60.00, 28" vacuum 3 c.f.m. at 850 r.p.m. William Reid Co., Chicago 14, Ill.

STAINLESS Steel, bar or sheet assortment, ten full pounds \$3.00 prepaid. Industrial Engineering, 1155 S. Kenmore, Los Angeles 6, California.

BLOWERS, Metal blower cabinets, gas burners, oil burners, furnaces. Blower wheels, bearings. Wholesale, retail. Peerless Sales, 4322 Sheridan, Lincoln 6, Nebr.

INDEX Heads for sale. Very inexpensive. Sixty-two different divisions. Used on small lathes, drill press, milling machines, etc. Make gears, hobbs, cutters, etc. Very accurate, and durable. Not a toy. Used by defense schools and hobbyists. Write for free folder. Long's Index Heads, 2117 East B St., Torrington, Wyo.

ENGINES, MOTORS, DYNAMOS

FRACTIONAL Hp. motors, open type, 110 volts a.c., 14 r.p.m., designed for display equipment with six foot rubber cord \$3.45 each. f.o.b. Hoboken. Laikin, 526 Washington Street, Hoboken, New Jersey.

MOTOR Bargain: 12 r.p.m. worm gear reduction a.c. electric motors, new, for revolving displays, toys, hobby, etc. \$15.00 value, \$8.75 each while they last. Quantity discounts. Mack Manufacturing Corporation, Dyersville, Iowa.

SELVYN Motors: 110 volt, 60 cycle, a.c., army surplus. Can be used for remote control, beam antennas, bingo, signaling, wind indicators, many other uses. Light weight, high torque. Original cost \$100.00 pair, our price \$20.00 pair. Guaranteed new, original packing. Write for our new bulletin on rectifiers, horns and government surplus materials. Met Exchange, 333 Canal Street, New York.

BIG Pay jobs in welding. Complete welding lessons and reference books, 516 pages, 41 lessons. \$2.00 copy. Money-back guarantee. Hobartweld, Box 1255-M, Troy, Ohio.

NEW 1/2 H.P. O.E. electric motors \$11.00. Also rebuilt 1/3, 1/4 h.p. \$16.50, \$21.00. A.C. Motors, 3101 N. 32nd St., Philadelphia, Penna.

NEW Kohler electric plants a.c. and d.c. Other electric plants rebuilt. Write E. F. Schmaltz, 314 Wyoming Ave., Kingston, Penna.

150 AMPERE Generator for welding \$47.50. Extra flexible cable, 10 ft. lengths \$2.75. Other bargains. Butler Electric Company, 1885 Milwaukee, Chicago 47.

MODEL Engines, castings, supplies, catalogue, 25c. Howardo, A3, 2417 N. Ashland, Chicago 14.

WINDING Data, listing 225 motors, single and three phase, \$1.00. Motor Data Co., Box 7631, Kansas City 3, Mo.

BOATS, OUTBOARD MOTORS, ETC.

BOATS And all about them. How to select, build, repair and operate. For 40 years the leading practical boating magazine. Trial subscription, 12 issues for \$1.00. Motor Boat, 62 Gold Street, New York 7.

BUILD Your own boat. New easy way at half cost. Blueprints, list of materials and instructions for 12' rowboat \$1, for 16' inboard motor boat \$4, postpaid. J. Boreland, Dept. A, 250 W. 57 St., New York 19, N. Y.

NINE Plywood boat plans 50c. Catalogue boat building plans 10c. The Rudder, 15 Murray Street, New York.

USED Marine motors, propellers, marine fittings, conversion manifolds. Stokes Marine Supply, Coldwater, Michigan.

10' OR 15' Folding Kayak plans \$1.00. Foldcraft, 4015 Oketo, Chicago 34.

MARINE Power - Easily convert any Ford motor (domestic and foreign) with Osco parts and kits. Complete catalogue 25c (coin). Osco Motors Corp., 2020 East Orleans St., Dept. M, Philadelphia 34, Pa.

FULL Size, cut to shape boat patterns, blueprints. 7 1/2 - 38 feet. Illustrated "Build a Boat" catalog, 10c (coin). "How to Build Boats" book, \$1.00. Cleveland Boat Blueprints Co., Dept. A-66, Cleveland, Ohio.

BOAT Designers are highly paid professionals. Complete course by mail. Catalog. Westlawn, Montville, N. J.

ATHLETIC EQUIPMENT-BODY BUILDING COURSES

DEADLY Judo-Piercing fighting technique. Complete course (200 photographs) special \$1.00. Variety House, Box 46-BA, Wall Station, New York City.

DEFEAT A boxer. Secret Ju-Jitsu defense. Complete instructions 25c. Dr. Malcolm Smith, 1104 Union Ave., Montreal 3, Canada.

BAR-BELLS, Exercise equipment. Courses. Special offers! Free booklet. Good Barbell Co., 3261-PM Watson Rd., St. Louis (9), Mo.

SPORTING GOODS, GUNS, FISHING TACKLE, TRAPPING, ETC.

SWAP Guns, or get spot cash! We pay more, sell for less. Large selection of bargains in new and used rifles, shotguns, handguns. Send 25c (refundable with first order) for "guaranteed bargain catalog" and swap list of new and used guns. Klein's Sporting Goods, 503th South Halsted, Chicago 7.

ARCHERS-Write for free folder describing new tool for quick fastening of arrow tips. Hunt-Quin, 1332 E. Wayne, Ft. Wayne 4, Ind.

2800 BARGAINS, Firearms, binoculars, war relics, catalog 30c. Smith Firearms, Runnede, New Jersey.

AMMUNITION Available to qualified purchasers. List 10c. Rudolph's, Atchison, Kansas.

SEND 10c For list 100 used guns. Frayseth's, Willmar, Minnesota.

USED Guns, bought, sold, exchanged. List stamp. Howe Fur Company, Coopers Mills, Maine.

FIELD GLASSES, MICROSCOPES, TELESCOPES, MAGNIFIERS

PORRO Prisms 1 1/2" x 15/16" oval face. Manufactured by world-famous opticians for army and navy 8 x 50 binoculars. Rejected for slightly chipped edges. Outstanding bargain! 30c ea. 4 for \$1.00 postpaid. No c.o.d. Remit with order. Ross, 70 W. Broadway, New York 7, N. Y.

TELESCOPES-Real powerful 17 power telescopes. They make all objects appear 17 times closer. Price only \$3. United Co., 2309-PM Lawrence, Toledo, Ohio.

BUILD Your own reflecting telescope. Complete plan with each kit. Send for free catalog. Mayflor Products, Katonah 1, N. Y.

MAKE Your own efficient compound microscope. Lenses and instructions 50 to 200 power \$2.00. 400 to 800 power \$3.00. Instructions alone 10c. Carl Jamer, Manorville, N. Y.

BINOCULARS, Telescopes, watches. Buy, sell, trade. Paul Schwoer, Donnellson, Iowa.

MAKE Your own powerful, efficient astronomical telescope. Perfect lenses and instructions. 50X \$1.00, 100X \$2.50, 200X \$3.50, 400X \$5.50. Instructions alone 10c. Carl Jamer, Manorville, N. Y.

TELESCOPES, Microscopes, cameras, binoculars: bought, sold, repaired, Lists 10c. Specify instrument wanted. Rasmussen and Reece, 41 Market, Amsterdam, N. Y.

ANTIQUES, RELICS, INDIAN GOODS, CURIOS

MUSEUM Material world variety Indian relic identification chart. Catalogue 25c. Museum Supplies, 6601 Oshkosh, Chicago 31, Illinois.

LARGE Prehistoric Arizona Indian relic collection \$1500.00. Information upon request. Pearl Palmer, 1245 E. Garfield, Phoenix, Arizona.

SEND Twenty-five cents for deed to Goodenough mine and catalog of other Alaska curios and Indian made goods. Alaska Specialty Company, Box PM 1921, Ketchikan, Alaska.

20 ARROWHEADS \$1. Lynn Crandall, Box 697, Idaho Falls, Idaho.

TEN Seashells \$1.00, catalogue 5c. Tim West, 6431 Buford, Houston 12, Texas.

COINS, Minerals, glass, Indian relics. Catalogue 5c. Cowboy Lemley, Las Cruces, New Mexico.

10 FINE Indian arrowheads \$1.00. Catalog. Geo. Holder, Glenwood, Ark.

ANTIQUE Firearms, swords, daggers, powderhorns, Indian relics. Lists free. Antique Shop, 8P South 18th, Philadelphia 3, Penna.

20 ANCIENT Indian arrowheads \$1.00. List free. Lear's, Box 569, Galveston, Tex.

SWORDS, Rapiers, daggers, pistols, armor. Illustrated catalog 25c. Robert Abels, 860-A Lexington Ave., New York.

DOGS, PETS, BIRDS, RABBITS

WILD Geese, ducks, peafowl, pigeons, pheasants. Prices free. Jewell Game Farm, Danville, Ill.

EARN Your living plucking Angoras. House of Angora, Springfield, Illinois.

RAW Furs, rabbit skins wanted. Rabbit Fur Market, 908-M Fremont, Minneapolis 11, Minnesota.

RABBITS, Purebred pedigree. Food, furs, pets. Profitable business. Write Jun-stall Rabbitry, Greenville, N. C.

BUILD Your own rabbit hutch. Simple, inexpensive. Eliminates dirt, diseases. Photos, drawings 50c. River Hill Rabbitry, Box 644, Eagle River, Wis.

PUPPIES! Giant meat rabbits! Animal and bird supplies! What do you need? Details free. "Royal," Chazy, N. Y.

RAISE Moneymaking Angora rabbits. Wool \$15.00 pound. Plenty markets. Cash income. Future prospects bright. Particulars free. White's Rabbitry, Lawrence, Kansas.

RAISE Guinea pigs. Profitable; low cost feeding; small space required; small investment. Literature free. Guinea Pig Farms, 3456 West 116th, Chicago 43.

\$500.00 A YEAR raising canaries. Details free. George Gundrum, LeRoy, Mich.

RAISE Diamond Seal rabbits. \$25 each, continuous market. Price guaranteed. Literature 10c, with hutch plans \$1. Automatic cleaning, watering, feeding. Hansens Rabbitry, 1347 Miller Ave., Salt Lake City 5, Utah.

CHINCHILLA Giants, real. Most profitable. Prolific, easily raised anywhere. Breeders supplied reasonable. Satisfaction guaranteed. Send for free illustrated literature. (Illustrated catalogue, fur samples, 25c). Chin-Chin Farms, Melvin Behrens, Gen-Mgr., Dept. 4, 44 Chester Pike, Darby, Penna.

PIGEONS, Rabbits, 30 varieties. Catalogue 10c. Jim Houck, Tiffin, Ohio.

ST. BERNARD Pups: Champion sired beauties. Franklin Young, R4, Riverhead, Long Island, New York.

TRICKS 'N' Tips-The quick ways to teach your dog simple tricks. Send 25c to Box No. 392, Westfield, New Jersey.

RABBITS: Flemish Giants, New Zealand. Reasonably priced. Franklin Young, Riverhead, Long Island, New York.

RAISE Giant Chinchilla rabbits. Valuable fur. Delicious meat. Easily raised. Pleasant pastime. Large profit. Free booklet shows amazing profits from small investment. Willow Farm, R15C, Sellersville, Penna.

RAISE Guinea pigs. Make money at home. Big demand. Free booklet. Taylors Guinea Pig Farm, Hapeville, Georgia.

STANDARD Rabbit Journal, Milton, Pa. 3 years \$1.00, sample dime.

\$-RAISE Giant Chinchilla rabbits. Willow Farm, R15C, Sellersville, Penna.

A LIVING With rabbits and cavia. Markets waiting. Magazine 10c. Book describing twenty breeds and magazine 25c. Book and magazine (monthly) one year 50c. Address Small Stock, Dept. 2, Pearl River, N. Y.

TRAIN Your dog to do stage and screen tricks. Illustrated booklet 25c. Popular Mechanics Press, (C-43), 200 E. Ontario, Chicago.

FARMS, FARM LANDS, REAL ESTATE

TO Make money: Learn how to buy real estate. Send 25c for "Pointers on How to Make Money." Wm. M. Wells, 103-P No. Ave. 56, Los Angeles 42, Calif.

MISSOURI, Illinois, Florida lands, cheap, easy terms. Closing out. List. Williams Realty, Mt. Vernon, Illinois.

OPEN, Test locks—5 pass keys \$1.00. National Service, 322A Union Ave., Brooklyn 11, N. Y.

STROUT'S Farm catalog—Over thousand bargains—25 states—from Maine to Florida, west to California, Oregon and Washington. Write now for this big 132-page book. Free. Strout Realty, 255-P 4th Ave., New York 10, N. Y. 7 So. Dearborn St., Chicago 3, Ill. 453 So. Spring, Los Angeles 13, Calif.

HOMESITES \$450—Low terms. California's finest garden spot. On Morro Bay's wooded shores. Wonderful fishing, hunting, boating, etc. Fertile soil, soft water, temperate climate, congenial community. Free literature. Richard M. Otto, 6560 Hollywood Blvd., Hollywood 28, Calif.

FREE Catalog, farm bargains, 7 mid-west states. Many fully equipped for convenient quick start. Many pictures. Special service to help you locate quickly, if you state requirements, payment plan and general location desired in first letter. United Farm Agency, 491-MP Arcade Bldg., 1, St. Louis, Mo.

WEST'S Fall catalogue hundreds farm bargains, business opportunities Penna., New York, New Jersey, Ohio, Delaware, Maryland. Free copy. West's Farm Agency, HE, Pittsburgh 16, Penna.

WISCONSIN, Minnesota water frontages \$7 acre. 3505-A So. Hope, Los Angeles 7, Calif.

OZARK Farms, ranches, resorts. List free. Farm Finders, Lonsdale, Arkansas.

\$5.00 MONTHLY Buys 40 acres near town; price \$175.00. Free list. Box 425-P, Carthage, Mo.

OZARKS Guide, Lonsdale, Arkansas. Magazine for homeseekers, sportsmen, year. \$1.00.

GOOD Farms—Ranches, Washington, Minnesota, Montana, Idaho, Oregon, North Dakota. Dependable crops, favorable climate. Write for literature. Lists describing typical farms. Specify which state. J. W. Haw, 119 Northern Pacific Ry., St. Paul 1, Minn.

OZARK Farm bargains, 5 to 5000 acres. Frank, Mountain View, Mo.

POULTRY AND FARM SUPPLIES

PRACTICAL Money-making poultry raising helps from experimental farm for only 25c per year. Five years, \$1.00. Subscribe today! Poultry Tribune, Dept. 19, Mount Morris, Ill.

RAISE Poultry the moneymaking way. Get hidden profits. Make up to \$2500.00 in backyard. Particulars free. White Poultry Service, Box 155, Lawrence, Kansas.

FARM Mechanical book. Useful information on care and operation of tractors, tilling, seeding, haying, harvesting and other farm machinery. \$1.00 postpaid. Wirtson's, West Burlington, Iowa.

YOUR Greatest poultry problem will look simple when you read American Poultry Journal regularly. 500,000 poultrymen do, why not you? 2 years 50c, 5 years \$1.00. American Poultry Journal, 534 South Clark, Chicago.

CHICKS For broilers or layers. Pure breeds, crossbreeds. Write for folder, prices. Amstutz Hatcheries, Box 100, Orrville, Ohio.

KNOW How to raise poultry for profit. Read Northeastern Poultryman. Every issue packed with helpful hints and practical suggestions. Latest articles on breeding, feeding, and management. Read nationally. Subscribe now. 1 year 65c; 2 years \$1.00. Northeastern Poultryman, Dept. M, 376 Boylston St., Boston 16, Mass.

ROTARY Vacuum pumps for milking machines, pump only \$60.00. William Reid Co., 2271 Clybourn, Chicago 14, Ill.

RAISE Turkeys the new way. Write for free information explaining how to make up to \$2000.00 in your own backyard. Address National Turkey Institute, Dept. 3, Columbus, Kansas.

FARM And garden tractors. Complete information on two tractors you can build from auto parts, etc., at small cost, 25c. Popular Mechanics Press, (C-43), 200 E. Ontario, Chicago.

PROFITABLE OCCUPATIONS

SHELL Jewelry, novelties. Easy to make at home as hobby or to sell. Beginners kit \$1.00. Catalog free. Burton, Dept. M-3, Box 27, Station A, St. Petersburg, Fla.

MY Instruction in real estate subdividing based on 40 years experience costs nothing unless I make it earn something for you. From the first lesson I teach you to start small subdivisions in your own town with modest capital. Powers, 6007 Wakehurst, Baltimore 12, Md.

EXCELLENT Projects, make yourself for re-sale. Prints and circulars 25c. Murray, 615 Main St., Latrobe, Penna.

UP To \$5 per day for four hours easy interesting work, no selling or canvassing. Something different. So simple a child can do it. 25c coin brings full details and value in merchandise. Mrs. Nickell, Dept. PM, Rt. 1, Box 456, Bend, Oregon.

MECHANICALLY Inclined men—Own and operate general appliance repair shop. Complete, illustrated course shows you how. Welding, refrigeration, motor repair, how to get business, etc., all phases covered. Free literature. Christy Supply, Dept. 459, 2835 N. Central Ave., Chicago.

IS Independence worth \$1.00? Build picture projectors. Less than \$1.50. Sells anywhere \$20.00. Projects any picture any screen. Complete plans \$1.00. Penner, 61 Ashdale, Toronto, Canada.

NEW PM radio—Springboard to success! Real career in permanent, fascinating work! Men and women learn in one week to operate in aviation, marine, utilities, police, trucks, etc. Send postcard for free data! Topical Emprise Corporation, 1527 Highland Ave., Box 420, Louisville 4, Ky.

\$500.00 YEAR Raising canaries. Ideal business. Instructions book 50c. McGuire, Box 623, Dept.-G, Seattle 11, Wash.

THARS Gold in them thar hills. Panning gold is fun, healthy and profitable. New 160 page beginners book explains modern methods. Book and three large blueprints on small equipment \$3.00. Free literature. Old Prospector, Box 21871, Dutch Flat, Calif.

SOILLESS Gardening. Instructions 50c. Chemicals \$1.00. Gordon, 563 William, Winnipeg, Manitoba.

WELDING Pays. Learn with 1942 trade school text manual. 516 pages. Over 500 photos. \$2.00 copy. Money-back guarantee. Hobartweld, Box M-1253, Troy, Ohio.

WORK For yourself. Start immediately. Stamp brings information. J & R Coin Dealer, 1600 Genesee, Buffalo, N. Y.

BABY Shoes preserved. Complete instructions. Exclusive rights. M. E. Watson, Bellefontaine, Ohio.

MAKE \$300 To \$3000 a year in your back yard in your spare time raising our OWEL meat and fur rabbits. We start you right and teach you how and where to sell. Outdoor War Efforts Industries, Owatonna, Minnesota.

ALARM Clocks easily repaired, adjusted. Instructions 50c. Jones, 1210P Dudley, Utica 3, N. Y.

HAVE An office of your own. Learn collection agency business by correspondence. Many earn \$5000-\$15000 annually. Write for free bulletin. Franklin Publishing Company, Roanoke 7, Virginia, Dept. PM.

PROFITABLE Hobbies and avocations: 10c. Publishers, 710 Gaston, Fairmont, W. Va.

STORY Writing simplified! Don't dream—try! Handsome earnings. Fascinating home study. Circular free. The Segment System, P.O. Box 1504 Central Station, Toledo, Ohio.

LEARN Gagwriting. Particulars and 48 page jokebook 10c. Frankel, 1508 South Homan, Chicago 23.

EARN At home, learn at home. Short, easy course trains you in professional negative retouching. Free booklet. Duval School, Dept. A, 6519 Sunset, Hollywood 46, California.

PAINTING Flagpoles often pays \$50.00 daily. Particulars free. The Skyline Co., P.O. Box 1601 B, Uniontown, Penna.

"FROG Raising." New book tells how. Profitable. Marlboro House, 1635 Marlborough, Detroit 15, Michigan.

TWO Hour a day business plan. No starting capital. Details, P.O. Box 5253, Zone 1, E. Michigan Street Station, Indianapolis, Indiana.

BE Independent! Become associated with us in an essential proven profitable profession. Universal Exterminators, 950 Margate Terrace, Chicago 40, Ill.

GROW Green vegetables in cellar, six days. Sell hotels, grocers. Instructions, seed \$2.00. Temple, Pinnellas Park, Fla.

DOES \$5000 Yearly from your own collection-credit bureau business sound good to you? We've shown others how. Why not you? Write: Cole & Associates, Syracuse, N. Y.

ELECTRIC Clocks are every where you go. Buildings, homes, parking lots, factories. Repairs increasing. Our easy to learn course with pictures and drawings teach you how to repair these clocks. Electronic Supply Co., Dept. A, P.O. Box 2350, Houston 1, Texas.

TYPEWRITER Repairmen urgently needed. Earn \$40 to \$50 weekly spare time. Our easy to learn home study course teaches how to repair typewriters. Write for free information. Houston Typewriter Repair Service, P.O. Box 5357C, Houston, 12, Texas.

\$40.00 WEEKLY Made growing mushrooms, fresh, dried. Dominion patent 331583. Free spawn. North American; 169P Yonge, Toronto, Canada.

TYPEWRITER Repairing—Original course, simplified home study. Weber Typewriter Mechanics School, Box 269, Osborn, Ohio.

MUSHROOMS Grown; boxes, barrels. Instructions 50c. Spawn \$1.00. Gordon, 563 William, Winnipeg, Manitoba.

GOLD-STAMPING. Exceptional post-war opportunity. Free booklet. Home City Specialties, Dept. 1273, Springfield, Massachusetts.

LOCKSMITHING—Profitable business or hobby! New course teaches you how to pick locks, fit keys, de-code, masterkey, etc. Easy self-instruction lessons. Bargain price. Free details. Write—Nelson Company, Dept. 7-02, Chicago 4.

ANNOUNCING Home study course in commercial baking. Practical basic training. Good field for those with aptitude. Nearly depression proof. Send for free booklet, "Opportunities in the Baking Industry." National Baking School, 1315 Michigan Ave., Dept. 3431, Chicago 5, Ill.

BOOKS, PERIODICALS, PICTURES, POSTCARDS

SELF-EXPLAINING Bible: Illustrated circular free. Box 446-P, Minneapolis, Minn.

BUILD Your own fortune! The rules of fortune building are infallible and have been followed by successful men and women ever since the days of ancient Babylon. These rules were not taught to you in school, nor taught to you in college. Building and fortune is explained fully in the book, "If It's Wealth You Desire." Send \$1.00 for a postpaid copy. W. L. Bedard, 3420 Montclair, Detroit 14, Mich.

OUTSTANDING Books! Sample and lists 25c. "Association," Box 2501-P, Los Angeles.

1945 EDITION, Uranium and Atomic Power, DeMent & Dake \$3.98. For description write for our catalogue. Engineers' Book Service, 19 West 44th St., Room 1002, New York 18, N. Y.

WHAT Every Mason wants. We have Masonic books for Blue Lodge, Chapter, Commandery, Scottish Rite and Shrine. Our rituals are used the world over. Send for free catalog of books and rituals for Masons, Odd Fellows, Knights of Columbus, etc. Ezra A. Cook, Publisher, P.O. Box 796-PD, Chicago 90, Ill.

FREE Membership in our Technical Book Club. Current literature, guiding advice on all your book problems, premiums. No obligation. All books: technical, chemistry, homecraft, farming, etc. Free literature, specify subject. Modern Technical Book Co., Dept. 3MMC, 55 West 42nd St., New York 18.

WE Can supply you with almost any book. House of Berbeck, (Book Dealers), Box 2682, Detroit 31, Mich.

ATOMIC Energy! Unique, elementary, partly mathematical, new field theory! Write J. P. Kayne, H517, 4518 Clarendon, Chicago 40, Ill.

64-PAGE Opportunity magazine, 10c. Specialties, Box 503, Lafayette 7, Indiana.

CONCENTRATE. Have anything. Book explains. \$1.00. Booklovers, 28 Cassius Street, New Haven 11, Conn.

8 PHOTOGRAPHS Taken on Kwajalein during Marshalls invasion. \$1.00. Art Bazemore, 213 Tremont, Chattanooga 5, Tenn.

"HISTORY Of World War II," over 1100 page book, \$5.50. Melvin G. Zajas, 2734 Hamburg Turnpike, Lackawanna 18, N. Y.

NATIONAL Geographic Magazines, 1888-1945, any issue. Periodic Service, Dept. PM, Swarthmore, Penna.

MONEY-Making and instruction books. Write. Colin Couch, Elkin, N. C.

PACIFIC War pictures, latest scenes, new series, 11 different packets, each containing 10 actual glossy photographs, 2 1/2" x 3 1/2"—Saipan, Tarawa, Namur, Marshalls, Solomons, Guam, Okinawa, Philippines, etc. 25c single packet. Special: All 11 packets \$2. Postpaid. (Via airmail, send 10c per packet additional.) Satisfaction or money refunded. Lloyds, 1411-DP Northwest 17th, Oklahoma City 6, Oklahoma.

PHOTOGRAPH Battleship Missouri, 10c. Frederick Forman, 868 Lorimer, Brooklyn 22, N. Y.

GET Our books, chock-full of money-making ideas, formulas, information. Literature free. Madison, 290 Ashland Ave., Buffalo 13, N. Y.

MAGAZINE Subscription service. Agents wanted. Sutherland Agency, Ringgold, Va.

BEAUTIFUL Colored pictures. Lists free. No girls. Curtis, Box 1916PM, Denver 1, Colo.

TRADE Magazines. Business, vocational, diversion. Current single copies. Over 200 fields. Free price list. Commercial Engraving Publishing Co., 340 North Ritter, Indianapolis 1, Indiana.

BOOKS. (Out-of-print, new, used) quickly supplied. Many 25c bargains. Catalogue. Mid-West Book Service, 18870 Marx Ave., Detroit 3, Mich.

RARE Out-of-print books located. Bookfinders, 1210N 11th Ter., Birmingham, Ala.

BIG Profits taking subscriptions for all magazines. Agents' confidential catalog listing over 2500 periodicals and complete starting supplies free. Pines Subscription Agency, Flushing, New York.

MAGAZINES (Back dated)—foreign, domestic, arts. Books, booklets, subscriptions, etc. Catalog 10c (refunded). Cicero's, 863 First Ave., New York 17, N. Y.

"100,000 POST-WAR Jobs Abroad"—South America, China, India, Burma, Japan, Russia, Malaya. How, when and where to apply. Post-war U. S. participation in world reconstruction and trade demands thousands of American-trained mechanics, salesmen, technicians, engineers, foremen, laborers and business representatives—every trade needed. Our 15,000-word copyrighted forecast—compiled from business, professional and government sources—lists over 200 big U. S. firms with foreign interests, gives job information, salary brackets, contract tips, application letters, passport information, climatic conditions, etc.—everything needed for your immediate application. \$1.00. Return for refund in 7 days if not satisfied. Pacific Industrial Research Bureau, 262-E Studio Building, Portland 5, Oregon.

A RATIONAL View of Life \$1.00. Benjamin Seibert, Urbana, Ohio.

REBINDING: We bind magazines, old books, Bibles, hymnals. Heckman Bindery, Dept. D, North Manchester, Indiana.

COMPLETE War history. Descriptive folder free. Eugene McLean, Eureka, Cal.

INSTRUCTION 10c Books. Many subjects. "Hawkins," 215 Las Animas, Colorado Springs, Colorado.

GAMES, ENTERTAINMENT

HUNCH! A scientific psychological game, based upon actual hunches. By the inventor of the world-famous game, "Touring." Price 25c postpaid—no stamps. W. J. Roche, Cochran, Penna.

ONE Player pitches, other player bats. Like real baseball. New, scientific. \$2.69 c.o.d. Satisfaction guaranteed. Stroups Parlor Baseball, Tahlequah, Okla.

BE The life of the party. Surprise your friends. Call square dances in French Canadian like it's done in romantic province of Quebec. Full instructions in French and English for only \$1.00. J. Artish, 298 Redempteur, Hull, Que., Canada.

PASCINATING New card game. Free. P.O. Box 842, Denver 1, Colo.

MAGIC TRICKS, PUZZLES, JOKER NOVELTIES

NEW! Simplified card tricks! Amazing self-working bafflers \$1.00 postpaid. James W. Roundtree, 529 Elliott St., River Rouge, Michigan.

NEW! Never before advertised Magic Tricks—mystifying, practical, easy. Be first with new ones. Free circular. Isely's Magic Studio, 1715 Euclid Avenue, Cleveland 15, Ohio.

ENTERTAIN! Mystify! New, bigger magic catalog and 4 secret tricks 25c. Herbert, P-192 N. Clark, Chicago 1.

AUDIENCE-TESTED Magical effects. Free list. Sample trick 25c. House of Magic, 15 Park Row, New York 7, N. Y.

DEALERS! Magic dice box, glass penetration, peek deck, card mastery, etc. at wholesale. Circle Magic Manufacturers, 1661 Broadway, New York.

SLICK Tricks you perform easily. Clever party stunts! Dime brings big magic magazine, lucky piece, catalog. Magic Fun, Box 35A, Irvington 11, N. J.

NOVELTY Business for sale, sacrifice. Johnson, 2406 Anson Road, Dallas, Texas.

JOIN Magicians' Fraternity! Complete details and sample magic magazine. 20c. International Magicians, Mount Morris, Illinois.

AMAZING Tricks with dice. Magical secrets exposed. \$3.00 to W. Hansen, P.O. Box 1746, Dallas, Texas.

MAGIC Envelope 10c. Makes objects disappear. Magic Mart, 1423 Palou, San Francisco 24, Calif.

LOVE Triangle puzzle. New! Intriguing! Fool friends. 25c. Teo, 82 Lancaster Ave., Brooklyn, N. Y.

YEAR'S Cleverest tricks plus personal calendar 25c. Box 333, South Pasadena, Calif.

YOU Can easily astonish, mystify your friends by producing smoke clouds and many other astonishing tricks from empty hands and finger tips, with our new magic. Generous supply for \$1.00. Sem Tem, Box 754, Norwalk, Conn.

WANTED: 4000 Members to join "Mysto Magic Club." Remit \$2.00. Receive trick each month for one year. Magic catalog, book of 102 easy tricks, also 75c cork trick. Don't delay. Howard's Fun Shop, 908 1/2 Travis, Houston 2, Texas.

ESCAPE From any handcuff. Sensational secrets. Twenty-year professional. Book, \$1.00. MarTully, 86 Akron, Westmont 1, N. J.

WORLD'S Largest professional magic shop keeps you in touch with latest tricks. To receive mailings send 25c for new catalog. Holden, 230M W. 42nd St., New York.

25 EASY Card tricks, 10c coin. Victor Jones, Parma, Missouri.

DOUBLETALK. A riot of fun. Learn quickly. Simplified instructions 25c. Illustrated novelty lists included. Cable's Novelty Shop, 3166 W. 25th, Cleveland 9, Ohio.

BECOME Comedian! Free details! Kleinman, 25-31-B 30th Road, Long Island City 2, New York.

TRICKY Match box, it turns around! It stands up! and it opens, most weird uncanny magic novelty trick. Complete ready to do. 25c. The Magician, 2463-M, Kensington Ave., Philadelphia, Penna.

MAGIC: Big 160 page Illustrated Catalog Latest Magic Goods, 25c. For over 1/3 century we have supplied Professional as well as Beginner. Chicago Magic Co., 2300 N. Mason, Chicago 39.

EARN Money in any crowd. Call names of strangers, tell unspoken questions. Professional course mind reading, faked spiritualism, etc., \$1. Henderson, Box 341, San Bernardino, Calif.

SURPRISE, Astonish, thrill, with empty hands, make clouds of smoke appear from fingertips or huge snow flakes float in air also make a five foot ribbon with empty hands, etc. Easy to do with Magic Paste, special 2 tubes enough for 70 tricks \$1.00 postpaid with big magic catalog. The Magician, 2463-M, Kensington Ave., Philadelphia 25, Penna.

ATTRACTIVE Magic kit of 10 tricks (\$2.50 value) \$1.00 postpaid. Kogel's Magic Novelty Co., 6751-A Colbert St., New Orleans 19, La.

LEARN Ventriloquism, 3c stamp brings particulars. Smith, 801 Bigelow, Peoria, Ill.

"MAGIC Vanishing card." Throw it into air, it completely disappears, reproduces it later from spectator's pocket. Easy to do. Complete 25c with magic catalog. The Magician, 2463-C Kensington Ave., Philadelphia 25, Penna.

AMAZE And mystify your friends with highest quality magic. New catalogue 25c coin. Mazda Magic Co., Fond du Lac, Wis.

FREE! Large catalog of magical apparatus if you remit 25c for book "102 Easy Tricks." Robbins Co., 152-P West 42nd Street, New York.

500 TRICKS You can do! Douglas' famous catalog of 500 tricks, now only 10c. America's fastest service on magic for pocket, parlor, stage, professional, amateur. Douglas Magic Shop, Box 274, Dallas, Texas.

VENTRILQUISM. Complete course only \$1. LeSueur, 77 Wellesley, Toronto, Canada.

BE A magician. Large professional magic catalogue of latest tricks 25c. Ireland, C-109 North Dearborn, Chicago 2.

NEW Vanishing key and catalog 25c. Sterling Magic, 345 John R, Detroit, Mich.

MAGIC Tricks, puzzles, books, cards, punch boards. Catalog 10c. Specialty, Box 671, St. Louis 1, Mo.

COINS, TOKENS, CURRENCY

OLD Money wanted. Will pay \$100.00 for 1894 dime, S. mint, \$50.00 for 1913 Liberty head nickel (not buffalo). Big premiums paid for all rare coins. Send 4c for large coin folder. May mean much profit to you. Numismatic Co., 20 Mehl Bldg., Fort Worth, Texas.

OLD Coins, stamps, paper money and documents. Send description for prices. Mathewson's, Jackson, Georgia.

FOREIGN Coin and lists 10c. 20 different coins \$1.00 Odehon, Box 482, St. Louis, Mo.

MILITARY Medals, decorations, enameled orders, coins—bought, sold. Kenneth Lee, Security Bldg., Glendale 3, Calif.

WILL Pay \$10.00 each for certain Lincoln pennies! Indianheads \$50.00; dimes \$1,000.00. Catalogue 10c. Federal Coin Exchange, 11-PM, Columbus, Ohio.

12 WOODEN Nickels \$1.00; set 6 Ringling Brothers circus scrip \$1.00; both \$1.00. Super bargain list 3c. Bebee Coin Company, 1180 East 63rd, Chicago 37, Illinois.

50,000 COINS, Invasion bills, Philippines, China, Netherland Indies, Japan, Confederate currency. Illustrated lists free. Nagy, 83 South 18th, Philadelphia 3, Penna.

JAPANESE Invasion money! Fresh from the Philippines. The kind we'll all be using when Tojo dictates peace in the White House—unusual colors and designs. Medium and large bills 50c; extra large \$1; small notes, 25c. Over Seas Co., Box 190, Los Angeles 53, Calif.

FOREIGN Coins, 15 different \$1.00 postpaid. Stamp for price list. Milford Coin Co., 486 State St., New Haven 10, Conn.

WE Pay from \$2.00 to \$50.00 each for hundreds old, odd coins. Indian and Lincoln cents wanted. Keep all until posted. Send 10 cents for illustrated coin value book 4x6. Buying and selling prices. 40 years in business. Coin Exchange, 5, LeRoy, N. Y.

WORLD Coins, large itemized descriptive list 10c. Harry Elsholtz, Box 9014A, Pittsburgh 24, Pennsylvania.

COMMEMORATIVE \$1/2, Columbus, Stone Mountain, Texas, Cleveland, \$1.50 each. Illustrated catalogue, 25c. Norman Shultz, Salt Lake 8, Utah.

GET Profit and pleasure in collecting old coins. Send 10c for 56-page illustrated coin catalog. You'll be delighted with it. Send for it now. B. Max Mehl, 370 Mehl Bldg., Fort Worth, Texas. Largest rare coin establishment in U. S. Established 45 years.

QUICK Service; reasonable prices. United States catalog 10c. Foreign catalog 10c. Ben's Coin Company, 72 West Washington, Chicago 2, Illinois.

FREE! Foreign coin, banknote and coin collectors illustrated catalog to approval service applicants. Send 3c postage. Tatham Coinco, Springfield-125, Mass.

STAMP COLLECTING

WOW! \$10.00 Worth of fun only 10c. What a treasure hunt! Big package 500 foreign stamps—just as received from foreign missions other sources. Includes stamps from Afghanistan, Africa, South America, Philippines, Dutch Indies, Cape Juby, Palestine, etc., including airmails, commemoratives, and stamps worth up to 50c and 75c. This amazing offer is given for 10c to serious approval applicants only. One to a customer, money back if not more than delighted. Jamestown Stamp Co., Dept. 22, Jamestown, New York. Stamps—valued up to 50c and 75c each.

COLOSSAL! 1500 Mixed stamps. Prize packet catalogued at \$1.50 included. \$1.00. Lists, 25c extra, refunded. Victory Co., Bowler, Wisconsin.

XMAS Shopping problems? Gifts guaranteed to please everyone! Fine United States, all different, 155—30c, 210—\$1, 255—\$2 Richard Cole, 43 Rinewalt, Williamsville, N. Y.

FREE—Stamps of the Orient! Manchukuo, China, Straits-Settlements, Japan, Philippines and many other Far East countries contained in this interesting packet. Free to approval applicants. Send only 5c for mailing. Sherman, Box 92, Brooklyn 29, N. Y.

EXCELLENT Pictorial approvals. Reasonably priced. Crown Stamp Company, Box 331, Toronto, Canada.

RICH Man's approvals, poor man's prices. Grand value packet containing five mint sets, free with approvals. Stoll Stamp Service, 2630B West Burnett, Louisville 10, Kentucky.

PACKET Scarce United States before 1910. Only 10c to approval applicants. E. J. Banks, 6635-16 Ave., Kenosha, Wis.

55 DIFFERENT United States—5c. Approvals. Utechts, 1143 C North Keeler, Chicago 51.

TRIANGLES—(Mozambique Co.) other beauties, 10c. Approvals. Reuter, 611-C West 40th, Los Angeles 37.

FREE Packet with attractive approvals that satisfy. Pearl Field, Derby, Maine.

25 DIFFERENT Guatemala 10c with 1/4, 1/2, 1c approvals. Carroll's, 4357A S. Hoover, Los Angeles 37, Calif.

U. S. Price list. Send postage. Stanley Gibbons, 38-P Park Row, New York.

FREE—Pick 25c worth of stamps from our first U. S. approval selection. Approximately 100 stamps to choose from. Excellent value. No obligation to buy. Lists illustrating the most popular U. S. stamps—at prices you can afford—will be included. Don't miss this opportunity! Write today. S. C. Engel Co., 38 Park Row, New York City.

114 DIFFERENT Stamps from far away countries including airmail and Free Fighting French to approval applicants for 10c. Reich Stamp Co., 4647 Kenmore, Chicago 40, Dept. M9.

COMPLETE "United States" catalog with 1000 illustrations! Send 10c for mailing. Harris & Co., 137 Transit Building, Boston, Mass.

SMOKY Mountain commemorative sheet, largest U. S. stamp issued, and 33 U. S. including commemoratives, airmail, revenues, etc. Catalogs 75c.—To approval applicants for 5c. Curhan Stamp Company, Gloucester, Mass.

U. S. Collection fifty different mint unissued commemoratives 1921-1939 only \$2.00 with your request for approvals. Orange Stamp Company, Albany 7, N. Y.

UNITED STATES approvals complete coverage, fine quality, attractive prices. Seminole Stamps, Box 436, Coconut Grove, Florida.

AMAZING Offer! Assortment each of giant stamps, midjet stamps, flag stamps, airmail stamps, Free French Colonies, U. S. commemoratives and numerous others. Everything only 10c to approval applicants. Simon, Box 214, Iraan, Texas.

60 DIFFERENT U. S., 10c. Pricelist free. Seidenberg, Cassopolis, Mich.

FREE! Western Hemisphere packet. Postage 3c. Owens, 806 Welsh, Bay City, Michigan.

FREE! Pony Express set (facsimiles). Postage 3c. Roberts, 406 Building, Bay City, Michigan.

DEALERS—Wholesale list. Postage 3c. Frank, 5031 Queensberry, Baltimore 15, Md.

FREE! British Empire packet. Postage 3c. Williams, 606 Archer, Bay City, Mich.

FRESHLY Mounted approvals for collectors using Scott's International Junior album. Wiaschim, 55 Nagle Ave., New York 34.

SCARCE 1880 U. S.—Hussey local carrier stamp listed at 15c. Also Costa Rica No. 65 listed at 40c. Both sent free to approval buyers sending 3c postage. Pladon Stamps, 1717-M Idaho, Toledo 5, Ohio.

ZOWIE-E-E! A barrel of fun for only a dime. 500 United States—absolutely un-picked and unsorted—just as received from church missions. Many varieties, including large commemoratives, airmails, high denominations up to \$5.00! Stampdom's biggest package of fun—and you might find something really valuable! Price only 10c to serious approval service applicants. Money back if not delighted. Illustrated bargain lists with each order. Mystic Stamp Company, Department 80, Camden, New York.

WORLD'S Largest diamond and triangle stamps, free stamp magazine, stamps from fighting Free French, 20 stamps from 20 different countries, pictorials, airmails, big bargain 5c with approvals. Capital Stamps, Dept. 2, Little Rock, Ark.

118 DIFFERENT Stamps including commemoratives, charities, airmail sets, etc., only 3c to approval buyers. We buy collections. Badger Stamp Co., Milwaukee 3, Wis.

FREE! Canadian sets, royal visit, George VI, George V, coronation, jubilee, others, to approval applicants. Ensign, Box 118-M, South Orange, N. J.

FREE! The Stamp Finder! Send today for the big new edition, fully illustrated, enabling you instantly to identify all difficult stamps! Also fine packet strange, fascinating stamps from Bosnia-Herzegovina, Monaco, Patiala, Cyprus, etc., including maps, ships, animals and strange scenes. All free to approval applicants including 3c postage. Garcelon Stamp Company, Box 900, Calais, Maine.

CANADA 100 Different 25c—approvals all countries. Lists. Victoria Stamp Co., London, 4, Canada.

FREE! Leeward Is., Cayman Is., Turks and Caicos plus 60 different mint Geo. VI coronation poster stamps, to approval service applicants sending 3c postage. Tatham Stampco, Springfield-30, Mass.

VICTORY Packet free—Includes stamps from Tanganyika, British Cayman Islands, animal, scarce babyhead, coronation, early Victorian, airmail, map stamps, with big catalogue—all free. Send 5c for postage. Gray Stamp Company, Dept. PM, Toronto, Canada.

HOBBIES AND COLLECTIONS

BEAUTIFUL Flowered agate for collections or jewelry, sample \$5.00. Paul N. Barker, Midway, Wash.

FOOL'S Gold—From famous gold camp, 10c per sample. Also mineral specimens from famous local mines. Martin's Snap Shop, 506 Harrison Ave., Leadville, Colo.

"GENUINE" Arizona "rubies" (garnets). Send quarter for packet. Mineral Specimens, Box 2651, Phoenix, Arizona.

JAPANESE Surrender document, complete with signatures, seal of the Empire. Japanese text with English translations. Original size. Photocoped. \$2.50. Scholier, 507 E. Street N.W., Washington, D. C.

FOREIGN Military insignias: Sample; prices. Send 15c. Hobbyguld, P33 West 32nd St., New York, N. Y.

MEXICAN Semi-precious stones—amethysts, opal, turquoise. Sample box \$3.00 and \$5.00. (Refundable). Biel Continent Union, Apartado 2887, Mexico City.

COLLECTING Hobbyists. Exchange duplicates. List free. C. Bishop, Route 8, Kalamazoo 88, Michigan.

WHITTLES—20 Patterns, instructions, X-acto knife, wood. \$1.00. "Old Whittler," 1402 Charles, LaCrosse, Wis.

FOREIGN Decoration ribbons, list, sample, 20c. Foreign insignia packet, booklet, \$1.00. Insigniacrafts, 236-28th Ave. N.W., Calgary, Canada.

EXCHANGE Duplicates. Swappers everywhere. List free. Box 2168, Denver 1, Colorado.

UNUSED Match book covers, 100 all different \$1.00. 35 Royal Flash covers \$1.00. Free list. Charles Edelman, 1311C East 84, Cleveland 3, Ohio.

JEWELRY Stones removed from rings, etc., 100 assorted \$2.40; 50 large ones \$2.40. B. Lowe, Holland Bldg., St. Louis 1, Mo.

COLLECT Colorful army patches. Latest picture book and catalogue only 15c. Insignia Mart, 703 Broadway, New York

CAMERAS AND PHOTO SUPPLIES

CUT Film or plate camera owners: Enjoy using smaller sizes of cut film, when desired. Free details. Wodart Company, WS, Bridgewater, Mass.

CAMERAS, New takes Eastman standard black and white and colored film. Wonderful gift item. \$4.44 includes federal tax. Pabsch Co., Box 603, G.P.O., New York, New York.

HIGH Speed flash tubes at new low prices. Write for information on tubes. Mimeographed booklet on high speed photography including several circuit diagrams with descriptions and a bibliography. \$1.00 postpaid. Strobo Research, 2244 N. 45th St., Milwaukee 8, Wis.

COPY Anything at low cost! Fotoflex System, Box 181, Cincinnati 1, Ohio.

PHOTOGRAPHY For pleasure or profit. Learn at home. Practical basic training. Long established school. Write for booklet. American School of Photography, 1315 Michigan, Dept. 3431, Chicago 5.

ENLARGERS—Build your own. Kit of parts, \$8.00. Free particulars. Crescent Engineering, Box 251-P, South Pasadena, California.

HAVE You a camera? Improve your hobby of photography and learn how to make better pictures. Write today for our latest book catalog and sample copy of American Photography, containing articles and pictures by the world's foremost writers and photographers. Camera House, 601, 353 Newbury St., Boston 15, Mass.

AVAILABLE Film, flash bulbs, equipment, etc. Sheridan Radio and Camera Company, 6810 Sheridan Road, Chicago, Illinois.

USED Camera bargains—Flash Brownie \$1.50, Vest Pocket Kodak Special \$5.00, Graflex \$20.00, 5x7 View \$10.00, No. 828 color camera \$4.48, enlarger \$15.00, movie camera \$5.00, 16 mm. projectors \$5.00, \$8.00. Portrait lens \$5.00. Hundreds of others—35mm. Argus, Leica Contax—Rolleiflex—Roll film, enlarging, contact paper. Send 25c for latest list and descriptions. Used Camera Directory, Box 1631-M Canton, Ohio.

BASS Says: War time proves Bass leadership. Amazing selection of finest still cameras—Leica, Contax, new and used still available. Write for quotations. Satisfaction guaranteed or your money refunded. Bass buys 'em, sells 'em, trades 'em. 35c postpaid for 100 page book "Military & News Photography" by Jack Price. Up to the minute information. Bass Camera Company, Dept. AG, 179 W. Madison St., Chicago, Illinois.

OIL Coloring photographs can be a fascinating hobby or profitable sideline for those with artistic talent. Learn at home. Easy simplified method. Send for free booklet. National Photo Coloring School, 1315 Michigan, Dept. 3431, Chicago 5, Ill.

CASH! Spot cash for cameras, lenses, binoculars, movie or still, sound projectors. Send full description by mail, or wire for prompt cash offer. Over 30 years of dependability insures honorable dealings. 35c postpaid for 100 page book "Military & News Photography" by Jack Price. Up to the minute information. Bass Camera Company, 179 West Madison Street, Chicago, Illinois.

PHOTO FINISHING

ROLLS Developed, 8 prints 20c; 16 prints 35c. Reprints 4c; 10 for 35c; 35 for \$1.00. Overnight Studio, 146 Elm, Albany, Wis.

WE Have fresh films. Roll developed coupon for six 5x7 enlargements, 16 prints 25c. Reprints 3c. 35 mm. 36—3 1/2 x 4 1/2 prints \$1. New film \$1. Dick's Photo, Louisville, Ky.

FOR Snapshot film, all sizes, 127 to 116, at popular prices and better photo finishing, write Universal Photo Service, Box 612-AL, LaCrosse, Wisconsin.

PHOTO Copies made from any picture. Finest workmanship and materials. 5x7 size 50c. Original returned unharmed. Artcraft Studios, 906 East 14th Street, Oakland 6, California.

MONEY Back guarantee. 16 sparkling double clear Nu-Art prints, also 2 enamel finish enlargements. All complete 25c. Rolls or negatives. Prompt, careful, guaranteed. Lifetone Studios, Department 1239, Des Moines 8, Iowa.

BEAUTIFUL Enlargements. 4x6, 10c. 5x7, 15c. 8x10, 25c. Any size negative. Reprints, 3c. Prompt service. Imperial Foto, 122 Sharon, Glendale, Ohio.

BEAUTIFUL Oil colored enlargements. Your negatives: 8x10, \$2.00; 11x14, \$2.50. From photo 50c extra. Specify colors. Haynescraft, 706 8th, Washington 1, D. C.

NOW! Glossy photo finishing in gorgeous colors. Any 6-8 exposure roll 35c (coin). Colorcraft, Avoca, N. Y.

PERMANENT Oil hand-colored enlargements. Satisfaction or money back. 5x7—\$1.25; 8x10—\$2.00. Send negatives. Marlon Studio, Box 24, New York 34, N. Y.

BEAUTIFUL Oil hand tinted by expert. Enlargements from any favorite photograph, finest quality double weight paper, in mount to match. 5x7 inch \$1.50; 8x10 inch \$2.00. State colors. Original returned. Reprints 3c each. Home Studio, Wadsworth, Kans.

\$1.50 SPECIAL. 35 mm. 36 exposure roll finegrains developed. 3 beautiful 3x4 high gloss prints, 3 5/8 x 7", 1 8" x 10" enlargement from 4 best negatives a 1/3 exposure reload. Beautiful color prints from 35 mm. Kodachrome, 3x4 prints 75c each, minimum order \$1.50. Brown Color Labs, Box 214, Lansing 2, Mich.

2 BEAUTIFUL Hi-Gloss prints each good negative and enlarging coupon with each 6 or 8 exposure roll developed 25c. Owlphoto Co., Weatherford, Oklahoma.

18 BEAUTIFUL Deckledge Christmas cards made from your negatives \$1.00 including envelopes. Kodak films developed two deckledge prints of each negative 25c. Velox deckledge guaranteed reprints 2c each. Summers Studio, Unionville, Mo.

2 BEAUTIFUL Hi-Gloss prints each good negative and enlarging coupon with each 6 or 8 exposure roll developed 25c. Owlphoto Co., Weatherford, Oklahoma.

18 BEAUTIFUL Deckledge Christmas cards made from your negatives \$1.00 including envelopes. Kodak films developed two deckledge prints of each negative 25c. Velox deckledge guaranteed reprints 2c each. Summers Studio, Unionville, Mo.

Copyrighted material
DECEMBER 1945 **55A**

8 EXPOSURE Rolls 25c, over 8 exposure 40c, for one Velox print each and free enlargement coupon. Reprints 3c, minimum 25c. Fred D. Eastman, Bode, Iowa.

RETOUCHED Oil colored enlargements from negative or print. 5x7, \$2.50; 8x10, \$3.50. Specify corrections and colors. Arden Studios, Franklin Park, Illinois.

6-8 EXPOSURE Rolls developed and enlarged mammoth size 30c. Reprints 3c. Thrifty Photos, Box 46, South Gate, Calif.

CENTURY Delivers work and service that can't be beat. 8 exp. roll 25c with two professional enlargements free. Century Photo Service, LaCrosse, Wis.

ROLLS Developed and printed 25c. Reprints 2c; 5x7 enlargements, 15c; 8x10, 25c. Davis Studio, Guthrie, Okla.

SPECIAL—25 Reprints 50c. Suburban Studio, 1408-M Bond, Rockford, Illinois.

TECHNIFINISH 35mm. 36 exposure rolls, fine grain developed and beautifully enlarged to 3"x4" high gloss prints only 90c; 13 exposure rolls 59c. Credit given for non-printing negatives. Reprints only 90c for 36, 59c for 13. Reprints of selected frames from uncut rolls 4c each. Reloads for your empty cartridges: 36 exposure reloads 35c, 18 exposure reloads 20c. Fresh stock. Technifinish color prints 8"x10" from your 35mm. Kodachromes or 35mm. area of larger transparencies only \$3.00 in distinctive mounts; \$1.50 for additional prints from the same transparency. Black-and-white positives from your 35mm. negatives for your projector: 36 exposure positives 50c, 18 exposure 35c. Write for free mailing bag, sample print and complete information. Technifinish, Dept. 112, Rochester 3, New York.

FINER Finishing specials 25c. Eight exposure rolls developed with two prints of each or one enlarged print of each negative. Genuine nationally known Moentone Enamel finish. Superior quality since 1898. Moen Photo Service, 452 Moen Bldg., LaCrosse, Wis.

8 PRINTS. All enlarged to nearly postcard size, from your roll or negative, 25c. Willard Studios, Box 3535A, Cleveland 18, Ohio.

AT Last! Roll developed, all your snapshots hand-colored as beautiful as most actual colored photography 35c. Hand colored reprints 4c each—12 for 45c. National Photo Art Company, Janesville 26, Wis.

SENSATIONAL Introductory offer! Send snapshot or negative, this ad, and 3c. We'll send you a beautiful 7"x5" enlargement! Or, Kodak roll developed with 16 guaranteed deckle-edge velox fade-proof prints or 8 double-size prints, 25c! Special! From your negatives, 16 regular-size or 8 double-size reprints, 25c! Candid rolls—36 exp. 35mm. developed, vapo-rated, enlarged to 3x4, \$1.00! 18 exp. 50c. Reprints, 3x4, 3c each. We have new, perfect 35mm. film, low prices. Free mailers, details on request. American Studios, Dept. 279, LaCrosse, Wis.

OIL Coloring photographs can be a fascinating hobby or profitable sideline for those with artistic talent. Learn at home. Easy simplified method. Send for free booklet. National Photo Coloring School, 1315 Michigan, Dept. 344-A, Chicago 5, Ill.

BIGGEST \$1.00 Value in 35 mm. finishing today. 36 exposure fine grain 3 1/2 x 4 1/2 enlargements; deckled, embossed margin and date. Eighteen exposures 75c; 16 exposure splits 55c; 36 exposure reloads 50c. Special: return this ad with \$2.00 and we will send five 36 exposure reloads. Free mailers. 8 exposure rolls in beautiful, deckled contact finish with embossed wide margin, 25c. Mailbag Film Service, Box 5440A, Chicago 80.

PHOTOGRAPHY For pleasure or profit. Learn at home. Practical basic training. Long established school. Write for booklet. American School of Photography, 1315 Michigan, Dept. 3452, Chicago 5.

BEAUTIFUL Double-size pictures 31c each, from 116 and 120 negatives, 3 1/2 x 4 1/2 from all other sizes. All work guaranteed. Overnight service. Roll developed and 8 pictures 30c. Roll 12 pictures 45c. Roll 16 pictures 60c. Enlargements on double weight portrait paper 5x7—30c, 8x10—50c. Copies made from any picture 75c. Pacific Photo Service, Box 666, San Francisco, Calif.

EVERY Picture an enlargement! 8 sparkling deckle-edge enlargements and roll developed 25c coin; 116 size or smaller; enlarge reprints 3c. Enlarge Photo, Box 791D, Boston, Mass.

PHOTO Guide—Best of Popular Mechanics Magazine articles on photography reprinted in 168 page book \$1.25. Popular Mechanics Press, (C-43), 200 E. Ontario, Chicago.

MOTION PICTURES AND SOUND EQUIPMENT

PROJECTORS 35mm. sound, film. Nuss-lock, 4614 Green Tree, Milwaukee 9, Wis. 16MM. Bell Howell, Victor, Ampro, sound projectors. Delivery now. Dime brings catalog. Movico, Box 482, Ithaca, N. Y.

\$1 BRINGS "Surprise" assortment 8-mm. colorful titles! Guaranteed. LeMoine Films, Nevada, Missouri.

FREE, Year subscription offer. Amateur Screen News, 3021A Narragansett, Chicago.

RELIGIOUS New sound prints only. Screenart, 723 - 7th Ave., New York.

8MM. Movies bought, sold, exchanged. List free. Mail Values, Woodbury, Conn.

35MM. Sound films, sold, traded. Rogers, Box 26, East Atlanta, Georgia.

NEW 16mm. motor driven projectors, \$13.50; hand-cranked projectors, \$10.50. 100-ft. films, \$2.00. "Future Admirals," "Oyster Fleet," one reel sound, \$17.50, silent version, \$8.75. Oriole Film Company, Box 942, Baltimore 3, Maryland.

TAKE Your Christmas movies indoors. 100' 16 mm. \$4.25. 100' outdoor 16 mm. \$2.25. Ambassador, 479-A Quincy Street, Brooklyn, N. Y.

FILM; Free processing, 25 ft. Double 88 Weston 6, \$1.35; Weston 24, \$1.80; Weston 64, \$1.99. 100 ft. 16mm. Weston 6, \$2.50; Weston 24, \$4.85; Weston 64, \$4.95. Write for circular. Fromader Genera, Davenport 7, Iowa.

FILM Library of latest news, sports, travel, and comedies, with free borrowing privilege to our members. Home Movies Club, 2105 Irving, Denver 11, Colo.

35MM. Sound features, projectors. A Savarese, Woodcliff Lake, New Jersey.

UNUSUAL—Entertaining home movies—Travel, comedy, adventure, sports, news, Christmas subjects, many film bargains. Big 1945 catalog and sample, dime. Audet, Box 6520-BG, Philadelphia 38, Penna.

SENSATIONAL Full color movie subjects! 8mm., 16mm. Big catalog, 25c. Special! Projection length sample scenes (Kodachrome), "Waikiki Hula," \$1.00. Specify width. Iriscope kits, \$5.00. World in Color Productions, Box 392-P, Elmira, N. Y.

HOME Movie rentals, sales, exchange. 8-16mm. and sound. Latest releases—Money-saving rates. Details for stamp. Midland Film Exchange, Box 429, Oak Park 4, Illinois.

FREE. Movie film catalog; samples 10c. Goodwill Company, Jackson, Tennessee.

RENT 16 MM. sound films 50c reel. Large selection; free catalog. Film Service, 128 Chestnut Street, Roselle Park, N. J.

BEAUTIFUL Kodachrome slide and list, 25c. Art Slide Co., M-1, Canton, Ohio.

"THE World's Greatest Passion Play" all sizes sound and silent. Write Hemenway Film, 33-F Melrose St., Boston 16, Mass.

LEARN Movie projection, management. Free catalog. Theatre Institute, Elmira, N. Y.

BUY, Sell, trade 35mm., 16mm., 8mm. Samples 10c. Lists free. Paramount Films, Monmouth, Illinois.

GUARANTEED Fresh movie film! Three spools double 8mm. \$3.45! Six spools single 8mm. for Univex cameras, \$3.50! (Limit six spools each type.) Processing free! Will ship C.O.D. on \$1.00 deposit. State make of camera. Eco-S, 4038 Broadway, Kansas City 2, Missouri.

MOVIE Camera films, 100' 16mm. \$2.50. 25' double 8mm. \$1.25. Free developing. Better Films, 742 New Lots, Brooklyn 7, N. Y.

MOVIE Projectors bought and sold. List 10c. United, 2309-A Lawrence, Toledo, O.

I BUY, Sell, swap, rent s.o.f., 8 and 16mm. films. List free. Harvey Iris, Box 539, Brockton, Mass.

SEND Stamp for 16mm., 8mm. catalogue. Sterling's, 679 Northampton, Easton, Pennsylvania.

BASS Says: Leadership in the cine field is apparent in war times. Here ready—your choice of 8 mm. and 16 mm. apparatus. Write for quotations. Your old equipment is worth real money in trade—describe please. Or we buy for cash and pay immediately on receipt. Write to headquarters. Bass buys 'em, sells 'em, trades 'em. Satisfaction guaranteed or your money refunded. 35c postpaid for 100 page book "Military & News Photography" by Jack Price. Up to the minute information. Bass Camera Company, Dept. A, 179 W. Madison St., Chicago, Illinois.

SPECIAL Movie film, 8mm., 25 feet double-Weston 8, \$2.00. Super double X, Pan indoor 60, outdoor 100, 16 mm.—\$6.50. Super X Pan indoor 24, outdoor 50, \$5.75. Pan Weston 12, \$5.00, 16 mm. 100 feet Weston 6, \$4.00. Free developing. Exhibitors Film Exchange, 630 9th Ave., New York 19, N. Y.

MUSIC AND MUSICAL INSTRUMENTS

HAWAIIAN Guitar orchestrations. List on request. Complete course \$1.50. Hula folio 50c. Golden Gate Publications, 5472 Foothill, Oakland 1, California.

ACCORDIONS: All sizes and makes. Wholesale prices. Free catalogue. American Accordion Center, 39 S. Kedzie, Chicago 3, Ill.

PIANO Action regulating and repairing. Men or women. Learn to regulate and repair your own piano. Write today. Hal Davis, 1680 Crawford Rd., Cleveland 3, O.

ACCORDIONS—Special Christmas discount. Dealers prices. New or used. All sizes and makes. Free catalog. Buy now! Metro Accordion Co., 31 South Cicero, Chicago.

MAKE Money. Play guitar in orchestra. Spanish or Hawaiian. Ten lessons will start you playing. One dollar. Frank's Musicians Supply, 732 Jersey Ct., San Diego 8, Calif.

SONGWRITERS—Topnotch collaboration offer. Send best immediately. John Meyer, Sheboygan 12, Wis.

THE Complete Songwriter. \$2.00 M.O. postpaid. Learn to write music, words, arrangement and publishing—96 page book. Write for publication offer free. Puritan Publishing Co., Dept. APM, 343 So. Dearborn St., Chicago 4, Ill.

SONGWRITERS! Outstanding, amazing offer. Hibbler, CS, 2157 N. Avers, Chicago.

SONGWRITERS. A limited amount of musical compositions wanted for radio distribution. Tin Pan Alley Publications, 1587 Broadway, New York 19, N. Y.

ATTENTION: Harmonicas \$2, \$3, \$5, \$7.75, \$9.75 each. Guitars: free list. Musician's Shop, 2 E. Centre Street, Baltimore 2, Md.

SONGWRITERS. Words set to music. Printed copies. Composers Co-op. Assn., 1358 Greenleaf, Chicago.

POPULARIZE Your songs so you can bargain with song publishers regarding royalties. Seven effective ways to plug songs, 25c. Box 504, Burbank, California.

SONG Poems wanted—All subjects. Before sending poems, get the inside facts in our free booklet "Getting Ahead in Songwriting." Write today. Song Service, 331-C West 46th, New York.

ATTENTION! Amateur song writers. "Let your song ideas make your dreams come true." Expert arranging. Free information. Grant MacGregor (Hollywood Composer), 5079 Lemon Grove Ave., Hollywood 27, California.

POEMS Wanted for musical setting. Send poem for immediate consideration and free rhyming dictionary. Richard Brothers, 24 Woods Building, Chicago.

POEMS Wanted! I'll compose special music. Send poem for free examination. Eliot Wright, Box 3861-Z, Portland 8, Ore.

SONGWRITERS! Music for your poem. Billy Hannon, 6703 Oshkosh, Chicago 31.

PHONOGRAPH Records: Send us \$2.00, we will ship you 10 used phonograph "juke box records"—all different. Satisfaction guaranteed! Automatic Sales, 36 E. Hennepin, Minneapolis 1, Minn.

HAWAIIAN Guitar chord chart \$1.00. Over 630 chords in A Major—C Sharp Minor E-7th and B-11th tuning. Arranged by Sol Hoopii and Dick McIntire in note and diagram. Fator's, 935 W. Santa Barbara Ave., Los Angeles 37, Calif.

NEW Songs and lyrics wanted for popular radio program and professional promotion. Free examination. Transradio Music, Inc., Dept. P, 1650 Broadway, New York (Affiliate of B.M.I.)

SONGS Arranged and scored. Melodies composed for lyrics. Workmanship guaranteed. Write for particulars. Tommy Kilbourne, Box 1253, Bakersfield, Calif.

GUITARS. Band instruments, bought, sold. Free list. Rudolph's, Atchison, Kan.

POPULAR Piano in 12 lessons. Positively guaranteed, beginners or advanced. Get copies of hit parade tunes free with the course. Kelly School, 1734 30th Ave., San Francisco 22, Calif.

SONGWRITERS—Send poems for immediate examination and free book. "Your Future in Songwriting." Radio City Music Academy, 1674 Broadway, New York City 19.

WANTED! Lyrics, melodies for songs. We arrange, publish, sell. Superior Song Studios, Passaic, N. J.

ACCORDIONS. New and used at wholesale prices. Save up to \$100.00. Buy direct from factory. Del Principe, 307 So. Wabash, Chicago.

BEFORE Sending your poem to be set to music, know your composer. Free folder. Al Moquin, 5333 La Cresta Court, Hollywood 38, Calif.

MUSIC Arranged. Songs published. Frank Wildt, Music Publisher, Lancaster, Pennsylvania.

PLAY Swing piano! Send 10c for instruction bulletin. Christensen Studios, 751 Kimball Hall, Chicago 4, Ill.

POEMS Wanted for musical setting. Send poem for immediate consideration. Five Star Music Masters, 630 Beacon Building, Boston.

SONG Poems wanted. Free examination. McNeil, Master of Music, 510-PM South Alexandria, Los Angeles, Calif.

WRITE Songs. Big money and reputation. Write for information. J. Gordon Pub Co., 201 N. Hoyle Ave., Chicago.

RADIOS AND SUPPLIES

HEAD Phones; latest type, light weight, finest quality, adaptable for use in making crystal sets. Slightly used sets without head bands \$1.25. With leather covered adjustable head bands \$2.50. New sets without head bands \$1.75. New sets with leather covered adjustable head bands and rubber covers \$3.75. Add 25c for mailing, send check or money order—quantity limited. Department C, Nico Supply Co., 540 N. 17th St., Philadelphia 30, Penna.

BUILD Your own radio. Simple instructions. All kits complete including tubes. 4 tube T.R.F.—\$10.75. 5 tube Superheterodyne—\$17.95. National Radio Distributors, 140-M West 42nd Street, New York 18, N. Y.

YOUR New free catalog is ready! Radionic's catalog lists hard-to-get radio parts and books. All available for immediate shipment. Send today to: Radionic Equipment Co., Dept. 12D; 170 Nassau St., New York 7, N. Y.

PORTABLE Electric record player. Easy to make. Detailed plans 50c. Radio, 1545 Adams, Denver 6, Colorado.

TEN. Simple, easy to build crystal radio diagrams and crystal 25c postpaid. Potter, 1314 McGee, Kansas City 6, Mo.

BEGINNERS Radio repair booklet 25c. Radio, Box 311-Y, Benton Harbor, Mich.

REVISED Plans 18 long distance crystal sets, including "Radiobuilder"—25c. Laboratories, Box I-C, San Carlos 16, Calif.

FM Can now be heard on old radios! Very simple adaptor! Send postcard for free data! Topical Empire Corporation, 1527 Highland, Box 42, Louisville 4, Ky.

POSTCARD Size novelty radio! Complete plans, 25c. Harris, 2015 - 74th St., Brooklyn 4, N. Y.

SALVAGED. Precision wire wound resistors, assorted 5 \$1.00. Aircraft direct current meters dual type, convertible to volt-ampere meters \$2.95 c.o.d. add postage charges. Root, 2139 Addison, Houston 5, Texas.

CRYSTAL Frequency control units. All kinds, including 1000 kc. calibrating crystals. Also blanks. High quality. Low price. Prompt delivery. Standard Piezo Company, Box 164, Carlisle, Penna.

RADIOS. Farm and electric. Tubes, batteries, elec. irons. Retail O.P.A. prices. Belmont Sales, 440 Common St., Belmont 78, Mass.

BUILD Radio. Complete kit with tubes \$10.95. Details. Radio, 9418e Avenue "A", Brooklyn, N. Y.

BUILD Latest, extra-loud crystal set. Instructions, 20c. Booklet: "All About Crystals Sets." 45c. Amorose, R-4, Hungary Road, Richmond, Virginia.

HEADSETS. Finest quality, complete with headband, cord and plug. Adaptable for use with crystal or other type radios \$2.50 per pair. Shipping charges 25c extra. Arnold Radio, Middletown, Penna.

TELEVISION: Oscilloscopes. New RCA 5BP4 factory sealed \$18.00. Others; also television parts. Send 25c for list including Schematics RCA, GE, Andrea television sets. Electronics Service Supply, 294 W. 40th, New York City.

RADIO Tubes, parts, condensers. Free bargain lists. Potter, 1314 McGee, Kansas City, Mo.

RADIO Service men and experimenters send stamp for our giant radio catalogue. Save dollars. United Radio Co., (1000-V) Newark 1, N. J.

RADIO Service flat rate schedules solve pricing problems. Compiled from 20 years experience. Write for information. Radio Equipment Co., 1415 W. Franklin Ave., Minneapolis 5, Minn.

EXPERIMENTER'S Dream! Large assortment, coils, condensers, transformers, resistors, etc. \$25.00 value while they last \$3.98. Marko Supply, 2924 Logan Blvd., Chicago 47, Ill.

FAMOUS Razor blade radio! Illustrated plans 35c. New Radio, Lohrville, Iowa.

RADIO Technician and radio service courses. Training for federal licenses. American Radio Institute, 101 W. 63 St., New York City. Approved under G. I. Bill of Rights.

MAKE Simple, tubeless, batteryless, distance-getting crystal radios. Crystal and illustrated instructions 25c postpaid. Allen, P-427, Clinton, Missouri.

BUSINESS OPPORTUNITIES

START Home business making statuary, plaques, novelties, garden furniture, artificial marble flooring, liquid marble. Make your own flexible molds. Amazing profits. Folder free. Creative Publishers, Box 236-L, Winnetka, Illinois.

MECHANICALLY Inclined men — Own and operate general appliance repair shop. Complete, illustrated course shows you how. Welding, refrigeration, motor repair, how to get business, etc., all phases covered. Free literature. Christy Supply, Dept. 159, 2835 N. Central Ave., Chicago.

BUILD Neon signs and neon lighting. Easy to learn. Very small capital required. McMaster Sign Co., 730 State St., Bellingham, Wash.

ESTABLISH Yourself in profitable mail order business of your own. Free descriptive literature. Church, 814 North 24th Street, Billings, Montana.

START Toy factory making wooden trucks and trailers from plans designed by retired toy manufacturer. Complete plans \$3.50. Mr. Little, 22 Helicopter Dr., Baltimore 20, Maryland.

MAKE Flexible Molds. Statuary, Art Goods, Novelties, Artificial Marble Flooring, Liquid Marble. Literature free. Kemico, Park Ridge (12-M), Ill.

MONEY-MAKING Opportunity. Free literature. Readers' Service, 654 Peoples Building, Charleston, S. C.

MAKE \$10 To \$20 a day, or more, selling History World War II, J. Henfy Schlake, Box 813, Cincinnati 1, Ohio.

WE Start you in business, at home, sparetime, earning \$10-\$30 weekly selling by mail. Stamp appreciated but not necessary. Driscoll Sales Service, Box 2771-A, Denver, Colo.

MAKE Money by mail. Successful plan. No capital needed, no loans, sure profits. Particulars free! Specialties, Box 503, Lafayette 9, Indiana.

START Profitable home business now; capitalize spare time; free details. Manhattan House, 126 Lexington Avenue, New York 16.

IDEAS For starting to choose your own business, write to Dranichak & King, P.O. Box 310, Binghamton, New York.

ELECTRICAL Appliance repair. Open your own shop. Learn house wiring; electric motors, vacuum cleaners, washers, etc. Complete illustrated course shows how. Free booklet. Pacific Training School, Dept. AP-12, 4703 West Pico, Los Angeles 6.

FREE Valuable money-making self-help books. For particulars write, Mae Specialties Company, P.O. Box 23, Station L, New York 35, New York.

25,000 ENEMY Patents, now available for manufacture, royalty-free. 290 classifications. Particulars free. Patent Service Company, Saint Cloud 11, Minnesota.

STARTING Your own business? Write about opportunities. Details free. Jackson, Newcomb & Jackson Co., Dept. H, 115 State St., Springfield, Mass.

MAKE Soap at home. No machinery. Profitable. Literature free. Kemico, Park Ridge (SM-12), Ill.

PREPARE Now to start own business making Venetian blinds. Splendid prospects. Illustrated instruction book \$1.00. Elwert, 6900 North Ashland, Chicago 26.

ESTABLISH Yourself in profitable mail order business of your own. Free descriptive literature. Church, 814 N. 24th St., Billings, Montana.

IF You'd like to make \$5,000 annually or better, in an easily learned office business of your own, send for free details immediately. G. H. Cole, Pres., Syracuse 2, N. Y.

MAIL Order—Quick! While they last. Screwball book about mail order business. Serious advice. By greatest mail order experimenter of all time. \$1.00 till gone. Does you good. More'n dollar's worth, guaranteed. Rush order. Houston Maupin, Tipp City 2, Ohio.

SIX Leading mail order magazines 25c. Latest issues, all different. Kraft Publications, 3114-S1 Walnut, Chicago 12, Ill.

PANNING Gold—Vacation expenses—Occupation. New 160 page beginners book and three large blueprints—modern equipment \$3.00. Free literature. Old Prospector, Box 21864, Dutch Flat, Calif.

HOW To start your own business. Write Successful Income Builders, Hollywood 28, California.

PLASTICS Guide—Listing dealers in materials, molds, machines, equipment, accessories, supplies \$1. Plastics Digest, 3937P Tracy, Kansas City 4, Mo.

WANT To make \$100.00 weekly? No fool-in. Details and 64 page booklet of valuable moneymaking information that can mean immediate cash and your future independence. 25c postpaid. Write today, now. Wilkin, 1348-PM N. High, Hillsboro, Ohio.

WANT To start your own business? Here's some darned good common sense by experienced, nationally known business counselors in a cloth bound book of 240 pages. Tells how to take every step in choosing, locating, financing and operating your own business on little capital. Only \$3 postpaid. Landseire Service, 10 Murray St., New York 7, N. Y.

SELL Policos by mail. Small capital starts you. Send \$1.00 for sample and complete set up. Gulf Coast Industries, 209 West Keys, Tampa 3, Fla.

NEW Lawn mower sharpeners. Details for stamp. Anton Weillert, 142 Gaylord Street, Binghamton, N. Y.

MAKE Money. Start business, small capital. "Money Making Business Starters," 5 volumes—Ideas, \$1.00—singles 25c. Cooper, Sons, 326 18 Ave., Newark 3, N. J.

RAISE Chin-Chins, the big money-making rabbit. Big demand. Small investment. Profitable business for anybody anywhere. Willow Farm, R15, Sellersville, Penna.

INFORMATION — Locating articles, products (wholesale) etc. Rakes, Box 5931-2, Chicago 80.

MAKE Money by mail at home with new folio of business opportunities. Details free. Lar-Loc Sales Company, 260 Page Avenue, Staten Island 9, N. Y.

MAILORDER Business opportunities. Details—postal. Smith, 72-D Southbourne, Boston 30, Mass.

METAL-DETECTORS — Materials now available! We have the latest in circuit and mechanical design plus The Know How! Let us build yours. Write for literature. Metal Detectors, Box 6892, N. S. Pittsburgh, Penna.

OPPORTUNITIES — Foreign countries. Thousands of job opportunities in many fields. Information explaining where and how to apply. Lists of hundreds of firms with foreign interests \$1.00. Industrial Trade Surveys, Dept. 11, P.O. Box 4151, Los Angeles 24, Calif.

MAKE Your fortune in great new industry manufacturing, marketing products containing "DDT" the wonder-working insecticide. A waiting market. My Ten Master DDT Formulas and simplified manufacturing and marketing instructions for starting on small capital. Rush request for full details, free. Howard Robinson, Ph.G., 1316 S. Ohio, Sedalia 10, Mo.

HUGE Profits, new food specialties! 5,000 word course \$2.00. Tirekop, Box N-12, Madeira, Ohio.

UNPAINTED Wall plaques 2½c up. Illustrated list free. Oman, 642 Broadway, St. Paul 1, Minnesota.

HOW To make money by mail. Write us about this book. Bobbitt, 1609-PM 1609 Tenth Avenue North, Nashville, Tenn.

RUBBER Moulds for casting novelties. Latex for making moulds. Use thoroughly tested and approved products. Eastern Latex Laboratories, Box 153, Mattapan 26, Mass.

CAN The boss. Make strange new plastic 8c gallon. Makes durable, beautiful floors, walls, roofs. Bays Laboratory, Oklahoma City 9.

LIQUID Marble—Make in beautiful colors. Make your own flexible molds and cast plaques, novelties, statuary. Free information. Write—Bing Products, 621-AA Tremont Street, Boston 18, Massachusetts.

TREMENDOUS Profits mailing our literature. Generalprint, Cottage Place, East Orange, N. J.

FORMULAS Opportunity plans, bargain guide, literature free. Beejay's, 518 South 30th, Lafayette, Indiana.

MEN Or women. Do you want to have an income of \$5000 to \$10,000 or more per year in your own business? No previous experience needed. Our "Be your own boss" plan has been the means of many people becoming financially independent. Do not delay, get started now. Mail \$2.00 for complete plan to G. C. Products Co., 301 Clinton Ave., Newark 8, New Jersey.

DO YOU want to be independent? "Opportunities to Share" will show you the way. Over 400 pages filled with down-to-earth facts on starting a business of your own on small capital. Limited edition only \$5 or c.o.d. plus fees. Satisfaction guaranteed. Guild Publishers, 5902 Walnut, Kansas City 2, Missouri.

BUILD Your own independent, fascinating and very profitable business at home, spare or full time. \$50.00 and up weekly easily possible decorating beautiful imitation marble novelties and religious figures. Fast sellers by you, through agents, stores. Quickly learned and few dollars starts you making real money. We tell you, as manufacturers, how and furnish everything. Be our representative in your territory. Write for full information at once, Inghram Company, 2845 Sixth Street, Detroit, Michigan.

FOREIGN And domestic jobs, all kinds. Latest accurate information on jobs, firms and projects in U. S. and foreign countries. Mail \$2.00 to Industrial Research, Ltd., 403 Broadway Bldg., San Diego 1, Calif., for the 1946 edition of the Foreign Employment Digest. Lists the actual projects with application blanks. Cost more, worth more. 7 day refund privilege.

HOW To operate your own advertising agency profitably, brand new copyrighted manual reveals all. Learn how you can start from home, spare time with few dollars capital. No stock or equipment to buy. Earnings unlimited. Sincere folks get free details. P. Snyder, Box 4907-A, Philadelphia 19, Penna.

ORIGINAL Genuine rubber mold liquid. Mix ingredients cold! Kitchen beater! Enormous profits. Guaranteed formula \$3.00. Toms, Chemist, Park Road, Peoria, Ill.

PROFIT \$50 Out of every \$100 you sell. Join our Mailers Organization. Send stamp for information. Reliable Mailers, 1216 Park Row Bldg., New York City.

LEARN Candy making of every kind. Big profits. Instructions book \$2.00 c.o.d. plus charges. Artie Barnes, PM 1416, North Mosley, Wichita, Kansas.

WAR'S End makes sensational products available. Manufacture in basement or garage. Start on small capital. Complete instructions \$1.00. Emae, Box 1947, Los Angeles 53, Calif.

RUBBER—Moulding liquid, cast plaques. Sample. Kent's Studio, Worthington, Ohio.

BECOME Independent! Have your own business! Operate mothproofing, rug cleaning service: Sell products to users; \$240.00 weekly income, possible! Experience unnecessary! Details free. General Products, 246P - 5th Avenue, New York 1, N. Y.

SPARE Time mail business earned \$1400 monthly. Copyrighted instructions \$1.00. Wm. Boyd, 331 Fourth, Pittsburgh 22, Pa.

BE Your own boss. Work at home. Amazing profits. Literature free. Leonard, Box 42, Salem, Oregon.

EXPLODING Matches, cigarette loads, joke tricks, novelties. Complete line. Certified Products, Dept. 41, Louisville, Ky.

START Your own plastic manufacturing business. We supply everything and help you market your products. John Paul, 704 Walnut, Scottsdale, Penna.

INDEPENDENCE Without funds. "International Commerce Secrets." Dollar. Zigzag. Apartado 101, Guatemala, Central America.

YOUR Own business—As little as \$100 starts you now! No training needed! See our ad on page 38A. American Photocopy Equipment Co., 2849 N. Clark St., Dept. GF125, Chicago, Ill.

IF You want your own business, write: Business Opportunity Bulletins, 420 Market, San Francisco, Calif.

FINANCIAL Security, profitable tested lifetime opportunities, your own, no peddling. Practically no investment. Write National Supply, Box 1912, Fosston, Minn.

300 TESTED Moneymakers, 68 page book, over 40,000 words, 25c postpaid, business secrets, formulas, wholesale supply sources, galore, no ads, meat only. Business Plans Institute, East Colfax Station, Box 3254-M, Denver, Colorado.

BE Your own boss! Are you going into business? New illustrated book showing definite, workable plans, explaining how to finance, buy, sell in any business. Worth many times this price. Only \$1. Money-back guarantee. Get started now. Commercial Publishing, 8806 Commercial Avenue, Chicago 17.

300 TESTED Moneymakers, 62 pages, 40,000 words. Business plans, secrets, formulas, mail order plans. Wholesale suppliers. Now, you get—not just one plan—but all for only 25c postpaid. Start now, no waiting for free details costing \$1 to \$15. Money returned if dissatisfied. F. Larson, Galeton, Penna.

BUSINESS Engineering, publicity, copy writing, art work; cuts, market analysis, companies incorporated, capital secured, foreign service. H. J. Harder & Assoc., 175 S. High, Salem, Ore.

EXTRA Money. Sell names by mail stamp. Green, 55 Dodd St., East Orange, N. J.

HARDWARE Business is one of the most interesting and profitable of them all. Be independent. You can start your own retail store with small investment and no previous experience. 15,000-word, copyrighted booklet tells you how. \$1.00 postpaid. C. R. Divan, P.O. Box 325, Santa Monica, Calif.

LIQUID Marble—Colorful, glazed! Mold, brush, spray! Composition floors, Rubber-lastic molds. Particulars free. Marbleizing Service, Edwardsville, Illinois.

OPPORTUNITY For limited number of home workers to build steady income, full or spare time. No special skill or equipment. Industrial Development Service, 3006 Ridge Ave., Philadelphia 21, Penna.

OWN A mail-order paper products business. Sell envelopes, tags, bags, boxes by mail, wholesale. Tremendous demand. Steady profits. No capital necessary. Write Omaha Envelope Service, Dept. 112, 4721 California, Omaha 3, Nebr.

MAKE Plastic jewelry. Free information. Atler Company, 23-60 29th, Long Island 5, N. Y.

POST War plans now ready for a successful business of your own. Information free. Write Harry Large, 1812 S. Carmona Ave., Los Angeles 35, Calif.

RUBBER—Molding liquid, pre-war quality. Free Castwood model with sample quart \$2.95; gallon \$9.00, directions, Rubbercoat, 3873 California, San Diego, Calif.

\$24,500 REPORTED Using "schemes" from "Schemer" Magazine, Alliance, Ohio. 4th year. \$1.00; 4 samples, 30c.

SELL Books by mail. At home, spare time. Start small, grow big. Grand opportunity to establish clean, legitimate mail order business. "How" booklet 10c. Kraft Publications, 3114-51 Walnut, Chicago 12, Ill.

MAKE Extra money for Christmas taking subscriptions for leading magazines. Details, supplies free. American Readers' Service, Gwynedd, Penna.

INCORPORATE Your business. Delaware laws. Many advantages, free details. Tax Research Bureau, Inc., Delaware Trust Building, Wilmington, Delaware.

SELL Exclusive books of instruction by mail. Assorted subjects. Popular prices. 70% profit. Rush name for sample imprint circulars and full details. Financial Education, 404F, Mack Bldg., Denver 2, Colo.

SELL By mail with Elfeo Ready Made Circular Service! Large profits! Catalog free! Elfeo, 434 North Wells, Chicago 10.

ONLY \$7.30 Yearly, operates office under your own name. Co-operative Offices, 126 Lexington Avenue, New York.

RUBBER-LATEX Molding liquid. "The real thing." Sample quart, directions \$2.95. Gallon \$9.50. Plastic Material Supply, 1416-N2 Fletcher, Chicago.

AMAZING New liquid rubber for making molds. Footproof. Highly flexible. Gives positive results. Perfect reproduction of fine, intricate lines. Simple to use. Economical. No waste. \$3.50 quart, \$6.25 one-half gallon, \$11.45 gallon. No samples. Money-back guarantee. Write for free circular. Compo-Tex, Box 788-A, St. Louis, Mo.

HOMEWORKERS—Attention veterans! Castwood plastic gifts, novelties; material and instructions furnished. Sample quart with mold model. \$2.00. 20th Century Products, 3151-3 Southport, Chicago.

150 PROFITABLE Spare time, mail order, local business offers each month for six months—all for 10c. Lewis, 828-P Carpenter, Oak Park, Ill.

AMAZE Others. Add columns instantly. Add faster than adding machine. Free details. Math Institute, Box 633, Mobile 4, Ala.

PLASTIC-Intermix, makes ordinary casting plaster shatterproof. Pint develops 100 pounds, \$1.25 postpaid. Plastic Material Supply, 1416-N2 Fletcher, Chicago.

RUBBER—Airlastex liquid, pre-war quality. "Makes molds overnight." Sample pint, instructions \$1.50. Gallon \$9.00. 20th Century Products, 3151-3 Southport, Chicago.

A JOB Slave? Learn today how you can live a happy, prosperous "tomorrow" as your own boss. Details free. G. Kindig, 1629 Vine St., Philadelphia 3, Penna.

HOW To make shell jewelry. Here is the only complete course of home instructions for making tropical jewelry. Gives complete instructions and beautiful photographs for making 33 different styles of sea shell and fish scale earrings, brooches, pins, sprays and hair ornaments. Includes dyeing, pearlizing, lacquering, gilding and luminous methods. Also, wholesale prices for all materials required. \$1.00 per copy postpaid. House of Gifts, Box 4550-Pl, Coral Gables, Florida.

WORK For yourself. Your own business. Operate entirely by mail—direct from your home in spare time. Few dollars starts you. Literature free. Albert Wilcox, PM21, Nichols, Georgia.

NEW Flexible mold material, casts catalin plastic, concrete, plaster, in same mold. Literature. Sandex, Box M, Clyde, Ohio.

SELL By mail. Particulars free. Write, Frank J. Artz, 1060 Harding Drive, Toledo 9, Ohio.

SELL Cosmetics by mail. Women spend millions on beauty. You can make your share of this cosmetic money. Let us show you how. Details free. Frank J. Artz, 1060 Harding Drive, Toledo 9, O., Dept. B.

LEARN Profitable credit-collection agency business; earn \$5,000-\$10,000 upwards annually; sparetime opportunities excellent; postcard brings interesting literature free. Write: Educational Extension Service, Department 101, Los Angeles 36.

BOOKKEEPERS—Operate popular "Dollar-A-Week" bookkeeping and tax service. Full or spare time. Details free. Ellis, Box 200, Cedar Grove, N. C.

METALLIZE Baby shoes! Learn this easy, money making business from nationally recognized consultant. Small investment; free details. Joseph E. Kushner, B.S.Ch.E., R.D. 3, Stroudsburg, Penna.

AT Last! A genuine Storm-Proof cigarette, cigar and pipe lighter that requires no fluid of any kind, will not blow out and can't get out of order. This Storm-Proof lighter employing the charcoal principle, sells on sight just by lighting a cigarette. If interested, here are complete details—Storm-Proof lighters come fully guaranteed and must retail \$1.00. Your discount 40% in dozen lots, 50% 3 dozen and over including territory. Initial 2 samples trial order \$1.00, deductible from first wholesale order. Storm-Proof Lighter Company, 126 Lexington Avenue, New York.

START Big money business on shoe-string. New, successful cleaning service. Big demand everywhere. Easy, quick profits. Write for details, Americlean, 211 N. 7th St., St. Louis 1, Mo.

MAIL Order beginner's "Business Development Plan." "Profitable Mail Selling Idea." "Pointers Along the Mail Order Trail" show how to make mail order business pay! All three, in 10,000-word treatise, postpaid quarter. Satisfaction guaranteed. Maupin & Maupin, LaFayette 3, Indiana.

FLORIDA Opportunities—Pensacola offers exceptional opportunities for small industries, especially in the field of mahogany novelties and woodware, perfumes, soap, chemicals. Delightful year-round climate. Wonderful fishing, hunting, beach sports. For information write: Industrial Development Division, Municipal Advertising Board, Pensacola, Florida.

BUILD Miracle homes. Yours. Others. Chamberlain, Pittsmons Building, Pittsburgh 22, Penna.

PROFITABLE Plans and ideas. Details, Spada, 10 Lexington, Wethersfield 9, Conn.

BUILD Own business mailing penny post cards; six profitable plans with information for starting. Gordia Publishers, Box 23, Pawtucket, R. I.

"HOW To Finance Any Business, Obtain Capital." Research, Atkin 5, Minn.

"HOW To Make Simple Molds and Plaster Plaques." Profitable business or hobby! Instructive booklet 25c. Plastercraft, 1406 East 43rd Street, Cleveland 3, Ohio.

"10,000 ALASKA Fishing Jobs." Alaska's largest industry regularly employs thousands of men and women in seasonal production. Possible earnings up to \$5,000 in few weeks. Authentic 7,000-word copyrighted report gives job information, union requirements, sample application letter, names and addresses over 40 Alaska fisheries. Newest edition includes similar information on California, Oregon and Washington fisheries. Vital facts for immediate application in a permanent industry. \$1.00. 7-day refund privilege. Pacific Industrial Research Bureau, Dept. PM-9, 202 Studio Building, Portland 5, Oregon.

MAKE And mold genuine plastics. Forty illustrated work-sheets explain methods, processes. Authentic-simplified \$1. Free circular. *Plastics Digest*, 3937B Tracy, Kansas City 4, Mo.

START Profitable sideline business now! Complete free details and premium offer available. Write Sheboygan Publishing Co., Sheboygan, Wisconsin.

RECAST Old batteries into new. Latest achievements. Battery Laboratories, Minneapolis.

\$25 WEEKLY Working two hours daily. No canvassing. No manufacturing. Lycke, Box 2471, Cleveland 12, Ohio.

TYPEWRITER Repairing — Original course, simplified home study. Weber Typewriter Mechanics School, Box 269, Osborn, Ohio.

QUICK Money! "Repairing Car Batteries." At home. Easy too. Write Batteryman, 901 South Avenue, Grand Junction, Colo.

BOOKKEEPERS: General ledger and tax report experience. Operate permanent, profitable accounting service for the smaller business. Part or full time. Simplified method. Write now! L. A. Bell, 1400 West 25th Street, Cleveland 13, Ohio.

START Mailorder bookshop—Everything furnished; publisher cooperation. 25c brings booklet, exclusive setup, samples, exciting ideas. General Publications, Ossining, N. Y.

BECOME An "Attritionist Masseur." First improvement over Swedish massage in 100 years! Results unbelievable! Dr. Swearingen, 9128M, Station 8, Los Angeles.

COLORGLAZED Concrete pottery made without molds. New, low cost, patented method. Cemetery products, novelties, tiles, floors, etc. Basement leaksealing. Other moneymaking projects. Booklet, details free. Men only. National Pottery Company, Fergus Falls, Minnesota.

BIG Money making Hollywood style pottery, bird baths, wishing-wells, benches, stucco-rock. New method. Clever designs. Color with chemicals, water-paints, Marbling, colored glaze effects. Dime brings samples, pictures, literature. Hollywood Cementcraft, 8527 Wonderland Ave., Hollywood 46, California.

\$—RAISE Giant Chinchilla rabbits. Willow Farm, R 15A, Sellersville, Penna.

HOW And where to obtain capital. Fully explained. Particulars free. Star Service, Wapakoneta, Ohio.

MAIL Order business course shows you how to make money, spare or fulltime. Teaches professional mail order technique —not penny-snatching schemes. New success catalog free! Write—Nelson Company, Dept. 4-02, Chicago 4.

AGENTS—To mail our literature. Good profits. Home business. Maywood, 1133 Broadway, New York.

RAISING Canaries pays good profits. Valuable bird book—"Its Care, Breeding and Training." Price \$1.00. American Canary, 2839 N. Halsted, Chicago.

LIQUID Marble; snow-white, multi-colored. Glazed. Unglazed. Composition flooring. Lifetime wear. Any color. No priorities. Flexible molds. Plaster casting. Get into the big money now. Full information given free. Write Compo-Tex, Box 788-R, St. Louis, Mo.

BRUSH Plating outfits connect to a battery. No tanks necessary. Good paying business at home plating autoparts, bathroom fixtures, bicycles, reflectors, silvering mirrors. No shop or experience required. Outfits furnished. Free booklet. Gunmetal Co., Ave. H, Decatur, Ill.

127 WAYS To make money, in home or office, business of your own. Full particulars free. Elite Co., 214 Grand St., New York.

MONEYMAKING OPPORTUNITIES

WHAT Makes you think you couldn't sell by mail? We're doing it, happily! New! Different! Exclusive! Alive with money-making opportunity. Get free particulars, free samples. Write! The What-to-Do-Shop, Box 1082, Tacoma, Wash.

MAIL Order work with real profits. Compile and sell name lists. Start on shoestring. Stamp brings exciting details. Vulcan Service, 2312 Ave. E-Ensley, Dept. M-4, Birmingham, Ala.

INCREASE Your income! Unlimited opportunities. Random Company, Box 2688b, Los Angeles 24.

MECHANICALLY Inclined men — Own and operate general appliance repair shop. Complete, illustrated course shows you how. Welding, refrigeration, motor repair, how to get business, etc., all phases covered. Free literature. Christy Supply, Dept. 1159, 2835 N. Central Ave., Chicago.

FREE Literature, 200 moneymaking ideas. No investment required. Send postcard now. Lynch, 402-PM Hazlett, Baltimore 29, Md.

INTERESTED In steady extra income? Write Demonstrators, 1741 Harrison, Chicago.

LEARN Battery repairing, rebuilding. Engineer offers money making methods. Battery Bureau, 2225 North 44th St., Milwaukee, Wis.

PROFITABLE Local or mail order business in your home. Stamp brings free literature describing 137 proven plans. Kessler National Service, Box 392-PMD, Indianapolis 6, Indiana.

MAKE Liquid Marble, Plaster Plaques, Statuary, Instructions, formulas. \$1.00. Ideal Service, 179-M, Park Ridge, Ill.

ADVERTISING Tips on selling by mail \$1.00. Free plan included. Tom Ortiz, 3006 W. 22nd, Oklahoma City 7, Okla.

MAKE Money at home! Do it with anything you have! Capital unnecessary. Let a successful man with 44 years experience tell you how. Write postcard today! Carter, Box 8-DCB, New York.

THOUSANDS Articles wholesale. "Supply Source Directory" 10c. Ideal Service, 112, Park Ridge, Ill.

FREE! 25c Money making plan. Davis, Box 1015, Lynchburg, Va.

FASCINATING Mailorder legitimate plans, schemes. Nearly all profit. Rare information, samples, dime. Warco, Free-land, Mich.

25c BRINGS Business secrets, success plans, all tested. 25c refund coupon all postpaid. Rush, Wilkin, PM-1348 N. High, Hillsboro, Ohio.

EARNINGS \$2,000 Year easy; inventing simple items for special cash markets. Ideas only. No patents. Write, Hendrickson, Argyle 7, Wisconsin.

NEW, Latest list formulas. Rush name, B. Strickland, "Dept. AL," Thomasville, Ala.

LEARN Showcard writing at home in spare time. Fascinating, lifetime business of your own. No special skill needed. Free information. Sherwood Publishing Co., Box 8, Dept. 64, Irvington, N. J.

PROFITABLE Homework — Co-publishing mailorder's leading syndicated magazines. Low starting capital. Instructions, sample magazines, 25c. Business Builders, Bellflower 9, California.

WANT Financial independence? I've helped thousands. Dr. Tibolt, 31M, Philadelphia 20.

EARN Money evenings, copying and duplicating comic cartoons for advertisers. Adservice, Argyle 1, Wisconsin.

FREE Formula list! Chemist Robins, 24 South Hamlin, Chicago 24, Ill.

PUT Up powder and liquid-fast repeating products under your name. Large profits. Kohlen, 506 West 45th, Chicago 9.

BIG Mail free—Send 25c for 3 mo. subscription to Progressive Mail Trade Magazine and have your name printed in big mail directory—free. Sample copy 10c. Frank B. Vais, 3201 Harrison Ave., Brookfield, Illinois.

METALLIZE Baby shoes! Learn from nationally recognized consultant. See Kushner ad under Business Opportunities.

OUR List of names and addresses of 800 ladies who delight in beautiful homes and lovely flower gardens using mail order since October 1945 will make you money. Price \$5.00. Sheigin Mailing Agency, Athens, Texas.

WE Make big money in mail order business, let us show you how. G. W. Lowman & Sons 193, 363 Tulpehocken St., Reading, Penna.

QUARTER Brings 12 word ad that pulls dollars! Tanner, 1029 Franklin, Columbus 5, Ohio.

"MY Secret of Selling Certain Information by Mail" \$1.00. Complete. Postpaid. Not obtainable elsewhere. Will triple your income or money back. Fortunes are being paid for ideas. "My Secret" will show you how to cash in on one of these ideas. Be your own boss! Be independent! Have money! Be out of debt! Write today —now, and triple your income immediately. Dollar bill travels safely if folded in paper. None free. Write BW, Felgoise, 5606 N. 10th Street, Dept. 1245M, Philadelphia 41, Penna.

MONEY In the bank. Working for yourself. It's a great life. Book showing how, now only \$1.00. Details free. National Business Bureau, Department B-12, Box 5374, Chicago 7, Illinois.

BIG Profits. Manufacture custom arch supports. Jul Corssen, 2638 Geyer, St. Louis 4, Missouri.

NEED Extra money? Opportunities galore. Particulars, stamp. Jackson, Newfoundland 3, Kentucky.

\$200 MONTHLY With camera! Comprehensive guide, 50c. Frank Dickson, 808 Elizabeth St., Anderson, South Carolina.

RECEIVE Giant mails, latest moneymaking home work offers, opportunities, magazines. Your name listed 10c. New Age Enterprises, 578-A Prospect, New York City 55.

MAN, You'll like silvering mirrors, reflectors! Making sparkling chipped glass nameplates. Outfit prices. Sprinkle, Platter, V69, Marion, Indiana.

WHOLESALE Catalog, directory 10c. Hundreds of thousands articles. Stafford, Sunnyside-PM, Indianapolis 44, Ind.

METAL Identification tags. Agents sample. Silver quarter. James Parker, Stockton, Kans.

YOUR Big mail order opportunity—No time has ever been as good as right now. Get your start right. Let me show you how, what to sell and who will buy. Big profits, easy work at home. Write: H. S. Smith, 3138A So. Mabbett Avenue, Milwaukee 7, Wisconsin.

MONEYMAKING Books. Free list. Journalism booklet, 25c. Underhill, Beebe, Arkansas.

MONEY Made easily home or room. 25c brings details and two 25c folios or book. Bargain Specialty Company, Box 635C, Modesto, California.

START Profitable collection agency business: office; home; sparetime. Earn \$5,000-\$10,000 upwards annually. Investigate Educational Extension Service advertisement under Business Opportunities.

PUBLISH Your own magazine. Handsome 52 page format, well edited, illustrated. Cost low as \$1.00 month. Brings you prestige, profits. 25c brings sample, details. National Ord. Nebr.

THOUSANDS Of alarm clocks need repairing. Jewelry stores swamped. Our simplified course teaches you how to repair these clocks. Necessary tools and supplies furnished with course. Alarm Clock Repair Service, Dept. B, P.O. Box 1983, Houston, Texas.

INDEPENDENCE And your own business. No peddling. Little or no capital needed. You can't miss. Free details. Ranerva, Oakland, Nebraska.

GIANT Big mail! Hundreds of money making propositions, home work offers, including big magazine, all for a dime. Gardenville Publishers, Gardenville 11, N. Y.

\$—RAISE Giant Chinchilla rabbits. Willow Farm, R 15B, Sellersville, Penna.

I MAKE Big money in the mail-order business. You can do the same at home with my copyrighted system. Write me. I'll tell you how. F. Little, Box 8, Glenshaw P.O., Pittsburgh, Penna.

LICK After-war layoffs! Start own business: home, office. Booklet describing "Collection of 127 Tested Plans" free. Elite Co., 214 Grand St., New York.

LEARN Metascience. Remarkable drugless healing. No manipulation. No apparatus. Unbelievable simplicity and results. Inexpensive correspondence course. Write Metascience, De Land, Florida.

"MAIL Order World." Outstanding mail order magazine. Sample copy 10c. Martin's, Box 2414P, Bridgeport 8, Conn.

EARN Money at home! Thousands do "Home Worker Magazine" tells how. Sample, 25c. Sizemore, Box 7, 4917 North Kostner, Chicago.

FORMULAS, PLANS, ETC.

SUDSY Soapless non alkaline detergent similar to Dreft. Makes up easily at low cost. Formula \$5.00. J. E. Dick, Box 5641B, Indianapolis 1.

AUTHENTIC Formulary. 924 page illustrated book. 10,000 scientific formulas, recipes, secrets, instructions for most any product. Countless profitable business opportunities, including D.D.T. new insecticide. And our new book: "The More You Know the More You Can Earn." \$2.98 postpaid (c.o.d. U. S. only). Foreign \$3.25 delivered. Adams Brown Company, Dept. 362, Chestnut Hill 67, Mass.

"LUMINOUS Paint." 100 other formulas, plans—25c. D.D.T. insecticide \$1.00. Soap making. (20 formulas) \$1.00. Resilvering mirrors 20c. Ideal Service, 312, Park Ridge, Ill.

FORMULAS For cosmetics, insecticides, inks, auto polish, soaps, spot removers, and scores of others contained in new directory, 25c. Toledo Laboratories, 2671 Algonquin, Toledo, Ohio.

ANY Formula desired 25c. Satisfaction guaranteed. Hyrum Oaks, Rt. 3, Ogden, Utah.

MONEYMAKING Formulas. List and two samples, 10c. Random, Box 2688A, Los Angeles 28.

ANTI-FREEZE. Dependable. Cheap. Formula 25c. Duffy, K57, Covington, Ky.

10,000 **AUTHENTIC**. Scientific formulas, 924 page profit-bringing, illustrated giant book. Genuine bargain. Free literature will benefit you. Continental Publications, 79-02m Woodside, Elmhurst, New York.

TIRE Carcasses everywhere, from these reclaim rubber to make molds, tire plastic, etc. Details for stamp. Betke, Box 699, Borger, Texas.

REAL Manufacturing formulas. Lists free. Cummings, Chemist, Gordon Ave., Syracuse, N. Y.

FORMULAS: 15 Proven moneymaking formulas \$1.00. (Not stock-formula catalogue stuff), real unusual offers. List free. Marvel Laboratories, 6629 No. Maplewood, Chicago.

FORMULAS—Latest, best. Analysis. Literature free. Belfort, Engineering Building, Chicago.

COSMETIC Formulas. Make own hand lotions, cold creams, rouge, etc. Instruction booklet 25c. Popular Mechanics Press, (C-43), 200 E. Ontario, Chicago.

PLASTICS

ONE Hundred twenty eight page completely illustrated instruction book chock full of ideas and projects in all plastics now given with Kosto Plasti-Kit Number Three postpaid \$5.00 in U. S. Kit contains lucite, plexiglas, catalin, dyes, solvents, cements, polishing materials. Now ready. No waiting. Kosto Plasti-Kits, 3263 M Street, N.W., Washington 7, D. C. Dept. M9.

12 PLASTIC Luminous cutouts. Beautiful plastic crystal wrist band \$1.50 seller. All sent for \$1. Mfg., 1157 Stout, Denver 4.

FREE! Plastic fabricating manual—with plastic supplies catalogue—only 10c. Plastic Products Co., Box 384P, Massillon, Ohio.

PLASTICS—Instructions 50c. Chemicals, \$1.00. Alvin, 553 William, Winnipeg, Manitoba.

MONEY In plastics. Lucite plastic hobby kit contains 2 pounds masked lucite sheet material. Coloring dye and cement, with full instructions. Send \$2.50 to Plastic Specialty Co., 192 Lexington Ave., New York, N. Y.

LUCITE—Complete supplies. Price list, instructions free. Lucite sample 35c. Maurice Lannon, Postoffice Box 686, North Hollywood, Calif.

MOLD New plastic at home. Complete instructions \$1.00. Tirekop, Box E-12, Madeira, Ohio.

PLASTICS. Make your own at home. Formula and moulding instructions \$1.00. Box 84, Station K. Toronto, Canada.

PLASTIC Craftsmen—A new liquid plastic is now available. Give this kit as a Christmas present. Cast your novelties, book ends, model airplanes, etc. Casting kit contains one pint of plastic, plastic hardener, mold coating, mold separator, mold material, dyes for coloring, complete instructions. \$5.00 prepaid. Alexandria Brass and Plastics Shop, 1734 Price Street, Alexandria, Va.

CHEMISTRY

WINN'S New idea champion chemical-kits, apparatus-outfits and supplies for students home experimenting. (Established 1931.) Send 10c for catalog. John H. Winn, 124 W. 23rd St., Dept. 512, New York, N. Y.

CHEMISTRY Home study course free. Two dimes brings full particulars. Artcraft-1, Spring Valley, California.

SEMI-TECHNICAL Chemistry brochures. Literature free. Lankton, 310 Westmoreland, Lansing 15, Mich.

RECLAIM Valuable silver going to waste in every town. Instructive booklet describing details, \$1.00. Wier, Box 4398, Fort Worth 6, Texas.

CHEMICALS. Ounce quantities, apparatus. Catalog 5c. Fleischer's Laboratories, Everett 49, Mass.

HANDBOOK For chemical experimenters, illustrated, hundreds of experiments, 50c. Experiment booklet 15c. 1946 chemistry catalog 5c. Reading Scientific Company, Reading, Penna.

FREE Catalog. Chemistry, mineralogy, biology, optics. Tracey Laboratories, Evanston, Illinois.

NEW 36 Page chemical apparatus order book. Complete line of chemical glassware, apparatus and chemicals. Send 10c for this book. Standard Science Supply Co., 1232 N. Paulina St., Chicago.

CHEMICALS And apparatus for industrial, analytical, and private laboratories. Complete supply service for correspondence school students. Send 3c for catalog. Dept. M-43, Biological Supply Co., 1176 Mt. Hope Ave., Rochester 7, New York.

SPECTROSCOPE For quick chemical analysis \$2.50. Kutting Sons, Campbell, California.

LABORATORY Supplies at wholesale prices: Chemistry, biology, physics. Catalogue 10c. National Scientific Co., 2204 W. North Ave., Chicago. Established 1908.

HELP WANTED

CHANGING Your employment? Write about opportunities. Details free. Jackson, Newcomb & Jackson Co., Dept. G, 115 State St., Springfield, Mass.

RELIABLE Man with car wanted to call on farmers. Wonderful opportunity now. No experience or capital required. Permanent. Write today. McNeess Co., Dept. 651, Freeport, Ill.

AGENTS WANTED

25 WAYS To make money with luminous paint (shines in dark). Rush only 25c for profitable folio and luminous sample. Address, Lite-Saver, 97C, Saybrook, Conn.

FASTEST Selling item in America today! War honor scroll. Lifetime parchment. Beautifully 8 color printed. Eight sells, \$1.00. Sample, 50c. Mailmart, Box 403, Indianapolis 6, Indiana.

SENSATIONAL Seller. Excellent profits. Particulars free. Readers' Service, 652 Peoples Building, Charleston, S. C.

AGENTS Wanted for all year around household commodities used daily in every home. Big profits—repeat business. Send \$1.00 for sample, catalogue, Marshall Sanitary Products, 5535 N. Clark, Chicago 40.

EXCLUSIVE Territories granted. Call on garages, stations, hardware stores. Vaughan, Box 48, Sugarhouse Station, Salt Lake City 5, Utah.

RAZOR Blades thousand \$5.75. Dolls dozen \$12.00. Pencils gross \$1.95. 1728 bobby hairpins \$3.50. Send payment. Catalogs free. Mills Sales Co., 901 Broadway, New York 3.

\$1 STARTS You in business. Sell deluxe five fold ties. 100% wool interlining. Cost you only \$7 per dozen, you make \$5 dozen. Send \$1.00 for special introductory offer two five fold ties. Catalog complete line free. Phillip's Neckwear, 20 West 22nd St., Dept. K-24D, New York 10.

GREAT New money maker—Non skid checker board. New invention sells on sight. Checker clubs, train and plane riders, invalids, everyone. Checkers can't slide, fall off or skid. Play on any angle, anywhere. Pocket or regulation size. Details, sample \$1.00 postpaid. Side Line Sales Company, 58PM Congress Street, Hartford 6, Conn.

WOULD You like to make up to \$75 weekly commission? Then write Schutt Co., 244 East Ohio Street, Indianapolis 4, Indiana.

FREE Wholesale catalog, hard to get merchandise. American Merchandising, PM-2, 703 Vandiver Building, Montgomery, Alabama.

LOOK Here! Wanted—Men and women to start in business on our capital. Sell some 200 farm-home products. Thousands our dealers now make quick sales, big profits. For particulars write Raleigh Co., Dept. L-192-PPM, Freeport, Ill.

SILVER Plating liquid. Simply rub-on with a cloth. Cleans, silverplates, polishes, one rubbing. Puts on genuine 1000 fine silverplate. Renews silverplated ware like new. Silverplates onto brass, copper, bronze, etc. Lasting finish, won't come off. Sales representatives wanted. Details free. NuProcess Products, Dept. 197, Aurora, Ill.

DIGNIFIED Sparetime dollars. Home Educators, 1437 Juniata, Pittsburgh 12, Penna.

SCHOOL Seniors! A postal will bring you our Kwik-sell Cardalog of graduation name cards. Hot selling everywhere! Big profits! Hurry! Craftcards, Box 235-L, Pittsburgh 30, Penna.

JUST Out! History of World War II. Huge volume. Popular price. Authentic text. Official photographs. Big profits. Riverside Book Company, Iowa Falls, Iowa.

REPRESENTATIVE World's best seller, liberal deal. Family Altar, 1437 Juniata, Pittsburgh 12, Penna.

DOUBLE-DUTY Shopping bag. Zips open. Instantly changes from small to large size. Lightning seller. Samples sent on trial. Krastee, 146, Akron, Ohio.

JUST Released! Authentic reproduction of the Japanese surrender document. 13 x 16 inches—suitable, ready for framing. Sample 50c. Agents big profits! The Gardenville Publishers, Gardenville, New York.

DISTRIBUTORS, Agents, wanted! Sell "Silverene" sterling plating fluid; 60c bottle. Particulars free! Rabiro Products, 228P East 2nd Street, New York 9, N. Y.

AGENTS, Garages, service stations see Noble ad under Auto Supplies.

AUTHENTIC Reproduction of Japanese surrender document, 12x17. Sample and price list 50c. Bond, P.O. Box 1033, Philadelphia 5.

GREETING Card money-makers. Write for folder. Greenport Art Company, (Dept. 118), 252 12th Street, Brooklyn 15, N. Y.

ACE 5000 Plan—Gasoline dealers aid. Increases gallonage. Ace Products, Wilkes-Barre, Penna.

NOW You enjoy double profits selling Rugleen and Mothtex Concentrates to homes, hotels, rooming houses, etc. Send for new complete offer. Tremendous profits. Year round repeat business. Products used daily in every home. The Russell-Johnson Service, Clarksfield, Minnesota.

EASY Money selling \$3.50 leather wallets for Xmas. Sample \$1.50. Perkins Co., 41 Egremont Rd., Brookline 46, Mass.

EARN \$5-\$15 Day with veteran's beautiful service mementos, Sample 25c. Starlite, 2703, Geneva, Ohio.

MILLIONS Sold—Fastest selling novelty. Generous trial order \$1.00. Dime brings samples, wholesale prices. Here's another. Every car owner a prospect. Retail for \$1.50, costs 39c. Sample, exclusive territory offer 25c. Barkley Co., Dryden 11, Va.

SIMPLE, Dramatic demonstrations insure easy sales. Sensational \$3.00 fire extinguisher. Liberal discounts. Other products. Molonite Company, 5713 Euclid, Cleveland 3, Ohio.

200 MONEY Making plans, ideas, rare formulas, schemes, exposed secrets. Free folio. Formico Service, Box 572, Dayton, Ohio.

GOLD Lacquered window sign letters. New fonts, styles, absolutely beautiful. Free samples. Atlas, 7941 Halsted, Chicago.

WAR Honor scroll: All branches of service represented. 12 by 16. Space provided for name and photograph. Truly beautiful. Agents make big money. Sample 25c. E. Condon, Dept. 6, Upper Darby, Penna.

\$3 FIRE Extinguisher; quick sales, wholesale or direct; liberal profits. "Fire-Killer." 109 N. Franklin, Syracuse 4, N. Y.

SELL "Petite picture notes." Something really different in greeting cards. Sample free. Dunbar Cards, New Brunswick 20, N. J.

SCHOOL Seniors—Sell classmates America's most beautiful, distinctive graduation name cards. Positively highest commission. Largest selection. Lowest prices. Free cards and sample kit. Printcraft, 1423 East Elm Street, Scranton 5, Penna.

AGENTS: Stamping names on pocket-key protectors. Sample check with your name, address, 25c. Stamping outfits, Emblem checks, check-fobs, name plates. Hart Mfg. Co., 363 Degraw St., Brooklyn, N. Y.

AGENTS—Big line including food products. Fast selling premium and bargain deals. Low prices. Send card for big outfit offer with gift. Ho-Ro-Co, 2768 Dodder, St. Louis 7, Mo.

MEXICAN Feather pictures. Unusual novelty. 50c (stamps) bring \$2.00 worth samples, details. Refunded if unsatisfied. Aztec Art, Apartado 763, Mexico City.

BIG Profits taking subscriptions for all magazines. Agents' confidential catalog listing over 2500 periodicals and complete starting supplies free. Pines Subscription Agency, Flushing, New York.

WHOLESALE Sources. 500,000 articles. Free directory. Maywoode, 1133 Broadway, New York.

EXCELLENT Sideline for printing salesmen. Decalcomania name plates in small quantities. Also, make money applying initials on automobiles. Free samples. "Ralco," X-164, Boston (18), Mass.

PLATING Outfits for autopaarts, reflectors. Connect to a battery. No tanks necessary. Free booklet and particulars. Gunmetal Co., Ave. N. Decatur, Ill.

FREE Water and our concentrates, makes flavors, lotions, shampoos. 72 products. Labels, bottles furnished. Qualco, E-20030 Russell, Detroit.

ELITE Collection contains 127 plans for starting own business: home, office. Descriptive booklet free. Elite Co., 214 Grand St., New York.

DO You want agents for your proposition? Your ad in this space will place your message before hundreds of men seeking fast-selling products. My folder "How to Secure Agents," is filled with proof. I'll gladly send you a copy free. F. W. Johnson, Manager Classified Advertising, Popular Mechanics Magazine, 200 E. Ontario St., Chicago.

AGENCIES WANTED

TO Manufacturers of patented appliances and devices, toys and novelties. We wish to import saleable lines for exclusive Canadian agency. Send particulars to Dominion Enterprises Reg'd., 116 Spadina, Toronto, Canada.

HIGH-GRADE SALESMEN

MAIL Sales letters, your name. \$5.00 profit. \$1.00 complete. Hollinger, 142 East Union Ave., Dayton 10, Ohio.

BIG Profits—Easy selling with famous Double Seal Piston Ring Sets for Ford, Chevrolet, Plymouth, Dodge, DeSoto, Chrysler, Mercury cars and trucks. It is easy to sell Double Seal precision engineered piston ring sets to jobbers, automobile dealers, garages, repair shops and fleet owners. Individually packed ring sets make it thrifty, quick and easy for the auto service man to get the right rings for the job. The name "Double Seal" is his guarantee of quality and service backed by more than 33 years of piston ring manufacturing experience. Double Seal ring sets are priced to make you money! They are very competitively priced and are of exceptionally high quality. Your profit is generous and there is a liberal trade discount allowance for your customers. Plenty of free sales help furnished. Get started now. Orders filled from stock as fast as you can sell them. Write today for catalog, prices and full details about money making distributorships. Automotive Ring Division, Double Seal Ring Company, Box 866 M, Fort Worth 1, Texas.

BEAUTIFUL Red, white and blue, stars and stripes, welcome home pennant, size 15"x35". Send 25c for 2 pennants and wholesale prices. Welcome Home Pennant Co., 30 W. Harrison, Chicago.

DISTRIBUTORS, Salesmen, veterans. Sell "Changeceiver." Eliminates picking up change. Large profits, sells self. Plastic. Write H & H Products, Box 490, Arkansas City, Kansas.

SELL Famous "Re-Zil-Arch." Write, Everett Foot Cushion Company, Everett, Massachusetts.

SIDE Lines. Several departments. Relate background. Gansnot, 1133 Broadway, New York City.

1947 CALENDAR Samples ready! Several outstanding series from "World's Latest" Since Line. First outfit! Prepare now. Write H. W. Singleton Co., Dept. PM, Salt Lake City.

FREE! Latest issue Opportunity Magazine. Salesman's Guide. Inspiring, constructive. Shows how to earn money selling for others or in your own business. Hundreds postwar opportunities. Send name and describe what you have sold or are selling. Illustrated copy sent free. Opportunity Magazine, 620 N. Michigan, Dept. 17, Chicago 11, Ill.

\$4.97 PUTS You in lifetime business. Write Midwest Drug Co., Dept. 4, Columbus 16, Ohio.

EDUCATIONAL AND INSTRUCTION

WRITE Short stories at home for pleasure and profit. Fame, riches and happiness of achievement are rewards to be realized by students who acquire tested technique. Get free booklet from home study school with 50 years experience. Write today! Blackstone-Sprague, Dept. 112b, 307 North Michigan, Chicago 1.

GOOD Jobs and a sound postwar future await you in hotel and institutional field. Men and women—all ages—needed for well-paid positions that offer color, excitement, ever-new and fascinating duties. Record-breaking business in hotels, clubs, institutions, means even greater opportunities. Lewis School receiving calls for managers, assistant managers, stewards, hostesses, purchasing agents, and 55 other types of important positions. These are not temporary jobs, but important positions in an essential business that offers splendid opportunities in war or peace, good times or bad. Previous experience proved unnecessary! No need to leave your job to qualify. A good grade school education, plus Lewis Training qualifies you at home, in spare time. Our National Placement Bureau helps to place you—and our amazing Certified Job Plan—actually guarantees you will "make good" when placed. Write today for free book! Lewis Hotel Training School, Room DX-368, Washington 7, D. C. (First and only school of its kind—Now in its 30th year.)

INVESTIGATE Auto body and fender repair profits. You'll be convinced. Practical spare time home study and resident course including metal work, spray painting, welding may help you open your own repair shop or get a good job. Mechanically-minded men 18 to 60, write for free details. Utilities Engineering Institute, Dept. 14X, 1316 Beiden Ave., Chicago 14.

"HOW To Break and Train Horses"—A book every farmer and horseman should have. It is free; no obligation. Simply address Beery School of Horsemanship, Dept. 11012C, Pleasant Hill, Ohio.

MATHEMATICS, Arithmetic, algebra, geometry, trigonometry, physics, drafting, architectural, mechanical, electrical, structural, building estimating. Coach licenses: Professional engineer, architect, surveyor, electrician, plumber, stationary, refrigeration. Mondell Institute, 230 W. 41st, New York.

WELDING—Electric arc. Learn profitable trade quickly through actual practice. Individual welder instructions at bare cost of materials. Full particulars free. Valuable welding lessons book 50c. Hobart Welding School, Box M-1252, Troy, Ohio.

HOME Study. Write for bulletin R, real estate course; bulletin V, vocational courses or bulletin B, business course on operating any small business. Certified, low cost methods. DeVoto Schools, 35 Vicente, San Francisco 16, Calif.

PLASTIC Engineering pays big. Home study course. Low cost. Easy terms. Free booklet. Ohio Institute of Technology, Box P-221, Greenville, Ohio.

LEARN Chalk talk. Can make an interesting speaker of anyone. Command attention. Details free. Arthur E. Ryde, P.O. Box 1071, Springfield, Mass.

REFRIGERATION, Air-conditioning signs point to greatest servicing, installation demand in history. Men 18 to 60, prepare now for jobs or your own business. Write for free facts how UEI spare time home and school training has helped thousands "go places" since 1927. Utilities Engineering Institute, Dept. 15W, 1314 W. Beiden Avenue, Chicago 14, Illinois.

AMAZE With Super Memory! Facts, figures, names stick like burrs! Write A12, Thor Books, Box 1210, Chicago.

"CLEARHAND" Easy alphabet 3c. Textbook 25c. Jesse L. Cook, Bartow, Florida.

NEW, Used, home-study books; catalogs, dime. Westway Educational Service, Box 58-C, Los Angeles 35, Calif.

ANALYZE Handwriting. Unlimited opportunities in uncrowded profession. Complete course including free handwriting analysis \$1.00. Mayer, 681-P Market, San Francisco 5, California.

YOU Can master mathematics. Key to the electronic, atomic age. Mathematicians in great demand. \$300 to \$500 per month. Literature free. Universal School of Mathematics, 1104-PH Mohawk St., Los Angeles, California.

FIND Yourself—the real you. Dr. Tibolt, 32M, Philadelphia 20.

RARE Occult, astrology books rented. Lessons, 16860 Ventura, Encino, Calif.

FREE Correspondence courses! Postcard brings information. Lynch, 25 - 48th, Weehawken, N. J.

GOVERNMENT Jobs for veterans! Commence \$125-\$320 month. Men-women. Prepare now at home for postwar examinations. Full particulars and list of positions, free. Write today. Franklin Institute, Dept. K48, Rochester 4, N. Y.

GET Rid of money worries. Self-instruction books lead to bigger pay and a business of your own. Our free circulars G-26 will interest and benefit you. "The Guild," 2726 Holland Avenue, New York 67, N. Y.

SCHOLARSHIPS. University training at home for business and social success. Planned to meet your need. Give education and occupation. University Foundation, PM, St. Augustine, Florida.

USED Educational and technical books bought, sold, rented. Catalog free. Educational Exchange, Hengnar, Ala.

SEND 25c For Stereopix Navigation book. Addison-Wesley, Cambridge 42, Mass.

ROOFS, Hoppers, bays, polygons, segments. All lengths, cuts, safe loads, instantly. Vestpocket tables, \$1.00. Morgan, Box 1414, Great Falls, Montana.

LEARN Photo-engraving at home or in oldest, largest school in America. Work for newspaper or establish own profitable business. New Tasope' Photo-Engraving equipment available soon. Write for information. Veterans ask about G.I. training. The Aurora School of Photo-Engraving, Tasope' Bldg., Aurora, Mo.

LEARN Fascinating credit-collection agency business; office; sparetime. Investigate Educational Extension Service advertisement under Business Opportunities.

INVESTIGATOR Training. Phillips Secret Service, 1917B North Kenneth, Chicago 39, Illinois.

29 LANGUAGES By Linguaphone. Russian, Spanish, Portuguese—Direct conversational method for mastering any language quickly, easily, correctly at home. Send for free book. Linguaphone Institute, 83 RCA Bldg., New York.

HOME Studycourse, drugless therapy. Free literature. Institute of Drugless Therapy, Tama, Iowa.

LOCKSMITH Course. Lock picking, key fitting, etc. \$1.00 prepaid. Locksmith, Canadian, Texas.

MEDICAL Laboratory technicians in great demand. We train you in your spare time, in your own home. You can practice while studying. Write for free catalogue. Imperial Technical Institute, Box 973-E, Austin, Texas.

SECRET Investigation. Experience unnecessary. Investigators particulars free. George Wagner, M 125 West 86th, New York.

HORSEMEN—Learn to train and gait. Teach tricks. Free book. Animal Lovers Association, K-111, Tarzana, Calif.

USED Educational books on all subjects sold, rented, also bought and exchanged. Moneyback guarantee. Write today for free catalog and details. Lee Mountain, Pisgah, Alabama.

GOOD "Used" self-instruction educational books on all subjects bought, sold, rented, exchanged. Satisfaction guaranteed. Complete information and 32-page illustrated bargain catalog free. Write—Nelson Company, Dept. 2-62, Chicago 4.

PLAYS, STORIES, MANUSCRIPTS

I WANT New writers to cash hundreds of checks for \$1 to \$100, offered each month. The easiest way to write for pay. No previous experience necessary. Send for free details. No obligation. Saunders M. Cummings, Box 609-M, Colorado Springs, Colo.

IMMEDIATE Income for writers. My plan reveals how. Sell short personalized stories, waiting market, prompt remittance. Make me prove it, you'll be pleasantly surprised. P. Snyder, Box 4907-W, Philadelphia 19, Penna.

WRITERS: Cash-in now. World markets now open. Legal advice; translations; sales. Send for details. International Writer's Club, Box 6058, Houston 6, Texas.

WRITE Stories that sell: 21 lessons \$1. Maldonado, Box 51, Sunland, Calif.

NEW Writers needed to rewrite ideas in newspapers, magazines and books. Splendid opportunity to "break into" fascinating writing field. May bring you up to \$5.00 per hour spare time. Experience unnecessary. Write today for free details. No obligation. Postcard will do. Comfort Writer's Service, 210-P South Seventh St., 2, St. Louis, Mo.

CARTOONING, COMMERCIAL ART, SIGN PAINTING, ETC.

"HOW To Make Money With Simple Cartoons"—A book everyone who likes to draw should have. It is free; no obligation. Simply address Cartoonists' Exchange, Dept. 912-C, Pleasant Hill, Ohio.

LETTER Trucks with spray gun. Adhesive stencils. Samples for your name and details \$1.00. Wm. Beaman, Oregon, Ill.

ART Instruction books. \$1.00 each. Lists free. Schlotzauer's, Shenandoah, Va.

CARTOONISTS! Idea suggestions with gags; Twelve for two dollars. James Jacobs, Box 421, General Post Office, New York 1.

SIGN Painting made easy. Master 12 designs and letter everything. Diagram \$1.00. Peters Company, 4107 Riverdrive, Algonac, Michigan.

WE Print student's cartoons. Free literature. School of Cartoons, P.O. Box 3291, San Francisco 19, Calif.

CARTOONISTS! Latest list high pay markets, free. VanRyn, 1146 Sierrabonita, Pasadena, Calif.

MAKE Signs, letters, stencils. 9 complete alphabet pattern sets. 3 complete numeral pattern sets and catalog \$1.00. Sign Letter Distributors, P.O. Box 101, Mineola, N. Y.

CHALK Talks. Laugh producing program. \$1.00. Catalog 10c. Balda The Cartoonist, Oshkosh, Wisconsin.

CARTOON Course—22 easy lessons. 200 figure sketches. 25c coin postpaid. Snack-Pack Co., 32 E. Georgia, Indianapolis 4.

ADVERTISING AGENCIES, LETTER WRITERS, FOR ADVERTISERS

ADVERTISING Placed everywhere lowest rates. Reliable guidance on publications, expert assistance on ads without charge. Newspaper, magazine, mailing-list ratebook free. Chicago Advertising Agency, 20-P West Jackson, Chicago 4.

ADVERTISERS Service—For men going in business. Put our experience in merchandising and advertising back of your products. Write Van De Mark, Times Star Bldg., Cincinnati 2.

SELL Abroad. 50,000,000 prospects! Advertising instructions \$1.00. Tirekop, Box J-12, Madeira, Ohio.

20 WORDS \$2.60. Circulation 234,000. Goodall, 37 Gardner, Vallejo, California.

24 WORD Ad in 13 popular Sunday newspapers \$23.20, extra lines (6 words) \$5.80. Covers the South with each state's popular newspaper. "Copy in office Thursday for Sunday." List free. Alabama Advertising Agency, 214 Exchange Building, Birmingham 3, Alabama.

24 WORDS in 64 weeklies \$4.96. H. J. Darnell, 730 Hays, Jackson, Tenn.

EFFECTIVE Sales letters and literature written. \$5 page. Dudley Bunn, 126 Lexington Avenue, New York 16.

ADVERTISERS! 6,000,000 Circulation 25 Sunday national key newspapers, 18 words. \$39.25. "Terrific pullers" 20 popular newspapers \$8. "Free booklet." Newmarks Advertising Agency, 217-7th Ave., New York.

ADVERTISE: 24 Words, 149 newspapers, \$6.50. Lists free. Advertising Bureau, 4515-C Cottage Grove, Chicago 15.

INCH Display adv. 50 magazines yr. \$24. Wood's Popular Services, Atlantic City, (N. J.)

ADS Placed in out of town newspapers and magazines. Low rates. Catalogue free. Ideas that pay. Baker Advertising Agency, Successors Ankrum Agency, 189 W. Madison, Chicago 2.

FREE—New Advertisers Rate Guide. 44 pages. Includes everything. Lowest rates. E. H. Brown Advertising Agency, Merchandise Mart, Chicago.

BUSINESS SERVICE

NIAGARA Falls, New York; Niagara Falls, Ontario, Canada office address. Business, personal mail. Reformed when wanted. One dollar monthly. "Richards," Post Office Box 326.

SEATTLE And Bremerton: Reliable business or personal representation. Assignments \$1 per hr. H. Washington, Bx. 1741, Sta. A, Bremerton, Wash.

\$2.00 MONTHLY Maintains Washington, D. C., office address. Your business, personal mail reformed when wanted. "Hawkins." (Established 1917), 7-p Randolph Place.

CHICAGO Mail address. \$1 monthly. Faultless Organization, 3439-B Michigan, Chicago 16.

ACCOUNTING—Bookkeeping. Send your figures, we return completed book records, statements, tax returns. Guaranteed secrecy. Weekly, monthly, yearly service. \$1.00 starts your work, if any additional, pay postman. Ray Jenkins, 66 Charles Street, Mansfield 4, Massachusetts.

TO Whom it may concern: I will represent you in Cleveland. Personal or business assignments \$1 per hour. James W. Farley, Citizens Bldg., Cleveland 14, Ohio. Note: Would appreciate hearing from someone who wishes to enter this business in your city.

SPECIAL SERVICES

TRANSLATIONS. All languages, all subjects. Suner Translation Bureau, Suite 525, 51 Chambers St., New York 7.

PITTSBURGH Shopping and personal services performed. Bevan, 355 Keystone Drive, New Kensington, Penna.

FORWARDING. Prompt service, letters 25c. 5—\$1.00. Orlesters, Box 231, New York 30, N. Y.

WRITE To your friends from Hollywood. Send 50c for six Hollywood postcards. Write, stamp and return to be mailed with Hollywood postmark. Cherry, Box 1441, Los Angeles.

MAIL California post-cards to your friends—Los Angeles, Hollywood, etc. Send \$1.00. I will send dozen post-cards. Return to me for remailing. Letters mail 25c. L. Hanley, P.O. Box 4151, Los Angeles 24, California.

HOLLYWOOD Or Los Angeles address for business or personal prestige, \$1.50 mo. Hollywood Personal Services, Suite 218, 1154 N. Western Ave., Hollywood 28, Calif.

EXPERIMENTAL And model making in sheet metal. Send sketch. Will quote lowest price. Box 5042, Industrial Sta., St. Paul, Minnesota.

SALES Consultant for new or ailing businesses. John Morris, Box 5411, Philadelphia. "Since 1913."

GREAT Fun. Visit New York by mail. Evidence 25c. Souvenir 50c. Letters mailed 15c. Mail address service. Details free. Haller, 436 New York Ave., Brooklyn 25, N. Y.

TYPEWRITERS, DUPLICATORS, OFFICE DEVICES

PRINT Your own postal cards, paper, or anything on "Printomatic Self-feeding Rotary Postal Card Stencil Duplicator." Only \$9.50 with \$2.35 worth of supplies, stencils, ink, etc. Literature free. Pittsburgh Typewriter Supply, 336-RB Fourth Ave., Pittsburgh 22, Penna.

USED Mimeograph \$25. All makes office machines bought and sold. Catalog free. Schubert, Box 9818, Los Angeles 27.

NEW Postcard size stencil duplicator. Literature and samples free. Specialties, 4141 Fletcher, Chicago 41.

RUBBER STAMPS, OFFICE SUPPLIES

YOUR Name and address on a three line, cushioned, indexed rubber stamp with knob handle \$1.00. Extra lines 25c each. Ideal Rubber Stamp Company, Detroit 8, Mich.

PROMPT Service. Cushioned, indexed, 1 line 25c, 2—35c, 3—50c. Stampcraft, 1707 Virginia, Gary, Indiana.

BETTER Rubber stamps. Literature, pocket calendar free. Lee-Vall Press, Box 1242, Indianapolis 6, Indiana.

RUBBER Stamps, all kinds. Send for catalog. Excello, Box 500, Shreveport, La.

RUBBER Stamps, books, circulars. Parcel Press, 53 Astor Sta., Boston, Mass.

PRINTING, MULTIGRAPHING, MIMEOGRAPHING, GUMMED LABELS

100 8 1/2 x 11 LETTERHEADS And 100 envelopes \$1.00 postpaid. Benneville, 907 West Roosevelt, Philadelphia 40, Penna.

LETTERHEADS, Envelopes, blotters, cards, statements, shipping labels, \$4.00 per 1000 postpaid. Pricelist free. McCall Press, 1326 South 27th, Omaha, Nebraska.

1000 5 1/2 x 8 1/2 EMBOSSED Letterheads and 6 1/2 x 9 envelopes \$5.95. Enclose remittance. Barton Press, Sta. B, 6205, Miami, Florida.

100 8 1/2 x 11 LETTERS Mimeographed (like typewriting) \$1.50; additional 100's, 50c. Same day service. Multico, Cornhill, Boston 8.

BEAT Quality printing. Samples sent free. Mail Printing, Danvers, Mass.

150 LETTERHEADS And envelopes \$2.00 postpaid. Going Print Shop, P1544, Muskogee, Oklahoma.

500 3x6 CIRCULARS \$1.00; 100 word limit. Schultco, Box 41, Irwin, Penna.

PRINTING? Lowest prices, samples free. Churchill, 172 Pond, Randolph, Mass.

FIRST Class printing. Samples free. Walker Printing Service, Box 1298, Amarillo, Texas.

400 5 1/2 x 8 1/2 LETTERHEADS \$1.25. Samples free. Mango, 335 South 20th, Newark 3, N. J.

STRATHMORE Bond letterheads, envelopes \$0.45. L. Spada, 10 Lexington, Wethersfield 9, Conn.

500 8 1/2 x 11 LETTERHEADS And 500 6 1/2 envelopes \$4.65. Send \$2.00 deposit, balance c.o.d. Excelsior Press, Hampton, Va.

MIMEOGRAPH 500 Letters, \$1.50. Virgil Vogel, 631 West 61st Place, Chicago.

MIMEOGRAPHING. Varytype method. Particulars. Brennan, 336 S. Washington, Tiffin, Ohio.

5000 3x6 ENVELOPE Slips \$4.85 postpaid. Abbott Press, Oswego, Kansas.

100 LETTERHEADS, \$1.00. Mimeographing. Samples Artpress, Riverdale, Box 61, Dayton 5, Ohio.

STYLE! Printing designed to effectively advertise your business. Submit copy for estimate. Ace Printing, Brentwood, Md.

75 ELEGANT Cards \$1.00, embossed, postpaid. Write samples, prices. Benson, Box 1848-A, Chicago 90.

FINE Printing, office supplies. Catalog free. Treaster Printing, Milroy, Penna.

QUALITY Printing: 1000 8 1/2 x 11 Royal bond letterheads \$2.65, 25,000 \$1.85 per 1000. All types of printing at wholesale prices. Write for samples, State requirements. Printing Service, 7923 South Vermont Avenue, Los Angeles 44, California.

500 LABELS \$1.00; Illustrated. Samples, circular free. Presto, Dayton, Kentucky.

QUALITY Printing prepaid: Business, personal stationery. Letterheads, envelopes, statements. Prices reasonable. Samples. Mero Products, Box 344, Punxsutawney, Penna.

MODERN Design, top quality printing for less. Catalog free. Badger Press, 120 N. Green Street, Chicago 7.

BETTER Grade printing reasonable. Estimates on anything. Economic Press, Leonia, N. J.

MIMEOGRAPHING — Any copy. Reasonable. Mailers Service, Box 608-A, Chicago 90, Ill.

500 3 1/2 x 2 1/4 FOUR Line gummed stickers, 25c. Moritz Printery, Saginaw, Mich.

MIMEOGRAPHING—Letters, pricelists, formulas, instructions. Lowest prices. Lem's Letter Shop, 5710 Stanton, Detroit 8.

PRINTING OUTFITS AND SUPPLIES

PRINTING Equipment, type and supplies. Send stamp for details or dime for complete illustrated supply book. Kelsey Inc., X-11, Meriden, Conn.

RAPID Printing press. Automatic, compact. S. C. Peckham, Bryan St., Dallas, Texas.

MAKE Printing press, mimeograph cuts! Entire instructions \$1.00. Tirekop, Box A-12, Madeira, Ohio.

NEW Presses, type, supplies. Lists 3c. Levinson, Box 918, New York 8.

PRINTERS: You can make a quick-etch etcher for quickly making line cuts and halftones. Particulars free. Charles P. Medlock, Box 256-C, Goodland, Indiana.

PRINT At home—Send 10c for catalogue—presses, type, supplies. Barnhard Co., 6 Columbia St., Newark 5, N. J.

INEXPENSIVE Home-made printing press. Details free. Novelty Shop, Downs-ville, Louisiana.

PATENT ATTORNEYS

INVENTORS—First things come first. Your first move toward securing a patent on your invention is acquiring full information on what to do. Our two books "Patent Protection" and "When and How to Sell Your Invention" contain this information and other helpful data. Get them immediately, together with our "Evidence of Invention" form. They cost you nothing, you assume no obligation. Write now to Victor J. Evans & Co., Registered Patent Attorneys, 931-P Meridian Building, Washington 6, D. C.

PATENTS—Trade marks. Preliminary advice and disclosure form free. Personal service, Irving L. McCathran, 315 McLachlen Bldg., Washington 1, D. C. Registered Patent Attorney.

WHERE Can you sell your ideas? Have you a new idea, an improvement, a device of utility or novelty? Want to know where to sell it? Learn the facts first about its patentability. We have letters from manufacturers wanting new patented ideas. The present emergency market has created a big demand. Get our free book, "How to Protect, Finance and Sell Your Invention." Also free special form "Invention Record." No obligation. McCormrow & Berman, Registered Patent Attorneys, 134-C Atlantic Building, Washington 4, D. C.

PATENTS, Copyrights, Information free. Robert Daley, Registered Patent Attorney, 19 S. LaSalle St., Chicago.

INVENTORS: Learn now—without obligation—how to protect and sell your invention. Write for free "Record of Invention" form and complete information for making disclosure and establishing date of your invention. We also send our new free "Patent Guide for the Inventor," containing complete information about patent procedure and how to sell inventions; giving illustrations of many successful inventions; over 150 basic mechanical movements. We assure you prompt, confidential service. Delays may be dangerous. Write today for your free "Patent Guide" and "Record of Invention" form. Clarence A. O'Brien & Harvey Jacobson, Registered Patent Attorneys, 51B-L, Adams Building, Washington, D. C.

PATENTS. Promptness assured. Wilfred E. Lawson, 1524 K Street, N.W., Washington 5, D. C.

PATENTS. Protect your idea by securing free "Proof of Invention" folder. Exceptional personal service. Established 1906. E. E. Vrooman, 871 Woodard Bldg., Washington, D. C.

PATENTS Obtained; selling service, information, recording forms free. Labiner, World Building, New York.

INVENTORS—Before disclosing your invention to anyone send for form "Evidence of Conception"; Schedule of Government and Attorneys' Fees and instructions. Sent free. Lancaster, Allwine & Rommel, Registered Patent Attorneys, 411 Bowen Building, Washington 5, D. C.

PATENT Protection. Write for information. Fees. Record of invention. Free. Randolph & Beavers, 21-C Columbian Bldg., Washington, D. C.

"**INVENTOR'S** Guide." 100 mechanical movements, free: advice on patenting, selling inventions. Frank W. Ledermann, 134 Nassau Street, New York.

C. A. SNOW & Co., M-427 Snow Bldg., Washington 1, D. C. Registered patent attorneys. Established 1875. Literature mailed on request.

FOR INVENTORS

INVENTORS—Information on what to do first toward securing a patent on your invention is of vital importance. "Patent Protection" and "When and How to Sell Your Invention"—two valuable, richly illustrated books—explain fully what to do first, and a lot more. Get this information quickly, together with "Evidence of Invention" form. All three will be sent to you free. Write immediately to Victor J. Evans & Co., Registered Patent Attorneys, 932-P Merlin Building, Washington 6, D. C.

WHERE Can you sell your ideas? Have you a new idea, an improvement, a device of utility or novelty? Want to know where to sell it? Learn the facts first about its patentability. We have letters from manufacturers wanting new patented ideas. The present emergency market has created a big demand. Get our free book, "How to Protect, Finance and Sell Your Invention." Also free special form "Invention Record." No obligation. McCormrow & Berman, Registered Patent Attorneys, 134-B Atlantic Building, Washington 4, D. C.

PRODUCT Ideas wanted. Have you any ideas for postwar products? If they can utilize light metals our engineers will be glad to help you develop them. We are looking for new items to manufacture and are not soliciting fees for advisory service. We are also in a position to finance ideas of merit. No obligation. Write Box No. 29, Powerad Co., Advertising Agency, 79 Madison Avenue, New York City.

INVENTORS Search ideas before commercializing. Record made. Send sketch, description and/or drawing, and \$25.00. Write Inventors' Research Bureau, 2005 Wisconsin Tower Bldg., Milwaukee 3, Wis.

DEPENDABLE Patent and trade-mark searching—simple inventions \$5.00—trade names \$2.50. Write Raymond L. Smith, Patent Searcher, 302-M Bond Building, Washington 5, D. C. (Former U. S. Patent Office employee.)

1 SELL Patents. Established in 1900. Charles A. Scott, T33PM Garson Ave., Rochester, N. Y.

APPRAISE Your own invention way manufacturers do. Authentic methods show how you can estimate success; failure. How manufacturers compute royalties; prices. Information free. Industrial Management, T-A Randolph Place, Washington 1, D. C.

INVENTORS—Selling your ideas is our business. Write for details. Inventors Sales Service, Box 3005, Euclid Branch, Cleveland 17, Ohio.

EX-WAR Plants want new products, ideas, inventions. E. P. Galvin, 20 N. Wacker, Chicago 6.

HOW To protect unpatented inventions! Copyrighted Certi-Proof establishes proof. \$1 postpaid, or write for details. Warner Company, 1035 Monadnock Bldg., San Francisco, Calif.

PROTECT Your invention with registered trade marked name and drawing, without attorney fee expense. Complete instructions \$2. Satisfaction guaranteed. Charles Hall, Supplveda, Calif.

ATTENTION! Inventors. Drawings expertly prepared—at cost. John D. & Son., 140-0 Spruce St., Bridgeport 3, Conn.

INVENTORS: Learn now—without obligation—how to protect and sell your invention. Write for free "Record of Invention" form and complete instructions for making disclosure and establishing date of your invention. We also send our new free "Patent Guide for the Inventor,"

containing complete information about patent procedure and how to sell inventions; giving illustrations of many successful inventions; over 150 basic mechanical movements. We assure you prompt, confidential service. Delays may be dangerous. Write today for your free "Patent Guide" and "Record of Invention" form. Clarence A. O'Brien & Harvey Jacobson, Registered Patent Attorneys, 51A-L Adams Building, Washington, D. C.

INVENTORS: Avoid unnecessary expense. Write for free booklet explaining how our consulting and advisory service can assist you in deriving the greatest profit from inventing. Institute of American Inventors, Dept. 40-A, 1926 Eye Street, N.W., Washington, D. C.

INVENTIONS. All kinds, having profit possibilities, needed by specific manufacturers, cash or royalty basis. Write for free descriptive booklet, protective disclosure form, references, and instructions for safely disclosing your invention for sale. Address: The Invention Reporter, 5A-11106 So. Longwood Dr., Chicago.

PATENTED And unpatented inventions promoted. M. Joyce Humphries, 1424 Land Title Bldg., Philadelphia 10, Penna.

INVENTIONS Developed and patented; mere patentability is not enough to make an invention successful; we combine patentability with commercial construction at low cost. Thirty years experience; patent engineers. Development Co., 132 Nassau St., New York City.

INVENTORS—We will help you if you have a good idea. We supply the finances to patent your idea in your own name. You own the patent. We also arrange profitable manufacturing connections for inventions. Write without obligation. Patent Financing Corporation, 209H Hospital Trust Building, Providence 3, R. I.

HAVE Your idea or model developed now at pre-war prices. Forty years experience in developing, designing. Tool and die work. Inventors Laboratory, Madisonville, La.

RANDOLPH & Beavers: Registered Patent Attorneys, 11-E Columbian Building, Washington, D. C. In order to protect your invention and reap the reward that should be yours, patent your invention without delay, and at the same time have rights to sell as manufacturers convert to civilian production. Write for information and record form today.

CASH For practical ideas and inventions. Mr. Ball, AB-9441 Pleasant, Chicago.

INVENTIONS WANTED

PATENTED Or unpatented. Developed or undeveloped. As engineers, manufacturers and market analysts, we know what new products industry needs. If your idea is not patented write for details on your protection. Your idea may make you a fortune. Mason, Beall and Horton, Inc., 441 North Beverly Drive, Beverly Hills, Calif.

MANUFACTURERS Desire practical inventions and designs. Patented or unpatented. Cash or royalty basis. John D. & Son, 140-0 Spruce St., Bridgeport 3, Conn.

WANTED: Practical inventions for marketing through chain, drug and cigar stores. Particularly desire lighters, smokers' articles, etc., in plastic, wood or metal. Write Matt, 1412-DN Great Northern Building, Chicago 4.

INVENTIONS Wanted. Write Sidney Lee Company, 690 Market Street, San Francisco 4.

WANTED: Practical inventions. Inventors Patent Exchange, Research Division-B4, Hartford 1, Connecticut.

MANUFACTURER Desires postwar products to make and sell through drug, hardware, department stores and mail order. Or will handle sales only. Reputable, nationally-known organization capable of promoting nationwide sales as well as manufacture of items. Prefer non-electrical products of metal, glass, plastics, etc. Write P.O. Box 1373, Indianapolis, Indiana.

INVENTORS: Have you a sound, practical invention for sale, patented or unpatented? If so, write Institute of American Inventors, Dept. 4-D, Washington.

CASH For plumbing specialty inventions. Chicago Specialty Mfg. Co., 2954 Lawrence, Chicago 25, Illinois.

WANTED—Patented, unpatented inventions having profit possibilities, all kinds. If will sell, reply immediately. Descriptive booklet, references, free. Invention Reporter, 5B-11106 So. Longwood Drive, Chicago.

INVENTORS! Have you good patentable idea? Write Mr. Metzler, 11 West 42nd, New York.

MANUFACTURER Wants sensible mechanical device or idea with quick sales possibilities in low-priced field. Write Matt, 1412-D Great Northern Building, Chicago 4.

CASH For inventions, patented, unpatented. Mr. Ball, A-9441 Pleasant, Chicago.

PATENTS FOR SALE

HOUSEHOLD Device—Combination tube and toothbrush holder. Patents pending. Royalty basis preferred. Wm. Winslow, Vineland, N. J.

PATENTED, Articles everybody can use, license or sale. Write Arthur Thompson, Marysville, Calif.

SELL Outright. Patent gadget removes Spanish moss from trees, telegraph and electric light wires. Isaiah Scudder, 9201 Hudson Blvd., North Bergen, N. J.

FOR Sale or royalty. Attachment for Ford Ferguson tractors to make light delivery truck in a few seconds. Drawbar free. Pat'd pending. A. E. Deal, Morrisonville, Illinois.

HAVE Perfected boltless rail joint. Patent pending on same. Will sell for part cash and royalty basis. Manufacturers interested write Russell Conner, 20 Spring St., Delaware, Ohio.

MANUFACTURING

MODELS—Small lot manufacturing. Metals, plastics, etc. Milburn, Burlington, Kentucky.

MODELS AND MODEL SUPPLIES

MODEL Airplanes, gas models, solid models, gliders, gas engines, ship models, supplies, tools. Send 25c (includes refund coupon) for 63 page 8 1/2 x 11 profusely illustrated Master Model Airplane and Gas Model Catalogue. General Modelcraft Co., Dept. M12 - 91-17 173rd St., Jamaica 3, New York.

LANDLOCKED Sailors! Here's a beautiful, richly illustrated, fully descriptive catalogue of famous model ships—whalers, glavers, corvettes, etc., authentic in every detail. Send for it today. Only 10c. Marine Model Company, Inc., Dept. C-5, 29 W. 15th St., New York, N. Y.

BIG Illustrated model engine catalog 10c. Active Products & Supply Co., 53 W. Jackson, Chicago 4.

WORLD'S Largest selection model engine castings and drawings. Illustrated catalogue 10c. Wayne Miller, Engineering Bldg., Chicago 6.

MODEL Kits and supplies. List 10c. Badger Hobbcraft, 823 S. Second St., Milwaukee 4, Wis.

TOOLS. Model supplies, saw mandrels, steel. Catalog 10c. Terek, 6304 Patterson, Chicago 34.

1/4" SCALE Solid models—engineer designed. F4U Corsair and Black Widow. Precision prints and plenty of materials enable you to make an authentic scale model. No skimping. Everything supplied! Only \$2.98 each postpaid! Cash or money order. Barton Models, 26 Isabella Avenue, Newark 6, New Jersey.

MODEL Builders, experimental shops, manufacturers — 1500 assorted useful standard parts, 130 different items, all items marked, none are mixed. Total cost only \$9.00. Send 10c for detailed list. Albert A. Lohley, Dept. M, Mt. Prospect, Ill.

STREAM Engines, boilers, castings, blueprints, circulars 10c. Anton Bohaboy, 2297 Price, Rahway, New Jersey.

MINIATURE Steam locomotives, 1/4", 1/2", 3/4" scales. Castings, parts, rail! Thorough drawings with instructions. Catalog 25c. Little Engines, Wilmington, Cal.

SUBMARINES—Make latest U. S. 5" aluminum casting, wave mounted \$1.00. 12" model with outfitting instructions \$2.00—wave base \$1.00. Breeze Specialties, Puritan Rd., Saugus, Mass.

BRASS Gears and model supplies for the inventors. Send 10c for catalog. Pierce Model Works, Tinley Park, Ill.

CATALOGS (Illustrated) for modelers! Airplanes, 60 page book on solids. Features construction data, specifications, camouflage, 15c; railroads: 128 page "HO" guide. Equipment, accessories, fittings, 25c (includes refund coupon). Send coin or stamps for each profusely illustrated catalog desired. Folk's, "Nation's Leading Hobby House," 314-PM Fifth Ave., New York City 1.

SHIP And yacht model fittings and blueprints. Hundreds of items to choose from. Send for our war time supplement. A. J. Fisher, 1002 Etowah Ave., Dept. WM, Royal Oak, Mich.

SHIP Model kits and fittings. Complete line Fisher model yacht equipment. All Boucher, Fisher, Marine Model and Ideal kits, fittings and blueprints at standard prices. Most complete stock in New England. Send 10c for price list. James Bliss & Co., Inc., 229 State St., Boston, Mass.

BOAT Models. P.T., cabin cruiser, speedboat. Free circular. All Star, 2003 Lincoln Ave., Chicago 14.

HOME CRAFTSMEN

LEATHER Assortment kit. For only a \$1.00 you can get enough leather including pigskin and ostrich, to make many handcraft items. Also used for repair needs around the house. Postage prepaid. D. E. Products, Dept. 101, Rm. 1612, 104 S. Michigan, Chicago 3, Ill.

PLEXIGLAS And Lucite—The amazing crystal-clear plastics. Saw, drill, bend or twist them into hundreds of articles that are beautifully different! Special one-pound assortment including cement, project drawings, complete instructions—only \$1.25. Six pounds \$5.00; 25 pounds \$18.75. Masked sheets 12" x 12" (144 square inches) 1/4" \$2.50; 3/16" \$2.75; 1/2" \$3.00. Fast-acting cement \$1.00. Red, blue, yellow dyes \$1.00 each. Polishing compounds 65c. Please remit with order. Add 10% extra for postage. Satisfaction guaranteed. Carmen-Bronson, 165B East Third Street, Mount Vernon, N. Y.

BLUE Printed drawings. Duster for dusting insecticides. Fly swatter. Silent door closer. Woodpecker on stick. Price \$1.00 each. End table, tourist cabin, work bench, doll house, dog house, garage, roadside stand. Price 50c each. J. C. Snyder Co. Plan & Book Shop, 1924 W. Delaware St., Evansville 12, Ind.

MAKE Shell jewelry—For gifts, as a hobby or start a business. Free catalogue and price list. Complete illustrated book of instructions 75c. Florida Shellcraft Company, Box 1840, Sarasota, Florida.

BUILD Garages, chicken houses, etc., under \$25 for non-ratoned materials. Also, make a durable substitute for barn paint under 25c gallon. Beautifier, preserver. Instructions 25c. Unique Information Service, P.O. Box 2250, Winston-Salem, N. C.

CRAFTSMEN—Professional plastic projects. Lucite desk set, 33 sketches, dye sample and fabrication treatise. All \$1.00. Glassite, 625 Atlantic, Monterey Park, Cal.

BULLDOZER. Power shovel, earthmover. Prints and specifications of above original toy designs in wood \$1.00. Others available. Earthmover Toys, East Lansing, Mich.

LUCITE. Plexiglas, colored and clear sheets. Rods 1/4"—2" diameter. Lowest prices. Free listings. Craft Plastics, Box 129M, Somerville, N. J.

SPARKLING Colors for Lucite, Plexiglas with ingredients available drug stores. Two tested formulas, complete mixing and dyeing instructions. \$1.00. Kenson Plastic Products, 954 South LaBrea, Los Angeles 36, California.

FIFTY Clever action and pull toy patterns \$3. Catherine Schilder, Cresbard, S. Dak.

WITH Friendly remembrance and good wishes for a Merry Christmas and a Happy New Year. From Douglas Home Craftsman, Stamford, Connecticut.

PLASTICS And plastic supplies. Plexiglas, Catalin, Bakelite, Lucite and others, in sheets, rods, tubes and other shapes. Consult our complete list only 10c. Our special Holiday Kit offer, an \$8.00 value for only \$5.00 postage extra, include 50c to cover. It's fun, it's profitable, it's Douglas, for quality plastics and supplies. Douglas Home Craftsman, Dept. H, Box 34, Stamford, Connecticut.

PERSONALIZED Bookends, plans 25c, clear, simple instructions. E. Johnson, 305 Mayflower, Pittsburgh, Penna.

HAND Scraped surface plate for home workshops \$12.50 for 5" x 7" size. Herbert's Machinery, 2423 East 54th, Los Angeles 11, California.

SAVE Money. Build your own power saw and sander. Drawings and instructions, \$1.00. E. C. Stee, 712 4th Street, Bismarck, North Dakota.

LUMBER—Select hardwood assortment from manufacturer. Over 10,000 sq. in. Suitable for many home projects. \$2.00 prepaid. Day Bros. Mfg. Co., Inc., Canistota, New York.

CRAFTSMEN! Manufacture "Waldo, the Waddling Duck." Appealing, year 'round action pull toy. Easily constructed. Painting eliminated! Use our full color plates pasted on toy. Considerable time, labor, cost saved. Full size pattern—25c. Color plate sets 10c to 25c according to quantity ordered. Details free. Scully-Hall, 92-46 220th St., AM5, Queens Village 8, New York.

HOME Craftsmen—Amazing new tools, heretofore restricted to important war work of motor transport and aircraft plants are now available to you for the first time. With these patented, new war-developed Flex-Abrasive tools — wheels, micro-points, flexa-cones — scientifically made of soft, flexible, abrasive fabrics, you cut, shape, grind, and polish in one operation. Save time, labor; do fast precise work. Our advanced tapered thread design mandrel fits all standard rotary power units like Handee, Foredom, Crandall, others. Get useful Fracto-Kit of 15 assorted wheels, points, cones and two mandrels for low introductory price of \$1.95. Or big Master Kit with three mandrels and 36 assorted wheels, points and cones at only \$2.95. Send check or money order for either kit, pre-paid. Or write card or letter ordering either kit shipped c.o.d. for regular price plus small delivery charge. Complete satisfaction and professional results fully guaranteed. Write: Flex-Abrasive Co., Dept. 2-P-N, 100 N. LaSalle St., Chicago 2, Ill.

TOYS Easily made from scrap wood. 15 patterns 25c. 25 novelty patterns 25c. 15 lawn ornament patterns 25c. Complete Plexiglas construction kit only \$1.25 postpaid. Lynds, Medway, Mass.

TOYS. Novelties, lawn ornaments, silhouettes, patterns. List 10c. Modern Woodcraft, Saginaw, Michigan.

WEATHER Forecaster. Build from scrap. Modern design. Instructions 25c. Vanleuven, 4169 No. Grand, St. Louis, Mo.

JOLLY New action toys. Full size patterns. "Wiggling Motor Boat," "Sadie Seal," "Happy Hitch Hiker," "Waldo, the Waddling Duck," "Santa Claus," all for \$1.00. 25c each. Scully-Hall, 92-46 220th St., AN5, Queens Village 6, New York.

PANTOGRAPH. Available for immediate shipment. Precision instruments. \$2.50 postpaid. Enlarges drawings automatically. Eliminates using squares. Satisfaction guaranteed. Pantographs, Munising 1, Mich.

DYES For lucite, plexiglas, etc. 15 colors. Just dip to color. Trial combination, red, blue, yellow, \$1.25 postpaid. G. Baker Co., 685 Center Ave., River Edge, New Jersey.

PLASTICS—Plexiglas, Lucite, Bakelite, Lignolite, Lumarith, Ethocel in sheets, rods, tubes and strips. Fine assortment of standard sizes. Cements, dyes and other plastic supplies, too! Complete lists 10c. Carmen-Bronson, 165B East Third Street, Mount Vernon, N. Y.

"LUCITE," "Plexiglas" pieces, book of instructions and projects, 3 colors dye, cement \$2.00 postpaid. O.K. for overseas. Barnett Specialty, 5430 Hollywood Blvd., Hollywood 28, Calif.

PLASTIC Molding machine. Build the best yourself. A fascinating, inexpensive hobby. Parts and plans available. For information, C. R. Kiley, 4318 Oak St., Bellwood, Ill.

CRAFTSMEN—Fast selling, make children and adults lawn chairs. Plans and instructions \$1.00. Summercraft Studio, 42 Vernon St., Newton 58, Mass.

MYRTLEWOOD Turning blocks—Prices on request. Box 7146, Portland 1, Oregon.

STAINLESS Steel, bar or sheet assortment, \$1.00 postpaid. Industrial Engineering, 1155 South Kenmore, Los Angeles 6, California.

PLYWOOD—Beautiful nonpriority aircraft, cabinet and paneling stock. Thickness 1/16" through 1"; large, small panels. Fir, gum, birch, mahogany, walnut. Reasonable! Complete lists 10c. Carmen-Bronson, 165B East Third St., Mount Vernon, N. Y.

CATALOG: Patterns plywood novelty furniture, letters, numerals, plaques, frames, weathervanes, silhouettes, lawn ornaments, 100 books and booklets on crafts and hobbies, picture frame mouldings, tools, large line decal transfers. Other lines. Hundreds articles finely illustrated. Write Wo-Met Shop, Ashburn, Ga.

TOY Patterns. Circus wagons, trucks, carts, pull toys, etc. 35 patterns \$1.00. Continental Products, 907 Birch, Eau Claire, Wisconsin.

WHITTLES — 20 Patterns, instructions, X-acto knife, wood. \$1.00. "Old Whittler," 1403 Charles, LaCrosse, Wis.

CRAFTSMEN — Build and sell lawn chairs. Detail plans \$1.00. We tell you how we build, how and where we sell. The Woodcraft Shop, Danby, Vermont.

MAKE Shell jewelry. Shell, metal and plastic parts for manufacturing at home. Free illustrated catalogue and detailed instructions. Florida Supply House, Bradenton, Fla.

PATTERNS—Full size for rocking horse, swan rocker, doll stroller, cradle and boy's wheelbarrow, \$1.00 postpaid. Lincoln's Craft Shop, Farmington, Conn.

MAKE IT YOURSELF

RAIN Switch. Something new! Rings bell or turns on light at first few drops of rain. Easy to make; useful, instructive. Let your boy build it. Low cost. Send \$1.00 for plans. Address Box 862, Miami, Fla.

ELECTRO-MATIC Furnace for home or office. Convert now. Blue print and instructions how to build \$1.00. Electro-Matic, Box 734, Portland 7, Oregon.

SHELLWORKERS. Send for new wholesale illustrated catalog. Metal and plastic jewelry parts, seashells and supplies. Shell Novelty Co., Box 1664, Fort Myers, Florida.

CONCRETE Mixer, efficient hand power, inexpensive, from oil drum. Plans \$2.00. A. Mitkos, 8402 Corwin, Jennings 21, Mo.

COMPLETE Plans and instructions for building eight-foot bobsled, speedy skisled, and sporty toboggan. All three \$1.00. Universal, 2671 Algonquin, Toledo, Ohio.

BUILD Concrete block machine. Easy, inexpensive. Sell blocks, build home, garage, barn at low cost. Free details. Horne, 206 West Wilder, Tampa 3, Fla.

FIREPLACE Curtain mesh. Make your own fire screen. Beautiful brass or copper finish. Send measurements to Box 4662, Station B, Spokane, Wash.

WHEEL Assemblies for your own construction of scooter, wheelbarrow or wagon. 8" x 2" puncture-proof tire. Metal wheels with bearings and axles \$2.25 per wheel. Send orders to City Machine Company, 668 East Tallmadge Avenue, Akron, Ohio.

BUILD Motor-driven jig saw for \$3.00. Complete details \$1.00. Dutton, 626 In-sandee Ave., Cuyahoga Falls, Ohio.

FLUORESCENT Lights. How to make your own 20 watt lights for less than \$1.00 each. Material available. Complete guaranteed, detailed instructions \$1.00 cash, m.o. or war stamp. Checks \$1.10. Specialty Sales, Box 1086, Muncie, Indiana.

WATCHES, OLD GOLD, JEWELRY, ETC.

TRAIN Yourself for watchmaking, repair, adjustment. New, all-inclusive "Practical Course" for beginners, professionals. Illustrated. Sensational value. \$2.95 postpaid. Money back guarantee. We supply tools, materials. Modern Technical Book Co., Dept. 2MMC, 55 West 42nd Street, New York 18.

GENUINE Diamonds, out-of-pawn low prices, wonderful values. Unredeemed loans and big buying power enable us to offer beautiful gems at prices far less than original cost. Shipped free for inspection, appraisal. Send for big free list showing fine diamonds at startling low prices. Lloyd J. Butler, President, Prudential Loan Association, 133-SN North Clark St., Chicago 2.

"JEWELRY, Gem cutting, metalcraft," excellent for hobby, profession. All inclusive. Cutting, polishing, mounting, gem stones, metal, jewelry work for gift, household, sale. Interesting designs, 287 pages, illustrated. \$2.95 postpaid. We supply tools, materials. Modern Technical Book Co., Dept. MMC, 35 West 42nd St., New York 18.

ALUMINUM Identification bracelets \$1.95. Free engraving. Moyer, B-252-P, Milton, Penna.

OLD Jewelry wanted: For highest prices mail all watches, broken or usable, gold teeth, rings, spectacles, cigarette cases, silverware, diamonds, etc.—receive cash immediately. Satisfaction guaranteed or merchandise returned. Information free. Rose Smelting-Refining Co., Dept. A, 29 East Madison, Chicago.

WATCH Movements—Waltham, Elgin, others. Pocket watches. Ideal for beginners, repairmen, parts. \$1.00. Bezkor, 1491 Metropolitan Ave., New York 62.

WATCH Repairing: Complete course. Every part of watch fully explained. Many large pictures and drawings. Tools, material. Where to buy. \$2.75 money back guarantee. Park Place Supply Co., P.O. Box 1140A, Houston 1, Texas.

GOLD \$35.00 Ounce—Mail old gold teeth, diamonds, jewelry, watches—receive cash by return mail. Satisfaction guaranteed. Free information. Dr. Weisberg's Gold Refining Company, 1500-Q Hennepin, Minneapolis, Minn.

GEMS, Precious and semi-precious, all genuine, from world wide sources. Deal direct, no overhead, save money. Catalog 10c. Hill Co., Route 7, Salem, Oregon.

WATCH Repairing easy learned by our home study course. Watch repairers are in demand and are among the highest paid craftsmen today. Write for free information. Houston Chronometer & Watch Co., P.O. Box 5387C, Houston 12, Texas.

WATCH And clock repairing—complete practical course in modern horology. 66 illustrated self-instruction lessons. Just out! Low price. Information free. Write Nelson Company, Dept. 8-02-2, Chicago 4.

RAZORS, BLADES, SHARPENING

100 **DOUBLE** Edge or 80 single edge blades—\$2.00 prepaid. Wholesale accounts invited. Ace Company, 3518 32nd Street, Union City, N. J.

100 **BLU** Strike double edge \$1.25 postpaid. National, Box 301-M, Cincinnati 1, Ohio.

TOBACCO, SMOKERS' SUPPLIES

CIGARS: Extra fine. Direct from manufacturer. 15c value. 50 prepaid \$5.00. Lawrence, 1621 Ainslee, Chicago.

5c **CIGARS**, Also national brands wholesale available. Continental Cigars, Corning 1, N. Y.

CIGARS, Mild, prices on request. S. & E. Co., Box 266, Red Lion, Penna.

PIPES: Imported custom carved or virgin bruyeres \$3 postpaid. Satisfaction guaranteed or refund. Wilson, 770 Faile St., New York 59, N. Y. (Distributors wanted.)

SURVEYING INSTRUMENTS

GUARANTEED Factory rebuilt transits and levels for sale (cash or terms) or rent (with purchase option). We will repair, trade, or buy old instruments. Ship prepaid for estimate and valuation. For complete information. Write for list M1012, Warren-Knight Co., (Manufacturers of Transits and Levels), 136 N. 12th St., Philadelphia 7, Penna.

FOR THE HOME

FIREPLACE Circulator, efficient, easily constructed. Instructions, photographs \$2.00. Grapnel, RFD 4, Putnam, Conn.

REPLACEMENTS—Grates, firepots, linings, craxmend. Attractive prices. Magi-produx, Royal Oak, Michigan.

HOLIDAY Gift packages, tangerines, half bushel package \$3.50. Prepaid express. O. L. Stroman, Mission, Texas.

FOR SALE—MISCELLANEOUS

30,000 **THIRTY** Thousand, approx. genuine leather knife and fork scabbards. New, bought from government surplus. Size 1 1/2" x 7 1/2". About half of each. Will sell for \$90.00. Samples of both 25 cents prepaid. H. Poncer, P.O. Box 1278, El Paso, Texas.

CAMEL-BACK, Model railroad bridge. 114" span, 16" wide, 13" high. Bolted heavy steel construction, \$85.00. Standard Designers, Inc., Box 288, Asheville, N. C.

SOUVENIR From Hollywood. Life like turtle, hand made from large English walnut shell. Head and tail balanced, slightest movement put them in motion. Postpaid 50c, stamps excepted. Galen Henderson, 5440 Harold Way, Hollywood 27, Calif.

MEN'S Fine used suits, overcoats. Good condition. Get circular. Campbell Doggins, Box 949, Lexington, Ky.

SLIGHTLY Used eight spindle Curtis wood carving machine, fully equipped, with converter. Half Studios, 303 E. 14th St., Loveland, Colorado.

ALUMINUM Rivets—Army, Navy specification assorted sizes, 2 pounds 33c. Arizona Mfg. Co., P.O. Box 2691, Phoenix, Arizona.

STREAM Engine and copper boiler for sale. 1/3 h.p., complete, excellent condition. \$42. Valash, New Albin, Iowa.

ARMY Goods (used). Raincoats \$1, boote knives \$3.75, jeep hats and caps 10c, over-seas caps 10c, dungarees 95c, tool boxes \$1, gas mask bags 50c, steel helmets \$1, gun slings 75c, holsters 75c, canteens 50c, cups 15c, mess kits 35c, leggings 25c, cartridge belts 50c. Minimum shipment \$1. No. c.o.d. N. Y. Salvage, 144 Chambers St., New York City.

CUTTERS, Dental burs assorted, reclaimed job-lot, \$1.90 per gross. Wolf, 124 E. Hartlane, Philadelphia, Penna.

WANTED—MISCELLANEOUS

WANTED: Motor to convert bicycle into motor-bike. Give price, description. Dunakin, 819 Golf Lane, Wheaton, Ill.

WANTED: Assistance to organize and manufacture number of mechanical inventions, also several modern electro-mechanical toys. Details first letter. G. B. Downs, Mahoning St., Lehighton, Penna.

IF You want to swap, buy or sell anything, send 25c for The National Swappers Guide. It's chock full of swappers, sellers and buyers from coast to coast and opportunities to swap, buy and sell almost anything under the sun. National Swappers Guide, 610 St. Joseph, Evansville 12, Ind.

JUSTICE Buys almost anything! List free. 9762 Santa Monica, Beverly Hills, California.

AT Once! One "Brown Bobby" donut machine and recipe. O. A. Davis, Phillipsburg, Montana.

MERCURY (Quicksilver) — Cadmium, bismuth, tungsten, molybdenum, cobalt, vanadium. Write for quotations stating quantity. You'll receive guaranteed prices. Metallurgical Products Co., 35th and Moore Sts., Philadelphia, Penna. Established 1909.

PERSONAL

PERSONALIZED Pencils. Name gold. Dozen 50c. Christmas boxes. Pencil Market, 811 - 15th St., Knoxville 16, Tenn.

DANIEL Williamson. Make Christmas merry. Phone or write collect. Family.

MIDGET Bible. Size of postage stamp, three for 25c. Kaybee, Crescent Beach, B.C., Canada.

FEET Hurt? Why suffer needlessly? Send postcard today for free literature. No obligations. Stemmons Mfg. Co., Kansas City 2, Mo.

LIVE Longer, feel better, enjoy life. Free information. Fairchild Company, Mt. Vernon, Ohio.

PROFESSIONAL Cryptographic services: have undecipherable cipher. Huntington, 80-06 Champlain, Chicago.

SLEEPLESSNESS Unnecessary — Stop now with Sleep-Rise, soft waxen earstoppers. Set 10c. Free literature. Raymond Dow, 15 Park Row (1215AL), New York 7.

KNOW How to promote yourself—how to get a better job—or more pay in your present job. Details free. Machado (Consultant), 339-P, East 111th Street, Los Angeles 3, Calif.

NERVOUS? Bashful? "Fears?" Free, encouraging information. Jno. Englund, Ironwood, Michigan.

MAGNIFICENTLY-STRUCK 14-Carat gold plated "Saint Christopher Medal." Said to bring luck and protection. Ideal personal good-luck piece. Your full name engraved. Send only \$1.00 (print name). Keystone Bazaar, Dept. 5, P.O. Box 2077, Philadelphia 3, Penna.

SURPRISE Santa Claus letters for your little folks. Old Santa's picture on stationery mailed during Christmas. Will give children big thrill. Send child's name, complete address and 25c now. Santa Claus Headquarters, Box 4690, Charlotte 4, N. C.

SWEETHEART! Wife! Mother! \$1.00 buys beautiful war service honor scroll for your serviceman. Illustrated circular free. Mailmart Press M, Box 463, Indianapolis, 6, Indiana.

WRITE Beautiful penmanship in few hours. Write, Ozment, 9, St. Louis, Mo.

SWAP! Trade, Free list. "Swappers' Gazette," 2836-P Slevin, Louisville 12, Ky.

EXSERVICEMEN: Free billfold copy of discharge paper with order for full size photographic copy. Before lost or misplaced send discharge with \$1.00. Original and copies returned promptly. Electro Photo Co., Box 500, LaCrosse, Wisconsin.

FALSE Teeth that are loose can now be made to fit with Dr. Reese's Dental Plate Liner. Do it yourself—at home. My private formula. Not a paste or powder. Entirely new! Perfect, lasting fit guaranteed. Write for information, Dr. C. N. Reese, Dentist, Box 268A, Winnetka, Illinois.

BEAUTIFULLY Printed personal stationery. Free samples. H. J. Vrasel, Yonkum, Texas.

HAVE Fun! Pretend visiting California. 3 postcard views 20c. Address, return, I remit. Letters mailed 15c. Free information. Ira Smith, 153 Liberty, San Francisco 10, California.

MEXICAN Law practice. A. B. Flota, Box 236, El Paso, Texas.

BOOK Bargains. Illustrated catalogs free. Rialto, 349-B, Sackett, Brooklyn, N. Y.

HAIR Falling? Dandruff? Write Trichologist, 137 Lewis St., Phillipsburg, N. J.

MISCELLANEOUS

LUMINOUS Nursery wall decorations, fascinating cutouts glow in darkness. Complete set 35c. Two glowing nursery pictures suitable framing 25c. Circulars. Luminovelties, 469 Irving, Brooklyn, N. Y.

ATTENTION! Just out. Mirror necktie cabinet. Pat. app'd for. Write now. 705 Sunset Dr., Lorain, O., R.D. 1.

SWAPPE Shoppe. Trade anything, new or used. Gifts, novelties, etc., exchanged. Write Arlesters, P.O. Box 231, New York 30, N. Y.

PHOTOCELLS. Make your own. Material and instructions \$1.00. Details free. Hill Laboratories, Box 83, Glen Rock, N. J.

BIGGEST Money in tattooing now! No experience required. Complete instructions with outfits. Send for free literature. Tatuco, 651 South State, Chicago.

"RECEIVE Mail." Moneymaking offers, opportunities, catalogs. Name listed 10c. Ideal Service, 112, Park Ridge, Ill.

HEATING 6 Rooms \$25.00 yearly! Coal furnace. Circulars 10c. Rosenzweig, RR10 A2, Cincinnati.

ARE You interested in life, travel, adventure in the tropics? Free copy of magazine when published. Write, Tropical World, Suite 410 Bond Bldg., Washington, D. C.

SEEK Buried treasure. Methods, mysteries, devices explained. Circulars free. Century Press, Box 151-B, Glen Ellyn, Ill.

STAG Book matches, 10 for \$1.00. Logan Novelty Co., Bellefontaine, Ohio.

DARE To be somebody and get somewhere! Unleash the creative magic inherent in your best self. Smash inhibiting fears, gain confidence, discover new qualities in yourself. Make your confidence earn promotions. Put your imagination to work for you instead of against you. The writer of this course regained health, well-being and improved finances by the use of psychological principles. Get details of this personality-developing plan. No obligation. Money-back guarantee of satisfaction after trial period. Write today! Now! A card will do. School of Personal Psychology, Inc., 321 Starks Building, Louisville 2, Ky.

FREE Mail of opportunity. K & F Distributors, Flushing, N. Y.

LATEST Mail order propositions from many companies, sent steadily one year, 25c. Geo. Pfeiffer, Hackensack, N. J.

RECEIVE Mails, samples, moneymaking opportunities, literature. Your name in several mailing lists, 10c. Rogowski, 3415 Broadway, New York 13.

FETT Hurt, Arch supports made to order \$4.50 pair. Unbelievable comfort. Booklet free. Archcraft Company, 600 West 164 St., New York City 32, N. Y.

FREE Booklet. "Profitable Employment Opportunities in Latin-America." Enclose 3c postage. Vallesp, New York 13.

NERVOUS? Bashful? "Pears?" Free, encouraging information. Jno. Englund, Ironwood, Michigan.

YOUR Name featured "in lights" on famous Broadway theatre! Free sample! Rickarby, 403-P West 115th, New York 29.

"**BIBLE** Studies." 70 lessons 25c. Bulletin, Box 87, Station H, New York 25.

NOVELTY Stationery—"Happy Bachelors' Home For Old Maids," "Podunk County's Country Jail," and four others. Sheet size 8 1/2 x 11. 6 sets, 6 sheets with matching envelopes, each set in different color ink. Ideal for gifts. Box \$1.00. Lettercraft Shop, Chatham, Virginia.

"**ATTENTION**"—Send initial of wife, mother or sweetheart. Receive beautiful hand carved charm in Lucite. Start profitable business. \$3.95 complete. A & M Special Plastic Products, 898 River Road, Edgewater, N. J.

FOUNTAIN Pens—Amazing value \$1.25. Ideal gift. Plunger type filler, military clip, iridium tipped pen point, visible ink window. Gold initials free. Send money order. Johannah Pen Co., Box 157, Newark 1, N. J.

MEXICAN Feathered bird pictures. Ideal Xmas gifts. Sample 25c. Large framed picture \$1.00. Catalog with order. Foley, 217 Grafton St., Brockton, Mass.

JAP-O-LIGHTER, Jap hand grenade table cigarette lighter. Attractive, nickel-plated. Souvenir of Pacific war. Ideal Christmas gift for veterans or any smoker. Made in U.S.A. Five dollars. Send mail orders to Woodrow W. Davidson, Box 5953, Dallas, Texas.

FREE Catalog. Gifts, clothing, jewelry. Save money. Send today. Roland's, 6411 Stover, Cincinnati 12, Ohio.

LOST Keys, pets returned! Beautiful gold tag (name, address) \$1.00 (three different \$2.00). McCormac, Box WW-12, Madeira, Ohio.

RADIOS: New or used, bought and sold. Hagedorn, 2250 North 27th Milwaukee, Wisconsin.

HARD To get wallets \$2.95. Genuine leather, zipper all around wallets, with change purse, picture holders, twoway bill pockets, in black or brown. We mail c.o.d. Money back guarantee. Gold initials free if money sent with order. Send today, do not delay. J. L. Wallet Co., Box 448, Salem, Mass.

TRADE Magazines. Business, vocational, diversion. Current single copies. Over 200 fields. Free price list. Commercial Engraving Publishing Co., 34C North Ritter, Indianapolis 1, Indiana.

MEDICAL Laboratory technicians in great demand. We train you in your spare time, in your own home. You can practice while studying. Write for free catalog. Imperial Technical Institute, Box 973-J, Austin, Texas.

BEAUTIFUL Bronze grave markers, signs, reasonable. Berg, Box 3162, Bridgeport, Conn.

MEXICAN-AZTEC Featherwork tropical bird picture cards. Samples 25c. Bulletin free. Mexican Products Co., 126 No. Main, Tulsa 3, Okla.

LUMINOUS Paint. Best quality. Glows bright blue in dark. 1 oz. each paint and sealer only \$1.39 postpaid. Black Light Products, 450 E. Ohio St., Chicago 11, Ill.

GIGANTIC Mails, magazines, samples, listing 10c, three times 25c. Waddell's, 341 East 78th, New York 21.

SQUARE Dance instructions, calls, 25 sets, \$1.00. Rayburn, Lonsdale, Arkansas.

TATTOOING Outfits, designs, colors. Write today. Zets Studio, 728 Lesley, Rockford, Illinois.

GOOD "Used" self-instruction educational books on all subjects bought, sold, rented, exchanged. Satisfaction guaranteed. Complete information and 92-page illustrated bargain catalog free. Write—Nelson Company, Dept. 2-02-2, Chicago 4.

METAL. Mineral locators latest 1946 electronic type ready for immediate shipment. Fisher Research Laboratory manufactured 2 million dollars worth of electronic equipment for the U. S. Army, including some of the finest metal-locators. Experience gained is yours in the best metal, mineral locator. Free 16 page booklet upon request. Fisher Research Laboratory, Palo Alto, California.

ABC And spot welders. Make them yourself. Complete details 25c. Popular Mechanics Press, (C-43), 200 E. Ontario, Chicago.

1  **2**  **FLIGHT JACKET INSIGNIA**
With your own first name **50c** each
Come and get 'em, only... Postpaid

Dress up your sweater, blouse, or lumber jacket and look just like the men that fly our big bombers. Indicate selection by number and print carefully your first name, or your nick name. Mail with 50c today. Agents Make Money—Take orders. Set for \$1.00. Illustrated book of all Army Insignia Emblems only 25c.

INSIGNIA MART
703 Broadway, Dept. P, New York 3, N. Y.

3  **4** 

★ TRAIN for SUCCESS in the Poultry Business

YOU CAN MAKE MONEY FROM POULTRY

Study at home in spare time. Earn extra while learning...

25th ANNIVERSARY

Get ready now—the easy, scientific, inexpensive way! For 25 years, we've been helping thousands to greater success. During 25 years we have trained thousands of students, showing them how to establish poultry farms—how to avoid mistakes—how to cut losses—how to increase profits on established plants—how to have their own small profitable breeding plant and make a good living at it.

Proper management and "know-how" makes profits ANY season, for life. Our courses cover all phases of poultry raising, including plans for buildings, breeding, hatching, culling, sexing, caponizing, marketing, judging, exhibiting, and many others, etc., as planned by Harry M. Lamson, former Senior Poultryman for the United States Dept. of Agriculture. Endorsed by leading colleges, poultrymen everywhere. Write today for this Free Catalog "How to Raise Poultry for Profit." It fully describes courses, methods, service, opportunities, and easy payment plan.

National Poultry Institute
Dept. 50-E, Adams Center, N.Y.

YOU CAN SUCCEED... Send For this Book Today

SAVE WASTE PAPER

FIX TYPEWRITERS

A Simplified Practical Home Study Course. Many of our students now have their own business—Many Repair for others. Repair Shops Swamped. Health or Age no handicap.

WEBER TYPEWRITER MECHANICS SCHOOL
Box 269, Osborn, Ohio



CARTOON TO SUCCESS!

Learn to cartoon! Big pay! Easy, enjoyable work! Cartoon course, gag course, anatomy course and business course full of plans, markets, ideas. Drawing set and criticism. All one low price! Rush card for details!

HARTMAN SCHOOL, 2438 W. ST., LINCOLN 3, NEBRASKA

This Circular Trade-Mark Identifies the Genuine Webster—

The Merriam-Webster

WEBSTER'S NEW INTERNATIONAL DICTIONARY
Second Edition
UNABRIDGED

YOU may have had difficulty in obtaining a copy of WEBSTER'S NEW INTERNATIONAL DICTIONARY, Second Edition. But place your order with your dealer now. Only a short wait may be necessary.

The Merriam-Webster is the standard for State Supreme Courts, the Government Printing Office, newspaper offices, colleges and schools. It contains 3,350 pages, illustrations for 12,000 terms, and a total of 600,000 entries—122,000 more than any other dictionary.

G. & C. MERRIAM CO., Springfield 2, Mass.



"The Supreme Authority"



Three months after beginning your lessons I STARTED PLAYING IN A DANCE ORCHESTRA

"Now I have an orchestra of my own"
writes Bert Magyar of Barnwell, Alberta, Can.



"THREE months from the time I began taking your lessons I started playing with a dance orchestra, and now I have an orchestra of my own. "Due to my rapid progress with the Saxophone, many people ask

where and how I have been taking lessons. I can truly recommend your easy Course for any student who wishes to learn music a quick and easy way."
(Signed) BERT MAGYAR

Thousands have learned to play their favorite instrument this quick easy way for
ONLY 7c A DAY . . .

SO CAN YOU! You'd be amazed to read the many letters in our files, from people who have realized their musical ambitions by taking our courses . . . people who had no special gift for music, no previous training.

With this remarkable U.S. School no teacher method, you play real tunes by note from the very first lesson. You start with simple melodies. As you improve, you take up more difficult pieces. And al-

most before you know it, you find you can take many popular numbers and play them by note.

You'll be thrilled to know that you can learn your favorite instrument this simple, home-study way for less than 7c a day. That covers everything. If interested, send for Free Booklet and "Print and Picture" Sample. See how easy it is to learn music this quick, low-cost way. U. S. School of Music, 712 Brunswick Bldg., New York 10, N. Y.

FREE! Print and Picture Sample

U. S. School of Music
712 Brunswick Bldg., New York 10, N. Y.
Please send me Free Booklet and Print and Picture Sample. I would like to play instrument checked below.

Piano	Saxophone	Clarinet
Guitar	Trumpet, Cornet	Tenor Banjo
Hawaiian Guitar	Modern	Mandolin
Violin	Elementary	Practical
Piano Accordion	Harmony	Finger Control

Name..... Have You Instrument?.....
Address.....
City..... State.....

Save 2c—Stick Coupon on Penny Postcard

FIX ANY RADIO

Learn quickly to repair all radio sets. New, different Comparison method permits you to do expert work almost immediately. No previous radio knowledge needed. Introductory training included. Simple, picture suggestions tell you where to look for faults and how to make the repair. No testers needed for most jobs. Manual 8 1/2 x 11 in., 76 job-sheets, 16 blueprints. Many hints. New edition. Order manual-plan 8X. Only \$1.50, postpaid. Money back guaranteed.

SUPREME PUBLICATIONS 9 S. Kedzie Ave. Chicago 12, ILL.

Get Ready for Big After War Opportunities!

I Will Train You at Home Until You Get a GOOD PAY JOB in DRAFTING

Act now to get a better job with more pay and pleasant working conditions. Get into Drafting—the basic profession where all post war products will start. I will train you at home—give you experience—doing the same kind of jobs you will do with the best paying firms. I furnish instruments, drawing table and all equipment when you start. Write today for vital facts and FREE illustrated book. Give Age.

Engineer Dobe, Div. 112, Libertyville, Ill.



CODE-SENDING-RECEIVING-SPEED

Learn to send and receive Radio Code with greater speed. Stop nervous tension. Have confidence. Be proficient. Some system used by radiotelegraph specialists. Thousands of operators needed. Rush name for FREE book.

CANDLER SYSTEM CO., Dept. S-O, Box 928, Denver 1, Colo., U.S.A.

What Every Mason Wants



We have important Masonic books for Blue Lodge, Chapter, Commandery, Scottish Rite, and Shrine.

Our Rituals Are Used the World Over. Send for free catalog of books and rituals for Masons, Odd Fellows, Knights of Pythias, Knights of Columbus, etc. EZRA A. COOK, Publisher, P. O. Box PD, Chicago 90, Ill.

Listen to this Record!

SPEAK SPANISH

FRENCH, GERMAN, OR ITALIAN

Big opportunities awaiting Americans who speak Spanish. Learn as a child learns—"by listening" to these new CORTINA recordings.

Only 15 Minutes a Day



Cortinaphone Method famous for 60 years.

THOUSANDS have found it the most fascinating, most satisfactory method. Here is the quick, easy way to learn Spanish for PLEASURE AND BUSINESS. INVESTIGATE!

Sent on 5 Days Approval

"The Cortina Short-Cut"—tells just what you want to know. Interesting. Get it!

Write Today-NOW!

CORTINA Academy (Language Specialists for 60 Years)
Suite 6412, 105 W. 40th St., New York 18, N. Y.

Please send me—without obligation—your free booklet, "The Cortina Short-Cut." I am interested in (mark):

SPANISH French Italian German

Name.....

Address.....

DRAFTSMEN NEEDED



**PREPARE NOW for a
BETTER JOB
AND GREATER
OPPORTUNITIES**

If you are ambitious to hold a better job, make more money and have greater opportunities to get ahead, start now to become a draftsman. Or if you are now employed in routine drafting work and want a better job—as a real draftsman, on more important work, at bigger pay, start now to qualify for that job.

Learn at Home in Spare Time

American School has helped thousands to reach higher goals, and can help you. Our practical, up-to-date training plan can provide the know-how that fits men for responsible jobs and opens opportunities. Begin draftsman training now. Check, fill in and mail the coupon below for FREE information—today.

AMERICAN SCHOOL, Dept. DD945, Drexel Ave. at 58th St., Chicago 37, Ill.

Gentlemen: Send me FREE information covering special training in subjects checked below. No obligation on my part.

- | | |
|--|---|
| <input type="checkbox"/> Drafting and Design for Men and Women | <input type="checkbox"/> Electrical Engineering |
| <input type="checkbox"/> Architecture and Building | <input type="checkbox"/> Diesel Engineering |
| <input type="checkbox"/> Automotive Engineering | <input type="checkbox"/> High School Course |
| <input type="checkbox"/> Business Management | <input type="checkbox"/> Plastics |
| <input type="checkbox"/> Railway Training | <input type="checkbox"/> Mechanical Engineering |
| <input type="checkbox"/> Electronics, Industrial | <input type="checkbox"/> Aviation |
| | <input type="checkbox"/> Radio |

Name.....

Address.....

AIR RIFLES BENJAMIN AIR PISTOLS

ORDERS NOW ACCEPTED

EARLIEST POSSIBLE DELIVERY REALLY ASSURED—ACT NOW!

ORDER Latest Models BENJAMIN AIR RIFLES & BENJAMIN AIR PISTOLS AT ONCE. Send for our FREE ILLUSTRATED FOLDER and complete Specifications TODAY. BOTH CALIBRE BENJAMIN H-C PELLETS ARE AVAILABLE NOW. BENJAMIN AIR RIFLE CO., 812 MARION ST., ST. LOUIS 4, MO.

Success in Music!

**THE ONLY HOME STUDY
MUSIC CONSERVATORY OFFERING
ALL COURSES LEADING TO
DEGREE, BACHELOR OF MUSIC**

Personalized Instruction for Professionals, Advanced Students and Beginners by Eminent Music Teachers. Check courses which interest you and mail coupon for catalog and illustrated lessons.

UNIVERSITY EXTENSION CONSERVATORY

765 Oakwood Blvd., Suite U-288, Chicago 15, Ill.

- | | | | | | |
|--|---|---|---------------------------------------|--|-----------------------------------|
| <input type="checkbox"/> Piano | <input type="checkbox"/> Violin | <input type="checkbox"/> Cornet | <input type="checkbox"/> Trumpet | <input type="checkbox"/> Saxophone | <input type="checkbox"/> Clarinet |
| <input type="checkbox"/> Guitar | <input type="checkbox"/> Mandolin | <input type="checkbox"/> Voice | <input type="checkbox"/> Ear Training | <input type="checkbox"/> and Sight Singing | |
| <input type="checkbox"/> Choral Conducting | <input type="checkbox"/> Public School Music | <input type="checkbox"/> History of Music | | | |
| <input type="checkbox"/> Harmony | <input type="checkbox"/> Advanced Composition | <input type="checkbox"/> Arranging | | | |

Name.....

Street.....

City & State.....

Music experience..... Age.....



100 POWER 6 1/2 FT.

ONLY
\$1.95

ASTRO-TELESCOPE LENS KIT

Thrill yourself and entertain your friends with such heavenly sights as moon craters, Saturn's beautiful rings, comets, nebulas, and hundreds of interesting sights we guarantee you can see. A fascinating hobby for you. An ideal gift for that boy of yours. NOT A TOY.

A WONDERFUL LOW-COST XMAS GIFT

Kit includes all optical parts needed to build this powerful 6 1/2 ft. refractor, a 3" dia., 75° F.L. objective lens of high quality, 2 brass eyepieces of 40X and 100X ready to mount, color filter, diaphragms and building plan. New perfect lenses—not rejects. Remaining materials needed are readily found for less than \$2.00.

SIMPLE TO BUILD, TOO

Imagine building your own telescope a dozen times as powerful as fine binoculars in an evening of easy educational work, and at one-tenth the usual cost. Even a boy can do it with the easy instructions included.

UNBELIEVABLY LOW COST

Now amazing promises make possible a kit of 100X precision lenses, scientifically matched to peak performance, for the trifling price of \$1.95 POSTPAID, check or M.O. Money-back guarantee. Address an envelope now to:

BEELERSCOPE, BOX 235PM, North Hollywood, Calif.

If you enclose \$2.00 currency we'll return nickel with kit. DO IT NOW. Don't forget your return address. We mail same day. Mail it now and have your kit in a few days. Canada 5% extra. Send postcard for FREE telescope building plan and list of outstanding optical values.

LEARN MOVIE PROJECTION THEATRE MANAGEMENT

The Motion Picture Theatre Business offers big opportunities for trained men. Get into a fascinating field with a peace time future. Train at home in spare time. Free catalog. Established 17 years.

THEATRE INSTITUTE, 370 Washington St., Elmira, New York

Inventions Wanted Patented or Unpatented

Inventions can now be safely sold without patenting expense. If you have a practical, useful idea for sale, either unpatented or patented, write **INSTITUTE OF AMERICAN INVENTORS** Dept. 4, 1926 Eye St., N.W. Washington 6, D. C.

Fix Your Own ALARM CLOCKS

New, practical home course. Just out. Makes interesting hobby—profitable too. Save money by doing your own repairing at home. Easy if you know how. Price now only \$1.00. Details FREE. Send postcard. **THIS JEWELRY STORE, Genoa 3, Illinois**

Correspondence Courses in RADIO and ELECTRICAL ENGINEERING

LOW AS \$25

ELECTRICAL ENGINEERING. Get good grasp of wide electrical field. Modern. Very understandable. Theory made easy.

RADIO ENGINEERING. Extra fine course in radio, public address, photo-electric work. Trains you to be super-service man, real vacuum tube technician. Tuition ONLY \$25, either course. Deferred payment plan. Services needed badly.

FREE Write for free copies of school catalog, student magazine, etc.

FREE LINCOLN ENGINEERING SCHOOL, Box 931-PB4, Lincoln, Nebr.

RUPTURED?

Get Relief This Proven Way

Why try to worry along with trusses that gouge your flesh—press heavily on hips and spine—enlarge opening—fail to hold rupture? You need the Cluthe. No leg-straps or cutting belts. Automatic adjustable pad holds at real opening—follows every body movement with instant increased support in case of strain. Cannot slip whether at work or play. Light. Waterproof. Can be worn in bath. Send for amazing FREE book, "Advice To Ruptured," and details of liberal truthful 60-day trial offer. Also endorsements from grateful users in your neighborhood. Write: **CLUTHE SONS, Dept. 31, Bloomfield, New Jersey**

BIG MONEY NOW IN LIQUID MARBLE

THREE wonderful new opportunities for your own big money-making business—regardless of your age, sex, or previous experience!

1. LIQUID MARBLE. Make beautiful artificial Marble Slabs. Pour from liquid state. Glazed or unglazed. This marble may be mottled, veined, multi-colored or left in original snow-white state. The color is actually a part of the marble! Does not fade or wear away. Liquid Marble is unsurpassed on kitchen or bathroom walls. Easy to make and install.

2. PLASTIC FLOORING. May be made in any color or combination of colors. Gives a lifetime of wear. Dustproof, Soundproof, Verminproof. Resilient to the tread. Lay out solid from wall to wall or in pattern design of various shaped blocks.

3. FLEXIBLE MOLDS. For plaster casting. Make your own moulds for few cents each. \$1.00 in raw materials will make up to \$25.00 worth of finished goods. We furnish names of buyers. Write now for FREE information about our BIG THREE money-making opportunities! Get in on busy season just starting. Send penny postcard or letter. No obligation.

COMPO-TEX, Box 786-5G, ST. LOUIS 1, MO.



MAGIC LIQUID Prints Photos

On Wood, Leather, Cloth, Cards Letterheads or almost any surface. Use any snapshot or other negative. Make hundreds of prints without harming negative. Won't wash off. Easy to use. Complete kit for 100 or more photos now only \$1.00 postpaid, or \$1.25 C.O.D. (Canada \$1.50 money order only; no C.O.D.'s). Satisfaction positively guaranteed. Rush order today for the original, big, complete Magic Photo Printing Outfit.
L & M MFG. CO.
Dept. 390-E, 229 W. Breckinridge, Louisville 3, Ky.

BOYS! Jr. War Models GIRLS! ASSEMBLE SCALE MODELS YOURSELF

1 JEEP & GUN—1 PT BOAT—6 AIRPLANES
Kits Contain Full Instructions and All Parts for Easy Assembly

ALL 9 FOR 50c

Send 50c and 5c for Handling or Drop Us a Post Card and We Will Mail to You C.O.D.

COLUMBIA STAMP AND STATIONERY CO.
431 S. DEARBORN ST. CHICAGO 5, ILLINOIS

RADIO, ELECTRONICS and YOU!

There are big rewards in the communications line for the Radio man who has the answers! Too, the equipment that has made Radio communication possible is functioning now in other rewarding fields. Electron tubes in industry promise a whole new World of Electronics. I. C. S. has a variety of Radio Courses and a great new standard Electronics Course. Write for booklet, pick your Course.

International Correspondence Schools, Box 5565-K, Scranton 9, Pa.

HOW TO GET A BIG PAY JOB IN Real Estate

Write for
**FREE
BOOK!**

Tremendous real estate boom predicted. Big-pay, permanent jobs or your own 6-profit business. Salaries up to \$2,500 to \$10,000 a year in property management, brokerage, appraisal, loans, insurance, building. Many make fortunes selling real estate. Thousands of trained men, women, required yearly by real estate firms, insurance companies, banks, Federal agencies. Rush post-card for 32-page **QUIZ BOOK**—mailed FREE with full details on new and only 5-volume library, **MODERN REAL ESTATE PRACTICE!** Lane Books, Dept. B-12, 100 East Ohio St., Chicago 11, Illinois.

FOOT RELIEF

Don't worry—No matter how many ordinary arch supports, pads and braces have failed. **CUSTOM MADE RESEARCH FOOT BALANCERS** have relieved foot pains for 25 years. Write for **FREE ANALYSIS FOOT CHART** and interesting literature TODAY.

KINDSCHI FOOT APPLIANCE PRODUCTS
Dept. A1 321 W. Jefferson Dallas 8, Texas



:: SAVE WASTE PAPER ::

DECEMBER 1945



AC FUEL PUMPS

Pulsing steadily, hundreds of times a mile, your AC Fuel Pump is the strong, reliable heart of your fuel system. It has given you long, faithful service because of its inbuilt quality and scientific design.

You can prolong that faithful service indefinitely, if you insist upon an AC when you replace your present pump with a new or rebuilt one.

AC SPARK PLUG DIVISION • GENERAL MOTORS CORPORATION

LET'S FINISH THE JOB—BUY VICTORY BONDS



MAKE
Sure of
CHRISTMAS
PICTURES

Use the New, Improved
G-E Exposure Meter



Helps you get better pictures at all times. Sturdier. Lighter. New, improved cell and element, and no increase in price! Extremely sensitive. Always accurate. Now available at your dealer's. General Electric, Schenectady 5, N. Y.

Type DW-58

\$23.75

Federal tax included

GENERAL ELECTRIC

696-123



AUTO
BOOKS ON APPROVAL

SEND NO MONEY. Just mail the coupon for a complete set of Six Big Auto Books. 20th Edition. Whether you are a mechanic or helper, expert or apprentice, auto owner or driver, take immediate advantage of this FREE EXAMINATION OFFER.

MAKE GOOD MONEY NOW HOLD A PERMANENT JOB
America's autos must be kept in service, now and after the war. Men with "know how" are in demand, at big pay. These books will help you get and hold an important job, or give you a chance to go into business for yourself now or later. Any man who half tries to improve himself can learn auto servicing and repairing by this quick reference method. Use the JIFFY INDEX to find easily understood answer to any auto problem. These wonder books prepared by eleven of America's great automobile engineers. Many hundreds of valuable illustrations. Send the coupon TODAY.

A year's consulting privileges with our engineers now given with these books without extra charge.
Vocational Publishers Since 1898

CAN YOU FIX IT?

These wonder books tell step by step HOW to make difficult repairs and adjustments, how to keep a car at maximum efficiency, including latest improvements in car design and operation. Engine troubles and how to correct them well covered.

6 BIG VOLUMES
2800 pages, 2000 illustrations, wiring diagrams, etc., including Diesel engines. Beautiful modernistic, washable cloth binding.

AMERICAN TECHNICAL SOCIETY, Dept. A919
Drexel Ave. at 98th St., Chicago 37, Ill.

I would like to examine your Six-Volume Set of Auto Books. I will pay the delivery charges only, but if I choose I may return them express collect. If after 10 days' use I prefer to keep them, I will send you \$2 and pay the balance at the rate of only \$3 a month until \$24.00 has been paid. Please include consulting service as offered above.

Name

Address

City

State

Please attach letter stating age, occupation and address of employer and of at least one business man as reference. Men in service, also please give home address.

1 ★ ★ ★ ★ ★
A New Hobby!
COLLECT GENUINE U. S. MILITARY SHOULDER PATCHES
Make your den or lodge room the center of attraction with this fascinating hobby! Over 300 authentic military shoulder patches in stock, from 15c to 50c each! Send only 10c in coin for illustrated folder and price list.
MIDWEST SALES CO.
Dept. B
P.O. Box 1092 Omaha, Nebr.



New 1946 WHAT TO MAKE out now!

Our annual reprint of articles selected from our "CRAFTSMAN" Department is better than ever. It contains hundreds of ideas you can use around the home and in your workshop. 208 pages. 400 illustrations. Get the 50c paper edition from your News Dealer. We shall not sell this edition at all this year. In December we shall have it and the six previous volumes bound in good-looking, durable library cloth at \$1.25 each or \$8.00 for the complete set. A wonderful addition to any craftsman's library!

POPULAR MECHANICS PRESS
Dept. 617 200 E. Ontario St. Chicago 11

Say you saw it in
POPULAR MECHANICS

Handy Mail Order List

Little Library of Useful INFORMATION

5 for \$1.00
12 for \$2.00
25¢ Each

Here at amazingly low cost is the practical help and information you have always wanted. Articles in previous issues of Popular Mechanics have been classified according to subject and are now available in these handy reprint booklets.

- | | |
|---|---|
| <p>How to Use Measuring Tools—
Micrometers, Calipers, etc.—106.
Power Driven Saws—74.
Drill Presses, Grinders, Etc.—79.
Wood, Metal Turning—Lathes—81.
Filing Machine, Hacksaw, Cutoff Wheel, Shaper—82.
Lathe Tools You Can Make—101.
Workbenches—Tool Cabinets—47.
Spray Painting—94.
From Pattern to Casting—91.
Tool and Saw Sharpening—92.
Sharpening Drills, Wood Bits—90.
Successful Wood Turning—32.
How to Read Blueprint—71.
Metal Turning Lathes—99.
Operating a Metal Lathe—100.
Heat Treating, Hardening—102.
Working With Glass—103.
Servicing Elec. Motors—75.
Electromagnets & Solenoids—44.
Transformer Construction—41.
The Boy Electrician—43.
Soldering and Brazing—17.
Arc and Spot Welders—5.
Electroplating With Nickel, Chromium, Cadmium, Etc.—86.
Plating Leather, Wood, etc.—87.
Lower Your Fuel Costs—31.
Curing Leaky Basements—45.
Fitting Home Game Room—55.
Indoor & Outdoor Fireplaces—88.
Backyard Gardening—39.
Lawn and Garden Novelties—72.
Trellises, Pergolas, Fences—76.
Lawn and Garden Furniture—77.
Playground Equipment—73.
Concrete Garden Furniture—6.
Making Serving Trays—53.
Sanders—80.
House Wiring—89.
Pressure Finders—13.
Hanging Wallpaper—38.
Built-in Fixtures—78.
Bird Houses—7.
Magazine Racks—49.
Clock Cases—50.
Book Ends—52.
Small Tables—54.
Smoking Stands—56.
Desks—58.
Book Cases—59.
Action Toys—66.
High Flying Kites—67.
Telescopes—20.
Metal Craft—28.</p> | <p>Knots and Ropework—105.
Working With Plastics—61.
Simple Home Improvements—104.
Ridding Home of Insect Pests—107.
Children's Room Furniture—51.
Jigsawed Novelties—57.
Doll House & Doll Furniture—60.
25 Shelves You Can Make—84.
Novelties Turned on Lathe—82.
Inlay Pictures—Veneering—63.
Wood, Soap Carving—65.
Windmills & Weathervanes—68.
Lamps from Wood, Metal—69.
Home Work Opportunities—19.
Wood Finishing—40.
Boats—14 ft. Outboard—2.
Boats—14 ft. Sail Dinghy—26.
Boats—21 ft. Skoop—46.
Rowboats, Small Dinghy—83.
Small Sail Boats—84.
Two Outboard Runabouts—85.
Build Own Canoe, Kayak—30.
Build Class-E Ice Yacht—22.
Auto Kinks, Shortcuts—10.
Building Trailers—27.
Motor-Driven Midget Cars—34.
Stop Auto Elect. Troubles—95.
Photo Printers and Dryers—25.
Photo Darkroom Equipment—96.
Trick and Table Top Photos—97.
Cosmetic Formulas—12.
Food Products Formulas—15.
Metal Plating and Coloring—21.
Re-Silvering Mirrors—70.
Chemical Experiments—93.
Log Cabins, Tourist Houses—14.
Trapping Small Animals—33.
Farm and Garden Tractors—8.
Building Extra Attic Rooms—23.
Attractive Basement Rooms—24.
Small Looms—37.
Gem Cutting—42.
Photo Enlargers—1.
Photo Kinks—98.
Cleaning Formulas—11.
Taxidermy—9.
Magic—29.
Training Dogs—35.
Small Furnaces—36.</p> |
|---|---|

Check Titles Wanted, Clip, Mail with Remittance to
POPULAR MECHANICS PRESS, Dept. 605, 200 E. Ontario, Chicago, 11

NORTHROP AIRCRAFT, INC.

Announces the Establishment of THE NORTHROP AERONAUTICAL INSTITUTE

*dedicated to the training and
advancement of men for careers in aviation*



The entire aviation industry recognizes the critical shortage of aeronautical engineers, airline maintenance specialists, and expert master mechanics. For these important positions you must be trained to handle *all types* of civilian aircraft. Limited training in specialized subjects isn't enough. To handle a responsible, well-paid job for civilian air lines, air bases, maintenance depots, and manufacturers, you must have comprehensive, up-to-the-minute training.

To meet this need, NORTHROP AERONAUTICAL INSTITUTE has been founded.



Here, in a completely new school located in the midst of the big Northrop plant, you

will learn the aviation of *today*— and *tomorrow*. You will be surrounded by history-making, intensely interesting research and development work—jet propulsion, gas-turbine aircraft engines, radar, and advanced airplane designs pioneered by Northrop. You'll be right on the mile-long Northrop air field, next to the Northrop wind tunnel, the Northrop experimental laboratories, and the plant where the famous P-61 Black Widow night fighter was designed and built.



The Northrop Aeronautical Institute brings to aviation training completely new standards. Through the courses offered, you can now obtain specialized education for positions in postwar aviation. Every detail of every course is fitted to the new aviation requirements. Yet the

Northrop training programs are already proved by the education of many thousands of Northrop employees and Air Forces personnel.



Each Northrop student gets the benefit of completely modern technical information and advanced educational methods as well as extensive equipment for practical shop experience. Even the specially designed school buildings are new.

In this short space, it is impossible to tell half of the advantages of this great new school in the heart of one of the world's great aircraft-engineering plants. To get all the details, just send in the coupon. We will be glad to mail you an interesting booklet with complete information and pictures describing the school and the courses available.

NORTHROP
Aeronautical Institute
A Division of Northrop Aircraft, Inc.

1527 E. BROADWAY
NORTHROP FIELD, HAWTHORNE
LOS ANGELES COUNTY, CALIF.

INQUIRIES INVITED FOR CLASSES NOW FORMING

NORTHROP AERONAUTICAL INSTITUTE
1527 E. BROADWAY
HAWTHORNE, CALIFORNIA

Please send me your free, illustrated booklet and information, including starting dates and tuition rates, on the training courses checked.

NAME _____ AGE _____

ADDRESS _____

CITY _____ ZONE _____ STATE _____

Check one: Veteran In Service Civilian PM-1

- Aeronautical Engineer
- Airline Maintenance Specialist
- Airplane Mechanic
- Engine Mechanic
- Master Airplane and Engine Mechanic (A&E)
- Home study course Airplane & Engine Maintenance

No Waiting to LEARN

Start at Once to EARN!

This BIG BOOK SHOWS HOW

If it's Results you want, you can get action quickly with this practical book. Never before has a more helpful book been printed for those planning a business of their own. Gathered in this large illustrated volume are the formulas, recipes, facts and secrets that have contributed so largely to America's great industrial progress. Capitalize on this information for making most any conceivable product without experience. special equipment or previous knowledge of chemistry. Start at home, expand with profits—build for a profitable independence.

The experts who compiled this book are authorities, and present this information in simple, understandable language. They also give you wholesale supply sources for needed material, short cuts and economy methods for the most profitable results. Hundreds of good paying businesses have been built on a product made from a simple recipe. Opportunities in this field exist everywhere. Choose from any of the 102,000 facts and 10,000 formulas of which the following are only a very few:

10,000 FORMULAS, RECIPES SECRET PROFIT IDEAS

924 Illustrated Big Pages



Cloth Bound Size 5 1/2" x 8 1/2" x 2 1/4"

Jewelry Formulas, Lacquers, Laundry Preparations, Leather, Linoleum, Lubricants, Manicure Preparations, Marble (artificial), Metals, Mirrors, Oils, Ointments, Paints, Paper, Perfumes, Photography, Polishes, Powders, Remedies for Man, Beast or Fowl, Rubber Products, Refrigerants, Soaps, Solder and Soldering, Tooth Cements, Transfers, Transparencies, Varnishes and Thousands of others for making all sorts of profitable and practical things.

Prepare for "After-War-Business"

Especially recommended for Servicemen and War Workers planning a profitable business of their own.

This comprehensive book is an accepted authority by chemists, schools, industry, etc. and is the largest and most comprehensive book of its kind ever issued. Nothing else like it in existence. A single formula has been worth a thousand times this book's small cost to countless owners. Crammed with money-making ideas, invaluable for reference. Ideal for Factory, Home, Farm, Office or Workshop. As necessary as the dictionary and more useful for manufacturers, chemists and salesmen who put up products for profit.

This Complete Book Only \$2.98 POST PAID

Worth More

ALSO INCLUDED! Complete plans: "D.D.T." Insecticide. Also our New Book of Money Making Facts: "The More You Know the More You Can Earn—Easier and Quicker."

Immediate Shipment—Safe Delivery Guaranteed. \$2.98 postpaid. Canada or Foreign, \$3.25 U. S. Funds. (C.O.D. shipments U. S. A. only.)

ADAMS BROWN COMPANY Books of Applied Science Dept. 312, Chestnut Hill 67, Massachusetts, U. S. A.



Get ten big issues of America's Handwriting magazine for \$1.50. Free copy sent on request. THE EDUCATOR, 612 N. Park St., Columbus 8, Ohio

Be Your Own Boss GET INTO PLASTICS



LEARN PLASTICS

Fabrication & Casting For Financial Security

START AT HOME—SMALL CAPITAL NEEDED

Start your own Plastics business . . . with small capital . . . at home. Grow with this giant industry as you increase your "know-how" and skill. Plan now for your own business or prepare for exciting post-war Plastics jobs. Our revolutionary teaching plan covers production phases of fabrication, casting, cementing methods, mold making, compounding, dyeing, etc. You actually work with many types of Plastics materials. We supply everything. Check information desired. Home Training. Resident Course in Plastics Eng. Send this ad with your name and address in envelope or paste on 1c postcard to Dept. PM

VETERANS: Check here for special information

PLASTICS TECH 4707 Euclid Avenue Cleveland 3, Ohio

PRINT ANY PHOTO on Paper, Cloth, Leather or Wood

SIMPLE, EASY TO USE

Magic liquid takes only 2 minutes to reproduce any snapshot you have on to stationery, handkerchiefs, ties, scarfs, etc. Won't wash off. Won't hurt negative or fabric it's used on. Personalize your belongings! An ideal gift. Complete outfit enough to transfer 100 photos—only \$1.00 postpaid. Sent C.O.D. for \$1.21.

CHRISTY PHOTO SUPPLY, Dept. 2010 2835 N. Central, Chicago 34



300 WAYS TO MAKE MONEY

MONEY BACK GUARANTEE

\$1.00 VALUE

25¢

68 PAGES

40,000 WORDS

In "CASH IN" you get ALL the real money-makers—dozens of profitable tested mail order plans, confidential business secrets, dozens of practical tested formulas, successful tested schemes—actual experiences of men who have started on a shoestring—with less than \$10 capital.

25c a copy postpaid. Send U. S. stamps, money order, or coin.

NATIONAL PLANS INSTITUTE P. O. Box 26D, Station N, New York 23, N. Y.

LEARN MASTER MACHINIST MECHANICAL DRAFTING

Expert training on Lathes, Milling Machines, Shapers, Grinders, etc. Allied shops are completely equipped and modern.

Approved for G. I. Training Days, Evenings ALLIED SCHOOL OF MECHANICAL TRADES 1330 South Michigan Avenue Chicago 5, Illinois

Learn TOOL DESIGN

Now, as never before, draftsmen and tool designers are needed to redesign for peacetime reconversion. Qualify quickly. Many making \$100 to \$150 per week. More qualified men needed than available. Good pay jobs waiting. Rush name and kind of job wanted today for full free facts. Sixty age.

OHIO INSTITUTE OF TECHNOLOGY, Box 272, Greenville, Ohio

RADIO ENGINEERING

Broadcasting, Servicing, Electronics, Aviation, Marine & Police Radio taught thoroughly. 48 weeks' Engineering course equivalent to 3 years' college radio work. Approved Veteran Training. Co-educational. Catalog free.

VALPARAISO TECHNICAL INSTITUTE, Dept. D, Valparaiso, Ind.

BOOKS FOUND FREE!

WHAT BOOKS DO YOU WANT?

We quote lowest market prices. No charge for locating Hard-to-Find Books. All books. OLD or NEW mailed POST-FREE. SEARCHLIGHT BOOK CLUB, 22 East 17th St., New York City

Become a Doctor of PSYCHOLOGY

Win the degree of Ph.D. Teach the secret of contentment, happiness. Solve mental worries. Experience the revelation of truth. Chartered college. Individual help. Write for FREE book. COLLEGE OF UNIVERSAL TRUTH, 3153-B North Clark St., Chicago.

JIU-JITSU HOW TO BECOME EXPERT, Keep Health, Have Fun.

Teaching 35 years. Free information. Write

MODERN SCHOOL JIU-JITSU, Dept. EE, 5 W. 52nd St., N.Y.C. 19

NOW . . . ELECTROPLATING

Learn this profitable, interesting trade. Hobby or full time business. Chromium, Nickel, Gold, Silver, etc. Postcard brings full details, FREE.

PLATER HYDE, Dept. M, P.O. Box 176, National City, Calif.

FIBRE ARMS AND LEGS!

Light, correctly fitted, strong and comfortable. Natural appearance. Braces for all deformities. Scientific design. Fair Terms.

BUCHSTEIN-MEDCALF 610-3rd Av. S., Minnetonka, Minn.

SAY YOU SAW IT IN POPULAR MECHANICS



9 ways to be your own boss!

NOW, more than ever before, is the right time to start a small profitable business of your own... or train yourself for a practical money-making trade in which you can be **INDEPENDENT**. TODAY... take your first step, without cost or any obligation.

Just mail coupon—
and by return mail
you will get full in-
formation on the
courses listed here.

REAL ESTATE

SUCCESS... be a professional man!

Practical training on how to run a profitable real estate business of your own. Illustrated **self-study** lessons on farm and suburban properties, downtown operating. Gain a **working knowledge** of mortgages, listings, sales techniques, appraisals, property management, commercial leasing, contracts, etc. Real estate is the foundation of all wealth! **Rush coupon below for NEW facts** you should know about your future in real estate. There's no obligation.

practical REFRIGERATION

Brand New Streamlined Course for quick training. Authoritative step-by-step instruction on servicing household refrigerators... how to install, operate, repair. Easy-to-follow illustrated directions on troubleshooting, parts replacement, testing. Covers quick-freeze units, lockers, water coolers, freezers, air-conditioning systems, etc. **Amazing low price!** Free details, see coupon.



AUTO mechanics

Let this **PRACTICAL, LOW-PRICED** course get you started in the auto repair trade. Good mechanics make big money NOW... and have a **great future!** Self-training lessons show you exactly what to do and how to do it. It teaches servicing on all makes of cars... adjustments, tune-ups, etc. Clearly written and illustrated by expert engineers. Satisfaction or refund. Mail coupon for **FREE** details.



carpentry—building—estimating

BIG OPPORTUNITIES FOR MEN with the KNOW-HOW! There's a great future in the building trades... for **trained men**. Here are up-to-date lessons on how to plan, build, remodel houses. How-to-do-it instructions on stair building, steel square, roofing, painting and decorating, etc. Send for full information **FREE**... mail coupon below!



what to invent—how to invent

MECHANICAL DRAWING, DESIGNING, BLUEPRINT READING
Practical course for wide-awake practical men. **IDEAS**... how to get them, develop them, protect them and **promote** them! Expert information on how to turn your imagination into money. Plus illustrated self-study lessons on basic mechanical movements and devices. Mail coupon below for **FREE** details.



INSURE YOUR FUTURE

Mail This Coupon Today!

On this coupon check the subjects that interest you. Our world-famous copyrighted Success-Catalog will bring complete details. **FREE**... no cost, no obligation.

NELSON COMPANY

321 S. Wabash Ave., Dept. 8M02, Chicago 4, Ill.

watch and clock repairing



Learn at Home—In Your Spare Time

Prepare for a happy future of prosperity, security... and get a big-pay job now. Fascinating, high-grade occupation. You can **EARN WHILE YOU LEARN**. Excellent field for part-time work at home.

Practical Course in HOROLOGY

Thorough self-instruction training in American and Swiss watches, clocks. Special sections on alarm clock repairs. Interesting. **LEARN-BY-DOING** instruction method. Learn **QUICKLY**, easily. No previous experience necessary. **WATCHMAKING IS BASIC TRAINING FOR AIRCRAFT INSTRUMENT WORK** and other scientific precision jobs.

Amazing Low Price! • **Money-Back Guarantee!** Get into this fast-growing field NOW... big opportunity... don't delay. Mail coupon below for **FREE** information. No obligation.

locksmithing and key making

PRACTICAL UP-TO-DATE COURSE

How to pick locks, de-code, make master-keys, repair, install service, etc. New, self-instruction lessons for every handyman, home-owner, carpenter, mechanic, servicestation operator, fix-it shop, hardware dealer, gunsmith.

53 Easy Illustrated Lessons
Low Price! Satisfaction guaranteed or money back. Write now... no obligation!



practical RADIO servicing



SELF-INSTRUCTION COURSE

Teaches you the **practical** side of radio... repair, adjustment, operation, alteration, trouble-shooting. No previous knowledge necessary. Large clear illustrations, diagrams, charts, etc. **INTERESTING**

STEADY WORK! Set up a radio repair shop of your own—or prepare for booming industrial electronics. This useful, how-to-do-it course brings you all the fundamentals, including mathematics, review questions, problems, answers. Strictly up-to-date. Low price. Coupon below will bring you full information you want immediately. Mail it in today!

MAIL ORDER BUSINESS

Your Big Opportunity!

84-lesson course on proved, tested, up-to-date, profitable methods. Amazing treasure-house of the best mail order plans and practices. How to start your mail order business on a small one-man scale... how to keep it growing more and more profitable month after month. Money-making **FACTS**. Sensational details... **FREE**. Mail coupon below!



FREE! 100-page book... mail this now!

NELSON COMPANY, DEPT. 8M02, 321 S. WABASH AVE., CHICAGO 4, ILL.
Please send me—**Free** and without obligation—illustrated Success-Catalog containing information about the subject (or subjects) I've checked below. No salesman will call.

- | | | |
|---|--|--|
| <input type="checkbox"/> Watch and Clock Repairing. | <input type="checkbox"/> Locksmithing. | <input type="checkbox"/> Refrigeration. |
| <input type="checkbox"/> Practical Radio Servicing. | <input type="checkbox"/> Real Estate. | <input type="checkbox"/> Auto Mechanics. |
| <input type="checkbox"/> Mail Order Business. | <input type="checkbox"/> Carpentry. | <input type="checkbox"/> Inventions. |

NAME.....

ADDRESS.....

CITY..... ZONE..... STATE.....

Thanks, I can eat Steak again!

- Fit-Rite
- makes
- FALSE
- TEETH
- tight!



**REFITS and
RELINES
DENTAL PLATES!**



Makes
**False Teeth
TIGHT!**
Improved Newest
Plastic Reliner

LASTS FOR MONTHS!

FIT-RITE quickly makes loose, slipping, clattery dental plates fit snugly and comfortably. Eat, talk and laugh naturally and confidently!

FIT-RITE you apply — at Home

Simply squeeze FIT-RITE on your dental plates and put it in your mouth, where it hardens and makes false teeth feel and fit like new. No fuss, no muss—no heating. Not a paste or powder. Becomes a part of plate. You apply it yourself.

FIT-RITE IS 100% O.K. ON ANY DENTAL PLATE

FIT-RITE won't harm any denture or your gums. Tasteless, odorless, sanitary—cleanses and sweetens the mouth and helps prevent gum soreness. It won't come off with scrubbing or washing. EVERY APPLICATION GUARANTEED TO LAST FOR MONTHS OR NO COST.

SEND NO MONEY Send for a tube today, for only \$1.00. Use coupon below. Enjoy teeth like new again, 100% satisfaction guaranteed or money back.

FREE TRIAL OFFER!

SPECIAL—generous package of dental plate cleanser included absolutely free. This instant, brushless cleanser WORKS LIKE MAGIC and will not harm any denture. Try Fit-Rite first.

FIT-RITE CO. 1573 MILWAUKEE AVENUE
Dept. C-PM, Chicago 22, Ill.

Mail This COUPON -----

FIT-RITE COMPANY, Dept. C-PM

1573 Milwaukee Ave., Chicago 22, Ill.

Send 1 tube of FIT-RITE Dental Plate Reliner that you guarantee to satisfy 100%—or it won't cost me a penny.

- I will deposit \$1.00 plus postage with postman when package arrives.
- Enclosed is \$1.00—You pay postage.

NAME.....

ADDRESS.....

CITY..... STATE.....

P.S.: — RUSH THIS ORDER TODAY!

WANT INDEPENDENCE?

BE YOUR OWN BOSS!



ARE YOU GOING INTO BUSINESS?

We send you illustrated book packed with definite, workable plans. Tells how to finance, sell, buy . . . and worth many times low price of only \$1. Money-back Guarantee. Get started in business now.

Only \$1.00

Postpaid helps you start your own business.

COMMERCIAL PUBLISHING CO.
8810 So. Commercial Ave. • Chicago 17, Ill.

:: BUY VICTORY BONDS ::



There's a big post-war demand for trained Dental Technicians. Start now and learn this profitable profession—a career for both men & women. BE your own BOSS. Our amazing new method of teaching is a short cut to success for both young and old. Write for Free Booklet *P.*

National School, Mechanical Dentistry
10 W. JACKSON BLVD., CHICAGO, ILL.



**DRAW CARTOONS
BIG MONEY!**

EASY . . . PLEASANT WORK!
Let CHAS. H. KUHN, with 25 years actual experience in drawing a daily newspaper cartoon, teach you how to create, draw and sell your work. 52 complete lessons—one sent each week. Professional criticism on every lesson. Write today.

KUHN SCHOOL OF CARTOONING
420 MURPHY BUILDING Dept. M • INDIANAPOLIS 4, INDIANA

PRINTING PAYS BIG

"Make your future secure. Prepare for a highly paid position or a print shop of your own. Students throughout the world are enthusiastic in their praise of our training program and the personal attention given each student. Rush name today for free literature and sample lesson. No salesman will call. Dept. M125.

COMPLETE COURSE ONLY \$14.50 CASH
TERMS AVAILABLE

International School of Printing, Troy, O.

Say you saw it in
POPULAR MECHANICS

PRACTICAL TECHNICAL TRAINING FOR YOU

Specialize in Electricity, Radio and Electronics, Air Conditioning—Refrigeration—Welding. Prepare in six or twelve months for position as TECHNICIAN—or in two more years secure B.S. Degree in Electrical Engineering. Write for complete information and mention course desired.

MILWAUKEE SCHOOL OF ENGINEERING
P.M.-1245 N. Broadway and E. State, Milwaukee, Wisconsin

Learn BAKING At Home

Baking is one of America's high industries in wages. Nearly depression-proof. Thorough basic home course lays sound foundation. If you have aptitude, write for FREE BOOKLET, "Opportunities in Commercial Baking." National Baking School, 1315 Mich. Ave., Dept. 1359, Chicago 5



REFRIGERATION SERVICE MECHANICS COURSE
Learn at home—how to start your own repair shop on little capital. No previous experience needed. Common school education sufficient. Splendid opportunity for older men. Prepare now for after the war. FREE illustrated booklet. MECHANICS TRAINING SCHOOL, Dept. P-12, 4761 W. Pico, Los Angeles 6, Calif.

JET PROPULSION

Experimenters! New principle to drive boats, bicycles, model helicopters. Circular on plans. Rush name. H. Maugin, Tipp City 21, Ohio—or—Hudson Pub. Co., B3, 6112 Park Ave., West New York, NEW JERSEY.

Now YOU Can Lick Any AUTO REPAIR JOB!

IN LESS TIME—WITH LESS WORK



**FREE
7-DAY OFFER**

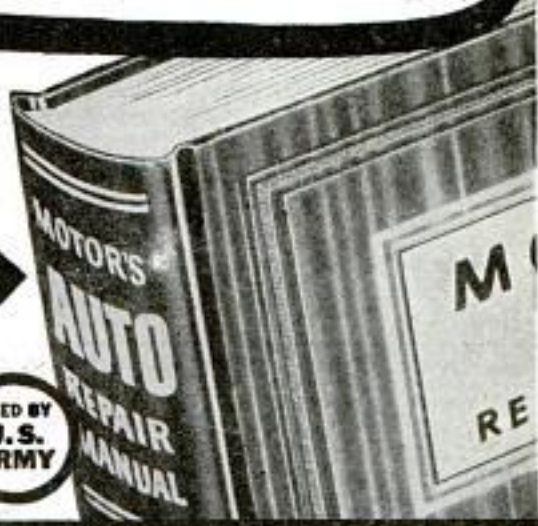

USED BY
U.S. ARMY

MoToR's New Auto REPAIR MANUAL shows you how to service and repair ANY part of ANY car!

No auto repair job is too tough when you've got MoToR's AUTO REPAIR MANUAL! YOU can repair anything from carburetor to rear end—quickly, easily, right! Just look up make, model, and the job in the quick index—and go to work! Clear, illustrated instructions lead you step by step.

To make such an amazing book possible, the engineer-editors of MoToR Magazine collected and "broke down" 150 official factory shop manuals for you, spotted all the vital repair information you need, dove-tailed it all together into ONE handy, easy-to-understand book.

No Other Manual Like It!

This BIG book—764 pages, 8½x11 inches, bound in sturdy fabric—brings you nearly 200,000 service, repair, adjustment, replacement, tune-up facts on every car built from 1935 to 1945. More than 1000 cut-away photos, diagrams, draw-

ings show you exactly WHAT to do and HOW to do it! Used by the U. S. Army, trade and technical schools everywhere, thousands of auto servicemen.

Now YOU—without cost—can see for yourself what a wonderbook MoToR's Auto Repair Manual really is. TRY it—FREE for 7 days! Learn first-hand how it can pay for itself the first few times you use it.

**SEND NO MONEY
7-Day Free Examination**

Just mail coupon below—without money! When the postman brings your book, pay him nothing. First make it show you what it's got! Unless you agree this is the greatest time-saver and work-saver you've ever seen—return book in 7 days and pay nothing. Mail coupon today! Address: MoToR Book Department, Desk 1P, 572 Madison Ave., New York 22, New York.

Clear, Pictured Facts on Every Job on Every Car Built Since 1935!

Nearly 200,000 service and repair facts on all these makes:

- | | | |
|-----------|-----------|------------|
| American | Ford | Oldsmobile |
| Bantam | Graham | Overland |
| Auburn | Hudson | Packard |
| Austin | Hupmobile | Pierce |
| Buick | Lafayette | Arrow |
| Cadillac | La Salle | Plymouth |
| Chevrolet | Lincoln | Pontiac |
| Chrysler | Lincoln | Reo |
| Cord | Zephyr | Studebaker |
| Crosley | Mercury | Terraplane |
| De Soto | Nash | Willys |
| Dodge | | |

764 big pages; including 50 pages of carburetor text, charts, illustrations, covering all models. Over 500 charts, tables: Tune-up Chart; Valve Measurements; Compression Pressure; Torque Wrench Reading; Starting Motor; Engine Clearances; Generator; Clutch & Brake Specifications; Front End Measurements, etc.; Engines; Electric, Fuel, Cooling, Lubricating Systems; Transmissions; Universals; Front Ends; Wheels; Rear Ends, etc.

Same FREE 7-Day Offer Applies on

MoToR's TRUCK REPAIR MANUAL

For mechanics, truck specialists, service stations, fleet owners. Covers EVERY job on EVERY truck made since 1936! 1400 pictures, 914 pages, 300,000 facts. Used by Armed Forces. Warranted to contain every essential fact you need to know. Sturdy binding, size 8½x11. Covers all types Gasoline En-

gines; Diesels and Hesselmanns, Fuel Systems, Governors, Lubrication Systems, Ignition Systems, Starters, Generators, Clutches, Transmissions, Axles, Torque Dividers, Transfer Cases, Brakes, Steering, etc., etc.

ALSO SERVICES buses, farm and industrial tractors, contractor and road building equipment, stationary power machinery, etc. (on all parts described in Manual). Offered on same FREE 7-Day examination as Auto Repair Manual. Check box in coupon at right.



Published by MoToR, The Leading Automotive Business Magazine. MoToR's manuals assure high standards of repair work.

MAIL COUPON NOW, FOR 7-DAY FREE TRIAL

MoToR Book Dept., Desk 1P, 572 Madison Ave., New York 22, N. Y. Rush to me at once! (check box opposite book you want)

MoToR's AUTO REPAIR MANUAL. If O.K. I will remit \$1 in 7 days, and \$1 monthly for 4 months, plus 35c delivery charge with final payment (\$5.35 in all). Otherwise I will return book postpaid in 7 days. (Foreign price, remit \$7 cash with order.)

MoToR's TRUCK REPAIR MANUAL. (Described at left.)

If O.K. I will remit \$2 in 7 days, and \$2 monthly for 3 months, plus 35c delivery charge with final payment (\$8.35 in all). Otherwise I will return book postpaid in 7 days. (Foreign price, remit \$11 cash with order.)

Print Name.....Age.....

Print Address.....

City.....Zone No. (if any).....

State.....Occupation.....

SAVE 35c! We pay postage if you ENCLOSE full payment. (Check, M.O. or Postal Note.) Same 7-day return-refund privilege.

This 176-page

FREE BOOK

is also your

GUIDE for the FUTURE



● Prepare for peacetime competition. Let this free book help you. It is issued by an organization known throughout the world for thorough engineering training. The examination subjects listed below are only a few of those dealt with. Without obligation, write today to Canadian Institute of Science & Technology, 46 Chester Bldg., 219 Bay Street, Toronto 1, Canada.

- | | | |
|-------------------------------|---|--|
| A.M.I. Mech. E.
Mechanical | A.M. Brit. I.R.E.
Radio and Telegraphy | A.M.I. Struct. E.
Structural |
| A.M.I.E.E.
Electrical | A.M.I.C.E.
Civil | Automobile
Mining |
| A.F.R.Ae.S.
Aeronautical | | London Matriculation
B.Sc. (Pure Science) |

Canadian Institute of Science & Technology Limited,
46 Chester Building,
219 Bay St., Toronto 1, Canada.

Please forward us free of cost or obligation of any kind your 176-page handbook, "ENGINEERING OPPORTUNITIES."

Name

Address

Course interested in

JUST OUT! NEW FROM COVER TO COVER

AUDELS REFRIGERATION and AIR CONDITIONING GUIDE



4 Books in One! Covering:
Basic principles, Servicing, Operation, Repair of
1—Household Refrigeration
2—Special Refrigeration Units
3—Commercial & Industrial Refrigeration
4—Air Conditioning Systems
A gold mine of essential important facts for ENGINEERS, SERVICEMEN & USERS.

A Good Book is a Good Friend! Here you have at your fingers' ends a Complete Library in ONE VOLUME, the necessary data you have been looking for on: MODERN UNITS, SYSTEMS & MACHINES, REFRIGERANTS, including Freon, Lockers, Water Coolers, Quick Freezing & Air Conditioning Systems, 1280 Pages, 46 chapters all Fully Illustrated & indexed for Ready Reference.

ANSWERS YOUR QUESTIONS
Get This Information for Yourself, Mail Coupon Today. No Obligation Unless Satisfied. **ASK TO SEE IT.**

\$4 COMPLETE • PAY ONLY \$1. A MONTH

AUDELS, Publishers, 49 W. 23rd St., New York 10, N.Y.

MAIL AUDELS NEW REFRIGERATION GUIDE for free examination. If O. K. I will send you \$1 in 7 days; then remit \$1 monthly until price of \$4 is paid. Otherwise I will return it.

Name

Address

Occupation

Employed by



SALESMEN FOR CITY AND COUNTY

Nationally Known Manufacturer

Build up a business of your own with Nationally Advertised Products bearing Underwriters' label. Sell to schools, factories, service stations, warehouses, hotels, restaurants, public institutions, truck and bus companies, grain elevators, house trailers, autos, farms, homes, etc. Capable man can earn real money. Established in 1916. Write letter with details, age, experience, etc.

THE FYR-FYTER CO.,

Dept. 90-12

Dayton 1, Ohio



\$1,506 TO \$2,650 A YEAR!

U.S. GOVERNMENT JOBS



Men, women. Common education often sufficient. Veterans get preference. Write immediately for FREE 32-PAGE BOOK with list of positions and full particulars telling how to qualify for them.

FRANKLIN INSTITUTE, Dept. K51, Rochester 4, N. Y.



Get Started in Radio

TEN "HOW-TO-DO-IT" BOOKS

Get a solid foundation in radio by means of the 10 timely text books. Each clearly written, profusely illustrated, contains over 15,000 words. You'll be amazed at the wealth of information packed into these handy books. Excellent for reference—ideal for technical library. Your money back if not satisfied.

5 Books for 50c - 10 Books for \$1
SENT TO YOU POSTPAID

- | | |
|---|-------------------------------------|
| No. 1—How To Make Four Decade Short Wave Sets | No. 4—All About Aerials |
| No. 2—How To Make The Most Peculiar All-Wave 1 and 2 Tube Receivers | No. 5—Beginners' Radio Dictionary |
| No. 3—Alternating Current for Beginners | No. 6—How To Have Fun With Radio |
| | No. 7—How To Read Radio Diagrams |
| | No. 8—Radio for Beginners |
| | No. 9—Simple Electrical Experiments |
| | No. 10—Television |
- Remit by check or money order—register letter if you send cash or stamps.
RADIO PUBLICATIONS, 23E West Broadway, New York (7)

ANALYZE HANDWRITING

Qualify for Certified Grapho-Analyst Degree. New unrounded, fascinating field of service. Gratifying earnings reported by graduates in Employment, Credit, Social Service, Police and Judicial, and Entertainment fields. Others have developed profitable private practice, full or spare time, as Personal Problem and Vocational Counselors. Send for 3000 word test lesson and Grapho-Analyst

FREE

ADDRESS A. I. G. A. Inc. 120 NOEL, MO.

WATCHES WANTED BROKEN OR USABLE

—all kinds, even Ingersolls. Highest prices paid for jewelry, rings, spectacles, cigarette lighters, gold teeth, etc. Cash mailed promptly.
LOWE'S, Holland Bldg., Dept. PM, St. Louis 1, Mo.

LAW

STUDY AT HOME for PERSONAL SUCCESS and LARGER EARNINGS. 35 year expert instruction—over 108,000 students enrolled. L.L.B. Degree awarded. All texts furnished. Easy payments. Send for FREE BOOK—"Law and Executive Guidance."

AMERICAN EXTENSION SCHOOL OF LAW
Dept. 60 M, 646 N. Michigan Ave., Chicago 11, Ill.

WELDERS VETERANS—Ask about G. I. Training. WANTED!

Earn up to \$12 a day or start your own business. Learn Welding by actual shop work. America's leading school. Established 1902. 41,000 graduates. Write for "Welding Facts." Greer Shop Training, Dept. 3125, 460 S. State St., Chicago

BARGAINS in WAR SURPLUS LENSES & PRISMS

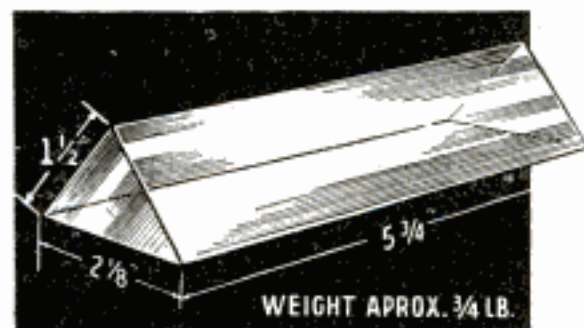

TANK PRISMS

In order that the tank driver shall not get shot in the face, 2 of these Silvered Prisms are used to make a Periscope. We have secured a number of these, 90-45-45 degree Prisms of huge size—5³/₈" long, 2¹/₈" wide, finely ground and polished. Used to build a Periscope, camera stereo attachment, range finder, etc. Excellent also for experiments, classroom demonstrations. Prism easily converted into desk name plate by affixing gold letters. 100 gold letters supplied at only 10c.

(Order Stock #3008-H.) Normally these Prisms would retail from \$24 to \$30 each.

SILVERED TANK PRISM

Stock #3004-H.....\$2.00 each Postpaid

PLAIN TANK PRISM

Stock #3005-H.....\$2.00 each Postpaid

FOUR TANK PRISMS—Special—\$7.00 Postpaid... The most sensational bargain we have ever been able to offer.

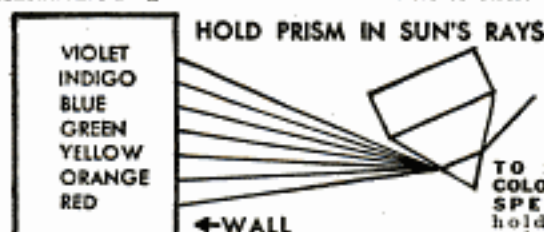

shown in drawing. White incident light which passes through prism is thus broken up into a band of primary colors known as the spectrum—a beautiful sight!

CLEANING BRUSH SET—12" flexible hollow plastic handle, circular construction, 4 brushes to set, range stiff to soft.

Stock #504-H.....Price \$1.00

MAGNIFIER SET... 5 Magnifying Lenses... Powers from 1 to 10. Various diam. for many uses. Free Booklet on Home-made magnifiers included.

Stock #1026-H.....\$2.00 Postpaid

OPTICS FROM 4-POWER PANORAMIC TELESCOPE—Excellent condition. Consists of Objective Prism, Dove Prism, Achromatic Objective Lens, Amici Roof Prism, Eye Lens Set (.... a \$60.00 value).

Stock #5016-H.....\$6.00 Postpaid

35 MM KODACHROME PROJECTING LENS SET—Consists of Achromatic Lens for projecting, plus a Condensing Lens and piece of Heat Absorbing Glass with directions.

Stock #4025-H.....\$1.95 Postpaid

ALL THE LENSES YOU NEED TO MAKE YOUR OWN TELESCOPE! ALL ARE ACHROMATIC LENSES

GALILEAN TYPE—Simplest to make but has narrow field of view.

Stock #5018-H 4 Power Telescope.....\$1.25 Postpaid

Stock #5004-H Small 2 Power Pocket Scope.....\$1.00 Postpaid

TERRESTRIAL TYPE—Have much wider field of view than Galilean Type.

Stock #5007-H 11 Power Telescope.....\$3.20 Postpaid

Stock #5008-H 20 Power Telescope.....\$3.45 Postpaid

Stock #5009-H 40 Power Telescope.....\$7.45 Postpaid

PRISM TELESCOPES—Uses Prism instead of Lenses to erect image and are much shorter than Terrestrial Type. Have wide field of view.

Stock #5010-H 6 Power Telescope.....\$3.00 Postpaid

Stock #5011-H 11 Power Telescope.....\$3.25 Postpaid

Stock #5012-H 20 Power Telescope.....\$7.25 Postpaid

All Items Finely Ground and Polished but Edges Slightly Chipped or Other Slight Imperfections which We Guarantee Will Not Interfere with Their Use. Come Neatly Packed and Marked.

You Can Easily Make Telescopes, Magnifiers, Photographic Gadgets and Hundreds of Experiments with these Low Cost Lenses. Excellent for XMAS gifts, too.

To translate millimeter measurements: 25.4 mm. equals one Inch.

SPECIALS IN LENS SETS

Big 10-Page Project and Idea Booklet with all sets.

Set #1-H "Our Advertising Special"—15 lenses for \$1.60 Postpaid. For making your own powerful telescopes, low power microscope, strong magnifiers, drawing projector, photo cells, telephoto lens, dummy focusing camera, Kodachrome viewer, stereoscopic viewer, ground glass and enlarging focusing aids. For experimental optics, portraits of babies and small pets, copying, ultra close-up shots, and many, many other uses.

Set #15-H "The Experimenter's Dream"—62 Lenses, Prisms and Optical Items, and New 50-Page Book, "Fun with Chipped Edge Lenses." \$15.00 Postpaid. The variety of Lenses and Prisms in this set will enable you to conduct countless experiments, build a great variety of Optical Equipment. A sensational buy.

New 50-Page Idea Book, "FUN WITH CHIPPED EDGE LENSES"

Contains wide variety of projects and fully covers the fascinating uses of all Lenses in sets listed above... only \$1.00 Postpaid.

14 POWER COLOR CORRECTED MAGNIFIER SET—Consists of 2 perfect 18 mm. diam. Achromatic Lenses and section of metal tubing for mount.

Stock #1044-H.....\$1.55 Postpaid

MONOCULAR SET OF LENSES AND PRISMS... From Navy's 7x50 Binocular. All the optics you need to make a 7 Power Monocular. Complete directions included.

Stock #5101-H.....\$5.00 Postpaid

SPECTROSCOPE SET... These sets contain all Lenses and Prisms you need to make a Spectroscope plus FREE 15-page Instruction Booklet.

Stock #1500-H Hand Type Spectroscope.....\$3.45 Postpaid

Stock #1501-H Laboratory Type Spectroscope.....\$6.50 Postpaid

MICROSCOPE SETS

Consisting of 4 Cemented Achromatic Lenses for making a 40 Power Pocket Microscope or 140 Power regular size Microscope. These color corrected Lenses will give you excellent definition and may be used for Micro-photography.

Stock #1037-H.....\$3.00 Postpaid

Consisting of Prism, Mirror and Condensing Lens. These used together with Stock #1037-H will make an excellent Micro-projector enabling you to get screen magnification of 400 to 1000 Power according to screen distance.

Stock #1038-H.....\$2.00 Postpaid

MISCELLANEOUS ITEMS

Stock No.	Item	Price
3016-H	Pentagon Prism	\$.75 each
2024-H	10 Pieces Circular A-1 Plate Glass (Diam. 31 mm.—for making Filter)	.25
4009-H	Heat Absorbing Glass 4" x 5"	.35 each
523-H	Six Threaded Metal Reticule Cells	.25
26-H	First Surface Aluminized Mirror, Diam. 1 ¹ / ₄ "	.25 each
624-H	Neutral Ray Filter, size 4 ³ / ₄ " x 2 ¹ / ₂ "	.25
22-H	Inclinometer—Aircraft type	.25 each
704-H	Lens Cleaning Tissue, one ream (480 sheets) size 7 ¹ / ₂ " x 11"	1.50
1030-H	2" Diam. Reducing Lens	.25 each
1031-H	Perfect 6 Power Magnifier—Diam. 28 mm.	.25 each
2043-H	Crossline Reticule—Diam. 29 mm.	.50 each
1034-H	Burning Glass Lens	.25 each

(Minimum order on above—\$1.00)

TANK PERISCOPE

Complete Set Mounted Components

Have fun! Make a real Periscope. Use it to see over the heads of crowds, to see under water, to see out windows without yourself being seen, and many other uses where observation by "remote control" is required. Originally constructed for U. S. Army Tanks, set consists of 2 fine Periscope mirrors mounted in metal and plastic. Perfect condition. Only plywood body frame is required to finish this exceptional Periscope. Set weighs 2³/₄ lbs. Overall length 6¹/₂", width 2¹/₈". Would normally retail at \$40 to \$50.

Stock #700-H.....\$3.00 Complete Set Postpaid
(Two Sets (four units).....Special \$5.50 Postpaid)

Order by Set or Stock No. • Satisfaction Guaranteed • Immediate Delivery

EDMUND SALVAGE COMPANY, P. O. AUDUBON, NEW JERSEY

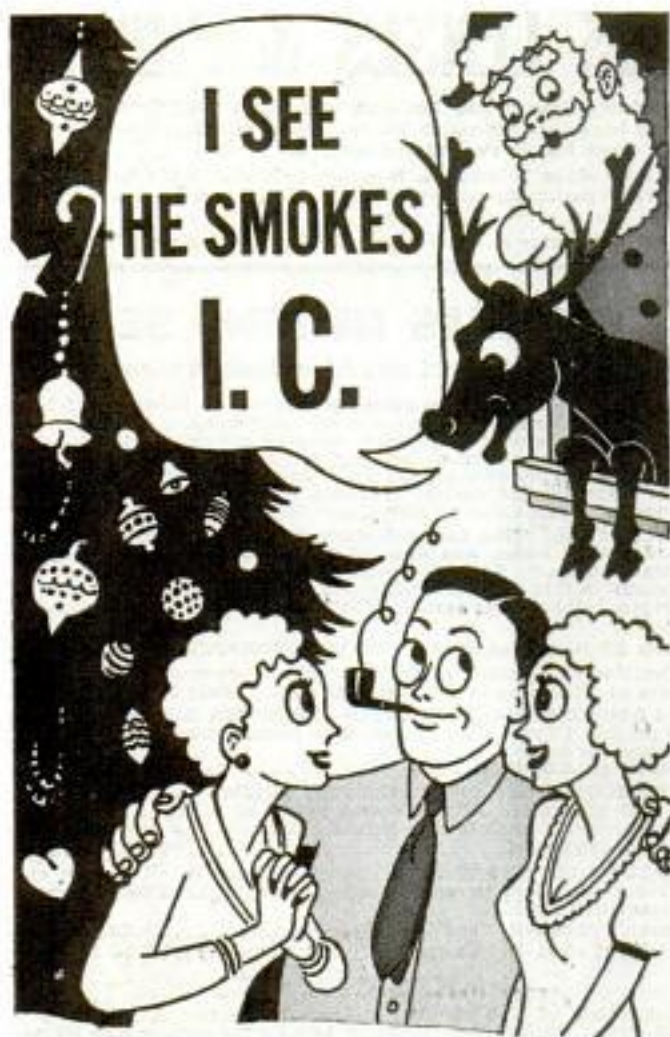

You'll see when you give I.C.

Incomparable Christmas spirit, with many a "dear" gathering 'round . . . that's the heart-warming holiday (or any day) result from a pipeful of Irish Castle Pipe Mixture. What "aroma appeal" and no wonder! Willoughby Taylor master-blended 8 of the world's finest tobaccos . . . top Turkish, virile Virginias, luscious Latakia, piquant Louisiana Perique, mild White Burley. You'll see that I.C. is the perfect smoke, the perfect gift!



IRISH CASTLE

CHRISTMAS SPECIAL

For a limited time (and only if your dealer is out of stock) we'll send you a half-pound humidor of Irish Castle Pipe Mixture for only \$1.10. Mail coupon with cash or check to Penn Tobacco Co., Dept. DP, Wilkes Barre, Pa

Name _____
Address _____

MANUFACTURERS -- INVENTORS

Personal Representation Is VITAL!

We specialize in contact service in all merchandising phases and non-related activities for \$2.50. Sales development on commission basis. Tell us what you want—perhaps we can help you too!

Address any Bureau for Prospectus:—

CALIFORNIA—Earl E. Borough, 419 24th St., Hermosa Beach.
OREGON and WASHINGTON—W. F. Sager—available Dec. 15th.
ILLINOIS and MISSOURI—R. J. Fahey, 6060 Maple St., St. Louis.
OHIO—Maurice Evers, 707 Ansonia St., Toledo.
COLORADO—A. F. Allen, 417 Hudson St., Denver.
INDIANA—Maurice E. Neligh, 509-E S.E. 1st St., Evansville.
MICHIGAN—J. Charters, 5559 Buckingham, Detroit.

OTHER STATES AVAILABLE SOON

LIAISON SERVICE BUREAU

HOME OFFICE—4509 Outer Washington Ave., Evansville, Ind.
W. S. Heininger, Director

REFRIGERATION

and AIR CONDITIONING

Train where the Army trained. Learn at home or in our big shops. Expert instructors—real machines. Easy to learn. Write for big FREE catalog today. No obligation. **COMMERCIAL TRADES INSTITUTE**, 209 W. Jackson Blvd., Dept. M12, Chicago, Ill.

APPROVED GI TRAINING

VETERANS ASK FOR GI PLAN

INVENTORS

WITH GOOD INVENTIONS

Should write us without delay for FREE BOOKLET, Protective Disclosure Form and facts about The Inventor's Most Logical Markets. Patented, Unpatented inventions, all kinds. Cash, Royalty, needed by specific manufacturers. If your invention is for sale, write today for full particulars. A Post-Card will do! Address:

THE INVENTION REPORTER

5C-11106 South Longwood Drive Chicago 43, Illinois

FLOYD CLYMER'S MOTOR SCRAPBOOK

Early cars, motorcycles, illustrated, described. Historical, educational. "A MUST," says TIME Magazine. Read about Ford, Hup, Dodge, Metz, KMP, Maxwell, Stutz, Reo, 250 others. No. 1 and No. 2 books, each different, \$1.50 each. 100% STEAM CAR EDITION, with steamer history, list of 125 makes, photos, \$2.00. All books postpaid. Cloth-bound \$1.00 extra. Motor-book catalog, 10c.

REO

Clymer, Dept. PM, 2125 W. Pico St., Los Angeles 6, Calif.

JET PROPULSION

Experimenters! New principle to drive boats, bicycles, model helicopters. Circular on plans. Rush name. Houston Maupin, Tipp City 12, Ohio.

COMB-A-TRIM

THE NEW QUICK TRIMMER

Something New! Trim your hair without any experience. It's easy! The excess hair comes off smoothly and easily by just pulling trimmer through hair like an ordinary comb. Also removes hair from legs—armpits. Save on hair-cut bills . . . Trim your own hair or the whole family's. Send 59c and your Comb-A-Trim will be sent at once.

59c



SPECIAL OFFER
Send \$1.00 for 2
Comb-A-Trims
and save 18c. **2 for \$1**

5 Extra Blades
(Year's Supply) 25c

COMB-A-TRIM CO.

1734 Carew Tower

Dept. R-1

Cincinnati, O.

★ SAVE WASTE PAPER ★

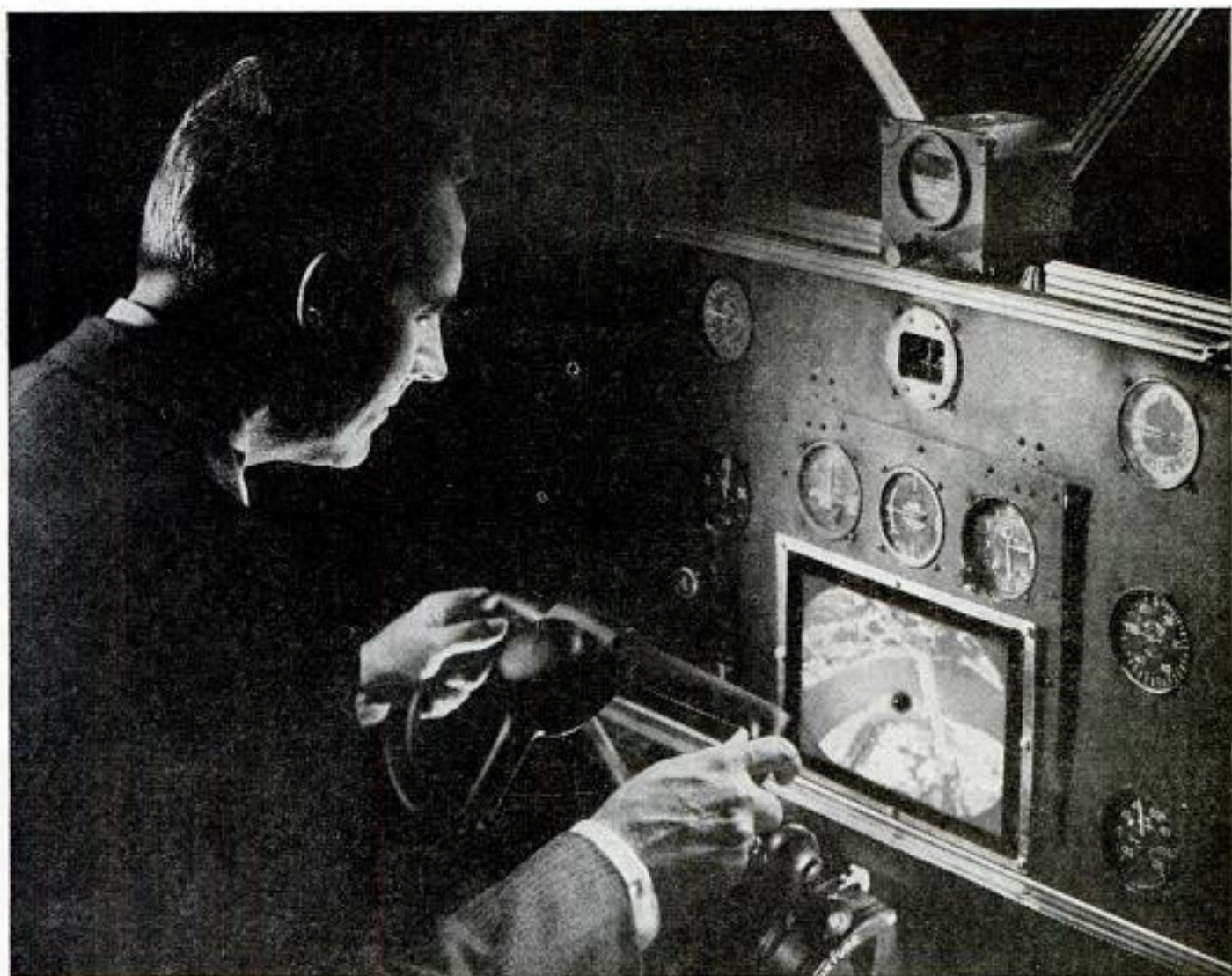

One of the many ways radar can serve aviation is by enabling the pilot to "see" through fog and darkness.

Radar—a "Moving Roadmap" for Flying

Pilots can now have an accurate radar "roadmap" of the earth below—showing landmarks and major details of terrain. Radar will make it a whole lot safer to fly at night or in stormy weather—as well as in broad daylight.

This is only one of the many possible uses for radar. For example, radar will "see" icebergs or islands many miles away—day or night—and will thus enable ships to avoid them. It will provide men with an amazing new "sixth sense"—and will be used in a great many ways yet to be discovered.

RCA research and engineering played a leading role in developing radar . . . the same research that goes into *all* RCA products.

And when you buy an RCA Victor radio or television set or Victrola, made exclusively by RCA Victor, you enjoy a unique pride of ownership. For you know, if it's an RCA it is one of the finest instruments of its kind that science has achieved.

Radio Corporation of America, Radio City, New York 20. Listen to *The RCA Show, Sundays, at 4:30 P.M., E.T., over the NBC Network.*

HOW RADAR WAS BORN

During RCA experiments at Sandy Hook in the early 1930's, a radio beam was shot out to sea. Men listening with earphones discovered that this beam produced a tone upon hitting a ship that was coming into the New York harbor.

Later on the question arose, "If radar could 'hear' couldn't it be made to 'see'?" So the viewing screen—or scope—was incorporated into radar. This scope is an outgrowth of all-electronic television that was invented and perfected at RCA Laboratories.



RADIO CORPORATION of AMERICA

So You'll See Better

 Nature designed your eyes for seeing by daylight. But the average person spends most of his waking hours under artificial light.

To develop better artificial light—for all living and working conditions—has been a continuous project of G-E engineers and research scientists. They have even developed a whole new Science of Seeing.

The pictures on this page illustrate a few ways in which G. E. is helping you see the day-by-day and night-to-night things more easily. *General Electric Company, Schenectady, N. Y.*



Powdered light. This luminous powder that you see is a phosphor. Coating the inside of every G-E fluorescent lamp, it transforms invisible rays into soft, cool light. Recently General Electric developed a remarkable new phosphor which will be used in a new fluorescent sun lamp to provide healthful summer sunshine all year round, economically and efficiently. And speaking of economy, G-E lamp research has reduced the cost of a 60-watt G-E bulb by 75% since 1923. Another way in which General Electric helps to bring More Goods to More People at Less Cost.



The tiny 7-watt G-E bulb in this night light makes darkened halls safely navigable for sleepy people. It's especially useful in homes with small children. And the cost of electric current has been brought so low that, at average residential rates, this little lamp will burn for four 8-hour nights for only a penny or so!

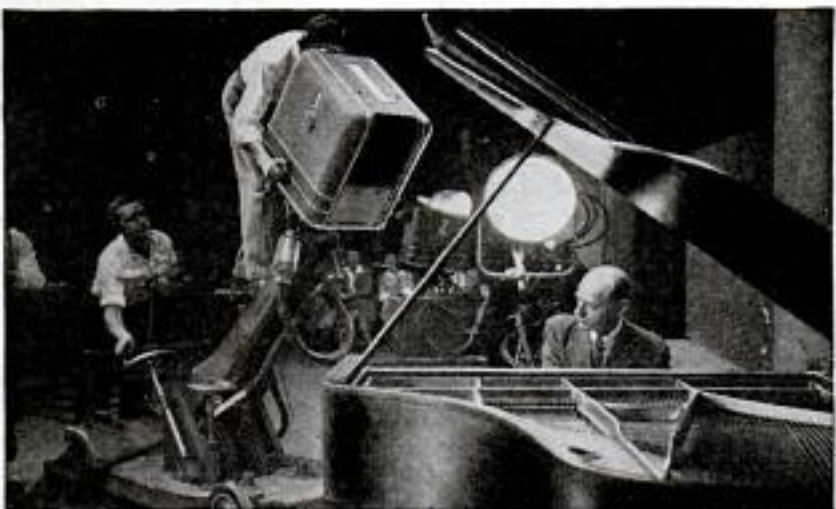

You'll soon see events as they happen—by improved television with a bigger screen and clearer reception. Back in 1928 a G-E engineer, Dr. E. F. W. Alexanderson, gave the first public television demonstration. And for more than five years now, G. E. has been telecasting regularly from its own station, WRGB, in Schenectady.

The best investment in the world is in your country's future

KEEP ALL THE BONDS YOU BUY

GENERAL  ELECTRIC



*Smoother than ever
- it's a new ride!*



This new Ford car—so big and smartly styled—offers more new developments than most pre-war yearly models . . . New multi-leaf springs give you a ride that's smooth and level . . . Brakes, too, offer major new advancements. They're oversize, self-centering hydraulics for quick, quiet stops . . . There's stepped-up power—and new thrift in gas and oil . . . Inside, new luxury awaits you. Colorful fabrics and trim in pleasing two-tone combinations . . . Choose from two great engines. The V-8, now increased from 90 to 100 horsepower; the 90 horsepower Six . . . Ask your Dealer about the smartest Ford cars ever built.

FORD MOTOR COMPANY

TUNE IN... THE FORD SHOW... CBS, Tuesdays, 10-10:30 P. M., E. S. T. THE FORD SUNDAY EVENING HOUR. ABC, Sundays, 8-9 P. M., E. S. T.



THERE'S A
Ford IN
YOUR FUTURE

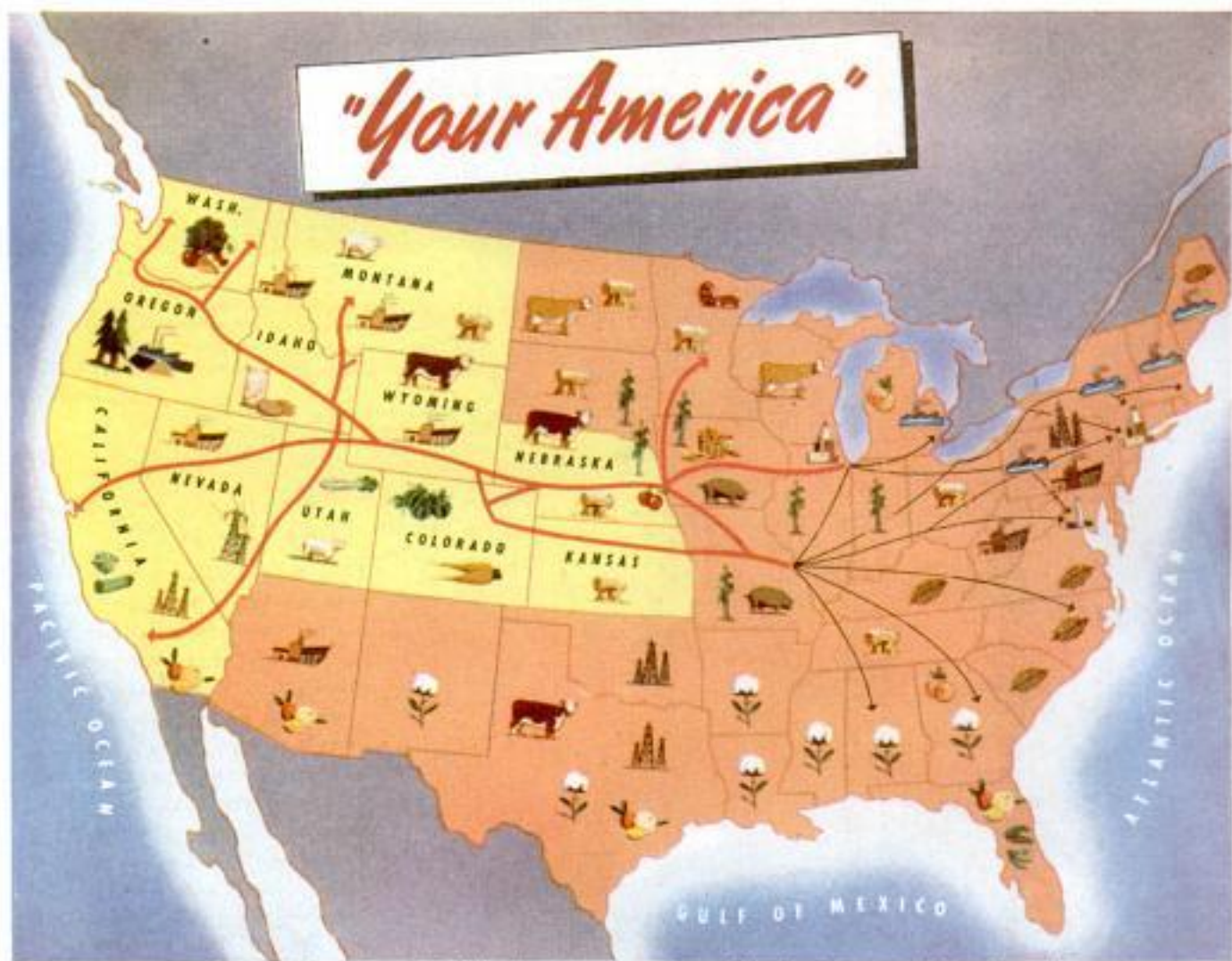

Map of "Your America" Showing Territory Served by the Union Pacific Railroad



For more than 75 years, Union Pacific has

served eleven western states... been a partner in their development... transported their people and products. This vast territory produces a great variety of agricultural products which not only feed and clothe the nation but are converted into a myriad of industrial uses.

The same eleven states also are a source of other industrial materials such as ores, minerals, lumber and petroleum. Rivers have been harnessed—providing irrigation and power. There is dependable rail transportation.

This vast western area has materials and facilities required for postwar expansion. There is plenty of space for such expansion and for homeseekers who desire a healthful contented life among friendly people in scenic surroundings.

★ ★ ★

Union Pacific... the Strategic Middle Route, uniting the East with the mid-West and Pacific coast... will, upon request, gladly furnish information regarding available industrial and mercantile sites or farm lands in the territory the railroad serves. Address Union Pacific Railroad, Omaha, Nebraska.

THE PROGRESSIVE
UNION PACIFIC RAILROAD
The Strategic Middle Route

Popular Mechanics Magazine

Registered in U. S. Patent Office and Canada

WRITTEN SO YOU CAN UNDERSTAND IT

Vol. 84

DECEMBER 1945

No. 6

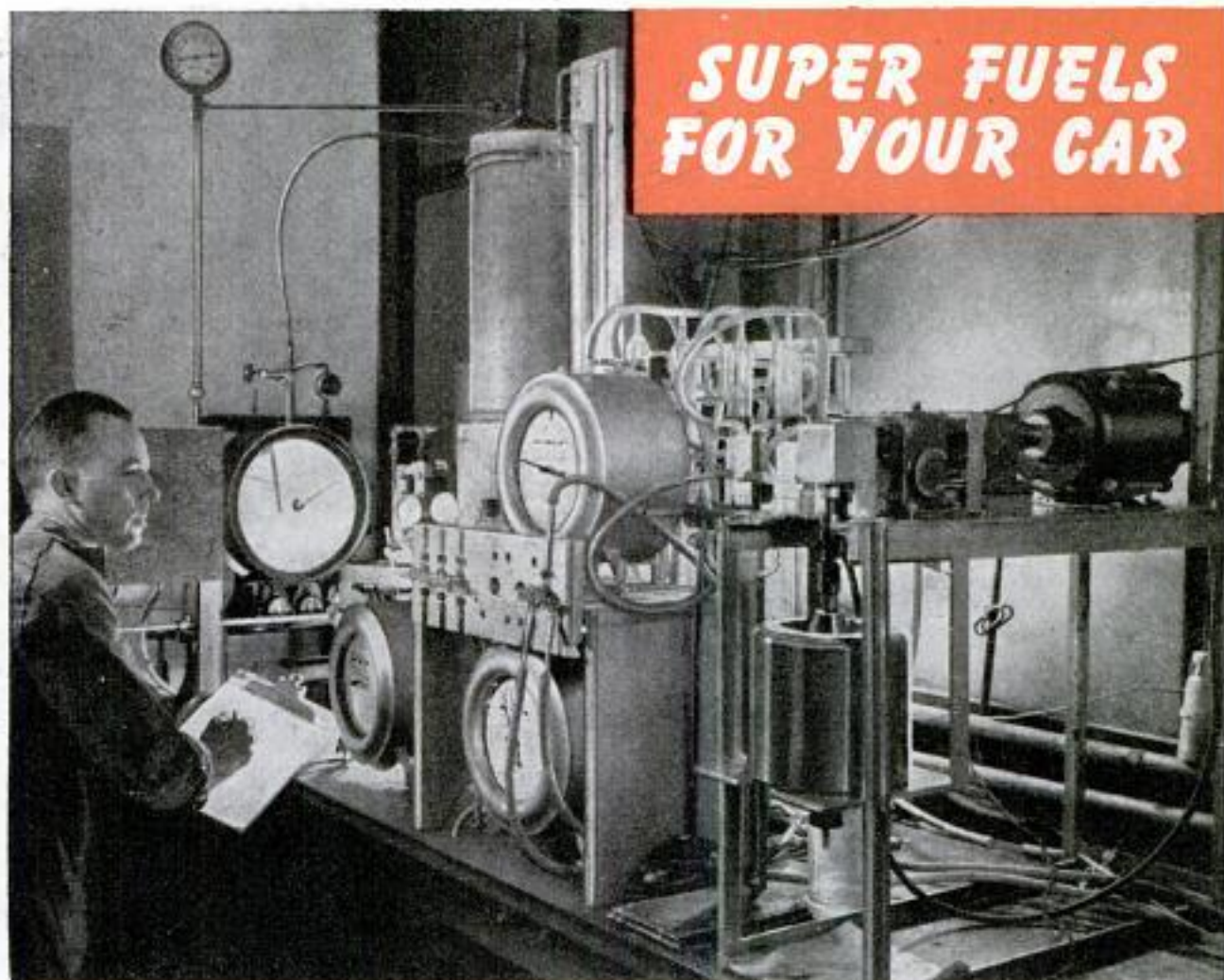

THE MOTORING PUBLIC is accepting as a matter of course the better gasoline which is pouring from pumps of rejuvenated service stations across the nation. However, the day is still far off when you'll be able to fill the jalopy's tank with 100-octane gasoline and sail right over the roof of the road hog ahead.

Even if you had been able to buy all the 100-octane aviation gasoline you wanted during the war, it wouldn't have done you much good; nor will it today. But you can buy higher-octane gasoline than the pre-war range, which means greater mileage and higher efficiency for cars with high compression engines. In 1940, the house brand or regular gasoline had a 75-76-

Right, arrangement of atoms in molecule of gasoline is secret of power. Black spheres are carbon atoms; red are hydrogen. Molecule of normal heptane at top produces knock. Below it is molecule of iso-octane

Experiment in catalytic dehydrogenation in laboratory of Universal Oil Products Co. is typical of research that boosted production of aviation gasoline from 42,000 barrels daily to a half million

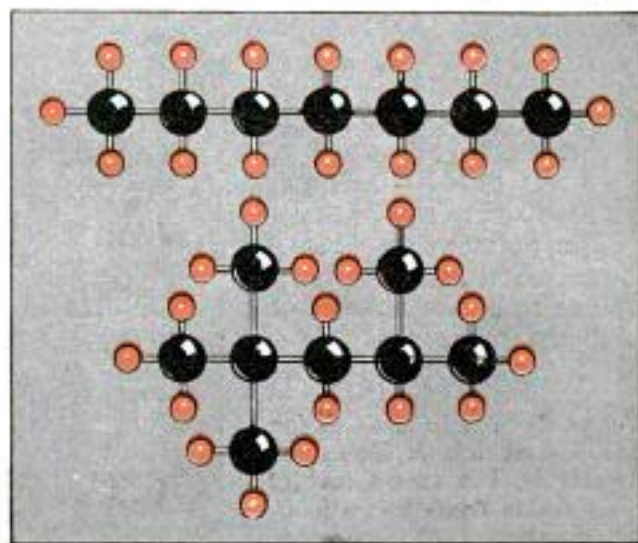

DECEMBER 1945

oil

Copyrighted material 1

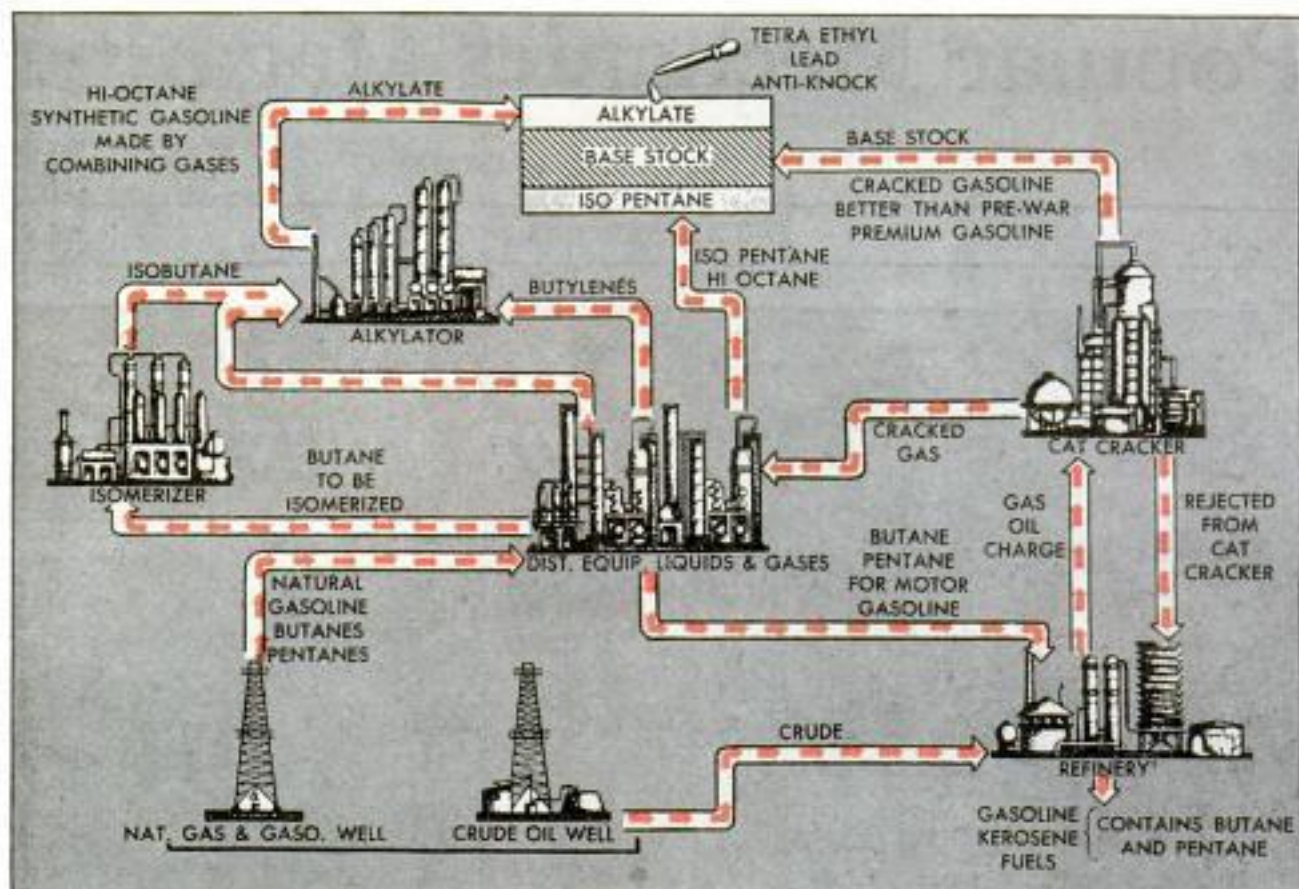

Chart from Petroleum Administration for War
 Here are principal steps involved in making 100-octane gasoline which is indicated in square marked alkylate, base stock and iso-pentane. Cat cracker produces base stock and returns the nonpotent fuel to the refinery

octane rating, and premium gas was 80-octane. Today the trend is to 80-octane for regular and 82 to 85 for premium gasoline. The 85 figure is aimed at getting the most out of postwar engines with higher compression ratios. Government regulations held regular gasoline to a maximum of 70-octane during the war, with premium at 76—when you could get it.

A significant trend in postwar gasoline purchases is evident in figures disclosed by a major oil company. Where regular gasoline outsold premium gasoline by 10 to one before the war, premium is outselling regular by approximately the same ratio today. Postwar motorists have become octane-conscious.

The octane scale itself is merely a measurement of the antiknock level of a given mixture of iso-octane, a gasoline hydro-

carbon having a knockless value of 100, and normal heptane, another gasoline hydrocarbon with a knockless value of zero. If a gasoline shows in these motor-method tests that its knockless value is equal to that of a blend of 70 percent iso-octane and 30 percent heptane, it is rated at 70-octane.

Vapor from regular aviation gasoline at left is highly inflammable, but safety fuel at right resists flame unless heated to above 100 degrees F. Standard Oil Co. (N.J.) photo

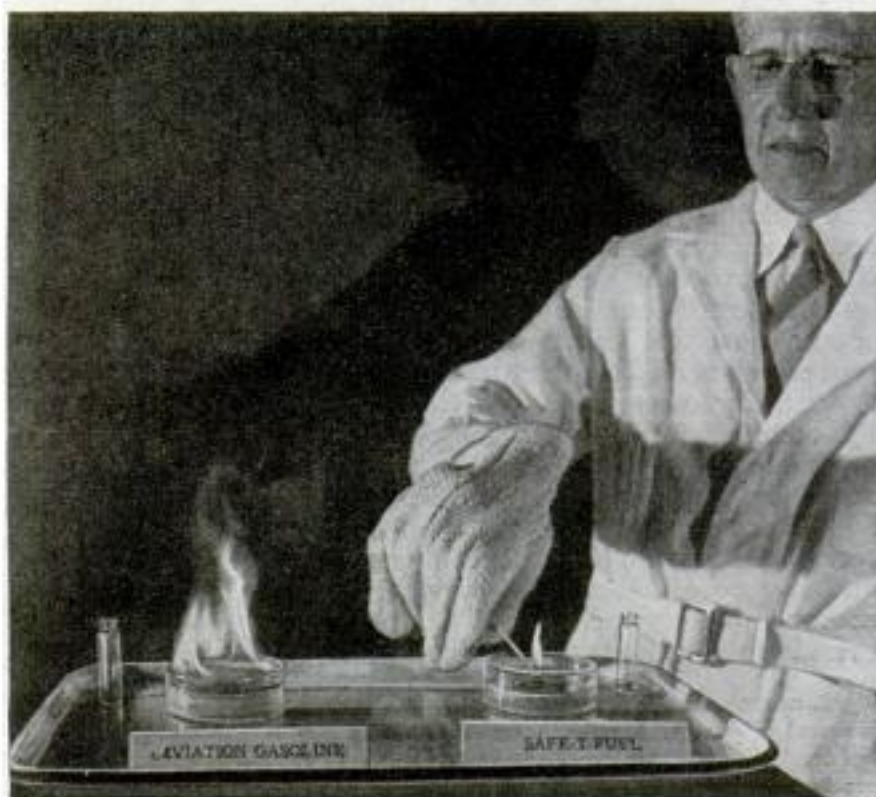

Spurred on by an insatiable demand for 100-octane gasoline for the thousands upon thousands of high compression, top efficiency aircraft engines of wartime, the petroleum industry literally lifted itself by its own bootstraps to reach a peak production of 500,000 barrels of aviation gas daily, compared with an average of 42,000 barrels a day by prewar processes. The net result is that the petroleum industry has become the largest mass production industry in the world, to quote Dr. J. F. Walter of the Universal Oil Products Company, a pioneer in petroleum research and processing development.

Although harnessing of atomic energy may some day present a real challenge to the petroleum industry, there is a strange kinship in the two fields. Originally, gasoline simply was distilled from crude petroleum, and operated the low compression engines of early motoring days quite successfully. But development of more efficient high compression engines created a need for better motor fuel, and it has been only in the last 25 years that such gasoline came into being. The secret of today's high-octane gasoline lies in rearrangement of the hydrocarbon atoms through new refining processes. The oil researchers were splitting molecules while the atom researchers were splitting atoms.

Returning from the realm of molecules and atoms, what do these petroleum developments mean to the average motorist?

Key to petroleum refining is distillation of crude oil into various fractions. Oil is heated to 800 degrees F. and is completely vaporized in fractionating tower. Vapors with different boiling ranges condense on trays and are drawn off for processing

Courtesy of The Lamp, Standard Oil Co. (N.J.)

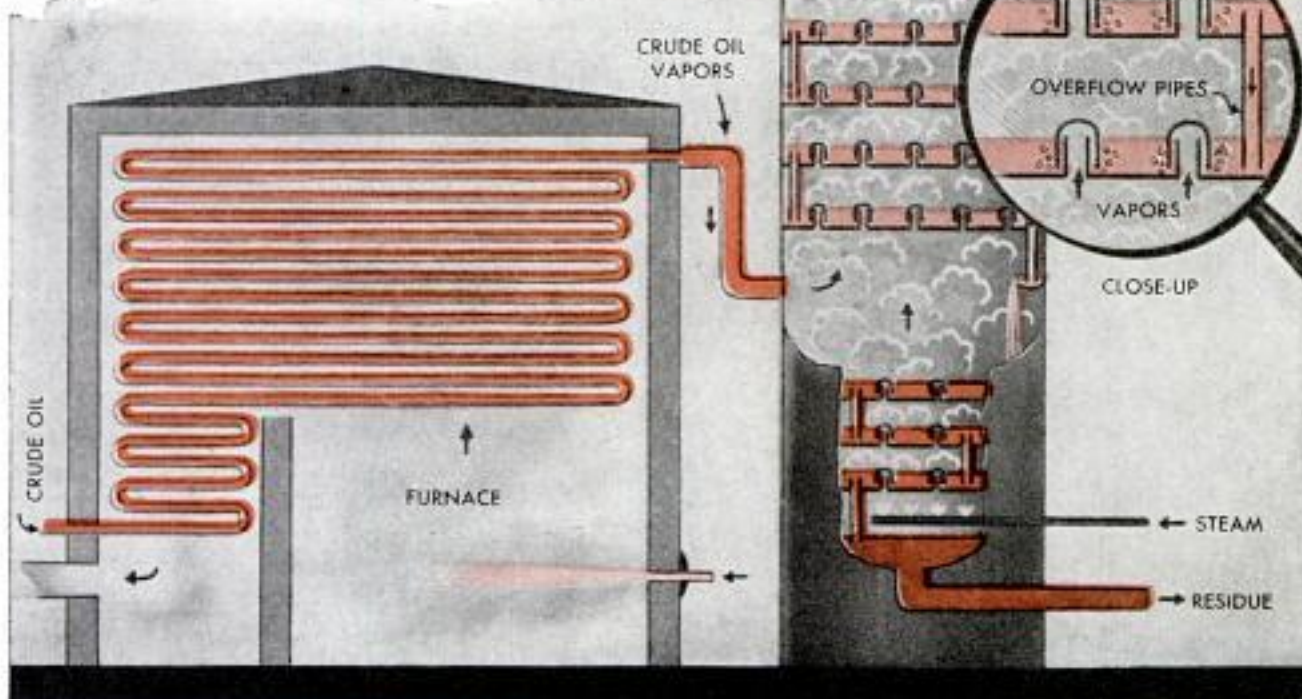

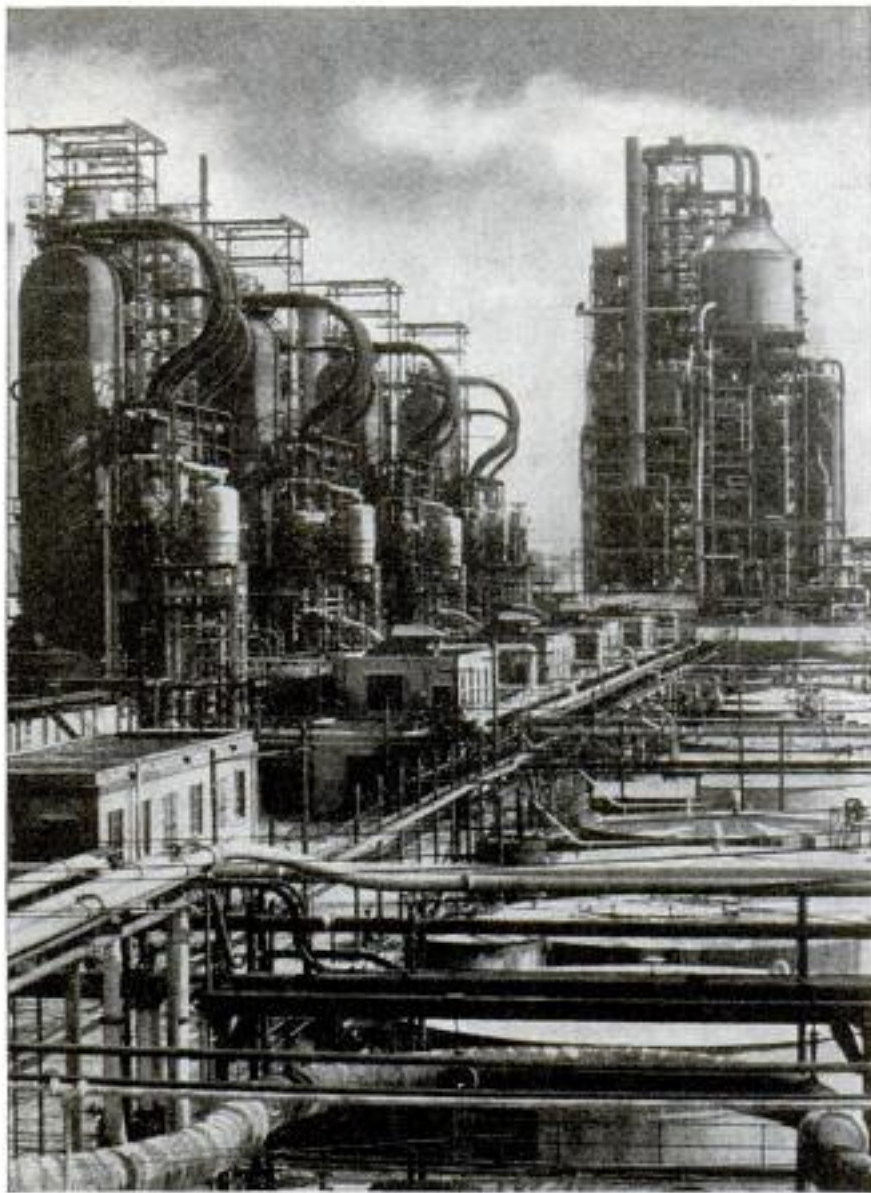

Above, cat crackers dominate scene at Standard Oil's Baton Rouge plant

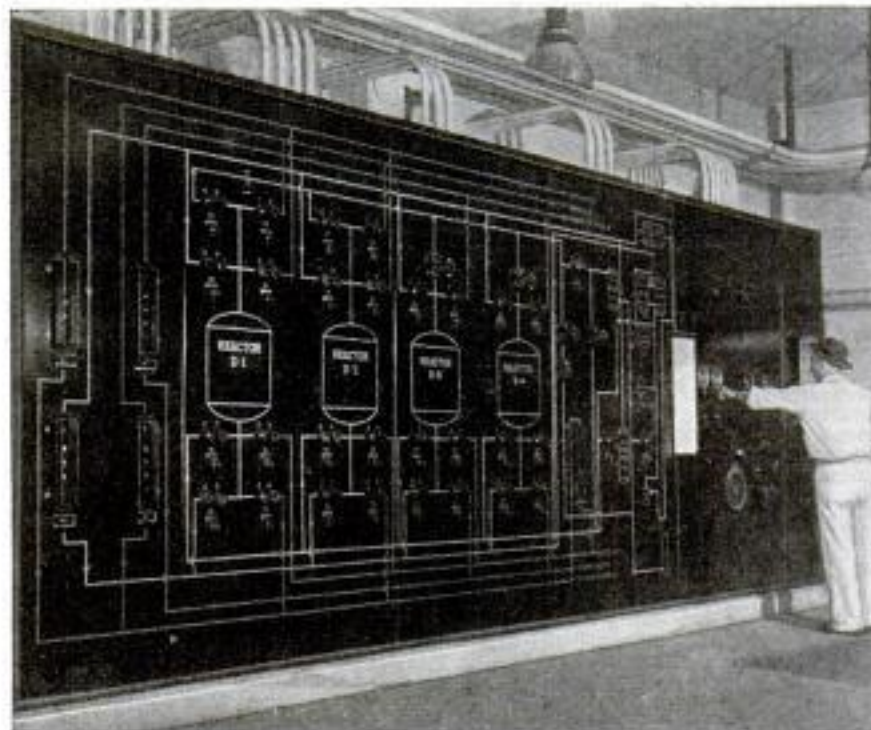

Control board of hydroforming plant operated by the Pure Oil Company

To the aviation industry? Simply this: so far as present vision permits, automobile engine design when carried to the nth degree of attainable high compression, a ratio of about 9 to 1, still will not require 100-octane gasoline and the complicated processes required for its production.

Even in commercial aviation, 100-octane gasoline is not an essential requirement for ordinary transport purposes, and 91-octane fuel, which can be made by comparatively simple processes, will suffice. From an economy standpoint, 100-octane is justified only where long flight requirements and premium loads are involved. In wartime, of course, the economy factor is the last to be considered.

For greater safety in commercial aviation, the Standard Oil Company of New Jersey has developed a new safety high-octane aviation fuel which does not create an inflammable envelope of vapors when exposed to air at normal temperatures. Having all the power characteristics of 100-octane fuel, the safety gasoline still is as safe as kerosene to handle and has a flash point of 100 degrees F., as compared with a flash point of 40 below zero for ordinary 100-octane gasoline. The new gasoline must be injected directly into engine cylinders. First use of the gasoline will be confined to aviation, but its eventual extension to motor engines is quite probable.

Measuring of antiknock qualities of gasoline by octane number alone is being examined critically within the industry. The present methods of evaluating fuel are the motor method, described previously, and the research

method. An 80-octane fuel measured by the motor method would be 92-93 by the research method. Neither is regarded as entirely satisfactory since other characteristics of the fuel such as chemical and physical factors are not taken into account. A third method of measuring fuel, called the Borderline method, relies on road tests for fuel evaluation and grades performance by a curve at varying speeds, instead of a number. This method was adopted by the Cooperative Fuel Research Committee in 1940. Pure Oil Company laboratories contributed greatly to this development. Its need is emphasized by Harry L. Moir, technical adviser to the Pure Oil retail marketing department, in a comparison of the requirements of L-head and valve-in-head engines at varying speeds. These follow:

L-Head Engine		
Speed, r.p.m.	Octane	Requirement
1000		71
1500		71
2000		73
2500		73
3000		76
Valve-in-Head Engine		
Speed, r.p.m.	Octane	Requirement
1000		82
1500		80
2000		79
2500		76
3000		74

(Continued to page 164)

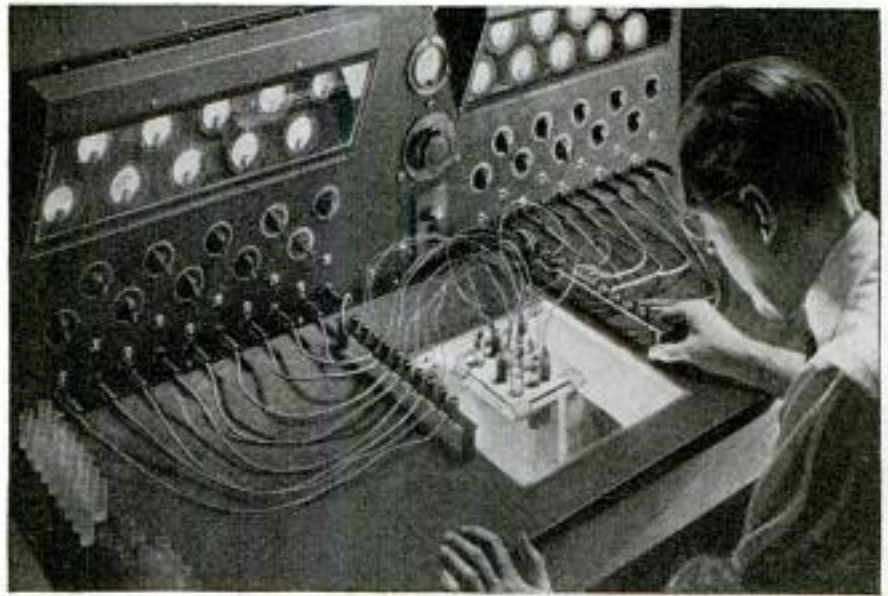

Gulf Oil Corp. photo and diagram
 Resembling a cross between telephone switchboard and radio, this electrolytic model takes guesswork out of water-flooding of wells to produce more oil

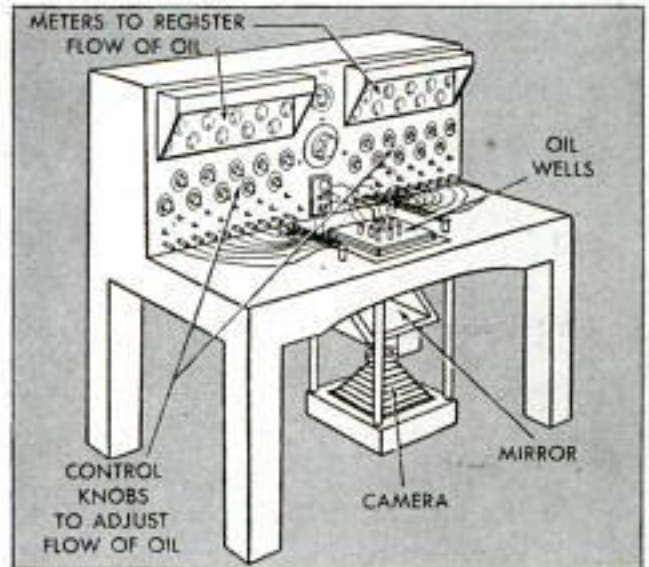

Flow of electric current in electrolytic model simulates flow of oil, gas or water in wells. Photo at left shows wells under study on model. Right, composite photo made on model showing various stages of flooding

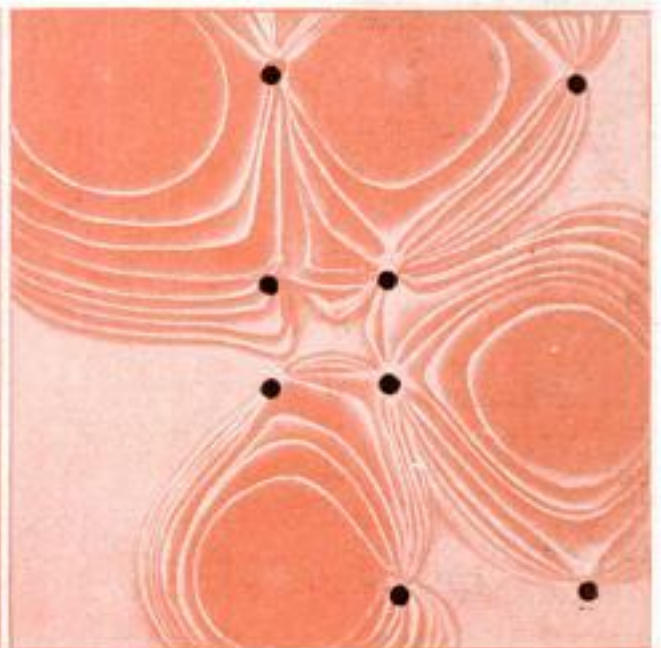
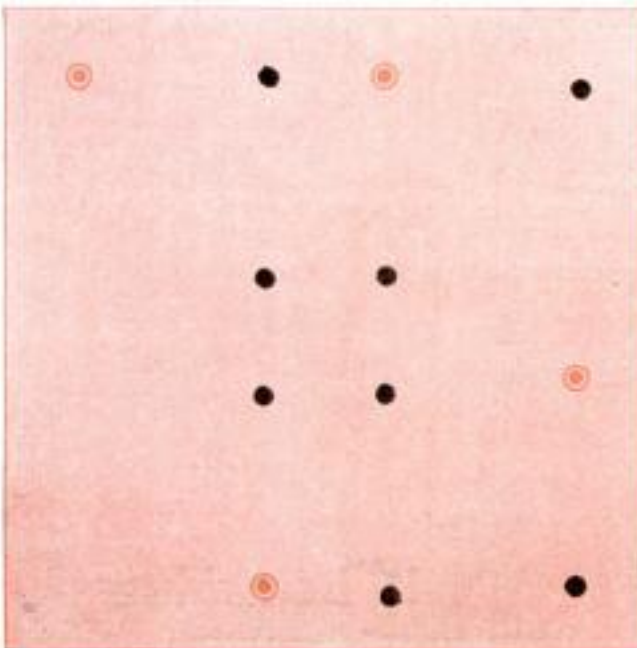



LCI Dons "Civies" To Supply Camps

Navy war equipment is now being channeled into peacetime work. On Lake Temagami, in northern Ontario, an LCI ferries supplies to lumber camps and resort areas. Carrying 50 tons or more, the craft is especially useful in shallow lakes and rivers.

Streamline Jeep

Men of the 478th Air Service Squadron, in the Philippines, had some spare time on their hands, also a smashed-up jeep and a couple of wrecked airplanes, so they decided to streamline their jalopy. They made a racer type body from the cowling of a C-46 engine, fashioned fenders out of emergency gas tanks and wound up with a speedy little runabout.



Paddle-Wheel Boat

Got some old motors and junked parts around the house? Why not make a boat out of them? Lynn E. Troxel of Rittman, Ohio, did. For power he selected the motor from an old washing machine, to which he added, among other things, used parts from an ancient automobile, a clutch from a sewing machine and a Ford coil. A pair of home-made paddle wheels completed the job. It works—but Troxel brings a pair of oars along, just in case.

Speedboat Is Built From Fuel Tanks

Proving that American GIs are not unique in their inventive capacity, Flying Officer B. W. Bentley of Australia salvaged two Kittyhawk belly tanks and added an old motorcycle engine to build a speedy boat for whiling away his off-duty hours. A wooden platform mounted on planks connects the tanks and forms a support for the engine.





David vs. Goliath

Small in size but packing a powerful punch, British midget submarines varied in length from 30 to 50 feet and were operated by crews of three or four men. Moving silently about 12 feet below water surface, these undersized subs scored many hits on Nazi ships before moving into the Far Eastern war. Their biggest bull's-eye was the German battleship, Tirpitz, which was crippled by the midget subs in a Norwegian fiord and later sunk by RAF planes.

Above, British midget submarine entering the harbor at Sidney, Australia. Right, view inside the craft

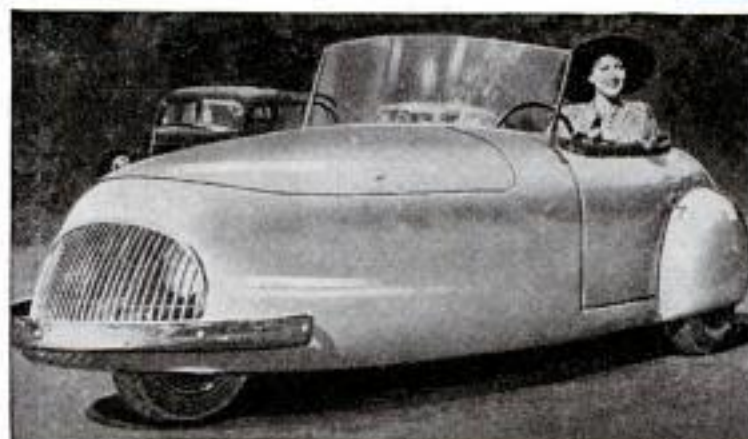
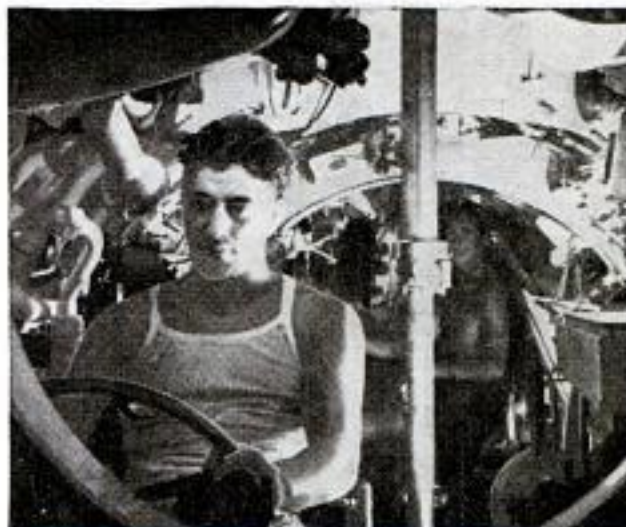

Three-Wheel Midget Auto Goes 100 Miles Per Hour

Equipped with a 58-horsepower aircraft engine, a small three-wheeled automobile is planned by a West Coast manufacturer who says it will go 100 miles per hour and travel 40 miles on a gallon of gasoline. In case of a puncture, an installed jack automatically raises the car when a button is pushed. A special foot pedal serves as both accelerator and brake.

DECEMBER 1945

*Warner Mfg. Co.
666 Hawthorne St.
Glendale, Calif.*

COMING UP— THE ALL-HYDRAULIC

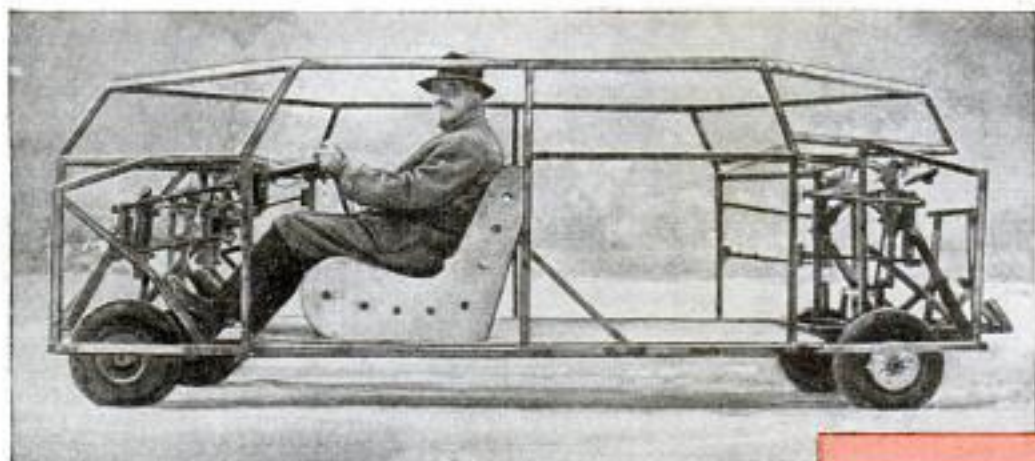
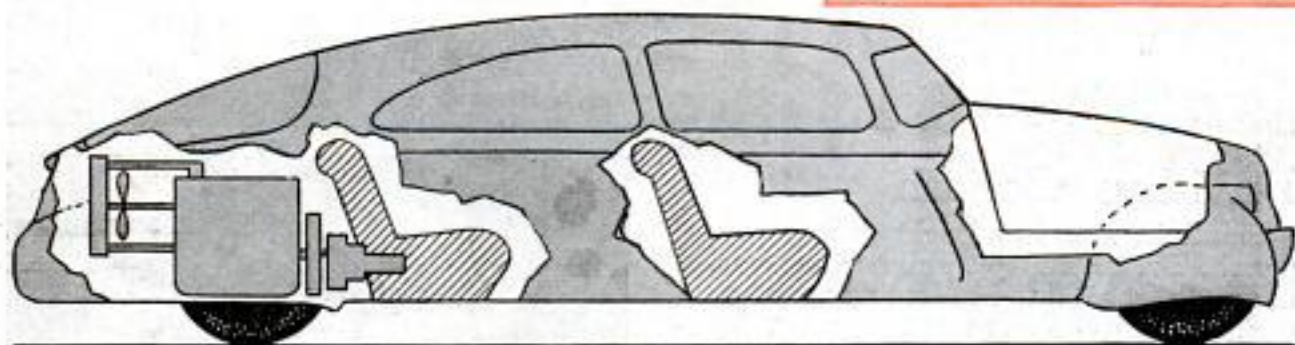
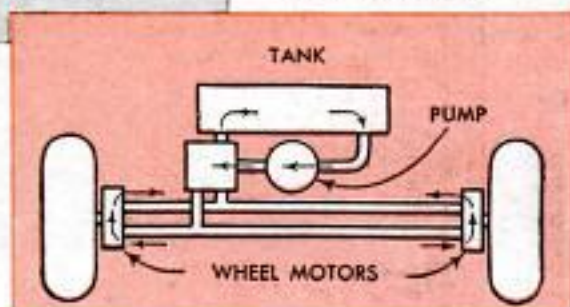
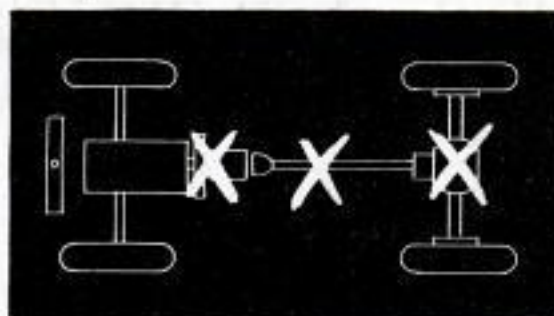

Diagram below illustrates the principle of the complete hydraulic drive. Note the flow of oil to both wheels under equal pressure, providing differential action without gears. A four-way valve (left of pump) reverses oil flow to replace reverse gear

Welded steel tubing, above, replaces conventional frame in this experimental hydraulic drive automobile developed by Ray Russell, shown seated at the wheel. Mounts for installing the engine are between the rear wheels. This photograph, taken before a plywood test body was added, shows airplane wheels and tires used experimentally and later replaced by standard automobile wheels and tires. This type of frame permits freedom of interior design with floor space unobstructed by the drive shaft or transmission



Above, artist's conception of the Russell car with engine located at the rear and luggage compartment under the hood at the front. Left, this diagram shows the power transmission parts—transmission, drive shaft, differential, rear axle and universal joints—eliminated by the use of hydraulic drive equipment, with a saving in weight up to 800 pounds



Here is the designer's idea of a rear engine, hydraulic drive car with full vision through a curved safety-glass windshield. Each spacious seat will accommodate four persons, side by side. The rear engine design prevents noise, vibration and fumes from reaching passengers. Wheel suspension is independent, both front and rear

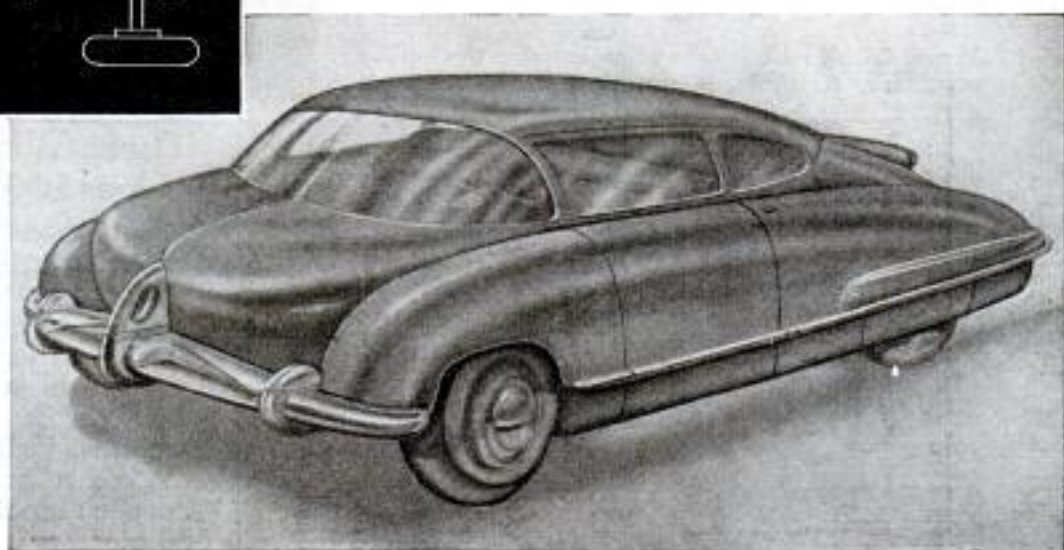

COMplete hydraulic drive is being tested in an experimental automobile whose "plumbing system," pumping oil from engine to drive wheels, eliminates some 800 pounds of conventional power transmission mechanism.

Developed by Ray Russell, Detroit engineer and industrial designer recently retained by the Ford Motor Company, this rear engine car does away with the need for a clutch, transmission, drive shaft, torque tube, differential, differential housing, universal joints and rear axle.

While details of the hydraulic equipment have not been revealed, the design is known to use multiple pumps, connected directly to the crankshaft of the engine, which force oil through motors on the wheels. A new type of braking action, provided by slowing down or reversing the flow of oil through the motor wheels, may eventually eliminate use of conventional drum type brakes, according to Russell.

Experimental models now under construction feature a frame of welded steel tubing, individual wheel suspension, hydraulically operated windows, driver's seat and windshield wiper and an engine that can be removed by taking out four bolts.

Russell believes that since it is so easy to remove the engine, garages some day will stock spare engines to be installed in cars while repairs are made on the original engines—in the same manner that rental batteries serve car owners while their batteries are being recharged.

Engineers and writers who recently rode in one of Russell's experimental hydraulic-drive cars equipped with a plywood body reported smooth, silent operation without excessive heat in the hydraulic system, a problem previously considered almost insurmountable.

From seven to 15 speeds forward and reverse can be produced in the hydraulic-drive car, depending upon the number of oil pumps. Three pumps produce seven speeds, or ratios, and four pumps provide 15 speeds. Because of this factor, Russell says, performance is unbelievably smooth—comparable only to steam. More power is available in low gear than in any passenger car built, and a higher ratio is produced for fast level driving than in any known overdrive, the designer states.

No public announcement has been made as to when the hydraulic car may go into production.

Electric "Long Tom" Toy Cannon



Operated electrically, a toy cannon patterned after the 155-millimeter "Long Tom" shoots a stream of wooden shells 30 feet but without enough force to break things. At the push of a button the gun makes a booming noise, shoots out the shells and even recoils like a real cannon.

Drilling Tool Does Several Jobs

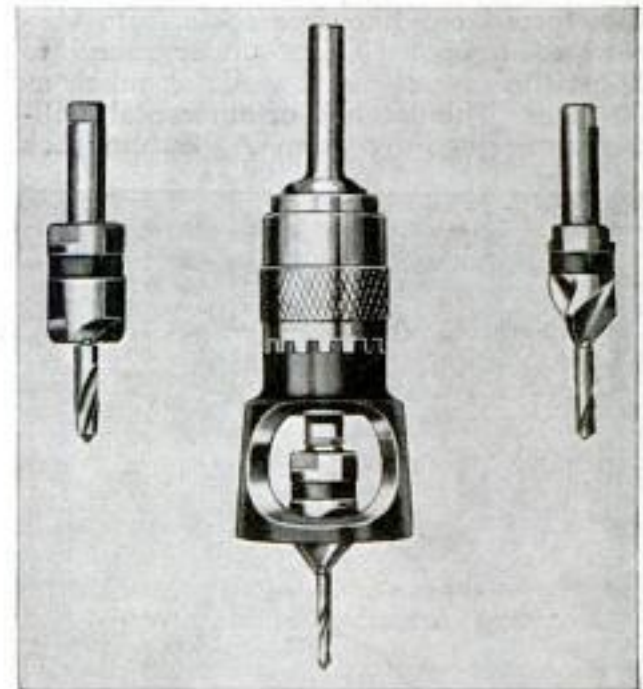

Drilling and countersinking, spotfacing or counterboring can be performed in one operation with a new interchangeable tool made of high speed steel carefully ground for close tolerances. The tool can be changed easily from one job to the next and put through a wide range of operations. With standard angle drill adapters or attachments, drilling and countersinking or drilling and spotfacing can be done in places usually difficult to reach.

*John A. Zublin
 2369 8 1st St
 L. A. Cal.*

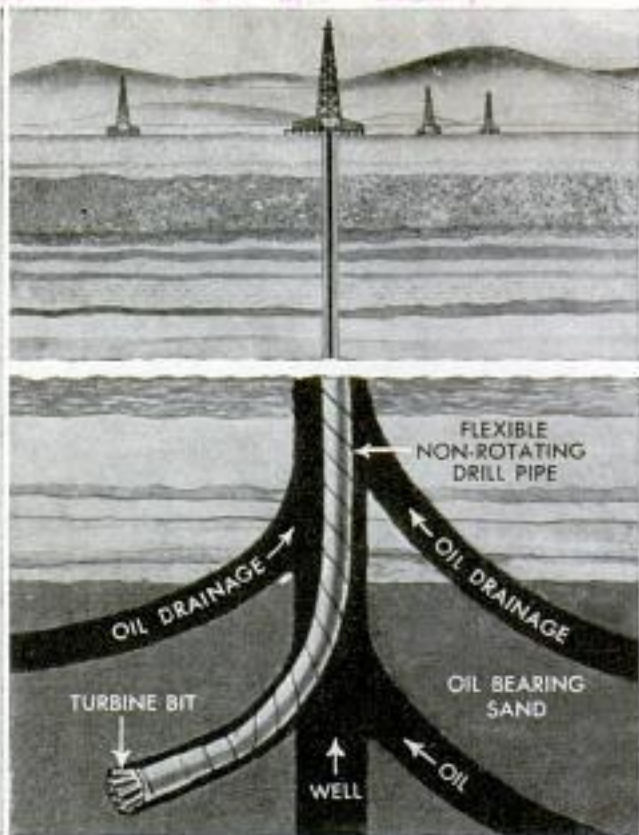
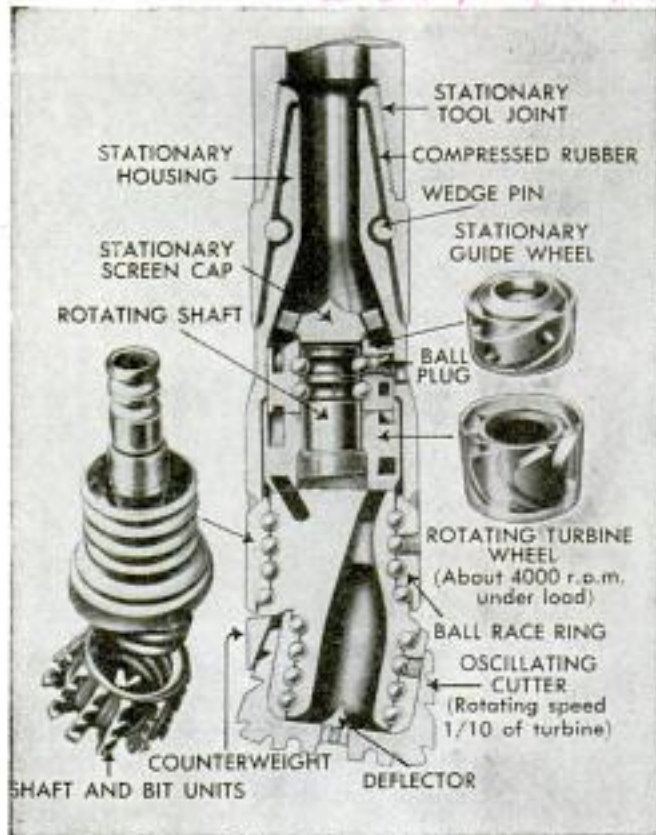

Rootlike Oil Drill

Spiral pipes tipped with turbine power bits sprout out like tree roots from vertical drill pipes 80 feet underground to boost the output of oil wells as much as 20 times. This method of horizontal drilling, conceived by John A. Zublin, Los

Angeles petroleum engineer, recently produced 25 barrels of oil per day from a California well abandoned 17 years ago when its yield fell to one barrel a day. Thousands of such abandoned wells exist in the United States. Power for the horizontal drills comes from fluid mud pumped down the drill pipe to the turbine.



Toolboxes Swing Out, Return Automatically

Sixteen toolboxes are kept in nine square feet of floor space on a welded rack designed by R. E. Qualkenbush of the Bell Bomber Plant's production handling equipment department at Marietta, Ga. Each section holding a toolbox swings out like a cabinet door. When the lid of a box is closed, the section swings back into place automatically. The rack was built from black pipe, angle and strap iron and plywood, and conserves both time and space.

Supercutting Alloy

Vanadium and titanium carbides bonded with a metallic nickel are essential constituents of a supercutting metal alloy developed in Germany for war uses. It required no tungsten, which was not produced in the Reich and had to be imported.



Aerial "Roadster" Has 500-Mile Range

Priced about the same as an expensive automobile, a two-seater monoplane is being manufactured by a West Coast builder for civilian flyers. The new plane—called the "Ensign"—has a cruising range of 500 miles, cruising speed of 112 miles per hour, and a service ceiling of 13,500 feet. A low-wing "flying roadster" of all metal construction, the ship made its debut recently at Long Beach, Calif.

Spiral Art Gallery Has 3/4-Mile Ramp

Equipped with a winding 3/4-mile ramp extending from the ground to the 10th floor, a \$1,000,-000 spiral-shaped building has been designed by Frank Lloyd Wright to house the Solomon R. Guggenheim collection of paintings in New York City. The paintings will be displayed—unframed and unglassed—along the ramp, protected against dust and moisture by an air conditioning and air cleaning system. Dust also will be removed from visitors' clothes by a vacuum-like device at the entrance. At the top of the building will be a large glass dome for projecting movies.

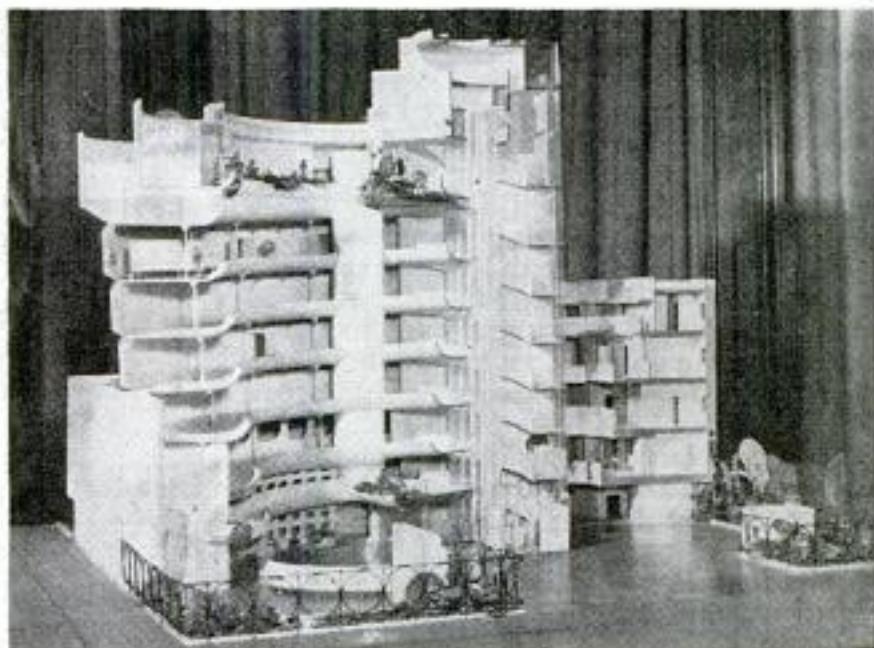

Mouse Electrician

With an electric light wire tied to its tiny harness, a pet mouse recently helped electricians by squeezing beneath a small building at Camp Holabird, Md., to pull the wire from one end of the structure to the other.

☐ Research indicates that quack grass, a lawn pest, compares favorably with hay as animal feed.

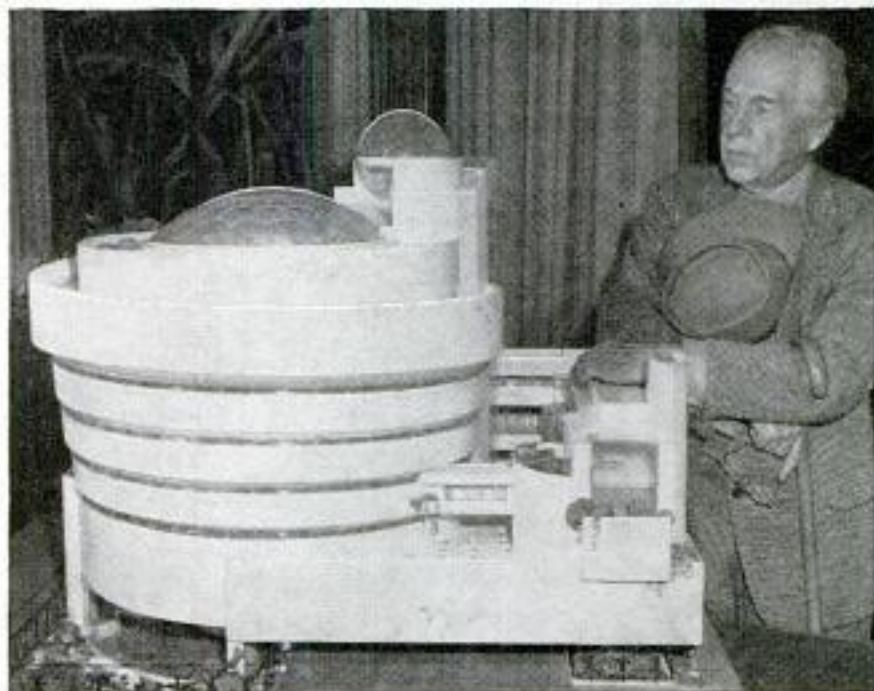

\$200,000,000 GATEWAY TO

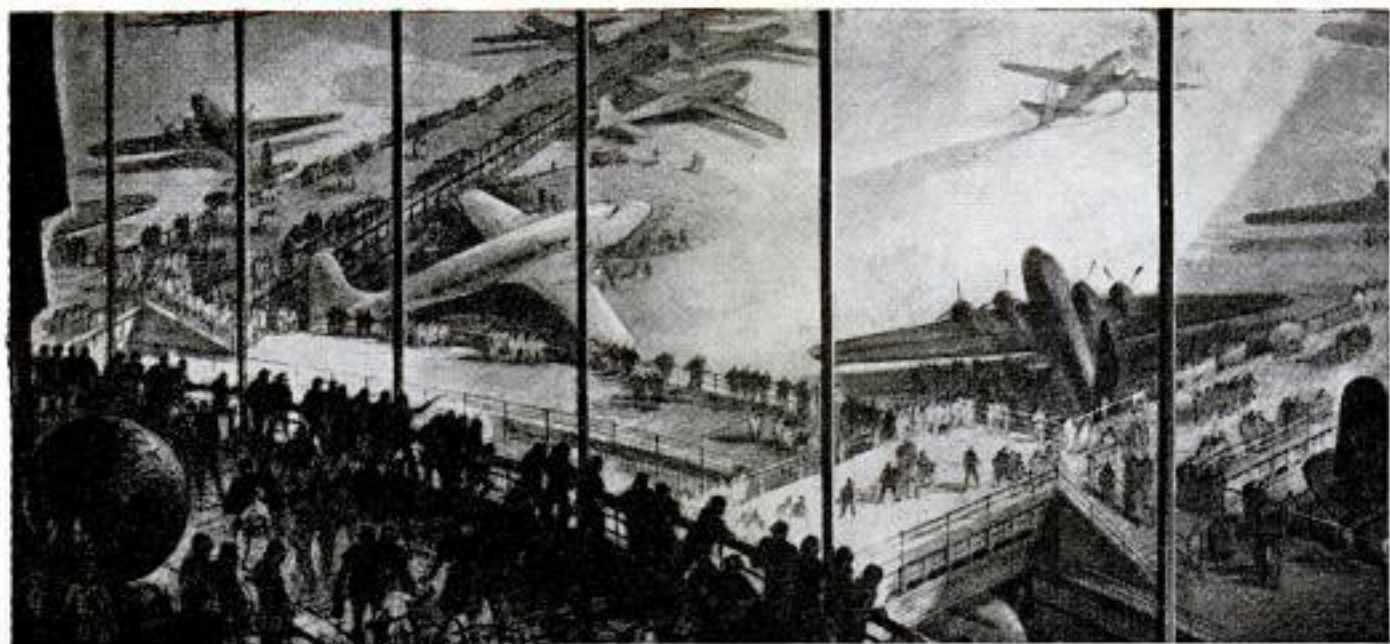

NEVER one to do things by halves, the City of New York is completing the first stage of its airport of tomorrow while many other cities are still talking about picking sites and drawing plans.

As this article appears, the first three runways of 4976-acre Idlewild Airport should be finished and ready for use. No token runways built just for the honor of being first, these are Runway A, 10,000 feet long, Runway B, 7500 feet, and Runway C, 8200 feet. All are constructed of reinforced concrete 12 inches thick and 200 feet wide, designed to stand up under pounding of planes weighing up to 150 tons.

Although 12 airlines already have signed up to use the facilities at Idlewild, actual 24-hour commercial operation probably will not get under way until next spring because of inability to complete hangars

Earthmover levels sand fill on low parts of airport. Forty-one million cubic yards of sand have been used



Sketch by Hugh Ferriss for Delano & Aldrich, architects, shows view from observation room at Idlewild

Eight times as big as LaGuardia Field, New York's fabulous Idlewild Airport will shortly be home to the transatlantic air liners

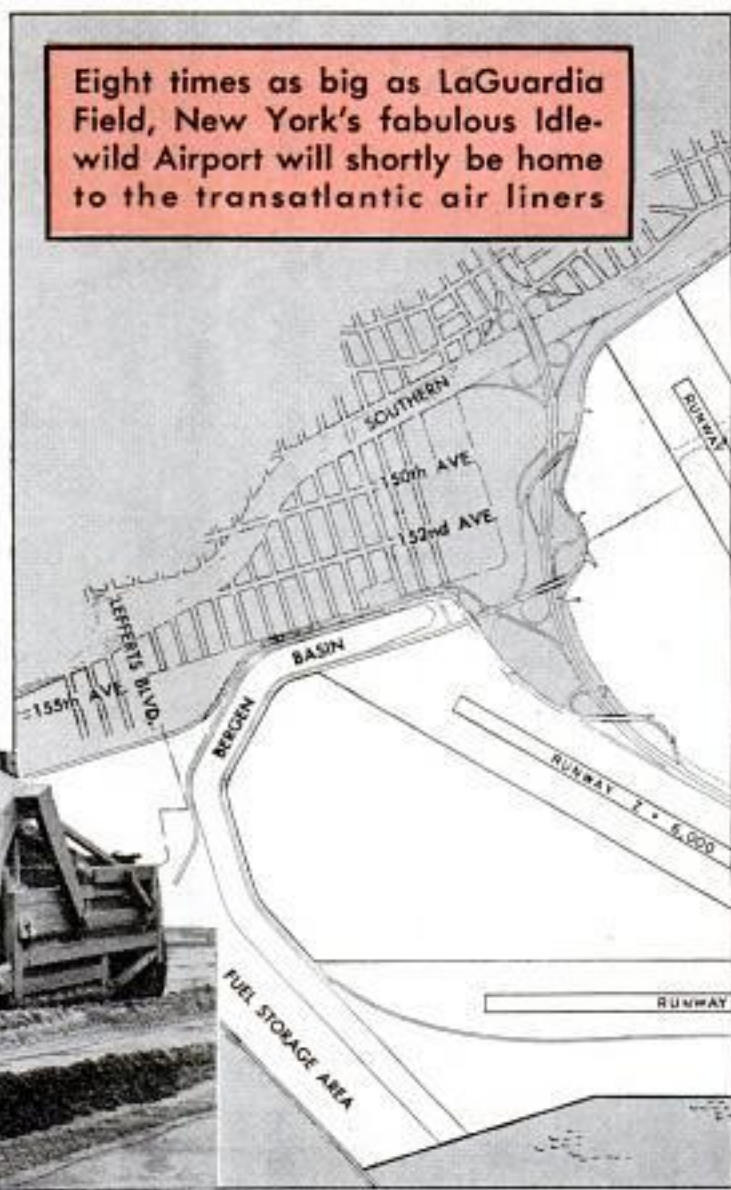

EUROPE

before then. The one-story temporary administration building and its control tower are scheduled for completion now, however, and planes undoubtedly are trying out runways at this moment.

Construction of the \$200,000,000 airport at the head of Jamaica Bay in the southeastern corner of New York City began in April 1942. Idlewild is eight times larger than LaGuardia Field's 550 acres and four times as big as the Navy's 1100-acre Floyd Bennett Airport at the lower end of Jamaica Bay.

LaGuardia Field will

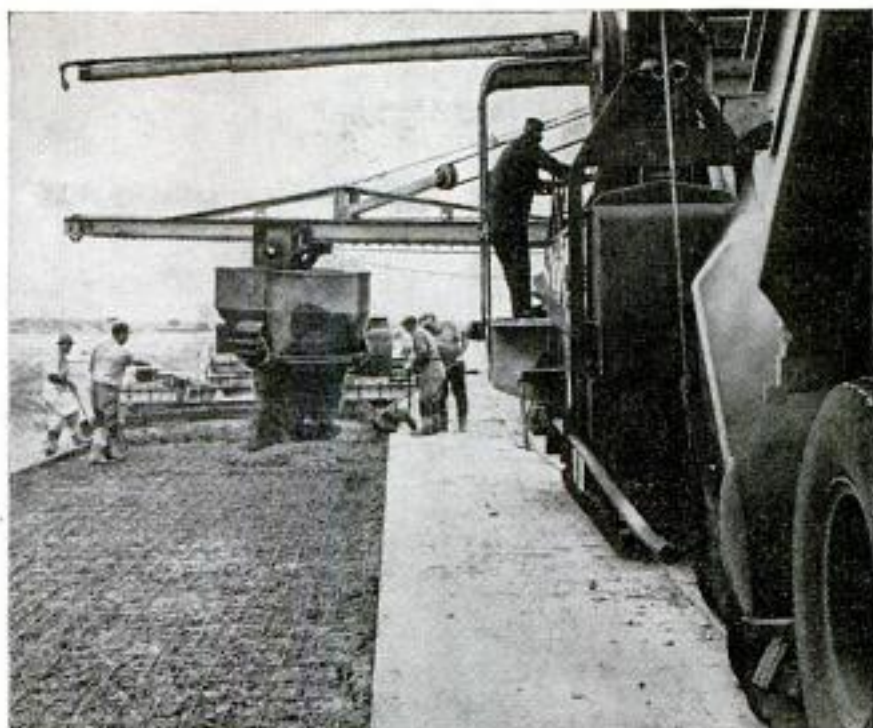

Mixing machine drops concrete on one of six major runways at Idlewild Airport. Below, plans for the 4000-acre landing field and buildings

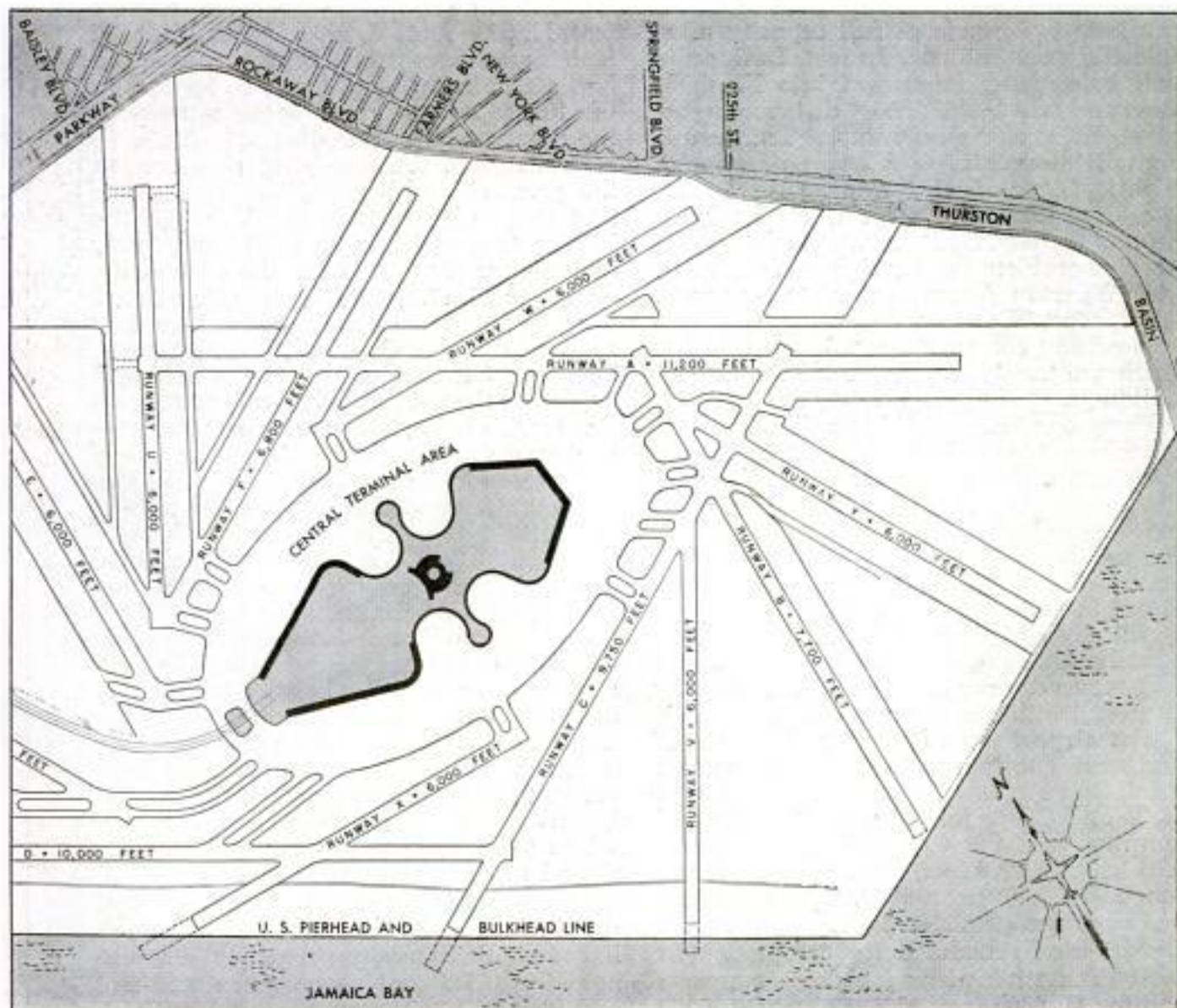

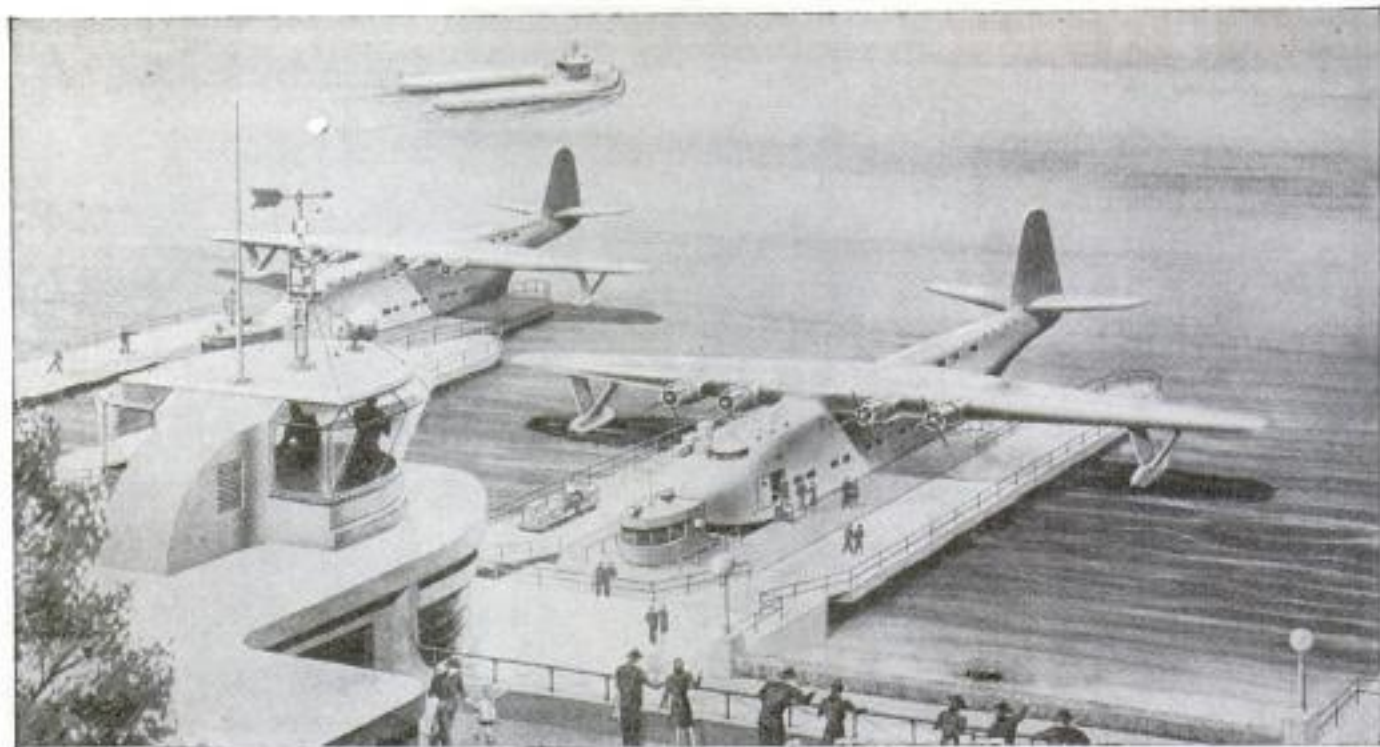

This is Glenn L. Martin Company's conception of facilities for handling seaplane passengers and freight, featured by U-shaped boats to tow planes and U-shaped docks. Idlewild Airport will have a special seaplane base

continue to operate at full capacity after Idlewild goes into use. In fact, LaGuardia will be expanded outward into Flushing Bay, and will handle short distance flights of about a 1000-mile radius. Transcontinental, intercontinental and transatlantic flights will have their terminals at Idlewild.

Site of the new airport, on lowlands around the bay, created a stupendous engineering problem for Jay Downer, engineer, and Wharton Green, associate engineer, who prepared the general layout and are supervising construction. Delano and Aldrich are the architects for all the airport buildings.

Forty-one million cubic yards of sand fill have been placed on the site by hydraulic suction dredges in the bay. E. J. Carrillo, field engineer, declared that 12 million more cubic yards of fill will be placed under the next contract for the second phase of operations, and eight million more will be added in future operations. About 10 feet of fill covers the original marshland, Mr. Carrillo said, and a total subsidence of two feet occurred over the site. No further settlement trouble is expected.

The airport runs five miles to the east and west, and two and three fourths miles north and south. The completed runways A, B and C are just half of the principal runways and the three others, D, 10,000 feet long, E, 6000 feet, and F, 7700 feet, are scheduled for use in 1947. Six additional runways are provided in the plans, with construction scheduled for completion in 1950. Tentative plans for these runways call for U, 6000 feet, V, 5650 feet, W, 6000

feet, X, 5200 feet, Y, 6000 feet and Z, 6000 feet. Experience gained in operation of the first six major runways will be applied to the future runways and specifications for the latter may be altered as a result.

Drainage of the low-lying area created the greatest problem encountered in the first stage of construction. Although the 10 feet of sand fill covers 3000 acres now and eventually will cover the entire site, contractors on foundation work have found it necessary to add more fill when they reached the muck beneath the first layer. Drainage trenches crisscross the field and a gigantic three-barreled storm sewer, 8400 feet long, is being laid to assure proper permanent drainage. Water from the storm sewer goes into Bergen Basin, a manufactured waterway at the edge of the airport that is 200 feet wide at the bottom, 6000 feet long and 30 feet deep. Two million cubic yards of earth were dredged from the bay to create Bergen Basin.

Choice of the site was made to provide both land and seaplanes with excellent landing facilities. The location on the bay assures a 15,000-foot basin and seaway for the largest flying boats envisioned for ocean travel. In addition, ocean-going tankers will unload their cargoes of fuel directly into airport storage tanks.

The three completed runways were designed to eliminate any waviness caused by taxiing heavily loaded airplanes, and the 12-inch-thick reinforced concrete is believed ample to assure permanent smoothness. Each 200-foot runway has a 50-foot shoulder of bituminous material on both

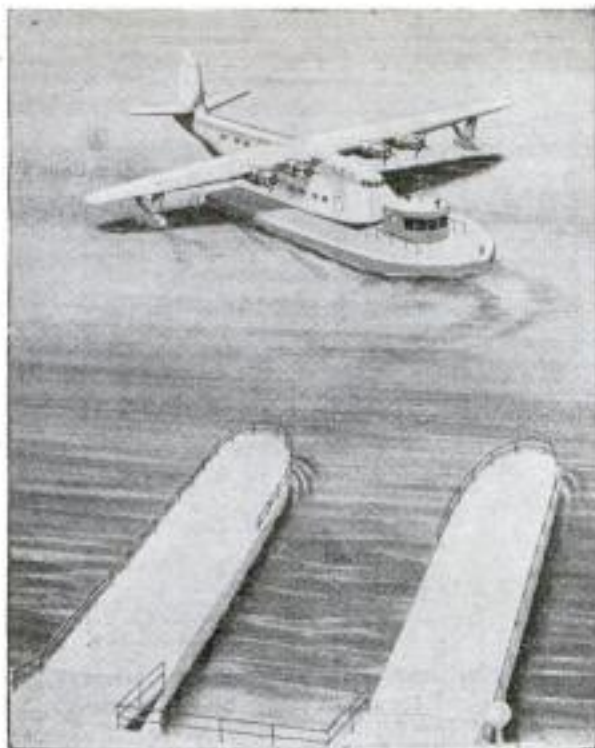

Hydraulic pipe bender that exerts 40-ton pressure twists steel pipe into desired shapes for electrical conduits at the airport

sides. This material can be ripped up easily and replaced by concrete should wider runways be desired in the future.

Newest types of giant earthmoving machinery, graders and concrete mixers, dredges and shovels are employed in construction of Idlewild. Specially designed for the operation are six planting machines which plant long bladed beach grass in the sand fill to anchor it and prevent erosion. The beach grass is brought in from the beaches farther out on Long Island, and completion of the planting is hampered only by a shortage of supply. Eight men ride on each tractor-drawn planter. Three are kept busy extracting stalks from

(Continued to page 160)



A surveyor lays out the line for 8400 feet of sewer pipe to drain low marshlands. Below, self-propelled subgrader moves ahead of concrete mixer to smooth surfaces for a long runway



9th. FLOOR
FURNITURE
DISHES
HOUSEWARE
→



What's wrong with this picture? An alert housewife would spot the hot iron burning a hole in the ironing board cover—but this one is burn-proof. The material is Asbeston, used for firefighter suits on carriers



Among other postwar products is the coupling (left) for a garden hose; it was originally designed to speed refueling of battleships and prevents leaks. Special holding lugs and locking ring make it easy to attach. Right, clogged salt shakers are dried out in a few minutes when placed on drier which is heated by two six-watt light bulbs. Drier takes up little space in the kitchen

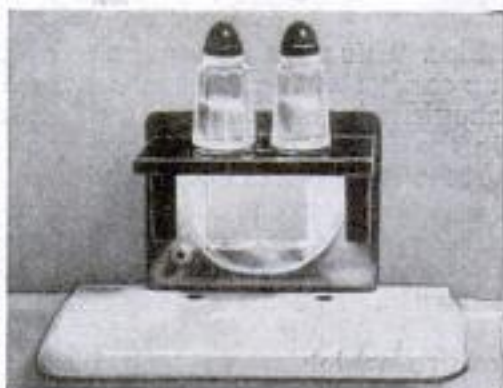

Below, one machine serves as a combination washing machine and dishwasher. Left, clothes washing unit is lifted out of cabinet to be replaced (right) with basket arrangement that holds service for six persons



"SHORE DUTY" ON A BATTLEWAGON



Like giant fingers, guns of USS Iowa point toward shore. Below, machine shop on ship

By Lieut. J. L. Williams, USNR

LIKE all things big—the Empire State Building, Primo Carnera and supercolossal Hollywood epics—battleships receive their share of friendly ribbing, particularly from other ships in the Navy. Sailors on destroyers that pull alongside to refuel call them “AOBB’s”—“AO” being the Navy’s designation for fleet oiler and “BB” for battleship.

Seamen aboard smaller vessels never tire of greeting their pals aboard the battlewagons with: “Say, how do you guys like shore duty?”

But the officers and men aboard the battleships can afford a sense of humor, knowing that the battleship is still the largest, most powerful vessel that fights on the seas. It’s a breath-taking sight to see one of these huge, steel-armored monsters, bris-



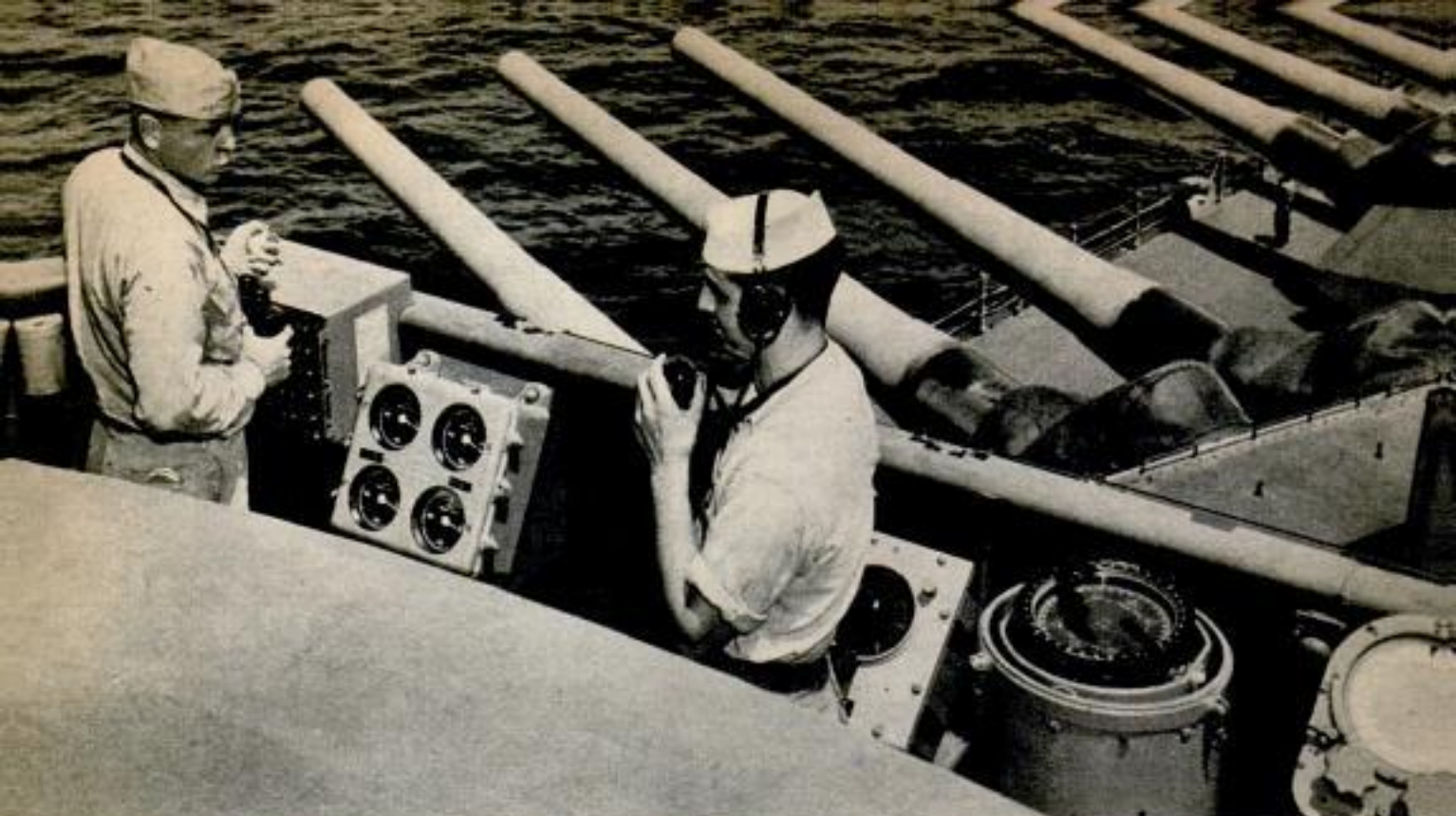

On bridge of Missouri, officer passes order to "talker" who phones it to stations



Sailors on Alabama "hit sack" when off watch with emergency gear at arm's reach. Below, "fish-eye" view of North Carolina

ting with guns, pulling at anchor. It's even more exciting to be aboard when a \$100,000,000 warship is plunging through the white caps on a mission of destruction.

The U. S. Navy now possesses more battleship strength than any other nation. On December 7, 1941, we boasted 16 battleships of which eight were blasted into the mud at Pearl Harbor. Since then we've raised, reconditioned and put back into service all but two. In addition we've added 12 modern 35,000 and 45,000-tonners—giving us a total of 26 battleships.

In this age of air warfare, battleships have naturally been overshadowed by the colorful exploits of aircraft carriers. But battleships have played two important, if not as spectacular, roles: (1) the slower pre-Pearl Harbor battleships have been used to soften up invasion beaches so that marines and soldiers could storm ashore, and (2) the speedier new battleships have been employed as essential elements of fast carrier task forces.

Slower though they may be, don't make the mistake of calling our pre-Pearl Harbor battleships "old." Any battlewise sailor will tell you that these so-called "old" battleships have done





One of Uncle Sam's new \$100,000,000 battleships is the USS Wisconsin, 45,000-ton giant of the Iowa class; its overall length is 860 feet. Armament includes nine 16-inch guns, 20 five-inchers and 128 others



Portside view of USS Washington, 35,000-ton battleship launched in 1940; it has complement of 2000 men

a lot of shooting in this war. They have new guns, turbines, fire control equipment, damage control apparatus and communications.

Nobody in the Navy, from admiral to apprentice seaman, seriously argues the question of battleships vs. carriers any more. The answer, as found in World War II, is battleships AND carriers—an unbeatable combination for raiding enemy strongholds or plastering beaches. Modern task force warfare is based on hit-and-run principles, not standing and slugging it out with the enemy. Task forces are made up of a combination of carriers, battle-

ships, cruisers, destroyers and submarines.

In spite of new battle tasks, traditional shipboard routine is maintained to a higher degree on battleships. Its very size lends a battlewagon a certain majesty and dignity—and this is reflected in the ordered life aboard.

Although the huge warships carry a complement of from 1500 to 2000 men, there is less crowding than on a carrier of approximately the same size. Battleships don't have to store planes, bombs, rockets, aviation gasoline, spare parts and flight gear. Nor do they have to provide quarters and messing facilities for the

30-year-old USS Pennsylvania helped pay off Pearl Harbor score with her 14-inch guns at Surigao Strait





Freshly baked bread is removed from ship's ovens through the hatch at right; at a single meal men on a battleship can polish off 1900 loaves

more of the peacetime "spit and polish" aboard battleships than other vessels of the fleet.

When radar instruments pick up contact with enemy ships and planes, a battleship gets ready for combat. A bugler blows the quick, brassy notes of "general quarters" over the loudspeakers and a bosun pipes a shrill tune and bawls "man your battle stations." There is less of the pell-mell rush that characterizes life on a carrier. The deliberation with which a battleship gets ready to fight is almost an insult to the enemy.

Even when a battleship is within range of enemy ships and planes, the daily routine proceeds much as usual.

"passengers" — the pilots, air crewmen, plane handlers and mechanics.

In a war of rolled sleeves and dungarees, officers and men aboard battleships maintained a high degree of personal neatness. Efficient shipboard laundries kept clothes washed and ironed. There was

Meals are served piping hot and on time, the ship's daily newspaper goes to press and the latest movies are shown below decks at night. If you remain below, you can almost convince yourself that a peacetime cruise is in progress.

The Navy makes much of the fact that

Left, control panel of "city size" power plant on ship. Right, ice cream mixer turns out 200 gallons daily

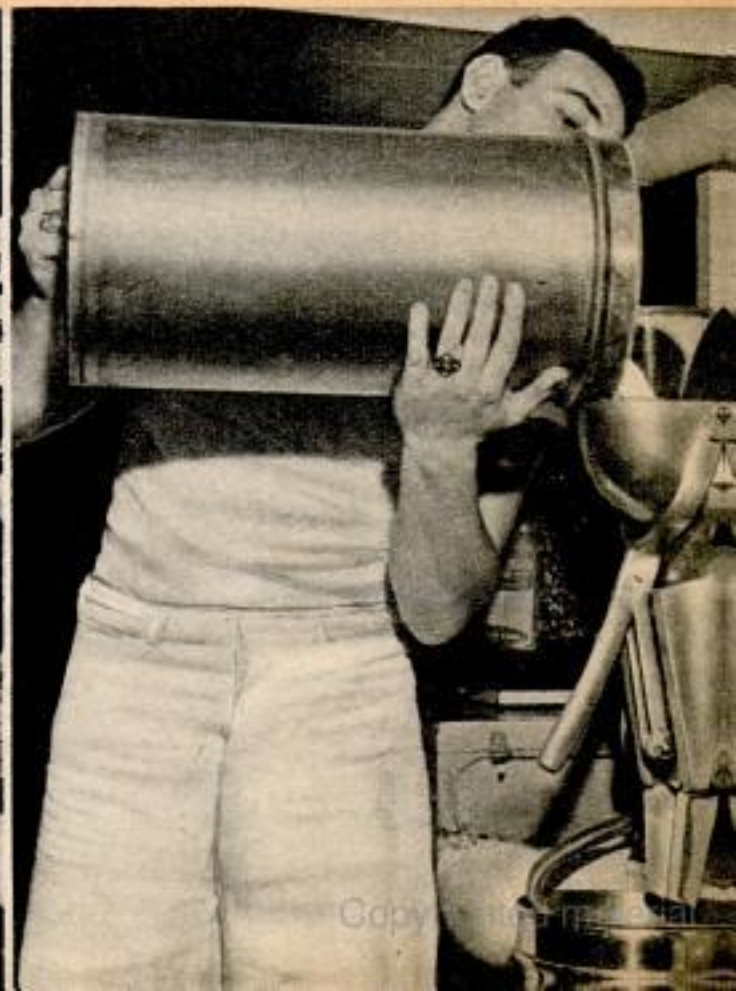

tasty chow is one of the best morale builders. Meals served on a battleship, cafeteria style, would do justice to the Waldorf-Astoria kitchens. Reefer space is large enough to store plenty of fresh food — steaks, chicken, turkey, fresh fruits and vegetables, milk, ice cream. There are no K rations on a battleship!

A battleship is a small, highly efficient city afloat, moved about the ocean by the 180,000 horsepower of its four geared turbines. Although its primary purpose is to throw steel and TNT at the enemy in large doses, its secondary purpose is to provide adequate sustenance and all the comfort possible for the men behind the guns.

A battleship's sick bay has complete medical and dental facilities and there is none of the "kitchen surgery" which emergencies sometimes make necessary on smaller ships. There are religious services for men of all major faiths—Protestant, Catholic and Jewish. A print shop produces a daily paper with regular press association news, photographs, columns, jokes and cartoons. A well-stocked library offers books and magazines for pleasure reading as well as technical books for advancement in rating. The "corner drug-store" is to be found in the ship's service store which carries a standard stock of cigarettes, candy, ice cream, toothpaste, shaving cream, writing materials and scores of other items.

The bluejacket who draws "shore duty" aboard a battleship considers himself lucky—despite the danger of death from a bomb, torpedo, shore gun or suicide plane.

It was once argued

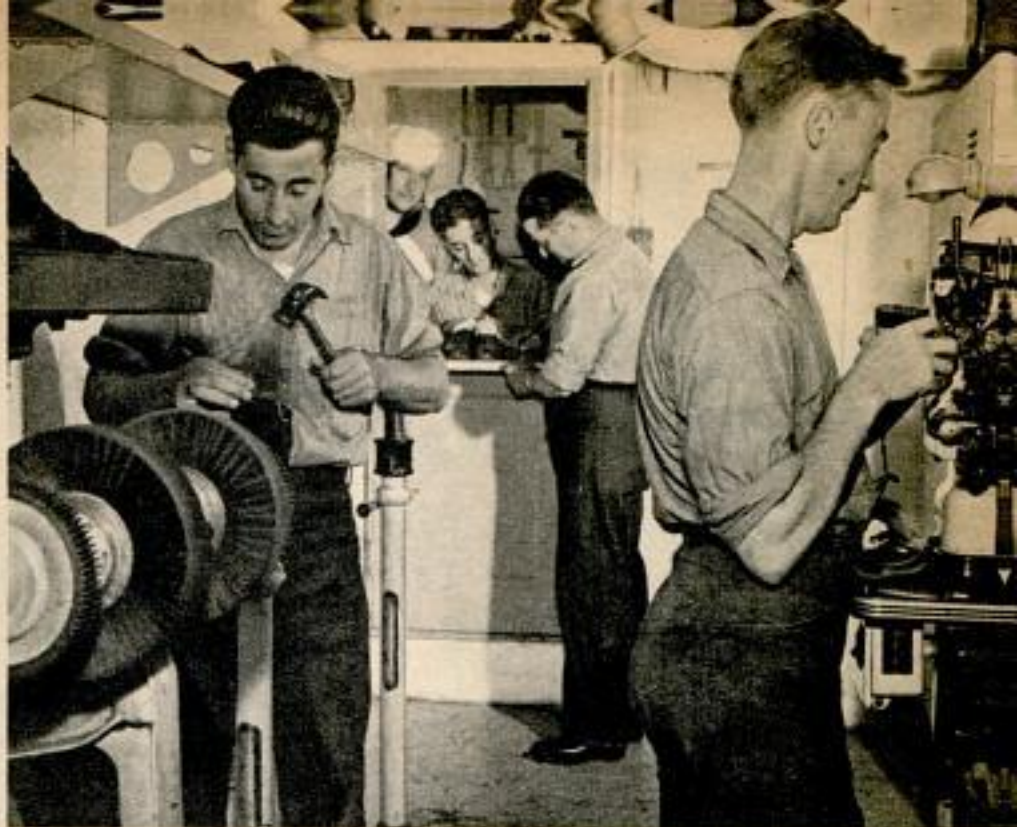

Cobbler's shop on battleship receives average of 90 shoes every day

that battleships would be sitting ducks for enemy bombers. But World War II proved that battleships are less likely targets than carriers and smaller vessels. The big warships now bristle with antiaircraft guns, mounted on every available bit of deck space. It is estimated that today's battlewagon has 100 times as much antiaircraft protection as prewar battleships.

The Japs found this out when the South Dakota, then known as "Battleship X," was attacked while convoying a task group in the Solomons. The enemy hurled three waves of dive bombers and torpedo bomb-



This battleship soda fountain handled 345 customers in 45 minutes during rush hours. Prices are reasonable



Officers and bluejackets man their stations on navigating bridge of USS North Carolina. Below, rows of big shells line decks. Note sun bather

ers, 84 planes in all, at the battleship and lost 33 of them. After that they were wary of attacking our battleships.

Jap Kamikaze suicide pilots found that a battleship was hardly a worthwhile target for their "sure-hit sure-kill" tactics. If a suicider managed to get through the hail of red-hot lead thrown at him, he smashed against steel decks and plating built to withstand 16-inch armor-piercing shells. The result was something like tossing an egg against a brick wall. Kamikazes scored some hits on our battleships but the damage was negligible.

Much to the disappointment of battleship admirals—and crews as well — the Pacific war

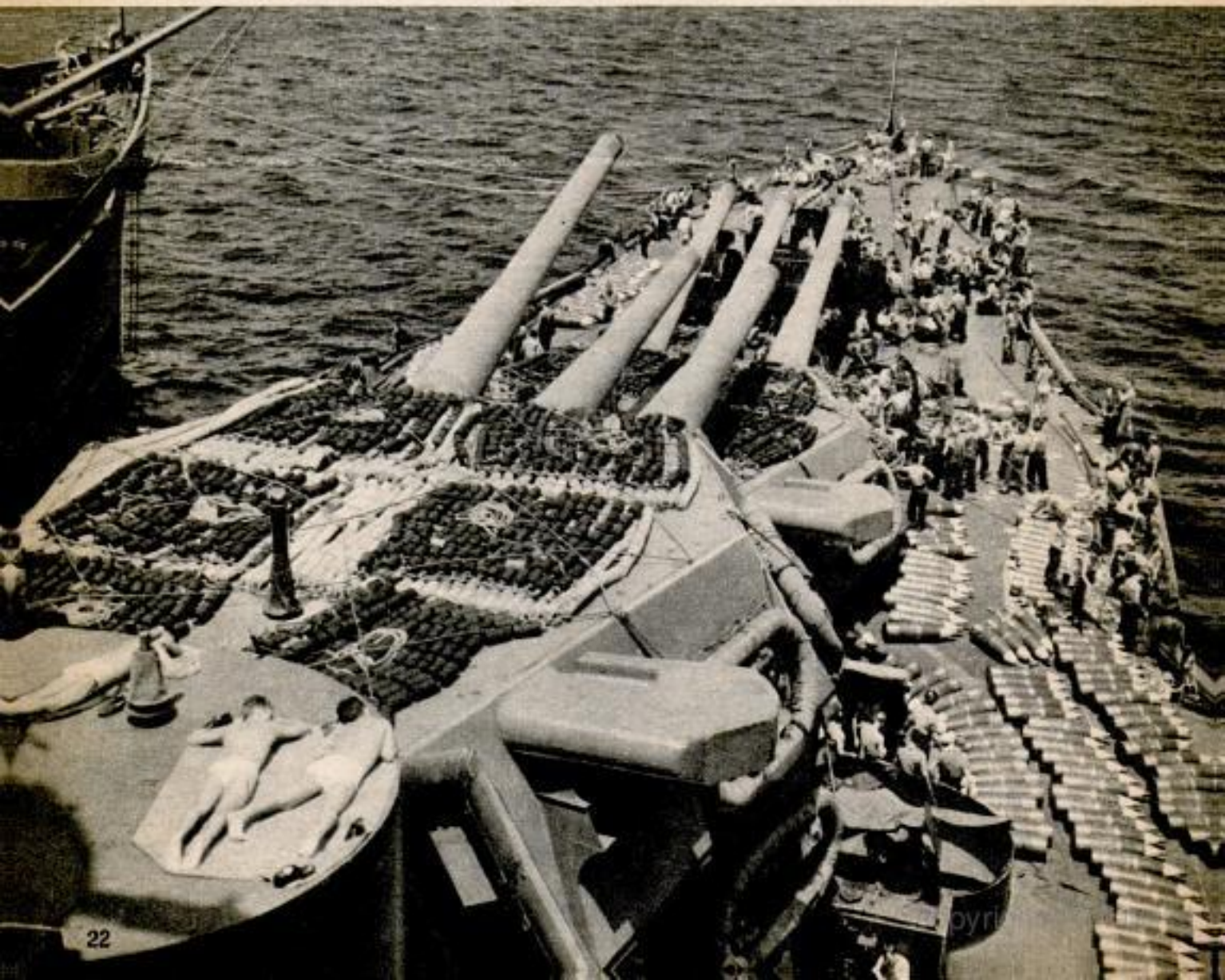



Aerial view of mighty USS Tennessee in the Pacific showing placement of her 12 long-range 14-inch guns

failed to produce any large-scale engagements between United States and Japanese battleships. The four major battles of the Pacific—the Battle of the Coral Sea, the Battle of Midway, the Battle of the Philippine Sea and the Battle of Leyte Gulf—were all carrier battles.

The nearest thing to a real battleship fight was the Battle of Surigao Strait when a group of pre-Pearl Harbor battleships took sweet revenge on a Jap task force.

In what has been called "a perfect tactical situation," the United States battleships waited in the darkness for the Jap force to come single file through the narrow channel. When the Jap ships were within range, the big guns of the American battlewagons opened fire, accomplishing the classical "crossing of the T" which every Annapolis student dreams about. The Jap force fled, every one of its ships having been sunk or crippled.

Reassuring sight from carrier deck are these powerful warships in the task force

One of the big tactical surprises of the war was naval gunfire support for landing operations and the advancement of ground troops. Battleship sailors puffed out their chests when Marshal von Rundstedt credited Allied naval guns in the Normandy invasion with making it impossible for him to bring up German reserves.

In the Pacific, gunfire from battleships had a demoralizing effect upon Japanese

(Continued to page 158)



MAPPING



MINIATURE replicas of Japan, laid out on the floors of sound stages in Hollywood and Washington, D. C., helped B-29 crews in the Pacific to recognize almost every bump, stream and industrial bombing target in the Nipponese homeland. Not only did the "floor maps"—representing 2700 square miles in Japan—show mountains, rivers, lakes and cities, but they also provided an accurate way to time bombing flights and plan the necessary altitudes. Cameras that were mounted on moving cranes simulated the speed and altitude of B-29s so that Japan-bound and homeward flights could be charted in complete detail.

At the 949th Engineer Aviation Topographic Company headquarters on Guam, Army men fabricated additional target models to guide B-29 airmen. Using wood shavings, casein glue, cardboard and sand, the model makers constructed topo-

Dotted with scores of sliver-sized models of Japanese factories, section above is ready to be inserted in large scale map to chart bombing missions. Below, bombardier's sights lined on a target. Right, completed miniature is checked against a reconnaissance photograph

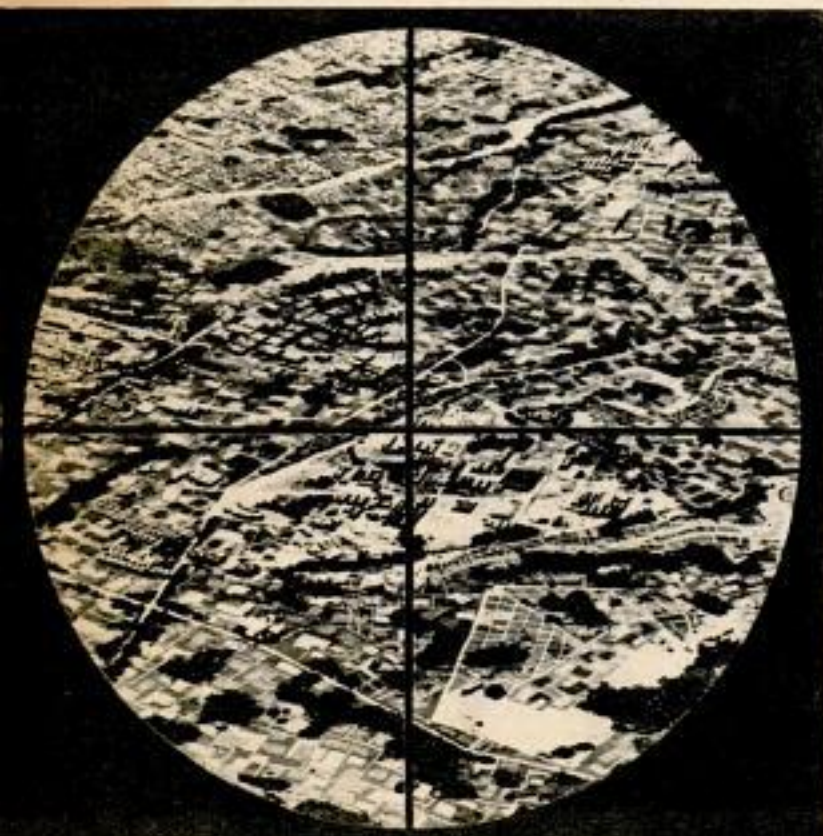

JAPAN FOR THE BOMBERS

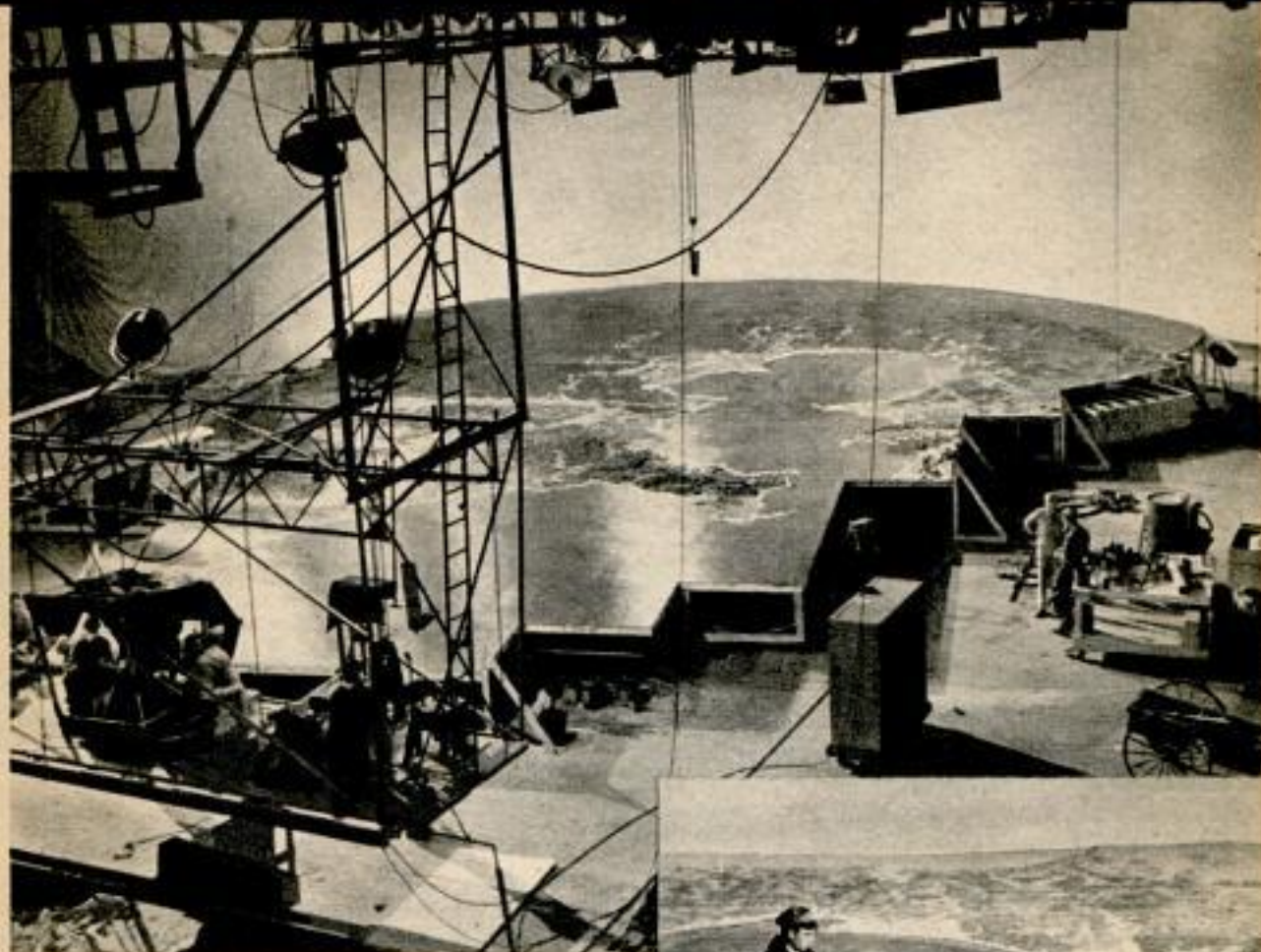

Above, cameras moved by swinging cranes took motion pictures of floor maps of Japan to aid flights of B-29s. Right, Nagasaki reduced to two feet to mile

graphic maps on a scale of two feet to a mile. Workmen turned out thousands of tiny buildings on electric buzz saws and kept the pin-sized structures in tin cans—one can often holding as many as 8000.

Model makers had such precise assignments as reproducing, to scale, an entire Japanese aircraft manufacturing plant. A plane model had a wingspread of $\frac{3}{8}$ inch and its tail was $\frac{1}{8}$ inch wide. One target model was dotted with 600 tiny model planes whose creation required a soldier, using a razor blade, to cut out 1800 wooden parts, each about the size of a splinter. In simulated bombing practice, the target models were moved rather than the "plane." By means of specially designed lenses, the bombardier got the illusion of making a bombing run. As the target moved into range, he released a "bomb"—actually a plumb—and if it dropped within four inches of the target he was given credit for a hit. So sturdy were the models of Japanese cities that some of the Army engineers insisted the models would hold together longer than actual Jap industrial



centers. One model fell from a table in the Guam workshop and not a single thimble-sized tool shed toppled from its perch. Reconnaissance photographs were the first step in making the models. The problem of coloring from black and white photographs was solved later by color photography.

"Balancing" Sidewalls Hold Up Hangar Roof

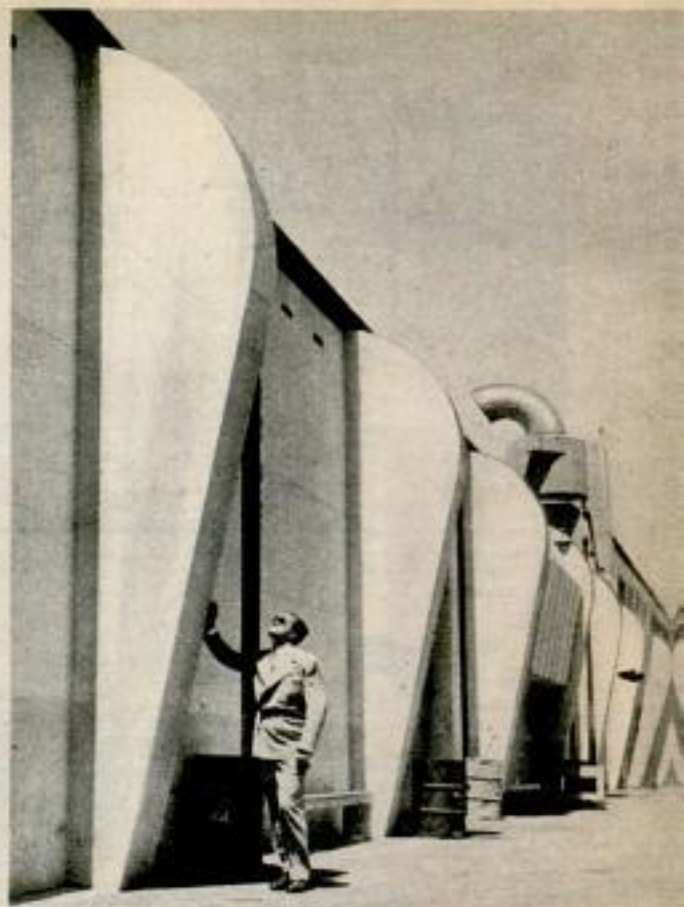
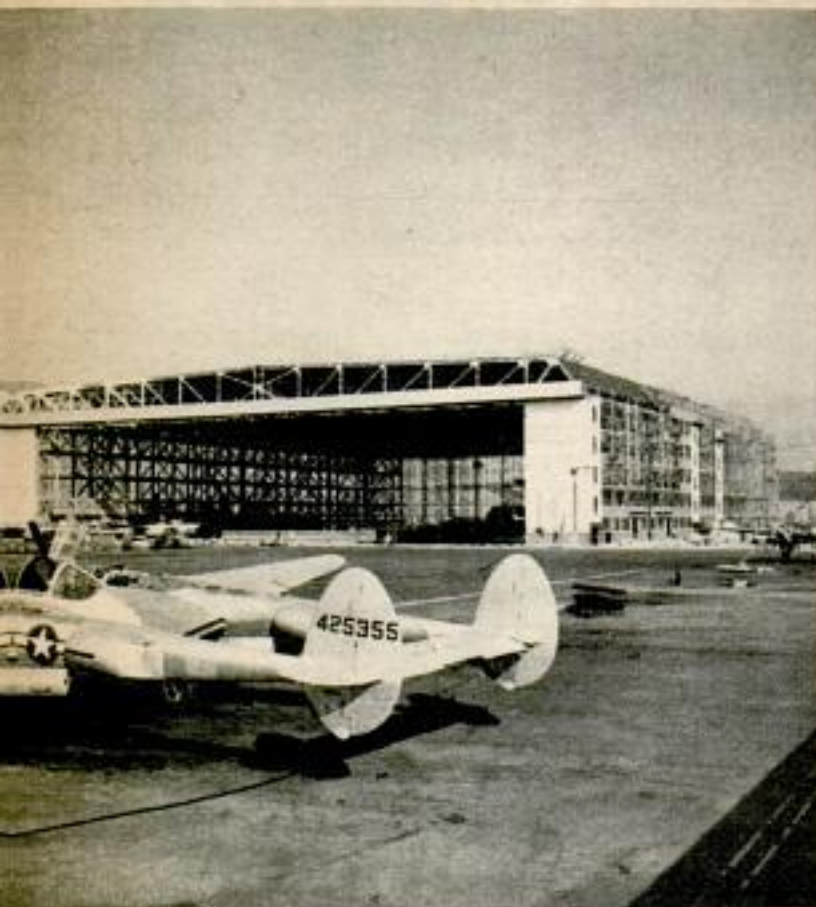

COUNTERBALANCED sidewalls bear the entire weight of the roof in a new type of building design, eliminating interior columns or other roof supports. Known as the three-hinge arch principle, the design is applied to factory and hangar buildings.

An outstanding example of the new design is a hangar 406 feet long, 302 feet wide and 60 feet high built by Lockheed Aircraft Corporation in Burbank, Calif. (Construction photo, top left; finished hangar, lower right.) The floor of the building is entirely free of columns. A crane attached to the roof can move two-ton loads.

In cross section, the building consists of

two vertical steel trusses that form the sidewalls (below at left) with their tops joined by the long roof truss. The inner chord of each vertical truss supports the weight, while the outer chord and the diagonal members counterbalance the weight of the roof truss. Several long balcony floors are built into the vertical trusses for use as offices and subassembly areas. A patent on the design has been applied for by its inventor, C. E. Noerenberg.

Construction is much lighter than for comparable buildings of other design, represents considerable saving in cost and is earthquake resistant. Additional floor

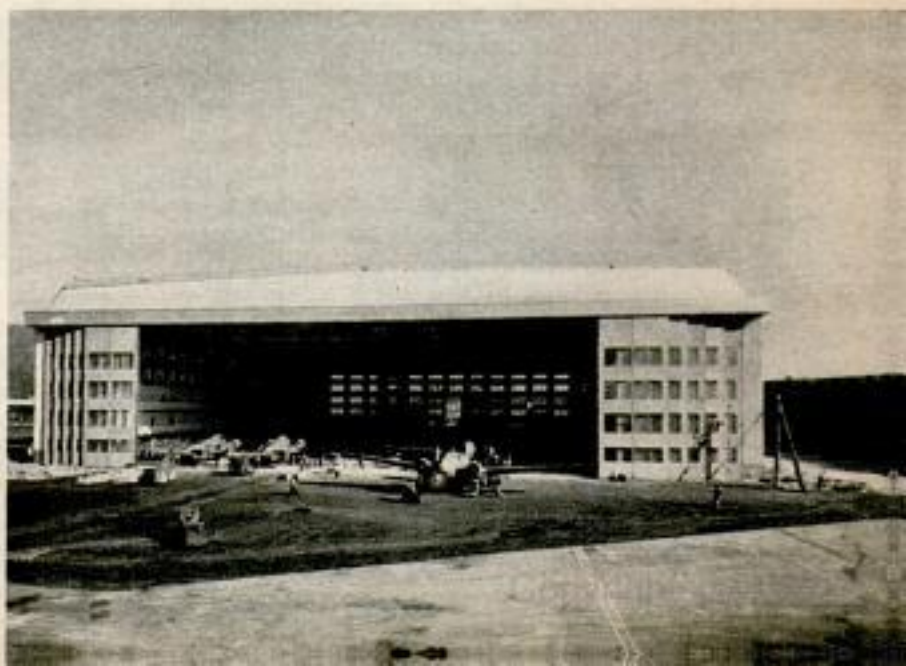

space can be provided inside the building at about half the usual cost. Cantilevered roofs extending outward from the sidewalls also may be added.

Hughes Aircraft Company, Culver City, Calif., uses a comparable principle in several of its factory buildings. In these the counterbalancing of the weight of the roof is obtained by means of exterior "upside-down" (see photo) reinforced concrete wall buttresses. The overhanging weight of these members balances the weight of the roof, eliminating interior roof supports.

Rocket Powder Tested by Sound

Supersonic waves of very high frequency have been harnessed by Hercules Powder Company engineers to detect rocket powder voids or air pockets. These might affect the rocket's accuracy or cause the motor to burst at time of firing. The waves are generated by a crystal connected to an electronic circuit. A minute flaw in a grain of powder deflects a percentage of the waves, which is recorded on a meter.

Driver's Test With Sound Movie Duplicates Traffic Problems

Driving skill is quickly and accurately revealed with a device which combines a Technicolor sound movie and the operation of a real automobile. The automobile is mounted in a testing slot which records the driver's reactions when faced with traffic problems shown on the screen. Re-

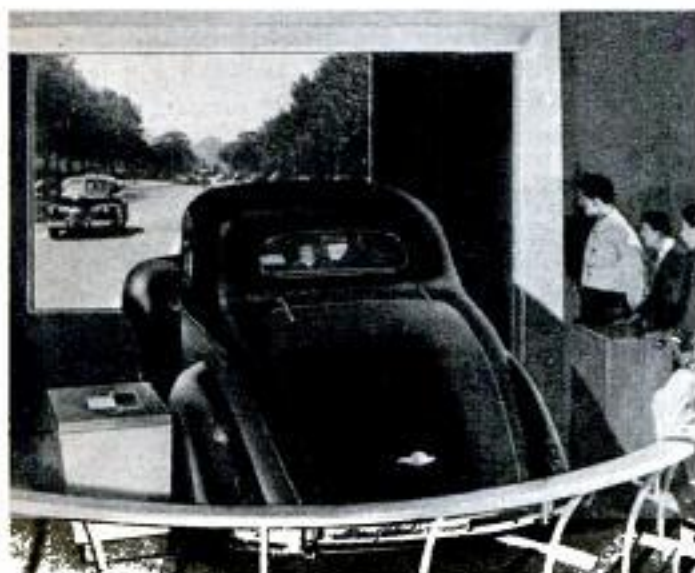

actions such as putting on the brakes or swerving to dodge a pedestrian or car are automatically recorded. Cheating is said to be impossible. Color perception, visual acuity, reaction time and attitude are all recorded on a card. The tester was developed by the Atlantic Refining Company.

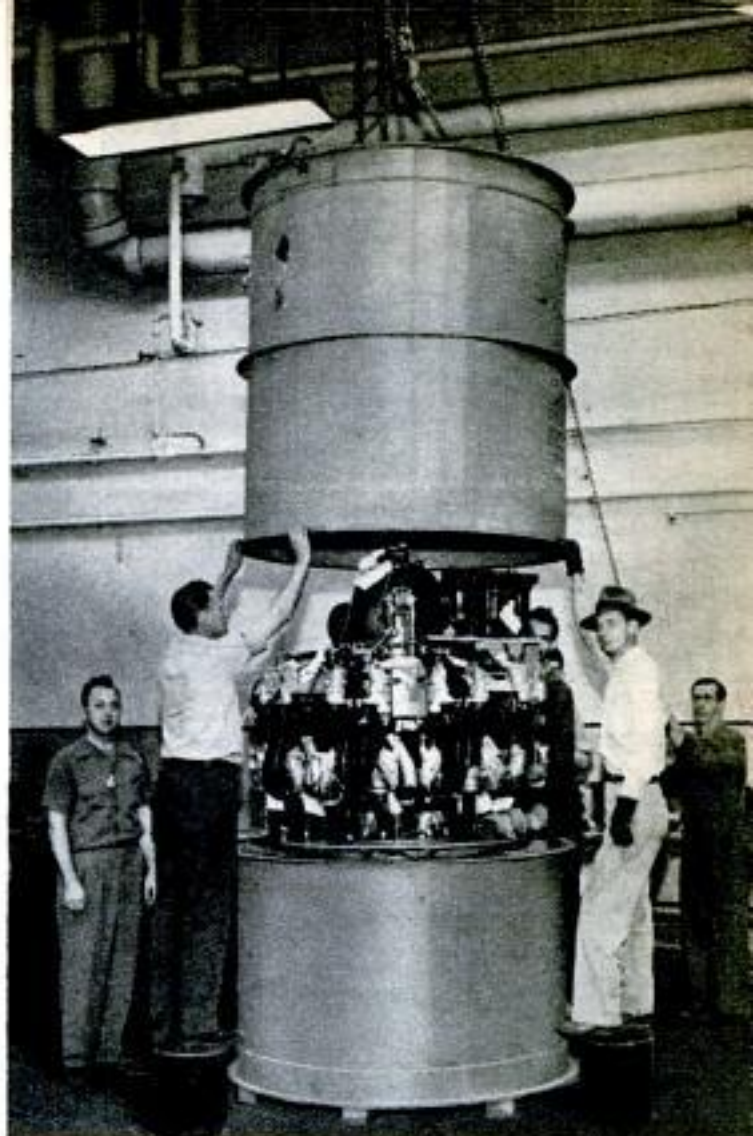

Engines "Canned" for Shipment

Aircraft engines can be shipped safely to advanced bases with an experimental "canning" process. The engine is packed in an iron can or tank which protects it from breakage and climatic effects. This packing method was devised by the engine test branch at Warner Robins Air Technical Service Command, Robins Field, Ga.

Direct-Reading Radiator Gauge Shows Antifreeze Protection

Testing three types of antifreeze—alcohol, methanol and glycol—a handy antifreeze meter gives a direct reading without requiring reference to a chart. All information is shown on the barrel of the meter. The instrument tests cold engines without warming up, and indicates how much antifreeze is needed.



"INCUBATOR BABIES" of the Plant World

By Dorothy S. Towle

THE transplanted Southerner who would like to grow an orange tree in the White Mountains, or the Northerner who wants blueberries in Texas, can renew his hope. Perhaps the things he dreams of aren't too far off.

Dr. Richard Jones, a young scientist, working on embryo culture in the botany department at the University of New Hampshire, is perfecting a technique for obtaining new varieties of plants which may result in an entirely new phase of plant breeding. As a result of his experiments, scientists may be able to develop unusual hybrids with varying degrees of resistance to temperature, drought or disease. Plants which normally grow only in acid soil may be crossed with hitherto incompatible plants to yield new varieties which will flourish in basic soil. Shade-loving plants may be crossed with other plants to give varieties which will tolerate strong sunlight, and fruits normally borne on vines may be grown on bushes. Almost any combination of characteristics can be visualized through this process although the method is limited to those plants in which the flowers will fertilize each other.

Embryo culture is not particularly new, but the handful of scientists in the country who have been working with it have had indifferent success in transferring seedlings from the plant food, or nutrient media, in which they were started, to the soil in which they are to be grown. In many experiments, only a small percent of the seedlings survived, but with Dr. Jones' new technique, as high as 91 percent have lived, and this percentage may be increased.

Preparing the seeds for embryo culture is exacting work. In fact, it involves a very delicate surgical operation. To understand it, it is necessary to know something about the structure of the seed itself. A plant seed consists of the outer protective coats, the young embryo, and the endosperm, or food material upon which the embryo depends until it develops green leaves and manufactures its own food.

In trying to cross certain varieties or species, the hybrid will mature, but seeds from the fruit are "dead." Thus the second generation is lost, and with it the pos-



Magnified 31 times are fully developed seed, left, seed from green tomato, right, and embryo of latter



Artificially fed seedling looks like this when it is ready to be transferred to soil medium. Below, tomato plant two weeks after embryo is taken from the seed

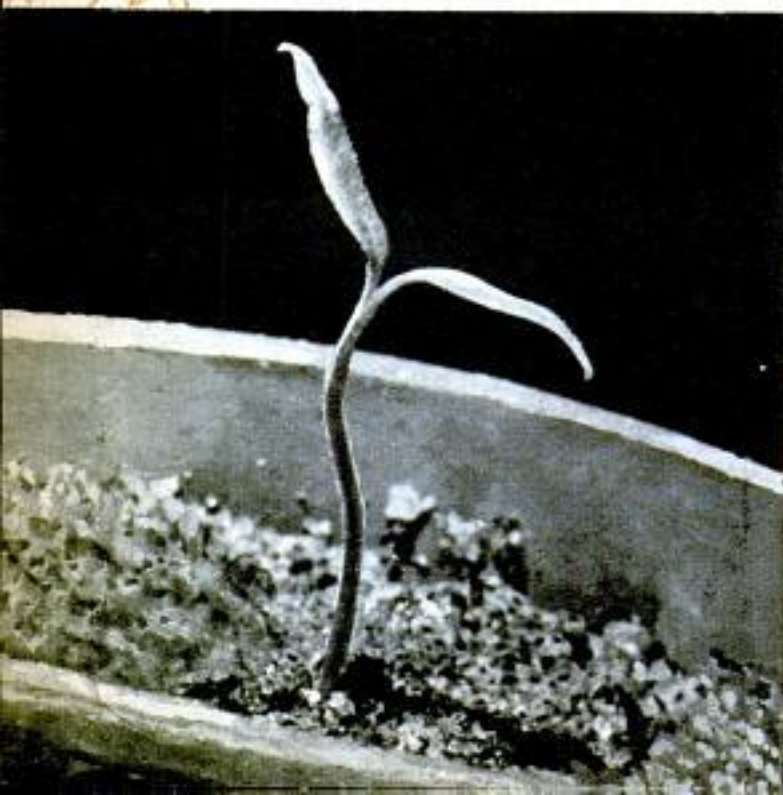

Grow oranges in New Hampshire? Blueberries in Texas? That's not so farfetched as it sounds, according to a modern Burbank who found a new technique for plant breeding

sibility of perpetuating or modifying the hybrid strain. There may be several reasons for this lack of vitality, depending upon the plant group, but one of the most common is the fact that the endosperm or food material does not develop properly and the embryo starves to death. In such cases, because the embryo dies in the seed, the seed will not germinate.

In embryo culture, the young seed is taken out of the green fruit and grown in a nutrient medium—taken out when the fruit is as small as one seventh of its mature weight, and before the embryo has a chance to starve. Suppose, for example, the scientist is interested in working with a particular variety of tomato whose seed consistently has failed to germinate. The green fruit is cut in half or quarters with a sterile knife, placed in a sterile petri dish and kept closely covered. The outer coat of one of the green immature seeds is taken off, the endosperm removed, leaving just the embryo. This is a precise operation, done aseptically under a microscope, with the operator wearing a gauze mask to avoid contaminating the embryo. Even in a fruit as large as the tomato, the embryo is little larger than the head of a pin. It is a pale translucent gray; in the seed it appears kidney-shaped, with a tiny bubblelike projection on the curved end containing the root, and with the leaves folded in toward the center.

Some scientists use small steel knives to remove the seed coat, or attempt to force the embryo out of the seed coat by pressure between two glass plates, but Dr. Jones has found that glass knives with long, flexible, needlelike blades are excel-

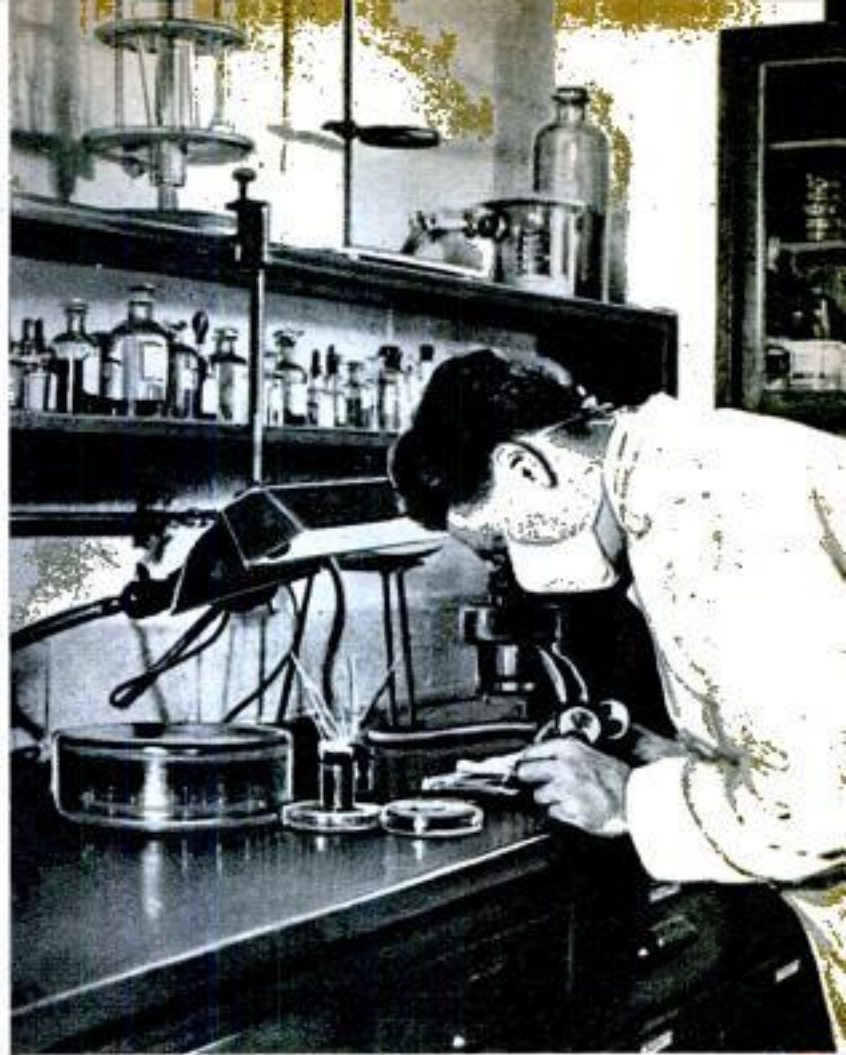

Dr. Richard Jones dissects seed to remove embryo. He wears a mask and performs delicate operation with sterile instruments

lent tools for this work. The small seeds when removed from the fruit are moist and slippery. In cutting through the tender coat, great care has to be taken not to damage the embryo. When the outer coat gives, the glass knife blade is flexible enough to yield with the coat, and there is less danger of cutting into the embryo itself.

When the embryo is removed it is put into seven or eight cubic centimeters of nutrient agar to which standard nutrients have been added. Dr. Jones uses a modification of the nutrient medium developed by Dr. Philip White, one of the foremost workers on plant tissue culture and cancer research, adding sugar and yeast extract and using slightly different amounts of minerals.

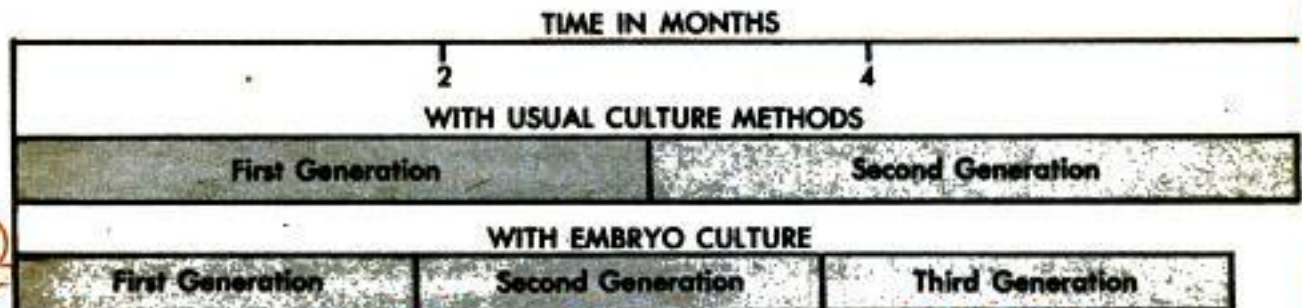

Taking embryo from seed of green fruit speeds culture in addition to assuring fertility of hybrid seeds



Left, transferring seedling grown from embryo to glass beads in a plant food solution. Right, working under ultraviolet lamp to guard against bacteria, embryo is placed in solution for artificial feeding

Not only must the embryo be removed under aseptic conditions, but the experimenter works under ultraviolet light to minimize the danger of contamination from bacteria or other air-borne organisms. When bacteria or molds do get into the jars in which the embryo is placed, contaminating growths form on the agar and the whole jar must be thrown out. The embryo is incubated at about 78 degrees F. for several days, until its root system develops and the seed leaves become green. As soon as these leaves become green, the plant can manufacture its own food; until then it must depend upon the food provided in the nutrient medium.

A critical stage in the life of the young seedling comes when the germinated seed is transferred from the nutrient medium to the "soil" in which it is to continue growth. Sterile garden soil, beach sand, quartz sand and glass beads all have been used successfully. The transfer from the nutrient agar to the soil medium is made under ultraviolet light to prevent contamination. For two days the young plant is watered with a solution of the same food plant in which it was started so there will be less shock to the protoplasm. Then, if beach sand or garden soil is used, it is watered in the usual way. If glass beads or quartz sand are used, the plants are watered with a solution of mineral nutrients—the beads or sand particles simply serve as a support for the roots to work around. Whatever medium is used, the seedling is covered with a glass beaker for 10 days, or until it is well started, and kept at room temperature. Then the beaker is removed and the plant is allowed to grow normally.

What does all this mean in terms of the individual gardener? Plant scientists have been working for many years crossing one variety or species of plant with another, often getting hybrids whose seeds will not germinate. If the seeds that lack vitality could be brought by artificial means to the stage where their leaves would form and they would begin to manufacture their own food, then the breeding of these varieties could go on rapidly. Artificial nourishment of the seed embryo seems to offer a means of accomplishing this end.

By using the Jones method, scientists may develop new varieties of fruits, vegetables and flowers which can be grown in all parts of the country under many conditions of environment. Furthermore, the plant breeder will not have to go through the whole life cycle, allowing the fruit to mature and giving the seed a rest period before planting it.

It means also that plant breeders will be able in a much shorter time to cross plants of one species with those of another, combining desirable features of each. They will be able to develop new varieties resistant to varying degrees of temperature, moisture, light, acidity and disease. They will be able to make hitherto impossible crosses between spreading vines and other plants, develop new plants of a bush variety which bear fruits but take less space in the garden, and make new crosses between wild and cultivated species.

What Dr. Jones and others in this field are doing will literally bear fruit in gardens from one end of the country to the other and the results of their work will be seen in gardens and on tables everywhere.

"Atom" Planes Used New Fuel System

Fuel-feeding systems shooting pressurized sprays of gasoline directly into B-29 engine cylinders supplied the getaway power needed by the two Superfortresses that dropped atomic bombs on Hiroshima and Nagasaki. Designed and built by Bendix Aviation Corporation, the "direct fuel injection" equipment is reported to cut down engine warm-up time and improve acceleration, cooling and engine operation. Two compact injection pumps—each synchronized with the main engine drive shafts—accurately divide fuel into equal parts and pump it at high pressure into the cylinders of the 18-cylinder, 2000-horsepower Wright engines via airtight stainless steel lines. Each pump contains nine plungers which spray the fuel in tiny shots—one spray from each plunger every twentieth of a second. Fuel precisely metered by a master control is injected directly into the cylinders at pressures ranging from 500 to 2500 pounds per square inch.

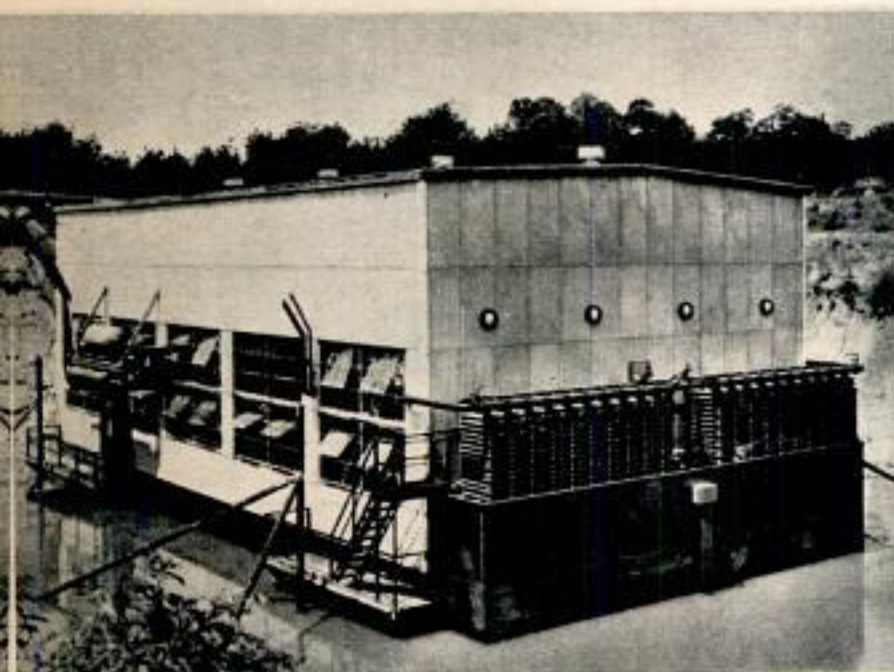

Pump Station on Barge

With a capacity of 100,000,000 gallons a day, a floating pumping station protects Oklahoma's second largest oil field against floods. When Pure Oil Company engineers found it impractical to locate a station on land at Cumberland Field, the pumping equipment was mounted on an 85-foot barge. Two Cooper-Bessemer Diesel engines are connected to 30 by 38-inch centrifugal pumps. Each engine also drives a generator to supply electric current for auxiliary units, such as the 30-horsepower motors in the cooling system. Flood protection is necessary due to the diversion of the Washita River around the field.

British Plane Has Main Wing Behind

With a small wing in front and a larger one behind, the British twin-engined Libellula appears to be flying backward when it takes to the air. The plane's peculiarity makes it especially suitable for aircraft carriers, since the pilot always has an unobstructed view. George Miles, of the firm which produced the British Miles Master, designed the new airplane.



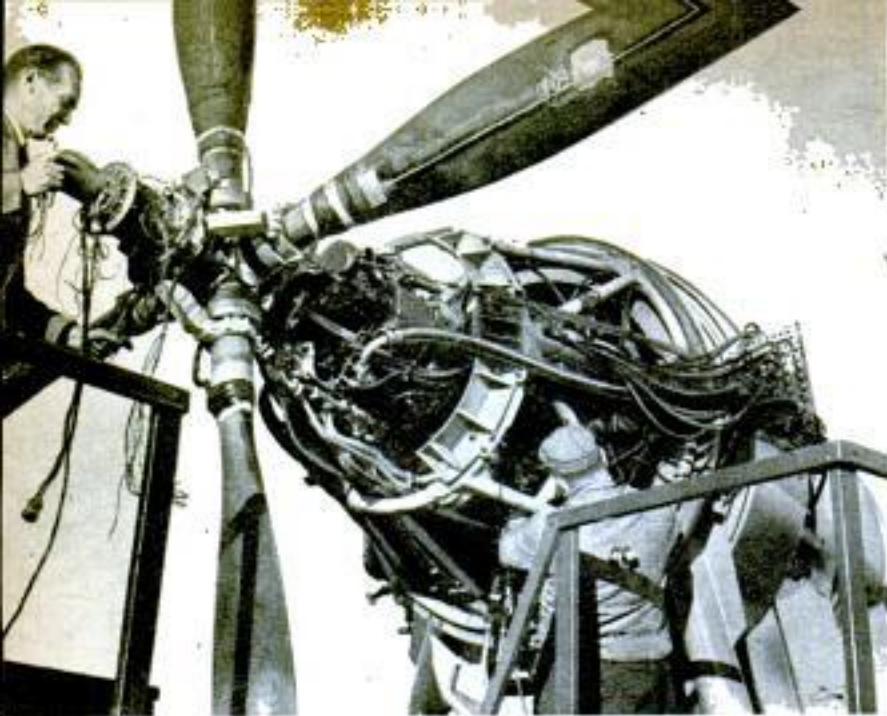

PROPJET ENGINE

COMBINING a propeller in front with jet propulsion in the rear, the Propjet, developed by General Electric for military purposes, may prove a long step toward the goal of efficient gas turbines for aircraft. Tested in an Army plane of advanced design,

First gas turbine engine to drive an airplane propeller and generate jet propulsion. Below, drawing shows how the G-E Propjet fits into wings of a plane

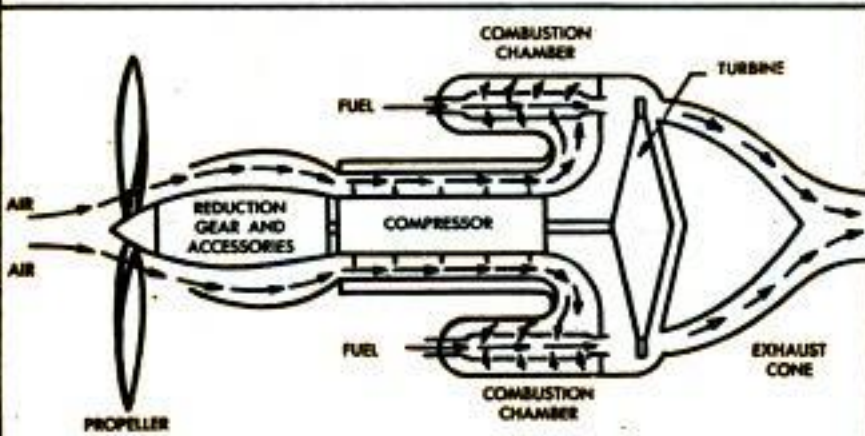
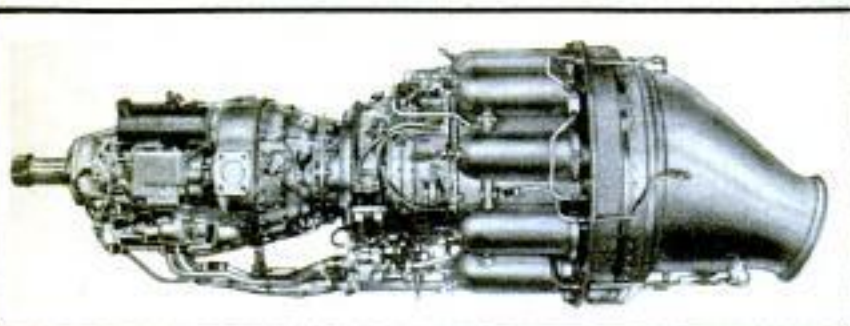

the engine performed well on kerosene in its first trial. The gas turbine gets its power from a whirling turbine wheel driven by hot gases supplied by burning liquid fuel. Air entering at the front of the engine is compressed and mixed with gases in a combustion chamber where the burning fuel greatly increases velocity and pressure. The gases then pass through the turbine which powers both compressor and propeller. The Propjet is light, creates little vibration and operates at full power for long periods on almost any liquid fuel.

Parallel photograph and diagram of the Propjet engine show its component parts

Revolving Cleaner Removes Rust, Sediment From Gasoline Cans

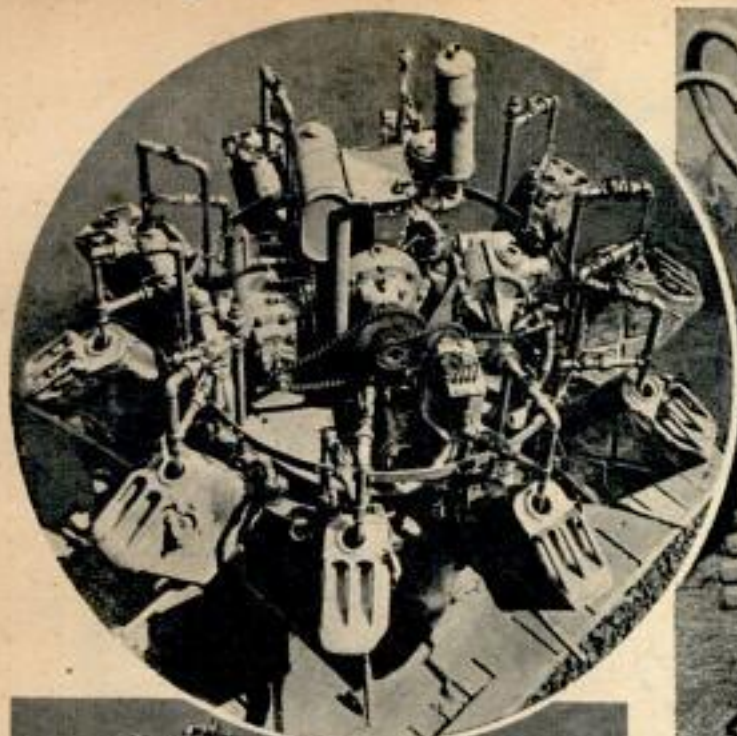

Gasoline drums and cans are cleaned of sand, mud, rust and sediment with a cleaner which looks like a bottling machine. Developed by the Quartermaster Corps, the machine is powered by a gasoline engine and cleans 10 five-gallon cans in 72 seconds. As the cans revolve, kerosene is sprayed under pressure into each one, after which the kerosene is removed by suction. An extension cleans 55-gallon drums.

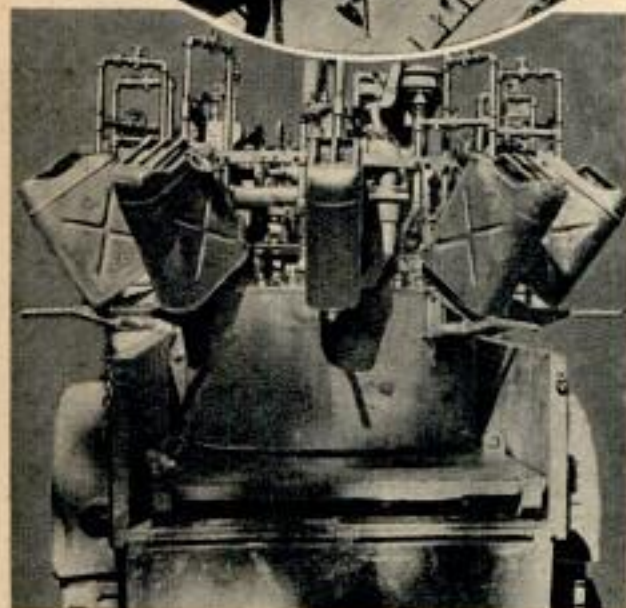

Five-gallon cans are placed on rack and pipe nozzles are inserted. Above right, extension nozzle for drums

"Third Hand" for Phone Leaves Two Hands Free

Equivalent to a third hand, a new device holds a cradle-type telephone in speaking-and-listening position and keeps both hands free. It is equipped with two clamps, one which fastens to the edge of the desk and the other to the telephone. The one at the telephone end is mounted on a universal joint to permit adjustment to the best angle for the individual. The holder consists of a curved tubular arm that swings out of the way when not in use. A third clamp locks the holder and mouthpiece to the base.





These steel-plastic exercisers are designed to strengthen arm and shoulder muscles

PROVING GROUND FOR INVENTIONS

GOT any ideas for an invention to make you rich?

The truth is that for every "million dollar" invention that pays off, thousands of ideas that looked good to their originators never earned a cent.

Of the 50,000 ideas and patents submitted since 1940 to the Crosby Research Foundation of Hollywood for possible marketing, less than one half of one per cent had enough merit to warrant putting them on the market. Some were too visionary to be practical, some conflicted with patents already granted, others had too limited a potential market, still others would cost more to manufacture than the public would be willing to pay.

Organized as a business venture by Bing Crosby and his brother, Larry, the foundation provides research, manufacturing, and marketing facilities for inventors who devise



Above, pump automatically works when water supply gets low. Below, left, wastebasket with removable bottom. Right, plastic pipe for cooler smoking

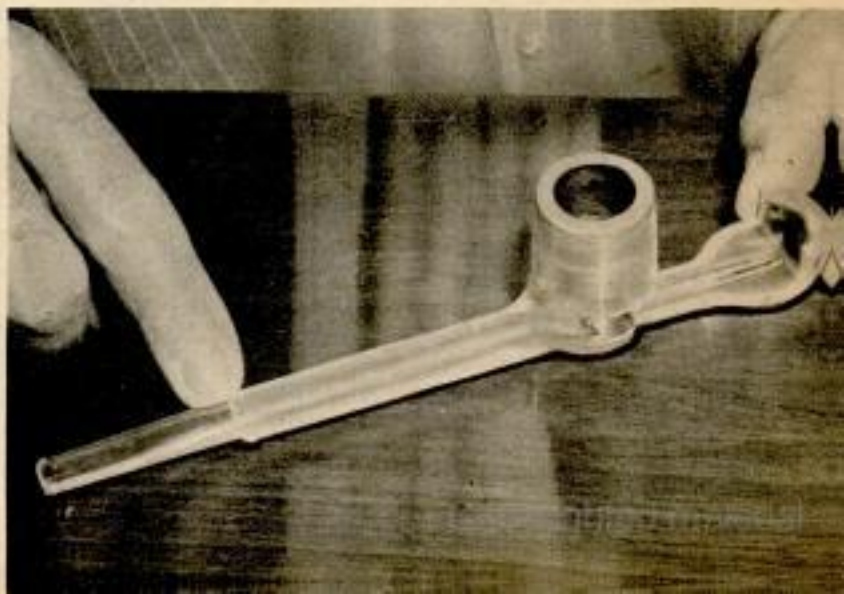

7928 Sunset Blvd.
Los Angeles, Cal.

new appliances that stand a chance to become widely used. Inventions are not purchased by the foundation, but standard royalties are paid to inventors on the basis of sales volume.

During the war, the Crosby Foundation helped develop the atomic bomb, a marine mine, an improved incendiary bomb and a device for detecting submarines.

The organization includes a staff of experts who consider the merits of ideas and inventions, conduct surveys to determine the potential markets and re-engineer and restyle devices that need such treatment. The "inventorprises" department then finances the manufacture of promising items and the "merchanteers" department arranges for national distribution through regular sales channels.

Right now the Crosby organization is readying patented articles for distribution



Above, horse race game sets odds for each horse. Left, a storage battery with visible liquid dial. In foreground, special wrenches

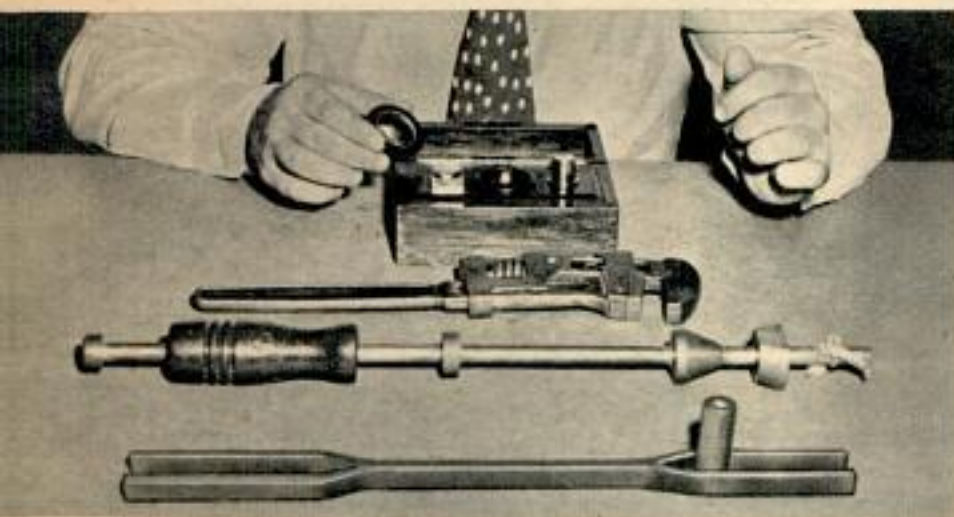

at the rate of one new item per week. Scheduled for sale this winter is an all-plastic, unbreakable smoking pipe with a replaceable briar bowl insert. The bowl is surrounded by a cooling chamber that provides a cool smoke. The stem may be taken apart for easy cleaning.

Another idea going on the market is a simple die-cast paint brush holder that clamps to the side of an open paint can. The holder keeps the brush handle away from wet paint on the can's rim and has a wiping bar, centered over the can, for removing excess paint from the brush. It will be on sale around Christmas time.

Other inventions the Crosby company is backing include: a built-in ceramic ash tray for bathrooms to prevent burn marks on window sills; a ceramic soap holder that lets the soap dry instead of becoming a soggy mess; a horse race game with its own totalizer that automatically changes odds for each horse at the start of a game; a streamlined plastic cigaret box that hands you a cigarette when you raise the lid; a hand-cranked metal paddle that mixes

Dual-purpose crutch, another of Crosby Foundation's sponsored inventions, has extra legs for sturdy seat



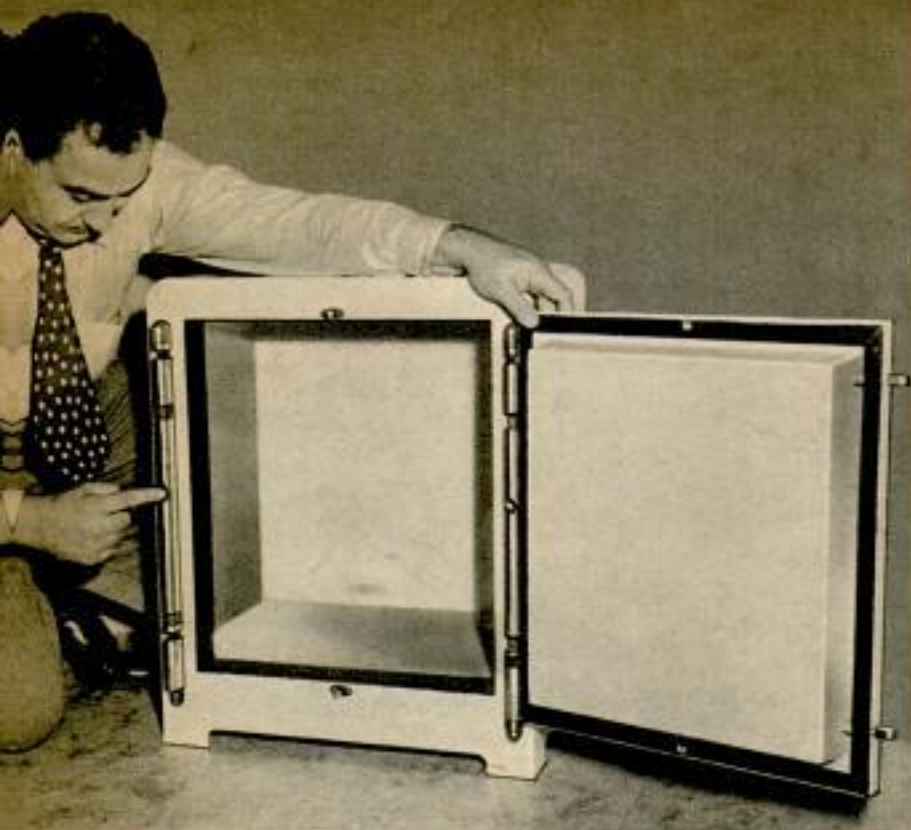

Refrigerator model has door that opens from either side at touch of a button. The door has hinges at both the left and the right

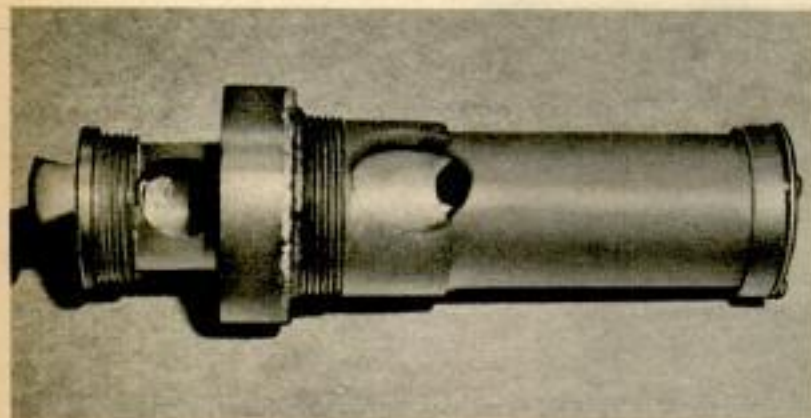

Above, self-breathing plastic spigot eliminates need of a second hole to facilitate pouring from barrels. Below, pants hanger with plastic teeth uses clamshell principle to grip the cloth securely



paint from the bottom up. Each idea was picked because it had wide appeal and could be sold at a price low enough to insure a large volume of sales.

Turned down by the Crosby firm were: a battering ram mouse trap, the principle of which, the inventor said, could also be used by warships to fend off torpedoes aimed at them; a plastic mine equipped with an electric eye for picking up its target and a propeller for chasing it; a camouflaged and armored top for foxholes that would require a squad of men to carry and install; a toothbrush with a self-contained supply of dentifrice; a zippered handbag without any new patentable ideas in its construction.

Other articles, while entirely sound and practical, had to be dropped because they would appeal to relatively few prospective purchasers.

Many inventors don't know how to protect their ideas, they are overly optimistic as to what their inventions should earn, and they don't understand the manufacturing and marketing problems involved in putting a new device on the market. H. L. Praeger, manager of the Crosby industrial system, has some sound advice from which such inventors could profit.

First of all, he says, protect yourself. Prepare a description and drawings of your idea, dated and signed, and have your signature witnessed by a notary public or by two witnesses who sign their names below your signature. Mail this material to yourself by registered mail and file the letter away unopened when you receive it. The purpose of this is to prove that you had your idea on a certain date. In case of a law suit charging patent interference you can hand your unopened letter to the judge or patent office examiner as proof of the time when you had your idea. Such a letter affords protection for a year from its date.

Second, find out if your idea is original. Employ a reputable patent attorney to make a search of Patent Office records to learn whether your idea conflicts with patents already issued. After

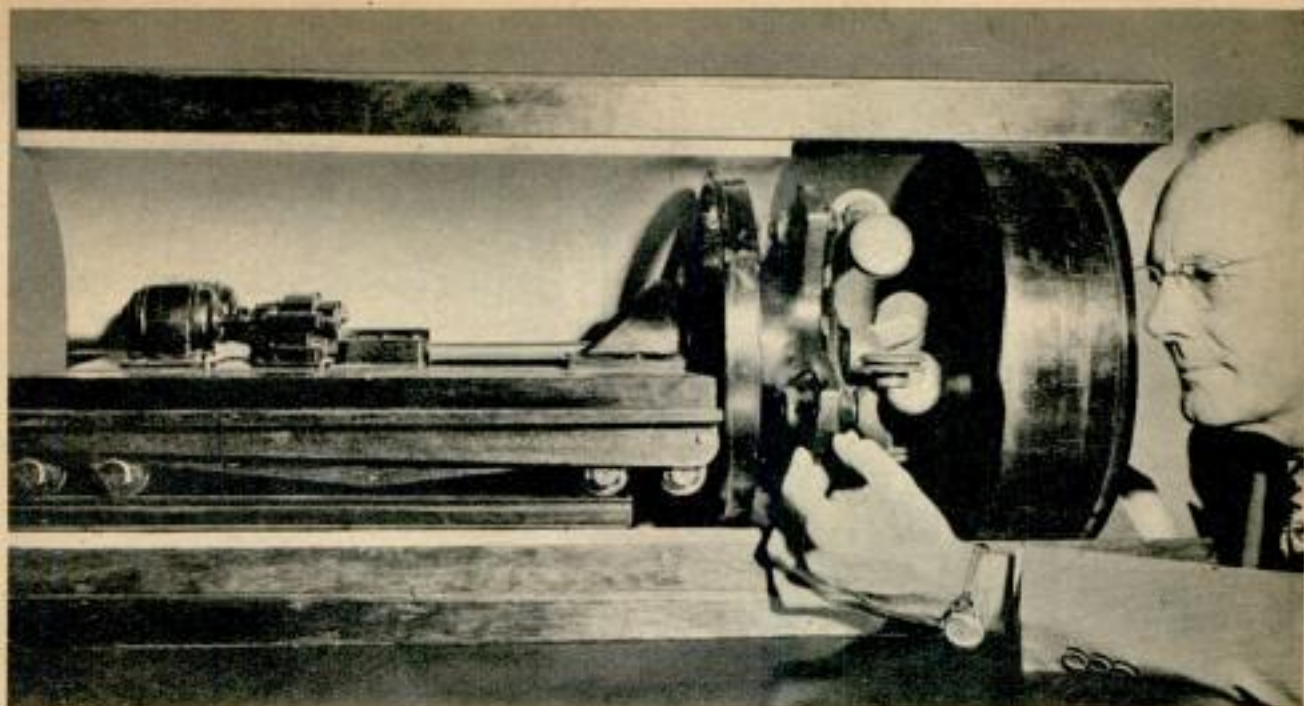

A research man examines model of tunnel digging machine that uses electric motors to operate cutting heads

making this search your attorney can give his opinion as to whether your idea would be granted a patent. His services should cost you from \$15 to \$75.

Third, learn whether your device could be sold at a profit. The way to decide this is to make a manufacturing and market survey. Show a model or drawing of your invention to several manufacturers. Ask them whether its engineering is sound, whether you should redesign it for greater economy of manufacturing, and get a close estimate of production costs.

Next ask a buyer for a large store how well your gadget would sell, considering its utility to the purchaser, advantages over comparable articles and its price. Its retail price, roughly, will amount to five times its cost of manufacture. You can dis-

play your idea freely while making these surveys because you have already protected it by the unopened registered letter.

Finally, you should apply for your patent only if these surveys are favorable and it appears that your device can be manufactured and sold at a profit. Attorney's fees for preparing descriptions, making drawings and filing for your patent will cost from \$150 to \$2500, including some \$80 in filing fees.

After making your surveys and obtaining a patent, you are then in a good position to discuss its production by a manufacturer. If you offer your patent for sale on a royalty basis you should expect to receive royalties amounting to from one to five percent of the wholesale price. Larger royalty percentages are quite rare.

Below, left, an ash tray with slot to hold match book securely. Right, paint brush holder attached to can

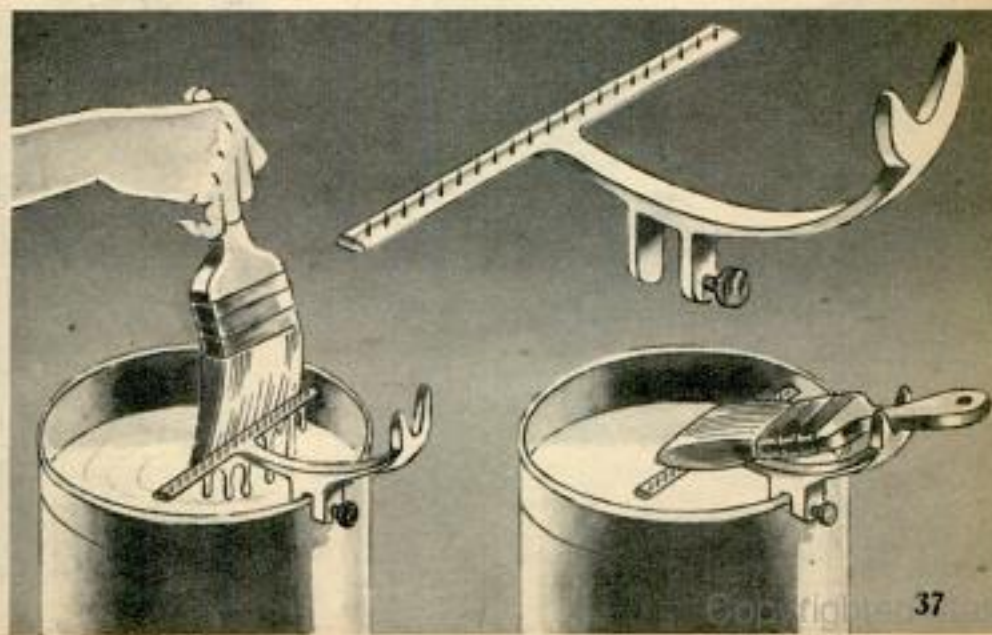



CABLE CAR built by Philip J. Kirst of Kenmore, N. Y., carries him across a gully to get firewood for his parents' weekend cabin. Car will support 500 pounds

LEFTOVER ALUMINUM TUBING designed for struts in B-29 Superfortresses is now being used by toy manufacturers to make nontipping bases for hobby horses Chicago Merchandise Mart photo

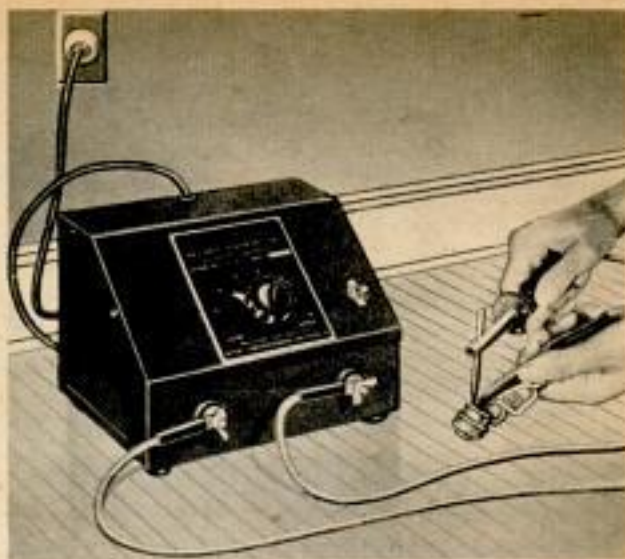

COMPACT SOLDERING UNIT designed for intricate electronic work reaches into spaces that an ordinary soldering iron can't touch. It develops an intense heat that is concentrated at the tip and can be regulated to eight different temperatures. The copper-plated carbon rod can be resharpened easily with a scraper or emery wheel. The unit may be used for etching on metal, and an adapter for wire stripping is available

WHEAT ROOTS that penetrated to a depth of nine feet in Deaf Smith County, Texas, are mounted on a chart that shows how rich soil is in calcium deposits

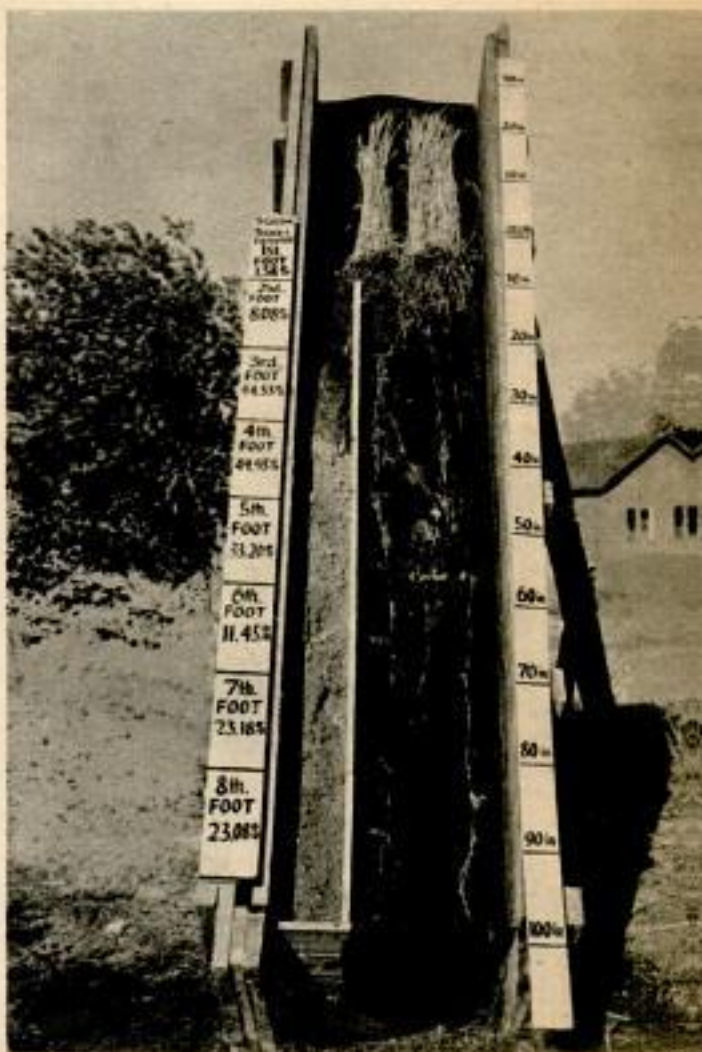



TOKENS are inserted in a meter dispensing unit to release gasoline to individual stations. This is a boon to both the service station operator and gasoline supplier. Instead of making daily deliveries of 100 to 200 gallons, the supplier fills the tank to the top. The operator does not pay for the full tank, but buys tokens which release 50 gallons at a time. This insures an ample supply of gasoline. The deposited tokens provide an accounting system

BALL BEARING ring on plug gauge (below) assures proper alignment and prevents jamming and wear. Free to turn in any direction, the gauge is automatically aligned regardless of the angle at which it enters. As the instrument enters the work of its own weight, it is impossible to jam even though the diameter of the gauge is the same as the opening. This prevents wear on bores in soft metals. The constant turning of the bearings adds to the life of the gauge



ELECTRONIC "mathematician" determines the proper location for new radio towers in a few minutes—a job that once required weeks of human figuring. The RCA machine, known as an Antennalyzer, adds, subtracts, squares and takes the square root of numbers and fractions. It contains 52 electron tubes. Electrical circuits are set up to simulate characteristics of a proposed transmission tower. A pattern of light on cathode ray tube shows right "blueprint"

"BIRD BATH" for airplane parts (below) keeps hangar floors free from grease. The shallow pan in which parts are washed is seven by four feet and is mounted on an accordionlike frame. This frame can be wheeled about wherever needed and expands from 32 inches to seven feet in height. It holds 15 gallons of cleaning liquid. Small parts, such as nuts, are washed in a basin covered with screen at one end of the pan. American Airlines mechanics built it

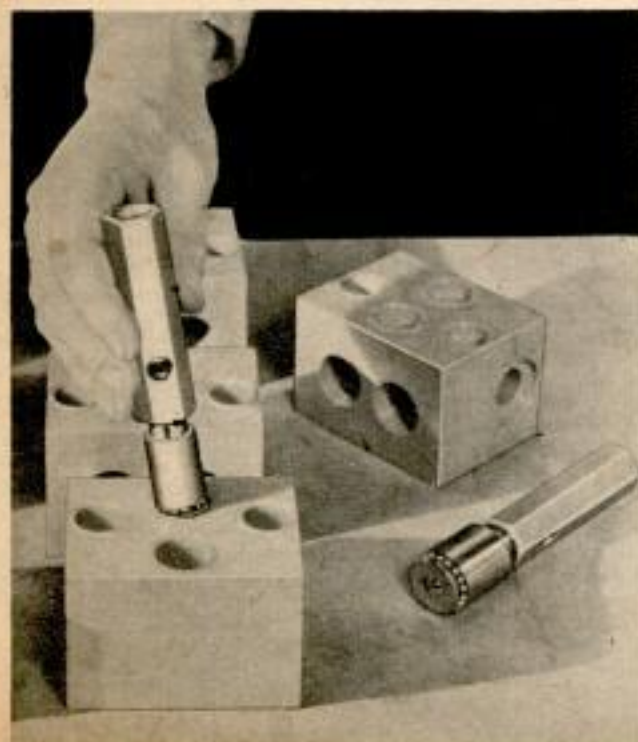

P-6 11

*Dow Corning Corp.
Midland, Michigan*

MEET THE SILICONE FAMILY

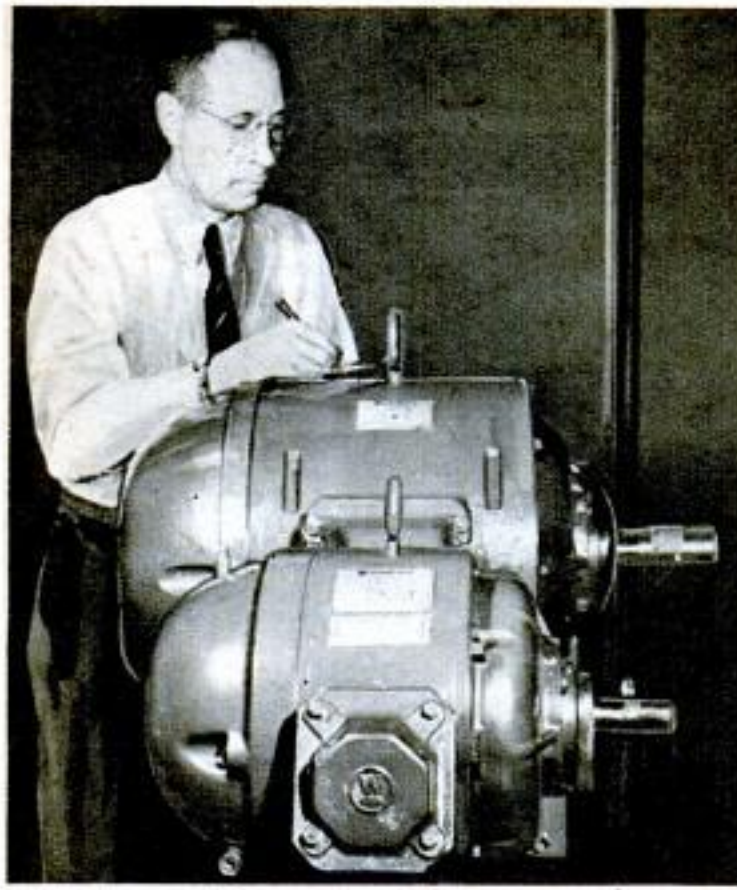

Silicone varnish on insulation of the small motor gives it power output of big one

CAN you imagine a liquid that flows like water 70 degrees below zero, that doesn't melt at 400 above, or an insulating varnish that doubles the life of electric motors? These and other wonders are now within the realm of possibility through the development of a new line of chemicals called silicones.

These new compounds are made up of rings and chains of silicon and oxygen atoms instead of the carbon atoms of the older organic chemistry. It might be called a "silica sand" instead of a "coal tar" chemistry.

For years artisans have wished for something in the nature of a liquid asbestos or an artificial mica that could be poured and moulded. With this new development, industry soon may have available a host of new plastics, elastomers, oils and coatings, all extremely resistant to heat. The new compounds possible are numberless and the industrial possibilities are beyond the range of the imagination.

It all began with some research in polymerization in connection with glass and plastics. Polymerization is the joining together of molecules to form long strings or an interlocking network. When this reaction takes place a material usually thickens or solidifies and yet does not change its

actual chemical composition. Formerly this reaction had been of interest only in plastics, rubber, glass and adhesives.

The older organic chemistry was based on the ability of carbon atoms to combine with four other atoms. Silicon atoms also combine with four other atoms and although chemists have long realized the possibility of developing an entirely new line of compounds based on this element the only familiar materials have been the inorganic natural compounds of quartz, glass, asbestos and mica. Now a start has been made which may result in a hundred thousand new chemical compounds.

The basic raw materials for the production of these new compounds are sand, brine, coal and oil. The brine is electrolyzed to produce magnesium metal and chlorine gas. With the aid of this, chlorine and silica sand are converted into silicon tetrachloride.

Organic chlorides are prepared from chlorine, coal tar and petroleum and with the aid of metallic magnesium, in what is known as the Grignard reaction, these organic chlorides and the silicon tetrachloride are combined. The magnesium does not enter permanently into the compound but only assists the reaction.

The organic-silicon chlorides are then hydrolyzed or combined with water and the resulting molecules are capable of being condensed or polymerized into long chains.

The distinguishing characteristic of most of these compounds is their remarkable resistance to heat, acids and electricity.

Some of the compounds are water-white liquids, some appear oily, some are of greaselike consistency and some are hard resins. They are insoluble in water but dissolve in certain organic solvents.

The greaselike compounds are already being used for high temperature lubrication with good success. Some of the liquids can be heated to 800° F. without evaporating and can be cooled to -50° F. and still remain fluid. They are being proposed as a heat transfer medium for industrial uses. The resinous silicones are being tried out as electrical insulating material in connection with continuous glass filaments and



These pictures demonstrate that silicone lubricant withstands higher temperature than petroleum jelly. Left, silicone lubricant is in the left-hand vessel; petroleum jelly in the other. Right, flame melts the jelly

to make possible motors much smaller in size with the same horsepower.

The trend toward higher operating temperatures for motors was stimulated by the advent of fibrous glass insulation but full advantage could not be taken of this material because of the heat failure of the organic varnishes used to impregnate it. With the discovery of resins of the silicone type, varnishes can be prepared that stand operating temperatures of 125 to 200° C.

Silicone liquids have a very small change in viscosity over a wide temperature range. They will stand both high and low temperatures and are already being used to impregnate packings and gaskets, as gauge

glass and dash pot liquids and for lubricating molds in the hot molding of plastics.

Greaselike products are being used for lubricating plug cocks in high temperature chemical apparatus to withstand temperature changes from -40° F. to 400° F.

The latest development in this new chemical field is a rubberlike material that actually contains no natural or artificial rubber. Silicon forms the chemical framework and lends its property of high temperature resistance. It has a lower tensile strength than rubber and could not be used for tires but is already being used as gaskets in B-29 superchargers and as a cushion for Navy searchlights.

Left, torch ignites silicone-varnished insulation; right, flame goes out seven seconds after torch is turned off

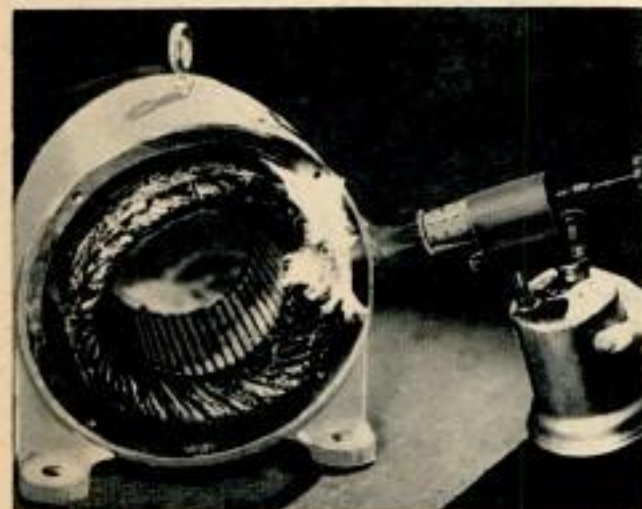



Gunners Practice On Robot Planes

One of the reasons why U. S. fighting men scored so many bull's-eyes in shooting at enemy aircraft was that we had radio-controlled, pilotless planes for target practice. The Air Technical Service Command has revealed that robot planes were used extensively to train air force gunnery students and to instruct radar students in tracing flying objects such as rocket bombs and airplanes. The Army developed two models, one a monoplane



Left, robot plane is target for gunners' practice. Center, operating plane by remote control. Right, parachute lands it



with a nine-foot wing span capable of flying 103 miles an hour, the other with a wing span of 11 feet 6 inches capable of 140 miles per hour. The plane is catapulted from the ground by either compressed coil springs or a

rubber shock cord. In air the flying robot can be made to perform intricate maneuvers—duplicating actual combat “squirmings”—by remote control. When the target plane's gasoline supply is exhausted, the ship is landed by a parachute opened by radio control.



AAP photos

Left, bomber panel has “buttons” which light up when oxygen supply to any crewman gets low. Above, dial indicates flow and pressure

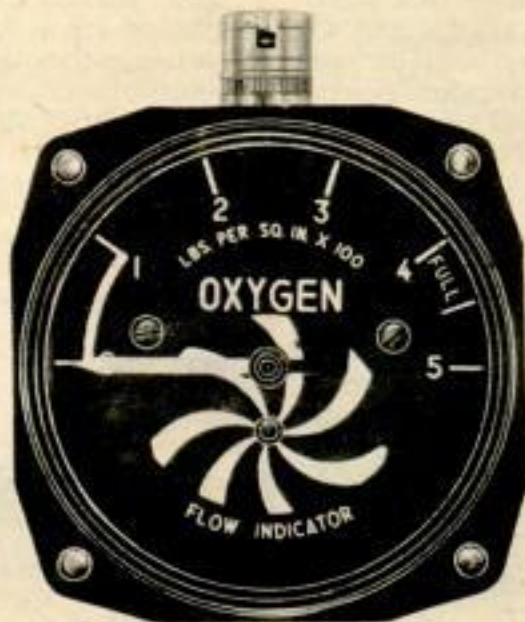

Plane Dial Lights Up If Oxygen Runs Low

Insufficient oxygen for a bomber crew is disclosed by an oxygen warning system which keeps tab on each airman. An oxygen combination indicator incorporates a pressure gauge and flow indicator, with pressure shown in hundreds of pounds by a pointer, and flow indicated by a luminous whirler disk. The central warning panel contains a time delay mechanism and warning lights arranged in the same pattern as the plane's oxygen stations. If a crew member receives insufficient oxygen, his warning lamp lights up.



Self-Elevating Outboard Motors

Giant war-developed outboard motors and propellers seem destined to be important cogs in postwar marine transportation. Available in gasoline or Diesel models from 45 to 330 horsepower, the so-called "Harbormasters" are suitable for use in towboats, tugs, police and fireboats, icebreakers, fishing craft, river ferries and such work boats as pile drivers and derricks. A feature of the unit is an elevation mechanism which permits the propeller to be raised outward and upward, either manually or by power. This flexibility enables heavily laden craft to be driven over submerged obstacles. In the war these big outboard motors propelled "Rhino Ferries" and "Rhino Tugs" to form mobile bridges over which invasion equipment rolled shoreward, and also took part in minesweeping operations, laying cable, maneuvering derricks and clearing port obstructions.

Featherweight Canoe

Aluminum canoes weighing only 38 pounds are being manufactured by the Grumman Aircraft Corporation at Bethpage, Long Island, wartime makers of Navy fighter planes. The canoes are so light that a girl can easily hoist one above her head and carry it.

Write to firms listed in the Where-to-Buy-It Index, page 8A, to learn more about products described in this magazine. Say you saw it in Popular Mechanics.



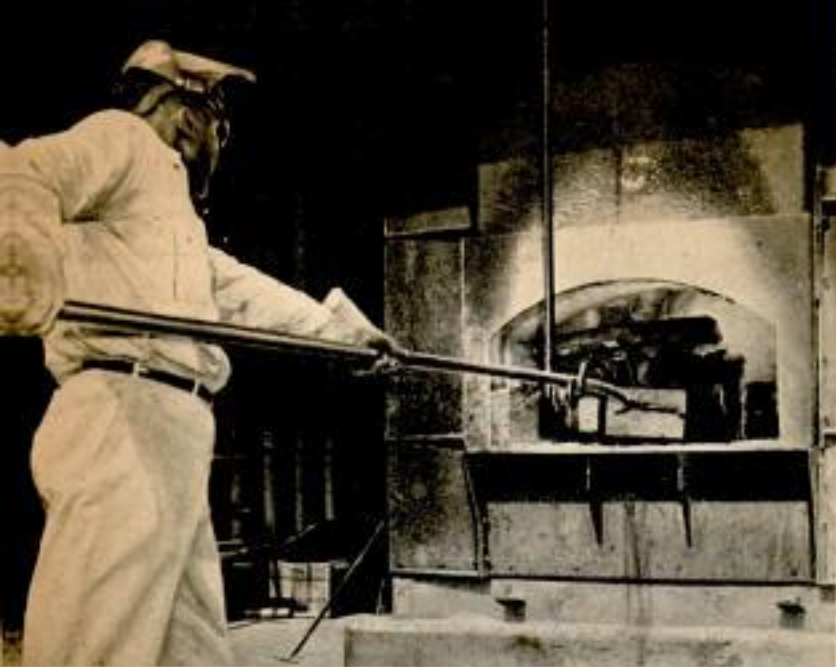

Above, left, parts from wrecked warplanes are pushed into a melting furnace to be reduced to molten aluminum. Right, after "cooking," the aluminum comes out in ingots. Below, left, ultraviolet lamp from a bomber is attached to a base for classroom work. Right, checking spark plugs from old Navy planes for possible reuse

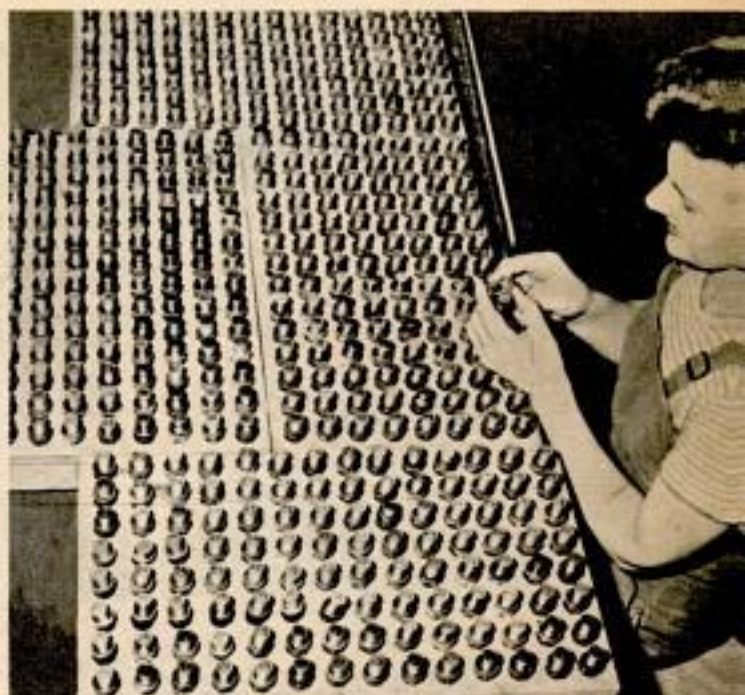

HUNDRED BILLION DOLLAR SCRAP PILE

DON'T be surprised if your new aluminum stew pot starts 'revving up' and takes off from the kitchen stove on a flight around the house."

That's the way one Navy scrap and salvage expert jocularly describes the conversion of war's debris to the economy of peace. Your new kitchen aluminum may have been a part of an airplane that shot down its quota of Japs or had a hand in the subjugation of Germany.

Cleaning up after Mars is a vast job that will last for years. The armed forces themselves get first crack at wrecked vehicles and equipment. Parts that are still good are "cannibalized" so that other units can be

repaired and restored to service. Scrap materials that are left over, from paper and lumber to plastics and steel, are being returned to industry for reworking and reuse.

Huge stores of obsolete or surplus items no longer needed by the services are being offered for sale. Everything from brooms to bulldozers, from electric wiring to sea-going ships, will be put on the block. The sales tag on a Flying Fortress minus armament, for instance, is \$39,000.

Called the world's greatest merchandising task, the job of peddling an estimated \$100,000,000,000 worth of goods is currently handled by the Surplus Property Board, a government agency. Retail sales to the

public are not planned. Instead, various government groups are advertising bulk lots of materials and equipment, selling to the lowest bidders. The materials then move through regular merchandising channels to consumers. Sales are running at the rate of \$50,000,000 per month.

Air compressors and blankets, to name two surplus items, can find uses without conversion, but to what practical use could you put half a million gas masks or a thousand rubber floats used in bomber fuel tanks or 10,000 hydraulic cylinders of assorted sizes?

One conversion organization took a gas mask apart and produced bicycle handlebar grips from the mask's rubber tubing, workshop goggles from the glass lenses, a powder-puff holder from the canister, and a toy gas mask from what was left over.

Large surplus metal electrical junction boxes become bases for electrical "hot plate" stoves; fluores-

Keep a sharp eye on that supercolossal white elephant, last year's bomber. It may turn up in next year's kitchen stove, bobby pin or bicycle

Smashed-up plane is moved to a salvage area where the "good" parts will be saved and metal sections melted

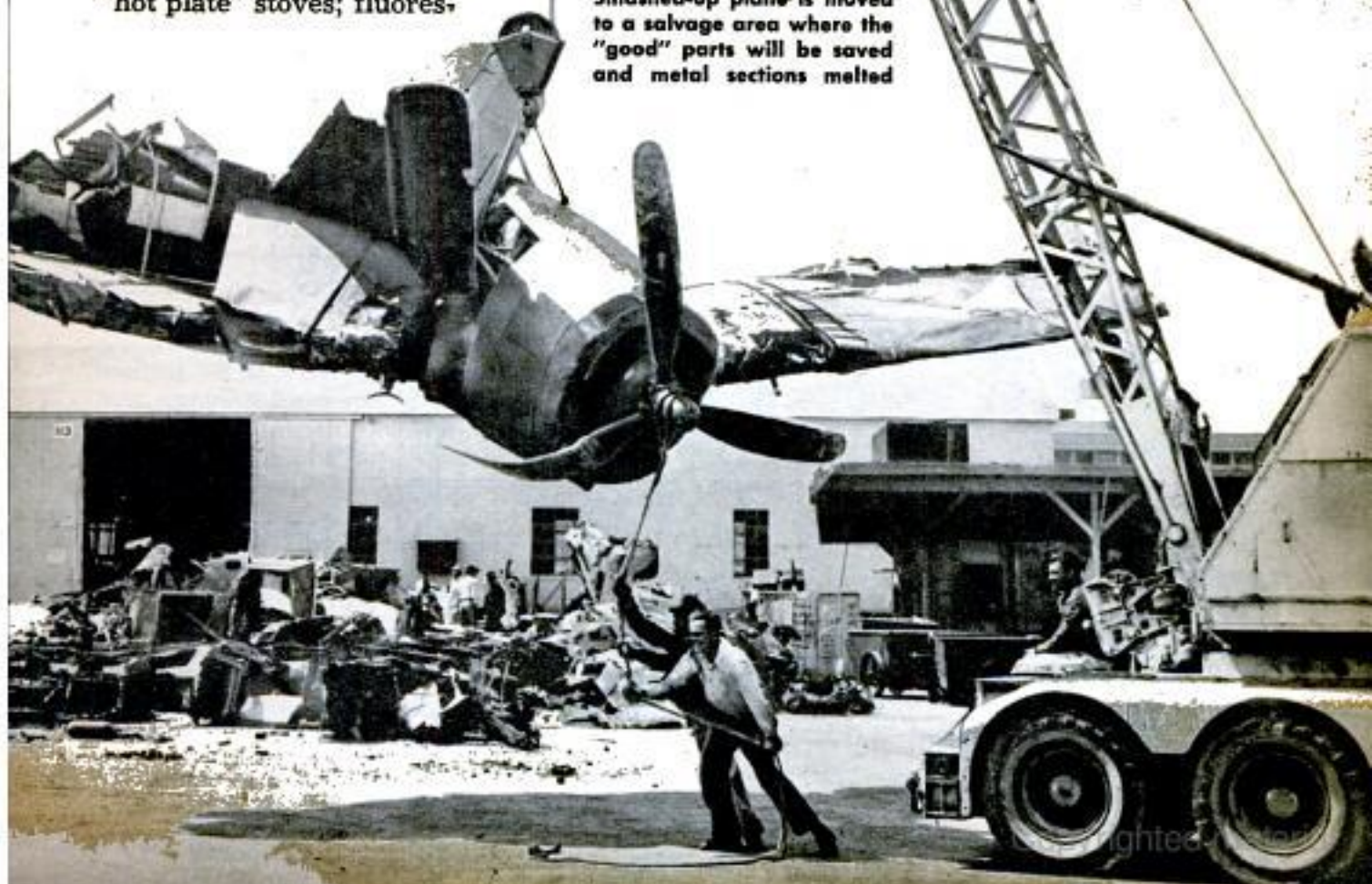



Piece by piece, wrecked fighting planes are taken apart by workers who salvage the metal and various parts. Below, inventory is made of salvaged materials stored at a naval air base



cent black-out lamps for irradiating the instrument dials of aircraft are converted to 110-volt operation and are used for studying fluorescent minerals and paints; large pieces of stainless steel scrap are cut to size, shaped and riveted into photographic development tanks; surplus hollow mooring buoys used by ships become excellent water-storage tanks for farm use.

Lengths of rolled aluminum alloy sections left over from the building of aircraft have infinite uses. Lightweight newspaper racks for street sales stands and lightweight bakery racks that can hold 30 pans of cookies and biscuits are only two representative items being made from these alloy sections. A whole field in itself is the adaptation of lightweight metals plus plastics and surplus aircraft parts in the manufacture of automobile trailers for vacation use.

Tidying up the battlefields is no mere figure of speech. That's where the reconversion job really begins. In Europe, maintenance companies followed closely on the heels of the combat outfits. Theirs was the clean-up job. Wrecked tanks, worn-out guns, blasted trucks and all the lost and damaged debris of battle were classified, sorted and headed toward the repair shops or junk piles within a couple of weeks from the time fighting had ceased.

Tank, truck and jeep motors were rebuilt at shops in western Europe at the rate of 20,000 per month. Everything that "rolls, shoots or explodes" that needed repairs was reconditioned for battle. At first it was estimated that 50 percent of the material used in Europe would have to be junked, but the sharp-eyed salvage men have reduced that figure to 20 percent. Reconditioned, the rest of the equipment was rushed to Japan.

The salvage process is essentially the same in all branches of the service for all kinds of equipment. Damaged aircraft, for example, that are moved to a salvage depot are first inspected to determine whether they can be safely repaired either by rebuilding minor portions or by substituting parts that are on hand.

s go to wor
upon;
mov

ask if
other-
e from
assem-
be put
wing is
stor-
plane
ing.
d.





The repair shops go to work if repairs are decided upon; otherwise salvage crews remove from the plane structure every assembly and item that could be put back in use. If an entire wing is in perfect shape it goes into storage against the day another plane of the same type needs a wing. Hydraulic cylinders are removed, inspected and put in stock, radios are removed, tested and put on the shelf. Armament, instruments, tail wheels and even spark plugs go through the same process. Control wires and cables, however, are never taken from an old or damaged aircraft for use in another.

The aluminum structure that remains, possibly consisting of the fuselage and a wing, is cut up by acetylene torches or giant shears and put into a melting furnace where it is reduced to molten aluminum. This is then poured into ingots and finally makes its way back to industry. Secondary aluminum such as this is not as strong as virgin aluminum but is entirely satisfactory for many purposes such as pots and pans.

It is estimated that the scrapping of old and damaged aircraft will provide one billion pounds of secondary aluminum. Virgin aluminum itself is now available without priority for manufacturing civilian items. All in all, including the tremendously in-



A wounded sailor and a WAVE admire a plastic cigarette holder made by convalescent seaman of parts from smashed planes

creased capacity for producing aluminum that the United States built up during the war, many times the amount of aluminum that was used before the war is available today.

Mare Island and other Navy yards that repair battle-damaged warships maintain vast scrap and salvage areas. Twisted deck

Below, left, clips from the wall of a bomber navigator's compartment serve as a handy spice rack for kitchen use. Center, bakery rack made from warplane aluminum scrap. Right, newsstand built from scrap aluminum





Soldier recuperating from war wounds learns how to design and fashion useful and decorative items from scrap aircraft copper and leather

plates, smashed funnels and even armored turrets that may have taken direct hits may all be removed from a ship that is in for repairs. These structural items are cut up for easy handling and returned to steel plants as scrap.

Salvaged parts that are removed from scrapped vessels or from ships that go through a modernization process go into the salvage "store." Here hundreds of electric motors, thousands of valves and pipe fit-

ting are left over in any manufacturing process. Douglas Aircraft Company produced 30 to 60 tons of scrap per month, ranging from stainless steel and aluminum alloy to leather and bits of plastic. Some of these materials can be used again but much of the scrap goes instead to Army and Navy hospitals and hospital ships. Convalescing servicemen, if provided with a few simple tools, turn out many handicraft articles from scrap materials while recuperating.

MOBILE PLANT EXTRACTS DRUGS TO TREAT MALARIA VICTIMS

Developed by the Cinchona Research Unit of the U. S. Army Engineer Board, a portable unit extracts antimalaria drugs from the bark of cinchona trees where they grow. This saves shipping tons of the dried bark to this country. The drug which is extracted is totaquina which contains quinine and other related chemicals. The extracting plant consists chiefly of three fabric bags about five feet high, watertight and resistant to acid and alkali, three tall metal cylinders, a small gasoline pump and a set of fabric drying trays. Mash made from the fresh bark is pumped through metal cylinders containing material re-

sembling charcoal. Several steps later a dark red liquid poured on the drying screens is collected as pink powder. This is totaquina, known as "poor man's quinine."

Paper Waste Improves Concrete

Tests conducted at Ohio State University show that cement produced with addition of calcium lignosulfonate, made from paper mill waste, lasts four to five times longer than ordinary concrete. The lignin product disperses cement particles by electrostatic action, preventing bunching which doesn't let all the particles get wet.

tings, scores of Diesel generator sets and other equipment are readied for service again.

At regular intervals the Mare Island salvage officer sent lists of the items he had on hand to the Navy's forward bases in the Pacific so that distant repair departments could draw on him for things they needed. Frequently, too, a ship that put in at Mare Island found that the salvage department could provide it with vitally needed gear that otherwise would have had to be shipped west from an eastern factory.

The salvaging of lumber alone is a major item with the Navy. During a five-month period 2,500,000 board feet of lumber were salvaged and reissued for new uses at Mare Island, not counting 11,000 boxes reclaimed and used again as shipping containers. Mare Island salvage activities put back into service some 222,000 items of equipment last year.

Salvage begins at the war plants, for scraps of material

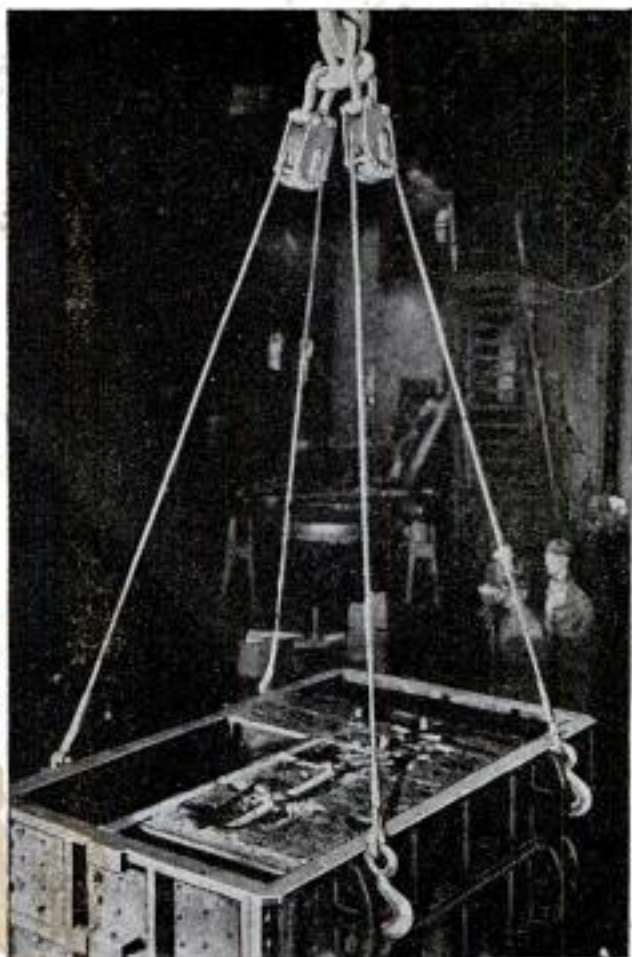

SELF-ADJUSTING SLING now on the market can lift heavy loads in a level position. A lightweight block containing wire rope is attached to the crane hook and the hook is lowered to the approximate center of gravity of the load. The sling is then attached. As the crane lifts, the ropes automatically adjust to level the load. When level, an automatic brake locks the cables to prevent slippage. Slings are available for lifting loads ranging from 1500 to 12,000 pounds



ORANGES BREATHE through 9000 pores per square inch into a specially designed respirometer that measures moisture and carbon dioxide content. Tests determine at what point an edible waxy solution stops the breathing when sprayed on the fruit. Breathing causes oranges to shrivel and lose flavor



ELECTRONIC "SWALLOW COUNTER" tests ability of airmen to withstand high altitudes. The tympanometer, developed by research engineers of Westinghouse Electric Corporation, has two oversize earphones into which are fitted two midget microwave transmitters that pick up and send out a record of eardrum movements or compensations, such as swallows, as the pilot adjusts himself to rarefied air. A receiver outside the test chamber records the data



SIREN ALARM guards locked doors of trailers used in supplying drugs and scarce commodities to a drugstore chain in California. The sirens, audible in a 800-1000-yard radius, are battery powered and can run continuously for hours. Time locks also make a record of each time a door is opened and closed

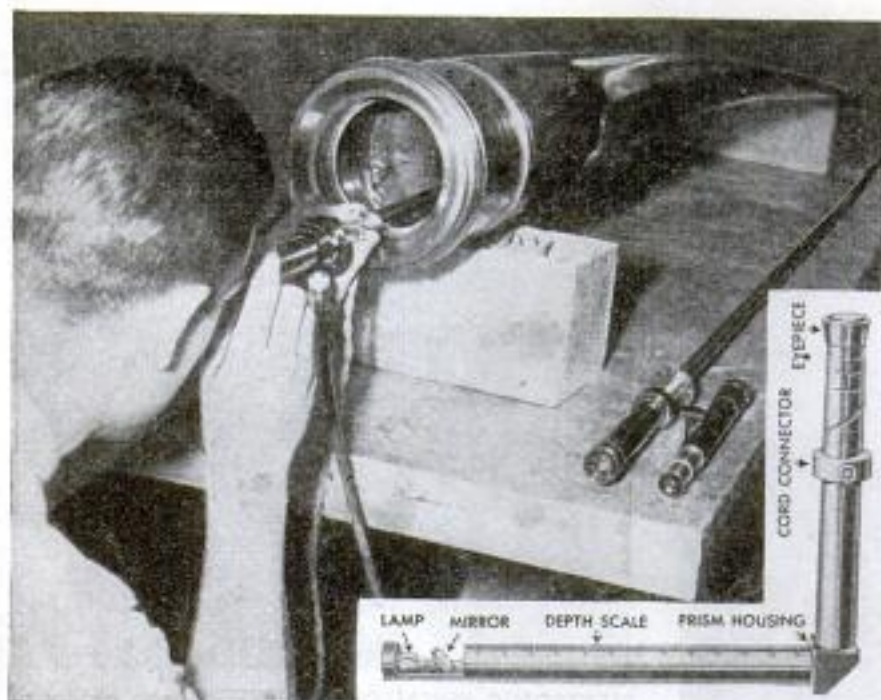

Borescope Looks Inside Gun Barrel

With an instrument operating somewhat on the principle of a periscope, the inner walls of gun barrels, engine cylinders or similar objects can be closely inspected. An adjustable mirror at one end of the instrument, which is known as a Borescope, picks up an image of the chamber wall. This wall is lighted by two small incandescent lamps behind the mirror. The image is transmitted to the eyepiece on the other end of the Borescope through a prism and lens system.

"Wash Line" Maze For Engine Parts

Hundreds of engine parts removed from wornout engines are hung on an automatic conveyor cleaning line at the Rome, N. Y., Air Technical Service Command for a three-hour washing trip. The conveyor moves slowly and a labyrinth arrangement of the line permits packing more than 400 feet of tanks and washers into a space only 46 by 86 feet. The system cleans parts twice as fast as old procedures.

ATSC photos

Baskets of engine parts, above right, emerge bright and clean after trip through labyrinth of tanks and washers shown below

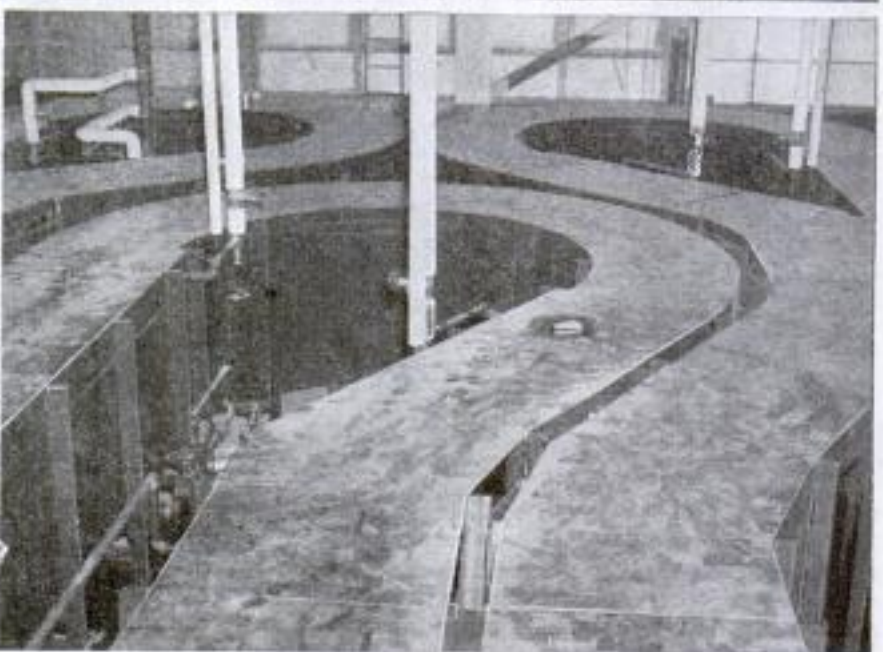

Fluorescent Lights Don't Flicker

Flickerless fluorescent lights are now available for residents in the area of Niagara Falls, N. Y., and Toronto, Canada, where 25-cycle current is produced by water-driven turbines. Development of a special rectifier tube and voltage doubler circuit eliminates flickers in fluorescent lights operating on this current.

More Fish Per Kilowatt

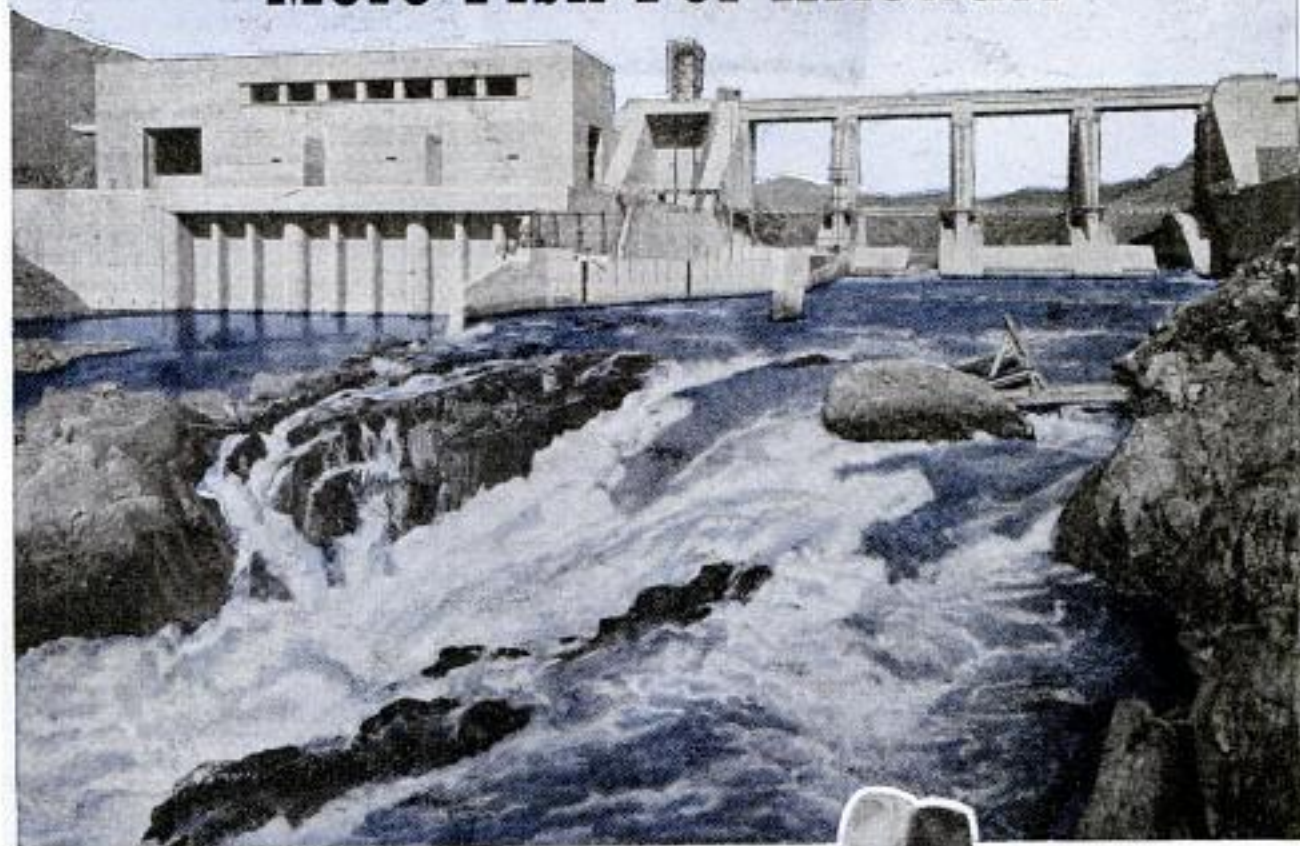

By Joe Mears

FISH ladders have been used on dams since colonial days. Crude or elaborate, they have helped salmon and other ocean fish fight their way above the dams to spawn. Young fish have been able to get past the ladders on their way to the sea.

The demand for bigger and better dams, especially the higher types designed for producing electricity, has brought the plight of migratory fish to the attention of conservationists, sportsmen and commercial fishermen.

"It looks as if we've either got to cross the salmon with the flying fish," said a noted biologist, "or do something about this orgy of dam building!"

When the pressure of commercial and recreational interests became strong enough, protection of migratory fish from the bad effects of dams became big business. On the Columbia River in Oregon and Washington, \$10,000,000 was spent to protect part of the \$25,000,000 salmon fishery from the

Fishway at Keswick Dam is left of center. At right of power house is elevator for lifting fish. Below, a 25-lb. female salmon

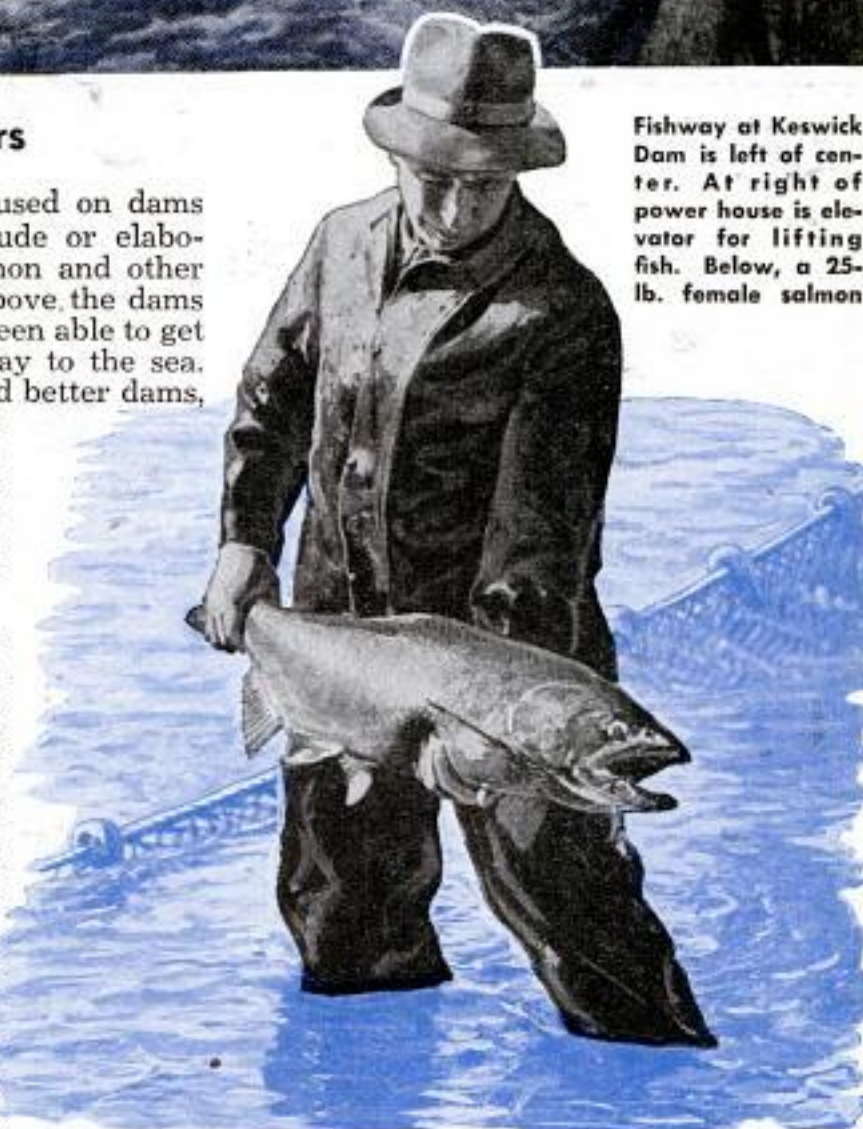

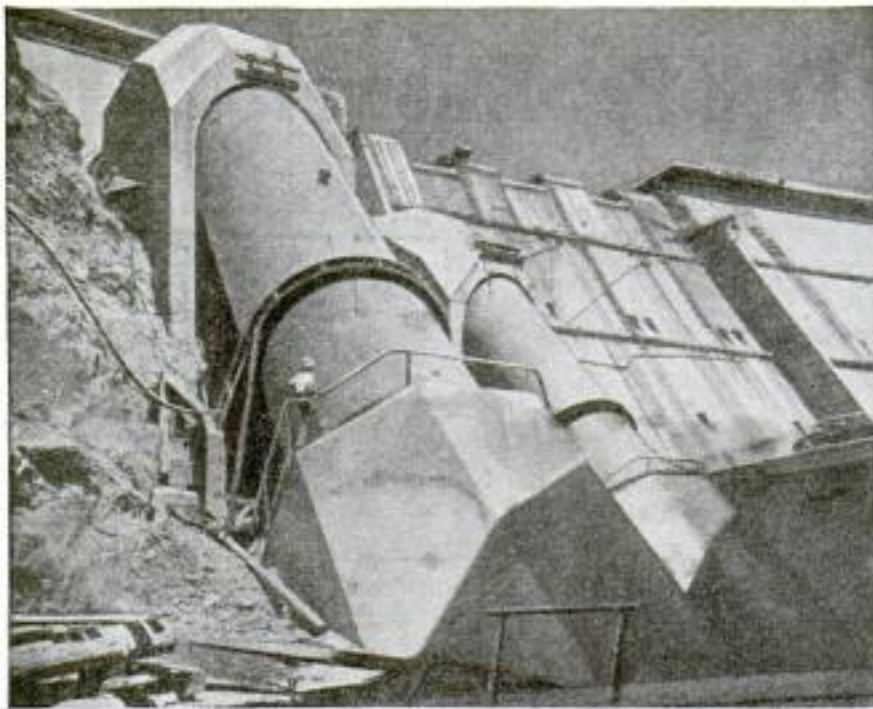

Migrating fish have small chance for life in churning water within these giant penstocks of Shasta Dam

menace created by the Bonneville and Grand Coulee dams. On the Sacramento River in northern California, an initial sum of \$2,000,000 has been spent to salvage as much as possible out of the annual salmon run.

It's a far cry from primitive fish ladders on the Atlantic coast to the multimillion-dollar projects on the Columbia and Sacramento. The development has been gradual. Every large-scale experimental project has required tedious trial-and-error research with mechanical guinea pigs.

Guinea pig No. 1 was the Bonneville project. There more than \$7,000,000 was spent on ladders and other devices designed to give passage to salmon and steelhead runs. Bonneville, 146 miles from the mouth of the Columbia, formed a 75-foot high barrier to fish fighting upstream to spawn.

Due to the moderate height of the dam, fish ladders worked well at first. As results became apparent, hopes of scientists of the Bureau of Reclamation and the Fish and Wildlife Service appear to have been premature. The Department of the Interior recently announced that Chinook salmon passing over Bonneville Dam have decreased to the lowest number recorded. In 1938, when the first count was made, 272,158 salmon went over the dam. The number rose to 461,713 in 1941 but since has declined sharply. In 1944 checkers

at the dam counted only 241,718.

The Fish and Wildlife Service blames this decline on construction of dams on the Columbia River and its tributaries which blocked the fish from their traditional spawning grounds, drying up of streams by use of water for irrigation, death of young salmon in irrigation ditches, overfishing due to lack of controls, water pollution chiefly from sewage and industrial waste, and erosion which has damaged spawning beds.

Young migrating salmon and steelhead must

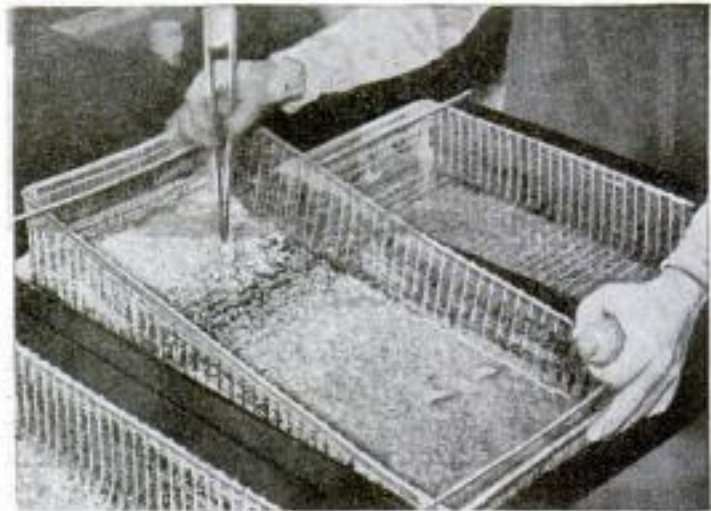

Bad eggs are sorted out in fish hatchery used to stock 151-mile reservoir behind Grand Coulee Dam. Below, fish ladder at Keswick Dam on the Sacramento River where migrating salmon are trapped





Salmon fishermen who enjoy catches like this are alarmed at threat of dams. Left, salmon salvage project on Sacramento cost \$2,000,000

pass through the dam on their way to the ocean, where they live for four years until they are ready to follow the age-old urge to multiply. Checkers have seen large chunks of wood pass undamaged through the penstocks of the huge hydroelectric plant, but they wonder if many salmon could survive the turbulence created by the vast outrush of pent-up water.

Dr. Ira W. Gabrielson, chief of the Fish and Wildlife Service, believes that engineers and the public may be oversold on the success of fish ladders.

"We are justified," says Dr. Gabrielson, "in being encouraged over the success attained in the upstream migration, but the success of the downstream migration is still an unknown factor. No successful means has been developed to guide downstream migrants into fishways and fish lad-

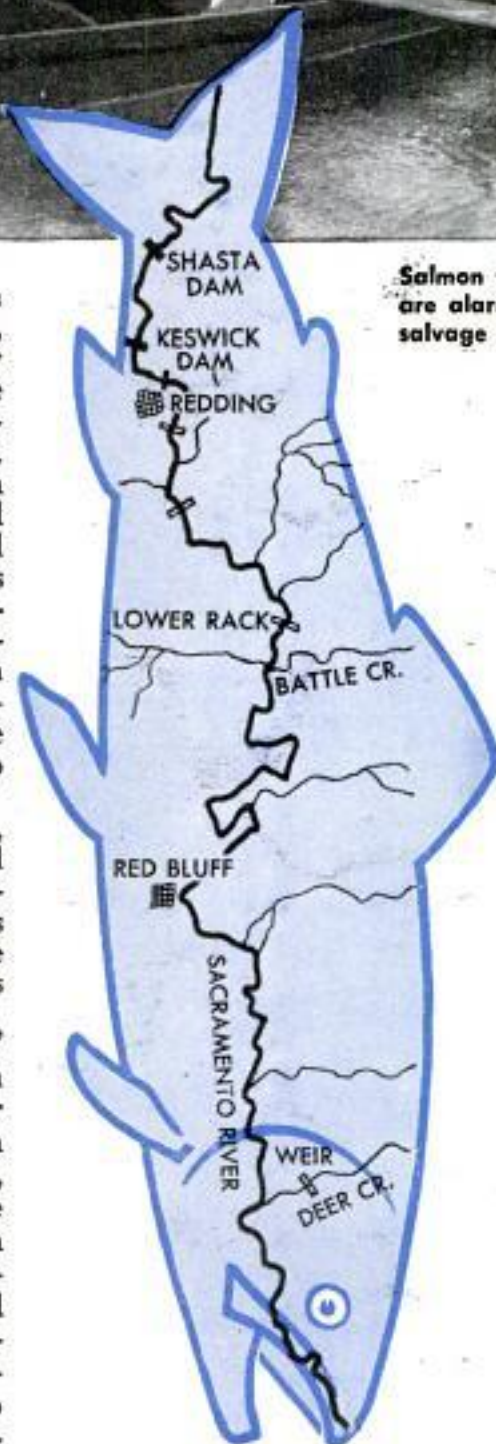

ders. Many fingerling fish probably are destroyed when passing through the turbines and over high dams."

The Fish and Wildlife Service's guinea pig No. 2 is at Grand Coulee Dam on the upper Columbia River, 450 miles above Bonneville, where \$3,500,000 has been spent for investigations, hatcheries, tank trucks and other devices. There is a growing belief that the entire project is more or less of a failure. It will take a couple of years more before scientists complete studies to determine how many salmon trapped below the dam and transported in tank trucks to side streams actually survived to spawn in the unfamiliar environment and how many small salmon were produced.

Regarding the survival of artificially spawned, hatchery reared salmon fingerlings, further studies will be required, but researchers don't think the results will justify the high cost.



Removing eggs from salmon in hatchery; they will be fertilized, hatched, and young fish placed in river

More hope is held out for success in the fight to get more fish per kilowatt-hour at guinea pig No. 3, the salmon salvage project at Shasta Dam on the upper Sacramento River. Many of the earlier mistakes of the Bonneville and Grand Coulee Dam experiments have been avoided.

The Sacramento is not nearly as important a salmon stream as the Columbia, but it is extremely valuable as an economic

and recreational factor in California. As a vital part of the vast Central Valleys project, in which more than 200,000 licensed sport anglers fished in 1941, the Sacramento's future welfare has aroused sportsmen and conservationists.

Chief consultant of the Shasta salvage project was Dr. Willis H. Rich, professor of biology at Stanford University. Dr. Paul R. Needham, for many years aquatic biologist of the Fish and Wildlife Service, renowned for his Pacific Coast trout investigations and now director of fisheries for the Oregon State Game Commission, directed the field work. Dr. James



Trap tank is loaded with salmon which are later put in tank truck for ride to hatchery. Below, 35-mile lake backed up by Shasta is fisherman's paradise



W. Moffett, aquatic biologist, is now in charge of the project.

Shasta Dam, like Grand Coulee, formed an impassable barrier because of its height and nature of construction. Shasta is of the gravity type, 602 feet high, higher than the Washington Monument. It is two thirds of a mile long on top. Three rivers, the Sacramento, Pit and McCloud, eventually will be backed up in their deep canyons as far as 35 miles, forming a great mountain lake.

"Although it might be possible and practical," said Dr. Needham, "to transfer adult salmon over the dam on their spawning migrations, nothing is known as to how they would react when confronted with the slack waters of the reservoir. If the adult salmon migrated up through the reservoir and spawned successfully in the streams above, there would still be the problem of getting the young down past the dam on their way to the sea."

If the young salmon did get past Shasta Dam, they would meet similar dangers at Keswick Dam, nine miles below, which was built to regulate stream flow and generate added power. It was decided that the mortality of fish would be too great to make the transfer of adult salmon above Shasta Dam worth while.

The Shasta salvage plan adopted by the Bureau of Reclamation is essentially simple. It calls for three separate operations. From January 1 to June 15 of each year, 10,000 spring-run salmon are transferred to Deer Creek, a tributary of the Sacramento, in tank trucks, and 2000 spring-run fish are taken to the Fish and Wildlife Service hatchery at Battle Creek to be held until ready for artificial propagation. From June 16 to October 10, 18,000 summer and early fall-run salmon are transferred to the Battle Creek hatchery. From October 1 to December 31, a fall-spawning plan is inaugurated

(Continued to page 152)

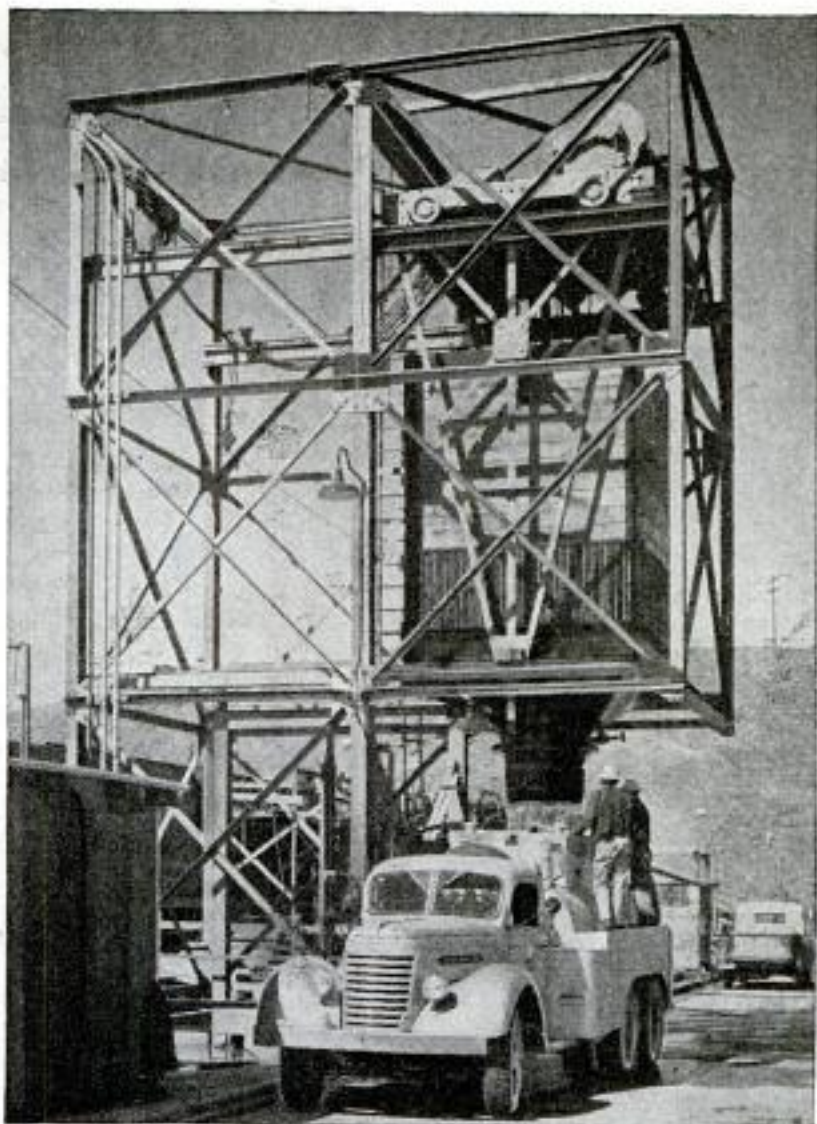

Loading 10,000-gallon tank truck with salmon trapped on ladders of barrier below Shasta Dam. Below, releasing fish into creek U. S. Fish and Wildlife Service photo





LIFE'S A GRIND to the Briton who coupled the rear wheel of his bicycle to a grindstone with a belt, and travels the countryside sharpening housewives' cutlery. The bicycle lets him cover a wide area and his own sturdy legs provide all the power he needs

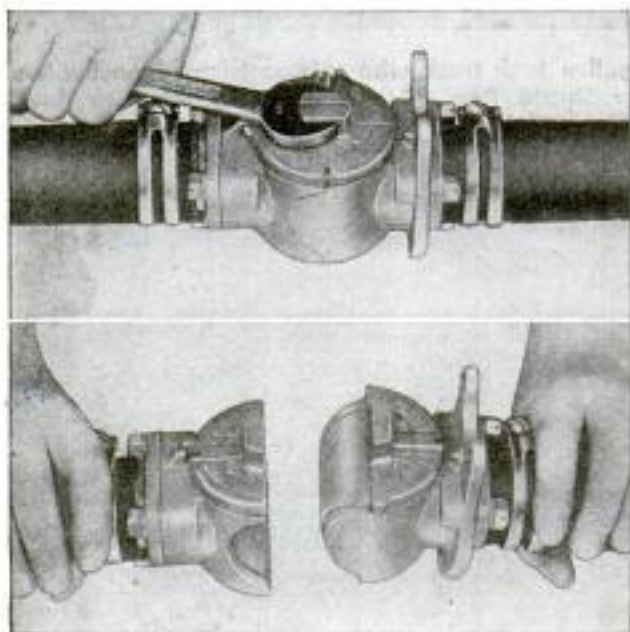

QUICK SEALING is provided for fuel, oil and hydraulic lines by a coupling which can be disconnected with a quarter-turn. Leakage or formation of dangerous vapors are prevented by the quick action. Both ends of the lines are sealed despite the disconnection and either may be opened again for drainage. Reconnection is simply and easily made. Developed for fast servicing of war planes, the coupling is being adapted for use in factories, foundries, refineries and laboratories where lines carry liquid products

"SHOT TREATMENT"

LABORATORIES often are full of smocked technicians and scientific equipment, but Mishawaka, Ind., boasts one that is far different. Its job is to pepper parts of engines and other war equipment with shot for a few seconds, then return them to their maker with a report on the process, known as shot peening.

Centrifugal and tangential forces combine in modern peening machines to throw the shot with high velocity. Shot is fed to the center of a rapidly rotating wheel, called a Wheelabrator, and travels out along blades that throw the shot much as you would throw a ball. The shot are chilled iron drops produced by molten cupola iron falling from a height into water.

Results of the process are: Higher rating of aircraft engines with no weight increase; less weight of engine parts with no decrease in strength; normal life for parts that had been failing prematurely; use of less expensive steels without sacrificing strength; elimination of grinding and polishing. Springs peppered by the shot last up to 20 times longer than unpeened springs. A machine testing the life of peened gears ran so long that its own gears wore out and had to be replaced by peened gears.

Shot peening produces a tougher outside layer on a metal part. The metal in this layer, only a few thousandths of an inch thick, is squeezed together by the rain of shot. Under alternate bending stresses, the compressed surface "gives" enough to forestall the tiny cracks which enlarge and cause failures.

Factories use shot peening machines in production of equipment. The laboratory's role is to establish standards that will maintain uniform results in manufacturing. A plant with its own peening machines may have breakage trouble with a crankshaft. It requires peening standards for time, size and direction of shot and other variables to maintain the best intensity of peening to a gauge height of .014-inch on sides and fillets of the shaft. Off to the laboratory goes the crankshaft. First the intensity is measured by gauge or arc height. When a strip of steel is peened on one flat side, squeezing of the surface layer causes the strip to become dished in shape. Amount of curvature represents intensity of peening, and is measured in thousandths of an inch. The operator uses a fixture and blocks holding test strips to determine the settings for the required intensity. Then the crankshaft itself is peened and returned to the manufacturer with the data.

TOUGHENS METAL

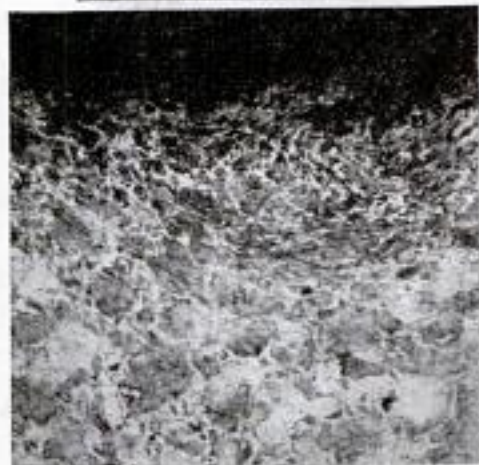
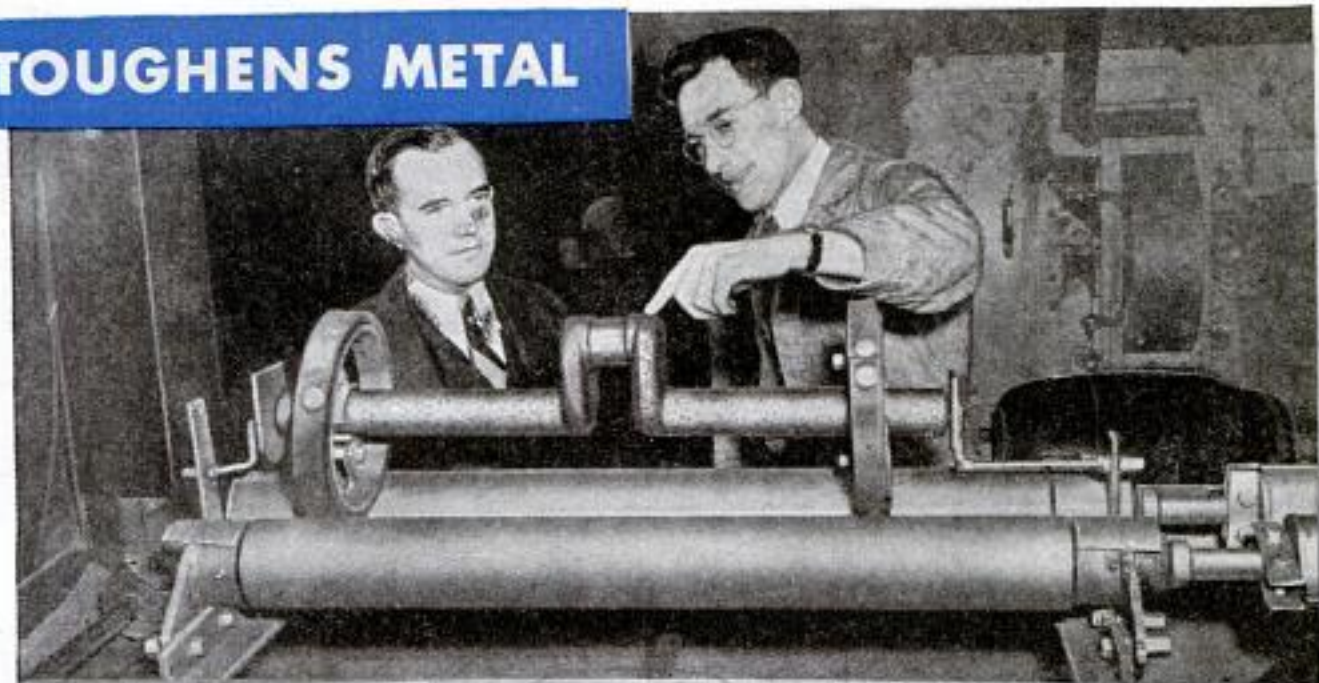

American Foundry Equipment photos
Crankshaft above has been shot peened in peening machine that hurled shot against it at high velocity. Process toughens part by squeezing metal in outside layer. Shot peened steel, left, magnified 200 times in microphoto, shows effect of shot barrage

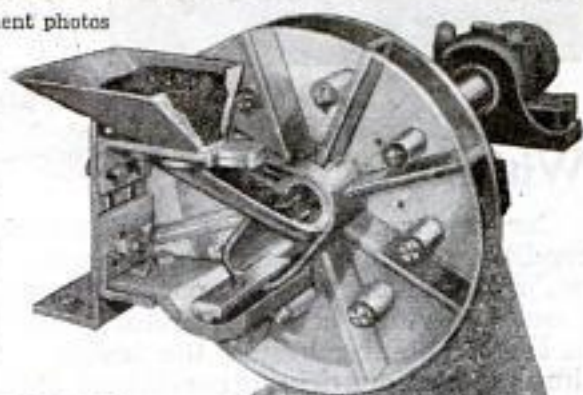

Shot in funnel of Wheelabrator above travels through opening in center to blades of rapidly rotating wheel and is hurled out against metal object



Above is the surface of shot peened steel, magnified seven times. Left, a Wheelabrator multi-table in action. Superimposed lines show the manner in which circular tables travel under blast of shot being applied to gears



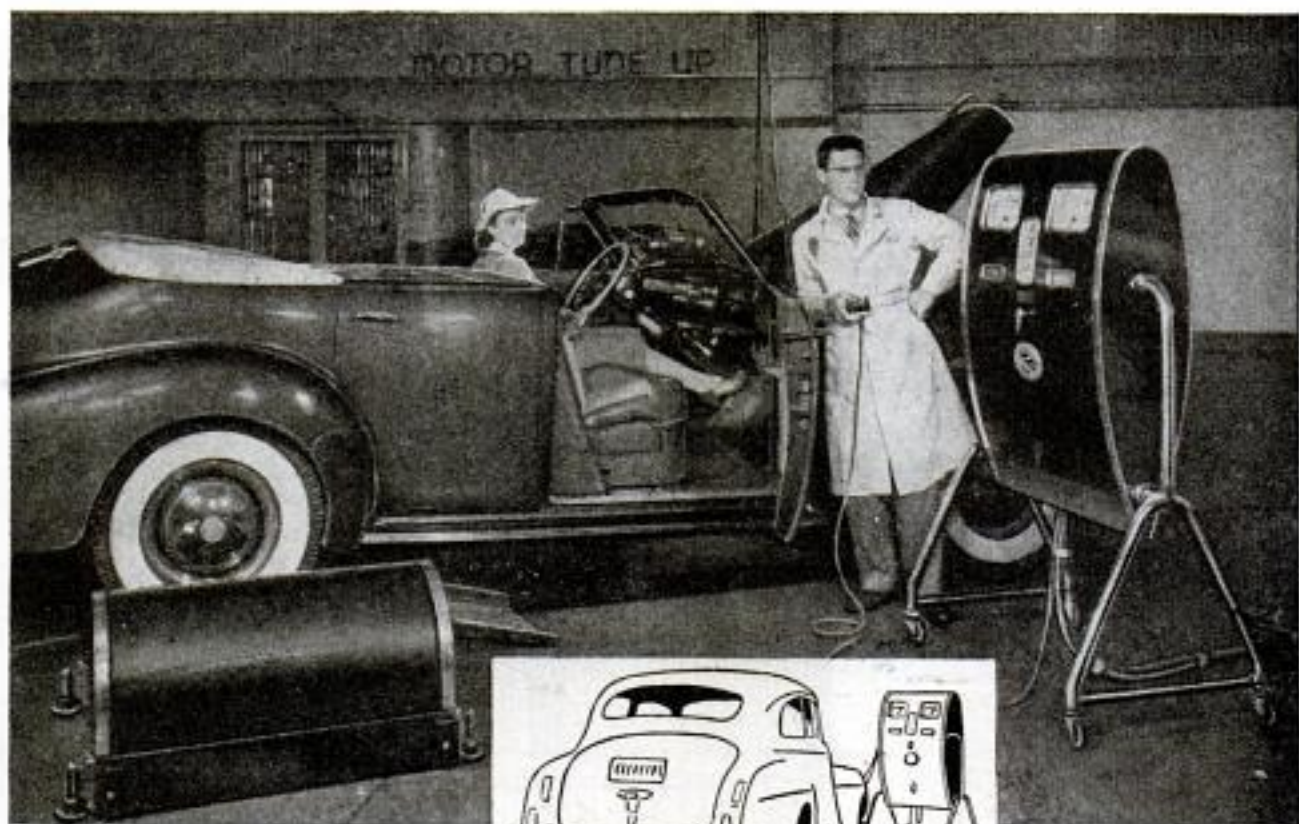

Automobiles Tested Without Moving

Car performance under actual running conditions is shown without the car traveling an inch on a "vest-pocket" proving ground. Giving a complete motor diagnosis in five to eight minutes, the testing unit simulates various driving conditions. Press-

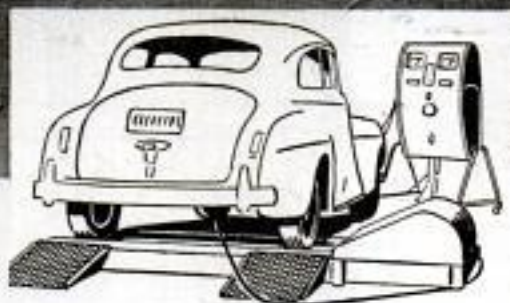

Testing unit requires only a small working area near automobile

ing a button subjects the car to conditions encountered in heavy traffic, on the open road, up a steep grade or under acceleration. The entire driving mechanism is checked and the performance of the individual parts is shown on an easily read dial.

Air-Boat Skims Over Mud Flats Covered With Only an Inch of Water

Employees of the Bear River Wildlife Refuge in Utah reach hitherto inaccessible regions with an air-propelled boat. Power unit and propeller are mounted several

feet above the duralumin shell of the shallow craft. It will travel over mud flats covered with an inch or two of water and on a river or lake filled with aquatic plants. The air-boat is moved from one locality to another on a special trailer that can be backed into the water.



Nails Are "Shot" Into Steel Plates

Extensive postwar use is predicted for a "nail gun" used to patch holes in the hulls of sunken ships. A charge of explosive drives a steel nail an inch and a half into solid steel plates. The terrific impact has almost a welding effect and the joints are said to be as strong as if riveted.

Two Million Car Garage

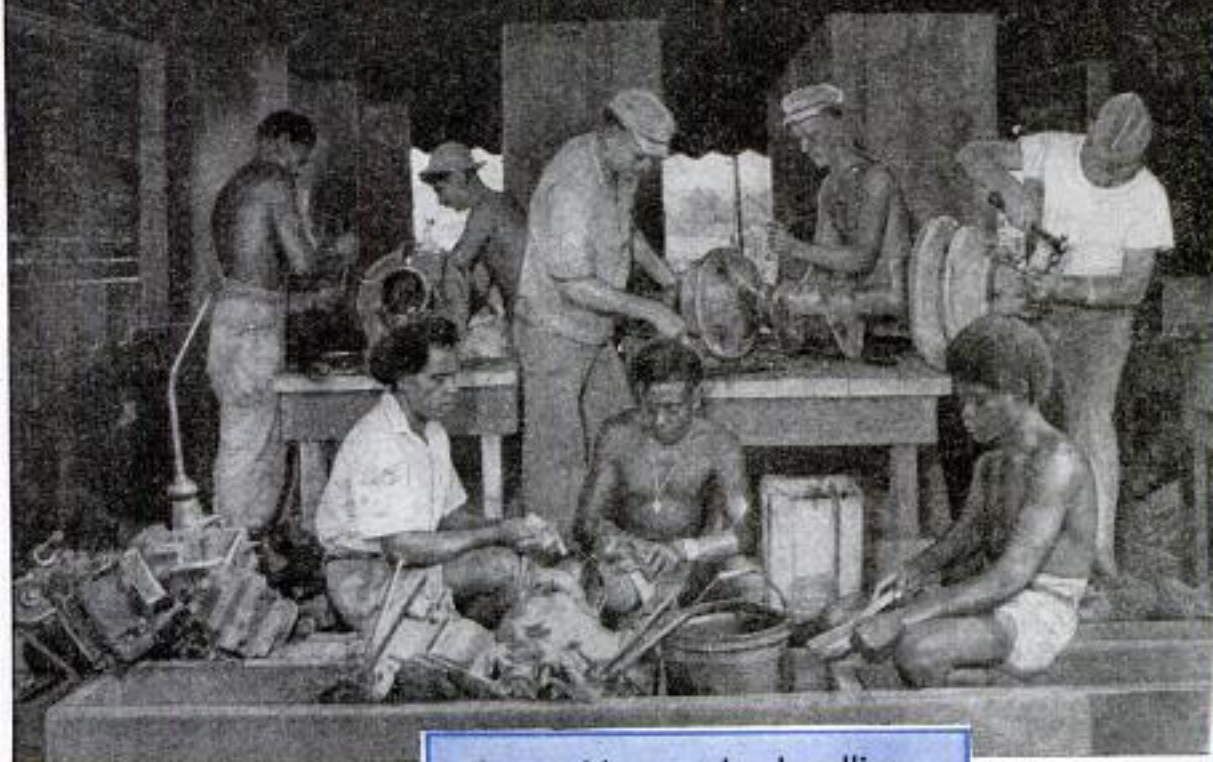

**By Major
Theodore H. Erbe**

IF ORDNANCE shops had not been there to keep the trucks rolling and the guns firing, American troops still might be fighting the Germans and the Japs. These war garages helped vitally to end the war.

The army owns about two million vehicles; in 1944, it obtained five million tons of military equipment which the Ordnance Department maintains. Ordnance issues over 2500 different types of trucks, tanks, rifles, guns, mounts and instruments. It stocks better than half a million individual spare parts. To keep 100 Sherman tanks in the war during their first year alone, ordnance shops required 2800 different parts and assem-

They seldom make headlines, but the ordnance men who operated a worldwide garage and repair shop for 2,000,000 Army vehicles and more millions of weapons have performed a herculean task under orders from the boss: "Throw the red tape out the window!"

Malaita natives work with ordnance troops to repair wrecked Army vehicle parts and other smashed gear

What's a little thing like mud to a U. S. mechanic who knew jeeps had to keep going into Germany?





Soldiers with the 9th U. S. Army replace a tank track near front lines in Germany. Mobile repair crews kept equipment pushing on

Knowing that an army moves on its wheels, Lieutenant General Levin H. Campbell, chief of army ordnance, told his Department: "When red tape interferes with business, throw the red tape out the window. Accept this, please, as a personal order from me!" His troops around the world took this sage advice and won commendations from such generals as Eisenhower, Devers, Patton.

Ordnance field shops, manned by soldiers sometimes augmented by civilians, rendered vital service in China, Alaska, Egypt and Okinawa. They frequently went ashore on D-day, ducking bullets and repairing equipment at the same time. The Stilwell lifeline to China could not have been built without their help. With the largest fleet of trucks in the world to maintain, these globe-spread shops had less than four vehicles in

blies, including a total of 528,772 individual pieces packed in 5212 containers.

In performing this astronomical repair job, ordnance shops daily repaired tens of thousands of field failures, sometimes under enemy fire. Ordnance troops in the 1st Army alone numbered over 15,000, scattered about in an area from 75 to 150 miles wide and up to 300 miles deep; they handled 2500 tons of supplies each day.

each 100 held up for more than four days. Now much of their story can be told.

The army maintains its gargantuan fleet in good repair by organizing all repair work into five echelons (levels). Servicing work and minor repairs, the first two echelons, were accomplished by the units using the trucks or weapons. Ordnance troops in the field performed the remaining three echelons of work. These included

Below, left, GI uses metal spray gun to rebuild broken bulldozer track. Right, fixing faulty transmission



medium, heavy and base maintenance.

Mechanics from these shops invariably moved to the front to do much of their work. Contact parties, road patrols and inspection teams from field shops constantly worked in forward areas. Some ordnance men plied their trades at artillery gun positions and, when they couldn't repair a gun, called back to the shops for a new weapon. One outfit in the 3rd Infantry Division built a truck-borne miniature shop which always worked with front-line combat regiments to render immediate service. Mechanics in Burma once rode horses over pack trails to repair rifles at the front.

The operation of field shops is best understood by tracing a disabled truck or gun from front to rear until it is fully reconditioned. If a Jap gunner knocked out an American 2½-ton GMC truck, for example, what happened?

First, it was removed rapidly from danger and evacuated to the rear by four or 10-ton wrecking vehicles that towed it to a collection point behind the lines. Here all damaged or wrecked vehicles were assembled for processing through the army's giant maintenance system. Huge armored tractor-trailers called "dragon wagons"—able to carry 40 tons of tank without a murmur—hailed disabled tanks and armored

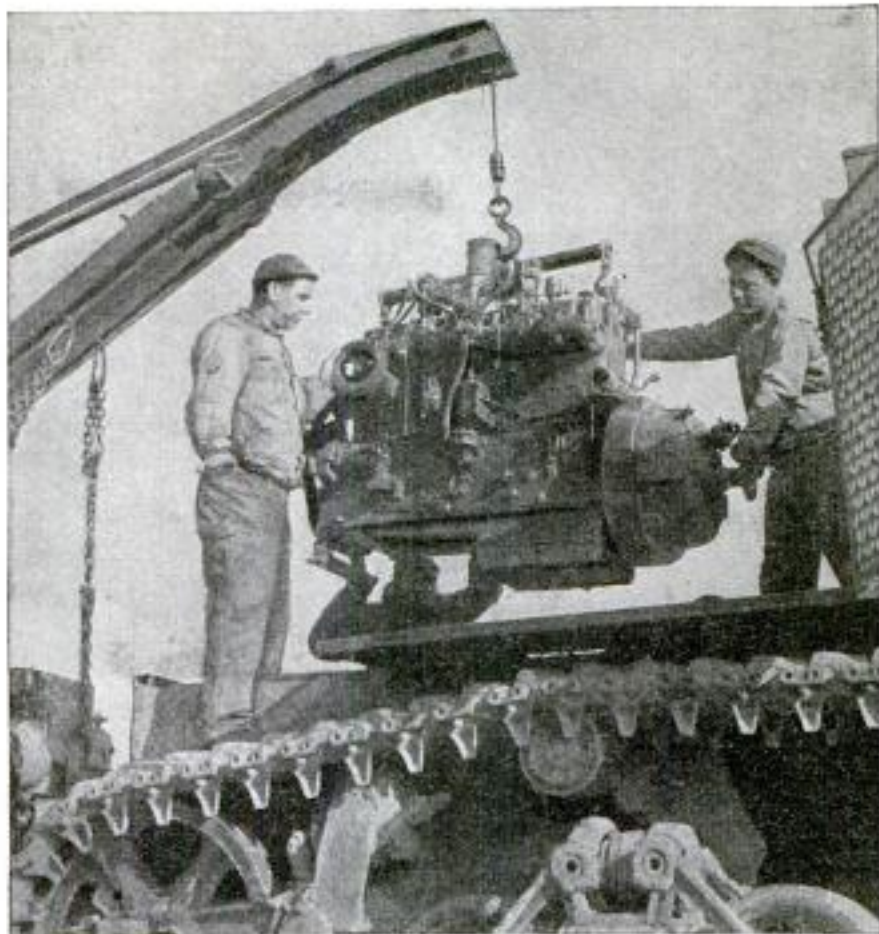

The job of repairing a tank is speeded up by installing a rebuilt engine

vehicles to this point. Ordnance contact parties inspected and repaired what units they could. Men from the division's light maintenance company worked here to the same end. But if these efforts failed to repair the damaged GMC, the truck was sent back to nondivisional ordnance shops.

It arrived at a well concealed medium maintenance company in bivouac from five to 25 miles behind the fighting lines. This fully mobile unit was staffed by six officers, one warrant officer and 169 enlisted men;

To keep 'em rolling, ordnance men operated an engine assembly line in their automotive shop on Guadalcanal

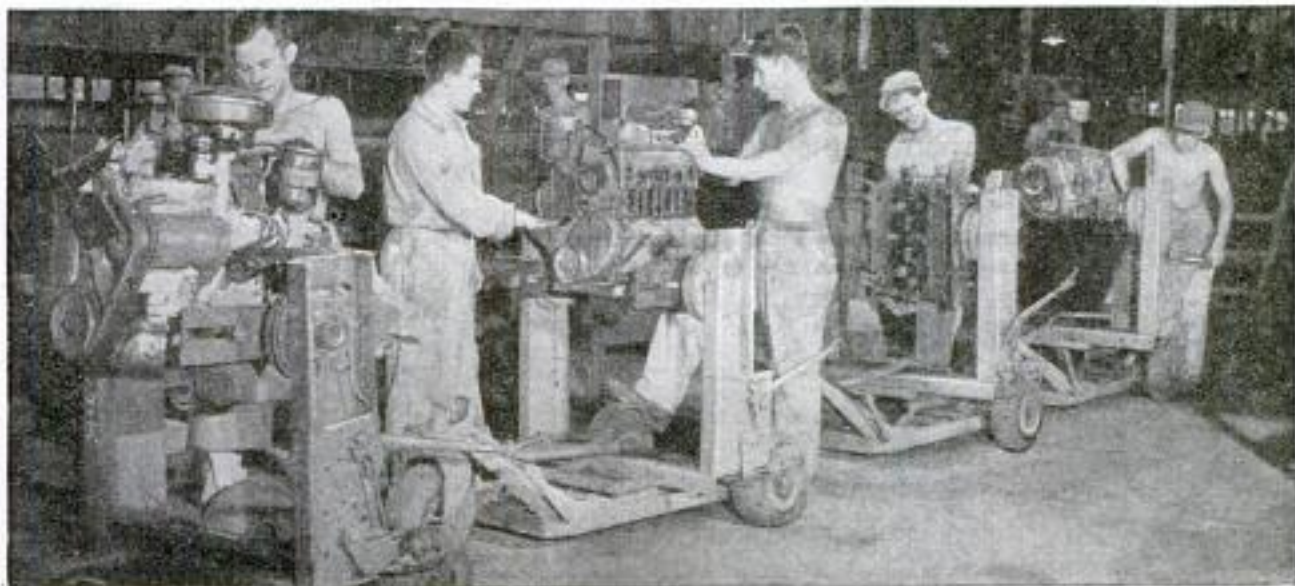

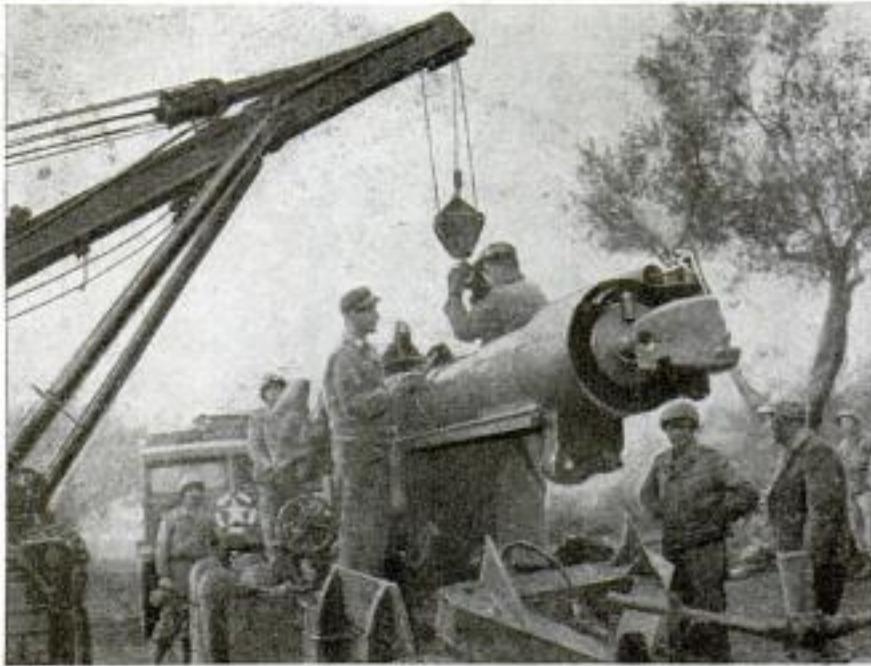

Jeeps or guns, Ordnance kept them fighting; changing a 155-mm. gun tube

its equipment was mounted on trucks for rapid movement, and its personnel frequently worked 20 or 24 hours a day. The unit in standard operation supported one infantry division of 15,000 men with medium or third echelon maintenance. Some medium companies served with the same divisions in both World Wars.

Inspectors checked the damage to the GMC truck, shop office clerks in the field headquarters wrote up a work order directing repairs, and wreckers towed the GMC to the automotive platoon. This group, one of three major parts in the shop, was prepared to change engines, radiators, assemblies such as starters and generators, and perform any type of medium work requiring a reasonable investment of time. The mechanics in this automotive platoon worked in the open, regardless of rain, mud and lack of shelter, often producing from 750 to 1000 completed repair jobs a month. They were forbidden to remove their tools and equipment from camouflaged trucks as this might slow up a sudden movement.

While the automotive mechanics were at work, men from the armament platoon re-

paired a broken machine gun on the damaged truck. Their tools and benches likewise were mounted in shop trucks. These specialists repaired all small arms, divisional artillery pieces up to 105 mm., instruments and fire control items. They even repaired watches.

When either the automotive or armament mechanics needed parts or supplies, they sent to the service and supply platoon which carried a full load of spare parts in specially designed trucks. These men calculated their stockages on the exact numbers of guns, weapons and other items

of equipment for which the shop was responsible. If the service and supply men didn't have the part required, they called upon their machine shop trucks. Crews in these vehicles manufactured vital parts, jigs, tools and fixtures.

If the medium shop mechanics reported that they could not repair the damaged GMC within 24 hours, the vehicle was towed back to a heavy maintenance field shop. Somewhat further behind the fighting, well out of any enemy artillery fire, this heavy shop was only semimobile and moved as infrequently as possible to avoid interrupting its highly technical work. While similar in organization and operation to the medium companies, this heavy company had far more time, tools and skill with which to work. It had a far larger responsibility, too, for it supported at least four infantry divisions and perhaps an entire field army.

(Continued to page 148)

U. S. "dragon wagon" using steel winch-powered cables picks up a disabled tank in three minutes for trip to GI garage



Periscope Gunsight on A-26 Invader

Developed in the final stage of the war, a periscope gunsight on the A-26 Invader enables a gunner to see in almost any direction. The periscope has a sight head on either end and passes completely through the fuselage. With a flip-over mirror the gunner's line of sight is transferred from one end of the periscope to the other. The sight is linked by remote control with two gun turrets which are operated by a single gunner on the medium bomber. As the gunner tracks an attacking plane on a dive which starts high above his own ship and passes far beneath, he can do so without once losing sight of the target. The gun turrets follow movements of the periscope sight and fire is switched automatically from one turret to another. This revolutionary gunnery system was designed and built by General Electric.

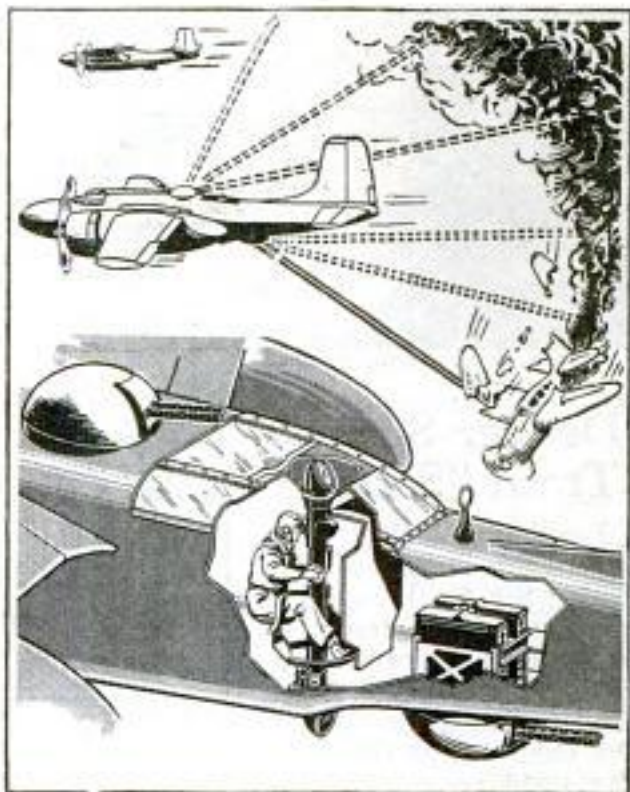
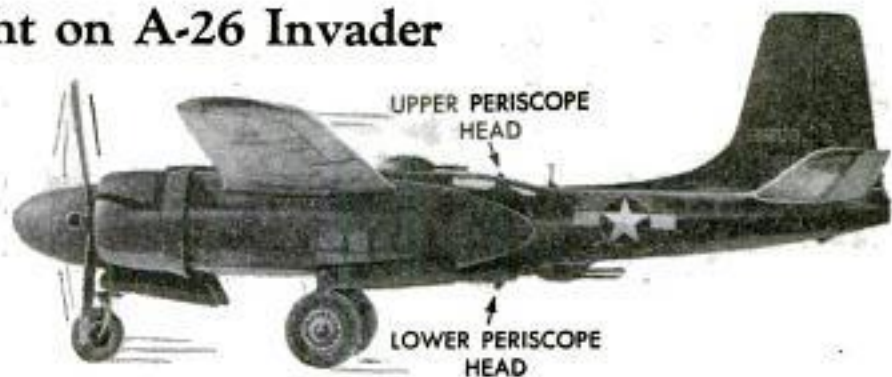

Stratosphere Brought to Earth In Bell Jar Test Chamber

Intense cold and extremely low pressure encountered at great heights are duplicated in a huge Plexiglas bell jar test chamber developed by Wright Aeronautical Corporation technicians. Reactions of ignition systems to the stratospheric air can be observed through the transparent sides of the jar. Besides the airtight dome chamber, equipment includes a refrigerating device that simulates sub-zero temperatures of five-mile heights or more. The dome weighs 350 pounds, furnishing a good air seal when resting on the rubber gasket which rims the edge of the platform. When necessary, a hoist lifts the dome from the platform. Parts of the ignition system being tested are powered by an electric motor. The refrigeration unit is specially built for the purpose. An instrument panel used in testing has a mercury manometer registering pressure within the dome, an altimeter and an electric tachometer.

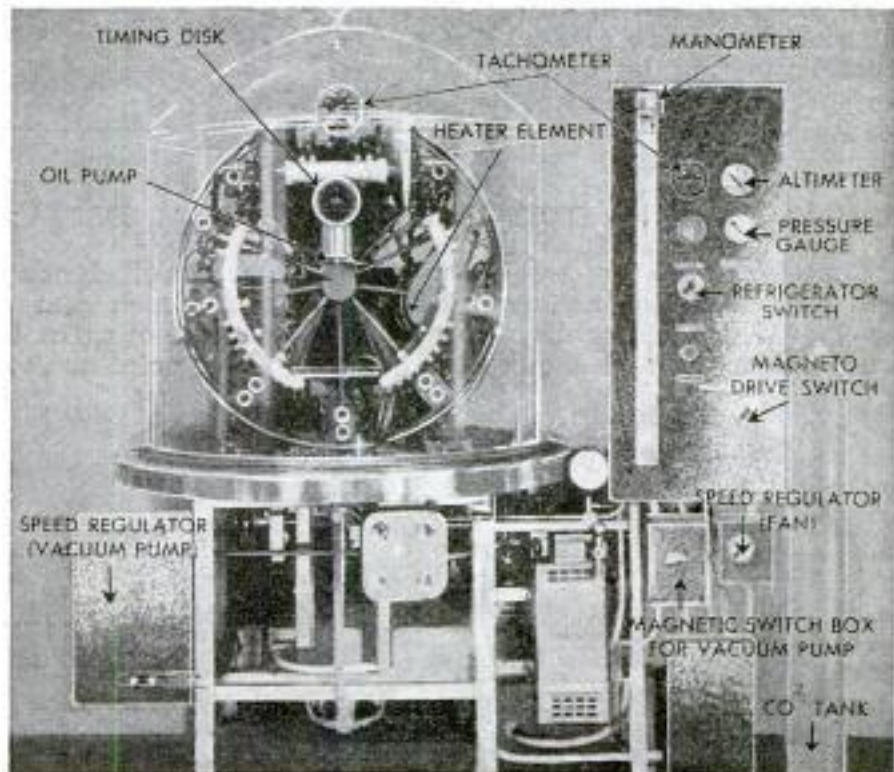

Blind Inspect Roller Bearings by Electronic Sound Gauge

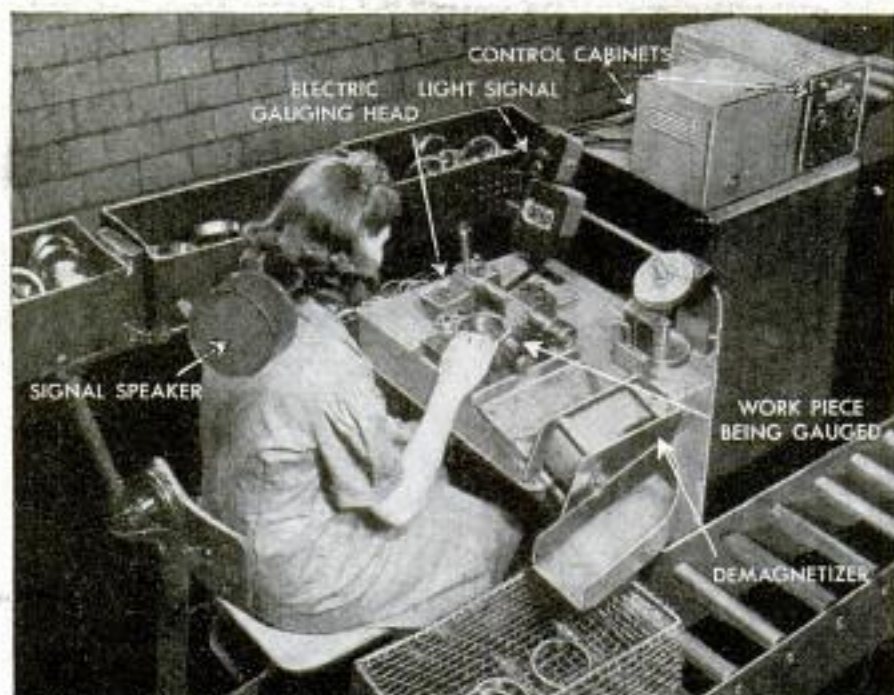

Timken Roller Bearing Co. photo

Fine tolerances in roller bearings are measured by a new electronic precision gauge which permits blind persons to inspect the work by sound. An electronic oscillator sounds a high note through a loudspeaker at the inspector's chair if the bearing is oversized, a low note if undersized, and a middle note if it is accurate. There are also three indicator lights on the system which enable a supervisor to make a quick visual check. The sensitive electronic gauge is accurate to within one five-millionth of an inch.

De-Icer Sprays Train "Shoes"

London's electric subway trains automatically de-ice the track as they go along. Four steel and felt rollers revolve in a bath of de-icing fluid next to the track. When the steel power shoes of the train pass over the rollers, the latter spin and smear each shoe with an antifreeze solution eliminating the need for special sleet trains or trackmen.

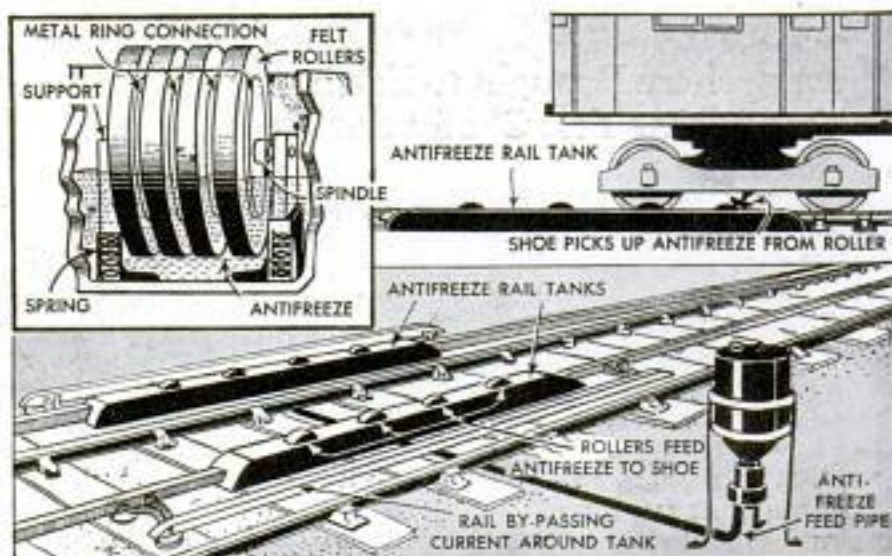

London News-Chronicle sketch

Dial Tells When to Shift Gears for Greatest Efficiency

Combining the features of speedometer and tachometer, an instrument developed by the White Motor Company tells the truck driver when he should shift gears for

most efficient operation. A spiral white line for each gear appears on the dial and a scale of r.p.m. is printed on the speedometer pointer. As the pointer moves around the dial, its edge crosses the spiral white line for each gear, showing the r.p.m. A white area on the pointer indicates the ideal range of 1700 to 2400 r.p.m. and a red area shows the engine is outside this range. When the end of the pointer touches the end of a gear line, a shift is indicated.

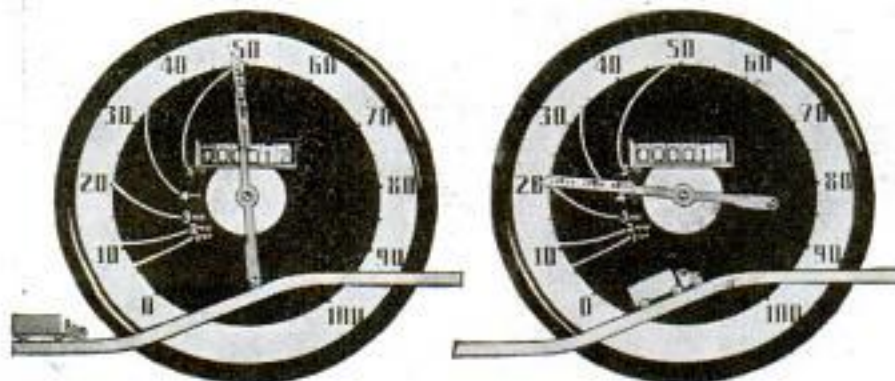

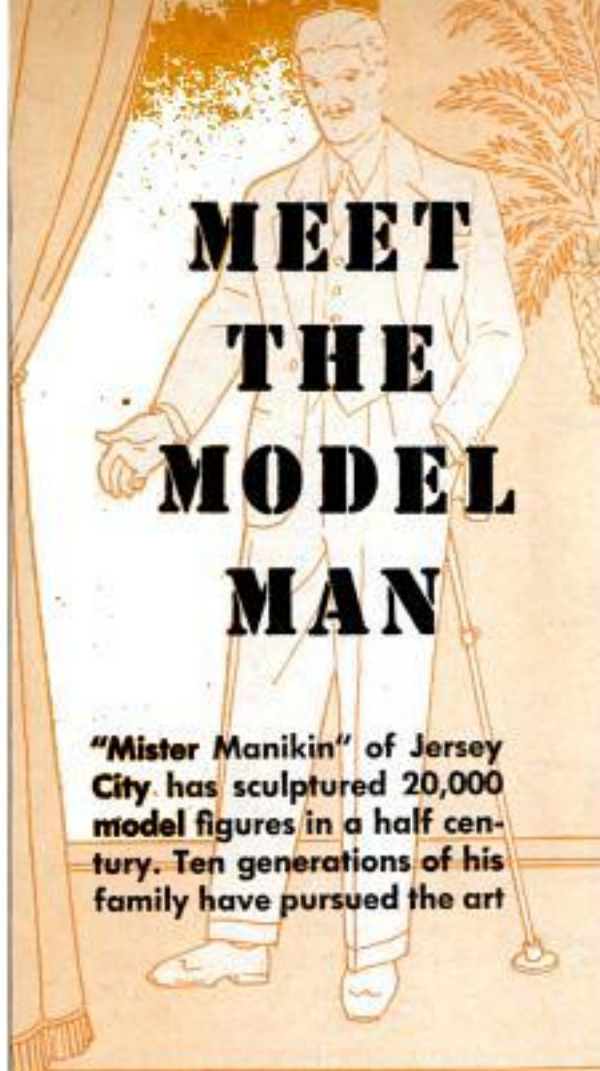

MEET THE MODEL MAN

"Mister Manikin" of Jersey City has sculptured 20,000 model figures in a half century. Ten generations of his family have pursued the art



Leopold S. Schmidt breaks mold and inspects face of wax manikin; cast marks will be scraped or melted off

IN and out of the fraternity of wax sculptors he is known as "Mister Manikin."

Leopold S. Schmidt of Jersey City, N. J., thinks more of that unofficial title than he would of a hundred Hollywood "Oscars." He is the 10th generation of a famous family of wax sculptors.

In the house that has been his home since 1900, Mr. Schmidt carves lifelike figures for show windows and museums. The house is living testimony to his tireless efforts. Clay dust covers everything, and magazine and newspaper cutouts are strewn about every room. His working studio, however, is in the back yard, a two-story wooden affair that was once a stable. Since "Mister Manikin" came to America in 1894, he has sculptured more than 20,000 individual wax figures, which is some kind of a record in this almost forgotten industry.

The Schmidt family's wax artistry has a 300-year history—on both sides of the family. Leopold was only 19 when he came to New York to visit his Uncle Gustav, who created the wax figures for the Eden Musee in 1884. The visit turned into a full-time job aiding his uncle in sculpturing museum figures and manikins. "I couldn't convince my uncle," said Leopold, "that the future for manikins lay in department stores, and

that we should promote them for window displays."

The first thing he did when he ventured out for himself was to tour the nation's key cities, talking to department store display managers. The idea was new and intriguing, but the road was difficult for Schmidt. Twenty years ago there were only about 150 firms in the United States using manikins. Today, there are thousands, exclusive of Hollywood's vast movie industry. A full-length Schmidt wax figure in 1900 cost \$150. In 1925 it brought \$350. Today Schmidt's price is about \$600.

In 1925 he began concentrating on museum pieces, principally because the orders for specialized pieces came in unsolicited. His authentic reproductions of famous people and historical episodes have been admired by millions of people at fairs and expositions and in wax museums. His life-size reproduction of the signing of the Declaration of Independence, displayed at the Philadelphia Tricentennial Exposition, is regarded by Schmidt as his finest work.

He is proud of his "breathing" mechanical figures in wax—probably the only breathing wax figures ever made—depicting a sleeping soldier, his wife and child, which he created in 1943. Experts, how-



Schmidt prepares figure of average AAF flier for mold; it was used to make copper model for testing heated suits. Below, torso of AAF figure

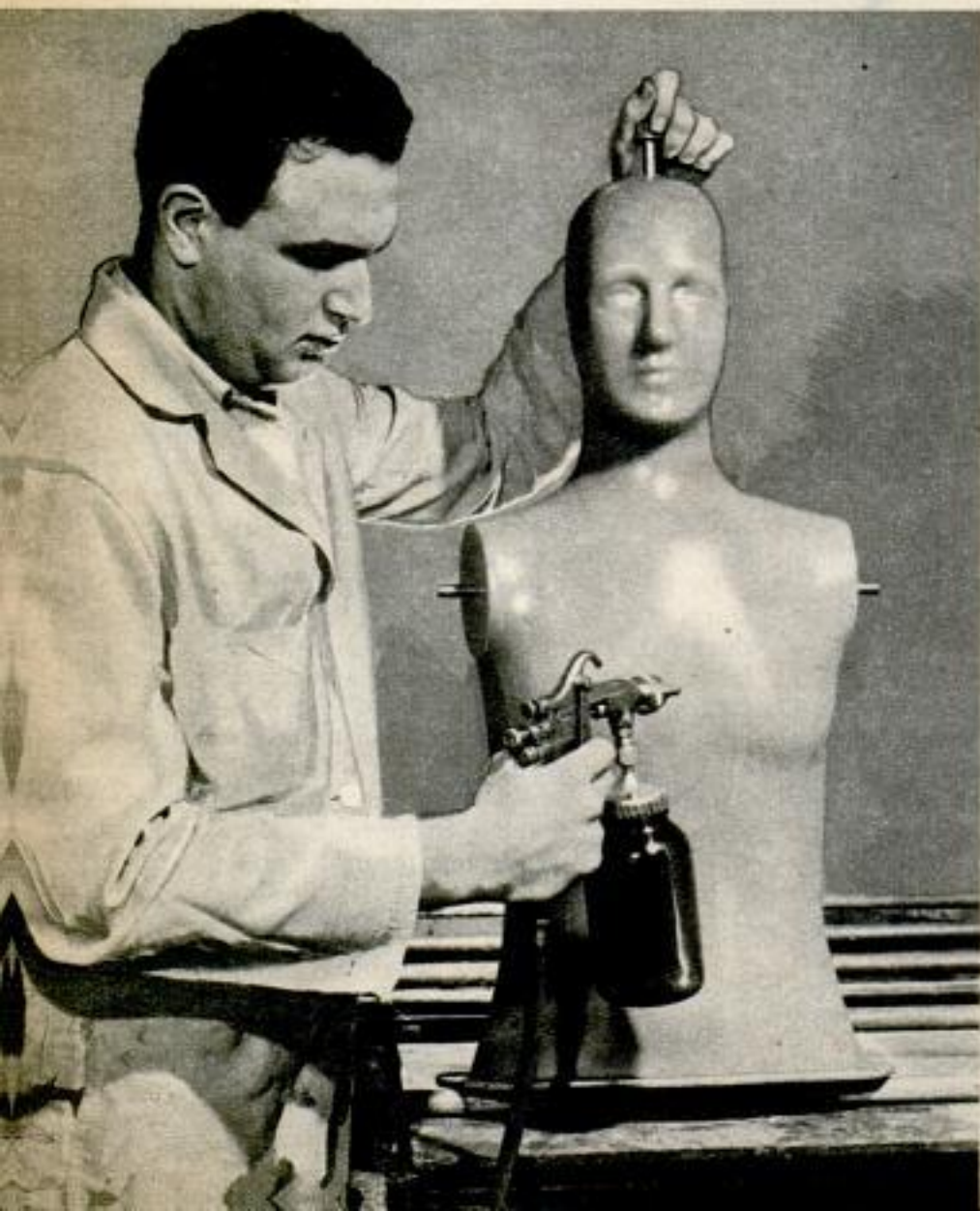

ever, maintain that his depiction of Leonardo da Vinci's painting, "The Last Supper," one of the high spots of the Atlantic City Steel Pier's permanent museum, rates among the best wax sculpturing of all time. Recently his "Spinners of All Nations," an attraction in the Museum of Science and Industry at New York's Rockefeller Center, is drawing favorable press acclaim. He has made many church figures, including wax reproductions of the Madonna and Child, and of Christ, as well as many of the Saints. Hollywood has also beckoned, and here lies, according to the artist, a tremendous new field.

Occasionally, Schmidt is called in for an unusual assignment by a captain of industry. George Matt-hem, the late vice-president of Standard Oil of New Jersey, once commissioned the wax sculptor to make a bronze bust of himself. Schmidt considers jobs like this a profitable sideline.

His most unusual contract came from the General Electric Company. Last year General Electric authorized him to build a "copper man," resembling both in size and features an average man. It was to be used for testing electrically warmed flying suits, casualty blankets and other equipment worn by bomber crews. It would, in other words, replace the human guinea pig. Each portion of this figure was so carefully worked out that the final job became a composite of the average Air Force man.

True to the Schmidt tradition, Leopold began to break his family into the business at an early date. His wife, son, two daughters, sons-in-law



and five relatives of his wife all work for him. He trained each of them personally. His wife and one daughter have complete responsibility for selecting, buying and putting on the hair. This is quite an important item, since only human hair is used and a half pound is required for the figuré of a woman. Most of these hair-selling firms secure their merchandise from Europe where peasants sell their hair for cash. A small quantity comes from China. An average head of hair for a Schmidt female figure costs \$48!

His son Walter is now an all-around expert and is shop foreman. Walter is unquestionably the heir to the title "Mister Manikin." One daughter specializes in painting the completed figures, and in accumulating ideas from current magazines.

Schmidt's business, oddly enough, is seasonal—at least as far as the manikins are concerned. His models are begun in November and December, and must be ready for trade display by January 15. Orders secured on the basis of these models must be ready for store windows by June.

Lifelike wax figures made by "Mister Manikin" depict signing of the Declaration of Independence. Below, arms of dummy are dipped in electric bath to copper-coat wax

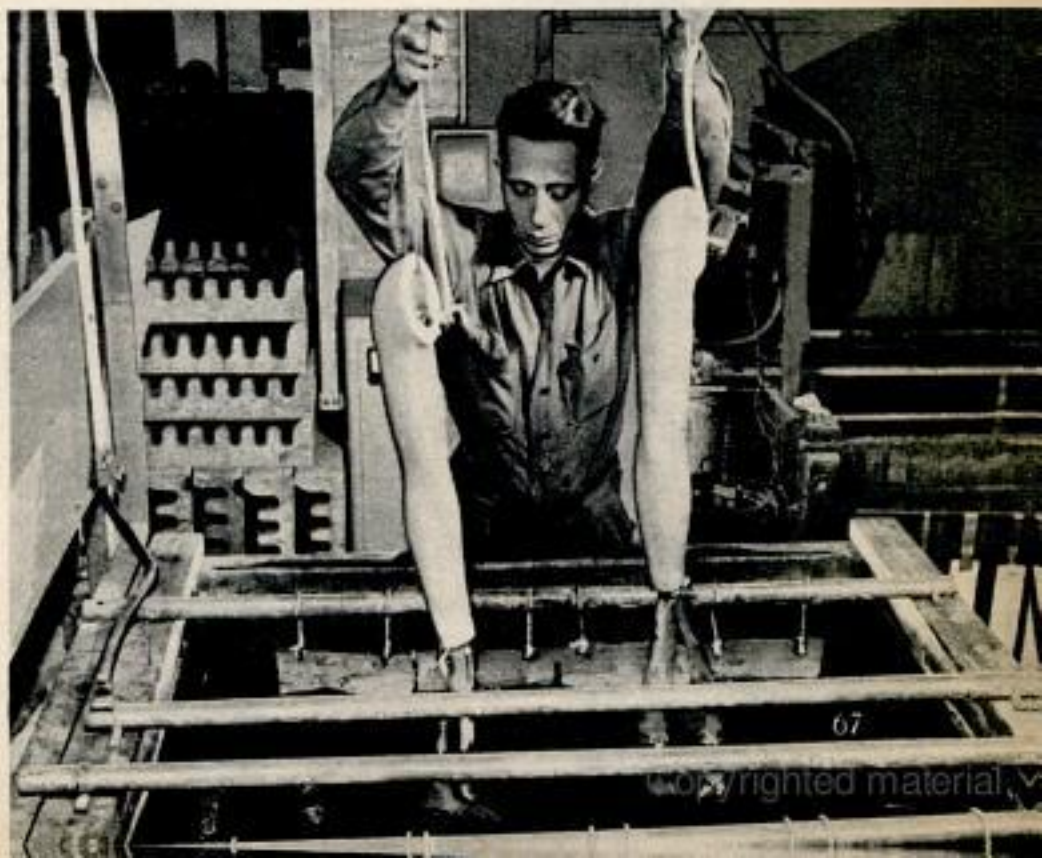



To form manikin body, Schmidt presses special clay onto skeleton made of lead pipe connected with wires; full-size figure takes 20 feet of lead. Below, applying an undercoat of paint



Schmidt employs the same method in making all his figures. He makes a skeleton from lead pipe connected with wires. For a full-size manikin this takes about 20 feet of lead and about four hours of concentrated work. Then he prepares his clay. He uses a special clay formula because ordinary clay dries out too quickly. The clay is pressed onto the skeleton by hand, forming the bulk of the body. After waiting one day for the clay to become workably dry, he takes his modeling tools, using the sling mainly for the contours. His fingers are still his most agile and adept tools. Satisfied that the human likeness has been achieved in body, Schmidt then cuts off the arms, making the arms and hands separately. The model, therefore, is only of the torso, looking very much like an Egyptian mummy. This model is cut in two—the upper torso and the lower torso. Then molds are made of plaster of paris and in three days they are ready for the wax treatment.

A specially prepared melted wax is drained into the molds and chilled at room temperature for three hours. The molds then are broken, and out comes the wax manikin, sans coloring, hair, eyes or arms. Schmidt inspects the figure, taking out all cast marks with scrapers and melting tools. The job of putting the body together now begins. Schmidt uses wooden joints in his creations.

The manikin is polished and washed with turpentine, and then hand-painted. This is most important, for the "personality" of the manikin is reflected in its own coloring. Schmidt selects the glass eyes that best match the personality he is striving for and inserts them. Then the hair is pressed in strand by strand by the expert Mrs. Schmidt. To accomplish this, she uses a needleholder with the eye cut in half. The hair is at-



tached to this and pressed three quarters of an inch into the wax scalp. It is so firmly held there that the hair can be combed, washed or shampooed without fear of coming out. Eyebrows and moustaches are inserted the same way. The wax manikin is now ready for delivery.

Sometimes, Schmidt makes manikins out of papier-mache, a composition of plaster, burlap and mache. This he does only on special orders. The steps are quite similar, differing only in that metal castings are used for joints instead of wood, and in "stuffing the mold." Layers of papier-mache and glue are spread in the mold (known in the trade as "pasting it out"), and, instead of being chilled as is the case with wax, it is placed in a drying cabinet at 125 degrees and baked for two days. Then the mold is broken, and the manikin is first smoothed, then subjected to special undercoats of casing paints, lacquered and finally hand-painted. The only other startling difference is that wigs are used and eyebrows painted onto the manikin.

Like most artists, Schmidt has a hobby—flying. In fact, it's a family hobby. In 1936, at the age of 61, Schmidt, his son Walter and his two daughters made their initial visit to a nearby airfield and went up for the first time in a sightseeing plane. All four became student pilots, receiving licenses.

"It's a funny thing," the 71-year-old sculptor remarked, "what can happen to an industry when a few people change nationalities. Wax sculpturing was originally a European industry—you might say a German one, even though Vienna and Paris had great wax artists, too—but today America is the world center for such art. Europe will have to look to the United States from now on."

Mister Manikin ought to know.



While manikin "holds still," hairs are inserted one at a time three fourths inch into wax scalp; it can be shampooed and combed. Below, placing real hair wig on papier-mache manikin

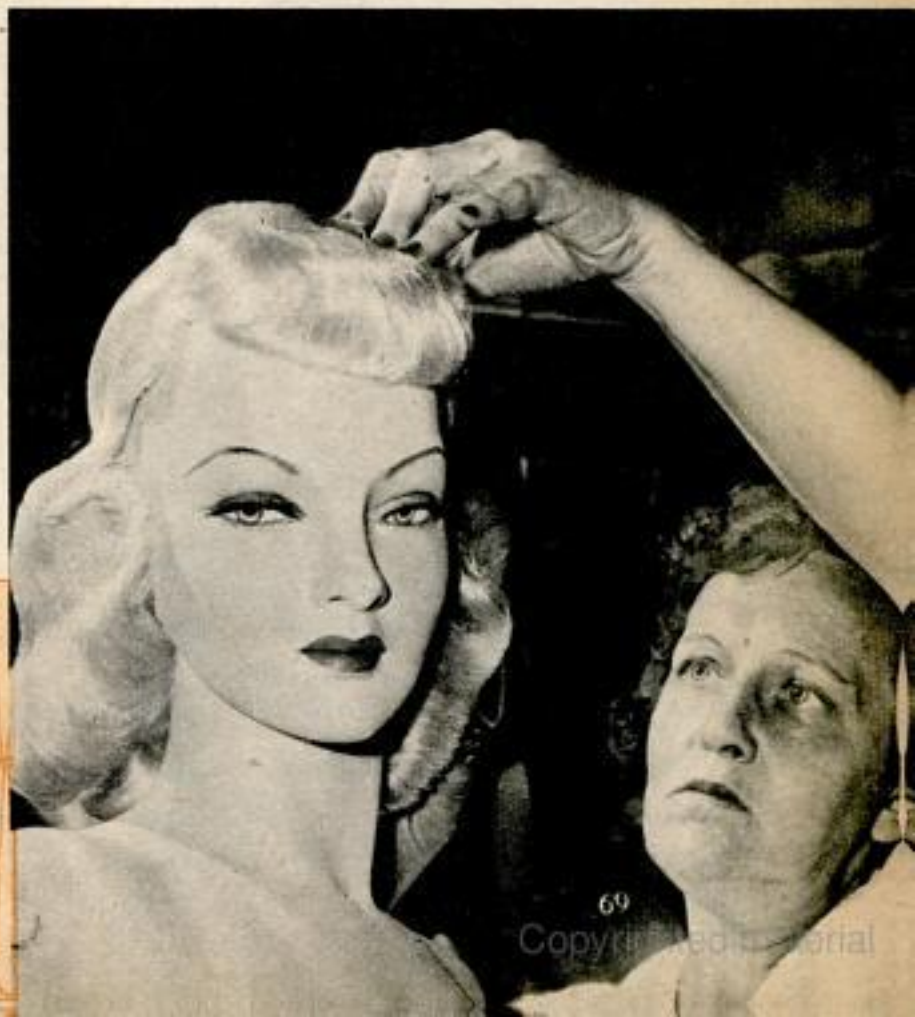



SIPHON TUBES made of transparent Tenite plastic are used for irrigation purposes. They are easily bent to various shapes to carry water from ditches to plants



PUSH BUTTON bomb control panel was developed by the Army Air Forces' armament laboratory to improve the accuracy of dropping bombs by manual control



ELECTRIC EEL generates enough current to light up 48 small bulbs in a demonstration at the Bronx Aquarium



HYDRAULIC PUMP for straightening bent frames is demonstrated by Sgt. Joseph Ferrara, Montclair, N. J.

INGENIOUS Army Air Force mechanics used a section of metal landing strip as a ramp to load equipment—even war vehicles—aboard huge cargo planes



LIFTING 1000-pound drums—a back breaking job—is performed by an air lift. The equipment consists of a double-acting cylinder hoist and three-way valve
Compressed Air Institute photo





U. S. Navy photo

AMBULANCE SERVICE for crippled planes was one of the duties assigned to U. S. Navy propulsion barges shortly before the Japs surrendered. As demonstrated in the above photograph, one of the barges, originally built as a pontoon barge to form part of a causeway, was used to transport a damaged Martin patrol bomber to a repair base. Seabees utilized the barge for this type of rescue work during the Okinawa operations

Air Technical Service Command photos

Droppable Cover For Sighting Blister

Side windows used by waist gunners on Superfortresses are protected by jettisonable covers. They keep the sighting blisters free of mud on takeoffs from wet airstrips. The covers, developed by the Air Technical Service Command, are made of cotton duck with a section of transparent material which makes it possible for the gunners to give their customary takeoff reports to the pilot on landing gear, flaps and engine performance. The cover is fitted with button holes at the edges which slip over metal clips attached to the fuselage. It is jettisoned with a cable threaded through holes in the clips and passed into the fuselage at the top of the window. The cable hole is plugged to allow for pressurization of the cabin.

☐ See the index, page 8A, to find where to buy products described in this magazine. Say you saw it in Popular Mechanics.





"Electric jeep" is plugged into B-24 to supply auxiliary power at Pueblo Army Air Base. It replaces back-breaking pushcart power plant. Box in rear contains a folding work table and toolbox

Clever These

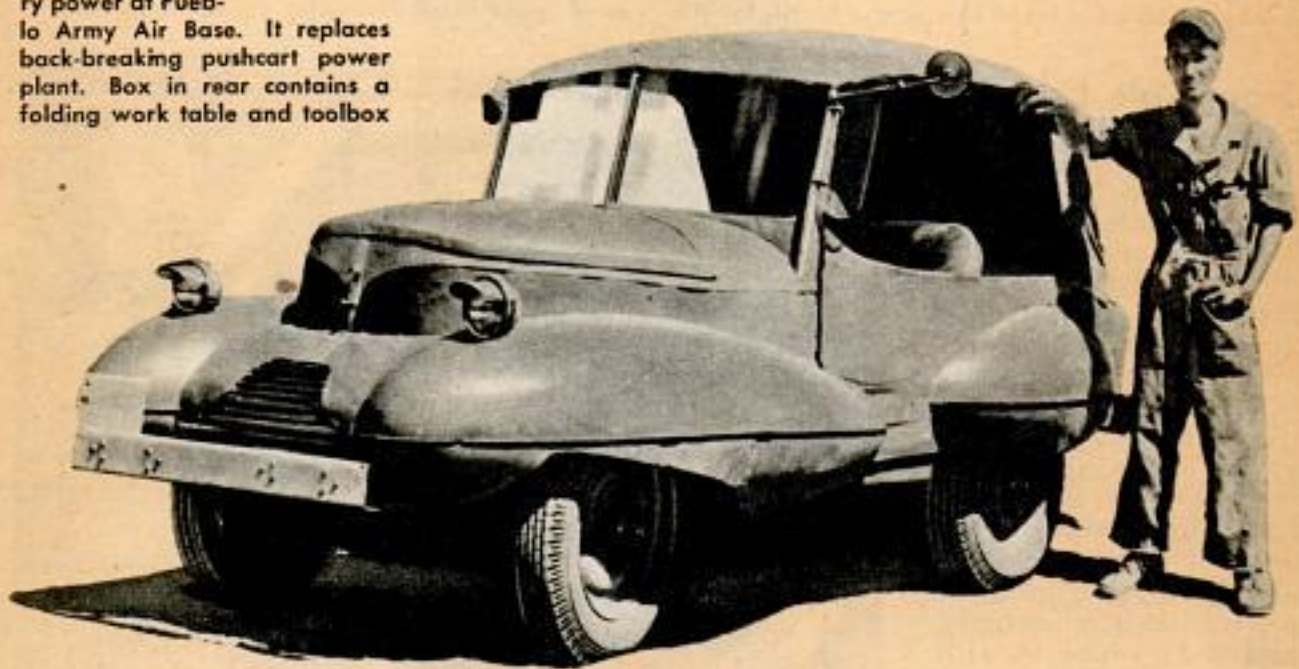

Those teardrop fenders were made from belly tanks of a P-38 and the front grill was part of ammunition rack on a B-24. T/Sgt. Wayne K. Pike of Pittsburg, Kans., stands beside his transformed jeep at a 13th Army Air Force base

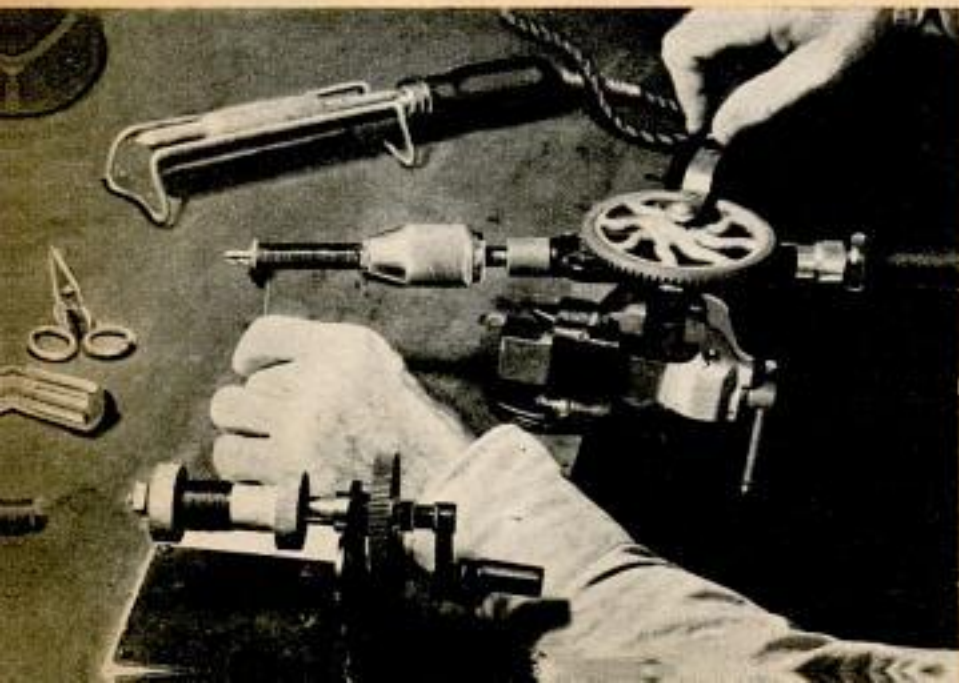

Left, rewinding coil on ingenious device built by men in radio repair section, 37th Division Signal Co. Wire is unwound from coil onto spool by turning crank and after break is found and soldered the wire is rewound





Yankees!



Curtiss-Wright Corporation reports an unorthodox method for straightening a bent propeller on a China airfield. With Japs advancing and no time to spare, the crew rammed jeep against tip to straighten blade

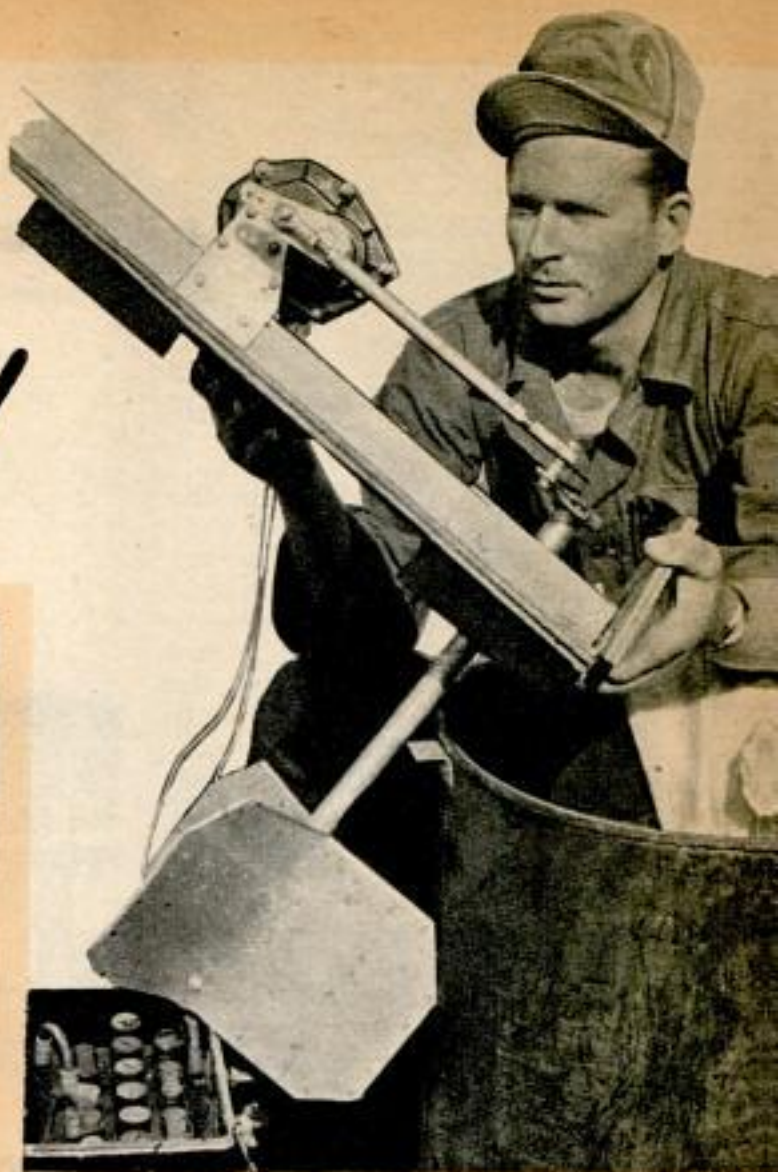

Building washing machines was a favorite pastime of inventive GIs. A Denver, Colo., private employed scrap from an airplane junk yard in England to put together his version of an electric washing machine

Below, transporting gasoline to advance air bases far beyond the reach of pipe lines was a major problem of the AAF. One outfit mounted tanks on trailers which rushed thousands of gallons to the front



Below, patching the thin skin of damaged bombers was a headache at the Pueblo Army Air Base until special maintenance car was built. It carries air compressor for riveting, generator and air storage tanks



"Picket Fences" on Wings Act as Brakes on P-61

Brakes "sprouted" from the wings of the Black Widow P-61 night fighters shortly before the war ended to prevent the fast planes from over-running enemy aircraft. Resembling little picket fences, the brakes enabled the Northrop-manufactured planes to slow down more quickly. Aerodynamicists report that the new brakes exert a force of one "G" when applied full force, which means the plane slows down so quickly that fliers are pushed forward by inertia at pressure equal to their own weight. Another late improvement was a "high activity" propeller designed to absorb the increased thrust of the ship's two Pratt & Whitney engines.



Cargo "Wing" Carries 3½ Tons and Accommodates 24 Passengers

A new airplane built under Burnelli flying wing patents carries 700 cubic feet of cargo in a space 20 feet long, 6 feet high and 6 feet wide. In addition, the plane holds 24 passengers and a three-man crew and has a galley and coat room. Wide doors at both sides of the ship can be removed for loading

freight. Powered by two 1200-horsepower Pratt & Whitney engines, the plane has a maximum speed of 200 miles per hour, cruising speed of 185 m.p.h. and a range of 2000 miles while carrying 3 to 3½ tons of freight. It was developed, built and tested at Montreal, Canada.

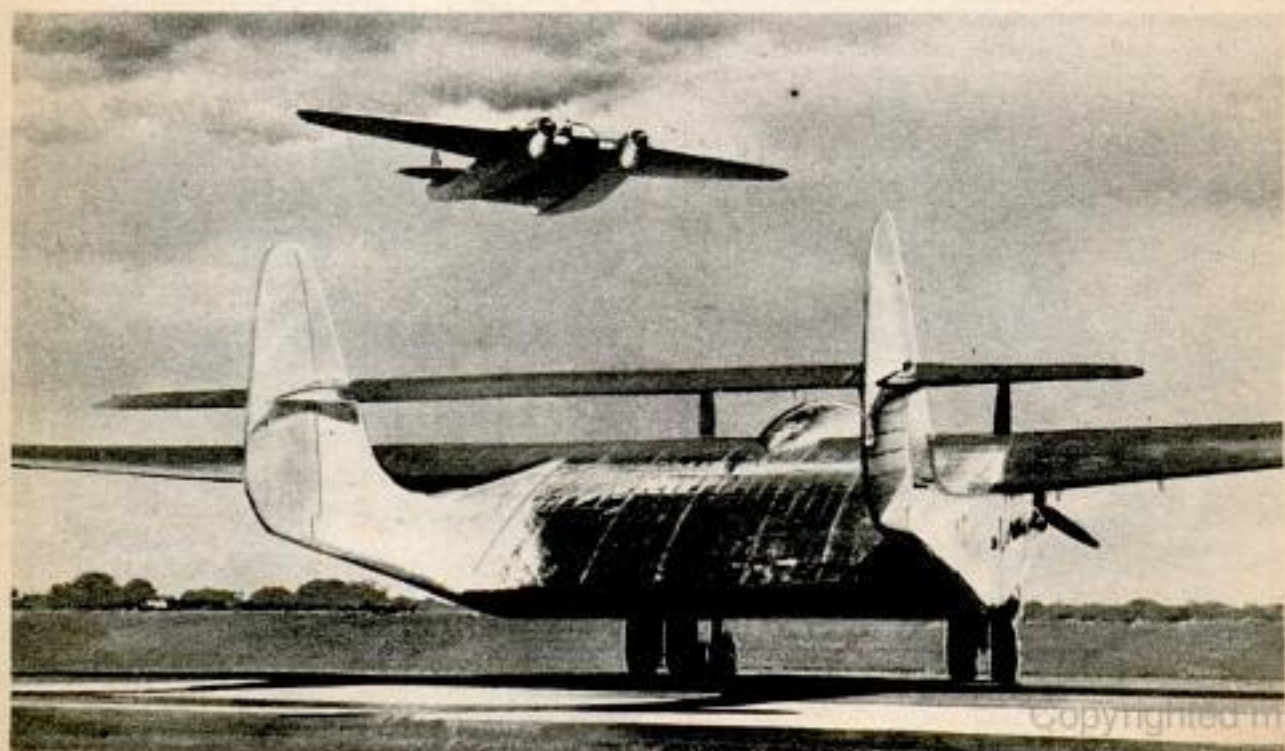



SHOPPING FOR FURNITURE?

Here are some pieces for the compact, modern home which serve several purposes and leave you plenty of room to turn around. Wall cabinets (above) extend across an entire wall with compartments for phonograph records, books and hidden writing desk

Chairs were once just something to sit on, but the designer who created the quilted job (above) added a hollow arm which will serve either the lady or man of the house. She can use it for a sewing kit or he can cache his pipe, slippers or magazine in it

Below, glass-topped dining room table has a built-in steam compartment in the center. It is designed for the home without domestic help, and for the hostess who dislikes running back and forth between kitchen and table. The table serves an average family

Below, this one is called the V-table—for versatility and variety. It's a combination china cupboard-dining table. The table divides down center and spreads in V-shape to seat more guests, or it can be fully extended and shoved back against walls



Green Grow the Atolls

The GIs wanted corn on the cob, fresh milk and watermelons, so they turned the islands of the Pacific from Oahu to Okinawa into an immense victory garden



Natives unload watermelons grown on Guadalcanal for GI meals. Below, cattle arrive at Guam to give fresh milk to the wounded

LETTER from a marine:

"Dear Mom:

"Believe it or not, we've had corn on the cob three times this month and cabbage and cucumbers every other day or so. It's a treat to dig into some fresh food after all these months of canned stuff . . ."

Multiply this sentiment by several million and you have the testimony of every U. S. soldier, sailor and marine in the Pacific—that crisp vegetables, cool fresh milk and other delectables, produced by American methods in the Japs' back yard, greatly aided our boys' health and spirits.

Quietly and without fanfare, a chain of victory gardens was planted from Oahu to Okinawa, from Guadalcanal to Guam. More than 5000 acres in the Solomons and 15,000 acres in the Marianas are supplying fresh corn, watermelons, cucumbers, tomatoes, cantaloupes, squash, cabbage, lettuce, radishes, peppers, eggplant and sweet pota-

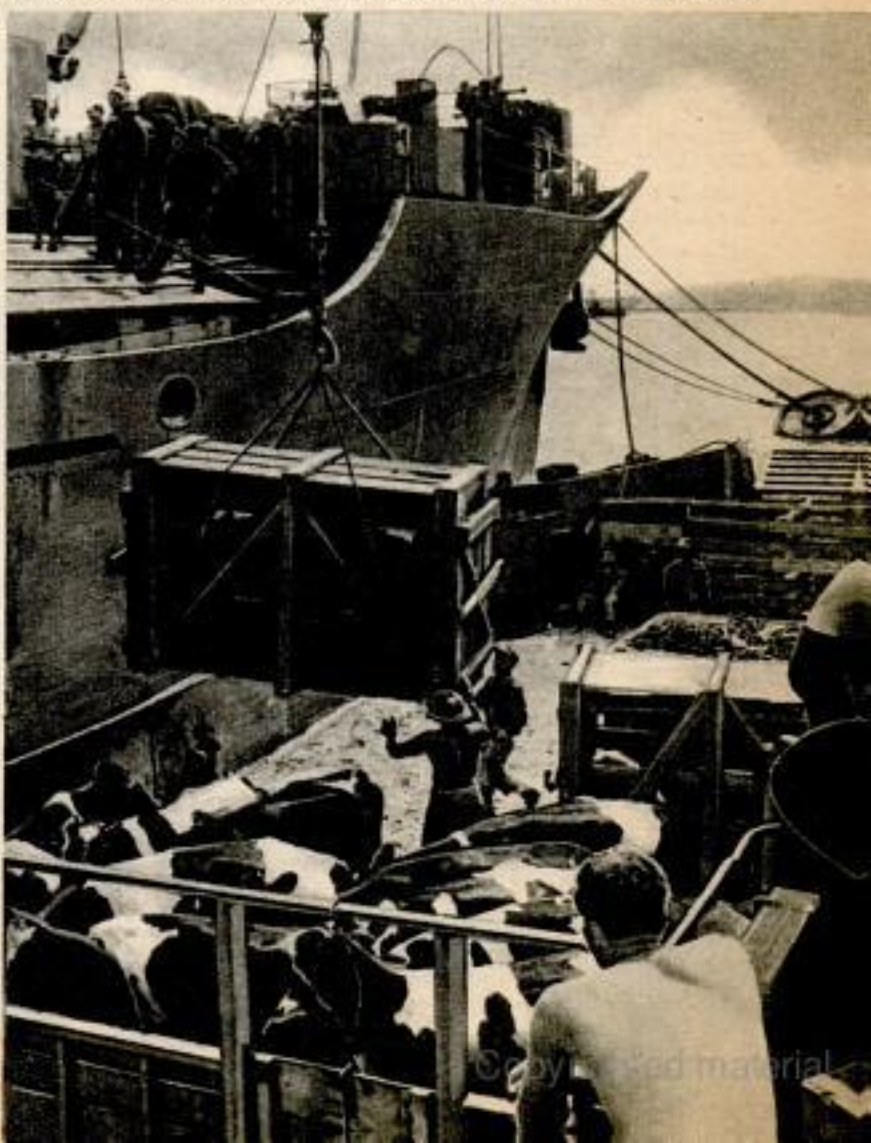



U. S. Marine Corps photo

Aided by a jeep, marines remove weeds from a Pacific island cornfield and dream of corn on the cob—battered

toes to garrison troops on conquered islands and hospitalized personnel from the battlefronts.

Approximately 3,000,000 pounds of fresh vegetables are being turned over to the Army and Navy in the Pacific each month, saving much valuable shipping space and providing troops with a varied menu. At an arbitrary value of 10 cents a pound,

the value of the crop is approximately \$300,000 per month. At this rate the \$1,500,000 spent for seeds, fertilizer and tools has already been paid off.

The Pacific victory gardens were planned, planted and picked under the supervision of "Cucumber Commandos"—agricultural experts of the Foreign Economic Administration—in cooperation

Left, tamed wild pigs caught in a Guadalcanal garden. Right, vegetables flown from Guam unloaded at two



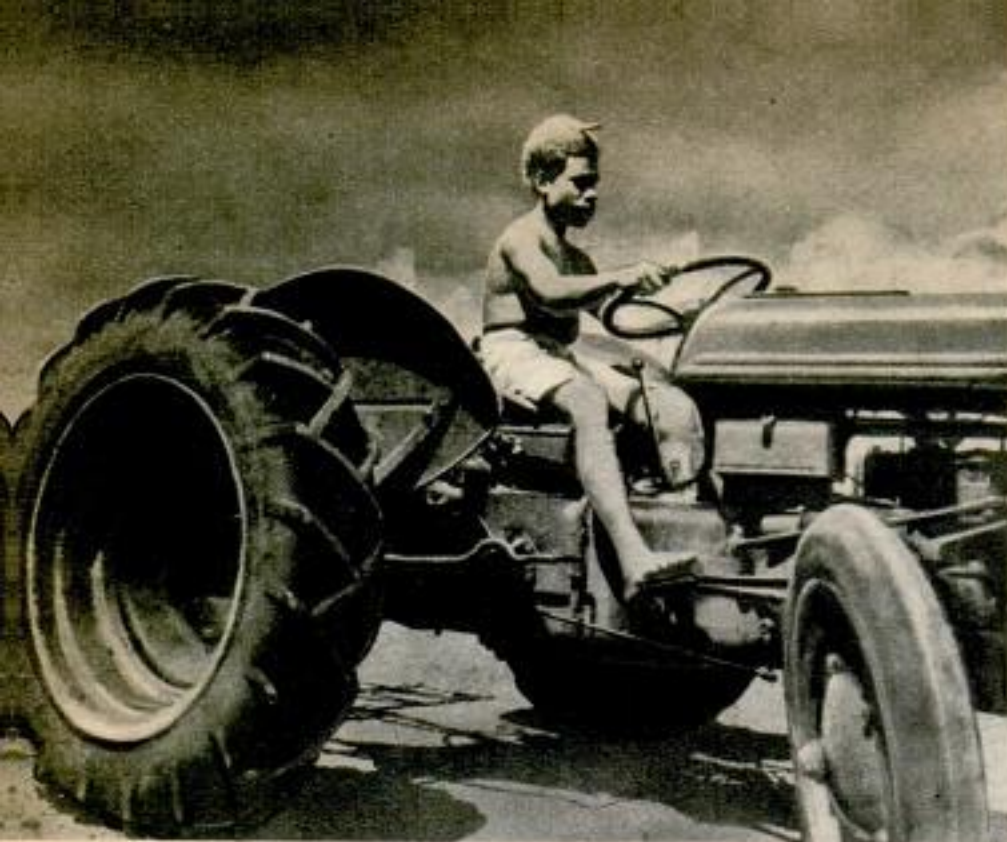

"What's this?" asks a native of Guadalcanal as he climbs aboard a tractor

with Army and Navy officers. The FEA experts often went ashore soon after assault troops to prepare the acreage for cultivation.

The FEA's military farm projects in the Pacific stem from a survey made in 1942 by Rear Admiral Richard E. Byrd, USN, of Antarctic fame. The Navy realized then that its few supply ships ("beef boats"), running up from Australia and New Zealand with reverse Lend-Lease meat and agricultural products, would not be sufficient to provide large amounts of fresh food for Pacific troops. To divert other ships to this purpose would take valuable space needed for ammunition and the implements

Marines on Iwo Jima use captured Jap sword to divvy up cold watermelon



of warfare. The solution was a program to grow fresh food on islands captured by soldiers and marines. Valuable space would be saved, the troops would be given a more balanced diet and the agricultural economy of the natives on war-ravaged islands would be restored.

Until the war started, the principal agricultural products of the natives were coconuts, papaya, breadfruit, taro and sweet potatoes. The FEA aimed to vary this diet with food that appealed to the American male appetite: fresh corn on the cob, ice-cold watermelon, lettuce and tomato salad.

The first FEA farm got under way in 1943 at Guadalcanal and served as a laboratory for others that followed. The land, covered either with a thick growth of jungle or tough, razor-edged bamboo grass growing five feet high, had to be cleared with a bulldozer. Contrary to appearances, the volcanic or coral soil of hot jungle-lush lands is often far from rich, lacking especially nitrogen. Three times as much fertilizer as usual had to be applied. Insect and fungus growths were encountered and from seven to 10 sprayings a year were necessary to keep them in check.

But to make up for all the difficulties, Mother Nature is generous at the equator with sunshine and rain. Consequently, the growing season required only three fourths the time needed in the United States. In fact, four crops a year can be grown in the seasonless lands down around the equator.

Success of the FEA victory gardens at Guadalcanal and other islands in the Solomons prompted the Navy to repeat the experiment in the Marianas when Saipan, Tinian and Guam were captured in the summer of 1944. And instead of 5000 acres, it was decided to put 15,000 acres under the plow. Soil and weather conditions in the Marianas,

(Continued to page 156)



"Suntan" Prevention for Lamps

Germ-killing lamps of the future may function four times as long as today's models following discovery of why the lamps' glass picks up a "suntan" from ultraviolet radiation. Dr. Harvey C. Rentschler, director of the Westinghouse Lamp Research

Laboratories, has found that an alkali substance in glass cuts down the efficiency of lamps used to kill air-borne bacteria in hospital operating rooms, nurseries and laboratories. However, the scientist reported that this alkali does not exist in quartz or in a special glass developed in the Corning Glass Works.



Duck Tires Inflated in Motion

If postwar vehicles adopt the system used on Army Ducks for inflating tires, all a driver will have to do is move a control on the instrument board. The amphibious Duck is equipped with central tire pressure control. It consists of an air compressor pump located toward the front of the engine, compressed air storage tank, air lines and rotating pressure joints attached to each wheel hub. The most ingenious part

of the system, devised after extensive experiments by the Truck and Coach Division of General Motors, builders of the Duck, is the hub device. This rotating pressure joint is attached to the hub by means of special studs and setscrews. The inner member turns with the wheel and the outer stationary member is fastened to the body of the vehicle. The air hose is attached to the joint and the entire unit is sealed against sand and water. A gauge on the instrument board tells the pressure.

By the Way—



Parachute jumpers now speak back to their planes with a tiny transmitter



Coast Guard engineer stayed under water 14 hours to repair fouled propeller so his LST could join Okinawa-bound fleet. Below, heartbeats of a sailor stricken on a ship in the Pacific are broadcast to Navy doctor at Honolulu. Instructions by radio helped save his life



A postwar promise is self-whipping cream that changes from liquid to fluff as it strikes air when poured from a can. Below, plans are under way to pipe steam to homes in Chisholm, Minn., from a central plant



Vitamin-rich sunflower seed is being used to make bread

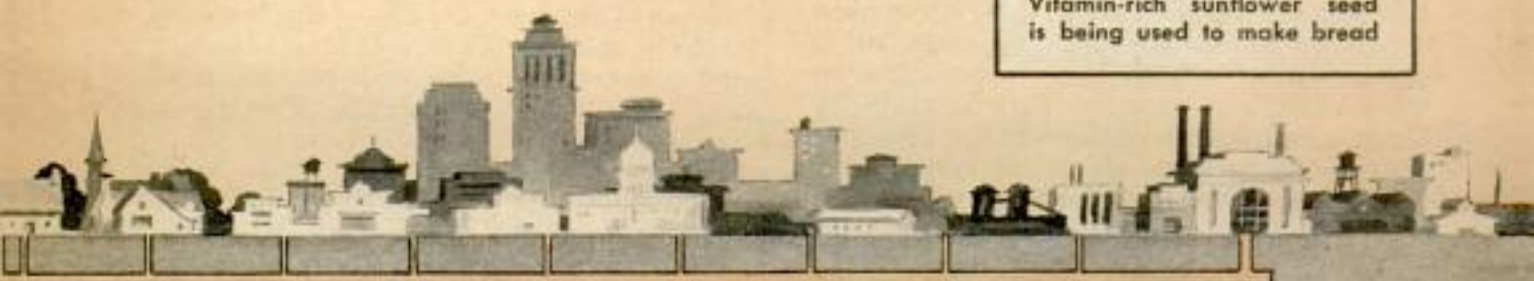

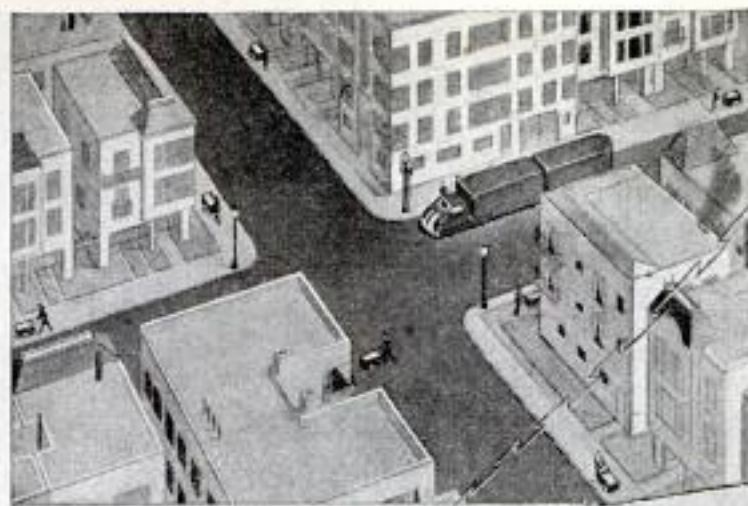

Big truck parks near residential intersection and eight salesmen, each with small rubber-tired conveyor, canvass neighborhood

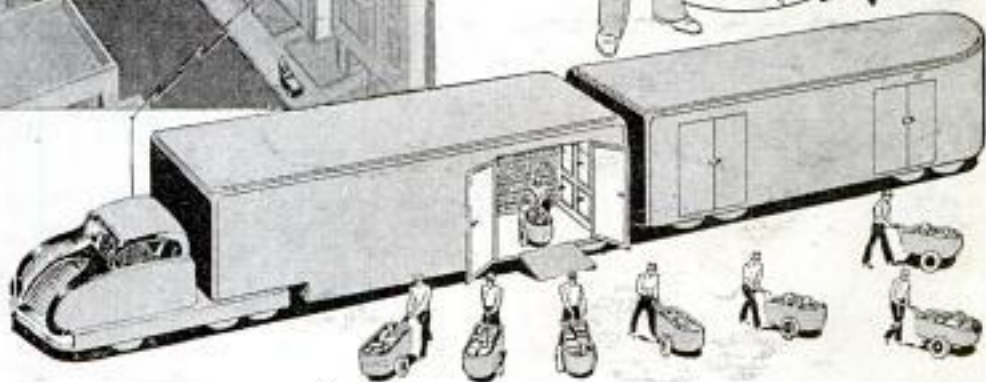

Future Store-on-Wheels Brings Food to Door

A streamlined, radio-equipped version of the old-fashioned country store-on-wheels has been designed to serve California housewives. Mobile stores 60 feet long and manned by eight smartly uniformed salesmen would cover residential areas three times a week, selling bread, butter, eggs and milk, taking orders for other foodstuffs and collecting clothes and other items to

be laundered or dry-cleaned. Each salesman would carry on his back a "walkie-talkie" radio to communicate with the driver of the huge truck in case a housewife decided to buy something not on his conveyor. A call to the parked "store" would bring the desired merchandise to the home by motorcycle. In addition to carrying fresh meats, poultry and frozen foods in refrigerated compartments, the food distribution concern plans to handle household appliances.

Attachment Converts Standard Drill Press Into Abrasive Belt Grinder

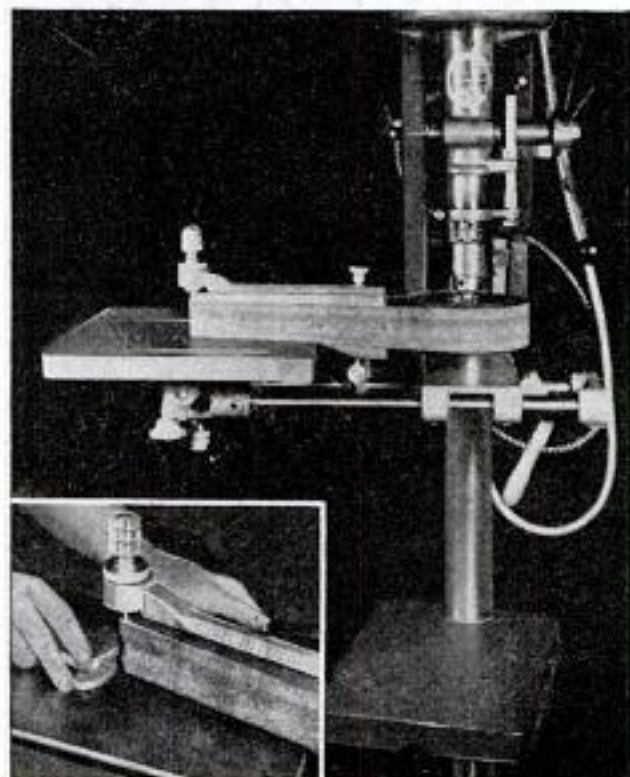

Making the drill press even more versatile, an abrasive belt grinder attachment fits all drill presses. It operates 11 times faster than the drill press spindle, providing speeds of 7,000 to 36,000 revolutions and from 700 to 4500 surface feet of abrasive a minute. Attached to the upright column, it can be swung out of way when not in use and does not interfere with normal operations. The grinder can be used for cutting, finishing, polishing and shaping of metal, wood, glass and plastics.

Fluorescent Yule Tree Lights

Fluorescent Christmas tree lights are available this year for the first time. The round bulbs are eight to a string and come in pastel shades of blue, green, coral and maize. They have a screw-type base which requires no auxiliary equipment to operate. Using about five watts of current, each bulb has a life of approximately 1000 hours, according to the manufacturer.



Signal men tie insulated wire to trees well above ground to delay relentless jungle rot

By Staff Sgt. John L. Kent

NATURE seemed to have conspired with the Japs in inventing special hazards for the communications men of our Army's Signal Corps in tropical regions of the Pacific and in Burma.

Some of the more obvious difficulties were recounted by a sergeant of a signal battalion who was stationed in the China-Burma-India Theater for 26 months. According to him, "getting the message through" involved problems never touched by "the books"—it was "snafu" (situation normal—all fouled up) all the time.

"When you are fighting in a part of the world where everything that doesn't rust quickly will rot away even faster, where batteries have less than half the normal life expectancy and insects do everything but march away with your telephone poles, you have to revise your thinking about signal supply," he said.

In the early Pacific campaigns, the Signal Corps encountered numerous difficulties in the operation of their equipment. Many of the early models of radios and telephones were not designed to function properly for any length of time in the excessive

MESSAGE FROM THE JUNGLE: SNAFU

heat and humidity, and failures occurred frequently.

The hot and moist climate found in the jungle promotes the rapid growth of fungus that corrodes wire, switch contacts and other metal parts. Various types of materials used in the construction of radios and telephones act as a sponge, soaking up small quantities of water. The water that fills the pores of the material destroys its insulating qualities and causes electrical failure. Condensation of moisture on metal surfaces causes rust and corrosion. The Signal Corps had to design special equipment which would be resistant to fungus growth and moisture. To make existing older models moistureproof, a special moistureproofing and fungiproofing kit, containing infrared lamps, brushes, spray guns and varnishes, was issued to Signal Corps units in the field.

Radio waves of walkie-talkie sets are absorbed by jungle dampness, wires corrode and insulation rots—but the U. S. Army Signal Corps kept vital war messages moving

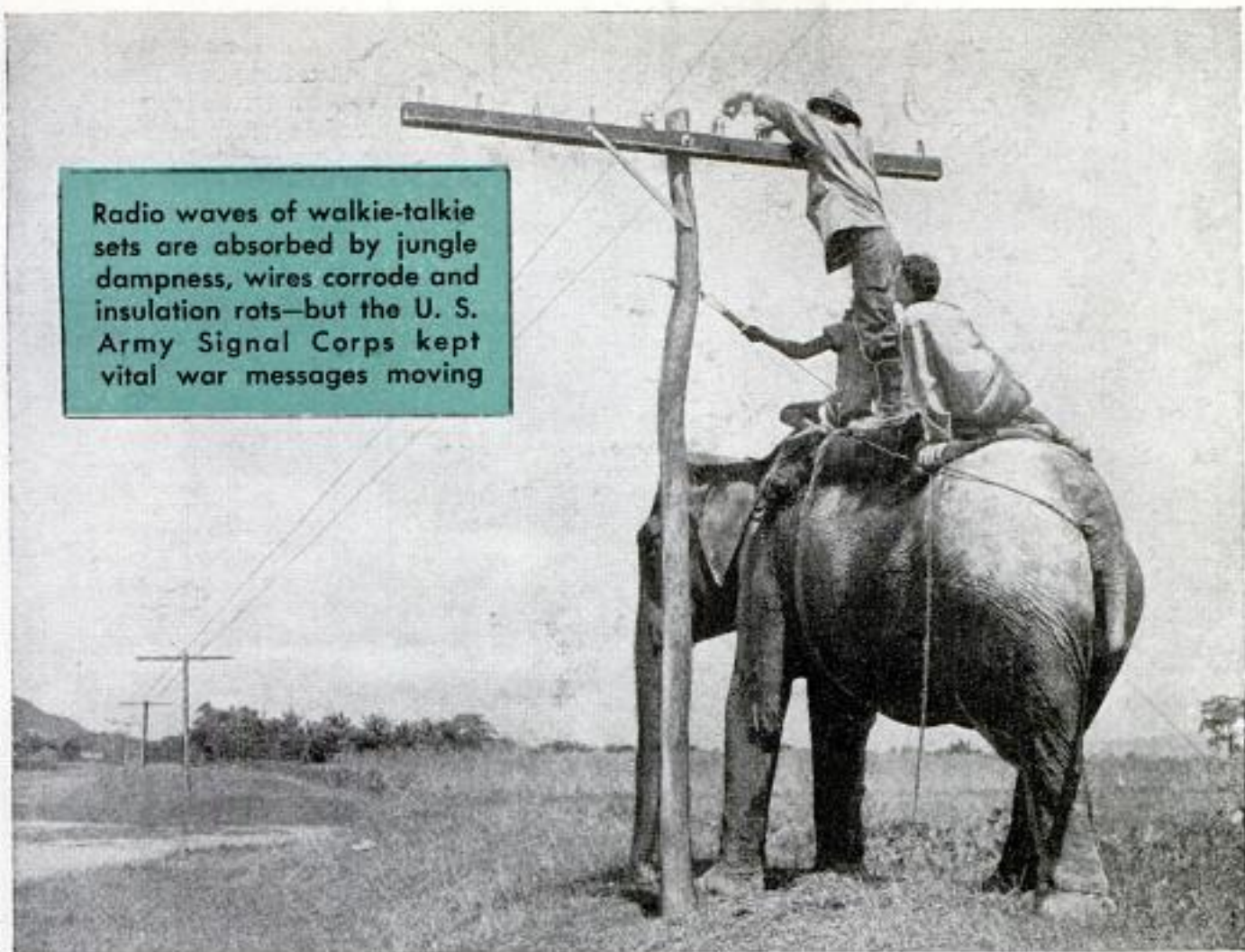

To treat the radios and telephones, parts of the equipment were taken out and dried under the infrared lamps to remove all moisture. Then they were sprayed with the moisture-resistant varnish and allowed to dry. This provided a reasonable degree of protection against fungus growth, salt spray and moisture. But with all these extra precautions failure of signal equipment was still higher than in temperate zones.

There are certain special compensations to offset some of the trouble encountered. One of them is the physique and temperament of the jungle elephant, whose "spirit of cooperation" with the pole-line construction men is remarkable.

"Consider this," says the sergeant. "The ele-

Elephant provided steady platform for pole-line construction men, saving bother with safety belt. Below, fire control switchboard in jungle





Signal Corps photos

When monsoon threatened work stoppage, signal men in India hired a native canoe and kept moving ahead. Below, captured Jap walkie-talkie, and at right, a Jap radio set and generator for vehicles

phant hauls the poles where you want them. He sets them in the ground for you. When they're up, he kneels, you climb onto his head, he rises and there you are on a high, steady platform from which you can string the wire without bothering about spurs or safety belts."

A Signal Corps officer, however, reports numerous hazards on South Pacific islands, without the relieving element of elephants. His unit worked in a jungle area where, to use his words, "the bamboo trees grow as high as 100 feet, crowding together in order to reach the light. They form an impenetrable wall." Drainage problems were terrific, as the terrain was all swamps, the highest place being only about 15 feet above sea level.

Bamboo poles about 80 feet high were used for stringing radio antennas, three of them, bound together, making a satisfactory substitute for a regular antenna pole, but it was not as easy as it sounds. An 80-foot bamboo is about five inches in base diameter; it takes three men to get one of these out of the swamps. Bamboo is very sharp and it is possible for troops to get badly cut when handling these large poles.

In the swampy country abounding in some of the is-



lands, swarms of mosquitoes as savage as flying tigers sink stingers into the sweating signal men, especially when they have to work at night. This was a terrible scourge in the early days of the war before aerosol bombs, as fumigants, served to mitigate this form of torture. Malaria and dengue fever took their toll of the men.

The Japs, cooperating with nature in her most destructive moods, provided all the expected hazards and a few more for good measure. When driven out of any given area they left mines and undetonated bombs.

An enemy hazard, not fully foreseen, was that Japanese bombers often aimed for radio installations in preference to air strips, even when the latter had fighter planes parked on them as tempting targets. This was noted repeatedly by Signal Corps officers.

It would appear that our Army should have had no difficulty with portable radio sets, such as the walkie-talkie and handie-talkie, since they do not require pole-line construction, the stringing of wire or the erection of radio towers. But this was not the case. Radio communication is generally poor in jungle areas. The jungle that engulfs all also absorbs the radio waves going through it to such an extent that the transmission path along the ground, which is normally used for short-distance military communication, is practically useless for ranges of over one mile. The Army's signal engineers made a study in the jungles of Panama to find the reason and possible solution. They found that to increase the power on the transmitters was useless; even with the power increased two hundredfold, the range would only double — increasing from one to two miles. But they found that they could get better signals by elevating the antennas and by locating the transmitters and receivers on high ground.

(Continued to page 150)



From stern of an amphibious Duck, soldiers lay communication wires between islands in the Admiralty group and to warships at anchor



Trouble shooter on field wire is trying to locate cause of snafu. Below, transmitter building at 6th Army headquarters on Luzon; in thick of fighting these men handled thousands of messages





COACH AND SLEIGH on the "Pioneer," a snow train of two "coaches" drawn by a track-type tractor, enable visitors to Blaney Park in the Upper Peninsula of Michigan to see the winter wonders of the park in comfort. One coach is enclosed and heated, the other is an old-fashioned open sleigh. Both are mounted on runners. In case of a blizzard, the tractor powers its own snowplow which opens the way ahead of the snow train



Wheatblast Cleans Plane Engines

Wheat in place of sand in conventional sandblasting equipment is reported to remove carbon and oxides more thoroughly from airplane pistons and cylinders, with less abrasion. Precision parts and openings formerly had to be masked to protect them from the sand. This is unnecessary with wheat and cuts the time for the operation in half. Wheat cleans so thoroughly it eliminates a 24-hour pre-soaking of the parts to help loosen carbon.

American Airlines photos

Above, wheatblasting with regular sandblasting equipment. Left, loading wheat into bin

Mold From Hair Fights Germs

Red pigment produced from a mold on human hair may prove an effective remedy for typhoid fever and some kinds of dysentery. Penicillin, also produced from mold, does not affect typhoid or dysentery germs. The red mold pigment is being tested at Israel Zion Hospital, Brooklyn, N. Y.

Flying Boat Carries Rescue Platform

When a Catalina flying boat alights on the water for a rescue operation, a collapsible platform is attached to a side blister gun mount. It takes only a few seconds to drop a pin into the gun mount, anchoring the platform, which then is thrust out the window blister. Padded supports on the platform protect the hull of the "Dumbo" rescue plane. Rescue workers snap their safety belts to rings on the frame. This frees both hands for lifting a man aboard.

Consolidated-Vultee photos
Top, attaching rescue platform to gun mount. Right, rescuers snap safety belts to the frame

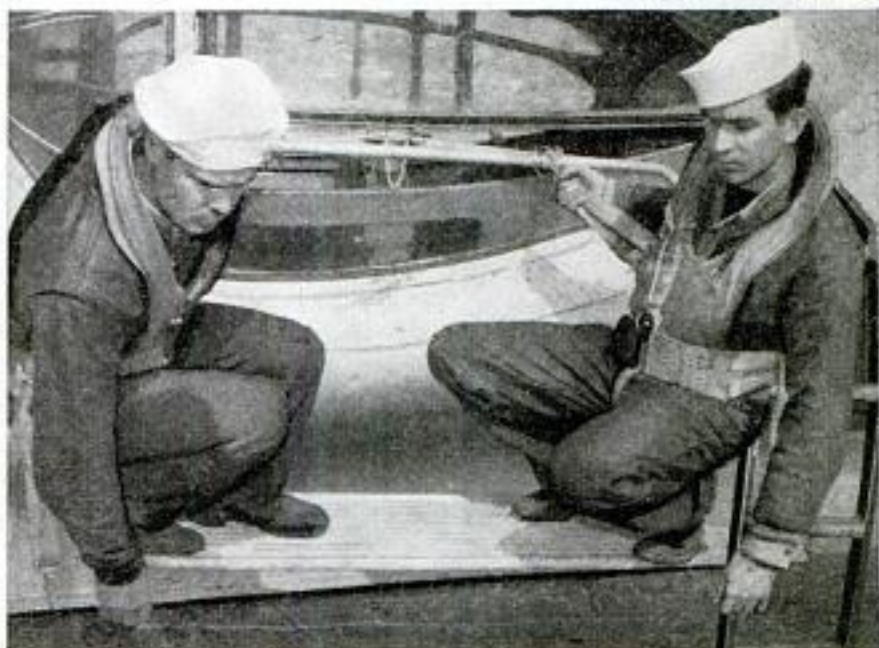
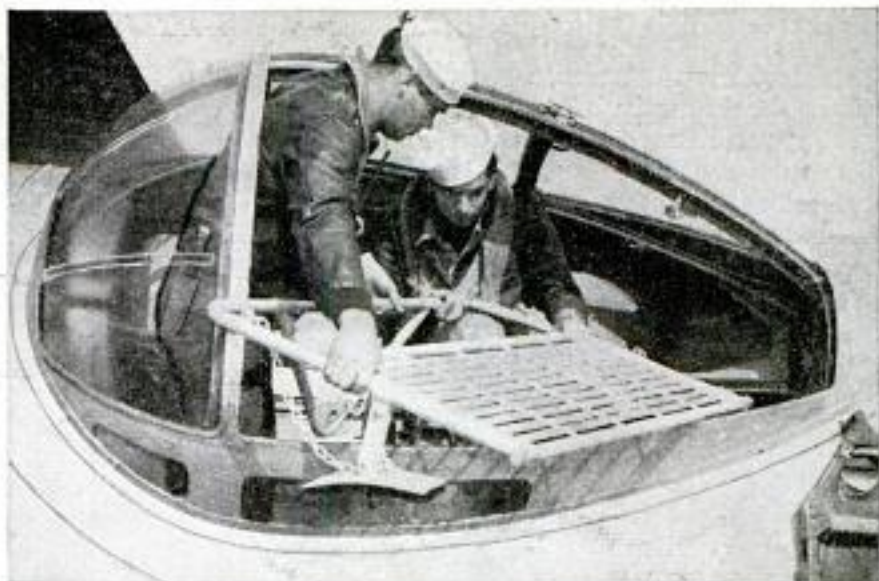

Electrocoat Fibers To Create Fabrics

Creation of new fabrics and unusual designs for material is made possible by an electrocoating process in which cloth fibers pass through an electrostatic field, become charged and stand on end. Then the fibers are hurled perpendicularly against an adhesive-coated backing which is dry-cured to hold them fast. As many as 300,000 electrocoated fibers, more than ten times those in woven goods, are in one square inch of fabric. Each electrocoated fiber is exactly perpendicular to its base, affording greater resiliency and uniformity in appearance. A few of the materials produced by electrocoating re-

semble delicate embroidery, "velvet" linings, dress fabrics and designs, chair upholstery and even the nap of a rug. The process is based on the old principle of rubbing a glass rod with a piece of silk to attract bits of paper to the rod, and is carried out by General Electric high voltage equipment.

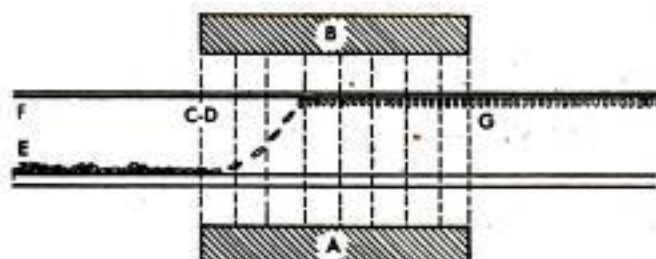

- A. Negative electrode
- B. Positive electrode
- C-D. Lines of electrical force
- E. Conveyor belt carrying fibers
- F. Fabric backing; adhesive side down
- G. Flock fibers anchored



Loose fibers, or flock, enter electrostatic field, receive electric charge and are repelled upward to backing

'Bubble Bath' Keeps Ice Away From Ducks' Winter Home

An ingenious "bubble bath" provides a colony of ducks in Wisconsin with an ice-free lagoon in zero temperatures. Utilizing a simple fact of physics—that water is densest at 39 degrees above zero, and expands instead of continuing to contract as the temperature drops from there, thus freezing from the top—Charles Martin, an

Allis-Chalmers Manufacturing Company engineer, built a grid of seven $\frac{3}{4}$ -inch pipes 84 feet long and spaced five feet apart. He drilled 588 $\frac{1}{32}$ -inch holes in the top side. On the shore, a motor drives a little air compressor to produce 15 cubic feet of air a minute. When the temperature reaches freezing, a thermostat starts the motor and the lagoon erupts into ripples. The bubbles force the warmer bottom air up and the lighter, colder surface water to the bottom, where it is warmed. Operation of the grid also creates a low pressure area near the bottom, sucking in seepage at a 50-degree temperature from nearby Lake Michigan. Operating expenses for four months, December through March, are about \$30. And the ducks love it.

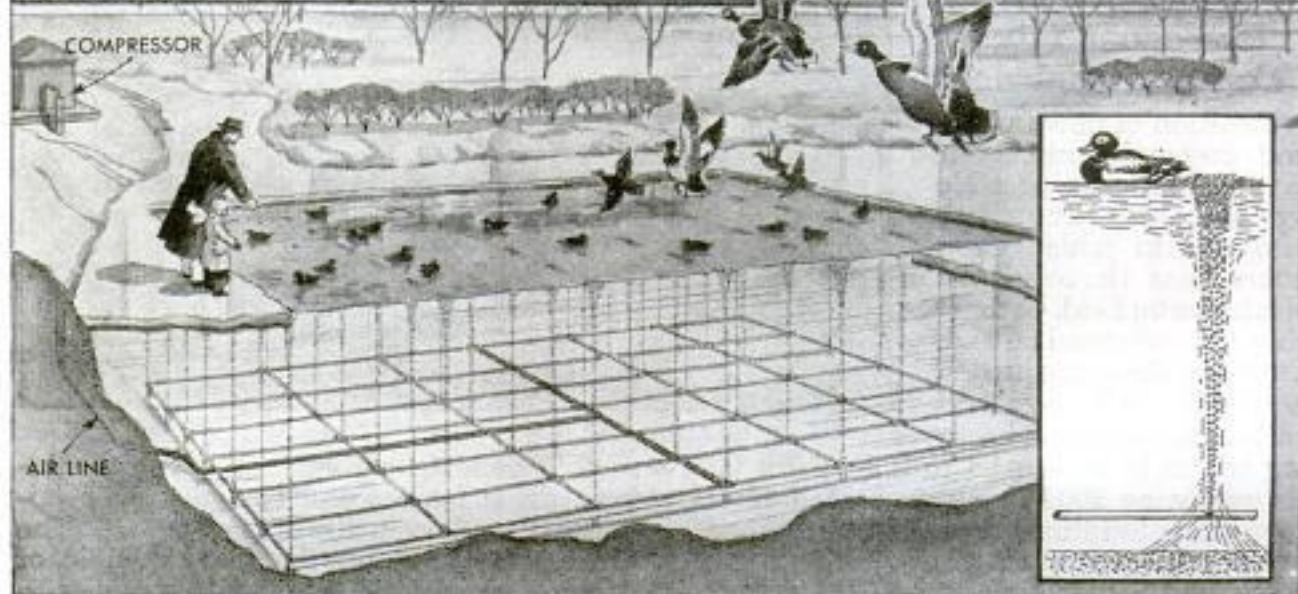

Blimps Spot Tuna for Fishermen

Now that no Jap submarines lurk off the West Coast, spotters in Navy blimps have developed a new way to keep their eyes sharp—they look for schools of tuna fish. When a blimp crew spots tuna racing along at about 30 miles an hour, the location is radioed to fishing boats which set out for the catch. Boats in sight of the blimp change their course briefly as a signal they have received the message. If a boat gives no such signal, the blimp crew assumes the boat has no radio. In this case, the blimp drops a smoke flare near the boat with the tuna location attached.

Film Filter Coated With Steel

Thin films of stainless steel on optical glass in vignetting filters have eliminated pictures bright in the middle but dark at the edges, previously encountered in aerial photography with wide angle lenses. The stainless steel film is deposited on the optical disk by an electro-vacuum precipitation process. Placed in front of the lens, the film is thickest and transmits least light at the center of the disk, growing gradually thinner and more transparent at the edge. By complementing the lens with which it is used, the filter permits photographs of even density.

Would you like to know more about commercial products described in this magazine? Many are now available. Addresses of the manufacturers or distributors of such items are in the Where-to-Buy-It Index, page 8A

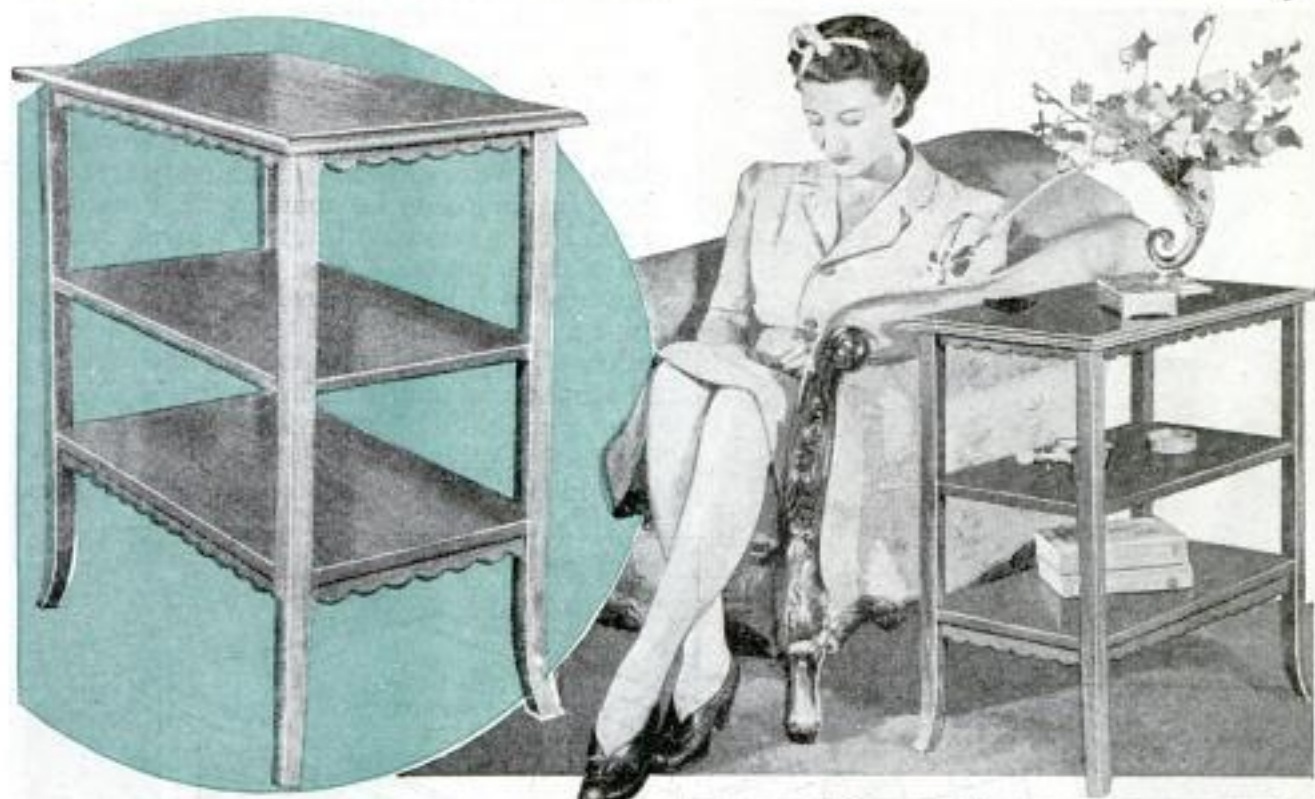

END TABLE

Matches Most Furniture

By Charles E. Troutt

DESIGNED to blend with almost any style of living-room furniture, this end table is constructed without the use of nails or screws and requires less than eight board feet of lumber. The wood selected should harmonize with that of the chair or sofa beside which it is to be placed.

The legs are cut as shown in detail B of Fig. 2, and a cardboard template of the dimensions indicated in detail A is used to shape the lower ends which serve as feet. Each foot should be laid out on adjacent sides of the leg, which is made of 1½-in. stock, and all saw cuts should be stopped about ¼ in. short of completion to give better support to the work. When all cuts have been partially made, the legs can be finished and sanded. Since the legs cannot be dressed on a jointer because of the curved feet, care should be exercised to cut exactly on the line.

The grooves for the scalloped top and bottom rails can be cut in the legs with a hand router. If this method is used, the router should be moved so that the cut-

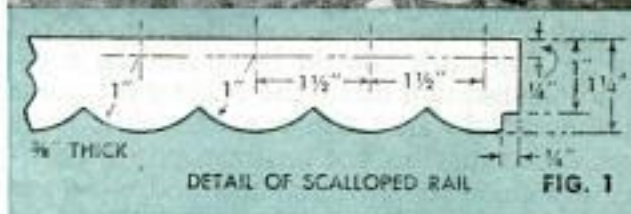



the leg grooves must be made short enough to allow the lower edges of the rails to be notched at the ends as in Figs. 1 and 3.

Dimensions for the table top and shelves are shown in Fig. 2. If these are glued up, using three or four narrow pieces for each and reversing the direction of the grain in alternate pieces, the tendency to warp will be minimized. The shape of the molded edge for the top of the table is given in the circular detail of Fig. 3. Grooves in the undersides of both the table top and the bottom shelf can be made with a router, as in Fig. 3, or again the work can be done on a drill press. If the dimensions given have been followed closely, it will be $\frac{13}{16}$ in. from the outside of the groove to the edge of the table top, and on the bottom shelf the distance will be $\frac{1}{4}$ in. If the dimensions have been varied slightly, an alternate method of locating the grooves would be to slip the rails into all four legs

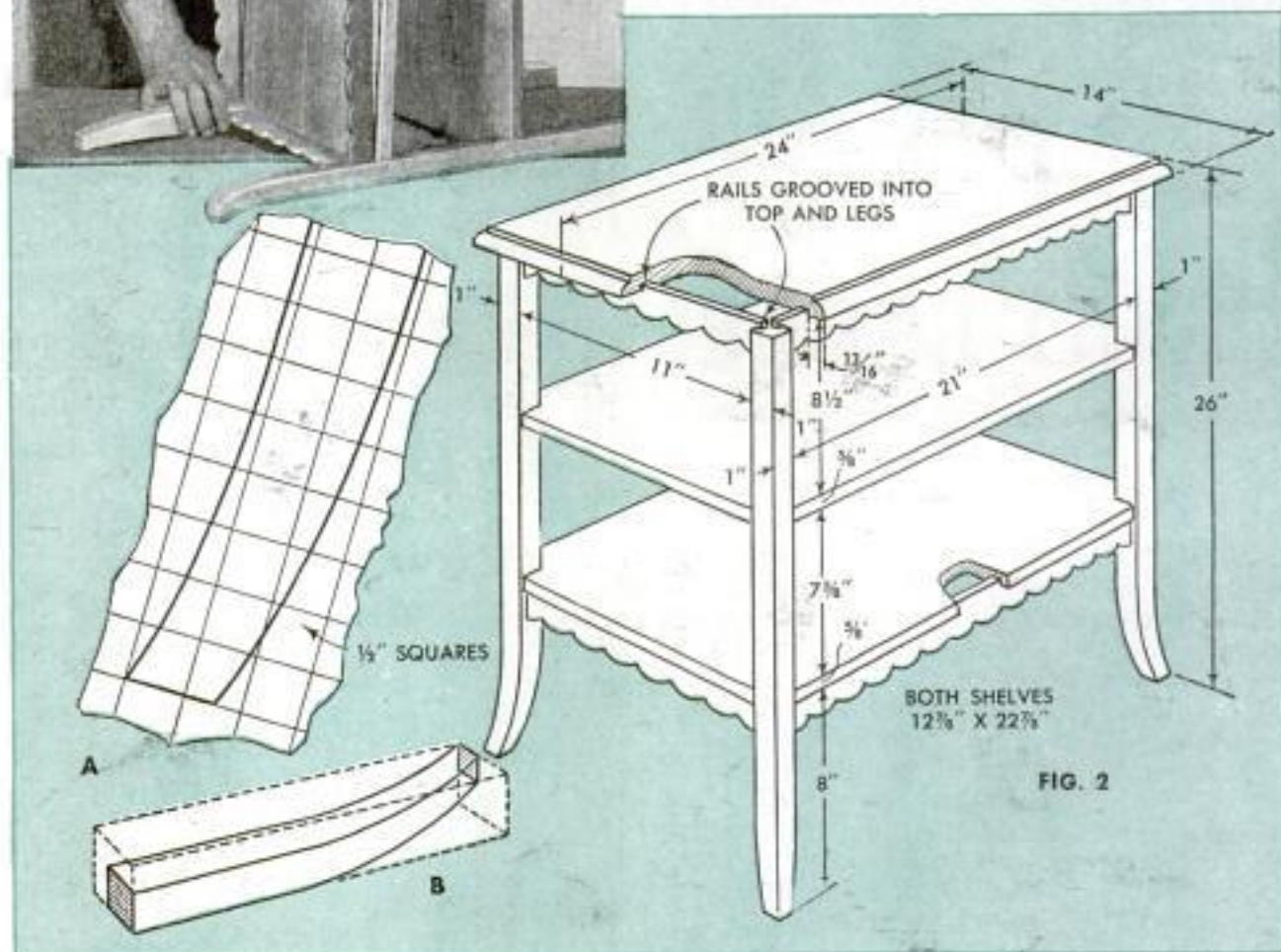

ting bit tends to make the router guide hug the work. Also, the grooves can be cut on a drill press by using either a router bit or a hollow chisel. When routing on a drill press the work should be moved in a direction that will make the cutting bit cause the work to hug the router guide. The grooves must be cut uniformly and accurately since the bottom shelf and table top are grooved to fit over the rails. Note that

of the table and then mark the grooves.

The rails should be a snug fit in the grooves, and are cut to the dimensions given in Figs. 1 and 2. It is possible to cut two rails at the same time on a jigsaw by tacking them together. If a fine blade is used this will eliminate sanding the scalloped edges.

Fig. 3 shows the method of fastening the center shelf to the legs by using dowels.

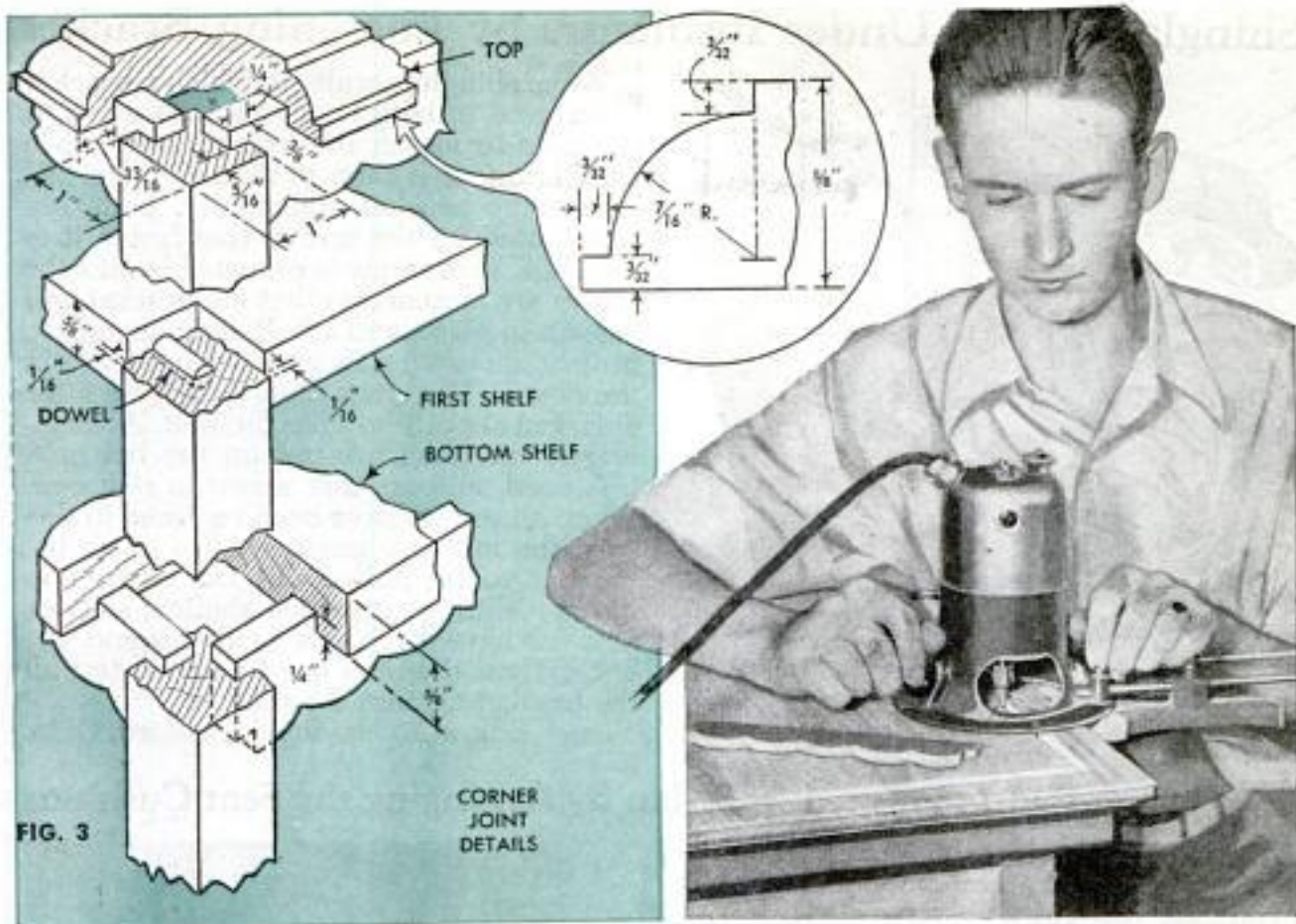

To complete the assembly, glue the short rails between the legs to form the two ends. As one operation, glue in the bottom side rails and the doweled center shelf. Following this, the bottom shelf can be slipped over the rails and glued. Then the upper

rails are glued into the grooves of the table top and the unit assembled to the legs. Using a sufficient number of clamps will assure good joints. Before finishing, the sharp corners of the legs and shelves, as well as the entire table, should be sanded.

Hot-Air Heater in Small Home Adapted From Oil Stove

Located in the basement of a cottage, cabin or other small building, a heating plant like the one shown will take the place of a more expensive furnace. The plant consists of an oil stove of the circulating type and a sheet-metal enclosure connected by a length of pipe to the register in the floor above. The enclosure is made in two parts; a jacket, which is open at top and bottom, and a tapering canopy. The grilled top of the stove is removed and the jacket is bolted in place. The canopy is placed on the jacket, and a length of hot-air pipe is fitted as shown. To avoid constant refilling, the reservoir in the stove is disconnected and a large oil drum, located at a safe distance, is connected by a feed pipe, a constant-level regulator being used to maintain the feed.

J. Modroch, Danbury, Conn.

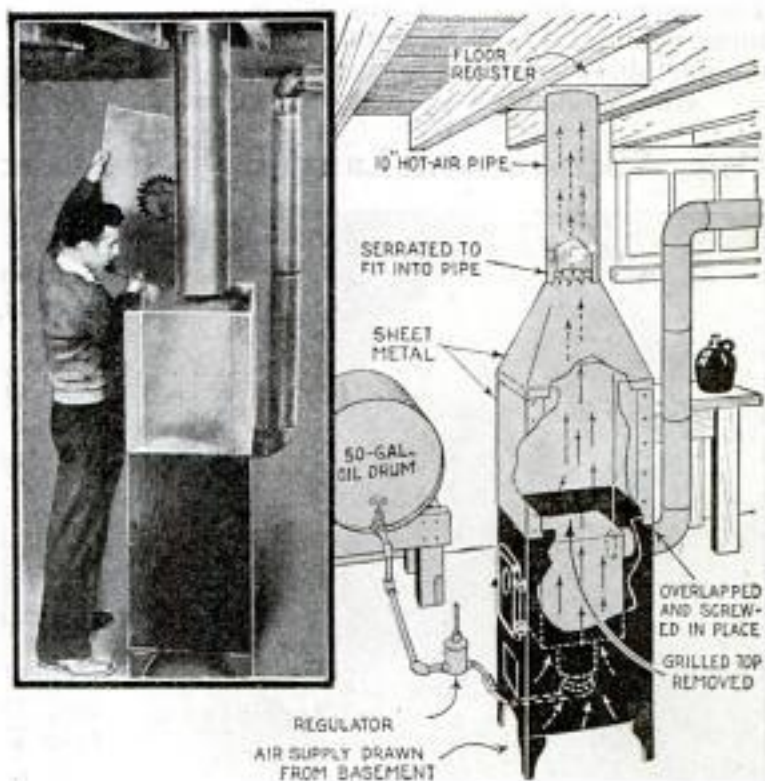

Shingle Slipped Under Insulators by Loosening Bracket



When shingling walls on which a bracket is screwed to hold heavy electric wires, it is easier to loosen the bracket and slip a shingle under it than to take it down. To loosen the bracket sufficiently, bolts are substituted for the screws that fasten it to the wall. One screw is removed before the others are loosened so that the bracket will remain in place, and a bolt, long enough to project about 2 in., is inserted from within the house. The screw hole may have to be enlarged slightly to take the bolt. A washer and nut then are put on the bolt and tightened, and another screw is removed. When all screws have been replaced in this way, the nuts are unscrewed to allow the bracket to be pulled out far enough to insert a shingle, in which shallow slots or notches have been cut to fit around the bolts. Then the nuts are tightened to pull the bracket against the shingle.

Edison R. Haviland, Bedford, Ohio.

Emergency Bed Is Formed in Sedan by Arranging the Seat Cushions

On week-end fishing trips or in an emergency when hotel accommodations are not available, the cushions of a 1941 model Chevrolet two-door town sedan can be arranged to form a bed. The front seat is moved as far forward as possible and the cushion is leveled by blocks of wood as indicated in the detail. The rear-seat cushion is raised against the backrest to form a "pillow." A support about 8 in. high, which can be formed from baggage or pieces of wood, is placed between the front and back seats, and the front backrest is laid on it. The space made available by this arrangement is about 4 by 6 ft., enough to provide comfortable sleeping quarters.

Charles A. Walhof, Rock Valley, Iowa.

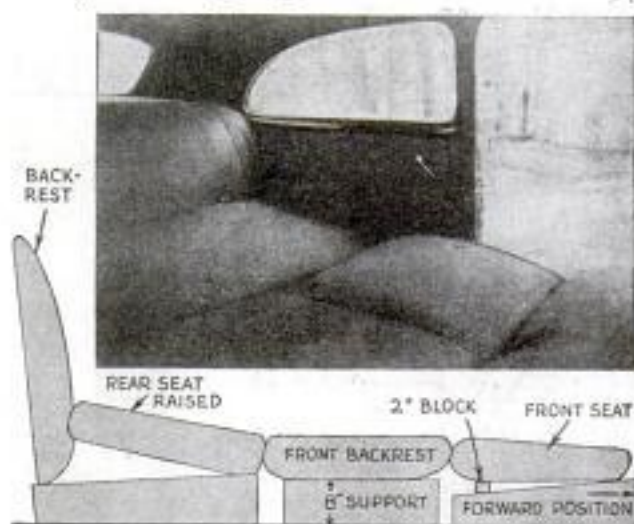

Pair of Scissors and Lamp Bulb Are Used for Testing Flashlight Cells



By using a pair of scissors and a lamp bulb you can determine whether a flashlight cell is exhausted. The bulb is set on the center contact of the cell, and the scissors are held so that one blade touches the base of the cell and the other blade contacts the threaded portion of the bulb base. If the cell is in good condition the bulb will light.—Wm. Swallow, Brooklyn, N. Y.

Rough Plastics Used as Lenses

If Lucite or Plexiglas rods are to be used in transmitting light, the ends through which the light enters and leaves the rod should be roughened by sawing or sanding. Polished surfaces of this material reflect light and prevent its transmission.

Robert A. Ridout, New Castle, Ind.

Frozen Water Pipe in Wall Thawed by Hot Air

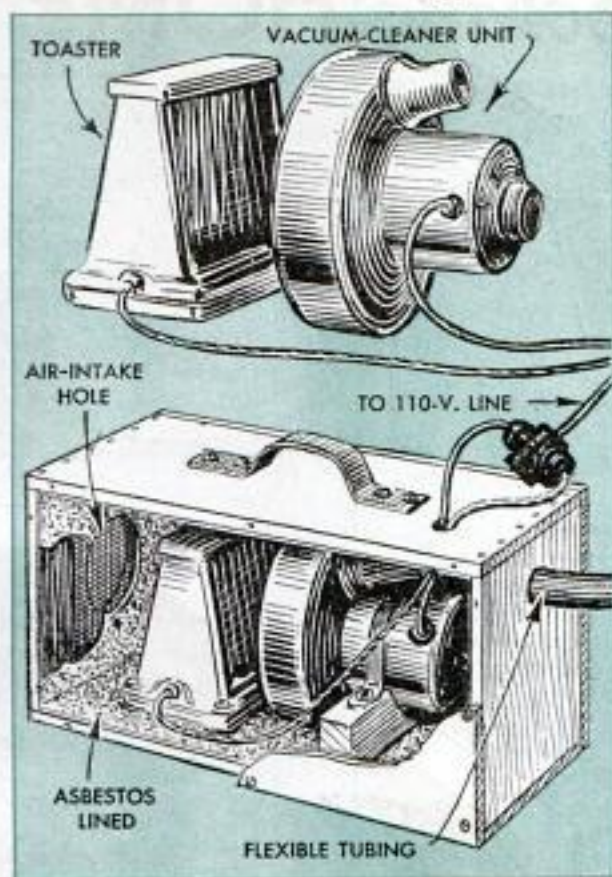

Frozen water pipes located between outer walls of a house ordinarily cannot be reached so that they may be thawed. However, by using this simple heating unit, hot air can be directed between the walls to thaw the pipes. The unit consists of an electric toaster, a vacuum-cleaner blower and a length of flexible tubing. The toaster is fastened on the floor of an asbestos-lined wooden box and

just behind an air-intake hole cut in the end of the box. Behind the toaster the blower is set in position to force air heated by the toaster out through the tubing. The method of attaching the tubing to the blower will be determined by the type of blower used.—David B. Clapp, Livingston, N. J.

Nails Sawed Under Siding to Remove It Without Splitting

When it is necessary to remove a few siding boards, they can be taken off without splitting by sawing off the nails with a piece of hacksaw blade. An extension for the blade is made by bending a 12-in. length of sheet metal along its center to form a channel in which the blade is held by a rivet set between the saw teeth as indicated in the detail. For a handle, a short length of broomstick will do. In use, the saw blade is slipped under the work and the nail is sawed through, after which the board can be lifted off.

C. H. Kinnard, Franklin, Tenn.

☞ In extremely cold weather add denatured alcohol, $\frac{1}{2}$ pt., to a tank of gasoline. The alcohol will mix with condensed moisture that may be present in the gasoline and thus keep it from freezing in the fuel line or carburetor.

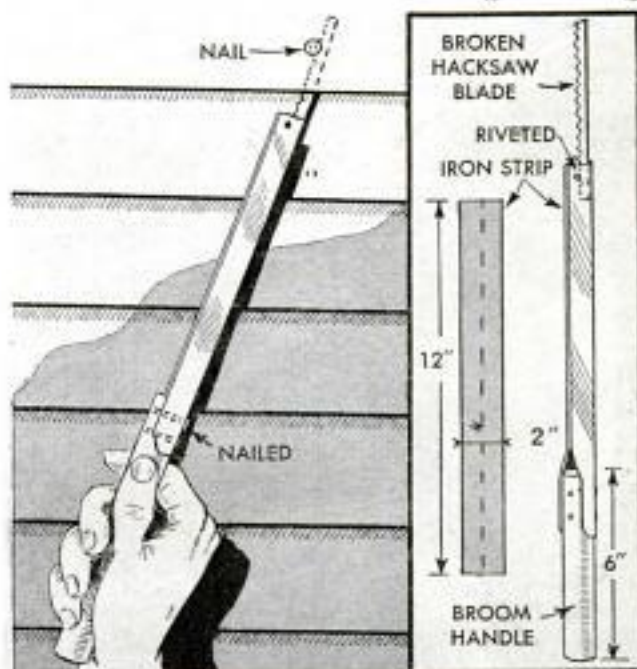

Solving HOME



Spring paper clips sewed to tape will transform a cloth-wrapped clothes hanger into a handy drying rack for small articles as shown above, left. Right: A baby's bottle can be kept warm by placing it in a pan of water set over the pilot light of a gas range

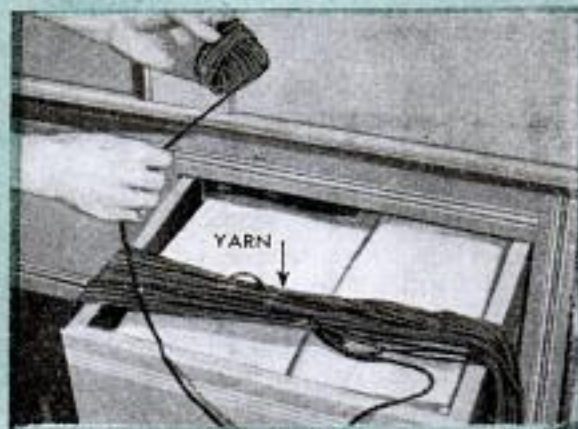

Above, left: If you do not have a regular yarn winder, a cabinet drawer makes a good substitute. Just pull it out and wind the yarn without removing the contents. Right: After washing fringed articles, you can arrange the fringe so that it looks neat without ironing it. Iron only the cloth, but comb out the fringe as shown

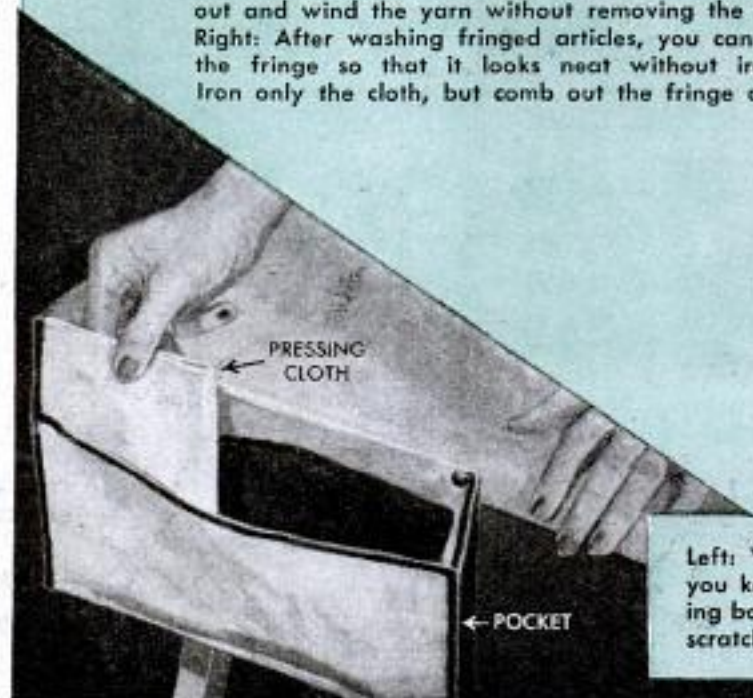
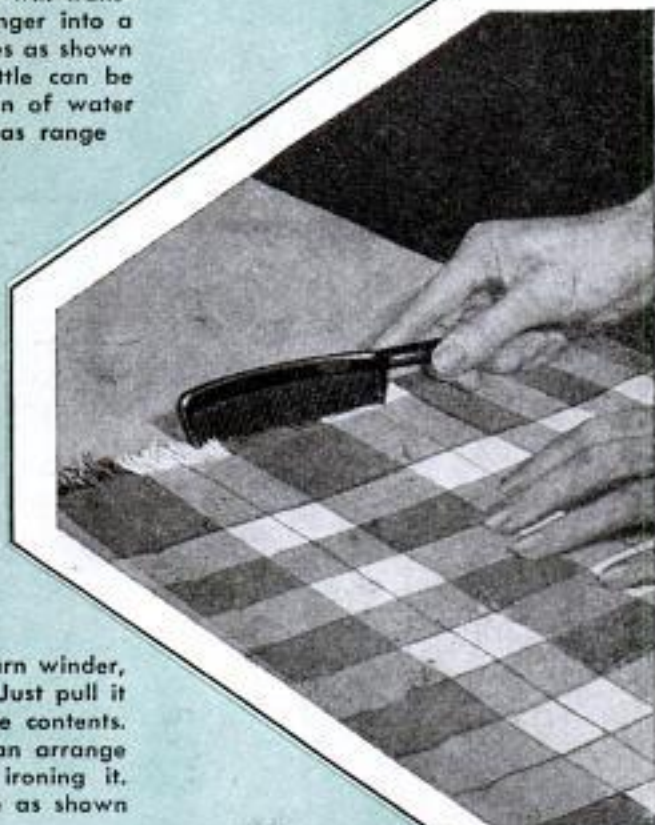

Left: You won't need to hunt for pressing cloths if you keep them in a cloth pocket tacked to the ironing board. Above: Colorless nail polish will smooth a scratched wooden crochet hook that snags the yarn

PROBLEMS

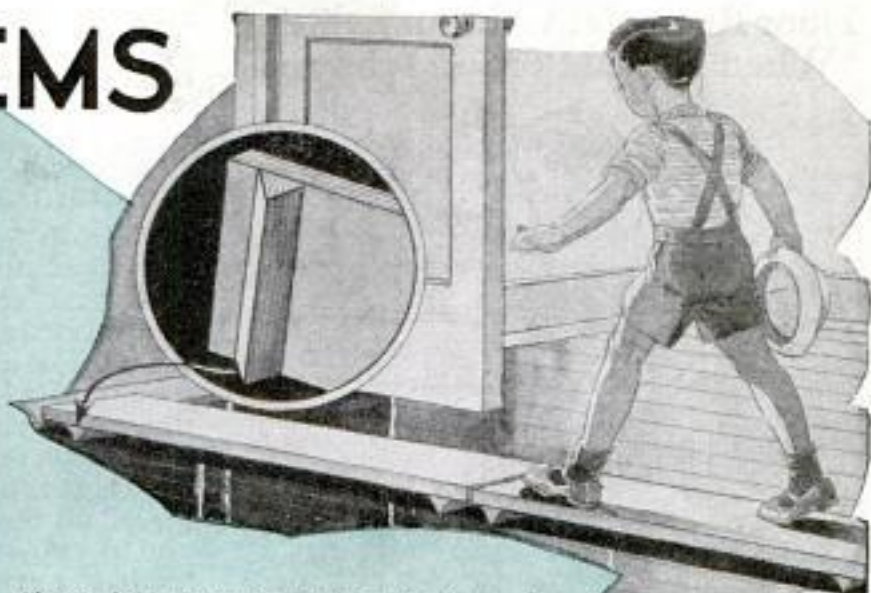
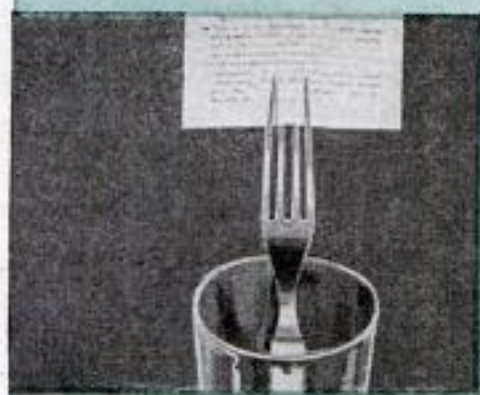

Above, left: A recipe card set between the tines of a fork placed in a drinking glass when you bake is easily read and stays clean. Above, right: Triangular cleats nailed to boards used as a walk over newly varnished floors leave only slight marks in the finish

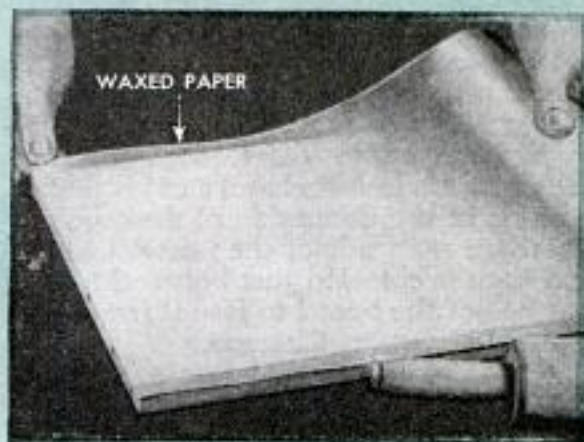
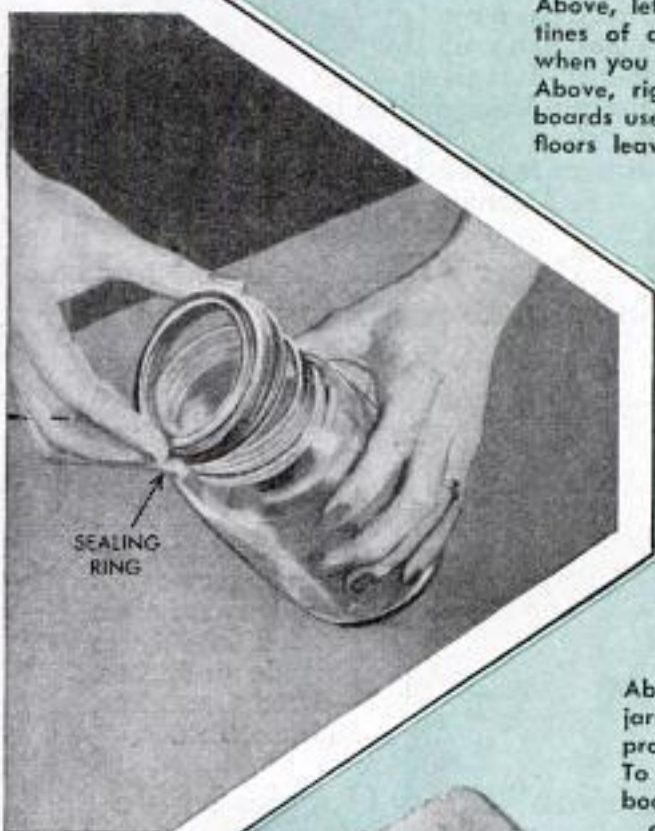

Above, left: Sealing rings kept on canning jars will be at hand when needed and will protect the jars from chipping when handled. To prevent dough from sticking to a pastry board, thumbtack a sheet of waxed paper over it as indicated at the right, above

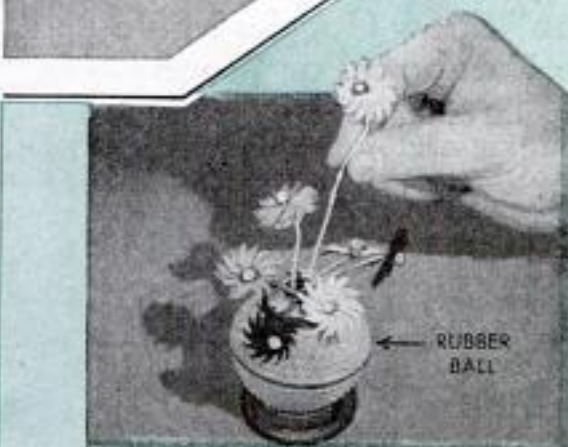

Above: Set on a caster cup, a hollow rubber ball slit to hold flowers can be used for a vase. Right: When making right-angle cuts in linoleum, round the corners to help avoid tearing it

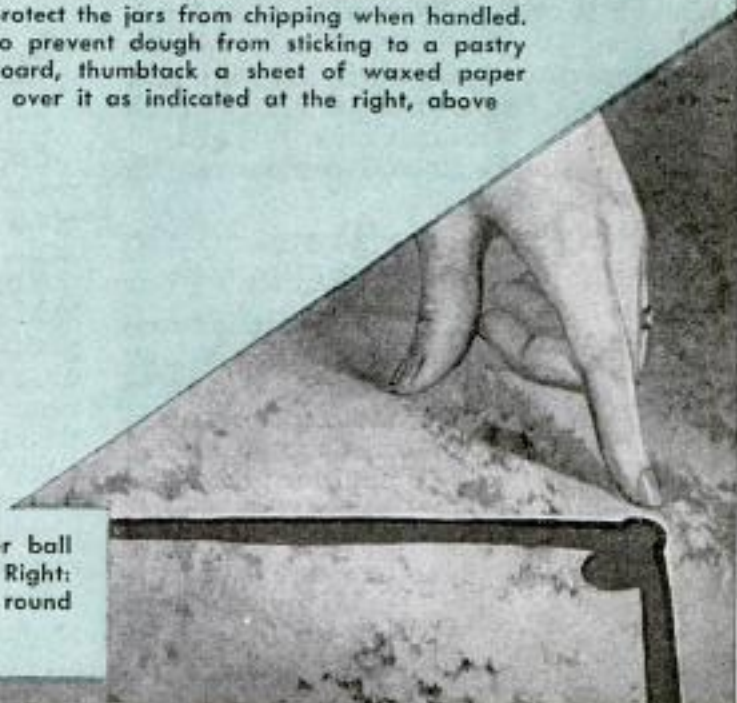

Floor Removed Without Splitting When Nailed Portion Is Sawed



By using a keyhole saw as shown, old flooring can be taken up without splitting, thereby saving it for reuse. After one board is removed to allow room for the saw, the latter is inverted and a cut is made at an angle in the underside of the adjoining board on each side of the joist. The cut portion then is chiseled just below the upper surface of the board to free it from the nail.—Axel E. Ogren, Chicago.

Bottle Warmer Heats Gluepot

When you want to keep a pot of glue warm for long periods, try an electric heater of the type used for a nursing bottle. Although it cannot be used to melt hardened glue, the heater will maintain an even temperature which will keep the glue workable. Of course, a small gluepot such as a glass jar or tin can must be used.

D. E. Horn, River Forest, Ill.

Key Ring Held on Trouser Belt By Spring-Steel Clip



Keys that are carried on a ring attached to the trouser belt cannot be dislodged accidentally and lost if the ring is held by a clip like the one illustrated. It is made from a 7-in. length of $\frac{1}{2}$ -in. spring steel bent so the key

ring can be removed only by being pulled up and then outward and downward to open it.—Earl C. Black, Westville, Ohio.

Stops Prevent Opening of Drawer To Expose Hidden Compartment

Valuables can be stored temporarily in a "secret" compartment at the back of a desk drawer if the drawer is fitted with stops to prevent its being pulled all the way out to expose the hidden articles. The stops are short lengths of iron rod fitted loosely into holes drilled in the edge of the drawer sides so they can be removed when the drawer is opened part way.

L. Meehan, Toronto, Ont., Canada.



Tissue Paper Twisted in Pipestem Substitutes for Smoke Filter

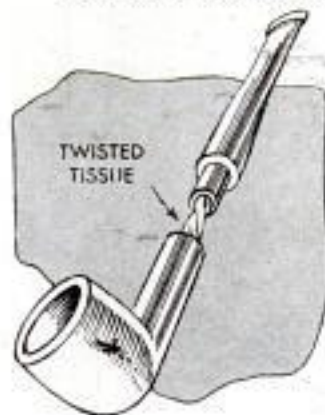

Tissue paper that has been twisted will absorb tobacco tar and nicotine in the stem of a pipe made to take a filter. The paper first is rolled and then twisted loosely to provide air spaces.—Fred Cornelius, El Paso, Tex.

"Eskimo" Snow Goggles Made From Cardboard or Wood

Snow goggles of the Eskimo type can be made by cutting narrow slits in a strip of oiled cardboard about 6 in. long and 1 in. wide. A V-shaped opening accommodates the bridge of the nose, and the goggles are held in the proper position by string or rubber-band temples run through holes at each end. More permanent goggles of this type can be made by whittling a piece of wood to the same size and curving it to fit the face.



Design and Construction of TELESCOPES

By Sam Brown

PART III

THE prismatic telescope is an astronomical telescope plus a pair of prisms for erecting the image. The most common example of this type of construction is the binocular instrument. One half of a binocular is a monocular. Some telescopes are used for a specific purpose and are named accordingly, a typical exam-

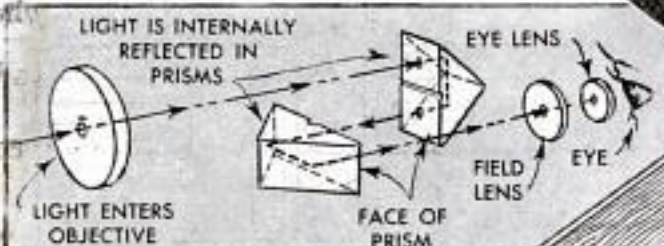
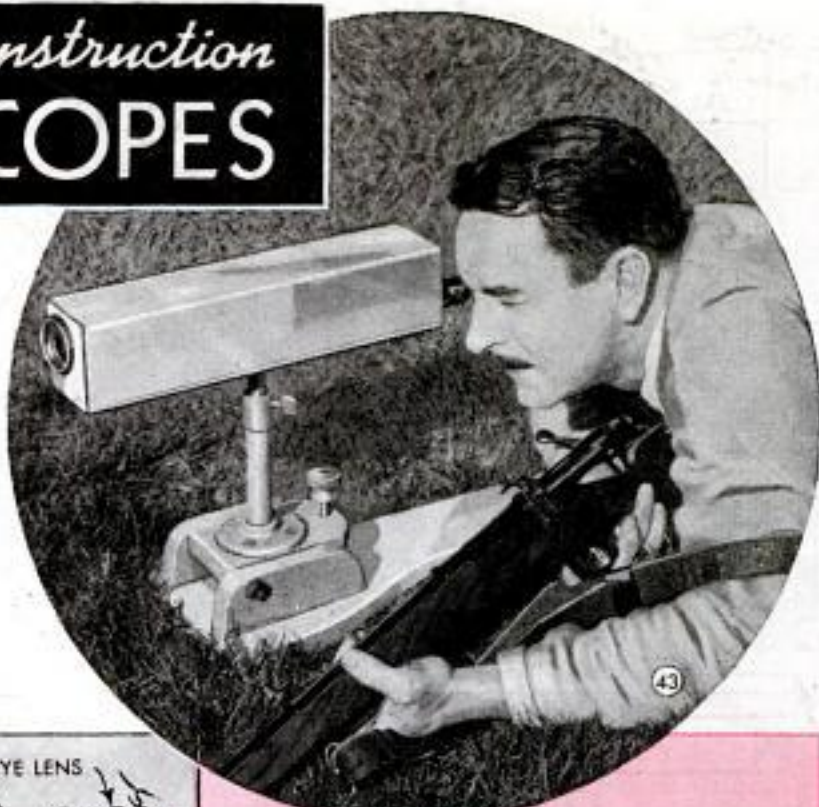

(44) HOW PRISM TELESCOPE WORKS

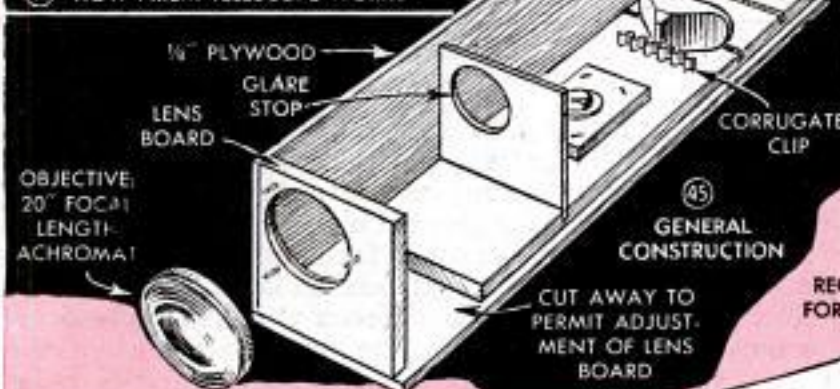

(45) GENERAL CONSTRUCTION

23X Spotting scope

uses 20-in. focal length objective and has prismatic erecting system. Main tube is covered with leather or canvas

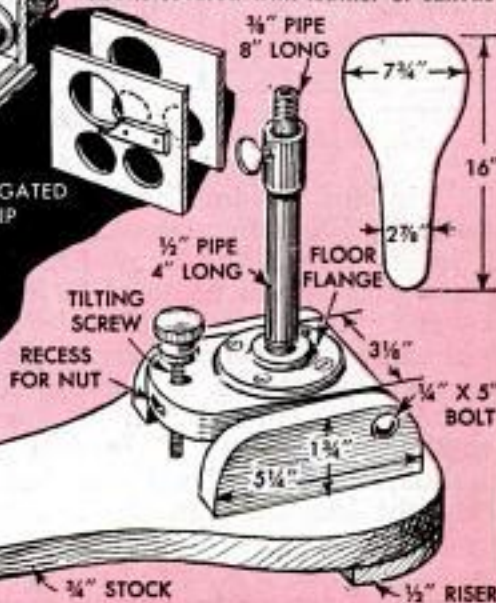

(46) MOUNT HAS HEIGHT AND ANGLE ADJUSTMENTS

Lenses	Inches		Millimeters	
	Dia.	F.L.	Dia.	F.L.
OBJECTIVE	1 3/4	20	44	508
FIELD	7/8	2	23	50
EYE	1/2	1 1/2	16	28

Data

EQUIV. FOCUS OF EYEPIECE = $\frac{28 \times 50}{28 + 50 - 15} = 22$ MM.
 MAGNIFICATION = $508 \div 22 = 23X$
 EXIT PUPIL = $\frac{1}{8}$ " = 2 MM.
 EYE RELIEF = $\frac{7}{16}$ IN.
 LUMINOSITY = 13%
 PRISMS—1-IN. FACE
 IMAGE SIZE = $20" \times .030 = .60" = \frac{3}{16}"$
 FIELD OF VIEW AT 1000 YDS. = 24 YDS. (APPROX.)

ple being a spotting scope, which is used to view the target in rifle shooting.

Prisms: Prisms are polished, angular pieces of glass, the kind commonly used in telescopes being 45-45-90-deg. prisms. The long side is the face, while the two short sides are the reflecting surfaces. The size of the prism is the width of the face. Fig. 44 shows how the prisms are used in a telescope. Made specifically for telescopes, the prisms are grooved across the face in order to make a definite dividing line and avoid ghost images which would be caused by overlapping rays at this point. The ends are usually rounded to conserve space. The two sizes that you will probably work with

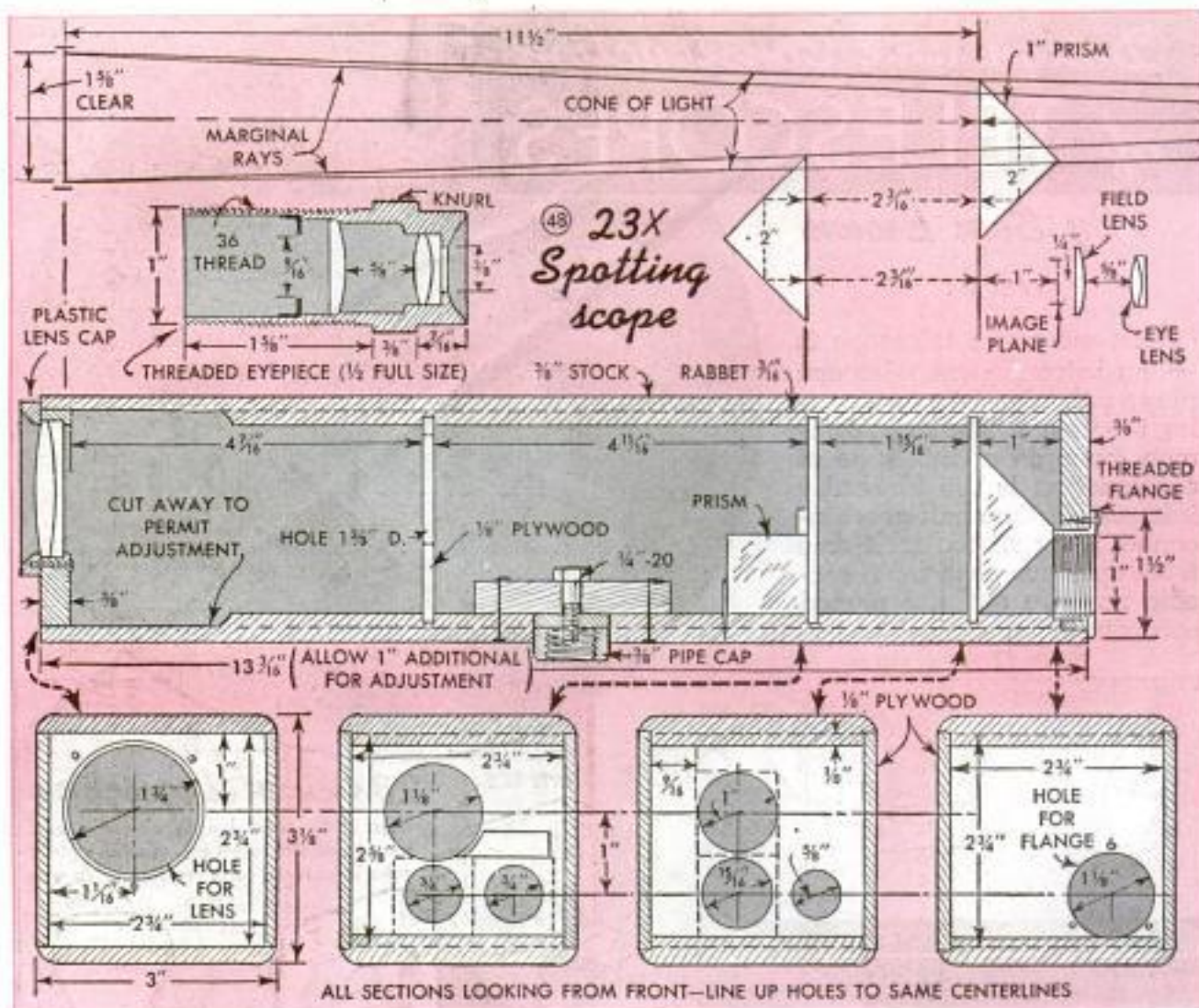

are 1 in. and $1\frac{3}{16}$ in. The 1-in. size is from the Navy 7X binocular while the smaller prism is from the Army 6X binocular. These prisms can be used in almost any power or type of prismatic telescope. The prime advantage of the prism erecting system is compactness. It adds somewhat to the bulk of the instrument but shortens the length considerably. The prism glass has an illusive quality of brilliance but actually the light loss through the two prisms is somewhat greater than through the two erecting lenses of a lens erecting system.

The 23X prismatic spotting scope: This design calls for a 20-in. focal length objective, which, with a 22-mm. focal length eyepiece (from Army 6X), gives 23-diameter magnification. Prisms are 1-in. face. Fig. 45 shows the general construction and Fig. 47 gives lens data, while Fig. 48 gives complete dimensions. The scope body is of wood construction in simple box form. The first prism, the one the light strikes first, is located in an upright position at the back of the box; the second prism is mounted flat on the box bottom. Plywood spacers hold the prisms in place and also provide for the passage of the cone of light admitted by the objective. The eyepiece is fitted in

a threaded mount. This type of focusing is satisfactory at set distances but is much too slow for general use. If you want this scope for general observation, it should be fitted with spiral focusing like the 10X monocular to be described later. It would also be practical to focus with a simple draw tube system. The principal point of the construction is to get the various holes lined up square. Use prism center lines as a guide and locate all holes from one master pattern drawn on cardboard.

A mount for the spotting scope is shown in Figs. 43 and 46. The $\frac{3}{8}$ -in. pipe fits into a pipe cap recessed and bolted to the bottom of the telescope as can be seen in Fig. 48. The pipe slides inside the 4-in. length of $\frac{1}{2}$ -in. pipe to provide height adjustment from 11 to 17 in. to objective centerline. Base on which the floor flange is mounted pivots on a carriage bolt and is tilted by means of a tilting screw.

Designing prismatic telescopes: Designing your own prismatic telescopes follows much the same procedure as used for astronomicals and terrestrials. Primary consideration should be given the objective and eyepiece. The prisms contribute nothing to the magnification; therefore, the power

you want must be obtained entirely by the ratio of FO to FE. Prisms should be of such a size or so located as to receive the full cone of light from the objective, although it is practical to sacrifice extreme edge rays.

Fig. 52 shows the complete layout and construction of a 10X monocular. The layout (at top of drawing) is what you make to determine size and location of prisms and also the general overall dimensions. In this example, the objective has a 52-mm. diameter by 193-mm. focal length (from Navy 7X binocular) and the prisms are 1-in. face (from Navy 7X). As used by the Navy, this glass has a 27-mm. eyepiece, which gives a magnification of 7 diameters. If you want higher magnification, you have to use a shorter focus eyepiece. The Army 6X binocular eyepiece, 22 mm., could be used and would give you 9X. The eyepiece shown uses an Army binocular eye lens, but a shorter focus field lens, the combination giving 20-mm. focus, hence, about 10X magnification.

The preliminary calculation should determine the exit pupil and luminosity. This glass has excellent illumination at 92 percent. However, don't get the idea that the 13 percent rating of the 23X spotting scope is hopeless—13 percent is a good value for anything over 20X magnification. It is worth mentioning here that prism instruments are often rated for illumination on the basis of the exit pupil squared. Thus, if the scope has a 5-mm. exit pupil, it would be rated 25. Using this calculation, the 100 percent standard would be the normal size of the eye pupil, squared: 25 for daylight and 49 for night.

Bench setup: Set up the objective and focus on well-lighted copy or a bare light bulb, not less than 20 ft. from lens. Use tracing or waxed paper as a ground glass to pick up the image as in Fig. 49. Measure the distance from the rear side of the objective to the image plane. Start your layout and transfer this dimension to the layout, as indicated by A, Fig. 52. Next, put the two prisms face to face as in Fig. 50 and move the assembly back and forth until you pick up a sharp image of the copy or light bulb. Measure the distance to the face of the first prism and set off this distance on your layout, indicated by B, Fig. 52. Now, referring to the Fig. 48 layout, you will note that the distance the light travels through a 1-in. prism is 2 in., a total of 4 in. for both prisms. Set off this distance, C, on your layout to establish the back image plane. Determine the image size. In this instance, the multiplying factor is .070, and this figure multiplied by the focal length of the lens ($7\frac{3}{8}$ in.) gives .53 in. for the image size. Call this $\frac{9}{16}$ in. for an even figure and mark the image size at



PICK UP IMAGE ON TRACING PAPER

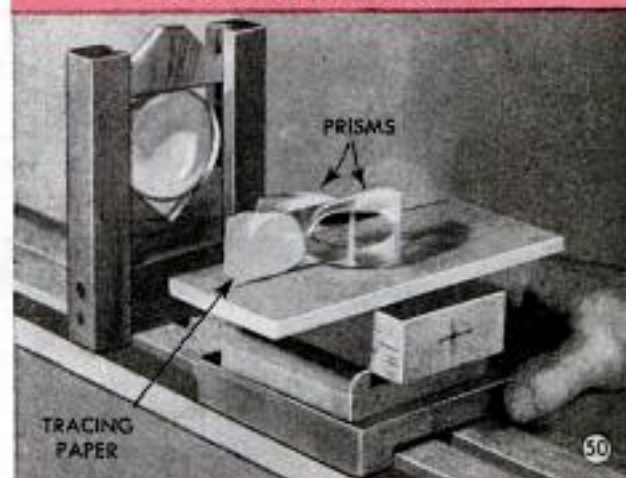

LOCATE IMAGE PLANE WITH PRISMS

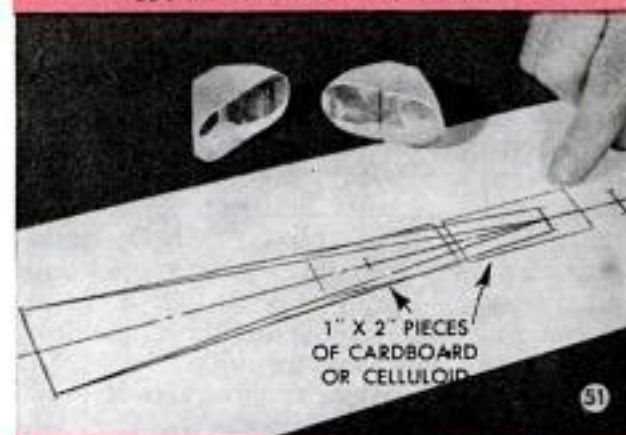

MAKE LAYOUT AND MANIPULATE PRISMS TO SUIT

the normal image plane and again at the back image plane, as indicated by L, Fig. 52. Draw lines K and M representing the marginal rays and the full cone of light. Your prisms must catch the marginal rays K and also as much of the weaker edge rays as possible. The best way to determine prism placement is to make two 1 by 2-in. oblongs of cardboard or celluloid. Manipulate these over your layout as in Fig. 51. The forward edge of the first oblong represents the face of the first prism. You can tell at a glance how far forward you can push it and still pick up the marginal rays.

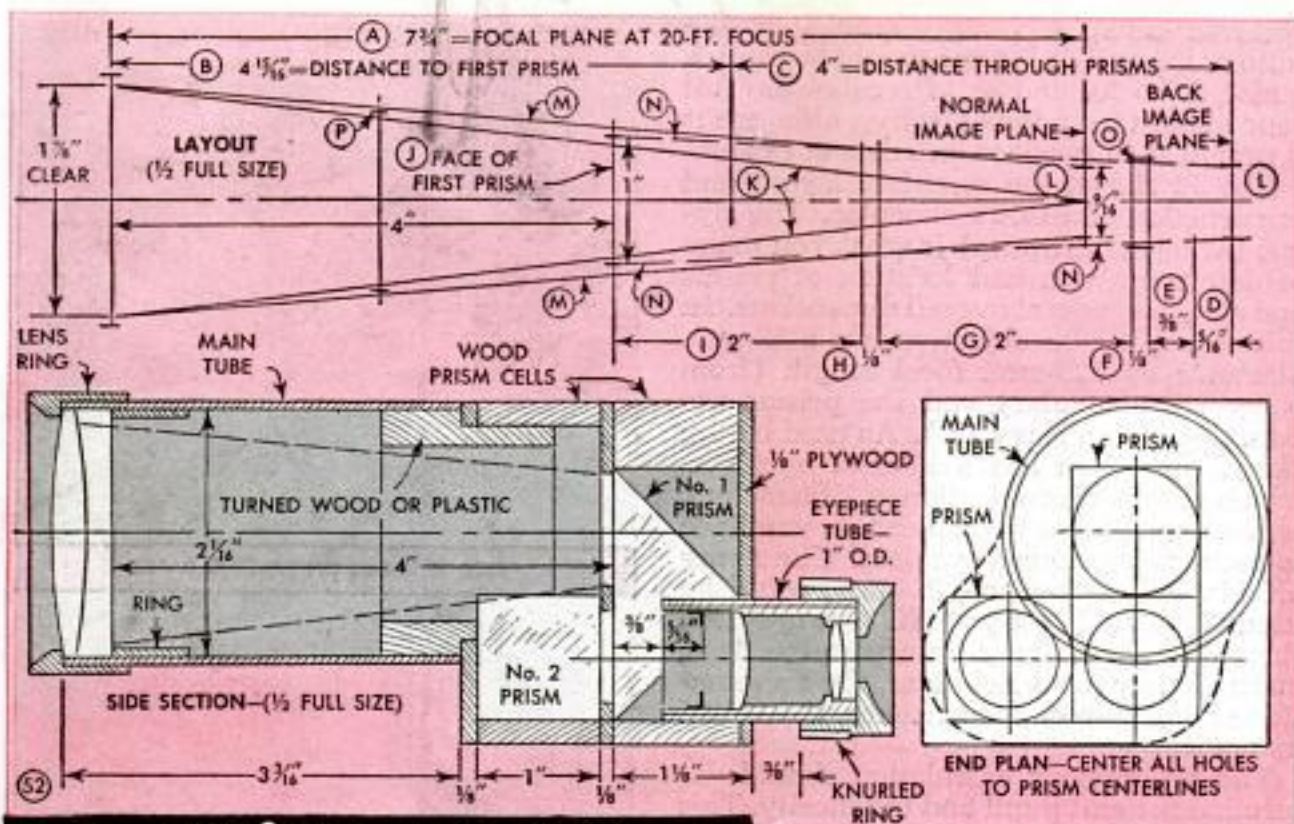

10x Prism monocular

OBJECTIVE: 52X193 MM.

PRISMS: 1"

FIELD LENS: 21X32 MM.

EYE LENS: 16X25 MM.

COMBINED FOCUS OF $\frac{25 \times 32}{25 + 32 - 16} = 20$ MM.

EYEPIECE

$M = 193 \div 20 = 10X$

$EP = \frac{3}{16}$ " STRONG = 5 MM.

EYE RELIEF: $\frac{7}{16}$ "

LUMINOSITY: 92%

FIELD (From Fig. 24): 70 YDS.

FIELD (Actual): 62 YDS.

WEIGHT: 1 LB.

The distance between the two oblongs is the spacing between the prisms. The distance between the back edge of the second oblong and the back image plane must be sufficient to permit focusing. What you finally arrive at in this case is D, $\frac{5}{16}$ -in. allowance for the distance the image plane will set inside the eyepiece tube; E, $\frac{3}{8}$ in. for focusing travel; F, $\frac{1}{8}$ -in. prism spacing; G, 2 in., the distance through the second prism; H, $\frac{1}{8}$ -in. prism spacing again, coming back; I, 2 in. for the first prism, arriving at J, the face of the first prism. This may sound complicated, but it is really very simple if you are actually on the job. If desired, you can now draw an outline of the prisms like Fig. 48. This shows both prisms flat, the same way you test them in the bench setup.

At this point J, it will be noted that the face of the prism catches all of the marginal rays and about halfway out to the lines representing the full cone of light. As mentioned before, it is practical to sacrifice some or all of the weak edge rays, so that this placement of the first prism face is quite satisfactory. What next? Well, you know that the maximum cone of light you

can catch on the first prism is 1 in. in diameter at J, so lines drawn from here to image size at the back image plane will establish guide lines for hole diameters needed to pass this same cone of light back to the image plane. These lines are marked N in the drawing, and O, for example, shows the diameter

of the hole at the back face of the second prism. If you want to use one or more glare stops ahead of the prisms, the hole diameters are determined in the same way, as at P.

Monocular construction: You will need two wood blocks exactly 1 in. thick to house the prisms, Fig. 54. The $\frac{1}{8}$ -in. spacing between prisms is taken up by a spacer of $\frac{1}{8}$ -in. plywood, and similar plywood pieces are used at the back and front of the housing. The whole thing is glued up like a triple decker sandwich, the prisms being held securely in the cutouts and between the various layers. Work carefully to prism center lines. Be sure that prisms are exactly at right angles since any rotation here will rotate your image twice as much. Prisms must be spotlessly clean and polished. The eyepiece tube is 1 in. in diameter, this size permitting it to work alongside No. 1 prism. Focusing is by means of a spiral groove cut half way across the eyepiece tube as in Fig. 55. Fig. 56 shows the monocular partly assembled and also shows how the turning which joins the main tube to the prism housing is cut away to fit over the second prism. Fig. 53 pic-

tures the finished job covered with a gray pebble-grain oilcloth.

General notes: Cut the main tube long when making any prism telescope. Check the final position of the objective by actually using the instrument; run the eyepiece in as far as it will go and then place the objective so that distant objects are in focus. Then the full focusing range is available for picking up nearer objects. The 23X spotting scope will focus down to about 40 ft.; the 10X monocular to about 30 ft. or even 20 if you want to make it that way. If you use spiral focusing, it is necessary to know in advance how much you will need for focusing. This travel will be very short with a short focus lens, but much longer with a long focus objective. Allow $\frac{3}{8}$ in. for lenses less than 10-in. focus; $\frac{3}{4}$ in., up to 14-in. focus; $1\frac{1}{8}$ in. at 18 and $1\frac{1}{2}$ in. at 20. These allowances will let you focus down to 30 or 40 ft. in all cases, possibly closer. When you make a bench setup at close range, remember that this represents the maximum extension of your telescope. If you make a bench setup by focusing on a distant object (this is advisable if you are using an objective of over 20-in. focal length) the setup will represent the telescope at its shortest draw.

The Kellner type of eyepiece gives best results with all prismatic instruments. The objective should always be a cemented achromat. If the lens is not cemented when you get it, you can dummy test it by cementing with glycerine. Final cementing should be done with Canadian balsam; in a pinch you can use a good grade of water white (clear) lacquer. The diameter of the objective controls the

luminosity of the telescope. The diameter of the objective does not control the field of view; except in the Galileian instrument, you can see just as much through a small objective as a large one.

(CONCLUSION)

Water Glass Strengthens Asbestos Used to Hold Resistance Wire

Asbestos that is to be used instead of fiber or plastic for attaching the wires of a resistance heating element will be strengthened so that it does not tear easily if it is treated with water glass. The asbestos is soaked in a solution consisting of equal proportions of sodium silicate or potassium sil-

icate and water; then the asbestos is allowed to dry thoroughly. After this treatment it can be more easily drilled and sawed. If desired, a piece of the desired thickness can be built up from several thin sheets by using water glass as an adhesive and clamping them between boards to dry.

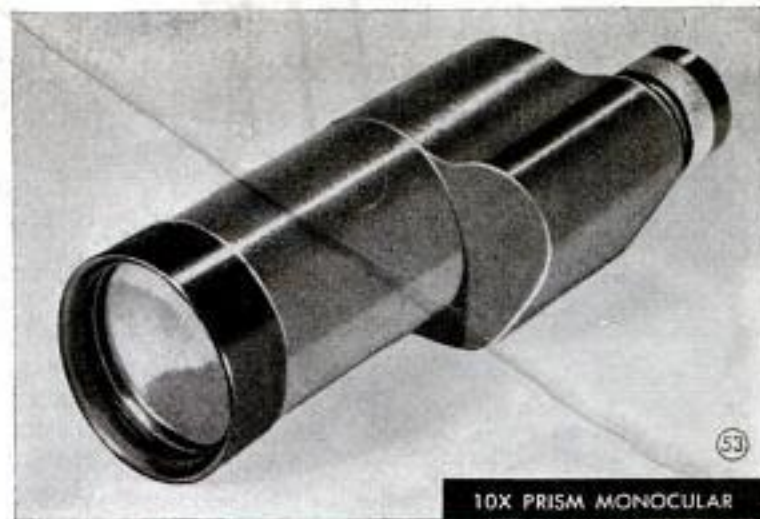

10X PRISM MONOCULAR

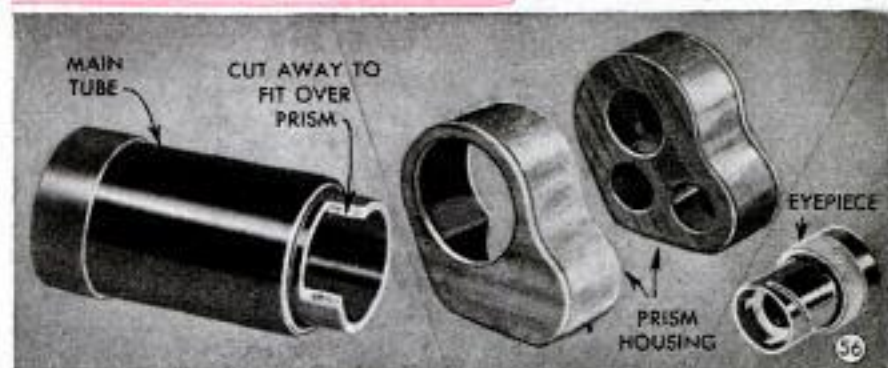
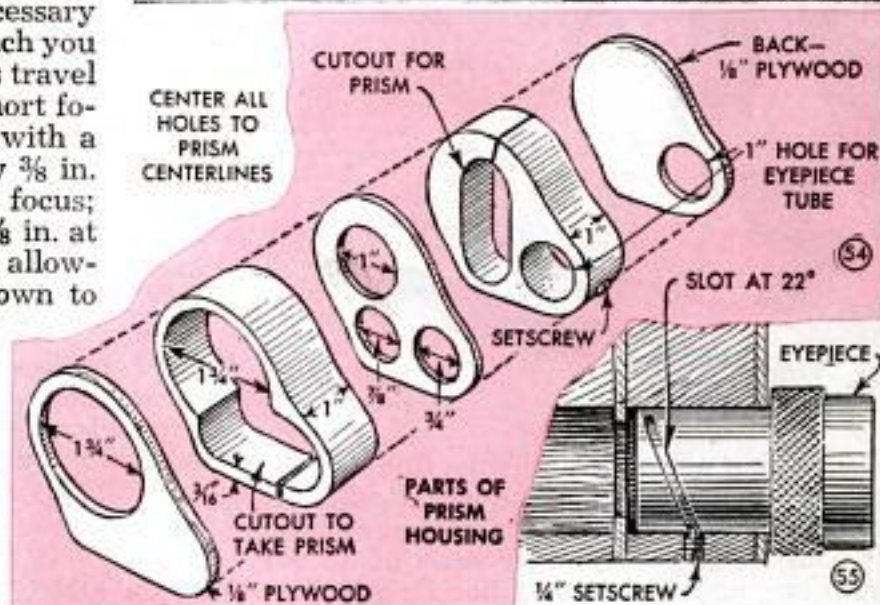

Engine Head Makes "Ice Plane" To Clean Skating Pond



Cleaning off snow and smoothing rough places on the ice of a skating pond is an easy job when this plane or scraper is used. It consists of the cylinder head of an old auto engine fitted with a handle which is made by assembling pipe and fittings to screw into the spark plug holes of the cylinder head as indicated. The scraper is pushed along by a skater and, as it is heavy and has sharp edges, it will remove snow and shave off rough places in the ice with little effort on the part of the skater.

Linens Arranged Neatly in Closet

Neat arrangement of linen need not be disturbed when one article is taken from a shelf if cardboard the size of the article is inserted between the pieces. This method prevents corners from being displaced when a piece is pulled out and only the item desired slides out.

Mrs. F. J. Tuccillo, Lime Springs, Iowa.

Bucket-Bail Grip Is Slit Spirally



If you place a short piece of hose over the bail of a bucket as a protection to your hand when carrying a heavy load, slit the hose spirally rather than straight in or-

der to slip it over the bail. When cut in this way, the hose will remain in place instead of pulling off when the slit is in line with the bail.

Magazine Binding Is Reinforced By Tape Stuck Under Staples

Pieces of transparent tape applied under the ends of staples used to bind the pages of magazines will prevent the pages from tearing at these places so that they fall out. The ends of the staples are pried up and the tape is placed between them, adhesive side down, after which the ends are bent down over the tape.—J. N. Parker, Bedford, Va.



Templates to Lay Out Corners

Used as templates to lay out rounded corners on panels, shelves and similar work, disks of plywood will serve in place of a standard fillet gauge. The disks are scribed to required diameters then sawed out carefully and smoothed, and a hole is drilled in each disk so that it may be held on a wire hook or nail when not in use.

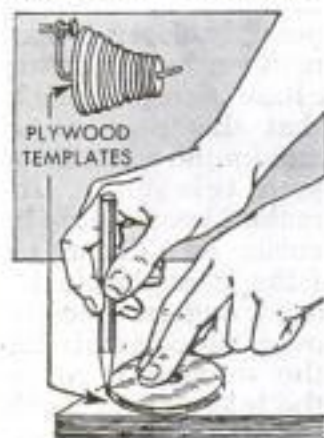

A. H. Alexander, Philadelphia, Pa.

Sheepskin Buckled on Wrist Aids in Washing Ceilings

To keep water from running down his arm when washing walls and ceilings, a decorator wears a strip of sheepskin on his wrist, with the wool side in. The sheepskin is cut just long enough to fit tightly in place without overlapping, and is held by a buckle and a short length of leather strap such as is used on roller skates.



John Krill, Youngstown, Ohio.

Bouncing Bobsled

HAS AUTO-SPRING BODY

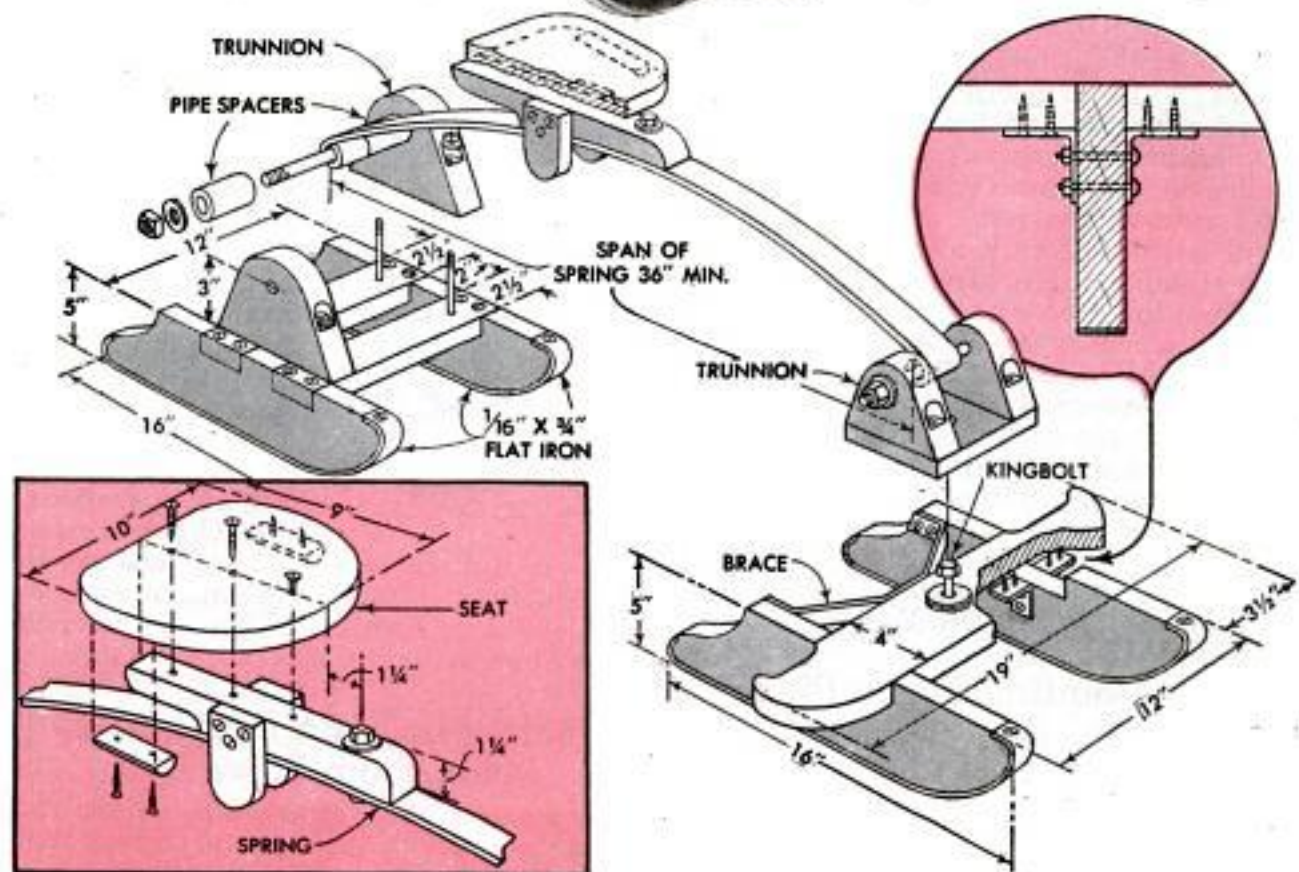

THE bumper the slide the better with this spring-bodied bobsled, which is steered with the feet so that the rider can hold on to the seat. The main leaf of an auto spring is held by lengths of iron rod set through wooden trunnions, which are bolted to cross members screwed to sled runners shod with strips of flat iron. Since the rear trunnions are widely spaced to prevent the sled from upsetting, the spring is centered on the rear rod by pieces of pipe. On the more closely spaced front

trunnions these are not needed, although washers may be used between the spring and trunnion sides. Corner irons reinforce the foot rest. The seat is screwed to a support that is attached by a kingbolt through the hole in the spring. Wooden guides screwed to the support prevent side sway of the seat, and narrow cleats are attached to the underside of the seat for finger grips. Spring and runner irons are painted to prevent rusting, and the wooden parts are shellacked and varnished.

Water-Heating Coil in Furnace Flushed to Keep It Clean



Frequent back-flushing of a water-heating coil in a furnace will keep it reasonably free of sediment and lime deposits. With the valve arrangement shown, flushing will require only a minute or two. In the cold-water side of the water line to the coil, install a shut-off cock and a sill cock or other suitable valve. Then run a hose or pipe from the sill cock to a basement drain. To flush the coil, close the shut-off cock and open the sill cock. This will cause the water to reverse its normal direction of flow through the coil and wash out the sediment. It's best not to flush the coil when there is a hot fire in the furnace as the coil then may act as a flash boiler and blow off steam. However, if handled carefully, the steam aids in the cleaning.

Robert A. Wilkinson, Van Wert, Ohio.

Jig for Pointing Fence Pickets

Faced with the job of pointing a number of fence pickets, one man used a jig for positioning them on his saw table. The jig consisted of a piece of $\frac{3}{4}$ -in. hardwood

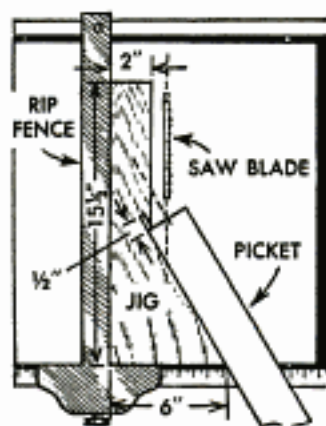

shaped as shown. When cutting the diagonal side of the jig the saw is run into the straight side for a distance of about $\frac{1}{2}$ in. This cut will form a point at the junction of the angle to help hold the work in position. To use the jig, the saw fence

is set so that when the jig is advanced with the work, the blade will enter the picket at the centerline. After one corner has been cut off, the jig is returned to starting position, the picket is turned over and run through for the second cut.

Aime E. Tetrault, Fairhaven, Mass.

Nails Driven at an Angle Hold Warped Boards

If you experience difficulty in keeping boards and planks nailed down when used around a dock or swimming pool because they warp and loosen the nails, drive the nails at an angle. By doing this you will enable the nails to withstand better the continuous pull exerted against them by the warped boards.—George Barr, Brooklyn, N. Y.



By doing this you will enable the nails to withstand better the continuous pull exerted against them by the warped boards.—George Barr, Brooklyn, N. Y.

Small Work Held in Drill Chuck When Drilling or Machining

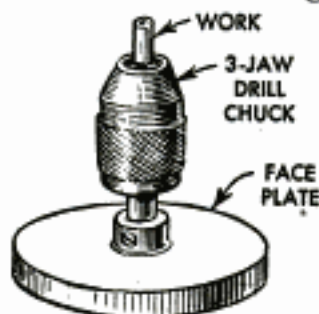

A $\frac{1}{2}$ -in. drill chuck mounted on a short shank and attached to the rear surface of a faceplate provides a handy tool for holding small work for light machine operations.

The chuck is especially useful when the ends of rods are to be drilled or ground as the machined surface of the faceplate provides a precision base when placed on a drill-press table.

Safety Lock on Dog Leash Made From Stove Bolt

A restless dog sometimes twists the spring snap on his leash in such a way that it becomes unfastened. On a recent trip when my dog was checked in the baggage car, I prevented this by putting a stove bolt through the snap and screwing the nut tight after snapping the leash on the dog's collar. A nick in the threads kept the nut from loosening.

B. B. Brues, Newtonville, Mass.

Painted handles on knives and other kitchen gadgets should never be allowed to stand in water. The wood will absorb water and cause the paint to chip off.

Table Christmas Tree Has Paper-Disk "Foliage"

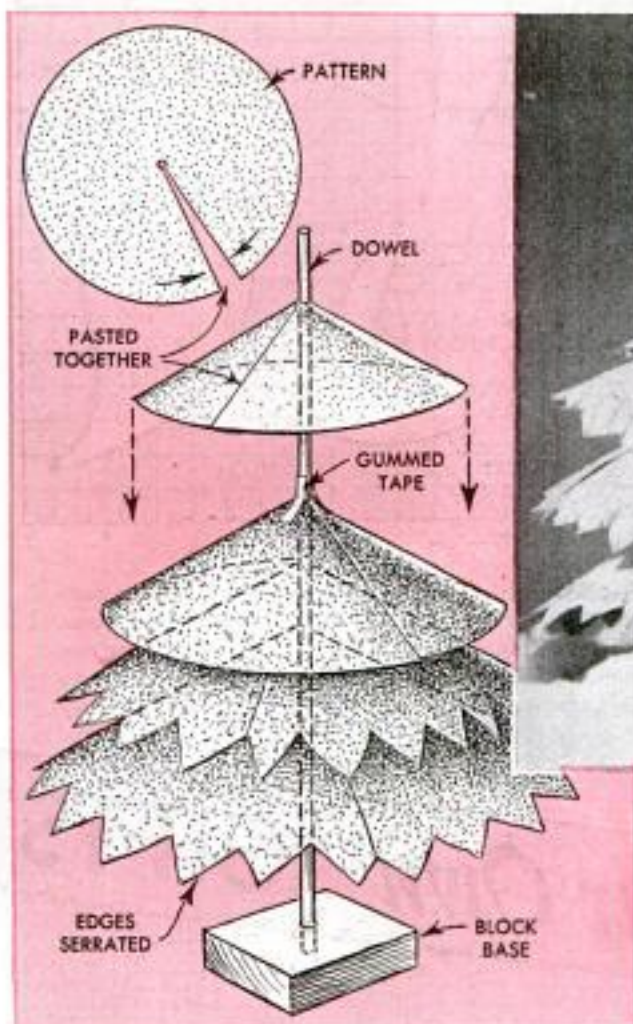

succeeding disk is cut to a smaller diameter so that the tree tapers naturally. From each disk a wedge-shaped piece is cut to its center, as shown in the upper detail. The cut edges are brought together and glued to form a cone and a hole is cut at the apex to fit the dowel "trunk." This may be tapered slightly and is set in a hardwood block which serves as a base. The cones are held by strips of gummed tape, and the edges are serrated. For trimming, mucilage is dropped on the cones and bits of colored paper are sprinkled over it.

Allan Carpenter, Chicago.

Built up of green-paper disks taped to a length of dowel, this "Christmas tree" is just the thing to decorate a table or sideboard. Any number of disks may be used. The diameter of the bottom disk determines the spread of the "foliage," and each

This Tool Cuts Long Laces From Small Piece of Leather

By making a tool like the one shown, you can cut thongs or laces of the desired widths from a piece of leather whenever an occasional need for them arises. The tool is a hardwood block shaped into a body or grip which is formed to fit the hand, and a narrower upper part in which notches of varying depths are cut, depth of each notch determining the width of lace. The body is slotted at a right angle to the notches to take a hacksaw blade that has been sharpened along the back edge. The body is drilled for a pin that fits into a notch ground in the toothed edge of the blade. In using the tool, a narrow tab is cut in the center of a piece of leather with a knife, and the tab is inserted in the notch of the correct depth and pulled through it, a lace being cut as the leather is drawn across the blade.—A. R. Wallis, Vancouver, Wash.

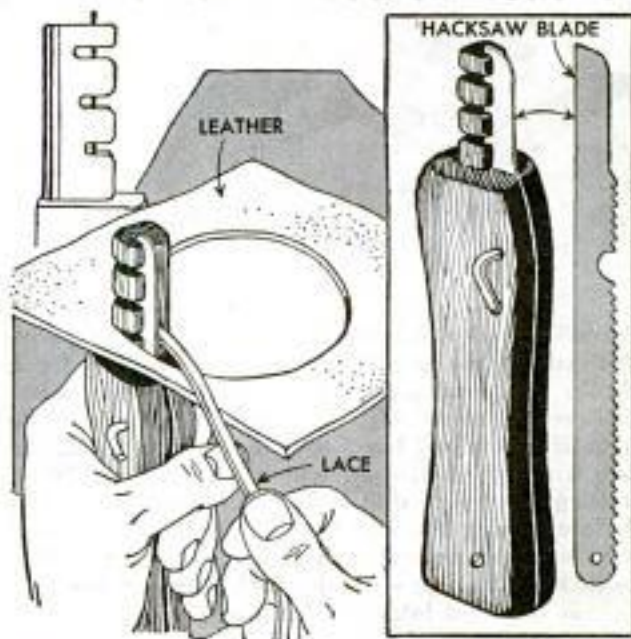



Walking penguin

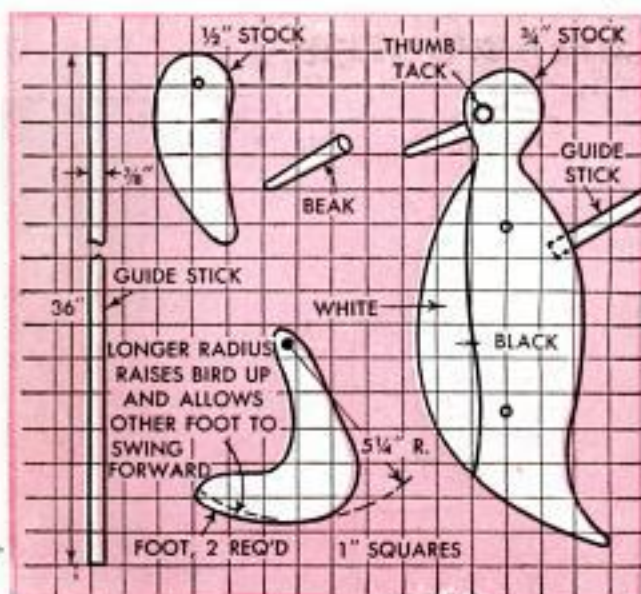

Realistic action of this toy as it waddles across the floor will please any small child. Body and head are one piece to which wings and feet are pivoted loosely. Curve of the feet is important as this allows the penguin to walk in a lifelike way



Make Your Own GIFTS



Rocking pup

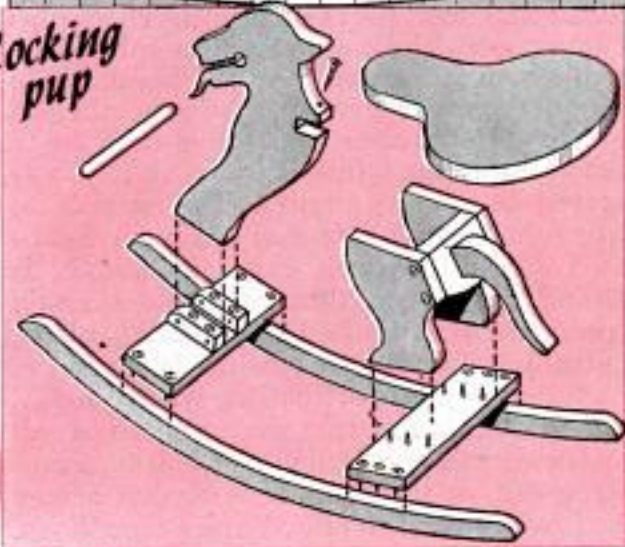
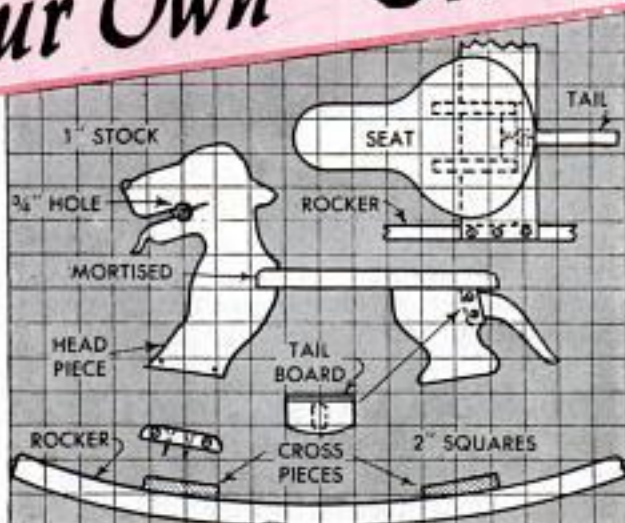

Standing under the tree on Christmas morning with his red tongue hanging out as though ready for a frolic, this rocking pup will make any youngster believe in Santa Claus. Construction takes little time if a scroll or band saw is available. And the job is not difficult, even with a coping saw. When cutting the head, drill a hole for a dowel handle before sawing the slot for the mouth. Then round all the edges, smooth with sandpaper and assemble with screws. Note that the front edge of the seat is mortised into the shoulders for rigidity

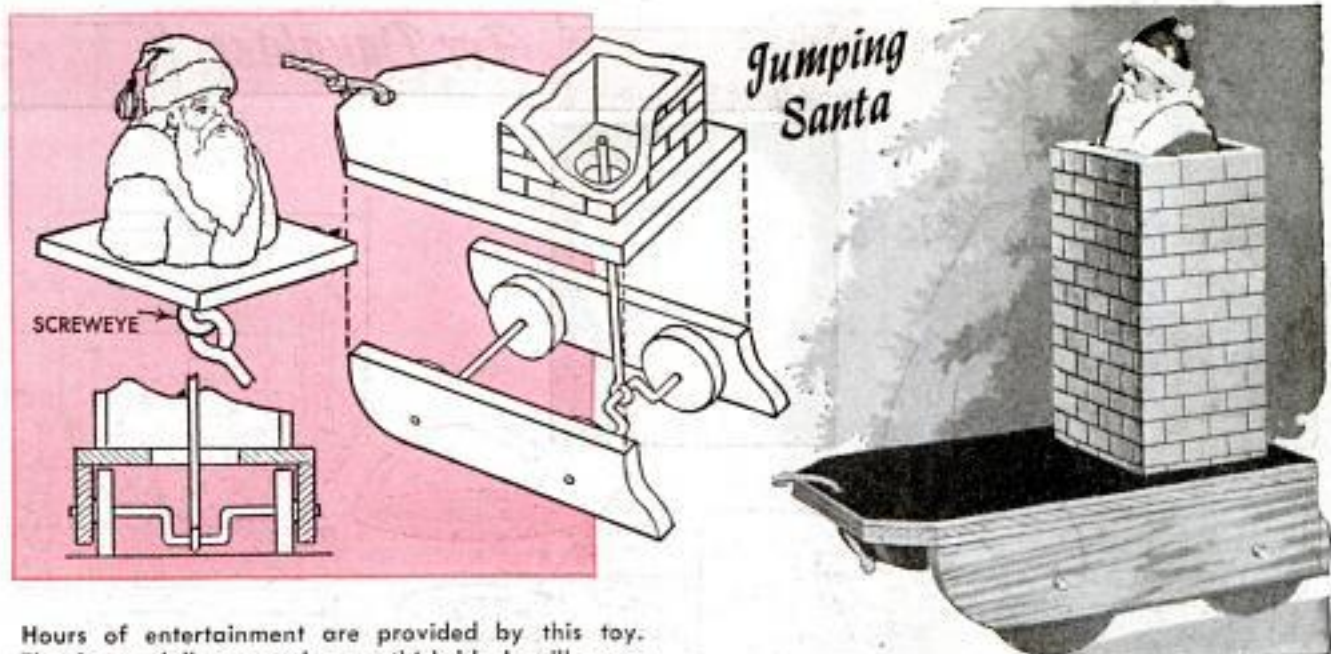

Hours of entertainment are provided by this toy. The Santa doll mounted on a thick block will move up and down due to the crankshaft action of the axle

for CHRISTMAS

Noah's Ark is a traditional gift for young children. In addition to the animals shown, zebras and monkeys can be sawed out to expand the menagerie

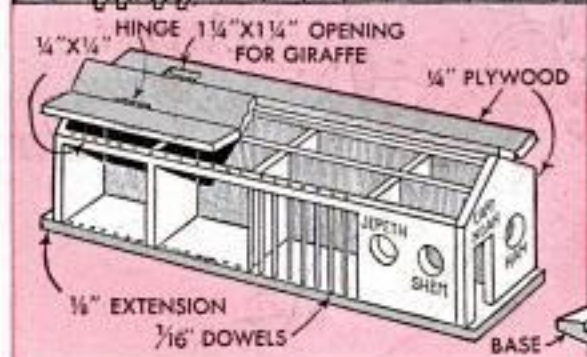
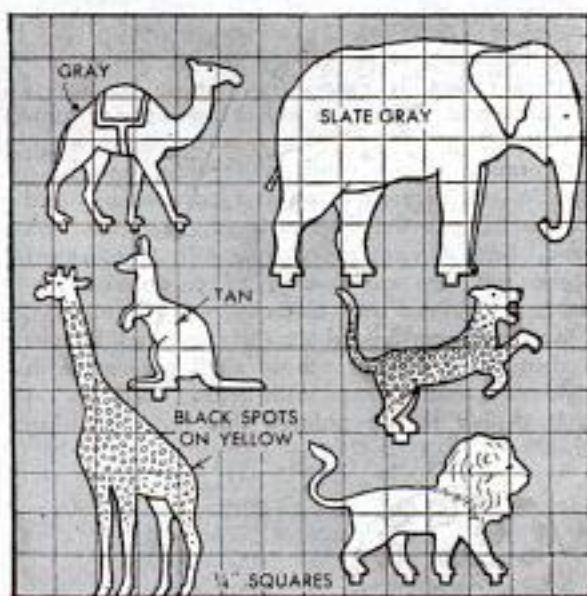

Noah's Ark

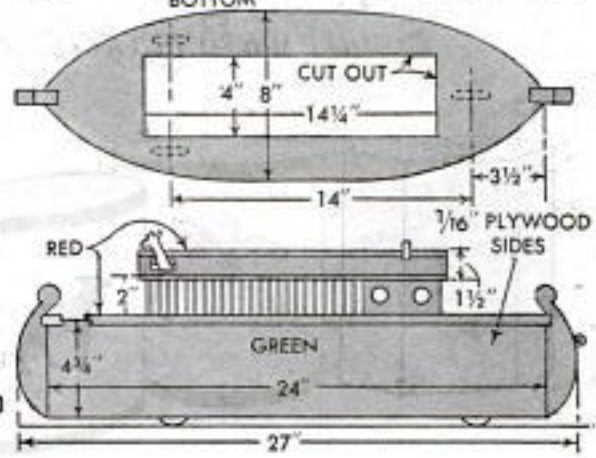
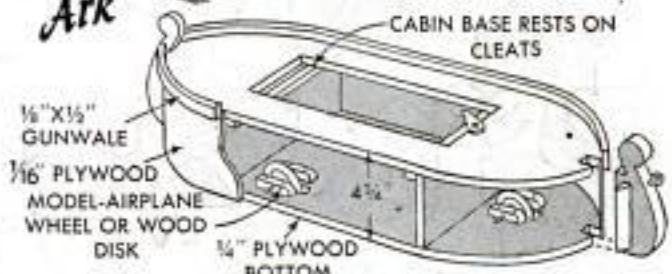

For Daughter

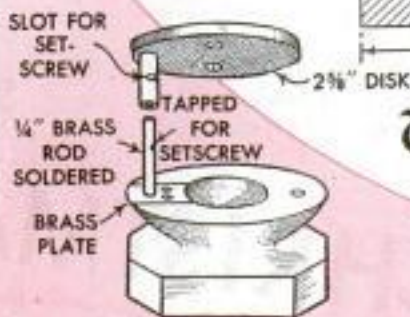
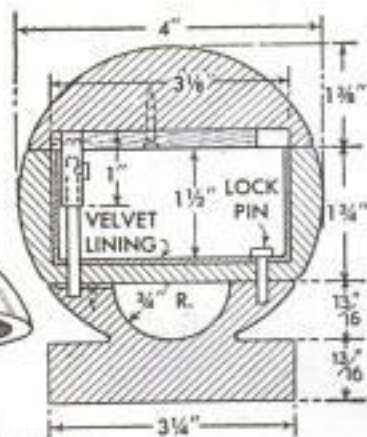

Trinket box

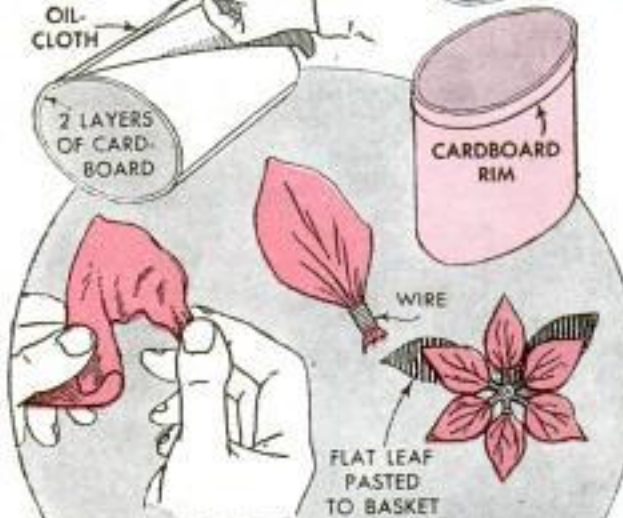

Smart wastebaskets

Above: Featuring a secret ring cavity, this attractive trinket box is made from three pieces of 2-in. hardwood. These are glued together for turning, paper being inserted to separate them later. After forming a 4-in. ball, turn center and base compartments, recess the top and fasten sleeve and rod assemblies to the lid and base. Then finish as desired. Left: Always a welcome gift, these smart wastebaskets are constructed of cardboard fastened to a plywood base and covered with oilcloth. The top also is cardboard similarly covered. Below: This string holder is a coconut shell covered with a bandanna and adorned with brass "earrings." A hole is drilled in the painted lips for the string

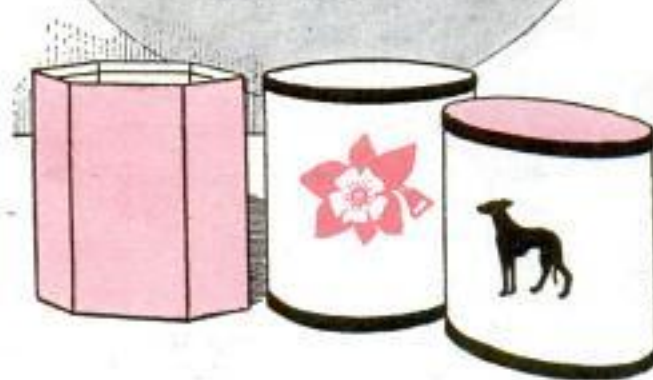

Coconut string holder

For Mother

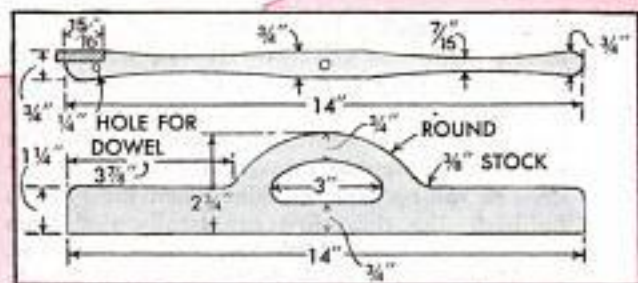
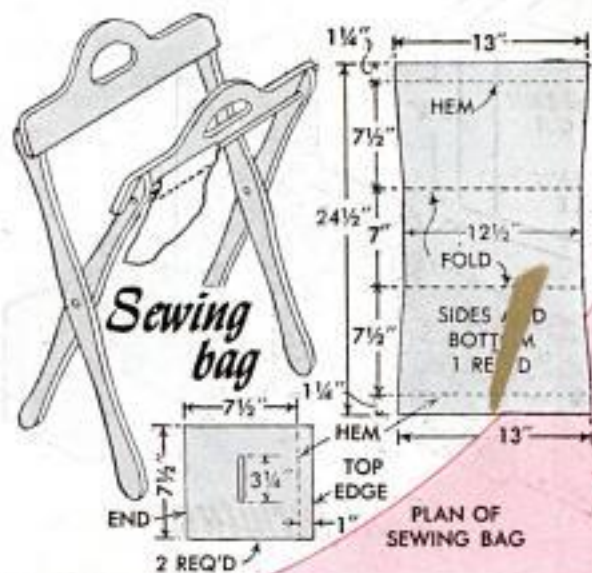

Above: Attractively colored oilcloth will make this sewing bag a gay and welcome gift. The cloth is cut as shown and all edges are sewed together, using bias tape of a contrasting color to bind the edges. Note that two $\frac{1}{4}$ -in. dowel rods hold the bag to the frame. Right and below: Ebony or rosewood, as well as walnut, can be used for this novel condiment set. The spoon is shaped by hand, and the other items are sawed and turned. Drill $\frac{1}{16}$ -in. holes for pepper and $\frac{3}{32}$ -in. holes in salt shaker



Wooden condiment set

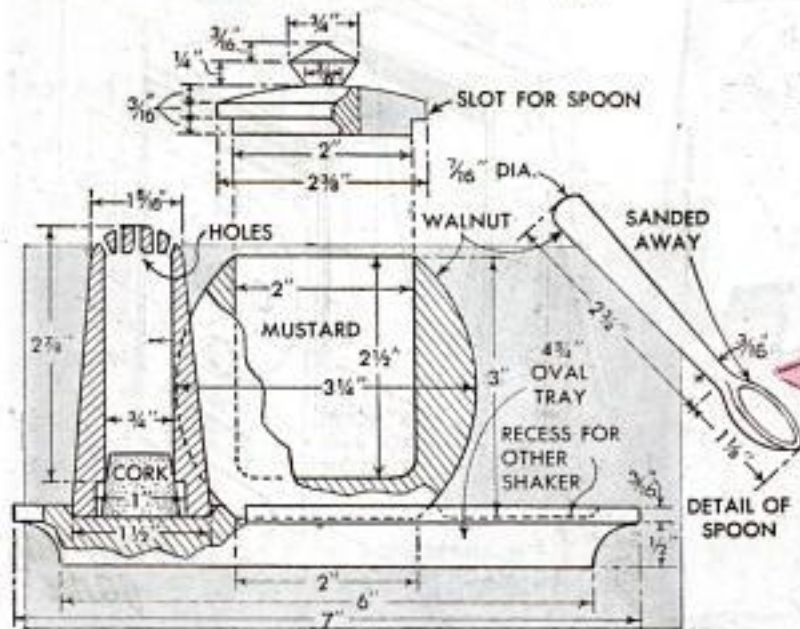

For Older Children

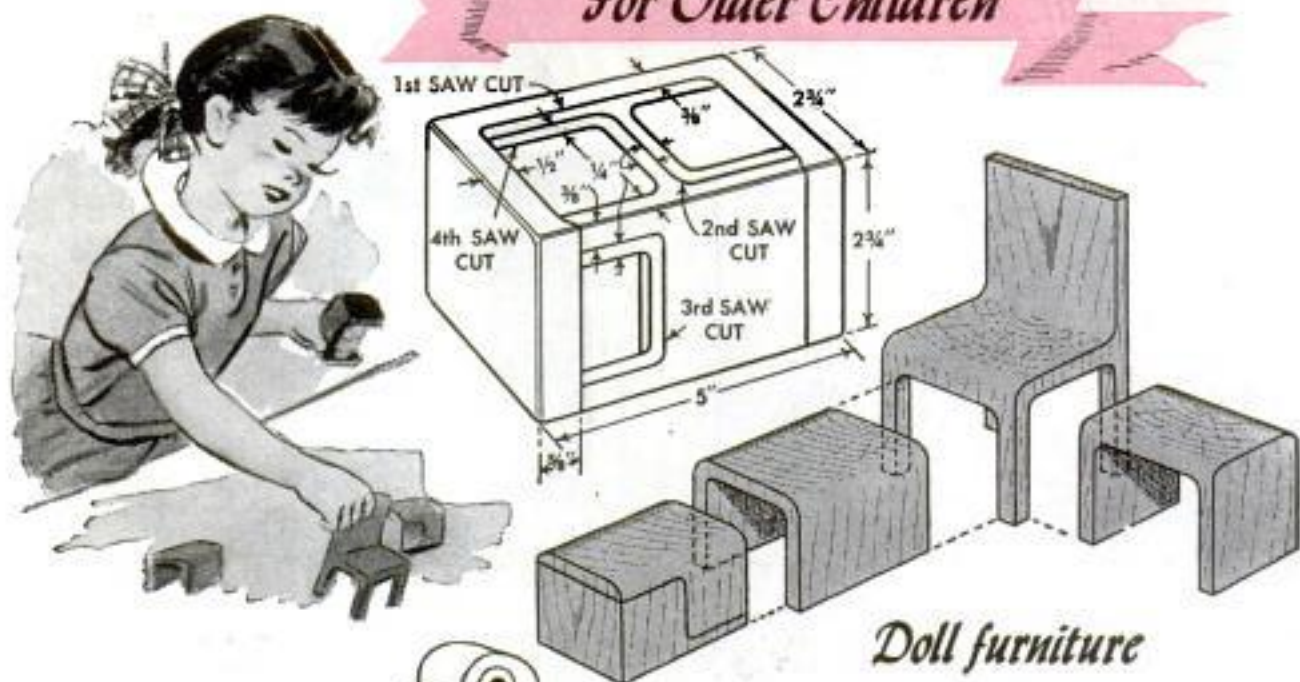

Doll furniture

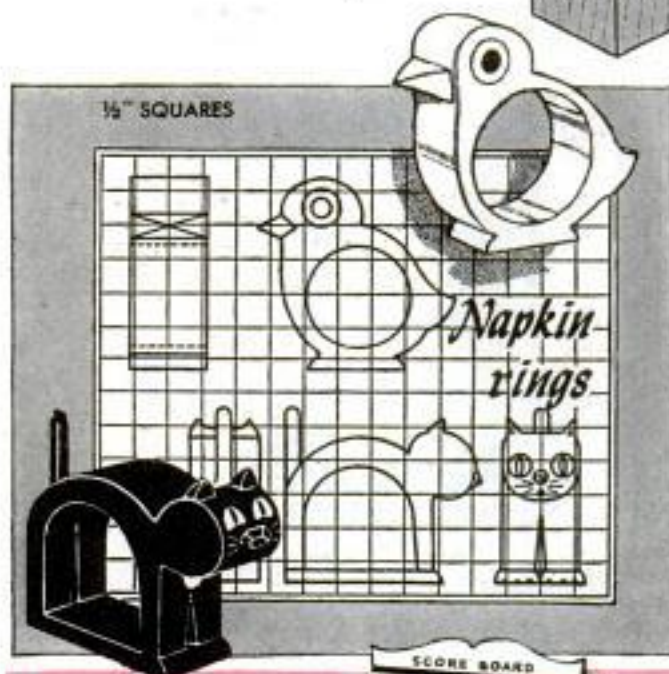

Above: Durability is a feature of this doll furniture, which includes end tables, chairs and footstools. They are all sawed from one piece of hardwood as shown in the diagram, and then stained and varnished or waxed. Left: Cat and chicken napkin rings will encourage children to roll up their napkins when the meal is finished. The rings first are scrollsawed from 1 1/2-in. stock, then whittled to shape. However, the kitten ring is made in two parts, the body and the base, with small V-grooves cut in the body for the legs. For the finish, apply a priming coat of shellac and then several coats of enamel. Below: Just for fun, try throwing bean bags. After the bags are thrown through the holes, they slide down and collect behind an opening from which they are readily removed. Note that when set up, the stand rests on the braces and on the feet cut in the front panel.

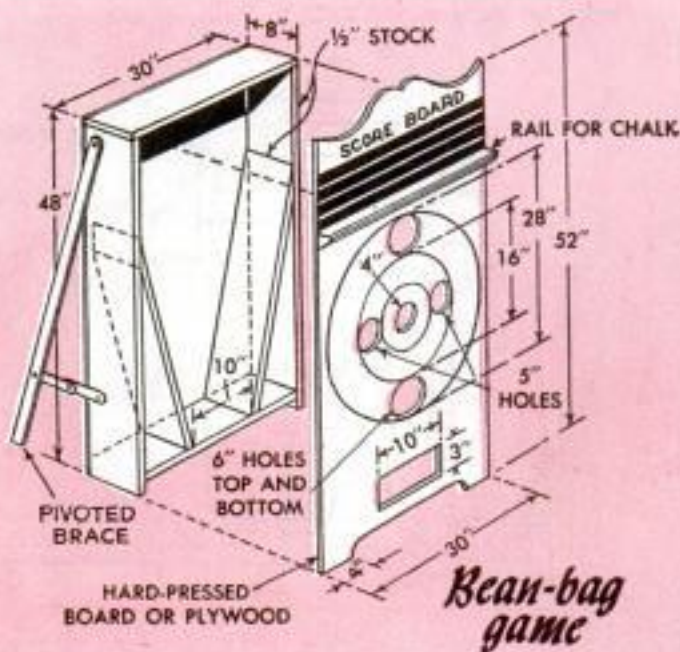

Bean-bag game

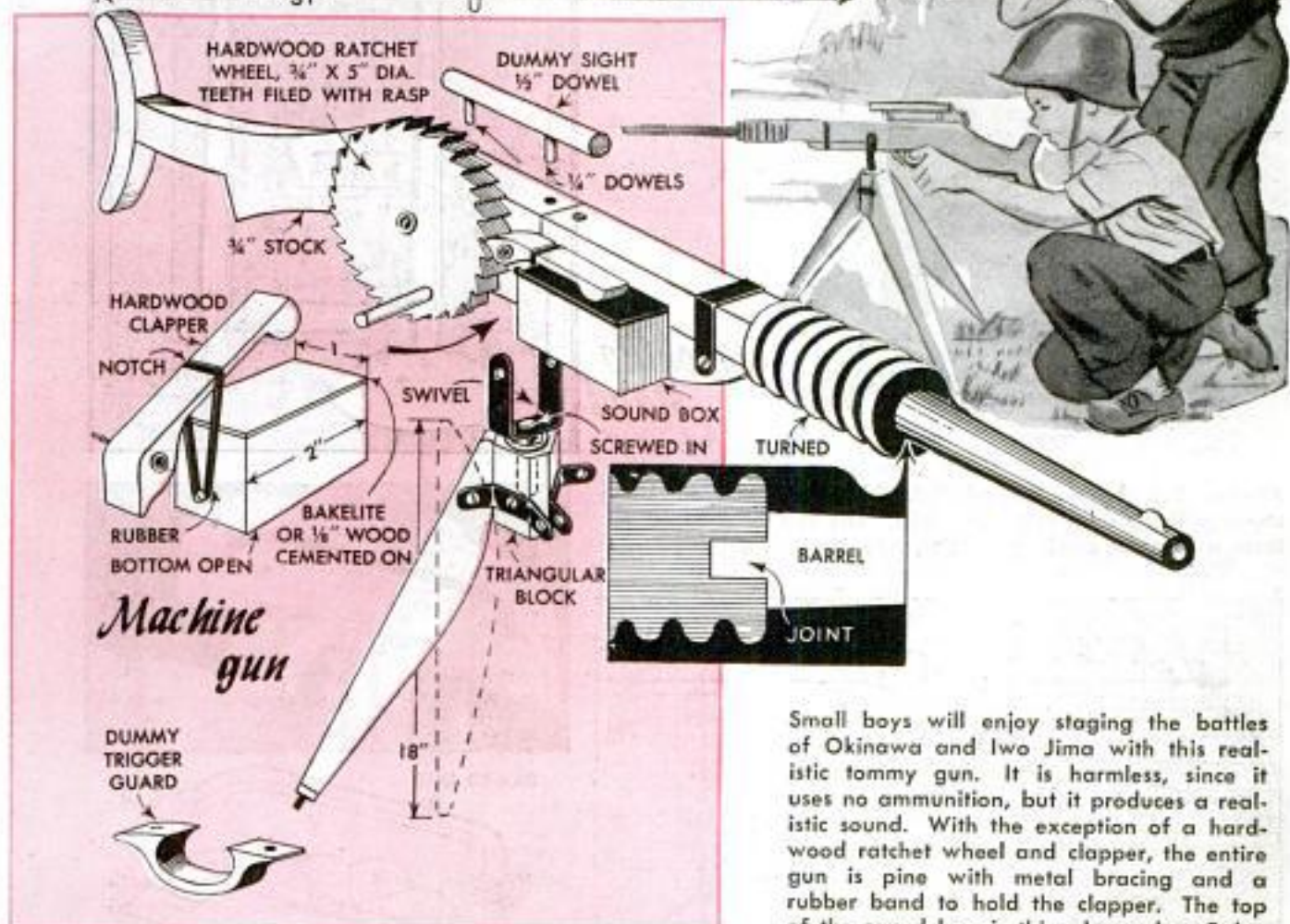
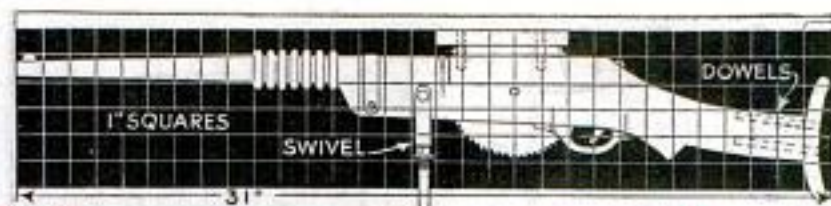

Small boys will enjoy staging the battles of Okinawa and Iwo Jima with this realistic tommy gun. It is harmless, since it uses no ammunition, but it produces a realistic sound. With the exception of a hardwood ratchet wheel and clapper, the entire gun is pine with metal bracing and a rubber band to hold the clapper. The top of the sound box is thin plywood or Bakelite secured with model-airplane cement. To add to the fighting effectiveness, a tripod can be made as shown. The gun is readily dismantled and carried from fox-hole to foxhole as the battle advances

Below: This eye-catching midget trellis will bring the outdoors inside during the winter months. It is built of $\frac{1}{8}$ -in. rod welded or soldered together

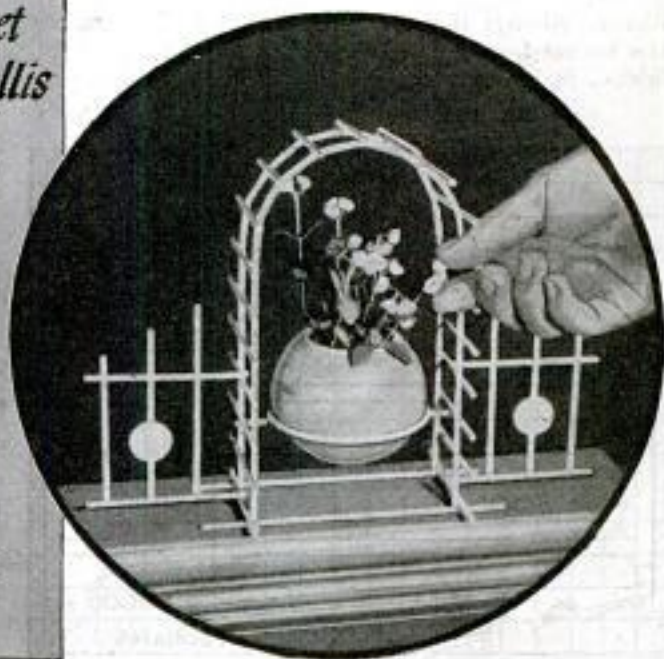
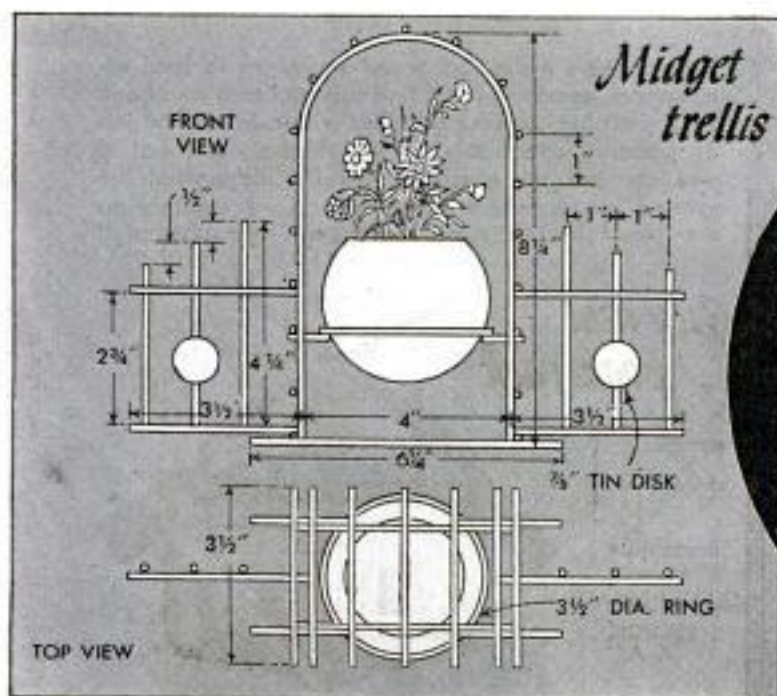

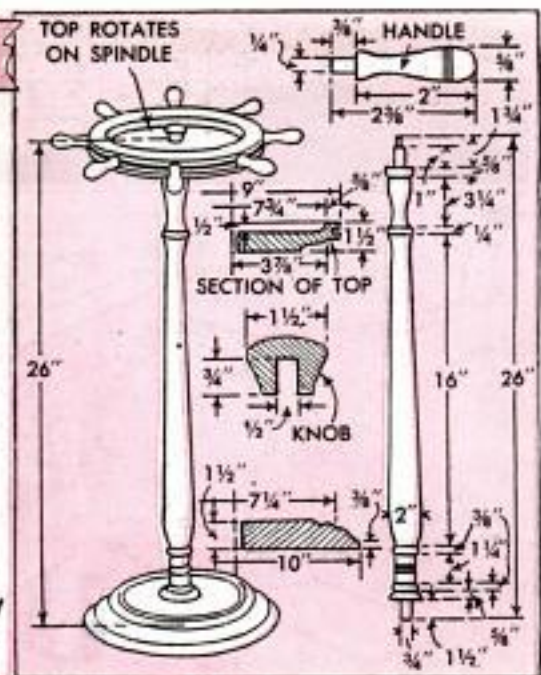

Above: For the nautical-minded, this ship's-helm smoking stand will be an appropriate gift. The top is recessed to form a tray for smoking articles, and is secured by a knob

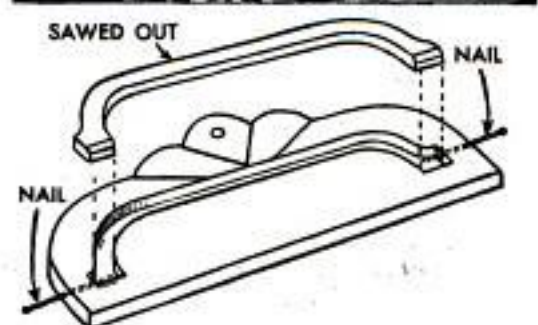
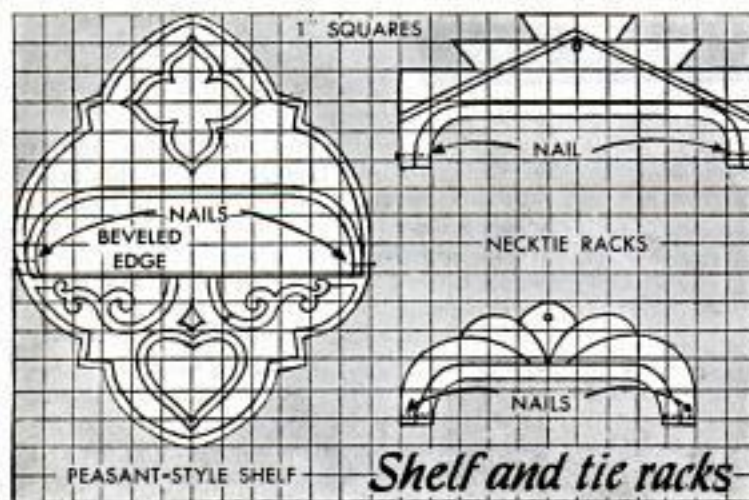

Above: Always a useful gift, shelves and tie racks can be cut from a single piece of wood and, when folded, fit into the space from which they were cut

Below: With a painted woodland scene to lend atmosphere, sportsmen will find this gun rack and book shelf pleasing. If you are adept with a brush, the job of painting a suitable scene will be easy, but if you are not an artist, a favorite photograph or printed scene, which should be glued securely to the wood before scrollsawing, can be substituted

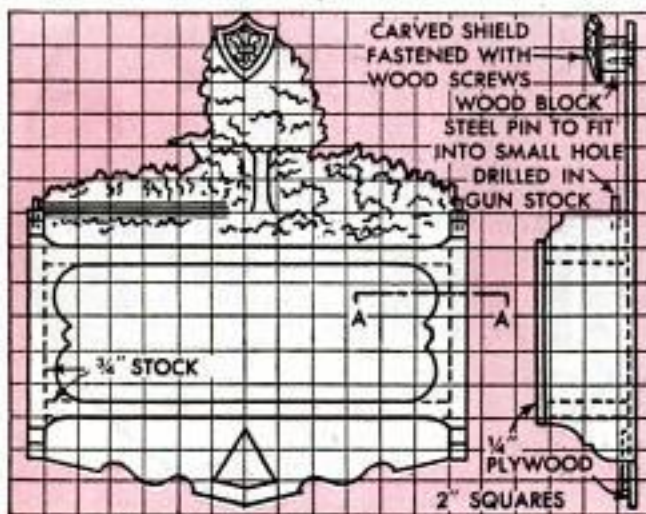

Gun and book rack



Painted Air Vents Cool Food Storage Cellar



Without any moving parts to wear out or require attention, a practical ventilating system for an underground food storage compartment can be made of a few lengths of tile drainpipe and some pieces of downspout. The drainpipe leads from ground level to open into the storage compartment at the floor to conduct cold air into the room. A 135-deg. downspout ell is inserted in the drainpipe opening for an air-intake vent. The ell is painted white to reflect heat, unless the vent is located in the shade, in which case painting may not be necessary. Another ell, painted black to absorb heat, is inserted through the ground to open into the room at ceiling level for the escape of warm air. Thus the ventilator operates solely by physical, rather than mechanical, laws, maintaining a cool temperature within the compartment by the reflection and absorption of heat.

Charles S. White, Vernon, Tex.

Paper Bags Line Wastebaskets

The large brown-paper bags in which groceries often are packed for carrying make excellent linings for wastebaskets and other waste containers. Refuse is emptied into the bag instead of directly into the basket, which then can be kept clean.

Handle of Well Pump Shielded To Protect Hands

Wrapped around a pump handle, strips of tape or thin rubber will provide a shield to prevent your hands from sticking to the metal on cold, frosty mornings. Cord wound around the handle and fastened with tape could also be used.



ALL-WOOD FIREPLACE, BOOKCASE

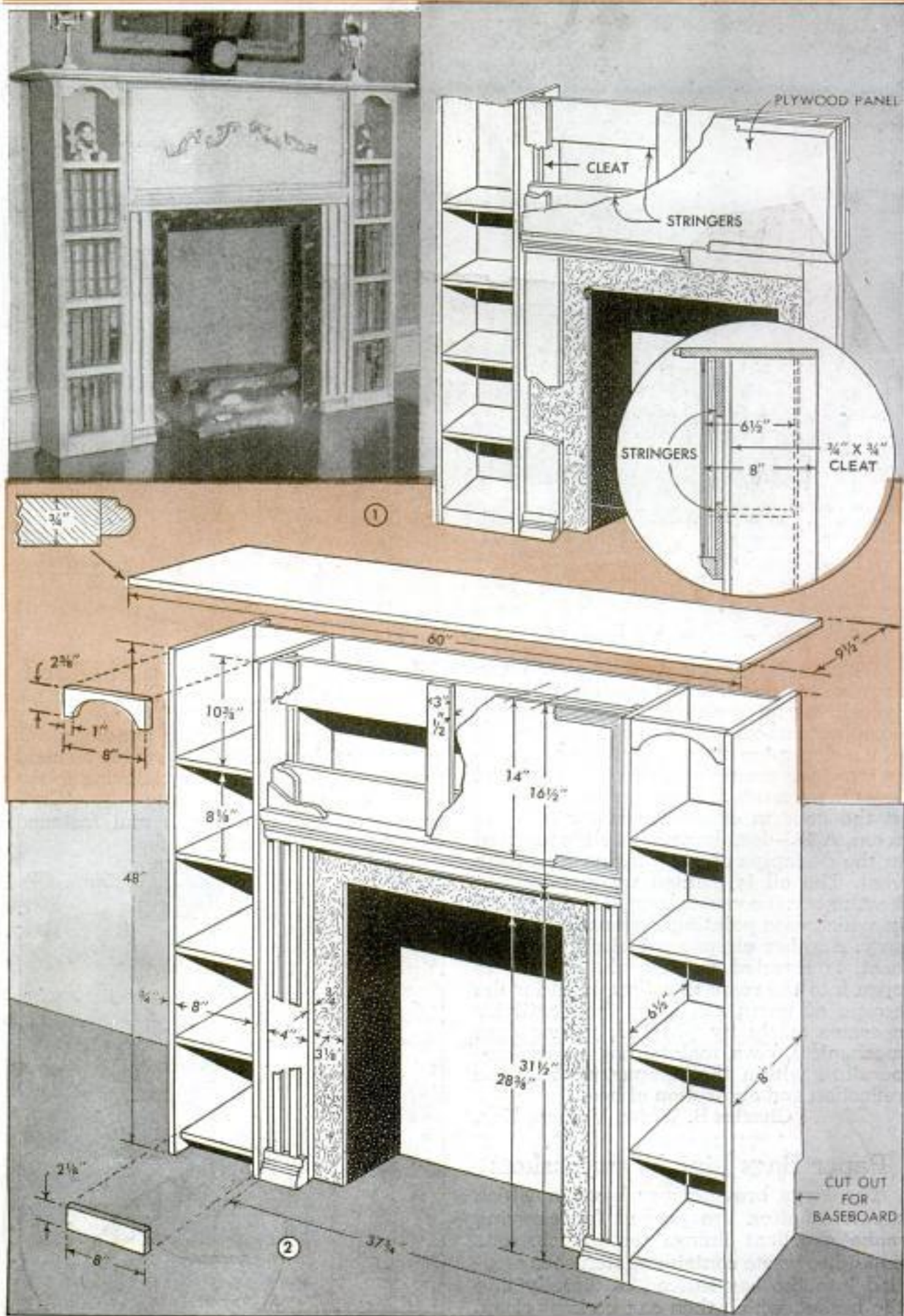

AND MANTEL

By Carl F. Baries

BLACK marbled linoleum contrasting with a white or ivory finish gives this unit a pleasing appearance in almost any surroundings. Construction is simple as the unit is nothing more than two pier cabinets or bookcases joined by stringers faced with plywood in which an opening is cut. If the unit is to be painted, almost any wood will do, but hardwood is better if you intend to use a stain-and-varnish finish. In this case, plywood to match the cabinets should be used for the mantel and front panels.

The cabinets are made as shown in Fig. 2, the rear edges of the side pieces being cut to fit over the baseboard. To accommodate books of varying heights, the top shelf is 10½ in. and the others 8½ in. Strips of wood are placed across the bottoms of the cabinets for aprons; and arched lintels are used across the tops. These serve not only as trim, but as a support to which the top may be nailed. Cleats are attached along the inside surfaces of the sides for stringers that hold the cases together, Fig. 1. Over the stringers three lengths of wood are nailed to support the panel and space it so that it extends flush with the edge of the molding as shown in the circular detail of Fig. 1. The mantel is a plywood panel that extends over the front and sides of the cabinets, and a strip of molding is bradded along the edges, as diagrammed in the upper left-hand detail of Fig. 2.

For the fireplace, a three-sided back is made of plywood, Fig. 3. This is placed loose between the cabinets or it can be nailed to the sides, in which case the dimensions shown will have to be increased. Sides of the back are hidden by an inverted U-shaped frame on which marbled linoleum is pasted. The frame is held in place by two wood strips attached to the cabinet sides, and molding is added to the strips for trim. The back should be painted brick red so that when a light is placed behind a stack of logs in the "fireplace," the reflection will suggest the glow of a real fire. Molding is applied to the edge of the sides and shelves of the cabinets, Fig. 4, and an ornament is glued on the front panel.

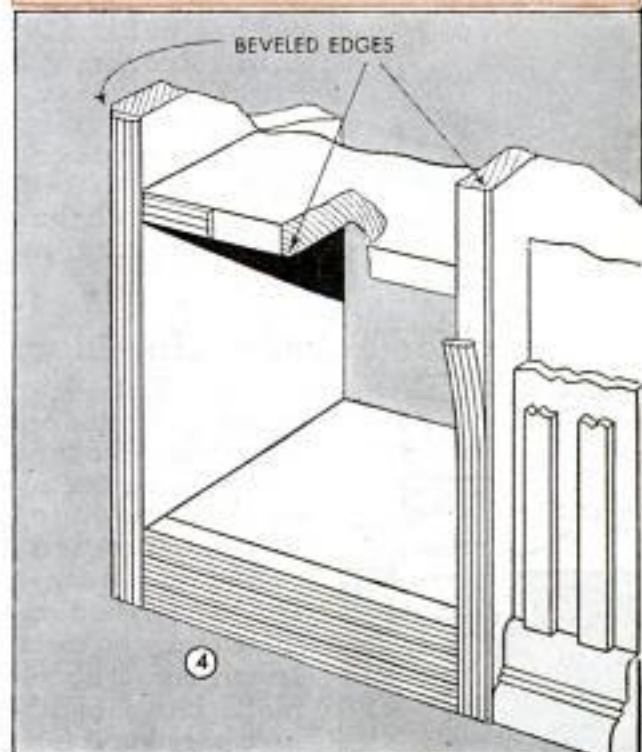
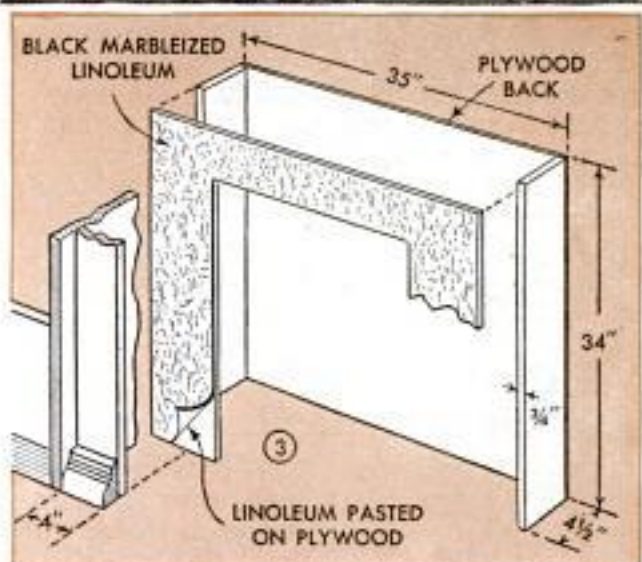

Spring Clothespin on Door Casing Holds Memos for Callers



Attached to the door casing, a spring-type clothespin can be used to hold memos for deliverymen and notes from callers. To attach the clothespin, one of the jaws is slipped out of the retaining spring and drilled and countersunk for a screw. After screwing this piece to the door casing, the clothespin is reassembled and ready for use.—Chas. Kimball, Los Angeles, Calif.

Wet Cloth Cools Fishline Guide While Soldering It to Rod

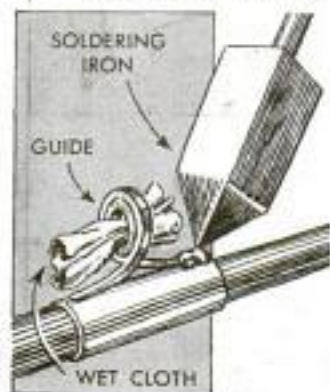

When a new agate or glass guide is soldered to a fishing rod, the heat of the soldering iron may crack the glass. This can be prevented by a piece of wet cloth inserted through the guide to keep it cool.

Moistener for Tobacco Humidor

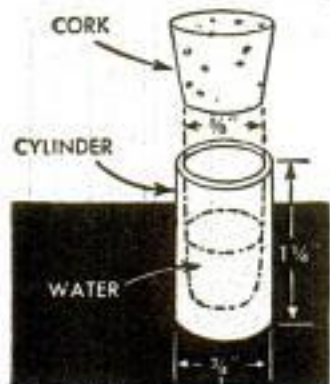

A small plaster-of-paris cylinder containing water will serve as a source of moisture when suspended in a tobacco humidor. The cylinder, which may be cast in any suitable mold, has a blind hole bored in it for

a water chamber. When the hole is plugged with a cork, water will seep through the cylinder walls to keep tobacco moist.

J. J. Paszkiet, Chicago.

Pencils Held in Cigarette Box Carried in Shirt Pocket

Pencils and pens, which ordinarily cannot be clipped to a shirt pocket, will not fall out if they are held in a cardboard box of the type used to package some brands of cigarettes. A container of this kind usually will fit a shirt pocket. The point of a pencil is pushed through one edge of the box to make holes in which pencils and pens may be wedged snugly. Also, the pencil lead will not soil the pocket.

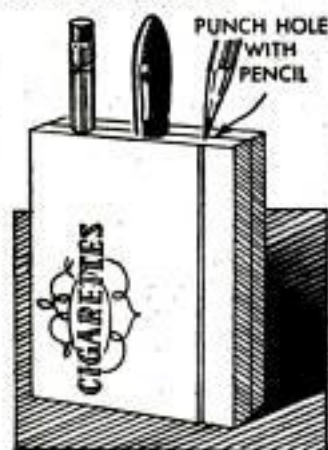

F. T. James, Hespeler, Ont., Can.

Baby-Buggy Wheels Kept Clean By Inner-Tube "Galoshes"

When taking a baby carriage outdoors in wet weather, the wheels can be kept clean by covering them with strips of inner tube, which are removed before taking the carriage indoors. The strips should be cut about 3 in. wide so that when stretched over the wheels they will fold over the rims.

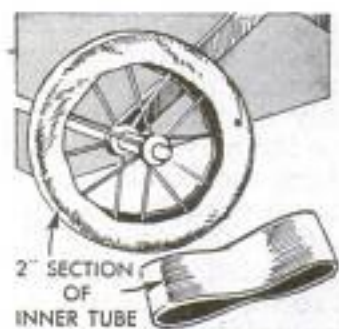

Wire Guide Located at Keyhole Is Useful in Dark Vestibule

Attached over an escutcheon, a length of wire bent as shown is useful for guiding a key at night or when the door is located in a dark vestibule. The ends of the guide are inserted in holes drilled in the door at the edge of the escutcheon, or the ends of the guide may be flattened and slipped under the escutcheon after loosening it.



Neat Frame Displays Photomounts Attractively

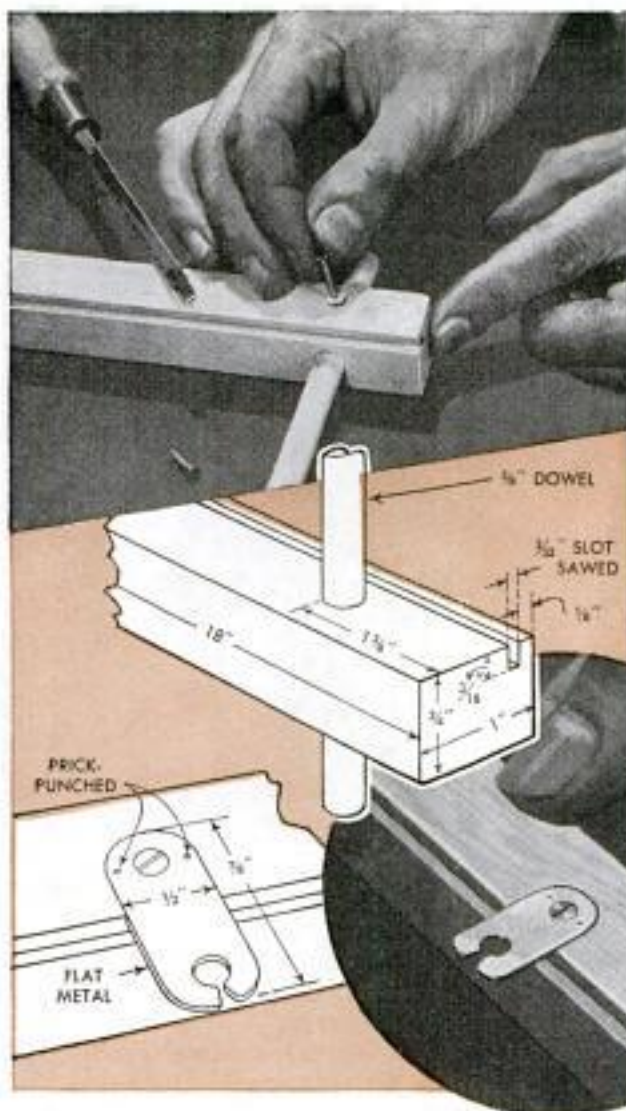

for the mount are sawed in the strips as indicated in the center detail, and holes are drilled near the edges for dowels, each of which is 23 $\frac{3}{4}$ in. long. To assure proper alignment of the holes, the strips are clamped together and each pair of holes is drilled at the same time. When in place, the dowels should project about 1 $\frac{1}{4}$ in., and are held by screws driven into countersunk holes

Photographs and other pictures will be set off to advantage in a simple frame like this one, which is made of dowels and two strips of wood. Dimensions shown are for a frame that will take a 16 by 20-in. photomount, although the size may be varied for any picture. To make the frame, slots

at the rear of the strips, as in the upper left-hand photo. For a hanger, a piece of flat metal, drilled and slotted as shown in the lower details, is attached by a screw to the rear surface of the upper strip, which is notched to receive the hanger.

Walter E. Burton, Akron, Ohio.

Spacer Adapts Large Plate Holder to Take Smaller Films

By slipping a spacer into the plate or cut-film holder of a 5 by 7-in. camera, 4 by 5-in. film may be used when the proper size is not available, or any size camera can be adapted to take smaller size film. For a 5 by 7-in. camera, a strip 1 $\frac{1}{2}$ by 5 in. is cut from a discarded negative for the spacer, or a piece of cardboard will serve the purpose equally well. The spacer is loaded into the holder as in Fig. 1, then the film is loaded on top of the spacer. After the film is inserted, another spacer of the same size is placed above it to keep it centered. The ground-glass back then is taped off as in Fig. 2 to show the position of the film.

Harry F. Leeper, Canton, Ohio.

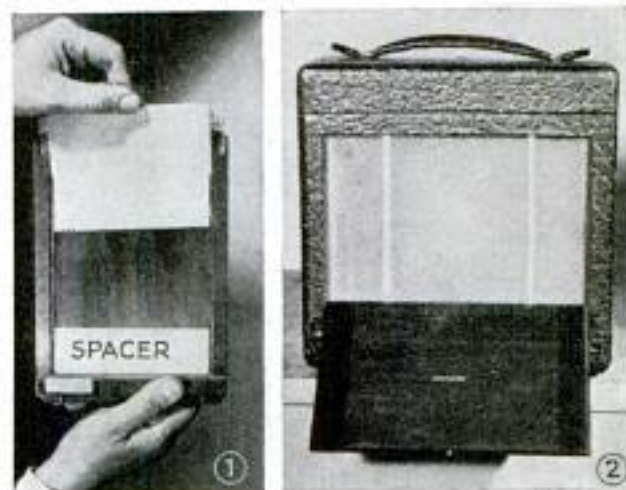

STOP IT



By Fred G. Korth

WHEN photographing any subject in action, the amount of illumination required is determined by the duration of the action as well as by the general light values in the picture. Any action, whether it is as fleeting as a child's smile or as continuous as the chewing of a large drill through a steel plate, requires a shutter speed rapid enough to "stop" the movement, or the action—which may have been the only reason for taking the picture—will vanish or smear into a blur on the film. Or, what is worse, the smile may freeze into



a grimace, and a glint of surprise may become a leer. For this reason it is generally necessary to use flash, especially indoors, where illumination usually is sufficient only for time exposures.

Any good synchronizer attached to the camera will do, since extension cords may be plugged in for additional lamps set away from the camera position. If the synchronizer cannot be detached from the camera so that it may be held off to one side to operate the shutter while directing light where it is needed, a plug may be screwed into the synchronizer socket instead of a lamp, with the cord extended to hold the lamp where it is needed. A three-cell flash unit is strong enough to be used with a 25-ft. cord, and a 5-cell unit for a cord of 50 ft. or more, using wire of 16 gauge or heavier. When long extension cords or many lamps are used, however, the cells must be fresh.

Although sometimes it may be preferable to use two or more small lamps instead of one large lamp, this cannot always be done. Scenes like that



with **FLASH**



shown in Fig. 7, in which there are many persons moving at various distances from the camera, require a medium or large lamp in order to use a speed of $\frac{1}{200}$ sec., which is necessary to catch the action and stop down the lens aperture sufficiently to get depth of focus throughout the picture.

Many photographs of children are effective solely because of their expressions. Such expressions as those shown in Figs. 1 and 6 call for fast shutter speeds rather than a small lens stop. A speed of less than $\frac{1}{50}$ sec. generally is too slow. But children lose interest quickly. The best way of keeping them in any pose is to use weak light for focusing and flash for exposing. Two flash lamps, one at each side of the subject, are used for balanced lighting, and the model is framed on the ground glass to allow plenty of room on the film for slight movement of arms and legs. In taking photographs like those in Figs. 2 and 3, speed is of the greatest importance. For these pictures, two small lamps in reflectors were used; one overhead,

slightly to one side and close to the subject, the other a little lower on the opposite side and about twice as far from the child.

Most animals are especially uncooperative as models. They insist on scampering away just as the photographer has set his tripod in position, or they drop their ears and look wistful and accusing at the very moment when their good qualities are about to be advertised. Moreover, they resist costuming, particularly when goggles are included in the wardrobe. For this reason it is best to have an assistant who can hold the animal while the camera is focused. All preparations to take the picture should be made before the animal is set in





a different kind of photography in which flash also is important. Scenes of machinery in action are, perhaps, more difficult to take than pictures of people for the reason that not only is there motion—often much more rapid than any movement made by a person—but machines usually are grimy and dark in tone and therefore they have poor light-reflecting qualities. Furthermore, as in the case of the rolling-mill scene, Fig. 10, the material being processed may have extraordinary reflecting values. White-hot steel, for instance, will be recorded on film as a brilliant flat-white blotch in a fraction of the time necessary to show even a faint image of the dull, dark machine on which it is rolled into sheets.

the required pose: one medium-size flash lamp is supported about a foot above and at the side of the lens, and shutter speed and aperture are adjusted. Then a paw is draped over the back of a chair to suggest diagonal lines, Fig. 4, goggles are eased in place, Fig. 5, the assistant removes his hands and the photographer presses the button for the exposure.

Scenes of a group at cards or people gathered around a fireplace, Figs. 8 and 9, unlike the dancers in Fig. 7, can be photographed without a synchronizer if the subjects are "briefed"—instructed to gaze into the fireplace, study their cards or look at one another rather than into the camera lens. To get a natural light for Fig. 8, a large lamp was placed deep in the fireplace without a reflector and a small lamp in a reflector was set 2 ft. above the camera to soften the hard side-shadows. For Fig. 9, two lamps were used. One was placed above the camera and 4 ft. to one side, the other 6 ft. to the other side at the same height.

Figs. 10 and 11 represent



The photographer, therefore, has to give an exposure short enough to prevent the steel from blurring the film, yet long enough to capture as much detail in it as possible, rendering in true tones the machine and the workman near it.

In taking this picture with a $\frac{1}{100}$ -sec. exposure, a long extension cord was strung over the left side of the machine to light the work and a second lamp was placed far to the right to illuminate the man and machine. In a scene such as that in Fig. 11, the workman becomes an integral part of the picture rather than a mere detail like the watcher in Fig. 10. The operator of the big drill, then, must seem to be actually performing the appropriate action, but must at the same time put on his best "look pleasant, please" ap-

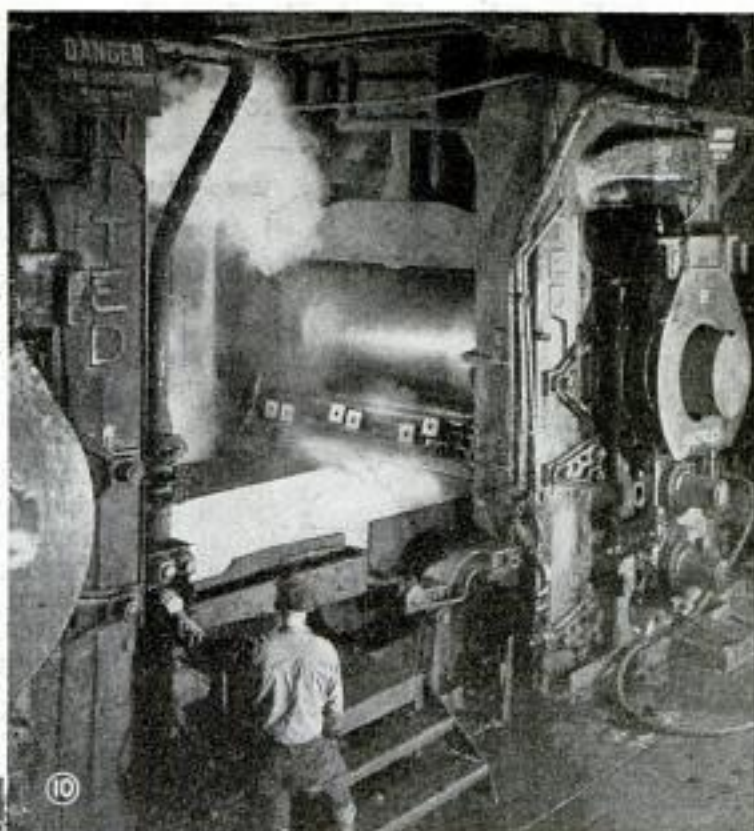

pearance. Since the big drill rotates at slow speed, its movement can be "stopped" easily with a shutter speed of $\frac{1}{100}$ sec. To take this photograph, three medium-size flash lamps were used. Two of these were placed at the right of the camera and one was held at the left. All three were directed so as to dissipate heavy shadows on the work and the operator, although no lamp was placed so that it illuminated the man's face from below.

Hose Holds Light-Reflecting Sheet on Picture Molding

To provide a light-reflecting surface in home portrait photography, many amateurs fasten a bed sheet, tablecloth or white drape against a wall with tacks or pins. However, these will mar the woodwork, and it is difficult to press pins into the plaster or trim. Also, wrinkles are likely to appear in a drape used as a background if it is suspended in this manner. A simple way of hanging a sheet or drape to avoid using pins and to eliminate wrinkles is to use pieces of rubber hose that are slit to fit over the picture molding, as shown in the details. These will not mar the wall or molding and, in addition, will occupy little space when stored away with other camera equipment.

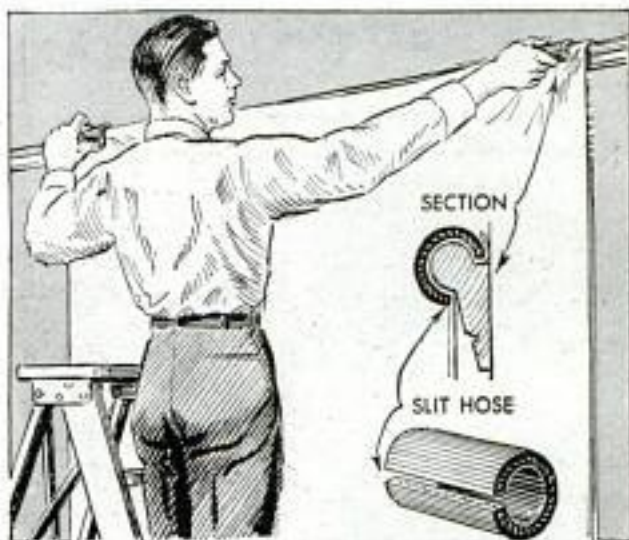

Camera Focusing Cloth Replaced By an Old Bellows

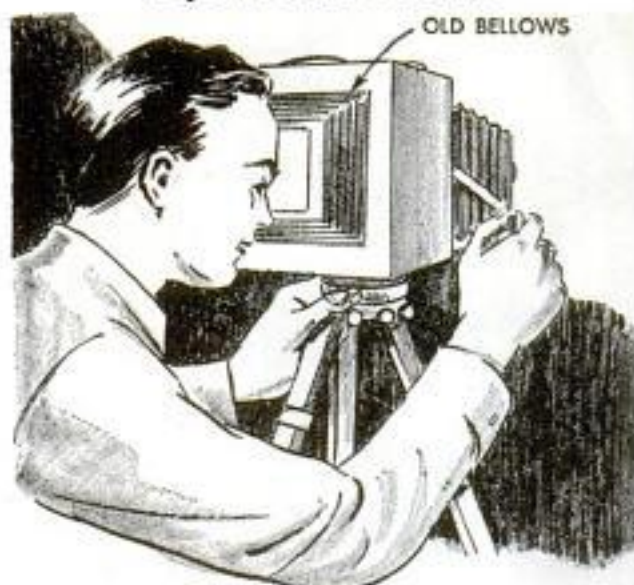

Instead of using a focusing cloth or hood to exclude light from a camera ground glass, you will find that the bellows from an old camera is just as practical and packs into a very small space for carrying. Also, the bellows is easier to handle in a wind than a cloth, and saves time because it is always ready for use and does not have to be thrown over the head and held in place each time you look into the glass. The bellows can be cemented to the ground-glass back, or may be held in place by other means as required. A stiff wire will serve to prop the bellows open while in use.—Ken Murray, Baltimore, Md.

Flood Lamp Can Be Clamped Directly to Movie Camera

To keep the floodlight focused directly on a moving subject while filming movies, a unit such as the one shown can be clamped directly to the camera. This type of lighting is satisfactory for close-ups and especially suitable for photographing chil-



dren because the photographer can follow the child about the home without stopping to move a separate lighting unit. Built-in reflector-type lamps can be used if the camera is loaded with extra fast film.

R. Swedlund, Buffalo, N. Y.

Your Signature Printed on Photos

It's an easy matter to print your name on a photo by means of a separate negative. First prepare a negative of your signature. This is done by writing your name with black ink on a white card, photographing it and processing the film.



After exposing a print, lay the name negative over the desired location in contact with the undeveloped print and cover the sensitized paper with a cardboard or black-paper mask from which a corner has been cut for the name negative. Then expose the signature with a flashlight as shown, holding the mask tightly against the print to prevent light from leaking in under the edges and fogging the photo. The name will appear in black on the finished print.

White-Light Switch in Darkroom Inverted for Identification

If all the electric-light switches in your darkroom are grouped together or controlled from the same panel, there's always a chance of fogging paper or film through accidentally throwing the switch for the white light instead of the one for the safelight. To prevent this, remove the switch operating the white light and replace it in an inverted position so that the toggle operates in reverse order to the others. Then when you intend to turn on the safelight you can tell the white-light switch from the others by the position of the toggle.

H. A. Kharas, Bombay, India.

Marking Darkroom Trays

White enamel trays used in processing photo films may be marked with grease pencil or black crayon to be easily identified in the dim light of a darkroom. On hard-rubber or plastic trays, which are usually of a dark color, yellow or red crayon will be more easily seen.





SINE BAR



V-BLOCK

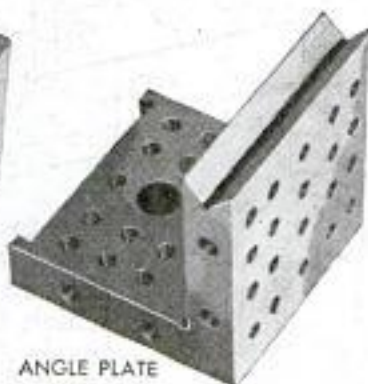

ANGLE PLATE



SMALL FIXTURES FOR THE TOOLMAKER

By Walter F. Debold

ALTHOUGH standard tools for precision machining operations can be purchased, toolmakers will find the sine bar, V-block and angle plate shown here especially useful, as these fixtures provide additional control over the work and can be made to any size. For instance, the angle plate may be used not only as a V-block, since one edge is grooved, but as a stop against which work may be held on a grinder bed, Fig. 1. Likewise, the V-block, besides serving as a fixture for laying out or grinding, Figs. 2 and 3, will hold work having collars or projecting heads as it is slotted across the V-groove to accommodate these projections. The block also has a small V-groove on one side at a right angle to the large groove across the top. All fixtures are made from tool steel or from machine steel that is then case hardened.

The angle plate is made as illustrated in Fig. 4. In a block of steel measuring $3\frac{1}{4}$ in. square by $3\frac{1}{4}$ in. long, a series of closely spaced holes is drilled for removing a segment. The angle thus formed is roughed out, leaving about $\frac{3}{16}$ in. for grinding. Holes are drilled for bolts to hold work, spacing of the holes being optional, although it is

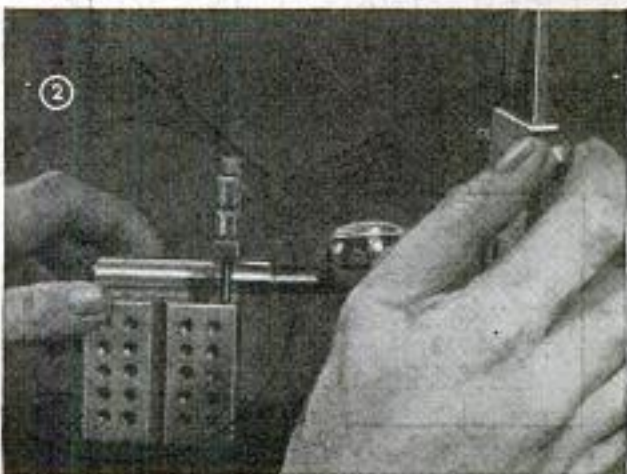
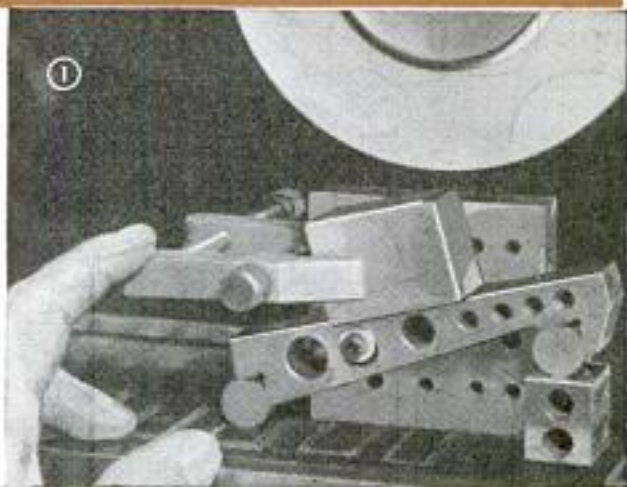

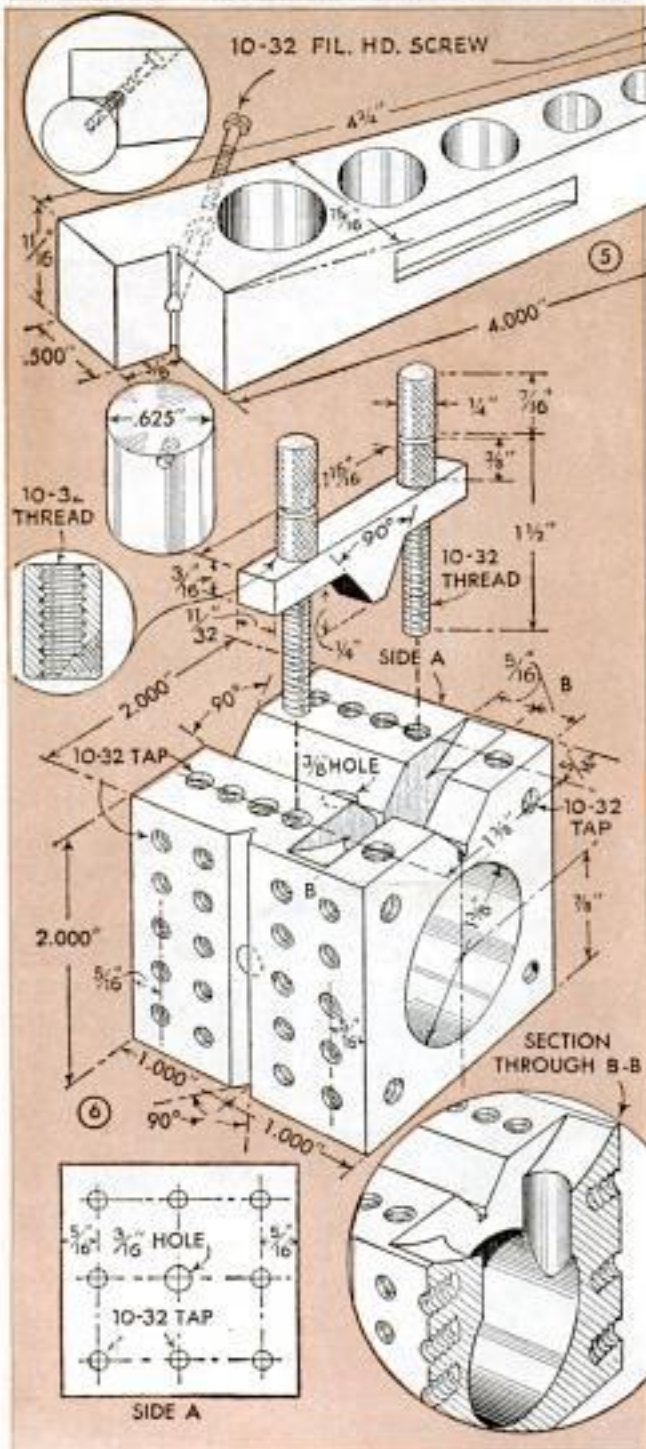
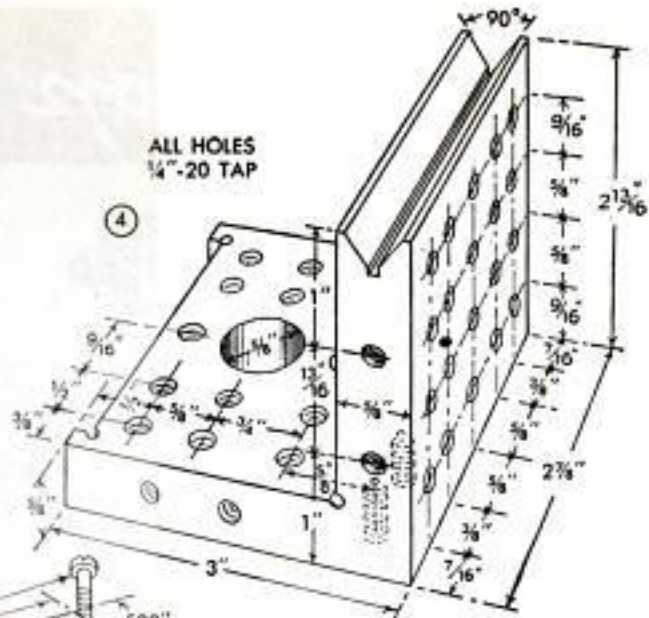
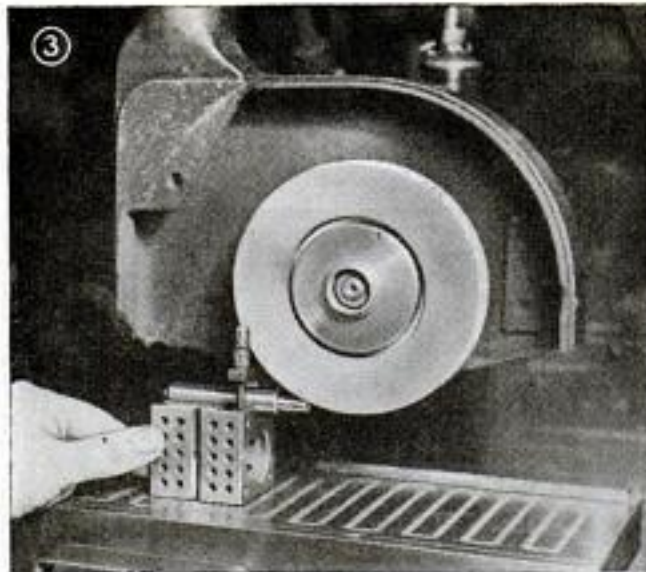

best to space them to coincide with the T-slots on the bed of the machine on which the plate is to be used. A V-groove is cut in the top edge of the vertical member and the plate is hardened and ground.

The sine bar, Fig. 5, is 4 in. long at the bearing

surfaces rather than 5 or 10 in., as are most standard bars, and will fit easily in a toolbox drawer. The bar is made from a piece of $\frac{3}{4}$ by 2 by 5-in. stock, rough-shaped to within $\frac{3}{64}$ in. of finish size, and holes are drilled to lighten it. One advantage of this type of sine-bar construction is that the bearing surfaces face in the same direction so that if too much is ground from one surface, more can be taken off the other to compensate. Plugs then are turned to exact dimensions, and holes are drilled and tapped in these and in the bar for fillister-head screws. In turning the plugs, the centers should be left projecting to form hubs by which they may be held for grinding. The projections can be ground off when the ends are trued after hardening.

The V-block and clamp are shown in Fig. 6. The block is roughed to shape and a large hole is drilled in the center to lighten it as well as to aid in clamping it to the work surface. The tapped holes are spaced as desired. They need not penetrate the block, as indicated in the circular detail, and the holes on one side can be spaced differently from those on the opposite side, as suggested in the lower left-hand detail. Then grooves are cut in the block and the clamp and screws are made. Each screw is provided with a threaded clamp-adjustment nut which can be unscrewed to loosen the clamp so that work may be placed in the V-groove without removing the screws from the block.

Drip Pan on Lathe Carriage Saves Cutting Oil

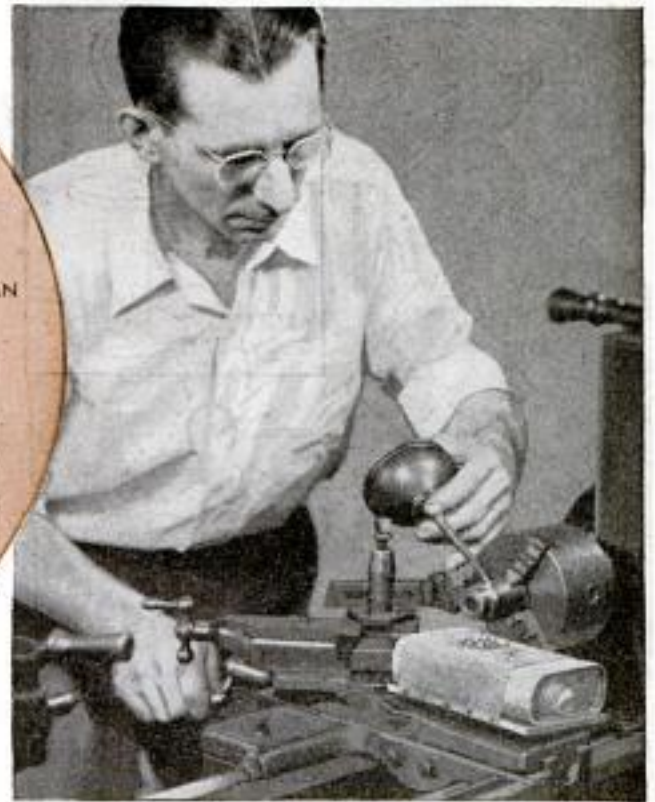
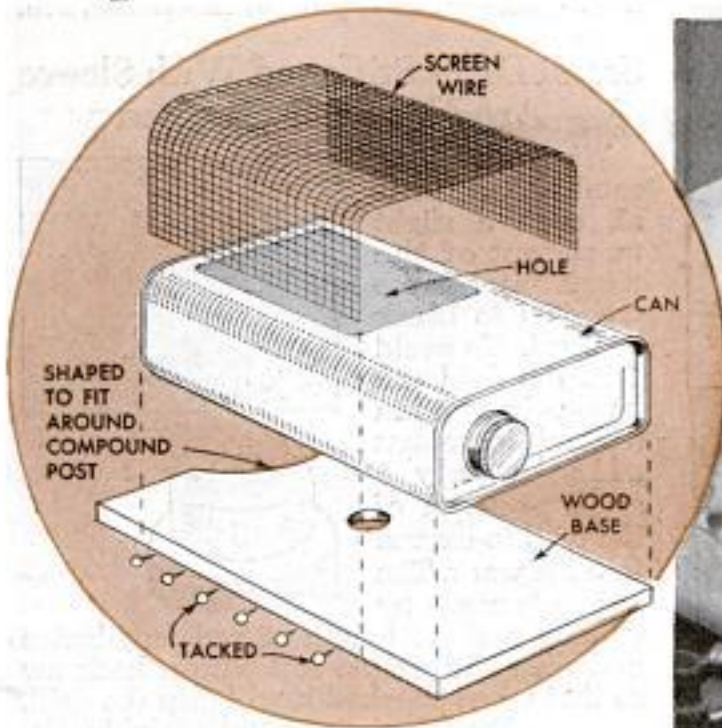

Set on a lathe carriage, a small rectangular can of the type in which salad oil or turpentine is sold will catch and save oil drippings for reuse and also will keep the lathe clean. An opening is cut in one side of the can, which is screwed to a wooden base. The base is shaped at one end to fit around the curve of the compound post and drilled for the stud or boss on the

lathe carriage as indicated in the left-hand detail. Then a piece of screen wire is tacked to the base and over the opening in the can to strain out chips. In use, the can may be worked close to the chuck and is instantly positioned or removed.

Reamer Is Floated in Holder if Lathe Centers Are Sprung

If your lathe centers are sprung slightly, a reamer held in the tailstock can be made to cut true by floating it in a special holder. The shank of the holder is turned to fit the tailstock taper, after which the body is drilled lengthwise to take the reamer. To

allow side play, this hole should be $\frac{1}{16}$ in. larger than the reamer shank. Two $\frac{1}{4}$ -in. holes are drilled to take coil springs, which center the reamer. They are held in place by two lengths of flat spring steel, attached to the holder by screws. The reamer is driven by a pin which fits tightly in the shank and loosely in holes drilled in the holder.—H. D. Chapman, Mt. Rainier, Md.

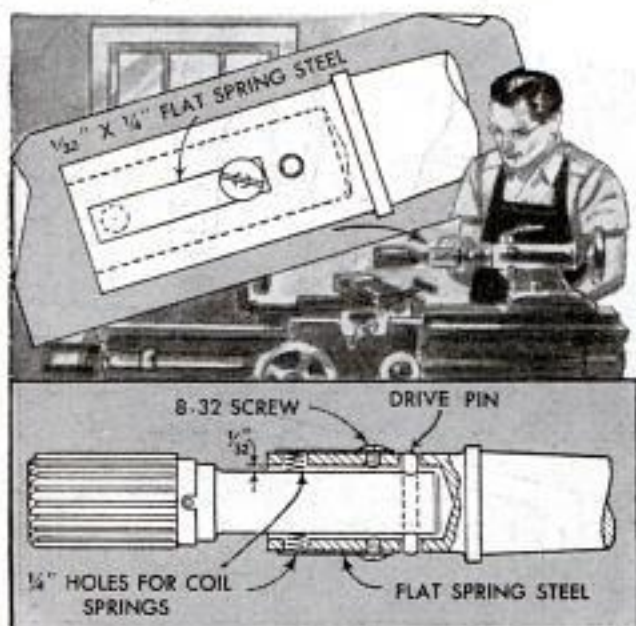

Plumbers' Soil Aids in Saw Filing

To reduce eyestrain when jointing or sharpening saw teeth, they can be coated with plumbers' soil, a water-soluble substance containing glue and lampblack. In filing, the soil will be removed, leaving the other teeth coated. The soil is brushed on and allowed to dry before filing is begun. When jointing, two coats are required, one before jointing and the other before sharpening. The same method can be used on band and circular saws.

☐ A tool for burning in shellac can be made from a piece of spring steel or a hacksaw blade fastened to a soldering iron.

Extension Cord Wound on Reel To Hold It Off the Floor



If an extension cord is wound on a reel it can be set directly on your work, and the cord will be kept off the floor where it might be walked on or otherwise damaged. A reel can be made from a metal spool of the type used for holding lamp cord and water-pump packing. A hole is cut in the reel as shown to take the cord, which is protected from abrasion by a rubber grommet. After the cord has been pulled through the hole so that the lamp socket seats tightly in the spool core, the core is filled with tar to hold the cord, which then is wound on the reel and fed out as required. The cord can be kept from unwinding by a notch filed in the lower flange and smoothed to keep the insulation of the cord from being cut. If desired, a wire cage may be attached to the reel to protect the lamp.

Padding Microscope Eyepiece Will Protect Spectacles



Laboratory workers who wear glasses sometimes have difficulty in using a microscope because their spectacles contact the metal edge of the eyepiece and become scratched. One way of avoiding this is to use a corn pad on the eyepiece. The adhesive on the pad

will hold it securely in place, and the felt ring will protect the glasses from touching the metal.—G. B. Taylor, Jacksonville, Fla.

Small Drills Stiffened With Sleeve Are Not Easily Broken

When drilling small holes in metal, even a slight movement of the work will cause the drill to break or bend. To avoid this, the drill can be chucked within a metal sleeve that allows only a small portion of the drill to extend into the work. The sleeve is made by drilling a short length of rod lengthwise and then slitting the rod with a hacksaw so that when chucked it will grip the drill.

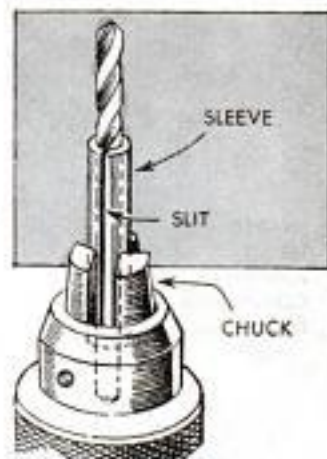

Emil Wittmann, Philadelphia, Pa.

Hooked Scraper Removes Burrs From Sheared Aluminum

When a large number of aluminum sheets are to be burred after shearing, a hook scraper like the one shown will do the work rapidly as it will burr both sides of an edge in one operation. The scraper is made by cutting a V-notch in one end of a strip of steel and beveling the sides of the notch to form cutting or scraping edges. The notched end is bent at a right angle and a grip is formed at the other end, after which the scraper is hardened to retain its cutting edge.

Wallace H. McClay, Pasadena, Calif.

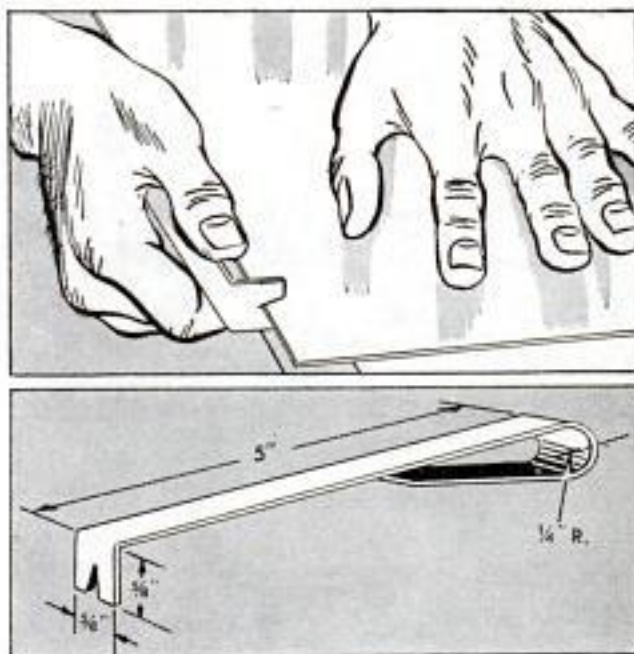

Power Tree Saw Is Made From Tractor Mower

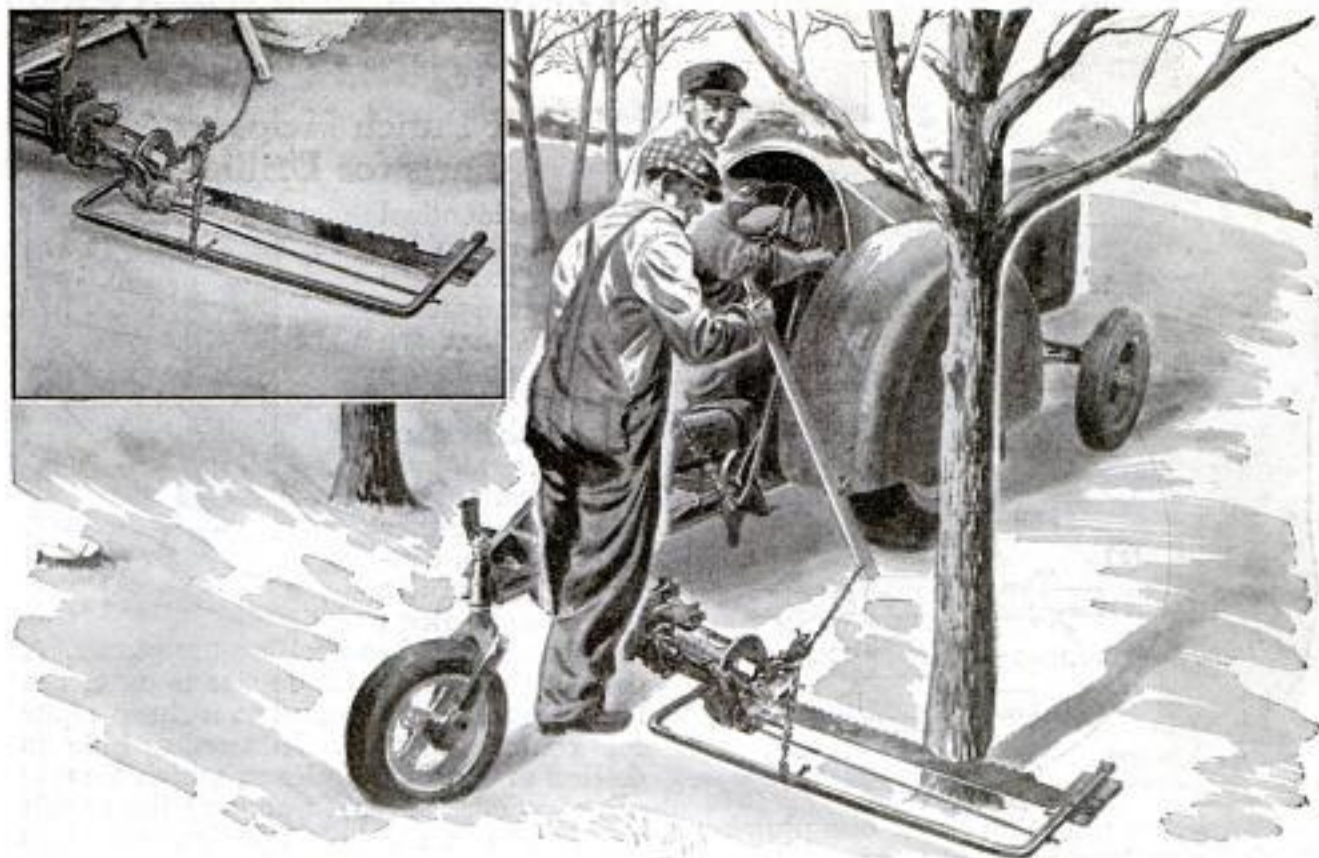

By substituting a saw blade for the cutter bar of a tractor mower, one orchard owner, who needed to remove 1500 trees to make room for adequate growth of others, was able to cut down as many as 150 trees a day. Ordinarily, not more than 25 trees can be chopped down in that length of time

by two men with axes. Moreover, the saw cuts the trees close to the ground, leaving only a short stump. The blade operates like a mower sickle and is fed into a tree by a wooden lever which is pivoted to a fender of the tractor and attached to the mower cutting bar with a short chain.

Rubber Bushing Forced Into Spring Eye by Draw Bolt

The job of replacing rubber bushings in auto springs will be simplified considerably by using a tool like the one illustrated. It consists of a $9\frac{1}{4}$ -in. draw bolt of a diameter slightly smaller than that of the shackle

bolt, a nut to be used as a pull block, a tube closed at one end to form a cup, and a hardwood spacer, which must be of a diameter to slide through the spring eye. The spacer and pull block are shaped as shown in the detail, so that they contact the outer and inner metal sleeves enclosing the rubber insert of the bushing. To replace a worn bushing, the shackle bolt is forced out of the spring eye and the draw bolt, with the cup in place, is inserted. Then the spacer is slipped on the bolt, the new bushing is put in position and the pull block is screwed on. When the draw bolt is tightened, the pull block draws the new bushing into the spring eye and forces out the worn bushing, which drops into the cup.

A. E. Kennedy, Englewood, N. J.

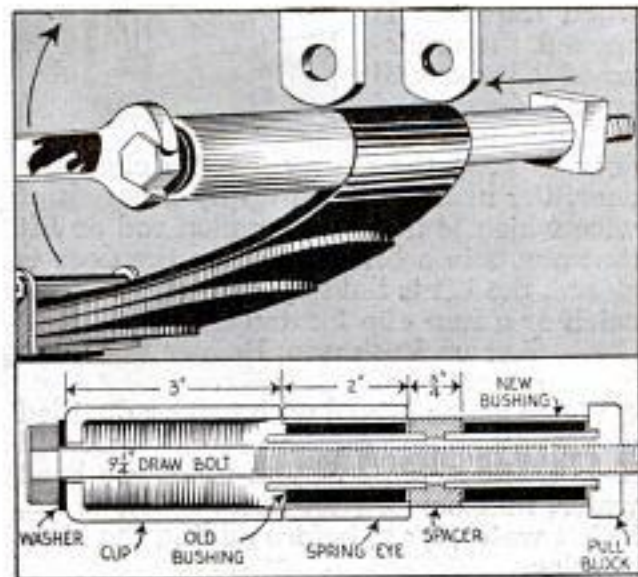

☐ If the air pressure in automobile tires is allowed to drop even as little as 5 lbs. below the recommended pressure, the life of the tires will be reduced 32 percent, while a drop of 9 lbs. decreases tire life 52 percent.

Reducer and Bushing Join Pipe When Union Is Not Available

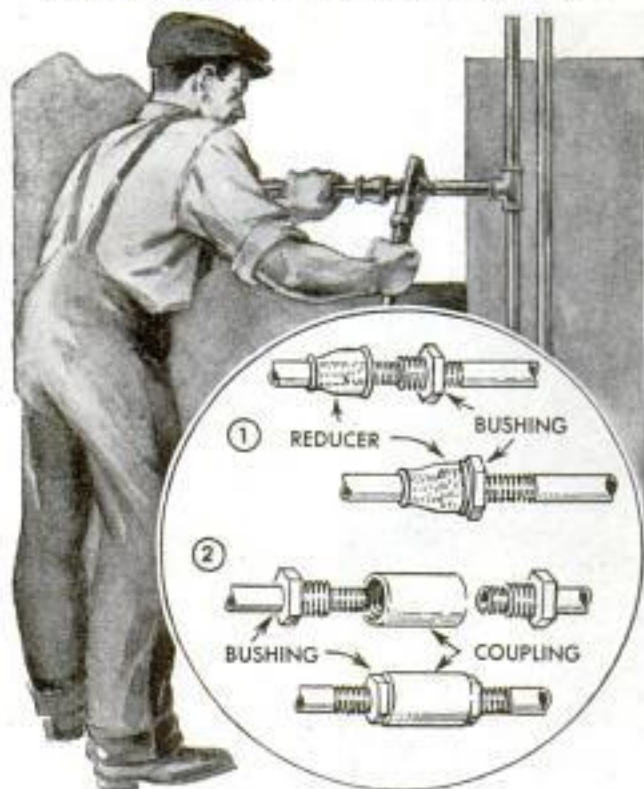

Having no union on hand, one plumber joined two lengths of pipe by a reducer and a bushing as in Fig. 1. The reducer is screwed on one pipe and the bushing on the other, the threads on this pipe being extended for twice their original length so that the bushing can be screwed on far enough to allow the ends of the pipe to meet inside the reducer. Then the bushing is backed up into the reducer and tightened. Another method of joining pipe is shown in Fig. 2. In this case two bushings are screwed into a coupling, the threads on one or both of the pipes having been extended so that the ends will meet.

Hog Waterer Is Made from Boiler And Auto Frame

Large capacity is a feature of this portable hog waterer, which is made from a boiler and an auto frame. The boiler is mounted on blocks that rest on the frame and is fitted to take a watering cup. After filling the boiler, care must be taken to

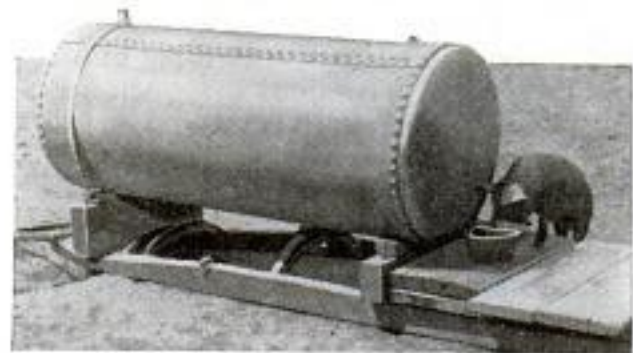

make all openings airtight so that water will not rise above the cup inlet. Planks are laid across the frame to make it easy for small pigs to drink.—A. M. Wettach, Mt. Pleasant, Iowa.

Center Punch Helps to Align Parts for Drilling

Where identical holes are to be drilled through two or more pieces of metal that are too thick to be drilled together, or are shaped so that one already drilled cannot be laid over another as a guide, a center punch made from a broken drill can be used to position the pieces. A drill of the required hole size is used, the broken end being ground to a sharp taper for center-punching. In use, a hole is drilled in one of the pieces, which then is aligned over the next one, and the punch is inserted in the hole and hammered to mark the center for drilling the second piece.—W. F. Johnson, Downers Grove, Ill.

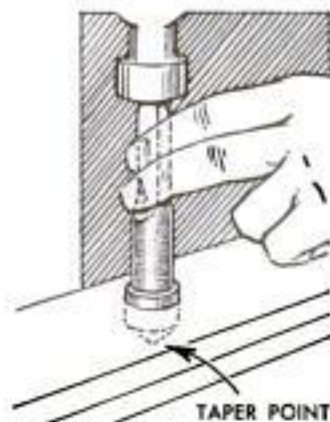

Hinge Holds Barn Door Open

To hold open the door of a barn, garage or other outbuilding that has an earth floor, a strap or T-hinge will be found useful. One blade of the hinge is screwed to the door near the lower edge so that when the door is opened, the unfastened blade will swing downward and dig into the floor to keep the door open. To close the door, the blade is lifted up by a length of wire which is tied to a wooden rod or lift that pivots in a bracket. When the door is closed, the lift is held up by a sheet-metal catch or a fuse clip located above it.

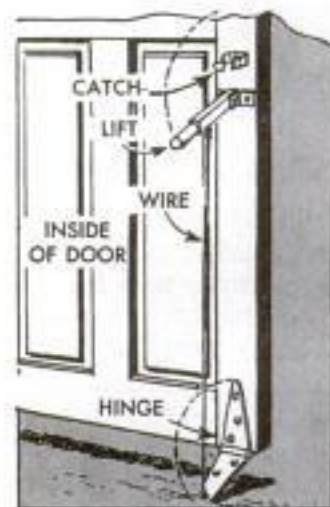

Avrum Froimson, Beaver Falls, Pa.

Water stains mixed with soft or distilled water will go into solution readily and will have a clear color. If you must use hard water, mix borax (not boric acid), $\frac{1}{8}$ oz., in hot water, 1 qt., before adding the stain powder.

Measuring Gauge Gives Fine Adjustment on Saw

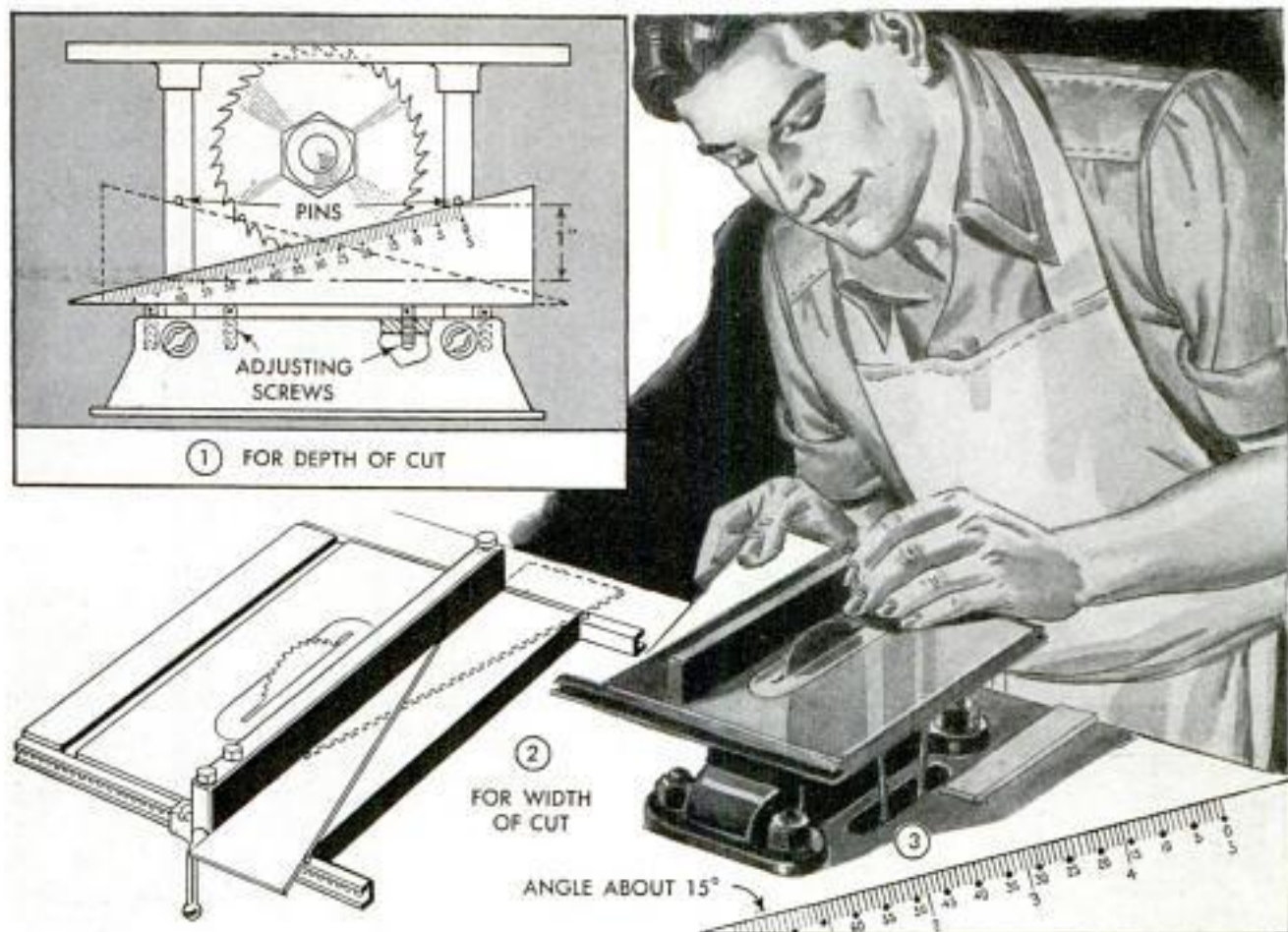

Modelmakers and others whose work requires cutting and grooving in fractions of an inch on small power saws not provided with finely graduated adjustments can obtain accurate results by using this measuring wedge. Briefly, the idea is to provide a wedge-shaped piece of metal with one side cut at an angle of about 15 degrees. The oblique side is marked off in an equal number of divisions, for example, a total of 64 divisions per inch of vertical drop as illustrated in Figs. 1 and 3. By having a level surface on which to slide the wedge, and by providing pins on the vertical sliding posts of the saw table, it is obvious that one of the pins resting on the wedge will be raised or lowered $\frac{1}{64}$ in. when the wedge is moved a distance of one division toward the wide or narrow end. The spaces on the wedge are actually much wider than $\frac{1}{64}$ in. If the scale is 4 in. for 1 in. of vertical drop, the spacing of the divisions will be $\frac{1}{16}$ in. although they represent $\frac{1}{64}$ in. of vertical measurement. Consequently it is much easier to make height adjustment on the saw with the wedge than it would be by measuring directly with a rule.

On a saw having two vertical posts supporting the table, a small hardened pin is set into a hole drilled in each post, holes in both posts being exactly the same distance from the surface of the table, and at a point

where the wedge reading is maximum. To adjust the table for depth of cut, the measuring wedge is placed first in the position shown in Fig. 1, contacting the pin on one leg, after which the wedge is reversed as indicated by the dotted lines, and the same adjustment is made on the other leg. To provide a perfectly true surface on which the wedge is set, two adjusting screws with the heads ground flat are fitted into tapped holes in the base. When making adjustment for depth it's a good idea to start out with the table surface flush with the saw teeth. Then the table is lowered for desired depth of cut by using the measuring wedge. When the saw teeth are sharpened, which slightly decreases the saw diameter, the adjusting screws on the base can be reset to compensate for the difference so that you will obtain the same reading on the wedge.

Besides making fine height adjustments, the same idea can be used to set the saw fence for widths of cutting. In this case the pins are fitted to the fence guides as in Fig. 2. They must both be located exactly the same distance from the saw. In this setup the fence is movable instead of the pins. However, the same method of adjustment is applied to get both ends of the fence exactly the same distance from the saw.

Ray Rusher, Chicago.

LATHE ATTACHMENTS

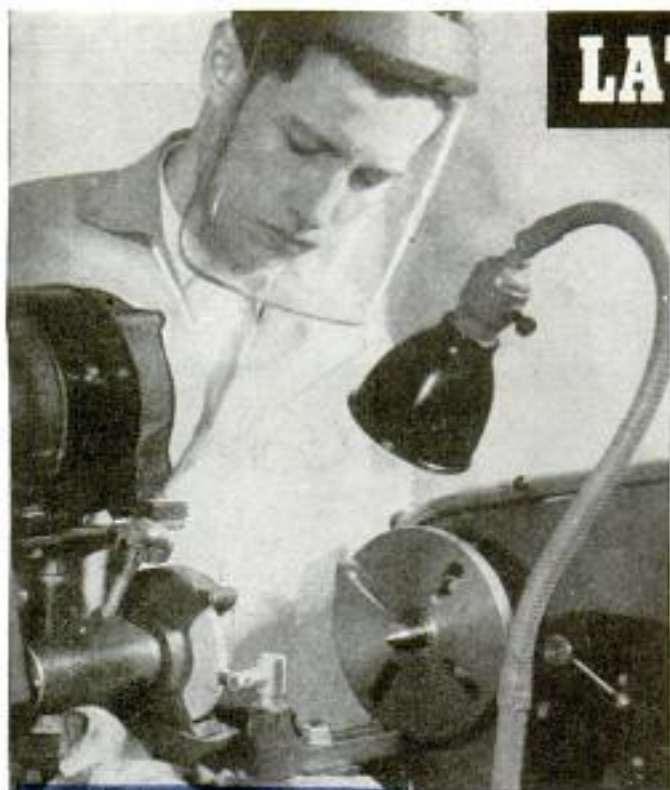

regular threading tool. To do this, the grinding-wheel face must be dressed to a 60-deg. angle.

To be most efficient, a grinder should be of correct size for the lathe on which it is used. A small grinder lacks rigidity and a heavy one may be unnecessarily expensive as well as bulky and inconvenient in use. The grinder should be either bolted securely to the lathe compound or held in the tool post. For bench lathes, a grinder designed for wheels of 3 or 3½-in. dia. and ¾ to 1½-in. width is most useful for external grinding. Grade and grain size of the wheels will, of course, depend on the type of work to be done. For mild steel, a vitrified aluminum oxide wheel of No. 46 grain and N grade, and for hardened steel, one of grade K of the same grain size, usually are best. A vitrified silicon carbide wheel of 36 grain, L grade, should be used for cast iron as well as for brass and other nonferrous metals. When the wheel is mounted on the spindle the nut should not be forced tight. It will tighten itself when the wheel contacts the work.

Most wheels of 3 or 3½-in. dia. can be

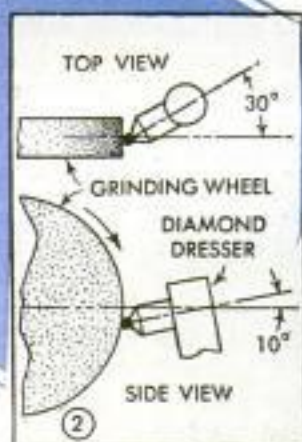
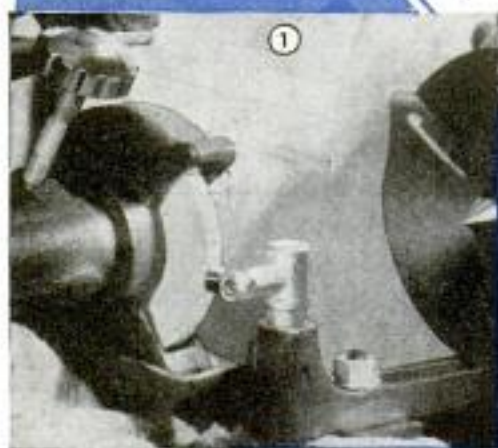

BY THE efficient use of a few accessories such as a tool-post grinder, a turret attachment, and a milling fixture and cutters, a metal-cutting lathe may be employed to do the work of several other machine tools. Thus its capacity will be increased while the cost of work done with it is reduced. For instance, with a tool-post grinder, a lathe will substitute, within limits, for an external, internal and surface grinder for small work, as shown in Figs. 3, 4, 6 and 8. Fig. 7 shows a machine spindle being ground internally while supported by a steady rest, and in Fig. 10 a screw thread is being precision ground to correct any errors that may have been made by the

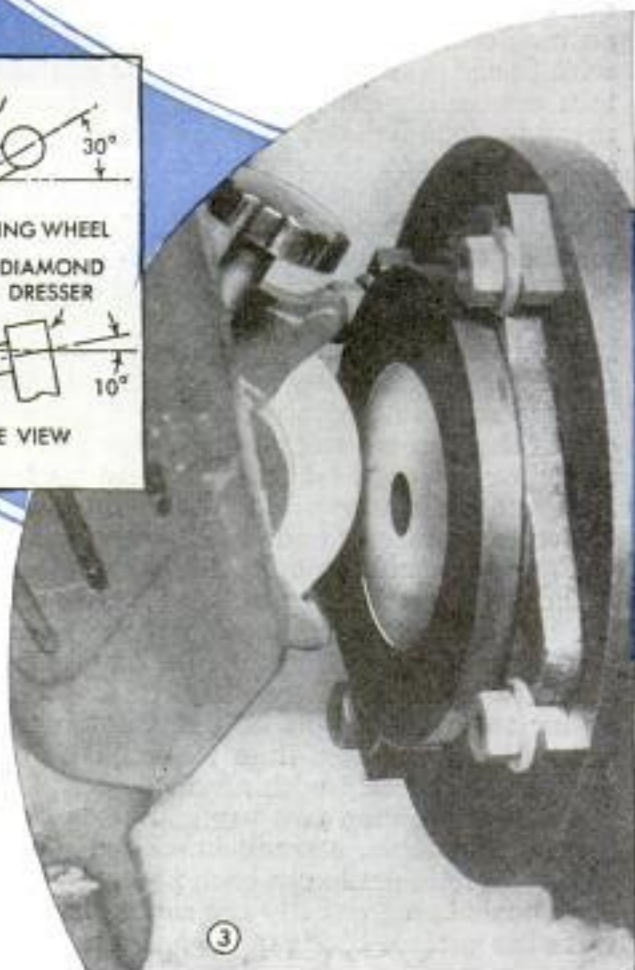

USED EFFICIENTLY

By H. J. Chamberland

operated safely at about 6000 surface ft. per min. However, since the wheel's cutting efficiency decreases as the diameter is reduced by wear, as large a wheel as possible should be used, the maximum diameter being determined by the wheel guard, which should be used whenever possible. Tool-post grinders usually have only two speeds, one for external use and the other for internal grinding, although some grinders have interchangeable pulleys by which the speed can be regulated to suit the wheel diameter.

For internal grinding, a slightly higher work speed and faster traverse feed may be used than for external grinding, and for rough-grinding a hole the infeed may be twice that used for external grinding because less heat usually is generated. The wheel

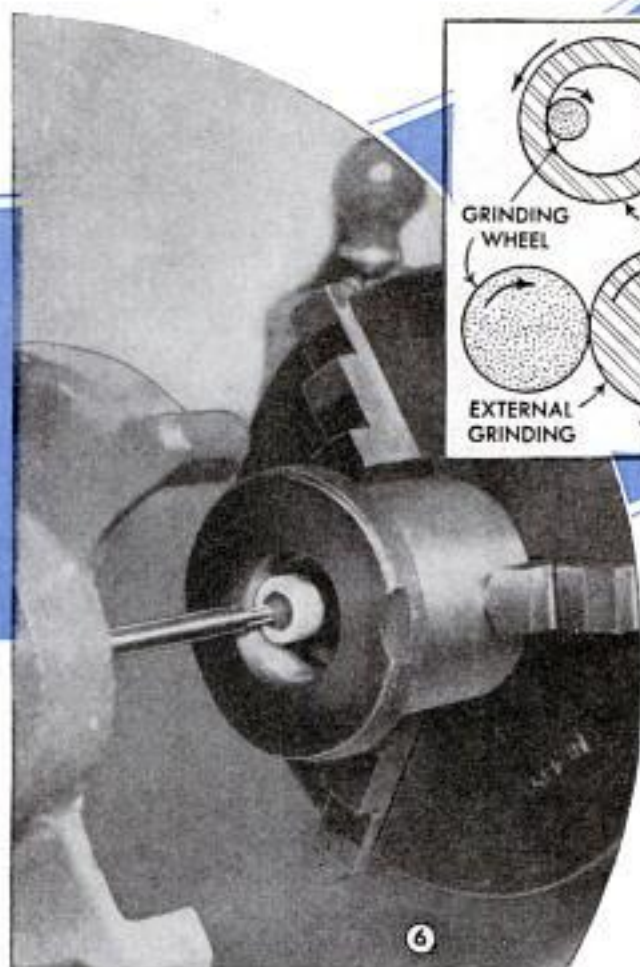

usually is of a diameter not less than one half that of the hole to be ground. Also, any vibration of the grinder will destroy the precision of the work. For external grinding, the wheel should rotate in the same direction as that of the work, but for internal grinding the wheel rotates in the opposite direction, Fig. 5. The same principle applies to surface-grinding work held on a faceplate, as indicated in Fig. 3.

Since no coolant is used for grinding in a lathe the infeed or depth of cut should not exceed .002 in. at one pass across the work. A safe procedure is to rough-grind to within .001 in. by removing .0005 in. at



Work held in Steady Rest for Grinding

each pass with a roughly dressed wheel, then dress the wheel fine and take about four light cuts to bring the work to exact size. By passing the wheel over the work a few times with no in-feed, a high finish will result.

In dressing or truing a wheel, a "wheel dresser" consisting of a diamond set in a holder is commonly used as in Fig. 1. Each time the diamond is used, the holder should be given a quarter turn to maintain a sharp cutting point on the diamond. A

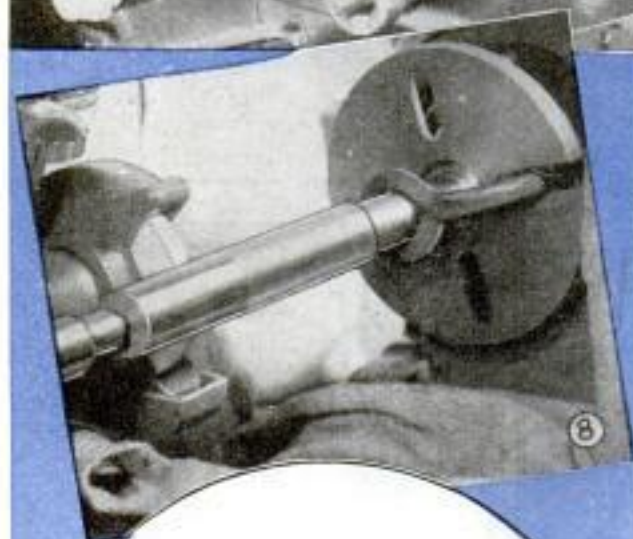

shop apron or other piece of heavy cloth should be spread on the lathe bed before dressing the wheel so that the abrasive will not fall onto the bed ways. To open the wheel face for rough-grinding operations, the dresser is positioned as shown in Fig. 2, and the wheel is passed over it rapidly at a depth of about .003 in. For a finish grind, the dresser must be passed slowly over the wheel several times, each cut being not more than .002 in. in depth. After the wheel is dressed, the lathe bed ways and other parts that may have been exposed should be cleaned carefully with kerosene to remove any particles of abrasive that may have fallen on them. When grinding shafts or spindles, center holes should be lapped with a compound of 400-grain aluminum oxide and sperm oil on a headstock center of cast iron or brass, as indicated in Fig. 9. This is particularly necessary if the center holes are rough or the work has been hardened.

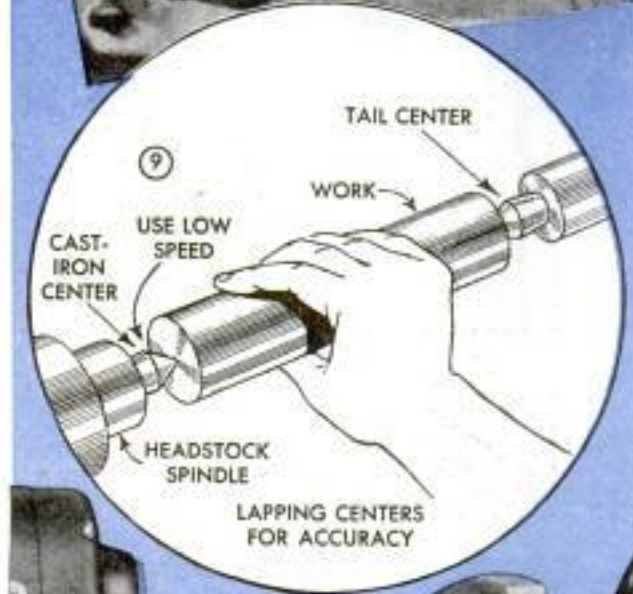

With a turret attachment, Figs. 11 to 14, a lathe will be equipped to perform certain operations ordinarily done on a screw machine and can turn out work on a production basis, as very little time is spent in changing from one cutting tool to another. A turret attachment can be held either on the cross carriage as in Fig. 12, or in the tailstock, Figs. 11 and 13, the style of each attachment being different. For use on the cross carriage, a square holder for tools generally is used. A tool post can be set back of the work as in Fig. 14, with the cutoff tool inverted and fed forward. Turret attachments held in the tailstock support the tools at an angle so that when the attachment is rotated the tools will be at the correct working position. Sometimes both types of turret attachment are used together, the tailstock turret holding tools for internal opera-

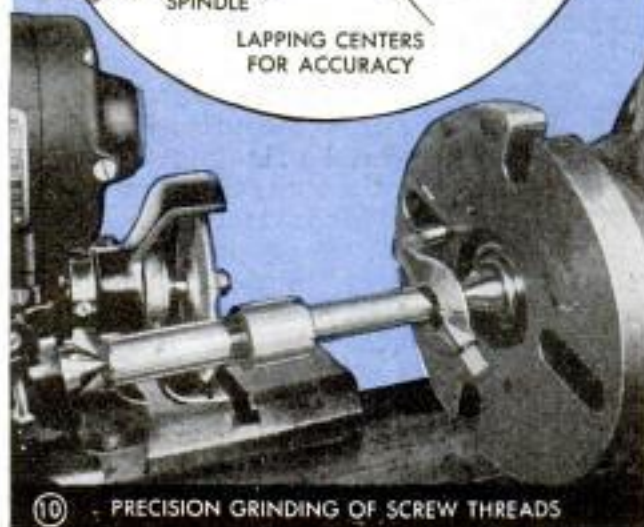

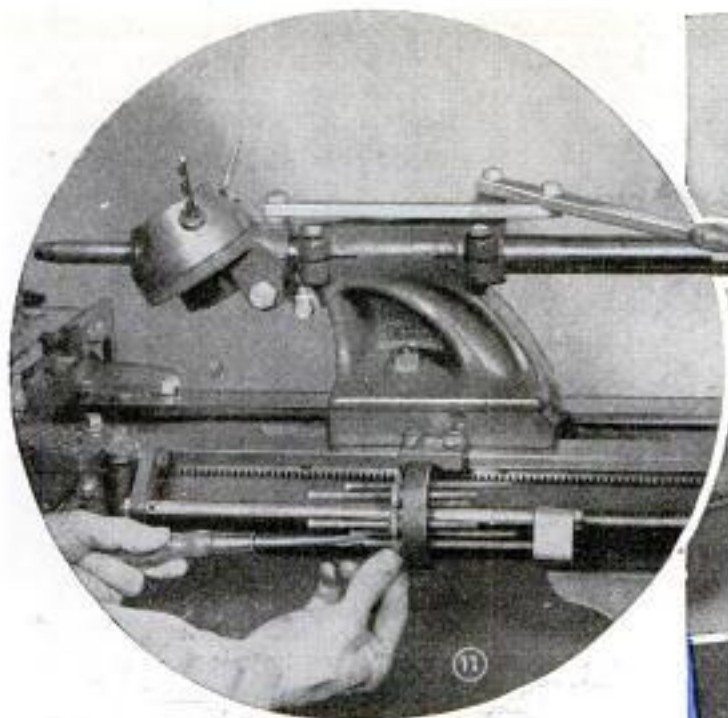

tions while the cross-carriage turret holds tools used for external operations. Cutting tools used in the cross-carriage type of turret ordinarily are larger than standard sizes because the tools may have to project farther from the holder for efficiency and therefore are subject to greater strain. The length and depth of cuts by any tool held in a turret are controlled by multiple stops attached to the front bed way or to the tailstock ram, Fig. 11. The stops are regulated by adjustable screws, each of which is marked to identify the operation it controls.

Another method of increasing the versatility of the lathe is to use a milling attachment and cutters of different kinds for a variety of milling operations. A few of the many cutters that are used for milling in a lathe are shown in Fig. 18. They are known by names that describe their uses. Cutter A is a plain milling cutter; it is provided with a key seat by which it can be held on an arbor and it may be reversed to cut in either direction; that is, for left-hand or right-hand milling. In right-hand milling on a lathe, the cutter rotates in the same direction as the chuck or faceplate rotates when ordinary turning is done, and the work held in the fixture gradually advances toward the operator from behind. In left-hand milling, the lathe spindle and cutter rotate in the opposite direction and the work is fed against the cutter in the same direction as the tool bit is fed in for regular turning. Detail B of Fig. 18 shows a keyseating cutter. Unlike the cutter shown at A, it cannot be reversed but is solid on its arbor, which must be mounted in a lathe so that the cutter rotates toward the operator, the

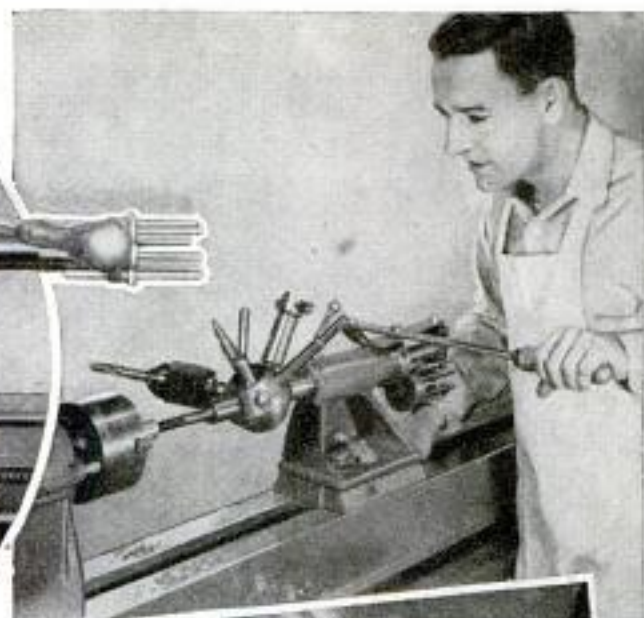

ATTACHMENT HELD ON CROSS CARRIAGE



ATTACHMENT HELD IN TAILSTOCK

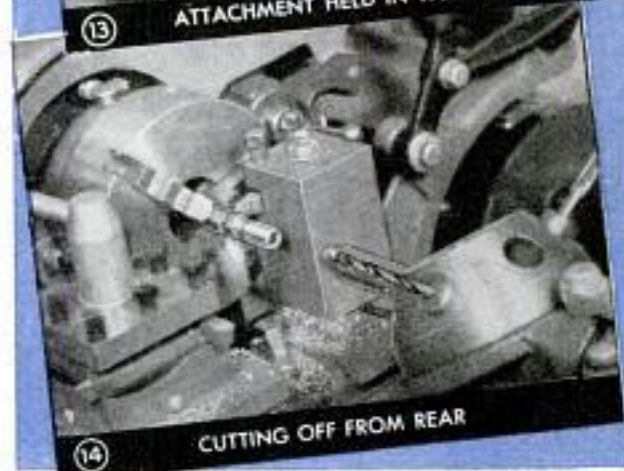

CUTTING OFF FROM REAR

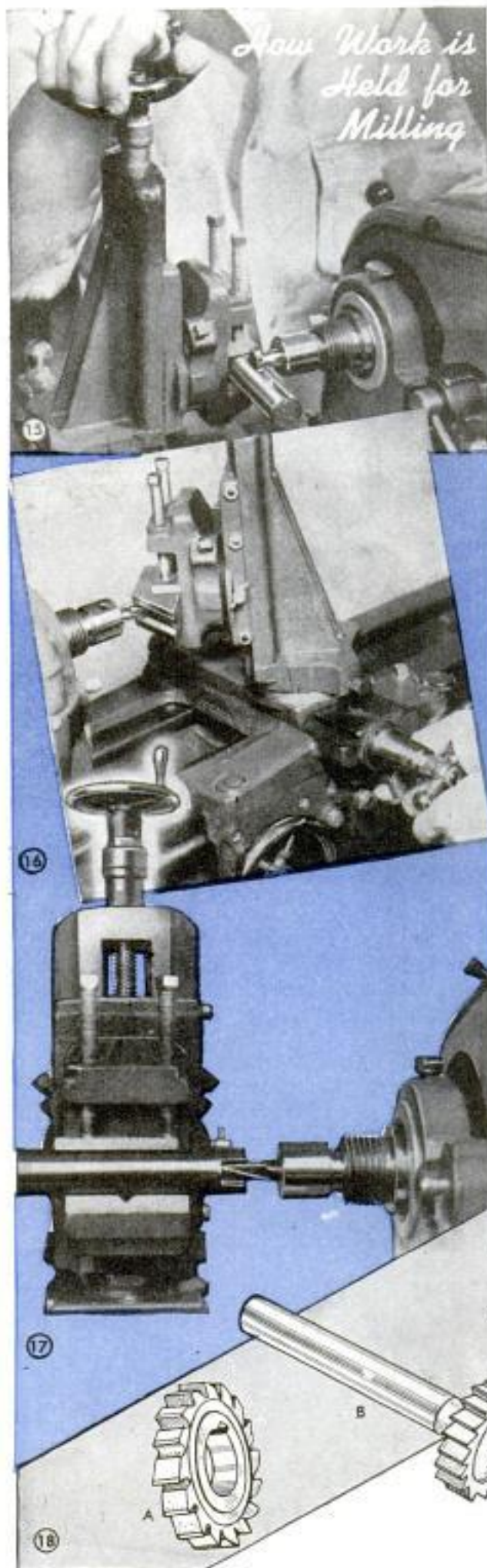

work being fed in from behind. In Fig. 15 a keyseating cutter is shown milling a slot in a shaft, the work being held in a milling attachment. Cutter C is a side mill, so called because the sides as well as the lips of the teeth are ground to a cutting edge. E is an angular cutter for left-hand milling of dovetails. In cutting dovetails, the female part may be cut in a single operation by using a 60-deg. angle cutter of required diameter, or an end mill may be used to cut a straight slot and the angles of the sides may be finished with a small angular cutter. The male part is then milled to fit. However, milling the angles separately means reversing the work unless a right and a left-hand end mill are used. In this case, care must be taken to keep the two cuts in perfect alignment. Arbor D, for the angular cutter E, has a left-hand thread so that when the cutter rotates against the work it will be tightened automatically. F is an end mill for right-hand milling, shown in use in Fig. 17 to mill a slot at the end of a shaft. By means of the swivel and vertical adjustments and the cross-slide feed of the milling attachment an end mill will produce cuts of various types without requiring the removal and resetting of the work in the attachment. For example, a shaft can be squared on the ends or opposite flats can be milled on it. In Fig. 16 the same cutter is shown milling a channel that can be made into a T-slot by replacing the end mill with cutter G, called a T-slot cutter. Detail H, Fig. 18, shows a double angular cutter, so called because the cutting edges ex-

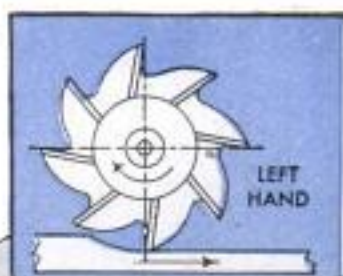

tend on both sides of each tooth to mill a V-shaped slot. Double angular cutters are made with an included angle of 45, 60 or 90 deg., but V-shaped cutters of any desired angle may be made up to special order.

For use in a lathe, fine cutters—those having many teeth—are best as the milling

attachment is not as rigid as a fixture bolted to the bed of a milling machine. Coarse cutters are used to best advantage only for heavy work on regular milling machines. Lard oil should be applied freely to the cutters during milling operations to help reduce heat and wear of the edges. When the cutters become dull they should not be ground unless a special grinding fixture is available; it is safer to extend the efficiency of the original grinds to the limit by careful honing of the cutting edges. When being honed, the cutter is placed on a suitable rest, Fig. 19, and the stone is held at an angle corresponding to the amount of clearance on the tooth. The angle of clearance is usually about 5 deg. To determine whether the side or end teeth have sufficient clearance, a shave test can be made by drawing a pencil across the teeth as in Fig. 22. A three-cornered stone is

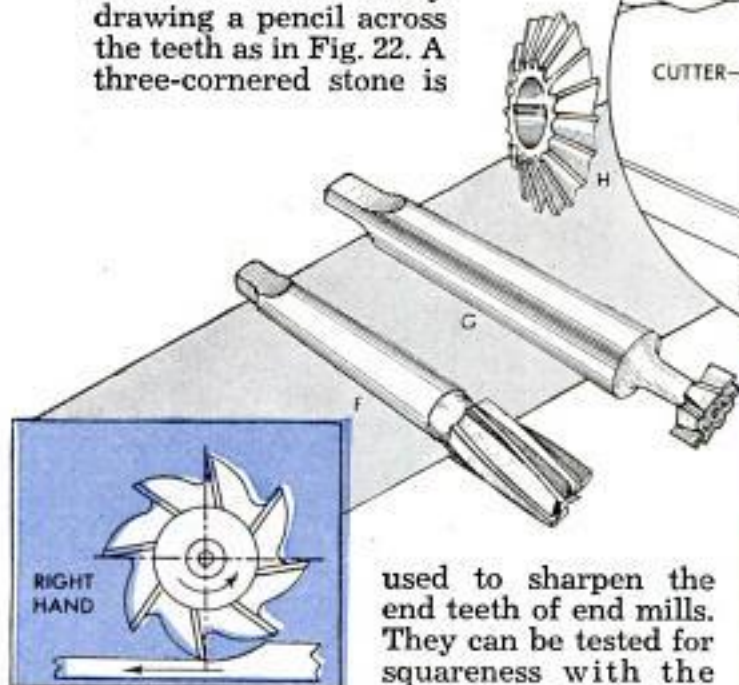
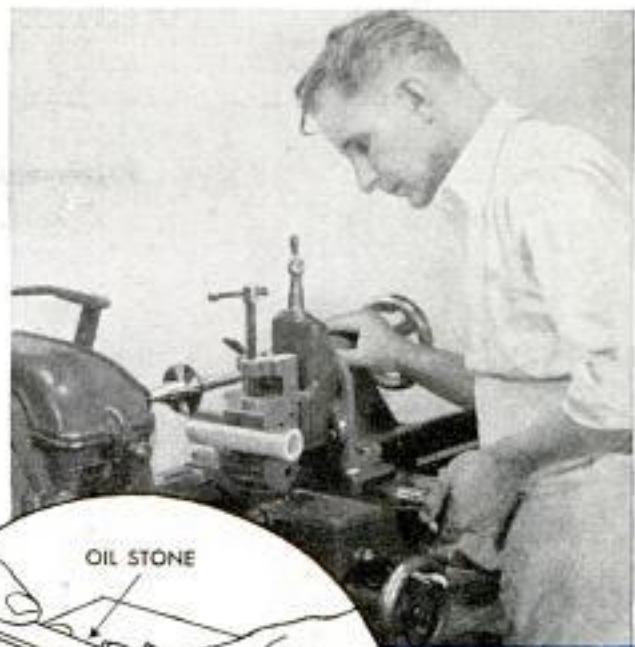

used to sharpen the end teeth of end mills. They can be tested for squareness with the peripheral teeth by

rocking the cutter on a small steel block as in Fig. 21. Peripheral teeth require no less than 4 deg. of clearance. This can be determined with fair accuracy by the aid of a 6-in. scale held on a tooth and parallel with the adjoining teeth as in Fig. 23.

Care must be taken in honing cutters to hold the stone so that it contacts the cutting edge of each tooth evenly, as a good stone will cut away the metal quickly and the edge may be ruined by a few incorrectly placed strokes. Side milling or angular cutters can be honed by lapping them on a cast-iron plate or a marble slab, Fig. 20. Lapping compound is used, and the cutter is rotated back and forth on the plate.

Crushing of wood when mounting it in a three-jaw chuck for turning can be avoided by wrapping it with light sheet metal.

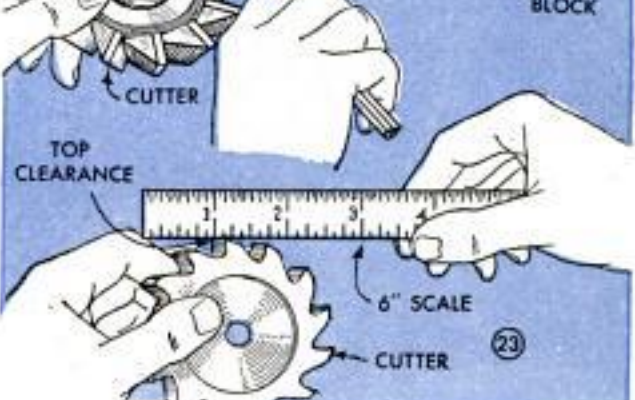
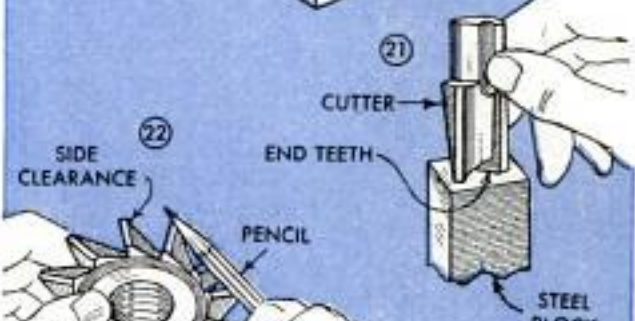
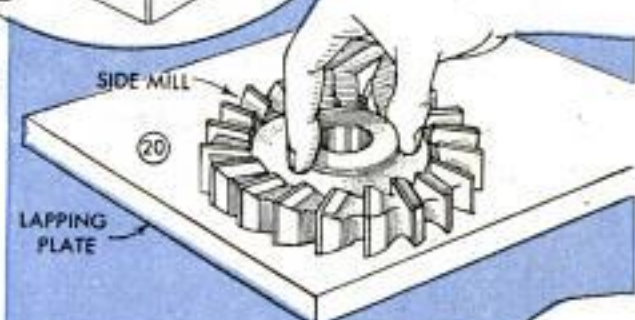
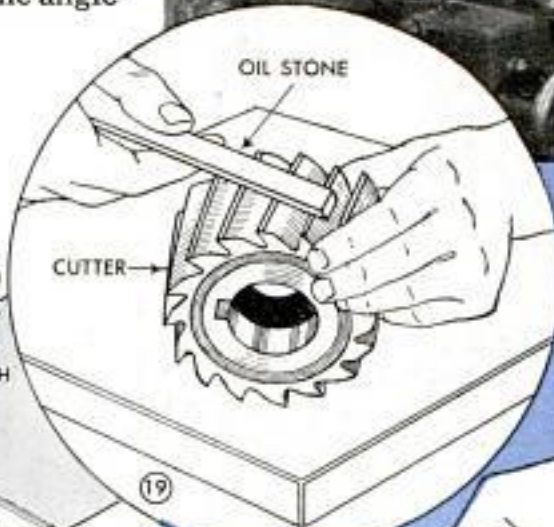

Hairdressers Use Magnetized Rod To Locate Hidden Pins



After setting a finger wave or dressing a permanent, beauty operators often move a magnetized bar over a patron's head to locate hidden hairpins used to hold the wave while drying. The bar is a short length of steel rod and is magnetized by being stroked over a magnet, or it can be held in the center of a coil connected to two dry cells wired in series. The magnetized rod is inserted in a container of the type used to hold lipstick, and plastic wood or other substance is used to hold it securely. A similar rod drawn by a length of string across the floor gathers hairpins that have been dropped.—I. M. Fenn, Chicago.

Flashlight Held on Screw Driver Illuminates Work



By attaching a pen-type flashlight to a screw driver you will have light in close quarters when your hands shade the work. The light is attached by two strips of tin looped over the screwdriver close to the bit end, where they are held by bolts and wingnuts. Herman Klein, Pittsburgh, Pa.

Numbering Welding Cables Simplifies Tracing Them

When a number of welding units are used in a small area, delays caused by tracing a welding cable to the machine can be avoided by numbering the cables and machines. A convenient method is to paint a number on a metal band and clamp it on

the end of the cable. The machine then is painted with a corresponding number so the worker can look at the number on his cable and go directly to the proper machine.—E. W. P. Downing, Norfolk, Va.

Draftsman Applies Banana Oil To Mend Torn Tracings

Instead of mending torn tracings with gummed tape, which may be noticeable on blueprints, one draftsman uses banana oil that has been allowed to evaporate until it is thick. The torn edges of the tracing are carefully mated and pressed together, and the oil is applied over them with a small brush. When dry, the repair is permanent.



W. Fraser Hughes, Nova Scotia, Can.

Clogged Sanding Belts Renewed By Cleaning on Buffer

Sanding belts that have become dull from clogging with wood dust often can be restored to effective use by going over them with a cloth buffer. The belt is removed from the sander and held lightly against the buffer, which removes the dust without damaging the grit.



Sanding disks and drums may be similarly serviced.—C. Nott, Jr., Elbridge, N. Y.

Slotted Nut Gripped in Lathe Dog Holds Threaded Work

When using a lathe dog in turning threaded work between centers, a slotted hex nut can be screwed on the work to be gripped in the dog. The cap screw of the dog is tightened on the nut which will clamp down on the work and hold it without damaging the threads.



Wm. E. Hesel, Grand Rapids, Mich.

Knurling Tool Adjusts to Light or Heavy Work

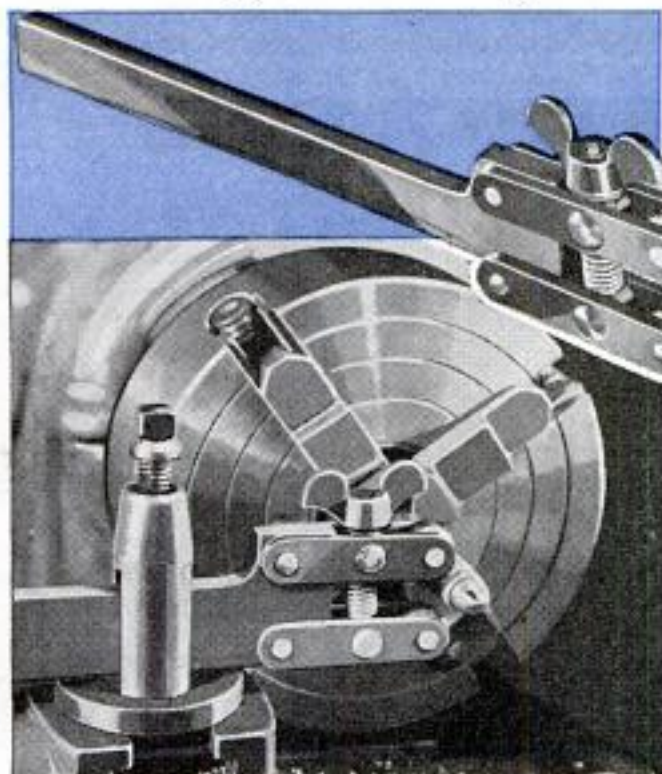

For light, small-diameter work, this adjustable knurling tool can be used as a hand tool to produce a clean-cut hand knurl. If there is heavier work of larger diameter, a short shank will adapt it for use in the tool post of a lathe. The shank was cut from $\frac{5}{16}$ -in. stock, the same thickness as the knurls which were used, and shaped as indicated by the solid lines for the lathe tool and by dotted lines for the hand tool. A shank 5 in. long is used for the lathe tool and the shank for the hand tool can be 7 in. long. The four arms holding the knurls were made from $\frac{1}{8}$ -in. stock, cut and drilled as shown. Two spacers, which adjust the knurls to the work, were turned to the dimensions given and cross-drilled, one being tapped $\frac{1}{4}$ -in.-20 and the other drilled clearance size to receive the adjusting screw. This screw was made from a short piece of $\frac{1}{4}$ -in. rod, threaded for a distance of about $\frac{3}{16}$ in. on the head end, screwed into a wing nut and riveted over to hold it in place. The other end of the rod was threaded to screw into the bottom spacer. In assembling the parts, the

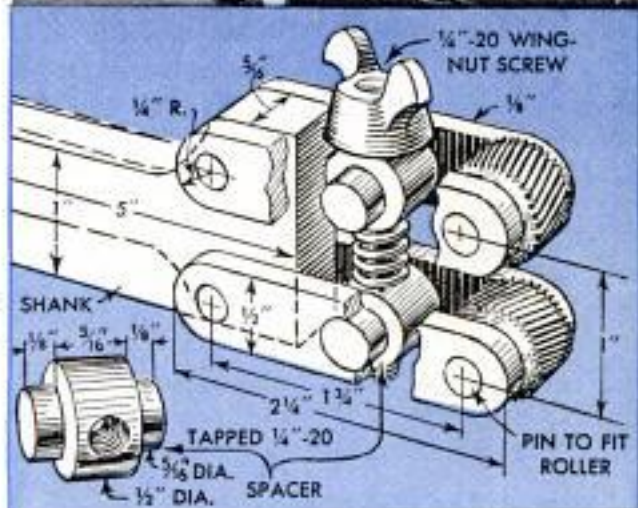

arms should be allowed to rock on the pins to give a self-centering action to the knurls when applied to the work. The compression spring shown between the spacers will add to the convenience of the tool.

Gary Moore, East Aurora, N. Y.

Shaft May Be Used as a Mandrel to Babbitt Bearings

When rebabbitting bearings, a mandrel is not always necessary because the shaft which runs in the bearing may be used as a mandrel itself. This is especially true if the shaft is undersize and a matching mandrel would be difficult to secure. The mold should be fashioned so that the babbitt can be poured quickly. If poured too slow-

ly, the shaft may heat unevenly and warp. In preparing the shaft for the mold, the journal can be coated with an oily soot and then covered with one layer of thin, tough paper. This will have an insulating effect and provide clearance between the shaft and the bearing. Some scraping may be required.—W. F. Schaphorst, Newark, N. J.

Half an Oil Drum Holds Sand For Checking Fires in Garages



An ideal container for holding sand used in extinguishing fires in garages, machine shops and other places where oil accumulates can be made by using one half of an oil drum that has been cut in two lengthwise. Legs, which are pieces of tire rim, are welded on the ends. Because of the container's shape, sand can be scooped out quickly.—Opie Read, Jr., Chicago.

Screen-Wire Roller in Paint Pan Coats Brush for Stippling



A better way of coating a stippling brush than dipping it in paint is to run it lightly over a roller placed in a shallow paint pan. The roller is a length of screen wire wrapped around and tacked to two wooden disks.

Only enough paint adheres to the screen to coat the brush so that excess paint will not drip off to spoil the appearance of the wall.

Striping Brushes Improvised From Scrap Material

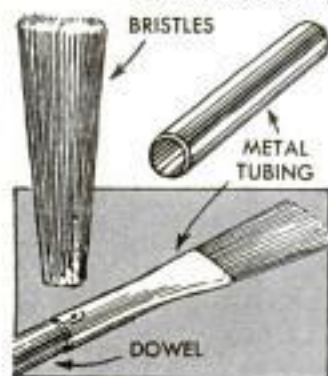

When a paint brush becomes clogged or worn out, it need not be discarded. The part of the bristles covered by the ferrule will serve to make a number of small brushes suitable for striping or edging. The

bristles are cut to the desired lengths and set into the end of a metal tube which is clamped together in a vise to form a ferrule. This is slipped over a length of dowel, which serves as a handle, and is prick-punched to keep it in place.

James McKeon, Collins, N. Y.

"Sanding Block" Shapes Edges Of Insulating Board

A strip of metal lath set into a grooved block at a slant provides a handy tool that can be used like a sanding block for quickly beveling or rounding the edges of insulating board and similar materials. A 2 by 3-in. block about 7 in. long with a groove $\frac{3}{4}$ in. wide and 1 in. deep is the most convenient size, and the lath is forced into the groove so that its sharp edges dig into the wood to hold it in place.

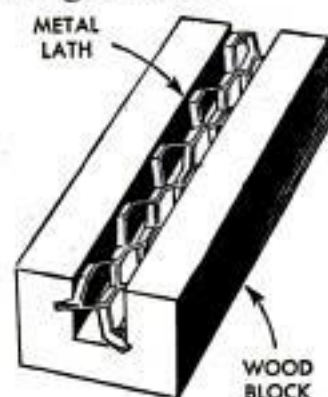

Claude N. Butts, San Francisco, Calif.

Chalk Line Used Instead of Level When Locating Corner Bead

By using a chalk line, you can position a metal corner bead vertically on a stud more quickly than when using a level, and the plastered wall will be equally true. The chalk line is suspended between nails at the top and bottom of the wall and spaced $\frac{3}{8}$ in. away from the stud, this distance being the thickness of the plaster. Then the bead is set over the edge of the stud, moved out to touch the line and nailed in place.—M. B. Birge, Rochester, Minn.

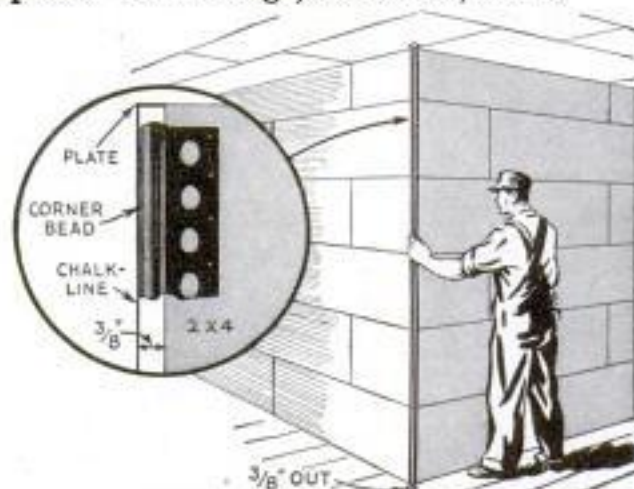

Shallow surface scratches in glass can be removed by rubbing them with a mixture of glycerine, water and red rouge, using a felt pad as an applicator.

Four Simple Kinks That Printers Find Useful

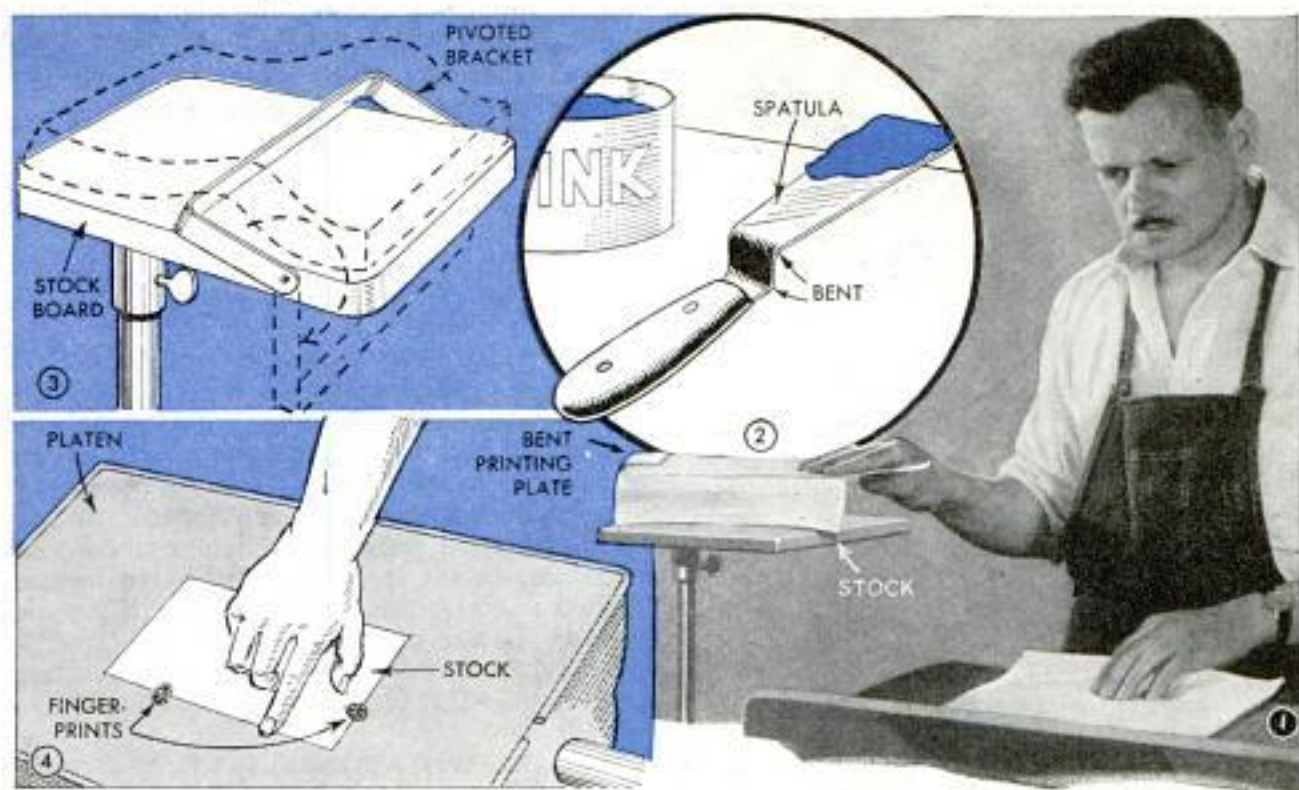

Printers have found these ideas time and labor savers in operating job presses. Fig. 1 shows how an old electrotype was bent at a right angle and used to weight a stack of paper on a stock board so that one sheet at a time could be removed and fed into a press. The bent end keeps the plate from sliding forward as a sheet of paper is removed. Bending the blade of a spatula as in Fig. 2 will not interfere with its use, but will prevent the blade from smearing ink over the workbench when it is laid aside. A metal bracket pivoted to a stock board as indicated in Fig. 3 will replace the stick that feeders of job presses sometimes use

under the center of a stack of paper on the stock board to prevent the paper from sliding when vibrated by the press. The bracket also aids in removing one sheet of paper at a time, and can be swung up in position or dropped down under the board when not needed. Fig. 4 shows a quick way of spotting locations for gauge pins by pressing the tip of a finger on one of the ink rollers, then transferring the ink smudge to both the stock and tympan sheet. When the stock is removed, the line of separation in the smudges will show plainly where the pins are to be inserted.

G. E. Hendrickson, Argyle, Wis.

Foundation Lines Marked Off by Aid of Layout Square

In laying out foundation lines, often it is difficult to set stakes so that lines strung from them will mark off an exact 90-degree angle. An accurate way of doing this is to drive the stakes through holes drilled near the ends of three boards assembled as indicated, the holes being spaced so that the stakes are exactly 3, 4 and 5 ft. apart. With the stakes in this position, the angle formed at the juncture of the 3 and 4-ft. lengths measures 90 deg. By stringing a cord around the stakes, straight lines can be laid out for a considerable distance by sighting along the cord and over the tops of the stakes.—Wm. T. Gooley, Chicago.

☐ An old spectacle case provides a handy container for carrying small drills.

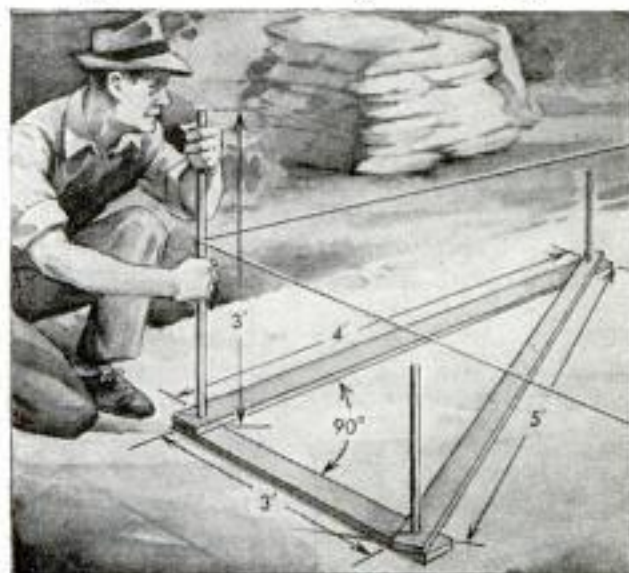

Glove Is Attached to Coat Sleeve To Free Hands for Writing



Deliverymen, messengers and others who have occasion to use a pencil outdoors in cold weather usually remove a glove while doing it. If it is inconvenient to put the glove in a pocket, it may be held out of the way by attaching it to a coat sleeve with an overshoe buckle as indicated, leaving the hands free for writing.

P. B. Horsley, Pembroke, Ont., Can.

Blueprints Stored in Glass Tubes

By removing the contact points at the ends of burned-out fluorescent tubes, the tubes may be used for storing blueprints, charts, maps and similar reference papers. The tubes may be stoppered with corks on which the contents of the tubes are recorded.—L. H. Houck, Jefferson City, Mo.

Holes Punched in Hacksaw Blade By Nail Set and Guide

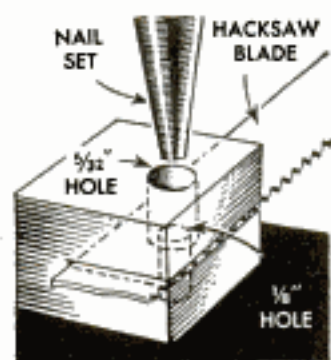

A nail set and a guide made from the head of a machine bolt can be used to punch new holes in broken hacksaw blades. First cut the head from a $\frac{3}{4}$ -in. square-head machine bolt and slot

it to take a hacksaw blade. Then drill a $\frac{1}{8}$ -in. hole through the bolt head to center on the hacksaw blade. Ream the hole in the top half with a $\frac{5}{32}$ -in. drill to allow for the taper on a nail set. To operate, rest the guide on a solid surface such as a bar of solder or a piece of sheet lead and punch the hole with a $\frac{1}{8}$ -in. nail set.

Leonard B. Ryan, Portland, Ore.

Heating Paint in Cold Weather Keeps It Fluid for Use

Paint that is to be used outdoors in cold weather should be stored, when not in use, in a room with an even temperature of about 70 deg. to prevent thickening of the paint due to cold. This will save much time that otherwise will be spent in thinning or stirring it to proper consistency. Also, if the can is set in a basin of warm water when used outdoors, the paint will remain fluid. More hot water should be added to the basin from time to time to maintain the heat.—Hal Geihm, Aurora, Ill.

Brush With Retractable Bristles Made From Package Handle

A pocket brush with retractable bristles suitable for typists can be made from a package handle and a tuft from a dusting brush. The bristles are wired to the end of a dowel of a size to slide freely in the bore of the handle, in which a $1\frac{1}{8}$ by $\frac{1}{8}$ -in. slit is cut to take a small bolt driven into the dowel for moving the bristles.

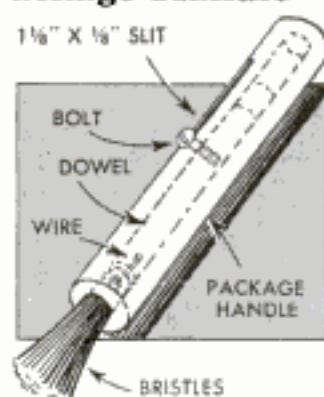

Frank Shore, New York.

Thermostatic Alarm on Brooder Warns of Low Temperatures

To warn of low brooder temperatures which might kill young chicks, an alarm can be wired to a thermostat to furnish audible indication that the brooder stove needs attention. The thermostat is installed beneath the canopy of the stove and connects to a buzzer located where it is sure to be heard.—Roger Huntington, Wrightstown, Wis.

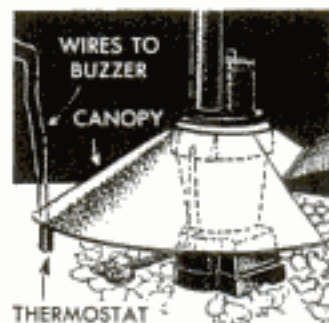



Suggestions for 1946

W"OW"-FREE performance is claimed by the manufacturer of the portable recording and play-back equipment shown in photo A. It will produce recordings on disks up to 16 in. in diameter, at either 33.3 or 78 revolutions per minute. Designed for the speech, language and music departments of schools and colleges, and other users of high-quality sound recording apparatus, it employs a simple "gear shift" arrangement by means of which four pitches can be instantly selected to cut 98, 118, 141 and 161 lines to the inch. The center-driven turntable assures accurate timing of recordings.

Although to be installed on fleet units and at shore stations, the new National ultra-high-frequency receiver, photo B, employs a mechanical construction feature that may be adapted easily to commercial models, including wall-flush home sets. When the handles at the sides are released, the interior assembly can be pulled out on a drawer slide and tilted to three different positions for inspection or repairs. Photo C shows a magnetic wire recorder that features an automatic timing device capable of turning the machine off after the proper time has elapsed for recording. Recordings may be played through either the speaker or headphones. Photo D: Some new receivers will be equipped with a built-in automatic timer; programs are selected for any 15-minute period by flipping out one of the 48 keys around the large electric clock dial. An electronic stethoscope is illustrated in photo E; this is capable not only of transmitting body sounds for the physician but of intensifying the sounds that the operator particularly wishes to hear. Photo F shows a portable record changer attachment which converts your a. c. table or console model home radio into an automatic phonograph.



HOW TO CONVERT A SILENT 16-MM.

By A. H. Ketzler

PART I

CONVERTING an old 16-mm. silent home movie projector into a sound machine for using 16-mm. film with a sound track was an interesting project for this experimenter in radio and electronics. Actually the homemade conversion to be described was not difficult and the results were highly satisfactory.

The writer was equipped to do the necessary semiprecision machine work on the sound head on a metal turning lathe in his home workshop.

The 10-watt audio amplifier, which will be described for construction next month in Part II of this article, is a compact and highly efficient general-purpose unit that was easy to build.

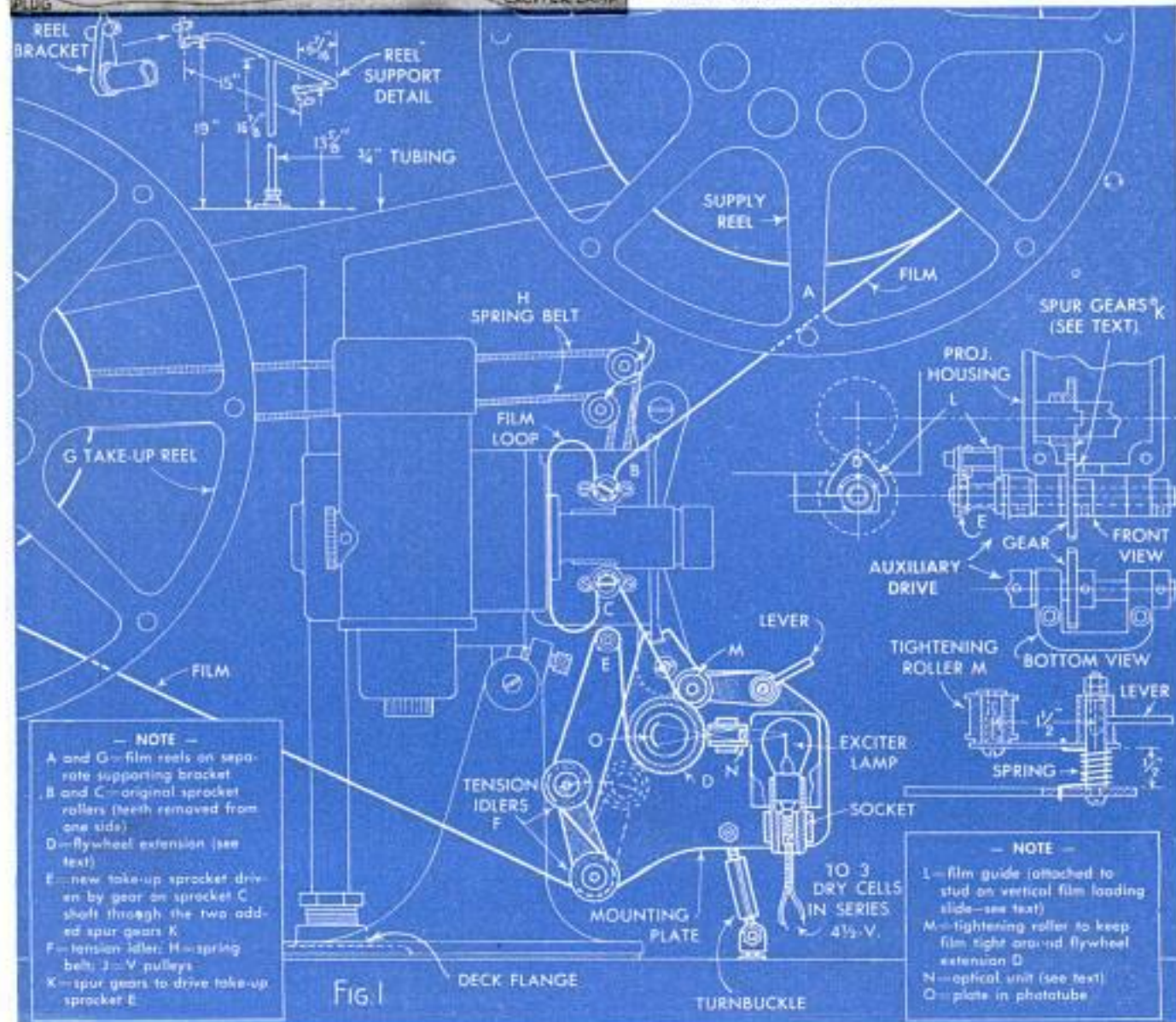
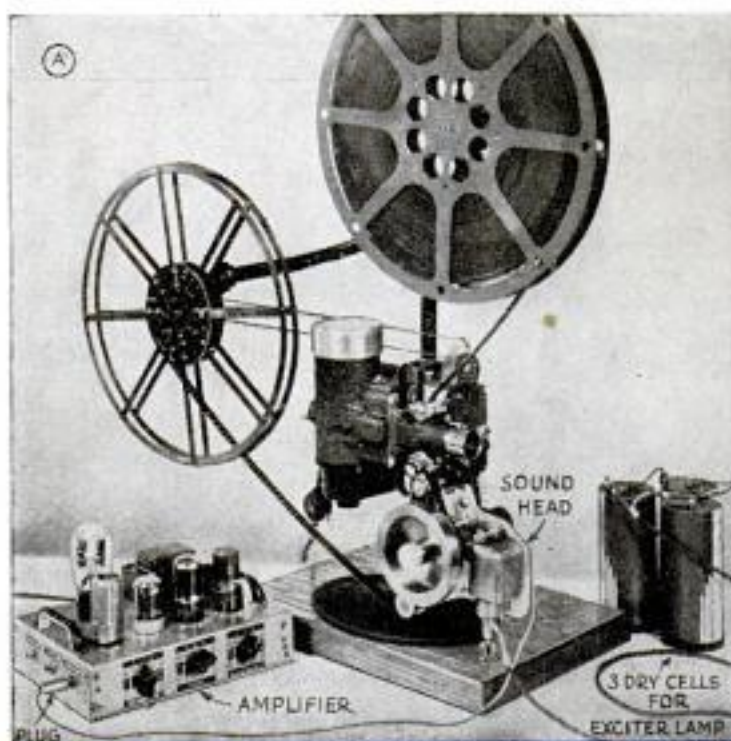

MOVIE PROJECTOR FOR SOUND . . .

Photo A shows the completed units ready for sound projection. Some old projectors of different construction would have made it necessary to change the sound head mounting and assembly to meet requirements. However, the layout arrangement would remain the same in practically all cases. This projector was mounted on a 1-in. wood base supported on four rubber feet, the base being large enough to provide room for mounting the large reel-supporting bracket detailed at upper left in Fig. 1. This was necessary because the projector was not designed to use 1600-ft. reels. The original reel brackets merely were removed and mounted on the $\frac{3}{4}$ -in. supporting bracket tubing; the bracket assembly then was mounted on the baseboard by means of a deck flange in the proper position to feed the film through the projector. The take-up reel (G) is driven by extending the spring belt (H) around V-pulleys (J) as indicated in Fig. 1. All parts of the sound head are supported on the mounting plate attached to the projector, and are carefully detailed in Figs. 2 and 2-A, and in the assembly section view 2-B on page 168.

In Fig. 1 it will be noted that the film comes from supply reel (A) around sprocket (B), then forms the loop through the gate and goes around sprocket (C). Sprocket rollers (B) and (C) have the teeth

(Continued to page 168)

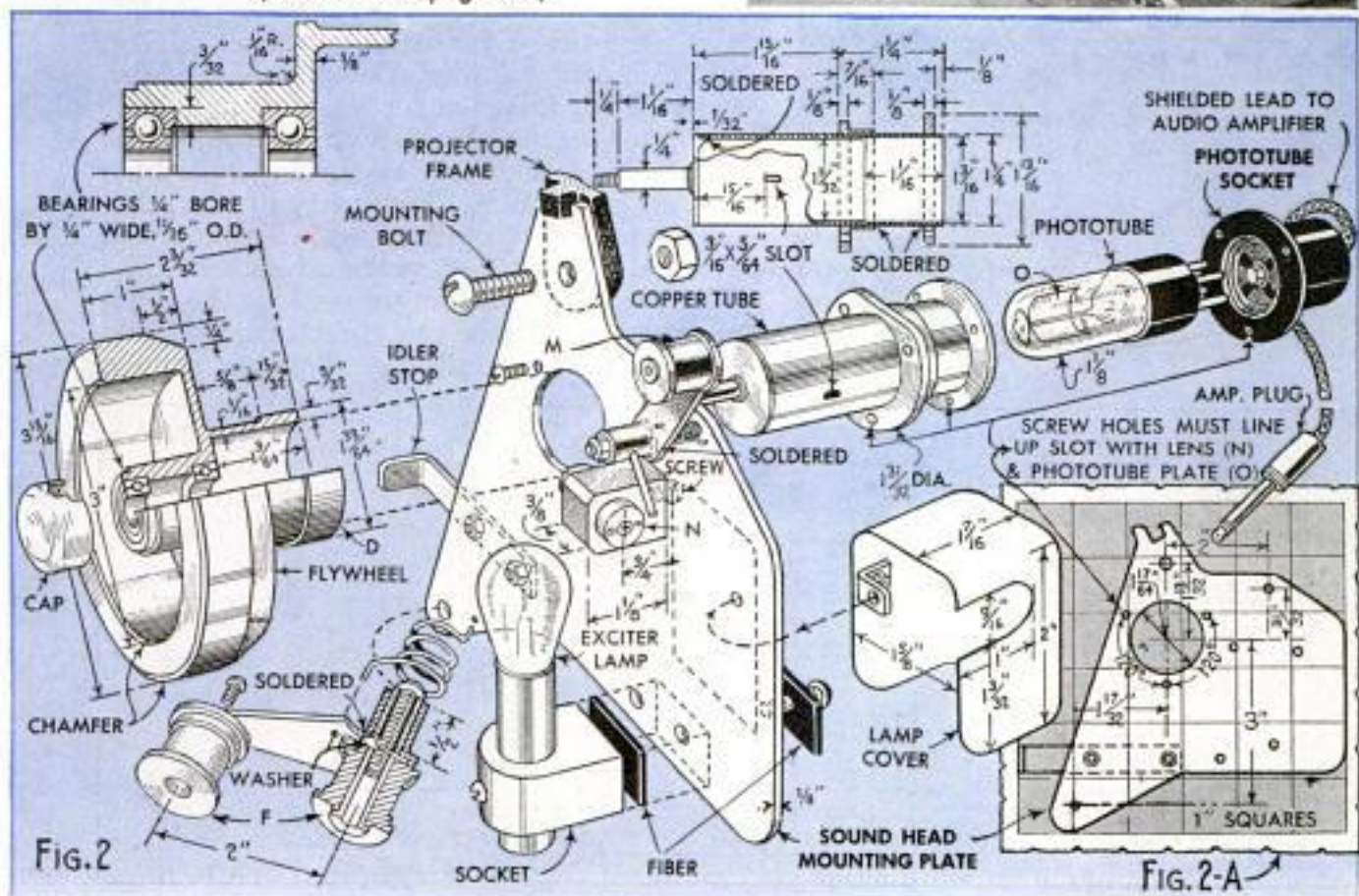
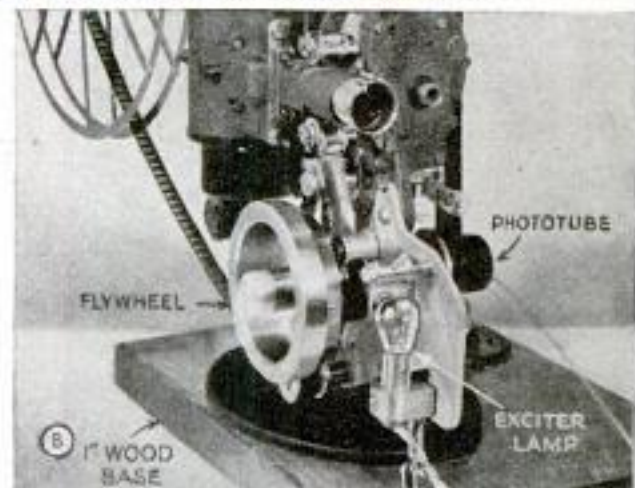

VHF Kit Receiver Includes the New FM Band

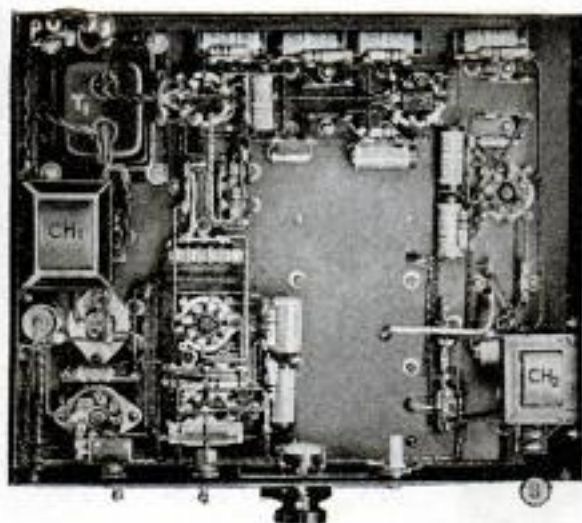
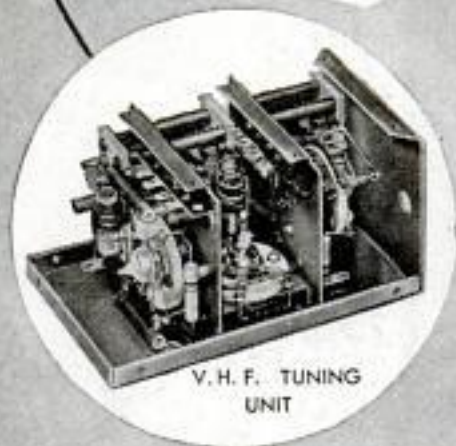

PRIMARILY designed for instruction and training purposes, this VHF (very-high-frequency) 10-tube FM-AM receiver kit is now available to civilian students and experimenters. It employs a straightforward and simple circuit with no frills or unnecessary components and offers the advancing amateur and experimenter an excellent opportunity to get started on the assembly of ultra-high-frequency receiving apparatus.

The receiver illustrated tunes from 88.6 to 107.6 megacycles and this range, of course, includes the new 92 to 106-megacycle FM broadcasting band so that you will be all set when FM moves "upstairs" to the new band. Very compact, sturdy and easily assembled, the kit comes complete with tubes and all necessary parts including a punched chassis and detailed instructions for assembly. The front panel is 6¼ by 12 in. wide and the chassis base is 3 by 10 by 12 in.

Photo A shows the completed receiver; the VHF tuning unit, shown with its cover removed in the inset photo, is the high-frequency heart of the receiver. This unit is mounted on the top of the chassis in the position indicated. It is constructed in two sections, out in the open, where every part is accessible for soldering and wiring. Emphasis is placed on simplicity and the use of extremely short leads. A type 956 acorn tube is employed as the r.f. amplifier, and a type 954 acorn tube is used for the first detector stage. The oscillator consists of a type 955 acorn tube in a plate-tuned inductive feedback circuit with excellent stability. Completely shielded, this unit is connected for filament and plate supply to the main chassis with only four wires. An underside view of the main chassis base appears in photo B. The conventional schematic circuit diagram is given in Fig. 1; it will be noted that a 150-30 voltage-regulator tube (VR) provides constant voltage for the high-frequency oscillator and first detector, and operates from a well-filtered power supply.

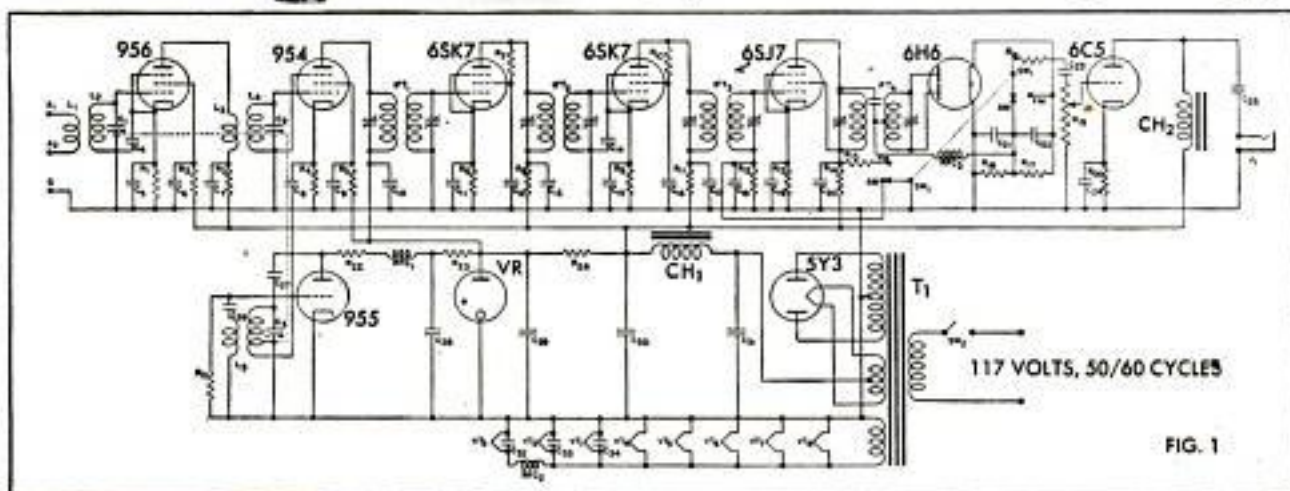

Give your living room The THERMOMETER TEST



One of these days when weather gets down below freezing, just try this thermometer test in your living room. You'll probably be amazed to find that there is as much as twenty degrees difference between the temperature at your ceiling and on your floor. (See chart below.)

That's because, in the average home, equipped with an ordinary on-and-off control system, the warm air rises to the ceiling, and the cold air forms in layers along the floor. But with Honeywell's new MODUFLOW control system, that's all different. By an ingenious method of control and supply, Moduflow nearly equalizes ceiling and floor temperatures. Much of the heat formerly wasted at the ceiling is used to heat the lower levels; result, blissful comfort from head to foot with greater efficiency of operation.

And here's the best news of all! Moduflow can be installed in your present automatic heating system. A limited number of Moduflow systems are now available. The sooner you order from your heating dealer, the sooner you will be able to enjoy the comfort of Moduflow. Mail the coupon today for an interesting booklet that tells how Moduflow will "evolutionize" house heating.

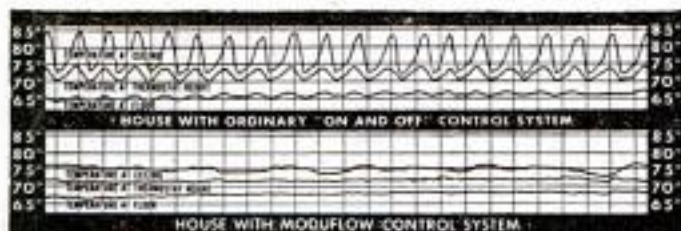

See how Moduflow smooths out the up-and-down temperatures caused by ordinary control systems. Shown above are actual temperature recordings taken in two identical houses — one with and one without Moduflow. Without Moduflow, temperature varies as much as 20 degrees from floor to ceiling. With Moduflow there is comfort temperature from ceiling to floor.

MODUFLOW

THE NEW HONEYWELL HEATING CONTROL SYSTEM



Send for this book FREE!

MINNEAPOLIS-HONEYWELL REGULATOR CO.
2907 Fourth Ave. So., Minneapolis 8, Minn.

Please send my free copy of "Heating and Air Conditioning the Postwar Home."

Name _____

Address _____

City _____ State _____

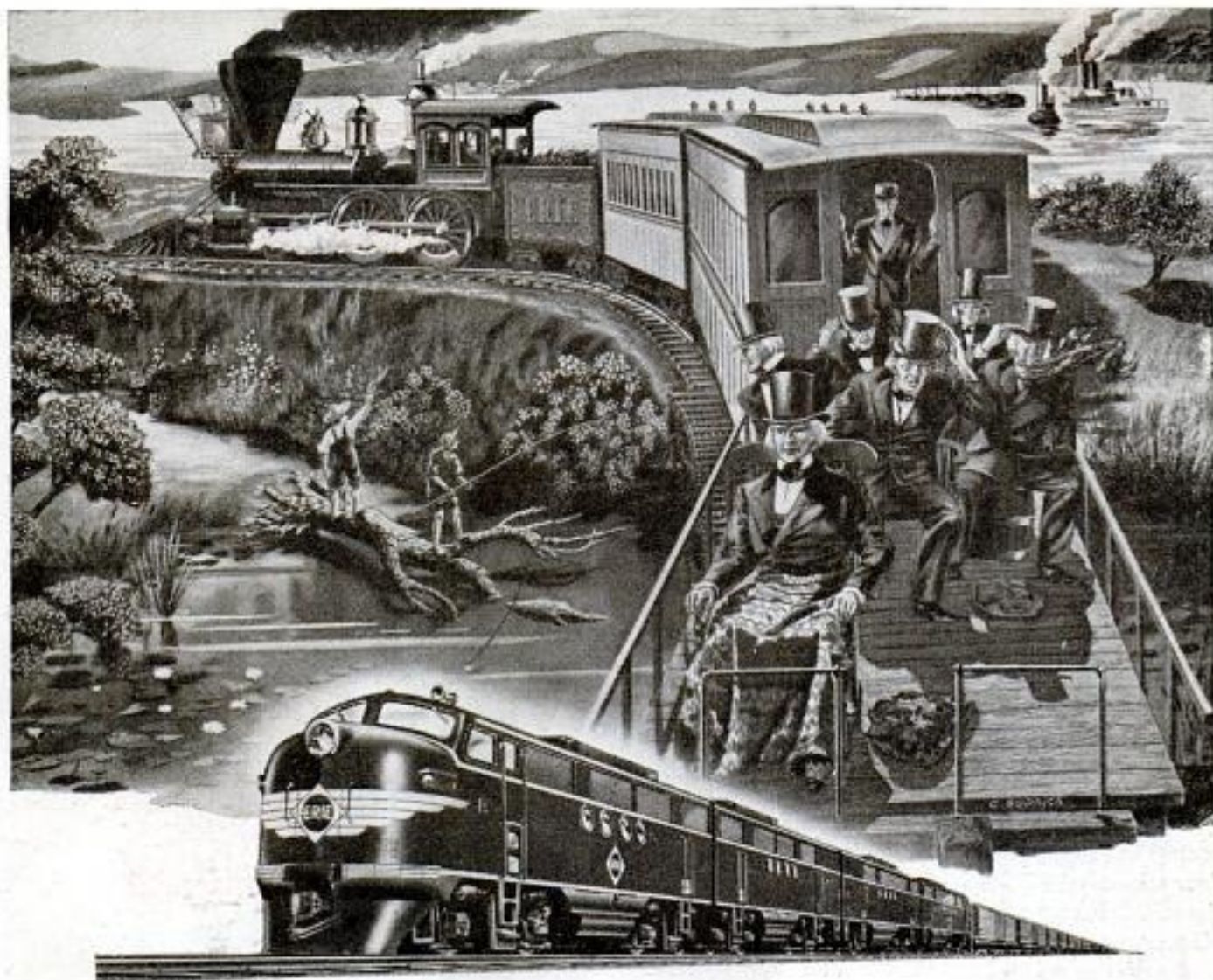

To celebrate the opening of the then longest rail line in America, the Erie Railroad arranged a now famous junket for May 14, 1851. Included among the guests who made the 427-mile trip were President Millard Fillmore, several members of his cabinet and Daniel Webster, who is pictured here as he elected to travel.

SAMPLE OF THE NEW AND BETTER

In his hair was the snow of 69 active years—but in the heart and mind of Daniel Webster was ever-youthful eagerness to sample new and better things.

So when the Erie Railroad celebrated the opening of the first "long" rail line, he prescribed his own accommodations. Other distinguished guests could ride in coaches if they preferred—Mr. Webster would take a rocking chair on an open flatcar, so as not to miss anything new and exciting.

Were he with us today, Daniel Webster would still find new and better things along the lines of the Erie. Heavy grades that "bottlenecked" freight movements

for a long time, have bowed down before General Motors Diesel locomotives—and long strings of freight cars now move with dependable on-time regularity without split-up between Chicago and Jersey City.

Here, as in the service of 83 other major lines and heavy industries, this modern motive power is dramatically heralding new and better things to come.

For their great power, their speed, their unmatched smoothness make one thing clear: *When whole lines become completely GM Dieselized, schedules can be clipped, costs still more reduced—and all your travels blessed with fresh new comfort and ease.*

ADD SECURITY
TO VICTORY
BUY MORE
VICTORY BONDS

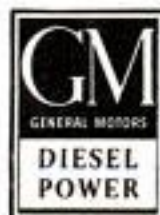

LOCOMOTIVES ELECTRO-MOTIVE DIVISION, La Grange, Ill.

SINGLE ENGINES ... Up to 200 H.P. }
MULTIPLE UNITS ... Up to 800 H.P. } DETROIT DIESEL ENGINE DIVISION, Detroit 23, Mich.

ENGINES 150 to 2000 H.P. CLEVELAND DIESEL ENGINE DIVISION, Cleveland 17, Ohio



"I Know
a **TOP**
Secret!"

I'VE HAD A PRE-VIEW IN LIONEL'S LABORATORY

I can tell you this—there are some sensational surprises coming from LIONEL! New train realism such as you have never seen before. It's all "*top secret*" now, but the news will break soon!

If you want a *preview* of what's coming see the new die cast trucks and solid steel wheels, and the new (remote control) *real railroad knuckle couplers* on the Lionel Trains now at your favorite store! This is *only* the beginning! (Suggest you send for these two *free* books—"Plans and Blue Prints" and "Candid Camera Shots of Lionel Trains in Action".)

"MODEL BUILDER" MAGAZINE \$1.00 Year. Eight issues a year—full of exciting pictures, plans, articles, ideas, and track layouts. Subscribe *now!* Boys! You need this magazine to help you build *more realistic model railroads*. Send dollar to Model Builder, 15 East 26th Street, New York 10, New York for your subscription (8 issues).



MAIL COUPON NOW FOR TWO FREE BOOKS

LIONEL

Electric Trains

The Lionel Corporation
Dept. No. MA
15 East 26th Street
New York 10, New York

Name.....

Address.....

City..... State.....

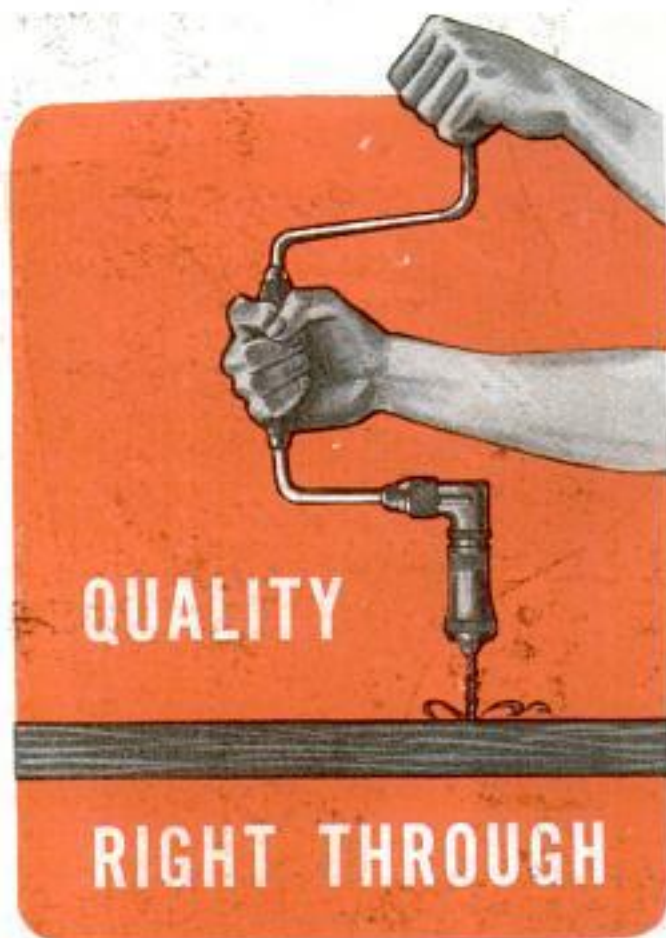

The first time you use a Millers Falls Brace and Bit you'll know you have hold of **QUALITY** tools. You'll *feel* the precise balance of the brace and the dispatch with which the bit speeds cleanly through the wood, however hard.

This same quality runs right through the complete line. There are Millers Falls hand and electric tools for a thousand and one uses. The variety is almost unlimited. But the sterling quality is the same.

See your dealer, Millers Falls fine tools are becoming increasingly available.

One Thing in Common—QUALITY!



Two Million Car Garage

(Continued from page 62)

The disabled truck, when processed, arrived in the automotive area, where skilled mechanics began repairs. They repaired the truck by replacing the engine, installing a new axle and running gear, rebuilding an assembly, or two, and reshaping the body and fenders.

The armament mechanics could either perform a major overhaul on the truck machine gun or replace it entirely. They, like the automotive men, were better equipped and more talented than their partners in the medium company. Heavy shop armament technicians repaired up to 155-mm. artillery as well as anti-aircraft weapons, electrical gun directors and complicated fire control systems.

The service and supply men carried their large stock of parts in six-ton vans rather than trucks. A vital link in the entire ordnance supply chain, they furnished parts, equipment and battle replacements to an entire army. If their services were needed for the truck, blacksmiths, electricians and combination welders helped complete the job. These men were noted for inventiveness—one shop in India-Burma found a way to manufacture critical bearings from old gasoline drums.

While the heavy maintenance shop was able to repair the damaged GMC and return it directly to the front, the old engine and other units removed from it during the process—valuable for salvage and reclamation—were sent further back to base shops for rebuilding and eventual reuse.

These base shops were entirely out of the fighting area so their work would not be disturbed, yet their job was important in keeping combat trucks rolling. Load after load of battlefield wreckage was dumped into these shops to be reconditioned and made ready for reuse.

These base shops usually were located in large towns or cities, where cheap labor, suitable buildings and quantities of heavy machinery were available. The base shops for the Stilwell Road, in Calcutta, India, were set up in old jute mills and the export branch of an American motor company. Naga head-hunters were among the 10,000 native workers employed by the Ordnance Department in the former CBI theater; some native mechanics worked in turn for British, Jap and American bosses.

Ordnance men often had unusual duties. Robert A. Walters was detailed to teach King Farouk of Egypt to fire an American army rifle. Another ordnance man learned

(Continued to page 150)



You, too, can enjoy "smooth going" with more efficient, economical and dependable engine performance by insisting on Champion Spark Plugs. Wartime driving emphasized enormously the primary importance of spark plugs as a means to these ends. It has also

demonstrated the fundamental superiorities inherent in all Champion Spark Plugs by the outstanding manner in which they proved their ability to insure maximum performance and dependability in every engine, on land, sea and in the air.

CHAMPION SPARK PLUG COMPANY, TOLEDO 1, OHIO



**They Finished Their Jobs
Let's Finish Ours**

They're easier to reach with "SUPERRENCHES"



● Awkward, hard-to-reach adjustments present no problem for these slim, taper-jawed "Superrenches". Forged from alloy steel, they are thin enough to operate half nuts yet their strength is equal to that of the strongest wrenches made.

Williams "Superrenches" are available in a wide range of patterns, with openings from 3/16" to 3-1/8". Write Department M-12 for free Tool Data Sheets.

J. H. WILLIAMS & CO.
BUFFALO 7, NEW YORK



DROP FORGINGS AND DROP-FORGED TOOLS

to be a safe-cracker—he was to open captured safes which had been booby-trapped. A medium shop at Anzio during the Italian fight improvised tankdozers and built portable 40-foot artillery observation towers on trucks. An outfit in Corsica reconditioned a railroad locomotive. Ordnance men converted tanks into ambulances so American casualties could be moved during active fighting.

Ordnance field shops throughout the world simplified overseas transport, conserved critical material and saved valuable time by on-the-spot repairs. But, more important, they reduced American casualties by maintaining the mobility and firepower that brought our enemies to their knees.

Message From the Jungle: Snafu

(Continued from page 85)

In hilly country, this would answer the problem, but most jungle is fairly flat, and this remedy could not be used. Besides, the soldier who would try to find a hill from which to send his message would present an easy target for Jap snipers.

The signal experts also found that they could obtain an increase in range by an alternate method, that of using sky-wave transmission, technically known as transmission via ionosphere. In this method, antennas radiating energy almost vertically are used, and the waves are sent up to the ionosphere layers that exist in the region about 60 to 200 miles above the earth. The radio waves hit this layer and are reflected back to earth where they can be picked up by the receiver. In spite of the fact that this alternate path may be as much as 400 miles longer, it does not absorb the radio signal as much as one mile of jungle growth.

Although our signal men are ready to swear that it was only our equipment that was being "loused up" by the jungle heat and humidity, the jungle is impartial. The Japs had the same problems with their equipment. We found this out from captured equipment. The Japanese signal equipment which fell into our hands hastened the defeat of the "jungle experts" in more ways than one. Carefully studied and analyzed by the Army Signal Corps, it played an important role in their eventual destruction. Four uses were made of this captured signal equipment:

It gave a direct aid in developing counter tactics to make enemy signal devices less effective. Any valuable ideas, devices or methods of moistureproofing were incorporated into American equipment. Ameri-

(Continued to page 152)



Hello Boys!

Do you know all these exciting facts about the famous **GILBERT HALL OF SCIENCE?**

Do you know

that the Gilbert Hall of Science is the largest scientific exhibit of its kind in the world? Visit it when you are in New York—at Fifth Avenue and 25th Street.



ERECTOR JUNIOR

Do you know

that the new Erector Jr. builds big bridges, cranes, airplane ride and other thrilling action models? It's made of wood—like famous mosquito bomber. You just "pin-peg" parts together.

Do you know

that the latest Erectors are super-mechanized and all-electric? Build army training parachute jump, giant Ferris wheel and other engineering marvels that whistle and buzz with action. Production is limited until Uncle Sam can spare the metal.

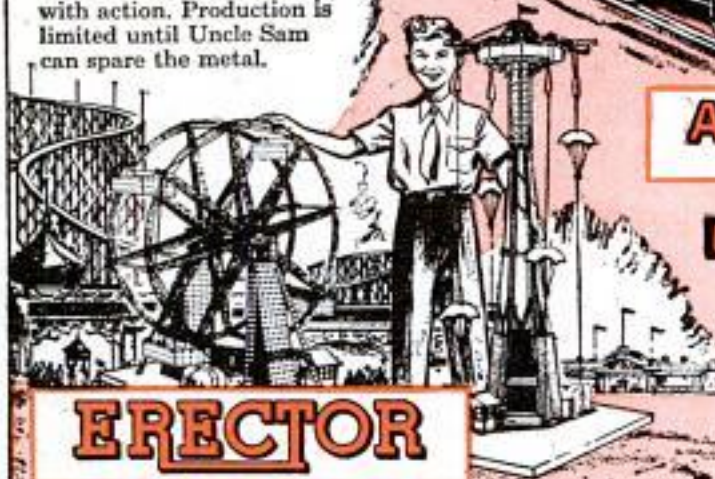

ERECTOR

AMERICAN FLYER

Do you know

that Gilbert American Flyer trains are the only scale model trains that both look and sound like real trains? Hear their realistic "choo-choos" change tone and tempo with every change in train speed. Watch for the latest models—to be ready when metal is available.

GILBERT CHEMISTRY SETS

Do you know

that Gilbert Chemistry Sets are far more than "toy" sets? Range of chemicals and apparatus are based on real laboratory technique. Write messages in invisible ink or fire ink. Make chemical weather flag. Hundreds of other spectacular experiments in organic, inorganic and electro chemistry.

Do you know that Gilbert craftsmen have been awarded the Army-Navy "E" four times for high achievement in war production?

Do you know that Mr. Gilbert will award prizes totalling \$200.00 to boys doing the most important scientific research in 1946? Write for details. Gilbert Hall of Science, 41 Erector Square, New Haven, Conn.

Do you know that when you see the words "developed at the Gilbert Hall of Science" on a scientific outfit, you can be sure it is the finest made?



No. 6 big two-door wooden laboratory puts over 400 exciting experiments at your finger tips.

The A. C. Gilbert Co., also manufacturers of Gilbert and Polar Cub Electric Fans • Gilbert Kitchen Kits • Vibrators • Electric Drills and other Gilbert Electric Appliances.

WHERE *Balance* COUNTS

Yes, tight rope walking means perfection in balance—perfection achieved by years of practice. In Plumb tools, too, balance—or “hang”—is a perfected quality, an accomplishment resulting from Plumb's century-old experience in making fine hand tools.

The forged steel head on every Plumb tool is weighed against the polished red tested hickory handle—shaped comfortably to fit the hand. Plumb's properly balanced tools make the job easier, do the work faster. That is why men who know good tools have, for five generations, chosen Plumb. Fayette R. Plumb Inc., Philadelphia 37, Pa.



PLUMB

HAMMERS • HATCHETS • AXES • SLEDGES

can signal men were trained in the use of enemy radios which were put to our use. Finally, intelligence officers were able to assess the economic state of the Japs by checking for inferior materials and substitutes found in the equipment.

These things were not left to chance or to the varying technical capacity of different men. Not only captured signal equipment but all possible information relating to it was forwarded to the Camp Coles Captured Equipment Section of the Signal Corps Ground Signal Agency at Bradley Beach, N. J., and to the branches at Camp Evans and Fort Monmouth. Here it was minutely studied, analyzed and results made known to our signal men in the field.

Often there was no signal equipment, either our own or captured, and then the jungle commander had to depend upon the foot messenger to “deliver the message to Garcia.” Also, since the many jungle conditions make radio and telephone communication uncertain, it was the foot messenger who constituted the primary and most reliable means of signal communication in jungle warfare.

More Fish Per Kilowatt

(Continued from page 35)

by closing the off-river racks and distributing 30,000 fall-run salmon to the river for natural reproduction.

Facilities for transfer of salmon from the river consist of a fish ladder, traps and lifts at Keswick Dam, below Shasta, and racks at Ball's Ferry. Keswick is used when river discharges exceed 15,000 cubic feet a second and the Ball's Ferry racks when it is less.

Seven automobile tank trucks are used to transfer salmon from Keswick and Ball's Ferry to the hatcheries. The Battle Creek hatchery has a capacity of about 58,000,000 eggs, approximately 29,000,000 fingerlings averaging 1½ inches and larger fingerlings. It has 28 outdoor ponds for use as holding and rearing reservoirs, a cold storage and ice-making plant.

Mortality of salmon trapped at Keswick and taken by fast trucks to Deer Creek and Battle Creek was high at first. This was due to delays caused by war conditions. However, as the salvage work progressed, the losses dropped. In 1943, out of 5245 salmon transferred from Keswick to Deer Creek only 1273 died, while in 1944 losses were even less although 8000 were moved to Deer Creek.

Last year, the second of the plan, saw a much heavier run of fish, almost 70,000

(Continued to page 154)

Need more power?



GET AN **AUTO-LITE** BATTERY

You can have the help of experts when you buy your next battery. Follow their example. They choose Auto-Lite batteries for service in the million-mile ocean-spanning Clippers, for service with our fighting forces in jeeps, tanks, and half-tracs.

The qualities experts look for in a battery are the same you need in your car battery—long life, quick starts, dependable power and low-cost operation. That's what you get when you buy an Auto-Lite battery—specified as standard equipment by leading automotive engineers.

AUTO-LITE BATTERY CORPORATION • TOLEDO, 1, OHIO

Manufacturing Plants at: Niagara Falls • Indianapolis • Atlanta • Oakland • Oklahoma City • Toronto



TUNE IN THE AUTO-LITE radio show starring Dick Haymes, with Helen Forrest and Gordon Jenkins' Orchestra, Every Saturday Night —8:00 P.M., E.T., on CBS.

AUTO-LITE BATTERIES

ENGINEERED AS A BALANCED UNIT OF THE ELECTRICAL SYSTEM

NOW! DUSTLESS SWEEPING



The Dustless brush is the only brush ever perfected for "Dustless" sweeping. This brush has a reservoir in its back for Arbitrin sweeping fluid. In the process of sweeping, Arbitrin filters through the brush and makes the best kind of sweeping compound out of every particle of dust it contacts. Besides reducing dust 97%, the Dustless brush also eliminates sweeping compound, saves labor and outlasts ordinary brushes 3 to 1. Get complete facts about this better method of sweeping. Write today.



- Dustless
- Speed Sweep
- Speed Wash brushes

MILWAUKEE DUSTLESS BRUSH COMPANY

528 N. 22nd Street • Milwaukee 3, Wisconsin

adult salmon, 10,000 more than had been estimated.

The results of the salvage program will not be known until the size of future returning cycles is determined. The 70,000 counted in 1944 are due to return from the ocean to spawn in 1948. If the count should drop to 35,000 the 1944 salvage would be considered only half successful.

Studies conducted at Shasta Dam are concerned with the size and distribution of the natural run, reaction of fish transferred from the river, the mortality of natural and transferred fish during the time they are in the creek preparatory to spawning, the manner and extent of utilization of gravel spawning beds in the streams, the beginning and end of the seaward migrations of salmon fry and the peaks of these migrations.

Chief among conclusions reached by researchers at Deer Creek is that natural spawning of spring-run salmon was more efficient and productive than placing them in the hatchery for artificial propagation. This bears out aquatic biologists' old contention that Mother Nature knows best.

On the other hand, hatchery propagation of fall-run fish was quite successful and now the Battle Creek hatchery will be used principally for such work. Results at Deer Creek have about convinced the experts that thousands of dollars and fish can be saved if emphasis is placed in the future on natural spawning.

Another important benefit derived from experiments in salvage work on the Columbia and Sacramento Rivers has been to focus interest of sportsmen and conservationists on the peril to wildlife inherent in unregulated dam building on a nationwide scale.

There are about 14,000,000 men and women in the United States who buy fishing licenses every year. They know recreational facilities must be vastly expanded after the war for thousands of servicemen and servicewomen who will be interested in fish as well as cheap kilowatt-hours.

Patients Without Lens in Eye Can See by Black Light

Patients whose eye lenses had been removed in cataract operations were able to read an eye testing chart from top to bottom under ultraviolet lighting in experiments at Harvard University. Professor George Wald, conducting the tests, was unable to see the chart in the "black light." Dr. Wald reports the eye lens in man is yellow in color and acts as a yellow filter at the ultraviolet end of the spectrum.

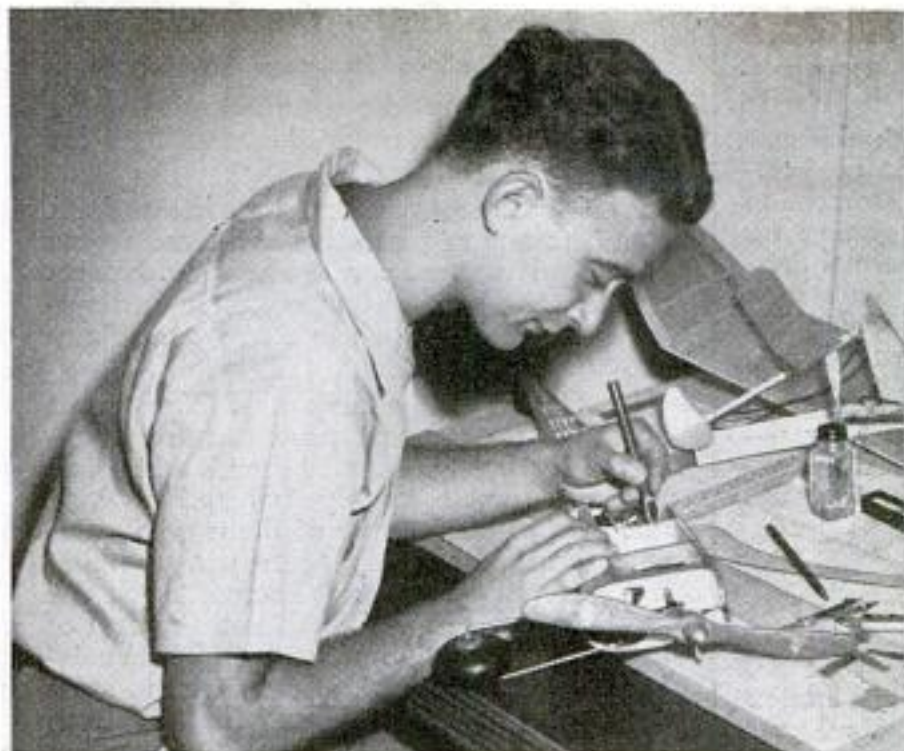

HIS PLANES WIN PRIZES— HE MAKES THEM WITH X-ACTO!

"Most Useful Tool in Model-maker's Workshop," Says Brilliant Young Designer

Model plane fans know Martin Powell. His original designs have been written up in the leading magazines. His models have been used for display and instruction purposes by Air Youth of America. He's won prizes with everything from elementary "R. O. G.'s" to complex gas models.

Here you see him, working on his newest design. And you notice he's using an X-acto Knife. He says he doesn't see how any modelmaker can get along without an X-acto. He likes its scalpel-keen edge, the variety of interchangeable blade shapes. With X-acto, you can get true accuracy in even the smallest detail. "Most useful tool in a modelmaker's workshop." That's what this young expert calls X-acto Knives.



PARENTS PLEASE NOTE! As a teacher of craft classes for young children (aged 8 to 12), Mr. Powell found the razor blades they'd been using meant cut fingers and too much

spoilage. "X-acto Knives were the answer to that," he says. "The firm-grip handles permitted the children to carve safely, and turn out better work. That means a lot more fun!"

HERE IT IS
The Hobbycrafter's Dream Gift!



X-acto Knife Chest. 3 X-acto Knives with complete assortment of extra blades, each neatly assigned to its special slot in a handy wooden chest. \$3.50 complete. No. 83 De Luxe All-Metal Knife Chest with 20 extra blades, \$5.

MERRY CHRISTMAS HOBBY NEW YEAR



What's his hobby? Modelmaking, whittling, leathercraft? Is he an artist, photographer, draftsman? X-acto Knives and Knife Chests make a really thrilling gift.



GIVE DAD HIS OWN . . . Or else he'll be borrowing yours. Doesn't a swell guy like him deserve an X-acto set of his own?



SISTER SUSIE, TOO! Girls like to make things too. Paper dolls or plane models, earrings or lapel gadgets . . . Sis can make 'em easily with an X-acto.



HINT TO WHITTLE'S MOTHER: Give him the X-acto No. 80 Whittler's Set, with special assortment of blades for plain and fancy whittling. Send 10c for the new 32-page X-acto Whittler's Handbook, full of helpful hints and things to make.



MODELS MAKE FINE GIFTS. Borrow the Bright Idea of Stanley C— of New Rochelle. He makes model planes with his X-acto Knife, to give to his friends for Christmas. And do they make a hit! Yours would too.



x-acto^{*} KNIVES & TOOLS

X-acto Knives & Knife Chests From 50c to \$5.00

Buy where you see this sign. At better hardware, hobby and gift shops
— or if not available write direct to

X-acto Crescent Products Co., Inc., 440 Fourth Avenue, New York 16, N. Y.

*Reg. U.S. Pat. Off.

HOW TO GET THE MOST OUT OF BETTER FUEL

Don't expect to fill your tank with the new, higher-octane gas and get top-grade performance from spark plugs you may have switched to during the war. Now that you're getting far better fuel—and have returned to normal driving, you need to consult your service station about changing to AC plugs that run *cooler* than those you may have used with wartime fuels.

The correct type of plug is *necessary* to avoid hard starting—loss of power—waste of gas—cracked insulators—rapid electrode wear—excessive oxide coating—misfiring under heavy loads.

The AC Heat Range, and today's wider heat range per plug, enable you to fit spark plugs exactly to engine operating conditions. That's why AC's were standard equipment on 2 of every 4 new cars and trucks—why your AC service station can help you to get the *utmost reliability* in spark plug performance. Have your plugs checked today. Be sure you have the type that will give you the best in performance.

AC SPARK PLUG DIVISION • GENERAL MOTORS CORPORATION



CLEAN PLUGS SAVE UP TO ONE GALLON OF GAS IN TEN



LET'S FINISH THE JOB — BUY VICTORY BONDS

Green Grow the Atolls

(Continued from page 78)

which lie in about the same latitudes as the Hawaiian Islands, made the area ideal for growing vegetables.

Pacific victory gardens range in size from small, one-man plots to good-sized farms of several hundred acres. The FEA experts provide the seed, fertilizer, tools and scientific advice while the Army and Navy provide the manpower.

In Guam, for example, a Navy unit staked out a 400-acre tract to grow vegetables for hospitals and other land installations. Approximately 100 sailors with farm experience, some of them off battleships and submarines, were put to work. They loved it because it brought back the familiar smell of the earth and the feel of growing things. On Guam and other islands, natives also are encouraged to start farms and become self-sufficient. Natives are fed by the military government when the battles have destroyed their homes and crops, but they are urged to re-establish themselves on farms as soon as possible.

Power-driven equipment is used on all FEA farms—tractors, plows, harrows, seeders, cultivators, fertilizer spreaders, etc. Many natives saw such equipment for the first time. Some of the farms are planted on the sites of Jap airfields, some are carved out of the virgin jungle. In such cases bulldozers fill bomb craters and uproot tree stumps. Jeeps also have done yeoman work on FEA farms in the Pacific pulling plows and sprayers.

Victory gardening on islands taken from the Japs was fraught with many hazards never encountered in the cornfields of Iowa or the truck gardens of southern California.

On Bougainville, for instance, a patch of corn was planted so close to the front lines that it was later destroyed in a tank battle between American and Jap forces. At Guadalcanal, wild pigs got into the vegetable gardens and did considerable damage until machine guns were set up and the marauders shot. A few were caught and fattened up for slaughter.

On Guam, approximately 24 Japs were shot when they came down from the hills to forage for food or to raid seed supplies from the FEA farms. On Tinian, Japs stole into the fields at night and tied hand grenades to the tools. FEA farms there were planted on the site of some of the heaviest fighting in Marpo Valley and sappers had to clear the area of booby traps, land mines and unexploded ammunition.

(Continued to page 158)



Welcome gifts of
lasting pleasure for
woodworking hobbyists..



DELTA-CRAFT*

low-cost Books and Plans

Delta-Craft Books and Plans — useful gifts that are low in cost, but priceless in the appreciation of the woodworking enthusiast who receives them from you!

Here are books of popular, shop-tested plans and projects in various combinations, to suit any hobbyist and any gift budget.

Solve the problem of how to please your friends who have home workshops, by ordering gifts of endless pleasure from this page. And don't forget to include a gift for yourself!

Modern Methods for Every Tool and Every Job!



Six valuable books of information worth knowing, to get speed, accuracy, safety and more satisfaction when working with power tools. Each contains close to 50 pages, over 200 illustrations to make every point clear!

These are the books:

- Getting the Most Out of Your Lathe.
- Getting the Most Out of Your Drill Press.
- Getting the Most Out of Your Circular Saw & Jointer.
- Getting the Most Out of Your Shaper.
- Getting the Most Out of Your Abrasive Tools.
- Getting the Most Out of Your Band Saw and Scroll Saw.



Check your gift list now!

Practical Finishing Methods!

Shows simple, easy methods of getting a smart, "factory-like" finish on completed projects. Authoritative advice on every practical known method of applying a finish to wood, metal, etc. Used by one of the leading paint and varnish manufacturers as a textbook for sales force!

Order "P" 50¢

*Trade Mark Reg. U. S. Pat. Off.

Classified Designs — A Whole Book on Each Subject!

Tried and tested projects arranged for quick reference. Hundreds of plans and pictures show "How to do it!" 21 *Lovely Lamps*. Popular designs. 19 *Charming Chairs*. Handsome, durable pieces. *One Evening Projects*. Dandy novelties, quickly built. *Garden Furniture and Novelties*. A swell collection. 40 *Fine Tables*. The finest of shop projects. *Furniture Designs*. Desks, beds, wardrobes, etc. *Novelties*. Small items. Interesting. *Toys, Games, Playground Equipment*. Real money-makers. *Small Furniture*. Footstools, magazine racks, etc.



A Whole Year's Subscription to The Deltagram!

Here's the popular, plan-packed homecrafters' magazine that provides a whole year's supply of fascinating woodworking plans and projects. Six big, exciting issues — every one a reminder of your thoughtfulness!

A gold-mine of ideas for more fun from woodworking. Latest tips on how to perform power tool operations more easily, more safely. Useful information helpful in producing beautiful, praise-worthy objects. Everything made clear by words and pictures.

Giant Project Library!

Ten detailed books that show what to make and how to make it! As many as 41 projects in each book — material for months of enjoyment in a homecraft shop. Each project is completely illustrated, minutely described, so that construction is easy. Wide range of projects, such as modern furniture, lamps, picture frames, garden furniture, games, toys, novelties, gifts, kitchen accessories, cutouts, and many, many other things that are fun to make, fun to use.



Published by the makers of



ORDER NOW! Really thrill your friends who are home workshop fans, by giving them Delta-Craft Books and Plans! Check your gift list now. Order your gifts by drawing a circle around each of the correct letters in the coupon below. Then mail it today with check, postal note, or money order. All material sent to you postpaid. Remember to order Delta-Craft Books and Plans for yourself, also!

Tear out coupon and mail today!

THE DELTA MFG. CO., 680N E. Vienna Ave., Milwaukee 1, Wis.

Enclosed find check, postal note, or money order for \$..... in full payment for Delta-Craft publications, the letters of which I have encircled below:

A B M N P

Name.....

Address.....

City..... (.....) State.....

NEXT TIME SAY BRIGHT STAR

and you will get a
FLASHLIGHT & BATTERIES
famous since 1909
for **QUALITY,**
STYLE and
SERVICE



BRIGHT STAR BATTERY CO. CLIFTON N. J.

before the plows could turn up the soil. At Saipan there was a standing order that tractor drivers must carry carbines at all times and at least one driver painted a little Jap flag on his machine to account for a Nip he killed while farming.

The first large-scale experiment in livestock raising in the Pacific was begun at Guam when 75 cows, 8 bulls, 6 heifers, 1043 hogs, 600 chickens, 100 ducks and 50 turkeys arrived aboard two specially fitted Victory ships. Upon arrival at Apra harbor, the animals were lowered in crates over the sides of the ships to the decks of LSTs which carried them to trucks on shore.

So great is the demand for fresh food in the forward areas of the Pacific that most vegetables are consumed where they are grown. The one exception is the air shipment of fresh vegetables from gardens on Guam, Tinian and Saipan to the barren, volcanic island of Iwo Jima, whose lava soil is not suitable for truck gardens.

Records are being kept on the larger farms developed by the FEA and the Army and Navy in the Pacific. Facts and figures on suitability of crops, annual yield, methods of combating insects and pests, harvesting methods and storage procedures are being carefully compiled.

Such information and experience as the FEA is gaining from its Pacific victory gardens now will help the natives to maintain a full bread basket in the future and may also set a pattern for helping hungry areas of the world—such as China and India—to reduce or wipe out starvation.

"Shore Duty" on a Battlewagon

(Continued from page 23)

troops. It is questionable whether or not we could have seized as many islands as quickly and at such low cost if battleship gunfire hadn't softened the beach defenses. Shore bombardment in the Pacific is called "the Spruance haircut"—derived from the stubby appearance of Kwajalein Island after guns of the Third Fleet, under the command of Admiral Spruance, sheared the tops off coconut palms.

Some battleships, the Pennsylvania, for example, former flagship of the United States Fleet, supported as many as 14 landings in the North, Central, South and Western Pacific. The "Pennsy" has shot 11,000,000 pounds of steel and explosives at enemy positions and more than 75,000 rounds of ammunition ranging from 14-inch shells to .50-caliber machine gun bullets.

Battleship gunners treat their giant weapons with loving care. Like flyers and

(Continued to page 160)

YOU WERE WRONG

THE TIME YOU PLAYED POKER ALL NIGHT

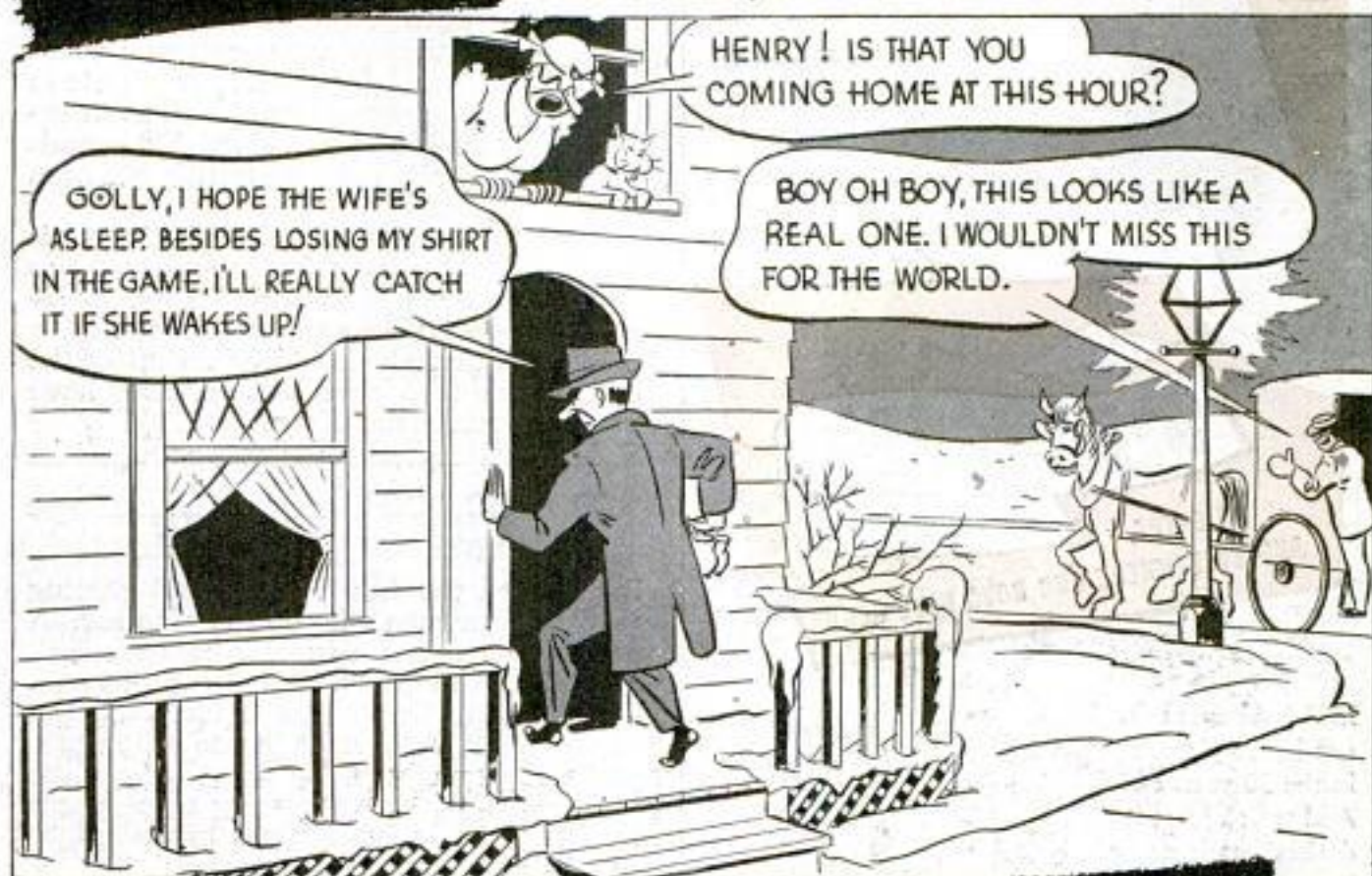

When you replace worn-out or inefficient spark, plug wires with Packard Four-Forty ignition cable, you are using the cable that is *right* for the job. No other high-tension cable can match it for long life and efficiency.

Packard Four-Forty ignition cable was scientifically developed by Packard Electric to meet extreme conditions. Its tough protective sheath resists the deteriorating effects of heat, cold, oil, moisture, corona and abrasion. Packard Four-Forty safeguards engine performance regardless of temperature or humidity . . . means more miles per replacement . . . stretches gas mileage.

**But... YOU'RE RIGHT
with
PACKARD CABLE!**

Long the replacement choice of service station operators, garages and car dealers everywhere, Packard cable is the original-equipment choice of leading car manufacturers. There is a reason for this wide acceptance—Packard cable is *right* for the job.

**PACKARD
CERTIFIED RE-WIRING SERVICE**

This sign means cable service at its best—the right Packard cable and the right methods. Thousands of dealers provide better electrical service as a result of the Packard Certified Re-Wiring Manual and Packard Certified Re-Wiring training films.

**CERTIFIED
RE-WIRING
SERVICE**

Packard
REG. U.S. PAT. OFF.
TRADE MARK

PACKARD ELECTRIC DIVISION
GENERAL MOTORS CORPORATION
WARREN, OHIO



BUY VICTORY BONDS

FOREMOST BUILDER OF AUTOMOTIVE AND AVIATION WIRING

THE SPHINX USED
TO LOOK DOWN UPON:



PIPES
LIKE
THESE
IN
EGYPT



LHS TODAY, IT'S
STERNCREST
STERLING

IN EGYPT,
AND EVERYWHERE OUR BOYS HAVE GONE

LHS has never turned out better pipes, nor more pipes, in the 50 years of LHS pipe-making. And yet, so great is the demand that dealers' stock are often depleted. But, good news—with war's end, more and more LHS pipes are now available for our civilian friends. Not all models yet, but a big selection, and all pre-war quality and workmanship. Your dealer has them.



\$5

Sterling Silver Band
Model No. 21
Antique Finish

IMPORTED
BRIAR

Also in plain finish.
Dozens of other
handsome models.

Also LHS
Sterncrest 14K
Specially selected
imported briar.
14K gold band.
Plain and antique
finishes . . . \$7.50

AT ALL GOOD DEALERS

KEEP ON BUYING
WAR BONDS



FREE—"Painters on Pipes"—Write

L & H STERN, INC., Stern Bldg., 56 Pearl St., Brooklyn 1, N. Y.

PT boat skippers, they bestow feminine names on the big 14 and 16-inch rifles. "Maggie the Mauler," "Lucky Lou" and "Belching Betty" have hurled a lot of hot lead at the enemy.

Expert battleship gunners can put as many as 18 heavy projectiles per minute in a small target area at 20 miles. The intermediate guns can throw about 150 rounds per minute while the antiaircraft guns can do slightly better.

One of the minor miracles of this war is that youngsters from farms and factories have become seasoned "men-o-war's-men." A battleship represents a collection of seagoing experts, but 90 percent of the officers and men aboard them today have had no previous naval service.

\$200,000,000 Gateway to Europe

(Continued from page 15)

bundles of the beach grass and passing them to four men who do the planting. A small plow opens a furrow beneath each planter and in it goes the clump of grass. The machine then fills the furrows as it moves along. A foreman inspects the work, and a workman walking along back of the machine makes any necessary adjustments by hand. All six machines can plant 30 acres a day, working at top speed.

Sixteen cubic yards of good sand fill are scraped up in 30 seconds by a giant Diesel-powered earthmover which lowers a scraper body to the ground and is dragged along by a powerful tractor. When the load is aboard, the operator raises the body and carries the fill to its destination.

Pipe galleries of wood are built around the storm sewers so inspections and repairs can be made without disturbing runways or taxiways overhead. A hydraulic pipe-bender applies 40-ton pressure to bend pipe up to 21 inches in diameter into desired shapes for electrical conduits which will light the field and provide power for the newest developments in airplane guidance.

By 1947, the permanent six-story administration building will be ready for use and the greatest railroad terminals will pale in comparison with the gigantic structure. The central area accommodating the building will cover 466 acres, nearly as large as LaGuardia Field itself. Three miles long, the building will have three-lane motor highways running through it, and 102 service gates for the various airlines using the airport. The central area and building are planned on the lines of an oval stadium, with connecting links to all present and projected runways.

(Continued to page 162)

These Cyclone Specialists are Chinese Doctors

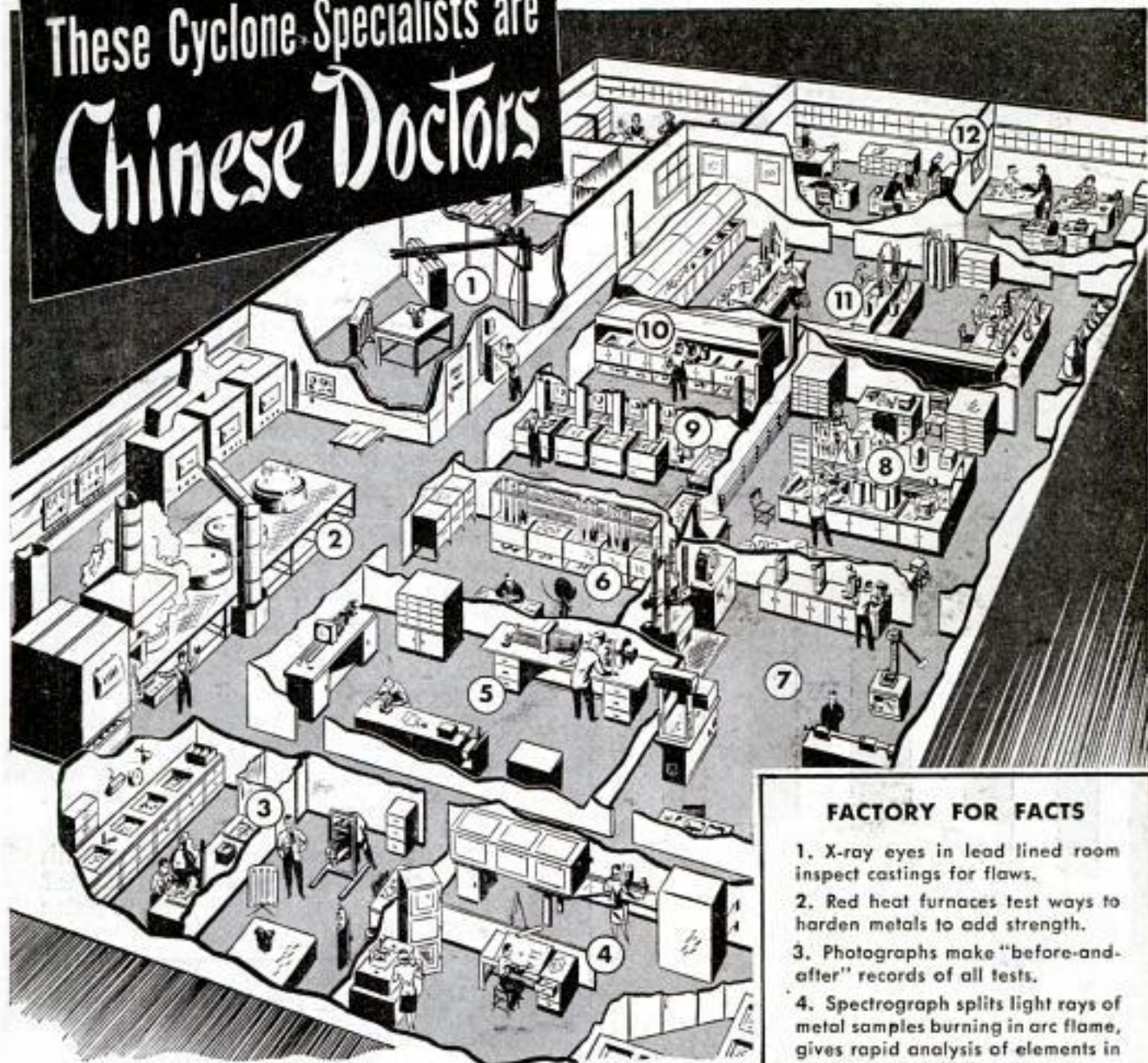

FACTORY FOR FACTS

1. X-ray eyes in lead lined room inspect castings for flaws.
2. Red heat furnaces test ways to harden metals to add strength.
3. Photographs make "before-and-after" records of all tests.
4. Spectrograph splits light rays of metal samples burning in arc flame, gives rapid analysis of elements in production materials.
5. Metallographers enlarge specimens 4,000 times for metallurgical study of grain structures.
6. Research projects on plastics, rubber, non-metallic materials.
7. Physical test section measures fatigue, impact, breaking point and hardness of engine materials.
8. Oil and gasoline scientists guarantee fuels of specified power.
9. Electro chemists develop and check plating methods.
10. Acids etch cross-sections of metals for grain flow study.
11. Chemists analyse alloys, study corrosion-resistance tests.
12. Scientific trouble-shooters aid production, foundries, shops, test cells. Research groups map out new development work.

Chinese doctors, so legend says, are paid to keep patients healthy, not just to cure them when sick. In this Materials Laboratory at Wright Aeronautical, scientists follow much the same idea — to make powerful Wright Cyclone aircraft engines even more powerful, more economical.

Heat, cold, salt, acids, light rays, endurance runs and utter destruction are used for one end: more power. Year after year, war or peace, research goes on. It's one more reason why Wright Cyclone engines continue to lead the parade of power.



Engineers' Pocket Size Handbook — crammed full of formulas, tables, aerodynamic data, plane designations, conversion factors, international vocabulary, maps. Send 25¢ in U.S. coin to Wright Aeronautical Corporation, Paterson 3, New Jersey, Dept. M.P.

WRIGHT
AIRCRAFT ENGINES
DIVISION OF
CURTIS WRIGHT
FIRST IN FLIGHT





FOR
YOUR FLASHLIGHT

BURGESS BATTERIES

RECOGNIZED BY THEIR
STRIPES • REMEMBERED
BY THEIR SERVICE

Accessibility to the heart of Manhattan will result from construction of Van Wyck Expressway, a six-lane depressed highway running directly from the airport to Queens Boulevard, which will provide 26-minute service from the center of the city to the airport. Bridges will separate grades at intersections to eliminate any direct cross-traffic. Southern Parkway will bring fast motor service to Brooklyn and the southern tip of Manhattan when the Battery-Brooklyn tunnel has been completed. Long Island Railroad trains from Pennsylvania Station will connect with an airport bus system.

General supervision of the project is under John McKenzie of the City Department of Marine and Aviation. Commissioner Robert Moses helped plan the connections between airport and parkways and expressways.

Figures on the completed project are staggering. There will be parking space for 30,000 cars. Approximately 40,000 persons are expected to be employed permanently in various airport activities. About 30,000 persons will go through the airline gates daily, besides thousands of tons of mail, express and freight. Plans are being made to handle 41 plane arrivals and 43 departures at the peak hour next year, and in five years 98 peak hour arrivals and 110 departures are expected.

Bound for London, Paris, Vienna, South America, the Caribbean, Moscow, Rome? You'll find all those names over the gates at Idlewild.

Tiny Wire Measures Pressure by Stretching Millionth of Inch

Liquid or gaseous pressures in various kinds of machines are measured accurately by an electronic instrument whose "nerve" is a hairlike filament wire. The slightest pressure variance in a machine to which the meter is attached changes the length of this wire—possibly stretching it a millionth of an inch. This changing of the wire's length also changes the amount of electric current that flows through it. And it is the measurement of this increase or decrease of current—amplified many times—that enables the engineer to measure the change in pressure. In one system, the pressure variance is registered on a dial. The Baldwin Locomotive Works, which designed the instrument, predicts widespread use for measurement and control work in steel mills, refineries, power houses, gas and oil pipe lines, chemical plants and by food processors and plastics manufacturers.



Cars must Start...no matter how cold

You know how difficult it is to start your engine on a bitter cold day . . .

Time and again you've ground your battery away, and waited and waited for a service car.

Casite is the *guaranteed* answer to winter starting. It retards congealing of oil, lets the engine spin over rapidly—and start—no matter how cold. Millions of car owners know that cars start *quicker* with Casite.

Casite is sold by service stations, car dealers and garages in every community. Put Casite in your crankcase oil now, and keep it there—for quick starting in winter—for better and smoother performance all-year-round.

CASITE

THE CASITE CORPORATION • HASTINGS, MICHIGAN

Quick Starting in Winter Weather or double-your-money-back

GUARANTEE—We guarantee that any motor capable of being started in a warm room will start promptly in the coldest weather when Casite is added to the crankcase according to instructions. If your car fails to start quickly, you get double-your-money-back by filling out guarantee certificate and mailing it to The Casite Corporation, Hastings, Michigan. Maximum refund is \$1.30 per pint, twice the nationally advertised price of Casite.



65¢ A PINT



HARLEY-DAVIDSON DAYS Are HERE AGAIN!

Harley-Davidson Motorcycles are again on their way to you! We're concentrating on production to meet unprecedented civilian demands for "The World's Champion Motorcycles". Typical of letters from thousands of eager riders, is one which says—"I saw what Harley-Davidsons did in the war. I won't be happy until I ride my own." And we'll get Harley-Davidsons to you just as fast as conditions permit. Yes, fun-packed tours, endurance runs, race meets, hillclimbs, and other thrilling motorcycle events are headed your way . . . See your

Harley-Davidson dealer early
— and MAIL THE COU-
PON NOW!



HARLEY- DAVIDSON MOTORCYCLES

HARLEY-DAVIDSON MOTOR CO.
Department P, Milwaukee 1, Wisconsin
Please send free copy of 24-page "Enthusiast" Magazine, filled with motorcycle action pictures and stories.

Name.....

Address.....

City.....State.....

Super Fuels for Your Car

(Continued from page 5)

Note that in the L-head engine octane requirements rise as speed increases, while the reverse is true in the valve-in-head engine. This means that a fuel in which the higher-octane material is concentrated in the lighter boiling fractions, first to reach the combustion chamber at low speeds, is suitable for the valve-in-head motor. By the same token, it does not perform well in the L-head engine, yet the proper fuel for that engine, with its higher octanes concentrated in the high boiling fractions, is rated by the same octane number as is the fuel best for valve-in-head operation.

New refining processes brought to a high point of efficiency during the war will continue to hold a major role in peacetime production of motor and aviation gasoline, lubricating oils and many more by-products than were ever obtained before from a barrel of crude oil.

Fluid catalytic cracking, a process by which high-octane gasoline and heating oil are obtained in profusion through use of a fine powder as catalyst, is certain to be a large source of motor gasoline. Another process that will provide fine motor gasoline is polymerization, through which high-octane gasoline can be made from gaseous, low-boiling hydrocarbons. Both iso-octane and cumene, highly antiknock material, are obtained in polymerization processes.

Alkylation and isomerization processes, transforming former by-products into efficient blending agents for aviation gasoline, will continue to provide gasoline for planes, with some motor fuel use for alkylate as a blending agent. The same raw materials used for production of butadiene for synthetic rubber turned out the essential aviation alkylates during the war; butane and iso-butylenes from the butadiene plants were a valuable source of supply.

Hydroforming or catalytic reforming, the process used for raising antiknock ratings of low quality naphthas, played an additional war role in production of toluene, base material for manufacture of explosives. Coke ovens, the normal toluene producers, just didn't have the capacity to turn out the enormous quantity required for the bombs and shells of World War II.

Through its ability to raise octane rating of the low quality naphthas, hydroforming will continue to supply improved gasoline in the peacetime market.

Lubricating oil products can be obtained in a wide range from any type of crude available, including many previously con-

(Continued to page 166)

**"Fresh, cool and mellow—
my Mastercraft Pipe
is a real pal"**

says **BING CROSBY**

Bing is one man who really knows, and loves, pipes. That he gets his greatest pleasure from his **MASTERCRAFT** Pipe is understandable when you consider its select pore-processed briar, which insures a mild, mellow-cool smoke. Smoke a **MASTERCRAFT** yourself — your mouth and mood will respond happily to its ever-fresh taste.

BING CROSBY
appearing in
"DUFFY'S TAVERN"
A Paramount Picture



\$2.50, \$3.50, \$5.00,
\$7.50 and \$10.00
In choice of any shape



Write for Free Illustrated
Brochure—"Pipe Legends"
MASTERCRAFT PIPE COMPANY, Dept. G,
2 West 47th Street, New York 19, N. Y.

Prized By Pipe Connoisseurs The World Over

DISSTON



The saw most
carpenters use

When buying a saw, follow the example of those who know saws best. Remember, Disston is the saw most carpenters use. Long experience with saws on every type of work, has proved to them that they can count on Disston Saws for faster, truer, smoother sawing and longer saw life.

Disston Saws—products of America's foremost manufacturer of saws—are made of the famous Disston Steel, by highly skilled saw makers, to provide you with the finest saws that can be made.

Take care of your Disston Saws and they will continue to serve you well. Many hardware retailers and saw repairmen provide a special saw sharpening service. They will be glad to help you keep your Disston Saw—or other quality make—in good, serviceable condition.

More and more Disston Saws will soon be available. Ask your Hardware Retailer for the saw you want—"The Saw Most Carpenters Use"—a Disston Saw.

HENRY DISSTON & SONS, INC.
1211 Tacony, Philadelphia 35, Pa., U. S. A.

ASK FOR YOUR FREE COPY



The Disston Saw, Tool and File Manual tells how to use and care for tools. FREE at your Hardware Store, or write to us for a copy.



sidered completely unsuitable, through new methods developed during the war. The Juik process makes it no longer necessary to employ "select" crudes for lubricating oils of top grades.

Research on all phases of petroleum operations is going ahead full steam despite the end of the war. Peacetime requirements, because of the economic factor not present in wartime operations, call for readjustments to permit use of all the advances made in the last four or five years. Fuel evaluation tests keep single cylinder test engines running 24 hours a day in the laboratories, and much new equipment has been designed to make this work more efficient. The large refinery designers and constructors such as the Lummus Company and M. W. Kellogg Company, the research and development laboratories spearheaded by Universal Oil Products Company, and the laboratories of the major oil companies all are welded in one general purpose—the improvement of motor fuel and full utilization of crude oil in the many new fields opened by war research.

Much is expected from the Synthol process of manufacturing gasoline from natural gas, with the Kellogg Company prepared to build plants for manufacturers desiring to enter this field. A refinement of the Fischer-Tropsch European process, the Synthol process is declared to permit manufacture of 75-octane gasoline (motor method) from natural gas at a production cost of about five cents a gallon. Diesel oil also can be produced by the process. Low-grade coal can be substituted for natural gas in the event that the supply of gas becomes inadequate.

The war has created an even closer basic relationship between the petroleum and chemical industries, with crude oil producing such things as synthetic rubber, solvents, insect repellents, polishes and waxes, plastics and fibers, refrigerants, resins and other products too numerous to mention. Coal tar has found a worthy rival in crude.

Plastic Torpedo "Retriever"

When torpedoes are tested by the Navy before the explosive heads are attached some of the costly "tin fish" dive to the ocean bed. Formerly, many were lost in this way. A plastic disk which dissolves in sea water helped solve this problem. This polyvinyl alcohol disk dissolves after a predetermined interval and admits water to the torpedo chamber. Water pressure forces a float through the disk which acts as a buoy, marking the location of the sunken torpedo.

WONDER PEN

is Back!

**Complete ELECTRIC Woodburning Outfit
BURN BEAUTIFUL DESIGNS in WOOD**



Again available! The real thing! Finest quality electrically heated pen and all materials. Burn and etch deeply on wood in rich shades of brown. Achieve gorgeous effects by applying colors. Sandpaper and varnish to a fine finish. It's fascinating fun! Decorate your room or home. Make good money selling your own handiwork.

**ONLY PEN WITH GUARANTEE
800 WORKING HOURS**

Long life point and heating coils. Comfortable, cool cork grip. Standard 4½ ft. cord and plug.

DECORATE CORK, LEATHER, ETC. TOO

Make coasters, trays, highball jackets. Decorate belts, fobs, monograms. Create your own art pieces.

ALL MATERIALS COMPLETE:

- | | |
|--------------------------------|-----------------|
| Guaranteed Electric Wonder Pen | 2 Paint Brushes |
| 2 Plaques 6½ x 4½ | 6 Colors Paint |
| 4 Pc. Bookends 5 x 4 | Pkg. Nails |
| 3 Plaques Approx. 4½ x 4 | 2 Sandpapers |
| 4 Plaques Approx. 3 x 4 | Bottle Varnish |

EASY TO LEARN

Full instructions. Use all-purpose point for lining, etching, shading.

**AVAILABLE DIRECT FROM
FACTORY NOW. AT
STORES IN 1946**

Supply limited. Use coupon now.

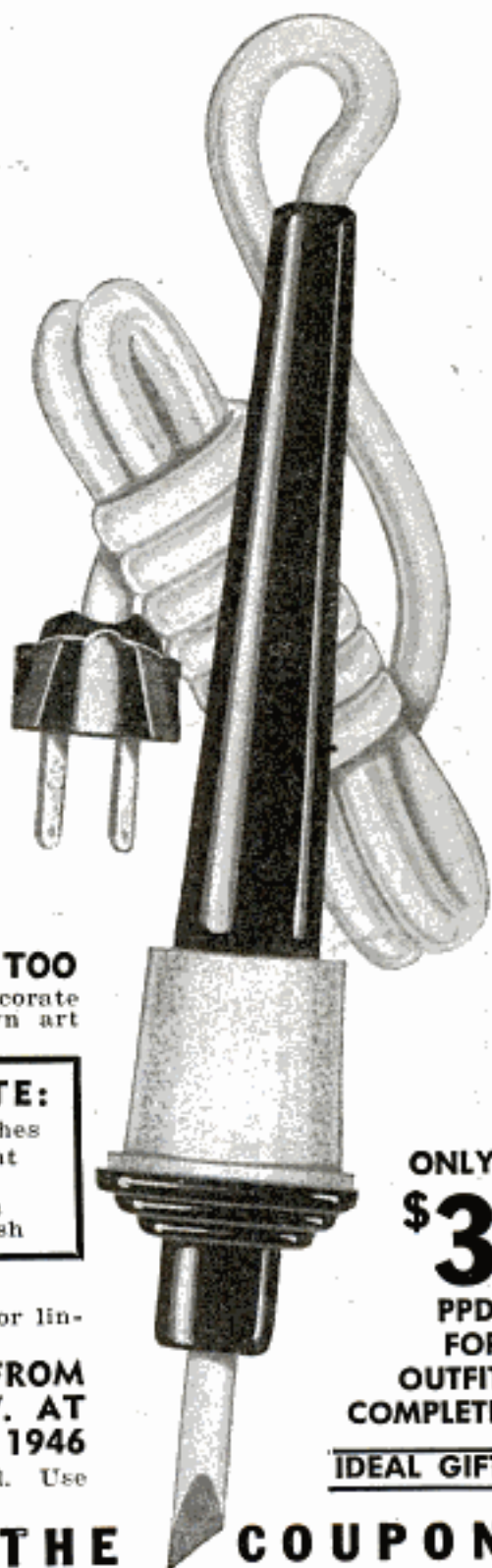

**ONLY
\$3
PPD.
FOR
OUTFIT
COMPLETE**

IDEAL GIFT

SEND THE COUPON

American Toy and Furniture Co.

727 S. La Salle • Chicago 5

Please send me complete 26 piece Electric Woodburning Outfit direct from factory. \$3 enclosed.

Name.....

Address.....

City..... State.....

(\$3.25 west of Rockies and in Canada. U. S. currency.)

**AMERICAN TOY
& FURNITURE CO.**



KNOW ALUMINUM "Type A"—Special cut to help file clear itself of soft filings.



YOUR STAINLESS STEEL—Extra-tough single-cut file for smooth-filing stainless steel.



FILES LONG ANGLE LATHE—Self-clearing file for finishing work revolving in lathe.



AND GET BRASS—Short upcut, very fine long-angle overcut to break up filings.



AHEAD SUPER-SHEAR—Specially designed file with very sharp milled curved teeth.



LEAD FLOAT—Coarse short-angle teeth for "floating" (smoothing) lead, babbitt, etc.

INDUSTRY is demanding "The right file for the job" and Nicholson is the manufacturer that can provide it. 3000 kinds, cuts and sizes in Nicholson and Black Diamond brands. Our handbook "FILE PHILOSOPHY" tells about many of them; also how to use and take care of files. FREE to production heads, shop foremen, die, model and pattern makers. At hardware and mill-supply houses.

NICHOLSON FILE CO., 22 Acorn St., PROVIDENCE 1, R. I.
(In Canada, Port Hope, Ont.)

NICHOLSON
FILES FOR EVERY PURPOSE
NICHOLSON U.S.A. MADE IN U.S.A.

How to Convert a Silent 16-mm. Movie Projector for Sound

(Continued from page 143)

removed from the sound track side. From sprocket (C) the film runs around the flywheel extension (D)—see Figs. 2 and 2-B—which is just wide enough to permit the sound track edge of the film to run in the clear. The light beam from the exciter lamp, passing through a commercial lens slit (N), goes through the sound track and the slot in the phototube housing to plate (O) in the phototube. These varying sound track light impulses are changed to corresponding electrical impulses by the phototube and fed directly to the input of the audio amplifier unit, just as a microphone changes sound waves to electrical impulses which are then amplified and again changed to sound waves by the loud-speaker.

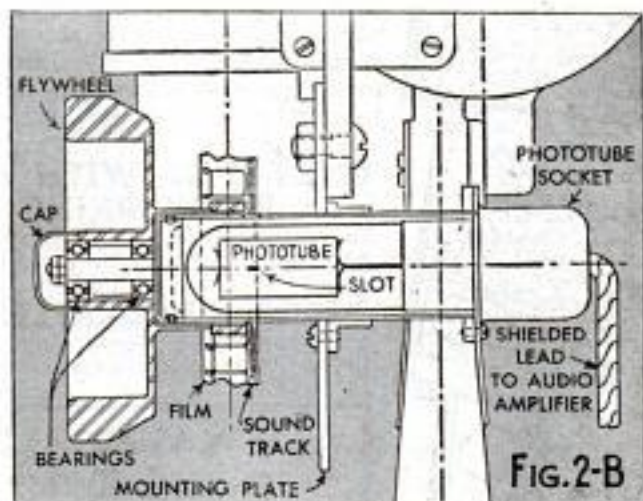

After passing over the flywheel extension (D) the film goes up and around the home-made single-row-tooth sprocket (E) which is detailed at right in Fig. 1, then over and around the tensioning device (F)—detailed in Fig. 2—and to the take-up reel (G). Take-up sprocket (E) is driven from the shaft on sprocket (C) through two little spur gears (K). These are Boston No. G-143, 48-pitch, 1/8-in. face, 14 1/2-degree pressure angle, 54 teeth, 1 1/8-in. pitch diameter. The bearings for the flywheel also were selected from Boston and were catalog No. 404-2, 1/4-in. bore by 1/4-in. wide by 1 1/16-in. outside diameter.

The film guide (L) for sprocket (E) is attached to a stud which is in turn fastened to the vertical slide on this projector so that when the slide moves up for film threading it also lifts the film guide; after the film is in position the slide is moved down into place.

Tightening roller (M), detailed in Fig. 1, keeps the film tight around flywheel extension (D).

(To be continued) --

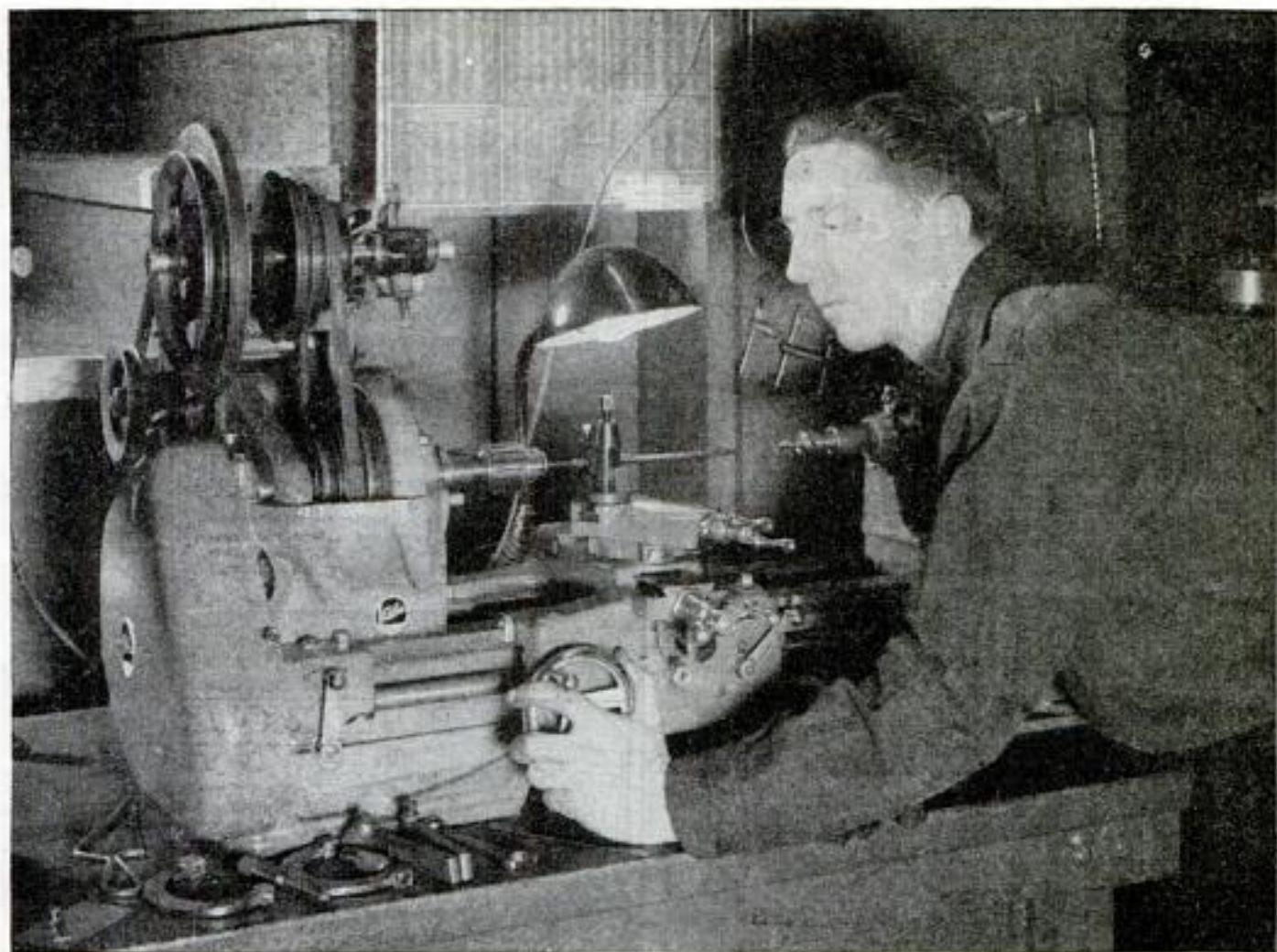

AN *Atlas* LATHE IN YOUR WORKSHOP . . .

A world of almost limitless opportunities for pleasure and profit opens up for you when you own an Atlas lathe.

Hundreds of useful things of metal, wood, or plastic can be made for your home—and home equipment repaired. Valuable tools can be made to add to your shop facilities. And if you have the time and interest you can make special tools—as does S. G. Williams, above—for profitable sale.

Whatever project you undertake, an Atlas will help you make the most of

your mechanical skill. It gives you the precision needed for delicate operations—the strength required for heavy cuts. It gives you a wide selection of speeds and feeds—and complete versatility in all the fundamental lathe machining operations. Yet it will come to you—at an exceptionally low price.



SEND FOR FREE CATALOG

Have you seen this new 64 page Atlas catalog? Send for your copy today. And be sure to ask your distributor to show you the Atlas 4 Tool Team in action before you buy new shop equipment. Atlas Press Company, 1243 N. Pitcher St., Kalamazoo 13D, Michigan.

Atlas 4 TOOL TEAM



P. R. MALLORY & CO. Inc.

MALLORY

Tropical*

DRY

BATTERIES

*REG. U. S. PAT. OFF.

Look for them soon

in Special

Commercial Designs

Originally developed by Mallory for the Signal Corps, Mallory Tropical Dry Batteries have significant contributions to make to dry battery effectiveness. Their military applications demonstrated from four to six times the service life of the batteries they replaced, far longer shelf life, and—practically constant voltage.

Before long, these advantages will be translated into special commercial applications of unusual interest.

P. R. MALLORY & CO., Inc.
INDIANAPOLIS 6, INDIANA

Test-O-Lite

the MODERN TROUBLE SHOOTER



THE NEON GLOW

... LOCATES TROUBLE INSTANTLY in electric circuits, fuses, cut-outs, motors, radios, appliances. Tests everything electrical from 100 to 550 volts. Indicates hot or grounded wires. Tells AC from DC. Far superior to ordinary clumsy test bulb.

PUTS "FINGER" ON THE TROUBLE SPOT - - QUICKLY

Saves precious time. Indispensable in shop or home. Has patented safety features. Vest pocket size with clip. Lifetime guarantee. List \$1.50. Purchase through regular electrical dealers.

L. S. BRACH MFG. CORP.
55 Dickerson St. Newark, N. J.



FUSES



MOTORS



OUTLETS

BUILD YOUR OWN RADIOS

Kits of all sizes, ready to assemble. Complete with instructions.

FREE RADIO PARTS CATALOG

Send for your copy today!

Write for these exclusive items:

Tube and Circuit Book.....10c

Giant Radio Reference Map 15c

Handy Tube-Base Calculator 25c

Address Leo, W9GFQ

Dept. P-M-12, Council Bluffs, Ia.



Wholesale
RADIO LABORATORIES

PLASTICS

Plexiglas, Lucite, Bakelite, Lignolite, Lumarith, Ethocel, Cellulose, Acetate now available in sheets, tubes and strips. Fine assortment of sizes. No priority required. Cements, dyes and other plastics supplies, too! Send 10c today for complete Catalog!

CARMEN-BRONSON CO., Dept. 12-B
165 E. Third St. Mt. Vernon, N. Y.

SHAW and Peppy-PalTM GARDEN TRACTORS

1 to 9 H.P. Circulars on request. Building more now. We supply repairs for all SHAW Tractors sold in our 42 years in business.

BUILD YOUR OWN RIDING TRACTOR—"WAR HORSE"

using old auto parts, powered by 2 H.P. or larger air-cooled engine; or walking type Garden Tractor 1/2 to 3 H.P. or convert truck or auto into Farm Tractor. Each with steel or rubber tires; will plow, cultivate. Plans for building, in few hours, any one of above, postpaid for \$1.00 (state which wanted) or all 3 for \$2.00. Money Back Guaranteed!

SHAW MFG. CO., 4512 Front St.
Galesburg, Kansas
6680 North 4th St. Columbus, Ohio

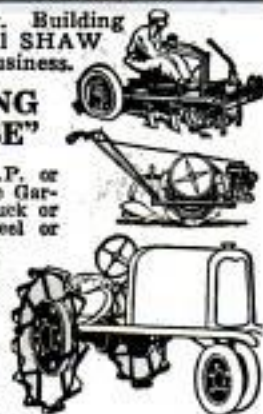

Let safety share the ride...
Drive with Guide Sealed Beam Units



BUY VICTORY BONDS

LET SAFETY SHARE THE RIDE—
REPLACE WITH GUIDE



All the safety that can now be built into automotive lighting is yours when you have Guide Sealed Beam units. They give you an even, easy-on-the-eyes pattern of light for all your driving needs: an upper beam, bright and far-reaching for country roads—a lower beam, glare-free and ample for city streets and meeting other cars. They also give you the important Guide safety feature of *double protection*—no dim-out for the life of the unit, no black-out if a stone or blow should crack the lens. For Sealed Beam lighting at its best, ask for Guide units.

NO DIM-OUT—Your Guide Sealed Beam unit is sealed against dirt, dust and traffic film. It stays bright for the life of the unit—does not lose its efficiency, as earlier-type headlamps do.

NO BLACK-OUT—Your Guide Sealed Beam unit will not fail in case of an accident to the lens. The bulb within the sealed unit continues to burn with full intensity—lights the way safely until the damaged unit can be replaced.

GUIDE LAMP DIVISION OF GENERAL MOTORS CORPORATION

SAFE HEADLAMPS ARE "CORRECTLY AIMED" HEADLAMPS—HAVE YOURS CHECKED TODAY

**"MAKE MINE
Carhartt's
FOR EXTRA WEAR
AND EASY FIT"**

• A reputation is hard to get and easy to lose. That's why the Carhartt family of overall makers has jealously guarded the quality materials and workmanship of its work garments.

If you've never worn Carhartts before, ask for them by name and get the kind of comfortable fit, extra stout reinforcing, ample cut and superior wearing qualities of Carhartt sanforized Master Cloth that pay out in bed rock satisfaction and economy.

At the Better Dealers Everywhere

HAMILTON CARHARTT OVERALL CO.
Established 1889

Detroit
Atlanta

Dallas
Carhartt Park, Ky.



**CARHARTT
WORK CAPS**

Non-shrinking, full cut, high crowned, comfortable and cool—with exclusive eyelet ventilation.

**GET HIM THIS HANDY SET!
BROWNE CLAMPS of 1001 Uses**

for Home Workshop



Handiest thing in the shop! Twelve select quality, finely finished malleable Browne Clamps—in most useful sizes—mounted on attractive metal hang-up rack. Also provides space for other clamps. Consists of:

\$2.95
Post-paid

SET NO. 10

Ideal XMAS GIFT

Send check or money order today for immediate delivery.

The Majestic Co., 1035 Erie St., Huntington, Ind.

MAKE MORE MONEY

Applying or Selling **ROOF
Lasting COATING**

Extra profitable, easy to apply. Exclusive new formula makes this America's best roof coating for felt, composition, steel, slag, iron, gravel, concrete and metal roofs. Definitely superior in all climates, at all temperatures. Act at once!

DEALERS & AGENTS WANTED
Write for Details of Our Proposition

LASTING PRODUCTS COMPANY
MANUFACTURERS OF PAINTS, PUTTIES, PLASTICS
FRANKLINTOWN ROAD PLANT, BALTIMORE 23, MARYLAND

**BUILD
THIS
TUG
BOAT**



**KIT
\$7.50**

Every landlocked sailor will enjoy building this tough SEA GOING TUGBOAT for game room or study. Authentically detailed—14" long, 7" high. Completely shaped hull—simple to build. Add 25c for packing and shipping. Big catalogue only—10c. Address Dept. 5.

MARINE MODEL CO., INC., 29 W. 15th St., N. Y. C.

THIS LABEL IS
YOUR PROTECTION



Carhartt
FOR OVER 50 YEARS A FRIEND TO ORGANIZED LABOR

LOOK FOR IT

YOU NEED THESE CRAFTSMAN'S TOOLS

SUPER DRILL GRINDER



Sharpens round shank drills from 3/32" to 1 1/16" diameter. Grinds Old Drills like new in 4 different drill point angles. Grinds Short, Medium and Long Twist Drills from 1 1/4" up to 11" long, for hand or power grinding wheels.

70,000 NOW IN USE!

Grinds your drills like factory in 25 seconds. Gives perfect center and clearance. Saves drills, time and money. No shop should be without the Super Drill Grinder. Guaranteed to do the work or money back. The Grinder that gives a round point!

Only **\$2.95**
POSTPAID

SUPER ARBOR

(PATENT PENDING)

A combination drilling or grinding wheel attachment. For 3/4" motor shafts. Will take grinding wheel with 1" hole on shaft and 3/4" hole on small end. Extension can be used for rag or wire wheel, or 3/4", 24-thread drill chuck which holds drills from No. 60 to 3/4" in diameter. Right hand thread only.

Price Only **\$1.50**
POSTPAID



SUPER HACKSAW

AND FLAT DIE FILE HOLDER



The tool with 100 uses! Holds broken hacksaw blades—used by mechanics, electricians, plumbers, auto mechanics, hobbyists and repairmen. Perfect for all-round household needs; ideal for difficult close-quarter work. Nothing like it for tool and die men. Price, without saw blade.

Only **95c**
POSTPAID

CRANDALL MFG. CO.

1512 West Slauson, Dept. FA-12
Los Angeles 44, California



Give your faithful old car a Christmas gift

LENGTHEN engine life, restore original power, save oil, and give yourself 1 to 5 more miles per gallon on gas merely by asking your repairman to recondition your engine. To insure the very best results have him install the set of Sealed Power Piston Rings that we engineered for your particular make and model of engine.

Sealed Power—preferred by engine builders for 34 years—Muskegon, Michigan and Windsor, Ontario.

KEEP YOUR WAR BONDS! GET \$4 FOR \$3!

No other ring sets use 26 Basic Designs

No one piston ring design can meet all replacement needs. Sealed Power Individually Engineered Ring Sets are made up from twenty-six (26) basic ring designs, which permit each set to be specifically engineered to do the best possible job in a particular make of engine.

These ring sets are engineered to save gas without sacrifice of oil economy, to save oil without inducing friction and cylinder wear. Each set gives *balanced* performance in a particular engine.

Piston Rings
Pistons
Cylinder Sleeves
Valves
Water Pumps
Chassis Parts



© 1945. Sealed Power Corp.

SEALED POWER PISTON RINGS

BEST IN NEW CARS! ★ BEST IN OLD CARS!

WORKSHOP WISDOM

Gluing Veneers

Cascamite urea resin glue is ideal for veneering because it is non-alkaline, doesn't react chemically with acid woods like oak or mahogany to cause stain.

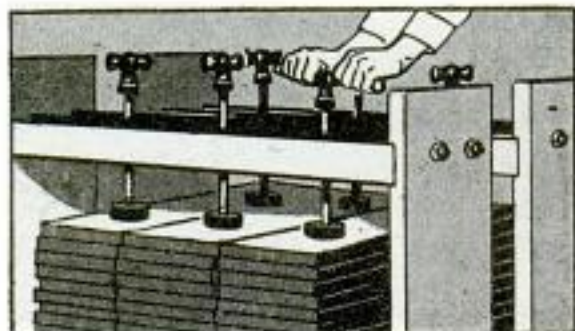

1. Make standard *Cascamite* mixture. (See package.) Add $\frac{1}{2}$ lb. fresh white wheat or rye flour and up to $\frac{1}{2}$ lb. of extra water for each pound of *Cascamite* in the standard mix. Stir until smooth. This makes a strong, light-colored, low-cost, stainfree veneering glue.
2. Apply glue to each surface. Assemble panel and apply all possible pressure as quickly as possible (within 15 minutes).
3. Retain pressure overnight, if practicable. After pressing, air dry panels for 24 to 48 hours.

Why *Cascamite* is preferred:

Easy to use. *Cascamite* is mixed and used cold. Makes veneering easy and practical. No heating of glue, lumber or caul boards necessary.

Strong. *Cascamite*, even with flour added, is as strong and water-resistant as casein glue—as strong as the wood itself.

Economical. You mix *Cascamite* as you need it. No waste. Used with flour, it costs no more than casein glue.

You can get *Cascamite* urea resin glue—and *Casco*, the standard household repair glue—10¢, 25¢, and larger sizes at hardware stores.

NEW GLUING GUIDE containing household repair and gluing hints, details on veneering. Free on request. Address a postcard to: Casein Company of America, Dept. PM-15, 350 Madison Ave., New York 17, N. Y.



CASCAMITE

Dry Powder Urea Resin Glue

KEEP WARM! SAVE FUEL!

Mortite



Seal your home against drafts and cold, stop those expensive heat leaks! It's easy with MORTITE, the pliable, plastic tape which goes on quickly, is effective immediately. You need no tools to apply. Simply press MORTITE into place around windows, doors, baseboards, etc. You'll be surprised at the difference it makes. MORTITE also keeps out dust and dirt, fills cracks, etc. Roll, about 80 ft., is enough for 5 windows.

Get MORTITE at hardware, paint, dept. stores and lumberyards.

ASK FOR FREE J. W. MORTELL CO. MORTITE CIRCULAR 522 Burch St., Kankakee, Ill.

\$1.25

Higher cost of
Rollies & Canada



SOLDERING Simplified

with this revolutionary gun-type iron

INSTANT HEATING—Fast Handling



The streamlined BAKER Flash will do the work of several ordinary type irons—faster, easier, more economically. Instant heating, high or low heat as desired, by control of your "trigger finger". Hot only when actually soldering. Non-tiring, protected gun grip and perfect balance for easy, steady application. Unexcelled for work in close places. Operates from standard storage battery or plug-in with 110-volt transformer. Only \$4.75 post paid. With transformer, \$8.95. Send check or money order.

BAKER-PHILLIPS CO., 3051 Lyndale S., Minneapolis 8, Minn.

AMAZING MYSTERY BUTTON



Startles Everybody. With this Electronic Button you can make your own Telephone—Amplifier—Detectaphone. Attach this button to piece of cardboard—transmit conversation to another room. Music also transmitted to distant places. Most interesting, electrical apparatus ever discovered. Enables you to perform hundreds of experiments. So tiny it can be concealed in dozens of places. A Pre-War Product. Electronic Button including 5000 word instruction booklet with 20 illustrated experiments postpaid only \$1.95.

Electronic Products Company, Saint Charles, Ill.

Burpee GIANT ZINNIAS
Scarlet, Yellow, Rose, Lavender and White
Dahlia-flowered, 5 in. across, easy to grow, 3-ft. plants, fibestools, all 5 10¢ Pkts. seeds postpaid for 10¢!
Burpee Flower & Veg. Seed Catalog Free.
W. ATLEE BURPEE CO.
503 Burpee Bldg. or 503 Burpee Bldg.
Philadelphia 32, Pa. or Clinton, Iowa

FREE 20 GENUINE PRE-WAR PIPE CLEANERS

NOTHING TO BUY!



WRITE TODAY!

If you smoke a pipe you'll be delighted with these 20 genuine, pre-war pipe cleaners, so hard to get these days! We'll also send you, free, our 32-page smoker's guide, illustrated with pipes, tobaccos, pouches, etc. Pipe cleaners and guide are FREE. Mail a postcard with your name and address to Dept. CC.

LANE TOBACCO, LTD., 156 E. 42nd ST., NEW YORK

"YANKEE" TOOLS

also make friends

Vast throngs of new shop workers, trained in war industries, used "Yankee" Tools for the first time . . . mastered fresh trade skills which will stand them in good stead in the years to come. They have learned what skilled mechanics have long known . . . that "Yankee" Tools complete innumerable tasks *faster, easier, and better.*

"YANKEE" SPIRAL SCREW DRIVER No. 130A
A Size for Every Purpose

"YANKEE" TOOLS

make good mechanics better

North Bros. Mfg. Co., Phila. 33, U. S. A.
Established 1880

Makers, also, of "Yankee-Handyman" Tools



PLATING EQUIPMENT

Has contributed to nearly every major wartime development, and is now being made available for civilian use. See your dealer or write for catalogue. • BRUSH PLATING KITS • SMALL TANK PLATING UNITS • SPECIAL HEAVY DUTY PLATERS. Complete kits (less batteries) at \$1.50 per kit and up. Unconditionally guaranteed!

RAPID ELECTROPLATING PROCESS, INC.
1414-A SOUTH WABASH AVE., CHICAGO 5, ILL.

New Designs in

FRANZITE GRIPS

Modernize Your Gun! Improve Your Score!

Most durable grips made. Positively unbreakable! For Colt, Smith & Wesson, Hi-Standard, Orgies, Luger & Mausers in a wide choice of beautiful designs in ivory, pearl, walnut, onyx, etc. Low prices. FREE CATALOG. Dealers Wanted.

SPORTS, INC., (Mrs.) 5501 Broadway, Dept P-12, Chicago 40, ILL.

HERE'S A **BLADE**
YOU'LL LIKE!



5 BLADES
FOR 25c

HOSPITAL
STAND
RAZOR BLADES

NEWARK 2, NEW JERSEY

take
these easy steps
NOW
to modernize
your home



STEP ① — INSULATE THE ATTIC



Comfort is the first step in home modernization! Get more comfort—and fuel savings by insulating your attic with Balsam-Wool—completely sealed, wind-proof and moistureproofed. This famous insulation is easy to apply between rafters to create an extra attic room.

STEP ② — BUILD NEW ROOMS WITH NU-WOOD



Once Balsam-Wool is applied, finish walls and ceiling with Nu-Wood—the insulating interior finish that comes in soft, glowing colors. Nu-Wood, too, adds extra insulation and hushes noise.

STEP ③ — NEW LIFE FOR OLD ROOMS



If you're tired of shabby wallpaper, cracked plaster and peeling paint, here's quick relief! Nu-Wood Interior Finish applied on old wall and ceiling surfaces gives you *lasting* beauty. Available in tile, plank, board and wainscot.

—AND PLAN YOUR NEW HOME NOW!

If you are planning a new home, make it more livable with Balsam-Wool and Nu-Wood! You'll get more value for your money—more comfort and beauty. For full information, see your lumber dealer or mail the coupon!

WOOD CONVERSION COMPANY
Dept. 210-12 First National Bank Building
St. Paul 1, Minnesota

Please send me full information on Balsam-Wool and Nu-Wood. I am a Home owner , Renter , Architect , Contractor , Student .

Name

Address

City State

Balsam-Wool GUARANTEED
SEALED INSULATION
BALSAM-WOOL • PRODUCTS OF WEYERHAEUSER • NU-WOOD

SAY YOU SAW IT IN POPULAR MECHANICS

DICK KOLLMAR,

Radio's Popular "BOSTON BLACKIE"
chooses **Forecaster!**

"Top of my Xmas Gift list for service men abroad is a mellow-smoking, sweet-flavored Forecaster. If there are any more to spare, friends at home will get them."



Dick Kollmar is typical of the gift-giving American who knows the life-long enjoyment a Forecaster will yield. It's a finely made pipe that gives real smoking pleasure without demanding a premium price. That's just why so many Forecasters are going to servicemen . . . they too find real pleasure and relaxation in a Forecaster smoke. If your dealer is temporarily out of stock, it's because the armed services come first. Keep asking though! Once you own a Forecaster you'll enjoy it always. National Briar Pipe Co., Jersey City, New Jersey.

\$1.50

SIR SHELDON
in natural
briar, \$2.50

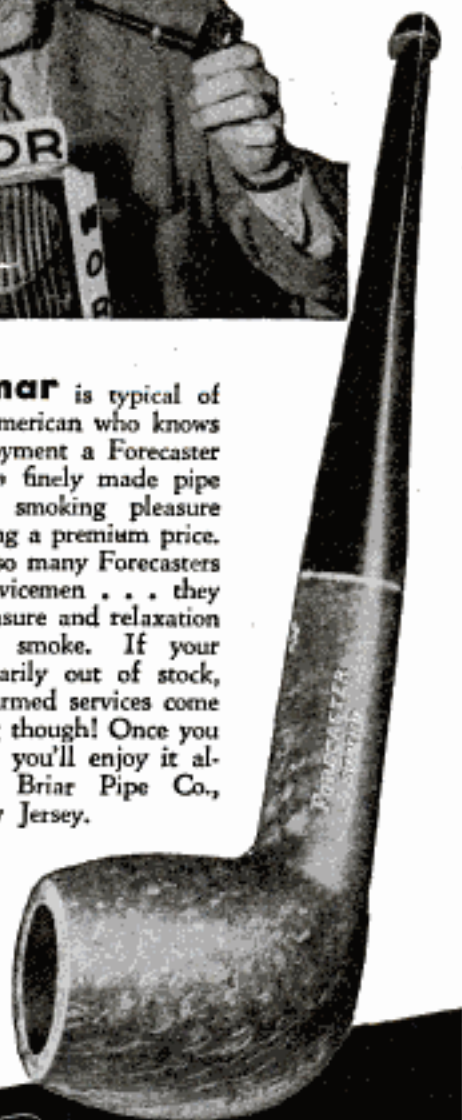

NATIONAL
Forecaster
SUPERB

Say you saw it in Popular Mechanics!

Electrically Welded Endless

Paramount

**BAND
SAW
BLADES**

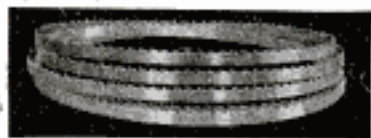

Made in widths from 1/2" to 1 3/4"

Make your band saw do more work for you. The proper width of blade will extend the scope of this important machine. Burrill's Paramount Blades are made from tough Nickel Alloy Steel properly tempered. Teeth accurately set and filed, and all saws carefully straightened. Send order and check today. Delivery will be made as promptly as war conditions permit, from a few days to a week or two. You can obtain these saws at the following prices:

1/2"-3/16"-3/8" wide, 5'6" long.....\$.90 each
3/4"-3/16"-3/8" wide, 6'6" long..... .95 each
1"-3/16"-3/8" wide, 7'6" long..... 1.10 each

Other sizes at proportional prices

Your satisfaction is guaranteed
BURRILL SAW & TOOL WORKS
407 E. Main St., Ilion, N.Y.



**QUICK
FIXER!**

Loose drawer pulls can be easily reset with **PLASTIC WOOD**. It belongs in your home repair kit.



**PLASTIC
WOOD**

HANDLES LIKE PUTTY • HARDENS INTO WOOD

SOON

**THE WORLD'S SAFEST ELECTRIC
JIG SAWS** will again carry the name

SYNGRO
SYNGRO DEVICES, INC.
Ferndale 20, Michigan



MEN

This heavy Horseshoe Ring, hand-made, hand-engraved, inlaid with genuine abalone pearl, is a **KNOCK-OUT!** Ideal for personal wear or gift. Shoe and shank of virtually everlasting Monel Metal is

GUARANTEED 20 YEARS

Supply is limited...act NOW! SEND NO MONEY, just name and ring size. Pay Postman on delivery, tax included, ONLY \$3.98...NOT one cent more. Return in five days for refund if not delighted. Address:

National Jewelry Co., Dept. 404-H, Wheeling, W. Va.

GRAPHITE GUS ASKS:

**HAVE YOU HAD
YOUR FIRST LESSON
IN GRAPHITE
LUBRICATION?**



If not stop in at a Supply store and buy any one of the three graphite products pictured at the right and get the "feel" of these amazingly tough lubricants. They lubricate lastingly despite heat, pressure or speed—on metals, wood, leather, rubber or fibre surfaces.

These three lubricants will lick hundreds of problem jobs, but there are many more graphite products for endless other services.

Act today and send for Data Sheet Directory and learn the Where and How of all Dixon graphite products. Write to Graphite Gus.



DIXON'S GRAPH-AIR GUN

Filled with Microfyne powdered graphite, it's the slickest gadget you ever saw for lubricating locks and hard-to-reach mechanisms, in shop, office, car, boat, home. Will not leak or gum. Described on Data Sheet #8.

30¢
At your Dealer



**DIXON'S
GRAPHITE SLIPSTIK**

For fast rub-on lubrication. Used like a crayon. Fine for fire arms, sticking doors and windows, bicycle chains—1001 mechanisms in shop, office, car, boat, home. Keep one near you. Described on Data Sheet #23.

15¢
At your Dealer



**DIXON'S GRAPHITE
LATHE-CENTER LUBRICANT**

Used in thousands of plants for one of the toughest lube jobs known—lathe dead centers—under severest conditions of heat, pressure and speed. Use wherever "hot spot" lubrication is needed. Described on Data Sheet #15.

20¢
1 oz. tube
At your Dealer

Joseph **DIXON** Crucible Company • Div. 26C12 • Jersey City 3, N. J.

A GRAPHITE FOR EVERY JOB—At Mill, Hardware, Auto & Marine Supply, Sporting Goods Stores



Cylinders



Pumps



Bearings



Chains



Hoists



Gears



Pipe Threads



Gaskets



Packing

GILBERT CHEMISTRY SETS
bring boys fame
and big awards

MEET Frederick C. Menenko, America's No. 1 boy chemist of the year, who won a \$100.00 award for his chemical research. He says, "After 10 years of chemical study, it makes me proud to feel that I started with a Gilbert Chemistry Outfit."

There are good reasons why more boys have won fame and big awards with Gilbert Chemistry Sets than any other kind. They are far more than "toy" sets. Range of chemicals and apparatus are based on real laboratory technique. Write messages in invisible or fire ink. Make chemical weather flag. Hundreds of other spectacular experiments in organic, inorganic and electro chemistry.

\$200.00 IN CASH AWARDS

Mr. Gilbert will award prizes totaling \$200.00 to boys doing the most important research in chemistry in 1946. Write for details. Gilbert Hall of Science, 403 Erector Square, New Haven, Conn.

NO. 6 DOUBLE FEATURE, DOUBLE FUN LABORATORY

Big two-door wooden cabinet crammed with chemicals and apparatus. Over 400 spectacular experiments.

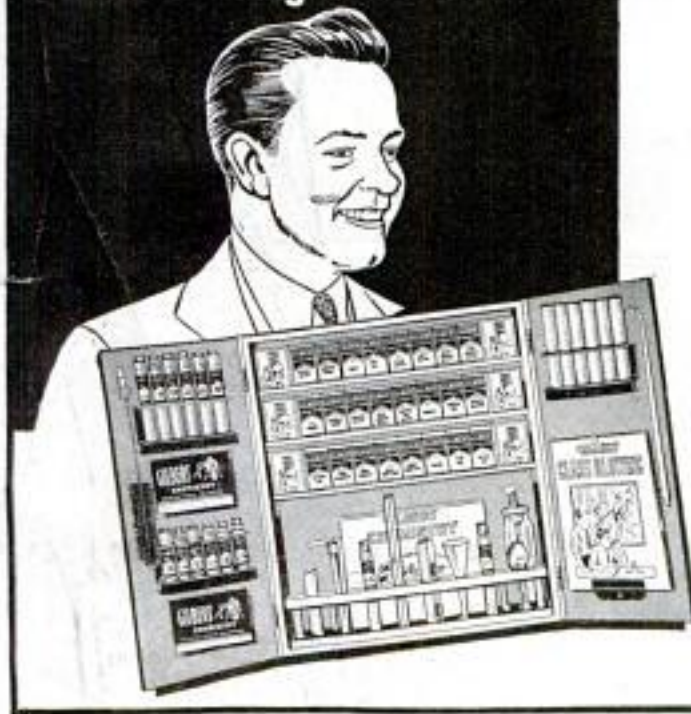



A pipe he'll treasure for its fine smoking qualities

Any man who knows a fine pipe when he sees it will be delighted to receive a Sterling Hall . . . For here is a pipe that has won wide recognition for its smoking qualities as well as for its aristocratic appearance.

Only selected materials go into its manufacture. And details such as bowl angle, selection of grain, depth and pitch of bore are all painstakingly checked to assure perfect pipe craftsmanship.

At better shops in a full range of handsome models—with an inlaid sterling silver band. \$3.50 individually boxed.

Briarcraft, Inc., 347 Fifth Avenue, New York 16, N. Y.

SAY YOU SAW IT IN POPULAR MECHANICS



KRW ARBOR PRESSES BENCH TYPE AND HYDRAULIC

NEEDED IN EVERY SHOP—SAVE TIME AND MONEY—DO BETTER WORK, QUICKER.

No shop is complete without a small arbor press. Pressing and squeezing operations can be done better and faster on a KRW Arbor Press. Stop using vise and sledge hammer methods—they generally deliver spoiled work in the end. KRW Factory-To-You Prices give you greater value for your money. Order today.

KRW Bench Type Arbor Presses, 3 sizes
 No. 37-P 1/2 Ton, \$13.25*
 No. 37-O 1 Ton, \$23.00*
 No. 37-N 3 Ton, \$33.00*
 *Prices F.O.B. Arcade, N. Y. Slightly higher west of Rockies. Stand illustrated extra.



KRW Hydraulic Presses are built in 25, 50, 60 and 75 ton sizes. Prices start at \$198.00*.

K. R. WILSON, Dept. 17, 215 Main St., BUFFALO 3, N. Y.
 Builders of Shop Equipment for Ford Dealers Since 1916



ELECTRICITY FOR ANY JOB ANYWHERE



Reliable, economical electric service anywhere, anytime, with an Onan Electric Generating Plant. Driven by Onan built, 4-cycle, gasoline engines, these power plants are of single-unit, compact design and sturdy construction. Suitable for all types of service.

Models range from 350 to 35,000 watts. A.C. types from 115 to 660 volts; 50, 60, 180 cycles, single or three-phase; 400, 500 and 800 cycle, single phase; also special frequencies. D.C. types range from 8 to 4000 volts. Dual voltage types available. Write for engineering assistance or detailed literature.

ONAN
 D. W. ONAN & SONS, 2512 Royalston Ave., Minneapolis 5, Minn.

STAR COMET TACKER

For tacking insulation, upholstery, roller shades, shelf paper, decorations, etc. One hand operated. Just squeeze handle, drive twinpoint tacks right where you want them. Tack where you can't swing a hammer. Always ready, no spilled tacks.



Red H Twist Drills

Finest high speed steel, perfect points, supremely accurate. Needed by every mechanic and home craftsman. Set of 29 drills from 1/16" to 3/4" in handy case. Straight shank only. Write for prices and name of nearest distributor. Some territory still available to hustlers.

Essential rated orders must be filled first

STAR PAPER FASTENER CO. Dept. SG Norwalk, Conn.

WOOD WORKERS

LUMBER—PLYWOOD AVAILABLE

Harold Hunt wants to send revised No. 14 catalog, 124 pages of woodworking ideas. UNEQUALED BARGAINS in imported and American woods, supplies. Those already holding this catalog—send for revised sheets. CRAFTSMAN WOOD SERVICE CO. 2729 S. Mary St., Dept. A-64, Chicago 8, Ill.

only 10¢

MARCOT KEY MACHINE



MARCOT #8 Key Machine...\$55.00
 2,592 Assorted Key Blanks... 73.50
 Auto Code Book & Set of Auto Depth Keys... 10.50
 Set—Key Files, Tools, Pins, Springs, Thimbles... 10.50
 Key Machine Cabinet... 20.00

A. J. MARCOTTE CO., 1200 N. Kedzie Ave. CHICAGO 51, ILL.



JOHNSON SEA-HORSES ARE BACK - at 1942 Prices



Every effort is being made to accelerate the present limited production to full schedules within the next three to six months. • As available, all Johnson Sea-Horse Outboard Motors are being shipped to *dealers*. Look for the name of your Johnson Dealer under "Outboard Motors" in your classified phone book. See him without delay and get your name on his list.

 JOHNSON MOTORS, 400 Pershing Road, Waukegan, Ill.

JOHNSON SEA-HORSES for DEPENDability

For Men who Really Know Pipes



MOUTHPIECE TUBE prevents backflow of moisture

CONDENSING CHAMBER traps and holds bitter juices and sediment

BOWL GUARD keeps shank and bowl dry

REMOVABLE SECTION eases thorough cleaning

CHAMBER GUARD bars tobacco fragments from bit

\$1.50

Selected Briar

Royalton
CROWN

Patented

HENRY LEONARD & THOMAS, INC.,
OZONE PARK 17, N. Y.

ROYALTON CROWN DELIVERS COOL, DRY SMOKING right down to the last puff of every bowlful. Its condensing well and other patented features, trap all acrid juices and saturated tobacco shreds. Enjoy Royalton Crown; there is no other pipe of its type—in its class.

BUILD the
COMET
B-29
SUPERFORTRESS



- **IT'S BIG!**
26½" WINGSPAN!
- **IT'S AUTHENTIC!**
Right down to the last detail!

\$2.50

At your
Comet
Dealer

**ONE OF
MANY
OUTSTANDING COMET MODELS**

You'll find your biggest model-building thrills in Comet's ALL Balsa Solid Model of the B-29! A super-kit with many finished and semi-finished parts; finished turrets and blisters of formed plastic; scaled dual wheels, complete decal sheet, many other features! Comet Design makes it easy to build—assures better results!

COMET MODEL AIRPLANE & SUPPLY CO. INC.,
CHICAGO • NEW YORK

SAY YOU SAW IT IN POPULAR MECHANICS



**HUNTER'S
COMPASS**
Hunting Case,
Watch Type, All Metal, Jeweled **\$3.75**

**Engineers All Metal Army
Type Hand-Sighting**

LEVELS

\$1.50



PUBLIC SPORT SHOPS

13 S. 16th St., Phila. 2, Pa.

No COD's

ROLL FILM

No limit at present

Size	Price	Made to exacting U. S. Government standards, this fine tested war surplus film has just been released. Panchromatic high speed. 8 exposures. Orders filled by return mail. Please order a minimum of 4 rolls. Include 18¢ to cover postage and handling. No C.O.D.'s please. We suggest you send us your order today.
127	- 27c	
120	- 33c	
620	- 33c	
116	- 38c	
616	- 38c	

Howard West, 3 W. 42 St., New York 18, N. Y. Dept. C12

MINK Easterns \$40.00 EACH
Labradors Yukons

All shipments made subject to 5 days' inspection before acceptance.

The quality of my mink is indicated by the fact that I have netted an average of \$20.00 a pelt on all mink skins sold during the past 5 years.

WHITE, SILVERBLU, and BLACK CROSS MINK Priced on Request
WHITE FACE, PLATINUM SILVER, and PEARL PLATINUM FOX

BOOK "Domestic Mink" \$1.00

HARRY SAXTON'S MINK RANCH, Bemus Point, N. Y.

BUILD this GAS ENGINE

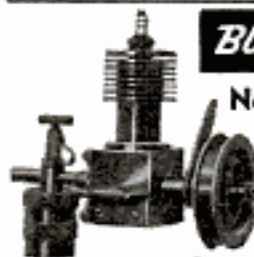

No Castings! No Special Tools.

All you need is a lathe and some scrap shafting. Speed and power for motor cars, boats, etc. Two cycle, ½" bore, ¼" stroke. With our unique construction methods you can also design other engines incorporating your own ideas. No castings or pattern worries. Order complete plans and step-by-step instructions NOW—satisfaction guaranteed. Engine Plans, \$1.75. Carburetor plans, 75¢. Mailed postpaid on receipt of remittance. R. W. Howe, Engineering, 6515 Appoline, Detroit 27, Mich.

**SEE how much MORE you can do with a
HOBART "Simplified" Arc Welder**



HOBART A.C.
Transformer Type
Arc Welder.
HOBART
300 Amp
Portable Electric
Arc Welder.

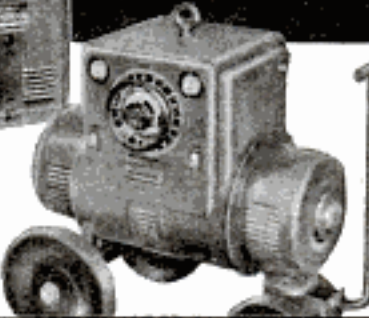

There's all the difference in the world in Hobart "Simplified" Arc Welding and just plain old arc welding. It's the extra speed . . . better control of the arc and greater ease with which you weld, that makes Hobart the choice of operators the world over. "Multi-Range" Dual Control, Exclusive Remote Control, Polarity Control and Exceptional Stabilization are just a few of the many reasons why Hobart is the fastest selling arc welder on the market today. Ask for a complete Arc Welder Catalog . . . it's FREE!

HOBART BROTHERS CO. Box M-1251 TROY, OHIO



HOBART "One of the World's Largest Builders of Arc Welders."

Big Demand for Wood! Prices Never as High! QUICK PROFITS with OTTAWA

Log Saw of
the Future
TODAY!



OTTAWA 6 H-P LOG SAW

FELLS TREES • SAWS LOGS Buzzes Up Poles and Limbs

Unbeatable combination! 3 in 1 machine. Does everything you need fast and easy. You can turn wood lot into cash quickly and profit by present high prices.

USE ENGINE FOR BELT JOBS—When not sawing wood, use the engine to grind feed, pump water, etc. Pulley furnished.

THOUSANDS IN USE EVERYWHERE

Speed Up Production!

Thousands NOW making more money with an OTTAWA LOG SAW. You can beat the labor shortage with this powerful machine. Saws the human way, only many times faster. Starts easy in any weather.

350 Saw Strokes per Minute

Air cooled motor—a blessing in winter. No shut-downs or strikes. Many exclusive OTTAWA features. Uncle Sam needs you to help relieve the nation wide fuel shortage. No priority needed when you buy an OTTAWA. Plan to get yours at once!

What Users Say "My 6 H-P Ottawa is a mighty magnet of power and energy. It is always ready to work in any kind of weather and makes log sawing a pleasure. It is easy to operate profitably and economically."—Edward Andrews, California.

FREE Big Catalog Write today for your FREE copy of the Ottawa Catalog. Contains complete information of the "6" and other Ottawa Saws.

OTTAWA MANUFACTURING COMPANY, 1227 PINE STREET, OTTAWA, KANSAS

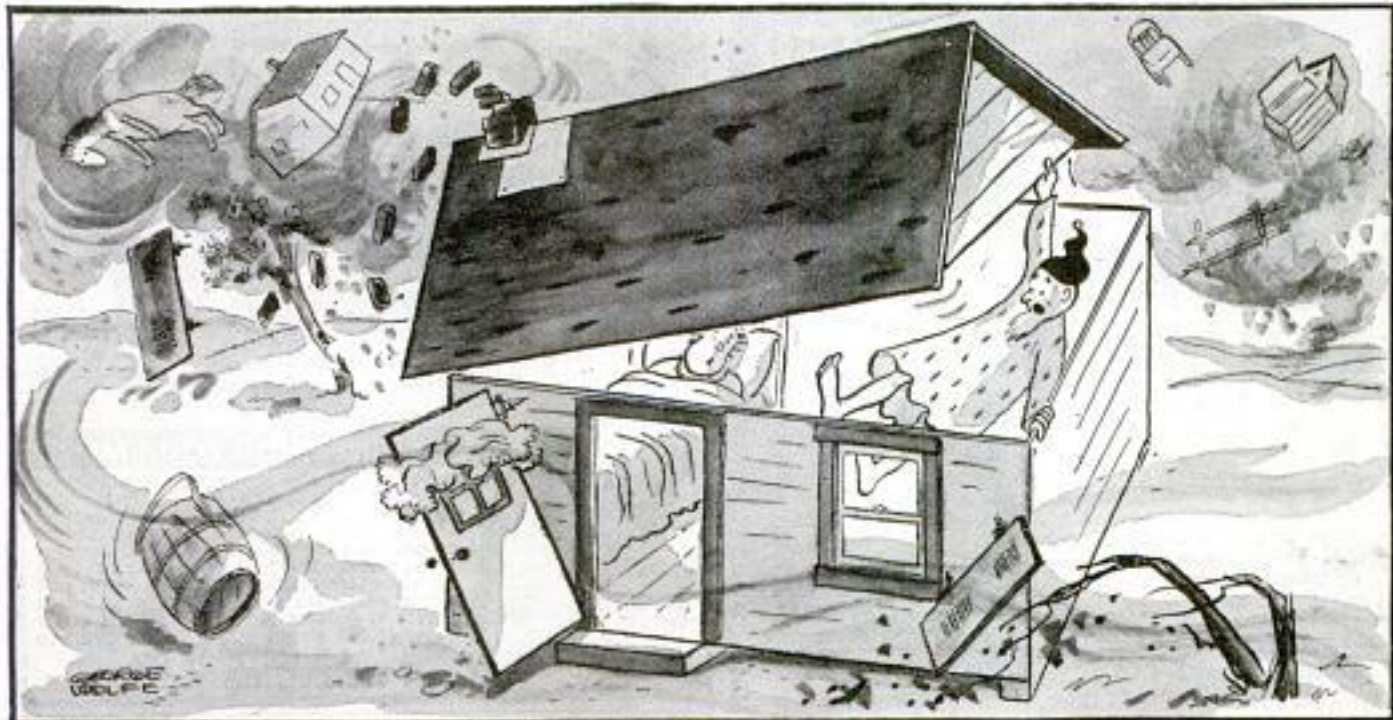

Quick, Ma! Hand me the Weldwood Glue!

When you want to fix things fast . . . remember Weldwood Glue. It's quick to mix . . . easy to use . . . tremendously strong . . . stain-free . . . rot-proof . . . and permanent. At hardware stores, lumber yards, chain stores.



WELDWOOD
PLASTIC RESIN
WATERPROOF GLUE

UNITED STATES PLYWOOD CORPORATION, New York 18, N. Y.

CHECK THE SPEED OF EVERY ROTATING PART



The "Standard" Tachometer (Speed Indicator) enables you to quickly read the revolutions per minute of pulleys, shafts or revolving mechanisms.

This Tachometer provides you with a simple way of checking your machinery for its most efficient operation. Just touch the end of the Tachometer spindle to the shaft or revolving part and immediately read off the RPM.

Tests prove "Standard" Tachometer the equal of expensive instruments within its range of 500 to 3000 RPM. Weighing five and one half ounces, it easily fits in pocket or tool kit.

Ruggedly constructed of metal and sealed against dust — requires no lubrication.

Tachometers \$1.50 prepaid. Send money order or check.

STANDARD MACHINERY COMPANY

1575 Elmwood Avenue,

Providence 7, R. I.

FOOT PAINS STOPPED or Your MONEY BACK



Air-Cooled ARCH-HEELERS

Get Quick Lasting Relief

Wear Guaranteed Proved ARCH-HEELERS in any shoes for aching feet, metatarsal pains, burning callouses, corns, weak arches. Must please you or Your Money Back. Made of selected leather, specially shaped with soft cushions to gently lift bone joints, release nerve pressure, free blood circulation, align entire foot. Springy. Air cooled. Comfortable, even in tight fitting shoes. Users praise them. "I wouldn't take \$5 for mine!" says one. Pair only \$1.

Send No Money

Send name, address and shoe size. Pay postman \$1 plus C.O.D. charge. Or save C.O.D. by sending price with order. Money back if not pleased after 30 days. Send Today.

ARCH HEELER CO., Dept. Z-12 COUNCIL BLUFFS, IOWA

PAINT STRIPING TOOL

ONLY \$1.00 POST PAID

Try it! See the Added Beauty

With this NEW TOOL, (not a brush) everyone can now draw lines with paint, enamel, lacquer, etc. Used on autos, models, toys, games, imitation tile walls, cabinets, furniture, linoleum floors, signs, bulletin boards, sporting goods, home workshop projects, etc. Send only \$1.00 for complete tool for painting a 1/16" wide stripe, including adjustable guide, operating instructions, etc. C.O.D. price \$1.25.

As easy to use as a pencil.



Patented

Extra interchangeable tips for making 1/64", 1/32", 3/64", 1/16", 2/32" and 1/8" wide stripes lines—.50 each.

Every Painter and Craftsman Should Own One.

Send for your tool and so many additional width tips you need today. Use it. If you are not satisfied that you can do better work, add character as well as beauty to your product or project, return the tool and we'll refund your money promptly.

Paint Dealers; Write for literature, etc.

WENDELL MFG. CO. 4234 N. Lincoln Ave. CHICAGO 18, ILL.

ORDER NOW!



NEW

ECHOPHONE EC-1A RADIO RECEIVER

Be one of the first to own this popular set for short-wave and regular broadcast reception. Order now for earliest delivery. Many new features! Covers entire tuning range from 550 Kc. to 30 Mc. (550 to 9.85 meters) in 3 bands. For 115-125 volts AC-DC. Automatic noise limiter. Built-in PM speaker. Complete with tubes.

Net, F.O.B. Chicago

\$2950

ALLIED RADIO CORP.

833 W Jackson Blvd., Dept. 5-MM-5, Chicago 7, Ill.

- Ship ECHOPHONE EC-1A at earliest moment.
- Enclosed \$..... Full Payment
- Part Payment. Balance C.O.D.
- Send additional information on Echophone EC-1A.
- Send information on other Communications Receivers and Time Payment Plan, without obligation.

Name.....

Address.....

City..... Zone..... State.....

What's easy as a stamp to buy?
What makes your note take off and fly?



Dennison AIR MAIL LABELS

At Stationery Departments Everywhere

MACHINE SHOP EQUIPMENT

Every man who owns a workshop should have a copy of this new, authentic catalog of Machine Shop Equipment... the latest tools made by the biggest manufacturers in the United States. Replete with illustrations, descriptions, prices. Prompt delivery on most tools listed in this catalog. Available at the cost of printing—50c a copy—Get yours today! Price of Catalog Refunded an First Order over \$5.00. Send check or Money Order to

CENTER TOOL CO.

154 Centre St., New York 13, N. Y.

New OTTAWA WOOD SAW

For Tractors



—Makes wood sawing fast and easy. Can cut enough wood to pay for itself quickly. Easily moved while attached. Big heavy blade. FREE details.

LOW PRICE

OTTAWA MFG. CO. W1227 Oak Ave., Ottawa, Kans.

ORDER NOW FOR PREFERRED DELIVERY

Sand Casting—Forging—Heat Treating—Case Hardening BRONZE FOUNDRY



is again available in limited quantity without priority. Orders filled in sequence as received. **INVENTORS—SCHOOLS—CRAFTSMEN** use **FOUNDRYETTE** for making castings quickly for new inventions, for instruction, and general purpose. Order now for early delivery. Three sizes are available capable of making bronze castings of 1½, 3, and 6 pounds weight, aluminum, copper, brass, etc., \$17.50, \$24.00, \$34.50, f.o.b. Kansas City. Domestic gas supply and 110 volt AC or DC energy required for operation. Write for circular.

KANSAS CITY SPECIALTIES CO.
Box 6022, Dept. P-61 Kansas City, Mo.

ARMSTRONG TOOL HOLDERS

enabled American industry to change to war production "over night." For they are the permanent, multi-purpose tools used by 96 per cent of the machine shops and tool rooms, on lathes, planers and shapers—the tools used to make dies and jigs, to build production machines. They are the tools you will want for your own shop—**ARMSTRONG TOOL HOLDERS** for industry, **ACE Tool Holders** for home work shops.



ARMSTRONG BROS. TOOL CO.

"The Tool Holder People"
368 N. Francisco Ave., Chicago 12, U.S.A.



LOCATES TROUBLE INSTANTLY IN ALL ELECTRICAL DEVICES

HANLAN APPLIANCE TESTER

In this single unit are combined all the necessary tests for examining every appliance. Checks thermostats under actual working conditions. Tells instant it opens or closes. Controls the heat on soldering irons. Prevents over-heating. Tests continuity, open circuits, etc. Checks automatic irons, vacuum cleaners, motors, shavers, bulbs, appliances with 3-way switches, etc. Great time, effort and money saver! **ONLY \$9.50 COMPLETE.**

Pat. Pend.

FREE with each Tester. New, Complete Practical Course in electrical appliance repairing. **WRITE FOR CIRCULAR.**
HANLAN CO., 1419-A, West Jefferson, Los Angeles 7, Calif.

GLOWS in the DARK

MAKE BIG MONEY Selling Luminous Pictures

WRITE
FOR
FREE
SAMPLE

Your customers will gasp with wonder at these amazing new luminous pictures, statues, novelties. Be the first to sell them! Religious, nursery, glamour and other subjects. Sell on sight.

Madison Mills, 303 Fourth Ave., New York 10, N. Y.

WOODWORKING IS FUN



With the hobbyist, smart, accurate work starts with good measuring equipment. And there, as usual, is where Stanley leads!

Stanley "Zig-Zag"

Rules, for example, have the features you need and in a handy-to-use form—straight-grained hardwood sticks—durable metal joints and tips—large, readable numerals and sharp graduations. Supplementing these are Stanley Boxwood Rules, Pull-Push Rules, Caliper Rules, Measuring Sticks—just about everything for measuring. Ask for Stanley Rules!

Let Experts Help in Your Selection— Stanley has a free booklet for you, "The Joy of Accomplishment". Crammed with helpful suggestions, it contains: a primary list of tools and a list of tools to be added as needed. You'll also find the big Stanley textbook: "How to Work with Tools and Wood" mighty useful. It's yours for only \$1.00. Mail the coupon today.

STANLEY THE TOOL BOX
OF THE WORLD

MAIL NOW

Stanley Tools, 1115 Elm Street, New Britain, Conn.

Please send by return mail

- The FREE booklet: "The Joy of Accomplishment."
- 188-page book: "How to Work with Tools and Wood." \$1.00 enclosed.

(In Canada: Send order to Stanley Tool Co. of Canada, Ltd., Roxton Pond, Quebec.)

Name.....

Address.....

City..... State.....



Now! A Better Soldering Tool... THE KWIKHEAT

Has Built-in
Thermostat
Control!



6 TIP STYLES

- #0—\$1.25
- #1—\$1.25
- #2—\$1.25
- #3—\$1.25
- #4—\$1.75

HOT, READY FOR USE ONLY 90 SECONDS after plugging in! Kwikheat is the only soldering iron with a thermostat built into the tool itself*—maintaining the proper level of heat for most efficient, economical operation. **SAFE!** ... Cannot overheat—**ECONOMICAL!** ... Lasts longer—saves tips and requires less retinning. **POWERFUL!**—225 watts—yet exceptionally light weight (14 oz.). Well-balanced with cool protecting plastic handle. Modern streamlined design. Six interchangeable tip styles adapt one Kwikheat Iron to all your soldering jobs. You will be proud to own America's finest and most versatile soldering tool... from tip to plug Kwikheat is in a class by itself. Ask your dealer to demonstrate the quick-heating feature now!

*patented
Kwikheat iron with choice of #0, #1, #2, or #3 tips \$11.00
Set of 5 tips, consisting of #0, #2, #3, #4, and #5 . \$6.00



Dept. PM-12, Kwikheat Division of
SOUND EQUIPMENT CORP., 3903 San Fernando Rd., Glendale, 4 Calif.

Power FOR MANY USES

Wherever... Whenever... You Need It

Power at low cost wherever you're located... whenever you need it is furnished by Sheppard Diesel Generating Sets operating efficiently on the cheapest fuel (domestic furnace oil). No stand-by charges... no gasoline hazard. They occupy a minimum of space... are delivered complete, ready to provide power without the addition of a single accessory. The Model 7 Sheppard Diesel is shown direct-connected to a 5 KW Generator. Other models ranging from 3 to 30 KW, AC or DC, single and three phase. Write today for literature, engineering help and advice about obtaining WPB approval... all FREE.

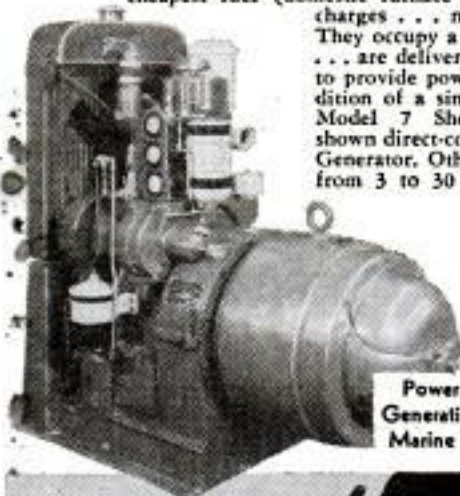

Power Units • 8 to 50 HP
Generating Sets • 3 to 30 KW
Marine Engines • 8 to 56 HP

Sheppard ALL AMERICAN Diesels

R. H. SHEPPARD CO. 48 MIDDLE ST. HANOVER, PA.

Greatest of all Hand Tools

Gives 1 Hand
TON-GRIP!



Does more things, easier and quicker, than any other tool! Remains locked to the work with hands removed. Holds anything, any shape, with a grip that never slips. Is actually Hand-Vise, Clamp, Super-Plier, Adjustable End-Wrench, Pipe-Wrench, Locking Wrench and Toggle-Press—**ALL IN ONE!** Light, trim, handsome. Made of fine alloy steel. Zinc plated. 2 sizes—7" and 10".

PETERSEN MFG. CO.,
Dept. C-12 DeWitt, Nebr.

WISE-GRIP WRENCH



AMICI (ROOF) PRISMS

90° double inversion. Accuracy 2-sec. arc. 2 sizes: 1.6" x .83" and 2.6" x 1.4"
Small Large
Grade A (perfect) \$8.00 \$3.00
Grade B (slight defects) \$4.00 \$5.00
Grade C (chipped roofs) \$2.00 \$1.00
Satisfaction Guaranteed—Sent Prepaid on Receipt of Check or Money Order

INDUSTRIAL SERVICE

302 LUMBER EXCHANGE BLDG., MINNEAPOLIS, MINN.

DIE-LESS DUPLICATING

Many small parts can be formed without dies, to duplicated accuracy of .001" with DI-ACRO Precision Machines.—Benders, Brakes, Shears. Save die expense and time delay. Ideal for experimental and research work, making samples, models, etc., as well as regular production runs.

Write for descriptive literature.
O'Neil-Irwin Mfg. Company
341 8th Ave. South
Minneapolis 15, Minn.



SHEAR



BENDER



BRAKE

BUILD YOUR OWN MACHINE TOOLS!

Blueprints \$1.00 - Catalog FREE



Detail construction Blueprints on 4 Lewis metal and wood-working tools prepared for \$1.00. Includes prints for Lewis 10" Shaper, Milling Machine, Drill Press, Vice, 16" Band Saw, 6" Jointer. Plans or semi-finished castings available for these tools save up to 90% of comparable new tool cost.

Illustrated 22-page Catalog—sent free with Blueprint Order—describes 30 Lewis mach. WHITE 106411

LEWIS MACHINE TOOL CO.

P.O. Box 116, Sta. A, Dept. M-24, Los Angeles 31, Calif.

MOTORISTS

NOW SAVE MONEY ON GASOLINE!



Now you can get up to 30% extra gasoline mileage with a Vacu-matic on your car. Quicker pick-up, smoother running, added power and precious gasoline savings guaranteed.

Automatic Supercharge Principle
Vacu-matic is entirely different! Operates on the Supercharge principle. Saves gas. Automatically provides a better gas mixture. Guaranteed to give up to 30% extra gas mileage, more power and better performance.

FITS ALL CARS

Constructed of six parts, fused into a single unit. Adjusted and sealed at the factory. Very quickly installed by anyone.

AGENTS TRIAL OFFER

Every car, truck, tractor a prospect. Send name, address on postcard for big money-making offer and how you get yours for introducing.

VACU-MATIC CO., 7617-1259 W. State St., Wauwatosa 13, Wis.

MONEY-BACK GUARANTEE!



RATS! ... kill them easily and quickly with no-muss, no-fuss K-R-O Ready-Mixed, in Bis-Kit form!

Each can holds a variety of rat-appealing red-squill baits that are deadly to rats but safer than poison for use around humans, livestock, pets, and poultry. Two convenient sizes: 35c and \$1. Also K-R-O Powder: 75c, at your drug, seed, or hardware store. The common brown rat breeds 6 to 10 litters a year! Get K-R-O, today.
The K-R-O Company, Springfield, Ohio.

GAS ENGINES IN STOCK



The G. H. Q. miniature gasoline engine that really operates is available. Over 100,000 sold to date. 1/5 H. P. Complete with fly-wheel and propeller, fuel 15 accessories and full instructions for \$20; with major accessories \$15; with coil and condenser only \$9.95. Fully bench tested and ready to run. Power for all models. Send only \$1.00—Shipped Collect C.O.D. same day. Send for free illustrated Catalog of hundreds of hobby items.

GHQ MOTORS, Dept. BV125, P.O. Box 193, Station O, N.Y. 11, N.Y.

PLASTAKIT

Make your own ornaments, decorations and jewelry designs out of plastic. Box of 60 pieces including such pieces as boats, anchors, hearts, pilots' wheels, flower baskets, also 2 plastic bases to make your own brooches. All complete, including earclips, glue and pins. Now the latest rage. Send \$2 . . . box sent postpaid. No C.O.D.'s.

WASHINGTON EMBLEM CO.

Dept. E Box 1067 Providence, R. I.

Make Any Article GLOW IN THE DARK with Magic New Discovery!

Don't pay big prices for luminous articles. Make your own! Sell at big profit or keep for your pleasure. With our complete outfit and confidential instructions, it's easy! A stroke of the brush—any article glows in the dark like magic! Lasts indefinitely. Absolutely harmless. Hundreds of uses. Use on ties, bows, jewelry, house numbers, furniture, pictures, statues, toys, etc. Order NOW! Supply limited. Money-back guarantee.

\$1.00 Complete Lite-Glo Kit, \$1.00. Send name, address, pay postman \$1.50 plus postal charges! Send cash, we pay postage.

LITE-GLO, Dept. 312-LN, Topeka, Kan.

Icons: SERVICE FLAG, LIGHT SWITCH, MEDICATIONS, JEWELRY, CLOCKS

No Grander Gifts for Model Builders! CLEVELAND MODELS

WORLD'S finest line of authentic 3/4" built-up flying scale models used by men in the services—the "air-latoerats" of model airplane construction Kits—tops in authentically engineered, super-detailed designs. MFM (Master Flying Model) Kits contain full size drawings, all printed-out curved wood parts, all cut strips, tissue, prop material, insignia, wheels, cements, colored dope, and many other items. Get and build your favorites now.



- 77 1/2" Boeing B-17 "FORTRESS" MFM Kit \$12.50 SF-100
- 46" Douglas A-20 "HAVOC" MFM Kit \$8.50 SF-115
- 48 1/2" Martin B-26 "MARAUDER" MFM Kit \$8.50 SF-135
- 55" Mitchell B-25, MFM Kit SF-125 \$8.50
- 49 3/4" Lockheed "HUDSON" MFM Kit \$7.50 SF-95
- 40 3/4" DeHav. "MOSQUITO" MFM Kit \$4.50 SF-145



50 3/4" Republic P-47 "THUNDERBOLT" MFM Kit SF-81 \$400

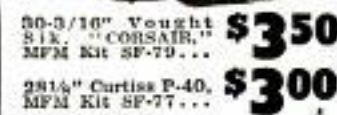

50-3/16" Vought SIK. "CORSAIR" MFM Kit SF-79 \$350



28 1/4" Curtiss P-40, MFM Kit SF-77 \$300



25 1/4" Bell P-39 "AIRACOBRA" MFM Kit SF-76 \$300



39 3/4" Grumman "AVENGER" MFM Kit SF-93 \$400



29 3/4" Jap "ZERO" MFM Kit SF-86 \$300



38 3/4" Lockheed P-38 "LIGHTNING" MFM Kit SF-85 \$400



30" Hawker "HURRICANE" MFM Kit SF-78 \$300

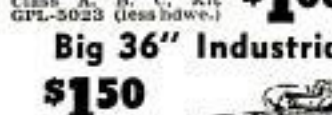

33 3/4" Westland "WHIRLWIND" MFM Kit SF-103 \$350



PLAYBOY Senior Gas Model, Kit GP-5017 (less hdw.) \$4.50
PLAYBOY Junior Gas Model, Kit GP-5018 (less hdw.) \$2.50



31 1/4" Grumman "HELLCAT" MFM Kit SF-97 \$350

World's Biggest \$1.00 Values in Glider and Gas Models!

- Glider! Biggest \$1.00 Model in U.S. "4" Super Condor Soarer, Soars for hours. Kit E-5019. \$100
- Tether "SHARPIE" Class A, B, C, Kit GP1-5023 (less hdw.) \$100

Big 36" Industrial Training Models

- \$150 EACH KIT
- "BLACK WIDOW" Night Fighter, Kit T-155, \$150

- Famous "PIPER CUB" Kit T-94, \$1.50
- Other 36" "T" Kits are "SPITFIRE" Kit T-73; "LIGHTNING P-38" Kit T-85; "MUSTANG" Kit T-91; "WHIRLWIND" Kit T-103. Each Kit, \$1.50.

CLEVELAND MODEL & SUPPLY CO.
4508E115 Lorain Ave. ★ ★ ★ Cleveland 2, Ohio, U. S. A.

SEE YOUR DEALER FIRST. If ordering direct, include 20c extra for packing-postage.
CATALOG 5c (none free)



For a Merry Christmas!

Whether receiving or giving, the gift of the year is Northland Skis. Perfectly balanced and matched, Northlands are handmade from selected, super quality woods. Insist on genuine Northlands, choice of champions, identified by the Deerhead trademark.

★ Get FREE 48 page Ski Manual. Edited by Hannes Schneider. 82 illustrations. Sent postage paid (offer does not apply in Canada).

NORTHLAND SKI MFG. CO.

World's Largest Ski Manufacturers

95 MERRIAM PARK • SAINT PAUL 4, MINNESOTA

BURN YOUR NAME ON TOOLS WITH THE ARKOGRAF



PROTECT YOUR TOOLS FROM THEFT
Write with electricity any name or design on the hardest and finest tools and instruments, or any metal, like writing on paper with pen or pencil. Thousands used by mechanics, garages, machine shops.
Complete Outfit \$3.50—Prepaid Anywhere
Interesting illustrated circular free. Write today.
ARKOGRAF PEN CO., 3977 S.E. Stark, Portland 15, Ore.



"I WOULDN'T BE WITHOUT ONE"

THAT'S what machinists, engineers, draftsmen, carpenters and scores of others are saying about this unique pocket rule... and no wonder, the Streamline is actually five rules in one!

With its unique tape lock and extra foot, the Streamline, in addition to regular measurements, can be used for inside measuring, calipering, "blind" measuring; and as a height gauge and scribe.

Its case is sturdily constructed of high-grade chrome plated steel with tape of imported Swedish spring steel. There is nothing internal that will bend, loosen or jam. Blades are easily interchanged.

Why not order your rule today... priorities are no longer necessary.

MASTER

TRADE MARK
WOOD AND TAPE RULES

MASTER RULE MFG. CO., INC.
815 E. 136th St., New York 54, N. Y., Dept. F-12
Branch: P.O. Box 1587, Oakland, Cal.

Enclosed find \$2.65 for the new 6 ft. "Streamline" complete with spare blade.

NAME _____
ADDRESS _____
CITY _____ STATE _____

IMMEDIATE DELIVERY!!

RADIOS

FLATIRONS TOASTERS ETC.



RADIOS
\$15⁹⁵ and up

WRITE FOR CATALOG
Send now for our low prices and illustrated catalog on brand-new 1946 models; radios and electrical appliances. Enclose 3¢ stamp and state items you are interested in.

ONE-A-LUX RADIO & TELEVISION CO.
Dept. 12PM - 303 W. 42nd St., New York 18, N.Y.

NEW 6 in 1 CIG-SMOKER



IT'S A SENSATION—The Safe-Gard Holder—Filter—Fire Shield—Ash Retainer—Smoke Cooler—and Automatic Snuffer... enjoy new thrills in safe cigaret smoking at home—shop—office—auto—in bed—prevents fires, burns, ash mess. Made of miracle, durable Silverglas. It's a beauty—tops for gifts.

2 for \$1.00—Postpaid—12 for \$5.00
Pat. & Mr., **SAFE-GARD MFG. CO.**
21 Perry-Payne Bldg., Cleveland 13, Ohio

AGENTS WRITE

GEARS

In Stock - Immediate Delivery



Gears, speed reducers, sprockets, thrust bearings, flexible couplings, pulleys, etc. A complete line is carried in our Chicago stock. Can also quote on special gears of any kind. Send us your blueprints and inquiries.

Send for Complete Catalog No. 10
CHICAGO GEAR WORKS
440-48 N. Oakley Blvd., CHICAGO 12, ILL.

Big Money for Workers In Home or Shop



Licensed Concrete Specialists wanted. No experience needed. Make *Colorglazed* concrete pottery without molds. New, low cost, patented method. Cemetery products, novelties, tiles, etc. Basement leaksealing. Other big pay projects. Booklet, details free. Men only.

NATIONAL POTTERIES COMPANY
542 Lincoln Avenue Fergus Falls, Minnesota

TRAIN

Your VOICE!

Results GUARANTEED



We build, strengthen the vocal organs—not with singing lessons—but by sound, scientifically correct silent and vocal exercises and absolutely guarantee complete satisfaction with results. Write for Voice Book, FREE. Sent to no one under 17 years old unless signed by parent.

Perfect Voice Institute, Studio 1359, Kimball Hall Bldg., Chicago 4, Ill.

BEST SHAVE EVER OR MONEY BACK!

Patented **SPEED-HONE**



Shave with a grin—not a groan... For smoother shaves—use SPEED-HONE! SPEED-HONE puts "velvet-edge" on razor blades. MILLIONS IN USE. Dozens of shaves from every blade. Only 10¢. If dealer can't supply, send dime for sample.

Keeps Blades Keen

CURTIS CANDY COMPANY DEPT. PM
CHICAGO 13, ILL.

SIGNS EASILY AND EXPERTLY PAINTED WITH LETTER PATTERNS

AND SHOWCARDS MANY SIZES & STYLES WRITE FOR FOLDER!

JOHN F. RAIN
1329-31 N. Central Ave.
CHICAGO 51, ILL.

V-8 DUALS AND SINGLES



A genuine steel pack muffler WITH A BEAUTIFUL MOTORBOAT TONE. Sandee Mufflers feature improvements far in the lead, years ahead of competition. Increases mileage and power, reduces back pressure and gives better performance. Savings in gasoline will pay for a Sandee Muffler.

V-8 FORD AND MERCURY DUALS **\$17.50**

SINGLES—FIT IN PLACE OF REGULAR MUFFLER

Chav., V-8 Ford, Plym., \$5.00 Chrys., Olds., Buick, etc., \$7.00

These mufflers will outlast two regular stock replacements.

Dealers Wanted

SANDEE MUFFLER CO.

7523 S. WESTERN AVE., LOS ANGELES 44, CALIF.



IDENTIFICATION BRACELET only \$1.95. Heavy silver plated, name engraved without extra charge. Orders shipped same day. We also make these with a STERLING SILVER tag, heavy weight, with nickel silver chain, each boxed, \$2.95. We pay tax and postage.

MONT PETIT MFG. CO.
15 E. Pearson St., Dept. R Chicago, Ill.

ANYONE CAN
DO THIS IF
THEY HAVE
OUR CHART

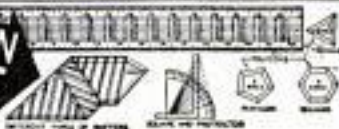

SPECIAL
OFFER
FOR
AGENTS

Blue Print 27"x36" shows how to find length of any polygon; find any angle in degrees, frame octagon scale, rather tables and many other sizes. Can be scaled down for model work as well as full scale framing. Also Chart changing pitches to degrees for use with Radial Saws. Send 50c in Coin or M. O. No Checks or Stamps. MASON & PARRISH ENGINEERS, 2031-B N. Burdick St., Kalamazoo 81, Mich.

★
Pours
at 40°
Below

ONLY
FIENDOIL

has everything tools and light mechanisms need in an oil— **35¢**
Cleans Metal • Prevents Rust 2 oz. size
Lubricates

At Hardware and Sports Stores
McCAMBRIDGE & McCAMBRIDGE CO.
Baltimore 23, Md.

BURNED OUT or BROKEN ELECTRIC



HEATING ELEMENTS REPAIRED
WITH NEW AMAZING NICHROCITE

Simply overlap ends, apply Nichrocite Paste and turn on current. Used by large utility companies. Trial order, \$1.00; 4 oz., \$2.50; 1 pound, \$8.00. Armstrong Mfg. Co., Box 961-C, Minneapolis, Minn.



ONE-MAN SAWMILL LESS THAN \$110.00
Easy To Turn Trees Into Money

Makes Lumber, ties, shingles, crates, bath, studding, siding.



BELSAW MODELS

in to 24 feet sawing lengths. Patented Mechanical Feed, accurate set works null positive drive. Use tractor or old auto engine for low cost power. Thousands used for commercial sawing. Pays for itself quickly.

Send postcard today for FREE booklet, "How To Make Lumber" & Catalog of Woodworking Equipment.

BELSAW MACHINERY COMPANY
Dept. 1811-U 3542 Main Street, Kansas City 2, Mo.

HINGES
or other
fixtures
LOOSE
?

Tighten
them
for
good

this way!

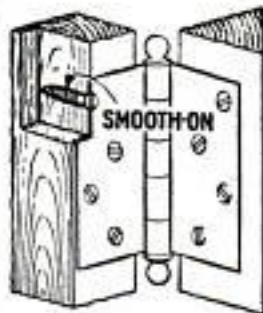

Remove the screws and fill in the holes and any unevenness under the hinge or other loose fixture with Smooth-On No. 1 Iron Repair Cement mixed with water to form a soft paste. Insert the screws in the soft Smooth-On and turn up tight. Overnight the Smooth-On will harden like metal and hold the part tightly in place.

Easy, isn't it? And just as easy to seal cracks, stop leaks, tighten loose parts in heating and plumbing systems with this half-century-old home repair necessity. Keep it on hand for emergencies. Get it in inexpensive 1 3/4-oz., 7-oz. or larger sizes at your hardware dealer's. If he hasn't it, write us.

FREE

REPAIR HANDBOOK
SAVES YOU MONEY

40 pages. 170 diagrams. Clear directions for dozens of practical, short-cut repairs. Pocket size. Just send the coupon.

Mail This Today

Smooth-On Mfg. Co., Dept. 37,
570 Communipaw Avenue, Jersey City 4, N. J.
Please send me my Smooth-On Handbook.

Name.....

Address.....

12-45.....

1895-1945
Half a
Century of
Dependable
Service

Do it with **SMOOTH-ON**



Useful
TOOLS

SET
T-52
Deluxe
Electrical
Ignition
and
Radio Set

All For \$13.00
List Price
See your dealer or write us

SPINTITE SET

A Positive Need in Every RADIO, HOME and ELECTRICAL SHOP.

Contains Chuck Type Handle, Reamawl, 3 Screw Drivers, 2 Pliers, 7 SPINTITES and Insulated, Neutralizing Alignment Wrench.

WALDEN
WORCESTER
WRENCHES

STEVENS WALDEN, INC.

WORCESTER 4, MASSACHUSETTS

MAKE MORE MONEY

APPLYING OR SELLING

CORKSTONE PLASTIC FLOORING

EASY TO APPLY

Here's your opportunity to get into business for yourself applying or selling Corkstone, the economical, top-grade plastic flooring. Plenty of profit. Act without delay!



Dealers & Agents Wanted

WRITE FOR DETAILS OF OUR PROPOSITION

We believe in teamwork and cooperation. We'll help you get started. No cost; no obligation. Act today!

LASTING PRODUCTS COMPANY

MANUFACTURERS OF PAINTS, PUTTIES, PLASTICS
FRANKLINTOWN ROAD PLANT, BALTIMORE 23, MARYLAND

Opportunity

FOR MAN WITH CAR

NO BOSSES—You'll be your own boss—go and come as you like.

NO LAYOFFS—You'll have a big pay job as long as you want it.

NO STRIKES—You'll be working for yourself in a pleasant, interesting, healthful job.

Use Your Car as McNESS STORE ON WHEELS.

Serve a rich trading area regularly with popular line of quality home and farm necessities. Easy to establish big volume, permanent business now. Make more money than ever before—We'll help you start. Write today for McNess Dealer Book—Tells all about this wonderful opportunity—no obligation. Write today.

THE McNESS COMPANY

149 Adams St. Freeport, Ill.

NOW AVAILABLE!

Crosman Silent Rifles—America's favorite compressed air rifles for indoor and outdoor shooting are back again! Available in 22 cal. single shot and Magazine Loading Types. At your dealer—or order direct. Ask for Crosman SUPER-PELLS too—the better ammunition for all compressed air rifles. .177 Cal.—\$1.80 per M. .22 Cal.—\$2.00 per M.

CROSMAN ARMS CO., INC. • Rochester 7, N. Y.

RAFTER LENGTHS. A new vest pocket book for the carpenter, estimator. Gives lengths, Side cuts, Plumb cuts, Deductions. For all your rafters to fit any building from one inch wide to forty feet wide. Gives the numbers to cut on the square. Also gives degrees for same cuts for Radial Saws. All standard pitches from 1/4 to 3/4 are given. Just open book to pitch page and there in plain print are your lengths, side cuts, etc. Any one who knows what a jack rafter is can frame a roof correctly if he has this great book. Price one dollar, prepaid.

BUILDERS' TOPICS. Dept. M, Med. Arts Bldg., Seattle 1, Wash. Original teachers of the square in five easy lessons, by mail. Send for FREE list of plan books—Kamp Rabins to Mansions.

DO YOU

WANT a permanent business profession of your own? Then BECOME A FOOT CORRECTIONIST.

Earnings in this greatly needed profession run as high as \$50-\$100 weekly after a few weeks home training—not medical or chiropody—no further capital needed, no goods to buy. 50th year. Write for free booklet.

Stephenson System of Foot Correction

28 Back Bay.

Boston, Mass.

PLASTIC STOCK & KITS

PLEXIGLAS SHEETS: New, per square foot, following thicknesses; 1/16" \$1.60; 1/8" \$2.00; 3/16" \$2.25; 1/4" \$2.75; 5/16" \$3.75; 1/2" \$4.75; 3/4" \$7.50; 1" \$9.50. 5% discount on orders over 5 square feet and 10% over 10 square feet. Other Plastic Supplies. **PLASTIC KITS:** \$2, \$5 and \$10 each. We pay shipping charges. Send Money Order to—**PLASTIC SUPPLY CO., 2618 St. Louis Ave., St. Louis 6, Mo.**

PIERCE

*Reg. U. S. Pat. Off.

Parashock

17 JEWELS



\$49⁷⁵ Federal Tax Included
AGAIN AVAILABLE!

- Water, shock and dust-protected
- Anti-magnetic
- Luminous dial and hands
- Sweep second hand
- Wafer-thin
- Stainless steel back case

With 24-hour dial \$52.50
 Yellow gold-filled, steel back . . . \$57.50

Mailings here and abroad. Immediate delivery. Address Dept. PM12. Send checks or money orders to

THE HOUSE OF WATCHES
 430 Madison Avenue (49th Street)
 New York, N. Y.
 Complete Catalogue on Request

FREE! 40 Page
Hobby Catalog

Over 1000 Items — Over 300 Photos

Our new 40-page catalog—just off the press—is the "bible" of wide-awake modelers. Practically every nationally advertised model is listed and many, many hard-to-get items. Planes, engines, boats, gliders, supplies, etc.

America's Hobby Center, Dept. B125, 156 W. 22 St., N.Y. 11, N.Y.

Now You Can Own
OFFICIAL COMBAT PHOTOS

Only \$1.20 per Set of 20 4" x 5" Glossy Prints

Action shots by Official Army, Navy, Air Corps, Marine Corps and Coast Guard on-the-spot photographers include: Japan Bombed, Tarawa Operation, Iwo Jima Operation, Battles of Coral Sea and Santa Cruz, Normandy Landing, Okinawa Landing, Air Action over Germany, German Atrocities, Sicily and many other exciting sets.

OFFICIAL PHOTOS CO., Dept. A-1 1434 N. Western Av., Hollywd 27, Cal.

Write for Descriptive Circular

BUILD THESE PROJECTS



For garden or lawn. Easy to build. Easy to sell. Detailed blueprints Model B-25 Dutch Windmill \$60; Model DM-60 Old Mill \$80. Lawn Figure Patterns—Sunbaker Girl, Dutch Boy, Tulip Girl, Holland Fair, 35c each, all 4—\$1.00. Catalog illustrating many models, send 10c today.

CRAFTSMAN'S MODEL CO., Dept. P-85, 2030 N. 41st St., Milwaukee, Wis.

FOR XMAS — Get This NEW INVENTION
CRACKS BLACK WALNUTS
 BUTTERNUTS, ENGLISH WALNUTS

NO FLYING SHELLS

75% MEATS IN QUARTERS. \$1.50 delivered—send cash, stamps, check, money order. C. O. D. 21 cents extra. Money-back guarantee. Order early—NOW.

POTTER, 142N. Main, Sapulpa, Okla.



Now You Can be
TALLER
 than "SHE" is!

Adler Elevator Shoes make you almost 2 INCHES TALLER, "Confidentially", and comfortably, the instant you put them on. Worn and praised by thousands. Look like any other stylish shoes — no high heels! Write for amazing catalog, mailed in plain wrapper. Adler, 122 E. 42nd St., New York 17, N. Y., Dept P31-1.

THE THRILL EVERY BOY WANTS MOST!



Schwinn-Built Bicycles

Precision made—streamline design for years and years of safe, trouble-free riding by America's largest maker. Insist on the Schwinn label—it's your guarantee of the world's finest bicycle.

SEND FOR THIS COLORFUL FOLDER FREE!

Shows Hollywood stars riding their Schwinn-Built Bicycles. It's FREE — just send your name and address today to



ARNOLD, SCHWINN & COMPANY
 1721 N. KILDARE AVE., CHICAGO 39, ILL.



BUY WAR BONDS

ANCO RAIN-MASTER

"Dead-Locker"

WINDSHIELD WIPER
ARMS and BLADES

BLADE SNAPS ON...
STAYS PUT

FINGER-
TIP
RELEASE

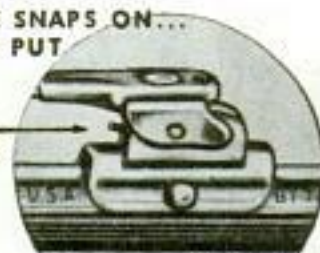

CAN'T FALL OFF
CAN'T BLOW OFF

(A war-born invention—by ANCO—first)
for military aircraft—now for your car.)

DON'T SHOOT YOUR GAS-PUMP MAN!

He's doing the best he can. Sure, he knows how dangerous it is for you to drive your car... in stormy weather... with your dull old windshield wipers that smear and smear. He'd gladly put on for you quickly a pair of keen new ANCO RAIN-MASTER Wiper Blades and Arms. He has them—Newest Models! But he forgets to remind you? Too busy? You can't shoot him for that!



After all, it's *your* car to protect. So *you* remind *him*. Get RAIN-MASTERS...patented features...original equipment on many makes of high grade cars and trucks... used in war—on our fighting tanks and trucks and ships and bombers too...because ANCO RAIN-MASTERS clean quicker, clean cleaner... last longer. May save you a costly smashup.

Ask for RAIN-MASTER Windshield Wiper Arms and Blades next time you buy gas.

THE ANDERSON COMPANY
Established 1918
GARY, INDIANA

Fuse Puller—Circuit Tester

For
Home
or
Factory

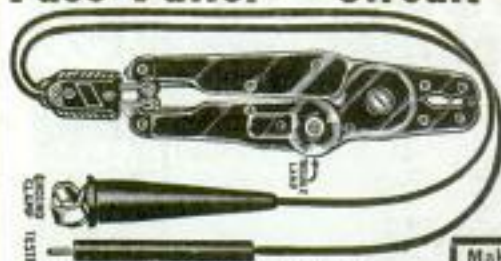

TESTS 110-250 VOLTS

Makes a Useful
Xmas Gift

When motors stop and lights go out, this tool quickly **LOCATES DEAD CIRCUITS** and safely removes blown Fuse. The Star Test Pocket Plier is made of a Transparent Plastic having in one of the legs a small lamp in series with a resistance and can be used to test 110 to 250 volts circuit. The Plier will pull fuses from 10 to 100 Amperes. Thousands of Electricians find this tool handier than Test Lamps. Price \$2.75 each without Leads, \$1.50 additional for Leads, plus 10¢ postage. Can be obtained from General Electric or Westinghouse Stores or directly from us. Order NOW. **STAR PLIER CO., 233 Canal St., New York 13, N. Y.**



"WONDER" ELECTRIC BUTTON

Most interesting electrical apparatus ever discovered. Make your own Telephone Amplifier, Detectors, Transmitters, your voice or music in distant rooms. Perform hundreds of fascinating experiments. So tiny it can be concealed in dozens of places. Send \$1 now for literature and free 5,000 word instruction booklet with 60 illustrated experiments. **SPECIAL OFFER 6 buttons and booklets sent post-paid for \$5.**
BUCK MFG. COMPANY, Box A-28, No. Aurora, Ill.



SAND-O-FLEX BRUSH BACKED SANDING WHEEL

Fit $\frac{1}{2}$ " or $\frac{3}{8}$ " motor shafts. (Adaptors for other sizes available.) Produces fine finish on wood, metal, plastic, rubber, etc. Also body finishing, wood carving. Eight strips of abrasive in magazine coil feed to positions before brushes. Perfectly finished work. Cartridge refills, \$1.30 for wood or metal. Order now, or write for descriptive folder.

\$16.50
Postpaid

WOODWORKERS' TOOL WORKS, Inc.
Dept. P.M., 222 S. Jefferson St., Chicago 6, Ill.

BUILD Boucher MODELS

CLIPPER TANKER FREIGHTER
Everything for the Model Ship Builder Since 1905

34 DIFFERENT
MODEL KITS
\$5 to \$35

Send 35c for 96
PAGE ILLUSTRATED
CATALOGUE

BOUCHER SHIP MODELS 36 EAST 12TH ST. NEW YORK, N.Y.



Fiber covering prevents condensing of moisture on cold water pipes. Anyone can apply it. Neat looking, Permanent. Enough for 30 ft. of $\frac{1}{2}$ " to 1" pipe, \$1.00 P.P. in U.S.

NEW KIND OF CAULKING CORD that sticks and seals weathertight. Just smooth it into the crack. Guaranteed, 100 ft. roll in can. \$1.00.

HOME INDUSTRIES MFG. CO., 1318 So. 30th Ave., Omaha 5, Nebr.

CRESCENT TOOLS

Give Wings to Work

ASK YOUR
HARDWARE
DEALER

BRUSH PLATING OUTFITS

for re-plating articles in the home and shop. No tanks necessary. Free particulars.

GUNMETAL CO., AVE. M, DECATUR, ILLINOIS



TOMBSTONES \$13.69

Freight Paid.

Interested! Write us now for Free Catalog. Made of best Marble & Granite. Service direct to you by mail. Why wait.

U. S. MARBLE & GRANITE CO. Oneco, Fla.

THOMPSON INBOARD MARINE ENGINE

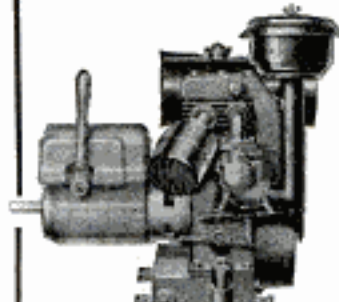

with
Flexi-Drive
TRANSMISSION \$127.50

2-HP, 3-HP and 6-HP Models
4-Cycle — Air-Cooled
H.D. Magneto and Carburetor
Full Ball Bearing Drive and Reverse Gear
Quick Starting, Economical

2 H.P. Model, \$127.50
3 H.P. Model, 175.00
6 H.P. Model, 210.00
For Detailed Scale Drawings of WORK or PLEASURE BOATS, suitable for above engines, send \$2.50 (F.O.B. Grand Rapids, Mich., U.S.A.)

THOMPSON ENGINEERING CO. 212 Winchester Place, N. E. Grand Rapids 2, Mich., USA

PERMANENTLY WRITE IN HARDEST METAL ELECTRICALLY

PROTECT YOUR TOOLS
Electronic Scribe

NEED SIGNATURE OR DESIGN IN ANY METAL, HARDEST TOOL, GUN, TRAP, CRAM BAR, PISTON, METAL INSTRUMENT, KIT, SAFE AND MORE. AC-DC & WIRE & AMP. ELSA PREPARED. (NO COPIES)
JAMES E. HANDEE CO., ANN ARBOR, MICHIGAN



Signature Personalize Your Tools

PLYWOOD

Beautiful aircraft, cabinet and paneling stock now available for prompt shipment without priority. Panel sizes from 6" x 6" up to 48" x 96". Thicknesses from 1/16" through 1". Fir, gum, birch, oak, walnut and mahogany. Reasonably priced! **Send 10c Today for Complete Catalog!**

CARMEN-BRONSON CO.

165 E. 3rd St. Dept. 12-B Mt. Vernon, N. Y.

\$19.95

Full Set



MICROMETERS

Six piece set, in velvet lined leather case. Special price, only \$19.95.

Precision machined in one thousandths, up to 4" outside and 3/4" inside measurements. Guaranteed accurate, easy to read and adjust. Satisfaction guaranteed or money back. Also indicators and gauges. Shipped prepaid on receipt of remittance. On C.O.D. shipments, send deposit of \$2.00.

FREE FOLDER

MICRO PRODUCTS, 211 Jos. Campau, Detroit 7, Mich.



Balance 4" x 5" Base. With either 56.00 Metric or Avoirdupois Weights ...

Catalog with 2000 illustrations of Laboratory Apparatus sent for 75 cents. Catalog listing 10,000 chemicals, drugs, minerals, etc. and 1700 scientific books sent for 25 cents. 100 scientific books 10 cents.
LABORATORY MATERIALS CO., 7321 Vincennes Ave., Chicago 21, Ill.

TRAILER AXLES, HITCHES, AND PARTS

● If you are interested in purchasing trailer axles, hitches, and other trailer parts, contact us promptly. Complete house trailer blue prints. \$1.00. Write for free literature.



HAMMER BLOW TOOL COMPANY, Dept. 112, WAUSAU, WIS.



DRILL-INDEX

A compact container for indexing and filing twist drills. Eliminates search. Made entirely of steel in nine sizes. See your dealer or write to

Foot Schultz Bldg. HUOT MFG. CO. St. Paul 1, Minn.

COLOR CONCRETE WITH CHEMICALS

A business of your own. Big money making Hollywood style pottery and birdbaths without moulds. Washing-wells, stucco-rock, benches, Marbling and cement water-paints. 10c brings sample, literature, pictures. Hollywood CementCraft, 8529 Wonderland Ave., Hollywood 46, California

WINDOW SIGN LETTERS

For Store Fronts and Office Windows. Anyone can put them on. Samples furnished. Genuine Gold and Silver. **METALLIC LETTER CO., 430 N. Clark St., Chicago 10**

FOR ANY BOY 7 to 10

HANDEE IS THE PRIZE GIFT
Give a Handee this year to your son, dad, friend—give one to yourself! It's not only a tool, it's a hobby, a new outlook! Satisfy that urge to create. Know the thrill of turning out professional-looking projects. With the HANDEE you can make beautiful gifts or things to sell—ship, train and plane models, costume jewelry, wood carvings, puppets, initialed tumblers, engraved trays—articles of every description.

HANDEE TOOL OF 1001 USES

A toolshop in your hand! The original hand tool and today's finest, HANDEE grinds, drills, cuts, carves, cleans, sands, saws, sharpens, engraves. You'll like its speed, its smooth performance. Perfectly balanced, fits your hand. It's fascinating, modern! Wt. only 12 oz. AC or DC. 25,000 r.p.m.
Postpaid with 7 accessories..... \$18.50

- Make things from
- Wood - Plastics
 - Metals - Glass
 - Linoleum
 - Leather - Alloys
 - Horn - Stone
 - Bone, etc.

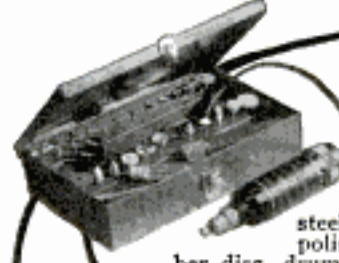

GET A GOOD START GET THE HANDEE KIT

HANDEE Tool and 45 most popular accessories, in a handsome, compact, steel carrying case! Set includes steel cutter, drills, bristle brushes, polishing wheels and points, rubber disc, drum sander and bands, mounted wheels, Speed Oil, sandpaper discs. You'll be amazed at what you can accomplish!

Complete, postpaid \$25.00

FOR YOURSELF OR A FRIEND... THE GIFT OF A LIFETIME!



NEW!

ACCESSORY CASE

Tool owners have been wanting it for years! Sensational assortment of finest quality, time-tested accessories for use on any portable tool; packed in a steel, hinged-top carrying case. IMMEDIATE DELIVERY. Postpaid \$25.00 (Handee Tool not included)

ORDER NOW! USE THIS COUPON

Write for FREE Catalog

CHICAGO WHEEL & MFG. CO.
1101 W. Monroe St., Dept. PM
Chicago 7, Ill.

Send me HANDEE TOOL HANDEE KIT
 ACCESSORY CASE. Remittance enclosed.
 Send C.O.D. Send 64-page Catalog.

Name.....
(Please print)

Address.....

1. Cleaner, cooler smoke enters your mouth, because—
2. Sensational filter whirl-cools smoke, collects flakes and slugs, absorbs juices.
3. Replace filter when discolored.

Don't Tolerate Tongue Bite. Try Milder Medico Filtered Smoking.



PIPE
\$1
with box of 10 filters

Genuine Filters for MEDICO Pipes, Cigarette & Cigar Holders Packed Only in this Red and Black Box.



"63.59% prefer filter pipe smoking"

AMERICAN LEGION MAGAZINE SURVEY NO. 2, "THE MAN WHO WAS GI JOE"

UNCONDITIONALLY GUARANTEED

ALDOR

AUTOMATIC SPARK PLUGS

NON FOULING — AIR COOLED THERMOSTATIC HEAT CONTROL YOU GET INCREASED POWER SMOOTH PERFORMANCE INSTANT STARTING GREATER MILEAGE

For Cars, Trucks, Tractors, Marine Engines, Outboard Motors, Motorcycles, Buses, Farm Machinery and Lighting Plants

ALDOR AUTOMATIC SPARK PLUGS are the result of more than 40 years' experience in the manufacture of all firing spark plugs **MILLIONS IN DAILY USE** are giving the utmost in power and smooth performance to satisfied users

PRICE \$1.00 EACH—4 OR MORE .85 EACH
See Your Dealer or Order From

A. L. DOERING MFG. CORP.
BAYSIDE, NEW YORK.
ORDERS SHIPPED PARCEL POST PREPAID
SEND CHECK, MONEY ORDER OR C.O.D.

"FIRES IN OIL"

HANDY ELECTRIC TEST-LITE

Instantly Tells if Circuit is Broken!

Electric trouble shooter with hundreds of uses. Locates blown fuses, tests appliances, motors, spark plugs, electric fences, grounded lines, cables, etc. Neon indicator glows on voltages from 60 volts AC to 550 volts AC or DC. A necessity for experimenting. Complete instructions—easy to use. Satisfaction guaranteed. Available from dealers or 50¢ postpaid by return mail. Address Dept. B.

50¢

Ne-O-Lite Mfg. Co., Rockford, Ill., U.S.A.

ARC-WELDER

For Light or Heavy Work

No rewinding necessary—use coils taken from old auto generators.

Works on 110 or 220 A.C. Has 23 different tests. Complete plans and BIG Catalog 35¢.

LEJAY MFG. CO. 3347 LeJay Bldg. Minneapolis, Minn.

HOBBY THAT PAYS

Make your own arrow heads. It's fun. Instructions and photo, \$1.00

BOX 272, WHITE SWAN, WASH.

56" 1 1/2" HOLLOW SQ. TRAILER AXLE

CAP.—2000 LBS.—\$6.75 EACH F.O.B. DETROIT

STRONG MACHINE & AXLE COMPANY
9710 Lompkin Hamtramck 12, Michigan

Now ELECTRICAL APPLIANCES

Repair your own

with CHANITE Self-Welding ELECTRICAL HEATING ELEMENT flux. Generous amount, instructions enclosed \$1.00 postpaid. Guaranteed nothing like it. Stick Form 25¢ ea., \$2.00 dozen.

CHANITE SALES COMPANY, 914 So. Main, Fort Worth 4, Tex.

SAVE WASTE PAPER

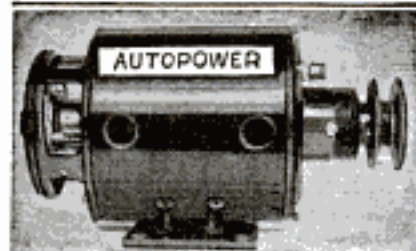

TURN SCRAP INTO MONEY

AUTOPOWER tells you how in plain, easy, simple, and illustrated instructions that anyone can follow. Change auto generators into useful, practical AC and DC generators and motors with voltage from 2 to 1,000 volts, for power, light, welding, radio, sound, etc. No previous experience nor special tools needed. Generators can be driven by wind, water, fan belt, etc. Already used and endorsed by thousands. Send for your copy of "AUTOPOWER." Only \$1.00 postpaid.

AUTOPOWER INC., 2118 Pine St., St. Louis 3, Mo.



What better Xmas Gift—A SCHERR MAGNI-RAY



Every craftsman, sportsman, stamp collector, mechanic, will welcome this tool that makes seeing easier. The Magni-Ray not only **MAGNIFIES**, but also **FLOOD-LIGHTS** the piece under inspection, with powerful, concentrated rays shielded from the operator. Hundreds of uses around any home. Gives **TWO-EYE SEEING** without distortion.

Eye-piece adjustable for angle and height. Heavy base. Lens of finest optical glass, ground by experts. Complete with two bulbs, cord, switch, clamp and stand, \$18.50. Immediate delivery on 10-day money-back basis. Shipped C.O.D. or on receipt of check or money order. **ORDER NOW.**

GEO. SCHERR CO. 200-A LAFAYETTE ST.
NEW YORK 12, N. Y.

KING OF ELECTRIC SWITCHES

VERSATILE SWITCH OF A THOUSAND USES
MILLIONS IN POSTWAR APPLICATIONS



Floodlights your porch when the door is opened—sounds alarm when window is opened—signals arrival of mail—controls heating of furnace, filling of water tank, these and many other services are performed by this versatile switch. Shipped with instruction sheet showing numerous illustrated uses for this device at the low price of \$1.00 postpaid.

KING PRODUCTS COMPANY Batavia 2, Illinois

OTTAWA TRACTOR SAW



FREE BOOK
and
Price List

350 CUTS PER MINUTE

Make money sawing wood. Use Ottawa—fastest cutting. Cuts large, small logs easiest way. Fells trees. One man operates. Thousands in use. Built to last with heavy, stiff saw blade. Positive safety clutch control; uses power take-off any tractor. **OTTAWA MFG. CO., D1227 Forest Ave., Ottawa, Kan.**

NEW CHEAP OIL BURNER

FOR COOKING & HEATING STOVES-FURNACES
HEAT YOUR HOME, COOK YOUR MEALS
WITH CHEAP FURNACE OIL



NO MORE SHOVELING COAL OR ASHES. New Fuelizer Starter Vaporizing System turns Cheap 130 Flash Furnace Oil into Oil Gas heat without clogging up. **LIFE-TIME GUARANTEE** against defects. **\$1.00-BONUS OFFER FOR TESTING.** We will let you try it in your own stove or furnace for one month. Get Yours for introducing. Big profits. Be first. Send in your name today.

NORTHWEST MFG. CO. 535-P 5th Ave. Mitchell, So. Dak.

THE NEW THERMO-SAW

AN IDEAL XMAS
GIFT



\$4.50
complete

Cuts $\frac{1}{2}$ " or $\frac{3}{4}$ " stock by 110V. A.C. current through special transformer. Steel Nichrome blades. Size 11 x 4 $\frac{1}{2}$ x 3 $\frac{1}{2}$ will cut stock 14" wide and 36" long, without necessity of turning stock. No holes to drill. Working pattern included. Extra blades 20c doz. Simple and safe to operate.

**NOISELESS... NO VIBRATION
NO SAWDUST... SIMPLE PRINCIPLE**

BOISSELIER MFG. CO., PM 12, GLEN ELLYN, ILL. Enclosed find \$4.50 (\$4.75 for Canada and Foreign). Please ship postpaid complete Thermo-Saw, ready to plug in, with 12 blades and pattern. I have Alternating Current (A.C.) available.

WRITE NAME AND ADDRESS IN MARGIN BELOW



— Any old Boat...
and an **EVINRUDE!**

● Sure — you'd rather go fishing in a sleek modern boat — but it's fisherman's luck to find only battered old tubs on the best fishing waters! So you take what you get and like it.

● And after all it's *the motor that counts!* It means everything to have a motor that starts instantly, and purrs along smoothly and quietly, through fair weather and foul, on trip after trip and day after day. Such a motor makes a world of difference to any man's vacation!

● That is the kind of performance you can expect from your new peacetime Evinrude . . . performance that, *on any boat*, brilliantly reflects Evinrude's 36 years of *know how* in the building of fine outboard motors. **EVINRUDE MOTORS, Milwaukee, Wis.**

—EVINRUDE—

OUTBOARD  MOTORS

BUY MORE WAR BONDS — AND HOLD THEM!



Now

THE BATTLE-PROVED "TOUGH-TEST" WATCH

Now available, the watch to wear *all* the time—dress or work or sport—because it was created for military dress wear *plus* battle use (and proved in fox-holes). It's absolutely WATERPROOF, super-SHOCK-TOUGH (shatterproof crystal and sealed-in, shock protected, *guaranteed* 17 jewel movement) and ANTI-MAGNETIC. Yet it's a *handsome* dress watch. Now it's available to you at a special low price—but only direct from our New York showroom. Send for detailed, descriptive literature or send \$32.95 (tax included) and we mail watch anywhere in the world with unlimited 30 day money-back guarantee.

LAMONT
Internationally famous
Watches

New York Office—Dept. A
597 Fifth Avenue, New York 17, N. Y.

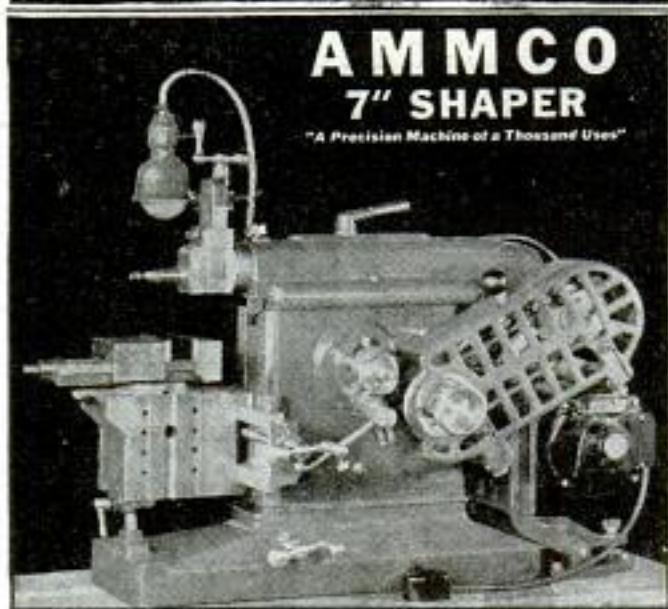

AMMCO 7" SHAPER

"A Precision Machine of a Thousand Uses"

A wide variety of jobs can be done accurately, quickly, easily, and economically on the AMMCO Shaper (7" stroke).

Construction incorporates many features you would expect to find only in larger, more expensive machines... For example: WAYS of ram, tool head, and front face of the main frame are of the "VEE" type, hand scraped to insure accuracy and long life. Available for stationary installation or as portable unit.

Write today for specifications and prices

AMMCO

2140 Commonwealth Ave. North Chicago, Ill.

ELECTRIC SOLDERING IRON



Light weight. Compact. Heats almost at once. Three different size interchangeable tips make soldering easy even in tightest places. Sold on money-back guarantee. Send cash with order. We ship postpaid.

\$2.95

R-L Electronic Corp.

731 W. WASHINGTON BL., DEPT. P., CHICAGO 6, ILL.

MAKE YOUR OWN WORK BENCH

Detailed plans and measurements shown clearly in drawings. Unusually efficient vises. Full description accompanying.

\$1

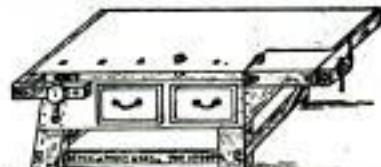

ALL FOR

A. J. RUTARO

Box 4154 Village Station

West Los Angeles 24, Cal.



MATCHLESS

Genuine Gerstner Tool Chests have never been equalled in their better construction and finer finish. Free Catalog for Machinist and Toolmaker.

GERSTNER TOOL CHESTS

445 Columbia St.,

Dayton 7, Ohio



GENUINE U.S. BARGAINS

Genuine Army Folding Litters, used, \$7.95
Used Army Bale Knives with Seaboard 2.50
Slightly Used Army Calson Wheels with Axles, 36" high, weight per pair with Axle, 322 lbs. \$35.00
Thousands of Other Bargains in Military, Outdoor & Sport Goods for Hunter, Farmer, Scout. Send 10c for 32-page catalog returned with first order.

A and N SUPPLY CO.
4720 LESTER ST. RICHMOND, VA.



Collect U. S. Army Shoulder Patches



An interesting, fascinating hobby. From 20c to 50c each. Master set of 400 patches—\$97.50. Special Christmas Assortments \$1, \$5, \$10, \$25, \$50. Official patches available for every major Army and Air Corps Unit. Send \$1 for sample selection of patches and PATCH CATALOGUE. Orders from Canada—add 20%.



SPRINGER'S

276 San Francisco Street
EL PASO, TEXAS



SAY YOU SAW IT IN POPULAR MECHANICS

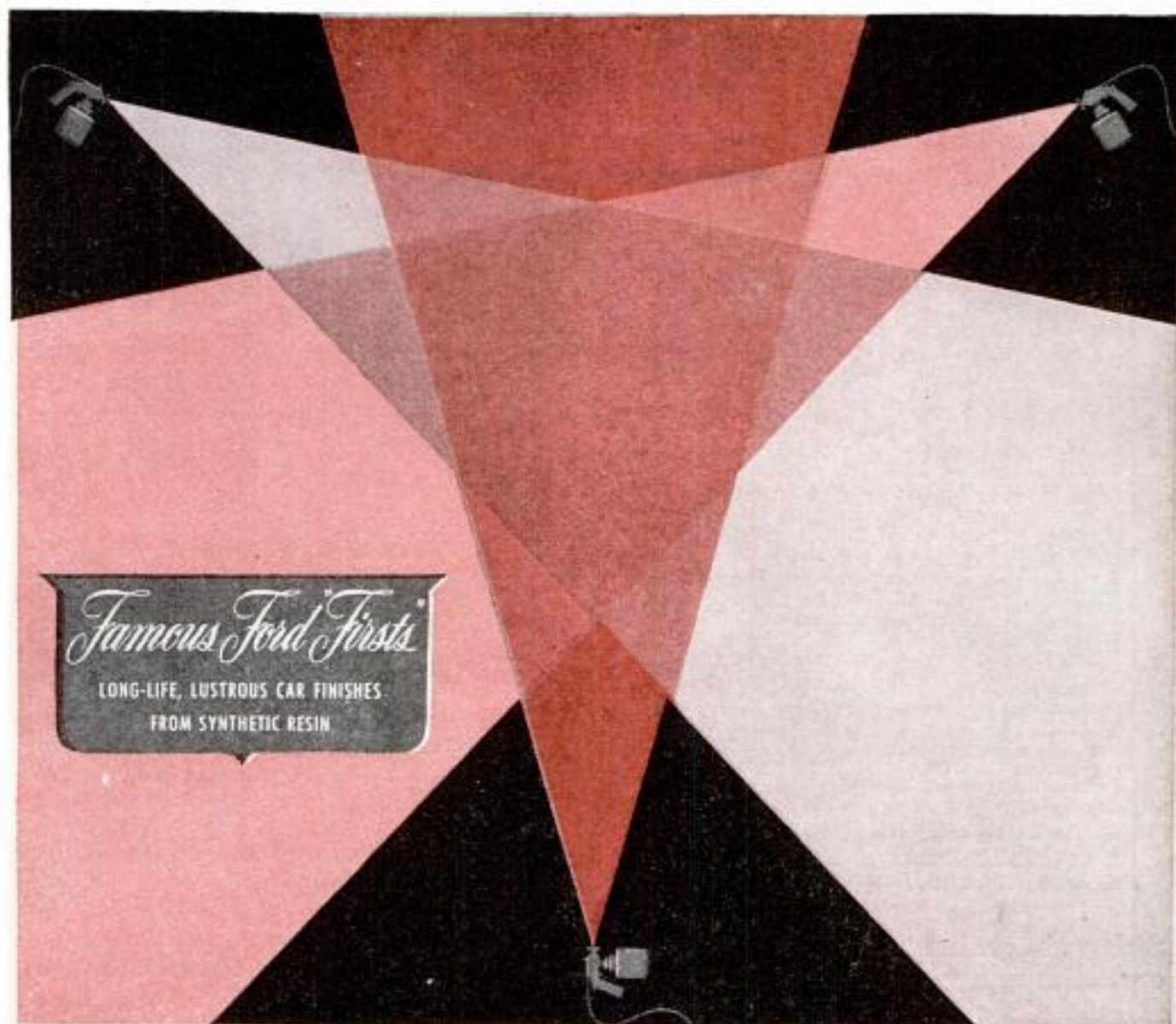

1st

to use synthetic
enamel on motorcars!



You've probably wondered why Ford cars have stayed so shining bright through the war years. The secret is a Ford "first"—the use of synthetic resin enamel.

This Ford enamel is a truly lasting finish. It holds indefinitely its color and luster. It protects more completely than other finishes, for it is applied in thicker coats, and needs no sanding or polishing. This synthetic enamel adheres more firmly to bodies and fenders. And it means added economy for Ford owners, for it reduces car finishing time from several weeks to a few hours.

In 1928, Ford introduced its use on certain car and truck parts. Five years later, methods of applying it to the entire car were perfected, and since then all Fords have been synthetic resin enameled.

This long-life finish is one result of Ford desire to better products and processes continually—an attitude that will bring many more Ford "firsts"—and ever-finer Ford-built cars and trucks.

TUNE IN . . . THE FORD SHOW . . . CBS, Tuesdays, 10-10:30 P.M., E.T. THE FORD SUNDAY EVENING HOUR ABC, Sundays, 8-9 P.M., E.T.

EXPECT THE "FIRSTS" FROM FORD!

.....

Beautiful Polished Metal
CIGARETTE LIGHTER

Engraved WITH ANY GIVEN NAME



Light as a feather.
Perfect size for pocket or purse.
Double fluid capacity.

\$4.00

Engraved with name.

We pay postage

Actual Size

A gorgeous gift for man or woman. Smart—practical—desirable. High, brilliant finish. A precision constructed cigarette lighter of top quality and beauty. Comes in protective flannel bag. Prompt delivery. Send \$4.00 for each lighter you order.

ARROW METAL PRODUCTS

108 N. Jefferson Chicago 6, Ill.

Arrow Metal Products, 108 N. Jefferson, Chicago 6, Ship postpaid.....lighters at \$4.00 each.

Enclosed is \$.....payment in full. PM

Name

Address.....

City.....Zone.....State.....

Engrave following names.....

"Light Bulb" Used for Brazing
Heats Parts to 900 Degrees



Radiation from an incandescent filament, such as is used in light bulbs, is used for brazing operations in the research laboratories of Westinghouse Electric Corporation. With this method, copper parts in a "hydrogen bottle" are heated by radiation to about 900 degrees Centigrade. The filament itself attains a heat of 2000 degrees.

Automatic Charger for Plane Gun
Prevents Jamming in Action

Thinking for itself, an automatic gun charger developed by General Electric for the B-29 Superfortress, P-61 Black Widow and other warplanes prevents jamming of guns by defective ammunition. The device cocks the gun, recognizes an ammunition failure, helps dispose of a defective round, and inserts and fires a new one. The firing unit fires the gun normally, a timing unit determines when to charge the gun if a defective round occurs, and the charging unit clears defective ammunition. Should the gun fail repeatedly for eight successive rounds, the device stops all further operation of the gun. A small air compressor operating the charger provides pressure of 1000 pounds per square inch, without air bottles, and is mounted on the turret.

Instant-Start Fluorescent Lamp

Operating faults in high humidity areas are overcome by an instant-start 40-watt fluorescent lamp. An invisible coating effectively prevents formation of a film of moisture and cannot be rubbed or scratched off.

RADIO PARTS KITS

For Immediate Delivery! —

NOW YOU CAN get what you want, and get it quickly! **CONCORD** has complete stocks of all standard radio parts required for **POPULAR MECHANICS KITS** in addition to the well known line of Concord Kits! Also every kind of radio part and electronic equipment... standard lines, dependable quality, exceptional values. Order from former Catalogs No. 94 and No. 345. And write for special **VICTORY CLEARANCE FLYER**, offering thousands of items at money-saving prices. Mail coupon for **FREE COPY**.



CONCORD RADIO CORP.

LAFAYETTE RADIO CORPORATION

CHICAGO 7, ILL. 901 W. Jackson Blvd. • 255 Peachtree St. ATLANTA 3, GA.

CONCORD RADIO CORPORATION, Dept. P-125

901 W. Jackson Blvd., Chicago 7, Ill.

Please RUSH FREE Concord's Victory Clearance Flyer.

Name.....

Address.....

City.....State.....

WE WILL PAY
\$100.00 to \$500.00

each for clever, original, practical, patentable

IDEAS FOR TOYS

which we consider worthy of manufacturing

Prefer pull toys or educational toys which can be made of wood, plastic or metal.

If accepted, and not already patented, we will defray cost of procuring same on assignment to us.

A working model, or workable drawing from which a model could be produced, should accompany each idea submitted.

In submitting any idea it will be understood that no obligation on the part of Play Hour Toys will be assumed or incurred in the event the submitted idea is refused for any cause.

PLAY HOUR TOYS

1722 Adams Street

Toledo 2, Ohio

The New EXCITING HOBBY START A Craftex PHOTO-PAGE ALBUM

Develop Your Own Pictures on Album Page

NO DARK ROOM — OR — EXPERIENCE NEEDED

Takes but a few minutes to a page—makes Photostats—Photocopies—Negatives from prints and prints from negatives. SET COMES TO YOU COMPLETE WITH PHOTO PRINTING DEVICE—CORDOBA COVERED ALBUM—CRAFTEX SENSITIZED PAGES—PLASTIC TRAYS—CRAFTEX READYMIXED CONCENTRATED CHEMICALS—STAINLESS STEEL CLIPS.

\$11.75 Plus 20% Tax

DEALERS WANTED

CRAFTEX LABORATORY

4615 Elston Ave.—Dept. 301

Chicago 30, Ill.

THE GEM MAKER

Amateurs or professionals . . . hobbyists or jewelers

Polish your own gems with a B&I Gem Maker. You will find this a profitable adventure. All necessary lapidary equipment is furnished, including a

super-charged diamond blade for sawing, and all wheels for grinding, shaping and polishing, also complete instructions. The complete

equipment as shown, less motor and belt, for only \$29.50, f.o.b., Burlington, Wis. Write today for information and literature on the Gem Maker and accessories.

B&I MFG. CO., Dept. S, Burlington, Wis.

KEEP YOURSELF UP-TO-DATE ON WOOD VENEERS LUMBER & SUPPLIES

with CONSTANTINE'S MASTER MANUAL

Published by the leading suppliers to woodworkers, the most complete book ever offered. More than a catalog, contains valuable information on lumber inlays, veneers, wood finishing, etc. 83 inlay border designs in full color, 6 pages of full color inlays plus a wood identification chart showing over 60 rare woods in natural color. Send only 25c today and we will include FREE a year's subscription to our publication, Chips & Chats.

ALBERT CONSTANTINE & SON, INC.
 791D E. 135th Street, New York 54, N. Y.

CONSTANTINE'S
 MASTER MANUAL
 WOODWORKERS
 with A YEAR'S
 SUBSCRIPTION TO
 Chips & Chats



FLYING SUITS \$7⁹⁵ AIR CORPS (Type F-1)

Delivered anywhere in U.S.A.

All-wool with extra inter wool lining. Zipper in front, on legs, sleeves, and pocket. Elastic wool collar, wrist and leg bottoms.

These suits are dry cleaned as they were slightly used. However, they are perfect in every respect.

Electrically wired for use on 24 volts DC. PLENTY WARM WHEN WORN WITHOUT ELECTRICAL ATTACHMENT.

Color, sky blue. Ideal for pilots, truck drivers, motorcyclists, hunters, ranchers, mechanics, or any sport to keep warm. Sizes small, medium, large.

Sold with money-back guarantee, \$7.95 delivered anywhere in U.S.A., prepaid. Send check or money order.

S & C
 Equipment Company
 1915 S. State St., Dept. P
 Chicago 16, Illinois



BELL



WATER PROOF

Shockproof, anti-magnetic, radium dial and hands, unbreakable crystal, precision tested, sweep second hand.

No. DO 121	\$39.75
15 jewels, stainless steel back	
No. DO 217	\$42.50
17 jewels, stainless steel back	
No. DO 328 SELF-WINDING	\$59.75
17 jewels, stainless steel case	

Mail Orders Promptly Filled. Postpaid. Fed. Tax Incl.
 Write for Free Illustrated Booklet "DO"

BELL WATCH COMPANY

Time and Life Bldg., Rockefeller Center, New York 20, N. Y.

SAY YOU SAW IT IN POPULAR MECHANICS

RED-ITCHY SKIN?

watch out—it's often

ECZEMA

**'Invisible'
Liquid
Promptly
Relieves
Torture!**



First applications of wonderful soothing Zemo—a Doctor's highly medicated invisible liquid—quickly relieve intense itching burning of Eczema, Psoriasis and similar annoying skin and scalp irritations due to external cause. Zemo also aids healing. Amazingly successful for over 35 years! Apply any time—doesn't show on skin. First trial of clean, stainless liquid Zemo convinces! Buy Extra Strength Zemo for mean cases.

At all drugstores.

ZEMO

Train Your Own HORSES!

Colts • Stock Horses • Circus Horses
Gait Show Horses — Write for FREE BOOK
ANIMAL LOVERS' ASSOCIATION
Box KA-111, Tarzana, Calif.



PIB AMAZING NEW LIQUID INSULATION

**Fights
Electrolysis
and Corrosion!**



You'll find hundreds of uses for PIB, the new liquid insulation, in your home or commercial shop. It prevents electrolysis with non-solderable joints . . . fights battery corrosion and shorts between terminals. PIB moisture-proofs any ignition system, seals old and cracked insulation, makes all types of batteries last longer.

PIB flows easily . . . penetrates . . . dries pliable . . . endures. PIB is so effective that it's used on engines of Army and Navy vehicles during amphibious operations. Use PIB on any gasoline or electric motor . . . industrial and farm machinery . . . home appliances, boats, planes.

1 TREATMENT FOR 6-MONTH SAFETY!

1-oz. bottle . . . 75¢ 4-oz. bottle . . . \$1.50

Send TODAY for FREE booklet on PIB

U. S. Industrial Chemicals, Inc., Dept. D-5,
60 E. 42nd Street, New York 17, N. Y.

USI Product



Ask for PIB at service stations—
hardware, electric, dep't stores!

Rays Measure Thickness of Pipe And Tell Density of Liquid

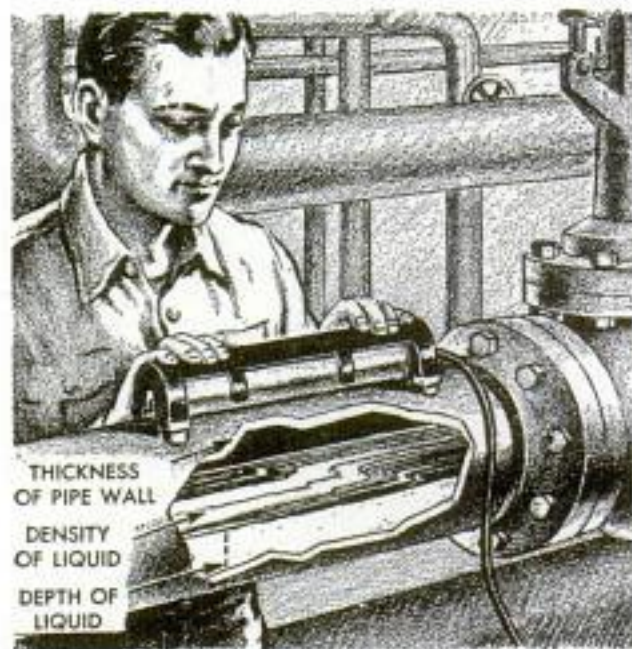

Radium rays now are utilized to shoot through iron pipes and the steel walls of boiler tanks to tell engineers exactly how thick the metal is. The same rays penetrate liquids, such as chemicals or oil, to supply accurate information on the level and density of the liquids—which would show, for example, if the proper "mix" was present. An electronic device called the Penetron employs rays created by radium salt to make these precise measurements. In checking the wall thickness of an enclosed container that would be difficult to measure in any other way, the rays are directed into the metal. Some of the rays are scattered in all directions by the electrons in the atoms of the wall. The rays that bounce back—called back-scattered radiation—are "captured" in a recording instrument that reveals their intensity. Thickness of the wall can be determined by measuring the intensity of the rays.

Acid-Treated Cotton Fabric Resists Mildew and Water

Cotton fabric treated with various acids, including acetyl, has been developed by the U. S. Department of Agriculture's Southern Regional Research Laboratory at New Orleans to resist mildew, dampness and other conditions which cause materials to rot. To test the new fabric, scientists buried it for six months in soil teeming with microorganisms that would have rotted ordinary cotton in a week. The treated material withstood the "bugs" and the dampness. It seems well suited for making mildewproof clothing, rotproof tents and awnings for damp climates, and fish nets that can be stored wet.

POPULAR MECHANICS

Copyrighted material



MOTO-TOOL ★ THE "POCKET-SIZE" MACHINE SHOP

PUT THIS "WAR VETERAN" TO WORK *Approximately 27,000 R.P.M.*

READ MOTO-TOOL'S RECORD

Long before Pearl Harbor Dremel Moto-Tools had won their spurs in tool rooms, machine shops, home workshops. Now they have the respect of every branch of the armed forces. And thousands of them helped establish production records at General Electric, Westinghouse, Remington Arms, Ford, Nash-Kelvinator, Consolidated Aircraft, Douglas and others.



MOTO-TOOL KIT

Kit No. 2 with 23 high grade accessories and Model 2 Moto-Tool, in hardwood case. \$23.50
Model 2 Moto-Tool, with 1 accessory. \$16.50

Now that priorities have been lifted, Moto-Tool can work for you. Moto-Tool owners daily discover new jobs that can be done more expertly in less time. In fact, new purchasers find dozens of uses in addition to those they had in mind. So great is the time and labor that Moto-Tools save, thousands of mechanics and craftsmen would find it difficult to get along without these mighty little midgets.

ONLY MOTO-TOOLS HAVE ALL THESE FEATURES

A Model 2 Moto-Tool develops a speed of approximately 27,000 rpm. Weighs only 13 oz. Shaped to fit the hand. Sturdily built with shock-proof bakelite housing. Balanced for vibrationless operation. Uses 110-120 AC or DC current.

10 DAY TRIAL—MONEY BACK GUARANTEE

Ask your dealer today about Dremel Moto-Tools and Accessories. If he does not handle them, order direct from factory on 10 day trial. We ship postpaid if cash in full accompanies order. If you prefer to send only \$2.00, Moto-Tool will be shipped C.O.D. for balance plus postage. Catalog sent FREE.



Model 2 Illustrated

A FEW OF THE JOBS THAT MOTO-TOOL CAN DO FOR YOU

- Sharpening
- Finishing
- Touching Up
- Sanding
- Drilling
- Mortising
- Engraving
- Burring
- Grinding
- Polishing
- Burnishing
- Inlaying
- Sawing
- Scoring
- Cleaning
- Routing
- Cutting
- Rasping
- Carving
- Brushing
- Dressing

WATCH FOR THE RETURN OF MOTO-SAW

Dremel Moto-Saw... the sensational electric scroll saw... will be back as soon as materials are available.

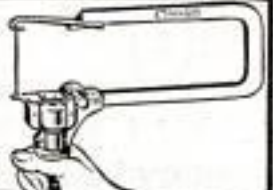

DREMEL MFG. CO. 115-M RACINE, WIS. U.S.A.

120 MILES PER GALLON

Complete motor ready to mount on ordinary balloon-tired bicycle. No mechanical skill required to install. No alteration of bike necessary. Easy to operate.



Can be pedaled by merely releasing clutch. Speed 5 to 40 M.P.H. Shipped prepaid complete with 4 cycle, 2 1/2 H.P. motor, all attachments and heavy duty stand. Get complete facts about this low-cost, convenient transportation.

Write today for descriptive illustrated literature.

WHIZZER MOTOR SALES CO.
Dept. A, 3132 E. Washington, Los Angeles 23, California

NEW PATENTED WAR DEVELOPED TOOL

HOME CRAFTSMEN—amazing new tools, heretofore restricted to important war work of motor transport and aircraft plants, are now available to you for the first time. These patented, new war-developed Flex-Abrasive tools—wheels, micro-points, flexa-cones—scientifically made of soft, flexible, abrasive fabrics. Cut, shape, grind, and polish in one operation. Save time, labor; do precise work. Advanced tapered thread design mandrel fits all standard rotary power units; like Handoc, Poredom, Crandall, others. Get useful Practo-Kit of 15 assorted wheels, points, cones and two mandrels for low price of \$1.95. Big Master Kit with three mandrels and 36 assorted wheels, points and cones, only \$2.95. Send check or money order for either kit, prepaid. Or you can order either kit shipped C.O.D. for regular price plus small delivery charge. Satisfaction guaranteed. Write: Flex-Abrasive Co., Dept. 2-P-F, 100 N. LaSalle Street, Chicago 2, Ill.



\$1.95 SPEC. ASS'T.

SEND NO MONEY!

ALL-METAL MACHINE GUN



\$2.25

Prepaid in U.S.A.

4 for \$8.00
Prepaid in U.S.A.

MONEY ORDER—CASHIER'S CHECK—U.S.A. ONLY

An all-metal toy with a million thrills for any red-blooded American boy. Nicely finished. Perfectly engineered and fabricated. Over 19 inches long.

DEALERS: Wire for prices in dozen or gross lots. Ready for immediate shipment. Packed in individual cartons. An ideal gift item for your toy department.

FOOL-PROOF, HARMLESS, REQUIRES NO AMMUNITION. A SWELL GIFT

ENGINEERS FABRICATING CO., Dept. P.M.
1906 N. Cicero Ave., Chicago 39, Illinois

Enclosed find \$..... Please send me.....
All-Metal Machine Guns.

Name.....

Address.....

City..... Zone..... State.....

DECEMBER 1945

199

Copyrighted material

Announcing—A New Drill Press Accessory

THE BARRON ROTARY SURFACE SANDER

\$5.95
COMPLETE



Note these Special

Features—Made of Alcoa aluminum. Machined and balanced for smooth operation in drill press chuck. For surface sanding woods, plastics or polishing metal surfaces. Complete with 20 instantly removable sanding cup discs. No messy glueing needed. Leaves an agate smooth, absolutely true surface finish. Does not leave waves, ripples, steps or striations in work piece. The only tool of its kind. Shipped prepaid on 10 DAY MONEY BACK GUARANTEE for \$5.95.



The IMPROVED Barron Multi-Purpose Drill Press Planer.. \$7.50

Not only surface planes toughest woods and plastics to precision limits—but rabbets, routs, tenons, panels, grooves, beads. Will cut rabbets, tenons, panels, etc. to a depth of 1" with special Barron extra long hi-speed cutter blades. Thousands now in use. Made of Alcoa aluminum, machine finished thru-out. Vibrationless. Fits any drill press. Shipped prepaid on 10 DAY MONEY BACK GUARANTEE on receipt of cash, money order or C.O.D. for \$7.50.

Baron ALL-METAL Auxiliary DRILL PRESS Table.. \$8.85



Hard Alcoa aluminum die casting heavily ribbed—machined both sides. Has 234 sq. inch extra large working surface. Equipped with Barron Steel Planer Fence. Can also be used for shaper operations, innumerable other drill press uses. A real buy at \$8.85, express collect.

See Your DEALER . . . Or Write For CATALOG

BARRON TOOL CO., INCORPORATED
369 Architects Bldg. Detroit 1, Mich.

BARRON PRECISION WORK SHOP TOOLS

BUILD THIS FREEZER AND STORAGE UNIT

ALL MATERIALS COST LESS THAN \$50!



A 50 gallon oil barrel is used for the outer shell, a 30 gallon oil barrel for the inner container, and the compressor unit is salvaged from an old household refrigerator. Easy to make. Zero temperature keeps meats, fruits, vegetables, etc. in fresh condition for indefinite period of time.

Complete instructions, material list, and fourteen view composite photograph of construction details sent for... **\$1.00**

MASON FREEZERS, GENEVA, N.Y.

Plastic Clamp for Tubing

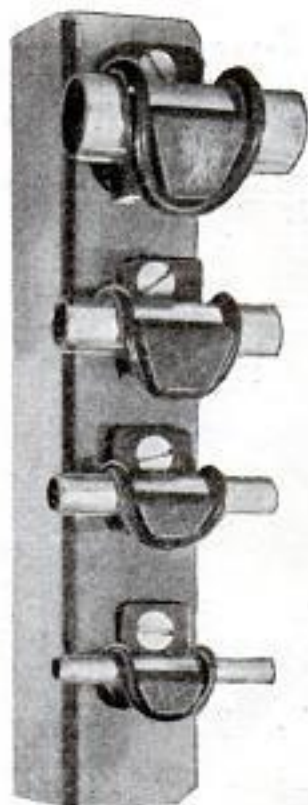
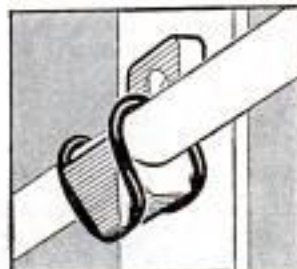
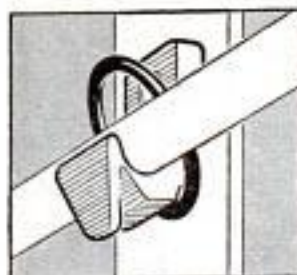
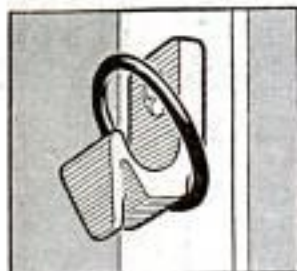

Tubes and conduits of all kinds can be fastened to a wall or frame with a new clamp shaped like an inverted lateral "S." Tubing is placed on the open side of the curve and an elastic clamping ring passed around the back of the base, over the tubing and down the front where it is hooked under the curve at the front of the "S." The ring can be made of synthetic rubber or other elastic material, and the clamp of a fabric base phenol fiber or from sheet metal. The clamp is screwed to the wall, but no tools are needed to install or remove the tubing.

Electric Eye Counts Meteors

Meteors, or shooting stars, now can be recorded automatically and their brilliance measured by an instrument which employs two electric eyes. This is the first known electrical recording of meteors, according to the developers of the "sky detective," Dr. C. W. Gartlein of Cornell University and Joseph C. Logue of the school of electrical engineering. In operation, the photoelectric cells are aimed at various portions of the sky and synchronized so that when one cell intercepts light brighter than that being received by the other cell, a recording pen on a graph is set in motion. The jagged line made by the pen not only records the presence of the shooting star but also gives a reading of its brilliance.

for Christmas

SOLID 10K GOLD, GENUINE ONYX TOP, INITIAL RING

\$16.50 DELIVERED
20% Fed. Tax Incl.

Massive! A ring for a man! All 10K yellow gold ring and initial with genuine black Onyx top... distinctive design and beautiful workmanship. Delivered complete, all charges paid, for only \$16.50 if cash with order... \$17.25 if C.O.D. Satisfaction or your money back. Send length of string for finger size and be sure to specify initial wanted.



H. E. KRISMAN and **715 Washington Ave.,**
COMPANY St. Louis 1, Mo.

★ ★ 500 PERSONAL LABELS Only

COMPLETE NAME AND ADDRESS PRINTED ON EACH!

500 Personal Labels, only 50c Postpaid! Two-colors—handsome blue printing of your complete name and address on attractive white gummed label paper! Use on letters, envelopes, postcards, checks, books, tools, egg cases, etc. HUNDREDS OF USES! Wonderful for those in Service! Order today! FAST SERVICE. Limited supply. Money-back Guarantee.

50c

WESTERN STATIONERY CO., Dept. 237-N, Topeka, Kan.

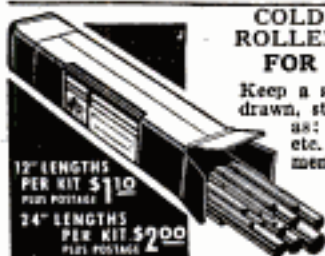

COLD ROLLED STEEL RODS FOR HOME WORK SHOPS

Keep a supply of these free machining, cold drawn, steel rods on hand for many uses such as: studs, pins, special screws, spacers, etc. Each kit contains a complete assortment of sizes, by sixteenths, from 3/16" to 24" inclusive. Furnished either in 12" or 24" (approx.) lengths.

Order today from
GENERAL METALS SUPPLY CO.
742 Park Ave. River Forest, Ill.

AMAZING ELECTRIC SWITCH

ELECTRIC SWITCH OF A THOUSAND USES
MILLIONS NOW IN USE



Turn on your porch light when you open the door—sound an alarm when the mail is put in the box—shut off the water when the tank gets full, these and many other services are performed with this amazing switch. Shipped with an instruction sheet showing more than 40 illustrated uses for this device, at the bargain price of \$1.00 postpaid.

ELECTRONIC PRODUCTS CO. St. Charles 10, Illinois

do you WORRY?

Why worry and suffer any longer if we can help you? Try a Brooks Patented Air Cushion. This marvelous appliance for most forms of reducible rupture is GUARANTEED to bring YOU heavenly comfort and security—day and night—at work and play—or it costs you NOTHING. Thousands happy. Light, neat-fitting. No hard pads or springs. For men, women, and children. Durable, cheap. Sent on trial to prove it. Not sold in stores. Beware of imitations. Write for Free Book on Rupture, no-risk trial order plan, and proof of results. All Correspondence Confidential.



Brooks Company, 359 State St., Marshall, Mich.



HANDKERCHIEF TEST

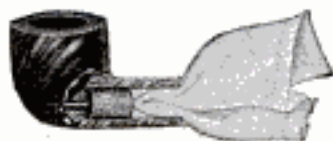

PROVES VITAL ZONE SPOTLESS AND FREE FROM "GOO"—no matter how often you smoke it!



HESSON GUARD MILANO



RE-RING YOUR OWN CAR

Complete sets of Simplex Piston Rings are engineered and packaged so that any handyman can easily recondition his own car.

Rings are unbreakable and each packed in separate envelopes and marked for the groove in which it is to be placed. Complete detailed installations with each set.

Ask in your local store for "Rings made by Simplex"—they last longer.



BUY WAR BONDS AND KEEP THEM

SIMPLEX PISTON RINGS

SIMPLEX PRODUCTS CORP., Cleveland, O.



.. for these **SHOP-TESTED**
mounted wheels and points!

- Proved by shop surveys to be the 12 shapes most universally used.
- Need no breaking-in period.
- Run absolutely true.
- Have no hard and soft spots.
- Are usable right down to the mandrel.

The ideal Christmas gift for the home hobbyist...
send check or money order TODAY to —

BAY STATE ABRASIVE PRODUCTS CO.

Box 121 - WESTBORO MASS.



DESIGN FEATURES
CYLINDER—1 piece
CRANKCASE—aluminum-alloy
PISTON—machined from steel, hardened and lapped to cylinder
BALL-BEARING—Radial and thrust
BORE .900, STROKE .950, DISPL. .604, WGHT. 12 ozs.

"OK" Super "60" is palm-size power plant! Gives consistent flying power to model airplanes! A snap to start! Many exclusive design features including PATENTED PORTING for complete instantaneous scavenging. TOP SPEED (to 9000 RPM) Super "60" with coil, spark-plug, gas tank, condenser \$24.00 at all model hobby shops.

FREE! Descriptive Brochure and Installation diagram.
(Send stamped and addressed envelope)

HERKIMER TOOL & MODEL WORKS
HERKIMER (Dept. PM) NEW YORK

Cup on Golf Club Picks Up Ball To End Stooping Over Hole



Convalescent soldiers and other persons who have difficulty in stooping to retrieve a golf ball after putting now can use a rubber vacuum cup attached to the end of a putter. The cup holds the ball firmly until it is removed with the fingers, and doesn't interfere with the club.

Siphonproof Gas Tank Cap

Motorists no longer need worry about losing gasoline to siphon thieves if they equip their car with a new keyless, theftproof, siphonproof gas tank cap. Designed in such a way that one model fits all shapes and sizes of filler pipes, the cap has a swaged neck to permit rapid filling and cast-in bottom baffles to prevent siphoning of gasoline from the tank. You simply screw it on and it stays put.



*Crandall Mfg. Co.
1512 W
L.A. 411
Cal*

Copyright material

VanRoy

The one and only Pipe of its Kind

Featuring the NEW
Ajustomatic
STEM



FREE-TURNING
SELF ALIGNING

VanRoy Ajustomatic
Bard . . . \$5



Smokers of the old style screw-stem pipes have long dreamed of the time when they could own a pipe that would be free of the usual screw-stem ailments. That day—and the VanRoy Ajustomatic—are here! • This is more than just another screw-stem. It is a totally new kind of pipe. New—because the stem is “float-mounted”—accurately lines up with the bowl as straight as a die every time. • The patented Ajustomatic stem can be turned as often as you like—it will never lock at an off angle. Thanks to VanRoy precision, you get this care-free alignment for the life of the pipe. Ajustomatic rates your life-long friendship, too, for its fine smoking qualities. • Give yourself the satisfaction of owning this latest—and greatest—VanRoy contribution to pipe contentment.



Signal of Quality in Pipes

VANROY COMPANY, INC., Empire State Building, New York 1



**MAKING
YOUR WISHES
COME TRUE...**

One wish has been fulfilled. Won by 3½ years of deadly struggle. With God's help, we have prevailed.

Now we have a chance to make another wish come true. For most of us, the outlook is a bright one. If we will simply use the brains, the will, the energy, the enterprise . . . the materials and resources . . . with which we won our war, we can't fail to win the peace and to make this the richest, happiest land the world has known.

Your wishes have been wrapped in that bright outlook. Your wish for a cottage by a lake. For your boy's col-

lege education. For a trip you long to take. For a "cushion" against emergencies and unforeseen needs.

You can make those wishes come true by buying bonds today . . . buying them regularly . . . and holding on to them in spite of all temptation.

There's no safer, surer investment in the world. You can count on getting back \$4 for every \$3 you put in E Bonds—as surely as you can count on being a day older tomorrow.

So why not be patriotic and smart at the same time?

**FULFILL YOUR WISH—BUY EXTRA BONDS
IN THE GREAT VICTORY LOAN!**

POPULAR MECHANICS MAGAZINE

This is an official U. S. Treasury advertisement—prepared under auspices of Treasury Department and War Advertising Council

For Your Man's Xmas
at home or abroad

To dad or brother, hobby or lover
...your gift of a fine pipe will mark
you as a "solid sender." The Biltmore
Blue Ribbon is a sweet-smaker, light
in the teeth, cool on the draw... a life-
time of pleasure. Many models...
choice century-old American briar...
rich-grained, with a craftsman finish.
Biltmore Pipe Co., 220 Fifth Ave., N.Y.

\$3.50



For a super special gift
choose a Biltmore of im-
ported Algerian Briar, as
\$5 \$7.50 \$10

Biltmore
"BLUE
RIBBON"
PIPES

HULL LEADS THE WAY

Driving again, you can depend on
the HULL STREAMLINE AUTO
COMPASS for road direction. Im-
proved in performance and accuracy. Ask your
dealer for a HULL—the leader. Circular free.
Price \$3.50.

HULL MFG. CO.

P.O. Box 246-D1

Warren, Ohio



EXPERIMENT WITH BLACK LIGHT!

FUN! THRILLS! PROFITS! See seven page article on this fascinating science in June 1945 issue of Popular Mechanics. We furnish all supplies. Trial Kit of 8 lacquers only \$6.25. Black bulb for testing, \$2.00. Lamps, lacquers, crayons, fabrics, etc. Write for descriptive list and full details today!

BLACK LIGHT PRODUCTS, 450 East Ohio Street
Chicago 11, Illinois

TRIG SLIDE RULE

Patent Pending

● Fits the pocket. Quickly solves trigonometry, radio, and electricity problems. Simply set the slides and read the answers for all three sides and angles of a triangle. Gives degrees, sines, cosines, and tangents of angles. Entirely automatic. Easy instructions included. Price only 75c or we will mail C.O.D. plus postage. Special offer to agents and dealers.

REED MFG. CO., 124 W. 4th St., Los Angeles 13, Calif.

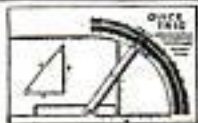

FREE BOOK ON PLASTICS

Answers your "Plastic" Questions. Flexible Molds. Liquid Marble. Plastic Flooring. A guide to Money Making Opportunities. Tells you how to start. Questions and Answers. If you're interested in this new field write now!

BING PRODUCTS DEPT. A1, 621 TREMONT ST.
BOSTON 18, MASS.

DECEMBER 1945

A WONDERFUL HEAD ON ITS SHOULDERS

Yes, sir, this is the plier with the 3-purpose head (plier, cutter, wrench)—and the compound action that gives over twice the power. It's the **BERNARD**—and there is no other plier like it.

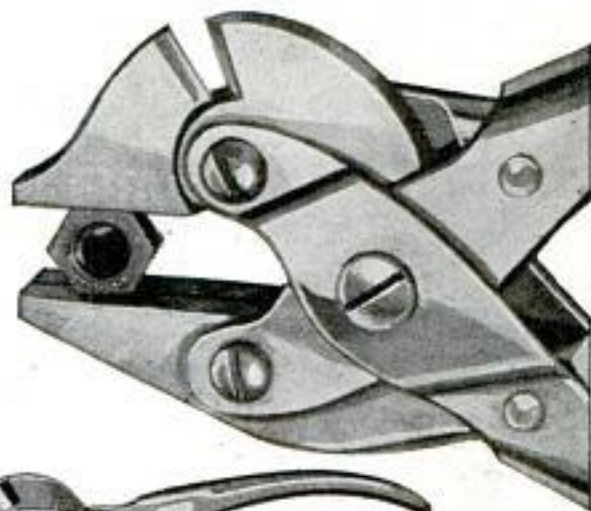

Jaws always parallel. Close like a vise. Hold FAST. Don't slip. Won't mar the nut.

Cutter on outside of head, convenient to use. 6" size cuts 8-penny nail easily.

Open throat—just the thing for handling wire. Note how jaws fit snug against wire.

Your local hardware store has **BERNARD** parallel-action pliers and other **BERNARD** tools: They are ideal gifts for Christmas.

For an interesting, illustrated catalogue of **BERNARD** pliers, nippers, cutters, pruners, etc., please use the coupon below.

BERNARD

TRADE MARK REGISTERED

Wm. Schollhorn Co., New Haven 9, Conn.

"Quality Tools Since 1870"

Wm. Schollhorn Company
7512 Chapel Street, New Haven 9, Conn.

Sirs: Please send me your free, illustrated catalogue of **BERNARD** hand tools.

NAME _____

STREET _____

PLACE _____ STATE _____

(Zone No.)

SAY YOU SAW IT IN POPULAR MECHANICS

ADD POWER

to your
CRAFT SKILL

Write on steel... engrave on glass, plastics... slice into wood, linoleum, cardboard, cloth... tool leather... hammer, file, chisel... do "hand quality" work with

BURGESS
vibro-tool

Trade Mark Reg. U. S. Pat. Off.

Vibro-Tool complete with 20 ordinary engraving needles **\$7.50**

Vibro-Tool plus complete set of attachments **\$10.90**

Attach check or M. O., or sent C.O.D.



Tools Leather



Carves Wood



Engraves Glass



Slices Cardboard

(HANDICRAFT DIVISION)
BURGESS BATTERY COMPANY

166 N. Wabash Ave., Chicago 1, Ill.

Windmill Made of Split Oil Drums Operates Pump and Generator



Steel oil drums were used to make a windmill on a ranch at Maybelle, Colo. Five halves of drums were mounted on a vertical shaft, three above the others, and the windmill operates a pump and a small generator. The barrel halves are attached in such a way that they are always headed into the wind.

Electric Gauge for Drydock Crane Lessens Danger of Upsetting

Boom-type cranes and similar equipment used aboard floating drydocks by the Navy have less chance of overturning with use of a crane stability gauge developed by General Electric. An indicating instrument in front of the operator shows when the crane is attempting to pick up too great a load, and also safeguards against extending the boom too far. Additional equipment automatically prevents the operator from hoisting an overload and sounds an alarm before the crane reaches its load limit.

Sensitive Instrument Weighs Air To Gauge Thrust of Engine

Engine thrust and torque and other stress and strain problems can be gauged with a sensitive instrument that measures and weighs with air. A flexible diaphragm forms one face of an airtight chamber. Compressed air enters the chamber through a pilot valve. Force to be measured is applied to the outside of the diaphragm and is opposed by internal pressure, which provides a direct measure of the external force.

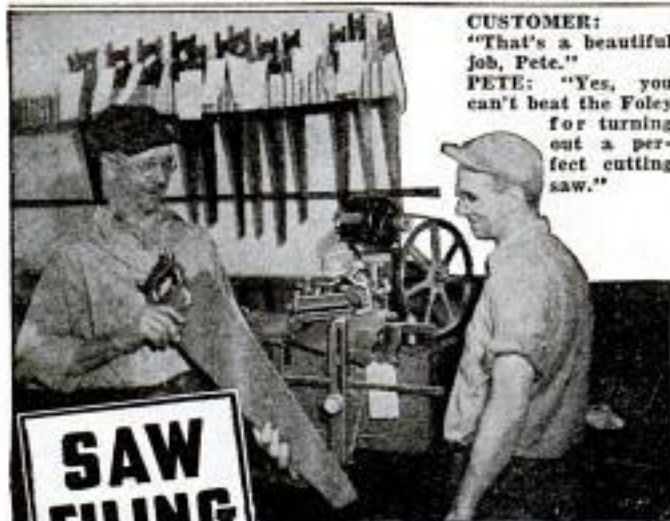

CUSTOMER:
"That's a beautiful job, Pete."
PETE: "Yes, you can't beat the Foley for turning out a perfect cutting saw."

is a Good Business

With the Foley Automatic Saw Filer you can have a fine cash business with steady customers and make a good living. The Foley automatically joints the saw, making all teeth even in size, shape, spacing. The Foley is the only machine that files all hand saws, also band and cross-cut circular saws.

SEND FOR FREE PLAN—Shows how to start a saw repair shop. No canvassing. Send coupon today.

FOLEY Automatic SAW FILER

FOLEY MANUFACTURING CO.
1216-5 Foley Bldg., Minneapolis 13, Minnesota
Send Free Plan on Saw Filing business, no obligation

Name _____

Address _____





This Complete Home Workshop
\$34⁹⁵-

5
LATHE
DRILL
PRESS
CIRCULAR SAW
EMERY WHEEL
SANDER

Durable! Powerful! Heavily Built!
Five power tools in one compact unit. Fabricated steel construction with high quality bronze bearings. Lathe 37" between centers. 6" or 8" circular saw. Drill press pulls 1/2" drill in steel. Uses 1/4 H.P. motor. Designed to handle all types of home woodworking jobs. Get the facts now before prices advance. Write Today!

EMRICK MACHINE CO.
1602 FULFORD ST.
KALAMAZOO, MICHIGAN

Write—FOR LITERATURE



MILL IT ON YOUR LATHE WITH A **PALMGREN** MILLING ATTACHMENT

Now — you can do milling, slotting, grinding, grooving, squaring shafts, sawing at angles, and many other important operations on your lathe. **PALMGREN MILLING ATTACHMENT** is a necessary fixture for small shops, schools and emergency work in large plants. Fits South Bend, Atlas, Craftsman, Logan, Sheldon and all other makes. It has 360° graduation for rotary angle adjustments, also graduated feed and adjustment screw. Easily mounted by straddling lathe's regular tool post. Try one—it will quickly pay for itself.

IMMEDIATE DELIVERY

No.	Width Jaws	Depth Jaws	Jaws Open	Weight Pounds	Base Opening	Price F. O. B. Factory
150	3 1/4"	3"	3 1/2"	6 1/2	3"	\$18.75
250	2 1/4"	1 7/8"	2 1/4"	11	3 1/4"	24.75
400	4"	1 1/2"	4"	25	2"	39.75

Order from your dealer or jobber. Write for circular No. 105
CHICAGO TOOL AND ENGINEERING CO.
Mfrs. of PALMGREN PRODUCTS for Over 25 Years
8365 South Chicago Avenue • Chicago 17, Illinois



\$75,000 for boy MODEL BUILDERS

- 8 UNIVERSITY SCHOLARSHIPS**
- 588 CASH AWARDS**
- 36 CONVENTION TRIPS**

Here's the biggest news you've read in a long time. You are eligible to try for these awards in the TWO competitions listed below—if you reside in the United States and are between the ages of 12 and 19 inclusive.

- 1. NAPOLEONIC COACH COMPETITION—316 awards, including two \$5,000 and two \$3,000 scholarships. In this, you build a miniature model Napoleonic Coach to plans we furnish you.**
- 2. MODEL CAR DESIGN COMPETITION—316 awards, including two \$4,000 and two \$2,000 scholarships. All you do is make a solid model automobile embodying your own ideas of motorcar design.**

Rules are simple and fair

In both competitions the following regulations will prevail. Boys 12 years old, or older, but not yet 16 by September 1, 1945, compete in the Junior Division. Boys 16 years old, or older, and not yet 20 on September 1, 1945, compete in the Senior Division. All boys within these age limits are eligible to Guild Membership. There are no dues or entrance fees of any kind. Each member shall receive, without charge, an official Guild membership card and button, and a full set of Guild drawings and instructions. Both competitions close July 15, 1946, and are open to all boys within the age limits, including the sons of General Motors employees. In all cases where the son of a General Motors employe qualifies for an award, duplicate awards will be made.

FISHER BODY CRAFTSMAN'S GUILD

An educational foundation sponsored by Fisher Body Division of General Motors

General Motors Bldg., Detroit 2, Michigan
Gentlemen: Please enroll me in the Fisher Body Craftsman's Guild for 1946, in the

Napoleonic Coach Competition
 Model Car Design Competition

Send me full instructions without charge

Name _____
Address _____
City _____ Zone _____ State _____
I was born on the _____ day of _____ 19____
Name of parent or guardian _____

Dept. 28

NEW TOOL READY! War Industry's Handy, All'Round Machine Now Available To Home Shops!

The world-famous Mead Band-sander—invented for and used by hundreds of war plants—is at last available to you for home workshop use! This remarkable machine quickly shapes, sands, carves and polishes wood, metal, plastic! Works equally well on inside cut-out openings or irregular outside edges. Gets at places no other can! Tilting table for bevelling, chamfering. Rust-and-sweat proof top. Ball bearings. Saves time, labor, money on jobs in any home or industrial shop. Invaluable to home-craftsmen, makers of patterns, tools, dies, signs, costume jewelry, castings, forgings, ornaments, radio and electrical parts, stampings, etc. Nothing else like it. Sold on 6 Day Trial, money back guarantee.

Circular Free!

Cuts Fast and Clean . . .
Saves Filing, Sanding Work

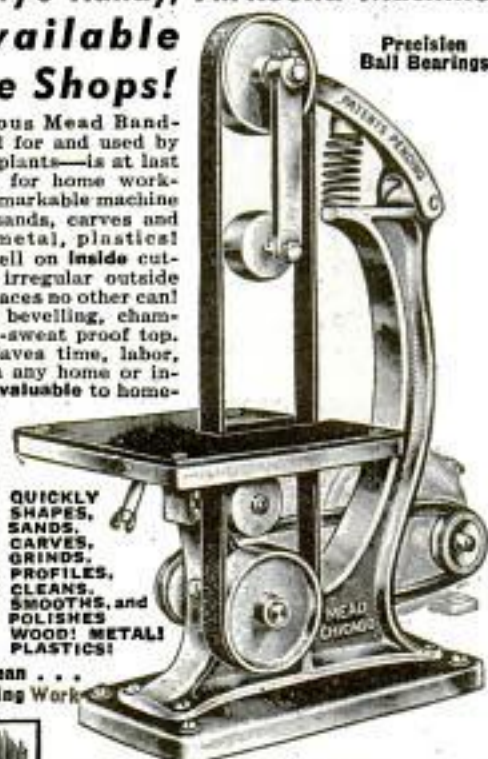

**QUICKLY
SHAPES,
SANDS,
CARVES,
GRINDS,
PROFILES,
CLEANS,
SMOOTHES, and
POLISHES
WOOD! METAL!
PLASTICS!**



Write for FREE Circular

Send for free details on "the machine that amazed the experts!" Rush a postcard today for Circular, surprisingly low price. Hurry!
MEAD SPECIALTIES CO.
4114 N. Knox Ave., Dept. 112, Chicago 41, Ill.



Attach to bike handlebar in a jiffy. Works like air indicator on an airplane.

**\$1.00
EACH**

Add 25c for handling and shipping.

SPARGO PRODUCTS COMPANY, Boston 6, Mass.

Name.....

Address.....

PM1.....

Height Gauge Has Small Channel For Holding Magnifying Glass

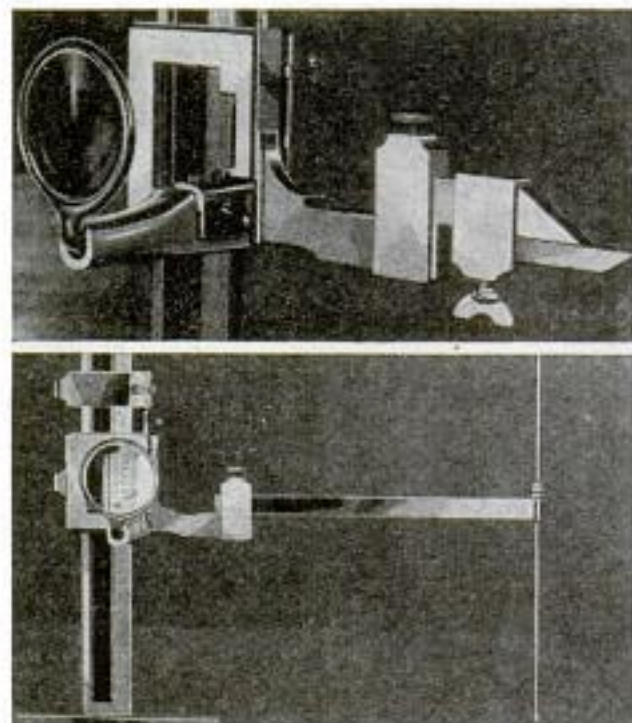

By attaching a magnifying glass to a height gauge as illustrated, both your hands will be free for other work. The glass is mounted in a fixture that slides into a channel bolted to the gauge, and can be removed easily when the gauge is placed in the toolbox.—Fred T. Oetjen, Newton, Ia.

Index Tabs on Typewriter Scale Help in Aligning Cards

When typing file cards, it is often difficult to align them evenly because of their stiffness. An easy way to do this is to attach two celluloid index tabs to the typewriter scales to serve as a gauge. These will show



whether the tops of the cards are parallel with the tops of the tabs. They can be left on permanently as they may be useful for other purposes, as in filling out various forms and in typing letterheads and envelopes.—Allen Fiske, Chicago.

Damp Towel Tightens Chair Seat

To tighten a cane-chair seat that sags, turn the chair upside down and lay a damp towel on the underside of the cane. After 30 min., remove the towel but leave the chair upside down until dry.—Joseph Greene Cleveland, Minneapolis, Minn.

Your Rust Troubles are Over CORODEX Rust Remover

is the war-time miracle liquid heretofore sold only to war plants. CORODEX positively removes RUST and CORROSION regardless of depth, from iron, steel, brass, bronze, copper, chromium and nickel. Clean and salvage your tools, hardware, sports equipment, household utensils, etc. for a few cents a piece. NO RUBBING. See "Needle's Eye" article December 1944 issue.

• Ask your dealer or send \$1.00 for full quart F.O.B. Chicago, Express. Valuable "Manual of Rust Control" sent FREE with order.

ALLIED PRODUCTS COMPANY
1133 NEWPORT AVE., PM12 CHICAGO 13, ILL.



You Can WELD

Anything! Anywhere! Anytime!
With the New Model

FORNEY ARC WELDER

32 VOLT DC, 110-220 AC

• A complete workshop in itself, capable of doing heavy steel construction, light metal welding, brazing or soldering. As sturdy as the Rockies, it's mounted on a heavy steel base with cast aluminum case and easy-rolling cast aluminum wheels. Built with voltage control. Better on R.E.A. lines. Light, compact, powerful, fully equipped, low priced. Forney products are sold and used throughout the world. Machines for small shops or big plants, priced from \$20 up. Get full information, today. Several dealer territories now open. Write:

FORNEY MFG. CO.
FORT COLLINS 2, COLORADO

Army-Navy Type HEADPHONES

TYPE HS-33

Save up to 70% on genuine U.S. Signal Corps headphones. These are the better \$10.00 headphones for only \$2.95. Leather-covered headband, detachable rubber cushions, lightweight construction, impedance 8000 ohms. Ea. **\$2.95**

Write for our illustrated literature featuring all types of radio parts.

Arrow Radio Co., Dept. G, 2205 W. Division St., Chicago 22, Ill.

LAW

STUDY AT HOME for PERSONAL SUCCESS and LARGER EARNINGS. 35 years expert instruction—over 108,000 students enrolled. LL.B. Degree awarded. All texts furnished. Easy payments. Send for FREE BOOK—"Law and Executive Guidance."

AMERICAN EXTENSION SCHOOL OF LAW
Dept. 60 M, 646 N. Michigan Ave., Chicago 13, Ill.

DRILL PRESS OWNERS . . .



Convert your drill press into a multi-purpose machine with the new NOBUR ANGLE ADAPTOR.

Write for literature.

NOBUR MANUFACTURING CO., Dept. M
910 N. Orange Dr., Los Angeles 38

New 1946 SHOP NOTES Now Ready!

FOR EVERY MAN WHO USES TOOLS

One of these books is issued each year and is a reprint of articles published in our Shop Notes Department. It contains the cream of experience of years, of hundreds of our country's most successful mechanics. 50c per copy at your News Dealer, or send 60c to

POPULAR MECHANICS PRESS

Dept. 618 200 E. Ontario St. Chicago 11

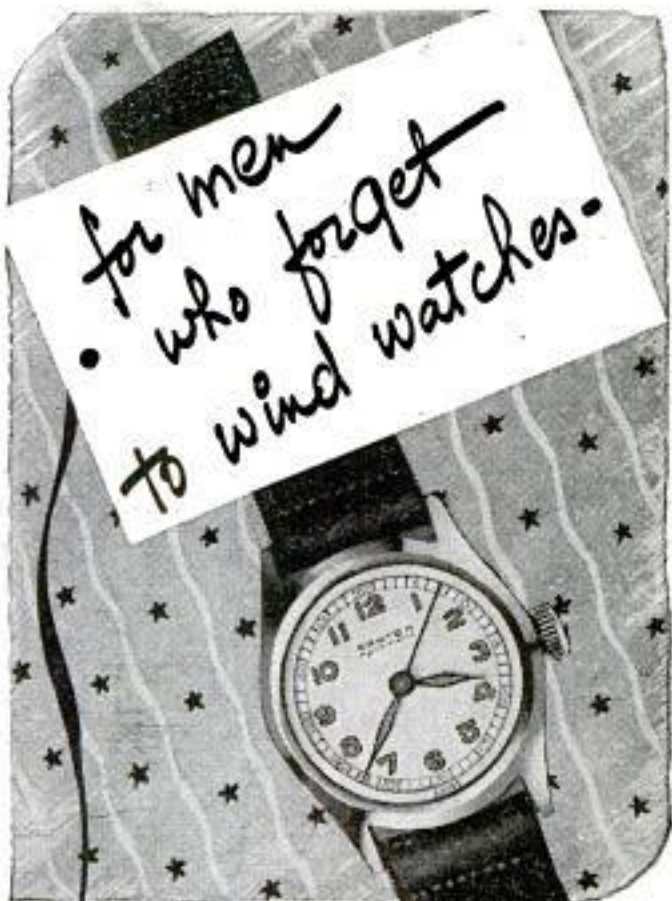

Give a CROTON AQUAMATIC the wonderful waterproof watch that winds itself!

No man's memory is infallible—but the Croton Aquamatic *is!* It keeps on running day and night, *without winding!* It actually winds itself, by natural motions of the wrist. It's *more accurate*, too. In a 30-day wearing test, 3-Aquamatics proved to be *13.5% more accurate* than the average of 9 other famous hand-wound watches.

It's CERTIFIED Waterproof!

You can leave the Aquamatic on when you wash your hands, bathe or swim. Hot or cold water can't harm it. This 17-jewel Croton is *sturdy*. It resists shocks, doesn't tarnish and the crystal can't break. Other features:—sweep-second hand, radium dial, waterproof strap. This is the ideal man's gift for only \$49.50! Fed. Tax Incl.

P. S. If not now available at your dealer, write for Free Booklet. Croton Watch Co., 48 W. 49th St., N. Y. 19

Croton

WATERPROOF AQUAMATIC

FREEZE and SAVE PERISHABLE FOOD IN A HOME-BUILT LEJAY FAST FREEZER

ENJOY BUILDING THIS HANDY FREEZER

When you consider how necessary such equipment is to the modern household, you will realize what these complete plans mean to men, like yourself, who enjoy making such things, and get a big kick out of saving money in doing so. Its sturdy simplicity and ease of construction appeal to all handy men and amateurs.

NO KNOWLEDGE OF REFRIGERATION REQUIRED

Plans are easy to follow and you may have much of the material at hand. FAST FREEZERS made from these plans have been in use since 1938.

MILK COOLER

PLANS, TOO

are included at no extra cost. Send only \$1.00 for the FAST FREEZER plans and enjoy these long evenings with an interesting and profitable project.

Christmas Wrapping if requested.

LEJAY MFG. CO.

447 LeJay Building
MINNEAPOLIS 8, MINN.

PLANS ONLY

\$1.00



FROZEN STORAGE
from 5° above
to 10° below
zero

For Fish,
Meat Game
Fruit etc.

5 Sizes
8-40 Cu.Ft.
capacity

LENSES 500,000 OF THEM

Get your precision prisms and lenses while they last. U. S. Army and Navy surplus. Send 3 cent stamp for list. A. Jaegers, 120-14P-115th Ave., So. Ozono Park 20, N.Y.

IDEAL GIFT for Returning Veterans

Honorable Discharge AUTO EMBLEM

Now you can really honor your service man! Give him this beautiful, permanent souvenir. Fastens over auto license plate—easily, quickly. Identifies him as World War II veteran. Richly designed in 5 colors—gold, silver, red, white and blue. Authentic design, deeply embossed in heavy sheet steel. Genuine chrome and durable baked enamel finish, 4 3/8 x 5 1/4". Guaranteed to please you. Only.....

\$1



SEND NO MONEY Send only name, address. Mailed promptly. On arrival, pay postman \$1 plus C.O.D. charge. Or, save C.O.D. by sending price with order. Money back if not pleased. Write for quantity price. Send Today!

JAY HENRY CO., Dept. P-125, Box 1296, Omaha 1, Nebr.

Precision Made, Standard

ELECTRIC EYE

(Photo Electric Cell)

For home or plant. Accurate, dependable, precision made for years of service, 28 ft. maximum range. To ring bells, operate lights, signals, doors, count objects, controls machines, etc. Saves time, labor, money. 100 times more sensitive than human eye. Complete 110 volt, \$42.50 delivered (plus tax). Shipped C.O.D. on regular purchase order or C.O.D. with \$5.00 deposit. Money refunded if not satisfied.

Descriptive folder on request—write

COAST WHOLESALE & MANUFACTURERS

6505 South Broadway Los Angeles 3, California

PLASTIC HOMES

New Building Material! Resurface old homes; build new ones. Colorful Beautiful LIQUID MARBLE—SANITARY COMPOSITION FLOORING—Durable, noiseless; put on like plaster; resilient—yielding as cork; lasts like stone; plain or marked in tile design. RUBBERLASTIC Mold Compound—Mold novelties, statuary, toys, gifts, plaques, rubber animals. COLORED POTTERY—Bedbaths, garden furniture, vases. TILLEX ROOFING—tile-like colors. Illustrated literature and colorings other Compositions and Plastics Free. RAPID MARBLEIZING SERVICE, Dept. 10. Specialists in Composites and Plastics. Edwardsville, Illinois.

ARMY RADIO PHONES only \$14.95



Made to U. S. Army Specifications, passed by Signal Corps Inspectors. Dynamic Microphone and dynamic receiver of finest quality—Water, shock, weather and altitude proof, used on tank and aircraft (B1B) intercom systems. For recording, for battery-less telephone, talk through your radio set or use earphones for pocket-size set loud speaker.

Complete two receiver, cord set, head band, and dynamic hand microphone. Less than regular cost of dynamic mic. \$14.95 postpaid.

Electronic Products Co., St. Charles, Ill.

The Chief WORK BENCH

Built to Last a Lifetime!

With Bottom Shelf and 18" Sq. Drawer. 2"x6", Solid Plank, Grooved and Dovetailed Top and 1"x8" Back Rail, Shellacked to a Smooth, Satiny Finish.

• 6 Ft. Long • 34" High • 26" Deep. Shipped Knock-down, with Bolts, Nuts and Screws and ABC Chart for Quick, Simple Assembly.

Prompt Delivery
MOHAWK LUMBER CO.

14525 W. Chicago Boulevard
DETROIT 27, MICHIGAN



\$16.95
F.O.B. DETROIT

Send Check or Money Order, or With Ship C. O. D. (\$5 Deposit)

MOHAWK LUMBER CO. Dept. 12
14525 W. Chicago Blvd. Detroit 27, Mich.
Enclosed Check Money Order for \$
Ship CHIEF WORK BENCHES at
Quantity
\$16.95 each, F.O.B. Detroit, Mich.
 Send C.O.D., \$5 Deposit Enclosed.

NAME.....
ADDRESS.....
CITY..... STATE.....
No Priority Necessary!

It's Easy to Seal Out Drafts
and Dust With
KALK-KORD

Quickly—
Without
Tools!



Just press Kalk-Kord into cracks and holes with fingers—it caulks and seals inside or out—stays pliable—non-hardening.

The original caulking compound in soft, rope-like form, Kalk-Kord has hundreds of uses around the house. Keeps out drafts around window and door frames; seals and fills holes in walls, in wood, or plaster. It's waterproof and can be painted over at once.

Neat and clean to use—thousands of boxes sold to satisfied users everywhere. Packed in convenient rolls. Get your box today.

Buy at your nearest Sears-Roebuck Retail Store
or order by mail from Sears

PRESSTITE ENGINEERING COMPANY

3978 Chouteau Ave.

St. Louis 10, Mo.

...give  pleasure



CUSTOM-MADE FOR THE CARRIAGE-TRADE

Since 1856

SAY YOU SAW IT IN POPULAR MECHANICS



M-SCOPE MINERAL, METAL LOCATORS

Unsurpassed in Efficiency

FREE 16 PAGE BOOKLET ON REQUEST

FISHER RESEARCH LABORATORY
PALO ALTO, CALIFORNIA



DECEMBER 1945

Now
for EVERY WORK SHOP!
NEW
Invention
Electroplates
by BRUSH



Easy to Plate **CHROMIUM**
GOLD, SILVER, NICKEL, COPPER

... For Pleasure and Profit!

If you have a workshop—at home or in business—you need this new Warner Electroplater. At the stroke of an electrified brush, you can electroplate models and projects—you can replate worn articles, faucets, tools, fixtures, silverware, etc. with a durable, sparkling coat of metal... Gold, Silver, Chromium, Nickel, Copper or Cadmium. Method is easy, simple, quick. Everything furnished—equipment complete, ready for use. By doing a bit of work for others, your machine can pay for itself within a week. So make your shop complete by getting a Warner Electroplater right away. Send today for FREE SAMPLE and illustrated literature. ACT AT ONCE! Mail Coupon.

WARNER ELECTRIC CO., DEPT. D-6
663 North Wells, Chicago 10, Illinois

FREE Details & Sample!

WARNER ELECTRIC CO., 663 North Wells, Chicago 10, Dept. D-6
Gentlemen: Send Free Sample and Details to:

Name _____

Address _____

City _____ State _____

NEW! DIFFERENT! THRILL Your Friends With

LIQUID LIGHT

Chemistry Brings You ...

100 AMAZING EXPERIMENTS AND GAMES with cold liquid light. Write with fire. Form whirlpools of light. Make "Neon Tubes" of liquid. 97 other experiments with LIQUID LIGHT in blue, yellow, pink. 10 items in each Kit. **SEND NO MONEY—THE PERFECT GIFT—** Pay postman \$2.98 plus postage. Or send cash and we pay postage. **MONEY BACK IF NOT SATISFIED! FREE Booklet—** "100 Magic Experiments" with each Kit. **FREE**

MAIL NOW

PELHAM SCIENTIFIC PROJECTS, Dept. B

1 Wolfs Lane, Pelham 65, New York

Send me _____ LIQUID LIGHT Kits.

I enclose \$2.98 for each Kit. I will pay on delivery.

Name _____

Street _____

City _____ State _____

NEW! Ideal Gift for Your Service Man!

Heavy 10K Solid Gold Souvenir Service Ring of World War II. A beautiful and authentic ring that your service man will be proud to wear and cherish forever. It plainly shows that he is a Veteran of our Armed Forces of World War II. Available in all sizes. We pay postage and Fed. Tax. No. 1214 10K Solid Gold \$18.00
Solid Sterling Silver - - - - \$6.00

Send for Circular of Service Jewelry

EDWIN W. LANE CO., Dept. PM, 32 W. Randolph St., Chicago 1.



211

Copyrighted material

MORE HELPFUL BOOKS

Use Them to Make and Save Money

FORTY POWER TOOLS
YOU CAN MAKE

How to Read
BLUEPRINTS

GARDEN BOOK

SAVE \$100 A YEAR ON
YOUR CAR

THE YOUNG CRAFTSMAN

BUILD A BOAT
FOR PLEASURE OR PROFIT

WELDING-BRAZING
AND SOLDERING

CONCRETE HANDBOOK

The
BOY MECHANIC

FORTY POWER TOOLS YOU CAN MAKE (New Edition)

If you want an inexpensive motorized workshop that will speed up your work and do it accurately, get this amazing book. Explains how to make forty different machines, such as lathes, drill press, jig saw, band saw, circular saw, sanders, from pipe fittings, old auto parts, wood, etc. (Cloth) \$1.25.

HOW TO READ BLUEPRINTS

This important subject covered in simple language. Shows how to read the "prints," which all machine shop construction and production follow. Gives signs, symbols, etc. (Cloth) \$1.50.

THE BOY MECHANIC (New)

A completely new book. The book for your boy—for any boy. Describes hundreds of things for boys to do. Crammed full of pictures. (Cloth) \$2.00.

PAINTING, FURNITURE FINISHING & REPAIRING

A new book for craftsmen, home owners, painters, handymen and manual training classes. Covers repairs and finishing, restoring antiques, spray and brush painting. Rare woods shown in actual colors. (Cloth) \$1.50.

GARDEN BOOK

Build your own trellises, fences, lawn furniture, outdoor fireplaces, attractive ornaments, etc. (Cloth) \$1.00.

WELDING, BRAZING AND SOLDERING

How to construct welding equipment and use it effectively. Small arc welder, spot welder, arc torch. Tricks of soldering, brazing, heat treating iron and steel. (Cloth) \$1.25.

YOUNG CRAFTSMAN

The book that thrills, entertains and trains young minds and hands. Over 450 easy craft projects—things to make—things to do. Hundreds of pictures. (Cloth) \$1.50.

BUILD A BOAT FOR PLEASURE OR PROFIT

How to build 17 low-cost boats at home—power, sail or row boat. Prepared especially for the home builder with limited tools, no experience and little money to spend. (Cloth) \$1.50.

CONCRETE HANDBOOK

Doing your own concrete work and making things of cement is simplified and made downright easy with the Popular Mechanics Handbook. For the home owner, handyman and construction men. (Cloth) \$1.50.

YOUR CAR

Save up to \$100.00 a year on your car. Make your car last longer. Auto-owners guide describes hundreds of simple car repairs, shortcuts, how to operate your car economically. (Cloth) \$1.50.

PHOTO GUIDE

Contains over 200 articles on making at low cost, your own camera and darkroom equipment; getting better photos; tricks, gadgets. (Cloth) \$1.50.

SHOP NOTES (1946)

Popular Mechanics annual mechanic's guide. For every man who uses tools. Few of subjects covered are lathe operation, drafting, shop practice, using hand and power tools, welding, autos, electricity, time and money-saving shortcuts, 50c at U. S. newsstands, 60c postpaid by mail.

Order from

POPULAR MECHANICS PRESS

200 E. Ontario St., Chicago 11, Ill.

POPULAR MECHANICS

Copyrighted material

The basic "know how" for the metal-cutting lathe operator



Not a "shop kinks" book but an easy-to-read, easy-to-understand textbook that starts at the beginning and goes thru each standard lathe operation.

"The Care and Operation of a Lathe" (2nd edition) is a book every home craftsman should have. Over 100 pages, 224 illustrations and charts. Bound in enduring dark blue fabricoid. 75c postpaid. Send for your copy today.



SHELDON MACHINE CO., INC.
4266 N. Knox Ave. Chicago 41, U.S.A.

MADE FROM IMPORTED BRIAR



Enjoy unmatched sweet smoking quality, outstanding fine grains, in modern designs, \$3.50 to \$10. At leading tobacconists everywhere. Write for free illustrated booklet.



C. B. WEBER & CO. 141 Cator Ave., Jersey City 5, N. J.

HOW TO FIX ZIPPERS

DON'T DISCARD GOOD CLOTHES or other zipper articles. No special tools, just a screwdriver or ice pick. Simple instructions with sketches. Mail \$1.

HELPMORE, Dept. (A), P. O. Box 140, LAKEWOOD, N. J.

LAWN ORNAMENT-NOVELTY PATTERNS

28 Lawn Ornament Patterns, 25c. Other patterns; 15-20" high; Dutch Girl, Dutch Boy, Pirate, Bull Terrier, Mexican Girl, Mexican Boy, Dwarf, Penguin, Flower Girl, 10c each. 25 Novelty Patterns, 25c. All 62 Full Size Patterns, \$1.00 Postpaid. Stretcher Pattern Service, Dept. A-8, Box 383, Belington, W. Va.

RADIO PARTS GRAB BAG!!

\$25 value assortment of Coils, Condensers, Transformers, Resistors, Controls, etc. An experimenter's dream. While they last, only.....

MARKO SUPPLY, Dept. P.M. 12
2924 Logan Blvd. Chicago 47, Ill.

\$3.98

ARE YOU LUCKY?

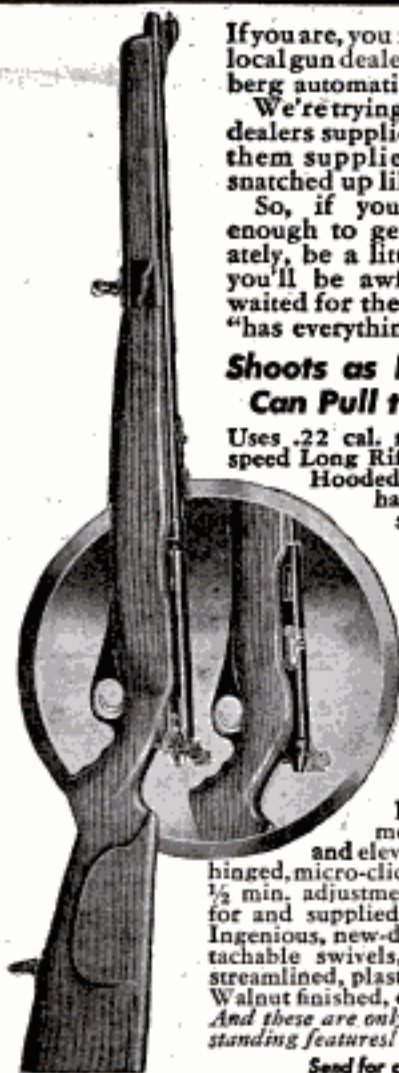

If you are, you might find your local gun dealer has this Mossberg automatic, Model 51M.

We're trying our best to get dealers supplied and to keep them supplied, but they're snatched up like hot cakes.

So, if you're not lucky enough to get one immediately, be a little patient and you'll be awfully glad you waited for the automatic that "has everything."

Shoots as Fast as You Can Pull the Trigger

Uses .22 cal. regular or high speed Long Rifle. Capacity, 15. Hooded ramp front sight has 4 attached inserts. Rear sight

\$22.80
(\$23.55 West of the Rockies)

has screw adjustments for windage and elevation. New \$100 hinged, micro-click peep sight with 1/2 min. adjustments, as designed for and supplied to U. S. Army. Ingenious, new-design safety. Detachable swivels, non-breakable, streamlined, plastic trigger guard. Walnut finished, oil-rubbed stock. And these are only a few of its outstanding features!

Send for catalogue

O. F. MOSSBERG & SONS, Inc.

56512 St. John Street :: NEW HAVEN 5, CONN.

A CHRISTMAS PRESENT FOR ALL FISHERMEN—BLUE CAT GAFF

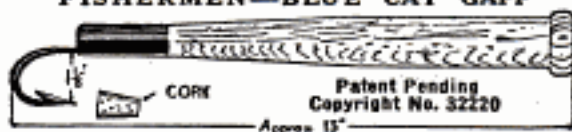

No tackle box complete without it. Surest way of landing a fish. Lifting 100 lbs. does not bend the hook. See Your Dealer. If he does not have it in stock, send \$1.00 to Kennard Mfg. Co., 3718 Michigan, Kansas City 3, Missouri. It will be sent to you Postpaid.

SAY YOU SAW IT IN POPULAR MECHANICS

Now A DYNAMIC HEAVY DUTY INDUSTRIAL WELDER

TO SAVE YOU VALUABLE TIME and MONEY!

This portable DYNAMIC WELDER—easily carried right to the job—plugs into any convenient properly wired 110 volt light circuit—works on IRON, STEEL, BRASS, BRONZE, AND OTHER METALS—has 8 metallic and carbon arc welding heat stages—does work you would think only possible with a larger more expensive machine. Once you see a DYNAMIC in operation, you won't want to be without it. Its simplicity will amaze you. In a year the DYNAMIC only costs you about \$6 a day. Helmet, rods, cables, holder and operating instructions, etc., furnished.

DYNAMIC SUPERCHARGED WELDER

DESIGNED TO DO HIGH GRADE WELDING INEXPENSIVELY—Maintenance Men; Farmers; Mechanics; Machine Shops; Foundries; Auto, General Repair and Job Welding Shops; all using the DYNAMIC find it so indispensable and useful that they cannot afford to be without it. If inexperienced, you can easily learn to do a variety of high-grade welding jobs by following the practical, simplified operating and welding instructions furnished.

Member of the Chicago Association of Commerce

DYNAMIC WELDER CO. • 13 East 23rd St., CN Chicago 16, Ill.

FOR ONLY

\$23.50

COMPLETE... AVAILABLE NOW WITHOUT PRIORITIES!

Write Today for Particulars.

Get details on our 10 day trial offer.

FARM IMPLEMENTS

BICYCLE REPAIRS

SHOP WORK

HOME APPLIANCES

AUTOMOBILE REPAIRS

DECEMBER 1945

Copyrighted material 213

WORLD'S

LOWEST PRICED ADDING MACHINE

VEST POCKET SIZE

MAKES IDEAL GIFT

Baby Calculator makes an ideal gift—for every Gift occasion. Birthday—Graduation—Christmas—Anniversaries. For men, women, children—teachers, business people, home or shop use. **COMES PACKED READY FOR GIFT WRAPPING.**

TEN DAY TRIAL

Money Back Guarantee

Because we know that our machine is the very best Calculator to be obtained at this low price, we make this 10 Day Trial offer, on a positive money back guarantee! Don't buy ANY Calculator without this guarantee! Send only name and address, pay postman \$2.50 plus postage (if cash is sent, we pay postage—you save up to 40c). (Send full cash if outside U.S.) Money back within 10 days if not delighted.

Fits vest pocket or purse. Guaranteed Accurate. Operated as easily, and as reliable, as machines costing many times as much. NOT A TOY or GADGET. Substantially made of 28-gauge steel—guaranteed for life against defects in construction. Beautiful looking, modernized design. Finished in Black, Silver and Red. You positively can't buy a Calculator of equal quality for as little money. **ACCEPTED AS THE FINEST LOW PRICED CALCULATOR FOR OVER 30 YEARS!** Operates with a flick of your finger. Adds, subtracts, multiplies, divides—counts up to ten million. Pays for itself over and over in mistakes avoided, and time saved.



IDEAL XMAS GIFT

FREE TRIAL

ONLY

\$2.50

AGENTS WANTED

TOTAL COST

SEND NO MONEY

FREE!!

Each Baby Calculator enclosed in beautiful rich-looking Leatherette Case—at no extra cost.



CALCULATOR Machine Co. (Mfrs.)

DEPT. 173, P. O. BOX 1118, CHICAGO, ILLINOIS

USE COUPON

CALCULATOR MACHINE CO. (Mfrs.)

P. O. Box 1118, Dept. 173, Chicago, Ill.

Your Calculator is just what I've been looking for. Send one at once (C.O.D.) or (I am enclosing \$2.50).

Name.....

Address.....

City.....State.....

AUTO ENGINE SPEED CONTROL GOVERNORS

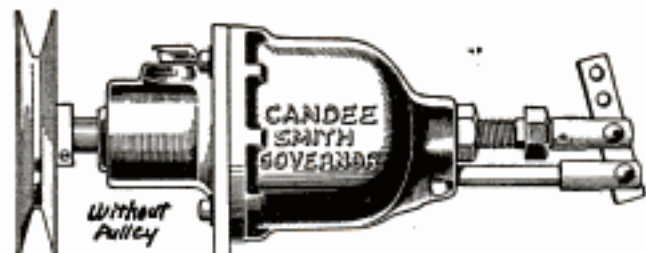

Without Pulley

Give constant or changeable speed to any auto or truck engine, when used for power. Guaranteed. Instructions. Oil ring bearing, \$12.50. Full ball bearing, \$19.00. Postage west of the Mississippi, 50c; east of Mississippi, 85c.

Agents Wanted: Parts Dealers, Garages, Wreckers, Implement Dealers. General Merchants, etc. Free circulars.

Pulleys to 3", \$1.00, wt. 1 lb.; to 6", \$1.50, wt. 1 1/2 lb.



State size of opening and distance between bolt holes.

1", \$3.75; 1 1/4", \$5.25; 1 1/2", \$6.50; 1 3/4", \$7.50; V8, \$7.00.

Mailing weight, 3 lbs. If remitting, enclose for postage. You may order from this ad, or we will send circulars.

Stocks carried: In Montreal: 7546 Wiseman St. In Latin America: East Asiatic Co. In Auburn, N. Y.: 3 Seminary Ave. Auburn Welding Supply.

CANDEE, Dept. H, 2641 S. Hill, Los Angeles 7, Calif.

PEPSI-COLA HITS THE SPOT

HOME INDUSTRY OPPORTUNITIES

Make Good Door Mats from Old Tires with simple homemade cutting and hole punching equipment powered with a 1/4 HP motor. Different styles. Illustrated instructions, 50c. Profitable Toy Making. From scrap wood, paper, metal, rubber, linoleum, cloth, plaster, etc., 25c. Liquid Rubber from Old Tires. Make molds, door mats and rubber articles. Ten formulas and processes, 50c. How to Make 30 Useful Articles of Wire and Sheet Metal with homemade dies. Illustrated, 50c. Rubber Mold Making. Marbleizing, glazing, etc., 25c. Security in a Small Farm. Twenty ways described, 25c. 10 Local Business Plans net up to \$200 a month, 25c. Collection of 100 Selected Formulas, 25c.

All 8 of the Above List of Booklets and Formulas, \$2.00. No C.O.D. HOME INDUSTRIES, 1318 So. 30th Ave., Dept. PM, Omaha 5, Nebr.

NEW WAYS CUT BUILDING

cost of houses, garages, poultry and farm buildings, cabins and stores. Make wall-high, insulated blocks with inside and outside finish with simple, homemade equipment. Composition roofs and floors. Ten formulas. Cement panels and tiles. Stream-lined roof, walls and gutters. Several ways to use cheap wood with cement makes strong buildings. Wallboard of sawdust. Save hundreds of dollars. 100 money and labor saving ideas. Mixer and buzz saw easily made from an old auto. 40 proved ways to earn \$10.00 to \$15.00 a day. Guaranteed illustrated booklets, \$1.00.

MAKE FURNITURE OF COMPOSITION cement, sawdust, asbestos, paper. Some part scrap wood and metal. Illustrated instructions to make tables, cabinets, chests, racks, shelves, incised sinks, lawn novelties and toys. 80 per cent profit. 50c.

HOW TO MAKE ACCURATE SHOP MACHINES: Band, jig and circular saws, electric drills, sanding wheels, forgo, tools, electric wood cutters and many other things from old auto parts and washing machine motors. Illustrated, 50c.

HOME MFG. ENTERPRISES, 50 selected home shop projects. Illustrated, 50c. Special: All five booklets described above, \$2.00 postpaid. No C.O.D.

HOME INDUSTRIES, 1318 So. 30th Ave., Dept. PM, Omaha 5, Nebr.

Enclosed find \$..... for which mail booklets as checked.

NAME.....

ADDRESS.....

CITY.....STATE.....

:: BUY VICTORY BONDS ::

POPULAR MECHANICS

Copyrighted material

WAR SURPLUS BARGAINS

* * * * *

SENSATIONAL VALUES FOR QUICK LIQUIDATION



GI BELTS

Of heavy canvas webbing. Adjustable eyelets all around. Used, but guaranteed.

A107—Each.....**98c**

BANDOLEERS



Army Bandoleers of heavy khaki. Used by hunters, boy scouts, etc. Well made, serviceable, guaranteed new.

A129—11 POCKET, EACH.....**49c**



Mess Kits

Regulation Army Mess Kits. Ideal for campers, boy scouts, etc. Slightly used but guaranteed perfect. Two pieces. Folding handle.

A116—EACH.....**69c**



Regular U. S. Gov't issue canteens. Plastic screw top cap chained to body. Slightly used.

A117—METAL BODY, Each.....**69c**

A118—PLASTIC BODY, Each.....**69c**

A109—Canteen Covers, new, Ea. **69c**

A119—Canteen Covers, used, Ea. **35c**

A120—Canteen Cups, used, Ea. **25c**



U.S. Govt. BOLO KNIFE

Extra heavy. For farm, home or jungle use. Blade of Gov't. Formula cutlery steel. Walnut riveted handle, 3 1/2 inch hilt, 10 1/2 inch blade. You'll find hundreds of uses for a bolo knife. Blade will take and hold a keen cutting edge. Wt., 2 lbs.

A112—with Army Sheath.....**\$4.95**

A212—Leather Sheath, extra.....**\$1.50**



PUP TENTS

Regulation Army Pup Tents of durable, brown canvas. Used, but in good condition. Fine for campers, outdoorsmen, boy scouts, etc. Grand Xmas gift for children.

A100—Tent Only.....**\$4.95**

A110—Tent, new.....**\$7.95**

A101—Ropes, wooden poles and stakes for above. Per set.....**\$1.00**



SHIPS BELLS

Purchased from U.S. Maritime Comm. Measures 10 inches high, 9 3/4 inch diam. Big 8 inch clapper. Weight 15 lbs. Fine for farms, clubs, estates, etc. All new.

A541, ONLY.....**\$9.85**

PROF. TELEGRAPH KEY

Purchased from the gov't. Finest design and construction. Mass measures 3x4 3/8 inches. Original value \$2.50. All parts of instrument brass. Adjustable.

A147—EACH.....**98c**



BLITZ CAN

Standard Gov't. blitz cans. Used and scuffed but guaranteed leak-proof. Measures 18 1/2 x 13 1/2 x 6 1/2 inches. Welded seams. Screw cap. Capacity 5 gal. A splendid bargain.

A542—EACH.....**85c**



CAVALRY SPURS

Genuine wishbone type cavalry spurs. Nickeled brass.

A103, Pair.....**98c**

A103 Spur straps per set of four.....**50c**



CATHODE RAY TUBE

Purchased from U.S. Gov't. for experimenters in electronics, radar, etc. Slightly used for test work. Guaranteed perfect. Tubes are standard No. 5BP1 or 5BP4 with 5 inch screen. Each tube tested before shipment. Specify number when ordering. Tube list on request.

EACH, express collect.....**\$12.00**



RADIO HEAD PHONES

Extremely sensitive with 4000 ohms resistance. Brand new and fully guaranteed. With moisture-proof cord and phone plug. A splendid value for the radio serviceman and experimenter.

A106—PAIR.....**\$2.95**

A108—New super sensitive phone, Pair.....**\$5.95**

7-LB. RADIO PARTS ASSORTMENT

A "gold mine" for the radio serviceman. Hundreds of valuable radio, radar and electronic parts, including rivets, soldering lugs, sockets, coils, resistors, trimming condensers, etc.

A130R—7 LBS.

\$1.79



RUBBER CUP WITH LID

Measures 3 1/2 x 3 1/2 inches—of genuine live rubber. Snug fitting lid. Makes fine tobacco humidifier, etc. All guaranteed perfect.

A503—EACH.....**59c**

AMMUNITION BOX

Fine for storing valuables, carrying lunches, etc. Of heavy gauge metal 7 1/2 x 11 x 4 inches. Fire-proof. Hinged lid with folding handle. Olive drab finish. Used, but perfect. A splendid value.

A825—EACH.....**25c**



McCLELLAN SADDLE

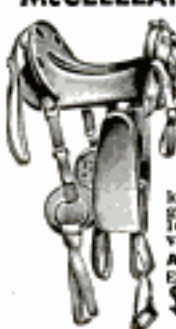

Brand new! McClellan model saddles. Top grade cowhide with hair girth, fender and 12 inch seat. Has straps for blanket roll and knapsack. Buckles, girth and stirrups. A splendid value.

A145—EACH.....**\$13.95**

27 LENSES, ALL NEW. PERFECT.

For experimental work in optics. Consists of 27 precision ground and polished prisms and lens elements in assorted diameters and focal lengths. Big variety, positive, negatives, etc. Actual value over \$100.00.

A519—27 PIECES.....**\$7.95**



50 LENSES, SEMI-FINISHED

Blanked and formed ready for polishing. Negatives, positives, and prisms in Crown and Flint glass. Worth many times this low price.

A520-50—LENSES, ONLY.....**\$1.95**

MODEL CLAY



Made in England. Used by artists, designers, sculptors, etc. for modeling. In 1 lb. packages.

A108—Pound, EACH.....**25c**

COMB. AIR PILLOW-LIFE BELT



Every outdoorsman, hiker, camper, boy scout, etc., should have one. Made of air tight, waterproofed, rubberized khaki 10 x 40 inches when deflated. Swimmers, boatmen, etc., use them as life-belt or beach raft. Quickly inflated or deflated. Folds compactly for storage. Used, but guaranteed perfect.

A127—EACH.....**98c**

OXYGEN GAUGE



Oxygen pressure gauge. Calibrated 0 to 2500 lbs. per sq. in. pressure. 2 1/2 inch dial, 3/4 inch threaded shank.

A144—EACH.....**98c**

OFFICERS WATCH COMPASS



Brand new gov't surplus. Army-Navy model. Single jewel mounted needle. Silver colored dial. A splendid value.

A174—EACH.....**\$3.35**



AVIATORS GOGGLES

U. S. Aviator Goggles. Oversize design with sponge rubber shock lining. Curved lenses. Elastic head band. Fine for industrial use, motorcyclists, etc. Hinged nose arch. Slightly used, guaranteed perfect.

A189—PAIR.....**\$5.95**

"MIKE" BUTTON

Microphone button for experiments in electronics and other electrical apparatus. Used in telephone, amplifier and detection circuits. Measures 2 1/2 in.

Brand new. A512—EACH.....**98c**



ORDER DIRECT FROM THIS AD

Values galore! Hundreds of hard-to-find items for home, shop and outdoors. Make remittances by money-order, bank draft or personal check. Send 25% deposit on C.O.D. orders. No C.O.D.'s on orders for less than \$5.00. Include sufficient postage on parcel-post orders—any overage will be promptly refunded. All quotations F.O.B. Chicago. Used items and materials are guaranteed serviceable and as described. Your money back if not more than satisfied.

BIG ILLUSTRATED CATALOG FREE

Dept. PM12
STARK'S
509 So. State St.
CHICAGO 5, ILL.

SHIPS LANTERN



Purchased from the Navy. Stands 22 1/2 inches high, 9 3/4 inches wide. Of heavy sheet metal. Windproof ventilation. Mounts on any wall. Burns oil—may be wired for electricity. All new.

R516—EACH.....**\$12.50**

CORK FLOAT

Measures 5 1/2 by 3 ins. Solid cork. Used as buoy, also for deep sea live bait fishing or muskellunge boat. White and red finish. New. A161—EA.....**75c**



SOUTH BEND



PLAN YOUR SHOP AROUND THIS LATHE

9-INCH LATHE FEATURES

- Fine workmanship by highly experienced machine tool craftsmen
- Superfinished spindle with large bearings
- Belt drive for smooth, quiet operation at high speeds
- Back-gear drive for power and low speeds
- 6, 8, 12 or 16 spindle speeds
- Thread cutting range (Model A)—4 to 224 per inch, 48 pitches
- Precision lead screw for thread cutting
- Worm drive and friction clutch for power longitudinal and cross feeds
- Three hand-scraped V-ways and a flat way on bed insure perfect alignment of headstock, saddle and tailstock

This South Bend 9" x 3' Model C Precision Bench Lathe (less electrical equipment and bench) can be yours for only \$110.50. The Model B Lathe, similar to the Model C but featuring an automatic apron, power longitudinal feeds, and power crossfeeds, lists at \$164.50. The Model A Lathe, same as Model B but with quick change gear box making threads and feeds instantly available without changing gears, sells for \$224.50. The required motor and control switch, not included in the lathe prices, range from \$14.00 to \$39.00 depending on horsepower, current, and type of control. All prices are f.o.b. South Bend, and although no price changes are contemplated, prices are subject to change without notice. For complete information and specifications write for Catalog 9-G.



SOUTH BEND LATHE WORKS

LATHE BUILDERS SINCE 1906

455 E. MADISON STREET, SOUTH BEND 22, INDIANA

Printed by Popular Mechanics Company, Chicago, Ill., U. S. A.

ELECTRONIC experts have lately outdone themselves in giving us "vest pocket" reception. They have made possible hearing aids easily concealed in the palm of the hand. They have designed radios the size of a cigarette case. And now they give us a postwar edition of the amazing Handie-Talkie—famed GI sending and receiving set. A key to these accomplishments is "Eveready" batteries. One of these storerooms of power, the "Eveready" "Mini-Max" battery, weighs only 1½ ounces. Yet, size for size, it is the most powerful "B" battery ever made.

Registered trade-marks "Eveready" "Mini-Max" distinguish products of National Carbon Company, Inc.

EVEREADY
TRADE-MARK



An "Eveready" "Mini-Max" Battery, with an "Eveready" Flashlight Battery, in the palm of a hand. Insist on "Eveready" batteries. They're dated to assure freshness. Fresh batteries last longer!

"VEST POCKET" POWER

War-time battery research packs giant power into midget space

HANDIE-TALKIE—five pounds of concentrated two-way radio. Powered with "Mini-Max" batteries, it will be ideal, when available, for fire fighting, outdoor jobs, exploring, auto racing.

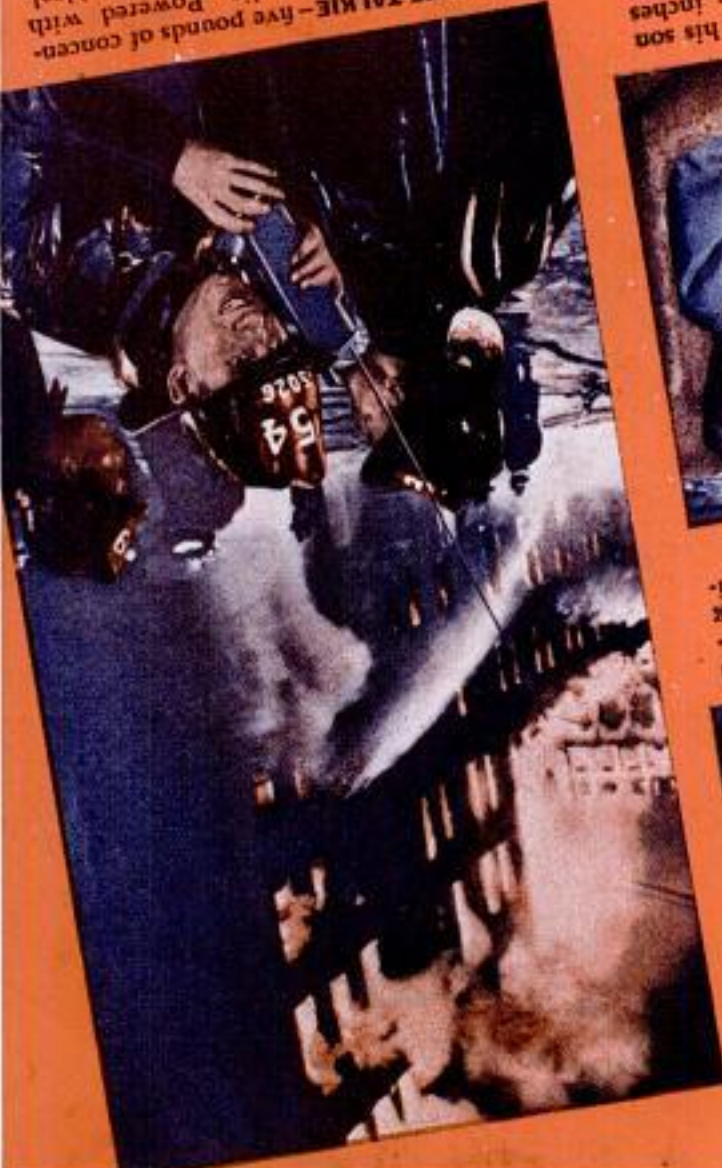

BREAST-POCKET HEARING AID—lets Dad hear his son play those first tunes. It measures 4¾ by 2½ inches and weighs a mere 6 ounces. Yet, its "Mini-Max" "B" Battery—available now—has phenomenally long life.



SIZED LIKE A CIGARETTE CASE, this radio is easily carried. Personal carphone permits listening without bothering others. Strong, day-long reception, thanks to the tiny, powerful "Mini-Max" battery, now available.



LISTEN EVERY SUNDAY TO SHEAFFER'S WORLD PARADE—NBC Complete Network, 3 P.M. E.T./2 P.M. C.T./1 P.M. M.T./12 P.M. P.T.

SHEAFFER'S

Copyright 1945, W. A. Sheaffer Pen Co.
Manufactured in U.S.A. Pat. Off.

Sheaffer's are still scarce, but supplies are increasing daily. VALIANT "TRIUMPH" pen, \$12.50; pencil, \$5; complete set, \$17.50. Federal excise tax additional. Other sets, \$3.95 up. Complete range of Colors.

The exclusive features found only in Sheaffer's 14-K gold, cylindrical *Lifetime* POINT introduce startling new standards of writing ease and smoothness! But Sheaffer's pens offer even more... Their Streamlined Balance... Their spiral surface where fingers touch... The transparent barrel... The new self-adjusting clip that holds. Embody all these and many more Sheaffer features in one beautiful writing instrument and you have the new White Dot TRIUMPH pen — the pen that pleases every eye — with a choice of points to suit every hand. W. A. Sheaffer Pen Co., Fort Madison, Iowa, U.S.A., and Toronto, Ontario, Canada.

THE WHITE DOT
ON THE PEN
IDENTIFIES IT!

THE NEW
Lifetime
POINT

New "TRIUMPH"
Pens
New *Trimline*
Pencils



TO THIS GIFT!

THERE'S *More Point*

