

POPULAR MECHANICS

MAGAZINE



WRITTEN SO YOU CAN UNDERSTAND IT

REG'D. TRADE MARK, GREAT BRITAIN, No. 41026

REG. U.S. PAT. OFF.

NOVEMBER
25 CENTS
30c IN CANADA

12 PASSENGER
HELICOPTER
PAGE 49



BEAUTY TAKES A BOW



When you see those new cars with Body by Fisher—you'll be quick to say that beauty takes a bow. They are truly beautiful.

It's easy to see that the Fisher Body organization has come out of the war with its skill and craftsmanship at a new peak.

So when you have the pleasure of selecting a new car again, there's one thing to remember—be sure that it carries the emblem of Body by Fisher.

It stands today, as it has stood for more than 37 years, as the sure sign of a better automobile. It means that all the skills inherent in the Fisher Body organization have now been combined to bring you greater beauty, to give you greater comfort and safety.

Body by Fisher



BETTER BY FAR

Fisher Body Craftsman's Guild Model-Building Competition—8 university scholarships, 624 other awards for boys 12 years of age and older. Enroll now! Guild Headquarters: General Motors Bldg., Detroit 2, Michigan.

BUY VICTORY BONDS — They finished their job — Let's finish ours

You get Body by Fisher

only on

GENERAL MOTORS CARS



CHEVROLET



PONTIAC



OLDSMOBILE



BUICK



CADILLAC

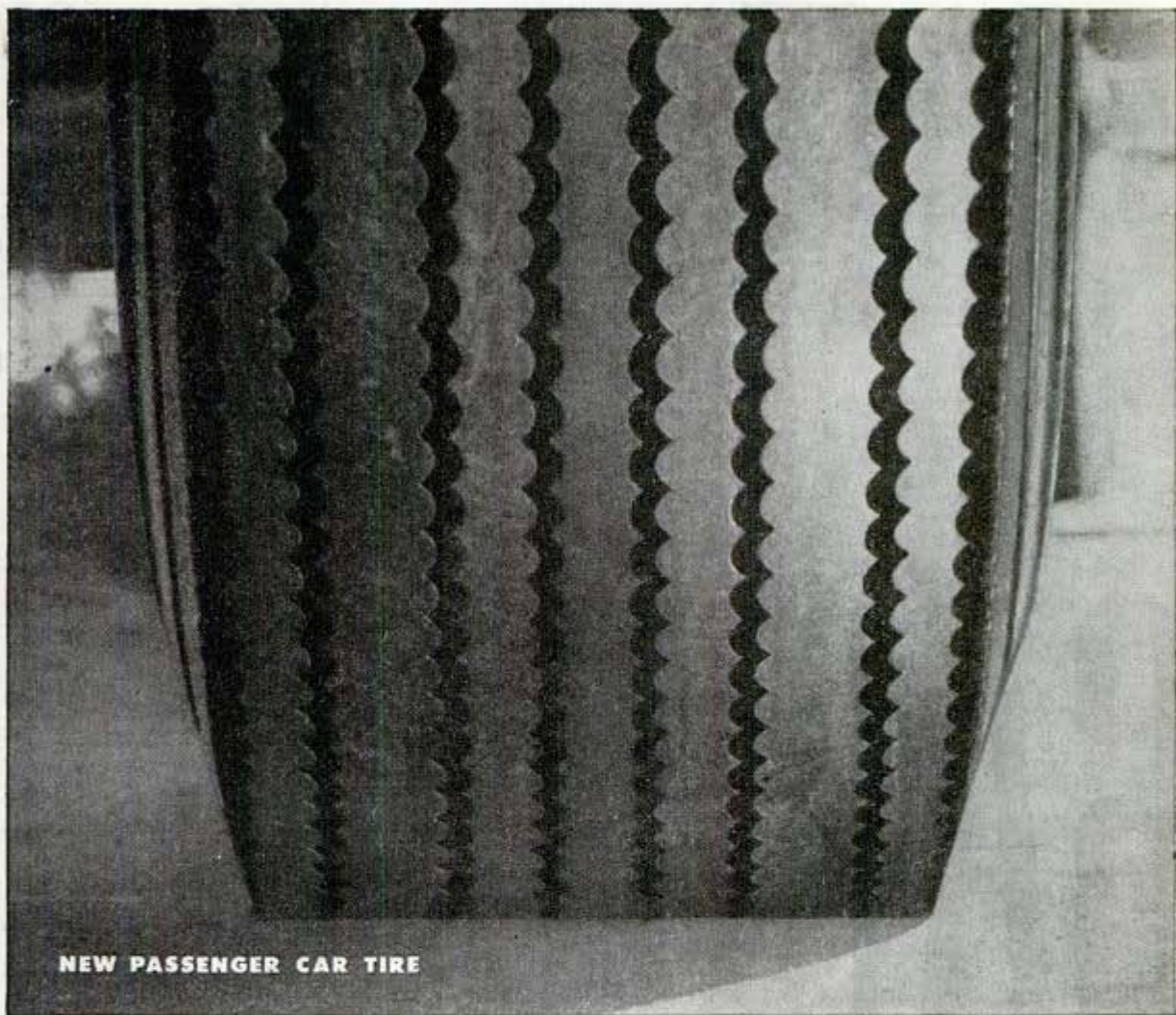

NEW PASSENGER CAR TIRE

COMING SOON: A SYNTHETIC TIRE THAT WILL OUTWEAR PREWAR TIRES

THIS isn't a guess. A new kind of tire has been developed, and tests show that *it will outwear prewar passenger car tires.*

It is made of a new kind of synthetic rubber developed by B. F. Goodrich—different from the ordinary synthetic rubber in general use by the tire industry.

The new tire has had more than 2,000 separate tests. Taxicab fleets, state police departments and the B. F. Goodrich test fleet have run it 16,800,000 test miles. Not only does it give longer tread wear than prewar tires, but it has more resistance to bruising or damage

from accident.

A new, slightly different shaped tread—we call it the "road level" tread—is another feature that means longer wear. Engineers had wished for years to make a tread just slightly flatter. But that more desirable shape always set up strains in the tire body, or "carcass," as it is called. B. F. Goodrich developed an entirely new and stronger cotton cord, designed it into a carcass that stands all these strains and permits the use of the new flatter, longer-wearing tread.

In a few weeks these new tires will begin to be produced in large

volume for shipment to our dealers, but supplies may be limited for quite a while. So take good care of the tires you have—make them last until you can replace them with these new, better B. F. Goodrich Silvertowns. *The B. F. Goodrich Company, Akron, Ohio.*



NOVEMBER 1945

This One



093A-5R0-Q97N

1A

• • •



TINY GIANT WITH A HISTORY

Long before the war, the men who design your Bell Telephone System were looking for an electron tube with frequency capabilities never before attained. With it, they could transmit wide bands of telephone messages—hundreds of them simultaneously through coaxial cable—economically, and over long distances.

They developed a tube which set a new standard in broad-band, high-frequency amplification. So minute that its electrode system had to be inspected under a magnifying glass, the tube could amplify either the voices of 480 people talking at the same time, or the patterns of television. Long-distance, broad-band transmission became a commercial reality.

6AK5



When war came, this tube excelled all others as an amplifier in certain military equipment. It then grew into the 6AK5, one of the great little tubes of the war. Besides producing 6AK5's in large quantities, the Western Electric responded to emergency needs of the Army and Navy by furnishing design specifications and production techniques to other manufacturers, of whom at least five reached quantity production. On every battlefield it helped our ships and planes to bring in radio signals.

Developing electron tubes of revolutionary design has been the steady job of Bell Laboratories scientists ever since they devised the first practical telephone amplifier over thirty years ago. Now tubes like the 6AK5 will help speed the living pictures of television, as well as hundreds of telephone conversations simultaneously over coaxial highways of the Bell System.

BELL TELEPHONE LABORATORIES

Exploring and inventing, devising and perfecting for continued improvements and economies in telephone service.



Popular Mechanics Magazine

Registered in U. S. Patent Office and Canada

H. H. WINDSOR, Founder

H. H. WINDSOR, Jr., Editor and Publisher

Next Month

BEFORE the war most motorists couldn't tell an octane from an octopus. They learned about octane rating of gasoline during the war when automobile engines revived the game of "Knock, Knock, Who's There?" The "who" in this case was a fuel of low rating. A December feature tells what petroleum experts have achieved since 1940. It's enough to make your postwar car sit up and purr.

CHRISTMAS is just around the corner—and so are a few million Christmas shoppers. Let the millions mob the department stores; you can do your shopping in your basement. An article next month suggests personal gifts you can make for every member of the family—and how to make them.

SINCE Leopold S. Schmidt came to America 51 years ago he has made 20,000 of those lifelike figures you see in show windows and museums—the kind you almost tip your hat to. "Meet the Model Man" in next month's issue.

YOU'VE heard someone remark—"You should have seen her expression! If only I could have snapped her picture!" But emotions flicker and vanish, and a posed smile is frozen. The best rule is to "Stop It With a Flash." Fred Korth offers tips on fast action photography in December.

CONVERTING an old 16-mm. silent home movie projector for sound was not a difficult problem for one radio experimenter who did it successfully at low cost in his home workshop. A two-part construction article in the Radio and Electronics section, beginning next month, tells you how to do it.

WHAT makes an invention click? The Crosby Foundation, subject of a December article, helps sort duds from winners.

NOVEMBER 1945

Volume 84	NOVEMBER 1945	Number 5
Managing Editor.....	Roderick M. Grant	
Assistant Managing Editor.....	Wayne Whittaker	
Shop Notes and Crafts Editor.....	James R. Ward	
Radio and Electronics Editor.....	Frank L. Brittin	
Art Director.....	Frank Beatty	
Associate Editor.....	John R. Kinsey	

In This Issue

Bringing the Atom Down to Earth	1
Prop + Jet = Fireball	8
The Big Pit	11
Cruisers Are a Tough Breed	17
Fighting With Fire	28
Robot Crews Fly the Air Liners	34
One Step Short of Tokyo	43
Helium Is a Busy Bachelor	50
ServRon 10—Floating Arsenal	59
c/o Postmaster, San Francisco	65
It's Our Turn at the Potter's Wheel	76
A Bridge for Every Mile	82

For the Craftsman

Serve It Western Style	89
"Reading" Your Stoker Fire	98
Novelty Jewelry From Sheet Metal	108
Building Your Own Telescope	114
Hints on Hammering	125
Thread Cutting on Your Lathe	130
Radio and Electronics	141

Other items, and manufacturers of available products described, are listed on pages 8A and 10A

Published monthly by POPULAR MECHANICS COMPANY, 200 East Ontario Street, Chicago 11, Ill. H. H. Windsor, Jr., president; Paul H. Dunakin, vice president and general manager; D. F. Windsor, vice president and secretary-treasurer; Glover L. Perkins, advertising manager. Single copy in the United States, 25 cents; subscription rates in United States and possessions, and countries of the Pan-American Postal Union, 1 year, \$2.50; 2 years, \$4.50; 3 years, \$6.00. Single copy in Canada, 30 cents; subscription rates, 1 year, \$3.00; 2 years, \$5.50; 3 years, \$7.50. To all other countries add \$1.00 a year over United States prices for overseas postage. If you plan to move, notify us at least 60 days in advance so you will not miss an issue. Give both old and new addresses. Entered as Second Class Matter, September 15, 1903, at the Post Office at Chicago, Illinois, under Act of March 3, 1879. Entered as Second Class Matter at Post Office Dept. Canada. Copyright 1945, by Popular Mechanics Company. Copyright under International Copyright Union. All rights reserved under Pan American Copyright Union. Printed in the United States of America.

3A



WITH the final victory won, we now will be able to go ahead with the construction of the new Defoe Model Homes. Right now is the time to get your name on our mailing list so that you will receive one of the first Defoe catalogs.

● ● Into the building of these homes will go months of construction, research and experimentation, *plus* the modern techniques of practical design and compactness which Defoe engineers learned while building many different types of fighting ships for both the American and British navies.

● ● As fast as the completion of our final Navy contract will permit, Defoe will produce complete homes with advantages of beauty, comfort and livability heretofore unknown in their price range. There will be nothing stereotyped, extreme or fantastic in Defoe homes. They will combine convenience with a wide range of individual designs in houses large or small—yet they will bring you

all of the economies made possible by volume production.

● ● It will pay you to investigate what Defoe will offer in your particular housing problem. Fill in the enclosed coupon and get it on the way to Defoe today.

Defoe

DEFOE SHIPBUILDING CO., BAY CITY, MICH.

HOUSING DIVISION
DEFOE SHIPBUILDING COMPANY
BAY CITY, MICHIGAN

Please send me further information about the
1946 Model Homes by Defoe.

Name _____

Street _____

City & State _____



FREE
 YOUR COPY OF
"TOOL NOTES"
is waiting for you

Industrial Arts Instructors, students, homeworkshop enthusiasts and all tool users will want a copy of TOOL NOTES. Published during the war as Crescent Tool Company's contribution to speed war training, it was widely used in technical schools, war plants and by the Army and Navy. Now Crescent is

offering it FREE to tool users. It tells and shows you how to use and repair all types of pliers, wrenches, hacksaws, screwdrivers, snips, cold chisels, etc., also how to do specific operations quicker and better. Mail the coupon today. Crescent Tool Company, Jamestown, N. Y.

CRESCENT TOOL CO.



JAMESTOWN, NEW YORK

MAIL THE COUPON AT ONCE!



Crescent Tool Company, Jamestown, N. Y.

Gentlemen:

Please send me my Free copy of TOOL NOTES

Name.....

Address.....

City..... Zone..... State.....

CRESCENT TOOLS
Give Wings to Work

In Your Mind's Eye

The Secret of MENTAL CREATING

IF you just like to dream, read no further. There comes a time when your fancies *must be* brought into light—and stand the test of every-day, hard realities. Are you one of the thousands—perhaps millions—whose thoughts never get beyond the stage of *wistful wishing*? Do you often come to from a daydream with the sigh, "If only I could bring it about—*make it real!*"

All things begin with thought—it is what follows that may take your life out of the class of those who hope and dream. Thought energy, like anything else, can be dissipated—or it can be made to produce actual effects. *If you know how to place your thoughts* you can stimulate the creative processes within your mind—through them you can assemble things and conditions of your world into a happy life of accomplishment. *Mental creating* does not depend upon a magical process. It consists of *knowing how* to marshal your thoughts into a power that draws, compels and organizes your experiences into a worth-while design of living.

ACCEPT THIS *Free* BOOK

Let the Rosicrucians tell you how you may accomplish these things. The Rosicrucians (not a religious organization), a world-wide philosophical fraternity, have preserved for centuries the ancients' masterful knowledge of the functioning of the inner mind of man. They have taught men and women how to use this knowledge to *recreate their lives*. They offer you a free copy of the fascinating book, "The Mastery of Life." It tells how you may receive this information for study and use. Use coupon opposite.

The ROSICRUCIANS
(AMORC)

SAN JOSE

CALIFORNIA

SCRIBE: K. O. P.
The Rosicrucians (AMORC),
San Jose, California.
Please send free copy of "The Mastery of Life,"
and I shall read it as directed.

Name.....

Address.....

City.....

**"What's he got
that I haven't got?"**

LOOK at the successful men you know. "What have they got" that you haven't?

Very little, probably. In most ways these men are no brighter or naturally more capable than average. Many of them probably have no more formal education or better natural aptitudes than you.

But that little extra they have is important. They have the special knowledge and ability for which business is glad to pay well—they know the what, why and how of business. They have also the confidence and aggressiveness which come from knowing that they know and can apply their knowledge.

You may add that extra—may get that same profitable knowledge and ability—that same confidence and aggressiveness—if you are willing to pay the price in earnest, necessary study. For LaSalle has spent 37 years developing, testing and proving, with over a million student members, spare-time success training in certain specialized business fields. What scores of thousands of men and women—many just like you—have done, you should be able to do.

You need not leave your home or interrupt your job; you need pay comparatively little money. But you must be ambitious and willing to study seriously. And soon after you start training, the results will begin to show up in your own confidence and in your work. For what you learn at home tonight is so practical that often you can apply it on the job tomorrow.

How much do you want success—more money, a promotion or a new job, prestige and responsibility? If you really want it, you will use the coupon below to find out what LaSalle training can do for you. It costs only a postage stamp, but a coupon like it has been the starting point to real success for scores of thousands—and can be for you.

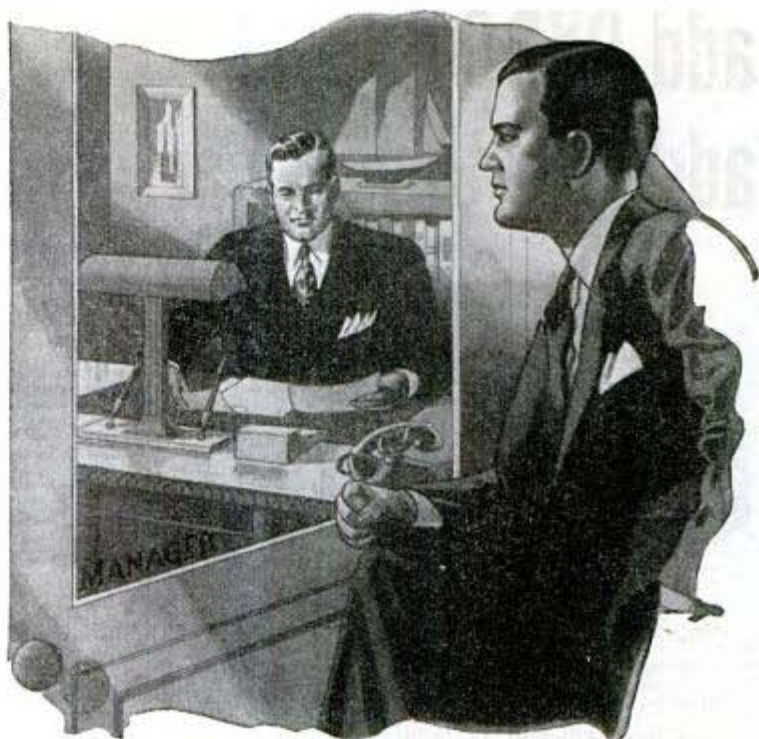

LA SALLE Extension University
A Correspondence Institution

Dept. 1164-R • 417 S. Dearborn • Chicago 5, Ill.

I want to know how LaSalle can help me win success in the field I have checked below. Please send me your free 48-page booklet about that field and your success training in it.

- | | |
|--|--|
| <input type="checkbox"/> Accountancy | <input type="checkbox"/> Salesmanship |
| <input type="checkbox"/> Bookkeeping | <input type="checkbox"/> Effective Speaking |
| <input type="checkbox"/> C.P.A. Coaching | <input type="checkbox"/> Executive Management |
| <input type="checkbox"/> Business English | <input type="checkbox"/> Industrial Management |
| <input type="checkbox"/> Law: LL.B. degree | <input type="checkbox"/> Traffic Management |
| <input type="checkbox"/> Foremanship | <input type="checkbox"/> Stenotypy |

Name.....Age.....

Position.....

Address.....

City, Zone and State.....

LA SALLE EXTENSION UNIVERSITY
A Correspondence Institution

add PYROIL add LIFE to your car



FOR THOSE last tough miles your car must drive . . . those miles you worry about . . . enjoy the comfort of knowing that you have efficient lubrication that reduces frictional wear, rust and corrosion. Know that you have no carbon formations or sludges. Know that you have a clean motor that *stays clean and stays lubricated.*

Next time you drive into your gas station . . . just say "add PYROIL" . . . and add life to your car.

Manufactured and Guaranteed by Pyroil Company, W. V. Kidder, Founder, 511 Pyroil Bldg., La Crosse, Wisconsin.

PYROIL COMPANY

511 Pyroil Bldg., La Crosse, Wisconsin

I want my car to last and run properly. Please tell me more about Pyroil and how it can accomplish this for me.

Name.....

Address.....

City or Town.....State.....



Jerry, the talking dog is entertaining hospitalized veterans by courtesy of the PYROIL Company.

WHERE-TO-BUY-IT INDEX

Manufacturer's name and address appear in parentheses directly after items believed by us to be commercially available

AUTOMOTIVE

Parisian taxicab designed for comfort.....	32
New features of 1946 automobiles.....	39
Gearless cycle does 70 miles on a gallon (Wyse Laboratories, 211 S. Ludlow, Dayton 2, O.).....	42
Berth on forepeak of trailer for extra driver.....	48
French try "pocket" car, Swedes design four-seater.....	71
Two packaged engines power 77-foot trailer.....	81

AVIATION

2000-mile Navy bomber carries rockets and torpedo.....	10
Huge German plane has 90-man capacity.....	10
Metal wing tanks used as cabin ferry tanks.....	25
Eight parachutes float rescue boat into ocean.....	26
Cadets "air legs" tested by swing.....	26
Amphibian plane has bunks and galley for campers.....	27
Empty canteens form floats for flyers downed at sea.....	47
Navy helicopter has twin rotors and carries 12 men.....	49
Photographer rides in belly tank to film battle.....	58
Kindergarten cadets try wings at junior flying school.....	63
Flexible strato-suit protects flyers at 15-mile heights.....	63
New Mustang fighter equipped with 10 rockets.....	64
Flying "bathtub" carries freight 450 miles nonstop.....	70
Electronic gas gauge measures plane's fuel by weight (Minneapolis-Honeywell Regulator Co., Minneapolis 8, Minn.).....	70
B-24 camouflaged to look like four planes.....	70
Fuel system on plane uses last drop of gas.....	81
Pusher-type plane for private pilot lands like a glider.....	88

INDUSTRY

Liquid insulation keeps electric motor running under water (U. S. Industrial Chemicals, Inc., 1910 Lincoln Bldg., New York).....	33
Screen images of flying particles made in two billionths of a second.....	33
One man moves 800 pounds with three-wheel drum truck (Sabin Machine Co., 6536 Carnegie Ave., Cleveland, O.).....	33
Ordinary soot finds many uses.....	40
Micrometer uses FM to measure 1/10-millionth inch.....	42
Illuminated magnifier aids in close inspection (George Scherr Co., Inc., 200 Lafayette St., New York 12).....	47
Glass tube sucks up hot steel for testing.....	47
Sense-of-touch tool worn on tip of finger (Faso Manufacturing Co., Bayside, N. Y.).....	47
Pulp mill waste yields alcohol for synthetic rubber.....	48
"Speedometer" for molasses tells rate liquids flow.....	53
Sealing stick for pipe joints (Lake Chemical Co., 607 N. Western Ave., Chicago 12).....	53
Sapphire precision gauges need no wear allowance (Sapphire Products Div., Elgin National Watch Co., Aurora, Ill.).....	55
Brand "typed" on tubing helps identify wires (Ralph C. Goxhead Corp., 333 Sixth Ave., New York).....	74
"Pin ball" tester reveals hardness of metals (Steel City Testing Laboratory, 8843 Livernois, Detroit 4, Mich.).....	75

MILITARY

Rocket "pipe organ" played dirge for Japs.....	7
Secrets that helped win the war.....	16
Lightweight "kickless" cannon absorb their own recoil.....	22
Grandpappy of the Duck and Weasel.....	24
Automatic sextant averages own readings.....	58
Pontoon barges for seaplane repair carried by LSTs.....	71
TNT divers blasted away obstacles to invasion landings.....	72
Australian submarine gun popular with Yanks.....	75
Umbrella becomes planetarium for classes in navigation.....	87

PHOTOGRAPHY

Projector has base-up lamp that can be changed while hot (Bell & Howell Co., 1801 Larchmont Ave., Chicago 13).....	33
Camera for blueprints occupies two rooms.....	56
Movie projector has power cord that winds itself (Eastman Kodak Co., Rochester 4, N. Y.).....	74

RADIO AND ELECTRICAL

Neon lamp tests conductivity of rubber.....	23
Radio for marines works under water (Western Electric Co., 195 Broadway, New York 7).....	42
Two wings swing light of fluorescent desk lamp (Sylvania Electric Products, Inc., Salem, Mass.).....	48
Two-way FM radio on Jeeps aids MPs in Europe.....	88

RAILROADS

Jammed railroad turntable moved by Jeep.....	49
Improved locomotive scoops take on water at 80 m.p.h.....	55
Cafeteria-lounge car accommodates 50 diners.....	64

MISCELLANEOUS

Jap engine powers cycle built by Coastguardman.....	23
Synthetic horse of steel bucks like the real thing.....	23
Homemade commissary feeds firemen fighting fires.....	25
Electric model of valley shows functions of dam.....	27
Music played on "typewriter" with standard keyboard (Electronic Corp. of America, 45 W. 18th St., New York 11).....	54
Rangers adopt flame thrower to fight forest fires.....	54
Electric eye closes rattrap with electrocution chamber (Electronic Traps, Inc., 7 Norfolk Pl., Rochester 6, N. Y.).....	87

Craftsman and Shop Notes Index

ART AND ARTIST

Swivel stand holds ink bottle level on sloping board.....	92
Sticks pivoted to drawing board aid in making perspectives.....	96
Notch in end of tube controls flow of oil color.....	104
Inked lines show width of pens held in corrugated board.....	112
Work hold-downs eliminate use of thumbtacks.....	128
Thumbtacks removed from board held by rubber bands.....	140

(Continued to page 10A)

"EVEN BETTER THAN I HAD!"



Of course, the I. C. S. Course which Bill is studying has it all over the one the Boss completed. I. C. S. texts constantly are revised in response to student questions and reactions . . . brought up to date on technical advances.

Today's texts embody the experience of more than 54 years, the expenditure of nearly six million dollars. This is the reservoir of Vocational Training knowledge from which every student draws his personalized instruction.

I. C. S. graduates, including many employers, will tell you how good I. C. S. Courses were in their day. But current texts, they find, are better.

Employers have a very real interest in I. C. S. This famous educational system regularly reports the progress of its students to the men for whom they're working. And it regularly receives letters expressing keen appreciation for this service.

I. C. S. training goes on record with these executives — counts in your record. Join the "coming" men! Mail the coupon for your own information as thousands of now successful men did for theirs. Possibly your own employer was one of them.

INTERNATIONAL CORRESPONDENCE SCHOOLS



BOX 5558-K, SCRANTON 9, PENNA.

Without cost or obligation, please send me full particulars about the course *before* which I have marked X:

- Air Conditioning and Plumbing Courses**
- Air Conditioning
- Heating Plumbing
- Refrigeration Steam Fitting
- Chemistry Courses**
- Chemical Engineering
- Chemistry, Analytical
- Chemistry, Industrial
- Chemistry, Mfg. Iron & Steel
- Petroleum Refining Plastics
- Pulp and Paper Making
- Civil Engineering, Architectural and Mining Courses**
- Architectural Drafting
- Architecture
- Bridge and Building Foreman
- Building Estimating
- Civil Engineering Coal Mining
- Contracting and Building
- Highway Engineering
- Lumber Dealer
- Reading Structural Blueprints
- Sanitary Engineering
- Structural Drafting
- Structural Engineering
- Surveying and Mapping

- Electrical Courses**
- Electrical Drafting
- Electrical Engineering
- Power House Electric
- Practical Electrician
- Practical Telegraphy
- Telegraph Engineering
- Internal Combustion Engines Courses**
- Auto Technician Aviation
- Diesel-Electric
- Diesel Engines Gas Engines
- Mechanical Courses**
- Aeronautical Engineering
- Airplane Drafting
- Flight Engineer
- Foundry Work
- Heat Treatment of Metals
- Industrial Engineering
- Industrial Metallurgy
- Mechanical Drafting
- Mechanical Engineering
- Mold-Loft Work
- Patternmaking
- Reading Shop Blueprints
- Sheet-Metal Drafting
- Sheet-Metal Worker

- Ship Drafting
- Ship Fitting
- Shop Practice
- Steel Mill Workers
- Tool Designing
- Welding, Gas and Electric
- Radio Courses**
- Electronics
- Radio, General
- Radio Operating
- Radio Servicing
- Railroad Courses**
- Air Brake Car Inspector
- Locomotive Engineer
- Locomotive Fireman
- Railroad Section Foreman
- Steam Engineering Courses**
- Boilermaking
- Combustion Engineering
- Engine Running
- Marine Engineering
- Steam Electric
- Steam Engines
- Textile Courses**
- Cotton Manufacturing
- Rayon Weaving

- Textile Designing
- Woolen Manufacturing
- Business and Academic Courses**
- Accounting Advertising
- Arithmetic Bookkeeping
- Business Correspondence
- Business Management
- Certified Public Accounting
- College Preparatory
- Commercial
- Cost Accounting
- Federal Tax
- First Year College
- Foremanship
- French
- Good English
- High School
- Higher Mathematics
- Illustrating
- Motor Traffic
- Postal Service
- Salesmanship
- Secretarial
- Sign Lettering Spanish
- Stenography
- Traffic Management

Name..... Age..... Home Address.....

City..... State..... Present Position..... Working Hours..... A.M. to..... P.M.

Canadian residents send coupon to International Correspondence Schools Canadian, Ltd., Montreal, Canada.

British residents send coupon to I. C. S., 71 Kingsway, London, W. C. 2, England.

DISCOUNT TO DISCHARGED VETERANS—SPECIAL TUITION RATES FOR MEMBERS OF THE ARMED FORCES

AUTOMOTIVE

Altered hinges permit garage door to clear high pavement... 97
 Gripper aids in attaching strap-on chains.....124
 Screen in filler pipe prevents gas siphoning.....124
 Windshield cleaning fluid thaws frozen fuel-tank cap.....127
 Canvas at back of truck covers load on tailgate.....128
 Carrier for storage battery is easy to make.....136
 Patching blown-out inner tubes.....138
 Oil drum raised on auto hoist for filling service barrel.....140
 Silt hose supports price tag on battery post.....140

FARM

Dishpan used as chicken waterer heated by electric lamp...136
 Stamped metal tags record live weight of fowl.....140

HAND TOOLS

Hole in chisel tapered with round file..... 91
 Gripper block helps when laying floors.....113
 Wheelbarrow kit keeps tools always at hand.....123
 Wood block adjusts height of workbench light.....122
 Small screw driver from pen nib and holder.....124
 Tapping jig reduces breakage and starts taps true.....128
 Double-end tap cuts rough and finish threads.....128
 Aluminum wire in mechanical pencil used for marking metals 129
 Self-centering punch holder useful in layout work.....126
 Inside handle for tray improves toolbox.....126
 Jig eliminates center-punching when drilling out rivets.....138
 Plastic face added to hammer by slip-on tube.....138
 Skirted holder for prick punch.....139

HOME IMPROVEMENTS

Using wooden storm sash on steel casement windows..... 93
 Pipes set in cement make durable fence posts..... 97
 Automatic check damper for use with stoker.....103
 Sealed-beam headlights converted to floodlight.....106
 Disk-type ventilator for storm sash.....124
 Improving ceiling heater unit.....138

HOUSEHOLD

Small child turns doorknob with extension handle..... 92
 Child reaches faucets by standing on covered drawer..... 93
 Solving home problems..... 94
 Kerosene prevents drain traps from freezing.....107
 Metronome improvised from three tin cans.....120
 Snap fasteners on overshoes taped to protect hose.....120
 Breakage of crayons avoided by wrapping with tape.....120

OFFICE

Filing-cabinet drawer pulls out from toggle-switch plate.... 92
 Wall maps held by rubber bands to prevent tearing.....106

PAINT AND PAINTING

Right-angle fitting on spray gun permits use on ceilings....104
 Paint can hangs clear of ladder on simple hook.....122
 Rubber band on paste-bucket bail serves as rest for brush...136

PHOTOGRAPHY

Metal-tube tripod for color-slide projector.....121
 Battery tester for photoflash gun.....121
 Box camera adapted for 35-mm. films.....123
 Small cut film held in large camera by cardboard insert....123

POWER TOOLS

Handscrew used as drill-press vise..... 96
 Jig holds irregularly shaped work for sawing.....113
 Table raised to get more use from magnetic jigsaw blade...120
 Odd-sized dado cuts made with notched block.....122
 Backstop held in lathe chuck while turning.....129
 Fly cutter bores rough and finish holes in one operation...129
 Size mark on end of twist drill not effaced by chuck jaws...129
 How to coil band-saw blades.....139

RADIO AND ELECTRONICS

Basic principles of radar.....141
 Electronic photo-print timer for enlarger or contact printer...142
 Sharp tuning crystal set for experimenters.....144

STORE AND SHOP

Mold aids in sorting machine screws.....104
 Worn brushes renewed by cutting off end.....106
 Plane handle on butcher's brush provides comfortable grip...140

WOODWORKING

Making sanding drums for hand grinders..... 96
 Cigarette box made from three jigsawed pieces.....107
 Jointer cuts tenons on round stock.....107
 Spindles marked for sawing spirals by hand.....137

MISCELLANEOUS

Rubber bands cut from finger cot..... 91
 Small-mouthed bottles filled with oil can..... 92
 Ink reservoir added to ordinary pen..... 96
 Time record for student pilots held on knee by tab..... 97
 Scoring prevents spread of crack in glass.....104
 Rubber disk used as glove in handling glass.....104
 Color designs with triangle blocks.....105
 Iron bar on exit helps pedestrians avoid trucks.....137
 Name engraved in tin plating identifies steel traps.....140

IMPORTANT NOTICE

It is the intention of this magazine to provide its readers with information regarding the latest developments in the mechanical arts. We take no responsibility as to whether the disclosures contained in our articles are covered by patents and advise readers to investigate this subject before making, using, or selling any of the products, machines, or processes described in order to avoid possible liability for patent infringement.

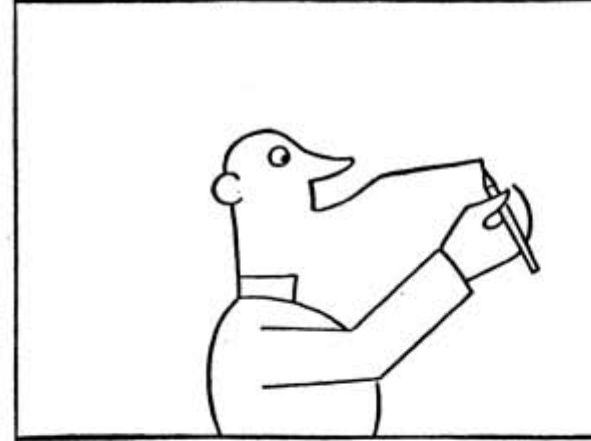
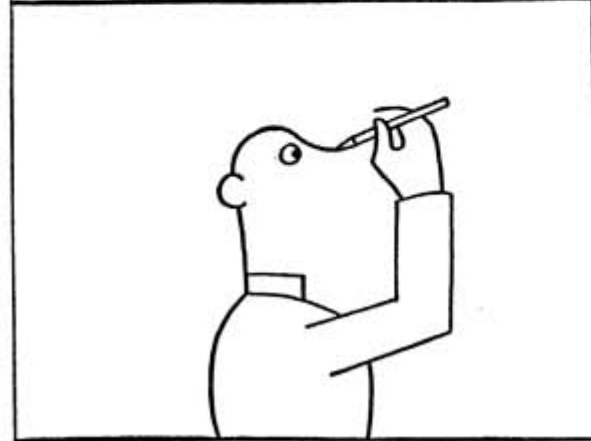
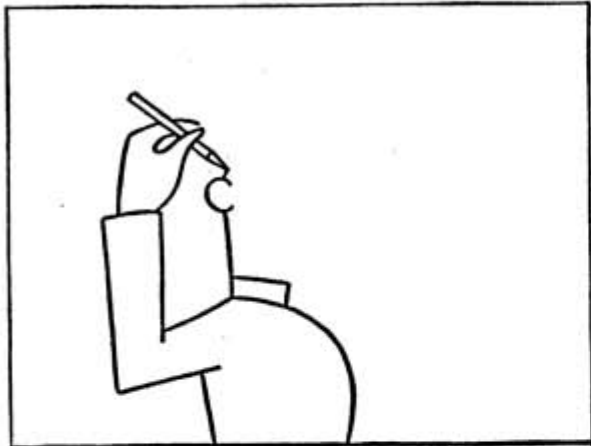

O. SOGLOW

AUDELS REFRIGERATION & AIR CONDITIONING GUIDE....\$4

New from Cover to Cover—1280 Pages, Fully Illus. Covering basic principles, servicing, operation & repair of household, commercial & industrial refrigeration & air conditioning. A gold mine of essential important facts for engineers, servicemen, users.

AUDELS CARPENTERS & BUILDERS GUIDES—4 Vols.\$6

A practical illustrated trade assistant on modern construction for carpenters, joiners, builders, mechanics and all woodworkers. 4 vols., 1600 pages, 2700 illustrations, flexible covers. Pocket size. Each volume sold separately \$1.50 a vol.

AUDELS AUTOMOBILE GUIDE...\$4

A practical quick ready reference book for auto mechanics, service men, operators & owners. Explains theory, construction & servicing of modern motor cars, trucks, buses & auto type Diesel engines. 1540 pages, fully illustrated. 55 chapters. Indexed. A standard book for mechanics. New fluid drive covered.

AUDELS DIESEL ENGINE MANUAL.\$2

A practical, concise treatise with questions and answers on the theory, operation and maintenance of modern diesel engines including General Motors 2 cycle Diesel. 384 pages, fully illus., flexible binding, pocket size. All details plainly brought out, this book is of extreme value to engineers, operators & students.

AUDELS WIRING DIAGRAMS.....\$1

210 Pages. Illustrated. Gives practical facts on wiring of electrical apparatus. It shows clearly how to wire apparatus for practically all fields of electricity. Each diagram is complete & self-explanatory. Highly Endorsed Pocket Companion.

AUDELS PLUMBERS & STEAMFITTERS GUIDES—4 Vols.\$6

A Practical Trade Assistant & Ready Reference. Explains in plain language & by clear illustrations, diagrams, charts, graphs, pictures principles of modern plumbing practice including Marine Pipe Fitting and Air Conditioning. 4 Vols.—1670 Pages—3642 Diagrams. Pocket size. Each Vol. Sold Separately \$1.50 a Vol.

AUDELS SHEETMETAL WORKERS HANDY BOOK.....\$1

Practical inside information. Fundamentals of Sheet Metal Work. 388 pages. Illustrated. 11 sections. Clearly written. Essential & important facts, figures, pointers in everyday language. Ref. Index.

AUDELS SHEETMETAL PATTERN LAYOUTS.....\$4

Developed by Experts for Sheet Metal Workers, Layout Men & Mechanics. A Practical Encyclopedia in 10 Sections, size 7 x 10 x 2—1125 Pages—350 Layouts—1600 Illustrations. 1001 Key Facts. Fully indexed for ready reference in answering your layout problems. Covers all phases of sheet metal work including Pattern Cutting, Pattern Development & Shop Procedure.

AUDELS ANSWERS ON BLUE PRINT READING.....\$2

For Mechanics & Builders. Covers all types of blue print reading including ship & airplane. 376 pages, fully illustrated.

AUDELS NEW MACHINIST & TOOLMAKERS HANDY BOOK...\$4

Covers modern machine shop practice in all its branches. 5 practical books in 1. New from cover to cover. Tells how to set up & operate lathes, screw and milling machines, shapers, drill presses and all other machine tools. 1600 pages, fully illustrated, 5 x 8 1/2 x 2. Indexed. 5 sections. 1—Modern Machine Shop Practice. 2—Blue Print Reading & How to Draw. 3—Calculations & Mathematics for Machinists. 4—Shop Physics. 5—How to Use the Slide Rule. 60 chapters. Easy to read and understand. A shop companion that answers your questions.

AUDELS MATHEMATICS & CALCULATIONS FOR MECHANICS \$2

Mathematics for home study or reference. 700 pages, 550 illus. Practical mathematics from beginning. How to figure correctly. Easy, correct methods covering a complete review. Ill. & Indexed.

AUDELS HANDY BOOK OF PRACTICAL ELECTRICITY.....\$4

For maintenance engineers, electricians & all electrical workers. 1440 Pages. 2600 Illus. Covers important electrical information in handy form—including Marine Wiring, Radio Principles, Welding. Indexed. A Key to a practical understanding of electricity.

AUDELS RADIOMANS GUIDE.....\$4

A key to the practical understanding of radio including Frequency Modulation, Television, etc., Aircraft & Marine Radio. For radio engineers, servicemen, amateurs. 772 pages. 400 illustrations & Diagrams. Photos. Review Questions & Answers. Reference Index. Authentic, clear, concise.

AUDELS ELECTRONIC DEVICES...\$2

Tells What You Want to Know About Electric Eye. Easily Understood. Covers photo-electric cells & their applications. Amplifiers, illumination, frequencies, voltage, photocell, tubes, Ohm's Law, wiring diagrams, etc.

AUDELS WELDERS GUIDE.....\$1

A concise, practical text on operation & maintenance of all welding machines for all mechanics. Over 400 pages, illustrated. Covers all methods of electric and acetylene welding including airplane work.



AN AUDEL GUIDE IS A GOOD FRIEND!

Use the brains and experience of others in these Guides of the Trades. Save time and money with right methods, short cuts, labor saving ideas. CHECK NOW! You can look over any Audel Guide in your home. Start the Easy Payments if satisfied.

CUT HERE MAIL ORDER

THEO. AUDEL & CO., 49 W. 23 St., New York 10, N.Y.

Please mail me for 7 days' free examination the books marked (X) below. I agree to mail \$1 in 7 days on each book or set ordered, and to further mail \$1 a month on each book or set ordered until I have paid purchase price.

- If I am not satisfied with Guides I will return them.
- Audels REFRIGERATION & Air Conditioning Guide . \$4.
 - Audels POWER PLANT ENGINEERS GUIDE . 4.
 - Audels PUMPS, HYDRAULICS & AIR COMPRESSORS . 4.
 - Audels WELDERS GUIDE . 1.
 - Audels BLUE PRINT READING . 2.
 - Audels SHEET METAL WORKERS Handy Book . 1.
 - Audels SHEET METAL PATTERN LAYOUTS . 4.
 - Audels AIRCRAFT WORKER . 1.
 - Audels MATHEMATICS and CALCULATIONS . 2.
 - Audels MACHINISTS & TOOLMAKERS Handy Book . 4.
 - Audels MECHANICAL Dictionary . 4.
 - Audels AUTOMOBILE GUIDE . 4.
 - Audels DIESEL ENGINE MANUAL . 2.
 - Audels MARINE ENGINEERS Handy Book . 4.
 - Audels SHIPFITTERS Handy Book . 1.
 - Gueths MECHANICAL DRAWING COURSE . 1.
 - Rogers DRAWING and DESIGN . 2.
 - Audels MILLWRIGHTS and Mechanics Guide . 4.
 - Audels CARPENTERS and Builders Guides (4 vols.) . 6.
 - Audels PLUMBERS and Steamfitters Guides (4 vols.) . 6.
 - Audels MASONS and Builders Guides (4 vols.) . 6.
 - Master PAINTER and DECORATOR . 2.
 - Audels GARDENERS & GROWERS GUIDES (4 vols.) . 6.
 - Audels ENGINEERS and Mechanics Guides Nos. 1, 2, 3, 4, 5, 6, 7 and 8 complete . 12.
 - Audels Answers on Practical ENGINEERING . 1.
 - Hawkins Aids to ENGINEERS EXAMINATION . 2.
 - Audels ELECTRICIANS EXAMINATIONS . 1.
 - Audels WIRING DIAGRAMS . 1.
 - Audels Handy Book of PRACTICAL ELECTRICITY . 4.
 - Audels ELECTRICAL POWER CALCULATIONS . 2.
 - Hawkins ELECTRICAL Guides at \$1. each . 10.
 - Audels ELECTRONIC DEVICES . 2.
 - Audels ELECTRIC Dictionary . 2.
 - Audels RADIOMANS GUIDE . 4.
 - Audels NEW ELECTRIC LIBRARY at \$1.50 a Volume Vols. I, II, III, IV, V, VI, VII, VIII, IX, X, XI, XII.

Name.....
 Address.....
 Occupation.....
 Employed by..... PM

AUDEL, Publishers, 49 W. 23 St., N. Y. 10

**I Will
Show You
How to**

Learn RADIO

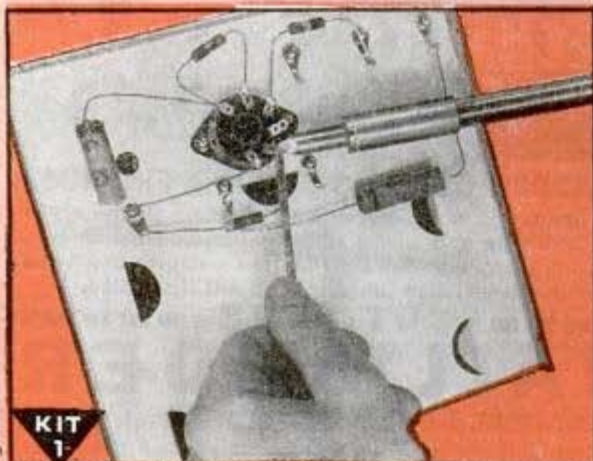

**KIT
1**

I send you Soldering Equipment and Radio parts; show you how to do Radio soldering; how to mount and connect Radio parts; give you practical experience.



**KIT
2**

Early in my course I show you how to build this N.R.I. Tester with parts I send. It soon helps you fix neighborhood Radios and earn EXTRA money in spare time.

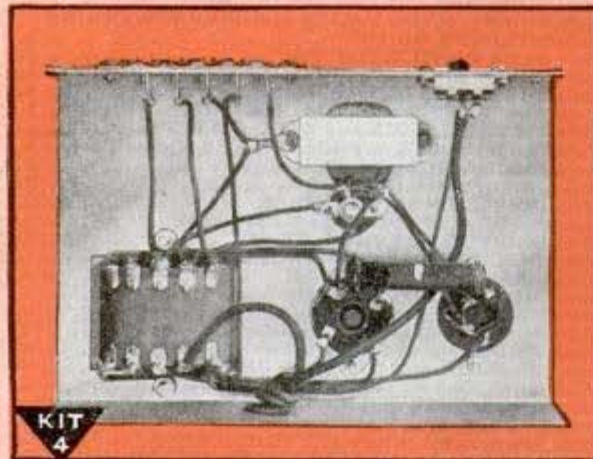

**KIT
4**

You get parts to build this Vacuum Tube Power Pack; make changes which give you experience with packs of many kinds; learn to correct power pack troubles.

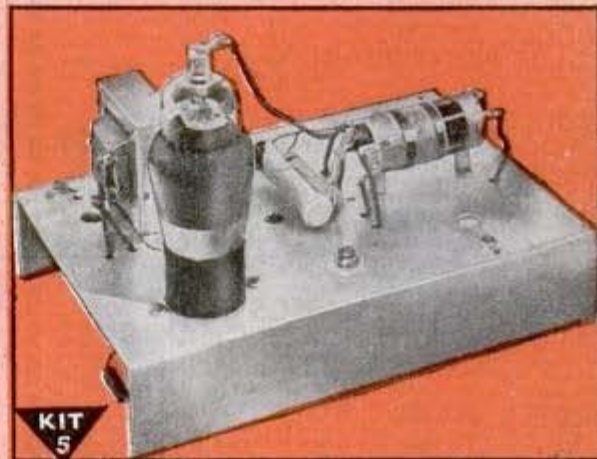

**KIT
5**

Building this A. M. Signal Generator gives you more valuable experience. It provides amplitude-modulated signals for many tests and experiments.

MEN I TRAIN AT HOME GET GOOD JOBS LIKE THESE

**\$250 a month
in own shop**



"I am now operating a radio shop for myself and own all my equipment. Right now I only repair radios, because there are none to sell, but I average \$250 a month."—J. M. SCRIVENER, JR., Aberdeen, Miss.

**Fixing Radios
Profitable Hobby**



"I am doing radio work in my spare time, and find it a profitable hobby. My extra earnings run about \$10 a week. I certainly am glad I took your N.R.I. Course."—FERDINAND ZIRBEL, Chaseley, North Dakota.

**Chief Engineer
Station KWLM**



"Am now Chief Engineer of Station KWLM and in charge of maintenance of Police Station KRIN, County Highway Dept. Also have my own business. Mighty glad to be in radio."—LLOYD V. STENBERG, 516 Litchfield Ave., W., Willmar, Minn.

**Still Climbing in
Air-craft Radio**



"I am still climbing as a result of my N.R.I. training. I now do aircraft radio work at Greenwood Army Air Field, and operate a radio shop in my spare time."—JAMES L. BOYETT, P.O. Box 218, Greenwood, Miss.

by Practicing in Spare Time

**I Send You
6 Big Kits
of Radio Parts**



KNOW RADIO *Win Success* I Will Train You at Home

Send coupon for **FREE Sample Lesson**, "Getting Acquainted with Receiver Servicing," and **FREE 64-page book**, "Win Rich Rewards in Radio." See how N.R.I. trains you at home. Read how you practice building, testing, repairing Radios with **SIX BIG KITS** of Radio parts I send you.

Future for Trained Men Is Bright in Radio, Television, Electronics

The Radio Repair business is booming NOW. Fixing Radios pays good money as a spare time or full time business. Trained Radio Technicians also find wide-open opportunities in Police, Aviation, Marine Radio, in Broadcasting, Radio Manufacturing, Public Address work, etc. Think of the boom coming now that new Radios can be made! Think of even greater opportunities when Television and Electronics are available to the public!

Many Beginners Soon Make \$5, \$10 a week EXTRA in Spare Time

The day you enroll I start sending **EXTRA MONEY JOB SHEETS** to help you make **EXTRA** money fixing Radios in spare time while learning. **MAIL COUPON** for sample lesson and 64-page book **FREE**. It's packed with facts about opportunities for you. Read about my Course. Read letters from men I trained, telling what they are doing, earning. **MAIL COUPON** in envelope or paste on penny postal. **J. E. Smith, President, Dept. SMP, National Radio Institute, Pioneer Home Study Radio School, Washington 9, D. C.**

● OUR 31st YEAR of TRAINING MEN for SUCCESS in RADIO

MAIL NOW!

MR. J. E. SMITH, President, Dept. SMP
National Radio Institute,
Washington 9, D. C.

Mail me **FREE**, your sample lesson and
64-page book. (No salesman will call.
Please write plainly.)

Age.....

Name.....

Address.....

City..... State.....**4FR**
(Please include Post Office Zone Number)

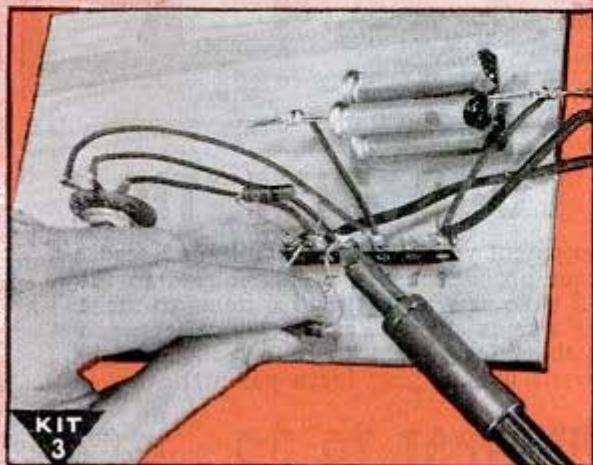

**KIT
3**

You get parts to build Radio Circuits; then test them; see how they work; learn how to design special circuits; how to locate and repair circuit defects.



**KIT
6**

You build this Superheterodyne Receiver which brings in local and distant stations—and gives you more experience to help you win success in Radio.

SAMPLE LESSON FREE

Gives hints on Receiver Servicing, Locating Defects, Repair of Loud-speaker, I. F. Transformer, Gang Tuner, Condenser, etc. Mail Coupon.

GETTING ACQUAINTED WITH
RECEIVER SERVICING

**My Radio Course Includes
TELEVISION • ELECTRONICS
FREQUENCY MODULATION**

INVENT

NOW IS THE TIME TO PATENT AND SELL YOUR INVENTION

Now, more than ever before, is the right time to patent your invention. Why? Because manufacturers everywhere presently engaged in war production are looking ahead to the future by buying up patent rights now, so they will have new and attractive items to make and sell for civilian consumption as soon as the war is over. This is what happened during and after the last war. Hence, the smart thing for you to do is to look ahead to the future too. Protect your invention and yourself by applying for a patent now.

FREE "PATENT GUIDE" EXPLAINS WHAT TO DO

Our Free 48-page "Patent Guide for the Inventor", containing complete information about patent procedure and selling inventions; answers many important questions concerning Patents that inventors constantly ask. It tells what facts, details, drawings, sketches, etc., are necessary to apply for a Patent; how to protect your invention through dated and witnessed disclosure; how to do this at once to safeguard your rights; how Patent Office Records can be checked to determine whether the invention is probably patentable before filing fees need be paid; discusses costs involved and a practical way these can be paid as the application progresses. It tells how some inventors secured financial backing; how many simple inventions have proved large commercial successes; how Patents covering improvements also can be profitably utilized and marketed; and countless other facts that every inventor will want to know. And in addition, our "Patent Guide" contains illustrations of over 150 basic mechanical movements.

WHY YOU NEED EXPERT ASSISTANCE

The Patent Laws were enacted for your benefit—to give you protection for the features of your invention which are Patentable. But these features must be legally and concisely set forth in the form of "claims". This phase of the procedure is so complex that the U.S. Patent Office advises the Inventor to engage a competent Registered Patent Attorney. We maintain a large staff—carefully trained registered patent attorneys—expert draftsmen—experienced searchers—to serve you. We have been serving inventors for more than twenty years. Write for a free copy of our "Patent Guide for the Inventor" today. Clarence A. O'Brien & Harvey B. Jacobson, Registered Patent Attorneys, 51-L Adams Building, Washington 4, D. C.

**CLARENCE A. O'BRIEN
& HARVEY B. JACOBSON**

REGISTERED PATENT ATTORNEYS

Free Book for **TORS**

48
PAGES
Over 150
Mechanical
Movements

FREE **"RECORD OF INVENTION"**

With our free "Patent Guide for the Inventor" you will receive also free a "Record of Invention" form. This "Record of Invention" enables you to conveniently make a proper, dated disclosure of your invention before you file your patent application, which will prove of great value to you, should the occasion for evidence arise.

TAKE FIRST STEP NOW

Remember, in Patent matters action is important. Delay can be costly. Therefore, take your first step now—toward protecting your invention. Send for your free copy of our "Patent Guide for the Inventor" containing complete information about patent procedure and selling inventions. At the same time, receive a free "Record of Invention" form with complete instructions for making a disclosure of your invention and establishing its date. This step costs you nothing—yet may be vital to your success. Mail the coupon in an envelope, or paste it on a penny postcard—now.



CLARENCE A. O'BRIEN **& HARVEY B. JACOBSON**

CLARENCE A. O'BRIEN & HARVEY B. JACOBSON
Registered Patent Attorneys before the United States Patent Office
51-L Adams Building, Washington 4, D. C.

Please send me your 48-Page "Patent Guide for the Inventor" and your specially prepared "Record of Invention" form FREE. This request does not obligate me.

Name.....

Address.....

City..... State.....

(Please write or print plainly.)

*Worthy of
Your Trust*

I'LL SHOW YOU HOW TO SUCCEED IN RADIO

Here's the right training for Big Post-War Pay!



F. L. Sprayberry, one of the country's foremost Radio Teachers.



A RADIO SERVICE BUSINESS OF YOUR OWN



A GOOD JOB IN RADIO & TELEVISION BROADCASTING



RADIO-ELECTRONIC SERVICE ENGINEER

BE A RADIO ELECTRONICIAN

NOW! YOU CAN PREPARE AT HOME IN SPARE TIME FOR AMAZING OPPORTUNITIES AHEAD IN RADIO • ELECTRONICS • TELEVISION



I SUPPLY A FULL RADIO SET for practical Easy LEARNING



The offer I make you here is the opportunity of a lifetime. It's your big chance to get ready for a wonderful future in the swiftly expanding field of Radio-Electronics INCLUDING Radio, Television, Frequency Modulation and Industrial Electronics. Be wise! NOW'S the time to start. Opportunities ahead are tremendous! No previous experience is necessary. The Sprayberry Course starts right at the beginning of Radio. You can't get lost. It gets the various subjects across in such a clear, simple way that you understand and remember. And, you can master my

entire course in your spare time. It will not interfere in any way with your present duties. Along with your Training, you will receive my famous **BUSINESS BUILDERS** which will show you how to make some nice profits while learning.

Prepares You for a Business of Your Own or Good Radio Job
My training will give you the broad, fundamental principles so necessary as a background, no matter which branch of Radio you wish to specialize in. I make it easy for you to learn Radio Set Repair and Installation Work. I teach you how to install and repair Electronic Equipment. In fact, you'll be a fully qualified **RADIO-ELECTRONICIAN**, equipped with the skill and knowledge to perform efficiently and to make a wonderful success of yourself.

SPRAYBERRY TRAINING GIVES YOU BOTH TECHNICAL KNOWLEDGE—SKILLED HANDS

There's only one right way to learn Radio Electronics. You must get it through simplified lesson study combined with actual "shop" practice under the personal guidance of a qualified Radio Teacher. It's exactly this way that Sprayberry trains you . . . supplying real Radio parts for learn-by-doing experience right at home. Thus, you learn faster, your understanding is clear-cut, you acquire the practical "know-how" essential to a good-paying Radio job or a Radio business of your own.

I'll Show You a New, Fast Way to Test Radio Sets Without Mfg. Equipment

The very same Radio Parts I supply with your Course for gaining pre-experience in Radio Repair work may be adapted through an exclusive Sprayberry wiring procedure to serve for complete, fast, accurate Radio Receiver trouble-shooting. Thus, under Sprayberry methods, you do not have one cent to outlay for manufactured

Test Equipment which is not only expensive but scarce.

Read What Graduate Says "One Job Nets About \$26.00"

"Since last week I fixed 7 radios, all good-paying jobs and right now I am working on an amplifier system. This job alone will net me about \$26.00. As long as my work keeps coming in this way, I have only one word to say and that is, 'Thanks to my Sprayberry Training' and I am not afraid to boast about it."—ADRIEN BENJAMIN, North Grovenordale, Conn.

DON'T PUT IT OFF!

Get the facts about my training—now! Take the first important step toward the money-making future of your dreams. All features are fully explained in my big, illustrated **FREE Catalog** which comes to you along with another valuable **FREE book** you'll be glad to own. Mail Coupon **AT ONCE!**

JUST OUT! FREE!

"How to Read Radio Diagrams and Symbols"

. . . a valuable new book explaining in simple English how to read and understand any Radio Set Diagram or circuit. Includes translations of all Radio symbols. Send for this **FREE** book now, and along with it I will send you another big **FREE** book describing my Radio-Electronic training.



GET FREE BOOKS

SPRAYBERRY ACADEMY OF RADIO

F. L. Sprayberry, President
Room 10115, Pueblo, Colorado.

Please rush my **FREE** copies of "How to MAKE MONEY in RADIO, ELECTRONICS and TELEVISION," and "HOW TO READ RADIO DIAGRAMS and SYMBOLS."

Name..... Age.....

Address.....

City..... State.....

(Mail in plain envelope or paste on penny postcard)



Will You Let Me PROVE I Can Make YOU a New Man?



LET ME START SHOWING YOU RESULTS LIKE THESE

<p>5 inches of new Muscle</p> <p>"My arms increased 1 1/2", chest 2 1/2", forearm 3/4". —C. S., W. Va.</p>	<p>What a difference!</p> <p>"Have put 3 1/2" on chest (normal) and 2 1/2" expanded." —F. S., N. Y.</p>
<p>Here's what ATLAS did for ME!</p> <p>John Jacobs BEFORE John Jacobs AFTER</p>	<p>For quick results I recommend CHARLES ATLAS</p> <p>"Am sending snapshot showing wonderful progress." —W. G., N. J.</p> <p>GAINED 29 POUNDS</p> <p>"When I started, weighed only 141. Now 170." —T. K., N. Y.</p>

CHARLES ATLAS

Awarded the title of "The World's Most Perfectly Developed Man" in international contest — in competition with ALL men who would consent to appear against him.

This is a recent photo of Charles Atlas showing how he looks today. This is not a studio picture but an actual untouched snapshot.

Here's What Only 15 Minutes a Day Can Do For You

I DON'T care how old or young you are, or how ashamed of your present physical condition you may be. If you can simply raise your arm and flex it I can add **SOLID MUSCLE** to your biceps—yes, on each arm—in double-quick time! Only 15 minutes a day—right in your own home—is all the time I ask of you! And there's no cost if I fail.

I can broaden your shoulders, strengthen your back, develop your whole muscular system **INSIDE** and **OUTSIDE**! I can add inches to your chest, give you a vise-like grip, make those legs of yours lithe and powerful. I can shoot new strength into your old backbone, exercise those inner organs, help you cram your body so full of pep, vigor and red-blooded vitality that you won't feel there's even "standing room" left for weakness and that laxy feeling! Before I get through with you I'll have your whole frame "measured" to a nice, new beautiful suit of muscle!

What's My Secret?

"Dynamic Tension!" That's the ticket! The identical natural method that I myself developed to change my body from the scrawny, skinny-chested weakling I was at 17 to my present super-man physique! Thousands of other fellows are becoming marvelous physical specimens—my way. I give you no gadgets or contraptions to fool

with. When you have learned to develop your Strength through "Dynamic Tension" you can laugh at artificial muscle-makers. You simply utilize the **DORMANT** muscle-power in your own God-given body—watch it increase and multiply double-quick into real solid **MUSCLE**.

My method—"Dynamic Tension"—will turn the trick for you. No theory—every exercise is practical. And, man, so easy! Spend only 15 minutes a day in your own home. From the very start you'll be using my method of "Dynamic Tension" almost unconsciously every minute of the day—walking, bending over, etc.—to **BUILD MUSCLE and VITALITY**.

FREE BOOK "Everlasting Health and Strength"

In it I talk to you in straight-from-the-shoulder language. Packed with inspirational pictures of myself and pupils—fellows who became **NEW MEN** in strength, my way. Let me show you what I helped THEM do. See what I can do for YOU! For a real thrill, send for this book today. **AT ONCE, CHARLES ATLAS, Dept. 811, 115 East 23rd St., New York 10, N. Y.**



**CHARLES ATLAS, Dept. 811
115 East 23rd St., New York 10, N. Y.**

I want the proof that your system of "Dynamic Tension" will help make a New Man of me—give me a healthy, husky body and big muscular development. Send me your free book, "Everlasting Health and Strength."

Name.....
(Please print or write plainly)

Address.....

City..... State.....

INVENTORS

LEARN HOW TO
PROTECT and SELL
YOUR INVENTION

GET NEW **FREE** BOOK



FREE

Invention Record
Know How Successful
Inventors Protect and
Sell Their Inventions

MODERN BUSINESS WANTS INVENTIONS
Practical and novel inventions are in big demand today. The opportunity for quick money is enticing. Sales sources are many if your invention has merit. But, be *sure*—before you place your device in strange hands—that it is fully protected. A United States Patent gives you this protection. *The first step toward inventive success always is—and always has been—the application for a U. S. Patent. There is no other way to protect your invention in accordance with the laws of this country.*

MAKE THIS RECORD NOW If you have an invention, and wish to secure it for the future, act at once. Have it dated now and recorded in our office. We will send you this **FREE** Invention Record Form for the purpose. Fill out the Invention Record Form fully describing the nature of your invention. Make a sketch of its main features. Mail it to us and we will record the date it was received in our office. The earlier the date the better your chance of combating rival inventors who may lay claim to your idea later. *Don't delay a single minute in taking this important step. Your whole future may depend upon it. Mail the coupon for our FREE Invention Record Blank and New FREE Book today!*

HOW WE SERVE YOU AS REGISTERED PATENT ATTORNEYS

The U. S. Patent Office strongly recommends—unless the inventor is familiar with such matters—that he employ the services of a Registered Patent Attorney in the preparation of his Patent Application. We are Registered Patent Attorneys fully qualified to represent you at the Patent Office. We have had long experience in studying hundreds of types of inventions. This gives us the ability to judge your invention and to describe it accurately and convincingly in technical language. It gives us the perception to center arguments upon those details of your invention which, in our judgment, will be looked upon most favorably by the Patent Office Examiner.

Mail the coupon today for our new **FREE** Book, "How to Protect, Finance and Sell Your Invention," and our **FREE** Invention Record Form—maybe this step will pave the way to future security for you and your family. Act Today!

McMORROW & BERMAN
Registered Patent Attorneys
135-G Atlantic Building, Washington 4, D. C.

Our new **FREE** Book is a book every inventor should have. Mail the coupon today for "How to Protect, Finance and Sell Your Invention" and learn . . .

- How to know if there is a prior U. S. patent on your invention.
- How to save steps in getting patent action.
- How to prepare your application for presentation to the Patent Office.
- How you may patent an improvement on something in use now.
- How to obtain funds to patent and promote your invention.
- How to find a buyer or backer for your invention.
- How to protect yourself in making royalty agreements.

McMORROW & BERMAN
REGISTERED PATENT ATTORNEYS
135-G ATLANTIC BUILDING, WASHINGTON 4, D. C.

Send me your new **FREE** book, "How to Protect, Finance and Sell Your Invention"—and "Invention Record" form at once. I understand that this request does not obligate me.

NAME

ADDRESS

CITY..... STATE.....

(Write or print name clearly)

YOU LEARN WHILE YOU EARN



There's rhyme and there's reason in that statement of I. C. S. advantages to you. The courses of these famous schools are especially designed for study in your spare time. At work you prove and apply what you learn. This system is backed up by 54 years of I. C. S. experience in training men in virtually every industrial and business field. It works so well that analysis shows about 99% of today's 100,000 active I. C. S. students are holding down jobs while they study. Many of the men now filling top positions in commerce and industry obtained their business or technical training from I. C. S. in just that way. What they achieved in *their* spare time, you can do in *yours*. Start now—as they did—by mailing this coupon:

INTERNATIONAL CORRESPONDENCE SCHOOLS



BOX 5559-K, SCRANTON 9, PENNA.

Without cost or obligation, please send me full particulars about the course *before* which I have marked X:

- | | | | |
|---|--|---|---|
| <p>Air Conditioning and Plumbing Courses</p> <ul style="list-style-type: none"> <input type="checkbox"/> Air Conditioning <input type="checkbox"/> Heating <input type="checkbox"/> Refrigeration <input type="checkbox"/> Plumbing <input type="checkbox"/> Steam Fitting <p>Chemistry Courses</p> <ul style="list-style-type: none"> <input type="checkbox"/> Chemical Engineering <input type="checkbox"/> Chemistry, Analytical <input type="checkbox"/> Chemistry, Industrial <input type="checkbox"/> Chemistry, Mfg. Iron & Steel <input type="checkbox"/> Petroleum Refining <input type="checkbox"/> Plastics <input type="checkbox"/> Pulp and Paper Making <p>Civil Engineering, Architectural and Mining Courses</p> <ul style="list-style-type: none"> <input type="checkbox"/> Architectural Drafting <input type="checkbox"/> Architecture <input type="checkbox"/> Bridge and Building Foreman <input type="checkbox"/> Building Estimating <input type="checkbox"/> Civil Engineering <input type="checkbox"/> Contracting and Building <input type="checkbox"/> Highway Engineering <input type="checkbox"/> Lumber Dealer <input type="checkbox"/> Reading Structural Blueprints <input type="checkbox"/> Sanitary Engineering <input type="checkbox"/> Structural Drafting <input type="checkbox"/> Structural Engineering <input type="checkbox"/> Surveying and Mapping | <p>Electrical Courses</p> <ul style="list-style-type: none"> <input type="checkbox"/> Electrical Drafting <input type="checkbox"/> Electrical Engineering <input type="checkbox"/> Power House Electric <input type="checkbox"/> Practical Electrician <input type="checkbox"/> Practical Telephony <input type="checkbox"/> Telegraph Engineering <p>Internal Combustion Engines Courses</p> <ul style="list-style-type: none"> <input type="checkbox"/> Auto Technician <input type="checkbox"/> Diesel-Electric <input type="checkbox"/> Diesel Engines <input type="checkbox"/> Aviation <input type="checkbox"/> Gas Engines <p>Mechanical Courses</p> <ul style="list-style-type: none"> <input type="checkbox"/> Aeronautical Engineering <input type="checkbox"/> Airplane Drafting <input type="checkbox"/> Flight Engineer <input type="checkbox"/> Foundry Work <input type="checkbox"/> Heat Treatment of Metals <input type="checkbox"/> Industrial Engineering <input type="checkbox"/> Industrial Metallurgy <input type="checkbox"/> Mechanical Drafting <input type="checkbox"/> Mechanical Engineering <input type="checkbox"/> Mold-Loft Work <input type="checkbox"/> Patternmaking <input type="checkbox"/> Reading Shop Blueprints <input type="checkbox"/> Sheet-Metal Drafting <input type="checkbox"/> Sheet-Metal Worker | <ul style="list-style-type: none"> <input type="checkbox"/> Ship Drafting <input type="checkbox"/> Ship Fitting <input type="checkbox"/> Shop Practice <input type="checkbox"/> Steel Mill Workers <input type="checkbox"/> Tool Designing <input type="checkbox"/> Welding, Gas and Electric <p>Radio Courses</p> <ul style="list-style-type: none"> <input type="checkbox"/> Electronics <input type="checkbox"/> Radio, General <input type="checkbox"/> Radio Operating <input type="checkbox"/> Radio Servicing <p>Railroad Courses</p> <ul style="list-style-type: none"> <input type="checkbox"/> Air Brake <input type="checkbox"/> Locomotive Engineer <input type="checkbox"/> Locomotive Fireman <input type="checkbox"/> Railroad Section Foreman <input type="checkbox"/> Car Inspector <p>Steam Engineering Courses</p> <ul style="list-style-type: none"> <input type="checkbox"/> Boilermaking <input type="checkbox"/> Combustion Engineering <input type="checkbox"/> Engine Running <input type="checkbox"/> Marine Engineering <input type="checkbox"/> Steam Electric <input type="checkbox"/> Steam Engines <p>Textile Courses</p> <ul style="list-style-type: none"> <input type="checkbox"/> Cotton Manufacturing <input type="checkbox"/> Rayon Weaving | <ul style="list-style-type: none"> <input type="checkbox"/> Textile Designing <input type="checkbox"/> Woolen Manufacturing <p>Business and Academic Courses</p> <ul style="list-style-type: none"> <input type="checkbox"/> Accounting <input type="checkbox"/> Arithmetic <input type="checkbox"/> Business Correspondence <input type="checkbox"/> Business Management <input type="checkbox"/> Certified Public Accounting <input type="checkbox"/> College Preparatory <input type="checkbox"/> Commercial <input type="checkbox"/> Cost Accounting <input type="checkbox"/> Federal Tax <input type="checkbox"/> First Year College <input type="checkbox"/> Foremanship <input type="checkbox"/> French <input type="checkbox"/> Good English <input type="checkbox"/> High School <input type="checkbox"/> Higher Mathematics <input type="checkbox"/> Illustrating <input type="checkbox"/> Motor Traffic <input type="checkbox"/> Postal Service <input type="checkbox"/> Salesmanship <input type="checkbox"/> Secretarial <input type="checkbox"/> Sign Lettering <input type="checkbox"/> Stenography <input type="checkbox"/> Traffic Management <input type="checkbox"/> Advertising <input type="checkbox"/> Bookkeeping <p style="text-align: right;"><input type="checkbox"/> Spanish</p> |
|---|--|---|---|

Name..... Age..... Home Address.....

City..... State..... Position..... Working Hours..... A.M. to..... P.M.

Canadian residents send coupon to International Correspondence Schools Canadian, Ltd., Montreal, Canada.
British residents send coupon to I. C. S., 71 Kingsway, London, W. C. 2, England.

DISCOUNT TO DISCHARGED VETERANS—SPECIAL TUITION RATES FOR MEMBERS OF THE ARMED FORCES

"Re-convert" to a GOOD FUTURE JOB

Your Choice of 2 Great Fields

*There's a
World of
Opportunity
in*



ELECTRICITY OR

Jobs Like These in ELECTRICITY

Armature Expert
Aviation Electrician
Maintenance Engineer
Illuminating Expert
Power Plant Operator
Automotive Electrician
Wiring Contractor
Motor Tester
Signal and Alarm Work
Industrial Electronics
Your Own Business

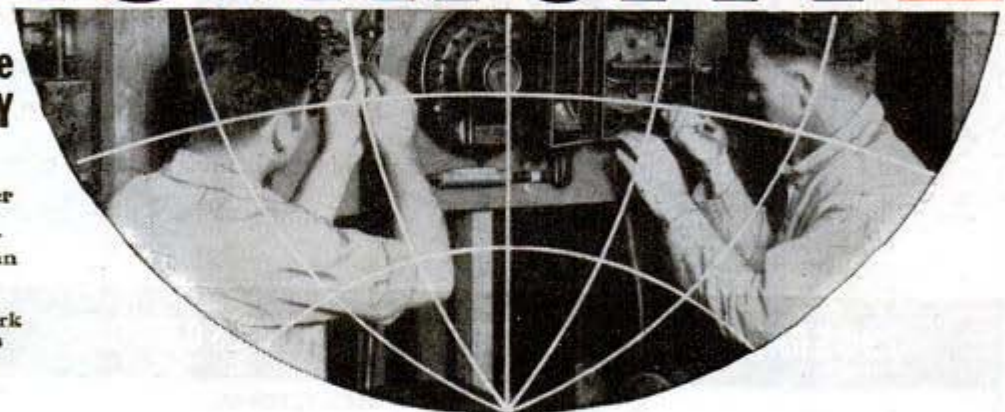

LEARN BY DOING ON ACTUAL EQUIPMENT

Factories are "re-converting" to peacetime production. YOU must do the same! But good-pay jobs with a real future demand special training—training you may have been unable to get because you were serving your country either in the armed forces or in a war plant.

Now, by investing a few weeks in practical shop-training at Coyne, you can prepare for a lifetime of opportunity. Choose either Electricity, or Radio-Electronics. Here you learn-by-doing on full-size equipment. You get basic principles, then apply them as you will later on the job, all with friendly help and guidance from instructors who take a personal interest in you.

Why be satisfied with a "one-operation" job when Coyne gives all-around training? BE READY for tremendous developments just ahead. Mail coupon now for the facts.

Whether you are 16 or up to 40, with or without some shop experience—you'll make quick progress at Coyne. 46 years success preparing fellows like yourself for bigger jobs, better pay.

LIFETIME EMPLOYMENT SERVICE

First I train you for a good job and future, then assist you in getting located. As a Coyne graduate, use this service whenever you need it—no charge.

MEN WITH PHYSICAL DISABILITIES

We have facilities for men with physical disabilities whether caused by war or other causes. If you have a physical disability of any kind check the coupon for information.

VETERANS!

This great training is available
to YOU IN ITS ENTIRETY under
GI BILL OF RIGHTS

IN A FEW SHORT WEEKS AT **COYNE**

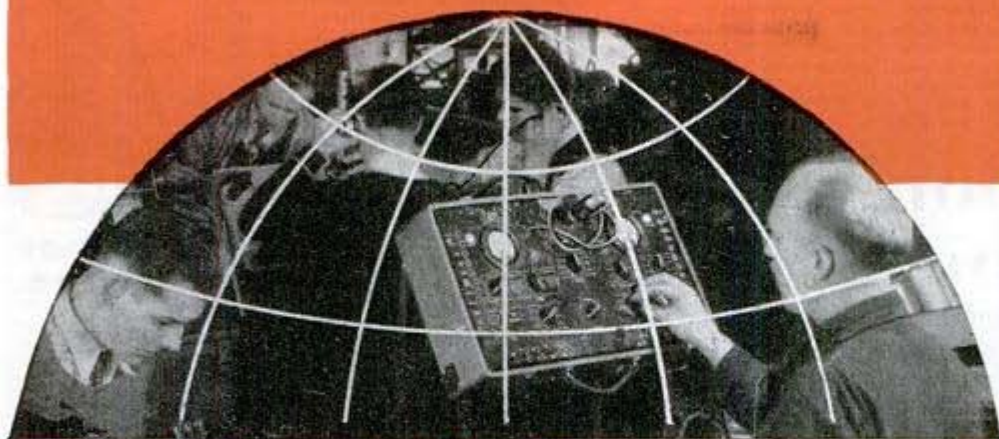

H. C. LEWIS, Pres., Coyne Electrical School, who has helped thousands to greater opportunities in Electricity, Radio - Electronics.

RADIO-ELECTRONICS -TELEVISION

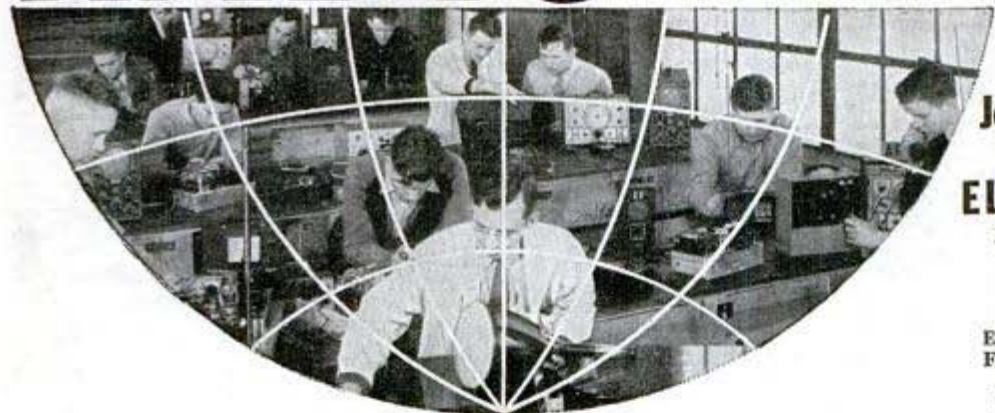

Jobs Like These in RADIO-ELECTRONICS

- Radio Manufacturing
- Radio Receivers
- Automobile Radio
- Public Address and Sound Systems
- Electronics Technician
- Frequency Modulation
- Television
- Radio Merchandising
- Your Own Business

Select Field You Prefer.. GET THIS FREE BOOK NOW

STUDENT FINANCE PLAN

If you are short of money I'll arrange to finance most of your tuition and you can pay it back in easy monthly payments after you graduate. We'll help you get a part time job if you wish, so you can **earn while learning**. I have many plans to help you. Send coupon for complete details. No salesman will call. You are the sole judge. You need Coyne training NOW.

COYNE ELECTRICAL SCHOOL
 H. C. LEWIS, Pres. Dept. 85-72H
 500 S. Paulina Street, CHICAGO 12, ILLINOIS

Some men prefer Electricity, others Radio-Electronics. Check your choice below for my BIG FREE BOOK on that field. Fully illustrated. No cost or obligation. Do it at once—for **Your Future**.



MAIL THIS COUPON TODAY

H. C. LEWIS, Pres., COYNE ELECTRICAL SCHOOL, 500 S. Paulina Street, Dept. 85-72H, Chicago 12, Ill.

Send me your BIG FREE BOOK—for the course checked below. Also full details of your "Pay-after-Graduation" plan.

- ELECTRICITY RADIO-ELECTRONICS
 Send special G.I. Bulletin Physical disability

NAME.....

ADDRESS.....

CITY.....STATE.....

INDUSTRIAL ELECTRONICS and ELECTRICAL REFRIGERATION

Included With Either Course

Right now I am including at no extra tuition cost, extra training in the big new fields of Industrial Electronics and Electric Refrigeration, with either my Electrical or Radio Course.

NO EXTRA COST



Earns Living Writing— Before Finishing Course

"I have always had the desire to write. I saw your ad, borrowed the money to pay for the course. Before finishing your course, I had become self-supporting as a correspondent for the state papers. I believe that if anyone wants to be a writer and will apply himself to your course, he will soon know whether his living is coming out of the writing market."—
Edward Foster, Tahina, Okla.

Why Don't You Write?

It's much simpler than you think!

SO many people with the "germ" of writing in them simply can't get started. They suffer from inertia. Or they set up imaginary barriers to taking the first step.

Many are convinced the field is confined to persons gifted with a genius for writing.

Few realize that the great bulk of commercial writing is done by so-called "unknowns." Not only do these thousands of men and women produce most of the fiction published, but countless articles on business affairs, home and shop crafts, local and club activities, gardening, hobbies, etc., as well.

Such material is in constant demand. Every week thousands of checks for \$25, \$50 and \$100 go out to writers whose latent ability was perhaps no greater than yours.

The Practical Method

Newspaper work demonstrates that the way to learn to write is by writing! Newspaper copy desk editors waste no time on theories or ancient classics. The story is the thing. Every copy "cut" goes through the course of practical criticism—a training that turns out more successful authors than any other experience.

That is why Newspaper Institute of America bases its writing instruction on the Copy Desk Method. It starts and keeps you writing in your own home, on your own time. And upon the very same kind of actual assignments given daily to metropolitan reporters. Thus you learn by doing, not by studying the individual styles of model authors.

Each week your work is analyzed constructively by practical writers. Gradually they help to clarify your own distinctive style. Writing soon becomes easy, absorbing, profitable, too, as you gain the "professional" touch that gets your material accepted by editors. Above all, you can see constant progress week by week as your faults are corrected and your writing ability grows.

Have You Natural Ability?

Our Writing Aptitude Test will reveal whether or not you have natural talent for writing. It will analyze your powers of observation, your imagination and dramatic instinct. You'll enjoy taking this test. There is no cost or obligation. Simply mail the coupon below, today. Newspaper Institute of America, One Park Avenue, New York 16, N. Y. (Founded 1925)

Free

Newspaper Institute of America,
One Park Avenue, New York 16, N. Y.

Send me, without cost or obligation, your Writing Aptitude Test and further information about writing for profit as promised in Popular Mechanics, November.

Mr. {
Mrs. {
Miss {

Address.....
(All correspondence confidential. No salesman will call on you.) 72-T-815

Copyright 1945 Newspaper Institute of America

TRI-STATE COLLEGE

Degree in 2 1/2 years

B. S. Degree in Civil Electrical, Mechanical, Chemical, Radio, Aeronautical, Engineering; Business Administration, Accounting, Secretarial Science. Short diploma courses, (36 weeks) in Surveying, Drafting. VETERANS under the G.I. Bill or Public Law 16 can complete work here in shortest possible time. Special Prep. Dept. Also Refresher Courses. 62nd year. Tuition, living costs low. Enter Jan., March, June, Sept. Catalog.

4115 College Avenue, Angola, Ind.



ENGINEERING

HIGH SCHOOL AT HOME

Most well-paid positions demand high school training. Without it, or equivalent, you can't advance to the full extent of your abilities in any trade, business or profession. Whatever your age, however you're situated, IT ISN'T NECESSARY TO STRUGGLE UNDER THAT HANDICAP. I.C.S., famous for more than 50 years, enables you to start your own high school in your own home. You're in a class by yourself—study in your spare time—acquire a high school education at astonishingly low cost. Authoritative text! Rapid Progress! Write today for free booklet. International Correspondence Schools, Box 5561-K, Scranton 9, Pa.

TRAIN



Your VOICE!

Results GUARANTEED

We build, strengthen the vocal organs—not with singing lessons—but by sound, scientifically guaranteed complete satisfaction with results. Write for Voice Book, FREE. Sent to no one under 17 years old unless signed by parent.

Perfect Voice Institute, Studio 1358, Kimball Hall Bldg., Chicago 4, Ill.

INVENTORS

WITH GOOD INVENTIONS

Should write us without delay for FREE BOOKLET, Protective Disclosure Form and facts about The Inventor's Most Logical Markets. Patented, Unpatented inventions, all kinds. Cash, Royalty, needed by specific manufacturers. If your invention is for sale, write today for full particulars. A Post-Card will do! Address:

THE INVENTION REPORTER

5C-11106 South Longwood Drive Chicago 43, Illinois

STATEMENT OF THE OWNERSHIP, MANAGEMENT, CIRCULATION, ETC., REQUIRED BY THE ACTS OF CONGRESS OF AUGUST 24, 1912, AND MARCH 3, 1933, of Popular Mechanics Magazine, published monthly at Chicago, Illinois, for October 1, 1945.

Subscribed at Illinois, County of Cook, ss.
Before me, a Notary Public in and for the State and county aforesaid, personally appeared H. H. Windsor, Jr., who having been duly sworn according to law, deposes and says that he is the Editor of the Popular Mechanics Magazine, and that the following is, to the best of his knowledge and belief, a true statement of the ownership, management (and if a daily paper, the circulation), etc., of the aforesaid publication for the date shown in the above caption, required by the Act of August 24, 1912, as amended by the Act of March 3, 1933, embodied in section 357, Postal Laws and Regulations, printed on the reverse of this form, to-wit: First. That the names and addresses of the publisher, editor, managing editor, and business managers are: Publisher, Popular Mechanics Company, 200 East Ontario St., Chicago, Ill.; Editor, H. H. Windsor, Jr., 200 East Ontario St., Chicago, Ill.; Managing Editor, R. M. Grant, 200 East Ontario St., Chicago, Ill.; Business Manager, F. H. Dunakin, 200 East Ontario St., Chicago, Ill. Second. That the owner is: (If owned by a corporation, its name and address must be stated and also immediately thereunder the names and addresses of stockholders owning or holding one per cent or more of total amount of stock. If not owned by a corporation, the names and addresses of the individual owners must be given. If owned by a firm, company, or other unincorporated concern, its name and address, as well as those of each individual member, must be given.) Popular Mechanics Company, 200 East Ontario St., Chicago, Ill. H. H. Windsor, Jr., 200 East Ontario St., Chicago, Ill. H. H. Windsor, Jr., Trustee for H. H. Windsor III and Wm. T. Windsor, 200 East Ontario St., Chicago, Ill. Third. That the known bondholders, mortgagees, and other security holders owning or holding 1 per cent or more of total amount of bonds, mortgages or other securities are: (If there are none, so state.) The Equitable Life Assurance Society of the United States, 29 S. La Salle St., Chicago, Ill. Fourth. That the two paragraphs next above, giving the names of the owners, stockholders, and security holders, if any, contain not only the list of stockholders and security holders as they appear upon the books of the company but also, in cases where the stockholder or security holder appears upon the books of the company as trustee or in any other fiduciary relation, the name of the person or corporation for whom such trustee is acting, is given; also that the said two paragraphs contain statements embracing affiant's full knowledge and belief as to the circumstances and conditions under which stockholders and security holders who do not appear upon the books of the company as trustees, hold stock and securities in a capacity other than that of a bona fide owner; and this affiant has no reason to believe that any other person, association, or corporation has any interest direct or indirect in the said stock, bonds, or other securities than as so stated by him. Fifth. That the average number of copies of each issue of this publication sold or distributed, through the mails or otherwise, to paid subscribers during the twelve months preceding the date shown above is Not daily publication. (This information is required from daily publications only.) H. H. Windsor, Jr., Editor. Sworn to and subscribed before me this 17th day of September, 1945. N. E. Toole, Notary Public. (My commission expires March 24, 1948.)

WHICH OF THESE *Opportunities* INTERESTS *You* MOST?

Accounting & C. P. A.
Air Conditioning
Architecture & Building
Automotive Engineering
Aviation—Practical
Aviation Drafting & Design
Better Foremanship
Bookkeeping
Business Management

Diesel Engineering
Drafting & Design
Electrical Engineering
Electricity—Practical
Electronics, Industrial
High School Courses
Machine Shop Operations
Mechanical Engineering
Plastics Engineering
Plumbing—Practical

Private Secretary
Radio Operating & Servicing
Railway Training
Refrigeration
Sheet Metal Pattern Drafting
Shop Management
Surveying & Topographical
Drafting
Tool Making

THINK! LOOK FORWARD!

Business is making Post-war plans

Men and Women are preparing for the future

WHAT ARE YOU DOING ABOUT YOUR TOMORROWS?

● *Today*, choose the job you want—and prepare for it. Or if you are already engaged in the work you like best, start training *now* for quicker promotion. Acquire the knowledge that will help you to get ahead faster, make more money and have greater security.

Invest part of your spare time in more rapid progress. Start training now, in spare time in your own home. Be ready to grasp your opportunity and step out ahead of those who lack the ability you have attained.

American School, founded in 1897 as an educational institution *not for profit*, can help you to reach your goal just as it has helped others during the past forty-eight years. Give serious thought to the list above. Pick one or more subjects that interest you. Then check the coupon at right, add your name and address and mail it at once. The school will send you details on its training plan and outline of study prepared by specialists. There is no charge, no obligation, so send the coupon immediately.

PRACTICAL, EFFECTIVE HOME • STUDY TRAINING SINCE 1897

Take This First Easy Step

CHECK, CLIP AND MAIL COUPON NOW

AMERICAN SCHOOL, Dept. G845 Drexel at 58th, Chicago 37, Ill.
Without obligation, Please send FREE and postpaid, bulletin and details of the Subject checked.

- | | | |
|--|---|--|
| <input type="checkbox"/> PLASTICS ENG'R | <input type="checkbox"/> Accounting and C. P. A. | <input type="checkbox"/> Drafting and Design for Men and Women |
| <input type="checkbox"/> Refrigeration | <input type="checkbox"/> Bookkeeping | <input type="checkbox"/> Radio |
| <input type="checkbox"/> Architecture and Building | <input type="checkbox"/> Private Secretary | <input type="checkbox"/> High School |
| <input type="checkbox"/> Practical Plumbing | <input type="checkbox"/> Diesel Engineering | <input type="checkbox"/> Air Conditioning |
| <input type="checkbox"/> Automotive Engineering | <input type="checkbox"/> Surveying & Topographical Drafting | <input type="checkbox"/> Mechanical Eng. |
| <input type="checkbox"/> Aviation Drafting | <input type="checkbox"/> Sheet Metal Pattern Drafting | <input type="checkbox"/> Shop Management |
| <input type="checkbox"/> Aviation | <input type="checkbox"/> Electrical Engineering | <input type="checkbox"/> Tool Making |
| <input type="checkbox"/> Business Mgmt | <input type="checkbox"/> Electronics, Industr. | <input type="checkbox"/> Better Foremanship |
| <input type="checkbox"/> Railway Training | | <input type="checkbox"/> Machine Shop Operations |

Name..... Occupation.....
Address..... Age.....
City..... State.....

AMERICAN SCHOOL

Dept. G845 Drexel at 58th Street, Chicago 37

\$2000

of Old Line Legal Reserve
LIFE INSURANCE

(at age 21) \$ **178** A MONTH*
ONLY — Other ages in proportion

*One Half Permanent Rate in effect 5th year

Buy as little as \$1500. of this solid protection—or more—at proportionately low rates. *But buy your Postal Policy now!*

Postal Life of New York has specialized for 40 years in insurance by mail and over the counter. The savings due to this direct dealing are passed on to policy holders. Current dividends 9½%. Further savings are made if premiums are paid quarterly, semi-annually or annually.

POSTAL LIFE OF NEW YORK

operates under the rigid New York State Insurance Laws and has paid out over

\$55,000,000.00

to its Policy Holders and Beneficiaries.

Postal issues all Standard Policies to men or women, from ages 10-60, at low cost.

Send coupon today for rates on this Modified "4" Policy at your age and other details. *Life Insurance is vital!*

CLIP AND MAIL COUPON TODAY

POSTAL LIFE INSURANCE COMPANY

511 Fifth Ave., Dept. M-506
New York 17, N. Y.

Mail me without obligation complete information about your low-cost Modified "4" Policy at my age.

Name

Date of Birth

Occupation

Address

(Street and No., Zone, City and State)

GET INTO PLASTICS

Start
Your Own
Business

BE YOUR OWN BOSS
Small Capital — Work at Home



FABRICATION



CASTING

Get into new Plastics business. Start in your own home. Small Capital needed. As you increase your knowledge and skill, you can grow with this Big Industry. This opportunity is yours today . . . so get started now in what may mean a Big paying Plastics business of your own — or prepare for post-war Plastics employment. This New educational plan gives you the sound fundamental knowledge plus the practical training you need to be a success in Plastics. The actual practical work consists of working with many different types of Plastics materials — teaching you in your own home, fabrication, shaping, forming, finishing, cementing methods, mold making, casting, compounding, dyeing, etc. For full information send this ad with your name and address in an envelope or paste on a penny postcard to Dept. N.

PLASTICS TECH 4701 Euclid Avenue
Cleveland 3, Ohio

HOW TO GET A BIG PAY JOB IN Real Estate

Write for
FREE BOOK!

brokerage, appraisal, loans, insurance, building. Many make fortunes selling real estate. Thousands of trained men, women, required yearly by real estate firms, insurance companies, banks, Federal agencies. Rush post-card for 32-page **QUIZ BOOK**—mailed **FREE** with full details on new and only 5-volume library **MODERN REAL ESTATE PRACTICE!** Lane Books, Dept. B-11, 100 East Ohio St., Chicago 11, Illinois.

AUDELS Carpenters and Builders Guides 4 vols. \$6



Inside Trade Information for Carpenters, Builders, Joiners, Building Mechanics and all Woodworkers. These Guides give you the short-cut instructions that you want—including new methods, ideas, solutions, plans, systems and money saving suggestions. An easy progressive course for the apprentice and student. A practical daily helper and Quik Reference for the master worker. Carpenters everywhere are using these Guides as a Helping Hand to Easier Work, Better Work and Better Pay. To get this assistance for yourself, simply fill in and mail the **FREE COUPON** below.

Inside Trade Information On:

How to use the steel square—How to file and set saws—How to build furniture—How to use a mitre box—How to use the chalk line—How to use rules and scales—How to make joints—Carpenters arithmetic—Solving mensuration problems—Estimating strength of timbers—How to set girders and sills—How to frame houses and roofs—How to estimate costs—How to build houses, barns, garages, bungalows, etc.—How to read and draw plans—Drawing up specifications—How to excavate—How to use settings 12, 13 and 17 on the steel square—How to build hoists and scaffolds—skylights—How to build stairs—How to put on interior trim—How to hang doors—How to lay floor—How to paint



THEO. AUDEL & CO., 49 W. 23rd St., New York City

Mail Audels Carpenters and Builders Guides, 4 vols., on 7 days' free trial. If O.K. I will remit \$1 in 7 days, and \$1 monthly until \$6 is paid. Otherwise I will return them. No obligation unless I am satisfied.

Name

Address

Occupation

Reference

ENJOY GREATER OPPORTUNITIES...

for **GOOD PAY** and a
BRIGHT FUTURE

Get into **RADIO ELECTRONICS**
THROUGH DEFOREST'S A-B-C
TRAINING & EMPLOYMENT SERVICE



**PREPARE AT HOME IN SPARE TIME
or IN OUR CHICAGO LABORATORIES**

Radio, Electronics, Radar—and all the many applications and opportunities of each, are wide open to *trained men!* If you are even slightly mechanically minded . . . if you can follow clear, easy-to-understand instructions—you can prepare *now* for this *Good Pay, Bright Future Industry*—in your **SPARE TIME AT HOME**, or right here in **OUR MODERN CHICAGO LABORATORIES!** When you complete our training you'll be fully qualified for a good-pay job in the Radio-Electronics Industry—or to start a business of your own. Mail coupon **TO-DAY** for **FREE** information!

VETERANS!

DeForest's offers you Residential or Home Study G. I. Training.

**A MOVIES MAKE LEARNING
FASTER—EASIER**

An exclusive DeForest's home radio training advantage is "Learn-by-Seeing" MOVIES. You use a genuine DeVry Motion Picture Projector and Specially Prepared Training Films to help you master important Radio Fundamentals **FASTER—EASIER . . . right in your own home!**

**B ACTUAL "SHOP
EXPERIENCE" FROM 133
PRACTICAL EXPERIMENTS**

You "Learn-by-Doing" by making 133 fascinating experiments with 8 Big Kits of Radio Parts and Assemblies. You build modern Radio Receiving Circuits, Electric Eye Devices, an Aviation Band Circuit, Public Address System, Wireless Microphone, and scores of other interesting, practical Radio-Electronic Devices. DeForest's valuable "Block System" permits easy and quick rearrangement of parts and circuits, with no unnecessary, time-consuming mechanical work required.

**C "SYNCHRO-GRAPHIC"
LESSON TEXTS SPEED
PROGRESS**

Another exclusive DeForest's advantage is the "Synchro-Graphic" feature of the 90 Lesson Texts, prepared under the personal supervision of Dr. Lee DeForest, the "Father of Radio." Makes progress speedier because all lesson diagrams and charts are printed on sheets that *fold out*—keeping illustrations constantly synchronized to text. Eliminates confusion from frequent flipping of pages to refer back or ahead to illustrations mentioned in text.

YOU GET EFFECTIVE EMPLOYMENT SERVICE

When you complete DeForest's Training you get the help of De Forest's Effective Employment Service which has placed so many men in good-pay jobs with the industry's leading manufacturers . . . an *extra* service available to you regardless of where you live, regardless of when you want to use it—without added cost!

SEND FOR FREE INFORMATION

Mail the coupon today for the big book "Victory for You!" and the Equipment Folder. See how you can make your start towards a *good-pay job and a bright future* in the vast billion-dollar Radio-Electronics Industry. Or if interested in DeForest's **RESIDENTIAL TRAINING** in the modern **CHICAGO LABORATORIES** shown at left, write for special details.



DEFOREST'S TRAINING INCLUDES INSTRUCTION IN MOTION PICTURE SOUND EQUIPMENT, FM RADIO AND TELEVISION . . .

E. B. DeVry, President
DEFOREST'S TRAINING, INC.
2535-41 North Ashland Avenue, Dept. PM-B11
Chicago 14, Illinois, U.S.A.
Please send me your "VICTORY FOR YOU!"
BOOK and EQUIPMENT FOLDER



Name _____ Age _____

Address _____

City _____ Zone _____ State _____

If under 18, check here for special information.

If a veteran of World War II, check here.

DeFOREST'S TRAINING, INC.
CHICAGO 14, ILLINOIS



SO IT NEEDS FIXING

By S. T. CHRISTENSEN
the "Fix-it Man"

WELL, I guess I'm the fellow to see, for I've repaired thousands of refrigerators (home and commercial both), vacuum cleaners, radios, washing machines, irons, fans, lamps, mangles, motors, etc. In fact, many of my customers call me their "electrical appliance doctor." And, "doctoring," I might add, has paid me a good substantial income for quite a few years. Funny, in a way, how I got started. Always liked to tinker and by experimenting around I found that most electrical appliances had many things in common. That, regardless of what the appliance was used for, or who the manufacturer was, the basic principles were much the same. From fixing my own appliances to fixing friends' and then for strangers at a fee, seems now to have been but a small step.

What to Charge?

At first, I let the owner decide the charge and, frankly, I was amazed at what I earned per hour. But then, when one figures what initial costs are involved in buying most electrical appliances, one can readily see that spending extra dollars for repairs is well worth while. Before long I was making more in my spare time repairing than from my regular job. The result . . . I went into business for myself. When war came, business boomed, for new appliances were not available.

For a while, repair parts (needed on some

jobs) were a little difficult to get. But that situation seems to have adjusted itself for many repair parts have today the high priority rating of AA2. After all, we must provide for the health and well-being of our civilian population.

The Future Offers

Friends ask me about my future. And, I think I've got a grand one. Age is no handicap in repairing. I have in my files enthusiastic letters from repairmen ranging in age from 18 to 79 years. After the war, we're bound to see hundreds of new products on the market . . . products that the average person never dreamt of. These new products and our old appliances are all going to need at some time or other "fixing." Well, I'll still be the fellow to do it. The field open for appliance repairmen is unlimited. I don't worry at all about too much competition.

If You Are Ambitious

To the contrary, I've prepared a complete course, chuck full of simple, easy to understand photos and drawings and written in the same non-technical language as this article. I know the course is good, because I have hundreds of men all over the country writing to me telling me how the course has helped swell their pockets with cash. If you too want to prepare now for your future, I suggest you read the next page and send me the handy coupon."

Advertisement



**BIG MONEY
INDEPENDENCE**

*A PROFITABLE
LIFETIME
BUSINESS
OF
YOUR OWN!*

LEARN ELECTRICAL APPLIANCE REPAIRING

PREPARE NOW FOR THE FUTURE

If now in war work, start your home appliance repair business NOW in your spare time and be set with a business of your own when the war is over. You don't need elaborate fixtures or expensive equipment to be a successful repairman. Operate from your garage, basement, vacant store, etc. Work as many hours as you wish—the home appliance repairman is his own boss. It is a profitable occupation for on many types of repairs it is not unusual for a repairman to charge on the basis of \$5.00 to \$6.00 per hour. Don't gamble with your future—learn a trade that will always support you. Remember, as long as electrical appliances are used, there will be a need for electrical appliance repairmen.

If you are at all mechanically inclined—can hold and use tools—then you have all of the qualifications required for becoming a big money earning home appliance repairman. It does not matter if you have not had a great deal of schooling or had previous experience along these lines—**WE WILL TEACH YOU.** Age should be no barrier—nor should any minor physical handicap.

New Course Tells All

Profusely illustrated, our new course shows you in simple, easy to understand language and drawings how to make each repair on refrigerators, vacuum cleaners, washing machines, motors, etc. Explains and gives you a working knowledge of electricity, welding, nickel plating, etc. Shows you how to build the power tools you need and how to solicit and keep business coming to you. Not a theory course but an honest to goodness course written by and used by repairmen the country over. Price of course is so low that the savings on your own household appliance repairs will quickly pay for it. Act now! Mail the handy coupon below today.

----- Read What Our Students Say About Course -----

I really believe your course the best investment a mechanically minded man can make.—Claude E. Allen, Indianapolis, Ind.
I have received your Course in Appliance Repairing and I must say I am well pleased with same. I am only sorry I did not have said Course some years ago. I have learned so much more through this course I would not part with it.—Charles Schwarz, Hamilton, Ohio.

The Course in Appliance Servicing arrived a few days ago. Want to take out a few minutes of my valuable time to let you know that this is just what I have been looking for ever since I opened up my Fix-It shop. I must admit that you told the truth when you said that it contains quite a bit more information than I bargained for.—P. J. Bretl, Sebring, Ohio.

I am a mechanic for the Western Union Telegraph Co. Three days after receiving the lessons in refrigeration I earned the exact cost of the course.—Henry S. Lee, Washington, D. C.
I work day times at the shipyard and after 4:00 P.M. I operate from my cellar and garage. I average \$10.00 to \$15.00 clear every day.—Walter Hanby, Brockton, Mass.

GET STARTED TODAY — MAIL THIS COUPON

CHRISTY SUPPLY CO.
2835 N. Central Ave., Dept. D-2703
Chicago 34, Illinois

Please send me free illustrated literature about America's Fastest Growing Industry — **ELECTRICAL APPLIANCE REPAIRING.**

Name.....

Address.....

City..... State.....





REFRIGERATION AIR CONDITIONING

Air Conditioning and Refrigeration are among the great industries of today and tomorrow. Installations everywhere—in restaurants, shops, homes, etc., need service. Thousands of businesses are waiting for new installations. Today, more and more homes are being air conditioned. The Refrigeration and Air Conditioning industries are headed for greater prosperity and men who have the "know how" and experience should ride along.

Train Now Before the Expected EXPANSION Begins

Experts predict large demand for men to install and service Air Conditioning and Refrigeration equipment. . . Rise to the kind of job which requires a competent, trained man who can carry the responsibilities of installing costly equipment and maintaining it. If he knows the answer when he is called in for consultation, his reputation grows and his pay should grow also.

Follow This Way to Knowledge

If over 17, and under 60, here's all it takes to get you ready for experience in this modern industry. Just invest a limited amount of your spare time—while you are still on your present job. Through our balanced training, you learn first through home study, how to handle Installation, Maintenance & Service Work on Refrigeration and Air Conditioning equipment. Then you can get practical training in our big shops under capable instructors—experienced men who'll take a personal interest in helping you learn. When you're through you should have knowledge that enables you to get started in this vast industry.

WANT YOUR OWN REPAIR SHOP?

UEI training is easily understood by mechanically inclined men. You gain experience when you complete your course. Equipment, tools and personal following can accumulate as you progress. Soon you may find it wise to set up your own shop.

GET FREE FACTS RIGHT NOW!

It costs you nothing to get all the facts about this great field. Simply mail the coupon below and we'll tell you, without obligation the whole, sensational story of what's ahead in Refrigeration and Air Conditioning. Mail the FREE coupon now.



UTILITIES ENGINEERING INSTITUTE
1314 W. Belden Avenue, Dept. 1115, Chicago 14, Ill.

Please send me the FREE FACTS about opportunities in Air Conditioning and Mechanical Refrigeration. I have marked the one that interests me most.

Air Conditioning Mechanical Refrigeration

NAME _____ AGE _____

ADDRESS _____

CITY _____ ZONE _____ STATE _____

Learn to Service and Repair ELECTRICAL APPLIANCES

Learn to be a service mechanic on all types of electrical appliances . . . and prepare now for a permanent future, independence and security, operating a business of your own. You won't have to worry about losing your job when the next depression comes if you have your own electrical appliance repair business. There is always a demand for repair work . . . and it can't be done by a machine. Our practical, easy to learn home-training teaches you how to repair washing machines, vacuum cleaners, stoves, lamps, motors, irons, etc., and how to do house wiring. Also how to start your own business on little capital. Write today for FREE illustrated booklet which will explain in detail. No obligation. No salesman will call.

PACIFIC TRAINING SCHOOL
4701 W. Pico, Dept. AP-11, Los Angeles 6, California

PLAY GUITAR LIKE THE COWBOYS DO... 8 1/2 A LESSON

Just out—very latest guaranteed, simple, easy method. Play cowboy songs the Western way in a few minutes by ear. Surprise and amaze your friends. Be in big demand at parties, camps, public entertainments, on the radio, etc. 12 Complete Lessons. **SEND NO MONEY** Pay postman only \$1.00 plus postage and P.O.D. charges, or send \$1.00 and get EXTRA SONGS all postpaid. (Canada, \$1.25 money order only.) Nothing else to buy. Positive money back guarantee. Rush order today. **WESTERN RANGER STUDIOS, Dept. 1511, Hutchinson, Kans.**

RADIO, ELECTRONICS and YOU!

There are big rewards in the communications line for the Radio man who has the answers! Too, the equipment that has made Radio communication possible is functioning now in other rewarding fields. Electron tubes in industry promise a whole new World of Electronics. I. C. S. has a variety of Radio Courses and a great new standard Electronics Course. Write for booklet, pick your Course.

International Correspondence Schools, Box 5561-K, Scranton 9, Pa.

Become a Real Estate Broker!

A profitable Lifetime career in one of America's Finest Professions. For complete details and free copy of Pamphlet Entitled "The Real Estate Brokerage Business as a Professional Career." Write J. A. STEIN, Post Office Box 1565, Dept. 1, St. Petersburg, Florida.

"HOW TO REMEMBER NAMES & FACES"

Increase your income, circle of friends and enjoyment of life by learning the important secret of easily remembering names and faces as explained in this new booklet by David M. Roth, famous memory expert. \$1.00 postpaid. Write—**ROTH MEMORY SYSTEM, Dept. L, 1121 S. Hill, Los Angeles 15**

LEARN PORTRAIT PAINTING AT HOME

● Previous art training or talent NOT necessary. The Stuart System teaches you, in 11 easy-to-follow lessons, to (1) locate features *exactly* to correspond to model's features, (2) outline head and face to correspond to model's outline, (3) make each feature a true portrait of that feature in the model, (4) produce shadows and shading that *exactly* correspond to that of model's face, (5) mix flesh paint tints that are like living flesh. Our students' portraits look alive. You, too, can make *exact* charcoal and oil likenesses. Send for free booklet today.

STUART STUDIOS,
121 Monument Circle, Room 6115, Indianapolis 9, Ind.
Please send me free book and outline of lessons.

Name _____
Street _____
City _____ State _____

**MEN! Here's
a Chance to
Earn Money**



Which of these books can help you GET A BETTER JOB AND MAKE MORE MONEY

known in painting circles the world over. These men are helping thousands find themselves a profitable future... and helping them earn more money doing work they like.

No publishers overstocks... no books that didn't sell, but beautifully printed editions of every craft and trade. Gateway Books are written by experts like H. H. Siegle, 35 years a woodworking authority; and H. N. Vanderwalker, authority; and H. N. Vanderwalker, authority. These men are helping thousands find themselves a profitable future... and helping them earn more money doing work they like.

Take advantage of Gateway Books the way these men have. Here's what they say, "Your Air Conditioning book is excellent... just what I needed."... "Gateway Books have helped me get started again in business." A teacher says, "We plan to use three of your books this fall." These people realize the value of Gateway Books... they can help you to the Road to Success. So, choose the books you want and send today... All books unconditionally guaranteed.

Guarantee

You take no chances. All Gateway Books are backed by a money back guarantee. They must satisfy or your money will be cheerfully and promptly refunded.

CHECK THIS LIST OF MONEY MAKING BOOKS

1. CARPENTRY CRAFT PROBLEMS. 302 pages and over 700 illustrations explaining carpentry craft problems in detail... **\$2.00**

2. BUILDING—FORMS, STAIRS, ROOFS. Latest information on forms, staircases and roof building. For carpenters or helpers. 210 pages, 495 illustrations... **\$2.00**

3. QUICK CONSTRUCTION. Temporary buildings, roof and platform problems, special uses of tools, shingles, cornices and hundreds of useful subjects for the amateur or professional. 250 pages, 670 illustrations... **\$2.00**

4. MODERN HOMECRAFT. 240 pages of ideas for modern furniture... and how to make it. Gives working drawings... **\$3.00**

5. WOODEN BOAT AND SHIP BUILDING. Solves every problem of building wooden ships and boats. 244 pages... **\$2.00**

6. MATHEMATICS. Includes all phases of practical problems. 224 pages... **\$2.00**

7. SLIDE RULE AND LOGARITHMIC TABLES. Uses and principles of slide rule and logarithmic tables fully covered. Includes even 10 place log tables. 200 pages... **\$1.50**

8. WELDING. Arc, Spot, butt, electric, gas welding and cutting, hand forging, etc. 250 pages, 56 illustrations... **\$1.50**

9. MACHINE SHOP PRACTICE. 408 pages, 310 illustrations of complete information on all phases of machine shop practice. Clear, concise, authoritative... **\$3.00**

10. SHEET METAL WORKERS MANUAL. Complete instruction and information on every phase of sheet metal working. Includes many tables. 552 pages, 375 illust... **\$2.00**

11. INTERIOR WALL DECORATION. Practical working methods for plain and decorative finishes on all types of wall surfaces. 185 illust., 491 pages... **\$3.00**

12. FURNITURE, FURNITURE FINISHING, DECORATION AND PATCHING. New book that covers: 1. Period Furniture, 2. Furniture Decoration, 3. Furniture Finishing, 4. Furniture Patching, 5. Modern Special Finishes. 580 pages, 353 illust... **\$4.00**

13. SILK SCREEN METHODS. How to make silk screens... methods, materials and equipment needed. Complete, authoritative, and handy... fully illust., 240 pages... **\$3.00**

14. STENCILS AND THEIR USE. How to make and use stencils for all types of decorations. 148 pages—illust... **\$1.50**

15. THE MIXING OF COLORS AND PAINTS. How to mix colors for interior decorating, arts, crafts, general mixing methods. A handy book for professional and amateur painters. 302 pages fully illust... **\$2.00**

16. SPRAY PAINTING. Spraying technique and operating instructions on paints, materials, finishes. 125 fully illust. pages **\$1.50**

17. HOUSE PAINTING METHODS. 400 pages and 150 illust. cover the subject of house painting (of any surface) thoroughly... time and money saver... **\$2.00**

18. WOOD FINISHING. Wood finishes and problems... tools... materials... requiring 900 pages and 353 illustrations... **\$2.00**

19. CYCLOPEDIA OF PAINTING AND DECORATING. Covers methods, tools and materials for the home and workshop, including every branch of painting and decorating. Any particular job is fully explained with illustrations to clarify the text. 350 pages—288 illust... **\$3.00**



23. SPEED BOARD. Eliminates Triangle, T-square, Protractor, Rules. 24" x 20 3/8" Masonite Board... strong steel arms... clear plastic square, 4 scales, full graduation protractor, nine cut-out circles. Favorite of professionals... marvelous for amateurs. Guaranteed... **\$3.95**

24. REFRIGERATION SERVICE AND ICE MANUAL. Domestic and commercial refrigeration used in markets, milk depots, soda fountains, etc., and in homes. 300 pages, illust... **\$2.00**

25. PLUMBING INSTALLATION AND REPAIR. 236 page book on how to repair leaky faucets, clogged toilets, drains, traps, vents, sewers, etc. 153 illust... **\$2.00**

26. PRACTICAL ELECTRICITY AND HOUSE WIRING. Excellent for home repair work. 200 pages, 227 illustrations... **\$1.50**

27. ARMATURE AND MAGNET WINDING. The construction of armatures and their repairs, fully covered with numerous illustrations to speed the job. 270 pages... **\$1.50**

28. DIESEL ENGINES AND DIESEL ELECTRIC POWER. A complete book on Diesel engines, their construction and care of equipment. 300 pages, 200 illust... **\$2.50**

29. HANDBOOK OF ORNAMENT FOR ARTISTS, DESIGNERS, JEWELERS, ARCHITECTS, ETC. Topics covered include: Elements of Decoration, Decorated Objects, and Ornament applied to Features. Nearly 2,000 illust., 548 pages. Complete, authoritative... **\$5.00**

30. GRAINING. A 240 page comprehensive book of instruction on the art of graining all surfaces. 64 full page color plates... **\$3.00**

31. PRACTICAL PHOTOGRAPHY. A modern and complete study of all the elements of basic photography. Hundreds of illustrations leaves nothing to doubt... **\$3.00**

Special!



20. CYCLOPEDIA OF RADIO AND ELECTRONICS. Non-technical reference book of 1,000 pages, 1,700 headings, 1,178 illustrations, 130 tables, and 105 graphs. Covers over 500 subjects **\$5.00**

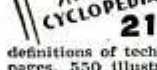

21. ELECTRICAL AND RADIO DICTIONARY. Over 3,800 definitions of technical words and terms. 300 pages, 550 illustrations... **\$2.50**

Completely New!

AIR CONDITIONING

AND REFRIGERATION. Actually 4 big books in one. Includes all phases of air conditioning, cooling, heating and equipment needed. 706 pp., 27 huge chapters, 84 charts, 351 illust... **\$4.00 ONLY**



The GATEWAY Book Co.

A. R. Lynk, President
32 N. State, Dept. PM-11, Chicago 2, Ill.
Phone STAtE 2791

CHECK, CLIP AND MAIL THIS COUPON NOW

THE GATEWAY BOOK CO.

Dept. PM-11, 32 N. State, Chicago 2, Ill.

Please send the books I've circled. I understand that if any of the books are not satisfactory, I may return them and my money will be refunded. No COD's accepted outside the U. S.

1 3 5 7 9 11 13 15 17 19 21 23 25 27 29 31
2 4 6 8 10 12 14 16 18 20 22 24 26 28 30

(Please print name clearly)

Name.....

Address.....

City..... State.....



Become a REAL ESTATE Specialist

BIG OPPORTUNITIES! U.S. Housing Administration Survey reveals 12,600,000 homes needed. Vast population shifts, Govt. loans to veterans, wide-spread urge to "buy something real," higher incomes—mean tremendous real estate expansion. Prepare NOW to cash in on big profits. Learn in spare time at home. No need to quit present job. Start "on the side"—then build up full time business as your own boss; pleasant outside work, your own working hours.

Write for FREE BOOK

Our practical home-study course prepares you for this money-making, big future business. No previous experience needed. Free book describes course—tells how you can quickly learn to make excellent income. Write NOW for FREE BOOK. No cost; no obligation; no salesman will call. SCHOOL OF REAL ESTATE TRAINING, Inc., Dept. 811, 126 Bedford St., Stamford, Conn.

FREE BARGAIN CATALOG of BOOKS

25,000 books of all publishers listed in our 51st Annual Bargain Catalog of 320 pages. Old-time favorites—latest "best sellers." Reference, Fiction, Juvenile, History, Scientific, etc. Supplying schools, colleges, libraries and thousands of individual customers. Send postcard today for our new 1946 catalog, "Bargains in Books."

THE BOOK SUPPLY COMPANY, Dept. 132
564-566 West Monroe Street Chicago 6, Illinois

CODE SPEED SHORT CUT

Be an expert. Learn to be a Telegraph or Radio Operator. Thousands of men needed. Intensely interesting work—good pay. Learn at home or wherever you are, quickly, easily with the famous Candler Speed System. Book of particulars free.

CANDLER SYSTEM CO., Dept. S-M, Box 928, Denver 1, Colo., U.S.A.

WRITERS

YOU CAN WIN \$25.00 Monthly Prize for best true life story! Any subject! Any length! Send penny postcard for fair-and-square contest rules—TODAY!

TRUTH PUBLISHING CO.
Dept. A-10
136 Liberty St. New York 6, N.Y.

NOW . . . ELECTROPLATING

Learn this profitable, interesting trade. Hobby or full time business. Chromium, Nickel, Gold, Silver, etc. Postcard brings full details, FREE.

PLATER HYDE, Dept. M, P.O. Box 176, National City, Calif.

Success in Music!

THE ONLY HOME STUDY MUSIC CONSERVATORY OFFERING ALL COURSES LEADING TO DEGREE, BACHELOR OF MUSIC

Personalized Instruction for Professionals, Advanced Students and Beginners by Eminent Music Teachers. Check courses which interest you and mail coupon for catalog and illustrated lessons.

UNIVERSITY EXTENSION CONSERVATORY

765 Oakwood Blvd., Suite U-275, Chicago 15, Ill.

- Piano Violin Cornet Trumpet Saxophone Clarinet
- Guitar Mandolin Voice Ear Training and Sight Singing
- Choral Conducting Public School Music History of Music
- Harmony Advanced Composition Arranging

Name

Street

City & State

Music experience..... Age.....



You'll see when you smoke I.C.!

Interesting Cycling, you bet—and Incomparable Companionship with a pipeful of Irish Castle. How the ladies love its aroma-appeal. This custom-blend was tailored to taste by the master hand of Willoughby Taylor himself. That's why it took 8 rare tobaccos to create I.C. . . . Turkish for mellowness . . . tangy Virginias for fragrance . . . Latakia for zest, and Perique for spice . . . sound White Burley for body and satisfaction. It's love at first sight with every puff... You'll see, when you smoke I.C.!



IRISH CASTLE

GET ACQUAINTED SPECIAL

For a limited time (and only if your dealer is out of stock) we'll send you a half-pound humidor of Irish Castle Pipe Mixture for only \$1.10. Mail coupon with cash or check to Penn Tobacco Co., Dept. NP, Wilkes Barre, Pa.

Name

Address

INVENTORS

HERE ARE 4 GOOD REASONS

Why you should send for these books

Immediately!

1 MANUFACTURERS NEED YOUR INVENTIONS—Your Opportunity

War plants and critical materials have been released for civilian production! Manufacturers are looking for new products—new processes!

Who will supply these new products—these new processes? America's Inventors, of course. They always have!

Filing your application in the U. S. Patent Office for a patent may prove to be the door opener for you—manufacturers prefer to talk to inventors whose applications for patents are filed.

2 TIME WAITS FOR NO MAN—Your Chance to Profit

If you have an idea for a patentable invention—in your head or on your workbench—keeping it there won't do you any good. It won't pay royalties to you there.

While you're doing nothing about it—some other inventor may come up with the same idea and cash in. It has happened. Be first to apply for a patent—that's the way to benefit in case of controversy.

3 PATENTS MAKE JOBS—A Challenge to You

The postwar economy of the Nation calls for full employment for 60,000,000 workers. Wouldn't you like to feel that your invention gave employment to even a small percentage of that number . . . in addition to the possible financial rewards you'd receive?

VICTOR J. EVANS & CO. has helped inventors for nearly 50 years. They can help you. An experienced staff of draftsmen, specification writers and patent attorneys will take care of all details for you. All you have to do is send us a description of your invention. You can pay on our deferred payment plan. Remember—you can get a patent yourself, **BUT**—the U. S. Patent Office advises that unless an inventor is familiar with patent matters he should employ a competent registered patent attorney.



4 THE BOOKS TELL YOU WHAT TO DO

Thousands of successful inventors have followed the advice found in these two books. They tell you, step by step, the procedures required by the U. S. Patent Office; they give you valuable suggestions on financing, selling a patent; they illustrate 115 mechanical movements that may help you complete your invention. And—**THEY'RE FREE**—in addition to important Evidence of Invention Form that will give you a record of the date of your disclosure. **SEND FOR ALL THREE TODAY.**

VICTOR J. EVANS & Co.

MERLIN M. EVANS

Registered Patent Attorney

Main Office: 930-M Merlin Building
Washington 6, D. C.

Pittsburgh Office: 521-N Empire Building

Los Angeles Office: 738-N Security Building

Rush by return mail. Free copies of your books, "Patent Protection" and "When and How to Sell an Invention"—also important—"Evidence of Invention" form.

Name.....

Address.....

City and State.....

**HERE'S YOUR FIRST STEP—
MAIL THIS COUPON Today!**

The set of
books
that makes



MASTER MACHINISTS and leads to bigger pay!

This big home-study and reference course gives you the practical facts on machines and methods you need to advance in machine shop work. Take advantage of the other man's experience as found in books, to solve your problems, increase your efficiency, with

The AMERICAN MACHINISTS' LIBRARY

6 volumes—2368 pages—2516 illustrations
(A combined home-study course and reference library)

This library of machine shop practice was written for practical men. It gives you the best methods for every kind of machine shop work. It fully explains lathes, drills, and other machine tools and their operation, automatic screw machines, speeds and feeds, gear design and production, jigs and fixtures, punch and die work, metal surfacing, etc., etc. Plainly written—completely illustrated—the best kind of help to the machine shop man who wants to advance himself.

No money down—special price—easy payments.

EXAMINATION COUPON

McGRAW-HILL BOOK CO., 330 W. 42nd St., N. Y. 18

Send me for ten days' examination the American Machinists' Library. If satisfactory I will send you \$1.50 in 10 days and \$3.00 monthly until the price of \$19.50 is paid. If not wanted, I will return the books postpaid. (To insure prompt shipment write plainly and fill in all lines.)

Name
Home Address
City and State
Company
Position PM-11-45

**SICKNESS or ACCIDENT
can't rob me of my savings**

**I'VE A FAMILY MUTUAL
HOSPITALIZATION POLICY**

Costs
only **3¢** A DAY • EACH ADULT
1½¢ A DAY • EACH CHILD

FOR SICKNESS OR ACCIDENT
Hospital Expenses paid (beginning with the first day), up to \$540.00

FOR ACCIDENT
Doctor Expense paid, up to \$135.00 Loss of Wages reimbursed up to \$300.00
Less of Life by Accident \$1000.00

WAR COVERAGE and EXTRA BENEFITS
Childbirth Expense paid, up to \$80.00

Sickness or accident can easily wipe out, in a few weeks, savings it may have taken years to accumulate. Don't let this happen to you. With a Family Mutual Hospitalization policy, you'll be able to pay your hospital bills. In case of accident, you will be reimbursed for your doctor expenses and for loss of time from work. You may choose any hospital in the United States and your own family doctor may attend you. Benefits applying to children are 50% of those paid adults.

MAIL COUPON TODAY—No Agent Will Bother You

FAMILY MUTUAL LIFE INSURANCE CO., WILMINGTON 99, DEL.

Family Mutual Life Insurance Co., PM-9
601 Shipley St., Wilmington 99, Del.
Please send me without obligation, complete information on
your Economical Hospitalization Plan.

NAME
ADDRESS
CITY STATE

BECOME A
SERVICE
EXPERT

REFRIGERATION and AIR CONDITIONING

Millions of Older
Units Need Expert
Service. Big After-
the-War Expansion
Will Create Even
More Opportunities

Approved for
Veterans "G.I."
Training

Now, not "next week," is the time to start training for a top-pay job in this vital field. A drastic shortage of trained service experts exists. Many thousands more will be needed for big post-war expansion caused by new industrial uses. Train NOW to get your pick of best jobs. We will give you the practical training you need. For 2 years we trained men and women for the Army and Navy only, in fine-precision aircraft instrument work. So our methods must be right. Common schooling is all you need. Our unique system makes everything easy to grasp. You can train at home and in our big Chicago shops. Write for full facts TODAY, without obligation.

INDUSTRIAL TRAINING INSTITUTE

2150 Lawrence Avenue, Dept. P11, Chicago 25, Illinois

Trains MAGAZINE

The illustrated monthly about railroads

Travel America in your armchair with TRAINS, the magazine which tells what the railroads do and how they do it. Fine maps, photos and explanatory diagrams. Read now about the new streamliners you'll soon be riding... Ask your newsdealer or send 25 cents for a copy.

TRAINS MAGAZINE, Dept. M, Milwaukee, 3, Wis.



**SIMPLE EASY INVENTION
TRIMS HAIR AT HOME!**

**SAVES
BARBER BILLS**

Trims hair as it combs! Easy!
Quick! Keeps men's, women's
children's hair trim, neat, freshly-
cut looking all the time! Trims,
tapers, thins out uneven hair. Use
like ordinary comb. Safe, Simple.

No experience required. Fine for legs, underarms! Sells like wild!

SAMPLES FOR AGENTS Sample offer sent im-
mediately to all who
send name at once. A penny postal will do. SEND NO MONEY. Just
your name. KRISTEE CO., 687 Bar St., AKRON, OHIO

DRAW for MONEY

Be An ARTIST!

Trained Artists Are Capable of
Earning \$30-\$50-\$75 A WEEK

Use Your Spare Time to Prepare
for a Profitable Peacetime Art
Career!

It's pleasant and interesting to study Art
the W.S.A. way. **COMMERCIAL ART, DE-
SIGNING and CARTOONING**—all in ONE
complete home study course. No previous
Art experience necessary—we teach you
step by step—hundreds have profited by
our practical method since 1914. TWO
ART OUTFITS FURNISHED. FREE BOOK,
"Art for Pleasure & Profit"—tells all
about our course, instruction, service,
what our graduates say—and commer-
cial opportunities for you in Art.

FREE BOOK gives details!

WASHINGTON SCHOOL OF ART
Studio 1211P, 1115 15th St., N.W., Wash, 5, D.C.

Send free booklet and full particulars.

Name AGE.....
Address
City State

Is your future in the air ?

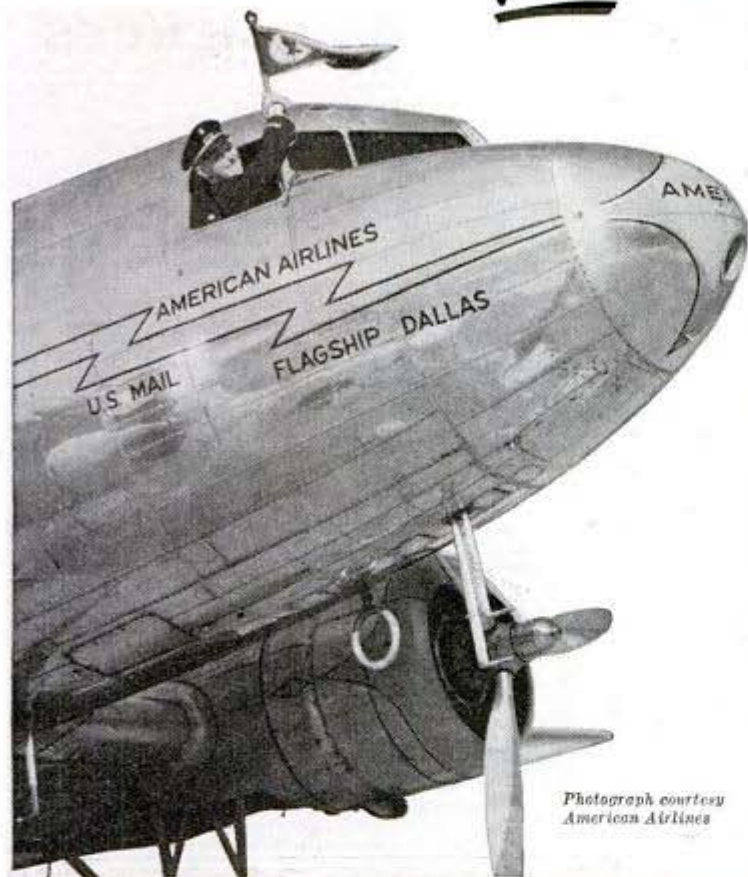

Photograph courtesy
American Airlines

“UP IN THE AIR” about your future?
Or do you see your future in the air?

There's all the difference in the world between those few words.

The man who is “up in the air” about his future doesn't know where he's going. And he doesn't get anywhere.

The man who sees his future in the air is busily *training* himself for a responsible post in Aviation. He has selected a great industry that is becoming a greater one. He knows the position he wants and is making progress towards it.

Many are obtaining their training from the famous International Correspondence Schools. Spare-time study with I. C. S. — at low cost — has many advantages for the man with a definite objective in the aircraft industry. Mail the coupon for full information on practical, authoritative I. C. S. training.

INTERNATIONAL CORRESPONDENCE SCHOOLS



BOX 5560-K, SCRANTON 9, PENNA.

Without cost or obligation, please send me full particulars about the course *before* which I have marked X:

Air Conditioning and Plumbing Courses

- Air Conditioning
- Heating Plumbing
- Refrigeration Steam Fitting
- Chemistry Courses**
- Chemical Engineering
- Chemistry, Analytical
- Chemistry, Industrial
- Chemistry, Mfg. Iron & Steel
- Petroleum Refining Plastics
- Pulp and Paper Making

Civil Engineering, Architectural and Mining Courses

- Architectural Drafting
- Architecture
- Bridge and Building Foreman
- Building Estimating
- Civil Engineering Coal Mining
- Contracting and Building
- Highway Engineering
- Lumber Dealer
- Reading Structural Blueprints
- Sanitary Engineering
- Structural Drafting
- Structural Engineering
- Surveying and Mapping

Electrical Courses

- Electrical Drafting
- Electrical Engineering
- Power House Electric
- Practical Electrician
- Practical Telephony
- Telegraph Engineering
- Internal Combustion Engines Courses**
- Auto Technician Aviation
- Diesel-Electric
- Diesel Engines Gas Engines

Mechanical Courses

- Aeronautical Engineering
- Airplane Drafting
- Flight Engineer
- Foundry Work
- Heat Treatment of Metals
- Industrial Engineering
- Industrial Metallurgy
- Mechanical Drafting
- Mechanical Engineering
- Mold-Loft Work
- Patternmaking
- Reading Shop Blueprints
- Sheet-Metal Drafting
- Sheet-Metal Worker

- Ship Drafting
- Ship Fitting
- Shop Practice
- Steel Mill Workers
- Tool Designing
- Welding, Gas and Electric

Radio Courses

- Electronics
- Radio, General
- Radio Operating
- Radio Servicing
- Railroad Courses**
- Air Brake Car Inspector
- Locomotive Engineer
- Locomotive Fireman
- Railroad Section Foreman

Steam Engineering Courses

- Boilermaking
- Combustion Engineering
- Engine Running
- Marine Engineering
- Steam Electric
- Steam Engines
- Textile Courses**
- Cotton Manufacturing
- Rayon Weaving

- Textile Designing
- Woolen Manufacturing

Business and Academic Courses

- Accounting Advertising
- Arithmetic Bookkeeping
- Business Correspondence
- Business Management
- Certified Public Accounting
- College Preparatory
- Commercial
- Cost Accounting
- Federal Tax
- First Year College
- Foremanship
- French
- Good English
- High School
- Higher Mathematics
- Illustrating
- Motor Traffic
- Postal Service
- Salesmanship
- Secretarial
- Sign Lettering Spanish
- Stenography
- Traffic Management

Name..... Age..... Home Address.....

City..... State..... Position..... Working Hours..... A.M. to..... P.M.

Canadian residents send coupon to International Correspondence Schools Canadian, Ltd., Montreal, Canada.

British residents send coupon to I. C. S., 71 Kingsway, London, W. C. 2, England.

DISCOUNT TO DISCHARGED VETERANS—SPECIAL TUITION RATES FOR MEMBERS OF THE ARMED FORCES

I'll PROVE I can make
you, too,
**TOUGH as a
MARINE**
..... and add
Powerful POUNDS
and Vital INCHES of
DYNAMIC MUSCLE
to your ARMS, LEGS,
BACK, CHEST,
and SHOULDERS
says
George F. Jowett
WORLD'S GREATEST
BODY BUILDER
..OR IT WON'T COST YOU A CENT!

Let me prove to YOU that you can put inches of dynamic muscles on your arms! Add inches to your chest! Broaden your shoulders and power-pack the rest of your body. I can do for you what I've done for thousands the world over, including many officers and men now in the U. S. and British Armed Forces!

GIVE ME 10 MINUTES A DAY!

I'll Show You My Secrets Of Body Building
I'll help you learn the "Progressive Power Method" through which I rebuilt myself from a physical wreck to the holder of more strength records than any other living athlete or teacher! No matter how skinny or baby you are, you can learn my methods right in your own home. Through my proved secrets I show you how to develop your power, inside and out, until YOU are fully satisfied that you are the man you want to be. "The Jowett System," says R. F. Kelly, Physical Director of the YMCA, Atlantic City, "is the greatest in the world!" If you want a physique that will inspire respect from men, and admiration from women... ACT LIKE A HE-MAN! Decide at once! The famous book, "Nerves of Steel—Muscles Like Iron" will be included FREE! Priceless for the strength fan! Full of photos of marvelous power-bodied men who will show you what Jowett has done for them and how he can do the same for you. Reach out... Grasp this Special Offer today!

PROVE TO YOURSELF IN ONE NIGHT!

Send only 25c for test Course, "Molding a Mighty Arm." Read it the evening it arrives—learn from experience the thrill you can give your muscles!

SEND FOR THESE FIVE FAMOUS COURSES IN BOOK FORM
**ONLY 25c EACH
or ALL 5 for \$1.00**

Jowett Institute of Physical Culture
230 Fifth Avenue
Dept. 908-A
New York 1, N.Y.

This Book Free!



BOOK WITH PHOTOS OF FAMOUS STRONG MEN
MAIL COUPON NOW **FREE**



Jowett Institute of Physical Culture
230 Fifth Avenue, Dept. 908-A New York 1, N. Y.
George F. Jowett: Your proposition looks good to me. Send by return mail, prepaid, the courses checked below, for which I enclose (). Include FREE book of PHOTOS.

- All 5 courses for... \$1
- Molding a Mighty Arm 25c
- Molding a Mighty Back 25c
- Molding a Mighty Chest 25c
- Molding Mighty Legs 25c
- Molding a Mighty Grip 25c
- Send all 5 C.O.D. (\$1 plus postage.) No orders less than \$1 sent C.O.D.

NAME.....Age.....
(Please print plainly. Include Zone Number.)

ADDRESS.....

STUDY AT HOME

With A Chartered Educational Institution

Men with specialized training win higher positions, insure larger earnings, and are bigger successes in business and public life. Opportunities NOW greater than ever before. Send for our Catalog.

ARTS AND SCIENCES

Courses in Philosophy; Education; Letters; Public Health; Medical Jurisprudence; Psychology; Sociology; Physics; Chemistry; Plastics; Geology; Political Science; Theology; Business and Commerce; Accounting; Mathematics; Statistics; Agriculture.

ENGINEERING

Courses in Electrical, Civil, Mechanical, Drafting, Architectural, Steam, Aeronautical, Radio, Structural, Mining, Industrial, Highway, Petroleum, Marine, Chemical, Diesel, Automobile and Air Conditioning Engineering.

LAW

Complete Professional Law Course includes 20 Hornbook Series college grade textbooks. Courses also in Commercial Law, Patent Law and Medical Jurisprudence. McKinley-Roosevelt Incorporated, 4610-K, Sheridan Rd., Chicago 40, Ill.

SHORTHAND in 6 Weeks at Home

Famous Speedwriting system. No signs or symbols; uses ABC's. Easy to learn; easy to write and transcribe. Fast preparation for a job. Surprisingly low cost. 100,000 taught by mail. Used in leading offices and Civil Service. Write for free booklet.

SPEEDWRITING, Dept. 1511-5, 55 W. 42 St. N. Y. 18

\$UCCESS for YOU... in ADVERTISING

Profitable • Fascinating • Many Opportunities
Easy to learn in short time from an Expert. NOT a "School"... A "Successful Adv. Executive."
Write for Free booklet *Success for You in Advertising*.
G. H. JENSSEN, A, 450 E. Ohio, Chicago 11.

LEARN MEAT CUTTING At Home - In Spare Time



Get into the vital meat industry. Concise, practical Home Training based on 25 years proven instruction methods used at National's famous resident school. Prepares you for bigger pay as Meat Cutter, Supervisor, market manager or store manager in your own store. Go as rapidly as your spare time permits. Diploma. Start NOW to turn your spare hours into money. Send for FREE bulletin today. No obligation.

National School of Meat Cutting, Inc., Dept. U-63, Toledo 4, Ohio

LAW

STUDY AT HOME for PERSONAL SUCCESS and LARGER EARNINGS. 35 years expert instruction—over 108,000 students enrolled. LL.B. Degree awarded. All texts furnished. Easy payments. Send for FREE BOOK—"Law and Executive Guidance."

AMERICAN EXTENSION SCHOOL OF LAW
Dept. 59-M 646 N. Michigan Ave., Chicago 11, Ill.

Learn Public Speaking Learn theory and fundamentals at home—in spare time. Then acquire actual experience and practice. Send for FREE booklet "Power of Effective Speech."
North American School, Dept. 135E,
1315 S. Michigan Ave., Chicago 5, Illinois

HOW RUPTURE MISERY MAY DISAPPEAR

Don't go on day after day suffering the tortures of a clumsy truss that presses on your hips and back, gouches your flesh, slips and slides and leaves your rupture DANGEROUSLY UNPROTECTED. Get the truth about rupture care and how the newly patented Vita-Pneumatic Nature-Ade (U.S. Reg.) appliance with its unique features can help your rupture misery disappear. Write at once for FREE booklet containing much valuable information.
PNEUMATIC APPLIANCE, 103 PARK AVE., N. Y. 17, N. Y., DEPT. 45B

WIN POSTWAR SUCCESS in Radio TELEVISION ELECTRONICS



Cash in on War Developments. Win and Hold a Big Job in Industry. Own Your Own Business in One of the Greatest and Best Established Fields in the World. Learn Radio by the Modern

You build a long-distance super-heterodyne—other experimental units—with the equipment furnished you.

SHOP METHOD HOME TRAINING OF THIS GREAT NATIONAL TECHNICAL TRADE SCHOOL

YOU read and hear about the great progress made during the war in Radio, Electronic power and control, Television. Do you ever think what all this means to YOU—PERSONALLY—right now and in the future? Compare the job you now have with the opportunities in RADIO, TELEVISION and ELECTRONICS.

1. Thousands of technicians needed in Radio and Television stations and communication companies to operate, repair and maintain equipment.

2. Radio has grown from \$100,000,000 to \$5,000,000,000 and is still growing.

3. Experts say Television offers the astounding number of 500,000 jobs right in the start.

4. Electronics in industry and the home opens a brand new unexplored field.

Now, the amazing speed-up training, that proved so successful in war time is available, at last, to you in Radio, Television and Electronics. Send the coupon. Learn the facts about this educational development.

Try out the FREE sample lesson and see for yourself what you can accomplish in a surprisingly short time by SHOP METHOD HOME TRAINING.

Back of this course are the great training shops and experimental laboratories of National Schools—one of the oldest and finest technical training institutions in the world. Here instructors, engineers and research men are actually working with students and technicians to bring you, right in your own home, the most sound, practical and advanced training methods.

You have the advantage of the latest developments—the newest and most improved methods. Yet you can continue with your present job—carry on with what you are doing. Send the coupon and learn how.

After the War What?

Face Facts. Is the job you're doing going to last? What is its future and yours? How are you going to meet conditions when the world returns to civilian production. RADIO IS A BIG, SOUND, WELL-ESTABLISHED BUSINESS. Television is going to start off soon with a boom. F.M. (Frequency Modulation) is here to stay. No one knows how great the electronics industry will be. When you hang up your uniform—when your war job folds up—step proudly, as a trained expert into a new field—an essential industry. Learn about all these opportunities. Read the book National Schools will send you. Fill out coupon!

Build Hundreds of Experiments with Equipment that Comes with Your Course

You actually LEARN BY DOING when you train with National for you are furnished with the latest Radio-electronic equipment, right out of the shops and laboratories of National Schools to work with in your own home. Build receiving sets, testing instruments, signal generators and other devices. With this equipment you REALLY ARE AN EXPERIENCED RADIO TECHNICIAN when you have completed your National training.

Get Started Now

In a few months—perhaps only weeks—you may start making good money in Radio—accept A BIG PAY JOB in industry—GET INTO A PROFITABLE, LIFETIME BUSINESS OF YOUR OWN with little or no capital. Take the first step now. Fill out and mail the coupon immediately.

NATIONAL GRADUATES MAKE SUCCESS RECORDS



Joe Grumlich, Lake Hiawatha, N. J. writes "My latest offer was for \$5,800.00—but I am doing well where I am now engaged. I am deeply indebted to National."

O. K. Ivey, Washington, D. C., writes in a letter of recommendation: "I believe National offers the best course to be had in radio. Keep up the good work!"



R. R. Wright of Blackfoot, Idaho: "Due to my training at National I was selected to instruct in the laboratory work of the Navy and Marines."



Read What Hundreds of Others Say. Send the Coupon Immediately

FREE LESSON

See for yourself how Shop Method Home Training is different—how it will work for you. Get this FREE LESSON. Study it! Use it! Keep it without obligation. With it comes "YOUR FUTURE IN RADIO"—profusely illustrated it describes the jobs waiting for trained men—the vast opportunities in RADIO NOW—TELEVISION IN THE NEAR FUTURE. Send coupon.



Send the Coupon and prove to yourself what YOU can do in RADIO!

NATIONAL SCHOOLS

LOS ANGELES 37, CALIFORNIA EST. 1905

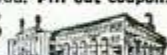

MAIL OPPORTUNITY COUPON FOR QUICK ACTION

National Schools, Dept. 11-PM
4000 South Figueroa Street
Los Angeles 37, California

(Mail in envelope or paste on penny post card.)

Mail me free the Sample Lesson and Opportunity Book. I understand no salesman from National will call on me.

Name..... Age.....

Address.....

City..... Zone..... State.....

DRAFTING



GET THIS
Free
TRIAL LESSON
Send Coupon



TO PROVE TO YOU how easy it is to learn Drafting at home by the Chicago Tech method, this 40 year old technical college will send you a *Free Trial Lesson in Drafting*. No charge for this Lesson now or later.

Mail Coupon
Below

Get ready for a peacetime career. Look into the opportunities in Drafting. Read the want-ads for proof of the urgent demand for draftsmen in the aircraft, machinery, electrical and building fields. The draftsman always comes first on any new project in industry.

The Draftsman—"The Key Man"

No new machines can be built, no airplanes constructed, no bridges or buildings erected until the draftsman has completed his work. Real immediate opportunities exist in Drafting—the profession upon which all construction is vitally dependent. Drafting is clean, interesting, well paid work. Investigate today what Drafting offers you.

Learn in Spare Time,—at Home! (or at the College in Chicago)

With our easy step-by-step method (and the tools we furnish) you can learn in your spare time at home. Convenient terms. Now is the time to prepare in Drafting for peacetime opportunities. Send the coupon or a post card for the Trial Lesson and complete information,—all FREE.

CHICAGO TECHNICAL COLLEGE

P-206 Tech. Bldg., 2000 S. Michigan Ave., Chicago 16, Ill.

Yes,—please send me **FREE** Trial Lesson in **DRAFTING**.

- | | |
|---|--|
| <input type="checkbox"/> Architectural Drafting | <input type="checkbox"/> Building Construction |
| <input type="checkbox"/> Aircraft Drafting | <input type="checkbox"/> Machine Drafting |
| <input type="checkbox"/> Electrical Drafting | <input type="checkbox"/> Structural Drafting |

Name.....

Address.....

City..... Zone.....

State..... Age.....

"I'm Waiting
for the **BEST**
Handy-Sized
Dictionary"



PAPER RATIONING, plus unprecedented demand, has made WEBSTER'S COLLEGIATE hard to get. But your bookseller will do his best to provide your copy!

Based on and abridged from Webster's New International Dictionary, Second Edition—"The Supreme Authority"—and edited with the same careful scholarship. Defines all the words most commonly used. 1,300 pages; 110,000 entries. \$4.00 to \$8.75, depending on choice of binding. G. & C. Merriam Co., Springfield 2, Mass.

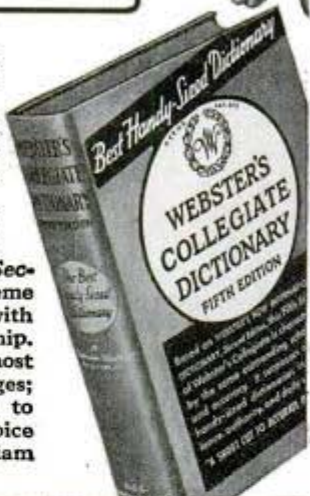

WEBSTER'S COLLEGIATE *a Merriam-Webster*

CARTOONING



CASH IN on Big Cartoon Market. BECOME CARTOONISTS QUICKLY with our NEW, EASY METHOD. No experience necessary. Prepared by successful cartoonists. Only \$2.85 postpaid. SATISFACTION GUARANTEED. Sample LESSON PLATE and interesting literature FREE.

NATIONAL ARTISTS BUREAU
Dept. A-3, Box 4248 DALLAS 8, TEXAS

So You Think You're Living?

Yes, you're going through the motion, all right—eating, sleeping, working and all that. But are you really **LIVING**? And how do you **KNOW** you are living? To find out read "Life Unlimited," a message for immortals. Your copy mailed free on request.

LIFE UNLIMITED, Dept. PM-11

3227 Indiana Ave. St. Louis 18, Mo.



Begin today. Write now for our Free Book, "How to Become a Good Penman." It contains spellings and tells how others learned to write in spare time. Enclose 10¢ for your name beautifully written and a pen point suitable for shaded writing. Write today.

THE TAMBLYN SCHOOL OF PENMANSHIP
N-441 Ridge Building, Kansas City, Mo.

GET INTO REFRIGERATION AND AIR-CONDITIONING

Start building your future today in one of the fastest growing and most profitable of industries. Prepare for high pay jobs or GET INTO YOUR OWN BUSINESS with small capital. Learn on actual equipment in our resident classes.

COURSES IN
Refrigeration Service Eng.
Refrigeration & Air-Conditioning Service Eng.
Refrigeration & Air-Conditioning Engineering

VETERANS
eligible for training under G.I. Bill

Send this ad with name and address for full information.
VETERANS (PLEASE CHECK) **CIVILIAN**

BOSTON TECHNICAL INSTITUTE
SCHOOL OF REFRIGERATION
4707 EUCLID AVENUE CLEVELAND 3, OHIO

**LEARN
AT HOME**



START YOUR OWN BUSINESS



PLASTICS

FABRICATION

New - Profitable Industry!

**MAKE PRODUCTS
LIKE THESE**

YOU'LL really enjoy learning plastics this new, interesting way! For you'll actually make beautiful, useful plastics articles during your home study training with Plastics Industries Technical Institute.

NOW'S YOUR OPPORTUNITY—Yes, the exciting age of plastics is here! Demands of war have caused phenomenal growth in the plastics industry—creating exceptional opportunities for those who know plastics. If you are a person with an eye to the future, you won't remain on the outside looking in—you'll want a choice position in the growing, expanding plastics field—or a plastics business of your own.

WE SUPPLY MATERIALS—For your interesting and practical work with plastics, we supply handsome, colorful, transparent rods, sheets and tubes of plastics from which you make useful, attractive creations. You saw, cement, machine, buff, form, dye, decorate, cast and laminate various types of plastics.

You also design your own plastics articles—develop your own ideas—express your originality. Earn money while learning.

A COMPLETE COURSE—This practical training in plastics fabrication is only one part of the Plastics Institute home study course. In addition, you learn about the many types of plastics, their manufacture, characteristics, properties and uses—intensive coverage of molding and mold design—testing and cost analysis—everything to help prepare you for your place in plastics.

START YOUR FUTURE TODAY—Mail the coupon below now! We will send you an interesting, illustrated free booklet with valuable information about plastics. We'll tell you how, at small cost, you can prepare for a future in this important industry while carrying on your present work. Don't put it off. Clip the coupon and mail it today!

VETERANS: ASK ABOUT G.I. TRAINING



NEW YORK Dept. PM 5-11, 123 E. 42nd St. **CHICAGO** Dept. PM 5-11, 221 N. La Salle St. **LOS ANGELES** Dept. PM 5-11, 1601 S. Western

SPECIAL RATES FOR SERVICE MEN

Plastics INDUSTRIES TECHNICAL INSTITUTE

Plastics Industries Technical Institute
221 N. La Salle St., Dept. PM5-11, Chicago 1

Mail in Envelope or
paste on penny postcard

Gentlemen: Please send me the booklet "World of Plastics" and information on your training program. I understand there is absolutely no obligation.

Name.....Occupation.....
Street.....Age.....
City.....Zone.....State.....

Veterans: Check for special information. If under 18: Check for special booklet.

FREE BOOKLET
Send for It Today!

FREE!



The famous 64-page, fact-packed book that has stimulated thousands of men!

"Forging Ahead in Business" is a practical, thoughtfully-written book with "punch" and common sense on every page. It carries a message of vital importance to every man who wants to make more money, get a better job and improve his station in life.

Partial Contents:

- Law of Success
- Highway of Achievement
- Forging a Career
- Making Decisions
- Organized Knowledge
- Failure and Success

Noted Contributors

Among the prominent men who have contributed to the Institute's training plan, which is described in "Forging Ahead in Business," are: Thomas J. Watson, President, International Business Machines Corp.; Clifton Slusser, Vice President, Goodyear Tire & Rubber Co.; Frederick W. Pickard, Vice President and Director, E. I. du Pont de Nemours & Co.

Simply return the coupon below, and your FREE copy of "Forging Ahead in Business" will be mailed to you.

MAIL COUPON TODAY

ALEXANDER HAMILTON INSTITUTE
Dept. 336, 71 West 23rd Street, New York 10, N. Y.
In Canada: 54 Wellington Street, West, Toronto 1, Ont.
Please mail me, without cost, a copy of the 64-page book—"FORGING AHEAD IN BUSINESS."

Name.....
Firm Name.....
Business Address.....
Position.....
Home Address.....

HOW to BREAK and TRAIN HORSES

THIS GREAT BOOK FREE!

Every farmer, every lover of horseflesh should have a copy of it. This amazing book tells how to know horses—how to break them—how to train them—how to make money as a master horseman. Write for it today—FREE, together with my special offer of a course in Animal Breeding. If you are interested in Gaiting and Riding the saddle horse check here Do it today—now. You'll never regret it.

BEERY SCHOOL OF HORSEMANSHIP
Dept. 11011-D • • Pleasant Hill, Ohio

TRAIN for SUCCESS in the Poultry Business

YOU CAN MAKE MORE MONEY from POULTRY. Proper management means profits ANY season, for life. Get latest scientific methods that avoid losses and mistakes. Our famous system of Home Study Training has helped thousands to success. Extra profits from the start. FREE Catalog; describes courses, methods, service. Write today to Dept. 30-D.

NATIONAL POULTRY INSTITUTE, Adams Center, N. Y.

ENGINEERING DEGREE IN 27 MONTHS

INDIANA TECHNICAL COLLEGE

Aeronautical, Chemical, Civil, Electrical, Mechanical, and Radio Courses. B.S. degree, 1-yr. diploma in Electrical, Mechanical, and Radio Service; Drafting, Prep. courses. Gov't. approved for G.I.'s. Low rate. Earn board. Large industrial center. Demand for graduates. Enter Dec., March, June, Sept. Catalogue. 5115 E. Washington Blvd., Ft. Wayne 2, Ind.

ELECTRICAL TRAINING

8 months intensive residence course in fundamentals of industrial electrical engineering, including radio, electronics. Prepares for technician, engineering aides. Approved for veteran training. Classes begin Feb. 25, July 8. Catalog.

BLISS ELECTRICAL SCHOOL
121 Takoma Ave., Wash. 12, D. C.

MASTER MACHINIST Learn by doing in completely equipped modern shops. Approved for G.I. training. Days, Evenings and Part Time. Men and Women.

MECHANICAL DRAFTING

TOOL ENGINEERING

ALLIED SCHOOL OF MECHANICAL TRADES
1330 South Michigan Avenue, Chicago 5, Illinois

STAMMER ?

This new 128-page book, "Stammering, Its Cause and Correction," describes the Bogue Unit Method for scientific correction of stammering and stuttering—successful for 44 years. Benj. N. Bogue, Dept. 1830, Circle Tower, Indianapolis 4, Ind.

GET THIS FREE BOOK!

Learn LANDSCAPE GARDENING

A thorough, interesting, home study course for those who wish to become LANDSCAPERS, GARDENERS, DESIGNERS, etc., for profit or pleasure. Write today for FREE INFORMATION to

NATIONAL LANDSCAPE INSTITUTE
Dept. P-11, 756 So. Broadway, Los Angeles, Calif.

IDEAS and INVENTIONS . . . WANTED . . .

Cash in on your new ideas, inventions and methods now! Responsible buyers reach you quickly and easily through the Nation-Wide Bureau of Ideas. This free service costs you absolutely nothing, offers complete protection. Write for all details today.

MORTON MANUFACTURING COMPANY,
353 North Leamington Avenue, Chicago 44, Illinois.

THIS COMPLETE, SIMPLE, PRACTICAL COURSE FOR SELF-INSTRUCTION WILL QUICKLY GIVE YOU

a complete mastery of MATHEMATICS



THE ESSENTIAL KNOWLEDGE FOR SO MANY OF TODAY'S JOBS IN BUSINESS AND INDUSTRY

GET A BETTER JOB in America's great industries, and prepare to seize your coming opportunities—learn mathematics. Mathematics is the basic requirement of all mechanical and scientific work, and of all business or industry based on science. You need mathematics to understand all technical work, to supervise operations, to improve, speed up and check on

your work. Such basic training is quickly recognized today, and gladly paid for.

Now you can learn mathematics by an easy, inexpensive and time-saving method. This very simple and extremely interesting course in book form has been prepared for you by an expert who has devoted a lifetime to teaching practical men the fundamentals of this important subject.

MATHEMATICS For Self Study

By J. E. Thompson, B.S. in E.E., A. M.,
Dept. of Mathematics, Pratt Institute

These books start right from the beginning with a review of arithmetic that gives you all special short cuts and trick problems that save countless hours of your time and make you more valuable to yourself and your job. Then they go right into higher mathematics and show how simple it is when an expert explains it for you. Don't let appearances fool you, mathematics is easy. In no time at all you will be tackling with ease the most difficult questions on this subject.

Thousands of Jobs Are Waiting for Trained Men

INDUSTRY is working at top capacity to meet the needs of our gigantic industrial program. Trained mechanics and technicians are in urgent demand, and in practically ALL of these jobs a knowledge of mathematics is required. Give yourself this basic preparation now by this quick, inexpensive method.

A Complete Course and Reference Library in These Five Volumes • 1,598 Pages • Illustrated

ARITHMETIC: Starting with a quick review of principles, this volume presents all the special calculation methods used in business and industry which every practical man should know. Fundamental in all computations in engineering, both in the plant and in the field. Essential methods for rapid calculation such as is needed in setting lathes, etc. Hundreds of other applications to technical work.

ALGEBRA: Starting with simple practical problems, this book shows you, step by step, how to apply algebraic methods to problems which are involved in all business and industrial work relating to machines, engines, boats, autos, planes, etc. Logarithms and slide rule, and many other practical applications.

GEOMETRY: States clearly all needed facts about plane figures, circles, polygons, etc. Covers all the topics essential in drafting, engineering. Sheet metal work, so important in airplane construction, is a direct application of these principles.

TRIGONOMETRY: This volume makes easy the principles of angles and triangles, shows you how to use tables that explain their functions. Practically every problem in ma-

chine work, land surveying, mechanics, astronomy, and navigation is solved by methods of trigonometry. These methods are explained simply, with actual examples of calculations of height and distance, the construction of buildings, bridges, and dams, the cutting of gears, etc.

CALCULUS: You will enjoy mastering calculus in this interesting new way, and will find it will enable you to solve problems that can be solved by no other method. This branch of mathematics deals with rate problems. It is essential in computation involving objects moving with varying rates of speed. It also enables you to find the most efficient design for any kind of mechanism, engine, or moving vehicle.

These are but a few of the hundreds of practical subjects simplified and clearly explained for you in this complete 5-volume illustrated home-study course in mathematics.

MAIL THIS COUPON

D. VAN NOSTRAND COMPANY, INC.
250 Fourth Ave., New York 3, N. Y.

Send me MATHEMATICS FOR SELF STUDY in 5 volumes. Within 10 days I will either return the books or send you \$2.95 as first payment, and \$2.00 a month for three months until the total price of \$8.95, plus a few cents postage, is paid.

(If you send remittance of \$8.95 with this coupon, we will pay the postage. Same return privilege, refund guaranteed.)

Name

Address

City Zone No. State

(if you know it)

Reference

Address

Popular Mech. Nov. 45

An Expert Gives You His Simplified Methods

Mr. Thompson, the author of these books, is not an ordinary teacher of mathematics. He has had many years experience in giving students the kind of mathematical training they need in practical work. He presents each practical method and problem in the clearest and simplest way. He gets right down to the kind of information that you need in your daily work.

Send No Money

Examine These Books for 10 Days FREE!

Send no money now. The coupon at the right brings you the 5 books for 10-days' trial. After 10 days, if not completely satisfied, return the books to us without obligation. If you keep them, send us the small down payment of \$2.95, balance in three monthly payments.

AVIATION Career

MAXIMUM TRAINING IN MINIMUM TIME

CAL-AERO TECH TRAINING will add dollars to your pay check all the rest of your life. Specializing in AERONAUTICAL ENGINEERING and MASTER AVIATION MECHANICS since 1929, Cal-Aero Tech training is carefully designed for just one thing—TO MAKE MORE MONEY FOR YOU. An alumni of over 6000 successful graduates proves our career training is unsurpassed.

VETERANS —Write us about Aviation Training, as provided under "G.I. Bill of Rights."



CAL-AERO TECHNICAL INSTITUTE
MAJOR C. C. MOSELEY PRES SINCE 1929
FORMERLY CURTIS SWORTH TECHNICAL INSTITUTE

GRAND CENTRAL AIR TERMINAL
GLENDALE 1, CALIFORNIA
LOS ANGELES COUNTY

MAIL THIS COUPON TODAY!

Cal-Aero Technical Institute, Grand Central Airport, Glendale 1, California
Please send full information on Aviation Training FREE—without obligation, Dept. PM-11

Name _____ Birth Date _____
Street _____
City _____ State _____

Your OWN Business!



As little as \$100
Starts You NOW!

No Training Needed

Make good money by making photo-exact copies of important papers, letters, drawings, photos, veterans' discharges, etc.—for local firms, lawyers, real estate men, accountants, advertising men, engineers, architects, others. Every business is your prospect for error-proof, low-cost photocopies. New, amazingly simple

method requires no lens, darkroom, or training! A table-top with only \$100 worth of APÉCO equipment puts you in business for yourself! Easy to start . . . many prospects . . . quick results . . . pleasant work—here's a combination that's a real money-making opportunity—good for a lifetime!

APÉCO
"America's Most
Widely Used
Photocopy
Equipment"

Get Full Information! MAIL COUPON NOW!

AMERICAN PHOTOCOPY EQUIPMENT CO.
2849 N. Clark St., Dept. GF115,
Chicago 14, Ill.

Please send me your illustrated book and details about the APÉCO business opportunity.

NAME _____
STREET _____
CITY _____ STATE _____

No Waiting to LEARN Start at Once to EARN! This BIG BOOK SHOWS

If it's Results you want, you can get action quickly with this practical book. Never before has a more helpful book been printed for those planning a business of their own. Gathered in this large illustrated volume are the formulas, recipes, facts and secrets that have contributed so largely to America's great industrial progress. Capitalize on this information for making most any conceivable product without experience, special equipment or previous knowledge of chemistry. Start at home, expand with profits—build for a profitable independence.

The experts who compiled this book are authorities, and present this information in simple, understandable language. They also give you wholesale supply sources for needed material, short cuts and economy methods for the most profitable results. Hundreds of good paying businesses have been built on a product made from a simple recipe. Opportunities in this field exist everywhere. Choose from any of the 10,000 facts and 10,000 formulas of which the following are only a very few: Adhesives, Alloys, Anti-Freeze Solutions, Cosmetics, Beverages and Liquors, Candy, Gum, Casein, Celluloid, Ceramics, Cheese, Cleaning Preparations, Concrete, Copper, Cotton, Dentifrices, Depilatories, Dyes, Embalming Fluids, Enameling, Glass, Glazes, Household Formulas, Inks, Insecticides, Irons, Jewellers' Formulas, Lacquers, Laundry Preparations, 924 Illustrated Big Pages

10,000 FORMULAS, RECIPES SECRET PROFIT IDEAS

Leather, Linoleum, Lubricants, Manicure Preparations, Marble (artificial), Metals, Mirrors, Oils, Ointments, Paints, Paper, Perfumes, Photography, Poisons, Powders, Remedies for Man, Beast or Fowl, Rubber Products, Refrigerants, Soaps, Solder and Soldering, Tooth Cements, Transfers, Transparencies, Varnishes and Thousands of others for making all sorts of profitable and practical things.



Prepare for "After-War-Business"

Especially recommended for Servicemen and War Workers planning a profitable business of their own.

This comprehensive book is an accepted authority by chemists, schools, industry, etc. and is the largest and most comprehensive book of its kind ever issued. Nothing else like it in existence. A single formula has been worth a thousand times this book's small cost to countless owners of profitable and money-making ideas. Invaluable for reference. Ideal for Factory, Home, Farm, Office or Workshop. As necessary as the dictionary and more useful for manufacturers, chemists and salesmen who put up products for profit.

This Complete Book Only
\$2.98
POST PAID
Worth More

ALSO INCLUDED! Complete plans: "D.D.T." Insecticide, Eliminator Flies, Mosquitoes, Fleas, Lice, Moths, Bed bugs, Roaches, etc. Big opportunity for an exterminating business.

Immediate Shipment—Safe Delivery Guaranteed, \$2.98 postpaid, Canada or Foreign, \$3.25 U. S. Funds, C.O.D. shipments U. S. A. only.)
ADAMS BROWN COMPANY Books of Applied Science
Dept. 311 Chestnut Hill 67, Massachusetts, U. S. A.

LEARN MONEY-MAKING CARTOONING IN SPARE TIME — by Easy Picture Chart Method

Same Simplified Method that has helped train creators of "Ferry & Pirates," "Freckles," "Out Our Way," "Winnie Winkle," "Reg'lar Fellars," "Strange as It Seems," "The Neighbors," and many others. Earn while learning. Send 10c for Picture Chart (to test your ability), and full details. (State age.)
Landon School of Cartooning, Dept. 4511 Philadelphia 11 Pa.



MAGIC LIQUID Prints Photos

On Wood, Leather, Cloth, Cards Letterheads or almost any surface. Use any snapshot or other negative. Make hundreds of prints without harming negative. Won't wash off. Easy to use. Complete kit for 100 or more photos now only \$2.98 postpaid, U. S. A. only. (Canada \$1.50 money order only; no C.O.D. \$). Satisfaction positively guaranteed. Rush order today for the original, big, complete Magic Photo Printing Outfit, & D. P. G.

Dept. 390-D, 229 W. Breckinridge, Louisville 3, Ky.

DRAFTING SPRINGBOARD TO SUCCESS!

Increased salary, larger responsibilities, a real career instead of just a job—these are to be had by the trained draftsman. I.C.S. makes the way to thorough, practical training open to you. Check up and you'll find nearly every "big name" American in engineering and production acquired experience at the drafting board. Many of them started by writing for the I.C.S. free booklet. Send for it today! It can be the most important act of your life.

International Correspondence Schools, Box 5561-K, Scranton 9, Pa.

ANALYZE HANDWRITING

Qualify for Certified Grapho-Analyst Degree. Earn up to \$100 weekly, up to \$1 hourly spare time, in new uncrowded profession . . . Graduates in employment and credit fields, police departments, courts, and in private practice as Personal Problem and Vocational Counselors. 3,000 word test lesson and illustrated GRAPHO-ANALYST Free.



ADDRESS A.I.G.A., INC., 120 JOPLIN, MO.

THOUSANDS NOW PLAY who never thought they could!



Learned Quickly at Home

I didn't dream I could actually learn to play without a teacher. Now when I play for people they hardly believe that I learned to play so well in so short a time.
*H. C. S., Calif.



Plays at Dances

I have completed your course and your lessons have been most satisfactory. I can play all of the popular songs. I have also earned money playing at dances.
*E. N. J., New York.



Wouldn't Take \$1000 for Course

The lessons are so simple that anyone can understand them. I have learned to play by note in a little more than a month. I wouldn't take a thousand dollars for my course.
*S. E. A., Kansas City, Mo.



Finding New Joy

I am finding a new joy that I never experienced before, for I have always wanted to play, but had given up hope until I heard of your course.
*C. S., Lucien, Okla.



You Can't Beat It

I am glad to tell anyone about the U. S. School. It is just what they say it is and they will do what they say they will. If you want to learn music you can't beat it!
*W. E. D., N. Mex.

*Actual pupils names on request. Pictures by professional models.

You, too, can play any instrument By this EASY A-B-C Method

YOU think it's difficult to learn music? That's what thousands of others have thought! Just like you, they long to play some instrument—the piano, violin, guitar, saxophone or other favorites. But they denied themselves the pleasure—because they thought it took months and years of tedious study to learn.

Learn in Spare Time at Home

And then they made an amazing discovery! They learned about a wonderful way to learn music at home—without a private teacher—without tedious study—and in a surprisingly short time. They wrote to the U. S. School of Music for the facts about this remarkable short-cut method. And the facts opened their eyes! They were amazed to find how easy it was to learn.

The result? Over 750,000 men and women have studied music at home this simple, A-B-C way. Now, all over the world, enthusiastic music-lovers are enjoying the thrilling satisfaction of creating their own music. They have found the key to good times, popularity and profit.

COSTS LESS THAN 7¢ A DAY

And that's what YOU can do, right now. Get the proof that you, too, can learn to play your favorite instrument—quickly, easily, in spare time at home for less

than seven cents a day. Never mind if you have no musical knowledge, training or talent. Just read the fascinating booklet and Print and Picture sample that fully explain all about the famous U. S. School method. If interested tear out the coupon now, before you turn the page, U. S. School of Music, 711 Brunswick Bldg., New York 10, N. Y. Largest school of its kind in the world. (47th year)

FREE!

Print and Picture
Sample

NOTICE

Please don't confuse the U. S. School of Music method with any system of teaching music "by ear" or by trick charts. Our method teaches you to play by actual notes—not by any trick or number system.

U. S. SCHOOL OF MUSIC,
711 Brunswick Bldg., New York 10, N. Y.

I am interested in music study, particularly in the instrument checked below. Please send me your free illustrated booklet, "How to Learn Music at Home," and your free Print and Picture Sample.

Piano	Saxophone	Clarinet	Practical
Guitar	Trumpet, Cornet	Trombone	Finger
Hawaiian	Reed Organ	Flute	Control
Guitar	Tenor Banjo	Modern	Piccolo
Violin	Ukulele	Elementary	Mandolin
Piano Accordion		Harmony	

Name..... Have You
(Please Print) Instrument?.....

Address.....

City..... State.....

NOTE: If you are under 16 years of age, parent must sign coupon.

SAVE 2c—STICK COUPON ON PENNY POSTCARD

Do you want

- ➔ ..to go to College?
- ➔ ..or to enter a Profession?
- ➔ ..or get an Office Position?

(Such as Accounting, Architecture, Nursing, Dentistry, Teaching, Social Work, Osteopathy, Beauty Culture, Optometry, Embalming, Chiroprody, Law, Medicine, etc.)

To get anywhere, you practically **MUST** finish High School **FIRST**. You can complete our simplified High School Course in **SPARE** time at home, as **FAST** as your time and abilities permit. Equivalent to resident school work—prepares you for college, pre-professional examinations, business, industry. Standard texts furnished. Diploma. Credit for H. S. subjects already completed. Single subjects if desired. Low tuition, easy terms. American School, Chicago, est. 1897—endorsed by educators. Finish your high school education **NOW**. Write **TODAY!**

High School Course at Home

Many Finish in 2 Years

American School, Dept. H845, Drexel Ave. at 68th St., Chicago 37, Ill.

Gentlemen: Send me **FREE** information covering special training in subjects checked below. No obligation on my part.

- | | |
|--|--|
| <input type="checkbox"/> High School Course | <input type="checkbox"/> Diesel Engineering |
| <input type="checkbox"/> Architecture and Building | <input type="checkbox"/> Drafting and Design for Men & Women |
| <input type="checkbox"/> Automotive Engineering | <input type="checkbox"/> Plastics |
| <input type="checkbox"/> Business Management | <input type="checkbox"/> Private Secretary |
| <input type="checkbox"/> Electrical Engineering | <input type="checkbox"/> Mechanical Engineering |
| <input type="checkbox"/> Elec. and Gas Refrigeration | <input type="checkbox"/> Aviation |
| <input type="checkbox"/> Air Conditioning | <input type="checkbox"/> Salesmanship |
| <input type="checkbox"/> Railway Training | <input type="checkbox"/> Radio |
| <input type="checkbox"/> Electronics, Industrial | |

Name.....

Address.....

SILVERPLATE

Electrically by Brush!



NEW!

AMAZING LOW COST WAY TO PLATE GENUINE SILVER ON Models, Projects, Worn Fixtures

Hundreds of uses for this complete Silverplating Outfit! New, patented *electrified* brush and concentrated compound of **Atomic Silver** work like magic. Easily and quickly, you can apply a heavy, permanent coat of *Genuine Silver* to any conductive surface . . . on models, projects, silverware, jewelry, etc. Outfit includes Degreaser, **Atomic Silver Compound**, Battery Power-Pack, *Nylon-Lucite Electrolytic Brush*, **Solid Silver Anode**, Leads, Connectors and simple instructions in compact carrying case. *All at amazing low cost!* Small shipping charge collected on delivery. **ORDER TODAY.**

Homecrafters, Dept. D-2
360 NORTH MICHIGAN AVE.
CHICAGO 1, ILLINOIS

ONLY \$12.50

The Tool of A
101 USES



Write your own Future in Photography

Prepare now for a well-paid position today and a career that is sound and substantial as well as different, fascinating and profitable. Photography offers ever-increasing opportunities for both men and women. **FREE** book tells how N.Y.I. experts can quickly train you at home or thru resident, day or evening instruction in our up-to-the-minute N. Y. studios. ALL branches of black and white, motion picture and **COLOR** photography. Write **TODAY!**

NEW YORK INSTITUTE OF PHOTOGRAPHY
Dept. 49 10 West 33 Street New York 1, N. Y.

MECHANICAL ENGINEERING PAYS!

This is the machine age. And back of every machine—every part—are the engineers who designed it, the trained mechanics who built it. No wonder there's high pay . . . many opportunities to advance . . . for these indispensable men. Be one of them! Don't stick in a rut! Let I.C.S. show you the way to success! These Schools, famous for more than 50 years, offer authoritative, practical Courses to meet the needs of almost any man in mechanical trades. Mechanical Engineering . . . Drafting . . . Mechanical Drawing . . . Shop Practice. Write today for free booklet.

International Correspondence Schools, Box 5561-K, Scranton 5, Pa.

Get Ready for Big After War Opportunities!

I Will Train You at Home Until You Get a GOOD PAY JOB in

DRAFTING

Act now to get a better job with more pay and pleasant working conditions. Get into **Drafting**—the basic profession where all post war products will start. I will train you at home—give you experience—doing the same kind of jobs you will do with the best paying firms. I furnish instruments, drawing table and all equipment when you start. Write today for vital facts and **FREE** illustrated book. Give Age.

Engineer Dobe, Div. 111, Libertyville, Ill.

BUILD AND FLY

your own motorcycle powered monoplane, at home. Easy to build, short run take offs, and a sweet plane to fly. No special tools needed. Cheap. Tested plans, guaranteed, \$1.00. Just the plane you have been waiting for. **ORDER TODAY. NOW. AEROTECH, DEPT. 50, DEARBORN, MICHIGAN.**



"How to Make Money With Simple Cartoons"

A book everyone who likes to draw should have. It is free; no obligations. Simply address

CARTOONISTS' EXCHANGE

Dept. 911-D

Pleasant Hill, Ohio

LEARN MOVIE PROJECTION THEATRE MANAGEMENT

The Motion Picture Theatre Business offers big opportunities for trained men. Get into a fascinating field with a peace time future. Train at home in spare time. Free catalog. Established 17 years.

THEATRE INSTITUTE, 370 Washington St., Elmira, New York



Wonderful, new device, guides your hand; corrects your writing in a few days. Big improvement in three hours. No failures. **Complete outline FREE.** Write C. J. Ozment, Dept. 34, St. Louis, Mo.

DO ANY JOB.. EASIER.. QUICKER
MAKE MORE MONEY in the
BIG OPPORTUNITY
FIELDS

SEND NO MONEY
 Select the Books
 YOU Need Now!
 We Ship C.O.D.
 Anywhere in U. S.
 and Will Refund
 Amount Paid if
 Not Satisfactory.

Here's the Help You Need
For Best Paying Jobs
Right NOW!

FREE TRIAL
IN YOUR OWN HOME

Used by Army, Navy, Other Government
 Depts., 200 Schools and Industrial Firms.

Don't submit to tough, heartbreaking job competition, now that wartime jobs are over. Get into one of these big opportunity fields. Big money and many other advantages await you if you prepare now. Here is the help you need—EASY—QUICK—AT LOW COST. Thousands of men have already used these famous books. Beginners and experienced men alike have doubled and tripled their earnings with this help. You too, can now get the special knowledge you need for top pay, better jobs, or a business of your own. This is your GOLDEN OPPORTUNITY.

AIR CONDITIONING

Big air conditioning boom interrupted by war will be bigger than ever. It's ready to GO now! Get this non-technical book by international authority and be ready for your share of millions to be spent. Covers whole field. 450 pages. Illustrated. \$3.50.

AIRPLANE WELDING

All metal airplane building offers big peacetime opportunities. New 2nd edition of this famous book by J. B. Johnson, Materials Division, Wright Field. The authoritative and practical book on Airplane welding and materials brought right up to date. 420 pages, 193 pictures. \$3.50.

MODERN WELDING PRACTICE

Newest book on all types of welding and heat treatment of metals. Written by recognized specialists in training men for production jobs. Practical and Non-Technical. Covers everything you need to know. Prepare for best pay jobs now. Price \$4.00.

430 Pages
 277 Illus.
 Practical and Non-Technical

everything you need to know. Prepare for best pay jobs now. Price \$4.00.



BODY & FENDER REPAIR

Owners will spend big money to keep their good older cars looking like the new ones coming out. This is a practical money-making guide, ideal for shop owners and every man who wants a share of the millions to be spent in keeping old cars looking new. Tells how to get a good job or start business of your own with small capital. 325 pages, 232 illustrations. \$3.00.



DYKE'S FAMOUS CARBURETOR BOOK

This famous book has been the standard guide in the best paying auto work for a generation. It has helped thousands of men make money. New edition covers engine tune-up, compression, ignition, carburetion, fuel pump valves, etc. Use this book to specialize in this big field. 244 pages, 549 illustrations. \$3.00.

HOUSE WIRING NEW 1945 EDITION

Get this new sixth edition of this standard and practical electrical wiring book. It gives complete practical instruction on every phase of house wiring in one handy volume. Goes further than most books on subject. Hand-book style. Gives National Electric Code. 400 pages, 669 illustrations. Electrical work will reach a new high with millions of new homes to be built. Get started now. \$2.50.

15 Million Refrigerators
 Need Service and
 Repairs

REFRIGERATION—Book of the Hour!
Biggest Opportunity in Many Years!

NEW PRINTING—ALMOST 1000 PAGES

408 Pictures—17 Diagrams in Colors Makes All Refrigerator Service Maintenance, Repairs Simple as A. B. C.

Thousands of Refrigerators need repairs! Owners will pay big for competent service which will be needed more and more. Get MODERN GAS AND ELECTRIC REFRIGERATION, the non-technical guide to all types of refrigerators and get your share of this new profit. Get a job or start your own service business. This book will help you make money anywhere. Price \$5.00.



NEW 20th EDITION
Leading Auto Book for Over 32 Years

World's Greatest AUTO BOOK
New Material on Transmissions, Trucks, Tractors, Diesels, Aircraft and Auto Engines

Now with millions of cars needing repairs and thousands of men needed to do the work, you need the famous DYKE Auto Book more than ever before. Brand new 20th Edition covers all principles, construction, repair, adjustments, testing, troubles and remedies of all cars. Over a half million copies of 20 editions of Dyke's have been sold. Gives specifications of old and newer cars. World's biggest book value, \$6.00. This big book, a complete auto library in one volume, has 1453 pages—4600 illustrations and diagrams—weighs 6 lbs.—equal to 4 ordinary books.

ENGINEERS HANDBOOK

World famous Bailey's handbook of universal questions and answers for Stationary, Marine and DIESEL engineers and firemen. Prepares for any license examination. This is the one book that men should have if they want to reach the top in installation, maintenance and operation of Diesel and steam plants. Pocket size, \$2.00.

Mail Coupon to
Goodheart-Willcox Co., Inc.
 2099 S. Michigan Ave., Dept. 111, Chicago, 16, Ill.

SEND NO MONEY! Mail Coupon

GOODHEART-WILCOX CO.,
 2099 S. Michigan Ave., Dept. 111, Chicago 16, Ill.
 Send books checked, C.O.D. I will pay postman, plus few cents charges. If not satisfactory I will return books in 5 days and you will refund money paid. (Outside U.S. or possessions remit with order.)

- | | |
|--|--|
| <input type="checkbox"/> Gas & Electric Refrigeration \$5.00 | <input type="checkbox"/> Sheet Metal Layout . . . \$3.00 |
| <input type="checkbox"/> Dyke's Auto Book \$6.00 | <input type="checkbox"/> Air Conditioning \$3.50 |
| <input type="checkbox"/> Dyke's Carburetor Book . \$3.00 | <input type="checkbox"/> Engineers Handbook . . . \$2.00 |
| <input type="checkbox"/> Modern Welding \$4.00 | <input type="checkbox"/> Body and Fender Repair . \$3.00 |
| <input type="checkbox"/> Airplane Welding \$3.50 | <input type="checkbox"/> House Wiring \$2.50 |
| | <input type="checkbox"/> Shop Math. (2 vols.) . . . \$3.00 |

If remittance accompanies order we will pay all postage charges under same return privilege.

Name.....
 Address.....
 City..... State.....

REFRIGERATION AIR CONDITIONING MODERN SHOP TRAINING

approved
GI
training



TRAIN WHERE THE ARMY TRAINED

This new, fast growing industry needs trained men for big paying jobs. Get in on the ground floor by starting now with the only civilian trade school selected for Army Training Program in this big, new industry.

LEARN BY DOING WORK ON REAL MACHINES

Train at home or in our big shops. Work with tools on actual machines. Simple to master by our special training methods. Big opportunities now waiting. In a few short months you can be a qualified REFRIGERATION SERVICE ENGINEER, ready to move into a big paying job or be your own boss with your own business.

FREE BIG 16 PAGE BOOK OF VALUABLE INFORMATION

This big free book tells you all about the opportunities that await. Read the fascinating story of the tremendous growth and development of this industry—how you can get in on the ground floor if you ACT NOW. Write today!



Send Coupon TODAY!

ACT NOW!
LEARN IN YOUR SPARE TIME AT HOME

Commercial Trades Institute, Dept. M-11
209 W. Jackson Blvd., Chicago 6, Ill.
200 S. 20th St., Birmingham, Ala.

Without obligation, please send me the facts. Let me judge for myself the opportunities and post-war security this training offers.

Check here if interested in GI training.

NAME.....

ADDRESS.....

CITY..... STATE.....

AUDELS

POWER PLANT ENGINEERS GUIDE

WITH QUESTIONS AND ANSWERS

NEW FROM COVER TO COVER!

JUST PUBLISHED—For All Engineers, Firemen, Water Tenders, Oilers, Operators, Repair Men and Applicants for Engineers' License Examinations.

A Complete Steam Engineers' Library in One Book!
1500 PAGES—65 CHAPTERS
1700 ILLUSTRATIONS.FULL INDEX

1001 FACTS AT YOUR FINGER ENDS! PRACTICAL INFORMATION IN HANDY FORM FEATURING:

Basic principles of Steam Engineering, including Boiler Construction, Operation and Repairs. Gives practical information on: Boiler Calculations, fuels, feed

pumps, water heaters, economizers, water treatment, injectors, traps, draught, safety valves, oil burners, stokers, condensers, ejectors, cooling towers, evaporators, steam and hot water heating, pipe fitting & tubing. Contains complete data on all types of Steam Engines and Turbines, Indicators, Valve gear, Valve setting, Air Compressors, Hoists, Gas and Diesel Engine Operation, Lubrication.

\$4

COMPLETE PAY \$1 A MONTH. **Get this information for yourself—ASK TO SEE IT—Mail coupon today!**

AUDEL, Publishers; 49 W. 23 St., New York 10, N.Y.

Mail AUDELS Power Plant Engineers Guide (Price \$4) on 7 days free trial. If O.K. I will remit \$1 in 7 days and \$1 monthly until \$4 is paid. Otherwise, I will return it.

Name.....
Address.....
Occupation.....
Employed by..... P.....

Do You Make Mistakes in English?

EVERY time you speak or write you show just what you are. Mistakes in English reveal you as a person who lacks education and refinement. Lack of language power prevents you from presenting your thoughts in the strongest possible way. No matter what you do, real command of English will help you to your goal. Stop making mistakes in spelling, punctuation, pronunciation. Increase your vocabulary.



WONDERFUL INVENTION

Only 15 minutes a day with Sherwin Cody's new invention—and you can actually SEE your English improve. It teaches by HABIT—makes it easier to do the RIGHT way. Wonderful self-correcting lessons include spelling, punctuation, grammar and expression.

FREE BOOK ON ENGLISH Lack of language power may easily be costing you friendships, income every year. See what Mr. Cody can do for you; it costs nothing to find out. Mail a postal card or letter this very minute for free book. "How You Can Master Good English in 15 Minutes a Day." It will prove a revelation to you. WRITE NOW. Address:

Sherwin Cody School of English, 511 B & O Bldgs., Rochester 4, N. Y.

SPEAK SPANISH

LEARN THIS EASY WAY

ONLY 15 MINUTES A DAY.

Cash in on tremendous expansion of our So. American trade. Big jobs NOW opening up everywhere to Spanish-speaking Americans. Cortinaphone Method, famous for 60 YEARS, teaches you to speak like a native. Learn quickly, easily, at home, just "by listening" to CORTINA RECORDS as thousands have. PROVE it to yourself—you take no risk. French, German, Italian also taught by this amazing method. Send for FREE BOOK, "The Cortina Short-Cut." State language interested in. WRITE NOW. Cortina Academy, Suite 6411A, 105 W. 40 St., N. Y. 18, N. Y.

JUST LISTEN TO THIS RECORD

What Every Mason Wants



We have important Masonic books for Blue Lodge, Chapter, Commandery, Scottish Rite, and Shrine.

Our Rituals Are Used the World Over. Send for free catalog of books and rituals for Masons, Odd Fellows, Knights of Pythias, Knights of Columbus, etc. EZRA A. COOK, Publisher, P. O. Box 796, FN, Chicago 90, Ill.

LAW STUDY AT HOME

Legally trained men win higher positions and bigger success in business and public life. Greater opportunities now than ever before. Law corporations are headed by men with legal training.

More Ability: More Prestige: More Money

We guide you step by step. You can train at home during spare time. Degree of LL. B. Successful graduates in every section of the U. S. We furnish all text material, including 14-volume Law Library. Low cost, easy terms. Get our valuable 42-page "Law Training for Leadership" and "Evidence" books FREE. Send for them NOW.

LASALLE EXTENSION UNIVERSITY, 417 South Dearborn Street
A Correspondence Institution Dept. 1164-L Chicago 5, Ill.

Correspondence Courses in RADIO and ELECTRICAL ENGINEERING LOW AS \$25

ELECTRICAL ENGINEERING. Get good grasp of wide electrical field. Modern. Very understandable. Theory made easy.
RADIO ENGINEERING. Extra fine course in radio, public address, photo-electric work. Train you to be super-service man, real vacuum tube technician. Tuition ONLY \$25, either course. Deferred payment plan. Services needed badly.

FREE LINCOLN ENGINEERING SCHOOL, Box 931-P83, Lincoln, Nebr.

GET THIS FINE SUIT NO MONEY TO PAY!

BIG CASH EARNINGS, TOO!
Big news! This fine tailored suit yours without paying one cent—and big cash earnings, too! It's easy! Just take a few orders for famous Gibson Tailoring. Earn up to \$10 in a day and get your own suit as extra bonus. Dozens of rich new fabrics superbly tailored in latest styles, at low prices produce orders on sight. Money back guarantee. FREE SAMPLES! Write today giving name, address, age, etc. for big complete outfit of actual samples and details of amazing new Bonus Suit and money-making plan—All Sent Free! No experience. SEND NO MONEY!
W. Z. GIBSON, Inc., 500 S. Throop St., Dept. Y-516, Chicago 7, Ill.

Find your Future in

BAKING



**GET INTO ONE OF THE
TOP ESSENTIAL INDUSTRIES**

The commercial baking field has provided, for many years, numerous opportunities for steady employment, responsible positions, good earnings—even profitable private enterprises . . . opportunities for those who are qualified and experienced. You may find your future in this big business.

Commercial baking—a leading industry of known stability—requires and welcomes trained personnel. . . . Men and women who have gained the fundamentals of commercial baking from sound training and experience have the advantage for good progress in this field.

**SOUND BASIC TRAINING
NOW AVAILABLE**

The National Baking School teaches baking fundamentals by a sound, practical "learn-by-doing" method. It teaches by a home study plan that is free from red tape and unnecessary theory.

Through our method you learn the basic principles of baking by easy steps, by simplified, illustrated lessons, by actual practice and by close supervision of a competent instructor. The N.B.S. Course of Modern Baking Practice and Management offers thorough basic training to those with

aptitude and ambition, who wish to lay a solid foundation for the experience that may lead to success in commercial baking.

WRITE FOR FREE BOOKLET

There are many more facts and details about the baking industry—and about the N.B.S. home study course you should know. They are fully explained in a booklet, a copy of which is yours without cost. You will find it interesting and helpful—and it may even pay you good dividends. Mail your request today!

MAIL COUPON NOW

You owe it to yourself to find out more about the possibilities in commercial baking — and what *this* basic training may do for YOU. The *free* booklet "Opportunities in the Baking Industry" will tell you. Send the coupon NOW!



National Baking School, 1315 S. Michigan
Dept. 1358, Chicago 5, Ill.

Please send me a free copy of your booklet, "Opportunities in the Baking Industry," without obligation.

NAME

ADDRESS

CITY..... ZONE..... STATE.....

NATIONAL BAKING SCHOOL

1315 S. Michigan Ave., Dept. 1358, Chicago 5, Ill.

INVENTORS

Do Not Delay

Have you ever been startled by seeing a successful article on the market, and exclaimed—"Why, I invented THAT 5 years ago—I didn't think it valuable enough to Patent!"

The Patent Laws were intended for the Protection of the Inventor, and the Inventor who slumbers on his Rights may wake up to find someone else reaping the reward that could have been his.

Write NOW for Information and Record of Invention form FREE. RANDOLPH & BEAVERS, Registered Patent Attorneys, Columbian Bldg., Washington, D. C.

PERSONALIZED SERVICE — REGISTERED PATENT ATTORNEYS

RANDOLPH & BEAVERS

11-D Columbian Bldg., Washington, D. C.

Please send me full particulars on Patents, fees, etc., and "RECORD OF INVENTION" form—FREE.

Name

Street

City State



HUNTING and FISHING

is a monthly magazine crammed full of hunting, fishing, camping, dog and boating stories and pictures, invaluable information about guns, fishing tackle, game law changes, best places to fish and hunt—countless ideas that will add more fun to your days afield.

Special Trial Offer

Send 25c in stamps or coin and we will send you Hunting & Fishing for six months.

HUNTING & FISHING MAGAZINE

251 Sportsmen's Bldg., Boston, Massachusetts

:: SAVE WASTE PAPER ::

PATENTS AND TRADE MARKS

C. A. SNOW & CO.

Registered Patent Attorneys Since 1875
Write for Free Book and "Certification of Invention" form.
427 SNOW BUILDING, WASHINGTON 1, D. C.

PATENT YOUR IDEAS

SEND FOR FREE BOOK — HOW TO OBTAIN A PATENT

Written by Former Member Examining Corps (1922-24) U. S. Pat. Office.

CARL MILLER, Registered Patent Attorney
Former Member Examining Corps U. S. Patent Office
Woolworth Bldg., Dept. 115-A New York — Bond Bldg., Dept. 115-A Washington, D. C.

PATENTS Protect Your Ideas

By securing FREE my "PROOF OF INVENTION" folder. Exceptional Personal Service. Excellent References. Established 1906.
E. E. VROOMAN, 871 Woodward Bldg., WASH., D. C.

Learn to Speak SPANISH

FRENCH, GERMAN OR ITALIAN

This Quick, Easy Way

ONLY 15 MINUTES A DAY. Know a second language for better business or social position; read foreign books; really enjoy travel. Speak like a native just "by listening" to CORTINA RECORDS. Learn quickly, easily at home as thousands have! Cortinaphone Method famous for 60 YEARS. Write today for FREE book "The Cortina Short-Cut." State language interested in.

CORTINA ACADEMY, Suite 6411, 105 W. 40th St., New York 18, N.Y.

YOU CAN ADVANCE IN PLASTICS!

Plastics can be the next great industry; it is expanding as swiftly and largely as the automotive, radio and aviation businesses. Already, it is an important industry and a growing one. With I. C. S. training, you can take advantage of the many opportunities in Plastics today. At the same time, you prepare for the vast possibilities of tomorrow. Write for the free booklet containing full information! Do it right now!

International Correspondence Schools, Box 5561-K, Scranton 9, Pa.

FIX TYPEWRITERS

A Simplified Practical Homestudy Course. Many of our Students now have their own Business—Many Repair for others. Repair Shops Swamped. Health or Age no handicap.

WEBER TYPEWRITER MECHANICS SCHOOL
Box 269, Osborn, Ohio

FIBRE ARMS AND LEGS!

Light, correctly fitted, strong and comfortable. Natural appearance. Braces for all deformities. Scientific design. Fair Terms.

610-3rd Av. S., Minneapolis, Minn.

BUCHSTEIN-MEDCALF

YOU can be the BOSS!

and WIN the PROFITS of YOUR WORK

Get SECURITY, INDEPENDENCE and FREEDOM . . . Be Your Own Boss

101 Ways To Be Your OWN BOSS. is a practical working guide that shows you how to plan and operate any business or shop at a PROFIT. Here are a few of the things you learn from this book; money needed; business potentials; locations; rents; merchandising; financing; selling; buying; promotion; advertising; etc.

KNOWLEDGE OF 600 MEN

101 Ways To Be Your Own Boss is the compiled knowledge of 600 SUCCESSFUL men. Over 100 businesses covered in detail. It shows you how you too can be a success. Let us know the business you are interested in when ordering your copy. Satisfaction Guaranteed by the Money Back Gateway Guarantee if you are not more than pleased. Thrift copy only \$1.00 postpaid . . . \$1.25 C.O.D. Deluxe Edition \$2.49 postpaid or \$2.85 C.O.D. Send today and start getting all the profits of your work.

AT LAST

101 WAYS TO BE YOUR OWN BOSS

by MICHAEL GOVE

\$100 Paper Deluxe Ed. \$2.49

MONEY BACK GUARANTEE

THE GATEWAY BOOK CO.
32 N. State St. Dept. PC-9,
Chicago 2, Ill.

SEND TODAY

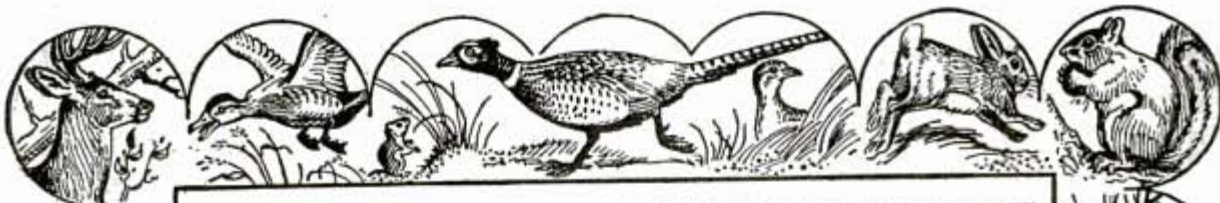

HUNTERS! LEARN NOW AT HOME to MOUNT BIRDS



Animals, Game-heads, Fish, Pets and to Tan Skins. Save your valuable trophies. Kill only a FEW game birds but DOUBLE your interest and pleasure in hunting.

MEN, BOYS! Be an expert taxidermist! Learn quickly BY MAIL, from our simple lessons. A wonderful, profitable hobby for expert hunters and ALSO FOR BOYS and YOUTHS on farm or in city.

FUN • FASCINATION • PROFIT

Have a Home Museum

SPORTSMEN, YOUNG AND OLD. Here is the grandest hobby in the world for Hunters, Anglers. If you EVER hunt or fish, even seldom, YOU will be delighted with taxidermy. Save those wonderful trophies; mount them just like life, and create a home museum that will amaze family and friends and make you well known and popular.

Help Save the Game

Shoot fewer specimens, yet double your fun. Help save the disappearing wild-game. Join "DUCKS UNLIMITED" in wild-game preservation. Shoot only a FEW wild-ducks, mount them for your den or home and have MORE PLEASURE than you ever had by killing the bag limit. Help keep wild-game forever. "Eat your trophy and have it too."

WHAT YOU LEARN

Our simple lessons teach you QUICKLY, right in your own home in your spare time, to MOUNT—beautifully and permanently, BIRDS, ANIMALS, GAME-HEADS, FISH, just like museum exhibits. You will also learn the wonderful KROME-TANNING. You can then TAN fine furs for garments, also skins into real leather. Write today.

LESSONS WORTH \$1,000.00

E. J. Riordan says: "I am more than delighted. My friends are amazed and urge me to mount their specimens. I think your course is worth a thousand dollars, yes it is priceless to sportsmen. I am known everywhere as a 'taxidermist,' and earn fine profits in my spare time mounting for other sportsmen. All thanks to your great school."

HE AND PARTNER SUCCEED

John H. Sizis writes: "I and Bob, my partner, who is only 14 years of age have mounted more than 50 specimens. I shall send you a picture of our 'museum' which is becoming famous. We learned quickly from your simple lessons, in spare time. Your great school is doing a wonderful job. All sportsmen should join it."

MEN, BOYS, Send Today! Don't delay. Obtain FREE BOOK before the supply is exhausted. . . nothing like it in the entire world. Write Now. A Postal will do.

NORTHWESTERN SCHOOL OF TAXIDERM Y
3378 Elwood Bldg. Omaha 8, Nebraska

300,000 STUDENTS

This vast number of MEN, BOYS AND WOMEN are delighted members of the famous, reliable 35 year old sportsmen's school. Think of that! They are located all over the world. YOU are invited to join this grand throng. Send for the FREE BOOK this very minute.

Sportsmen, Boys

All hunters of COURSE save their trophies now-a-days. The school INVITES THE BOYS TOO; boys as young as 12 or 13 years succeed in Taxidermy. Get the FREE BOOK, join the school.

BIG, EASY PROFITS

Mount and Tan for others. Work comes from far and near. Many students earn fine PROFITS from spare time. SO CAN YOU. RUSH THE COUPON.

Wild-Game Not Needed

Mount squirrels, rabbits, pigeons, frogs, chicks, crows, hawks. Make craft-work: book-ends, door-stops, gun-racks hundreds of valuable and delightful creations. What a Hobby for you!

FREE BOOK!

Yes, FREE, 44 pages, with 100 unique pictures of taxidermy work. No other book in the world like this. It will thrill and amaze you. Ask today for your free copy. State your AGE.

Send the Coupon!

Write name plainly in coupon or margin, or a post card will do. Rush your request, as free books may be exhausted quickly. Decide now. Don't wait a moment. State your age.

FREE BOOK

Northwestern School of Taxidermy, 3378 Elwood Bldg., Omaha, Neb. Send me your free illustrated book "How to Mount Game". Also tell me how I may learn this fascinating art easily and quickly by mail. No obligation. State your age.

Name _____ Age _____

Address _____



HEAR

WITH
Revolutionary
COMFORT!

Beautiful
Black
or
Ivory



Beltone

the QUALITY
ELECTRONIC
HEARING AID

This IS ALL YOU WEAR

NO SEPARATE BATTERY PACK!

NO BATTERY WIRE!

About 1/2 the Weight and Bulk
of Most Hearing Aids

A nationally known quality, lifetime hearing aid. Pleasant, life-like hearing. Plug in tubes, replaced as easily as a light bulb. Inconspicuous, flesh-color ear piece and cord.

BELTONE HEARING AID CO.

Dept. PM10, 1450 W. 19th St., Chicago 8, Ill.

Sirs: Please send FREE booklet on BELTONE.

NAME _____

ADDRESS _____

CITY, ZONE
AND STATE _____

MAIL THIS COUPON
Today!

"YOU ARE UNDER ARREST!"



There's a Thrill in Bringing a Crook
to Justice Through Scientific

CRIME DETECTION!

I have taught thousands this profitable, pleasant profession. Let me teach you, too, in your own home. Learn Finger Printing and Secret Service Methods thoroughly, quickly and at small cost.

53% of All American Bureaus of Identification employ students or graduates of I. A. S. You, too, can fit yourself to fill a responsible crime detection job with good pay and steady employment. Get details now. Let me show you how I can prepare you for this fascinating work, during spare time, in your own home. You may pay as you learn. Write today . . . Now . . . Be sure to state age.

INSTITUTE OF APPLIED SCIENCE
1920 Sunnyside Ave., Dept. 1358, Chicago 40, Ill.

Be A
**FINGER
PRINT
Expert**

FREE!!!
Send for Thrilling
"BLUE BOOK
OF CRIME"

1946 Government Jobs!

Start \$1,506 to \$2,650 year



MEN—WOMEN. Thousands postwar positions. Prepare NOW for next Examinations. Write immediately for free 32-page book, with list of positions and particulars telling how to qualify. Veterans get preference.

FRANKLIN INSTITUTE
Dept. J52
Rochester 4, N. Y.

CHEMISTRY IS OPPORTUNITY!

There's no limit to the chemist's chances for advancement . . . in salary . . . in importance. Experimental development into giant new industries. Established industries rely on laboratories. I.C.S. training . . . practical . . . thorough . . . opens this great field to you. Instruction papers specially written by noted chemical engineers, consulting chemists, metallurgists. And these big experts are EASY TO UNDERSTAND. Our editors have explained all technical terms simply, clearly. Any person of ordinary intelligence can learn and make rapid progress. You have ambition. We have the training you need. Send now for free booklet! International Correspondence Schools, Box 5561-K, Scranton 9, Pa.

RAFTER LENGTHS. A new vest pocket book for the carpenter, estimator. Gives lengths, Side cuts, Plumb cuts, Deductions. For all your rafters to fit any building from one inch wide to forty feet wide. Gives the numbers to cut on the square. Also gives degrees for same cuts for Radial Saws. All standard pitches from 1/4 to 3/4 are given. Just open book to pitch page and there in plain print are your lengths, side cuts, etc. Any one who knows what a jack rafter is can frame a roof correctly if he has this great book. Price one dollar, prepaid.

BUILDERS' TOPICS. Dept. M, Med. Arts Bldg., Seattle 1, Wash. Original teachers of the square in five easy lessons, by mail. Send for FREE list of plan books—Kamp Kabinis to Mansions.

ARTISTS MAKE MONEY

Find out your ability. Send name, age, occupation and address for Free Vocational Art Test.

ART INSTRUCTION, INC. (Formerly Federal Schools)
11135 Art Instruction Building, Minneapolis, Minnesota

PRINT ANY PHOTO

on Paper, Cloth, Leather or Wood

SIMPLE, EASY TO USE

Magic liquid takes only 2 minutes to reproduce any snapshot you have on to stationery, handkerchiefs, ties, scarfs, etc. Won't wash off. Won't hurt negative or fabric it's used on. Personalize your belongings! An ideal gift. Complete outfit enough to transfer 100 photos—only \$1.00 postpaid. Sent C.O.D. for \$1.21.

CHRISTY PHOTO SUPPLY, Dept. 1910
2835 N. Central, Chicago 34





CLASSIFIED Advertisements



Advertisements in this section 50 cents per word, each insertion, minimum 10 words, payable in advance To be inserted under proper classification in December issue, copy should be in our office November 5th

December issue on sale December 1st

F. W. Johnson, Manager, Classified Advertising

Popular Mechanics Magazine, 200 East Ontario Street, Chicago 11, Illinois

YOU'LL PROFIT

By reading and answering the classified ads in this section. Hundreds of opportunities to make and save money.

AUTOMOBILES, MIDGET CARS

MASTER Ignition power booster \$3.00. Mileage; pep; easier starting. Satisfaction guaranteed. Master Co., 1702 E. Geneva, Milwaukee 11, Wisconsin.

FLOYD Clymer's popular motor books! Mercedes-Benz Book just out. Describes Grand Prix racing, 100 illustrations, photos world's fastest cars, drivers \$2.00, cloth-bound \$3.00. — Power and Speed, 200 illustrations, world's most famous racing book \$2.50. — Ab Jenkins (world's distance record holder) book "Speed on Salt" \$1.50, cloth-bound \$2.50. — Saga Roaring Road, historical book early day American automobile racing \$2.50. — Speed "How to Obtain It" \$1.50. — Motorcycling Manual, wonderful book, dozens motorcycles described, illustrated, \$2.00. (See our ad under Motorcycles). — Motorcycles "How to Manage Them" \$2.00. — English Motorcycle Service Manual, all about servicing various foreign motorcycles \$1.50. — Motor History of America "World's Wonder Book of Automotive Industry," all about Ford, Chrysler, Durant, Willys, Olds, Buick, others, 416 pages, lists 1600 different makes American automobiles \$3.00, cloth-bound \$4.00. — Floyd Clymer's Historical "Motor Scrapbooks" — the book Time Magazine called a "must" . . . specifications, illustrations, photographs hundreds early automobiles and motorcycles . . . No. 1 and No. 2 now ready, entirely different, \$1.50 each, cloth-bound \$2.50 each. — Clymer's Steam Automobile Scrapbook . . . Historical, illustrated review, early and late Steam Cars \$2.00, cloth-bound \$3.00. — Modern Steam Car, different book \$2.00. — All books postpaid. Sent overseas without request. We pay postage, guarantee delivery. Send dime for America's most complete Motor-book catalog. Clymers, 2125 W. Pico, Los Angeles 6, Calif. (See our ads under Motorcycles.)

PROFESSIONAL Midget racer, motor-scooter, midget car and midget motorcycle. Plans, specifications, for all four contained in illustrated handbook, 25c. Big list used motors, motorscooters, Servicycles, etc., included free! Midwest, 3839 Drummond, Toledo, Ohio.

GARAGE Doors, all types, controlled from dashboard. Complete "Build Yourself" plans \$1.00, refundable. Free particulars. Kaytor Laboratories, Lynwood, Cal.

STEAM Car Scrapbook. Compiled by Floyd Clymer. Historical, authentic, amusing. Ads, photos, descriptions 250 early steam cars, with fascinating story by one-time world's youngest auto dealer. Postpaid \$2.00. Deluxe cloth-bound \$3.00. Clymers, 2125 W. Pico, Los Angeles 6, Cal.

BUILD Midget racer from castoff parts! Plans, specifications, construction information, \$1.00. Motor Supply, Box 1682-CS, Toledo, Ohio.

INTERESTING, Educational, illustrated English "Motor" magazine on foreign automobiles, 50c postpaid. Clymers, 2125 W. Pico, Los Angeles 6, Calif.

CUSTOMIZE Your automobile. Illustrated, new restyling ideas, instructions, suggestions, specific model changes by simple methods, \$1. Speed Wheel, Box 723-E, Arcadia, California.

Popular Mechanics Magazine, 200 E. Ontario St., Chicago, Ill.

Dear Mr. Johnson: During the round table sessions of our monthly meetings, we discuss many phases of advertising and mail order. It may interest you to know that at one meeting, the subject of classified mediums was brought up, and attending members voted about six to one that Popular Mechanics is the best classified puller published.

Sincerely yours,

Arthur Sizemore, President,
Illinois Association of Mail Order Men

(Original letter on file in our office)

1945 **IGNITION Supercharger**, \$4.00. Pep, mileage, fast starting. EG Mfg. Co., 355a E. 149 St., New York.

REPAIR Your car. Motor parts for all engines, chassis parts, ignition and carburetor parts, etc. New replacement parts. Genuine and highest quality at manufacturers' retail parts. P.O.B. Chicago. No body parts. B & N Engineering Co., Box 3454 Merchandise Mart P.O., Chicago 54, Illinois.

AUTOMOBILE Racing book, fifth edition, well illustrated. Instructions on building bodies, frames, engines, Ford A and B conversions. Plans. AAA rules, specifications. Roadster racing, Indianapolis cars. \$1.00 postpaid, \$1.30 C.O.D. Ray Kuns, Dept. 47, Madisonville, Cincinnati 27, Ohio.

AUTO SUPPLIES AND EQUIPMENT

"PEPY" Gas engine governors make automobile motors power units. \$9.50 up, circulars. Harris Machinery, Minneapolis, Minn.

GASOLINE Saving device. Chevrolet 1932-1942. Walert Company, 3429 No. 10th St., Milwaukee 6, Wis.

OIL Pumping motors—Brought back to normal without ring job. Write for particulars. Joe Mullner, Box 3102 I, St. Paul, Minn.

FORD V-8's any model. Get double mileage from distributor fuel pump. Parts, instructions \$1.00. Muncie Supply Service, B747, Muncie, Indiana.

CARBURETOR Repair kits containing all the essential parts for completely rebuilding a specific car or tractor carburetor. Lists on request. Carburetor Service, 600 LaPrairie, Ferndale, Michigan.

1000 MOTORISTS Needed to make gas saving test. Up to 30% savings. For trial test offer write Vacu-matic Carburetor Co., 7617-1256 W. State Street, Wauwatosa, Wis.

MOTORISTS: For fresh air without draft, install Noblo, clear, plastic, patented, wind-deflector that clips in one minute in rear of driver's window. To eliminate those annoying motoring drafts and find new driving comfort, write today for information or send year, make, model, body style and \$3.95 check or money-order. Noblo Sales, Box 1214, San Diego, Calif.

POWER Booster—New Aqua-Charger, a scientific device designed by aircraft engineers applies to your car or truck the famous water-injection that has given aircraft extra speed and power. Aqua-Charger reduces carbon formation. Kills ping even under heavy load on steep grades. Has effect of raising octane rating of any gasoline. Increases gasoline mileage. Aqua-Charger \$17.95 postpaid. Give auto make, year. Write for folder. Associated Machine and Engineering Company, 40 George St., Torrington, Conn.

UNIVERSITIES And Oil Corporation tests prove Whirlgas Turbinator, \$3 carburetor amplifier, increases motor mileage and power. Users report gasoline economy exceeding 40%. Wrench installs 15 minutes. Give auto make, year. John Hanley, 5719 Loraine, Detroit 8, Mich.

HAVING Car trouble? New, used, guaranteed auto, truck parts save money. Transmission specialists. Describe needs; immediate reply. Victory, 2439½ Gunnison, Chicago 26.

GENERATORS, Magnets, distributors, carburetors, new and rebuilt, for most any model car, truck or engine. Many old models in stock. Hundreds of electrical items, parts, etc. Order anything you need from us today at list price or less. Simms Magneto, 52 E. Cullerton, Chicago 16, Ill.

ANTI-FREEZE, Noncorrosive, inexpensive—manufacture yourself. Send stamp. Box 699, Borger, Texas.

PLATING Outfits for auto parts. Connect to a battery. No tanks used. Free particulars and proofs. Gunmetal Co., Ave. J, Decatur, Ill.

AUTO TRAILERS

BUILD Your own trailer! Save money! Have every feature you want! Plans for house, sport, camp and utility trailers. Catalog describing 9 models 10c. 15c in Canada and overseas. Jim Dandy, Box 125-A, Wausau, Wisconsin.

MOTORCYCLES, BICYCLES, MOTOR-SCOOTERS AND SUPPLIES

PARTS, Accessories, pistons, chain Harley Davidson motorcycles, George's, P.O. Box 114, El Paso, Texas.

DISC Wheels, metal 5" with 5/16", 8" with 3/8" axle shaft hole. Furnished with 1 1/2", 5/8", 3/4" tire. Also without tire. Low prices. Write for price list. Universal Cycle, 4713 Virginia, St. Louis, Mo.

MOTORBIKE And motor repair manual. Containing motorbike, scooter plans. Helpful information \$1.00. Variety Enterprise Co., P.O. Box 124, Evansville, Ind.

LARGE Stock Indian parts. Expert motor rebuilding. Indian Motorcycle Sales, Kansas City 1, Mo.

MOTORCYCLE Engines with air propellers \$65. Storms, 199 Broadway, Asheville, N. C.

PARTS For motor scooters, models, etc., made to order, send drawings. Paul Hobson, 5937 S. Halsted, Chicago.

MOTORCYCLISTS! The "Phantom" is truly the sport windshield of the century. All clear transparent plastic with highly polished chromium plated framework. Can't be beat for appearance. Fits all makes and models. Priced at \$12.50. See your dealer or send remittance to us. Shipped prepaid anywhere in U. S. Quick service. Your money refunded if not satisfied. Comiskey Engineering Co., 5203 Irving Park Road, Chicago 41, Ill.

"MODERN Motorcycle Mechanics," revised enlarged second edition, 560 pages, 300 illustrations. Covers operation, maintenance and reconditioning British and American motorcycles. Has received highest praise from riders, experts and manufacturers everywhere. "A book no motorcyclist can afford to be without." Price \$3.00 postpaid. Nicholson Bros., Motorcycle Engineers, Saskatoon, Canada.

1942 OUSHMAN Motorscooter \$60; Briggs-Stratton motorbike \$45; midget car \$30; Briggs-Stratton motor \$10, other motors as low as \$3.50; plenty of tires for motorscooters and small cars \$1 up. (Mail-order only.) Send 25c for big War-Bargain catalogue Number Ten listing hundreds of bargains in motorscooters, midget cars, tires, parts, plans, etc. (35c by first class mail.) Midget Motors Directory, Athens, Ohio.

THE New greatly improved airspeed indicator is ready for immediate delivery. This beautifully enclosed instrument is quickly attachable to your bicycle handle bar for air pressure reading as you ride. \$1.00 in United States, \$1.20 in foreign countries, plus 10c shipping charges. Order quickly for Christmas. Spargo Products Co., East Boston 28, Mass.

FLOYD Clymer's Motorcycling Manual. 120 illustrations. Information, specifications, descriptions dozens motorcycles. Engines, transmissions, carburetors, square four, two piston singles, overhead camshafts, spring frames, hydraulic forks, sidecars, riding instructions. Two cycle engines and power bicycles described, illustrated. \$2.00 postpaid. Clymers, 2125 W. Pico, Los Angeles 6, Calif.

BUILD America's lowest priced motor-scooter speedster! Complete plans, specifications, \$1.00. Big list used motors, etc., included free! Motor Supply, Box 1682-CS, Toledo, Ohio.

DEPENDABLE Bicycle generators \$2.85 prepaid. Ten day trial. L. Kimley, High-land, Williamsville, N. Y.

FLOYD Clymer's popular motorcycle automobile books. See advertisement under Automobiles! Clymers, 2125 W. Pico, Los Angeles 6, Calif.

TIRES, Tubes, wheels, for industrial trucks, carts, wheelbarrows, scooters, midget cars, coaster wagons. Nationally known makes, first-line quality. Sizes 8" to 18" o.d. in 2, 4, and 6 ply tires, separate inner tubes, heavy duty demountable wheels. Also caster forks, straight and swivel types. Free illustrated circular and prices. Jahant Co., 626 East Exchange Street, Akron 6, Ohio.

ENGLISH "Motorcycling" Magazine. Interesting, educational, foreign motorcycles. Racing, new-old models, advertisements. 50c sample copy. Clymers, 2125 W. Pico, Los Angeles 6, Calif.

PLANS. Scale drawings, specifications, illustrations for building attractive motor scooter complete \$2.00; plans electrically driven bicycle \$1.50. Postpaid. Clymers, 2125 W. Pico, Los Angeles 6, Calif.

SEND 25c For complete motorbike plans and parts list. Motorbike Service, 1304 Indiana, New Albany, Ind.

HARLEY Davidson parts, accessories, supplies, expert service. Send \$2.25 for army motorcycle instruction book and bulletins or 10c for bulletins only. Knuth's, 2491 Fondulac Ave., Milwaukee 6, Wis.

TIRES And industrial wheels, suitable for scooters, wheelbarrows, farm equipment, etc. All sizes. Bicycles and accessories. Largest assortment in America. Send dime for list. Cycle Transport Company, 1241 So. Michigan Ave., Chicago 5, Illinois.

MOTORCYCLE Parts, new and used. List 10c. Ballak, 811 N. 9th, St. Louis 1, Mo.

ELECTRIC Motorbike built from your bicycle. \$1.00 brings instructions-specifications. Mowery, Box 994, Lancaster, Pa.

BOYS! Repair your own bike. "Bicycle Repair Manual" 65c. R. G. Klausner, Shelbyville, Ill.

BUILD Scooters, trailers, midgets, conversions. Large manual \$1.00. Illustrated circulars dime. Craftsmann Books, Box 1153-P2, Milwaukee 1, Wis.

BICYCLE Repair book, how to buy, rebuild, sell used bicycles, pocket size 50c. John Collett, Handley, Texas.

AVIATION

PROPELLERS For airplanes, ice-snow sleds, air boats, crop dusters. Literature 5c. Banks Propeller Co., R.F.D. 7, Ft. Worth, Texas.

PROPELLERS—Correct size, pitch for any motor. Airliner 3 blade for ice, snow sleds, boats, orchard defrosters. Fast delivery. Standard Aerocraft, Ft. Worth, Texas.

LUSCOMBE \$65, Cub \$300. New catalog 25c, lists thousands of sensational bargains in airplanes, motors, parts, parachutes, supplies. Aviation "Business Opportunity" section included free! National, Box 1682-CS, Toledo, Ohio.

HUNDREDS Of war-bargain airplanes and gliders, some probably located near you. Send 25c (35c by first class mail) for complete directory. Used Aircraft Directory, Athens, Ohio.

JET Propulsion experiments. New principle to drive boats, bicycles, model helicopters. Circular on plans. Rush name. Houston Maupin, Tipp City 53, Ohio.

FLYING Flea, plans \$1.00. Lightplane manuals, blueprints. Illustrated circular 20c. Craftsmann Books, Box 1153-P1, Milwaukee 1, Wisconsin.

ELECTRICAL SUPPLIES—EQUIPMENT

ELECTRICAL Appliance repair. Open your own shop. Learn house wiring; electric motors, vacuum cleaners, washers, etc. Complete illustrated course shows how. Free booklet. Pacific Training School, Dept PA-11, 4703 West Pico, Los Angeles 6.

ELECTRIC Automobile heaters! Starts cold motors quickly. Saves gasoline, operates from light current. Postpaid \$1.95. Harris Machinery, Minneapolis, Minn.

SELPWELD Electric element fix 75c; \$1.50. Slotin, 328 Bannerman, Winnipeg, Manitoba.

FREE Catalog of welders, welding supplies, generators, fencers, and other electrical items. Write LeJay Company, Minneapolis 8, Minn.

NOW—Repair your own electrical appliances with Chanite Self-welding Electrical Heating Element Flux. Instructions delivered, price \$1.00. Stick form 25c ea., \$2.00 doz. Chanite Sales Company 914 South Main, Fort Worth, Texas.

BATTERY Charger and eliminator kits, relays, rectifiers, surplus bargain list 10c. Milton Burisma, Route 5, Grand Rapids, Mich.

ASK Ted Riseaman about electric fan assembly parts. 427 East Jefferson, Springfield, Illinois.

BROKEN—Burned out electrical heating elements quickly repaired. Use new amazing Nichrome Paste, simply overlap ends and turn on current. Family size \$1.00 bill. Satisfaction guaranteed. Armstrong Mfg., 861-X, Minneapolis, Minn.

ELECTRIC Pencil: Writes-engraves all metals \$1.00 postpaid. Beyer Mfg., 4515-H Cottage Grove, Chicago 15.

WELDING, SOLDERING, PLATING

ACETYLENE Welding outfits like new; arcwelders, flame cutting machines. Eagle Welding, Dept. PM, 5085 Broadway, Chicago 40, Ill.

RODS, 1/16", 5/64", 3/32" Assortment. 200 rods \$1.98, postpaid. General ac/dc arc. Guaranteed. "Welder," 15766M Blackstone, Detroit 23. Six 1/4" carbons \$1.00.

ARC Welders wanted by the thousands. Learn with 516 page lessons manual. Over 500 how-to-do-it photos. \$2.00 copy. Money-back guarantee. Hobartweld, Box M-1154, Troy, Ohio.

BUILD A.C. arcwelder, 100, 200, 300 amperes. Plans \$1.00 each. Welders Club, AB-3432, Chicago 54.

BEFORE Buying any welder, see "Multiweld" ad on Page 172.

NEW Model electric welder 110 volt a.c.-d.c.; will weld all metals; easy to use; full directions. Complete with power unit, flame and metallic arc attachments, carbons, fluxes, rods, mask; all for \$19.95. Used by the navy. Magic Welder Mfg. Co., 239-MP9 Canal St., New York City.

WELDING, Cutting, aircraft welding and soldering equipment. Electric arc welders. Superior Oxy-Acetylene Co., Hamilton, Ohio.

SLIGHTLY Used arc welders. Recommended by R.E.A. Guaranteed. Forney Mfg. Co., Fort Collins, Colo.

MACHINERY, TOOLS AND SUPPLIES

BUILD Quickchange gear box for 12" Craftsman, 10" Atlas lathes. Complete drawings, instructions \$3.00. No castings. Stevens Engineering, 2604 Military, Los Angeles 34, Calif.

BLUEPRINTS For toolmakers vise and bench lathe turret. \$1.00 each. Design Engineering Service, South Charleston, W. Va.

DRILL Grinder—Grinds drills to factory accuracy. Calipers with direct reading scales. Circle cutters. New tool grinder. Lowest prices. Free literature. Factory, 811-B East 31st, Kansas City 3, Mo.

USEFUL, Practical metal or woodworking tools—Mills, shapers, drill presses, vises and many others—quickly built using Lewis plain or semi-finished castings, supplied with materials and blueprints. Cost a fraction of comparable finished tools. Blueprints only available at nominal cost. Send 10c to cover cost of mailing catalog describing 23 items. Lewis Machine Tool Co., Box 116, Station A, Dept. M-58, Los Angeles 31, California.

NEEDLEFILES Genuine Swiss; circular free. Harkay, 116 Nassau St., New York 7, N. Y.

SAPPHIRE Scriber, excellent for layout work and glass cutting. Cuts all materials except diamond. \$1.00 postpaid. Minerals Specialty Co., 5411 Virginia, Kansas City, Mo.

PRECISION Welding, brazing on small intricate parts. All metals. Weldcraft, Fox Lake, Illinois.

SATURATED Handy hones for fine mirror finishes. Sample 10c. Semco Laboratories, 4439 Lincoln Ave., Chicago 25, Ill.

CONCRETE Building block machines and molds. Easy payments. Catalog free. Concrete Machine Co., 5129 South Compton Ave., St. Louis 11, Mo.

MAKES Gears, cuts splines and keyways, portable hand tool held in vise, does work of milling machine, a real new tool. Write Wiese Company, Perry, Iowa.

HARDWARE, Machinist tools, model supplies, taps, dies, drills, saw mandrels, pulleys, engine castings, steel. Catalog 10c refunded. Terek, 6304 Patterson, Chicago 34.

"YOU Need these Craftsmen's Tools." See our ad page 172.

METALS, Plastics, bearings, machine screws, tools, etc. Everything for machine builders. Catalogue 10c. Metplus Supply Co., 1420 So. 16th Ave., Maywood, Ill.

TOOLS: Visegrips, CeeTee, waterpump, needlenose, diagonal cutter, pliers, crescent wrench, pipewrench, plastic screwdriver, clawhammer, hacksaw and 12 sockets 7/16 to 1" including 1/2" flex handle and universal joint. Universals complete 25 piece guaranteed tool kit only \$49.85. Immediate shipment! Try us first, we have it, can get it, or it isn't made! Catalog and price list free! Order now! Universal Tool Company, 1527 Grand PM, Kansas City, Mo.

ROTARY Vacuum pumps \$60.00. 28" vacuum 3 c.f.m. at 850 r.p.m. William Reid Co., Chicago 14, Ill.

STEINLESS Steel, bar or sheet assortment, ten full pounds \$5.00 prepaid. Industrial Engineering, 1155 S. Kenmore, Los Angeles 6, California.

GEARS For inventors, experimenters, model makers, schools, work shops, laboratories, etc. Government surplus made of brass, bronze, Dural, steel and stainless steel. 12 matched pairs; 24 gears, bevel, spur and ratchet. List price \$12.00, our price \$2.50. 25 matched pairs; 50 gears, includes larger gears, also sets of worm gears. List price \$30.00, our price \$5.00. 50 matched pairs; 100 gears better assortment, also crown, helical, internal and worm sets. List price \$75.00, our price \$10.00. Limited quantity. Order now. Met Exchange, 323 Canal Street, New York 13, N. Y.

BLOWERS, Metal blower cabinets, gas burners, oil burners, furnaces. Blower wheels, bearings. Wholesale, retail. Peerless Sales, 4323 Sheridan, Lincoln 6, Nebr.

EXPERIMENTERS, Craftsmen, repairmen—400 valuable new springs. 75 kinds, numerous sizes, 10,000 uses, \$2.00. Utility assortment, \$1.00. Deluxe assortment, \$3.00. Jumbo, \$5.00. Guaranteed. Technico, Box 246-A, West Hartford, Conn.

INDEX Heads for sale. Very inexpensive. Sixty-two different divisions. Used on small lathes, drill press, milling machines, etc. Make gears, hobs, cutters, etc. Very accurate, and durable. Not a toy. Used by defense schools and hobbyists. Write for free folder. Long's Index Heads, 2117 East B St., Torrington, Wyo.

ENGINES, MOTORS, DYNAMOS

NEW Kohler electric plants a.c. and d.c. Other electric plants rebuilt. Write E. F. Schmalz, 314 Wyoming Ave., Kingston, Penna.

BIG Pay jobs in welding. Complete welding lessons and reference books. 516 pages. 41 lessons. \$2.00 copy. Money-back guarantee. Hobartweld, Box 1155-M, Troy, Ohio.

MOTORS, Small 6 volt d.c. reversible 2000 r.p.m. 2" diameter, short shaft extension, suitable for operating models and gadgets. Postpaid \$1.25. Walthers, 247 Eric, Milwaukee, Wis.

150 AMPERE Generator for welding \$47.50. Extra flexible cable, 10 ft. lengths \$2.75. Other bargains. Butler Electric Company, 1885 Milwaukee, Chicago 47.

SELSYN Motors: 110 volt, 60 cycle, a.c. army surplus. Can be used for remote control, beams, antennas, bingo, signaling, wind indicators, many other uses. Light weight, high torque. Original cost \$100.00 pair, our price \$20.00 pair. Guaranteed new, original packing. Met Exchange, 323 Canal Street, New York 13, N. Y.

MODEL Engines, castings, supplies, catalogue. 25c. Howardo, A3, 2417 N. Ashland, Chicago 14.

WINDING Data, listing 225 motors, single and three phase, \$1.00. Motor Data Co., Box 7631, Kansas City 3, Mo.

BOATS, OUTBOARD MOTORS, ETC.

10' OR 15' Folding Kayak plans \$1.00. Foldcraft, 4015 Oketo, Chicago 34.

SAILKITS 100 Square feet \$7.50. canvas, airplane dope, winter boat covers, curtains, Swedish kerosene stoves, carbide lamps, boat hardware and equipment. Catalogue. Alan-Clarke Co., 96 Chambers St., New York City.

KAYAK. Easily built. Instructions \$1.00. Gee, 1211 Frisco, Par Rockaway, N. Y.

USED Marine motors, propellers, marine fittings, conversion manifolds. Charles F. Stokes, Coldwater, Michigan.

MARINE Power — Easily convert any Ford motor (domestic and foreign) with Oeco parts and kits. Complete catalogue 25c (coin). Oeco Motors Corp., 2020 East Orleans St., Dept. M, Philadelphia 24, Pa.

USED Outboard motor parts. Outboard Exchange, 1194 Remsen Ave., Brooklyn, 12, N. Y.

FULL Size, cut to shape boat patterns, blueprints. 7½ - 38 feet. Illustrated "Build a Boat" catalogue, 10c (coin). "How to Build Boats" book, \$1.00. Cleveland Boat Blueprints Co., Dept. A-66, Cleveland, Ohio.

BOAT Designers are highly paid professionals. Complete course by mail. Catalog. Westlawn, Montville, N. J.

ATHLETIC EQUIPMENT, BODY BUILDING COURSES

BAR-BELLS. Exercise equipment. Courses. Special offers! Free booklet. Good Barbell Co., 3261-PM Watson Rd., St. Louis (9), Mo.

SPORTING GOODS, GUNS, FISHING TACKLE, TRAPPING, ETC.

INFLATABLE Rubber boats and dual life preserver belts. Ideal for sportsmen. Belts use Sparklet cartridges or inflate by mouth. With cartridges, new, \$1.98. Mae West life vests used, repairable, with repair kit, \$2.95. Used but tested, guaranteed, \$3.95. New (seconds) for automatic inflation \$9.95. Collapsible rubber boats \$39.50 to \$99.50. Order from advertisement or write for circular. Karl Ort, Dept. PM-7, York, Penna.

INDIAN Trapping, fishing, hunting secrets—stories. New book \$1.00. Chief Blackbird, 679-P Dupont North, Minneapolis 11, Minn.

BRAND New guns available for immediate delivery in trade for your used rifles, shotguns, handguns, reels, rods, outboards, cameras and other sports equipment. Save money by dealing with America's biggest traders who offer maximum trade allowances for your merchandise as full or part payment for new guns. Ship your merchandise for appraisal, or write full description today. We also pay spot cash for equipment. Send 25c (refunded with first order) for full "guaranteed bargain catalog" featuring new and used guns and other "hard-to-find" items. Klein's Sporting Goods, (Sixty Years Fair Trading), 502TH South Halsted, Chicago 7.

CHUM Attracts fish, from 6 or 7 miles, to your hooks. Fresh or salt water. Cheap. Easy. Make 6 rigs. Learn 8 secrets. Use 10 methods. Know 55 chums. U. S. Chumming Guide \$1.00. Fish Research, 5912D Thompson, Philadelphia 31, Penna.

GUNS Refinished like new by factory methods, as used by leading gun manufacturers. Send for circular. Middletown Metal Finishing Company, 45 River Road, Middletown, Connecticut.

2000 BARGAINS, Firearms, binoculars, war relics, catalog 30c. Smith Firearms, Runnemed, New Jersey.

AMMUNITION Available to qualified purchasers. List 10c. Rudolph's, Atchison, Kansas.

SEND 10c For list 100 used guns. Frayseth's, Willmar, Minnesota.

USED Guns, bought, sold, exchanged. List stamp. Howe Fur Company, Coopers Mills, Maine.

FIELD GLASSES, MICROSCOPES, TELESCOPES, MAGNIFIERS

BUILD Your own reflecting telescope. Complete plan with each kit. Send for free catalog. Mayflor Products, Katonah 1, N. Y.

REAL 17 Power Telescopes \$3. United, 2309-E Lawrence, Toledo, Ohio.

MAKE Your own efficient compound microscope. Lenses and instructions 50 to 200 power \$2.00. 400 to 800 power \$3.00. Instructions alone 10c. Carl Jamer, Manorville, N. Y.

BINOCULARS, Telescopes, watches. Buy, sell, trade. Paul Schweer, Donnellson, Iowa.

MAKE Your own powerful, efficient astronomical telescope. Perfect lenses and instructions. 50X \$1.00, 100X \$2.50, 200X \$3.50, 400X \$5.50. Instructions alone 10c. Carl Jamer, Manorville, N. Y.

TELESCOPES, Microscopes, cameras, binoculars: bought, sold, repaired. Lists 10c. Specify instrument wanted. Rasmussen and Reece, 41 Market, Amsterdam, N. Y.

ANTIQUES, RELICS, INDIAN GOODS, CURIOS

INDIAN Relics, beadwork, coins, minerals. Catalog 5c. Sistershop, Northbranch, Kansas.

50,000 INDIAN Arrows, tools, rainbow variations. Don McKillop, Regina, Sask.

SELL, Exchange, buy: Relics, guns, antiques, coins. Lists 6c. Paul Summers, Stamford, Texas.

20 ANCIENT Indian arrowheads \$1.00. List free. Lear's, Box 569, Galveston, Tex.

SWORDS, Rapiers, daggers, pistols, armor. Illustrated catalog 25c. Robert Abels, 860-A Lexington Ave., New York.

MUSEUM Supplies—27 specimens Indian relics, fossils, gemstones \$3.50. Illustrated catalogue, identification chart 25c. Museum Supplies, 6601 Oaksh, Chicago 31, Illinois.

DOGS, PETS, BIRDS, RABBITS

PUPPIES! Giant meat rabbits! Animal and bird supplies! What do you need? Details free. "Royal," Chazy, N. Y.

RAISE Moneymaking Angora rabbits. Wool \$15.00 pound. Plenty markets. Cash income. Future prospects bright. Particulars free. White's Rabbitry, Lawrence, Kansas.

ANGORA Rabbits—Wool brings \$15.00 pound! Book "Angora Care-Management" tells everything. \$1.00. Self-cleaning scientific hutch (for all rabbits), plans, specifications \$1.00. Automatic feeder plans \$1.00. All three \$2.50. Catalog pedigreed Angoras free. Grinsteads, Dept. 15-A, Edwardsville, Illinois.

COTTONTAIL Rabbits, jumbo frogs, coon dogs, fishing canes. Vol Brashears, Berryville, Ark.

RAISE Guinea pigs. Profitable; low cost feeding; small space required; small investment. Literature free. Guinea Pig Farms, 3456 West 116th, Chicago 43.

\$500.00 A YEAR raising canaries. Details free. George Gundrum, LeRoy, Mich.

RAISE Diamond Seal rabbits, \$25 each, continuous market. Price guaranteed. Literature 10c, with hutch plans \$1. Automatic cleaning, watering, feeding. Hansens Rabbitry, 1347 Miller Ave., Salt Lake City 5, Utah.

CHINCHILLA Giants, real. Most profitable. Prolific, easily raised anywhere. Breeders supplied reasonable. Satisfaction guaranteed. Send for free illustrated literature. (Illustrated catalogue, fur samples, 25c). Chin-Chin Farms, Melvin Behrens, Gen-Mgr., Dept. 4, 44 Chester Pike, Darby, Penna.

PIGEONS, Rabbits, 30 varieties. Catalogue 10c. Jim Houck, Tiffin, Ohio.

DOG Owners—Teach your dog to retrieve! Send only \$1.00 for complete instructions. Box No. 392, Westfield, N. J.

ST. BERNARD Pups: Champion sired beauties. Franklin Young, R4, Riverhead, Long Island, New York.

TRICKS 'N' Tips—The quick ways to teach your dog simple tricks. Send 25c to Box No. 392, Westfield, New Jersey.

RABBITS: Flemish Giants, New Zealand. Reasonably priced. Franklin Young, Riverhead, Long Island, New York.

RAISE Giant Chinchilla rabbits. Valuable fur. Delicious meat. Easily raised. Pleasant pastime. Large profit. Free booklet shows amazing profits from small investment. Willow Farm, R15C, Sellersville, Penna.

RAISE Guinea pigs. Make money at home. Big demand. Free booklet. Taylors Guinea Pig Farm, Hapeville, Georgia.

STANDARD Rabbit Journal, Milton, Pa. 3 years \$1.00, sample dime.

1—RAISE Giant Chinchilla rabbits. Willow Farm, R15C, Sellersville, Penna.

A LIVING With rabbits and caviae. Markets waiting. Magazine 10c. Book describing twenty breeds and magazine 25c. Book and magazine (monthly) one year 50c. Address Small Stock, Dept. 2, Pearl River, N. Y.

SHEPHERDS, Collies, terriers, airfares, trained dogs. Edmond Stone, Charlton, Iowa.

FARMS, FARM LANDS, REAL ESTATE

STROUT'S Farm catalog—Over thousand bargains—25 states—from Maine to Florida, west to California, Oregon and Washington. Write now for this big 132-page book. Free. Strout Realty, 255-P 4th Ave., New York 10, N. Y. 7 So. Dearborn St., Chicago 3, Ill. 453 So. Spring, Los Angeles 13, Calif.

HOMESITES \$450—Low terms. California's finest garden spot. On Morro Bay's wooded shores. Wonderful fishing, hunting, boating, etc. Fertile soil, soft water, temperate climate, congenial community. Free literature. Richard M. Otto, 6560 Hollywood Blvd., Hollywood 28, Calif.

GOVERNMENT Land \$1.00 acre up. Information all states 25 cents. National Tax Service, 833A Majestic Bldg., Detroit.

OPEN Test locks—5 pass keys \$1.00. National Service, 322A Union Ave., Brooklyn 11, N. Y.

120 ACRES, 1 Mile village, mostly timber. Johns White River, shack, Ozarks. \$1,800.00, half cash. Bob Pace, Combs, Ark.

FREE Catalog, farm bargains, 7 mid-west states. Many fully equipped for convenient quick start. Many pictures. Special service to help you locate quickly, if you state requirements, payment plan and general location desired in first letter. United Farm Agency, 491-MP Arcade Bldg., 1, St. Louis, Mo.

WEST'S Fall catalogue hundreds farm bargains, business opportunities Penna., New York, New Jersey, Ohio, Delaware, Maryland. Free copy. West's Farm Agency, HE, Pittsburgh 16, Penna.

WISCONSIN, Minnesota water frontages \$7 acre. 3505-A So. Hope, Los Angeles 7, Calif.

OZARK Farms, ranches, resorts. List free. Farm Finders, Lonsdale, Arkansas.

\$5.00 MONTHLY Buys 40 acres near town; price \$175.00. Free list. Box 425-P, Carthage, Mo.

OZARKS Guide, Lonsdale, Arkansas. Magazine for homeseekers, sportsmen, year \$1.00.

GOOD Farms—Ranches. Washington, Minnesota, Montana, Idaho, Oregon, North Dakota. Dependable crops, favorable climate. Write for literature, lists describing typical farms. Specify which state. J. W. Haw, 119 Northern Pacific Ry., St. Paul 1, Minn.

OZARK Farm bargains, 5 to 5000 acres. Frank, Mountain View, Mo.

POULTRY AND FARM SUPPLIES

CHICKS For broilers or layers. Pure breeds, crossbreeds. Write for folder, prices. Amstutz Hatcheries, Box 100, Orville, Ohio.

MAKE More money with poultry. Magazine with experimental farm explains how. Order today! One year 25c; five years, \$1.00. Poultry Tribune, Dept. 19, Mount Morris, Ill.

YOUR Greatest poultry problem will look simple when you read American Poultry Journal regularly. 500,000 poultrymen do, why not you? 2 years 50c, 5 years \$1.00. American Poultry Journal, 533 South Clark, Chicago.

AVOID Unnecessary trouble on tilling, seeding, haying, harvesting machinery, tractors, water supply, lawn mowers, stokers. Learn about fire prevention, lightning protection, weights, measures, etc. Order our new book, \$1.00 postpaid. Wirtson's, West Burlington, Iowa.

KNOW How to raise poultry for profit. Read Northeastern Poultryman. Every issue packed with helpful hints and practical suggestions. Latest articles on breeding, feeding, and management. Read nationally. Subscribe now. 1 year 65c; 2 years \$1.00. Northeastern Poultryman, Dept. M, 376 Boylston St., Boston 16, Mass.

ROTARY Vacuum pumps for milking machines, pump only \$60.00. William Reid Co., 2271 Clybourn, Chicago 14, Ill.

RAISE Turkeys the new way. Write for free information explaining how to make up to \$3000.00 in your own backyard. Address National Turkey Institute, Dept. 3, Columbus, Kansas.

PROFITABLE OCCUPATIONS

ESTABLISH Permanent, profitable mail order business at home. Free literature describes giant collection of tested, workable business plans. Write Straus, Box 71, Kensington Station, Brooklyn, N. Y.

SIMPLIFIED Chemical gardening. Instruction 50c. Chemicals \$1.00. Gordon, 553 William, Winnipeg, Manitoba.

SHELL Jewelry—Profitable hobby! Samples and instruction \$1.00. Shell packages, 10c and 50c. For folder and supplies write Sarasota Shell Shop, Box 2046, Sarasota, Florida.

NEW FM radio—Springboard to success! Real career in permanent, fascinating work! Men and women learn in one week to operate in aviation, marine, utilities, police, fire, etc. Send postcard for free data! Topical Emprise Corporation, 1527 Highland Ave., Box 420, Louisville 4, Ky.

PAINTING Flagpoles often pays \$50.00 daily. Particulars free. The Skyline Co., P.O. Box 1601 B, Uniontown, Penna.

WELDING Pays. Learn with 1942 trade school text manual, 516 pages. Over 500 photos. \$2.00 copy. Money-back guarantee. Hobartweid, Box M-1153, Troy, Ohio.

MECHANICALLY Inclined men—Own and operate general appliance repair shop. Complete, illustrated course shows you how. Welding, refrigeration, motor repair, how to get business, etc., all phases covered. Free literature. Christy Supply, Dept. 458, 2835 N. Central Ave., Chicago.

LEATHERCRAFT Supplies. Catalog 10c. Art Craft Supply Co., Box 148, Fort Worth, Texas.

MAKE—Sell, paste "wood filler." Formula 25c. Satisfaction guaranteed. Joseph Jones, Box 172, Phenix City, Alabama.

WELDING Manual, finely illustrated, 420 pages, \$1.65. Eagle Welding, 5085 Broadway, Chicago 40, Ill.

STORY Writing simplified! Don't dream—try! Handsome earnings. Fascinating, complete home study. Circular free. Segment System, P.O. Box 1504 Central Station, Toledo, Ohio.

"FROG Raising" New book tells how. Profitable. Marlboro House, 1035 Marlborough, Detroit 15, Michigan.

TWO Hour a day business plan. No starting capital. Details, P.O. Box 5253, Zone I, E. Michigan Street Station, Indianapolis, Indiana.

EXPERT Tire technicians are in big demand! You too can become an expert at tire repairing and recapping. Earn \$60.00 to \$100.00 per week. For full information write at once to Tech Tire Engineering, 329-A South Ave., Westfield, New Jersey.

UP To \$5 per day for four hours easy interesting work, no selling or canvassing. Something different. So simple a child can do it. 25c coin brings full details and value in merchandise. Mrs. Nickell, Dept. PM, Rt. 1, Box 456, Bond, Oregon.

A LOCOMOTIVE Engineer or railroad conductor is interesting work. Information on how to obtain these positions 50c. The Student Railroader, Box A53, Elmhurst, Ill.

BE Independent! Become associated with us in an essential proven profitable profession. Universal Exterminators, 950 Margate Terrace, Chicago 40, Ill.

DOES \$5000 Yearly from your own collection-credit bureau business sound good to you? We've shown others how. Why not you? Write: Cole & Associates, Syracuse, N. Y.

BABY Shoes preserved. Complete instructions. Exclusive rights. M. E. Watson, Bellefontaine, Ohio.

HOMEWORKERS Make, sell, shell jewelry, novelties. Beginners kit, \$1.00. Catalog free. Burton, Box 27, Station A, St. Petersburg, Fla.

GROW Green vegetables in cellar, six days. Sell hotels, grocers. Instructions, seed \$2.00. Temple, Pinnellas Park, Fla.

GINSENG Fall planting instructions dime, seeds reasonable. Specialty Farm, Rockford, Minn.

ELECTRIC Clocks are every where you go, buildings, homes, parking lots, factories. Repairs increasing. Our easy to learn course with pictures and drawings teach you how to repair these clocks. Electronic Supply Co., Dept. A, P.O. Box 2350, Houston 1, Texas.

EXCEPTIONAL Profits raising mink. Finest breeding stock available. Details furnished. Franklin Young, Riverhead, Long Island, New York.

TYPEWRITER Repairs men urgently needed. Earn \$40 to \$50 weekly spare time. Our easy to learn home study course teaches how to repair typewriters. Write for free information. Houston Typewriter Repair Service, P.O. Box 5357C, Houston, 12, Texas.

\$40.00 WEEKLY Made growing mushrooms, fresh, dried. Dominion patent 331583. Free spawn. North American, 169P Yonge, Toronto, Canada.

TYPEWRITER Repairing—Original course, simplified home study. Weber Typewriter Mechanics School, Box 269, Osborn, Ohio.

MUSHROOMS Grown; boxes, barrels. Instructions 50c. Spawn \$1.00. Gordon, 553 William, Winnipeg, Manitoba.

GOLD-STAMPING. Exceptional post-war opportunity. Free booklet. Home City Specialties, Dept. 1273, Springfield, Massachusetts.

LOCKSMITHING—Profitable business or hobby! New course teaches you how to pick locks, fit keys, de-code, masterkey, etc. Easy self-instruction lessons. Bargain price. Free details. Write—Nelson Company, Dept. 7-02, Chicago 4.

ANNOUNCING Home study course in commercial baking. Practical basic training. Good field for those with aptitude. Nearly depression proof. Send for free booklet, "Opportunities in the Baking Industry," National Baking School, 1315 Michigan Ave., Dept. 3431, Chicago 5, Ill.

BOOKS, PERIODICALS, PICTURES, POSTCARDS

WE Can supply you with almost any book or photograph record album. House of Berbeck, (Book Sellers), Box 2682, Detroit 31, Michigan.

"SIMPLIFIED Dancing," \$1.00! Free catalogs! Books! Novelties! Hirsch, Spring Valley 2, N. Y.

SUBSCRIPTIONS Any magazine, trade journal printed. Catalog 10c. Cassell Publishers Service, Westfield, New Jersey.

OPERATE Profitable subscription agency, complete supplies, wholesale catalog listing 5000 magazines 25c (refunded). New York Circulation Service, 30-Z Church Street, New York.

THE Essential Book Company. Books for self improvement. Write today for list of success building books. 7157 St. Lawrence, Chicago 19.

POPULAR Movie stars in color. These beautiful photos of female favorite stars in lifelike colors will thrill you. Judy Garland, Betty Grable, June Allyson, Sonja Henie, Gloria DeHaven, Gene Tierney, Ingrid Bergman, Lana Turner, Alice Faye, Jane Russell, Betty Hutton, Paulette Goddard, Lauren Bacall, Jeanne Crain, Shirley Temple, Greer Garson. Entire set of 16 photos, size 8x10 only \$1.00 postpaid. Irving Klaw, 212 East 14 St., Dept. GS-1, New York City 3.

CHINESE Physicians secrets, unpublished history, peculiar healing arts, illustrations, \$1.00. Garding Lui, Box 6227 Metropolitan Station, Los Angeles, Calif.

CLASSIFIED Directory. Over 3200 trade, business, professional, diversion-magazines. Addresses; subscription prices, \$1.00 postpaid. Commercial Engraving Publishing Co., 3400 North Ritter, Indianapolis 1, Indiana.

INCREASE Your income and friendships by learning the important secret of easily remembering peoples names as explained in "How to Remember Names and Faces," a new booklet by David M. Roth, famous memory expert. \$1.00 postpaid. Order today. Roth System, Dept. S, 1121 So. Hill St., Los Angeles 15.

FREE—100 Page catalog of new and used college and home study text and reference books at a saving. Est. 1902. Long's College Book Co., Dept. M, Columbus 1, Ohio.

WHAT Every Mason wants. We have Masonic books for Blue Lodge, Chapter, Commandery, Scottish Rite and Shrine. Our rituals are used the world over. Send for free catalog of books and rituals for Masons, Odd Fellows, Knights of Columbus, etc. Era A. Cook, Publisher, P.O. Box 796-PN, Chicago 90, Ill.

GENERAL Eisenhower's biography. Descriptive folder free. Eugene McLean, Eureka, California.

PRESERVE War experiences in writing; priceless family history. Complete instruction. \$1.00. Myers, P.O. Box 1504 Central Station, Toledo, Ohio.

MAGAZINE Subscription service. Agents wanted. Sutherland Agency, Ringgold, Va.

ORIGINAL Order letters wanted on books, health books, health articles. Kourenhoff, Box 121, San Francisco.

BEAUTIFUL Colored pictures. Lists free. No girls. Curtis, Box 1916PM, Denver 1, Colo.

HISTORY World War II. Educational and other books. Bibles. Literature free. Premiums given. J. Henry Schlake, Box 813, Cincinnati 1, Ohio.

TRADE Magazines. Business, vocational, diversion. Current single copies. Over 200 fields. Free price list. Commercial Engraving Publishing Co., 340 North Ritter, Indianapolis 1, Indiana.

BOOKS. (Out-of-print, new, used) quickly supplied. Many 35c bargains. Catalogue. Mid-West Book Service, 18870 Marx Ave., Detroit 3, Mich.

JOIN Bonus Book Club. Save half. Bookmaster, Box 588-D, Stillwater, Okla.

RARE. Out-of-print books located. Bookfinders, 1210N 11th Ter., Birmingham, Ala.

BIG Profits taking subscriptions for all magazines. Agents' confidential catalog listing over 2500 periodicals and complete starting supplies free. Pines Subscription Agency, Flushing, New York.

MAGAZINES (Back dated)—foreign, domestic, arts. Books, booklets, subscriptions, etc. Catalog 10c (refunded). Cicerone's, 863 First Ave., New York 17, N. Y.

"100,000 POST-WAR Jobs Abroad"—South America, China, India, Burma, Japan, Russia, Malaya. How, when and where to apply. Post-war U. S. participation in world reconstruction and trade demands thousands of American-trained mechanics, salesmen, technicians, engineers, foremen, laborers and business representatives—every trade needed. Our 15,000-word copyrighted forecast—compiled from business, professional and government sources—lists over 200 big U. S. firms with foreign interests, gives job information, salary brackets, contract tips, application letters, passport information, climatic conditions, etc.—everything needed for your immediate application. \$1.00. Return for refund in 7 days if not satisfied. Pacific Industrial Research Bureau, 262-E Studio Building, Portland 5, Oregon.

PROOF Of earth's concavity, 225 pages, \$1. Theocracy, Bl720 Hough, Ft. Myers, Fla.

A RATIONAL View of Life \$1.00. Benjamin Seibert, Urbana, Ohio.

REBINDING: We bind magazines, old books, Bibles, hymnals. Heckman Bindery, Dept. D, North Manchester, Indiana.

DEVELOP Concentration. Book, \$1.00. Booklovers, 28 Cassius Street, New Haven 11, Conn.

KNOWLEDGE Is power. Amazing book bargains. Free colorful catalogues. Continental Publications, 79-02 Woodside Ave., Elmhurst, New York.

COMPLETE War history. Descriptive folder free. Eugene McLean, Eureka, Cal.

FREE Membership in our Technical Book Club entitles you to current literature, guiding advice on all your book problems, premiums. No obligation. All books: technical, chemistry, physics, plastics, optics, watchmaking, business, sports, photography, farming, music, languages, occultism, astrology, all homecraft, etc. Free literature, specify subject. Modern Technical Book Co., Dept. MMC, 55 West 42nd St., New York 18.

ANY Book on architecture, art, craft, supplied. Catalog, stamp, Artcraft, P.O. Box 6827, Baltimore 4, Maryland.

BOOKFINDERS! (Scarce, out-of-print, unusual books) supplied promptly. Send wants. Clifton, Box 1377PM, Beverly Hills, Calif.

INSTRUCTION 10c Books. Many subjects. "Hawkins," 215 Las Animas, Colorado Springs, Colorado.

GAMES, ENTERTAINMENT

BE The life of the party. Surprise your friends. Call square dances in French Canadian like it's done in romantic province of Quebec. Full instructions in French and English for only \$1.00. J. Artish, 298 Redempteur, Hull, Que., Canada.

FASCINATING New card game. Free. P.O. Box 842, Denver 1, Colo.

MAGIC TRICKS, PUZZLES, JOKER NOVELTIES

WORLD'S Largest professional magic shop keeps you in touch with latest tricks. To receive mailings send 25c for new catalog. Holden, 220M W. 42nd St., New York.

25 EASY Card tricks, 10c coin. Victor Jones, Parma, Missouri.

DOUBLETALK. A riot of fun. Learn quickly. Simplified instructions 25c. Illustrated novelty lists included. Cable's Novelty Shop, 3166 W. 25th, Cleveland 9, Ohio.

MAGICIANS' Handbook and catalog—10c. Magic-Craft Studio, 2307 N. 34 St., Milwaukee 10, Wis.

MAGIC Trick kit—75c. Hedemark, 1216 Park Row, New York.

ENTERTAIN Friends with professional magic. Catalog 25c. Herbert, P-192 No. Clark, Chicago 1.

BECOME Comedian! Free details! Kleinman, 25-31-B 30th Road, Long Island City 2, New York.

250 **MAGIC Tricks** only 10c. Rush! Magic Mart, 1423 Palou, San Francisco 24, Calif.

FLOATING Cigarette trick. Cigarette floats in mid air, with instructions, dime. Eastwood, Box 623, Parkersburg, W. Va.

TRICKY Match box. It turns around! It stands up! and it opens, most weird uncanny magic novelty trick. Complete ready to do. 25c. The Magician, 2463-M, Kensington Ave., Philadelphia, Penna.

MAGIC: Big 160 page Illustrated Catalog Latest Magic Goods, 25c. For over 1/3 century we have supplied Professional as well as Beginner. Chicago Magic Co., 2300 N. Mason, Chicago 39.

EARN Money in any crowd. Call names of strangers, tell unspoken questions. Professional course mind reading, faked spiritualism, etc., \$1. Henderson, Box 341, San Bernardino, Calif.

SURPRISE, Astonish, thrill, with empty hands, make clouds of smoke appear from fingertips or huge snow flakes float in air also make a five foot ribbon with empty hands etc. Easy to do with Magic Paste, special 2 tubes enough for 70 tricks \$1.00 postpaid with big magic catalog. The Magician, 2463-M, Kensington Ave., Philadelphia 25, Penna.

ATTRACTIVE Magic kit of 10 tricks (\$2.50 value) \$1.00 postpaid. Kogel's Magic Novelty Co., 6751-A Colbert St., New Orleans 19, La.

LEARN Ventriloquism, 3c stamp brings parlor tricks. Smith, 801 Bigelow, Peoria, Ill.

"MAGIC Vanishing card." Throw it in to air, it completely disappears, reproduce it later from spectator's pocket. Easy to do. Complete 25c with magic catalog. The Magician, 2463-C Kensington Ave., Philadelphia 25, Penna.

AMAZE And mystify your friends with highest quality magic. New catalogue 25c coin. Mazda Magic Co., Fond du Lac, Wis.

FREE! Large catalog of magical apparatus if you remit 25c for book "102 Easy Tricks." Robbins Co., 152-P West 42nd Street, New York.

500 **TRICKS** You can do! Douglas' famous catalog of 500 tricks, now only 10c. America's fastest service on magic for pocket, parlor, stage, professional, amateur. Douglas Magic Shop, Box 274, Dallas, Texas.

VENTRILQUISM. Complete course only \$1. LeSueur, 77 Wellesley, Toronto, Canada.

New Vanishing key and catalog 25c. Sterling Magic, 345 John R, Detroit, Mich.

BE A magician. Large professional magic catalogue of latest tricks 25c. Ireland, C-109 North Dearborn, Chicago 2.

MAGIC Tricks, puzzles, books, cards, punch boards. Catalog 10c. Specialty, Box 671, St. Louis 1, Mo.

COINS, TOKENS, CURRENCY

OLD Money wanted. Do you know that coin collectors pay up to \$100.00 for certain U. S. cents? And high premiums for all rare coins? We buy all kinds. Send 4c for large coin folder. May mean much profit to you. Numismatic Co., Dept. 20, Fort Worth, Texas.

20 **DIFFERENT** Coins \$1.00. 20 different bills \$1.00. Oddehon, Box 482, St. Louis, Mo.

WE Buy Indian pennies, Lincoln pennies, and old rare coins. Highest prices paid. Indian pennies worth up to \$15.00 each. Lincoln pennies up to \$2.00 each. Other rare coins \$5.00 to \$2000.00 each. Send 25c today for new 1945 price catalogue of all wanted U. S. coins. American Rare Coin Co., Dept. L, Transportation Bldg., Chicago 5.

YAMASHITAS' Army once owned this Japanese occupation of the Philippine paper money. 10 peso bill for 50 cents; 3 different for \$1.50; 6 different for \$3.00. Lloyd E. Panzram, Waseca, Minn.

WANTED—United States coins, highest prices paid. Catalogue 10c. United Coin Co., 219 Mill St., Newtonville, Mass.

MEXICAN Bills, ten different, \$1.00. Coins, lists. Oliver Arnold, Macon, Mo.

WILL Pay \$100.00 each for certain Lincoln pennies! Indianheads \$50.00; dimes \$1,000.00. Catalogue 10c. Federal Coin Exchange, 10-PM, Columbus, Ohio.

FREE—My price list with 35 Indianheads, 10 Missouri tokens \$1.00. Leo Greenstreet, Union, Mo.

NEED U. S. coins for your collection? Send me your list. William H. Kenworthy, Waterville, Maine.

GENUINE Japanese invasion bill direct from Philippines for dime. Eight different \$1.50. Seven Philippine coins including 50, 20, 10, 5 and 1 centavo for dollar. R. Preston, CMI/c USN Airbase 961, Z-Div., Care of FPO, San Francisco.

FOREIGN Coins, 15 different \$1.00 postpaid. Stamp for price list. Milford Coin Co., 486 State St., New Haven 10, Conn.

JAP invasion money—forced on Philippine people. Valuable to collectors! Five, ten, fifty Centavos 40c each; one, five, ten Pesos \$1.00 each; 100 Peso bill \$3.00. Complete set \$5.00. Norman, 393 West End Ave., New York 24.

50,000 **COINS.** Invasion bills, Philippines, China, Netherland Indies, Japan, Confederate currency. Illustrated lists free. Nagy, 8-D South 18th, Philadelphia 3, Pa.

WANTED—U. S., foreign gold coins. Highest cash prices paid. Collector's super bargain list 3c. Bebee Coin Company, 1180 East 63rd, Chicago 37, Illinois.

30 **DIFFERENT** Lincoln cents \$1.50. American catalog premium list all coins \$1.00. J&R Coin Dealer, Box 23, Sta. E, Buffalo 11, N. Y.

WE Pay from \$2.00 to \$50.00 each for hundreds old, odd coins. Indian and Lincoln cents wanted. Keep all until posted. Send 10 cents for illustrated coin value book 4x6. Buying and selling prices. 40 years in business. Coin Exchange, 5, LeRoy, N. Y.

WORLD Coins, large itemized descriptive list 10c. Harry Elsholz, Box 9014A, Pittsburgh 24, Pennsylvania.

COMMEMORATIVE 1/2c. Columbus, Stone Mountain, Texas, Cleveland, \$1.50 each. Illustrated catalogue, 25c. Norman Shultz, Salt Lake 9, Utah.

GET Profit and pleasure in collecting old coins. Send 10c for 56-page illustrated coin catalog. You'll be delighted with it. Send for it now. B. Max Mehl, 370 Mehl Bldg., Fort Worth, Texas. Largest rare coin establishment in U. S. Established 45 years.

QUICK Service; reasonable prices. United States catalog 10c. Foreign catalog 10c. Ben's Coin Company, 72 West Washington, Chicago 2, Illinois.

FREE! Foreign coin, banknote and coin collectors illustrated catalog to approval service applicants. Send 3c postage. Tatham Coinco, Springfield-125, Mass.

OLD STAMPS WANTED

I WILL Pay \$100.00 each for 1924 1c green Franklin stamps, rotary perforated eleven (up to \$1,000.00 each unused). Send 6c today for large illustrated folder showing amazing prices paid. Vernon Baker, (PM-511), Elyria, Ohio.

STAMP COLLECTING

SEND For special sheets 32-A and 32-B. Outstanding stamp bargains for serious collectors only. Alpine Co., Box 536, New Rochelle, N. Y.

LOW Priced United States approvals. Steger, 1165 Downing, Denver 3, Colorado.

WHAT Have you to offer? A collection? A "shoe box" accumulation? Anything in stamps. We urgently need them. Spot cash paid. Cosmopolitan Stamp Co., 1457 Broadway, Dept. 11-E, New York.

DOLLAR Each, 1500 foreign, 2000 British, 2000 Canada. Seiden, 1331 Intervale, New York 59.

WANT One? Rare "Emu"—3c (with approvals.) Estates, (Box P485) Foxlake, Wis.

FREE Stamps with approvals. Robert Smith, 801 Market, McKeesport, Penna.

SURPRISE Lot—Rare high value Philippines, Falklands, diamonds, triangle and others, only 10c with approvals. Deluxe Approvals, Box 4127, Los Angeles 24, Calif.

5000 **MIXED U. S. None** better. \$1.25. Lists. Weatherby, Medina, Ohio.

FREE! 25 Different British Colonies Approvals. Stamp House, 7235-A Sheridan, Chicago 26.

FLAG Stamp free with U. S. approvals. Wenigman, 1906 Summerdale, Chicago.

GRAND Cayman. Only a dot on the map but a popular British Colony. Mint set of four only six cents with a request for equally low priced British Colonies approvals. Forest D. Wilson, 711 North A Street, Tampa 6, Florida.

PREMIUM Given approval applicants. Arkay Stamp Co., 4023 John, Fort Wayne 5, Ind.

ONE, Two, four, five dollar U. S. stamps free to approval applicants. United Stamp Service, Box 1789-M, Miami 10, Florida.

JEEPERS! Russia 10 diff. and victory stamps 10c with approvals. Southland, 1805 Roosevelt, Los Angeles, Calif.

WEIRD Diamond, triangles, 5c to approval applicants. References, Seiden, 1331 Intervale, New York 59.

OLD Scarce U. S. seconds. Approvals. Hershfeld, 551 Clinton, Newark 8, N. J.

FLASH! Amazing value! Djibouti, Bechuanaland, Camerons, Dominica, others, all 6c, approval applicants only. Southwest Stamps, Box 117, Long Beach 1, Calif.

LADY Collector disposing thousands early U. S. covers—27 different \$1.00. (12 before 1890). Mrs. Phillip Corson, Plymouth Meeting, Penna. Also covers for specialists.

100 **DIFFERENT** Large and small colorful Russian stamps yours for \$1.00. Robert Boger, 3401 Oakmont Ave., Philadelphia 36, Penna.

FREE—30 Different U. S. with approvals. Taubers, 1755 Ocean Parkway, Brooklyn, N. Y.

ATTENTION Collectors in foreign lands; will trade U. S. for yours! Alwick, 5437 Nagel, St. Louis 9, Missouri.

FOREIGN Grabags, 50c; \$1.00; \$1.50. Slotin, 328 Bannerman, Winnipeg, Manitoba.

1000 **GRABAGS** 15c Each. Super bags 25c. Zandy, 630 Bingham, Reading, Pa.

CEYLON Set free with approvals. Davis, 803 South 10th, Waco, Texas.

U. S. Confederate state set 5c. Valentini, Box 1069, St. Petersburg 1, Fla.

UNBEATABLE! Including Abyssinia, Aden, Solomons, Grahamsland, Pitcairns, Albania, U. S. Commemoratives, Venezuela, etc. Everything 10c to approval applicants. Diana Stamp Mart, Box 1221, Dept. 3C, Plainfield, N. J.

GENERAL Approvals consisting mostly of airmails, pictorials and commemoratives from 1c up, mint and used, sets and singles. To encourage you to look at them I will give a regular 10c package of Fold-O-Hinges to those who enclose 3c postage. W. E. Baker, 10 Evansdale St., Lake Mary, Fla.

STAMP Collectors' names, 100 latest 25c. Stamporium-P, 2560 Rochester, Detroit 6.

PINE Approvals, freshly mounted. Fast, personal service. Tell me what countries you prefer and I'll send their stamps. Skinner, 345 East Ocean, Long Beach 2, Calif.

MAGAZINE—Year subscription 25c! "Stamp Post," Station A, Pasadena, Calif.

20 **DIFFERENT** Mexico—3c with approvals. Premiums with purchases. Brandwein Stamp Company, Box 92, Bayonne 2, N. J.

60 **STAMPS** 5c. Paul's Approvals, 1203 Albany, Schenectady, N. Y.

60 **DIFFERENT** U. S. commemoratives including famous Americans, Columbian, Army, Navy, hinges, approvals, all 25c. Ray Bovard, 309 East 3rd Ave., Cheyenne, Wyoming.

50 **STAMPS** From 50 lands 5c to approval applicants. Hurry! W. J. Lange, Marion, Iowa.

BEAUTIFUL Pictorials, triangle, Free French, 5 cents to approval applicants. Green & Company, Norwood, Ohio.

FREE! Haiti victory set to approval applicants. Riedel, Greensburg, Penna.

FREE Premiums for stamp collectors—albums, stock books, atlases, stamps, etc., to our regular customers. Send for the low priced foreign approvals and our Point System Plan. Charles Horn, Santa Ana, Calif.

25 **DIFFERENT** Canada, 3c with approvals. Jefferson Stamp Co., 1300 Jefferson St., N.W., Washington 11, D. C.

PITCAIRNS—"Mutiny on the Bounty" issue—three values mint. Only ten cents to approval applicants. Thiem, 1100 1/2 St. Paul, Rochester, New York.

STAMP Exchange—Send 200 different with dime. Will send you 200 different. Mumma, 212 Stevens, Lancaster, Penna.

VERTICAL Pair U. S. Scott's 605, plus Japanese occupation note for Philippines, send 5c for cost of mailing. This offer made to sincere approval applicants. Prompt service, reasonable prices. H. W. Chapel, Box 1182, Portland, Oregon.

U. S. \$4, \$5, \$10 Stamps and U. S. pack-ets only 3c to approval buyers. Wineholt Stamp Co., Woodbine 5, Penna.

30 BEAUTIFUL Airmails, 10c. Selected approvals. Louis Morrison, Milmont Park 1, Penna.

NEW Zealand peace stamps—Unused, set (eleven), \$1.50. Dealers \$1.25 set. Dawson, 56 Calgary Street, Auckland, N. Z.

FINE United States stamps on approval. Unzeitig, 679 E. 3, St. Paul, Minn.

45 DIFFERENT Unused U. S. commemoratives \$2.00. Will buy collections and accumulations. Charles Mekeel, 2101 East Market, York, Penna.

1000 MIXED U. S. on paper 25c. Jem Stamps, Port Jefferson, N. Y.

CHINA—Every stamp with a historical meaning. Twenty of these colorful stamps offered approval applicants for 10c. Collins' 71 Coleridge St., San Francisco 10, Calif.

U. S. Advanced collectors approvals. Davis, 172 Clinton Pl., Hackensack, N. J.

UNITED States, foreign, 300 fine \$1.00. Bonus. "Stamps," Gaylordville, Conn.

UNITED States—No. 65, No. 223, No. 228, No. 248, No. 254, No. 409, No. 414, No. C30, No. C31. Send 50c. Approvals accompany. Whiton—Stamps, Norwalk 4, Conn.

U. S. And foreign approval departments. Return postage paid. Atwater, P.O. Box 1583M, Miami 35, Florida.

25 DIFFERENT New Zealand, 10c to applicants for my quality foreign or U. S. approvals. Karr-Ross, DeRidder, La.

43 MIXED Indian cents \$1.00—50 different coins from 50 different countries \$5. Lists, approvals, DelMonte, 40 West 18, New York 11.

\$1, \$2 CHILE; Scarce 1863 Mexico; 25 different Columbia midgets, Czechoslovakia, etc. Catalogued 70c and bargain lists—All 15c. 100 different catalogued \$2.25—25c; U. S. mission mixture 75c pound. Haynes, 7316 Summerfield Road, Toledo 12, Ohio.

FREE U. S. list, 10,000 prices. Send postage. Wakonda, 198 Broadway, N. Y. (7).

POSITIVELY Greatest free offer—Latest Scott's International \$5.00 stamp album—covering entire world, contains 36,000 illustrated, descriptive spaces; Scott's 1946 Standard \$5.00 catalogues "Philately's Encyclopedia"—absolutely free to applicants for foreign approvals becoming customers. Bargain Stamp Service, Palm Springs, California.

FIFTY Canadian, Newfoundland, including earlier, commemoratives, 10c. Approvals, Reede, 696 Gerrard, Toronto.

BOX Stamps containing hundreds all different, cataloging up to 25c each. Everything \$1.00. Longacre Shop, 108 West 42nd, New York City.

FREE—25 Different Japanese pictorials and commemoratives to approval applicants. Charles Cleveland, 806 North Humphrey, Oak Park, Illinois.

BECHUANALAND Protectorate, gorgeous Tonga, exotic Pitcairn Isle, beautiful French Colonies—Everything 3c with approvals! Saxons, Walden, N. Y.

FREE! Price list of U. S. and foreign. Maco pages. Webb Stamp Company, Box 1665, Waterbury 89, Conn.

U. S. Approvals? Thousand books for your inspection. Box 488, Minneapolis.

CASH Waiting for collections and accumulations. Richard Groman, 306M East Hamilton, Allentown, Penna.

222 DIFFERENT, 10c. Approvals, Best Stamps, Box 139, Bangor, Maine.

25 DIFFERENT United States free. Approval applicants. Standard, 3817 Sackett, Cleveland, Ohio.

NOTICE! Mixed foreign, off paper, better than average condition, 25c per 100, \$1.00 per 500. Satisfaction guaranteed. Karr-Ross, DeRidder, Louisiana.

U.S.A. 50c "China Clipper" No. C-22 only 10c to approval applicants. "Stanley, the Stamp Man," 3120 South Adams Ave., Milwaukee 7, Wisconsin.

U. S. Approvals to serious collectors. Lundgren, Box 2532, Minneapolis, Minn.

DANDY United States approvals. Write immediately. Sullivan, Endicott Building, St. Paul 1, Minn.

FREE Gifts to purchasers of our approvals. Stamps, 6341 Dennis, Detroit 10, Michigan.

JUNGLELAND Flying fish triangle, tiny "amputated" triangle, enormous American flag stamp printed in six colors, Siberia, Arabia, Spice Islands, 50 year old colonial stamp, others—only 5c with approvals. H. Penny, Rowayton, Conn.

FREE Stamp album. To approval applicants we will send 96-page stamp album for "all nations" with 700 illustrations and spaces for almost 3000 stamps. Enclose two 3c stamps for mailing. Stamp Premiums, Inc., Flatiron Bldg., Fort Worth, Texas.

SCARCE Five shilling British stamp only 10c with superb approvals. B. Greenzang, 440 Berriman St., Brooklyn, N. Y.

SCARCE "Pole to Pole" packet! Stamps from strange, mysterious countries only—Greenland (North Pole), Solomons, Spanish Morocco, Bhopal, Patiala, Siberia, Grahamland (South Pole), Djibouti, Zanzibar, etc., and including stamps cataloging up to 25c each! Our price only 5c to approval applicants. Big dime packet list free! Methuen Stamp Service, Inc., Dept. 136, Lawrence, Mass.

100 DIFFERENT 10c With approvals. Jacobsen, 59 Nagle Ave., New York 34, New York.

FOREIGN Pictorial approvals. Brandan, 1912 3rd Ave. South, Minneapolis 4, Minn.

TURKS, Caicos, Grenada, Brunel, Dominica, Caymans; everything 3c with approvals. Vikings, 130(Z) Clinton St., Brooklyn, N. Y.

8 ATTRACTIVE Airmails, 3c with approvals and lists. Gaydos, Kenosha, Wis.

U. S. Price list. Send postage. State Stamp Service, 1225 Park Building, Pittsburgh 22, Penna.

FREE U. S. price list. Postage 3c. Mark Hanna, 335 - 5th Avenue, Pittsburgh 22, Penna.

THE Best United States and Philippine Islands approvals. Largest varieties. America's lowest selling prices. Stamp Company, Albany 7, New York.

1000 WELL Mixed U. S. 25c. Monjar, 1750 Fairmount, Cincinnati, Ohio.

100 DIFFERENT Of the world \$1.00. H. Spradlin, 2204 No. L, Fort Smith, Ark.

UNITED States approvals. Fine quality—priced right. Klein, 3630 N.W. 21st Court, Miami 37, Florida.

PENNY Approvals by country. M. H. Hoerning, 115 Farmington, Ark.

CYPRUS, Malta, Mauritania, Kenya, Uganda, Tanganyika; 3c with approvals. Smith, Box 71-A, Roselle, N. J.

NEW Brazil diamonds 10c with approvals. Vargo Stamps, Racine, Wisconsin.

19th CENTURY U. S. commems. Civil War-battlefield revenues, \$4 and \$5. Stamps free to U. S. approval applicants. Metropolitan Stamps, 198C Broadway, New York.

PREMIUM Approvals, British colonials, Latin American. Thirty-five diff. Canada to applicants enclosing (five cents 5c). "Crescent Stamps," London, Canada.

EXOTIC Pictorial collection: Tahiti spearfishing, Melanesian idol, Carib archer, Colombo harbor, Reunion produce, Jugoslavia, Philippines, Porto Rico, Malagasy farmer, Dutch Indies, South Africa, Roman's charity, Martinique settlement, Newfoundland codfish, Djibouti locomotive, Victoria. Everything only 5c. Imperial Stamp Co., Yonkers 1, N. Y.

HAWAII—Three old Hawaiian stamps, only 10c with approvals. Western Stamps, Box 4042, Los Angeles 24, Calif.

SPECIAL—Airmails, 19 different, including zeppelin, triangles, Latin-America, 5c with approvals. Continental Company, (Dept. B), Box 606, New Rochelle, New York.

LIBERAL Offer, thick packet with Seychelles, Fiji, U. S. commemoratives, Tete, Djibouti, Inini, Congo, Porto Rico, Philippines and multitude others. Everything only 10c to approval applicants. Burmaster, Box 1910 A, Los Angeles, Calif.

BRITISH Colonies and South America on approval. Theo. Stevens, Box 3705, Kercheval Station, Detroit 15, Mich.

EXCELLENT Pictorial approvals. Reasonably priced. Crown Stamp Company, Box 331, Toronto, Canada.

RICH Man's approvals, poor man's prices. Grand value packet containing five mint sets, free with approvals. Stoll Stamp Service, 2630B West Burnett, Louisville 10, Kentucky.

PACKET Scarce United States before 1910. Only 10c to approval applicants. E. J. Banks, 6635-16 Ave., Kenosha, Wis.

APPROVAL Sheets. Frederick B. Driver, 401 Finance Building, Philadelphia 2, Pa.

55 DIFFERENT United States—5c. Approvals. Utechs, 1143 C North Keeler, Chicago 51.

TRIANGLES—(Mozambique Co.) other beauties, 10c. Approvals. Reuter, 611-O West 40th, Los Angeles 37.

FREE Packet with attractive approvals that satisfy. Pearl Field, Derby, Maine.

25 DIFFERENT Guatemala 10c with 1/4, 1/2, 1c approvals. Carroll's, 4374 S. Hoover, Los Angeles 37, Calif.

U. S. Price list. Send postage. Stanley Gibbons, 38-P Park Row, New York.

FREE—Pick 25c worth of stamps from our first U. S. approval selection. Approximately 100 stamps to choose from. Excellent value. No obligation to buy. Lists illustrating the most popular U. S. stamps—at prices you can afford—will be included. Don't miss this opportunity! Write today. S. C. Engel Co., 38 Park Row, New York City.

WOW! \$10.00 Worth of fun—only 10c! 500 foreign stamps, unsorted and unpicked, just as received from church missions, other sources. Africa, So. America, Australia, China, Philippines, Dutch Indies, and other countries. Includes few commemoratives, airmails, and stamps cataloging up to 25c or more each! Biggest value in stampdom—and you might find something really valuable! Price only 10c to serious approval applicants! Money back if not delighted. Jamestown Stamp Co., Dept. 22, Jamestown, New York.

114 DIFFERENT Stamps from far away countries including airmail and Free Fighting French to approval applicants for 10c. Reich Stamp Co., 4647 Kenmore, Chicago 40, Dept. M9.

COMPLETE "United States" catalog with 1000 illustrations! Send 10c for mailing. Harris & Co., 137 Transit Building, Boston, Mass.

SMOKY Mountain commemorative sheet, largest U. S. stamp issued, and 33 U. S. including commemoratives, airmail, revenues, etc. Catalogs 75c—To approval applicants for 5c. Curhan Stamp Company, Gloucester, Mass.

U. S. Collection fifty different mint unsorted commemoratives 1921-1939 only \$2.00 with your request for approvals. Orange Stamp Company, Albany 7, N. Y.

UNITED States approvals complete coverage, fine quality, attractive prices. Seminole Stamps, Box 436, Coconut Grove, Florida.

AMAZING Offer! Assortment each of giant stamps, midget stamps, flag stamps, airmail stamps, Free French Colonies, U. S. commemoratives and numerous others. Everything only 10c to approval applicants. Simon, Box 214, Iraan, Texas.

60 DIFFERENT U. S., 10c. Pricelist free. Seidenberg, Cassopolis, Mich.

FREE! Western Hemisphere packet. Postage 3c. Owens, 806 Welsh, Bay City, Michigan.

FREE! Pony Express set (facsimiles). Postage 3c. Roberts, 406 Building, Bay City, Michigan.

DEALERS—Wholesale list. Postage 3c. Frank, 5031 Queensberry, Baltimore 15, Md.

FREE! British Empire packet. Postage 3c. Williams, 606 Archer, Bay City, Mich.

FRESHLY Mounted approvals for collectors using Scott's International Junior album. Wlaschinn, 55 Nagle Ave., New York 34.

SCARCE 1880 U. S.—Hussey local carrier stamp listed at 15c. Also Costa Rica No. 65 listed at 40c. Both sent free to approval buyers sending 3c postage. Pladon Stamps, 1717-M Idaho, Toledo 5, Ohio.

ZOWIE-E-E! A barrel of fun for only a dime. 500 United States—absolutely unpicked and unsorted—just as received from church missions. Many varieties including large commemoratives, airmails, high denominations up to \$5.00! Stampdom's biggest package of fun—and you might find something really valuable! Price only 10c to serious approval service applicants. Money back if not delighted. Illustrated bargain lists with each order. Mystic Stamp Company, Department 80, Camden, New York.

WORLD'S Largest diamond and triangle stamps, free stamp magazine stamps from fighting Free French, 20 stamps from 20 different countries, pictorials, airmails, big bargain 5c with approvals. Capital Stamps, Dept. 2, Little Rock, Ark.

118 DIFFERENT Stamps including commemoratives, charters, airmail sets, etc., only 3c to approval buyers. We buy collections. Badger Stamp Co., Milwaukee 3, Wis.

150 PROFITABLE Spare time, mail order, local business offers each month for six months—mail for 10c. Lewis, 828-P Carpenter, Oak Park, Ill.

AMAZE Others. Add columns instantly. Add faster than adding machine. Free details. Math Institute, Box 633, Mobile 4, Ala.

THE Real truth about selling names by mail. Revealing ideas for stamp. J. Greene, 55 Dodd St., East Orange, N. J.

ASTOUNDING Modern mailorder plan brings quick profits. Darrah, Orono, Me.

PLASTIC, French enamel, jewelry, manufacturing revealed. Start profitable business. Complete instructions, descriptions, drawings, \$1.00. Attler Company, 23-60 29th, Long Island City 5, N. Y.

PLASTIC-Intermix, makes ordinary casting plaster shatterproof. Pint develops 100 pounds, \$1.25 postpaid. Plastic Material Supply, 1416-N2 Fletcher, Chicago.

EXTRAORDINARY Money-maker: particulars free. Skyland Specialties, 93 Cloves Street, West Asheville, N. C.

SELL By mail to college students. Big market. Specialized instructions. Write: John B. Martin, 1101 West State St., Jacksonville, Illinois.

THREE New small business plans. Little or no capital. Never before offered. They're tops! Particulars, 3c stamp. E. Reese, 465-A Douglas Bldg., Seattle.

\$100 To \$800 Profit weekly. We start you in photo business—no experience needed—new equipment makes excellent photos in 5 minutes. Exclusive. Write now to Federal Identification Co., 1012 NW 17th St., Dept. 15, Oklahoma City, Okla.

RUBBER—Airlastex liquid, pre-war quality. "Makes molds overnight." Sample pint, instructions \$1.50. Gallon \$9.00. 20th Century Products, 3151-3 Southport, Chicago.

YOUR Own business—As little as \$100 starts you now! No training needed! See our ad on page 404. American Photocopy Equipment Co., 2949 N. Clark St., Dept. GF15, Chicago, Ill.

IMPRESSIVE N. Y. mailing address only \$2 monthly. United, 141 Broadway.

A JOB Slave? Learn today how you can live a happy, prosperous "tomorrow" as your own boss. Details free. G. Kindig, 1629 Vine St., Philadelphia 3, Penna.

BIG Opportunity mails or any formula 25c. Bruce Murphy, Mohler, Oregon.

START Home business making statuary, plaques, novelties, garden furniture, artificial marble flooring, liquid marble. Make your own flexible molds. Amazing profits. Folder free. Creative Publishers, Box 236-L, Winnetka, Illinois.

HOW To make shell jewelry. Here is the only complete course of home instructions for making tropical jewelry. Gives complete instructions and beautiful photographs for making 33 different styles of sea shell and fish scale earrings, brooches, pins, sprays and hair ornaments. Includes dyeing, pearlizing, lacquering, gilding and luminous methods. Also, wholesale prices for all materials required. \$1.00 per copy postpaid. House of Gifts, Box 4550-PI, Coral Gables, Florida.

MAKE Flexible Molds. Statuary Art Goods, Novelties, Artificial Marble Flooring, Liquid Marble. Literature free. Kemico, Park Ridge (10-M), Ill.

BIG Earnings await you in Mechanical Dentistry. Quickly learn scientific dental-plastics art in spare time by mail. Complete illustrated course teaches, gives professional standing. All materials and tools furnished, also guidance in establishing your own laboratory at home or office, spare or full time. Write immediately to Ward Lucas, President, Dental Plastics College, Box 4294 Village Station, Los Angeles 24, Calif.

WORK For yourself. Your own business. Operate entirely by mail—direct from your home in spare time. Few dollars starts you. Literature free. Albert Wilcox, FM21, Nicholls, Georgia.

SELL Books and courses by mail. Particulars free. Fadenrecht, Corn, Okla.

POSTWAR Security! The greatest legitimate scheme ever devised to secure a big mailing list and a stream of dimes. Free particulars. Jack Killion, 7922 South Vermont Avenue, Los Angeles 44, California.

ADVERTISING Tips on selling by mail. Starting plan included. Details free. Young, Box 61B, Medford 55, Mass.

START Home mailorder business. Amazing literature free. Kemall, Park Ridge, Ill.

LUCITE Cameo pins, picture frames, compacts. Wholesale prices, samples \$1.00 postpaid. N. Y. Article Co., 116 West 45th St., New York 19, N. Y.

NEW Flexible mold material, casts cat-alin plastic, concrete, plaster, in same mold. Literature. Sanflex, Box M, Clyde, Ohio.

LATEX For making flexible moulds, plaster models. Start your own profitable business. Complete instructions. Eastern Latex Laboratories, Box 153, Mattapan 28, Mass.

HOW To help yourself to postwar prosperity. Send postal today. William LaHue, 1129 Spring, Canton 1, Ohio.

MAKE Strange new plastic, 8c gallon. Makes attractive, durable floors, walls, roofs. Bays Laboratory, Oklahoma City 9, Okla.

SELL By mail. Particulars free. Write, Frank J. Artz, 1060 Harding Drive, Toledo 9, Ohio.

MOLDERS Notice, new plaque model of "Raising the flag on Iwo Jima." Illustrated leaflet. Sanflex, Clyde, Ohio.

MAKE Soap at home. No machinery. Profitable. Literature free. Kemico, Park Ridge (SM-10), Ill.

SELL Cosmetics by mail. Women spend millions on beauty. You can make your share of this cosmetic money. Let us show you how. Details free. Frank J. Artz, 1060 Harding Drive, Toledo 9, O., Dept. B.

MANUFACTURE Patented fireproofing compound. Fireproof clothing, home furnishings, automobile upholstery. Sell agents, homes, hotels, hospitals. Formula, instructions, license—\$2.00. Pring, 20 Winnett, Toronto, Canada.

LEARN Profitable credit-collection agency business; earn \$5,000-\$10,000 upwards annually; sparetime opportunities excellent; postcard brings interesting literature free. Write: Educational Extension Service, Department 101, Los Angeles 38.

BOOKKEEPERS—Operate popular "Dollar-A-Week" bookkeeping and tax service. Full or spare time. Details free. Ellis, Box 200, Cedar Grove, N. C.

METALLIZE Baby shoes! Learn this easy, money making business from nationally recognized consultant. Small investment; free details. Joseph B. Kushner, B.S.Ch.E., R.D. 3, Stroudsburg, Penna.

AT Last! A genuine Storm-Proof cigarette, cigar and pipe lighter that requires no fluid of any kind, will not blow out and can't get out of order. This Storm-Proof lighter employing the charcoal principle, sells on sight just by lighting a cigarette. If interested, here are complete details—Storm-Proof lighters come fully guaranteed and must retail \$1.00. Your discount 40% in dozen lots, 50% 3 dozen and over including territory. Initial 2 samples trial order \$1.00, deductible from first wholesale order. Storm-Proof Lighter Company, 126 Lexington Avenue, New York.

START Big money business on shoe-string. New, successful cleaning service. Big demand everywhere. Easy, quick profits. Write for details. Americlean, 211 N. 7th St., St. Louis 1, Mo.

MAIL Order beginner's "Business Development Plan," "Profitable Mail Selling Idea," "Pointers Along the Mail Order Trail" show how to make mail order business pay! All three, in 10,000-word treatise, postpaid quarter. Satisfaction guaranteed. Maupin & Maupin, LaFayette 3, Indiana.

INTERESTING! Revealing! Mail order business success laws. "Candid facts." Dime (coin) refundable. Parke Publications, Carrel Building, Quebec, Canada.

YOU Can make \$5,000 yearly, up, in an easily learned office business of your own. Write G. H. Cole, Pres., Syracuse, N. Y., for free details.

FLORIDA Opportunities—Pensacola offers exceptional opportunities for small industries, especially in the field of mahogany novelties and woodware, perfumes, soap, chemicals. Delightful year-round climate. Wonderful fishing, hunting, beach sports. For information write: Industrial Development Division, Municipal Advertising Board, Pensacola, Florida.

BUILD Miracle homes. Yours. Others. Chamberlain, Fitzsimons Building, Pittsburgh 22, Penna.

PROFITABLE Plans and ideas. Details. Spada, 10 Lexington, Wethersfield 9, Conn.

PROSPERITY Plans and formulas. Start successful home business. Particulars free. Frank J. Newton, La Grange, Ill.

"HOW To Finance Any Business. Obtain Capital." Research, Aitkin 5, Minn.

BUILD Own business mailing penny post cards; six profitable plans with information for starting. Gordin Publishers, Box 23, Pawtucket, R. I.

"HOW To Make Simple Molds and Plaster Plaques." Profitable business or hobby? Instructive booklet 35c. Plastercraft, 1406 East 43rd Street, Cleveland 3, Ohio.

"10,000 ALASKA Fishing Jobs." Alaska's largest industry regularly employs thousands of men and women in seafoods production. Possible earnings up to \$5,000 in few weeks. Authentic 7,000-word copyrighted report gives job information, union requirements, sample application letter, names and addresses over 40 Alaska fisheries. Newest edition includes similar information on California, Oregon and Washington fisheries. Vital facts for immediate application in a permanent industry. \$1.00. 7-day refund privilege. Pacific Industrial Research Bureau, Dept. PM-9, 202 Studio Building, Portland 5, Oregon.

MAKE And mold genuine plastics. Forty illustrated work-sheets explain methods, processes. Authentic-simplified \$1. Free circular. Plastics Digest, 3937B Tracy, Kansas City 4, Mo.

START Profitable sideline business now! Complete free details and premium offer available. Write Sheboygan Publishing Co., Sheboygan, Wisconsin.

RECAST Old batteries into new. Latest achievements. Battery Laboratories, Minneapolis.

MONEY-MAKING Business. Big profits! Successful Income Builders, Hollywood 28, California.

FREE Literature. Earn extra cash. Easy home business. Experience unnecessary. H. Thomas, 808 W. 68, Los Angeles 44, Cal.

\$25 WEEKLY Working two hours daily. No canvassing. No manufacturing. Lycka, Box 2471, Cleveland 12, Ohio.

TYPEWRITER Repairing—Original course, simplified home study. Weber Typewriter Mechanics School, Box 269, Osborn, Ohio.

QUICK Money! "Repairing Car Batteries." At home. Easy too. Write Batteryman, 901 South Avenue, Grand Junction, Colo.

BOOKKEEPERS: General ledger and tax report experience. Operate permanent, profitable accounting service for the smaller business. Part or full time. Simplified method. Write now! L. A. Bell, 1400 West 25th Street, Cleveland 13, Ohio.

START Mailorder bookshop—Everything furnished; publisher cooperation. 25c brings booklet, exclusive setup, samples, exciting ideas. General Publications, Ossining, N. Y.

BECOME An "Atritionist Masseur." First improvement over Swedish massage in 100 years! Results unbelievable! Dr. Swearingen, 9128M, Station S, Los Angeles.

COLORGLAZED Concrete pottery made without molds. New, low cost, patented method. Cemetery products, novelties, tiles, floors, etc. Basement leaksealing. Other moneymaking projects. Booklet, details free. Men only. National Potteries Company, Pergus Falls, Minnesota.

BIG Money making Hollywood style pottery, bird baths, wishing-wells, benches, stucco-rock. New method. Clever designs. Color with chemicals, water-paints. Marbling, colored glaze effects. Dime brings samples, pictures, literature. Hollywood Cementcraft, 8527 Wonderland Ave., Hollywood 46, California.

—RAISE Giant Chinchilla rabbits. Willow Farm, R 15A, Sellersville, Penna.

PLASTIC Houses—Build yourself! Re-surface old buildings! Wonderful building material. Write Marbleizing Service, Edwardsville, Illinois.

HOW And where to obtain capital. Fully explained. Particulars free. Star Service, Wapakoneta, Ohio.

MAIL Order business course shows you how to make money, spare or fulltime. Teaches professional mail order technique—not penny-snatching schemes. New success catalog free! Write—Nelson Company, Dept. 4-02, Chicago 4.

AGENTS—To mail our literature. Good profits. Home business. Maywood, 1133 Broadway, New York.

RAISING Canaries pays good profits. Valuable bird book—"Its Care, Breeding and Training." Price \$1.00. American Canary, 2839 N. Halsted, Chicago.

LIQUID Marble; snow-white, multi-colored. Glazed. Unglazed. Composition flooring. Lifetime wear. Any color. No priorities. Flexible molds. Plaster casting. Get into the big money now. Full information given free. Write Compo-Tex, Box 786-R, St. Louis, Mo.

BRUSH Plating outfits connect to a battery. No tanks necessary. Good paying business at home plating autoparts, bathroom fixtures, bicycles, reflectors, silvering mirrors. No shop or experience required. Outfits furnished. Free booklet. Gunmetal Co., Ave. H. Decatur, Ill.

127 WAYS To make money, in home or office, business of your own. Full particulars free. Elite Co., 214 Grand St., New York.

MONEYMAKING OPPORTUNITIES

TREASURE Finders. See Goldak advertisement in Miscellaneous section.

BIG Profits. Manufacture custom arch supports. Jul Corssen, 2638 Geyer, St. Louis 4, Missouri.

MECHANICALLY Inclined men—Own and operate general appliance repair shop. Complete, illustrated course shows you how. Welding, refrigeration, motor repair, how to get business, etc., all phases covered. Free literature. Christy Supply, Dept. 1158, 2835 N. Central Ave., Chicago.

NEED Extra money? Opportunities galore. Particulars, stamp. Jackson, Newfoundland 3, Kentucky.

\$2,000 YEAR Sideline easy, inventing simple items for special cash markets. Ideas only. No patents. Write today. Hendrickson, Argyle 7, Wisconsin.

MAKE Money in mail order—Easy if you know how. Our complete instructions teach you. Begin at home, then expand. Only 25c. Lods, 100 Alden Place, New Orleans 19, Louisiana.

\$200 MONTHLY With camera! Comprehensive guide, 50c. Frank Dickson, 808 Elizabeth St., Anderson, South Carolina.

RECEIVE Giant mails, latest money-making home work offers, opportunities, magazines. Your name listed 10c. New Age Enterprises, 578-A Prospect, New York City 55.

START Money-making business. Free folder. Successful income business. Hollywood 28, California.

MAN. You'll like silvering mirrors, reflectors! Making sparkling chipped glass nameplates. Outfit prices. Sprinkle, Plat-er, V80, Marion, Indiana.

GIANT Mails, moneymaking offers galore. Write Warren, Freeland 1, Mich.

WANT Financial independence? Proved plan helps hundreds. Tiboit, 21M, Philadelphia 20.

BUSINESS Books. Literature free. 100 plans 50c. 50-25c ppd. guaranteed. Rex, Box 3236R4 Chouteau Sta., St. Louis, Mo.

POPULAR Mail order magazines, money making opportunities. 1/2 pound, 10c. Thomason, 857 East Jessamine, Fort Worth 3, Texas.

PROFITABLE Mail order or local business in your home. Free booklet describes 125 proven plans. Kessler National Service, Box 392-PMN, Indianapolis 6, Ind.

SPARE Time money, 300 ways, 25c postpaid. Cutt, 452 Humboldt, Buffalo 14, N. Y.

QUICK Cash plan 25 cents. Poulsen & Company, Zion 2, Ill.

SERVICE Men! Ex-service men! Defense workers! You've helped win the war! What now? Let us help you find your place in a post-war world! Particulars free. Educational Publications, P.O. Box 561, Miami Beach 39, Fla.

WHOLESALE Catalog, directory 10c. Hundreds of thousands articles. Stafford, Sunnyside-PM, Indianapolis 44, Ind.

SWAP Sell anything, send list get ours 25c. National Traders, 299 Summit, Buffalo, N. Y.

SAMPLES Magazines, moneymaking offers galore; free. Clifton Hillhouse, Box 1372, Lincoln 1, Nebr.

MAIL Order work with real profits. Compile and sell name lists. Start on shoe-string. Stamp brings exciting details. Address: Vulcan Service, 2312 Ave. E-Ensley, Birmingham 8, Ala.

MAKE Money at home. Do it with anything you have! Capital unnecessary. Let a successful man with 44 years experience tell you how. Write postcard today! Carter, Box 8-DBB, Station A, New York.

LETTER Trucks with spray gun. Adhesive stencils. Samples for your name and details \$1.00. Wm. Beaman, Oregon, Ill.

THOUSANDS Of recently compiled names, complete data of newly born infants, 1c each. Minimum order 250. R. Gordon, P.O. Box 561, Miami Beach 39, Florida.

THE Atomic bombs of better business. For full details, write: Bertha Allison, Cross Plains, Texas.

METAL Identification tags. Agents sample. Silver quarter. James Parker, Stockton, Kans.

BOOKKEEPERS. Build profitable book-keeping service, part or full time. Plan and instructions \$2. Money back guarantee. Tax-Saver System, Dept. G, Fort Worth, Tex.

COMPILE Names. Profitable. Stamp brings details. Sharp, 904 Pennsylvania, Kansas City 6.

YOUR Big mail order opportunity—No time has ever been as good as right now. Get your start right. Let me show you how, what to sell and who will buy. Big profits, easy work at home. Write: H. S. Smith, 3139A So. Mabbett Avenue, Milwaukee 7, Wisconsin.

MIDGET Motion pictures: Complete working model with plans for easily making amusing, earning money with same. \$2.00. Midget Motion Pictures, Hollywood 28, California.

IF You want to swap, buy or sell anything, send 25c for The National Swappers Guide. It's full of opportunities to swap, buy and sell almost anything under the sun. 610 St. Joseph, Evansville 12, Ind.

THOUSANDS Articles wholesale. "Supply Source Directory" 10c. Ideal Service, D10, Park Ridge, Ill.

HOW I averaged \$200.00 monthly, making household necessity and giving premium made from waste. Instructions \$1.00. Pring, 20 Winnett, Toronto, Can.

MONEYMAKING Books. Free list. Journalism booklet, 25c. Underhill, Beebe, Arkansas.

MONEY Made easily home or room, 25c brings details and two 25c folios or book. Bargain Specialty Company, Box 635C, Modesto, California.

START Profitable collection agency business: office; home; sparetime. Earn \$5,000-\$10,000 upwards annually. Investigate Educational Extension Service advertisement under Business Opportunities.

INSURE Your future against poverty, failure. Learn how to become prosperous, independent. You will never be broke when you use this valuable advice, anywhere, any age, learned in one hour. No selling. No capital required. No business to start. Most remarkable thing ever written. Over million sold. Changing the lives of many people. Should be in every home. Money back guarantee. Postpaid \$1. Outside U. S. \$2. The Gilbert Service, P.O. Box 1464, Mobile 8, Ala.

MAKE Plaster Plaques, Statuary, Liquid Marble. Instructions, formulas, \$1.00. Ideal Service, 179-M, Park Ridge, Ill.

PUBLISH Your own magazine. Hand-some 52 page format, well edited, illustrated. Cost low as \$1.00 month. Brings you prestige, profits, 25c brings sample, details. National, Ord. Nebr.

MAKE Colorful plastic jewelry with sparkling "Wonder-links." Easily assembled without tools or equipment. Profitable sideline! Free details. Beginner's outfit, \$1 (refundable). Hughes, 218 Sidell, Danville 3, Illinois.

EARN Money evenings, copying and duplicating comic cartoons for advertisers. Adservice, Argyle, Wis.

THOUSANDS Of alarm clocks need repairing. Jewelry stores swamped. Our simplified course teaches you how to repair these clocks. Necessary tools and supplies furnished with course. Alarm Clock Repair Service, Dept. B, P.O. Box 1983, Houston, Texas.

INDEPENDENCE And your own business. No peddling. Little or no capital needed. You can't miss. Free details. Ranerva, Oakland, Nebraska.

GROW Dwarfed trees. Instructions 25c. McGuire, P.O. Box 628, Dept. G, Seattle 11, Wash.

GIANT Big mail! Hundreds of money making propositions, home work offers, including big magazine, all for a dime. Gardenville Publishers, Gardenville 11, N. Y.

\$-RAISE Giant Chinchilla rabbits. Willow Farm, R 15B, Sellersville, Penna.

I MAKE Big money in the mail-order business. You can do the same at home with my copyrighted system. Write me. I'll tell you how. F. Little, Box 8, Glen-shaw P.O., Pittsburgh, Penna.

LICK After-war layoffs! Start own business: home, office. Booklet describing "Collection of 127 Tested Plans" free. Elite Co., 214 Grand St., New York.

LEARN Metascience. Remarkable drug-less healing. No manipulation. No apparatus. Unbelievable simplicity and results. Inexpensive correspondence course. Write Metascience, De Land, Florida.

"MAIL Order World." Outstanding mail order magazine. Sample copy 10c. Martin's, Box 2414P, Bridgeport 8, Conn.

EARN Money at home! Thousands do "Home Worker Magazine" tells how. Sample, 25c. Sizemore, Box 7, 4917 North Kostner, Chicago.

FORMULAS, PLANS, ETC.

RELIABLE Formulary. 924 page illustrated book, 10,000 scientific formulas, recipes, secrets, instructions for most any product. Countless profitable business opportunities, including D.D.T. new insecticide that eliminates flies, mosquitoes, moths, lice, fleas, roaches, "bbs," etc. \$2.98 postpaid (c.o.d. U. S. only). Foreign \$3.25 delivered. Adams Brown Company, Dept. 361, Chestnut Hill 67, Mass.

BURGOO, Kentucky's famous formula easily made from different varieties of food. Unusual flavor. Hot seller. 50c. Campbell Doggins, Box 949, Lexington, Ky.

10,000 AUTHENTIC, Scientific formulas, 924 page profit-bringing, illustrated "wonder book" \$2.49 postpaid. Colorful folder free. Continental Publications, 79-02 Woodside Ave., Elmhurst, New York.

GASOLINE Gas machines, 30c rates, plans \$1. Ideal Specialties, Lakewood 5, R. I.

SUDSY, Flaky detergent similar to Drest. Non-alkaline. Easy on hands. Contains no soap or water softeners. Cleans like magic in any water. Easy to make at very low cost. Formula five dollars. J. E. Dick, P.O. Box 5641, Indianapolis 1, Ind.

DDT, Chemicals, formulas, bulk products, containers. Farrand Chemical, Tyronne, Penna.

CHEMICAL Analyses of all kinds of minerals. Assayers. Formulas for the manufacturer for almost any kind of article. 10 perfume formulas \$1.00. Lincoln Laboratories, 7528 Sheridan Road, Chicago 26, Illinois.

MANUFACTURE Paints. Your garage a factory. No equipment, capital needed. Complete instructions, formulas—suppliers \$2.00. Industrial Chemist, 1828 60th, Kenosha, Wis.

MONEY-MAKING Formulas—low as 5c each. Send dime for list and two sample formulas. Random, P.O. Box 2688, Los Angeles 28, Calif.

"FORMULAS For Profit." Book jammed full of formulas, 638 pages. Edited by experts, chemists, engineers, technicians, professors. Postpaid \$1.75. Hart's Sales, 1808 Crawford, Cleveland, Ohio.

START A business of your own. Experience or capital not needed. Manufacture fast selling home necessities from cheap chemicals. Information free. Nuway Formulas, 2709 Florida, Longview, Wash.

"LUMINOUS Paint," 100 other formulas, plans—25c. Soap-making, (20 formulas) \$1.00. Resilvering mirrors 30c. Ideal Service, 310, Park Ridge, Ill.

NEED Chemists? Formulas. Professional services. Consulting. Scientific Company, Swarthmore, Pennsylvania.

MANUFACTURE Fast-selling Products yourself. Formula catalog free. Kemico, Park Ridge (16), Ill.

120 SPECIALLY Selected formulas for quality and profit. The Jeffers Company, Pittsburg, Kansas.

WORKSHOP And farm formulas. Money making manufacturing ideas. \$1.00. Nu-Way Formulas, Box 1016, Longview, Wash.

TIRE Carcasses everywhere, from these reclaim rubber to make molds, tire plastic, etc. Details for stamp. Betke, Box 699, Borger, Texas.

REAL Manufacturing formulas. Lists free. Cummings, Chemist, Gordon Ave., Syracuse, N. Y.

FORMULAS: 15 Proven moneymaking formulas \$1.00. (Not stock-formula catalogue stuff), real unusual offers. List free. Marvel Laboratories, 6629 No. Maplewood, Chicago.

FORMULAS — Latest, best. Analysis. Literature free. Belfort, Engineering Building, Chicago.

PLASTICS

PLASTICS. Make your own at home. Formula and moulding instructions \$1.00. Box 84, Station K, Toronto, Canada.

ASSEMBLE Lucite gifts—Ideal for Xmas or profitable side-line. No tools necessary! Everything furnished! Popular designs. Illustrated catalog, lists—25c. Plastic Products Co., Box 384-A, Massillon, Ohio.

PLASTICS. Instructions 50c, compound 75c. Alvin, 553 William, Winnipeg, Manitoba.

PLASTIC Kits—Plexiglas, cement, sandpaper, instructions, diagrams, \$1.45 prepaid. Naval Te Plastic Scrap, P.O. Box 106, Brooklyn 19, New York.

DOUGLAS Offers you all in plastics and plastic supplies. Catalin, plexiglas and lucite, and others. One pound assortment \$1.00. Complete list 10c. Douglas Home Craftsman, Box 34, Dept. 1C, Stamford, Connecticut.

PLASTIC Mold your small parts. Whittier Plastic, 309 Gregory, Whittier, Calif.

PLASTIC Consultant—Complete advice on plastic problems. Fee reasonable. 65 E. Rich Street, Columbus 15, Ohio.

CHEMISTRY

CHEMICAL Experimenter's supply catalog 5c. Colonial Chemical Co., DPM-2, Brockton 28, Mass.

SEMI-TECHNICAL Chemistry brochures. Literature free. Lankton, 310 Westmoreland, Lansing 15, Mich.

WINN'S New idea champion chemical kits, apparatus-outfits and supplies for students home experimenting. (Established 1931.) Send 10c for catalog. John H. Winn, 124 W. 23rd St., Dept. 511, New York, N. Y.

ROBERT Daley, Chemical Patent Attorney, 19 South LaSalle St., Chicago.

RECLAIM Valuable silver going to waste in every town. Instructive booklet describing details. \$1.00. Wier, Box 4398, Fort Worth 6, Texas.

CHEMICALS. Ounce quantities, apparatus. Catalog 5c. Fleischer's Laboratories, Everett 49, Mass.

HANDBOOK For chemical experimenters, illustrated, hundreds of experiments, 50c. Experiment booklet 15c. 1946 chemistry catalog 5c. Reading Scientific Company, Reading, Penna.

FREE Catalog. Chemistry, mineralogy, biology, optics. Tracey Laboratories, Evanston, Illinois.

NEW 36 Page chemical apparatus order book. Complete line of chemical glassware, apparatus and chemicals. Send 10c for this book. Standard Science Supply Co., 1232 N. Paulina St., Chicago.

CHEMICALS And apparatus for industrial, analytical, and private laboratories. Complete supply service for correspondence school students. Send 3c for catalog. Dept. M-43, Biological Supply Co., 1176 Mt. Hope Ave., Rochester 7, New York.

SPECTROSCOPE For quick chemical analysis \$2.50. Kutting Sions, Campbell, California.

LABORATORY Supplies at wholesale prices: Chemistry, biology, physics. Catalogue 10c. National Scientific Co., 2304 W. North Ave., Chicago. Established 1908.

HELP WANTED

RELIABLE Man with car wanted to call on farmers. Wonderful opportunity now. No experience or capital required. Permanent. Write today. McNess Co., Dept. 651, Freeport, Ill.

AGENTS WANTED

SELL Genuine rubber raincoats, leather jackets, over 200 styles shoes for men, women. Special exclusive features. Tremendous demand. Unusual profits. Sales outfit free. Write Consolidated, Dept. S-123, Chippewa Falls, Wis.

TAX Law forces merchants keep records; sell Green's; every merchant your prospect; big commissions; yearly repeat business. Millgreen Publishing Co., 370 Seventh Avenue, New York.

MAKE Money! "Silverene" silverplating, polishing liquid; 1/2 pint \$1.25—bottle, 60c. Particulars free! Rabiro, 228 East 2nd Street, New York 9, N. Y.

GREETING Card money-makers. Write for folder. Greenport Art Company, (Dept. 118), 252 12th Street, Brooklyn 15, N. Y.

PLASTIC Jewelry, pins, earrings, etc. Carded job lots, \$4.00 per 100. W. Wooley, 115-B Donald, Peoria, Ill.

ACE 5000 Plan—Gasoline dealers aid. Increases gallonage. Ace Products, Wilkes-Barre, Penna.

NOW You enjoy double profits selling Ruggleen and Moxthex Concentrates to homes, hotels, rooming houses, etc. Send for new complete offer. Tremendous profits. Year round repeat business. Products used daily in every home. The Russell-Johnson Service, Clarksfield, Minnesota.

EASY Money selling \$3.50 leather wallets for Xmas. Sample \$1.50. Perkins Co., 41 Egremont Rd., Brookline 46, Mass.

STRANGE "Dry" window cleaner. Sells like wild. Replaces messy rags, liquids. Simply glide over glass. Samples sent on trial. Kristee 145, Akron, Ohio.

EARN \$5-\$15 Day with veteran's beautiful service mementos. Sample 25c. Starlite, 2703, Geneva, Ohio.

MILLIONS Sold—Fastest selling novelty. Generous trial order \$1.00. Dima brings samples, wholesale prices. Here's another. Every car owner a prospect. Retail for \$1.50, costs 39c. Sample, exclusive territory offer 25c. Barkley Co., Dryden 11, Va.

AGENTS—Mail dealers! Here's something really different. Imagine selling four songs and four books, all for 35c—and still making a big profit! Sample set and confidential wholesale prices, 25c. Wood, 921 Jackson, Tulsa, Okla.

START Your own business on our capital. Always your own boss. Hundreds average \$3,000 to \$5,000 annual sales year after year. We supply stocks, equipment on credit. 200 home necessities. Selling experience unnecessary to start. Wonderful opportunity to own pleasant, profitable business backed by world wide industry. Write Rawleigh Co., Dept. I-U-PPM, Freeport, Illinois.

\$1 STARTS You in business. Sell deluxe five fold ties. 100% wool interlining. Cost you only \$7 per dozen, you make \$5 dozen. Send \$1.00 for special introductory offer two five fold ties. Catalog complete line free. Phillips Neckwear, 20 West 22nd St., Dept. K-24C, New York 10.

SENSATIONAL Seller. History of World War II with Jap surrender. Large book. Over 1100 pages, 200 photographs and maps. Only \$3.50. Every home prospect. Write quickly for full details. Universal House, 1008-B Arch St., Philadelphia, Pa.

SOLDIERS And sailors to sell in spare time. Good money, fast selling Service-men's item. Landseaire, 10 Murray St., New York 7, N. Y.

SELL Xmas cards. Sample box \$1. Video, Box 2032, Philadelphia 3.

SIMPLE, Dramatic demonstrations insure easy sales. Sensational \$3.00 fire extinguisher, Liberal discounts. Other products. Molonite Company, 5713 Euclid, Cleveland 3, Ohio.

GUARANTEE Larger profits, sales. Money refundable. Literature. Sample coal treatment free. Coalaid Company, Waterloo 2, Iowa.

WOULD You like to make up to \$75 weekly commission? Then write Schutt Co., 244 East Ohio St., Indianapolis, Ind.

WAR Honor scrolls; sells on sight—for all branches of service; big profits. Success Co., Box 932, Birmingham, Alabama.

SILVER Plating liquid. (NuSilver trade mark.) Apply with a cloth. Simply rub-on with a saturated cloth, dry-off and buff-up bright with a dry soft polishing cloth. All done in 1 minute. It cleans, silverplates and polishes from the one application. Easily done at home or in the office by anyone. NuSilver Plating Liquid is a more than 60% (1/2 plus) genuine U. S. government treasury department domestic silver solution, 1000 fine (pure silver) sterling. It renews all sterling and plated silverware. It also silverplates onto brass, copper, bronze, zinc, nickel-silver, german-silver, and some other composition metals. Over 100 uses listed to date. NuSilver is a permanent lasting finish. Won't wash off. Won't brush off. Won't boil off. Once applied as directed it is there to stay. NuSilver Plating Liquid is a widespread and intensive seller. Working sales-distributors are wanted for areas not now being worked. Details by letter-mail. NuProcess Products Laboratories, Dept. 191, Aurora, Illinois.

200 MONEY Making plans, ideas, rare formulas, schemes, exposed secrets. Free folio. Formico Service, Box 572, Dayton, Ohio.

LANDSLIDE. 10 Sales, profit \$15. Sell America's peace prayer seals, 1946—1st peace year. Special trial. Sample, \$4 worth \$1. Evangel, Box 3825, Cleveland 10, Ohio.

SENSATIONAL Seller. Excellent profits. National Readers' Service, 650 Peoples Building, Charleston, S. C.

LARGE Distributor seeks agents for nearly 200 Bible and book items, including war history books retailing \$1.00-\$18.00. Splendid profits! 25c brings big catalog, complete details! Royalty, Box 748-I, Passaic, N. J.

SELL Big, sturdy Constructo Sets. Especially good Xmas item. Mail \$2.00 for sample and agent's proposition to G. C. Products Co., Dept. C, 301 Clinton Avenue, Newark 8, New Jersey.

PORTRAITS: Send for description of "special." Underwood, 3704 VanBuren, El Paso, Texas.

EASY Money during leisure time. New item everyone wants on sight. Details, sample. International Industry, Culver City, Calif.

QUICK Selling perfumed beads, earrings, combs. Particulars free. Sample line \$1.00. Mission, 2328 W. Pico, Los Angeles 6, Calif.

AGENTS Wanted for all year around household commodities used daily in every home. Big profits—repeat business. Write for catalogue and samples. Marshall Sanitary Products, 5535 N. Clark, Chicago 40.

GOLD Lacquered window sign letters. New foils, styles, absolutely beautiful. Free samples. Atlas, 7941 Halsted, Chicago.

WAR Honor scroll: All branches of service represented. 12 by 16. Space provided for name and photograph. Truly beautiful. Agents make big money. Sample 25c. E. Condon, Dept. 6, Upper Darby, Penna.

LUMINOUS Pictures that glow in the dark. Large manufacturer wants factory representatives; wonderful new item; fast seller; free sample. Madison Mills, 303 Fourth Ave., New York City.

\$3 FIRE Extinguisher; quick sales, wholesale or direct; liberal profits. "Fire-Killer," 109 N. Franklin, Syracuse 4, N. Y.

SCHOOL Seniors! A postal will bring you our Quick-Sell Catalog of graduation name cards. Hot selling everywhere! Big profits! Hurry! Craftcards, Box 235(L), Pittsburgh 30, Pennsylvania.

SELL "Petite picture notes." Something really different in greeting cards. Sample free. Dunbar Cards, New Brunswick 20, N. J.

SCHOOL Seniors—Sell classmates America's most beautiful, distinctive graduation name cards. Positively highest commission. Largest selection. Lowest prices. Free cards and sample kit. Printcraft, 1423 East Elm Street, Scranton 5, Penna.

AGENTS—Big line including food products. Fast selling premium and bargain deals. Low prices. Send card for big outfit offer with gift. Ho-Ro-Co, 2768 Dodier, St. Louis 7, Mo.

AGENTS: Stamping names on pocket-key protectors. Sample check with your name, address, 25c. Stamping outfits. Emblem checks, check-fobs, name plates. Hart Mfg. Co., 303 Degraw St., Brooklyn, N. Y.

MEXICAN Feather pictures. Unusual novelty. 50c (stamps) bring \$2.00 worth samples, details. Refunded if unsatisfied. Aztec Art, Apartado 762, Mexico City.

MAGIC Races—At touch of lighted cigarette, six horses are off! Watch them run! 55 races in mailing carton—\$1.00. Agents' commission—40%—in dozen lots. Order direct from this ad, or send 10c for sample envelope (5 races) and complete details. Pines, Box 32, Flushing 25, N. Y.

BIG Profits taking subscriptions for all magazines. Agents' confidential catalog listing over 2500 periodicals and complete starting supplies free. Pines Subscription Agency, Flushing, New York.

WHOLESALE Sources. 500,000 articles. Free directory. Maywoode, 1133 Broadway, New York.

EXCELLENT Sideline for printing salesmen. Decalomania name plates in small quantities. Also, make money applying initials on automobiles. Free samples. "Ralco," X-164, Boston (18), Mass.

PLATING Outfits for autoparts, reflectors. Connect to a battery. No tanks necessary. Free booklet and particulars. Gunmetal Co., Ave. N. Decatur, Ill.

FREE Water and our concentrates, makes flavors, lotions, shampoos. 72 products, labels, bottles furnished. Quolco E-2030 Russell, Detroit.

ELITE Collection contains 127 plans for starting own business; home office. Descriptive booklet free. Elite Co., 214 Grand St., New York.

AGENCIES WANTED

I WISH to represent American firms (novelties, etc.) in this country. Write MVL, Box 3642, Johannesburg, South Africa.

LEADING Swedish house of model experts seeks sole agency for Sweden. Airplanes, ships, railroads and autocars. Reply to "Models," care of Gumaelius Advertising Agency, Stockholm, Sweden.

IN Argentina. We accept exclusive representations for the sale of electro-mechanic machinery. Address: Electrotecnica Argentina, Rivadavia 933, Buenos Aires, Argentina.

HIGH-GRADE SALESMEN

MAKE Unusual spare or full-time profits showing genuine leather jackets, raincoats, 200 style and comfort shoes. Sample outfit free. Rush postcard. Victor Thomas Co., Dept. V-86, Chippewa Falls, Wis.

VALUE Packed service that's profit dynamite for you. Ultra-new. Hollinger, 142 East Union Avenue, Dayton 9, Ohio.

EXCEPTIONAL Opportunity to earn \$20.00 to \$60.00 a day and establish an income for life selling for only \$3.50 a year a \$2000.00 accident policy. Previous selling experience not necessary to immediate large earnings. Must have car and devote full time. Write W. Clement Stone, 5322 Sheridan Road, Chicago 40.

FREE! Latest Issue Opportunity Magazine. Salesman's Guide. Inspiring, constructive. Shows how to earn money selling for others or in your own business. Hundreds postwar opportunities. Send name and describe what you have sold or are selling. Illustrated copy sent free. Opportunity Magazine, 620 N. Michigan, Dept. 17, Chicago 11, Ill.

\$4.97 PUTS You in lifetime business. Write Midwest Drug Co., Dept. 4, Columbus 15, Ohio.

EDUCATIONAL AND INSTRUCTION

WELDING—Electric arc. Learn profitable trade quickly through actual practice. Individual welder instructions at bare cost of materials. Full particulars free. Valuable welding lessons book 50c. Hobart Welding School, Box M-1152, Troy, Ohio.

"HOW To Break and Train Horses"—A book every farmer and horseman should have. It is free; no obligation. Simply address Beery School of Horsemanship, Dept. 11011C, Pleasant Hill, Ohio.

REAL Estate. Study at home through experienced brokers. DeVoto Realty Schools, 35 Vicente, San Francisco 16, Calif.

"CLEARHAND" Easy alphabet 3c. Handbook 25c. Jesse L. Cook, Bartow, Fla.

GOOD Jobs and a sound postwar future await you in hotel and institutional field. Men and women—all ages—needed for well-paid positions that offer color, excitement, ever-new and fascinating duties. Record-breaking business in hotels, clubs, institutions, means even greater opportunities. Lewis School receiving calls for managers, assistant managers, stewards, hostesses, purchasing agents, and 56 other types of important positions. These are not temporary jobs, but important positions in an essential business that offers splendid opportunities in war or peace, good times or bad. Previous experience proved unnecessary! No need to leave your job to qualify. A good grade school education, plus Lewis Training qualifies you at home, in spare time. Our National Placement Bureau helps to place you—and our amazing Certified Job Plan—actually guarantees you will "make good" when placed. Write today for free book! Lewis Hotel Training School, Room DW-368, Washington 7, D. C. (First and only school of its kind—Now in its 30th year.)

WHY Grow old? The fountain of youth is no longer a myth. Prof. Maxwellton's lecture tells you where and how to find it. Yours for only \$1 postpaid. Scientific Method Ext., Box 436-P, No. Hollywood, Calif.

NERVOUS, Self-conscious, lack confidence in yourself? Send for free literature. Dr. Malcolm Smith, Dept. E, 1104 Union Ave., Montreal 3, Canada.

AMAZE With Super Memory! Facts, figures, names stick like burrs! Write A 11, Thor Books, Box 1210, Chicago.

BUSINESS. Practical home study course for starting, operating any small business. DeVoto Schools, 35 Vicente, San Francisco 16, Calif.

FIND Yourself—the real you and your real opportunity. Advance "years in months." Dr. Tibolt, 22M, Philadelphia 20.

YOU Can master mathematics. Key to the electronic, atomic age. Mathematicians in great demand. \$200 to \$500 per month. Literature free. Universal School of Mathematics, 1104-PM Mohawk St., Los Angeles, Calif.

USED Educational and technical books bought, sold, rented. Catalog free. Educational Exchange, Henagar, Ala.

REFRIGERATION And air-conditioning offer opportunities to alert, mechanically-minded men, 18 to 60. Since 1927 UET spare time training has helped thousands prepare for jobs, repair shop ownership. Get free opportunity facts today. Write Utilities Engineering Institute, Dept. 15W, 1314 W. Belden Avenue, Chicago 14, Ill.

WRITE Short stories at home for pleasure and profit. Fame, riches and happiness of achievement are rewards to be realized by students who acquire tested technique. Get free booklet from home study school with 50 years experience. Write today! Blackstone-Sprague, Dept. 111b, 307 North Michigan, Chicago 1.

BECOME A Doctor of Psychology and Metaphysics. Teach secret of contentment, happiness. Win degree of Ps.D or Ms.D. Solve mental worries. Free book. College of Universal Truth, 5153-B North Clark, Chicago.

LEARN Profitable auto body and fender repairing. Practical spare time home study and resident course includes metal work, spray painting, welding. An opportunity for mechanically-minded men, 18 to 60 that may lead to owning your own shop. For free facts write Utilities Institute, Dept. 14X, 1316 Belden Ave., Chicago 14.

SEND 25c For Stereopix Navigation book. Addison-Wesley, Cambridge 42, Mass.

ROOFS, Hoppers, bays, polygons, segments. All lengths, cuts, safe loads, instantly. Vestpocket tables, \$1.00. Morgan, Box 1414, Great Falls, Montana.

LEARN Photo-engraving at home or in oldest, largest school in America. Work for newspaper or establish own profitable business. New "Tasope" Photo-Engraving equipment available soon. Write for information. Veterans ask about G.I. training. The Aurora School of Photo-Engraving, Tasope Bldg., Aurora, Mo.

LEARN Fascinating credit-collection agency business; office; sparetime. Investigate Educational Extension Service advertisement under Business Opportunities.

INVESTIGATOR Training. Phillips Secret Service, 1917B North Kenneth, Chicago 39, Illinois.

HOME Bible course. Simple, helpful, instructive. Total cost \$3.00 includes textbooks, examinations certificate. \$1.00 starts you, or simply request prospectus. The Bible Study School, 382 Van Houten Street, Paterson 1, N. J.

NEW Used, home-study books; catalogs, dime; refunded. Westway Educational Service, Box 58-C, Los Angeles 35.

29 LANGUAGES By Linguaphone. Russian, Spanish, Portuguese—Direct conversational method for mastering any language quickly, easily, correctly at home. Send for free book. Linguaphone Institute, 83 RCA Bldg., New York.

HOME Studycourse, drugless therapy. Free literature. Institute of Drugless Therapy, Tama, Iowa.

LOCKSMITH Course. Lock picking, key fitting, etc. \$1.00 prepaid. Locksmith, Canadian, Texas.

MEDICAL Laboratory technicians in great demand. We train you in your spare time, in your own home. You can practice while studying. Write for free catalogue. Imperial Technical Institute, Box 973-E, Austin, Texas.

SECRET Investigation. Experience unnecessary. Investigators particulars free. George Wagner, M 125 West 86th, New York.

HORSEMEN—Learn to train and gait. Teach tricks. Free book. Animal Lovers Association, K-111, Tarzana, Calif.

USED Educational books on all subjects sold, rented, also bought and exchanged. Moneyback guarantee. Write today for free catalog and details. Lee Mountain, Pisgah, Alabama.

GOOD "Used" self-instruction educational books on all subjects bought, sold, rented, exchanged. Satisfaction guaranteed. Complete information and 92-page illustrated bargain catalog free. Write—Nelson Company, Dept. 2-02, Chicago 4.

PLAYS, STORIES, MANUSCRIPTS

COMPLETE Assistance for writers. Inquire National Writers Club, 1837 Champa, Denver 2, Colorado.

NEW Writers needed to rewrite ideas in newspapers, magazines and books. Splendid opportunity to "break into" fascinating writing field. May bring you up to \$5.00 per hour spare time. Experience unnecessary. Write today for free details. No obligation. Postcard will do. Comfort Writer's Service, 210-P South Seventh St., 2, St. Louis, Mo.

CARTOONING, COMMERCIAL ART, SIGN PAINTING, ETC.

LEARN Chalk talk. Can make an interesting speaker out of anyone. Command attention. Details free. Arthur E. Ryde, P.O. Box 1071, Springfield, Mass.

"HOW To Make Money With Simple Cartoons"—A book everyone who likes to draw should have. It is free; no obligation. Simply address Cartoonists' Exchange, Dept. 911-C, Pleasant Hill, Ohio.

LEARN Showcard writing at home in spare time. Fascinating, lifetime business of your own. No special skill needed. Free information. Sherwood Publishing Co., Box 8, Dept. 64, Irvington, N. J.

MAKE Signs, letters, stencils, 9 complete alphabet pattern sets, 3 complete numeral pattern sets and catalog \$1.00. Sign Letter Distributors, P.O. Box 101, Mineola, N. Y.

CARTOONING—Personalized instruction and commercial potentialities. Write: Spiegel Cartoons, 10 South Perry, Poughkeepsie, N. Y.

BARGAINS, Books, courses. Quick landscape painting, poster art-lettering, art studies, cartooning. Write today for free literature. Art Book Shop, Kimmwick-4, Mo.

CHALK Talks. Laugh producing program, \$1.00. Catalog 10c. Balda The Cartoonist, Oshkosh, Wisconsin.

CARTOON Course—22 easy lessons. 200 figure sketches. 25c coin postpaid. Snack-Pack Co., 32 E. Georgia, Indianapolis 4.

HELPFUL Books on hundreds of subjects. Catalog free. Popular Mechanics Press, (C-43), 200 E. Ontario, Chicago.

ADVERTISING AGENCIES, LETTER WRITERS, FOR ADVERTISERS

ADVERTISE Profitably: \$20.00 reaches 5,000,000 Sunday newspaper readers with 24-word ad. Newspaper, magazine, mailing-list ratebook free. Chicago Advertising Agency, 20-PA W. Jackson, Chicago 4.

24 WORD Ad in 13 popular Sunday newspapers \$23.20. Covers the South. Alabama Advertising Agency, Exchange Building, Birmingham 3, Alabama.

35 WORDS 12,000 Readers \$1.00. Magazine 10c. Renick, Holland, N. Y.

20 WORDS \$2.50. Circulation 234,000. Goodall, 37 Gardner, Vallejo, California.

ADVERTISING: Placed in any publication, anywhere. Write for mail-order rate sheet "M." LeGrand Advertising Agency, (Established 1923), Floral Park, N. Y.

24 WORDS in 64 weeklies \$4.96. H. J. Darnell, 730 Hays, Jackson, Tenn.

EFFECTIVE Sales letters and literature written, \$5 page. Dudley Bunn, 126 Lexington Avenue, New York 16.

ADVERTISERS! 6,000,000 Circulation 25 Sunday national key newspapers. 18 words, \$39.25. "Terrific pullers" 20 popular newspapers \$8. "Free booklet." Newmarks Advertising Agency, 217-7th Ave., New York.

ADVERTISE: 24 Words, 149 newspapers, \$6.50. Lists free. Advertising Bureau, 4515-C Cottage Grove, Chicago 15.

INCH Display adv. 50 magazines yr. \$24. Wood's Popular Services, Atlantic City, (N. J.)

ADS Placed in out of town newspapers and magazines. Low rates. Catalogue free. Ideas that pay. Baker Advertising Agency, Successors Ankrum Agency, 189 W. Madison, Chicago 2.

FREE—New Advertisers Rate Guide. 44 pages. Includes everything. Lowest rates. E. H. Brown Advertising Agency, Merchandise Mart, Chicago.

BUSINESS SERVICE

WASHINGTON, D. C., office address for business, personal mail—reforwarded when wanted. Complete service, \$2.00 monthly. "Hawkins," (Established 1917), 7-o Randolph Place.

SAN FRANCISCO, I will represent you here business or personal assignments, \$1.50 per hour. Frank, P.O. 511, Burlingame, Calif.

ACCOUNTING—Bookkeeping. Send your figures, we return completed book records, statements, tax returns. Guaranteed secrecy. Weekly, monthly, yearly service. \$1.00 starts your work, if any additional, pay postman. Ray Jenkins, 66 Charles Street, Mansfield 4, Massachusetts.

TO Whom it may concern: I will represent you in Cleveland. Personal or business assignments \$1 per hour. James W. Farley, Citizens Bldg., Cleveland 14, Ohio. Note: Would appreciate hearing from someone who wishes to enter this business in your city.

NEW ORLEANS 18, La. Will represent you here, also interested distributors. Joseph M. Schroder, 2119 Lowerline St.

SPECIAL SERVICES

SALES Consultant for new or ailing businesses. John Morris, Box 5411, Philadelphia. "Since 1913."

THE Products Review. New things on the market and vital trade data. Copy 50c. Chaffee's American Trade Service, 308 Washington, Chicago 6.

GREAT Fun. Visit New York by mail. Evidence 25c. Souvenir 50c. Letters mailed 15c. Mail address service. Details free. Haller, 436 New York Ave., Brooklyn 25, N. Y.

TYPEWRITERS, DUPLICATORS, OFFICE DEVICES

NEW Postcard size stencil duplicator. Literature and samples free. Specialties, 4141 Fletcher, Chicago 41.

USED Typewriters, mimeograph, multi-graph, presses, supplies, appliances. Dixie-Graph, King, N. Car.

PRINT Your own postal cards, paper, or anything on "Printomatic Self-feeding Rotary Postal Card Stencil Duplicator." Only \$9.50 with \$2.35 worth of supplies, stencils, ink, etc. Literature free. Pittsburgh Typewriter Supply, 336-RA Fourth Ave., Pittsburgh 22, Penna.

RUBBER STAMPS, OFFICE SUPPLIES

BETTER Rubber stamps. Inquiries invited. Literature free. Lee-Vall Press, Box 1242, Indianapolis 6, Indiana.

FINEST Rubber stamps, knob handles, indexed, 3 lines 75c. Thousand vellum business cards \$1.85. Complete lines. Lowest prices, quoted on request. Black's, Pigeon, Mich.

RUBBER Stamps, all kinds. Send for catalog. Excello, Box 500, Shreveport, La.

RUBBER Stamps, books, circulars. Parcel Press, 53 Astor Sta., Boston, Mass.

KNOB Handle, cushioned, 2 lines 35c. 3-45c. Stamp Works, Centerport, N. Y.

PRINTING, MULTIGRAPHING, MIMEOGRAPHING, GUMMED LABELS

STYLE! Printing designed to effectively advertise your business. Submit copy for estimate. Ace Printing, Brentwood, Md.

75 ELEGANT Cards \$1.00. embossed, postpaid. Write samples, prices. Benson, Box 1849-A, Chicago 90.

200-8 1/2x11 HAMMERMILL Letterheads \$1.00 postpaid. Envelopes same. Race Printing, Hudson, N. Y.

\$1.00 POSTPAID: 100 8 1/2x11 Bond letterheads and 100 envelopes. Bensenville, 907 West Roosevelt, Philadelphia 40, Pa.

BOND Envelopes, letterheads—500, \$2.95; both \$5.25 postpaid. Modern Print, Box 34, Hyattsville, Maryland.

2000 PRINTED Letterheads, \$3.00; envelopes \$6.25. Psychological Publishers, Remington, Indiana.

BUSINESS, Personal stationery. State requirements. Samples, price list free. How Printing Company, 723 Eunice, Webster Groves 19, Missouri.

100 LETTERS Mimeographed (as if typewritten) 300 words, \$1.50; additional 100's, 50c. Same day service. Multico, 9 Cornhill, Boston 8, Massachusetts.

LETTERHEADS, Envelopes \$3.50 pre-paid. Standard Press, Box 381, St. Louis, Mo.

100 WEDDING Invitations or announcements, process embossed \$8.75, includes envelopes. Send for free samples. Sierra Press, 629 Gough Street, San Francisco, Calif.

FINE Printing, office supplies. Catalog free. Treaster Printing, Milroy, Penna.

PENCILS Stamped with any imprint up to 40 letters. Dozen 50c, 3 doz. \$1.00, gross \$3.50 postpaid. James Virtue, 5301 Atlantic Ave., Ventnor, N. J.

QUALITY Printing. L. Battin, P.O. Box 332, Wood Dale, Ill.

300 PRINTED No. 6 1/2 Envelopes \$1.00. Wood, 7 Clinton Ave., Brockton 52, Mass.

1,000 BUSINESS Cards \$2.75; 1,000 letterheads, or envelopes, \$4.50. Crowe, Boelus, Nebraska.

100 8 1/2x11 BOND Letterheads and 100 envelopes, \$1.00 postpaid. Royal Publications, Prospect Heights, Illinois.

BUSINESS Letterheads, envelopes, 150 each, \$2.00. Crane, 3024 White, Kansas City 3, Missouri.

SOCIAL Stationery. Printed, boxed, 200 sheets 6x7, 100 envelopes. Hammermill bond. \$2.00, postpaid. Veniskey, 1925 W. Cary St., Richmond 20, Va.

QUALITY Printing: 1000 8 1/2x11 Royal bond letterheads \$2.65, 25,000 \$1.85 per 1000. All types of printing at wholesale prices. Write for samples. State requirements. Printing Service, 7922 South Vermont Avenue, Los Angeles 44, California.

500 LABELS \$1.00; Illustrated. Samples, circular free. Presto, Dayton, Kentucky.

200 8 1/2x11 BOND Letterheads or 6 1/2 envelopes \$1.25. Estimates, samples. Foster Sign & Printing Co., 4020-A Cottage Grove Ave., Chicago 15, Ill.

300 HALF Size letterheads, 200 envelopes \$2.00, 5000 6x9 circulars \$8.50. Abbott Press, Oswego, Kansas.

QUALITY Printing prepaid: Business, personal stationery. Letterheads, envelopes, statements. Prices reasonable. Samples. Mero Products, Box 344, Punxsutawney, Penna.

HIGRADE Letterheads 8 1/2x11, 500—\$2.95, 1000—\$4.50. Postpaid east of Mississippi. William Jones, Dept. PM, Westbury Avenue, Mineola, New York.

DISTINCTIVE Printing reasonably priced. Free samples. Cramer, Box 993, Chicago.

PRINTING, Embossing, planographing. Free estimates. Spada, 10 Lexington, Wethersfield 9, Conn.

400 5 1/2x8 1/2 LETTERHEADS \$1.25. Mango, 555 South 20th, Newark 3, N. J.

MODERN Design, top quality printing for less. Catalog free. Badger Press, 120 N. Green Street, Chicago 7.

BETTER Grade printing reasonable. Estimates on anything. Economic Press, Leonia, N. J.

MIMEOGRAPHING—Any copy. Reasonable. Mailers Service, Box 606-A, Chicago 90, Ill.

500 3/4x2 1/4 FOUR Line gummed stickers, 25c. Moritz Printery, Saginaw, Mich.

MIMEOGRAPHING—Letters, pricelists, formulas, instructions. Lowest prices. Lem's Letter Shop, 5710 Stanton, Detroit 8.

PRINTING OUTFITS AND SUPPLIES

RAPID Printing presses. All metal, no cast iron, compact. Automatic, throws out printed matter as printed. S. C. Peckham, 2317 Bryan St., Dallas, Texas.

PRESSES, Type, supplies, bargain bulletins 3c. Levinson, Box 918, New York 8.

PRINTERS: You can make a quick-etch etcher for quickly making line cuts and halftones. Particulars free. Charles P. Medlock, Box 256-C, Goodland, Indiana.

PRINT At Home—Send 10c for catalogue—presses, type, supplies. Barnhard Co., 6 Columbia St., Newark 5, N. J.

INEXPENSIVE Home-made printing press. Details free. Novelty Shop, Downs-ville, Louisiana.

PATENT ATTORNEYS

INVENTORS: Learn now—without obligation—how to protect and sell your invention. Write for free "Record of Invention" form and complete information for making disclosure and establishing date of your invention. We also send our new free "Patent Guide for the Inventor," containing complete information about patent procedure and how to sell inventions; giving illustrations of many successful inventions; over 150 basic mechanical movements. We assure you prompt, confidential service. Delays may be dangerous. Write today for your free "Patent Guide" and "Record of Invention" form. Clarence A. O'Brien & Harvey Jacobson, Registered Patent Attorneys, 51B-L, Adams Building, Washington, D. C.

PATENTS. Promptness assured. Wilfred E. Lawson, 1524 K Street, N.W., Washington 5, D. C.

INVENTORS—First things come first. Your first move toward securing a patent on your invention is acquiring full information on what to do. Our two books "Patent Protection" and "When and How to Sell Your Invention" contain this information and other helpful data. Get them immediately, together with our "Evidence of Invention" form. They cost you nothing, you assume no obligation. Write now to Victor J. Evans & Co., Registered Patent Attorneys, 931-M Merline Building, Washington 6, D. C.

PATENTS. Protect your idea by securing free "Proof of Invention" folder. Exceptional personal service. Established 1906. E. E. Vrooman, 871 Woodard Bldg., Washington, D. C.

PATENTS—Trade marks. Preliminary advice, book and disclosure form free. Personal service. Irving L. McCathran, 315 McLachlen Bldg. Washington 1, D. C. Registered Patent Attorney.

WHERE Can you sell your ideas? Have you a new idea, an improvement, a device of utility or novelty? Want to know where to sell it? Learn the facts first about its patentability. We have letters from manufacturers wanting new patented ideas. The present emergency market has created a big demand. Get our free book, "How to Protect, Finance and Sell Your Invention." Also free special form "Invention Record." No obligation. McMorrow & Berman, Registered Patent Attorneys, 134-A Atlantic Building, Washington 4, D. C.

PATENTS Obtained; selling service, information, recording forms free. Labiner, World Building, New York.

INVENTORS—Before disclosing your invention to anyone send for form "Evidence of Conception"; Schedule of Government and Attorneys' Fees and Instructions. Sent free. Lancaster, Allwine & Rommel, Registered Patent Attorneys, 411 Bowen Building, Washington 5, D. C.

PATENT Protection. Write for information. Fees. Record of invention. Free. Randolph & Beavers, 21-C Columbian Bldg., Washington, D. C.

"INVENTOR'S Guide." 100 mechanical movements, free; advises on patenting, selling inventions. Frank W. Ledermann, 154 Nassau Street, New York.

C. A. SNOW & Co., M-427 Snow Bldg., Washington 1, D. C. Registered patent attorneys. Established 1875. Literature mailed on request.

FOR INVENTORS

INVENTORS: Learn now—without obligation—how to protect and sell your invention. Write for free "Record of Invention" form and complete instructions for making disclosure and establishing date of your invention. We also send our new free "Patent Guide for the Inventor," containing complete information about patent procedure and how to sell inventions; giving illustrations of many successful inventions; over 150 basic mechanical movements. We assure you prompt, confidential service. Delays may be dangerous. Write today for your free "Patent Guide" and "Record of Invention" form. Clarence A. O'Brien & Harvey Jacobson, Registered Patent Attorneys, 51A-L Adams Building, Washington, D. C.

PROTECT First without revealing patent later. Document and instructions one dollar. Dickinson, 1512 Twenty-Eighth West, Seattle 99, Washington.

SELL Your inventions, ideas now! List of manufacturers buying inventions, ideas for new products. \$1.00. S. Hahn, 645 Bergen Ave., Jersey City 4, N. J.

DEPENDABLE Patent searches—simple inventions (classified) \$5.00. Trade-mark searches (names) \$2.50. No inventions accepted until classified by U. S. patent office. For classification instructions write Raymond L. Smith, Patent Searcher, 302-K Bond Building Washington 5, D. C. (Former U. S. patent office employee.)

INVENTORS: Avoid unnecessary expense. Write for free booklet explaining how our consulting and advisory service can assist you in deriving the greatest profit from inventing. Institute of American Inventors, Dept. 40-A, 1926 Eye Street, N.W., Washington, D. C.

INVENTIONS. All kinds, having profit possibilities, needed by specific manufacturers, cash or royalty basis. Write for free descriptive booklet, protective disclosure form, references, and instructions for safely disclosing your invention for sale. Address: The Invention Reporter, 5A-11106 So. Longwood Dr., Chicago.

PATENTED And unpatented inventions promoted. M. Joyce Humphries, 1424 Land Title Bldg., Philadelphia 10, Penna.

WHERE Can you sell your ideas? Have you a new idea, an improvement, a device of utility or novelty? Want to know where to sell it? Learn the facts first about its patentability. We have letters from manufacturers wanting new patented ideas. The present emergency market has created a big demand. Get our free book, "How to Protect, Finance and Sell Your Invention." Also free special form "Invention Record." No obligation. McMorrow & Berman, Registered Patent Attorneys, 1349 Atlantic Building, Washington 4, D. C.

INVENTIONS Developed and patented; mere patentability is not enough to make an invention successful; we combine patentability with commercial construction at low cost. Thirty years experience; patent engineers. Development Co., 132 Nassau St., New York City.

TECHNICAL Advice; development, design, production, marketing. Pyramid Consulting Engineering Service, 14257 Gratiot Avenue, Detroit 5, Michigan.

INVENTORS—Information on what to do first toward securing a patent on your invention is of vital importance. "Patent Protection" and "When and How to Sell Your Invention"—two valuable, richly illustrated books—explain fully what to do first, and a lot more. Get this information quickly, together with "Evidence of Invention" form. All three will be sent to you free. Write immediately to Victor J. Evans & Co., Registered Patent Attorneys, 932-M Merline Building, Washington 6, D. C.

LARGE California plastics organization, now successfully manufacturing and merchandising scores of art, gift, and household ware items through department, drug and novelty stores, is interested in adding new items to its line. Inventors are invited to submit ideas for new plastic or metal products, fabricated or molded suitable for large quantity production. Also interested in electronic or radio products. Write giving full details. Precision Specialties Co., 210 N. Western Avenue, Los Angeles 4, California.

INVENTORS—We will help you if you have a good idea. We supply the finances to patent your idea in your own name. You own the patent. We also arrange profitable manufacturing connections for inventions. Write without obligation. Patent Financing Corporation, 209H Hospital Trust Building, Providence 3, R. I.

YOUR Model or model part developed and fabricated from your sketch. Satisfaction and secrecy assured. Quotation on request. C. R. Kiley, 4318 Oak St., Bellwood, Ill.

ILLUSTRATED Drawings with description in circular form to manufacturers. Brings quick results for your ideas. Reasonable cost. Inventors & Mfg.'s Creative Service, 628 Loews Bldg., Los Angeles 14, Calif.

HAVE Your idea or model developed now at pre-war prices. Forty years experience in developing, designing. Tool and die work. Inventors Laboratory, Madisonville, La.

PRESENT Your ideas to manufacturers in an attractive form. Mechanical or other drawings made at reasonable cost. Write Paul Quinn, 76 Forman Street, Bradford, Penna.

RANDOLPH & Beavers: Registered Patent Attorneys, 11-E Columbian Building, Washington, D. C. In order to protect your invention and reap the reward that should be yours, patent your invention without delay, and at the same time have rights to sell as manufacturers convert to civilian production. Write for information and record form today.

CASH For practical ideas and inventions. Mr. Ball, AB-9441 Pleasant, Chicago.

INVENTIONS WANTED

LARGE Manufacturer seeks new products, ideas. Franklin Engineering, 20 North Wacker, Chicago 6.

WANTED: Practical inventions for marketing through chain, drug and cigar stores. Particularly desire lighters, smokers' articles, etc., in plastic, wood or metal. Write Matt, 1412-DN Great Northern Building, Chicago 4.

THERE'S A big future for you if you let us market your ideas and inventions. Exclusive distributorship wanted on new items. Write or wire. Akron Sales Co., 739 N. Main Street, Akron 10, Ohio.

NEW Products wanted. If you have a patent, or an idea of merit, we would be interested in buying outright or manufacturing on a royalty basis. Address correspondence to Rowe Industries, Dept. A, 3120 Monroe Street, Toledo, Ohio.

INVENTORS Attention! Have you an invention patented or patentable of a novel electrical or mechanical device? Are you the owner of dies you wish to dispose of? If you have either or both give full particulars. We are a highly rated manufacturing concern with a nation-wide distributing organization. Your rights will be scrupulously respected. Lion Manufacturing Corp., Dept. B N, 2640 Belmont Ave., Chicago 18, Illinois.

MANUFACTURERS Desire practical inventions and designs. Patented or unpatented. Cash or royalty basis. John D. & Son, 140 Spruce St., Bridgeport 5, Conn.

PHOTOGRAPHY Ideas or inventions developed and manufactured. Also similar items. Knoxville Co., Traffic Station Box 7, Minneapolis 3, Minn.

INVENTIONS Wanted. Write Sidney Lee Company, 690 Market Street, San Francisco 4.

WANTED: Practical inventions. Inventors Patent Exchange, Research Division-B4, Hartford 1, Connecticut.

MANUFACTURER Desires postwar products to make and sell through drug, hardware, department stores and mail order. Or will handle sales only. Reputable, nationally-known organization capable of promoting nationwide sales as well as manufacture of items. Prefer non-electrical products of metal, glass, plastics, etc. Write P.O. Box 1373, Indianapolis, Indiana.

INVENTORS: Have you a sound, practical invention for sale, patented or unpatented? If so, write Institute of American Inventors, Dept. 4-D, Washington.

CASH For plumbing specialty inventions. Chicago Specialty Mfg. Co., 2954 Lawrence, Chicago 25, Illinois.

WANTED—Patented, unpatented inventions having profit possibilities, all kinds. If will sell, reply immediately. Descriptive booklet, references, free. Invention Reporter, 5B-11106 So. Longwood Drive, Chicago.

INVENTORS! Have you good patentable idea? Write Mr. Metzler, 11 West 42nd, New York.

MANUFACTURER Wants sensible mechanical device or idea with quick sales possibilities in low-priced field. Write Matt, 1412-D Great Northern Building, Chicago 4.

CASH For inventions, patented, unpatented. Mr. Ball, A-9441 Pleasant, Chicago.

PATENTS FOR SALE

FINANCING And manufacturing facilities wanted for promoting new type, low cost, insect destroying screen. H. J. Emmons, 439 9th Ave. S.W., Cedar Rapids, Iowa.

OUTRIGHT Or royalty. Tire gauge that registers on dash when tire gets low. Fits any car or truck. Will double the life of tires. Cheap to manufacture. Has been approved by the best engineers. Patented. Roy Depee, 307 W. Main, Spokane, Wash.

PATENTED Fishing tackle, power sweeper, others, made easily. Territory or sale. Thompson, 68 Marysville, Calif.

HAVE Perfected boltless rail joint. Patent pending on same. Will sell for part cash and royalty basis. Manufacturers interested write Russell Conner, 20 Spring St., Delaware, Ohio.

BUCKET. Empties from bottom. Tilting unnecessary. Hundreds of uses. Surpasses old type. Equipped with sieve for ashes. Outright or royalty. P. D. Perkins, R.F.D. 5, Richmond 23, Va.

FOR Post war manufacture. A combination bar clamp and jack. Instantly attached to 2 inch lumber. Any length. Something different. Write C. Phil Stuart, Box 275, Gorham, N. H.

MANUFACTURING

LET Us help you produce that postwar product with our low cost automatic screw machine facilities. Zetco Products Co., Bellefontaine, Ohio.

MANUFACTURING, Dies, stampings mechanical products. Baum's Metal Specialties. Kansas City, Mo.

MODELS—Small lot manufacturing. Metals, plastics, etc. Milburn, Burlington, Kentucky.

MODELS AND MODEL SUPPLIES

LANDLOCKED Sailors! Here's a beautiful, richly illustrated, fully descriptive catalogue of famous model ships—whalers, slavers, corvettes, etc., authentic in every detail. Send for it today. Only 10c. Marine Model Company, Inc., Dept. C-3, 29 W. 15th St., New York, N. Y.

MODEL Engine catalog, railroad supplies, 25c refunded. Simonsen, A-3054 Greenwood, Chicago 13.

STREAM Engines, boilers, castings, blueprints, circulars 10c. Anton Bohaboy, 2297 Price, Rahway, New Jersey.

MINIATURE Steam locomotives, 1/4", 1/2", 3/4" scales. Castings, parts, rail! Thorough drawings with instructions. Catalog 25c. Little Engines, Wilmington, Cal.

GAS Model engines—"Super Scraper" class B .290 cubic inches \$18.50. Hurricane class B .24 cubic inches \$24.95. Equipped with coil and condenser. Postpaid. Send 25c (includes refund coupon) for large profusely illustrated Master Model Airplane Catalogue listing hundreds of hobby items. General Modelcraft Company, Dept. M11, 91-17 173rd Street, Jamaica 3, New York.

SUBMARINES—Make latest U. S. 5" aluminum casting, wave mounted \$1.00. 12" model with outfitting instructions \$2.00—wave base \$1.00. Breeze Specialties, Puritan Rd., Saugus, Mass.

BRASS Gears and model supplies for the inventors. Send 10c for catalog. Pierce Model Works, Tinley Park, Ill.

ILLUSTRATED Catalogue over 100 model engine castings and drawings, 10c postpaid. Active Products Supply Co., Suite 609, Monadnock Block, Chicago 4.

CATALOGS (Illustrated) for modelers! Airplanes, 60 page book on solids, Features construction data, specifications, camouflaging, 15c; railroads: 128 page "HO" guide. Equipment, accessories, fittings, 25c (includes refund coupon). Send coin or stamps for each profusely illustrated catalog desired. Polk's, "Nation's Leading Hobby House," 314-PM Fifth Ave., New York City 1.

SHIP And yacht model fittings and blueprints. Hundreds of items to choose from. Send for our war time supplement. A. J. Fisher, 1002 Etowah Ave., Dept. WM, Royal Oak, Mich.

MODEL Kit and supply catalog—10c coin. Al's Hobbies, 2131 W. Vliet, Milwaukee 5, Wisconsin.

SHIP Model kits and fittings. Complete line Fisher model yacht equipment. All Boucher, Fisher, Marine Model and Ideal kits, fittings and blueprints at standard prices. Most complete stock in New England. Send 10c for price list. James Bliss & Co., Inc., 220 State St., Boston, Mass.

WORLD'S Largest selection model engine castings and drawings. Illustrated catalogue 10c. Wayne Miller, Belle Plaine, Iowa.

RAILWAY Models, complete line, informative catalog HO and O gauge, 79 pages 25c. Walthers, 247 Erie, Milwaukee, Wisconsin.

BOAT Models. P.T., cabin cruiser, speedboat. Free circular. All Star, 2003 Lincoln Ave., Chicago 14.

HOME CRAFTSMEN

PANTOGRAPHS. Available for immediate shipment. Precision instruments. \$2.50 postpaid. Enlarges drawings automatically. Eliminates using squares. Satisfaction guaranteed. Pantographs, Munising 1, Mich.

28 LAWN Ornament patterns 25c. Other patterns; 15"-20" high; Dutch girl, Dutch boy, pirate, bull terrier, Mexican girl, Mexican boy, dwarf, penguin, flower girl, 10c each; 3 for 25c. 25 novelty patterns 30c. All 62 full size patterns \$1.00 postpaid. Strother, Box 383-HX, Belington, W. Va.

DYES For lucite, plexiglas, etc. 15 colors. Just dip to color. Trial combination, red, blue, yellow, \$1.25 postpaid. G. Baker Co., 685 Center Ave., River Edge, New Jersey.

12 RUBBER Molds to make plaster paris ash trays \$25. Sample \$3.50, 20 trays \$1. Irons, 204 Maple, Terre Haute, Ind.

ATTENTION Home craftsmen. Dress your own grinding wheels with a diamond dresser. Hand tool five dollars. Fromholz Diamonds, 3211 Granada, Tampa, Florida.

"LUCITE", "Plexiglas" pieces, book of instructions and projects, 3 colors dye, cement, \$2.00 postpaid. O.K. for overseas. Barnett Specialty 5430 Hollywood Blvd., Hollywood 28, Calif.

SANTA Is here in a jolly, big, action pull toy. Fun for youngsters and grown ups. Every home should have this big 16" colorful Santa Claus in front of the Christmas tree for rollicking laughter on Christmas morn. A delightful project for home craftsmen. Full size pattern—25c. Five gay action toys including Santa—\$1.00. List on request. Scully-Hall, 92-45 220th Street AK5, Queens Village 8, N. Y.

PLASTIC Molding machine. Build the best yourself. A fascinating, inexpensive hobby. Parts and plans available. For information. C. R. Kiley, 4318 Oak St., Bellwood, Ill.

1000 TELUHOW Plans for homeworkers. List, dime. C. King, E. Kingston, N. H.

TOYS. Full sized patterns, table and chairs, doll stroller, circus group, colonial cradle, \$1.00. 80 patterns, 40 lawn ornaments, 20 novelties, 20 silhouettes, \$1.00. List 10c. Modern Woodcraft, Saginaw, Michigan.

JIG-SAW Owners, manufacture extraordinary item. Appeals to millions. Free literature. Fritz Foundry, 622 N. Fulton, Allentown, Penna.

LUCITE. Free listings masked sheets 12"x12" c.o.d., only 1/2", \$1.75, 3/16" \$2.25, 1/4", \$2.50. Projects, dyes. Craft Plastics, Box 129M, Somerville, N. J.

TREASURE Finders. New powerful Goldak electronic locaters now ready. Amazing sensitivity. At last the war time developments in electronics can be yours for finding minerals and metals. Radically new type. New circuits, new principle of operation. Money back guaranteed locate gold, silver or any metal at greater depth than any other device. Write for full details. Send stamp. The Goldak Co., 1544 W. Glencaks, Glendale 1, Calif.

SLEEPLESSNESS Unnecessary — Stop noise with Sleep-Rite, soft waxen earstoppers. Free sample, enclose stamp. Raymond Dow, 15 Park Row, (1215AK), New York 7.

HARD to get wallets \$2.95. Genuine leather, zipper all around wallets, with change purse, picture holders, twoway bill pockets, in black or brown. We mail c.o.d. Money back guarantee. Gold initials free if money sent with order. Send today, do not delay. J. L. Wallet Co., Box 448, Salem, Mass.

TAILORED Homes plan book. Sixty floor plans of one-story houses with your selection of exteriors! \$1.00. Select homes, two-story houses in colors, \$2.00. H. P. Jones, 486K Brandeis Bldg., Omaha 2, Neb.

INFORMATION. Any subject. The Roxbys, 747 S. New Hampshire, Los Angeles 5.

LUMINOUS Nursery wall decorations. Fascinating cut-outs glow in darkness. Complete set 35c. Circulars, sample 3c. Luminovelties, 469 Irving, Brooklyn, N. Y.

22 BEAUTIFUL Audubon bird prints, 9"x12 1/2", full colors on finest paper. Ideal for framing, home office, club, school, den, stores; also gifts. \$2.95 postpaid. No C.O.D.s. Creste-Andover, 415M Lexington, New York.

BEAUTIFUL Bronze grave markers, signs, reasonable. Berg, Box 3162, Bridgeport, Conn.

PECANS (Stewarts) 1945 crop. 50c lb. f.o.b. 10 lbs. or more. J. E. Hutchins, 611 Floyd St., Covington, Georgia.

WRITE Souvenir post cards from sunny south. We send you fifteen for \$1.00. You address, stamp and return for mailing here. Dixie Sales Co., 314 City Bank Building Charlotte, N. C.

SOUTH-AMERICAN Opportunities. Profitable employment. Fertile lands free. Mailorder selling. Interesting information. 10c. Vallesp, 395 Broadway, New York 13.

MEXICAN Feathered bird pictures. Sample 25c, framed \$1.00 (stamps). Foley's, 217 Grafton St., Brockton, Mass.

BRASS Letter scale, sturdy, no springs. Extremely accurate. Weighs fractions to 4 ounces, 2 1/2"x5". Saves postage, uncertainty. Only \$1.50 postpaid. Satisfaction guaranteed or cash returned. Specialty Products Co., 1919 West Holly Street, Phoenix, Arizona.

ADVERTISING Tips on selling by mail. \$1.00. Ortez, 3006 W. 22 St., Oklahoma City, Okla.

PERSONAL Shoe shine unit for everyday use; with polish 25c postpaid. Essential Products Co., Williamsburg 1, Mo.

BLACK-LIGHT Experimenters, we carry complete stock of fluorescent materials and equipment. Blacklight bulb and generous sample fluorescent lacquer \$1.50. Additional colors \$1.00 each. Stamped envelope brings price list. Ultra-Violet Engineering Company, 108 Mesa Street, Vallejo, California.

ALASKA! Fun map, city of Ketchikan, 10c. Northwoods Specialties, Box 124, Engadine, Michigan.

HEATING 6 Rooms \$25.00 yearly! Coal furnace. Circulars 10c. Rosenzweig, RR10 A1, Cincinnati.

DARE To be somebody and get somewhere! Unleash the creative magic inherent in your best self. Smash inhibiting fears, gain confidence, discover new qualities in yourself. Make your emotions earn promotions. Put your imagination to work for you instead of against you. The writer of this course regained health, well-being and improved finances by the use of psychological principles. Get details of this personality-developing plan. No obligation. Money-back guarantee of satisfaction after trial period. Write today, now. A card will do. School of Personal Psychology, Inc., 321 Starks Bldg., Louisville 2, Ky.

VICTORY Bird: Should be in every service home. Beautiful. Artistic. Pleasing. Hand made (extraordinary). \$2.00. Newlyn Novelty Co., Hollywood 28, Calif.

RUST-OFF Removes rust from chrome, all steels, porcelains. Cleans copper and brass quickly. No hard rubbing required. 6 oz. bottle postpaid U.S.A. only 50c coin. M. W. Lindquist Co., 6741 Nevada E., Detroit 12, Mich.

LUMINOUS Paint. Best quality. Glows bright blue in dark. 1 oz. each paint and sealer only \$1.39 postpaid. Black Light Products, 450 E. Ohio St., Chicago 11, Ill.

"RECEIVE Mail." Moneymaking offers, opportunities, catalogs. Name listed 10c. Ideal Service, 110. Park Ridge, Ill.

RECEIVE Mails, moneymaking opportunities, samples, literature. Your name in several mailing lists, 10c. Rogowski, 3415 Broadway, New York 31.

MEXICAN-AZTEC Featherwork tropical bird picture cards. Samples 25c. Bulletin free. Mexican Products Co., 126 No. Main, Tulsa 3, Okla.

ATTENTION Coal users. Save fuel by using Coal-Aid. Information sent upon request. Pettam Specialties, Crown Point, Ind.

TRADE Magazines. Business, vocational, diversion. Current single copies. Over 200 fields. Free price list. Commercial Engraving Publishing Co., 34C North Ritter, Indianapolis 1, Indiana.

INFORMATION — Locating articles, products (wholesale) etc. Rakes, Box 5931-2, Chicago 80.

GIGANTIC Mails, magazines, samples, listing 10c, three times 25c. Waddell's, 341 East 76th, New York 21.

MEDICAL Laboratory technicians in great demand. We train you in your spare time, in your own home. You can practice while studying. Write for free catalogue. Imperial Technical Institute, Box 973-J, Austin, Texas.

SQUARE Dance instructions, calls, 25 sets. \$1.00. Rayburn, Lonsdale, Arkansas.

TATTOOING Outfits, designs, colors. Write today. Zeis Studio, 728 Lesley, Rockford, Illinois.

GOOD "Used" self-instruction educational books on all subjects bought, sold, rented, exchanged. Satisfaction guaranteed. Complete information and 92-page illustrated bargain catalog free. Write—Nelson Company, Dept. 2-02-2, Chicago 4.

MAKE THIS SUIT YOURS NEW PLAN



Earn CASH Showing to Friends!

Write at once if you want this fine made-to-measure suit! You can get it by taking a few orders from friends and earn up to \$10.00, \$12.00 in a day. Your personal suit helps you take more orders with Pioneer latest style, made-to-measure guaranteed suits at amazingly low prices. Also complete line of Ladies' Tailored Suits. No experience, no money needed. Write today for FREE SAMPLES—telling about yourself—age, etc. No obligation—act now!

PIONEER TAILORING COMPANY

Congress and Throop Sts., Dept. Y-1116, Chicago 7, Illinois

THERE'S MONEY IN CARTOONS!

RAYE BURNS will teach you HOW to CREATE ORIGINAL CARTOONS at home that you may SELL! Course contains 26 lessons and over 600 illustrations. All for Only \$2.85

Send name and address for free details.

RAYE BURNS SCHOOL, Dept. M, Box 3583, CLEVELAND, OHIO

ELECTRICITY MEN NEEDED

GOOD JOBS • GOOD PAY • GOOD FUTURE

Through spare time home study you can qualify for a starting job in electrical work and prepare for bigger pay promotions. Or if now employed in this field you can acquire know-how which can win you a bigger, better job. It's not difficult to master principles of equipment used in generating, transmission and use of electricity. Begin now. Send name and address today for FREE information.

AMERICAN SCHOOL, Dept. EE845, Drexel Ave. at 58th St. Chicago 37

Name

Street

City, State

3 books full of KNOW-HOW on "Practical DESIGN for ARC WELDING"

HOBART "Simplified" ARC WELDERS

YOU NEED THESE BOOKS if you are a designer, engineer, draftsman, welder or connected with welding in any way. Three large volumes that contain the latest . . . most up to date publications on good welding design as compiled by Robert Kinkead, one of the outstanding welding consultants of the country. Here are designs that cover every major industry. Designs that are comparable to products you are now building. Sample pages FREE on request! Hobart Bros. Co. Box M-115 Troy, Ohio

FREE! Welder's "Handy Vest Pocket Guide" that contains valuable information on welding.

"One of the World's Largest Builders of Arc Welders."

Increasing your hold on your job and giving yourself a chance for advancement

Few men deliberately plan to work persistently on self-improvement. If progress comes naturally, they're happy; if it doesn't, they worry or ignore the situation. Yet it is possible to pay attention to self-improvement with considerable hope of success. A noticeable degree of advancement is practically assured any one who will make an intelligent and persistent effort. Thousands of men have proved this for themselves, with:



The Croft Library of Practical Electricity

The Croft Library is a complete electrical educator. It is founded on practice—on 20 years of shirt-sleeve experience—on work as it is actually done. It is jammed from cover to cover with the kind of hard-headed facts you want. Written so that the beginner can easily understand it, yet so sound, so thorough, that it is the daily guide of 59,000 highly paid electrical workers and engineers. Croft tells you the things you need to know about motors, generators, armatures, commutators, transformers, circuits, switchboards, distribution systems—electrical machinery of every type—wiring for light and power—wiring of finished buildings—underwriters and municipal requirements—illumination in its every phase—the most improved methods of lighting lamps—and lamp effects, etc.—how to do a complete job, from planning it, to completion.

No money down—easy payments

Fill in and mail the coupon attached and we will send you the entire set of seven volumes for ten days' examination on approval. We take all the risk—you assume no obligation. If you decide to keep the books, send \$3.00 in ten days and the balance at the rate of \$3.00 a month. Send the coupon NOW and see the books for yourself.

McGraw-Hill Book Co., 330 W. 42nd St., New York 18, N. Y.
Send me for ten days' examination on approval the Croft Library of Practical Electricity, 7 vols. If satisfactory I will send you \$3.00 in 10 days and \$3.00 monthly until the price of \$18.00 is paid. If not wanted, I will return the books postpaid. (To insure prompt shipment write plainly and fill in all lines.)

Name.....
Home Address.....
City and State.....
Company.....
Position..... PM-11-45



There's a big post-war demand for trained Dental Technicians. Start now and learn this profitable profession—a career for both men & women. BE your own BOSS. Our amazing new method of teaching is a short cut to success for both young and old. Write for Free Booklet *P*

National School, Mechanical Dentistry
10 W. JACKSON BLVD., CHICAGO, ILL.

ANY BOOK IN PRINT!



Delivered at your door. We pay postage. Standard authors, new books, popular editions, fiction, reference, medical, mechanical, children's books, etc.—all at guaranteed savings. Send card now for Clarkson's 1946 Catalog.

FREE Write for our great illustrated book catalog. A short course in literature. The buying guide of 300,000 book lovers. The answer to your Christmas gift problem, FREE if you write NOW—TODAY!
CLARKSON PUBLISHING COMPANY
Dept. PM5, 1253 S. Wabash Ave. Chicago 5, Ill.



Thrilling Work **COLORING PHOTOS**
Fascinating vocation learned at home by those with aptitude. Thrilling pastime. Keesee method brings out life-like colors. Free booklet.
NATIONAL PHOTO COLORING SCHOOL
1315 S. Michigan, Dept. 1358, Chicago 5

Learn REFRIGERATION and AIR-CONDITIONING

ARE YOU HANDY WITH TOOLS?

Exceptional opportunity for men of all ages up to 60. The demand for repair and service mechanics in both REFRIGERATION and AIR-CONDITIONING is acute and will continue. You can easily and quickly—

Learn to Be a Service Mechanic at Home or in Our Shops

Our practical, thorough course is easy to grasp and can be studied at home in your spare hours. No previous experience is needed. A common school education is enough. Learn how to start your own business with \$50.00 worth of tools in garage or basement. Open up your own shop or take a well paid job in this active field.

**START
YOUR OWN
REPAIR SHOP**

Write for free booklet today. No obligation whatever.

MAIL COUPON TODAY



Send for **FREE BOOKLET!**

Mechanics Training School

4701 W. Pico, Dept P-11, Los Angeles 6, Calif.

Dear Sirs: Please send me, without obligation, your free catalog and full details.

Name.....

Address.....

City..... State.....

DRAFTSMEN NEEDED



**PREPARE NOW for a
BETTER JOB
AND GREATER
OPPORTUNITIES**

If you are ambitious to hold a better job, make more money and have greater opportunities to get ahead, start now to become a draftsman. Or if you are now employed in routine drafting work and want a better job—as a real draftsman, on more important work, at bigger pay, start now to qualify for that job.

Learn at Home in Spare Time

American School has helped thousands to reach higher goals; and can help you. Our practical, up-to-date training plan can provide the know-how that fits men for responsible jobs and opens opportunities. Begin draftsman training now. Check, fill in and mail the coupon below for FREE information—today.

AMERICAN SCHOOL, Dept. DD845, Drexel Ave. at 58th St., Chicago 37, Ill.

Gentlemen: Send me FREE information covering special training in subjects checked below. No obligation on my part.

- | | |
|--|---|
| <input type="checkbox"/> Drafting and Design for Men and Women | <input type="checkbox"/> Electrical Engineering |
| <input type="checkbox"/> Architecture and Building | <input type="checkbox"/> Diesel Engineering |
| <input type="checkbox"/> Automotive Engineering | <input type="checkbox"/> High School Course |
| <input type="checkbox"/> Business Management | <input type="checkbox"/> Plastics |
| <input type="checkbox"/> Railway Training | <input type="checkbox"/> Mechanical Engineering |
| <input type="checkbox"/> Electronics, Industrial | <input type="checkbox"/> Aviation |
| | <input type="checkbox"/> Radio |

Name.....

Address.....

Start to SPEAK A FOREIGN LANGUAGE CORRECTLY IN ONLY 7 DAYS



WHICH can bring YOU the biggest returns in business, in social life?

FOR many years to come government activities in Europe and South America will open countless opportunities for Americans who know one or more foreign languages. Business will be on the lookout for men and women to conduct affairs with foreign firms, maintain contact with individuals, manage overseas offices.

GET PROOF Get proof that now you can master your choice of four basic languages—easily, pleasantly and right in your own home! Get proof that within *one short week* you will have learned useful words and will be speaking phrases and even entire sentences in Spanish, French, German or Italian correctly and fluently.

Because Funk & Wagnalls knew that following the war there would be a great demand for a quick, easy way to learn a foreign language, this great publishing house started long ago to lay the groundwork for this announcement.

Now after three years of the most painstaking preparation, the completely new, up-to-the-minute improved Language

Phone method is ready for you—ready to give you *quick* mastery of the basic language of your choice by *listening* to a language master!

HOW THE LANGUAGE PHONE METHOD WORKS

Have you ever noticed how easily you acquired the *tune* of a new popular song? Actually this calls for memorizing hundreds of musical notes and phrases; yet you do all this unconsciously, not by laboriously memorizing the individual notes.

Well, that's just how easily you can learn to converse in another language—when

THIS BOOK IS FREE—SEND FOR IT AT ONCE · Don't Delay!

you use the new Language Phone Method!

This way, sitting comfortably at home, you listen to the cultured voice of an internationally famous language professor, electrically transcribed on records. At the same time you see the words he is speaking in a printed supplementary conversation-pronouncing manual. This way almost at once you start to speak and read the language you are studying.

NOT A "Correspondence Course"

Using the new Language Phone Method, you spend no tedious hours memorizing grammar rules and mere lists of words. You can have as many or as few "language-study companions" as you choose (a roomful can listen as well as one person!). And—you don't pay for high, by-the-lesson, tuition. You pay only one, moderate known-in-advance sum for *everything needed to give you complete mastery of the language.*

METHOD ENDORSED

Learning a foreign language through the medium of phonograph records has been an important part of the Army and Navy war-effort program. The success

has been so great that leading college educators have given it their fullest approval, and signified their intention of using the record method of teaching in colleges, universities and schools throughout the country.

Start RIGHT HERE To Mold Your Future—let a foreign language multiply your opportunities!

STOP MERELY WISHING you could speak Spanish, French, German or Italian! Now you can make your wish come true! You'll be amazed at how quickly and enjoyably you progress from speaking just a single simple sentence to rattling off a complete conversation.

Take advantage of this opportunity which may spell success for you and your family and fill in the coupon below. It will bring you a complimentary copy of the beautiful 24-page booklet shown here, and information about how you can get a complete, new Language Phone kit for seven days' free trial. Remember, when you send in this coupon you are not ordering anything. You are merely requesting your free copy of the booklet. There is no obligation on your part, and no agent will call on you.

THE NEW 1946 FUNK & WAGNALLS LANGUAGE PHONE METHOD

Thirty-six brand-new electrically transcribed lesson records in each of our French, Spanish, German and Italian Language Courses... New self-teaching language guidebooks... Two-language dictionary... Commercial business and travel section in each advanced course... All records and textbooks in a handsome, simulated leather carrying case.

18 Records Double Faced

All included in YOUR 7 DAYS' FREE TRIAL!

Here's what you get—all sent to you for seven days' free trial.

- 36 Recorded Units (on 18 double-faced records) electrically transcribed in world-famous RCA-Victor and National Broadcasting Company studios.
- Conversation-pronouncing Manual synchronizing with the first 26 Recorded Units, enabling you to see as you hear lessons.
- Advanced Supplement of Business Forms. 10 Recorded Units which give instructions for business correspondence in the language you are studying.
- Self-teaching Language Guidebooks by world-famous linguists. Complete texts, permitting study without use of Recorded Units.
- 2-Language Dictionary in two complete sections, separately thumb indexed. A permanent, valuable addition to your library.
- Carrying Case compartmented to hold all foregoing study aids. Covered in durable simulated leather on sturdy wood frame; luggage handle; reinforced hinged top.



MAIL THIS COUPON

FUNK & WAGNALLS COMPANY, 354 Fourth Avenue, New York 10, N. Y.

Yes, send me my free copy of the 24-page booklet about your easy method of learning a foreign language, and tell me how I may obtain a complete Language Phone kit to try out in my own home for seven days.

() SPANISH () FRENCH () GERMAN () ITALIAN
Check language desired

Please Print Name
Name and Address Plainly Address
PM3 City State

Your Service Man an AUTHOR?

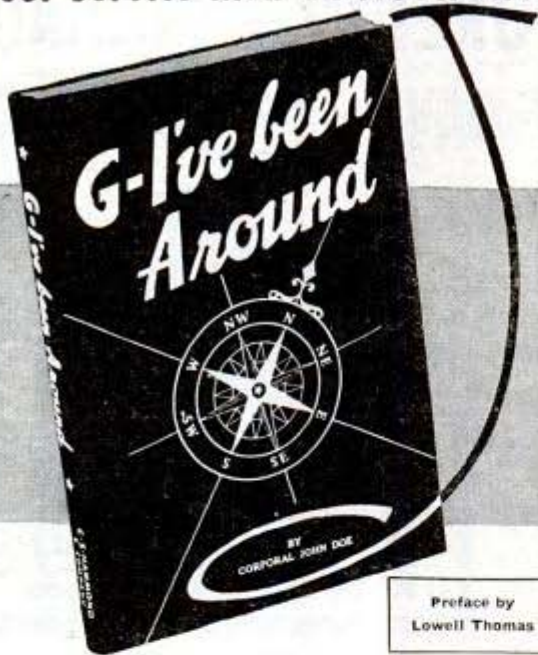

Preface by
Lowell Thomas

Yes, and here's his book—with his name embossed on it!

In this unique record book, filled in by him, there's a place for everything in his service career—pages of facts and figures, routes and ribbons, billets and buddies, photos and pin-ups; scrap section for clippings. Also contains Pictorial History of World War II, Training Camp Map of U. S., colored maps of all foreign areas to spot the places he served. What a gift for every serviceman and woman, or for wife, mother or sweetheart! 123 pages, size 7" x 10". His name (as author) embossed on attractive cover, no extra charge.

Just \$1.95 postpaid.

(Print name plainly.)

C. S. HAMMOND & CO., Suite 411, 88 Lexington Ave., New York 16, N. Y.

JUST OUT! NEW FROM COVER TO COVER

AUDELS REFRIGERATION and AIR CONDITIONING GUIDE



4 Books in One! Covering:

- 1—Basic principles, Servicing, Operation, Repair of
 - 2—Household Refrigeration
 - 3—Special Refrigeration Units
 - 4—Commercial & Industrial Refrigeration
- 5—Air Conditioning Systems

A gold mine of essential important facts for ENGINEERS, SERVICEMEN & USERS.
A Good Book is a Good Friend! Here you have at your fingers' ends a Complete Library in ONE VOLUME, the necessary data you have been looking for on: MODERN UNITS, SYSTEMS & MACHINES, REFRIGERANTS, including Freon, Lockers, Water Coolers, Quick Freezing & Air Conditioning Systems.
1280 Pages, 46 chapters all Fully Illustrated & indexed for Ready Reference.

ANSWERS YOUR QUESTIONS Get This Information for Yourself. Mail Coupon Today. No Obligation Unless Satisfied. ASK TO SEE IT.

\$4 COMPLETE • PAY ONLY \$1. A MONTH

AUDELS, Publishers, 49 W. 23rd St., New York 10, N. Y.
MAIL AUDELS NEW REFRIGERATION GUIDE for free examination. If O. K. I will send you \$1 in 7 days then remit \$1 monthly until price of \$4 is paid. Otherwise I will return it.

Name _____
Address _____
Occupation _____
Employed by _____ PM

"The Book They're Talking About"



MAKE MAGIC YOUR HOBBY

ENTERTAIN FOR FUN OR PROFIT! Be popular at parties, clubs, etc. Everybody enjoys magic tricks. Send only \$2.00 for box of 10 different, amazing tricks. No skill required. All apparatus and instructions included. FREE—with order—large catalog of magical apparatus and book of "102 Easy Tricks." Prompt shipment guaranteed. Rush order TODAY! D. ROBBINS & CO., Dept. PM-11, 152 W. 42nd St., N. Y. 18.

PRINTING PAYS BIG

"Make your future secure. Prepare for a highly paid position or a print shop of your own. Students throughout the world are enthusiastic in their praise of our training program and the personal attention given each student. Rush name today for free literature and sample lesson. No salesman will call. Dept. M115

COMPLETE COURSE ONLY \$14.50 CASH
TERMS AVAILABLE

International School of Printing, Troy, O.

5 SECRETS OF WINNING GOLF

Easy to Learn "Dynamic Swing" Every Pro Uses. \$1.00
PLAY IN THE 70's. Get out of the "dub" class.
Five basic secrets eliminate hook and slice . . . make you MASTER OF EVERY CLUB. Learn in a few days. COMPLETE COURSE NOW ONLY \$1.00 postpaid, or sent C.O.D. for \$1.00 plus 24c for postage and fee. Money back if not amazed with results, so order NOW! SYLVAN COMPANY, 125 Seventh Ave., Dept. P-11, LaGrange, Ill.

RADIO ENGINEERING, Broadcasting, Servicing, Electronics, Aviation, Marine & Police Radio taught thoroughly. 48 weeks' Engineering course equivalent to 2 years' college radio work. Approved Veteran Training. Co-educational. Catalog free.

VALPARAISO TECHNICAL INSTITUTE, Dept. D, Valparaiso, Ind.

WELDERS VETERANS—Ask about G. I. Training. WANTED!

Earn up to \$12 a day or start your own business. Learn Welding by actual shop work. America's leading school. Established 1902. 41,000 graduates. Write for "Welding Facts."
Greer Shop Training, Dept. 3115, 460 S. State St. Chicago

WATCHES WANTED BROKEN OR USABLE

—all kinds, even Ingersolls. Highest prices paid for jewelry, rings, spectacles, cigarette lighters, gold teeth, etc. Cash mailed promptly.
LOWE'S, Holland Bldg., Dept. PM, St. Louis 1, Mo.

Learn PHOTOGRAPHY at Home

Splendid opportunities. Prepare in spare time. Practical basic training. Long-established school. Send for free book, "Opportunities in Photography." No obligation.
American School of Photography, 1315 S. Michigan Ave., Dept. 1358, Chicago 5, Ill.

MONEY for MEN ALL FREE

THE PLASTEX Industry needs manufacturers on small scale and for big production of Lamp and Clock Stands, Art Goods and Novelties in Plastex and Marble imitation. Experience unnecessary. 1/2c material makes regular 10c store sellers. Rubber moulds furnished for speed production. Small investment brings good returns. Big chain store orders now being placed. Ambitious men have chance for real prosperity. Our Free booklet will interest and benefit you.
PLASTEX INDUSTRIES, Dept. P, 1085 Washington Ave., New York, N. Y.



Now ANY **AUTO REPAIR JOB** Can Be "Duck Soup" For You!

**MoToR's New AUTO REPAIR MANUAL
 Shows You How to Service and Repair
 ANY Part of ANY Car!**

**FREE 7-DAY
 OFFER!**



NOW you can "polish off" the HARDEST jobs the EASIEST way! MoToR's AUTO REPAIR MANUAL is ready to show you how to repair anything from carburetor to rear end—with the least possible amount of time and effort!

Suppose plain-talking car engineers from every auto plant in America got together and showed you all the things you needed to know about, repairing and servicing the cars they had designed and manufactured! That's really what you get in this big manual! Right at your fingertips, the main "dope"

from 150 Official Factory Shop Manuals, covering every make car built since 1935!

Easy to use, too! Quick-index leads you to right page in jiffy! Just follow simple instructions step-by-step.

SEE HOW MUCH YOU GET!

764 pages, 8½ x 11 inches, bound in sturdy covers, 200,000 service, repair, adjustment, replacement, tune-up facts on all makes and models built from 1935 to 1945. More than 1000 cut-away photos, diagrams, drawings show you exactly WHAT to do and HOW to do it. Used by U. S. Army, trade and technical schools everywhere, thousands of auto servicemen.

Now YOU—without cost—can see for yourself what a wonderbook MoToR's Auto Repair Manual really is. TRY it—FREE for 7 days! Learn first-hand how it can pay for itself the first few times you use it.

SEND NO MONEY 7-Day Free Examination

Just mail coupon at right, without money! When the postman brings your book, pay him nothing. First make it show you what it's got! Unless you agree this is the greatest time-saver and work-saver you've ever seen—return book in 7 days and pay nothing. Mail coupon today! Address: MoToR Book Dept., Desk 1N, 572 Madison Ave., New York 22, N. Y.

Published by MoToR, The Leading Automotive Business Magazine. MoToR's manuals assure high standards of repair work.

Covers All These Makes!

American
 Bantam
 Auburn
 Austin
 Buick
 Cadillac
 Chevrolet
 Chrysler
 Cord
 Crosley
 De Soto
 Dodge
 Ford
 Graham
 Hudson
 Hupmobile
 Lafayette
 La Salle

Lincoln
 Lincoln
 Zephyr
 Mercury
 Nash
 Overland
 Oldsmobile
 Packard
 Dodge
 Arrow
 Plymouth
 Pontiac
 Reo
 Studebaker
 Terraplane
 Willys

USED BY
 U. S.
 ARMY

Clear, Pictured Facts on Every Job on Every Car Built Since 1935!

Nearly 200,000 service and repair facts on all 31 makes, 764 big pages; including 50 pages of carburetor test, charts, illustrations, covering all models. Over 500 charts, tables; Tune-up Chart; Valve Measurements; Compression Pressure; Torque Wrench Reading; Starting Motor; Engine Clearances; Generator; Clutch and Brake Specifications; Front End Measurements, etc.; Engines; Electric Fuel, Cooling, Lubricating Systems; Transmissions; Universals; Front Ends; Wheels; Rear Ends, etc.

Same FREE 7-Day Offer Applies on MoToR's TRUCK REPAIR MANUAL

For mechanics, truck specialists, service stations, fleet owners. Covers EVERY job on EVERY truck made since 1936! 1400 pictures, 914 pages, 300,000 facts. Used by Armed Forces.

All types Gasoline Engines, Diesels, Hesselman, Fuel Systems, Governors, Lubrication Systems, Ignition Systems, Starters, Generators, Clutches, Transmissions, Axles, Torque Dividers, Transfer Cases, Brakes, Steering, etc.

ALSO SERVICES buses, farm and industrial tractors, contractor and road building equipment, stationary power machinery, etc. (on all parts described in Manual.) Check box in coupon at right.



MAIL COUPON NOW FOR 7-DAY FREE TRIAL

MoToR Book Dept., Desk 1N, 572 Madison Ave., New York 22, N. Y. Rush to me at once: (check box opposite book you want).

MoToR's AUTO REPAIR MANUAL. If O. K. I will remit \$1 in 7 days, \$1 monthly for 4 months, plus 35¢ delivery charge with final payment (\$5.35 in all). Otherwise I will return book postpaid in 7 days. (Foreign price, remit \$7 cash with order).

MoToR's TRUCK REPAIR MANUAL. (Described at left.) If O. K., I will remit \$2 in 7 days, and \$2 monthly for 3 months, plus 35¢ delivery charges with final payment (\$8.35 in all). Otherwise I will return book postpaid in 7 days. (Foreign, remit \$11 cash with order).

Print Name _____ Age _____

Print Address _____

City _____ Zone No. _____

(if any)

State _____ Occupation _____

SAVE 35¢! We pay postage if you ENCLOSE full payt., (check, M. O.). Same 7-day return-refund privilege.

Keep that "TICKING" Car

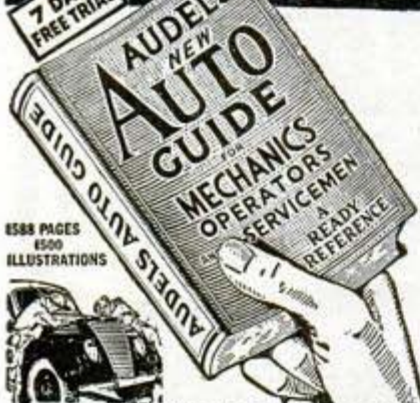

Every operator and mechanic needs AUDELS AUTO GUIDE.

This book saves time, money and worry. Highly endorsed. It presents the whole subject of auto mechanics:

- 1—Basic principles
 - 2—Construction
 - 3—Operation
 - 4—Service
 - 5—Repair
- Handy Size, Easily understood.

NEW FLUID DRIVE, HYDRAULIC SHIFT AND DIESEL ENGINES FULLY COVERED

Over 1500 pages—1540 illustrations showing inside views of modern cars, trucks and buses with instructions for all service jobs.

4 COMPLETE • PAY ONLY \$1. A MONTH ←

ASK TO SEE IT!—To Get This Assistance for Yourself Simply Fill in and Mail Coupon Today.

AUDEL Publishers, 49 West 23rd St., New York
MAIL AUDELS NEW AUTO GUIDE for free examination, if O. K. I will send you \$1 in 7 days; then remit \$1 monthly until price of \$4 is paid. Otherwise I will return it.

Name.....

Address.....

Occupation.....

Employed by..... P.M.

AN INFANT INDUSTRY ... SUDDENLY MATURED PLASTICS

Get In at the Start—and Grow

Plastics is a new industry which the nation's war needs is forcing to quick maturity. Already Plastics are indispensable in practically every branch of the Service—Aircraft, Ordnance, Chemical, Marine, Signal Corps, etc. Opportunities? Nearly everything, from homes to clothing, from gadgets to tools, will be affected by Plastics.

Spare Time Training Now Ready

The time to get started is *now*. You can prepare at home, in your spare time, to take your place in an infant industry that even now is leaping into prominence. A new, practical training plan is now ready to help you realize your ambitions and build your future security. Act now. Don't delay. Mail this coupon today.

AMERICAN SCHOOL, Dept. P845
Drexel Ave., at 58th St., Chicago 37, Ill.

Send me **FREE** information covering special training in subjects checked below. No obligation on my part.

- | | |
|--|--|
| <input type="checkbox"/> Plastics | <input type="checkbox"/> Radio |
| <input type="checkbox"/> Electrical Engineering | <input type="checkbox"/> Automotive Engineering |
| <input type="checkbox"/> Drafting and Design for Men and Women | <input type="checkbox"/> Architecture & Building |
| <input type="checkbox"/> Diesel Engineering | <input type="checkbox"/> Business Management |
| <input type="checkbox"/> Mechanical Engineering | <input type="checkbox"/> High School Course |
| <input type="checkbox"/> Aviation | <input type="checkbox"/> Railway Training |
| | <input type="checkbox"/> Electronics, Industrial |

Name.....

Address.....

FREE 32-PAGE BOOKLET ABOUT MODEL RAILROADING

THE WORLD'S MOST FASCINATING HOBBY



FREE 32-PAGE BOOKLET tells all about this absorbing hobby for skilled tradesmen, business and professional men. Give yourself hours of satisfaction and relaxation building your own scale model railroad which performs and looks like the real thing. It's easy and relatively inexpensive. Get started now. Send at once for our free booklet "Your Model Railroad."

MODEL RAILROADER MAGAZINE
DEPT. MR MILWAUKEE 3, WISCONSIN

MAKE MONEY AT HOME BY MAIL

MAIL ORDER BUSINESS Hits-the-Spot for extra spare time earnings. New Mail Order Business Course shows you how to make dollars not dimes by mail. Contains **TWENTY-FIVE** instructive lessons plus four tested money-making plans. Was written especially for beginners and spare time mail order dealers, from author's **TWENTY-FIVE** years of experience. Write for free details **TODAY!**

REHKOP CO., Box 87, Bolivar 10, Mo.

JIU-JITSU HOW TO BECOME EXPERT, Keep Health, Have Fun

Teaching 35 years. Send 10c for sample lesson
MODERN SCHOOL JIU-JITSU, Dept. WW, 5 W. 52nd St., N.Y.C. 19

Vocational Interest Tests

given easily by mail, \$2. Should you study electricity, law, machine shop, salesmanship or what? Write for free details about interest and aptitude tests that will help select the career for which you are best suited. Get into the right job now and get ahead. Personnel Publishing Co., 459 Turk St., San Francisco, Cal.

MOTIVATION: The Creator's 5 Question System of Reason and Creation.

The only book that shows **HOW** to ask five questions: (1) to reason and create BELIEFS that can not be resisted or refuted; (2) to **MOTIVATE WILL** to DOMINEER FORCES of Nature to hold or change the position of desired things; (3) to accomplish your own aim and purpose. Shows **HOW** to reason and create friends and enemies at will. Etc. **YOUR HIDDEN POWERS**, \$3 postpaid, 10 days return privilege.

EFFECTIVE THINKING FOUNDATION, Box 404-V, Hollywood, Calif.



LANGUAGE IS POWER

... Forge ahead, win special assignments, promotion, better job in global peace time opportunities through ability to speak a foreign language.

MASTER A NEW LANGUAGE quickly, easily, correctly by

LINGUAPHONE

The world-famous Linguaphone Conversational Method brings voices of native teachers INTO YOUR OWN HOME. You learn the new language by LISTENING. It's amazingly simple; thousands have succeeded.

HOME-STUDY COURSES IN 29 LANGUAGES
Send for **FREE** book—

LINGUAPHONE INSTITUTE
99 RCA Building, New York 20, N.Y. • Circle 7-0830

LINGUAPHONE INSTITUTE,
98 RCA Bldg., New York 20, N.Y.

Send me the **FREE** Linguaphone Book.

Name.....

Address..... City.....

Language Interested.....

How to GUARANTEE YOURSELF A GOOD LIVING....

THE only way you can GUARANTEE yourself a good living, come good times or bad, is to KNOW MORE than the average job-seeker about something important in the business world... something employers will pay you well for, or that you can use to set up a prosperous, independent Business of Your Own. ●●● Here are listed just a few of the present and Post-War OPPORTUNITIES available to you. Here's your chance to choose the kind of occupation, trade or profession you'd like to master—here's that all-important practical information you require. ●●● Just mail coupon for big FREE 100-page Success-Catalog showing thousands of ways to better your condition and IMPROVE and ENRICH YOUR LIFE.



Real Estate SUCCESS... be a professional man

Practical training on how to run a profitable Real Estate Business of your own. Illustrated self-study lessons on farm and suburban properties, downtown operating. Gain a working knowledge of mortgages, listings, sales techniques, appraisals, property management, commercial leasing, contracts, etc. Real estate is the foundation of all wealth! **RUSH COUPON BELOW** for NEW facts you should know about your future in real estate. There's no obligation.

Practical REFRIGERATION

Brand New Streamlined Course for quick training. Authoritative step-by-step instruction on servicing household refrigerators... how to install, operate, repair. Easy-to-follow illustrated directions on troubleshooting, parts replacement, testing. Covers quick-freeze units, lockers, water coolers, freon, air-conditioning systems, etc. Amazing low price! Free details, see coupon.

AUTO Mechanics

Let this **Practical, Low-Priced** course get you started in the auto repair trade. Good mechanics make big money NOW... and have a great future! Self-training lessons show you exactly what to do and how to do it. It teaches servicing on all makes of cars... adjustments, tune-ups, etc. Clearly written and illustrated by expert engineers. Satisfaction or a refund. Mail coupon now for FREE details.

Carpentry ~ Building ESTIMATING

There's a great future in the building trades for trained men. Up-to-date lessons how to plan, build, remodel houses, instructions: stair building, steel square, roofing, painting decorating, etc. Send for full information **FREE**. Use coupon.

MAIL ORDER BUSINESS YOUR BIG OPPORTUNITY!

24-lesson course on proved, tested, up-to-date, profitable methods. Amazing treasure-house of best mail order plans and practices. How to start your mail order business on a small one-man scale, how to keep it growing more and more profitable month after month. Money-making facts. Free sensational details. Mail Coupon!

INSURE YOUR FUTURE — Mail This Coupon Now!
On this coupon check the subjects that interest you. Our world-famous copyrighted Success-Catalog will bring complete details, **FREE**... no cost, no obligation.

NELSON CO. 321 SOUTH WABASH AVENUE
Dept. 8L02, CHICAGO 4, ILL.

Watch & Clock Repairing



Learn at home in your spare time. Prepare for a Happy Future of prosperity, security, and get a big-pay job now. Fascinating! You can earn while you learn. Excellent field for part-time work at home. **Practical Course in HOROLOGY.** Thorough self-instruction training in American and Swiss watches and clocks. Special section on alarm clock repairs. Learn-by-doing instruction method. Interesting, Quick, Easy. No previous experience needed. Watchmaking is basic training for Aircraft Instrument Work and other scientific precision jobs. Fast-growing field... big opportunity. Mail coupon for **FREE** information TODAY.

Locksmithing & Key Making

PRACTICAL UP-TO-DATE COURSE

How to pick locks, de-code, make master-keys, repair, install service, etc. New, self-instruction lessons for every handy man, home-owner, carpenter, mechanic, service station operator, fix-it shop, hardware dealer, or gunsmith. **53 Easy Illustrated Lessons** LOW PRICE! Satisfaction guaranteed or money back. Write now—no obligation!

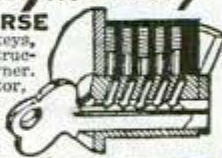

Practical RADIO Service

SELF-INSTRUCTION COURSE teaches you the practical side of radio... adjustment, operation, trouble-shooting. No previous knowledge necessary. Large, clear illustrations, diagrams, charts, etc. **Interesting Steady Work!** Set up a radio repair shop of your own—or prepare for booming industrial electronics. This useful, how-to-do-it course brings you all the fundamentals including mathematics, review questions, problems, answers. Strictly up-to-date. Coupon below will bring you full information you will want. Mail it in today. No obligation.

What to INVENT how to INVENT

MECHANICAL DRAWING, DESIGNING, BLUE-PRINT READING—Practical course for the wide-awake practical men. IDEAS... how to get them, develop them, protect them and promote them! Expert information on how to turn your imagination into money. Plus illustrated self-study lessons on basic mechanical movements and devices. Mail coupon below for **FREE** details. No obligation.

FREE! 100-page book... mail this now!

NELSON CO., DEPT. 8L02, 321 S. WABASH AVE., CHICAGO 4, ILL.

Please send me—Free, without obligation—illustrated Success-Catalog containing information about the subject (subjects) I've checked below. No salesman will call.

- | | | |
|---|--|--|
| <input type="checkbox"/> Watch and Clock Repairing. | <input type="checkbox"/> Locksmithing. | <input type="checkbox"/> Refrigeration. |
| <input type="checkbox"/> Practical Radio Servicing. | <input type="checkbox"/> Real Estate. | <input type="checkbox"/> Auto Mechanics. |
| <input type="checkbox"/> Mail Order Business. | <input type="checkbox"/> Carpentry. | <input type="checkbox"/> Inventions. |

NAME _____
ADDRESS _____
CITY _____ ZONE _____ STATE _____

**BE READY FOR
A BETTER JOB
AT BIGGER PAY**



**PREPARE NOW
FOR POST-WAR
BUILDING
BOOM**

**Thousands of
Trained Men
Will Be Needed**

● New homes and other structures to be built after peace returns will provide a tremendous number of well-paid jobs. Men trained in Architecture, Drafting, Contracting, Carpentry and related building trades will cash in BIG on their knowledge and skill. YOU can train in spare time at home, at low cost, for a big-pay job in this rich field. American School can help you to success just as it has helped others during its 48 years. Check, fill in and mail coupon NOW for FREE information.

AMERICAN SCHOOL, Dept. BS45, Drexel Ave. at 58th St., Chicago 37, Ill.

Send me FREE information about your special training plan covering subjects checked below.

- | | |
|--|--|
| <input type="checkbox"/> Architecture and Building | <input type="checkbox"/> Automotive Engineering |
| <input type="checkbox"/> Drafting and Design | <input type="checkbox"/> Diesel Engineering |
| <input type="checkbox"/> Contracting | <input type="checkbox"/> Mechanical Engineering |
| <input type="checkbox"/> Practical Plumbing | <input type="checkbox"/> Plastics Engineering |
| <input type="checkbox"/> Air Conditioning | <input type="checkbox"/> Aviation <input type="checkbox"/> Radio |
| <input type="checkbox"/> Refrigeration | <input type="checkbox"/> Business Management |
| <input type="checkbox"/> Electrical Engineering | <input type="checkbox"/> High School Courses |

Name.....

Address.....

PRACTICAL TECHNICAL TRAINING FOR YOU



Millions of Air-Conditioning Units, Heating Plants, and Refrigerators need Expert Service NOW! Also in the big postwar building boom trained men will be in great demand to meet urgent requirements for Refrigeration, Heating, Cooling, Quick Freeze, and Air Conditioning Research, Sales and Service for homes, commercial plants, farms, dairies and other installations.

Are you one of the many men who won't be satisfied to go back to your old job—or want a business of your own? Then get the training NOW provided by our short, practical courses—planned for men who LOOK AHEAD. Over 30,000 technicians and engineers in good paying positions the world over were trained at MSOE since 1903. Many of our graduates own their own businesses. Write NOW—let's get together—it will be the most important step you ever took.

AIR CONDITIONING and REFRIGERATION



MILWAUKEE SCHOOL OF ENGINEERING
P.M.-1 145 N. Broadway & E. State, Milwaukee, Wis.
Please send BIG FREE BOOK just off the press—and give me complete information on

- | | |
|---|----------|
| <input type="checkbox"/> REFRIGERATION SERVICING..... | 3 months |
| <input type="checkbox"/> AIR CONDITIONING, REFRIGERATION & HEATING..... | 6 months |
| <input type="checkbox"/> TECHNICIAN'S COURSE..... | 1 year |
| <input type="checkbox"/> Electronics <input type="checkbox"/> Arc Welding <input type="checkbox"/> Drafting | |
| <input type="checkbox"/> Electrical Engineering (B. S. Degree) | |

NAME.....

ADDRESS.....

CITY & STATE.....

SHAW and "Peggy-Pol" "DU-ALL" GARDEN TRACTORS

1 to 9 H.P. Circulars on request. Building more now. We supply repairs for all SHAW Tractors sold in our 42 years in business.

BUILD YOUR OWN RIDING TRACTOR—"WAR HORSE"

using old auto parts, powered by 2 H.P. or larger air-cooled engine; or walking type Garden Tractor 1/2 to 3 H.P. or convert truck or auto into Farm Tractor. Each with steel or rubber tires; will plow, cultivate. Plans for building, in few hours, any one of above, postpaid or \$1.00 (state which wanted) or all 3 for \$2.00. Money Back Guaranteed!

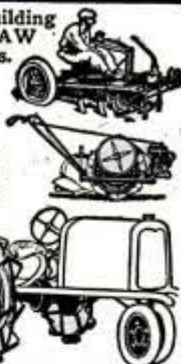

SHAW MFG. CO., 4511 Front St.

Galesburg, Kansas

668G North 4th St., Columbus, Ohio



CLEAN HANDS

Quickly remove grime and grease from hands, and almost anything, with SKAT, original and best Paste Soap.

AT ALL GROCERS

Skat Co., Dept. P, Hartford 6, Conn.

New SOLDERING GUN

Original, Exclusive Graphite Heating Element

COPPER TIP HEATS IN 5 SECONDS

Control button gives high or low heat as desired. Do expert soldering repair work better, faster, easier. Solders heavy work. Used by U. S. Navy. Operates from 6 volt storage battery or hot lead on car, truck tractor. For 110 AC use transformer, \$5.00 with battery clips and lead wires; \$8.75 including transformer. Write today; send no money; pay postman plus usual postal charges. Distributors wanted.

METELEC CO., 3110 W. 28th St., Minneapolis 5, Minn.

HOUSE PLAN BOOKS...

Do Your Selecting and Planning Now. Build Later.



- | | |
|---|--------|
| America's Best Low-Cost Homes—Fine selection of 2 story homes, Cost \$1,200 to \$8,100..... | \$1.00 |
| Do Luxe Small Homes—210 popular designs, cost \$1,100 to \$10,000..... | 1.00 |
| New American Homes—88 high class designs, \$3,900 to \$15,000..... | 1.00 |
| New Brick Homes—4 to 7 rooms, \$3,600 to \$7,400..... | .50 |
| New Small Homes—62 designs, \$2,300 to \$6,700..... | .50 |
| Artistic Homes—Selected for unusual features, \$2,600 to \$9,000..... | .50 |
| Colonial Homes—48 designs..... | .50 |
| Low Budget Homes—5 small, medium size, \$2,100 to \$8,000..... | .50 |
| Spanish and Western Homes..... | .50 |
| Sunshine Homes—For warm climates, \$1,900 to \$7,600..... | .50 |
| New Duplex Book..... | .50 |

Send Your Order to
POPULAR MECHANICS PRESS
Dept. 613
200 E. Ontario Chicago 11, Ill.

LOW COST!

Make Power Tools from Auto Parts

Send today for new edition, featuring tools you can make of wood. Build your own lathe, drill press, sander, circular, scroll and band saw and other power tools you have always wanted, from discarded parts, at low cost. Simplified instructions, hundreds of pictures and diagrams make building easy. Order today. Only \$1.25. Money back if not satisfied.



POPULAR MECHANICS PRESS, Dept. 614, 200 E. Ontario St., Chicago, Ill

ELECTRICIANS!

Get This
Book of 150
Valuable Wiring
Diagrams

Free!

ACCEPT THIS AMAZING
BOUND VOLUME AS MY
GIFT TO YOU! . . .

Here's one of the greatest "get acquainted" offers ever made. This book of 150 Electrical Shop Prints and Wiring Diagrams is YOURS—absolutely FREE. IT'S an outright gift—you pay nothing to get it and nothing to keep it.

The book is "chuckful" of valuable charts, diagrams, wiring methods and instructions for reading and using wiring shop prints. You'll find its pages packed with up-to-the-minute electrical information. All the shop prints are full size with full explanatory information... they have all been developed and pretested in the big Coyne Training Shops. I WANT YOU TO HAVE THIS BOOK AS MY GIFT and HERE'S ALL YOU HAVE TO DO TO GET IT:



H. C. Lewis

Examine My New 7 Volume Set

Get This Book of 150 Shop Prints Free!

To get your FREE copy of this Shop Print book all you have to do is to let me send you my complete new 7 volume set of electrical books—COYNE PRACTICAL APPLIED ELECTRICITY for 7 days FREE examination. Here's a set of books written for the "beginner" or "oldtimer" in electrical work who is anxious to get ahead. This 7 volume set covers everything electrical from house wiring to advanced DC & AC motors and equipment. Thousands of "show how" diagrams and photos.

SEND NO MONEY!

The new 7 volume set of practical electrical books is so NEW, so DIFFERENT and so UNIQUE that you have to see the set to really appreciate how much it can mean to you and your future. So here's what I'll do—I'll send you the complete set of 7 volumes (pictured below) at my risk, postpaid for 7 days FREE Examination. I'll also send you the New Coyne Book of 150 Shop Prints & Motor Diagrams as my FREE gift to you to KEEP REGARDLESS OF WHETHER OR NOT YOU DECIDE TO KEEP THE 7 VOLUME SET COYNE PRACTICAL APPLIED ELECTRICITY.

Keep ALL the books 7 days. If not 100% pleased with the 7 volume set just return it and you owe nothing. If you keep the 7 volumes you can pay for them at the special low rates shown here in the coupon at right.

Coupon Is Not An Order — UNLESS You Decide to Keep the Books

YOU'RE NOT BUYING THIS SET WHEN YOU SEND THIS COUPON, you're merely asking to see them FREE for 7 days. The coupon becomes an order only if you decide to keep the 7 vol. set after 7 days' examination. SEND COUPON NOW!

BOOKS

MUST EARN 5 TIMES THEIR COST OR YOUR MONEY BACK

I personally guarantee that at the end of 1 year after you receive these books, they must have earned five times their cost or you can return them and I'll refund every cent you paid.



FREE BOOK COUPON

H. C. Lewis, Pres., Coyne Electrical School, Dept. 85-R6
500 South Paulina St., Chicago 12, Illinois

Send me the NEW 7 volume set COYNE APPLIED PRACTICAL ELECTRICITY. Also send me the bound volume of 150 Shop Prints which I am to keep FREE WHETHER I KEEP THE 7 VOL. SET OR NOT. I'll either return the 7 volume set in 7 days and keep the 150 Print book and owe nothing or I'll keep the 7 vol. set and pay \$3.00 in 7 days and \$3.00 per month until \$21.00 is paid or send \$19.75 cash. You include FREE one year consultation service and Technical Bulletins.

NAME _____ Age _____

ADDRESS _____

CITY _____ Zone _____ STATE _____

Check here if you want to pay postman cash price of \$19.75 (you save \$1.25) delivered. Same 7-day examination privilege and Money-Back Guarantee.

7 AMAZING VOLUMES

Cover everything from home wiring to DC-AC Motors and Equipment. Over 8000 subjects—2000 illustrations—5000 facts.

VOL. 1 Electrical Principles & circuits—signal systems—telephony; 450 pages.

VOL. 2 Wiring for Light, Power—Neon, Fluorescent, Aviation Lighting—Household Appliances—Farm Electricity; 460 pages.

VOL. 3 D. C. Motors and Controls, installation, operation and Maintenance, Welding—620 pages.

VOL. 4 A. C. Motors and Controls—Electronics—700 pages.

VOL. 5 Armature & Stator Winding and Repair—350 pages.

VOL. 6 Refrigeration & Air Conditioning; Radio—610 pages.

VOL. 7 Automotive, Diesel and Battery—420 pages.

COYNE ELECTRICAL SCHOOL

Dept. 85-R6 500 S. Paulina St., Chicago 12, Ill.

HOW YOU CAN BUILD A MIGHTY BODY

Quickly! Easily! Pleasantly
—in 10 minutes a day in your own home

"The World's greatest molder of men"—at last reveals to you in these five complete book-courses (value \$5 each).

1. How YOU Can Build a Mighty ARM!



A. PASSAMONT
First prize for physical perfection.

Let me give YOU, TOO, such a pair of chat-breaking biceps. The strongest-armed man in the world, George F. Jowett, planned this course for you. His great experience stands as proof that YOU, TOO, can get the arms men respect and women admire.

Complete Arm Course 25c

2. How YOU Can Build a Mighty CHEST!



REX FERRIS
Champion of South Africa, says, "I owe everything to Jowett Methods."

Look at the Heroic Chest of this Jowett Pupil. A powerhouse of energy, Ferris writes, "I want to add my sincere gratitude to that of thousands of pupils for wonderful results from your course. Your course is by far the best." If you have a narrow, sunken chest I can improve it so that you will be proud to show it off.

Complete Chest Course 25c



CHAS. SCHAFER
An amazing Jowett product. Once a puny weakling, now versatile athlete.

3. How YOU Can Build a Mighty BACK!

Look at his rock-like Back now! He says, "You have worked wonders for me. You are head and shoulders above the rest in your profession." Let me help YOU, TOO, build a back of power. Square shoulders with enviable military spread. A spine as strong as a steel shaft.

Complete Back Course 25c

4. How YOU Can Build a Mighty GRIP!



W. BURNS
A Jowett-made Olympic Strength Champion.

YOU, TOO, can have a Manly Grip like this Jowett pupil. What would you give for a forearm like that, with its bone-crushing grip? Fingers strong as steel pincers. A hand like an iron vise. YOU, TOO, can get these symbols of real manliness. I have proved to thousands this is no mere dream. Let me mold a pair of arms like this for you . . . with a grip of might, a handshake that will win friends—success.

Complete Grip Course 25c



BOB MITCHELL
A Jowett Champion—not in words but by ACTUAL RECORDS.

5. How YOU Can Build Mighty LEGS

What would you give to have the all-round herman strength of Bob Mitchell? It's reasonable to assume that what I have done for thousands, I can do for you. I myself increased my thighs by 8 inches, my calves by 5 inches, by this simple, unbeatable method. I'll help you build legs that are real props of leaping, tireless power!

Complete Leg Course 25c

Last Chance! Get All 5 Picture Courses for \$1.00



Send for them now and learn the "World's Greatest Secrets of Body Building." FREE! Marvellous Photo Book of Famous Strong Men, "Nerves of Steel—Muscles like Iron".

RUSH COUPON NOW

BOOK WITH PHOTOS OF FAMOUS STRONG MEN

MAIL COUPON NOW

FREE



George F. Jowett
Champion of Champions

Jowett Institute of Physical Culture
230 Fifth Avenue, Dept. 908-B New York 1, N. Y.
George F. Jowett: Your proposition looks good to me. Send by return mail, prepaid, the courses checked below, for which I enclose (). Include FREE book of PHOTOS.
 All 5 courses for . . . \$1 Molding Mighty Legs 25c
 Molding a Mighty Arm 25c Molding a Mighty Grip 25c
 Molding a Mighty Chest 25c Molding a Mighty Back 25c
 Send all 5 C.O.D. (\$1 plus postage.) No orders less than \$1 sent C.O.D.

NAME Age
(Please print plainly. Include Zone Number.)

ADDRESS

BIG MONEY NOW IN LIQUID MARBLE

THREE wonderful new opportunities for your own big money-making business—regardless of your age, sex, or previous experience!

1. LIQUID MARBLE. Make beautiful artificial Marble Slabs. Pour from liquid state. Glazed or unglazed. This marble may be mottled, veined, multi-colored or left in original snow-white state. The color is actually a part of the marble! Does not fade or wear away. Liquid Marble is unsurpassed on kitchen or bathroom walls. Easy to make and install.

2. PLASTIC FLOORING. May be made in any color or combination of colors. Gives a lifetime of wear. Dustproof, Soundproof, Verminproof. Resilient to the tread. Lay out solid from wall to wall or in pattern design of various shaped blocks.

3. FLEXIBLE MOLDS. For plaster casting. Make your own moulds for few cents each. \$1.00 in raw materials will make up to \$25.00 worth of finished goods. We furnish names of buyers. Write now for FREE information about our BIG THREE money-making opportunities! Get in on busy season just starting. Send penny postcard or letter. No obligation.

COMPO-TEX, Box 786-SG, ST. LOUIS 1, MO.



Get Started in Radio TEN "HOW-TO-DO-IT" BOOKS

Get a solid foundation in radio by means of these 10 timely text books. Each clearly written, profusely illustrated, contains over 15,000 words. You'll be amazed at the wealth of information packed into these handy books. Excellent for reference—ideal for technical library. Your money back if not satisfied.

5 BOOKS for 50c—10 BOOKS for \$1.00

- SENT TO YOU POSTPAID
- No. 1—How to Make Four Doerle Short Wave Sets
 - No. 2—How to Make The Most Popular All-Wave 1 and 2 Tube Receivers
 - No. 3—Alternating Current for Beginners
 - No. 4—All About Aerials
 - No. 5—Beginners' Radio Dictionary
 - No. 6—How To Have Fun With Radio
 - No. 7—How To Read Radio Diagrams
 - No. 8—Radio for Beginners
 - No. 9—Simple Electrical Experiments
 - No. 10—Television

Remit by check or money order—register letter if you send cash or stamps

RADIO PUBLICATIONS 23D West Broadway New York (7)

FENCING EXCITING FUN HARMLESS

NEW—Clean—Healthful. Develops Strong Body—Alert Mind. Become best swordsman in your neighborhood. **FREE BOOK LET** (with foils) teaches Quickly—Easily. **HARMLESS** because the 3 ft. Spring Steel Foils (swords) have safety rubber buttons. Complete outfit 2 foils (swords) and FREE Instructions. Now Only \$1.98 postpaid. **MAIL CHECK or MONEY ORDER Today.**

LEE PRODUCTS CO., 1613 B-First Ave., New York 28, N.Y.

Learn TOOL DESIGN

Now, as never before, draftsmen and tool designers are needed to redesign for penicetime reconversion. Quality quickly. Many making \$100 to \$150 per week. More qualified men needed than available. Good pay jobs waiting. Rush name and kind of job wanted today for full free facts. State age.

OHIO INSTITUTE OF TECHNOLOGY, Box 215, Greenville, Ohio

CARTOON TO SUCCESS!! \$2.00 P.P.

Hartman will teach you to CREATE ORIGINAL SALABLE CARTOONS! Cartoon course contains 30 lessons, hundreds of illustrations. Only \$2.00 P.P.

Or write for details about our Cartoon Course, Gag Course, Business Plans and Markets.

HARTMAN SCHOOL, 2438 W. St. Lincoln 3, Nebr.

SELL YOUR STORIES

Rich rewards. New and old publications need fresh, original fiction—now. Send us your best manuscript for free critical report. We'll tell you the TRUTH about your writing ability. No obligation, ever.

ASSOCIATED MANUSCRIPT SERVICE
Box 2629—PM Portland, Oregon

SIGNS EASILY AND EXPERTLY PAINTED WITH LETTER PATTERNS AND SHOWCARDS

AND MANY SIZES & STYLES WRITE FOR FOLDER

JOHN F. RAHN
1230-31 N. Central Ave. CHICAGO 51, ILL.

SAY YOU SAW IT IN POPULAR MECHANICS

FIX ANY RADIO

Amazing New Invention



Complete plan, only **\$1.50**

In manual form, 8 1/2 x 11" Trouble-shooting charts. Data on 346 radio tubes. 76 large job-sheets. 1,000 time-saving hints. Covers many types of sets—new and old. FM. portables, etc. Developed by Beitman, noted engineer, teacher, and author. Order today without risk—use 10 days.

FOR BEGINNERS OR EXPERTS

Learn quickly to repair radio sets. New revolutionary different comparison picture-method quickly simplifies radio servicing. No previous radio knowledge required. Introductory training included. Find any fault with ease. Do expert radio work almost immediately. Repair radios in minutes instead of hours. Plan U.S. Copyrighted. Take advantage of this new invention.

NO EQUIPMENT NEEDED

Most tests described require the use of only a screw driver, pliers and a piece of wire—no testers needed. Simple point-to-point picture suggestions tell you where to look for defects, how to test radio circuits and parts, and how to make the repair. You may try the plan for 10 days without any risk.

NEW 1945 EDITION

REPAIR RADIOS IN MINUTES

Read the introductory job-sheets, follow the step-by-step picture blueprints, and fix any radio in a matter of minutes. Do radio work for fun and profit. The complete simplified training is yours for only \$1.50, postpaid. 10 days no risk trial.

MORE HELP—IF NEEDED

Supplement your study, clear-up all hard problems, get ahead in Radio. A companion 19 lesson Practical Radio manual will give you added assistance, help you get ahead faster, present important facts in greater detail. Include this large manual also in your trial order. See coupon.

RADIO MADE EASY

Let this unique plan with its easy-to-understand diagrams, simplified illustrations, hints, job-sheets, and practical examples teach you basic radio facts. Learn important shortcuts in radio trouble-shooting. Make needed tests without testers, trace the signal, measure voltage, within the hour after receiving the plan. Follow the comparison tests given on large trouble-shooting blueprints. Over 1,000 repair hints. Data on all tubes. Circuits and hints for many types of radios—new and old models.

PRICE ONLY
\$1.50
COMPLETE

10 DAYS "NO RISK" TRIAL

Examine and use Simplified Radio Servicing plan for 10 days in your own home. Apply this technique and repair one or more radios. Then decide to keep this greatest radio training bargain, or return the material and get your money refunded in full. You take no risk.

No Risk TRIAL ORDER COUPON

SUPREME PUBLICATIONS, 9 S. KEDZIE AVE., CHICAGO 12, ILL.

Ship the following manuals to me for 10 days' trial under your money-back guarantee. I am enclosing \$..... full price. Ship postpaid.

Simplified Radio Servicing @ \$1.50 Practical Radio Manual @ \$2.95
Complete manual as described Companion Volume, 19 lessons.

Name.....PMN

Address.....

Learn this Profitable Profession



IN 90 DAYS AT HOME

Money-Making Career Open to Men and Women, 18 to 50

Hundreds of men and women between 18 and 50 make \$10 to \$20 in a single day giving scientific Swedish Massage and Hydro-Therapy treatments. There is big demand from doctors, hospitals, sanatoriums and clubs. Graduates earn large full time incomes from these or in private practice in their own offices. Others make good money from home treatments given in spare time. Learn this interesting, money-making profession in your own home, through our home study course. Same instructors as in our nationally known resident school. You can win independence and prepare for future security by qualifying for your Diploma. Course can be completed in 3 to 4 months. Many earn while they learn. Begin your training at once.



Anatomy Charts & Booklet FREE

Enroll now and we will include, at no extra cost, many needed supplies. Fit yourself to help meet growing demand for massage now and after the war. Send the coupon at once for complete details, Anatomy Charts and 32-Page Illustrated Booklet, FREE, postpaid.

THE COLLEGE OF SWEDISH MASSAGE
Dept. 564-F, 100 East Ohio St., Chicago 11, Illinois

Please send me FREE and postpaid, Anatomy Charts, 32-page Booklet and complete details on Home Training.

Name.....
Address.....
City..... State.....



OPPORTUNITIES AHEAD

For Men Who are Trained in AUTO BODY & FENDER WORK

Men 18 to 60. Want a future with good pay, perhaps a business of your own later? If you are mechanically inclined, start now to learn to become an auto body mechanic and fender repair man. This fast growing field has great possibilities for trained men with experience. U.E.I. spare time, home-study training combined with actual shop practice gives you sound, basic knowledge of latest, best methods so you may get the experience which may bring you big pay. Capable instructors supervise your studies and actual practice on automobiles. Course includes acetylene welding, spray painting, use of hand and power tools.

THOROUGH, RELIABLE TRAINING

U.E.I. has trained men for new opportunity fields since 1927 and many students are now making good. Auto body and fender repairing is one of the best profit-makers in any garage or service station. Little capital required for mechanically inclined men to get into this business. Free employment placement service, or we will show you how to start your own shop. Get the facts FREE, without obligation. Write today.

UTILITIES ENGINEERING INSTITUTE

AUTO-CRAFTS DIVISION
1314 Belden Avenue, Dept. 1115X, Chicago 14, Ill.

Gentlemen:—YES! I want to get into profitable Auto Body and Fender Repair Work. Please send me FREE FACTS at once. This inquiry does not obligate me in any way.

Name..... Age.....
Address.....
City..... Zone..... State.....

THIS EASY WAY TEACHES PIANO Without Music!

NO LONG HOURS
PRACTICING SCALES
OR EXERCISES...
**PLAY SONGS
FIRST DAY**



**You May Play Any Song
in 10 Days without being
Able to Read a Note . . .**

If you want to quickly learn how to play the piano... if you want to play song hits, waltzes, marches, hymns, two steps, red hot numbers and western songs, like "Don't Fence Me In" . . . here's amazing news. Now at last Mr. Dave Minor has perfected a wonderfully easy play-by-ear piano course that must teach you piano playing in only ten quick days or no cost. No scales, no long exercises. You start playing songs from the first lesson, and so soon it's amazing you're playing the piano surprisingly well. Mr. Minor's course is complete. It contains all the pictures, all the instruction, everything you need. The complete course sent for your inspection, trial and approval.



SEND NO MONEY—Make This Conclusive 10 Day Test. Just send your name and address today. On arrival deposit \$1.49 plus postage through postman. There is nothing more to pay. Inspect course carefully, see how simple yet thorough it is. Follow it for 10 days. Then if you aren't actually playing the piano and playing it well, if you aren't entirely satisfied and delighted with your discovery, return the course and get your money back. Piano playing is more popular than ever. **DON'T WAIT BUT WRITE TODAY!** If you act now you will receive without extra cost the wonderful, big 72-page Dave Minor piano song book of 50 songs. You quickly learn to play the songs the Dave Minor method or money back. Get in on this 2 FOR 1 offer NOW. **DAVE MINOR, Room 49-PP, 230 E. Ohio St., Chicago II, Ill.**

2 for 1 OFFER
\$1.49
ONLY \$1.49
COMPLETE



HARMONICA MAGIC COMPANY

World's largest distributors of instruction
Book on the Harmonica

No notes—no scales—no exercises—10 easy lessons—in 10 minutes. Just follow simple and complete instructions. 75 songs included.

NOW OFFERS \$2.50

A Harmonica and the Harmonica Magic Instruction book—both for only.....

SEND NO MONEY Send only name and address. Pay postman \$2.50 plus postage on delivery. All cash orders postpaid to you.

HARMONICA MAGIC CO.

Box 3445
Dept. FM2

Merchandise Mart
Chicago 54, Ill.

INTRODUCING-New Victory Model HANDIWELD ELECTRIC ARC WELDER



**PLUGS INTO
LIGHT SOCKET**

Victory Model Handiweld Arc Welder operates from 110 volts, A.C. or D.C. current same as other arc welders higher priced; generates tremendous heat to weld all metals. Not a toy welder that uses carbons, but actually uses standard coated rods—sizes 1/16" and 3/32". However, due to Priorities a generous supply of 1/16" rods only are supplied with the welder. Guaranteed not to burn out. Repairs fenders, auto bodies, radiators, machinery parts, etc. Take Victory Model Handiweld anywhere to job, operate right from light socket. You'll find a thousand uses for this welder around

your home, garage, workshop. Also in garages, factories, repair shops, tin snops; mechanics, inventors, plumbers, farmers, etc. Order a "Victory Model" Handiweld now.

SEND NO MONEY We'll rush one to you with rods, helmet, operating instructions, and all necessary parts with the exception of a large jar and a small piece of extension cord; these most everyone has. Pay postman only \$1.95 plus a few cents postage. If not delighted return Victory Model Handiweld in 5 days from receipt and money paid for it will be refunded promptly. Rush your order now.

KUMFY PRODUCTS, Dept. B-202, CINCINNATI 26, OHIO

FLOYD CLYMER'S MOTOR SCRAPBOOK



Early cars, motorcycles, illustrated, described. Historical, educational. "AMUST," says TIME Magazine. Read about Ford, Buick, Dodge, Stutz, EMF, Maxwell, Stutz, Geo, 250 others. No. 1 and No. 2 books, each different, \$1.50 each, 100% STEAM CAR EDITION, with steamer history list of 125 makes, photos, \$3.00. All books postpaid. Cloth-bound \$1.00 extra. Motor-book catalog, 10c.

CLYMER, Dept. PM, 2125 W. Pico St., Los Angeles 6, Calif.

LEARN WATCH REPAIRING



AT HOME. By our modern and original system of instruction you can learn every part of the **WATCH REPAIRING TRADE AT HOME.** Prepare yourself for a well-paying position or start in business after completing our course of instruction. Good watch repairers are in demand and generally earn very good salaries. For particulars apply to the **Waltham School of Watch Repairing** 759 North Milwaukee St., Milwaukee 2, Wis.

FREE Music Catalog

OVER 1300 STANDARD, CLASSICAL & TEACHING PIECES for piano, violin and voice in World Famous McKinley Sheet Music and Book Editions—the teachers' standard for nearly 50 years. Splendid arrangements. Write today enclosing 3 cent stamp for return postage. Dept. 3378. **McKINLEY PUBLISHERS, Inc., 425 S. Wabash, Chicago 5**

LAW

STUDY AT HOME FOR PERSONAL SUCCESS and LARGER EARNINGS. 35 years expert instruction—over 108,000 students enrolled. LL.B. Degree awarded. All texts furnished. Easy payments. Send for **FREE BOOK**—"Law and Executive Guidance."
AMERICAN EXTENSION SCHOOL OF LAW
Dept. 59-M, 646 N. Michigan Ave., Chicago 11, Ill.

HAIR CAN BE SAVED

"GIVE YOUR HAIR A CHANCE"
is the amazing book by J. W. KING, Sr., B. on dandruff, baldness, thinning and graying hair. Much valuable information.—Ohio State Medical Journal. Best investment.—Science Education. Debunks hair fads.—Scientific American. Scientific fact.—Cosmetology Magazine. Without commercial bias.—Jeans Biological. Book of a scientist.—Home Acrea. Enormous assistance.—Fictorial Review, Practical.—Science News Letter. Send only \$2.00 today for postpaid copy of this authentic instruction, on how to save your hair. 6th printing. Prompt refund if not helped.
BRADNER PUBLISHING CO. (EST. 1933) Dept. 39, Cambridge 42, Mass.



BETTER JOBS-BETTER PAY FOR SKILLED MEN!

**QUICK TRAINING BOOKS
SHIPPED for Examination
SEND NO MONEY**

NOW is the time for every ambitious man to prepare for a better job at bigger pay with American Technical Society's easy-to-understand self-training books. All sets interestingly prepared by long-experienced experts and profusely illustrated. Spare time reading can give you the "know how" that brings more money. Use the jiffy index to find out what you need to know in a hurry. **Any set of books sent for examination.**



**8
BIG BOOKS**

**APPLIED
ELECTRICITY**

MEN who understand electricity are needed in all kinds of industries. This New 19th Edition of 8 big books contains over 3700 pages, 2700 illustrations and 134 tables. Latest subjects fully covered. Includes electronics, F.M. radio, arc welding, blueprint reading and many up-to-date subjects. **Total price only \$34.80. Sent on trial.**

**BUILDING, ESTIMATING
and CONTRACTING**



8 Volumes. This big set should make it easy for any carpenter to become a contractor. Invaluable to builders. Architectural drawing and design, estimating, concrete forms, building, heating, painting, decorating and many other subjects well covered. **Total price only \$34.80. Sent on trial.**



**MODERN
SHOP PRACTICE**

New Edition—8 Big Volumes

3000 pages with nearly 3000 illustrations, and a big binder of nearly 900 pages of original shop tickets and 1300 illustrations in addition to the 8 volumes. Among subjects covered are mechanical drawing, tool making, pattern making, foundry work, machine shop practice and management, and hundreds of other subjects which can fit you for a better job. **Total price only \$34.80. Sent on trial.**

AUTOMOBILE ENGINEERING
20th Edition—6 Volumes

Whether you are expert or beginner, you will find great value in these books which tell, step by step, how to make repairs, and keep cars at maximum efficiency. 2800 pages, 2000 illustrations, wiring diagrams, data sheets, etc. **Total price \$24.80. Sent on trial.**



PRACTICAL AVIATION

6 Volumes Prepared by Experts

The most complete and best illustrated set of Aviation instruction and reference books we have ever published. It covers whole range of subjects from first principles of flight through late types of engines, instruments, meteorology, gliding. **Total price \$19.80. Sent on trial.**

DIESEL ENGINEERING

6 Volumes. Over 3400 pages. Hundreds of illustrations. **Total price \$29.80. Sent on trial.**

DRAFTING

For beginners or experts in machine trades, compiled by well-known engineers and written so you can understand every word. Contains hundreds of blueprints, charts and diagrams which will help you to acquire "know how" and prepare for a good job. **5 Volumes, 1600 pages. Total price only \$19.80. Sent on trial.**

ANY SET ON APPROVAL

All you need do to get any set for personal examination is to fill in and mail the coupon and give required information. Read the generous offer in coupon and send today.

AMERICAN TECHNICAL SOCIETY

Vocational Publishers Since 1898

Dept. X819, Drexel at 58th Street, Chicago 37, Illinois

SEND COUPON TODAY

**AMERICAN TECHNICAL SOCIETY, Dept. X819
Drexel at 58th Street, Chicago 37, Ill.**

Send for 10 days' free use, the following set of books:

I will pay the delivery charges only, and if fully satisfied, will send you \$2.00 in 10 days and then \$3.00 a month until the total price of \$..... is paid. If I return the books in 10 days I will owe you nothing. You are to include a Year's Consulting Privileges with your engineers without extra charge.

Name.....

Address.....

City..... State.....

Please attach letter stating age, occupation and name and address of employer, and at least one business man's name as reference. Men in service, also please give home address.



The New Age of Chemistry

As peace comes the amazing miracles of our chemists which have played such an important part in bringing victory will bring new and better standards of health, more comfortable living, greater prosperity.

This New Age of Chemistry offers splendid opportunities for a bright and successful future to young people interested in chemistry.

CHEMCRAFT

REG. U. S. PAT. OFF.

Chemcraft will help you, as it has helped other boys and girls for over 30 years, to understand the principles of chemistry. And performing the many experiments explained in the manuals is a source of exciting enjoyment and entertainment.



This is Chemcraft Outfit No. 5, with 61 chemicals and pieces of apparatus. It contains special features and the manuals describe nearly 600 experiments. Price \$5.00

Other Chemcraft Outfits from \$1.00 to \$3.50, \$10.00, \$15.00, and \$25.00. If your dealer is out of stock, you may order from us.



IT'S FREE

Booklet describes fully all Chemcraft Outfits, explains many interesting experiments you can do at home, and tells some of the amazing things made possible by chemistry. MAIL COUPON.

THE PORTER CHEMICAL COMPANY
75 Prospect Ave., Hagerstown, Md.

Gentlemen: Send me your Free Booklet, "The Age of Chemistry."

Name

Address

City State



ONLY
\$1.95

ASTRO-TELESCOPE LENS KIT

Thrill yourself and entertain your friends with such heavenly sights as moon craters, Saturn's beautiful rings, comets, nebulae, and hundreds of interesting sights we guarantee you can see. A fascinating hobby for you. An ideal gift for that boy of yours. NOT A TOY.

A WONDERFUL LOW-COST XMAS GIFT

Kit includes all optical parts needed to build this powerful 6 1/2 ft. refractor, a 3" dia., 75" F.L. objective lens of high quality, 2 brass eyepieces of 50X and 100X ready to mount, color filter, diaphragms and building plan. New perfect lenses—not rejects. Remaining materials needed are readily found for less than \$2.00.

SIMPLE TO BUILD, TOO

Imagine building your own telescope a dozen times as powerful as fine binoculars in an evening of easy educational work, and at one-tenth the usual cost. Even a boy can do it with the easy instructions included.

UNBELIEVABLY LOW COST

Now amazing processes make possible a kit of 100X precision lenses, scientifically matched to peak performance, for the trifling price of \$1.95 POSTPAID, check or M.O. Money-back guarantee. Address an envelope now to:

BEELERSCOPE, BOX 235PM, North Hollywood, Calif.

If you enclose \$2.00 currency we'll return nickel with kit. DO IT NOW. Don't forget your return address. We mail same day. Mail it now and have your kit in a few days. Canada 5% extra. Send postpaid for FREE telescope building plan and list of outstanding optical values.

MAKE MONEY CASTING AT HOME

FREE FACTS SENT



Make hundreds of Plaster Casts, quick, easy. Sell output to stores, novelty shops, etc. Enormous profits. No experience. Very little capital needed. Start in basement, garage or workshop. Complete, simple instructions anyone can follow. Start now while merchants are begging for merchandise to sell. Rush.

PLASTIC ARTS STUDIOS, R.R. 5, Dept. 28, Muncie, Ind.

ACCOUNTANT

BECOME AN EXPERT

Executive Accountants and C. P. A.'s earn \$2,000 to \$10,000 a year. Thousands of firms need them. We train you thoroughly at home in spare time for C. P. A. examinations or executive accounting positions. Previous experience unnecessary. Personal training under supervision of staff of C. P. A.'s. Placement counsel and help. Write for free book, "Accountancy, the Profession That Pays." LASALLE Extension University, 417 So. Dearborn St. A Correspondence Institution Dept. 1164-H Chicago 5, Ill.

Learn Penmanship

You can learn plain, rapid writing or fancy ornamental writing for social and business advancement, right in your own home during spare time by my Simplified Method. Write for my free book, "How to Become an Expert Penman," which shows what others have accomplished by taking my Courses. Send 10c for one of my favorite Pen Points and your name with a beautiful flourished bird written on a card. Write today. T. M. Tevis, Box 25K, Chillicothe, Mo.



Fix Your Own ALARM CLOCKS

New, practical home course. Just out. Makes interesting hobby—profitable too. Save money by doing your own repairing at home. Easy if you know how. Price now only \$1.00. Details FREE. Send postcard. THIES JEWELRY STORE, Genoa 3, Illinois

Inventions Wanted

Patented or Unpatented

Inventions can now be safely sold without patenting expense. If you have a practical, useful idea for sale, either unpatented or patented, write INSTITUTE OF AMERICAN INVENTORS Dept. 4, 1926 Eye St., N.W. Washington 16, D. C.

BARGAINS in WAR SURPLUS LENSES & PRISMS



All Items Finely Ground and Polished but Edges Slightly Chipped or Other Slight Imperfections which We Guarantee Will Not Interfere with Their Use. Come Neatly Packed and Marked.

YOU CAN EASILY MAKE

Telescopes, Magnifiers Photographic Gadgets and Hundreds of Experiments with these Low Cost Lenses. Excellent for XMAS gifts, too.

To translate millimeter measurements; 25.4 mm. equals one inch.

TANK PRISMS

In order that the tank driver shall not get shot in the face, 2 of these Silvered Prisms are used to make a Periscope. We have secured a number of these, 90-45-45 degree Prisms of huge size— $5\frac{3}{4}$ " long, $2\frac{1}{8}$ " wide, finely ground and polished. Used to build a Periscope, camera stereo attachment, range finder, etc. Excellent also for experiments, classroom demonstrations. Prism easily converted into desk name plate by affixing gold letters. 100 gold letters supplied at only 10c. (Order Stock # 3008-N). Normally these Prisms would retail from \$24 to \$30 each.

SILVERED TANK PRISM

Stock # 3004-N.....\$2.00 each Postpaid

PLAIN TANK PRISM

Stock # 3005-N.....\$2.00 each Postpaid

FOUR TANK PRISMS Special — \$7.00 Postpaid

.....The most sensational bargain we have ever been able to offer.

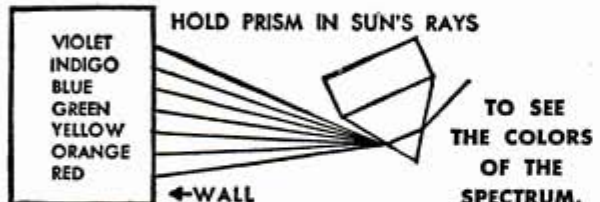

hold a plain tank prism in sun's rays as shown in drawing. White incident light which passes through prism is thus broken up into a band of primary colors known as the spectrum—a beautiful sight!

CLEANING BRUSH SET—12" flexible plastic handle, circular construction, 4 brushes to set, range stiff to soft.

Stock # 504-N.....Price \$1.00

MAGNIFIER SET.....5 Magnifying Lenses... Powers from 1 to 10. Various diam. for many uses.

Free Booklet on Home-made magnifiers included.

Stock # 1026-N.....\$2.00 Postpaid

8 MM PROJECTOR CONDENSING LENSES—Consists of two Condensing Lenses with combined F.L. of $\frac{1}{2}$ inch.

Stock # 4027-N.....\$1.00 Postpaid

16 MM PROJECTOR CONDENSING LENSES—Consists of two Condensing Lenses with combined F.L. of one inch.

Stock # 4026-N.....\$1.00 Postpaid

35 MM KODACHROME PROJECTING LENS SET—Consists of Achromatic Lens for projecting, plus a Condensing Lens and piece of Heat Absorbing Glass with directions.

Stock # 4025-N.....\$1.95 Postpaid

ALL THE LENSES YOU NEED TO MAKE YOUR OWN TELESCOPE! ALL ARE ACHROMATIC LENSES

GALILEAN TYPE—Simplest to Make but has Narrow Field of View.

Stock # 5003-N Power of either 5, 6 or 10. \$1.60 Postpaid

Stock # 5004-N Small 2 Power Pocket Scope. \$1.00 Postpaid

TERRESTRIAL TYPE—Have Much Wider Field of View than Galilean Type.

Stock # 5007-N 11 Power Telescope.....\$3.20 Postpaid

Stock # 5008-N 20 Power Telescope.....\$3.45 Postpaid

Stock # 5009-N 40 Power Telescope.....\$7.45 Postpaid

PRISM TELESCOPES—Uses Prism instead of Lenses to Erect Image and are much shorter than Terrestrial Type. Have wide field of view.

Stock # 5010-N 6 Power Telescope.....\$3.00 Postpaid

Stock # 5011-N 11 Power Telescope.....\$3.25 Postpaid

Stock # 5012-N 20 Power Telescope.....\$7.25 Postpaid

SPECIALS IN LENS SETS

Big 10 Page Project and Idea Booklet with all sets.

Set # 1-N "Our Advertising Special" 15 Lenses for \$1.60 Postpaid. For making your own powerful telescopes, low power microscope, strong magnifiers, drawing projector, photo cells, telephoto lens, dummy focusing camera, Kodachrome viewer, stereoscopic viewer, ground glass and enlarging focusing aids. For experimental optics, portraits of babies and small pets, copying, ultra close-up shots, and many, many other uses.

Set # 15-N—"The Experimenter's Dream"—62 Lenses, Prisms and Optical Items, and New 50-Page Book, "Fun with Chipped Edge Lenses". \$15.00 Postpaid. The variety of Lenses and Prisms in this set will enable you to conduct countless experiments, build a great variety of Optical Equipment. A sensational buy.

NEW 50-PAGE IDEA BOOK, "FUN WITH CHIPPED EDGE LENSES"

Contains wide variety of projects and fully covers the fascinating uses of all Lenses in sets listed above—only \$1.00 postpaid.

LENS FOR KODACHROME EYE-VIEWER—Color corrected cemented Lens 38 mm. diam., 2 inch F.L.

Stock # 6129-N.....\$1.00 Postpaid

MONOCULAR SET OF LENSES AND PRISMS...

From Navy's 7 x 50 Binocular. All the optics you need to make a 7 Power Monocular. Complete Directions included.

Stock # 5101-N.....\$5.00 Postpaid

SPECTROSCOPE SET... These sets contain all Lenses and Prisms you need to make a Spectroscope plus FREE 15-page Instruction Booklet.

Stock # 1500-N Hand Type Spectroscope.....\$3.45 Postpaid

Stock # 1501-N Laboratory Type Spectroscope \$6.50 Postpaid

MICROSCOPE SETS

Consisting of 4 Cemented Achromatic Lenses for making a 40 Power Pocket Microscope or 140 Power regular size Microscope. These color corrected Lenses will give you excellent definition and may be used for Micro-photography.

Stock # 1037-N.....\$3.00 Postpaid

Consisting of Prism, Mirror and Condensing Lens. These used together with Stock # 1037-N will make an excellent Micro-projector enabling you to get screen magnification of 400 to 1000 Power according to screen distance.

Stock # 1038-N.....\$2.00 Postpaid

MISCELLANEOUS ITEMS

Stock No.	Item	Price
3016-N	Pentagon Prism.....	\$.75 each
2024-N	10 Pieces Circular A-1 Plate Glass (Diam. 31 mm.—for making Filter).....	.25
4009-N	Heat Absorbing Glass 4" x 5".....	.35 each
523-N	Six Threaded Metal Reticle Cells.....	.25
26-N	First Surface Aluminumized Mirror, Diam. 1 1/4".....	.25 each
624-N	Neutral Ray Filter, size 4 3/4" x 2 1/2".....	.25
22-N	Inclinometer—Aircraft type.....	.25 each
704-N	Lens Cleaning Tissue, one ream (480 sheets) size 7 1/2" x 11".....	1.50
1030-N	2" Diam. Reducing Lens.....	.25 each
1031-N	Perfect 6 Power Magnifier—Diam. 28 mm.....	.25 each
1043-N	Crossline Reticle—Diam. 29 mm.....	.50 each
1034-N	Burning Glass Lens.....	.25 each

(Minimum order on above—\$1.00)

TANK PERISCOPE

Complete Set Mounted Components

Have fun! Make a real Periscope. Use it to see over the heads of crowds, to see under water, to see out windows without yourself being seen, and many other uses where observation by "remote control" is required. Originally constructed for U. S. Army Tanks, set consists of 2 fine Periscope mirrors mounted in metal and plastic. Perfect condition. Only plywood body frame is required to finish this exceptional Periscope. Set weighs $2\frac{3}{4}$ lbs. Overall length $6\frac{1}{4}$ " width $2\frac{1}{8}$ ". Would normally retail at \$40 to \$50. Stock # 700-N. \$3.00 Complete Set Postpaid (Two Sets (four units) ... Special \$5.50 Postpaid.)

Order by Set or Stock No.—Satisfaction Guaranteed

EDMUND SALVAGE COMPANY-P.O. AUDUBON, NEW JERSEY

So you'll be safer



Radar will make travel safer. General Electric scientists are working along these lines. Among many other G-E developments are better street lighting, which reduced night traffic accidents in one city 93 per cent in ten months . . . a tiny gage which prevents accidents to workers around cranes . . . a new hay-drying system that helps prevent farm fires caused by storing wet hay.

Working on developments such as these, G-E engineers and research scientists are helping to make life safer for you. *General Electric Co. Schenectady, N. Y.*



Radar prevents collision. This actual photograph taken on the bridge of the "American Mariner," U. S. Maritime Service Training Ship, shows General Electric's new peacetime radar Electronic Navigator helping plot a safe course. The officer is looking at the G-E Navigator's radar screen, which shows him the position of the ship and the objects around it. On ships or planes, in fog or darkness, radar will warn pilots of unseen hazards.

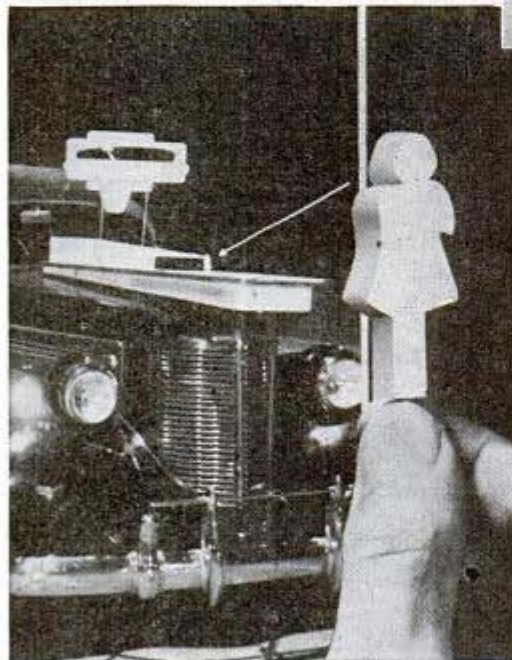

2-inch doll saves lives. Central character of an ingenious apparatus to test street lighting is a tiny doll that represents the average pedestrian as seen at a distance. The complicated device measures visibility and glare. It was devised by General Electric engineers to help make streets and highways safer for night driving.

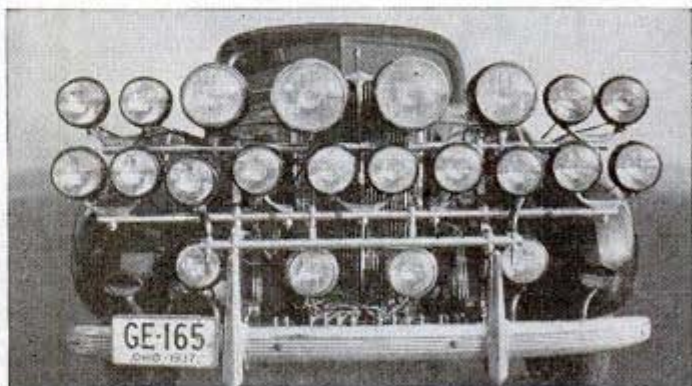

Bug-eyed auto was the car used in development of G-E Sealed Beam headlights adopted by the automobile industry. The Sealed Beam headlamps give more and safer light. Tests show that the average G-E Sealed Beam lamp gives 99 per cent as much light near the end of its life as it did when brand new. About 45 lamps of Sealed Beam type have been developed by General Electric for the Army and Navy.

The best investment in the world is in your country's future.

KEEP ALL THE BONDS YOU BUY

GENERAL  ELECTRIC

952-638-211

Popular Mechanics Magazine

Registered in U. S. Patent Office and Canada

WRITTEN SO YOU CAN UNDERSTAND IT

Vol. 84

NOVEMBER 1945

No. 5

BRINGING THE ATOM DOWN TO EARTH

By
Wm. F. McDermott

THERE were three atom bombs and four explosions: New Mexico, Hiroshima, Nagasaki and, the fourth and most shattering of all, the blast that plummeted the minds of untold millions into the strange new world of atomic energy.

The fact is that the dreaded but alluring atomic age is already here. Whole nations have grasped that fact almost with the speed of light. They may cringe before it—but they want it for its advantages and in spite of its dangers.

What does it portend for the future? Is a breath-taking revolution—industrial, social and even political—at hand? Has a new starting point in history arrived? Are science and invention, in unleashing unlimited power, about to turn the world upside down? Here's a prediction:

Within five years the first harnessing of the atom for peace will have been achieved, and within 10 years it will be the useful servant of man in a score of different ways.

Before we do any crystal-gazing, however, let's look at what some of the world's greatest thinkers and scientists, including several who were in on

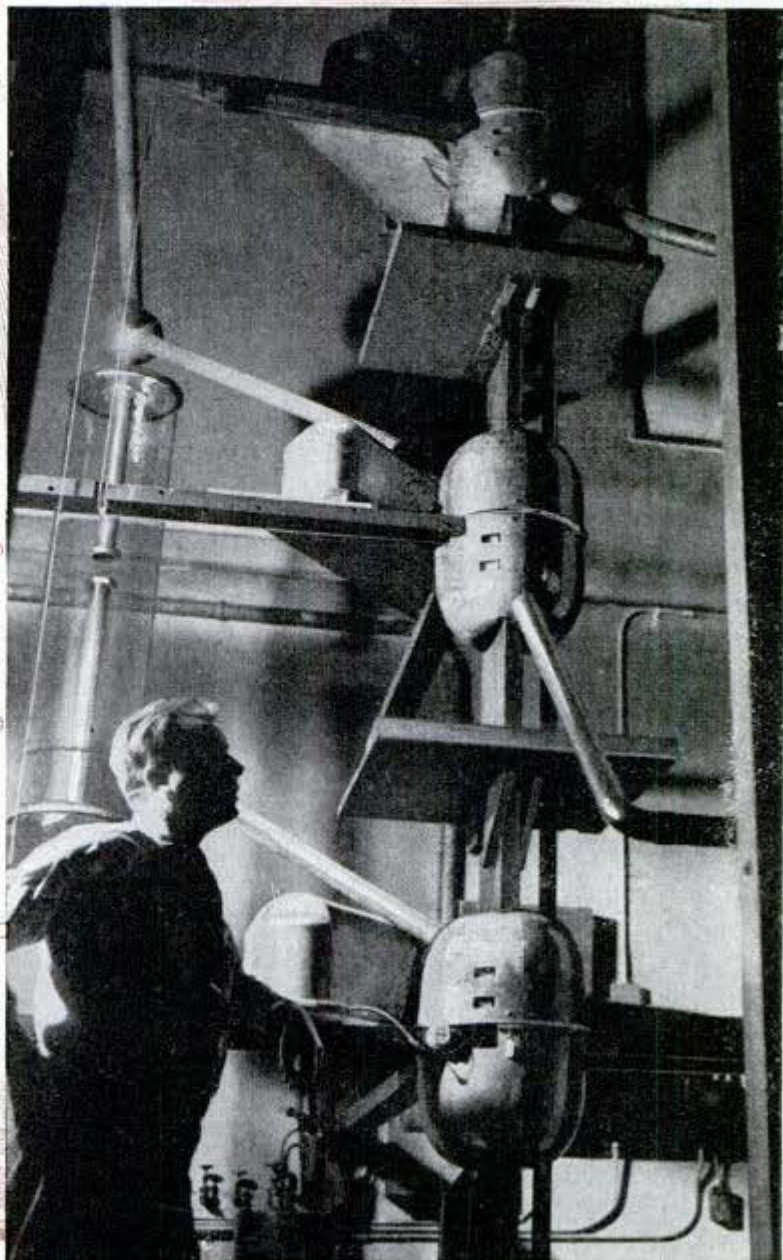

Dr. Samuel K. Allison, head of the University of Chicago's new nuclear institute, inspects one type of atom smasher—a voltage multiplying unit

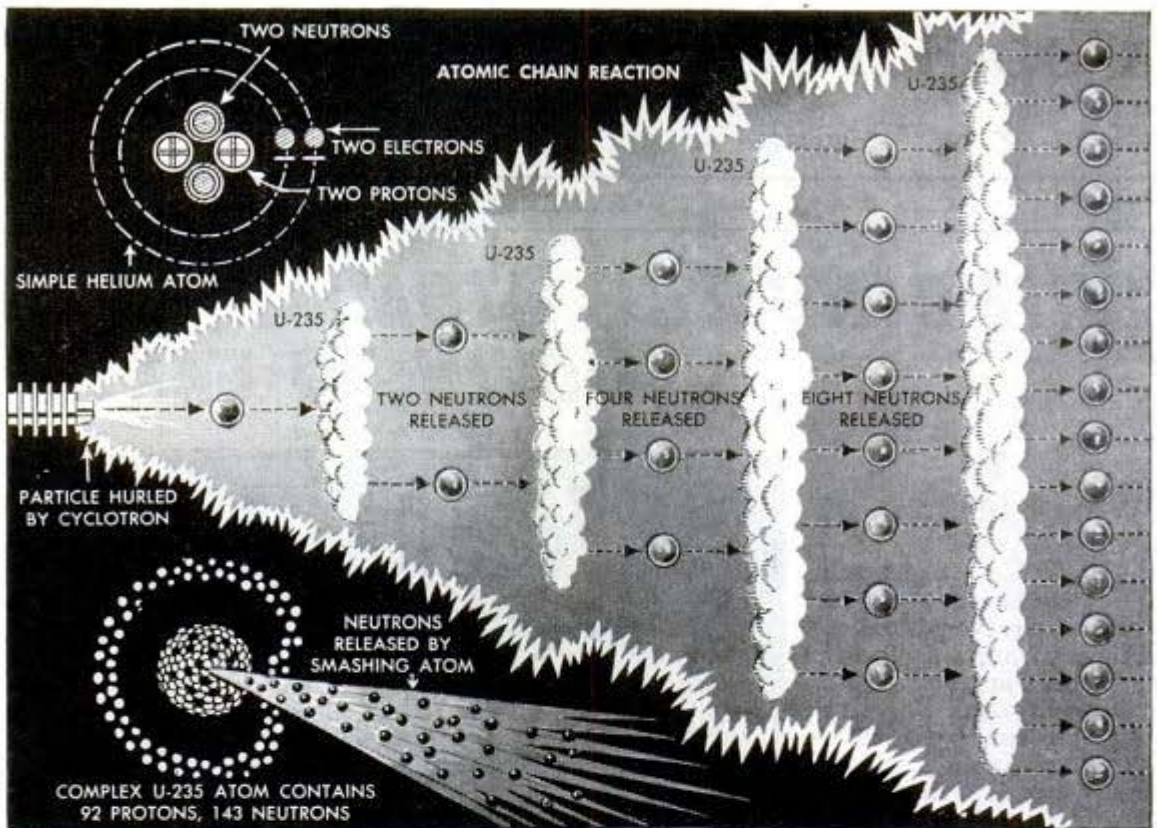

Simplified version of atomic chain reaction which releases tremendous energy; not shown are unstable atoms formed by splitting U-235 which throw off gamma and beta rays as well as the "trigger" neutrons

the miracle of the atom bomb, have ventured to foresee about man's capture of this secret of the universe:

1894—H. G. Wells predicted world-wide use of atomic energy and the employment

of atom bombs by 1954, saying that civilization would either destroy itself or adapt itself to a life as different as that of another planet.

1905—Einstein, declaring matter to be highly concentrated energy, calculated that 10 billion kilowatt-hours of energy are locked up in a pound of matter.

1926—Prof. James F. Morris, Massachusetts Institute of Technology, asserted that matter consists of "unthinkable amounts of

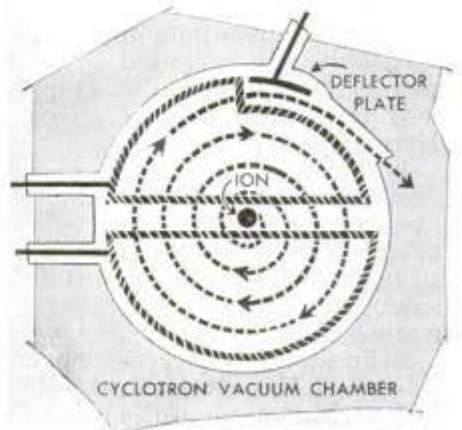
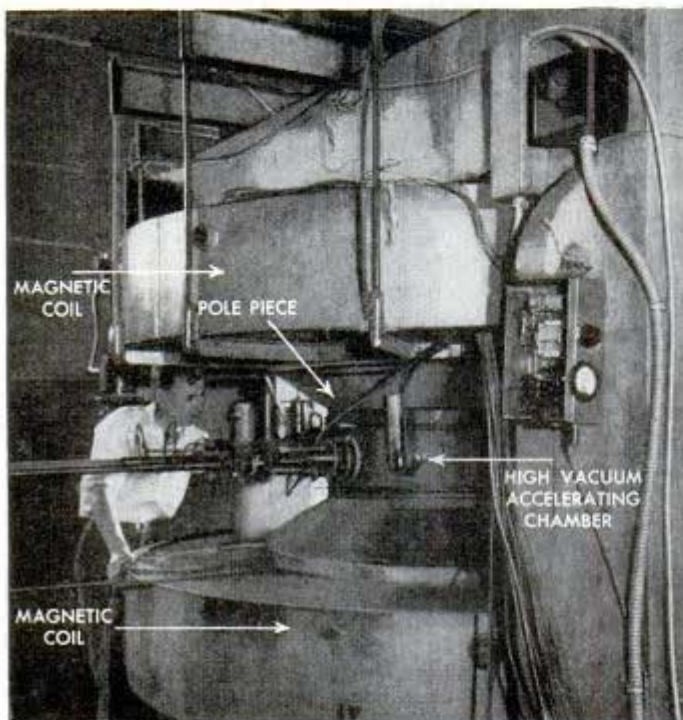

Diagram shows spiral path of ion in vacuum chamber of cyclotron at left; leaving chamber it is hurled at U-235

bound-up energy," while Dr. Karl Schlessel, German scientist, forecast: "The time is not far distant when, with the liberation of the atom, man will forget there ever was such a thing as suffering or poverty."

1939—Dr. Arthur H. Compton, Nobel Prize winner, addressing the Association for the Advancement of Science, said that atomic power, long-sought goal of science, was nearer man's practical use than was even dreamed of a year before. This power, locked in the nucleus of the atom, is of such tremendous order that a minute quantity of it would be sufficient to transport a liner across the ocean or to fire a gun from Chicago to Berlin.

1940—Dr. R. M. Langer, California Institute of Technology, one of the leading scientists in the development of the atom bomb, predicted that atomic energy would "change the face of the earth," with Sunday driving in a propellerless plane 50 miles above the ground, with free power for everyone for all possible uses and with unimaginable convenience for everyone's pleasure.

Even before Pearl Harbor, the curtain was quietly drawn on atomic developments, but the most feverish experimentation in all history swung into full speed. Four years later, that curtain was literally torn to pieces with the crash of the bomb on Hiroshima. The unleashed power not only met every expectation, but seemed to give prophetic promise of the fulfillment of every amazing chronicle of what the release of atomic energy might mean to the future of mankind.

Below, artist's conception of uranium engine adapted from 1941 issue of Popular Mechanics

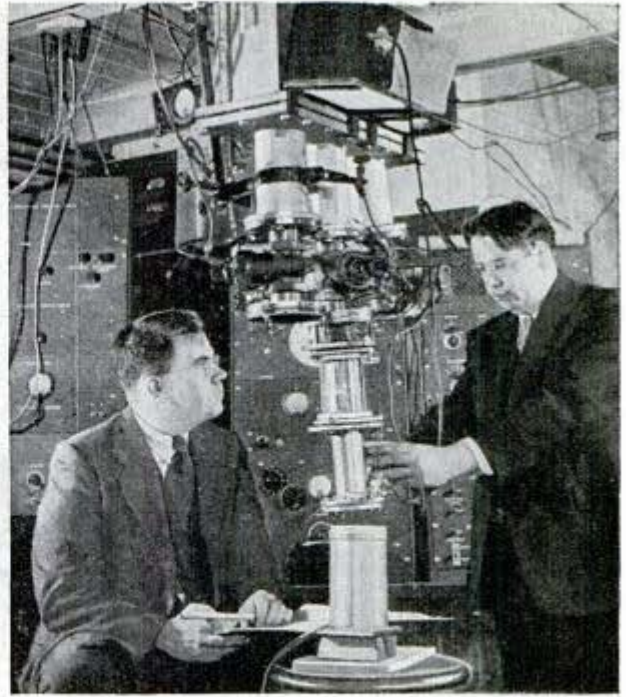

This is the target end of 90-ton atom smasher in Westinghouse research laboratory. Below, iron core of electromagnet built for cyclotron at University of California

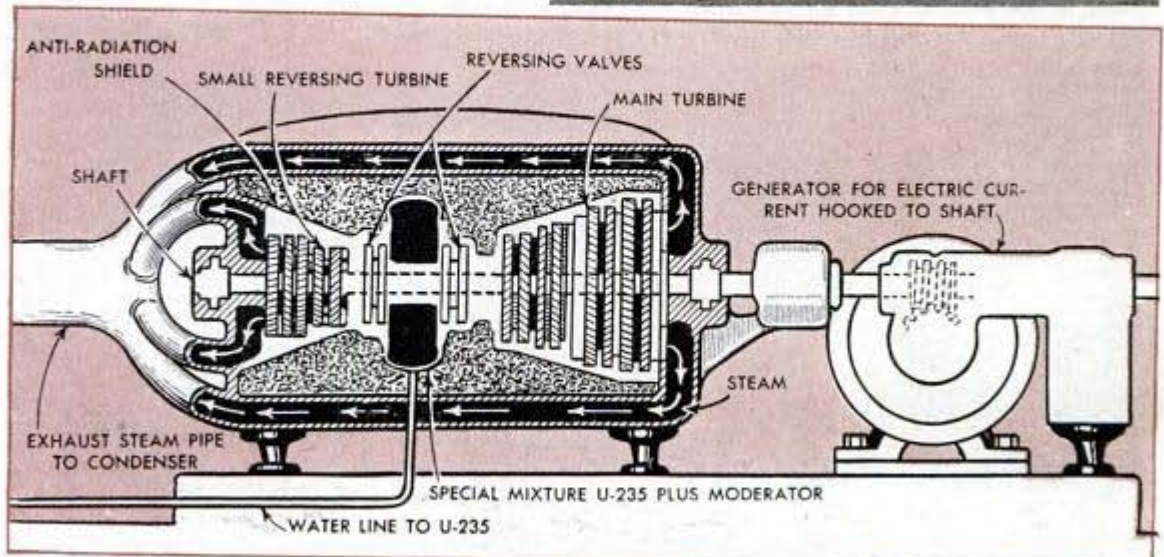
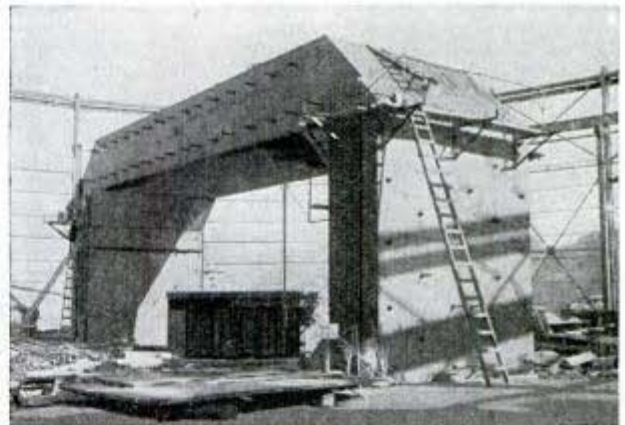

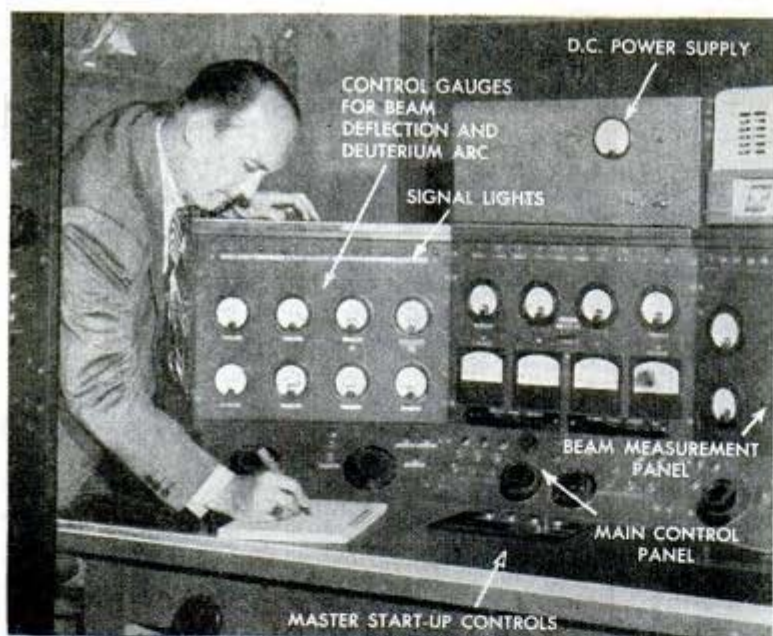

Control panel of cyclotron at University of Chicago permits remote and accurate control during experiments and protection from dangerous rays



Pittsburgh Press photo
Demonstrator at atomic power show in Pittsburgh Buhl Planetarium shows how slow-moving neutron enters nucleus of U-235 atom, splitting it to release second neutron which strikes another atom. Below, radium neutrons hit U-235 embedded in paraffin and screen records splitting atom



Cautious scientists, whose secrecy for years had equalled their applied genius — both complete — lifted the veil for a peek into the future. They who had worked closest to the atom bomb foresaw near-miracles to come. One of the most effective projections into the future was made by Dr. Reuben G. Gustavson, eminent scientist and dean of faculties of the University of Chicago, whose work on the atom bomb was of major importance.

Energy 400,000,000 times more powerful than derived from any other power source can be delivered, he told the Executives Club in Chicago. And just as important as that was his assertion that, if resources were made available, an experimental atomic plant could be placed in operation by next April, and in five or 10 years production of such power could be made economical! He added that atomic developments may bring about the long-sought cure for cancer.

The logical first step will be to capitalize on the knowledge of the atom bomb — namely, apply the known controlled form of atomic power. That is as a superexplosive. Where could constructive use be made of such devastation as was visited on the two Japanese cities, laying waste many square miles at a single blow, and leveling as many as 18,000 buildings?

One of the likeliest effective services would be in checking forest fires. Even as enemy cities were being blown to pieces, a great conflagration ravaged more than a quarter of a million acres of fine timber in Oregon. Fire fighters struggled in vain to make clearings

The story of atomic research has been told as it developed through recent years in these articles in previous issues of Popular Mechanics:

Smashing Atoms	- - -	March 1937
Putting the Atom to Work	- - -	May 1938
Sharpshooting at the Atom	- - -	July 1940
Harnessing the Atom	- - -	Sept. 1940
Exploring the Heart of the Atom	- - -	Nov. 1940
The Miracle of U-235	- - -	Jan. 1941
Siege Gun of Science	- - -	Sept. 1941
Giving Atoms the Third Degree	- - -	Nov. 1941
"Tracer Bullets" of Science	- - -	May 1942
Atomic Power for War and Peace	- - -	Oct. 1945

beyond which the onrushing flames could not go — yet a path a quarter of a mile wide in advance of the blaze, such as controlled, minute atom bombs might blast in a single second, would have done what thousands of men couldn't do.

Already there is speculation as to the possibility of some weather control by atomic forces. The mayor of a Florida city asked that a bomb be exploded in the midst of a hurricane, to see if it might scatter or check it. That raises the question whether something akin to a vast tidal wave might be started whose destructiveness would be still greater. It is believed, however, that the atom bomb does affect the weather. Although the sun was shining brightly when the atom bomb was dropped on Hiroshima, a missionary reported that a hurricane struck the city half an hour after the bombing. In



Electrostatic generator of California Institute of Technology performs same work as cyclotron in atom-smashing experiments. Below, scientists in New Mexico used tanks coated with lead inside to guard against radioactivity in studying first A-bomb explosion





Scientist holds Roentgenometer testing for radioactivity in sand after first explosion in New Mexico. Note canvas bags over shoes

another case a storm cleared away soon after a bomb was exploded.

A tremendous iceberg sank the Titanic, luxurious liner which was the pride of all the seas in its day, back in 1912. Even today icebergs are a menace to navigation, and their presence must be taken into account in charting the courses of vessels.

This scene in Hiroshima testifies to tremendous power of A-bomb



Atom bombs, or well placed atomic explosive charges, offer the possibility of clearing the oceans of these floating dangers. Broken into icy slivers, they might dissolve in the warmer water and disappear. The terrific heat engendered by an atom bomb, shown by the way sand was fused into slabs in the New Mexico experiment, indicates that heat as well as violence would aid in vaporizing the icebergs.

Icebergs do not form the only frozen barriers of the sea to man. Vast expanses of ice tie up harbors often for six months or more of every year. Russia is an example of a great nation virtually ice locked half the time because her ports are so far north. She may get year-round ports as the result of this war.

The question arises: Does not atomic power make possible keeping open those ice-bound ports the whole year round by recurring blasts, or at least opening ports weeks sooner than usual and keeping them open weeks longer? The use of heavy ice-breaking boats may give way before long to a string of atomic explosions that will make a winter path for ships as clear as in summer time.

Sea power was shown in this war to be as effective as ever in the history of the nations. While air power is a new and major factor, yet it has neither eliminated nor minimized seagoing traffic; also, with "one world" at hand—at least in trade and commerce—there is bound to be undreamed-of traffic on the seven seas. Now, if ocean floors could give up their dead—sunken ships—there would be a parade of watery ghosts which would probably stretch farther than the merchant marines of the world today, and many of them would be found to have been the victims of hidden rocks and treacherous shoals.

Here the tumultuous power of the atom may soon come into play. Explosions that level cities can also lay waste many a granite "hell gate" where ships totter into a watery grave. With the limited

(Continued to page 160)

Rocket "Pipe Organ" Played Dirge for Japanese

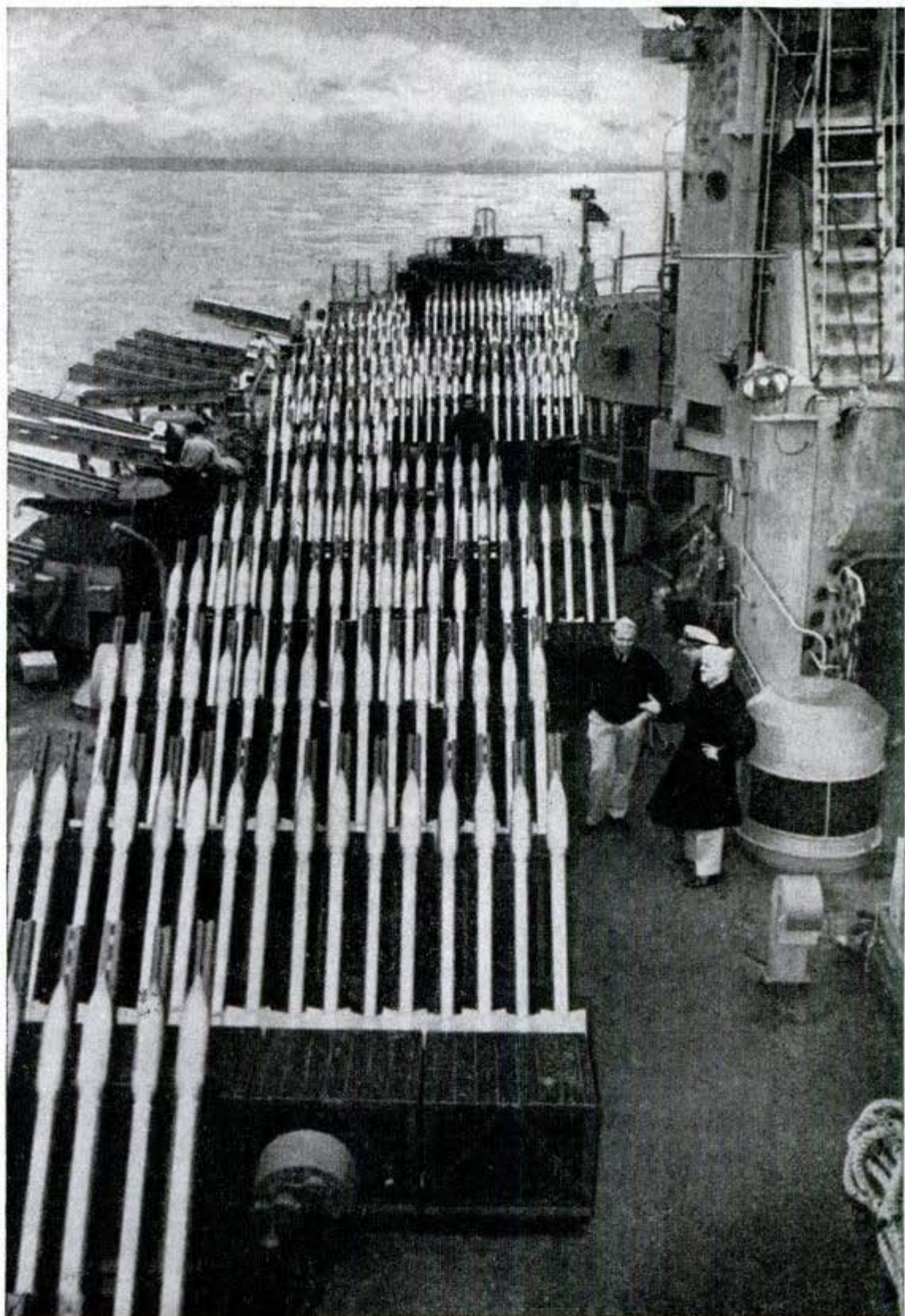

Row on row of rockets were all set to be turned loose against the Japs—if they hadn't surrendered. This photograph—recently released by the Navy—shows rocket launchers on the deck of a landing craft.

NOVEMBER 1945

MORE POWER for globe-circling civilian transports is foreseen with the successful combination of jet propulsion and reciprocating engine in the Navy's new fighter, the Ryan FR-1 Fireball.

This low-winged fighter, designed for quick takeoff from a carrier, is powered by a Wright Cyclone 1350-horsepower radial engine in the nose and a General Electric jet propulsion engine between cockpit and tail. The engines can be used separately or in combination.

The reciprocating engine drives a broad-bladed Curtiss propeller and gives the Fireball a maximum speed of 320 miles an hour. The thermal jet alone, far more powerful than a conventional engine of the same weight, drives the fighter at 300 miles an hour. Top speed with both engines is still a Navy secret, but is believed less than the total of the two figures. At a cruising speed of 207 miles an hour, the regular engine gives the Fireball a 1500-mile range.

In addition to greater speed, the combination of jet and propeller affords a quick getaway and fast rate of climb. Thirty seconds after the G-E jet engine is started, the fighter is ready for takeoff.

Improved maneuverability is another operational feature of the Fireball. At a demonstration in Washington, D. C., a squadron of 12 of the new fighters did a tight loop in formation at 400 miles an hour. This squadron was in training for an attack on Japan, but the war ended first.

Designed and built by the Ryan Aeronautical Company of San Diego, Calif., the Fireball is a single seater, exceptionally streamlined for a twin-engine craft. Both engines are completely enclosed. Air scoops for the nose engine are within the engine cowling, and the intakes for the jet engine are in the leading edge of the wings near the fuselage.

This propeller-jet fighter packs a lethal wallop. It has two .50-caliber machine guns in each wing and carries a 1000-pound bomb under each of the wings. Instead of bombs, it can carry rockets or droppable fuel tanks, depending on its use.

Aviation enthusiasts, however, are more interested in the impact of this plane on future aircraft power plants than against any potential foe. The thermal jet, as a primary or auxiliary source of power, may help boost huge transports into the air and provide a powerful and smooth functioning engine for the stratosphere. The compressor can take in air at 76 degrees below zero, while in the same engine the turbine is working in extreme heat. The jet burns almost any kind of liquid fuel and consumes less fuel at high altitudes due to decreased drag. The jet unit is an improved model of the engine used on the P-59 Airacomet.

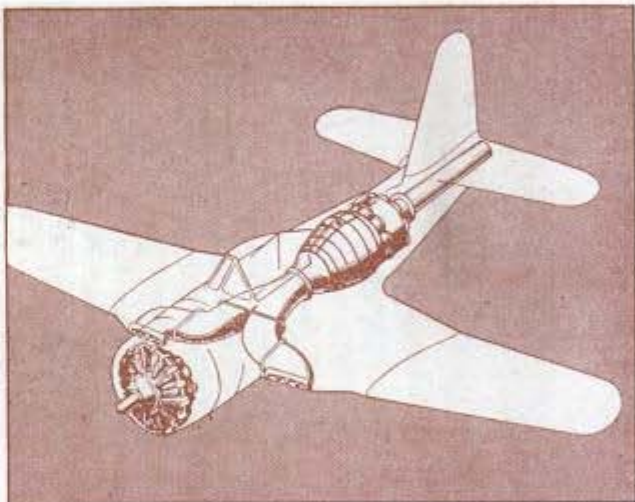

The unique combination of reciprocating engine in the nose and jet propulsion engine back of cockpit gives the Ryan Fireball balance as well as speed and maneuverability. Below, wings fold up. Fireball is first Navy carrier plane with tricycle landing gear

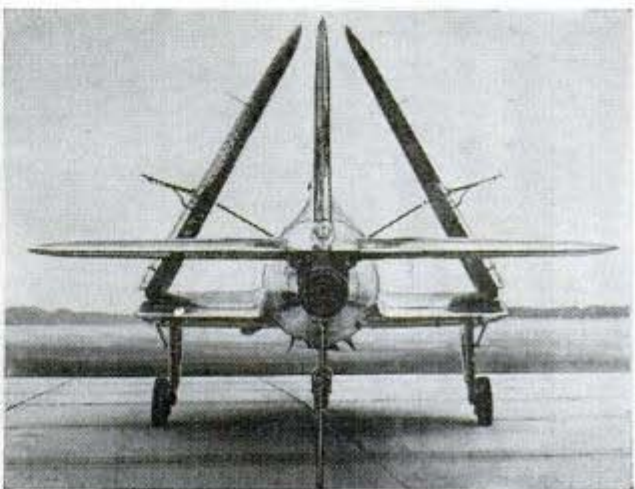

JET = FIREBALL



With both engines completely enclosed, Fireball looks like single engine fighter. Exhaust for jet comes out under tail, and air intakes are in leading edge of wing near fuselage. The fighter carries rocket launchers (right) under each wing, 1000-pound bombs or droppable fuel tanks



Silhouettes show distinctive lines of new fighter. Right, mechanic adjusts fuel line on front of General Electric jet engine

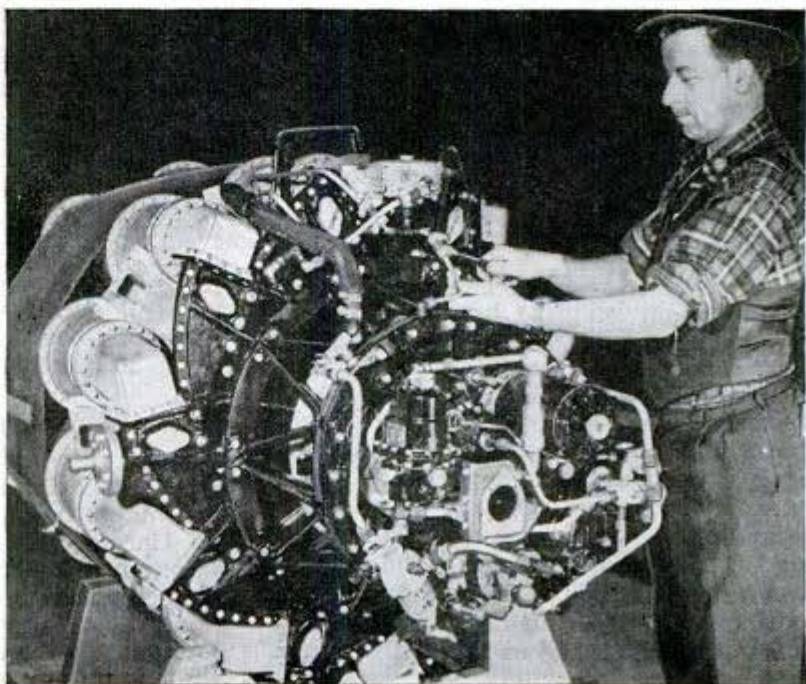

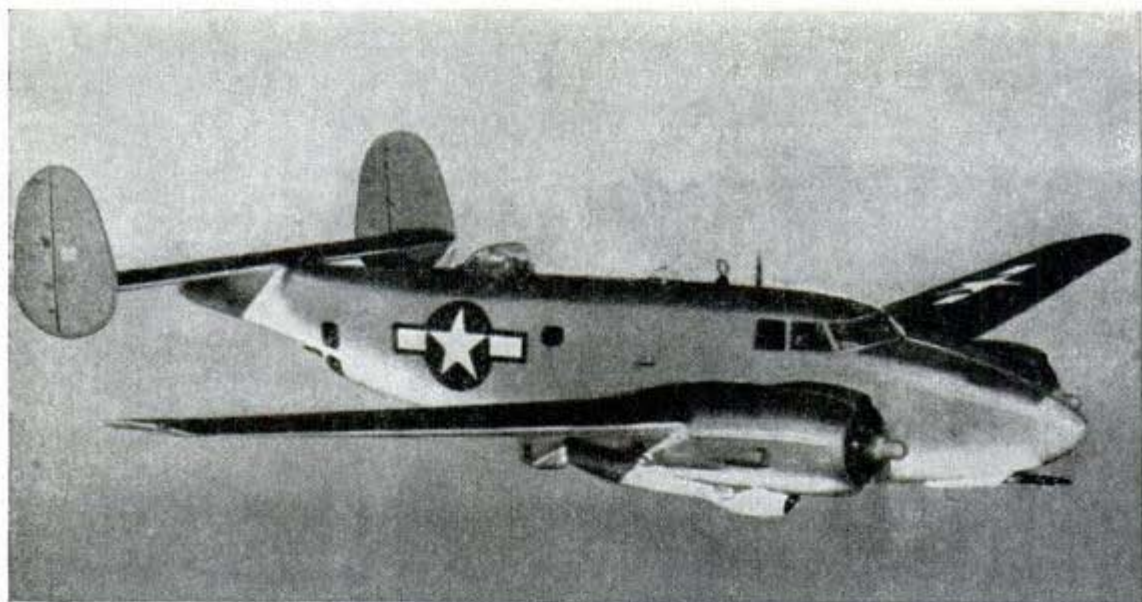

2000-Mile Navy Bomber

Taking part in the final knockout of Japan was a new Navy medium bomber, the PV-2 Harpoon, with a range of more than 2000 miles. The Harpoon carries a full size 1800-pound torpedo, has four rockets under

each wing and is armed with ten .50-caliber machine guns. It has a speed of over 300 miles an hour. Built by Lockheed Aircraft Corporation, the two-engined bomber was flown on dangerous 1500-mile round trip missions from Aleutian bases to Jap positions in the Kurile Islands.



Nazi 'B-29' Carries 90 Men

Among enemy craft being analyzed at Wright Field is a giant Junkers-290, one of the largest planes built by the Nazis. It was captured near Munich and flown to Dayton, Ohio. The huge craft, comparable in size to the Boeing B-29 Superfortress, has four 1700-horsepower engines, a wing span of 138 feet and length of 92 feet 10 inches. Built as a transport which can be converted into a bomber, the plane can carry 10,000 pounds of bombs or 90 men and has a range of 2000 miles. Maximum speed is about 240 miles an hour at 18,000 feet. The "Alles Kaputt," as this "all-through" bomber is appropriately named, is not a

high altitude craft like the B-29, which has a ceiling well over 35,000 feet. The B-29 has more powerful engines (2200 horsepower), greater range (about 3600 miles), is faster (over 300 miles an hour) and can carry 10 tons of bombs.

Wax-Free Lubricant for Engines

Particular advantages in cold weather are claimed for a nonpetroleum lubricant for internal combustion engines developed by Carbide and Carbon Chemicals Corporation. Wax-free, it can be made to any desired viscosity and has a density approximating that of water. Carbon residues are low and sludge and varnish formation in the engine are practically eliminated.



The BIG PIT

PART 2

MOTHER NATURE is an old party with a great deal of foresight, which she exercised admirably when she placed the iron ore ranges of the Lake Superior district close to the waters of the Great Lakes.

Proximity of the Mesabi, Cuyuna, Vermilion, Gogebic, Menominee and Marquette ranges to the low-cost transportation offered by the lakes has probably contributed more than any other factor to the tremendous development of our iron and steel industry. Removal of millions of tons of ore from the open pit and underground mines in Minnesota, Wisconsin and Michigan, as described last month, is only half the story. Transportation of the ore to the blast furnaces of the great iron and steel centers is a gigantic operation that has taxed all the mechanical ingenuity of the railroads, lake transportation companies and the iron and steel makers.

More than 40,000,000 tons of ore were hauled overwater to the mills up to last August 1, almost 50 percent of the quota of 92,000,000 tons set before the end of the war. The operators expect a good peacetime ore demand for years, meeting huge requirements of the heavy industries—railroads,

Great Northern Railway photo

Oliver Iron Mining Co. photo
 "Endless" ore train leaves Hibbing, Minn., en route to docks at Duluth. Below, thawing out ore in car with steam from a locomotive

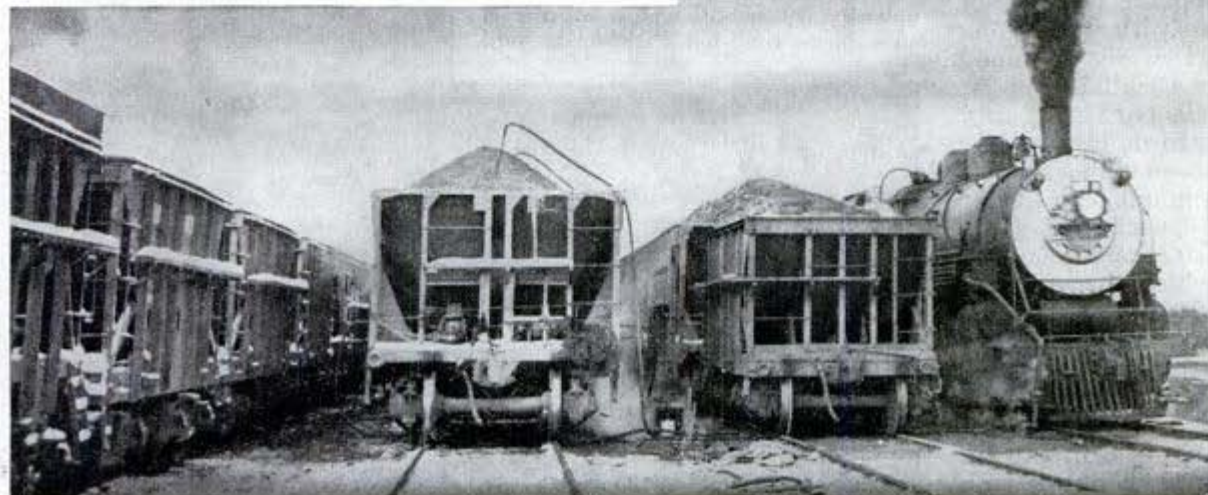
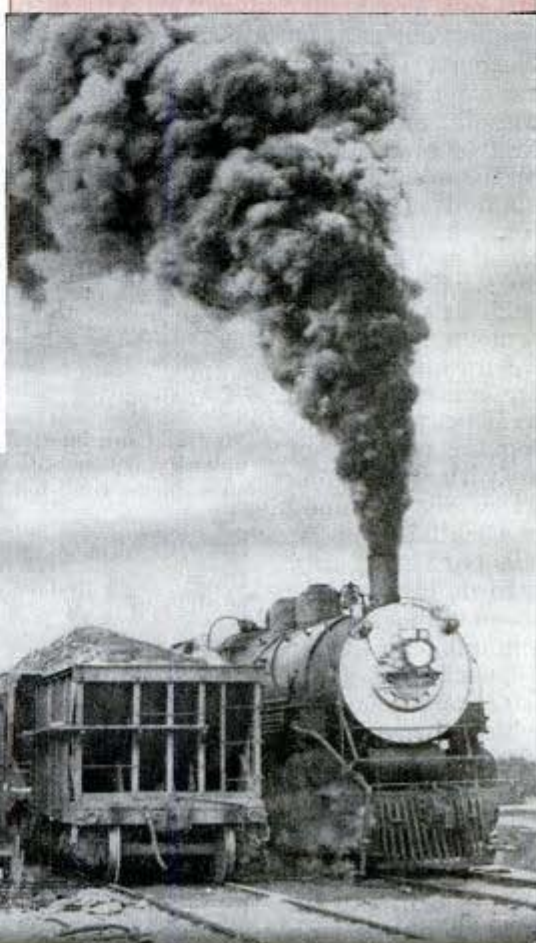



Samples of iron ore from loaded cars are analyzed in Hibbing laboratory to obtain proper grade for mills

automobile makers, construction companies—for civilian iron and steel equipment.

The Mesabi Range, whose pride is the three-mile-long Big Pit, affords a good illustration of what happens to the ore after the electric shovels have gouged it out.

Highest grade ore can be loaded into the ore cars and hauled by rail directly to the loading docks at Duluth, Superior or Two Harbors. Unfortunately, this simple process can't be applied to all the ore mined at Mesabi, and much of it must be treated first to obtain the proper grade required by the mill. Various

methods are used to remove useless material and condition ore for the furnaces, such as washing to remove sand; drying for ore with water content as high as 15 percent; roasting for removal of sulphur; crushing when ore is mined in rocklike chunks; sinterizing, by which the ore is fused with a specific amount of coke for a specialized purpose; nodulizing, in which the ore goes into a concentrator and a magnetic separator takes out unwanted material.

All this processing is done to fill specific orders on

hand from the mills. After an ore car has been loaded at any of the treating plants, or loaded directly, five samples of its contents are removed for testing. By the time the ore trains reach classification yards on their way to the docks, a report has arrived showing the exact composition of each carload of ore—its iron, phosphorus, silica, alumina, manganese and moisture content.

Phosphorus content is highly important, since the ore used in Bessemer furnaces for making steel must contain no more than 0.045 percent phosphorus, while high phos-



Way bills are inserted in machine which automatically records weight of cars in scale house near big classification yard



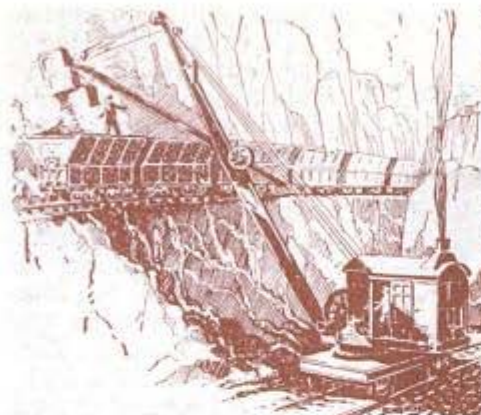

phorus ores are satisfactory for open hearth furnaces. Highest grade ore being extracted today contains about 52 percent natural iron.

Armed with the chemical data on each car and its weight, taken at the classification yard, the yard grader then distributes the cars into blocks sufficient to fill a specific vessel, and containing a grade of ore ordered for delivery to a certain mill.

Eight railroad lines find ore hauling a profitable business: The Duluth, Missabe & Iron Range Railroad; the Great Northern Railway Company; Northern Pacific; Soo; Chicago and North Western Railway; Chicago, Mil-

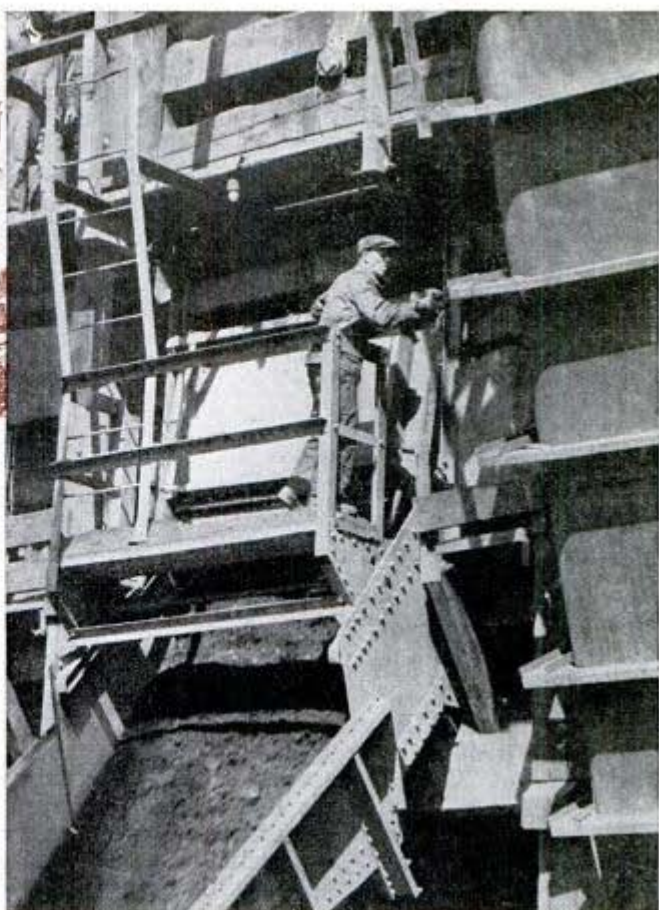

Great Northern Railway photos

Ore rushes down chute from dock "pocket" on way to vessel. Below, moving iron ore from train to boats at Allouez Docks





Pittsburgh Steamship Co. photo
 Unloading new 639-foot ore boat which carried to Conneaut, Ohio, one of largest iron ore cargoes—16,383 tons. Hulett unloader is at work

waukee, St. Paul & Pacific Railway; Duluth, South Shore & Atlantic, and the Lake Superior & Ishpeming.

Serving a 50-mile area of the Mesabi Range about 100 miles northwest of Duluth, the Great Northern's ore assembly point is at Kelly Lake, Minn., a train yard of 2588-car capacity. The trains routed through here serve 68 mines, with hauls from mine to lake averaging 110 miles. The cars carry about 60 tons of ore.

The 90 to 130-pound rails are fully tied-plated with heavy plates equipped with rail anchors. Lines are well ballasted with a minimum of 4000 cubic yards per mile of processed gravel or mine tailings. There are 3250 hardwood ties per mile.

the Mesabi pours into the 1352 pockets of the four docks, each pocket having an average capacity of 326 tons. Three of the docks are of steel and concrete construction and the fourth of timber. They are from 1868 to 2272 feet long, exclusive of approaches.

Each dock has four tracks on top, at a level 75 to 81 feet above the lake. Pockets are spaced to correspond with the hatch spacing of the ore boats which tie up below them. Ore cars run out over the pockets, dump their loads, and the ore then is cascaded into the boats by long rows of chutes suspended from each pocket. A record for loading in a 24-hour period was set June 19, 1944, when 22 boats were loaded

Except for one mile of single track, all the Great Northern ore lines are double tracked and block-signalized. Electric air compressors located at three points on the range save 30 minutes formerly required for the locomotives to pump enough air for brakes. All the locomotives are steam and burn coal from the East, much of it carried in by ore boats returning from the lower lakes.

Near Superior, Wis., the Great Northern operates the Allouez Docks, largest iron ore docks in the world, with a total capacity of 441,800 gross tons of ore. Here ore from

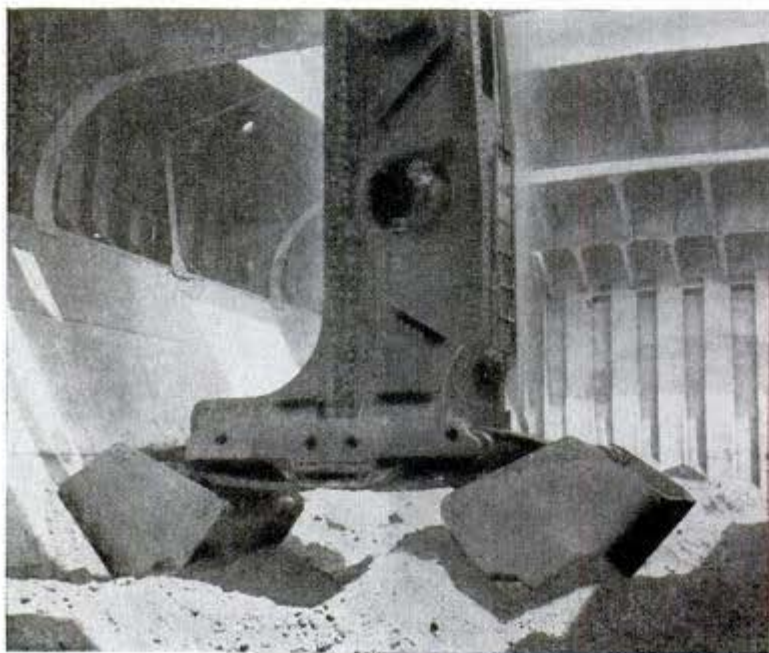

Operator sits directly over bucket in Hulett unloader and rides down into hold of boat as it takes huge bite of ore at Gary, Indiana, steel works

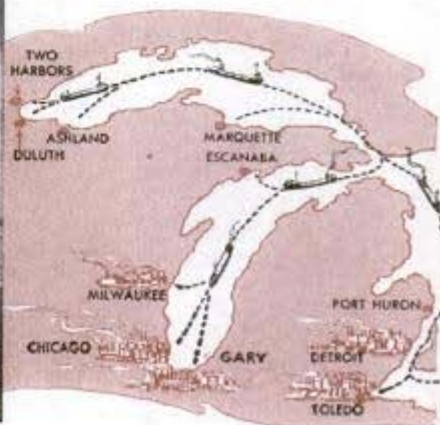

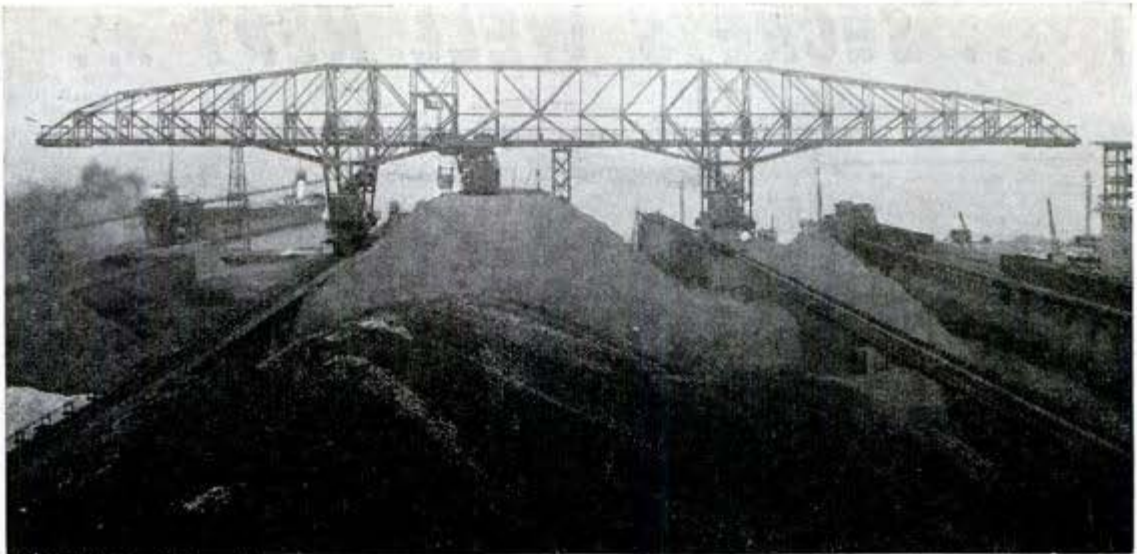

U. S. Steel Subsidiaries photo

Automatic "grabs" run on tracks along arms of bridge carrying ore from ship's hold to stockpile or cars

at Allouez with a total of 266,804 gross tons of ore. Twenty-four vessels can tie up at the dock at once, and 16 can be loaded simultaneously. A total of 2184 vessels was loaded there in 1944.

The Duluth, Missabe & Iron Range Railroad maintains huge docks at Duluth, Proctor, and Two Harbors. In a speed test at the latter port, a freighter cleared the dock with 12,506 gross tons of ore in 16½ minutes. Other docks are maintained at various points on the lake by the other railroads serving the different ranges of the district.

Each spring brings a literal rebirth to the open pit country, since winter operations there must be confined to stripping and maintenance work, and mining goes on

only in the underground mines, the ore being piled into stock piles to await transport to the mills.

First comes the ice report for the Great Lakes by the Weather Bureau, early in March. Near the estimated date at which the waterways can be opened, the railroads supply cars for loading at the mines, usually coinciding with the date the ore boats leave lower lake ports for their first cargoes. Coast Guard icebreakers, among them the new \$10,000,000 icebreaker Mackinaw, smash through the last recalcitrant ice to clear a passageway. The earliest shipment was made on March 27, 1942, from Allouez, and the latest cargo left the docks there December 5 of that year, a

(Continued to page 158)

Journey's end — molten iron made from the ore in blast furnace flows into ladles at works of the Carnegie-Illinois Steel Corporation in Gary

Map shows lifeline linking iron ore docks in north with great iron and steel centers

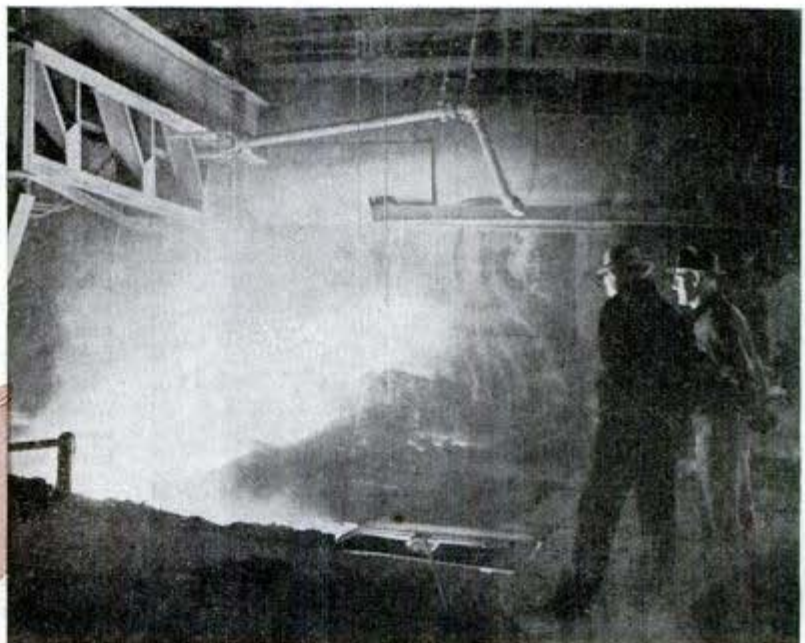

... SECRETS WELL KEPT ...

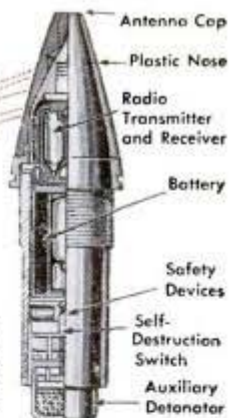
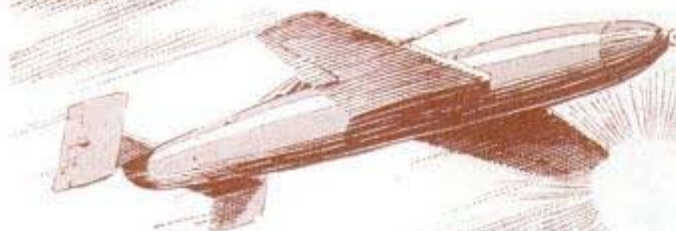

Jap suicide plane at top is blasted by a projectile exploded by a radio proximity fuse. Above, right, closeup of fuse. It also fought secretly in combating the Nazi buzz bomb attacks on London in 1944. Smaller than a pint milk bottle, the fuse automatically exploded 5-inch shells that came within 70 feet of their targets

Detonator-type primer half as big as aspirin tablet exploded "goop" fire bombs



Another well-guarded secret was the flight, in June 1944, of six Navy patrol blimps from this country to the Mediterranean to fight Nazi subs. Two others went to Africa

The Germans had developed a torpedo with a range of 80 miles which had an acoustic head that "listened" for targets

Floating tank raises its canvas walls to convert it into a sea-going weapon. Below, disguised by the boatlike framework that enables it to swim, the flotation equipped tank lumbers ashore

The world's biggest gun—built for the Nazis by the Krupp Works—was discovered by an American officer in a Bavarian forest soon after V-E Day. Weighing 1344 tons, the monstrous gun fired 8-ton, 31.5-inch shells a distance of 30 miles. Designed for use against the Maginot line which crumbled without this intended blasting, the gun was employed against Sevastopol



Worn-out Flying Fortresses, carrying no pilot or other crewmen, crashed down on the heavily defended German island of Helgoland with 11-ton bombs. An Allied pilot and co-pilot would take the B-17 up in England, head it across the North Sea and then bail out before crossing the English coast. Radio control did the rest

When the European war ended, the Nazis were preparing to build jet-propelled U-boats with underwater speed of 25 knots

CRUISERS ARE A TOUGH BREED

The story of the fighting cruiser *Columbia* as interpreted from her log by Thomas E. Stimson, Jr.

MAYBE you are one of the landlubbers who thinks a ship is just a piece of machinery. Brother, that's wrong.

Take me. I'm a 10,000-ton cruiser, a lightweight, fast and tricky. I've been scared at times and I've been lucky and I've even been embarrassed. You can't say that about a piece of inert machinery.

I've kept on fighting when I was badly hurt. I fought at Guadalcanal, at Munda, I bombarded Bougainville, I helped at Leyte, Mindoro, Lingayen Gulf, and I've been in half a dozen other sea fights besides.

My guns fired 45,000 rounds of shells during one four-month period alone—800 tons of metal—and my



Last-minute supplies are loaded on USS *Columbia* by a crane. Below, the cruiser's anti-aircraft guns dealt with Jap planes

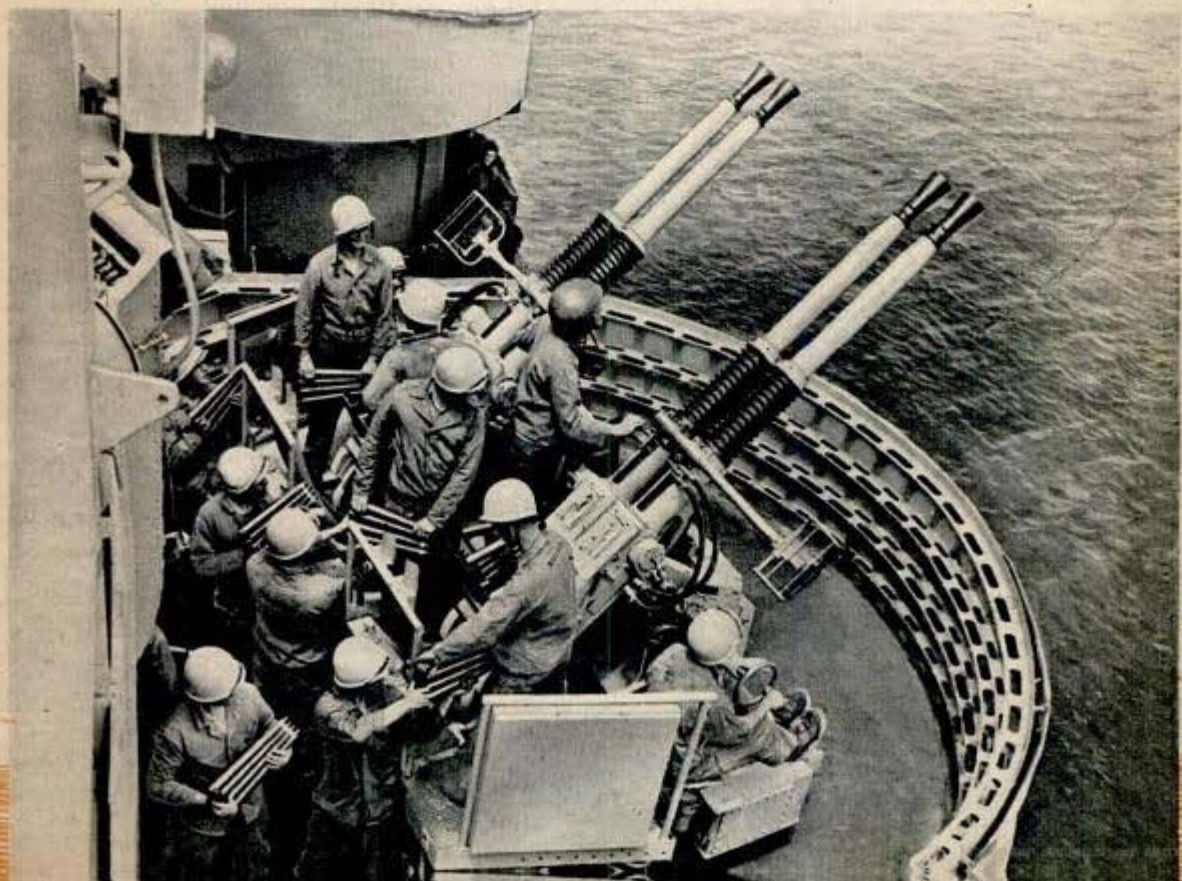



Mask, gloves save spotter from Jap plane flames
Below, ammunition handlers for anti-aircraft gun



score card includes two Jap warships sunk, 24 Jap planes downed, and an uncounted number of enemy shore installations knocked out during eight bombardments.

I've seen more action than lots of ships several times my age. I'm three years old.

We cruisers are a tough breed. Some of us have had our bows blown clear off but only a few have been sunk. We come in three sizes, light, heavy, and large. We are raiders, we act as anti-aircraft ships to protect transports and carriers, we bombard the enemy shore, we back up amphibious landings and take part in fleet engagements. We carry aircraft and do long-range scouting.

As a light cruiser I have very little armor and depend on my main batteries of six-inch guns, twin-mounted five-inch dual purpose guns, and 40 and 20-millimeter automatics for protection. I'm a floating porcupine although the books say I'm supposed to run from heavier ships that out-gun me. The war wasn't fought that way and as an example I'll tell you about my worst scare, the Battle of Surigao Straits during the initial Philippine landings.

It was a few hours before daybreak. A big part of the Jap fleet with the battleships Fuso and Yamashiro in the lead was closing with an American task force. I was in front, with nothing in front of me except the Japs. It was a very uncomfortable place, for one salvo of 14-inch shells could have sunk me without a trace. Jap shells began to land so close the men on my deck were splashed by their spray.

I'll dip my flag to our destroyers. They ran in past me and hit the Japs with torpedoes. That slowed down the Jap battle-wagons but didn't put them out of action.

By now the range was so short that my sister cruisers and I were getting in some hits with our relatively light guns. All in all, we punched so many holes in the big Japs that we set them on fire and sank both. A lot of Jap ships went to the bottom that morning and I take credit for helping



sink those two. I wasn't scratched.

At daybreak there was nothing in sight except two blazing pools of oil where the battleships had been, and a Jap destroyer scurrying around looking for survivors. My fire control men adjusted their instruments, trained a turret around to bear on the destroyer, and sank her.

My most embarrassing moment was earlier in the war. For a few hours one night I was the most unpopular ship in the Pacific. We had been in a scrap that day and I'd taken a small hit under the bow. No one on board knew I'd been holed, for I was shaking with recoil at the time.

After dark, however, other ships in the task force signaled that we were showing a light. My skipper couldn't understand it, after an inspection showed we were completely blacked out. The other ships still insisted I had a light burning, an obvious advertisement to any Japs in the area. Finally my crew found a light in the forepeak, shining through the hole the Jap shell fragment had made. Under the bow, it wasn't visible from deck.

This is the USS Columbia, a tough cruiser which KO'd two Japanese ships and 24 planes

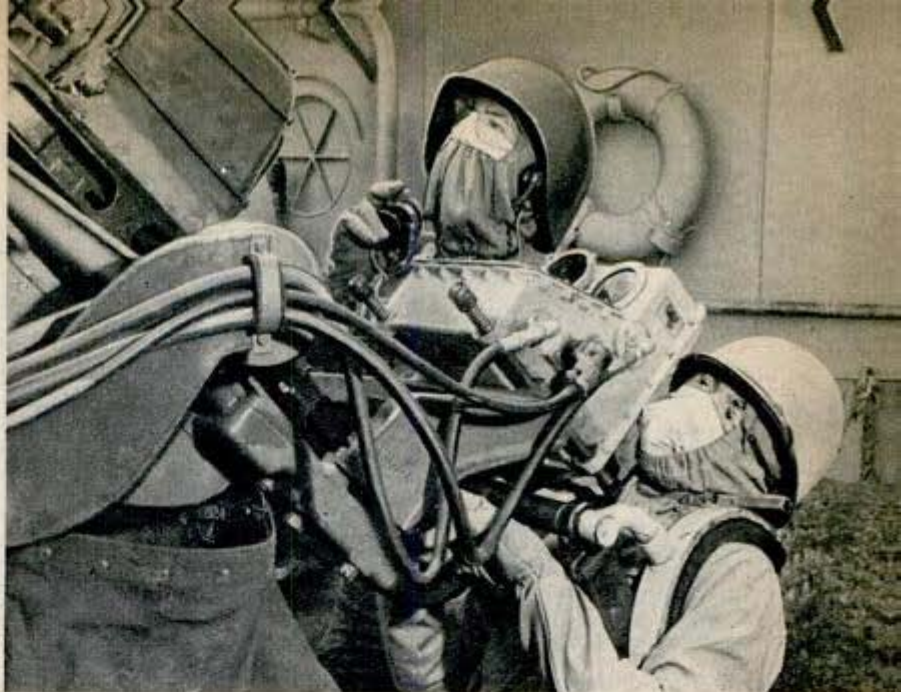

With flashproof clothing protecting their bodies and faces, two gunners operate a 20-mm. antiaircraft gun. Below, seamen move shells encased in metal containers to ammunition magazines below deck





If fire control instruments are knocked out, five-inch turret guns are pointed by this manually operated sighting device mounted on top of the turret

In the old days, they tell me, a warship's crew was pretty well protected during battle. Everyone was below, or in turrets, or in the armored conning tower. The airplane has changed that. Today lookouts, anti-aircraft gun crews, damage control parties, and other groups all have to fight in the open. They have little protection beside metal helmets and antifeather clothes.

These men on the topside stations are parts of a coordinated team. En route to the Lingayen Gulf landing, for example, a Jap "kamikaze" suicide plane was sighted by the lookouts, headed straight for me. The anti-aircraft gunners began to pick the plane to pieces as soon as it came within range. The shells tore off parts of the plane's structure, killed its engine and no doubt killed its pilot, but the plane kept heading in. It swerved between my stacks and dived into the sea alongside, so close that gasoline was sprayed on my deck. At once the damage control parties went to work with fire hoses, washing the gasoline over the side before it could catch fire. That was teamwork.

It was teamwork, too, that kept me afloat during the next few days while Jap suicide planes pounded me. One suicide plane got through my anti-aircraft fire in spite of numerous hits, crashed into my stern and exploded.

For a few seconds I thought I was coming apart everywhere. A magazine was blown open, I was on fire and my bottom

Right, seamen, rehearsing for battle, practice passing dummy powder charges to six-inch gun breech

had opened up. A huge cloud of smoke and flames jetted up through the hole the plane had made. My whole after end was a shambles but the damage control parties got it doused and then rigged pumps to get rid of the water coming in through my hull.

Meanwhile it was discovered that my steering gear was wrecked and my after turrets were out of action. The electrical system was shorted by water. But my engines were still unharmed, and I could maneuver by using my twin propellers.

I'd been hurt but that wasn't the time to quit. My forward turrets were as good as ever and I kept on firing. Meanwhile other Jap planes kept coming in. My anti-aircraft barrels stayed hot all afternoon and I knocked down every plane that got close. A diver went over the side, in full view of the Japs on shore, and put on temporary patches. That helped a lot and for two days I continued my shore bombardment.

Then I caught it again. A Jap plane got close enough to slam a bomb into my for-

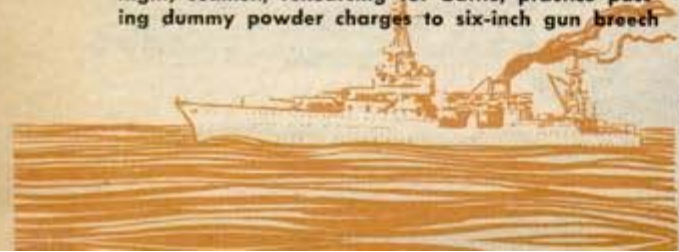



ward control station, putting it out of action and starting several fires. Hastily, phone circuits were rigged to connect forward turrets with after control stations. I wasn't efficient, but I was in action. Nearly a quarter of my crew had been disabled and the men still at their stations had had little rest for four days. Pumps were going constantly and my steering gear was still faulty. Radio Tokyo meanwhile was telling the world I'd been sunk.

I stood by, pitching shells ashore, until the beachhead had been secured. Then began the long, slow trip back to a repair station on the West Coast. With many men killed in action, it was a solemn voyage.

That's my story. My crew were the heroes of it. Me, I'm content with a message a sister ship flashed in my direction when I had to request some medical supplies at Lingayen Gulf. The message read, "Only too glad to assist in every way possible a ship that has fought bravely, and though battle-scarred is unbowed."

Stern deck is hidden beneath ammunition which is being moved below by line of men. Photo below shows gunners operating 20-mm. anti-aircraft gun

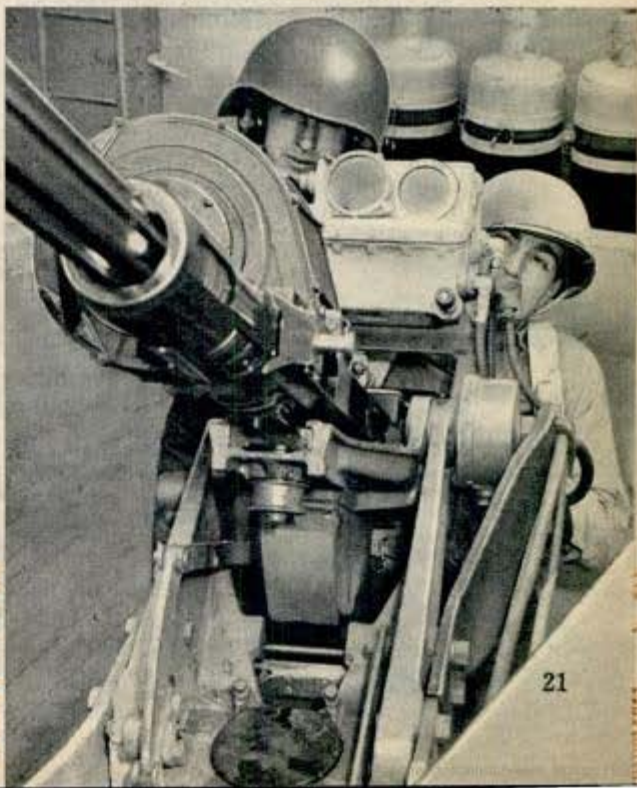

LIGHTWEIGHT "KICKLESS" CANNON ABSORB OWN RECOIL



Firing artillery shells with no more recoil than a .22 rifle, 57 and 75-millimeter "kickless" cannon were used successfully against the Japs. Weighing only 45 pounds, the 57-mm. rifle can be fired from the shoulder or a small tripod and tosses a three-pound

Recoilless 75-mm. rifle, above, left, weighs 110 pounds. The 57-mm. rifle can be fired from a tripod, above, or shoulder as at left

shell two miles. Telescopic sights permit great accuracy in firing. A 14-pound shell is thrown more than four miles by the 75-mm. rifle, which weighs 110 pounds. A regular field artillery 75 and wheeled carriage weigh 3400 pounds. The kickless guns, while resembling rocket weapons, are rifled, increasing accuracy, and fire standard artillery ammunition rather than rocket projectiles. Secret of the recoilless gun is in the breech and the cartridge case fitting into it. Instead of being tightly closed to prevent the backward leakage of gases when the gun is fired, the breech is left partly open, with a series of tubes to guide the flashback. Cartridge case walls are perforated, permitting part of the gases to flow outward and back. This force is sufficient to offset the recoil, but the escaping gases compel the men to work at the side, rather than the back, of the gun.



Cab of Tomorrow for Paris

Parisian taxicabs, beloved but ancient, will be replaced by five to six-passenger vehicles designed for comfort rather than beauty. The motor is placed between the two front seats, and the vehicle, though long, is almost as low as the jeep. Doors slide sideways to open and close. The roof is transparent and opens halfway, while large windows give the driver a better view for dodging pedestrians. A roof fixture shows whether the cab is empty or full

POPULAR MECHANICS



SYNTHETIC STEED OF STEEL

"Synthy," a synthetic horse made of a steel barrel suspended by ropes from each of the four uprights of an unused radio tower, took the place of Texas horses that went to war. Missing their regular horseback rides, a group of Port Arthur girls rigged up the substitute, complete with



saddle and sawdust on the ground below. By pulling on the ropes in rhythm, the girls cause "Synthy" to trot, lope or gallop. When they jerk the ropes out of unison, the steed becomes a real bucking bronco.

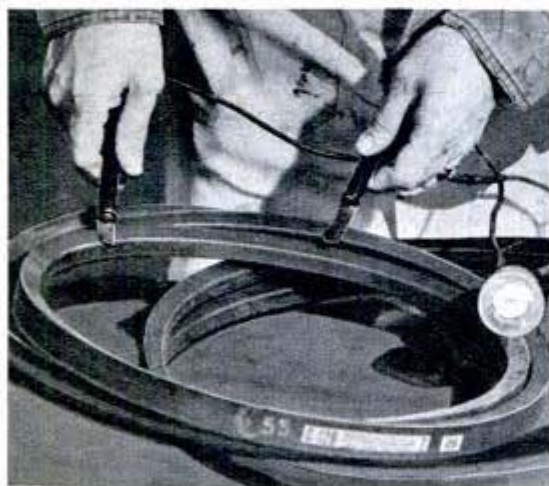

Neon Lamp Lights Up on Tester If Rubber Is Conductive

Conductivity of rubber belts or other rubber articles is easily determined by a B. F. Goodrich Company testing apparatus. Static-conducting rubber is used where static sparks might cause explosions, and has peacetime applications for washing machines and other household appliances. The tester consists of lamp cord and plug, two-watt neon glow lamp in socket, and two metal clamps or flat terminals with insulated handles. Terminals and lamp are connected in series. Small areas on the tested article are moistened with water and one clamp applied to each area. If the lamp glows, the rubber is a static conductor.

Jap Engine Powers Motorcycle Built by Coastguardman

Parts of the homemade motorcycle constructed by Coastguardman Gerald G. Grant in the Southwest Pacific include a Japanese outboard engine, a sprocket and two chains from a Jap motorcycle, two wheels from a Signal Corps wire cart, a cut-down bicycle frame, and a seat from an old lifejacket. He got the engine from a New Guinea native for six packs of cigarettes. The cycle does 40 miles an hour and travels 100 miles on a gallon of gasoline.

☐ The world's largest penicillin factory is being erected near Liverpool, England.



GRANDPAPPY OF THE DUCK



National Geographic photo
Dr. Thomas A. Jaggard, Jr., sitting beside
Sea Turtle, amphibious motor car resulting
from his experiments with Sand Crab.
Below, Sea Turtle on an Aleutian island



Rugged descendant of Sea Turtle is the Weasel which
can climb steep bank; it's powered by Studebaker engine



National Geographic photo
Sea Turtle takes to the sea during Aleutian expedition.
This 21-foot steel craft was the second amphibious car
designed by Dr. Jaggard. It was powered by a Ford Mod-
el T engine and had twin screw propellers. First used to
study volcanic formations, Sea Turtle fathered wartime
DUKW shown below grinding ashore with full load
U. S. Marine Corps photo

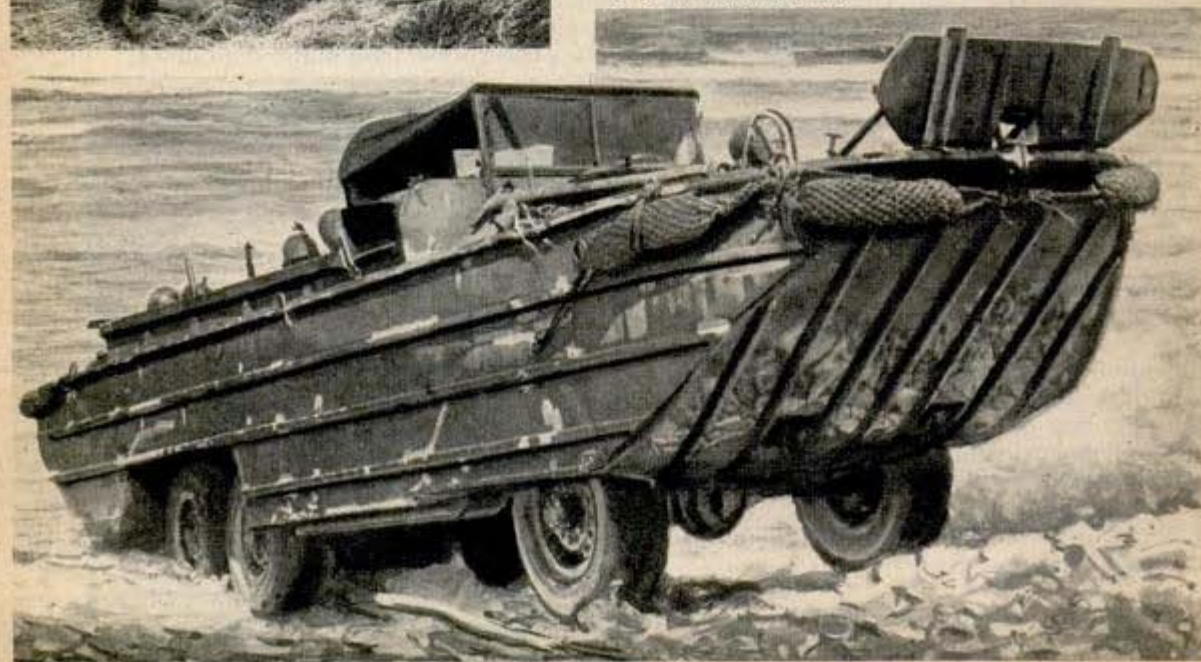

AND WEASEL

By Master Technical Sergeant Jack Black,
Marine Corps Combat Correspondent

ANYTHING is possible in war—even the breeding of a species of duck with a turtle and a crab among its ancestors.

That's the family history of the amphibian truck, familiar to every invasion beachhead as the "duck," derived from its military designation DUKW. This invaluable tool for waging war was fathered by a sea turtle and had a sand crab for a grandsire.

Dr. Thomas A. Jaggar, Jr., noted University of Hawaii volcanologist, invented the first practical wheeled amphibian.

An Alaskan expedition to study explosive Mount Katwain in 1927 furnished Dr. Jaggar with the motive for developing an amphibious motor car. After several months of experimentation, he completed his pioneer water bug and dubbed it "Ohiki," which is Hawaiian for sand crab.

Several hundred skeptical spectators witnessed the formal launching January 17, 1928, at Hilo, Hawaii. Many wagers were lost as the Ohiki lumbered off the highway and trundled along the beach into the water. Editors hailed the "auto that sails the seas and boat that runs on land." Dr. Jaggar's initial amphibian was a skiff 21 feet long with a beam of five feet four inches, mounted on an elongated Ford chassis. A Smith "Formatruck" axle was used in the rear. Just forward and mounted through the sides of the boat was a Ruckstall axle to which sidewheel paddles were attached. The rear wheels were chain driven from the Ruckstall axle. The front wheels were disked and served as rudders.

As the testing progressed, improvements were added to the Ohiki. An eight-horsepower outboard motor doubled the original speed of two miles an hour. On land the maximum speed was 25 miles per hour.

The first steel model, 21 feet long and weighing 3700 pounds, was called "Honukai"—Sea Turtle. Twin screws had replaced the paddles. Watertight compartments were built into the hull, fore and aft. The radiator was on top of the cabin. A cooling pipe for the circulating water encircled the boat below the water line. Gears were specially contrived to give numerous low speeds and allow all combinations of propellers and land drive.

During the junket in the Aleutians the Honukai was used with success. Returning to Hawaii, Dr. Jaggar continued experimenting. When war clouds gathered he made his amphibian data available to the War and Navy Departments.

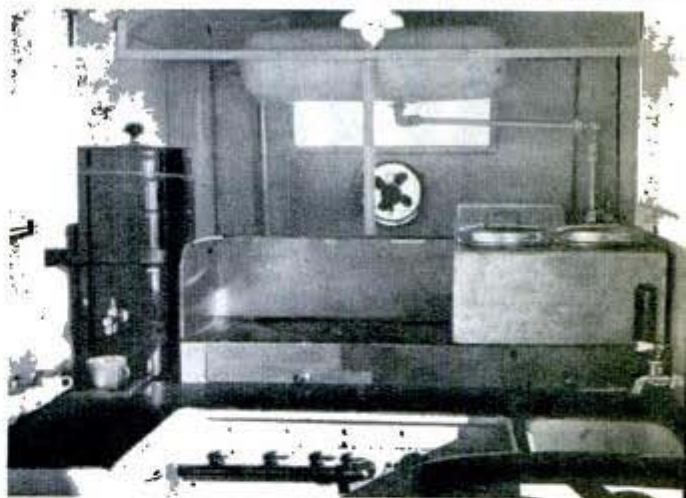

FEEDING FIREMEN while they battle stubborn blazes is a problem that's been licked by the Los Angeles Battalion 2, which purchased a milk truck and converted it into a self-contained commissary unit. A steam table was made from old boiler plate and ice cream containers and old stove parts from junkyards provided a hot plate and two-burner gas plates. Fuel for several days is provided by a butane tank while a butane coffee urn provides plenty of steaming java.

METAL WING TANKS salvaged from C-47 Skytrains by M/Sgt. Merrill A. Shaw of Seattle, Wash., were put to good use as cabin ferry tanks for long hops across water. The metal tanks conserve about 30 percent in space, compared with papier-mache bolero tanks used formerly in C-47 long hops, and carry 200 additional gallons of gasoline. They support light baggage and make room for 5 to 7 more passengers.





Eight Parachutes Float Rescue Boat Down to Sea

Easily attached to the bomb rack of a PB-4Y, an 18-foot plywood airborne rescue boat is now standard equipment for the air-sea rescue activities of the Coast Guard. Weighing 1500 pounds, the rescue boat is equipped with water, rations, motor, sail and Gibson Girl radio, all protected against shock. Footholds on the hull make it easy for swimmers to get aboard. The boat is dropped at an air-speed of 90 miles an hour and eight standard parachutes open and buoy it gently into the sea. Eight men can be accommodated aboard the lifeboat. A larger airborne rescue boat used by the Army Air Forces weighs 3500 pounds and carries full provisions to keep 12 men 15 days at sea. A few minutes after the AAF boat is dropped, it can be moving under power provided by two engines able to do eight knots.



Rescue boat attached to PB-4Y; sail, oars or motor propel it

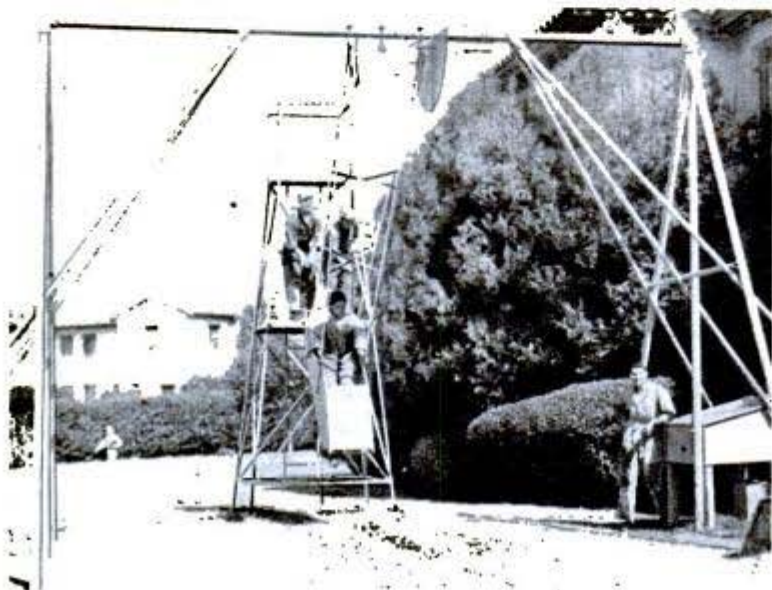

Cadets' "Air Legs" Tested by Swing

Susceptibility of student pilots to airsickness is determined by giving them a ride on a swing much like that on a school playground. The AAF School of Aviation Medicine notes that there is no sure cure for airsickness, and advises flyers and passengers to eliminate all known causes of worry and fear, to get plenty of sleep and to avoid overeating, especially fatty foods. Even a veteran pilot may lose his air legs, the school cautions.

Electrical Valley Tells Dam's Story

What actually happens in the working of a dam is demonstrated by a scale model dam and river valley, electrically operated. The model, designed by C. S. Lynch, executive vice-president of the Arkansas Power & Light Company, and built by Frank H. Beale, is supplied with water by two electric pumps. One runs constantly to represent the normal stream flow, and the other supplies water which is stored in a large glass tank at the head of the model and is used to create miniature floods. The model valley is complete with farms, roads, bridges, industries, an airport and a hospital. The model is being shown throughout the Southwest to demonstrate why flood control dams must have empty reservoirs and power dams require full ones.

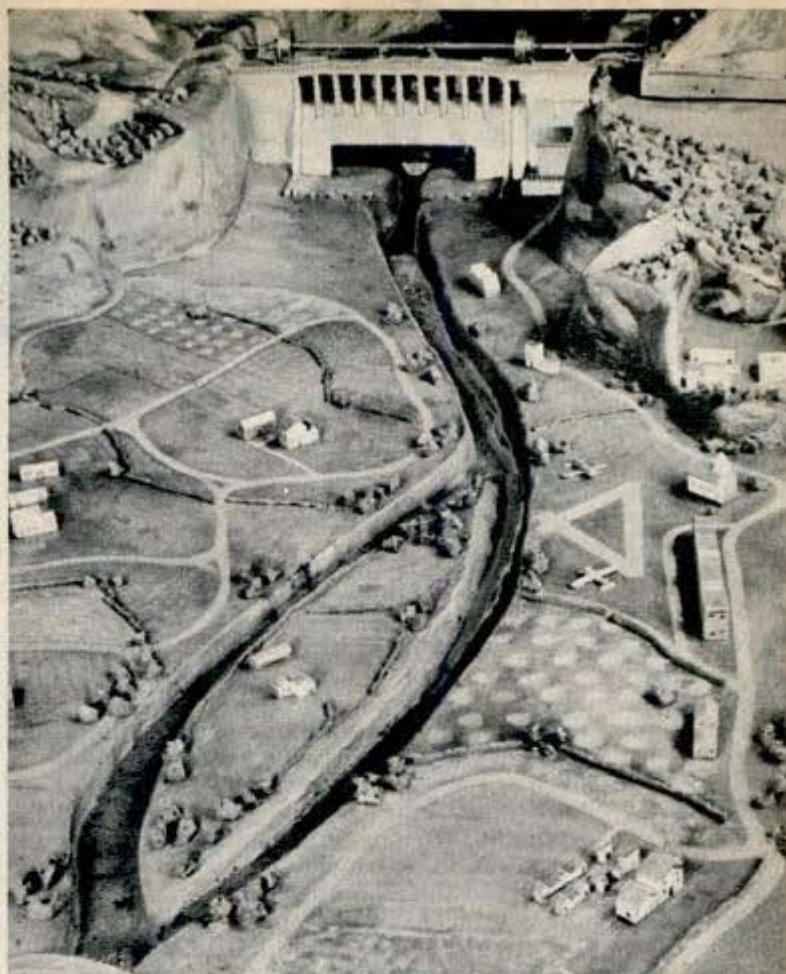

Bunks and Galley For Air Campers

If the postwar pilot of a Trimmer amphibian spies a wilderness lake that looks like good fishing, he can stop there for two or three days and live in comfort. The three seats in this twin-engine plane can be made up into two comfortable berths and there is a built-in galley for hot meals. Designed as a combination business-pleasure plane, the Trimmer has two 85-horsepower engines, top speed of 132 miles an hour and a cruising range of 600 miles. The wing span is 35 feet 6 inches and the weight empty is 1470 pounds. With a full load of 2200 pounds, the plane can take off from water in 635 feet. Landing speed is 48 miles an hour. The Trimmer, which is be-



ing built by Commonwealth Aircraft, Inc., is expected to be used for short commercial services as well as by private pilots.

FIGHTING WITH FIRE



By John L. Kent

IN THE closing days of the war, our Air Forces set out methodically to burn Jap cities to the ground after naming their targets many hours in advance.

Fire bombing of the enemy's manufacturing centers had been stepped up from 1000-ton incendiary raids in March to 6000-ton flights in August. According to Major General Curtis E. LeMay, commander of the 21st Bomber Command, 1000-plane raids carrying 10,000 tons of incendiary bombs were planned, since our bases on Okinawa were in close range and the B-29s could increase their bomb load.

In medieval times attackers tossed balls of burning pitch over castle walls with improvised catapults. In World War II, our flyers carried fire over the Jap walls—in this case their anti-aircraft artillery and fighter planes—in fire bombs.

Using fire in war is not new, but it was the English who first planned to use fire in recent times as a fighting weapon. Flaming death awaited Hitler's hordes had they attempted an invasion of England during 1940-41. Having lost almost all their equipment during the evacuation at Dunkerque, the English devised methods of fighting off the threatened invasion of the British Isles with man's primitive weapon—fire.

"Oil defenses" capable of setting the Channel ablaze were evolved, and billowing smoke towering above an impenetrable strip of searing flames would have met the enemy's assault craft. Behind this barrier a secondary "inshore" line of oil defenses was set up. Reservoirs of petroleum were connected with the sea by large pipes hidden in the sand and running under the sea from 100 to 200 yards out. The petroleum was to be set aflame by chemicals like calcium phosphide which ignites on contact with water. The chemicals were to be directed through pipes in ball-like form to dissolve in the water and set the oil afire. This flame barrage could not be operated in rough seas, and was established only along the critical stretch of the coast in the Dover-Folkestone area.

Stories have been told of charred and burned bodies washed up on South English beaches. Perhaps Hitler did attempt to invade England in a small force, somewhat as we invaded the French coast at Dieppe to get first-hand information about

These flame throwers at an English Channel port stood ready to repel Nazis. Below, vertical jet used as defense against low-flying airplanes



B-29, right, drops incendiary bomb on Osaka. Center, droppable tank filled with explosive jellied gasoline. Bottom, Marines burn out Jap caves on Iwo



coast defenses. If he did, his men never reached shore.

In addition to the oil barrage, the English had portable flame throwers mounted on Bren gun carriers, which could throw a flame 150 yards. These were ready on the piers along the river mouths and inlets to repel any amphibious attack. The same flame throwers were used during the Allied landings at Normandy; because of the "sting" this device could deliver, the troops called it the "Wasp."

The English made another novel use of fire when they devised a method of lifting the perpetual fog which hangs over the





Ordnance men in England prepare incendiary bombs for plane getting ready to fire enemy installations



British Isles. It enabled the Allies to maintain round-the-clock bombing of Germany, regardless of weather. The fog was simply burned off the air bases by oil burners strung along the runways like lights. They generated enough heat to melt the fog like magic. One man sitting in a control tower could press a button and within six minutes planes were landing with perfect visibility. When the last plane was down safely, the operator pressed the "off" button and the fog immediately settled over the field. This invention was known as FIDO—meaning "fog investigation dispersal operation."

FIDO installations also helped American daylight bombers caught in fogs. In one day last winter, 91 U. S. Eighth Air Force planes landed at one FIDO base when their own field was blacked out by fog. Altogether, FIDO helped over 2500 Allied planes land safely since November 1943.

In the Pacific, fire first was employed by the Americans during the fight for Guadalcanal, when the M1A1 flame thrower, using thickened gasoline, proved effective in blasting Japs out of their holes. Early in 1944, the Chemical Warfare Service Tech-

Left, round oil patches grow larger, finally form a continuous strip to be ignited as an English Channel defense against invasion. Below, Britain's wall-of-flame plan prepared to turn back any Nazi landing

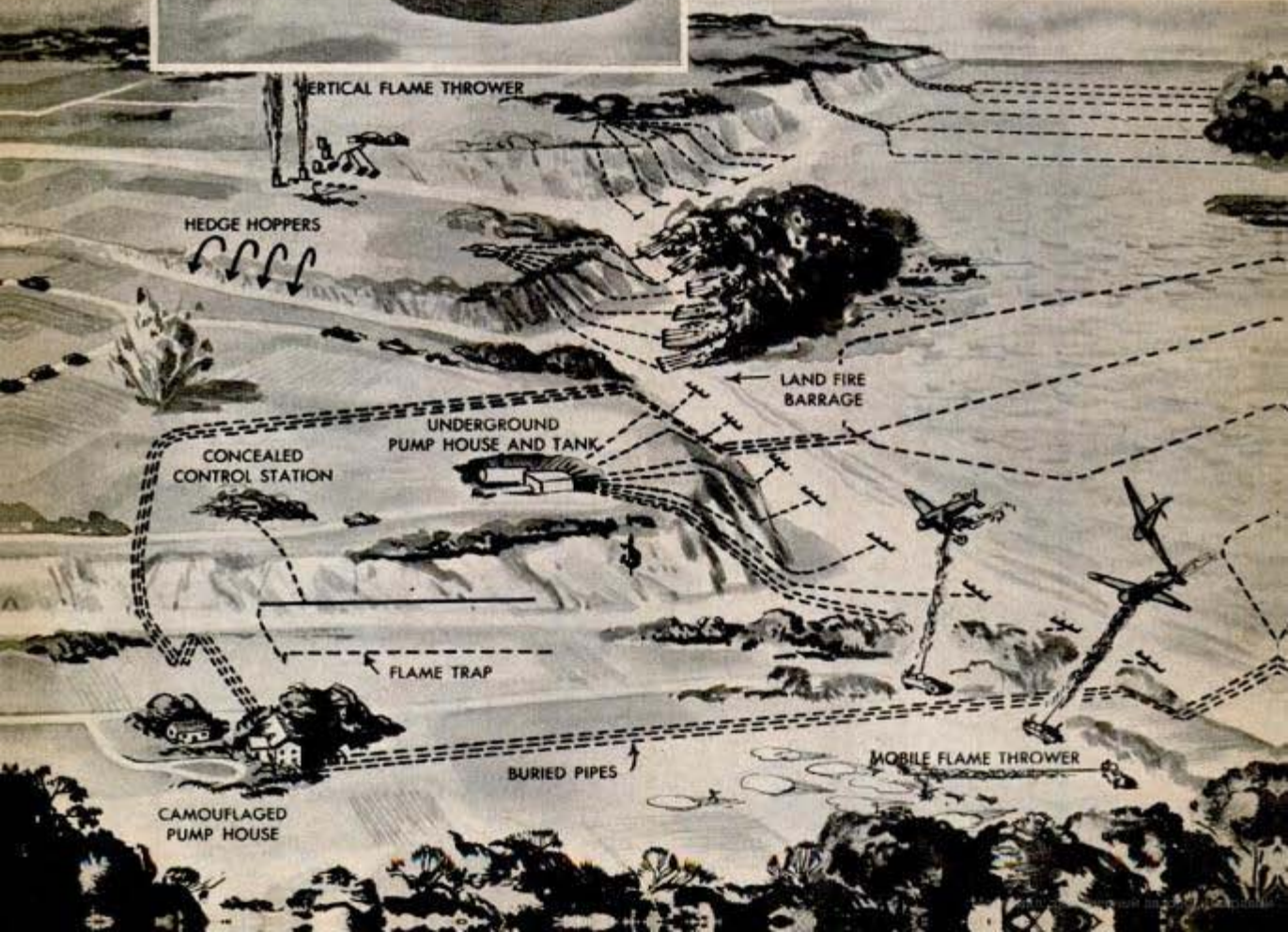

nical Command developed another model, the M2-2 portable flame thrower, especially designed to provide the tremendous pressure needed to eject the newer types of thickened gasoline. The development of "gel," as this thickened gasoline mixture is called, is a story in itself. The use of gel was made possible by the discovery of USAT, an innocent white powder capable of transforming ordinary gasoline into incendiary jelly. This powder can be shipped in small packages and mixed with gasoline in battle zones. The powder is poured into a drum of gasoline, paddled and aged for a few hours.

When flame throwers were adapted for use on tanks, the same gasoline mixture was used. Tank flame throwers were used in great quantities in the Pacific; on Okinawa one unit was completely equipped with flame throwers on tanks. Some equipped with extension hoses poured a searing fire on Japs holed up in steep, cave-

studded ridges. The hose extensions came in 50-foot sections which were joined to form lengths up to 500 feet. Coupled to fuel containers in the tank, the hose conveyed the fuel under pressure to the nozzle where two members of the tank crew controlled the hose, aimed the gun, and fired concentrated splashes of flame into Jap strongpoints.

The flame thrower's thickened gasoline also is used in the M47 100-pound petroleum bomb and the M69 10-pound bomb. The M47 is a thin-walled bomb which scat-

Clouds of smoke rise from oil piped to surface of English Channel to thwart possible Nazi invasion



Rain of fire bombs from B-29s heads for docks and warehouses at Osaka





Thirty-eight "Tokyo Fireflies," small incendiary bombs, fit into a big 500-pound missile, shown beside K. T. Keller, president of Chrysler Corporation

ters great chunks of fire for a distance of 40 yards. The M69 is dropped in clusters which open in mid-air by means of time fuses, releasing a shower of firesticks upon the target.

The Army's Chemical Warfare Service had other tricks up its sleeve. The latest of its incendiary bombs is the 500-pound blockburner or "goop" bomb. In addition to jellied gasoline, it contains powdered magnesium, liquid asphalt and other ingredients. These combine to form a synthetic lava that flows into corners and

other hard-to-reach places. A small-scale version of the goop bomb is the M74, a 10-pound tubular bomb that ejects its complex "insides" almost instantly after landing on a target.

The fire qualities of goop were discovered when a quantity stored in a California war plant suddenly burst into flame. Samples were rushed to Edgewood Arsenal, Md., for study. There, Chemical Warfare Service technicians added gasoline and other ingredients, plus white phosphorus. The resultant synthetic lava is a rubbery material which burns with an intensely hot flame. The "lava bomb" resembles a 19-inch length of hexagonal pipe. A collapsible metal tail springs open when the bomb is released from its cluster. A sensitive fuse in the nose ignites the incendiary upon impact.

Inside the bomb is a plastic cup which holds a small quantity of white phosphorus, a few pounds of the synthetic lava and a dome-shaped ejection diaphragm. Blown open by a burster charge, the diaphragm works like a piston, expelling the phosphorus and lava in a miniature eruption. Gobs of lava fly out 25 yards, cling to any surface and burn.

The Army also introduced a 165-pound fuel tank, which, loaded with jellied gasoline, was especially adapted to targets of Japanese construction. The tanks weigh 1100 pounds loaded, and two are easily mounted on the P-47 Thunderbolt or other bomber-attack plane. This tank was used with remarkable success in France, where 460,000 gallons of jellied gasoline were dropped on German-held Bordeaux.

During the first six months of 1945 the Chemical Warfare Service furnished nearly 160,000 tons of fire bombs to all theaters, but the incendiary bombs booked for Japan for 1946 amounted to nearly 850,000 tons—a total of 150,000,000 bombs.

That, as the Japs would have found out, is a lot of fire bombs.

U. S. tank flame thrower shoots out a stream of fire that reaches approximately 180 feet
Signal Corps photo





THREE-WHEEL DRUM TRUCK, with its third wheel forming a foot pedal to give greater leverage, can be loaded and moved by one person. Requiring no manual lifting, the truck easily and safely picks up and transports drums or barrels weighing up to 800 pounds. The truck is simply pushed up to the barrel, an adjustable hook is slipped over the top rim, and a pull on the handle automatically loads it. The foot pedal over the third wheel gives greater leverage for an easy "break-over." The added wheel also supports the load when the truck is standing alone.



LIQUID INSULATION that brought amphibious landing vehicles through the surf in A-1 condition will find many postwar uses. This waterproofing liquid is used on electric motors, ignition systems, batteries, internal combustion engines or wherever protection against moisture or corrosion is required, and it is so effective that an electric motor covered with the liquid will continue operating even when submerged. In one test, a 1/2-horsepower motor and an exposed light bulb have been in operation under water for over two years. There is no short circuit in the water.



SCREEN IMAGES of particles being hurled through the air at amazing speeds are made with a phosphorescent screen. Viewed in a darkened room, shadow images of the particles at the moment of an explosion glow for half a minute. A paper disk about a foot in diameter is attached to a motor which rotates it at 12,500 revolutions per minute. At this speed centrifugal forces explode the disk and a ray of infrared light hits a photoelectric cell and operates a special mercury flash lasting only two billionths of a second. The light energizes all parts of the screen not shaded by broken parts of the disk, resulting in a shadow picture. This device was developed to test supercharger speeds up to 30,000 revolutions per minute.

BASE-UP LAMP which can be changed while hot is a feature of a postwar 35-mm. still projector for showing color or black and white slides. As shown in center photo at right, cap lifts off to expose base of lamp, which can be lifted out without use of gloves since it is unnecessary to have contact with heated glass. Lamp heat is reduced in operation by a motor-driven fan. Rack and pinion focusing mechanism is operated by turning a knurled knob.

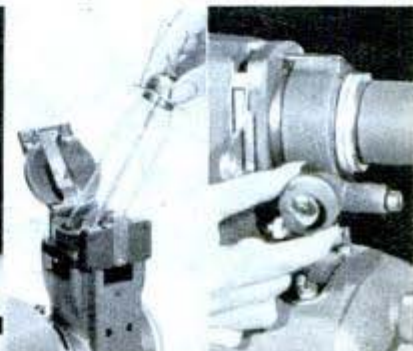

ROBOT CREWS FLY THE AIR LINERS

MOST of the work of flying the postwar air liners is to be performed by robot flight crews. The human pilots and copilots are simply commanders-in-chief who direct the labors of their mechanical employees.

Such a flight crew consists of 100 or more different mechanisms, electric or hydraulic, each of which is built to do one job correctly and rapidly. The robot crew of the B-29, forerunner of the 100-passenger Boeing Stratocruiser that has crossed the continent in six hours and three minutes, consists almost entirely of electric motors. The robots that do the work on the Douglas Skymaster, on the other hand, are nearly all actuated by hydraulic force.

Even the 7000-pound landing gear of the B-29 is retracted by electric motors. Its electronic automatic pilot can make as many as 300 flight corrections per minute. The only hydraulic device on the plane is a booster for applying the brakes.

On the Lockheed Constellation, both hydraulic pressure and electric motors are used. A dozen powerful hydraulic slaves whose specialty is brute strength do the heavy work. They raise the ponderous landing gear and move the great control surfaces in response to the pilot's commands. They squeeze the brakes to bring



Spread out below are some of the 152 electric motors used on a Boeing B-29. Girl is holding up 1/4-horsepower motor

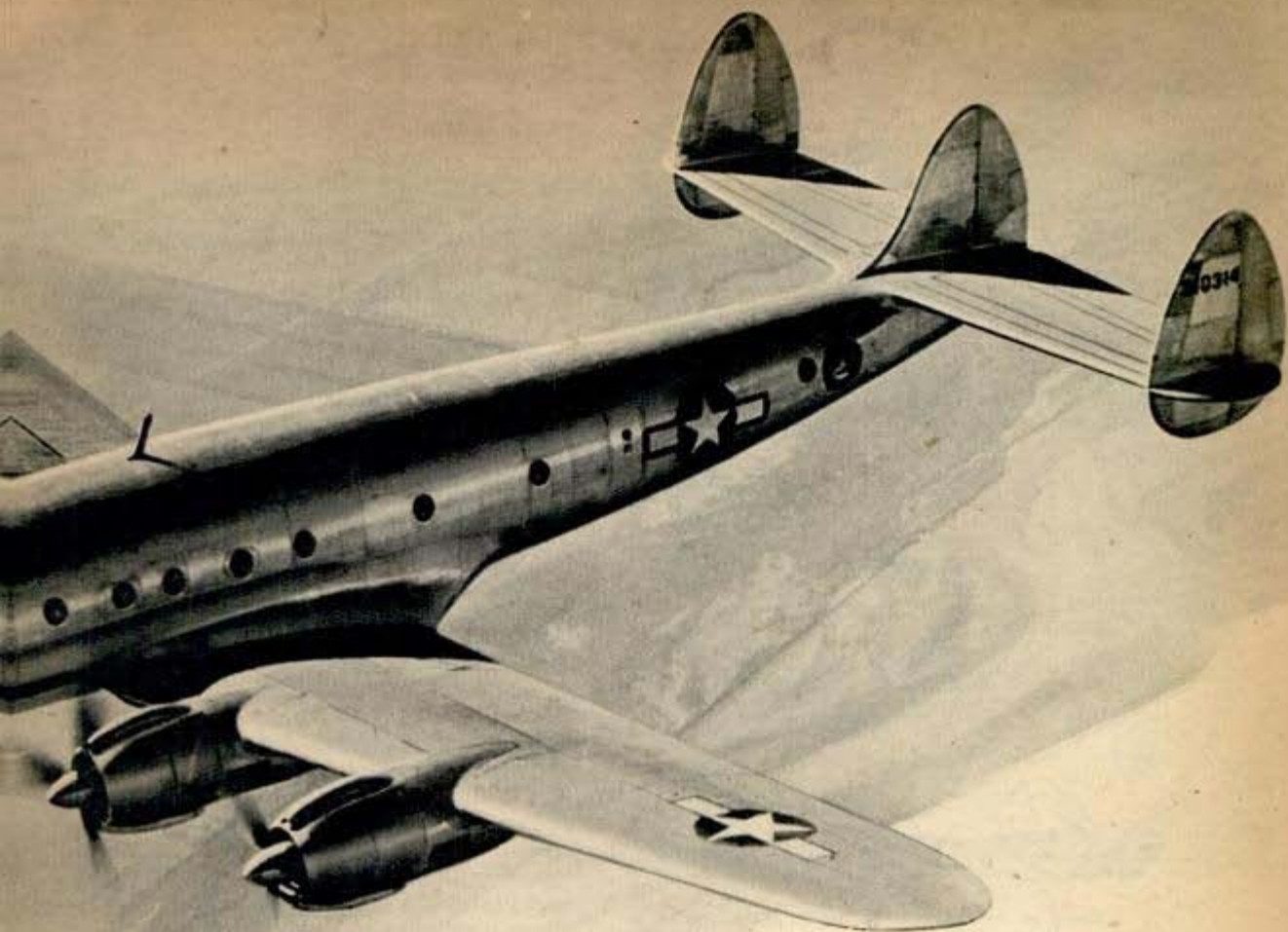

the 43-ton transport to a stop within a short distance after landing.

Smaller jobs are handled by servo-motors that are stationed at strategic points throughout the plane. Some of the motors act as electric muscles that work for the pilot, others have their own thinking apparatus and perform their duties automatically.

Such extreme mechanization is necessary because the two pilots and the engineer of a great air liner have neither the time nor strength to attend to all of their duties in person. Too, much of the work must be done in portions of the plane that are inaccessible during flight. In these places a tiny hydraulic valve or a small motor is installed.

In addition to this mechanical labor battalion, the pilot of a Constellation has in his charge a fire alarm system and a fire fighting department. He is also the head of a complex intelligence network that keeps him supplied with up-to-the-instant news on the functioning of his aircraft.

On the 64-passenger Lockheed Constellation electric and hydraulic "slaves" perform the heavy work for crew. Below, testing one of the intricate wiring circuits for Constellation

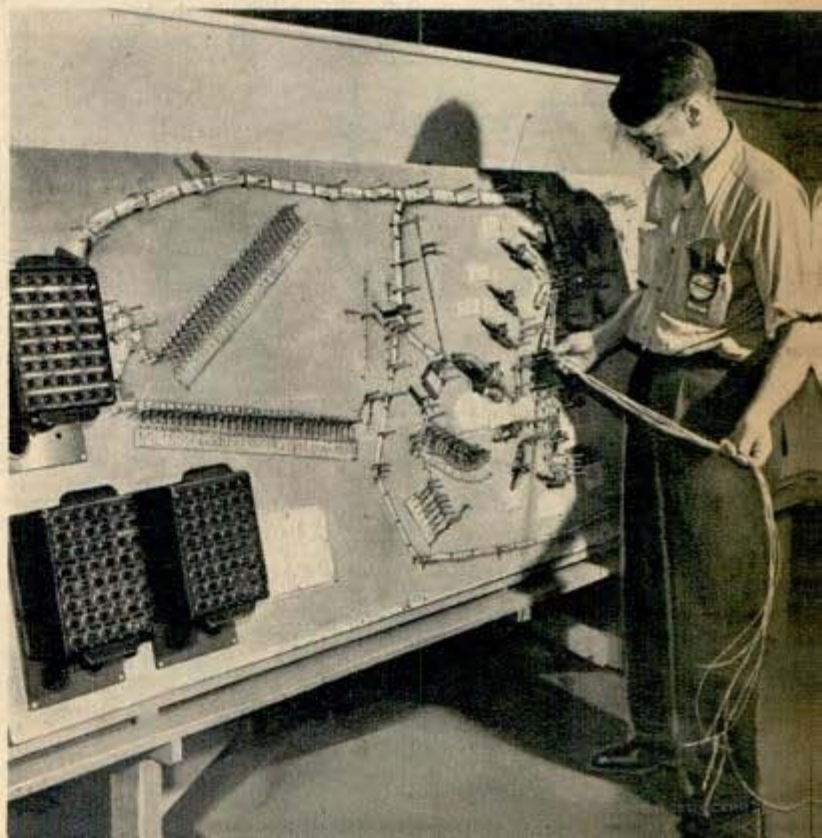



Tiny autosyn motors back of panel operate engine instruments on Constellation. Below, checking hydraulic cylinder that retracts the Constellation's landing gear

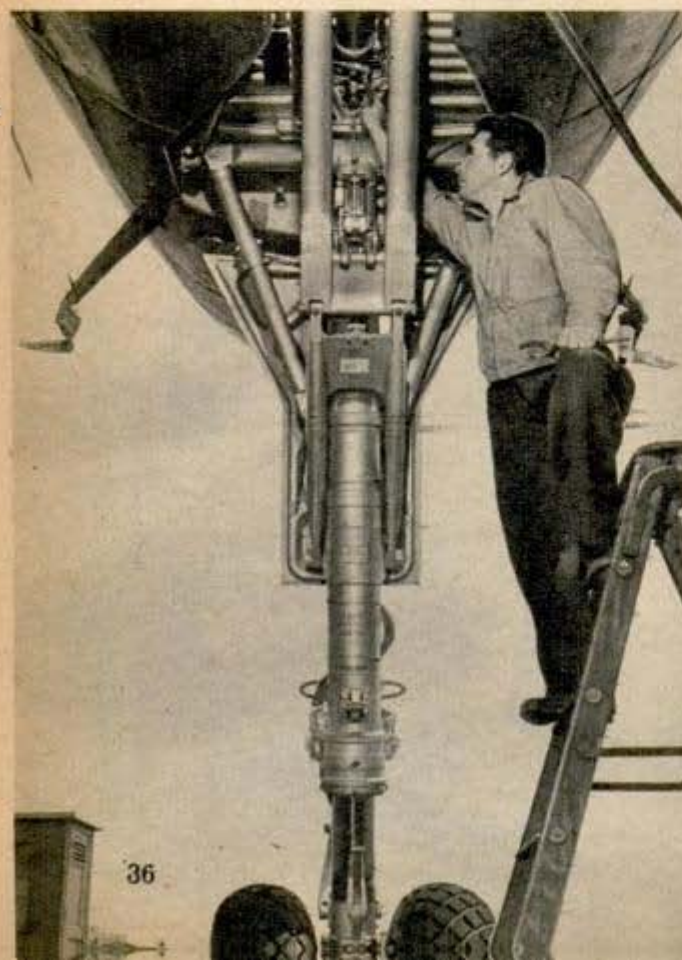

An endless stream of reports is received in the flight quarters in the form of instrument readings and flashes of light from baby signal lamps. Typical examples are:

"All four of the ship's doors are closed and locked."

"Landing wheels have left contact with the ground."

"Hydraulic pressure is steady at 1700 pounds per square inch."

The reporting service shows when the landing gear is retracted and locked, the condition of the plane's cabin pressure system, operation of the plane's lights, and functioning of the four engines.

The Constellation has more than 50 electric motors in its "crew" and approximately as many more of the autosyn type that activate its instruments. All of the motors are of lightweight design and they range in size from 10-horsepower units down to $\frac{1}{2000}$ horsepower in an autosyn motor.

Some of the tasks to which motors may be put on an air liner include reeling in the trailing radio antennae, operating the governors of the propellers, opening and closing the cowl flaps of the engine compartments, and even supplying pressure to pulsate the rubber de-icing boots on the leading edges of the airfoil surfaces. On some transports, motors pump anti-icing fluid to the propeller blades. Other motors, back in the tail, boost the pressure in the long hydraulic lines that supply force for moving the tail surfaces.

"Gill motors" on a high altitude passenger transport open and close radiator intakes so that pressurized air may be cooled before it is admitted to the cabin. Similarly, small servo-motors regulate the amounts of fuel that are supplied to the cabin heaters. These fuel control motors operate automatically in response to cabin thermostats.

Other jobs that motors perform include pumping fuel to the engines, operating the windshield wipers, and blowing warmed air against the cockpit windows as an antifrosting measure.

The autosyn motors of the instrument systems are a special class of midgets. They work in pairs. One acts as a measuring device by metering the amount of current that flows through it and this current in turn operates its synchronous twin that is mounted behind the corresponding instrument dial on the engineer's instrument board. The armature of this second autosyn moves the needle of the dial itself. Autosyns are used for transmitting many kinds of information including engine heats, engine revolu-

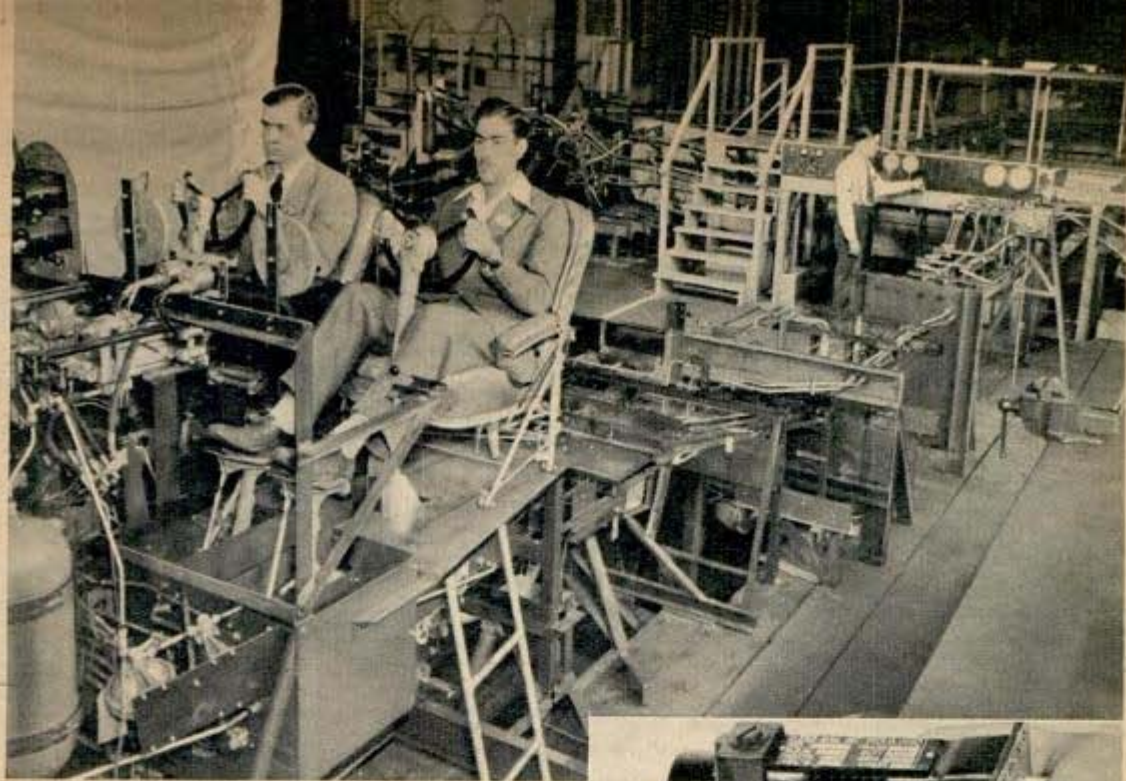

Full scale working model tests hydraulic apparatus and electric motors. Note "toe" brakes on the pedals

tions, and oil pressures and temperatures.

Some autosyn units weigh as little as five and a half ounces and may develop as little as $\frac{1}{2000}$ horsepower, but they are accurate to within one degree on a 360-degree circle when moving the needle of an instrument. They are assembled in air-conditioned, lint-free factories where the girl employees may use neither nail polish nor face powder because even tiny particles of these substances could unbalance the fine parts. An autosyn motor that is smaller than your thumb may have in it nine coils of wire of 50 turns each. Final inspection is with a 20-power microscope.

Solenoids, too, are used for specialized jobs. Opening a primer valve to build up fuel pressure before an engine is started is performed by a solenoid. Solenoids lock the landing gear in place and a solenoid vibrator boosts magneto voltage during the time the engine that spins the magneto is turning over slowly. An oil dilution solenoid injects gasoline into the oil system to insure easy starting in cold weather.

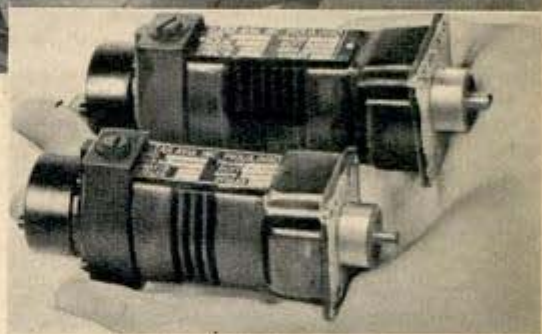

Lear, Inc., photo

These electrical "muscles" each weigh less than one pound; they move vital parts of air liner. Below, test rigging on elevators simulates flight loads to check hydraulic boosters that move controls in air





These electric motors for aircraft might be called "pilot" and "copilot." Between them is small rotor

The fire detection system on the Constellation consists both of thermostatic warning devices and a heatable link system, units of which are located at points where fires might start. A master warning light that is operated by either system furnishes an alarm for the pilot, while the location of the fire itself is shown by a bank of lights in front of the engineer. The fire fighting department consists of reservoirs of fire fighting substances, connected by lines to the areas that are served by the warning system. An external connection is provided so that the lines may also be connected to a ground supply of carbon dioxide, for use if fire should occur while the plane is on the ground.

On the Douglas Skymaster, hydraulic

pressure does much of the work that is done by motors on some other planes. The hydraulic installation, in addition to operating the landing gear, steerable nose wheel, wing flaps and brakes, also actuates the automatic pilot, the engine cowl flaps, the windshield wipers and the carburetor air-filter doors. Nevertheless, the Skymaster has a complete electrical system. The main supply is of the 24-volt d.c. single-wire type, the plane's structure serving as the ground return. In addition there are two alternating current systems for operating autosyn instrument motors, the remote indicating compass, the radio loop and other specialized equipment.

The sizes and speeds of passenger transports today are at the point where manual control of the plane's control surfaces, or booster mechanisms to do most of the work of moving the control surfaces, is optional. As sizes go up and speeds increase, manual control will become too difficult for any pilot, necessitating booster power for controlling all large, high-speed aircraft.

Mechanization of the civilian passenger liners is not yet complete, for a number of war-developed instruments are being adapted for installation on air transports. Most important of these is radar, by which a pilot will be able to see his surroundings on an illuminated screen in darkness or fog.

An air position indicator that tells at a glance the plane's exact position by latitude and longitude is another instrument that will be used, augmenting celestial navigation and radio position checks. Finally, blind landing systems that remove all guesswork and chance of error are being developed.

Waterproof motor fits in nose of Douglas Skymaster to operate blower that ventilates the pilots' compartment





The '46 SHOW WINDOW



Top, Studebaker Champion is designed for taking the bumps without the passengers knowing it. Studebaker is building cars in four body types and variety of colors. Above, front view of Champion with horizontal grille. Note the new hood emblem

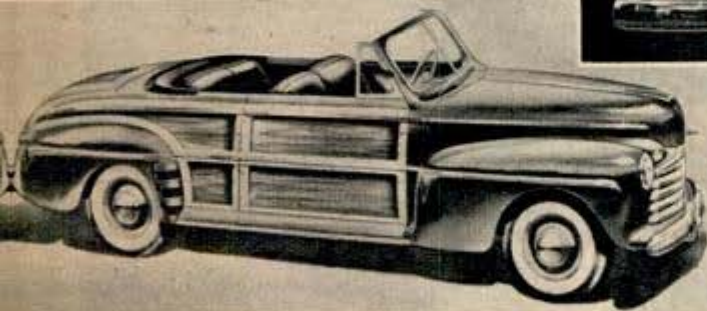

Ford Sportsman's Convertible is combination of station wagon and convertible coupe. It is fitted with leather upholstery. Right, sleek Pontiac features new grille, relocated parking lamps and heavier bumper. Below, four-door Buick sedan has full airflow fender, restyled grille



WE NEED MORE SOOT

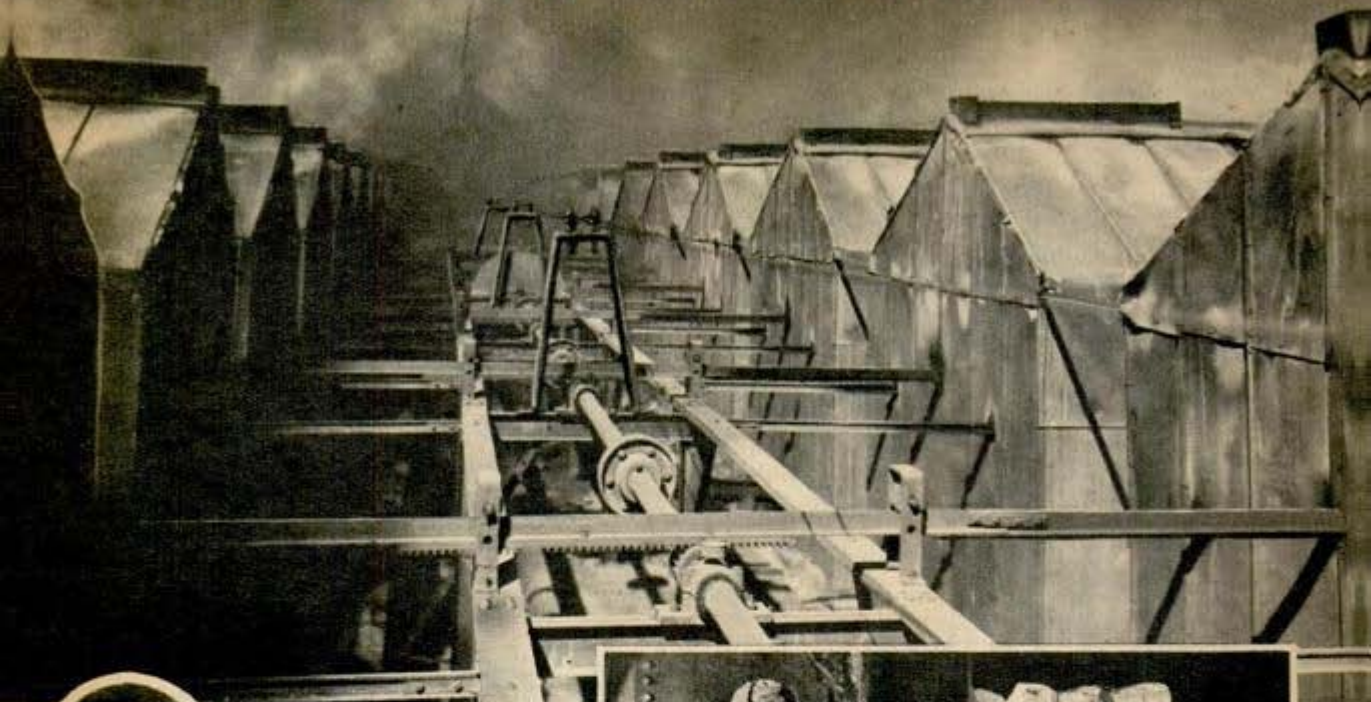

Continental Carbon Co. photos

Natural gas fuels carbon black plant above. Shaft moves iron plates in burner buildings. At right, feeding bags of soot into press before shipment. Carbon black in ink is studied below



Binney & Smith Co. photo



ALL OF US are aware of the rubber industry's tremendous job both in war and peace. Everyone can see in photographs and newsreels the rubber pads that thrust powerful tanks forward to crush the enemy, and the rubber tires on which graceful B-29s thundered down an airstrip on another trip to Japan. But how many persons realize that the very backbone of rubber is carbon black—another name for soot!

Remember the white tires of 30 years ago? They were made of cotton fabric and rubber, the latter strengthened by a reinforcing pigment of zinc oxide. After about 3000 miles they fell apart. Then an English scientist discovered that carbon black, mixed into tire formulas in place of the pigment, made the rubber several times stronger. This process was perfected in America, and today's tires, with a strong

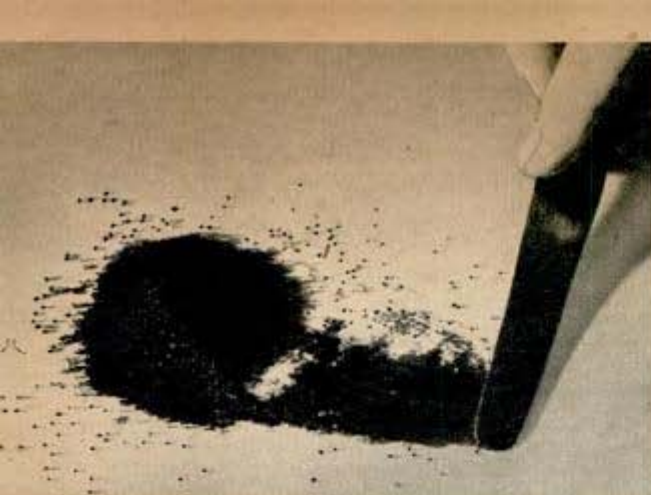

Binney & Smith Co. photo

Tiny beads of carbon black, above, made by special process. Right, testing biggest U. S. tire, built by Goodyear. It has overall diameter of 110 inches

fabric backbone, use rubber containing special grades of carbon black which gives them a strong, durable surface good for 20,000 miles or more. And if carbon black researchers continue to succeed, tomorrow's tires may even outlast the auto!

Research already has conquered serious problems. It was difficult at first to mix the carbon black particles in rubber batches. The process was done openly, raising great clouds of dust. Binney & Smith Company laboratories tackled the problem and came up with a machine that forms carbon black into small pellets, dust-free and easily transported. The toughest military tires are made with these pellets.

World War II brought a demand for rub-

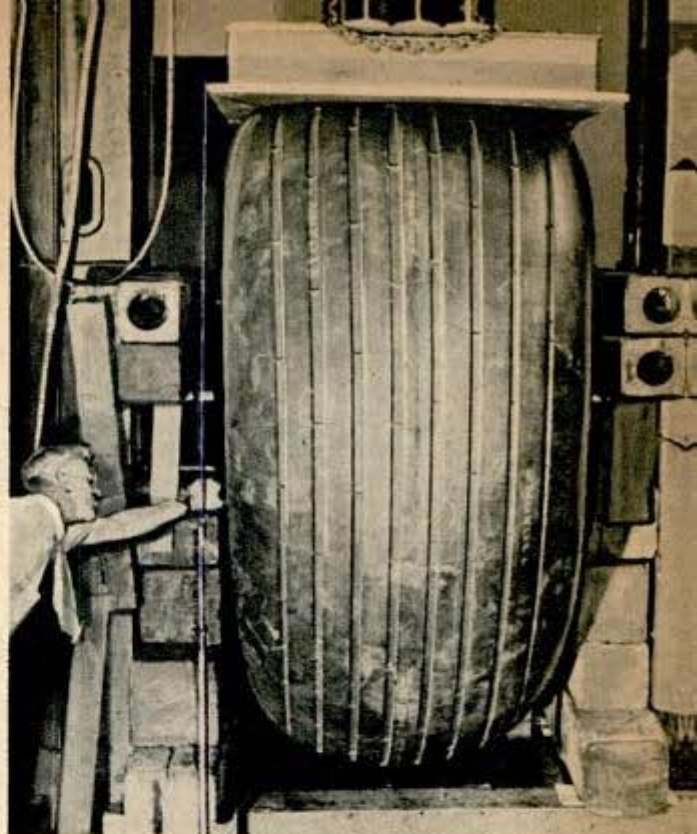

ber that would conduct electricity. The technicians found that certain carbon black produced in furnaces is electrically conductive. Made with this carbon black, airplane tires grounded static electricity that might have ignited fuel tanks. Shoes soled with conductive rubber ground electricity that might cause munitions explosions.

(Continued to page 156)

Inside a burner building. Hundreds of burning jets leave soot on slow-moving iron plate; scraper removes it
Continental Carbon Co. photo

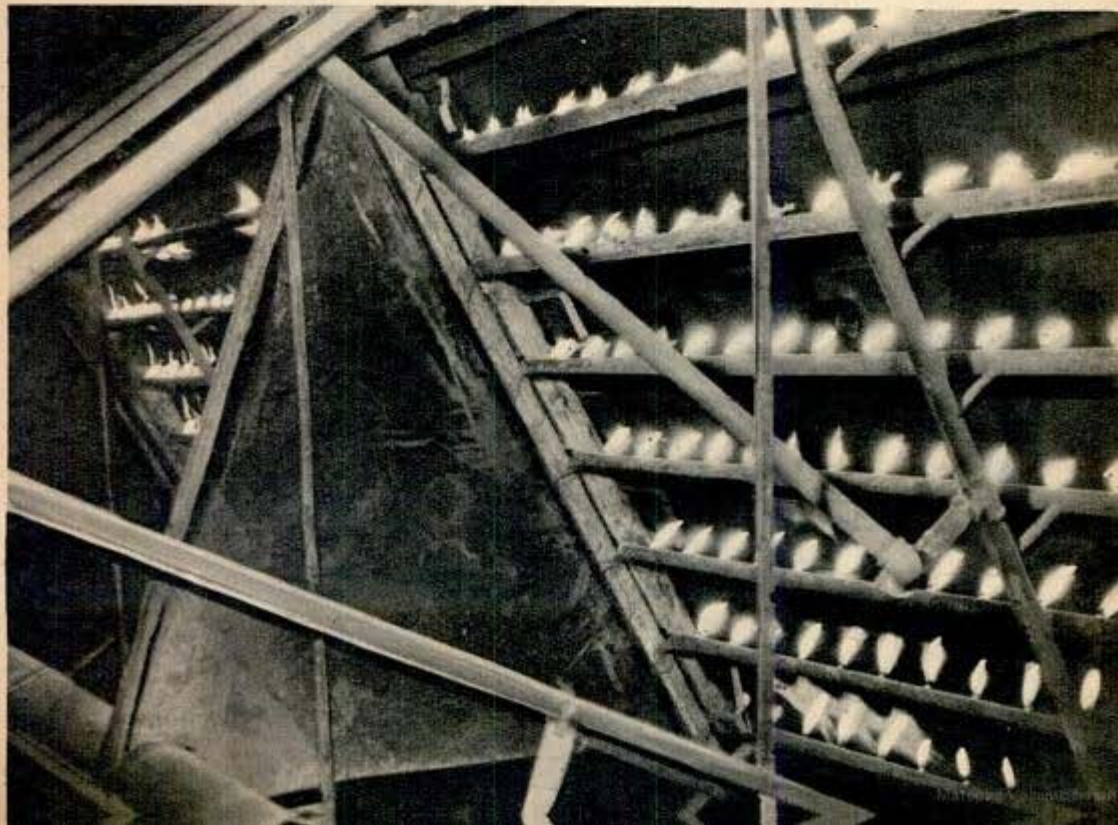



Gearless Cycle Does 70 Miles On One Gallon

Neither a motorcycle nor scooter, a streamlined speedster able to travel 70 miles per gallon of gasoline is ready for mass production. A centrifugal hydraulic transmission developed by the speedster's inventor eliminates gear shifting entirely. The speedster weighs 245 pounds, has aircraft-type wheels and a speed up to 56 miles per hour from a three or four-horsepower motor. It is fully cushioned, with an alloy steel tubular frame, and is equipped with roller bearings throughout.

Micrometer "Tunes In" on FM To Record 1/10-Millionth Inch

Rapid changes in position only one fifty-thousandth the thickness of newsprint can be measured with an electrical micrometer which records movements as small as one tenth of a millionth of an inch. The tool uses the principle of frequency modulation radio to measure position of moving objects without touching them. The wave length of light is the standard used in calibrating it. Minute errors in high precision lathe spindles were determined by the instrument. The micrometer also is the heart of an apparatus used to record changes in crystal structure when steel is heated rapidly, and in electric welding.

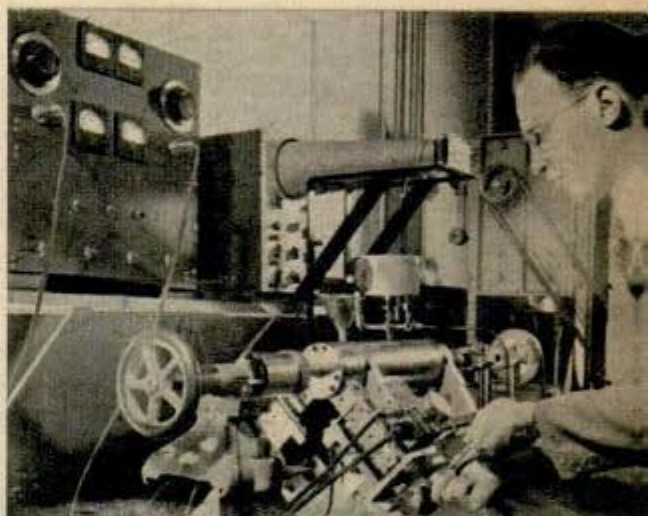

"Dunkproof" Radio for Marines

Radio headsets and lip microphones used by marines on invasion barges are built to withstand a ducking in sea water. A specially designed "gland" in the new microphone will pass air but exclude water. The microphone is one half inch thick and no larger than a half dollar. In tests, the "mike" and handset assembly have been soaked five times in water for a 25-minute period and then baked at 125 degrees Fahrenheit without damage to the equipment. The complete unit weighs only 20 ounces.

☐ A thin layer of nylon sandwiched into the rubber walls of aircraft fuel tanks developed by the Glenn L. Martin Company prevents leaking of high-octane gas fumes.

Amphibious vehicles by the thousand are lined up at marine supply center



One Step Short of Tokyo

the Leathernecks operated their largest supply base in the South Pacific — a production line on a coral beach

By S/Sgt. George E. McMillan

Photographs by T/Sgt. Arnold Johnson

HIS finger pointed to the speedometer reading. Two hundred miles. He waved his arm across the communications jeep. "Look at her," he said.

The torn and ragged edges of the fenders were corrugated with rust. The metal seat frames were twisted, and the seats themselves were water-logged and splotted with mold.

"If she had just gone 20 miles she would have done her duty—been worth what she cost the American people in dollars and sweat."

Marine supply men have hardened themselves to the high cost of amphibious warfare. What mattered to them was perfect functioning of equipment during those critical minutes when Leathernecks were clawing for a foothold on a Jap-defended beach.

The jeep must hold together while being lifted in and out of cargo holds. She must withstand the tortuous trip over coral reef,

Up she goes! New tread is fitted on tractor which was brought in for repair after battle on Peleliu
Marine Corps photos





Ammunition storage hut at supply depot is inspected by Col. J. M. Pearce, commanding officer. Below, marines fitting new tire on bogie wheel for a tank

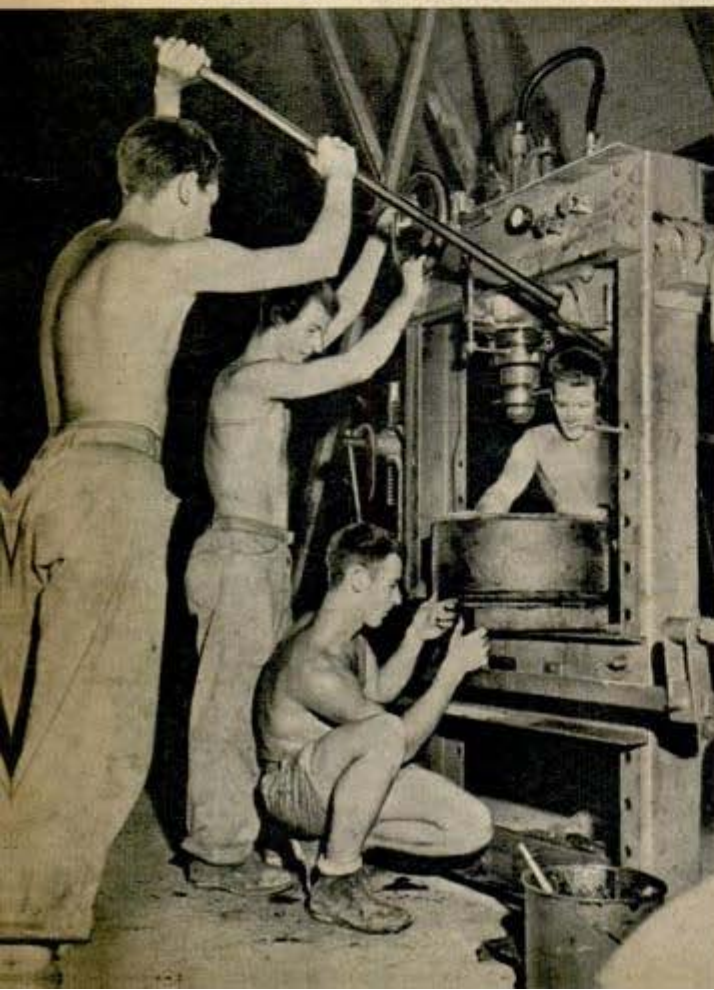

the lash of salt water, and must drive through sand and on into the mangrove swamp behind the beach.

Her radios must work, then and there. There is no time for fixing and no radio repair men with fancy testing equipment. They must work for marines, men who are fighters first and radio operators second.

So if this signal jeep had done nothing but send out the messages for the first few hours (and that's what she did at Guam), she was well worth the money and trouble it took to make sure she got there in good shape.

Nobody understands better, or practices more faithfully, this axiom than the 3400 men of the largest marine supply center in the South Pacific—men like Master Technical Sergeant Leslie R. Tinkler, in the corps eight years, who was an operator at Radio Shanghai in peacetime marine life and had overseen the fitting of the jeep before she left for Guam.

From the air this depot looks—except for the palm trees—like any large military base in the world. You see the patterns of quantity: long lines of warehouses, symmetric rows of artillery pieces, the squat squares of a tank park, the diagonals of a lumberyard, the molehills of tarpaulin-covered ammunition dumps.

The difference is in the job, and in the men. Here are the Tinklers, the high-ranking enlisted men and warrant officers, who have learned the traditional marine respect for weapons and equipment through years of service.

This is not a depot in the sense that its principal task is to receive, store and ship war materials. It is, rather, a series of shops and production lines where war equipment mass-produced in the United

Below, rewinding radio coil after it has been lacquered and covered with a fungicide for tropic use

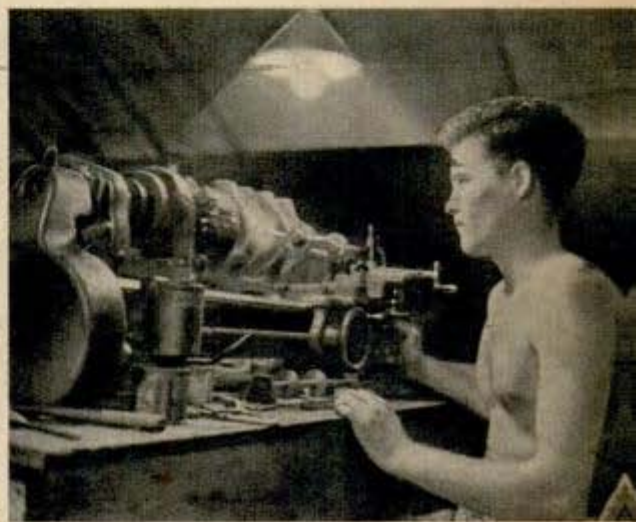

States is modified to fit amphibious assault.

The Guam jeep will be refitted in such a production line, a line that begins at a long, broad plywood table where marines sit on high stools taking apart radio sets, sets with parts still shiny and the smell of newness about them.

New or old, when the radio reaches this bench it is disassembled, soldered connections are broken, even the coils are unwound, and the whole jumble is put in a large vaultlike heating cabinet. When the parts are dry, they are laid on a revolving table and sprayed with a mix which includes lacquer and a fungicide. The coils are rewound, the set reassembled, new connections are soldered, and then the metal box is sealed and put in a heavy rubber case which is closed with a zipper.

Meanwhile the jeep chassis is going through another production line. New parts are put in where needed; loose joints are welded; new metal boxes to hold the radios and batteries are installed, and the whole jeep is painted. Then the vehicle is given an overall coat of a new preservative that is used by the men of this base as freely as a doctor uses sulfa in battle. Finally jeep

Giant crane moves vehicles at depot



NOVEMBER 1945

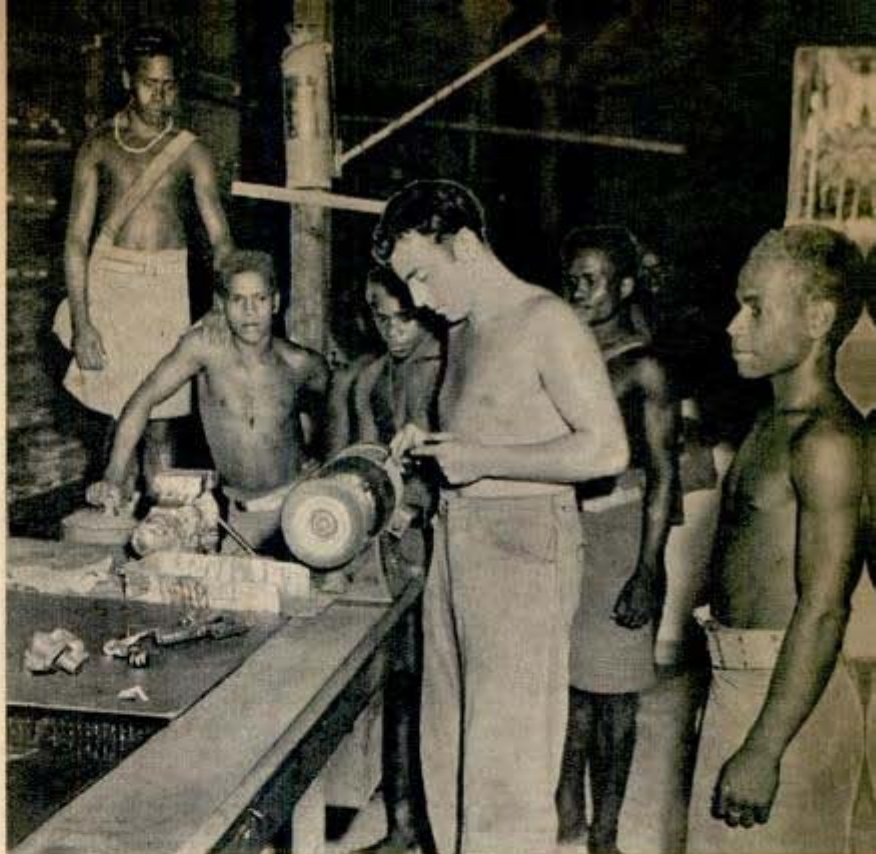

Natives stare in awe as sparks fly from knives they have brought in to be sharpened. Below, assembly line for cleaning and dipping parts

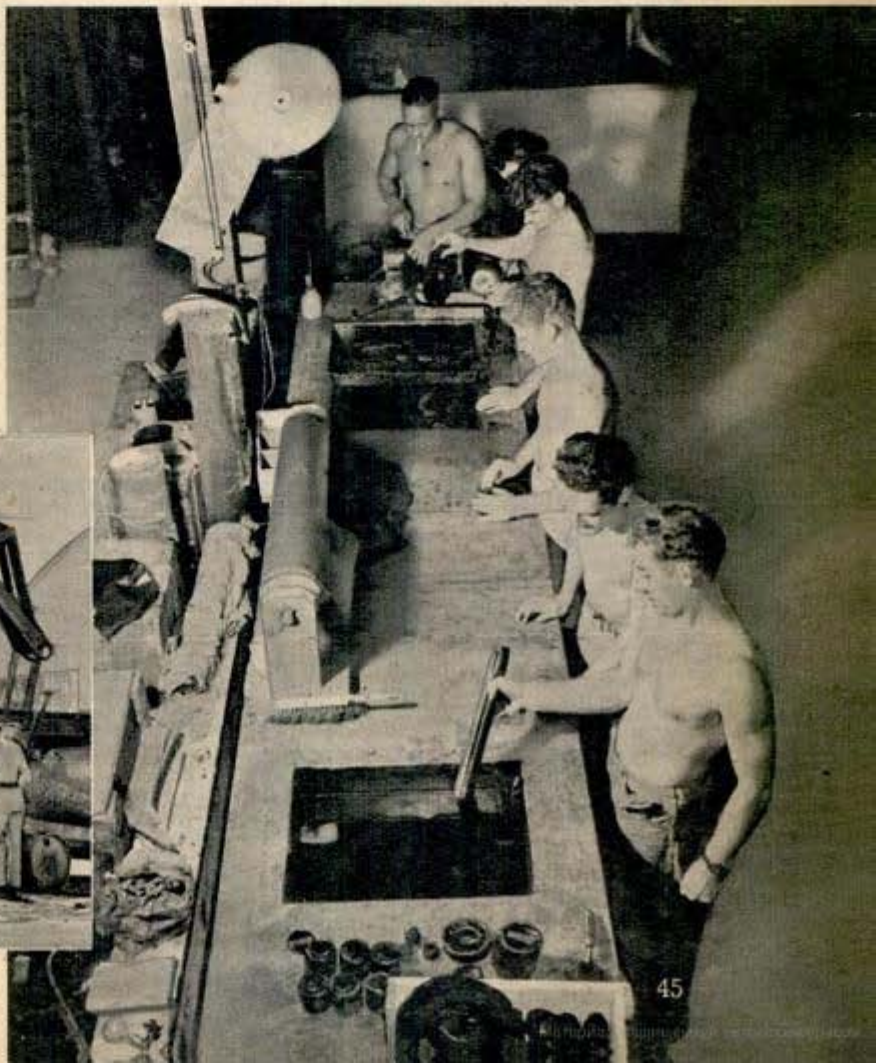

45



Chain belt carries rusted 155-mm. shells which are being repaired



Veteran jeep from Guam is sprayed with preservative after repair job. Below, setting lathe to make jig for fuse setter on shells



and radio meet, and together they are ready for another blitz.

The battle to get equipment in perfect working order goes on throughout the depot. At the engineering small parts warehouse, a group stands alongside a workbench into which sinks are built. All the parts in the warehouse, and there are thousands upon thousands—gears, sprockets, screws—pass along this table.

Each part is buffed with steel brushes, washed in preservative, wrapped in wax paper so heavy it folds like canvas, and finally the sealed package is dipped in wax. A gear at the end of the line looks like a huge candle.

In the instrument section, across the island, a marine stands at the kind of machine that makes your milkshake in the corner drugstore. In the metal cup are binocular lenses around which the shaker is throwing an ammonium compound. "They're new, or at least they just came from the States," he says above the whirr of the shaker. "Yet, we've got to take them apart and clean them and seal them up tighter than they were when we got them."

Up the road, in a coral-graveled lot where the dericks, graders and entrenchers are kept a group is fuming over the tread of a crane.

"Cleats are frozen," says a master technical sergeant. "You wouldn't think they'd rust that much. Tread won't work at all now. We've got to unlink, scrape, put preservative on, and reassemble it."

Back in the shade of a coconut grove, a crew loads bags of cement on pallets. Behind them stand long rows of the wooden platforms. These can be dragged along roads by bulldozers on the beachhead, saving three or four steps in loading and unloading from ship to

(Continued to page 152)



ILLUMINATED WIDE-FIELD MAGNIFIER, equipped with two 110-volt bulbs and a two or three-inch lens, throws a scientifically correct light on the object in the magnification field. The device may be turned to any angle by a universal clamping attachment, and may be raised and lowered quickly for numerous purposes such as machine parts inspections, examination of currency and signatures, or virtually any fine work requiring visual examination.



WHITE HOT STEEL is sucked up like lemonade in a straw with a glass tube fitted with a rubber bulb on one end. This procedure is used to obtain a sample of slag-free metal for carbon analysis. When the steel cools, the glass is broken and the test piece is weighed and placed in a high temperature furnace to determine carbon content. Before this method was introduced at U. S. Steel Corporation plants, samples were secured by drilling into slugs of cooled metal.



MAKESHIFT FLOATS made by tying empty water canteens together can be used to keep airmen afloat when they are forced down at sea. Use of the canteens is only one of many water safety measures that are taught at a six-day survival course for physical instructors of the 1st Air Force at Mitchel Field, N. Y. The men also are taught how to swim with weights and how to protect themselves from sharks.



SENSE-OF-TOUCH TOOL locates nuts, bolts or screws which must be fixed in invisible or remote positions. This compact tool, which is worn like a ring on the finger tip, also grips the nut or bolt to hold it in position, and enables a mechanic to use his sense of touch, which is almost impossible with a wrench or screwdriver. When not in use the tool is turned around out of the way, leaving the hand free.



Pulp Mill Waste Yields Alcohol To Make Synthetic Rubber

Butyl alcohol, a prime ingredient in making a superior synthetic rubber, is produced from the sulphite liquor waste of pulp mills in the Northwest. Research chemists at the University of Washington obtain other valuable products from the waste that has menaced the fishing industry of Puget Sound. The sulphite liquor used in producing one ton of pulp yields 75 pounds of butyl alcohol, 40 pounds of acetone and about two gallons of ethyl alcohol. A solid fuel of pealike granules which burns like coal and a yeast fodder for livestock also are produced in the conversion process. The various products are made from the raw liquor by chemical precipitation, fermentation and distillation. The residue is pure water.

Berth Above Trailer Cab Built for Extra Driver

Perched on the forepeak and above the cab of large semitrailers, a berth for an extra driver is designed to provide better rest than conventional berths placed back of the regular driver in the cab. Invented by S. C. Thrasher, maintenance superintendent of Central Motor Lines, Charlotte, N. C., the berth furnishes more ventilation and greater freedom from road noises. Two sealed beam headlights under the covers provide heat in winter. The occupant can signal the driver at any time by a pushbutton which blows the horn.

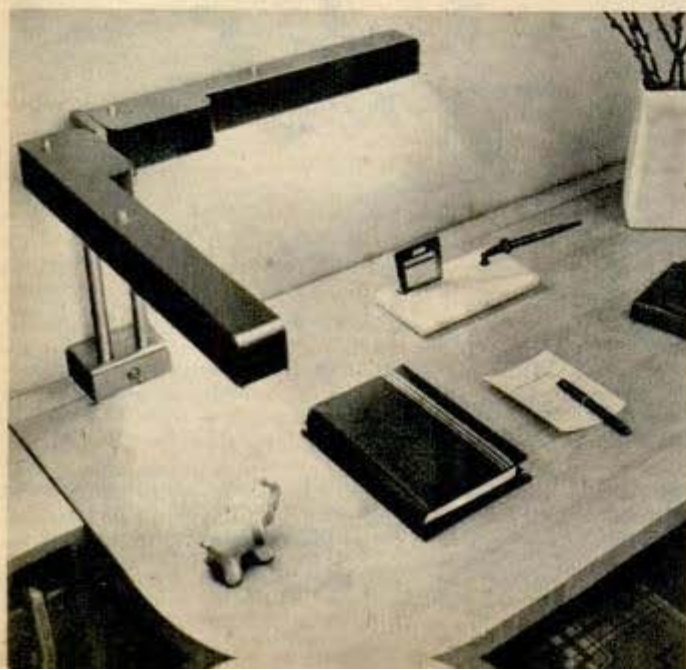

Two Wings Swing Light Of Fluorescent Lamp

Two swinging wings of a two-tube fluorescent desk lamp can be adjusted to direct the light for best results. Each wing is adjustable through 90 degrees and can be set for either left or right-hand use. Both units can be flattened against a wall to conserve space and to light a wider area.

More than 45,000,000 pairs of rubber boots and shoes for troops were made during the war, according to the Rubber Manufacturers Association.



Navy's Helicopter For Land or Sea Has Twin Rotors

Forty-eight feet long and 13 feet high, the world's largest helicopter for Navy-Coast Guard air-sea rescue and special transport duty is undergoing tests. Power is provided by twin rotors, one at each end, and the craft can land within a 100-foot circle. The pilot's cabin is at the forward end, and space for 12 men or cargo is provided amidships. P-V Engineering Forum, Inc., of Sharon Hill, Pa., is the builder.

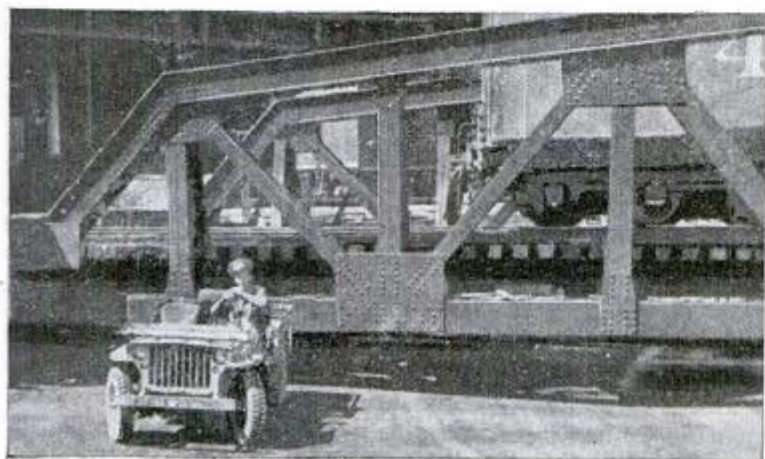

Jammed Turntable Moved by Jeep

If you ever have occasion to move a railroad turntable, don't try to push it. Just call for a jeep. That's what the Santa Fe Railroad did when an accident jammed its huge platform at Barstow, Calif. The Marine Quartermaster Depot obliged with a jeep which moved the turntable quickly into place.

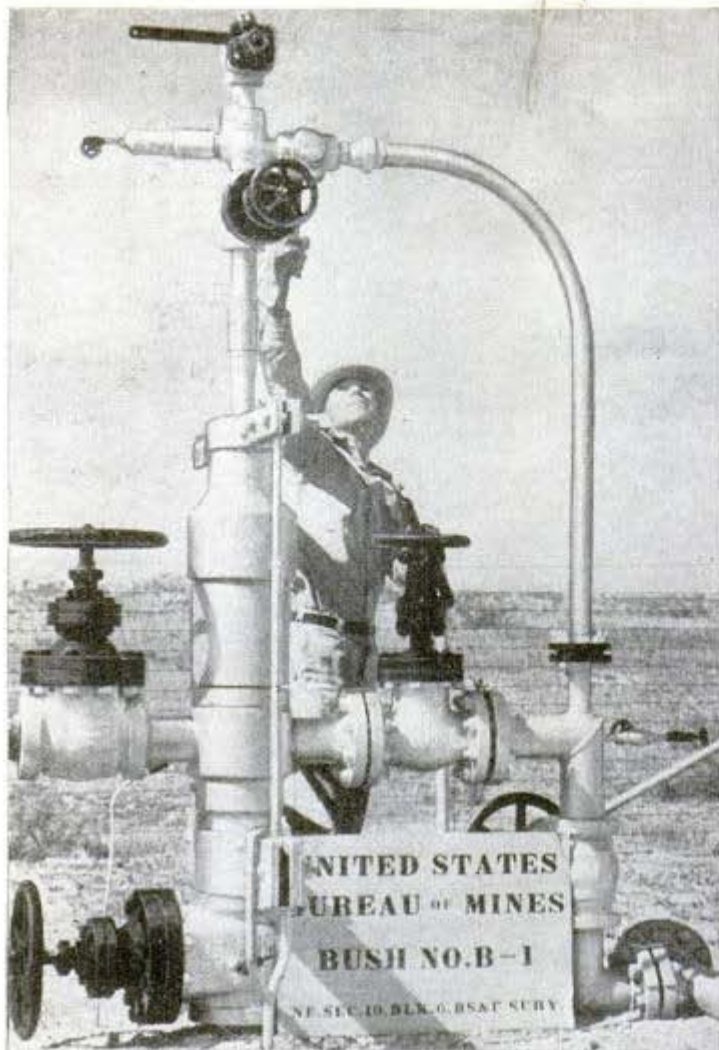

Helium-bearing natural gas is piped back into underground reservoir for storage of surplus gas at 50,000-acre Cliffside field in Texas. Below, helium dilutes inflammable anesthetics in hospital



HELIUM IS A BUSY BACHELOR

By
Howard Stephenson

HELIUM, the buoyant gas that refuses to burn, sold at the rate of \$2500 a cubic foot in 1918. Today its price is under half a cent a cubic foot and will go lower.

War uses for helium multiplied so fast that U. S. Bureau of Mines officials predict important new uses in peacetime. Five plants now make helium, compared with one before the war. Production in 1945 will be 25 times that of 1940.

For the first time there is now sufficient helium to supply every research laboratory interested in exploring new techniques. Postwar civilian supply is ample for present and new industries.

In metal working, aviation and medicine, spectacular results were obtained with helium during the war. The element, lightest of all gases except hydrogen, was really a "war baby" of 1918, but World War I ended before its value had been tested in practice.

All the world's helium supply is produced in the U.S.A. in plants owned and operated by the government. This means American control of lighter-than-air flight and strict licensing control of any foreign users of helium. A new U. S. transport industry, based on the helium-filled blimp, is being organized. Its managers are confident of taking a share of postwar air freight and passenger business on a world scale.

It takes 6,500,000 cubic feet of helium to inflate the largest blimps. But helium is cheap,

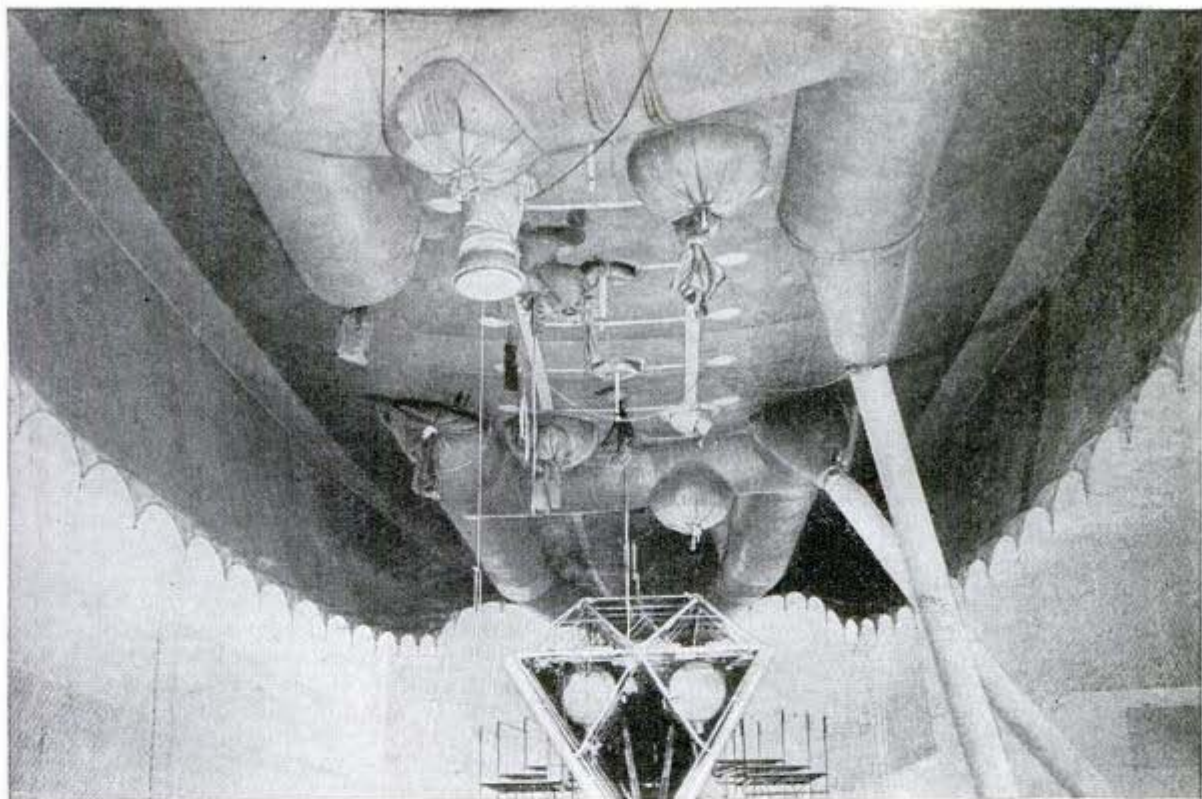

Goodyear Aircraft Corp. photo
Covered with weighted net, helium inflated envelope
for lighter-than-air ship awaits car installation

inert, and leakage losses are extremely small. Since 1940 more practical knowledge of helium-filled lighter-than-air ships has been acquired by actual operation than in the previous quarter century.

"Helium is the lifeblood of the airship," says Rear Admiral Charles E. Rosendahl, Chief of Naval Airship Training and Experimentation. "Blimps can fly slowly enough to accompany convoys at their slow speeds. Not a single one of the thousands



Helium prevents magnesium from bursting into flame during welding operation. Chain holds sheet of magnesium in place. Right, helium tank at air station



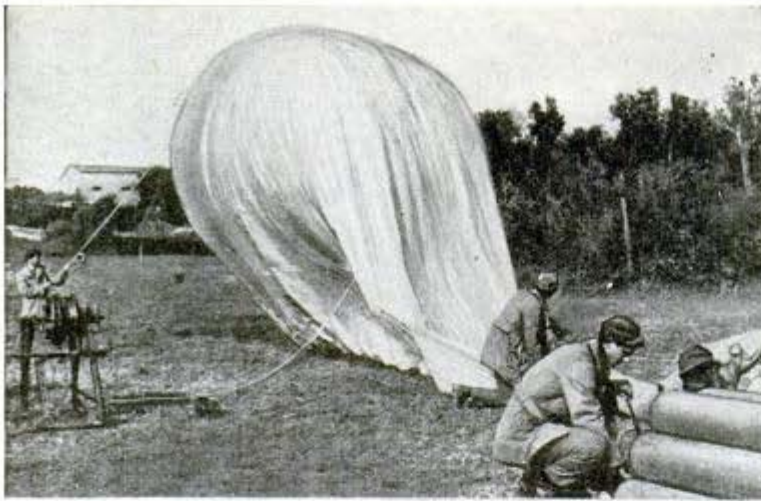

Helium was used to inflate thousands of barrage balloons. Cylinders in foreground supply the gas

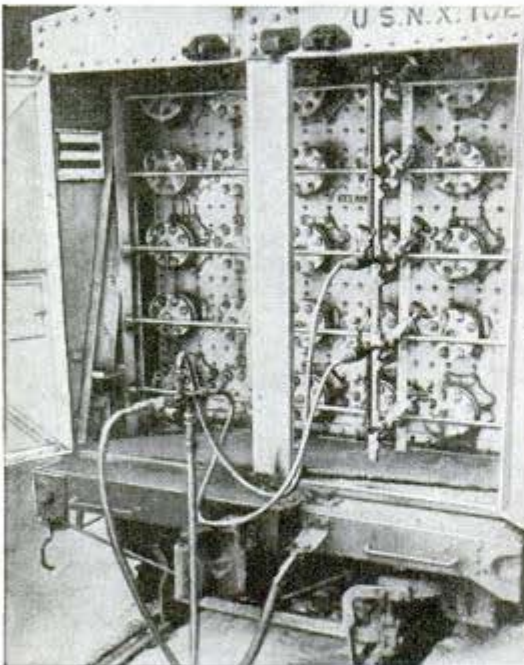

Above, end view of latest helium tank car shown below. Gas is discharged into cylinders. It requires 6,500,000 cubic feet of helium to fill giant blimp

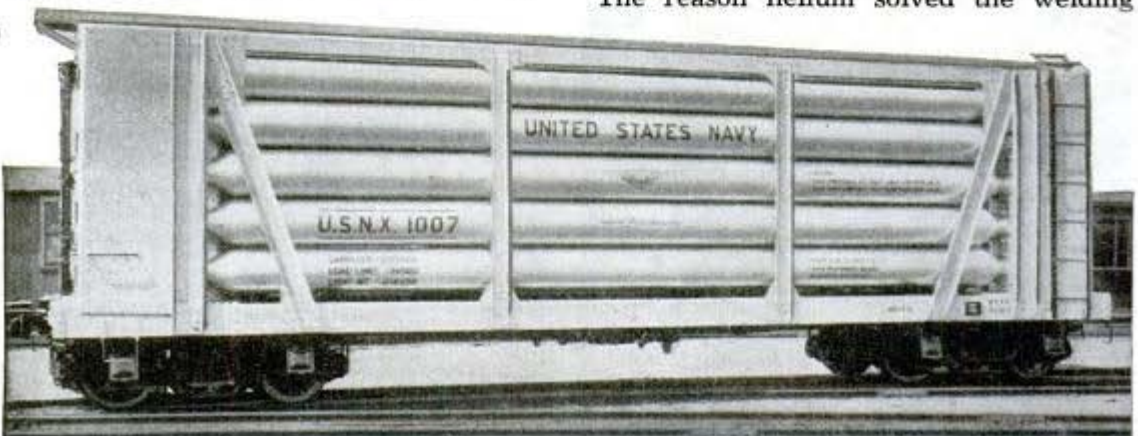

of ships which were escorted by blimps ever suffered a successful attack by a submarine."

Hydrogen was formerly used to inflate blimps but this came to a dramatic end when the German Hindenburg was destroyed in a few seconds of flames and terror in May 1937. The highly inflammable hydrogen ignited as the big zeppelin was descending at Lakehurst, N. J.

During the war, pleas of airframe makers for lighter, stronger metals

for plane parts received a superb answer when the wonder metal, magnesium, reached high enough production to begin to count in the war score. But magnesium, the stuff they put in flash bulbs, would burst into flame at the touch of the welder's torch. A special electric welding instrument was devised. It has a hollow handle and a nozzle through which a stream of invisible helium can be squirted over the magnesium surface. The helium forms a blanket in and around the welded joint, smothering any inclination to ignite, cooling the atmosphere and permitting better fusion.

It was thought other gases might be used and some were tried, nitrogen, for example. But nitrogen combined with particles of the metal and formed magnesium nitride. Contact with moisture would render such a joint worthless. No detrimental compound is formed in a helium-blanketed weld, which is as strong as the original material.

In metallurgy, the making of alloys can be conducted in an atmosphere of helium which permits strict control of the minute quantities of rare alloy metals. Aluminum may be welded to steel under a helium blanket—a major advancement in airplane construction.

The reason helium solved the welding

problem is that it is a "bachelor" gas, so called because it refuses to combine with any other element. It wouldn't combine with the magnesium and it wouldn't combine with the oxygen in the air. Bachelors are supposed to have their little peculiarities and helium is not lacking in these.

Its masculinity is attested to by its chemical symbol, He. Helium is the hardest gas to isolate. It can't be seen, tasted or smelled. It is the least soluble gas, the best gaseous conductor of electricity, except neon, and of heat, except hydrogen. It is also lightweight.

Helium may help reduce the weight of postwar air liners. Experiments conducted by Consolidated-Vultee Aircraft Corporation revealed a saving of 180 pounds when helium was used instead of air to fill the tires on the big Model 37 air liner. Punctureproof tubes are able to hold the light gas at the required pressure.

Helium possesses three cardinal virtues for use in medicine. It is light. It is inert. It is not toxic. For over 20 years, the Bureau of Mines, which produces and controls the world helium supply, has encouraged medical research with helium. Director R. R. Sayers, himself a physician, and many other Bureau scientists have conducted and supervised portions of this research.

Now that a plentiful supply of helium is in prospect, efforts of research scientists are being redoubled. The "chemical cop" already is on duty in scores of military and naval units and in some civilian hospitals.

It is used in the operating room to dilute highly inflammable anesthetics. Helium, next to carbon dioxide, is the best available fire preventer and carbon dioxide can't be administered with anesthetics.

For the treatment of asthma, substitution of helium for nitrogen content of the air provides relief in breathing. Helium is only one seventh as heavy as nitrogen and the muscular force needed to move it is only one third that for air; thus it makes an ideal oxygen carrier through obstructed passages. The proportion is usually 79 percent helium and 21 percent oxygen. Such treatment must be given under competent medical direction.

An adventuresome wartime medical role played by the invisible bachelor gas was in deep-sea diving and rescue work. It now enables men, breathing a mixture of helium and oxygen, to walk on the sea floor 400 feet below the surface. Some day, laboratory results indicate, this may be increased to 1200 feet. Before the use of helium, 200 feet was the limit of physical safety. Ships and cargo of almost incalculable total value lie strewn around the

(Continued to page 148)

'Speedometer' for Molasses



You can gauge the speed of "molasses in January" with a viscosimeter developed by the General Electric Company. This device consists of a metal cup of known capacity from which the liquid flows through a hole in the bottom. In a cold chamber test a cup of molasses drained out in three minutes and 41 seconds compared with four seconds for milk and kerosene. Even at summer temperatures molasses required 35 seconds to drain. Practical use of the viscosimeter, of course, is to measure the viscosity of various liquids—a prerequisite in making many mixtures.

Sealing Stick for Pipe Joints

Joint compound for pipe threads is now available in stick form. The handy stick, always ready for use, is unaffected by air, water, steam or acid. It lubricates and seals pipe joint threads, nuts, bolts, or gaskets.



End of the war hasn't ended the need for saving your waste paper. Supplies still are short and will be for some time to come but paper must be found to package material for occupation forces. Save paper!

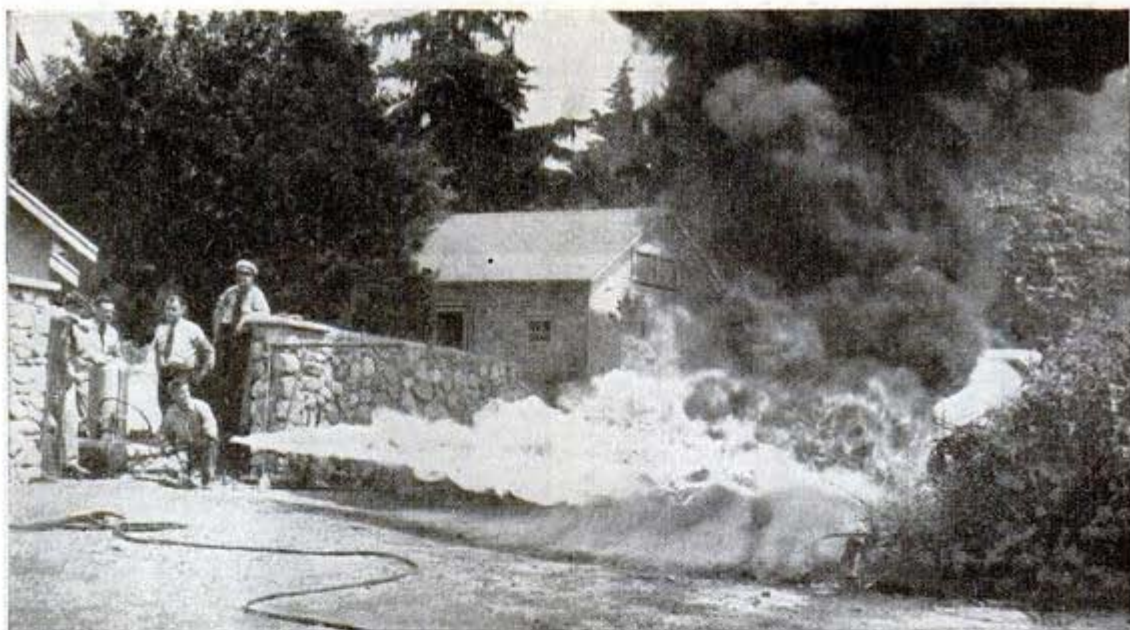

Rangers Use GI Torch To Fight Forest Fires

Green brush is quickly set on fire with a flame thrower designed to create firebreaks in fighting forest fires. This adaptation of the military flame thrower was built by forestry technicians of Los Angeles County, Calif. It consists of a 90-pound butane tank which supplies the pressure, a 35-gallon tank of Diesel fuel and 100 feet of hose with a special nozzle attached.

A pilot flame of butane, which can be used to set fire to dry, inflammable material, burns constantly in the nozzle. When the pressure is turned on, flames and oil are

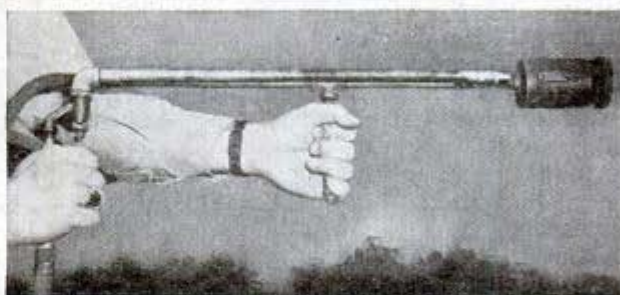

Top, flame thrower sets fire to pile of green brush. Above, right hand releases pressure which projects flames and oil

thrown out from 30 to 60 feet. The first model was built for transport by truck, but portable units are planned for use in inaccessible mountain regions.



Music Is Played on "Typewriter" With Standard Keyboard

Resembling a portable typewriter, a newly patented musical instrument has a similarly lettered keyboard and produces 32 musical notes. A special music book enables a person without previous musical knowledge to play many tunes. Aside from its use as a musical instrument, the "Typatune" can be used to teach touch typing. Early production of these instruments was absorbed by the Red Cross and Veterans Administration for therapy programs, but they are expected to be on the market soon.

Names and addresses of makers or sellers of commercial products described in this magazine are listed in the Where-to-Buy-It Index, page 8-A. Write to them for additional information and be sure to say you saw it in Popular Mechanics.



"Jerkwater" Scoop Drinks at 80 m.p.h.

Marking its 75th anniversary this year, the system which permits locomotives to refill their boilers with water "on the fly" is so improved today that the job is done at 80-mile-an-hour speeds. Formerly locomotives had to slow down to 35 miles an hour at the track pans, from which, incidentally, the term "jerkwater" came into being. As the train passes over the eight-inch-deep track pan, a scoop is lowered from the tender by air pressure controlled from the engine cab. The scoop dips into the water a little more than four inches, and takes on about 2½ gallons per lineal foot, or 5000 gallons in 2000 feet. Damage from high-speed pressures was overcome by an iron pipe vent system for the tenders.

Sapphire Gauges for Precision Need No Wear Allowance

Sapphire plug and ring gauges for precision operations requiring interchangeable parts show an amazing resistance to wear and outlast hardest steel alloy and cemented carbide gauges, their manufacturer declares. Next to the diamond, the sapphire is the hardest substance known, and can be ordered in exact sizes needed



NOVEMBER 1945



Roaring over track pans, locomotives refill their boilers with scoops lowered from the tender by air

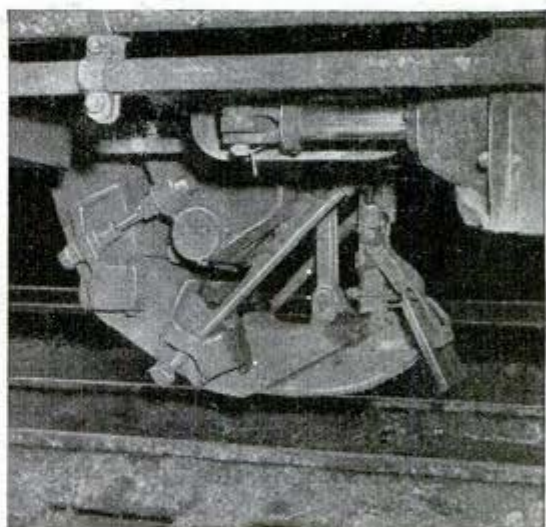

without allowance for wear. Being practically inert, sapphire reacts to few chemicals and is not subject to burring.

Diesel-Turbine as Truck Team

Combination of a Diesel engine, supercharger and turbine as the power plant for heavy trucks is foreseen for putting exhaust gas to work effectively. As outlined to the Society of Automotive Engineers, the supercharger would increase the Diesel engine's power output approximately 50 percent, and the turbine would drive the supercharger. The Diesel engine might be used later only as a combustion chamber for the turbine and to drive the supercharger, the turbine providing power.

55

TWO-ROOM



Retouchers at work on big negative from giant camera used in making blueprints. Negatives can be as large as 4 by 8 feet

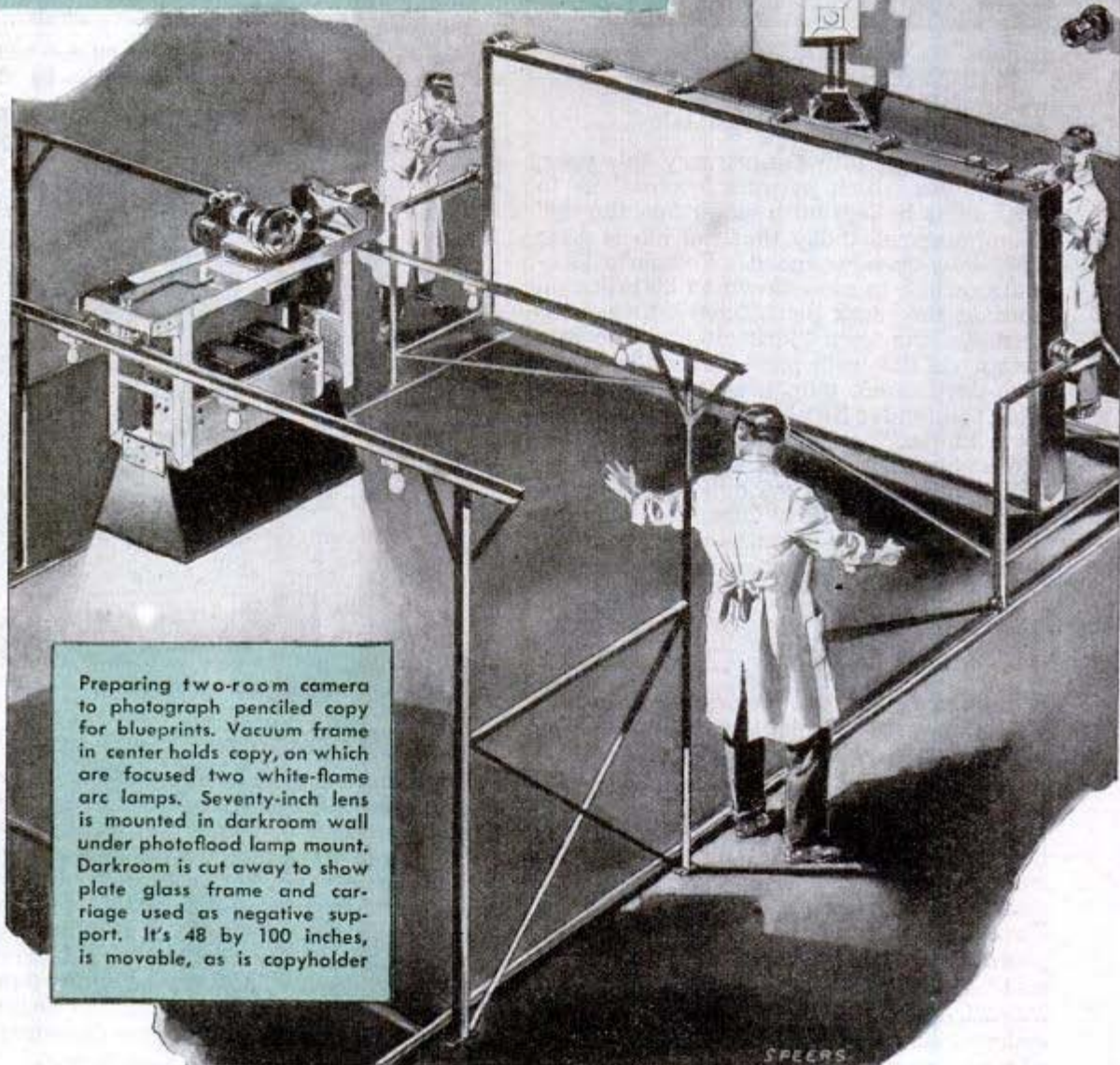

Preparing two-room camera to photograph penciled copy for blueprints. Vacuum frame in center holds copy, on which are focused two white-flame arc lamps. Seventy-inch lens is mounted in darkroom wall under photoflood lamp mount. Darkroom is cut away to show plate glass frame and carriage used as negative support. It's 48 by 100 inches, is movable, as is copyholder

SPEERS

CAMERA ...



Adjusting diaphragm of specially constructed 70-inch lens in camera, entirely designed by photographic staff of GMC Truck & Coach Division. Below, unloading darkroom negative frame

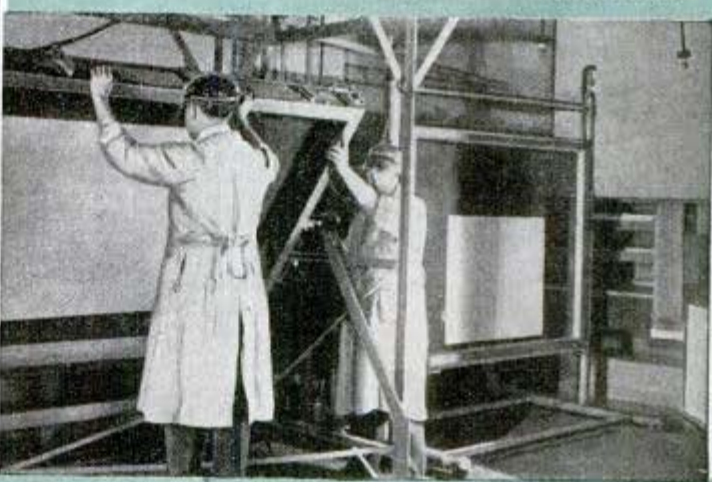

Stayflat frame at back of camera interior is loaded with film, below left. Strong light is focused on frame holding subject matter and correct exposure given. Airbrushing corrects the cloth positive

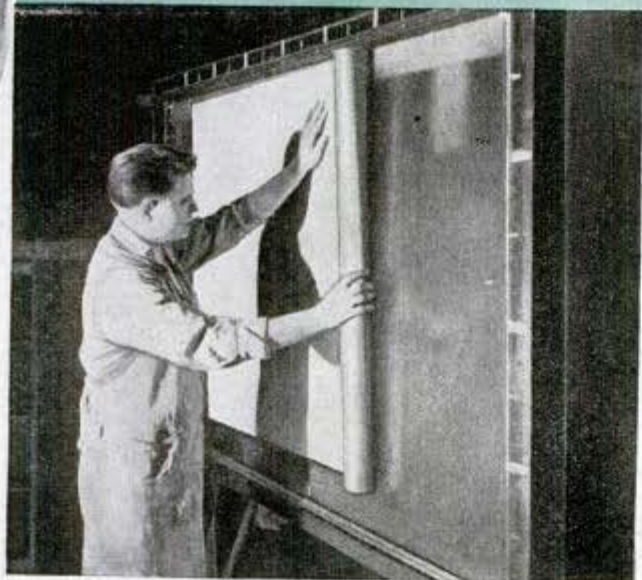

Rider in P-38 Belly Tank Films Battle



Squeezed into the belly tank of an Army P-38 Lightning fighter, Marine Combat Correspondent David D. Duncan went on a picture-taking mission over Okinawa during some of the hottest fighting.

Wind Blows 3000 Miles an Hour Through Supersonic Tunnel

Vast peacetime applications are foreseen for two new Army wind tunnels, costing a total of \$2,000,000, that will produce speeds up to four times that of sound, about 3000 miles an hour. One of the supersonic tunnels is for bombs and the other for ballistics. Both tunnels are part of one closed circuit through which compressed air is forced by a five-unit power plant developing 14,000 horsepower. In the ballistics tunnel, a flexible throat nozzle can be opened or closed to change air speeds. The throat is made of long strips of quarter-inch steel plate, and the speed is changed by power-driven jacks which close it to a

one-inch aperture or open it to 18 inches. Test sections of the tunnel are a little more than a foot wide and a trifle less than two feet tall. Scale test models of brass are placed in these sections on a special mounting rod. Observation ports of glass a foot and a half in diameter permit observation of the model at high speeds and photographing of the airflow pattern around it. Temperatures in the bomb tunnel during tests are about 100 degrees below zero.

Automatic Sextant For Navy Aviators Averages Readings

Driven by clockwork, a new sextant being used by the Naval Air Transport Service automatically continues to take sights of the object toward which it is pointed, and averages the readings to reduce errors to a minimum. The sextant can make up to 60 separate readings in two minutes. A mechanical brain in the instrument does the averaging and the results are read through a window.



SERVRON 10-FLOATING ARSENAL

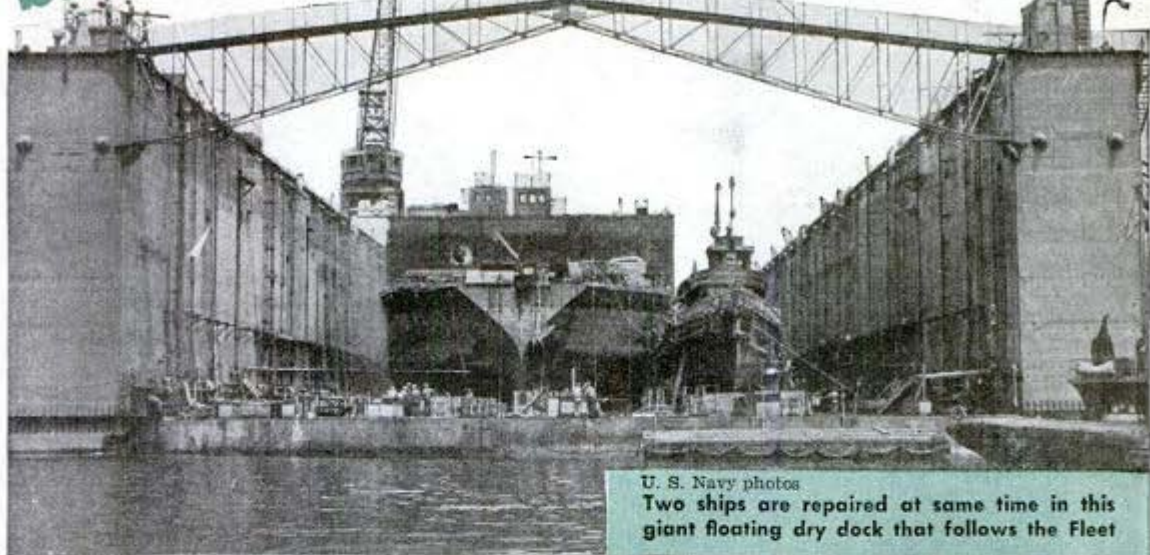

U. S. Navy photos

Two ships are repaired at same time in this giant floating dry dock that follows the Fleet

THE STORY of how the United States Navy is able to repair mighty men-of-war far out in the unindustrial wastes of an ocean is largely the story of Service Squadron 10—Admiral Nimitz's famed "secret weapon."

ServRon 10, as this industrial city afloat is called in Navy lingo, is credited by its commander, Commodore Worrall R. Carter, USN, as being the one factor in naval warfare that has decisively disproved the defeated Japs' cardinal faith—that the Pacific Ocean's tremendous distances would cancel out the American Navy's superior strength.

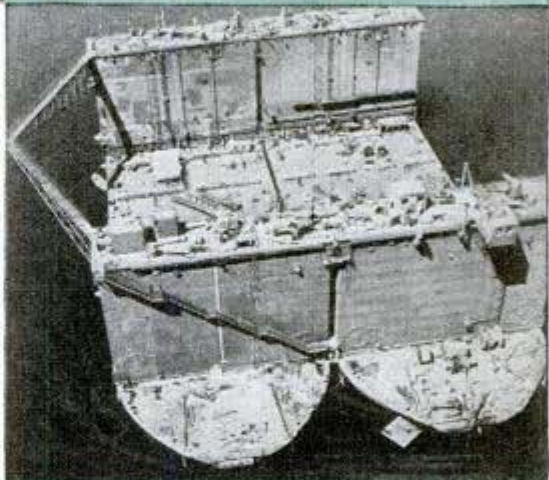

Dry dock is assembled in sections; here two are welded together. Ten sections (below) provide room for servicing a big battleship





Repair ship of ServRon 10 is veteran USS Oglala, sunk at Pearl Harbor and now completely modernized



Navy tanker steams through rough sea after refueling flat-top in distance. Below, high-decked Navy barracks ship is typical of craft which serve as home in forward areas to bluejackets of ServRon 10

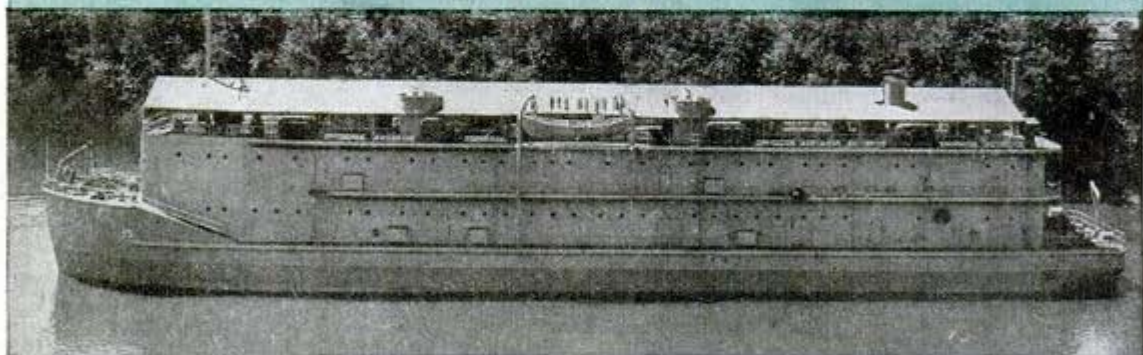

ServRon 10, with a greater population than many of America's factory cities, is equipped to keep a colossal naval task force in action by ministering to its needs for fuel, ammunition, food, fresh water, medical supplies, clothing, spare parts and even personnel. It has enabled many a seriously damaged ship to limp back to a U. S. Navy yard. Few cities of any size can accomplish the feats of this ocean-going metropolis with its 36 different types of vessels. Here, in one integrated force of several hundred ships and other craft, are joined every facility required to keep the combatant ships striking and striking again.

Backed up by this mobile "little Detroit,"

Task Force 58 was able to change the old "hit-and-run" tactics of carrier warfare to "hit and stay"—the slogan of 58's commander, Vice-Admiral Marc A. Mitscher, USN.

The more than 400 "factories afloat" include electrical equipment repair ships, tugboats, fresh-water tankers, a bakery ship, floating cranes, floating offices, floating refrigerated warehouses, floating dry docks; ships to tend destroyers, submarines, Diesel engines, landing craft, torpedo boats and aircraft. In the Iwo Jima operation ServRon 10 was stationed as far away from San Francisco as San Francisco is from London. Yet for that one operation

alone enough food was loaded on the task force vessels to feed Columbus, Ohio (a city of 300,000) for 30 days; enough spare clothing to clothe 1,500,000 persons, and enough candy, shaving cream, toothpaste and miscellaneous items to stock 6000 drug stores—including 100 million cigarettes.

Those phenomenal figures give some idea of the size of the task of Serv-Ron 10, but they indicate its duties only in the line of supply; they tell nothing of the thousands of man-hours spent daily in sweating out repairs and routine servicings for ships coming in for everything from major hull repairs from Jap suicide bombing to a new power plant or a keel-scraping for removing barnacles.

For a glimpse of the workings of such floating machine shops, consider the internal combustion repair ship. It can maintain any Diesel engine,

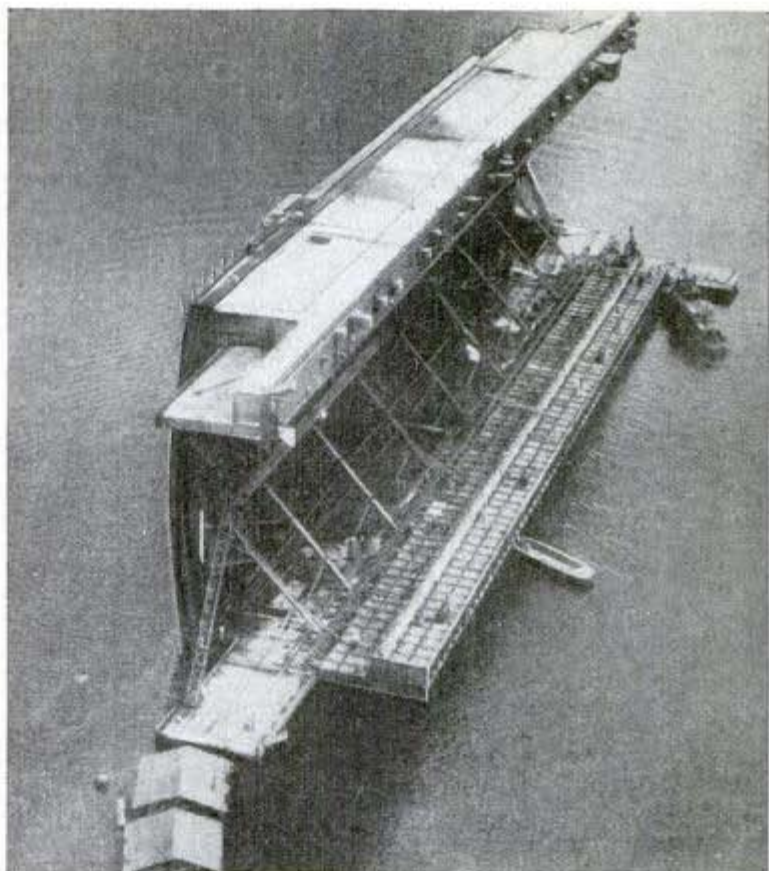

Too wide for Panama Canal locks, floating dry dock is tipped on side for passage. Below, typhoon ripped bow off Pittsburgh, but she made it to Guam

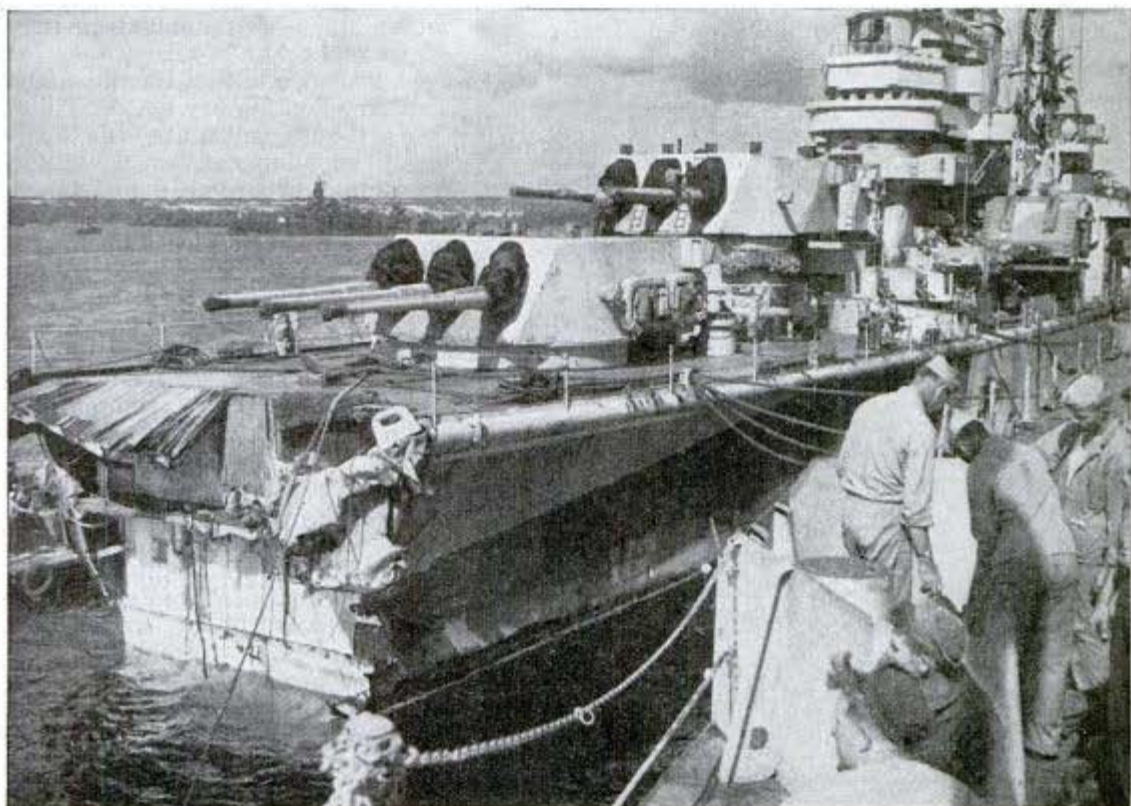

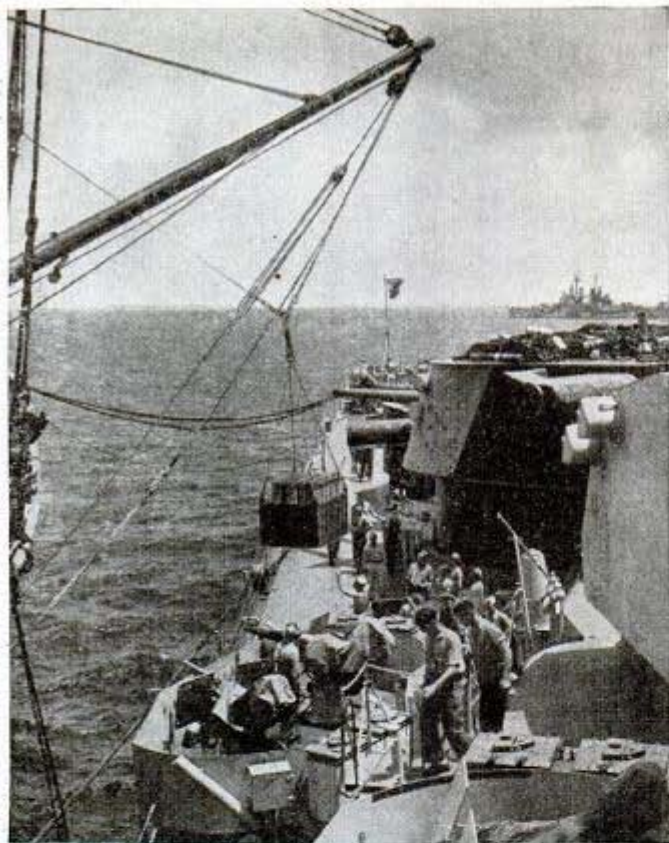

Steady, men! Cruiser takes load of ammunition from supply ship at sea. Below, repair crew removing the drooping bow of cruiser after torpedo collapsed forward deck

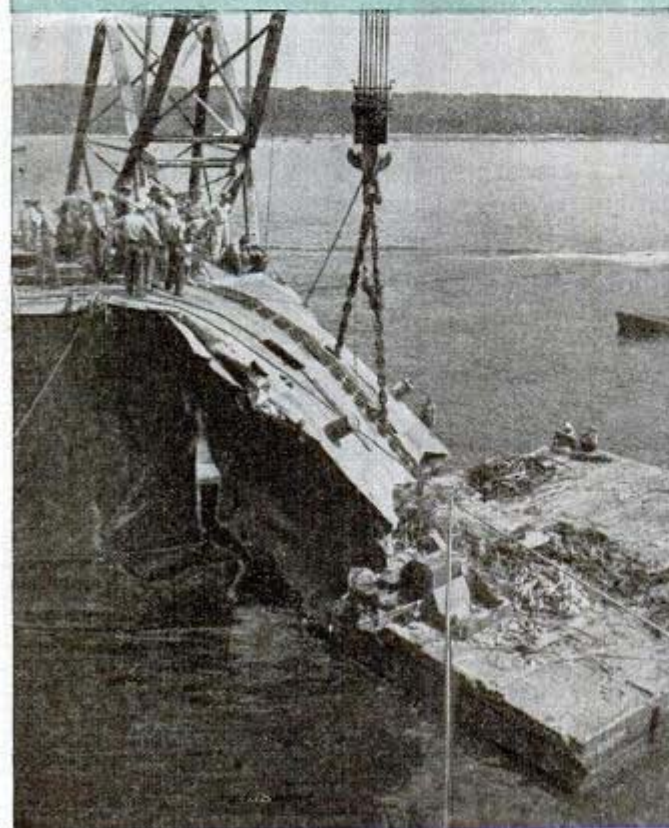

from the monsters that develop 6000 horsepower to little compressor motors of five horsepower or less. The Diesel engine is the heart of practically all our amphibious craft; therefore, the 215 men of the repair crew aboard must be able to keep any Diesel in tiptop operating condition, and also to instruct operating crews on how to keep their engines fit.

To speed the task of about 300 repair jobs a week, the ship includes a spare parts section, with shelf after shelf filled with Diesel spares — valves, springs, pistons, injectors; a machine shop, with the newest lathes, drill presses, milling machines and grinding equipment; and, because carrying thousands of blueprints to sea would be impracticable, the reference section contains a microfilm library, with negatives of blueprints for every type Diesel motor used in Navy ships. When blueprints are required, a specific negative is enlarged and, if necessary, new parts can be made from raw stock.

The barracks ship is actually a long way from its namesake, the Ritz-Carlton, in both distance and appearance; yet it enables crewmen of ServRon 10 to live in moderate comfort anywhere that the other ships of the squadron may drop anchor.

A recent addition has been the military floating dry docks. These are self-sufficient units, able to operate at advanced bases with a minimum of outside assistance. Though not self-powered, they can be moved by Fleet tugs at surprising speed. They vary in size from 1000-ton capacity AFDs (Auxiliary Floating Dock) to the giant 100,000-ton capacity ABSDs (Advanced Base Sectional Dock), composed of several sections with folding wing walls that can be assembled after arrival.

Through floating dry docks the Navy has mobile facilities able to dry-dock every type and size of vessel built or contemplated. They have enabled damaged combatant vessels to return to action in a matter of days, instead of the months previously required for the round trip to the States.

Even extensive repair of battle damage could be accomplished

(Continued to page 150)

Kindergarten Cadets Try Wings at Junior Flying School



To prove his contention that "even a child can fly a light plane," Alfred B. Bennett of Middletown, Ohio, assembled a class of boys and girls ranging from 5 to 12 years of age. In "ground school" they were taught the principles of flight. They learned about the action of air on the wings and



Top, teaching students principles of aerodynamics; above, boy at controls

tail surfaces by watching pieces of yarn that had been glued on. They made the acquaintance of ailerons, sticks, struts, rudders and fins. When they were taken aloft, the youngsters actually handled the controls of the plane. Reactions of the children and the plane were recorded by a movie camera on a wing strut.

Flyers' Flexible Strato-Suit Sustains Life at 15-Mile Heights

Made of rubberized fabric, a new flexible, pressurized "Strato-Suit" for flyers may enable flyers to go farther than ever before into the stratosphere. Developed by the AAF Air Technical Service Command and B. F. Goodrich Company, the suit has proved practical in pressure-chamber tests equivalent to 80,000 feet, or 15 miles above the earth. When fully pressurized the suit surrounds the airman with four pounds of air pressure. It provides oxygen for breathing, microphone and earphones for communication, and electricity for heated underwear. All are "piped in" via a single junction assembly which can be disconnected in one quick movement. A transparent plastic bubble headpiece is removed in less than a second by a secret device. Donned in two minutes, the suit has airtight and watertight zipper closures.

Pulp Waste Found Good for Soil

Long regarded as the largest waste in industry, lignin, a by-product of pulp and paper mills, is now found useful with fertilizers to add humus and organic matter to poor soil. A potential 12,000,000 tons of this waste now discharged into streams and rivers can be used for soil improvement, research at Yale University has disclosed.



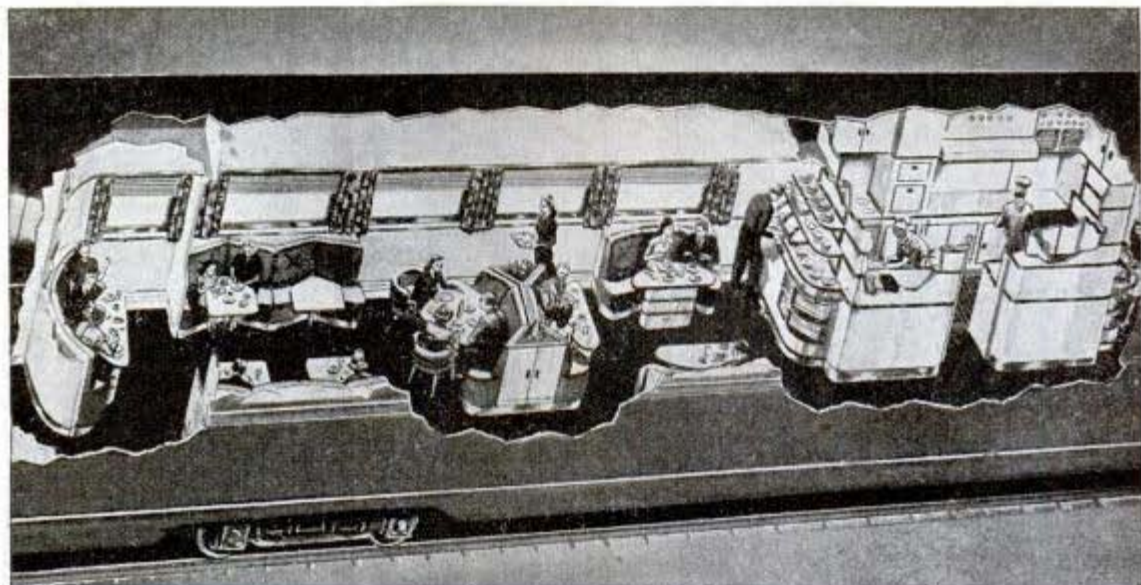

Cafeteria-Lounge for Trains

There will be no more last calls to dinner aboard postwar trains which have self-service grillroom cars. These cars, designed by Pullman-Standard Car Manufacturing Company, combine the practicality of a cafeteria with the luxury of a lounge car. The kitchen is placed in the center of the car with a food bar on either side. The car accommodates 50 patrons who may order anything from a sandwich to a full meal. Arrangement of tables and chairs is similar to that of a lounge car.

North American Aviation, Inc., photos

10 Rockets on P-51 Boost Armament Of New Model

With five rocket launchers under each wing, the new P-51H Mustang fighter can launch a destructive blast as potent as a full broadside from a destroyer. This airplane, which played an important part in the final phase of the war against Japan, also has six .50-caliber machine guns and racks to carry 1000-pound bombs or extra fuel tanks. The P-51H has a speed in excess of 460 miles an hour, a range of more than 1000 miles (an increase of 37 percent over the P-51D) and a ceiling of 42,000 feet. Powered by a 2000-horsepower engine, the plane is reported to have a rate of climb 26 percent faster than previous models. The new Mustang is 700 pounds lighter due to some 50 structural changes and the use of lighter alloys.

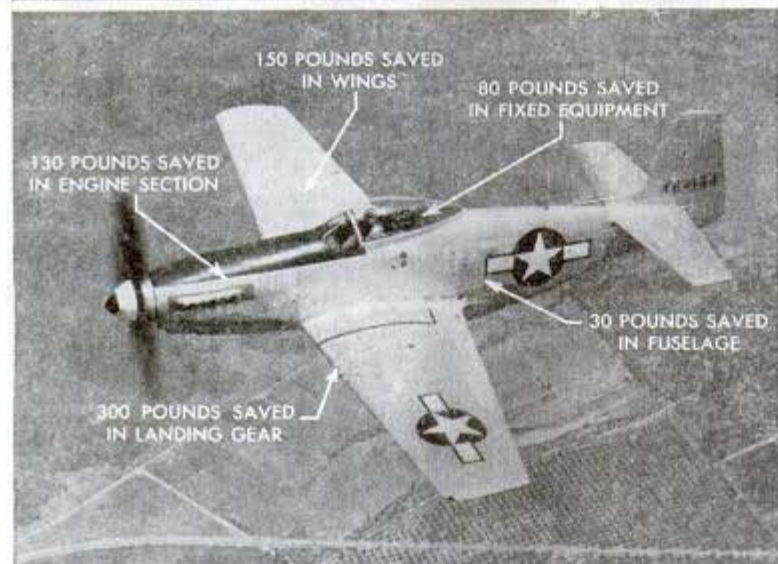



Soldiers don't have to be told to smile when the mail arrives

By Thomas E. Stimson, Jr.

NOW it can be told. Some of the letters that you mailed to soldiers in the Pacific during the war were put aboard ships that moved directly toward islands still in Jap hands when the mail left home. Postal schedules and fighting schedules were linked so closely that

sometimes your letters were delivered only a couple of hours after your soldier sighted the island and charged ashore to capture it. Perhaps your letters got there ahead of him, if he was in one of the last waves of men to hit the beach.

Fighting postmen of the Army Postal Service, carrying a mailbag in one hand

"GI Pony Express" carried the mail to some units in Europe





Machine at San Francisco APO puts V-mail in envelope, seals it. B-25 is loaded with mail to drop by chute

and a carbine in the other, often went ashore with the second or third wave in an amphibious assault. They dug their fox-holes, set up their equipment and went to work. There was mail to distribute, mail to collect and money orders to write.

At Leyte, 700 pounds of mail arrived just as the first waves were storming ashore. It was taken in at once for beachhead distribution at the next chow call.

At Kiska in the Aleutians, the postal unit lost its equipment when its boat was swamped in the heavy surf. Without a desk, the postal officer lay on his side in the mud to write out money orders. He had plenty of last-minute customers among the men who were just going into battle.

All through the war, soldier mail was a high priority item that ranked just below ammunition, hospital supplies and food. When the average soldier joined the Army he left home for the first time in his life and naturally was homesick after he was shipped abroad. Mail from home was of high importance to keep up his spirits.

Because of that, early in the war, the Army Postal Service turned the Pacific into a vast rural free delivery system. Each letter and package carried an invisible "special delivery" mark. Army letter carriers used aircraft, warships, transports, LSTs, jeeps and even parachutes to deliver their goods, and they kept the mail moving. One air mail letter traveled 26,682 miles in 23 days before it finally managed

to catch up with its traveling addressee.

A civilian is apt to live at the same address for a dozen years but a fighting soldier may have been moved a dozen times in 12 months. This postal headache was solved by providing each soldier with an Army Post Office number that represented the unit to which he was attached. In essence, the soldier always had the same address. The unit APO number followed him around.

Mail to all soldiers in the Pacific with the exception of those stationed in Alaska funnels through the Army Post Office of San Francisco. This enormous forwarding organization has its eye on the clock every minute to assure the best connections with planes and ships. It is at work 24 hours a day.

When you address a letter to a certain APO number, "c/o Postmaster, San Francisco," your letter first moves through a huge postal concentration center on the coast where civilian post office clerks break down the mail into V-mail, air mail and first class matter. The next breakdown splits each class into batches destined to the same APO numbers.

Then the Army takes over. The troop locator section determines from its files the geographical point at which the APO on your letter is now located. A routing is worked out to move your letter and the rest of the mail with the greatest speed. Possibly your letter will be put on a ship



U. S. Signal Corps photo
Directory holds postal data on every soldier to move through San Francisco Post Conveyor below stacks mail

that day, possibly it will be rushed by train to Portland or San Diego in time to catch a ship that will make more direct connections.

Measured in millions of units per day, 100 carloads or more per day during the pre-Christmas rush, the San Francisco APO has put mail on as many as 27 different ships during a 24-hour period. Mail always gets top stowage under the last hatch to be sealed so that it will be the first item of cargo to be taken off at the ship's destination. When a troop unit makes several moves while mail is en route to it, the mail may be rerouted during its journey to reach the men without delay.

Part of the reason why military mail flows so smoothly is that the Army has put experienced postal men in charge. Lieut. Col. John H. Van Meter, commanding officer of the San Francisco APO, is a former United States Post

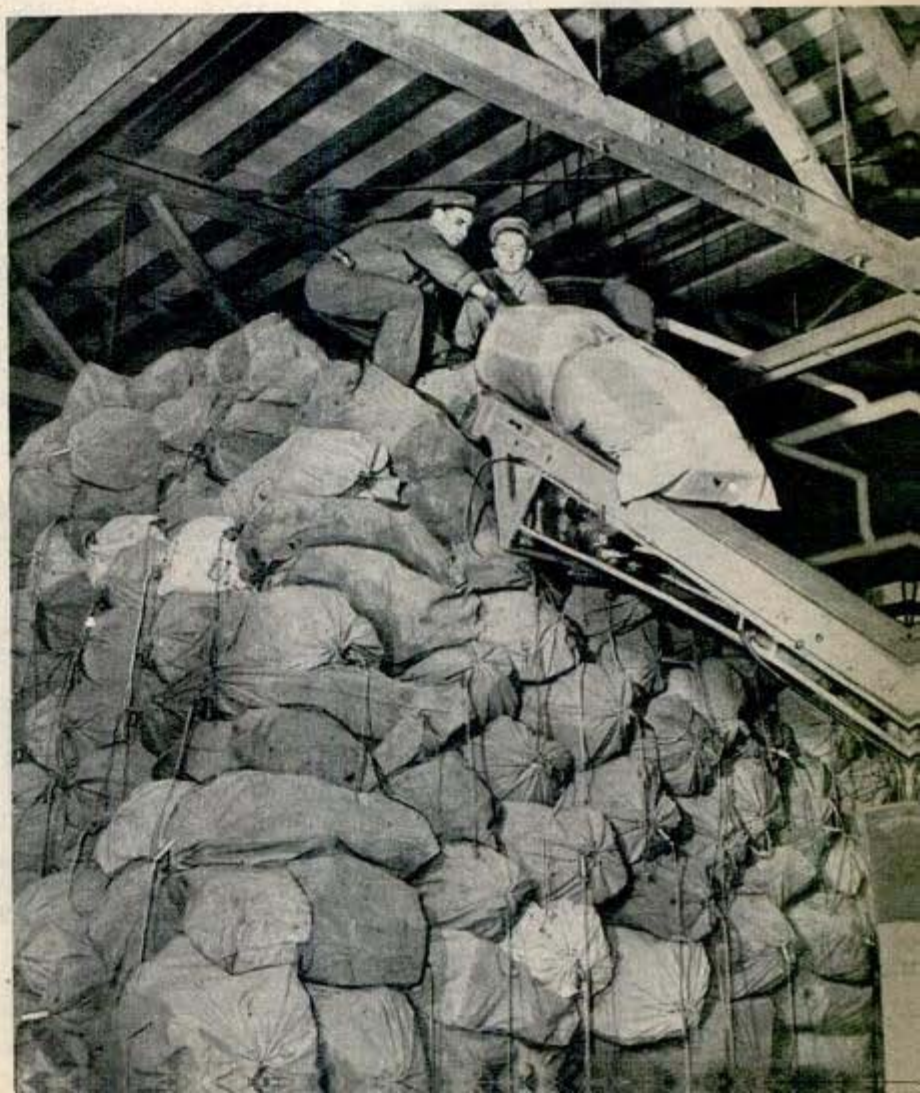

Office inspector. Major A. F. Reagan, his executive officer, was assistant postmaster at Natick, Mass. Men with post office experience helped to train the men who form the postal units in the field. The Army Postal Service is a portion of the Army Service Forces.

Aside from the routine work of assembling the mail and forwarding it to its destinations, the San Francisco APO performs a number of special services that have paid for themselves a thousand times over in gratitude and appreciation.

When Colonel Van Meter receives word that a certain outfit in a local staging area has been

Lightweight canceling machine used by APO units in the field



Part of package distribution line at San Francisco APO. This setup is for one particular overseas unit



alerted for sea he also learns the sailing hour and the ship on which the men will sail. This is continuing for reassignment and redeployment units. At once all incoming mail for that unit is diverted from its regular channel and this special collecting continues until just about the time the ship leaves its dock. While the ship is moving out toward the Golden Gate all of the last-minute mail for the men is put aboard a fast dispatch boat and delivered. Examination of postmarks shows that some of this mail, written locally, was posted only five hours before.

Service beyond the ordinary flow of the mails led to the idea of "mail call" on inbound hospital ships. When a man wounded in the Pacific had to be returned to the mainland for treatment, his name and transportation schedule were forwarded by air to San Francisco. Immediately, in San Francisco, all mail addressed to him at his APO number was intercepted and held out. At the same time any mail for him that reached his field APO was returned by air mail to San Francisco. Collections continued until the ship was several hours offshore, then a launch carried the mail for delivery at sea. As many as 12,000 pieces of mail have been delivered to an inbound hospital ship by this special service.

Except for V-mail, which it processes in each direction, the Army Post Office of San Francisco handles outbound mail only. Inbound mail from soldiers abroad is received by civilian post offices on the coast and distributed through regular channels.

The Navy maintains a comparable postal system through its Fleet Post Offices, the chief FPO for the Pacific also being in San Francisco. Mail for sailors and marines on ships and at shore stations in the Pacific moves the same as Army mail, on the fastest vehicles over the shortest routes.

There always was a chance that mail would be destroyed or damaged by enemy action but the principal reasons for slow delivery or nondelivery were improper addressing and poor packaging.

How would you go about delivering a pair of eyeglasses that were found unpackaged and unaddressed in a mail sack? How could you trace the destination of a good wrist watch that had been in a package that was bombed open by the Japanese? With the watch was a business card of a jeweler at

"7th & Park," on the back of which were a few words addressed to "Bill" and signed "Mother." There were no other clues.

In San Francisco, Major Reagan thought that there was a chance that the owners could be traced, so he turned detective. Puzzling over the "7th & Park" address that accompanied the wrist watch, he consulted the stack of classified telephone directories on file at the library. In Baltimore, he found, there was a jeweler at such an address, so he sent a description of the watch to the jeweler and asked who had bought it. The jeweler hadn't kept a record of the sale, so he passed the story on to the local newspapers. "Mother" read the story, furnished the APO with "Bill's" full name and address, and within a week the watch was on its way.

The eyeglasses were restored to their owner by similar deduction. Major Reagan observed that the frame contained an odd screw, suggesting that it had been repaired overseas. Australia, he reasoned, was the most likely place at which such a repair might have been made. He sent the glasses to an Army oculist who broke down their prescription and then he mailed copies of the prescription to a number of Australian firms. Sure enough, one of them had repaired the glasses and could furnish the name of the customer. The soldier was now in a hospital in Tennessee, it turned out, and Reagan forwarded the glasses to him.

But don't bank on getting special "directory" service of this kind for packages that you send overseas. Deliveries are most rapid when the addresses are plain and complete and when packaging is strong. Remember that your mail may be transhipped several times, it may receive un-

Sailors carry sacks of mail aboard ship for distribution

NOVEMBER 1945



Portable distribution case of canvas and plywood used for field sorting

avoidable rough handling, it may get wet at sea, and be exposed to humidity in the jungles. Wrap each package with several layers of strong paper. Use two lengths of twine lengthwise and two crosswise, with a knot at each crossing. Pack your parcel solidly. Weight is limited to five pounds and size to 15 inches long, 36 inches length and girth combined. List the contents, your name and the addressee's name, and place the list inside the package.





Flying "Bathtub" Carries Freight On 450-Mile Nonstop Trip

Designed by British engineers for carrying light freight or passengers, the Miles Aerovan has a cruising range of 450 miles. Its speed is about 115 miles an hour. The

plane has a single high wing and is powered by two engines. With a triple tail, somewhat resembling that of the Lockheed Constellation, and a tublike fuselage, the Aerovan presents an odd appearance. The rear compartment has a door large enough for a sedan to be taken aboard.

Electronic Gauge Measures Fuel

Gasoline in the fuel tanks of military aircraft is measured by weight with an electronic capacity type indicator that is unaffected by varying temperatures. Multiple pickup points compensate for wing tilt which causes as much as 20 percent error in conventional float gauges. In the electronic system, a long tube is mounted in the tank and an amplifier and meter in the fuselage. Resembling a section of pipe with two smaller pipes inside, the tube actually is an electrical condenser. Gasoline flows inside the tank unit between the two smaller pipes and a minute electrical current moves from one small pipe through the gasoline to the other tube. Changes in height of the liquid in

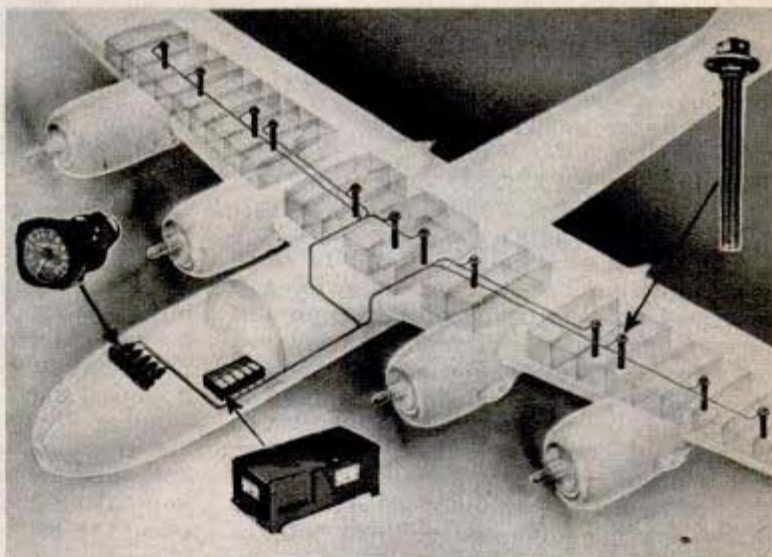

the tank unit cause a corresponding change in the electrical capacitance of the gasoline, which is measured electronically by the amplifier and registered in gallons on the meter. Expected postwar uses are in the refining industry, for storage vats, and for measuring moisture content of grains.



B-24 Camouflaged Into 4 Planes

Ingenious application of camouflage to a B-24 Liberator resulted in a plane which looked like four Liberators, with their nose turrets, engine nacelles and tail surfaces all in a row.

☞ The "twilight sleep" drug, scopolamine, a hypnotic and sedative, prevents seasickness in two out of three persons and in tests among servicemen has had no effect on their efficiency.

French 'Pocket' Car, Swedish 4-Seater

Sweden's postwar automobile, a streamlined four-seater two-door model featuring a rectangular hood somewhat reminiscent of the Cord, was a great attraction at the Swedish Fair, held recently at Gothenburg. Rectangular grillwork covering the radiator and parallel with the front bumper gives the car a modernistic appearance. Running boards are eliminated completely. French manufacturers meanwhile offered a miniature auto, of simple design, weighing 500 pounds and traveling about 60 miles on a gallon of gasoline. Its lines look as if they were taken from an amphibious tank.

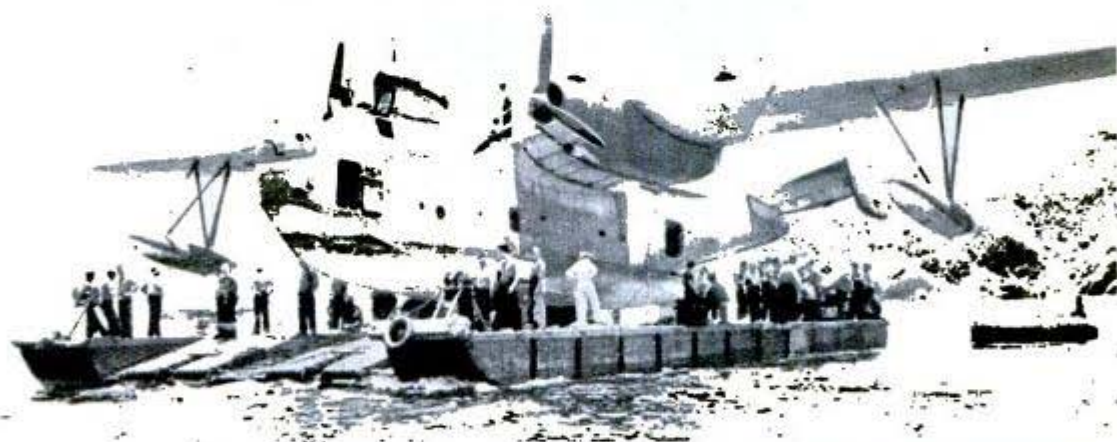

Seaplanes Ride Pontoon Barges Propelled by Outboard Units

Pontoon barges were carried by LSTs beyond advanced bases in the Pacific to speed repair work on seaplanes. These barges are fastened to the sides of the big landing ships. They are launched by removing the turnbuckles and chains that hold them in position and then cutting a cable. The barge drops into the water. One landing ship can carry four barges. They can be joined together to form floating platforms of varied sizes which are equipped with outboard propulsion units.

PBM rests on barges, above, carried by LST as at right



TNT DIVERS



Training for underwater demolition work, Navy men tie explosives to rocky Hawaiian shoreline. Below, ready for action, they head for first target—Peleliu



Below, while U. S. bombers strafe Jap-held beaches at Balikpapan, Navy divers wait to plant undersea TNT



SWIMMING warriors, you might call them—those shockproof Navy men who dove under water and planted explosives to blast away natural and man-made obstructions from enemy beach approaches.

Losses among the underwater demolition teams were high—40 percent at Normandy—because the TNT divers hit the beaches days ahead of actual invasions.

Wearing only swimming trunks, tennis shoes fitted with fins, and goggles, they looked for mines, spikes and other enemy-installed invasion barriers. In Japanese waters, they were alert for hardwood posts wedged into reefs along with cribs of logs and netting packed with cement and coral. Often these guards were interwoven with barbed wire and interlaced with mines.

Once these landing obstacles were located, the underwater sailors tied cords of high explosives around the objects to be blown out. Then the swimmers got out of the area fast. With synchronized watches and in radio communication with their commanding officer, the men hopped into rubber boats on prearranged signals and hurried to their landing craft to escape the deluge of flying coral, concrete, steel and broken timbers from the explosions.

Underwater demolition teams, drawn from both the Navy and the Army, landed at H-hour on Normandy. Under fire from enemy-held strongholds, they helped clear the way to victory.

In Southern France, the undersea dy-



His explosives planted under water, a diver comes up



Underwater fighters tie cords of high explosives to mines, logs, coral deposits and other invasion obstacles

nameters knocked out large numbers of enemy obstructions with virtually no loss of life. At Okinawa, 3000 underwater barriers were blown to bits by the swimming sailors, and at Guam 1000 bull's-eyes were chalked up.

Teams of 87 enlisted men and 13 officers worked both day and night at two main

jobs: (1) to find mines and other obstacles in the way of invasions and get general hydrographic information and (2) to eliminate all obstructions where necessary.

While the TNT divers were bobbing along on the water's surface or probing down below, fighting ships and planes protected them by blasting the enemy's shore.



Left, his fin-equipped shoes pointing skyward, a Navy diver lands upside-down in his rubber boat. Right, 8000 pounds of tetrytol planted under water by Navy divers explode off the coast of Peleliu to aid invasion

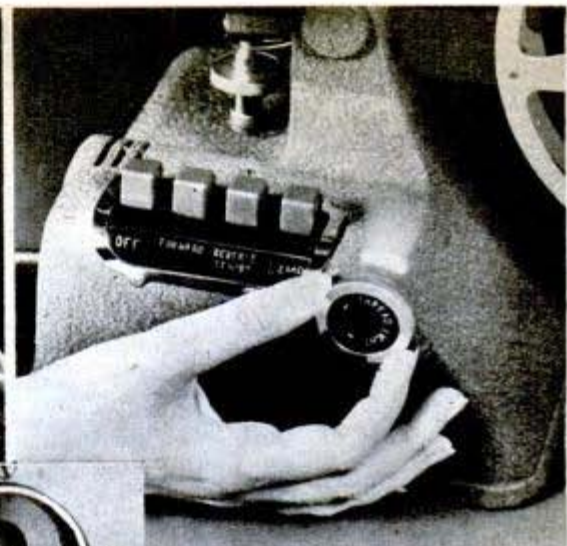

Power Cord Winds Self On Movie Projector

Simplicity and ease of operation are emphasized in a new 16-millimeter motion picture projector already in limited production. The electrical cord is coiled on a spring-tensioned reel in the base of the projector and retracts automatically



Push-button control and self-winding power cord feature 16-mm. projector

when not in use. Film sprockets and film gate are illuminated by a separate thread light. Major projection controls are contained in a panel having four push buttons. A lever halts projection for enjoyment of single frames, and a threading knob makes adjustments easy during threading or still projection.



Brand 'Typed' on Tubing Helps Identify Wires

Flexible plastic tubing is branded for identification purposes with a machine that operates as simply as a typewriter. The branding machine, which applies indelible letters by heat each time a key is hit, not only resembles a typewriter in appearance but has a standard keyboard. The brand is "typed" on in various colors which are said to be as resistant to acids and oils as the plastic itself. Identification sleeves are used extensively on electrical wiring in airplanes and ships. Plastic tubing is also used for insulation. For either purpose the branding machine operates at 30 or more characters a minute.



62 Miles of Wire in Pound

One third the size of a human hair, delicate wire used by General Electric for tiny coils of electronic circuit measuring instruments measures 62 miles to the pound. Even with six coats of insulation it is as fine as a cobweb.

POPULAR MECHANICS



Submachine Gun Becomes Pistol By Detaching Butt

Australian soldiers have a strong fancy for most equipment of their American allies, but the reverse is true of the simple, rugged and lightweight Owen submachine gun invented by a young Australian. Weighing 10 pounds, the Owen gun uses 9-mm. ammunition, fires 725 rounds a minute. Each magazine will take 33 rounds, but usually is loaded with 28 to avoid jamming and to save the spring. The gun has a foregrip, carries the magazine on top, and is sighted with both eyes open. If dropped, it is designed to fall on its side, with mechanism clear of mud and dust. Both firing pin and extractor are part of the bolt, and the trigger mechanism, packed in grease, is water and dustproof. Made of oil-impregnated metal, the bolt never requires atten-

Spent magazine of Owen gun is removed with a flick of the wrist and a new one clicked home in a fraction of a second, above left. U. S. officers fire the gun from hip and lying down. Bayonet catches fasten the parts



tion. With a detachable butt, the gun may be used pistol-fashion. Although the gun hasn't the stopping power at close quarters of our heavy .44-caliber slugs, it was extremely popular for jungle fighting because of its lightness. It costs the Australian government less than \$30 to manufacture.



"Pin Ball" Tester for Metals Reveals Hardness

Metal can be tested for hardness "on location" with a portable testing unit. Requiring no special skill to operate, the tester consists of a spring-actuated hammer containing a striking ball. By resting the hammer on the metal to be tested and releasing the ball under impact of a spring, an impression is made on the test piece. The diameter of the impression is checked with a microscope; comparison of this diameter with data on a chart determines whether or not the metal comes within specified hardness.

IT'S OUR TURN AT THE POTTER'S WHEEL



Fashioning of chinaware and pottery has become an American art. Here a delicate object is sculptured for a master mold

CERAMICS, a lusty youngster in American industry, today holds undisputed world leadership in production and technical skill, thanks to typical Yankee ingenuity in exploiting the secrets of an ancient art. In attaining this pre-eminence the industry has exploded the fanciful and mesmeric charm of the word "imported."

The alchemy of our potter's art belongs to the 20th century—largely to the 1930s and early '40s, when the greatest strides were made. In the early 30s, more than a third of all the chinaware sold in this country was imported; of those imports, Germany and Japan together sent 87 percent. By 1940 the total of all imports had declined to 11.8 percent.

Before the war, Japan maintained a sort of trade espionage in this country so that

her 45,000 ceramic workers and 2106 pottery chimneys might be kept busy. Time was when "Dresden," "Tokyo" and other foreign imprints were the despair and envy of domestic potters.

The production of pottery in this country furnishes a study in anachronism. Side by side with the potter's wheel and other crude implements of the distant past are the latest in labor and timesaving devices. But the ceramic art has not lost affinity with the ancients. Inert clay, whether by hand or machine, still takes shape, grace and symmetry, much as it did centuries ago in the Nile valley or the pagodas of China.

Early in the 18th century, European potters learned the secret of porcelain from China, whence it derives its name. In 1769 the first true china appeared in this coun-

Handwritten note:
Hart, Inc.
Boston 5, 79

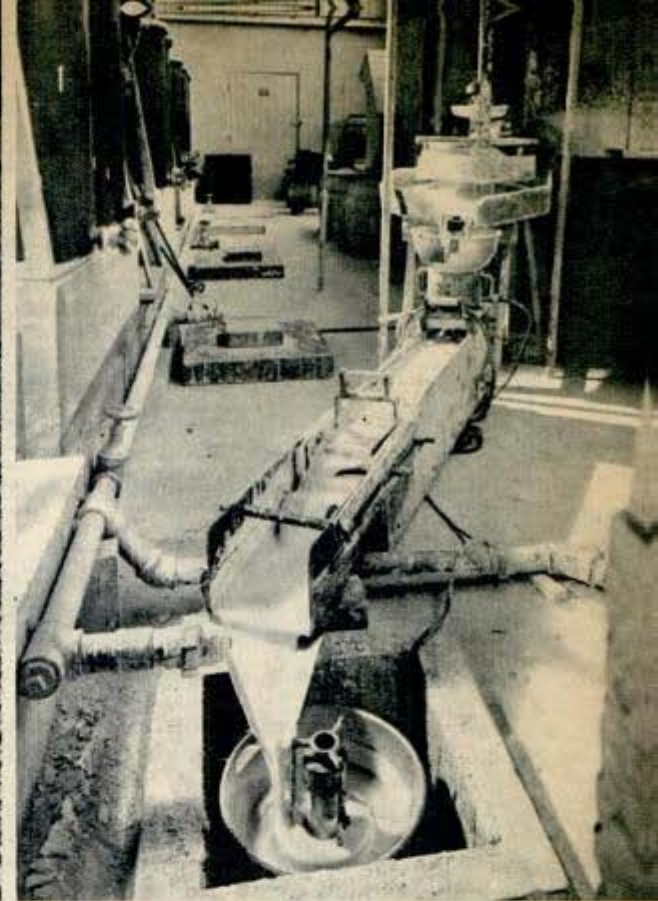

Clay is mixed with feldspar and flint, water is added. Electro-magnetic slip trough takes iron bits from mix

try—in Philadelphia. Failure after failure marked the early American endeavor, however, and the industry didn't get off to a successful start until 1882, when workmen were brought here from the famous pottery in Belleek, Ireland, to duplicate the thin eggshell ware made there that is noted for its luster glaze.

Much accomplished since then stems from the early influence of Irish Belleek. The American ware, however, has eliminated the high glassy and mother-of-pearl effect that characterizes Belleek. Because the Irish local clay is 75 percent feldspar, it differs from the bone china process common in English ware.

Bone ash comes from animal bones that have been calcined. Feldspar, generally in use here, is a glistening white powder, the product of crushed rock formations. Neither adds anything to the strength of china but acts as a flux or solidifying element.

French china, as typified by the Theodore Haviland ware

of Limoges, France, is distinguished by its low temperature bisque fire and high temperature glaze. Haviland began his career in America as an importer of English china, later went to Limoges where he set up his kilns and won fame for his ware. In 1937, manufacture of the American Theodore

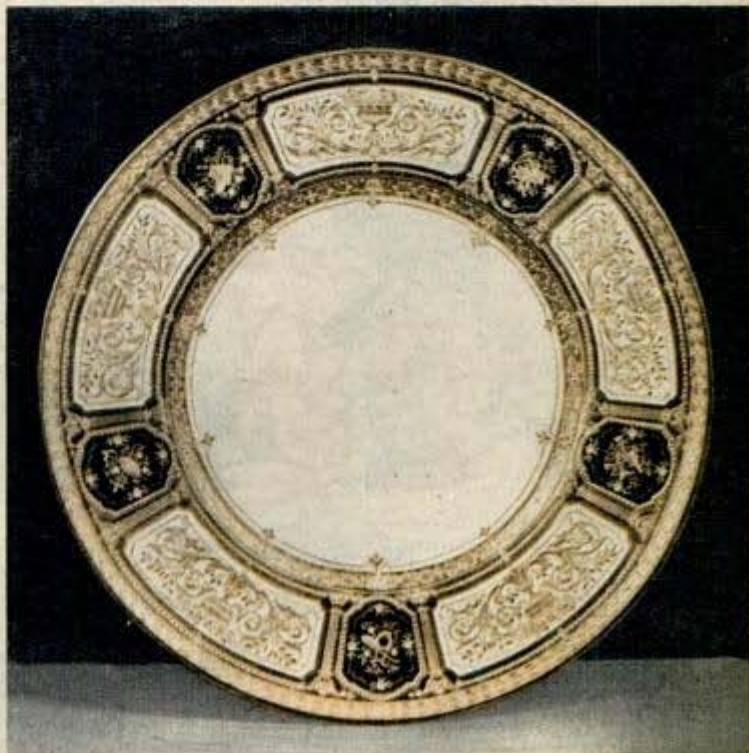

Nellie Melba plate, given to her by Victor when diva retired, is example of fine china. Value is \$6000 a dozen



Modern potter's wheel, jiggering machine makes simple shapes. Green ware is fired in bisque kiln, above right

Haviland china was begun in Newcastle, Pa., from the original molds and designs created in Limoges.

Pottery, in common English usage, applies to all opaque ware as distinguished from porcelain, or its synonym, china. Porcelain, as found today in fine table sets, is vitreous and highly translucent. It is non-absorbent and when struck has a clear, bell-like sound.

There are two types of porcelain, the

natural or hard paste type and the artificial or soft paste porcelain. Feldspathic china is a hard paste type while bone china is the soft paste or artificial porcelain.

Semiporcelain is generally found in hotel ware and in bathroom fixtures and accessories. It is semivitreous because it is not so high-fired as pure porcelain. Earthenware, or common pottery, represents all that the ancients knew about the ceramic art, until the technique was learned from the Chinese.

Gold printing is transferred from steel etching by press and tissue paper

Rich deposits of potter's clay, flint and feldspar abound in this country. As a rule, the clay is mined from several different areas, washed and stored in bins. These clays are creamy white in color and very fine in texture. When ready for the pottery, the clay is mixed with feldspar and flint and placed in a large revolving cylinder containing water and flint pebbles. By this process of "pebble grinding," the minerals are ground into uniform density.

After 50 hours, the mixture attains a thick, creamlike consistency. It then is forced through a fine wire screen by air pressure for two hours to remove larger particles. What is left is a fine-textured fluid called "slip." Some pot-





Glazing, or dipping in liquid glass, must be done deftly. Translucence over light discloses glazing flaws

teries, instead of using slip, employ a soft pliable clay mixture from which moisture has been pressed. It is then thrown with great force into the molds.

The slip is forced over an electro-magnetic trough to remove all metallic iron particles before it is ready for "aging." Why this aging is necessary no one seems quite sure, yet it is done according to the oldest of principles known in the art.

Properly aged for several days, the slip is ready for casting in plaster of Paris molds. These molds are placed upon a "jiggering" machine, a flat, revolving disk that is the modern prototype of the ancient potter's wheel. Slip is poured into the mold and allowed to thicken until semiplastic when it is ready to "work."

Only simple shapes are produced on the wheel or "jigger." Elaborate or intricate shapes such as handles, spouts and knobs are cast in molds and attached separately to pitchers, pots and similar objects by hand. Slip is used as an adhesive.



Cylinders made of steatite test penicillin. Below, hand-painting a design





Photographed at Marshall Field & Co., Chicago
Woodrow Wilson set was first presidential
service designed and manufactured in America



Quaint teapot and dinner plate of Crinoline
pattern by Gladding McBean of Los Angeles



Castleton china in Gloria motif, above, made
by Shenango (Pa.) Pottery. Gold-rimmed cup,
golden handle mark Haviland's Kenmore china



Frances Poe, Chicago artist, molds, fires, glazes and
paints models of animals such as this prong buck

Next comes the drying process which ordinarily requires 24 hours. One pottery in Buffalo uses a technique new to the industry—drying by infrared process, which cuts drying time for hotel chinaware from two hours to only 15 minutes.

For fine china, however, the green ware must lose all its moisture by slow evaporation. Then the pieces are ready for the firing (at 2200 degrees F.) that gives them a vitreous and translucent quality. Because the forms cannot be exposed to direct heat without discoloration or cracking, they are placed in coarse clay containers called "saggers."

After 30 hours in this inferno, the ware is in a white, vitrified state called "biscuit ware." The pieces that survive warping or any other imperfection undergo a blast of fine sand which scours every trace of a ridge or bubble. Clinging particles of sand are removed by compressed air.

In a few seconds, the biscuit ware is glazed by an expert craftsman who dips it in liquid glass, accurately and delicately so that the finish is even and uniform. Another step is glaze firing at 2100 degrees F. In the glaze kiln the liquid glass is fused with the body of the ware, giving it a rich, ivory-cream tint.

(Continued to page 154)

*North American Aviation, Inc.
 Longwood, Calif.*



Two Power Packages Drive 77-Foot Trailer

Measuring 77 feet from bumper to bumper, and nine and a half feet wide, eight Army super truck-trailers carry 34 complete tail-cone assemblies each between California and Texas plants of North American Aviation, Inc. Two V-8 Mercury engines, on a removable mount which pulls out from under the hood for repair or replacement, power each truck. Cargoes are light and bulky rather than heavy. The vehicles are said to be the largest now in operation.

☐ Fish wardens in Quebec have captured fish for study by electrocuting them with a 400-volt, 60-ampere shock administered by a 25-kilowatt generator applied to a pool five feet deep, 250 feet long and 15 feet wide.

Twin V-8 engines on removable mount which pulls out from beneath hood can be replaced quickly in supertrailer operation



Foolproof Fuel System on Plane Uses Last Drop of Gas

Aircraft engines are assured of a continuous supply of gasoline as long as there is a drop in the principal tanks with an improved fuel system. The new system, which pipes all fuel through the main tank, reduces the chance for human error in the manipulation of a fuel selector valve. Formerly, the selector valve was switched to the main tanks for takeoff, then back to the auxiliary tanks until exhausted, and then to main tanks again. With the new system, fuel level valves in the main tank automatically open when the gasoline drops below a certain level. This keeps the main tank filled from the auxiliaries until they are empty. The selector valve in the new system permits piping of fuel direct from any tank to the engine in case the main tank is

damaged. This system was first installed in P-47 fighters, but it has been adapted to the A-26 and other two-engine models by using one unit for each engine.

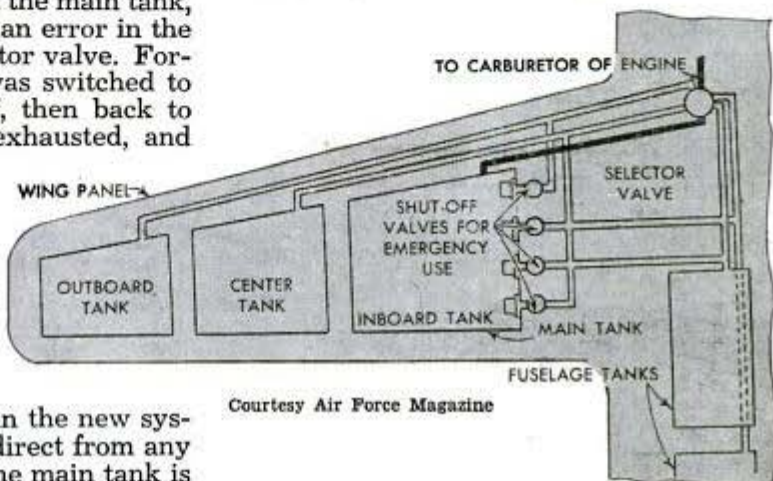

A BRIDGE FOR EVERY MILE



112-year-old stone bridge at Relay, Md., carries heaviest B & O rolling stock. Engineers say it will last for centuries



Portland Cement Association photo

Reinforcement assembly moves over gantry to steel form in construction of 3½-mile concrete trestle. Below, Santa Fe's Super Chief speeds across steel trestle over canyon in Arizona

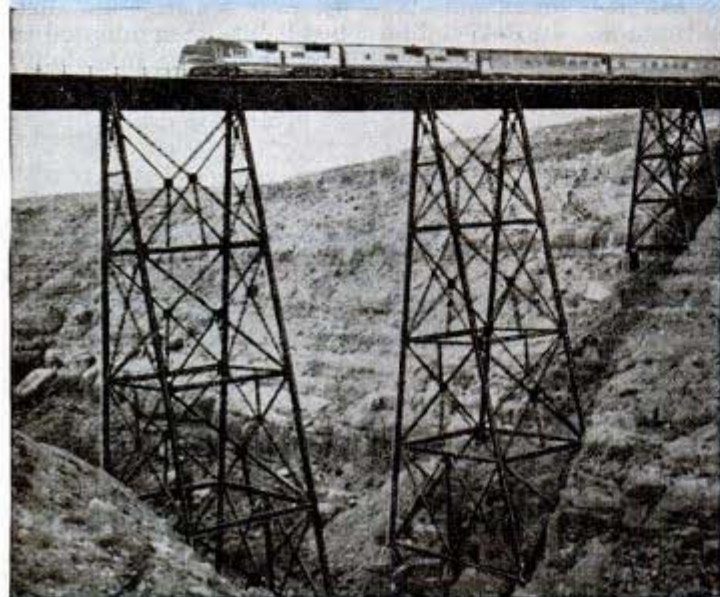

IF ALL the railroad bridges in the United States were placed end to end their 4000 miles of length would reach from Newfoundland to beyond San Diego. There is a bridge for every mile of railroad track in the country.

These structures cost more than two and a half billion dollars to build and require 40 million dollars a year for maintenance. Present schedules are possible only because of the structures that carry the roadbeds across rivers and valleys, saving minutes and hours of detouring.

Back in the 80s the surveyors of the Southern Pacific ran their lines west to the Pecos River in Texas and then found themselves face to face with a chasm 300 feet deep and 2100 feet across. There was no safe way to span the river gorge and so they diverted the line to the south, to an easier crossing.

But a decade later, as soon as metallurgists and bridge designers were confident that

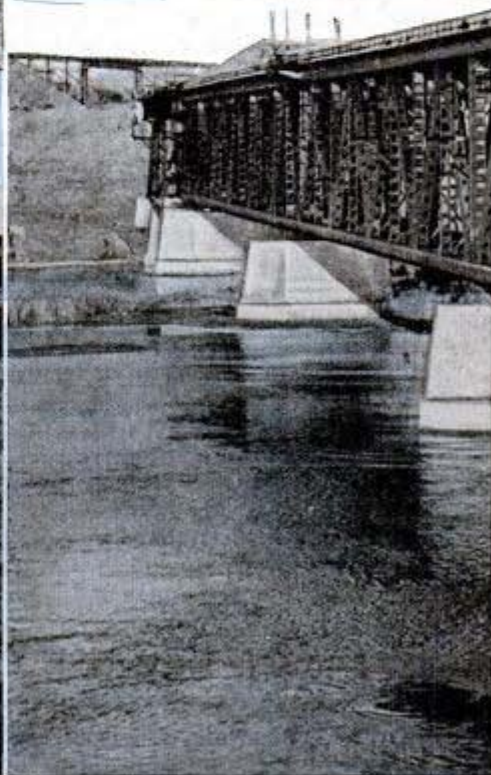



Diesel locomotive slows pace across old cantilever bridge which was a bottleneck until replaced with modern span. Below, new double-track bridge at Needles, Calif. Santa Fe photo

it could be done, a bridge was put across the Pecos at the original site. This one bridge shortened the line by 11 miles, eliminated 14 smaller metal spans, two quarter-mile tunnels and 3000 feet of wooden trestle, and reduced track curvature from 10 to five degrees. In its 50 years of life the Pecos bridge has saved many hundreds of thousands of hours of train operation. Since it was first built it has been strengthened to carry the heavier loads that are hauled today.

Bridges rarely wear out. Frequent inspections, followed by maintenance and renewal work when necessary, keep them up to their original strength. But bridges do become obsolete. Entirely satisfactory for the loads and speeds that prevailed when it was built, such a bridge becomes out of date when heavier rolling stock is used, heavier loads are carried and faster speeds are scheduled. Often it can be strengthened to support modern traffic; sometimes it must be entirely replaced.





To guard against rust, old paint is seared with multiple-burner torch and removed with a power-driven brush that leaves surface clean for fresh coating
Oxweld Railroad Service Co. photos

Early this year the Santa Fe completed a new double-track bridge across the Colorado near Topock, Ariz., to replace just such a bottleneck. The old structure had a 10-mile-per-hour speed limit and carried a gauntlet track that permitted only one train at a time to cross over it. The new no-speed-limit bridge saves from five to 10

minutes of operating time per train, a saving important enough to warrant its construction as a wartime measure.

Far less imposing in appearance than the cantilever structure that it replaces, Santa Fe's new span is a good example of modern bridge construction. Of deck truss design, the bridge is built under the roadbed, so to speak, instead of being built around and over the roadbed. There are no bridge members to interfere with the carrying of extra-wide loads. The rails are on wooden ties that are laid in a ballasted roadbed, giving a smooth ride and eliminating the usual bridge rumble.

In designing the new bridge the engineers planned for loads that might be imposed upon it by extraordinary circumstances. They used as a basis the effect that two doubleheaded locomotives would have if they were moving side by side in the same direction at high speed over the bridge, at the same time that a 100-mile-per-hour side wind was blowing. Such a situation, of course, is highly improbable.

The bridge is designed to support a load of 7200 pounds per lineal foot, nearly twice the weight of a heavily loaded freight, and this strength is multiplied six times by safety factor allowances. As is the case with all metal structures, the Topock bridge is designed to flex under a load. The center of the lower chord of each span is one inch higher than its ends and under a heavy load the center deflects to one inch below the horizontal, then arches upward again when the load is removed.

One of the forces that must be considered

Hell Gate Bridge in New York looks like a toy from plane, but it is 305 feet high and carries four tracks



in designing a bridge is the thrust that will be imparted to it when a train sets its brakes while crossing the structure. Transmitted to the foundations, this force would tend to cause movement of the foundation piers. This is avoided in the Topock bridge by anchoring one end of each span to a concrete foundation pier and by resting the other end of the span on the next pier by means of big steel rollers. Thus a span simply stretches on its rollers without affecting the foundations when it receives a lengthwise thrust. The rollers also absorb contraction and expansion movements caused by temperature changes.

The Colorado is a shallow river in the vicinity of Topock and yet the engineers had to bridge a deep chasm. The concrete foundation piers go down through layers of sand and gravel to bedrock. Each pier was built in the form of two side-by-side concrete cylinders that were sunk by the pneumatic process. The midstream pier is among the deepest ever built by this method, its bottom being 121 feet below river level.

The caisson crews that were employed inside the cylinders, removing the river gravels so that the cylinders would sink, worked in air pressures of up to 50 pounds per square inch. High pressures were necessary to prevent water in the gravels from rising up inside the cylinders while the excavation was being done. Two hours under this pressure constituted a full working day and the men went through a gradual compression in an air lock before descending to work, and a gradual decompression upon completing their shift. Excavated material was removed by means of buckets that were hoisted through air locks at the tops of the cylinders and also by means of a "blow pipe" that exhausted into the open atmosphere. This tube swept up sand and gravel just like a vacuum cleaner when its



British soldiers test section of unit construction bridge which helped patch the bombed railroads in Europe as Allied troops advanced

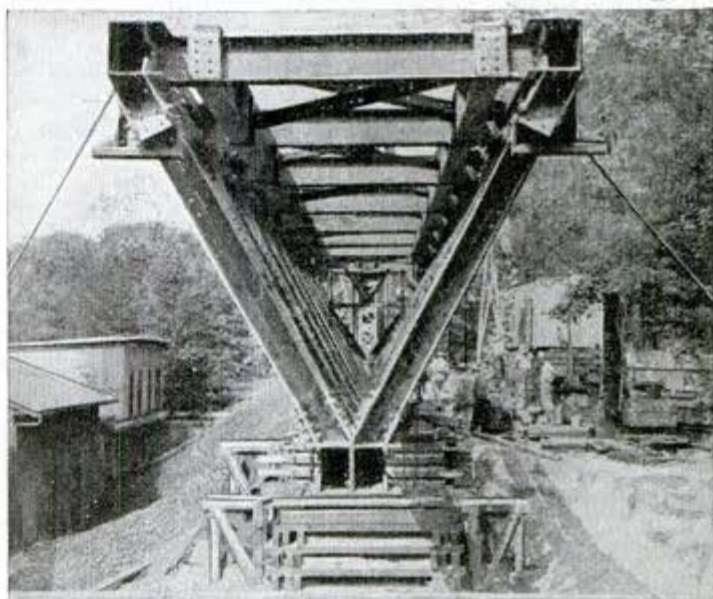

Fort Pitt Bridge Works photos

Above, demountable V-type deck bridge during assembly; rails are laid on top of bridge. Finished V bridge below is a through type. Bolted as a temporary structure, it can be riveted for permanence

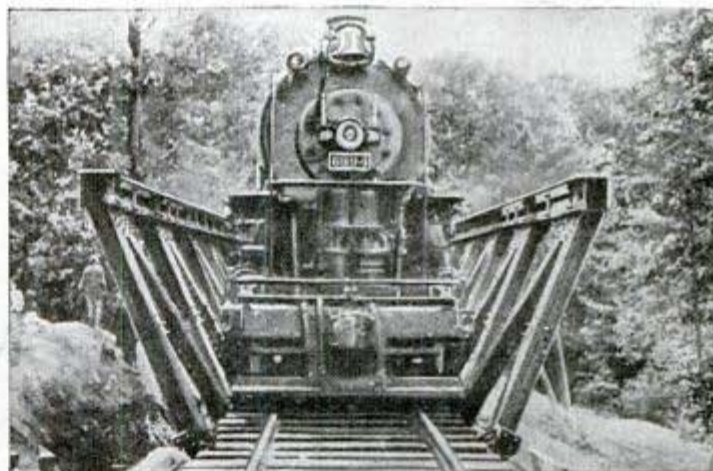



U. S. Army engineers built this bridge across the Rhine at Wesel, Germany, in just 10 days. Below, looking into steel piling cofferdam as concrete is placed for pier of Santa Fe's new Colorado River bridge

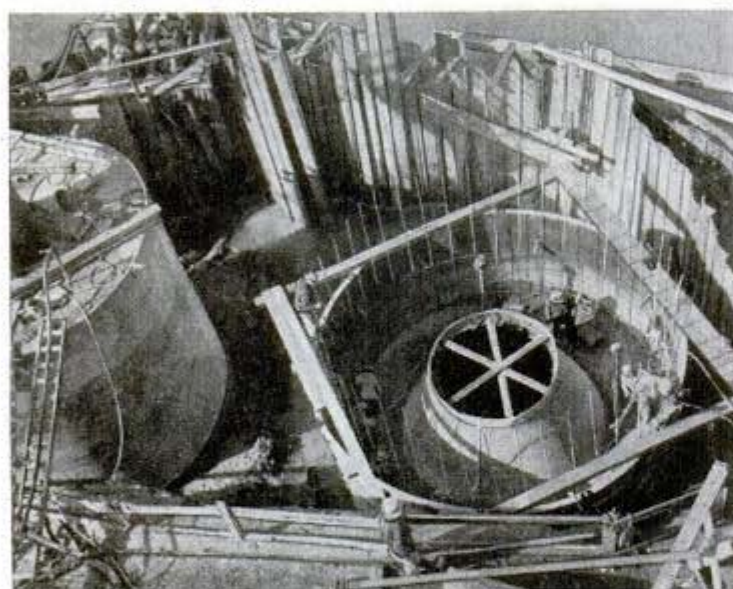

Below, Illinois Central train crossing dam at Gilbertsville, Ky.



valve was opened. Each pair of cylinders was filled with concrete upon completion and then joined at the top by a concrete cap, forming a finished pier.

Recently the Pennsylvania Railroad was confronted with a similar bridge replacement problem but in its case there was no possibility of building a new bridge on a new alignment. Its 2529-foot Long Bridge across the Potomac at Washington, D. C., was 40 years old and was carrying as many as 260 trains per day, some of which were limited to 15 miles per hour over the structure. A stronger bridge would allow this traffic to speed up and so, with no other location available, the engineers built their new bridge outside of the old one and then transferred the load from the old bridge to the new structure without once interfering with train traffic.

They built 11 new piers midway between the existing piers to reduce the length of each span, placed the girders of the new bridge in

position on all the piers outside the trusses of the old bridge, supported the existing floor system on temporary floor beams hung from the new girders, and then introduced new floor beams to support permanently the load on the new girders. After that the old bridge structure could be dismantled piece by piece.

The necessity for creating sturdy railroad bridges that could span long gaps is the chief reason bridge engineering has developed to its present high point. The oldest and possibly the best railroad bridges in the world are built of stone. Such a viaduct is the Baltimore & Ohio's stone bridge at Relay, Md., now 112 years old. It carries today's heaviest rolling stock with ease and probably will last for additional centuries.

Stone arch bridges have tremendous strength but they are expensive and are not suitable for long spans. Brick or concrete arches have similar objections. Modern bridge design had to wait for the development of steels that possess extreme strength in relation to their weight. Steel makes possible the long truss spans and girder spans that are common in bridge design today, as well as cantilever, steel arch and suspension bridges. Each bridge is custom designed for its site and it often happens that a single long bridge may actually consist of a number of short spans of different design, attached end to end.

During the war engineers designed for military use a demountable V-type bridge which is easily assembled or dismantled. In peacetime it can be used as a temporary replacement for bridges that have been destroyed by floods or tornadoes. The bridge can be made into a permanent structure by replacing connection bolts with rivets.

Another bridge of special design is said to be earthquake proof. It was built by the Southern Pacific Railroad across the Pajara River between Gilroy and Watsonville Junction, Calif. The bridge is mounted on rockers with one end anchored and the other riding free in a recessed abutment. An electrical recording device stops trains if the piers move more than three-quarters of an inch.

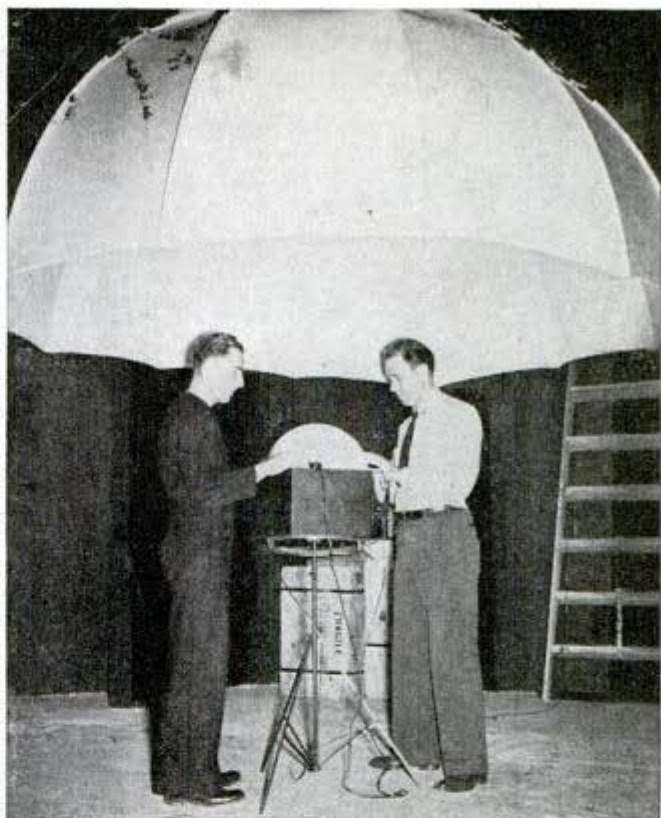

Umbrella Planetarium

Students at the Alameda Naval Air Station in California learn to recognize constellations and stars used in celestial navigation from the inside of a big white canvas umbrella. This rudimentary planetarium is placed over a stellar globe. A light inside the globe projects beams through holes to form dots of light on the umbrella in the exact pattern of the stars. By rotating the globe, the umbrella reflects the appearance of the sky at any hour of the night, any season.

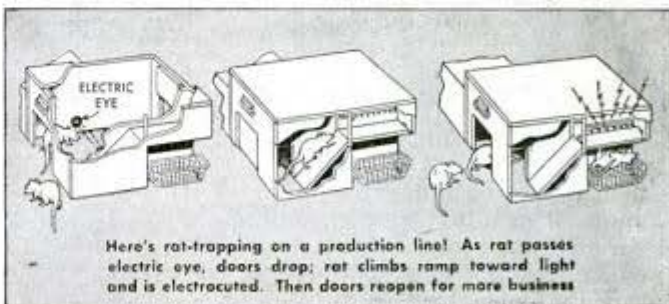

Electric Rattrap A boxlike trap built like a tunnel has doors at each end that drop when the rat breaks an electric eye beam. An inside door admits the rat to a ramp leading to the "execution room," where his weight closes the door and electrodes send a killing shock through his body. Then the floor of the death chamber drops and the dead rat is deposited in a basket. The trap automatically resets itself and can be plugged into an ordinary electrical outlet.

Two-Way FM Radio on Jeeps for MPs Snags Lawbreakers Overseas

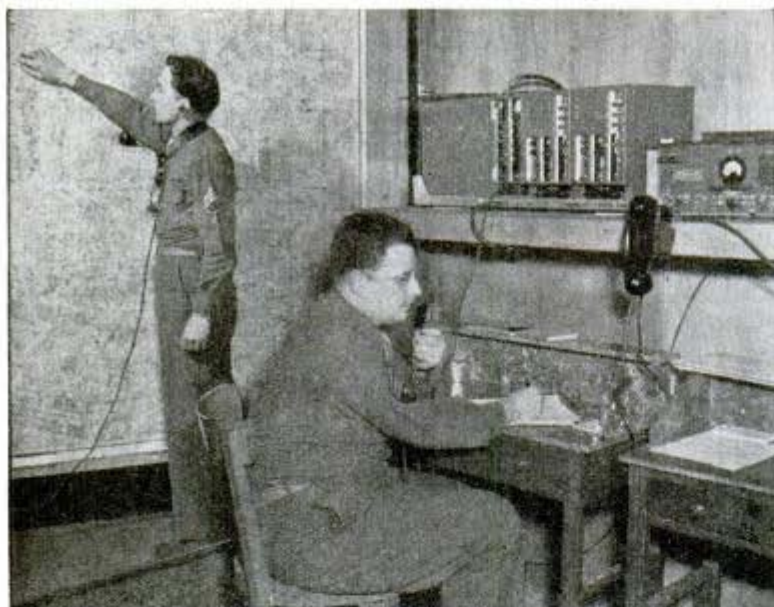

Jeeps operated by American military police in Paris and other European cities are equipped with two-way FM (frequency modulation) broadcasting equipment. This radio network is modeled after the police system in a number of large U. S. cities. In Paris, the nerve center of the network is on top of a former department store. No building in the French city was found tall

enough for signals to reach all roving patrols, so a relay station was built on the Eiffel Tower. The radio-jeep patrol has enabled alert military police to track down black market operators, hijackers of military vehicles, AWOL soldiers and other lawbreakers.

Top, in control room of Paris station calls are relayed to cars. Below, MPs await call

Pusher-Type Plane For Private Pilot Lands Like Glider

With an engine mounted on top of the wings and the propeller behind them, a pusher-type light plane will cruise 110 miles an hour on 65 horsepower. It has a top speed of 135 miles an hour and a cruising range of 400 miles. This two-place business and pleasure craft, being tested by the Jarvis Manufacturing Company, Glendale, Cal., is built to land safely at 40 miles an hour on a rough field. It has a single main landing wheel, similar to that used for gliders, and a three-inch steel nose skid. A tail wheel and two retractable wing wheels are used in taxiing. The plane cannot ground loop, according to the designer, Volmer S. Jensen. It is expected to sell for less than \$2000.

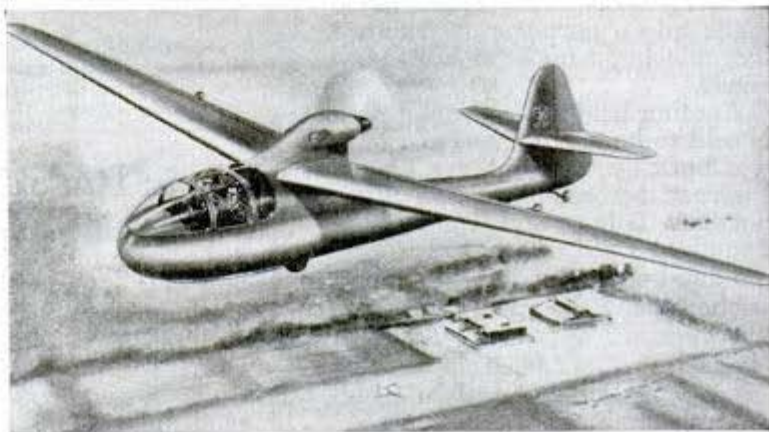

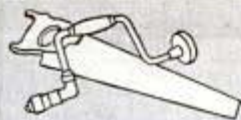

The Craftsman



Serve It Western Style

By Roberta L. Fairall

IF YOU want something different for your informal luncheons and buffet dinners, try a set of western-styled table accessories such as pictured in Fig. 1. Your guests will enjoy these comic reminders of the Old West.

Beverage tray: This is the heart of the set and is shown in Fig. 3. It holds two bottles, six glasses and a refrigerator jar for ice. A jigsawed figure at the back and U-shaped handles at the ends are notched into the tray so that they project $\frac{1}{2}$ in. below it to serve as feet or supports. A cleat at the front provides the fourth support. Jigsawed hands are mortised into the upper surface to hold the bottles, each hand

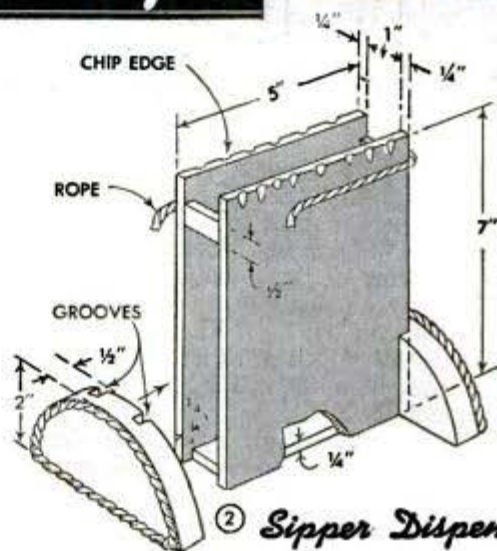

② Sipper Dispenser

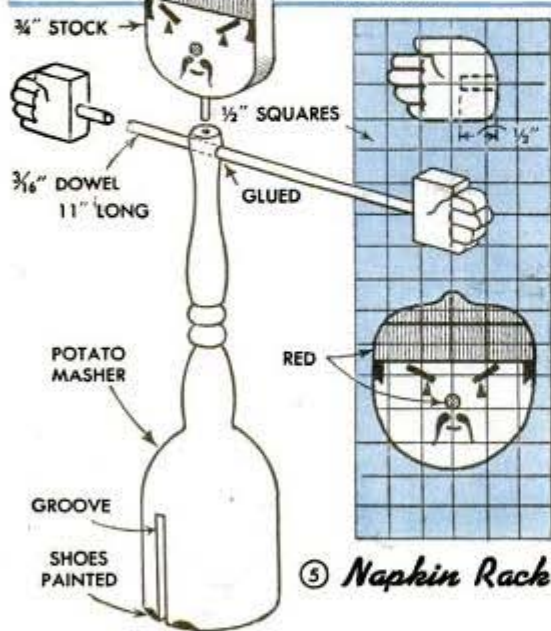
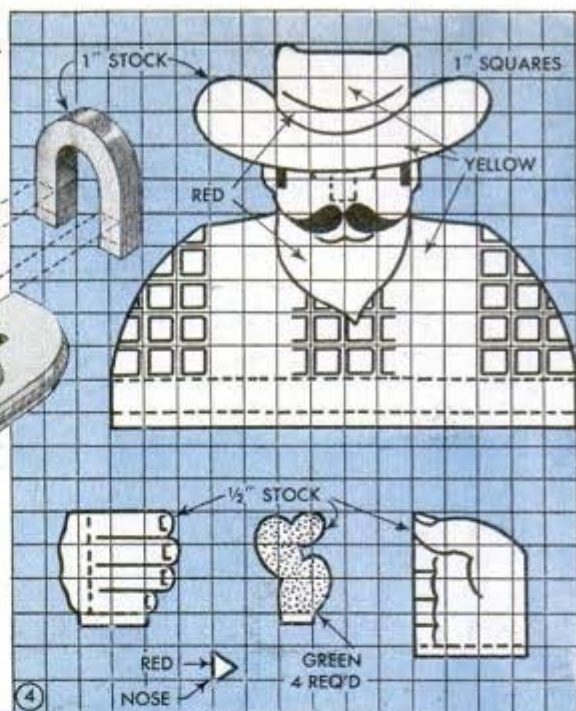
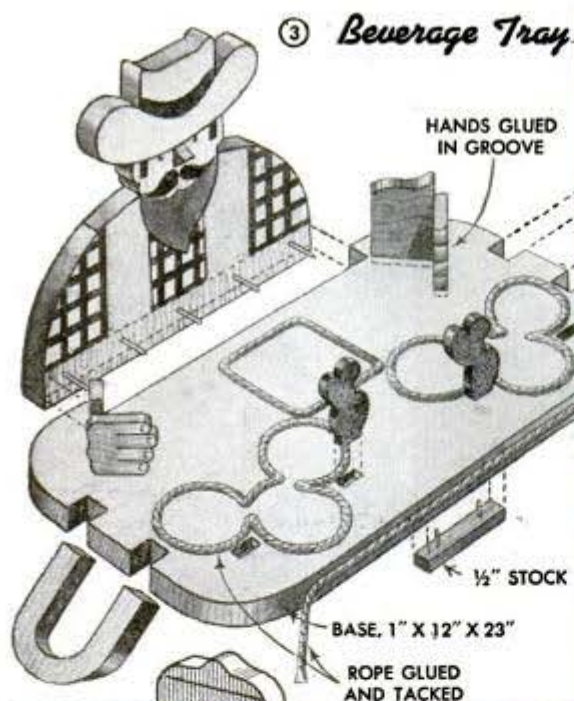

supports. Chipping the top edges and binding the sides and upper part with rope carries out the western atmosphere.

Napkin rack: Paper napkins are appropriate with this set, and the little ranch cook in Fig. 5 will keep them on his outstretched arms ready for use. A wooden potato masher serves as his body, which is grooved at the bottom to simulate legs with toes of shoes painted on. A jigsawed head is doweled to the upper end of the body, the latter being drilled horizontally for a dowel carrying two jigsawed hands.

Coasters: These are a "must" to protect polished surfaces, and good ones can be

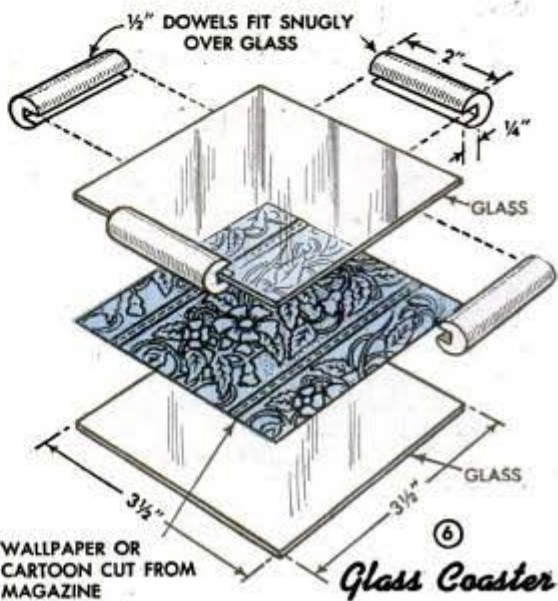

being made in two parts according to the patterns in Fig. 4. Small rope glued and tacked in place is used to bind the edge of the tray and to form holders for glasses and ice jar. A row of jigsawed cacti mortised into the tray adds a western touch.

Sipper dispenser: For the convenience of your guests, you'll want a holder for sipping straws. The one in Fig. 2 matches the tray, especially if you put a "wanted" poster of the figure on the tray on one side of the dispenser. The front and back are assembled with a bottom and two spacer strips, after which the unit is glued into grooves cut in two half circular sides or

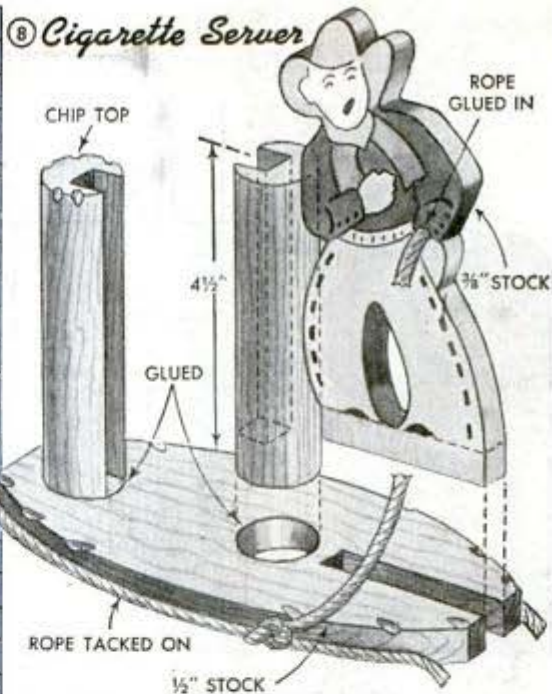
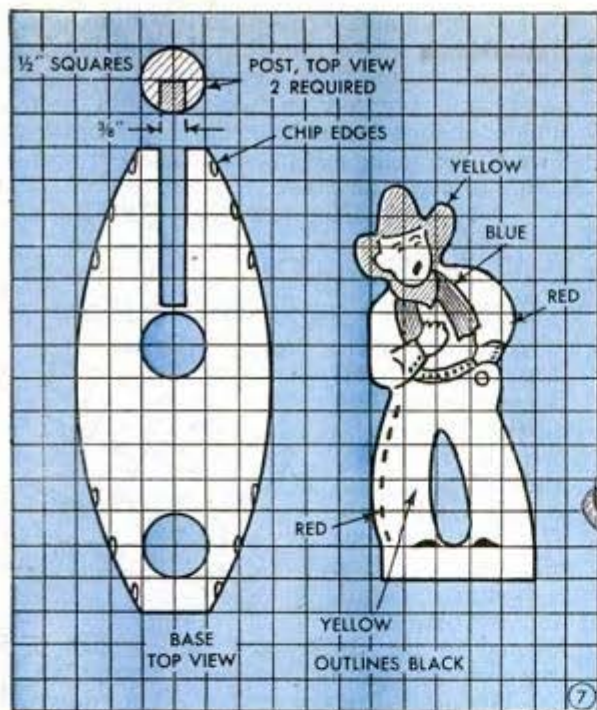

made by sandwiching wallpaper or magazine cartoons between two pieces of glass as in Fig. 6. Four pieces of dowel grooved to fit tightly over the two thicknesses of glass hold the assembly together. A little adhesive may be needed on the dowels.

Cigarette server: This is pictured in Fig. 8, and completes the set. It consists of a base, a cowboy cutout, and two vertical

dowels which are channeled to take the ends of the cigarettes, the base and cowboy being cut according to the patterns in Fig. 7. When the dispenser is filled, the cigarettes and dowels simulate a panel of a pole fence against which the cowboy is leaning. Both the base and dowels are chipped and the base is bound with rope, which extends up to the cowboy's hand.

Round File Tapers Drilled Hole to Take Tang of Chisel

The next time you fit a small chisel or file into a wood handle, use this method to get a snug fit. Drill the tang hole to nom-

inal size, then chuck a round file in the tailstock and use the file to enlarge the hole to proper size. The file preferably should be coarse-cut, and should be withdrawn repeatedly, the file being stationary while the wood handle rotates. If a hole larger than the file is needed, press lightly with a wood block against the end of the turning as it spins in the lathe.

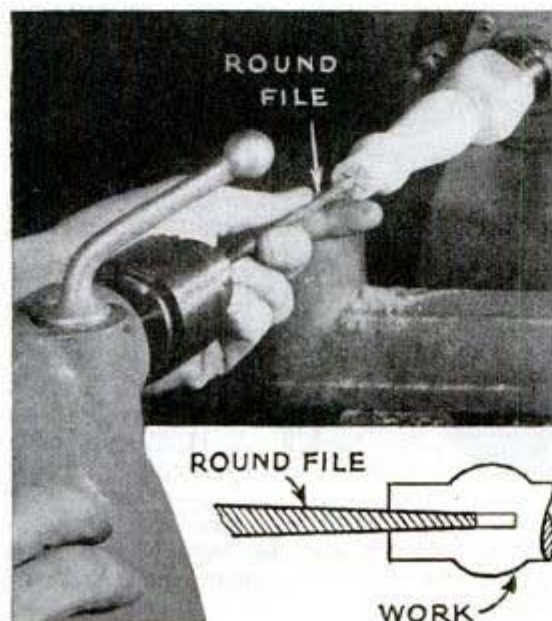

Rubber Bands From Finger Cot

A rubber finger cot cut into strips will form elastic bands of any desired width. Length of the bands may be varied by cutting the cot diagonally. To facilitate cutting, a strip of thin cardboard can be rolled and inserted in the cot.



Joseph Jay Gould, Brooklyn, N. Y.

☞ To remove iodine stains from linens rub the stained area with a slice of lemon.

Extension Handle Enables Child To Turn Latch on Door

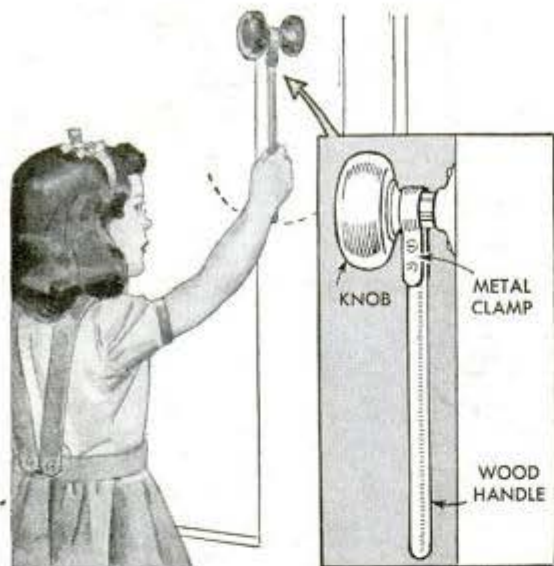

You can save yourself many steps in opening and closing a door for a child who is too small to reach the doorknob, if you use an extension handle on the knob. It consists of a suitable length of broomstick or large dowel clamped to the knob shank with a piece of sheet metal folded tightly around the shank and screwed to the handle. The clamp must be tight enough to turn the knob when the handle is moved.

A. Armstrong, Missoula, Mont.

Sprayer Aids in Dressing Leather

The usual messy job of applying neats-foot oil or other liquid compounds to leather garments is a much cleaner task if the oil is applied with a household sprayer, preferably of the continuous spray type, although others will do. Mildew spots that are not too deep can be removed by spraying them heavily, letting the oil soak a few minutes, then rubbing lightly with a cloth.

E. F. Brandt, St. Augustine, Fla.

Stand Holds Ink Bottle Level On Sloping Table

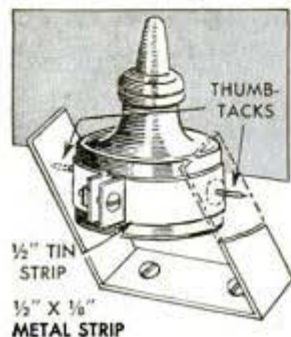

With a stand like this one, draftsmen will be able to keep their ink bottles level even when they are placed on a tilted table. The stand is made from two strips of light sheet metal. One strip is bent

to a U-shape and screwed to the table, and the other is formed around the ink bottle, the ends being bent outward at a right angle and pierced to take a small bolt, which clamps the strip around the bottle. Two thumbtacks are pressed through both strips to serve as pivots.

A. Giandomenico, New York.

Pulls for Filing-Cabinet Drawers Cut From Toggle-Switch Plate

Drawer pulls that will take index cards for filing cabinets can be made from the ends of a toggle-switch wall plate. The ends are cut off as shown in the right-hand detail, and a tongue is formed in the center portion of each of these pieces as indicated in the upper left-hand detail. After the tongue is bent down, holes are drilled in the corners for screws to attach the pull, and the index card is slipped behind it.

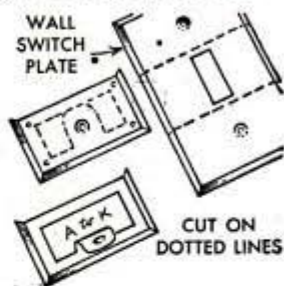

Lewis B. Rogers, Redlands, Calif.

Fruit Jar and Tape Trap Roaches

An effective trap for roaches can be improvised from a fruit jar and adhesive tape. Stick the tape on the jar, running from top to bottom, and place jelly or other sweets inside the jar. The tape makes it possible for the insects to get into the jar, since they are not able to climb the smooth sides of a jar without some assistance.

John D. Mitchell, Chandler, Ariz.

Small-Mouthed Bottles Refilled With Aid of Oil Can



Dispensing bottles of the type used for lotions ordinarily cannot easily be refilled because the mouth is too small. By filling an oil can with the fluid to be used and inserting the spout in the bottle, the latter can be refilled.—A. H. Waychoff, Phoenix, Ariz.

Greasy accumulations on kitchen walls and woodwork can be removed before painting by washing the surfaces with a solution of trisodium phosphate.

Wooden Storm Sash Fit Inside Steel Windows

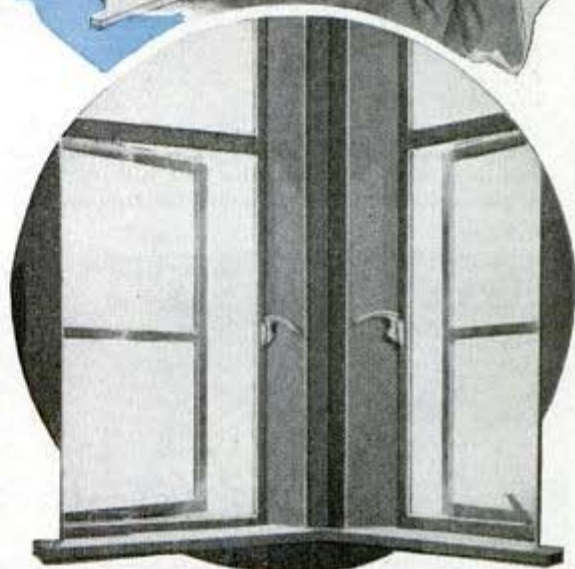
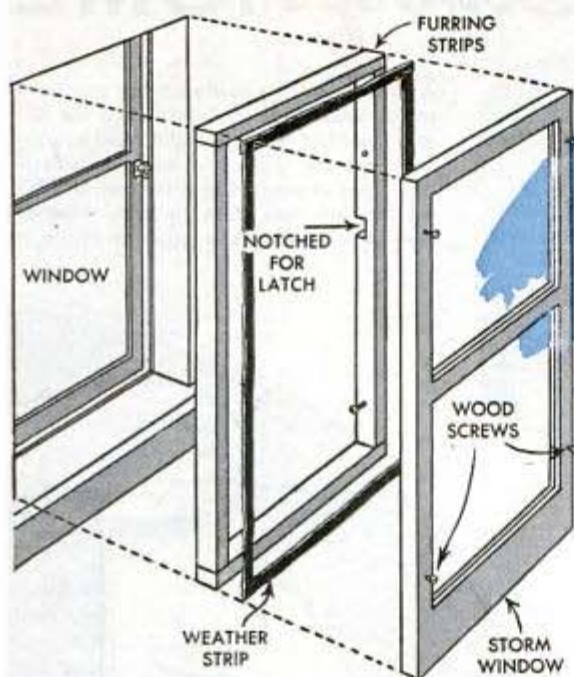

To avoid excessive condensation on his steel casement windows that opened outward, as indicated in the circular detail, one homeowner installed ordinary wooden storm sash on the inner sides of the windows. To do this, first close and lock the windows and remove any hardware that will interfere with installing a wooden frame on the inner side of the casing. Then build the frame of 1 by 2-in. furring strips to fit the window frame, screwing the wide sides of the strips against the sides of the window openings. On some types of windows notches may have to be cut in the frame to clear fittings and allow it to set against the steel casement. Place 1-in. felt weather stripping around the frame before

mounting the storm sash, which is drawn tightly against the frame with wood screws, and paint the assembly to harmonize with the room.—Arthur Mobbs, Dumont, N. J.

Child Reaches Faucets by Standing on Covered Drawer

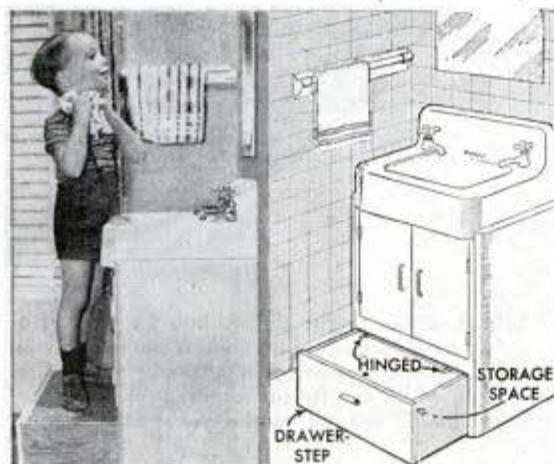

As a means of teaching my young son to help himself rather than depend on others, I added a hinged cover to the drawer in a cabinet under the lavatory. Now the boy can reach the faucets by standing on the cover, which can be raised to get at the contents.—A. T. Eyman, Rochester, N. Y.

Tobacco Pouch Serves as Case For Electric Shaver

When the carrying case of your electric shaver wears out, you will find that a tobacco pouch will serve just about as well. A pouch having a slide fastener to close it is preferable to the roll-type pouch.

D. E. Horn, River Forest, Ill.

Solving HOME



A shield made by cutting away part of a metal cake cover as indicated at the left will keep hot fat in a skillet from splashing over the stove and wall. Below: If you store waste fat in a tin can, a folded strip of tape stuck to both sides of the lid will provide a grip for lifting it

Right center: To stiffen a limp tape measure, lay it between sheets of waxed paper and press with a moderately hot iron. The heat will soften the wax sufficiently to impregnate the tape measure

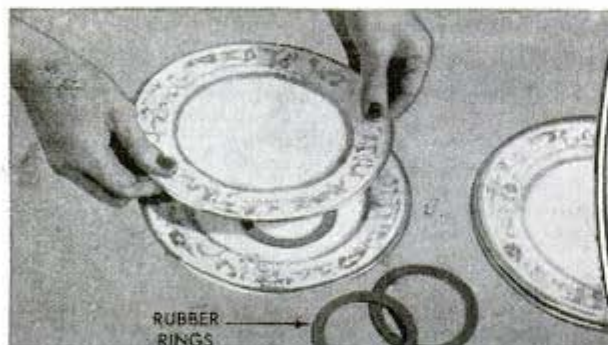

Fruit-jar rings placed between hand-painted china dishes as shown above will help prevent scratches when the dishes are stacked. Right: The bases of thin candles can be enlarged to fit holders snugly by wrapping them with strips of corrugated paper

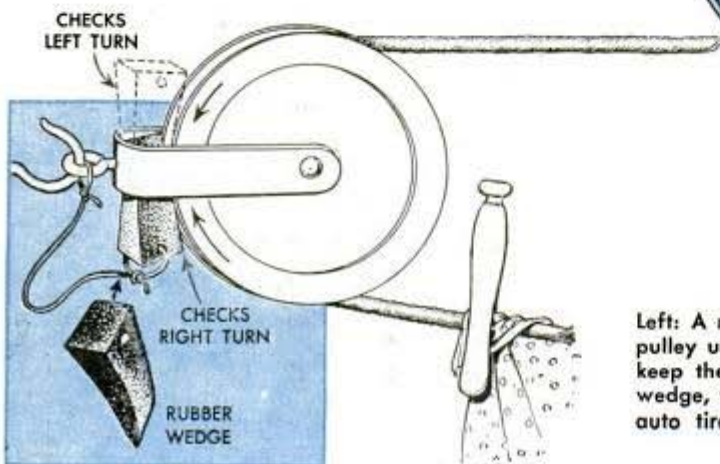

Left: A rubber wedge slipped into the yoke of a pulley used to support an endless clothesline will keep the line stationary in a strong wind. The wedge, which can be cut from a rubber heel or auto tire, is secured to the yoke with a cord

PROBLEMS

Removable panels on a full-size bed keep a baby from falling out. They are held in brackets, the uprights being cut away to fit into them as indicated at right. Below: You can hang your hat with your coat on a wire hook screwed to the hanger



Left center: If your cupboard shelves are deep, you will save time in selecting spices and extracts by keeping them on a sheet-metal tray. This can be pulled out to expose articles placed at the end

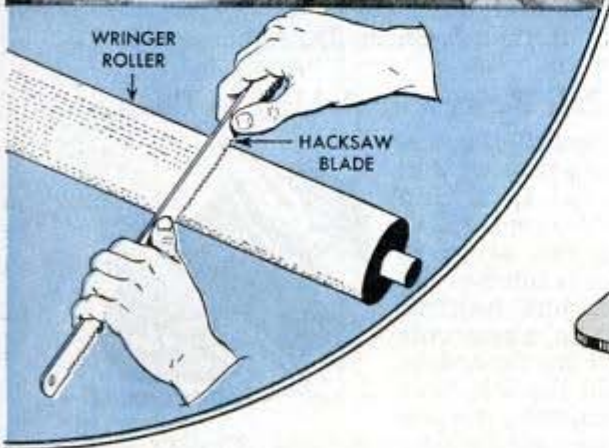
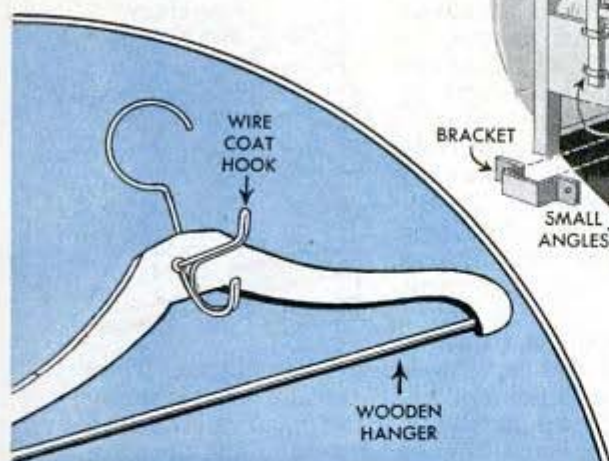

Above: If a measuring cup is coated with flour, molasses can be poured from it without adhering to the sides. Left: When rollers on a clothes wringer become smooth and fail to grip soapy clothes, roughen them with a hacksaw blade

When part of the friction catch on an oven door wears so that it will not hold, substitute a door strike plate. After being cut and filed as shown at the right, the plate is slipped under the porcelain facing on the door to engage the catch

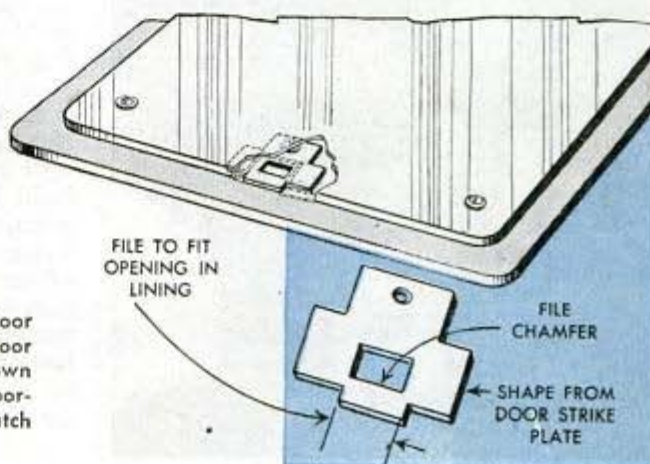

Sticks Pivoted to Drawing Board Aid in Making Perspectives

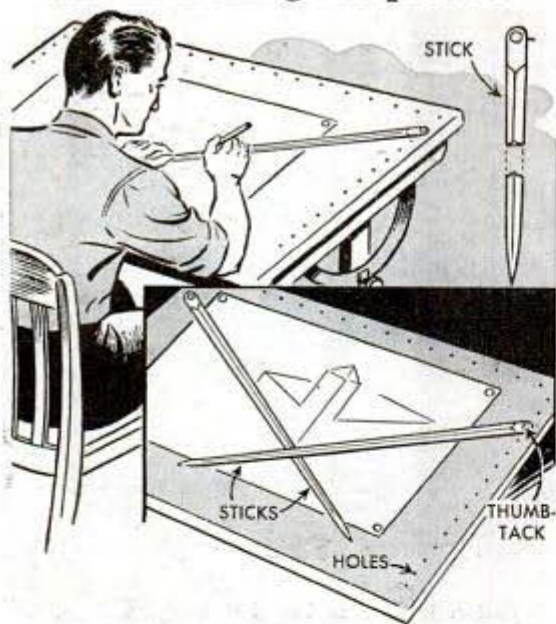

Two sticks shaped as indicated will be found an aid in making perspective drawings. They are pointed at one end and flattened at the other end to take thumbtacks, which serve as pivots. The tacks are inserted in holes drilled at equal intervals along the sides and top of the drawing board to get the desired angles.

Robert J. Dierkes, Milwaukee, Wis.

Wood Strips on Handscrew Jaws Hold Work in Drill Press

An excellent drill-press vise, especially suitable for holding thin metal for drilling, can be made by screwing wood strips to the jaws of an ordinary handscrew. An adjustable-type handscrew is preferable,

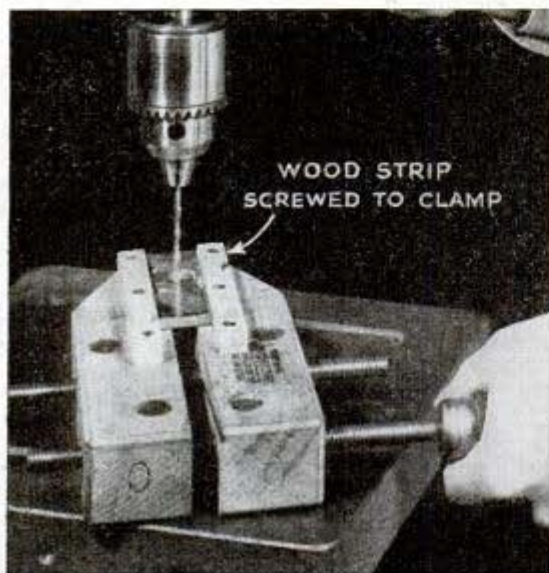

as this style will grip wedge-shaped pieces as well as rectangular and square work. The strips are $\frac{3}{8}$ by $\frac{1}{2}$ by $4\frac{1}{2}$ in., and are fitted $\frac{1}{4}$ in. in from the inner edge of the jaws. They do not interfere with normal use of the handscrew. The handscrew handle should be gripped by hand to prevent rotation.

Hand-Grinder Sanding Drum Made From Abrasive Cloth

Small sanding drums for use on hand grinders can be improvised by attaching abrasive cloth to steel rods, which serve as mandrels. To attach the cloth, first wind several turns of adhesive tape, sticky side down, on the rod, cutting off the tape to leave a small tab. Then attach the tape to the tab and wind it sticky side up until the drum is of the desired diameter. Now cut a strip of the abrasive cloth to a size that will produce exactly one turn around the drum and press it firmly in place.—S. Muns, Hemstead, L. I.



Strike Plate Plugged With Screw Prevents Locking Door

To prevent his small son from locking himself in a room, one man drove a screw into the bolt opening of the strike plate flush with the plate. The screw prevented the bolt from entering the plate, yet could be removed quickly.

Arthur F. Short, Jr., Apopka, R. I.

Ink Reservoir Added to Pens

By fitting a narrow strip of thin metal in a pen holder and curving the strip so that it touches the pen just behind the tip, a reservoir will be formed to hold the ink, thus permitting the pen

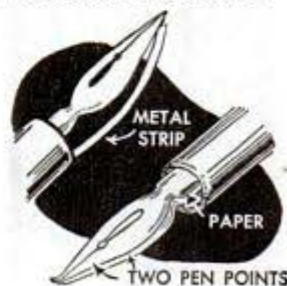

to be used for longer periods. Another way of creating an ink reservoir is to lay one pen over another with a piece of paper between them for a spacer. The tip of the under pen should be bent upward slightly to touch the other, care being taken to avoid scratching the tip when this is done.

Henri C. Holgate, Florence, Ariz.

Pipes Set in Cement Make Durable Fence Posts

This neat looking fence with iron pipe for posts will outlast a wooden-post fence many times. Pipes of approximately 2 in. in diameter are given a coat of red-lead paint and driven about 3 ft. into the ground, spacing them 5 or 6 ft. between centers. Then a hole is dug around each pipe for a 20-in. length of heavy paper or cardboard tubing which serves as a concrete form. These forms should project about 1 in. above the ground level as shown in the lower left-hand detail. The tops of the posts may be plugged with cement or threaded and capped. For the top and bottom rails, 12 or 14-ft. lengths of 2 by 4-in. stock are lap-jointed at every other post. These joints should be given a heavy coat of white lead before securing them to the posts with U-bolts as illustrated in the upper and center details. If U-bolts of the size needed can-

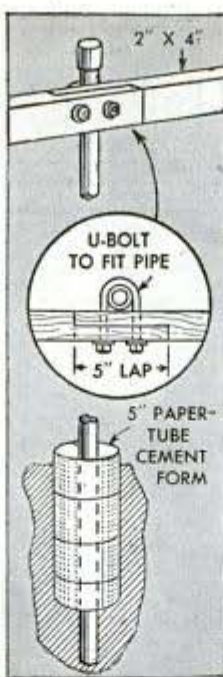

not be purchased, they can be made from 3/8-in. iron rods threaded on the ends and bent around the posts. Wire fencing is stapled to the rails and the completed fence painted.—Otto Merker, Chicago.

Student Pilot's Flight-Record Pad Is Held on Trouser Leg

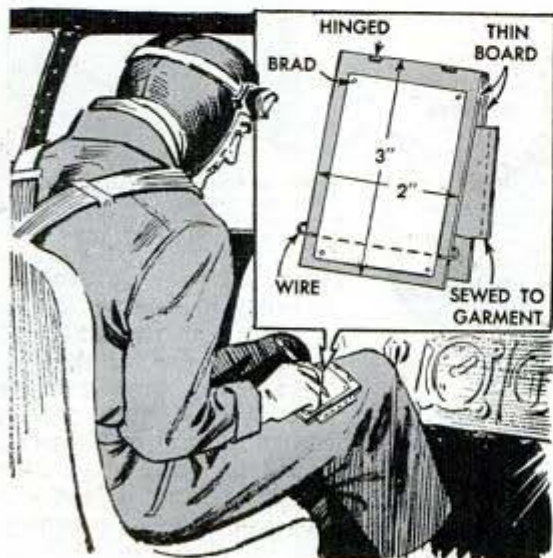

For recording take-off and landing times, student airplane pilots will find this knee memo pad superior to the patch of adhesive tape sometimes applied to a leg of their flying suits. The pad is made by hinging two pieces of thin board at one end and bradding to one of them a writing pad consisting of a sheet of celluloid fastened over

a carbon back. Such a pad can be bought at most novelty stores. When written on with a stylus, the celluloid sheet is pressed into the carbon back to form legible inscriptions, which disappear when the celluloid is lifted from the back. A length of wire bent to fit loosely around the board can be moved along under the celluloid to raise it and remove inscriptions. The pad can be inserted and held conveniently in a cloth tab sewed on the trouser leg.

Ted Bryan, Kingsport, Tenn.

Altered Hinges Permit Door To Clear High Pavement

In cold weather the concrete pavement under garage doors sometimes heaves so much the doors cannot be opened. To solve the problem, cut away a small portion of each hinge, as shown, so that the doors can be raised vertically to clear the obstruction, then swung open.

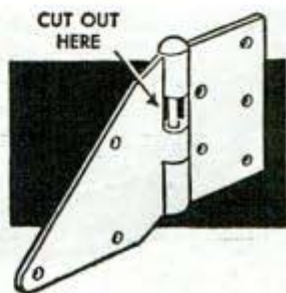

"READING" YOUR STOKER FIRE

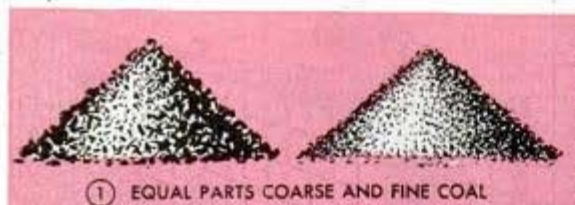

IN ONE respect the attention required by the stoker-fired heating plant is similar to that of the hand-fired plant—all details are important. When the stoker is installed in a heating system of adequate capacity the fire largely takes care of itself, and it is true that the less it is disturbed the better. Suppliers of standard stoker coals say that from a combustion standpoint a rather "dirty" fuel bed is better than a scrupulously clean one. Once the fire has been properly started and the correct cycle of operation established for the season, until some other development makes a change necessary there are only a few simple details that require careful attention at regular intervals.

Figs. 1 and 2 suggest two precautions that can save a lot of trouble if followed regularly. Although stoker coals usually are supplied in uniform sizes a certain amount of breakage occurs in handling. This means that in each season's supply you will



(Parts of text and certain illustrations by courtesy of Bituminous Coal Institute and Appalachian Coals, Inc.)

have at least a small quantity of fine particles of coal. The important thing when filling the stoker with varying sizes of coal is to mix equal

parts of fine and coarse fuel in the hopper. This will assure uniform feeding of the fine and coarse particles into the retort. Where the coal varies in size this precaution should always be observed. When filling the hopper, wear gloves and inspect each shovelful. It takes more time, of course, but by this process you are almost certain to discover a chance spike, bolt, or other foreign object before it can get into the mechanism and cause delay or breakage at a critical time.

Before firing the stoker for the first time in the fall, be sure that the furnace is clean.





speed control for coal feeds. A correct air adjustment is one that will maintain a maximum depth of fuel bed without objectionable soot formation in the firebox and gas passages, or smoke discharge from the chimney. Avoid mixing different kinds or grades of coals. Once the stoker has been adjusted for a satisfactory grade and size of fuel it's best to continue with that size and grade.

Although one of the most common errors in household stoker operation is the use of too much air, too little air will cause a smoky fire. Also, if too much coal is being fed, the fire will be sluggish and smoky, Fig. 5, and soot deposits will build up on the heating surfaces. The fuel bed will form a heavy coke tree as in Fig. 12, and the clinker "ring" will be thin and

irregular, and may not form in the normal length of time. Large pieces of the coke tree will break away from the central mass and die out, resulting in an accumulation of unburned fuel around the sides of the firebox. On the other hand, if the fuel bed is supplied with too much air the fire will become steadily thinner and

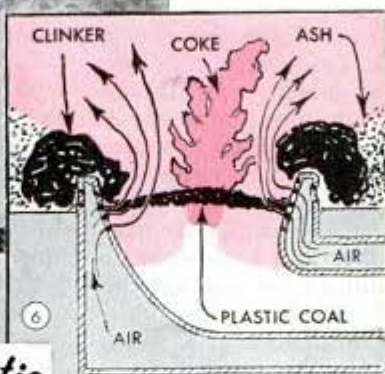

Fuel and air ratio

If you have a steam or hot-water system, always check the water level. See that the stoker is properly serviced and lubricated, and be sure that the feed screw, windbox and tuyere openings are free of ashes, clinker or other obstructions. If the hopper is fitted with smokepipe, check to see that it is clear. Fill the hopper to about one fourth its depth, start the stoker and allow it to run until the retort fills level with the top. Then stop it and check all the controls, both manually operated and automatic, to see that they are in working order. Place several small pieces of dry kindling and twisted newspapers on top of the coal in the retort, sprinkle a scoopful of coal over this as in Fig. 3, ignite the kindling, Fig. 4, and immediately start the stoker again. Don't forget to fill the hopper after making the necessary adjustments.

Proper depth of fuel bed to maintain will vary according to the coking properties of the coal used. Coals that form hard, strong coke usually require a deep fuel bed, while those that form soft coke generally burn best in a shallow fuel bed. In the average household stoker a fuel-bed depth ranging from 6 to 10 in. gives best results. Most late model stokers are equipped with automatic air-control devices and variable-

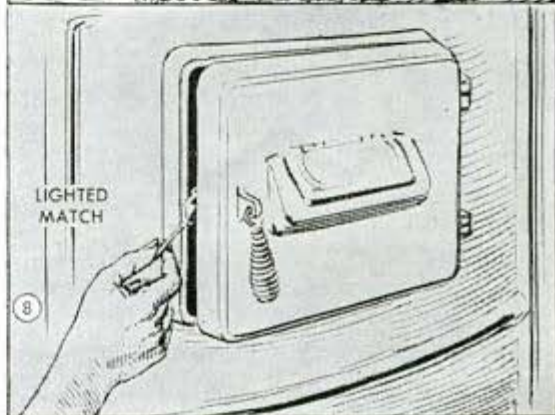

ash will be blown clear of the fuel bed to settle on the heating surfaces. A thin coke tree, Fig. 6, will appear at the center of the fuel bed, the tree sometimes being surrounded by dead, burned-out areas adjacent to the edges which act as passages for the excess air. If the fire door is opened while the stoker is running likely you will see streamers of sparks in the firebox, Fig. 7, and perhaps even in the smokepipe or chimney.

Another reliable and perhaps more sensitive indicator with most stoker coals is the nature and shape of the clinker formed by fusion of the ash and residues. With even a comparatively small amount of air in excess of requirements, the clinker tends to form deep in the fire bed and sometimes so low that it will partially obstruct the tuyere openings. The remedy for any of these troubles is to cut down the excess air or coal, as the case may be. Generally, it is best to adjust one or the other, then observe results before making other changes. If too much air is indicated, cut down the air and note results before increasing the coal feed. Proceed in the same way where too much coal is indicated.

The amount of "free" or natural draft in the firebox is very important when burning high-volatile coals. As a general rule it should be kept at the minimum. In most heating plants this will be indicated by the simple check pictured in Fig. 8. With the stoker running and the smokepipe and chimney heated to normal operating temperatures open the fire door about 1 in., then strike a match and hold it in the position shown. The natural draft should be just strong enough to draw in the flame gently toward the firebox. If the draft is excessively strong, set the smokepipe dampers to produce the correct draft as indicated by the match flame. However, if the installation is equipped with an automatic damper, the check damper should not be used. Instead adjust the automatic damper. It should be kept in mind, too, that there are many other conditions, both inside and outside the building, that will affect the natural draft.

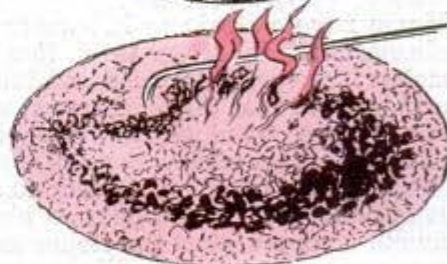
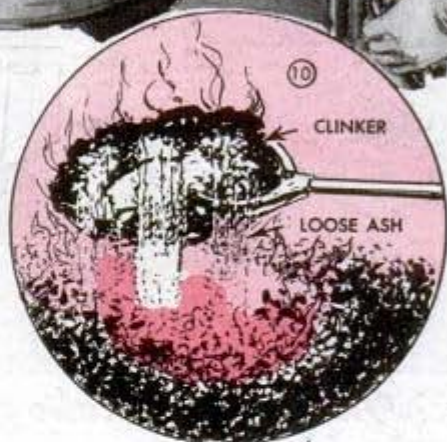

11 LEVEL FIRE BED

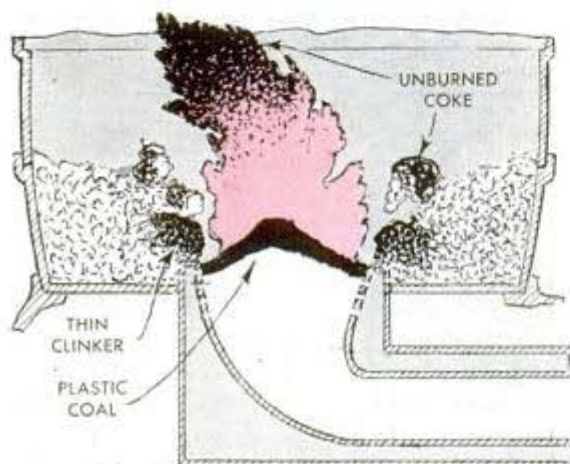

12 HEAVY COKE TREE

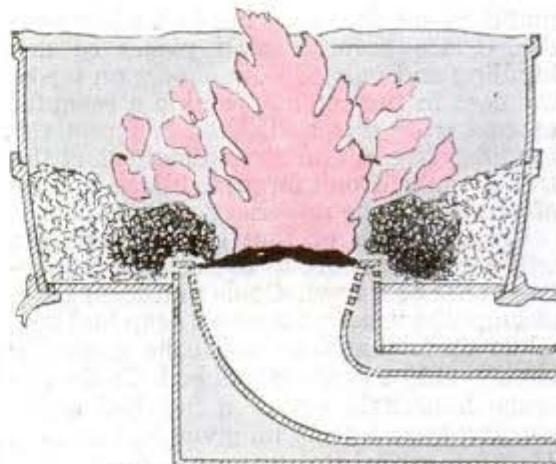

13 PROPER COMBUSTION

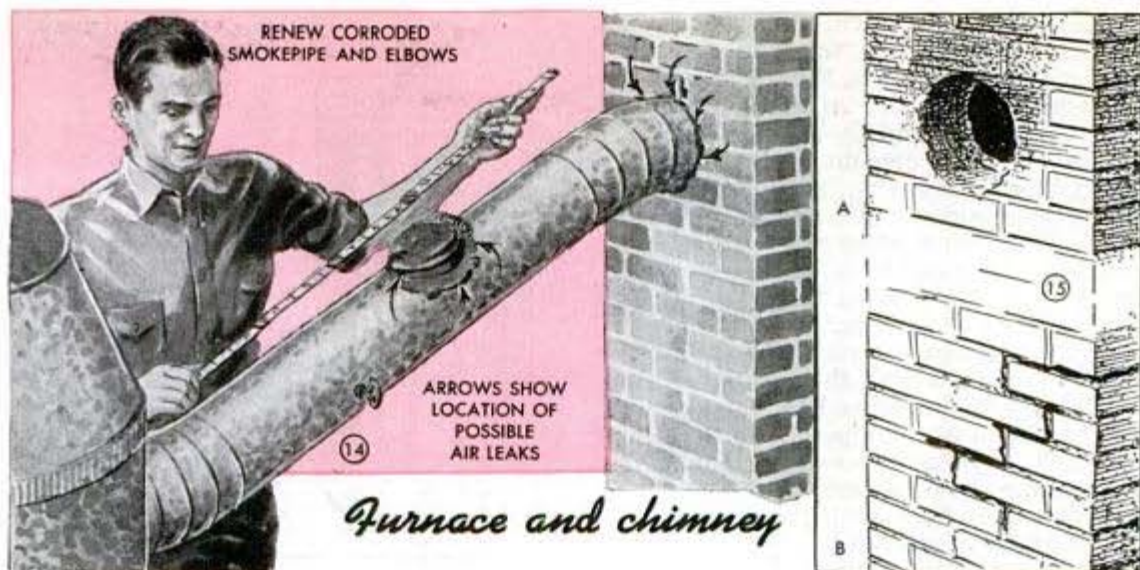

Furnace and chimney

Remove the clinker at regular intervals as in Fig. 9, using special clinker tongs. Be careful to disturb the fire bed as little as possible. Before withdrawing the clinker from the firebox turn it over as in Fig. 10 and shake off the loose ash and live coals. Then with a curved poker rake the surrounding loose ash into the cavity and level the fuel bed as in Fig. 11. In mild weather it's a good idea to run the stoker for a short

interval to recondition the fire after removal of the clinker. The frequency of cleaning the fire depends on the ash content of the coal and the amount of fuel consumed.

Most late model stokers are equipped with an electric clock type of hold-fire control, the purpose of the device obviously being to keep the fire from going out during long intervals in mild weather when there is no demand for heat. It serves the dual purpose of promoting good combustion, Fig. 13, and of converting ash into clinker. For this reason its proper adjustment is important. In adjusting for a given kind and size of coal, carefully follow the directions of the stoker manufacturer. Some older model stokers are fitted with a stack thermostat to control hold-fire. This device is, of course, set to operate the stoker for short intervals during the "off" period when stack temperature drops below a certain point. Due to variations in heating plant installations proper adjustment of any hold-fire control device is often a matter of "cut and try" until you attain the cycle or time interval of operation which gives best results. General practice favors the longer cycle; that is, it will be found that 4 min. operation once every hour is better than 2 min. twice every hour.

In any home installation it's well to check the chimney and smokepipe at the start of each season. Unused stovepipe openings into the chimney, detail A, Fig. 15, should be closed permanently, and the brick should be examined for cracks, detail B. A corroded smokepipe should be replaced, and care must be taken that there are no air leaks at the check damper or where the pipe enters the chimney, Fig. 14. Any of these openings, even though quite small, will act as miniature check dampers. If the

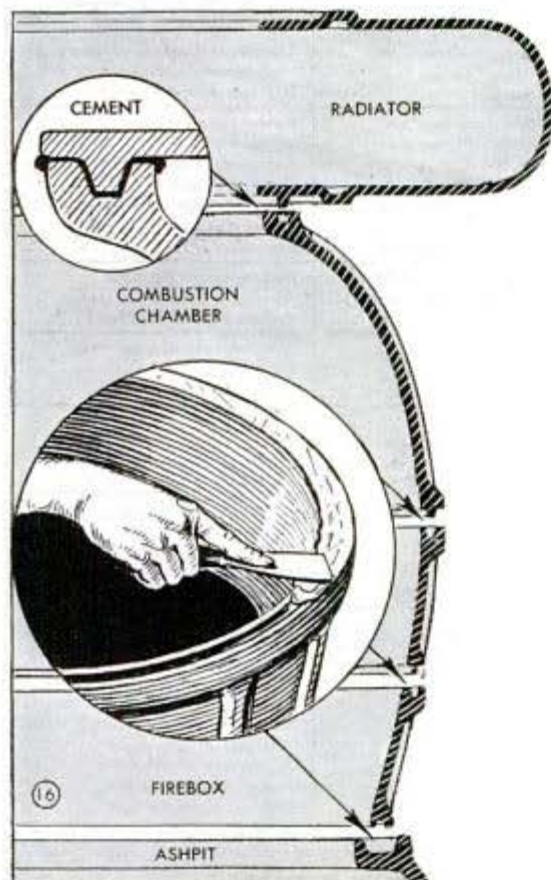

furnace is of the warm-air type and of cast-iron construction, then the condition of the cemented joints, Fig. 16, should be checked periodically. Any leaks in these will permit gas and fly ash to enter the house. When recementing these joints, clean them thoroughly, and be sure that the new cement is spread to a uniform thickness so that when the parts are set together there will be no openings or thin spots where the cement is likely to crack out within a short time.

In the average home it is almost impossible to locate a wall thermostat so that it will not be influenced to some extent by drafts and wall temperatures that may vary. For these reasons a comfortable room temperature should be the guide in setting rather than the actual thermometer reading. Much can be done toward more uniform heat distribution by adjusting register shutters. In addition, the best practice has shown that there is little, if any economy in a variation of more than 5 to 7 degrees between the day and night setting of the thermostat, Fig. 17. Wider variations throw a heavy load on the heating plant during the early morning warm-up period, and after a night at the low thermostat setting, the fire will not be in the best condition to deliver peak efficiency just when needed most. It is better to remove the clinker and condition the fire in the morning before setting up the thermostat, as the clinker then has had time to cool and harden and will be easy to handle.

The table in Fig. 18 explains common stoker troubles, their causes and remedies. This does not in any way supplant the specific instructions furnished by the manufacturer of your stoker. If there is any variation, follow the maker's instructions. However, close study of the causes and remedies given will enable you to cope with most of the ordinary difficulties which usually are quite simple to remedy.

Thermostat setting

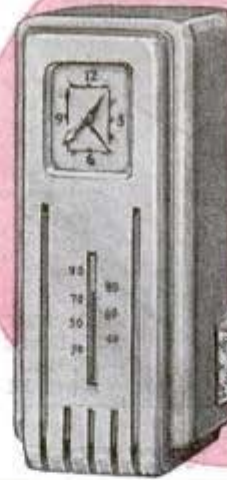

(17) NOT MORE THAN 7° MARGIN BETWEEN DAY AND NIGHT

(18) SUGGESTIONS FOR OVERCOMING OPERATION DIFFICULTIES *		
TROUBLE	CAUSE	REMEDY
Hopper gas	Excessively dirty fuel bed Clinker in retort Fuel bed too thick Hopper lid not sealed Hopper smokepipe plugged	Clean the bed thoroughly Remove the clinker Reduce thickness of bed Refit lid and gasket Remove cap and clean pipe
Smoke (chimney) (Either during "on" or "off" period, or both)	Fuel bed too thick Not enough air Poor draft Coarse coal Faulty chimney or smokepipe	**Reduce coal feed **Increase air Adjust smokepipe damper Mix fine and coarse coal Repair chimney and pipe
Smoke (basement) "on" period	Firebox draft too weak Too much air	Adjust smokepipe damper Decrease air by fan adjustment
Cake trees	Heavy trees—feed too fast Thin trees—too much air Coal too fine	**Increase air, or reduce feed **Increase feed, or decrease air, or maintain thicker fuel bed Mix coarse and fine coal
Not enough heat	Coal feed rate too low Air supply rate too low Poor draft Dirty fuel bed Heating surfaces dirty Coal too fine Limit switch set too low	Increase feed Increase air Adjust smokepipe damper Clean fuel bed Clean castings thoroughly Mix coarse and fine coal See stoker instructions
Too much heat	Wrong setting of hold-fire control (in mild weather) Coal feed rate too high	Reduce operating time Reduce rate of coal feed
Fly ash	Fuel bed too thin Too much air Dirty fuel bed	Increase rate of coal feed Decrease air Clean fuel bed
Soot	Fuel bed too thick Air supply rate too low Hold-fire control set incorrectly	**Decrease coal feed Increase air supply Increase operating periods of hold-fire control
Not enough air	Fan adjustment too low Siftings in windbox Water in air duct Retort openings blocked Basement too air-tight	Increase fan opening Clean windbox Remove the water Remove foreign material Admit more air
Fire goes out	Switch off, or fuses blown Hold-fire set improperly Clutch out, or pin sheared Coal arched in hopper Fuel-air ratio wrong Excessive draft Drive belt slipping	Rebuild fire Close switch or renew fuses Change setting Throw in clutch, or renew shear pin, or remove obstruction Break arch and push coal down to warm Adjust one or the other Reduce firebox draft Tighten, or renew belt

* It is assumed that the stoker has been properly installed and that heating plant is of adequate capacity

** Always do one then observe results before proceeding.

Automatic Check Damper for Use With Stoker

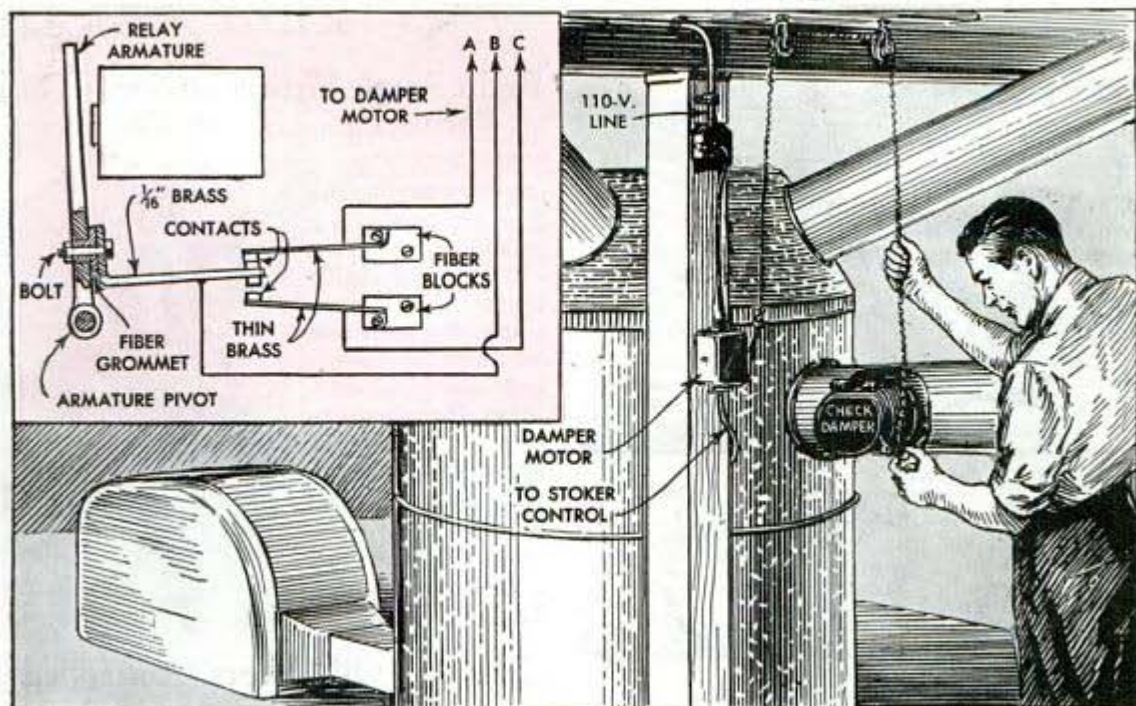

On older types of stokers that are not equipped with an air control for limiting the amount of natural draft through the firebox, a reasonably close control can be provided by automatically operating a check damper in the smokepipe as indicated. The damper closes when the stoker starts to operate and opens when it stops, thus checking the draft.

The check damper is operated by a motor unit of the type used with a wall thermostat for automatic damper control in hand firing. For use with a stoker, the unit is wired to a double-contact switch instead of a thermostat, the switch having connections for three wires the same as the thermostat and being actuated by the armature relay of the stoker control.

The particular type of relay in the stoker control will determine the method of making and mounting the switch. In the switch shown, an arm with double contacts at one end was mounted on the relay armature so that when the armature moved in starting or stopping the stoker it also moved the arm slightly to make or break the circuit between two spring contacts. The arm was insulated from the armature by a fiber grommet and the two brass contacts were insulated by being mounted in fiber blocks.

Most damper motor units have two electrical circuits, one of 110 volts to operate the motor and one of low voltage which flows through the thermostat to control the motor. The low-voltage circuit consists of the three wires that were formerly con-

nected to the room thermostat. These wires are now connected to the switch you installed in the stoker control in the same way as they were connected to the thermostat. The common wire, or wire B in the detail, which was connected to the blade or movable arm of the thermostat, is soldered to the arm of the switch, and the two remaining wires A and C are soldered to the two spring-brass contacts in the switch.

Mount the motor unit on a post, wall or other convenient place and connect one of its arms to the check damper by means of a small chain passed over pulleys as indicated. Plug the motor into the 110-volt circuit and check its operation by starting and stopping the stoker. If the damper closes when it should open, reverse the connections of wires A and C, or change the position of the arm on the motor unit.

Check Radiator-Cap Gasket On Sealed Cooling System

Antifreeze solutions sometimes cause deterioration of the gasket on the radiator cap of a car having a sealed cooling system. For this reason, when putting in your antifreeze, check this gasket and replace it when necessary to assure a perfect seal for the system.

☛ To move a stove, refrigerator or other heavy piece across a floor easily without marring it, place a piece of waxed paper under the legs or casters.

Thread Molds Aid When Sorting Machine Screws and Bolts

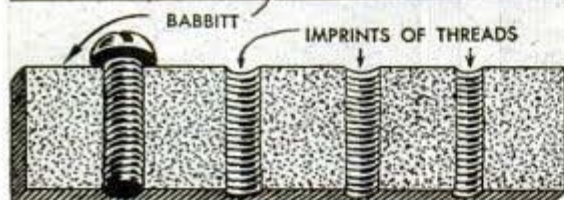

The difficult job of accurately sorting a number of machine screws or bolts of various sizes is simplified by using a mold like the one shown. This is a piece of lead, babbitt or other soft metal imprinted with the threads of the various sizes of screws to be sorted. The imprints can be made by driving the screws sideways against the metal, or by heating the screws and melting the imprints into the metal. The screws are sorted by placing them in the imprints to see if their threads correspond with those of the print.

E. P. Barnhart, Whittier, Calif.

Cleaning Kerosene-Stove Wicks

To clean the wick of a kerosene stove or heater, first wipe the charred end with a cloth and then rub it over a piece of screen tacked to a wooden frame. Before replacing the wick, wipe the shield enclosing it.

Don C. Higbee, Downey, Calif.

Crack in Window Pane Checked By Arcs Scored at End

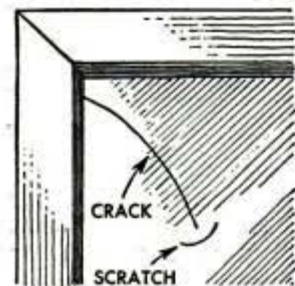

If a short crack appears in a window or door pane, you can prevent it from eventually extending across the glass by scoring short arcs on both sides of the crack near the end

of the crack. Use a glass cutter to make the arcs and scribe them carefully, making them not over $\frac{1}{2}$ in. in length.

M. L. Piatt, Alameda, Calif.

Right-Angle Fitting on Spray Gun Permits Its Use on Ceilings

By attaching a spray gun to the fluid cup by means of a street elbow or a right-angle brass coupling, the gun can be used for painting overhead surfaces that ordinarily cannot be sprayed. Thus fitted, the gun can be pointed up without tilting the fluid cup.—Sam Brown, Marion, Ohio.



Flow of Oil Colors Controlled By Notching End of Tube

When spreading small amounts of oil colors from a tube you will be able to control the flow more easily if you cut a small notch in the threaded end of the tube. The notch should be shallow so that the cap



will cover it to prevent drying out the contents. In use, the tube is held vertically so that the color will flow through the notch. The same method can be used for controlling the flow of adhesives or other fluids contained in tubes.

Rubber Disk Used as a Glove For Handling Glass

Large sheets of glass will be less likely to slip out of your grasp or to cut your hands if you use a rubber disk in the manner of a glove. The disk, which can be cut from an inner tube, is provided with a thumbhole at one side to help keep it in place.—H. R. Wallin, Washington, D. C.



COLOR DESIGNS with Triangle Blocks

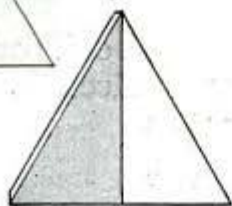
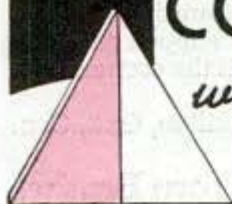

By

Ralph L. Ralston

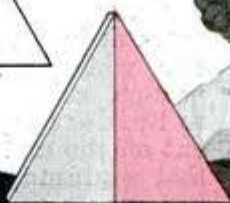

TRIANGULAR blocks cut from fiber board or plywood and colored as shown in the upper detail can be used in many ways for practical purposes and for entertainment. As a toy, the blocks will keep children engrossed for hours because the pieces may be combined into stars, arrows, strips and other shapes, the colored portions forming designs within the shapes as illustrated. Mother can use the triangles as suggestions for quilting and Dad may find the blocks a new "wit challenger" not merely as a puzzle but as a pattern for setting tile or in decorating chests and cabinets with inlays. Any number of triangles may be used, although 12 pieces are generally enough for most purposes. The blocks may be of any size, each one being divided by a line running through the apex and perpendicular to the base. Each block is painted red and white, blue and white, or blue and red. Four blocks of each color combination were used in most of the patterns shown here, but any other colors may be substituted.

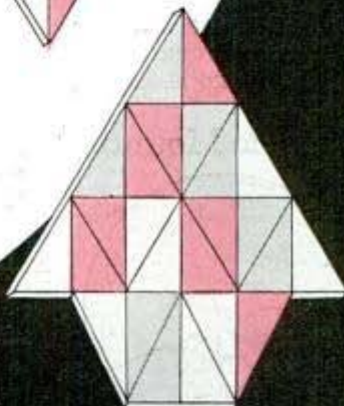
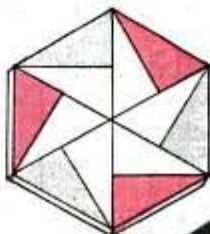
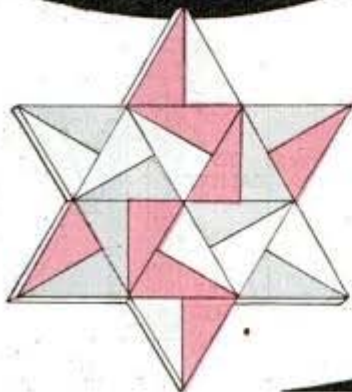
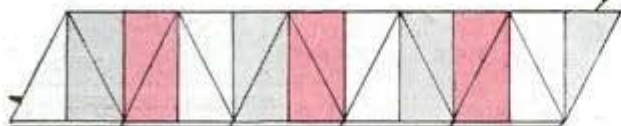
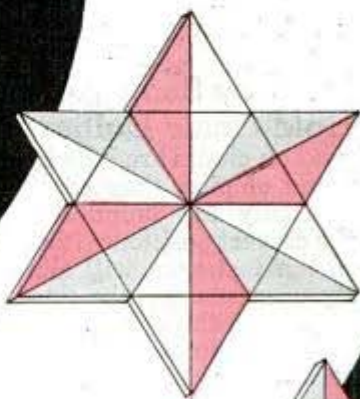
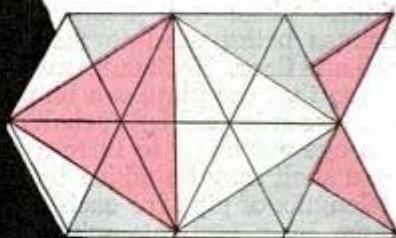

Gas Hot Plate Mounted on Stand Made From Pipe Fittings

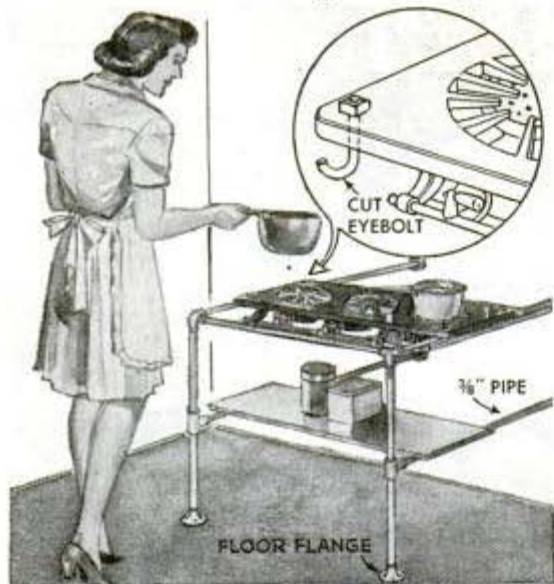

When no stand is available for supporting a hot plate, one can be formed from pipe fittings. These are assembled as shown, flanges being used to fasten the pipe to wall and floor. Horizontal members are spaced so that the plate can be placed on them, where it is held by eyebolts with part of the eye cut away to form a hook. If desired, a shelf may be added by using two short lengths of pipe for each leg and joining them by a tee, into which cross members are screwed.

R. E. Murray, Fremont, Ohio.

Pins Replaced by Snap Fasteners To Hold Chair Doilies

If doilies used on chairs are held by snap fasteners instead of pins, they can be removed more easily for laundering and replaced in the correct position without difficulty. Also, the fasteners will eliminate the possibility of scratching the fingers of children who play on the chairs. One part of a fastener is sewed to each corner of the doily and the other part is sewed in position on the chair.

Beatrice E. Reese, St. Petersburg, Fla.

Flexible Mounting for Wall Maps

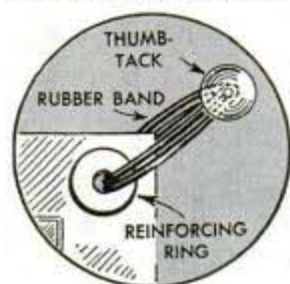

Large maps or plans tacked to a wall expand during humid weather and become limp. Tightening and retacking them when in this condition does not effect permanent

improvement as the contraction on drying enlarges the tack holes. Mounting the map with short rubber bands slipped through gummed reinforcements at the corners will keep it taut and smooth.

D. H. Matheson, Hamilton, Ont., Can.

Cutting Off End of Worn Brushes Exposes Serviceable Bristles

When wire brushes become worn at the outer end, which is the portion subjected to hardest wear, cut off the end so that undamaged bristles are exposed. The end of the wooden back should be sized with glue or several coats of shellac to prevent moisture absorption.



Old Sealed-Beam Lights Used As 6-Volt Floodlamps

Instead of discarding sealed-beam auto headlights when one of the filaments burns out, you can use them to make a driveway floodlight and a portable lamp. For the former, a transformer is used. This is connected as shown, and the light is attached to a garage wall or a conveniently located post. The portable lamp unit is enclosed in a plywood or scrap-wood box with a hinged lid held by a hook. The lamp is battery-operated and is controlled by a toggle switch, which can be located under a handle taken from an old suitcase.

O. Kelly, East Greenbush, N. Y.

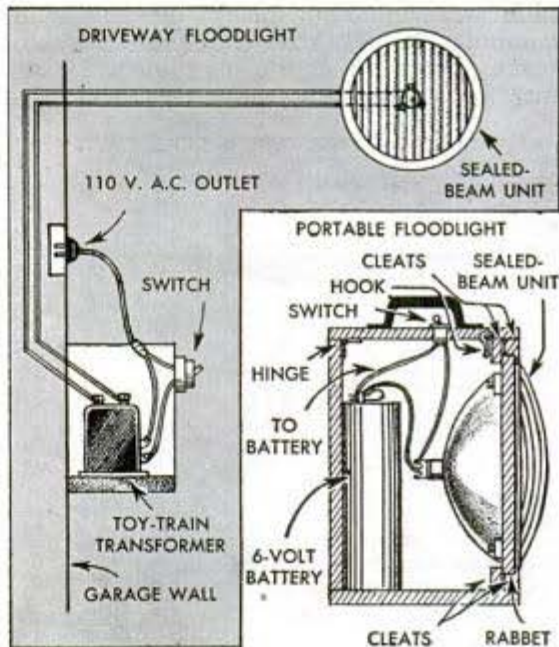

Three-Piece Cigarette Box Is Sawed to Shape

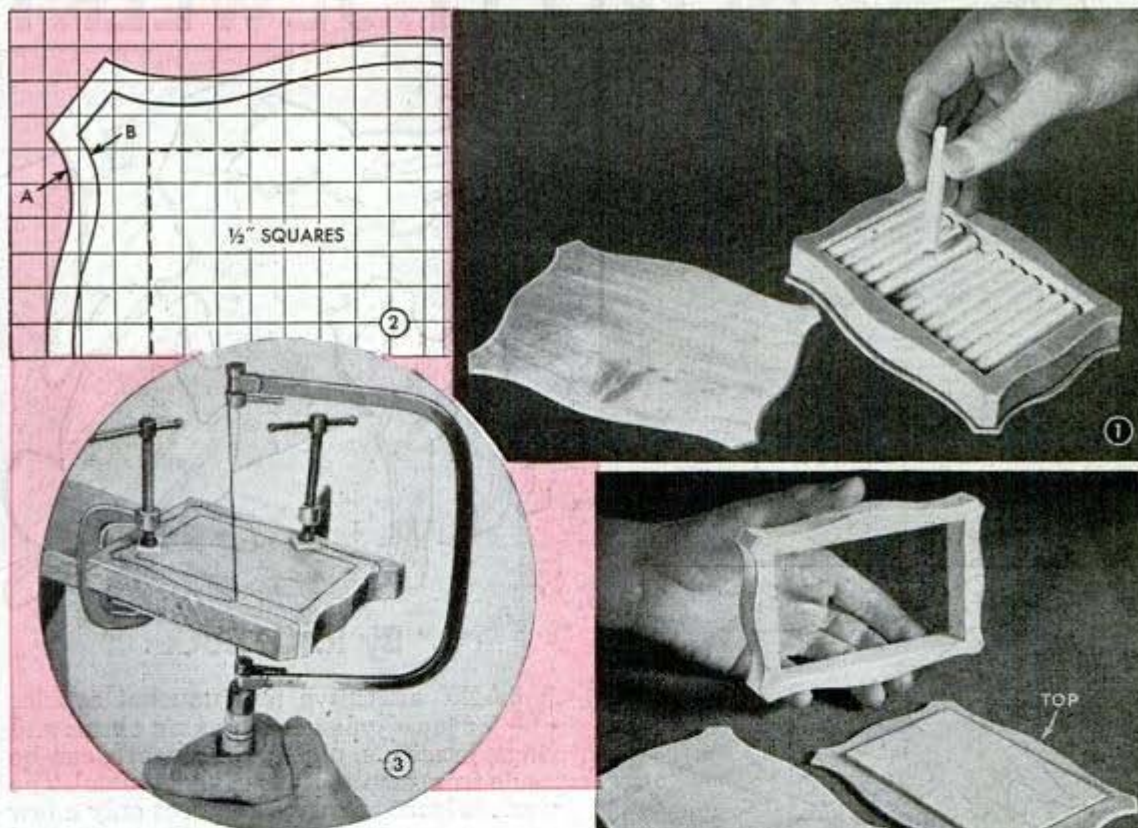

This neat box, which is large enough to hold two layers of regular-size cigarettes as shown in Fig. 1, is exceptionally attractive when made of walnut or mahogany. Top and bottom pieces are of $\frac{1}{8}$ -in. stock, and are jigsawed to the shape represented by line A of Fig. 2. The body of the box is made of $\frac{5}{8}$ -in. stock, and is marked off according to line B, Fig. 2, after which it is jigsawed to shape as in Fig. 3. From this piece a rectangular cutout, shown by the dotted line in Fig. 2, is made to take the cigarettes. For king-size cigarettes, the

width can be increased. To form a shoulder on the top, a rectangular piece is cut to fit into the cutout of the body and positioned as in Fig. 4, after which all parts are glued together. The box is sanded smooth and finished by staining and varnishing, then rubbed down with fine steel wool or pumice and oil.—Charles and Bertram Brownold, Woodmere, N. Y.

Tenons at Ends of Round Work Cut Quickly on Jointer

Lacking other means, smooth tenons can be cut on round stock by working the wood on a jointer. A wooden guide block clamped to the jointer table serves both as guide and stop. The work is pushed along the guide and into the cutter until it is stopped by a shoulder on the guide block, after which it is rotated slowly in the same direction as that of the cutterhead.

☐ If a house is to be unoccupied during the winter months, drain the plumbing system and pour light oil or kerosene into the drain traps. Kerosene does not freeze, and will take the place of water in preventing seepage of sewer gas into the house.

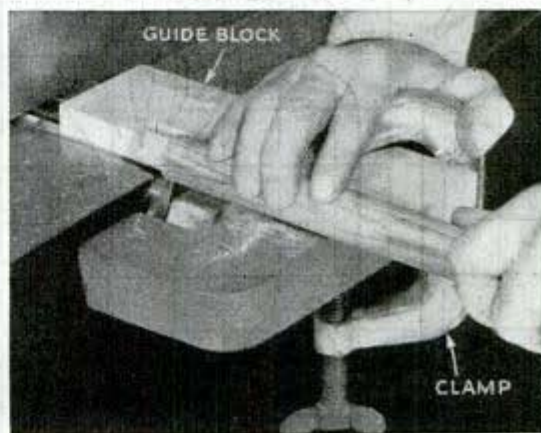

NOVELTY JEWELRY

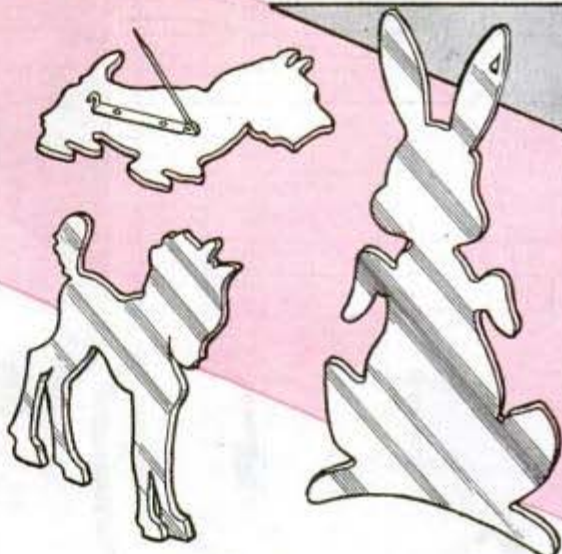

By R. O. Buck

MANY attractive and unusual articles of jewelry, such as napkin clasps and rings, bracelets, pins and brooches, can be made from small pieces of sheet metal. The work is learned easily, requires only a few common hand tools and provides unlimited opportunity for originality in design. Novelty jewelry makes an ideal gift and for this reason it finds a ready market wherever souvenirs are in demand.

Materials: Half-hard aluminum, soft brass, cold-rolled copper, German silver, nickel and many other metals and alloys are suitable, the thickness, or gauge, of the metal depending on the article to be made. For napkin clasps and rings, 16-gauge metal is suitable, but for pins and other ornamental items, metal as light as 36 gauge, which is a little less than $\frac{1}{64}$ in., can be used.

Napkin clasps: These popular and useful articles not only are the easiest to make, but illustrate the procedures to be followed in fashioning the more difficult pieces. From a sheet of 16-gauge aluminum or German silver, a strip 2 by $5\frac{1}{4}$ in. is cut with tin snips as in Fig. 13. A design such as one of those shown in Fig. 3 is drawn on paper, which is cemented to the metal strip. Shellac or rubber cement can be used as an adhesive. When this has dried, the metal is trimmed down roughly to the shape of the design, then scrollsawed to finish size. For sawing, a notched and slotted board is used as in Fig. 1. The board is clamped to the workbench and the metal is positioned so that the lines to be sawed are over the notched cutout. The work should be held firmly on the cutting board

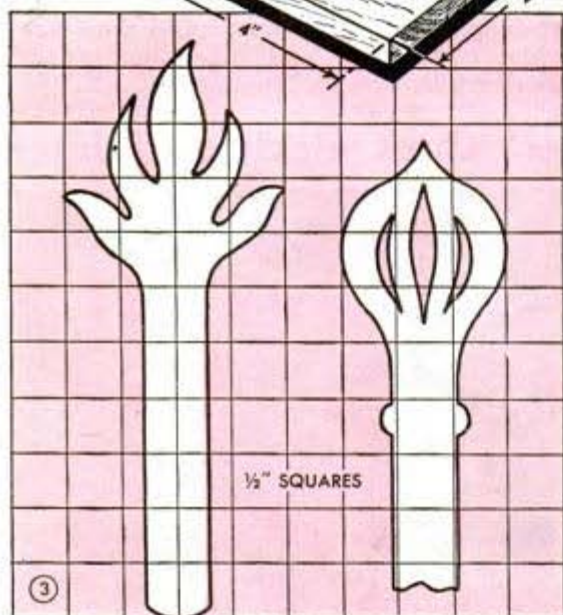
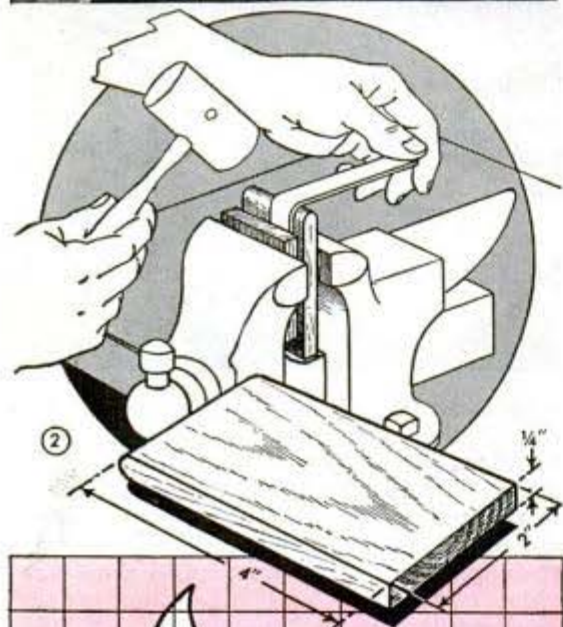

from SHEET METAL

Servicemen especially will find that crafting jewelry from metal not only solves the gift problem, but also offers a profitable recreation

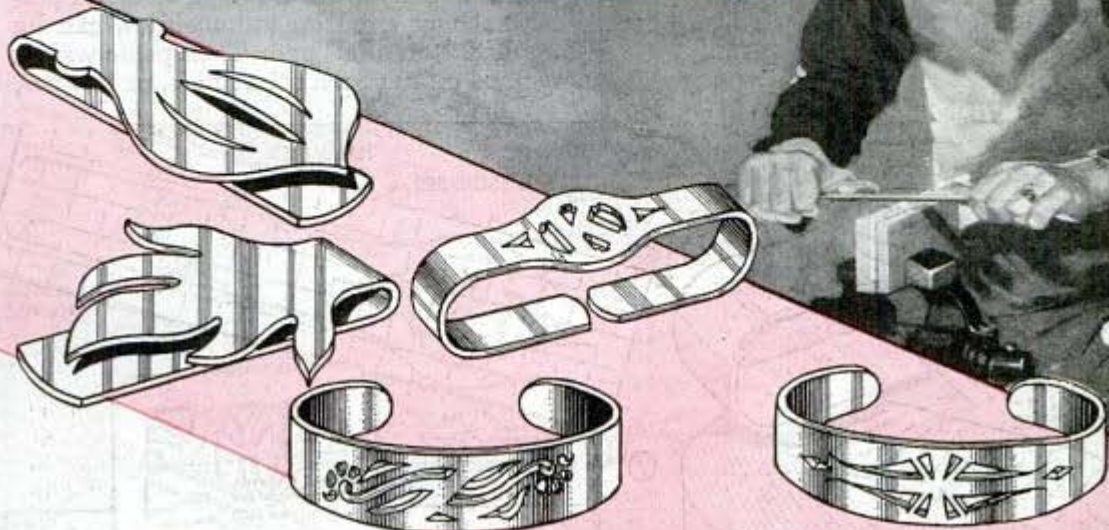

Photos courtesy United Service Organization, Chicago

to prevent vibration while being sawed, as this may cause the blade to break. With the blade teeth pointing toward the handle, the saw is tilted forward slightly except when cutting a sharp corner. This must be done slowly to allow the blade to clear away enough stock to turn without binding or breaking. Wax rubbed on the blade will serve as a lubricant so that it will cut freely.

When using a design like that shown in the right-hand detail of Fig. 3, portions of the metal must be sawed out. This is done by first drilling small holes through which the saw blade can be inserted. The work is clamped between two wood blocks as in Fig. 5 so that the drill will cut through the metal without damaging the workbench. The locations of the holes should be center-punched before drilling so that the drill will not slip out of place and scratch the metal.

After all sawing has been done, the edges are smoothed by draw-filing. The work is held in a vise between two blocks of wood, which are placed about $\frac{1}{8}$ in. below the edge of the work in order to give greatest support to it. A small mill file then is gripped with both hands and drawn flat in one direction only along the edge of the

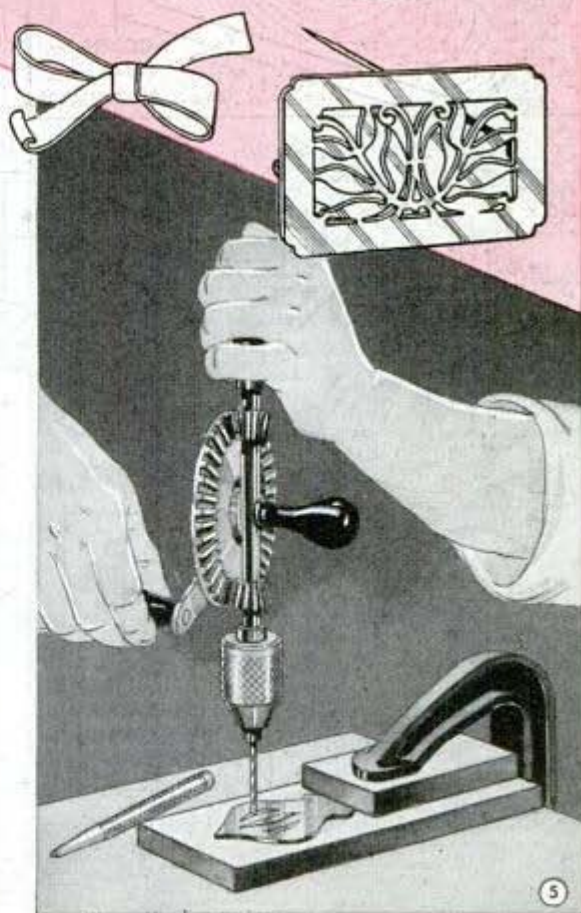



metal, Fig. 4. Because aluminum and other soft metals clog a file quickly, chalk should be rubbed on the file frequently to prevent its filling up. When all edges have been filed smooth, they should be rubbed down with a strip of medium emery cloth followed by a strip of No. 0 cloth.

The metal is polished with a fine abrasive such as powdered pumice or ordinary kitchen scouring preparations applied with a damp cloth. Fine steel wool can be used to produce a dull, rich finish, but for a bright luster jeweler's rouge, or metal polish such as used on automobiles, can be applied with a felt pad. Then paste wax is rubbed on to protect the finish, or lacquer,

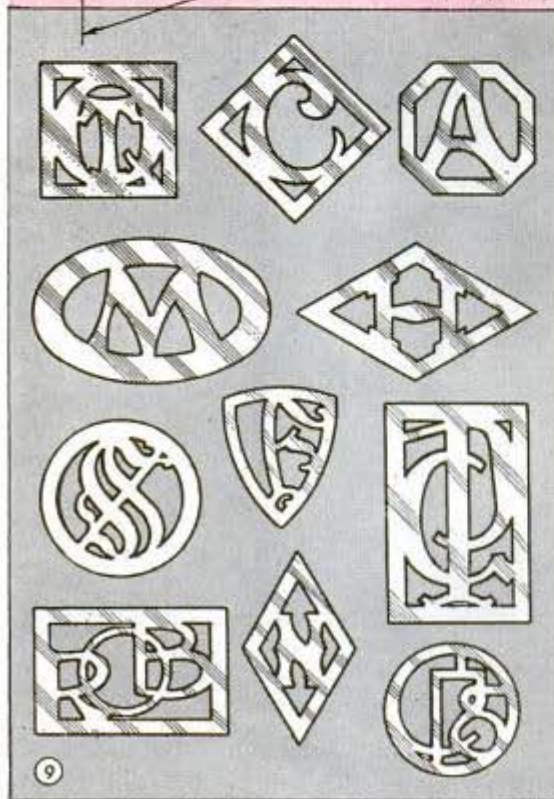
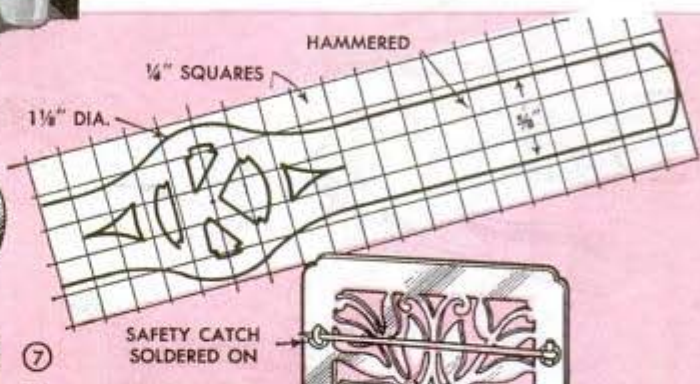

which is more durable, is applied with a small brush, Fig. 6.

To shape the clasp, the scrolled end is clamped between two blocks in a vise as in Fig. 2, the end of one block being rounded to assure a uniform curve when the metal is bent over it. When shaping the clasp push down gradually with one hand and at the same time tap it lightly with a mallet.

Napkin ring: The napkin ring, Fig. 7, is made in the same way as the clasps, although a differently shaped forming block is used. Monograms and initials, which may be varied to suit individual requirements for decorating the ring, are illustrated in Fig. 9. Before shaping and polishing the ring, its entire surface, or a

small portion of it, can be hammered to produce a pleasing effect. This is done by tapping the surface lightly with a ball-peen hammer, or by indenting the surface with a punch made by rounding one end of a short length of $\frac{3}{8}$ -in. dowel. To bend the ring, a line is marked on one side of the forming block across its center, and the strip of metal, after being scrollsawed, filed and polished as previously explained, is positioned over it so that half its length extends on each side of the line. The strip, of course, must be aligned carefully along the edges of the block so that, when bent, the ends will meet exactly. Then the strip is covered with a small wooden block and

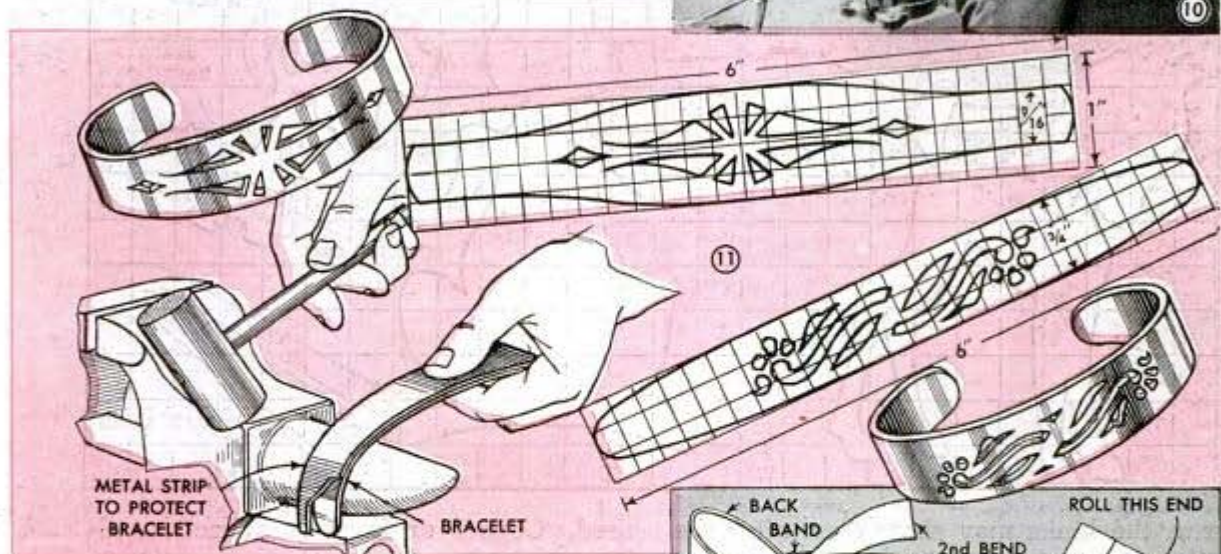

clamps are tightened over the work, after which the ends are bent and tapped with a mallet until the ring is completely formed.

Filigreed bracelets: Although they are made in much the same way as the napkin rings, the bracelets shown in Fig. 11 require a little more experience because of the intricacy of their designs and the small portions to be sawed out. Nickel or German silver is preferable to brass, copper or aluminum for making bracelets. These are formed over the end of an anvil as in Fig. 10. When doing this work, care must be taken to avoid distorting the web pieces of the design. For this reason, a thin metal strip is laid over the work to protect it while it is tapped with a mallet, as indicated in the lower left-hand detail of Fig. 11.

Pins and brooches: Several kinds of pins and brooches are shown in Figs. 8, 12 and 14. For the filigree-type brooch, Fig. 8, 20-gauge silver or German silver is suitable. When sawing metal of this thickness, it is best to use the slotted end of the sawing board shown in Fig. 1, rather than the notched end, so that the work will be well supported. If the piece buckles under the

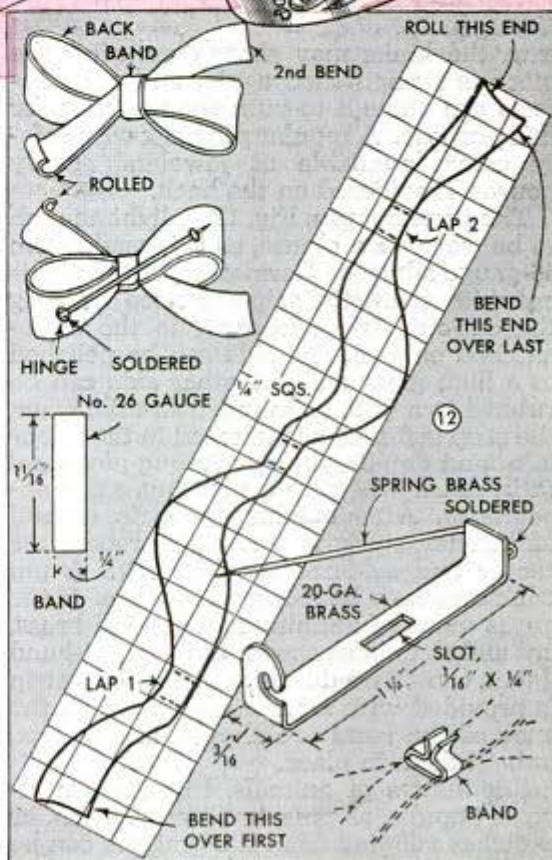

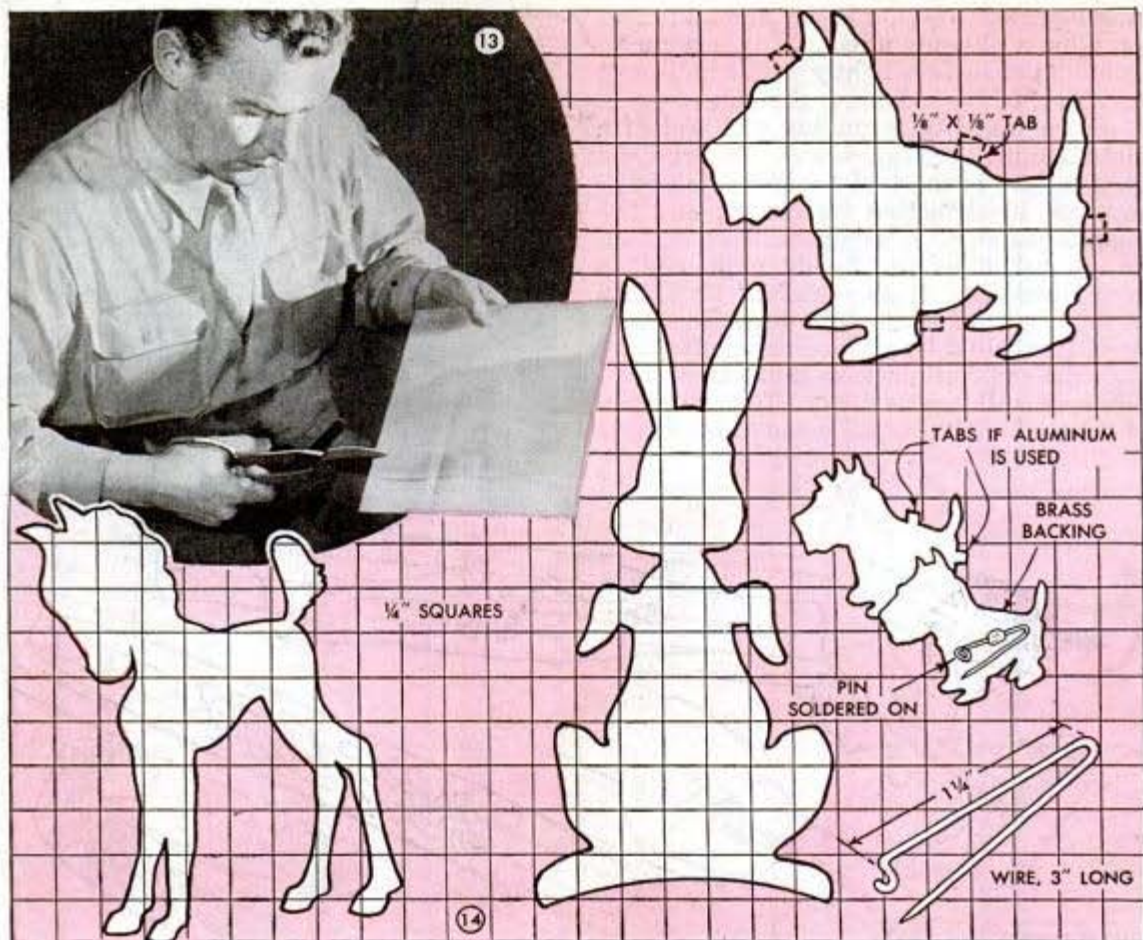

saw, the kinks may show even after the piece is straightened again, and such defects are enough to ruin the material for this purpose. A regular pin back with safety catch, available at jewelers' supply houses, is soldered on the back.

The bowknot pin, Fig. 12, is light enough to be worn on a blouse, as it is made from 36-gauge silver or German silver, which is cut with small tin snips. Before bending the cut-out strip according to the cross-hatched pattern, one side can be polished to a high gloss and the other side can be rubbed to a dull, satin finish so that, when the strip is folded as indicated in the upper left-hand details, the alternating gloss and satin finish will give a pleasing, silky appearance. After bending the strip, a band of heavier stock is wrapped around the center and soldered at the back. A pin back may now be soldered in place. If the pin is made of aluminum, a strip of brass, cut and shaped as shown in the right-hand detail, can be used instead. The brass strip is provided with a slot through which the ends of the band are slipped and peened to hold them in place.

Silhouettes of animals, Fig. 14, are always popular as pins, but trees, leaves, or sketches adapted from illustrations can be

used. Copper or brass is attractive, although aluminum also is satisfactory. However, if aluminum is used the pin fastening cannot be soldered to the back unless special solder is used. Instead, tabs should be provided for folding over a brass backing to which the pin can be attached, as indicated in the right-hand details of Fig. 14. If a pin back or pin mounting is not available, one can be improvised from a length of spring wire, or an ordinary safety pin may be substituted.

Inked Lines Show Width of Pens Held in Corrugated Board

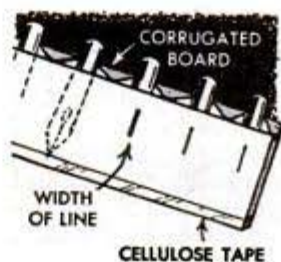

Artists will find that a strip of corrugated cardboard sealed at the bottom edge is an excellent means of holding an assortment of lettering pens. By drawing a line with each pen on the outside of the pocket in which it is held, the proper point can be selected merely by glancing at the strip.

Thomas J. Mahan, East St. Louis, Ill.

Jig Holds Irregularly Shaped Work for Sawing

With this jig, it is possible to hold work of irregular shape safely and cut it accurately on a circular saw. It is especially handy in gripping disks to be cut as in the upper photo, or for holding rods and tubes to be cut off as in the lower photo. The jig consists of two blocks of $\frac{3}{4}$ -in. plywood held together by two carriage bolts, the heads of the bolts being countersunk into the lower block. The jig is guided straight across the saw table by a strip nailed to the underside of the lower block to slide in the miter-gauge groove in the table. If the jig is used to grip cylindrical work, such as rods and tubes, two V-grooves, one above the other, should be cut across the inner faces of the blocks to hold the work.

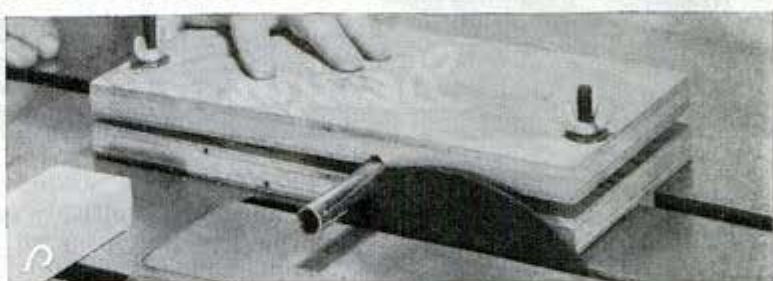

Gripper Block Assures Tight Seams When Laying Floor

When laying a new floor where a sub-floor is not used, this gripper block will provide a rigid stop for a pry bar used to force warped flooring boards into position

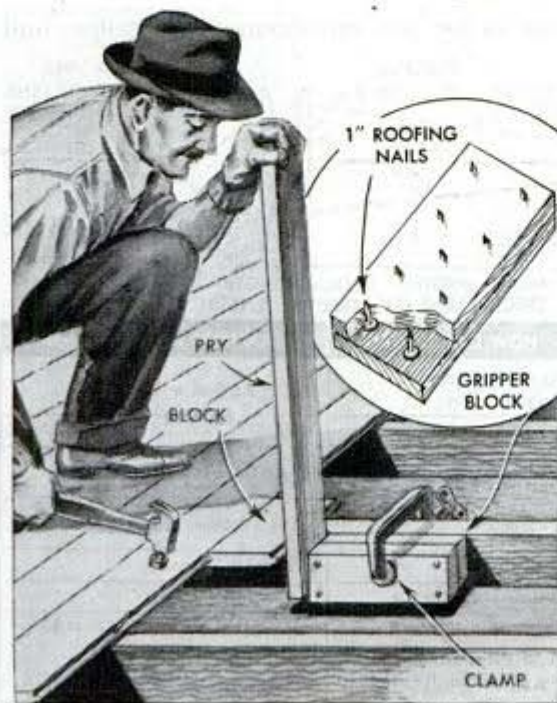

before nailing them. The block is made from two $\frac{3}{4}$ -in. pieces, one of which is drilled to take roofing nails that project through it slightly. The other piece is screwed in place over the nail heads to hold them. In use, the block is attached to a joist with a C-clamp so that the projecting ends of the nails sink into the joist to prevent slipping. A piece of 2 by 4-in. stock about 3 ft. long is used as a pry bar. To avoid damaging the tongue or groove on a floor board, place a short block of flooring between the pry bar and the board.

Harold Jackson, Kankakee, Ill.

Part of Tennis Ball Used as Shield Over Greasy Trailer Hitch

By cutting off about one third of an old tennis ball and using the remainder as a cup to be slipped over the metal ball of an auto-trailer hitch, you can keep your hands and clothing from becoming soiled by accidentally brushing against these parts. Also, the tennis ball will be a shield against rain and weather and help prevent rusting.

A. W. Skerry, Pomona, Calif.

Door hinges can be kept from squeaking by an application of powdered graphite.



Design and Construction

24

IMAGE SIZE (40° APPARENT FIELD)			
M	Factor	M	Factor
8X	.087	17X	.042
9X	.077	18X	.038
10X	.070	19X	.036
11X	.063	20X	.035
12X	.058	21X	.033
13X	.054	22X	.031
14X	.049	24X	.029
15X	.047	26X	.026
16X	.044	28X	.024

IF YOU made one of the telescopes described last month, you already are familiar with the basic information necessary to construct a terrestrial telescope, which is one for viewing objects on land. Obviously, it must show an upright image, and in order to do this with the astronomical telescope already described, it is necessary to add two lenses between the objective and eyepiece, as in Fig. 25. This type of erecting system permits added magnification through the erectors.

Normal lens system: This also is shown in Fig. 25. The field lens and eye lens making up the eyepiece are the same as for the astronomical telescope, and

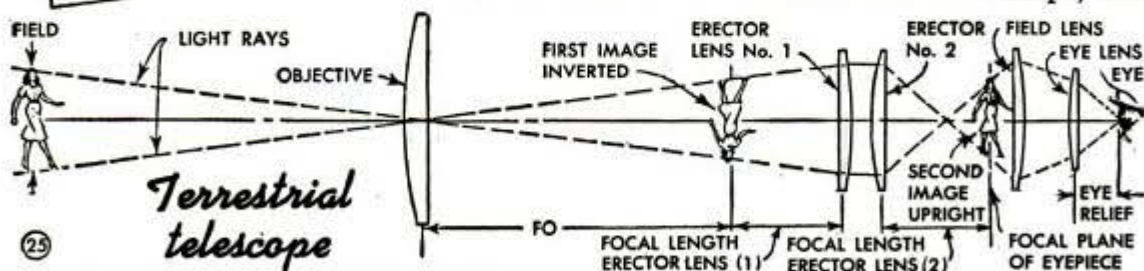

CHARACTERISTIC	NORMAL VALUE	HOW CALCULATED	EXAMPLE, 11X (from text)
1 Equivalent focus of objective	1 to 3 times focal length of objective	FO times erector magnification	$132 \times 2 = 264$ mm.
2 Erector magnification	1X to 3X	$E-2 \div E-1$	$80 \div 41 = 2X$
3 Magnification	13 times DO (in inches)	FO or equivalent FO divided by FE	$264 \div 24 = 11X$
4 First image size	$\frac{1}{4}$ " to $\frac{3}{4}$ "	Value from Fig. 24 times FO	$.063 \times 5.18 = .326 = \frac{3}{16}$ "
5 Exit pupil	2 to 5 mm. ($\frac{1}{16}$ " to $\frac{3}{16}$ ")	DO \div M	$32 \div 11 = 3$ mm.
6 Eye relief	$\frac{3}{16}$ " (min.) to 1"	Measure direct	$\frac{3}{16}$ " scant
7 Luminosity	10 to 100%	$(DO \div 5)^2 \div M^2$	$(32 \div 5)^2 \div 11^2 = 36 \div 121 = 30\%$
8 Field in yds. at 1,000 yds.	10 to 90 yards depending on magnification	Read value from Fig. 24 as yards (see text)	63 yards (see text)

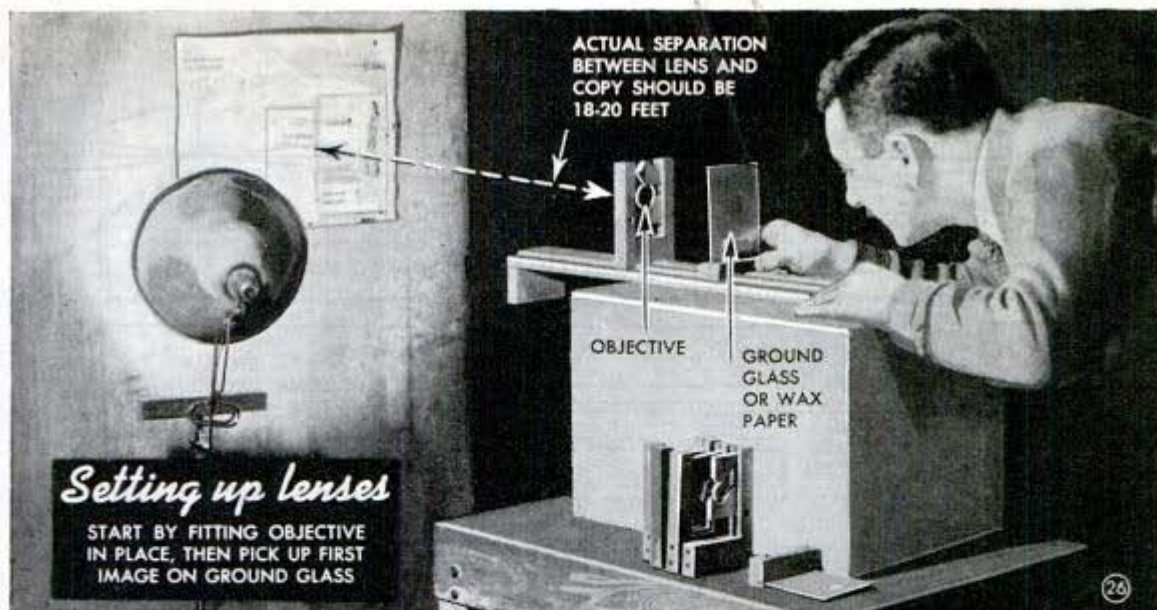

Setting up lenses

START BY FITTING OBJECTIVE IN PLACE, THEN PICK UP FIRST IMAGE ON GROUND GLASS

of TELESCOPES PART 2 *By Sam Brown*

can be Huygenian, Ramsden or Kellner as previously described. The one shown here is a Ramsden. The eyepiece together with the two erectors make an erecting eyepiece, and all four lenses are mounted at a fixed spacing in the draw tube. Fig. 25 shows erectors of equal focal length, spaced at their focal lengths from the two image planes. With this setup, the erectors give unity magnification; that is, they add nothing to the magnification of the system.

Designing your own scope: The best way to make a scope is to design and test your own. First, select suitable lenses, Fig. 32, and run through the simple calculations and other data. Then make a layout, tracing the light rays and, at the same time, check the system on the optical bench. This procedure, using the 11X scope shown in Fig. 23 as an example, will be described in detail. Preliminary calculations are given in the right-hand column of the table.

Making the layout: Start the layout as in Fig. 30, drawing a centerline and a line indicating the diameter of the objective. Set up the objective on an optical bench, with test copy about 20 ft. away. Take a piece of ground glass and pull it back from the objective until you get the image in sharp focus, Fig. 26. This image marks the first image plane. Measure the distance from objective to image plane and make a corresponding line on your layout. Next, set up the first erector lens and move it back and forth

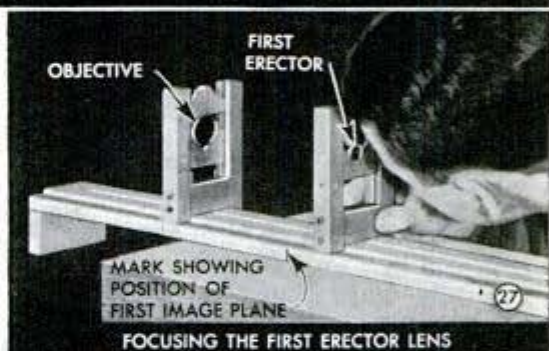

FOCUSING THE FIRST ERECTOR LENS

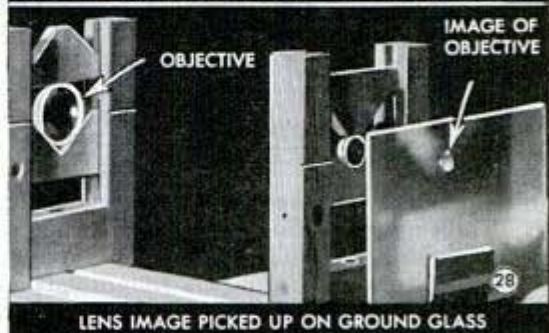

LENS IMAGE PICKED UP ON GROUND GLASS

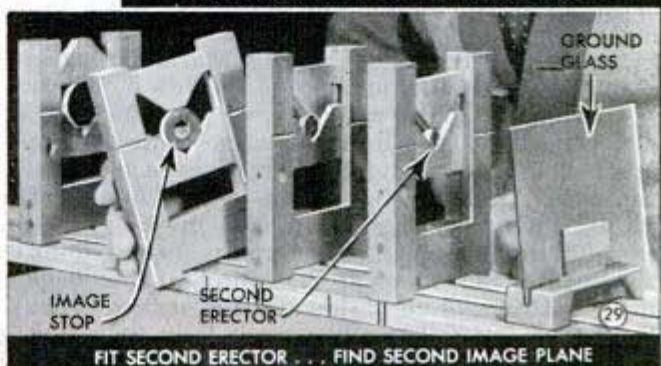

FIT SECOND ERECTOR . . . FIND SECOND IMAGE PLANE

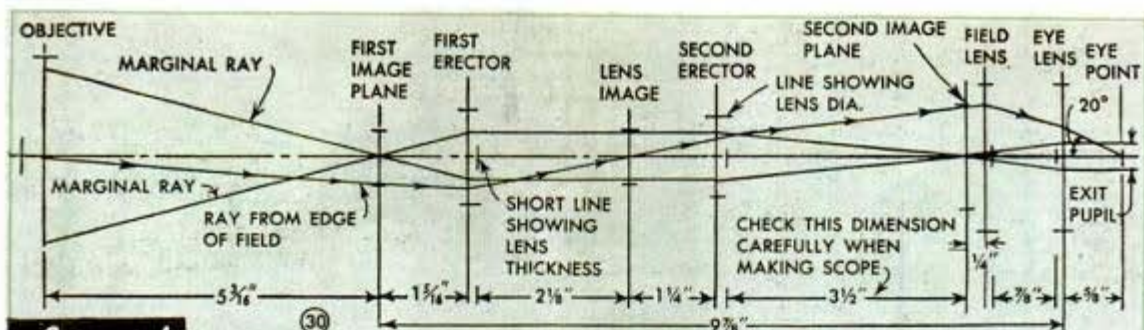

Layout

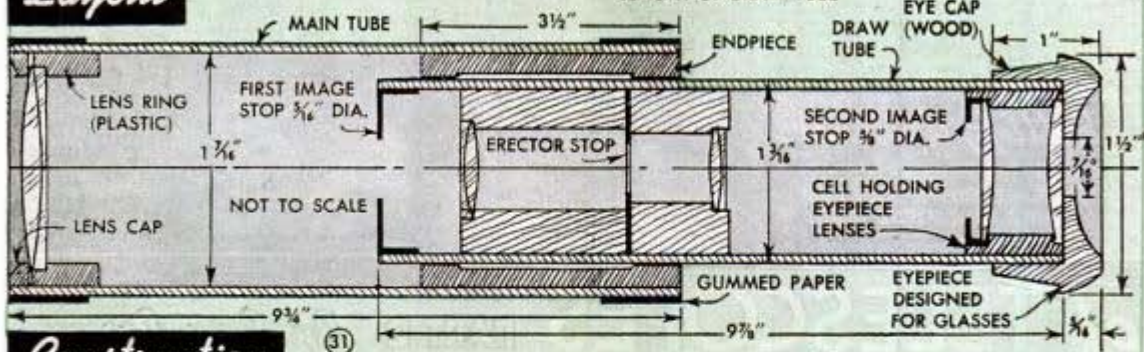

Construction

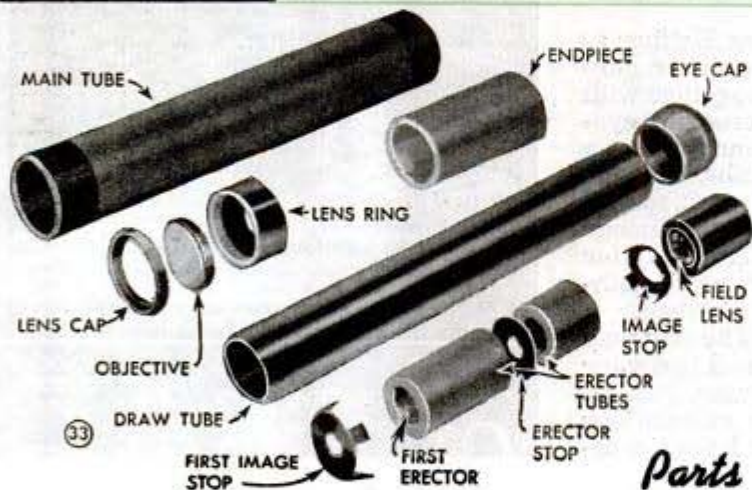

32 Lenses

	Inches		MM.	
	Dia.	F.L.	Dia.	F.L.
Objective	1 1/4	5 3/16	32	132
E-1	5/8	1 1/8	15	41
E-2	1/2	3/8	12	80
Field	3/8	1 3/16	22	32
Eye	3/8	1 3/16	22	32

See right col. Fig 25 for other data

11X Terrestrial

This typical scope, ideal for hunting or observation, is used to show method of setting up and checking lens systems.

Parts

until you get the copy in sharp focus, Fig. 27. Then measure the distance from image plane or objective and mark on the layout.

Size of image: Find 11X magnification in Fig. 24, and opposite this read the factor, .063. Apply calculation No. 4, Fig. 25; the answer is 5/16 in., which is the size of the image at the first image plane. Mark the diameter on the layout.

Tracing the light rays: Now, you can draw the light rays from objective to first erector, Fig. 30, using only three rays to represent the extremes, thus embracing all of the many light rays which pass through the telescope. The pair of marginal rays comes to a focus at the center of the image plane and continues until it strikes the first erector. The other ray is from the extreme edge of the field or picture and

will pass through the extreme edge of the same "picture" inside your telescope. The erector lens must be large enough to receive these rays.

Close or spaced erectors: Here you have to decide whether you want the erectors close together or spaced well apart. Either way is suitable. Close spacing has an advantage in compactness, but it also requires longer eye relief. Therefore, it is best to space the erectors farther apart in order to shorten eye relief.

Lens image: In wide spacing, there will be an image of the objective lens between the erectors, and in close spacing, the image will be behind the second erector. The next step is to find this lens image. Use the ground glass and move it up behind the first erector until you get a circle of

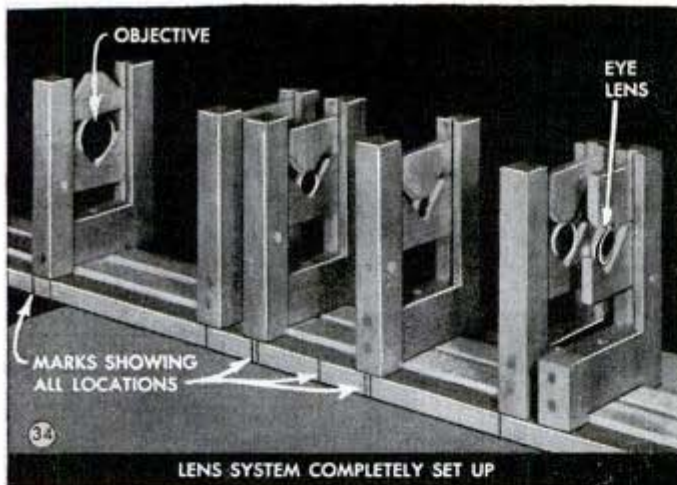

LENS SYSTEM COMPLETELY SET UP



VISUAL CHECK OF MAGNIFICATION

light in sharp focus as in Fig. 28. This is the lens image. Mark its size and position on the layout. Continue the light rays. The marginal rays are parallel with the centerline. Note that since they originally passed through the edge of the objective, they now will pass through the edge of the objective image. Similarly, the ray from the edge of the field, which originally passed through the center of the objective, now passes through the center of the objective image. These rays continue until they strike the second erector. To favor the small second erector, it is placed about $1\frac{1}{4}$ in. behind the lens image.

The second image: Put the ground glass behind the second erector and pull it back until you get a sharp image of the copy. This is the second image plane, and will be upright. Indicate its position on the layout and make a ring of cardboard with a central hole the same size as the first image, which is $\frac{5}{16}$ in. Mount this disk at the first image plane as in Fig. 29. Since you are using 2X magnification through the erectors, the image on the ground glass at the second image plane should be about $\frac{5}{8}$ in. in diameter. Mark the diameter on the layout. Set up the eyepiece and focus. Mark the position of field and eye lenses on the layout. Continue the light rays from the second erector, through the second image, to the field lens. Fig. 34 shows the complete setup on an optical bench. On the layout, you now work from the eye end to complete the ray tracing. Find the exit-pupil point, Fig. 36. Mark this point on the layout and draw a line from it to the eye-lens line at an angle of 20 deg. to the centerline. Connect this point on the eye lens with the end of the

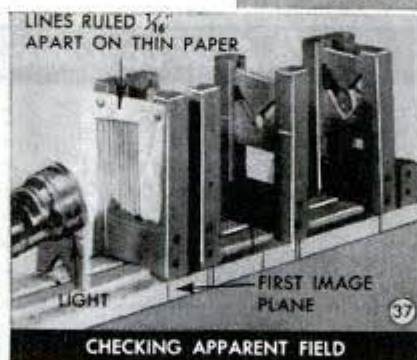
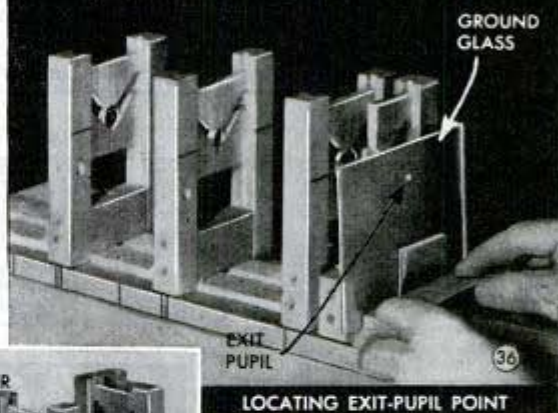

CHECKING APPARENT FIELD

edge-of-field ray at the field lens. Measure the diameter of the exit pupil and draw lines parallel with the centerline, connecting them with the ends of marginal rays at the field lens.

Mechanical construction: This is shown in

Figs. 31 and 33. Two tubes are used; one houses the objective and the other carries the erecting eyepiece. The hole in the eye cap is determined by the 20-deg. line on the layout. The depth of the eye cap should be such as to set the proper eye relief. The one shown is shallow for use with eye glasses. The scope as set up is focused at 20 ft., which represents the longest extension required.

Visual check of magnification: Make a visual test by looking through the telescope with one eye and directly at the copy with the other eye, Fig. 35. You will see the two views one over the other. Note sizes; that is, so many lines of copy as seen by scope covers the full sheet of copy as seen by eye. Now measure the two distances. In this particular case, $1\frac{3}{4}$ in. of copy seen through the scope covers the full height of

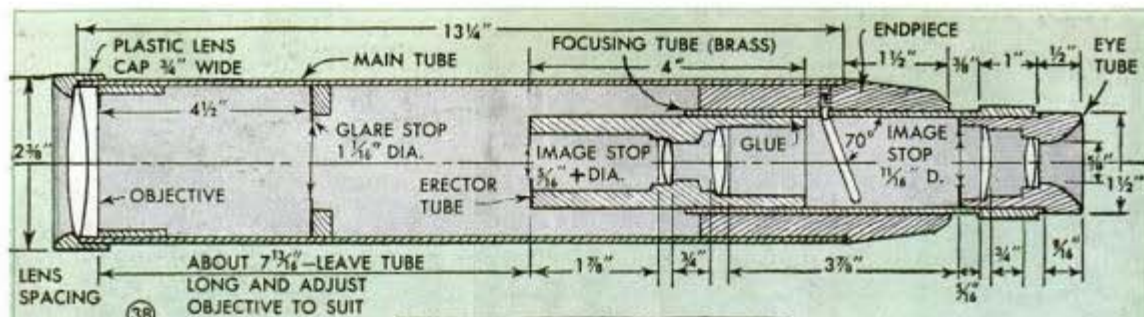

LENSES					14x Spiral focusing			TUBES			
	Millimeters		Inches		Combined focus of eyepiece = $\frac{45 \times 38}{45 + 38 - 19} = 27$ mm.	Main	Dia.	Length	Erector	Dia.	Length
	Dia.	Focus	Dia.	Focus							
Objective	52	193	2.04	7.60	Erector magnification = $95 \div 49 = 1.9X$		2 1/4" I.D.	13 1/4"			
Erector 1	18	49	.71	1.93	Equiv. focus of objective = $193 \times 1.9 = 367$ mm.				1 3/8" O.D.	4"	
Erector 2	25	95	.98	3.74	Magnification = $367 \div 27 = 13 1/2 X$				2 1/4" O.D.	3 3/8"	
Field	26	45	1.02	1.77	Luminosity = 59%				1 3/8" I.D.	5 3/8"	
Eye	17	38	.67	1.49	Field (actual) = 40 yds. at 1,000 yds.				1 1/2" O.D.	1 1/4"	

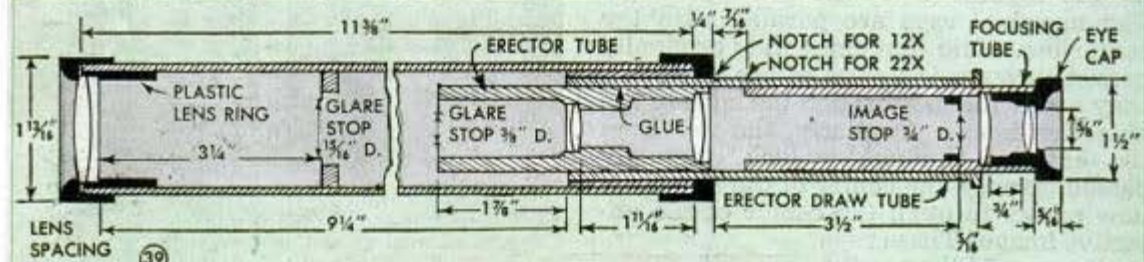

LENSES					12x to 22x variable			TUBES					
	Millimeters		Inches		Eyepiece: 27 mm. focus Erector magnification: 1.9X Equiv. focus of objective = $181 \times 1.9 = 344$ mm. Magnification = $344 \div 27 = 13X$ normal Luminosity at 12X = 35% Luminosity at 22X = 10% Field (12X): 42 yds. at 1,000 yds. Field (22X): 23 yds. at 1,000 yds. <th rowspan="2">Main</th> <th rowspan="2">Dia.</th> <th rowspan="2">Length</th> <th rowspan="2">Erector</th> <th rowspan="2">Dia.</th> <th rowspan="2">Length</th>	Main	Dia.	Length	Erector	Dia.	Length		
	Dia.	Focus	Dia.	Focus									
Objective	36	181	1.42	7.13			1 11/16" O.D.	11 3/8"					
Other lenses same as scope at top of page. Various styles or powers of eyepieces can be substituted without affecting the general construction									1 3/8" O.D.	3 3/8"			
									*Erector draw	1 3/8" I.D.	6"		
									Focusing	1 3/8" O.D.	4 1/4"		
									Eye cap	1 1/2" O.D.	1 1/4"		

copy, 20 in. Then, 20 divided by 1.75 equals about 12X magnification.

Visual check of field: The field is checked by measuring the width of copy you can see through the scope at 20 ft. Multiply this distance in inches by 4 to get the approximate field in yards at 1000 yards. In this case, the field at 20 ft. measures 14 in., so the field at 1000 yards will be 56 yds. This is a little less than the paper value as determined from calculation No. 8, Fig. 25. No. 8 calculation is based on maintaining a full 40-deg. apparent field, which is not always the case.

Visual check of apparent field: The apparent field angle is the extreme angle which light rays make on reaching the eye; the true field angle is the apparent field angle divided by the magnification. Values given in Fig. 24 take a 40-deg. apparent field for granted. You can make a visual check by ruling lines 1/16 in. apart on a sheet

of tracing or other thin paper. Mount this at the first image plane and illuminate it from the objective side, Fig. 37. Count the number of lines you can see through the eyepiece. If the eyepiece is maintaining a 40-deg. field, you should see five lines. Less than this means you are not getting a 40-deg. field, the reason being that erector magnification at the second image plane makes the image too large to be viewed by a normal-size eyepiece. This merely means that the field of view will be somewhat reduced in size and calculation No. 8 cannot then be used.

Luminosity: In daylight, the pupil of your eye is about 5 mm. in diameter. Calculation No. 7, Fig. 25, gives light percentage and is based on 100 percent for a 5-mm. pupil. At night, the pupil of your eye dilates to about 7 mm. To find luminosity of any scope as a night glass, substitute 7 for 5 in the calculation.

Conjugate magnification:

As described, erector magnification is obtained when the second erector is of longer focal length than the first. Another way of getting erector magnification is by setting up the lenses at distances other than their focal lengths. This works exactly like a camera. Consider the first image to be a solid object, such as a person's head. To get a large picture of this object, the camera lens is pushed close to it, at the same time extending the bellows. You do the same thing in a telescope by pushing the first erector closer to the first image plane. This gives a large second image at a distance farther back than the focal length of the second erector. A small amount of conjugate magnification usually is introduced when any lens system is set up by eye; you can deliberately introduce a great amount of magnification in this way. The 11X scope can be pushed up to 30X if desired. However, note that the second image is much too large to be viewed by the eyepiece, with the result that you lose field area, and the increase in magnification means less illumination. Conjugate magnification cannot be calculated by the simple rules given, but it is easily determined visually.

Specific designs: Dimensioned designs are impractical as there is no assurance that you can get tubes and lenses specified. However, such designs are useful as a general guide, and two are shown and briefly described. The first is a 14X spiral-focusing scope, as diagrammed in Fig. 38 and further illustrated by Figs. 23, 40, 41 and 42. It is a solid model and does not telescope. Using the short objectives described in this article, the whole range of focusing from 20 ft. to infinity is very short, averaging $\frac{1}{2}$ in. or less of travel. Hence, it is practical to make a solid scope and confine the focusing to a threaded or spiral-focusing device. This one uses a spiral. It is cut about halfway across the focusing tube, which should be metal or plastic to have the required stiffness. The job is easily

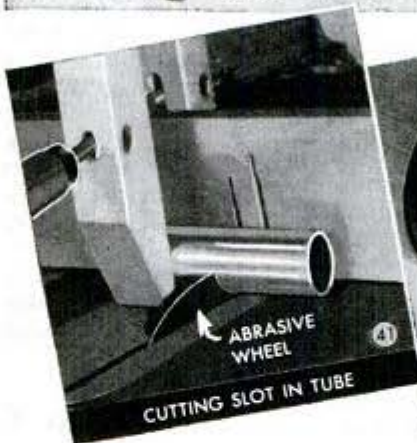
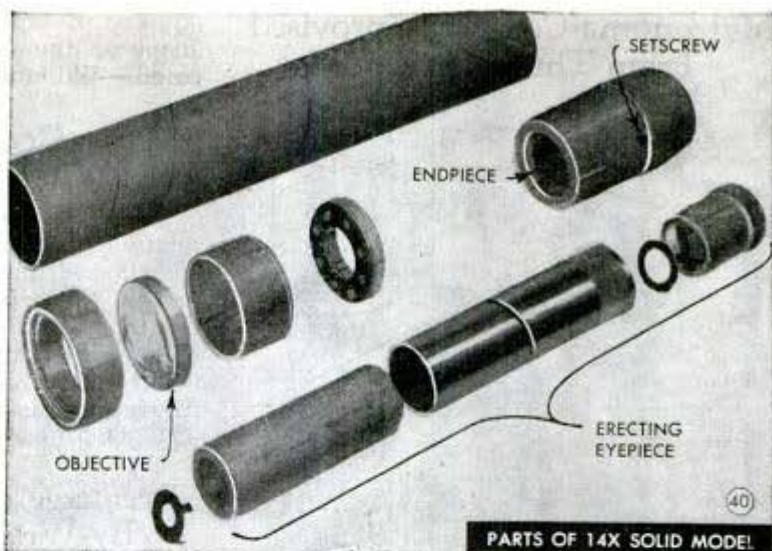

done on a circular saw, using an abrasive wheel, as shown in Fig. 41. A setscrew through the endpiece engages in this slot, permitting a travel of about $\frac{3}{8}$ in. as the focusing tube is turned. The wooden tube in which erectors are mounted is a drive or glued fit inside the focusing tube. Lens spacing is about normal, so that the true magnification is equivalent to DO divided by FE, or 14X. The eyepiece is a modified Kellner, with field lens of slightly longer focus than eye lens.

The second specific design, Figs. 23 and 39, features conjugate magnification. As previously described, high magnification is obtained by pushing the erectors close to the first image; at the same time it is necessary to extend the eyepiece a considerable distance to bring the object into focus. In this scope, the erector draw tube slides inside the main tube and the focusing tube slides inside the erector draw tube. Marks or notches on the erector tube indicate the setting for high or low magnification and the setting can be anywhere between these marks.

(Continued next month)

Metronome Can Be Improvised From Three Tin Cans



Three tin cans and a shutoff cock can be assembled to make a metronome. One of the cans should be a little smaller than the others so that it can be placed within another. The cock is soldered over a hole punched close to the edge of one can, which is partially filled with water and set at the edge of a table. The second can is placed on the floor under it, and the third, which has an air hole punched in the bottom, is inverted and placed within the second. The cock is turned to allow water to drip at the desired frequency and strike the inverted can, which amplifies the sound.—Wm. Riederich, Elmhurst, Ill.

Needle and Thread Guide Wick Through Cigarette Lighter

The usual difficult job of getting a new wick into a cigarette lighter can be simplified if a threaded needle is used as a guide. Sew through the new wick, loop the thread around the end, and secure it tightly. After removing the old wick from the lighter, insert the needle and thread in the wick opening and pull the new wick through, then trim with a pair of scissors.—James D. Callahan, Lincoln, Nebr.

Snap Fasteners on Overshoes Taped to Protect Hose



Adhesive tape will help prevent snags and runs in your hose caused by the snap fasteners on overshoes. Cut small

squares of tape and stick them over the snaps on the inside of the shoes as indicated.—William Swallow, Brooklyn, N. Y.

Shaving Cream Is Good Lubricant When Driving Screws

To avoid temperature difficulties common when wax or soap is used as a lubricant for driving screws, one handyman prefers the brush type shaving cream for the job. Besides being the right consistency at all times, it leaves no stain on the wood into which the screw is driven, and the tube or jar is neat and easy to store.

C. D. Mulcahy, Jr., Las Cruces, N. Mex.

Breakage of Crayons Avoided By Wrapping With Tape

If a small child presses so hard on crayons that they are reduced to short pieces, wind gummed paper tape around them spirally. This reinforcement strengthens the crayons so that they are difficult to break. The tape can be peeled off easily as the crayons wear down.—Benjamin Nielsen, Aurora, Nebr.



Code to Type Secret Messages

Anyone using the touch system of typewriting can write secret messages easily by simply shifting the hands one key to the right, and then operating the machine in the usual manner. As an example, the familiar phrase, "Now is the time for all good men," would appear "Mpe od yjr yo,r gpt s;; hppf ,rm/" To transpose, the operator uses the "hunt and punch" system, but strikes the key to the left of the letter in the message.

Table of Magnetic Jigsaw Raised To Use Unworn Teeth of Blade

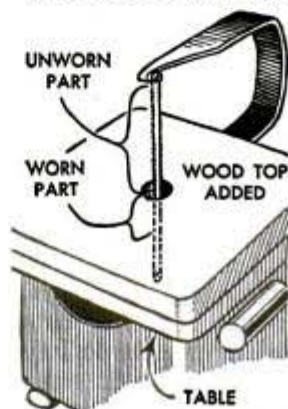

When the lower portion of the blade on a magnetic jigsaw becomes dull, add a wooden top to the table so that unworn teeth, higher on the blade, will contact the work. The top is trimmed to fit, and a hole is drilled for the blade.

Metal-Tube Tripod for Color-Slide Projector

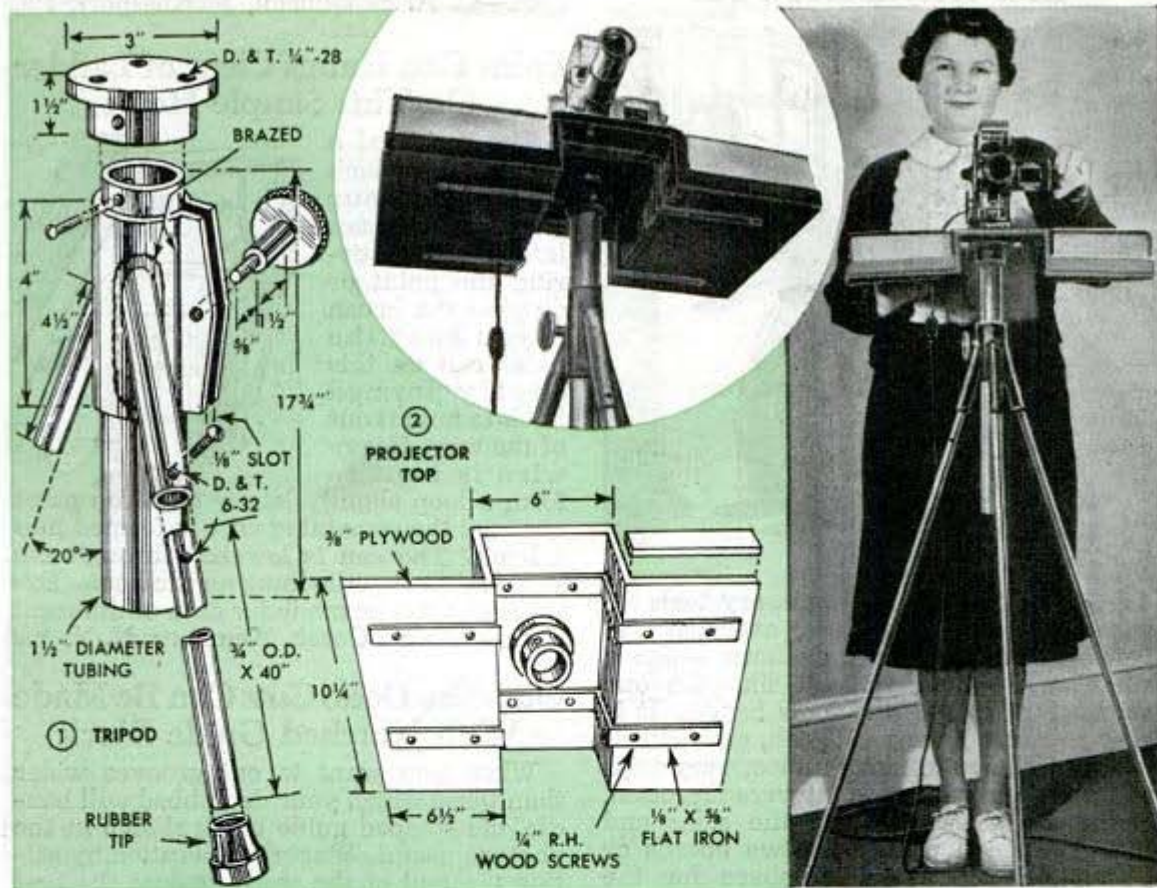

Designed for use when projecting color slides, this sturdy tripod is adjustable in height and may also be used with a movie projector. It has a wide top or platform on which there is ample space for the projector and two boxes of slides or other equipment. The tripod can be made from any corrosion resistant tubing such as brass, aluminum, duralumin, etc., and is assembled as in Fig. 1. A main or center tube that carries the head slides inside an adjustment clamp to which leg sockets are brazed. The head is turned to the size and shape indicated, and is held in the upper end of the tube by a setscrew. A 4-in. length of 1 1/2-in. tubing with a 1/8-in. slot cut in it between two pieces of flat iron which have been brazed on as shown serves as the adjustment clamp. The flat pieces are drilled and tapped for a thumbscrew for tightening. After the clamp has been completed, the leg sockets of 3/4-in. I.D. tubing are brazed to it at angles of 20 degrees. The sockets are spaced equally and are drilled and tapped at their lower ends for setscrews, which hold the legs in place. These are 40-in. lengths of 3/4-in. O.D. tubing, which have rubber crutch tips slipped over the lower ends. The projector top

or platform completes the job, and is assembled from plywood and flat-iron strips and screwed to the tripod head as indicated in Fig. 2. For a neat appearance give the clamp and leg sockets a black crackle finish and glue green felt on the projector top.—Alfred Harth, Chicago.

Battery Tester for Photoflash Gun

A tester for dry cells used in a photoflash gun can be improvised from a flashlight bulb, a short length of extension cord and two rubber plugs. One wire of the cord is soldered to the center terminal of the bulb and the other to the threaded base, after which the cord is inserted through the neck of the male plug and fastened to the screw posts. By pulling the cord tight, the bulb will seat itself in the neck of the plug. The plugs then are assembled and screwed into the gun case.



George T. Lundeen, Madison, Wis.

☞ The glass of a filament-type black-light bulb makes an excellent filter when used with an ordinary photoflood lamp.

Necessary Tools Always at Hand In a Wheelbarrow Kit

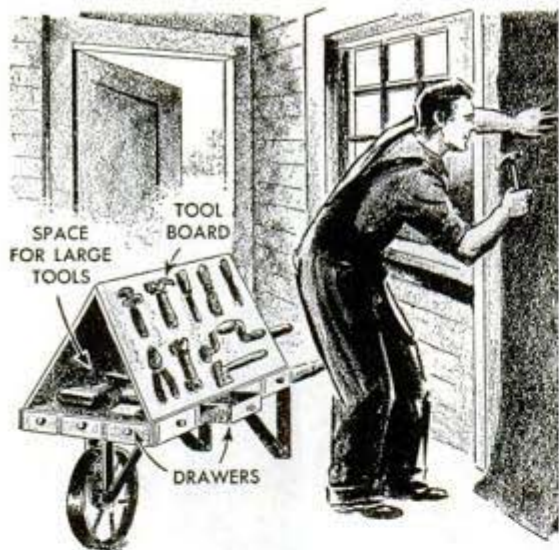

In order to have the necessary tools always together for making everyday repairs around the home or farm, make a wheelbarrow-type tool kit like the one shown for keeping the tools handy. It is easy to move from job to job, and with it you won't have to make unnecessary trips to the shop to get tools that were forgotten. There are drawers along the sides and front for small parts, and two boards or panels provide mounting space for the smaller hand tools. Space for large tools is provided under the panels.

Cpl. H. S. Hamrick, Titusville, Fla.

Overhead Light Can Be Raised By Wood Block on Cord

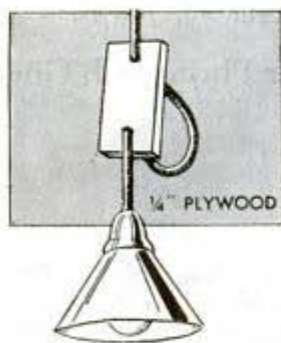

Adjusting the height of a light over a workbench can be done by means of a block of wood which is drilled to take the lamp cord. Of course the socket must be removed to allow the cord to be threaded through the holes.

Stopping Leaks in Gasoline Tanks

It's unnecessary to drain and remove the gas tank from your car in order to stop a pinhole leak. All you need is a wood screw of a size to fit the hole, a leather washer and some liquid solder. First, wire-brush the surface around the leak, then drive in the screw with the washer on it. When leaking has stopped and the surface is dry,

cover the patch with enough liquid solder to form a substantial covering over the spot.—C. A. Broadhead, McKeesport, Pa.

Paint Can Hangs Clear of Ladder On This Simple Hook

The rung of a ladder on which you hang your paint can will not interfere with stirring the paint or dipping the brush if you hang the paint can on this easily formed hook to hold it out of the way. Heavy wire is bent to

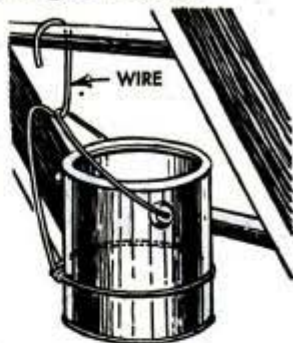

form a loop slightly larger than the paint can, and the remaining wire is formed into a hook. The can is lowered through the loop and the handle hung on the hook. Extra hooks can be made for cans of different sizes.—Leo W. Corah, Kenmore, N. Y.

Odd-Size Dado Cuts Can Be Made With Notched Guide Block

When you want to cut grooves wider than those which your dado head will handle, the stepped guide block shown in the photo is useful. Start the operation by setting the end of the work against the first step of the guide block. Make the cut, which will be the thickness of the dado head. Then reset the work against any shoulder of the guide block to get the required width of cut. The guide also can be used with a single saw, stepping up one notch to cut a groove $\frac{3}{16}$ in. wide.

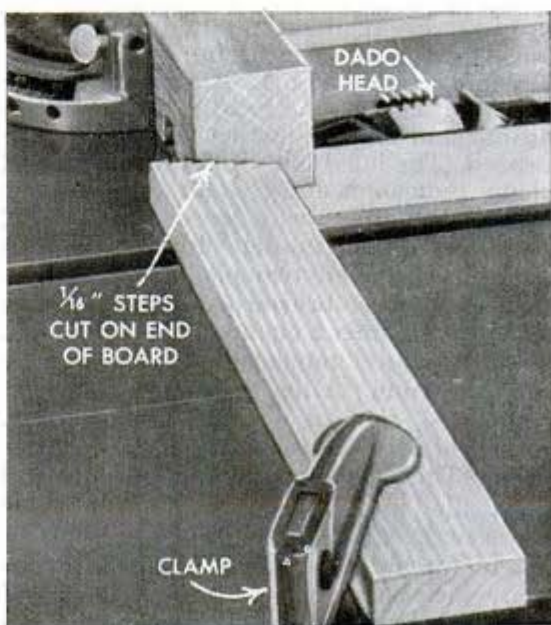

Adapting a Box Camera to Take 35-mm. Film

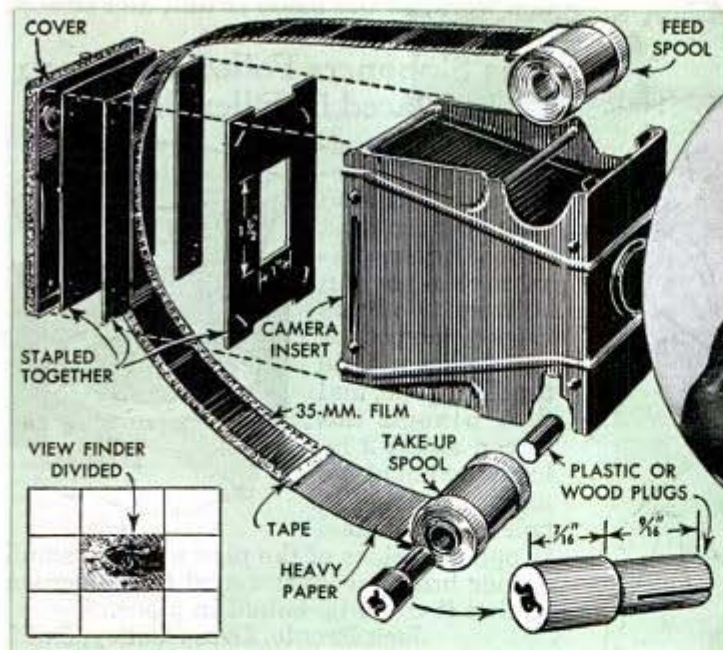

it passes over the rollers on the camera insert. Next, two wooden or plastic plugs are

Box cameras can be adapted to take 35-mm. film if this size is preferable because the cost per exposure is lower. To make the change, an auxiliary mask is needed. This consists of a back piece, two guide strips and a frame, all of which are cut from cardboard and stapled together as indicated in the upper left-hand detail. The back should be slightly smaller than the camera cover, and the guide strips are spaced to allow the film to move snugly between them. The frame has a 1 by 1½-in. cutout in the center, which is equal to the size of two single 35-mm. frames. A small recess the width of the film is cut in the top and bottom edges of the frame so that the latter will not scratch the film as

made. One acts as a spacer to keep the take-up spool centered. The other plug is slotted at both ends. One end fits over the key in the take-up spool and the other end slips over the film winding key on the camera. In use, the feed spool is placed in the trough provided for this purpose and the film is pulled out, pushed through the cardboard mask and attached by cellulose tape to a strip of heavy paper, which is wound on the take-up spool. One revolution of the film-winding key advances the film about 1½ in. for the first six frames, then about 1¾ in. Divide the glass view finder into nine equal parts; the center division will serve to position the camera for an exposure.—Merel Meyer, Chicago.

Small Cut Film Held in Large Camera by Cardboard Insert

Any small-size film can be used in a 4 by 5 or even larger camera without a reducing back if a cardboard insert is fitted into the regular film holder. A septum to take the smaller-size film is centered on this and glued in place, and a strip of cellulose tape is applied at the top of the septum to hold the film. Dimensions of the substitute film then are penciled on the ground glass.

R. M. Roland, Chicago.

☐ The handles of old toothbrushes can be used as stirring rods when mixing small amounts of chemicals such as reducers and toners. As the handles are made of plastic, they will not affect the solutions and can be cleaned in running water.

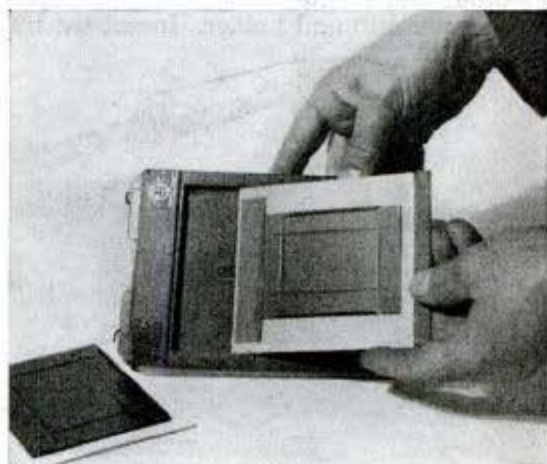

Gripper to Attach Skid Chains Of the Strap-On Type



Attaching strap-on type skid chains is no problem if you use this gripper piece to pull the strap through the slots in disk wheels. It consists of a length of leather with steel grips at one end. In use, the gripper end is slipped through the wheel slot from the outside and fastened to the end of the chain strap, which then is pulled through the slot as indicated.

O. H. Dissman, Westfield, N. J.

Small Screw Driver Improvised From Pen Nib and Holder

If you need a small screw driver for emergency repairs on eyeglasses, watches or other fine work, you can improvise one from a pen nib and holder. Insert the nib



pointed end first in the holder and you will have a screw driver that is ideal for this work, as the blade is thin and strong.

Gas Siphoners Foiled by Screen Placed in Filler Pipe

To prevent siphoning of gasoline from his auto tank, one motorist bolted heavy $\frac{1}{8}$ -in. mesh screen between two brass rings of the proper size to fit inside the filler pipe, and then placed this screen about 2 in. from the top of the pipe. To install it, holes were drilled in opposite sides of the pipe and two small corner braces were fastened to the screen so that it could be bolted in place.

Jack Bronte, Grass Valley, Calif.

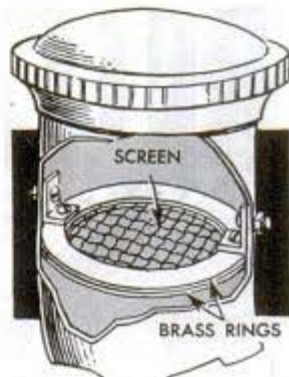

Disk-Type Vents in Storm Sash Control Ventilation Closely

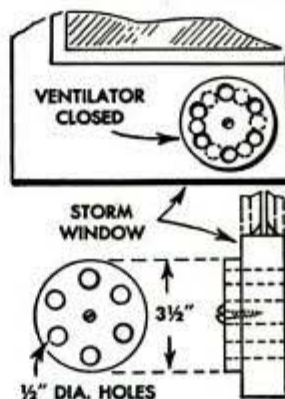

Instead of propping storm sash open, or using pivoted flaps over large openings in them to permit ventilation, use disks in which equally-spaced holes are drilled to coincide with similar holes drilled in the sash. This permits fine adjustment of venti-

lation to get just the amount desired. When drilling the holes in the disks be sure they are spaced exactly like those in the window so that when the disks are turned to a predetermined position all the openings are closed.—Harold Akst, Freeport, N. Y.

Blotting Paper Protects Shelves In Medicine Cabinets

Use blotting paper to line shelves in medicine cabinets and the bottoms of cosmetic drawers. Then if liquids that stain are spilled or run down the sides of the containers, they will be absorbed without damaging the shelves. Large sheet blotters made for desk pads are ideal for this purpose, and can be obtained in a variety of colors to harmonize with the shelves or drawers.—Shirley L. Adler, Denver, Colo.

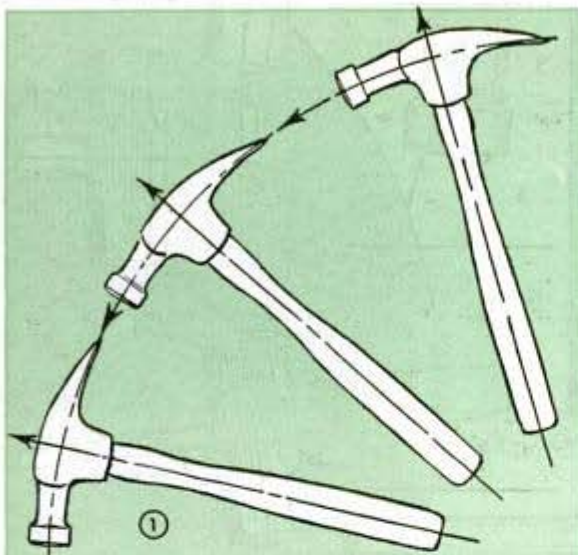

HINTS ON *Hammering* by W. Clyde Lamme

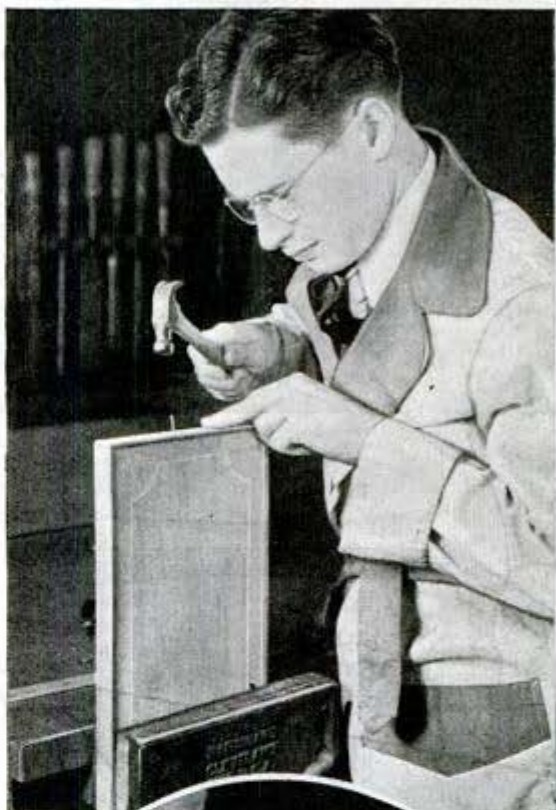

SKILLFUL handling of a hammer results from the trained coordination of eye and hand. Muscular action alone can build up and control the force of the blow, which will lack direction unless you can clearly see the object to be struck. Thus, any hammering operation compares quite closely with the technique of throwing a ball.

Fig. 5 details and names parts of the head of an ordinary "nail" hammer. This is important to know when you buy one. Examine the head of a top-quality hammer and you will see that the poll and face are ground to a true curve, the cheeks are sized equally, the eye is slightly tapered and the claws are finished and ground to identical shape. And along the handle of a well-balanced tool is a point where the hammer hangs and "feels" just right when you grasp the handle in your hand.

Fig. 2 shows the accepted manner of holding a hammer when doing any work requiring a degree of precision. The thumb extended along the handle as shown aids in control, gives a surer grip and is less tiring in most hammering operations. On nearly all hammers the handle is shaped to give the most comfortable grip when

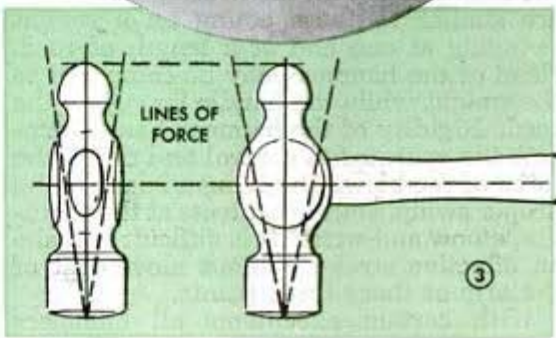

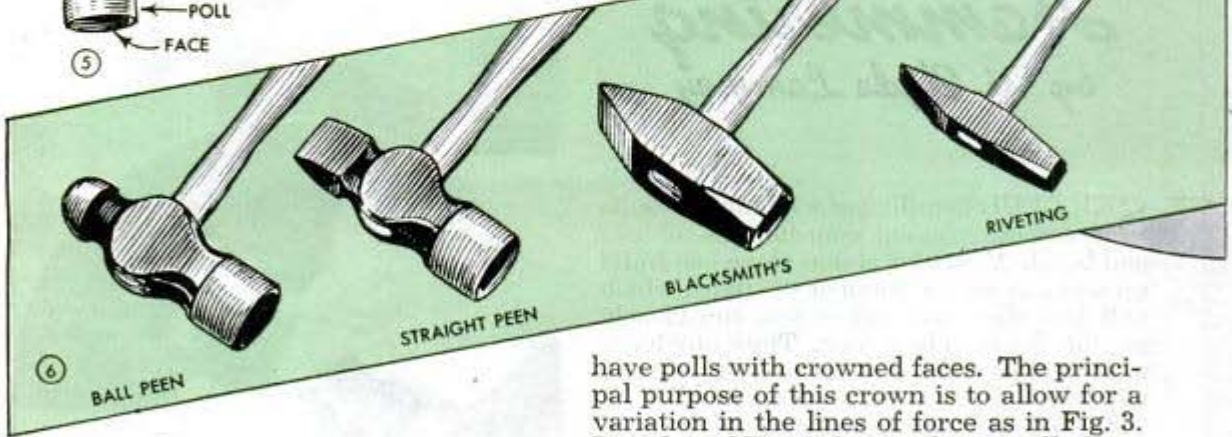
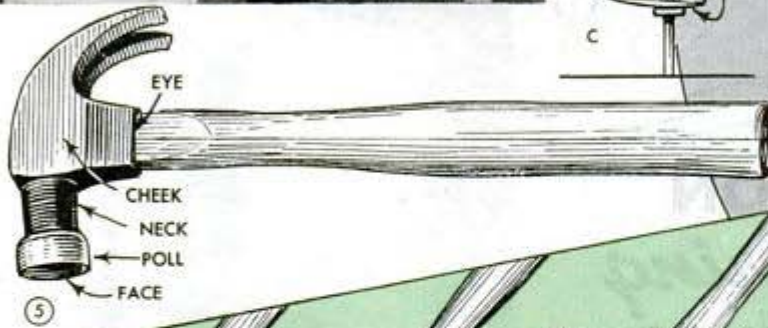
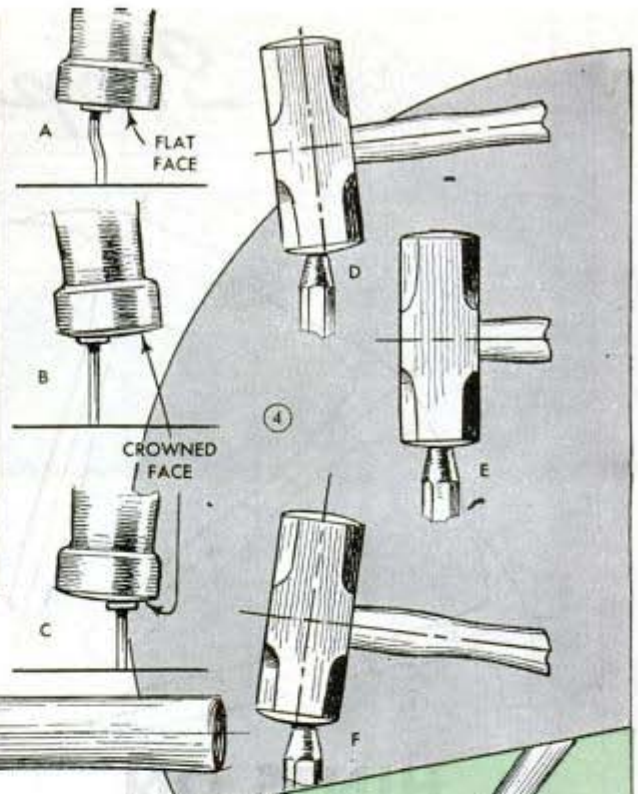

grasped approximately at the point indicated. The common types of hammers, hatchets and sledges used by craftsmen in a variety of work are shown in Fig. 6.

Fig. 1 shows in a simplified manner how the forces acting on the head of a hammer are similar to those acting on a weight swinging at one end of a length of cord. Head of the hammer may be compared to the weight while the handle supplants the cord. Rigidity of the hammer handle enables the operator to control and direct the force of the blow. In giving a hammer the proper swing, your arm pivots at the shoulder, elbow and wrist. It is difficult to make an effective stroke without movement of the arm at these three points.

With certain exceptions all hammers

have polls with crowned faces. The principal purpose of this crown is to allow for a variation in the lines of force as in Fig. 3. Detail A of Fig. 4 shows what usually happens when you try to drive a nail with a hammer having a poll face either worn or ground flat, or where the surface of the face is otherwise irregular. Generally the nail will bend or the hammer head will glance off the head of the nail. Details B and C show, in somewhat exaggerated form, how a crowned face helps to prevent this. Due to the curve of the poll face the centerline or axis of the hammer can angle as much as 5 degrees or more with the centerline of the nail and still the blow will be fully effective. Likewise it will be seen from details D and F of Fig. 4 that the angle can vary about the same amount in another direction; that is, the angle of the handle can vary 5 degrees or more above or below the theoretical perpendicular, as

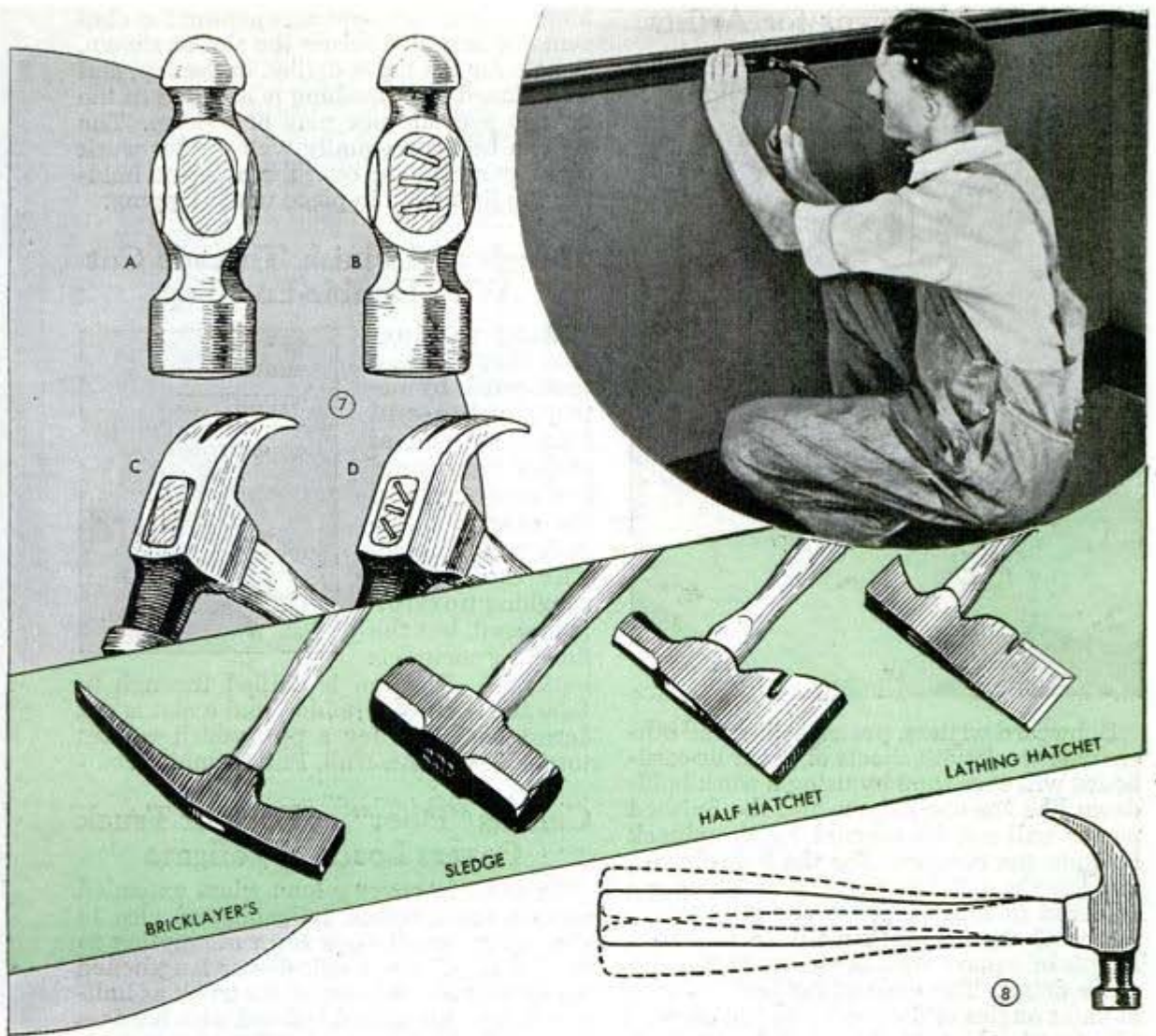

shown at E in Fig. 4, and still the blow will be delivered with full force. Therefore, it's important that the poll face of any hammer used for these purposes be ground to a regular curve without pits or irregularities.

As indicated in Figs. 7 and 8 there's a trick in fitting a hammer handle. First, it's important to trim the handle to a close fit in the eye. In some hammers the eye is slightly tapered. The purpose of this is to

prevent the handle from pulling out when wedged in place. The error of fit shown in details A and C of Fig. 7 should be avoided as it may result in the irregularity diagrammed in Fig. 8. When properly fitted the handle will wedge into the head as shown at B and D, Fig. 7, and will be true with the head both vertically and horizontally. If available, metal wedges should be used to tighten the handle in the head.

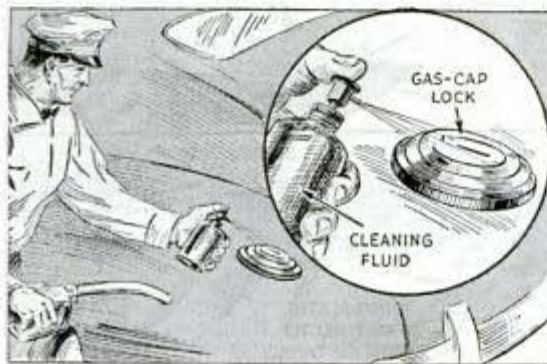

Frozen Lock on Fuel-Tank Cap Thawed With Glass Cleaner

If the lock on the gas-tank cap of your car freezes so that the key will not enter, you can save time in freeing it by using windshield cleaning fluid. This can be sprayed over the lock, as only a few drops are needed to thaw the ice so that the key will enter and turn the lock.

Plastic paint can be given a "rough texture" effect by applying it with a rough 4-in. wall brush, used in a semicircular sweep.

Work Hold-Downs for Artists Eliminate Use of Thumbtacks



Showcard writers, poster artists and others who work with sheets of paper or cardboard will save time by using a work hold-down like the one shown, and the finished poster will not be marred by thumbtack holes in the corners. For the hold-downs, two lengths of flat iron are used. These are soldered to hinges, which are attached to pieces of sheet metal bent to fit around a length of square rod, as shown in the circular detail. The ends of the rod are bent at right angles and screwed to the corners of a drawing board to form a slide on which the hold-downs can be adjusted for different sizes of work. By bending the ends of the hold-downs at a right angle, they will grip the lower edge of the board snugly.

Opie Read, Jr., Chicago.

Tapping Jig Reduces Breakage And Starts Taps True

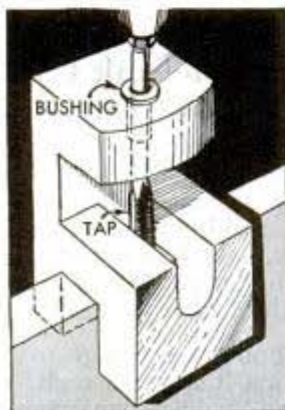

To prevent breakage of taps through faulty starting, a jig like the one shown can be used, especially in production shops for tapping holes located along edges of plates. The jig is made from any available scrap. A slot the size of the plate is milled

along the bottom, and an opening for chip removal is milled across the slot as shown. A hole for the tap is drilled in the top, and a hardened steel bushing is inserted in the hole to prevent side play of the tap. The jig can be used equally well on flat work by aligning the tap over the hole and holding the jig firmly in place while tapping.

Rough and Finish Threads Cut With Double-End Tap

Many production shops speed their work by using double-end taps. One end of such a tap is used for roughing and the other for finishing the thread. The end of the roughing portion is tapered, but the finishing portion is bottomed.

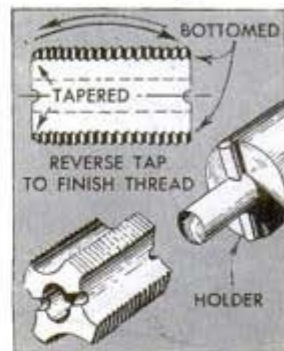

The tap is drilled through to take the shaft of a holder, and a slot is cut across each end for a pin, which rotates the tap.—Gordon Null, Philadelphia, Pa.

Canvas "Door" at Back of Truck Covers Load on Tailgate

In order to cover a load when extended out on the lowered tailgate, and also to discourage small boys from attempting to "hop a ride," one truck driver lengthened the canvas at the back of the truck as indicated. The lower end is fitted with harness snaps attached to small coil springs which engage ring plates screwed to the underside of the tailgate. The springs also keep the canvas from flapping.

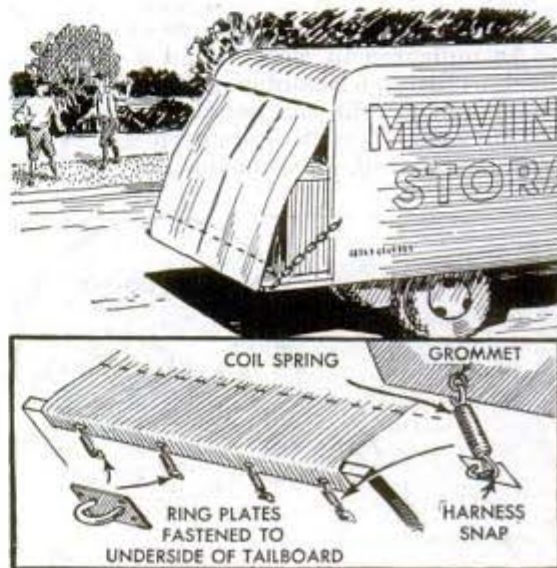

Backstop Held in Lathe Chuck While Turning

Unlike backstops often used in lathe chucks, this one will not fall out of place while machining work, as it is held by a rivet which slips into a shallow hole in the chuck face. The stop is a piece of flat iron having a round-headed rivet near one end. The backstop is held against the chuck with the rivet head in the hole while the work is pushed against it and the chuck jaws tightened. This method of mounting keeps the backstop from falling out.

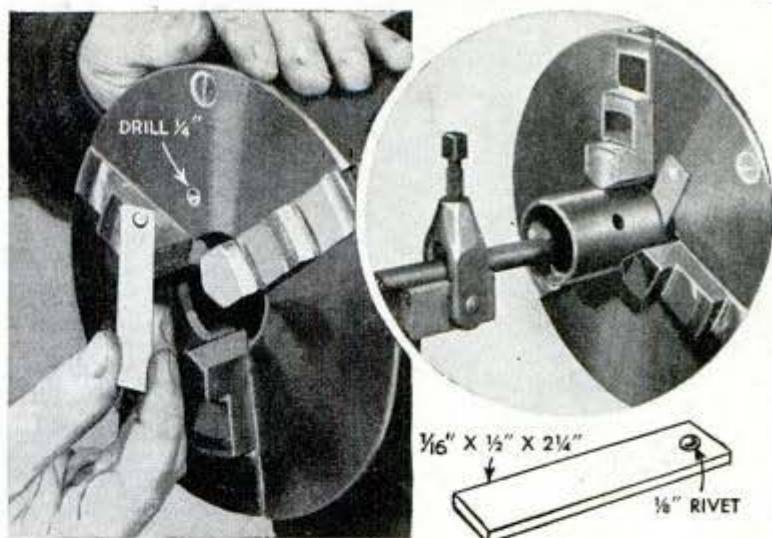

Fly Cutter Bores Rough and Finish Holes in One Operation

Used with a spring-collet chuck on a drill press, a boring-bar or fly-cutter holder that turns in a bushing on the drill-press table can be used for rough-boring holes as well as for finishing them without changing cutting bits. The holder is a round bar slotted at a 45-deg. angle to provide room for three or four cutting bits with spacers between them. The bits are positioned so that they overlap slightly to allow successive depths of cut, progressing from rough to light cutting, and are held in the bar with socket-head setscrews. Stepped bores can be cut also with this tool by setting the bits to cut the required depth of the steps, spacers being used to allow for the length of the steps. The drill-press stop should be set so that the spindle will feed only to the required depth. When cutting finish bores,

the spindle should be allowed to come to a full stop at the bottom of the cut to eliminate the spiral groove caused by the dragging of the tool when it is withdrawn from the hole. The tool then will cut a straight, shallow groove that may be rubbed down with emery cloth to remove the burred edge and leave a smooth bore.

Orville E. Hyler, Peoria, Ill.

Size Mark on End of Twist Drill Is Not Effaced by Chuck Jaws

As the shanks of twist drills are not hardened, the identifying marks stamped on them often become effaced when the drills slip in the chuck. If the shank end is ground flat and the size is stamped on this, the marks will not become obliterated.

Frank Sima, Berwyn, Ill.

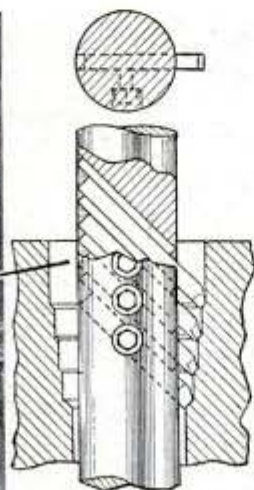
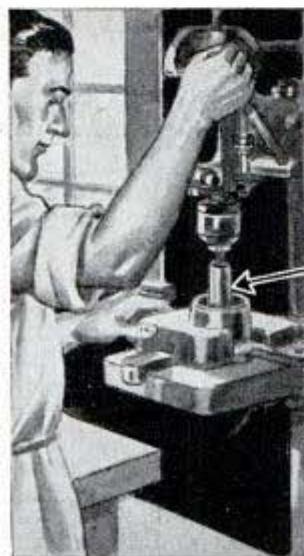
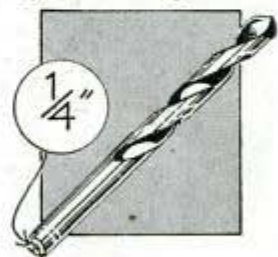

Mechanical Pencil Grips Wire Used for Marking Metal

If a lead pencil cannot be used to mark metals, aluminum wire may be suitable. For convenience, the wire may be inserted in a mechanical pencil in place of the lead.

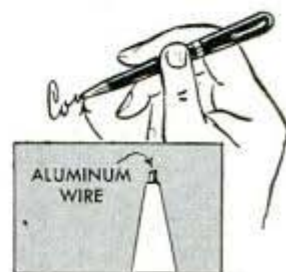

THREAD CUTTING

By H. J. Chamberland



ONE of the most interesting of all lathe operations is cutting screw threads because it requires an accurate sense of timing on the part of the operator and his fullest attention to many details, and also because the work can be varied to cut threads of many different kinds. In ordinary turning, such as in facing, the spindle speed remains constant while the tool can be hand-fed across the work at almost any rate of speed, depending upon the metal being turned. Moreover, the tool can be fed in and stopped at any point on the work without damaging it, except



CLEARANCE



SEMI-QUICK GEAR TRAIN TO SPEED SETUP

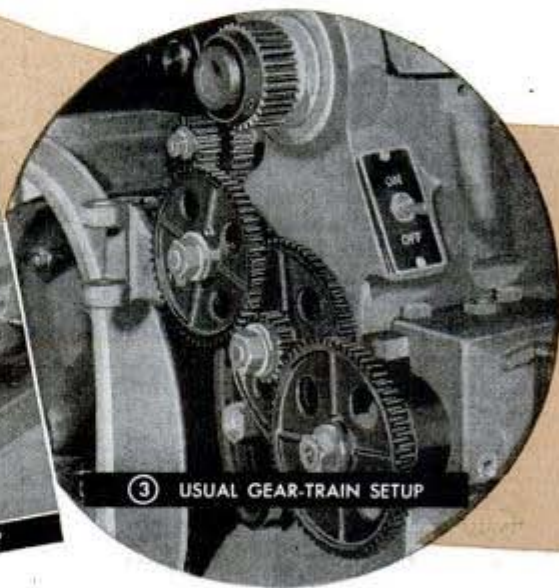

USUAL GEAR-TRAIN SETUP

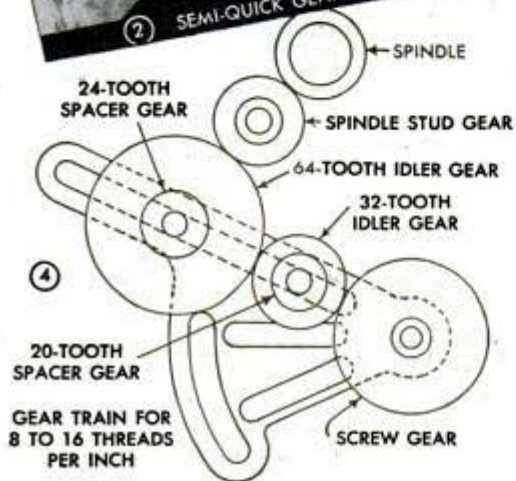

in taking a finishing cut, when a shallow shoulder will result. But in cutting threads, the ratio between spindle speed and rate of feed is of the greatest importance as it determines the pitch of the thread being cut, and the feed cannot be stopped short of the end of the thread unless the tool is withdrawn or it will cut into and spoil the threads. Also, threads generally are not cut in one operation but by successive passes of the tool over the work, the cutter taking a deeper bite at each pass. When the tool has been withdrawn and positioned for the next pass, it can be fed in only at specified intervals so that it will coincide with the thread cut in its previous travel over the work.

When preparing to cut threads, the lathe,

on your LATHE

and especially the lead screw, must be clean and free from dust and chips. The centers should be aligned carefully so that the work will run concentrically, and the work must be straight and true within .001 in. to assure uniform depth of thread. These precautions having been taken, the next step is to set up the proper gear train to cut the desired thread. This is done by removing certain gears and replacing them with others of different size, or by changing their location, Fig. 3. On some lathes gear changing is done automatically by setting a lever at desig-

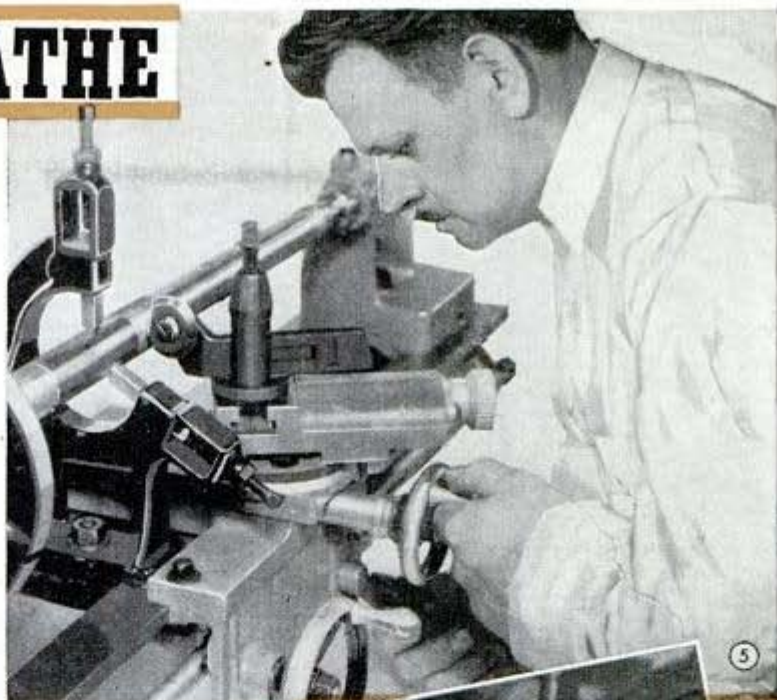

CUTTING ACME-FORM SCREW THREAD



CHECKING AMERICAN NATIONAL THREAD

nated positions; others use a semi-quick arrangement of gears to speed the setup, Fig. 2. With the semi-quick setup, six different threads can be cut with the same gear train, whereas with the usual gear train only three different threads can be cut. Regardless of design, all lathes are provided with a chart by which the desired gear train may be selected. It is important, of course, to check the setup to make sure that gears with the proper number of teeth have been selected and that they are positioned in correct order on the bracket, Fig. 4. The gears must be arranged so that the carriage will travel toward the headstock for a right-hand thread. For a left-hand thread, the carriage can be reversed to

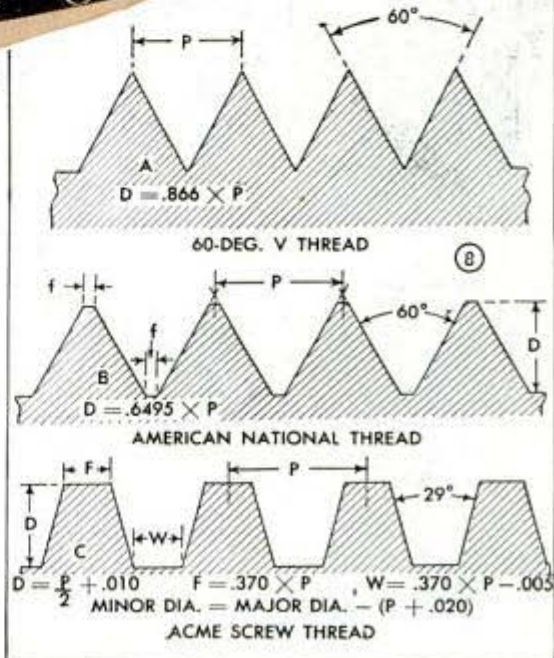

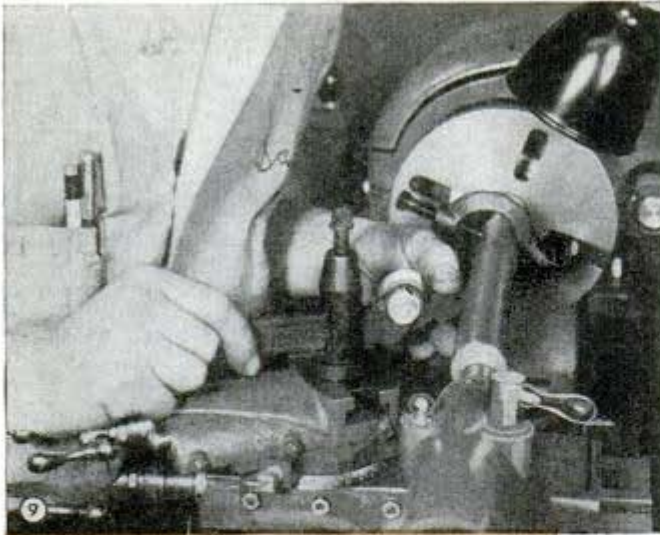

travel toward the tailstock. The gears should not mesh tightly but have clearance, as indicated in the detail below Fig. 1. Clearance can be determined by adjusting the gears with a piece of paper between the teeth. When the gears are properly arranged, a small amount of graphite grease should be applied to the teeth for smooth, noiseless operation.

Although there are many forms of threads, only the three most commonly used need be considered here. These are the V, American National and Acme, shown in Fig. 8. Notice that the first two are 60-deg. threads. The V-form generally is used only for fine threading, while the Acme is a coarse,

strong thread such as that used on the screw of a lathe. The threads are diagrammed according to a simplified formula in which D represents single depth of thread, P is pitch, and F designates the width of the flat at bottom and top, which are also known as the root and crest. Since the top and bottom of Acme threads are not equal, W is used for the bottom dimension. As shown in the upper details of Fig. 10, pitch is the distance from a point on one thread to a corresponding point on the next thread, measured parallel with the axis. The distance a screw advances axially in one turn is called the "lead." When cutting the usual single thread, therefore,

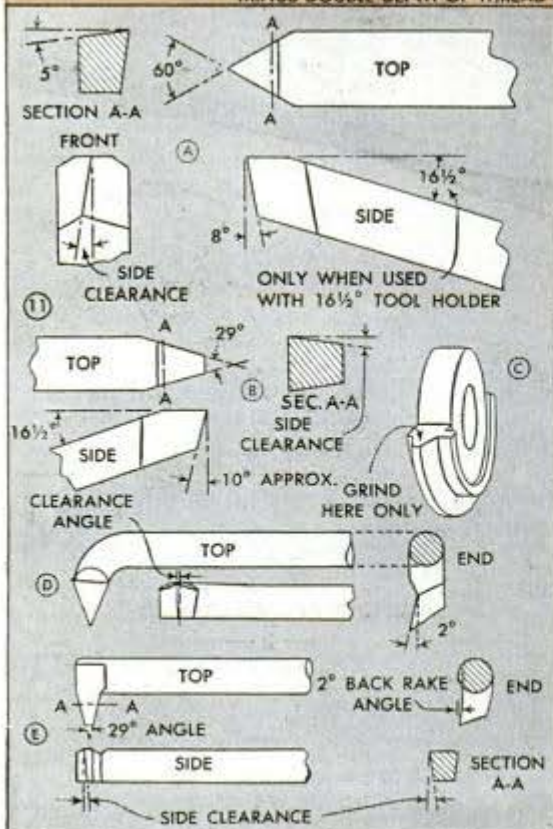
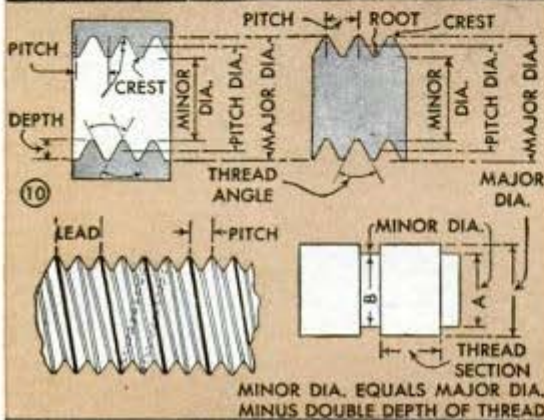

(12) DOUBLE DEPTH OF THE V AND NATIONAL-FORM THREADS

Threads Per Inch	American National (U. S.) (in inches)	Theoretical V Thread (in inches)
80	.0162	.0216
72	.0180	.0240
64	.0203	.0271
60	.0217	.0289
56	.0232	.0309
50	.0260	.0346
48	.0271	.0361
44	.0295	.0394
40	.0325	.0433
36	.0361	.0481
32	.0406	.0541
30	.0433	.0577
28	.0464	.0619
27	.0481	.0642
26	.0500	.0666
24	.0541	.0722
22	.0590	.0787
20	.0650	.0866
18	.0722	.0962
16	.0812	.1083
14	.0928	.1237
13	.0999	.1332
12	.1085	.1443
11 1/2	.1130	.1506
11	.1181	.1575
10	.1299	.1732
9	.1443	.1925
8	.1624	.2165
7 1/2	.1732	.2309
7	.1856	.2474
6	.2165	.2887
5 1/2	.2362	.3149
5	.2598	.3464
4 1/2	.2887	.3849
4	.3248	.4330
3 1/2	.3712	.4949
3 1/4	.3997	.5329
3	.4330	.5773

the lead is equal to the pitch, but when cutting a double thread, the lead is twice the pitch, as shown in the lower left-hand detail, Fig. 10.

Pitch diameter of a straight screw thread is equivalent to the diameter of an imaginary cylinder that would pass through the threads at points where the width of the threads would equal the width of the spaces between adjacent sides of the threads. This is illustrated in the right-hand detail of Fig. 10, which shows also the major and minor, or largest and smallest diameters of threads. When the major diameter is known, the minor diameter can be determined from the table, Fig. 12, which lists the double depth of threads from 3 to 80 per inch.

Various threading tools are illustrated in Fig. 11. The pointed tool A is used to cut V-threads, but can be used also to cut threads with a V-bottom, leaving the top flat. A screw cut in this manner will fit a National-form nut. This tool can be used to cut National-form threads when the point is ground to fit the proper slot of the gauge shown in the left-hand detail, Fig. 14. Tool B, Fig. 11, is used to cut Acme threads after grinding the point to fit the gauge shown in the right-hand detail of Fig. 14. Fig. 6 shows an Acme thread being cut. Tool bits like these must be carefully and repeatedly ground so that the angle is exactly right and allows enough side clearance to compensate for the rapid advance of the tool. Detail C, Fig. 11, shows a circular-type tool used for cutting external National-form threads, and Fig. 5 shows the tool in use. Internal threads are cut in the same way as external threads, except that tools of the type shown at D and E, Fig. 11, are used. Fig. 16 illustrates the cutting of an internal thread. In the case of internal threads, the bore of the hole becomes the minor diameter of the thread, and must be as accurately turned for concentricity as a shaft or spindle that is to be externally threaded.

Cutting tools can be ground more easily if gripped in a holder. The tool is held against the face of a wheel, Fig. 13, or against the side as in the upper left-hand detail of Fig. 15. The lower left-hand details show correctly and incorrectly ground tools for purposes of comparison. The circular-type tool is very easily ground against the side of the wheel, as in the upper right-hand detail of Fig. 15. The entire cutting surface of the tool must be kept flat on the wheel, its axis parallel with the wheel side. The Acme tool will

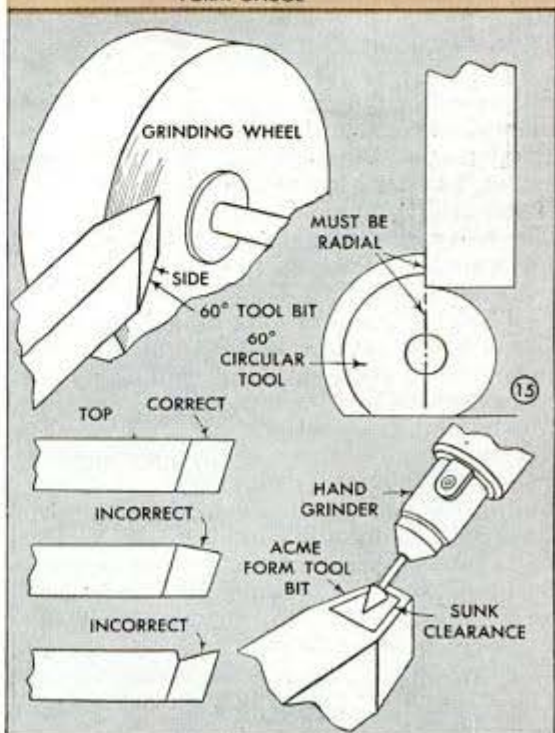
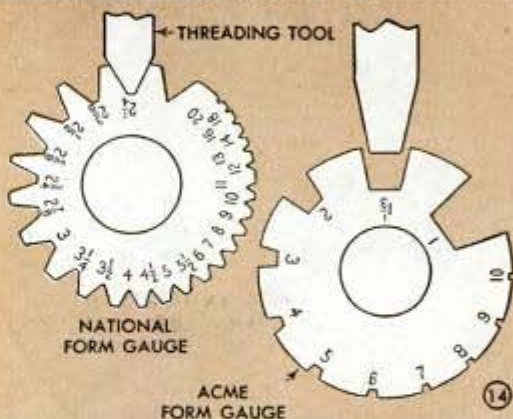



16 SETUP FOR CUTTING INTERNAL THREAD

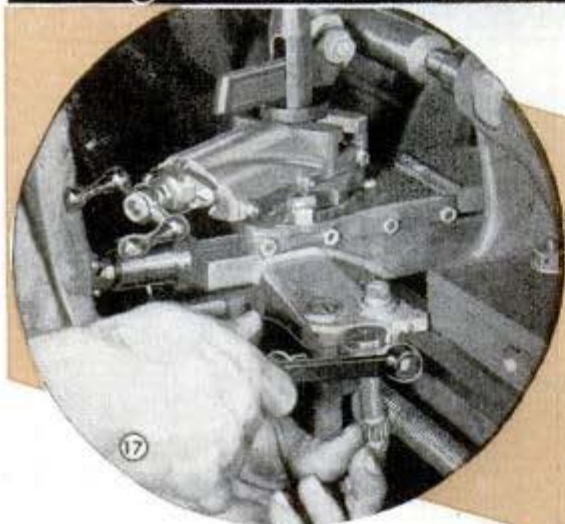

17

cut more easily if a slight clearance is ground in the face near the cutting edges, as indicated in the lower right-hand detail. The clearance should not, however, be closer to the edge than $\frac{1}{32}$ in.

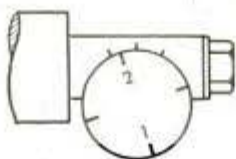

2

When all preparations have been made, the tailstock center is lubricated with some preparation such as white lead and sperm oil, graphite and tallow, or red lead and mineral oil to keep the center from heating excessively, and the work is positioned between lathe centers as in Fig. 1. It must not be removed from the centers until the thread is completely cut because it is almost impossible to recenter it in the original position. The compound rest is set at an angle of 29 deg., Fig. 17, and the tool is mounted in the tool post with the point of the tool exactly on the lathe-center line, Fig. 9, a center gauge being used to position the tool.

The threading dial, Fig. 18, is set by tightening a nut to engage a pinion against the lathe feed screw, as shown in Fig. 17, causing the dial to rotate with the feed screw. The purpose of the dial is to position the tool accurately in relation to the work so that after being withdrawn at the completion of a cut, the tool will return to the same starting place for the next cut, thus eliminating the necessity of reversing the direction of the carriage to return the tool after each cut. Standard threading dials are divided by four marks, as shown in the left-hand detail of Fig. 18, but additional marks may be provided, as in the right-hand detail, to suit exceptional threading operations. When cutting threads of 6, 8, 12 or any other even number per inch, the dial is engaged when any one of its four marks coincides with a stationary mark on the dial housing. If the

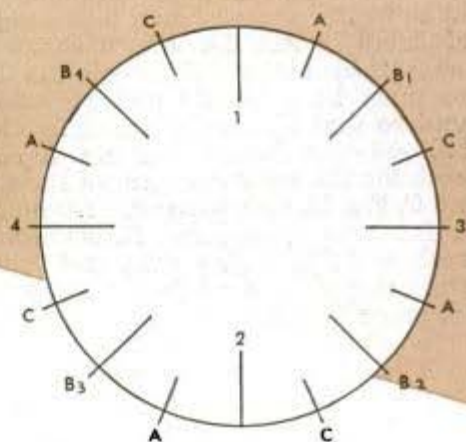

18 EXTRA MARKINGS FOR CUTTING MULTIPLE THREADS



19 LARD OIL APPLIED TO THREAD BEING CUT

threads are odd numbered, the dial is engaged only when mark 1 or 2 is in line with the stationary mark. For half-numbered threads, such as those of $4\frac{1}{2}$, $5\frac{1}{2}$ or $7\frac{1}{2}$ per inch, the dial must be engaged at the same mark on each successive cut. A slow spindle speed is used in thread cutting, thereby assuring ample time to engage the dial at the proper mark, and lard oil is applied to the work after each cut, Fig. 19. The tool is always fed into the work with the compound. When feeding in the tool, the gauge mark on the compound must be noted so that cuts of suitable depth are taken. For roughing the thread in steel, the maximum depth of cut should be not over .005 in., and for the last two or three cuts, no more than .001 in. Heavier cuts may be taken on brass, bronze and aluminum. As the thread nears completion, it can be checked with a screw-pitch

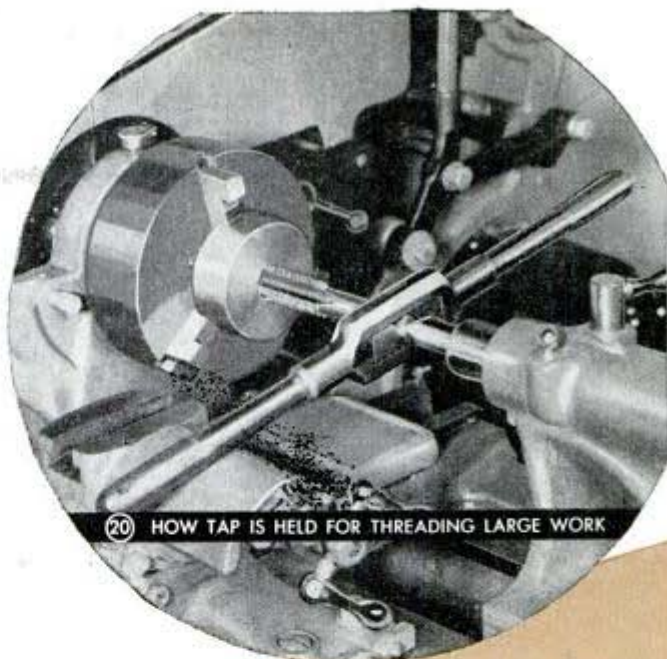

20 HOW TAP IS HELD FOR THREADING LARGE WORK

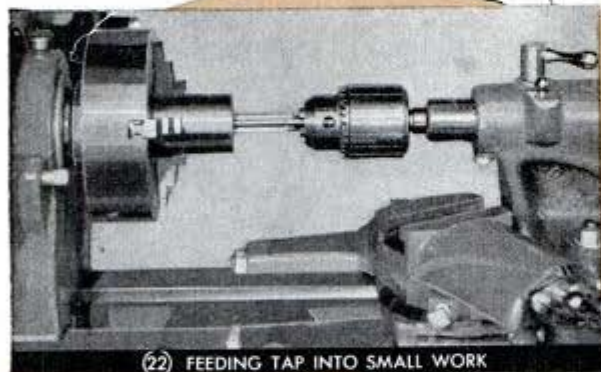

22 FEEDING TAP INTO SMALL WORK

gauge, Fig. 7. Left-hand threads are cut in the same way as right-hand threads, except that for left-hand cutting the carriage travels toward the tailstock and the compound rest is set at 29 deg. in the opposite direction.

For threading bores under 1 in. in diameter, taps are used instead of internal threading tools, as in this case taps are easier to use and will remove more metal in a given time than any other cutting tool that can be used for this purpose. If the bore is long, the work should be done on a lathe. In that event, the back gears are used for maximum driving power and minimum spindle speed. Taps under $\frac{1}{2}$ in. in diameter usually are gripped in a drill chuck that is held in the tailstock, Fig. 22. The



21 WHEEL FACE SHAPED TO FIT CONTOUR OF TAP CHAMFER

tailstock ram should be controlled so that its advance will correspond to that of the tap into the work. Large taps are gripped in a tap wrench and centered, with the wrench handle resting against the compound as in Fig. 20. The ram must be advanced gradually with a constant pressure to prevent breaking the tap. Taps should never be ground freehand if it is possible to use more reliable means. The only safe procedure is to hold the tap on centers that are positioned to keep the angle of the chamfer in line with the wheel face, Fig. 21. For best results, the wheel face should be concave to fit the contour of the chamfer. Each chamfer should be relieved to within $\frac{1}{64}$ in. of the cutting edge, and then oilstoned.

❑ Lacquer-enamel tints can be made by mixing tube colors in oil with clear lacquer, a procedure that is quite practical although lacquer and linseed oil ordinarily are not used together.

Self-Centering Holder for Punch Is Useful in Layout Work



Those whose work requires drilling holes located in an arc or around the circumference of a circle will find an adjustable self-centering punch holder like the one shown a great help. It is made by cutting a slot in a length of $\frac{1}{16}$ by $\frac{3}{4}$ -in. flat iron for about three quarters of its length, and giving the unslotted end a quarter twist as shown. This end then is bent into an eye in which a center punch can be held snugly. As a pivot, a bolt held by a wing nut can be used. The head is cut off and the bolt is inserted in the slot and threaded into an acorn nut, which will center the holder in any punch mark in the work.

Used Brick Moistened in Water To Soften Dried Mortar

When reclaiming used brick, dried mortar can be removed more easily if the brick are first piled, then wet with a hose and allowed to stand overnight. By doing this, moisture will penetrate the mortar so that it will not adhere to the brick so firmly. Wetting the brick also eliminates most of the dust from the cleaning operation.

John Krill, Youngstown, Ohio.

Dishpan for Watering Chickens Is Heated by Electric Lamp

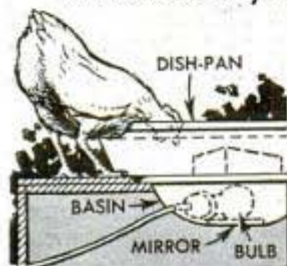

A dishpan can be used as a chicken waterer that will not freeze if it is set on a box over a basin in which an electric lamp is placed. The box is cut out to take the

basin, which is drilled for an electric cord. A small mirror is placed under the lamp to direct the heat against the pan. This can be weighted by a brick to prevent tipping.

Arlo Ranniger, Coon Rapids, Iowa.

Carrier for Storage Battery Is Easy to Make

A length of heavy wire having a couple of $\frac{3}{4}$ -in. iron washers at each end will provide a handy carrier for storage batteries. A hand grip is made by drilling a short dowel through the center and inserting a piece of

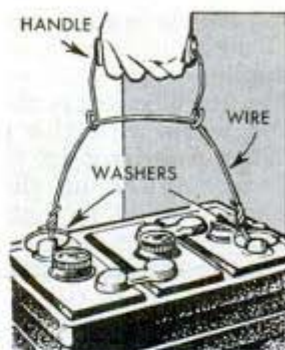

wire, which is bent over the carrier as shown. To use the carrier, slip the washers over the binding posts of the battery and raise it. The inner edges of the washers will bite into the posts and hold firmly.

George E. Gambler, Bethlehem, Pa.

Inside Handle Improves Toolbox

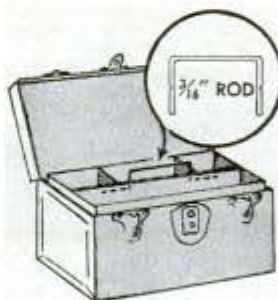

tray, and a length of rod or heavy wire is bent to a U-shape and inserted in them, the ends being bent at a right angle to prevent slipping.—R. Scaford, New York.

Rubber Band on Bucket Bail Serves as Rest for Brush



To keep his paste brush out of the bucket when not in use, one paper hanger lays the brush on a rubber band slipped over the bail ears. The band, which can be cut from an inner tube, also holds the bail upright so it can be grasped quickly.

Spindles Marked for Sawing Spirals by Hand

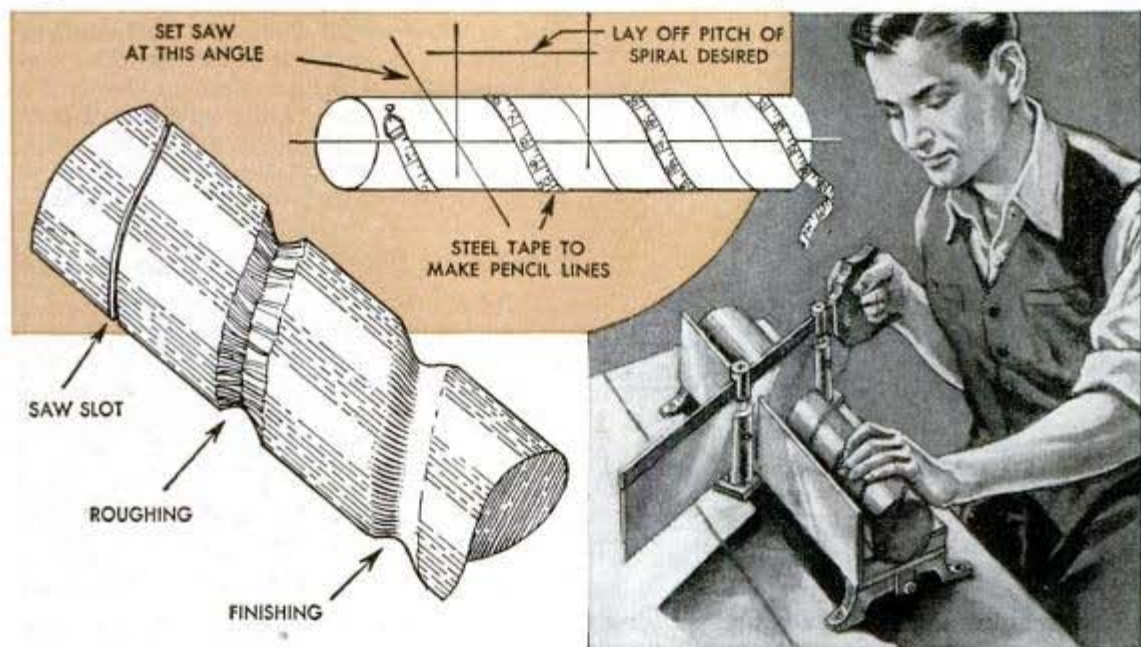

Cutting spiral grooves accurately in a wooden spindle with a handsaw and a miter box is not difficult. The pitch of the spiral is laid out on the spindle, over which a steel tape is wound so that one edge of the tape coincides with the layout marks to serve as a guide for tracing the course of the spiral around the spindle. After this is done, the spindle is placed on the miter-

box bed and the saw is adjusted at the angle of the spiral. A saw cut is made to a depth of about $\frac{1}{32}$ in., then the spindle is rotated and sawed again, the process being repeated until the full length of the spindle has been cut. The groove is roughed out by chisel to the desired width and sanded smooth as indicated in the left-hand detail.

Ralph D. Curtis, Santa Monica, Calif.

Bar on Exit Helps Pedestrians Avoid Oncoming Trucks

To prevent employees from hurrying through a doorway into an adjoining truck driveway, where they were in danger of being hurt by oncoming trucks, the proprietor of a dairy screwed an iron bar to the frame of the door. One end of the bar is bent so that when installed it projects at an angle into the driveway, leaving only a narrow passage for pedestrians. Now employees are retarded long enough within the building to be warned of approaching danger, and cannot hurry through the exit into the path of trucks.

Gemma Hayes, New York.

Sawdust Aids in Removing Paint

Using sawdust with paint remover is often more effective than merely applying the remover and scraping the work. The remover is brushed on and the work surface is scrubbed until it no longer feels tacky. Then more remover is added, sawdust is spread over it and scrubbed with a wood block until the work is dry, after which the paint can be scraped off easily.

John B. Cornell, Graniteville, R. I.



Jig Eliminates Center-Punching When Drilling Out Rivets

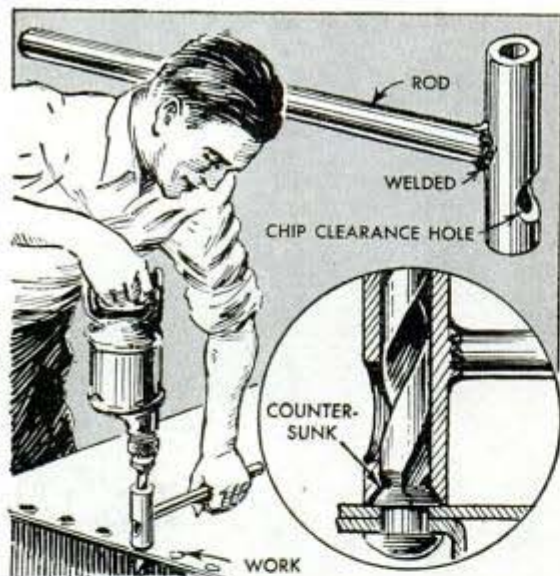

In removing rivets by center-punching and drilling, the drill sometimes works off center, thus spoiling the rivet hole. A jig like the one shown will guide the drill true, as well as eliminate the need for center-punching the rivet. It is made by welding two lengths of round stock of suitable size at right angles, one to be used as a handle and the other, of slightly larger diameter, to be used as the guide. The latter is drilled to size, a chip-clearance hole is made near the lower end, and the bottom edge is countersunk to fit over a rivet head in seating the guide.

Improving Ceiling Heater Unit

Warm air from a ceiling heater unit of the type having a blower usually remains at a fairly high level in the room, circulat-

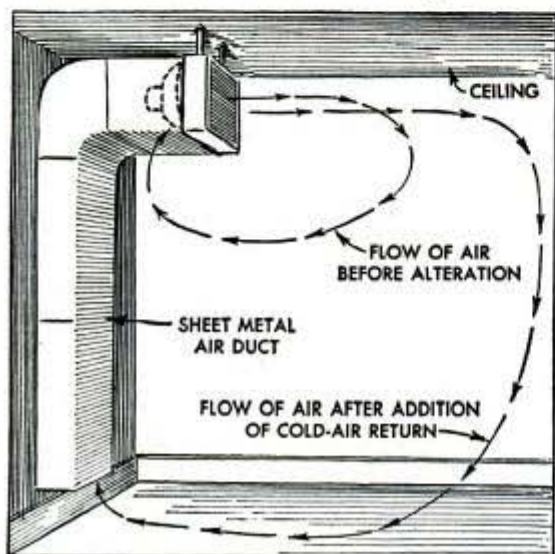

ing close to the ceiling, unless some provision is made for leading the cool air at floor level up to the heating unit. To do this, a sheet-metal duct can be installed. The area of the cool-air duct should be two or three times larger than that of the warm-air vent so that the velocity of cool air drawn across the floor will be reduced, otherwise this circulation may cause discomfort.—W. R. Bufkin, Evansville, Ind.

Patching Blown-Out Auto Tubes

Often when a tire blows out the tube is torn so badly that the torn edges fall inward and a regular patch cannot be applied. However, by first applying a small patch to the inside surface of the tube under the tear and bringing the torn edges together over the patch, they will be held while an external patch is applied. Of course, the inner surface of the tube surrounding the opening must be cleaned as usual before applying the patch.

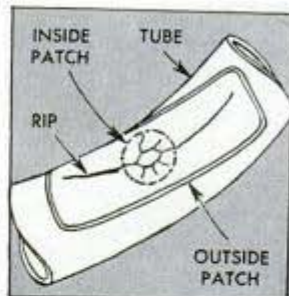

Harold L. Williams, Bronx, N. Y.

Plastic Face Added to Hammer By Slip-On Tube

If occasionally you need a hammer with a plastic face and your toolbox is already crowded, you can make a simple attachment that slips over the face of your regular hammer and takes very little room in the box. The attachment consists of a short length of steel tubing, long enough to project over the edge of the hammer face, and a plug of plastic that is fitted into the end of the tube. The tubing is reamed out so that it fits the hammer snugly, then the plug is turned down to fit tightly into the end of the tube. After this the edge of the plug is turned flush with the outside of the tubing.—S. Winston, Brooklyn, N. Y.



Unless the thermostatically operated carburetor heat control valve, which warms the combustible mixture in most cars before it enters the cylinder, is working properly, top economy and efficiency in engine performance are impossible.

Three-Step Method of Coiling Band-Saw Blade

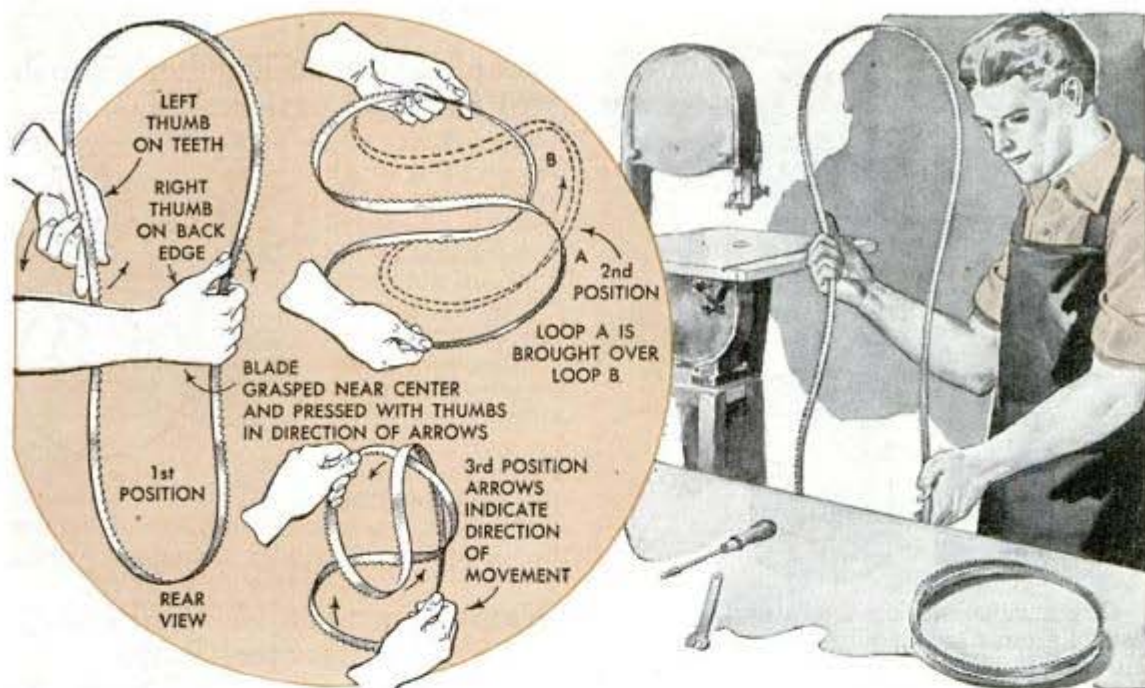

Coiling a band-saw blade is easy to do if you bear in mind that it must be folded in three parts, or loops, in order to coil properly. The first step is to grasp the blade correctly, as the manner in which this is done determines how the first loop will be formed. Both hands hold the blade at about the center, the left hand turned downward with the thumb on the teeth and the right hand turned upward with the thumb on the back edge, as shown in the left-hand detail. The thumbs must not press against

the sides of the blade. Next the hands are slowly turned at the wrist so that the left hand swings upward and the right hand swings downward away from the body. This motion will throw the blade into two loops, A and B, as shown in the upper righthand detail. Then loop B is carefully moved over loop A, as diagrammed in the lower right-hand detail, which brings the blade into the third position. Now the loops are moved as indicated by the arrows to coil the blade ready for storing.

Skirted Holder for Prick Punch Prevents Injury to Fingers

When a prick punch is accidentally tilted as it is struck, the hammer may glance off and strike the operator's fingers. But injury of this kind is prevented when the punch is set in a holder like the one shown, which keeps the punch in a vertical position as in Fig. 3. Also, the holder is grasped instead of the punch, as the latter is retained by a ring soldered to it as shown in Fig. 1. The assembly can thus be lifted and moved from one mark to the next, Fig. 2. The holder consists of a 1-in. disk such as a piece of rod, which is drilled to take the punch, as indicated in the lower right-hand detail, and a sheet-metal skirt is cut to the form shown in the lower left-hand detail, and soldered around the disk. As the skirt is cut away to form a large opening, the work can be seen at all times.

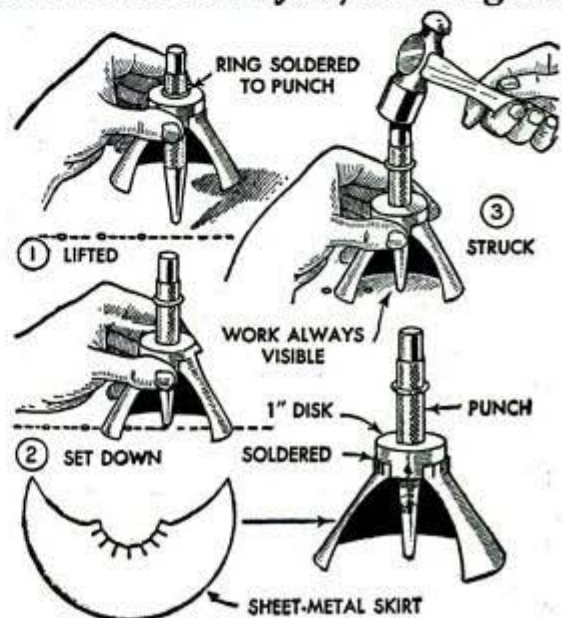

Keep a magnet at the lathe for cleaning metal chips out of hard-to-get-at places.

Oil Drum Raised on Auto Hoist To Fill Service Barrel

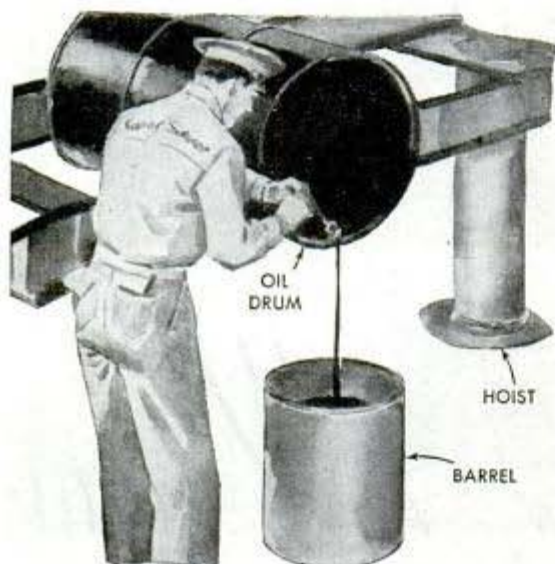

One service-station operator fills an oil barrel from a drum without heavy lifting. He merely rolls the drum onto a hydraulic hoist and turns it tap-end outward. Then the barrel is set on the floor in front of the drum, and the hoist is raised.

Maurice Rogstad, Menominee, Wis.

Stamped Metal Tags Tied to Fowl Record Their Live Weight

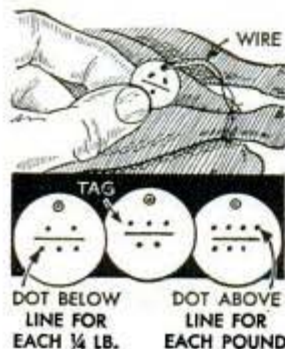

One poultry dealer who sells live weight tags the birds so that they can be identified after being dressed. The tags, which are small disks of copper tied to cords, are prick-punched to show pound and quarter-pound weights, the pound marks being stamped above a scored cross line and the quarter-pound marks below. The tags can be cleaned and used repeatedly.—J. W. Cartmill, Tampa, Fla.

Slit Hose Supports Price Tag On Auto-Battery Post



By slitting a length of auto-heater hose for a short distance, it can be used to hold a price tag on a storage battery. The hose is slipped

over one of the terminal posts to support the tag in a vertical position so that it can be read easily.

Plane Handle on Butcher's Brush Provides Comfortable Grip

One butcher screwed a knob and handle taken from a discarded wood plane to the back of the steel-bristle brush used for cleaning his cutting block. As considerable pressure on the brush is required to clean the block, the knob and handle provided an easy method of exerting the necessary force without tiring his hands.

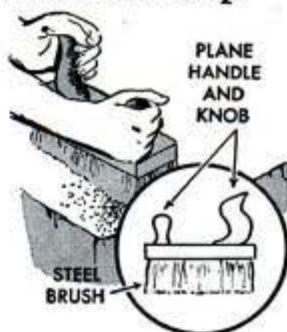

Name Engraved in Tin Plating Identifies Steel Traps

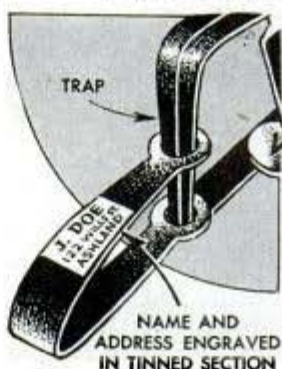

As a means of identification, one trapper tinned a small portion of the spring on each of his traps and engraved his name and address in the plating with a nail. With ordinary use, the inscription will last indefinitely.

Thumbtacks for Drawing Board Are Held by Rubber Bands

Instead of replacing thumbtacks in the drawing board when removing finished work, one show-card writer attaches them to long rubber bands, which he staples to the edge of his board. When the tacks are needed again, they are easily reached without pulling them from the drawing board.

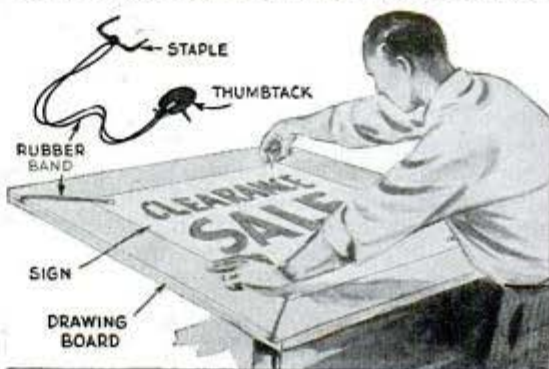



BASIC PRINCIPLES OF RADAR

RADAR systems are based upon the fact that extremely short radio waves have the uncanny ability to bounce off a solid object and be instantly picked up by a suitable receiver. In other words, these microwaves will be reflected upon encountering any object having different electrical characteristics from those of the transmission medium. Since it is known that radio waves have the same speed as light, the time they require to travel from the transmitter to the target and be reflected back to the receiver, if accurately determined, will show the distance to the target.

Consisting fundamentally of a transmitter and a receiver, the radar unit broadcasts short waves over the area to be explored. When some of these waves are reflected back to the receiver, as in Fig. 1, the transit time is determined by viewing the received signals on the screen of a cathode-ray tube provided with a scale graduated to show distance. Directly above the scale a horizontal image of the continuously transmitted signal is reproduced. The signals reflected from the target are received, amplified and then superimposed on the horizontal signal and these appear as vertical signals at points on the tube screen which show the exact distance from target to receiver. For example, T_1 in Fig. 2 would indicate a target 3 miles away; T_2 , 7 miles and T_3 , 15 miles. As the targets move, the images on the screen keep pace with them. The vertical and horizontal position of the target is determined by rotating directional antenna in a manner similar to that employed with an ordinary radio direction finder.

Photo A shows a "Philco" type SG ship search radar master station; any number of repeater viewing units may be located at remote points on the ship. Photo B, made at the Westinghouse East Pittsburgh laboratory in 1933, demonstrates the radar principle; at this time it was called radio "beamcasting."

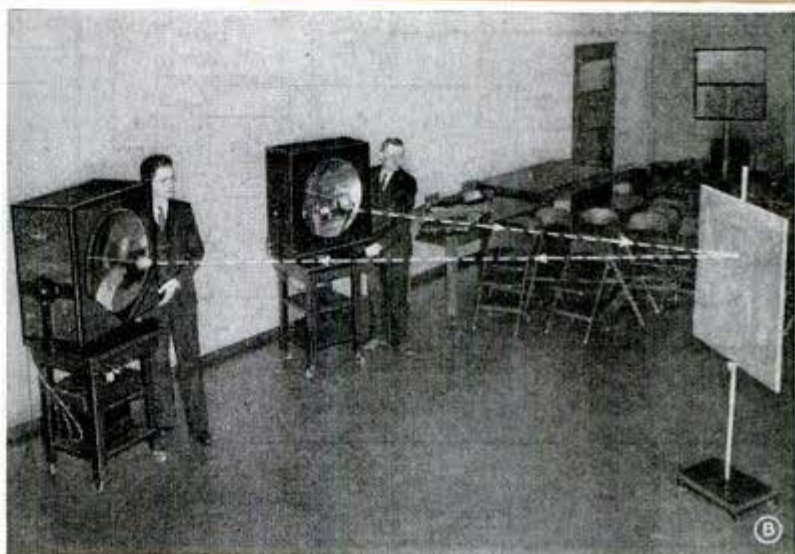
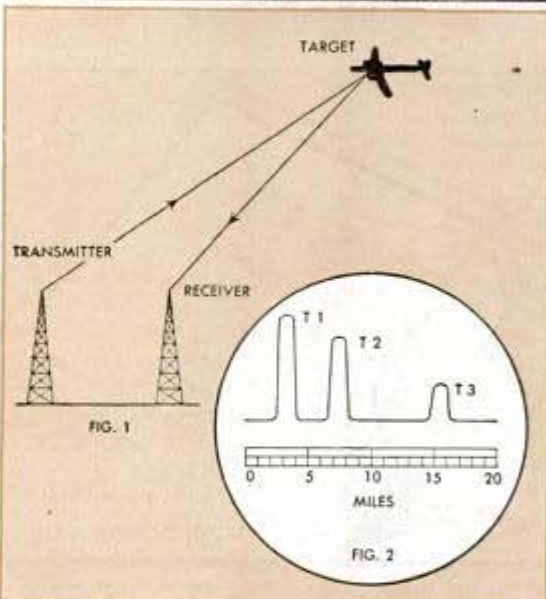

ELECTRONIC PHOTO-PRINT TIMER

By Arthur I. Rattray

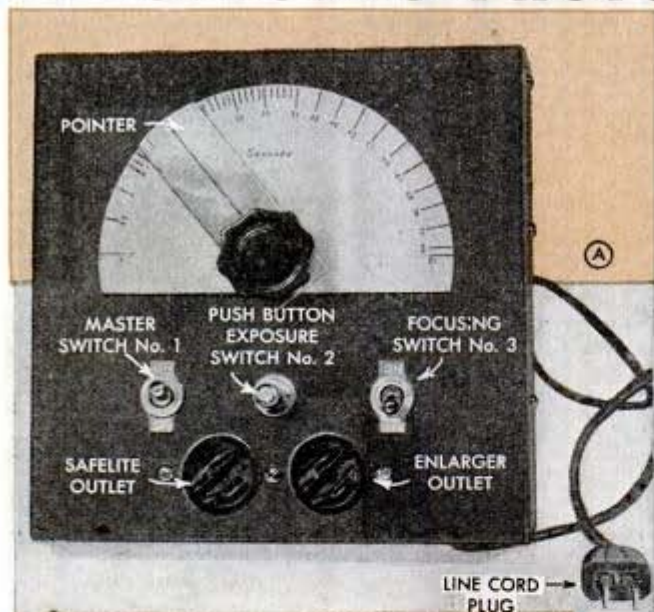

ACCURATELY controlled timing enables the busy photographer to make uniform prints. This is especially important when making a large number of duplicate prints, such as personalized Christmas cards and similar printing of favorite snapshots. This electronic timer is easily calibrated by means of any self-starting electric clock, with a sweep second hand, plugged into the "enlarger" socket. The time range is from 1 to 80 seconds and the unit will control any electrical appliance or lamp that does not draw more than 250 watts. The relay winding is in the plate circuit of the 117L7-GT tube which, when heated, draws plate current and closes the relay.

The "safelite" is on all the time except during the exposure timing period.

The sheet metal base is detailed in Fig. 1 and the schematic circuit diagram is given in Fig. 2; a simplified pictorial wiring diagram appears in Fig. 3. Switches 1 and 3 are ordinary s.p.s.t. toggle types. Photos A, B and C show various views of the completed unit.

In operation, during the warm-up period

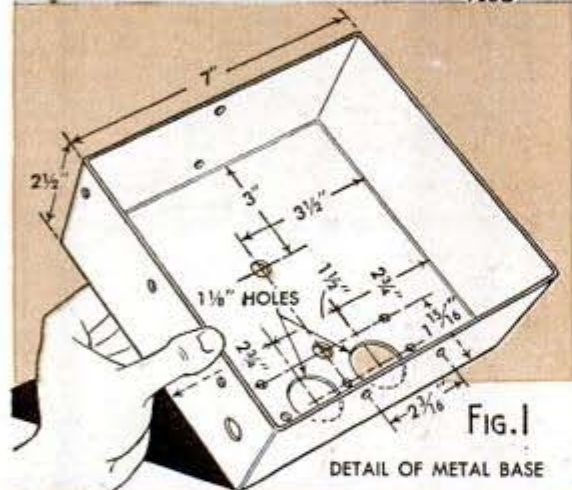

FIG. 1

DETAIL OF METAL BASE

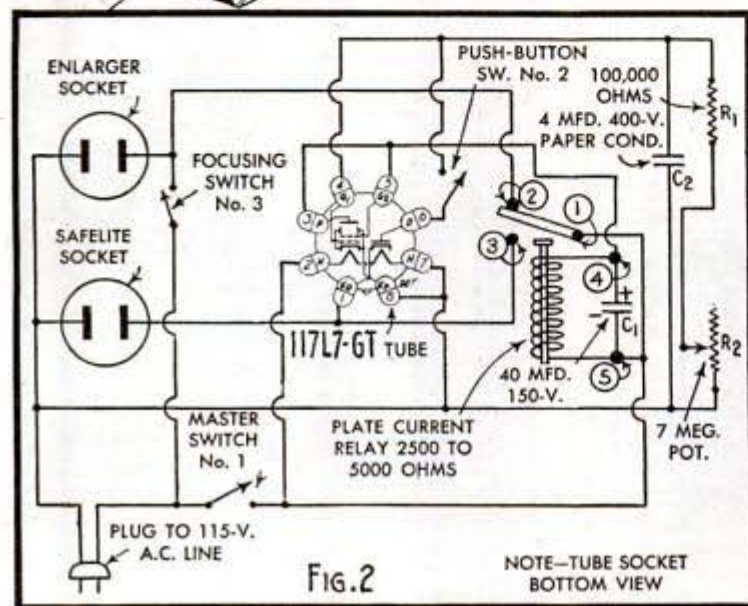
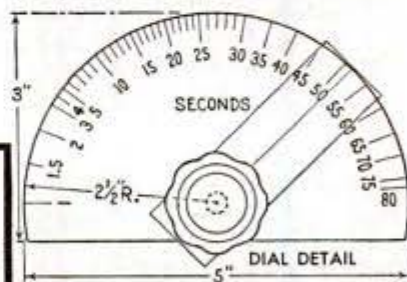

FIG. 2

NOTE-TUBE SOCKET
BOTTOM VIEW



for ENLARGER or CONTACT PRINTER

with master switch No. 1 on, the enlarger or printer lamp will light, but as soon as the initial warm-up period is complete it will automatically go out unless focusing switch No. 3 is thrown on for focusing purposes. Keep switch No. 1 on while focusing. Select the time desired by varying control R_2 (dial knob), then press push-button exposure switch No. 2. Switch No. 2 is a s.p.s.t. normally open, push-to-close momentary-type. When it is pressed, condenser C_2 charges; this places a high negative bias on the control grid of the tube, reducing its plate current immediately to the point where the relay drops out. The time required for the plate current to build up again to the point where the relay is actuated is the timing period of printing.

To calibrate your timer, secure the white paper dial on the chassis under pointer R_2 . The pointer is made from a strip of clear plastic $\frac{1}{16}$ by 1 by 3 in. Mark the seconds on the dial as indicated by the sweep second hand of the clock; where the various seconds come in on your dial scale will be approximately at the points shown. The unit should be warmed up for 20 to 30 minutes before calibration, and before using. Student list number for this unit is R-389.

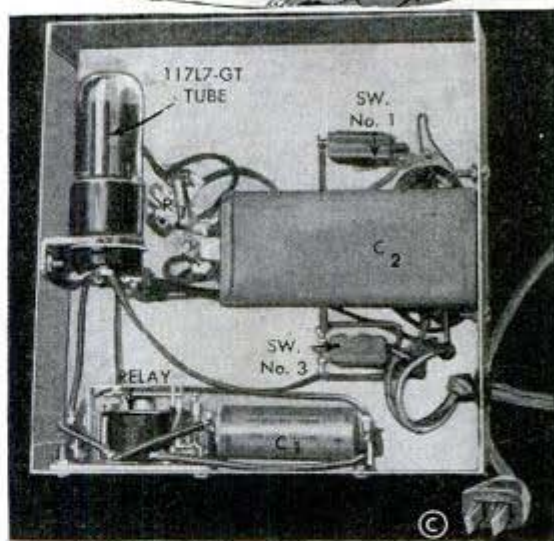

no longer available

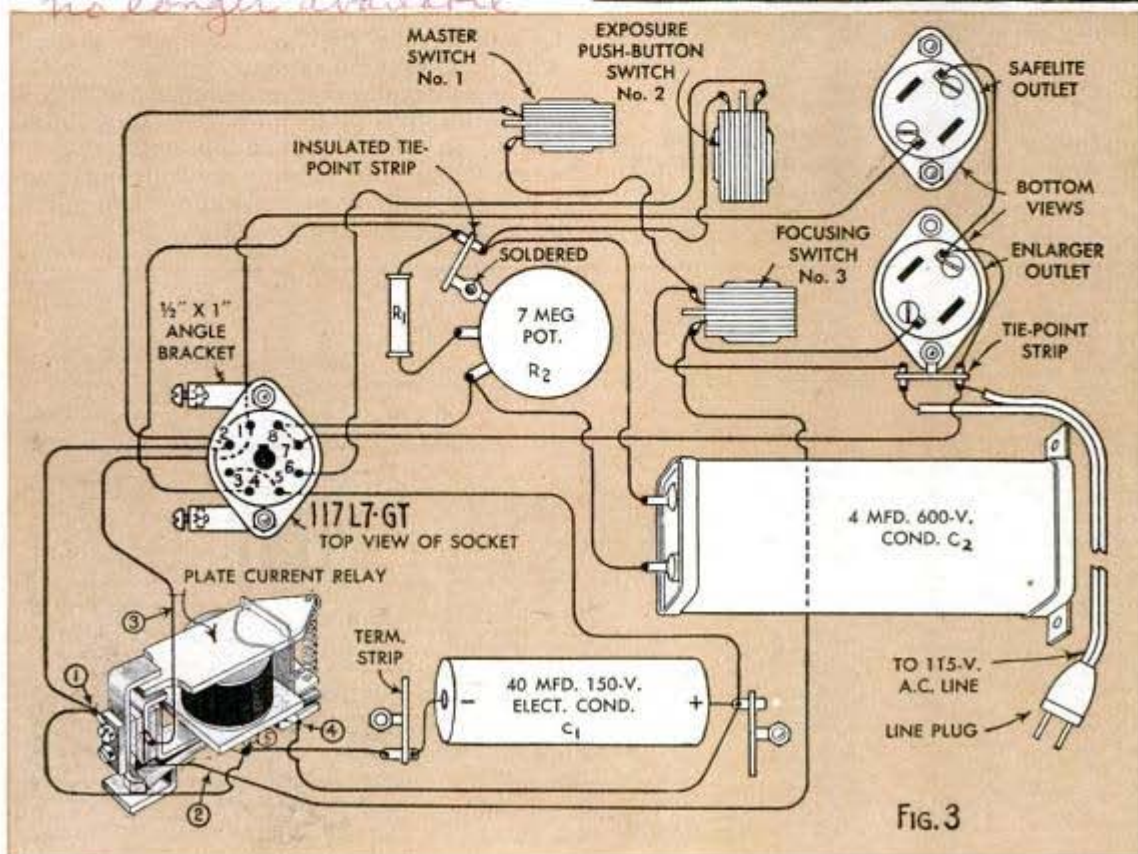
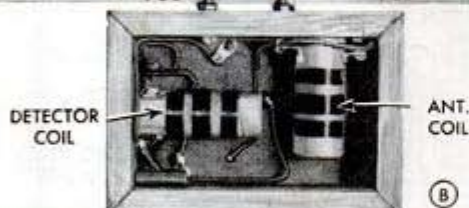
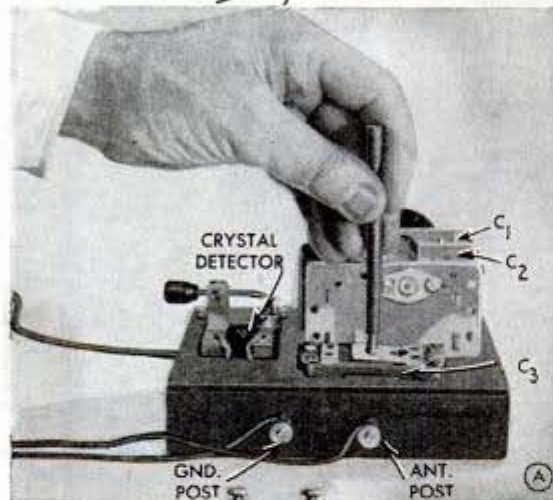

FIG. 3

Sharp-Tuning Crystal Set for Experimenters

By Walter B. Ford



IF YOU are a finicky crystal set experimenter here is one that you will like to try. It employs the band-pass principle and provides two tuned circuits resulting in real selectivity which brings in the desired local station in congested radio areas without sacrificing tonal quality.

The parts are few and quite simple; however, the coil winding details must be followed carefully for maximum results. Two-gang variable tuning condenser (C_1 and C_2) is a common broadcast receiver type; C_3 may be a trimmer condenser of 3-30 mmfd. or similar capacity as the value is not critical; C_4 is a 200-volt .00025-mfd. paper-type tubular fixed condenser, and the crystal detector is an adjustable type. The case is made of $\frac{1}{2}$ -in. wood strips $1\frac{1}{2}$ in. wide; top is $\frac{1}{8}$ -in. hard-pressed wood.

Although the coils may be wound on cardboard mailing tube of the diameter specified, the ones used in the model were close-wound on wooden dowel rod on a lathe, and are as detailed in Figs. 1, 2 and 3. A $\frac{1}{2}$ -in. hole was drilled through the center of each piece, then small holes were drilled through the sides to anchor the coil ends and mount the terminal lugs. No. 30 enameled wire is used for all coils. Both the antenna coil and detector coil windings L_1 and L_2 are identical, and were coated with "coil dope" lacquer.

The schematic diagram appears in Fig. 4 and a top view pictorial wiring diagram in Fig. 5. In operation, condenser C_3 acts as a selectivity and volume control; once set for best results in your location it requires no further attention.

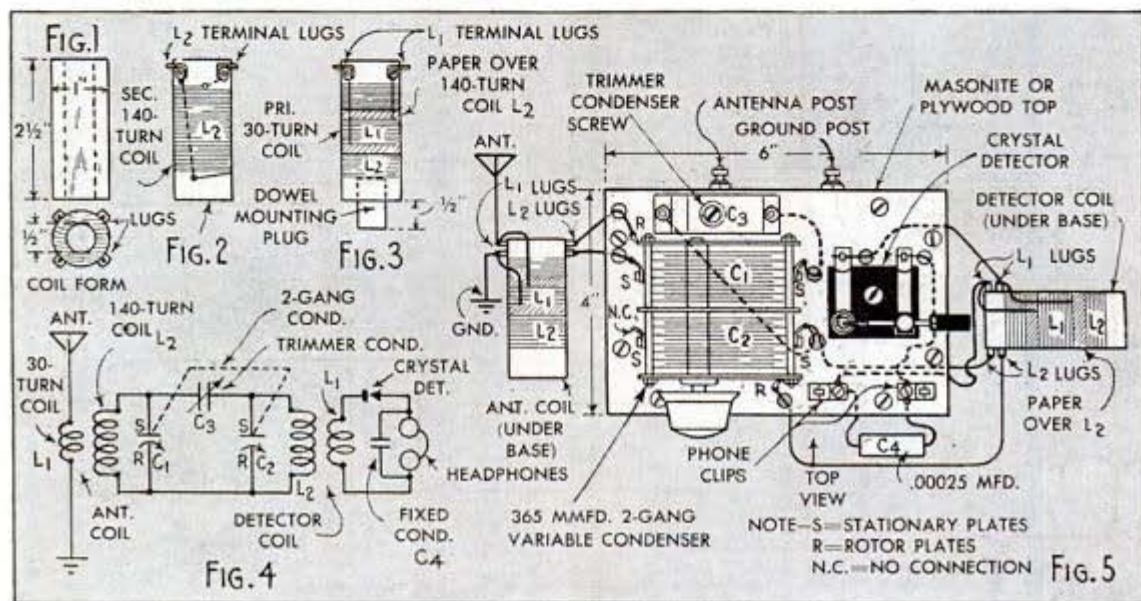

Tough but oh so gentle

When you install new piston rings, it will pay you to get Hastings rings. They *stop* oil-pumping, *check* cylinder wear, *restore* engine performance. Ask your motor specialist.

HASTINGS MANUFACTURING CO. • HASTINGS, MICHIGAN
Hastings Ltd., Toronto



TO SPEED THE PACE OF PROGRESS

— and bring you better things more quickly

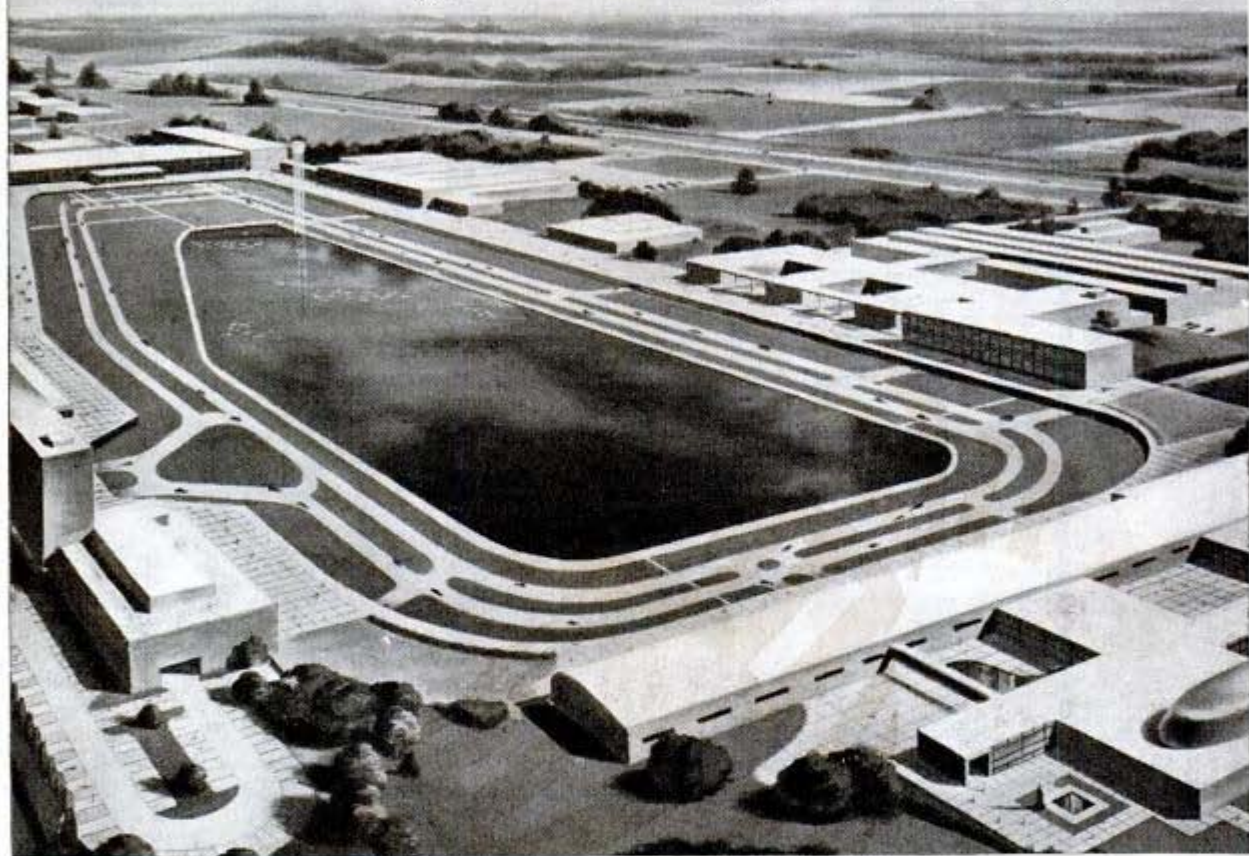

LOCATED ON a major highway leading from Detroit, access to the Center will be through the Administration Building sketched here. A system of modern roadways will provide practical opportunity to study traffic control as well as to make simple road tests of new car developments.

A FLOOD OF SUNSHINE will pour into the southern windows of the Research Buildings where experimental work is carried on in such diverse fields as the study of chlorophyl, research into fuels and engine design.

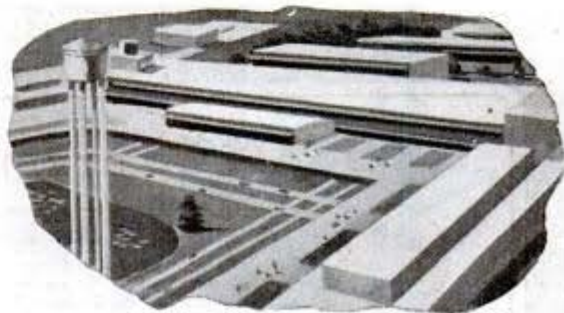

KEEP AMERICA STRONG—BUY VICTORY BONDS

**The New
GENERAL MOTORS TECHNICAL CENTER**
**will be created to stimulate opportunities,
promote employment and bring about
MORE and BETTER THINGS for MORE PEOPLE**

THESE are times when the world cries out for new and finer things. There is a great hunger, broad as all mankind, for happier relationships among men—for greater individual opportunity for accomplishment, for more and better goods within reach of everyone.

It is by satisfying this hunger that we can bring greatest benefit to our national economy in the future. Through such action lies the road to more good jobs, to an ever-rising standard of living through the continual replacement of old things with new and better ones.

The General Motors Technical Center is dedicated to such an objective. It will occupy a 350-acre tract of land outside of Detroit as soon as conditions permit. Its purpose is to develop new things that add to the comfort and security of our living, and to enable existing things to be made more efficiently, hence at lower selling prices, so more people may own and enjoy them—all with expanding job opportunities.

It will shorten the time required to bring the work of creative thinkers out of the idea stage and into usable reality.

Here in groups of buildings designed especially for the purpose, General Motors will gather in advantageous and inspiring new surroundings the most modern facilities for research,

advanced engineering, styling and the development of new manufacturing techniques.

Here physicists and engineers will discover new facts and convert them into new improved products. Stylists will give them new and more attractive form. Process engineers will develop better manufacturing techniques for making them.

Science here will go to work in the interest of economic progress. And history is full of proof that when science is so harnessed, more jobs are created, more comforts and conveniences are brought within reach of more people.

Serving as a source on which the engineering staffs of all of our Divisions may draw, the General Motors Technical Center will stimulate improvement in all General Motors products. Automobiles, refrigerators, Diesel engines, locomotives and other good and useful things may be expected to be improved at even faster pace than in the past.

But the work of the Technical Center will not be confined to existing things. It is dedicated to the idea that progress is the servant of mankind and that whosoever advances it not only helps himself but his fellow men. Its goal will be "more and better things for more people," whether that comes through improvement of the old or development of the new.

GENERAL MOTORS

MORE AND BETTER THINGS FOR MORE PEOPLE

CHEVROLET • PONTIAC • OLDSMOBILE • BUICK • CADILLAC • BODY BY FISHER • FRIGIDAIRE • GMC TRUCK AND COACH • GM DIESEL

Every Sunday Afternoon—GENERAL MOTORS SYMPHONY OF THE AIR—NBC Network

THE SPHINX USED
TO LOOK DOWN UPON:



PIPES
LIKE
THESE
IN
EGYPT



LHS TODAY, IT'S
STERNCREST
STERLING

IN EGYPT,
AND EVERYWHERE OUR BOYS HAVE GONE

LHS has never turned out better pipes, nor more pipes, in the 50 years of LHS pipe-making. And yet, so great is the demand that dealers' stock are often depleted. But, good news—with war's end, more and more LHS pipes are now available for our civilian friends. Not all models yet, but a big selection, and all pre-war quality and workmanship. Your dealer has them.

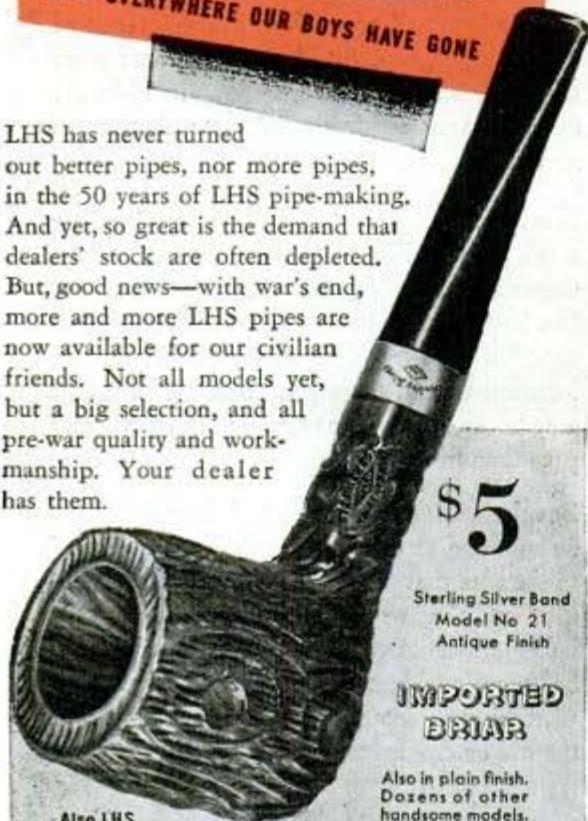

\$5

Sterling Silver Band
Model No. 21
Antique Finish

IMPORTED
BRIAR

Also in plain finish.
Dozens of other
handsome models.

Also LHS
Sterncrest 14K
Specially selected
imported briar,
14K gold band,
Plain and antique
finishes . . . \$7.50

AT ALL GOOD DEALERS

KEEP ON BUYING
WAR BONDS



Reg. U.S. Pat. Off.

FREE—"Pointers on Pipes"—Write

L & H STERN, INC., Stern Bldg., 56 Pearl St., Brooklyn 1, N.Y.

Helium Is a Busy Bachelor

(Continued from page 53)

world in ocean depths. It is conservatively estimated that postwar divers will be able to recover a billion dollars more in salvage than they could have without helium.

Similar advantages are experienced in tunneling and other caisson work where men are subjected to high atmospheric pressures. Curiously, the "sky bends" suffered by some aviators at altitudes over 30,000 feet, and the "ear block" affliction, which is familiar alike to passengers and flyers, can also be prevented by breathing a man-made air of which helium is the chief component.

Though helium had been identified as part of the sun's atmosphere as far back as 1868 and its existence on earth established in 1895, the scene of its real advent as a future useful commodity was the village of Dexter, Kansas, in 1903. Drilling for oil, prospectors at Dexter had produced a flow of natural gas instead which was found to contain two percent helium.

Commercial companies, invited to assist in improving the process for extracting helium from natural gas, performed valuable service, but when the military significance of helium became known, it was decided to make its production a government monopoly. During World War II, Congress appropriated nearly \$17,000,000 for four new helium plants, all now in operation.

Recently the Bureau of Mines arranged to store surplus helium gas in a vast underground reservoir in a 50,000-acre natural gas field near Amarillo, Texas. A pipe line connects the reservoir with helium plants, insuring supplies on short notice.

What about the helium supply? Bureau of Mines estimates place our American potential at over 10 billion cubic feet, enough for quite a while. The natural gases of other continents contain very small percentages of helium.

(Continued to page 150)

**Model Builders
Attention!**



	V	V-2	V-3
Hex	1/2"	3/8"	5/16"
Thread	3/8"-24	1/4"-32	1/4"-32
Thread Length	7/32	7/32	5/32
Weight, Grams	8	3 1/2	2 1/2

Actual Size V-Plug

Champion spark plugs for model gas engines give the same dependable performance as regular Champions. Silliment sealed. Sillimanite insulator. Alloy needlepoint electrodes for easy starting. One piece construction.

CHAMPION

SPARK PLUG COMPANY • TOLEDO 1, OHIO



Because of their dependability

CHAMPION SPARK PLUGS

serve these leading airlines



The American people always give an overwhelming vote of confidence to that which they know they can depend upon. Champion Spark Plugs have won this vote of confidence and are preferred by users on land, sea and in the air.

CHAMPION SPARK PLUG COMPANY • TOLEDO 1, OHIO

DRILL PROTECTOR & DEPTH GAUGE

All in One

ENDS DRILL BREAKAGE

Now you can drill faster—and not worry about drill breakage. And you can do more accurate work. The new, precision-made Hartwell Protector & Depth Gauge reinforces drills, prevents them from bending or breaking. It is also a *depth gauge* and *stop*—can be used to measure depth of holes or to limit length of drill travel through thin material. It is available in 15 selected sizes, 1/16 through "F"—and will fit standard drill chucks.

HARTWELL

Engineering Company
Designers • Manufacturers • Distributors
3417 Crenshaw Blvd., Los Angeles 16, California

FREE: "Home Drilling Guide" for users of breast and portable power-driven drills. Write to above address.

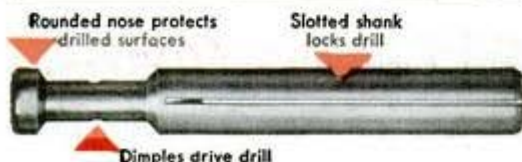

Rounded nose protects drilled surfaces

Slotted shank locks drill

Dimples drive drill

GET IT AT YOUR HARDWARE STORE

There may exist another vast, untapped supply above the stratosphere. To think of such a supply as recoverable is as far-fetched as the idea was, in 1916, that there ever might be helium enough to fill a big balloon. But a helium-filled balloon has ascended with passengers to 72,395 feet, the highest yet. With designs improved by war experience, man will go higher.

ServRon 10—Floating Arsenal

(Continued from page 62)

virtually in the battle area, but more generally this is done at Navy yards, so that the floating dry docks will not be tied up and thereby imperil other ships needing repairs of a less serious nature.

Although ships of the supply "train" are designed for duties other than fighting, many such vessels have lively combat records. The USS Current, a Fleet tug, along with three other salvage vessels, made a 1000-mile dash into Jap-controlled waters and towed two damaged American warships to safety.

There are no wharves in the forward areas, so cargo handling means booming from ship to ship, or from ship to barge or boat. But that doesn't hinder the work of a special Seabee stevedore battalion which transferred thousands of tons of ammunition and other supplies into the magazines of warships that pounded the Japs from the Philippines to the Honshu coast. Loading nine LSTs with ammunition at sea for a combat operation was one of the Seabees' feats. The battalion considers that its toughest stevedore job was discharging the cargo of a torpedoed ammunition ship. They unloaded 2900 tons of precious high explosive at the rate of a ton per man-hour. In loading a battleship for preinvasion bombardment, they passed the ammunition at the rate of 40 tons an hour, completing their assignment four days early.

Even halfway around the world, the Navy likes to maintain its reputation as the best-fed military force in world history. Food is fuel to stoke the energetic officers and men of ServRon 10, and the arrival of a refrigerator ship from the States is like the arrival of Christmas. In its capacious zero-temperatured holds may be enough food to sustain a city of 100,000 for a month.

One of the proudest feats of ServRon 10 was the utilization of thousands of tons of American steel, accumulated by the Japs in anticipation of war. Painted with Japanese characters, huge "I" beams, made and stamped by American mills and bought by the Japs for some 20 fortified island in-

(Continued to page 152)

AUTO-LITE SPARK PLUGS

IGNITION ENGINEERED



"Ah did hear Paw tell 'er the spark plugs needed a good cleanin'."

DIRTY PLUGS NEED "PLUG-CHEK" TOO!

Cleaning a spark plug often isn't enough. The plugs may be faulty, the wrong type or improperly gapped. Auto-Lite "Plug-Chek" inspection service is the quick and accurate way to find what corrections should be made to improve gas mileage as much as 12%, according to tests by the American Automobile Association.

Have your spark plugs inspected the "Plug-Chek" way by your friendly Auto-Lite dealer. But if new plugs are needed, ask for Auto-Lite spark plugs — they're ignition engineered.

THE ELECTRIC AUTO-LITE COMPANY

TOLEDO, 1, OHIO • Merchandising Division • TORONTO, ONT.

BUY MORE BONDS

Now! CBS

Saturdays 8:00 P.M., E.T.

The **AUTO-LITE** Radio Show
starring

Dick Haymes

HELEN FORREST • GORDON JENKINS'
ORCHESTRA AND CHORUS



NOW! DUSTLESS SWEEPING



The Dustless brush is the only brush ever perfected for "Dustless" sweeping. This brush has a reservoir in its back for Arbitrin sweeping fluid. In the process of sweeping, Arbitrin filters through the brush and makes the best kind of sweeping compound out of every particle of dust it contacts. Besides reducing dust 97%, the Dustless brush also eliminates sweeping compound, saves labor and outlasts ordinary brushes 3 to 1. Get complete facts about this better method of sweeping. Write today.



- Dustless
- Speed Sweep
- Speed Wash brushes

MILWAUKEE DUSTLESS BRUSH COMPANY

528 N. 22nd Street • Milwaukee 3, Wisconsin

stallations, were put to good use in repairing battle-scarred Yank ships.

ServRon 10 is the "business end" of the American secret weapon whose long barrel is the well-guarded supply line from the continent. Backing up the service ships are some 300 advance bases, the miniature Pearl Harbors and Mare Islands that the Navy has installed on barren or tropical islands. In excess of 100,000 tons of supplies are moved each day, enough to fill the holds of 16 Liberty ships. Into these bases, and on to the Fleet, flows an estimated fourth of the industrial output of the United States, under the direction of Admiral Frederick J. Horne, USN, Vice-Chief of Naval Operations. At the peak, about 500,000 men were on duty in such bases.

It is the supply tender that keeps our Fleet mobile. Take the instances of water, fuel and ammunition. One admiral recently declared we were winning the Pacific War on fresh water. Most of the islands have little or no natural fresh water supply; distilling ships have been the answer, supplying our island outposts or ships under way.

Men—material—bases—ships: these are the components of Navy victory. Men with the new skills to repair delicate electronic devices; material—10 million spare parts; bases dotting the ocean; ships by the hundreds. From the enemy's viewpoint, the picture must have been one of engulfing destruction long before the final surrender.

One Step Short of Tokyo

(Continued from page 46)

shore. A production line for pallets is one of the thriving industries of the island.

Salvage operations are a major concern of the depot. There is one rule for each repair job: the equipment must work like new when it gets off the beach. Many weapons are rebuilt in the small arms repair unit.

"Nothing goes out of this shop we wouldn't want to use ourselves if we were face to face with the enemy," said a warrant officer, whose pride is a vaporizing tank. "Just hang one of these beat-up rifles down in the vapor, and the grease and coral and other stuff on it will drip right off. It's mighty powerful stuff. They call it trichlorethylene."

A new crew of Navy specialists has been brought into the depot to repair the huge, awkward LVTs (amphibious tractors). Under sprawling tarpaulins the men weld, retread, paint and repair engines on these vehicles 24 hours a day.

(Continued to page 154)

Why old cars "feel" better with **MARFAK LUBRICANT**

Marfak chassis lubricant is scientifically prepared to overcome the wear of bearing surfaces in old cars. Wear increases clearances, causing play and chattering in spring shackles, steering knuckle, king pins, etc. (Figure 1). These constant shocks further accelerate the wear of bearing surfaces and can cause front-wheel shimmy and excessive tire wear.

Fig. 1

Marfak protects new bearings, sticks to the job and cushions shocks in worn bearings of old cars. Ordinary lubricants jar out.



The combination of its ingredients gives Marfak "body" that keeps the clearances between vital bearings filled with a lubricant that has both cohesive and adhesive qualities. You can *feel* its cushioning effect as you drive.

Fig. 2

Marfak forms protective collars that keep out dust and dirt, keep working lubricant fresh. Ordinary lubricants gum up and dry out.

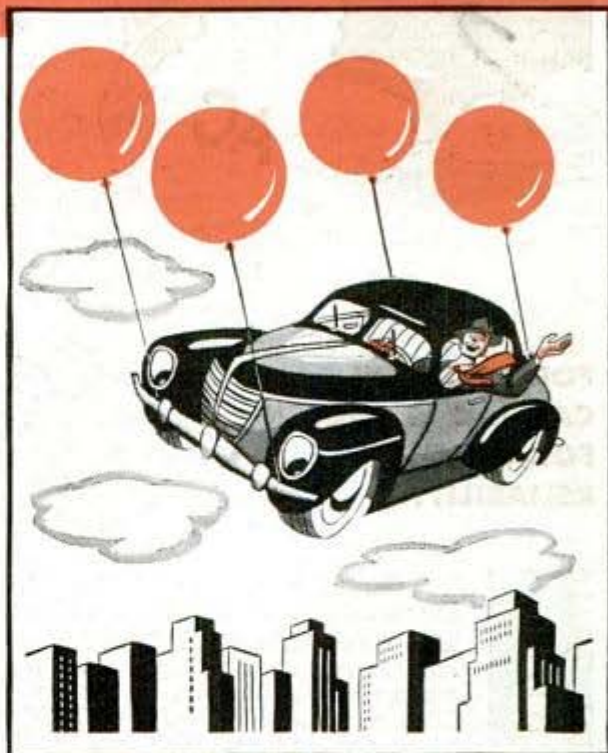
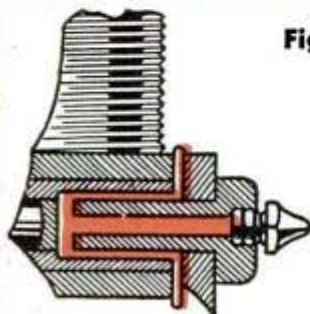

Not only does Marfak cling to bearing surfaces and resist any tendency to wash-out, jar-out or squeeze-out, but it forms a protective collar that keeps out dust and dirt. (Figure 2).

Marfak also resists oxidation, and retains its superior lubricating qualities far beyond the life of ordinary lubricants. Because it stays on the job, it reduces wear and saves money by eliminating costly repairs and preserving tires.

Change to Marfak now. You'll find it economical in the long run, for it will help keep your car on the road!

THE TEXAS COMPANY



Don't miss the **TEXACO STAR THEATRE** on Sunday nights with **JAMES MELTON** and famous guest stars. See your newspaper for time and station.

You're welcome at **TEXACO DEALERS**

Let us
MARFAK
your car



Boston to Brownsville

FOR PLANE OR CAR—AC IS CHOSEN FOR UTMOST RELIABILITY



Aircraft Spark Plug

The Great Silver Fleet of Eastern Airlines standardizes on AC Spark Plugs. The remarkable reliability of these ceramic spark plugs began with the plugs which AC, alone, built for the Liberty engines of World War I. With Lindbergh, Acosta, Maitland, Byrd, — the Constellation and C-97, — these AC plugs set new, historic records. And in Allied fighters and bombers of World War II, improved versions of these ceramic AC's further proved their reliability.

AC pioneering with spark plugs for cars, trucks, and tractors made these aviation achievements possible. Indeed, it is one reason why 2 out of 4 new cars and trucks were AC equipped.

AC SPARK PLUG DIVISION • GENERAL MOTORS CORPORATION

AC SPARK PLUGS

LET'S FINISH THE JOB—BUY VICTORY BONDS

Far out on a bare tip of the island, in the midst of acres of ammunition dumps, an assembly line is at work salvaging thousands of tons of rusty 155-mm. shells. The shells are scraped clean, inspected and given a coat of camouflage paint.

The shoe and textile men fix an average of 1000 pairs of marine "boondockers" a month, and also repair cots and jeep tops. Sometimes a pair of nurse's shoes arrives to break the monotony.

It's Our Turn at the Potter's Wheel

(Continued from page 80)

Now the ware is ready for decorating, most of which is done by hand. After this work the ware again is fired so that the decoration becomes an integral part of the china.

The ceramics industry served nobly in the war. In 1942 Lenox, Inc., of Trenton, N. J., opened its Lenoxite division to manufacture steatite, or soapstone, which is mined in Tennessee.

Steatite won't shrink when high-fired, and has proved highly valuable for making radio and radar precision instruments, coil forms, resistor spools, insulators and mounting blocks.

Potency of the wonder drug, penicillin, is tested by dropping a solution into tiny steatite cylinders which have been placed in a round flat glass petri dish, surfaced with bacteria that penicillin destroys. The seepage of the sirupy solution creates an area of light around the base of the cylinder, the extent of this area determining the drug's strength.

Most designs in chinaware, figurines, plaques and garden earthenware come either from factory or studio artists. Quite a few studio designers, however, find artistic expression in creating art objects for art's sake. One of these is Frances Poe, a Chicago painter who models large American game animals as a hobby.

Miss Poe, who spent four years in developing her technique, defied authorities who told her that such fragile forms were incompatible with the nature of clay; yet she succeeded in producing the whitetail deer and other animals without a supporting base. Each piece is individually modeled, fired, painted and glazed by hand. Skeletal measurements from the Chicago Museum of Natural History insure anatomical accuracy.

Domestic excellence in quality and design of tableware got its first real send-off when, in 1918, President and Mrs. Wood-

(Continued to page 156)



Savage Model 745—Lightweight Automatic—Combines the speed of an automatic with the ease of handling and light weight of a 'double'.

DOUBLES AT DUSK...

"The birds had been sitting close . . . we'd been working heavy cover and I was dog tired. Toting a heavy gun didn't help any, either. The pay-off came late in the afternoon. A pair flushed, but before I could swing my old 'blunderbuss' it was too late. Then Bill's Savage *Lightweight Automatic*—pounds lighter and seconds faster—came up like lightning. His two shots were so fast they sounded like one. It was 'Doubles At Dusk' for Bill . . . one of the greatest thrills in upland bird shooting.

"If a fellow keeps his eyes open he can usually cash in on past hunting experiences. From now on, I'm off heavy field guns. I want a shotgun that combines the split-second speed of an automatic with the fast handling and light weight of a 'double.' That's why I'm buying a new Savage *Lightweight Automatic* when I can get one."

SAVAGE ARMS CORPORATION, UTICA, N.Y. • PLANTS IN UTICA, N.Y. AND CHICOPEE FALLS, MASS.



Savage Model 99—Hi-Power Rifle, a favorite with big game hunters. Streamlined, solid breech design, fast lever action, pulverizing power. A variety of styles and calibers, including Savage .300 and Savage .350-3000.

Savage Model 6—32 Caliber Automatic Rifle. Great for speed shooting at small running game. One of a great line of Savage .22's and medium power rifles.

Some SAVAGE Models Available Now . . .

The same skill and manufacturing "know-how" which enabled Savage Arms Corporation to produce more than 2,500,000 military arms during 5½ years of war production is now being applied to the manufacture of Savage Sporting Arms. Some models are available NOW . . . many more will be soon. See your dealer . . . and remember your new Savage is worth waiting for.



SAVAGE

WORLD FAMOUS FOR
DEPENDABILITY AND
ACCURACY

Manufacturer of Rifles and Shotguns, Lawn Mowers and Refrigeration Equipment.

NEXT TIME SAY BRIGHT STAR

and you will get a
FLASHLIGHT & BATTERIES
famous since 1909
for QUALITY,
STYLE and
SERVICE



BRIGHT STAR BATTERY CO. CLIFTON N. J.

row Wilson became the first occupants of the White House to choose a state dining service of American make—1700 pieces.

Each piece has a center of creamy white, an outer and an inner border of encrusted dull 24-carat gold separating a band of ivory tint. Each plate bears a seal of the President of the United States and the outer gold border has for its motif the Stars and Stripes.

No alien chinaware has been in the White House service since.

We Need More Soot

(Continued from page 41)

Tank trucks with these tires can dispense with the familiar dragging chain. Conductive rubber may well figure in postwar automotive products.

Another job for the technicians is further development of carbon black that resists heat. Tires made with this type of carbon black alone have been found to be cool running but have poor abrasion resistance. Continental Carbon Company workers have made recent advances in this field, and success may mean tires that are virtually blowoutproof.

Other industries have found many uses for carbon black. Paint makers employ it to add or subtract slight differences of color for hundreds of individual shades of paint. It's found in large volume in high grade black finishes such as automobile lacquers and varnishes. Carbon black in inks had an important role in developing modern high speed printing processes.

Total carbon black production for 1945 is estimated at 1,240,000,000 pounds in a survey by the United Carbon Company, Inc. This compares with 991,000,000 pounds last year and 477,000,000 pounds in 1938.

Paper manufacturers, who long have used carbon black in industrial paper products, found carbon black especially suitable for blackout curtains. Then came the paper shortage, with a dearth of bags and wrapping paper. Only waste paper was available for civilian needs, and it could not be used unless de-inked, a costly process. Why not try carbon black? Customer reactions were tested with black wrapping paper and bags. Results were surprising. People actually preferred the black paper, considered it more decorative and liked the way it withstood extra handling without soiling. Manufacturers now plan full production of black wrapping paper after the war. Black paper is important, too, for protecting photographic film from light.

Carbon black even fits into the concrete

(Continued to page 158)

"When I need a knife, I reach for X-acto!"

Expert Hobbycrafter Says X-acto Indispensable For Fine or Heavy Work

"Couldn't do without those handy little cutters," says Kenneth Whatmore, New York advertising executive. "Boats are my main hobby, and I find a hundred uses for my easy-cutting, non-slip X-acto knife, both in heavy building and fitting, and in carving the trim by hand.

"But believe me, X-acto is just as ideal for delicate jobs, too. Recently I designed a model post-war store, and cut the whole thing out of cardboard, in miniature, with tiny showcases, furniture, and even a merchandise display. I don't know how I could have done such a tricky job without those keen-edged, sharp-pointed X-acto blades to get in and around the sharp curves and corners."



Always Sharp, Always Ready —Blades For Every Purpose Quickly Interchangeable



Take your choice of three firm-grip handle styles, designed to fit the hand perfectly, giving greater skill and control.

Then slide in the most suitable of the 10 assorted blade shapes. (This takes about five seconds.) Each designed for a special purpose. All of finest surgical

steel, ground to scalpel-sharpness.

See how effortlessly X-acto cuts paper, rubber, wood or plastics. How easy it is to get that expert touch. Whenever you need a knife, reach for your X-acto — you'll have a lot less trouble, and a lot more fun!

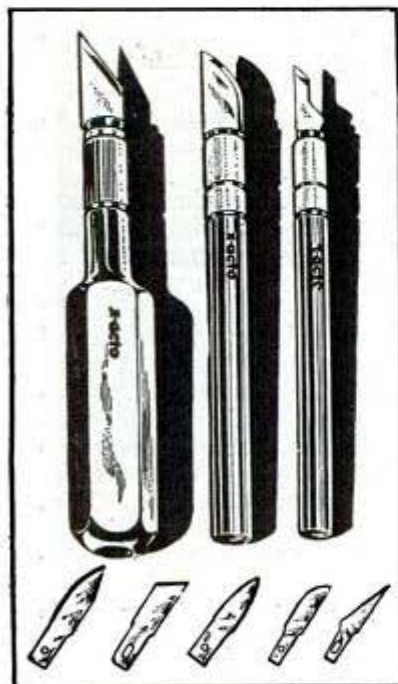

Christmas Inspiration!

X-acto De Luxe All-Metal Knife Chest, \$5. Three X-acto Knives, with an assortment of extra blades, in a handy wooden chest. Dream gift for hobbycrafters... man, boy, or girl.

*Reg. U.S. Pat. Off.

WHO USES X-ACTO?

Artists, photographers, draftsmen. Modelmakers, whittlers, woodcrafters. Botany and biology labs. Bookkeepers, taxidermists, tree nurseries. How do you use X-acto? We like to hear of new uses for this most versatile of knives.



X-ACTO TOOLS, TOO

Handy, sturdy, precise — Each perfect for its purpose



X-acto* KNIVES & TOOLS

X-acto Knives & Knife Chests From 50c to \$5.00

Buy where you see this sign. At better hardware, hobby and gift shops — or if not available write direct to

X-acto Crescent Products Co., Inc., 440 Fourth Avenue, New York 16, N. Y.

Send for these Helpful Booklets:

- (1) How to Build Scale Model Planes,
- (2) Boat Whittler's Handbook, 10¢ each.

Say you saw it in Popular Mechanics!



WHEN SPEED COMES EASY

Strong and swift the graceful greyhound covers distance with bullet-speed because the breeders developed fast action as his foremost quality. Plumb tools, too, are made for fast action—to do your work quicker and better.

But Plumb quality goes beyond getting your work done faster. The hang, the solid single-piece head of unblemished steel, the easy-grip handle of selected hickory, are the features that make Plumb outstanding wherever fine tools are known. Fayette R. Plumb, Inc., Philadelphia 37, Pennsylvania.



NAIL HAMMER



BALL PEIN HAMMER



HALF HATCHET

PLUMB

HAMMERS • HATCHETS • AXES • SLEDGES

industry. Traffic engineers sought an economical means of deadening light glare that reflected from pavements, causing accidents. Experimenting on newly paved roads, they found that one pound of carbon black mixed with 100 pounds of cement gave the road a neutral shade that absorbed light. Extra amounts of carbon black produced permanent black center lines in highways, eliminating constant repainting of dividing lines.

Army engineers overseas read of this with interest, for concrete landing strips flashed in the sun and were easily spotted by enemy aircraft. Carbon black added to the concrete now provides a satisfactory partial camouflage for new air strips.

All this with so commonplace a thing as soot! And the black stuff can be bought for as little as five cents a pound!

The Big Pit

(Continued from page 15)

254-day season. Usually the shipping season averages 6 to 6½ months.

Sometimes in early spring or early fall, freezing temperatures grip the North Country. Then ore in the ore cars hardens, and must be steamed to prevent it from becoming like concrete. This is done by running steam through hose lines from locomotives or special steaming plants to the cars and ramming the nozzles of the hose into the ore loads.

About 285 vessels make up the lake fleet, with numerous new carriers built by the United States Maritime Commission in operation. With the end of the war, 244 of these vessels were left in the ore trade as of Sept. 1, the others shifting to grain and coal transport. Tonnage of the fleet totals 2,940,090 gross tons. Leaving the Lake Superior ports, the boats head for the docks around Chicago, where the iron ore is unloaded in stock piles directly opposite the blast furnaces, or on to Conneaut, Ohio, where it is loaded into ore cars again for transport to the giant mills in the Pittsburgh area.

The overwater journey to Conneaut is about 900 miles, with another 200 to 300 miles of rail travel from mine to dock and dock to mill. It is this long overwater haul that permits economical transportation to the Pittsburgh mills of Bessemer ore containing as low as 45 percent iron. Of the 81,874,930 tons shipped from the Lake Superior district last year, 80,674,930 tons went by the water route, 1,200,000 tons going all rail.

Ore boats are unloaded swiftly with me-

(Continued to page 160)

On the Spot

...ABOUT WHAT BATTERY TO BUY?



TUNE IN THE AUTO-LITE radio show starring Dick Haymes, with Helen Forrest and Gordon Jenkins' Orchestra, Every Saturday Night -8:00 P.M., E.T., on CBS.

GET AN AUTO-LITE BATTERY

You can have the help of experts when you buy your next battery. Follow their example. They choose Auto-Lite batteries for service in the million-mile ocean-spanning Clippers, for service with our fighting forces in jeeps, tanks, and half-traes.

The qualities experts look for in a battery are the same you need in your car battery—long life, quick starts, dependable power and low-cost operation. That's what you get when you buy an Auto-Lite battery—specified as standard equipment by leading automotive engineers.

AUTO-LITE BATTERY CORPORATION • TOLEDO, 1, OHIO

Manufacturing Plants at: Niagara Falls • Indianapolis • Atlanta • Oakland • Oklahoma City • Toronto

AUTO-LITE BATTERIES

ENGINEERED AS A BALANCED UNIT OF THE ELECTRICAL SYSTEM

USE Snap-on TORQUEMETERS

COMPLETE RANGE
OF TYPES AND SIZES
FOR PRODUCTION
ASSEMBLY
MAINTENANCE

WHEREVER ACCURATE
BOLT TENSION
IS REQUIRED

FROM ZERO TO 30 INCH
POUNDS
— UP TO 2000
FOOT POUNDS



DISTORTION caused by inaccurate tensioning of studs and bolts wastes power, promotes wear and is often the cause of mechanical failure. With Snap-on Torquemeters precision tensioning is done more quickly and easily than "guesswork" tightening. Even inexperienced workers pull to specified tension every time . . . they see the torque reading as pressure is applied . . . they work swiftly, confidently, accurately.

In many plants Snap-on Torquemeters are standard wrench equipment for a wide range of assembly operations. *Wherever Torquemeters are used in the factory, it is equally important that they be used in service and maintenance work.*

The full range of Snap-on Torquemeters is covered in the 1945 catalog of 3000 Snap-on tools for production, assembly, maintenance. Mailed on request. Write, SNAP-ON TOOLS CORPORATION, 8062-K 28th Avenue, Kenosha, Wisconsin.



chanical unloaders, including the Hulett unloader in which the operator sits directly over the bucket and rides down into the hold with it. Mechanical bridges running at right angles to the vessels to be unloaded are fitted with automatic "grabs" which run over a trolley-train attached to arms of the bridges, and, after scooping up the ore from a ship's hold, deposit it in railroad cars or stockpiles at the furnaces. The bridges themselves move backward and forward along the unloading dock.

The ore boats don't return empty to Lake Superior, but carry coal and other material which isn't obtainable in the North Country. Though the ore fleet never fired a shot, it delivered the stuff that blasted the Axis out of existence.

Bringing the Atom Down to Earth

(Continued from page 6)

power we now have at hand we clear the channels of rivers of snags and hazards and we take out of harbors the natural menaces to traffic. Now with atomic explosive power, there is every reason to believe we will move out and conquer similar major dangers of the high seas.

That isn't all. As we may clear old channels, we may well make new ones. Remember reading how the French spent decades in trying to dig the Panama Canal and then failed? We took modern machinery and modern science (primarily to conquer yellow fever and malaria) and did it. At that, it required years of arduous toil. With atomic power controlled, as it will be just as other natural forces have been harnessed, a new Panama Canal is possible in weeks instead of years. One foresees such a channel charted, with calculations showing the exact amount of explosive power needed to remove rock or soil; then tiny holes dug, and a string of atomic pellets buried along the right-of-way. The switch is thrown—a deafening roar and clouds of dust and smoke follow. When they clear away, the rough channel lies before you, the major job done. Significantly, the atom-bomb explosions in New Mexico and Japan were outward and upward, not downward, thus making such power immensely effective for channel purposes.

From time immemorial, water transportation has been rated as ideal, both in smoothness and in cheapness. That is why even hand-dug canals are to be found the world over. Now that undreamed-of energy has been tapped, one may reasonably believe that atom-dug systems of canals will interlace every continent of the world.

(Continued to page 162)

HARLEY-DAVIDSONS ✓ ON THOUSANDS OF

"Want-First" LISTS

On war fronts and the home front, thousands of fellows are looking forward to the time when they can own Harley-Davidson Motorcycles. They know plenty about the dependable performance of Harley-Davidsons under toughest road and weather conditions — and in the deluge of letters they send in, they keep saying, "I've got a new Harley-Davidson on my want-first list."

Thanks, fellows — and you'll get that time-proved dependability that has made Harley-Davidson Motorcycles famous for economy, speed, and stamina. The war has further demonstrated the unmatched power and lasting qualities of Harley-Davidsons. You'll be proud to own and ride this World Champion Motorcycle!

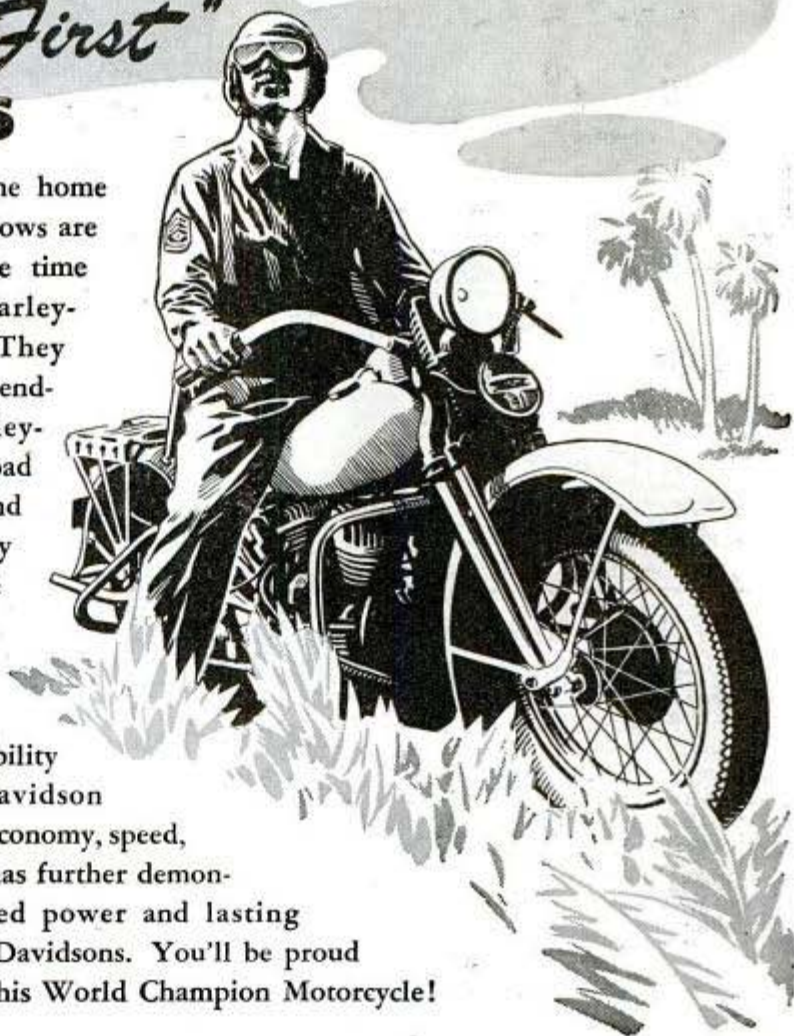

HARLEY-DAVIDSON *Motorcycles*

HARLEY-DAVIDSON MOTOR COMPANY, Dept. P, Milwaukee 1, Wis.

Please send at once free copy of 24-page "Enthusiast" Magazine, filled with motorcycle action pictures and thrilling stories.

Name.....

Address.....

City..... State.....





LOOKING for the speediest, smoothest cutting curved-tooth files in the world? Examine, "feel," try today's Nicholson Superior brand. Improved milling machinery—made only by Nicholson—forms the teeth with an accuracy, uniformity and "razor-edge" sharpness never before achieved in files of this type.

Special attention has been given to proper rake and clearance. Correct curve provides a double-shearing action that makes it easy to prevent file running off line. Nicholson hardening methods keep the teeth cutting longer.

Use Nicholson Curved Tooth Files on cast iron, sheet steel, commercial annealed tool steel; on aluminum, magnesium, babbitt, brass, lead, soft alloys; on plastics, hard rubber, wood. *Standard, Fine and Smooth* cuts—for fast metal removal down to fine-finishing; for lathe, die and tool work. Rigid and flexible types.

FREE BOOK, "FILE PHILOSOPHY"—48 illustrated pages on kinds, use and care of files. For master mechanics, production and purchasing heads.

NICHOLSON FILE CO., 22 Acorn St., PROVIDENCE 1, R. I.
(In Canada, Port Hope, Ont.)



Inland pleasure travel by boat may then come into style again.

Land benefits are foreseeable the same as those of water. Prehistoric animals made their trails across mountains, and buffalo and Indians followed them. Next came twin lines of steel and finally ribbons of concrete. All have followed the few mountain passes available, such as through the Rockies. Unlimited explosive power, as revealed by the atom bombs, throws wide open the possibility of cutting mountain passes down further, even blasting small peaks out of the way—in short, of making massive cuts for transcontinental roads.

Many portions of America are spotted with lakes, such as Michigan, Wisconsin and Minnesota; others, such as Kansas, where I came from, hardly know what the word means. Yet standing bodies of fresh water are rated high as both a health and agricultural benefit. I have seen scores of places in my rambles where a little variation of the topography would have made a beautiful lake, with all of the attendant benefits and pleasures. A controlled atomic blast might easily in such a case serve a double purpose—deepen a natural basin and throw up an earthen dam or barrier that would hold the water back and produce a lake.

One may see another variant of the use of atomic energy in earth removal. That is in strip-mining. In many coal and iron ore regions the veins lie only a few feet, maybe 15 or 20, below the surface. Stripping off the top dirt is a tedious job. Atomic explosives can be visualized as performing this task in minutes.

Time will be required, of course, to refine atomic power to the point where it can be used for precision jobs. But that will come, sooner perhaps than many of us think. As to what the splitting of the atom will make possible, estimates range all the way from fantastic conceptions by dreamers to remarkable ideas by scientists, whose sober judgment has always made them cautious. A few glimpses will be of interest.

On the seemingly fantastic side, a compendium of scientific opinion, issued more than a decade ago, contained the prediction that enough heat could be generated by smashing the atoms in a pound of water to raise the temperature of 100,000,000 tons of water—as much as flows over Niagara Falls in four hours—from freezing to the boiling point. It asserted that a breath of air contains enough atoms which, if split, would yield the energy to keep a plane flying for a year, or that a heavy train could girdle the globe several times on the atomic

(Continued to page 164)

*Advancements
everywhere
you look ...*



RELAX IN LUXURY! Rich two-tone interior. New fabrics are pleasing to the eye and touch. Smartly tailored and rightly contoured seats spell "comfort."



BRAKES THAT ARE QUICK AND QUIET! Improved hydraulics with new self-centering feature. Extra-size—big enough to stop a car of twice the weight!

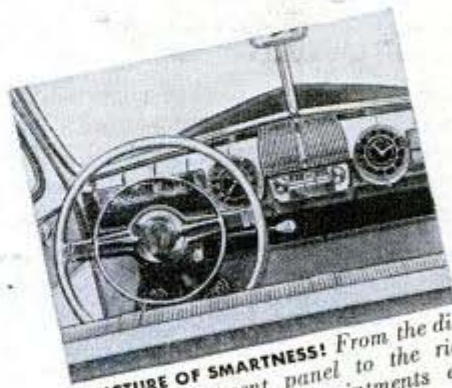

A PICTURE OF SMARTNESS! From the distinctive instrument panel to the rich plastics and trim, appointments are both colorful and practical.

Meet the new Ford for 1946! Big, beautiful—and with more new developments than many pre-war yearly models . . . It's new in style—with a broader hood and bright new massive grille...There's ten more horse-

power—and still more over-all economy . . . And for a luxurious, level ride, this car has new multi-leaf springing. Always, you travel smoothly, gently . . . Take your choice of two great en-

gines. The spirited V-8, now 100 horsepower—or the lively 90 horsepower Six . . . Production of these new cars is fast hitting its stride. Keep in touch with your Ford dealer.



FORD MOTOR COMPANY

There's a Ford in your future!

DISSTON

The saw most
carpenters
use



The widespread preference shown for Disston Hand Saws by carpenters and other saw users is a tribute to their fine cutting qualities. Records show many instances of Disston saws that have been in use for a half century or longer.

During the present shortage of tools, owners of Disston saws have been particularly fortunate. The fine quality of their saws has kept them serving well through the emergency, and assures many more years of dependable service.

Many hardware retailers and saw repairmen provide a special saw sharpening service. They will be glad to help you keep your Disston saw—or other quality make—in good, serviceable condition. If you need a new Disston saw or other tool for *essential* work, discuss your problem with your Hardware Retailer.

HENRY DISSTON & SONS, INC.

1111 Tacony, Philadelphia 35, Pa., U. S. A.



ASK FOR YOUR FREE COPY

Ask your Hardware Retailer for FREE copy of the Disston Saw, Tool and File Manual, or write to us.

energy from a railroad ticket; again, that a puff of cigarette smoke could run a tractor for a year, while from a shovelful of coal could be taken enough power to run all of New York's machinery for five years.

We also look back to 1931 and find the Berlin Institute of Physical Research claiming one gram of water contains \$125,000 worth of energy—it would cost that much to produce it by ordinary means. Two years later W. D. Harkness of the University of Chicago estimated a pound of hydrogen to be equal to 10,000 tons of coal; the atomic energy in a handful of snow would heat a large apartment house for a year; a trip around the world could be made on the energy generated from a teaspoon of water; a gram of matter would send an airplane around the world without stopping to refuel. And now, by way of variety, we have the chief of the U. S. Rocket Society saying that a trip to the moon by way of atomic power is not only possible, but one may before long go joy-riding among the planets!

On the other hand, within recent days Dr. Samuel K. Allison of the University of Chicago, another great scientist foremost in atom-bomb development, said that we may be heating whole cities with atomic energy within a few years. None less than the National Advisory Committee for Aeronautics has just affirmed that "it is not fantastic to visualize a fuel supply the size of a brick with sufficient power to fly around the world many times." The best and most authoritative picture of all is contained in the authorized release on the atom bomb, which spoke of it containing the explosive force of 20,000 tons of TNT.

The main point is, we are at the gateway to a new world, the world of unlimited power. As to the time required to reduce atomic energy to efficient use, one can only guess. Some great minds say a few months to five years, others say a generation, and a few assert it will take a century. A Gallup poll showed people generally believe that "atomic energy will be harnessed to supply power for industrial and other uses within the next 10 years." Bearing that out is the statement by Prof. M. E. Oliphant of Birmingham, England, University, one of the scientists responsible for the development of the atom bomb, that inside of the next decade atomic energy will replace all forms of power for large-scale production.

If the atom can be split, it can also be mastered, in the view of most authorities, particularly those associated with the bomb development. High regard must be given to the affirmation of Dr. J. R. Oppenheim-

(Continued to page 166)



Be "All Set" For '46

— ORDER YOUR EVINRUDE NOW!

PRETTY SWELL . . . after all the wartime years of doing without . . . to be able to confidently say, "Next year I'm certainly going to have a new Evinrude".

Trouble is . . . so many people are definitely planning on owning new Evinrudes next year, that inevitably some of them are going to be disappointed.

It's true, next year's Evinrudes are on the production lines right now. And Evinrude's

facilities are more extensive and finer than ever before. But the demand for Evinrudes is unprecedented in Evinrude history.

So, if it's a genuine *Evinrude* you want, guard against disappointment by calling on your Evinrude dealer *now*. A modest down payment will assure delivery of the model you choose. The new catalog of 1946 Evinrudes will be mailed on request — write for it today! EVINRUDE MOTORS, 5115 N. 27th Street, Milwaukee 9, Wisconsin.



FOR YOUR OLD EVINRUDE!

Right now is the time to make sure that your motor will be *ready to go* on your first trip next season. Take it to your Evinrude dealer for a complete check-up, needed repairs, and safe winter storage. If you plan to turn it in on a new model, discuss a trade-in right now. Your old motor will be accepted as a *priority down payment* on any new Evinrude.

EVINRUDE

— OUTBOARD MOTORS —



Here's a helping hand

ON HOME MODERNIZATION ...

EVERYONE WANTS MORE COMFORT—

Comfort comes first in your modernized home! And the way to get it is to apply Balsam-Wool in your attic! Then you'll have a warmer home in winter—save up to 20% on fuel bills. Then, too, you'll have a cooler home in summer. Balsam-Wool is easy to apply—windproof, moistureproof and fire resistant.

NEED AN EXTRA ROOM?

If you are cramped for space, build a new room quickly with Nu-Wood! Nu-Wood builds new rooms or partitions quickly and easily. Multiple-purpose Nu-Wood insulates, decorates and quiets noise—to give you more value for every dollar!



NEW LIFE FOR "TIRED" ROOMS

Old walls and ceilings are quickly covered with Nu-Wood to create brand new rooms in the modern manner. Nu-Wood is available in tile, plank, wainscot—with predecorated wood moldings.



PLANNING A NEW HOME?

... then be sure to include Balsam-Wool Sealed Insulation and Nu-Wood Interior Finish! See your lumber dealer or mail the coupon.



Balsam-Wool

GUARANTEED SEALED INSULATION.

Wood Conversion Company
Dept. 210-11, First National Bank
Building, St. Paul 1, Minnesota

Please send me full information on Balsam-Wool and Nu-Wood. I am a
Home owner Contractor
Renter Student
Architect

Name

Address

City.....State.....

HERE'S REAL HELP FOR YOU!

We will be glad to give you full information about Balsam-Wool and Nu-Wood. Plan your modernization or new building program NOW—mail the coupon!

BALSAM-WOOL • Products of Weyerhaeuser • NU-WOOD

er, credited by the War Department with being as much responsible for the atom bomb as any other scientist, that world changes by 1965 will be more marked than those which took place in the two decades following Faraday's revolutionary work with electricity.

There is good reason to expect quick action. We live at a feverish pace as the result of the war, and this pace cannot be expected to slacken much. Reconversion is only the prelude to swift action of many kinds at hand. And so great is the realization of the import of the discovery of the means to harness atomic energy that we can expect the greatest peacetime scientific race against time in all history.

We read comparisons of the time it took the auto and the airplane to come into general use. The first gasoline auto was invented in Europe in 1882, but widespread use did not begin until about 1910. The plane was two decades reaching general acceptance. When Marconi sent his first wireless waves across the English Channel, he was gravely informed by "experts" that radio waves never would cross the ocean. Yet Marconi did it in just two years!

One would stick his neck out if he attempted to set a minimum time limit on the commercialization of atomic energy; he is wiser if he points to the astounding genius which split the atom, and to other unbelievable attainments of science and industry in recent years, and simply says: "Any time!"

Most authorities to date do not envision early atomic energy plants in autos or airplanes using pinpoint supplies of atoms for power; rather they foresee, at first, atomic energy developed and capitalized in vast generating plants for electricity or direct power, which will be available for every purpose where distributed energy is used. In the case of big ships, of course, atom fission may supply the power direct—in fact, back in 1939 the Navy allotted \$2,000,000 for atomic power experimentation for just such a purpose.

Even with such restricted use as that, one can see an incredibly thrilling era ahead. Although each one of us now has something like 113 mechanical slaves working for him, as Dr. Karl T. Compton, president of the Massachusetts Institute of Technology, affirms, that may be multiplied countless times. Homes heated and lighted for a cent or two a day, or by power possibly furnished free as a public utility. Highways across the nation lighted as bright as day will make night travel a delight. Planes of 2000-miles-an-hour speed are foreseen,

(Continued to page 168)

Ingenious New Technical Methods

To Help You With Your Reconversion
Problems

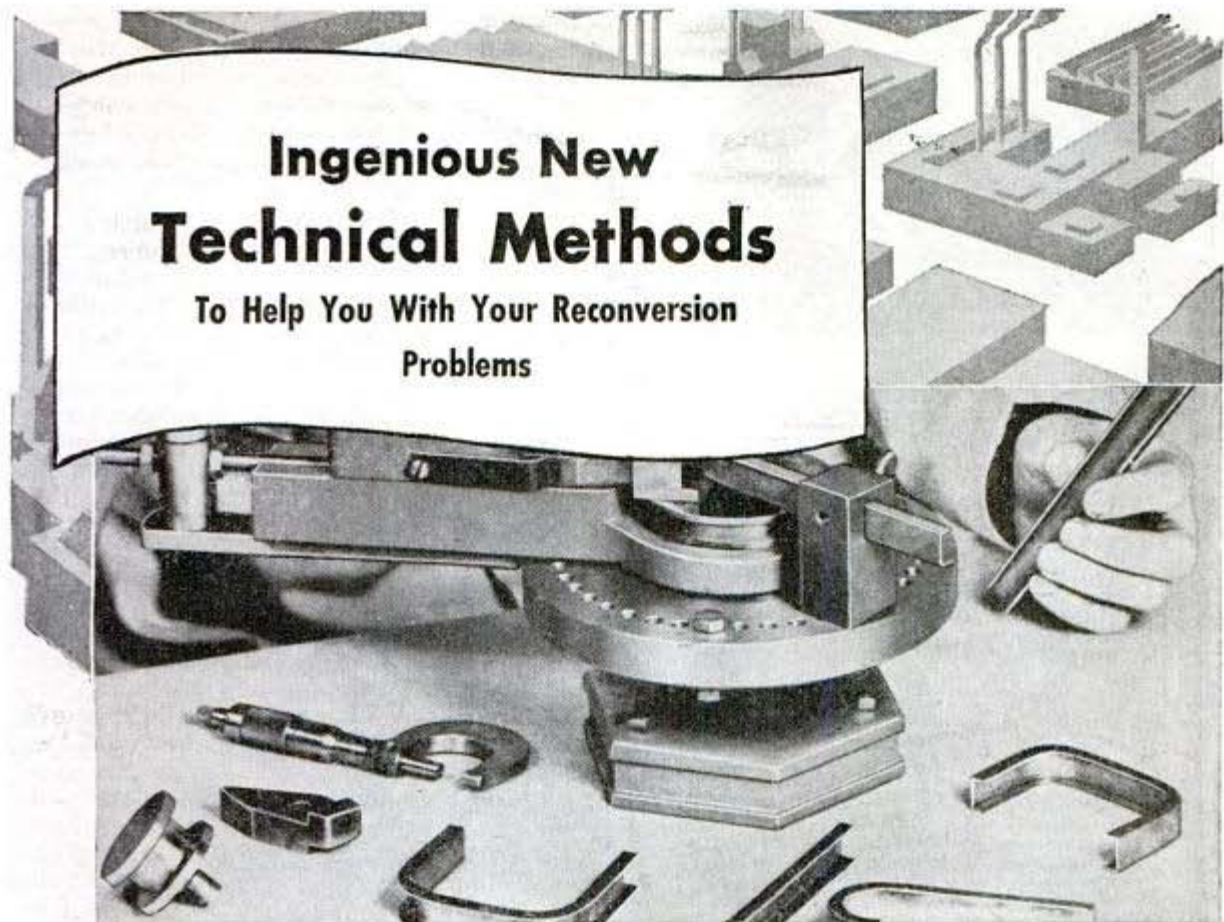

"DIE-LESS DUPLICATING" ELIMINATES TIME LOSS AND DIE EXPENSE!

The DI-ACRO Bender is a precision unit, designed to form and duplicate an unlimited variety of parts and pieces—eliminating, in many cases, the need for special dies. Tubing can be accurately formed with the DI-ACRO Bender to a center line radius as small as $2\frac{1}{2}$ times the outside diameter of the tube without distortion. Shapes and outlines, impossible to obtain with regular production dies, are easily formed with the DI-ACRO Bender. These include round, half-round, hexagon, and square rod, tubing, angle, channel, moulding, strip, stock and bus bar.

Stops may be set and material guides mounted for production work in excess of 1000 operations per hour. The Bender is compact and portable, ideal for temporary or permanent work. There are no extra parts to purchase, as the DI-ACRO Bender has been built to cover a wide working range, with simple conversions.

Peacetime production for industry, forecasts the return of Wrigley's Spearmint Gum—that favorite "help on the job," for workers everywhere. But Wrigley's Spearmint will be back only when conditions permit its manufacture in quality and quantity to meet your needs. Until that day, we ask you to remember the famous Wrigley's Spearmint Wrapper shown at right, as your guarantee of the finest chewing gum that can be made.

You can get complete information from
O'Neil-Irwin Manufacturing Co., Minneapolis 15, Minn.

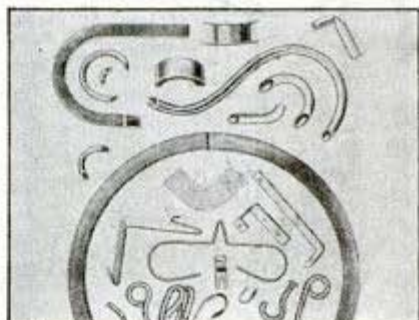

Typical Shapes Formed by the DI-ACRO Bender



Remember this wrapper

Z-89

The Best Marlin RIFLES SINCE 1870

- Marlin Rifles are being made again! Quantities are limited but several thousand sportsmen will soon own brand new Marlins...the best in 75 years. Honest guns—safe, accurate, long-lived. Built to standards that made the name famous with war-improved skills.

Model 39-A

By many considered the world's best all-around light rifle, .22 cal., lever action, 25 shots.

OTHER MARLIN .22 RIFLES

MODEL 81-DL BOLT ACTION .22 CALIBER REPEATER

Dependable patented magazine feeder. Automatic side ejection. 25 shots for vermin and small game.

★

MODEL 80-DL CLIP MAGAZINE .22 REPEATER

8 fast shots for small game. Among rifles recommended for target practice by N. R. A. Man-sized gun at a low price.

★

MODEL A1-DL AUTOMATIC .22 CALIBER RIFLE

6 shots as fast as you can pull the trigger. Ideal for fast-moving small game, vermin.

If you're lucky enough to get a new Marlin, treat it well. It will repay your care with many long years of service.



THE
Marlin
FIREARMS COMPANY
New Haven, Conn.

with any spot on earth only six or seven hours from one's doorstep. Cities will be scattered because there will be no need for congestion at the source of power. Coal mines will become a curiosity like the dodo. One can have controlled agriculture in his back yard, growing the finest vegetables and fruits as he desires. He need never want for the daintiest and rarest delicacies direct from the garden.

Unlimited power will mean the production of ample food, clothing, housing and other necessities as well as myriad luxuries, for everyone. Poverty and famine, slums and malnutrition will disappear from the face of the earth. Diseases will be attacked with fresh vigor because there is to be an ample margin of time for the cultivation of health and superb care of the body. Abundant time for study and research will make a game of mental development, and intelligence and education will reach a new high. Wars will fade out as an amplitude of production of all things necessary to adequate and enjoyable living anywhere and everywhere will remove the fundamental economic and material rivalries that provoke war. Just as America, with an abundance of resources and with high standards of living, is a peaceful nation, so the spread of wealth over the poorer sections of earth, where wars breed, will destroy the swamps where such evils generate. A new and excellent culture, the like of which the world has never before glimpsed, is likely to come into being.

As to healing, eminent scientists point out that X-rays, radium and atomic energy are links in the same chain of radioactive substances and forces, and therefore an astonishing new era of success in the treatment of disease which X-ray and radium now effectively treat, particularly cancer, may be expected.

The by-products of solving the mystery of the atom will doubtless be as valuable as they will be intriguing. One very intelligent financial editor suggests that unlimited atomic energy may so increase our production that a corresponding enhancing of the national wealth will be so great that it will "outrun our public debt"—in other words, make the public debt relatively such a small item that it can be handled without a convulsion in the process!

No one can chart the future, but evidence is at hand that the greatest magic carpet of all the ages is being unrolled. It remains for man to use it for his own good rather than his ruin. But we need not fear. In the long run, man usually chooses the thing that will keep him going and improve his lot—at least an atomic trifle!

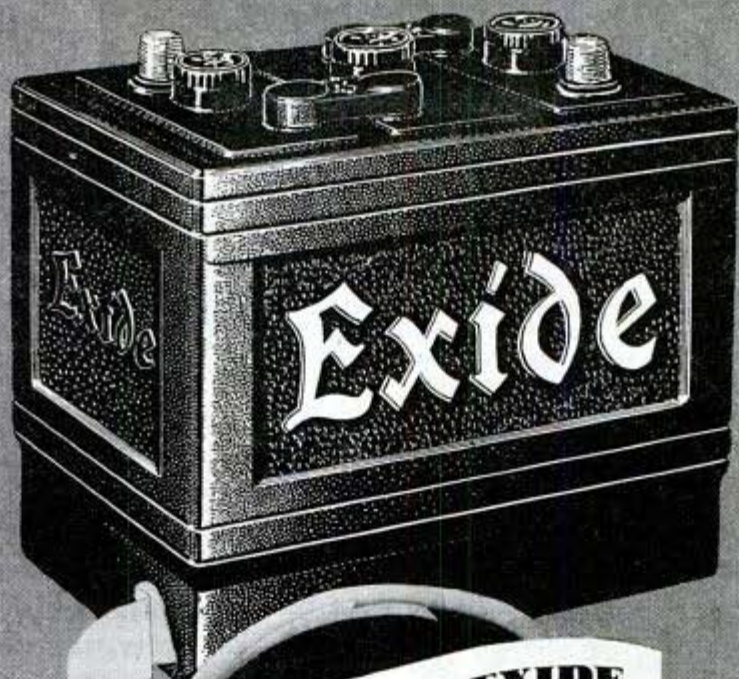

WHEN IT'S AN EXIDE

... YOU START

A good dealer is known by the fine products he sells and the dependable service he renders. Generally both will be found in the establishment of the man who sells brands of KNOWN high quality.

THE ELECTRIC STORAGE BATTERY COMPANY
Philadelphia 32

Exide Batteries of Canada, Limited, Toronto



BUY TO LAST

Depend on the Exide dealer for good products, good service.

DICK KOLLMAR,

Radio's Popular "BOSTON BLACKIE"
chooses **Forecaster!**



"Top of my Xmas Gift list for service men abroad is a mellow-smoking, sweet-flavored Forecaster. If there are any more to spare, friends at home will get them."

Dick Kollmar is typical of the gift-giving American who knows the life-long enjoyment a Forecaster will yield. It's a finely made pipe that gives real smoking pleasure without demanding a premium price. That's just why so many Forecasters are going to servicemen . . . they too find real pleasure and relaxation in a Forecaster smoke. If your dealer is temporarily out of stock, it's because the armed services come first. Keep asking though! Once you own a Forecaster you'll enjoy it always. National Briar Pipe Co., Jersey City, New Jersey.

\$1.50

SIR SHELDON
in natural
briar, \$2.50

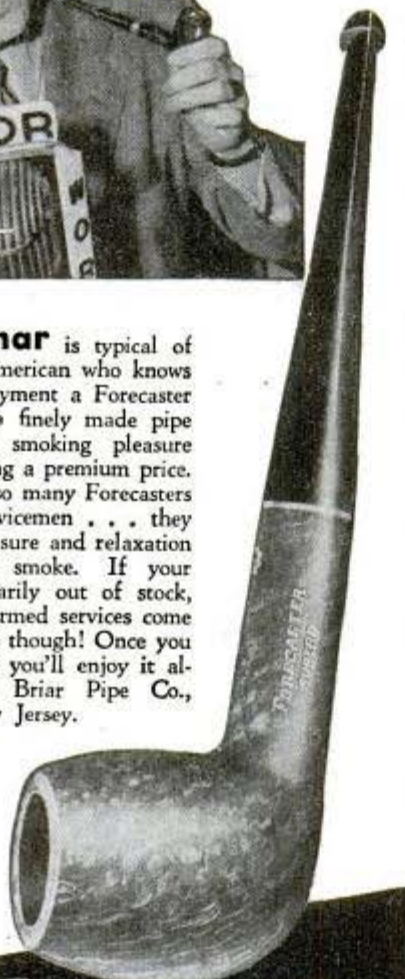

NATIONAL
Forecaster
SUPERB

NAMECHAIN

Personalized
KEY CHAIN
Spells YOUR NAME
in full

DURABLY CONSTRUCTED
IN GOLD PLATE

The Perfect Gift

Each Namechain made to your order . . . up to 16 letters allowed. Individually packed in Gift Box. Orders filled in one day. Sent Postpaid for \$3.50.

Namechain Mfg. Co.
19 E. Pearson St., Dept. S, Chicago 11, ILL.

Handles can be used over and over with 1, 4, 5 and 6 lb. hammer heads.

Johnson **LEAD HAMMERS**
WITH SHUR-GRIP HANDLES

Specially-designed Shur-Grip Handle assures "bull-dog" grip — one almost indestructible. Send for complete price list, No. 1H.

JOHNSON TOOL CO.
L. H. COOK, Owner • • • EAST PROVIDENCE, R. I.

MARCOT KEY MACHINE

MARCOT #8 Key Machine..\$55.00
2,592 Assorted Key Blanks.. 73.50
Auto Code Book & Set of
Auto Depth Keys..... 10.50
Set—Key Files, Tools, Pins,
Springs, Thimbles..... 10.50
Key Machine Cabinet..... 20.00

\$169.50

A. J. MARCOTTE CO., 1200 N. Kedzie Ave.,
CHICAGO 51, ILL.

RADIO PHONE SET

Dynamic microphone and dynamic receivers of the finest quality. Made to U. S. Army Signal Corps Specifications and passed by Signal Corps Inspectors. Water shock weather and altitude proof. Precise and delicate as a watch; rugged as a tank. Were used on tank and aircraft intercom systems. Part of B-19 equipment. Can be used for record recording, telephone sets, for talking through radio, and many other uses. Inside of earphones make fine loud speakers for pocket radios. Complete set consisting of two receivers, cord set, lead band, and dynamic hand microphone for less than regular cost of dynamic mic: \$14.95 post paid.

Electronic Products Co., St. Charles, Ill.

QUICK FIXER!

Broken furniture is one of many home repair jobs that can often be done easily with **PLASTIC WOOD.**

PLASTIC WOOD

HANDLES LIKE PUTTY • HARDENS INTO WOOD

*When Junior borrows the car be glad
it has Guide Sealed Beam Units*

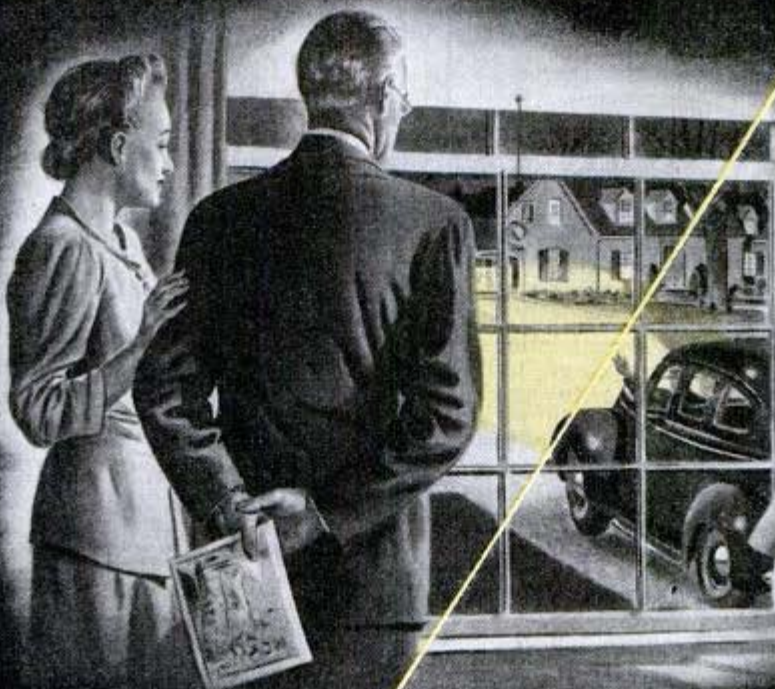

BUY VICTORY BONDS

SAFE HEADLAMPS ARE "CORRECTLY AIMED" HEADLAMPS—
HAVE YOURS CHECKED TODAY



Guide Sealed Beam headlamp units represent the safest automotive lighting that science and research have yet developed. Their far-reaching "upper" beam spreads a "carpet of safety" for country driving; their glare-free "lower" beam is properly distributed for city driving and for meeting cars on the highway.

They're right, they're bright — and they stay that way! For Guide Sealed Beam units *will not grow dim, will not fail* even if the lens is cracked by a stone or blow. That is the Guide "double protection" feature — no dim-out, no black-out. It is yours at no extra cost.

NO DIM-OUT—The Guide Sealed Beam unit is sealed against dirt, dust and traffic film. It stays bright throughout its long life — maintains high efficiency without service or maintenance.

NO BLACK-OUT—Your Guide Sealed Beam unit will not fail in case of an accident to the lens. The bulb within the sealed unit continues to burn with full intensity—lights the way safely until the damaged part can be replaced.

GUIDE LAMP DIVISION OF GENERAL MOTORS CORPORATION

LET SAFETY SHARE THE RIDE — REPLACE WITH GUIDE



HOW TO OBTAIN SHOP TOOLS

at the earliest possible moment and
**PAY FOR THEM OUT OF
PATRIOTIC SAVINGS
IN WAR BONDS**

Own versatile, low-cost, sturdy

Boice-Crane
Band Saws - Saw Jointers
Jig Saws - Spindle Shapers
Belt Sanders - Spindle Sanders
Drill Presses - Lathes
Thickness Planers

Write today for folder on the

*Boice
Crane*

PURCHASE PRIORITY PLAN

a safe, convenient plan for forward-looking shop men and home craftsmen.

True, government priority restrictions are removed, but civilian power tool delivery delays will continue to exist for many months. You can avoid prolonged waiting for your tools, or the necessity of buying something less satisfactory, by reserving a preferred delivery position now. Use this convenient coupon to get details.

BOICE-CRANE CO.
943 Central Ave., Toledo, Ohio

Please send, without obligation or cost, details of the Boice-Crane Purchase Priority Plan, together with a copy of your catalog on shop tools.

NAME _____

STREET _____

CITY _____

**AIR
RIFLES**

BENJAMIN

**AIR
PISTOLS**

ORDERS NOW ACCEPTED

EARLIEST POSSIBLE DELIVERY REALLY ASSURED—ACT NOW!

ORDER Latest Models **BENJAMIN AIR RIFLES & BENJAMIN AIR PISTOLS AT ONCE.** Send for our **FREE ILLUSTRATED FOLDER** and complete Specifications **TODAY.** BOTH CALIBRE **BENJAMIN H-C PELLETS ARE AVAILABLE NOW.**
BENJAMIN AIR RIFLE CO., 812 MARION ST., ST. LOUIS 4, MO.

Watch Crystals You CAN'T BREAK



PROTECT YOUR WATCH

A watch with a broken crystal is useless. Go to any jeweler—ask him for a **G-S FLEXO CRYSTAL 100% BREAKPROOF.** Fitted while you wait. Any size. Any shape. **Guaranteed.**
GERMANOW-SIMON MACHINE COMPANY, Rochester, N.Y.

MULTIWELD "150" A. C. ARC WELDER



Not a toy, but a **HEAVY DUTY** quality welder for 110 or 220 A.C. Heavy transformer, four large continuously wound coils (no solder). Over 200 different heats at hairline control. Use any type A.C. electrode 1/16", 3/32", 1/8", 5/32" and 3/16". Low operating cost. Two year guarantee!

\$82.50

F.O.B., CHICAGO

LECTROWELD "225"

Can be used on 110 v. 50 or 60 cycle in lower setting or 220 v. 50 or 60 cycle single phase current. Electrodes up to (not including) 1/4 inch. Both machines ideal for carbon-arc process. Two year guarantee.

\$112.50

F.O.B., CHICAGO

PHILLIP WILSON, 309 E. Bridge St., Streator, Ill.

★ ★ 500 PERSONAL GUMMED LABELS

COMPLETE NAME AND ADDRESS
PRINTED ON EACH!

500 Personal Labels, only 50c Postpaid! Two-colors—handsome blue printing of your complete name and address on attractive white gummed label paper! Use on letters, envelopes, postcards, checks, books, tools, egg cases, etc. **HUNDREDS OF USES!** Wonderful for those in Service! Order today! **FAST SERVICE.** Limited supply. Money-back Guarantee.

Only
50¢

WESTERN STATIONERY CO., Dept. 237-M, Topeka, Kan.

(STANLEY) NEW PLAN SET (of Five Plans)—10c

FIVE New Plans for Small Colonial Furniture, including: Book Stand, Magazine Case, Magazine Stand, Bench. Postpaid for 10c. Stanley Tools, 1115 Elm St., New Britain, Connecticut.

YOU NEED THESE CRAFTSMAN'S TOOLS

SUPER DRILL GRINDER



Sharpens round shank drills from 3/32" to 1 1/16" diameter. Grinds Old Drills like new in 4 different drill point angles. Grinds Short, Medium and Long Twist Drills from 1/8" up to 1 1/2" long, for hand or power grinding wheels.

70,000 NOW IN USE!

Grinds your drills like factory in 25 seconds. Gives perfect center and clearance. Saves drills, time and money. No shop should be without the Super Drill Grinder. Guaranteed to do the work or money back. The Grinder that gives a round point!

Only
\$2.95
POSTPAID

SUPER ARBOR

(PATENT PENDING)

A combination drilling or grinding wheel attachment. For 3/8" motor shafts. Will take grinding wheel with 1" hole on shaft and 3/8" hole on small end. Extension can be used for rag or wire wheel, or 3/4", 24-thread drill chuck which holds drills from No. 60 to 3/4" in diameter. Right hand thread only.

Price Only

\$1.50

POSTPAID

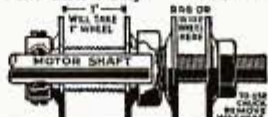

SUPER HACKSAW

AND DIE FILE HOLDER



The tool with 100 uses! Holds broken hacksaw blades—used by mechanics, electricians, plumbers, auto mechanics, hobbyists and repairmen. Perfect for all "round household needs"; ideal for difficult close-quarter work. Nothing like it for tool and die men. Price, without saw blade.

Only

95¢

POSTPAID

CRANDALL MFG. CO.

1512 West Slauson, Dept. FA-11
Los Angeles 44, California

LIONEL

**REALISM
WILL AGAIN BE
YOURS — SOON!**

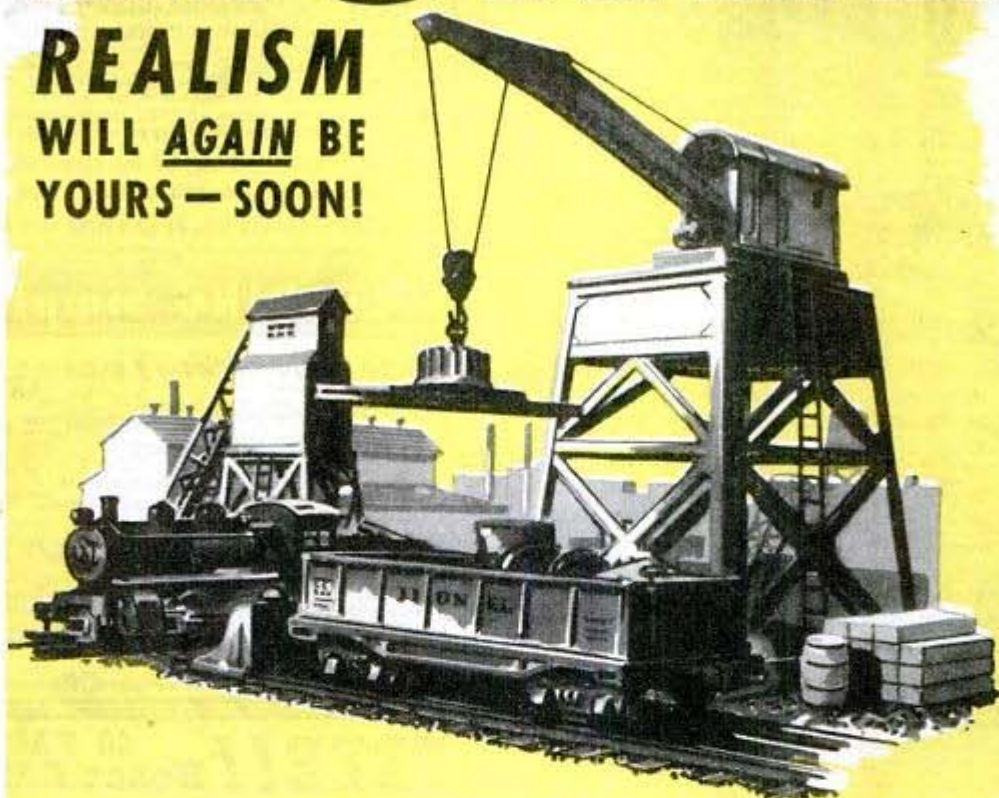

Along the gleaming right of way of your personal pike, Lionel freights and passenger trains will soon be rolling—newer, finer, more realistic than ever before.

Startling improvements are being made in both locos, cars, and accessories. Some of these things are "Top

Secret" and cannot be told now.

New and undreamed of realism is on the way. In the meantime, plan out your new model pike. To guide and help you in your planning, here are two brand new books. They are FREE to everyone who loves model railroading.

BOTH BOOKS FREE CLIP AND MAIL THIS COUPON NOW!



The Lionel Corporation
Dept. No. M
15 East 26th Street, New York 10, N. Y.
Please rush my Two Big FREE Booklets!

Name

Address

City Zone No. State

FOUR OUTSTANDING FEATURES

Originally developed by Mallory for the U. S. Signal Corps, they give—

- ⚡ From 4 to 6 times the life of the batteries they replace—in smaller size.
- ⚡ Continuous service—need no rest periods.
- ⚡ Practically constant voltage throughout operating life.
- ⚡ Far longer "shelf life"—withstand extremes of heat or humidity.

These features now are being incorporated in designs for commercial use—look for announcements in the near future.

P. R. MALLORY & CO., Inc.
MALLORY
Tropical*
DRY
BATTERIES

*REG. U. S. PAT. OFF.

P. R. MALLORY & CO., Inc.
INDIANAPOLIS 6, INDIANA

FOREDOM *Flexible Shaft* MACHINES

with the "PENCIL-SIZE" handpiece

Foredom's remarkable PENCIL-SIZE HANDPIECE gives you finger-tip control in performing scores of tasks—grinding, polishing, deburring, sharpening, cleaning, slotting, milling, etc. Gets into tight places that ordinary tools cannot reach. Used on all metals, wood, glass and plastics. Model 505 as illustrated \$17.50. Other models, some with larger, ball-bearing handpieces, up to \$48.75.

Catalog No. 82 on request.

OVER 50,000 FOREDOMS HAVE BEEN SOLD
FOREDOM ELECTRIC CO., 27 Park Place, New York 7, N. Y.

SOLDERING Simplified

with this revolutionary gun-type iron

INSTANT HEATING—Fast Handling

The streamlined BAKER Flash will do the work of several ordinary type irons—faster, easier, more economically. Instant heating, high or low heat as desired, by control of your "trigger finger". Hot only when actually soldering. Non-firing, protected gun grip and perfect balance for easy, steady application. Unexcelled for work in close places. Operates from standard storage battery or plug-in with 110-volt transformer. Only \$4.75 post paid. With transformer, \$8.95. Send check or money order.

pat.
pend.

BAKER-PHILLIPS CO., 3051 Lyndale S., Minneapolis 8, Minn.

FREE!! 40 PAGE HOBBY CATALOG

Over 1000 Items — Over 300 Photos

Our new 40 page catalog is the "bible" of wide-awake modelers. Hundreds of models to choose from! Planes, engines, boats, jeeps, tanks, gliders, supplies, etc. Send for yours today!

AMERICA'S HOBBY CENTER, Dept. B115, 40 E. 21 St. N. Y. 10, N. Y.

BUILD AN ARC WELDER FROM OLD GENERATOR

For Light or Heavy Work. 75-200 amperes. Complete PLANS 35c. Send today and we'll include FREE our Big NEW Catalog.

LEJAY MANUFACTURING CO.
1347 LeJay Bldg., Minneapolis, Minn.



REFRESHING SHAVES FOR "SMART" MEN!



5 BLADES FOR 25c

Concave-honed
HOSPITAL
BRAND
RAZOR BLADES
NEWARK 2, NEW JERSEY

NOW! A LOW-COST PRECISION MILL FOR PRODUCTION, EXPERIMENTAL AND HOME USE

Diamond

MODEL B-12
Net weight—440 lbs.

Ideally suited to needs of experimenters, home craftsmen and precision manufacturers. Powerful, sturdy; for oil precision milling. Beautifully finished. 6 spindle speeds • non-slipping, double vee belt drive • tapered roller spindle bearings • 12" table travel • 6" transverse and 9" vertical table movements. Immediate delivery without priority. All types accessories available. Price only \$372.00 f.o.b. Los Angeles, less motor. Distributors in principal cities. Write for folder!



DIAMOND MACHINE TOOL CO.
3434 E. Olympic Blvd., Los Angeles 23, Calif.



Manufacturers of the DIAMOND Line of Precision Milling Machines and Accessories

**THE TRUTH
THE WHOLE TRUTH and
NOTHING BUT THE TRUTH**



*about the condition
of your oil*

When the service man wipes your dipstick on a clean, white AC Oil Test Pad,—and then shows you the smear on the Pad,—*he's showing you the actual condition of your engine oil.*

If the smear has a black, thick center; or if tiny black specks show up in the smear; there's damaging dirt in the oil.

AC Oil Filters and Elements keep oil clean. Dirty oil clogs piston rings. Then, valves become sticky and carbon forms faster, causing loss of power. As your power goes *down*, consumption of oil and gas goes *up*.

So, whenever you have your oil checked, be sure the service man shows you the facts of its condition—with an AC Oil Test Pad.

AC SPARK PLUG DIVISION
GENERAL MOTORS CORP.



AC
OIL FILTERS

SPEED FINAL VICTORY—BUY WAR BONDS



**STOPS
SQUEAKS**

3-IN-ONE Oil lubricates without gumming, cleans, polishes, prevents rust. Use it regularly on locks, hinges, sewing machines, tools



"3-IN-ONE" OIL

**RECORD YOUR
NEGATIVES AND PRINTS!**



Use this specially designed rubber stamp to keep an accurate, permanent record of your prints.

**\$100
POST
PAID**

For Yours and
Posterity's Sake
—Record the Back
of every "Snap"
You Take!

GEORGE REINHARDT 6813 VAN NUYS BLVD.
VAN NUYS, CALIFORNIA

**HOLD-E-ZEE
AUTOMATIC GRIP SCREWDRIVERS**

Hold-E-Zees do the job better, faster. They excel wherever screwdrivers are used. Gripper instantly released by spring action, sliding up out of way when not in use. *High-quality materials throughout.*

Upton Bros., Inc.
86 Exchange St.
Rochester 4,
N. Y.



At
Leading
Dealers Everywhere



To-night... pick up your pipe

A load of Christian Peper Pouch Mixture will help you forget the problems of the day as you settle back and relax with this friendly smoke.

There's down-to-earth satisfaction in the honest fragrance, the just-right mildness of "Peper's Pouch," superb blend of fine imported and domestic tobaccos.

POCKET-SIZE PACKAGE
AT TOBACCO COUNTERS **25c**

Christian Peper · St. Louis
Fine Tobaccos Since 1852



Be the authority on accuracy in your shop!

A man's work is only as good as his measurement. You can be the "accuracy man" in your shop. Learn to work with genuine Ford "Jo-Blocks," guaranteed accurate to within 4 or 8 millionths of an inch, plus or minus. For as little as \$23 list price, you can own a fine working set of Jo-Blocks—keep your mikes and gages at millionth-inch precision. There is only ONE true American-made Jo-Block, made only by—

**WRITE FOR
THESE FREE
BOOKLETS!**

An absorbing story of the search for precision. A new De Luxe Catalog of Ford Jo-Blocks and Accessories.

FORD MOTOR COMPANY
Johansson Division
Dept. 1011, Dearborn, Michigan

Johansson
GAGE
BLOCKS



HUNTER'S COMPASS

Hunting Case,
Watch Type, All Metal, Jeweled **\$3.75**

**Engineers All Metal Army
Type Hand-Sighting**

LEVELS

\$1.50



PUBLIC SPORT SHOPS

13 S. 16th St., Phila. 2, Pa.

No COD's

OTTAWA TRACTOR SAW



**FREE
BOOK
and
Price List**

350 CUTS PER MINUTE

Make money sawing wood. Use Ottawa—fastest cutting. Cuts large, small logs easiest way. Falls trees. One man operates. Thousands in use. Built to last with heavy, stiff saw blade. Positive safety clutch control; uses power take-off any tractor.
OTTAWA MFG. CO., D1127 Forest Ave., Ottawa, Kan.

DEVELOP THE POWERFUL INFLUENCE



FEUCHTINGER Method Guaranteed
IN YOUR VOICE

DO IT YOURSELF AT HOME

Write for the Voice Book—FREE!

Sent only to those over 17yrs of age

PERFECT VOICE INSTITUTE

Studio 9358

Kimball Hall Bldg., Chicago 4, Ill.

KELNOR

AMERICA'S FINEST LINE OF
LIGHTWEIGHT ELECTRIC
SOLDERING
IRONS

FOR CRAFTSMEN IN FACTORY
AND HOBBY SHOPS IF YOUR
DEALER DOES NOT CARRY, WRITE
KELNOR MANUFACTURING CO.,
CENTRAL TOWER,
SAN FRANCISCO 3, CALIFORNIA

REG. U. S. PAT OFF PATS. APP FOR

PLASTICS

Plexiglas, Lucite, Bakelite, Lignolite, Lumarith, Ethocel, Cellulose, Acetate now available in sheets, tubes and strips. Fine assortment of sizes. No priority required. Cements, dyes and other plastics supplies, too! Send 10c today for complete Catalog!

CARMEN-BRONSON CO., Dept. 11-B

165 E. Third St.

Mt. Vernon, N. Y.

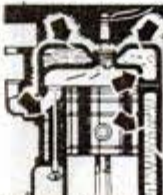

REPAIR CRACKED BLOCKS AND HEADS—

External and internal leaks in blocks, cylinders and valve ports quickly and easily with LUSCO PLASTIC SEAL.
90 day Service Guaranteed or your money back. Send money order or check for full pint—more than sufficient for average repair... **\$3.00** Postpaid

C. F. LUSK CO., 4646 EUCLID AVE., CLEVELAND 3, OHIO

Most makes of power tools look alike — but . . .
advanced engineering features of
DELTA-MILWAUKEE POWER TOOLS
mean greater operating satisfaction

1 Lubricated-for-life Ball Bearings. You don't have to worry about oiling these bearings — they're lubricated for life when they leave the factory. And they are double-sealed against harmful dust, to assure you of longer bearing life.

2 Pre-loaded Bearings. This is the result of an extra manufacturing operation that reduces the "play" in the bearings, to help you enjoy long-time operating efficiency and accuracy.

3 Precision-bored Bearing Seats. These bearing seats help keep all parts lined up properly, so that you have greater assurance of producing finished pieces exactly according to dimensions.

4 Precision-ground Shafts. These are shafts built to run without any "wobbling" which might throw off your measurements.

5 Dynamically-balanced Pulleys. The pulleys which transmit the power from your motor to your power tool are balanced to help eliminate annoying, damaging vibration.

Ask your Delta dealer to let you know when he receives his first shipment of these famous power tools. Then, see how they are built to help assure you of accuracy, dependability, safety, economy. Or place your order with your dealer now, so that you can be among those to receive delivery at the earliest moment.

**A Whole Year of Woodworking
 Fun, Projects, and Ideas**

for
50¢

. . . in THE Deltagram
 . . . the popular, plan-packed
 homecrafters' magazine



Delivered to your home six times a year. Page after page of fascinating, shop-tested plans and projects helpful in producing beautiful objects your friends admire. Ideas, news, shop tips on performing woodworking operations more easily, more quickly, more safely. Crystal-clear, step-by-step instructions in

words and pictures.

The new subscription year for The Deltagram has just started. By subscribing right now, you're still in time to receive the first new issue. Fill out the coupon below and mail it today with coin, postal note, or money order. Only 50¢ for all six exciting issues!



TEAR OUT COUPON AND MAIL TODAY!

THE DELTA MANUFACTURING COMPANY
 680M E. Vienna Avenue, Milwaukee 1, Wisconsin
 Enclosed is 50c in payment for a full
 year's subscription to The Deltagram.

Name.....
 Address.....
 City..... (.....) State.....



HANDKERCHIEF TEST



PROVES VITAL ZONE SPOTLESS
AND FREE FROM "GOO"—no matter
how often you smoke it!



HESSON GUARD

MILANO

Do a Better Job WITH ONE OF THESE EMPIRE LEVELS

Smallest, most handy and accurate Level made. "Cigar-shaped"—no sharp corners to tear pocket. Aluminum stock. Only 3 oz. wt. 9" long. Has Level, Plumb, 45° Vials.

EMPIRE TORPEDO LEVEL



No. 26\$1.75



ALUMINUM LEVEL — No. 151

Cast and Machined, a Beautiful Tool, with Patented, Removable Level and Vial.

With 2 Plumb, 2 Levels, 2 — 45° Vials. 18".....\$5.00
24".....\$5.50 28".....\$6.25

Order EMPIRE LEVELS from your local dealer.
Write direct for literature.

EMPIRE LEVEL MFG. CO.
717 S. 6th St. Dept. P-237 Milwaukee 4, Wis.

Send for our Catalog of
TOOLS & EQUIPMENT for DEVELOPMENT
WORK WATCHMAKERS TOOLS...

Send for our
CATALOGUE
of Precision Tools, Equip-
ment for Development
Work, for the making of
New Worlds.
"Mail Orders Only"

HENRY PAULSON & CO. CHICAGO U.S.A.



"WONDER" ELECTRIC BUTTON

Most interesting electrical apparatus ever discovered. Make your own Telephone-Amplifier Detectophone. Transmit your voice or music to distant rooms. Perform hundreds of fascinating experiments. So tiny it can be concealed in dozens of places. Send \$1 now for button and OFFER 6 buttons and booklets sent post-paid for \$3.

BUCK MFG. COMPANY, Box A-28, No. Aurora, Ill.

FALSE TEETH

KLUTCH holds them tighter

KLUTCH forms a comfort cushion; holds dental plates so much firmer and snugger that one can eat and talk with greater comfort and security; in many cases almost as well as with natural teeth. Klutch lessens the constant fear of a dropping, rocking, chafing plate. 25c and 50c at druggists . . . If your druggist hasn't it, don't waste money on substitutes, but send us 10c and we will mail you a generous trial box.

KLUTCH CO., Box 4593-K, ELMIRA, N. Y.

The Chief WORK BENCH

Built to Last a Lifetime!

With Bottom Shelf and 18" Sq. Drawer. 2"x6", Solid Plank, Grooved and Dovetailed Top and 1"x8" Back Rail, Shellacked to a Smooth, Satiny Finish.

MOHAWK LUMBER CO. Dept. 32
14525 W. Chicago Blvd. Detroit 27, Mich.
Enclosed Check Money Order for \$.....
Ship.....CHIEF WORK BENCHES at
Quantity.....
\$16.95 each, F.O.B. Detroit, Mich.
 Send C.O.D., \$5 Deposit Enclosed.

NAME.....
ADDRESS.....
CITY..... STATE.....
No Priority Necessary!

• 6 Ft. Long • 34" High • 26"
Deep. Shipped Knock-down, with
Bolts, Nuts and Screws and ABC
Chart for Quick, Simple Assembly.

Prompt Delivery
MOHAWK LUMBER CO.
14525 W. Chicago Boulevard
DETROIT 27, MICHIGAN

A CHRISTMAS PRESENT
HE'D APPRECIATE

\$16.95
F.O.B. DETROIT

Send Check or Money
Order, or Will Ship
C. O. D. (\$5 Deposit)

JOBS *from Thin Air*

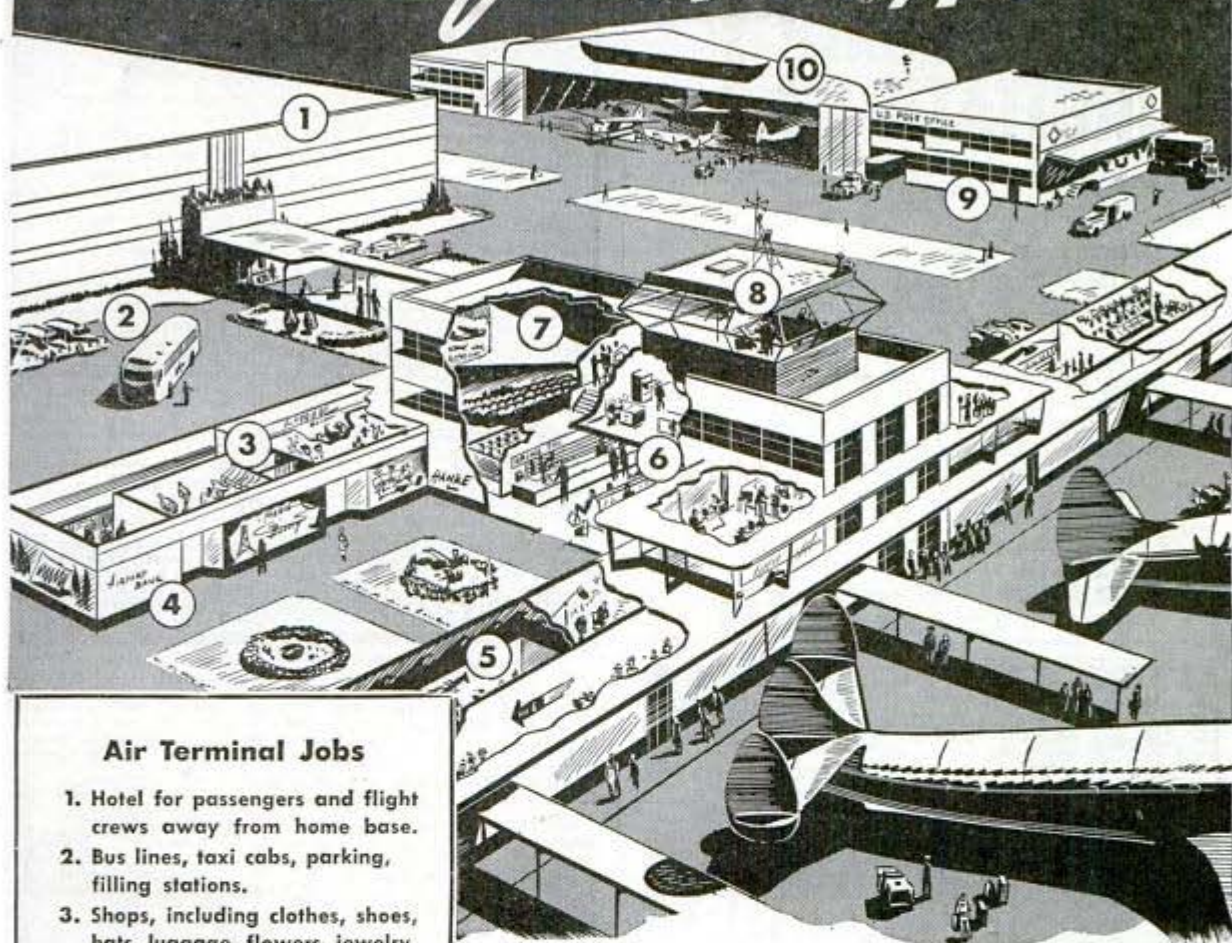

Air Terminal Jobs

1. Hotel for passengers and flight crews away from home base.
2. Bus lines, taxi cabs, parking, filling stations.
3. Shops, including clothes, shoes, hats, luggage, flowers, jewelry, drugs, books and photographs.
4. Branch of local bank.
5. Restaurants, lunch bars, soda fountains.
6. Airline employees: 112 for each plane in service.
7. Newsreel Theatre.
8. Control tower operators.
9. Post Office and air cargo.
10. Flying school and light plane sales agency.

Send for "ENGINOLOGY" — 25¢

Learn more about aviation's source of power. Enginology explains super-charging, combustion and engine principles in non-technical terms; describes their relation to planes and propellers. Just send 25 cents in U. S. coin to:

Wright Aeronautical Corporation
Dept. PM, Paterson 3, N. J.

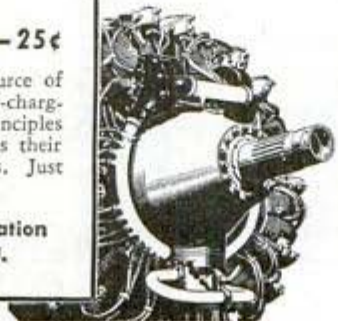

Here are new jobs created by aviation. In this modern air terminal, several thousand men and women have jobs which didn't exist before.

Air service made these jobs, and Wright Cyclone engines helped build this form of transportation. More Cyclone-powered planes, such as the Lockheed Constellation, are now going into service. That means new air terminals, new opportunities for thousands of jobs.

WRIGHT

AIRCRAFT ENGINES

DIVISION OF
CURTISS  WRIGHT
FIRST IN FLIGHT

YOU CAN'T BEAT this to relieve itching of SKIN and SCALP IRRITATIONS

So
Many
Druggists
Say!



Here's a Doctor's formula — Zemo — a stainless liquid which appears invisible on the skin — yet so highly medicated and soothing that the first applications promptly relieve itching, burning of Eczema, Psoriasis and similar skin and scalp irritations — due to external cause. Zemo ALSO aids healing.

Apply clean, stainless, invisible Zemo any time. It won't show on skin. Buy Extra Strength Zemo for mean cases.

ZEMO

MICROSCOPES SUPPLIES-ACCESSORIES & SCIENTIFIC INSTRUMENTS
 BEL SPENCER NEW & USED LEITZ ZEISS MEDICAL INDUSTRIAL AMATEUR
 BOUGHT-SOLD-EXCHANGED-REPAIRED
 Send for FREE LIST
 NATIONAL SCIENTIFIC INSTRUMENT CO. 119 CHAMBERS ST. N.Y.

SEAL OUT WINTER'S DRAFTS AND DIRT — CUT FUEL BILLS — WITH —
KALK-KORD
 SEAL CRACKS QUICKLY, EASILY, WITHOUT TOOLS

Kalk-Kord, the original non-hardening caulking compound in soft, rope-like form, enables you to effectively seal window and door frames, cracks and crevices, inside or out.

Just press Kalk-Kord into the crack or hole with fingers; no tools required. Kalk-Kord will not harden, check, or crack. It seals tightly and stays tight.

Don't wait till cold weather — use Kalk-Kord to seal out winter's cold right now. It cuts heating bills; saves cleaning of walls and drapes due to soot and dust. Use it also to plug and seal holes in wood or plaster. Kalk-Kord is waterproof and can be painted over at once, if desired.

Packed in convenient rolls, ready for use — neat and clean to work with. Anyone — and everyone — can use Kalk-Kord. Get a box today.

Buy Kalk-Kord at your nearest Sears-Roebuck retail store, or order by mail from Sears.



PRESSITE ENGINEERING COMPANY
 3978 CHOUTEAU AVE. • ST. LOUIS 10, MISSOURI

RAPID PLATING EQUIPMENT

Has contributed to nearly every major wartime development, and is now being made available for civilian use. See your dealer or write for catalogue. • BRUSH PLATING KITS • SMALL TANK PLATING UNITS • SPECIAL HEAVY DUTY PLATERS. Complete kits (less batteries) at \$1.50 per kit and up. Unconditionally guaranteed!

RAPID ELECTROPLATING PROCESS, INC.
 1414-A SOUTH WABASH AVE., CHICAGO 5, ILL.

BUILD YOUR OWN MACHINE TOOLS! Blueprints \$1.00 - Catalog FREE



Detail construction Blueprints on 6 Lewis metal and wood-working tools prepared for \$1.00. Includes prints for Lewis 10" Shopper, Milling Machine, Drill Press, Vice, 16" Band Saw, 6" Jointer, Plane or semi-finished castings available for these tools save up to 80% of comparable new tool cost.

Illustrated 22-page Catalog free with Blueprint Order—describes 30 Lewis tools. WRITE TODAY!

LEWIS MACHINE TOOL CO.

P.O. Box 116, Sta. A, Dept. M-23, Los Angeles 31, California

Big Money for Workers In Home or Shop



Licensed Concrete Specialists wanted. No experience needed. Make Colorized concrete pottery without molds. New, low cost, patented method. Cemetery products, novelties, tiles, etc. Basement leak-sealing. Other big pay projects. Booklet, details free. Men only.

NATIONAL POTTERIES COMPANY

542 Lincoln Avenue Fergus Falls, Minnesota

KEEP TOOLS SHARP!

GRIND your cutting edges on this 5000 f.p.m. grinder, then hone to razor sharpness on 110 r.p.m. coarse-fine reversible oilstone.

A VERSATILE MACHINE
 Useful for many jobs—makes good gem cutter or pottery wheel. Free folder.



CLAUSING MFG. CO. OTTUMWA IOWA

Make Any Article GLOW IN THE DARK with Magic New Discovery!



Don't pay big prices for luminous articles. Make your own! Sell at big profit or keep for your pleasure. With our complete outfit and confidential instructions, it's easy! A stroke of the brush—any article glows in the dark like magic! Lasts indefinitely. Absolutely harmless. Hundreds of uses. Use on ties, flowers, jewelry, house numbers, furniture, pictures, statues, toys, etc. Order NOW! Supply limited. Money-back guarantee.

\$1.00
 Send No Money
 Complete Lite-Glo Kit, \$1.00. Send name, address, pay postman \$1.00 plus postal charges. Send cash, we pay postage.

LITE-GLO, Dept. 312-LM, Topeka, Kan.

:: SAVE WASTE PAPER ::

It's a Great Machine for Industry...
IT'S A GREAT MACHINE FOR YOU



Atlas 10" LATHE

American production experts have been making amazing records with Atlas lathes. They rely on them for precision work . . . for ease of set up and operation . . . for sound engineering to maintain accuracy through long 'round the clock production schedules.

That's important to remember when you select your new commercial or home shop lathe. Atlas has proved its precision, proved its dependability, proved its value. It is a great machine tool for you. See your Atlas dealer for complete specifications and prices and availability information.

ATLAS PRESS COMPANY

1143 N. PITCHER ST., • KALAMAZOO 13D, MICHIGAN

- CONSTRUCTION AND OPERATING FEATURES**
- * Precision-ground flat bed ways.
 - * Precision Spindle and Bearings.
 - * Reversible, automatic, power-Cross and Longitudinal Feeds.
 - * Complete V-belt Drive.
 - * 16 speeds — 28 to 2072 RPM — quickly selected and changed.
 - * Extra power for heavy jobs.
 - * Cuts all standard threads.

SEND FOR LATEST CATALOG



AUTHORIZED DISTRIBUTOR



LOOK FOR THIS SIGN

BLACK on WHITE for BETTER SIGHT

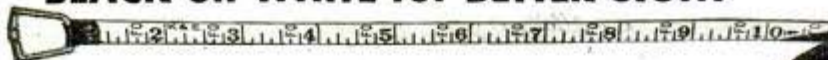

WYTEFACE Steel Tapes have black graduations on a crack-proof white surface. Easy to read in any light, from any angle. Faster measurements with fewer errors. Designed for hard service. Resists abrasion from rails, pipe, rocks, concrete. Protected against rust.



WYTEFACE
TRADEMARK
STEEL MEASURING TAPES

KEUFFEL & ESSER CO.
EST. 1867

NEW YORK • HOBOKEN, N. J.
CHICAGO • DETROIT • ST. LOUIS
SAN FRANCISCO • LOS ANGELES
MONTREAL



Drafting
Reproduction
Surveying Equipment
and Materials
Slide Rules
Measuring Tapes

ADD POWER to your CRAFT SKILL



Write on steel... engrave on glass, plastics... slice into wood, linoleum, cardboard, cloth... tool leather... hammer, file, chisel... do "hand quality" work with

**BURGESS
vibro-tool**

Trade Mark Reg. U. S. Pat. Off.

Vibro-Tool complete with 20 ordinary engraving needles \$7.50

Vibro-Tool plus complete set of attachments \$10.90

Attach chuck or M. O., or sent C.O.D.



Tools Leather



Carves Wood



Engraves Glass



Slices Cardboard

(HANDICRAFT DIVISION)

BURGESS BATTERY COMPANY

166 N. Wabash Ave., Chicago 1, Ill.

SAY YOU SAW IT IN POPULAR MECHANICS

MEN



This Horseshoe Ring, Handmade, Hand-engraved, inlaid with simulated pearl, is a **KNOCKOUT!** Shoe and shank of everlasting Monel Metal is

GUARANTEED 20 YEARS

Supply is limited... act now. SEND NO MONEY with order, just name and ring size. Pay on arrival, tax included, ONLY \$3.98, NOT one cent extra for anything! Return in five days for refund if not delighted. Address:

NATIONAL JEWELRY CO.

Dept. 404-H

Wheeling, W. Va.

FOOT RELIEF

Don't worry—No matter how many ordinary arch supports, pads and braces have failed. CUSTOM MADE RESEARCH FOOT BALANCERS have relieved foot pains for 25 years. Write for FREE ANALYSIS FOOT CHART and interesting literature TODAY.

KINDSCHI FOOT APPLIANCE PRODUCTS
Dent. A1 321 W. Jefferson Dallas 8, Texas



FREE

OTTAWA Post Hole Driller

A high speed, one-man driller equipped with fast new type auger. For any row crop tractor. Easy to operate from driver's seat. Make big money doing custom digging. Guaranteed. Write for details. OTTAWA MFG. CO., 1127 Elm St., Ottawa, Kans.



KRW ARBOR PRESSES BENCH TYPE AND HYDRAULIC

NEEDED IN EVERY SHOP—SAVE TIME AND MONEY—DO BETTER WORK, QUICKER.

No shop is complete without a small arbor press. Pressing and squeezing operations can be done better and faster on a KRW Arbor Press. Stop using vise and sledge hammer methods—they generally deliver spoiled work in the end. KRW Factory-To-You Prices give you greater value for your money. Order today.

KRW Bench Type Arbor Presses, 3 sizes

No. 37-P ½ Ton, \$13.25*
No. 37-O 1 Ton, \$23.00*
No. 37-N 3 Ton, \$33.00*

*Prices F.O.B. Arcade, N. Y. Slightly higher west of Rockies. Stand illustrated extra.



KRW Hydraulic Presses are built in 25, 50, 60 and 75 ton sizes. Prices start at \$198.00*.



K. R. WILSON, Dept. 17, 215 Main St., BUFFALO 3, N. Y.
Builders of Shop Equipment for Ford Dealers Since 1916



WONDER PEN

is Back!

Complete ELECTRIC Woodburning Outfit BURN BEAUTIFUL DESIGNS in WOOD



Again available! The real thing! Finest quality electrically heated pen and all materials. Burn and etch deeply on wood in rich shades of

brown. Achieve gorgeous effects by applying colors. Sandpaper and varnish to a fine finish. It's fascinating fun! Decorate your room or home. Make good money selling your own handiwork.



ONLY PEN WITH GUARANTEE 800 WORKING HOURS

Long life point and heating coils. Comfortable, cool cork grip. Standard 4½ ft. cord and plug.

DECORATE CORK LEATHER, ETC. TOO

Make coasters, trays, highball jackets. Decorate belts, fobs, monograms. Create your own art pieces.

EASY TO LEARN

Full instructions. Use all-purpose point for lining, etching, shading.

AVAILABLE DIRECT FROM FACTORY NOW. AT STORES IN 1946

Supply limited. Use coupon now.

ALL MATERIALS COMPLETE:

Guaranteed Electric Wonder Pen
2 Plaques 6½ x 4½
4 Pc Bookends 5 x 4

3 Plaques Approx. 4½ x 4
4 Plaques Approx. 3 x 4
2 Paint Brushes
6 Colors Paint
Pkg. Nails
2 Sandpapers
Bottle Varnish

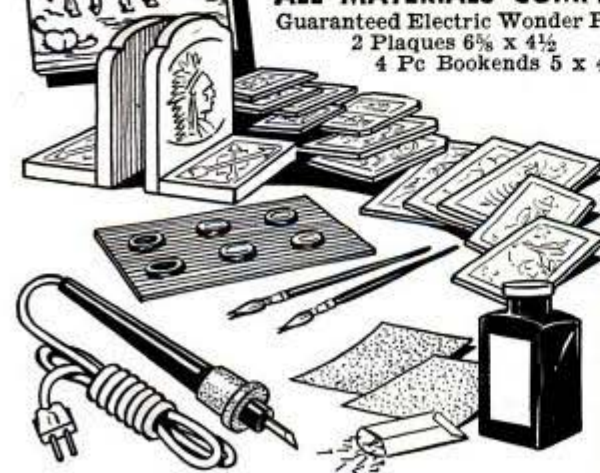

ONLY
\$3
FOR
OUTFIT
COMPLETE
& POSTPAID

SEND THE COUPON

American Toy and Furniture Co.

727 S. La Salle • Chicago 5

Please send me complete 26 piece Electric Woodburning Outfit direct from factory. \$3 enclosed.

Name.....

Address.....

City..... State.....

(\$3.25 west of Rockies and in Canada. U. S. currency.)

AMERICAN TOY & FURNITURE CO.



Carhartt

**BROWN DUCK
OVERALLS**
For Those Extra
Tough Jobs

WORK CAPS

Washable, comfortable and cool; with breather eyelets.

• Here's another exclusive work garment you'll be glad to know about—Carhartt Brown Duck Overalls.

Built for those extra tough jobs, these 11 oz. bib overalls and coats to match are just the ticket for structural workers, bridgemen, electricians, and linemen, road builders, foundry men, ship workers, truck drivers, freight handlers and a hundred and one other rough and ready occupations.

Made by the makers of the famous union label brand of Carhartt work clothes, they're dependable, wear-resisting and rugged. Back three generations of overall makers who have backed the unions for over 50 years—BUY CARHARTT OVERALLS!



HAMILTON CARHARTT OVERALL CO.

Detroit, Mich.
Atlanta, Ga.

Carhartt Park, Ky.
Dallas, Texas

Carhartt

UNION MADE WORK CLOTHES

50 Years a Friend to Organized Labor

SAY YOU SAW IT IN POPULAR MECHANICS

EVERY SHIP MODEL ENTHUSIAST SHOULD OWN THIS BOOK!



"SHIP MODELS ILLUSTRATED"

\$2
POSTPAID

The ace of all ship model books. Pictures all types from Clippers to Corvettes. A guide to modeling. Close-up photos and detailed drawings. Actual plans—and a glossary of nautical terms. Catalogue of kits and supplies included. Catalogue only—10c.

Address Dept. 3

MARINE MODEL CO., INC., 29 W. 15th St., N. Y. C.

FREE

20 GENUINE PRE-WAR PIPE CLEANERS

NOTHING TO BUY!



If you smoke a pipe you'll be delighted with these 20 genuine, pre-war pipe cleaners, so hard to get these days! We'll also send you, free, our 32-page smoker's guide, illustrated with pipes, tobaccos, pouches, etc. Pipe cleaners and guide are FREE. Mail a postcard with your name and address to Dept. CC.

WRITE TODAY!

LANE TOBACCO, LTD., 156 E. 42nd ST., NEW YORK



FEET HURT? Try Dr. BARRON'S New Foot Cushion

Many with tired, aching feet have found happy relief! So comfortable—LIKE WALKING ON A PILLOW! Made of fine soft, spongy material, leather covered. So light, flexible—cushions and helps relieve your feet from heel to toes. If you suffer from metatarsal callouses, corns, foot pains or fallen arches, try Dr. Barron's Foot Cushion. Wear in any shoes—helps make walking a pleasure. Doctor says: "I recommend Foot Cushions to foot sufferers." Send only \$1.98 for A PAIR—or will ship C. O. D., plus postage. STATE SHOE SIZE AND IF MAN OR WOMAN. 30 DAY TRIAL GUARANTEE. Money back if you don't get blessed relief! ORTHO CO., 111 W. 83rd St., Dept. 49-N, New York City 24

LEPAGE'S GLUE

LEPAGE'S
MODEL
AEROPLANE
GLUE

LEPAGE'S
LIQUID
SOLDER



HOBART A.C.
Transformer Type
Arc Welder.
HOBART
300 Amp
Portable Electric
Arc Welder.



SEE how much MORE you can do with a HOBART "Simplified" Arc Welder

There's all the difference in the world in Hobart "Simplified" Arc Welding and just plain old arc welding. It's the extra speed . . . better control of the arc and greater ease with which you weld, that makes Hobart the choice of operators the world over. "Multi-Range" Dual Control, Exclusive Remote Control, Polarity Control and Exceptional Stabilization are just a few of the many reasons why Hobart is the fastest selling arc welder on the market today. Ask for a complete Arc Welder Catalog . . . it's FREE!

HOBART BROTHERS CO. Box M-1151 TROY, OHIO



HOBART "One of the World's Largest Builders of Arc Welders."

ORDINARY BALANCE WHEEL

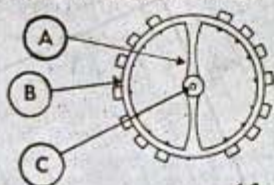

Peek inside the average watch and you'll find a balance wheel with rigid arm (a) connecting rim (b) with balance staff (c). Shocks and falls find it unprotected — throw the full weight of the balance wheel onto the fine pivots of the balance staff. Result: pivot breakage — damage to sensitive mechanisms.

But the Wyler Incaflex is really Shockproof!

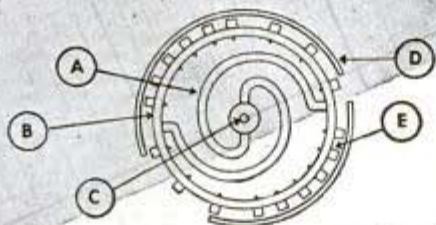

WYLER INCAFLEX

The secret is the famous WYLER balance wheel, with flexible arm (a) connecting rim (b) with balance staff (c). Here, shock merely pushes the flexible arm toward patented limitation ring (d). Rim covers distance (e) and is cushioned by limitation ring — thus preventing pivot breakage — making for a lifetime of perfect performance! Get a WYLER INCAFLEX today! It's the choice of men of action everywhere!



*The Only Shockproof Watch
with a Flexible Balance Wheel*



17 jewels • Sweep second hand
Luminous dial • Stainless steel case

WYLER WATCH AGENCY • ROCKEFELLER CENTER, NEW YORK 20, N. Y.

Royalton CROWN

FOR MEN WHO
REALLY KNOW PIPES



MOUTHPIECE TUBE prevents backflow of moisture

CONDENSING CHAMBER traps and holds bitter juices and sediment

BOWL GUARD keeps shank and bowl dry

REMOVABLE SECTION eases thorough cleaning

CHAMBER GUARD bars tobacco fragments from bit

Patented

THIS PIPE SAFEGUARDS YOUR RIGHT TO pure smoking pleasure! Bitter juices and slugs are trapped by the condensing well and other patented features that make Royalton Crown different from all other pipes. Even after the longest sessions of steady smoking, the bowl and mouthpiece of this pipe remain remarkably dry and cool.

150
Selected Briar

HENRY LEONARD & THOMAS, INC., OZONE PARK 17, N. Y.



WHO'S THE WORLD'S
GREATEST
NEWS PHOTOGRAPHER?



Why, it's YOU . . . You're tops on the greatest news flashes of all—the action shots of your family and friends. Ideal camera for your beat is Mercury II—so easy to handle it makes even lightning-speed, clear-as-life color shots a cinch!

1/1000-second shutter,
super-precision

MERCURY II

It's a UNIVERSAL



ESPECIALLY DESIGNED FOR COLOR! Color shots sharp in both background and foreground, at a fraction of usual cost—with a fraction of usual guesswork—thanks to Universal's war work in precision optics. Uses standard 35mm. color or black-and-white film cartridges.

READY NOW—ASK YOUR DEALER!

UNIVERSAL CAMERA CORPORATION

NEW YORK • CHICAGO • HOLLYWOOD



A genuine steel pack muffler WITH A BEAUTIFUL MOTORBOAT TONE. Sandee Mufflers feature improvements far in the lead, years ahead of competition. Increases mileage and power, reduces back pressure and gives better performance. Savings in gasoline will pay for a Sandee Muffler.

V-8 FORD AND MERCURY DUALS **\$17.50**

SINGLES—FIT IN PLACE OF REGULAR MUFFLER

Chov., V-8 Ford, Plym., \$5.00 Chrys., Olds., Buick, etc., \$7.00

These mufflers will outlast two regular stock replacements.

Dealers Wanted

SANDEE MUFFLER CO.

7523 S. WESTERN AVE., LOS ANGELES 44, CALIF.

BUILD YOUR
OWN RADIOS

Kits of all sizes, ready to assemble. Complete with instructions.

FREE RADIO PARTS CATALOG

Send for your copy today!

Write for these exclusive items:

Tube and Circuit Book 10c

Giant Radio Reference Map 15c

Handy Tube-Base Calculator 25c

Address Leo, W9GFQ

Dept. P-M-11, Council Bluffs, Ia.



Wholesale
RADIO LABORATORIES

Sand Casting—Forging—Heat Treating—Case Hardening
BRONZE FOUNDRY



is again available in limited quantity without priority. Orders filled in sequence as received. **INVENTORS—SCHOOLS—CRAFTSMEN** use **FOUNDRYETTE** for making castings quickly for new inventions, for instruction, and general purpose. Order now for early delivery. Three sizes are available capable of making bronze castings of 1½, 3, and 6 pounds weight, aluminum, copper, brass, etc., \$17.50, \$24.00, \$34.50, f.o.b. Kansas City. Domestic gas supply and 110 volt AC or DC energy required for operation. Write for circular.

KANSAS CITY SPECIALTIES CO.

Box 6022, Dept. P-60

Kansas City, Mo.

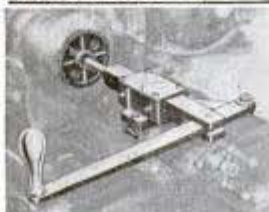

New INTERNAL KEY SEATER

for Atlas, Craftsman, and Similar Lathes

Attaches 30 seconds—cuts kerways in 1 or 2 minutes. Also splines, oil grooves. Ready for delivery.

JOHN E. KANDLER CO. **\$18.75**
210 N. Rose Street
Kalamazoo 12, Mich. F.O.B.

New Designs in
FRANZITE GRIPS

Modernize Your Gun! Improve Your Score!
Most durable grips made. Positively unbreakable! For Colt, Smith & Wesson, Hi-Standard, Origes, Luger & Mausers in a wide choice of beautiful designs in Ivory, pearl, walnut, onyx, etc. Low prices. **FREE CATALOG.** Dealers Wanted.
SPORTS, INC., (Mfrs.) 5501 Broadway, Dept. P-11, Chicago 40, ILL.



"SHAME ON YOU . . .
WASTING THE
COUNTRY'S GAS AND
OIL . . . WHY DON'T YOU
INSTALL BURD GRAF-FLOX
PISTON RINGS?"



BURD "GRAF-FLOX" PISTON RINGS STOP OIL, FUEL AND POWER LOSSES

You don't have to drive a peppy, sluggish car that steals gas and oil. You can enjoy new-engine performance . . . new-car gas and oil economy. If you install a set of Burd "Graf-Flox" Piston Rings you'll be amazed at how quickly they seat . . . compensate for any degree of cylinder wear . . . completely seal compression and control oil. There are reasons be-

hind this unusual performance: (1) Burd's 30 years' experience making piston rings. (2) The controlled tension of Burd electric-furnace iron. (3) The exclusive "Graf-Floxing" process that assures self-lubrication. Mail the coupon today for the Burd "Graf-Flox" story and two free books.

BURD PISTON RING CO., Dept. PM, Rockford, Illinois



MAIL THIS COUPON FOR 2 FREE BOOKS

BURD PISTON RING CO., Dept. PM, Rockford, Illinois

Gentlemen:

I'd like a FREE copy of your "Handy Handbook" which tells how to keep my car in good working order. Also send a "Car Economy Record Book" for keeping my mileage costs.

Name

Address

City..... State.....



SEND FOR THIS
TIME SAVING **OHMITE**
Ohm's Law Calculator

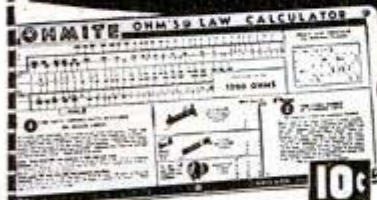

Figures Ohms,
Watts, Amperes
Volts... Quickly!
Any Ohm's Law
Problem solved
with one setting

10c

of slide. All values direct reading. (4 1/8" x 9")

Send only 10c in coin to cover cost of handling.

OHMITE MFG. CO., 4931 Flournoy St., Chicago 44, Ill.

FREE BOOK Tells How To

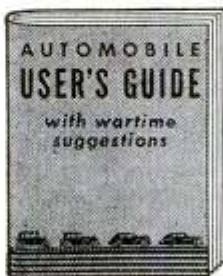

- get better gas economy
- prolong tire life
- preserve exterior finish
- keep your car in the best operating condition.

Get a FREE COPY from any General Motors dealer, or use coupon below.

Customer Research Dept., Room 1763
GENERAL MOTORS, DETROIT 2, MICH.

Please send FREE COPY of new edition 64-page
"Automobile User's Guide"—containing 196
practical suggestions on care and operation.

Mr. _____
Mrs. _____ please print
Miss _____

Address..... please print

City..... Zone State

Make of car
now owned.....
11..... year model

UTICA TOOLS

ALL TYPES
FOR MORE TOOL
MILEAGE

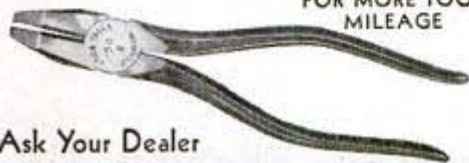

Ask Your Dealer

U-T-I-C-A

UTICA DROP FORGE & TOOL CORP.
★ UTICA, N. Y. ★

Announcing—A New Drill Press Accessory

THE BARRON ROTARY SURFACE SANDER

\$5.95 COMPLETE



Note these Special

Features—Made of Alcoa aluminum. Machined and balanced for smooth operation in drill press chuck. For surface sanding woods, plastics or polishing metal surfaces. Complete with 20 instantly removable sanding cup discs. No messy glueing needed. Leaves an agate smooth, absolutely true surface finish. Does not leave waves, ripples, steps or striations in work piece. The only tool of its kind. Shipped prepaid on 10 DAY MONEY BACK GUARANTEE for \$5.95.



The IMPROVED Barron Multi-Purpose Drill Press Planer.. \$7.50

Not only surface planes toughest woods and plastics to precision limits—but rabbets, routs, tenons, panels, grooves, beads. Will cut rabbets, tenons, panels, etc. to a depth of 1" with special Barron extra long hi-speed cutter blades. Thousands now in use. Made of Alcoa aluminum, machine finished thru-out. Vibrationless. Fits any drill press. Shipped prepaid on 10 DAY MONEY BACK GUARANTEE on receipt of cash, money order or C.O.D. for \$7.50.

Baron ALL-METAL Auxiliary DRILL PRESS Table.. \$8.85



Hard Alcoa aluminum die casting heavily ribbed—machined both sides. Has 234 sq. inch extra large working surface. Equipped with Barron Steel Planer Fence. Can also be used for shaper operations, innumerable other drill press uses. A real buy at \$8.85, express collect.

See Your DEALER... Or Write For CATALOG

BARRON TOOL CO., INCORPORATED
369 Architects Bldg. Detroit 1, Mich.

BARRON PRECISION WORK SHOP **TOOLS**

STOKER EMPTIES OWN ASH!

A remarkable stoker already used by thousands of home owners—fits into any furnace or boiler. Manufactured since 1934. So automatic it takes the coal from your present coal bin through a pipe to the furnace, going around corners if necessary. Keeps house at even temperature, empties its own ash in sealed containers, no coal to shovel, no clinkers to dig, only bituminous stoker of its kind on the market. Send for full information NOW!

POCAHONTAS FUEL COMPANY INCORPORATED
344 EAST 131st STREET • CLEVELAND 8, OHIO

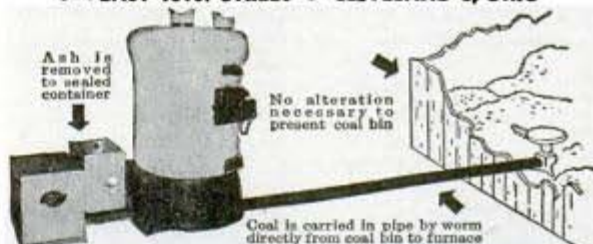

WOOD WORKERS

LUMBER—PLYWOOD AVAILABLE

Harold Hunt wants to send revised No. 14 catalog. 124 pages of woodworking ideas. UNEQUALED BARGAINS in imported and American woods, supplies. Those already holding this catalog—send for revised sheets. **CRAFTSMAN WOOD SERVICE CO.**
2729 S. Mary St., Dept. A-63, Chicago 8, Ill.

only 10¢



NEW CHEAP OIL BURNER

FOR COOKING & HEATING STOVES-FURNACES
HEAT YOUR HOME, COOK YOUR MEALS
WITH CHEAP FURNACE OIL



NO MORE SHOVELING COAL OR ASHES. New Fuelizer Starter Vaporizing System turns Cheap 130 Flash Furnace Oil into Oil Gas heat without clogging up. LIFE-TIME GUARANTEE against defects. \$1.00-BONUS OFFER FOR TESTING. We will let you try it in your own stove or furnace for one month. Get Yours for introducing. Big profits. Be first. Send in your name today.



NORTHWEST MFG. CO. 535-N 5th Ave. Mitchell, So. Dak.

Sensational!
New!

ARC-MELT SOLDERING UNIT

THE RADICALLY NEW UNIT THAT HANDLES ALL TYPES OF INTRICATE WORK!

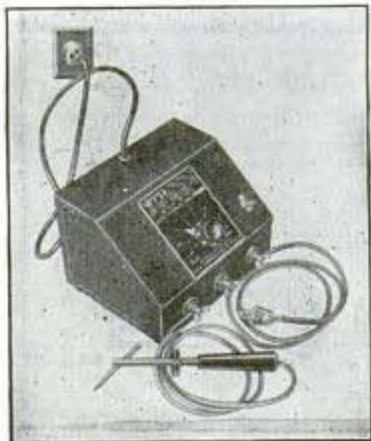

• This machine was developed to meet an exacting need for speed and accuracy on the most intricate work. The tip (copper-plated carbon rod) gets 'way down into smallest spaces. It may be resharpened repeatedly.

Heat is concentrated only at TIP... which becomes red-hot on contact. No current drain!

Fully tested, perfected and PROVEN in thousands of actual jobs! TWENTY-FOUR heat temperatures instantly! Use with flux, same as ordinary soldering iron. Excellent for etching on metal. Maximum secondary output 5 volts. Complete, compact, efficient... fully guaranteed for one year. Orders filled promptly. Order now, or request circular.

WYSE LABORATORIES
211 S. Ludlow St., Dayton 2, Ohio

• A precision machine for smallest to heavy-duty work. Shipping weight 32 lbs. Shipped F.O.B. Dayton, send check or specify C.O.D. **\$39.85**

Adjustable wire-stripper adapter also available. Ask for information.

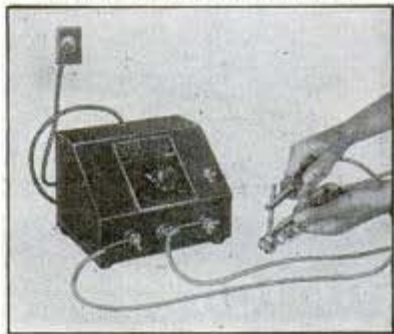

husky, accurate

A New Low-Cost 18" Drill Press That Can Really Take It

This New Duro 18" Drill Press has been designed and built to handle a much heavier load continuously than ordinary low-priced units. Has many new features including: special design for quick-changing of belts; head casting slotted to provide take-up when wear develops from movement of quill; six-spline telescopic self-aligning spindle that reduces play; heavy ribbed cast iron table and base with large machined surface and grooves for collecting coolant; base provided with "T" slots for bolting jigs; improved simplified depth gauge. Efficient production foot feed available. Specifications include: 3/4" capacity. No. 2 Morse Taper. 4 New Departure Ball Bearings. Speed range 425 to 2030 R.P.M. Spindle travel—5". Drills to center of 18" circle. Maximum distance from base to spindle—49". Maximum distance from table to spindle—19". Overall Height—68". Size of overall base—18" x 28 1/2". Diameter of column—3 1/2". Weight of Model A3088 (as illustrated) less motor, 350 lbs. Also available in bench model.

Send for Catalog—showing low-cost single and multiple-spindle Drill Presses, Metal-Cutting Band Saws, Circular Saws, Jointers, Routers, Shapers, Grinders, Lathes, Scroll Saws, Flexible Shaft Units, and Portable Electric Drills. Gives full specifications and prices.

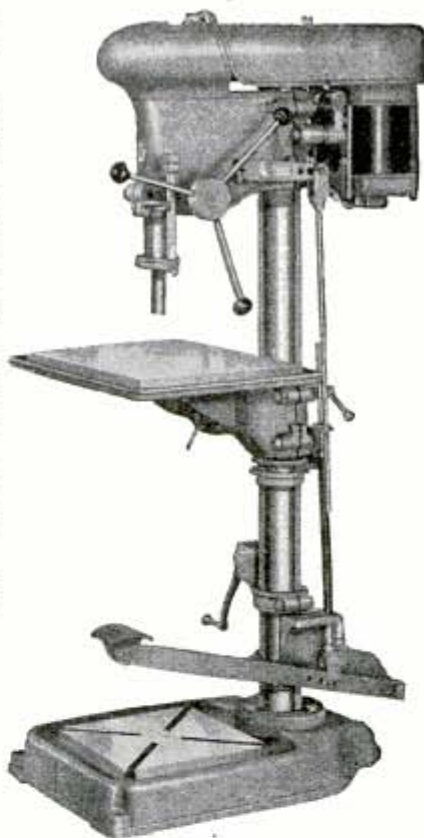

DURO TOOLS

MACHINE TOOL DIVISION

DURO METAL PRODUCTS CO., 2681 N. KILDARE AVE., CHICAGO 39, ILL.

ALSO MAKERS OF DURO HAND TOOLS

ONE-MAN SAWMILL LESS THAN \$110.00

Easy To Turn Trees Into Money

Makes Lumber, ties, shingles, crates, lath, studding, siding.



BELSAW MODELS

In to 24 ft. lengths. Patented Mechanical Feed, accurate set works and positive dogs. Use tractor or old auto engine for low cost power. Thousands used for commercial sawing. Pays for itself quickly. Send postcard today for FREE booklet, "How To Make Lumber" & Catalog of Woodworking Equipment.

BELSAW MACHINERY COMPANY

Dept. 1811-T 3542 Main Street, Kansas City 2, Mo.

AMAZING MYSTERY BUTTON



Startles Everybody.

With this Electronic Button you can

make your own

Telephone Amplifier—Detectophone. Attach this button

to piece of cardboard—transmit conversation to another

room. Must also be transmitted to distant places. Most

interesting, electrical apparatus ever discovered. Enables you

to perform hundreds of experiments. No tiny it can be con-

cealed in dozens of places. A Free-War Product. Elec-

tronic Button including 5000 word instruction booklet

with 50 illustrated experiments postpaid only \$1.00.

Electronic Products Company, Saint Charles, Ill.

ELECTRICITY FOR ANY JOB ANYWHERE



Reliable, economical electric service anywhere, anytime, with an Onan Electric Generating Plant. Driven by Onan built, 4-cycle, gasoline engines, these power plants are of single-unit, compact design and sturdy construction. Suitable for all types of service.

Models range from 350 to 35,000 watts, A.C. types from 115 to 660 volts; 50, 60, 180 cycles, single or three-phase; 400, 500 and 800 cycle, single phase; also special frequencies. D.C. types range from 6 to 4000 volts. Dual voltage types available.

Write for engineering assistance or detailed literature.

ONAN

D.W. ONAN & SONS, 2511 Royalston Ave., Minneapolis 5, Minn.



\$29.95

Plus 10% Tax

Now THE BATTLE-PROVED "TOUGH-TEST" WATCH

Now available: the watch to wear *all* the time—dress or work or sport—because it was created for military dress wear *plus* battle use (and proved in fox-holes). It's absolutely WATERPROOF, SUPER-SHOCK-TOUGH (shatterproof crystal and sealed-in, shock protected, guaranteed 17 jewel movement) and ANTI-MAGNETIC. Yet it's a handsome dress watch. Now it's available to you at a special low price—but only direct from our New York showroom. Send for detailed, descriptive literature or send \$32.95 (tax included) and we mail watch anywhere in the world with unlimited 30 day money-back guarantee.

LAMONI

Internationally famous

Watches

New York Office—Dept. A
597 Fifth Avenue, New York 17, N. Y.

This Complete Home Workshop
\$34⁹⁵

5
LATHE
DRILL
PRESS
CIRCULAR SAW
EMERY WHEEL
SANDER

Durable! Powerful! Heavily Built!
 Five power tools in one compact unit. Fabricated steel construction with high quality bronze bearings. Lathe 37" between centers. 6" or 8" circular saw. Drill press pulls 1/2" drill in steel. Uses 1/4 H.P. motor. Designed to handle all types of home woodworking jobs. Get the facts now before prices advance. Write Today!

EMRICK MACHINE CO.
 1602 FULFORD ST.
 KALAMAZOO, MICHIGAN

Write—FOR LITERATURE

REMOVES ALL FINISHES

ANTI-EVAPORANT FILM
ACTIVE SOLVENTS
PAINTS—
DOES NOT RUN OR BLEED

DOES NOT INJURE HANDS

STAYLEZE
ACTIVE SOLVENTS
ANTI-EVAPORANT
7% SOLID
MORE EFFICIENT

NO BENZOL-ACID-CAUSTIC-ALKALI—SAFER TO USE

New type semi-paste remover quickly lifts off paint, enamel, varnish, shellac, lacquer, bakelite and other synthetic resin finishes. (Removes emulsified resin water paints, too.) Stays wet longer — stays put on upright or overhead surfaces — strips clean, quick. One coat usually enough (apply with brush or spray). Contains no benzol, acid, caustic, alkali, or wax — harmless to hands, bristles, surface stripped. All sizes (pint 65c) at paint and hardware stores.

FREE CIRCULAR
 "How to Remove Paints, Varnishes, Lacquers, etc." Also describes other Savogran Products: Heavy Duty Cleaner, Crack Filler, Wood Putty, Remover & Bleacher (renews floors), Paint Brush Cleaner, Coldfoam Soapless Soap Powder.

THE SAVOGRAN CO.
 DEPT. 22, BOSTON 10, MASS.

It's Orange!

SAVOGRAN STRYPEEZE

IN EVERY WELL-EQUIPPED HOME WORKSHOP

FOOT PAINS STOPPED or Your **MONEY BACK**



Air-Cooled ARCH-HEELERS

Get Quick Lasting Relief
 Wear Guaranteed Proved ARCH-HEELERS in any shoes for aching feet, metatarsal pains, burning callouses, corns, weak arches. Must please you or Your Money Back. Made of selected leather, specially shaped with soft cushions to gently lift bone joints, release nerve pressure, free blood circulation, align entire foot. Springy. Air cooled. Comfortable, even in tight fitting shoes. Users praise them. "I wouldn't take \$5 for mine!" says one. Pair only \$1.

Send No Money Send name, address and shoe size. Pay postman \$1 plus C.O.D. charge. Or save C.O.D. by sending price with order. Money back if not pleased after 30 days. Send Today.

ARCH HEELER CO., Dept. Z-11, COUNCIL BLUFFS, IOWA

PAINT STRIPING TOOL ONLY **\$1.00** POST PAID

Try it! See the Added Beauty
 With this NEW TOOL (not a brush) everyone can now draw lines with paint, enamel, lacquer, etc. Used on autos, models, toys, games, imitation tile walls, cabinets, furniture, linoleum floors, signs, bulletin boards, sporting goods, home workshop projects, etc. Send only \$1.00 for complete tool for painting a 1/16" wide stripe, including adjustable guide, operating instructions, etc. C.O.D. price \$1.25. Extra interchangeable tips for making 1/64", 1/32", 3/64", 1/16", 3/32" and 1/8" wide stripe lines—.500 each.



As easy to use as a pencil.
Every Painter and Craftsman Should Own One.
 Send for your tool and as many additional width tips you need today. Use it. If you are not satisfied that you can do better work, add character as well as beauty to your product or project, return the tool and we'll refund your money promptly.
 Point Dealers: Write for literature, etc.
WENDELL MFG. CO. 4234-B Lincoln Ave. CHICAGO 18, ILL.

MINK Easterns \$40.00 EACH
Labradors Yukons

All shipments made subject to 5 days' inspection before acceptance.
 The quality of my mink is indicated by the fact that I have netted an average of \$20.00 a pelt on all mink skins sold during the past 5 years.
WHITE, SILVERBLU, and BLACK CROSS MINK Priced on Request
WHITE FACE, PLATINUM SILVER, and PEARL PLATINUM FOX
BOOK "Domestic Mink" \$1.00
HARRY SAXTON'S MINK RANCH, Bemus Point, N. Y.

METAL Watch Band ONLY **\$1.98**

New! Stainless steel! Ideal for men. Overcomes leather's faults. Handsome, comfortable, rust and stain-proof. Always looks new. Fits any wrist. SEND NO MONEY. Pay on arrival plus fees. Or send \$1.98 for prepaid shipment. 7-day money-back guarantee.
PROGRESSIVE PRODUCTS
 Box PM-301, Madeira, O.

New OTTAWA WOOD SAW

For Tractors
 —Makes wood sawing fast and easy. Can cut enough wood to pay for itself quickly. Easily moved while attached. Big heavy blade. FREE details.
OTTAWA MFG. CO.
 W1127 Oak Ave., Ottawa, Kans.



MOTO-TOOL ★ THE "POCKET-SIZE" MACHINE SHOP

PUT THIS "WAR VETERAN" TO WORK *Approximately 27,000 R.P.M.*

READ MOTO-TOOL'S RECORD

Long before Pearl Harbor Dremel Moto-Tools had won their spurs in tool rooms, machine shops, home workshops. Now they have the respect of every branch of the armed forces. And thousands of them helped establish production records at General Electric, Westinghouse, Remington Arms, Ford, Nash-Kelvinator, Consolidated Aircraft, Douglas and others.



MOTO-TOOL KIT
Kit No. 2 with 23 high grade accessories and Model 2 Moto-Tool in hardwood case. \$23.50
Model 2 Moto-Tool, with 1 accessory. \$16.50

Now that priorities have been lifted, Moto-Tool can work for you. Moto-Tool owners daily discover new jobs that can be done more expertly in less time. In fact, new purchasers find dozens of uses in addition to those they had in mind. So great is the time and labor that Moto-Tools save, thousands of mechanics and craftsmen would find it difficult to get along without these mighty little midgets.

ONLY MOTO-TOOLS HAVE ALL THESE FEATURES

A Model 2 Moto-Tool develops a speed of approximately 27,000 rpm. Weighs only 13 oz. Shaped to fit the hand. Sturdily built with shock-proof bakelite housing. Balanced for vibrationless operation. Uses 110-120 AC or DC current.

10 DAY TRIAL—MONEY BACK GUARANTEE

Ask your dealer today about Dremel Moto-Tools and Accessories. If he does not handle them, order direct from factory on 10 day trial. We ship postpaid if cash in full accompanies order. If you prefer to send only \$2.00, Moto-Tool will be shipped C.O.D. for balance plus postage. Catalog sent FREE.



Model 2 Illustrated

A FEW OF THE JOBS THAT MOTO-TOOL CAN DO FOR YOU

- Sharpening
- Finishing
- Touching Up
- Sanding
- Drilling
- Mortising
- Engraving
- Burring
- Grinding
- Polishing
- Burnishing
- Inlaying
- Sawing
- Scoring
- Cleaning
- Routing
- Cutting
- Rasping
- Carving
- Brushing
- Dressing



DREMEL MFG. CO. 115-L RACINE, WIS. U.S.A.

WATCH FOR THE RETURN OF MOTO-SAW

Dremel Moto-Saw... the sensational electric scroll saw... will be back as soon as materials are available.

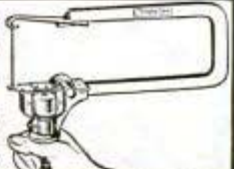

DEXTER UNIVERSAL LATHE CHUCK

well-made, accurate, strong, serviceable



IDEAL for Home Workshops
Easily attached to standard lathes, Adapters available.
2"-\$10; 3"-\$16; 4"-\$19;
5"-\$24; 6"-\$28
Includes inside and outside jaws
DANDY FOR XMAS
Send Check or Money Order

THE LEAVITT MACHINE COMPANY
ORANGE MASSACHUSETTS

HANDY ELECTRIC TEST-LITE

Instantly Tells if Circuit is Broken! Electric trouble shooter with hundreds of uses. Locates blown fuses, tests appliances, motors, spark plugs, electric fences, grounded lines, cables, etc. Neon indicator glows on voltages from 60 volts AC to 550 volts AC or DC. A necessity for experimenting. Complete Instructions—easy to use. Satisfaction guaranteed. Available from dealers or 50c postpaid by return mail. Address Dept. B.

50c

Ne-O-Lite Mfg. Co., Rockford, Ill., U.S.A.

KEEP WARM! SAVE FUEL!

Mortite

Seal your home against drafts and cold, stop those expensive heat leaks! It's easy with MORTITE, the pliable, plastic tape which goes on quickly, is effective immediately. You need no tools to apply. Simply press MORTITE into place around windows, doors, baseboards, etc. You'll be surprised at the difference it makes. MORTITE also keeps out dust and dirt, fills cracks, etc. Roll, about 80 ft., is enough for 5 windows.



\$1.25

Higher cost of Rockies & Canada

Get MORTITE at hardware, paint, dept. stores and lumberyards.

ASK FOR FREE J. W. MORTELL CO. MORTITE CIRCULAR 522 Burch St., Kankakee, Ill.

NOVEMBER 1945



Have YOUR OWN Business

SAW FILING

You can have a good, steady, cash business of your own reconditioning saws with the Foley Automatic Saw Filer, which makes old saws cut like new again. The Foley is the ONLY machine that files all hand saws, also band and circular saws. Easy to operate—no eyestrain.



SEND FOR FREE PLAN—shows how to start in spare time—no canvassing. Send coupon today—no salesman will call.

FOLEY Automatic SAW FILER

FOLEY MANUFACTURING CO.
1116-5 Foley Bldg., Minneapolis 13, Minnesota
Send Free Plan on Saw Filing business, no obligation

Name _____

Address _____



BUILD the
COMET
B-29
SUPERFORTRESS



● **IT'S BIG!**
 26½" WINGSPAN!

● **IT'S AUTHENTIC!**
 Right down to
 the last detail!

\$2.50

At your
 Comet
 Dealer

**ONE OF
 MANY
 OUTSTANDING COMET MODELS**

You'll find your biggest model-building thrills in Comet's ALL Balsa Solid Model of the B-29! A super-kit with many finished and semi-finished parts; finished turrets and blisters of formed plastic; scaled dual wheels, complete decal sheet, many other features! Comet Design makes it easy to build—assures better results!

COMET MODEL AIRPLANE & SUPPLY CO. INC.,
 • CHICAGO • NEW YORK •

**KEEP YOURSELF UP-TO-DATE ON
 WOOD LUMBER & SUPPLIES**

with
**CONSTANTINE'S
 MASTER MANUAL**

Published by the leading suppliers to woodworkers, the most complete book ever offered. More than a catalog, contains valuable information on lumber inlays, veneers, wood finishing, etc. 83 inlay border designs in full color, 4 pages of full color inlays plus a wood identification chart showing over 60 rare woods in natural color. Send only 25c today and we will include FREE a year's subscription to our publication, Chips & Chats.

ALBERT CONSTANTINE & SON, INC.
 7910 E. 135th Street, New York 54, N. Y.

CONSTANTINE'S
 MASTER MANUAL
 WOODWORKERS
 with A YEAR'S
 SUBSCRIPTION TO
 Chips & Chats



PLYWOOD Beautiful aircraft, cabinet and paneling stock now available for prompt shipment without priority. Panel sizes from 6" x 6" up to 48" x 96". Thicknesses from 1/16" through 1". Fir, gum, birch, oak, walnut and mahogany. Reasonably priced! **Send 10c Today for Complete Catalog!**

CARMEN-BRONSON CO.
 165 E. 3rd St. Dept. 11-B Mt. Vernon, N. Y.

NOW AVAILABLE!

Crosman Silent Rifles—America's favorite compressed air rifles for indoor and outdoor shooting are back again! Available in 22 cal, single shot and Magazine Loading Types. At your dealer—or order direct. Ask for Crosman SUPER-PELLS too—the better ammunition for all compressed air rifles. .177 Cal.—\$1.80 per M. .22 Cal.—\$2.00 per M.

CROSMAN ARMS CO., INC. • Rochester 7, N. Y.

FLIGHT JACKET INSIGNIA
 With your own first name **50c** each
 Come and get 'em, only... Postpaid

Dress up your sweater, blouse, or lumber jacket and look just like the men that fly our big bombers. Indicate selection by number and print carefully your first name, or your nick name. Mail with 50c today. Agents Make Money—Take orders. Sell for \$1.00. Illustrated book of all Army Insignia Emblems only 25c.

INSIGNIA MART
 703 Broadway, Dept. P, New York 3, N. Y.



BURNED OUT or BROKEN ELECTRIC
**HEATING ELEMENTS REPAIRED
 WITH NEW AMAZING NICHROCITE**

Simply overlap ends, apply Nichrocite Paste and turn on current. Used by large utility companies. Trial order, \$1.00; 4 oz., \$2.50; 1 pound, \$8.00.

Amstrong Mfg. Co., Box 861-C, Minneapolis, Minn.



HOME MECHANICS - Attention!

New -
 FOR ALL THOSE PIPE REPAIR JOBS
 NO MESS - NO WASTE - Use handy, Easy to use

PIPETITE-Stik
 PIPE JOINT COMPOUND - IN STICK FORM

Features!
 Unaffected by air, water, steam, acid, gas, brine, etc. • Lubricates and completely seals pipe joint threads, nuts, bolts, gaskets, turn-buckles, etc • Prevents rusting, joints easily taken apart, months and years after applying • Withstands vibration, temperature changes, deflection, pressure • Increases thread life • Contracts or expands with the pipe. Joints can be disconnected and remade without having to clean the threads.

NO LEAKS
TIGHT JOINTS ASSURED
HARDY AS A PENCIL

Just rub 3 or 4 strokes across pipe threads. It spreads and fills threads when turned.

Send 15c

At Most Good Hardware Counters. DEALERS INVITED

© LAKE CHEMICAL CO., Dept. PM, 607 N WESTERN AVE., CHICAGO 12, ILL.

MEAD AIR PRESS

—FOR GREATER PRODUCTION!

For greater production at less cost, use Mead Air Press. Hundreds of industrial plants now employ them for staking, crimping, assembly and similar operations. Large model delivers 1200 lbs. pressure on 100 PSI, 7½" clearance—small model delivers 400 lbs. pressure on 100 PSI, 4" clearance. With foot control these presses speed up countless bench jobs, save muscular effort. Write for Free MEAD AIR POWER CATALOG of Air Presses, Air Vises, Air Collets, etc.

MEAD SPECIALTIES CO.

4114 No. Knox Avenue, Dept. PM-11,
Chicago 41, Illinois



ORDER NOW FOR PREFERRED DELIVERY

HOME INDUSTRY OPPORTUNITIES

Collection of 100 Selected Formulas. Modern, practical, economical. 25c.
Rubber Mold Making, reinforcing, marblizing, glazing, selling, etc., 25c.
How to Make 30 Useful Articles of Wire and Sheet Metal with homemade Dies. Illustrated. 50c.
Make Good Door Mats from Old Tires with simple home-made equipment powered with a ¼ H.P. motor. Illustrated instructions. 50c.
Profitable Toy Making. Scrap wood, paper, metal, rubber, linoleum, etc., 25c.
Security in a Small Farm. Twenty ways described, 25c.
Local Business Plans net up to \$200.00 per month, 25c.
Regaining Health for men and women for a few cents and a few minutes a day. Sanitarium health secrets, 25c.
Mail Order Plans. Helps on 70 different lines of mail order selling. Price 50c.
How to Put Up and Sell Food Products. Seasonal plans, 15c.
Printing Devices. How to make several different kinds, 25c.
Liquid Rubber from Old Tires. Make molds, door mats and rubber articles. Ten formulas and processes, 50c.
All 12 of the above list of booklets and formulas, \$3.00
HOME INDUSTRIES, 1318 S. 30th Ave., Dept. PM, Omaha 5, Nebr.

FALSE TEETH FIT TIGHT with Dentyte

Soften DENTYTE by warming—spread it on your plate—put in mouth and bite to make a perfect impression. Remove plate—and allow few minutes to "set." You get an absolutely perfect fit. Sore gums vanish—no more slipping or loose teeth. DENTYTE is firm but resilient. For both Uppers and Lower. Each lining lasts for months. Immediately removable with fingers. Full size jar—(a year's undreamed of comfort per plate), postpaid only \$1. Send dollar bill at our risk. Easy to order. Easy to use. Unconditionally Guaranteed.

Dental Products Corp. Dept. PM-53, Manheim, Pa.



YOU'RE NATURALLY
MORE

Confident



WHEN YOU LOOK YOUR BEST

You know how people talk about the fellow with the "porcupine" hair. Be careful this never happens to you! Now it's so easy to keep your hair smartly and neatly well-groomed *all day long* with Glover's Imperial Hair Dress. Try the one-minute massage tomorrow morning with Glover's Hair Dress and see the difference in more natural-looking softness that makes you feel sure of yourself. NON-ALCOHOLIC to avoid scalp dryness... ANTISEPTIC for clean, *protected* scalp! Ask for Glover's at any Drug Store or Drug Counter—or mail the Coupon today!

GLOVER'S *Imperial* HAIR DRESS

FREE
TRIAL SIZE

Send Coupon for Free Trial Size—with easy instructions for the famous Glover's 3-Way Medicinal Treatment and FREE booklet, "The Scientific Care of the Hair."



MAIL COUPON

Glover's, 101 W. 31st St.,
Dept. 1A11, New York 1, N. Y.

Send Free Trial Application package in plain wrapper by return mail, containing Glover's Imperial Hair Dress, GLO-VER Shampoo, and Glover's Mange Medicine in hermetically-sealed bottles, with informative FREE booklet. I enclose 10¢ to cover cost of packaging and postage.

Name _____

Address _____

City _____ Zone _____ State _____

GUM GRIPPER

TIGHTENS FALSE TEETH

OR NO COST

Amazing NEW Plastic Reliner

LASTS FROM 4 to 6 MONTHS



NOW—in a jiffy—you can make loose, slipping dental plates fit snug and comfortable. Eat, talk in comfort, laugh freely—for "Gum Gripper" enables you to enjoy that feeling of almost having your own teeth again!

● APPLY IT YOURSELF — AT HOME

"GUM GRIPPER" amazing plastic Reliner tightens dental plates quickly, makes them hold firmly and fit like new! Just squeeze from tube, spread evenly, put plate in mouth, wear it while "Gum Gripper" sets in few minutes. No heating necessary.

● USE ON ANY DENTAL PLATE

"Gum Gripper" will not harm denture or irritate gums. Sanitary, tasteless, odorless. Keeps mouth sweet and clean, prevents sore spots. Application of plastic "Gum Gripper" is guaranteed to last 4 to 6 months—or no cost. Can be scrubbed or washed. Rev. A. J. Wigley, Pittsburgh, Pa., writes: "Best material I ever used. I have not relined my lower teeth for 2 months."

SEND NO MONEY—Order a tube today—it's only \$1.00. Fill out and mail coupon below. You'll be delighted! Satisfaction guaranteed or your money back.

FREE Generous size package Dental Plate cleaner included free of extra cost. Cleanses dental plates without brushing. Will not harm denture.

GUM GRIPPER

127 N. Dearborn St., Dept. 71-F, CHICAGO

GUM GRIPPER, Dept. 71-F, 127 N. Dearborn St., Chicago 2, Ill.

Send me a tube of "Gum Gripper." You guarantee it to satisfy—or it will not cost me a penny.

I will deposit \$1.00 plus postage with postman when package arrives.

Enclosed is \$1.00—You pay postage.

NAME.....

ADDRESS.....

CITY..... STATE.....



BETTER BUILT
Genuine Gerstner Tool Chests are made better to please every machinist, toolmaker, diemaker, patternmaker. Free catalog.

GERSTNER TOOL CHESTS
445 Columbia St., Dayton 7, Ohio

Build These Cleveland Model "Supervalues"!

Boeing B-29 "Superfortress" 28 1/2" line-controlled model of the greatest of all bombers. Kit AU-200. **\$100**



Biggest \$1.00 Model in U.S. 8 1/2" Super Condor Soarer, Soars for hours. Kit E-5019. **\$100**

"Build the Models the Men in the Air Force Build" **\$100**

SEE YOUR DEALER FIRST. In ordering direct, add 20c extra for packing-postage.

36" **PIPER CUB**
The civilian plane that went to war, and did a darn good job. Rubber or gas, tether or free flight. C-D Kit T-94..... **\$150**

CATALOG 5c (Circular free)

CLEVELAND MODEL & SUPPLY CO.
4508E105 Lorain Ave. ★ ★ ★ Cleveland 2, Ohio, U. S. A.

MACHINE SHOP EQUIPMENT

Every man who owns a workshop should have a copy of this new, authentic catalog of Machine Shop Equipment... the latest tools made by the biggest manufacturers in the United States. Replete with illustrations, descriptions, prices. Prompt delivery on most tools listed in this catalog. Available at the cost of printing—50c a copy—Get yours today! Send check or M.O. to

CENTER TOOL CO.
154 Centre Street, New York 13, N. Y.

BEST SHAVE EVER OR MONEY BACK!

Patented **SPEE-D-HONE**

Shave with a grin—not a groan... For smoother shaves—use SPEE-D-HONE! SPEE-D-HONE puts "velvet-edge" on razor blades. MILLIONS IN USE. Dozens of shaves from every blade. Only 10c. If dealer can't supply, send dime for sample.

KEEPS BLADES KEEN

CURTISS CANDY COMPANY DEPT. 714 CHICAGO 13, ILL.

SAVE MONEY ON SURPLUS WAR GOODS

\$100 Authoritative New Book Tells How THOUSANDS of surplus war items can be bought direct from U.S. Tools, photo supplies, motors, radios, motorcycles, hardware, boats, foods, etc. Veterans get top priority. Geyer's Guide to Surplus Property tells who can buy and where. Full of valuable information. Send \$1.00 bill, check or money order today for your copy. Postpaid. H. M. GEYER, 604-B Board of Trade Bldg., Los Angeles 14, Cal.

TRAILER AXLES, HITCHES, AND PARTS

● If you are interested in purchasing trailer axles, hitches, and other trailer parts, contact us promptly. Complete house trailer blue prints, \$1.00. Write for free literature.

HAMMER BLOW TOOL COMPANY, Dept. 111, WAUSAU, WIS.

SAY YOU SAW IT IN POPULAR MECHANICS

Some Models are War Casualties — But all will be Peace-time Favorites

BASS OUTDOOR FOOTWEAR

WEEJUNS
FOR LEISURE WEAR

QUAIL HUNTERS
FOR FIELD & STREAM

SPORTCASINS
FIRST ON THE FAIRWAY

SKI BOOTS
SMOOTH ON THE SLOPES

G. H. BASS & CO., 65 MAIN STREET, WILTON, MAINE



TURN SCRAP INTO MONEY

AUTOPOWER tells you how in plain, easy, simple, and illustrated instructions that anyone can follow. Change auto generators into useful, practical AC and DC generators and motors with voltage from 2 to 1,000 volts, for power, light, welding, radio, sound, etc. No previous experience nor special tools needed. Generators can be driven by wind, water, fan belt, etc. Already used and endorsed by thousands. Send for your copy of "AUTOPOWER." Only \$1.00 postpaid.

AUTOPOWER INC., 2118 Pine St., St. Louis 3, Mo.



60 PIECE UNIVERSAL ARBOR TOOL SET (3/32" shaft) \$1⁹⁵



Includes assortment of engraving and carving burrs, grind stones, cutoff wheels, polishing buffs, bristle polishing brush, 2 mandrel arbors, circular saw, garnet and emery sanding discs—truly a super value.

DE LUXE SET \$3⁹⁵

140 Pieces (Illustrated)
All the above in larger quantities plus many other hard to get items, many with demountable shafts—boxed to keep neat and easy to use. Really a \$5.95 value. Will ship to any part of the world prepaid. Send Check, Money Order or Cash. For special over-seas pack include 15c extra for small set or 25c extra for de luxe set.



GENERAL AIRE CO. 447 W. Norris Street Philadelphia 22, Pa.



NEW! Sell Popular ALL WOOL Buffalo Check Shirt -

BIG PROFITS FOR YOU!



Every Outdoor man a prospect. Smartest color and style combined with warm snug comfort. Genuine ALL WOOL Buffalo Check Shirts, Full cut, patented storm cuffs. Amazingly low priced, with generous profit for you.

COMPLETE LINE—Leather and wool jackets, raincoats, 200 fast selling shoe styles for men and women. Our salesmen making biggest profits in this field, using Actual Samples we furnish FREE. Write today for FREE SAMPLE OUTFIT.

MASON SHOE MFG. CO., Dept. M-282, Chippewa Falls, Wis.

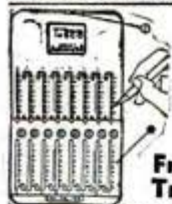

POCKET ADDING MACHINE

STURDY STEEL construction for lifetime use. Adds, subtracts, aids multiplication. Capacity 999,999.99. A real machine—guaranteed 5 years. Thousands of satisfied users. Send name and address. We ship immediately. On delivery, pay postman \$2.50 (plus C.O.D. and postage charges). If you send \$2.50 with order, we pay postage. Leatherette case 25c additional. Your money back after 10 days trial if not satisfied.

Free Trial \$2⁵⁰

Send no money

TAVELLA SALES CO., 19-PA West Broadway, New York 7, N. Y.

Get This NEW INVENTION CRACKS BLACK WALNUTS

BUTTERNUTS, ENGLISH WALNUTS

75% MEATS IN QUARTERS. \$1.50 delivered—send cash, stamps, check, money order. C. O. D. 21 cents extra. Money-back guarantee. Order early—NOW.

POTTER, 141 N. Main, Sapulpa, Okla.

NO FLYING SHELLS



do you WORRY?

Why worry and suffer any longer if we can help you? Try a Brooks Patented Air Cushion. This marvelous appliance for most forms of reducible rupture is GUARANTEED to bring YOU heavenly comfort and security—day and night—at work and play—or it costs you NOTHING. Thousands happy. Light, neat-fitting. No hard pads or springs. For men, women, and children. Durable, cheap. Sent on trial to prove it. Not sold in stores. Beware of imitations. Write for Free Book on Rupture, no-risk trial order plan, and proof of results. All Correspondence Confidential.



Brooks Company, 359 State St., Marshall, Mich.

A "MUST" FOR EVERY HOME WORKBENCH



BERNARD Pliers

Give You These Exclusive Advantages

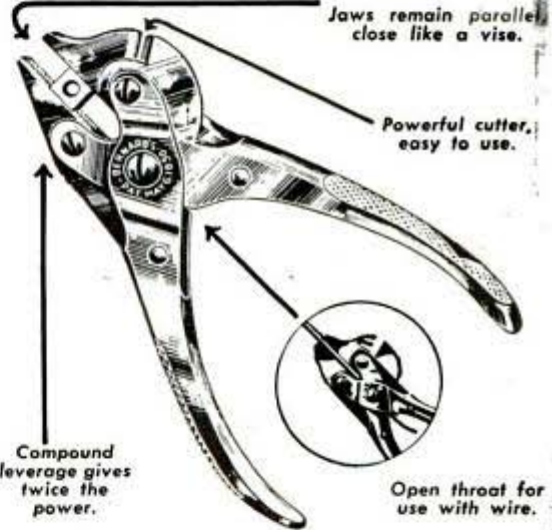

Whether your interest is woodworking, metal craft, leather craft, jewelry, model building—whatever it may be, there are BERNARD tools that are a pleasure to use because they do the job better. Look for the name BERNARD on the handles. At your local hardware store.

Send for FREE catalogue of BERNARD tools. Use coupon:

WM. SCHOLLHORN COMPANY

"Quality Tools Since 1870"

WM. SCHOLLHORN COMPANY
7611 Chapel St., New Haven, Conn.

SIRS: Please send me free catalogue of BERNARD Tools.

NAME:

STREET:

PLACE: STATE:

SAY YOU SAW IT IN POPULAR MECHANICS

For Improved Performance

the new
**Amprosound
"Premier 10"**

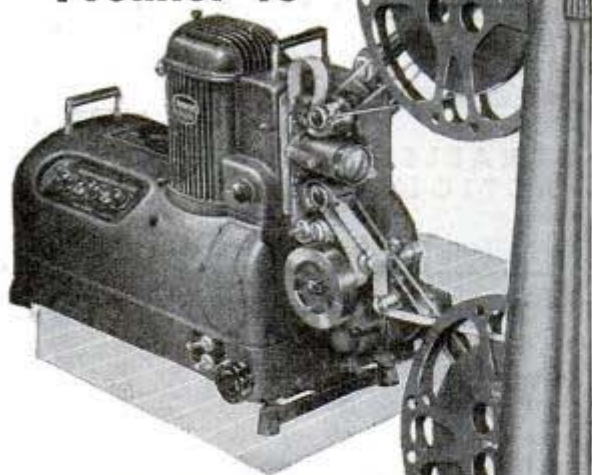

New 16mm. sound projector has many basic improvements derived from wartime experience

War is a hard teacher—but a good one! Ampro made *good* projectors before Pearl Harbor, but the war taught us how to make *better* ones. The new Amprosound "Premier 10" is dramatic proof of this fact. For here is a machine with numerous important refinements and improvements that reaches new high levels of projection efficiency. It is now available in restricted quantities for civilian use. For the complete story of this new projector, write today for special folder on the Amprosound "Premier 10."



AMPRO CORPORATION • CHICAGO 18
A General Precision Equipment Corporation Subsidiary



A New Hobby!



**COLLECT GENUINE
U. S. MILITARY
SHOULDER PATCHES**



Make your den or lodge room the center of attraction with this fascinating hobby! Over 300 authentic military shoulder patches in stock, from 15c to 50c each! Send only 10c in coin for illustrated folder and price list.



MIDWEST SALES CO.
Dept. A
P.O. Box 1092 Omaha, Nebr.

**Now! TWO AMAZING
WOODWORKING Tools
TO USE ON YOUR DRILL PRESS**

Berry Rotary Disc Sander! Produces controlled, uniform surfaces. Duplicates parts without variation. Finished work has a smooth, satin finish. Patented FLEX-TOP "gives" if surface is irregular. Complete with sanding discs. postpaid or C.O.D. \$9.95



Berry Rotary Planer! Planes, panels, tenons, rabbets and routs. Patented angle-set (not vertical) hollow-ground blades cut beneath surface, insuring a smooth, shearing cut. No tearing of wood! Planes, parallels and finishes an 8" x 24" board in 30 seconds. Complete, postpaid or C.O.D. \$7.50

5-day trial offer. Free literature. **ACT TODAY!**
H. J. BERRY MFG. CO., 2297 Scott St., Detroit 7, Mich.

★ ONLY ★
FIENDOIL
★ Pours at 40° Below ★
★ has everything tools and light mechanisms need in an oil— **35¢**
★ Cleans Metal • Prevents Rust 2 oz. size
★ Lubricates
★ At Hardware and Sports Stores
McCAMBRIDGE & McCAMBRIDGE CO.
Baltimore 23, Md.

LAW
STUDY AT HOME for PERSONAL SUCCESS and LARGER EARNINGS. 35 years expert instruction—over 108,000 students enrolled. LL.B. Degree awarded. All texts furnished. Easy payments. Send for FREE BOOK—"Law and Executive Guidance."
AMERICAN EXTENSION SCHOOL OF LAW
Dept. 59-M, 646 N. Michigan Ave., Chicago 11, Ill.

**MOTORISTS
NOW SAVE MONEY
ON GASOLINE!**



Now you can get up to 30% extra gasoline mileage with a Vacu-matic on your car. Quicker pick-up, smoother running, added power and precious gasoline savings guaranteed.
Automatic Supercharge Principle
Vacu-matic is *entirely different!* Operates on the Supercharge principle. Saves gas. Automatically provides a better gas mixture. Guaranteed to give up to 30% extra gas mileage, more power and better performance.

FITS ALL CARS
Constructed of six parts, fused into a single unit. Adjusted and sealed at the factory. Very quickly installed by anyone.
AGENTS TRIAL OFFER
Every car, truck, tractor a prospect. Send name, address on postcard for big money making offer and how you get yours for introducing.
Vacu-matic Co., 7617-1255 W. State St., Wauwatosa 13, Wis.

-or would you rather be
a hitch-hiker?



With hitch-hiking you lose your independence. You become a dependent with an inferiority complex. Don't let this happen to you. Keep your car on the road. At the first sign of excessive loss of power and oil pumping install "Rings made by Simplex." They are designed for quick and easy reconditioning of tired and worn engines. Obtainable at auto supply stores or service shops everywhere. Surprisingly economical tool.

BUY AND KEEP VICTORY BONDS

SIMPLEX PISTON RINGS

SIMPLEX PRODUCTS CORP., 3020 Kelley Ave., Cleveland, O.

HULL PRECISION...

Dial delicately balanced, rotating on jewel bearing, the **HULL STREAMLINE AUTO COMPASS** gives precision performance. Simplified magnetic compensation. Limited supply at your dealer's—\$3.50. Write for free circular.

HULL MANUFACTURING CO.
P. O. Box 246-D12 Warren, Ohio



BUILD this GAS ENGINE

No Castings! No Special Tools.

All you need is a lathe and some scrap shafting. Speed and power for midget cars, boats, etc. Two cycle, 1/2" bore, 1/2" stroke. With our unique construction methods you can also design other engines incorporating your own ideas. No casting or pattern worries. Order complete plans and step-by-step instructions NOW—satisfaction guaranteed. Engine Plans, \$1.75. Carburetor plans, 75c. Mailed prepaid on receipt of remittance. **R. W. Rowe, Engineering, 8825 Appoline, Detroit 27, Mich.**



Streamlined 3-WHEEL ROLLER SKATE with ICE SKATE Attachment



\$4.25 pr.
plus postage

Speed, Safety and Easier Skating. Brake Exclusive Feature. For Rink, Figure and Sidewalk Skating. Ice Skate Attachment \$1.90 plus postage. Give size when ordering.



B. & E. Machine Products, 4529 Ravenswood, Chicago 40, Ill.

BRUSH PLATING OUTFITS

for re-plating articles in the home and shop. No tanks necessary. Free particulars.
GUNMETAL CO., AVE. M., DECATUR, ILLINOIS

RADIO PARTS GRAB BAG!!

\$25 value assortment of Coils, Condensers, Transformers, Resistors, Controls, etc. While they last, only **\$3.98**

MARKO SUPPLY, Dept. P.M. 11
2924 Logan Blvd. Chicago 47, Ill.



DECORATIVE DECALCOMANIA

TRANSFERS Imported Designs of all Sizes & Types—Flowers, Fruits, Figures, Silhouettes, Birds, Dogs, Horse Heads, Ships, Juvenile, Tropical, Chinese, Peasant, Colonial, Patriotic, Inlay, Borders, Initials, etc., for Furniture, Doors, Walls, Trays and what not. Catalog with 800 illustrations in color sent for 25c. Deductible on first order of \$1.00 up. **L. C. WELLS, Dept. PM-511, 25 E. 26th St., New York, 10.**

:: SAVE WASTE PAPER ::

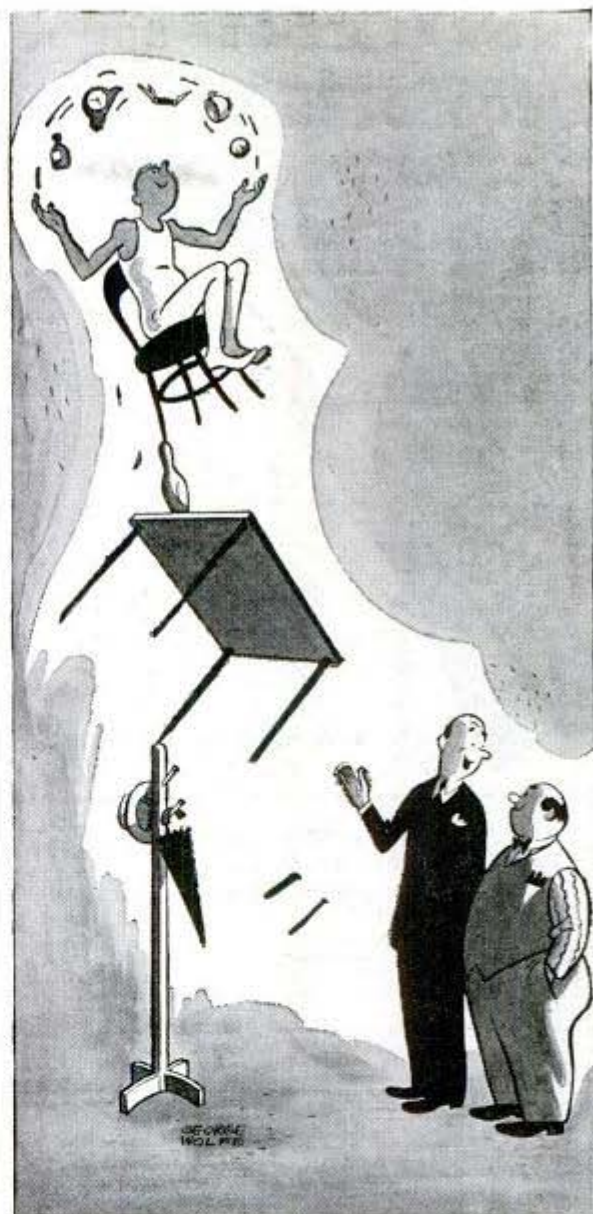

"Gosh no — he never falls — they're all held together with Weldwood Glue"

WHEN you want to hold things tight . . . remember Weldwood Glue. It's quick to mix . . . easy to use . . . tremendously strong . . . stain-free . . . rot-proof . . . and permanent. At hardware stores, lumber yards, chain stores.



WELDWOOD PLASTIC RESIN WATERPROOF GLUE

UNITED STATES PLYWOOD CORPORATION
New York 18, N. Y.

NOW IT CAN BE SOLD "MOSSBERG G.I."

Named in honor of the world's best fighting man. Used by U. S. Army and Navy for training and marksmanship instruction. Your dealer will be supplied with this rifle and other models as promptly as possible.

Use coupon below for free, illustrated, descriptive folder.

.22 caliber, 7-shot, bolt action, clip repeater
— Model 44 U.S.



\$26.20
(\$26.96 west of the Rockies)

Standard on the "Mossberg G.I." New — No. S100 Receiver sight, with $\frac{1}{4}$ " micro "click" adjustments for windage and elevation. Originally designed for and supplied to U. S. War Department.

O. F. MOSSBERG & SONS, INC.
NEW HAVEN 5, CONN.

O. F. MOSSBERG & SONS, INC.
56511 St. John St., New Haven, Conn.

Sirs: Please send me your free descriptive folder on the "Mossberg G.I."

NAME.....
STREET.....
CITY.....STATE.....
(Zone No.)

THOMPSON INBOARD MARINE ENGINE

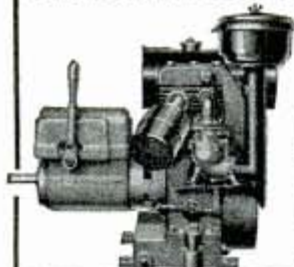

Flexi-Drive

TRANSMISSION \$127.50

2-HP, 3-HP and 6-HP Models

4-Cycle — Air-Cooled

H.D. Magneto and Carburetor

Full Ball Bearing Drive and Reverse Gear

Quick Starting, Economical

2 H.P. Model, \$127.50 For Detailed Scale Drawings of
3 H.P. Model, 175.00 WORK or PLEASURE BOATS,
6 H.P. Model, 210.00 suitable for above engines, send \$2.50
(F.O.B. Grand Rapids, Mich., U.S.A.)

THOMPSON ENGINEERING CO., 212 Winchester Place, N. E.
Grand Rapids 2, Mich., USA

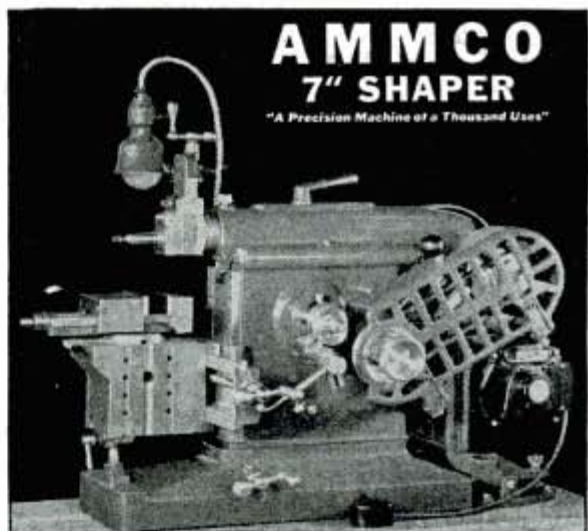

AMMCO 7" SHAPER

"A Precision Machine of a Thousand Uses"

A wide variety of jobs can be done accurately, quickly, easily, and economically on the AMMCO Shaper (7" stroke).

Construction incorporates many features you would expect to find only in larger, more expensive machines... For example: WAYS of ram, tool head, and front face of the main frame are of the "VEE" type, hand scraped to insure accuracy and long life. Available for stationary installation or as portable unit.

Write today for specifications and prices

AMMCO

2140 Commonwealth Ave. North Chicago, Ill.



Balance 4" x 9" Base. With either 56.00
Metric or Avoirdupois Weights ...

Catalog with 3000 Illustrations of Laboratory Apparatus sent for 75 cents. Catalog listing 10,000 chemicals, drugs, minerals, etc. and 1700 scientific books sent for 25 cents. 100 scientific books, 10 cents.
LABORATORY MATERIALS CO.
7321 Vincennes Ave. Chicago 21, Ill.



YOUR DOGS TIRED?

\$1.00 brings Guaranteed results
and Free Rotary Arch Massager
FOOT FOUNDATION

1200A 14th St. Lubbock, Texas



BUILDING WITH COMPOSITION

strongly reinforced with cheap wood. Several formulas. Modern stream-lined roof, walls and gutters in one. How to build a house 22x24, three rooms, as low as \$100 for materials, garage, \$20, 20x40 poultry house, \$30. Farm buildings for a few dollars. Home-made equipment to make wall-high building blocks with inside and outside finish. Also roof, wall and floor tile in color, and durable wallboard of sawdust. Labor saving. Long lasting. No painting. Make doors and windows. Sectional cabins, 100 money-saving ideas. Mixer and saw easily made from an old auto. 40 business plans. Earn \$10 a day. Guaranteed, illustrated instructions, \$1.00.

MAKE FURNITURE OF COMPOSITION cement, sawdust, asbestos, paper. Some part scrap wood and metal. Illustrated instructions to make tables, cabinets, chests, racks, shelves, inclosed stinks, lawn novelties and toys, 500 per cent profit. 50c.

HOW TO MAKE ACCURATE SHOP MACHINES: Band, jig and circular saws, electric drills, sanding wheels, forge, tools, electric wood cutters and many other things from old auto parts and washing machine motors. Illustrated, 50c.

HOME MFG. ENTERPRISES, 50 selected home shop projects, illustrated, 50c.

Special: All of the booklets described above, \$2.00 postpaid. No C.O.D.

HOME INDUSTRIES, 1318 South 30th Ave., Dept. PM, Omaha 5, Neb.

SAY YOU SAW IT IN POPULAR MECHANICS



2,160" SPOOL of SCOTCH TAPE

Genuine Scotch Brand paper-backed electrical and radio tape, approx. $\frac{1}{2}$ " wide. Sticks to any dry surface. Insulates turns on transformers, coils, radio parts, etc. Perfect for attaching paper to glass or any flat or curved surface. Our price is way below the actual value! FREE Radio Parts Catalog sent with Tape.

Clip this ad, write your name and address in margin. Mail with 50c to
OLSON RADIO WAREHOUSE, 73-J Mill St., Akron 8, Ohio

ONLY
50^c
POSTPAID

For Your Man's Xmas
at home or abroad

To dad or brother, hobby or lover
...your gift of a fine pipe will mark
you as a "solid sender." The Biltmore
Blue Ribbon is a sweet-smoker, light
to the teeth, cool on the draw... a life-
time of pleasure. Many models...
choice century-old American briars...
rich-grained, with a craftsman finish.
Biltmore Pipe Co., 220 Fifth Ave., N.Y.
\$3.50



For a super special gift
choose a Biltmore of im-
proved Algonquin Briar, at
\$5 \$7.50 \$10

Biltmore
"BLUE
RIBBON"
PIPES

FOR IMMEDIATE DELIVERY

AGENTS SALESMEN **\$2.40 DOZ.**

Timely fast selling Specialty—easy to carry. Everybody buys our Clear View Identico Case. The perfect Wallet Insert—4 Plastic Pockets with two heavy plastic covers. Metal spiral bound—fits into Wallet, Vest or Briefcase pocket and Ladies' purse. Sells like "Hot Cakes." Price 50c ea. Cost you \$2.40 Doz. Postpaid. Order trial Dozen today. Do not send personal checks. GUARANTEE Sale of 1st order or money refunded for unsold portion. FREE 3 color display card, sample attached, with 1st order. Dept. PM

BEACON SALES CORP. 37 S. Wabash, Chicago 3



Fix Scratches, Dents, Nicks the Professional Way!

Get This Handy Kit!

Repair damaged furniture surfaces with new practical kit. Enables anyone to do fast, easy touch-up jobs like a professional cabinet finisher. Makes furniture and cabinets look new. Every home and shop needs this remarkable kit. Pays for itself over and over!

Amazing Results—Easy to Use

Kit includes 23 different items—scratch removers for slight scratches, assorted shades of shellac sticks for deep nicks, bottles of light and dark stains, shading lacquer, alcohol lamp with fuel, stainless steel spatula, touch-up brushes, scratch sticks, steel wool, sandpaper, rubbing liquid. Packed in handy leatherette finish case. Send for it today. Best investment of lifetime. Fully guaranteed. Detailed instructions supplied.

\$3.95
Postpaid

AMERICAN HOUSEHOLD BUREAU
Dept. F, 520 N. Michigan Ave., Chicago, Ill.



"secret"

of the waterproof watch that winds itself!



What keeps the Croton Aquamatic going? The natural motions of your wrist! You can wear it night and day — it won't "run down" or need winding.

13.5% MORE ACCURATE, TOO!

In a 30-day wearing test by a famous laboratory, three Croton Self-Winding Aquamatics proved to be 13.5% more accurate than the average of nine nationally-famous stem-wind watches.

A Croton has everything! Guaranteed waterproof—resists shocks—sweep second hand—unbreakable crystal—radium dial. Everything a man wants in a 17-jewel watch (plus self-winding) for only \$49.50! Fed. Tax Incl.

P. S. Write for Booklet L19.
Croton, 48 W. 48th St., N. Y. 19.

Croton SELF-WINDING

WATERPROOF AQUAMATIC



Briarcraft Smokemaster

sidetracks rank moisture

You'll make an extremely pleasant discovery when you light up your Smokemaster for the first time. The cool, sweet, fragrant smoke will tell you instantly that you've found a really different pipe. For Smokemaster actually sidetracks moisture.

An ordinary pipe cleaner, folded and inserted in the stem, absorbs harsh, biting moisture as soon as it forms—smoke never passes through distasteful juices.

In a wide range of handsome models of native briar.

Pat. No. 2,166,537



Smoke passes through tube slotted at bottom. Moisture is absorbed by pipe cleaner underneath.

Smokemaster Custom-made \$1.50
Smokemaster Standard \$1

At leading dealers everywhere

Briarcraft, Inc., 347 Fifth Ave., New York 16, N.Y.

SAY YOU SAW IT IN POPULAR MECHANICS



IDEAL XMAS GIFT KIT

For Servicemen and Civilians

a handy compact shoe shine kit. Streamlined shining without soiling hands . . . easy, fast, simple. Just apply and buff for a brilliant lasting shine. Comes in tan or black, rolled in 24-inch buffer. State color wanted. Special Gift Kit, \$1 postpaid. (Described on page 87 of the October issue of Popular Mechanics.)

DAVID SHINE STICK, 3106 1st Bank, St. Paul 1, Minn.

IF  FALSE
TEETH
SLIP OR DROP

tighten them

PERFECTLY—PERMANENTLY

with

PLASTI-LINER One
Application
Lasts for Life of Plate

The only professionally developed plastic reliner for home use that refits all dental plates perfectly, permanently and safely. Hardens in mouth—makes plates fit like new!

Money-back guarantee . . . easy to use. Send \$1 for upper or lower—\$2 for both. We pay postage. If sent C. O. D. pay postman, plus charges.

PLASTI-LINER CO.

617P-619 Main St., Buffalo 3, N. Y.

PROFESSIONAL
WELDERS' ---
INDUSTRIAL
ARC WELDER
NOT A "CHEAP" MAKESHIFT

General repair work,
light manufacturing,
garage service, repair
shops, etc.

\$76.50

Construction and workmanship of our most expensive welding equipment; exclusive Borm design; welds light and heavy materials; performance equals higher-priced equipment. Simple switch—no changing of cables; economical operation; portable; guaranteed years of service.

WRITE FOR LITERATURE
BORM MANUFACTURING CO.
ELGIN, ILLINOIS



Other models
available up to
350 amps.

EXPERIMENT WITH **BLACK LIGHT!**

FUN! THRILLS! PROFITS! See seven page article on this fascinating science in June 1945 issue of Popular Mechanics. We furnish all supplies. Trial Kit of 8 lacquers only \$6.25. Black bulb for testing, \$2.00. Lamps, lacquers, crayons, fabrics, etc. Write for descriptive list and full details today!

BLACK LIGHT PRODUCTS, 450 East Ohio Street
Chicago 11, Illinois

∴ **SAVE WASTE PAPER** ∴

AUTO ENGINE SPEED CONTROL GOVERNORS



\$19.50

Give constant or changeable speed to any auto or truck engine, when used for power. Guaranteed. Instructions. Oil ring bearing, \$13.00. Ball bearing, \$19.50. Prepaid.

Agents Wanted: Parts Dealers, Garages, Wreckers, Implement Dealers, General Merchants, etc. Free circulars.



Stocks carried: In Montreal: 7546 Wiseman St. In Latin America: East Asiatic Co. In Auburn, N. Y.: 3 Seminary Ave., Auburn Welding Supply.

CANDEE, Dept. G, 2641 S. Hill, Los Angeles 7, Calif.

BURN YOUR NAME ON TOOLS WITH THE ARKOGRAF

PROTECT YOUR TOOLS FROM THEFT

Write with electricity any name or design on the hardest and finest tools and instruments of any metal. Also writing on paper with pen or pencil. Tools used by mechanics, garages, machine shops.

Complete Outfit \$3.50—Prepaid Anywhere

Interesting illustrated circular free. Write today. ARKOGRAF PEN CO., 3927 S.E. Stark, Portland 15, Ore.

:: SAVE WASTE PAPER ::

NO HUFFING... NO PUFFING
with this Jim Dandy... **GUARANTEED**
SELF-BLOWING Alcohol BLOW TORCH



This is the handiest little dandy you ever used. No workshop is complete without one. Gives a pointed flame of concentrated heat of over 1400° F. Made entirely of brass and nickel plated throughout. Leakproof construction insures long life flame and maximum pressure. Priming is automatic. Operates about 3/4 of an hour on each alcohol filling. Operation starts within 15 seconds and it remains working for about 3/4 of an hour. Immediate deliveries.

\$175

ea.
plus 10¢ for postage.
Check or M.O.

BRAFTEX PRODUCTS CO. 3123 BROADWAY NEW YORK 10, N. Y.

THE NEW THERMO-SAW

AN IDEAL XMAS GIFT



\$4.50 complete

Cuts 3/8" or 1/2" stock by 110V, A.C. current through special transformer. Steel Nichrome blades. Size 11 x 4 3/8 x 3 3/4 will cut stock 1 1/2" wide and 36" long, without necessity of turning stock. No holes to drill. Working pattern included. Extra blades 20¢ doz. Simple and safe for children.

**NOISELESS... NO VIBRATION
NO SAWDUST... SIMPLE PRINCIPLE**

BOISSELIER MFG. CO. GLEN ELLYN, ILL.

Enclosed find \$4.50 (\$4.75 for Canada and Foreign). Please ship postpaid complete Thermo-Saw, ready to plug in, with 12 blades and pattern. I have Alternating Current (A.C.) available.

WRITE NAME AND ADDRESS IN MARGIN BELOW

Both FREE

THIS USEFUL PROTRACTOR RULE

THIS HANDY REPAIR HANDBOOK

SMOOTH-ON CEMENTS

STOPS LEAKS

SMOOTH-ON

CEMENT'S FORM

for the Motor Car and Boat Home, Factory and Power Plant

All you have to do is sign and mail the coupon. You'll receive, without any expense whatsoever:

- 1.—An accurate metal protractor clearly marked, with angles reading in both directions and the straight side scaled in inches. Indispensable for the home craftsman.
- 2.—The 40-page, pocket size Smooth-On Handbook, showing how to make dozens of necessary home repairs, with Smooth-On Iron Cements. 170 diagrams. Clear, concise directions. Conveniently indexed.

WHAT THE HANDBOOK SHOWS

This repair handbook shows how you can SEAL CRACKS in furnace, boiler, stove, water heater, radiators, piping, auto crank and gear cases, water jackets, etc. . . . STOP LEAKS at seams, threaded or flanged joints, bolts, rivets, etc. . . . TIGHTEN loose screws, bolts, handles, pulls, casters, fixtures, etc., on tools, utensils, furniture . . . WATERPROOF wet cellars, concrete, brick or stone floors, walls, cisterns, troughs, tanks, pools, etc.

Your neighborhood hardware store handles Smooth-On Cements. Easy to use. Require no heat. Make durable repairs. Get a can of Smooth-On today. And be sure to mail the coupon before our limited supply of protractors is gone.



— Sign and Mail Now —

Smooth-On Mfg. Co., Dept. 37,
570 Communipaw Avenue, Jersey City 4, N. J.
Please send the Smooth-On Handbook.

Name

Address

11-45.....

Free

Do it with SMOOTH-ON

GET THIS BOOK

on how to build over 100 items
for **FUN and PROFIT**



LEJAY MANUAL

\$1.50

WORTH \$12.35
If Plans Bought Individually

SIMPLE PLANS for PRACTICAL PROJECTS

Whether or not you are mechanically inclined, the projects in these plans will appeal to you for their usefulness and practicality. They will save you money and make money for you, too, in jobs and repairs for neighbors and friends, because the plans embody all kinds of electrical devices.

NO EXPENSIVE TOOLS REQUIRED

The tools you have around the house are all you need for these projects and most of the necessary material can be found around workshops, garages and scrap yards. Being able to make your own welder helps a lot in doing other jobs, and the LeJay Manual shows you how easy it is to do this; also, how to make over 100 different items. . . . Sent on three days trial—money back if not satisfied. Only \$1.50, Canada, \$1.75.

THE NEW MODERN LEJAY

FAST-FREEZER PLANS

FROZEN STORAGE **\$100.**

For Fish, Meat, Fruit, etc.
From 5° above to 10° below zero.

5 SIZES—8 to 40 Cubic Feet Capacity

NO KNOWLEDGE OF REFRIGERATION REQUIRED

—Plans are easy to follow and you may have much of the material at hand. FAST FREEZERS made from these plans have been in use since 1938.



MILK COOLER PLANS, too, are included at no extra cost. Send only \$1.00 for the FAST FREEZER plans—or save 25c and send \$2.25 for both these plans and the LeJay Manual.

BOTH

LEJAY MFG. CO

747 LeJay Building,
MINNEAPOLIS - 8 - MINN.

\$2.25

PIERCE

*Reg. U. S. Pat. Off.



Parashock
17
JEWELS

\$49.75 Federal Tax Included
AGAIN AVAILABLE!

- Water, shock and dust-protected
 - Anti-magnetic
 - Luminous dial and hands
 - Sweep second hand
 - Wafer-thin
 - Stainless steel back case
- With 24-hour dial \$52.50
Yellow gold-filled, steel back . . . \$57.50
- Mailings here and abroad. Immediate delivery. Address Dept. PM Send checks or money orders to

THE HOUSE OF WATCHES
430 Madison Avenue (49th Street)
New York, N. Y.
Complete Catalogue on Request

Monuments Freight Paid Anywhere in U.S.A.

\$13.00 Up. Guaranteed Genuine Marble & Granite. Deal direct with Us by mail. Save. Write for Free catalog today.

U. S. MARBLE & GRANITE CO. Oneco, Fla. A-18

COLOR CONCRETE WITH CHEMICALS

A business of your own. Big money making Hollywood style pottery and birdbaths without moulds. Washing-wells, stucco-rock, benches, Marbling and cement water-paints, 10c brings sample, literature, pictures. Hollywood Cement-Craft, 8529 Wonderland Ave., Hollywood 46, California

SHAVE BELLO WITH MY UNUSUAL

TEACH HIM HOW TO SHAVE BELLO

hollow grinding abrasive strap sharpener. Gives 20plus, CONSTANT COMFORT, fast, clean shaves per double edge blade. HE-MAN'S GIFT. SERVICE-MAN'S GODSEND. Col. J. J. Foy, Texas, says: "I blades 15 years in my Bellos. Or send 10c for a 50 shave blade plus How to Shave book

MOLDABLE COMPOSITIONS For Every Purpose. Make and use yourself! Complete Instructions, directions.

Any 1 Instruction Set below \$1. Special—Any 3 \$2.50; any 8 \$5; any 20 \$10. Just check list and return with money. Catalog other Compositions free.

..Liquid Marble. ..Composition Flooring. ..Tile Roofing. ..Powdered Wood. ..Rubberastic Molds. ..Moldable Celluloid. ..Plastic Tile. ..Plastic Works. ..Sawdust Plastic. ..Toy Making. ..Doll Compositions. ..Colored Pottery. ..Gesso Compound. ..Wood Dough. ..Featherweight Stone. ..Compo Novelties. ..Miniature Vases. ..Building Blocks. ..Tennis Court Compo. ..Lithite Marble. ..Complex Ornaments. ..Glass Substitute. ..Cast Metal Toys. ..Plaster Casting.

PLASTIC HOMES New building material. Resurface old homes—build new ones. Colorful! Beautiful! Particulars free.

RAPID MARBLEIZING SERVICE, Dept. 10
Specialists in Compositions and Plastics
Edwardsville, Illinois

Now You Can be **TALLER** than "SHE" is!

Adler Elevator Shoes make you almost 2 INCHES TALLER. "Confidentially", and comfortably, the instant you put them on. Worn and praised by thousands. Look like any other stylish shoes—no high heels! Write for amazing catalog, mailed in plain wrapper. Adler, 122 E. 42nd St., New York 17, N. Y., Dept PM-8.

:: SAVE WASTE PAPER ::

SENSATION OF THE DAY—and night!

REX-LITE
TRADE MARK

Powerful . . . striking in design . . . built to specifications of U. S. Air Forces . . . 3-cell flashlight throws a beam approximately 500 feet. Durable all plastic case. Uses standard "D" size batteries.

May be carried, hung on belt, stood on floor. Weight only 4 ozs. without batteries. Two-position switch: steady and safety. Plated reflector.



MAKES A FINE XMAS GIFT!

\$2.65

Sent postage prepaid on receipt of money order . . . if C.O.D. send \$1 deposit. Write for quantity prices.

AGENTS WANTED
Write for our attractive proposition today!

RANAY CO. Dept. C 21 W. 3rd St. Cincinnati 2, Ohio



Collect U.S. Army Shoulder Patches

Fascinating hobby. Grand for decorating dens, bars, game rooms. Patches 20c to 50c each. Complete set of 250 for \$38.00. Official patches available for every major Army and Air Corps unit. Send \$1 for sample assortment and illustrated catalogue. Orders from Canada—add 20%.



SPRINGER'S

276 San Francisco St. EL PASO, TEXAS

RADIO PARTS KITS

For Immediate Delivery!—

NOW YOU CAN get what you want, and get it quickly! **CONCORD** has complete stocks of all standard radio parts required for POPULAR MECHANICS KITS in addition to the well known line of Concord Kits! Also every kind of radio part and electronic equipment . . . standard lines, dependable quality, exceptional values. Order from former Catalogs No. 34 and No. 345. And write for special VICTORY CLEARANCE FLYER, offering thousands of items at money-saving prices. Mail coupon for FREE COPY.

FAST SERVICE!

Orders shipped in 24 hours from Chicago or Atlanta. Amplifiers, Intercoms, etc. Now available for immediate delivery without priority.

CONCORD RADIO CORP.

LAFAYETTE RADIO CORPORATION

CHICAGO 7, ILL. 901 W. Jackson Blvd. • 265 Peachtree St. ATLANTA 3, GA.

CONCORD RADIO CORPORATION, Dept. P-115

901 W. Jackson Blvd., Chicago 7, Ill.

Please RUSH FREE Concord's Victory Clearance Flyer.

Name

Address

City State

SAY YOU SAW IT IN POPULAR MECHANICS

NOVEMBER 1945

Make this simple test! See why you

GET MORE HEAT



1. Hold a flame at the side of your finger. Feel much heat? *Very little.*

FROM LESS FUEL



2. Now hold your finger directly over the flame. Feel much heat? *Plenty!*

with the genuine ESTATE

HEATROLA HEATER

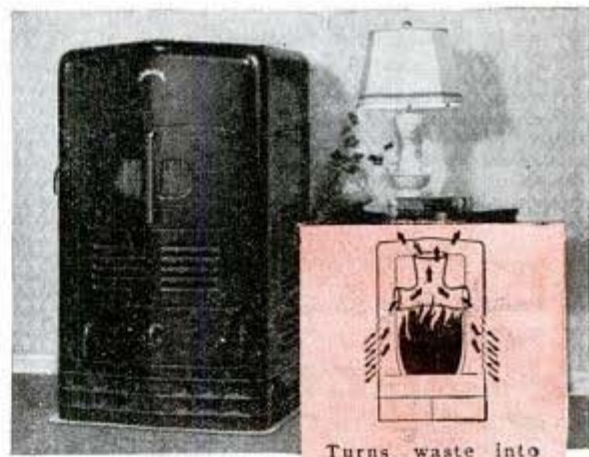

Turns waste into warmth. Only the genuine Estate Heatrola Heater has the Intensi-Fire Air Duct, built directly over the flame.

Before you buy any home heater . . . see the genuine Estate Heatrola Heater . . . the recognized leader for over 20 years. Circulates healthful warmth throughout the rooms...makes less fuel go farther.

THE ESTATE STOVE COMPANY, Hamilton, Ohio
Your best buy is the best you can buy

. . . the genuine

ESTATE Heatrola HEATER

FOR COAL, WOOD, OIL

The gift I thought no one could give me...



*So inconspicuous

LISTEN... they're singing Little Town of Bethlehem, and I can actually hear them! Me, who thought I'd lost the priceless gift of hearing forever.

I'd grown to hate the very thought of Christmas. While others would be happy, I'd feel out of it... alone, resentful, imprisoned in a world of silence.

But tonight, I'm as thrilled as a child that Christmas is coming. For I'll be part of things, again.

And, I'll offer a prayer of thanks for a husband like David. It was he who overcame my foolish fears about wearing a hearing aid and induced me to try a Zenith. That's his Christmas gift to me... hearing... the gift I thought no one could give me.

* * *

If you have friends or relatives who are hard of hearing, take them to a Zenith dispenser for a free demonstration of the Zenith Radionic. If they can be helped—make the Zenith Radionic your Christmas gift. You'll be giving a lifetime of better hearing! Mail coupon today for name of your local dispenser, plus free literature.

Choice of Amplifier Colors at no Extra Cost.

Super-powered A-3-A \$50

Standard Model A-2-A \$40

Model B-3-A (Bone Conduction) \$50

THE NEW

ZENITH

RADIONIC HEARING AID

BY THE MAKERS OF ZENITH RADIOS



PASTE ON PENNY POSTCARD AND MAIL

ZENITH RADIO CORPORATION, Dept. PM-11A
6001 Dickens Avenue, Chicago 39, Illinois

Please send me FREE literature about the Zenith Radionic Hearing Aid—plus name of nearest dispenser.

Name.....

Address.....

City..... State.....

Physicians check here for special literature.

BUY MORE VICTORY BONDS

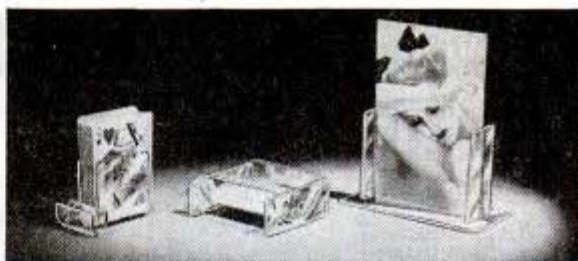

PLASTICS Assembly SET \$3.95

Earn Big Profits at Home NOW!

Learn to manufacture fabricated Plastic Items!

Our sets and simple instructions open the doors to this new Big Earnings field. Get in on the ground floor! Earn while you learn! Make beautiful gifts with our sets! A complete package of plastic materials—jigs—instructions to go with each set. Special introductory offer postpaid, \$3.95 each set.

OTHER COUNTRIES, \$4.60 THERMO-PLAST CO.

Dept. c 737 Venice Blvd., Los Angeles 15, Calif.

DO YOU

WANT a permanent business profession of your own? Then BECOME A FOOT CORRECTIONIST.

Earnings in this greatly needed profession run as high as \$50-\$100 weekly after a few weeks home training—not medical or chiropody—no further capital needed, no goods to buy. 50th year. Write for free booklet.

Stephenson System of Foot Correction

28 Back Bay,

Boston, Mass.

Now for EVERY WORK SHOP!

NEW Invention Electroplates by BRUSH

Easy to Plate CHROMIUM GOLD, SILVER, NICKEL, COPPER
... For Pleasure and Profit!

If you have a workshop—at home or in business—you need this new Warner Electroplater. At the stroke of an electrified brush, you can electroplate models and projects—you can replate worn articles, faucets, tools, fixtures, silverware, etc. with a durable, sparkling coat of metal... Gold, Silver, Chromium, Nickel, Copper or Cadmium. Method is easy, simple, quick. Everything furnished—equipment complete, ready for use. By doing a bit of work for others, your machine can pay for itself within a week. So make your shop complete by getting a Warner Electroplater right away. Send today for FREE SAMPLE and illustrated literature. ACT AT ONCE! Mail Coupon.

WARNER ELECTRIC CO., DEPT. D-5
663 North Wells, Chicago 10, Illinois

FREE Details & Sample!

WARNER ELECTRIC CO., 663 North Wells, Chicago 10, Dept. D-5

Gentlemen: Send Free Sample and Details to:

Name.....

Address.....

City..... State.....

"I Never Realized How Much Improvement a Good Screen Makes"

A home movie and camera fan writes: "My first projection of my Kodachromes on a Radiant Screen with the 'HY-FLECT' glass beaded surface really thrilled me! Colors came out rich, clear and warm. Even black-and-whites showed 100% improvement. When I think how many hundreds of dollars I have invested in equipment for making pictures—I now realize it was short-sighted economy to show them on a make-shift screen . . ." This is typical of hundreds of letters received from enthusiastic Radiant users from all corners of the country.



Send for FREE Book on Projection

Mail coupon today for FREE copy of 48 page illustrated book, "The Secrets of Good Projection." Gives complete information on getting best projection results under all conditions. Also for free circular giving specifications, features, and prices of Radiant Screens for all purposes.



The Radiant Screen here illustrated is Model DS—portable, sturdy, compact, easily set up, quickly adjustable.

The Radiant Line includes a complete range of wall, ceiling and table models in sizes 22" x 30" to 20 feet by 20 feet and larger.



RADIANT

BETTER SCREENS FOR BETTER PROJECTION

RADIANT MANUFACTURING CORPORATION

1179 W. Superior St., Chicago 22, Ill.

Gentlemen: Without obligation, please send me free copy of 48 page illustrated book, "The Secrets of Good Projection." Also circular showing complete line of Radiant Screen.

Name

Address

City.....Zone.....State.....

110-VOLTS AC from DIRECT CURRENT

with KATO KONVERTERS. Furnish standard 110-v AC from 32, 110, or 220-v. DC.

Special motors and generators 25 to 800 cycles.

Good deliveries on 5, 7½, 15 & 25 KW. AC generators. Mgr's of motor generators, frequency changers and high frequency generators.

KATO ENGINEERING CO.

55 Elm Street, MANKATO, MINN., USA



SHELDON

S-56



The BIG Small Lathe

For the homecraftsman who wants the best—this SHELDON 10" Precision Lathe is unequalled in the moderate price field. 11¼" swing, 1" collet capacity, full quick-change gear box, power longitudinal and cross feeds, underneath V-belt drive, 5 drawer steel bench. Write for circular.

SHELDON MACHINE CO., Inc.
4266 N. Knox Ave., Chicago 41, Ill.

Send for the new Fabricoid Bound Instruction Manual Today Only 75c

The Care and Operation of a Lathe

BELL



WATER PROOF

Shockproof, anti-magnetic, radium dial and hands, unbreakable crystal, precision tested, stainless steel back.

No. VE 185	
15 jewels, small second hand.....	\$29.75
No. VE 186	
15 jewels, sweep second hand.....	\$32.50
No. VE 187	
17 jewels, sweep second hand.....	\$34.75

Mail Orders Promptly Filled. Postpaid. Fed. Tax Incl.
Write for Free Illustrated Booklet "VE"

BELL WATCH COMPANY

Time and Life Bldg., Rockefeller Center, New York 20, N. Y.

\$75,000 for boy MODEL BUILDERS

8 UNIVERSITY SCHOLARSHIPS

588 CASH AWARDS

36 CONVENTION TRIPS

Here's the biggest news you've read in a long time. You are eligible to try for these awards in the TWO competitions listed below—if you reside in the United States and are between the ages of 12 and 19 inclusive.

1. NAPOLEONIC COACH COMPETITION—316 awards, including two \$5,000 and two \$3,000 scholarships. In this, you build a miniature model Napoleonic Coach to plans we furnish you.

2. MODEL CAR DESIGN COMPETITION—316 awards, including two \$4,000 and two \$2,000 scholarships. All you do is make a solid model automobile embodying your own ideas of motorcar design.

Rules are simple and fair

In both competitions the following regulations will prevail. Boys 12 years old, or older, but not yet 16 by September 1, 1945, compete in the Junior Division. Boys 16 years old, or older, and not yet 20 on September 1, 1945, compete in the Senior Division. All boys within these age limits are eligible to Guild Membership. There are no dues or entrance fees of any kind. Each member shall receive, without charge, an official Guild membership card and button, and a full set of Guild drawings and instructions. Both competitions close July 15, 1946, and are open to all boys within the age limits, including the sons of General Motors employees. In all cases where the son of a General Motors employe qualifies for an award, duplicate awards will be made.

FISHER BODY CRAFTSMAN'S GUILD

An educational foundation sponsored by
Fisher Body Division of General Motors

General Motors Bldg., Detroit 2, Michigan
Gentlemen: Please enroll me in the Fisher Body
Craftsman's Guild for 1946, in the

- Napoleonic Coach Competition
 Model Car Design Competition

Send me full instructions without charge

Name _____

Address _____

City _____ Zone _____ State _____

I was born on the _____ day of _____ 19____

Name of parent or guardian _____

Dept. 18

SAY YOU SAW IT IN POPULAR MECHANICS

FREE! MOST COMPLETE RADIO PARTS CATALOG



EVERYTHING in RADIO
ELECTRONICS for Training
Maintenance or Repair



New R-F Resonance and
Coil Winding Calculator
No. 37-955. Postpaid, 25c



NEW
Parallel Resistance & Series
Capacitance Calculator
No. X37-960. Postpaid, 25c

RADIO'S FINEST BOOK VALUES

Specially prepared to aid radio training in schools
and industry. Full of valuable data. Send for all six!

Radio Formulas and Data Book No. 37-752...10c

Dictionary of Radio Terms No. 37-751...10c

Radio Circuit Handbook No. 37-753...10c

Radio Builders' Handbook No. 37-750...10c

Simplified Radio Servicing No. 37-755...10c

Radio Data Handbook No. 37-754...25c

All Six Books No. 37-799...75c

ALLIED RADIO CORP.

833 W. Jackson, Dept. 5-L-5, Chicago 7

ALLIED RADIO

GET BIG PROFITS from
SMALL INVESTMENT

OTTAWA

6 H-P LOG SAW



Log Saw of the
Future TODAY!

FELLS TREES...
SAWS LOGS Fast, Easy

Buzzes
Up
Small
Limbs

Demand for wood increases! Prices are higher than ever before. You can make real money sawing wood, if you have an Ottawa. Equipped with an easy to start, air-cooled 6 H-P engine. Designed for easy handling. Complete one-man machine with safety Saw Guide and other exclusive Ottawa features for fast sawing.

USE FOR OTHER JOBS—when not sawing wood, use engine for any belt job. Thousands in use. **FREE BOOK** and price list. Write today.

OTTAWA MFG. CO., 1127 Pine Street, Ottawa, Kans.

NUTS AND SCREWS, BOLTS, RIVETS, WASHERS, Etc. TO YOU

BIG 5 LB. ASSORTMENT



More than 1000 pieces. Great for mechanics, repairmen, hobbyists, experimenters. Worth double. Satisfaction guaranteed. Order now. Write for bargain list of fiber, bakelite, rubber, felt washers, pads; radio lugs, clips, connectors, etc.

\$1.98
2 for \$3.69

HUDSON TRADING CORPORATION

N165 W. Hubbard Street Chicago 10, Illinois



IDENTIFICATION BRACELET only \$1.95. Heavy silver plated, name engraved without extra charge. Orders shipped same day. We also make these with a **STERLING SILVER** tag, heavy weight, with nickel silver chain, each boxed, \$2.95. We pay tax and postage.

MONT PETIT MFG. CO. Chicago, Ill.
15 E. Pearson St. P.

Look! 2 SCREW DRIVERS IN

Blade Fits Both Standard & Phillips Screws
Use either end of blade desired—for Phillips or standard screws. Shaft of special tool steel is quickly changed; securely held in genuine Xcelite plastic handle by special ball lock. Handle is shock-proof, fire resistant. Supplied in 3 popular sizes—also in stubby type.

Write Dept. J
PARK METALWARE CO., INC.
Orchard Park, N. Y.

XCELITE "Combination Detachable" Screwdrivers

ARC WELDERS

Post war models now available. No other Welder so complete. A Forney Welder is a complete workshop in itself. You can do any kind of Welding, any position; Braze castings, copper, brass, or aluminum. Solder intricate work to the heaviest. Better penetration — no magnetic blow. Now available in all voltages—220, 110, 440 and 32 volts.

UNCONDITIONALLY GUARANTEED

Double spun glass insulation. There is no better materials at any price than is found in the Forney.

There is a Forney Product in every town in the U.S.A. Competent Export Department. Some Distributor territory available.

Machines of all sizes from home workshop to heavy plant maintenance. — From \$20 up.

FORNEY MFG. CO., Ft. Collins, Colo.

Built with voltage control. Better on R.E.A. Lines.

FOR ANY BOY 7 to 10

HANDEE IS THE PRIZE GIFT
Give a Handee this year to your son, dad, friend—give one to yourself! It's not only a tool, it's a hobby, a new outlook! Satisfy that urge to create. Know the thrill of turning out professional-looking projects. With the HANDEE you can make beautiful gifts or things to sell—ship, train and plane models, costume jewelry, wood carvings, puppets, initialed tumblers, engraved trays—articles of every description.

HANDEE TOOL OF 1001 USES

A toolshop in your hand! The original hand tool and today's finest. HANDEE grinds, drills, cuts, carves, cleans, sands, saws, sharpens, engraves. You'll like its speed, its smooth performance. Perfectly balanced, fits your hand. It's fascinating, modern! Wt. only 12 oz. AC or DC. 25,000 r.p.m.

Postpaid with 7 accessories..... **\$18.50**

Make things from
Wood - Plastics
Metals - Glass
Linoleum
Leather - Alloys
Horn - Stone
Bone, etc.

GET A GOOD START GET THE HANDEE KIT
HANDEE Tool and 45 most popular accessories, in a handsome, compact, steel carrying case! Set includes steel cutter, drills, bristle brushes, polishing wheels and points, rubber disc, drum sander and bands, mounted wheels, Speed Oil, sandpaper discs. You'll be amazed at what you can accomplish!

Complete, postpaid **\$25.00**

FOR YOURSELF OR A FRIEND... THE GIFT OF A LIFETIME!

NEW!

ACCESSORY CASE
Tool owners have been wanting it for years! Sensational assortment of finest quality, time-tested accessories for use on any portable tool; packed in a steel, hinged-top carrying case. **IMMEDIATE DELIVERY.** Postpaid **\$25.00** (Handee Tool not included)

ORDER NOW! USE THIS COUPON

Write for FREE Catalog

CHICAGO WHEEL & MFG. CO.
1101 W. Monroe St., Dept. PM
Chicago 7, Ill.

Send me () HANDEE TOOL () HANDEE KIT
() ACCESSORY CASE. Enclosed is money order. () Send C.O.D. I'll pay mailman.

Name.....
(Please print)

Address.....

Now YOU can own Famous WAR PEN

The INKMAKER Pen "Makes Its Own Ink"

Everywhere you hear returning war veterans sing the praises of the pen that never needs an ink bottle, yet never runs out of ink!

Now, you too, can own the war-born Inkmaker Pen that "Makes its own ink"! Yes, you can enjoy continuous fresh, lustrous, quick-drying ink generated from a concentrated ink battery—a battery that lasts months without replacement—you just add plain water. And, the pen carries its own spare battery. Stacks of unsolicited letters from G.I.'s, from officers from all points of the globe, laud the pen that is not bottle-fed . . . needs no ink bottle nursing.

Guaranteed for Lifelong Service

And here's why. There is no perishable rubber sac to deteriorate, no ink filling lever or push button to wear out; no metals to corrode. This absence of complicated mechanisms really justifies the strong "Guarantee of Lifelong Service" packed with every Inkmaker pen.

A Triumph in Craftsmanship. Exquisitely styled and streamlined. Precision built of durable materials, yet feather light for effortless writing. A 14-K gold point, tipped with costly iridium for permanent smooth writing. Every Inkmaker pen is equipped with the exclusive patented Ink-O-Guard that prevents leaking even at high altitudes and under all climatic conditions.

FILLS ITSELF



Simply place pen in water, fills automatically.

An Ideal Gift to yourself, to your friends, to your loved ones in the service. Choice of three colors. Each pen includes 4 Ink Batteries, 2 in pen and 2 extra. Refills always available, 2 for 25c.

When Ordering: Use the coupon order form. Specify point: Fine, Medium, Heavy. Specify color: (Give also second choice) Jet Black, Burgundy, Navy Blue. Enclose \$1.00 per pen with order and pay postman balance \$7.75 per pen plus C.O.D. charges. Or enclose full \$8.75 per pen and we will ship prepaid.

INKMAKER PENS, 40 So. Clinton St. Dept. 211, Chicago 6, Ill.

INKMAKER PENS, 40 S. Clinton St., Dept. 211, Chicago 6, Ill.

Please ship.....

- I enclose.....in full. Ship prepaid.
 I enclose \$1.00 per pen and will pay postman balance \$7.75 per pen plus C.O.D. charges.

Name.....

Address.....

City.....Zone.....State.....



Your Rust Troubles are Over CORODEX Rust Remover

is the war-time miracle liquid heretofore sold only to war plants. CORODEX positively removes RUST AND CORROSION from iron, steel, brass, bronze, copper, chromium and nickel, regardless of depth, renewing tools, hardware, sports equipment, household utensils, etc., thus salvaging easily, with slight effort, many articles for future use—for a few cents. See notice "NEEDLE'S EYE", December 1944 issue.

• Ask your dealer or send \$1.00 for full quart F.O.B. Chicago. Valuable "MANUAL OF RUST CONTROL" included with order.

ALLIED PRODUCTS COMPANY
1133 NEWPORT AVENUE, CHICAGO 13, ILL.

120 MILES PER GALLON

Complete motor ready to mount on ordinary balloon-tired bicycle. No mechanical skill required to install. No alteration of bike necessary. Easy to operate.



Can be pedaled by merely releasing clutch. Speed 5 to 40 M.P.H. Shipped prepaid complete with 4 cycle, 2 1/2 H.P. motor, all attachments and heavy duty stand. Get complete facts about this low-cost, convenient transportation. . .

Write today for descriptive illustrated literature.

WHIZZER MOTOR SALES CO.
Dept. A, 3132 E. Washington, Los Angeles 23, California

G E A R S

In Stock - Immediate Delivery

Gears, speed reducers, sprockets, thrust bearings, flexible couplings, pulleys, etc. A complete line is carried in our Chicago stock. Can also quote on special gears of any kind. Send us your blueprints and inquiries.

Send for Complete Catalog No. 10 CHICAGO GEAR WORKS
440-48 N. Oakley Blvd, CHICAGO, ILL.



Now Repair your own ELECTRICAL APPLIANCES

with CHANITE Self-Welding ELECTRICAL HEATING ELEMENT flux. Generous amount. Instructions enclosed \$1.00 postpaid. Guaranteed nothing like it. Stick Form 25c ea., \$2.00 dozen. CHANITE SALES COMPANY, 914 So. Main, Fort Worth 4, Tex.

WINDOW SIGN LETTERS

For Store Fronts and Office Windows. Anyone can put them on. Samples furnished. Genuine Gold and Silver. METALLIC LETTER CO., 430 N. Clark St., Chicago 10

SAY YOU SAW IT IN POPULAR MECHANICS

WORLD TOURS in YOUR EASY CHAIR

Treasured Scenes in Natural Kodachrome Slides

Over 900 Masterpieces in glowing color—unequaled views throughout the United States, Canada, Alaska, Mexico, Latin America and Europe—all distinguished color transparencies. Packed in related sets of six slides each. Just a few listed below. Free complete catalog with every set.



- | | | |
|---|--|---|
| 1—Yosemite (4 sets) | 12—California Missions (2 sets) | 27—Palestine (13 sets) |
| 2—California Big Trees (1 set) | 13—Santa Barbara (1 set) | 28—Egypt (14 sets) |
| 3—Mount Rainier National Park (1 set) | 14—Argentina (15 sets) | 29—Rocky Mountain National Park (15 sets) |
| 4—Lake Louise and Banff (Alberta) (1 set) | 15—Brazil (1 set) | 30—Mesa Verde National Park (1 set) |
| 5—Glacier National Park (4 sets) | 16—Ports of South America (10 sets) | 31—Alaska (4 sets) |
| 6—Yellowstone National Park (5 sets) | 17—Mexico (13 sets) | |
| 7—Bryce National Canyon (3 sets) | 18—New York (13 sets) | |
| 8—Hawaii (14 sets) | 19—Navy Ships in Action (15 sets) | |
| 9—Grand Canyon, Arizona (5 sets) | 20—War Planes in Action (13 sets) | |
| 10—Hollywood (13 sets) | 21—Western Wild Flowers in Bloom (12 sets) | |
| 11—Painted Desert, Arizona (1 set) | 22—Washington, D. C. (11 set) | |
| | 23—Tunisia (1 set) | |
| | 24—Malta and Yugoslavia (1 set) | |
| | 25—Greece, Athens (2 sets) | |
| | 26—Turkey (1 set) | |

ONLY \$3.00 A SET, POST PAID
 Please send.....Set Nos.....
 Send C.O.D.
 I enclose Check or Money Order.
 All sets shipped same day your remittance received.

American Masterpieces
Bell, California. Dept. PM-11

MILL IT ON YOUR LATHE

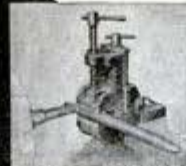

WITH A

PALMGREN

MILLING ATTACHMENT



Now you can do milling; cutting keyways, slotting, surfacing, sawing at angles, grinding, recessing, squaring shafts, beveling, grooving and many other important operations right on your lathe. PALMGREN MILLING ATTACHMENT with VISE is a necessary fixture for small shops and emergency work in large plants. Adaptable for South Bend, Atlas, Craftsman, Logan, Sheldon and all other lathes, it has graduated vertical angle adjustments, is easily mounted by straddling lathe's regular tool post. Every lathe owner should have one... it will quickly pay for itself. Immediate delivery.

No. 250	Nos.	Width Jaws	Depth Jaws	Jaw Open	Weight Pounds	Base Open- ing	Price F.O.B. Plant
	150	1 1/2"	1"	1 5/8"	6 1/2	1"	\$18.75
	250	2 1/2"	1 7/16"	2 3/8"	11	1 1/4"	\$24.75
	400	4"	1 1/2"	4"	25	2"	\$39.75

Order from your dealer or jobber. Send for our Circular No. 105.
CHICAGO TOOL AND ENGINEERING CO.
Mfrs. of PALMGREN PRODUCTS for Over 25 Years
8365 South Chicago Avenue Chicago 17, Illinois

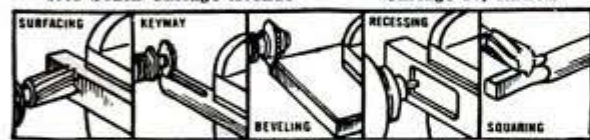

Ribbed with Steel these rugged WORK-HANDLERS Protect and Save

Steel-ribbon reinforced from finger tips to bottom of palm, these tough chrome tanned cowhide gloves give maximum protection and service in handling sharp-edged, rough, jagged parts or materials... sheets, bars, boards, stampings, castings, scrap,

etc. They save time, speed work, save hands. Or what's your need? Over 4300 proved safeguards, gloves, mitts, aprons, leggings, etc., in Steel-Grip line. Used by big industrials since 1910. Write for catalog today.

INDUSTRIAL GLOVES CO.
6512 Garfield Blvd., Danville, Ill.
(In Canada: Safety Supply Co., Toronto)



WORLD'S FINEST VIEWER FOR COLOR SLIDES

Hollywood

PROFESSIONAL VIEWER

Crystal-clear magnification equal to theatre screen projection... thrilling third dimensional effect... takes any 2" x 2" slide... spiral grooved eyepiece for precision focusing... extra large lens... made of brilliant plastic.

AT ALL LEADING RETAIL STORES CRAFTSMEN'S GUILD

6916 Romaine St., Dept. PM, Hollywood 38, Calif.

Please rush the Hollywood Professional Viewer complete with 3 film tracks for only \$3.00.

Find enclosed \$

Send C.O.D.



3 FILM TRACKS
with every viewer
... for 35 mm, 16
mm and 8 mm film
strips. Send your
order NOW!

\$3.00

POSTAGE PAID IF PAYMENT IS ENCLOSED

Quick Change Gear Box for Atlas and Craftsman Lathes

Cut threads from
4 to 224 per inch



Only
\$75.00

F.O.B.
Chicago

Sold on
money-back
guarantee
if not
satisfied.

This gear box is constructed of all-steel gears in aluminum casting with bronze bearings throughout. Easy to install. Full instructions with shipment. Speedy production; maintained accuracy. Easy to set. Prompt delivery.

THE O'BRIEN MACHINE CO.
Dept. P.M. 1620 Highland Ave. Chicago 26, Ill.



**ORDER
NOW!**

NEW ECHOPHONE EC-1A RADIO RECEIVER

Be one of the first to own this popular communications-type set for short-wave and regular broadcast reception. Many new features! Covers entire tuning range from 550 Kc. to 30 Mc. (550 to 9.85 meters) in 3 bands. For 115-125 volts AC-DC. Automatic noise limiter. Built-in PM speaker. Compact and reliable. Complete with tubes. Net... **\$2950**

F. O. B. Chicago

ALLIED RADIO CORP.

833 W. Jackson Blvd., Dept. 5-LL-5, Chicago 7, Ill.

- Ship ECHOPHONE EC-1A at earliest moment.
 Full Payment
 Enclosed \$..... Part Payment. Balance C.O.D.
 Send full information on Communications Receivers and Time Payment Plan, without obligation.

Name.....

Address.....

City..... Zone..... State.....

SAY YOU SAW IT IN POPULAR MECHANICS

Men Who Make Things SAY:



KEEP THIS HANDY!
you'll find it
helps in no end
of ways

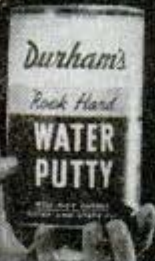

In any type of homecraft, there's no limit to the things you can do with Durham's Rock-Hard Water Putty, the modern powdered plastic. Molds fascinating figures. Fills chipped places in antiques. Makes lasting repairs in wood, plaster, tile or similar material. Keeps indefinitely. So economical—just mix with water, and it's ready to use. Hardens quickly—then you can saw it, chisel it, paint it.

Most patching materials may shrink, chip off or fall out. But Durham's Rock-Hard Water Putty does not shrink. It sticks and stays put. Order from your lumber, hardware or paint dealer.

SPECIAL — 4 lb. can only \$1

To home craftsmen, we will send the big 4-pound can, postpaid anywhere in U. S., for only \$1. So many helpful ways to use it. We guarantee complete satisfaction or refund every cent of your money. Order today. Donald Durham Co., 240 School St., Des Moines, Iowa.

MONEY-SAVING OFFER—ORDER NOW



DRILL-INDEX A compact container for indexing and filing twist drills. Eliminates search. Made entirely of steel in nine sizes. See your dealer or write to
HUOT MFG. CO.
Foot Schultz Bldg. St. Paul 1, Minn.

SAY YOU SAW IT IN POPULAR MECHANICS

AMP Solderless ELECTRICAL REPAIR KIT



SPEED UP ELECTRICAL MAINTENANCE

PERFECT REPAIRS WITHOUT SOLDER OR HEAT

KIT COMPLETE—

NOTHING ELSE TO BUY

NO SOLDER!

A Strip insulation from wire with all-purpose tool.

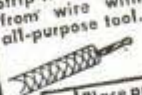

NO SOLDER!



AMP Solderless and Tool are listed by Underwriters Laboratories, Inc. for electrical work 60 to 110 volts.

AT LAST FOR CIVILIAN USE

The AMP, precision all-purpose tool cuts and strips wire, and installs AMP terminals on wire. Assortment of 100 all-copper terminals in kit, for wire sizes 22 to 10; same AMP terminals used by millions on famed warcraft.

Save time, money—anybody can do it. Handiest kit you ever bought. Get yours today.

B Place proper terminal on stripped wire.



\$5.95 COMPLETE
All-purpose tool and 100 terminals



C Attach terminal with all-purpose tool.

FINISHED CONNECTION LIKE THIS

Send cash, check, or money order to
AIRCRAFT-MARINE PRODUCTS INC.
1527-33 N. FOURTH STREET, HARRISBURG, PA.

WAR DEVELOPED ABRASIVE GADGET

NOW AVAILABLE for home workshops, experimenters, hobbyists. Hundreds of uses in homes from kitchen to garage—from sharpening knives to removing rust, scorch, metal burns, caked and burnt materials. Shapes and polishes metals, plastics, glass or wood.

Flexible abrasives that helped build Allison engines to torpedoes. Limited amount now available in assorted kit form. Each kit contains one mandrel, 12 assorted wheels, points and cones for \$1.00—or 2 mandrels and 30 assorted wheels, points and cones \$3.00.

Mail in your order today for \$1.00 or \$2.00 assortment postpaid to you on receipt of remittance.

FLEX-ABRASIVE COMPANY

100 N. LaSalle, Dept. 10

Chicago 2, Ill.

The SCHERR MAGNI-RAY

INVALUABLE FOR MECHANIC, SPORTSMAN, STAMP COLLECTOR, GUNSMITH, ETC.

MAGNIFIES the piece under inspection, and FLOODLIGHTS it with rays shielded from user. Widely used in shops, also valuable in the home workshop, checking threads, reading small markings on taps and drills, inspecting precision work. Invaluable for gunsmiths checking headspace, sear and hammer angles—stamp collectors—sportsmen, tying files and other fine work—general use, inspecting small photos, removing splinters,

examining maps and charts, etc. Eyepiece adjustable for height and angle. Lens of genuine optical glass ground by experts. Three types, A—3" lens, medium magnification, \$16.65. B—2" lens, 3 x, \$24.75. C—5" lens, with handle on eyepiece for use apart from base, \$29.70. Further details on request. Prompt delivery on 10-day money back basis. Shipped C.O.D., or on receipt of check or money order.



GEO. SCHERR COMPANY, Inc. 200-A LAFAYETTE STREET
NEW YORK 12, N. Y.



Making Music..

THE THRILL OF A LIFETIME!

A makeshift bandstand... a group of happy youngsters... and Conn band instruments—perfect combination for *the thrill of a lifetime*, **MAKING MUSIC!** Age is no handicap—neither is it an advantage. Anyone who can whistle a tune can play a wind instrument!

Making music yourself is so much more fun, so much more thrilling, than listening to others. It provides a satisfaction unsurpassed by any other single activity... and it helps relax the mind and body! If you have never experienced this thrill, if you have never played a wind instrument—find out now how *you* can enjoy it—how *easy* it is! Send for **FREE** Books, shown at right. **C. G. CONN LTD., ELKHART, INDIANA.**

Write... FOR FREE BOOKS

TEEN-AGERS—Ask for "Fun and Popularity Through Music." Ideas and examples, how *you* can enjoy advantages and opportunities which playing a wind instrument provides.

PARENTS—Ask for "Music, The Emotional Outlet for Youth." An important guide for growing children that is widely acclaimed by authorities on youth problems.

See your friendly Conn dealer, or send coupon direct to C. G. Conn Ltd., Elkhart, Indiana.



C. G. CONN LTD.,
1131 Conn Building, Elkhart, Indiana.
Without obligation, please send **FREE** Book checked below.

- "Fun and Popularity Through Music"
 "Music, The Emotional Outlet for Youth"

NAME _____

ADDRESS _____

CITY _____ ZONE _____ STATE _____



WORLD'S LARGEST MANUFACTURERS OF BAND INSTRUMENTS

ANCO RAIN-MASTER

"Dead-Locker"

WINDSHIELD WIPER
ARMS and BLADES

BLADE SNAPS ON...
STAYS PUT

FINGER-
TIP
RELEASE

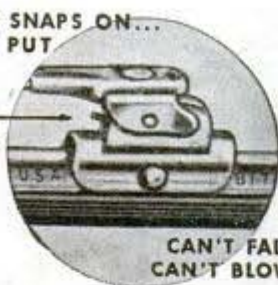

CAN'T FALL OFF
CAN'T BLOW OFF

(A war-born invention—by ANCO—first)
(for military aircraft—now for your car.)

DON'T SHOOT YOUR GAS-PUMP MAN!

He's doing the best he can. Sure, he knows how dangerous it is for you to drive your car... in stormy weather... with your dull old windshield wipers that smear and smear. He'd gladly put on for you quickly a pair of keen new ANCO RAIN-MASTER Wiper Blades and Arms. He has them—Newest Models! But he forgets to remind you? Too busy? You can't shoot him for that!



PATENTS
MAKE JOBS

After all, it's *your* car to protect. So you remind *him*. Get RAIN-MASTERS... patented features... original equipment on many makes of high grade cars and trucks... used in war—on our fighting tanks and trucks and ships and bombers too... because ANCO RAIN-MASTERS clean quicker, clean cleaner... last longer. May save you a costly smashup.

Ask for RAIN-MASTER Windshield Wiper Arms and Blades next time you buy gas.

THE ANDERSON COMPANY

Established 1918

GARY, INDIANA

NOW AVAILABLE!

POWER AT THE FLICK OF
A SWITCH WITH SHEPPARD

Load-Control



The flick of any one lighting or appliance switch on an electrical circuit supplied by a Sheppard Diesel Generating Set equipped with LOAD-CONTROL will automatically start the generator. Turn off the switch and it immediately stops the power plant. LOAD-CONTROL cuts operating time of the unit to periods when power is actually required—it reduces fuel consumption and prolongs the life of equipment. Sheppard LOAD-CONTROL requires no special wiring. Simply connect to present service leads. This exclusive Sheppard feature is available with any of our AC generating sets.

Sheppard Diesel Units are also available with: Remote station control from manual, thermostatic or similar type switch. Line failure starting and stopping for use on standby generating sets. R. H. SHEPPARD CO., 3048 MIDDLE ST., HANOVER, PA.

Sheppard ALL AMERICAN Diesels



A SNAP TO START

"O.K."

SUPER '60'
ENGINE

FOR
MODEL AIRPLANES
FOR
FREE FLIGHT
OR
CONTROL-LINE



DESIGN FEATURES

CYLINDER—1 piece
CRANKCASE—
aluminum-alloy
PISTON—machined
from steel, hard-
ened and lapped
to cylinder
BALL-BEARING—
Radial and thrust
BORE .900, STROKE
.950, DISPL. .604,
WGHT. 12 ozs.

"OK" Super "60" is palm-size power plant! Gives consistent flying power to model airplanes! A snap to start! Many exclusive design features including PATENTED PORTING for complete instantaneous scavenging. TOP SPEED (to 9000 RPM) Super "60" with coil, spark-plug, gas tank, condenser \$24.00 at all model hobby shops.

FREE! Descriptive Brochure and Installation diagram.
(Send stamped and addressed envelope)

HERKIMER TOOL & MODEL WORKS

HERKIMER (Dep't PM) NEW YORK

POPULAR MECHANICS

WAR SURPLUS BARGAINS

* * * * *

SENSATIONAL VALUES FOR QUICK LIQUIDATION



GI BELTS

Of heavy canvas webbing. Adjustable around. Eyelets all around. Used, but guaranteed.

A129-11 POCKET, EACH..... 98c

BANDOLEERS



Army Bandoleers of heavy khaki. Used by hunters, boy scouts, etc. Well made, serviceable, guaranteed new.

A129-11 POCKET, EACH..... 49c



Mess Kits

Regulation Army Mess Kits. Idea for campers, boy scouts, etc. Slightly used but guaranteed perfect. Two pieces. Folding handle.

A118-EACH..... 69c



Regular U. S. Gov't issue canteen. Plastic screw top cap chained to body. Slightly used.

A117-METAL BODY, Each..... 69c

A118-PLASTIC BODY, Each..... 69c

A119-Canteen Covers, Each... 35c

A120-Canteen Cups, Each... 25c



U.S. Govt. BOLO KNIFE

Extra heavy. For farm, home or jungle use. Blade of Gov't. Formula cutlery steel. Walnut riveted handle. 3 1/2 inch hill, 10 1/2 inch blade. You'll find hundreds of uses for a Bolo knife. Blade will take and hold a keen cutting edge. Wt., 2 lbs.

A112-with Army Sheath..... \$4.95

A212-Leather Sheath, extra..... \$1.50



PUP TENTS

Regulation Army Pup Tents of durable, brown canvas. Used, but in good condition. Fine for campers, outdoorsmen, boy scouts, etc. Grand Xmas gift for children.

A100-Tent Only..... \$4.95

A101-Ropes, wooden poles and stakes for above. Per set..... \$1.00



SHIPS BELLS

Purchased from U.S. Maritime Comm. Measures 10 inches high, 9 3/4 inch flare. Big 8 inch clapper. Weight 15 lbs. Fine for arms, clubs, ex-states, etc. All new.

A541, ONLY... \$9.85



HEAD NETS

Real protection from insects, etc. Fits over hat. Draw strings in net. Celluloid window. For campers, fishermen, etc.

A509, ONLY.. 89c



BLITZ CAN

Standard Gov't. blitz cans. Used and scuffed but guaranteed leak-proof. Measures 1 1/2 x 1 1/2 x 1 1/2 inches. Welded seams. Screw cap. Capacity 5 gal. One of a bargain.

A542-EACH..... 85c



CAVALRY SPURS

Genuine wishbone type cavalry spurs. Nickel plated.

A102, Pair... 98c

A103-Spur straps per set of four..... 50c



CATHODE RAY TUBE

Purchased from U.S. Gov't. for experimenters in electronics, radar, etc. Slightly used for test work. Guaranteed perfect. Tubes are standard No. 5BP1 or 5BP4 with 5 inch screen. Each tube tested before shipment. Specify number when ordering. Tube list on request.

EACH, express collect..... \$12.00



RUBBER CUP WITH LID

Measures 3 1/2 x 3 1/2 inches—of genuine live rubber. Snug fitting lid. Makes fine tobacco humidifier, etc. All guaranteed perfect.

A503-EACH..... 59c



RADIO HEAD PHONES

Extremely sensitive with 4000 ohms resistance. Brand new and fully guaranteed. With moisture-proof cord and phone plug. A splendid value for the radio serviceman and experimenter.

A106-PAIR..... \$2.95

7-LB. RADIO PARTS ASSORTMENT

A "gold mine" for the radio serviceman. Hundreds of valuable radio parts, including rivets, soldering lugs, sockets, coils, resistors, trimming condensers, etc.

A1308-7 LBS. \$1.79

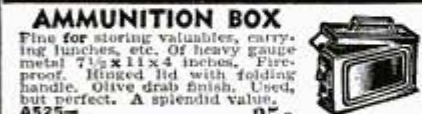

AMMUNITION BOX

Fine for storing valuables, carrying lunches, etc. Of heavy gauge metal 7 1/2 x 11 x 4 inches. Fire-proof. Hinged lid with folding handle. Olive drab finish. Used, but perfect. A splendid value.

A525-EACH..... 25c

PLASTICS LUCITE AND PLEXIGLASS

In sheet form. Good workable sizes. Transparent. For costume jewelry, etc. Easy to work and polish.

A280-5 LB. \$4.75

ASST. \$4.75

27 LENSES, ALL NEW, PERFECT.

For experimental work in optics. Consists of 27 precision ground and polished prisms and lens elements in assorted diameters and focal lengths. Big variety, positive, negative, etc. Actual value over \$100.00.

A519-27 PIECES \$7.95

50 LENSES, SEMI-FINISHED

Lenses similar to above but not polished. All are blanked and formed ready for polishing. Negatives, positives, and prisms in Crown and Flint glass. Worth many times this low price.

A520-50 LENSES, ONLY..... \$1.95



BICYCLE DUFFLE BAG

Heavy canvas pouch. Attach to bicycle for lunches, shopping, books, etc. Has three 11 x 12 inch pockets. Used, and slightly soiled, but in good usable condition. Has oversize flap with two straps.

A113-EACH..... 98c

CATALAN-ASST. COLORS

Extruded shapes, rounds, half rounds, etc. Easy to machine. Furnished in assorted colors, shapes and lengths.

A281-5 LB. \$4.75

ASST. \$4.75



COMB. AIR PILLOW-LIFE BELT

Every outdoorsman, hiker, camper, boy scout, etc., should have one. Made of air tight, waterproofed, rubberized khaki 10 x 40 inches when deflated. Swimmers, boatmen, etc., use them as life-belt or beach raft. Quickly inflated or deflated. Folds compactly for storage. Used, but guaranteed perfect.

A127-EACH..... 98c



SADDLE BAGS

Made of finest top grain leather. Rivet reinforced seams. Bottom and side gussets. Each canvas lined bag measures 12 x 13 inches. Fine for motorcyclists. May be separated to make two duffel bags. Used, but perfect.

A151-EACH..... \$7.95



OFFICERS WATCH COMPASS

Brand new gov't. surplus. Army-Navy model. Single jewel mounted needle. Silver colored dial. A splendid value.

A174-EACH... \$3.35



AVIATORS GOGGLES

U. S. Aviator Goggles. Over-size design with sponge rubber shock lining. Curved lenses, elastic head band. Fine for industrial use, motorcyclists, etc. Hinged nose arch. Slightly used, guaranteed perfect.

A159-PAIR..... \$5.95



"MIKE" BUTTON

Microphone button for experimenters in electronics and other electrical apparatus. Used in telephonic amplifier and telephone circuits. Measures 2 1/2 in. Brand new.

A512-EACH... 98c

ORDER DIRECT FROM THIS AD

Values galore! Hundreds of hard-to-find items for home, shop and outdoors. Make remittances by money-order, bank draft or personal check. Send 25% deposit on C.O.D. orders. No C.O.D.'s on orders for less than \$5.00. Include sufficient postage on parcel-post orders—any overage will be promptly refunded. All quotations F.O.B. Chicago. Used items and materials are guaranteed serviceable and as described. Your money back if not more than satisfied.



SHIPS LANTERN

Purchased from the Navy. Stands 2 1/2 inches high, 9 3/4 inches wide. Of heavy sheet metal. Windproof ventilation. Mounts on any wall. Burns oil—may be wired for electricity. All new.

A516-EACH... \$12.50



CAMERA TRIPOD

Purchased from U.S. Gov't. For cameras up to 5x7 in. Extends to 39 inches, folds to 23 inches. Has 5 1/2 inch brass head with extended threading screw. Extra sturdy design. Adjustable. Brand new.

A150-EACH... \$4.95

BIG ILLUSTRATED CATALOG FREE

STARK'S

Dept. PM11
509 So. State St.
CHICAGO 5, ILL.



CORK FLOAT

Measures 5 1/4 by 3 ins. Solid cork. Used as buoy, also for deep sea live bait fishing or Muskege float. White and red finish. New.

A101-EA... 75c

WORLD'S

LOWEST PRICED ADDING MACHINE

VEST POCKET SIZE

MAKES IDEAL GIFT

Baby Calculator makes an ideal gift—for every Gift occasion. Birthday—Graduation—Christmas—Anniversaries. For men, women, children—teachers, business people, home or shop use. Comes packed ready for gift wrapping.

TEN DAY TRIAL Money Back Guarantee

Because we know that our machine is the very best Calculator to be obtained at this low price, we make this 10 Day Trial offer, on a positive money back guarantee! Don't buy ANY Calculator without this guarantee! Send only name and address, pay postman \$2.50 plus postage (if cash is sent, we pay postage—you save up to 40c). (Send full cash if outside U.S.) Money back within 10 days if not delighted.



IDEAL XMAS GIFT

Fits vest pocket or purse. Guaranteed Accurate. Operated as easily, and as reliably, as machines costing many times as much. NOT A TOY or GADGET. Substantially made of 28-gauge steel—guaranteed for life against defects in construction. Beautiful looking, modernized design. Finished in Black, Silver and Red. You positively can't buy a Calculator of equal quality for as little money. ACCEPTED AS THE FINEST LOW PRICED CALCULATOR FOR OVER 30 YEARS! Operates with a flick of your finger. Adds, subtracts, multiplies, divides—counts up to ten million. Pays for itself over and over in mistakes avoided, and time saved.

CALCULATOR Machine Co. (Mfrs.)
DEPT. 172, P. O. BOX 1118, CHICAGO, ILLINOIS

USE COUPON
CALCULATOR MACHINE CO. (Mfrs.)
 P. O. Box 1118, Dept. 172, Chicago, Ill.
 Your Calculator is just what I've been looking for. Send one at once (C.O.D.) or (I am enclosing \$2.50).

Name.....
 Address.....
 City..... State.....

AGENTS WANTED

FREE TRIAL

ONLY \$2⁵⁰

TOTAL COST SEND NO MONEY

FREE!!

Each Baby Calculator enclosed in beautiful rich-looking Leatherette Case—at no extra cost.



RENEW VALUABLE EQUIPMENT CITIES SERVICE RUST REMOVER

Now you can quickly and easily clean rust or corrosion from steel, iron, chromium, copper, aluminum and nickel. Cleans enamel and porcelain as well. It is nonflammable, contains no dangerous acids. Four years' test proves it safe for tools and equipment. Buy it NOW at these amazingly low prices. Send the coupon today.

16 oz. — 65c
1 gal. — \$2.80



We Pay Postage
Send In Your Order Now for
**CITIES SERVICE
ANTI-CORRODE**



Get rid of rust and corrosion AND KEEP THEM AWAY! Cities Service Anti-Corrode forms a thin, soft, transparent film on a metal surface, making it impervious to moisture from either fresh or salt water. Has exceptional lasting qualities for products of this type. Dip, brush or spray your tools and equipment—keep them bright and free from rust and corrosion. This is your opportunity at low introductory prices.

LOW INTRODUCTORY OFFER
1 gal. — \$1.75

CITIES SERVICE SOLVENT No. 26

A new cleaning agent that quickly and safely cleans oil, grease, paint, varnish, carbon deposits, etc., from metals, porcelain, stone or wood. Also removes oxides from copper, zinc and zinc alloys. Saves time, labor, expense. Non-corrosive. Harmless. Rub, dip, brush or spray.

1 gal. \$2.72



FILL IN AND MAIL THIS COUPON

YOUR ORDER WILL BE SHIPPED POSTAGE PAID

Special Order Division

Cities Service Oil Co., 401 New York Ave., Trenton, N. J.

I enclose check or money order for \$..... Please send

NAME.....

ADDRESS.....

P. M.

LOCATES TROUBLE INSTANTLY IN ALL ELECTRICAL DEVICES



HANLAN APPLIANCE TESTER

In this single unit are combined all the necessary tests for examining every appliance. Checks thermostats under actual working conditions. Tells instant it opens or closes. Controls the heat on soldering irons. Prevents over-heating. Tests continuity, open circuits, etc. Checks automatic irons, vacuum cleaners, motors, shavers, bulbs, appliances with 3-way switches, etc. Great time, effort and money saver! ONLY \$9.50 COMPLETE.

Pat. Pend.

FREE with each Tester. New, Complete Practical Course in electrical appliance repairing. WRITE FOR CIRCULAR.

HANLAN CO., 1419-A, West Jefferson, Los Angeles 7, Calif.

GAS ENGINES IN STOCK



The G. H. Q. miniature gasoline engine that really operates is now available. Over 100,000 sold to date. 1/5 H.P. Complete with flywheel and propeller, fuel 15 accessories and full instructions for \$20. With major accessories at \$15. With coil and condenser only, \$9.95. Fully bench tested and ready to run. Power for all models. Send only \$1.00 — Shipped Collect C.O.D. same day. Send for free illustrated Catalog of hundreds of hobby items.

GHQ MOTORS, Dept. BV115, 40 E. 21 St., New York 10, N.Y.

PLASTAKIT

Make your own ornaments, decorations and jewelry designs out of plastic. Box of 60 pieces including such pieces as boats, anchors, hearts, pilots' wheels, flower baskets, also 2 plastic bases to make your own brooches. All complete, including earclips, glue and pins. Now the latest rage. Send \$2... box sent postpaid. No C.O.D.'s.

WASHINGTON EMBLEM CO.

Dept. P

Box 1067

Providence, R. I.

Now A DYNAMIC HEAVY DUTY INDUSTRIAL WELDER

Available Now Without Priorities!

TO SAVE YOU VALUABLE TIME and MONEY!

Designed to Do High-Grade Welding *Inexpensively*

Maintenance men, farmers, mechanics, machine shops, foundries, auto, general repair and job welding shops using the DYNAMIC WELDER find it so indispensable and useful that they cannot afford to be without it. If inexperienced you can easily learn to do a variety of high-grade welding jobs by following the practical, simplified operating and welding instructions furnished.

WORKS ON IRON, STEEL, BRASS, BRONZE and OTHER METALS

Has eight metallic and carbon arc welding heat stages. Does work you would think only possible with a larger, more expensive machine.

READ WHAT USERS SAY...

Repair Shop Owner says, "It will do more than you say!"

"I want to say I operate a repair garage and am more than satisfied with the welder. It will do more than you say." C. P., Butler, Ohio

It's the Greatest Portable Outfit

"Now I am equipped for all kinds of welding and I must say it's the greatest portable outfit for welding any man could ever wish to own. I wouldn't sell mine for the cost of plenty welders I have seen which were very high in cost but not in convenience. You may put me on file as a booster of your wonderful welding product." W. J. B., St. John, N. B., Canada

Better Than I Expected

"I have done quite a little welding with my welder and will say it is better than I expected. The price, convenience, and variety of work that can be done with the Dynamic are the attractive points." W. R. P., Portland, Ore.

EASY TO OPERATE!

DYNAMIC SUPERCHARGED WELDER

GET DETAILS ON OUR 10-DAY TRIAL OFFER!

Once you see a DYNAMIC in operation you won't want to be without it. Its simplicity will amaze you. In a year the DYNAMIC only costs you about 6c a day. Comes complete, ready to operate, with helmet, rods, cables, electrode holder and operating instructions, etc. Nothing else to buy. Write today for Free particulars. Act now and get details on our amazingly low priced Dynamic Welder and 10 day trial offer.

DYNAMIC WELDER CO.

13 EAST 23rd—CM CHICAGO 16, ILL.



SHOP MAINTENANCE

AUTOMOBILE REPAIRS



AN IDEAL AND PRACTICAL GIFT FOR ANY MAN!

MORE VERSATILITY

FROM SOUTH BEND LATHES WITH THESE ATTACHMENTS



Handlever Bed Turret for 9" or 10" lathes multiplies their versatility through multiple tooling for repetitive operations.

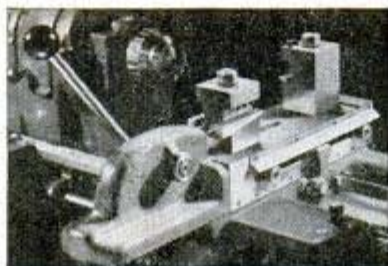

Handlever Double Tool Cross Slide for 9" or 10" lathes speeds up successive operations through the use of three cutting tools.



Screw Feed Double Tool Cross Slide for 16" lathes has both manual and power cross feed. Large graduated feed dial.



Handlever Draw-in Collet Attachment saves time on bar work. Collet can be operated and stock fed without stopping spindle.



Handwheel Draw-in Collet Attachment is ideal for production and toolroom work that requires extremely close tolerances.



Collets from 1/16" to 1" in 1/64" steps. Complete sets of collets will save time.

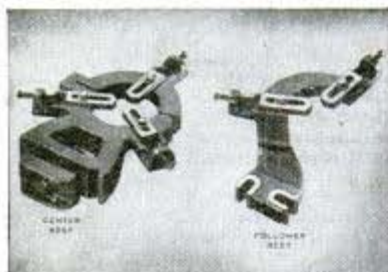

Center Rest and Follower Rest for supporting long bar work while turning, threading, drilling, boring, etc.



4-Way Turret Tool Block permits use of four cutting tools which simplifies tooling for repetitive operations.

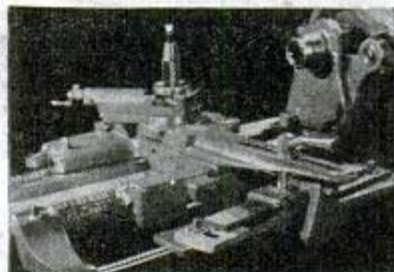

Taper Attachment for accurate taper turning and boring. Quickly engaged. Graduated in both degrees and taper per foot.

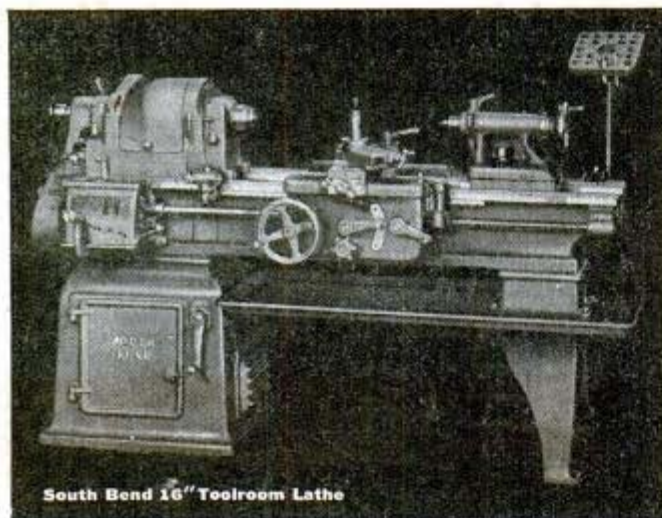

South Bend 16" Toolroom Lathe

These and other practical attachments greatly increase the capacity of South Bend Lathes for a wide variety of operations. They simplify difficult set-ups, save time and effort, and often eliminate delay and expense of making special fixtures.

Write for Catalog 77R in which all South Bend Attachments are illustrated and described. Also, state size and type of lathe for which required. Attachments only available for use on South Bend Lathes.



SOUTH BEND LATHE WORKS

Lathe Builders Since 1906

455 E. MADISON STREET, SOUTH BEND 23, INDIANA

PRINTED BY POPULAR MECHANICS COMPANY, CHICAGO, ILL., U. S. A.

LIGHTER MOMENTS with
fresh Eveready Batteries
Dated



"Are you sure we aren't a little lower than you thought?"

NO MORE NEED to accept substitutes for fresh, *dated* "Eveready" flashlight batteries! Your dealer has ample supplies of these famous, long-life batteries right now—in the size you need.

That's because—for the first time since Pearl Harbor—production is now adequate to take care of *both* military and civilian needs.

So ask your dealer for fresh, *dated* "Eveready" flashlight batteries... with the famous *date-line* that means *full power, fresh energy, long and dependable service.*



EVEREADY
FLASHLIGHT BATTERIES

The word "Eveready" is a registered trade-mark of National Carbon Company, Inc.



If you ask for
"PRESTONE"
ANTI-FREEZE

and he says **SURE**



**you're safe...
 and you know it!**

Your dealer may not be able to say "Sure." There's an even more limited supply available than last year, because the Armed Forces still require so much non-boil-away anti-freeze.

But if he *can* supply you with "Prestone" anti-freeze, you're all set for the cold weather. "Prestone" anti-freeze can't boil away, evaporate or foam off. It protects against rust and corrosion. One shot lasts all winter—you're safe and you know it!

Here's how anti-freeze is being distributed this year

To assure anti-freeze protection of the nation's motor vehicles, the War Production Board, with the cooperation of the Anti-Freeze Industry Advisory Committee, set up a state allocation plan for the distribution of all anti-freezes. This plan is intended to assure motorists of some kind of anti-freeze protection. Some "Prestone" brand anti-freeze will be available in all communities.

NATIONAL CARBON COMPANY, INC.
 Unit of Union Carbide and Carbon Corporation



The registered trade-marks "Eveready" and "Prestone" distinguish products of National Carbon Company, Inc.

**WHY
 OUR ARMED
 FORCES
 STILL NEED
 ONE-SHOT
 ANTI-FREEZE**

Vast numbers of our tanks, trucks, planes, warships, etc. remain at various points throughout the world. This tremendous investment of the American people must be protected—and protected properly. That is why our armed forces still require quantities of one-shot anti-freeze.

Time Too Short

Even though the requirements of the services have been reduced, not enough "Prestone" anti-freeze can be made to meet both military and civilian needs this Winter.



O.P.A.
 Retail Ceiling Price
\$2.65
 per gallon
 SAME PRODUCT
 SAME PRICE

PRESTONE
TRADE MARK
ANTI-FREEZE