

POPULAR MECHANICS

MAGAZINE

WRITTEN SO YOU CAN UNDERSTAND IT



OCTOBER
25 CENTS
30c IN CANADA

SEE PAGE 50





FOR TIRES THAT GO A LONG WAY SAFELY

Choose a name you can trust in Rubber

You'll be money—and miles—ahead if you remember this important fact:

Truck owners keep accurate records of tire performance. Hence it's significant that truck owners buy a greater share of Seiberling's tire production than that of any other major tire manufacturer!

Yes, today, more than ever, it will pay you to remember that the name "Seiberling" means a better tire for the long run. It is *A Name You Can TRUST In Rubber.*

SEIBERLING

Experts in Rubber

Guard Your Tires!

There are not yet enough new tires for all who want and need them. That's why it will pay you to guard your present tires, make them last. See your Independent Seiberling Dealer for dates when new tires will be available.

SEIBERLING RUBBER COMPANY
Akron, Ohio, U. S. A. • Toronto, Ontario, Canada



**SEIBERLING
TIRES**



RETAILED ONLY BY FREE,
INDEPENDENT BUSINESS MEN
DISPLAYING THIS SIGN OF QUALITY

"Your America"

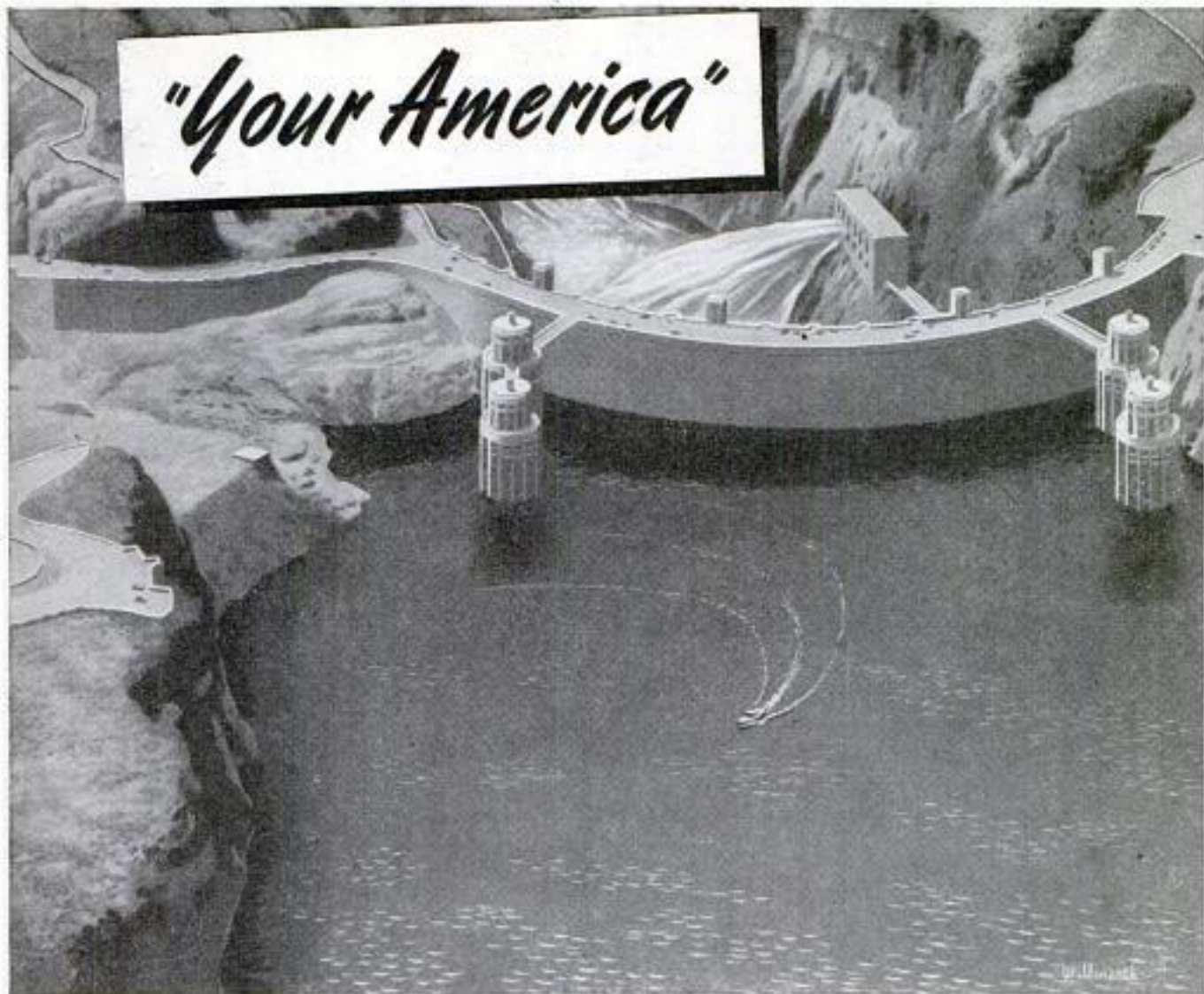

NEVADA

... Harnessed by mighty Boulder Dam, the rushing Colorado River provides irrigation for agriculture, power for industry. From Nevada's farms and ranches come food for the nation's fighters and workers. From its mines come gold, silver, copper, magnesium, tungsten and other minerals of high industrial value.

The distribution of these products calls for dependable rail transportation. Union Pacific provides that transportation over the Strategic Middle Route, uniting Nevada with the East and the Pacific Coast.

A great era lies on the peacetime horizon for

THE PROGRESSIVE UNION PACIFIC RAILROAD

this progressive western state. Vast quantities of ores and minerals are yet to be mined. There are the facilities—and the space—for industrial expansion.

Opportunity looms large in Nevada. All that is required to convert the state's resources into prosperity for a business or an individual is the same driving spirit of enterprise and initiative that helped to develop Nevada and to build this great nation—*your America*.

NOTE: Write Union Pacific, Omaha, Neb., for information regarding industrial or business sites in Nevada or other western states.



This One



FNZH-YGH-TOF4

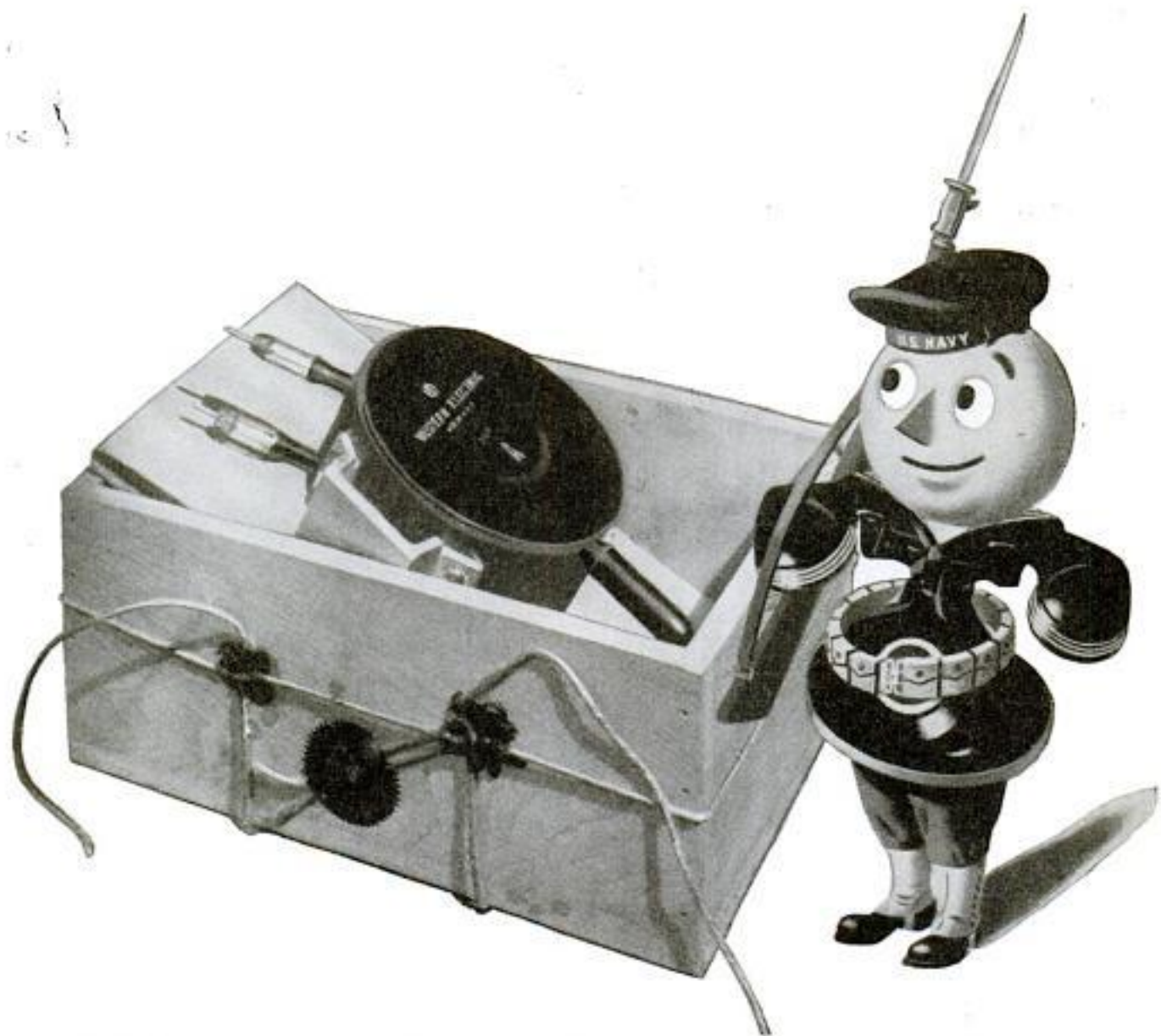

VICTORY REVEALS A MYSTERY

More than two years ago, an engineer of the Laboratories visited *U. S. S. Boise*, returned with a mysterious box which went into the Laboratories' vault. Now, victory opens the box and discloses a special kind of electron tube called a magnetron. It was part of a Radar which furnished data to aim *U. S. S. Boise's* guns during the night action off Savo Island on October 11-12, 1942. Because of the high frequency generated by this magnetron, the Radar was not detected by the enemy, and the action was a complete surprise. Six Japanese warships were sent to the bottom in one of the early Pacific victories.

This magnetron is a symbol of the Laboratories' enormous war program. Half of it was devoted to Radar, the other half gave birth to radio transmitters and receivers, sonar apparatus for the Navy, loudspeaker systems for ships and beach-heads, fire-control apparatus for anti-aircraft artillery. Coming months will unfold the story.

Bell Telephone Laboratories' war work began before the war; until now, it claimed practically all our attention. With victory, we will go back to our regular job—helping to bring you the world's finest telephone service.

BELL TELEPHONE LABORATORIES



Popular Mechanics Magazine

Registered in U. S. Patent Office and Canada

H. H. WINDSOR, Founder

H. H. WINDSOR, Jr., Editor and Publisher

Next Month

NO ONE is going to put all the railroad bridges in America end to end. But if it were done by some Paul Bunyan, you could ride all the way from Newfoundland to beyond San Diego on railroad bridges. There is one for every mile of track. One old-timer described in a November feature is 112 years old and still going strong.

ARE you dumping a shovelful of coal in the ashcan every time you fill your stoker? Of course you aren't, but maybe the stoker is wasting an equivalent amount of fuel because of inefficient operation. A story next month explains how to adjust and operate a stoker to get the most heat.

MECHANICAL slaves consisting of robots driven by electrical motors and hydraulic pressure will fly the giant postwar airliners. How the human pilot and his crew of robots will fly you to the end of the world with maximum safety is told in November.

MAKING scrap sheet metal into costume jewelry is an easy way of solving a gift problem, and may be turned into a profitable hobby. An article in the November Craftsman section tells how to fashion brooches, bracelets and other items.

WHEN an ancient art, such as making fine china, teams up with modern U. S. industrial genius something's bound to happen. It has. The result is American leadership in ceramics. An article next month tells how we got "Our Turn at the Potter's Wheel."

ELECTRONICALLY controlled timing takes guesswork out of photoprinting and enlarging. An article in the Radio and Electronics section next month tells how to build and calibrate an inexpensive electronic photoprint timer.

Volume 84	OCTOBER 1945	Number 4
Managing Editor.....	Roderick M. Grant	
Assistant Managing Editor.....	Wayne Whittaker	
Associate Editor, Shop Notes and Crafts.....	James R. Ward	
Radio and Electronics Editor.....	Frank L. Brittin	
Art Director.....	Frank Beatty	
Associate Editor.....	William E. Taylor	

In This Issue

The Big Pit	1
The World's Fastest Airplane	8
Grand Slam in Subs	13
Atomic Power for War and Peace	18
"Workin' on the Railroad"	20
Radar Sees the Unseen	34
Science Is the Umpire	44
High Pressure Diver	50
Testing Warships	56
Nine Lives for Battlewagons	60
A Billion Dollars' Worth of Dams	65
"It's Impossible, But We'll Try It"	76
Fleet Under Two Flags	82

For the Craftsman

Building Your Own Telescope	100
Leathercraft for Fun and Profit	108
Tricks of Trapping	114
Masking Tape for Lettering	125
How to Taper, Face and Bore	130
Radio and Electronics	141

Other items, and manufacturers of available products described, are listed on pages 8A and 10A

Published monthly by POPULAR MECHANICS COMPANY, 200 East Ontario Street, Chicago 11, Ill. H. H. Windsor, Jr., president; Paul H. Dunakin, vice president and general manager; D. F. Windsor, vice president and secretary-treasurer; Clover L. Perkins, advertising manager. Single copy in the United States, 25 cents; subscription rates in United States and possessions, and countries of the Pan-American Postal Union, 1 year, \$2.50; 2 years, \$4.50; 3 years, \$6.00. Single copy in Canada, 30 cents; subscription rates, 1 year, \$3.00; 2 years, \$5.50; 3 years, \$7.50. To all other countries add \$1.00 a year over United States prices for overseas postage. If you plan to move, notify us at least 60 days in advance so you will not miss an issue. Give both old and new addresses. Entered as Second Class Matter, September 15, 1903, at the Post Office at Chicago, Illinois, under Act of March 3, 1879. Entered as Second Class Matter at Post Office Dept., Canada. Copyright 1945, by Popular Mechanics Company. Copyright under International Copyright Union. All rights reserved under Pan American Copyright Union. Printed in the United States of America.



When papered walls begin to peel
From age or from the heat,
A strip or two of Texcel Tape
Will keep them looking neat.
(Texcel won't creep loose—the "stickum's" bonded on!)

The kitchen curtain starts to rip?
Don't let that bother you.
Quick! Take a strip of Texcel Tape
And mend it good as new.

(Texcel mends securely—the "stickum's" bonded on!)



So many things about a house
This Texcel Tape can do—
From wrapping up to fastening down
In place of string or glue.

(Texcel holds and holds—the "stickum's" bonded on!)

Yes, Texcel is an improved tape
Whose "stickum's" bonded on!
It won't come off, it won't dry out,
It holds with lots of brawn.

So make a mental note right now
Though cellophane tape's at war,
That improved Texcel Tape will be
The first brand you'll ask for.

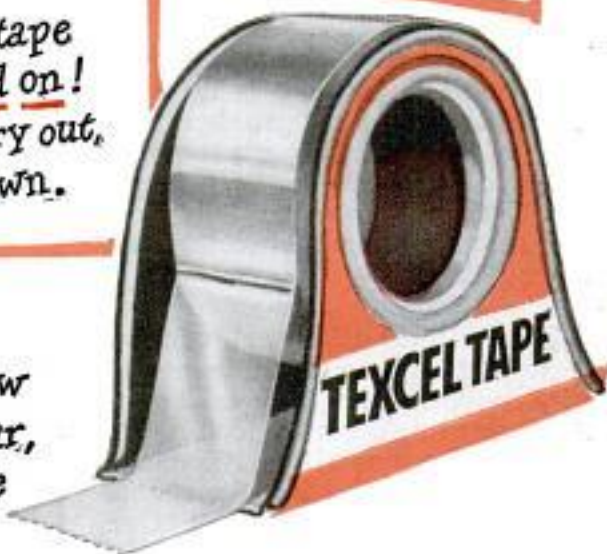

Texcel Tape

REG. U. S. PAT. OFF.

CELLOPHANE TAPE — STICKS WITH A TOUCH

INDUSTRIAL TAPE CORPORATION
A Subsidiary of
Johnson & Johnson
New Brunswick, N.J.

Outwitting the weather

 How science copes with Old Man Weather is illustrated by these ideas and devices from General Electric laboratories.

How high are the clouds? A ceilometer measures this for airmen. How wet is the weather? A fungus farm in a G-E laboratory helps design military equipment to resist fungus in the world's wettest areas.

On this page are a few more examples of the way General Electric research and engineering are being devoted to this phase of human comfort and health. *General Electric Company, Schenectady, N. Y.*



Cloudy but bright. When clouds darken the sky, lights come on in this schoolroom. No one has to remember; a General Electric automatic light control with an "electric eye" keeps constant watch on daylight, safeguards young eyes by turning on the lights whenever they are needed.



Cucumber magic. Vines in electrically heated soil (right) grew twice as tall, and bore one month earlier. The heating cable, developed by G-E engineers, is buried in the soil and thermostatically controlled. More than 15,000 commercial growers use G-E soil-heating cable.



Weather detective goes aloft in the small box suspended from the balloon. Some 12 miles up the balloon bursts, and the box is parachuted back to earth. On the way up, this electronic device, called the G-E Stratometer, gives a running commentary on the weather—temperature, humidity, air pressure—and sends this information back to earth by radio signals. The information gathered by the G-E Stratometer can be used to help predict the weather.

★

Hear the G-E radio programs: The G-E All-girl Orchestra, Sunday 10 p. m. EWT, NBC—The World Today news, Monday through Friday 6:45 p. m. EWT, CBS—The G-E House Party, Monday through Friday 4:00 p. m. EWT, CBS.

FOR VICTORY—BUY AND HOLD WAR BONDS

GENERAL  ELECTRIC

BORN OF WAR



★ Over a MILLION
Coleman Military
Burners went to war!



You'll use it
for **FUN**



The Amazing Outdoor "Pocket" Stove of Tomorrow!



All during the war, this famous Coleman Military Burner was used by our fighters on battlefronts all over the world—for cooking food, heating drinks, purifying water and even keeping warm.

Soon, it will be the Coleman "Pocket" Stove you'll want along on every outdoor trip—the grandest little sport stove you ever touched a match to! **BURNS ANY KIND OF GASOLINE—White or Leaded!** Ready in minutes for quick-cooking action.

Compact, amazingly efficient! Easy to carry as a quart size can of food. Only 8½ inches high; 4½ inches in diameter. Telescoping case makes two handy cooking utensils. It's the perfect pal for your hunting, fishing and camping trips—for vacations, picnics, backyard snacks. Thousands of uses around the home and in the workshop. Quality built for long, trouble-free service. Watch for the Coleman "Pocket" Stove. You'll want one!

New Pictorial Folder showing some of the many uses for this little "Wonder Stove" now in preparation. Copy will be mailed to those requesting as soon as it is available. Write for your copy.

THE COLEMAN COMPANY, INC., 264-PM, Wichita, Kansas
Philadelphia 8 • Los Angeles 54 • Honolulu, T. H. • Toronto, Canada



NEW Coleman "Pocket" STOVE

••• ARE YOU ASKING •••

"How Can I Make Sure of My Postwar Success?"

THAT'S a vital question for you to answer soon.

For postwar adjustment will change many things. Jobs that are good now may be very different then. War emphasis is on production in the plant—peace may shift it to the office, store, management and sales. Overalls and slacks may, for many, give way to white collars and dresses.

Now is the time to plan and prepare—to get ready for the new opportunities. By training now in spare time, you can get in on the ground floor when peace comes.

LaSalle home study training—complete, authoritative, moderate in cost—will quickly prepare you for your chosen field, ready for the preferred positions. In our 36 years, over a million ambitious men and women have found it interesting and helpful in securing promotions or better jobs.

Send the coupon at right for full, free information. Or if you are not sure which is the best field for you, write us for our frank counsel—without obligation.



LASALLE EXTENSION UNIVERSITY
A Correspondence Institution
DEPT. 1064R
417 South Dearborn Street
Chicago 5, Illinois

I am interested in preparing myself for postwar success. Please send me your free 48-page booklet on the training course I have checked below.

ACCOUNTANCY
MODERN EXECUTIVE
MODERN FOREMANSHIP
INDUSTRIAL MANAGEMENT

<input type="checkbox"/> Accounting	<input type="checkbox"/> C. P. A. Coaching
<input type="checkbox"/> Bookkeeping	<input type="checkbox"/> Industrial Management
<input type="checkbox"/> Business Correspondence	<input type="checkbox"/> Executive Management
<input type="checkbox"/> Business English	<input type="checkbox"/> Traffic Management
<input type="checkbox"/> Salesmanship	<input type="checkbox"/> Stenotypy
<input type="checkbox"/> Law: LL.B. Degree	
<input type="checkbox"/> Business Law	
<input type="checkbox"/> Effective Speaking	

Name _____ Age _____
Present Position _____
Address _____
City and State _____

clip and mail this coupon today!



as Mileage piles up . . .



your car needs . . . PYROIL more than ever!

Maybe you are wondering how many miles the old bus has left. From now on the miles you drive are plenty tough. Give your car every possible help to carry you through. Add PYROIL—and be sure that lubrication is efficient—that you have a protective coat of oil on cylinder walls—that wear, rust and corrosion are not encouraged through simple neglect. Ask your station attendant to add PYROIL—a pint in your crank-case and 3 ounces in your gas tank every 250 miles. Just say—"add PYROIL"—and add life to your car.

Manufactured and Guaranteed by Pyroil Company, W. V. Kidder, Founder, 510 Pyroil Bldg., LaCrosse, Wis.



PYROIL COMPANY

510 Pyroil Building, LaCrosse, Wisconsin

I want my car to last and run properly. Please tell me more about Pyroil and how it can accomplish this for me.

Name

Address

City or Town State



Jerry, the talking dog, is entertaining hospitalized veterans, by courtesy of the PYROIL Company.

WHERE-TO-BUY-IT INDEX

Manufacturer's name and address appear in parentheses directly after items believed by us to be commercially available

Yanks' "Whizz Bang" blasted Japs out of caves.....	6
Artificial moonlight helped spot Japs at night.....	6
British jet fighter is Gloster Meteor.....	7
Hydraulics harnessed to signals for ship telegraph (Liquidometer Corp., Marine Div., 41-38 37th St., Long Island City 1, N. Y.).....	7
Exhaust runs turbosupercharger to boost plane's speed.....	12
Thread of stainless steel used to sew up wounds.....	12
Jack-in-box map shows flyers how to dodge weather hazards (Noble & Noble, Publishers, 72 Fifth Ave., New York).....	12
Naal U-boat secrets revealed.....	17
Pickaback bridges ride on tanks.....	23
Tape recorder helps GIs correct speech.....	30
Plastic screw reduces damage (S. S. White Dental Mfg. Co., Plastic Div., 10 E. 40th St., New York).....	30
Wingless B-29s train gunners.....	30
Flexiglas disks speed drawing of parallel curved lines (Designed by Charles A. Jackson, Ferguson, Mo.).....	31
Aluminum garage door can be opened by child (Berry Door Co., Birmingham, Mich.).....	31
Model shows how cargo ships are built.....	31
Boy collects 1100 war insignia of Allied fighting forces.....	31
Movement of magnetic pole is plotted by plane.....	32
Carrier jack helps change wheels of heavy planes.....	32
Cream keeps fresh for a year after "flash sterilization".....	32
Boat built of P-38's gas tanks.....	32
Night prowler with a sting—P-61.....	43
Sheep keep grass short on airfield.....	48
Boy builds midget paddle-wheel boat.....	48
Inlaid table and chairs contain million pieces.....	48
Truck scoop tosses loads over top of cab (Western Industrial Engineering Co., 3301 Medford St., Los Angeles 33, Calif.).....	48
Japs make dummy tank out of volcanic ash.....	48
Cabin cruiser has projecting deck.....	48
Residential area camouflages Douglas Aircraft plant.....	49
Amateur prospector carries assay lab in suitcase.....	54
Engine "cavesdropper" warns of defects (Sperry Gyroscope Co., 30 Rockefeller Plaza, New York).....	54
Oiling stick for band saw blade (Kindt-Collins Co., 12651 Elmwood Ave., Cleveland, O.).....	54
Proving ground for safety in synthetic products.....	55
Water-cooled chair keeps occupant comfortable.....	58
Mask for bull prevents him from charging.....	58
Flying flash bulb for reconnaissance planes.....	58
Television reflects bids from many cities.....	58
Seahawk is Navy's new scout plane.....	59
Phosphorescent tape glows in dark (Conti-Olo Div., Continental Lithograph Corp., 952 E. 72nd St., Cleveland, O.).....	59
Airliners warmed by radiant heaters (Surface Combustion Corp., Toledo, O.).....	60
Heat controls speed of blower fan (Webster Electric Co., Racine, Wis.).....	60
Twin bull's-eyes record practice hits of aerial gunners.....	70
Plant broadcaster has built-in phonograph (Operadio Manufacturing Co., St. Charles, Ill.).....	70
Sulfa "bandage" poured on burns.....	70
Flying command post operates from grounded plane.....	71
Saved by the silk—parachutes have many uses.....	72
"Harvester" picks up golf balls.....	74
Russians report restoring life to 12 fatally wounded soldiers.....	74
Eight-room birdhouse is built like a tower (Chandler Murphy, 4620 W. Lake Harriet Blvd., Minneapolis, Minn.).....	74
Vibrator for hydraulic press repeats automatic strokes (Denison Engineering Co., Columbus, O.).....	74
Life jackets run obstacle course in circular testing tank.....	75
Dial adjusts cooker's pressure (Aluminum Goods Mfg. Co., Manitowoc, Wis.).....	75
"Bombsight" for centering drill is accurate to .001 inch (Master Specialty Co., Minneapolis, Minn.).....	81
Shoeshine stick fits in compact outfit (David Shine Stick, 3173 First National Bank Bldg., St. Paul 1, Minn.).....	87
Radio-telephones for autos work like walkie-talkies.....	88
Electric refrigerators on rails cut perishable food losses (Win-charger Corporation, Sioux City, Iowa).....	88
Robot timer switch controls radio or lights (Warren Telechron Co., Ashland, Mass.).....	144
Radio service cement for repairing speaker comes (General Cement Mfg. Co., Rockford, Ill.).....	144

Craftsman and Shop Notes Index

ART AND ARTIST

Toothpicks plug holes in drawing board.....	98
Using clip board as sketching board.....	105
Lettering with a carpenter's pencil.....	105
Swinging shelf on drawing table holds instruments.....	136
Knife for cutting Ben Day quickly.....	140

AUTOMOTIVE

Truck doors held open by wooden arms.....	98
Tongs used to align U-bolts in auto spring bar.....	113
Valve springs replaced without removing cylinder head.....	136
Auto lift handles freight.....	138
Holders prevent pipe load shifting on truck.....	140
Whistle on gas-pump hose tells when tank is full.....	140

FARM

Heavy objects lifted to truck by plank lever.....	129
Arrow above barn door guides driver on load of hay.....	129

HAND TOOLS

Tin can makes holder for soldering iron.....	92
Hole drilled in tap wrench for smaller taps.....	92

(Continued to page 10A)

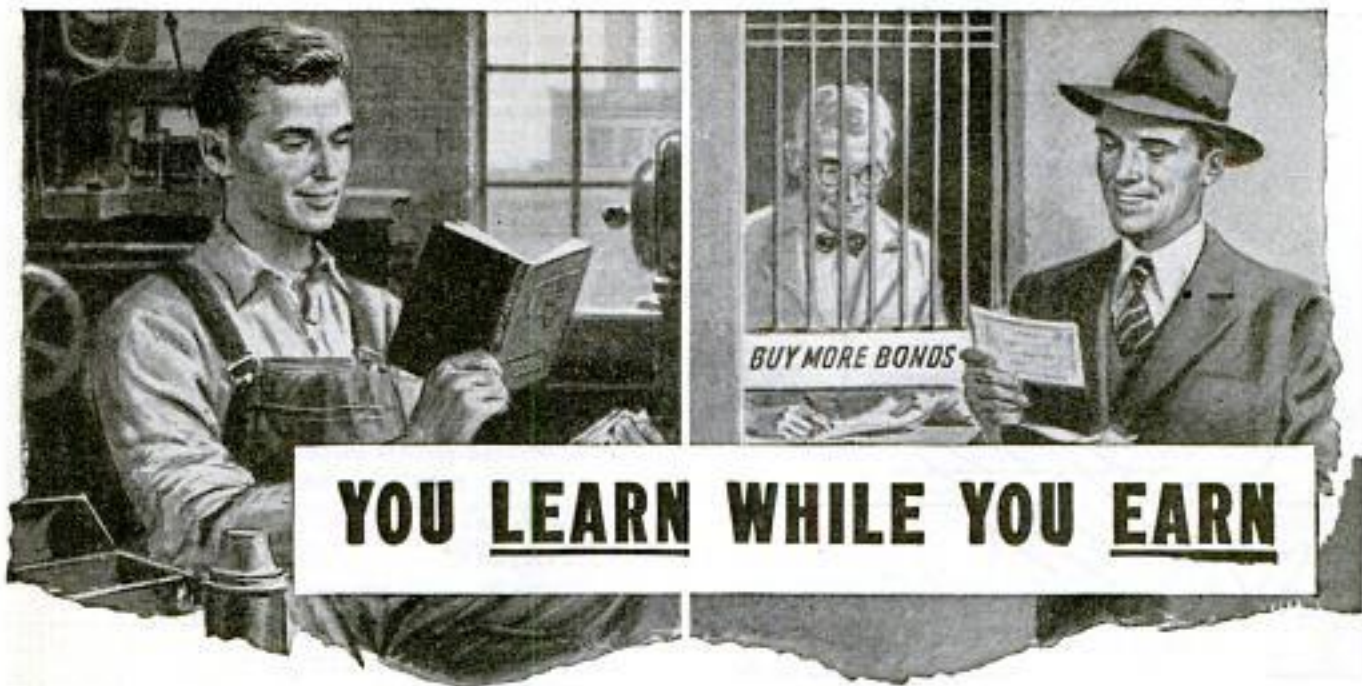

YOU LEARN WHILE YOU EARN

THERE'S rhyme and there's reason in that statement of I. C. S. advantages to *you*.

The courses of these famous schools are especially designed for study in your spare time. At work you prove and apply what you learn.

This system is backed up by 54 years of I. C. S. experience in training men in virtually every industrial and business field. It works so well that analysis shows about

99% of today's 100,000 active I. C. S. students are holding down jobs.

Many of the men and women now filling top positions in commerce and industry obtained their business or technical training from I. C. S. in just that way. What they achieved in *their* spare time, you can do in *yours*.

Start *now* — as they did — by marking and mailing this coupon:

INTERNATIONAL CORRESPONDENCE SCHOOLS



BOX 5554-K, SCRANTON 9, PENNA.

Without cost or obligation, please send me full particulars about the course *before* which I have marked X:

Air Conditioning and Plumbing Courses

- Air Conditioning
- Heating Plumbing
- Refrigeration Steam Fitting

Chemistry Courses

- Chemical Engineering
- Chemistry, Analytical
- Chemistry, Industrial
- Chemistry, Mfg. Iron & Steel
- Petroleum Refining Plastics
- Pulp and Paper Making

Civil Engineering, Architectural and Mining Courses

- Architectural Drafting
- Architecture
- Bridge and Building Foreman
- Building Estimating
- Civil Engineering Coal Mining
- Contracting and Building
- Highway Engineering
- Lumber Dealer
- Reading Structural Blueprints
- Sanitary Engineering
- Structural Drafting
- Structural Engineering
- Surveying and Mapping

Electrical Courses

- Electrical Drafting
- Electrical Engineering
- Power House Electric
- Practical Electrician
- Practical Telephony
- Telegraph Engineering

Internal Combustion Engines Courses

- Auto Technician Aviation
- Diesel-Electric
- Diesel Engines Gas Engines

Mechanical Courses

- Aeronautical Engineering
- Airplane Drafting
- Flight Engineer
- Foundry Work
- Heat Treatment of Metals
- Industrial Engineering
- Industrial Metallurgy
- Mechanical Drafting
- Mechanical Engineering
- Mold-Loft Work
- Patternmaking
- Reading Shop Blueprints
- Sheet-Metal Drafting
- Sheet-Metal Worker

- Ship Drafting
- Ship Fitting
- Shop Practice
- Steel Mill Workers
- Tool Designing
- Welding, Gas and Electric

Radio Courses

- Electronics
- Radio, General
- Radio Operating
- Radio Servicing

Railroad Courses

- Air Brake Car Inspector
- Locomotive Engineer
- Locomotive Fireman
- Railroad Section Foreman

Steam Engineering Courses

- Boilermaking
- Combustion Engineering
- Engine Running
- Marine Engineering
- Steam Electric
- Steam Engines

Textile Courses

- Cotton Manufacturing
- Rayon Weaving

which I have marked X:

- Textile Designing
- Woolen Manufacturing

Business and Academic Courses

- Accounting Advertising
- Arithmetic Bookkeeping
- Business Correspondence
- Business Management
- Certified Public Accounting
- College Preparatory
- Commercial
- Cost Accounting
- Federal Tax
- First Year College
- Foremanship
- French
- Good English
- High School
- Higher Mathematics
- Illustrating
- Motor Traffic
- Postal Service
- Salesmanship
- Secretarial
- Sign Lettering Spanish
- Stenography
- Traffic Management

Name..... Age..... Home Address.....
 City..... State..... Present Position..... Working Hours..... A.M. to..... P.M.

Canadian residents send coupon to International Correspondence Schools Canadian, Ltd., Montreal, Canada.
 British residents send coupon to I. C. S., 71 Kingsway, London, W. C. 2, England.

DISCOUNT TO DISCHARGED VETERANS—SPECIAL TUITION RATES FOR MEMBERS OF THE ARMED FORCES



G. SOGLOW

(Continued from page 8A)

Tight screws removed by heating with soldering iron.....	113
Sheath protects saws from rusting.....	118
Pocket-size radius and fillet gauge.....	126
Rubber shield for flashlight lens.....	127
Beam compass made from pipe fittings.....	128

HOUSEHOLD

Washing machine emptied quickly by pump.....	91
Chalkline marks quilting pattern.....	92
Solving home problems.....	94
Threading yarn through a needle.....	96
Paraffin protects felt hat from perspiration stain.....	99
Window guard protects young children.....	107
Scouring with crushed egg shells.....	113
Small child operates wall switch with string.....	120
Laundry bag in hamper saves time.....	120
Resurfacing wringer rolls.....	128

OFFICE

Eraser shield keeps particles out of typewriter.....	98
Strip on file box protects cards from bending.....	98
Cellophane improves stencil cutting.....	98
Clipping sheets together facilitates addressing.....	105
Colored background protects checks.....	129

PAINT AND PAINTING

Plaster-and-paint mixture for finishing cabinets.....	92
Stripping tool taped for use on new finish.....	128
Stain-and-shellac mixture speeds wood finishing.....	126
Spray gun adapted for any size glass jar.....	126

PHOTOGRAPHY

Photofood stand made from dowels is adjustable.....	121
Dense photoprints reduced with iodine.....	121
Simple improvised photo press.....	121
Photoprint washer circulates water.....	122
Making photoprint paper box easy to open.....	122
Tank reels polished to prevent sticking of film.....	122
Screw in expansion shield locks tripod leg.....	122
Taking flash photos with hand-held camera.....	122
Tin foil renews worn photofood reflectors.....	123
Cardboard on flash reflector concentrates light.....	123

POWER TOOLS

Arbor holds thin stock for facing.....	128
Leather washer absorbs shock of drill-press spindle.....	128
Chuck collar aids in tapping in lathe.....	137
Heavy roller squeezes cleaning solution from belt.....	138

RADIO AND ELECTRONICS

Auto radio converted for 110-volt a.c. operation.....	141
How to build a three-tube "cake pan" phone amplifier.....	142
Radio soldering hints.....	144
Offset screw driver aids in removing loctal-type tubes.....	144
Removing dust from variable condenser plates.....	144
Repairing cracks and tears in speaker cones.....	144
Added toggle switch permits presetting of volume control.....	144
Small parts taped for soldering.....	144
Inexpensive base and panel for student sets.....	144
Hint for users of portable extension-type loop antenna.....	144

STORE AND SHOP

One padlock locks all workbench drawers.....	106
Cloth samples wound on shade rollers.....	137
Film-viewing box fits under glass counter top.....	138

TOYS, GAMES AND NOVELTIES

Ornamental figures cut from sheet metal.....	98
Knock-down playhouse can be set up quickly.....	97
Marble game resembles croquet.....	99
Automatic control slows toy train at curves.....	119

WOODWORKING

Period clock case has electric works.....	89
Wooden towel rack has swinging arms.....	91
Ornamenting or making a chessman box.....	93
Using short bar clamps for wide work.....	92
Compass makes guide line for cutting balsa.....	96
Jointer used for chamfering post ends.....	99
Wood block guides chisel in turning cylinders.....	119
Shower-curtain rings hold wood blocks on C-clamps.....	129
Recesses cut with molding head on circular saw.....	129

MISCELLANEOUS

Apron for toilet articles is handy while traveling.....	92
Wire frame supports flag on indoor standard.....	92
Easy way to close overhead garage doors.....	96
Pencil erasers quiet rattling door.....	105
Rudder helps steer outboard-motor boat.....	106
Hand-operated clock teaches children to tell time.....	107
Rack burns leaves as they are raked.....	112
Sheet-metal wall thimble for stovepipe.....	118
Tight spots in cabinet drawers located with carbon paper.....	120
Dividing inches into odd fractions.....	120
Soldering with woodburning pencil.....	120
Craft quiz.....	124
Reversed hasp makes lock more secure.....	128
Cutting sandpaper uniformly.....	129
Fingers grip warped envelopes for printing.....	129
Adjustable gambrel for hanging butchered livestock.....	140

IMPORTANT NOTICE

It is the intention of this magazine to provide its readers with information regarding the latest developments in the mechanical arts. We take no responsibility as to whether the disclosures contained in our articles are covered by patents and advise readers to investigate this subject before making, using, or selling any of the products, machines, or processes described in order to avoid possible liability for patent infringement.

AUDELS REFRIGERATION & AIR CONDITIONING GUIDE....\$4

New from Cover to Cover—1280 Pages, Fully illus. Covering basic principles, servicing, operation & repair of household, commercial & industrial refrigeration & air conditioning. A gold mine of essential important facts for engineers, servicemen, users.

AUDELS CARPENTERS & BUILDERS GUIDES—4 Vols.\$6

A practical illustrated trade assistant on modern construction for carpenters, joiners, builders, mechanics and all woodworkers. 4 vols., 1600 pages, 3700 illustrations, flexible covers. Pocket size. Each volume sold separately \$1.50 a vol.

AUDELS AUTOMOBILE GUIDE....\$4

A practical quick ready reference book for auto mechanics, servicemen, operators & owners. Explains theory, construction & servicing of modern motor cars, trucks, buses & auto type Diesel engines. 1540 pages, fully illustrated. 55 chapters. Indexed. A standard book for mechanics. New fluid drive covered.

AUDELS DIESEL ENGINE MANUAL.\$2

A practical, concise treatise with questions and answers on the theory, operation and maintenance of modern diesel engines including General Motors 2 cycle Diesel. 384 pages, fully illus., flexible binding, pocket size. All details plainly brought out, this book is of extreme value to engineers, operators & students.

AUDELS WIRING DIAGRAMS.....\$1

310 Pages. Illustrated. Gives practical facts on wiring of electrical apparatus. It shows clearly how to wire apparatus for practically all fields of electricity. Each diagram is complete & self-explanatory. Highly Endorsed Pocket Companion.

AUDELS PLUMBERS & STEAMFITTERS GUIDES—4 Vols.\$6

A Practical Trade Assistant & Ready Reference. Explains in plain language & by clear illustrations, diagrams, charts, graphs, pictures principles of modern plumbing practice including Marine Pipe Fitting and Air Conditioning. 4 Vols.—1670 Pages—3542 Diagrams. Pocket size. Each Vol. Sold Separately \$1.50 a Vol.

AUDELS SHEETMETAL WORKERS HANDY BOOK.....\$1

Practical inside information. Fundamentals of Sheet Metal Work. 388 pages. Illustrated. 11 sections. Clearly written. Essential & important facts, figures, pointers in everyday language. Ref. Index.

AUDELS SHEETMETAL PATTERN LAYOUTS.....\$4

Developed by Experts for Sheet Metal Workers, Layout Men & Mechanics. A Practical Encyclopedia in 10 Sections, size 7 x 10 x 2—1125 Pages—350 Layouts—1600 Illustrations. 1001 Key Facts. Fully indexed for ready reference in answering your layout problems. Covers all phases of sheet metal work including Pattern Cutting, Pattern Development & Shop Procedure.

AUDELS ANSWERS ON BLUE PRINT READING.....\$2

For Mechanics & Builders. Covers all types of blue print reading including ship & airplane. 376 pages, fully illustrated.

AUDELS NEW MACHINIST & TOOLMAKERS HANDY BOOK...\$4

Covers modern machine shop practice in all its branches. 5 practical books in 1. New from cover to cover. Tells how to set up & operate lathes, screw and milling machines, shapers, drill presses and all other machine tools. 1600 pages, fully illustrated, 5 x 6 1/2 x 2. Indexed. 5 sections. 1—Modern Machine Shop Practice. 2—Blue Print Reading & How to Draw. 3—Calculations & Mathematics for Machinists. 4—Shop Physics. 5—How to Use the Slide Rule. 60 chapters. Easy to read and understand. A shop companion that answers your questions.

AUDELS MATHEMATICS & CALCULATIONS FOR MECHANICS \$2

Mathematics for home study or reference. 700 pages, 350 illus. Practical mathematics from beginning. How to figure correctly. Easy, correct methods covering a complete review. Ill. & Indexed.

AUDELS HANDY BOOK OF PRACTICAL ELECTRICITY.....\$4

For maintenance engineers, electricians & all electrical workers. 1440 Pages, 2600 illus. Covers important electrical information in handy form—including Marine Wiring, Radio Principles, Welding. Indexed. A Key to a practical understanding of electricity.

AUDELS RADIOMANS GUIDE.....\$4

A key to the practical understanding of radio including Frequency Modulation, Television, etc., Aircraft & Marine Radio. For radio engineers, servicemen, amateurs. 772 pages. 400 Illustrations & Diagrams. Photos. Review Questions & Answers, Reference Index. Authentic, clear, concise.

AUDELS ELECTRONIC DEVICES...\$2

Tells What You Want to Know About Electric Eye. Easily Understood. Covers photo-electric cells & their applications. Amplifiers, illumination, frequencies, voltage, photocell, tubes, Ohm's Law, wiring diagrams, etc.

AUDELS WELDERS GUIDE.....\$1

A concise, practical text on operation & maintenance of all welding machines for all mechanics. Over 400 pages, illustrated. Covers all methods of electric and acetylene welding including airplane work.

AUDEL, Publishers, 49 W. 23 St., N. Y. 10



AN AUDEL GUIDE IS A GOOD FRIEND!

Use the brains and experience of others in these Guides of the Trades. Save time and money with right methods, short cuts, labor saving ideas. CHECK NOW! You can look over any Audel Guide in your home. Start the Easy Payments if satisfied.

CUT HERE MAIL ORDER

THEO. AUDEL & CO., 49 W. 23 St., New York 10, N. Y.

Please mail me for 7 days' free examination the books marked (X) below. I agree to mail \$1 in 7 days on each book or set ordered, and to further mail \$1 a month on each book or set ordered until I have paid purchase price.

If I am not satisfied with Guides I will return them.

- Audels REFRIGERATION & Air Conditioning Guide . \$4.
- Audels POWER PLANT ENGINEERS GUIDE . 4.
- Audels PUMPS, HYDRAULICS & AIR COMPRESSORS 4.
- Audels WELDERS GUIDE . 1.
- Audels BLUE PRINT READING . 2.
- Audels SHEET METAL WORKERS Handy Book . 1.
- Audels SHEET METAL PATTERN LAYOUTS . 4.
- Audels AIRCRAFT WORKER . 1.
- Audels MATHEMATICS and CALCULATIONS . 2.
- Audels MACHINISTS & TOOLMAKERS Handy Book . 4.
- Audels MECHANICAL Dictionary . 4.
- Audels AUTOMOBILE GUIDE . 4.
- Audels DIESEL ENGINE MANUAL . 2.
- Audels MARINE ENGINEERS Handy Book . 4.
- Audels SHIPFITTERS Handy Book . 1.
- Gueths MECHANICAL DRAWING COURSE . 1.
- Rogers DRAWING and DESIGN . 2.
- Audels MILLWRIGHTS and Mechanics Guide . 4.
- Audels CARPENTERS and Builders Guides (4 vols.) . 6.
- Audels PLUMBERS and Steamfitters Guides (4 vols.) . 6.
- Audels MASONS and Builders Guides (4 vols.) . 6.
- Master PAINTER and DECORATOR . 2.
- Audels GARDENERS & GROWERS GUIDES (4 vols.) . 6.
- Audels ENGINEERS and Mechanics Guides Nos. 1, 2, 3, 4, 5, 6, 7 and 8 complete . 12.
- Audels Answers on Practical ENGINEERING . 1.
- Hawkins Aids to ENGINEERS EXAMINATION . 2.
- Audels ELECTRICIANS EXAMINATIONS . 1.
- Audels WIRING DIAGRAMS . 1.
- Audels Handy Book of PRACTICAL ELECTRICITY . 1.
- Audels ELECTRICAL POWER CALCULATIONS . 2.
- Hawkins ELECTRICAL Guides at \$1. each . 10.
- Audels ELECTRONIC DEVICES . 2.
- Audels ELECTRIC Dictionary . 2.
- Audels RADIOMANS GUIDE . 4.
- Audels NEW ELECTRIC LIBRARY at \$1.50 a Volume Vols. I, II, III, IV, V, VI, VII, VIII, IX, X, XI, XII.

Name.....

Address.....

Occupation.....

Employed by.....



You build this A. M. SIGNAL GENERATOR to get valuable experience. Provides amplitude-modulated signals for test and experiment purposes.

(Left) Radio Servicing pays many good money for full time work. Many others make \$5, \$10 a week EXTRA fixing Radios in spare time.



Learn RADIO

WITH THE 6 BIG KITS OF



J. E. SMITH, President
National Radio Institute
Our 31st Year of Training Men
for Success in Radio

BE A SUCCESS IN RADIO I Will Train You at Home

Here's a *practical* way to learn Radio at home in spare time—to train for a good Radio job, or to start your own spare time or full time Radio Service Business!

You get Radio EXPERIENCE building real Radio Circuits with kits of standard parts I send. You get solid KNOWLEDGE of Radio, Television, Electronic fundamentals from my easy-to-grasp lessons. You follow the same "50-50" method that helped hundreds of beginners make \$5, \$10 EXTRA a week in spare time while learning . . . and prepared them for full time Radio jobs at good pay.

Future for Trained Men Is Bright in Radio, Television, Electronics

The Radio Repair business is booming NOW. There is good money fixing Radios in your spare time or own full time business. And trained Radio Technicians also find wide-open opportunities in Police, Aviation and Marine Radio, in Broadcasting, Radio Manufacturing, Public Address work, etc. Think of the boom coming now that new Radios can be made! And think of even greater opportunities when Television and Electronics are available to the public! Get into Radio NOW.

MEN I TRAINED AT HOME Get Good Jobs Like These

Averages Over \$60 a Week

"Not long ago I was working 16 hours a day in a filling station at \$10 a week. Now I have my own radio business and average over \$60 a week. The N.R.I. course is fine."—ALBERT C. CHRISTENSEN, 1116-10th Avenue, Sidney, Neb.



Fixing Radios Profitable Hobby

"I am doing radio work in my spare time, and find it a profitable hobby. My extra earnings run about \$10 a week. I certainly am glad I took your N.R.I. Course."—FERDINAND ZIRBEL, Chaseley, North Dakota.



Has Good Job in Broadcasting

"The N.R.I. course gave me the strength to tackle jobs without fear of failure. At present I am a member of the engineering staff of a large broadcasting chain."—SERGE A. DESOMOV, 849 First Ave., New York, N. Y.



From Elevator Man to Supervisory Job

"Since taking your Course I have moved up from elevator operator to a supervisory job in our Electronics Division. My investment in N.R.I. training has been returned tenfold."—EARL D. HARRISON, 103 Galt Ave., Verdun, P. Q., Canada.



Runs Repair Shop for Sears Roebuck

"I was a barber and not working steadily. After about 30 lessons in your Course, I came with Sears Roebuck and now run their radio service shop here, at a nice steady income."—NORMAN P. FURNOFF, 1023 E. 13th St., Davenport, Iowa.



FIND OUT ABOUT THIS **TESTED WAY**

You build this **MEASURING INSTRUMENT** yourself early in the Course—use it for practical Radio work on neighborhood Radios to pick up **EXTRA** spare time money!

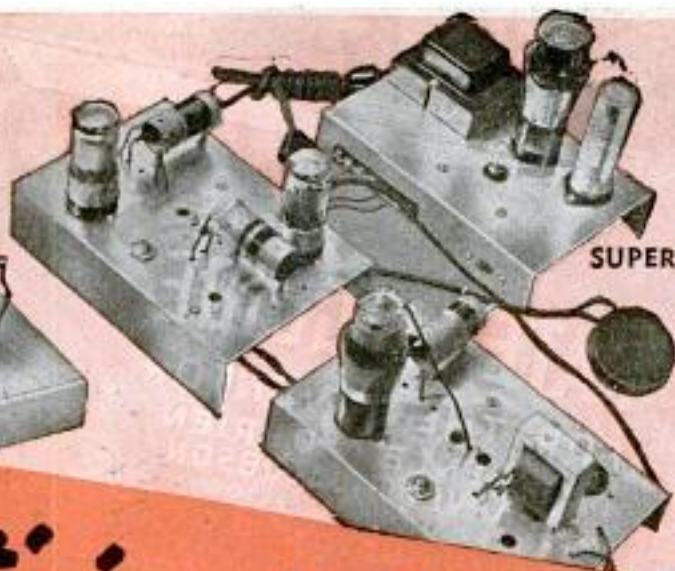

You build this **SUPERHETERODYNE CIRCUIT** that brings in local and distant stations. You get *practical* experience putting this set through fascinating tests!

by Practicing in Spare Time

RADIO PARTS I SEND YOU

Many Beginners Soon Make \$5, \$10
a Week **EXTRA** in Spare Time

The day you enroll I start sending **EXTRA MONEY JOB SHEETS** to help you make **EXTRA** money fixing Radios in spare time while learning. You **LEARN** Radio principles from my easy-to-grasp Lessons—**PRACTICE** what you learn by building real Radio Circuits with the six kits of Radio parts I send—**USE** your knowledge to make **EXTRA** money while getting ready for a good full time Radio job.

My Radio Course Includes
TELEVISION ★ ELECTRONICS
FREQUENCY MODULATION

Find Out What **N. R. I.** Can Do for **YOU**

MAIL COUPON for **FREE** 64-page book. It's packed with facts about opportunities for you. Read the details about my Course. Read letters from men I trained, telling what they are doing, earning. Just **MAIL COUPON** in an envelope or paste it on a penny postal.—**J. E. SMITH, President, Dept. 5KP, National Radio Institute, Pioneer Home Study Radio School, Washington 9, D. C.**

Sample Lesson
64 Page Book
BOTH FREE

FREE LESSON gives hints on Receiver Servicing, Locating Defects, Repair of Loudspeakers, I.F. Transformer, Gang Tuner Condenser, etc., 31 illustrations. Study it—keep it—use it—without obligation! Mail Coupon **NOW** for your copy!



GET BOTH 64 PAGE BOOK **FREE**
SAMPLE LESSON

Mr. J. E. SMITH, President, Dept. 5KP, NATIONAL RADIO INSTITUTE, Washington 9, D. C.
Mail me **FREE**, without obligation, Sample Lesson and 64-page book, "Win Rich Rewards in Radio." (No salesman will call. Please write plainly.)

Age.....

Name.....

Address.....

City..... State..... 4FR

(If you have a Post Office zone number please include it.)

TO GOOD PAY

NEW BOOK *for*

PATENT GUIDE FOR THE INVENTOR

CLARENCE A. O'BRIEN
& HARVEY B. JACOBSON
REGISTERED PATENT ATTORNEYS
WASHINGTON, D. C.



FREE RECORD OF INVENTION

This FREE Record of Invention form enables you to conveniently make a sketch of your invention and have it witnessed in a manner of value to you, should the occasion for evidence arise.

48
PAGES
Over 150
Mechanical
Movements

LATEST FACTS ON INVENTIONS

Is your invention something for the home, the farm, the factory, the store? Would you like to know whether anything like it has ever been invented, and if not, how to protect your invention? Our new 48-page book "Patent Guide for the Inventor" will show you how to proceed with your invention. You'll get a good idea of whether you "have something" or not. Would you like to know how you may judge the marketability of your invention? This book gives you several important tests prepared by authorities. Read of the experiences of Bell, Edison, Westinghouse, and other outstanding, successful inventors who patented and thereby protected their inventions. This book not only tells you how to obtain a patent, it also explains the steps that must be taken afterward to promote the success of your invention. MAIL THE COUPON TODAY to Clarence A. O'Brien & Harvey B. Jacobson, Registered Patent Attorneys, 51-K, Adams Building, Washington 4, D. C.

**CLARENCE A. O'BRIEN
& HARVEY B. JACOBSON**
REGISTERED PATENT ATTORNEYS

INVENTORS

NOW Is the Time to PATENT and SELL Your Invention

Now, more than ever before, is the right time to patent your invention. Why? Because manufacturers everywhere presently engaged in war production are looking ahead to the future by buying up patent rights now, so they will have new and attractive items to make and sell for civilian consumption as soon as the war is over. This is what happened during and after the last war. Hence, the smart thing for you to do is to look ahead to the future too. Protect your invention and yourself by applying for a patent now.

Patent Guide Shows What To Do

Our "Patent Guide for the Inventor" answers many important questions concerning Patents that inventors constantly ask. It tells what facts, details, drawings, sketches, etc. are necessary to apply for a Patent, how to protect your invention through dated and witnessed disclosure; how to do this AT ONCE to safeguard your rights; how Patent Office Records can be checked to determine whether the invention is probably patentable before filing fees need be paid; discusses costs involved and a practical way these can be paid as the application progresses. It tells how some inventors secured financial backing; how many simple inventions have proved large commercial successes; how Patents covering improvements also can be profitably utilized and marketed, tells countless other facts of interest.

Why You Need Expert Assistance

The Patent Laws were enacted for your benefit—to give you protection for the features of your invention which are Patentable. But these features must be legally and concisely set forth in the form of "claims." This phase of the procedure is so complex that the Patent Office advises the Inventor to engage a competent Registered Patent Attorney. We maintain a large staff—carefully trained registered patent attorneys—expert draftsmen—experienced searchers—to serve you. We have been serving inventors for more than 20 years.

Take First Step Now

With the Patent Guide you will receive also Free a "Record of Invention" form which will enable you at once to establish the date of your invention, before you file your Patent application. This step costs you nothing yet may be vital to your success. Remember—in Patent Matters, ACTION is IMPORTANT. Delay can be costly. Mail the coupon in an envelope, or paste it on a penny postcard NOW.

*Worthy of
Your Trust*

Get

**FREE
COPY**

*Mail
Coupon
Today*

CLARENCE A. O'BRIEN & HARVEY B. JACOBSON

CLARENCE A. O'BRIEN & HARVEY B. JACOBSON

Registered Patent Attorneys before the United States Patent Office

51-K Adams Building, Washington 4, D. C.

Please send me your 48-Page "Patent Guide for the Inventor" and your specially prepared "Record of Invention" form FREE. This request does not obligate me.

Name.....

Address.....

City..... State.....

(Please write or print plainly.)

Come Along For a
**FLYING
LESSON!**



New Booklet Shows You How Easy It Is To Fly

This exciting new booklet, "How to Fly a Piper Cub," takes you on a typical flying lesson. Shows you how easy it is to take off, climb, turn, glide and land in a Piper Cub. Written and directed by a certified flight instructor. Includes many other features and full-color pictures of Piper Cubs. For your copy send 10c in stamps or coin for postage-handling, Piper Aircraft Corporation, Department PM105, Lock Haven, Pennsylvania.

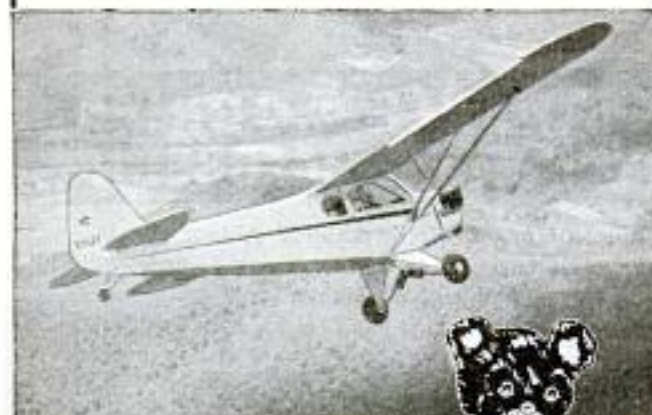

PIPER CUB

POINTS THE WAY TO WINGS FOR ALL AMERICANS



SAVE WASTE PAPER



Speak **SPANISH** THIS EASY WAY ONLY 15 MINUTES DAILY



LEARN Spanish for better business or social position. Read foreign books — really enjoy travel. **CORTINA Method** "famous for over 60 years" teaches you to speak like a native. Learn quickly, easily at home "by listening" to *Cortinaphone records*. Thousands have, why not you? You take no risk under our Five Day Approval offer. **FRENCH, GERMAN, ITALIAN** also taught by this amazing method. Write today for free book—"The Cortina Short-Cut." State language interested in.

CORTINA ACADEMY—Established in 1882
Dept. 6410 105 West 40th St., New York 18, N. Y.



TRI-STATE COLLEGE

B. S. Degree in 27 Months

Distinguished for technical 2½-year courses in Civil, Electrical, Mechanical, Chemical, Radio, Aeronautical Engineering; Business Administration, Accounting, and Secretarial Science.

EX-SERVICE MEN can complete work here in shortest possible time. Special Prep. Dep't. Also **REFRESHER COURSES**. 36-Week Courses in Surveying, Drafting. Low tuition. Low living costs. Cosmopolitan student body. 62nd year. Enter Sept., Jan., March, June. Catalog. 4105 College Ave. **ANGOLA, INDIANA**

LEARN MONEY- MAKING CARTOONING

IN SPARE TIME — by Easy Picture Chart Method
Some Simplified Method that has helped train creators of "Ferry & Pines," "Freckles," "Out Our Way," "Winnie Winkle," "Regular Fellows," "Strange As It Seems," "The Neighbors," and many others. Earn while learning. Send 10c for Picture Chart (to test your ability), and full details. (STATE 826.)

Landon School of Cartooning, Dept. 4510, Philadelphia 11 Pa.



BE READY FOR
A BETTER JOB
AT BIGGER PAY

PREPARE *Now*
FOR POST-WAR
BUILDING
BOOM



Thousands of
Trained Men
Will Be Needed

● New homes and other structures to be built after peace returns will provide a tremendous number of well-paid jobs. Men trained in Architecture, Drafting, Contracting, Carpentry and related building trades will cash in BIG on their knowledge and skill. YOU can train in spare time at home, at low cost, for a big-pay job in this rich field. American School can help you to success just as it has helped others during its 48 years. Check, fill in and mail coupon NOW for FREE information.

AMERICAN SCHOOL, Dept. 8748, Drexel Ave. at 58th St., Chicago 37, Ill.

Send me FREE information about your special training plan covering subjects checked below.

- | | |
|--|--|
| <input type="checkbox"/> Architecture and Building | <input type="checkbox"/> Automotive Engineering |
| <input type="checkbox"/> Drafting and Design | <input type="checkbox"/> Diesel Engineering |
| <input type="checkbox"/> Contracting | <input type="checkbox"/> Mechanical Engineering |
| <input type="checkbox"/> Practical Plumbing | <input type="checkbox"/> Plastics Engineering |
| <input type="checkbox"/> Air Conditioning | <input type="checkbox"/> Aviation <input type="checkbox"/> Radio |
| <input type="checkbox"/> Refrigeration | <input type="checkbox"/> Business Management |
| <input type="checkbox"/> Electrical Engineering | <input type="checkbox"/> High School Courses |

Name.....

Address.....

15 Minutes a Day!

Give me just this
and I'll prove I can make you
A NEW MAN!

I'M "trading-in" old bodies for new! I'm taking men who know that the condition of their arms, shoulders, chests and legs—their strength, "wind," and endurance—is not 100%. And I'm making NEW MEN of them. I'm giving them the kind of powerful, healthy HE-MAN build that spells SUCCESS in life and business.

Only 15 Minutes a Day!

Are you ALL MAN—tough-muscled, on your toes every minute, with all the up-and-at-'em that can lick your weight in wildcats? Or do you need the help I can give you—the help that has already worked such wonders for other fellows, everywhere?

All the world knows I was ONCE a skinny, scrawny 97-lb. weakling. And NOW it knows that I am the holder of the title, "The World's Most Perfectly Developed Man." How did I do it? How do I work miracles with the bodies of other men in only 15 minutes a day? The answer is "Dynamic Tension," the amazing method I discovered and which changed me from a 97-pound weakling into the champion you see here!

In just 15 minutes a day, right in the privacy of your own home, I'm ready to prove that "Dynamic Tension" can lay a new outfit of solid muscle over every inch of your body. Let me put new, smashing power into your arms and shoulders—give you an armor-shield of stomach muscle—strengthen your legs into real columns of surging stamina. If lack of exercise or wrong living has weakened you inside, I'll get after that condition, too, and show you how it feels to LIVE!

FREE This Famous Book that Tells You How to Get a Body that Men Respect and Women Admire

My book, "Everlasting Health and Strength," tells you exactly what "Dynamic Tension" can do. And it's packed with pictures that SHOW you what it does. RESULTS it has produced for other men. RESULTS I want to prove it can get for YOU! If you want to learn how you can actually become a NEW MAN, right in the privacy of your own home and in only 15 minutes a day, then man!—get this coupon into the mail to me as fast as your legs can get to the letterbox! CHARLES ATLAS, Dept. 810, 115 East 23rd St., New York 10, N. Y.



Charles Atlas

—actual photo of the man who holds the title, "The World's Most Perfectly Developed Man."

Charles Atlas—America's Greatest "Builder of Men"

Among all the physical instructors and "conditioners of men" ONLY ONE NAME STANDS OUT. That name is Charles Atlas!

In every part of the country Charles Atlas is recognized as "America's Greatest Builder of Men." Thousands upon thousands have put their physical development into his capable hands!

Now more than ever, employers are "on the lookout" for vigorous, red-blooded HE-MEN who can be depended on to do a better job. That is why so many men of every age and condition are today asking Charles Atlas to prepare them physically for success.

MAIL THIS COUPON NOW!

CHARLES ATLAS, Dept. 810
115 East 23rd St., New York 10, N. Y.

I want the proof that your system of "Dynamic Tension" will help make a New Man of me—give me a healthy, husky body and big muscular development. Send me your free book, "Everlasting Health and Strength."

Name

(Please print or write plainly)

Address

City

Zone No.

(if any)

State

Check here if under 16 for Booklet A.

INVENTORS

LEARN HOW TO
**PROTECT and SELL
YOUR INVENTION**

GET NEW **FREE** BOOK



FREE

**Invention Record
Know How Successful
Inventors Protect and
Sell Their Inventions**

MODERN BUSINESS WANTS INVENTIONS

Practical and novel inventions are in big demand today. The opportunity for quick money is enticing. Sales sources are many if your invention has merit. But, be *sure*—before you place your device in strange hands—that it is fully protected. A United States Patent gives you this protection. *The first step toward inventive success always is—and always has been—the application for a U. S. Patent. There is no other way to protect your invention in accordance with the laws of this country.*

MAKE THIS RECORD NOW If you have an invention, and wish to secure it for the future, act at once. Have it dated now and recorded in our office. We will send you this **FREE** Invention Record Form for the purpose. Fill out the Invention Record Form fully describing the nature of your invention. Make a sketch of its main features. Mail it to us and we will record the date it was received in our office. The earlier the date the better your chance of combating rival inventors who may lay claim to your idea later. *Don't delay a single minute in taking this important step. Your whole future may depend upon it. Mail the coupon for our FREE Invention Record Blank and New FREE Book today!*

HOW WE SERVE YOU AS REGISTERED PATENT ATTORNEYS

The U. S. Patent Office strongly recommends—unless the inventor is familiar with such matters—that he employ the services of a Registered Patent Attorney in the preparation of his Patent Application. We are Registered Patent Attorneys fully qualified to represent you at the Patent Office. We have had long experience in studying hundreds of types of inventions. This gives us the ability to judge your invention and to describe it accurately and convincingly in technical language. It gives us the perception to center arguments upon those details of your invention which, in our judgment, will be looked upon most favorably by the Patent Office Examiner.

Mail the coupon today for our new **FREE** Book, "How to Protect, Finance and Sell Your Invention," and our **FREE** Invention Record Form—maybe this step will pave the way to future security for you and your family. Act Today!

McMORROW & BERMAN
Registered Patent Attorneys
135-F Atlantic Building, Washington 4, D. C.

- Our new **FREE** Book is a book every inventor should have. Mail the coupon today for "How to Protect, Finance and Sell Your Invention" and learn . . .
- How to know if there is a prior U. S. patent on your invention.
- How to save steps in getting patent action.
- How to prepare your application for presentation to the Patent Office.
- How you may patent an improvement on something in use now.
- How to obtain funds to patent and promote your invention.
- How to find a buyer or backer for your invention.
- How to protect yourself in making royalty agreements.

McMORROW & BERMAN

REGISTERED PATENT ATTORNEYS
135-F ATLANTIC BUILDING, WASHINGTON 4, D. C.

Send me your new **FREE** book, "How to Protect, Finance and Sell Your Invention"—and "Invention Record" form at once. I understand that this request does not obligate me.

NAME

ADDRESS

CITY..... STATE.....

(Write or print name clearly)

Guide books to YOUR future!

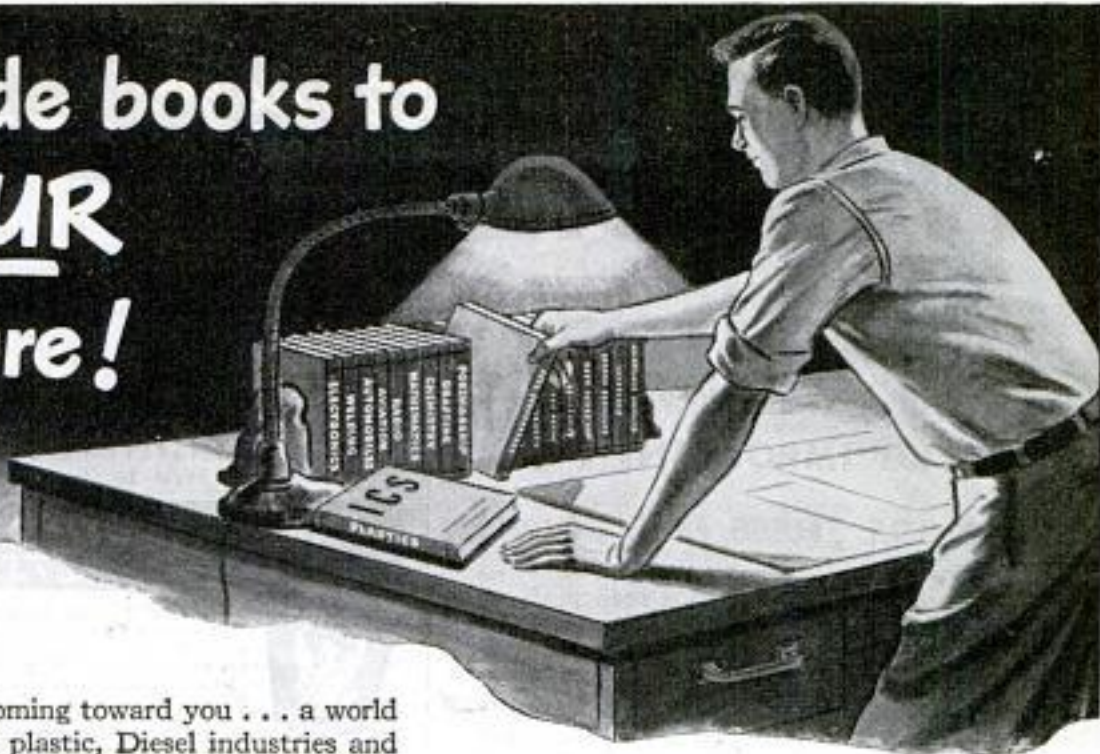

THE FUTURE is coming toward you . . . a world of new electronic, plastic, Diesel industries and changing older ones.

Famous International Correspondence Schools texts are informed, authoritative, practical guides to any field in that future. And the time to begin your training in any one of 400 I. C. S. Courses is **RIGHT NOW**.

Without preparation, what will be your chance in competition with fellow workers who are studying now to qualify as experts?

You know the answer.

With I. C. S. training, you can advance today and be fully prepared for the challenge and the opportunities of the coming era. An I. C. S. Course is more than job insurance—important as that is. For the earnest, ambitious man or woman, it is Success Insurance—backed by a 54-year record of training industrial and business leaders.

Mark and mail the coupon below for full information. Act now!

INTERNATIONAL CORRESPONDENCE SCHOOLS



BOX 5555-K, SCRANTON 9, PENNA.

Without cost or obligation, please send me full particulars about the course *before* which I have marked X:

- | | | | |
|---|---|---|--|
| <p>Air Conditioning and Plumbing Courses</p> <p><input type="checkbox"/> Air Conditioning
<input type="checkbox"/> Heating <input type="checkbox"/> Plumbing
<input type="checkbox"/> Refrigeration <input type="checkbox"/> Steam Fitting</p> <p>Chemistry Courses</p> <p><input type="checkbox"/> Chemical Engineering
<input type="checkbox"/> Chemistry, Analytical
<input type="checkbox"/> Chemistry, Industrial
<input type="checkbox"/> Chemistry, Mfg. Iron & Steel
<input type="checkbox"/> Petroleum Refining <input type="checkbox"/> Plastics
<input type="checkbox"/> Pulp and Paper Making</p> <p>Civil Engineering, Architectural and Mining Courses</p> <p><input type="checkbox"/> Architectural Drafting
<input type="checkbox"/> Architecture
<input type="checkbox"/> Bridge and Building Foreman
<input type="checkbox"/> Building Estimating
<input type="checkbox"/> Civil Engineering <input type="checkbox"/> Coal Mining
<input type="checkbox"/> Contracting and Building
<input type="checkbox"/> Highway Engineering
<input type="checkbox"/> Lumber Dealer
<input type="checkbox"/> Reading Structural Blueprints
<input type="checkbox"/> Sanitary Engineering
<input type="checkbox"/> Structural Drafting
<input type="checkbox"/> Structural Engineering
<input type="checkbox"/> Surveying and Mapping</p> | <p>Electrical Courses</p> <p><input type="checkbox"/> Electrical Drafting
<input type="checkbox"/> Electrical Engineering
<input type="checkbox"/> Power House Electric
<input type="checkbox"/> Practical Electrician
<input type="checkbox"/> Practical Telephony
<input type="checkbox"/> Telegraph Engineering</p> <p>Internal Combustion Engines Courses</p> <p><input type="checkbox"/> Auto Technician <input type="checkbox"/> Aviation
<input type="checkbox"/> Diesel-Electric
<input type="checkbox"/> Diesel Engines <input type="checkbox"/> Gas Engines</p> <p>Mechanical Courses</p> <p><input type="checkbox"/> Aeronautical Engineering
<input type="checkbox"/> Airplane Drafting
<input type="checkbox"/> Flight Engineer
<input type="checkbox"/> Foundry Work
<input type="checkbox"/> Heat Treatment of Metals
<input type="checkbox"/> Industrial Engineering
<input type="checkbox"/> Industrial Metallurgy
<input type="checkbox"/> Mechanical Drafting
<input type="checkbox"/> Mechanical Engineering
<input type="checkbox"/> Mold-Loft Work
<input type="checkbox"/> Patternmaking
<input type="checkbox"/> Reading Shop Blueprints
<input type="checkbox"/> Sheet-Metal Drafting
<input type="checkbox"/> Sheet-Metal Worker</p> | <p><input type="checkbox"/> Ship Drafting
<input type="checkbox"/> Ship Fitting
<input type="checkbox"/> Shop Practices
<input type="checkbox"/> Steel Mill Workers
<input type="checkbox"/> Tool Designing
<input type="checkbox"/> Welding, Gas and Electric</p> <p>Radio Courses</p> <p><input type="checkbox"/> Electronics
<input type="checkbox"/> Radio, General
<input type="checkbox"/> Radio Operating
<input type="checkbox"/> Radio Servicing</p> <p>Railroad Courses</p> <p><input type="checkbox"/> Air Brake <input type="checkbox"/> Car Inspector
<input type="checkbox"/> Locomotive Engineer
<input type="checkbox"/> Locomotive Fireman
<input type="checkbox"/> Railroad Section Foreman</p> <p>Steam Engineering Courses</p> <p><input type="checkbox"/> Boilermaking
<input type="checkbox"/> Combustion Engineering
<input type="checkbox"/> Engine Running
<input type="checkbox"/> Marine Engineering
<input type="checkbox"/> Steam Electric
<input type="checkbox"/> Steam Engines</p> <p>Textile Courses</p> <p><input type="checkbox"/> Cotton Manufacturing
<input type="checkbox"/> Rayon Weaving</p> | <p><input type="checkbox"/> Textile Designing
<input type="checkbox"/> Woolen Manufacturing</p> <p>Business and Academic Courses</p> <p><input type="checkbox"/> Accounting <input type="checkbox"/> Advertising
<input type="checkbox"/> Arithmetic <input type="checkbox"/> Bookkeeping
<input type="checkbox"/> Business Correspondence
<input type="checkbox"/> Business Management
<input type="checkbox"/> Certified Public Accounting
<input type="checkbox"/> College Preparatory
<input type="checkbox"/> Commercial
<input type="checkbox"/> Cost Accounting
<input type="checkbox"/> Federal Tax
<input type="checkbox"/> First Year College
<input type="checkbox"/> Foremanship
<input type="checkbox"/> French
<input type="checkbox"/> Good English
<input type="checkbox"/> High School
<input type="checkbox"/> Higher Mathematics
<input type="checkbox"/> Illustrating
<input type="checkbox"/> Motor Traffic
<input type="checkbox"/> Postal Service
<input type="checkbox"/> Salesmanship
<input type="checkbox"/> Secretarial
<input type="checkbox"/> Sign Lettering <input type="checkbox"/> Spanish
<input type="checkbox"/> Stenography
<input type="checkbox"/> Traffic Management</p> |
|---|---|---|--|

Name..... Age..... Home Address.....

City..... State..... Present Position..... Working Hours..... A.M. to..... P.M.

Canadian residents send coupon to International Correspondence Schools Canadian, Ltd., Montreal, Canada.
British residents send coupon to I. C. S., 71 Kingsway, London, W. C. 2, England.

DISCOUNT TO DISCHARGED VETERANS—SPECIAL TUITION RATES FOR MEMBERS OF THE ARMED FORCES

Evans Helps INVENTORS

For nearly 50 years the Victor J. Evans' Staff of Registered Patent Attorneys, searchers, draftsmen and specification writers have helped thousands of inventors secure patents. They can help you! All you need do NOW is take . . .

THE FIRST IMPORTANT STEP..

SEND FOR THESE FREE BOOKS!

They are full of valuable information. They tell you the steps you must take to secure a Patent . . . types of Patents . . . how Inventions are developed . . . financing a Patent. They show 115 fundamental mechanical movements that may help you complete your invention.

DON'T WAIT 'TILL TOMORROW— Send the coupon for these FREE BOOKS TODAY—so you can learn the procedures that are required by the United States Patent Office . . . so that you can secure protection as soon as possible.

PATENTS WANTED BY INDUSTRY

Now... FOR POSTWAR

Nationally known manufacturers are looking for new items to make and sell. They are looking for devices or improvements in machines and processes that will help them turn out more products faster and cheaper. Housewives, automobile owners, boat owners, men and women in all

walks of life will be ready buyers for items that inventors like you will provide.

IT'S UP TO YOU!

Are you going to wait and let someone beat you to it —OR WILL YOU ACT NOW AND BE GLAD YOU ACTED?



VICTOR J. EVANS & Co.

Registered Patent Attorneys for Nearly 50 Years
930-L Merlin Building, Washington 6, D. C.

Please send me your books—"Patent Protection" and "When and How to Sell Your Invention"—also important "Evidence of Invention" form, without cost or obligation.

Name

Address

City and State

MAIL THIS TODAY

Write your own Future in Photography

Prepare now for a well-paid position today and a career that is sound and substantial as well as different, fascinating and profitable. Photography offers ever-increasing opportunities for both men and women. FREE book tells how N. Y. I. experts can quickly train you at home or thru resident, day or evening instruction in our up-to-the-minute N. Y. studios. ALL branches of black and white, motion picture and COLOR photography. Write TODAY!

NEW YORK INSTITUTE OF PHOTOGRAPHY
Dept. 49 10 West 33 Street New York 1, N. Y.

MAKE MONEY CASTING AT HOME FREE FACTS SENT



Make hundreds of Plaster Casts, quick, easy. Sell output to stores, novelty shops, etc. Enormous profits. No experience. Very little capital needed. Start in basement, garage or workshop. Complete, simple instructions anyone can follow. Start now while merchants are begging for merchandise to sell. Rush.

PLASTIC ARTS STUDIOS, R.R. 5, Dept. 28, Muskegon, Ind.

"How to Make Money With Simple Cartoons"

A book everyone who likes to draw should have. It is free; no obligations. Simply address

CARTOONISTS' EXCHANGE
Dept. 910-D Pleasant Hill, Ohio

Keep that "TICKING" Car



Every operator and mechanic needs AUDELS AUTO GUIDE.

This book saves time, money and worry. Highly endorsed. It presents the whole subject of auto mechanics:

- 1—Basic principles
 - 2—Construction
 - 3—Operation
 - 4—Service
 - 5—Repair
- Handy Size, Easily understood.

NEW FLUID DRIVE, HYDRAULIC SHIFT AND DIESEL ENGINES FULLY COVERED

Over 1500 pages—1540 illustrations showing inside views of modern cars, trucks and buses with instructions for all service jobs.

4 COMPLETE • PAY ONLY \$1. A MONTH

ASK TO SEE IT!—To Get This Assistance for Yourself Simply Fill in and Mail Coupon Today.
AUDEL Publishers, 49 West 23rd St., New York
MAIL AUDELS NEW AUTO GUIDE for free examination. If O. K. I will send you \$1 in 7 days; then remit \$1 monthly until price of \$4 is paid. Otherwise I will return it.

Name

Address

Occupation

Employed by..... P.M.

Prepare for YOUR FUTURE Now

You'll Need "ALL-AROUND" Training to Meet New Conditions!

Get Ready QUICK—in 1 of these 2 Opportunity Fields!



ELECTRICITY in its Many Branches...

Electricity is a permanent necessity in war or peace. Be ready for the opportunities in such branches as Power Plant Work, Motors, Armature Winding, Industrial and House Wiring, Maintenance, etc., with COYNE shop training.



This big fire-proof building is occupied entirely by the Coyne Electrical School.

RADIO-ELECTRONICS... A great field

now, even greater growth ahead. Prepare for a real Radio career. Learn construction, operation, trouble-shooting on Radio Receivers, Public Address Systems, Sound Picture Units, FM, Photo-Cells, Television—the practical COYNE way.

"LEARN-BY-DOING"-12 WEEKS TRAINING

I'll Finance Your Training

Where will YOUR JOB be in the years to come? Many "one-operation" jobs that pay well today may no longer exist later on. Plan for steady pay and advancement by training NOW, while there's still time! Come to the big shops of COYNE in Chicago, for "all-around" training in Electricity or Radio-Electronics—the 2 great opportunity fields of today and tomorrow. I'll finance most of your training.

TRAIN ON ACTUAL EQUIPMENT!

My famous "Learn-by-Doing" method gives you practical experience on full-size equipment. Not by correspondence, but actual shop work. You are trained right here in the Coyne shops, that has been training men and young men for over 46 years.

START NOW—PAY LATER! LIFETIME JOB SERVICE TO COYNE GRADUATES

Don't let lack of money hold you back. My "Pay-Tuition-after-Graduation" plan has helped thousands. Coupon brings details. Many earn while learning, to help take care of living expenses while here. Men from 16 up to 40, with or without experience. Coyne training is for you!

First I train you for a good job and future, then assist you in getting located. As a Coyne graduate, use this service whenever you need it—no charge. Also FREE review privileges at any time. Get the facts!

INDUSTRIAL ELECTRONICS and Electric Refrigeration

Included With Either Course—No Extra Charge
Extra training in these great fields of INDUSTRIAL ELECTRONICS and ELECTRIC-REFRIGERATION makes you more valuable to employer, leads to opportunities for bigger pay. This valuable EXTRA TRAINING included with either my Electrical or Radio Course, without extra cost. We also have facilities for men with physical disabilities whether due to war or other causes. Check coupon for details if you have a physical disability of any kind.

COYNE ELECTRICAL SCHOOL
H. C. LEWIS, Pres. Founded 1899

500 So. Paulina Street, Dept. 75-72H, CHICAGO 12, ILL.



VETERANS—Coyne is equipped to train those who qualify for training under the G. I. Bill of Rights. Check coupon for Special G. I. Bulletin.

PICK FIELD YOU LIKE—SEND FOR BIG BOOK

FREE *H.C. Lewis*



Some men prefer Electricity, others Radio-Electronics. Whichever interests you most, we will train you in 12 short weeks at Coyne—on full-size equipment, by my famous "Learn-by-Doing" method. I have a big, fully illustrated book on each course, and will send you the one you want, without the slightest cost or obligation. Simply check below, then mail coupon in envelope or paste on post-card. No salesman will call. You are the sole judge. Don't delay. Your future is at stake. Rush coupon to me—TODAY.

H. C. LEWIS, Pres.,
COYNE ELECTRICAL SCHOOL

500 S. Paulina St., Dept. 75-72H, Chicago 12, Ill.
Send me your BIG FREE BOOK—for the course checked below. Also full details of your "Pay-After-Graduation" plan.

ELECTRICITY RADIO-ELECTRONICS
 Physical disability Send special G. I. Bulletin

NAME.....

ADDRESS.....

CITY.....STATE.....

The set of
books
that makes



MASTER MACHINISTS and leads to bigger pay!

This big home-study and reference course gives you the practical facts on machines and methods you need to advance in machine shop work. Take advantage of the other man's experience as found in books, to solve your problems, increase your efficiency, with

The AMERICAN MACHINISTS' LIBRARY

6 volumes—2368 pages—2516 illustrations

(A combined home-study course and reference library)

This library of machine shop practice was written for practical men. It gives you the best methods for every kind of machine shop work. It fully explains lathes, drills, and other machine tools and their operation, automatic screw machines, speeds and feeds, gear design and production, jigs and fixtures, punch and die work, metal surfacing, etc., etc. Plainly written—completely illustrated—the best kind of help to the machine shop man who wants to advance himself.

No money down—special price—easy payments.

EXAMINATION COUPON

McGraw-Hill Book Co., 330 W. 42nd St., N. Y. 18

Send me for ten days' examination the American Machinists' Library. If satisfactory I will send you \$1.50 in 10 days and \$3.00 monthly until the price of \$19.95 is paid. If not wanted, I will return the books postpaid. (To insure prompt shipment write plainly and fill in all lines.)

Name
Home Address
City and State
Company
Position PM-10-45

AVIATION Career

DON'T WAIT UNTIL THE WAR IS OVER!

Since 1929 Cal-Aero Technical Institute has been specializing in modern, progressive training for Aeronautical Engineers and Master Aviation Mechanics. Prepare now for your Aviation Career. BE READY! Opportunities are great today and will be greater in tomorrow's Age of Flight. **DISCHARGED VETERANS**—Write us about Aviation Training as provided under "G. I. Bill of Rights."



**CAL-AERO
TECHNICAL INSTITUTE**

MAJOR C. C. HOSELY PRES. SINCE 1929

GRAND CENTRAL AIRPORT
GLENDALE 1, CALIFORNIA
(LOS ANGELES COUNTY)

MAIL THIS COUPON TODAY!

Cal-Aero Technical Institute, Grand Central Airport, Glendale 1, California. Send information and illustrated catalogue on Aviation Training. FREE... without obligation... Dept. PM-10

Name Birth Date
Street
City State

STUDY AT HOME

With A Chartered Educational Institution

Men with specialized training win higher positions, insure larger earnings, and are bigger successes in business and public life. Opportunities NOW greater than ever before. Send for our Catalog.

ARTS AND SCIENCES

Courses in Philosophy; Education; Letters; Public Health; Medical Jurisprudence; Psychology; Sociology; Physics; Chemistry; Plastics; Geology; Political Science; Theology; Business and Commerce, Accounting; Mathematics; Statistics; Agriculture.

ENGINEERING

Courses in Electrical, Civil, Mechanical, Drafting, Architectural, Steam, Aeronautical, Radio, Structural, Mining, Industrial, Highway, Petroleum, Marine, Chemical, Diesel, Automobile and Air Conditioning Engineering.

LAW

Complete Professional Law Course includes 20 Hornbook Series college grade textbooks. Courses also in Commercial Law, Patent Law and Medical Jurisprudence.

McKinley-Roosevelt Incorporated, 4610-K, Sheridan Rd., Chicago 40, Ill.



TRAIN

Your VOICE!

Results GUARANTEED

We build, strengthen the vocal organs—not with singing lessons—but by sound, scientifically correct silent and vocal exercises and absolutely guarantee complete satisfaction with results. Write for Voice Book, FREE. Sent to no one under 17 years old unless signed by parent.

Perfect Voice Institute, Studio 1357, Kimball Hall Bldg., Chicago 4, Ill.

FIX TYPEWRITERS

A Simplified Practical Home-study Course. Many of our Students now have their own Business—Many Repair for others. Repair Shops Swamped. Health or Age no handicap.
WEBER TYPEWRITER MECHANICS SCHOOL
Box 269, Osborn, Ohio

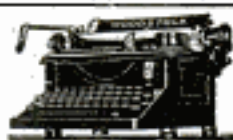

It's BETTER! So-Lo's WOOD PLASTIC

Works like putty—hardens into real wood. Takes nailing, sawing, planing. Repairs cracks and holes in furniture, flooring, etc. Stays soft in jars. 1/3 lb. jar 25c, 1 lb. jar 50c.
At Hardware or 10c Stores.



Millions Save with So-Lo Menders



LEARN PORTRAIT PAINTING AT HOME

● Previous art training or talent NOT necessary. The Stuart System teaches you, in 11 easy-to-follow lessons, to (1) locate features *exactly* to correspond to model's features, (2) outline head and face to correspond to model's outline, (3) make each feature a true portrait of that feature in the model, (4) produce shadows and shading that *exactly* correspond to that of model's face, (5) mix flesh paint tints that are like living flesh. Our students' portraits look alive. You, too, can make *exact* charcoal and oil likenesses. Send for free booklet today.

STUART STUDIOS,

121 Monument Circle, Room 6105, Indianapolis 9, Ind.

Please send me free book and outline of lessons.

Name
Street
City State

WHICH OF THESE *Opportunities* INTERESTS *You* MOST?

Accounting & C. P. A.
Air Conditioning
Architecture & Building
Automotive Engineering
Aviation—Practical
Aviation Drafting & Design
Better Foremanship
Bookkeeping
Business Management

Diesel Engineering
Drafting & Design
Electrical Engineering
Electricity—Practical
Electronics, Industrial
High School Courses
Machine Shop Operations
Mechanical Engineering
Plastics Engineering
Plumbing—Practical

Private Secretary
Radio Operating & Servicing
Railway Training
Refrigeration
Sheet Metal Pattern Drafting
Shop Management
Surveying & Topographical
Drafting
Tool Making

THINK! LOOK FORWARD!

Business is making Post-war plans

Men and Women are preparing for the future

WHAT ARE YOU DOING ABOUT YOUR TOMORROWS?

● *Today*, choose the job you want—and prepare for it. Or if you are already engaged in the work you like best, start training *now* for quicker promotion. Acquire the knowledge that will help you to get ahead faster, make more money and have greater security.

Invest part of your spare time in more rapid progress. Start training now, in spare time in your own home. Be ready to grasp your opportunity and step out ahead of those who lack the ability you have attained.

American School, founded in 1897 as an educational institution *not for profit*, can help you to reach your goal just as it has helped others during the past forty-eight years. Give serious thought to the list above. Pick one or more subjects that interest you. Then check the coupon at right, add your name and address and mail it at once. The school will send you details on its training plan and outline of study prepared by specialists. There is no charge, no obligation, so send the coupon immediately.

PRACTICAL, EFFECTIVE HOME - STUDY TRAINING SINCE 1897

Take This First Easy Step

CHECK, CLIP AND MAIL COUPON NOW

AMERICAN SCHOOL, Dept. G745, Drexel at 58th, Chicago 37, Ill.
Without obligation, Please send FREE and postpaid, bulletin and details of the Subject checked.

- | | | |
|--|---|--|
| <input type="checkbox"/> PLASTICS ENG'R | <input type="checkbox"/> Accounting and C. P. A. | <input type="checkbox"/> Drafting and Design for Men and Women |
| <input type="checkbox"/> Refrigeration | <input type="checkbox"/> Bookkeeping | <input type="checkbox"/> Radio |
| <input type="checkbox"/> Architecture and Building | <input type="checkbox"/> Private Secretary | <input type="checkbox"/> High School |
| <input type="checkbox"/> Practical Plumbing | <input type="checkbox"/> Diesel Engineering | <input type="checkbox"/> Air Conditioning |
| <input type="checkbox"/> Automotive Engineering | <input type="checkbox"/> Surveying & Topographical Drafting | <input type="checkbox"/> Mechanical Eng. |
| <input type="checkbox"/> Aviation Drafting | <input type="checkbox"/> Sheet Metal Pattern Drafting | <input type="checkbox"/> Shop Management |
| <input type="checkbox"/> Aviation | <input type="checkbox"/> Electrical Engineering | <input type="checkbox"/> Tool Making |
| <input type="checkbox"/> Business Mgmt | <input type="checkbox"/> Electronics, Industr. | <input type="checkbox"/> Better Foremanship |
| <input type="checkbox"/> Railway Training | | <input type="checkbox"/> Machine Shop Operations |

Name..... Occupation.....
Address..... Age.....
City..... State.....

AMERICAN SCHOOL

Dept. G745, Drexel at 58th Street, Chicago 37

ELECTRICAL BOOKS

shipped for
EXAMINATION



**8
BIG BOOKS**

SEND NO MONEY

**MODERN
ELECTRICITY
INCLUDING RADIO
AND REFRIGERATION**

Here's great news for anyone interested in Electricity. NEW, up-to-date 1945 Edition of Applied Electricity with new subjects fully covered, including blueprint reading, electronics, F. M. radio, fluorescent lighting, 8 Big Books sent for examination!

NEW Edition for
Beginners and
Experts

Over 3700 pages, 2700 illustrations and 134 tables in most complete electrical work we have published. Dynamos, motors, diesel plants, power stations, transmission—everything explained for easy understanding.

**BIG FIELD! Big Demand!
Big Pay!**

Men who understand electricity are needed now in all kinds of industries, and will be needed when war production has ended. Practically every business depends on electrical knowledge, and men who know this subject make big money. Learn easily with these new, interesting books. Send coupon for a set of books on approval. See how they will help you to get ahead faster.

**SEND
NOW**

[A year's consulting privileges with our engineers now given to all buyers of this famous Cyclopaedia of Electricity.]

AMERICAN TECHNICAL SOCIETY
Vocational Publishers Since 1898

American Technical Society, Dept. E719, Drexel at 58th St., Chicago 37
Send for 10 days' free use, 8 volume set of New 19th Edition, Applied Electricity, including a certificate entitling me to consulting privileges for one year. I will pay the delivery charges only on the books. If I wish I may return them in 10 days and owe you nothing, but if I keep them, I will send \$2.00 after 10 days, then \$3.00 a month until the total price of only \$34.80 is paid.

NAME
ADDRESS
CITY STATE

Please attach letter stating age, occupation and name and address of employer and have at least one business man as reference. Men in service, also please give home address.

Always write your name and full address clearly when answering advertisements.

AUDELS Carpenters and Builders Guides

4 vols. \$6



Inside Trade Information for Carpenters, Builders, Joiners, Building Mechanics and all Woodworkers. These Guides give you the short-cut instructions that you want—proving new methods, ideas, solutions, plans, systems and money saving suggestions. An easy progressive course for the apprentice and student. A practical daily helper and Quick Reference for the master worker. Carpenters everywhere are using these Guides as a Helping Hand to Easier Work, Better Work and Better Pay. To get this satisfaction for yourself, simply fill in and mail the FREE COUPON below.

Inside Trade Information On:

How to use the steel square—How to file and set saws—How to build furniture—How to use a mitre box—How to use the chalk line—How to use rules and scales—How to make joints—Carpenters arithmetic—Solving mensuration problems—Estimating strength of timbers—How to set girders and sills—How to frame houses and roofs—How to estimate costs—How to build houses, barns, garages, bungalows, etc.—How to read and draw plans—Drawing up specifications—How to excavate—How to use settings 12, 13 and 17 on the steel square—How to build hoists and scaffolds—skylights—How to build stairs—How to put on interior trim—How to hang doors—How to lay floor—How to paint



THEO. AUDEL & CO., 49 W. 23rd St., New York City

Mail Audels Carpenters and Builders Guides, 4 vols., on 7 days' free trial. If O.K. I will remit \$1 in 7 days, and \$1 monthly until \$6 is paid. Otherwise I will return them. No obligation unless I am satisfied.

Name
Address
Occupation
Reference P.M.

Become a REAL ESTATE Specialist

BIG OPPORTUNITIES! U.S. Housing Administration Survey reveals 12,600,000 homes needed. Vast population shifts, Govt. loans to veterans, widespread urge to "buy something real," higher incomes—mean tremendous real estate expansion...Prepare NOW to cash in on big profits. Learn in spare time at home. No need to quit present job. Start "on the side"—then build up full time business as your own boss; pleasant outside work, your own working hours.

Write for FREE BOOK

Our practical home-study course prepares you for this money-making, big future business. No previous experience needed. Free book describes course—tells how you can quickly learn to make excellent income. Write NOW for FREE BOOK. No cost; no obligation; no salesman will call. SCHOOL OF REAL ESTATE TRAINING, Inc., Dept. 810, 126 Bedford St., Stamford, Conn.

Get into Good Paying AUTO BODY and FENDER WORK



BIG DEMAND in Auto Body and Fender work. Start training now spare time at home for good pay work now and postwar. Practical shop experience included. U.E.I. Training covers metal work, welding, painting, etc. Placement service—or we will show you how to start own shop. Behind U.E.I. TRAINING is a large national organization founded 1927.

Write today for Free Facts—No obligation

AUTO-CRAFTS DIVISION • UTILITIES ENGINEERING INSTITUTE
1314 BELDEN AVENUE, DEPT. 1105X, CHICAGO 14, ILLINOIS

LEARN WATCH REPAIRING



AT HOME. By our modern and original system of instruction you can learn every part of the WATCH REPAIRING TRADE AT HOME. Prepare yourself for a well-paying position or start in business after completing our course of instruction. Good watch repairers are in demand and generally earn very good salaries. For particulars apply to the Wisconsin School of Watch Repairing 759 North Milwaukee St., Milwaukee 2, Wis.

HIGH SCHOOL AT HOME

Most well-paid positions demand high school training. Without it, or equivalent, you can't advance to the full extent of your abilities in any trade, business or profession. Whatever your age, however you're situated, IT ISN'T NECESSARY TO STRUGGLE UNDER THAT HANDICAP. I.C.S., famous for more than 50 years, enables you to start your own high school in your own home. You're in a class by yourself—study in your spare time—acquire a high school education at astonishingly low cost. Authoritative texts! Rapid Progress! Write today for free booklet. International Correspondence Schools, Box 5557-K, Scranton 9, Pa.

DRAW for MONEY

BE AN ARTIST!
Trained Artists are Capable of Earning \$30, \$50, \$75 a week



Use Your Spare Time to Prepare for a Profitable Art Career! **COMMERCIAL ART, DESIGNING and CARTOONING**—all in ONE complete home study course. No previous Art experience necessary—we teach you step by step—hundreds have profited by our practical method. **TWO ART OUT-FITS FURNISHED.** Full information in colorful, FREE BOOK, "Art for Pleasure & Profit"—tells all about our course, service, what our graduates say—and commercial opportunities for you in Art.

FREE BOOK gives details!

WASHINGTON SCHOOL OF ART
Studio 1210P, 1115 15th St., N.W. Wash. 5, D.C.
Send me your booklet and full particulars about your course.

Name Age
Address
City State

ELECTRON WILL POINT WAY TO OUR FUTURE
DR. ...
ADD ...
al Elect ...
ness L ...
Gr ...
ce — Lim ...
HOLT, of b ...

HUGE POST-WAR MARKET FOR FM-SETS ENVISIONED
PLANNING IS HELD ...
Add ...
Fly t ...
ake ...

FAMILIES PLAN LARGE POST-WAR OUTLAYS ON RADIOS, APPLIANCES
ARE ACCUMULATING FUNDS
Chas ...

Let TODAY'S HEADLINES Guide You to TOMORROW'S OPPORTUNITIES

Learn RADIO ELECTRONICS DeFOREST'S MODERN "A-B-C" WAY .. at Home

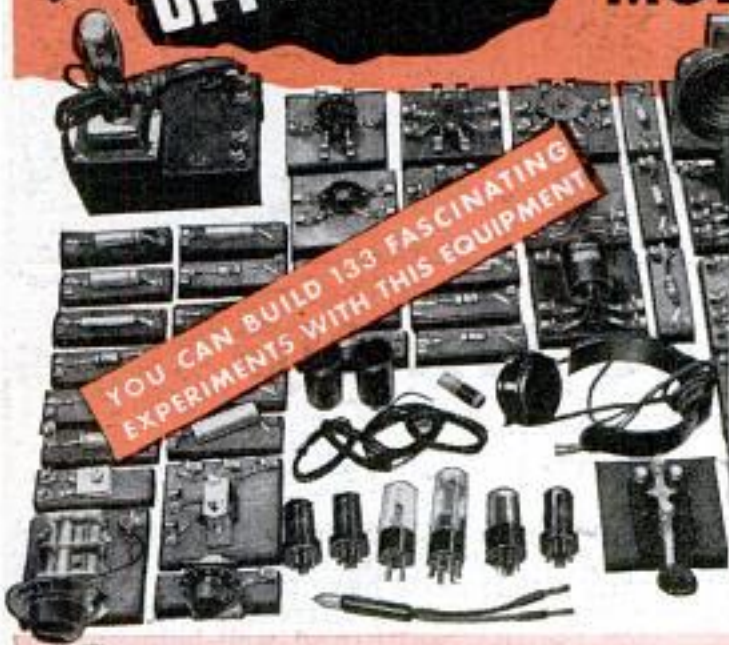

YOU CAN BUILD 133 FASCINATING EXPERIMENTS WITH THIS EQUIPMENT

Plan your future the way business men do: Watch the headlines! Pick a field that's "in the news"—one with many opportunities for interesting, PROFITABLE EMPLOYMENT or a good chance for establishing a BUSINESS OF YOUR OWN with little capital. Pick a field that offers a variety of interesting opportunities—a field with one of America's most promising futures... and see how you may MAKE YOUR START TOWARD A PLACE IN THIS FIELD BEFORE JOB COMPETITION BECOMES ACUTE. WRITE FOR DeFOREST'S BIG, FREE, ILLUSTRATED BOOK—"VICTORY FOR YOU." Learn how DeForest's prepares you at home, in your leisure time—without interfering with the work you are now doing—then helps you make your start in the vast BILLION DOLLAR Radio-Electronics field.

You Get EMPLOYMENT SERVICE

DeForest's Employment Service offers you the advantage of long and favorable contacts with some of America's foremost Radio-Electronics concerns. "VICTORY FOR YOU" tells you how this Service has helped many to their start in Radio-Electronics. You'll see how DeForest students and graduates are prepared to win and to hold good paying jobs—how DeForest students start businesses of their own, with little, if any, capital.

A You "LEARN-BY-DOING" at Home with Practical Equipment

Enjoy a "Home Laboratory." DeForest's provides 8 BIG KITS OF RADIO ASSEMBLIES AND PARTS to give you valuable practical experience at home. Build modern Radio Receivers and Circuits that operate. Build Electric Eye Devices, an Aviation Band Receiver, a Public Address System, a Wireless Microphone and numerous other fascinating experiments—in fact, 133 in all, in your spare time at home. NEW colorful Kit Supplement tells you about DeForest's "Home Laboratory," and how you use valuable Radio parts and sub-assemblies to get real practical experience as you learn.



B Home Movies Help You Learn FASTER... EASIER

With DeForest's, you use a genuine DE-VRV 16mm. Motion Picture Projector and exciting training films to help you learn some of Radio's fundamentals FASTER... EASIER. SEE what happens inside of many circuits you are working on. SEE how electrons function. SEE how RADIO waves are changed into sound. Get DeForest's big, free book! Use it as a key to show you the way to Radio-Electronics job-opportunities of today and tomorrow—the opportunities the headlines tell about.

Send for FREE BOOK & SUPPLEMENT TODAY!

C WELL-ILLUSTRATED LOOSE-LEAF LESSONS



Dr. Lee DeForest

Prepared Under Supervision of Dr. Lee DeForest

DeForest's provides 90 loose-leaf lessons prepared under the supervision of the man often referred to as the "Father of Radio"—Dr. Lee DeForest, inventor of the Audion Tube, and holder of over 300 important patents... ACT PROMPTLY! See how you can learn

Radio the simple A-B-C DeForest's way—by Reading... by Doing... by Seeing—at Home. Mail coupon Now!

DeFOREST'S TRAINING INC., Chicago, Ill.

DeFOREST'S TRAINING, INC., 2533-41 N. Ashland Ave., Dept. PM-B10 Chicago 14, Illinois, U. S. A.

Send me both your big book "VICTORY FOR YOU" and Kit Supplement, showing how I may make my start in Radio-Electronics with your simple A-B-C home training plan. No obligation.

Name _____ Age _____
 Address _____
 City _____ Zone _____ State _____
 If under 16, check here for special information. If a veteran of World War II, check here.





SO IT NEEDS FIXING

By S. T. CHRISTENSEN

the "Fix-it Man"

WELL, I guess I'm the fellow to see, for I've repaired thousands of refrigerators (home and commercial both), vacuum cleaners, radios, washing machines, irons, fans, lamps, mangles, motors, etc. In fact, many of my customers call me their "electrical appliance doctor." And, "doctoring," I might add, has paid me a good substantial income for quite a few years. Funny, in a way, how I got started. Always liked to tinker and by experimenting around I found that most electrical appliances had many things in common. That, regardless of what the appliance was used for, or who the manufacturer was, the basic principles were much the same. From fixing my own appliances to fixing friends' and then for strangers at a fee, seems now to have been but a small step.

What to Charge?

At first, I let the owner decide the charge and, frankly, I was amazed at what I earned per hour. But then, when one figures what initial costs are involved in buying most electrical appliances, one can readily see that spending extra dollars for repairs is well worth while. Before long I was making more in my spare time repairing than from my regular job. The result . . . I went into business for myself. When war came, business boomed, for new appliances were not available.

For a while, repair parts (needed on some

jobs) were a little difficult to get. But that situation seems to have adjusted itself for many repair parts have today the high priority rating of AA2. After all, we must provide for the health and well-being of our civilian population.

The Future Offers

Friends ask me about my future. And, I think I've got a grand one. Age is no handicap in repairing. I have in my files enthusiastic letters from repairmen ranging in age from 18 to 79 years. After the war, we're bound to see hundreds of new products on the market . . . products that the average person never dreamt of. These new products and our old appliances are all going to need at some time or other "fixing." Well, I'll still be the fellow to do it. The field open for appliance repairmen is unlimited. I don't worry at all about too much competition.

If You Are Ambitious

To the contrary, I've prepared a complete course, chuck full of simple, easy to understand photos and drawings and written in the same non-technical language as this article. I know the course is good, because I have hundreds of men all over the country writing to me telling me how the course has helped swell their pockets with cash. If you too want to prepare now for your future, I suggest you read the next page and send me the handy coupon."

Advertisement



**BIG MONEY
INDEPENDENCE**

*A PROFITABLE
LIFETIME
BUSINESS
OF
YOUR OWN!*

LEARN ELECTRICAL APPLIANCE REPAIRING

PREPARE NOW FOR THE FUTURE

If now in war work, start your home appliance repair business NOW in your spare time and be set with a business of your own when the war is over. You don't need elaborate fixtures or expensive equipment to be a successful repairman. Operate from your garage, basement, vacant store, etc. Work as many hours as you wish—the home appliance repairman is his own boss. It is a profitable occupation for on many types of repairs it is not unusual for a repairman to charge on the basis of \$5.00 to \$6.00 per hour. Don't gamble with your future—learn a trade that will always support you. Remember, as long as electrical appliances are used, there will be a need for electrical appliance repairmen.

If you are at all mechanically inclined—can hold and use tools—then you have all of the qualifications required for becoming a big money earning home appliance repairman. It does not matter if you have not had a great deal of schooling or had previous experience along these lines—**WE WILL TEACH YOU.** Age should be no barrier—nor should any minor physical handicap.

New Course Tells All

Profusely illustrated, our new course shows you in simple, easy to understand language and drawings how to make each repair on refrigerators, vacuum cleaners, washing machines, motors, etc. Explains and gives you a working knowledge of electricity, welding, nickel plating, etc. Shows you how to build the power tools you need and how to solicit and keep business coming to you. Not a theory course but an honest to goodness course written by and used by repairmen the country over. Price of course is so low that the savings on your own household appliance repairs will quickly pay for it. Act now! Mail the handy coupon below today.

----- Read What Our Students Say About Course -----

I really believe your course the best investment a mechanically minded man can make.—Claude E. Allen, Indianapolis, Ind.

I have received your Course in Appliance Repairing and I must say I am well pleased with same. I am only sorry I did not have said Course some years ago. I have learned so much more through this course I would not part with it.—Charles Schwarz, Hamilton, Ohio.

The Course in Appliance Servicing arrived a few days ago. Want to take out a few minutes of my valuable time to let you know that this is just what I have been looking for ever since I opened up my Fix-It shop. I must admit that you told the truth when you said that it contains quite a bit more information than I bargained for.—P. J. Bretl, Sebring, Ohio.

I am a mechanic for the Western Union Telegraph Co. Three days after receiving the lessons in refrigeration I earned the exact cost of the course.—Henry S. Lee, Washington, D. C.

I work day times at the shipyard and after 4:00 P.M. I operate from my cellar and garage. I average \$10.00 to \$15.00 clear every day.—Walter Hanby, Brockton, Mass.

GET STARTED TODAY—MAIL THIS COUPON

CHRISTY SUPPLY CO.
2835 N. Central Ave., Dept. D-2603
Chicago 34, Illinois

Please send me free illustrated literature about America's Fastest Growing Industry—ELECTRICAL APPLIANCE REPAIRING.

Name.....

Address.....

City..... State.....

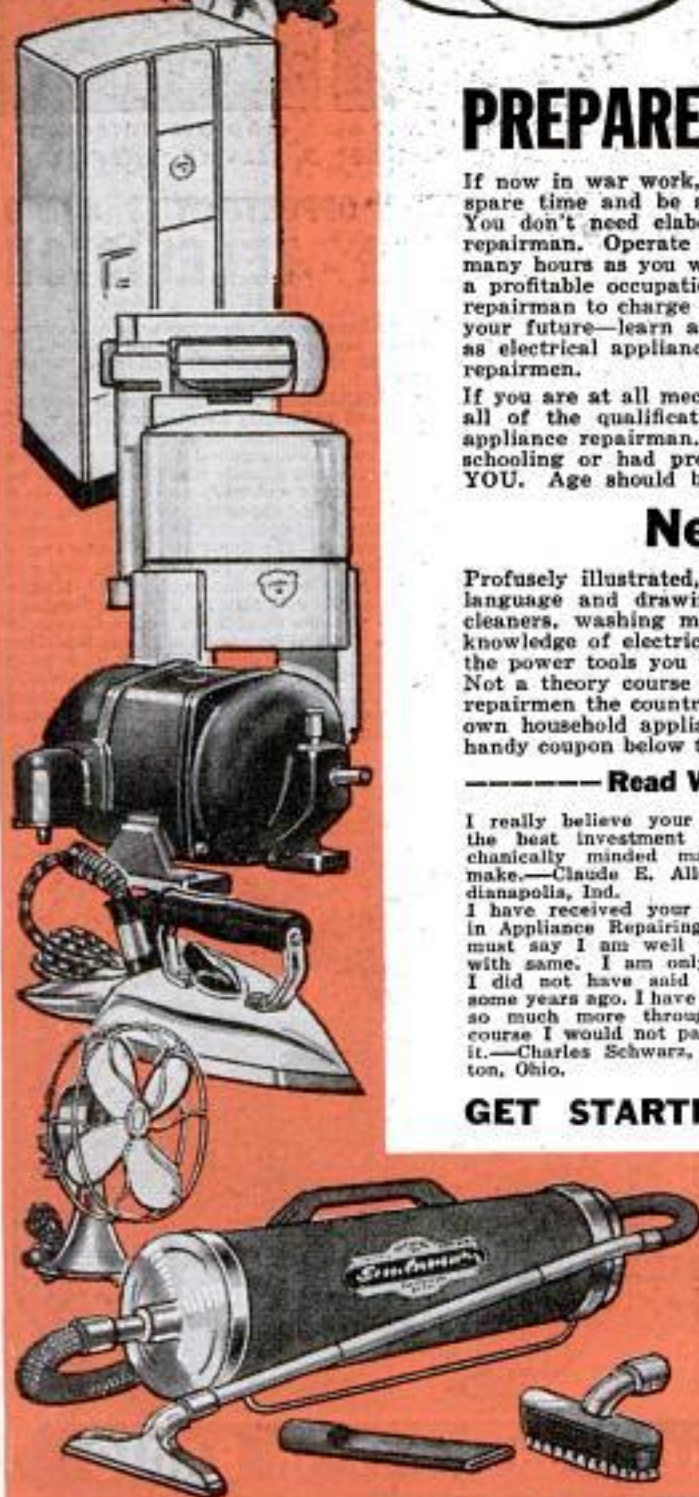

**I'LL SHOW YOU
HOW TO SUCCEED
IN RADIO**

BE A RADIO

**Here's the right
training for
Big Post-War
Pay!**



**A RADIO SERVICE
BUSINESS OF YOUR OWN**



**A GOOD JOB IN RADIO &
TELEVISION BROADCASTING**



**RADIO-ELECTRONIC
SERVICE ENGINEER**

**I'LL PREPARE YOU FOR THE AMAZING OPPORTUNITIES AHEAD
in RADIO - ELECTRONICS - TELEVISION**



The offer I make you here is the opportunity of a lifetime. It's your chance to become a RADIO-ELECTRONICIAN . . . the kind of Technical Expert who'll cash in on the big developments ahead in the swiftly expanding field of Radio-Electronics INCLUDING Radio, Television, Frequency Modulation and Industrial Electronics. Be wise! NOW'S the time to start. Opportunities are tremendous! Just show me that you're determined to get ahead and I'll do the rest. I'll give you exactly what you need to be able to roll up your sleeves and with expert hands, do a workmanlike job installing, operating or repairing any piece of Radio-Electronic equipment. No previous knowledge of Radio is necessary. The Sprayberry Course starts right at the beginning of Radio. You can't get lost. It gets the various subjects across in such a clear, simple way that you learn easily and fast . . . you understand and remember. And you can master my entire Course in your spare time . . . right at home. It will not interfere in any way with your present duties. Along with your Training, you will receive my famous BUSINESS BUILDERS which will show you how to make plenty of nice spare time profits while learning.

**I SUPPLY A FULL
RADIO SET
for EASY LEARNING**

**YOU DO PRACTICAL EXPERIMENTS
GET REAL "SHOP" EXPERIENCE...**

There's only one right way to learn Radio-Electronics. You must get it through simplified lesson study combined with actual "shop practice" and backing this up, you must have the personal guidance of a qualified Radio-Electronics Teacher. This is EXACTLY how Sprayberry teaches you. All Sprayberry lesson text is written in plain, simple English anyone can readily understand. Technical details are reduced to simplest terms and there are plenty of illustrations, charts and tables to make it all the easier. But most important of all, you get a full and complete set of real RADIO PARTS and components . . . everything you need to build a fine, modern Radio Receiving Set which you can sell later on at a nice profit. But while you're in training, these parts will serve a valuable purpose in experimental work.

Radio Breakdowns Occur Right Before Your Eyes

You'll be shown how to perform a whole series of interesting tests and experiments which will give you the real low-down on basic Radio. You will see Radio break-

downs occur before your very eyes. You will learn the very latest methods for trouble-shooting, for making speedy, efficient repairs. You'll come to understand all about Radio parts, their uses, why and how a Radio works. You'll get the finest kind of LEARN-BY-DOING experience right at home and it's this sort of preconditioning that will make you into a real Radio man. Put Sprayberry Training to any test and you'll find that every phase of it is designed for clear-cut understanding. You'll see that it's the one Training Course that gives the Student the practical know-how essential to a good-paying Radio job or a Radio Business of his own.

I'll Show You a New, Fast Way to Test Radio Sets Without Mfg. Equipment

The very same Radio parts I supply with your Course for gaining pre-experience in Radio Repair work may be adapted through an exclusive Sprayberry wiring procedure to serve for complete, fast, accurate Radio Receiver trouble-shooting. Thus, under Sprayberry methods, you do not have one cent of outlay for manufactured Test Equipment.



NOW IS THE TIME TO MAKE YOUR START IN RADIO

ELECTRONICIAN

SPRAYBERRY RADIO TRAINING

Gives you Both



It's a matter of practical common sense that the quality and thoroughness of your Radio Training will have a big influence on your future in Radio. We don't believe in trick schemes to teach you Radio. We don't rely on gadgets or anything of the sort. What we do employ is a hard-hitting, straight line, thoroughly proved method of PRACTICAL instruction that really gets RESULTS and gets them quickest and surest for the Student. Far more than an ordinary "theory" Course, Sprayberry Training is a full scale, broad gauge Radio Training which places equal stress on training your hands as well as your head. Not only will it fix the knowledge you need clearly in your mind . . . but it will develop the skill of your hands to give that knowledge full and useful expression. It means you get the stuff you need to make fast progress in Radio. It means you're prepared in the right way to step into any one of many varied and interesting Radio jobs with a good salary and the assurance of regular increases. It means you will have the confidence and ability to hold down the kind

of job you'll be proud to tell your friends about. If that's the kind of SOLID RADIO TRAINING you think would appeal to you, then look no farther. **SPRAYBERRY HAS EXACTLY WHAT YOU WANT!**

PREPARES YOU FOR A BUSINESS OF YOUR OWN OR GOOD RADIO JOB

My Training will give you the broad, fundamental principles so necessary as a background, no matter which branch of Radio you wish to specialize in. I make it easy for you to learn Radio Set Repair and Installation Work. I teach you how to install and repair Electronic Equipment. In fact, you'll be a fully qualified RADIO-ELECTRONICIAN, equipped with the skill and knowledge to perform efficiently and to make a wonderful success of yourself.

DON'T PUT IT OFF!

Get the facts about my Training—now! Take the first important step toward the money-making future of your dreams. All features are fully explained in my big, illustrated FREE Catalog which comes to you along with another valuable FREE book you'll be glad to own. Mail Coupon AT ONCE!

Read These Letters From Men I Trained:

Harold C. Schor writes: "While I was taking your Course, I made more than enough to pay for the Training by repairing Radio sets. Shortly after I completed the Course, I obtained a position managing the Radio Service Department of a large electrical dealer. In the past four months I have earned nearly \$600.00. Your Training has meant so much to me that it would take a great many pages to tell you just how much I have really benefited from it."

Stephen Skovran writes: "Since taking your Training, I have made in my spare time an average of about \$60.00 a week. I have paid all my outstanding bills and have a stock of Radio tubes and parts amounting to \$150.00 which is all paid for. I have a list of about 300 customers and it's still growing. For this, I have you and your School to thank and believe me, it's highly appreciated."

Adrien Benjamin writes: "Since last week, I fixed 7 Radios, all good-paying jobs and right now I am working on an amplifier system. This job alone will net me about \$20.00. I have only one word to say, and that is 'Thanks to my Sprayberry Training.' I am not afraid to boast about it."



F. L. Sprayberry, one of the country's foremost Radio Teachers.

Get Your FREE BOOKS JUST OFF THE PRESS

"How to Read Radio Diagrams and Symbols" a valuable new book which explains in simple English how to read and understand any Radio Set diagram or circuit. Includes translations of all Radio symbols and many other useful facts and data. Send for this FREE book now and along with it, I will send you another big FREE book, completely describing my Radio-Electronic Training.

MAIL COUPON

Don't miss this Offer!



SPRAYBERRY ACADEMY OF RADIO

F. L. Sprayberry, President
Room 10105, Pueblo, Colorado

Please rush my FREE copies of "How to MAKE MONEY in RADIO, ELECTRONICS and TELEVISION" and "How to READ RADIO DIAGRAMS and SYMBOLS."

Name..... Age.....

Address.....

City..... State.....

(Tear off, paste on penny postcard or mail in envelope)

DRAFTING

GET THIS
Free
TRIAL LESSON
Send Coupon



TO PROVE TO YOU how easy it is to learn Drafting at home by the Chicago Tech method, this 40 year old technical college will send you a *Free Trial Lesson in Drafting*. No charge for this Lesson now or later.

Mail Coupon Below

Get ready for a peacetime career. Look into the opportunities in Drafting. Read the want-ads for proof of the urgent demand for draftsmen in the aircraft, machinery, electrical and building fields. The draftsman always comes first on any new project in industry.

The Draftsman—"The Key Man"

No new machines can be built, no airplanes constructed, no bridges or buildings erected until the draftsman has completed his work. Real immediate opportunities exist in Drafting—the profession upon which all construction is vitally dependent. Drafting is clean, interesting, well paid work. Investigate today what Drafting offers you.

Learn in Spare Time,—at Home! (or at the College in Chicago)

With our easy step-by-step method (and the tools we furnish) you can learn in your spare time at home. Convenient terms. Now is the time to prepare in Drafting for peacetime opportunities. Send the coupon or a post card for the Trial Lesson and complete information,—all FREE.

CHICAGO TECHNICAL COLLEGE

N-206 Tech. Bldg., 2000 S. Michigan Ave., Chicago 16, Ill.

Yes,—please send me **FREE** Trial Lesson in **DRAFTING**.

- | | |
|---|--|
| <input type="checkbox"/> Aircraft Drafting | <input type="checkbox"/> Machine Drafting |
| <input type="checkbox"/> Electrical Drafting | <input type="checkbox"/> Structural Drafting |
| <input type="checkbox"/> Architectural Drafting | <input type="checkbox"/> Building Construction |

Name.....

Address.....

City..... Zone.....

State..... Age.....

Say you saw it in *Popular Mechanics!*

Learn to Service and Repair ELECTRICAL APPLIANCES

Learn to be a service mechanic on all types of electrical appliances . . . and prepare now for a permanent future, independence and security, operating a business of your own. You won't have to worry about losing your job when the next depression comes if you have your own electrical appliance repair business. There is always a demand for repair work . . . and it can't be done by a machine. Our practical, easy to learn home-training teaches you how to repair washing machines, vacuum cleaners, stoves, lamps, motors, irons, etc., and how to do house wiring. Also how to start your own business on little capital. Write today for **FREE** illustrated booklet which will explain in detail. No obligation. No salesmen will call.

PACIFIC TRAINING SCHOOL
4701 W. Pico, Dept. AP-10, Los Angeles 6, California

ANALYZE HANDWRITING

Qualify for Certified Grapho-Analyst Degree. Earn up to \$100 weekly, up to \$1 hourly spare time, in new uncrowded profession . . . Graduates in employment and credit fields, police departments, courts, and in private practice as Personal Problem and Vocational Counselors. 3,000 word test lesson and illustrated **GRAPHO-ANALYST** Free.

ADDRESS **A.I.G.A., INC., 120 JOPLIN, MO.**

RADIO, ELECTRONICS and YOU!

There are big rewards in the communications line for the Radio man who has the answers! Too, the equipment that has made Radio communication possible is functioning now in other rewarding fields. Electron tubes in industry promise a whole new World of Electronics. L. C. S. has a variety of Radio Courses and a great new standard Electronics Course. Write for booklet, pick your Course.

International Correspondence Schools, Box 5557-K, Scranton 9, Pa.

Good Handwriting HELPS YOU WIN SUCCESS!

It's so important to write a good hand for business and social advancement. Poor illegible penmanship often causes costly errors and marks you for failure. Why write a poor hand? It's so easy to learn at home in spare time. Write for our new free booklet today. If you wish, send 10¢ for a penpoint suitable for shaded writing and your name beautifully written.

THE TAMBLYN SCHOOL OF PENMANSHIP
In Business Since 1895 N-441 Ridge Bldg., Kansas City, Mo., U. S. A.

Success in Music!

THE ONLY HOME STUDY MUSIC CONSERVATORY OFFERING ALL COURSES LEADING TO DEGREE, BACHELOR OF MUSIC

Personalized Instruction for Professionals, Advanced Students and Beginners by Eminent Music Teachers. Check courses which interest you and mail coupon for catalog and illustrated lessons.

UNIVERSITY EXTENSION CONSERVATORY

765 Oakwood Blvd., Suite U259, Chicago 15, Ill.

- | | | | | | |
|--|--|---|---------------------------------------|---|------------------------------------|
| <input type="checkbox"/> Piano | <input type="checkbox"/> Violin | <input type="checkbox"/> Cornet | <input type="checkbox"/> Trumpet | <input type="checkbox"/> Saxophone | <input type="checkbox"/> Clarinet |
| <input type="checkbox"/> Guitar | <input type="checkbox"/> Mandolin | <input type="checkbox"/> Voice | <input type="checkbox"/> Ear Training | <input type="checkbox"/> and Sight Singing | |
| <input type="checkbox"/> Choral Conducting | <input type="checkbox"/> Public School Music | <input type="checkbox"/> History of Music | <input type="checkbox"/> Harmony | <input type="checkbox"/> Advanced Composition | <input type="checkbox"/> Arranging |

Name.....

Street.....

City & State.....

Music experience..... Age.....



Learn **PLASTICS**
FABRICATION

New - Profitable Industry!

START YOUR OWN BUSINESS

YOU'LL really enjoy learning plastics this new, interesting way! For you'll actually make beautiful, useful plastics articles during your home study training with Plastics Industries Technical Institute.

NOW'S YOUR OPPORTUNITY—Yes, the exciting age of plastics is here! Demands of war have caused phenomenal growth in the plastics industry—creating exceptional opportunities for those who know plastics. If you are a person with an eye to the future, you won't remain on the outside looking in—you'll want a choice position in the growing, expanding plastics field—or a plastics business of your own.

WE SUPPLY MATERIALS—For your interesting and practical work with plastics, we supply handsome, colorful, transparent rods, sheets and tubes of plastics from which you make useful, attractive creations. You saw, cement, machine, buff, form, dye, decorate, cast and laminate various types of plastics. You also design

your own plastics articles—develop your own ideas—express your originality. Earn money while learning.

A COMPLETE COURSE—This practical training in plastics fabrication is only *one* part of the Plastics Institute home study course. In addition, you learn about the many types of plastics, their manufacture, characteristics, properties and uses—intensive coverage of molding and mold design—testing and cost analysis—everything to prepare you for your place in plastics.

START YOUR FUTURE TODAY—Mail the coupon below now! We will send you an interesting, illustrated free booklet with valuable information about plastics. We'll tell you how, at small cost, you can prepare for a future in this important industry while carrying on your present work. Don't put it off. Clip the coupon and mail it today!

VETERANS: ASK ABOUT G.I. TRAINING

NEW YORK

CHICAGO

LOS ANGELES

Dept. PM 5-10, 122 E. 42nd St.

Dept. PM 5-10, 221 N. La Salle St.

Dept. PM 5-10, 1601 S. Western

SPECIAL RATES FOR SERVICE MEN

Plastics
INDUSTRIES TECHNICAL INSTITUTE

Plastics Industries Technical Institute
221 N. La Salle St., Dept. PM5-10, Chicago 1

Mail in Envelope or
paste on penny postcard

Gentlemen: Please send me the bookler "World of Plastics" and information on your training program. I understand there is absolutely no obligation.

Name.....Occupation.....

Street.....Age.....

City.....Zone.....State.....

Veterans: Check here for special information.

If under 18: Check here for special booklet.

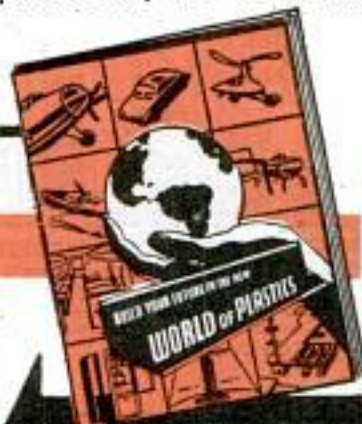

FREE BOOKLET

Send for it Today!



REFRIGERATION AIR CONDITIONING

Air Conditioning and Refrigeration are among the great industries of today and tomorrow. Installations everywhere—in restaurants, shops, homes, etc., need service. Thousands of businesses are waiting for new installations. Today, more and more homes are being air conditioned. The Refrigeration and Air Conditioning industries are headed for greater prosperity and men who have the "know how" and experience should ride along.

Train Now Before the Expected EXPANSION Begins



Experts predict large demand for men to install and service Air Conditioning and Refrigeration equipment. . . Rise to the kind of job which requires a competent, trained man who can carry the responsibilities of installing costly equipment and maintaining it. If he knows the answer when he is called in for consultation, his reputation grows and his pay should grow also.

Follow This Way to Knowledge
If over 17, and under 58, here's all it takes to get you ready for experience in this modern industry. Just invest a limited amount of your spare time—while you are still on your present job. Through our balanced training, you learn first through home study, how to handle Installation, Maintenance & Service Work on Refrigeration and Air Conditioning equipment. Then you can get practical training in our big shops under capable instructors—experienced men who'll take a personal interest in helping you learn. When you're through you should have knowledge that enables you to get started in this vast industry.

WANT YOUR OWN REPAIR SHOP?
UEI training is easily understood by mechanically inclined men. You gain experience when you complete your course. Equipment, tools and personal following can accumulate as you progress. Soon you may find it wise to set up your own shop.

GET FREE FACTS RIGHT NOW!
It costs you nothing to get all the facts about this great field. Simply mail the coupon below and we'll tell you, without obligation the whole, sensational story of what's ahead in Refrigeration and Air Conditioning. Mail the FREE coupon now.

REFRIGERATION TRAINING Since 1927

UTILITIES ENGINEERING INSTITUTE
1314 W. Belden Avenue, Dept. 1105, Chicago 14, Ill.

Please send me the FREE FACTS about opportunities in Air Conditioning and Mechanical Refrigeration. I have marked the one that interests me most.

Air Conditioning Mechanical Refrigeration

NAME _____ AGE _____

ADDRESS _____

CITY _____ ZONE _____ STATE _____

Do You Make Mistakes in English?

EVERY time you speak or write you show just what you are. Mistakes in English reveal you as a person who lacks education and refinement. Lack of language power prevents you from presenting your thoughts in the strongest possible way. No matter what you do, real command of English will help you to your goal. Stop making mistakes in spelling, punctuation, pronunciation. Increase your vocabulary.

WONDERFUL INVENTION

Only 15 minutes a day with Sherwin Cody's new invention—and you can actually SEE your English improve. It teaches by HABIT—makes it easier to do the RIGHT way. Wonderful self-correcting lessons include spelling, punctuation, grammar and expression.



FREE BOOK ON ENGLISH Lack of language power may easily be costing you friendships, income every year. See what Mr. Cody can do for you; it costs nothing to find out. Mail a postal card or letter this very minute for free book, "How You Can Master Good English in 15 Minutes a Day." It will prove a revelation to you. WRITE NOW. Address:

Sherwin Cody School of English, 510 B & O Bldg., Rochester 4, N. Y.



Complete Course Only \$15.00

DRAW CARTOONS BIG MONEY!

EASY . . . PLEASANT WORK!

Let CHAS. H. KUHN, with 25 years actual experience in drawing a daily newspaper cartoon, teach you how to create, draw and sell your work. 52 complete lessons—one sent each week. Professional criticism on every lesson. Write today.

KUHN SCHOOL OF CARTOONING
420 MURPHY BUILDING Dept. M INDIANAPOLIS 4, INDIANA

ACCOUNTANT

BECOME AN EXPERT

Executive Accountants and C. P. A.'s earn \$2,000 to \$10,000 a year. Thousands of firms need them. We train you liberally at home in spare time for C. P. A. examinations or executive accounting positions. Previous experience unnecessary. Personal training under supervision of staff of C. P. A.'s. Placement counsel and help. Write for free book, "Accountancy, the Profession That Pays."

LASALLE Extension University, 417 So. Dearborn St.
A Correspondence Institution Dept. 1064-H Chicago 5, Ill.

It's Really WATER-PROOF!

So-Lo's CLEAR CEMENT

Mends china, glass, porcelain, wood, metal, marble, model airplanes. Transparent. Stands boiling water. Large tube 10c. Many other So-Lo Menders. Ask for them. At Hardware or 10c Stores.



Millions Save with So-Lo Menders

MASTER MACHINIST MECHANICAL DRAFTING TOOL ENGINEERING

Learn by doing in completely equipped modern shops. Approved for G.I. training. Days, Evenings and Part Time. Men and Women.

ALLIED SCHOOL OF MECHANICAL TRADES
1330 South Michigan Avenue, Chicago 5, Illinois

LAW

STUDY AT HOME for PERSONAL SUCCESS and LARGER EARNINGS. 35 years expert instruction—over 108,000 students enrolled. LL.B. Degree awarded. All texts furnished. Easy payments. Send for FREE BOOK—"Law and Executive Guidance."

AMERICAN EXTENSION SCHOOL OF LAW
Dept. 58-M, 646 N. Michigan Ave., Chicago 11, Ill.



Fix Your Own ALARM CLOCKS

New, practical home course. Just out. Makes interesting hobby—profitable too. Save money by doing your own repairing at home. Easy if you know how. Price now only \$1.00. Details FREE. Send postcard.

THIES JEWELRY STORE, Genoa 3, Illinois

"Why, he knows all about me!"

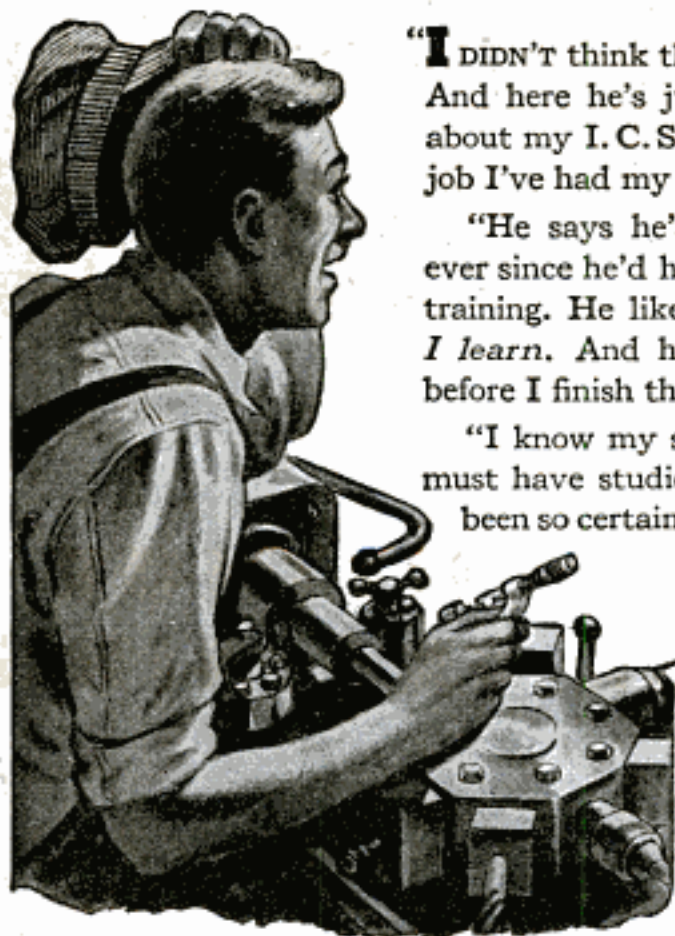

"I DIDN'T think the boss knew my name. And here he's just stopped by to talk about my I. C. S. Course and the bigger job I've had my eye on.

"He says he's had *his eye on me* ever since he'd heard I was getting that training. He likes the idea of my applying what I learn as *I learn*. And he says there'll be good news for me even before I finish the course.

"I know my studies showed in my work. But I guess he must have studied with I. C. S. himself or he couldn't have been so certain about just where I was getting my training."



Quite possibly the boss *is* an I. C. S. graduate. Thousands of employers are. Whether he is or isn't, however, he knows about your studies. I. C. S. regularly reports student progress to superiors. Letters of employer appreciation for this service are a regular part of our mail. So are student and graduate letters telling us of advancements—600 a month on an average. There *must* be a connection. Mail the coupon for full information.

INTERNATIONAL CORRESPONDENCE SCHOOLS



BOX 5556-K, SCRANTON 9, PENNA.

Without cost or obligation, please send me full particulars about the course *before* which I have marked X:

- | | | | |
|---|---|--|--|
| <ul style="list-style-type: none"> <input type="checkbox"/> Air Conditioning and Plumbing Courses <input type="checkbox"/> Air Conditioning <input type="checkbox"/> Heating <input type="checkbox"/> Plumbing <input type="checkbox"/> Refrigeration <input type="checkbox"/> Steam Fitting Chemistry Courses <input type="checkbox"/> Chemical Engineering <input type="checkbox"/> Chemistry, Analytical <input type="checkbox"/> Chemistry, Industrial <input type="checkbox"/> Chemistry, Mfg. Iron & Steel <input type="checkbox"/> Petroleum Refining <input type="checkbox"/> Plastics <input type="checkbox"/> Pulp and Paper Making Civil Engineering, Architectural and Mining Courses <input type="checkbox"/> Architectural Drafting <input type="checkbox"/> Architecture <input type="checkbox"/> Bridge and Building Foreman <input type="checkbox"/> Building Estimating <input type="checkbox"/> Civil Engineering <input type="checkbox"/> Coal Mining <input type="checkbox"/> Contracting and Building <input type="checkbox"/> Highway Engineering <input type="checkbox"/> Lumber Dealer <input type="checkbox"/> Reading Structural Blueprints <input type="checkbox"/> Sanitary Engineering <input type="checkbox"/> Structural Drafting <input type="checkbox"/> Structural Engineering <input type="checkbox"/> Surveying and Mapping | <ul style="list-style-type: none"> Electrical Courses <input type="checkbox"/> Electrical Drafting <input type="checkbox"/> Electrical Engineering <input type="checkbox"/> Power House Electric <input type="checkbox"/> Practical Electrician <input type="checkbox"/> Practical Telephony <input type="checkbox"/> Telegraph Engineering Internal Combustion Engine Courses <input type="checkbox"/> Auto Technician <input type="checkbox"/> Aviation <input type="checkbox"/> Diesel-Electric <input type="checkbox"/> Diesel Engines <input type="checkbox"/> Gas Engines Mechanical Courses <input type="checkbox"/> Aeronautical Engineering <input type="checkbox"/> Airplane Drafting <input type="checkbox"/> Flight Engineer <input type="checkbox"/> Foundry Work <input type="checkbox"/> Heat Treatment of Metals <input type="checkbox"/> Industrial Engineering <input type="checkbox"/> Industrial Metallurgy <input type="checkbox"/> Mechanical Drafting <input type="checkbox"/> Mechanical Engineering <input type="checkbox"/> Mold-Loft Work <input type="checkbox"/> Patternmaking <input type="checkbox"/> Reading Shop Blueprints <input type="checkbox"/> Sheet-Metal Drafting <input type="checkbox"/> Sheet-Metal Worker | <ul style="list-style-type: none"> <input type="checkbox"/> Ship Drafting <input type="checkbox"/> Ship Fitting <input type="checkbox"/> Shop Practice <input type="checkbox"/> Steel Mill Workers <input type="checkbox"/> Tool Designing <input type="checkbox"/> Welding, Gas and Electric Radio Courses <input type="checkbox"/> Electronics <input type="checkbox"/> Radio, General <input type="checkbox"/> Radio Operating <input type="checkbox"/> Radio Servicing Railroad Courses <input type="checkbox"/> Air Brake <input type="checkbox"/> Car Inspector <input type="checkbox"/> Locomotive Engineer <input type="checkbox"/> Locomotive Fireman <input type="checkbox"/> Railroad Section Foreman Steam Engineering Courses <input type="checkbox"/> Boilermaking <input type="checkbox"/> Combustion Engineering <input type="checkbox"/> Engine Running <input type="checkbox"/> Marine Engineering <input type="checkbox"/> Steam Electric <input type="checkbox"/> Steam Engines Textile Courses <input type="checkbox"/> Cotton Manufacturing <input type="checkbox"/> Rayon Weaving | <ul style="list-style-type: none"> <input type="checkbox"/> Textile Designing <input type="checkbox"/> Woolen Manufacturing Business and Academic Courses <input type="checkbox"/> Accounting <input type="checkbox"/> Advertising <input type="checkbox"/> Arithmetic <input type="checkbox"/> Bookkeeping <input type="checkbox"/> Business Correspondence <input type="checkbox"/> Business Management <input type="checkbox"/> Certified Public Accounting <input type="checkbox"/> College Preparatory <input type="checkbox"/> Commercial <input type="checkbox"/> Cost Accounting <input type="checkbox"/> Federal Tax <input type="checkbox"/> First Year College <input type="checkbox"/> Foremanship <input type="checkbox"/> French <input type="checkbox"/> Good English <input type="checkbox"/> High School <input type="checkbox"/> Higher Mathematics <input type="checkbox"/> Illustrating <input type="checkbox"/> Motor Traffic <input type="checkbox"/> Postal Service <input type="checkbox"/> Salesmanship <input type="checkbox"/> Secretarial <input type="checkbox"/> Sign Lettering <input type="checkbox"/> Spanish <input type="checkbox"/> Stenography <input type="checkbox"/> Traffic Management |
|---|---|--|--|

Name..... Age..... Home Address..... Working

City..... State..... Position..... Hours..... A.M. to..... P.M.

Canadian residents send coupon to International Correspondence Schools Canadian, Ltd., Montreal, Canada.

British residents send coupon to I. C. S., 71 Kingsway, London, W. O. 2, England.

DISCOUNT TO DISCHARGED VETERANS—SPECIAL TUITION RATES FOR MEMBERS OF THE ARMED FORCES



**HERE IS
THE MODERN
QUICK AND
EASY WAY**

**BASIC RADIO
LABORATORY
INCLUDED!**



*To Master
Radio
Television
and Electronics*

**SHOP METHOD
HOME TRAINING**

By a Real, Established Resident School

Don't just envy the man who is making such a success in Radio. Don't be on the outside looking in on America's next great industry—P.M., Television and the wonder world of Electronics. Get in there yourself, on the ground floor, with a fine, well paid job or a lifetime business of your own. This **AMAZING NEW TRAINING SYSTEM THAT DEMONSTRATES BY ACTUAL PRACTICE** makes it possible for you to take your place quickly and with absolute assurance in this great and growing industry. For details send the coupon below.

This is the practical, and sure way for you to get the training and experience necessary for a successful career in Radio, Television and Electronics. Here is a fully tested and approved method—simple, direct, easy to understand and put into practice. Fill out and send the coupon on this advertisement for a test lesson to prove to yourself how different, sure and effective this course is.

Results Quick and Profitable

No longer do you have to think of Radio as a great mystery—Television as something complicated and Electronics as vague

and technical. Here it is presented as simple as A.B.C. and backed up with down-to-earth experience methods right from the National Shops and laboratories. This training is so practical YOU START EARNING GOOD MONEY ON THE SIDE AFTER THE FIRST FEW LESSONS.

You can get such training only from National Schools because only National—one of the oldest and best equipped technical trade schools in the world—has the shops where instructors work with students and technicians to bring you—right in your own home—in your spare time—the kind of instruction and practice that assures definite progress right from the start.

The way to understand how this is possible is to see it for yourself. All it takes is a penny. Fill out and paste the coupon on a post card (or if you wish put it in an envelope) and mail it right now.

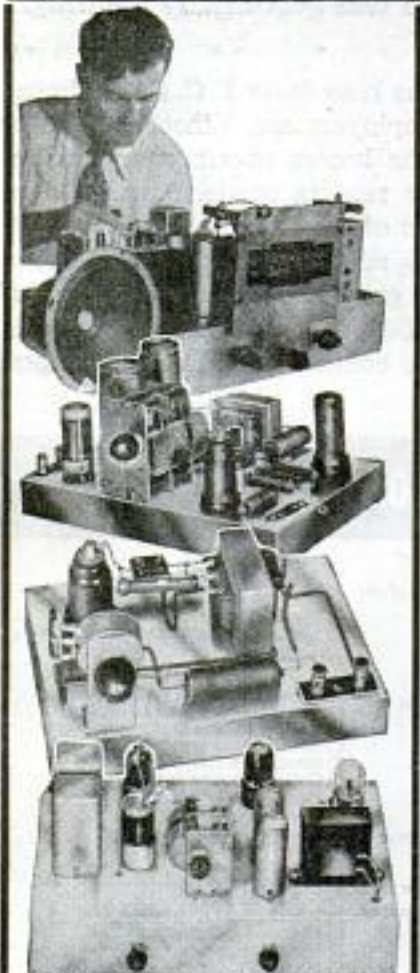

Here is some of the electronic equipment that is furnished at no extra cost with your course of National training. Build a big, long distance superheterodyne and other types of modern receivers, testing instruments, signal generators—all full sized, actual operating sets with your National equipment. In this way you really do learn by doing. You get to be a REAL EXPERIENCED TECHNICIAN. The test lesson that comes to you will show you how this is possible. Send the coupon for it now.



Above: Skilled instructors at National Schools developing the most effective training methods and trying them out.

Right: Testing new electronic equipment at National before releasing it to students.



MARK AND MAIL THIS COUPON

GET INTO RADIO ELECTRONICS TELEVISION ... NOW

SUCCESS AND SECURITY FOR YOU IN THIS GREAT, ESTABLISHED INDUSTRY

Face facts! Radio is one of the country's great, fundamental industries with a volume of over \$5,000,000,000. It demands tens-of-thousands of skilled maintenance men, skilled operators, technicians—everywhere. Civilian production and up-keep has been practically at a stand-still during the war. Right now and for years to come **RADIO WORK IS BOOMING** as never before in history.

F.M., Fac-Simile and Television are in their infancy but they are only waiting for materials to get into big scale production and use. Experts estimate more than a half-million jobs in these fields **RIGHT IN THE START.**

Electronics is found in nearly every industry and in many new homes. Electronics will be the wonder worker of the future and so provides good pay jobs for men who know its basic principles.



Photo Courtesy of G. G.

What will you be doing when you hang up your uniform?—when your war job folds up. Before you gamble your future **SEE FOR YOURSELF WHAT NATIONAL TRAINING CAN DO FOR YOU.** Send your coupon now.



Above: As a National trained man you can be your own boss—start a flourishing business of your own on little or no capital. It's what you **KNOW** that counts. Left: In industry the better jobs and the better pay go to the man who **knows** what he is doing in Radio, Television and Electronics.

Get started now. You may be closer to your goal than you think. In a few short weeks you may be making your first money as a radio technician—perhaps laying the foundation of **YOUR OWN PROFITABLE BUSINESS FOR A LIFETIME OF SECURITY.** Take the first step now. Reach out for opportunity. Fill in and mail the coupon here, **at once.**

Good Jobs Go To National Trained Men

Share in the success of National graduates. Joseph Grumlich of Lake Hiawatha writes: "My latest offer was for \$5,800.00 as Radio Photo Engineer, but I am doing well where I am and I am deeply indebted to National."



Learn a trade that will support you always—anywhere you go. Cash in on the demand for Radio, F.M., Television and Electronic operators, maintenance men, supervisors and technicians.



C. B. Kolb, Perry, Oklahoma, worked in a hardware store while getting started in radio. Now he services more than a hundred sets a month at a good sound income.

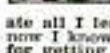

H. W. Schroeder, stationed in California: "I appreciate all I learned at National and now I know it is my best chance for getting ahead in the Navy."



Robert Adamsen, Kearney, Nebraska, National graduate, has two radio jobs—makes double pay as an instructor and as engineer at Station KGFV.



FREE GET THESE 2 BIG BOOKS



Trained Men Wanted

The man who really knows modern Radio is in greater demand today than ever before—not only in Radio proper but in Television and Electronics—in Aviation, Transportation, Communications. **Good jobs are wide open, WAITING FOR YOU,** in the production, operation and maintenance of modern electronic equipment—in radio stations, in hundreds of industries—in homes, theatres and studios. Good, sound training in this important field is absolutely necessary. And now, National Schools brings such training to you **no matter where you live or what you may be doing**—not only the fundamental theory but the actual experience that comes with **knowing shop practice and working with real equipment**—demonstrating each step with first-hand knowledge.

Only National can offer you such practical training because only National has the plant to back it up. **Sample this training yourself. MAIL THE COUPON FOR A FREE LESSON.**

NATIONAL SCHOOLS

LOS ANGELES 37, CALIFORNIA EST 1905

MAIL OPPORTUNITY COUPON FOR QUICK ACTION

National Schools, Dept. 10-PM
4000 S. Figueroa Street
Los Angeles 37, California

(Mail in envelope
or paste on
penny post card)

Mail me free the Sample Lesson and Opportunity Book. I understand that no salesman from National Schools will call on me.

Name..... Age.....

Address.....

City..... Zone..... State.....

GET ALL THE FACTS

The Steady Pay Profession Good Times or Bad!

SCIENTIFIC CRIME DETECTION

FOLLOW
THIS MAN

Operator
No. 38



It Is Easy to Learn!

I will teach you this fascinating science during your spare time at home. It pays to be an expert in Finger Printing, Firearms Identification, Police Photography and Secret Service Methods. I have trained hundreds of men and women now successfully serving in identification bureaus throughout America. You, too, may quickly prepare yourself to become a well-paid valued officer of the law, often sharing in the generous rewards offered for wanted criminals.

FREE! 53 PER CENT
"BLUE BOOK OF CRIME"

This book is full of exciting information on scientific crime detection. It will show how you can get started in a grand career. Now at amazingly low cost. Clip coupon now... Mail it today.

of all Identification Bureaus in the U. S. employ students and graduates of I. A. S. A majority of these men are heads of Bureaus. Many of them knew nothing about crime detection before training with me. Now they have steady jobs, good salaries and a fine future. Write today for full particulars and free book. Give age.

INSTITUTE OF APPLIED SCIENCE
1920 Sunnyside Ave., Dept. 1357 Chicago 40, Ill.

INSTITUTE OF APPLIED SCIENCE
1920 Sunnyside Ave., Dept. 1357, Chicago 40

Gentlemen: Without any obligation on my part, send me the "Blue Book of Crime," and complete list of Identification Bureaus employing your students or graduates, together with your low prices and Easy Terms Offer. (Literature will be sent ONLY to persons stating their age.)

Name.....

Address.....

Age.....

AUDELS

POWER PLANT ENGINEERS GUIDE

WITH QUESTIONS AND ANSWERS

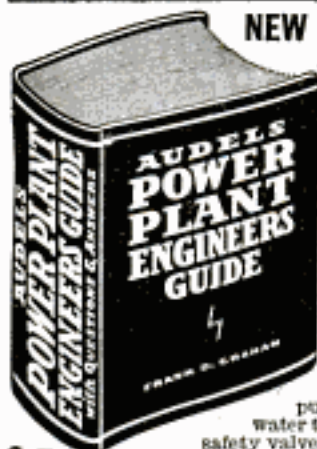

NEW FROM COVER TO COVER!

JUST PUBLISHED—For All Engineers, Firemen, Water Tenders, Oilers, Operators, Repair Men and Applicants for Engineers' License Examinations.

A Complete Steam Engineers' Library in One Book!
1500 PAGES—65 CHAPTERS
1700 ILLUSTRATIONS—FULL INDEX

1001 FACTS AT YOUR FINGER ENDS!

PRACTICAL INFORMATION IN HANDY FORM FEATURING:

Basic principles of Steam Engineering, including Boiler Construction, Operation and Repairs. Gives practical information on: Boiler Calculations, fuels, feed

pumps, water heaters, economizers, water treatment, injectors, traps, draught, safety valves, oil burners, stokers, condensers, ejectors, cooling towers, evaporators, steam and hot water heating, pipe fitting & tubing. Contains complete data on all types of Steam Engines and Turbines, Indicators, Valve gear, Valve setting, Air Compressors, Hoists, Gas and Diesel Engine Operation, Lubrication.

\$4 COMPLETE PAY \$1 A ONLY 1 MO. Get this information for yourself—ASK TO SEE IT—Mail coupon today!

AUDEL, Publishers; 49 W. 23 St., New York 10, N.Y.

Mail AUDELS Power Plant Engineers Guide (Price \$4) on 7 days free trial. If O.K. I will remit \$1 in 7 days and \$1 monthly until \$4 is paid. Otherwise, I will return it.

Name.....

Address.....

Occupation.....

Employed by.....

PM

HOW TO BREAK and TRAIN HORSES

THIS GREAT BOOK

FREE!



Every farmer, every lover of horseflesh should have a copy of it. This amazing book tells how to know horses—how to break them—how to train them—how to make money as a master horseman. Write for it today—**FREE**, together with my special offer of a course in Animal Breeding. If you are interested in Gaiting and Riding the saddle horse check here Do it today—now. You'll never regret it.

BEERY SCHOOL OF HORSEMANSHIP
Dept. 11010 - - - Pleasant Hill, Ohio



Make Stairs Attractive... Safe!

with So-Lo's PLASTIC STAIR TREADS

Look, feel, wear like rubber. Waterproof, washable, non-skid. Curved "nosing" for extra safety. Nosing Treads, 9x18", 20c ea., 9x24", 30c ea. Flat Treads 9x12", 10c ea. At Hardware or 10c Stores.

Millions Save with So-Lo Menders

What Every Mason Wants



We have important Masonic books for Blue Lodge, Chapter, Commandery, Scottish Rite, and Shrine.

Our Rituals Are Used the World Over. Send for free catalog of books and rituals for Masons, Odd Fellows, Knights of Pythias, Knights of Columbus, etc.
EZRA A. COOK, Publisher, P. O. Box 796, PO, Chicago 90, Ill.

CHEMISTRY IS OPPORTUNITY!

There's no limit to the chemist's chances for advancement in salary... in importance. Experiments develop into giant new industries. Established industries rely on laboratories. I.C.S. training... practical... thorough... Opens this great field to you. Instruction papers specially written by noted chemical engineers, consulting chemists, metallurgists. And these big experts are **EASY TO UNDERSTAND**. Our editors have explained all technical terms simply, clearly. Any person of ordinary intelligence can learn and make rapid progress. You have ambition. We have the training you need. Send now for free booklet International Correspondence Schools, Box 5557-K, Scranton 8, Pa.



MAGIC LIQUID Prints Photos

On Wood, Leather, Cloth, Cards, Letterheads or almost any surface. Use any snapshot or other negative. Make hundreds of prints without harming negative. Won't wash off. Easy to use. Complete kit for 100 or more photos now only \$1.00 postpaid, or \$1.25 C.O.D. (Canada \$1.50 money order only; no C.O.D.'s). Satisfaction positively guaranteed. Rush order today for the original, big, complete Magic Photo Printing Outfit.
L. & M. MFG. CO.
Dept. 390-C, 229 W. Breckinridge, Louisville 8, Ky.

MONEY FOR MEN ALL FREE

THE PLASTEX Industry needs manufacturers on small scale for big production of Lamp and Clock Stands, Art Goods and Novelties in Plastex and Marble imitation. Experience unnecessary. 1/2c material makes regular 10c store sellers. Rubber moulds furnished for speed production. Small investment brings good returns. Big chain store orders now being placed. Ambitious men have chance for real prosperity. Our Free booklet will interest and benefit you.

PLASTEX INDUSTRIES, Dept. P, 1035 Washington Ave., New York, N.Y.



1920

A. G. HOFFMAN
PRESIDENT

1945

E. F. HOFFMAN
VICE-PRESIDENT

MIDWEST RADIO CORPORATION CELEBRATES ITS

25th Anniversary Year

The year 1945 completes a quarter-century of pioneering, of progress, of achievement, of leadership in the field of radio for the Midwest Radio Corporation. Very few radio manufacturers can match the unbroken record of continuous manufacture and of faithful adherence to high quality standards which MIDWEST RADIO has established and maintained during the past twenty-five years.

Since its establishment in 1920, Midwest Radio Corporation has figured prominently in the pioneering of many outstanding radio developments. Among them: Single dial, 3-gang condenser battery sets . . . all electric radios . . . superheterodyne . . . screen grid . . . amplified and resonant AVC . . . dual speakers . . . 2400 meters band . . . shielded switching . . . noise reducing antenna system . . . push button tun-

ing . . . ceramic porcelain insulation . . . reinforced capacitors . . . pre-balanced coil assembly . . . acoustisonic louvres . . . 9-Band dial . . . and others too many to mention.

Today—although still engaged exclusively in the production of electronic and radio instruments for our Armed Forces—Midwest is planning new and finer radios for the post-war period.

Plan to Buy Your Postwar Radio Direct from the Midwest Factory

That's how thousands of Midwest Radio owners; for 25 years, have enjoyed the finest in radio . . . and at SAVINGS UP TO 50%. Midwest's Factory-to-You plan of distribution has been amazingly popular because it enables you to buy better radios for less, and because the Midwest organization is directly responsible to you.

WRITE FOR CATALOG NOW!

There is already a heavy advance demand for the Midwest Radio Catalog to be issued after Victory. To be sure that you will receive one of the first copies, send the coupon below requesting that your name be placed on the preferred list. The print order will be limited, so act now!



Send this coupon TODAY!

Mr. A. G. Hoffman, President
Midwest Radio Corporation
Dept. 15-AA, 909 Broadway
Cincinnati 2, Ohio

Gentlemen: Please place my name on your list to receive the first post-war catalog of MIDWEST RADIOS.

Name.....

Address.....

City..... Zone..... State.....

MIDWEST RADIO CORPORATION

DEPT. 15-AA . . . 909 BROADWAY . . . CINCINNATI 2, OHIO



AUTO

BOOKS ON APPROVAL

SEND NO MONEY. Just mail the coupon for a complete set of Six Big Auto Books, 20th Edition. Whether you are a mechanic or helper, expert or apprentice, auto owner or driver, take immediate advantage of this FREE EXAMINATION OFFER.

MAKE GOOD MONEY NOW HOLD A PERMANENT JOB

America's autos must be kept in service, now and after the war. Men with "know how" are in demand, at big pay. These books will help you get and hold an important job, or give you a chance to go into business for yourself now or later. Any man who half tries to improve himself can learn auto servicing and repairing by this quick reference method. Use the JIPPY INDEX to find easily understood answer to any auto problem. These wonder books prepared by eleven of America's great automobile engineers. Many hundreds of valuable illustrations. Send the coupon TODAY.

A year's consulting privileges with our engineers now given with these books without extra charge.

Vocational Publishers Since 1898

CAN YOU FIX IT?

These wonder books tell step by step HOW to make difficult repairs and adjustments, how to keep a car at maximum efficiency, including latest improvements in car design and operation. Engine troubles and how to correct them well covered.

6 BIG VOLUMES

2800 pages, 2000 illustrations, wiring diagrams, etc., including Diesel engines. Beautiful modernistic, washable cloth binding.

AMERICAN TECHNICAL SOCIETY, Dept. A719
Drexel Ave., at 58th St., Chicago 37, Ill.

I would like to examine your Six-Volume Set of Auto Books. I will pay the delivery charges only, but if I choose I may return them express collect. If after 10 days' use I prefer to keep them, I will send you \$2 and pay the balance at the rate of only \$3 a month until \$24.00 has been paid. Please include consulting service as offered above.

Name
Address
City State

Please attach letter stating age, occupation and address of employer and of at least one business man as reference. Men in service, also please give home address.

Enjoy Yourself...
Here's Your HOBBY!

MAKE PROFESSIONAL-LOOKING PROJECTS
Worth \$5.00 to \$50.00 Each

CHOICE OF 6 NEW HOBBIES!

- FUNDAMENTALS OF PLASTIC FABRICATING
- The Technique of PLASTIC CASTING
- HOW TO Pressure Mold PLASTICS
- Decorative PLASTIC SPRAYING
- SOLDER-ARC Metal Crafting
- ELECTROPLATING for Fun & Profit

FOLLOW A FASCINATING PASTIME WITH A PROMISING FUTURE. HAVE FUN... WHILE YOU LEARN TO EARN!

Enjoy a worth while hobby... making beautiful lamps, clocks and other gifts and furnishings for your home. No, not ordinary "school" projects... but distinctive designs equal to those sold in New York's high priced shops. It's so easy to do now!

New Methods—New Materials
Wartime developments in Rainbow plastics, Extrusions, Onyx-like Coatings, Overlays in Colorful patterns of Rare Woods, Exotic Lizard-Skin finishes—and remarkable applications in metals and woods—are yours to enjoy in a hobby that includes everything.

Projects, materials and simple instructions created by America's leading artisans. And yet, they are yours to enjoy at low cost. So have fun while YOU SAVE ONE-THIRD OR MORE on attractive gifts and beautiful things for your home.

EVERYTHING YOU NEED... FREE Details
Projects, Plans, Instructions and Materials!

MAIL THIS COUPON TODAY!
HomeCrafters Guild, Dept. D-1
360 No. Michigan Ave., Chicago 1, Ill.
Send details of your hobby plan.

Name.....
Address.....
City..... Zone..... State.....

for MEN and WOMEN
YOUNG AND OLD!

TRAIN FOR KEY JOB OR BUSINESS OF YOUR OWN

REFRIGERATION and AIR CONDITIONING

Millions of Older Units Need Expert Service. Big After-the-War Expansion Will Create Even More Opportunities. Approved for Veterans "G. I." Training.

A key job—a successful business of your own—you can have either in this vital, war-hit industry. A serious shortage of service-experts exists in every branch. Big post-war boom will open thousands of new opportunities. Get ready for your big chance. We'll give you the practical training you need—at home—and in our big Chicago shops, largest and most completely equipped in the country. No advanced schooling needed. Our unique methods make everything easy to grasp. We've trained thousands. Pay as you go. Quit when you want to. Get the full facts without obligation. Write TODAY.

INDUSTRIAL TRAINING INSTITUTE

2150 Lawrence Avenue, Dept. P1K, Chicago 25, Ill.



Quick! Easy! Requires NO HEAT NO ELECTRICITY

So-Lo's POT and PAN MENDER

Just squeeze a drop on the hole. Dries overnight into a waterproof heat-proof, airtight mend. Hundreds of uses. Large tube 10c.

At Hardware or 10c Stores.

Millions Save with So-Lo Menders

LAW STUDY AT HOME

Legally trained men win higher positions and bigger success in business and public life. Greater opportunities now than ever before. Big corporations are loaded by men with legal training.

More Ability: More Prestige: More Money

We guide you step by step. You can train at home during spare time. Degree of LL. B. Successful graduates in every section of the U. S. We furnish all text material, including 14-volume Law Library, Law cost, easy terms. Get our valuable 48-page "Law Training for Leadership" and "Evidence" books FREE. Send for them NOW. LASALLE EXTENSION UNIVERSITY, 417 South Dearborn Street A Correspondence Institution Dept. 1064-L Chicago 5, Ill.

PRINTING PAYS BIG

"Make your future secure. Prepare for a highly paid position in a print shop of your own. Students throughout the world are enthusiastic in their praise of our training program and the personal attention given each student. Rush name today for free literature and sample lesson. No salesman will call. Dept. Hx. 77."

COMPLETE COURSE ONLY
\$14.50 CASH
TERMS AVAILABLE

International School of Printing, Troy, O.

DRAFTING SPRINGBOARD TO SUCCESS!

Increased salary, larger responsibilities, a real career instead of just a job—these are to be had by the trained draftsman. I.C.S. makes the way to thorough, practical training open to you. Check up and you'll find that nearly every "big name" American in engineering and production acquired experience at the drafting board. Many of them started by writing for the I.C.S. free booklet. Send for it today! It can be the most important act of your life.

International Correspondence Schools, Box 5557-K, Scranton 8, Pa.

Learn PHOTOGRAPHY at Home

Splendid opportunities. Prepare in spare time. Practical basic training. Long-established school. Send for free book, "Opportunities in Photography." No obligation. American School of Photography, 1315 S. Michigan Ave., Dept. 1357, Chicago 5, Ill.

THERE'S MONEY IN CARTOONS!

RAYE BURNS will teach you HOW to CREATE ORIGINAL CARTOONS at home that you may SELL! Course contains 25 lessons and over 600 illustrations. All for Only..... **\$2.85**

Send name and address for free details. RAYE BURNS SCHOOL, Dept. M, Box 3583, CLEVELAND, OHIO

BE YOUR OWN BOSS... IN YOUR OWN BUSINESS

LEARN PLASTICS FABRICATION AND CASTING

"I Train You for Success"



Paul Davis, B.S.M.E., Founder of the first Plastics Fabrication Home Training Course.

SMALL CAPITAL . . . START IN YOUR OWN HOME

Get into new Plastics Business. **START IN YOUR OWN HOME. SMALL CAPITAL NEEDED.** As you increase your knowledge and skill **YOU GROW WITH THIS BIG INDUSTRY.**

This opportunity is **YOURS TODAY . . .** SO get started now in what can be a **BIG PAYING** Plastics business of your own—prepare for post-war jobs. This **NEW** educational plan gives **YOU** the sound fundamental knowledge **PLUS** the practical training you need to be a **SUCCESS IN PLASTICS.** The actual practical work consists of working with many different types of Plastics materials—teaching you **IN YOUR OWN HOME,** fabrication, shaping, forming, finishing, cementing methods, mold making, casting, compounding, dyeing, etc.

FOR FULL INFORMATION FILL COUPON AND SEND IN ENVELOPE OR PASTE ON A PENNY POSTCARD TO DEPT. M.



Practical Training Lessons
Including:



All Materials
and 5 Complete
Working Kits.

PLASTICS TECH

Division of **BOSTON TECHNICAL INSTITUTE**
SCHOOL OF PLASTICS, 4707 Euclid Avenue, Cleveland 3, Ohio

GENTLEMEN: Please send me **FREE** New 1946 Success Booklet'

NAME AGE

STREET P. O. ZONE

CITY STATE

It's YOUR future—Make the most of it!



Start now to earn the bigger pay in electrical repair

WAS there ever such an opportunity to get started in electrical maintenance and repair—and at top-notch wages? Are you ready—with experience and ability—to cash in on it? Others are getting just the sort of background needed—quick! practical!—to handle the great variety of electrical maintenance and repair work **TODAY**—from this well-known electrical library. You can too!

THE LIBRARY OF ELECTRICAL MAINTENANCE AND REPAIR

5 vols., 1826 pages, 1724 illustrations

Gives you the "know-how" to tackle any wiring or motor job. Five books show you **HOW**—to install all types of motor and generator units—to inspect and repair motor starters and generators—to diagnose motor and generator troubles—to figure new windings for old cores—DC and AC windings—to test armature windings—test induction motors, etc., etc. One book is full of trouble-shooting charts that show quickly symptoms, causes, specific remedies, etc.

Take the first step toward improving **YOUR** future—**Mail this coupon TODAY**

No money down—special price—easy payments—**FREE** trial

McGraw-Hill Book Co., 330 W. 42 St., New York 18, N. Y.

Send me for ten days' free examination the Electrical Maintenance and Repair Library. If satisfactory I will send you \$1.00 in 10 days and \$2.00 monthly until the price of \$15.00 is paid. If not wanted I will return books postpaid. (To insure prompt shipment write plainly and fill in all lines.)

Name
Home Address
City and State
Company
Position P36-10-45

★ **SAVE WASTE PAPER** ★

OCTOBER, 1945

"The Book They're Talking About"

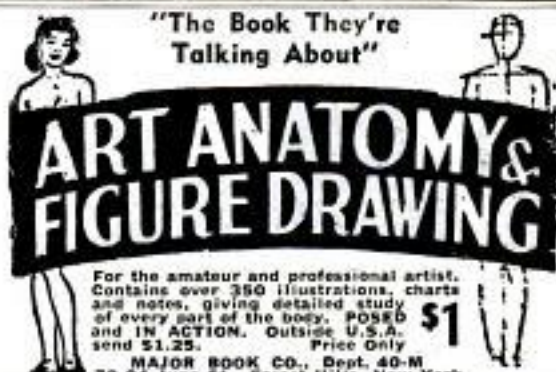

For the amateur and professional artist. Contains over 350 illustrations, charts and notes, giving detailed study of every part of the body. **POSED and IN ACTION.** Outside U.S.A. send \$1.25. Price Only **\$1**

MAJOR BOOK CO., Dept. 40-M
72-04 Jung St., Forest Hills, New York



HAVE FUN WITH MODEL RAILROAD

Here is without a doubt the Most Exciting and Thrilling Adult Hobby. You'll just love it! Listen—Find out Right Now about this Great Sport. **25c** Brings you our **Giant 78** page Informative Catalog, which tells you all about this most interesting Hobby. Send for your Catalog right this minute. Wm. K. Walther, Inc., 251 E. Erie St., Milwaukee, Wis.

HOW TO WRITE for PROFIT

Many a former clerk, soldier, housewife, mechanic, teacher is now writing for profit. Why not you? You can learn and start making money right in your home . . . under the unique, practical methods of Palmer training . . . for writing fiction, newspaper features, magazine articles, radio scripts. Palmer is endorsed by such famous writers as Gertrude Atherton, Rupert Hughes, Katherine Newlin Burt said, "I'd have started ten years sooner . . . but there was no Palmer Institute then." Ruth Comfort Mitchell said, "You are making it possible for beginners to travel over a highway, instead of a rough road. You are proving ours is a profession . . . calling for such sound, sane, constructive training as you offer." Hundreds of successful graduates. To find out if you have writing ability, send for our "Talent Finder." Return it for our frank, confidential analysis and advice. No cost or obligation. It may start you on an ideal career.

PALMER INSTITUTE OF AUTHORSHIP
6362 Hollywood Blvd. Hollywood 28, Calif. Dept. TV105

Do you want

→ .. to go to College?

→ .. or to enter a Profession?

(Such as Accounting, Architecture, Nursing, Dentistry, Teaching, Social Work, Osteopathy, Beauty Culture, Optometry, Embalming, Chiropractic, Law, Medicine, etc.)

→ .. or get an Office Position?

To get anywhere, you practically MUST finish High School FIRST. You can complete our simplified High School Course in SPARE time at home, as FAST as your time and abilities permit. Equivalent to resident school work—prepares you for college, pre-professional examinations, business, industry. Standard texts furnished. Diploma. Credit for H. S. subjects already completed. Single subjects if desired. Low tuition, easy terms. American School, Chicago, est. 1897—endorsed by educators. Finish your high school education NOW. Write TODAY!

High School Course at Home

Many Finish in 2 Years

American School, Dept. H745, Drexel Ave. at 58th St., Chicago 37, Ill.

Gentlemen: Send me FREE information covering special training in subjects checked below. No obligation on my part.

- | | |
|--|--|
| <input type="checkbox"/> High School Course | <input type="checkbox"/> Diesel Engineering |
| <input type="checkbox"/> Architecture and Building | <input type="checkbox"/> Drafting and Design for Men & Women |
| <input type="checkbox"/> Automotive Engineering | <input type="checkbox"/> Plastics |
| <input type="checkbox"/> Business Management | <input type="checkbox"/> Private Secretary |
| <input type="checkbox"/> Electrical Engineering | <input type="checkbox"/> Mechanical Engineering |
| <input type="checkbox"/> Elec. and Gas Refrigeration | <input type="checkbox"/> Aviation |
| <input type="checkbox"/> Air Conditioning | <input type="checkbox"/> Salesmanship |
| <input type="checkbox"/> Railway Training | <input type="checkbox"/> Radio |
| <input type="checkbox"/> Electronics, Industrial | |

Name.....

Address.....

Learn this Profitable Profession

IN 90 DAYS AT HOME

Money-Making Career Open to Men and Women, 18 to 50

Hundreds of men and women between 18 and 50 make \$10 to \$20 in a single day giving scientific Swedish Massage and Hydro-Therapy treatments. There is big demand from doctors, hospitals, sanatoriums and clubs. Graduates earn large full time incomes from these or in private practice in their own offices. Others make good money from home treatments given in spare time. Learn this interesting, money-making profession in your own home, through our home study course. Same instructors as in our nationally known resident school. You can win independence and prepare for future security by qualifying for your Diploma. Course can be completed in 3 to 4 months. Many earn while they learn. Begin your training at once.

Anatomy Charts & Booklet FREE

Enroll now and we will include, at no extra cost, many needed supplies. Fit yourself to help meet growing demand for massage now and after the war. Send the coupon at once for complete details. Anatomy Charts and 32-Page Illustrated Booklet, FREE, postpaid.



THE COLLEGE OF SWEDISH MASSAGE
Dept. 364-M, 100 East Ohio St., Chicago 11, Illinois

Please send me FREE and postpaid, Anatomy Charts, 32-page Booklet and complete details on Home Training.

Name.....

Address.....

City..... State.....

INTRODUCING-New Victory Model HANDIWELD ELECTRIC

ARC WELDER

RETAILS ONLY \$1.95

FULLY GUARANTEED



PLUGS INTO LIGHT SOCKET

Victory Model Handiweld Arc Welder operates from 110 volts, A.C. or D.C. current same as other arc welders higher priced; generates tremendous heat to weld all metals. Not a toy welder that uses carbon, but actually uses standard coated rods—sizes 1/16" and 3/32". However, due to Priorities a generous supply of 1/16" rods only are supplied with the welder. Guaranteed not to burn out. Repairs fenders, auto bodies, radiators, machinery parts, etc. Take Victory Model Handiweld anywhere to job, operate right from light socket. You'll find a thousand uses for this welder around your home, garage, workshop. Also in garages, factories, repair shops, tin shops, mechanics, livestock, Handiweld now.

SEND NO MONEY We'll rush one to you with rods, helmet, operating instructions, and all necessary parts with the exception of a large jar and a small piece of extension cord; these most everyone has. Pay postman only \$1.95 plus a few cents postage. If not delighted return Victory Model Handiweld in 5 days from receipt and money paid for it will be refunded promptly. Rush your order now.

KUMFY PRODUCTS, Dept. A-202, CINCINNATI 26, OHIO

PRINT ANY PHOTO

on Paper, Cloth, Leather or Wood

SIMPLE, EASY TO USE

Magic liquid takes only 2 minutes to reproduce any snapshot you have on to stationery, handkerchiefs, ties, scarfs, etc. Won't wash off. Won't hurt negative or fabric it's used on. Personalize your belongings! An ideal gift. Complete outfit enough to transfer 100 photos—only \$1.00 postpaid. Sent C.O.D. for \$1.21.

CHRISTY PHOTO SUPPLY, Dept. 1810
2835 N. Central, Chicago 34



Get Started in Radio

TEN "HOW-TO-DO-IT" BOOKS
Get a solid foundation in radio by means of these 10 timely text books. Each clearly written, profusely illustrated, contains over 15,000 words. You'll be amazed at the wealth of information packed into these handy books. Excellent for reference—ideal for technical library. Your money back if not satisfied.

10¢ each 5 for 50¢ 10 for \$1.00 PREPAID

We cannot fill orders for less than 5 books

- | | |
|--|-------------------------------------|
| No. 1—How To Make Four Doerle Short Wave Sets | No. 4—All About Aerials |
| No. 2—How To Make The Most Popular All-Wave 1 and 2 Tube Receivers | No. 5—Beginners' Radio Dictionary |
| No. 3—Alternating Current for Beginners | No. 6—How To Have Fun With Radio |
| | No. 7—How To Read Radio Diagrams |
| | No. 8—Radio for Beginners |
| | No. 9—Simple Electrical Experiments |
| | No. 10—Television |
- Remit by check or money order—register letter if you send cash or stamp.
RADIO PUBLICATIONS, 23C West Broadway, New York (7)

Inventions Wanted

Patented or Unpatented

Inventions can now be safely sold without patenting expense. If you have a practical, useful idea for sale, either unpatented or patented, write
INSTITUTE OF AMERICAN INVENTORS
Dept. 4, 1926 Eye St., N.W. Washington 6, D. C.

MEN! make
your post-war plans
NOW



Which of these books can help you GET A BETTER JOB AND MAKE MORE MONEY

Why wait . . . get set now for those higher pay jobs in the post war period. Act now . . . especially when it is so easy. Gateway books help you tackle jobs you've always had your eye on . . . jobs that mean dollars

in your pocket. Thousands have been helped to success and higher pay with Gateway Books. They are written by experts for men like yourself . . . men who want to get ahead. Don't delay . . . choose your books, check your numbers, clip and mail coupon. Send no money, pay postman when books arrive.

Send No Money

ORDER TODAY FROM THIS LIST

1. **CARPENTRY CRAFT PROBLEMS.** 302 pages and over 700 illustrations explaining carpentry craft problems in detail. \$2.00
2. **QUICK CONSTRUCTION.** Temporary buildings, roof and platform problems, special uses of tools, shingles, cornices and hundreds of useful subjects for the amateur or professional. 250 pages, 670 illustrations. \$2.00
3. **BUILDING—FORMS, STAIRS, ROOFS.** Latest information on forms, staircases and roof building. For carpenters or helpers. 210 pages, 495 illustrations. \$2.00
4. **WOODEN BOAT AND SHIP BUILDING.** Solves every problem of building wooden ships and boats. 244 pages, 124 illustrations. \$2.00
5. **WELDING.** Arc, spot, butt and electric welding, etc. 280 pages, 88 illustrations. \$1.50
6. **DRAKE'S BASIC MACHINE SHOP PRACTICE.** 408 pages, 310 illustrations of complete information on all phases of machine shop practice. \$3.00
7. **SHEET METAL WORKERS MANUAL.** Complete instruction and information on every phase of sheet metal working. Includes many tables, 552 pages, 375 illust. \$2.00
8. **MATHEMATICS.** Includes all phases of mathematics to help reader solve all practical problems. 224 pages, many illustrations. \$2.00
9. **SLIDE RULE AND LOGARITHMIC TABLES.** Uses and principles of slide rule and logarithmic tables fully covered. Includes even 10 place log tables. 200 pages. \$1.50
10. **MODERN HOMECRAFT.** 240 pages of ideas for modern furniture . . . and how to make it. Gives working drawings . . . fully illustrated. \$3.00
11. **REFRIGERATION SERVICE MANUAL.** Domestic and commercial refrigeration used in markets, milk depots, soda fountains, etc., and in homes. 300 pages, illust. \$2.00
12. **PLUMBING INSTALLATION AND REPAIR.** 236 page book on how to repair leaky faucets, clogged toilets, drains, traps, vents, sewers, etc. 183 illust. \$2.00
13. **PRACTICAL ELECTRICITY AND HOUSE WIRING.** Excellent for home repair work, 200 pages, 217 illustrations. \$1.50
14. **ARMATURE AND MAGNET WINDING.** The construction of armatures and their repairs, fully covered with numerous illustrations to speed the job, 270 pages. \$1.50
15. **DIESEL ENGINES AND DIESEL ELECTRIC POWER.** A complete book on Diesel engines, their construction and care of equipment. 300 pages, 200 illust. \$2.50

16. **HANDBOOK OF ORNAMENT** for artists, designers, jeweler, architects, etc. Topics covered include: Elements of Decoration, Decorated Objects, and Ornaments applied to Features. Nearly 3,000 illus., 548 pp. Complete, authoritative. \$5.00
17. **SPANISH GRAMMAR.** Special. Contains 62 lessons—in idiom, parts of speech, numerals, time, months, travel terms, newspaper Spanish, etc. . . . even 15 business letters—All for \$1.50

28. AIR CONDITIONING HANDBOOK

Here is the book every man will want. New Air Conditioning markets are opening every day. This book shows you how to capitalize on this big money . . . high pay field. Get set today.



SHARE IN THE MILLIONS TO BE SPENT

This big, NEW book will show you how you can make more money in Air Conditioning . . . heating and refrigeration fields. Nothing is omitted. Complete and authoritative . . . actually four big books in one. Here are just a few of the subjects covered in the 706 fact filled pages: Heating with Hot Water; Heating with Steam; Radiators and Piping; Heating with Warm Air; Cooling Loads; Cooling with Refrigerants or Chilled Water; Circulation of Air; Distribution of Air; Duct Design; Duct Construction; Fan Burners; Coal Stokers; Automatic Controls . . . and hundreds of other money making subjects. 706 pages, 64 big charts and 351 illust. Only \$4.00

29. WOOD FINISHING.

Wood finishes and problems . . . tools . . . materials . . . repairing. 360 pages and 353 illust. \$2.00

30. CYCLOPEDIA OF PAINTING AND DECORATING.

Covers methods, tools and materials for the home and workshop, including every branch of painting and decorating. Any particular job is fully explained with illustrations to clarify the text. 350 pages—288 illust. \$3.00



31. SPEED BOARD—ELIMINATES TRIANGLE—T-SQUARE PROTRACTOR—RULES.

24" x 20 1/2" Masonite board . . . strong steel arms . . . clear plastic square, 4 scales, full graduation protractor, nine cut out circles. Favorite of professionals . . . MARVELOUS for amateurs. GUARANTEED. Only \$3.95



Special!

17. CYCLOPEDIA OF RADIO AND ELECTRONICS. Non-technical reference book of 1,000 pages, 1,700 headings, 4,128 illustrations, 130 tables, and 105 graphs cover over 500 subjects. \$5.00

18. ELECTRICAL AND RADIO DICTIONARY. Over 3,800 definitions of technical words and terms. 300 pages, 550 illust. \$2.50

19. COMBINATION OFFER. If both books are bought together . . . your price is only \$7.00 . . . You save!

20. **HANDBOOK OF ADVERTISING LAYOUT.** Written and illustrated by one of the country's leading advertising men, it is practical and sound. \$3.00
21. **INTERIOR WALL DECORATION.** Practical working methods for plain and decorative wall finishes. 185 illust. 491 pages. \$3.00
22. **SILK SCREEN METHODS.** How to make silk screens, materials needed. Complete, authoritative. Fully illust. 240 pages. \$3.00
23. **STENCILS AND THEIR USE.** How to make and use stencils for all types of decorations. 148 pages—illust. \$1.90
24. **THE MIXING OF COLORS AND PAINTS** How to mix colors for interior decorating, arts, crafts, general mixing methods. A handy book for professional and amateur painters. 302 pages fully illust. \$2.00
25. **SPRAY PAINTING.** Spraying technique and operating instructions on paints, materials, finishes. 125 fully illust. pages \$1.50
26. **HOUSE PAINTING METHODS.** 400 pages and 150 illust. cover the subject of house painting (of any surface) thoroughly . . . time and money saver. \$2.00
27. **GRAINING.** A 240 page comprehensive book of instruction on the art of graining all surfaces. 64 full page color plates. \$3.00

The GATEWAY BOOK CO.
Dept. PM-10, 32 N. State St.
Chicago 2, Ill.
State 2791

Send No Money

GUARANTEE
Gateway Books are unconditionally guaranteed. They must satisfy or we'll refund the purchase price. No questions asked.

CHECK, CLIP AND MAIL THIS COUPON NOW

THE GATEWAY BOOK CO.
32 N. State St. Dept. PM-10, Chicago 2, Ill.

OK. Send the books I've circled C.O.D. I'll pay postman cost of books plus a few cents postage and handling charge. If any book is not entirely satisfactory, I will return it in 5 days and you will refund my money. Sorry, NO C.O.D.'s can be accepted outside the U. S.

1 3 5 7 9 11 13 15 17 19 21 23 25 27 29 31
2 4 6 8 10 12 14 16 18 20 22 24 26 28 30

(Please print name clearly)

Name.....
Address.....
City..... Zone..... State.....

Learn REFRIGERATION and AIR-CONDITIONING

ARE YOU HANDY WITH TOOLS?

Exceptional opportunity for men of all ages up to 60. The demand for repair and service mechanics in both REFRIGERATION and AIR-CONDITIONING is acute and will continue after the war. You can easily and quickly—

Learn to Be a Service Mechanic at Home or in Our Shops

Our practical, thorough course is easy to grasp and can be studied at home in your spare hours. No previous experience is needed. A common school education is enough. Learn how to start your own business with \$50.00 worth of tools in garage or basement. Open up your own shop or take a well paid job in this active field.

START YOUR OWN REPAIR SHOP

Write for free booklet today. No obligation whatever.

MAIL COUPON TODAY



Send for FREE BOOKLET!

Mechanics Training School

4701 W. Pico, Dept P-10, Los Angeles 6, Calif.

Dear Sirs: Please send me, without obligation, your free catalog and full details.

Name _____

Address _____

City _____ State _____

8 BIG BUILDING BOOKS



For EXAMINATION SEND NO MONEY

Learn to draw plans, estimate, be a live-wire builder, do remodeling, take contracting jobs. These 8 practical, profusely illustrated books cover subjects that will help you to get more work and make more money. Architectural design and drawing, estimating, steel square, roof framing, construction, painting and decorating, heating, air-conditioning, concrete forms and many other subjects are included.

BETTER JOBS — BETTER PAY UP-TO-DATE EDITION

Keep busy now at good pay, and be prepared for after-war building boom. Big opportunities are always for MEN WHO KNOW HOW. These books supply quick, easily understood training and handy, permanent reference information that helps solve building problems.

These books are the most up-to-date and complete we have ever published on these many subjects.

Coupon Brings Eight Big Books For Examination

AMERICAN TECHNICAL SOCIETY Vocational Publishers since 1898
Dept. G719 Drexel at 58th Street Chicago 37, Ill.

You may skip me the Up-to-Date edition of your eight big books, "Building, Estimating and Contracting," without any obligation to buy. I will pay the delivery charges only, and if fully satisfied in ten days, I will send you \$2.00, and after that only \$3.00 a month, until the total price of only \$34.50 is paid. I am not obligated in any way unless I keep the books.

Name _____

Address _____

City _____ State _____

Please attach a letter stating your age, occupation, employer's name and address, and that of at least one business man as a reference. Men in service, also please give home address.



A New Hobby!



COLLECT GENUINE U. S. MILITARY SHOULDER PATCHES



Make your den or lodge room the center of attraction with this fascinating hobby! Over 300 authentic military shoulder patches in stock, from 15c to 50c each! Send 3c stamp for FREE illustrated folder and price list!



MIDWEST SALES CO.

P. O. Box 1092 Dept. PM Omaha, Nebr.

MECHANICAL ENGINEERING PAYS!

This is the machine age. And back of every machine—every part—are the engineers who designed it, the trained mechanics who built it. No wonder there's high pay . . . a many opportunities to advance . . . for these indispensable men. Be one of them! Don't stick in a rut! Let I.C.S. show you the way to success! These Schools, famous for more than 50 years, offer authoritative, practical Courses to meet the needs of almost any man in mechanical trades. Mechanical Engineering . . . Drafting . . . Mechanical Drawing . . . Shop Practice. Write today for free booklet.

International Correspondence Schools, Box 5557-K, Scranton 9, Pa.

Mends Most Anything! So-Lo's "No Heat" LIQUID SOLDER

Top quality. Waterproof. Mends faucets, drains, radiators, lamps, radios—hundreds of uses! Large tube 10c. Many other So-Lo Menders. Ask for them. At Hardware or 10c Stores.



Millions Save with So-Lo Menders



CODE-RECEIVING SPEED

Learn to send and receive Radio Code with greater speed. Stop nervous tension. Have confidence. Be proficient. Save systems used by radiotelegraph specialists. Thousands of operators needed. Rush name for FREE book.

Dept. S-L, Box 928, Candler System Co., Denver 1, Colo., U.S.A.

HAVE YOU A NEW OR IMPROVED ITEM OR IDEA?

An established reputable organization offers facilities for development, financing and expert sales promotion. We are not brokers or agents, and are interested only in merit and saleability. Write JULIAN J. BEHR CO., Cincinnati 2, Ohio.

Learn BAKING At Home

Baking is one of America's high industries in wages. Nearly depression-proof. Thorough basic home course lays sound foundation. If you have aptitude, write for FREE BOOKLET, "Opportunities in Commercial Baking." National Baking School, 1315 Mich. Ave., Dept. 1357, Chicago 5



Learn Penmanship

You can learn plain, rapid writing or fancy ornamental writing for social and business advancement, right in your own home during spare time by my Simplified Method. Write for my free book, "How to Become an Expert Penman," which shows what others have accomplished by taking my Courses. Send 10c for one of my favorite Pen Points and your name with a beautiful scrawled bird written on a card. Write today. T. M. Tevis, Box 25K, Chillicothe, Mo.

Learn to Mount Birds and Animals—Send Coupon for Free Book!

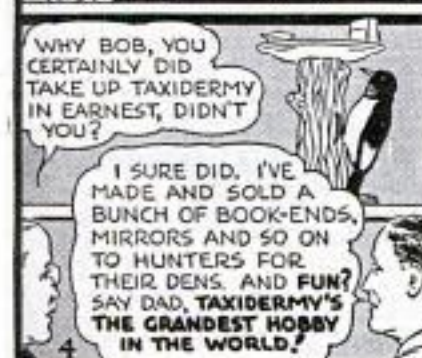
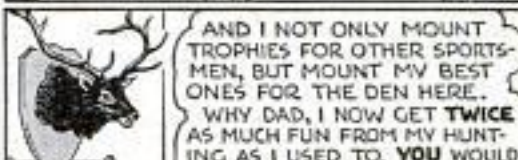
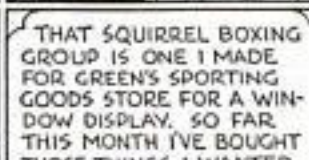
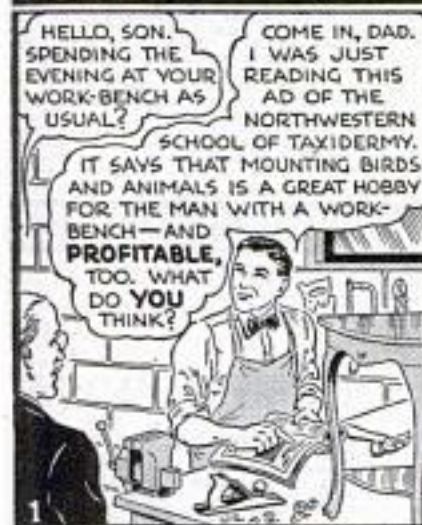

Fun-Fascination-Profits

Be a Taxidermist. All Secrets Revealed. Learn at Home



Save Your Hunting Trophies

Mount (stuff) expertly your valuable **game-birds, animals, fish, game-heads**. Preserve them just like **life**. That is Taxidermy. Learn at home by **mail**. Decorate home and den with nature's art. Make undreamed-of **profits** in spare time, in your shop. You can. Will you? Win fame as a taxidermist. Investigate. Mail coupon NOW.

Wild Game Not Needed

Use **common** specimens: squirrels, rabbits, chicks, pets, owls, pigeons—even frogs. Make useful articles like those shown here. Mount them in human and humorous positions. This is craft and novelty taxidermy. It's **fun—and profitable**. All included in our unique lessons. It's **marvelous**. Write the school this minute.



Success Guaranteed

This old reliable school has graduated 200,000 students in Taxidermy. 30 years in business. Our great success permits this **guarantee**. We **know** we can teach **you**. It's a grand money-making **hobby**. You **must** be interested, if you hunt or fish or have a work-shop. **Ask for the free book** and learn all about Taxidermy.

BIG PROFITS From Your Shop in Spare Time

Many students earn from \$40 to \$75 monthly in spare time. Some earn thousands of dollars each year. Sportsmen bring their trophies to be mounted. Besides you can sell your own **Novelty** groups for homes, dens and for merchants' window display.



Mail Coupon

Or a postcard will do. No obligation on your part. The beautiful **Book**, with hundreds of entrancing **Pictures** is **Free**. Don't miss your **Only Chance** to get this remarkable book **Free and Postpaid**. Write today. State your **Age**.

LEARN TANNING

The lessons teach tanning harness, sole, crone leather; also furs. Expert methods. **Very profitable**.

Northwestern School of Taxidermy
3377 Courtney Bldg. Omaha, Neb.

FREE BOOK

Northwestern School of Taxidermy, 3377 Courtney Bldg., Omaha, Neb.
Gentlemen: Please send at once, your free 48-page book on Taxidermy without any obligation on my part. Tell me how I can learn Scientific Taxidermy at home.

Name..... Age.....
Address.....



Can a Man MY Age Become a HOTEL EXECUTIVE

Even Though He Has No Previous Hotel Experience?

Would you like to step into a well-paid position as Hotel or Club Manager, Purchasing Agent, Social Director, Apartment Hotel Manager, Assistant Manager or one of the many other positions in the essential hotel and institutional field? Would you like to be able to look forward happily to the future—confident of a sound, substantial permanent career? The success of Lewis graduates from 18 to 50 PROVES you can—though you never had a minute's experience in hotel work.



Becomes Hotel Steward Although He Knew Nothing About Hotel Work

"Shortly after receiving my diploma from the Lewis Hotel Training School, I gave up my job in a power plant and accepted a position obtained for me by the Lewis Placement Bureau as Assistant to the Manager of a famous Virginia country club. Now Steward of this 350-room North Carolina hotel, have been here eleven months and have had three raises in salary," writes C. P. Hearse.

Step Into a Well-Paid Hotel Position FREE Book Gives Fascinating Facts

Our FREE Book, "Your Big Opportunity," explains how you can qualify for a well-paid position at home, in leisure time. It tells how you are registered FREE of extra cost in the Lewis National Placement Service; shows how you can be a Lewis Certified Employee—certified to "make good" when placed in a position. Mail the coupon NOW!

LEWIS HOTEL TRAINING SCHOOL
Room DT-324, Washington 7, D. C.

30th SUCCESSFUL YEAR

Send me the Free Book, "Your Big Opportunity," without obligation. I wish to know how to qualify for a well-paid position at home, in my leisure time.

Name.....

Address.....

City..... State.....

AN INFANT INDUSTRY ... SUDDENLY MATURED PLASTICS

Get In at the Start—and Grow

Plastics is a new industry which the nation's war needs is forcing to quick maturity. Already Plastics are indispensable in practically every branch of the Service—Aircraft, Ordnance, Chemical, Marine, Signal Corps, etc. Opportunities? Nearly everything, from homes to clothing, from gadgets to tools, will be affected by Plastics.

Spare Time Training Now Ready

The time to get started is now. You can prepare at home, in your spare time, to take your place in an infant industry that even now is leaping into prominence. A new, practical training plan is now ready to help you realize your ambitions and build your future security. Act now. Don't delay. Mail this coupon today.

AMERICAN SCHOOL, Dept. P745
Drexel Ave. at 98th St., Chicago 37, Ill.

Send me FREE information covering special training in subjects checked below. No obligation on my part.

- | | |
|--|--|
| <input type="checkbox"/> Plastics | <input type="checkbox"/> Radio |
| <input type="checkbox"/> Electrical Engineering | <input type="checkbox"/> Automotive Engineering |
| <input type="checkbox"/> Drafting and Design for Men and Women | <input type="checkbox"/> Architecture & Building |
| <input type="checkbox"/> Diesel Engineering | <input type="checkbox"/> Business Management |
| <input type="checkbox"/> Mechanical Engineering | <input type="checkbox"/> High School Course |
| <input type="checkbox"/> Aviation | <input type="checkbox"/> Railway Training |
| | <input type="checkbox"/> Electronics, Industrial |

Name.....

Address.....

No Waiting to LEARN! Start at Once to EARN!

This BIG BOOK SHOWS HOW

If it's Results you want, you can get action quickly with this practical book. Never before has a more helpful book been printed for those planning a business of their own. Gathered in this large illustrated volume are the formulas, recipes, facts and secrets that have contributed so largely to America's great industrial progress. Capitalize on this information for making most any conceivable product without experience, special equipment or previous knowledge of chemistry. Start at home, expand with profits—build for a profitable independence.

The experts who compiled this book are authorities, and present this information in simple, understandable language. They also give you wholesale supply sources for needed material, short cuts and economy methods for the most profitable results. Hundreds of good paying businesses have been built on a product made from a simple recipe. Opportunities in this field exist everywhere. Choose from any of the 102,000 facts and 10,000 formulas of which the following are only a very few:

10,000 FORMULAS, RECIPES SECRET PROFIT IDEAS

Alloys, Adhesives, Antifreeze Solutions, Cosmetics, Beverages and Liquors, Candy, Gum, Casein, Celluloid, Ceramics, Cheese, Cleaning Preparations, Concrete, Copper, Cotton, Dentifrices, Depilatories, Dyes, Embalming Fluids, Enameling, Glass, Glazes, Household Formulas, Inks, Insecticides, Iron, Jeweler's Formulas, Lacquers, Laundry Preparations, Leather, Linoleum, Lubricants, Manicure Preparations, Marble (artificial), Metals, Mirrors, Oils, Ointments, Pastes, Paints, Paper, Perfumes, Photography, Polishes, Powders, Remedies for Man, Beast or Fowl, Rubber Products, Refrigerants, Soaps, Solder and Soldering, Tooth Cements, Transfers, Transparencies, Varnishes and Thousands of others for making all sorts of profitable and practical things.



Prepare for "After-War-Business"

Especially recommended for Servicemen and War Workers planning a profitable business of their own.

This comprehensive book is an accepted authority by chemists, schools, industry, etc. and is the largest and most comprehensive book of its kind ever issued. Nothing else like it in existence. A single formula has been worth a thousand times this book's small cost to countless owners. Crammed with money-making ideas, invaluable for reference. Ideal for Factory, Home, Farm, Office or Workshop. As necessary as the dictionary and more useful for manufacturers, chemists and artisans who put up products for profit.

This Complete Book Only
\$2.98
POST PAID

Worth More

ALSO INCLUDED! Complete plans: "D.D.T." Insecticide, Eliminates Flies, Mosquitoes, Fleas, Lice, Moths, Bed bugs, Roaches, etc. Big opportunity for an exterminating business.

Immediate Shipment—Safe Delivery Guaranteed, \$2.98 postpaid, Canada or Foreign, \$3.25 U. S. Funds. (C.O.D. shipments U. S. A. only.)
ADAMS BROWN COMPANY Books of Applied Science
Dept. 310 Chestnut Hill 67, Massachusetts, U. S. A.

IT'S FREE Don't Miss This NEW BOOKLET

"The Age of Chemistry"

New 1945 Chemcraft Chemistry Booklet describes many amazing experiments you can perform; and tells of the big opportunities, both now and in the future, for boys with a knowledge of chemistry... Send Today.

THE PORTER CHEMICAL COMPANY
55 Prospect Ave., Hagerstown, Md.



Get Ready for Big After War Opportunities!

I Will Train You at Home Until You Get a GOOD PAY JOB in

DRAFTING

Act now to get a better job with more pay and pleasant working conditions. Get into Drafting—the basic profession where all post war products will start. I will train you at home—give you experience—doing the same kind of jobs you will do with the best paying firms. I furnish instruments, drawing table and all equipment when you start. Write today for vital facts and FREE illustrated book. Give AGE.

Engineer Debe, Div. 110, Libertyville, Ill.

BALDNESS IS AVOIDABLE

"GIVE YOUR HAIR A CHANCE" is the amazing book by J. W. KING, So. D. on dandruff, baldness, thinning and graying hair. Much usable information.—Ohio State Medical Journal. Best investment.—Science Education. Debunks hair facts.—Scientific American. Scientific fact.—Sunset Magazine. Without commercial bias.—Teaching Biologist. Book of a scientist.—Home Acrea. Enormous assistance.—Pictorial Review. Practical.—Science News Letter. Send only \$2.00 today for postpaid copy of this authentic instruction, on how to save your hair. 6th printing. Prompt refund if not helped.

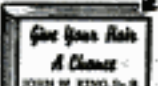

BRADNER PUBLISHING CO. (Est. 1933) Dept. 31, Cambridge 42, Mass.

INVENTORS

WE LOCATE BUYERS

for and have many requests from manufacturers for New Invention of merit. Patented or Unpatented. Cash or Royalty. If will sell, write us today for a FREE PROTECTIVE DISCLOSURE FORM, Descriptive Booklet, References, and Full Particulars of our services to inventors. NO OBLIGATION. A post-card will do. Address:

THE INVENTION REPORTER
50-11106 South Longwood Drive Chicago 43, Illinois

DO ANY JOB.. EASIER.. QUICKER
MAKE MORE MONEY in the
BIG OPPORTUNITY
FIELDS

SEND NO MONEY
 Select the Books
 YOU Need Now!
 We Ship C.O.D.
 Anywhere in U. S.
 and Will Refund
 Amount Paid if
 Not Satisfactory.

Here's the Help You Need
For Best Paying Jobs
Right NOW!

FREE TRIAL
IN YOUR OWN HOME

Used by Army, Navy, Other Government
 Depts., 200 Schools and Industrial Firms.

Don't submit to tough, heartbreaking job competition, now that wartime jobs are over. Get into one of these big opportunity fields. Big money and many other advantages await you if you prepare now. Here is the help you need—EASY—QUICK—AT LOW COST. Thousands of men have already used these famous books. Beginners and experienced men alike have doubled and tripled their earnings with this help. You too, can now get the special knowledge you need for top pay, better jobs, or a business of your own. This is your GOLDEN OPPORTUNITY.

AIR CONDITIONING

Big air conditioning boom interrupted by war will be bigger than ever. It's ready to GO now! Get this non-technical book by international authority and be ready for your share of millions to be spent. Covers whole field. 450 pages. Illustrated. \$3.50.

AIRPLANE WELDING

All metal airplane building offers big peacetime opportunities. New 2nd edition of this famous book by J. B. Johnson, Materials Division, Wright Field. The authoritative and practical book on Airplane welding and materials brought right up to date. 420 pages, 193 pictures. \$3.50.

MODERN WELDING PRACTICE

Newest book on all types of welding and heat treatment of metals. Written by recognized specialists in training men for production and non-technical jobs. Practical and Non-Technical. Covers everything you need to know. Prepare for best pay jobs now. Price \$4.00.



430 Pages
 277 Illus.
 Practical and Non-Technical

everything you need to know. Prepare for best pay jobs now. Price \$4.00.



REFRIGERATION—Book of the Hour!

Biggest Opportunity in Many Years!

NEW PRINTING—ALMOST 1000 PAGES

408 Pictures—17 Diagrams in Colors Makes All Refrigerator Service Maintenance, Repairs Simple as A. B. C.

Thousands of Refrigerators need repairs! Owners will pay big for competent service which will be needed more and more. Get MODERN GAS AND ELECTRIC REFRIGERATION, the non-technical guide to all types of refrigerators and get your share of this new profit. Get a job or start your own service business. This book will help you make money anywhere. Price \$5.00.

BODY & FENDER REPAIR

Owners will spend big money to keep their good older cars looking like the new ones coming out. This is a practical money-making guide, ideal for shop owners and every man who wants a share of the millions to be spent in keeping old cars looking new. Tells how to get a good job or start business of your own with small capital. 325 pages, 282 illustrations. \$3.00.



DYKE'S FAMOUS CARBURETOR BOOK

This famous book has been the standard guide in the best paying auto work for a generation. It has helped thousands of men make money. New edition covers engine tune-up, compression, ignition, carburetion, fuel pump valves, etc. Use this book to specialize in this big field. 244 pages, 549 illustrations. \$3.00.

HOUSE WIRING NEW 1945 EDITION

Get this new sixth edition of this standard and practical electrical wiring book. It gives complete practical instruction on every phase of house wiring in one handy volume. Goes further than most books on subject. Hand-book style. Gives National Electric Code. 400 pages, 669 illustrations. Electrical work will reach a new high with millions of new homes to be built. Get started now. \$2.50.

15 Million Refrigerators
 Need Service and
 Repairs



NEW 20th
EDITION
Leading Auto Book for Over 32 Years

World's Greatest AUTO BOOK

New Material on Transmissions, Trucks, Tractors, Diesels, Aircraft and Auto Engines

Now with millions of cars needing repairs and thousands of men needed to do the work, you need the famous DYKE Auto Book more than ever before. Brand new 20th Edition covers all principles, construction, repair, adjustments, testing, troubles and remedies of all cars. Over a half million copies of 20 editions of Dyke's have been sold. Gives specifications of old and newer cars. World's biggest book value, \$6.00. This big book, a complete auto library in one volume, has 1483 pages—4600 illustrations and diagrams—weighs 6 lbs.—equal to 4 ordinary books.

ENGINEERS HANDBOOK

World famous Bailey's handbook of universal questions and answers for Stationary, Marine and DIESEL engineers and firemen. Prepares for any license examination. This is the one book that men should have if they want to reach the top in installation, maintenance and operation of Diesel and steam plants. Pocket size, \$2.00.

Mail Coupon to
Goodheart-Willcox Co., Inc.
 209 S. Michigan Ave., Dept. 110, Chicago, 16, Ill.

SEND NO MONEY! Mail Coupon

GOODHEART-WILCOX CO.,
 209 S. Michigan Ave., Dept. 110, Chicago 16, Ill.
 Send books checked, C.O.D. I will pay postman, plus few cents charges. If not satisfactory I will return books in 5 days and you will refund money paid. (Outside U.S. or possessions remit with order.)

- | | |
|--|--|
| <input type="checkbox"/> Gas & Electric Refrigeration \$5.00 | <input type="checkbox"/> Sheet Metal Layout \$3.00 |
| <input type="checkbox"/> Dyke's Auto Book \$6.00 | <input type="checkbox"/> Air Conditioning \$3.50 |
| <input type="checkbox"/> Dyke's Carburetor Book . \$3.00 | <input type="checkbox"/> Engineers Handbook . . . \$2.00 |
| <input type="checkbox"/> Modern Welding \$4.00 | <input type="checkbox"/> Body and Fender Repair . \$3.00 |
| <input type="checkbox"/> Airplane Welding \$3.50 | <input type="checkbox"/> House Wiring \$2.50 |
| | <input type="checkbox"/> Shop Math. (2 vols.) . . . \$3.00 |

If remittance accompanies order we will pay all postage charges under same return privilege.

Name
 Address
 City State

EVERY ELECTRICAL WORKER NEEDS THIS ELECTRICIANS 1945 HAND BOOK

**For Everyday Help
On The Job!**

Brand new... up to the minute. Contains over 5,000 electrical facts—wiring diagrams—essential electrical formulas—latest code rules, tables, charts and wiring methods. Includes Industrial Electronics data. It's a gold-mine of practical, down-to-earth helps and ideas to save you time and money. A book every Electrical Worker can use every day. Pocket size, 4 1/4 by 7 inches, flexible leatherette cover to stand hard usage.

SEE IT FREE!

See this book FREE for 7 days at my expense. If you decide you don't want to keep it, send it back and you owe nothing. If you keep the book you pay only \$2.75 after 7 days' FREE examination.

400 Pages

Electrical Circuits
Reading Wiring
Diagrams
Wiring Methods
Motors
Switching & Control
Illumination
Industrial
Electronics, Etc.

**H. C. LEWIS, President
Coyne Electrical School, Dept. 75-R6
500 S. Paulina St., Chicago 12, Ill.**

I want to see the New Coyne Electricians Handbook. Send me a copy for 7 days' FREE examination. If after 7 days I do not want the book I will return it and owe you nothing. If I keep it I will pay \$2.75 within 7 days and the book is mine.

NAME.....Age.....

ADDRESS.....

TOWN.....Zone.....STATE.....

If you prefer to pay postman cash price shown above on delivery, check here. Same FREE examination & money back guaranteed.

**FREE TRIAL
COUPON**

DRAFTSMEN NEEDED



**PREPARE NOW for a
BETTER JOB
AND GREATER
OPPORTUNITIES**

If you are ambitious to hold a better job, make more money and have greater opportunities to get ahead, start now to become a draftsman. Or if you are now employed in routine drafting work and want a better job—as a real draftsman, on more important work, at bigger pay, start now to qualify for that job.

Learn at Home in Spare Time

American School has helped thousands to reach higher goals, and can help you. Our practical, up-to-date training plan can provide the know-how that fits men for responsible jobs and opens opportunities. Begin draftsman training now. Check, fill in and mail the coupon below for FREE information—today.

AMERICAN SCHOOL, Dept. DD745, Drexel Ave. at 58th St., Chicago 37, Ill.

Gentlemen: Send me FREE information covering special training in subjects checked below. No obligation on my part.

- | | |
|--|---|
| <input type="checkbox"/> Drafting and Design for Men and Women | <input type="checkbox"/> Electrical Engineering |
| <input type="checkbox"/> Architecture and Building | <input type="checkbox"/> Diesel Engineering |
| <input type="checkbox"/> Automotive Engineering | <input type="checkbox"/> High School Course |
| <input type="checkbox"/> Business Management | <input type="checkbox"/> Plastics |
| <input type="checkbox"/> Railway Training | <input type="checkbox"/> Mechanical Engineering |
| <input type="checkbox"/> Electronics, Industrial | <input type="checkbox"/> Aviation |
| | <input type="checkbox"/> Radio |

Name.....

Address.....



300 WAYS TO MAKE MONEY

MONEY BACK GUARANTEE

\$1.00 VALUE

25¢

**68
PAGES**

**40,000
WORDS**

In "CASH IN" you get ALL the real money-makers—dozens of profitable tested mail order plans, confidential business secrets, dozens of practical tested formulas, successful tested schemes—actual experiences of men who have started on a shoestring—with less than \$10 capital.

25c a copy postpaid. Send U. S. stamps, money order, or coin.

**NATIONAL PLANS INSTITUTE
P. O. Box 265, Station N, New York 23, N. Y.**

TRAIN for SUCCESS in the Poultry Business



YOU CAN MAKE

MORE MONEY from POUL-

TRY. Proper management means profits ANY season, for life. Get latest scientific methods that avoid losses and mistakes. Our famous system of Home Study Training has helped thousands to success. Extra profits from the start. FREE Catalog; describes courses, methods, service. Write today to Dept. 50-C. NATIONAL POULTRY INSTITUTE, Adams Center, N. Y.

Study at home in spare time. Earn extra while learning...

LEARN MOVIE PROJECTION THEATRE MANAGEMENT



The Motion Picture Theatre Business offers big opportunities for trained men. Get into a fascinating field with a peace time future. Train at home in spare time. Free catalog. Established 17 years.

**THEATRE INSTITUTE, 370 Washington St.,
Elmira, New York**

YOU CAN ADVANCE IN PLASTICS!

Plastics can be the next great industry... expanding as swiftly and largely as the automotive, radio and aviation businesses. Already, it is an important industry and a growing one. With I. C. S. training, you can take advantage of the many opportunities in Plastics today. At the same time, you prepare for the vast possibilities of tomorrow. Write for the free booklet containing full information! Do it right now! International Correspondence Schools, Box 5557-K, Scranton 9, Pa.



Wonderful, new device, guides your hand; corrects your writing in a few days. Big improvement in three hours. No failures. Complete outline FREE. Write C. J. Ozment, Dept. 34, St. Louis, Mo.

Thrilling Work COLORING PHOTOS



Fascinating vocation learned at home by those with aptitude. Thrilling pastime. Keen method brings out life-like colors. Free booklet.

**NATIONAL PHOTO COLORING SCHOOL
1315 S. Michigan, Dept. 1357, Chicago 5**

So-Lo's PIPE JOINT COMPOUND

**LEAK-PROOFS, RUST-PROOFS,
SEALS and LUBRICATES**



For use on boilers, tanks, plumbing, valves—all piping. Gives a permanent closure. Prevents corrosion. Large tube 10c. Many other So-Lo Menders. At Hardware or 10c Stores.



Millions Save with So-Lo Menders



KNOWLEDGE
THAT HAS
ENDURED WITH THE
PYRAMIDS

A SECRET METHOD FOR THE MASTERY OF LIFE

WHENCE came the knowledge that built the Pyramids and the mighty Temples of the Pharaohs? Civilization began in the Nile Valley centuries ago. Where did its first builders acquire their astounding wisdom that started man on his upward climb? Beginning with naught they overcame nature's forces and gave the world its first sciences and arts. Did their knowledge come from a race now submerged beneath the sea, or were they touched with Infinite inspiration? From what concealed source came the wisdom that produced such characters as Amenhotep IV, Leonardo da Vinci, Isaac Newton, and a host of others?

Today it is known that they discovered and learned to interpret certain *Secret Methods* for the development of their inner power of mind. They learned to command the inner forces within their own beings, and to master life. This secret art of living has been preserved and handed down throughout the ages. Today it is extended to those who dare to use its profound principles to meet and solve the problems of life in these complex times.

This Sealed Book—FREE

Has life brought you that personal satisfaction, the sense of achievement and happiness that you desire? If not, it is your duty to yourself to learn about this rational method of applying natural laws for the mastery of life. To the thoughtful person it is obvious that everyone cannot be entrusted with an intimate knowledge of the mysteries of life, for everyone is not capable of properly using it. But if you are one of those possessed of a true desire to forge ahead and wish to make use of the subtle influences of life, the Rosicrucians (not a religious organization) will send you *A Sealed Book* of explanation without obligation. This *Sealed Book* tells how you, in the privacy of your own home, without interference with your personal affairs or manner of living, may receive these secret teachings. Not weird or strange practices, but a rational application of the basic laws of life. Use the coupon, and obtain your complimentary copy.

The ROSICRUCIANS

SAN JOSE

(AMORC)

CALIFORNIA



AMENHOTEP IV
Founder of Egypt's
Mystery Schools

Use this
coupon for
FREE
copy of book

SCRIBE M. C. T.
The Rosicrucians (AMORC)
San Jose, California

Please send free copy of *Sealed Book*,
which I shall read as directed.

NAME _____

ADDRESS _____

CITY _____

INVENTORS

Do Not Delay

Have you ever been startled by seeing a successful article on the market, and exclaimed—"Why, I invented THAT 5 years ago—I didn't think it valuable enough to Patent!"

The Patent Laws were intended for the Protection of the Inventor, and the Inventor who slumbers on his Rights may wake up to find someone else reaping the reward that could have been his.

Write NOW for Information and Record of Invention form FREE. RANDOLPH & BEAVERS, Registered Patent Attorneys, Columbian Bldg., Washington, D. C.

PERSONALIZED SERVICE — REGISTERED PATENT ATTORNEYS

RANDOLPH & BEAVERS

11-D Columbian Bldg., Washington, D. C.

Please send me full particulars on Patents, fees, etc., and "RECORD OF INVENTION" form—FREE.

Name

Street

City State

FREE PATENT BOOKLET

OF COSTS and OTHER USEFUL INFORMATION ABOUT PATENTS

EUGENE H. PURDY, REGISTERED PATENT ATTORNEY
900 F. ST., N.W. ROOM 801-A WASHINGTON 4, D. C.

NAME

ADDRESS

PATENTS Protect Your Idea: By securing FREE my "TROOP OF INVENTION" folder. Exceptional Personal Service. Excellent References. Established 1906. E. E. VROOMAN, 871 Woodward Bldg., WASH., D. C.

AIR RIFLES BENJAMIN AIR PISTOLS

ORDERS NOW ACCEPTED

EARLIEST POSSIBLE POSTWAR DELIVERY ASSURED—ACT NOW! ORDER Latest Models BENJAMIN AIR RIFLES and AIR PISTOLS AT ONCE. Send for our FREE ILLUSTRATED FOLDER and complete specifications TODAY. BENJAMIN H-O PELLETS ARE AVAILABLE.

BENJAMIN AIR RIFLE CO., 812 MARION ST., ST. LOUIS 4, MO.



HUNTING and FISHING is a monthly magazine crammed full of hunting, fishing, camping, dog and boating stories and pictures, invaluable information about guns, fishing tackle, game law changes, best places to fish and hunt—countless ideas that will add more fun to your days afield.

Special Trial Offer
Send 25c in stamps or coin and we will send you Hunting & Fishing for six months.

HUNTING & FISHING MAGAZINE
251 Sportsmen's Bldg., Boston, Massachusetts

PATENTS AND TRADE MARKS

C. A. SNOW & CO.

Registered Patent Attorneys Since 1875
Write for Free Book and "Certification of Invention" form
427 SNOW BUILDING, WASHINGTON 1, D. C.

PATENT YOUR IDEAS NOW TO OBTAIN A PATENT
SEND FOR FREE BOOK

Former Member Examining Corps (1923-24) U. S. Pat. Office.
CARL MILLER, Registered Patent Attorney
Former Member Examining Corps U. S. Patent Office
Woodworth Bldg., Dept. 105-A New York — Bond Bldg., Dept. 105-A, Washington, D. C.

LEARN MEAT CUTTING
At Home — In Spare Time

Get into the vital meat industry. Concise, practical Home Training based on 25 years' proven instruction methods used at National's famous resident school. Prepares you for bigger pay as Meat Cutter, Supervisor, market manager or more money in your own store. Go as rapidly as your spare time permits. Diploma. Start NOW to turn your spare hours into money. Send for FREE bulletin today. No obligation.

National School of Meat Cutting, Inc., Dept. U-62, Toledo 4, Ohio

12 PHOTO and INITIALED RINGS
ONLY \$1.95 Complete. PLAST-O-CRAFT RING KIT contains complete material, fabricating equipment and instructions for making 12 beautiful plastic rings in assorted colors. Initials, small photographs and stones can be placed in the setting. Ideal for clubs, class rings, societies, gifts, etc. Simple to make and lots of fun. A practical way to learn plastics. Send check or money order for \$1.95. We pay postage and ship immediately. Money-back guarantee.

Dept. M-10, PLAST-O-CRAFT COMPANY, 13401 Cerise Ave., Hawthorne, Calif.

ARTISTS MAKE MONEY
Find out your ability. Send name, age, occupation and address for Free Vocational Art Test.
ART INSTRUCTION, INC. (Formerly Federal Schools)
10135 Art Instruction, Building, Minneapolis, Minnesota

FIBRE ARMS AND LEGS!
Light, correctly fitted, strong and comfortable. Natural appearance. Braces for all deformities. Scientific design. Fair Terms.

BUCHSTEIN-MEDCALF 616-3rd Av. S., Minneapolis, Minn.

HOW RUPTURE MISERY MAY DISAPPEAR

Don't go on day after day suffering the tortures of a clumsy truss that presses on your hips and back, poaches your flesh, slips and slides and leaves your rupture DANGEROUSLY UNPROTECTED.

Get the truth about rupture care and how the newly patented Vita-Pneumatic Nature-Ade (U.S. Pat.) appliance with its unique features can help your rupture, misery disappear. Write at once for FREE booklet containing much valuable information.

PNEUMATIC APPLIANCE, 103 PARK AVE., N. Y. 17, N. Y., DEPT. 45A

ELECTRICITY MEN NEEDED

GOOD JOBS • GOOD PAY • GOOD FUTURE

Through spare time home study you can qualify for a starting job in electrical work and prepare for bigger pay promotions. Or if now employed in this field you can acquire know-how which can win you a bigger, better job. It's not difficult to master principles of equipment used in generating, transmission and use of electricity. Begin now. Send name and address today for FREE information.

AMERICAN SCHOOL, Dept. EE745, Drexel Ave. at 58th St. Chicago 37

Name

Street

City, State



9 ways to be your own boss!

NOW, more than ever before, is the right time to start a small profitable business of your own... or train yourself for a practical money-making trade in which you can be **INDEPENDENT**. TODAY... take your first step, without cost or any obligation.

Just mail coupon—and by return mail you will get full information on the courses listed here.

REAL ESTATE

SUCCESS... be a professional man!

Practical training on how to run a profitable real estate business of your own. Illustrated self-study lessons on farm and suburban properties, downtown operating. Gain a working knowledge of mortgages, listings, sales techniques, appraisals, property management, commercial leasing, contracts, etc. Real estate is the foundation of all wealth! **Rush coupon below for NEW facts you should know about your future in real estate.** There's no obligation.

practical REFRIGERATION

Brand New Streamlined Course for quick training. Authoritative step-by-step instruction on servicing household refrigerators... how to install, operate, repair. Easy-to-follow illustrated directions on troubleshooting, parts replacement, testing. Covers quick-freeze units, lockers, water coolers, freon, air-conditioning systems, etc. **Amazing low price! Free details, see coupon.**

AUTO mechanics

Let this **PRACTICAL, LOW-PRICED** course get you started in the auto repair trade. Good mechanics make big money NOW... and have a great future! Self-training lessons show you exactly what to do and how to do it. It teaches servicing on all makes of cars... adjustments, tune-ups, etc. Clearly written and illustrated by expert engineers. Satisfaction or refund. Mail coupon for **FREE** details.

carpentry—building—estimating

BIG OPPORTUNITIES FOR MEN with the KNOW-HOW! There's a great future in the building trades... for trained men. Here are up-to-date lessons on how to plan, build, remodel houses. How-to-do-it instructions on stair building, steel square, roofing, painting and decorating, etc. Send for full information **FREE**... mail coupon below!

what to invent—how to invent

MECHANICAL DRAWING, DESIGNING, BLUEPRINT READING
Practical course for wide-awake practical men. **IDEAS**... how to get them, develop them, protect them and promote them! Expert information on how to turn your imagination into money. Plus illustrated self-study lessons on basic mechanical movements and devices. mail coupon below for **FREE** details.

INSURE YOUR FUTURE

Mail This Coupon Today!

On this coupon check the subjects that interest you. Our world-famous copyrighted Success-Catalog will bring complete details. **FREE**... no cost, no obligation.

NELSON COMPANY
321 S. Wabash Ave., Dept. 8K02, Chicago 4, Ill.

watch and clock repairing



Learn at Home—In Your Spare Time
Prepare for a happy future of prosperity, security... and get a big-pay job now. Fascinating, high-grade occupation. You can **EARN WHILE YOU LEARN**. Excellent field for part-time work at home.

Practical Course in HOROLOGY

Thorough self-instruction training in American and Swiss watches, clocks. Special sections on alarm clock repairs. Interesting. **LEARN-BY-DOING** instruction method. Learn **QUICKLY**, easily. No previous experience necessary. **WATCHMAKING IS BASIC TRAINING FOR AIRCRAFT INSTRUMENT WORK** and other scientific precision jobs.

Amazing Low Price! • Money-Back Guarantee! Get into this fast-growing field NOW... big opportunity... don't delay. Mail coupon below for **FREE** information. No obligation.

locksmithing and key making

PRACTICAL UP-TO-DATE COURSE

How to pick locks, de-code, make master-keys, repair, install service, etc. New, self-instruction lessons for every handyman, home-owner, carpenter, mechanic, service station operator, fix-it shop, hardware dealer, gunsmith. **53 Easy Illustrated Lessons** Low Price! Satisfaction guaranteed or money back. Write now... no obligation!

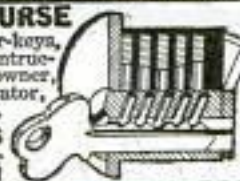

practical RADIO servicing

SELF-INSTRUCTION COURSE

Teaches you the practical side of radio... repair, adjustment, operation, alteration, trouble-shooting. No previous knowledge necessary. Large clear illustrations, diagrams, charts, etc. **INTERESTING STEADY WORK!** Set up a radio repair shop of your own—or prepare for booming industrial electronics. This useful, how-to-do-it course brings you all the fundamentals, including mathematics, review questions, problems, answers. Strictly up-to-date. Low price. Coupon below will bring you full information you want immediately. Mail it in today!

MAIL ORDER BUSINESS

Your Big Opportunity!

34-lesson course on proved, tested, up-to-date, profitable methods. Amazing treasure-house of the best mail order plans and practices. How to start your mail order business on a small one-man scale... how to keep it growing more and more profitable month after month. Money-making **FACTS**. Sensational details... **FREE**. Mail coupon below!



FREE! 100-page book... mail this now!

NELSON COMPANY, DEPT. 8K02, 321 S. WABASH AVE., CHICAGO 4, ILL.

Please send me—**Free** and without obligation—illustrated Success-Catalog containing information about the subject (or subjects) I've checked below. No salesman will call.

- | | | |
|---|--|--|
| <input type="checkbox"/> Watch and Clock Repairing. | <input type="checkbox"/> Locksmithing. | <input type="checkbox"/> Refrigeration. |
| <input type="checkbox"/> Practical Radio Servicing. | <input type="checkbox"/> Real Estate. | <input type="checkbox"/> Auto Mechanics. |
| <input type="checkbox"/> Mail Order Business. | <input type="checkbox"/> Carpentry. | <input type="checkbox"/> Inventions. |

NAME _____
 ADDRESS _____
 CITY _____ ZONE _____ STATE _____

Boys! Sportsman! Sensational New Wrist Type Luminous Dial COMPASS

Readable By Day or Night!
TRAIL-BLAZER
COMPASS

HERE ARE THE FEATURES THAT MAKE THIS THE
GREATEST COMPASS "BUY" In All AMERICA!

- Airplane Type "Sealed In Liquid" Unbreakable Compass
- Shatterproof, Shockproof, Waterproof Construction
- Luminous "See In The Dark" Dial
- Withstands Heat, Will Not Freeze
- Latest Type Plastic Case
- Shows Degrees in All Directions
- Newest Wrist Watch Style Design
- Genuine Leather Strap



Only
\$1.98
Includes
Leather
Strap

Examine for
10 Full Days
at Our Risk!

• What a Compass this is! Made to give superior performance under any and all climatic conditions. Will not freeze at even 40 degrees below zero. Works perfectly under a blazing sun. Guides you accurately all hours of the day and night.

SEND NO MONEY!

The Ideal Compass for everyone—Boy Scouts, Hunters, Fishermen, Hikers, Motorists and all sports lovers. Unfailing and unbreakable. Complete with smartly styled wrist band.

Pay postman only \$1.98 C.O.D. plus few cents postage on arrival. If not delighted return in 10 days for full refund.

ILLINOIS MERCHANDISE MART, Dept. 237
500 N. Dearborn St., Chicago 10, Illinois

Rush me the Trail-blazer Plastic Compass on your Money Back Offer. I will pay postman \$1.98 plus postage on arrival with the understanding that if I am not completely satisfied, I can return it within 10 days for full refund.

NAME.....
ADDRESS.....
TOWN.....STATE.....

GIANT TELESCOPE OFFER



BIG-POWERFUL OVER 3½ Feet Long!

The Yankee Clipper Super Telescope is by far the biggest, most powerful Telescope ever made to sell for only \$1.98 with Carrying Case included. It's guaranteed Super power and measures over 3½ feet in length from end to end. Lenses are of optically-ground polished glass. So powerful you can clearly see people and wild life miles away and watch what they're doing when they can't see you. Sensational! Exciting! Fun and adventure such as you've never known before.

Only
\$1.98
CARRYING CASE
INCLUDED



Large
Optical
Lenses

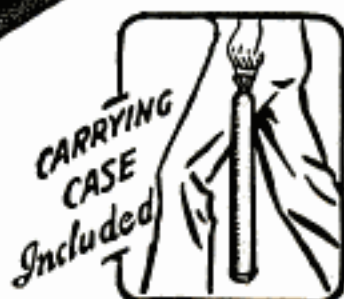

Examine
For 10 Days
At Our Risk!

Just write name and address on handy order coupon and mail back to us today. Upon arrival of Yankee Clipper Telescope with Carrying Case deposit only \$1.98 plus a few cents postage with postman. If you are not positively thrilled and delighted with the way this Yankee Clipper Super Telescope helps you to see great distances return in 10 days for full refund. Rush order today and get durable Canvas Military Style Case on this special offer. Hurry—while the supply lasts.

Send No Money!

ILLINOIS MERCHANDISE MART, Dept. 3159
500 N. Dearborn St., Chicago 10, Illinois

Please rush me the Yankee Clipper Telescope with Carrying Case. On arrival I will pay postman only \$1.98 plus few cents postage charges. If not delighted I can return in 10 days and get my money back in full.

NAME.....

ADDRESS.....

CITY & ZONE.....STATE.....

Enclosed find \$1.98. Please ship the Telescope with Carrying Case all postage charges prepaid.

**WORLD'S
BEST
WANT AD
MEDIUM**

CLASSIFIED Advertisements



Advertisements in this section 50 cents per word, each insertion, minimum 10 words, payable in advance
To be inserted under proper classification in November issue, copy should be in our office October 4th

November issue on sale November 1st

F. W. Johnson, Manager, Classified Advertising

Popular Mechanics Magazine, 200 East Ontario Street, Chicago 11, Illinois

YOU'LL PROFIT

By reading and answering the classified ads in this section. Hundreds of opportunities to make and save money.

Popular Mechanics Magazine,
200 E. Ontario St., Chicago, Ill.

Dear Mr. Johnson: Our records show that approximately \$500.00 worth of business has been received as a result of the ad which was placed in your magazine in January. About 80% of this business came from the U. S. A., 15% from Canada and 5% from England. We have five small gift shops placing orders regularly, that contacted us through the ad, and we still get an occasional new inquiry or order. (Original letter on file in our office) Very truly yours, L. L. Russell & Co.

AUTOMOBILES, MIDGET CARS

FLOYD Clymer's popular motor books! Mercedes-Benz Book just out. Describes Grand Prix racing, 100 illustrations, photos world's fastest cars, drivers \$2.00, cloth-bound \$3.00. — Power and Speed, 200 illustrations, world's most famous racing book \$2.50. — Ab Jenkins (world's distance record holder) book "Speed on Salt" \$1.50, cloth-bound \$2.50. — Saga Roaring Road, historical book early day American automobile racing \$2.50. — Speed "How to Obtain It" \$1.50. — Motorcycling Manual, wonderful book, dozens motorcycles described, illustrated, \$2.00. (See our ad under Motorcycles). — Motorcycles "How to Manage Them" \$2.00. — English Motorcycle Service Manual, all about servicing various foreign motorcycles \$1.50. — Motor History of America "World's Wonder Book of Automotive Industry," all about Ford, Chrysler, Durant, Willys, Olds, Buick, others, 416 pages, lists 1600 different makes American automobiles \$3.00, cloth-bound \$4.00. — Floyd Clymer's Historical "Motor Scrapbooks" — the book Time Magazine called a "must" . . . specifications, illustrations, photographs hundreds early automobiles and motorcycles . . . No. 1 and No. 2 now ready, entirely different, \$1.50 each, cloth-bound \$2.50 each. — Clymer's Steam Automobile Scrapbook . . . Historical, illustrated review, early and late Steam Cars \$2.00, cloth-bound \$3.00. — Modern Steam Car, different book \$2.00. — All books postpaid. Sent overseas without request. We pay postage, guarantee delivery. Send dime for America's most complete Motor-book catalog. Clymers, 2125 W. Pico, Los Angeles 6, Calif. (See our ads under Motorcycles.)

PROFESSIONAL Midget racer, motor-scooter, midget car and midget motorcycle. Plans, specifications, for all four contained in illustrated handbook, 25c. Big list used motors, motorscooters, Servicelyces, etc., included free! Midwest, 3639 Drummond, Toledo, Ohio.

GARAGE Doors, all types, controlled from dashboard. Complete "Build Yourself" plans \$1.00, refundable. Free particulars. Kaytor Laboratories, Lynwood, Cal.

STEAM Car Scrapbook. Compiled by Floyd Clymer. Historical, authentic, amusing. Ads, photos, descriptions 250 early steam cars, with fascinating story by one-time world's youngest auto dealer. Postpaid \$2.00. Deluxe cloth-bound \$3.00. Clymers, 2125 W. Pico, Los Angeles 6, Cal.

SEE Our ad under Motorcycle classification for motorscooter bargains. Midget Motors Directory, Athens, Ohio.

BUILD Midget racer from castoff parts! Plans, specifications, construction information, \$1.00. Motor Supply, Box 1682-CS, Toledo, Ohio.

INTERESTING, Educational, illustrated English "Motor" magazine on foreign automobiles, 50c postpaid. Clymers, 2125 W. Pico, Los Angeles 6, Calif.

1945 IGNITION Supercharger. \$4.00. Pep, mileage, fast starting. EG Mfg. Co., 355a E. 149 St., New York.

SAVE Gasoline. Complete instructions guaranteed, 50c. Box 270, Edgemont, East St. Louis, Illinois.

REPAIR Your car. Motor parts for all engines, chassis parts, ignition and carburetor parts, etc. New replacement parts. Genuine and highest quality at manufacturers' retail parts. P.O.B. Chicago. No body parts. B & N Engineering Co., Box 3454 Merchandise Mart P.O., Chicago 54, Illinois.

CUSTOMIZE Your automobile. Illustrated, new restyling ideas, instructions, suggestions, specific model changes by simple methods. \$1. Speed Wheel, Box 723-E, Arcadia, California.

AUTOMOBILE Racing book, fifth edition, well illustrated. Instructions on building bodies, frames, engines. Ford A and B conversions. Plans, AAA rules, specifications. Roadster racing, Indianapolis cars. \$1.00 postpaid, \$1.30 C.O.D. Ray Kuns, Dept. 47, Madisonville, Cincinnati 27, Ohio.

AUTO SUPPLIES AND EQUIPMENT

AMAZING New Moto-Vator injects water-vapor into motor just like newest fighter planes. Burns 15% water; saves 20% to 30% gas; prevents carbon; increases power! Eliminates carbon and valve jobs. Not a gadget. Sensational performance keeps motor like new. Let this device start you in business. Wonderful possibilities. Send 10c for booklet giving complete details. Dept. M, SX Laboratories, P.O. Box 37, Middle Village, Long Island, New York.

SPECIAL Big 15-lb. box of over 3,000 popular size assortment of steel bolts, nuts, screws, washers, cotter pins, hose clamps, etc. \$3.00 postpaid. Melts Aircraft, Hardware Department, New Brunswick, N. J.

INVENTION Uses kerosene to run motors. Circular on plans. Rush name. Houston Maupin, Tipp City 36, Ohio.

GASOLINE Saving, center flow carburetor throttle. Walert Company, 3429 N. 10th St., Milwaukee 6, Wisconsin.

CONSTRUCT Auto burglar alarm, which when auto is touched, charges auto with electricity that shocks anyone, but yourself. Illus. instructions \$1.00. L. D. Blythe, White City 3, Kans.

POWER Booster—New Aqua-Charger, a scientific device designed by aircraft engineers applies to your car or truck the famous water-injection that has given aircraft extra speed and power. Aqua-Charger reduces carbon formation and kills ping even under heavy load and on steep grades. Has effect of raising octane rating of gasoline over 10 points and increasing gasoline mileage. Aqua-Charger and installation instructions \$17.95 postpaid. Give make and year of car. Associated Machine and Engineering Company, 46 George Street, Torrington, Conn.

CARBURETOR Repair kits containing all the essential parts for completely rebuilding a specific carburetor. Lists on request. Carburetor Service, 600 LaPrairie, Ferndale, Mich.

HAVING Car trouble? New, used, guaranteed auto, truck parts save money. Transmission specialists. Describe needs; immediate reply. Victory, 2439½ Gunnison, Chicago 25.

SMITHY'S Dual exhaust system for V8 Ford and Mercury. Increased horsepower, gas, mileage, performance and life by eliminating back pressure. Instructions included, simple to install, price \$20.00. Also replacement mufflers for all other cars \$4.75 to \$6.25. Smithy's Muffler Shop, 2335 India Street, San Diego, California.

UNIVERSITIES And Oil Corporation tests prove Whirligns Turbinator, \$3 carburetor amplifier, increases motor mileage and power. Users report gasoline economy exceeding 40%. Wrench installs 15 minutes. Give auto make, year. John Hanley, 5719 Loraine, Detroit 8, Mich.

GENERATORS. Magnetos, distributors, carburetors, new and rebuilt, for most any model car, truck or engine. Many old models in stock. Hundreds of electrical items, parts, etc. Order anything you need from us today at list price or less. Simms Magneto, 53 E. Callerton, Chicago 16, Ill.

UNLOCKEEZ Is a patent pending device, guaranteed to open push button auto locks instantly, also many other cars. \$2.00 per unit with instructions. Unlockeez, Box 209, White Plains, N. Y.

FLUORESCENT Driving lights for any car or truck. Blueprints, instructions—\$2.00. Superior Tool, Box 1036-A, Anderson, Indiana.

ANTI-FREEZE, Noncorrosive, inexpensive—manufacture yourself. Send stamp. Box 699, Berger, Texas.

PLATING Outfits for auto parts. Connect to a battery. No tanks used. Free particulars and proofs. Gunmetal Co., Ave. J, Decatur, Ill.

AUTO TRAILERS

BUILD Your own trailer! Save money! Have every feature you want! Plans for house, sport, camp and utility trailers. Catalog describing 9 models 10c. 15c in Canada and overseas. Jim Dandy, Box 123-A, Wausau, Wisconsin.

MOTORCYCLES, BICYCLES, MOTOR-SCOOTERS AND SUPPLIES

1942 CUSHMAN Motorscooter \$60; Briggs-Stratton motorbike \$45; midget car \$30; Briggs-Stratton motor \$10; tires for motorscooters and small cars at factory prices, mailorder only. Send 25c for big War-Bargain catalog Number Ten, just out of hundreds of bargains. (35c by first class mail.) Midget Motors Directory, Athens, Ohio.

FLOYD Clymer's Motorcycling Manual, 120 illustrations. Information, specifications, descriptions dozens motorcycles. Engines, transmissions, carburetors, square four, two piston singles, overhead camshafts, spring frames, hydraulic forks, sidecars, riding instructions. Two cycle engines and power bicycles described, illustrated. \$3.00 postpaid. Clymers, 2125 W. Pico, Los Angeles 6, Calif.

BUILD America's lowest priced motor-scooter speedster! Complete plans, specifications, \$1.00. Big list used motors, etc., included free! Motor Supply, Box 1682-CS, Toledo, Ohio.

DEPENDABLE Bicycle generators \$2.85 prepaid. Ten day trial. L. Kimley, Highland, Williamsville, N. Y.

FLOYD Clymer's popular motorcycle, automobile books. See advertisement under Automobiles! Clymers, 2125 W. Pico, Los Angeles 6, Calif.

TIRES, Tubes, wheels, for industrial trucks, carts, wheelbarrows, scooters, midget cars, coaster wagons. Nationally known makes, first-line quality. Sizes 8" to 18" o.d. in 2, 4, and 6 ply tires, separate inner tubes, heavy duty demountable wheels. Also caster forks, straight and swivel types. Free illustrated circular and prices. Jahant Co., 626 East Exchange Street, Akron 8, Ohio.

ENGLISH "Motorcycling" Magazine. Interesting, educational, foreign motorcycles. Racing, new-old models, advertisements. 50c sample copy. Clymers, 2125 W. Pico, Los Angeles 6, Calif.

MOTORBIKE Manual. Contains motorbike, scooter plans. Helpful hints and catalog section, also a small motor tuncup leaflet \$1.00. Variety Enterprise Co., Post Office Box 124, Evansville, Ind.

FOR That odd job keep on hand mixed aircraft bolts, nuts, washers, 5 lbs. \$1.00 postpaid. Alvin, 3704 Gordon, Ft. Worth, Texas.

PLANS, Scale drawings, specifications, illustrations for building attractive motor scooter complete \$2.00; plans electrically driven bicycle \$1.50. Postpaid, Clymers, 2125 W. Pico, Los Angeles 6, Calif.

SEND 25c For complete motorbike plans and parts list. Motorbike Service, 1304 Indiana, New Albany, Ind.

HARLEY Davidson parts, accessories, supplies, expert service. Send \$2.25 for army motorcycle instruction book and bulletins or 10c for bulletins only. Knuth's, 2491 Fondulac Ave., Milwaukee 6, Wis.

TIRES and industrial wheels, suitable for scooters, wheelbarrows, farm equipment, etc. All sizes. Bicycles and accessories. Largest assortment in America. Send dime for list. Cycle Transport Company, 1241 So. Michigan Ave., Chicago 5, Illinois.

"**MODERN** Motorcycle Mechanics" manual, enlarged, revised, second edition, 560 pages, 300 illustrations. The most up-to-date and complete motorcycle book published. Extensively covers design, operating, maintenance, and reconditioning. Harley-Davidson, Indian and British makes. "A book no motorcyclist can afford to be without." Immediate deliveries. Price \$3.00. Nicholson Brothers, Motorcycle Engineers, Saskatoon, Canada.

MOTORCYCLE Parts, new and used. List 10c. Ballak, 811 N. 9th, St. Louis 1, Mo.

PARTS, Accessories, pistons, chain Harley Davidson motorcycles. McCann's, P.O. Box 114, El Paso, Texas.

ELECTRIC Motorbike built from your bicycle. \$1.00 brings instructions-specifications. Mowery, Box 994, Lancaster, Pa.

BOYS! Repair your own bike. "Bicycle Repair Manual" 65c. R. G. Klausner, Shelbyville, Ill.

BUILD Scooters, trailers, midgets, conversions. Large manual \$1.00. Illustrated circulars dime. Craftsman Books, Box 1153-P2, Milwaukee 1, Wis.

BICYCLE Repair book, how to buy, rebuild, sell used bicycles, pocket size 50c. John Collett, Handley, Texas.

AVIATION

LUSCOMBE \$65. Cub \$300. New catalog 25c, lists thousands of sensational bargains in airplanes, motors, parts, parachutes, supplies. Aviation "Business Opportunity" section included free! National, Box 1682-CS, Toledo, Ohio.

PROPELLERS, High grade—fast delivery—lists free. Fit any motor, for planes, sleds, boats, deboosters, fans. Aircool conversion diagrams 50c. Standard Aircraft, Ft. Worth, Texas.

ACTUAL Airplane photographs: Packets, each containing 20 genuine glossy prints: B-29 Superforts, Flying Fortresses, Naval Aircraft, Army Fighters, Army Trainers. 25c each packet; all 5 for \$1, postpaid. Lloyd, 1411-PO Northwest 17th, Oklahoma City 6, Oklahoma.

HUNDREDS of war-bargain airplanes and gliders, some probably located near you. Send 25c for complete directory. Used Aircraft Directory, Athens, Ohio.

PROPELLERS For airplanes, ice-snow sleds, air boats. Lowest prices, fastest service. Literature 5c. Banks Propellers, R.P.D. 7, Ft. Worth, Texas.

JET Propulsion experiments. New principle to drive boats, bicycles, model helicopters. Circular on plans. Rush name. Houston Maupin, Tipp City 53, Ohio.

FLYING Plea, plans \$1.00. Lightplane manuals, blueprints, illustrated circular 20c. Craftsman Books, Box 1153-P1, Milwaukee 1, Wisconsin.

BATTERIES, GENERATORS, ETC.

EDISON Batteries. Light, Power. Fifteen year life. Five year guarantee. Complete lighting plants. Free literature. See Jay Company, 321 Yonkers Avenue, Yonkers, New York.

ELECTRICAL SUPPLIES, EQUIPMENT

ASK Ted Riseman about electric fan assembly parts. 427 East Jefferson, Springfield, Illinois.

QUICK, Get on mailing list—receive illustrated catalog sheets surplus and stock engines, motors, tools, parts, materials. Suggestions for use. Rush name. Houston Maupin, Tipp City 64, Ohio.

SURPLUS Lighting fixtures used on U. S. navy flattops in airplane stowage spaces for general lighting. 300 w. to 500 w. Water tight and vapor-proof. Excellent outdoor lighting fixtures for farms, gasoline service stations, parking lots, amusement parks, and for all other outdoor general purposes. \$12.50 each. Times Appliance Company, Inc., 72 Duane Street, New York City.

IRON Elements, toaster, percolator, stove \$1.50. Fluorescent 1-lt. \$9.00, 2-lt. \$15.00, 25" long; 2-burner hot plates \$12.95 prepaid. Aesco, Box 415, Austin 3, Texas.

ELECTRICAL Appliance repair. Open your own shop. Learn house wiring; electric motors, vacuum cleaners, washers, etc. Complete illustrated course shows how. Free booklet. Pacific Training School, Dept. AP-2, 4703 West Pico, Los Angeles 6.

BROKEN—Burned out electrical heating elements quickly repaired. Use new amazing Nichrome Paste, simply overlap ends and turn on current. Family size \$1.00 bill. Satisfaction guaranteed. Armstrong Mfg., 361-X, Minneapolis, Minn.

ELECTRIC Pencil: Writes-engraves all metals \$1.00 postpaid. Beyer Mfg., 4515-H Cottage Grove, Chicago 15.

NOW—Repair your own electrical appliances with Chanite Self-Welding Electrical Heating Element Flux. Instructions delivered, price \$1.00. Chanite Sales Company, 914 South Main, Fort Worth, Texas.

WELDING, SOLDERING, PLATING

MULTIWELD Production type A-C welders. Single hairline control, over 200 heats, 1-ph. 110-220 volts, 150 or 225 amp. \$82.50, \$112.50. Two year guarantee. Garages, shops, farmers—write: Phillip Wilson, 309-E Bridge, Streator, Ill.

ARC Welders wanted by the thousands. Learn with 516 page lessons manual. Over 500 how-to-do-it photos. \$2.00 copy. Money-back guarantee. Hobartweld, Box M-1054, Troy, Ohio.

WELDING Equipment and supplies, gas or electric, new and used. Sell, buy and exchange. Welding Headquarters, Chicago 47, 2425 Milwaukee Ave.

FREE Information, make guaranteed electric welder, easy from old scrap, costs about \$1.00. Write "International," 6347 Farnell-G, Chicago, Illinois.

BUILD Your own arc welder. We furnish all parts. Plans, catalog 25c. Frazee Electric, Box 5086, San Francisco 1.

SELF-WELD Electric element fix packets: 50c; \$1.50. Alvin, 553 William, Winnipeg, Manitoba.

NEW Model electric welder 110 volt a.c.-d.c.; will weld all metals; easy to use; full directions. Complete with power unit, flame and metallic arc attachments, carbons, fluxes, rods, mask; all for \$19.95. Used by the navy. Magic Welder Mfg. Co., 239-MP9 Canal St., New York City.

ARC Welders and brazers, new and used. 220 volt, 32 volt and 110 volt. Unconditionally guaranteed. Forney Manufacturing Co., Ft. Collins, Colo.

SUPER Welder—For home, farm, factory. Makes even beginner an expert. Improved on type used by navy. Fully equipped with metallic arc and flame torch handles, carbons, rods, fluxes, mask, etc. Complete directions. Operates a.c.-d.c., 110 volts. No extra wiring needed. Guaranteed. \$19.95. Save 2% send check with order. Super Welder Manufacturing Co., Dept. A, 23 East 20 Street, New York.

WELDING, Cutting, aircraft welding and soldering equipment. Electric arc welders. Superior Oxy-Acetylene Co., Hamilton, Ohio.

A.C. Arc welders, all sizes. Catalog dime. Frazee, Box 5086, San Francisco 1.

SLIGHTLY Used arc welders. Recommended by R.E.A. Guaranteed. Forney Mfg. Co., Fort Collins, Colo.

MACHINERY, TOOLS AND SUPPLIES

TOOLS: Vise-grips, Cee-Tee, waterpump, needlenose, diagonal cutter pliers, crescent wrench, pipewrench, plastic screw-driver, clawhammer, hacksaw and 12 sockets 7/16 to 1" including 1/2" flex handle and universal joint. Universals complete 25 piece guaranteed tool kit only \$49.35. Immediate shipment! Try us first, we have it, can get it, or it isn't made! Catalog and price list free! Order now! Universal Tool Company, 1527 Grand PM, Kansas City, Mo.

PLAN Your postwar workshop now around Lewis mills, shapers, drill presses and other metal and woodworking tools—and save up to 80% of usual cost by completing them yourself. Plain or semi-finished castings furnished with all materials and construction blueprints. Send 10c to cover cost of mailing catalog describing 23 items. Lewis Machine Tool Co., P.O. Box 116, Station A, Dept. M-57, Los Angeles 31, California.

ROTARY Vacuum pumps \$60.00. 28" vacuum 3 c.f.m. at 850 r.p.m. William Reid Co., Chicago 14, Ill.

MILLING Attachment for Atlas lathes. Photographs for dime. Depoy Model Shop, Muncie, Indiana.

1/2" AND 3/4" Saw mandrels, \$2.50 to \$12.50. 20 oz. anvil, 50c. Growlers \$5.00. Catalog 10c. Frazee, Box 5086, San Francisco 1.

QUICK, Get on mailing list—receive illustrated catalog sheets surplus and stock engines, motors, tools, parts, materials. Suggestions for uses. Rush name. Houston Maupin, Tipp City 65, Ohio.

AD Entitled "Super Drill Grinder"—See our ad page 192.

HIGH Speed drills, taps, milling cutters, end mills, tungsten carbide tipped tool and lathe bits, etc. Bargain prices. Send for price list. Box 212, Milwaukee 9, Wis.

BUILD Quick-change gear box for 12" Craftsman lathe. Complete drawings, instructions \$3.00. No castings. Stevens Engineering, 2904 Military, Los Angeles 34, Calif.

MACHINIST Tools, hardware, model maker supplies, saw mandrels, taps, belts, screws, steel. Catalog 10c refunded. Terek, 6304 Patterson, Chicago 34.

HIGH Speed drills. We are closing out our entire stock of 15,000 dozen at less than wholesale price. Number 19 or 23, \$2.25 per doz.; Number 34 or 35, \$1.75 per doz.; Number 42 or 46, \$1.50 per doz.; Number 52, \$1.35 per dozen. More than 100 other sizes at comparable prices. All well known brands, made by such companies as Cogsdill Twist Drill Company, Standard Tool Company, Union Twist Drill Company, Chicago-Latrobe, Cleveland Twist Drill Co. No orders accepted for less than one dozen of any one size. The Adams Co., 1210 Farnam St., Omaha 2, Nebraska.

HOUSE Plan template. Draw plans for new homes and remodeling, faster, neater. Made of clear sheet plastic, with accurate cut-outs for drawing doors, windows, plumbing and electric fixtures, fireplace, stairs, molding, roof-pitch, etc. Standard 1/4" scale. Satisfaction guaranteed. \$1.50 postpaid. Timely Products, Box 206-C, Columbus 9, Ohio.

STAINLESS Steel, bar or sheet assortment, ten full pounds \$1.50 prepaid. Industrial Engineering, 1155 S. Kenmore, Los Angeles 6, California.

GEARS For inventors, experimenters, model makers, schools, work shops, laboratories, etc. Government surplus made of brass, bronze, Dural, steel and stainless steel. 12 matched pairs; 24 gears, bevel, spur and ratchet. List price \$12.00, our price \$2.50. 25 matched pairs; 50 gears, includes larger gears, also sets of worm gears. List price \$30.00, our price \$5.00. 50 matched pairs; 100 gears better assortment, also crown, helical, internal and worm sets. List price \$75.00, our price \$10.00. Limited quantity. Order now. Met Exchange, 323 Canal Street, New York 13, N. Y.

BLOWERS, Metal blower cabinets, gas burners, oil burners, furnaces. Blower wheels, bearings. Wholesale, retail. Peerless Sales, 4322 Sheridan, Lincoln 6, Nebr.

EXPERIMENTERS, Craftsmen, repairmen—409 valuable new springs, 75 kinds, numerous sizes, 10,000 uses. \$2.00. Utility assortment, \$1.00. Deluxe assortment, \$3.00. Jumbo, \$5.00. Guaranteed. Technico, Box 248-A, West Hartford, Conn.

INDEX Heads for sale. Very inexpensive. Sixty-two different divisions. Used on small lathes, drill press, milling machines, etc. Make gears, hobs, cutters, etc. Very accurate, and durable. Not a toy. Used by defense schools and hobbyists. Write for free folder, Long's Index Heads, 2117 East B St., Torrington, Wyo.

ENGINES, MOTORS, DYNAMOS

BIG Pay jobs in welding. Complete welding lessons and reference books. 516 pages. 41 lessons. \$2.00 copy. Money-back guarantee. Hobartweld, Box 1065-M, Troy, Ohio.

SEL-SYN Motors; 110 volt, 60 cycle, a.c., army surplus. Can be used for remote control, beam antennas, bingo, signaling, wind indicators, many other uses. Light weight, high torque. Original cost \$100.00 pair, our price \$20.00 pair. Guaranteed new, original packing. Met Exchange, 323 Canal Street, New York 13, N. Y.

WATER Motors—Cancelled war orders. 3"—\$3.00, 4"—\$4.00, 5"—\$5.00, "6"—\$6.00. Prepaid, order now. Duplex Motors, Burlington, Iowa.

MODEL Engines, castings, supplies, catalogue, 25c. Howardsco, AS, 2417 N. Ashland, Chicago 14.

MOTORS, Small 6 volt d.c. reversible 3000 r.p.m. 2" diameter, short shaft extension, suitable for operating models and gadgets. Postpaid \$1.25. Walthers, 247 Erie, Milwaukee, Wis.

DUPLEX Motors, Burlington, Iowa. The Universal motor built for water, oil, air, steam. Pressures 250 lbs. or less. Specials built to order. Novelty motors \$3.50 and \$7.50 prepaid.

WINDING Data, listing 225 motors, single and three phase, \$1.00. Motor Data Co., Box 7631, Kansas City 3, Mo.

BOATS, OUTBOARD MOTORS, ETC.

BUILD Your own boat, blue prints, list materials and instructions for 12' row-boat \$1, for 16' inboard motor boat \$4 postpaid. P. Boreland, 250 W. 57 St., New York 19, N. Y.

BOATS And all about them. How to select, build, repair and operate. For 40 years the leading practical boating magazine. Trial subscription, 12 issues for \$1.00. Motor Boat, 82 Gold Street, N. W. York 7.

USED Marine motors, propellers, marine fittings, conversion manifolds. Charles F. Stokes, Coldwater, Michigan.

MARINE Power—Easily convert any Ford motor (domestic and foreign) with Osco parts and kits. Complete catalogue 25c (coin). Osco Motors Corp., 2020 East Orleans St., Dept. M, Philadelphia 34, Pa.

USED Outboard motor parts. Outboard Exchange, 1194 Remsen Ave., Brooklyn, 12, N. Y.

FULL Size, cut to shape boat patterns, blueprints. 7 1/2 - 32 feet. Illustrated "Build a Boat" catalog, 10c (coin). "How to Build Boats" book, \$1.00. Cleveland Boat Blueprints Co., Dept. A-66, Cleveland, Ohio.

BOAT Designers are highly paid professionals. Complete course by mail. Catalog, Westlawn, Montville, N. J.

ATHLETIC EQUIPMENT, BODY BUILDING COURSES

BAR-BELLS, Exercise equipment. Courses, Special offers! Free booklet. Good Barbell Co., 3261-PM Watson Rd., St. Louis (9), Mo.

SPORTING GOODS, GUNS, FISHING TACKLE, TRAPPING, ETC.

SCOOP! New .22 bolt action target rifles available for immediate delivery! H&R single shot (.22LR) with new post-war features; 22" barrel, pistol grip walnut stock and full forearm; Lyman rear prep. ramp blade front sights; thumb safety, swivels; weight 6 1/2 lbs. Precision made; beautifully balanced, accurate. Satisfaction guaranteed or your money back. OPA approved price, \$28.24 prepaid. Trade in your old gun, reel, rod, etc.; or send check, money order in full (20% deposit on C.O.D.s.) Klein's Sporting Goods, 501RH South Halsted, Chicago 7.

KRAG Rifles, \$20.00 to \$30.00; antique and modern guns and pistols, war relics, 52 page catalog, 25c coin. Retting, Shokan, N. Y.

INFLATABLE Rubber boats and life-belts—(Dual life preserver belts.) Ideal for sportsmen. Belts use Sparklet cartridges or inflate by mouth. With cartridges, new, \$2.98. Mae West life vests, used, repairable, with repair kit, for mouth inflation \$2.95. Used but tested and guaranteed \$3.95. New (seconds) with automatic inflation \$9.95. Collapsible rubber boats \$39.50 to \$99.50. Order from this advertisement or write for circular. Karl Ort, Dept. PM-6, York, Penna.

GUN Bluing solution, (hot water, chemical process) formula, instructions, 25c. F. Washburn, Battle Ground, Indiana.

TRAPPERS—Catalog listing our famous lures, methods free. V. Tingley, Coudersport, Penna.

GUNS Refinished like new by factory methods, as used by leading gun manufacturers. Send for circular. Middletown Metal Finishing Company, 45 River Road, Middletown, Connecticut.

2000 BARGAINS, Firearms, binoculars, war relics, catalog 30c. Smith Firearms, Rummel, New Jersey.

AMMUNITION Available to qualified purchasers. List 10c. Rudolph's, Atchison, Kansas.

SEND 10c For list 100 used guns. Frayseth's, Willmar, Minnesota.

USED Guns, bought, sold, exchanged. List stamp. Howe Fur Company, Coopers Mills, Maine.

FIELD GLASSES, MICROSCOPES, TELESCOPES, MAGNIFIERS

MAKE Your own efficient compound microscope. Lenses and instructions \$5 to 200 power \$2.00, 400 to 800 power \$3.00. Instructions alone 10c. Carl Jamer, Manorville, N. Y.

BINOCULARS, Telescopes, watches. Buy, sell, trade. Paul Schweer, Donnellson, Iowa.

REAL 17 Power telescopes \$3. United, 2309-P Lawrence, Toledo, Ohio.

STEP Up your vision 40 times! Master Magnifier No. 40 magnifies 40 diameters, furnishes its own bright illumination, is fitted with scale, intervals of 0.001 inch. Shows clearly many things invisible to normal vision and measures to within 0.001" minute details not measurable by other means. For precision inspection of textiles (weave, strands, uniformity of dyeing), paper, printing, engravings, fine cracks in weldings; crazing in plastics; texture, pinholes and blisters in plating; incipient corrosion; deterioration of paint, varnish; degree of polish, smoothness, accuracy and wear of dies, tools, fine edges, sharp points; fineness and uniformity (adulteration) of powders. Many applications in industry, technical problems and scientific hobbies. Battery model: \$38.50, Electric model: \$42.35. Portable case: \$4.00. Full details free on request or you can send order with remittance on absolute 30-day money-back guarantee. Address R. P. Cargile, 118-P Liberty Street, New York 6, New York.

BUILD Your own telescope objectives and mirrors, plans, parts. Send for free list. Mayfor Prod. Corp., Katonah 1, N. Y.

MAKE Your own powerful, efficient astronomical telescope. Perfect lenses and instructions. 50X \$1.00, 100X \$2.50, 200X \$3.50, 400X \$5.50. Instructions alone 10c. Carl Jamer, Manorville, N. Y.

TELESCOPES, Microscopes, cameras, binoculars: bought, sold, repaired. Lists 10c. Specify instrument wanted, Rasmussen and Reece, 41 Market, Amsterdam, N. Y.

ANTIQUE, RELICS, INDIAN GOODS, CURIOS

SWORDS, Rapiers, daggers, pistols, armor. Illustrated catalog 25c. Robert Abels, 860-A Lexington Ave., New York.

MUSEUM Supplies—27 specimens Indian relics, fossils, gemstones \$3.50. Illustrated catalogue, identification chart 25c. Museum Supplies, 6601 Oshkosh, Chicago 31, Illinois.

50,000 ANCIENT Indian arrows, tools, rainbow variations. Don McKillop, Regina, Sask.

COINS, Minerals, glass, Indian relics. Catalogue 5c. Cowboy Lemley, Las Cruces, New Mexico.

ANTIQUE Firearms, swords, daggers, powderhorns, tomahawks. Lists free. Nary's, 8 South 18th, Philadelphia 3, Pa.

ANTIQUES List 25c. "Antique Shop," 111 1/2 W. High, Piqua, Ohio.

DOGS, PETS, BIRDS, RABBITS

RAISE Snowwhite English Angora rabbits. Wool sells as high as \$14.50 a lb. Send 25c for literature. Snowwhite Angora Colony J. Malta, Mont.

BE Independent! Raise Angora rabbits. Booklet 50c. Wool brings \$14.50 per pound. Angora Farm, Kensett, Iowa.

PIGEONS—Bargains! Genuine racing homers \$1.50 each—\$12.00 dozen. Morris Farm, Batavia, Ill.

DOG Owners—Teach your dog to retrieve! Send only \$1.00 for complete instructions. Box No. 392, Westfield, N. J.

ST. BERNARD Pups: Champion sired beauties. Franklin Young, Rt. 4, Riverhead, Long Island, New York.

ANGORA Rabbits—Wool brings \$10.00 pound! Book "Angora Care-Management" tells everything, \$1.00. Self-cleaning scientific hutch (for all rabbits), plans, specifications \$1.00. Automatic feeder plans \$1.00. All three \$2.50. Catalog pedigree Angoras free. Grinsteads, Dept. 15-A, Edwardsville, Illinois.

TRICKS 'N' Tips—The quick ways to teach your dog simple tricks. Send 25c to Box No. 392, Westfield, New Jersey.

REAL Chinchilla giants—Most profitable. Prolific, easily raised anywhere. Breeders supplied reasonable. Satisfaction guaranteed. Send for free illustrated literature, fur sample. Chin-Chin Farms, Melvin Behrens, Gen.-Mgr., Dept. 4, 44 Chester Pike, Darby, Penna.

RAISE Moneymaking Angora rabbits. Wool \$10 pound. Plenty markets. Particulars free. White's Rabbitry, Lawrence, Kansas.

MONEY Raising rabbits. Investigate. Polder 10c. Close Rabbitry, Tiffin, Ohio.

RABBITS: Flemish Giants, New Zealand, Reasonably priced. Franklin Young, Riverhead, Long Island, New York.

RAISE Giant Chinchilla rabbits. Valuable fur. Delicious meat. Easily raised. Pleasant pastime. Large profit. Free booklet shows amazing profits from small investment. Willow Farm, R15C, Sellersville, Penna.

STANDARD Rabbit Journal, Milton, Pa. 3 years \$1.00, sample dime.

RAISE Guinea pigs. Make money at home. Big demand. Free booklet. Taylors Guinea Pig Farm, Hapeville, Georgia.

RAISE Giant Chinchilla rabbits. Willow Farm, R15C, Sellersville, Penna.

A LIVING With rabbits and cavia. Markets waiting. Magazine 10c. Book describing twenty breeds and magazine 25c. Book and magazine (monthly) one year 50c. Address Small Stock, Dept. 2, Pearl River, N. Y.

POINT Free meat—Raise delicious domestic rabbits. Small space needed. Ready market. Largest magazine in the industry tells you how. \$1.00 per year. Send dime for sample—no stamps. Small Stock Magazine, Lamoni 2, Iowa.

SHEPHERDS, Collies, terriers, airdales, trained dogs. Edmond Stone, Chariton, Iowa.

PUPPIES And supplies; also pedigreed Flemish Giant meat rabbits and supplies; what do you need? Royal Kennels, Chazy, N. Y.

FARMS, FARM LANDS, REAL ESTATE

ALASKA Homesteads, trapping, etc. Large list of free booklets 25c. Barwoods, 2037 42nd St., Astoria, N. Y.

FOR Sale: 78 acres land, enough cultivation to make living, \$1000.00 worth timber, house, barn, good fishing, hunting. Bob Pace, Combs, Ark.

40 ACRES Virgin Missouri land \$125. Terms and complete Ozark information. Write Armstrong, Shook, Missouri.

FREE Catalog, farm bargains, 7 mid-west states. Many fully equipped for convenient quick start. Many pictures. Special service to help you locate quickly, if you state requirements, payment plan and general location desired in first letter. United Farm Agency, 491-MP Arcade Bldg., 1, St. Louis, Mo.

STROUT'S New fall farm catalog just out! Hundreds of bargains from Maine to Florida, west to California and Oregon. Save time, gas, money. Write today for this book. Free. Strout Realty, 255-P 4th Ave., New York 10, N. Y.

WEST'S Fall catalogue hundreds farm bargains, business opportunities Penna., New York, New Jersey, Ohio, Delaware, Maryland. Free copy. West's Farm Agency, HE, Pittsburgh 16, Penna.

WISCONSIN, Minnesota water frontages \$7 acre. 3505-A So. Hope, Los Angeles 7, Calif.

OZARK Farms, ranches, resorts. List free. Farm Finders, Lonsdale, Arkansas.

\$5.00 MONTHLY Buys 40 acres near town; price \$175.00. Free list. Box 425-P, Carthage, Mo.

HOMESITES \$300—Low terms. California's finest garden spot. On Morro Bay's wooded shores. Wonderful fishing, hunting, boating, etc. Fertile soil, soft water, temperate climate, congenial community. Free literature. Richard M. Otto, 6560 Hollywood Blvd., Hollywood 28, Calif.

OZARKS Guide, Lonsdale, Arkansas. Magazine for homeseekers, sportsmen, year \$1.00.

OZARKS Guide, Lonsdale, Arkansas. Magazine for homeseekers, sportsmen, year \$1.00.

OCTOBER 1945 53A

GOOD Farms—Ranches. Washington, Minnesota, Montana, Idaho, Oregon, North Dakota. Dependable crops, favorable climate. Write for literature, lists describing typical farms. Specify which state. J. W. Haw, 119 Northern Pacific Ry., St. Paul 1, Minn.

OSARK Farm bargains. 5 to 5000 acres. Frank, Mountain View, Mo.

POULTRY AND FARM SUPPLIES

ROTARY Vacuum pumps for milking machines, pump only \$60.00. William Reid Co., 2271 Clybourn, Chicago 14, Ill.

AVOID Unnecessary trouble on tilling, seeding, haying, harvesting machinery, tractors, water supply, lawn mowers, stokers. Learn about fire prevention, lightning protection, weights, measures, etc. Order our new book, \$1.00 postpaid. Wirtson's, West Burlington, Iowa.

KNOW How to raise poultry for profit. Read *Northeastern Poultryman*. Every issue packed with helpful hints and practical suggestions. Latest articles on breeding, feeding, and management. Read nationally. Subscribe now, 1 year 65c; 2 years \$1.00. *Northeastern Poultryman*, Dept. M, 376 Boylston St., Boston 18, Mass.

RAISE Turkeys the new way. Write for free information explaining how to make up to \$3000.00 in your own backyard. Address National Turkey Institute, Dept. 3, Columbus, Kansas.

PROFITABLE OCCUPATIONS

MEN—Get into business for yourself—cleaning and polishing floors and walls in hotels, hospitals, stores, offices, show rooms, etc. Franklin's new method and top quality products make work easy and highly profitable, with assured repeat business. Write for free plan. Franklin Research Co., Dept. PM, 5134 Lancaster Ave., Philadelphia 31, Penna.

A LOCOMOTIVE Engineer or railroad conductor is interesting work. Information on how to obtain these positions 50c. The Student Railroader, Box A53, Elmhurst, Ill.

SELL By mail! Fascinating, profitable. 25c brings sample booklet, circular, confidential prices. J. Jones, Box 172, Phenix City, Alabama.

BE Independent! Become associated with us in an essential proven profitable profession. Universal Exterminators, 950 Margate Terrace, Chicago 40, Ill.

DOES \$5000 Yearly from your own collection-credit bureau business sound good to you? We've shown others how. Why not you? Write: Cole & Associates, Syracuse, N. Y.

CASTING Plastics instructions 50c. Plastic \$1.00. Alvin, 553 William, Winnipeg, Manitoba.

MECHANICALLY Inclined men—Own and operate general appliance repair shop. Complete, illustrated course shows you how. Welding, refrigeration, motor repair, how to get business, etc., all phases covered. Free literature. Christy Supply, Dept. 457, 2835 N. Central Ave., Chicago.

WELDING Pays. Learn with 1942 trade school text manual, 516 pages. Over 500 photos. \$2.00 copy. Money-back guarantee. Hohartweid, Box M-1653, Troy, Ohio.

DOUBLE Your money back if not delighted with description, new mail-order profits! Rush 10c. MacCormack, 10-J, Madeira, Ohio.

SILVER Plating. Instructions 50c chemicals \$1.00. Alvin, 553 William, Winnipeg, Manitoba.

PRESERVE Written war experiences for priceless family history. Easy. Instruction \$1.00. Also new, simple short story writing study, complete, \$5.00. Circular free. Myers, Postoffice Box 1504, Central Station, Toledo, Ohio.

LEARN Collection business. Start your agency at home or small office. Dignified, profitable, easy. Complete home course. Free booklet. Pacific School, 1272 So. Bronson, Los Angeles 6.

PEACE! Can start you rising in new radio field! Thousands new nontechnical salaried radio positions! Learn in one week! Postcard brings free data! Topical Emprise Corporation, Box 42 R, Louisville 4, Ky.

BABY Shoes preserved. Complete instructions. Exclusive rights. M. E. Watson, Bellefontaine, Ohio.

START Advertising and letter shop. Complete low cost home training shows how. Free booklet. Pacific School, 1272 So. Bronson, Los Angeles 6.

HOMEWORKERS. Make, sell, shell jewelry, novelties. Beginners kit, \$1.00. Catalog free. Burton, Box 37, Station A, St. Petersburg, Fla.

MAKE \$300 To \$3000 a year in your back yard in your spare time raising our OWEI meat and fur rabbits. We start you right and teach you how and where to sell. Outdoor War Efforts Industries, Owatonna, Minnesota.

GROW Green vegetables in cellar, six days. Sell hotels, grocers. Instructions, seed \$2.00. Temple, Pinnellas Park, Fla.

GINSENG Fall planting instructions dime, seeds reasonable. Specialty Farm, Rockford, Minn.

EXCEPTIONAL Profits raising mink. Finest breeding stock available. Details furnished. Franklin Young, Riverhead, Long Island, New York.

START A home business in spare time. Make extra money. Experience not essential. Literature free. Rolf S. Iverson, Box 915A, Grand Central Annex, New York 17, N. Y.

ELECTRIC Clocks are every where you go, buildings, homes, parking lots, factories. Repairs increasing. Our easy to learn course with pictures and drawings teach you how to repair these clocks. Electronic Supply Co., Dept. A, P.O. Box 2350, Houston 1, Texas.

TYPEWRITER Repairmen urgently needed. Earn \$40 to \$50 weekly spare time. Our easy to learn home study course teaches how to repair typewriters. Write for free information. Houston Typewriter Repair Service, P.O. Box 5357C, Houston, 13, Texas.

\$40.00 WEEKLY Made growing mushrooms, fresh, dried. Dominion patent 331583. Free spawn. North American, 1629 Yonge, Toronto, Canada.

TYPEWRITER Repairing—Original course, simplified home study. Weber Typewriter Mechanics School, Box 269, Osborn, Ohio.

MUSHROOMS Grown: boxes, barrels. Instructions 50c. Spawn \$1.00. Gordon, 553 William, Winnipeg, Manitoba.

GOLD-STAMPING. Exceptional post-war opportunity. Free booklet. Home City Specialties, Dept. 1273, Springfield, Massachusetts.

LOCKSMITHING—Profitable business or hobby! New course teaches you how to pick locks, fit keys, de-code, masterkey, etc. Easy self-instruction lessons. Bargain price. Free details. Write—Nelson Company, Dept. 1-02, Chicago 4.

ANNOUNCING Home study course in commercial baking. Practical basic training. Good field for those with aptitude. Nearly depression proof. Send for free booklet, "Opportunities in the Baking Industry." National Baking School, 1315 Michigan Ave., Dept. 3431, Chicago 5, Ill.

BOOKS, PERIODICALS, PICTURES, POSTCARDS

PACIFIC War pictures, latest scenes, new series of 11 different packets, each containing 10 actual glossy photographs, 2½" x 3½", of Saipan, Tarawa, Namur, Marshalls, Solomons, Admiralties Islands, etc. 25c single packet, 5 assorted \$1. Special: All 11 packets \$2. Postpaid. (Via airmail, send 10c per packet additional.) Satisfaction or money refunded. Lloyds, 1411-OP Northwest 17th, Oklahoma City 6, Oklahoma.

SUBSCRIPTIONS Any magazine, trade journal. Printed catalog 10c (refunded). Cassell Publishers Service, Westfield, N. J.

BOOKS Found. Scarce, out-of-print books supplied quickly. Send list of books wanted. Any subject. Reasonable. Clifton, Box 1377pm, Beverly Hills, Calif.

WHAT Every Mason wants. We have Masonic books for Blue Lodge, Chapter, Commandery, Scottish Rite and Shrine. Our rituals are used the world over. Send for free catalog of books and rituals for Masons, Odd Fellows, Knights of Columbus, etc. Ezra A. Cook, Publisher, P.O. Box 796-PO, Chicago 90, Ill.

FREE Membership in our Technical Book Club entitles you to current literature, guiding advice on all your book problems, premiums. No obligation. All books: technical, aeronautics, automotive, building, construction, electricity, radio, television, electronics, mechanics, mathematics, chemistry, plastics, optics, watchmaking, all homecrafts, woodworking, business, sports, photography, farming, music, languages, occultism, astrology, etc. Free literature, specify subject. Modern Technical Book Co., Dept. 2MMC, 55 West 42nd St., New York 18.

BEAUTIFUL Colored pictures. Lists free. No girls. Curtis, Box 1918PM, Denver 1, Colo.

MECHANICAL, Technical, electrical, aircraft books and magazines. Over 200 fields. Specify. Free price list. Midwest Publications, 363 Paul Brown Building, 818 Olive St., St. Louis, Missouri.

VETERANS' Journal, the first and only independent veterans' publication in America. Sample copy ten cents. Yearly subscription one dollar. *Veterans' Journal*, 1428 S. Penn Sq., Philadelphia 2, Pa.

FIGHTERS Pictures! All kinds. \$x10. Decorate barroom, den, workshop. Free list. Barry Reid Co., Box 74, Sunnyside 4, Long Island, N. Y.

WE Can supply you with almost any book or phonograph record album. House of Berbeck, (Book Dealers), Box 2862, Detroit 31, Mich.

22 BEAUTIFUL Audubon bird prints, 9" x 12½", full colors on finest paper. Ideal for framing, home, office, club, school, den, stores; also gifts. \$2.95 postpaid. No C.O.D.s. Creste-Anderson, 415M Lexington, New York.

MAC ARTHUR Authentic biography. Inside story of Philippines defense. Dollar and half. Eugene McLean, 1325 Bryant Street, Eureka, California.

MAGAZINE Subscription agents wanted. Everything supplied 10c. New York Circulation Service, 30 Church Street, New York 7.

GOING In business? A list of books giving expert advice and suggestions free. Recommended book list on any subject free. Helpful Book League, 15 East 40th St., New York 18, N. Y.

BOOKS For architects, artists, craftsmen. Catalog, 3c. Artcraft, Box 6827, Baltimore 4, Maryland.

MONEYMAKING Books, free list. Industrial Research Analyst, Boston 19, Mass.

3 SALES Books 50c. Hedemark, 1216 Park Row, New York.

RELIGIOUS, Educational books, gifts, greetings. Lists free. Marie Gilpin, 7318 Beatty, Fort Wayne 6, Ind.

LATEST G.I. cartoon book 50 "Famous Firsts" in the army. A souvenir valuable to discharges, and a chuckle for those going in, or in service now. Data on point system and G.I. bill of rights. Ideal Christmas gift. Order today. Send \$1.00 to author (postpaid anywhere). Capt. V. Wesley Carmack, Convoy Section, Ft. Sheridan, Ill.

BACK Number magazines. Fleischhacker PM, 1642 N. Fairfield, Chicago, Ill.

BOOKS! Magazines! Art! Money-making opportunities! Free lists! Hirsch, Spring Valley 2, N. Y.

HISTORY World War II, Educational and other books. Bibles. Literature free. Premiums given. J. Henry Schlake, Box 813, Cincinnati 1, Ohio.

TRADE Magazines. Business, vocational, diversion. Current single copies. Over 200 fields. Free price list. Commercial Engraving Publishing Co., 34C North Ritter, Indianapolis 1, Indiana.

BOOKS. (Out-of-print, new, used) quickly supplied. Many 35c bargains. Catalogue. Mid-West Book Service, 18870 Marx Ave., Detroit 3, Mich.

JOIN Bonus Book Club. Save half. Bookmaster, Box 583-D, Stillwater, Okla.

RARE, Out-of-print books located. Bookfinders, 1210N 11th Ter., Birmingham, Ala.

BIG Profits taking subscriptions for all magazines. Agents' confidential catalog listing over 2500 periodicals and complete starting supplies free. Pines Subscription Agency, Flushing, New York.

OUTSTANDING Books! Sample and lists 25c. "Association," Box 2501-P, Los Angeles.

MAGAZINES (Back dated)—foreign, domestic, arts. Books, booklets, subscriptions, etc. Catalog 10c (refunded). Cicerone's, 883 First Ave., New York 17, N. Y.

"100,000 POST-WAR Jobs Abroad"—South America, China, India, Burma, Japan, Russia, Malaya. How, when and where to apply. Post-war U. S. participation in world reconstruction and trade demands thousands of American-trained mechanics, salesmen, technicians, engineers, foremen, laborers and business representatives—every trade needed. Our 15,000-word copyrighted forecast—compiled from business, professional and government sources—lists over 200 big U. S. firms with foreign interests, gives job information, salary brackets, contract tips, application letters, passport information, climatic conditions, etc.—everything needed for your immediate application. \$1.00. Return for refund in 7 days if not satisfied. Pacific Industrial Research Bureau, 202-E Studio Building, Portland 5, Oregon.

PROOF Of earth's concavity, 225 pages, \$1. Theocracy, B1720 Hough, Ft. Myers, Fla.

A RATIONAL View of Life \$1.00. Benjamin Seibert, Urbana, Ohio.

REBINDING: We bind magazines, old books, Bibles, hymnals. Heckman Bindery, Dept. D, North Manchester, Indiana.

GAMES, ENTERTAINMENT

PASCINATING New card game. Free. P.O. Box 842, Denver 1, Colo.

MAGIC Races—Cigarette touch starts lines glowing. Sample and formula \$1.00. Fire ink writes secretly. L. Sobolewski, Box 519, Midlothian, Illinois.

PASCINATING Fun with "Thirteen Rummy" card game! Folding felt board with 350 chips for \$1.98, money back if not satisfied. D'Autremont, Dayton 2, Ohio.

MAGIC TRICKS, PUZZLES, JOKER NOVELTIES

DON'T Pass this opportunity for a riot of fun wherever you go. Learn "Double-talk" in ten minutes with simplified instructions. Guaranteed. Free novelty included. 25c. Cable, 2069 W. 59, Cleveland 2, Ohio.

WANTED: 4000 Members to join "Mysto Magic Club." Remit \$2.00, receive trick each month for one year. Large magic catalog, book of 102 easy tricks, also 75c cork trick. Don't delay. Howard's Fun Shop, 908 1/2 Travis, Houston 2, Texas.

ENTERTAIN Friends with professional magic. Catalog 25c. Herbert, P-192 No. Clark, Chicago 1.

84 CARD Tricks and our latest catalog of magic tricks only 25c. Ball Square Company, Dept. 23-H, 697 Broadway, Somerville 44, Mass.

AMAZE! Mystify! Become magician! Earn big money! Fascinate friends! Half pound circulars, listing hundreds revealing books, startling secrets, mysteries, apparatus, illusions. 25c. Neimar, 2851 Milwaukee, Chicago, Illinois.

MAGIC Bulletin and catalog—free. The Magic-Craft Studio, 2307-N. 34th St., Milwaukee, Wis.

BECOME Comedian! Free details! Kleinman, 25-31-B 30th Road, Long Island City 2, New York.

250 MAGIC Tricks only 10c. Rush! Magic Mart, 1423 Palou, San Francisco 24, Calif.

FLOATING Cigarette trick. Cigarette floats in mid air, with instructions, dime. Eastwood, Box 623, Parkersburg, W. Va.

TRICKY Match box, it turns around! It stands up! and it opens, most weird uncanny magic novelty trick. Complete ready to do. 25c. The Magician, 2463-M, Kensington Ave., Philadelphia, Penna.

MAGIC: Big 160 page Illustrated Catalog Latest Magic Goods. 25c. For over 1/3 century we have supplied Professional as well as Beginner. Chicago Magic Co., 2300 N. Mason, Chicago 39.

EARN Money in any crowd. Call names of strangers, tell unspoken questions. Professional course mind reading, faked spiritualism, etc., \$1. Henderson, Box 341, San Bernardino, Calif.

LEARN Magic—Two new books with 100 amazing tricks, sent to you with our new well illustrated catalog—\$2.50 value sent for \$1.00 postpaid. Fast service. Loftus Magic Company, 119 1/2 South Main Street, Salt Lake City, Utah.

SURPRISE, Astonish, thrill, with empty hands, make clouds of smoke appear from fingertip or huge snow flakes float in air also make a five foot ribbon with empty hands, etc. Easy to do with Magic Paste, special 2 tubes enough for 70 tricks \$1.00 postpaid with big magic catalog. The Magician, 2463-M, Kensington Ave., Philadelphia 25, Penna.

ATTRACTIVE Magic kit of 10 tricks (\$2.50 value) \$1.00 postpaid. Kogel's Magic Novelty Co., 6751-A Colbert St., New Orleans 19, La.

10 MAGIC Tricks and catalog, 25c. Magical Enterprises, Levering, Michigan.

LEARN Ventriloquism, 3c stamp brings particulars. Smith, 801 Bigelow, Peoria, Ill.

"MAGIC Vanishing card." Throw it into air, it completely disappears, reproduce it later from spectator's pocket. Easy to do. Complete 25c with magic catalog. The Magician, 2463-C Kensington Ave., Philadelphia 25, Penna.

AMAZE And mystify your friends with highest quality magic. New catalogue 25c coin. Mazda Magic Co., Fond du Lac, Wis.

FREE! Large catalog of magical apparatus if you remit 25c for book "102 Easy Tricks." Robbins Co., 152-P West 42nd Street, New York.

500 TRICKS You can do! Douglas's famous catalog of 500 tricks, now only 10c. America's fastest service on magic for pocket, parlor, stage, professional, amateur. Douglas Magic Shop, Box 274, Dallas, Texas.

VENTRILLOQUISM. Complete course only \$1. LeSueur, 77 Wellesley, Toronto, Canada.

NEW Vanishing job and catalog 25c. Sterling Magic, 345 John R, Detroit, Mich.

BE A magician. Large professional magic catalogue of latest tricks 25c. Ireland, C-109 North Dearborn, Chicago 2.

MAGIC Tricks, puzzles, books, cards, punch boards. Catalog 10c. Specialty, Box 871, St. Louis 1, Mo.

COINS, TOKENS, CURRENCY

OLD Money wanted. Will pay fifty dollars for nickel of 1913 with Liberty head (no buffalo). We pay cash premiums for all rare coins. Send 4c for large coin folder. May mean much profit to you. Numismatic Co., Dept. 20, Fort Worth, Texas.

RINGLING Brothers circus scrip, complete set 5 \$1.00; 13 wooden nickels \$1.00; both \$1.65. Super bargain list 3c. Bebee Coin Company, 1180 East 63rd, Chicago 37, Illinois.

30 DIFFERENT Lincoln cents \$1.50. American catalog premium list all coins \$1.00. J&R Coin Dealer, Box 23, Sta. E, Buffalo 11, N. Y.

FOREIGN Coin and lists 10c. 20 different coins \$1.00. Oddehon, Box 482, St. Louis, Mo.

WE Purchase Indianhead pennies. Complete coin catalogue 10c. Allen Fairview, 277 Broadway, New York 7.

WILL Pay \$10.00 each for certain Lincoln pennies! Indianheads \$50.00; dimes \$1,000.00. Catalogue 10c. Federal Coin Exchange, 9-PM, Columbus, Ohio.

40 MIXED Indian cents \$1.00—50 different cents from 50 different countries \$5. Lists, approvals. DelMonte, 725 West 172, New York 32.

50,000 COINS. Confederate, Philippine invasion bills. Illustrated lists free. Nagy, 8 1/2 South 18th, Philadelphia 3, Penna.

WE Pay from \$2.00 to \$50.00 each for hundreds old, odd coins. Indian and Lincoln cents wanted. Keep all until posted. Send 10 cents for illustrated coin value book 4x8. Buying and selling prices. 40 years in business. Coin Exchange, 5, LeRoy, N. Y.

FOREIGN Coins, 15 different \$1.00 postpaid. Stamp for price list. Milford Coin Co., 486 State St., New Haven 10, Conn.

WORLD Coins, large itemized descriptive list 10c. Harry Elsholz, Box 9014A, Pittsburgh 24, Pennsylvania.

COMMEMORATIVE \$1 1/2. Columbus, Stone Mountain, Texas, Cleveland, \$1.50 each. Illustrated catalogue, 25c. Norman Shultz, Salt Lake 9, Utah.

GET Profit and pleasure in collecting old coins. Send 10c for 56-page illustrated coin catalog. You'll be delighted with it. Send for it now. B. Max Mehl, 370 Mehl Bldg., Fort Worth, Texas. Largest rare coin establishment in U. S. Established 45 years.

QUICK Service; reasonable prices. United States catalog 10c. Foreign catalog 10c. Ben's Coin Company, 72 West Washington, Chicago 2, Illinois.

FREE! Foreign coin, banknote and coin collectors illustrated catalog to approval service applicants. Send 3c postage. Tatham Coinco, Springfield-125, Mass.

OLD STAMPS WANTED

I WILL Pay \$100.00 each for 1924 1c green Franklin stamps, rotary perforated eleven (up to \$1,000.00 each unused). Send 6c today for large illustrated folder showing amazing prices paid. Vernon Baker, (PM-510), Elyria, Ohio.

STAMP COLLECTING

FREE—Tannon Touva "teddybear" triangle. Reunion, Uganda, Tanganyika, old American colony, including stork stamp, war refugees, others—all free with approvals for 3c postage. Dominion Stamps, Arlington, Virginia.

JUNGLELAND Flying fish triangle, tiny "amputated" triangle, enormous American flag stamp printed in six colors, Siberia, Arabia, Spice Islands, 50 year old colonial stamp, others—only 5c with approvals. H. Penny, Rowayton, Conn.

ARE You the sporting type who gets a thrill out of hunting scarcities? For only \$1 we will send you twenty different stamps picked at random from large collections. Order as many sets as you wish. Stamp Sales, Room 206, Commercial Bank Building, 114 N. Carroll St., Madison 3, Wisconsin.

FREE Stamp album. To approval applicants we will send 96-page stamp album for "all nations" with 700 illustrations and spaces for almost 3000 stamps. Enclose two 3c stamps for mailing. Stamp Premiums, Inc., Flatiron Bldg., Fort Worth, Texas.

WHAT Have you to offer? A collection? A "shoe box" accumulation? Anything in stamps. We urgently need them. Spot cash paid. Cosmopolitan Stamp Co., 1457 Broadway, Dept. 10-E, New York.

FREE. 30 Different Cossack diamond, "half stamp" triangle, Gobi, others. Approvals included. Send 3c postage. Pilgrim Co., Waverly, Baltimore 18, Md.

31 DIFFERENT With George Washington stamps from Brazil and Ecuador; Pirate Island; victory issue; medical set; others—all 4c with approvals. Grayson Company, Sherman, Texas.

SUPER Collection: Japanese Philippines occupation, midget set, triangle, air mail stamp showing our Saviour, India, China, Siam, Paraguay, Honduras, Angola pictorials, etc. All for 10c if you ask for approvals. Brown Stamp Co., 2007 W. 75 St., Los Angeles 44, Calif.

BOUNTY Mutiny 5c. Mint set (3) from Pitcairn Island only 5c and postage with request for moderately priced mint British Colonies approvals by serious collectors only. No penny items—references requested. Glen D. Wilson, 711 North A Street, Tampa 6, Florida.

SCARCE Five shilling British stamp only 10c with superb approvals. B. Greenzang, 440 Berriman St., Brooklyn, N. Y.

FREE Packet with approvals. Thompson, 27 Glenwood Place, East Orange, N. J.

DIFFERENT And unusual foreign approvals. Kirklands, 7212 Farwell, Chicago 31, Illinois.

U. S. Mixture—large variety, commemoratives, airmails, old issues, etc. 75c postpaid. Haynes, 7316 Summerfield Road, Toledo 12, Ohio.

AMAZING—Rare Philippine high value, many others, only 10c to approval applicants. Deluxe Approvals, Box 4127, Los Angeles 24, Calif.

SCARCE "Pole to Pole" packet! Stamps from strange, mysterious countries only—Greenland (North Pole), Solomons, Spanish Morocco, Bhopal, Patiala, Siberia, Grahamland (South Pole), Djibouti, Zanzibar, etc., and including stamps cataloging up to 25c each! Our price only 5c to approval applicants. Big dime packet list free! Methuen Stamp Service, Inc., Dept. 138, Lawrence, Mass.

TANNU Tuva triangles. Two of these big, colorful pictorials and 20 different stamps for 10c to applicants for our approval sheets. Alpine Co., Box 536, New Rochelle, N. Y.

WANTED: Mint Korea sheets \$5.35. Bielefeld, New Knoxville 1, Ohio.

100 DIFFERENT 10c with approvals. Jacobsen, 59 Nagle Ave., New York 34, New York.

300 DIFFERENT Given free with approvals. Postage 3c. Windsor Stamps, 1435 East 67 Place, Chicago 37.

FOREIGN Pictorial approvals. Brandan, 1913 3rd Ave. South, Minneapolis 4, Minn.

TURKS, Cocos, Grenada, Brunel, Dominica, Caymans; everything 3c with approvals. Viking, 130(Z) Clinton St., Brooklyn, N. Y.

SMOKY Mountain sheet—approvals 5c. Guy Freese, 154 East Kern Road, South Bend, Ind.

8 ATTRACTIVE Airmails, 3c with approvals and lists. Gaydos, Kenosha, Wis.

YEAR Subscription only 25c! "Stamp Post." Station A, Pasadena, Calif.

NAPOLEON Stamp, seventeen others 4c with approvals. Dollar, 268 East Elmwood, Shreveport 16, Louisiana.

HOW To make money with hobbies. Particulars free. Dun-Mar Co., 227 Hill, Dept. C, Memphis 7, Tenn.

U. S. Price list. Send postage. State Stamp Service, 1225 Park Building, Pittsburgh 22, Penna.

FREE U. S. price list. Postage 3c. Mark Hanna, 335 - 5th Avenue, Pittsburgh 22, Penna.

THE Best United States and Philippine Islands approvals. Largest varieties. America's lowest selling prices. Stamp Company, Albany 7, New York.

20 DIFFERENT Early Turkey—3c with approvals. Premiums with purchases. Brandwein Stamp Company, Box 92, Bayonne, N. J.

1000 WELL Mixed U. S. 25c. Monjar, 1750 Fairmount, Cincinnati, Ohio.

100 DIFFERENT 10c. 40 scarce Philippines \$1.80. 150 U. S. commemoratives \$2.75. Morris Stamp Company, Rockaway, N. J.

100 DIFFERENT Of the world \$1.00. H. Spradlin, 2204 No. L. Fort Smith, Ark.

U. S. Approvals. Better grade. Fast service. Reasonable. Box 488, Minneapolis.

UNITED States approvals. Fine quality—priced right. Klein, 3630 N.W. 21st Court, Miami 37, Florida.

PENNY Approvals by country. M. H. Hoerning, 115, Farmington, Ark.

MYSTERY Packet 10c approval applicants. Standard, 3817 Sackett, Cleveland, Ohio.

CYPRUS, Malta, Mauritania, Kenya, Uganda, Tanganyika; 3c with approvals. Smith, Box 71-A, Roselle, N. J.

FINE Foreign approvals, singles and sets for general collectors. Net prices you will like. Wood, 5719 Wabash, Kansas City 4, Missouri.

BRITISH Somaliland set 10c with interesting approvals. Rheasme, 8949 Routhier, Montreal 12, Canada.

FINE Approvals. Reasonable. Lee's Approval Service, 1440 E. Osborn, Phoenix, Arizona.

NEW Brazil diamonds 10c with approvals. Vargo Stamps, Racine, Wisconsin.

45 UNUSED U. S. commemoratives \$2.00. Will buy collections and accumulations. Mekeel, 2101 E. Market, York, Penna.

NOTICE! Mixed foreign. Better than average condition, 25c per 100, \$1.00 per 500. Satisfaction guaranteed. Karr Ross, De Ridder, Louisiana.

PRESIDENTIALS Complete. (15c—\$5.00) \$1.10. Famous Americans \$1.44. Free catalogue. Jenellaco, 3921 Hereford, Saint Louis, Missouri.

UNCANCELLED Hitler stamps. 10 different \$1.00. War souvenir price list, five German ration stamps 10c. Peters, Box 308-C, Hemet, Calif.

EXCHANGE! Chinese stamps all descriptions. Used or mint. Sets, singles, common or commemoratives. New current bills, revenues, income tax, etc. Prompt airmail service. Inquiries solicited. Daking Briqueite Co., Shiang-Kuo-Shi, Chungking, China.

GERMAN Hitler stamps brought over by American soldiers in small quantities as souvenirs. These stamps are bound to be very scarce because all remainders have been burned by Allied governments. The most unique items in any collection. We will send two values, mint, one regular size and one large size, both for only 10c to sincere approval applicants. Please state whether approvals should consist of United States or foreign or both. Approval Headquarters, Globus Stamp Company, 268 4th Avenue, New York City 10, Dept. 301.

19th CENTURY U. S. commems. Civil War-battleship revenues, \$4 and \$5. Stamps free to U. S. approval applicants. Metropolitan Stamps, 190C Broadway, New York.

UNITED States approvals. Davis Co., 172 Clinton Place, Hackensack, N. J.

PICTORIALS, 50 Different. Wonderful value. 10c. Approvals. Franciscan, 376 Oak St., San Francisco 2, California.

1000 MIXED U. S. old and new 25c. Kolona, Troy 3, Ohio.

50 COUNTRIES 10c With foreign approvals. Padiez, So. River, New Jersey.

ICELAND—Excellent free packet. Postage. Frits, 1699 Riverview, Decatur 45, Illinois.

AMAZING! Free! World's smallest stamp, with approvals. Estates, (Box P473), Foxlake, Wis.

FREE Stamp contest. Valuable prizes to all. Gerhardt, 2804 Rio-grande, Austin, Texas.

PITCAIRN Islands—first three values mint. Only ten cents to approval applicants. Thiem, 1100½ St. Paul, Rochester, N. Y.

30 BEAUTIFUL Airmails, 10 selected approvals. Louis Morrison, Millmont Park 1, Penna.

GENUINE Confederate stamp 10 cts. Approvals. Kataja, Sherbrooke Ave., Hartford 6, Conn.

ALL-WORLD, 1500, large variety, \$1. Missions Outlet, Rev. Marshall, Paterson 1, N. J.

IMPORT Your own! Information \$1.00. Soules, Alma Ave., Menominee, Mich.

PREMIUM Approvals, British colonials, Latin American. Thirty-five diff. Canada to applicants enclosing (five cents 3c). "Crescent Stamps," London, Canada.

POSITIVELY Greatest free offer—Latest Scott's International \$5.00 Stamp Album—covering entire world, contains 38,000 illustrated, descriptive spaces; Scott's 1945 Standard \$5.00 catalogues "Philately's Encyclopedia"—absolutely free to applicants for foreign approvals becoming customers. Plymouth, A-8, Bell, Calif.

OVERSEAS Veteran brought back many stamps. Free new U. S. memorial with 25 foreign stamps 25c. Ball, 2329 Third, Trenton, Michigan.

EXOTIC Pictorial collection: Tahiti spearfishing, Melanesian idol, Carib archer, Columbo harbor, Reunion produce, Jugoslavia, Philippines, Porto Rico, Malagassian farmer, Dutch Indies, South Africa, Roman's charity, Martinique settlement, Newfoundland codfish, Djibouti locomotive, Victoria. Everything only 5c. Imperial Stamp Co., Yonkers 1, N. Y.

CHOICE African packet 50 all different. A galaxy of scenes showing lions, tigers, native chiefs, and jungle villages. All for ten cents to serious approval applicants. Detroit Postage Stamp Co., Dept. M, Detroit 21, Mich.

HAWAII—Three old Hawaiian stamps, only 10c with approvals. Western Stamps, Box 4042, Los Angeles 24, Calif.

SPECIAL—Airmails, 19 different, including seppelin, triangles, Latin-America, 5c with approvals. Continental Company, (Dept. B), Box 606, New Rochelle, New York.

ONE, Two, four, five-dollar U. S. stamps free to approval applicants. United Stamp Service, Box 1789-M, Miami 10, Florida.

CHOICE Approvals 1/2c up. Stamps, 1267 Tutwiler, Memphis 7, Tenn.

PENNY Approvals, that satisfy. Neil Gronberg, Box 5441-P, Philadelphia 43, Penna.

LIBERAL Offer, thick packet with Seychelles, Fiji, U. S. commemoratives, Tete, Djibouti, Inini, Congo, Porto Rico, Philippines and multitude others. Everything only 10c to approval applicants. Burmaster, Box 1910 A, Los Angeles, Calif.

EXOTIC Pitcairn Islands! Besauteous French Colonies, gorgeous Tonga—Everything 3c with approvals! Extra! Extra! First 200 collectors answering ad receive additional gift. Saxons, Valley Stream, N. Y.

COMPLETE U. S. and foreign departments, prompt personal service. Fair prices, return postage paid. Atwater, P.O. Box 1583M, Miami 35, Florida.

BRITISH Colonies and South America on approval. Theo. Stevens, Box 3706, Kercheval Station, Detroit 15, Mich.

FREE—25 Different unused foreign stamps to approval applicants sending 3c postage. Universal Stampco, 1216-C Park Row Building, New York 7, N. Y.

EXCELLENT Pictorial approvals. Reasonably priced. Crown Stamp Company, Box 331, Toronto, Canada.

ALASKA Embossed air mail cover with photo stamp. Attractive. Unique. Send 15c stamps or coin. Arctic Cachet Company, Box 118, Ketchikan, Alaska.

RICH Man's approvals, poor man's prices. Grand value packet containing five mint sets, free with approvals. Stoll Stamp Service, 2630B West Burnett, Louisville 10, Kentucky.

PACKET Scarce United States before 1910. Only 10c to approval applicants. E. J. Banks, 6635-16 Ave., Kenosha, Wis.

APPROVAL Sheets. Frederick B. Driver, 401 Finance Building, Philadelphia 2, Pa.

55 DIFFERENT United States—5c. Approvals. Utechts, 1143 C North Keeler, Chicago 51.

TRIANGLES—(Mozambique Co.) other beauties. 10c. Approvals. Reuter, 611-C West 40th, Los Angeles 37.

FREE Packet with attractive approvals that satisfy. Pearl Field, Derby, Maine.

25 DIFFERENT Guatemala 10c with 1/2, 1/2, 1c approvals. Carroll's, 4357A S. Hoover, Los Angeles 37, Calif.

U. S. Price list. Send postage. Stanley Gibbons, 38-P Park Row, New York.

FREE—Pick 25c worth of stamps from our first U. S. approval selection. Approximately 100 stamps to choose from. Excellent value. No obligation to buy. Lists illustrating the most popular U. S. stamps—at prices you can afford—will be included. Don't miss this opportunity! Write today. S. C. Engel Co., 38 Park Row, New York City.

WOW! \$10.00 Worth of fun—only 10c! 500 foreign stamps, unsorted and unpecked, just as received from church missions, other sources. Africa, So. America, Australia, China, Philippines, Dutch Indies, and other countries. Includes few commemoratives, airmails, and stamps cataloging up to 25c or more each! Biggest value in stampdom—and you might find something really valuable! Price only 10c to serious approval applicants! Money back if not delighted. Jamestown Stamp Co., Dept. 22, Jamestown, New York.

114 DIFFERENT Stamps from far away countries including airmail and Free Fighting French to approval applicants for 10c. Reich Stamp Co., 4647 Kenmore, Chicago 40, Dept. M9.

COMPLETE "United States" catalog with 1000 illustrations! Send 10c for mailing. Harris & Co., 137 Transit Building, Boston, Mass.

SMOKY Mountain commemorative sheet, largest U. S. stamp issued, and 23 U. S. including commemoratives, airmail, revenues, etc. Catalogs 75c—To approval applicants for 5c. Curhan Stamp Company, Gloucester, Mass.

U. S. Collection fifty different mint un-issued commemoratives 1921-1939 only \$2.00 with your request for approvals. Orange Stamp Company, Albany 7, N. Y.

UNITED States approvals complete coverage, fine quality, attractive prices. Seminoles Stamps, Box 435, Coconut Grove, Florida.

AMAZING Offer! Assortment each of giant stamps, midget stamps, flag stamps, airmail stamps, Free French Colonies, U. S. commemoratives and numerous others. Everything only 10c to approval applicants. Simon, Box 214, Iraan, Texas.

60 DIFFERENT U. S., 10c. Pricelist free. Seidenberg, Cassopolis, Mich.

FREE! Western Hemisphere packet. Postage 3c. Owens, 806 Welsh, Bay City, Michigan.

FREE! Pony Express set (facsimiles). Postage 3c. Roberts, 406 Building, Bay City, Michigan.

DEALERS—Wholesale list. Postage 3c. Frank, 5631 Queensberry, Baltimore 15, Md.

FREE! British Empire packet. Postage 3c. Williams, 606 Archer, Bay City, Mich.

POUND Bag unpecked stamp mixture containing thousands \$1.00. Longacre Shop, 100 W. 42nd St., New York City.

FRESHLY Mounted approvals for collectors using Scott's International Junior album. Wlaschm, 55 Nagle Ave., New York 34.

SCARCE 1880 U. S.—Hussey local carrier stamp listed at 15c. Also Costa Rica No. 65 listed at 40c. Both sent free to approval buyers sending 3c postage. Pladon Stamps, 1717-M Idaho, Toledo 5, Ohio.

ZOWIE-E-E! A barrel of fun for only a dime. 500 United States—absolutely unpecked and unsorted—just as received from church missions. Many varieties, including large commemoratives, airmails, high denominations up to \$5.00! Stampdom's biggest package of fun—and you might find something really valuable! Price only 10c to serious approval service applicants. Money back if not delighted. Illustrated bargain lists with each order. Mystic Stamp Company, Department 89, Camden, New York.

WORLD'S Largest diamond and triangle stamps, free stamp magazine, stamps from fighting Free French, 20 stamps from 20 different countries, pictorials, airmails, big bargain 5c with approvals, Capital Stamps, Dept. 2, Little Rock, Ark.

118 DIFFERENT Stamps including commemoratives, charities, airmail sets, etc., only 3c to approval buyers. We buy collections. Badger Stamp Co., Milwaukee 3, Wis.

FREE! The Stamp Finder! Send today for the big new edition, fully illustrated, enabling you instantly to identify all difficult stamps! Also fine packet strange, fascinating stamps from Bosnia-Herzegovina, Monaco, Patiala, Cyprus, etc., including maps, ships, animals and strange scenes. All free to approval applicants enclosing 3c postage. Garcelon Stamp Company, Box 900, Calais, Maine.

FREE! Canadian sets, royal visit, George VI, George V, coronation, jubilee, others, to approval applicants. Ensign, Box 118-M, South Orange, N. J.

CANADA 100 Different 25c—approvals all countries. Lists. Victoria Stamp Co., London, 4, Canada.

FREE! Leeward Is., Cayman Is., Turks and Caicos plus 60 different mint Geo. VI coronation poster stamps, to approval service applicants sending 3c postage. Tatham Stampco, Springfield-30, Mass.

DANDY United States approvals. Write immediately. Sullivan, Endicott Arcade, St. Paul, Minnesota.

VICTORY Packet free—Includes stamps from Tanganyika, British Guyana Islands, animal, scarce babyhead, coronation, early Victorian, airmail, map stamps, with big catalogue—all free. Send 5c for postage. Gray Stamp Company, Dept. PM, Toronto, Canada.

HOBBIES AND COLLECTIONS

FOOL'S GOLD—From famous gold camp, 10c per sample. Also mineral specimens from famous local mines. Martin's Snap Shop, 506 Harrison Ave., Leadville, Colo.

500,000 COLORFUL Grass skirts: Wholesale \$1.00, \$1.45, \$1.75 postpaid. Free list. Order airmail. Enterprise Incorporated, Box 51, Rarotonga, Cook Islands, South Pacific.

COLLECTING Hobbyists. Exchange duplicates. List free. C. Bishop, Route 6, Kalamazoo 88, Michigan.

"GENUINE" Arizona "rubies" (garnets). Send quarter for packet. Mineral Specimens, Box 2651, Phoenix, Arizona.

WHITTAKER'S — 20 Patterns, instructions, X-acto knife, wood, \$1.00. "Old Whittaker," 1402 Charles, LaCrosse, Wis.

FOREIGN Decoration ribbons, list, sample, 20c. Foreign insignia packet, booklet, \$1.00. Insigniacrafts, 236-29th Ave. N.W., Calgary, Canada.

EXCHANGE Duplicates. Swappers everywhere. List free. Box 2166, Denver 1, Colorado.

UNUSED Match book covers. 100 all different \$1.00. 35 Royal Flash covers \$1.00. Free list. Charles Edelman, 13110 East 84, Cleveland 3, Ohio.

JEWELRY Stones removed from rings, etc., 100 assorted \$2.40; 50 large ones \$2.40. B. Lowe, Holland Bldg., St. Louis 1, Mo.

RADIO Control—the hobby of tomorrow. Send 25 cents for Instruction Manual to Radio Control Headquarters, Box 214, Deal, New Jersey. No stamps.

COLLECT Colorful army patches. Latest picture book and catalogue only 15c. Insignia Mart, 703 Broadway, New York

MINERALS AND PRECIOUS STONES

CUT Your own gem stones with a B & I Gem Maker, all necessary equipment, less motor and belt, \$29.50 f.o.b. factory. Write for literature. B & I Mfg. Co., Burlington, Wis., Dept. 8.

CAMERAS AND PHOTO SUPPLIES

GARY Camera Co. may help you in your photographic needs. Visit or write us. Gary Camera Co., 619 Washington, Gary, Indiana.

"BIG Bertha" telephoto camera easily made. Trifling cost. Objects miles away photograph close up. Ultra sharp pictures. Telephoto lens and instructions \$2.00. Instructions alone 10c. Carl Jamer, Manerville, N. Y.

USED Camera bargains—Flash Brownie \$1.50, Vest Pocket Kodak Special \$5.00, Graflex \$20.00, 5x7 View \$10.00, No. 828 color camera \$4.48, enlarger \$15.00, movie camera \$5.00, 16 mm. projectors \$5.00, \$3.00. Portrait lens \$5.00. Hundreds of others—35mm. Argus, Leica Contax—Rolleiflex—Roll film, enlarging, contact paper. Send 25c for latest list and descriptions. Used Camera Directory, Box 1631-M, Canton, Ohio.

PORTRAITS: Send for description of "special." Underwood, 3704 VanBuren, El Paso, Texas.

NEGATIVE Etching is easier, smoother with the Paragon-Etcher. Postpaid only \$5.00. M. Pinkerson, 5635 Catherine St., Philadelphia 43, Penna.

NEGATIVE Drying rack: holds 12 negatives—very handy for dark rooms, \$1.25. Extra clips for weights 35c per dozen. Sterling, 505 Elmwood Ave., Brooklyn 30, New York.

BOTTLES, Quart, brown, set of 4 permanently marked—film developer, paper developer, stop bath, fixer—\$1.25. Separately 40c each. Sterling, 505 Elmwood Ave., Brooklyn 30, New York.

LOVELY Lucite picture frames. See Glassite's ad in Moneymaking Opportunities.

CANDID Camera. Build your own. Complete kit of parts \$1.50. Money back guarantee. Free particulars. Hollycam Company, Box 272-B, La Jolla, California.

PHOTOGRAPHY For pleasure or profit. Learn at home. Practical basic training. Long established school. Write for booklet. American School of Photography, 1315 Michigan, Dept. 3431, Chicago 5.

HAVE You a camera? Improve your hobby of photography and learn how to make better pictures. Write today for our latest book catalog and sample copy of American Photography, containing articles and pictures by the world's foremost writers and photographers. Camera House, 601, 353 Newbury St., Boston 15, Mass.

BASS Says: War time proves Bass leadership. Amazing selection of finest still cameras—Leica, Contax, new and used still available. Write for quotations. Satisfaction guaranteed or your money refunded. Bass buys 'em, sells 'em, trades 'em. 35c postpaid for 100 page book "Military & News Photography" by Jack Price. Up to the minute information. Bass Camera Company, Dept. AG, 179 W. Madison St., Chicago, Illinois.

OIL Coloring photographs can be a fascinating hobby or profitable sideline for those with artistic talent. Learn at home. Easy simplified method. Send for free booklet. National Photo Coloring School, 1315 Michigan, Dept. 3431, Chicago 5, Ill.

CASH! Spot cash for cameras, lenses, binoculars, movie or still, sound projectors. Send full description by mail, or wire for prompt cash offer. Over 30 years of dependability insures honorable dealings. 35c postpaid for 100 page book "Military & News Photography" by Jack Price. Up to the minute information. Bass Camera Company, 179 West Madison Street, Chicago, Illinois.

PHOTO FINISHING

6-8 EXPOSURE Rolls developed and enlarged mammoth size 30c. Reprints 3c. Thrifty Photos, Box 46, South Gate, Calif.

CENTURY Delivers work and service that can't be beat. 8 exp. roll 25c with two professional enlargements free. Century Photo Service, LaCrosse, Wis.

BEAUTIFUL Oil colored enlargements. Your negatives: 8x10, \$2.00; 11x14, \$3.50. From photo 50c extra. Specify colors. Hayscraft, 706 8th, Washington 1, D. C.

FRESH 35 MM. film. 25 ft. \$1.60. 8x10 enlargement from 35 mm. negative \$1.00. Taylor Brown, 2112 Farnam, Davenport, Iowa.

PROFESSIONAL 8x10 Enlargements, 50c oil colored \$1.50; includes free 5x7. Arden Studios, Franklin Park, Illinois.

PHOTOS Copied 25c. Enlargement 25c. Roy Tichenor, 1805 Elm, Cincinnati 10.

"NEW Photo-coloring." Send two dimes with photograph. American Delight Studio, 709 East 6th St., New York 9, N. Y.

ROLLS Developed and printed 25c. Reprints 2c; 5x7 enlargements, 15c; 8x10, 25c. Davis Studio, Guthrie, Okla.

EMBOSS Christmas cards including envelopes from your own negative. 12 for 75c. For samples send negative and 25c. Film Capital Service, 813 Dewey Ave., Rochester 13, N. Y.

8x10 ENLARGEMENTS (Send negative) 25c. Reprints any size 2 1/2c each. Roll developed, 2 prints, negative 25c. Paramount Photo, Slatington, Penna.

100 QUALITY Photostamps, \$2.00. Gunned, perforated, for stationery, etc., free sample. Herman Neely, Somerset, Kentucky.

MONEY Back guarantee—16 sparkling double clear Nu-Art prints, also 2 enamel finish enlargements. All complete 25c. Rolls or negatives. Prompt, careful, guaranteed. Lifetone Studios, Department 1039, Des Moines 8, Iowa.

SPECIAL—25 Reprints 50c. Suburban Studio, 1498-M Bond, Rockford, Illinois.

TECHNIFINISH 35mm. 36 exposure rolls, fine grain developed and beautifully enlarged to 3" x 4" high gloss prints only 90c; 18 exposure rolls 55c. Credit given for non-printing negatives. Reprints only 90c for 25, 65c for 18. Reprints of selected frames from uncut rolls 4c each. Reloads for your empty cartridges: 36 exposure reloads 35c, 18 exposure reloads 20c. Fresh stock. Technifinish color prints 8" x 10" from your 35mm. Kodachromes or 35mm. area of larger transparencies only \$3.00 in distinctive mounts; \$1.50 for additional prints from the same transparency. Black-and-white positives from your 35mm. negatives for your projector: 36 exposure positives 50c, 18 exposure 35c. Write for free mailing bag, sample print and complete information. Technifinish, Dept. 112, Rochester 3, New York.

FINE Finishing specials 25c. Eight exposure rolls developed with two prints of each or one enlarged print of each negative. Genuine nationally known Moentone Enamel finish. Superior quality since 1898. Moen Photo Service, 452 Moen Bldg., LaCrosse, Wis.

REPRINTS 3c Each, any number, minimum order 25c. Fred D. Eastman, Bode, Iowa.

DO You want the best from your films? Eight wide-margin deckled-edge panel embossed contact prints, only 25c. 12 to 15 exposures 50c—credits for failures. Free enlargement coupon with each roll. For prints of unusual quality, try Speedway Photo Service, P.O. Box 726, Indianapolis 6, Indiana.

8 PRINTS, All enlarged to nearly post-card size, from your roll or negative, 25c. Willard Studios, Box 3535A, Cleveland 18, Ohio.

AT Last! Roll developed, all your snapshots hand-colored as beautiful as most actual colored photography 35c. Hand colored reprints 4c each—12 for 45c. National Photo Art Company, Janesville 26, Wis.

SENSATIONAL Introductory offer! Send snapshot or negative, this ad, and 3c. We'll send you a beautiful 7" x 5" enlargement! Or, Kodak roll developed with 16 guaranteed deckled-edge velox fade-proof prints or 8 double-size prints, 25c! Special! From your negatives, 16 regular-size or 8 double-size reprints, 25c! Candid rolls—36 exp. 35mm. developed, vaporated, enlarged to 3x4, \$1.00! 18 exp. 50c. Reprints, 3x4, 3c each. We have new, perfect 35mm. film. Low prices. Free mailers, details on request. American Studios, Dept. 279, LaCrosse, Wis.

ROLL Developed and 8 beautiful enlargements 2 to 6 times larger. Deckled edge—high gloss. Any 8 exposure roll 25c coin. 12 ex. 35c—18 ex. 50—36 ex. \$1.00. Reprint enlargements 3c each. Alden Photos, 94-3 Astor Sta., Boston 23, Mass.

OIL Coloring photographs can be a fascinating hobby or profitable sideline for those with artistic talent. Learn at home. Easy simplified method. Send for free booklet. National Photo Coloring School, 1315 Michigan, Dept. 344-A, Chicago 5, Ill.

BIGGEST \$1.00 Value in 35 mm. finishing today. 36 exposure fine grain 3 1/2 x 4 1/2 enlargements; deckled, embossed margin and date. Eighteen exposures 75c; 18 exposure splits 55c; 36 exposure reloads 50c. Special: return this ad with \$2.00 and we will send five 36 exposure reloads. Free mailers. 8 exposure rolls in beautiful, deckled contact finish with embossed wide margin, 25c. Mailbag Film Service, Box 5440A, Chicago 30.

PHOTOGRAPHY For pleasure or profit. Learn at home. Practical basic training. Long established school. Write for booklet. American School of Photography, 1315 Michigan, Dept. 3452, Chicago 5.

BEAUTIFUL Double-size pictures 3 1/2 x 4 1/2 each, from 116 and 120 negatives, 3 1/2 x 4 1/2 from all other sizes. All work guaranteed. Overnight service. Roll developed and 8 pictures 30c. Roll 12 pictures 45c. Roll 16 pictures 60c. Enlargements on double weight portrait paper 5x7—30c, 8x10—60c. Copies made from any picture 75c. Pacific Photo Service, Box 666, San Francisco, Calif.

EVERY Picture an enlargement! 8 sparkling deckle-edge enlargements and roll developed 25c coin; 116 size or smaller; enlarge reprints 3c. Enlarge Photo, Box 791D, Boston, Mass.

MOTION PICTURES AND SOUND EQUIPMENT

HUNDREDS 8-16MM. films, silent, sound. Illustrated catalogs, dime. "Surprise" assortment 8-mm. colorful titles \$1. LeMoine Films, Nevada, Missouri.

HOME Movie rentals, sales, exchange, 8-16mm. and sound. Latest releases—Money-saving rates. Details for stamp. Midland Film Exchange, Box 429, Oak Park 4, Illinois.

FREE Movie film catalog; samples 10c. Goodwill Company, Jackson, Tennessee.

DRAMAS — Glamour, sample, Dime. Zientek, 1129 Monroe Circle, Baltimore 25, Maryland.

FINEST Movie screens, inexpensive, make them yourself. Free literature. Snow White Screen Company, Danville, Illinois.

PROJECTORS 35mm. portable silent. Nusslock, 4614 Green Tree, Milwaukee 9, Wis.

SENSATIONAL Full color movie subjects! 8mm., 16mm. Big catalog, 25c. Special! Projection length sample scenes (Kodachrome), "Waikiki Hula," \$1.00. Specify width. Iriroscope kits, \$5.00. World in Color Productions, Box 392, Elmira, N. Y.

RENT 16 MM. sound films 50c reel. Large selection; free catalog. Film Service, 128 Chestnut Street, Roselle Park, N. J.

BEAUTIFUL Kodachrome slide and list, 25c. Art Slide Co., M-1, Canton, Ohio.

PURCHASE, Sell, exchange: Films, projectors. Maurice Mann, 34 Sprague St., Fitchburg, Mass.

"THE World's Greatest Passion Play," all sizes sound and silent. Write Hemenway Film, 33-F Melrose St., Boston 16, Mass.

OFFICIAL Films, Craig editing equipment, Da-Lite screens, other supplies. Lists free. John J. Hill and Company, 512 Kelly Street, Atlanta 3, Georgia.

LEARN Movie projection, management. Free catalog. Theatre Institute, Elmira, N. Y.

ENTERTAINING As well as instructive home movies—including famous titles and subjects in 8mm. and 16mm. film—from \$3.00 up. Send dime for big 1945 catalog and sample. Audet, Box 6320-BG, Philadelphia 26, Penna.

FRESH Movie camera films price reductions. Ambassador, 479-A Quincey Street, Brooklyn, N. Y.

BUY, Sell, trade 35mm., 16mm., 8mm. Samples 10c. Lists free. Paramount Films, Monmouth, Illinois.

GUARANTEED Fresh movie film! Three spools double 8mm. \$3.45! Six spools single 8mm. for Univex cameras, \$3.50! (Limit six spools each type.) Processing free! Will ship C.O.D. on \$1.00 deposit. State make of camera. Ess-3, 4038 Broadway, Kansas City 2, Missouri.

BARAINS In 16mm. 1600' reels, sound films, sound projectors, rentals. Harris, 303 West 42 Street, New York 18.

MOVIE Camera films, 100' 16mm. \$2.50. 25' double 8mm. \$1.25. Free developing. Better Films, 742 New Lots, Brooklyn 7, N. Y.

WE Can supply movie film in both 16mm. and double 8. Write us for kinds and prices. Fromader Genera Co., Davenport 7, Iowa.

MOVIE Projectors bought and sold. List 10c. United, 2309-A Lawrence, Toledo, O.

8MM-16MM. Films. Free catalogue (sample film 10c). Parkway Exchange, 53 Rockaway Parkway, Brooklyn, N. Y.

8MM.-16MM. Silent-sound film. Complete rental library. All latest subjects. Free catalogue. (sample film 10c). Garden Film, 317 West 50th, New York 19.

I BUY, Sell, swap, rent s.o.f., 8 and 16mm. films. List free. Harvey Iris, Box 539, Brockton, Mass.

FRESH Movie camera films. Ambassador, 479-A Quincey Street, Brooklyn, N. Y.

SEND Stamp for 16mm., 8mm. catalogue. Sterling's, 679 Northampton, Easton, Pennsylvania.

SPECIAL Movie film, 8mm., 25 feet double-Weston 8, \$2.00. Super double X, Pan indoor 60, outdoor 100, 16 mm.—\$6.50. Super X Pan indoor 24, outdoor 50, \$5.75. Pan Weston 12, \$5.00. 16 mm. 100 feet Weston 6, \$4.00. Free developing. Exhibitors Film Exchange, 630 9th Ave., New York 19, N. Y.

BASS Says: Leadership in the cine field is apparent in war times. Here ready—your choice of 8 mm. and 16 mm. apparatus. Write for quotations. Your old equipment is worth real money in trade—describe please. Or we buy for cash and pay immediately on receipt. Write to headquarters. Bass buys 'em, sells 'em, trades 'em. Satisfaction guaranteed or your money refunded. 35c postpaid for 100 page book "Military & News Photography" by Jack Price. Up to the minute information. Bass Camera Company, Dept. A, 179 W. Madison St., Chicago, Illinois.

MUSIC AND MUSICAL INSTRUMENTS

HAWAIIAN Guitar chord chart \$1.00. Over 650 chords in A Major—C Sharp Minor E-7th and B-11th tuning. Arranged by Sol Hoopii and Dick McIntire in note and diagram. Fator's, 935 W. Santa Barbara Ave., Los Angeles 37, Calif.

PLAY Piano without lessons in 30 minutes (not by ear). New patented Play-At-Once Keyboard Sheet Music. \$1 for 3 complete pieces. Money back. Keyboard Music Co., 722PM Kimball Building, Chicago 4, Ill.

HAWAIIAN Guitar method \$1.25. Five guitar orchestrations \$1. Catalog on request. Golden Gate Publications, 5472 Foothill, Oakland 1, Calif.

PIANISTS—Quickly improve technique, sightreading, accuracy, memorizing, playing through mental-muscular coordination. Free booklet. Broadwell Studios, Dept. 45K, Covina, Calif.

ACCORIONS, Concertinas. Bought, sold, repaired, refinished, tuned and cleaned. Malmfeldt, 5555 So. Kolmar Ave., Chicago 29, Ill.

GUITAR Course. Simplified. Lesson, send \$1. Gee, 1211 Frisco, Far Rockaway, N. Y.

ACCORIONS, All sizes, makes. Free catalog. Buy direct. Wholesale prices. Metro Accordion Co., 31 S. Cicero, Chicago.

NEW Songs and lyrics wanted for popular radio program and professional promotion. Free examination. Transradio Music, Inc., Dept. P, 1630 Broadway, New York (Affiliate of B.M.I.)

POEMS Set to music. Copyright secured. 20 years experience. Write Capitol Tunes Co., Colorado Bldg., Washington, D. C.

WE Want song poems and lyrics on all subjects. We offer the services of a noted Hollywood motion picture composer and arranger. Send your poem today for consideration and our liberal offer. Hollywood Melodies, P.O. Box 2168PM, Hollywood 28, Calif.

SONG Poems wanted, for musical settings. Send poems for free examination and receive free rhyming dictionary and instructive booklet outlining opportunities. (No obligation.) United Music Corporation, Salem 32, Indiana.

SONGWRITERS—Write to Pleasant Music, 51 Davis St., Oakville, Conn.

SONGWRITERS. Hollywood music agents now reviewing original material for radio presentation. Agents contracts offered for songs accepted. Submit your material now, for consideration. Studio Center Music Company, 1717 N. Vine St., Hollywood 28, California.

SONGWRITERS Publishing agreement free. Mid-West Music Press, 5428 Broadway, Chicago 40.

HARMONICAS \$2. Instruments bought and sold. Catalog. Musician's Shop, 2 E. Centre St., Baltimore 2, Md.

SONG Poem melodies, \$2.00. Jiles, 2065 Oak St., Santa Ana, Calif.

SONGWRITERS. Hollywood organization now examining original lyrics for group approval and partnership agreement after musical setting recognized Hollywood Craftsmen in all branches of music now available for post war musical collaboration. Worthy talent guaranteed immediate response by staff after review. Forward your lyrics or complete songs for examination. All material not placed under contract will be returned at our expense. Musical Craftsmen of Hollywood, P.O. Box 1181M, Hollywood, California.

ACCORIONS: All sizes and makes. Wholesale prices. Free catalog. American Accordion Center, 39 S. Kedzie, Chicago 12, Ill.

MONEY Back guarantee to teach you Hawaiian, Spanish guitar or piano in fifty lessons \$5.00. Each ten lessons one dollar. Franks, Musicians Supply, 732 Jersey Court, San Diego 8, California.

PROFESSIONAL Song Lead Sheets with chords. Four copies \$5.00. MacGregor, 5079 Lemon Grove, Hollywood 27, Calif.

SONGS Arranged and scored. Melodies composed for lyrics. Workmanship guaranteed. Write for particulars. Tommy Kilbourne, Box 1253, Bakersfield, Calif.

GUITARS. Band instruments, bought, sold. Free list. Rudolph's, Atchison, Kan.

MUSIC Composed, music printed, since 1910. Reginald Belcher, Bloomfield, N. J.

LYRIC Writers. For outstanding melodies write Danford Hall, Composer, 1358 Greenleaf, Chicago, Ill.

POPULAR Piano in 12 lessons. Positively guaranteed, beginners or advanced. Get copies of hit parade tunes free with the course. Kelly School, 1734 30th Ave., San Francisco 22, Calif.

"YOU Can Make Records," authoritative, practical guide, \$1. Hughbanks, Phonograph, Osborne, Kansas.

SONGWRITERS—Before sending your poems anywhere, get the facts in our free booklet "Getting Ahead in Songwriting." Write today. Song Service, 331-C West 46th, New York.

SONGWRITERS—Special offer—Write Edward Madden, 1360 Lodi, Syracuse, N. Y.

WANTED! Lyrics, melodies for songs. We arrange, publish, sell. Superior Song Studios, Passaic, N. J.

OUR "Play by Ear" piano course together with Mayberry Chord Slide starts you playing popular songs immediately. Easy as child's play. Enjoy this simple modern method. Both \$3.00. White Agency, 7024 Eastern Ave. Northwest, Washington 12, D. C.

SONGWRITERS! Outstanding, ethical offer. Hibbler, C3, 2157 N. Avera, Chicago.

ACCORIONS. New and used at wholesale prices. Save up to \$100.00. Buy direct from factory. Del Principe, 307 So. Wabash, Chicago.

BEFORE Sending your poem to be set to music, know your composer. Free folder. Al Moquin, 5333 La Cresta Court, Hollywood 38, Calif.

SONGWRITERS: Royalty contract free. Write for details. Puritan Publishing Co., 343 S. Dearborn St., Chicago, Ill.

SONGWRITERS—Send poems for immediate examination and free book, "Your Future in Songwriting." Radio City Music Academy, 1674 Broadway, New York City 19.

MUSIC Arranged. Songs published. Frank Wildt, Music Publisher, Lancaster, Pennsylvania.

SONG Poems wanted, for musical settings. Send poems for free examination. Write for free instructive booklet outlining opportunities. United Music Corporation, Salem 4, Indiana.

"THE Complete Songwriter." A new home study course of instruction—words, music and arrangement. Simple, practical. 96 page book. \$2.00, postpaid. M.O. Puritan Publishing Co., Dept. APM, 343 So. Dearborn St., Chicago, Ill.

SONG Writer's attention! The amazing demand for phonograph records, accelerated by more than 300,000 juke boxes and the hits popularized warrants your immediate consideration. We are offering song-poem writers the rare opportunity of having established composers collaborate on appealing material received this month. Rocca Records, Box 987P, Hollywood 28, Calif.

POEMS Wanted. To be set to music. Send your song poem today for free examination by nationally famous hit composer of "Dream a Little Dream of Me." Our new 6 step plan is most liberal and complete ever offered. Write today for free booklet. Screenland Recorders, Dept. PM, Hollywood 28, Calif.

PLAY Swing piano! Send 10c for instruction bulletin. Christensen Studios, 751 Kimball Hall, Chicago 4, Ill.

POEMS Wanted for musical setting. Send poem for immediate consideration. Five Star Music Masters, 630 Beacon Building, Boston.

SONGWRITERS—Send poem for immediate examination and free rhyming dictionary. Richard Brothers, 24 Woods Building, Chicago.

SONG Poems wanted. Free examination. McNeil, Master of Music, 510-PM South Alexandria, Los Angeles, Calif.

WRITE Songs. Big money and reputation. Write for information. J. Gordon Pub Co., 201 N. Hoyne Ave., Chicago.

RADIOS AND SUPPLIES

YOUR New free catalog is ready! Radionic's catalog lists hard-to-get radio parts and books. All available for immediate shipment. Send today to: Radionic Equipment Co., Dept. 10D; 170 Nassau St., New York 7, N. Y.

LEARN Radio easier—faster! "The Mystery of Radio (How it Works)" illustrates, explains radio principles, wiring circuits, connections, etc. in easy-to-understand terms. Only 60c. Details free. Scientific Radio Service, Box 1285, Sioux City 7, Iowa.

BUILD Your own radio set. Our simple instructions require no previous experience. Complete kit with tubes \$10.75. Details. National Radio Distributors, 140 West 42nd Street, New York 18, N. Y.

CRYSTAL Radio experimenters. Crystals, detectors, coils, condensers, diagrams. Catalog free. Hulet, 29 East 39th, New York.

FIREPROOF Liquid solder! Large tube 50c. A. Miceli, 412 Massachusetts, Buffalo 13, New York.

RADIO Tubes, parts, condensers. Free bargain lists. Potter, 1314 McGee, Kansas City, Mo.

RAPID Radio tester, patent applied for. W. D. Loy, 135 B Street, S.E., Washington 3, D. C.

COMPLETE Radio kits \$10.95, multi-tester kits, surplus transmitters, receivers, etc. Free catalog. Radio, 120 Cedar St., New York, N. Y.

BUILD Latest, extra-load crystal set. Instructions, 20c. Booklet: "All About Crystal Sets," 45c. Exceedingly loud crystals available. Amorose Radio, R-4, Hungary Road, Richmond, Virginia.

REVISED Plans 18 long distance crystal sets, including "Radiobuilder"—25c. Laboratories, Box 1-C, San Carlos, California.

FOXHOLE Radio. Batteryless, tubeless, amazing. Kit \$3.75. Simple illustrated plan 50c. New radio earphones \$2.75. Complete aerial kit \$1.00. Radio service trade-kinks \$4.94. Gadgets, Box 28, Jackson Heights, N. Y.

2650 RADIO Tube substitutions with very valuable and handy data. 176 pages. Send \$3.00 for prepaid copy. Radio Equipment Co., 1415 W. Franklin Ave., Minneapolis 5, Minn.

SURPLUS Radio parts, wire, cable, motors, gears, hardware, bearings. Send for price list. Times Appliance Company, 73 Duane Street, New York City.

HEAD Phones: Latest type, light weight, finest quality, with plug for tuning in on Radio. Adaptable for use in making crystal sets, and intercommunication systems. Slightly used sets (without head bands) \$1.25. New sets (without head bands) \$1.75. Slightly used sets (with adjustable leather covered head bands) \$2.50. New sets (with adjustable leather covered head bands, rubber ear-pads included) \$3.75. Add 25c for mailing. Send check or money order. Quantity limited. Dept. A, Nico Supply Company, 540 N. 17th St., Philadelphia 30, Penna.

SURPLUS Government transmitters 30-50 watt with five Weston meters, 20MC to 42MC, 10 watt phone transmitter, etc. Send stamp for bargains. Nelson K. Storer, P.O. Box 722, York, Penna.

HEADSETS. Finest quality, complete with headband, cord and plug. Adaptable for use with crystal or other type radios. Shipping charges 25c extra. Arnold Radio, Middletown, Penna.

RADIO Service men and experimenters send stamp for our giant radio catalogue. Save dollars. United Radio Co., (1900-V) Newark 1, N. J.

EXPERIMENTER'S Dream! Large assortment, coils, condensers, transformers, resistors, etc. \$25.00 value while they last \$3.98. Marko Supply, 2924 Logan Blvd., Chicago 47, Ill.

FAMOUS Razor blade radio! Illustrated plans 35c. New Radio, Lohrville, Iowa.

RADIO Technician and radio service courses. Training for federal licenses. American Radio Institute, 101 W. 63 St., New York City. Approved under G. I. Bill of Rights.

FM Can now be heard on old radios! Very simple adaptor! Send postcard for free data! Topical Empire Corporation, 1527 Highland, Box 42, Louisville 4, Ky.

MAKE Simple, tubeless, batteryless, distance-getting crystal radios. Crystal and illustrated instructions 25c postpaid. Allen, P-427, Clinton, Missouri.

BUSINESS OPPORTUNITIES

START Home business making statuary, plaques, novelties, garden furniture, artificial marble flooring, liquid marble. Make your own flexible molds. Amazing profits. Folder free. Creative Publishers, Box 236-L, Winnetka, Illinois.

HOW To make shell jewelry. Here is the only complete course of home instructions for making tropical jewelry. Gives complete instructions and beautiful photographs for making 33 different styles of sea shell and fish scale earrings, brooches, pins, sprays and hair ornaments. Includes dyeing, pearlizing, lacquering, golding and luminous methods. Also, wholesale prices for all materials required. \$1.00 per copy postpaid. House of Gifts, Box 4550-PI, Coral Gables, Florida.

MAKE \$8-\$15 Daily. Own permanent business. No capital. New invention—Revolutionary clothesline hangers eliminates clothes props, pulleys. Nothing like it. Made easily, quickly with home tools. Materials cost 10c. Retail \$1.00 up. Sells when shown. Enormous non-competitive market among homes, apartment buildings, hotels, institutions, retail stores, agents. Simple drawings, complete work-sales instructions sent postpaid \$1.00. Rice, Inventor, 2007 Adams, Toledo 2, O.

HARDWARE Business is one of the most interesting and profitable of them all. Be independent. You can start your own retail store with small investment and no previous experience. 15,000-word, copyrighted booklet tells you how. \$1.00 postpaid. C. R. Divan, P.O. Box 325, Santa Monica, Calif.

MAKE Flexible Molds, Statuary, Art Goods, Novelties, Artificial Marble Flooring, Liquid Marble. Literature free. Kemico, Park Ridge (10-M), Ill.

OWN A mail-order paper products business. Sell envelopes, tags, bags, boxes by mail, wholesale. Tremendous demand. Steady profits. No capital necessary. Write Omaha Envelope Service, Dept. 94, 4721 California, Omaha 3, Nebr.

BIG Earnings await you in Mechanical Dentistry. Quickly learn scientific dental-plastics art in spare time by mail. Complete illustrated course teaches, gives professional standing. All materials and tools furnished, also guidance in establishing your own laboratory at home or office, spare or full time. Write immediately to Ward Lucas, President, Dental Plastics College, Box 4284 Village Station, Los Angeles 24, Calif.

BIG Mail order offers! Money making plans, opportunities, valuable merchandise bargains, samples, catalogues, magazines, etc., by listing your name in our big directory. One issue ten cents, three issues 25c. Results guaranteed. G. W. Lowman & Sons, 363 Tulpehocken St., Reading, Penna.

WORK For yourself. Your own business. Operate entirely by mail—direct from your home in spare time. Few dollars starts you. Literature free. Albert Wilcox, PM21, Nicholls, Georgia.

\$24,500 REPORTED Using "schemes" from "Schemer" Magazine, Alliance, Ohio. 47th year. \$1.00; 4 samples. 30c.

SELL Books and courses by mail. Particulars free. Fadenrecht, Corn, Okla.

POSTWAR Security! The greatest legitimate scheme ever devised to secure a big mailing list and a stream of dimes. Free particulars. Jack Killion, 7922 South Vermont Avenue, Los Angeles 44, California.

OPERATE Your own dandy home business. Sell used courses, books by mail. Complete system explained. Write Wil-munk, 419-A Clay, Watertown, N. Y.

START Mailorder and local business. Free literature. Stroups, Ashtabula, O.

ESTABLISH Lifetime mail order business from your home. No canvassing. Stamp for particulars. Case, Box 172, Seattle, Washington.

EARN Money with textile painting course. Free details. George Gundrum, LeRoy, Michigan.

FOR Best agency plans, formulas and mail order opportunities, bargain buyer's guide, information budget, get our free literature. Beejay's, 518 South Thirtieth, Lafayette, Indiana.

ADVERTISING Tips on selling by mail. Starting plan included. Details free. Young, Box 61B, Medford 55, Mass.

START Home mailorder business. Amazing literature free. Kemall, Park Ridge, Ill.

PLASTICS Guide—Listing dealers in materials, molds, supplies, machines, equipment, accessories. \$1. Plastics Digest, 3937B Tracy, Kansas City 4, Mo.

A GOOD Proposition in goods. Beautiful wall plaques and statuary. Write for circular. Pyramid Studio, Dept. 1, 1620 Michigan, Kansas City, Mo.

PREPARE Now for profitable post-war business—Avoid layoffs. Widely endorsed ideas. Start small—grow big, in business of your own. National Enterprises, 10 Waverly Place, New York.

557,000,000 CONSUMERS of the British Empire have been introduced to thousands of new products and ways of living by 3,000,000 American soldiers making a market you can't afford to overlook. "Worldwide Advertising Coverage" (Empire publication information) and "25 Tested Overseas Mailorder Plans" makes this market yours. Even beginners have netted over \$3500.00 yearly. Both publications \$1.00 postpaid. Bulletins included free. Anglo American Sales, No. 5 Waterloo St., Leicester, England. (5c postage.)

LIQUID Marble—Make in beautiful colors. Make your own flexible molds and cast plaques, novelties, statuary. Free information. Write—Bing Products, 621-R Tremont Street, Boston 18, Massachusetts.

LUCITE Cameo pins, picture frames, compacts. Wholesale prices, samples \$1.00 postpaid. N. Y. Article Co., 116 West 45th St., New York 19, N. Y.

NEW Flexible mold material, casts catalin plastic, concrete, plaster, in same mold. Literature. Sandtex, Box M, Clyde, Ohio.

RUBBERCOAT—Ideal mold making liquid. Sample quart \$2.95 with directions. San Diego Plastic Products, 3873 California St., San Diego, California.

LATIN America offers great opportunities! Send \$1.00 for copyrighted report containing over 200 U. S. firms doing business in Latin America. Latin American Research Bureau, 305 W. 8 St., Los Angeles 14, Calif.

LATEX For making flexible moulds, plaster models. Start your own profitable business. Complete instructions. Eastern Latex Laboratories, Box 153, Mattapan 28, Mass.

HOW To help yourself to postwar prosperity. Send postal today. William LaHue, 1129 Spring, Canton 1, Ohio.

MAKE Strange new plastic, 8c gallon. Makes attractive, durable floors, walls, roofs. Bays Laboratory, Oklahoma City 9, Okla.

SELL By mail. Particulars free. Write, Frank J. Artz, 1060 Harding Drive, Toledo 9, Ohio.

PLASTICRAFT—Real synthetic resin easily cast in simple molds. Quick curing. Fourth pound \$1.00 with instructions. Quantity prices. Plastics Digest, 3935B Tracy, Kansas City 4, Missouri.

MOLDERS Notice, new plaque model of "Raising the flag on Iwo Jima." Illustrated leaflet. Sanflax, Clyde, Ohio.

READ Tex Maupin's monthly letter. Money ideas—local business and mail order. New announcements, novelties. Rush name. Houston Maupin, Tipp City 61, O.

LIQUID Rubber for making molds for plaster castings. Finest quality. Samples? Sure! \$4.00 quart, \$12.00 gallon. W. Wooley, 115 Donald B, Peoria, Ill.

SELL Books by mail. Use your spare time. Start small, grow big. Grand opportunity to establish clean legitimate mail order business. "How" booklet 10c. Kraft Publications, 3209-81 Lake, Chicago 24, Ill.

MAKE Soap at home. No machinery. Profitable. Literature free. Kemico, Park Ridge (SM-10), Ill.

SELL Cosmetics by mail. Women spend millions on beauty. You can make your share of this cosmetic money. Let us show you how. Details free. Frank J. Artz, 1060 Harding Drive, Toledo 9, O., Dept. B.

MANUFACTURE Patented fireproofing compound. Fireproof clothing, home furnishings, automobile upholstery. Sell agents, homes, hotels, hospitals. Formula, instructions. License—\$2.00. Pring, 20 Winnett, Toronto, Canada.

ESTABLISH Yourself in profitable mail order business of your own. Free descriptive literature. Church, 814 N. 24th St., Billings Mont.

6 LEADING Mail order publications 25c. Kraft Publications, 3209-R3 Lake, Chicago 24, Ill.

LEARN Profitable credit-collection agency business; earn \$5,000-\$10,000 upwards annually; sparetime opportunities excellent; postcard brings interesting literature free. Write: Educational Extension Service, Department 101, Los Angeles 36.

EXCEPTIONAL Welding opportunity. Experience unnecessary. Particulars free. Hale, 2322 North Point, San Francisco 23.

BOOKKEEPERS — Operate popular "Dollar-A-Week" bookkeeping and tax service. Full or spare time. Details free. Ellis, Box 200, Cedar Grove, N. C.

GET The facts concerning "My View Points" about mail order schemes, plans, ideas, sales letters, circulars, booklets, formulas, advertising, circular-mailing and mailing-lists. Know the relationship of these "ten vital subjects" to the "direct-by-mail" order business. Send for free information to Henry E. Piltz Publications, Box 148, East Orange 2, N. J.

CHRISTMAS Gift sales afford money making opportunities! Rush request for free wholesale catalog. Unlimited market. Easy sales. Supplies furnished. Send penny card now! McGregor Magazine Agency, Dept. PM5, Mount Morris, Ill.

WANT To make \$100.00 weekly? No foolin'. Details and 64 page booklet of valuable moneymaking information that can mean immediate cash and your future independence. 25c postpaid. Write today, now. Wilkin, 1348-PM N. High, Hillsboro, Ohio.

MECHANICALLY Inclined men — Own and operate general appliance repair shop. Complete, illustrated course shows you how. Welding, refrigeration, motor repair, how to get business, etc., all phases covered. Free literature. Christy Supply, Dept. 157, 2835 N. Central Ave., Chicago.

SELL By mail abroad! Fifty million prospects! Details 10c. MacCormack, 10-E, Madeira, Ohio.

PLASTIC—Plastisizer intermix, makes ordinary casting plaster shatterproof. Pint develops 100 pounds \$1.25 postpaid. 20th Century Products, 3151, 3-B, Southport, Chicago.

START Your own business now. Little or no investment. Full or part time. Free booklet describing over 100 moneymaking plans. Anes-Hausen, Box 1643, New Orleans 11, Louisiana.

RAISE Chin-Chins, the big money-making rabbit. Big demand. Small investment. Profitable business for anybody anywhere. Willow Farm, R15, Sellersville, Penna.

BE Your own boss. Work at home. Amazing profits. Literature free. Leonard, Box 42, Salem, Oregon.

20 DIFFERENT Unpainted wall plaques 50c. Illustrated list free. Oman, 642 Broadway, St. Paul, Minn.

FLORIDA Minded gadgeteers. Beautiful, high, shady homesites; low building and living costs; mild, healthful climate; excellent water; well equipped, cooperative workshop, with outlet for products; congenial neighbors; fishing; sports; what more could be desired for the home of your dreams? Write for and give details. Tasso V. Orr, Villa Tasso, (Niceville), Florida.

METALLIZE Baby shoes! Learn this easy, money making business from nationally recognized consultant. Small investment; free details. Joseph B. Kushner, B.S.Ch.E., R.D. 3, Stroudsburg, Penna.

RUBBER-Molding liquid. Pre-war quality. Sample pint; directions \$1.50. Gallon \$9.00. 20th Century, 3151-3 Southport, Chicago.

AT Last! A genuine Storm-Proof cigarette, cigar and pipe lighter that requires no fluid of any kind, will not blow out and can't get out of order. This Storm-Proof lighter employing the charcoal principle, sells on sight just by lighting a cigarette. If interested, here are complete details—Storm-Proof lighters come fully guaranteed and must retail \$1.00. Your discount 40% in dozen lots, 50% 3 dozen and over including territory. Initial 2 samples trial order \$1.00, deductible from first wholesale order. Storm-Proof Lighter Company, 126 Lexington Avenue, New York.

START Big money business on shoe-string. New, successful cleaning service. Big demand everywhere. Easy, quick profits. Write for details. Americlean, 211 N. 7th St., St. Louis 1, Mo.

SELL By mail to college students. Specialized instructions. Write for details. John B. Martin, 1101 West State St., Jacksonville, Illinois.

HOMEWORKERS—Attention veterans! Castwood plastic gifts, novelties. Material, molds, instructions furnished. Sample quart with mold \$2.00 postpaid. Plastic Material Supply, 1416-N-2, Fletcher, Chicago.

HAVE A business of your own, full or part time, selling Ramsay Simplified Bookkeeping Systems. Practical, easily operated, moderately priced. Furnishes complete, accurate information required by government, which makes every business a prospect. Liberal commissions paid daily. Write for details. Ramsay Systems, Inc., 192 Lexington Ave., New York 16, N. Y.

POSTAGE Stamp machines. Operate your own route. New post-war 1946 models selling 1c and 3c stamps, \$30.00 complete. Average profit \$8.00 monthly per machine. No car or experience necessary. Operate in spare time. Merchants and operators, act now—order a sample machine. Free illustrated catalogue. Parkway, 3046G Tioga, Baltimore 15, Md.

MAIL Order beginner's "Business Development Plan". "Profitable Mail Selling Idea." "Pointers Along the Mail Order Trail" show how to make mail order business pay! All three, in 10,000-word treatise, postpaid quarter. Satisfaction guaranteed. Maupin & Maupin, LaFayette 3, Indiana.

WE Start you in business at home, spare time, earning \$10-\$30 weekly. Selling by mail. Stamp appreciated. Driscoll Sales Service, Box 371A, Denver, Colo.

CASH-COAXING. Dollar-digging mail-order letters, literature, complete campaigns created in Hollywood! Positive results! Investigate! Les Finkle Advertising, 1201 1/2 South Ogden, Los Angeles 35.

LEARN Collection business. Start your agency at home or small office. Dignified, profitable, easy. Complete home course. Free booklet. Pacific School, 1272 So. Bronson, Los Angeles 6.

INTERESTING! Revealing! Mail order business success laws. "Candid facts." Dime (coin) refundable. Parke Publications, Carrel Building, Quebec, Canada.

EXPAND Business with India. Wanted agencies of piece goods and other saleable lines of approved quality. Excellent business assured. Can export India made hosiery, soft goods, etc., Bankers Imperial Bank of India Forbandar. Samples and terms to Shariff Hassam & Bros., Forbandar, India.

START Toy factory making fascinating Top-O-Copier, the top that flies. Wood or plastic. \$1.00 for plans. W. C. DeWeese, Box No. 658, Del Rio, Texas.

RUBBER—Atlaxex. Mold making liquid "the real thing." Sample quart with instructions \$2.95, gallon \$9.50. Plastic Material Supply, 1416-N-2 Fletcher, Chicago.

START Profitable home business now; capitalize spare time; free details. Manhattan House, 126 Lexington Avenue, New York 16, N. Y.

SELL By mail. Interesting book plans, formulas, 25c postpaid. Stoll Specialty Service, 3103B East Ninth, Joplin, Mo.

YOU Can make \$5,000 yearly, up, in an easily learned office business of your own. Write G. H. Cole, Pres., Syracuse, N. Y., for free details.

ADVERTISING And letter shop. Open your own dignified, profitable agency. Home course teaches quickly, easily. Free booklet. Pacific School, 1272 So. Bronson, Los Angeles 6.

\$4.97 PUTS You in lifetime business. Write Midwest Drug Co., Dept. 4, Columbus 15, Ohio.

FLORIDA Opportunities—Pensacola offers exceptional opportunities for small industries, especially in the field of mahogany novelties and woodware, perfumes, soap, chemicals. Delightful year-round climate. Wonderful fishing, hunting, beach sports. For information write: Industrial Development Division, Municipal Advertising Board, Pensacola, Florida.

HOME Mail order business opportunities for you. Big profits. Small capital starts you. Write for interesting know how particulars. Adkins, 209 W. Keys, Tampa 3, Fla.

JOKES, Tricks, at wholesale. Storekeepers, jobbers, operators. The fad is sweeping the country. Make your store the hottest place in town. Schwamm, 237 East Ninth St., New York City 3.

MAKE Money. Used machinery sales agency. Little capital. Complete plan \$1.00. Roberts, Dept. A, 425 Beech, Arlington, N. J.

BUILD Miracle homes. Yours. Others. Chamberlain, Fitzsimons Building, Pittsburgh 22, Penna.

MAIL Merchandising course shows practical, proven, moneymaking methods. Eye-opening literature plus two premium offers free. Backeye Service, 63-PM Washington Avenue, Tiffin, Ohio.

BECOME A finance man. Particulars free. George Lenhoff, Lincoln 8, Nebr.

PROFITABLE Plans and ideas. Details. Spada, 10 Lexington, Wethersfield 9, Conn.

MAIL Order Mirror (monthly), 348A Sackett, Brooklyn, N. Y., shows how to earn extra money by mail. Sample 10c; \$1.00 yearly.

PROSPERITY Plans and formulas. Start successful home business. Particulars free. Frank J. Newton, La Grange, Ill.

BUILD Own business mailing penny post cards; six profitable plans with information for starting. Gordin Publishers, Box 23, Pawtucket, R. I.

MAIL Order starter and builder. Free details. Riley, 14568 Superior, Cleveland 18, Ohio.

"HOW To Make Simple Molds and Plaster Plaques". Profitable business or hobby! Instructive booklet 25c. Plastercraft, 1406 East 43rd Street, Cleveland 3, Ohio.

"10,000 ALASKA Fishing Jobs". Alaska's largest industry regularly employs thousands of men and women in seafood production. Possible earnings up to \$5,000 in few weeks. Authentic 7,000-word copyrighted report gives job information, union requirements, sample application letter, names and addresses over 40 Alaska fisheries. Newest edition includes similar information on California, Oregon and Washington fisheries. Vital facts for immediate application in a permanent industry. \$1.00. 7-day refund privilege. Pacific Industrial Research Bureau, Dept. PM-9, 202 Studio Building, Portland 5, Oregon.

INVESTIGATE Mail order selling. It's great opening letters containing cash, checks, money-orders. Amaze your friends. Write Young's, Kent 15, Ohio.

MAIL Business earned \$1400 monthly. Copyrighted instructions \$1.00. Boyd, 331 Fourth, Pittsburgh 22, Penna.

MAKE And mold genuine plastics. Forty illustrated work-sheets explain methods, processes. Authentic-simplified \$1. Free circular. Plastics Digest, 3937B Tracy, Kansas City 4, Mo.

MAKE Flexible molds! Cast plaques, novelties, bookends! Free sample! H. Tooker, 630-A Chestnut, Hamilton, Ohio.

LICK After war lay-offs. Start own business. Home; office. Free literature describing 127 tested business plans. Michael's Business Enterprises, 715 Lorimer St., Brooklyn 11, N. Y.

BOOKKEEPER-ACCOUNTANTS. Double your income. Operate a profitable book-keeping service spare or full time. Textbook, and particulars \$2. Tax-Saver System, Dept. D, Ft. Worth, Tex.

"HOW To Finance Any Business, Obtain Capital". Research. Aitkin 5, Minn.

SELL Exclusive books of instruction by mail. Assorted subjects. Popular prices. 70% profit. Rush name for sample imprint circulars and full details. Financial Education 431F, 728 15th St., Denver 2, Colo.

START Profitable sideline business now! Complete free details and premium offer available. Write Sheboygan Publishing Co., Sheboygan, Wisconsin.

ELECTRICAL Appliance repair. Open your own shop. Learn house wiring; electric motors, vacuum cleaners, washers, etc. Complete illustrated course shows how. Free booklet. Pacific Training School, Dept. AP-1, 4703 West Pico, Los Angeles 6.

RECAST Old batteries into new. Latest achievements. Battery Laboratories, Minneapolis.

MONEY-MAKING Business. Big profits! Successful Income Builders, Hollywood 28, California.

FREE Literature. Earn extra cash. Easy home business. Experience unnecessary. H. Thomas, 808 W. 68, Los Angeles 44, Cal.

ENJOY Financial independence! Operate your own business! Age, education, disability no handicap. Sales routes, home enterprises, mail order, store management, service repair work. Turner Company, 5675 Lannoo, Detroit 24, Michigan.

MAILORDER Beginners—Build profitable, permanent business. Plan free. Lee Wheeler, 531 Pier Ave., Santa Monica, Cal.

\$25 WEEKLY Working two hours daily. No canvassing. No manufacturing. Lycke, Box 2471, Cleveland 13, Ohio.

SELL Christmas cards, display signs, pictures, calendars, books, greeting cards. Big profits! Quick sales! Catalog free! Elfeo, 436 North Wells, Chicago.

TYPEWRITER Repairing—Original course, simplified home study. Weber Typewriter Mechanics School, Box 269, Osborn, Ohio.

QUICK Money! "Repairing Car Batteries." At home. Easy too. Write Batteryman, 901 South Avenue, Grand Junction, Colo.

BOOKKEEPERS: General ledger and tax report experience. Operate permanent, profitable accounting service for the smaller business. Part or full time. Simplified method. Write now! L. A. Bell, 1400 West 25th Street, Cleveland 13, Ohio.

PROFITABLE Mail order opportunities. Vassar Service, 332 Washington, Hoboken, N. J.

START Mailorder bookshop—Everything furnished; publisher cooperation. 25c brings booklet, exclusive setup, samples, exciting ideas. General Publications, Ossining, N. Y.

BECOME An "Attritionist Masseur". First improvement over Swedish massage in 100 years! Results unbelievable! Dr. Swearingen, 9128M, Station 8, Los Angeles, Colo.

COLORGLAZED Concrete pottery made without molds. New, low cost, patented method. Cemetery products, novelties, tiles, floors, etc. Basement leaksealing. Other moneymaking projects. Booklet, details free. Men only. National Pottery Company, Fergus Falls, Minnesota.

BIG Money making Hollywood style pottery, bird baths, wishing-wells, benches, stucco-rock. New method. Clever designs. Color with chemicals, water-paints. Marbling, colored glass effects. Dime brings samples, pictures, literature. Hollywood Cementcraft, 8527 Wonderland Ave., Hollywood 46, California.

\$—RAISE Giant Chinchilla rabbits. Willow Farm, R 15A, Sellersville, Penna.

PLASTIC Houses—Build yourself! Re-surface old buildings! Wonderful building material. Write Marbleizing Service, Edwardsville, Illinois.

HOW And where to obtain capital. Fully explained. Particulars free. Star Service, Wapakoneta, Ohio.

MAIL Order business course shows you how to make money, spare or fulltime. Teaches professional mail order technique—not penny-snatching schemes. New success catalog free! Write—Nelson Company, Dept. 4-02, Chicago 4.

AGENTS—To mail our literature. Good profits. Home business. Maywood, 1133 Broadway, New York.

RAISING Canaries pays good profits. Valuable bird book—"Its Care, Breeding and Training." Price \$1.00. American Canary, 2839 N. Halsted, Chicago.

LIQUID Marble; snow-white, multi-colored. Glazed. Unglazed. Composition flooring. Lifetime wear. Any color. No priorities. Flexible molds. Plaster casting. Get into the big money now. Full information given free. Write Compo-Tex, Box 785-R, St. Louis, Mo.

BRUSH Plating outfits connect to a battery. No tanks necessary. Good paying business at home plating autotaps, bathroom fixtures, bicycles, reflectors, silvering mirrors. No shop or experience required. Outfits furnished. Free booklet. Gunmetal Co., Ave. H, Decatur, Ill.

127 WAYS To make money, in home or office; business of your own. Full particulars free. Elite Co., 214 Grand St., New York.

MONEYMAKING OPPORTUNITIES

NOVELTY Manufacturing offers opportunity to start fascinating, highly profitable business, no expensive equipment needed, orders waiting, big profits, easily and quickly learned. Definite post war future. Plastex Products, 127 Clement St., San Francisco 18, Calif.

IF You want to swap, buy or sell anything, send 25c for The National Swappers Guide. It's full of opportunities to swap, buy and sell almost anything under the sun. 610 St. Joseph, Evansville 12, Ind.

MONEY Making books. Free descriptive list. 50 plans 25c. 100 plans 50c-ppd., guaranteed. Rex, Box 3236 R-3 Chouteau Sta., St. Louis, Mo.

THOUSANDS Articles wholesale. "Supply Source Directory" 10c. Ideal Service, 110 Park Ridge, Ill.

BIG Mail free—Send 25c for 3 mo. subscription to Progressive Mail Trade Magazine. Act at once and have your name printed in big Mail Trade Directory—free. Sample copy 10c. Frank A. Vails, 3201 Harrison Ave., Brookfield, Illinois.

HOW I averaged \$200.00 monthly, making household necessity and giving premium made from waste. Instructions \$1.00. Pring, 20 Winnett, Toronto, Can.

MAKE Money during lunch hour. 400% profit! Every smoker a hot prospect. Sample 25c. Lew Davis, Box 1015, Lynchburg, Virginia.

MONEYMAKING Books. Free list. Journalism booklet, 25c. Underhill, Beebe, Arkansas.

MONEY Made easily home or room, 25c brings details and two 25c folios or book. Bargain Specialty Company, Box 635C, Modesto, California.

MONEY Making plans. Free descriptive literature. Gerald McNeely, 3044 Jackson Blvd., Chicago 12, Illinois.

MECHANICALLY Inclined men—Own and operate general appliance repair shop. Complete, illustrated course shows you how. Welding, refrigeration, motor repair, how to get business, etc., all phases covered. Free literature. Christy Supply, Dept. 1157, 2335 N. Central Ave., Chicago.

FREE "Prize Contest Bulletin" describes many contests. Money making opportunity. Write, Cash Register, 210 5th Ave., New York 10.

TALBOTT'S Wholesale directory tells you where to buy wholesale. Only 25c. Talbott Company, Green Cove Springs, Florida.

START Profitable collection agency business; office; home; sparetime. Earn \$5,000-\$10,000 upwards annually. Investigative Educational Extension Service advertisement under Business Opportunities.

OPERATE The mailorder way. It's new. Repeats. A real money maker. Write for special bargain offer. R. E. Raines, 13516 Ashburton Rd., D. 24, Cleveland 10, Ohio.

MAKE Money with your hobby—Easy if you know how. Our complete instructions teach you. Begin at home, then expand. Only 25c. Lods, 100 Alden Place, New Orleans 19, Louisiana.

INSURE Your future against poverty, failure. Learn how to become prosperous, independent. You will never be broke when you use this valuable advice, anywhere, any age, learned in one hour. No selling. No capital required. No business to start. Most remarkable thing ever written. Over million sold. Changing the lives of many people. Should be in every home. Money back guarantee. Postpaid \$1. Outside U. S. \$2. The Gilbert Service, P.O. Box 1464, Mobile 8, Ala.

WANT Financial independence? New plan helps hundreds. Tibolt, 21M, Philadelphia 20.

25c BRINGS Business secrets, success plans, all tested. 25c refund coupon all postpaid. Rush. Wilkin, PM-1348 N. High, Hillsboro, Ohio.

PROFITABLE Local or mail order business in your home. Free booklet describes 125 proven plans. Kessler Service, Box 392-PM, Indianapolis 6, Indiana.

ASSEMBLE Lucite items. Free picture frame kit and catalog with our fabrication instructions for \$1.00. Glassite, 625 N. Atlantic, Monterey Park, Calif.

START Now! Mail order opportunities unlimited. Proven success formula, 25c. CCB Carter, Box 8, New York 12, N. Y.

25c STARTS You in money-making business! Sell new and used merchandise to friends and neighbors. Rush 25c (coin or stamp) for special introductory offer of three beautiful used dresses for \$1.00. Pay postman 75c balance plus few cents postal charges. Sell at big profit. Crown Company, 164-A Monroe St., New York 2.

MAKE Plaster Plaques, Statuary, Liquid Marble. Instructions, formulas. \$1.00. Ideal Service, 179-M, Park Ridge, Ill.

QUICK Cash plans 25 cents. Poulsen & Company, Zion 2, Illinois.

PUBLISH Your own magazine. Hand-some 52 page format, well edited, illustrated. Cost low as \$1.00 month. Brings you prestige, profits. 25c brings sample details. National Ord. Nebr.

MAKE Colorful plastic jewelry with sparkling "Wonder-links." Easily assembled without tools or equipment. Profitable sideline! Free details. Beginner's outfit, \$1 (refundable). Hughes, 218 Sidell, Danville 3, Illinois.

SELL Office supplies by mail. Samples, money-making information for 25c, refundable. Edgar W. Thomas, Barnesville 10, Ohio.

SELL By mail; supply other dealers. Particulars free. Harry Dean, Box 900-A, Galveston, Texas.

HELP Win the war first! Then man you'll like silvering mirrors, reflectors! Making sparkling chipped glass nameplates. Outfit prices. Sprinkle, Plater, V60, Marion, Indiana.

EARN Money evenings, copying and duplicating comic cartoons for advertisers. Adservice, Argyle, Wis.

THOUSANDS Of alarm clocks need repairing. Jewelry stores swamped. Our simplified course teaches you how to repair these clocks. Necessary tools and supplies furnished with course. Alarm Clock Repair Service, Dept. B, P.O. Box 1983, Houston, Texas.

INDEPENDENCE And your own business. No peddling. Little or no capital needed. You can't miss. Free details. Ranera, Oakland, Nebraska.

GROW Dwarfed trees. Instructions 25c. McGuire, P.O. Box 628, Dept. G, Seattle 11, Wash.

GIANT Big mail! Hundreds of money making propositions, home work offers, including big magazine, all for a dime. Gardenville Publishers, Gardenville 11, N. Y.

4—RAISE Giant Chinchilla rabbits. Willow Farm, R 15B, Sellersville, Penna.

"MAIL Order World." Outstanding mail order magazine. Sample copy 10c. Martin's, Box 2414P, Bridgeport 8, Conn.

I MAKE Big money in the mail-order business. You can do the same at home with my copyrighted system. Write me. I'll tell you how. P. Little, Box 8, Glen-shaw P.O., Pittsburgh, Penna.

LICK After-war layoffs! Start own business; home, office. Booklet describing "Collection of 127 Tested Plans" free. Elite Co., 214 Grand St., New York.

LEARN Metascience. Remarkable drug-less healing. No manipulation. No apparatus. Unbelievable simplicity and results. Inexpensive correspondence course. Write Metascience, De Land, Florida.

EARN Money at home! Thousands do! "Home Worker Magazine" tells how. Sample, 25c. Sizemore, Box 7, 4917 North Kostner, Chicago.

FORMULAS, PLANS, ETC.

MANUFACTURE Paints. No equipment capital needed. Complete instructions, formulas, \$2.00. Industrial Chemist, 1836 60th, Kenosha, Wis.

"LUMINOUS Paint." 100 other formulas, plans—25c. Soap-making, (20 formulas) \$1.00. Resilvering mirrors 25c. Ideal Service, 310, Park Ridge, Ill.

SENSATIONAL Soap formula 25c. Anthony Miceli, 412 Massachusetts, Buffalo 13, New York.

RELIABLE Formulary. 924 page illustrated book. 10,000 scientific formulas, recipes, secrets, instructions for most any product. Countless profitable business opportunities, including D.D.T. new insecticide that eliminates flies, mosquitoes, moths, lice, fleas, roaches, "bbs," etc. \$2.98 postpaid (c.o.d. U. S. only). Foreign \$3.25 delivered. Adams Brown Company, Dept. 360, Chestnut Hill 67, Mass.

NEED Chemists? Formulas. Professional services. Consulting. Scientific Company, Swarthmore, Pennsylvania.

ICELESS Ice—Colder, cleaner, cheaper. Duffy, 153, Covington, Ky.

ANY Formula or trade process supplied 50c. Jackson, Newfoundland 5, Kentucky.

MANUFACTURE Fast-selling Products yourself. Formula catalog free. Kemico, Park Ridge (16), Ill.

120 SPECIALLY Selected formulas for quality and profit. The Jeffers Company, Pittsburg, Kansas.

WORKSHOP And farm formulas. Money making manufacturing ideas. \$1.00. Nu-Way Formulas, Box 1016, Longview, Wash.

TIRE Carcasses everywhere, from these reclaim rubber to make molds, tire plastic, etc. Details for stamp. Betke, Box 699, Borger, Texas.

REAL Manufacturing formulas. Lists free. Cummings, Chemist, Gordon Ave., Syracuse, N. Y.

FORMULAS: 15 Proven money-making formulas \$1.00. (Not stock-formula catalogue stuff), real unusual offers. List free. Marvel Laboratories, 6629 No. Maplewood, Chicago.

FORMULAS—Latest, best. Analysis. Literature free. Belfort, Engineering Building, Chicago.

PLASTICS

ONE Hundred twenty eight page completely illustrated instruction book chock full of ideas and projects in all plastics now given with Kesto Plasti-Kit Number Three postpaid \$5.00 in U. S. Kit contains lucite, plexiglas, catalin, dyes, solvents, cements, polishing materials. Now ready. No waiting. Kesto Plasti-Kits, 3263 M Street, N.W., Washington 7, D. C. Dept. M9.

PLASTIC Consultant—Complete advice on plastic problems. Fee reasonable. 65 E. Rich Street, Columbus 15, Ohio.

MONEY In plastics! Plastic hobby kit 2 pounds lucite sheets, coloring dye, cement, instructions! Send \$2.50 to Plastic Specialty Co., 192 Lexington Ave., New York City.

PLASTICS—Without high heat or equipment, cheap! Formulas, instructions, \$1.00. Tirekop, L-10, Madeira, Ohio.

MAKE Sell plastic non-shatterable glass. Material, details \$1.00. Plasticseal, 1159 Stout, Denver 4, Colo.

CHEMISTRY

WINN'S Champion new idea chemical-kits, apparatus-outfits and supplies for students home experimenting. (Established 1931.) Send 10c for catalog. John H. Winn, 124 W. 23rd St., Dept. 510, New York, N. Y.

CHEMICAL Experimenter's supply catalog 5c. Colonial Chemical Co., DPM-1, Brockton 28, Mass.

CHEMICALS. Ounce quantities, apparatus. Catalog 5c. Fleischer's Laboratories, Everett 49, Mass.

FREE Chemical catalogue. Enclose 3c postage. Greenwood, 398 Broadway, New York.

HANDBOOK For chemical experimenters, illustrated, hundreds of experiments, 50c. Experiment booklet 15c. 1946 chemistry catalog 5c. Reading Scientific Company, Reading, Penna.

FREE Catalog, Chemistry, mineralogy, biology, optics. Tracey Laboratories, Evanston, Illinois.

CHEMICALS, Experimental quantities, 10c up. Prices on request. Chemical Development Co., 1285 W. 37th Drive, Los Angeles 7, California.

NEW 36 Page chemical apparatus order book. Complete line of chemical glassware, apparatus and chemicals. Send 10c for this book. Standard Science Supply Co., 1232 N. Paulina St., Chicago.

CHEMICALS And apparatus for industrial, analytical, and private laboratories. Complete supply service for correspondence school students. Send 3c for catalog. Dept. M-43, Biological Supply Co., 1176 Mt. Hope Ave., Rochester 7, New York.

SPECTROSCOPE For quick chemical analysis \$2.50. Kutting Sons, Campbell, California.

LABORATORY Supplies at wholesale prices: Chemistry, biology, physics. Catalogue 10c. National Scientific Co., 2304 W. North Ave., Chicago. Established 1908.

HELP WANTED

MEN Wanted (20-35 years), to work on railroad rail testing service cars. Jobs entail constant traveling. Electrical-mechanical experience preferred. Salary plus maintenance. WMC rules observed. Write full details to Personnel Dept., Sperry Products, Inc., 1505 Willow Ave., Hoboken, New Jersey.

RELIABLE Man with car wanted to call on farmers. Wonderful opportunity now. No experience or capital required. Permanent. Write today. McNeess Co., Dept. 651, Freeport, Ill.

AGENTS WANTED

SILVER Plating liquid. (NuSilver trade mark.) Apply with a cloth. Simply rub-on with a saturated cloth, dry-off and buff-up bright with a dry soft polishing cloth. All done in 1 minute. It cleans, silverplates and polishes from the one application. Easily done at home or in office by anyone. NuSilver Plating Liquid is a more than 50% (½ plus) genuine U. S. government treasury department domestic silver solution, 1000 fine (pure silver), sterling. It renews all sterling and plated silverware. It also silverplates onto brass, copper, bronze, zinc, nickel-silver, german-silver, and some other composition metals. Over 100 uses listed to date. NuSilver is a permanent lasting finish. Won't wash off. Won't brush off. Won't boil off. Once applied as directed it is there to stay. NuSilver Plating Liquid is a wide-spread and intensive seller. Working sales-distributors are wanted for areas not now being worked. Details by letter-mail. NuProcess Products Laboratories, Dept. 188, Aurora, Illinois.

SELL Christmas cards. Make easy money showing gorgeous Christmas, de luxe religious, birthday assortments, stationery. Over 100 quick sellers. Special offer. Write today for \$1 Christmas box assortment on approval. Hedenkamp & Co., 343 Broadway, Dept. PMO, New York 13.

QUICK Selling perfumed beads, earrings, combs. Particulars free. Sample line \$1.00. Mission, 2528 W. Pico, Los Angeles 6, Calif.

UP To 100% profit selling friends Christmas card assortments and personal stationery. Religious, gift wrapping, birthday assortments 35c up. Request 21 card \$1.00 Christmas box on approval. Free 25 for \$1.00 personal Christmas card and stationery portfolios. Special offer. Elmira Greeting Card Co., M-104, Elmira, N. Y.

AGENTS Wanted for all year around household commodities used daily in every home. Big profits—repeat business. Write for catalogue and samples. Marshall Sanitary Products, 5535 N. Clark, Chicago 40.

NEW Revolutionary collar stay, 2 piece type, holds collar perfectly even while worn open, fastest seller. Send 25c coin for sample Collarite, full particulars. Collarite Co., Box 1324, Tulsa, Okla.

SENSATIONAL Seller. History of World War II with Jap surrender. Large book. Over 1100 pages. 200 photographs and maps. Only \$5.50. Every home prospect. Write quickly for full details. Universal House, 1068-A Arch St., Philadelphia, Pa.

CALL On friends with sensational personal Christmas cards—25 for \$1.00 up. Also box assortments, including magnificent 21-card \$1.00 assortment. Profit 50c. Samples on approval. Wallace Brown, 323 Fifth Ave., Dept. T-4, New York 10, N. Y.

GREETING Cards, gift wrappings, stationery cabinets, novelties. Wholesale for stores, agents, clubs. 4154g Fifth Street, Philadelphia 40.

SELL Genuine rubber raincoats, leather jackets, over 200 styles shoes for men, women. Special exclusive features. Tremendous demand. Unusual profits. Sales outfit free. Write Consolidated, Dept. 8-122, Chippewa Falls, Wis.

REAL Live Mexican jumping beans. 20—25c, 100—85c, 500—\$2.00, 1000—\$3.00. J. J. Frank, 525P Palm, Rockford, Ill.

\$1 STARTS You in business. Sell deluxe five fold ties. 100% wool interlining. Cost you only \$7 per dozen, you make \$5 dozen. Send \$1.00 for special introductory offer two five fold ties. Catalog complete line free. Philip's Neckwear, 20 West 22nd St., Dept. K-24B, New York 10.

DISTRIBUTORS—Fishing rod holder, most ingenious patented features, feather-weight, retail \$8.00, sample \$4.00 prepaid. Ace Manufacturing Company, 1377 Haight, San Francisco.

LOOK Here! Wanted—Men and women to start in business on our capital. Sell some 200 farm-home products. Thousands our dealers now make quick sales, big profits. For particulars write Rawleigh Co., Dept. J-192-PPM, Freeport, Ill.

SHINE Shoes without "polish." New invention. Lightning seller. Shoes gleam like mirror. Samples sent on trial. Kristee, 144, Akron, Ohio.

GOLD Lacquered window sign letters. New foils, styles, absolutely beautiful. Free samples. Atlas, 7941 Halsted, Chicago.

JUST Out! History of World War II. Huge volume. Popular price. Authentic text. Official photographs. Big profits. Riverside Book Company, Iowa Falls, Iowa.

200 MONEY Making plans, ideas, rare formulas, schemes, exposed secrets. Folio free. Formico Service, Box 572, Dayton, O.

WAR Honor scroll: All branches of service represented. 12 by 16. Space provided for name and photograph. Truly beautiful. Agents make big money. Sample 25c. E. Condon, Dept. 8, Upper Darby, Penna.

MILLIONS Sold. Today's fastest selling novelty. 300% profit. Generous trial order \$1.00. Samples, wholesale prices 10c. Barkley Co., Dryden 11, Va.

FREE Details, two new counter cards. Excelsior Press, Hampton 4, Virginia.

COPYRIGHTED Plan—Increased sales, gas stations, new customers. Ace Products, Wilkes Barre, Penna.

CUT-BACKS! Why worry? Prepare and sell auto polish with our concentrate. Just add water. Send \$1.00 for pint trial and wholesale prices, makes 3 pints high grade polish. Acme Chemical Co., Waukegan, Illinois.

MAYBE? You can do better but \$750, one distributor's profits, 26 days. Simple, dramatic demonstrations sell \$3 fire extinguisher. Liberal discounts. Agents. Distributors. Other products available. Molonite Chemical Company, 5713 Euclid Ave., Cleveland 3, Ohio.

EVERY Car owner a prospect. Retail for \$1.50, costs 35c. Sample, particulars 25c. Barkley Co., Dryden 32, Va.

ELECTRIC Ironing cords with indicator light. Iron-So-Ezee Company, Mt. Washington, Ohio.

BIGGEST Profit selling our novelties. Aabaltos, 131 West 42nd, New York City.

LUMINOUS Pictures that glow in the dark. Large manufacturer wants factory representatives; wonderful new item; fast seller; free sample. Madison Mills, 303 Fourth Ave., New York City.

SALESMEN, Agents, distributors. Men, women, returning war veterans. Old established company has exceptional opportunity for you to develop lifetime business. Daily necessity for 100,000,000. Big repeats. Lytle Supply Co., Avenue 11, Fredericksburg, Ohio.

MEN And women wanted to sell hand colored 8" by 10 enlargements reproduced from any negative or print, placed in beautiful gold embossed easel frame, sell for \$2.25, for which you receive a commission of one dollar on every sale. Making \$25 a day is not hard. Mail us at once a deposit of one dollar and we will send you sample, identification card and sales kit. Your deposit is refunded after the sale of the first five pictures. Framed Photo Service Co., 130 West 42nd St., New York 18, N. Y.

SELL Christmas signs, religious mottoes, business slogans. Beautifully illustrated with sparkling tinsel. Everyone a prospect. Huge profits. Send for catalog or enclose dime for sample. Silvergio, 4824 Barry, Chicago 41, Illinois.

\$3 FIRE Extinguisher; quick sales, wholesale or direct; liberal profits. "Fire-Killer," 109 N. Franklin, Syracuse 4, N. Y.

SCHOOL Seniors! A postal will bring you our Kwick-Sell Cardalog of graduation name cards. Hot selling everywhere! Big profits! Hurry! Craftcards, Box 335(L), Pittsburgh 30, Pennsylvania.

SELL Bahamian sea shell jewelry. Send \$5.50 for 32 sample pieces. L. Russell Co., Manufacturers and Exporters, Box 295, Nassau, Bahamas.

SELL Auto body, radiator and soldering trade. New flux, saves time. Big profits. Write today. Crone Company, Parkland 2, Washington.

SELL "Petite picture notes." Something really different in greeting cards. Sample free. Dunbar Cards, New Brunswick 20, N. J.

SCHOOL Seniors—Sell classmates America's most beautiful, distinctive graduation name cards. Positively highest commission. Largest selection. Lowest prices. Free cards and sample kit. Printcraft, 1423 East Elm Street, Scranton 5, Penna.

AGENTS—Big line including food products. Fast selling premium and bargain deals. Low prices. Send card for big outfit offer with gift. Ho-Ro-Co, 2768 Dodier, St. Louis 7, Mo.

EX-O-LENE! Powerful mile stretcher. Extremely profitable. Guaranteed product. Distributors wanted. Thermoexwks, Peoria 4, Illinois.

AGENTS: Stamping names on pocket-key protectors. Sample check with your name, address. 25c. Stamping outfits. Emblem checks, check-fobs, name plates. Hart Mfg. Co., 303 Degraw St., Brooklyn, N. Y.

MEXICAN Feather pictures. Unusual novelty. 50c (stamps) bring \$2.00 worth samples, details. Refunded if unsatisfied. Aztec Art, Apartado 762, Mexico City.

START A profitable business. Over 100 sensational values. Men's used suits \$2.00, pants 35c, topcoats \$1.25, overcoats \$1.50, shoes 20c. Experience unnecessary. Free wholesale catalog. Superior, 1250-FB Jefferson, Chicago 7.

90c PROFIT Each \$1 sale! Sell permanent mothproofing solution. Employ agents. Experience unnecessary—we tell you how. Kinford Co., Wayne 3, Penna.

MAGIC Races—At touch of lighted cigarette, six horses are off! Watch them run! 55 races in mailing carton—\$1.00. Agents' commission—40%—in dozen lots. Order direct from this ad, or send 10c for sample envelope (5 races) and complete details. Pines, Box 32, Flushing 25, N. Y.

BIG Profits taking subscriptions for all magazines. Agents' confidential catalog listing over 2500 periodicals and complete starting supplies free. Pines Subscription Agency, Flushing, New York.

WHOLESALE Sources. 500,000 articles. Free directory. Maywoode, 1133 Broadway, New York.

EXCELLENT Sideline for printing salesmen. Decalcomania name plates in small quantities. Also, make money applying initials on automobiles. Free samples. "Italco," X-164, Boston (18), Mass.

PLATING Outfits for autoparts, reflectors. Connect to a battery. No tanks necessary. Free booklet and particulars. Gunmetal Co., Ave. N. Decatur, Ill.

FREE Water and our concentrates, makes flavors, lotions, shampoos, 72 products, labels, bottles furnished. Qualco, E-20030 Russell, Detroit.

ELITE Collection contains 127 plans for starting own business; home office. Descriptive booklet free. Elite Co., 214 Grand St., New York.

HIGH-GRADE SALESMEN

FREE! Latest issue Opportunity Magazine. Salesman's Guide. Inspiring, constructive. Shows how to earn money selling for others or in your own business. Hundreds postwar opportunities. Send name and describe what you have sold or are selling. Illustrated copy sent free. Opportunity Magazine, 620 N. Michigan, Dept. 17, Chicago 11, Ill.

LOOKING For a good selling job? An opportunity to make up to \$100 or more weekly. Then write Schutt Co., 244 East Ohio St., Indianapolis 4, Indiana.

MAKE Unusual spare or full-time profits showing genuine leather jackets, raincoats, 200 style and comfort shoes. Sample outfit free. Rush postcard. Victor Thomas Co., Dept. V-85, Chippewa Falls, Wis.

EXCEPTIONAL Opportunity to earn \$20.00 to \$40.00 a day and establish an income for life selling for only \$3.00 a year a \$2000.00 accident policy. Previous selling experience not necessary to immediate large earnings. Must have car and devote full time. Write W. Clement Stone, 5322 Sheridan Road, Chicago 40.

\$4.97 PUTS You in lifetime business. Write Midwest Drug Co., Dept. 4, Columbus 15, Ohio.

EDUCATIONAL AND INSTRUCTION

LICENSE Examinations — Professional engineer, architect, surveyor, stationary, marine, electrician, plumber, refrigeration, radio, mathematics. Mondell Institute, 230 W. 41, New York.

PLASTIC Engineering pays big. Home study course. Low cost. Easy terms. Free booklet. Ohio Institute of Technology, Box P-268, Greenville, Ohio.

LEARN Shoe rebuilding. Practical. Low tuition. Investigate. Gussias School, 3903 Lake St., Chicago.

LEARN Photo-engraving at home or in oldest, largest school in America. Work for newspaper or establish own profitable business. New Tasopec Photo-Engraving equipment available soon. Write for information. Veterans ask about G.I. training. The Aurora School of Photo-Engraving, Tasopec Bldg., Aurora, Mo.

ANALYZE Handwriting. Unlimited opportunities in uncrowded profession. Complete course including free handwriting analysis \$1.00. Mayer, 681-P Market, San Francisco 5, California.

WHY Don't you write? Writing short stories, articles, etc., will enable you to earn extra money. In your spare time we teach you to write the way newspaper men learn—by writing. Free "Writing Aptitude Test" tells whether you possess the fundamental qualities essential to successful writing. Write today! Newspaper Institute of America, Suite 570-S, One Park Avenue, New York 16, N. Y.

REFRIGERATION. Air-conditioning signs point to greatest servicing, installation demand in history. Men 18 to 60, prepare now for jobs or your own business. Write for free facts how UEFI spare time home and school training has helped thousands "go places" since 1927. Utilities Engineering Institute, Dept. 15W, 1314 W. Belden Avenue, Chicago 14, Illinois.

HOME Study courses. Over 300 subjects. New low cost method. Free bulletin. DeVoto Vocational Schools, 35 Vicente, San Francisco 16, Calif.

FREE Information, how to get the new magic shorthand and typing course for 35c. Evangel, Box 3825, Cleveland, Ohio.

THE Lord is coming! Repent. His signs are being fulfilled today. Get free genuine proofs. Scheall, Box 263X, Duluth, Minnesota.

VOCATIONAL Analysis. Write for information. Personal Counseling Service, Room 1085, 681 Market Street, San Francisco 5, Calif.

EISENHOWER Biography by Miller. Twenty-three thrilling chapters, sixteen pages of photographs. Only two dollars. Eugene McLean, 1325 Bryant Street, Eureka, California.

USED Educational and technical books, bought, sold, rented. Catalog free. Educational Exchange, Henagar, Ala.

PHOTO Retouching. Short, easy course trains you to earn at home. Free booklet. Duval School, 8519 Sunset Blvd., Hollywood 46, Calif.

AMAZE With Super Memory! Facts, figures, names stick like burrs! Write A10, Thor Books, Box 1210, Chicago.

WRITE Short stories at home for pleasure and profit. Fame, riches and happiness of achievement are rewards to be realized by students who acquire tested technique. Get free booklet from home study school with 50 years experience. Write today! Blackstone-Sprague, Dept. 110b, 397 North Michigan, Chicago 1.

LEARN Fascinating credit-collection agency business; office; sparetime. Investigate Educational Extension Service advertisement under Business Opportunities.

AUTO Body and fender work, metal work, spray painting, welding among giant auto industry's best profit producers. Practical spare time home study and resident course gives mechanically-minded men 18 to 60 valuable help toward good pay and a shop of their own. For free details write Utilities Institute, Dept. 14X, 1316 Belden Ave., Chicago 14.

WELDING—Electric arc. Learn profitable trade quickly through actual practice. Individual welder instructions at bare cost of materials. Full particulars free. Valuable welding lessons book 50c. Hobart Welding School, Box M-1052, Troy, Ohio.

"HOW To Break and Train Horses"—A book every farmer and horseman should have. It is free; no obligation. Simply address Beery School of Horsemanship, Dept. 11011C, Pleasant Hill, Ohio.

INVESTIGATOR Training. Phillips Secret Service, 1917B North Kenneth, Chicago 39, Illinois.

GOVERNMENT Jobs for veterans! Commence \$125-\$220 month. Men-women. Prepare now at home for postwar examinations. Full particulars and list of positions, free. Write today. Franklin Institute, Dept. H 52, Rochester 4, N. Y.

FIND Your real opportunity. Advance "years in months." Tibolt, 22M, Philadelphia 20.

HOME Bible course. Simple, helpful, instructive. Total cost \$3.00 includes textbooks, examinations, certificate. \$1.00 starts you, or simply request prospectus. The Bible Study School, 382 Van Houten Street, Paterson 1, N. J.

BE Successful! Read educational books. Free list. Henry Byrd, Second Annex, Alto, Ga.

SIMPLE New way. Teach yourself shorthand and typing course in a few weeks. Easily understood. Send 50c in coin to J. Gooday, 90-27 185th St., Hollis 7, Jam., N. Y.

NEW, Used, home-study books; catalogs, dime; refunded. Westway Educational Service, Box 58-C, Los Angeles 35.

29 LANGUAGES By Linguaphone. Russian, Spanish, Portuguese—Direct conversational method for mastering any language quickly, easily, correctly at home. Send for free book. Linguaphone Institute, 83 RCA Bldg., New York.

HOME Studycourse, drugless therapy. Free literature. Institute of Drugless Therapy, Tama, Iowa.

LOCKSMITH Course. Lock picking, key fitting, etc. \$1.00 prepaid. Locksmith, Canadian, Texas.

MEDICAL Laboratory technicians in great demand. We train you in your spare time, in your own home. You can practice while studying. Write for free catalogue. Imperial Technical Institute, Box 973-E, Austin, Texas.

SECRET Investigation. Experience unnecessary. Investigators particulars free. George Wagner, M 125 West 86th, New York.

HORSEMEN—Learn to train and gait. Teach tricks. Free book. Animal Lovers Association, K-111, Tarzana, Calif.

USED Educational books on all subjects sold, rented, also bought and exchanged. Moneyback guarantee. Write today for free catalog and details. Lee Mountain, Pisgah, Alabama.

GOOD "Used" self-instruction educational books on all subjects bought, sold, rented, exchanged. Satisfaction guaranteed. Complete information and 92-page illustrated bargain catalog free. Write-Nelson Company, Dept. 2-02, Chicago 4.

PLAYS, STORIES, MANUSCRIPTS

AN Imagination? Learn comic book writing. Free marketing. David Laurel, 81 No. Portland Ave., Brooklyn 1, N. Y.

AUTHOR'S Title service. Professional manuscript reading. Slogans originated. Minimum fee \$1. E. K. Paskas, 3067 West 116th Street, Cleveland 11, Ohio.

NEW Writers needed to rewrite ideas in newspapers, magazines and books. Splendid opportunity to "break into" fascinating writing field. May bring you up to \$5.00 per hour spare time. Experience unnecessary. Write today for free details. No obligation. Postcard will do. Comfort Writer's Service, 210-P South Seventh St., 2, St. Louis, Mo.

CARTOONING, COMMERCIAL ART, SIGN PAINTING, ETC.

"HOW To Make Money With Simple Cartoons"—A book everyone who likes to draw should have. It is free; no obligation. Simply address Cartoonists' Exchange, Dept. 910-C, Pleasant Hill, Ohio.

LEARN Cartooning, markets, plans and gag creating. Hartman, 2438 W. Lincoln 3, Nebr.

CARTOONING, Comics, chalk talk, charts, instruction, \$1.00. Free Cartoon Review, Brugman, Parkman, Ohio.

WE Print our students cartoons. Free folder. School of Cartoons, P.O. Box 3291, San Francisco 19, California.

FREEHAND Drawing, reproducing, enlarging, reducing made easy with our drawing guides. If you like drawing this will help you. Wonderful for children. One dollar, no stamps. Wittner Engineering Co., Niles, Mich.

CARTOON Course—22 easy lessons. 200 figure sketches. 25c coin prepaid. Snack-Pack Co., 32 E. Georgia, Indianapolis 4.

CHALK Talks. Laugh producing program, \$1.00. Catalog 10c. Balda The Cartoonist, Oshkosh, Wisconsin.

ADVERTISING AGENCIES, LETTER WRITERS, FOR ADVERTISERS

ADVERTISING Placed everywhere lowest rates. Reliable guidance on publications, expert assistance on ads without charge. Newspaper, magazine, mailing-list ratebook free. Chicago Advertising Agency, 20-P West Jackson, Chicago 4.

ADVERTISERS Printing service. Ask about copy-layout-printing that sells. Get more orders. Psychology, Inc., 321 Starks Bldg., Louisville 2, Ky.

24 WORDS in 64 weeklies \$4.98. H. J. Darnell, 730 Hays, Jackson, Tenn.

EFFECTIVE Sales letters and literature written, \$5 page. Dudley Bunn, 126 Lexington Avenue, New York 16.

ADVERTISERS! 6,000,000 Circulation 25 Sunday national key newspapers. 18 words, \$39.25. "Terrific pullers" 20 popular newspapers \$8. "Free booklet." Newmarks Advertising Agency, 217-7th Ave., New York.

ADVERTISE: 24 Words, 149 newspapers, \$6.50. Lists free. Advertising Bureau, 4515-C Cottage Grove, Chicago 15.

INCH Display adv. 50 magazines 77. \$24. Wood's Popular Services, Atlantic City, (N. J.)

ADS Placed in out of town newspapers and magazines. Low rates. Catalogue free. Ideas that pay. Baker Advertising Agency, Successors Ankrum Agency, 189 W. Madison, Chicago 2.

FREE—New Advertisers Rate Guide. 44 pages. Includes everything. Lowest rates. E. H. Brown Advertising Agency, Merchandise Mart, Chicago.

ADVERTISING Placed anywhere. Copywriting, salesletters, art-work, cuts, business engineering, post-war analysis and markets, foreign service. Associated Advertising, 304 First National Bank Building, Salem, Oregon.

BUSINESS SERVICE

WASHINGTON, D. C., office address for business, personal mail—re-forwarded when wanted. Complete service \$2.00 monthly. "Hawkins," (Established 1917), 7-M Randolph Place.

TO Whom it may concern: I will represent you in Cleveland. Personal or business assignments \$1 per hour. James W. Farley, Citizens Bldg., Cleveland 14, Ohio. Note: Would appreciate hearing from someone who wishes to enter this business in your city.

CHICAGO Mail address \$1 monthly Reliable. Confidential. Faultless Organization, 3439 Michigan, Chicago 16.

SAN FRANCISCO—Business or personal representation, assignments. Modest costs. Frank, P.O. Box 511, Burlingame, Calif.

BUFFALO, New York. Am looking for reliable concern to represent in this territory. Have sales engineering experience, car, bank references; age 35, executive type. Chester Weir, 1415 Eggert Rd.

NEW ORLEANS 18, La. Will represent you here, also interested distributors. Joseph M. Schroder, 2119 Lowerline St.

SPECIAL SERVICES

CHICAGO Shopping and personal services performed. Anderson, 4341N Meade, Chicago 34.

TYPEWRITERS, DUPLICATORS, OFFICE DEVICES

WORLD'S Lowest priced adding machine. Fits vest pocket. Ideal for any business or personal use. Accurate, reliable, sturdily built. Capacity up to 10 million. Adds, subtracts, divides, multiplies. The leader for over 30 years. Sold on a positive money back guarantee. Send only \$2.50 today! Calculator Machine Co., (Mrs.), Dept. 170, P.O. Box 1118, Chicago, Ill.

NEW Postcard size stencil duplicator. Literature and samples free. Specialties, 4141 Fletcher, Chicago 41.

USED Typewriters, mimeograph, multi-graph, presses, supplies, appliances. Dixie-Graph, King, N. Car.

PRINT Your own postal cards, paper, or anything on "Pantomatic Self-feeding Rotary Postal Card Stencil Duplicator." Only \$9.50 with \$2.35 worth of supplies, stencils, ink, etc. Literature free. Pittsburgh Typewriter Supply, 336-RA Fourth Ave., Pittsburgh 22, Penna.

RUBBER STAMPS, OFFICE SUPPLIES

RUBBER Stamps, all kinds. Send for catalog. Excello, Box 500, Shreveport, La.

RUBBER Stamps, books, circulars. Parcel Press, 53 Astor St., Boston, Mass.

KNOB Handle, cushioned, 2 lines 35c. 3-45c. Stamp Works, Centerport, N. Y.

PRINTING, MULTIGRAPHING, MIMEOGRAPHING, GUMMED LABELS

QUALITY Printing: 1000 8 1/2 x 11 Royal bond letterheads \$2.65. 25,000 \$1.85 per 1000. All types of printing at wholesale prices. Write for samples. State requirements. Printing Service, 7922 South Vermont Avenue, Los Angeles 44, California.

500 8 1/2 x 11 BOND Letterheads, 500 6 1/2 envelopes, both \$5.00 postpaid. Samples. Foster Sign & Printing Co., 4020-A Cottage Grove Ave., Chicago 13, Ill.

300 PRINTED No. 6 1/2 envelopes \$1.00. Wood, 246 Main, Brockton 1, Mass.

MIMEO Letters (as if typewritten) 100 copies (300 words) \$1.50; additional 100s, 50c. English, spelling, corrected free. Multico, Cornhill, Boston 8.

QUALITY Printing prepaid: Business, personal stationery. Letterheads, envelopes, statements. Prices reasonable. Samples. Mero Products, Box 344, Punxsutawney, Penna.

LETTERPRESS And offset printing. Submit sample or specification for estimate. 4154p Fifth Street, Philadelphia 46.

200-8 1/2 x 11 HAMMERMILL Letterheads \$1.00 postpaid. Envelopes same. Race Printing, Hudson, N. Y.

HIGRADE Letterheads 8 1/2 x 11, 500--\$2.95, 1000--\$4.50. Postpaid east of Mississippi. William Jones, Dept. PM, Westbury Avenue, Mineola, New York.

DISTINCTIVE Printing reasonably priced. Free samples. Cramer, Box 993, Chicago.

PRINTING, Embossing, planographing. Free estimates. Spada, 10 Lexington, Wethersfield 9, Conn.

500 EACH Standard--Return envelopes, 5 1/2 x 8 1/2 letterheads \$5.75, 1000 \$11.00. Send 1/2 deposit, balance c.o.d. Box PM1, Manchester, Connecticut.

PRINT Anything. Thousands or millions. Engraved letterheads, etc. Lowest rates. Faultless, 3439 Michigan, Chicago 18.

200 BUSINESS, Professional or name cards, \$1. Sims, Saline 1, Michigan.

400 5 1/2 x 8 1/2 LETTERHEADS \$1.25. Mango, 355 South 29th, Newark 3, N. J.

300 5 1/2 x 8 1/2 LETTERHEADS \$1.00. Ferry, 718 West Packard, Decatur, Illinois.

300 HALFSIZE Letterheads, 200 6 3/4 envelopes \$2.00, 5000 6x9 circulars \$8.50, 5000 3x6 circulars \$4.50. Abbott Press, Oswego, Kansas.

100 6 3/4 ENVELOPES Or 5 1/2 x 8 1/2 letterheads, 50c. Lowe, 915 Tunnel, Chattanooga 4, Tenn.

MODERN Design, top quality printing for less. Catalog free. Badger Press, 120 N. Green Street, Chicago 7.

NAME, Address printed 200 sheets, 100 envelopes \$1. Michel, Box 76P, New York 16.

100 8 1/2 x 11 BOND Letterheads and 100 envelopes \$1.00 postpaid, Benneville, 907 West Roosevelt, Philadelphia 40, Penna.

BETTER Grade printing reasonable. Estimates on anything. Economic Press, Leona, N. J.

MIMEOGRAPHING -- Any copy. Reasonable. Malters Service, Box 606-A, Chicago 90, Ill.

500 3 1/2 x 3 1/2 FOUR Line gummed stickers, 25c. Moritz Printery, Saginaw, Mich.

MIMEOGRAPHING--Letters, price lists, formulas, instructions. Lowest prices. Lem's Letter Shop, 5710 Stanton, Detroit 8.

PRINTING OUTFITS AND SUPPLIES

PRINTERS: You can make a quick-etch etcher for quickly making line cuts and halftones. Particulars free. Charles P. Medlock, Box 256-C, Goodland, Indiana.

HOME-MADE Printing press, duplicator, printers' cuts--details 10c. Tirkop, G-10, Madira, Ohio.

PRINT At home--Send 10c for catalogue--presses, type, supplies. Barnhard Co., 6 Columbia St., Newark 5, N. J.

INEXPENSIVE Home-made printing press. Details free. Novelty Shop, Downsville, Louisiana.

PRINTING Equipment, type and supplies. Send stamp for details or dime for complete illustrated supply book. Kelsey Inc., X-11, Meriden, Conn.

PATENT ATTORNEYS

INVENTORS--First things come first. Your first move toward securing a patent on your invention is acquiring full information on what to do. Our two books "Patent Protection" and "When and How to Sell Your Invention" contain this information and other helpful data. Get them immediately, together with our "Evidence of Invention" form. They cost you nothing, you assume no obligation. Write now to Victor J. Evans & Co., Registered Patent Attorneys, 931-L Merlin Building, Washington 6, D. C.

"PATENT-Particulars," free, airmailed. Sterling Buck, Park-North Avenues, Baltimore 17, Md.

PATENTS. Promptness assured. Wilfred E. Lawson, 1524 K Street, N.W., Washington 5, D. C.

WHERE Can you sell your ideas? Have you a new idea, an improvement, a device of utility or novelty? Want to know where to sell it? Learn the facts first about its patentability. We have letters from manufacturers wanting new patented ideas. The present emergency market has created a big demand. Get our free book, "How to Protect, Finance and Sell Your Invention." Also free special form "Invention Record." No obligation. McMorro & Berman, Registered Patent Attorneys, 1348 Atlantic Building, Washington 4, D. C.

INVENTORS: Learn now--without obligation--how to protect and sell your invention. Write for free "Record of Invention" form and complete information for making disclosure and establishing date of your invention. We also send our new free "Patent Guide for the Inventor," containing complete information about patent procedure and how to sell inventions; giving illustrations of many successful inventions; over 150 basic mechanical movements. We assure you prompt, confidential service. Delays may be dangerous. Write today for your free "Patent Guide" and "Record of Invention" form. Clarence A. O'Brien & Harvey Jacobson, Registered Patent Attorneys, 51B-J, Adams Building, Washington, D. C.

PATENTS. Protect your idea by securing free "Proof of Invention" folder. Exceptional personal service. Established 1906. E. E. Vrooman, 871 Woodard Bldg., Washington, D. C.

PATENTS Obtained; selling service, information, recording forms free. Labiner, World Building, New York.

PATENTS--Trade marks. Preliminary advice, book and disclosure form free. Personal service. Irving L. McCathran, 315 McLachlen Bldg., Washington 1, D. C. Registered Patent Attorney.

INVENTORS--Before disclosing your invention to anyone send for form "Evidence of Conception"; Schedule of Government and Attorneys' Fees and instructions. Sent free. Lancaster, Allwine & Rommel, Registered Patent Attorneys, 411 Bowen Building, Washington 5, D. C.

PATENT Protection. Write for information. Fees. Record of invention. Free. Randolph & Beavers, 21-C Columbian Bldg., Washington, D. C.

"INVENTOR'S Guide." 100 mechanical movements, free; advises on patenting, selling inventions. Frank W. Ledermann, 154 Nassau Street, New York.

C. A. SNOW & Co., M-427 Snow Bldg., Washington 1, D. C. Registered patent attorneys. Established 1875. Literature mailed on request.

FOR INVENTORS

WHERE Can you sell your ideas? Have you a new idea, an improvement, a device of utility or novelty? Want to know where to sell it? Learn the facts first about its patentability. We have letters from manufacturers wanting new patented ideas. The present emergency market has created a big demand. Get our free book, "How to Protect, Finance and Sell Your Invention." Also free special form "Invention Record." No obligation. McMorro & Berman, Registered Patent Attorneys, 1347 Atlantic Building, Washington 4, D. C.

INVENTORS--Information on what to do first toward securing a patent on your invention is of vital importance. "Patent Protection" and "When and How to Sell Your Invention"--two valuable, richly illustrated books--explain fully what to do first, and a lot more. Get this information quickly, together with "Evidence of Invention" form. All three will be sent to you free. Write immediately to Victor J. Evans & Co., Registered Patent Attorneys, 931-L Merlin Building, Washington 6, D. C.

PATENTED And unpatented inventions promoted. M. Joyce Humphries, 1424 Land Title Bldg., Philadelphia 10, Penna.

HAVE Your idea or model developed now at pre-war prices. Forty years experience in developing, designing. Tool and die work. Inventors Laboratory, Madisonville, La.

COMPLETE Inventors service. Free literature. Reasonable rates. Invention Development, 17720 Mission Blvd., Granada Hills, California.

APPRAISE Your own invention. Know its value before going farther. Authentic methods show how you can estimate success of different inventions. Tells how manufacturers compute royalties, prices. Information free. Industrial Management, 7A Randolph Place, N.W., Washington 1, D. C.

DON'T Disclose invention. Just ask for marketing offer. Inventions. 1860 Walnut, Harrisburg, Penna.

IDEAS Wanted. Have you any ideas for postwar products? If they can utilize light metals our engineers will be glad to help you develop them. We are looking for new items to manufacture and are not soliciting fees for advisory service. We are also in a position to finance ideas of merit. No obligation. Box 19, Powerad Co., Adv. Agency, 79 Madison Ave., New York City.

INVENTORS--Selling your ideas is our business. Write for details. Inventors Sales Service, Box 3005, Euclid Branch, Cleveland 17, Ohio.

INVENTORS: I specialize in patent office searching. You are invited to call any evening and talk with me personally. Phone Decatur 5305, Washington, D. C., or write Raymond L. Smith, 302 Bond Building, (Former U. S. Patent Office employee.)

INVENTORS: Learn now--without obligation--how to protect and sell your invention. Write for free "Record of Invention" form and complete instructions for making disclosure and establishing date of your invention. We also send our new free "Patent Guide for the Inventor," containing complete information about patent procedure and how to sell inventions; giving illustrations of many successful inventions; over 150 basic mechanical movements. We assure you prompt, confidential service. Delays may be dangerous. Write today for your free "Patent Guide" and "Record of Invention" form. Clarence A. O'Brien & Harvey Jacobson, Registered Patent Attorneys, 51A-J Adams Building, Washington, D. C.

INVENTORS: New military and commercial inventions urgently needed by manufacturers. Write for particulars. Institute of American Inventors, Dept. 4-A, Washington, D. C.

PRESENT Your ideas to manufacturers in an attractive form. Mechanical or other drawings made at reasonable cost. Write Paul Quinn, 76 Forman Street, Bradford, Penna.

WE Locate buyers meritorious patented, unpatented inventions. If will sell, reply immediately. Descriptive booklet, references free. Invention Reporter, 5A-11106 So. Longwood Drive, Chicago.

I SELL Patents. Established in 1900. Charles A. Scott, 773PM Garson Ave., Rochester, N. Y.

RANDOLPH & Beavers: Registered Patent Attorneys, 11-E Columbian Building, Washington, D. C. In order to protect your invention and reap the reward that should be yours, patent your invention without delay, and at the same time have rights to sell as manufacturers convert to civilian production. Write for information and record form today.

CASH For practical ideas and inventions. Mr. Bail, AB-9441 Pleasant, Chicago.

INVENTIONS Pay only when skillfully developed for commercial use, and protected as developed. We do both confidentially. Searches, reports, sales aid. Thirty years experience. Very reasonable charges. Development Co., Patent Engineers, 132 Nassau St., New York City.

INVENTIONS WANTED

HAVE You ideas, either patented or unpatented, that are worth developing? We will consider items of metal or plastic. Will furnish references. Dependable Mfg. Co., 1908 California St., Omaha 2, Nebr.

YOUR Invention presented to our clients free. Send description only. Zigrand Manufacturers Service, 504 Home, Trenton 10, N. J.

WANTED: Practical inventions. Inventors Patent Exchange, Research Division-B4, Hartford 1, Connecticut.

INVENTIONS And dies wanted--Large well rated manufacturer will buy your invention or tools and dies of articles suitable for mass production. Lion Mfg. Corp., 135 So. LaSalle, Dept. BJ, Chicago 3, Ill.

PATENTED. Unpatented, bought, sold, financed, no advance charges. Inventions Sales Company, Williamson Building, Cleveland, Ohio.

MANUFACTURER Desires postwar products to make and sell through drug, hardware, department stores and mail order. Or will handle sales only. Reputable, nationally-known organization capable of promoting nationwide sales as well as manufacture of items. Prefer non-electrical products of metal, glass, plastics, etc. Write P.O. Box 1373, Indianapolis, Indiana.

INVENTORS: Have you a sound, practical invention for sale, patented or unpatented? If so, write Institute of American Inventors, Dept. 4-D, Washington, D. C.

CASH For plumbing specialty inventions. Chicago Specialty Mfg. Co., 2954 Lawrence, Chicago 25, Illinois.

WANTED—Patented, unpatented inventions having profit possibilities, all kinds. If will sell, reply immediately. Descriptive booklet, references, free. Invention Reporter, 5B-11106 So. Longwood Drive, Chicago.

INVENTORS! Have you good patentable idea? Write Mr. Metzler, 11 West 42nd, New York.

MANUFACTURER Wants sensible mechanical device or idea with quick sales possibilities in low-priced field. Write Matt, 1412-D Great Northern Building, Chicago 4.

CASH For inventions, patented, unpatented. Mr. Ball, A-9441 Pleasant, Chicago.

PATENTS FOR SALE

FOUNTAIN Pen patents for sale on a revolutionary new pen. John A. Snodgrass, Box 107, Prescott, Arkansas.

FOR Sale or royalty, two speed gear, and vertical milling attachment for lathes, sprocket intermittent movement for projectors. Patents applied for. Chas. Dyer, Stratton, Maine.

EVERLASTING Electric fuse. Makes a circuit breaker of ordinary fuse box. Presents unlimited possibilities. Patent pending. P.O. Box 143, Martinsville, Va.

INVENTION For sale. Book end, representing the temptation of Christ. Mould is perfect. A. L. Jack, Box 14, Station B, Los Angeles 33, Calif.

NEW Type plastic selective change purse. Orville Petersen, 225-A Ave., N.W., Cedar Rapids, Iowa.

METAL Adjustable weather stripping. Simple to install. Big item for chain stores. Apt. B11, 5101 39th Ave., Long Island City 4, N. Y.

PATENTS Pertaining to caps, baby crib feeder and combination storm windows. Royalty basis or outright sale. 7207 Myron Ave., Cleveland 3, Ohio.

PATENTED Tire deflation indicator, low-priced, proven practical, simply constructed, easily installed and scarcely noticeable. Every vehicle with inflated tires, particularly trailers, needs its protection. Miller, Box 644, Salem, Oregon.

A FLEXIBLE Adjustable lever drag harrow, No. 2,347,979, royalty basis. Vincent Antal, Owatonna, Minn.

SELL Your patent through a small classified ad in Popular Mechanics. Many inventors have found buyers in this way. Ask me for proof—I'll gladly send it to you. P. W. Johnson, Manager Classified Advertising, 200 E. Ontario St., Chicago.

MANUFACTURING

INDUSTRIAL Diamonds mounted \$1.50. Models, tools, inventions, manufacturing. Any lot. Specialty Machine, 2321 Mitchell, Racine, Wis.

MODELS—Small lot manufacturing. Metals, plastics, etc. Milburn, Burlington, Kentucky.

MODELS AND MODEL SUPPLIES

CATALOGS (Illustrated) for modelers! Airplanes, 60 page book on solids. Features construction data, specifications, camouflage, 10c; railroads: 128 page "HO" guide. Equipment, accessories, fittings. 25c (includes refund coupon). Send coin or stamps for each profusely illustrated catalog desired. Polk's, "Nation's Leading Hobby House," 314-PM Fifth Ave., New York City 1.

SHIP And yacht model fittings and blueprints. Hundreds of items to choose from. Send for our war time supplement. A. J. Fisher, 1002 Etowah Ave., Dept. WM, Royal Oak, Mich.

MODEL Kit and supply catalog—10c coin. Al's Hobbies, 2131 W. Vliet, Milwaukee 5, Wisconsin.

LANDLOCKED Sailors! Here's a beautiful, richly illustrated, fully descriptive catalogue of famous model ships—whalers, slavers, corvettes, etc., authentic in every detail. Send for it today. Only 10c. Marine Model Company, Inc., Dept. C-1, 29 W. 15th St., New York, N. Y.

CONTEST Storage cells. Plexiglas construction. Screw cap, non-leak design. Alpha, 1.1 oz. 15 amperes. Beta 2.2 oz. 30 amperes test proven. \$2.85. Alpha, 7942 Elwood, Houston 11, Texas.

SHIP Model kits and fittings. Complete line Fisher model yacht equipment. All Boucher, Fisher, Marine Model and Ideal kits, fittings and blueprints at standard prices. Most complete stock in New England. Send 10c for price list. James Bliss & Co., Inc., 220 State St., Boston, Mass.

GAS Model engines available. Rocket motor Class C displacement .460 cubic inches \$24.80. Vivell 25 Class C displacement .35 cubic inches \$20.55. All engines equipped with coil and condenser. Postpaid. Other motors as soon as they become available. Inquiries invited. General Modelcraft Company, Dept. M10, 91-17 173rd Street, Jamaica 3, New York.

MINIATURE Steam locomotives, $\frac{1}{8}$ " to $\frac{1}{4}$ " scales. Castings, parts, rail. Thorough drawings with instructions. Circular free. Little Engines, Wilmington, Calif.

WORLD'S Largest selection model engine castings and drawings. Illustrated catalogue 10c. Wayne Miller, Belle Plaine, Iowa.

RADIO Control for your model. Send 25 cents for instruction manual to Radio Control Headquarters, Box 214, Deal, New Jersey. No stamps.

RAILWAY Models, complete line, informative catalog HO and O gauge. 79 pages 25c. Walther, 247 Erie, Milwaukee, Wisconsin.

SHIP Models and yacht supplies complete. Large 64 page catalogue 25c. Bill Wild's, 510 East 11 St., New York City.

BOAT Models. P.T., cabin cruiser, speedboat. Free circular. All Star, 2003 Lincoln Ave., Chicago 14.

HOME CRAFTSMEN

CELLULOID—Beautiful assortment. Mottles, opaques, onyx, pearls. Used by ring makers everywhere. One pound assortment—pieces approximately 30 sq. in. each. Price \$1.00. Please add 10c for postage. Craft Service, 337 University Avenue, Rochester 7, New York.

BULLDOZER, Power shovel, Earthmover. Prints and specifications of these designs in wood \$1.00. Also designs for other home and craft shop products available. Earthmover Toys, East Lansing, Michigan.

TOYS Easily made from scrap wood, 15 patterns 25c. Novelties from scrap wood, 25 patterns, 25c. 15 lawn ornament patterns 25c. Plastic, metal, and other craft supplies also available; send for price list. Lynds, Medway, Mass.

PLASTICS—Plexiglas, Lucite, Bakelite, Lignolite, Lumarith, Ethocel in sheets, rods, tubes and strips. Fine assortment of standard sizes. Cements, dyes and other plastics supplies, too! Complete lists 10c. Carmen-Bronson, 165B East Third Street, Mount Vernon, N. Y.

PLYWOOD Cut to size for shelves, lawn ornaments, toys, etc. Rexroat Woodcraft, Salem, Indiana.

MAKE Shell jewelry. Dollar kit makes three brooches. List free. Dixie Shell Service, Lakeland, Fla.

26 LAWN Ornament patterns 25c. Other patterns: 15"-20" high; Dutch girl, Dutch boy, pirate, bull terrier, Mexican girl, Mexican boy, dwarf, penguin, flower girl, 10c each; 3 for 25c. 25 novelty patterns 30c. All 62 full size patterns \$1.00 postpaid. Strother, Box 383-HT, Belington, W. Va.

"HAPPY Hitch Hiker." A new idea in comical pull toys. Will give your tot or toy shop a lift. Easily constructed. Full size pattern—25c. List of other toys on request. Scully-Hall, 92-46 220th St., A15, Queens Village 8, N. Y.

CRAFTSMEN—Fast selling, make children and adults lawn chairs. Plans and instructions \$1.00. Summercraft Studio, 42 Vernon St., Newton 58, Mass.

BUILD it yourself! Practical blueprinted plans for modernistic rocking crib. \$1.00. Longenecker Engineering Laboratories, Box 95, Elwood, Ind.

MYRTLEWOOD Turning blocks—Prices on request. Box 7146, Portland 1, Oregon.

STAINLESS Steel, bar or sheet assortment, \$1.00 postpaid. Industrial Engineering, 1155 South Kenmore, Los Angeles 6, California.

LUCITE Fabrication instructions and catalog of plastic projects 25c. Glassite, 625 N. Atlantic, Monterey Park, Calif.

"LUCITE" "Plexiglas" pieces, book of instructions and projects, 3 colors dye, cement, \$2.00 postpaid. O.K. for overseas. Barnett Specialty, 8619 W. Third, Los Angeles 36, Calif.

PLYWOOD—Beautiful nonpriority aircraft, cabinet and paneling stock. Thickness 1/16" through 1"; large, small panels. Fir, gum, birch, mahogany, walnut. Reasonable! Complete lists 10c. Carmen-Bronson, 165B East Third St., Mount Vernon, N. Y.

PLASTICS, All types, remarkably low priced. Free listings. Craft-Plastics, Box 129M, Somerville, N. J.

PLEXIGLAS And Lucite—The amazing crystal-clear plastics. Saw, drill, bend or twist them into hundreds articles that are beautifully different! Special one-pound assortment including cement, project drawings, complete instructions—only \$1.25. Six pounds \$5.00; 25 pounds \$18.75. Masked sheets 12"x12" (144 square inches) $\frac{1}{8}$ " \$2.50; $\frac{3}{16}$ " \$2.75; $\frac{1}{4}$ " \$3.00. Fast-acting cement \$1.00. Red, blue, yellow dyes \$1.00 each. Send no money! Pay postman cost and charges on delivery. Satisfaction guaranteed. Carmen-Bronson, 165B East Third Street, Mount Vernon, N. Y.

CERAMIC Jewelry supplies, bar pins, ear screws, for ceramic and woodworkers, also, glass and sea shell assemblers. Free catalog. Phila. Badge Co., 1007 Filbert St., Philadelphia, Penna.

CATALOG: Patterns plywood novelty furniture, letters, numerals, plaques, frames, weathervanes, silhouettes, lawn ornaments, 100 books and booklets on crafts and hobbies, picture frame mouldings, tools, large line decal transfers. Other lines. Hundreds articles finely illustrated. Write Wo-Met Shop, Ashburn, Ga.

TOY Patterns. Circus wagons, trucks, carts, pull toys, etc. 35 patterns \$1.00. Continental Products, 907 Birch, Eau Claire, Wisconsin.

PLANS—30 Toys, 10 puzzles, 10 lawn ornaments, in wood. \$1.00. Winfield Hess, Dept. 11, Dover No. 1, Penna.

PATTERNS—Full size for rocking horse, swan rocker, doll stroller, cradle and boy's wheelbarrow. \$1.00 postpaid. Lincoln's Craft Shop, Farmington, Conn.

WHITTLES—20 Patterns, instructions, X-acto knife, wood. \$1.00. "Old Whittler," 1402 Charles, LaCrosse, Wis.

CRAFTMEN—Build and sell lawn chairs. Detail plans \$1.00. We tell you how we build, how and where we sell. The Woodcraft Shop, Danby, Vermont.

MAKE Shell jewelry. Shell, metal and plastic parts for manufacturing at home. Free illustrated catalogue and detailed instructions. Florida Supply House, Bradenton, Fla.

MAKE IT YOURSELF

CRYSTAL Radio receivers. Easily constructed using Hulet's complete kit of apparatus, wonderful reception. Illustrated catalog free. Hulet, 29 East 39th, New York.

HOME. Build your own. House plans \$1.00. Tile mold plans \$1.00. W. Denham, Box 265, Murray, Ky.

HOME Telegraph. Two complete sending-receiving sets! Two-way communication. Easily put together. Complete parts, \$1.00. Robert Hulet, 29B East 39, New York.

FIREPLACE Curtain mesh. Make your own fire screen. Beautiful brass or copper finish. Send measurements to Box 4662, Station B, Spokane, Wash.

FLUORESCENT Lights. How to make your own 20 watt lights for less than \$1.00 each. Material available. Complete guaranteed, detailed instructions \$1.00 cash, m.o. or war stamp. Checks \$1.10. Specialty Sales, Box 1086, Muncie, Indiana.

KITS. Lovely lucite merchandise. See Glassite's ad in Money-making Opportunities.

BUILD Concrete block machine. Easy, inexpensive. Sell blocks. Build home, garage, barn, etc. at low cost. Free details. Horne, 206 West Wilder, Tampa 3, Florida.

MAKE Your own electric fuses for your home. Model \$2.00. W. G. Stonebraker, 6006 Harney, St. Louis 20, Missouri.

RADIO Control equipment. Control models, doors, etc., by radio. Send 25 cents for instruction manual to Radio Control Headquarters, Box 214, Deal, New Jersey. No stamps.

WATCHES, OLD GOLD, JEWELRY, ETC.

TRAIN Yourself for watchmaking, repair, adjustment, etc. New, all inclusive "Practical Course" for beginners and professionals, also tools, materials. Fully illustrated. Sensational value. \$2.95 postpaid. Money back guarantee. Modern Technical Book Co., Dept. MMC, 55 West 42nd St., New York 18.

GOLD \$35.00 Ounce—Mail old gold teeth, diamonds, jewelry, watches—receive cash by return mail. Satisfaction guaranteed. Free information. Dr. Weisberg's Gold Refining Company, 1500-Q Hennepin, Minneapolis, Minn.

GEMS. Precious and semi-precious, all genuine, from world wide sources. Deal direct, no overhead, save money. Catalog 10c. Hill Co., Route 7, Salem, Oregon.

GENUINE Diamonds, out-of-pawn low prices, wonderful values. Unredeemed loans and big buying power enable us to offer beautiful gems at prices far less than original cost. Shipped free for inspection, appraisal. Send for big free list showing fine diamonds at startling low prices. Lloyd J. Butler, President, Prudential Loan Association, 133-SL North Clark St., Chicago 2.

"JEWELRY. Gem cutting and metalcraft" excellent for hobby, profession. All inclusive. Cutting, polishing, mounting gem stones, metal, jewelry work, etc. for gift purposes, household, sale. Many interesting designs, projects with easily obtainable inexpensive material. 287 pages, 170 illustrations, \$2.95 postpaid. Modern Technical Book Co., Dept. 3MMC, 35 West 42nd St., New York 18.

JUSTICE Buys almost anything! List free. 9762 Santa Monica, Beverly Hills, California.

GUARANTEED Watch and clock repairing. Prompt service. Mail yours to Rite-Time, 1318 W. 95th St., Chicago, Ill.

WATCH Repairing easy learned by our home study course. Watch repairers are in demand and are among the highest paid craftsmen today. Write for free information. Houston Chronometer & Watch Co., P.O. Box 5367C, Houston 12, Texas.

WATCH And clock repairing—complete practical course in modern horology. 65 illustrated self-instruction lessons. Just out! Low price. Information free. Write Nelson Company, Dept. 8-02-2, Chicago 4.

RAZORS, BLADES, SHARPENING

100 **FIRST** Quality double edge razor blades \$1.50 postpaid. Guaranteed satisfaction. A. Masser, Cherokee, Kansas.

TOBACCO, SMOKERS' SUPPLIES

CIGAR Smokers! News! We offer box of superfine quality cigars, \$4.00 prepaid anywhere. Customers Maine to California ordering and reordering. Excellent 8c value. Real smoking pleasure. Send check, money order today. S & E Cigar Company, Box 266, Red Lion, Penna.

FINE Six cent cigars available soon. Be first on list for first shipments. Act now. Send no money, only name and address to P.O. Box 776, Dept. F-643, Chicago 90, Ill.

SURVEYING INSTRUMENTS

GUARANTEED Factory rebuilt transits and levels for sale (cash or terms) or rent (with purchase option). We will repair, trade, or buy old instruments. Ship prepaid for estimate and valuation. For complete information. Write for list M1010, Warren-Knight Co. (Manufacturers of Transits and Levels), 136 N. 12th St., Philadelphia 7, Penna.

FOR THE HOME

REPLACEMENTS — Stoves, furnaces, grates, firepots, linings? Magiproduct, Royal Oak, Mich.

FOR SALE—MISCELLANEOUS

USED Army field telephones—choice of leather or wood cases—\$3.50 each, \$15.00 per set. Express collect. Has magneto with bell crank. Does not include battery. Ideal for play, camping, etc. Connects by field telephone wire at 2c per foot. Connected in series of two, three or more. Limited quantity used artillery type wall phones (receiver and transmitter not included). Extra large crank magneto—ideal for experimental purposes or signaling. In steel case for wall installation—\$3.75 each, \$6.50 per set. Express collect. Write for catalog of camping equipment. Samet Sales Co., High Point, N. C.

ASBESTOS Mittens; gov. surplus, handy for shop, garage, etc. \$1.65 pair postpaid in U. S. Worth double, satisfaction guaranteed. Caribbean Salvage, Aibonito, Puerto Rico.

ARMY Goods (used). Raincoats \$1, parka suits \$3, jeep hats and caps 10c, overseas caps 10c, dungarees 95c, tool boxes \$1, gas mask bags 50c, steel helmets \$1, gun slings 75c, holsters 75c, canteens 50c, cups 15c, mess kits 35c, leggings 25c, cartridge belts 50c. Minimum shipment \$1. No C.O.D. N. Y. Salvage, 144 Chambers St., New York City.

COLORED Pencils 25c. Box 2 1/2x5. Anthony Miceli, 412 Massachusetts, Buffalo 13, New York.

GENUINE Leather wallet with 9 windows \$1.50. Free—name, address engraved on identification plate. Bonomo, Box 45, Sta. A, Brooklyn, N. Y.

CUTTERS. Dental burs assorted, reclaimed job-lot, \$1.90 per gross. Wolf, 1924 E. Hartlans, Philadelphia, Penna.

SELF-WINDING Extension reels equipped with 16 feet No. 18 electric cord. Suitable for factory or garage. These reels manufactured by Vacuum Cleaner Corporation of America on special order. Closing out at \$2.25 each postpaid. Radio Reel Co., 1116 Rust Building, Tacoma 2, Wash.

WANTED—MISCELLANEOUS

MINIATURE Furniture—scale. Inch equals foot—must be nice. H. Jones, 486K Brandeis Bldg., Omaha 2, Nebr.

MERCURY—Highest prices. Free containers. Write. Wholesale Terminal, Norwood, Mass.

WANTED—Old student lamps. Silver tea sets, trays. Old colored glassware. Figurines. Louise Hudson, 428 Mistletoe Ave., Youngstown 7, Ohio.

UNUSED Postage stamps U. S. wanted. Reasonable discount. Amerident, 489 Fifth Avenue, New York 17, N. Y.

MERCURY (Quicksilver) — Cadmium, bismuth, tungsten, molybdenum, cobalt, vanadium. Write for quotations stating quantity. You'll receive guaranteed prices. Metallurgical Products Co., 35th and Moore Sts., Philadelphia, Penna. Established 1909.

PERSONAL

ARTISTIC Greeting cards that create interesting distinctiveness. Hand designed. Water colors. Limited clientele accepted. Place your name now on our mailing list. Joseph Boullier, 8 Richfield Ave., Cranston, R. I.

SWAP: Trade. Three months 25c. "Swappers" Gazette," 2836-P Slevin, Louisville 12, Ky.

DREAM Dictionary, 500 dreams explained. Only 19c. Kaybee, Crescent Beach, B.C., Canada.

REAL 10 Power telescopes \$1.90, United, 2309-B Lawrence, Toledo, Ohio.

"INDIVIDUAL Service" brings personal letters of introduction. Write P.O. Box 966, Saginaw, Michigan.

MEXICAN Law practice. A. B. Flota, Box 236, El Paso, Texas.

BOOK Bargains. Illustrated catalogs free. Rialto, 349-B, Sackett, Brooklyn, N. Y.

HAIR Falling? Dandruff? Write Trichologist, 137 Lewis St., Phillipsburg, N. J.

PERSONALIZED Pencils. Any imprint, gold, not over 40 letters. Dozen 50c, 9 doz. \$1.00, gross \$3.60 delivered. Pencil Market, 611-15th St., Knoxville 16, Tenn.

MISCELLANEOUS

NEW Powerful Goldak electronic locators. Now ready. Amazing sensitivity. Two new models. Large model ideal for deep exploration both prospecting and treasure finding. Small, compact model, radically different, originally developed for important military use makes ideal treasure finder. At last available to the public. Money-back guaranteed to detect gold, silver and other metals and minerals at greater depth than any competitive device. Write for full details. The Goldak Co., 1544 West Glenoaks Blvd., Glendale 1, Calif.

WANTED. New toys in wood or steel. Let us be your distributor or manufacturer. Please submit working models to City Machine Company, 868 East Tallmadge Avenue, Akron, Ohio.

"RECEIVE Mail." Moneymaking offers, opportunities, catalogs. Name listed 10c. Ideal Service, 110, Park Ridge, Ill.

RECENT Discovery in copperplating. Use either copper, brass, steel, or aluminum anode. Compound enough to make 3 gals. \$3.00 or generous sample postpaid \$1.00. Sutherland Service, (Ranlo) Gastonia, N. C.

WHITE Plaques to paint. Free price list. Graham Co., 4348 Bloomington, Minneapolis 7, Minn.

LETTERS 15c, 25c Postpaid. Letteriffs, 82-29 60th Road, Elmhurst, N. Y.

LUMINOUS Paint. Best quality. Glows bright blue in dark. 1 oz. each paint and sealer only \$1.39 postpaid. Black Light Products, 450 E. Ohio St., Chicago 11, Ill.

UNPAINTED Wall plaques 2c up. Burgermaier, 15 Carl St., Dayton 3, Ohio.

RUPTURED? Improved appliance holds easily. Free trial. Free rupture facts. Earles Company, Flint, Michigan.

RECEIVE Mails, moneymaking opportunities, samples, literature. Your name in several mailing lists. 10c. Rogowski, 3415 Broadway, New York 31.

"BIBLE Studies." 70 lessons 25c. Box 87, Station H, New York 25.

THE Lord is coming! Repent, His signs are being fulfilled today. Get free genuine proofs. Scheall, Box 263X, Duluth, Minnesota.

MEXICAN-ARTIST Featherwork tropical bird picture cards. Samples 25c. Bulletin free. Mexican Products Co., 126 No. Main, Tulsa 3, Okla.

RECEIVE Mails, literature, opportunities. Your name in numerous mailing lists 10c. Abner Greenwood, 277 Broadway, New York 7.

TRICKS And tips for creating clever, distinctive, Christmas photo-cards. Complete instructions \$1.00 (bill). PicTrix, Dept. 12, 1213 Rosedale Drive, Dayton 7, Ohio.

PYRAMID Plan sells "anything" by mail or agents like wildfire! Working instructions \$1.00. MacCormack, 10-A, Madeira, Ohio.

HOBBY Books. Latest titles. Catalog free. Popular Mechanics Press, (C-43), 200 E. Ontario, Chicago.

OPEN Test locks—5 pass keys \$1.00. National Service, 322A Union Ave., Brooklyn 11, N. Y.

CUBAN Surprise mail 25c. postal money-order A. Boza, Cotorro 23, Cuba.

DEPENDABLE Cash markets want your ideas for simple home, workshop, garden or farm conveniences. Particulars free. Hendrickson, Argyle 7, Wisconsin.

METRIC Drawings \$10. S. Moore, Eng. 2605 W. 18th, Indianapolis.

ATTENTION Coal users. Save fuel by using Coal-Aid. Information sent upon request. Pettam Specialties, Crown Point, Ind.

OBTAIN Free fertile lands or profitable employment in Latin-America. Interesting information, 10c. Vallesp, 395-PO Broadway, New York 13.

OUTSTANDING Gifts, novelties and Christmas suggestions from the Redwoods and California. Useful gift and retail or wholesale literature 10c. Johnson, Rt. 1, Box 188, Eureka, California.

TRADE Magazines. Business, vocational, diversion. Current single copies. Over 200 fields. Free price list. Commercial Engraving Publishing Co., 34C North Ritter, Indianapolis 1, Indiana.

INFORMATION — Locating articles, products (wholesale) etc. Rakes, Box 5931-2, Chicago 80.

GIGANTIC Mails, magazines, samples, listing 10c, three times 25c. Waddell's, 341 East 76th, New York 21.

BIGGEST Money in tattooing now! No experience required. Complete instructions with outfits. Send for free literature. Tatuco, 651 South State, Chicago.

ALASKA Scenes in Kodachrome slides. 75c each. Free list. Alaska Film Company, Box 81, Ketchikan, Alaska.

25 SHELVES You Can Make. Booklet describing everything from wall shelf for dishes to knickknack shelf of white enameled wire and blue glass. 25c. Popular Mechanics Press, (C-43), 200 E. Ontario, Chicago.

FEET Hurt? Plastic arch supports made to order, unbelievable comfort. Impression material free. Archercraft Company, 600 West 164 St., New York City 32, N. Y.

MEDICAL Laboratory technicians in great demand. We train you in your spare time, in your own home. You can practice while studying. Write for free catalog. Imperial Technical Institute, Box 973-J, Austin, Texas.

SQUARE Dance instructions, calls. 25 sets, \$1.00. Rayburn, Lonsdale, Arkansas.

TATTOOING Outfits, designs, colors. Write today. Zeis Studio, 723 Lesley, Rockford, Illinois.

GOOD "Used" self-instruction educational books on all subjects bought, sold, rented, exchanged. Satisfaction guaranteed. Complete information and 92-page illustrated bargain catalog free. Write—Nelson Company, Dept. 2-02-2, Chicago 4.

FREE—"Amazing New Book"—"Profits From Classified Advertising." Tells how and what to advertise. Be sure to read this book before you invest one cent in advertising. Remember—it's free! Write for your copy now. F. W. Johnson, Classified Advertising Manager, 200 East Ontario Street, Chicago 11, Illinois.

\$100 MONTHLY

IF SICK OR INJURED

Plus HOSPITAL BILLS PAID



EXTRA LIBERAL New \$1 A MO. POLICY

Provides QUICK CASH when it's needed most — when sickness or accident strikes . . . to replace lost income, pay hospital bills, doctor bills, etc. Covers any and all accidents, all the common sicknesses, as specified. No waiting period for benefits.

NO MEDICAL EXAMINATION required! No red tape! Policy issued by mail at BIG SAVINGS. Ages 15 to 69. Actual policy sent for 10 DAYS' FREE EXAMINATION. Write for it today. No cost. No obligation. Just send name, age, address and name of beneficiary to—

ACCUMULATED CASH for accidental loss of life, limb or sight up to \$1,000, accumulated to

\$6000.00

ACCIDENT BENEFITS at rate up to \$100 per month, for as long as 24 months, or . . .

\$2400.00

SICKNESS BENEFITS for as long as 3 months, up to . . .

\$100.00

HOSPITALIZATION Pays \$5 per day and other hospital expenses for sickness or accident, to over . . .

\$650.00

THE SERVICE LIFE INSURANCE CO.

428A SERVICE LIFE BLDG. OMAHA 2, NEBR.

TRAINED MEN WANTED NOW FOR BIG PAYING JOBS



TRAIN WHERE THE ARMY TRAINED

This new, fast growing industry needs trained men for big paying jobs. Get in on the ground floor by starting now with the only civilian trade school selected for Army Training Program in this big, new industry.

REFRIGERATION—AIR CONDITIONING

Train at home or in our big shops. Work with tools on actual machines. Simple to master by our special training methods. Big opportunities now waiting. In a few short months you can be a qualified REFRIGERATION SERVICE ENGINEER, ready to move into a big paying job or be your own boss with your own business.

FREE BIG 16 PAGE BOOK OF VALUABLE INFORMATION

This big free book tells you all about the opportunities that await. Read the fascinating story of the tremendous growth and development of this industry—how you can get in on the ground floor if you ACT NOW. Write today!

ALL DETAILS SENT FREE

Send Coupon TODAY!

ACT NOW!

LEARN IN YOUR SPARE TIME AT HOME

Commercial Trades Institute, Dept. M-10
209 W. Jackson Blvd., Chicago 6, Ill.
200 S. 20th St., Birmingham, Ala.

Without obligation, please send me the facts. Let me judge for myself the opportunities and post-war security this training offers.

Check here if interested in GI training.

NAME

ADDRESS

TOWN.....ZONE.....STATE.....

CITY.....STATE.....

Enjoy Steady Work with a Future in Good Pay Field

WITH COYNE PRACTICAL BOOKS ON **ELECTRICITY**



H. C. LEWIS, Pres.

On 7 Days FREE Trial



START NOW TO KNOW ELECTRICITY as the experts know it with the NEW Coyne Practical Electrical Books. These great books, of COYNE Electrical School, show you new methods, labor and money saving ideas. THEY'LL HELP YOU get ahead in the keen competition for the big jobs NOW and in the future.

Every Coyne book is complete on the particular subject it covers. Written in clear simple language that the man "on the job" can understand. Hundreds of diagrams and pictures, large easy-to-read type. See any or all of these books for 7 days' FREE examination.

BE AN EXPERT IN YOUR LINE GET SET FOR BIGGER JOBS AHEAD

ELECTRICAL PRINCIPLES & CIRCUITS: Covers basic electricity, Telephony, Signal Systems, Formulas, Rules, etc. . . . \$3.25
410 pages

ARMATURE AND STATOR WINDING: Covers A. C. and D. C. Armature and Stator Repair and maintenance, testing, a valuable reference book. . . . \$2.25
290 pages

WIRING FOR LIGHT AND POWER: Electrical Construction, HOUSEHOLD APPLIANCE REPAIR, Neon and Fluorescent Lighting, Farm Electricity, Aviation Lighting. . . . \$3.25
475 pages

AUTOMOTIVE, DIESEL & BATTERIES: Service, Installation, Ignition, Lighting, Timing, etc. 510 pages . . . \$3.25

D. C. MOTORS & CONTROLS: New Methods of Installation, Operation & Maintenance . . . \$3.25
—450 pages

A. C. MOTORS & CONTROLS: Big 750 page book covers A. C. completely, new developments — labor savings ideas, a real buy . . . \$4.00

ELECTRICAL REFRIGERATION & AIR CONDITIONING: A timely book includes new methods of servicing, Deep Freeze Units, Radio. 375 pages \$3.25

SEE ANY OR ALL 7 BOOKS FREE

Although these books are valuable as individual volumes, the entire 7 books makes one of the most complete sets of Electricity ever published. Ideally suited as a self-study or reference set. Entire 7 volumes cover 3,000 subjects, 10,000 facts with thousands of diagrams and photos. Special Cash Price for entire 7 volumes only \$19.75 — time payment plan; \$21.00 payable \$3.00 after 7 days' FREE examination and \$3.00 per month.

7 DAY FREE TRIAL COUPON

H. C. Lewis, Pres., COYNE Electrical School, Dept. 75-R4
500 S. PAULINA STREET, CHICAGO 12, ILLINOIS

Send me the books checked below for 7 days' FREE examination. Within 7 days I'll either return them and owe nothing or pay price as shown. I understand, if the cost of the books I keep totals \$5.00 or more I can pay \$5.00 within 7 days and \$3.00 per month with no interest charges added.

- Electrical Principles and Circuits \$3.25
- Armature & Stator Winding & Repair \$2.25
- Wiring for Light and Power \$3.25
- Automotive, Diesel and Batteries \$3.25
- D. C. Motors and Controls \$3.25
- A. C. Motors and Controls \$4.00
- Electrical Refrigeration & Air Conditioning \$3.25

Check Here If You Want to See All 7 Books Free

COMPLETE 7 VOLUME SET: 7 volumes, also includes without cost One Year Consultation Service from the Coyne Staff and One Year of Technical Bulletins; Price \$21 on time payable \$3.00 a month — Cash Price \$19.75 (you save \$1.25).

NAME.....AGE.....

ADDRESS.....

TOWN.....ZONE.....STATE.....

CHECK HERE if want books sent C.O.D. You pay postman Cash Price shown above. Some 7 day examination and MONEY-BACK Guarantee.

"I'll show YOU how to make yourself COMMANDO-TOUGH

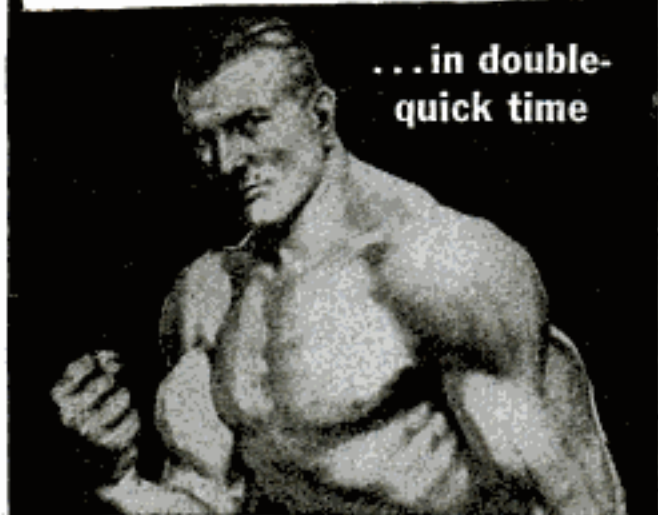

...in double-quick time

...OR IT WON'T COST YOU A CENT!"

says *George F. Jowett*

WORLD'S GREATEST BODY BUILDER

Let me prove to YOU that you can put inches of dynamic muscles on your arms! Add inches to your chest! Broaden your shoulders and power-pack the rest of your body. I can do for you what I've done for thousands the world over, including many officers and men now in the U. S. and British Armed Forces.

GIVE ME 10 MINUTES A DAY!

I'll Show You My Secrets Of Body Building

I'll help you learn the "Progressive Power Method" through which I rebuilt myself from a physical wreck to the holder of more strength records than any other living athlete or teacher! No matter how skinny or flabby you are, you can learn my methods right in your own home. Through my proved secrets I show you how to develop your power, inside and out, until YOU are fully satisfied that you are the man you want to be. "The Jowett System," says R. F. Kelly, Physical Director of the YMCA, Atlantic City, "is the greatest in the world!"

**PROVE TO YOURSELF
IN ONE NIGHT!**

Send only 25c for test Course, "Molding a Mighty Arm." Read it the evening it arrives—learn from experience the thrill you can give your muscles!

**SEND FOR THESE FIVE FAMOUS
COURSES IN BOOK FORM**

**ONLY 25c EACH
or ALL 5 for \$1.00**

If you want a physique that will inspire respect from men, and admiration from women... **ACT LIKE A HE-MAN!** Decide at once! The famous book, "Nerves of Steel—Muscles Like Iron" will be included FREE! Priceless for the strength fan! Full of photos of marvelous power-bodied men who will show you what Jowett has done for them and how he can do the same for you. Reach out... Grasp this Special Offer today!

Jowett Institute of Physical Culture
230 Fifth Avenue
Dept. 891-B
New York 1, N.Y.

*This
Book
Free!*



**BOOK WITH PHOTOS OF FAMOUS STRONG MEN
MAIL COUPON NOW**

FREE



Jowett Institute of Physical Culture
230 Fifth Avenue, Dept. 891-B, New York 1, N. Y.

George F. Jowett's Your proposition looks good to me. Send by return mail, prepaid, the courses checked below, for which I enclose (). Include FREE book of PHOTOS.

George F. Jowett
Champion of
Champions

- All 5 courses for... \$1 Molding Mighty Legs 25c
 Molding a Mighty Arm 25c Molding a Mighty Grip 25c
 Molding a Mighty Back 25c Molding a Mighty Chest 25c
 Send all 5 C.O.D. (\$1 plus postage.) No orders less than \$1 sent C.O.D.

NAME..... Age.....
(Print name)

ADDRESS.....

Say you saw it in Popular Mechanics!



TELEVISION
sets • tubes • parts

NEW FACTORY SEALED Cathode Ray Tubes for Television & Oscilloscopes	RCA 5BP4.....\$18.00 DuMont 5BP1 15.00 N-U 3AP1 9.00
--	---

Amphenol Coaxial cable, special for Television, 72 Ohm, factory price \$8.85 per ft., your price \$2.25 per ft., practically all types of radio tubes at ceiling prices.

Send for complete list of above and other television material and send your order to Dept. P.M. 10,
ELECTRONICS SERVICE & SUPPLY 264 W. 40th St.,
New York 18, N. Y.

BUILD AND FLY

your own motorcycle powered mono-plane, at home. Easy to build, short run take offs, and a sweet plane to fly. No special tools needed. Cheap. Tested plans, guaranteed, \$1.00. Just the plane you have been waiting for. **ORDER TODAY. NOW. AEROTECH, DEPT. 50, DEARBORN, MICHIGAN.**



6 MAGIC TRICKS

**MONEY BACK
GUARANTEE
MAILED POSTPAID**

COMPLETE APPARATUS AND ROUTINE

Real Professional Tricks—Not Toys. Include (1) Enchanted Card Frame, (2) The Traveling Cup, (3) Five-in-One Tube, (4) Snowstorms in Technicolor, (5) Chinese Laundry Ticket, (6) Flower in Button-hole. **A COMPLETE ACT—GET YOURS NOW.**

\$249

THE HOUSE OF YOGI East 303 Main, Niles, Mich.

ILLUSTRATED BOOKLETS

Sell our ILLUSTRATED COMIC BOOKLETS and other NOVELTIES. Each booklet size 4 1/2 x 2 3/4. Ten different sample booklets sent for 50c or 25 assorted for \$1.00 or 100 assorted for \$2.00. Shipped prepaid. Wholesale novelty price list sent with order only. No orders sent C.O.D. Send Cash, Stamps or Money-order.

REPSAC SALES CO.

1 West 13th St., Dept. 18-M New York 11, N. Y.

FLOYD CLYMER'S MOTOR SCRAPBOOK



REO

CLYMER, Dept. PM, 2125 W. Pico St., Los Angeles 6, Calif.

Early cars, motorcycles, illustrated, described. Historical, educational. "A MUST," says TIME Magazine. Read about Ford, Hug, Dodge, Metz, EMP, Maxwell, Stutz, Reo, 200 others. No. 1 and No. 2 books, each different, \$1.50 each. **100% STEAM CAR EDITION**, with steamer history, list of 125 makes, photos, \$2.00. All books postpaid. Cloth-bound \$1.00 extra. Motor-book catalog, 10c.

Become a Doctor of PSYCHOLOGY

Win the degree of Ps.D. Teach the secret of contentment, happiness. Solve mental worries. Experience the revelation of truth. Chartered college. Individual help. Write for FREE book. **COLLEGE OF UNIVERSAL TRUTH, 3153-B North Clark St., Chicago.**

LEARN ELECTROPLATING —

Complete Instructions by a practical plater, with formulas for Brass, Cadmium, Chromium, Copper, Gold, Nickel and Silver Solutions. Price \$1.00. Money Back Guarantee. **PLATER HYDE, Dept. A, P. O. Box 176, National City, Calif.**

MOTIVATION

The Creator's 5 Question System of Reason and Creation.

The only book that shows HOW to ask five questions: (1) to reason and create BELIEFS that can not be reasoned or refuted; (2) to MOTIVATE WILLS to DOMINEER FORCES of Nature to hold or change the position of desired things; (3) to accomplish your own aim and purpose. Shows HOW to reason and create friends and enemies at will. Etc. **YOUR HIDDEN POWERS**, \$2. postpaid. 18 days return privilege.

EFFECTIVE THINKING FOUNDATION, Box 404-V, Hollywood, Calif.

Now Repair your own ELECTRICAL APPLIANCES

with CHANITE Self-Welding ELECTRICAL HEATING ELEMENT Sux. Generous amount, instructions enclosed \$1.00 postpaid. Guaranteed nothing like it.

CHANITE SALES COMPANY, 914 South Main, Fort Worth 4, Texas

BIG MONEY and YOUR OWN BUSINESS in LIQUID MARBLE!

FREE INFORMATION ON THREE BIG NEW MONEY-MAKING OPPORTUNITIES



Regardless of your age, sex, previous experience, and whether you are an ex-serviceman or not, we will send you astonishing free facts about the unlimited possibilities—in your own business—with amazing LIQUID MARBLE and our other marvelous new products. To secure this information, absolutely free, fill in coupon below or send a letter or postcard. No salesman will call on you now or ever. Write TODAY! Offer limited.

- 1 **LIQUID MARBLE.** Make beautiful artificial Marble Slabs. Pour from liquid state. Glazed or unglazed. This marble may be mottled, veined, multi-colored or left in original snow-white state. The color is actually a part of the marble! Does not fade or wear away. LIQUID MARBLE is unsurpassed on kitchen or bathroom walls. Easy to make and install.
- 2 **PLASTIC FLOORING.** May be made in any color or combination of colors. Gives a lifetime of wear. Durable. Soundproof. Verminproof. Resistant to the tread. Lay out solid from wall to wall or in pattern design of various shaped blocks.
- 3 **FLEXIBLE MOLDS.** For plaster casting. Make your own molds for few cents each. \$1.00 in raw materials will make up to \$25.00 worth of finished goods. We furnish names of buyers.

Greatest Opportunities NOW!

With reconversion going ahead at full speed, NOW is the time to line up your own money-making business. We offer you our **BIG THREE** money-making opportunities together with other equally profitable businesses. (See paragraph at right.) Get the FREE facts TODAY!

COMPO-TEX, Box 786-SS, St. Louis, Mo.

FREE! EXTRA! If you write us promptly we will include free information about our other big money-making businesses. These include Compo-Tile Roofing and Cuen Stone, Plastic Wood, Artificial Marble and Granite, Stone and Metal Solder, Plastic Tile Cement, Papier Mache, and many others.

FREE INFORMATION COUPON!

COMPO-TEX, Box 786-SS, St. Louis, Mo.

Please send me free details of your **BIG THREE** Money-Making Propositions including LIQUID MARBLE. Also include information about the additional new business possibilities given directly above.

Name.....

Street.....

City..... State.....

JUST OUT! NEW FROM COVER TO COVER

AUDELS REFRIGERATION and AIR CONDITIONING GUIDE



4 Books in One! Covering:

- Basic principles, Servicing, Operation, Repair of
 - 1—Household Refrigeration
 - 2—Special Refrigeration Units
 - 3—Commercial & Industrial Refrigeration
 - 4—Air Conditioning Systems
- A gold mine of essential important facts for ENGINEERS, SERVICEMEN & USERS.

A Good Book is a Good Friend! Here you have at your fingers' ends a Complete Library in ONE VOLUME, the necessary data you have been looking for on MODERN UNITS, SYSTEMS & MACHINES, REFRIGERANTS, including Freon, Lockers, Water Coolers, Quick Freezing & Air Conditioning Systems. 1280 Pages, 46 chapters all Fully Illustrated & Indexed for Ready Reference.

ANSWERS YOUR QUESTIONS

Get This Information for Yourself. Mail Coupon Today. No Obligation Unless Satisfied. ASK TO SEE IT.

\$4 COMPLETE • PAY ONLY \$1. A MONTH

AUDELS, Publishers, 49 W. 23rd St., New York 10, N.Y.

MAIL AUDELS NEW REFRIGERATION GUIDE for free examination. If O. K. I will send you \$1 in 7 days; then remit \$1 monthly until price of \$4 is paid. Otherwise I will return it.

Name.....
Address.....
Occupation.....
Employed by..... PM

Smash those
Shackles of



HERE IS SINCERE HELP

Get these facts of Personal Analysis leading to peace of mind, self-confidence, accomplishment and daily development of your hidden personal power. Learn how this plan of FASCINATING HOME STUDY (written by a former member of the Clergy) can help you work out your PERSONAL PROBLEMS and instill confidence. Here is a complete, comprehensive, practical course of study based on factual experience. Its workable methods are easy to apply to YOUR particular problems. It builds will-power; shows you how to apply self-analysis, banishes fear, doubt and worry, deals with the Inferiority Complex Question...lines up your life in true perspective and gives you tested formulas for success! Write TODAY for this unusual Personality-Developing Plan. Send for complete details...at no charge. Clip COUPON BELOW and MAIL!

MAIL

SCHOOL OF PERSONAL PSYCHOLOGY

TODAY "A CHARTERED Non-Profit Institution"
321 Starks Bldg., 4th at Walnut, Louisville 2, Ky.
Dept. PM. — Without obligation, rush information to me on how your Personal Psychology Study Plan can HELP me.

Name.....
Address.....
Town..... State.....

THIS EASY WAY TEACHES PIANO Without Music!

NO LONG HOURS
PRACTICING SCALES
OR EXERCISES...
**PLAY SONGS
FIRST DAY**



**You May Play Any Song
in 10 Days without being
Able to Read a Note . . .**

If you want to quickly learn how to play the piano... if you want to play song hits, waltzes, marches, hymns, two steps, red hot numbers and western songs, like "Don't Fence Me In" . . . here's amazing news. Now at last Mr. Dave Minor has perfected a wonderfully easy play-by-ear piano course that must teach you piano playing in only ten quick days or no cost. No scales, no long exercises. You start playing songs from the first lesson, and so soon it's amazing you're playing the piano surprisingly well. Mr. Minor's course is complete. It contains all the pictures, all the instruction, everything you need. The complete course sent for your inspection, trial and approval.

SEND NO MONEY—Make This Conclusive 10 Day Test. Just send your name and address today. On arrival deposit \$1.49 plus postage through postman. There is nothing more to pay. Inspect course carefully, see how simple yet thorough it is. Follow it for 10 days. Then if you aren't actually playing the piano and playing it well, if you aren't entirely satisfied and delighted with your discovery, return the course and get your money back. Piano playing is more wonderful than ever. **DON'T WAIT BUT WRITE TODAY!** If you act now you will receive without extra cost the wonderful, big 72-page Dave Minor piano song book of 50 songs. You quickly learn to play the songs the Dave Minor method or money back. Get in on this 2 FOR 1 offer NOW. **DAVE MINOR, Room 49-MM, 230 E. Ohio St., Chicago 11, Ill.**

2 for 1 OFFER
\$1.49
ONLY
COMPLETE

ELECTRICAL TRAINING

8 months intensive residence course in fundamentals of industrial electrical engineering, including radio, electronics. Prepares for technician, engineering aides. Approved for veteran training. Classes begin Feb. 25, July 8. Catalog.

BLISS ELECTRICAL SCHOOL
120 Takoma Ave., Wash. 12, D. C.

● **SAVE WASTE PAPER** ●

New Accurate 10" Slide Rule

Instruction Book
FREE



**SPECIAL
COMBINATION OFFER**

Standard 10" Slide Rule and Instruction Book; Pocket Calculator for adding and subtracting up to 999,999; 6" Transparent Protractor and Graph Rule graduated in centimeters and inches—**ALL 3 for \$1.00 cash** (\$1.15 Foreign) **POSTPAID**.
New "TRIG" 10" Slide Rule, with Pocket Calculator and Transparent Protractor, **\$1.50** (\$1.65 Foreign) **POSTPAID**.

SPEAK SPANISH THIS EASY WAY

Big opportunities and jobs waiting for those who speak Spanish. Millions of dollars being invested in Mexico, Central and South America. *Enjoy more—earn more. Increase social, business, travel and reading pleasures.* **CORTINA Method famous for over 60 years, teaches you to speak like a native.** Learn quickly, easily at home. "by listening" to Cortinaphone records. Thousands have, why not you? No risk under our Five-Day Approval offer. **FRENCH, GERMAN, ITALIAN also taught by this amazing method.** Send for Free Book "The Cortina Short-Cut"—state language interested in.

CORTINA ACADEMY—Established in 1882
Dept. 6410A 105 West 40th St., New York 18, N. Y.

PERSONAL PHOTO STATIONERY

THAT CARRIES YOUR PHOTOGRAPH
Now... you can make your letters to that boy or girl in service and to friends at home like a "personal visit" when you use rich, two-fold **Photographic Stationery** with life-like photograph of yourself at the top. A marvelous morale builder. Ideal gift with a friend's picture. **SPECIAL OFFER**—Just send \$1.00 with photo, snapshot or negative for our Special Box of Photographic Stationery. Photo returned. **NATIONAL PHOTO ART, Dept. 24-1, Janesville, Wis.**

BEST SHAVE EVER OR MONEY BACK!

Patented
SPEED-HONE



Shave with a grin—not a groan... For smoother shaves—use **SPEED-HONE!** **SPEED-HONE** puts "velvet-edge" on razor blades. **MILLIONS IN USE.** Dozens of shaves from every blade. Only 10c. If dealer can't supply, send time for sample. **CURTIS CANDY COMPANY DEPT. PM CHICAGO 13, ILL.**

WATCHES WANTED BROKEN OR USABLE

—all kinds, even Ingersolls. Highest prices paid for jewelry, rings, spectacles, alarm clocks, cigarette lighters, gold teeth, etc. Cash mailed promptly.
Lowe's, Holland Bldg., Dept. PM, St. Louis 1, Mo.



Begin today. Write now for our Free Book, "How to Become a Good Penman." It contains specimens and tells how others learned to write in spare time. Enclose 15c for your name beautifully written and a pen point suitable for shaded writing. Write today.

THE TAMELYN SCHOOL OF PENMANSHIP
N-441 Ridge Building, Kansas City, Mo.

CINEMATOGRAPHY

Hollywood film technique; business films; educational and Free Lance film production—taught at home. Professional supervision. Write today for free, beautifully illustrated catalogue. **Motion Picture Institute**
217 S. Woodward Ave. of the U. S. A. Inc. Birmingham, Mich.

To those who think LEARNING MUSIC is hard

Just strike these notes and you're playing the beginning of the "Merry Widow" Waltz



Look at the diagram. The first note of the music is "D." Following the dotted line to the keyboard you'll find "D" is the white key between the two black keys near the middle of the keyboard. Now read below how you can learn to play any instrument quickly and easily.



Easy as A-B-C—COST LESS than 7c a day!

• Perhaps you think learning music is a tedious grind. It isn't any longer! Long hours of practicing scales and monotonous exercises are over.

You have no excuses for not getting started toward musical good times now! For through an easy method you can now learn to play right at home—without a teacher—for less than 7c a day.

Learn to Play by Playing

The lessons come to you by mail from the famous U. S. School of Music . . . complete instructions, clear diagrams, and all the

SUCCESS!

Here's what one of our thousands of pupils writes: "I learned more from your course than many of my friends who studied under private teachers have for years. The fact that I've already taken 2 courses and am now enrolling for a third should speak for itself." F. A. S., Indiana.

music you need. You learn to play by playing real tunes by note. First you are told how to do a thing. Then a picture shows you how. Then you do it yourself and hear it. Remember, don't confuse our method with any system claiming to teach music "by ear" or by trick methods. We teach you to play only from real notes!

FREE! Print and Picture Sample. Our illustrated Free booklet and "Print and Picture" Sample fully explain this remarkable method. So decide which instrument you want to play and mail the coupon today. U. S. School of Music, 710 Brunswick Bldg., New York 10, N. Y.

SUCCESSFUL 47TH YEAR

U. S. School of Music
710 Brunswick Bldg., New York 10, N. Y.

Please send me Free Booklet and Print and Picture Sample. I would like to play instrument checked below.

Piano	Saxophone	Modern Elementary
Guitar	Trumpet, Cornet	Harmony
Hawaiian Guitar	Reed Organ	Mandolin
Violin	Tenor Banjo	Practical Finger
Piano Accordion	Clarinet	Control

Name..... Have You Instrument?.....

Address

City..... State.....

Save 2c—Stick Coupon on Penny Postcard

INVENTOR'S ATTENTION

● WANTED—YOUR IDEA OR INVENTION

HERE is the service you have been waiting for: A COMPLETE INVENTOR'S SERVICE THAT YOU CAN AFFORD. Your Idea or Invention DEVELOPED, DESIGNED, PROMOTED; MODELS CONSTRUCTED, PATENT DRAWINGS, PATENT ADVICE.

WE TAKE your rough idea or sketch and develop, design, and draw it into a working device. We do all the work—You reap all the rewards. FREE CONSULTATION SERVICE AND FREE LITERATURE UPON REQUEST.

★ ★ ★ INVENTION DEVELOPMENT ★ ★ ★
17720 MISSION BLVD., GRANADA HILLS, CALIF.

Weldors, Designers,

Engineers...

Answer Your Design Problems with New...

HOBART Practical Design for ARC WELDING

Per Volume
\$3.50 Postpaid
Set of three...
\$10.00

Everyone connected with metal fabrication has design problems from time to time and here's your answer to many of them. Every Welder, Designer, Engineer and Draftsman should have these books to better understand good welding design. You're sure to find designs comparable, if not applicable to your own products no matter what type of fabrication was used. Invaluable for changing to welded design. Order today!

HOBART BROS. CO., Box M-1051, Troy, O.

HOBART "One of the World's Largest Builders of Arc Welders."

Quick help for Rupture!



Why put up with days . . . months . . . YEARS of discomfort, worry and fear—if we can provide you with the support you want and need? Learn NOW about this perfected truss-invention for most forms of reducible rupture. Surely you keenly desire . . . you eagerly CRAVE to enjoy most of life's activities and pleasures once again. To work . . . to play . . . to live . . . to love . . . with the haunting Fear of Rupture lessened in your thoughts! Literally *thousands* of Rupture sufferers have entered this *Kingdom of Paradise Regained* . . . have worn our support without the slightest inconvenience. Perhaps we can do as much for you. Some wise man said, "Nothing is impossible in this world"—and it is true, for where other trusses have failed is where we have had our greatest success in many cases! Even doctors—thousands of them—have ordered for themselves and their patients. Unless your case is absolutely hopeless, do not despair. The coupon below brings our Free Rupture Book in plain envelope. Send the coupon now.

Patented AIR-CUSHION Support Gives Wonderful Protection

Think of it! Here's a surprising yet simple-acting invention that helps Nature support the weakened muscles gently but securely, day and night. Thousands of grateful letters express heartfelt thanks for relief from pain and worry,—results beyond the expectations of the writers. What is this invention—how does it work? Will it help me? Get the complete, fascinating facts on the Brooks Air-Cushion Appliance—send now for free Rupture Book.

Cheap—Sanitary—Comfortable

Rich or poor—ANYONE can afford to buy this remarkable, LOW-PRICED rupture invention! But look out for imitations and counterfeits. The Genuine Brooks Air-Cushion truss is never sold in stores or by agents. Your Brooks is made up after your order is received, to fit your particular case. You buy direct at the low "maker-to-user" price. The perfected Brooks is sanitary, lightweight, inconspicuous. Has no hard pads to gouge painfully into the flesh, no stiff, punishing springs, no metal girdle to rust or corrode. It is GUARANTEED to bring you heavenly comfort and security or it costs NOTHING. The Air-Cushion works in its own unique way—softly, silently doing its part in providing protection. Learn what this patented invention may mean to you—send the coupon quick!



C. E. BROOKS,
Inventor

SENT ON TRIAL!

No . . . don't order a Brooks now . . . FIRST get the complete, revealing explanation of this world-famous rupture invention. THEN decide whether you want to try for the comfort—the wonderful degree of freedom—the security—the blessed relief that thousands of men, women and children have reported. They found our invention the answer to their prayers! And you risk NOTHING in making the TEST, as the complete appliance is SENT ON TRIAL. Surely you owe it to yourself to investigate this no-risk trial. Send for the facts—now—today—hurry! All correspondence strictly confidential.

FREE! Latest Rupture Book Explains All!

← Sent You in Plain Envelope **JUST CLIP and SEND COUPON**

Brooks Appliance Co., 359-A State St., Marshall, Mich.

PROOF!

Read These Reports on Reducible Rupture Cases

(In our files at Marshall, Michigan, we have over 44,000 grateful letters which have come to us entirely unsolicited and without any sort of payment.)

Never Loses a Day's Work in Shipyard

"A few weeks ago I received the Appliance you made for me. Wouldn't do without it now. My fellow workers notice how much better I can do my work and get around over these ships—and believe me, the work in a Navy shipyard is anything but easy. I never lose a day's work now."—J. A. Comer, 1505 Green Ave., Orange, Texas.

Perfect Relief—Full Satisfaction

"Your truss gives FULL SATISFACTION. I feel it my moral duty to testify to the world:—(A)—That I have been ruptured 45 years. (B)—was operated on scientifically ten years ago when 76 years of age; but the rupture returned soon. Have tried everything; but only now do I find PERFECT RELIEF in your appliance."—Lee R. Stroad, 601 E. Grove St., Kaufman, Texas.

MAIL THIS COUPON NOW!

BROOKS APPLIANCE CO.
359-A State St., Marshall, Mich.

Without obligation, please send your FREE BOOK on Rupture, PROOF of Results, and TRIAL OFFER—all in plain envelope.

Name

Street

City..... State.....

State whether for Man Woman or Child

"The Supreme Authority"

is worth a short wait. Your dealer will be glad to order it for you

YOU may have had difficulty in obtaining a copy of WEBSTER'S NEW INTERNATIONAL DICTIONARY, Second Edition. Paper restrictions and greatly increased demand are the reasons. But place your order now—only a short wait may be necessary.

The Merriam-Webster contains 3,350 pages, illustrations for 12,000 terms, and a total of 600,000 entries—122,000 more than any other dictionary. G. & C. MERRIAM COMPANY, Publishers, Springfield 2, Massachusetts.

WEBSTER'S NEW INTERNATIONAL DICTIONARY, Second Edition



CARTOON TO SUCCESS!! \$2.00

Hartman will teach you to CREATE ORIGINAL SALABLE CARTOONS! Cartoon course contains 30 lessons, hundreds of illustrations. Only..... P.P.

Or write for details about our cartoon Course, Gag Course, Business plans and markets.

HARTMAN SCHOOL, 2438 W. St., Lincoln 3, Nebr.



LANGUAGE IS POWER

... Forge ahead, win special assignments, promotion, better job in global peace time opportunities through ability to speak a foreign language.

MASTER A NEW LANGUAGE quickly, easily, correctly by

LINGUAPHONE

The world-famous Linguaphone Conversational Method brings voices of native teachers INTO YOUR OWN HOME. You learn the new language by LISTENING. It's amazingly simple; thousands have succeeded.

HOME-STUDY COURSES IN 29 LANGUAGES

Send for FREE book—

LINGUAPHONE INSTITUTE

98 RCA Building, New York 20, N.Y. • Circle 7-0830

LINGUAPHONE INSTITUTE,
98 RCA Bldg., New York 20, N.Y.

Send me the FREE Linguaphone Book.

Name

Address..... City.....

Language Interested.....

HEAR

WITH

Revolutionary
COMFORT!



Beautiful
Black
or
Ivory

Beltone

the QUALITY
ELECTRONIC
HEARING AID

This IS ALL YOU WEAR

**NO SEPARATE
BATTERY
PACK!**

NO BATTERY WIRE!
About 1/2 the Weight and Bulk
of Most Hearing Aids

A nationally known quality, lifetime hearing aid. Pleasant, life-like hearing. Plug in tubes, replaced as easily as a light bulb. Inconspicuous, flesh-color ear piece and cord.

MAIL THIS COUPON
Today!

BELTONE HEARING AID CO.

Dept. PMD, 847 W. Jackson Blvd., Chicago 7, Ill.

Sirs: Please send FREE booklet on BELTONE.

NAME.....

ADDRESS.....

CITY, ZONE
AND STATE.....

Say you saw it in Popular Mechanics!

INCLUDED
FREE! 'POWER PLUS'
OF EXTRA COST

THE BOOK THAT CONTAINS THESE WONDER COURSES
HOW TO DEVELOP MUSCLES OF STEEL
• HOW TO BOX • HOW TO PERFORM
HAIR-RAISING ACROBATICS • FUN-
DAMENTALS OF JUDO • AND OTHER
MUSCLE-BUILDING SUBJECTS



How would you like to have an Adonis-like body with the strength, stamina and speed of a panther? POWER-PLUS, the most unusual book of its kind, contains detailed instructions—all clearly illustrated—on how you may develop every muscle in your body to an all-time high in perfection. Let these courses help you build arms of steel with bulging biceps. See how much stronger and more sinewy your legs become! Watch the Sarno-Cleido Mastoid muscle in your neck become tougher! Note how your shoulder muscles, especially the Trapezius, become larger! Skinny weaklings have converted themselves into mightier, more powerful men than they ever dreamed they'd be with the aid of POWER-PLUS. Don't you, too, want to give yourself arms, legs and shoulders you'll be proud to display? POWER-PLUS is the amazing book that will help you become the man you've always wanted to be. And with this unique offer, you get this book FREE of extra cost.

SEND FOR THIS COLLECTION OF WORLD-FAMOUS STRONG MEN PHOTOS

Imagine—large-size portraits of 14 of the most powerfully-developed men in America—professional strong men including Joe Bonomo, the world's strongest man—can now be yours for just 97c. All portraits are autographed and will make a welcome addition to your collection. Let these men be your guide and inspiration in building your body to complete perfection. All 14 portraits are yours if you'll mail the coupon together with only 97c. And remember—you also receive your copy of POWER-PLUS, your guide to a perfect body, FREE of extra cost. Don't miss this offer! Fill in and mail the coupon now!



ACTUAL SIZE: 8"x11"

Joe Bonomo, Personal
BONOMO CULTURE INSTITUTE, DEPT. P1310 PLEASE PRINT
1841 Broadway, New York 23, N. Y.

I enclose 97c. Send postpaid, 14 autographed portraits of famous strong men, and my copy of 'POWER PLUS'—containing courses in muscle-building, boxing, judo, aerobatics and many other courses—FREE of extra cost.

- Send C.O.D. I'll pay postman 97c plus postage.
 I enclose 97c. Send postage prepaid.

Name _____
Address _____
City _____ Zone _____ State _____
Canada and Foreign \$1.25 with order

★ SAVE WASTE PAPER ★



100X ASTRONOMICAL TELESCOPE LENS KIT

ONLY
\$1.95

Thrill yourself and entertain your friends with such heavenly sights as moon craters, the beautiful rings of Saturn, comets, double stars. A fascinating hobby for you or an ideal gift for that boy of yours.

Kit includes all optical parts needed to build this powerful 6 1/2 ft. scope, a 3" dia., 75" F.L. objective lens and two assembled eyepieces of 50X and 100X, scientifically designed and matched, ready to mount. New, perfect lenses, not salvage—ground and polished. Remaining materials needed are readily found.

EASY TO MAKE

And so simple to build too. Even a boy can follow the easy instructions furnished with each kit. An evening of easy, pleasant educational work and this wonderful scope can be yours.

Most surprising of all is the unbelievably low cost. \$1.95 check or money order brings this complete precision kit to you postage paid. Order immediately to get yours without delay—money back guarantee. We ship the same day order received. Address an envelope now to

P. M. BEELERSCOPE CO.

Box 235 North Hollywood, Calif.

Don't forget your return address and your remittance. By the way, if you enclose two one-dollar bills, we'll return the nickel change with your kit. **DO IT NOW.**

Correspondence Courses in RADIO and ELECTRICAL ENGINEERING LOW AS **\$25**

ELECTRICAL ENGINEERING. Get good grasp of wide electrical field. Modern. Very understandable. Theory made easy.
RADIO ENGINEERING. Extra fee course in radio, public address, photo-electric work. Train you to be super-service man, real vacuum tube technician. Tutorial ONLY \$25. 60-day course. Deferred payment plan. Servicemen needed badly. Write for free copies of school catalog, student transcripts, etc.
FREE LINCOLN ENGINEERING SCHOOL, Box 931-PR2, Lincoln, Nebr.

Learn TOOL DESIGN

Now, as never before, draftsmen and tool designers are needed to redesign for peacetime reconversion. Qualify quickly. Many making \$100 to \$150 per week. Most qualified men needed. That available. Good pay jobs waiting. Rush name and kind of job wanted today for full free facts. State age.
OHIO INSTITUTE OF TECHNOLOGY, Box 271, Greenville, Ohio

BOOKS FOUND FREE!

WHAT BOOKS DO YOU WANT?

We quote lowest market prices. No charge for locating Hard-to-Find Books. All books. OLD or NEW mailed POST-FREE. **SEARCHLIGHT BOOK CLUB, 22 East 17th St., New York City**

Make BIG MONEY in Coming REAL ESTATE BOOM!



Get in the Swims NOW

PREPARE NOW for a big pay, permanent job or your own 6-Profit business in the predicted post-war real estate boom! Salaries up to **\$2,500.00 to \$10,000.00 a year** in property management, brokerage, appraisal, loans, insurance, building. Dignified, pleasant work. Many make fortunes in real estate. Thousands of trained men, women required yearly by real estate firms, insurance companies, banks, Federal agencies, etc. **Coming real estate boom** means even bigger demand for workers, greater earnings, larger profits. Rush post-card or coupon for **FREE 32-Page QUIZ BOOK** and full details on Modern Real Estate Practice—first and only complete, popular-priced home training and reference library in this entire field. **Hurry!**

**JOB SEEKERS!
REALTORS!
OWNERS!
BUILDERS!
INVESTORS!**

RUSH COUPON OR POST-CARD FOR 32-Page FREE BOOK!

LANE BOOKS, INC.
100 E. Ohio St., Dept. B-10, Chicago 11, Ill.
Send me **FREE, POSTPAID** and **WITHOUT OBLIGATION**, your 32-Page **QUIZ BOOK** and complete details on Modern Real Estate Practice.
Name _____
Home Address _____

INVENTORS

Complete instructions on how to **MAKE YOUR OWN DRAWINGS**

• The new book, *Making Patent Drawings* by Harry Radzinsky, gives complete instructions on all the special techniques of patent drafting, showing in detail each step in making patent drawings. Written by a patent attorney who has himself made thousands of patent drawings, this book gives you all the information you need to insure acceptance by the U. S. Patent Office of your drawings. **MAKING PATENT DRAWINGS** will save you time, effort, and money. Its price is only \$3. Write for a free examination copy today.

The Macmillan Co., 60 Fifth Ave., New York 11, N. Y.

SUCCESS for YOU... in **ADVERTISING**
Profitable • Fascinating • Many Opportunities
Easy to learn in short time from an Expert. NOT a "School" ... A "Successful Adv. Executive."
Write for Free booklet *Success for You in Advertising*.

G. H. JENSSEN, A, 450 E. Ohio, Chicago 11.

ENGINEERING DEGREE IN 27 MONTHS

INDIANA TECHNICAL COLLEGE

Aeronautical, Chemical, Civil, Electrical, Mechanical, and Radio Courses. B.S. degree: 1-yr. diploma in Electrical, Mechanical, and Radio Service; Drafting, Prep. courses. Gov't. approved for GI's. Low rate. Earn board. Large industrial center. Demand for graduates. Enter Dec., March, June, Sept. Catalogue: 5105 E. Washington Blvd., Ft. Wayne 2, Ind.

★ **SAVE WASTE PAPER** ★

CARTOONING



CASH IN on Big Cartoon Market. BECOME CARTOONISTS QUICKLY with our NEW, EASY METHOD. No experience necessary. Prepared by successful cartoonists. Only \$2.85 postpaid. **SATISFACTION GUARANTEED.** Sample LESSON PLATE and interesting literature FREE.

NATIONAL ARTISTS BUREAU

Dept. A-3, Box 4248 DALLAS 8, TEXAS

LEARN BASKETBALL

"LEARNING BASKETBALL" written by a former college player and coach. Read these easily understood and easily followed instructions—and **MAKE THE TEAM!** Send 25c in coin to:

THE SPORTS LIBRARY, Box 127, Station E, Columbus, Ohio

JIU-JITSU HOW TO BECOME EXPERT, Keep Health, Have Fun. Teaching 35 years. Send 10c for sample lesson

MODERN SCHOOL JIU-JITSU, Dept. WW, 5 W. 52nd St., N.Y.C. 19

RADIO ENGINEERING, Broadcasting, Servicing, Electronics, Aviation, Marine & Police Radio taught thoroughly. 48 weeks' Engineering course equivalent to 3 years' college radio work. Approved Veteran Training. Co-educational. Catalog free.

VALPARAISO TECHNICAL INSTITUTE, Dept. D, Valparaiso, Ind.

STAMMER ?

This new 128-page book, "Stammering, Its Cause and Correction," describes the Bogue Unit Method for scientific correction of stammering and stuttering—successful for 44 years. Benj. N. Bogue, Dept. 1829, Circle Tower, Indianapolis 4, Ind.

GET THIS FREE BOOK!



You'll see when you smoke I. C.

You too will be a *wise bird* ... you too will be *flying high* ... when you smoke I.C.! How it makes the ladies linger! There's a real reason for that remarkable Irish Castle "aroma-appeal." In fact, there are 8 reasons! Master-blender Willoughby Taylor eyed *all* the far-flung regions of the world and selected 8 top tobaccos to be blended into Irish Castle Smoking Mixture. Turkish for mellowness ... tangy Virginias for fragrance ... Latakia for zest, and Perique for spice ... sound White Burleys for body and satisfaction. *You'll see when you smoke I.C.!*



IRISH CASTLE

GET ACQUAINTED SPECIAL

For a limited time (and only if your dealer is out of stock) we'll send you a half-pound humidor of Irish Castle Pipe Mixture for only \$1.10. Mail coupon with cash or check to Penn Tobacco Co., Dept. OP, Wilkes Barre, Pa.

Name _____

Address _____

**I'll PROVE I can make
you, too,
TOUGH as a
MARINE**

..... and add
Powerful POUNDS
and Vital INCHES of
DYNAMIC MUSCLE
to your ARMS, LEGS,
BACK, CHEST,
and SHOULDERS

says
George F. Jowett
WORLD'S GREATEST
BODY BUILDER

..OR IT WON'T COST YOU A CENT!

Let me prove to YOU that you can put inches of dynamic muscles on your arms! Add inches to your chest! Broaden your shoulders and power-pack the rest of your body. I can do for you what I've done for thousands the world over, including many officers and men now in the U. S. and British Armed Forces!

GIVE ME 10 MINUTES A DAY!

I'll Show You My Secrets Of Body Building.

I'll help you learn the "Progressive Power Method" through which I rebuilt myself from a physical wreck to the holder of more strength records than any other living athlete or teacher! No matter how skinny or baby you are, you can learn my methods right in your own home. Through my proved secrets I show you how to develop your power, inside and out, until YOU are fully satisfied that you are the man you want to be. "The Jowett System," says H. F. Kelly, Physical Director of the YMCA, Atlantic City, "is the greatest in the world!" If you want a physique that will inspire respect from men, and admiration from women... **ACT LIKE**

A HE-MAN! Decide at once! The famous book, "Nerves of Steel—Muscles Like Iron" will be included FREE! Priceless for the strength fan! Full of photos of marvelous power-bodied men who will show you what Jowett has done for them and how he can do the same for you. Reach out... Grasp this Special Offer today!

**PROVE TO YOURSELF
IN ONE NIGHT!**

Send only 25c for test Course, "Molding a Mighty Arm." Read it the evening it arrives—learn from experience the thrill you can give your muscles!

**SEND FOR THESE FIVE FAMOUS
COURSES IN BOOK FORM
ONLY 25c EACH
or ALL 5 for \$1.00**

Jowett Institute of Physical Culture
230 Fifth Avenue
Dept. 891-A
New York 1, N. Y.

*This
Book
Free!*



**BOOK WITH PHOTOS OF FAMOUS STRONG MEN
MAIL COUPON NOW**

FREE



Jowett Institute of Physical Culture
230 Fifth Avenue, Dept. 891-A, New York 1, N. Y.
George F. Jowett: Your proposition looks good to me. Send by return mail, prepaid, the courses checked below, for which I enclose (). Include FREE book of PHOTOS.

George F. Jowett
Champion of Champions

- All 5 courses for... \$1 Molding Mighty Legs 25c
 Molding a Mighty Arm 25c Molding a Mighty Grip 25c
 Molding a Mighty Back 25c Molding a Mighty Chest 25c
 Send all 5 C.O.D. (\$1 plus postage.) No orders less than \$1 sent C.O.D.

NAME _____ Age _____
(Please print plainly. Include Zone Number.)

ADDRESS _____

TURN IDEAS INTO \$\$\$\$\$\$

SOME of the biggest money-making merchandise and promotional stunts began because some one thought of a NEW idea or a new angle, and SOLD it. Manufacturers are crying for new ideas in all lines—radio, electronics, household appliances, automobiles, entertainment; this startling new book tells you how to get and develop them, market them; how to protect your "brain child" from theft; how to think up sensational advertising campaigns, headlines that stop readers and sell goods. Invaluable to ex-service men starting their own business—or you can have an "idea business" and sell to others. Send only \$3 for complete book, containing 200 pages of workable ideas for all businesses, dozens of photographs. Money back in 5 days if not satisfied.

**HOW TO DEVELOP
PROFITABLE IDEAS** By **OTTO F. REISS**

Write to:
PRENTICE-HALL
Department M-7
70 Fifth Avenue
New York 11

A SIMPLIFIED ART ANATOMY OF THE HUMAN FIGURE
ONLY 51c POSTPAID
By Charles Carlson. The book they're talking about! One of the most informative books of its kind for both student and professional artists. Charts, notes, and over 350 drawings show detailed studies of every part of the body, posed and in action. PRICE OF LITTLE BOOKS, 80-A E. 11 St., New York 3

Learn LANDSCAPE GARDENING

A thorough, interesting, home study course for those who wish to become LANDSCAPEIS, GARDENERS, DESIGNERS, etc., for profit or pleasure. Write today for FREE INFORMATION to

NATIONAL LANDSCAPE INSTITUTE
Dept. P-10, 756 So. Broadway, Los Angeles, Calif.

**WELDERS VETERANS—Ask about G. I. Training.
WANTED!**

Earn up to \$12 a day or start your own business. Learn Welding by actual shop work. America's leading school. Established 1902. 41,000 graduates. Write for "Welding Facts."

Greer Shop Training, Dept. 3105, 460 S. State St. Chicago

Always write your name and full address clearly when answering advertisements.

150 SHOP PRINTS

**VALUABLE BOOK OF 150
ELECTRICAL & RADIO WIRING
DIAGRAMS FREE!**

**YOURS FOR MERELY EXAMINING MY NEW BOOK ON
ELECTRONICS**

Here's an opportunity to get a valuable book of 150 Electrical and Radio Wiring Diagrams ABSOLUTELY FREE. It's yours for merely examining my new book **ELECTRONICS FOR ELECTRICIANS AND RADIONEN**. This FREE book is not just an advertising novelty—it has 150 large wiring diagrams. Yet, it's yours FREE if you'll agree to look over my new Electronics book. This new 400 page book takes all the "mystery" out of Electronics. It's practical. It covers this important subject in the language of the man "on the job." Complete amazingly easy to follow data on **INSTALLATION, TROUBLE SHOOTING and MAINTENANCE**. Endorsed and used by dozens of Electrical Unions and thousands of Electrical and Radio workers.



SEND NO MONEY!

I'm so sure you'll like this great book that I'll give you my book of 150 selected Electrical—Radio wiring diagrams FREE for merely letting me send you a copy of **ELECTRONICS FOR ELECTRICIANS AND RADIONEN** for 7 day FREE examination. This offer is limited—send coupon NOW!

FREE BOOK COUPON

H. C. Lewis, Pres., COYNE Electrical School, Dept. 75-R5
800 S. PAULINA STREET, CHICAGO 12, ILLINOIS
I accept your offer. Send me **ELECTRONICS FOR ELECTRICIANS and RADIONEN**—also the FREE book of 150 selected Electrical & Radio Wiring Diagrams. I'll either return the Electronics book in 7 days or send you \$4.95. But regardless of whether or not I keep your Electronics book I understand the book of 150 wiring diagrams is mine to keep as your gift.

NAME _____ AGE _____
ADDRESS _____
TOWN _____ ZONE _____ STATE _____

BARGAINS in WAR SURPLUS LENSES & PRISMS



All Items Finely Ground and Polished but Edges Slightly Chipped or Other Slight Imperfections which We Guarantee Will Not Interfere with Their Use. Come Neatly Packed and Marked.

You Can Easily Make Telescopes, Magnifiers, Photographic Gadgets and Hundreds of Experiments with these Low Cost Lenses. Excellent for XMAS gifts, too.

To translate millimeter measurements: 25.4 mm. equals one inch.

TANK PRISMS

In order that the tank driver shall not get shot in the face, 2 of these Silvered Prisms are used to make a Periscope. We have secured a number of these, 90-45-45 degree Prisms of huge size—5 3/4" long, 2 3/8" wide, finely ground and polished. Used to build a Periscope, camera stereo attachment, range finder, etc. Excellent also for experiments, classroom demonstrations. Prism easily converted into desk name plate by affixing gold letters. 100 supplied at only 10c. (Order Stock #3008-H.) Normally these Prisms would retail from \$24 to \$30 each.

SILVERED TANK PRISM

Stock #3004-H.....\$2.00 each Postpaid

PLAIN TANK PRISM

Stock #3005-H.....\$2.00 each Postpaid

FOUR TANK PRISMS—Special—\$7.00 Postpaid... The most sensational bargain we have ever been able to offer.

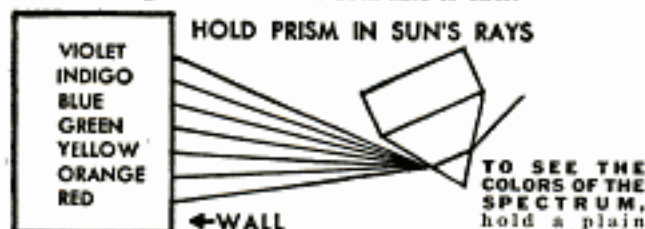

shown in drawing. White incident light which passes through prism is thus broken up into a band of primary colors known as the spectrum—a beautiful sight!

MAGNIFIER SET... 5 Magnifying Lenses... Powers from 1 to 10. Various diam. for many uses. Free Booklet on Home-made magnifiers included.

Stock #1026-H.....\$2.00 Postpaid

CLEANING BRUSH SET—12" flexible plastic handle, circular construction, 4 brushes to set, range stiff to soft.

Stock #504-H.....Price \$1.00

8 MM. MOVIE PROJECTING LENS SET—Consists of 2 Achromatic Lenses, diam. 15 mm. and a F.L. when combined of approx. one inch. Each lens has the new magnesium fluoride low reflection coating. Stock #4011-H.....\$1.40 Postpaid

16 MM. PROJECTING LENS SET—Consists of 2 Fluoride coated cemented Achromatic Lenses 1 inch diam. with combined F.L. of 2 inches. Stock #4024-H.....\$1.70 Postpaid

LENS FOR KODACHROME EYE-VIEWER... Color corrected cemented lens 41 mm. diam., 66 mm. F.L.

Stock #6116-H.....\$1.00 Postpaid

ALL THE LENSES YOU NEED TO MAKE YOUR OWN TELESCOPE! ALL ARE ACHROMATIC LENSES

GALILEAN TYPE—Simplest to make but has narrow field of view. Stock #5003-H Power of either 5, 6 or 10...\$1.60 Postpaid

Stock #5004-H Small 2 Power Pocket Scope...\$1.00 Postpaid

TERRESTRIAL TYPE—Have much wider field of view than Galilean Type.

Stock #5007-H 11 Power Telescope.....\$3.20 Postpaid

Stock #5008-H 20 Power Telescope.....\$3.45 Postpaid

Stock #5009-H 40 Power Telescope.....\$7.45 Postpaid

PRISM TELESCOPES—Uses Prism instead of Lenses to erect image and are much shorter than Terrestrial Type. Have wide field of view.

Stock #5010-H 6 Power Telescope.....\$3.00 Postpaid

Stock #5011-H 11 Power Telescope.....\$3.25 Postpaid

Stock #5012-H 20 Power Telescope.....\$7.25 Postpaid

Order by Set or Stock No.—Satisfaction Guaranteed

EDMUND SALVAGE COMPANY, P. O. AUDUBON, NEW JERSEY

SPECIALS IN LENS SETS

Big 10-Page Project and Idea Booklet with all sets.

Set #1-H "Our Advertising Special"—15 lenses for \$1.60 Postpaid, plus 10-page idea booklet. For copying, ULTRA CLOSE-UP SHOTS, macrophotography, experimental optics, magnifying and for making a two power f/16 Telephoto Lens, "Dummy Camera," Kodachrome Viewer, DETACHABLE REFLEX VIEW-FINDER for 35 mm. camera, stereoscopic viewer, ground glass and enlarging focusing aids, TELESCOPES, low power Microscopes and for many other uses.

Set #15-H "The Experimenter's Dream"—62 Lenses, Prisms and Optical Items, and New 50-Page Book, "Fun with Chipped Edge Lenses." \$15.00 Postpaid. The variety of Lenses and Prisms in this set will enable you to conduct countless experiments, build a great variety of Optical Equipment. A sensational buy.

New 50-Page Idea Book, "FUN WITH CHIPPED EDGE LENSES"

Contains wide variety of projects and fully covers the fascinating uses of all Lenses in sets listed above... only \$1.00 Postpaid.

MONOCULAR SET OF LENSES AND PRISMS... From Navy's 7x50 Binocular. All the optics you need to make a 7 Power Monocular. Complete directions included.

Stock #5101-H.....\$5.00 Postpaid

SPECTROSCOPE SET... These sets contain all Lenses and Prisms you need to make a Spectroscope plus FREE 15-page Instruction Booklet.

Stock #1500-H Hand Type Spectroscope.....\$3.45 Postpaid

Stock #1501-H Laboratory Type Spectroscope...\$6.50 Postpaid

100 Assorted Metal Gears—Instrument maker's surplus.

Stock #705-H (\$150.00 value).....\$10.00 Postpaid

MICROSCOPE SETS

Consisting of 4 Cemented Achromatic Lenses for making a 40 Power Pocket Microscope or 140 Power regular size Microscope. These color corrected Lenses will give you excellent definition and may be used for Micro-photography.

Stock #1037-H.....\$3.00 Postpaid

Consisting of Prism, Mirror and Condensing Lens. These used together with Stock #1037-H will make an excellent Micro-projector enabling you to get screen magnification of 400 to 1000 Power according to screen distance.

Stock #1038-H.....\$2.00 Postpaid

MISCELLANEOUS ITEMS

Stock No.	Item	Price
3016-H	Pentagon Prism	\$.75 each
2024-H	10 Pieces Circular A-1 Plate Glass (Diam.:31 mm.—for making Filter)	.25
4009-H	Heat Absorbing Glass 4" x 5"	.35 each
823-H	Six Threaded Metal Reticle Cells	.25
26-H	First Surface Aluminized Mirror, Diam. 1 1/4"	.25 each
624-H	Neutral Ray Filter, size 4 3/4" x 2 1/2"	.25
22-H	Inclinometer—Aircraft type	.25 each
704-H	Lens Cleaning Tissue, one ream (480 sheets) size 7 1/2" x 11"	1.50
1030-H	2" Diam. Reducing Lens	.25 each
1031-H	Perfect 6 Power Magnifier—Diam. 28 mm.	.25 each
2043-H	Crossline Reticle—Diam. 29 mm.	.50 each
1034-H	Burning Glass Lens	.25 each

(Minimum order on above—\$1.00)

POLAROID (Dyed)—Suitable for Experimentation. Consists 2 discs—2 1/2" diam. Some imperfections in glass.

Stock #622-H.....\$1.00 Postpaid

TANK PERISCOPE

Complete Set Mounted Components

Have fun! Make a real Periscope. Use it to see over the heads of crowds, to see under water, to see out windows without yourself being seen, and many other uses where observation by "remote control" is required. Originally constructed for U. S. Army Tanks, set consists of 2 fine Periscope mirrors mounted in metal and plastic. Perfect condition. Only plywood body frame is required to finish this exceptional Periscope. Set weighs 2 3/4 lbs. Overall length 6 1/2", width 2 1/8". Would normally retail at \$40 to \$50.

Stock #700-H.....\$3.00 Complete Set Postpaid (Two Sets (four units).....Special \$5.50 Postpaid)



Convenient, comfortable,
hospitable—that's Cleve-
land's favorite hotel

Hotel Cleveland

Cleveland, Ohio

Directly connected with
Union Passenger Terminal

★ SAVE WASTE PAPER ★

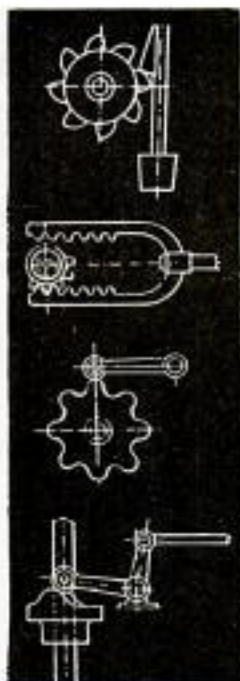

3000

DESIGNS, DRAWINGS, SKETCHES
of Mechanical Movements, Devices,
Appliances and Details

Every conceivable kind of mechanical motion is briefly explained and illustrated in this unusually valuable book. As far as known, the only work in existence which aims to provide side by side suggestion sketches of the various methods in use for accomplishing any particular movement or work. Indispensable to every engineer, inventor or mechanic. No need to rely on memory or experience now!

A FEW OF THE 3000 ARE: Ball and socket, Bearings, Brakes, Cams, Chain Gear, Chucks, Circular motions, Clutches, Conveying, Cranes, Cranks, Cutting, Eccentrics, Governors, Grips, Grinds, Indicators, Journals, Levers, Links, Nozzles, Parallel Motions, Pipes, Pivots, Power, Propulsion, Raising, Ratchets, Rotary Engines, Shafting, Signals, Slides, Swivels, Traps, Turbines, etc.

If you work with machinery, you need this **ENGINEERS' SKETCH BOOK** by Thomas W. Barber—355 pages, durably printed and bound in cloth. Mailed postpaid if you send order with \$2.98, or sent C.O.D. plus 27c postage. Money back if not exactly as described or if not satisfied.

KNICKERBOCKER PUB CO., 128 Greenwich St., Dept. M-21, New York 6, N. Y.

Learn Public Speaking

Learn theory and fundamentals at home—in spare time. Then acquire actual experience and practice. Send for **FREE** booklet "Power of Effective Speech."

North American School, Dept. 1357,
1315 S. Michigan Ave., Chicago 5, Illinois

LAW

STUDY AT HOME for **PERSONAL SUCCESS** and **LARGER EARNINGS**. 35 years expert instruction—over 108,000 students enrolled. L.L.B. Degree awarded. All texts furnished. Easy payments. Send for **FREE BOOK**—"Law and Executive Guidance."

AMERICAN EXTENSION SCHOOL OF LAW
Dept. 58-M, 646 N. Michigan Ave., Chicago 11, Ill.

FIX ANY RADIO

Amazing New Invention



FOR BEGINNERS OR EXPERTS

Learn quickly to repair radio sets. New revolutionary different comparison picture-method quickly simplifies radio servicing. No previous radio knowledge required. Introductory training included. Find any fault with ease. Do expert radio work almost immediately. Repair radios in minutes instead of hours. Plan U.S. Copyrighted. Take advantage of this new invention.

NO EQUIPMENT NEEDED

Most tests described require the use of only a screw driver, pliers and a piece of wire—no testers needed. Simple point-to-point picture suggestions tell you where to look for defects, how to test radio circuits and parts, and how to make the repair. You may try the plan for 10 days without any risk.

NEW 1945 EDITION

REPAIR RADIOS IN MINUTES

Read the introductory job-sheets, follow the step-by-step picture blueprints, and fix any radio in a matter of minutes. Do radio work for fun and profit. The complete simplified training is yours for only \$1.50, postpaid. 10 days no risk trial.

MORE HELP—IF NEEDED

Supplement your study, clear-up all hard problems, get ahead in Radio. A companion 19 lesson **Practical Radio** manual will give you added assistance, help you get ahead faster, present important facts in greater detail. Include this large manual also in your trial order. See coupon. →

RADIO MADE EASY

Let this unique plan with its easy-to-understand diagrams, simplified illustrations, hints, job-sheets, and practical examples teach you basic radio facts. Learn important shortcuts in radio trouble-shooting. Make needed tests without testers, trace the signal, measure voltage, within the hour after receiving the plan. Follow the comparison tests given on large trouble-shooting blueprints. Over 1,000 repair hints. Data on all tubes. Circuits and hints for many types of radios—new and old models.

10 DAYS "NO RISK" TRIAL

Examine and use **Simplified Radio Servicing** plan for 10 days in your own home. Apply this technique and repair one or more radios. Then decide to keep this greatest radio training bargain, or return the material and get your money refunded in full. You take no risk.

PRICE ONLY
\$1.50
COMPLETE

Complete plan, only **\$1.50**

In manual form, 8 1/2 x 11" Trouble-shooting charts. Data on 346 radio tubes. 76 large job-sheets. 1,000 time-saving hints. Covers many types of sets—new and old, portables, FM, etc. Developed by Beitman, noted engineer, teacher, and author. Order today without risk—use 10 days!

No Risk TRIAL ORDER COUPON

SUPREME PUBLICATIONS, 9 S. KEDZIE AVE., CHICAGO 12, ILL.
Ship the following manuals to me for 10 days' trial under your money-back guarantee. I am enclosing \$..... full price. Ship postpaid.

Simplified Radio Servicing @ \$1.50 **Practical Radio Manual @ \$2.95**
Complete manual as described. Companion Volume, 19 lessons.

Name:

Address:

HOUSE PLAN BOOKS...

Do Your Selecting and Planning Now. Build Later.



America's Best Low-Cost Homes —Fine selection of 1, 2 story homes. Cost \$1,200 to \$3,100.....	.50
De Luxe Small Homes —210 popular designs, cost \$1,100 to \$10,000.....	1.00
New American Homes —88 high class designs. \$3,900 to \$15,000.....	1.00
New Brick Homes —4 to 7 rooms. \$3,400 to \$7,400.....	.50
New Small Homes —62 designs. \$2,300 to \$6,700.....	.50
Artistic Homes —Selected for unusual features. \$2,600 to \$9,000.....	.50
Colonial Homes —48 designs.....	.50
Low Budget Homes —5 small, medium size. \$2,100 to \$3,000.....	.50
Spanish and Western Homes50
Sunshine Homes —For warm climates. \$1,900 to \$7,600.....	.50
New Duplex Book50

Send Your Order to
POPULAR MECHANICS PRESS
Dept. 613
200 E. Ontario Chicago 11, Ill.

LOW COST!

Make Power Tools from Auto Parts

Send today for new edition, featuring tools you can make of wood. Build your own lathe, drill press, sander, circular, scroll and band saw and other power tools you have always wanted, from discarded parts, at low cost. Simplified instructions, hundreds of pictures and diagrams make building easy. Order today. Only \$1.25. Money back if not satisfied.



POPULAR MECHANICS PRESS, Dept. 614, 200 E. Ontario St., Chicago, 11

"HOUSEHOLD STREAMLINERS"

Over 760 Time, Money, and Labor-Saving Suggestions for the home—a single hint may be worth more than the price of the whole book.
* * * * * **AN IDEAL GIFT FOR ANY HOUSEWIFE** * * * * *
Only \$1.00 postpaid. Sold on Money Back Guarantee.
ADIRONDACK PRESS, POTSDAM 7, N. Y.

★ SAVE WASTE PAPER ★

PRACTICAL TECHNICAL TRAINING FOR YOU



Millions of Air-Conditioning Units, Heating Plants, and Refrigerators need Expert Service NOW! Also in the big postwar building boom trained men will be in great demand to meet urgent requirements for Refrigeration, Heating, Cooling, Quick Freeze, and Air Conditioning Research, Sales and Service for homes, commercial plants, farms, dairies and other installations.

Are you one of the many men who won't be satisfied to go back to your old job—or want a business of your own? Then get the training NOW provided by our short, practical courses—planned for men who LOOK AHEAD. Over 30,000 technicians and engineers in good paying positions the world over were trained at MSOE since 1903. Many of our graduates own their own businesses. Write NOW—let's get together—it will be the most important step you ever took.

AIR CONDITIONING and REFRIGERATION



MILWAUKEE SCHOOL OF ENGINEERING
PM-1045 N. Broadway & E. State, Milwaukee, Wis.
Please send BIG FREE BOOK just off the press—and give me complete information on

- () REFRIGERATION SERVICING..... 3 months
- () AIR CONDITIONING REFRIGERATION & HEATING..... 6 months
- () TECHNICIAN'S COURSE..... 3 year
- () Electrical () Arc Welding () Drafting
- () Electrical Engineering (B. S. Degree)

NAME.....
ADDRESS.....
CITY & STATE.....

OCTOBER, 1945



THE FAITHFUL
HEART
OF YOUR FUEL
SYSTEM

AC FUEL PUMPS

Pulsing steadily, hundreds of times a mile, your AC Fuel Pump is the strong, reliable heart of your fuel system. It has given you long, faithful service because of its inbuilt quality and scientific design.

You can prolong that faithful service indefinitely, if you insist upon an AC when you replace your present pump with a new or rebuilt one.

AC SPARK PLUG DIVISION • GENERAL MOTORS CORPORATION

TAKE CARE OF YOUR CAR TILL
NEW ONES ARE AVAILABLE

HOW IS YOUR HOUSE HEATING IQ?



How would YOU answer these important questions?



Check YES or NO

YES NO



Do you think your fuel bill is too high?

Have you roasted in the living room in order to maintain a livable temperature in the rest of the house?

Have you found your kitchen too hot for cooking or washing dishes?

Do your rooms have "up-and-down" temperatures caused by "on-and-off" heat supply?

Is your bathroom too cold for that morning shower or evening tub?

Are your rooms hot at the ceiling and cold at the floor?

Are your floors too cold and drafty for the children to play on without catching cold?



The answer to these questions and many other house heating problems are given in the booklet, "Heating and Air Conditioning the Postwar Home," recently published by Minneapolis-Honeywell. It tells all about MODU-FLOW the remarkable new Honeywell control system.

Moduflow operates on an entirely different principle from the ordinary "on-and-off" heating system. It fur-

nishes heat *continuously* at just the right temperature to offset heat losses, which are continuous. No more drafts or chilly periods caused by intermittent heat supply — just blissful comfort from head to foot in every room.

Best news of all is that you can install Moduflow *right now* in your present automatic heating plant. Mail the coupon today for the booklet that tells all about Moduflow.



SEND FOR THIS BOOK

Minneapolis-Honeywell Regulator Co.
2907 Fourth Ave. S., Minneapolis 8, Minn.

Please send my free copy of "Heating and Air Conditioning the Postwar Home"

FREE

Name _____

Address _____

City _____ State _____

Buy and Hold MORE Victory Bonds!

MODUFLOW

THE NEW HONEYWELL CONTROL SYSTEM

Popular Mechanics Magazine

Registered in U. S. Patent Office and Canada

WRITTEN SO YOU CAN UNDERSTAND IT

Vol. 84

OCTOBER 1945

No. 4

By William E. Taylor

THEY say up in the North Country that Paul Bunyan dug the Big Pit with his bare hands when he wanted a spot for a gargantuan barbecue. That's hard to believe. Even the legendary hero of the timber camps couldn't have rounded up enough oxen to fill more than half of that colossal hole in the ground in Minnesota.

From the Big Pit has poured, in incredible quantities during the last decade, the ore for the iron and steel that armed the United Nations. Now its red earth is melting in the blast furnaces for the iron and steel products of peace.

Imagination runs wild at your first glimpse of this monstrous gash in the earth,



Electric shovel loads iron ore into small "Dumpton" at Spruce open pit near Eveleth, Minn. Below, around the Big Pit iron ore trains run on terraces at different levels removing ore and waste material

Oliver Iron Mining Co. photos



OCTOBER 1945

1
Copyrighted material



Great Northern Railway photo
 Three miles long and 420 feet deep, the Hull-Rust-Mahoning open pit mine is world's largest. It supplied 20 million tons of iron ore in 1944



Map shows location of famed Mesabi and other ranges which provide U. S. industry with fabulous amounts of iron ore. Below, underground mine in which ore is being loaded by electric scraper hoist. Note timbered entry



three miles long, from one-half to one mile wide, up to 420 feet deep and still growing. Mesabi, the range of the Big Pit, stands for giant.

Bill Bates, chief engineer of the Oliver Iron Mining Company at Hibbing, operator of the Hull-Rust-Mahoning open pit, world's largest iron ore mine, likes to think of the British journalist whom he showed around one day. The visitor stood staring down into the Big Pit for nearly five minutes, without a word. Finally he spoke, almost in a whisper:

"When I used to see the convoys steaming endlessly into England, I wondered where all the stuff was coming from. Now I know!"

The Big Pit doesn't supply all the iron ore from the Lake Superior district, of course, but the approximately 20.5 million tons shipped from Hull-Rust-Mahoning in 1944 was about one fourth of the district's total shipments of 81,874,930 tons from mines in Minnesota, Michigan and Wisconsin. Back in 1917, peak year of World War I, the Big Pit

shipped out more than 12,000,000 tons, a record until World War II came along. Demands of war upon iron mines are reflected in the total shipments from the six ranges of the three states—Mesabi, Cuyuna, Vermilion in Minnesota, Gogebic and Menominee in Michigan and Wisconsin, and Marquette in Michigan. For the five-year period, 1940-44, shipments totaled nearly 406,000,000 gross tons, compared with only 320,000,000 tons in the ten years 1930-39.

Increasing mechanization of the mines has made possible the necessary colossal production. Shooting ahead with new devices in recent years, nearly 650,000,000 tons of material had been taken from Hull-Rust up to January 1, 1945. That's a terrific amount when you realize that only 480,000,000 tons of material were removed in digging the Panama Canal!

The ore is extracted by two methods: open pit or strip mining, and underground mining. In the Big Pit, ore channels run northwest and southeast. Huge shovels, the largest having a 15-ton bite, cut below the tracks on which they rest and move to lower levels as the ore is removed. Layers

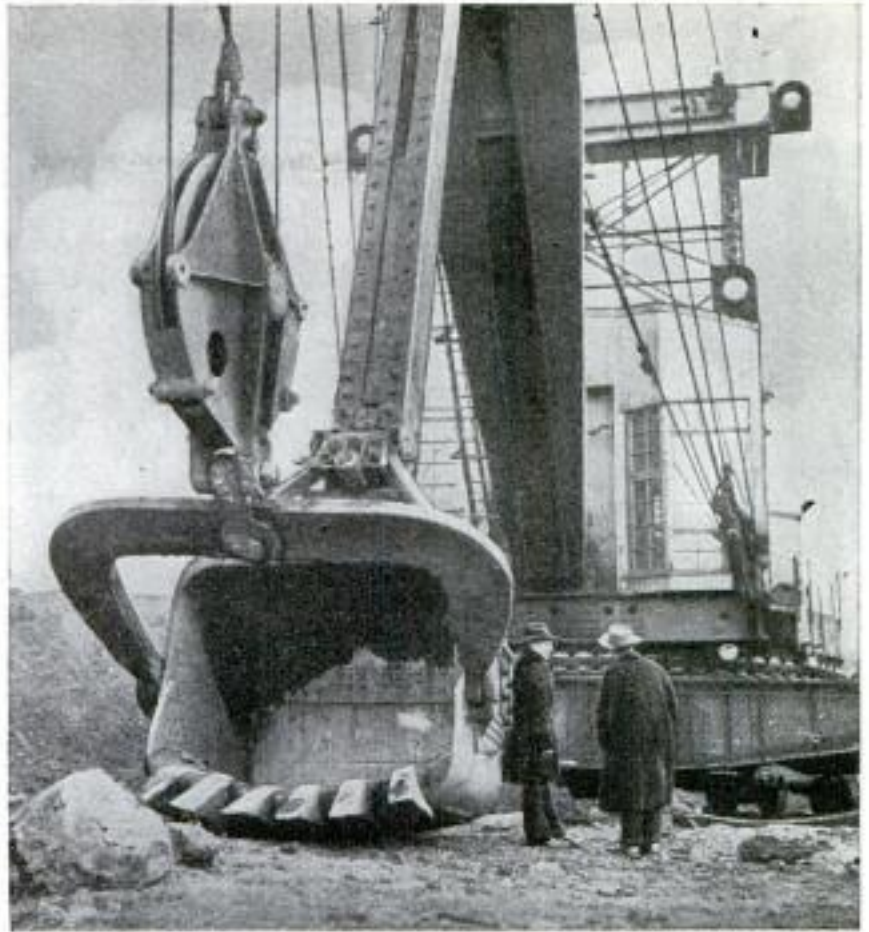

This huge shovel has moved enough ore to build many a warship and tank

of rock and shale, averaging nearly two thirds of a ton for every ton of ore taken out, must be stripped away to reach the rich ore deposits. Placed in huge piles near the pits, the waste rock has a future, too.

Most of the Lake Superior ore is hematite, which contains 70 percent iron when pure. It never is mined pure, but the Lake

Caterpillar "scraper wagon" takes heavy load of iron ore out of the Hull-Rust open pit at Hibbing, Minn.





Inland Steel Co. photo

Iron ore pours into railroad car from the head frame of loading device. Below, a typical cross-section of the Mesabi Range showing layers of ore

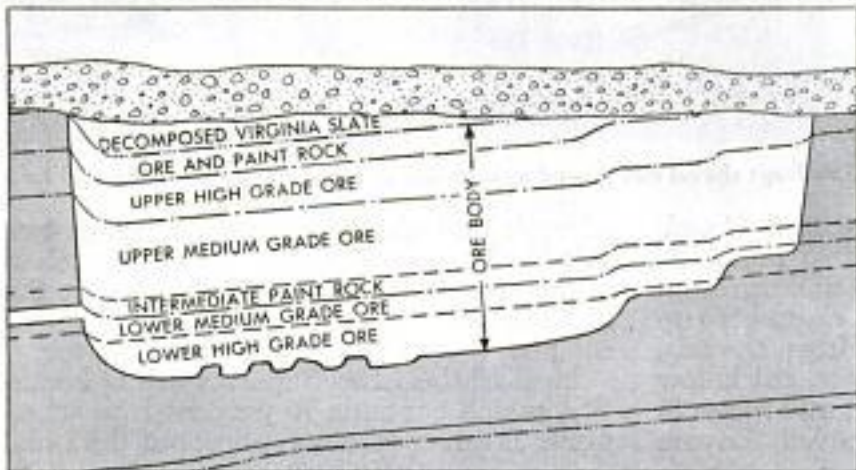

Adapted from U. S. Steel News drawing

Below, cyclone drills do exploratory work at Rouchleau mine, Virginia, Minn. Reserves of ore on Mesabi Range are estimated in billions of tons



Superior ore contains a high amount of iron, about 52 percent. It's a dark red granulated powder or rock, and when you flounder around the Big Pit on a damp day, it sticks like airplane glue.

All the shovels at Hull-Rust are electric or Diesel-powered, the older ones having been converted from steam. The older models move on wheels and tracks, but the new ones propel themselves on Caterpillar tracks. Bulldozers are everywhere, many hauling two-wheel scrapers which pick up several tons of ore as they're dragged along.

All the trucks at Hull-Rust now are Diesel-powered. They can start up the seven percent grades easily with full loads. Trucks vary from pint-sized Dumpsters, which back into incredible nooks and corners, to monsters which take a full load from the biggest shovels. Small "cats" penetrate into regions hitherto inaccessible and scoop out ore with hoe-type dippers of three eighths cubic yard capacity.

The mechanized operations permit removal of ore deposits passed up previously as too small to justify laying tracks to take the ore cars to them. Walls of the pit are lined with tracked terraces, but the maximum grade, three percent, for rail operation often made it impractical to reach some areas. Trucks, "cats" and small shovels have solved the problem of cleaning out the bottom of the pit.

Back in 1940, one Diesel-electric locomotive was ordered for Hull-Rust, just to see how Diesel power would haul the heavy ore cars. Today about 30 Diesel-electrics of 1000 horsepower bring the ore cars up the sides



Oliver Iron Mining Co. photo

Loading ore cars at Hull-Rust-Mahoning mine; the Big Pit contains more than 55 miles of railroad track

of the mine, and steam locomotives are used only for switching and emergencies. There are more than 55 miles of track in the pit and the trackage grows constantly.

Gigantic belt conveyors also make light work of hauling ore up the steep sides of the open pits on the iron range. In the Morris mine, adjacent to the Big Pit, a conveyor belt 2165 feet long, 32 inches wide, can carry 715 tons of ore per hour up a lift of 252 feet, on a grade of 24 percent. This was the first application of a steel cable belt developed by Goodyear. After three sea-

sons of operation, during which it lifted more than 1,000,000 tons of ore, the belt had stretched only $\frac{3}{100}$ of one percent.

Shop facilities have expanded in step with mechanization of the industry. In the locomotive shops at Hibbing, the Diesels are kept in perfect operating condition. No locomotive, Diesel or steam, has to be hauled away for any kind of repairs.

Giant grinding lathes maintain steel wheels of the locomotives at highest efficiency. In the machine shop, the routers,

(Continued to page 160)

Left, open pit with tower excavator at work; right, 2165-foot belt conveyor lifts 715 tons per hour



"Whizz Bang" Blasted Japanese Out of Caves



two and seven-eighths-inch pipe. The pipe was split along one side and had flanges attached so it could be screwed together like a clamp. The forward collar was welded onto the pintle and the rear collar was attached to the traversing and elevating mechanism. A heavy piece of pipe reinforced the trail leg to stand the shock. The original Whizz Bang had a bazooka sight, but this was discarded and the crew had to aim along the barrel and guess at elevation. When the weapon first went into action it was positioned about 50

yards from a tunnel entrance. After it had spewed forth eight 60-mm. shells every Jap inside the tunnel was dead. The weapon was used to capture four caves. It filled a special need for a direct trajectory weapon with sensitive detonation, tremendous concussion and fragmentation. Principal drawbacks were that the enemy could fire right down the muzzle at close range, and also the lack of breech loading. It was invented by Lt. Col. John E. Harbert and Sgt. Loren C. Craig.

When heavy artillery, mortar and aerial bombardment failed to neutralize Jap caves in northern Luzon, two men of the 32nd Division Ordnance built a special weapon to do the job. They called this hybrid piece a mortar-cannon, but the GIs dubbed it "Whizz Bang." It was made by attaching the tube of a 60-mm. trigger-fired mortar to the tripod of a .30-caliber Browning heavy machine gun. The barrel was held by two collars made of ordinary

Yanks Used Artificial Moonlight in Philippines to Spot Japs at Night

Moonlight was created by anti-aircraft searchlights along a 10-mile front a few months ago near Manila. The lights were

directed at clouds and the reflected beams gave an effect of full moonlight to prevent Japs from slipping into our lines.



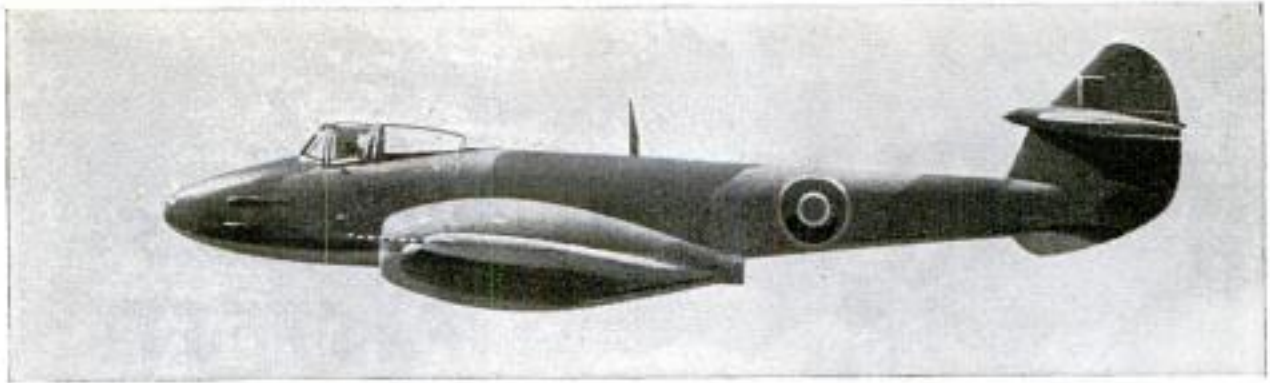

Twin jet British Meteor has high tail and four cannon in nose

British Jet Fighter

First Allied jet fighter to go into action against the enemy was the RAF Gloster Meteor. This twin-engine plane, nicknamed "Squirt" by British flyers, carries four 20-mm. cannon in the nose. It was used to shoot down German V-1 flying bombs over England and saw action in Europe during the last few months of the war. It has a wing span of 43 feet and is 41 feet long. Speed is believed comparable to the "more than 550 miles an hour" announced for the U. S. P-80 Shooting Star.

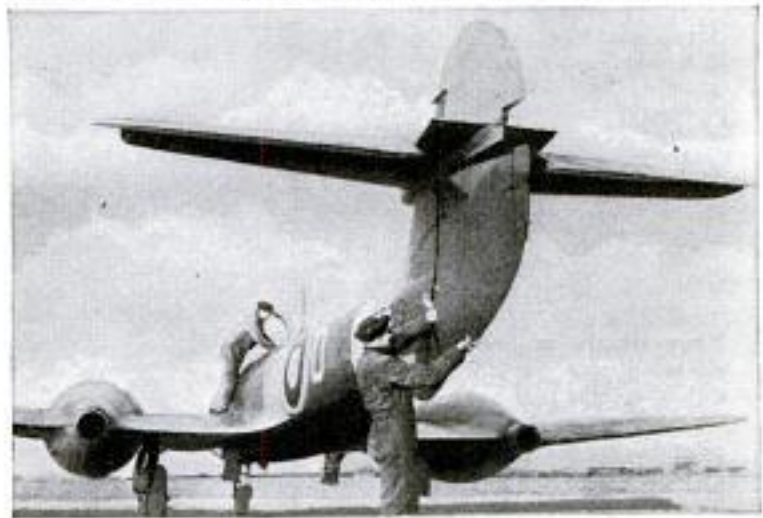

Hydraulic Ship Telegraph

Signals are transmitted from the bridge to engine room of a vessel with a hydraulic system developed to meet instantaneous transmission requirements of speedy PT boats. When the pilot moves the engine throttle handle to Ahead, Neutral or Back, the motion is transmitted instantly to an indicator dial marked A, N and B in the engine room. The dual hydraulic system automatically compensates for expansion or contraction caused by temperature changes, and is not dependent on electricity or other outside power. Wide application to pleasure and commercial vessels is foreseen.

The WORLD'S FASTEST AIRPLANE

P-80 SHOOTING STAR

Engine—G-E jet
Speed—Over 550 m.p.h.
Ceiling—Above 45,000 feet
Wing span—38 feet 10½ inches
Length—34 feet 6 inches
Armament—Six .50-caliber machine
guns, rockets and bombs

Huge nozzle in tail
vents exhaust gases.
Capt. Wallace Lien at
right was first Army
pilot to fly the P-80



IN AMERICA'S fastest fighting plane a pilot can leave La Guardia Field at four o'clock in the afternoon and land at Los Angeles before the clocks on the west coast strike five.

Flying through the time zones at 550 miles per hour he would almost make time stand still although his elapsed time would be something over four hours.

That's a graphic way to indicate the speed of Lockheed's jet-propelled P-80 Shooting Star. Called the world's fastest airplane, a propellerless P-80 recently flew from Dayton to New York in 62 minutes. Its top speed has been announced as "in excess of 550 miles per hour."

The P-80 is no freak racer but a standard military aircraft, equipped with six .50-caliber machine guns in its nose and capable of carrying rockets and bombs as well.

Droppable wing-tip fuel tanks provide a range comparable with that of other long distance fighter planes.

At a recent demonstration of the P-80 the public address system's announcer warned his audience: "He'll be coming in low across the field from the west. Watch closely, for you won't hear him approach!" Then a dot in the sky hurtled toward the field, blasted overhead and was out of sight again almost before the spectators had a chance to turn their heads. There had been a faint hum as the plane approached, a sudden blast of noise from its exhaust nozzle, and it was gone.

The wing of the P-80 is 38 feet 10½ inches from tip to tip and the plane is 34½ feet long. Its speed results from the terrific thrust of its power plant plus the aerodynamic cleanness of its bullet-shaped fuselage and the knifelike wing. To reduce resistance to a minimum the skin is attached with flush-type rivets that are then surface ground. Butt joints are filled with cement. The entire plane is given a pearl-gray paint baked on in a large oven and then buffed. Final treatment is to spray on wax and polish it to utter smoothness.

Much simpler in construction than aircraft that are powered with reciprocating engines, the Shooting Star is extremely easy to fly and is highly maneuverable. It has no torque problem and recovers from spins in half a turn or less. The superfighter has the fastest roll in the world and its performance is limited only by the pilot's ability to withstand tight turns and pull-

Even air liners are snails by comparison with the P-80 which flew from Dayton to New York in an hour



"Ears" of the clean-lined "Shooting Star," seen in head-on view, are air intake ducts. Below, engine of P-59 jet plane with ring of combustion chambers

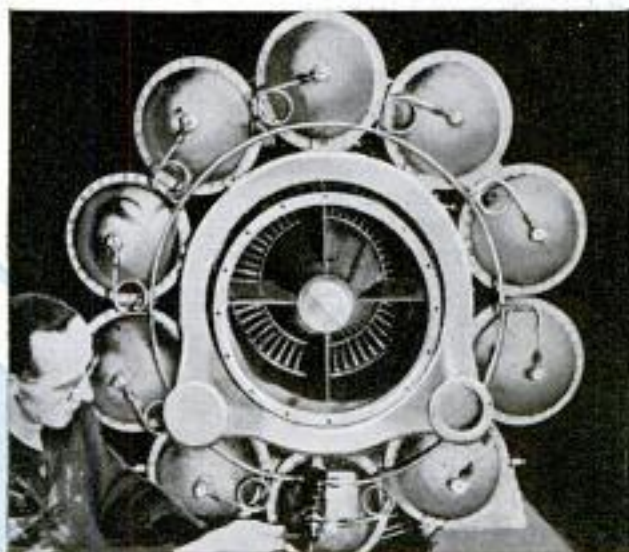

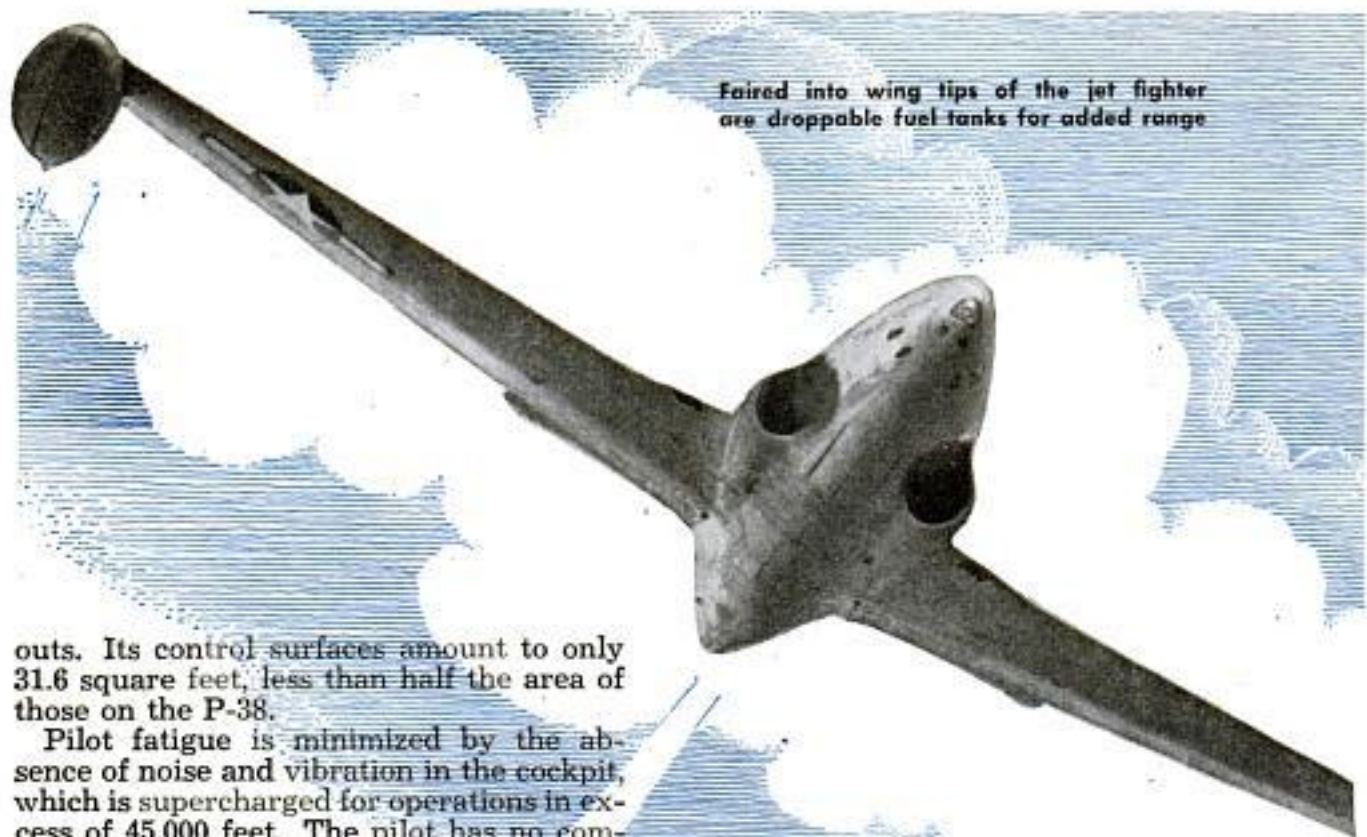

Faired into wing tips of the jet fighter are droppable fuel tanks for added range

outs. Its control surfaces amount to only 31.6 square feet, less than half the area of those on the P-38.

Pilot fatigue is minimized by the absence of noise and vibration in the cockpit, which is supercharged for operations in excess of 45,000 feet. The pilot has no complicated maze of instruments in front of him. The principal engine instrument is the tachometer and the only engine control is the throttle. These plus a few flight instruments and his control stick are all he needs. He starts his power plant by means of a battery-operated motor that spins a compressor at the same time that a spark plug ignites the fuel mixture. A small metal plug in the combustion chamber almost at once becomes white hot and serves to maintain ignition after the electrical plug is switched off. There is no spark interference with radio and no engine warm-up time is needed. The plane can take off at once.

Its General Electric gas turbine is the most powerful aircraft engine in the world and has but one moving unit, the compressor wheel and turbine wheel that rotate on a single shaft at more than 10,000 r.p.m. The gas turbine weighs considerably less than other types of power plants and its power is measured in thrust instead of conven-

tional horsepower. Thrust exists when the speed of the jetted exhaust gases exceeds the speed of the plane.

The power plant fits into the fuselage aft of the cockpit and the entire tail end of the plane may be detached, at the trailing edge of the wing, for servicing the engine. This

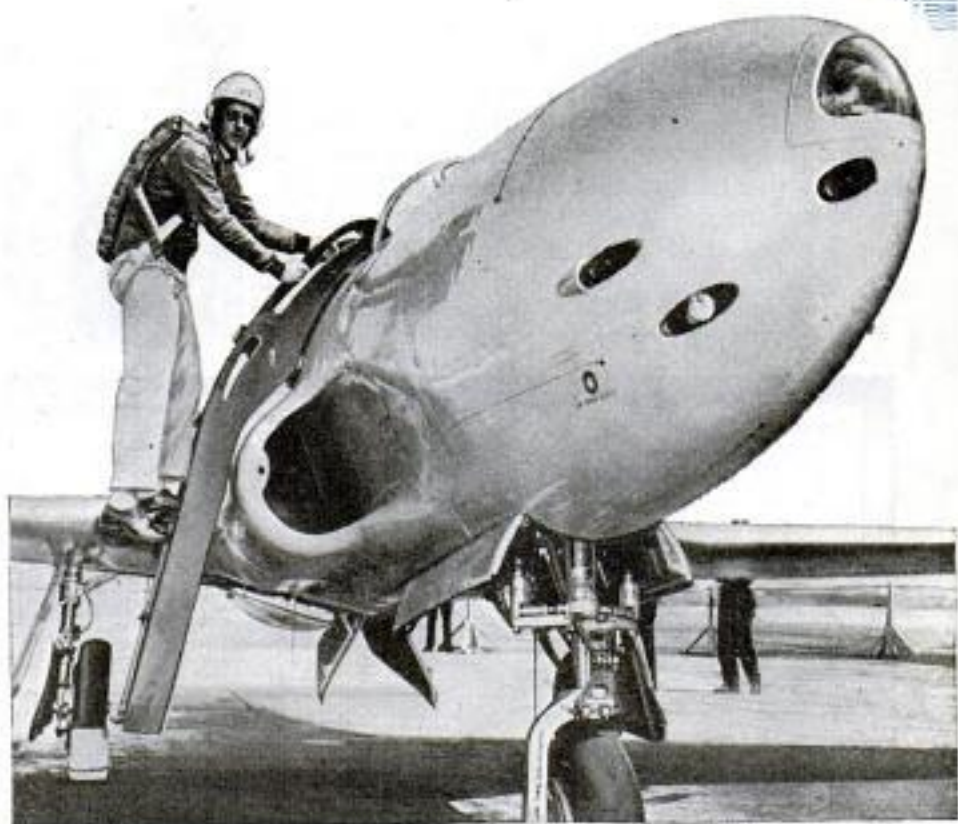

Tony LeVier, chief test pilot of Lockheed Aircraft, climbs into the tight cockpit for a trial of the fastest plane in the world



Air ducts hug the fuselage without marring aerodynamic lines; the cockpit is supercharged

is done by removing three fittings, the tail pipe clamp, and the control cables. A complete engine change takes less than 20 minutes.

Air for the turbine is drawn in through a large duct at the leading edge of each wing root and the exhaust gases jet from a large exhaust nozzle at the tail of the plane. Combustion of the kerosene fuel is complete and the plane leaves no trail of smoke or flame.

The guns in the nose are positioned to avoid blinding the pilot by muzzle flash, and are aimed with the aid of an electrical gyro-lead computing gun sight. Each gun is supplied from an ammunition box that feeds bullets perfectly even under the multiplied gravity pull of combat maneuvers. Guns and magazines can be replaced in less than 15 minutes. A gun camera in the right-hand air intake duct takes pictures of each combat action. The whole nose forward of the cockpit may be detached and a photo nose with camera equipment substituted. Able to outrun anything in the sky, the P-80 makes an ideal photographic reconnaissance plane. The pilot is protected by an armor glass windshield and steel armor plate forward and aft of his position.

Dagger-like radio antenna—there are two, side by side—projects from under fuselage

One of the many amazing things about the P-80 was the speed with which it was designed and built. Because of the war, Lockheed was asked to get its fighter into the air as fast as possible. Under Kelly Johnson, chief research engineer, the plane was designed, research was done, and construction of the first plane was completed in 143 days. The Shooting Star represents revolutionary changes in design from conventional aircraft and yet it was ready for flight in less than one third of the time usually taken.

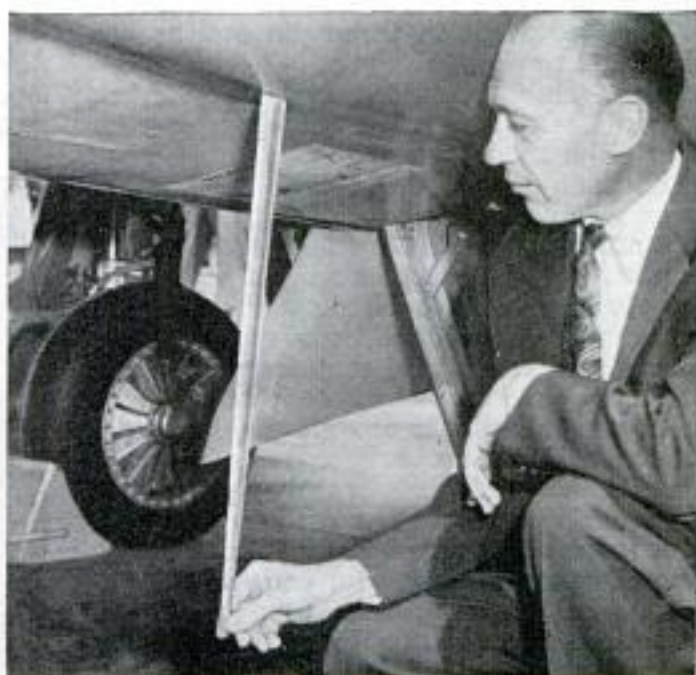

Exhaust Runs Turbosupercharger to Boost Plane Speed

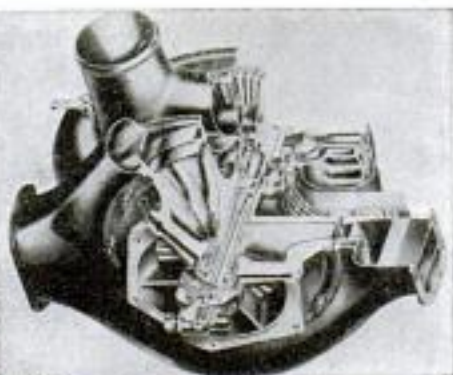
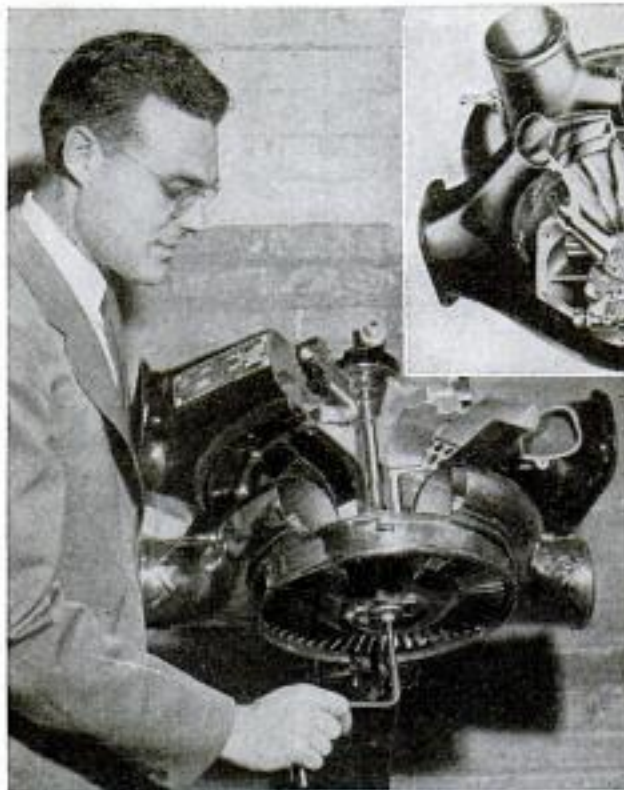

Cutaway, above, of the Wright "turbo." Left, a demonstrator hand-run model

up to 150 horsepower. This force spins the turbo's centrifugal compressor to create a compressing power sufficient to raise water to the top of a six-story building, inflate truck tires, or ventilate the average home. Installed in aircraft, the turbo acts as any other supercharger, but without inroads on horsepower of the engine itself. "Baffling" of exhaust noise in the surge of the gas through the turbo also reduces sharply the noise level in an airliner.

Thread Made of Stainless Steel Used to Sew Up Wounds

Stainless steel threads as fine as human hair are used as a nonabsorbable suture material. Wounds sewed with the chromenickel alloy suture can be exposed to heat and X-ray treatments with excellent results. The metal suture also can be left safely in place should a wound become infected. The stainless steel thread is pliable, has high tensile strength and can be knotted easily. This metal suture is expected to take its place along with such materials as silk, catgut, nylon, cotton, linen and horsehair now used in surgery. It was developed in the laboratories of Davis & Geck, Inc.

Jack-in-Box Map for Flyers Shows How to Dodge Cyclone

Weather maps in three dimensions are designed to teach flyers how to dodge cyclones, icing conditions and other flying hazards. Colored plates which spring up when the maps are opened show typical conditions of air masses over a 1000-mile area when a storm is brewing. The maps are made in sets of three. One shows the conditions that exist in an early stage of development of a cyclonic storm and the other two show conditions on cold and warm fronts. Frontal surfaces are shown in color—cold front in blue, warm in red, occluded (air shut in or shut out) in purple and rain in green. Arrows indicate usual movements of air masses and help the pilot determine conditions at various altitudes. The maps show where dangerous updrafts and downdrafts may occur and what direction a pilot should turn to avoid them. Practical data include 15 important icing rules for pilots. This three-dimensional aid

for flyers and students of physics, meteorology and aviation was prepared by the Special Devices Division of the U. S. Navy Bureau of Aeronautics.



GRAND SLAM IN SUBS

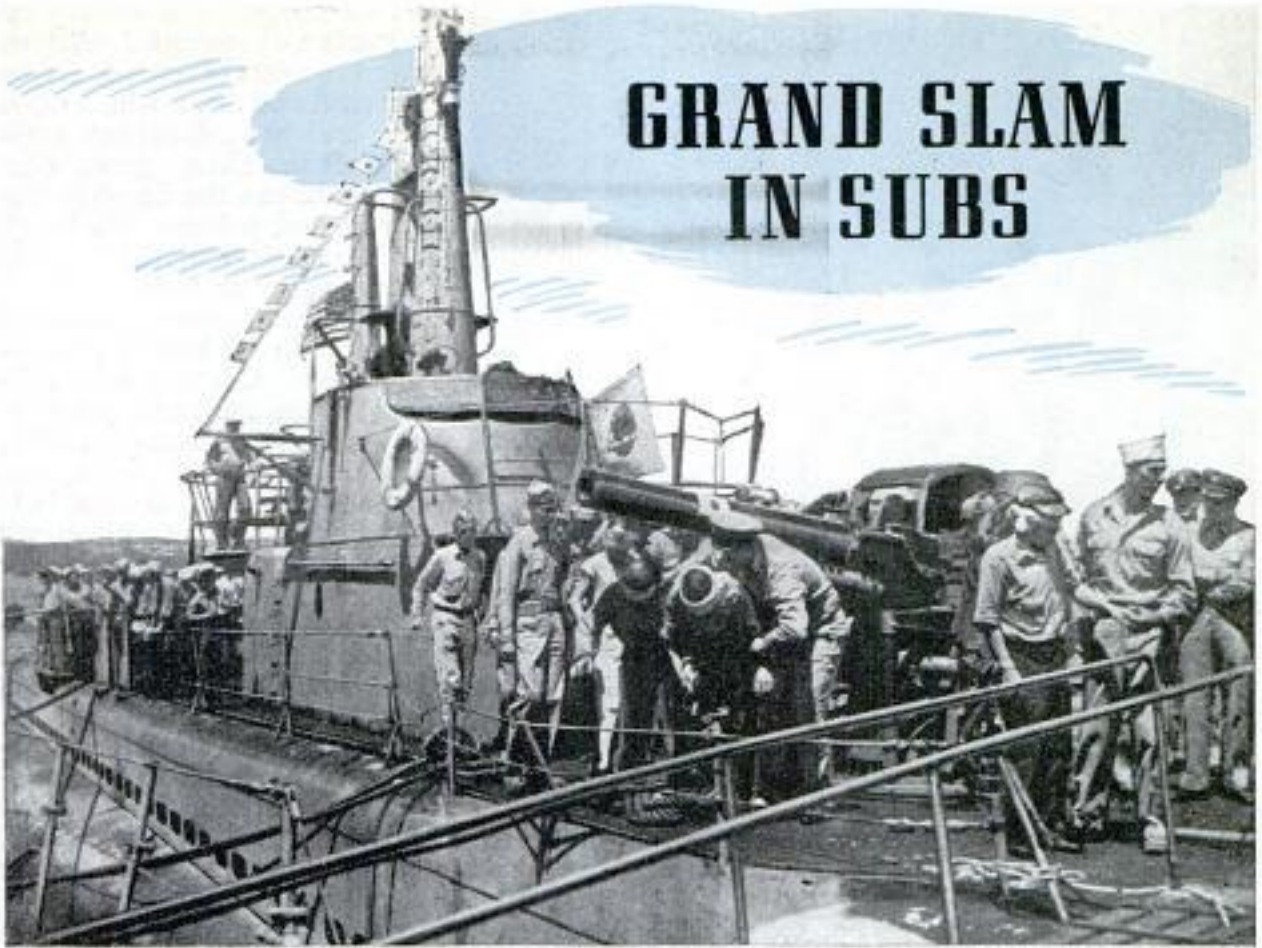

IN THE MIDDLE of bustling Pearl Harbor Navy Yard is a tall, cylindrical building which looks like a camouflaged Kansas silo. It is the submarine escape tower. Clustered below are office buildings, barracks, shops, warehouses, docks. Into these docks slide the graceful black hulls of United States submarines returning from war patrols. Some of them have had broomsticks at their masts denoting a clean sweep, and all of them have displayed tiny freshly painted red and white Jap flags on their conning towers.

Some of the more dramatic stories of the war are to be found aboard these ships and in the hearts of men who wear the golden dolphin insignia. However, until recently, the Navy turned thumbs down on submarine adventure stories. The more colorful aspects of the underwater war against Japan were closely guarded secrets.

Such secrecy has paid off. From December 7, 1941, to May 7, 1945, some 993 Jap ships—126 of them warships, including four carriers, 17 cruisers and 53 destroyers—have been sent to the bottom by our submarines. This represents about 4,500,000 tons sunk, approximately 75 percent of Japan's total loss.

U. S. Navy photos
Back from patrol in enemy waters, sub's crew looks on while Marines take charge of four Jap prisoners picked up after sinking a ship. Below, a periscope view of Jap cargo ship plunging bow first to its doom

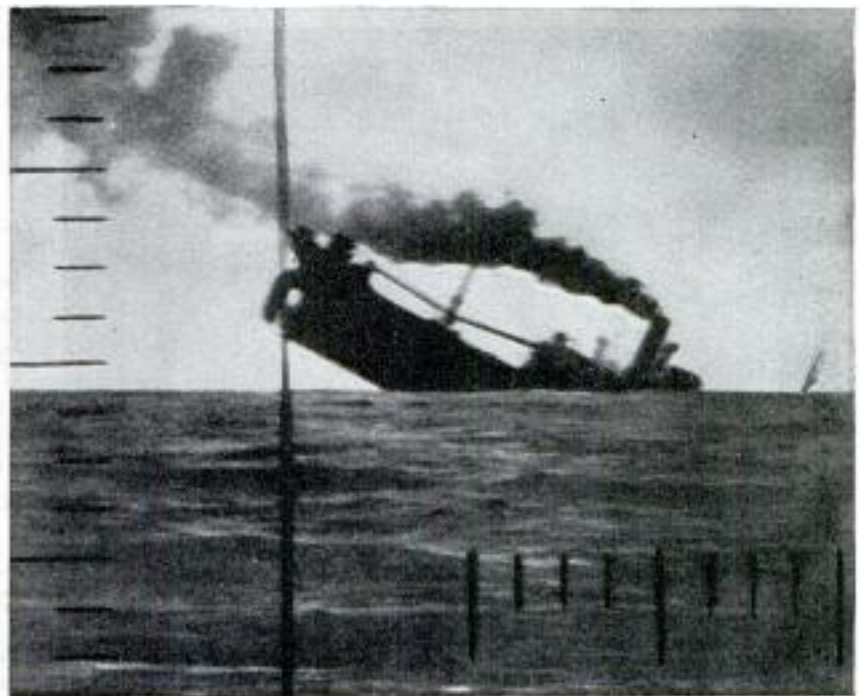



Officer sights target through periscope while crew mans stations

Such attrition doomed the entire Nipponese war effort. It made extremely difficult the job of supplying outlying garrisons, cut off the flow of raw materials to her factories and took an alarming toll of warships.

When the war began, we had exactly 111 submarines in service—ranging all the way from the obsolete "O," "R" and "S" types and the freakish, mine-laying giant, the Narwhal, to such modern types as the Grampus and the Gudgeon. Since December 7, 1941, building programs have called for 150 new subs of the long-range fleet type. Modern United States submarines are of about 1500 tons displacement and are a little over 300 feet long. Diesel-electric powered, they will cruise about 20 knots

on the surface and about 8 or 9 knots submerged. Armament consists of torpedo tubes forward and aft, a 3-inch deck gun and two .50-caliber anti-aircraft machine guns. Our new subs are the finest in the world and possess the latest scientific devices for waging underwater warfare.

Submarine crews consist of more than 60 highly competent men. Commanding officers, of the rank of commander or lieutenant commander, are the cream of Annapolis-trained officers. Unlike battleship or destroyer crews which, for the most part, are trained after they get on board, submariners are trained to perfection before they set foot on the slim decks of their craft.

Submarine duty requires a certain informality between officers and men. Submariners are picked not only for their perfect physical condition and high degree of skill, but also for congeniality and tolerance in their personal relations.

In spite of close quarters, long patrols and the hazardous nature of the work, submarine duty has its pleasant side. Vitamin pills and ultraviolet lamps insure good health. Radios, portable phonographs and the latest books and magazines provide relaxation. You won't find many submariners who would swap for any other kind of duty.

With impressive scores to their credit, submarine skippers are pretty cocky about knocking off Jap ships. One of the favorite stories around the Sub Base concerns a commanding officer on patrol. He had just been dealt a fistful of bridge cards when a Jap ship was sighted.

"Nobody touch this hand!" he ordered as he jumped up.

He made his way to the periscope and glued his face to the eyepiece. There was a big, fat Jap transport—10,000 tons if she weighed an ounce. He took careful aim, fired a spread of torpedoes and grinned happily as two of them found their mark.

Then he returned to the bridge game—and made a grand slam.



Fish-eye view of snow-capped Fujiyama was made through sub periscope

It might be said that the United States Navy has made a grand slam in subs against the Japs. Courage and skill are routine, and the chests of the submariners are among the most highly decorated in the whole Navy. A submarine skipper feels almost naked if he doesn't sport a Navy Cross or two. Commander Roy Davenport, USN, a sub skipper from Los Angeles, recently became the first Navy officer to win five Navy Crosses.

The first submarine skipper to win a Congressional Medal of Honor was Commander Howard Gilmore, USN. As he lay wounded on the bridge of his sub under attack by a Jap gunboat, he uttered his own death sentence in words that will live in naval history:

"Take her down!"

The crew obeyed and the submarine dove to safety without its skipper.

Tribute has been paid to the submarine time and time again by Fleet Admiral Chester W. Nimitz, USN.

"When the war first started," he said, "we were quite weak in surface ships and air forces, but we had a branch of the service that was immediately able to take the field and penetrate into enemy waters unsupported and start the war for us. I speak of our submarines.

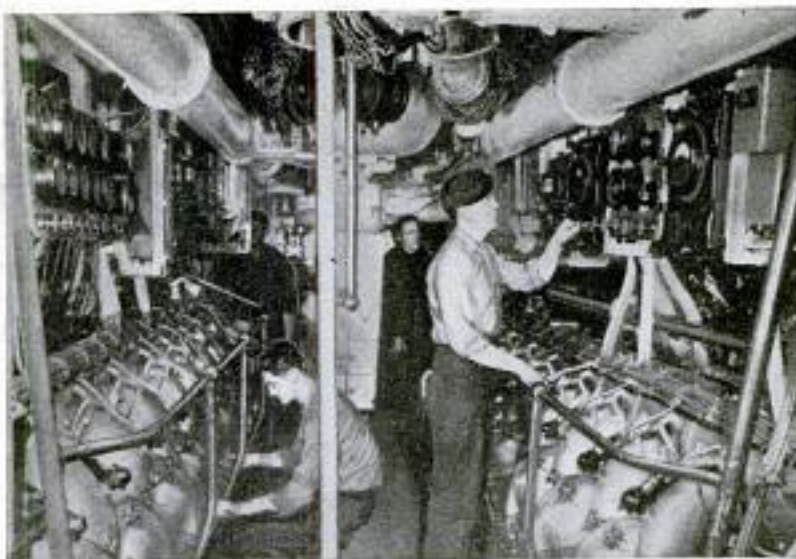

Machinist's mate checks huge twin Diesels which power U. S. subs operating on the surface; they provide speed of about 20 knots



Stowaway aboard! This hitch-hiking seal surprised crew when hatch was opened. Below, new U. S. sub has a distinctive conning tower



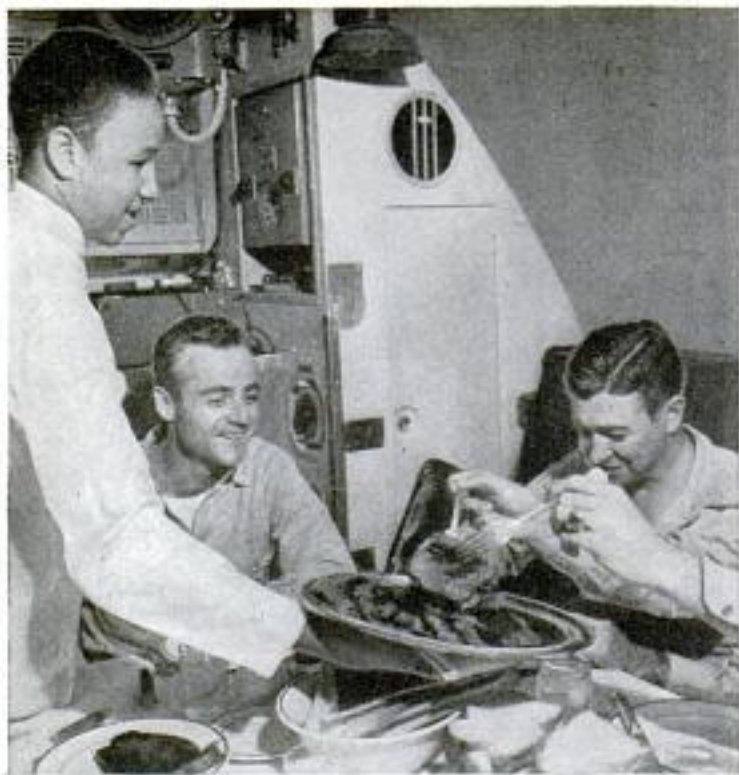

Chow time and a juicy steak bring smiles; food is Navy's best

"They have operated continuously throughout the war, day and night, between the surface and amphibious operations that we conducted, and they have turned in a fine performance of duty."

In the early, tragic days of the war, a few submarines of our Asiatic Fleet kept General MacArthur's forces fighting in the Philippines. Supplies, food, ammunition and medicines were carried into Manila Bay.



Shortly before the fall of Corregidor, one daring sub skipper stole past enemy shore batteries at night. Reaching the island fortress, he put ashore anti-aircraft ammunition to help Army gunners fight off the waves of Jap dive bombers. He then loaded up with a vast amount of gold, silver, jewels and securities belonging to the Philippine Commonwealth, banks and individuals. He also brought out several high-ranking American and Filipino officials, including the United States High Commissioner, Francis B. Sayre. Another American submarine was sent to the Dutch island of Timor in the Netherlands East Indies to rescue a group of fever-ridden, emaciated Australian flyers. The daring rescue was successfully accomplished, even while Jap patrols were searching the jungles and the beaches for the airmen.

Supplies, ammunition and instructions were also taken to Filipino guerillas during almost three years of Jap domination of their islands. In one instance, an American sub nosed its way several miles up a river and tied up at a pier while a Filipino welcoming party trotted out a band and played "Anchors Aweigh." The Japs nearby thought it was merely a local Filipino holiday celebration.

United States submarines have done to Japan what Nazi subs tried to do to England and failed. Japan, as an island power, bears the same relationship to the Asiatic continent that England does to the European continent. It was essential to our strategy of sea blockade that the homeland of Japan be deprived of oil, iron ore, coal, copper, aluminum, cotton, lumber and food.

The subs did their job well. Navy announcements on Jap shipping losses reveal that for the past year and a half coastwise steamers, fishing smacks and barges seem to be the only ships sunk. The big transports and cargo ships were picked off long ago. Sub skippers often complained they couldn't find anything to sink.

United States subs have long been operating right off Japan's front door. One of the more dramatic photographs of the second year of the war was a shot of

(Continued to page 158)

Old Glory flies from ice-coated conning tower as sub enters an Arctic port

U-BOATS GIVE UP SECRETS

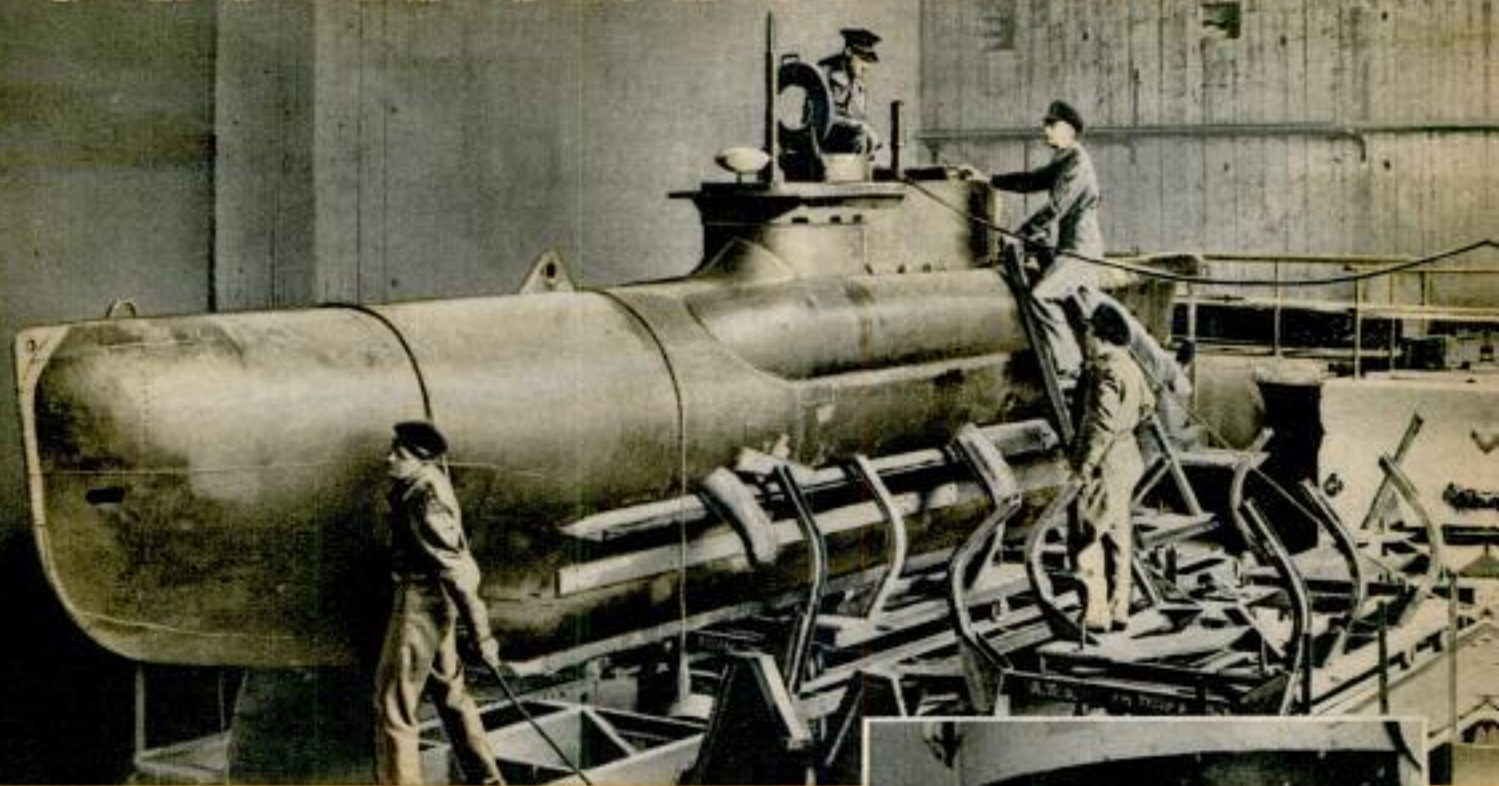

Captured two-man midget U-boat is inspected by British officers in gigantic shelter at Kiel. Delivered in sections, the U-boat was assembled there. Called the Seehund, midget is 39 feet long and is powered by Diesel engine and electric motor. Speed upon surface is 8 knots, submerged, 3 to 4 knots. It has two torpedoes



Looking through periscope of U-boat 234, which surrendered at Portsmouth, N. H., and disclosed sub secrets



That's no gun barrel you see on the 234, but a "Schnorchel" or breather, which enables U-boat to take in fresh air and eject foul air while totally submerged. It rests on deck when not in use. Radar equipment fitted to breather is shown at the right

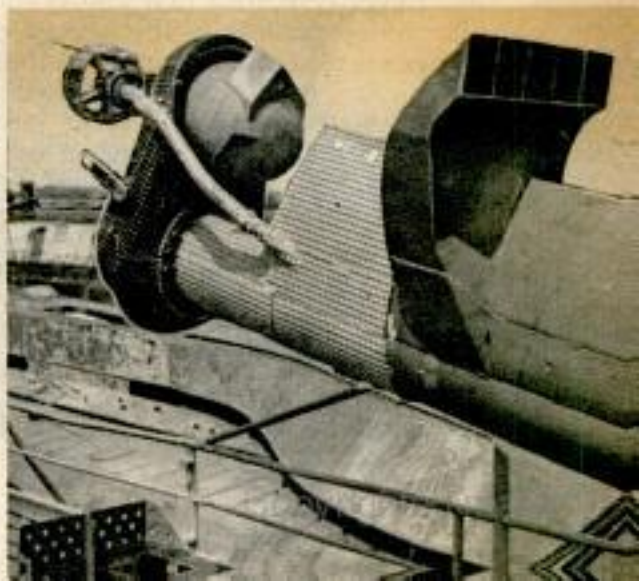



Smoke from atomic bomb rises 40,000 feet; blast is felt 250 miles away



Equals bomb load of 2000 Superforts



5000 atomic bombs could destroy all Japanese cities



Atomic bomb equals 4 trainloads of TNT



ATOMIC BOMB FOR WAR-

HARNESSING of atomic power appeared rather remote five years ago and Dr. R. M. Langer, atom research physicist of California Institute of Technology, seemed to be a trifle optimistic in his article, "The Miracle of U-235," which appeared in the January 1941 issue of Popular Mechanics. But dropping of the first atomic bomb on Japan made it evident that Dr. Langer actually was being overcautious when he wrote:

"Several months ago you read in Popular Mechanics that the secret of atomic power is close to solution and that possibly within a decade civilization will be using the tremendous amounts of energy contained in U-235, an isotope of uranium. Since then, additional research has opened up greater possibilities than ever."

Today's atomic bomb is a grim illustration of the incredible force unleashed when the energy that holds the atom together is released. Basis of the bomb is Uranium 235, a lustrous white metal having the same chemical proportions as uranium, but three points lighter in atomic weight. Bombard-

ing U-235 with neutrons, highly penetrating particles of matter thrown off by ordinary radioactive material, scientists were able to split the U-235 atom and release its tremendous energy.

Stored in the first atomic bomb was an explosive force greater than 20,000 tons of TNT, the total bomb load of 2000 Superforts. A single atomic bomb packs a punch nearly 2000 times that of the largest conventional bomb, the 11-ton "Volcano."

Hiroshima is—or was—proof of the atomic bomb's power to destroy 4.1 square miles of a city. In a test of the bomb in New Mexico, the pressure wave from the blast knocked down two men six miles from a steel tower from which the bomb was suspended. First came a blinding flash of light, then a great ball of fire. A flyer at Needles, Calif., 500 miles away, reported seeing the flash, and the blast rattled windows 250 miles away. Witnesses rhapsodized over the lights, calling them beautiful beyond comparison. Following the visual shock a huge varicolored cloud of smoke billowed up more than 40,000 feet. The steel tower

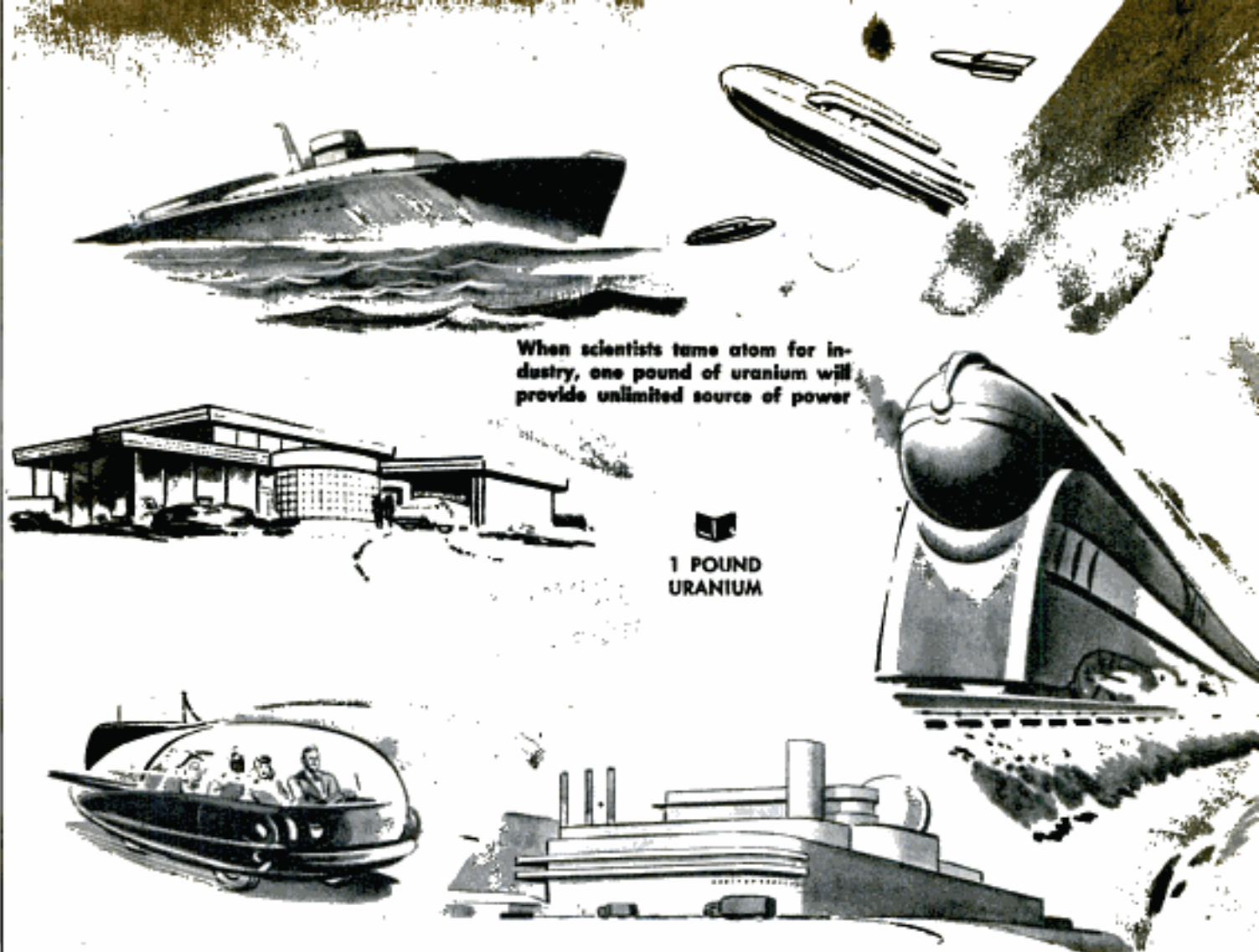

When scientists tame atom for industry, one pound of uranium will provide unlimited source of power

1 POUND URANIUM

ATOMIC POWER FOR PEACE



vaporized, and intense heat from the explosion fused the sand on which it stood into a silica-like crater.

Diverted into peacetime applications, atomic power possesses tremendous possibilities in providing cheap power and heat that promise to revolutionize our present concepts of living. Just when these can be achieved only time can tell, but wartime developments certainly will bring the atomic dream to realization years ahead of the most rosy estimates. Dr. Langer predicted these constructive uses of atomic energy:

A power plant the size of a typewriter, in its heart a one-pound package of uranium containing the same amount of power extracted from 250,000 gallons of gasoline. With a "butterfly" motor or U-235 engine, al-

ready well on its way to perfection, a car could be driven 5,000,000 miles without refueling. This power could be applied to all forms of transportation.

Cheap power for every home and factory without distribution lines. Electricity at less than $\frac{1}{10}$ cent per kilowatt-hour.

Jet-propelled aircraft, using uranium power, of a simple airfoil or flying wing design and able to fly several hundred thousand feet above the earth at several thousand miles an hour.

THE ENERGETIC ATOM

All matter is composed of atoms. Everyday objects differ from one another only because of a different arrangement of the same electrical forces which make up all atoms. Each atom is a tiny solar system, its sun a nucleus or spot of positive electricity, its planets the electrons. The nucleus is made up apparently of two particles of nearly equal mass: Protons, which have a positive charge, and neutrons, which have no charge. Uranium atoms are the largest known, and splitting the atoms of one gram of U-235, about .03 ounces, releases energy equivalent to 11,700 kilowatt-hours of electricity or about 5 million times the energy produced by burning a gram of coal.

One big community of the world, with no two points more than seven flying hours apart and no excuse for difference in material welfare. Most activities, including farming, located underground, with only transportation and recreation above the surface.

"WORKIN' ON THE RAILROAD"



Santa Fe photo

Off with the old, on with the new. Track gangs still use crowbars to remove rail, but a mechanical spike puller, below, is rapidly taking the place of muscle

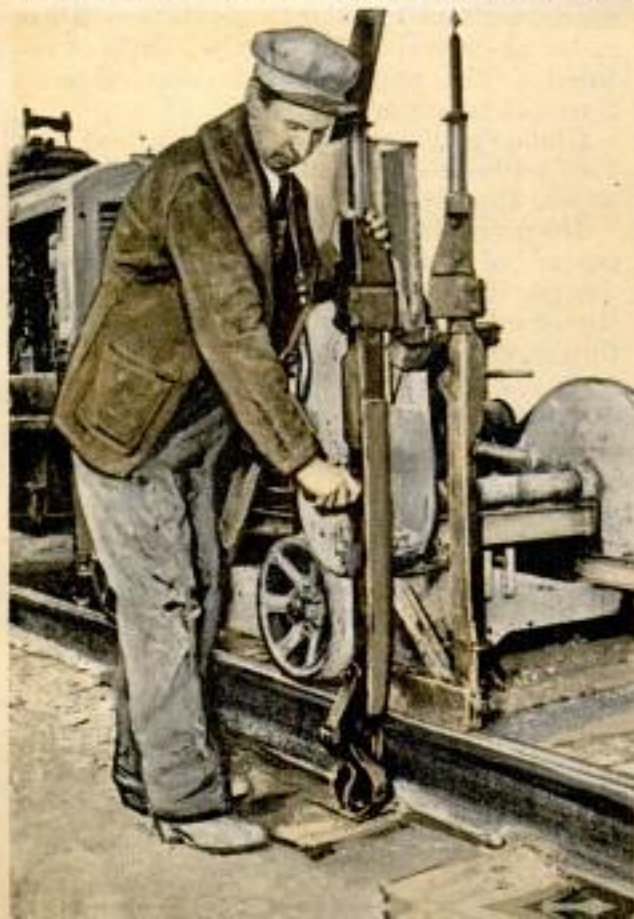

THERE was a time when "workin' on the railroad" meant a sweaty job with pick and shovel, gangs of tampers pounding the ballast hard in the new roadbed, three-man teams swinging steel mallets rhythmically against iron spikes anchoring the rail to clean new ties.

It still means that. Housekeeping along the right-of-way is still largely a tough, tiring job for muscles. But beyond the routine inspection and repairs by track walkers and section men, the scene is changing. Engine-driven spike pullers, pneumatic and electric tampers, rail-laying cranes, power jacks that hoist the track right out of its bed, "moles" that pick up and clean and replace ballast—these are a few of the mechanical advances which enable the railroads, desperate for help, to keep the house in order under the heaviest burden in history.

This housekeeping job isn't one for pikers. Maintenance of way and structures cost Class I railroads a record \$1,330,000,000 last year, according to estimates based on official figures for the first nine months of 1944. It shattered the previous high with a 20 percent increase over the 1943

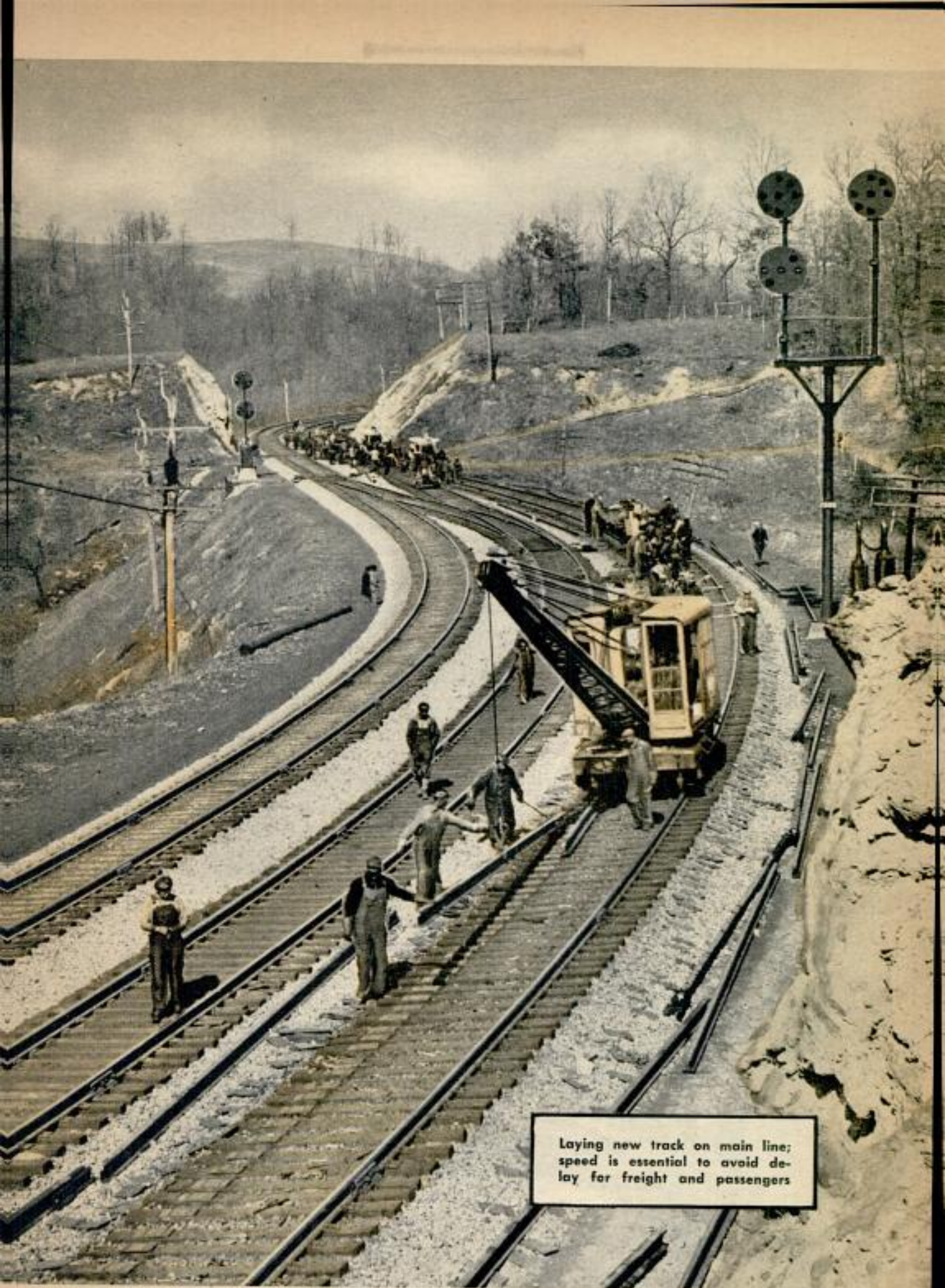

Laying new track on main line;
speed is essential to avoid delay
for freight and passengers

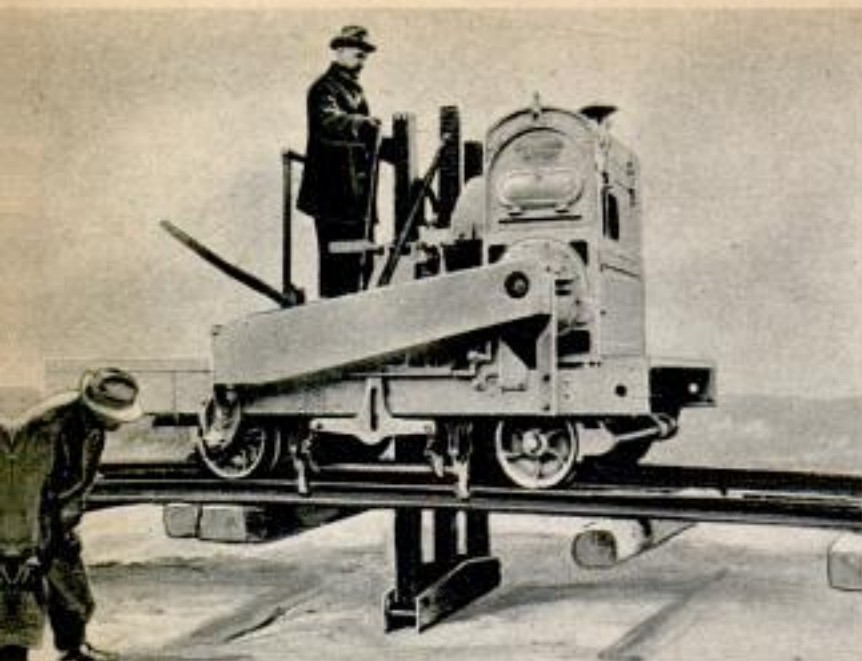

Nordberg Mfg. Co. photo

Track machine works in difficult places, can lift rails and ties three feet, or raise only one side of the track

maintenance bill of \$1,108,281,000. The Pennsylvania Railroad alone spent over \$108,000,000 in 1943 to maintain tracks and structures. Mechanized operations take a bow here, for without them the railroads would have been hard pressed to do the job in the face of higher costs of labor and materials.

Track laying and track maintenance took the lion's share of the 1944 bill—\$289,636,000—part going to the nearly 24,000 high school boys who enlisted for track work from May to October. Another part went

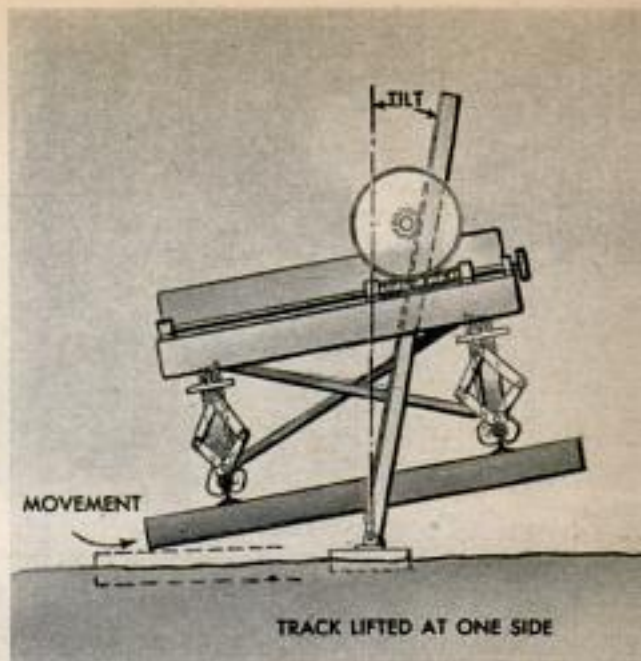

to the 50,000 Mexican laborers working on railroads north of the border under international agreement. The import quota for the Mexicans was raised to 75,000 for last summer. With record wartime traffic pounding the 414,000 miles of rails in the United States, the roads need all the manpower and all the equipment, new or salvaged, they can find.

A railroad, they say, is only as good as its track. Spurred by the manpower shortage, mechanized equipment is being called on more and more to assist the engineers,

Special loader attached to Caterpillar tractor removes old ties and tosses them into truck





Screen and flaps of power adze above keep chips from flying up. Cleaner for ballast, right, ejects dirt and cinders

steel gangs, section men, bridge builders, carpenters, tie makers—nearly a fourth of all railroad employees—in the year-round vigil required to keep track in good condition and wheels rolling safely.

Maintenance begins at the moment rails are manufactured. Each rail is lettered, dated, and given a heat or serial number which designates the five to seven rails made from a single ingot. Records show



Denver & Rio Grande Western photo

where each rail is laid, and if a flaw develops in one, all rails of the same series are examined.

Modern machinery eases the ballasting headache long suffered by the railroads. Chips of stone and other surfacing material are deposited from six to 12 inches deep under the ties as ballast, facilitating drain-

Another type of ballast cleaner moves along edge or center of ballast, deposits dirt along right-of-way Bessemer & Lake Erie photo



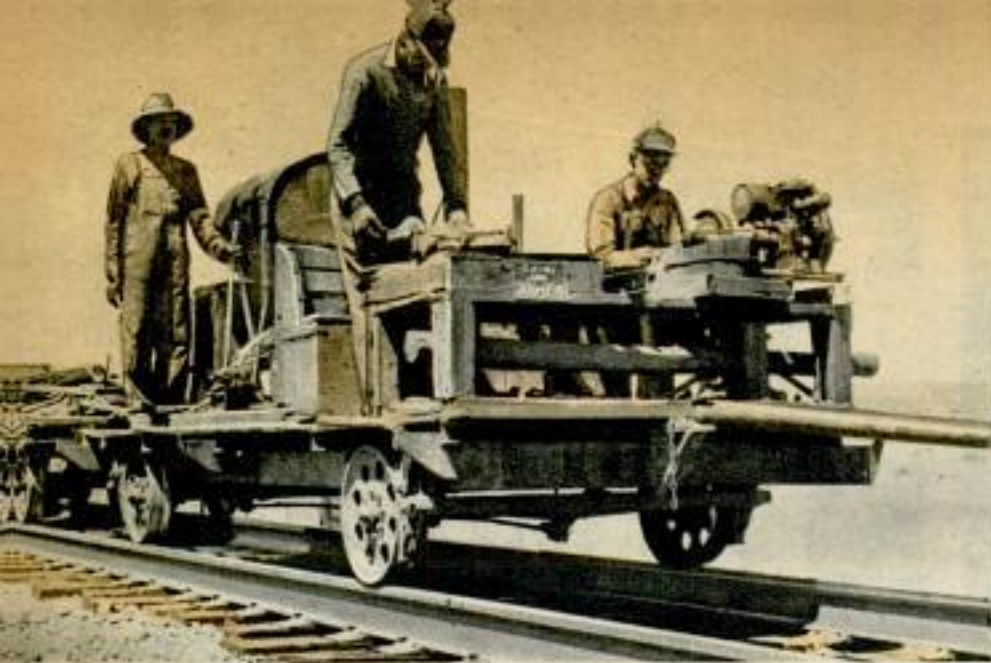

Santa Fe photo

Machine shop on wheels carries tools for almost any repair job

age, holding ties more firmly in place, and adding to roadbed stability. Ballast creates an almost continual job. Periodical replacement is necessary to remedy damage from high water and the pulverization caused by the pounding of heavily loaded cars.

Today the "mole" takes care of ballast with dispatch. A low-slung vehicle moving along the ballast's outer edge, the mole raises the stones into the machinery, cleans out dirt and cinders, and replaces the clean ballast on a smooth grade. The dirt is deposited alongside the



Air hammer spiking machine fits on head of spike and drives it into a tie with ease. Below, a compressed air unit, self-propelled, provides power to run the spiking machines
 Pennsylvania Railroad photo

right-of-way. The Pennsylvania Railroad uses a larger ballast cleaner "train," operating on the same principle, for the area between the tracks. This machine deposits the dirt in hopper cars that are hauled behind it.

Removal of old ties and rails once called for the last ounce of muscular energy, but today it can be done in a flash. Gasoline-powered self-propelled cranes lift worn steel in a jiffy, and Caterpillar tractors equipped with a special loader make short work of the ties. The loader has a two-pronged wedge-shaped fork which picks up six to 10 ties per load and averages 10 ties every 20 seconds. Especially useful in removing ties from abandoned trackage, the tractor and loader can cover a mile a day, pulling along with it a truck into which the ties are deposited.

Spikes are removed from ties with the greatest of ease by the mechanical spike puller, powered by a gasoline motor. The puller draws the spikes from both sides of the rails at the same time while moving along the track.

Speed is more important than ever in rail and tie replacement today, for every inch of track is needed to move military supplies to

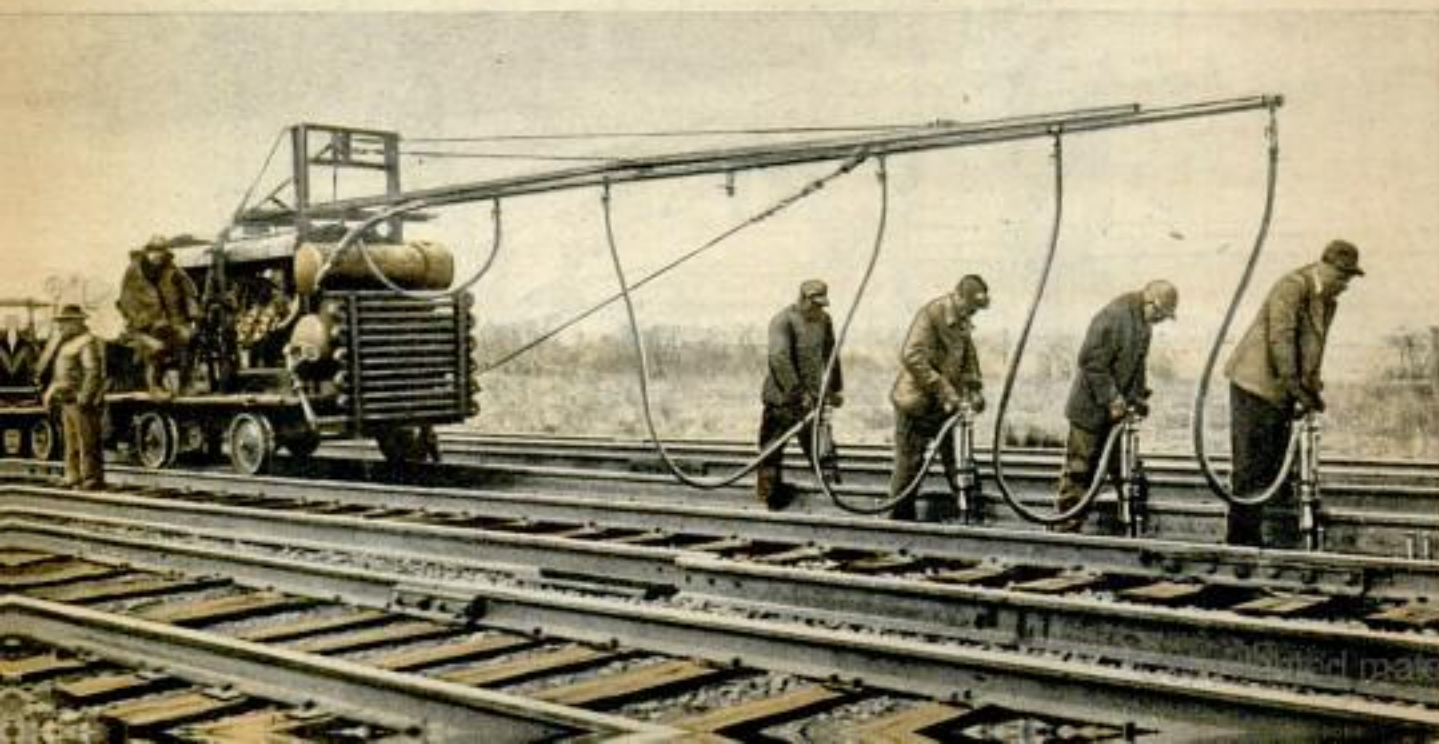



Pennsylvania Railroad photo

Gasoline-powered crane cuts heavy labor in lifting out worn tracks

their destination. Pneumatic tampers quickly pack ballast into a compact mass, and the roadbed is ready for new steel. Rails, ties, plates, spike bolts and other fastenings have been distributed, the rails unloaded from flat cars by derrick. Weighing from 116 to 152 pounds per yard, the rails must be dropped carefully, both ends landing on an even surface at the same time, to prevent damage.

Ties are adzed or trimmed to receive tie plates by a rotary power adzer which has two series of circular steel saws about $\frac{1}{4}$ inch thick. One series adzes the tie to the proper width inside the rail, and the other does the same outside. Screens and flaps keep wood chips from flying up. Pioneering with this machine,



Maintenance of signal box equipment is important on any railroad, and Santa Fe uses electrical shops on wheels to keep boxes working

Caterpillar Tractor photo

Too much time isn't spent on laying temporary track. Left, a Caterpillar tractor with bulldozer straightens out shifting rails for coal trains



It's a far cry from the old handcar to this one, motor-driven and light



Fairmont Railway Motors photo

the Norfolk and Western is able to replace approximately 1000 tie plates a day, covering about a sixth of a mile.

The gasoline crane lays the rails in position. A tie borer quickly bites into the ties, opening holes for the spikes. Pneumatic spike driving machines, powered by compressed air from a self-propelled unit, hammer the spikes home in a few seconds.

Even the bolting of new rails to plates is speeded up by a motor-driven rail bolter. First the bolts are run through and nutted by hand, then the machine comes along and tightens the nuts firmly.

Where lifting and shifting of track is necessary, the Nordberg track machine can do the work of 80 men with crowbars. A welded steel-framed car powered by a 40-horsepower gasoline engine, the machine can lift 25 tons and can function in

soft footing and other places where it is virtually impossible to work by hand. It can move track that is deeply frozen in the ground, and with the aid of a leveling device, can raise track as much as three feet. With the addition of a mast, boom and hoist, the machine also can lay and load rail.

Other mechanical aids to railroad maintenance include machine shops and electrical shops on wheels. Small cars carry oxy-acetylene apparatus used to build up worn rail ends by welding, thus adding to riding comfort and prolonging life of the rails.

Ties once had to be replaced every six or seven years in moist areas and lasted only a little longer in dry or desert regions. Creosote treatment has extended the life of a tie to 30 years. The solution, half creosote and half petroleum residuum or fuel oil, also is applied to all poles, crossing planks, and bridge and timber foundations. It forestalls decay and prevents damage by termites. Timber also is being treated chemically to resist fire hazards. The Santa Fe, with 13,137 miles of track and 60,000,000 ties, estimates that creosote alone saves it about \$5,000,000 yearly.

Rail corrosion, especially severe where there is brine drip from refrigerator cars, long has been a great problem. The Norfolk and Western combats it by removing scale with an oxyacetylene flame process, and covering the rails with an oil coating. Chemicals added to the brine have been

This ballast cleaning machine used by the Pennsylvania deposits dirt in hopper cars carried behind



found to neutralize the corrosion, and practical methods of application are being sought.

But the railroads do not live by machine alone. Once track has been laid, every mile must be tended as diligently as if it were sacred soil. Section crews must destroy weeds, grass and brush which create shade and dampness that foul ballast, corrode metal and rot ties. Because of a shortage of distillate, chemical sprayers have replaced burners which sear weeds with an intense flame. Operated like small automobiles, the sprayers remove all growth 18 to 24 inches from either side of the track.

Section men must watch for fire hazards on bridges and trestles, must attend at once to threats of landslides. In bad weather, they must be on constant duty against high water, ice, snow and other storm dangers, so that nothing imperils the safety of the trains with their precious cargoes of freight and humanity. Structures must be kept tidy and track drainage in order.

They no longer use "elbow grease" to get about on hand cars, however, but ride comfortably in motor-powered vehicles. On the Santa Fe and many other roads, extra track and bridge gangs live and travel in specially built trains with bunk cars, dining and kitchen cars, and tool and material cars. Often a recreation car and showers are provided.

Increased mechanization has made safety training even more vital for maintenance men. Power tool operators get special training. Shin guards and goggles are common equipment.

Conditioning track to stand up under modern 90 to 100-mile speeds has added to maintenance problems, but once the proper standards have been obtained the additional costs are not regarded as excessive. Many roads are carrying out bridge strengthening programs for their high speed lines. Track problems created by higher speeds and heavier tonnages have been solved generally by improved design and increased maintenance, rather than by changes in fundamental structure.



Tie borer in foreground works in team with spike drivers, rear



"Cat" with special loader above is used for loading ballast into cars. Portable phone below warns workers trains are due



PICKABACK BRIDGES

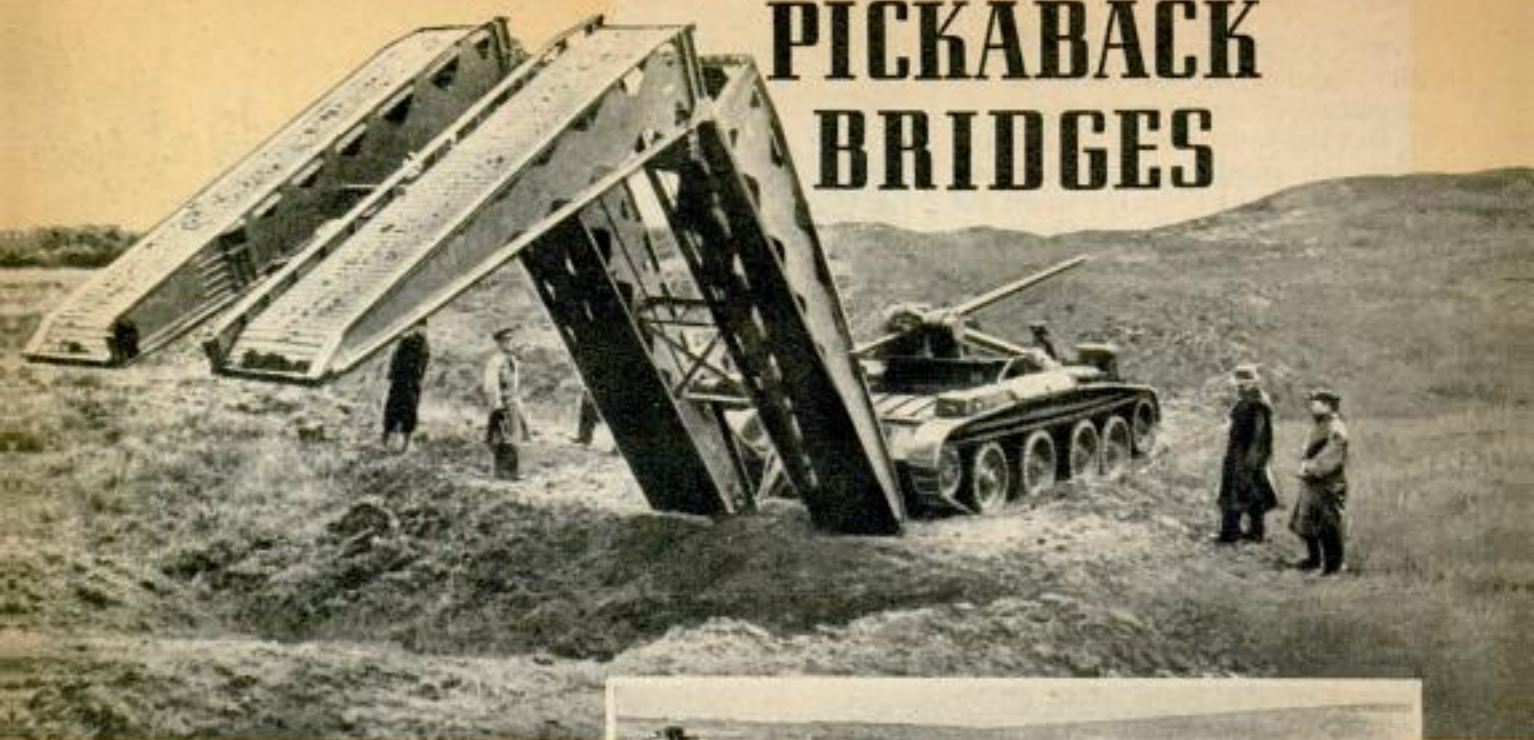

British official photos

British tanks which carry and lay their own bridges proved valuable in Europe and Burma. The bridging operations are controlled by crews inside the tanks, so they can carry on under fire in crossing of small rivers or canals, surmounting anti-tank ditches and scaling seawalls and cliffs. Above, scissors-type bridge built on Valentine tank as it automatically unfolds across a gulley. Bridge is carried on top of tank. Right, a tank crosses the scissors bridge. Tank that placed bridge in position is in background. The bridge-tank Twaby Ark, below, is driven directly into a gap and its ramps lowered, enabling other vehicles to pass directly over it





Churchill Bridgelayer is a 30-foot steel span trackway mounted on a Churchill tank. The tanks above are crossing a crater on span laid by the bridgelayer. Hydraulic arm of bridgelayer lifts the span, as at right, then moves it forward and lowers it across gap to be bridged



Still another type of bridge-tank, The Ark is a Churchill tank equipped with two trackways made of hornbeam sections of a small box girder bridge. These are fixed together to form a bridge projecting in front of the tank and held in place by wire rope. Ark at top left forms a ramp against a seawall, and another Churchill tank then scales the wall successfully by climbing over The Ark's ramp, left

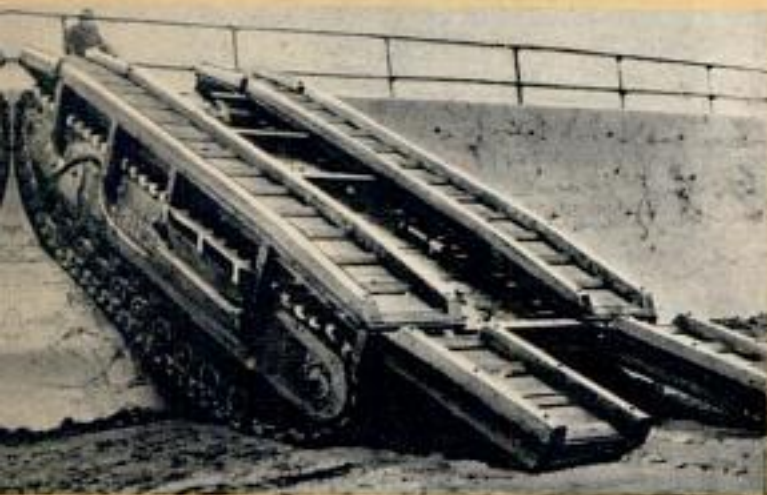

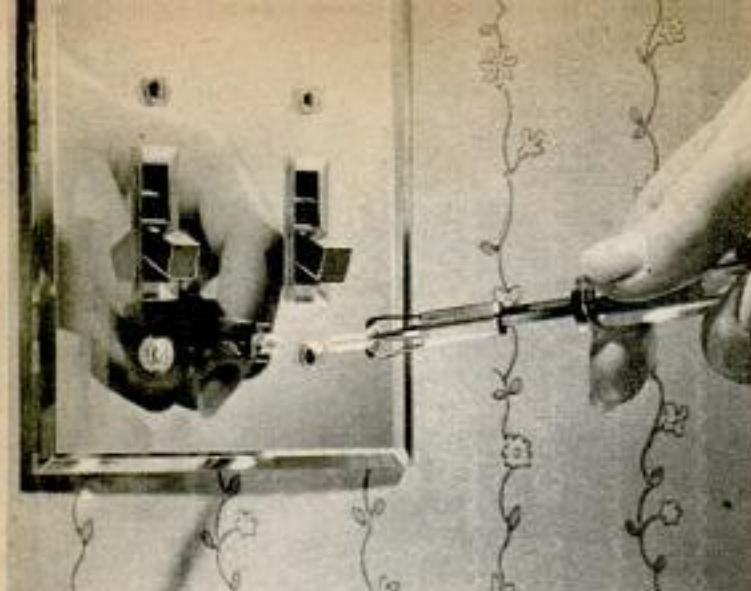

Plastic Screw Reduces Damage

Designed to prevent breakage of mirrored electric switch plates, a plastic screw made of Tenite is reported to exert less pressure than a metal screw. It is available now only in $\frac{1}{2}$ -inch length, with oval head, but $\frac{1}{4}$ to 1-inch sizes with oval, flat and round heads are planned for the future.

Wingless B-29s Train Gunners

Mounted on towers in combat formations, B-29 Superfortress fuselages, with sighting blisters and remote control turrets,

Tape Helps GIs Correct Speech

Air Force veterans who wish to correct their speech and improve their enunciation find aid in "talking back" to themselves via a tape recorder at the Army Air Force re-



gional and convalescent hospital at Miami Beach, Fla. In the "Mirrophone," resembling an oversized radio cabinet, a magnetic ribbon makes one-minute recordings which may be played back instantly, enabling flyers to listen to their words as often as they wish until flaws are eliminated.

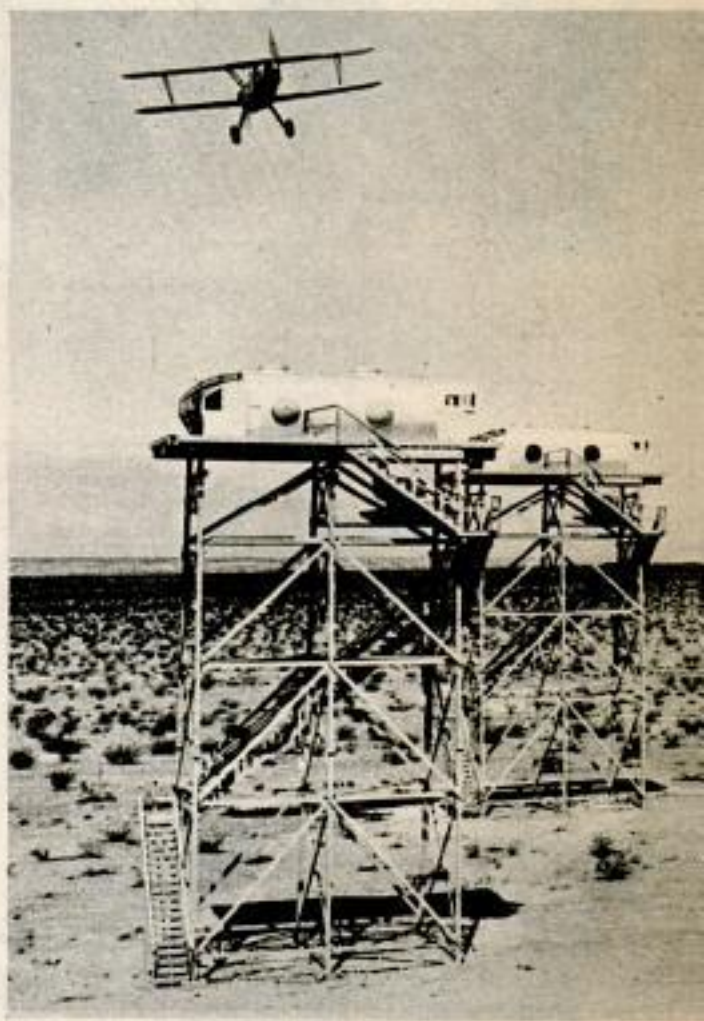

give student gunners realistic training at the AAF Western Flying Training Command, Las Vegas, Nev. Gun cameras record scores as "attacking" aircraft approach.

Disks Aid Drawing Curved Lines

Drawing a line parallel to a curved line can be done simply with a set of graduated transparent Plexiglas disks. The pencil point is inserted in the center hole of the disk, which then is propelled along the edge of the curve. Previously it took several minutes to adjust instruments for such a line.





ALUMINUM OVERHEAD GARAGE DOOR, built by aircraft methods so it won't sag or buckle, can be opened and closed by a small child. The entire operating mechanism is enclosed in a small box on the back of the lightweight door, eliminating tracks, weights and exposed springs. The door can be installed in less than 30 minutes, the builder declares



MINIATURE SHIPYARD an exhibit at the Los Angeles County Museum contains models showing various stages in the complex construction of cargo ships, from the laying of the keel to launching. Here is a replica of section of Consolidated Steel Corporation Yards with model of 10,000-ton C-1 cargo and passenger vessel about to leave ways to enter basin

COLLECTION OF 1100 WAR INSIGNIA of the United Nations military forces resulted when the soldier brother of Richard Marco sent him a shoulder patch. The 16-year-old youth has mounted and catalogued the emblems, which he loans for patriotic meetings or bond rallies. His latest project is collecting the patches of enemy units



Wandering Magnetic Pole Is Plotted by Plane

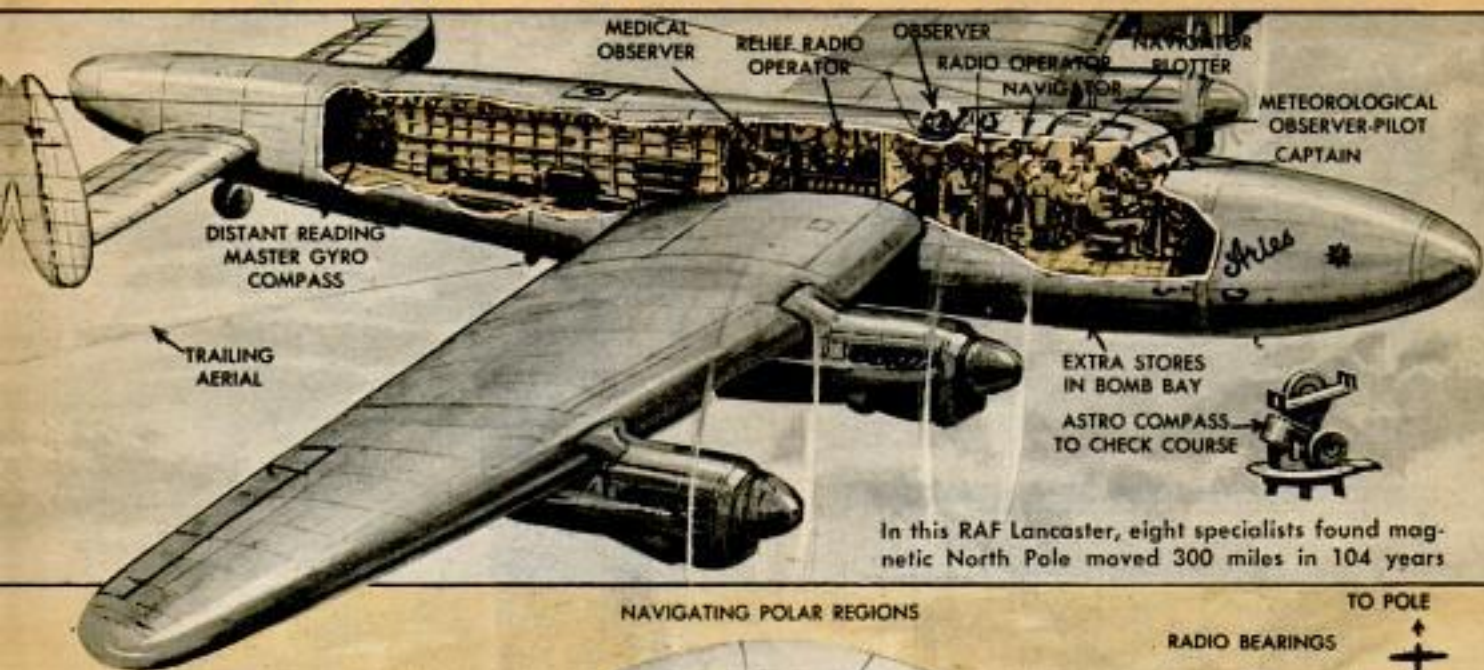

In this RAF Lancaster, eight specialists found magnetic North Pole moved 300 miles in 104 years

NAVIGATING POLAR REGIONS



Lines of force below are caused by earth's magnetism, are never parallel with surface except at equator. Aircraft go by geographic pole on map, but compass points to magnetic pole. Courses must allow for variation



On flight, Aries used radio bearings. By strength of signals over aerial, course A was corrected to true course for North Pole, B

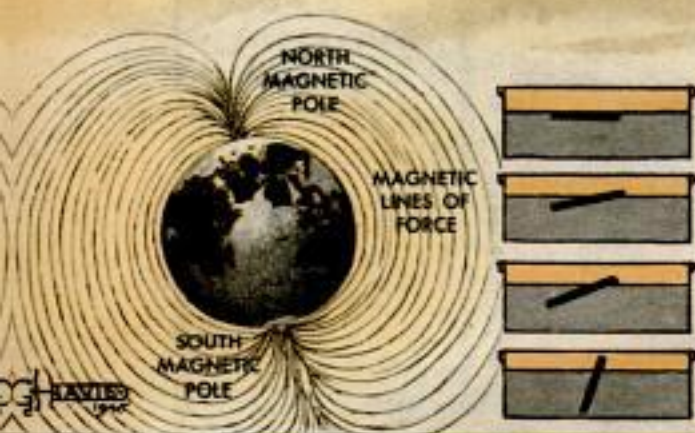

Top left, compass needle near equator. Next, dipping toward nearer pole. Then dip increases as magnetic pole is neared. Last, dip near pole of approximately 90 degrees. At that angle in final stage, compass is useless for navigation work



Arrows on map, above right, trace flight of Aries in locating true position of magnetic North Pole. Plane flew from Britain to Iceland, then over geographical North Pole. Flight over Magnetic Pole followed course to Goose Bay. Polar flights of Aries totaled 17,720 miles. Craft carried 7 compasses, 18 special devices



Carrier Jack Changes Wheels of Heavy Planes With Ease

Replacing the canvas sling and ropes formerly used with heavy manpower to change the 56-inch, 450-pound wheel and tire assembly of the B-24 Liberators, the hydraulic carrier jack makes the task a simple two-man job. While one man holds the wheel, the jack operator adjusts the carrier shaft to the proper height to fit the wheel bearings, then rolls back the jack so the shaft passes through the bearings.

The wheel then is lifted off the ground by a built in hydraulic jack which raises and lowers the shaft. The carrier jack, which runs on ball bearing wheels, then is moved to the plane and the carrier shaft raised to the height of the plane axle. A lock nut holds the jack to the plane axle shaft so it won't move while the wheel slides into place. The device was developed by G. A. Deming, a foreman at Willow Run.



Westinghouse photo

Cream Keeps Fresh for a Year After "Flash Sterilization"

Cream which is sterilized by a new process will keep fresh for a year at room temperatures. It is said to retain a fresh flavor. After "flash sterilization" at a temperature of about 270 degrees Fahrenheit, the cream is bottled and hermetically sealed in an electrically cleaned room. Air in the bottling room is cleaned by a Westinghouse Precipitron, and ultraviolet ray lamps kill all germs in the atmosphere. The actual sterilizing process requires only four minutes to kill all bacteria, compared with 30 minutes needed for standard pasteurization. The process, developed by the California Milk Products Company, Gustine, Calif., is used extensively to prepare cream for shipment to our forces overseas.

Ⓛ During the last decade (1935-1944), 170,000 persons have been burned and disfigured by fire in the United States.

Boat Built of P-38's Tanks

Two GIs of the 15th Air Force built a catamaran-type boat entirely out of scrap. The twin hulls are formed by gasoline tanks from a P-38 fighter plane. The power unit, which is suspended between the hulls, is a rebuilt air compressor motor and the propeller is made of scrap metal.



RADAR SEES THE UNSEEN

Today it is the seeing eye of the night fighter and the artilleryman, the navigator of ship and plane. Tomorrow it will be the traffic cop of the skies

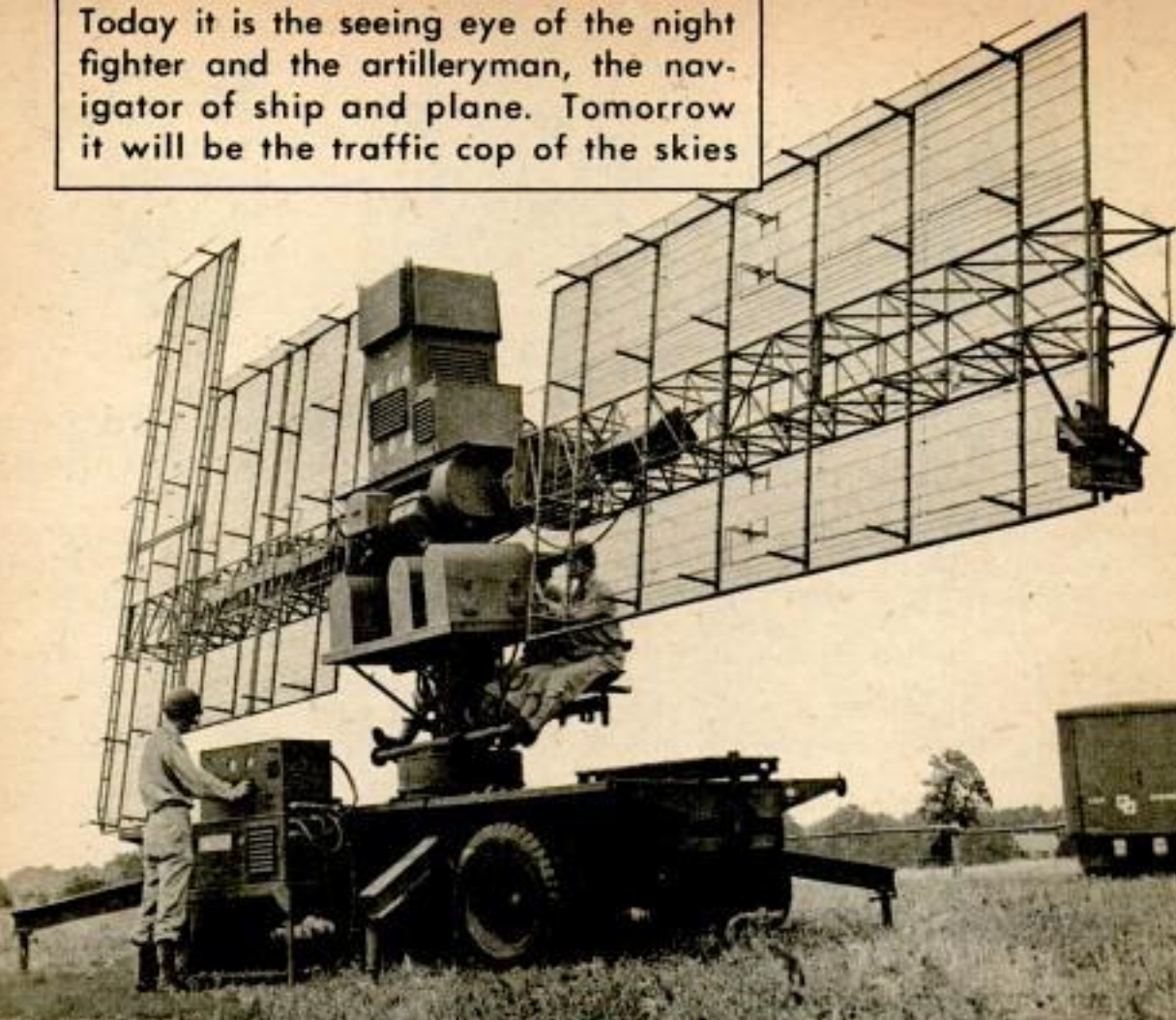

IN THE predawn blackness of Surigao Strait a column of destroyers was proceeding toward an advancing Jap task force. The captain of the lead destroyer was on the bridge, conscious that the force of battleships, cruisers and lesser ships had set a deadly trap for the Japs.

Then came the fireworks as brilliant broadsides plowed through the Jap craft. It was probably the greatest surface battle in naval history—and the destroyer captain, aware that the commodore of the destroyer force was below decks, called to him:

"Come up here for the sight of your life!"

"No, thanks," came the answer from the commo-

Mobile radar machine scans skies for aircraft; men on elevated seats operate vertical, horizontal and range scopes that fix position of the target. Below, sketch shows a radar unit linked with director and guns

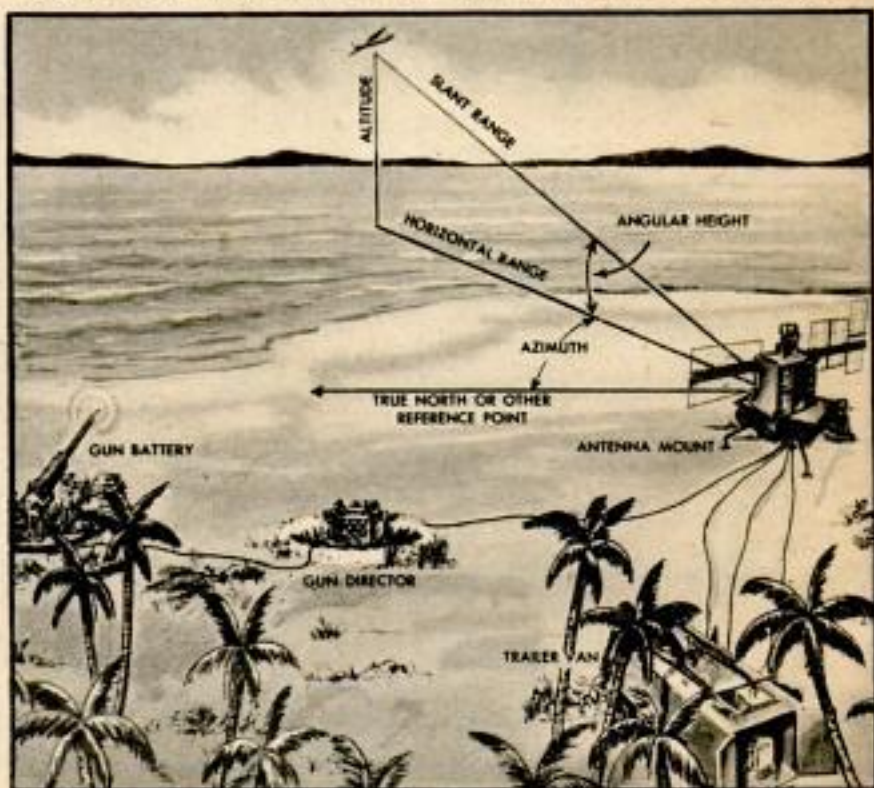

dore. "I can see it better from here."

His location was in Combat Information Center — CIC — the focal point for radar information aboard the ship. In spite of the haze of the sea, the smoke of battle and the blackness of night, radar, the invisible electronic searchlight that reflects what it sees, was picturing to him every detail of the battle going on above.

That is the big point about radar, the coined word meaning "radio detection and ranging." It can see farther than the eye can. Neither dark, nor fog, nor artificial smoke, nor the glare of the sun can longer lend the concealment that, in all military history, has been the basic element in surprise attack. From the beginning, Allied radar has been better than the enemy's.

We licked Germany and Japan in the laboratory, no less than in the factory and on the battlefield. The electronics industry, as applied to radar, hardly existed before 1940, but by July of this year approximately \$2,700,000,000 of radar equipment had been delivered to the Army and Navy. Co-operative efforts of the armies and navies, the scientists and industrialists of Britain and the United States, developed radar to the point where scores such as these were rung up:

Destruction of all but three of 105 buzz bombs sent against Britain in one day.

Destruction of enemy U-boats at the eventual rate of one every day.

Constant protection against enemy planes through a radar modification that immediately identifies the plane as friend or foe.

Protection of convoys so reliable that only one tenth of one percent of all types of convoyed ships were lost.

Antiaircraft gun control so accurate that crews use it instead of their own eyes.

Automatic alignment of searchlights on enemy aircraft.

Destruction by one China-based B-24 squadron of 110,-



U. S. Navy photos

Radar antennae of flat-top, radar-equipped carrier plane and five-inch guns directed by radar testify to tremendous role of "silent weapon" of World War II. Below, radar plot room on a big carrier





General Electric Co. photos

Navigator views radar screen which shows any obstacle above water in ship's path. Right, radar screen shows how obstacles as far as 30 miles away appear. Below, some of radar's varied uses

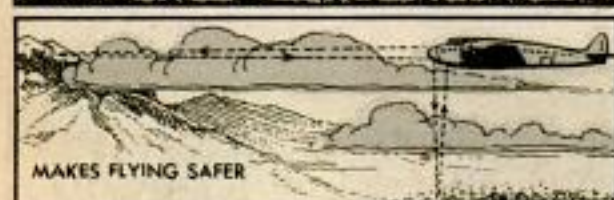

000 tons of Jap shipping in one month, entirely at night and guided by radar.

Development of blind-bombing techniques that enabled the Eighth Air Force to drop its greatest tonnage of bombs in a two-month period when targets were obscured all but four times.

Tactical air assaults during the "Battle of the Bulge" that not only overwhelmed German supply lines but also assured that Allied transport would not be bombed in error.

The complete radar unit con-

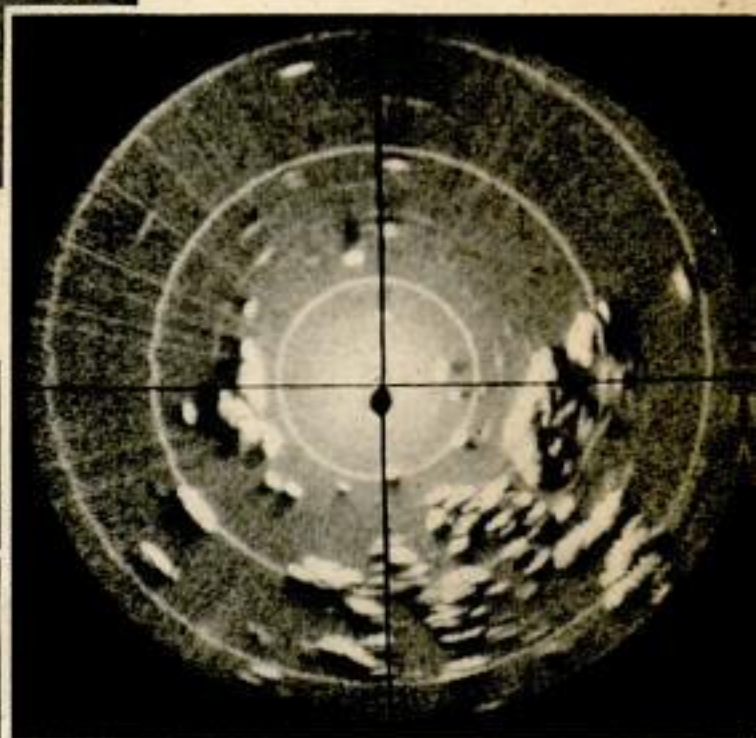

sists of a combination of a transmitter and receiver and indicators. In radar, unlike in communications, the transmitter and receiver are located at the same place, generally with a common antenna. The transmitter sends out energy in short, intense bursts—perhaps only a millionth of a second long—and during the intervals between transmission the receiver "listens" or, more accurately, since the signals are transformed into visual impulses on a radar screen, "looks." Because the signals travel at 186,000 miles a second, the elapsed time from transmission until the signal is reflected back to the station tells the distance of the reflecting object. As the reflected signals enter the receiving system, electronic devices register and measure the time interval in split microseconds and convert it into visual form which appears on the indicators. It is possible to measure this time-lapse with an accuracy that corresponds to only five or 10 yards' range—



U. S. Navy photo

Once painted out by censors, radar dome atop Martin Mariner houses antennae which guide plane to target

or one thirtieth of a millionth of a second.

Using a directional antenna, the radar set gets back a "pip" (slang for target indication) when the antenna is directed at the target. An even more spectacular indication of the direction and range of the target is obtained with PPI (Plan Position Indicator). In this case, the radar echoes draw a map on the face of a cathode-ray tube. The radar operator could imagine himself suspended high above the set, whether on a ship or plane or on the ground, looking down on the scene spread out below.

The entire radar instrument is built around the cathode-ray tube which is in effect a two-dimensional voltmeter with a weightless and inertialess pointer. This pointer is normally centered on the screen of the tube, but is deflected in instantaneous response to electrical or magnetic influence. In moving, it leaves a visible line or trace on the cathode-ray tube screen which the trained operator can easily interpret. Some of the information is immediately furnished to the gun directors, if the instru-

Despite heavy clouds, Norman coast appeared like this to radar operators on pre-invasion reconnaissance flights

ment is coupled to the guns, making it possible to have the gun follow a moving target, continually "on target." This is because the equipment furnishes the angle of elevation, altitude, slant range and azimuth, which are factors of gunnery computation.

The slant range is the direct distance between the target and the instrument. It is determined by converting time into distance. Actual calculations of slant range by radar operators are made by having a picture of the main pulse and of the target echo appear on the calibrated screen of a

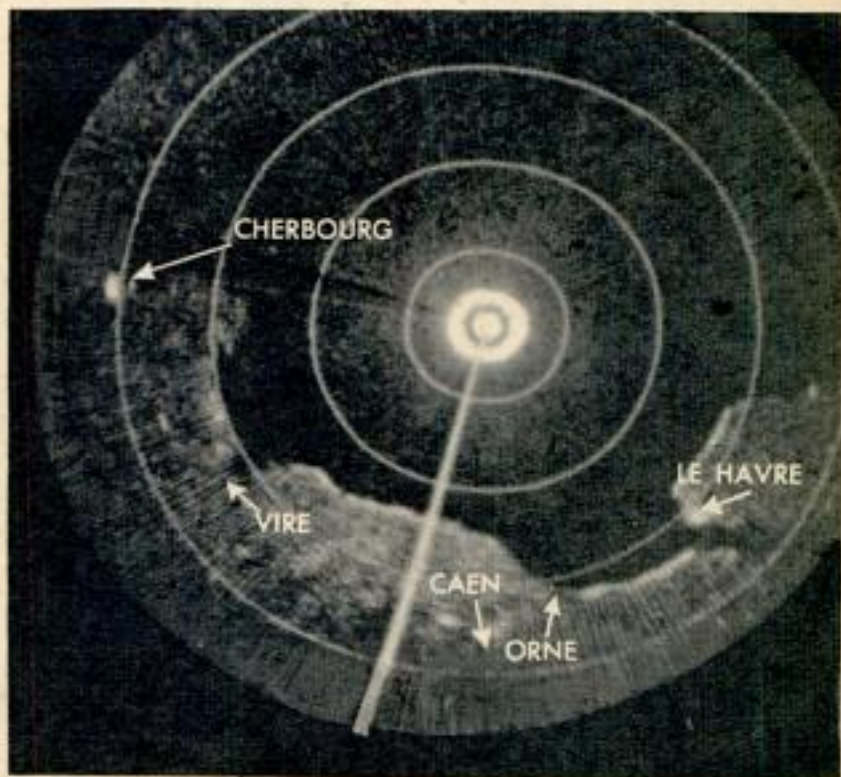

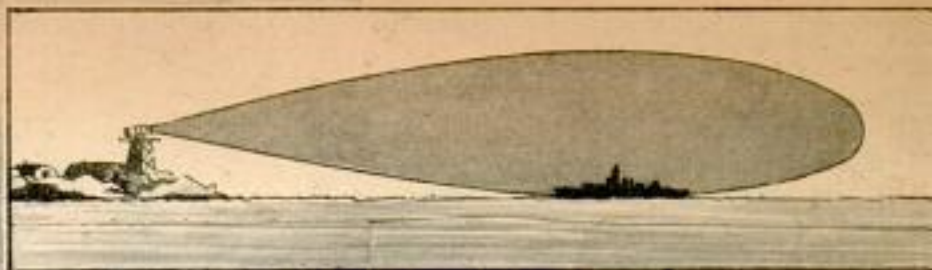

cathode-ray tube. The echo of the main pulse appears at a point along the scale which corresponds to the slant range of the target.

Effort has been made to develop microwave transmitters, since the ability of a set to distinguish two targets close together depends on the sharpness of the radar beam, and also because longer wave lengths require more cumbersome antennae. Current airborne radar sets show how well the matter of microwave transmission has been licked.

Early in the war the potentialities of radar at sea began to be apparent when a formation of cruisers was ordered to steam into an archipelago in the Solomons and bombard enemy shore installations—on the blackest of nights and through waters that had been charted only sketchily. Relying on their radar, the column steamed in formation at 25 knots, cruised confidently through the intricacies of the unfamiliar archipelago to the point to be bombarded, successfully evaded several minesweepers, found their objective and plastered it. Then, still at 25 knots, they turned in the narrow waters and

Radar station on British coast has 185-foot tower. Circle inset shows how "pips" appear on range scope. Below, scanning screen for airport and indicator to warn pilot of other craft
Civil Aeronautics Administration diagrams

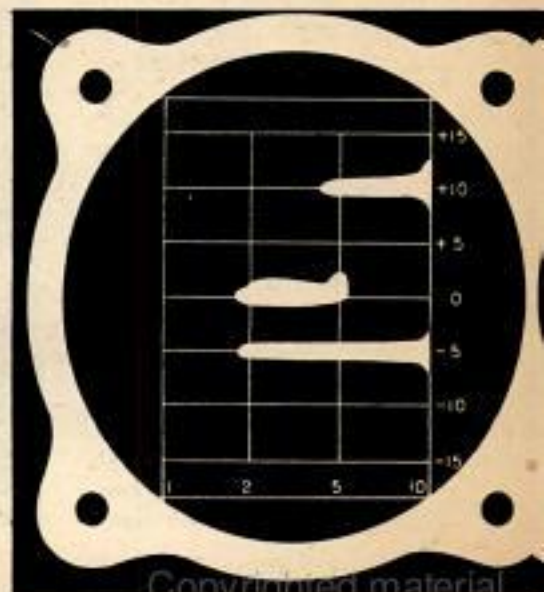
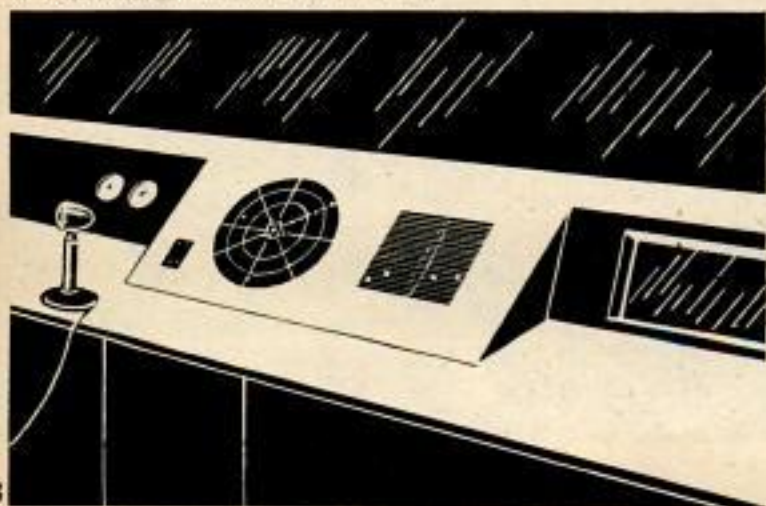

steamed out. On their arrival back at base they were able to report that one of the reefs on their crude charts was in error by about six miles. All this was done in zero visibility.

Radar's first critical test came in the Battle of Britain when, despite a shortage of fighter planes and pilots, the British were able to spot each incoming air raid in time to throw fighters against it. Their chain of defensive radar stations was begun four years before. The British had applied a discovery made in 1922 by two scientists, Dr. Albert Hoyt Taylor and Leo C. Young. In an attempt to measure the then relatively new short waves, the two were first annoyed and then excited by the fact that ships moving down the Anacostia River between their transmitter and receiver distorted the radio signals. That discovery was twinned with another experiment in 1925. Knowing that the Kennelly-Heaviside layer, the earth's "electric roof," reflected radio waves, the scientists attempted to determine its height by transmitting upward a very short pulse of radio energy, and then measuring the time it would take the reflected "echo" to return. This pulse ranging was the very basis of modern radar.

But the practical payoff of radar was in its many applications. One is IFF (Identification of Friend or Foe). This

Right, radar set used by British to direct fighter planes to best tactical position. Cabin houses both transmitter and receiver. Below, CAA direction indicator to warn pilots of aircraft near by; size of dots tells distance



U. S. Navy photo
Radar operator is guided by scope in center of set showing graphlike line and by large disk into which he is peering showing actual scene

was the electronic analogue of the painted insignia on a plane; instead of making its signal to human vision, it made it to the radar. It had a special signal by which a plane could identify itself to a challenger. Today IFF is used not only on aircraft but on every combat ship in the Allied navies.

With surface radar, IFF, and the latest operational information at his side, a CIC

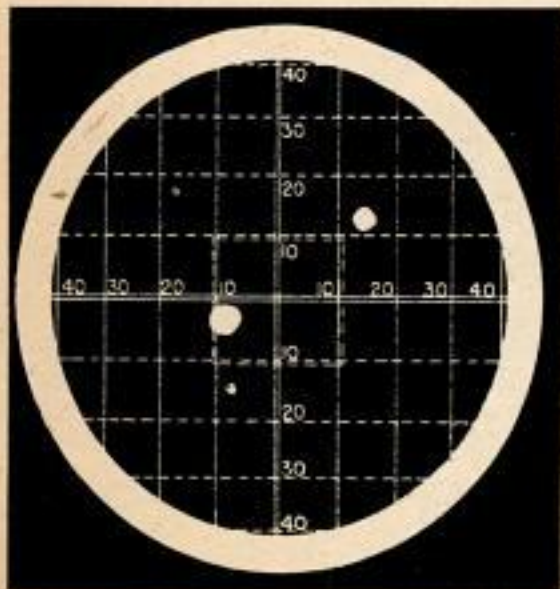
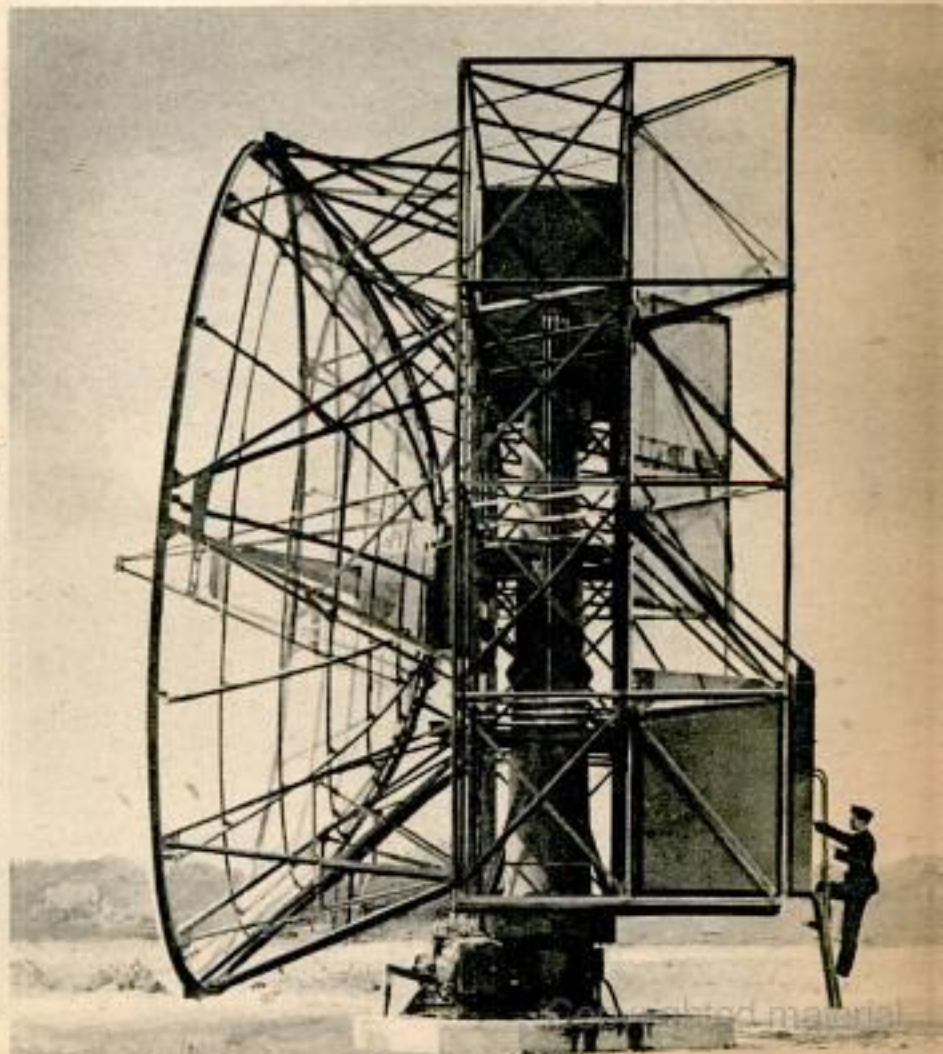

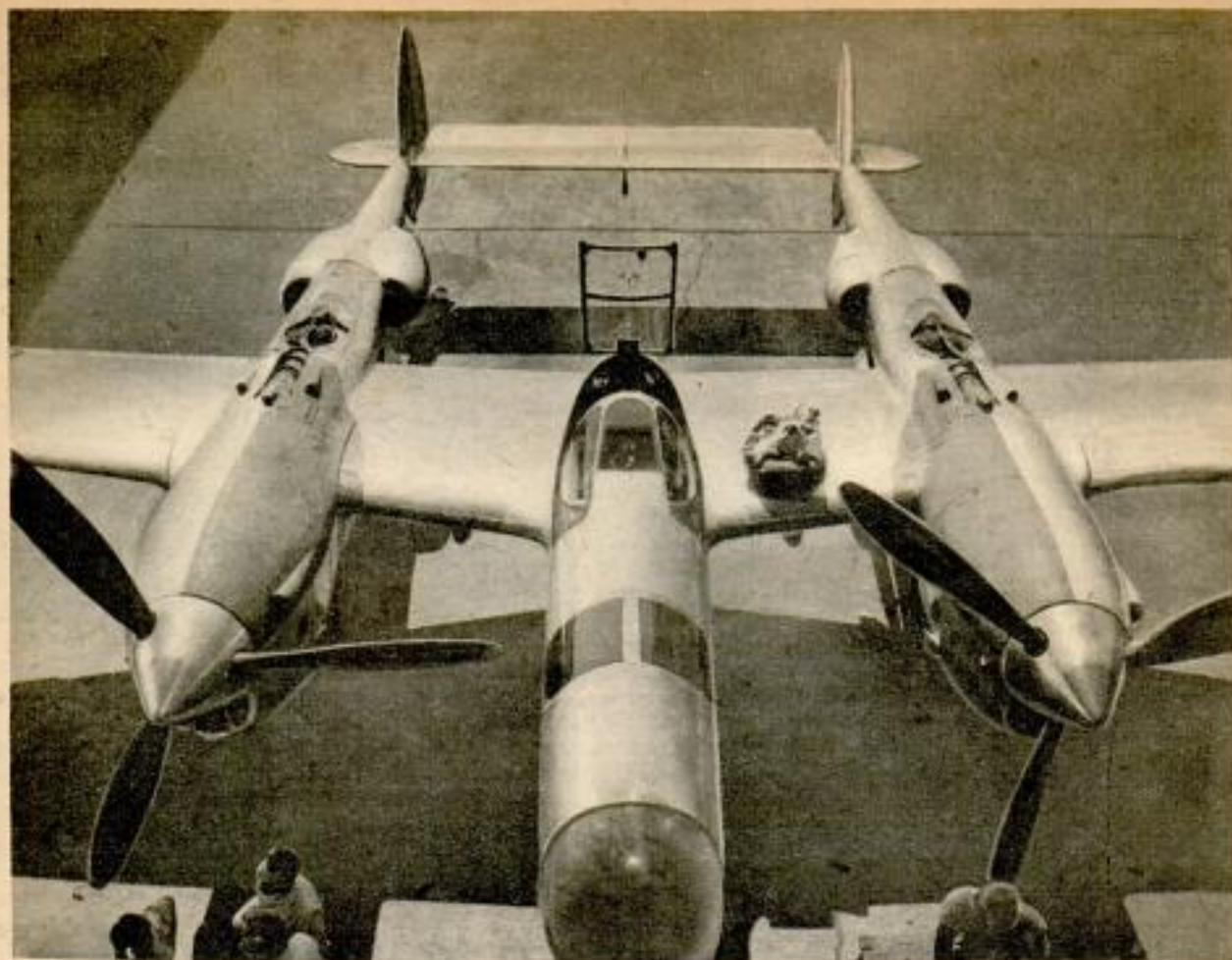

Radar equipment in elongated nose of P-38 Pathfinder guided bomber group to target in fog or darkness

officer can report as follows to a ship's captain, even on the darkest night:

"Several ships—probably five, two large and three in the screen; lead ship bearing 030, range 39,000, showing IFF; course 220 degrees, speed 18 knots, no zigzag; believed to be two CVEs on ferry duty with three cans in screen, as they are approximately three miles west of the supposed position of ferry group."

If such information can be furnished about friendly forces, it can do the same with enemy forces. Then the report above might be changed to:

"No IFF; evaluation—enemy; could be task force reported to have sortied from Tokyo Bay, consisting of one BB, one CL and three cans."

At this point, CIC would be feeding information to the gunnery department. The target's bearing and range, course and speed are fed into computers as the huge main battery directors swing swiftly into position. The two forces continue to close. New ranges and range rates automatically reposition the guns. Finally the radar indicates the enemy is within range. Word is given: "Commence firing!" The master salvo key is closed and nine 16-inch shells go hurtling through the night. So sensitive is radar that the operator can "watch" the

shells move across his screen toward the target "pip." Then he sees indication of their splashes and can quickly read off how much correction must be made. Again the guns boom, and this time the salvo appears to land squarely on the lead ship. The "pip" fades from the screen: The ship has been discovered, identified, tracked, fired upon and sunk without being actually seen. This happened many times.

Another phase of radar is BTO (Bombing Through Overcast). Members of the Eighth Air Force, piloting Flying Fortresses against Germany, called this device the "Mickey." Its function was to permit bombing by radar pilotage. Such a set was requested by the Army Air Forces in June, 1943. It was needed mainly to get the bombers off the ground during the bad target-visibility months of winter. One squadron of radar-equipped planes could lead 60 times their number on every raid. Utilizing the dozen planes so equipped, the Army could go out over Germany 10 to 20 times oftener than in the previous winter.

One problem caused by "Mickey" was that it gave the Allied pilots too much confidence and caused them to let down in dead-reckoning navigation. It painted an accurate picture of the terrain below—so, theoretically, comparing this picture with

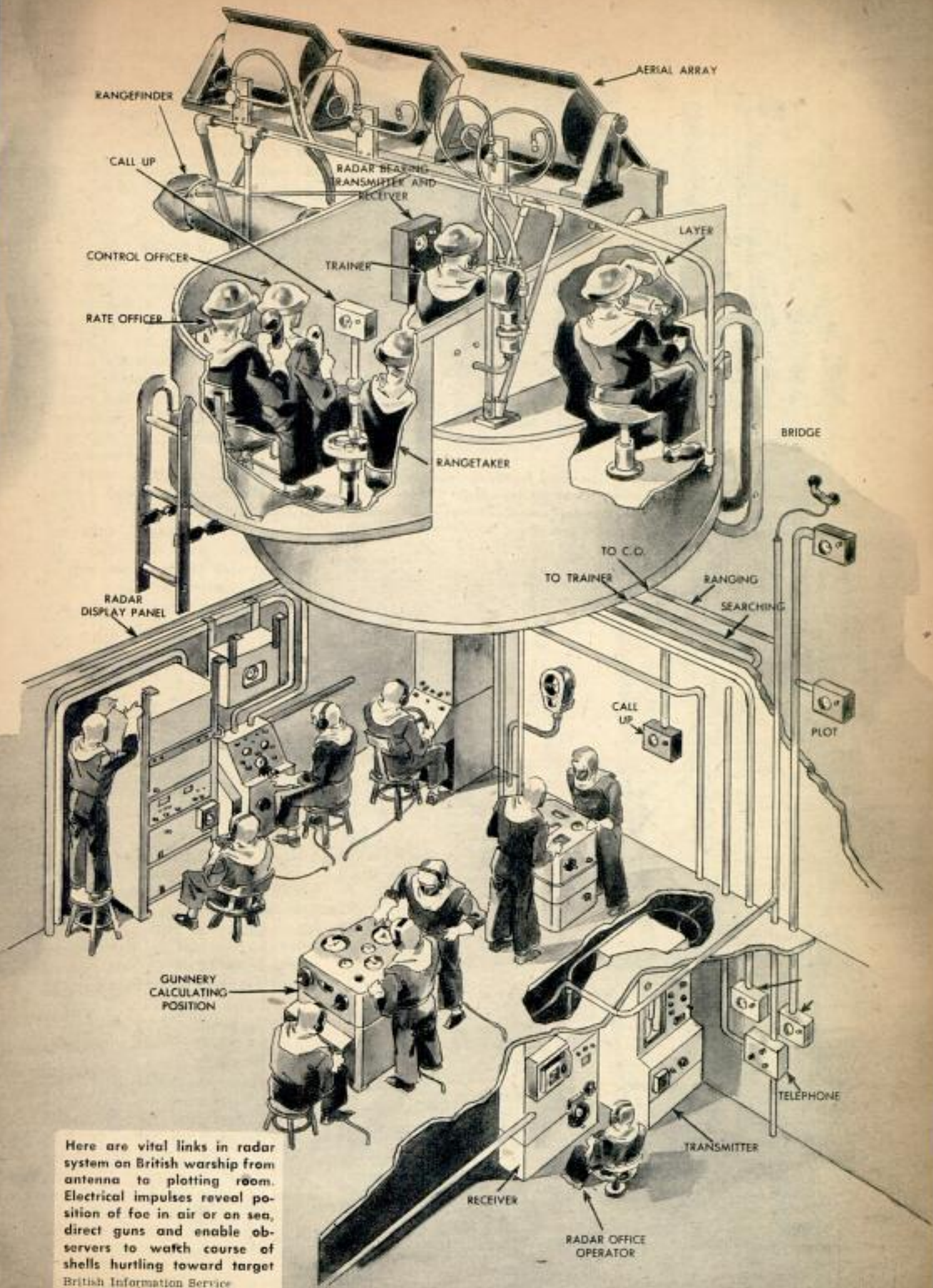

Here are vital links in radar system on British warship from antenna to plotting room. Electrical impulses reveal position of foe in air or on sea, direct guns and enable observers to watch course of shells hurtling toward target
 British Information Service



British official photos

Flying Fortress of RAF Coastal Command has radar devices extending from nose and under wings; these planes sought surfaced subs and convoy stragglers. Below, radar-controlled searchlight helped AA gunners locate Nazi bombers and flying bombs over England

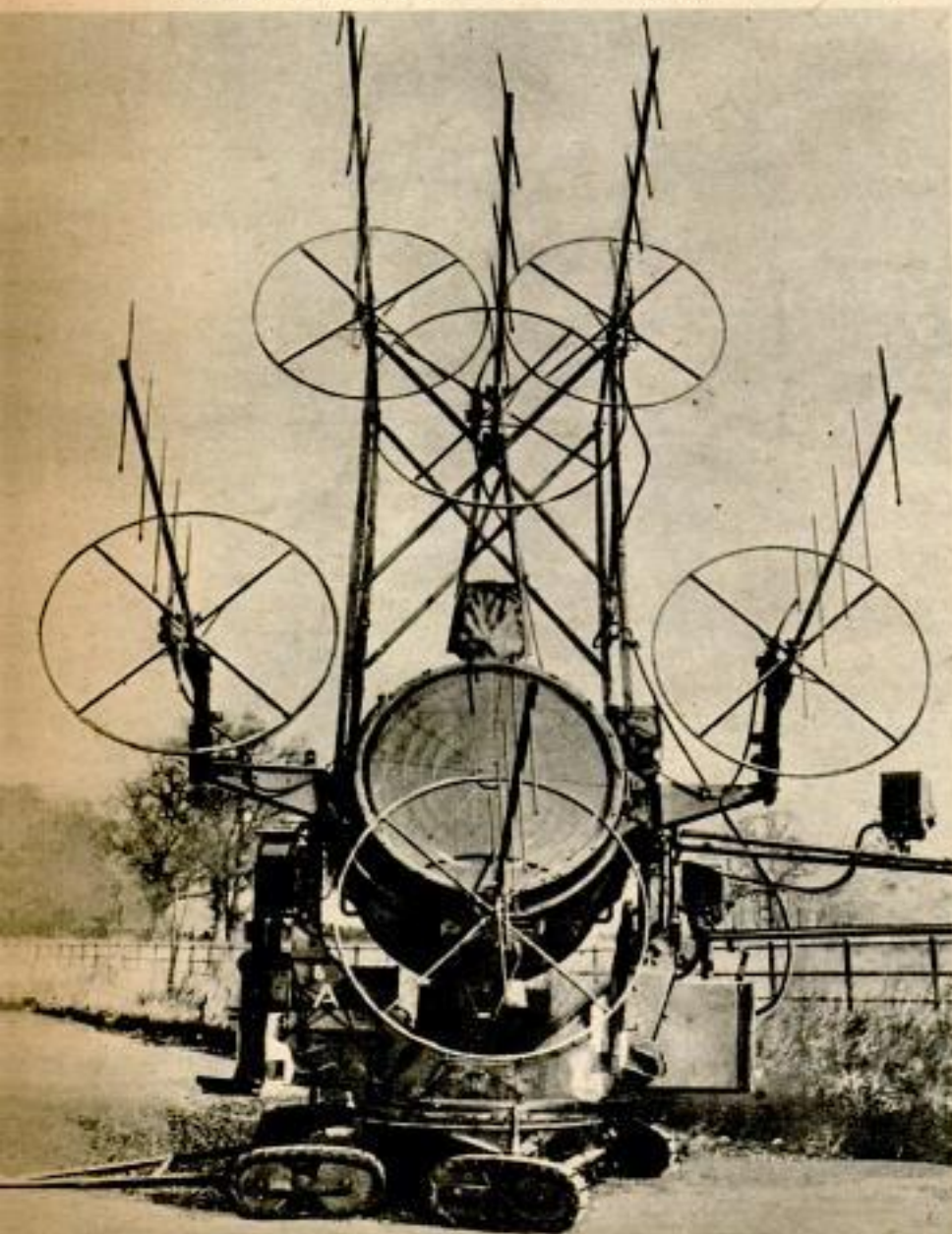

the contours of a map should establish where the plane was. But frequently two different places show almost the same arrangement of towns, rivers, mountains and land patterns. A radar navigation error resulting in our planes bombing Switzerland shows the importance of using dead reckoning.

One last radar device deserves mention: the radar altimeter. Just as the range to an aircraft can be measured from the ground, so the range to the ground can be measured from an aircraft. Crude radar altimeters antedated the war, but the development in radar art has made the present automatic radar altimeter simple, reliable and practical.

In the opinion of the Joint Board on Scientific Information Policy, there has been some too-optimistic, uninformed speculation about the peacetime uses of radar. It should make air and sea navigation continuous and fool-proof, regardless of night or weather. In its present form, however, it could hardly be considered useful for a locomotive or automobile.

First steps in applying radar to civilian aviation have already been taken by the Civil Aeronautics Administration, using equipment loaned by the Army and Navy.

The biggest influence radar will have after the war is indirect. The tremendous improvement of radar sets has made obsolete many of our prewar ideas about electronics. Many of radar's components are identical with those of a radio or television set or hearing aid. Individual radio communication is even beginning to appear practical, subject to certain limitations.

Altogether, it is fair to say that radar, as radar, will have a mild immediate beneficial effect on all our lives, by making it safer to travel by sea or by air. But the impact on electronics generally of techniques developed during the war because of radar will have profound and far-reaching effects on our daily life.

NIGHT PROWLER *with a* STING

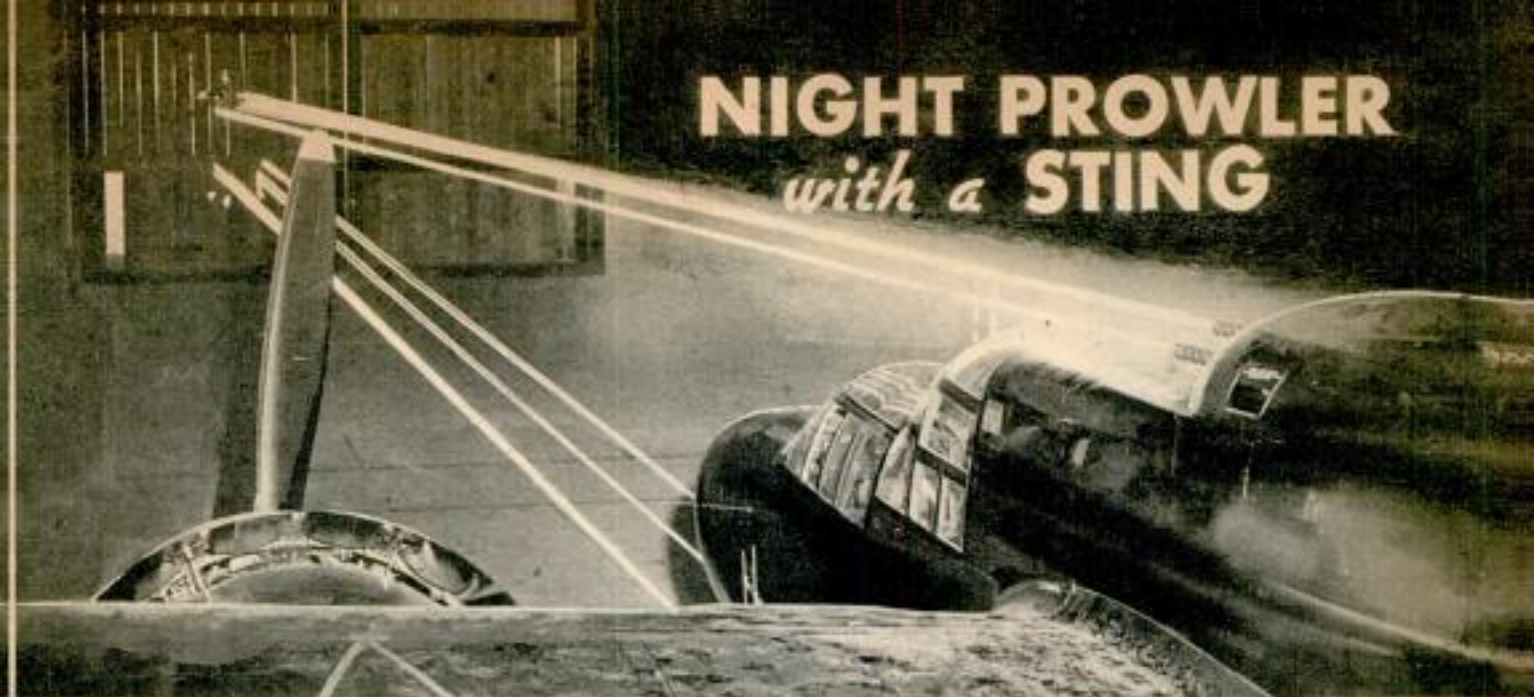

Northrop Aircraft photos

Tracer bullets and shells—5600 a minute from four .50-caliber machine guns and four 20-mm. cannon—rip target as Black Widow P-61 night fighter shows forward sting; converging fire chews up enemy planes



Glossy black paint makes P-61 almost invisible by searchlight. Right, setting guns to skip prop



Below, checking P-61 for combat on compass strip. Note 4 droppable tanks





SCIENCE IS THE UMPIRE

By Paul Gardner

IN DECEMBER 1939, one of the tensest moments in sports history occurred. With 40 seconds to play, the Washington Redskins were on the New York Giants' eight-yard line. Bo Russell had to kick a field goal to overcome the 9 to 7 lead of the Giants. Silent tension, such as only a crowd of 60,000 can exude, filled the atmosphere. Russell tried the kick.

At least \$50,000 for the players as well as hundreds of thousands in wagers rode with the ball. Referee Bill Halloran gauged the desperate attempt with his eye. There was an awful wait. Then Halloran ruled the kick wide. Thousands milled onto the field in protest. A riot was avoided only by magnificent police team work.



Electric uniform for fencing (note "tail") relays signal at every touch. It is used in epee championships. Below, artist's conception of fishing boat using radar to find school of fish



Science, in 1939, had not yet really entered the sports world. Science, within another decade, may make most of the decisions—accurately and incontrovertibly.

In football, an inconspicuous transmitter near the goal posts might flash invisible electric beams which if intercepted would record a goal. Other sports such as baseball, golf, bowling, fencing, track and field events, horse racing and tennis are due for some startling innovations.

The sport of fencing employs a unique electrical scoring device. In the national epee fencing championships special suits are worn with an electrical attachment which signals each touch. A touch may be made anywhere in the epee championships, thus making accurate judgment imperative.

Holcombe Ward, president of the United States Lawn Tennis Association, says tennis leaders are discussing use of the electric eye in tennis. Close decisions often have swayed momentous matches. Bill Tilden tossed scores of optical daggers at inoffensive linemen in his long career. Foot faults, service faults and outs of the future may well be settled by the unerring eye at Wimbledon, Forest Hills and Davis Cup classics.

Golf also will reflect scientific progress. Let us assume that you are at the sixth hole at the country club and you want to notify your wife that you will be late for dinner. A pocket walkie-talkie will connect you through the local telephone exchange.



Strings used by Brooklyn Dodgers for training pitchers to hit target "dead center" may be replaced by electric eye beams after the war



False starts are avoided by metal plates before runner; if hands are taken off, gun cannot be fired. Below, science records a close finish

Western Electric photo



Copyrighted material



Western Electric photo
Two-eyed camera gets set for some speedy action at air races

The next Olympic Games, perhaps in 1948 in Stockholm or London, will employ camera eyes for finishes and many other electric gadgets. The starting device for runners which was tried out successfully in Denmark just before the war will be used widely. Lawson Robertson, coach of many American Olympic teams, has designed a similar device in which all starters

place their hands on metal plates and the gun, electrically attached, will not fire if a man takes his hand off. This will eliminate ludicrous incidents such as took place at Randalls Island when all six sprint finalists were disqualified for two false starts each. Officials had to reinstate everybody to determine the American champion.

Most sports after the war may be governed by an electric eye camera such as is now used in horse racing. At race tracks, the first horse crossing the finish line beam sets off the camera which instantaneously takes a photo of the finish. Any sport utilizing a boundary line can employ such a beam.

High jump or pole vault contests may have invisible beams in place of the crossbar. A bell or other signal will tell indisputably whether or not the athlete made it. Dan Ferris, secretary-treasurer of the Amateur Athletic Union of the United States, declares that a series of beams can be arranged so that a man gets credit for the exact height of his jump should he go higher than the crossbar beam.

Sometimes world records have been taken away from jumpers when it was discovered that the bar sagged in the center. Light beams, of course, do not sag. In addition to the crossbar beam and those above it, there will be a visible light beam which will give the jumper an incentive.

As enthusiastic as Ferris about the application of science to postwar sport is Jack

Left, international chess game played by television. Right, bowler "trips" electronic beam guarding alley



Mara, president of the New York Giants, eastern champions of the National Football League. He well remembers the disturbance at the Giants-Redskins battle of 1939. He also realizes that the electric beam may yet be used to detect offsides, check on whether a team made its first down, and determine if a runner stepped out of bounds on the sidelines.

Elmer Layden, high commissioner of professional football, points out that football is the most difficult and complicated of games to officiate and anything that can make for increased efficiency will be welcome.

Baseball men, on the other hand, have already considered scientific umpiring and believe it would not be practical for their sport. The radio beam could not be applied in judging balls and strikes because the batter would break the beam himself if his hand or his bat were over the plate before the pitch.

Science, however, will invade the baseball world in the form of television. Baseball men are opposed to it because it would cut down the attendance at the ball park, but commercially sponsored television broadcasts are expected to more than cover the loss of attendance revenue.

In the postwar revival of sports, television will play a tremendous role. Everybody in the country will be potential spectators for single events. Boxing already is counting heavily on television. According to Mike Jacobs, the world's leading promoter, the next heavyweight championship fight will gross about \$6,000,000 because television will bring it simultaneously to hundreds of theaters. The present high for a heavyweight championship fight is \$2,600,000.

Jacobs believes that eventually a fight could be staged in a small studio with a handful of officials and spectators present, but with an audience of millions watching the battle by way of television.

And then there's the comfort of the postwar sports fan. Electric mittens, electric shoes and electric coats will be worn. Such garments keep aviators warm on high altitude flights. Why not spectators at football games on freezing days?

Televising a six-day bike race—millions will follow sports through this medium

NBC photo

OCTOBER 1945



Beams above crossbar assure credit for exact height of jump

With radio-telephone devices, football and other sports officials will explain decisions immediately to the entire crowd. The present football semaphore system is understood by few. The spoken word would clarify many knotty situations.

For many who have an understanding of only baseball or football, television will bring the refinements of golf, tennis and

(Continued to page 148)



Copyright



SHEEP CUT GRASS between the steel mat runways at San Bernardino, Calif., field of the Air Technical Service Command. Mowers couldn't be used over mats and grass was fire hazard until 400 sheep arrived



MIDGET SIDEWHEELER is powered by a two-horse-power gasoline engine and is only 14 feet long. Two 30-inch paddle wheels propel craft. It was built by 14-year-old David Bucher at Lake Mohawk, N. J.



INLAID in this table and 10 chairs are more than a million pieces of wood of 46 different varieties. Magnifying glass was used to set some small pieces



TRUCK SCOOP anchored to frame tosses loads over top of cab into open body. This one-man hydraulic unit is operated from cab by manipulating one lever

DUMMY TANK made by the Japs was constructed of volcanic ash. They cut cogs in the wheels and used a tree limb as cannon. Yanks found dummy on Iwo Jima



Patrol Industrial Designers Association
PROJECTING DECK like that of an aircraft carrier is featured on cabin cruiser designed by Ray Russell of Detroit. Convertible top is operated by push button

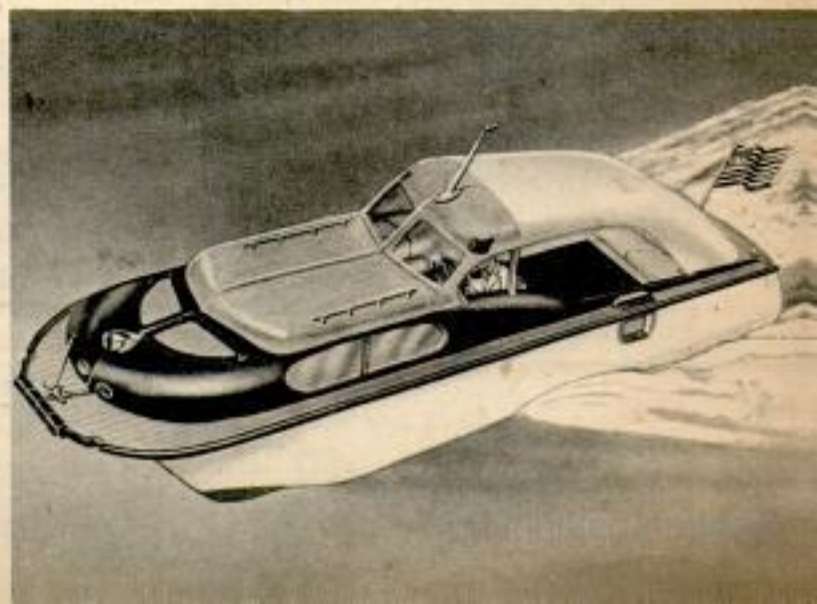

NOW THE LID IS OFF

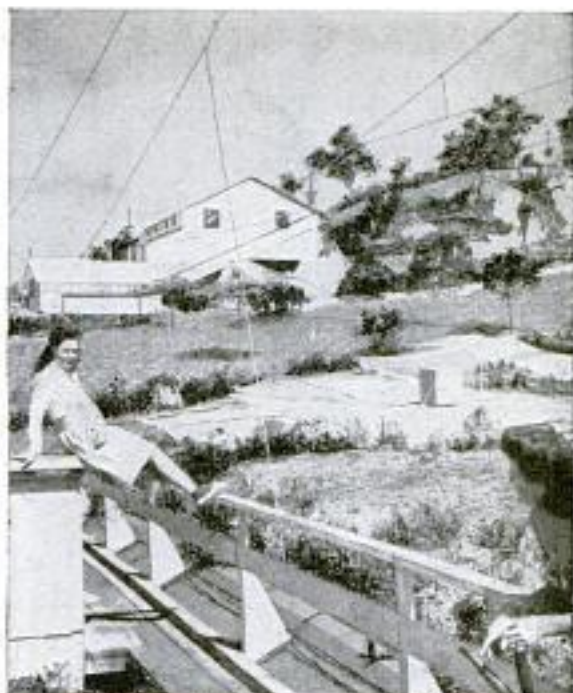
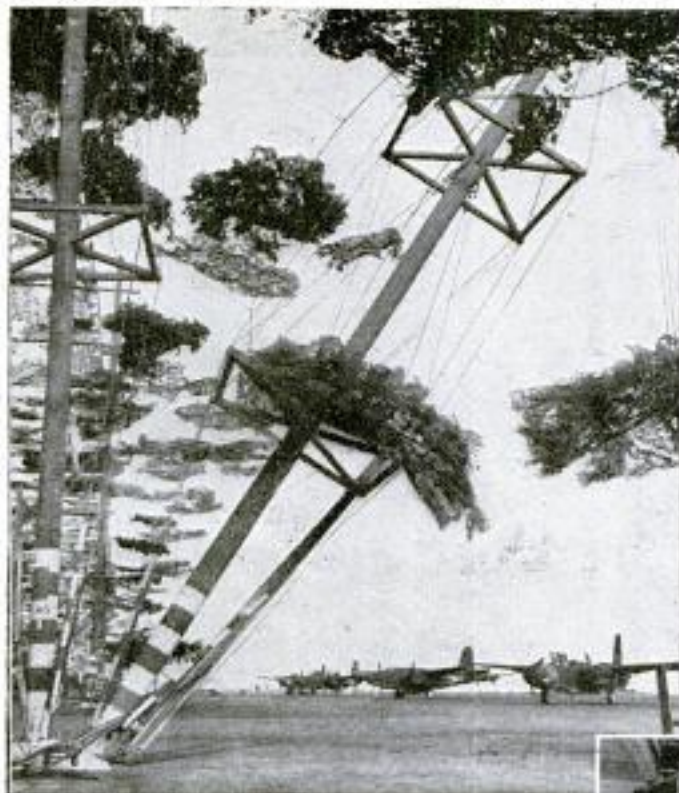

Workers pause while "gardening" amid fiber glass flowers to add realism to camouflage. Below, boulevard in front of main plant entrance

Four hundred 90-foot wooden poles like those above supported 4,489,000-square-foot net on which a complete residential subdivision was built to camouflage Douglas Aircraft's gigantic Santa Monica plant. Net of fiber glass slivers in strands was arranged between two layers of chicken wire and was strung along 1,120,000 feet of cables. Artificial gardens and homes blended perfectly into surrounding real community, as view below shows, and covered the entire plant and automobile parking areas



HIGH PRESSURE



Wearing lightweight suit with helium-oxygen mask of his own design, Jack Browne prepares to emerge from special tank after setting new deep-sea diving record. Below, a revolutionary "lung" developed by the young diver which carries its own supply of oxygen in cylinder

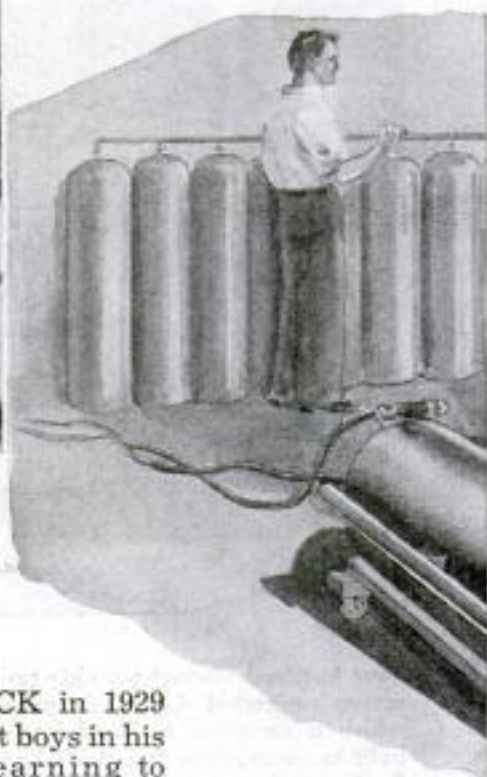

AWAY BACK in 1929 when most boys in his block were learning to swim, Jack Browne of Milwaukee, Wis., was learning to sink. While his neighborhood buddies were experimenting with old inflated inner tubes, Browne was tying weights on his feet for a stroll along the bottom of some nearby pond. A big tin can served as a diving helmet and a piece of discarded garden hose as an air line.

In those days it probably never occurred to the 12-year-old Milwaukeean that a few years later grateful officials of the U. S. Navy would be watching his experiments

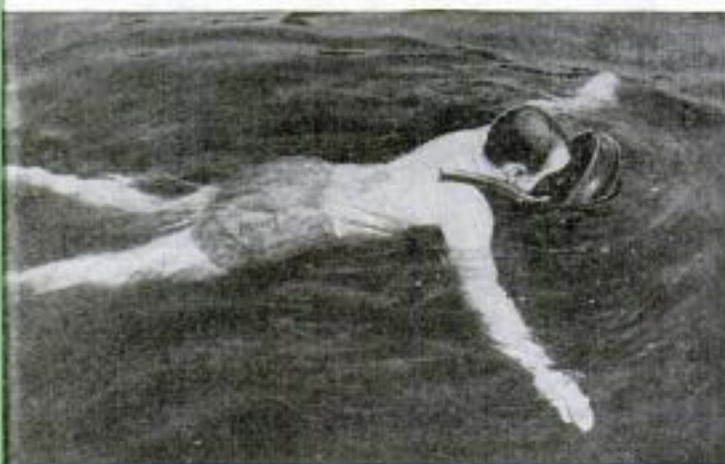

Above, swimmer wears inflated rubber "pillow" with breathing tube and window to locate sunken objects

DIVER

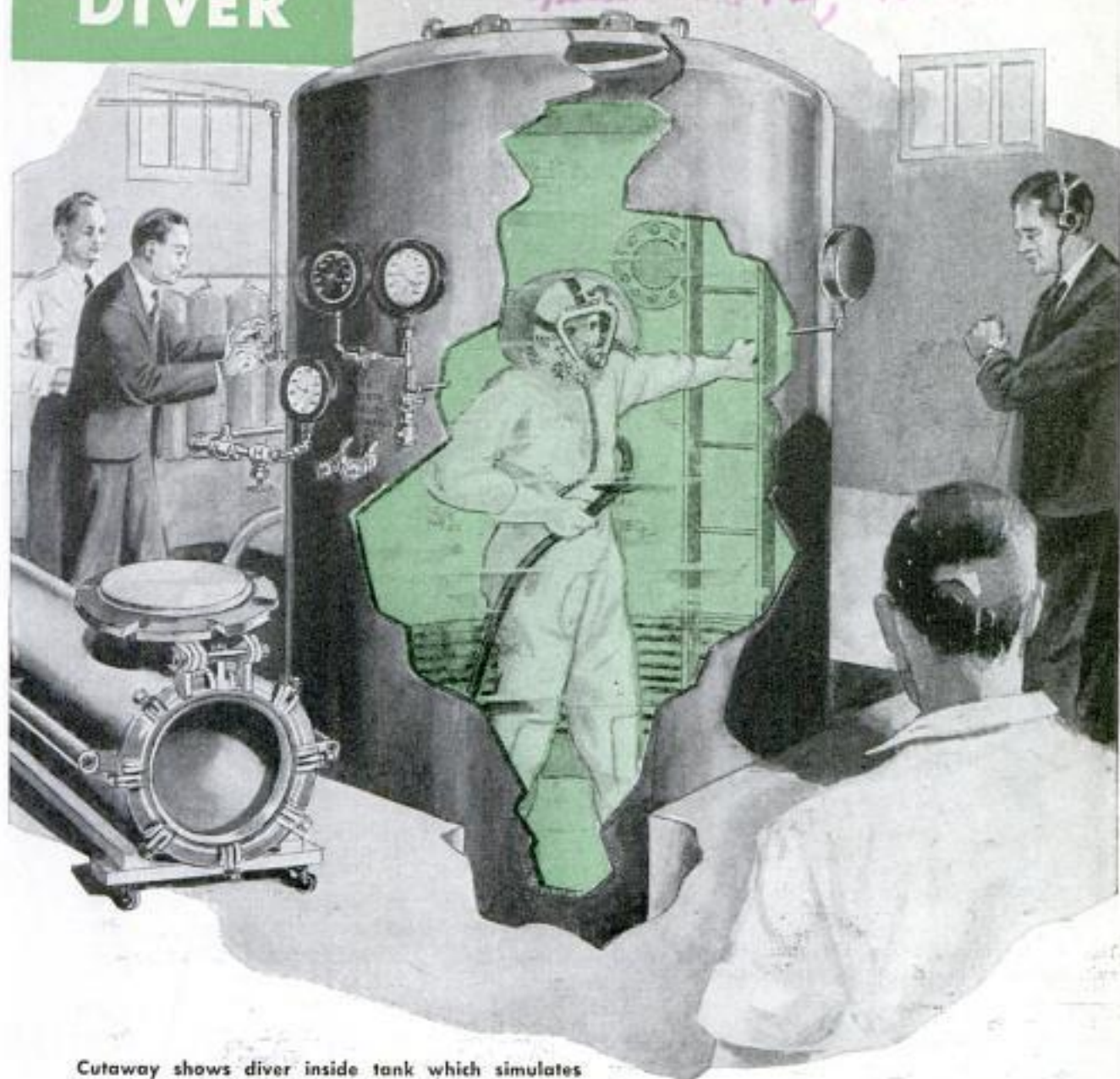

Cutaway shows diver inside tank which simulates deep-sea pressure of 550 feet. Cylinders in background supply oxygen and helium. Portable decompression chamber (left) helped diver avoid bends

with the keenest interest. Some of those officials were present recently when Browne, now 28, set a new world record of 550 feet for simulated deep-sea diving. He wore a revolutionary lightweight diving suit with many improvements of his own design.

When Browne perfected an ingenious diving "lung" a few years ago, he says he was thinking of treasure hunts and moss-covered gold bricks. He had no idea how handy it would be for rescue and construction work. This lung, which is only one of Browne's many practical inventions, has been used by our military forces all over the world. It is a favorite with bridge-building engineers, who sometimes not

only have to work under enemy fire but under water as well.

Divers can work for an hour and a half at a depth of 60 feet with the self-contained lung. It consists of a rubber and transparent plastic mask which fits over the face and a vestlike harness that rests on the shoulders. Tubes on either side of the mask connect with an oxygen cylinder on the front and a canister on the back for absorbing carbon dioxide in the breath. A weighted belt is worn with the lung. Post-war uses of this equipment include rescue and recovery work by lifeguards, light salvage work and some water sports such as spear fishing.

Browne insists that the lung is a simple invention and not nearly as important as the new lightweight diving suit which he has developed in cooperation with the



This is the revolutionary 50-pound diving suit. Below, clamp closes the back entrance



Navy. This suit weighs only 50 pounds compared with the standard 250-pound outfit used by deep-sea divers in the past. It was to test this suit that Browne made his simulated dive to 550 feet and incidentally set a new world record.

The suit is made of rubberized fabric with a built-in standard mask. Transparent plastic over the face affords wide visibility. Aside from reduction in weight, the suit's most outstanding feature is a back entrance which eliminates the cumbersome 12-bolt breast plate on ordinary heavy equipment. All the diver has to do is step into the suit and close the "back door" after him with an air tight clamp. Browne has also designed some new footgear to be worn with the suit. The square-toed shoes weigh 20 pounds each and have a wood inner sole for insulation and canvas tops for comfort.

Browne made his record "deep-sea" dive, oddly enough, in a tank containing only eight feet of water. Deep-sea pressure was produced by pumping air from cylinders into the tightly closed tank. This procedure, divers say, is far more dangerous than an actual open water dive. Failure of a valve or porthole when Browne was at 550 feet would have meant almost instant death. At that point the surface of the diver's body was under pressure of 570,000 pounds, or 240 pounds to the square inch, according to Dr. Edgar End, noted authority on air pressure and deep-sea diving. He supervised the test along with Capt. A. R. Behnke of the U. S. Navy Medical Center, Bethesda, Md.

Browne "descended" to 550 feet in only 10 minutes, but it took him seven hours to come up despite the fact that he was breathing a mixture of helium and oxygen. The slow ascent must be made to avoid the painful and sometimes fatal "bends." Browne, like many other deep-sea divers, substitutes helium for nitrogen in the breathing mixture.

Under high pressure the body absorbs in the blood and tissues a considerable amount of nitrogen. Helium is less soluble. When the pressure is removed, the nitrogen or helium goes out of

"Escape vest" carries 15-minute supply of oxygen. It was designed for escape from damaged vessel or "ditched" plane



solution in the form of gas bubbles. Helium bubbles are much smaller than those formed by nitrogen, lessening the danger and shortening the time of ascent.

When Browne first went under water in the tank he was breathing 55 percent oxygen and 45 percent helium. When he passed the 500-foot mark, breaking the record set by a Navy diver in 1938, he was breathing 87 percent helium and only 13 percent oxygen.

Browne was in telephone communication with observers outside the tank at all times. As the amount of helium was increased, his voice gradually changed into a metallic echo. On the way up, the amount of helium was reduced until he was breathing pure oxygen at 60 feet.

Four and a half hours after he entered the tank, the hatch was opened and Browne was whisked into a portable decompression chamber (which he also invented). This portable unit was placed on a truck and taken to a hospital equipped with a decompression chamber. Browne stepped out of this chamber two hours later.

"I guess this proves that a man can live at a depth of 550 feet in a diving suit," he said, "and perform practical work that far down. I think I could have gone down another hundred feet. The next thing I want to do is try this suit out in the open sea."

The portable decompression chamber

(Continued to page 152)

Right, diver holds search board which has plastic window for hunting sunken items. Below, board in use



On street corner in New York, a Navy diver gives deep-sea demonstration in glass-walled tank to help sell bonds. Chief petty officer is talking to the diver by phone



Carl Pool
1010 Magnolia St.
Los Angeles, Calif.



Amateur Prospector Carries Assay Lab In Portable Case

Encountering an interesting rock, Carl Pool, West Coast amateur prospector, doesn't wait to have it assayed. His portable laboratory made from a candy salesman's display case provides a chemical analysis on the spot. Ten collapsible trays in two tiers swing outward when opened to give easy access to alcohol burner, blowpipe, mortar and pestle, glassware and reagents which permit dozens of tests without the necessity for a return trip. When folded the equipment fits snugly into the case.

"Eavesdropper" Warns Of Engine Defects

Aircraft engine defects are revealed either before or during flight with a detonation indicator developed by a manufacturer of precision flight instruments. This sensitive device consists of a detonation pickup unit and harness attached to the cylinder walls. It observes changes in the frequency of vibrations and is connected through an amplifier to an indicator on the instrument board which flashes a warning. The indicator picks up defects which cannot ordinarily be detected unless the engine is taken apart. The indicator also reveals whether the quality of fuel being used is best for a particular engine.

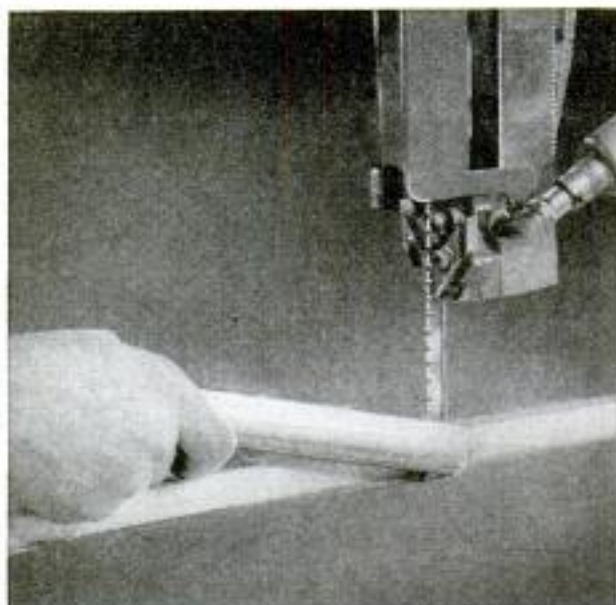
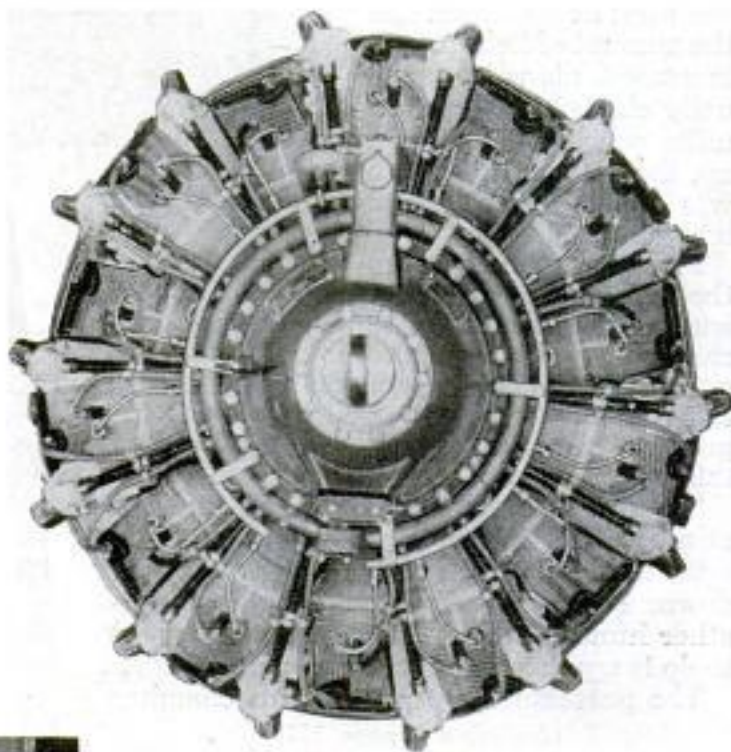

Oiling Stick for Band Saw Blade Is Held Against Moving Teeth

Band saw blades can be oiled while in motion with a lubricating stick which is pushed against the teeth. The stick, which is six inches long and one inch in diameter, makes cutting faster when used on a metal cutting saw and prevents the formation of metal chips that clog and break teeth. The lubricant prevents pitch from collecting on the blade of a wood cutting saw.

☐ The government's milkweed floss collection campaign in 1944 yielded approximately 1,650,000 pounds of floss, sufficient to meet government needs, and there will be no collection program this year.

Proving Ground for Synthetic Product Safety

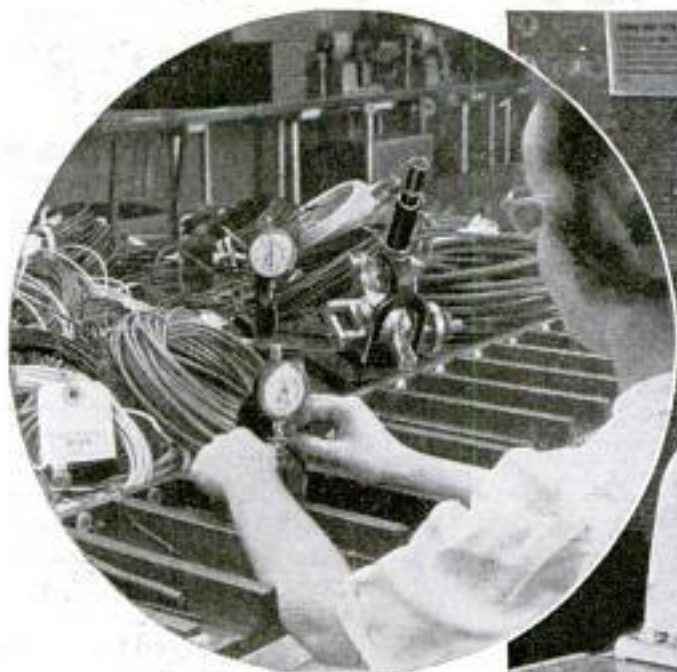

Underwriters' Laboratories photos

New methods of testing to learn safety and efficiency stem from the rapid rise in products made of plastics and synthetics. Reading in thousandths to half-thousandths of an inch, sensitive dial above gauges thermoplastic insulation and synthetic rubber used for wires and appliance cords. Companion tests indicate flexibility, brittleness and resistance

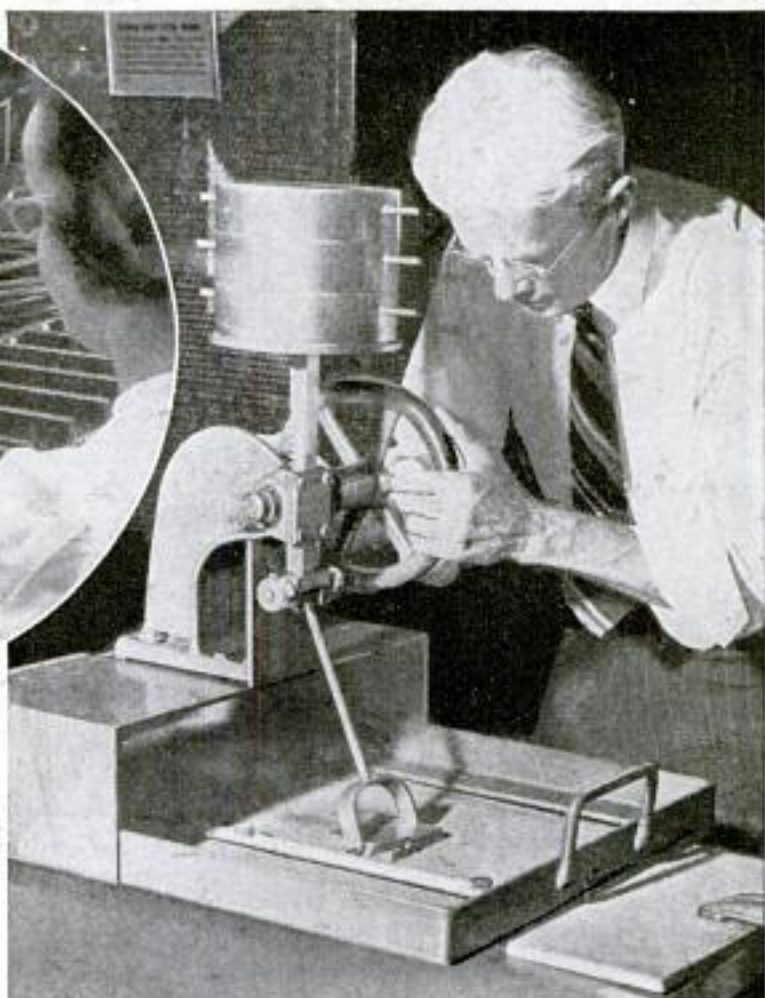

Simulating conditions produced by shoes on a person running or walking, apparatus above tests materials to make floor surfaces safe. It measures the coefficient of friction under practical conditions. Left, accurate photographic records of split-second operation of systems used for burglary detection are made possible by cathode ray oscillograph, beat frequency generator and various noise meters

In the Underwriters' Laboratories, Inc., engineers see that plug fuses blow out rapidly on over-current loads that cause fire hazards in buildings. Fuses are calibrated accurately and tested, right, for heat-resistance on new equipment. Some of the fuses, utilizing cold molded plastic cases, now have cellulose acetate plastic windows which replace mica for certain ratings. Safety of design will rate high in postwar products

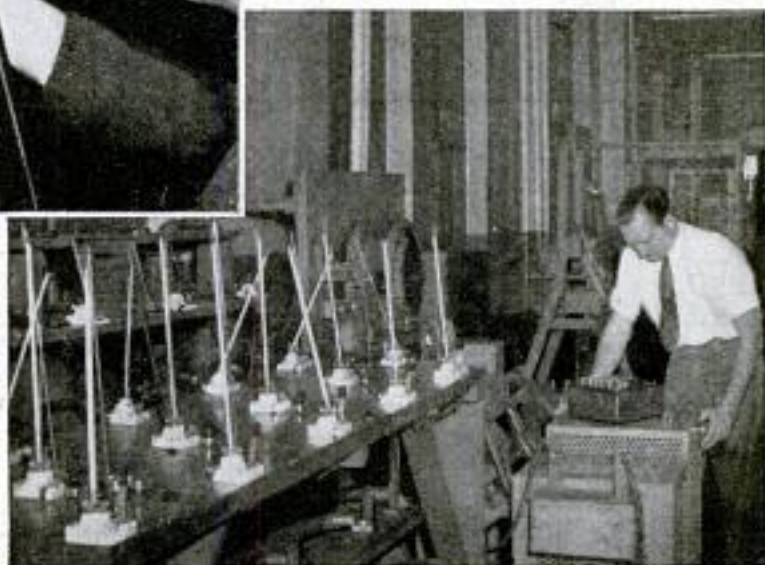

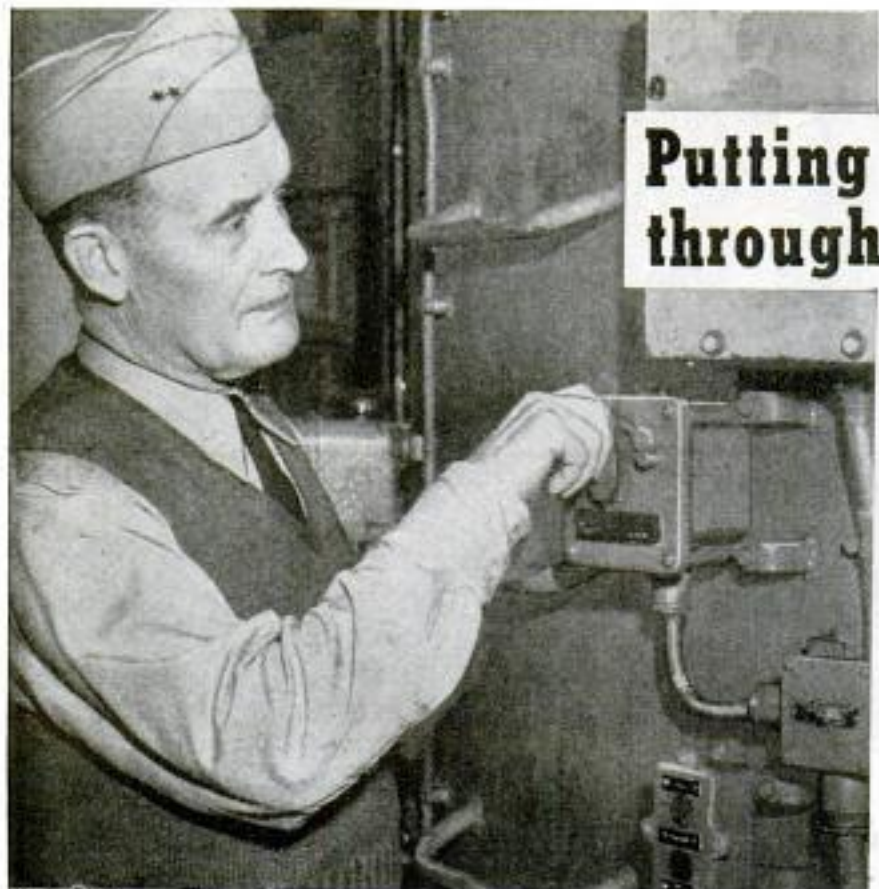

Navy photo
Admiral Noyes tries out general alarm system from bridge of new cruiser

Putting **WARSHIPS** through their paces

By Leigh Noyes

Rear Admiral USN

(President of the Board of
Inspection and Survey)

especially those concerning small vessels, are conducted by local boards.

The rigid inspection procedure of the Navy, developed over many years, has played no small part in the remarkable performance of our Fleet. Ships which we built to steam 50,000 miles between overhauls have traveled more than 200,000 miles.

LAST year the Navy commissioned 42,248 of the finest vessels that have ever put to sea. It is the job of the Board of Inspection and Survey to make sure that these vessels, from the largest battleship to the smallest landing craft, are mechanically perfect before they are commissioned.

It is probably safe to say that no decade in the 68-year history of the board has witnessed as many acceptance trials as were held during the fiscal year 1944. I speak from the experience of 60,000 miles of travel—on land—during that 12-month period, visiting shipyards on the east and west coasts, the Great Lakes and the Gulf.

The vessels commissioned during 1944 consisted of 678 combatant ships, 32,814 landing craft, 355 auxiliaries, 954 patrol and mine craft, 6887 small boats and 560 district craft. The combatant ships included battleships, aircraft carriers, cruisers, destroyers, destroyer escorts and submarines. Ordnance items for this period included 63,000 gun assemblies of 20-mm. caliber and larger and more than 500 million rounds of anti-aircraft ammunition.

The three chief functions of the Board of Inspection and Survey are (1) to hold acceptance trials for new and converted vessels; (2) to hold service trials for commissioned vessels to determine economy of operation, speed and maneuverability and (3) to survey and appraise damaged or obsolete craft. Many of the trials and surveys,

Nothing escapes the eyes of the naval inspectors from the main engines to an apparently insignificant nail hole in a bulkhead. Recently, when inspecting a converted ship for watertight integrity, it was found that screws had been improperly placed in a bulkhead to hold a bulletin board. In accordance with naval standards, all holes in bulkheads have to be welded or stopped up in such a manner that they cannot be blown out under pressure.

To illustrate the work of the board, let us "follow through" on the inspection that preceded the commissioning of a new aircraft carrier.

This flat-top was launched last December and the preliminary dock trial was held in March. The dock trial, held by the contractor, is to try out the main engine, and during this trial the ship is secured with heavy lines. The acceptance trial, conducted by the board, was held early in April.

The route for inspection is laid out for each deck. The ammunition hoists are carefully tested; airplane elevators and the bomb and torpedo elevators are operated and checked with full loads; the anchors are dropped and hove in and the time noted. Ordnance experts test out the battery with its directors and many fire control appliances. The steering gear is tried out from various control stations. Usually, part of the trial is conducted at

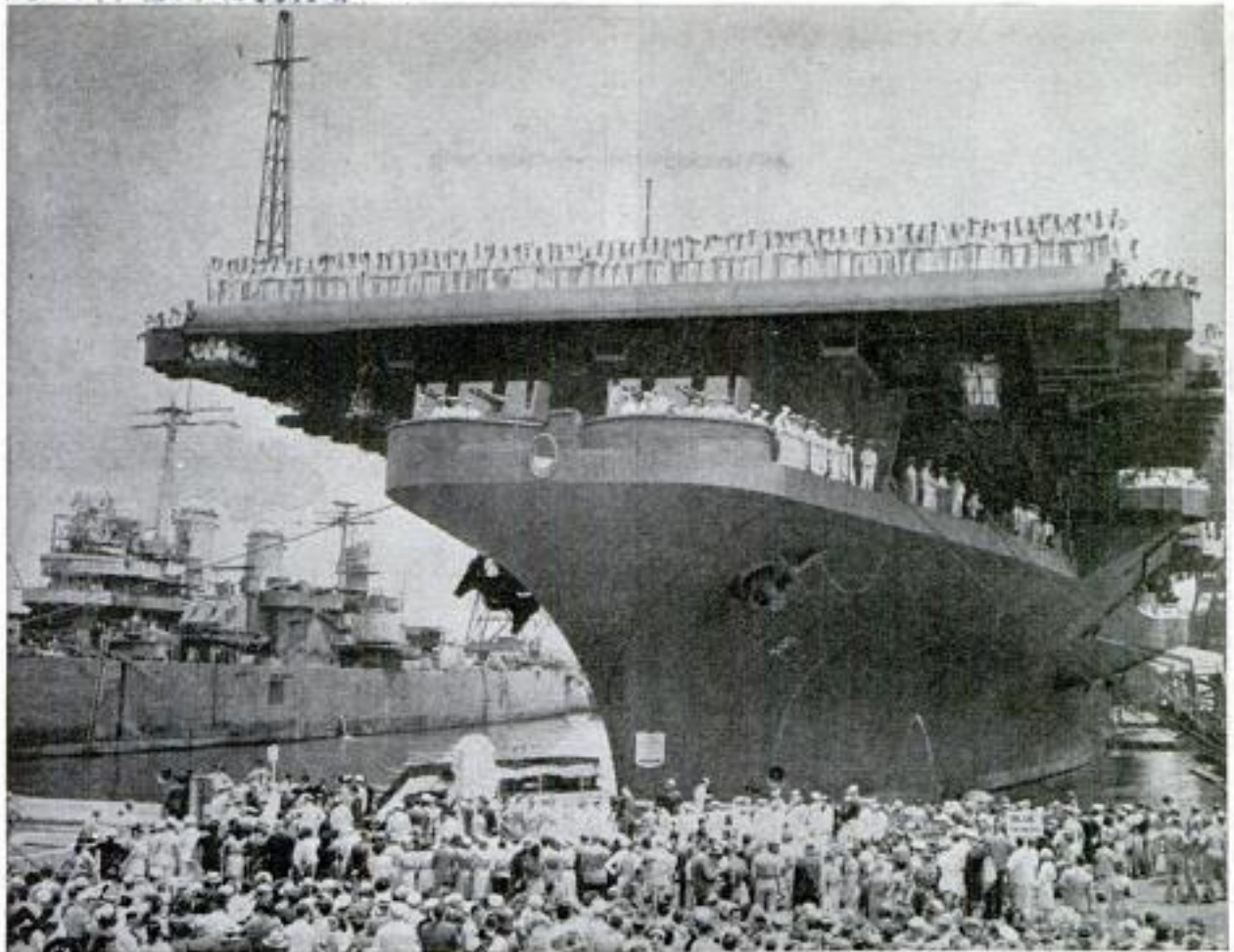

Before commissioning of this 27,500-ton aircraft carrier, sharp-eyed Navy inspectors tested every part

the dock and part with the ship under way for a full power test of all main engines.

The Diesel emergency equipment, which can carry on if the boilers are hit by a torpedo, is also given a grueling test. The rudder must be "put over" with the ship backing. Even the ship's laundry, which can accommodate 2000 men, is inspected. Incidentally, the laundries on our Navy's modern ships are a far cry from the days when all enlisted personnel had to wash their clothes in buckets.

After all the tests have been completed and found satisfactory, a general inspection of the ship is held. This includes all electrical radio and sound devices, many of which are of a highly secret nature.

At all times the inspectors are on the alert for such things as hot bearings, defective gears, improper temperature ranges that result in overheating, and any excessive or unusual noises. In all types of ships the noise level must be held to a minimum.

An important part of the work of the board at the present time is survey and appraisal of damaged or obsolete craft. No vessel, however, is marked for scrap or sale if any possible use can be found for it. An LST which was too badly damaged to be used in battle again is serving as an ad-

vanced base barracks ship in the Pacific. There are dozens of cases like this.

When small boats, such as landing craft, are damaged, they are disposed of by a local survey group aboard ship. A question frequently asked by prospective or former small boat owners is: Will many of these small craft be for sale now that the war is over? Thousands of these vessels will be disposed of, but one should bear in mind that the engines were built for efficiency from a military standpoint and not for economy of operation.

However, during the war years, the Navy's prime concern was not how to dispose of vessels, large or small, but how to acquire more. Our \$15,404,600,000 procurement program for 1945 had as its goal some 206 combatant vessels, 223 patrol craft, 56 mine craft, 694 auxiliaries, 657 district craft and 22,560 landing craft.

As the board has pursued its duties of inspection, playing its part in building up the most powerful navy in history, we have kept in mind the words of Secretary of the Navy James Forrestal:

"The greater our strength, the sooner our victory."

Japan's surrender proved how right he was.

Russell Mfg. Co.
 Oak & Mineral Sts.
 Platteville, Wis.



WATER-COOLED, this chair makes it easy to relax in 108-degree temperatures. Water flows continuously through back and seat, keeping occupant comfortable



BULL MASK with slits in peepers keeps 1000-pound bull from seeing when his head is raised, prevents him from charging his owner who invented the mask

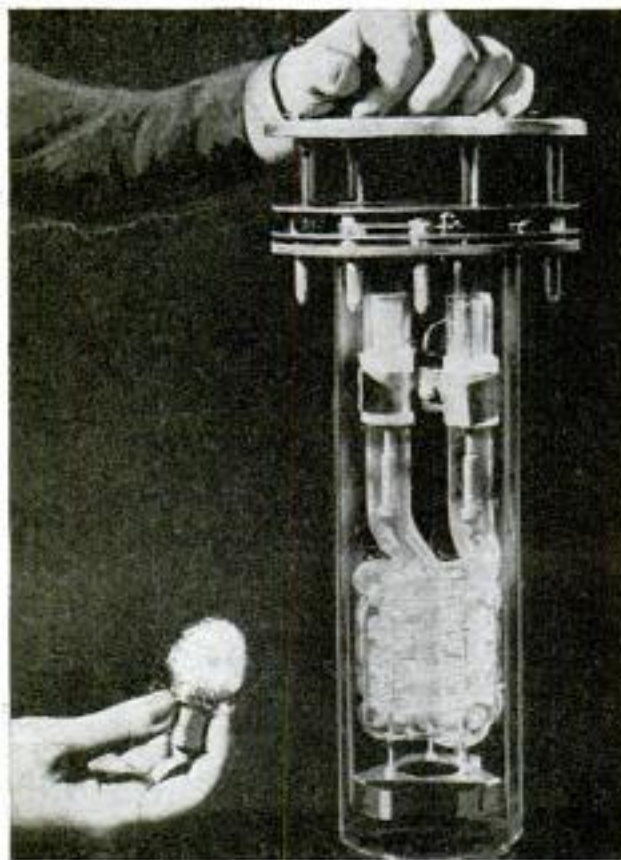

FLYING FLASH, the supertube shown compared with a photographer's flash bulb, shoots brilliant flashes earthward with machine-gun rapidity from reconnaissance planes. It lights ground two miles below



SELEVISION, a device embodying television principles and used for commodity buying and selling, reflects bids made by buyers or sellers in many cities on its white panel from "Quojector," machine at right

Electric Co.
 Lamp & Paint
 Nelson

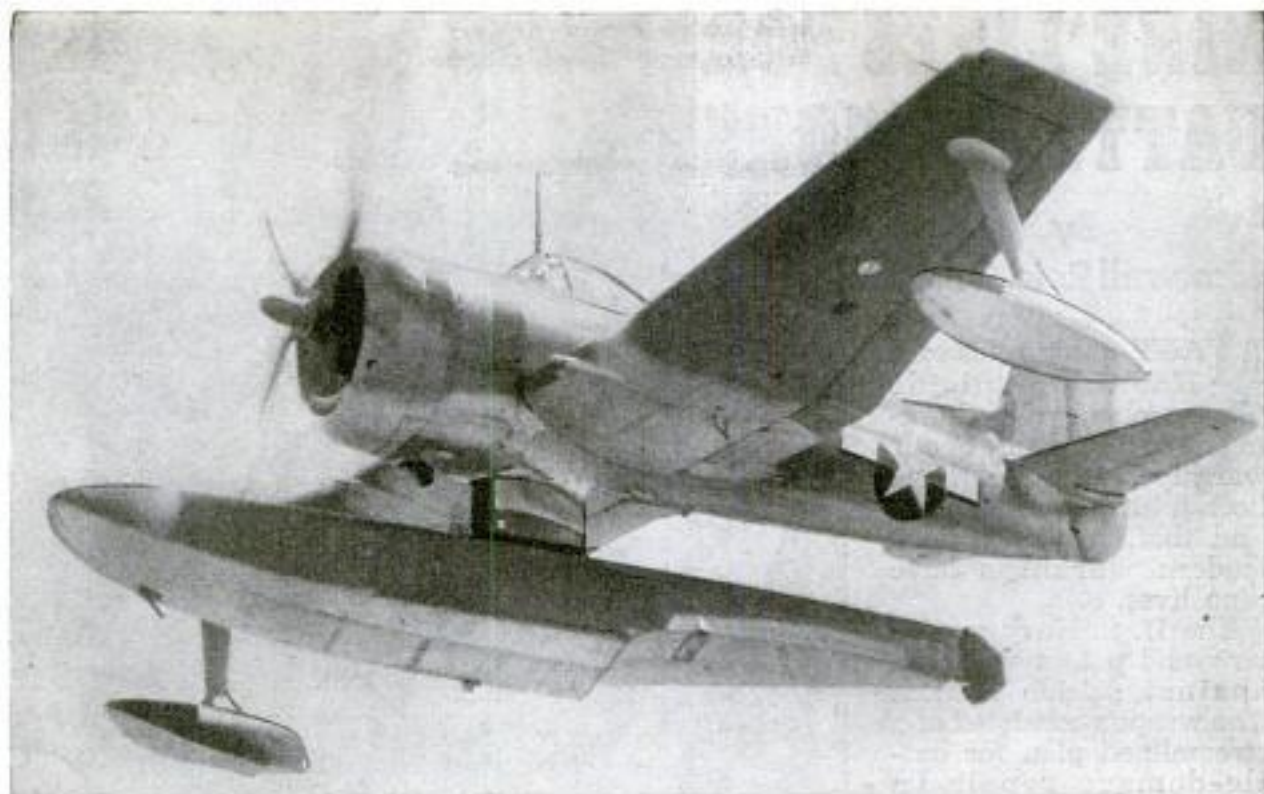

'Hot' Navy Seahawk Has Bombs in Float

In aviation parlance, "hot" is the word for a Navy scout plane that flies faster and higher than any previous model. It is the Curtiss SC-1 Seahawk, a single-place, single-float, low-wing craft powered with a nine-cylinder Wright Cyclone engine. This engine develops more than 1200 horsepower and is said to generate more power per pound than any other engine of its type. The Seahawk has nearly three times the horsepower of the Kingfisher which was also used for scouting, spotting and air-sea rescue operations. Despite its increased speed, the Seahawk has a low landing speed. The new seaplane not only boasts more potent firepower but if necessary can carry bombs in the main float which is equipped with bomb bay doors. Auxiliary fuel tanks can be carried in the float on long missions. When used for rescue work a bunk is installed behind the pilot's seat. The Seahawk can be launched by catapult, and with its folding wings occupies a minimum of deck space.

During the last decade (1935-1944), 100,000 persons have burned to death in the U. S.

Single-float Curtiss Seahawk is Navy's fastest scout plane. Below, Seahawk's nine-cylinder 1200-horsepower Wright engine

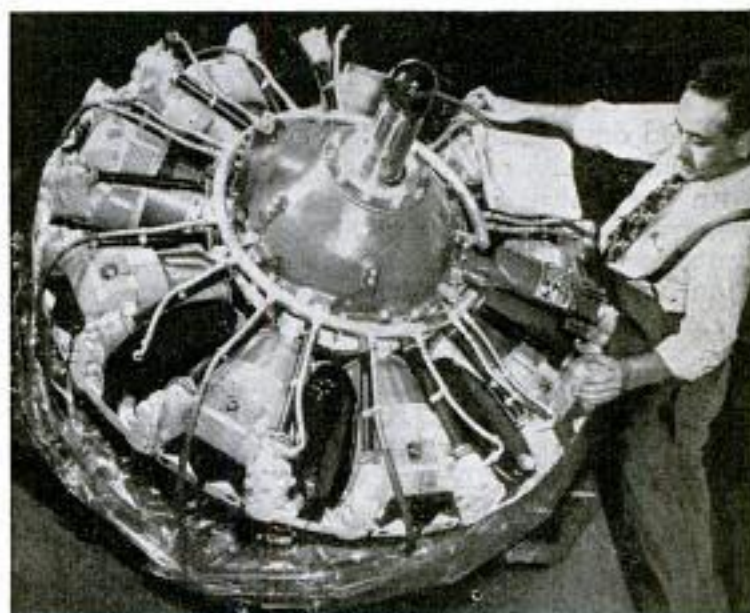

Phosphorescent Tape Glows in Darkness

Applied like adhesive plaster, a phosphorescent plastic tape displays a glossy surface in daylight and a blue-green glow at night. Sandwiched between the white adhesive and a plastic protective film, the phosphorescent pigment stores light and gives it off in the darkness. The moisture-resistant tape can be printed for use in all types of markings.



NINE LIVES FOR BATTLEWAGONS

By
Maxwell Reid Grant

MANY a Jap pilot of a Kamikaze suicide plane probably died thinking he had sunk one of our warships. It would have been a bit discouraging to find that, like cats, most modern warships have nine lives.

The U. S. Navy used a new and potent weapon against suicide attacks. The weapon consisted of a streamlined plan for battle-damage repair in which engineers and craftsmen worked like surgical teams to build substitutes for damaged sections and have them ready for replacement before a crippled craft reached drydock.

Salvage units operating with the fleet at Okinawa repaired battle damage to 823 ships. The units saved ships and cargoes worth more than half a billion dollars in battle areas.

Here's how the new system worked:

A wounded destroyer turns back on orders from the task force commander. Major repairs must be made. Below decks, photographers already are taking closeups of the battered hulk. Armed with these pho-

tographs and with detailed sketches, the ship's executive officer and a junior engineer take off in a Navy plane for the United States.

Meanwhile, the Navy's Bureau of Ships in Washington receives a coded radio message: "Destroyer XY seriously damaged by torpedo from suicide plane. Hole is between frames Number 28 and 35, extending

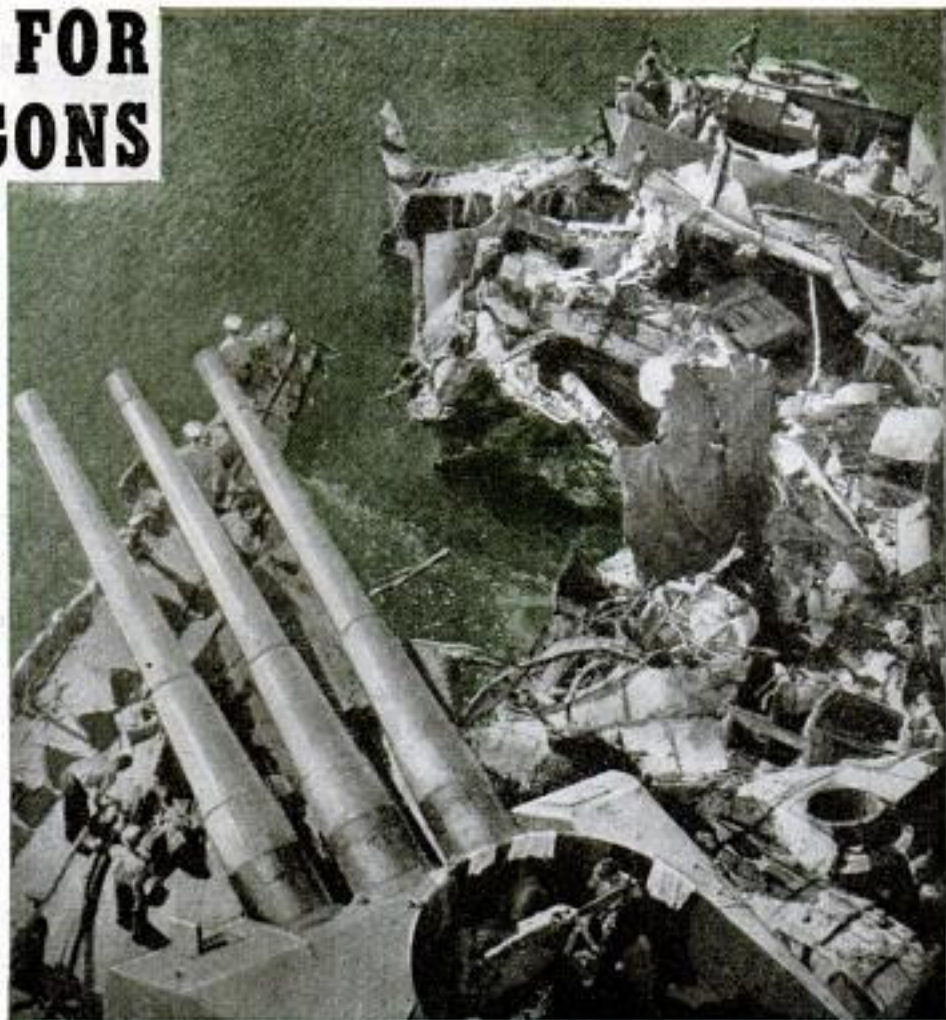

Making repairs on this severely damaged cruiser is all in the day's work

Rigging shop makes bow fenders, below left. Microfilm in right foreground holds all the plans in background



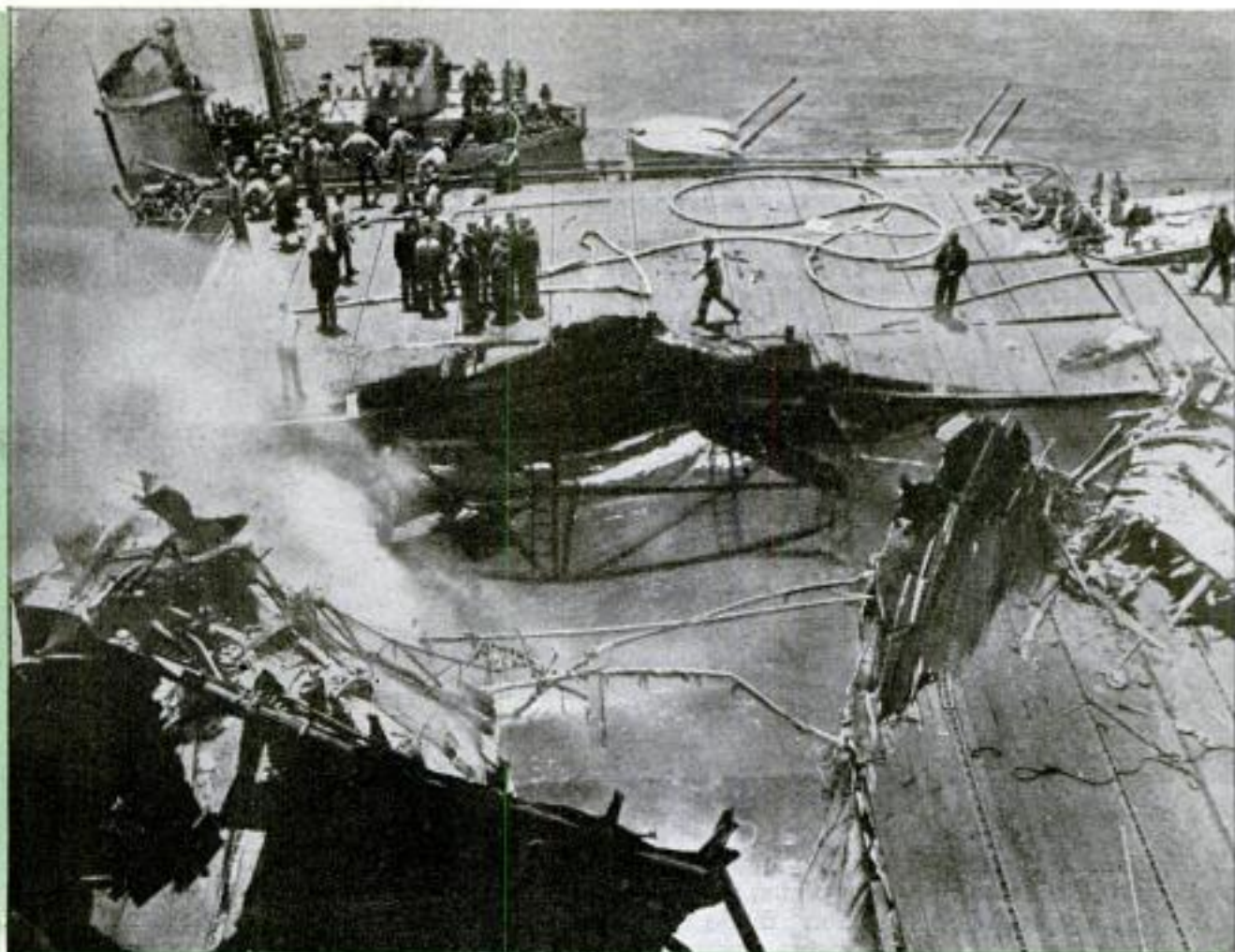

Hit by two Jap suicide planes, carrier Bunker Hill, above, got safely to Puget Sound Navy Yard for repair

from deck to 10 feet below water line. Four compartments flooded."

Down in the vaults where plans of all our fighting ships are stored, a reel of movie film is slipped into a projector. It is a microfilm copy of the destroyer's original blueprints, reduced from dozens of bulky bundles to a roll that can be concealed in

Divers had to remove powder from magazines of warship as water covered them after a sneak attack by the Japanese



one's palm. Moments later, plans of the damaged sections have been blown up to life size on enlarging paper, ready to be flown west.

Studying a timetable and a master chart of work plans for all the nation's repair yards, Navy officers "spot" the destroyer's job of surgery for a West Coast drydock and give it an "availability" of 30 days, estimated time for repairs. Out through a network of Navy communications flow orders to start procurement for needed equipment. Next day, when the two advance officers step ashore from their plane, they and the yard's production heads confer over the photos of the damage and the original "blueprints," and outline the job to be done. By next morning, a steel skeleton is taking shape in the fabricating department. Big as three boxcars, it is an oversize section somewhat longer than the original damaged compartments.

Two weeks later the crippled destroyer limps into the big drydock. Welders immediately cut away the edges of the gaping hole and remove the emergency plates which wall off

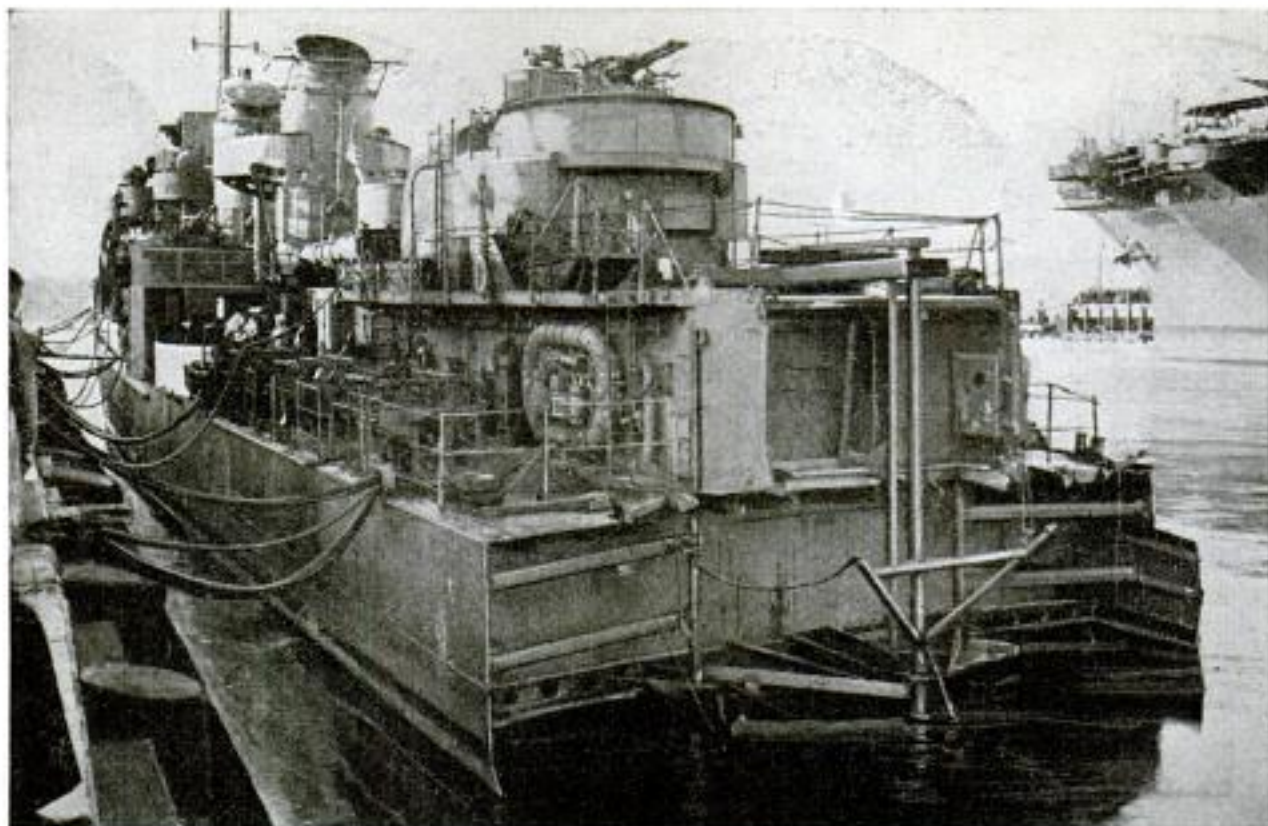

Mine in Alaskan waters blew the stern off this destroyer. She was towed to a West Coast yard for a new one

the flooded compartments. The big new section is lifted into place, its plates dovetailing nicely with the "incision" made in the ship's side. Repair experts swarm aboard, weld the section into place, install decks and bulkheads, then begin to connect up the intricate maze of electrical wiring, pressure tubing, and controls for naviga-

Cruiser settles evenly on keel blocks at big Navy drydock on West Coast

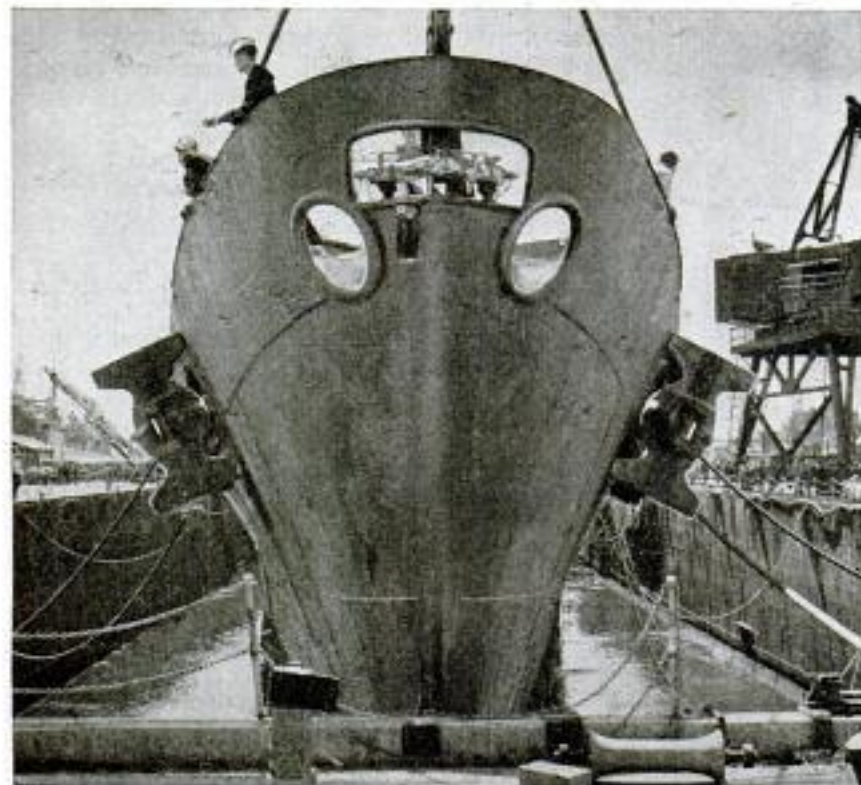

tion, fire, and other instruments. Fully 10 days before such an "operation" could have been completed in the old days, the "patient" is discharged and is on her way back to the battle area.

By such rapid-fire means, the Navy rushed fighting craft back into action. Thousands of skilled craftsmen—boiler-makers, electricians, ordinance workers, welders—formed the shipyard army assigned to repairing seriously damaged ships. Many of these ships were put aside for postwar repair. At San Francisco, repair work has increased six-fold. As many as 120 ships were undergoing repair at one time recently in its 30-odd yards and 150 subcontracting plants. Los Angeles area yards began to expand long before the battle for Leyte Gulf.

Microfilm speeded up repair work at the Fleet's advance bases, too, for shortage of air cargo space often delayed delivery of a major ship's bulky blueprints to remote spots. A battleship requires a big drydock

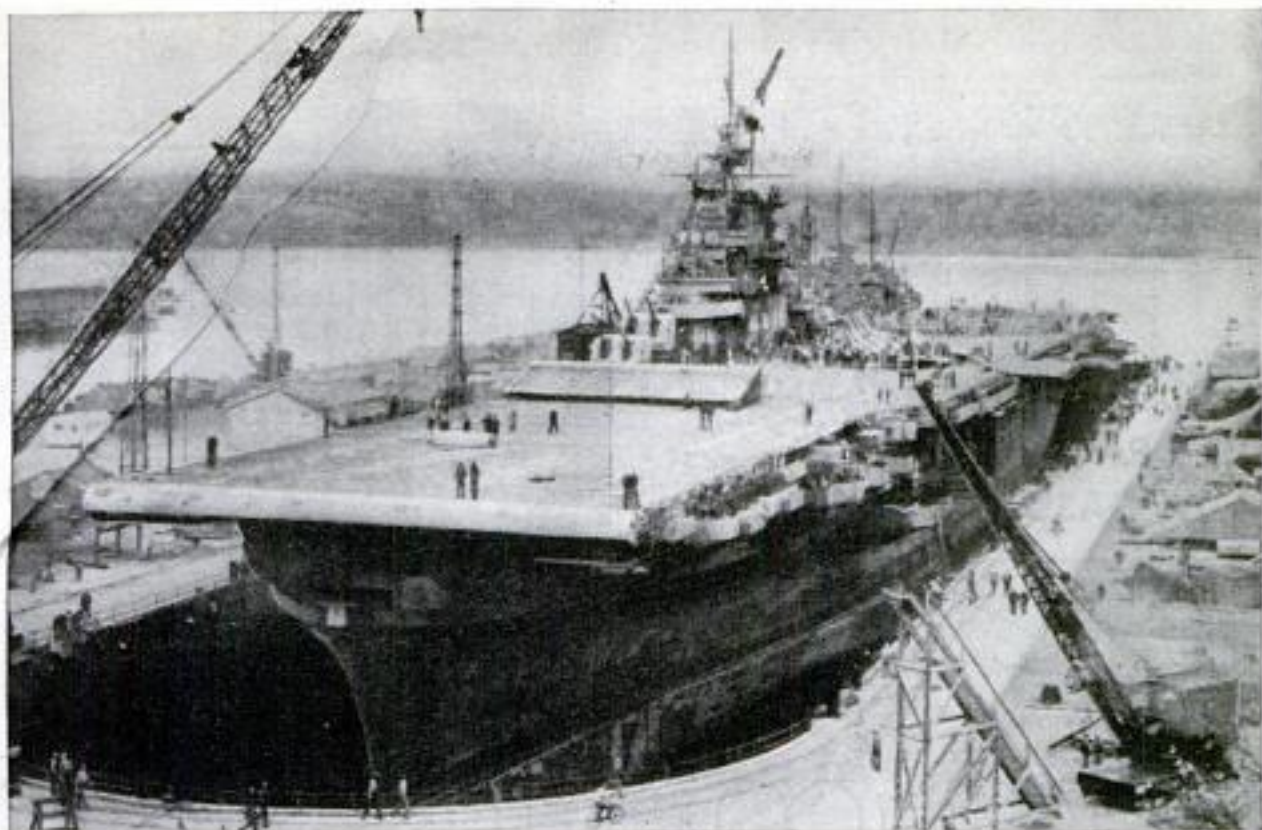

Carrier Bunker Hill, whose wreckage you saw on page 61, as she reached Puget Sound yard for "surgery"

for major repairs and its blueprints fill a freight car. Microfilmed plans of a "baby flat-top" total about one cubic foot, but the original blueprints would fill a nine by 12-foot room.

The escort carrier Kalinin Bay put in at U. S. Naval Drydocks at Terminal Island, near Los Angeles, with 25 holes in her skin. Thanks to microfilmed blueprints flown from Washington, she rejoined the Fleet six weeks sooner than ordinarily.

Off Leyte, at the height of the battle between Nippon's large battleship force and the little American escort carriers, a Japanese bomb struck the aircraft carrier Suwannee. Temporary repairs enabled the Suwannee to help turn back the superior force of the Japanese. But next day, two more Jap bombs destroyed the carrier's forward elevator and started bad fires on the hangar and flight decks. The carrier had to head for home. Photographs and descriptions of the damage were flown immediately to Puget Sound Navy Yard at Bremerton, Wash.

When the carrier arrived, so much of the new equipment was ready that at least four weeks were saved in repair and overhaul time. Some 55 miles of cable and enough pipe to carry a stream of water seven miles were installed in the ship for the reconditioning. Painters applied 42 tons of paint

(Continued to page 154)

Foredeck collapsed over torpedo hole, but cruiser Honolulu sailed home

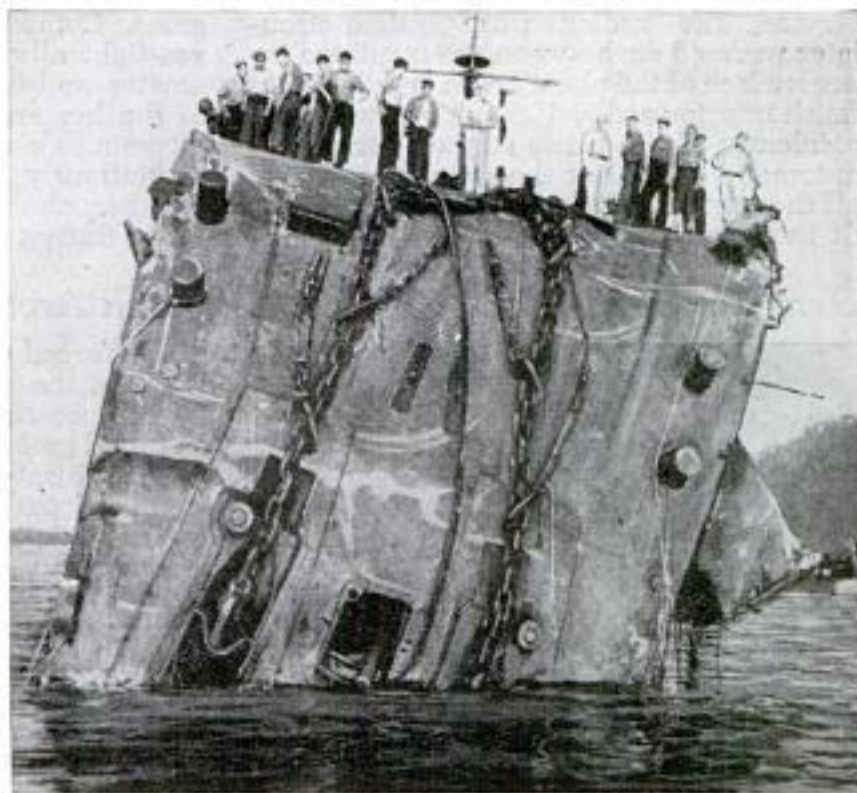

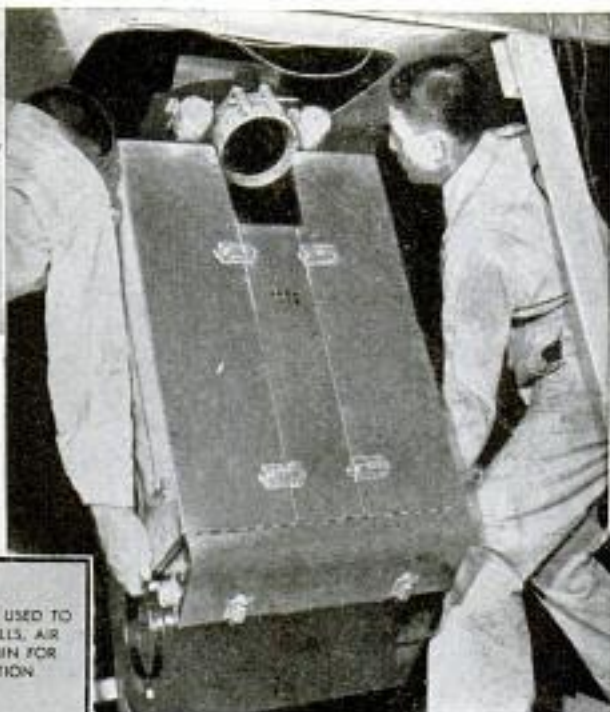
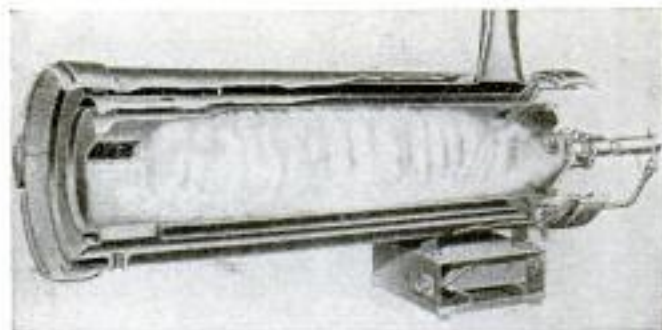

RADIANT PLANE HEATING USES PACKAGED UNITS WITH GASOLINE AS FUEL

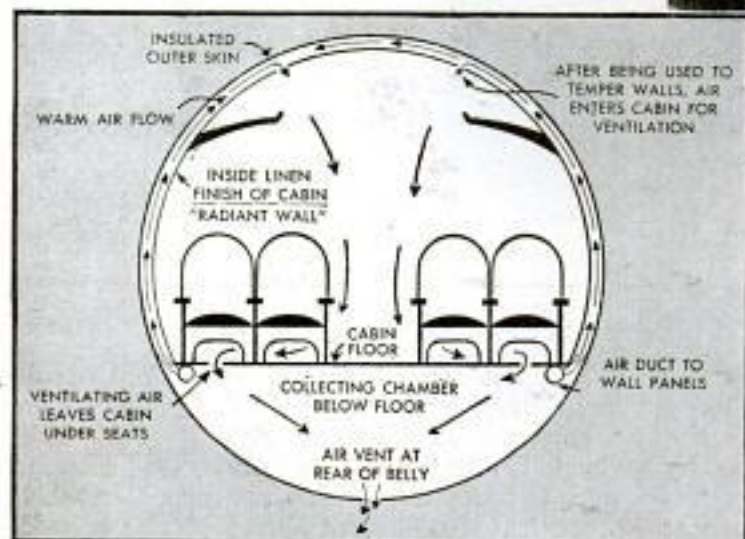

Radiant heating is applied to aircraft in packaged combustion type units installed in TWA Stratoliners released from military service. The "radiant wall" system circulates warmed air between the insulated inner surface of the plane's skin and the linen finish interior walls. Heaters operate independently of the plane engine, permitting automatic control of the warm air on and off the ground. The twin heating packages fit into the belly of the plane through a

quick access panel. Each includes an aircraft heater of 100,000 BTU capacity, thermostatic controls, fuel pumps, ventilating air blower, dampers and other automatic devices. A heater package can be removed and replaced by another in a matter of minutes. One heater is normally enough to warm the plane. In operation, the two units

are cycled on and off continuously. Surface temperature of the radiant walls never exceeds the design temperature of 90 degrees. Combustion occurs in a cylindrical gas-tight alloy steel shell, 8 inches in diameter and 36 inches long, in the center of the heater, with gasoline sprayed into incoming air and the mixture ignited by a continuously firing spark plug. In warm weather, the device keeps cool air circulating during flight.

Heat Controls Speed of Blower to Banish Arctic Blast and Save Fuel

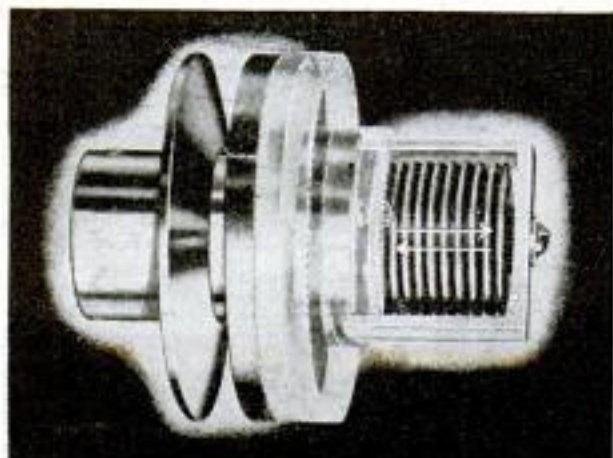

In a forced warm air heating system, the speed of the blower fan can be controlled by furnace temperature with a thermally operated speed-changing pulley. This eliminates a blast of cold air when the system is turned on and the hot over-run at the end of a heating cycle. A thermostatic bellows expands with the heat to shift the unit into high gear. This consists of forcing pulley sheaves to close, changing the position of the unit's V-belt to a larger driving circumference. As the temperature drops, the operation is reversed. A single-speed fractional horsepower motor can be used with this fuel-saving unit.

serrated edges of the wheel, its motion guided machinery which raised or lowered the sand box in the water, thus flushing the tides into the "delta," or drawing them back.

One question had to be answered—would the invading salt water make the transmitted water too brackish for irrigation use? So the water in the tidal chamber had to represent invading salt water, but it could not actually be salt water, because the salt deposits might build up in the channels and alter the hydraulic balance of the model. So they colored the "salt" water blue, and trained a spectrophotometer—which reads colors—on samples taken from the model at many points. For "blueness" they read "saltiness."

Studying both the ways in which they had simulated Nature and the ways in which the model's limitations forced them to deviate from her, the engineers spent many months working with the model to make sure it really represented, on a tiny scale, what happens in the real delta. Questions such as this came up: Surface tension of water could make no difference in the real delta, but, on the model scale, could it cause the water to behave differently? The answer is "no" but it took months, and many experiments in altering the tension in the model, to find out.



Micrometer measures stretch of one of a thousand bolts holding case of Grand Coulee 150,000 hp. hydro-turbine

After more than a year the model had undergone every conceivable check for accuracy. Then the engineers ran off thousands of tidal cycles at the rate of one every 90 seconds, a month's tides in 45 minutes, correlated their data, and had their answer: Natural channels could be used, with minor improvements by dredging. The bureau could safely save \$24,000,000.

Water discharge of proposed Bridge Canyon Dam, to be tallest concrete dam at 736 feet, is studied in model





Saw-toothed wheel above in tide machine forms profile of tides in San Joaquin Delta and enabled engineers to learn if fresh water could be transferred across delta model at right. Wheel controls lifting and lowering of sandfilled box in trough of water, simulating tides. Below, 8000-ft. belt conveyor for earth-fill dam



Such problems are tossed continually at the engineers of the bureau's eight laboratories in Denver, all under R. F. Blanks, chief of the division of engineering and geological control and research. The group of laboratories covers hydraulics, earth materials, microscopic investigations, machinery and metals testing, concrete and concrete materials, chemistry, paint, photoelastic studies, and special engineering investigations.

In constructing huge Boulder Dam, how could millions of tons of "setting" concrete be cooled off quicker than the hundreds of years Nature would take? Special



refrigerating pipes through the huge mass, 570 miles of them, and special low-temperature cements evolved in the laboratory solved that one.

Then there was the long apron of the Grand Coulee. In designing a huge dam which discharges thousands of tons of water each second, the water must be delivered to the channel below as smoothly as possible, or it may eat back under the toe of the structure—as witness the caverns under the lip of Niagara. Original plans called for a long apron. Laboratory studies showed it was possible to substitute what the engineers call a "bucket" instead, at a saving of \$4,750,000.

The bureau has bought nearly \$100,000,000 worth of cement. It tests cement all the time. It has de-

A Billion Dollars' Worth of Dams

are built first in miniature
by ingenious U. S. engineers
whose tamperings with nature
sometimes have strange effects

By Roscoe Fleming

ENGINEERS in the Denver laboratories of the U. S. Bureau of Reclamation—which in its 43 years of existence has built and operates a billion dollars' worth of dams and irrigation works—are constantly facing once-in-a-lifetime problems involving mighty forces and masses of Nature and how to bend them to the service of man. Often it takes more time and ingenuity to set up the machinery, controls and conditions exactly right, than it does later to run off the problem itself.

For example, within a few weeks the engineers simulated more California coastal tide cycles in an artificial delta than Nature had created since man settled there. This was done in the hydraulic laboratory, which always displays something interesting, such as a model for a dam of 1950 to be even bigger than Boulder. To create the delta, the laboratory floor was covered with a huge, delicately modeled relief map of concrete. Many parts of this map had to be accurate to the one-thousandth of an inch.

The artificial delta was part of the planning for the vast \$300,000,000 Central Valley Project in California, which the bureau is building to provide new livelihood and prosperity for hundreds of thousands of people. Essentially, it is designed to move water from the northern end of the great valley

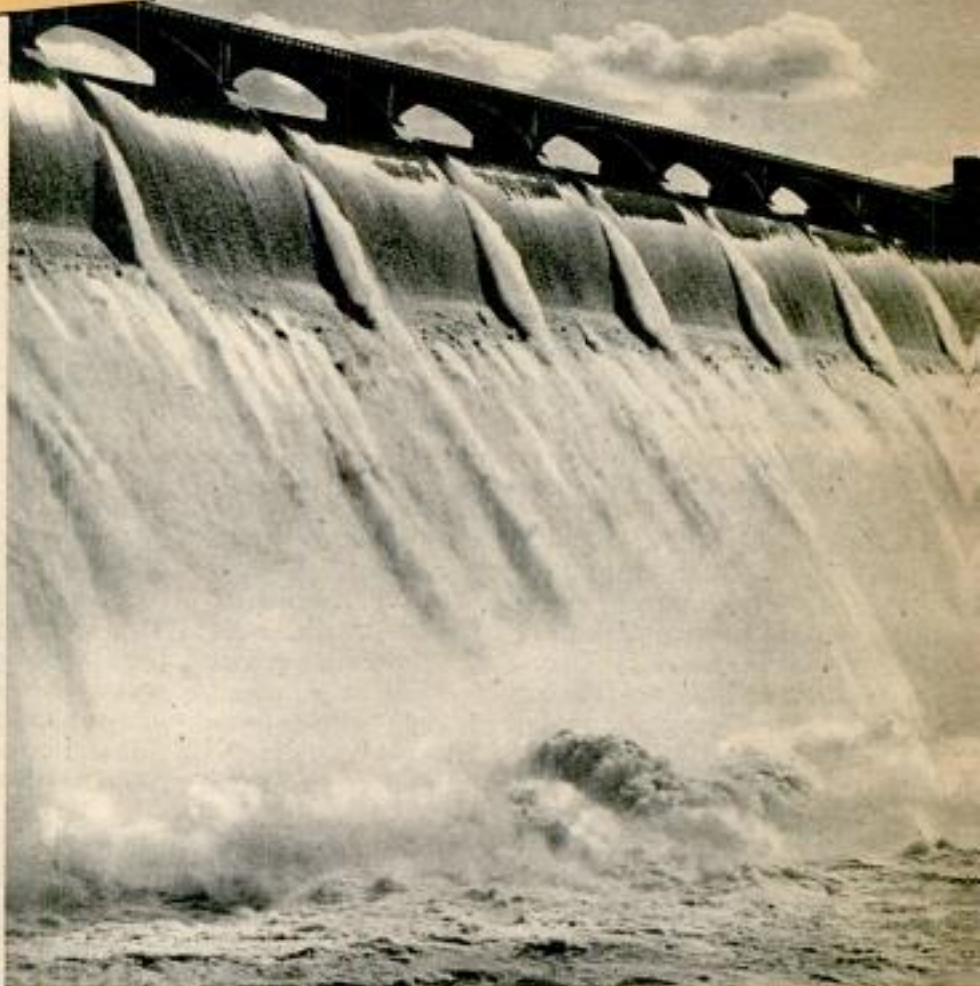

Laboratory shaved \$4,750,000 from cost of Grand Coulee Dam, above. Shasta Dam mockup below preceded real thing by years

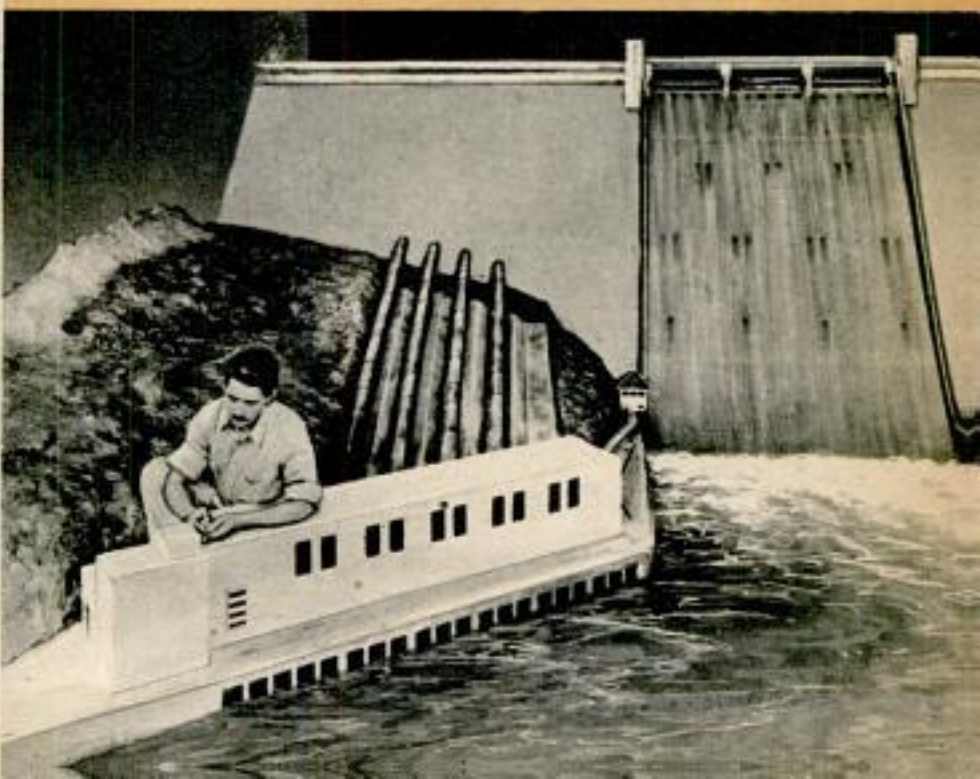

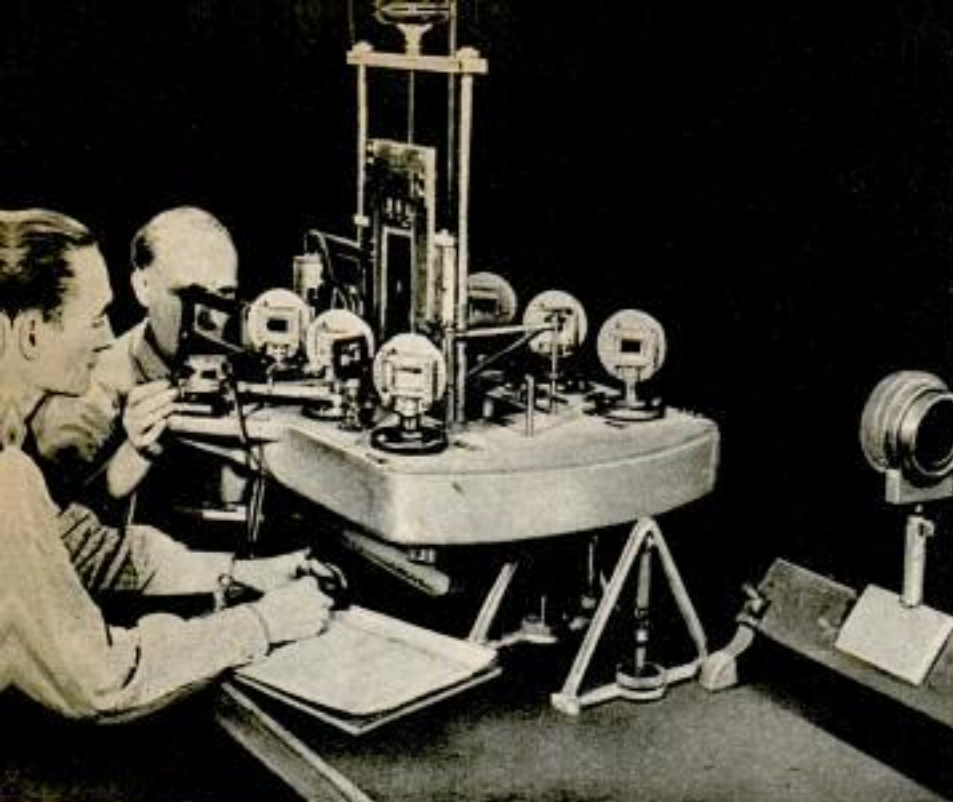

Engineers use photoelastic interferometer equipment in measuring stresses of model representing gallery of a planned gravity dam

to the hot, arid southern end, where it will grow lush crops.

The Sacramento River, from the north, and the San Joaquin, from the south, meet above San Francisco Bay, and thence crawl sluggishly to the bay through a hundred interlacing channels in a 2000-mile-square delta. Could some of these channels be used to transfer billions of gallons of water

deeper water.

Then they had to build a tide machine to reproduce the tide cycle of the upper bay. This was perhaps the most ingenious thing they worked out. The rim of a huge wheel was saw-toothed, in the pattern of the tides of a typical month. Below it in a miniature tidal channel was a huge weight, a box filled with sand. As a cam traveled the

from the northern mountains into the San Joaquin Valley, or would a new canal have to be built across the delta on high ground? The first project would cost \$8,000,000, the second \$32,000,000, and water-users and taxpayers would foot the bill. Experts said the natural channels could be used, but the Denver laboratories were called in for a double-check.

First, the engineers had to lay out the delta channels in concrete. In the space available, a foot of the model horizontally had to represent 4800 feet of the real delta. But vertically, the scale had to be changed to one to 100, since a 50-foot natural depth, let us say, comes out at one-eighth inch when reduced 4800 times, a mere wet smear of no value in studying the behavior of

Dorr clarifier units act as huge brooms in desilting basin, keep silt from flowing into All-American Canal

U. S. Bureau of Reclamation photos





Workmen caulk spillway seams of Shasta Dam. Pipes 15 feet in diameter, upper right, supply generator units

vised ways of making a concrete surface nearly as smooth as velvet, so that water glides along with little friction.

Originally bureau dams were built with an especially rich concrete mixture on the upstream face, to make them as water-tight as possible. Tests proved this unnecessary. And at Shasta Dam there was thought to be no satisfactory gravel nearby. The laboratories came up with the answer—special treatment of an aggregate so near that the gravel could travel to the dam by conveyor. This saved \$1,385,000.

In the concrete laboratory a huge press that can exert 4,000,000 pounds of pressure crunches concrete cores into fragments as engineers measure stresses and strains. Here also cycle after cycle of freezing and thawing, wetting and drying, test ability of concrete to "take it."

In a room beyond, an engineer may be fitting a

wooden model of a 108,000-kilowatt generator, in a tiny powerhouse like a doll's house, to check the design of a power plant of 1960. But new dams such as the contemplated Bridge Canyon Dam just below the Grand Canyon National Park, higher than Boulder, will have the powerhouses buried deep within the dam structure itself, for economy of design and for protection against possible bombing.

(Continued to page 148)

Elasticity of concrete gets a test in a 4,000,000-pound hydraulic compression device



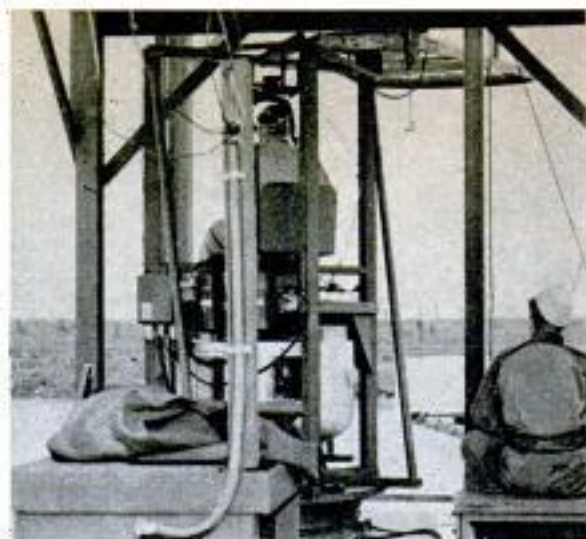
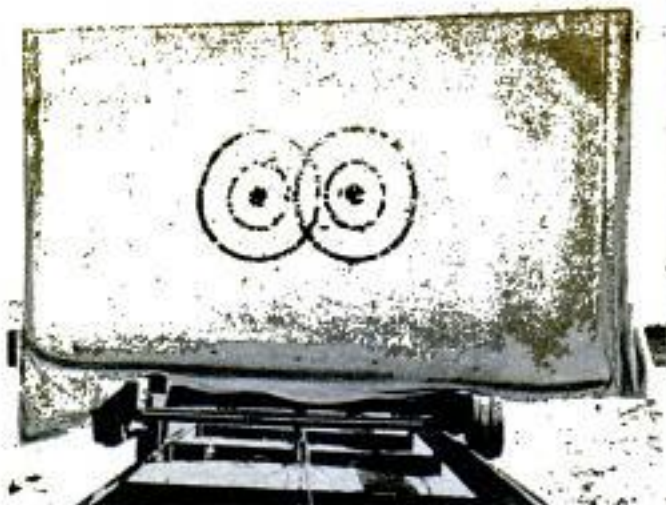

Bull's-eyes—one for each turret gun—are perforated by bullets as gunner (right) sights at plane below

Twin Bull's-Eyes Record Hits

Aerial gunners fire live .50-caliber machine gun bullets in an electric trainer at Avon Park Air Field, Fla. Built to train bomber crews, the new trainer has a platform with gun positions duplicating those on a Flying Fortress. A ball turret gunner, for example, is trained in that position on the platform. The gunner aims at a miniature plane suspended from an oval track. This target flies toward and away from him, simulating the movements of an attacking fighter. When the gunner fires, the bullets from his two machine guns crash into a target with twin bull's-eyes—one for each gun—located on a track 50 feet away.

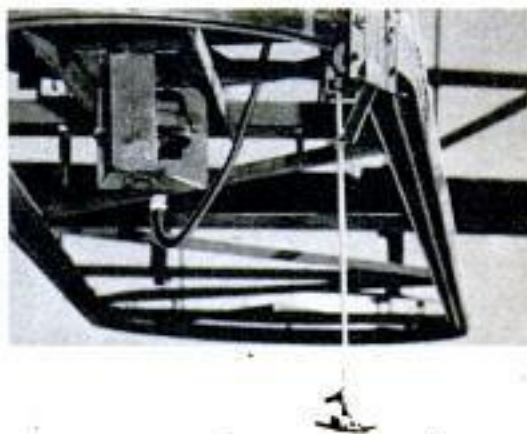

Plant Broadcaster in Single Unit Has Built-In Phonograph

Packaged into one compact unit, a plant music broadcasting and paging system now available requires only 22 inches of floor space. Servicing up to 100,000 square feet of a plant with 20 to 40 loudspeakers, the combined unit is intended to broadcast music to plant workers, make routine announcements, and locate key workers by paging. It has a built-in phonograph that provides continuous music for a half hour, automatically playing ten 12-inch or twelve 10-inch records. During paging, the music volume is lowered, but not entirely discontinued.

Sulfa 'Bandage' Poured on Burns

Sulfagel, a new liquid sulfa "bandage" for burns, forms a germ-tight, transparent coating that lets the physician watch healing progress without exposing the burned area, the *Journal of the American Pharmaceutical Association* discloses. Pharmacists tried 64 formulas before finding the best combination, which is essentially sulfadiazine, a form of gelatin and water.

FLYING COMMAND POST



Two of Mercury crew operate radio station, above, as officer in background uses land line telephone. Right, member of crew during a test of the radio equipment

H EART of a flying command post from which the Southeast Asia Command headed by Admiral Lord Louis Mountbatten conducted the successful Burma campaign of 1944-45 was a complete radio station installed in the Mercury, a C-47 cargo plane. The standard U. S. Signal Corps transmitter and receiver was the first such equipment to be permanently housed in aircraft for use on the ground, says the Army Air Forces, which outfitted the plane and supplied a crew from Wright Field, Dayton, Ohio. As soon as the C-47 had landed at an advanced airfield or other point on the front, power plants were turned on and radio operators began sending messages to forward units and receiving information on progress of the fighting. Using the installation, Lord Mountbatten maintained communications with combat commanders more than 1500 miles away during the campaign. In addition to technical apparatus, complete living facilities were carried in the flying command post, including gas stoves for preparing food and cots on which the personnel could sleep.

Starting up power plant, which was connected to tail of plane



Mercury operators install a set in a jeep for local use, above. Below, working on plane aerial and ground



Saved by the Silk

Parachutes have saved many lives even when the flyers haven't had to bail out and yank the rip-cord. The chute itself is one of the greatest survival aids an airman can have. Among emergency uses developed and tested by the AAF's Tactical Center at Orlando, Fla., are travel packs, signals, shelter, clothing, hunting and fishing equipment and innumerable devices to give first-aid



SUN PROTECTION



SANDAL

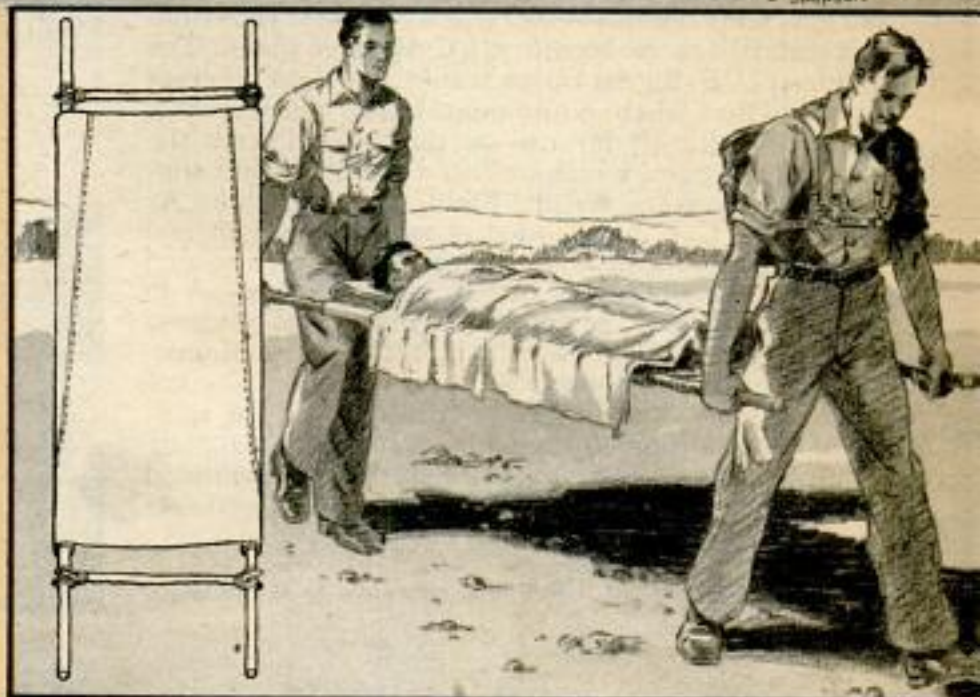

With a rectangle of chute cloth about 3 panels wide and 6 feet long, a simple litter is improvised. Cloth is rolled tightly on stout poles



RAFT SAIL

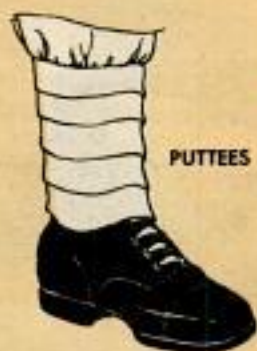

PUTTEES



SHADE HAT

TRAVEL PACK
AND SPLINT



BED
ROLL



FISHING
SEINE

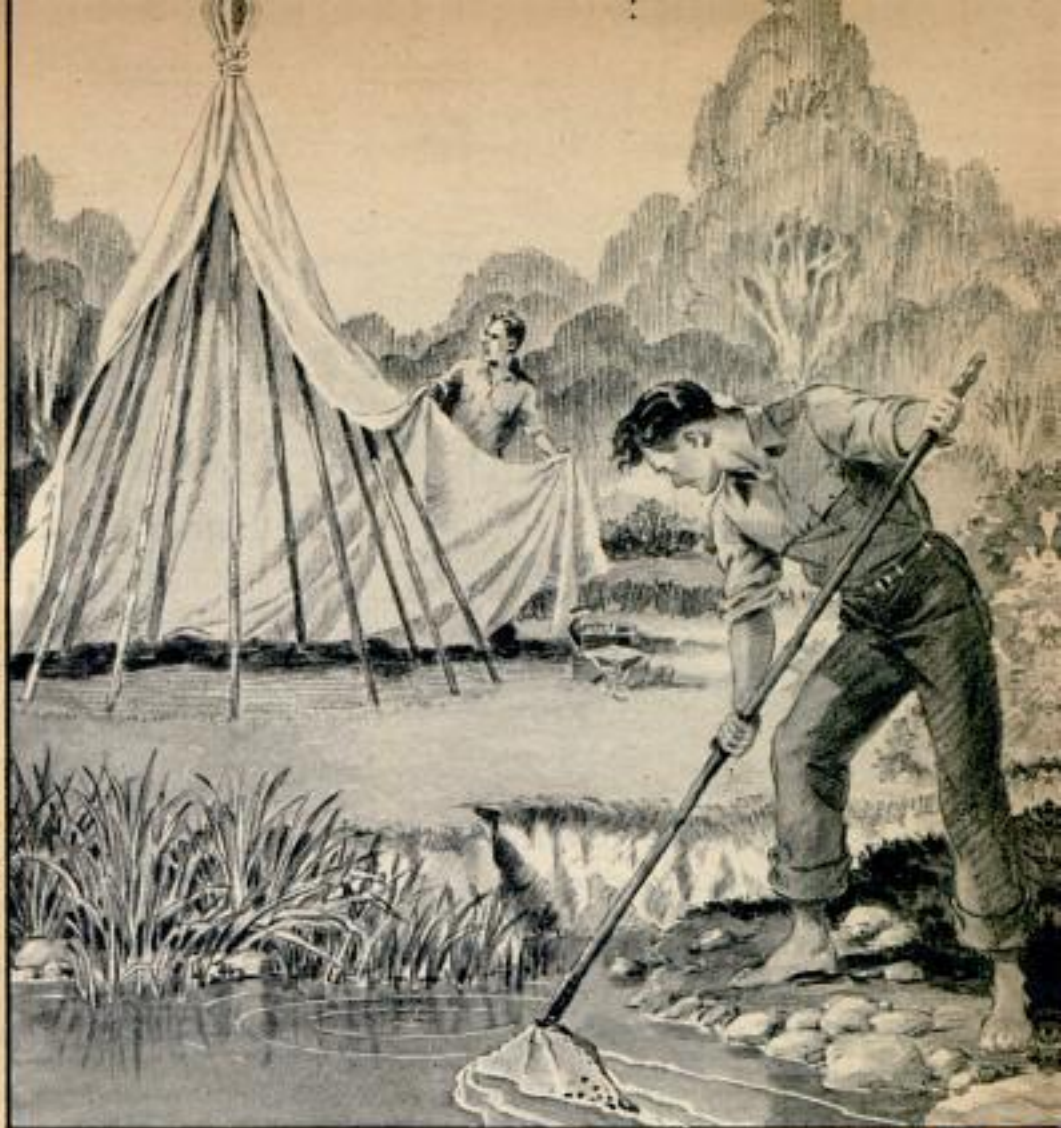

Pole paratepee and hand net for fishing, above, provide shelter and food. Paratepee takes 11 poles about 14 feet long, allows 3 men to sleep comfortably. Fire can be built inside. Frame of hand net is made from heavy wire of pack frame. Below is shelter using shroudline for ridgepole. Spread-out chute is ground marker. Small pieces also serve as signals





Golf Ball Harvester Thousands of golf balls are picked up in a few minutes at a practice driving range near Los Angeles with an ingenious "harvester" attached to a motorcycle. It consists of a series of thin wooden disks placed close enough together to pick up a golf ball. As the disks rotate, wooden tongues disengage the balls and they fall back into a collecting trough.

Russians Report Restoring Life to 12 of 51 Fatally Wounded Soldiers

Supplying oxygen direct to the lungs by a pulmotor and injecting blood into a vein and an arm artery in the direction of the heart has restored life to 12 of 51 fatally wounded Red Army soldiers, according to an article in the American Review of Soviet Medicine. The method furnishes nourishment to the heart muscle, the article declares. A private declared dead was giv-

en the treatment three and a half minutes later by a specially trained group of doctors; in about a minute his heart started to beat, and after three minutes breathing began, according to the Review. The soldier regained consciousness in an hour, and is reported alive and well today after 18 months, under observation at the All-Union Institute.

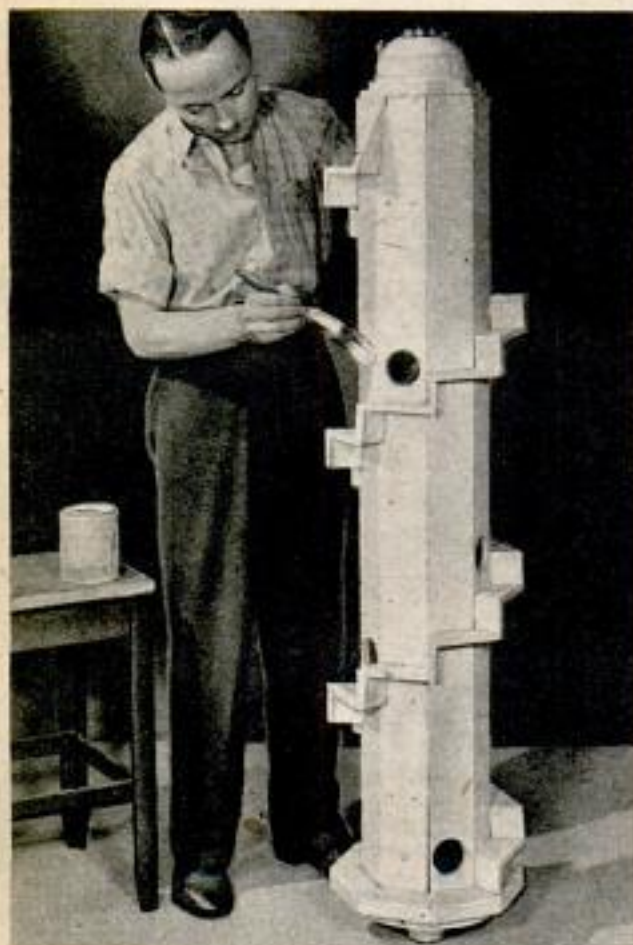

Eight-Room Martin "Penthouse" Is Built Like a Tower

When many martins fly north next spring they will find their postwar housing problem already solved. A new house which is built like a tower has been designed by a Minneapolis business executive. It has eight compartments and a winding stair which circles the tower. The martin tower requires no special tools to build.

Vibrator for Hydraulic Press

Any number of repeated pressure strokes can be applied automatically by the ram of a hydraulic bench press using a newly developed vibratory hydraulic pressure principle. Pressure on a hand or foot control lever causes the ram to descend from its full upstroke limit and make short, repeated automatic full pressure strokes until the operator releases the control lever. Pressures can be preset for any degree between 1600 and 8000 pounds. With an automatic cycling device, the ram makes any preset number of uniform pressure strokes. The vibratory principle adapts the hydraulic press for high-speed stamping, forming, forging, riveting, broaching, trimming and kindred processes.



Life Jackets Run Obstacle Course In Circular Testing Tank

Buoyancy and wearing qualities of life jackets get a rigorous test in a circular tank fitted with an obstacle course, developed by the Coast Guard Research and Development Division from an idea suggested by A. F. G. Lucas of the National Academy of Science. Five jackets, fitted on dummies and suspended from steel arms, can run through the tank in one test. A three-horsepower electric motor drives the jackets around the obstacle course at three speeds, running, swimming, and walking, operating much like a merry-go-round. The jackets, containing fillers of kapok, fibrous glass and treated cotton, are removed from the tank at intervals of 15 minutes, weighed to determine loss of buoyancy, and examined for other signs of deterioration.

Life jackets running through obstacle course, above left. Sailor, above right, prepares a jacket for testing. Right, weighing jacket for buoyancy loss



Dial Adjusts Cooker's Pressure

Pressure can be adjusted instantly to 5, 10 or 15 pounds by turning a dial knob on the cover of a cooker. The desired pressure is maintained throughout the cooking without change. The cover has a long handle to lock it against a gasket seal and to help remove the hot cover. Big enough to hold four quarts, the cooker also can be used for pressure canning.

IT TAKES 25 TONS of blueprint paper to construct a battleship. It takes seven pounds of kraft paper, three pounds of book paper, for each Signal Corps radio set. It takes your help in saving waste paper, for paper is still a No. 1 War Material Shortage!

"IT'S IMPOSSIBLE BUT WE'LL TRY IT!"

PART 2



For desert rescue with a blimp, Rear Admiral Rosendahl pins the DFC on Lieut. Peter Culbertson. Below, Marine flyer rescued at sea is removed from airship

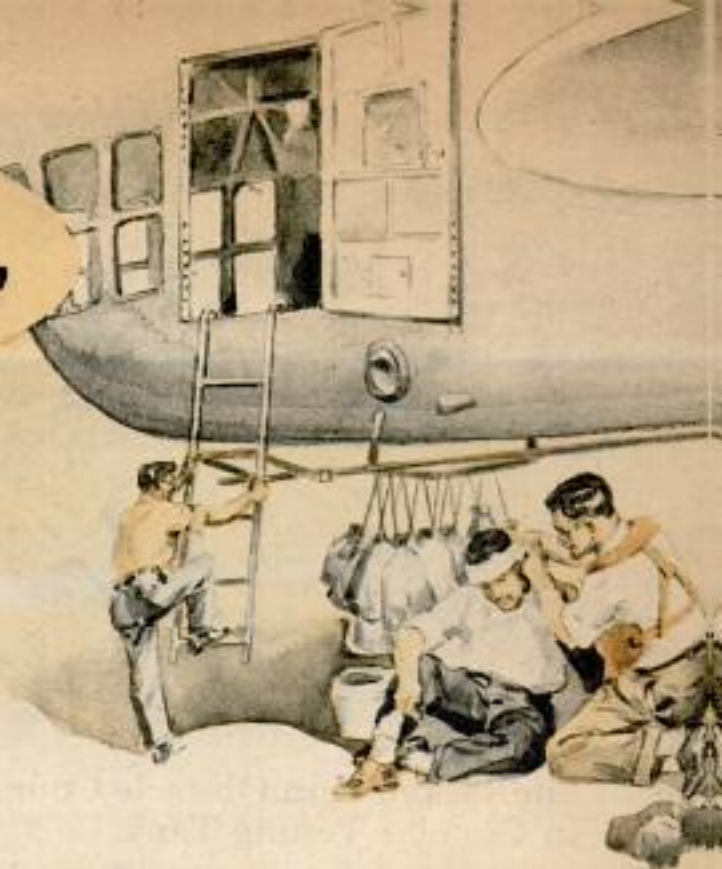

By Thomas E. Stimson, Jr.

TO ATTEMPT the impossible—the rescue by airship of two Navy flyers, one of them injured, who had parachuted into the blistering sands of Imperial Valley in California—there could have been no better choice than Lieutenant Peter Culbertson, USN, of Blimp Squadron X.

Receiving a call for help from Holtville, about 20 miles from where the flyers had hit the silk, and from which rescue parties tried in vain to penetrate the desert heat, the coast blimp station said: "It's impossible, but we'll try it." And Culbertson, hero of legendary blimp exploits, was assigned to command the rescue airship and a picked crew. Ensigns Herman K. Calahan and Alfred J. Hoffman were chosen as pilots; John Ralph Caver and Herbert W. Wilson, chief machinist's mates; Leonard N. Craig, Jr., airship rigger; Ollie Webb, aviation machinist's mate, and William N. Crow, pharmacist's mate.

They flew a standard K airship, 257 feet long, inflated with 500,000 cubic feet of helium. Aerial patrol operations since early in the war proved this type to be rugged and reliable. Nonrigid, it has no internal supporting structure.

Culbertson headed for San Gorgonio Pass, a pilot's headache that cuts through the mountains near Palm Springs. The prevailing westerly wind from the ocean drives into it, speeds up, and then boils with turbulence when it meets the hot light air of the desert. Flying is rough in the pass for even a heavy airplane and

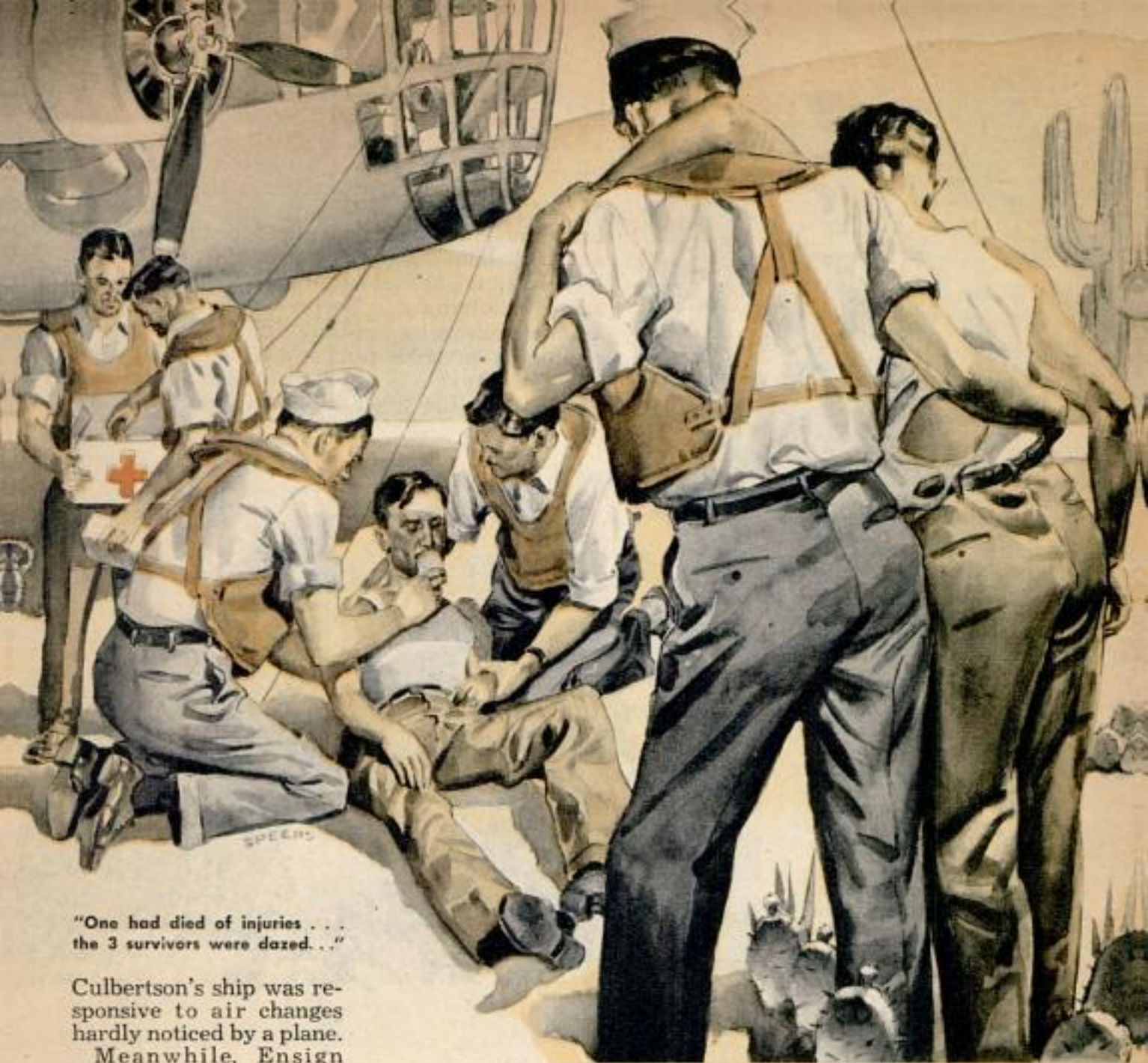

"One had died of injuries . . .
the 3 survivors were dazed . . ."

Culbertson's ship was responsive to air changes hardly noticed by a plane.

Meanwhile, Ensign Clement G. Williams and Ensign Ivan J. MacMahon, experienced ground officers, left the air station by airplane for Holtville. They would organize a ground party to handle the ship if Culbertson decided to land at the Holtville field.

In San Gorgonio Pass the blimp sped along with a tail wind that brought its speed up to 100 knots. It yawed wildly from side to side in the rough air and thermal currents boosted it straight up at a 2000-foot per minute rate. Culbertson blistered his hands on the control wheel as he fought to prevent the elevatorlike ascents. Meanwhile he had valved helium until he had transformed his ship from lighter-than-air to heavier-than-air.

An airship is a composite machine, part balloon and part airplane. Its basic lift is provided by the gas that distends its enve-

Ground crew fastens airship's nose to mobile mast

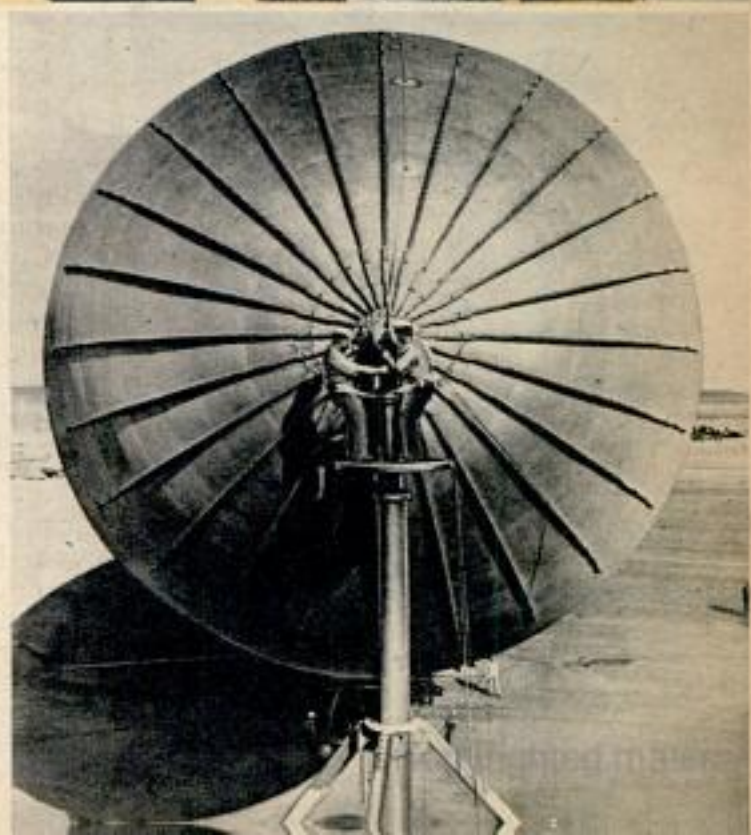



Wearing Mae West life preserver, airship's pilot grasps rudder control wheel while getting a report by intercom phone from aft lookout in cabin

New M-1 blimp, right, is largest nonrigid airship. It's composed of 3 connecting units. Electric stove heats coffee for crew, below

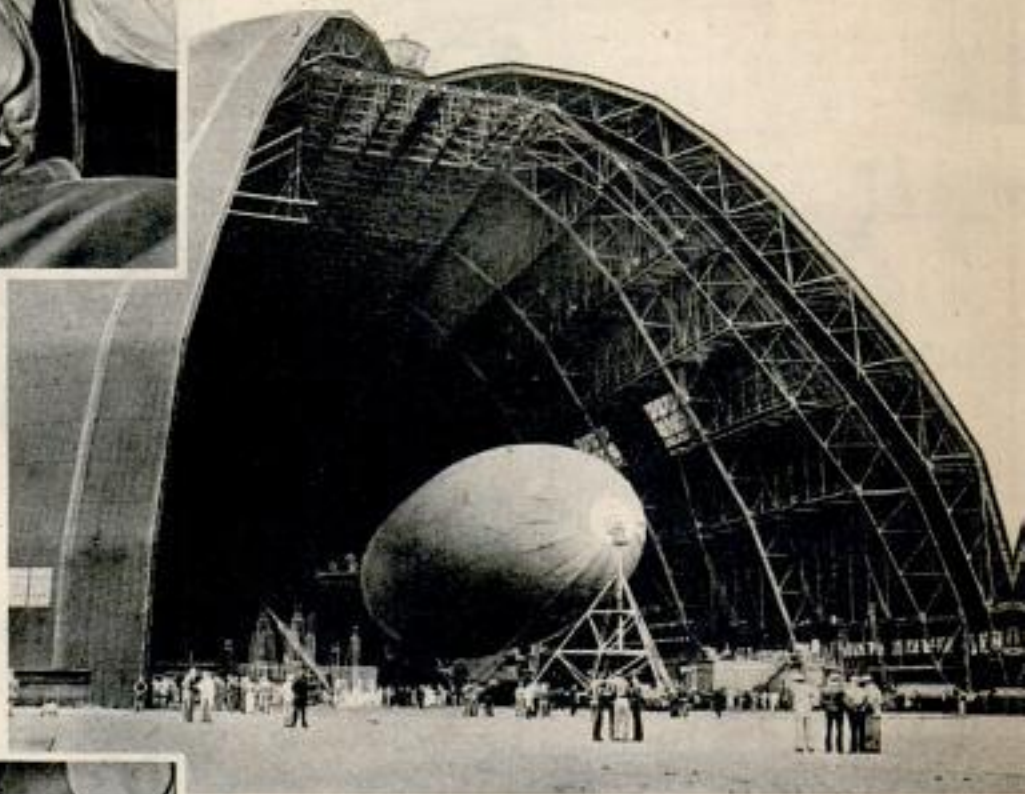

lope and it obtains additional lift from dynamic forces when driven ahead by its engines. Thus an airship frequently takes up a load that it could not lift by buoyancy alone. In that condition it depends on its engines for remaining aloft.

That was the situation in the pass. The airship had climbed to an altitude of reduced air pressure and its helium gas was expanding. A child's balloon, released, ascends until it bursts from expansion of its internal gas. Such a catastrophe is avoided in an airship by releasing part of the gas when its internal-pressure reaches a certain point. This allows the airship to fly safely at high altitude but also reduces the ship's lifting capacity. Culbert-

son's ship was 3000 pounds heavier when he emerged from the pass. He flew over the date palm groves of Indio, skirted the Salton Sea and arrived over Holtville.

From there a Navy plane, its pilot talking by radio, escorted him on the last lap. Over the sand dunes the plane dipped and pointed out the spot. Culbertson moved in, going down to 400 feet for a close look. One Navy flyer was sitting on the sand, supporting the other on his lap. Two Navy men who had persisted in a rescue attempt on foot were just arriving, 100 yards away.

It was now 5 p.m., but the temperature had dropped only a few degrees from a probable 131. The "hot stove" effect from the torrid ground made the airship hard to control. Instead of gently rolling dunes the terrain consisted of large sand hills with steep wind-drifted sides. Only one spot, half a mile away, appeared at all suitable for a landing. Culbertson decided to drift down to the pair who were moving and ask them to bring the others to that location.

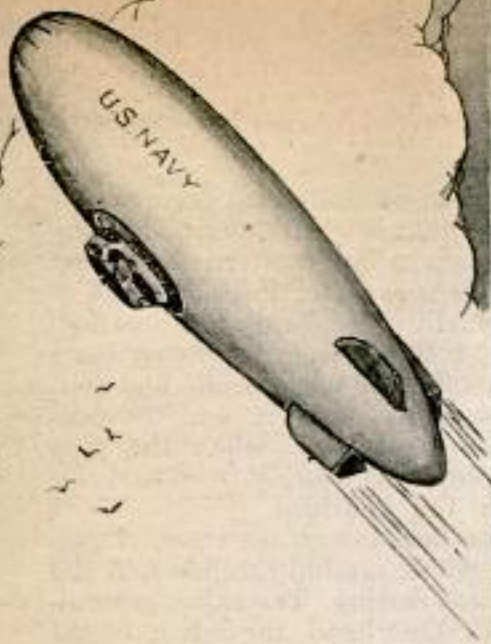

Mechanics on catwalk service engine and supports. Drawing shows how skipper proved an airship can climb

First he had to lighten ship. Gasoline consumption since leaving the pass had reduced the weight somewhat but the ship was still hundreds of pounds too heavy for a slow landing. He moved away, jettisoned fuel, and brought the ship nearly into equilibrium with the air. The ship nosed down, touching its landing wheel on top of a mound over which the two men were plodding. Culbertson shouted and one of them turned with an incurious stare, then moved on. Neither man seemed to grasp the fact that an airship was practically forming a roof over their heads. They were just about out on their feet.

Culbertson gunned the engines and climbed away. There appeared only one solution, a controlled crash landing. He told the crew he would try to make a hard spot landing, with the possibility of damaging the cabin. It was worth the chance.

On the home field blimp is fastened to mobile mast

He killed the starboard engine on the approach, headed across a valley toward a ridge, and killed the other engine. The forward end of the cabin plowed into the dirt, scooping it up until Culbertson and Calahan, at the controls in the forward lookout, got their shoes full of sand. The airship stopped and helium was valved to hold it there.

Meanwhile, the four men on the ground had joined company. Two became aware of the blimp and staggered to it. They were too weak to step up into the cabin without help. Crew members went to the remaining pair and led one back, carrying the other. Pharmacist's Mate Crow found that the latter had died of his injuries and the heat only a short time before. The three survivors were dazed, as if in the twilight stage of anaesthesia.

The situation of rescued and rescuers



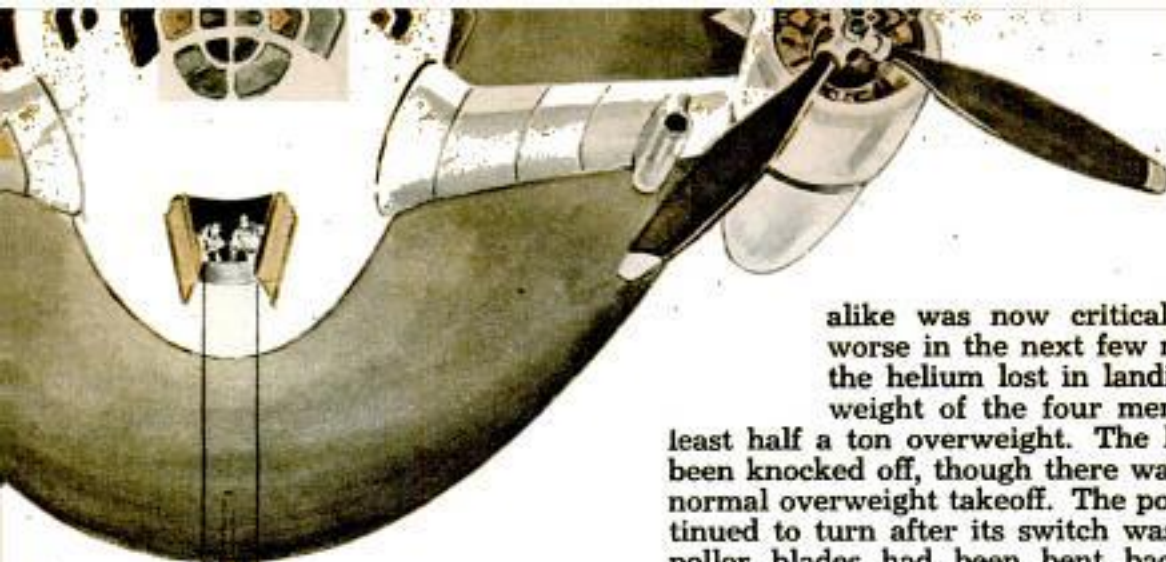

alike was now critical and became far worse in the next few minutes. Counting the helium lost in landing and the added weight of the four men, the ship was at least half a ton overweight. The landing wheel had been knocked off, though there was no runway for a normal overweight takeoff. The port engine had continued to turn after its switch was cut and the propeller blades had been bent back when the ship crashed. High test gasoline was leaking from fuel line connections loosened in the smashup.

While Culbertson was considering these factors and the rescued men were receiving first aid in the cabin, the whole airship lurched and slid slowly from the prominence on which it was resting. The cabin grounded in the bottom of the adjoining ravine. Overhead, the fabric of the envelope rested on the side of the hill, rubbing against the slope as it swayed in the hot air. The big airship, almost the size of a destroyer, was now in an apparently hopeless position.

His crew looked sick and Culbertson realized that they—and himself—needed action, at once. "Fellows, there's a lot of junk on this ship I never did like. Now's our chance to get rid of it. Come on, let's lighten ship!" Stocky, with the powerful arms of a wrestler, he ripped the metal cabin door from its hinges and pitched it away. Two men laughed and bent over the galley range. Out it went. Chairs, life jackets, overhead sleeping bunks, smoke flares, the emergency rubber life raft, everything that was loose or could be loosened was thrown out on the sand.

Culbertson had a plan that might work. He knew that the ship was sturdy enough to take the beating he was going to give it. First the port engine was cranked but it failed to start. The starboard engine, however, started at once, and Culbertson gave it full power. The ship



How lifesaving gear of blimp works is shown in drawing at left. Line with life ring passes through cabin, has bags of sand as counterbalance. Right, blimp spots crash victim, drops food and raft

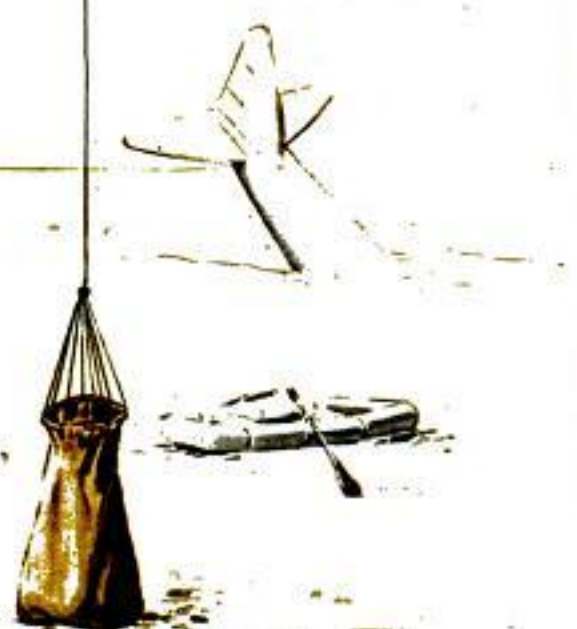

dragged itself along the ravine sluggishly, hit hard and bent back the tips of the thrashing propeller, then bounced up into the air. It drove ahead, hit again, and made a final bounce, clearing the rise in front of it with two feet to spare. Culbertson nosed down again at once to get the long tail over the same obstacle.

The rest is anticlimactic. The airship proceeded to Holtville on one set of bent propeller blades, discharged the people and the body it had picked up, and refueled. Propellers were taken from two airplanes to replace both sets of bent blades and the port engine was restored to use. Still heavy and without its taxi wheel, the ship was heaved up into the air by the ground crew at the command "Up Ship!" and began its all-night return trip to the coast.

Culbertson got a medal for the desert rescue but a week later things were back to normal. This time he frightened some passengers, heavier-than-air pilots, half out of their wits. There had been some supercilious remarks about rates of climb of airplanes versus airships. And someone had patted the side of the cabin. "Nice old sausage. Good old blimpsey."

Ace waited until he was 150 feet off the ground, just high enough to avoid bumping his tail. Then he wound the elevator wheel all the way back and held it there, pointing the ship's nose practically straight up. The passengers were tumbled backward to the rear of the cabin, just the spot they wanted anyway, because that's where they had left their chutes. Now they were fighting to get them on. Any plane pilot knows that you can't point an aircraft's nose straight up, close to the ground, at slow speed, and walk away from the wreck. Ace is still chuckling over their reaction in his airship.

He got his Air Medal for a rescue in May 1944, under circumstances opposite to those of the desert rescue. He was on ordinary patrol offshore. The day was cold and blustery, with a heavy sea and a 30-knot wind. Culbertson's radio operator picked up a message that two aircraft had collided at sea about 100 miles away.

Ace headed toward the area and went down low. It wasn't long un-

"Bombsight" For Centering Drill Is Accurate to .001 Inch

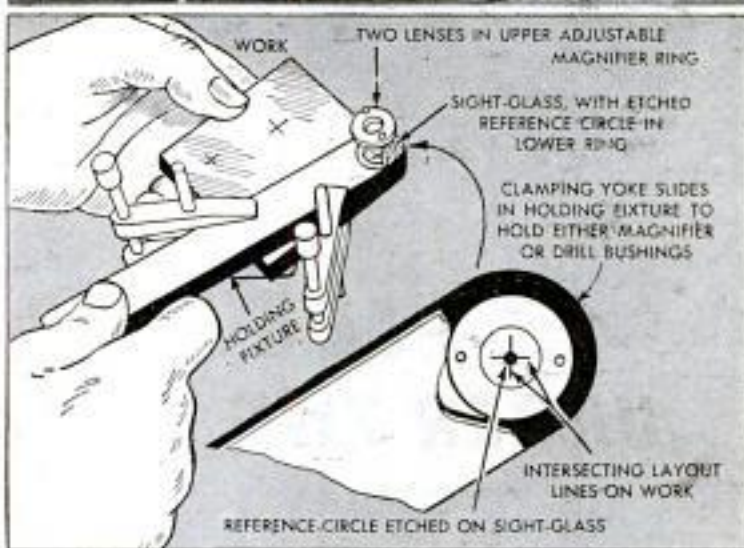
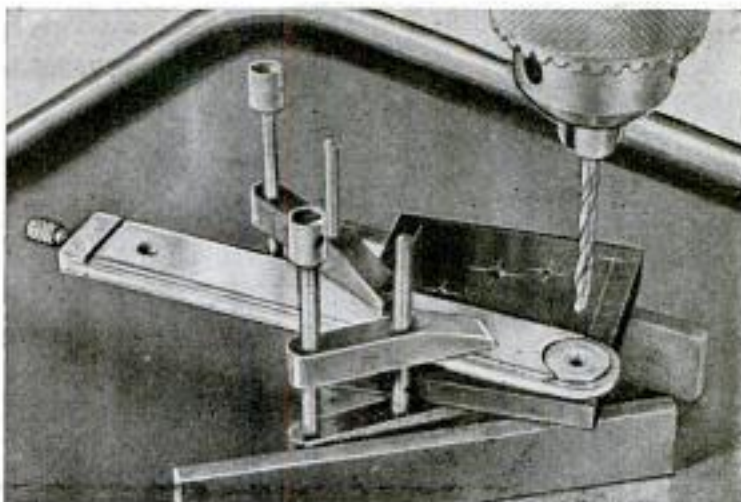

Holes can be drilled swiftly and accurately with an optical center locator which saves time in construction of tools and dies. After work has been laid out carefully, a compound magnifier is clamped over the holding fixture and moved slowly over the intersecting layout lines. When the reference circle etched on the sight glass is centered exactly over the layout lines, the holding fixture is clamped to the work. The magnifier then is removed and the correct drill bushing substituted. Holes can be located and drilled easily within tolerances of .001 inch.

til a lookout sighted a patch of marker dye in the water, with a man in a life raft in the middle of the patch. Some distance away a PBY flying boat also was conducting a search.

Today, all blimps are rigged for air-sea rescues. The lifesaving gear consists of a sea anchor to moor the airship to the ocean, and a large life ring secured to the end of a line. Several bags of sand form a counterweight at the other end and the line passes through the cabin. With these devices an airship can pick people up without difficulty under any condition of wind or sea.

But no airship carried this gear 18 months ago.

(Continued to page 150)



Fleet Admiral Nimitz reviews Royal Marines on British ship

the Jap-held Sakashima Islands while American soldiers and marines poured ashore in the attack on Okinawa. The second chance came in July when the Royal Navy teamed up with the powerful U. S. Third Fleet under Admiral Halsey to work over the Japanese home islands.

Both operations were missions of honor and revenge. Prime Minister Churchill had pledged the full weight of British strength to help destroy Japan, and every man-jack in the task force was eager to avenge the disastrous sinking of the battleships *Repulse* and *Prince of Wales* off Malaya shortly after Pearl Harbor.

Queen of the seas for 300 years, the Royal Navy has always been known in Anglo-American naval circles as the "senior partner." In its first Pacific operation against the Japs, it found itself inferior in numbers and experience to the colossal U. S. Pacific Fleet which had been locked in com-

FLEET UNDER TWO FLAGS

THE JAPS are said to love fireworks, but they didn't care much for the show put on by Admiral Halsey's mighty Third Fleet last July. Steel mills and factories were blasted by 16-inch naval gunfire, railroad ferries and ships were sunk by torpedoes, and grounded aircraft and hangars were wrecked by more than 1000 carrier planes.

It was even worse when the Navy announced that the British Pacific Fleet had participated in the raid upon Japan's "sacred soil" with a sizable force of carriers, battleships, cruisers and destroyers.

In a nutshell it meant that the world's No. 1 and No. 2 navies had pooled strength to hammer land and sea targets of the treacherous nation which once had possessed the world's No. 3 navy.

Earlier in the year, when it was first announced that the British Fleet was going into action in the Pacific, the Jap radio taunted the Royal Navy, calling it "more of a liability than an asset. . ."

Hard-bitten British officers and seamen from the country that produced Lord Nelson said nothing as they prepared their ships at Australian bases. They knew they'd get their chance later.

The first chance came in March when a British task force sailed out from a secret United States base and pounded

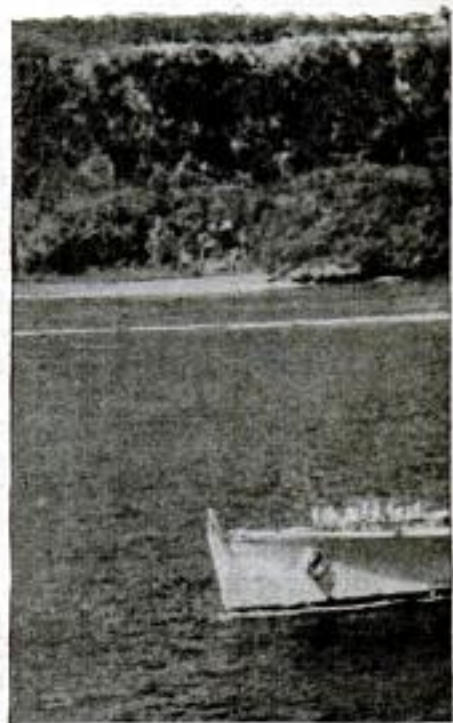

bat with Jap sea and air power for many months. It is true that elements of the British Fleet had fought the Japs around Singapore and the Dutch East Indies in the early part of the war while the British East Indies Fleet had battled the Nips from Ceylon to Java. But last spring marked the first time that a British task force had gone after the Japs in Western Pacific waters.

The British Pacific Fleet was a formidable outfit by any standards. It included such mighty battleships as the King George V and such aircraft carriers as the Illustrious, the Victorious and the Indomitable. Its strength in smaller warships was no less impressive—including such cruisers as HMS Black Prince, HM Canadian ship Aganda and HM New Zealand ship Gambia, and such destroyers as Troubridge, Tenacious and Termagant. It was a well-balanced and hard-hitting outfit.

HMS King George V steams majestically into harbor at Guam U. S. Navy photo



British official photos

Jap suicide plane crashes on deck of British carrier during operations against Sakashima Islands supporting U. S. Okinawa campaign. Below, another carrier hit in same action. Both resumed operations in a few hours

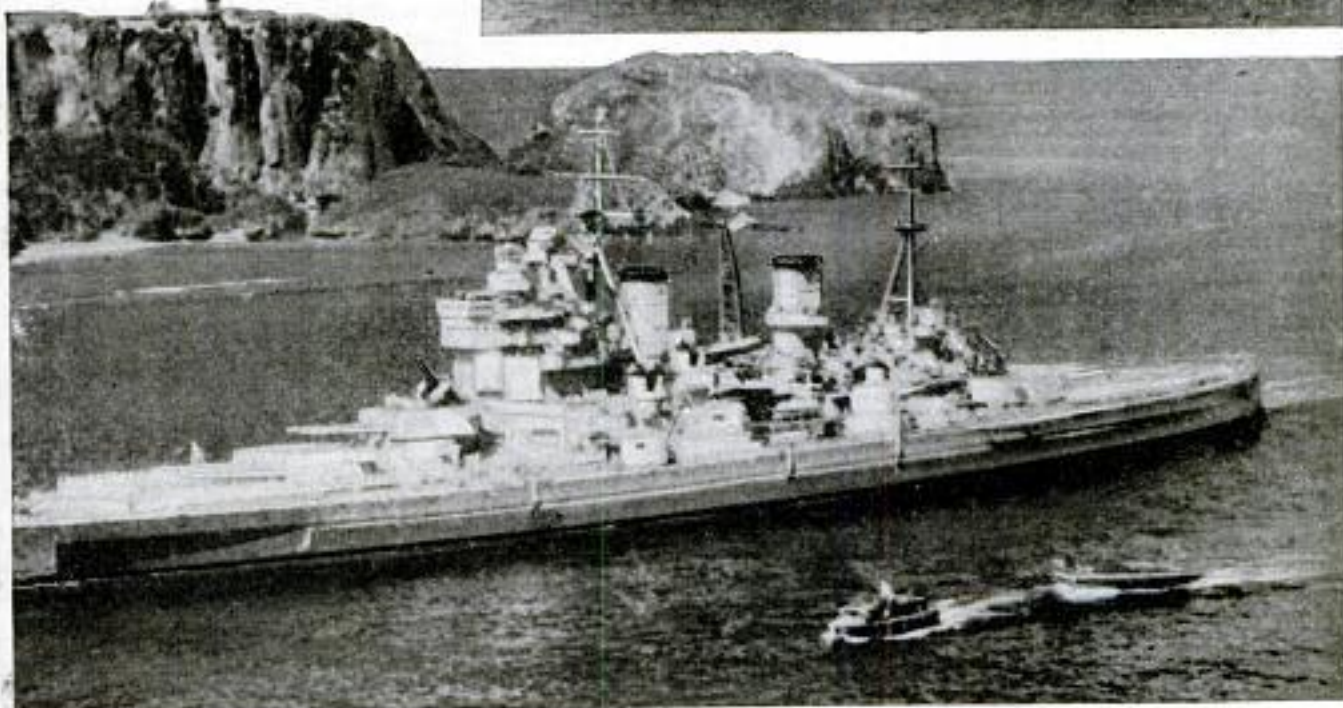

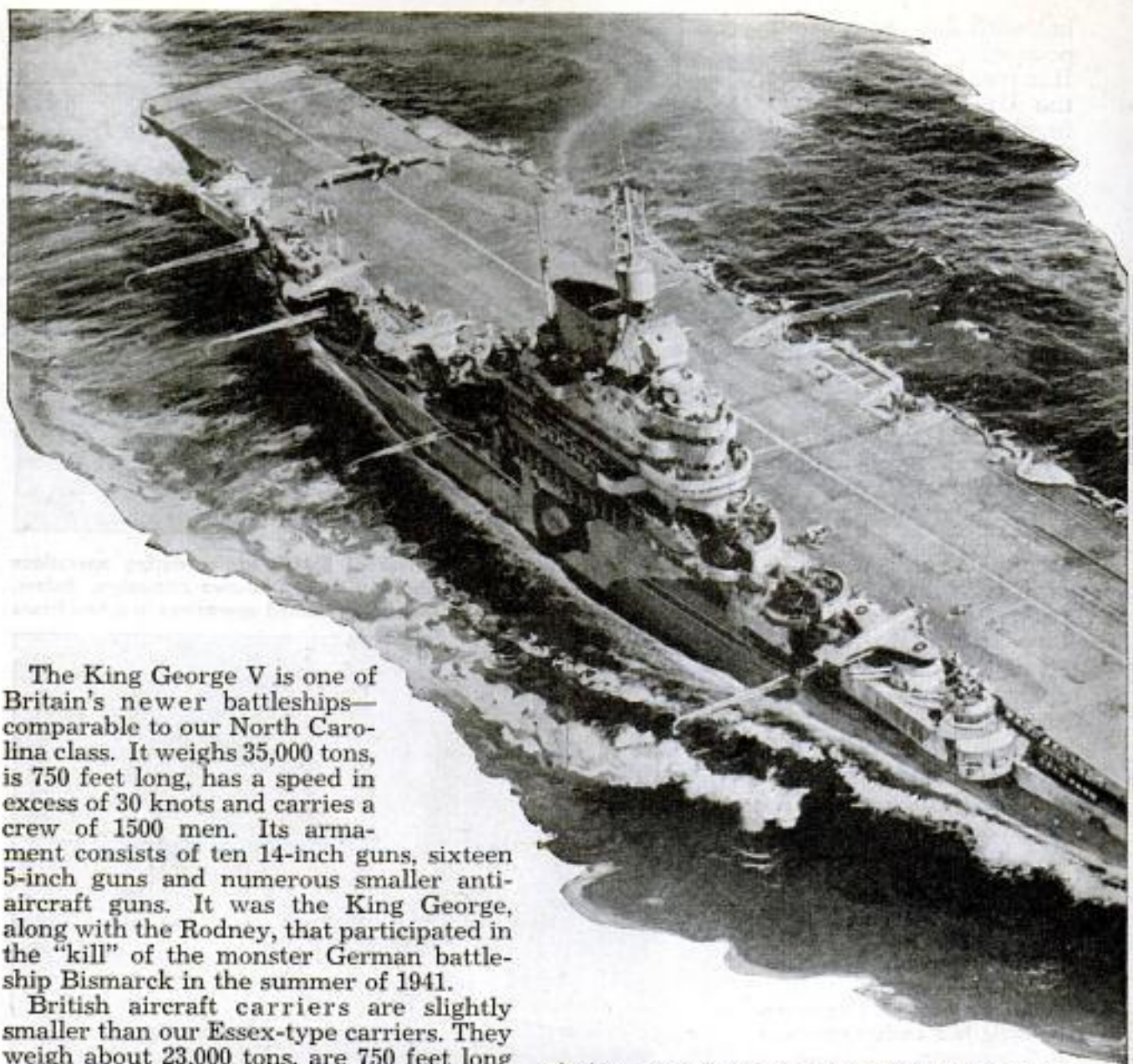

The King George V is one of Britain's newer battleships—comparable to our North Carolina class. It weighs 35,000 tons, is 750 feet long, has a speed in excess of 30 knots and carries a crew of 1500 men. Its armament consists of ten 14-inch guns, sixteen 5-inch guns and numerous smaller anti-aircraft guns. It was the King George, along with the Rodney, that participated in the "kill" of the monster German battleship Bismarck in the summer of 1941.

British aircraft carriers are slightly smaller than our Essex-type carriers. They weigh about 23,000 tons, are 750 feet long and carry approximately 70 planes. The Illustrious joined the British Fleet in 1940

The bow view above of HMS Indomitable was made from one of her planes. Below, British fleet train delivering supplies. Cruiser (center) is taking on fuel



and participated in the victory over the Italian Fleet at Taranto in November of that year. Planes from the Victorious helped to cripple the Bismarck in the North Sea. The Indomitable set out for Ceylon early in March 1942, and arrived just in time to beat off an attack by 100 Jap planes.

The crews aboard these ships are also veterans and come from all parts of the British Empire.

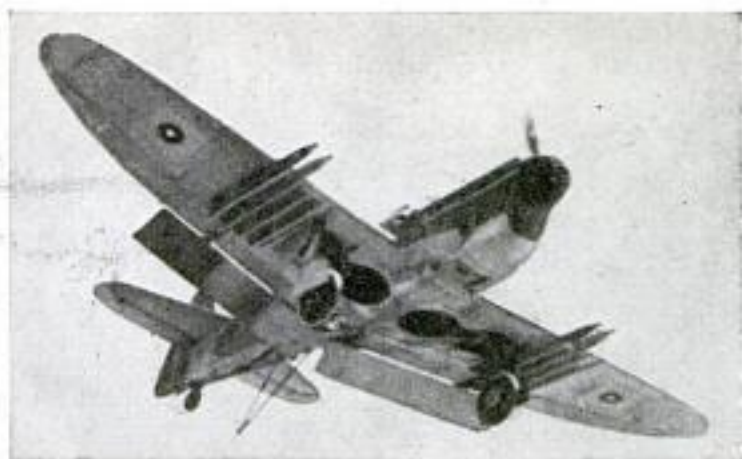

Rocket-carrying Firefly also has four cannon. It can fold wings back (below) to occupy small deck space



There are battleship officers from England, Wales and Scotland, flyers from Canada and South Africa, cruiser men from Australia and destroyer men from New Zealand. One ship even carries a lookout whose green turban wound tightly around his head marks him as a Sikh from India.

En route to battle, war correspondents and United States liaison officers were intrigued with the ancient seagoing custom of serving lime juice every morning at 11 and were delighted to discover the reason why British sailors are known the world over as "limeys."

Food was typically British: sausages, tea, toast and marmalade for breakfast; cold mutton and cheese for lunch; steak and kidney pie, mashed potatoes, brussel sprouts and currant tart for dinner. And of course there was always afternoon tea with bread, butter and raspberry jam.

During off-duty hours, officers played

shove half-penny, an old English pub game, or read copies of the London Illustrated. Enlisted men spun yarns, tossed darts or quoits, and played tombola, the only gambling game allowed in the British Navy.

But as the British task force approached its assigned target, a tenseness spread through the ships. Pilots of the combat air patrol kept a sharper lookout for any signs of Jap planes or ships; plotting room operations became more precise; "battle messing" was put into effect and men were served at their gun and lookout posts instead of in the mess hall.

The first operations against the Japs would be a test and every British sailor—from admiral to apprentice seaman—was aware of it. It was a test not only of courage and skill in battle, but an acid comparison between the "senior partner" and the veteran, battle-tough U. S. Pacific Fleet.



British Seafire is carrier-borne version of the famous Spitfire

There were those who had scoffed at the Royal Navy when it was first announced that it was on its way to the Pacific. These critics said: "The British fleet is too slow to operate with the fast carrier task forces of the U. S. Navy; their guns fire different caliber ammunition; they've had no experience refueling at sea or operating from bases for protracted lengths of time; their communications systems are different from what the Americans use; they aren't fa-

miliar with modern battle tactics evolved in the great war of distances in the Pacific."

What the critics didn't know was this: (1) The British ships were operating as a separate task force, (2) the British Pacific Fleet had organized its own fleet train to supply ammunition, fuel, food and other items, (3) the British had adopted United States fleet communications systems and had stationed U. S. Navy communications experts aboard so there would be no mix-ups, and (4) the British had adopted U. S. Pacific Fleet battle-tested formations.

The British Pacific Fleet task force had been assigned the job of neutralizing the Sakashima Islands—a handful of small islands about half way between Okinawa and Formosa. The Japs had a cluster of air fields there that could be used to stage planes up to Okinawa. If the British could keep this southern sea flank protected, it would allow the U. S. Pacific Fleet to give air cover to the Okinawa landing operations and to hit Kyushu fields to the north.

On March 26-27 the British task force threw its first strike at Sakashima. Fully loaded fighters, bombers and torpedo planes roared off the decks of the carriers to pound Jap aircraft and installations. The sudden appearance of the British ships, which had been a closely guarded secret, must have caught the Japs by surprise because there was little or no opposition. Approximately 20 Jap planes were destroyed on the ground, several small

HMS Howe, flagship of the British Pacific Fleet, carried 300 extra men to help man antiaircraft weapons

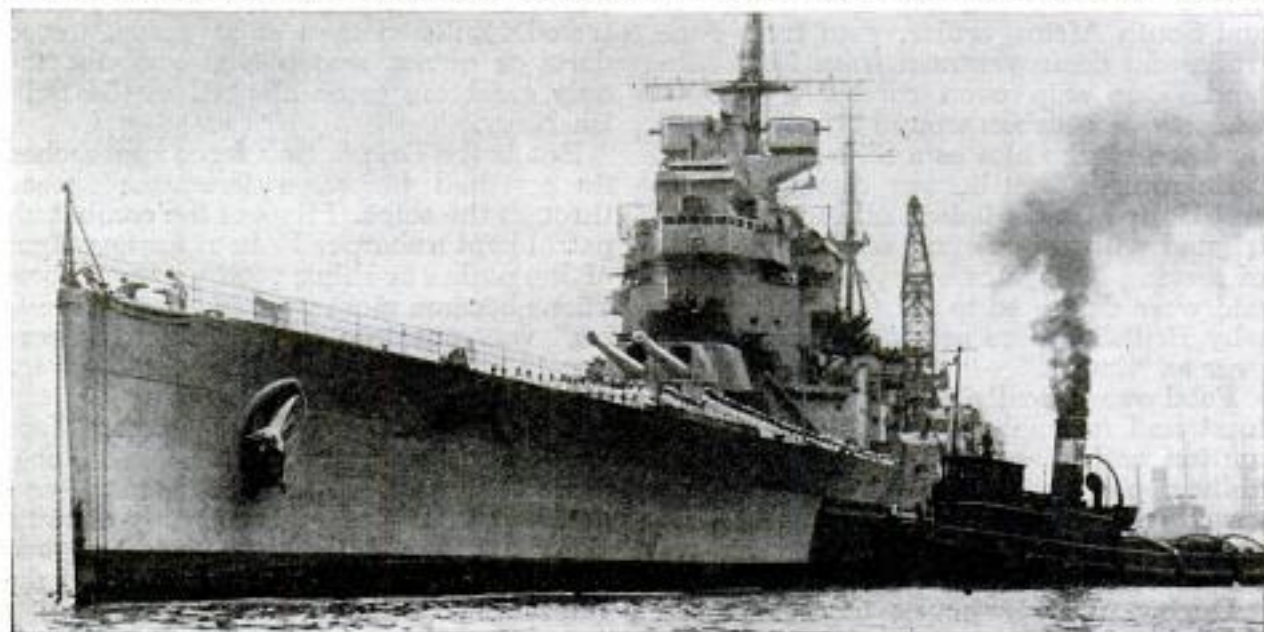

coastal vessels were damaged and the town of Ohama was left in flames. A second strike was made on March 31, again with little or no opposition.

The Japs struck back on Easter Sunday, April 1, about 7 in the morning while officers and men were finishing breakfast and preparing for church services. A green and brown Jap Zero came roaring out of the sun and machine-gun bullets hissed in the water alongside the flagship. At once antiaircraft guns began to clatter and the Zero was shot down in flames. Four others were shot down during the day without doing much damage to the task force. Each side had hit the other and had drawn blood—the British getting by far the best of the encounter.

British ships continued to throw air strikes at the Sakashima Islands, keeping the airfield torn up and planes inoperational so that they could not harass the landings on Okinawa. Royal Navy planes hit Sakashima four times in April and six times in May, shooting 31 planes out of the air and destroying or damaging 24 on the ground. Warehouses and barracks were bombed, small ships were sunk, locomotives and railroad tracks were blasted and troop-carrying trucks were strafed.

In such air strikes, the British used five types of first-line aircraft. Three were American-built—the trusty Avenger torpedo plane and the Hellcat and Corsair fighter-bombers, all of which have waged a lot of war against the Japs. Two were English-built—the Seafire fighter and the Firefly, a reconnaissance-fighter.

The Seafire is a carrier-borne version of the famous Spitfire which saved England in the German air attacks of 1941. It is powered by a Rolls Royce Merlin engine of 1470 horsepower, has two 20-millimeter cannon and four machine guns. Its wings fold at the tips as well as at the roots and its appearance has earned it the nickname of "praying mantis." It has an impressive combat record.

The Firefly is the most heavily armed fighter in service with the British Fleet, its armament consisting of four 20-millimeter cannon and rockets. During assaults or air strikes it can "blot out" antiaircraft positions and strong points. Equipped for high-speed reconnaissance, it carries aerial cameras. It has been used in strikes against German shipping off the coast of Norway and against the Japs in the Indian ocean.

In its Pacific baptism, the British fleet didn't rely upon planes alone. On May 4, heavy units of the task force, including battleships and cruisers, ran close inshore to bombard airfields at Hirara and Nobara on Miyako Island in the Sakashima group.

(Continued to page 156)



"Shine Stick" Invented by a skier who got the idea from applying hard wax to his skis, a four-inch "shine stick" gives a high polish to shoes. The stick fits in a pocket of a shine cloth which rolls into a compact outfit with a snap-fastened leather cover.

HONORABLE DISCHARGE EMBLEM



"THIS STANDS FOR HONORABLE SERVICE TO OUR COUNTRY"

Radio-Telephones for Autos Operate Like Walkie-Talkies



Automobile drivers could have the same two-way telephone service given homes with the mobile radio-telephone system planned by the American Telephone and Telegraph Company. The motorists would use a telephone exactly like the home handset, but operating on the walkie-talkie principle. It would be set normally for receiving and he would have to press a button to talk. His call would go by radio to special exchanges, where it would be transmitted over regular lines to the number called. Under present federal radio law, the user of the radiophone would have to obtain an operator's radio license, but the Federal Communications Commission has indicated a mere reading of the regulations at postoffices will be sufficient for users of such systems. Installations are planned for 13 cities when men and materials are available. A. T. & T. also is considering a commercial highway mobile service.

Just as easy to use as home phones will be the telephone planned for postwar drivers

Electric Refrigerators on Rails Cut Perishable Food Losses

Constant temperature to reduce losses in transportation of perishable foods is provided by an electrical refrigeration system for railroad cars. Heart of the system are two heater and fan units, each a foot and a half square, placed at opposite corners of the car. For cooling, ice is placed in cabinets at each end of the car and cool air is kept circulating by the fan, which displaces 1000 cubic feet of air per minute. A single re-icing is required instead of the four or five necessary for conventional refrigerator cars on a four or five-day trip. The heating element replaces charcoal, coke or alcohol heaters during the winter and is rated at 2250 watts. Two heaters in a car are ample for any kind of weather. Power for the system is provided by a 110-volt, five-kilowatt generator riding on the axle assembly. Thermostatic controls which can't be changed by jarring keep the temperature steady.

☐ The 105-millimeter shell container can be readily adapted for temporary splints for broken arms, the U. S. Army Medical Department advises.

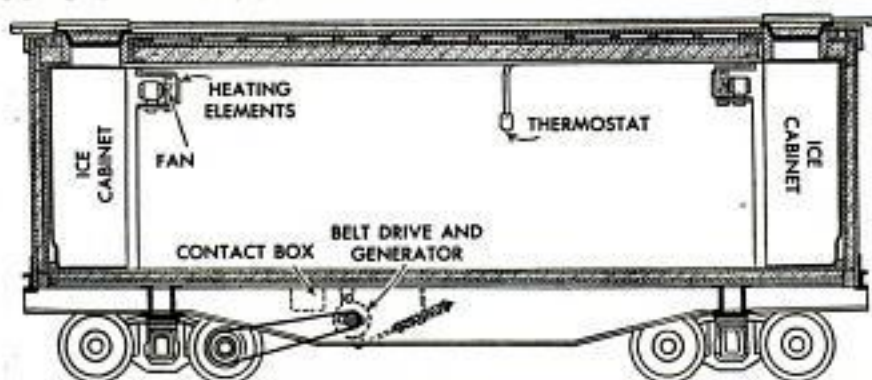

Heating elements of refrigeration system are in front of fan

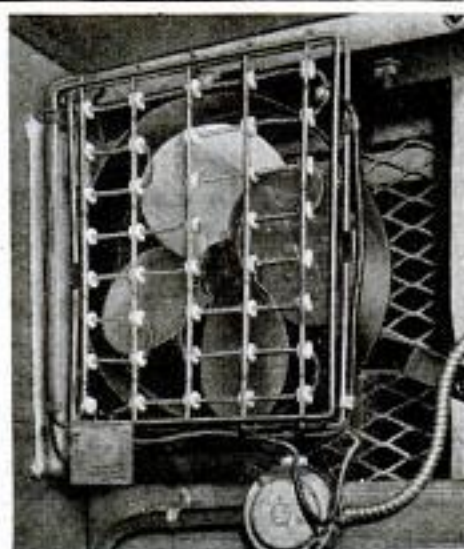



18th Century CLOCK CASE *has electric works*

YOU can adapt a small electric clock to harmonize with period furnishings by removing the works and putting them in a case like this one, which will look well on a mantelpiece or table. Or the works of an alarm clock may be used if desired. Wood for the case should match other furnishings in the room where it is to be used. For instance, in a paneled room, such as a library, pine is a good choice. If the clock is to be used in the living room, hardwood is preferable.

The case is assembled as shown in Fig. 1. Notice that the sides are butted against the bottom, where they are held by screws and a triangular cleat. Top edges of the sides, and ends of the top piece, however, should be mitered and glued, then secured by a similar cleat. All pieces are rabbeted so that the back panel, of $\frac{1}{4}$ -in. plywood, will seat flush with the edges. On the bottom and top pieces, the rabbet is routed out to leave the ends intact, the small remaining fillet being chiseled square, so that there

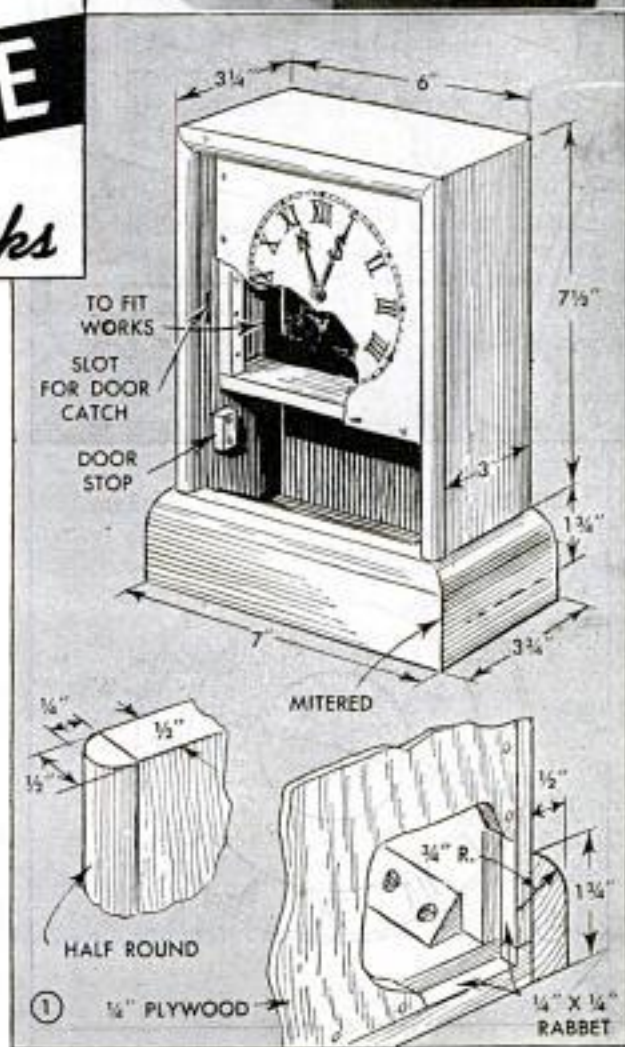

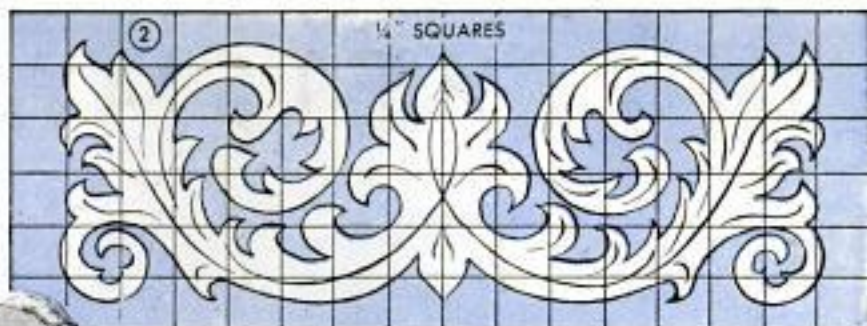
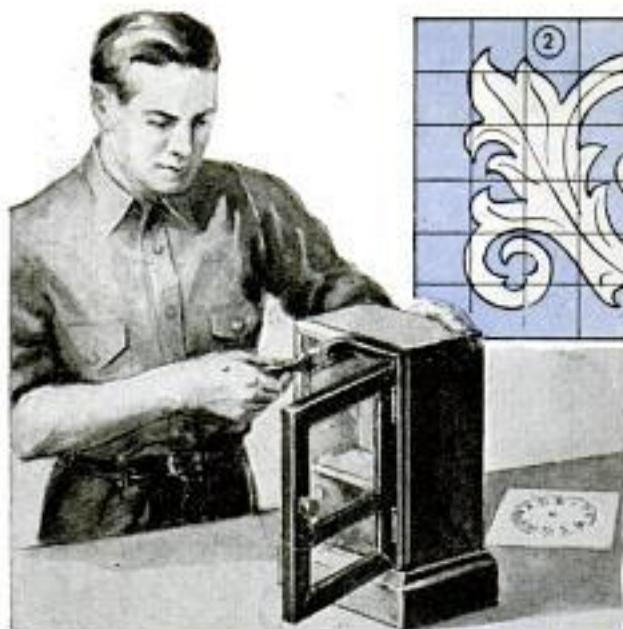

will be no gap at the corners after the back panel is screwed in place. Then wide molding is nailed along the sides and front to cover the joints, and half-round molding is bradded on the front edges, after which the nail holes are filled. As a frame for the works, cleats are nailed in the case, and a door stop is placed in line with and below the frame to space a door.

The door frame is shown in Fig. 3. Members are rabbeted as indicated in the sectional details to take pieces of glass, and the corners are mitered and joined by tongues and grooves as shown in the upper detail. Then a hole is drilled for a knob shaft, and the edge of the frame is recessed for a catch, which can be cut from thin sheet metal to the dimensions shown in the lower right-hand details. The shaft is a short length of metal rod, one end of which is filed to fit a square hole in the catch and drilled to take a cotter pin. A wooden knob then is forced over the rod. The door frame is mounted in the case by hinges and a slot is sawed to engage the catch, Fig. 1.

You may want to remove the face and hands of your clock and substitute others more in harmony with the period design of the case. The hands shown in the left-hand corner of Fig. 3 are appropriate, and a suitable dial, with Roman numerals, can be made as shown in Fig. 4. It is inked onto a square of stiff, glossy cardboard and antiqued by staining it with weak coffee, which gives it a slightly yellow cast. The hands are sawed from brass or other light sheet metal.

Now pieces of glass are installed in the door frame and held in place by strips of molding. The upper piece can be left clear, or flower designs can be painted in the corners to harmonize with the lower panel, on which a scrolled design should be applied in gold-bronze paint. Any ornate pattern will be appropriate for the lower panel, the one shown in Fig. 2 being merely a suggestion. It can be drawn on the rear surface of the glass with a stub pen, which will serve better than a brush for tracing the fine lines. When the gold paint is thoroughly dry, the entire surface is coated with flat black paint, after which a coat of varnish is applied to protect the paint.

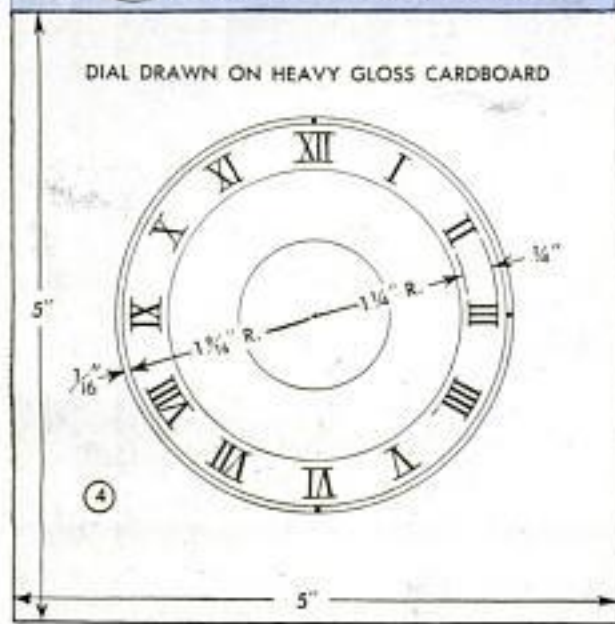
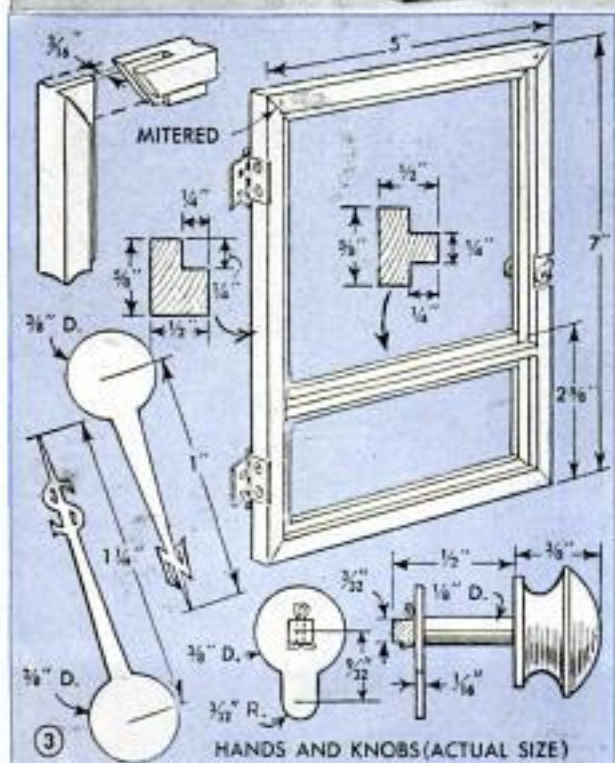

Wooden Towel Rack Folds Flat Against Wall

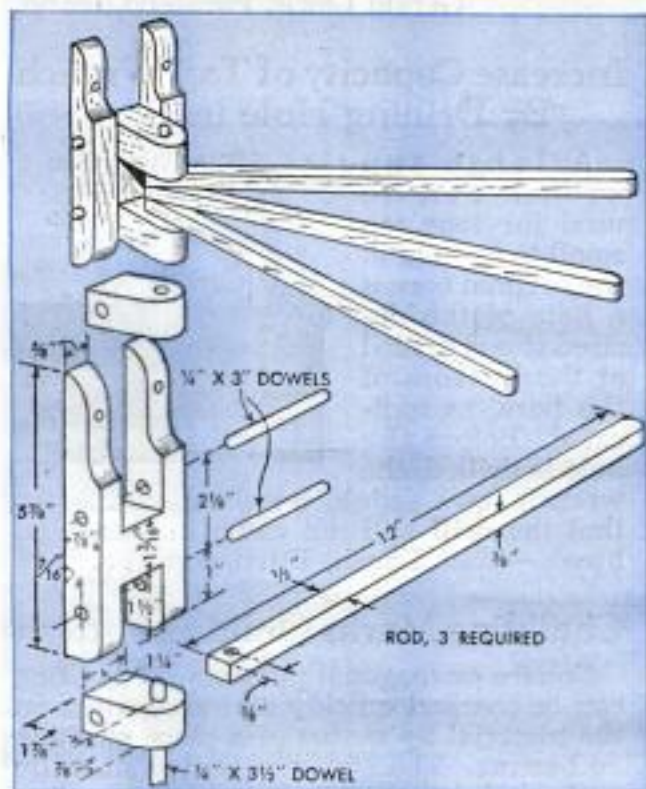

With three swinging arms, this easy-to-make rack provides plenty of room for hanging towels, and when not in use the arms fold out of the way against a wall. It consists of an H-shaped back piece in which two brackets are held by short lengths of dowel to support the arms. Front edges of the legs, or upright members of the back piece, are jigsawed to a curve as

shown. Holes are drilled for screws which attach the rack to a wall. Before the pieces are assembled, they should be carefully sanded to remove splinters, which may catch in cloths hung on the arms. The rack can be painted a bright color to harmonize with kitchen accessories or it can be enameled white to match bathroom fixtures.

Lewis Torrent, Muskegon, Mich.

Water Emptied Quickly From Washing Machine by Pump

Washing machines that have only a drain plug in the tub for emptying water can be equipped with a small motor and centrifugal pump which will withdraw the water quickly and empty it into an adjacent sink. Such an installation will be especially helpful in cases where there is no floor drain into which the water can be emptied. Only a small motor of $\frac{1}{20}$ or $\frac{1}{25}$ hp. is needed. This is mounted on a platform bolted to the washing machine legs, and the pump is coupled to it by a length of flexible tubing such as is used for auto service station air hoses. The intake side of the pump is connected by a piece of rubber hose to the tub outlet, an ordinary sink-faucet connector being used; a longer piece of hose fitted to the pump outlet carries the water away.—James B. Scott, Springfield, Mass.

☛ When washing walls with cleaning powder and soapy water, add enough flour to make a paste so that the mixture will cling to the wall and dissolve the dirt.

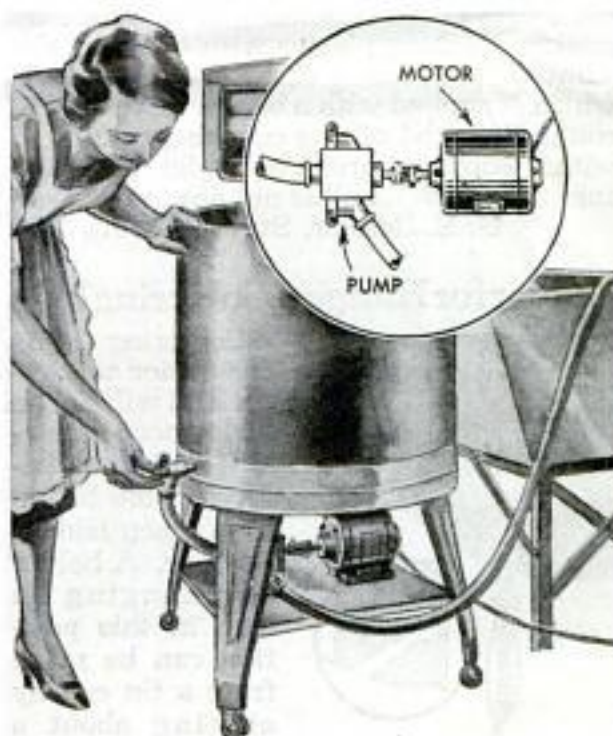

Apron to Hold Toilet Articles Is Handy When Traveling



Ladies who travel considerably will find that an apron with several pockets can be used as a handy kit for holding toilet articles such as combs, brushes, face powder, hairpins and small mirrors. An ordinary apron can be adapted to this purpose by sewing the pockets lengthwise to form several compartments of various sizes to accommodate these items. When not in use, the apron can be rolled up to enclose the toilet articles and stored with other luggage.—M. L. Piatt, Alameda, Cal.

Mixture for Finishing Cabinets Made From Plaster and Paint

A paint that is especially effective for radio and other cabinets can be made by mixing patching plaster with ordinary flat paint to produce a fairly thick mixture, which is applied with a brush. A variety of rough-textured effects can be worked out with a stippling brush or knife. The mixture covers well and is not apt to flake off.
G. E. Ressler, Stevens Point, Wis.

Holder for Hanging Soldering Iron

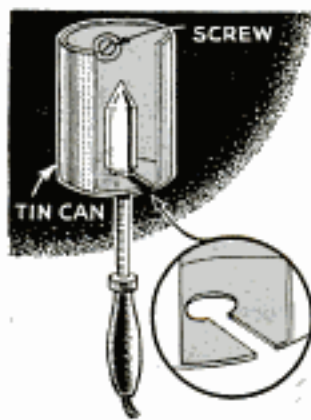

Soldering irons are easier to handle and will heat a little more quickly if hung vertically with the bit up than when laid on the side. A holder for hanging an iron in this position can be made from a tin can by cutting about a

third of its side away and notching the bottom to take the shaft, as shown.

Gerald Lewis, Pocatello, Idaho.

Increase Capacity of Tap Wrench By Drilling Hole in Bore

A large tap wrench can be used for taps too small to be held in the original bore if a hole of the desired size is drilled at the bottom of the bore, as indicated. Before the hole is drilled, the wrench jaws should be closed tightly so that the drill will not catch in them and break.—Matt Laush, Pittsburgh, Pa.

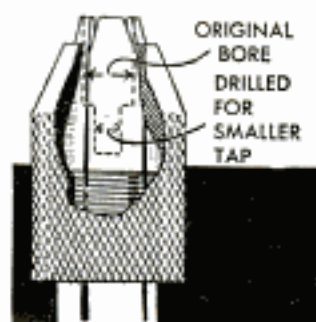

Chalkline Marks Quilting Pattern

Square or diagonal patterns for quilting can be marked quickly and accurately on the material by means of a piece of chalk and string. The string is coated liberally with chalk, then is held taut in position over the material and snapped against the cloth. This transfers a chalk line to the cloth and the mark will remain until it is rubbed off by brushing.

Wesley V. Korman, Mitchell, Neb.

Flag Hung Indoors Is Draped Over Wire Frame



Flags hung on standards for indoor display can be draped gracefully if their folds are supported on two wire frames. These are cut from two coat hangers as indicated. Eyes are formed in the ends of the wire to take wood screws which are driven into the flagstaff.

The frames should be placed on the staff so that their tips extend down to the top of the lowest stripe.

Help Yourself by Helping Others

Many readers want to know just how you solved some of those everyday problems in your home, work or hobby because they're having the same troubles. So why not send us a sketch, photo, or both, and brief descriptions? We pay promptly for all articles accepted. Address Homecraft Editor, Popular Mechanics, 200 E. Ontario, Chicago 11.

New "Face" Overlaid on Old Box for Chessmen

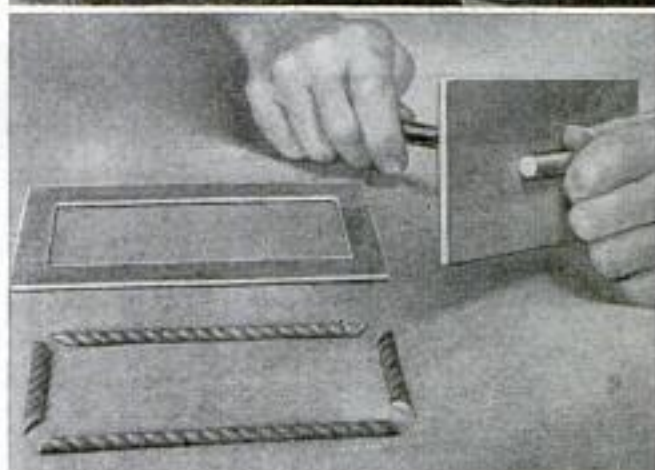
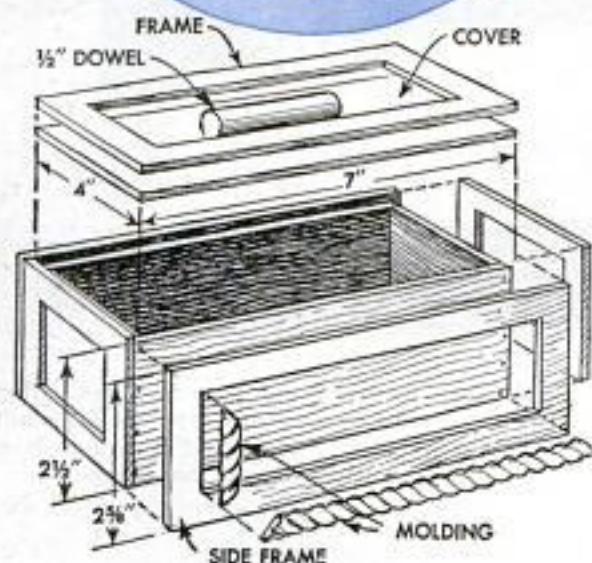
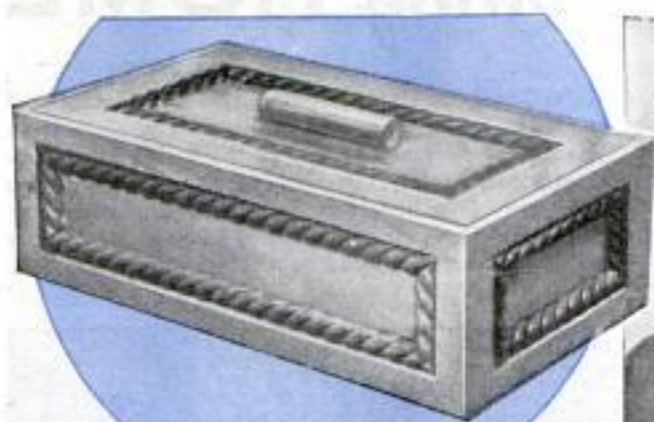

You can give your chessman box a rich, hand-carved appearance by overlaying sides and top with frames of thin wood in which strips of decorative molding are glued. Or you can make a new one by using a box of suitable size, such as a cigar box from which the lettering has been sanded. Cut the frames to fit the ends, sides and top of the box, making them wide enough to project about $\frac{1}{8}$ to $\frac{1}{4}$ in. above the top edges of the box. When glued in place the projecting edges will form rab-

bets into which the cover fits. Then miter pieces of molding and glue them along the inner edges of the frames. For a handle, fasten a short length of dowel to the cover with small screws driven from the underside. Finish the completed box with a coat of shellac diluted with alcohol; when dry, rub with fine steel wool and wax.—Chas. and Bertram Brownold, Woodmere, N. Y.

Short Bar Clamps Coupled Together to Span Wide Work

When gluing work that is too wide for your clamps, you can couple them together as shown, to make one clamp long enough to span the work. Another useful method of doing the job is to bolt two short clamps end to end after removing one of the tail-pieces and reversing the other. Or, instead of using two short clamps for this setup, one long clamp can be sawed off to shorten it to any convenient working length for ordinary use, and the piece cut off can be saved for rebolting to the clamp when needed for occasional long work.

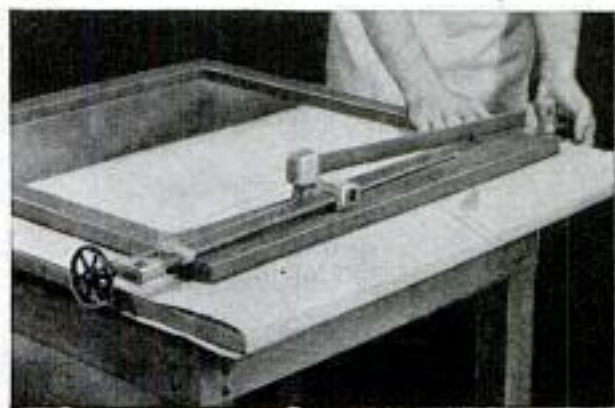

Solving HOME

Left: Spools of thread always will be at hand and easy to select if set on nails that project from cleats, which are screwed to the inside of a cabinet door. Below: Several envelopes of uniform size provide a handy file for recipes or other clippings cut from magazines and newspapers, if the flap of one is glued to the front of another



An old mesh handbag is an excellent substitute for a metal pan cleaner or pot scourer as shown below. It will last a long time and can be cleaned easily

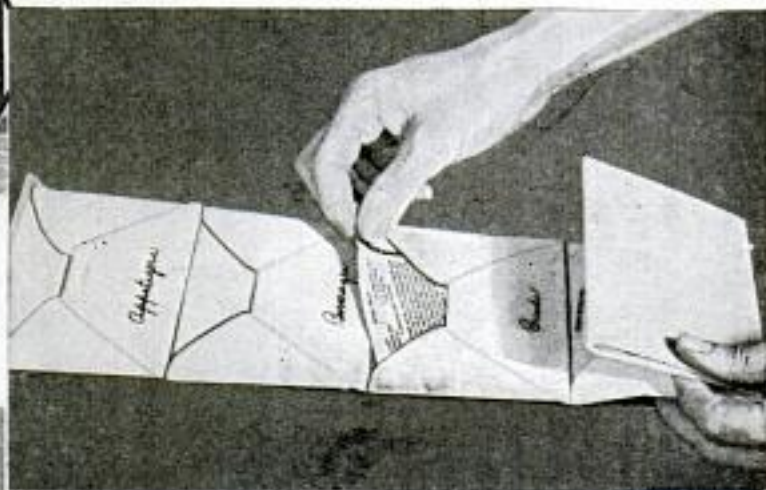

A self-soaping sponge can be made by inserting a cake of soap in a sponge that has been slit part way through the center. This also is a good method of using soap scraps

A square of linoleum is a handy item for a sewing room. Placed on a table it will protect the top surface when pinning and cutting material



Left: Wire coat hangers that are too wide for children's clothes can be reduced in width by bending them in slightly at the ends

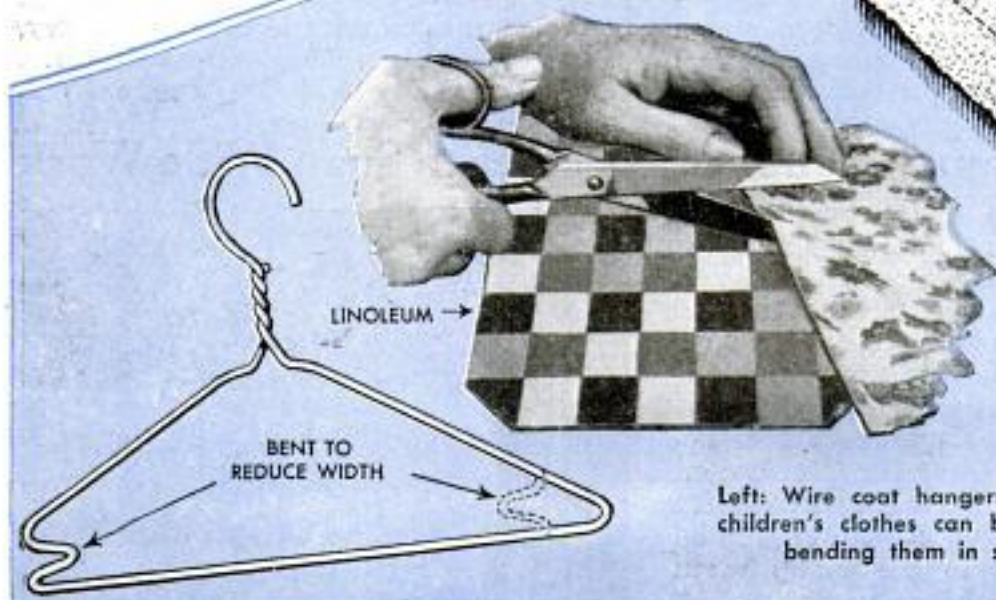

PROBLEMS

Right: Use of a self-draining shut-off valve in a water line inside the basement to prevent a sill cock from freezing will be unnecessary if you install a single valve as shown. The pipe extending through the building wall drains each time the valve is shut off. An ordinary valve can be used if the stem is lengthened

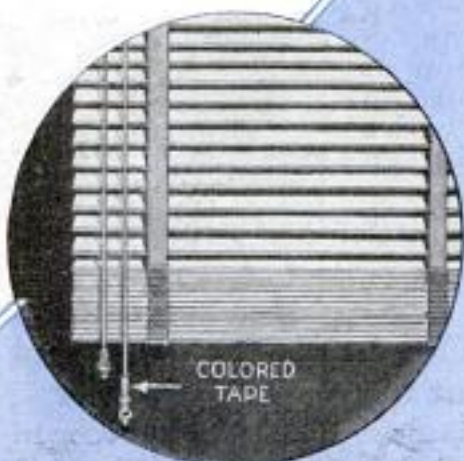

Left: By wrapping a small strip of colored tape around one of the pull cords of your Venetian blinds, you will be able to tell at a glance which cord to pull to tilt the slats forward



Storm windows can be hung without turn buttons by driving screws in the top edge and cutting off the heads. These fit holes drilled in the frames as shown above. Screen-door hooks at the bottom will hold the windows tight in the frame. Below: Lemons won't shrink or dry out if they are placed in a jar with a tight-fitting screw lid and stored in a refrigerator



You can carry needles safely in a small bottle. Stick them in the cork as above and add a wad of oiled cotton in the bottom to prevent rust



A shoe-box cover in the bottom of a paper shopping bag will protect the bottom from spilled liquids and keep the bag upright when it is placed on a floor or counter



Delivery-Truck Doors Held Open By Retractable Arms

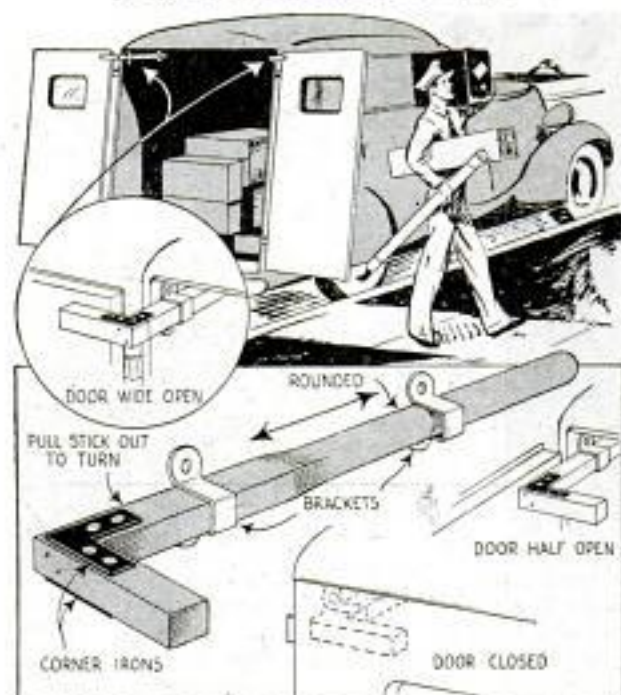

Delivery-truck doors can be kept open when the truck is standing on a slope, or when a strong wind is blowing, by wooden arms that are held in brackets screwed to the inside of the truck panels near the roof. The arms can be lengths of 2 by 4-in. stock, or similar material, one end of each piece being rounded for about half its length. At the other end a short piece of the same material is nailed or screwed at right angles, the joint being reinforced by corner irons. By pulling the arms part way out so that the squared sides are free of the brackets, the arms can be rotated so that the right-angle projections will hold the doors wide open, as shown in the circular inset. To close the doors, the arms are turned so the projecting pieces face inward.

Opie Read, Jr., Chicago.

Ornamental Sheet-Metal Figures Formed With Shears and Pliers



Thin sheet metal is all you need to form small, decorative, metal animals such as the dachshund shown, which can be made any size by enlarging the pattern. After cutting, the edges are filed smooth, the body is formed by bending along the center line and the ears and head are

shaped by hand or with pliers. When the figure has been polished, a thin coat of transparent lacquer may be applied to prevent tarnishing.

An Easy Way to Thread Yarn Through a Needle

The next time you have to thread yarn through a needle, try this simple method. First, insert the doubled end of a piece of thread through the needle and then insert the yarn end through the resulting loop of thread. You can now pull the thread and yarn through the needle with little trouble.—H. A. Severs, Dayton, O.

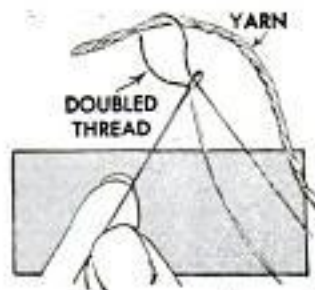

Closing Overhead Garage Doors Without Getting Out of Car

I have a three-section, overhead door in my garage that I can close as the car is backed out, thus making it unnecessary to get out of the car. To accomplish this, I fastened a clothesline rope to the upper section and ran it through a small eye bolt in the center section. When backing the

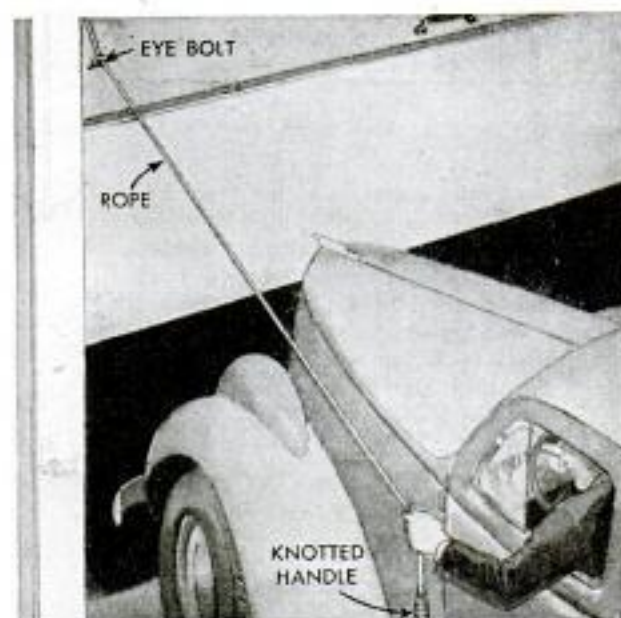

car out of the garage, I grasp the rope, which hangs at the left side of the doorway, and hold it. This pulls the door down. I hold on until the rope becomes taut after the door has closed, then release the rope and it snaps back out of the way.

Gerard E. Langelier, Woodbridge, Conn.

ⓄAn excess amount of oil on an auto starter, generator, distributor or other electrical apparatus may cause trouble.

Build this Knock-down PLAYHOUSE

This trim little playhouse can be set up in 5 min. and when taken down may be stored in a small space such as a closet. The walls are assembled as shown in the upper left-hand detail. A triangular cornerpiece, to which part B is screwed, slides behind strips C, which are glued and nailed to the walls. The roof is supported by a ridge pole and held in place by pins projecting from the ends of the corner pieces. The chimney can be made of the same material as the walls. Two sides are notched to fit the roof angle and glued together. The door is held by a latch which is lifted through a fingerhole in the door. Gaily colored flowers are painted on window boxes and shutters, which are shown in the crosshatched pattern

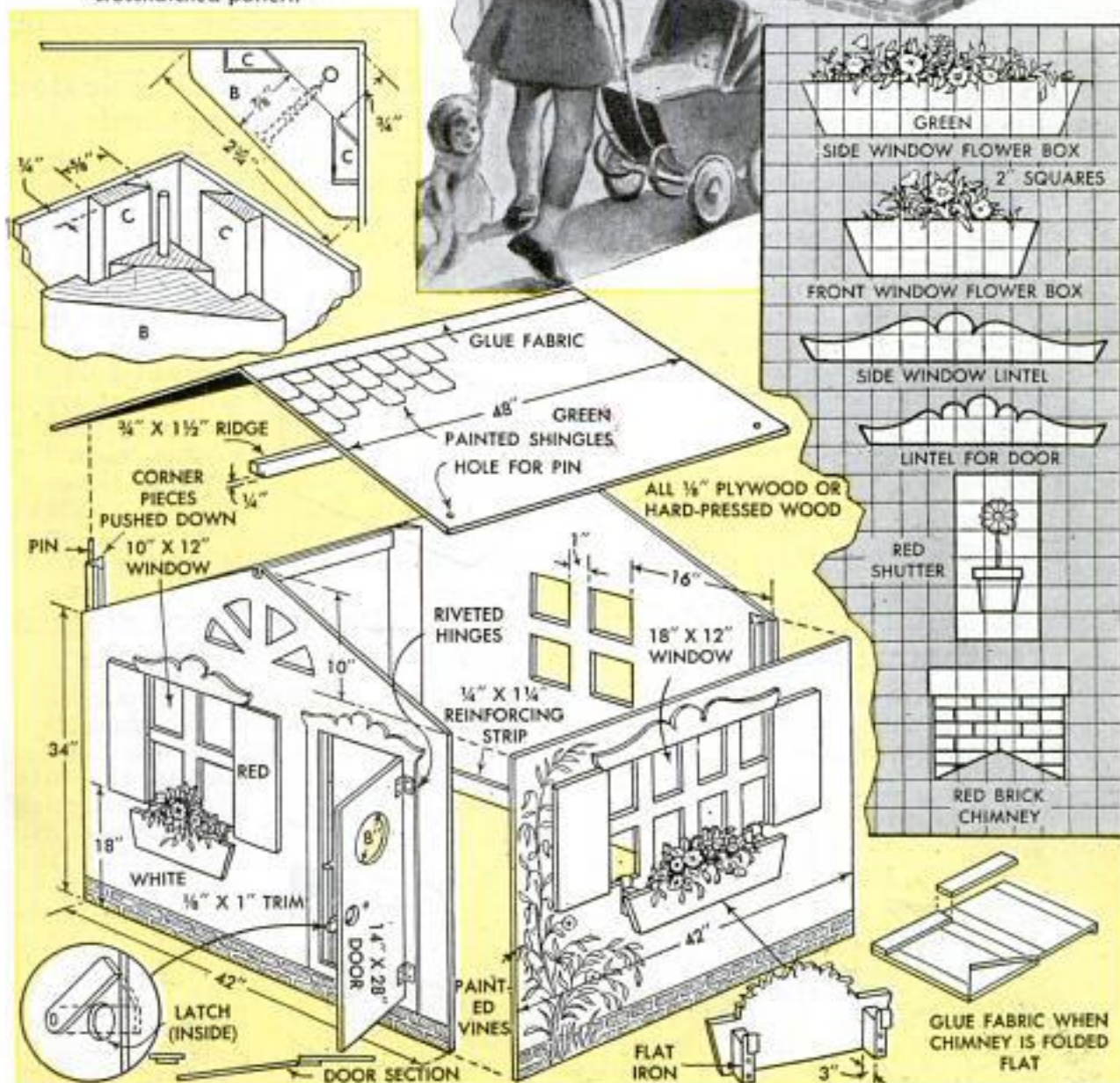
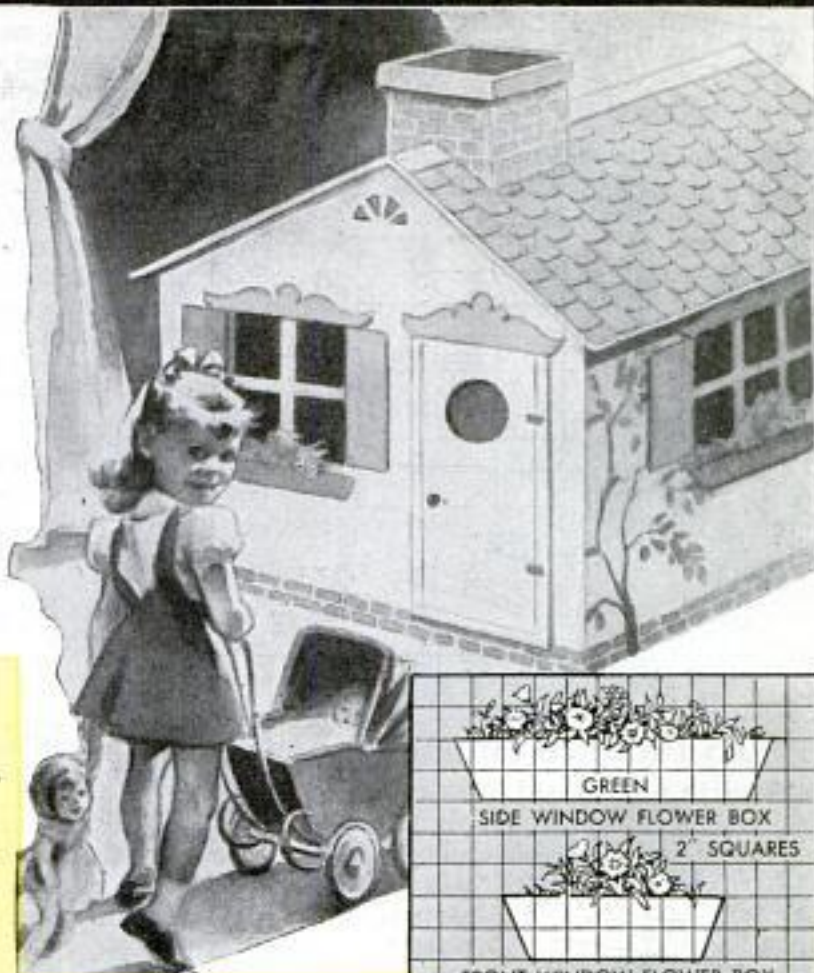

Sheet-Metal Typewriter Shield Catches Eraser Particles

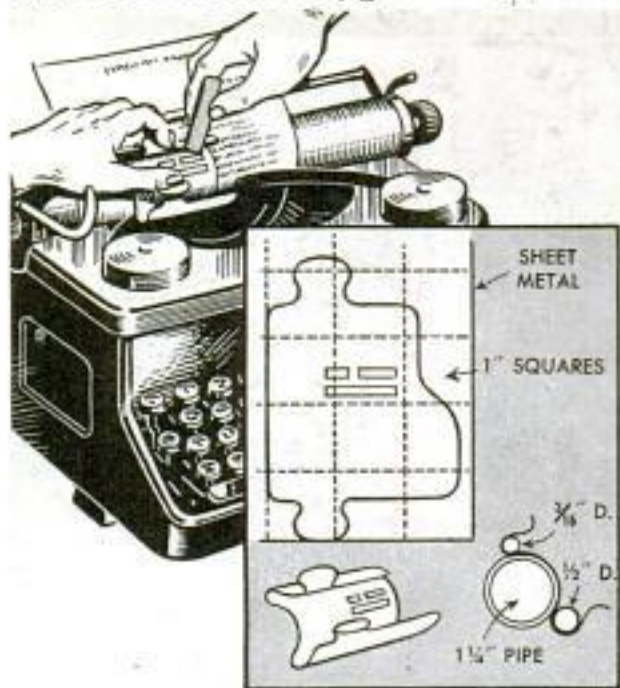

Typewriters often become clogged so that they need a general overhauling merely because eraser particles fall down onto the key levers where they become wedged and spoil the action. If you do not pull the carriage to one side when erasing so that the particles fall outside the machine, you can still avoid much of this trouble by using an eraser shield to catch them. It is cut from a $4\frac{1}{4}$ by $2\frac{5}{8}$ -in. sheet of thin metal to the shape indicated, and then $\frac{3}{16}$ -in. slots are cut out to provide openings through which typing can be erased. The shield then is formed over a length of $1\frac{1}{4}$ -in. pipe, the diameter of which corresponds to that of the platens on most standard machines. A trough is formed by bending the lower edge around a $\frac{1}{2}$ -in. dowel and the upper edge is bent around a $\frac{3}{16}$ -in. dowel as indicated in the lower detail. Finger tabs are provided for gripping the shield firmly when using it.

Thos. J. Mahan, East St. Louis, Ill.

Stencil Cut Through Cellophane To Produce Smooth Lines

Smooth, unblurred lines are made easily in cutting a mimeograph stencil with a stylus if a sheet of Cellophane first is placed over the stencil.



The Cellophane provides a smooth writing surface, insures against tearing the stencil and prevents the stylus from digging into or cutting entirely through the stencil and ruining it.—H. Perlman, Brooklyn, N. Y.

Wooden Strip Tacked in File Box Prevents Bending Cards

If the cover of a file box strikes the front cards and bends them over as it is closed, the cards can be protected by a strip of wood tacked to the inside of the front of the box.



A $\frac{1}{4}$ by $\frac{3}{4}$ -in. strip somewhat shorter than the length of the box will hold the cards away from the front of the box so that when the cover is closed it will not contact them.—L. Chirey, Milwaukee, Wis.

Compass Point Scores Guide Line For Cutting Balsa Strips

Straight, narrow strips of balsa can be cut accurately with a sharp knife if the wood is first grooved with the pointed end of a compass.



of a compass, which is held against a ruler and drawn across the wood at the proper line. This makes a deep groove which is easily followed and tends to keep the knife in line when cutting the wood.—W. Beck, Mt. Clemens, Mich.

Holes in Drawing Board Plugged With Round Toothpicks

You can renew the surface of your drawing board if it is pitted with thumbtack holes by dipping the pointed ends of round toothpicks into glue and forcing them firmly into holes.



After the glue has dried, break the toothpicks off, remove any jagged ends with a knife, and finish the job by sanding.—Richard Salzer, Baldwin, N. Y.

Marble "Croquet" Is Interesting Indoor Game



Children and adults alike will enjoy this novel marble game, which can be played on any flat surface such as a floor or table top. The game is somewhat like croquet, the object being to shoot a marble through eight cardboard wickets, the winner being the one who accomplishes this in the least number of plays. The wickets are pieces of cardboard hinged together with tape as indicated. Each wicket has a centralized hole at the lower side, triangular pieces of cardboard

being used to keep the marbles from lodging in the corners where the wickets are hinged together. Each piece is set in at a slight angle and is hinged to one of the wickets, a tab fitting into a slot in the opposite wicket to lock the piece in place and help make the wicket assembly rigid. When not in use, the assembly folds flat for storage. Rules of the game are optional. One shot in turn is the prevailing rule. If an opponent's play causes your marble to pass through a hole, your position is advanced or penalized accordingly, and your next play is resumed from that point.

R. L. Ralston, Jackson, Mich.

Ends of Posts Chamfered Uniformly by Passing Them Over Jointer

Rapid, uniform chamfering of posts can be done on a jointer. A board clamped to the fence stops the work at the same point

on each pass. The chamfer produced by this method is not a perfectly straight cut, but is slightly concave, the curvature matching the diameter of the cutter head. On most work, however, this slight curvature is of no consequence.

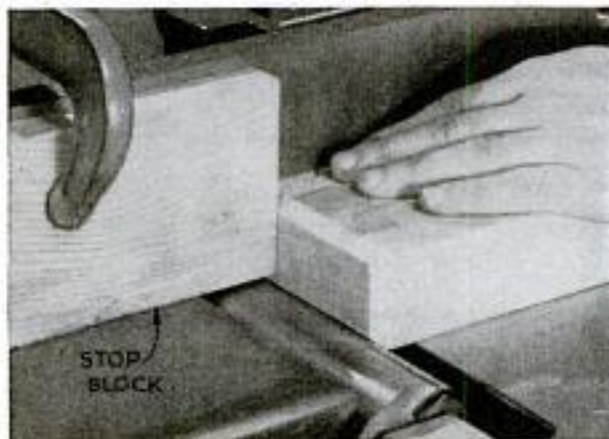

Paraffin Protects Felt Hat From Perspiration Stain

To prevent perspiration from soiling a felt hat, rub the sweat band with a piece of paraffin, being careful to cover thoroughly the lower edge of the band where it is sewed to the felt. This gives the hat band an invisible waterproof coating through which perspiration cannot penetrate.—E. L. Reynolds, Bronxville, N. Y.

Design and Construction

PART I

MAKING distant objects appear close by looking through pieces of curved glass is always thrilling, but the enjoyment is increased when you peer through a telescope that you yourself have made. The cost of making a telescope is especially low now because war-surplus stocks of perfect and chipped-edge lenses and prisms are available at low prices. You can make a good scope for as little as one dollar, and a really good terrestrial telescope for only three to five dollars for lenses.

Kinds of telescopes: Telescopes are divided into two

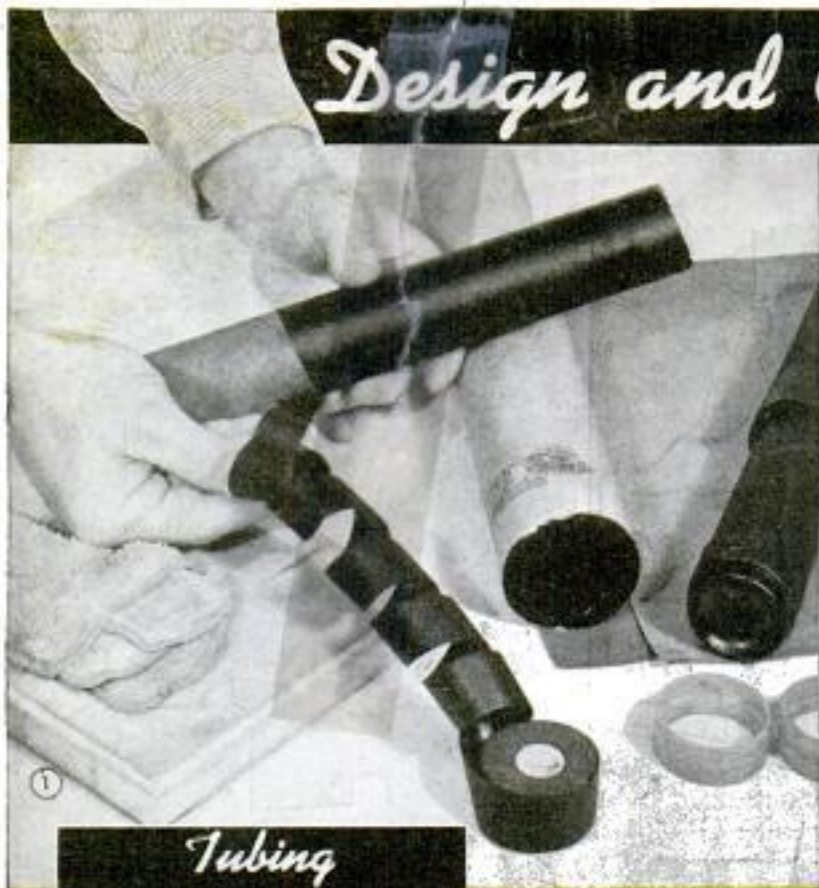

Tubing

Cardboard tubes are excellent for telescopes. The outside is wrapped with black gummed paper or covered with oilcloth

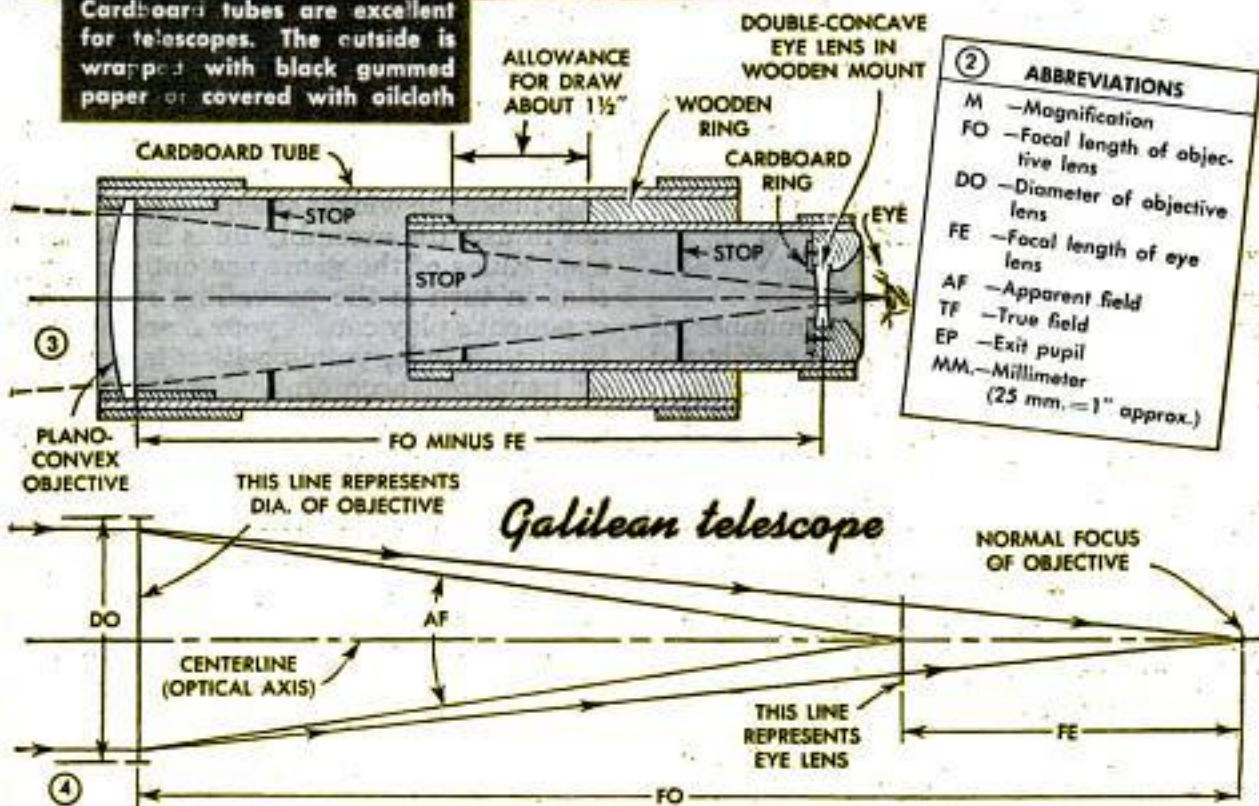

ABBREVIATIONS	
M	—Magnification
FO	—Focal length of objective lens
DO	—Diameter of objective lens
FE	—Focal length of eye lens
AF	—Apparent field
TF	—True field
EP	—Exit pupil
MM.	—Millimeter (25 mm. = 1" approx.)

Galilean telescope

NORMAL VALUES

- M—4 to 7X, top limit about 12X
- DO and FO—Value of f/4 to f/6
- FO—5" to 10" (127 to 254 mm.)
- DO—1" to 2 1/2" (25 to 64 mm.)
- AF—About 16° TF—2° to 4°
- FE—1" to 2" (25 to 50 mm.)
- DIA. OF EYE LENS—Any small size—1/8" to 1/4" dia.
- EP—Galilean telescope has no exit pupil

CALCULATIONS

- $M = FO \div FE$
- AF—Measure angle on layout
- $TF = AF \div M$
- $f/\text{number of objective} = FO \div DO$
- $FE = FO \div \text{Desired } M$
- Field in yards at 1000 yards = $\frac{DO \times 1000}{FO \times M}$

of TELESCOPES

By Sam Brown



main classes, reflectors and refractors. The reflector uses a mirror to pick up the image while the refractor uses a lens. This article deals exclusively with the refractor type. A refractor used for viewing heavenly bodies is called an astronomical telescope. It shows the image upside down, but this makes little difference when you are looking at a star. Telescopes for viewing objects on land show an upright image and are called terrestrial telescopes. These include various types, such as the Galilean, rifle-scope, spotting scope, monocular and just plain "telescope" or spy glass.

Galilean telescope: This scope is different from all others in that it has a

Optical bench

Some kind of bench is almost a necessity for checking lens systems previous to actual construction. The design shown is simple and practical

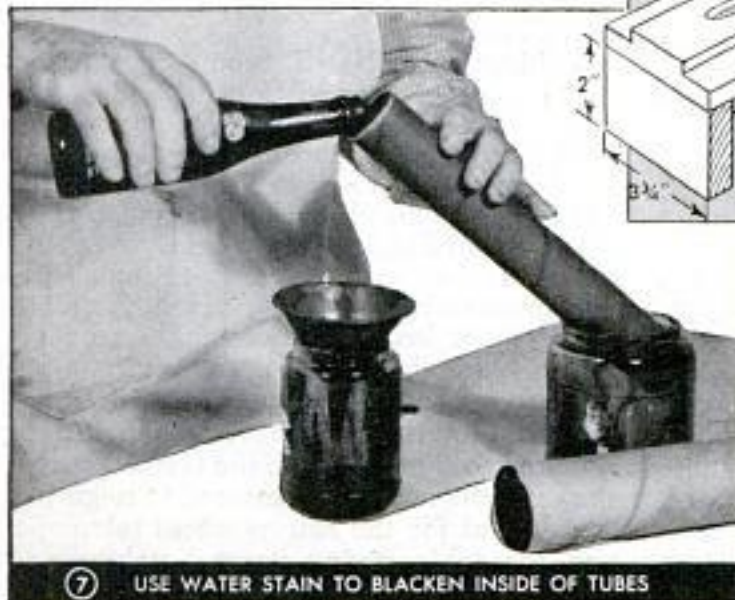
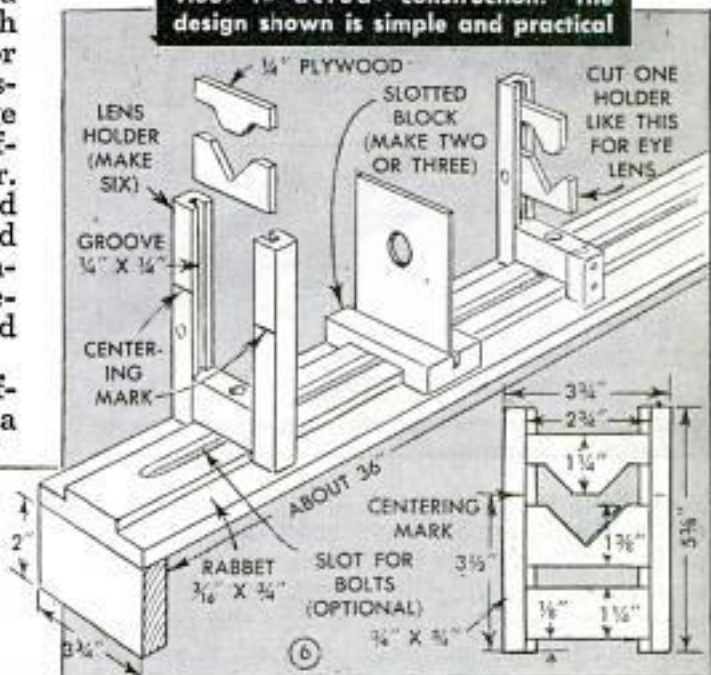

7 USE WATER STAIN TO BLACKEN INSIDE OF TUBES

negative lens for an eyepiece. Good features are simple construction, a clear, crisp field and an upright image. The one poor feature is that the field of view is small and decreases rapidly with increases in magnification. Hence, as made today, Galilean telescopes usually are confined to 6X or less.

Figs. 3 and 4 show the general construction and layout. Before

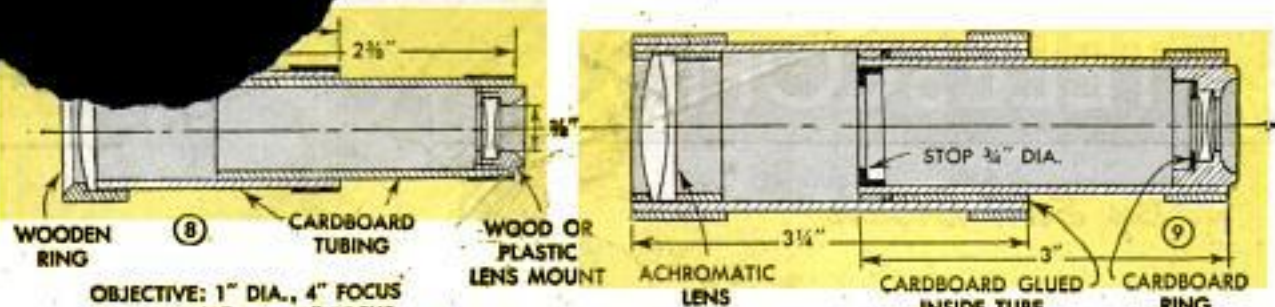

OBJECTIVE: 1" DIA., 4" FOCUS
 EYE LENS: 1/2" DIA., 1" FOCUS
 $M=4 \div 1=4X$
 FIELD AT 1000 YDS., 60 yds.

Galilean telescopes (ONE-HALF SIZE)

OBJECTIVE: 32 mm. dia., 132 mm. focus
 EYE LENS: 17 mm. dia., 28 mm. focus
 $M=132 \div 28=4\frac{1}{2}X$
 FIELD AT 1000 YDS., 54 yds.

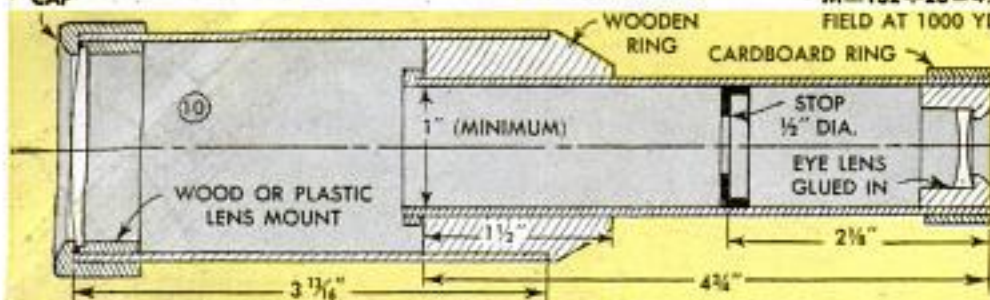

OBJECTIVE: 42 mm. dia.
 201 mm. focus
 EYE LENS: 17 mm. dia.
 28 mm. focus
 $M=201 \div 28=7X$
 FIELD AT
 1000 YDS., 29 yds.

Typical galilean telescopes

These designs show general construction. An achromatic objective lens is always an improvement. The scopes here are drawn as focused on an object at 18 ft. distance



11 GLARE-STOPS PREVENT INTERNAL REFLECTIONS

you study this, learn the abbreviations given in Fig. 2, and always read the symbols as full words. It is best to use normal values as given in Fig. 4 when designing your scope, particularly where the f /value of the objective lens is concerned. You will understand quickly that to get a large field with a Galilean telescope you would need a large-diameter objective. Specific instruments are diagrammed in Figs. 8, 9 and 10. These are shown set up at about an 18-ft. focus, whereas Fig. 4 shows the lens spacing at infinity. Focused at infinity means focused for a distant object, usually 300 to 400 yards away. Your telescope is at its shortest draw when focused at infinity. You will have to allow an extra half-inch or so on the draw so that you can focus on near objects. The whole range of focusing

from near to far objects is about 1/2 in. with the average objective, as most of the draw-tube travel is simply a matter of making the telescope as compact as possible. Glare stops prevent internal reflections. You can determine the diameter of these at any point from the AF lines, Fig. 4. One glare stop is enough for the Galilean. This can be made from cardboard with tabs turned over as in Fig. 11, pushed inside the draw-tube and fastened with a dab of glue.

Optical bench: An optical bench is handy for checking any lens system and almost a "must" when you get into five and six-lens systems. The design shown in Figs. 5 and 6 is simple and satisfactory. If you want to make a simpler setup, use a plain board and mount the lenses with modeling clay or wax on small blocks of wood. Test setups can be made indoors at about 18 ft., focusing on printed matter. Have a good light on the copy, but avoid light on the optical bench.

Tubeing: Cardboard tubing is satisfactory for all telescopes. Select sturdy tubes of good wall thickness. Use a black water stain or flat black lacquer to blacken the inside of the tubes as in Fig. 7. Cover the outside with black gummed tape, spiral-wound as in Fig. 1. Oilcloth, canvas or imitation leather in plain wrap-around style also makes a neat outer covering. A metallic-silver or bronze paper makes an ideal covering for the draw tube.

Astronomical telescope: The astronomical is different from the Galilean in that it has a real image inside the telescope, and the eye lens is positive instead of negative. The layout for the astronomical telescope, and the table giving normal values and simple calculations, are shown in Fig. 12.

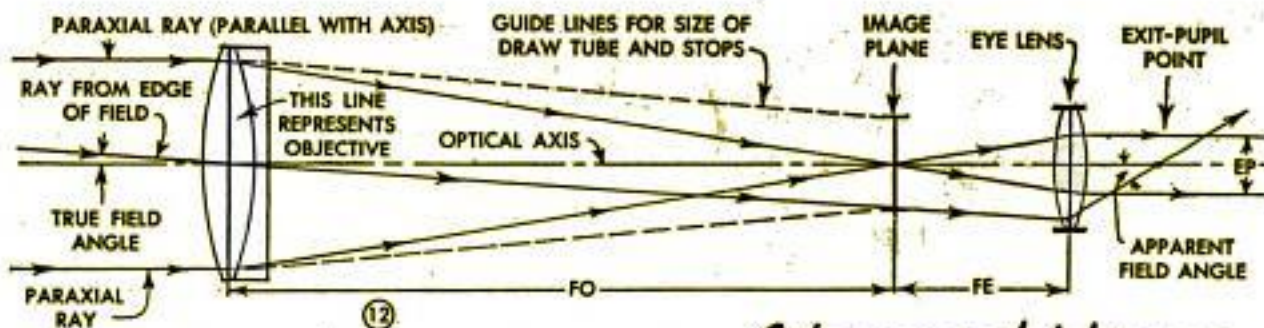

NORMAL VALUES

DO: $1\frac{1}{2}$ " and up. $f/10$ to $f/15$
 FO: 20" and up
 FO: 10 to 15 times DO
 M: 15 to 60 times DO
 EP: $\frac{1}{4}$ " to $\frac{1}{8}$ "
 FE: $\frac{1}{4}$ " to 1"
 AF: 40°
 TF: $\frac{1}{2}^\circ$ to 2°

CALCULATIONS

$M = FO \div FE$
 $M = DO \div EP$
 $EP = DO \div M$
 $FE = FO \div M$
 $TF = 40^\circ \div M$
 $f/\text{VALUE OF OBJECTIVE} = FO \div DO$
 FIELD IN YDS. } Read two right figures from table
 AT 1000 YDS. }

Astronomical telescope

13 SIZE OF IMAGE

Find figure opposite magnification and multiply this factor by focal length of objective lens

M	Factor	M	Factor	M	Factor
20X	.035	35X	.020	50X	.014
25X	.028	40X	.017	60X	.012
30X	.023	45X	.015	70X	.010

Select your lenses and make a layout as in Fig. 12, checking this directly from the actual setup as made on the optical bench. Determine the image size from table Fig. 13. The pair of paraxial rays will pass through the center of the image and continue until they strike the eye lens, from which they emerge parallel, as shown. The ray from the edge of the field will pass through the center of the objective and the edge of the image and continue until it strikes the eye lens. This is the most important ray to consider. If you can get this through the telescope, the hundreds of other rays from the object viewed will automatically get through. Note that the eye lens must be big enough to catch this ray.

Exit pupil: Stand back about a foot from the eye lens and look at it. You will see a round dot of light in the center. This is the exit pupil of the telescope. Actually, it is an image of the objective lens. Now put a piece of paper or ground glass behind the eye lens and move it back and forth until you get the smallest and sharpest circle of light, Fig. 14. This location is the exit-pupil point and it marks the proper location of the eye. Noting its position from the eye lens, complete your layout drawing as in Fig. 12, continuing the ray from the edge of field through the exit-pupil point. Look again at your test setup and note how large the exit pupil is. A big exit pupil means good illumination; a small exit pupil, poor illumination. Since the astronomical telescope is used for viewing a light source, the matter of illumination is not so important, and the exit pupil can be as small as $\frac{1}{64}$ in.

Experiments: While you have the astronomical telescope set up on the optical bench, make a few experiments. Remove the eye lens. Put a piece of ground glass or

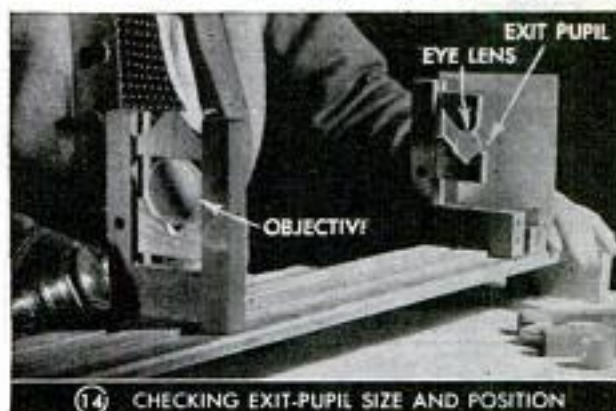

14 CHECKING EXIT-PUPIL SIZE AND POSITION

waxed paper at about the position of the image plane and move it back and forth until you get a sharp image. The image received in this manner covers a very wide field, much more than you can see through the eye lens. Now, in place of the ground glass put a piece of printed matter in the image plane. Place the eye lens in position and move it back and forth until the copy is sharp. The image is just the same as a solid piece of copy, and the purpose of the eye lens is to magnify it.

Eyepieces: There are better eyepieces than the single lens. The three common styles in use are shown in Figs. 15 to 19 inclusive. The Ramsden is the easiest to calculate and make; at the same time it is one of the best types of construction, giving a good field without distortion or other faults. The Kellner, Fig. 17, is a slight improvement on the Ramsden. The Huygenian, Fig. 18, is an old reliable, still popular. It differs from the Ramsden in that the image plane is behind the field lens. This style cannot be used directly as a magnifier. It has shorter eye relief (distance from eye point to eye lens) than the Ramsden, a point worth remembering when you are trying to get shorter or longer eye re-

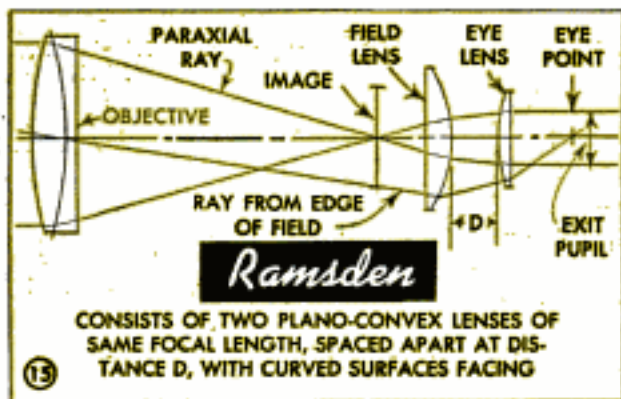

15

CALCULATIONS

D= TWO-THIRDS OF FOCAL LENGTH OF INDIVIDUAL LENS

EXAMPLES

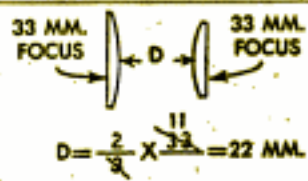

16

COMBINED FOCUS OF BOTH LENSES = $\frac{F \times F}{F + F - D}$

$$FE = \frac{33 \times 33}{33 + 33 - 22} = \frac{1089}{44} = 24 \text{ MM.}$$

Kellner

SAME AS RAMSDEN EXCEPT IT HAS A CEMENTED DOUBLET ACHROMAT AS EYE LENS. CALCULATIONS ARE SAME AS FOR RAMSDEN

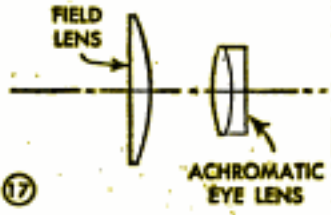

17

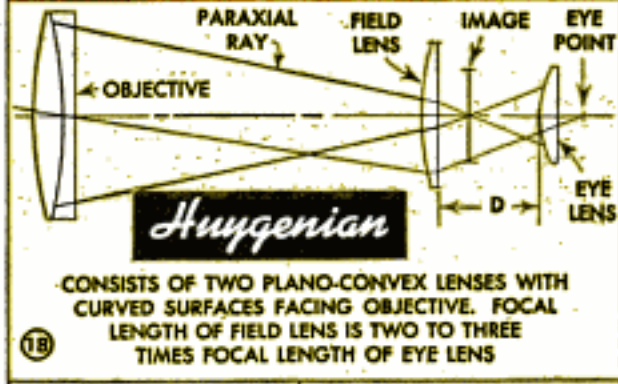

18

CALCULATIONS

D= ONE-HALF OF COMBINED FOCAL LENGTHS

EXAMPLES

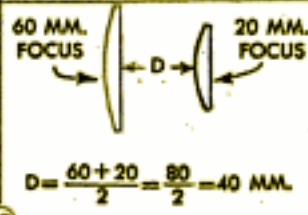

19

COMBINED FOCUS CALCULATED SAME AS RAMSDEN

$$FE = \frac{60 \times 20}{60 + 20 - 40} = \frac{1200}{40} = 30 \text{ MM.}$$

Eyepiece designs

Two lenses combined form an eyepiece and give better results than a single lens. Most popular style is the Ramsden although the Huygenian is an old favorite, especially for astronomical telescopes. The mounting can be wood, metal or plastic, turned to shape

lief. Of the two lenses in any eyepiece, the eye lens is the most important as it controls distortion and magnification much more than the field lens. The prime purpose of the field lens is to pick up the light rays from the edge of the field.

The combined focus of the two lenses in the eyepiece is determined by the calculations given in Fig. 16. The example in Fig. 16 shows that a 33-mm. field lens and a 33-mm. eye lens spaced 22 mm. apart will have a focal length of approximately 24 mm. This is not quite the same thing as a single 24-mm. focus lens. When you hold the single 24-mm. focus lens to your eye, you are sharply focused on any image or copy when the lens is 24 mm. away from the image or copy. In the combined lenses you will find the focal plane just a little ahead of the field lens because the 24-mm. focal length is measured from a point between the two lenses. As a matter of fact, the best correction of the combined lenses is obtained when the focal plane is exactly in the plane of the field lens. This means, however, that the field lens is sharply in focus; hence, you can see every speck of dust on it. When you note this condition, your lenses are spaced too far apart. Close them up until the dust specks disappear.

The image stop: The image stop is a round disk of cardboard placed in the image plane. The size of the hole is determined from Fig. 13; also, you can get a good idea of size by viewing a ruled piece of paper through the eyepiece. The image plane formed by the objective and the focal plane of the eyepiece always indicate the same plane when the telescope is focused. This stop is important because it clearly defines the field of view, cutting out weak edge rays and giving a sharp, clean-cut image. It is commonly made a part of the eyepiece, being located between the lenses in the Huygenian and ahead of the field lens in the Ramsden or Kellner. It should be dead sharp as viewed through the eye lens and, when the telescope is focused, it will always coincide with the image plane.

A typical astronomical telescope: Typical construction of a simple astronomical telescope is shown in Figs. 20, 21 and 22. This has a 2 3/8-in. diameter objective (2 1/4 in. clear) and the focal length is 36 in. A draw tube is used for rough focusing; critical focusing is done with a 40-pitch threaded eyepiece. The eyepiece is a Ramsden and can be of 1/4 to 1-in. focus. With a 1/2-in. eyepiece, the magnification would be 72X; with a 22-mm. eyepiece, the magnification would be 41X. Magnification could be pushed up to 144X with a 1/4-in. eyepiece. The exit pupil then would be about 1/64 in., representing about the limit for astronomical use.

Even though you may not wish to build an astronomical telescope, carefully study the drawings and text covering this subject as they are the basis for all terrestrial telescopes. You will need all this data in order to make the popular hand telescope or spy glass.

(Continued next month)

Astronomical telescope

This one will magnify up to 144X. It can be fitted with prismatic eyepiece and used at 40X for viewing objects on land



21 TURNING THE WOODEN ENDPIECE

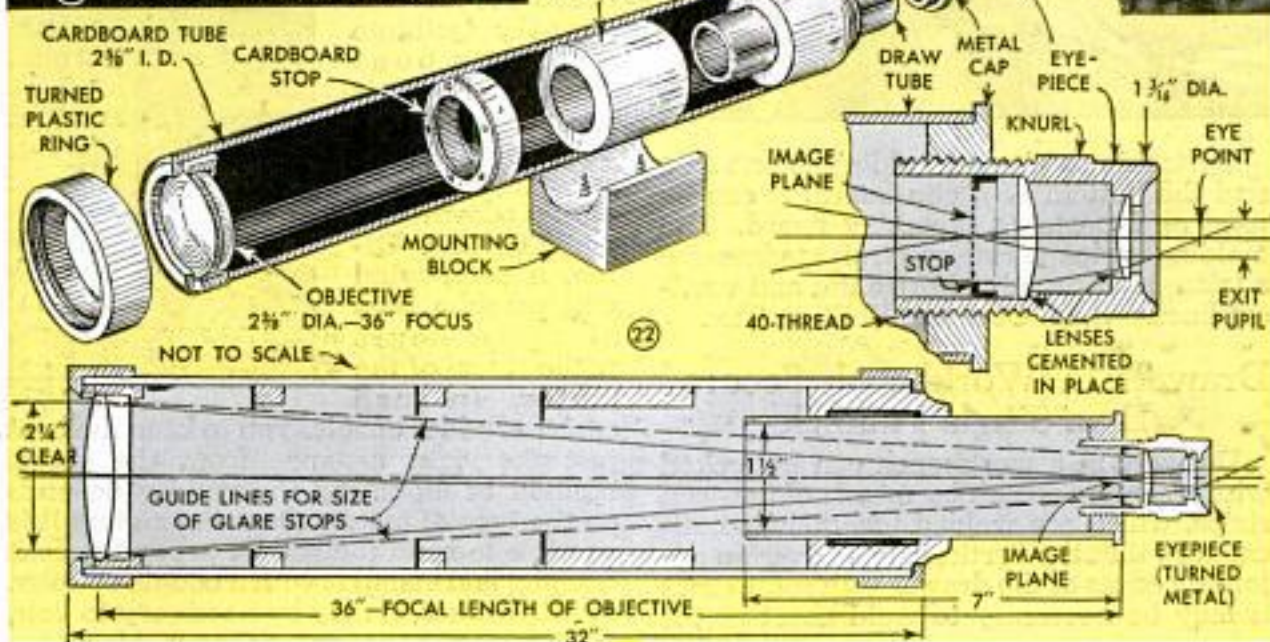

Clipping Sheets for Fast Copying

When addressing envelopes from mailing lists or sheets, each of which contains only one name, if you fasten the sheets together at the lower edge with a paper clip they will fall forward easily as you turn each one after doing your copying. This method is much faster than picking each sheet off a pile in order to copy one name and address.

—N. Campbell, Boston, Mass.



Pencil Erasers Quiet Rattling Door

Rattling of a door caused by a loose fit of the latch in the strike plate can be silenced by inserting two pencil erasers in the door stop. The erasers are forced tightly into holes drilled in the stop, after which the tips are shaved off with a knife until the door will close properly, with the erasers keeping the latch firmly pressed against the strike plate.

—Axel E. Ogren, Chicago.



Molding on Edge of Clip Board For Use in Sketching

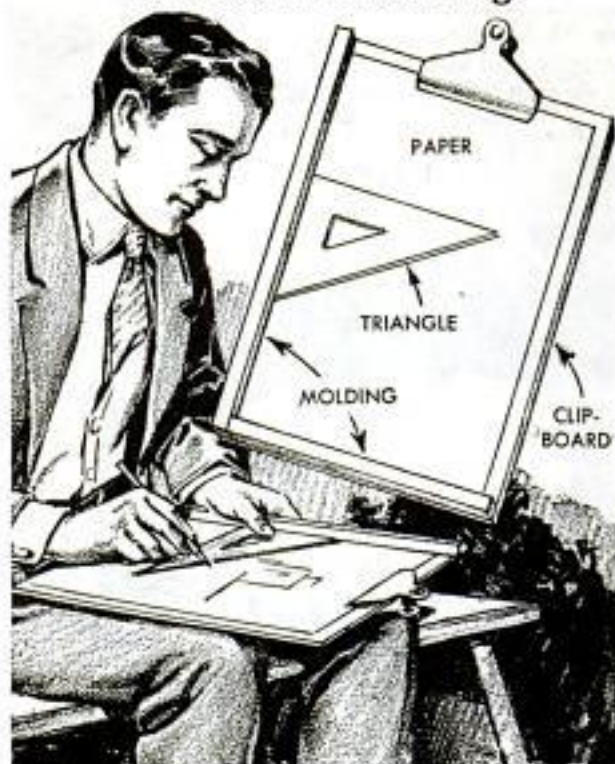

By tacking strips of molding to one side and the bottom of a clip board, it can be used as a portable sketching board. The molding strips serve as straightedges for a triangle in drawing horizontal and vertical lines.—R. H. Cochran, Phillips, Tex.

Drawers in Workbench Secured By a Single Padlock

Drawers in a workbench can be locked with a single padlock by means of flat-iron strips, which are welded together as indicated so that the vertical strips overlap adjoining edges of the drawers. In some cases it may be necessary to weld short pieces

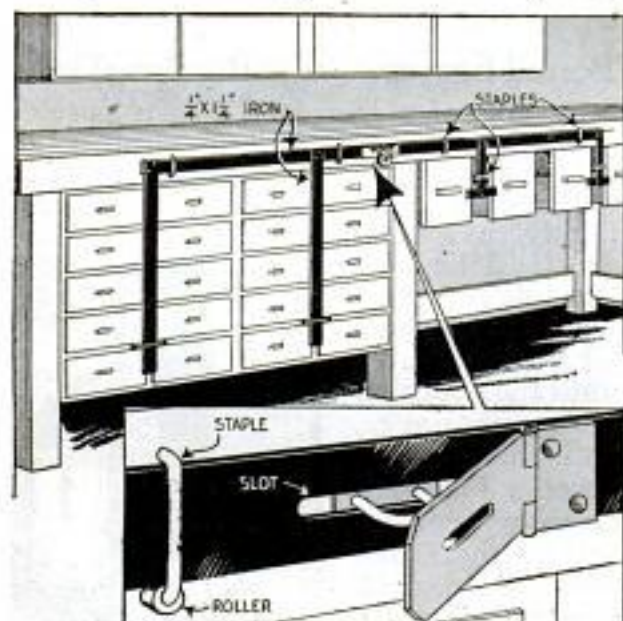

across the lower ends of the vertical strips as shown in order to reach drawers that are spaced apart several inches. The vertical strips are inserted through staples wide enough to allow them to be shifted to left or right when the padlock is removed, so that one tier of drawers can be opened at a time, thus making it unnecessary to lift out the strips in order to open the drawers. The staples carrying the horizontal strips are fitted with rollers, as shown in the lower detail, to facilitate sliding the strip. A hasp is riveted to the horizontal strip over a slot, through which a staple projects for inserting the padlock.

Abner Houge, Caledonia, Minn.

Rudder on Outboard Motor Helps Steer Boat Into Dock

A small sheet-metal rudder fastened to an outboard motor will greatly facilitate docking a boat when the motor is shut off. It also helps when steering a boat along shore downwind while casting. Often, a back wind will push a boat along for hours without use of the motor. In such cases, a rudder enables you to keep the boat just the right distance from the shore. Method of mounting the rudder depends on the type of motor. On some motors it is possible to bend the rudder around a shaft housing and clamp it with a couple of bolts. In other cases, it may be necessary to bolt, screw or otherwise attach the rudder.



C. H. Brown, Bel Air, Md.

Attractive Lettering Done Quickly With Carpenter's Pencil

You can do attractive free-hand lettering quickly by using an ordinary soft-lead carpenter's pencil which has been sharpened to a chisel edge on sandpaper. Held at about the normal writing slant, the pencil makes a pleasing variation in the width of lines at curves and provides a graceful finish for straight strokes.—Kenneth Murray, Baltimore, Md.

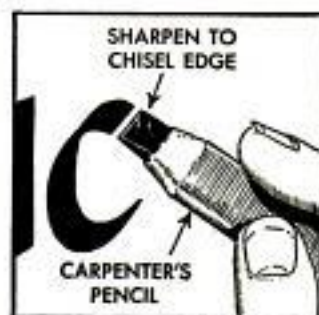

Wooden Window Guard Protects Small Children

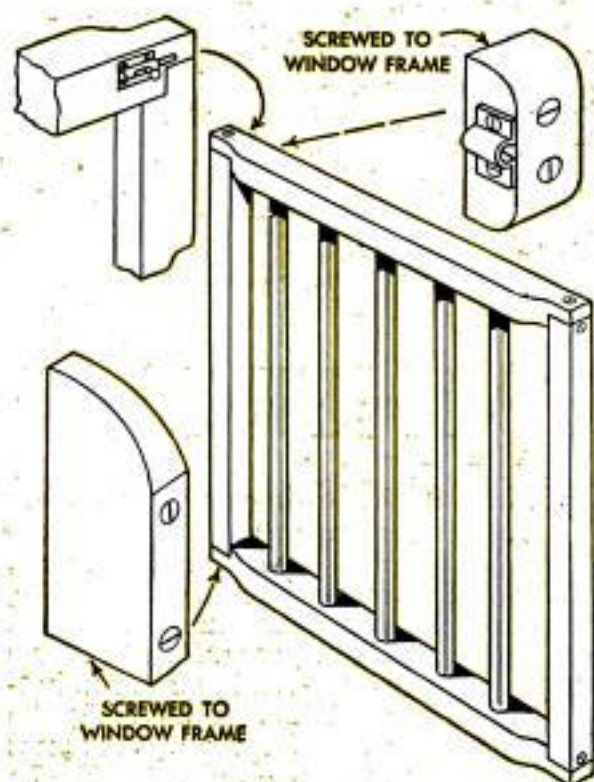

Your youngster can't lean out an open window if you install a window guard like the one shown. It can be removed in a jiffy, as it is merely set into the frame against the window stop where it is held by two cleats at the bottom and by sliding bolts at the top. Scrap pieces of yellow pine are suitable for the frame. Side rails can be made of $\frac{3}{4}$ by 2-in. stock, but, as lengths of $\frac{3}{4}$ -in. dowel are inserted in holes drilled in top and bottom rails, these should be a little wider and short enough to fit into the window frame loosely. They are tapered at the ends to join flush with the side rails, and are rabbeted and screwed at the joints. The cleats are set on the window sill and screwed edgewise against the frame with the guard in place so enough space is allowed between the cleats and the stop to take the guard. The cleats are tapered toward the top on the outside surface to permit the guard to be tilted inward slightly when being removed or set in place. The bolts, which are screwed to the outer edges of the top rail, slide into eyes screwed to blocks. These are attached to the stop, where they are hidden when the guard is in place. Or holes can be drilled in the stop to take the bolts, in which case neither the eyes nor the blocks are needed.

Edward A. Hine, Jr., New York City.

☛ To keep your household sponges fresh, simply soak them in cold salt water.

Children Learn How to Tell Time By Hand-Operated Clock

One teacher uses a hand-operated clock in her classroom for teaching pupils to tell time. The clock face is cut from plywood and shellacked, then numerals are painted on it with India ink. The hands are operated from the rear by a knob connected to the works of a discarded alarm clock, as shown in the detail. Only the gear mechanism is needed, so that the hour and minute hands will travel in correct ratio when the knob is rotated.

C. E. Lefevre, St. Paul, Minn.





LEATHERCRAFT

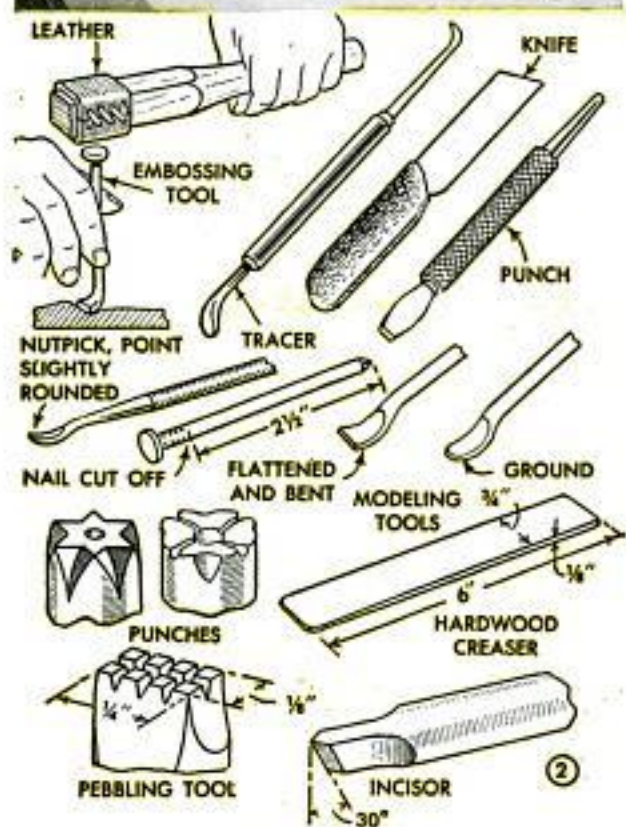

WORKING in leather is so easy that even a beginner can produce pleasing, salable articles. Few tools are needed, and most of these can be made from nails, bolts, nutpicks and other common objects, as shown in Fig. 2. A jackknife will do for cutting, but a leather-cutting knife is better adapted for skiving, or beveling the edges of leather, Fig. 13. Though it is not necessary to have a punch like that shown in Fig. 1, this tool is handier for making lacing holes than a nail, which of course can be used. Or a shoemakers' awl can be used as in Fig. 5, the holes being punched in the leather with the aid of a mallet.

For a billfold, the best material is English tooling calf, which has a velvety surface and retains impressions readily. Ooze calfskin or split cowhide with ooze finish also are suitable. To test leather, the thumbnail is pressed into it. If the impression remains, the leather is satisfactory. Five pieces are needed for the billfold shown in Fig. 3: a back piece, which is to be tooled; a second piece slightly shorter than the back to form a paper-money compartment; a piece to take a window, which can be celluloid or Cellophane; and two pockets. The second back piece is shorter than the first in order to prevent a

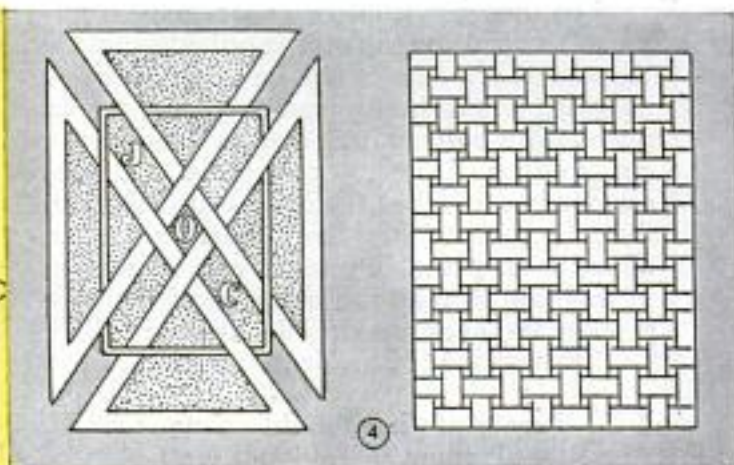
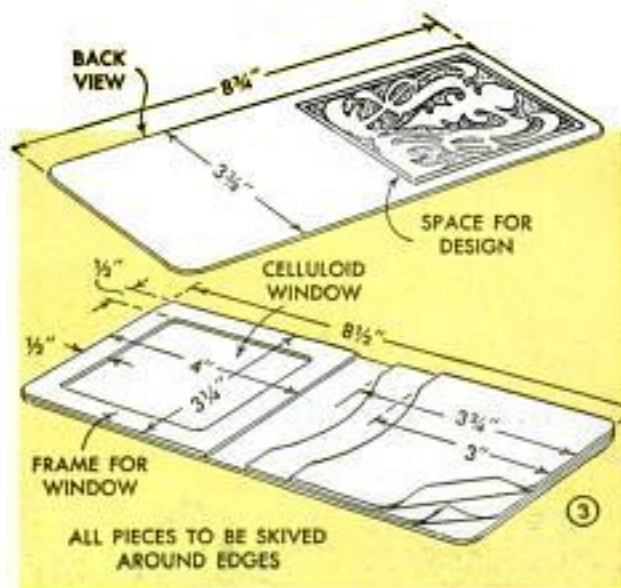



for Fun and Profit

Working with leather is fascinating and profitable. Leather articles attractively embossed and neatly laced make welcome gifts and find a ready sale. Most of the simple tools needed can be made at home

bulge when the pieces are laced and folded. Pieces to be tooled should be cut slightly oversize in case they are pulled out of shape while being worked. Also, margins permit the use of thumbtacks and paper clips for holding the work on a board for trimming.

The design to be tooled should not be intricate or have close lines. The one shown in Fig. 4 is a suggestion that may be varied in many ways. First the design is copied on heavy paper. Then the leather is dampened with a sponge. It should not be soaked so that water oozes out when it is being worked. Now the design is traced to the smooth or hair side with a hard pencil or tracing tool. A straightedge should be used to get clear, straight lines, and the tracing should proceed from the corners toward the center so that the lines do not extend beyond the marked edges, as lines thus traced will remain in the leather permanently. After the design has been

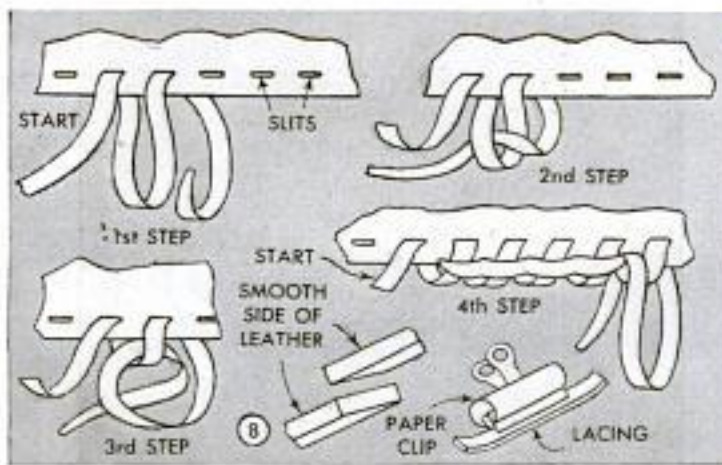
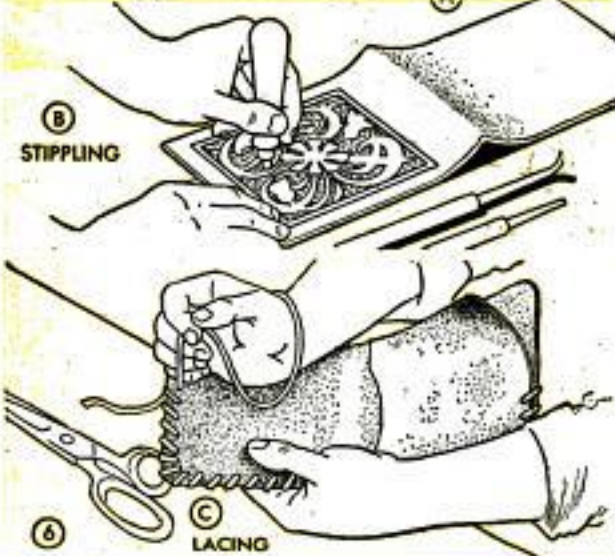

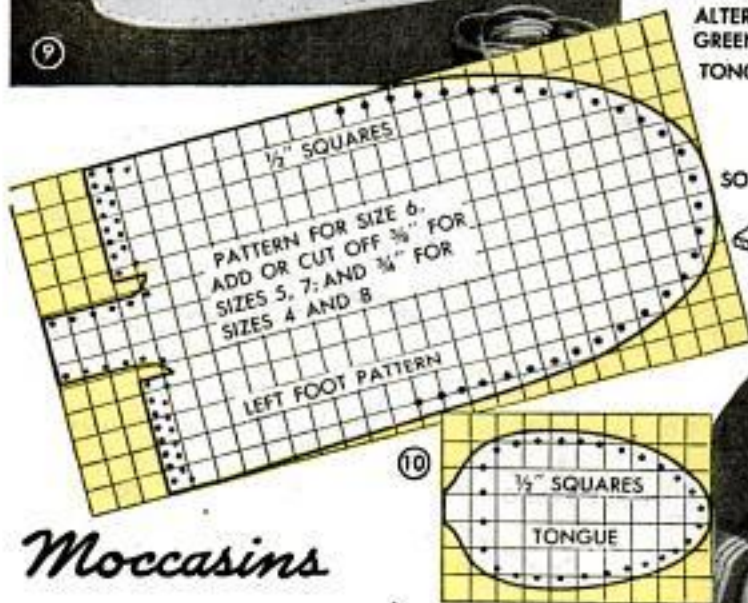

Moccasins

traced, the paper is removed and the leather is placed on a piece of plate glass or other smooth, hard surface, and again dampened, after which the outlines are re-traced as in Fig. 6A. For this purpose a nutpick can be used if the point is rounded slightly to prevent digging into the soft leather. The raised parts of the design can be brought up into bolder relief by using a modeling tool made from a nail with its point flattened and bent. The background can be stippled with an awl or nutpick as at B, Fig. 6, or it can be pebbled with a pebbling tool formed by filing slots in the flattened end of a spike. When all tooling is finished, the work is creased along the center with a hardwood creaser.

Now the pieces can be laced as at C, Fig. 6. Holes should be laid out carefully, not over $\frac{1}{4}$ in. apart, and about $\frac{1}{8}$ in. from the edge, and all pieces should be punched together so that the holes will register. Strips about $\frac{3}{16}$ in. or $\frac{1}{8}$ in. wide can be cut from a strip of calfskin with a sharp knife run

along the edge of a metal straightedge. If the laces are too short, they can be glued and spliced as in the lower details of Fig. 8, which also shows one method of lacing. After lacing around the article, the ends are pulled through two slits, glue is applied and the ends are tucked under the lacing. Then the billfold is ready to be waxed to protect it from scratches and wear. The work is laid on a hard surface where pressure can be applied, and wax is spread over it with a soft cloth, Fig. 7, after which the billfold is polished with a dry cloth to bring out the luster. Or wax can be applied with a soft brush such as a discarded toothbrush.

Two pieces of soft-tanned elk are needed for moccasins. These are cut to the pattern shown in the cross-hatched details, Fig. 10.

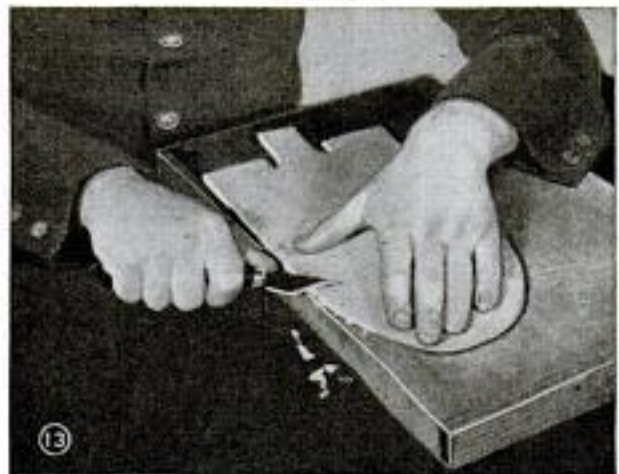
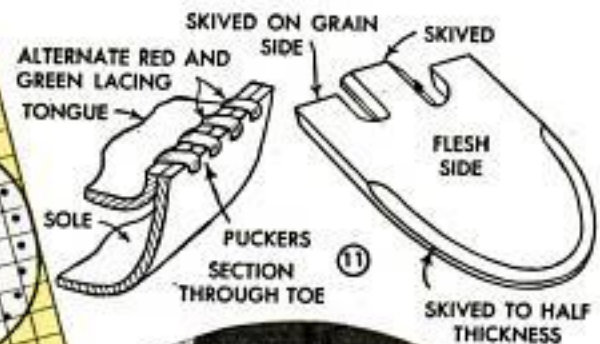

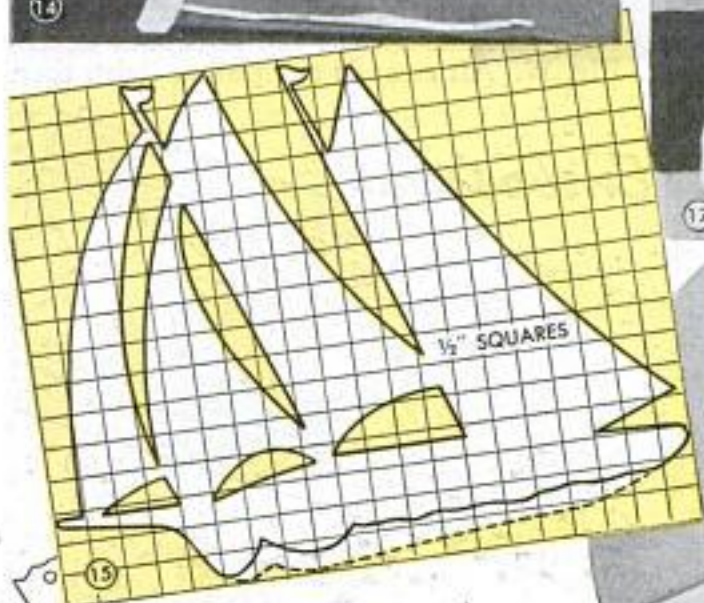
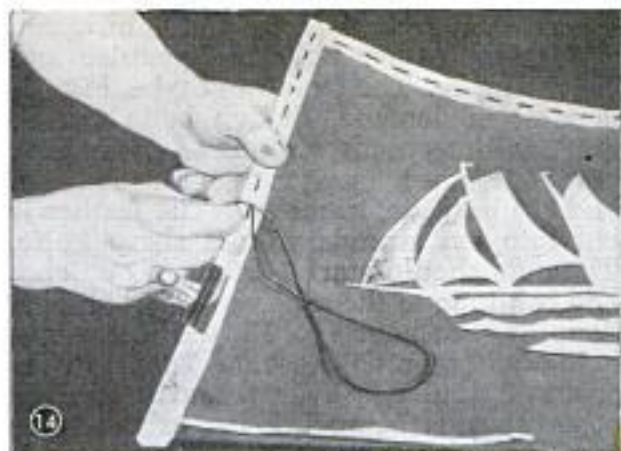

Belts

Note that the holes in the tongue are spaced closer than those around the toe and heel, so that the latter will pucker between holes when laced. As elk hide is heavy, the sole should be skived as indicated in Fig. 11 to permit puckering. Skiving is done by laying the piece along the edge of a board and slicing the edge of the leather at a slant or bevel, Fig. 13. Holes can be punched for laces easily with a leather punch, as indicated in Fig. 9, but the heel should not be punched until the moccasin has been fitted to the foot. Lacing is done with pointed laces, as they should fit the holes snugly. Two colors of $\frac{1}{8}$ -in. lacing may be used, each lace being about $2\frac{1}{2}$ times as long as the distance around the toe. Now the moccasin is put on the foot and the flaps are



folded around the heel. If these do not meet exactly, the back should be cut down and reshaped to fit. Then lacing holes are punched in the flaps and laces are inserted in the outer row of holes and the flaps are tied as shown in Fig. 12, after which the stay is brought up and laced through the inner row of holes.

Overlaying designs on a background of



Photo courtesy Chicago Servicemen's Center

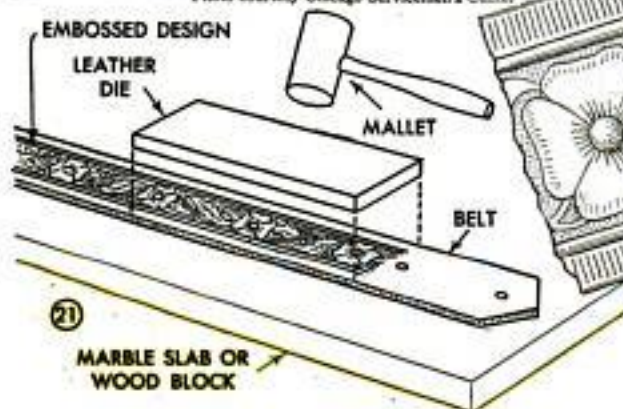

Embossing



leather is another interesting example of leathercrafting. Fig. 17 shows a pillow being decorated in this way. A pattern, Fig. 15, is laid out on heavy paper, then traced to the leather which is to form the overlay. Suede lambskin is best for both overlay and background. The design then is cut out with a sharp knife and placed, smooth side up, on the rough side of the background piece, where it is mounted with ordinary liquid glue that has been thinned slightly by being placed in a pan of warm water. The glue is applied to the rough side of the design, then scraped off with a knife to remove any surplus. If any parts fail to adhere when pressed against the background, additional glue can be applied with a pointed brush, Fig. 17. After the gluing is finished, the design is covered with tissue paper and weighted with a board loaded with a heavy object. A 1½-in. binding strip then is folded over the edges of the cover pieces (front and back of the pillow) and laced together with ⅛-in. lacing, as in Fig. 14, a paper clip being used to hold the pieces together. Holes are

spaced ⅜ in. from the edge and ½ in. apart.

Braided leather belts are popular and easy to make. The ten-strand type, Fig. 16, is most in demand, though belts can be made with as many strands as desired. A piece of leather ⅓ longer than finished size, and 1⅝ in. wide, is needed. The leather is cut into ten strands with a sharp knife. The cuts should start 7 in. from one end, and continue to the other end. Braiding is done as shown in Fig. 18, the uncut end being held by a nail. Strand 1 is laid over strand 2, under 3, over 4, and so on, the other strands being braided in the same way, as indicated in the left-hand detail, Fig. 16. All strands are pulled tight, then

flattened at intervals by being hammered on a hard surface while covered with a board, as in Fig. 19. Buckle and loop then are added, as shown in the center detail of Fig. 16. The strands at the ends of the belt are skived and glued between folds of the tongue after the buckle and loop have been inserted. When the glue is dry, holes are punched for the lacing, which goes through the strands and tongue.

Embossing a belt requires a die in which a design is cut, as in Fig. 20. Of course, a design can be tooled into the leather as previously described, but a die-formed design is more distinct. For the die, a 5-in. length of heavy cowhide about 1¼ in. wide is needed. A design such as the one shown in Fig. 22 is cut into it with an incisor, illustrated in Fig. 2. The tool is held firmly, and almost vertically, and cuts should be ⅛ in. deep. Next, the belt strap is moistened and laid on a hardwood board or slab of marble, the die is laid over it and pounded with a mallet as indicated in Fig. 21. The die then is moved along the belt and hammered again, until the entire belt has been embossed. After this, a buckle and strap are sewed on, and, if desired, the background can be darkened with leather stain to bring out the pattern.

Portable Incinerator Saves Carrying Leaves

If you burn leaves, a wire rack on wheels like this one will enable you to do the job where the leaves are raked instead of carrying them to a bonfire or incinerator. Rear wheels and handle of the rack were taken from a discarded lawn mower. The frame of a porch swing furnished the body, and its springs formed a grate from which the ashes fall onto a metal plate. Any other materials will do just as well, if the metal plate is spaced slightly below the grate so that ashes can be distributed evenly over the ground.—Edwards H. Smith, Beaver Dam, Wis.



Tight Screws Are Removed Easily By Heating With Soldering Iron



A well known method of removing wood or machine screws that have corroded is to heat their heads so that the expansion and contraction of the metal will loosen them sufficiently for removal with a screw driver. The method of applying heat, which often is a problem, can be solved easily

by using a soldering iron. The iron is applied to the screw as hot as possible. If

the iron has a bit or copper that can be removed, more rapid heating of the screw will result by reversing the bit so that a flat surface instead of a point will be presented to the screw head.

W. C. Wilhite, Carlinville, Ill.

Crushed Egg Shells Scour Bottles

Crushed egg shells provide an excellent abrasive for scouring milk bottles and other utensils. To clean a milk bottle, drop in the crushed shell of one egg, pour in a little hot water, and shake vigorously with a rotary motion for a few seconds. Soiled particles clinging to hard-to-clean portions of the bottle are removed by the sharp edges of the shell particles, and the bottle is cleaned perfectly. Try crushed egg shells, also, for scouring aluminum ware, granite utensils or other difficult scouring jobs.—Vera Esther Grate, Columbus, O.

Flat-Iron Tongs Align U-Bolts When Installing Car Spring

In order to avoid damaging the threads on a U-bolt when installing an auto spring, tongs can be used to align the bolt ends and force them into the holes in the supporting plate. The tongs are made from two pieces of flat iron hinged together at one end. One arm is flattened and notched to fit between the bolt threads as a pry bar. The end of the other arm is bent at right angles so that it can be inserted part way into the hole in the plate. In use, one end of the U-bolt is inserted in one of the plate holes, after which the tongs are used as indicated to line up the other end of the bolt with the hole in the plate.

Empty tobacco sacks filled with ashes, fine sand or commercial cleanser provide ideal emergency pot cleaners.

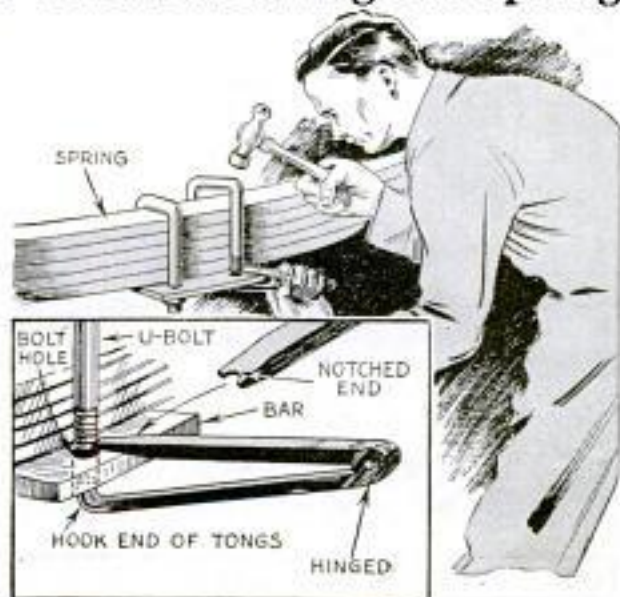



TRICKS *of*

By George L. Lewis

ALTHOUGH most fur-bearing animals can be trapped only during the "open" season prescribed by law, wolves and coyotes are considered so destructive to livestock that they may be caught at any time. In fact, many states pay a bounty for killing them. Before setting your traps, therefore, it is best to consult the laws of your state to determine when certain kinds of animals may be trapped. Wolves are numerous in Alaska and Canada, although they are found in considerable numbers in many sections of the United States as well, especially in the South and West. Coyotes, which are sometimes called "prairie wolves" or "brush wolves," are found in all far-western states and in many other localities as far east as New York. Usually bobcats and badgers inhabit the same sections, and foxes can be found in most parts of the country, though they are more numerous in the East. Minks and muskrats are plentiful in every state, in Alaska and Canada.

There are many methods of trapping, some of which require much equipment, but simple ways generally will be found highly successful and much less expensive, and will assure a reasonable return on the money invested for supplies. Steel traps for coyotes can be used also for foxes, bobcats and badgers. Sizes 4½ and 14 are best for wolves, size 3 or 4 for bobcats, badgers, lynxes and coyotes, and size 2 for foxes. The "jump" type, in the left-hand detail of Fig. 3, and the regular double-spring type, Fig. 2, are satisfactory. Gloves should be worn when handling traps used to catch land fur bearers, as any strange scent may frighten them away. For this reason it is unwise to smoke when attending your trap line. Also, before being used, all traps should be boiled for a few minutes in a tincture of sage leaves, tree bark, pine needles or grass to eradicate human scents and substitute, instead, the natural odors familiar to animals. Of course gasoline, ker-



①



②

SETTING TRAP FOR COYOTE



TRAPPING

osene, creosote and other volatile or pungent preparations used in camping must be kept as far from the traps as possible.

Coyotes will not approach traps set near trees, large stumps, rocks or brush, or among thick bushes or timber. The ideal place for a trap, therefore, is an open space about 30 ft. in diameter, nearly devoid of vegetation, where there is little grass, and where a bush grows not more than 16 in. high. If no small bush grows naturally in such a place, one can be transplanted, as in Fig. 2. The earth must be fairly dry and not contain gravel. Traps for all land animals except bears should be be staked down securely.

In preparing a set, first make a depression in the ground just wide and long enough to take the trap. This can be done best with a small hatchet or camp ax, Fig. 1. Although the trap shown beside the hunter has only one spring, the double-spring type should be used if the set is made for coyotes. The hole should be deep enough so that after the trap has been covered with a sheet of newspaper or strip of burlap and $\frac{1}{4}$ in. of fine dirt, the set is level with the surrounding earth. To spread the dirt, rub it between gloved hands as in Fig. 4, discarding all stones and large lumps. Keep all kinks out of the trap chain so that it will not rattle when an animal steps on it, and remove your tracks by brushing the surrounding ground lightly with a piece of cloth as in Fig. 5, or the scent bag shown in Fig. 12. For bait, apply scent to the top of a wooden stake that has been driven flush with the ground on the side of the trap nearest the bush so that the coyote will not step on the chain to get to the bait. The trap chain should be wired securely to the stake. For bait, oil of anise, 1 oz., added to ground carp, sucker or trout that has been allowed to decompose in a glass jar is satisfactory, though many other materials can be used. As a rule, each trapper prefers the particular type of bait that seems to be most attractive to the animals that are to be trapped.



4 DIRT RUBBED BETWEEN GLOVES



5 BRUSHING AWAY FOOTPRINTS



⑥

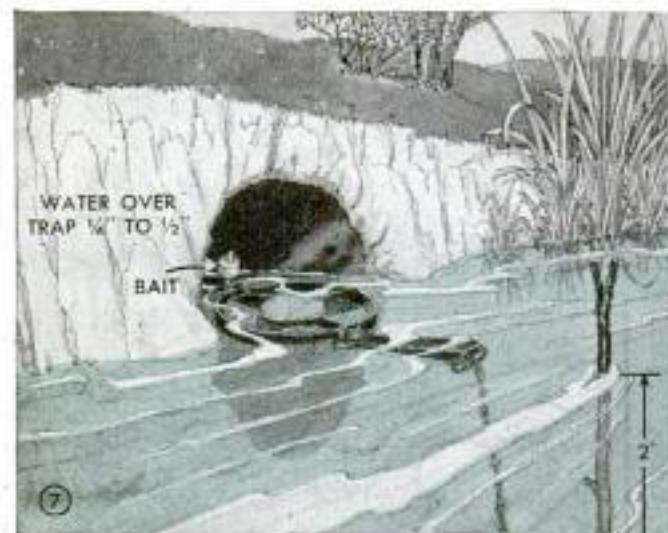

⑦

Ordinarily, it is not good practice to use meat for bait except when snow covers the ground. A good container for fish scents is a "pop" bottle with a 5 or 6-in. softwood plug for a stopper, Fig. 11. This can be removed easily without getting any of the scent on your hands. For a cover to protect the bottle from breakage, the sleeve of a discarded sweater or the leg of a pair of overalls sewed together at one end is excellent, Fig. 12. Moreover, the cover can be used to brush away footprints from around trap sets, thus making it unnecessary to carry extra equipment for this purpose.

Another way of setting a trap for large animals is to conceal it on a game trail regularly used by them, where it is secured by a peg driven down out of sight and covered with dirt. No scent is used for this type of set. When trapping coyotes in this way, great care must be taken in placing the trap on the trail, as coyotes are extremely wary. A trail out in the open should be selected, and the trap must be set not closer than 20 or 30 ft. to rocks,

trees, bushes or fences. Also, traps should not be set in the bed of a deep wash or dry ditch. On the other hand, for bobcats, wolves, foxes and badgers, these precautions are unnecessary. Lynxes can be caught right at the base of a tree. After completing a trail set, place a small stick or piece of brush directly across the trail about 2 in. from the concealed trap as in Fig. 6. In approaching the stick, a coyote will space its steps so as to step over it and directly into the trap.

Because of the great numbers of muskrats to be found in almost every pond, stream and lake, the pelts of these animals account for a great proportion of the average trapper's income. Muskrats are comparatively easy to trap if one important fact is kept in mind: their legs and feet are tender and brittle. If the animal is not drowned within a few seconds after being caught in a trap, it will twist off its leg and escape, and the trapper will have lost a valuable pelt. A number 1 or 1½ trap, such as shown in the right-hand detail of Fig. 3, is suit-



⑧ RAFT TRAP FOR MUSKRAT OR MINK



⑨

able. Set the trap near the edge of the water close to the animal's den so that the trap will be submerged to a depth of $\frac{1}{4}$ in. Be sure that the water within a foot or two of the trap is at least 2 ft. deep, Fig. 7, or add as much wire to the trap chain as necessary so that when caught, the muskrat can swim to deep water and drown. In cold weather, holes are cut in the ice to make the sets. Fig. 10 shows a rat being removed from such a set. Bait is placed on a small stick near the trap so that the muskrat must get into the trap in trying to reach it.

Where depth of water in a stream fluctuates, a raft trap can be used. This is made of poles or logs 6 to 9 in. in diameter and 18 to 24 in. long. These are joined at one end and braced at the other as in Fig. 8, a narrow board being nailed between the logs as a platform on which the trap is secured. This will be kept submerged by the weight of the logs. The set should be near water at least 2 ft. deep so that the muskrat will drown immediately. Parsnips are best for bait, though carrots, apples, potatoes and celery may be used.

The same size trap is suitable also for mink, skunk, weasel and marten. Of these,

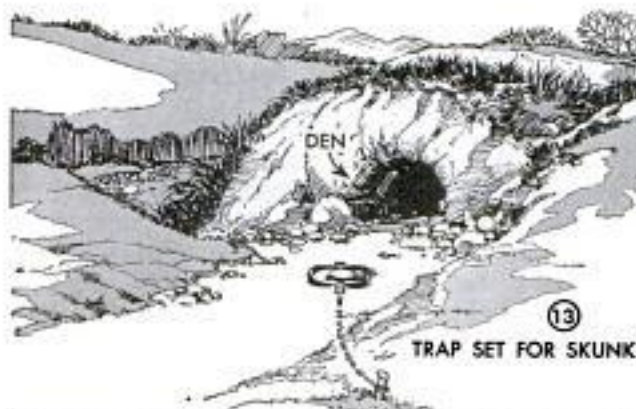

the mink has the most valuable pelt. This animal lives near water, its den being above water in the bank of a stream or shore of a lake or pond. The mink is a meat eater, feeding on fish, frogs, small turtles, crabs, crawfish, birds' eggs, mice, muskrats and rabbits. Traps should be set near driftwood at the water's edge, Fig. 9, and should be covered with rotted wood, dry leaves, grass or feathers as in Fig. 14. Also, the ground near the trap should be sprinkled with water as in Fig. 15 to remove all traces of human scent.

Traps for weasel and marten need not be set at the water's edge and can be left exposed. Although fish-oil scent can be used for bait, rabbit flesh or the heads and entrails of chickens are more satisfactory. Be sure, in removing a weasel from the trap, that you do not allow the white fur to become bloodstained, as such stains are



13

MAN SCENT DESTROYED WITH WATER

almost impossible to remove from the fur.

Skunks have no fear of traps, which can be exposed as in Fig. 13. Also, it is best to set the trap several inches back from the den entrance and stake it with a chain so that the trapped animal cannot drag it

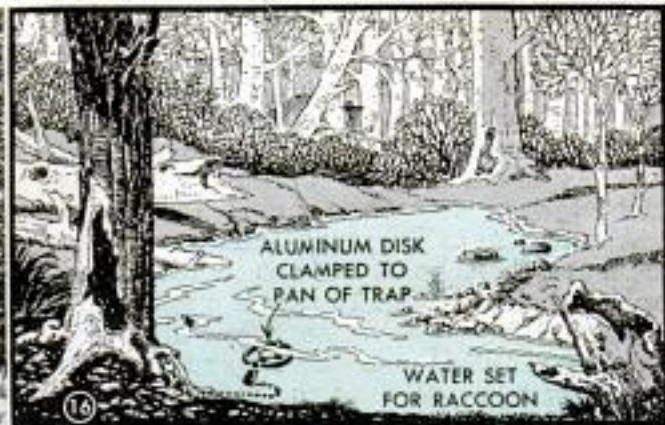

ALUMINUM DISK
CLAMPED TO
PAN OF TRAP

WATER SET
FOR RACCOON

down the burrow, as you may have considerable trouble digging out the animal. For bait, fish-oil scent may be used, but in larger quantities than for coyotes. This should be mixed with decayed meat or strong cheese. When caught, skunks should be shot with a 22-cal. rifle.

Raccoons prefer thickly wooded country. They frequent streams where heavy timber grows at the shoreline and are caught most often at the water's edge. Set your trap so that water covers it to a depth of $\frac{1}{2}$ in. as for a muskrat set, but instead of using regular bait, clamp a shiny metal disk on the trap pan as in Fig. 16, or the pan can be coated with aluminum paint.

Felt-Lined Sheath for Hand Saws Protects Against Rust

Saws can be protected from moisture and rusting when not in use by storing them in a sheath like this one. It is a wooden box with one end fitted with pieces of $\frac{3}{4}$ -in. stock cut to conform to the saw handles and lined with oiled felt, shown in black in the detail. Six such cutout pieces are

needed to hold three saws. Before assembling the endpieces, which are glued and screwed to top and bottom of the box, they should be shellacked or sized to be impervious to oil. Note that $\frac{3}{4}$ -in. play is allowed in height of the box so that saws can be lifted slightly for inserting or removing.

Fred Strickland, Portland, Ore.

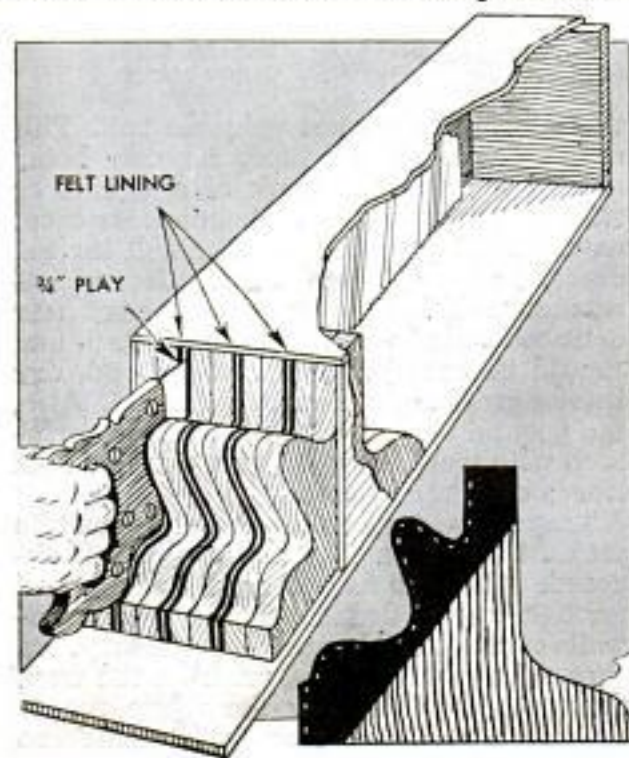

Wall Thimble for Stovepipe

If you are unable to purchase a thimble to protect a wall where a stovepipe runs through it, one can be made by bending a piece of sheet metal to shape and bolting or riveting it together at the joint, or you can use a piece of large stove or furnace pipe. The length of the thimble depends on the thickness of the wall, and its diameter should be at least 2 in. larger than that of the stovepipe. Two strips of metal formed to support the pipe are bolted or riveted in place as indicated.

Mrs. F. R. Platt, Elbridge, N. Y.

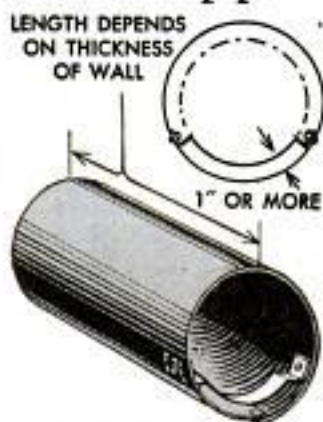

Automatic Control Slows Down Train at Curves

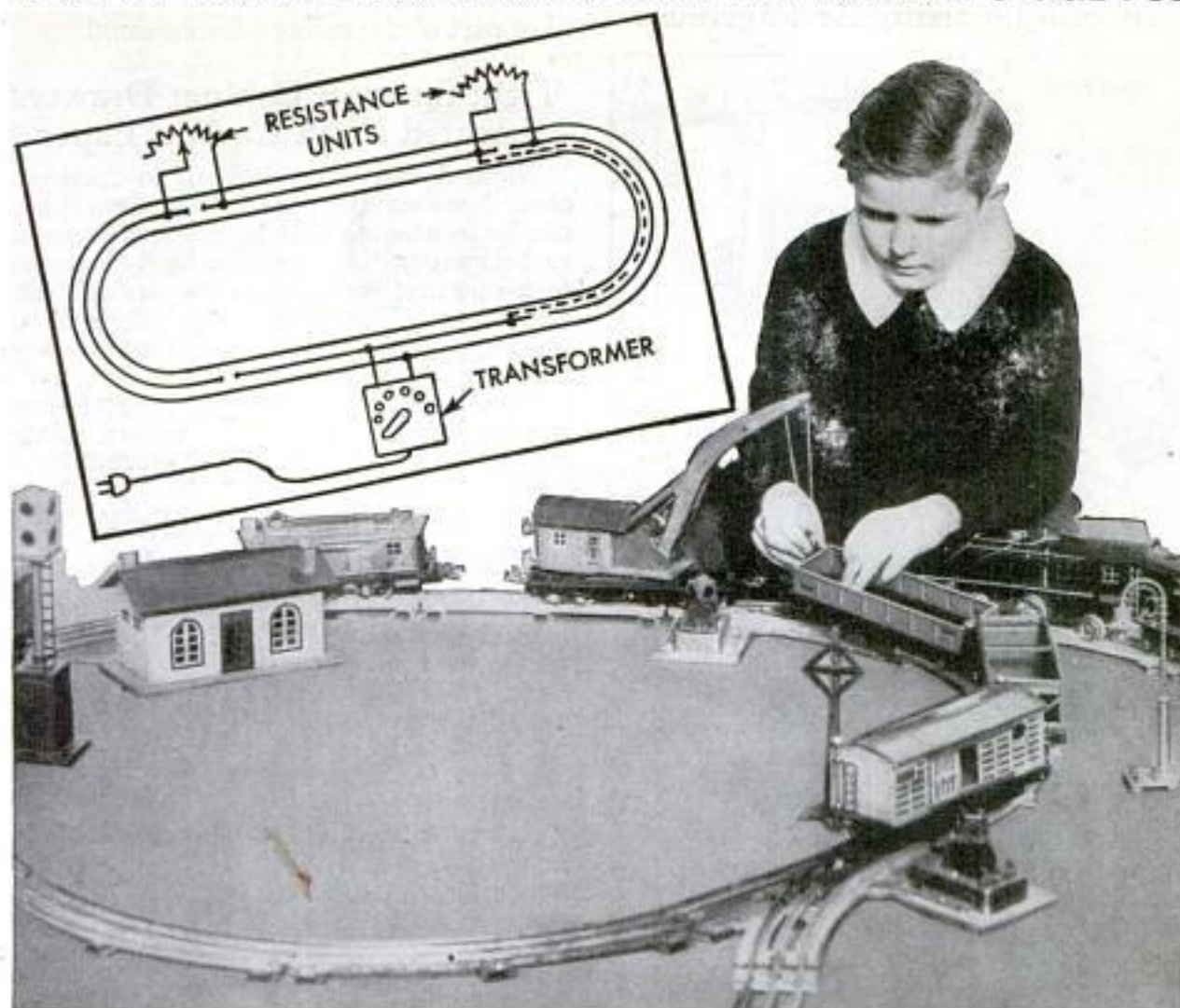

A simple change in the track system of your toy electric train will cause the train automatically to slow down at curves so that it will not jump the track, while allowing full speed on the straightaway. All you do is file off from the straight-track sections about $\frac{1}{16}$ in. from the ends of the center rails that connect with the curved sections, after taking out the pins, then at-

tach a variable-resistance unit to bridge the gaps as shown in the wiring diagram. The resistance unit can be adjusted so that the train will slow down when rounding the curves. To carry the full load of current to other sections of track, a length of insulated wire is attached to the center track, as shown by the broken line in the diagram.—Fred Lettino, Astoria, N. Y.

Block Clamped to a Chisel Guides Turning of Cylinder

When you want to turn a perfect cylinder in a wood-turning lathe, use this simple trick of clamping a block of wood to the chisel to control the depth of cut. Make the work as perfect as you can by ordinary turning, then carefully align the tool rest parallel with the lathe bed and proceed with a light finishing cut with the block of wood attached to a square-nose chisel for a stop guide as indicated. With a corresponding setting of the tool rest, the same setup can be used for turning tapers. Also, with a wooden pattern fitted to the tool rest, the same method can be used for duplicating long curves or other contours.

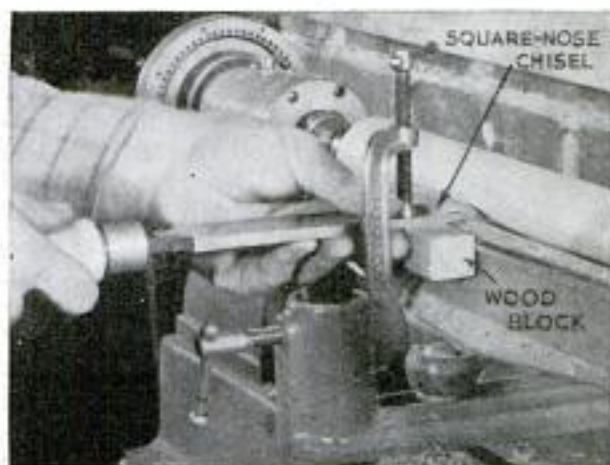

Small Child Operates Wall Switch By Simple String Arrangement

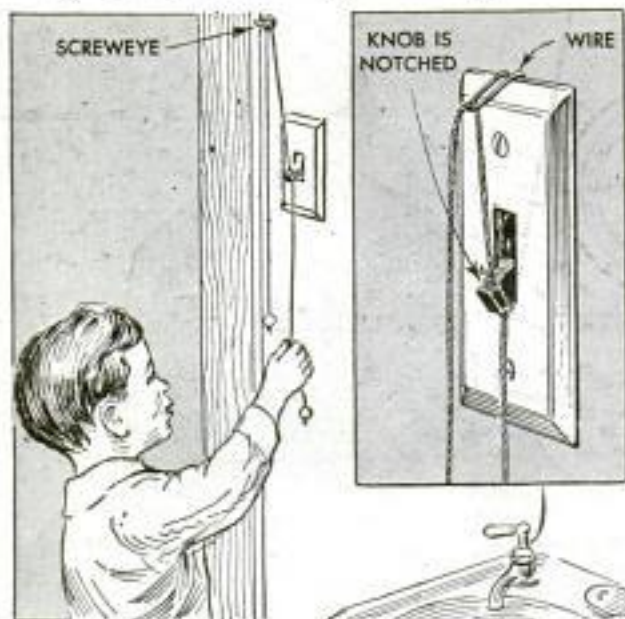

A child too short to reach a wall switch can turn it on and off if you tie a string to the toggle and arrange it as shown. One end of the string hangs down from the toggle and the other end is extended above it either by running it through a screw eye located on an adjacent door frame, or by bending a piece of wire to form a loop and fastening it behind the switch plate. The corners of the toggle should be notched so that the string will not slip off.

Laundry Bag Lining in Hamper Saves Time and Labor

Laundry bags made to fit inside your clothes hamper will facilitate the work of sending your laundry out. If you attach a pad and pencil to the hamper, also, and keep a record as each piece is placed in the bag, it will not be necessary to remove the clothes from the hamper, which can be lifted from the hamper and sent directly to the laundry.

E. E. Downey, Salisbury Mills, N. Y.

Checks Protected by Tinting



Erasures on checks are detected instantly if the background on which the amount is written has been tinted. Blocks of a contrasting color may be printed on those portions of the check, or colored ink or water

color may be used. Any attempted alteration by erasing will be indicated by removal of part of the colored background.

Tight Spots in Cabinet Drawers Located With Carbon Paper

When drawers are difficult to open and close because they stick, the tight place can be located quickly by placing sheets of carbon paper over the most likely location, then opening and closing the drawer several times. When the carbon paper is removed, it leaves a mark on the wood wherever the drawer is tight, and the excess wood can be planed off. The same method is also handy when doors and windows stick.—Stanton Tiernan, Baltimore, Md.

Soldering Iron for Light Work From Woodburning Pencil

An electrically heated pencil of the type used to burn designs into wood makes an excellent soldering iron for light work in an emergency. Such a pencil is also very handy for radio workers and others who have occasion to solder wires and do similar light soldering.



WOOD-BURNING PENCIL

Arthur Denton, East Hampton, N. Y.

Ruled Card Used to Divide Inch Into Odd Fractions

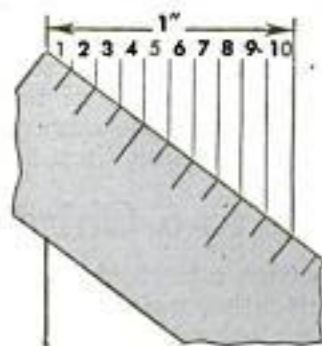

Inches can be divided into fractions not found on the ordinary ruler by the use of a card measured off into equal spaces. A $\frac{1}{4}$ -in. space makes a convenient unit in measuring out such fractions. For ex-

ample, to divide the inch into 10ths, simply draw two parallel lines an inch apart and lay the card diagonally across them so that 10 of the equal spaces are included between the lines; then mark the location of these points. Lines drawn at these points parallel to the outside lines marking the inch space will divide that space into 10 equal parts. If sixths of an inch had been required, the card would have been placed so that only six of the equal parts fell between the inch marks.

Wooden Photoflood-Lamp Stand Is Adjustable

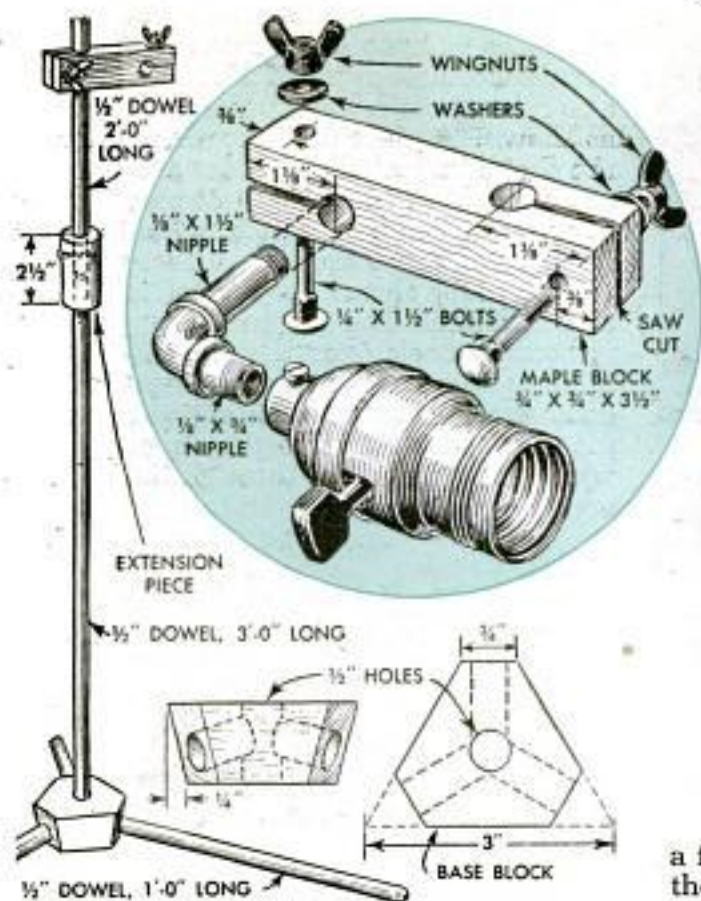

a few drops are needed, enough to darken the water in a small tray. Prints are immersed in the solution and kept there until the high lights take on a bluish tint, when the prints are transferred to a hypo fixing bath, in which they are allowed to remain until the bluish tint disappears.

For supporting a photoflood lamp, an adjustable stand can be made from a few lengths of dowel, some scrap wood, several pipe fittings and a standard lamp socket. When made to the dimensions given here, it will hold a lamp as high as 3 ft. without an extension, and up to 5 ft. high with one in place, as indicated in the left-hand drawing. Also, it can be taken apart quickly and stored in a small space. For a standard, a 3-ft. length of dowel is inserted in a hole drilled in a triangular block, the corners of which are cut off and the flats drilled at an angle to take dowel legs, as shown in the lower details. An extension for the standard is held by a coupling, which is merely a short length of 1-in. dowel drilled through the center. An adjustable head is made by drilling and slotting a wooden block, then inserting pipe fittings and bolts as in the circular detail.

Jack Wills, Brightwaters, N. Y.

Iodine Solution Acts as Reducer On Overexposed Photoprints

If a favorite negative is so thin that prints made from it are always dark from overexposure regardless of the grade of paper used, try reducing the print instead of intensifying the negative. Ordinary tincture of iodine can be used for this purpose. Only

Simple Improvised Photo Press

When I needed a press to flatten some photoprints and none was available, one was improvised from two pieces of plywood and a coil spring from a cushion. The photograph to be pressed was placed between the plywood pieces, which were laid under a low piece of furniture so that the spring exerted pressure on the upper piece of wood.—William Swallow, Brooklyn, N. Y.

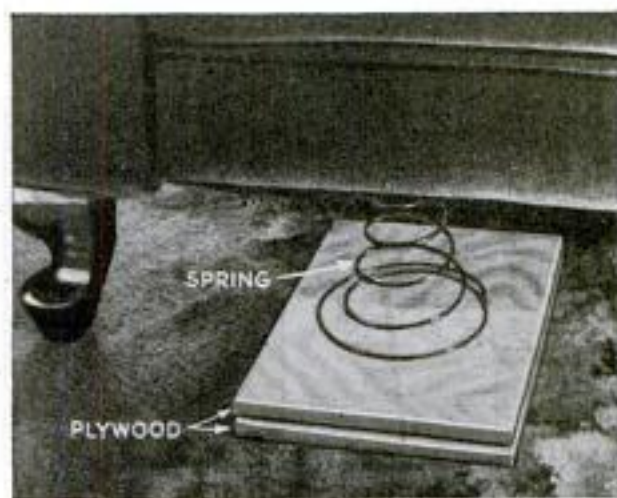

Washer Helps to Circulate Water Rapidly Over Prints

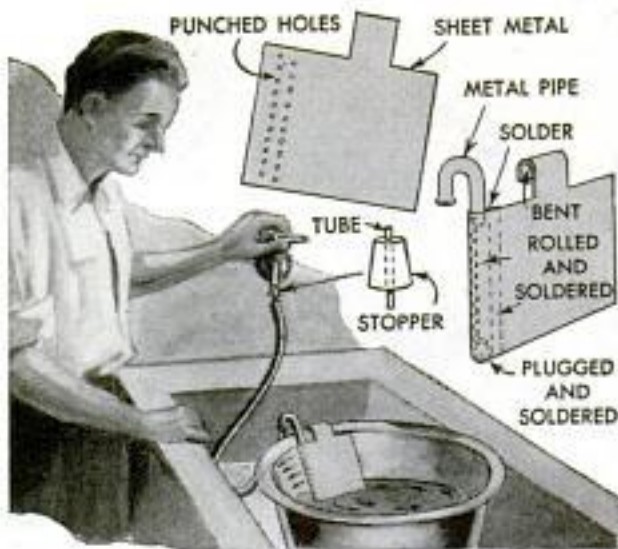

To wash photo prints after fixing so that all traces of hypo are removed, the water should circulate rapidly. For this purpose, a circular container can be used if equipped as shown. A piece of sheet metal is cut to the shape indicated and holes are punched at one end. Then a length of pipe is fitted at the punched end, which is bent around it tightly and soldered its full length. The bottom of the channel so formed is plugged and soldered. The tab in the upper edge is bent to hook over the rim of the container, and a rubber hose, connected to an ordinary faucet stopper, is slipped over the pipe to lead water into the channel, from where it is forced out through the holes to create rapid circulation in the container.

A. Borghi, Brooklyn, N. Y.

End of Print-Paper Box Beveled To Open Easily in Darkroom

You can avoid much of the difficulty often experienced in removing a tight-fitting cover from a box of photo-printing paper in a darkroom by keeping the paper in a box which has one end beveled.



The end and sides of the box should be cut at about the angle indicated. Pressing on this end of the closed box with the thumb and finger raises the cover at the opposite end so that it is easy to remove.

Wax on Reel of Developing Tank Prevents Sticking of Film

Roll film will slide easily when inserted in the grooves of a developing tank reel if a thin coat of hard wax is applied to the reel. The grooves can be coated uniformly with an old toothbrush. Care should be taken to smooth out or remove all lumps



of wax, as these may obstruct free passage of the film in the grooves. Also, if they adhere to the film, they may prevent the developer from acting on the emulsion and spoil the film.—C. E. Packer, Chicago.

Height Adjustment of Tripod Legs Locked by Lag Screws

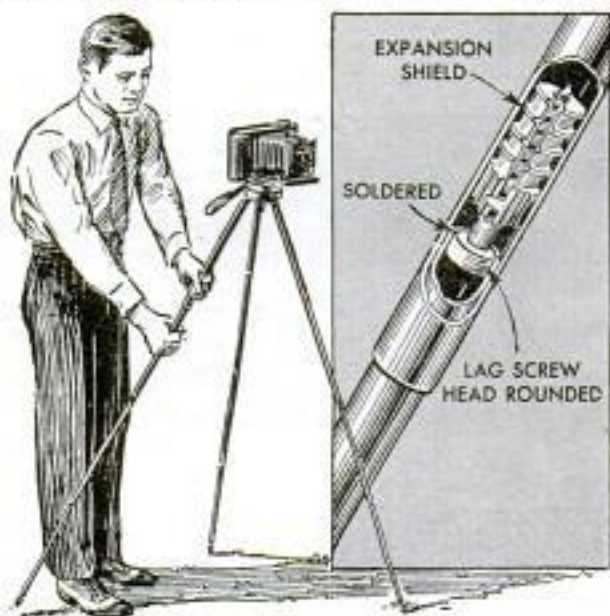

If the ball catch on the leg of a telescoping tripod is worn so that it will not hold the leg extended when a camera is mounted on the tripod, you can substitute a lag screw and expansion shield which will hold the leg securely at any desired extension. The head of the lag screw is rounded to fit snugly within the lower leg, where it is soldered. Then the shield is slipped inside the upper leg, and the screw is threaded into it. As the shield is not fastened, it can be pushed or pulled any distance, and when the lower leg is twisted, the screw turns into the shield to expand it and lock the leg.—Carl J. Terjung, Brooklyn, N. Y.

Homemade photo-developing tanks can be made leakproof by applying boat-caulking compound to the cracks. It is acidproof and will not dry out.

Open-Flash Photos With a Hand-Held Camera

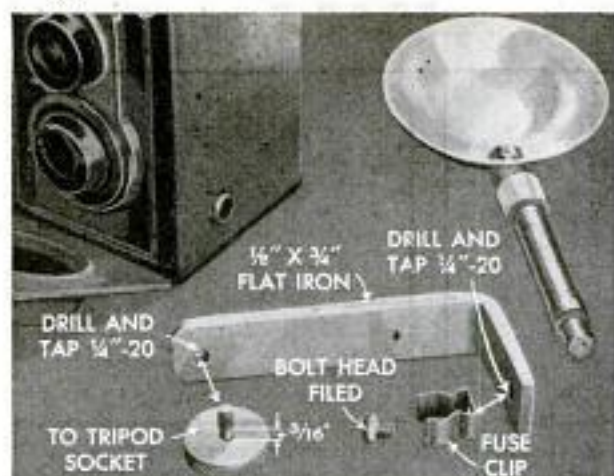

If a tripod is not used, photoflash exposures are difficult if not impossible to make without a synchronizer, as one hand is needed to hold the camera and the other to press the cable release. However, a bracket can be used to hold both the camera and the flash gun with one hand, leaving the other to operate the shutter. The bracket is made from a piece of flat iron bent to an L shape and drilled and tapped near the ends to take 1/4-20 bolts. A knurled-head bolt threaded into the hole in the longer end of the bracket engages the tripod socket in the camera. For a distance of about 3/16 in. adjacent to the head, the screw diameter is reduced enough to eliminate the threads. This permits it to turn in the threaded hole without dropping out when the camera is not attached. A clip taken from a discarded cartridge-fuse holder is attached to the shorter end of the bracket with a 1/4-20 bolt, the head of which is filed flat on two sides to permit it to slip between the clip prongs. In use, the flash-gun barrel is pressed into the fuse clip, and the bracket is grasped in one hand.

Frank Sues, Akron, O.

Worn Photo Reflector Renovated By Tin Foil Lining

When photoflood reflectors of the painted type lose their reflecting qualities as the paint cracks or chips off the inner surface, the luster can be renewed by lining the reflector with sheets of tinfoil, which can be taken from packages of film or obtained from photo studios. The inside of the reflector first is given a coat of shellac, which acts as an adhesive to bind the foil. Spun-metal reflectors that have become tarnished can be renovated in the same way. When applied inside an enlarger lamp housing, the foil not only increases the light, but also diffuses it.

J. B. Muecke, Ottawa, Kan.



Cardboard Serves as a "Ceiling" For Outdoor Flash Photos

Outdoor flash photos, especially those taken at night, are sometimes weak and flat because there is no ceiling that will reflect the light down onto the subject to give the necessary contrast. However, a sheet of light-colored, fairly heavy cardboard can be used as an improvised ceiling to direct the light of the flash over the scene. The cardboard should be just large enough to project over the reflector without sagging. A small hole in the cardboard allows it to be attached to the reflector with a paper clip.—C. C. Caswell, Clarinda, Ia.



CRAFT QUIZ



1. Snowshoe frames are made of—
 (a) Northern pine (c) Hemlock
 (b) Hickory (d) Northern cedar

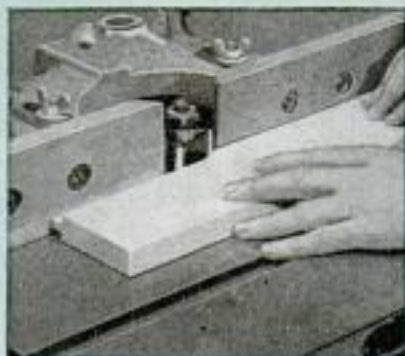

2. He is cutting a—
 (a) Tongue (c) Rabbet
 (b) Groove (d) Cove



3. This drill-press accessory is a—
 (a) French spindle (c) Carving bit
 (b) Molding head (d) Planer head

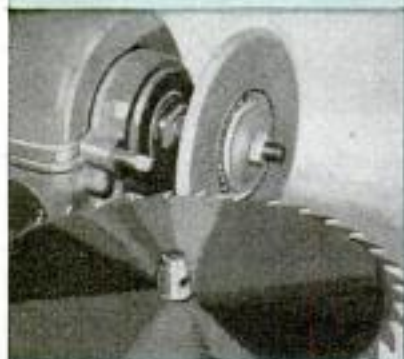

4. This work on a circular saw is—
 (a) Gumming (c) Kerfing
 (b) Swaging (d) Rolling



5. This 2-in. spiral has a lead of—
 (a) 3 in. (c) 1 in.
 (b) 1 3/4 in. (d) 4 1/2 in.



6. For smoothest cross-cutting, use a—
 (a) Planer saw (c) Rip saw
 (b) Chamfering saw (d) Crosscut saw



7. Band-saw blades require—
 (a) Gumming (c) Free wheeling
 (b) Tracking (d) Roller guides

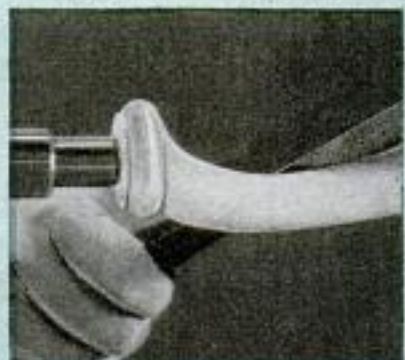

8. This table leg has a—
 (a) Pad foot (c) Dutch foot
 (b) Claw foot (d) Ball foot



9. Wood to turn this ball is—
 (a) Walnut (c) Maple
 (b) Mahogany (d) Yellow pine

ANSWERS: 1-b; 2-a; 3-d; 4-a (sometimes called galling); 5-b (lead is distance thread advances in one revolution); 6-a; 7-b; 8-b; 9-d; 10-c & d (both is another name for diamond dust); 11-d



10. Best abrasive for glass drilling is—
 (a) Silicon carbide (c) Diamond dust
 (b) Boron carbide (d) Bort



11. For smooth finish on dowels use paper—
 (a) No. 3 (c) No. 2/0
 (b) 60-grit (d) No. 3/0



Direct taping

Outline taping

MASKING TAPE

for Striping and Lettering

MASKING tape is a great help to the finisher with an occasional job of lettering or striping. The most popular tape is the crepe-back paper variety, which has enough flexibility for curves. The adhesive usually is rubber-base cement, which holds well, yet strips clean. However, plain paper or cloth tapes can be used.

Two methods of taping are commonly employed. In one, the tape is applied to the letter or stripe, the background being sprayed on while the stripe or letter is thus protected. In the second method, the background is sprayed first, then the letter is outlined and sprayed. Direct taping as applied

By this method, the work is covered with paper and tape so that only the stripe or lettering is exposed for spraying



⑦ SKETCH OR TRACE LETTERS



⑧ APPLY TAPE OVER SKETCH, OVERLAPPING ALL CORNERS



⑨ TRIM CORNERS WITH KNIFE OR LIFT TAPE, TRIM WITH SCISSORS

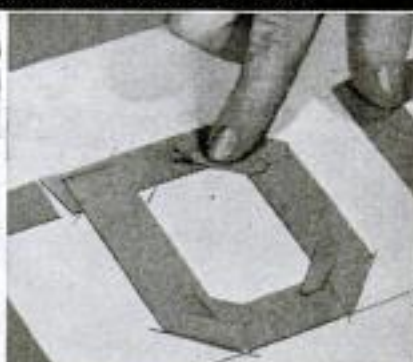

⑩ USE CUTTINGS TO FILL INSIDE



⑫

Direct Lettering

This method used for letters 3 to 10 in. high. Tape gives uniform stems

to a simple stripe is shown in Figs. 2 to 5 inclusive. The area comprising the stripe is sprayed first, using a round spray and allowing the edges to fan out. After this partial coat has dried, the tape is applied and pressed or rolled down firmly. The whole panel then is sprayed, after which stripping of the tape reveals the stripe. The direct method of spraying also is illustrated by Fig. 1. In this instance, the black stripe was first roughed in, followed by the white upper portion sprayed right over the tape, and finished by spraying the lower red portion while protecting the upper white with a cardboard mask.

⑬ TAPE WIDTH TO USE FOR DIRECT LETTERING

Height of Letter	Width of Tape *		
	Thin	Medium	Heavy
3	.515 (1/2)	.60 (1/2 or 3/4)	.75 (3/4)
3 1/2	.59 (1/2)	.70 (3/4)	.87 (7/8)
4	.69 (1/2 or 3/4)	.80 (3/4 or 7/8)	1.00 (1)
4 1/2	.76 (3/4)	.90 (7/8)	1.12 (1)
5	.86 (7/8)	1.00 (1)	1.25 (1 1/4)
6	1.03 (1)	1.20 (1 1/4)	1.50 (1 1/2)
7	1.20 (1 1/4)	1.40 (1 1/2)	1.75 (1 3/4)
8	1.37 (1 3/4)	1.60 (1 1/2)	2.00 (2)
9	1.54 (1 1/2)	1.80 (1 3/4)	2.25 (2 1/4)
10	1.70 (1 3/4)	2.00 (2)	2.50 (2 1/2)

* Based on stems 1/8, 1/4 and 1/2 the height. First figure is exact. Second figure is nearest standard width. All dimensions in inches

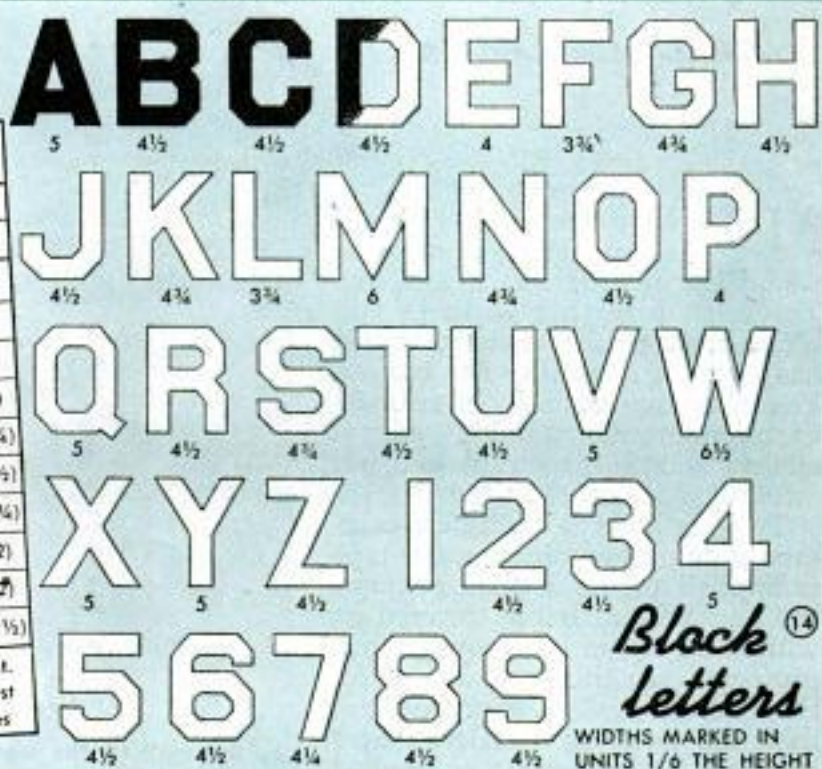

GATE 2

Outline lettering

This is especially useful for large letters. Tape is applied to the outlines of a paper pattern to make a combined mask and stencil

The second method of masking as used for a stripe is pictured in Fig. 6. The whole area of the work must be protected with tape and paper aprons, leaving the stripe area clear for spraying.

Direct masking of lettering is shown in photos 7 to 12. The inexperienced worker first should draw the lettering on paper, transferring the lines to the work by the familiar method of blackening the back of the paper and then tracing, Fig. 7. However, with very little experience it is quite easy to letter simple block letters, such as shown in Fig. 14, directly on the work. The table, Fig. 13, gives the width of tape to use for thin, medium and heavy stems. The widths of the letters themselves are determined by using a measuring unit one-sixth the height of the lettering. Note when taping, Fig. 8, that all corners are overlapped. This not only stiffens the letter for possible re-use, but also provides a guide when trimming the corners. Corners usually are cut with a stencil knife, as in Fig. 9, but it is also practical to mark corners with a pencil

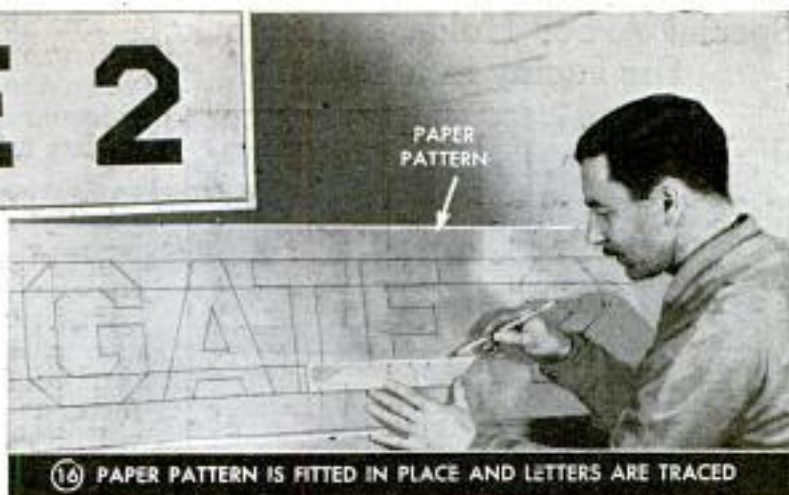

16 PAPER PATTERN IS FITTED IN PLACE AND LETTERS ARE TRACED

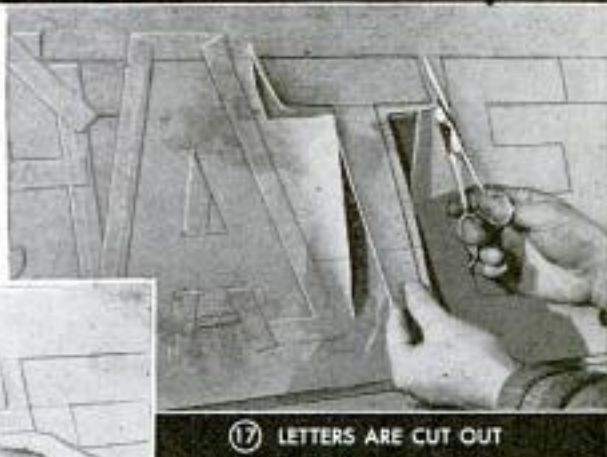

17 LETTERS ARE CUT OUT



18 TAPE APPLIED

and then lift the tape and cut with a pair of scissors, Fig. 10. In either case, the piece cut off fills the inside of the corner as shown in Fig. 11.

Letters over 10 in. high are done best with the outline method. Fig. 15 is an example. In this setup, the background color is finish-sprayed. A paper pattern of the lettering then is made, after which the lettering is transferred to the work as in Fig. 16. The paper pattern in this case serves a double purpose, since it also acts as a stencil. How this is done can be seen in Figs. 17 and 18, the letters being cut outside the line, and the tape applied to the exact outline of the letter and also overlapping the paper pattern, Fig. 18. Spraying is done as in Fig. 19. This combined mask and stencil can be stripped and used several times if needed.

Letters less than 3 in. high are best worked with a stencil cut directly from a wide tape. Wide tapes also are useful for more ornate lettering or designs. This kind of tape can be cut directly over the work.



19 SPRAYING IS DONE WITH ROUND SPRAY

Special Arbor Holds Thin Stock For Facing in a Lathe

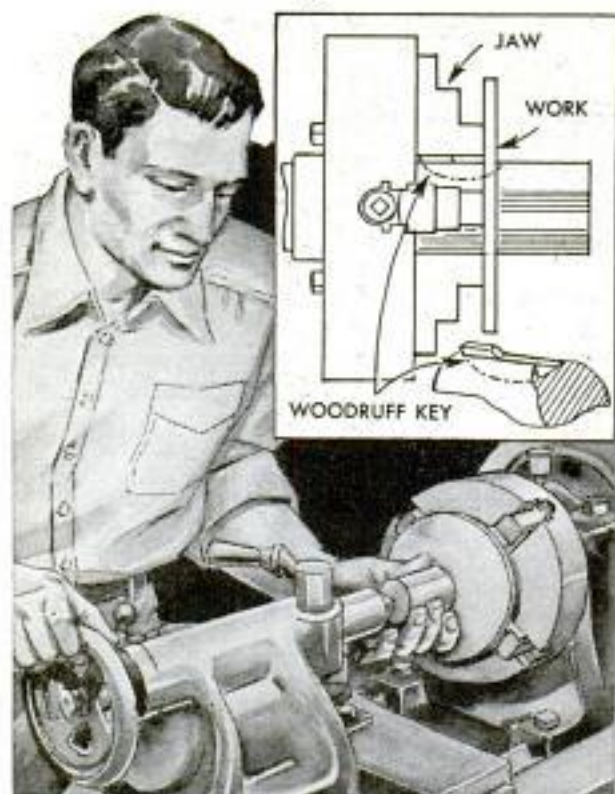

The problem of holding thin stock, such as large washers and similar work, in a lathe for facing, is solved by using an arbor like the one shown. It is a piece of round stock fitted with a Woodruff key, the stock being of a diameter to permit a sliding fit in the bore of the work. In use, the arbor is held by three jaws of a four-jaw chuck, the fourth jaw pressing down on one end of the key, which is stepped at this end. This forces the other end of the key tightly against the bore of the work to hold it firmly. With this arrangement, it is not necessary to remove the arbor from the chuck to take off the work. Instead, just loosen the jaw that presses on the key so that the work will slip off. An arbor of this type is especially handy if you have to face a number of pieces that have the same size bore.—H. Moore, Leeds, England.

Lock Is Made More Secure By Reversing the Hasp

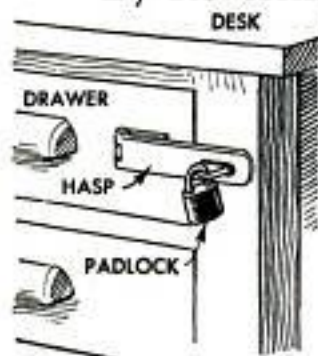

In cases where a hasp and padlock are used to secure a desk drawer, door of a building or lid of a tool-chest, screw the hasp in place as indicated and the lock will be more difficult to re-

move. The hasp is placed in a reversed position so that the screw heads are covered when the lock is in place. As a further safeguard, use bolts instead of screws, with a plate on the other side of the wood.

Bicycle Tube Repairs Wringer

Wringer rolls that have become soft, gummy or excessively pitted can be covered for temporary use with a section cut from a bicycle inner tube. One end of the tube is turned under, as shown, and stretched over the end of the roller. Water is applied to the tube so that it can be pulled over the wringer roll. Then the ends of the tube are trimmed.

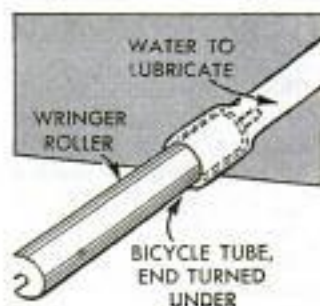

H. E. Arthur, Dunbar, W. Va.

Masking Tape on Striping Guide Protects New Paint Finish

In order to avoid waiting for the finish on a newly painted vehicle to dry hard so that striping can be applied, the end of the guide prong on the striping tool can be wrapped in masking tape. This is soaked in water until it is soft, after which the striper can be used immediately, as the softened paper will glide smoothly over the new finish without scratching.—R. L. Card, Tweed, Ont., Can.



Leather Washer Absorbs Shock Of Drill-Press Spindle



On drill presses where a spring returns the spindle to normal position, wear and noise are avoided by placing a heavy leather washer around the quill. This reduces the shock caused by the collar on the quill striking the head of the casting.—H. W. Holt, San Gabriel, Calif.

Heavy Objects Easily Lifted to Level of Truck

Farmers, dairymen and others whose work necessitates lifting heavy objects onto trucks can avoid much of the strain of this work by using a lever arrangement like the one shown. The device consists of a plank of suitable length and thickness pivoted across a frame, and a crank-shaped stop located near one end for holding the plank in the raised position. The pivot frame can be merely a short length of wood nailed to two stakes driven into the ground. In use, the crank stop is turned to permit the plank to be tilted forward so that the object to be loaded can be set on the end, which is provided with cleats to hold it. Then the plank is tilted up by pressing on the other end and secured by turning the crank over it. If desired, a truck now can be backed in and the load rolled onto it.

Walter C. Fabell, Brooklyn, N. Y.

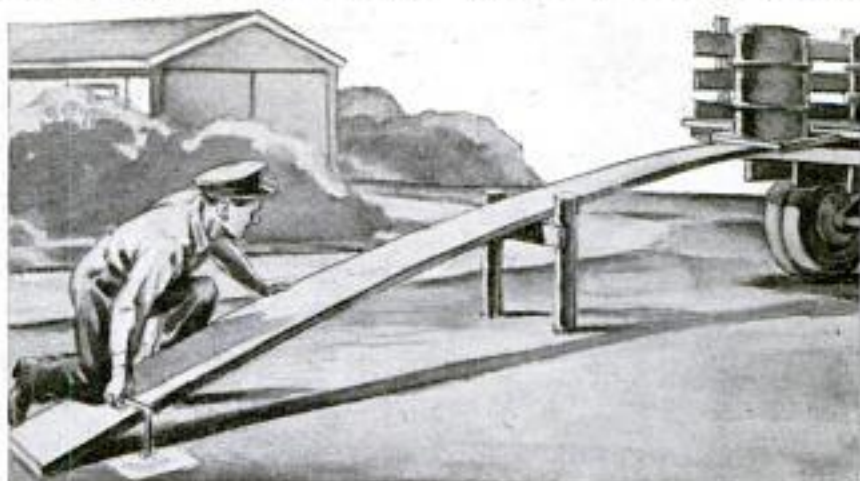

edge of the table acts as guide for the knife. Laying the paper on the table abrasive side down prevents slipping, and an ordinary table knife sharpened to a rough edge on an emery wheel makes an ideal cutter.

Harry French, Detroit, Mich.

Arrow Painted Above Barn Door Guides Driver of Hay Load

The difficulty of driving a load of hay into a barn without being able to see the sides of the doorway led one farmer to paint a large arrow on the wall directly in the center of the opening. By observing this guide, the driver can enter without having one side of the load rub heavily against the door post, which would not only make it difficult for the team to pull the load, but might also dislodge part of it.

Wood Auxiliary Jaws on C-Clamp Held by Shower-Curtain Rings



To hold wood blocks used as auxiliary jaws in place while adjusting C-clamps, one cabinetmaker secures the blocks with shower-curtain rings over which small screw eyes, driven into the blocks, are

slipped. When not needed, the blocks can be removed quickly by detaching the rings.

Jack Bronte, Grass Valley, Cal.

Sandpaper Is Cut Uniformly At Edge of Saw Table

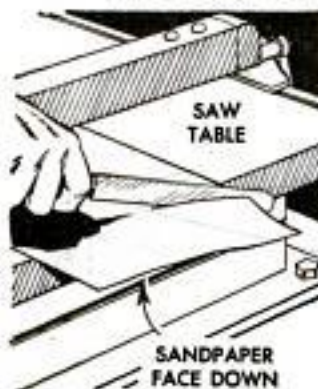

Sandpaper can be cut smoothly to uniform widths and lengths on a saw table. The paper is placed on the table against the saw fence, which then serves as a guide in cutting the pieces to uniform size. The

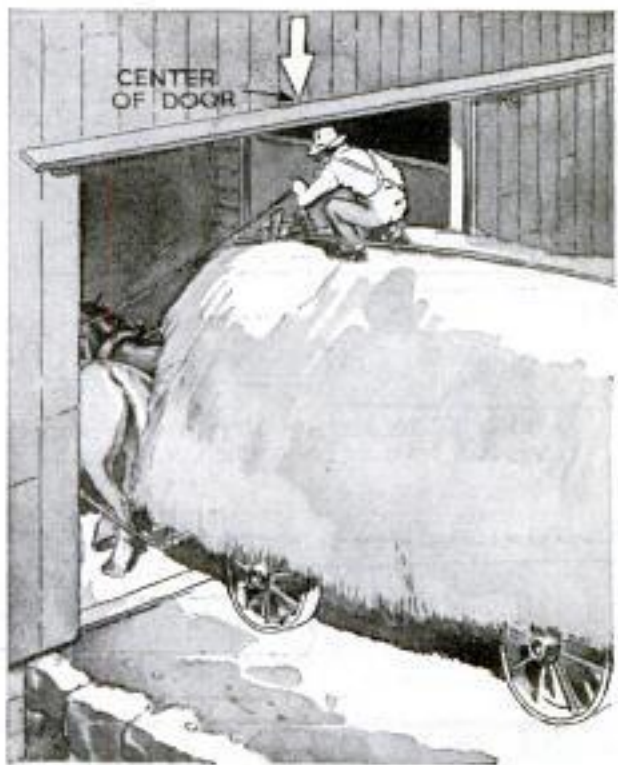

How to TAPER, FACE

by H. J. Chamberland

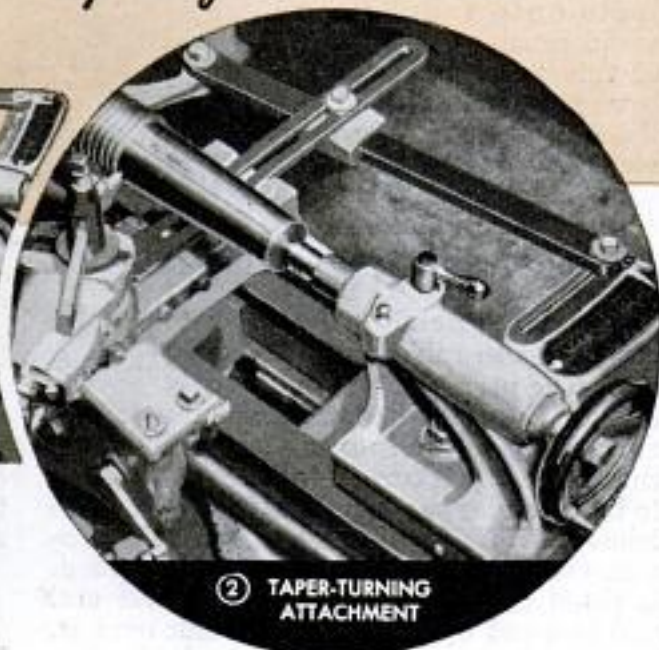
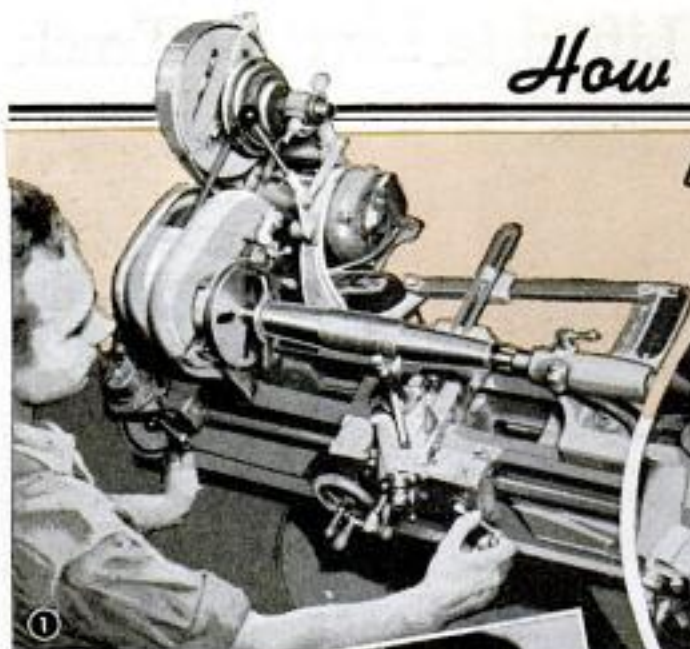

③ OFFSETTING TAILSTOCK CENTER RESULTS IN POOR BEARING SURFACES

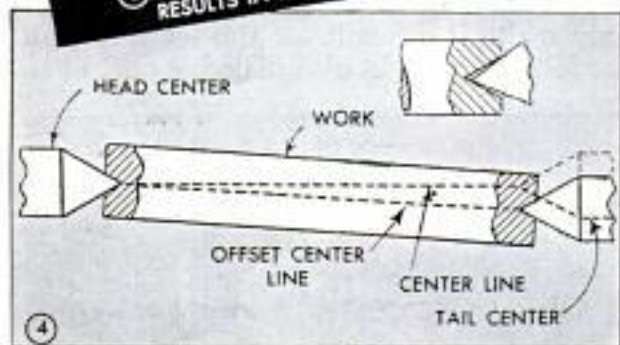

THE most common methods of turning tapers are to use an attachment like the one shown in Figs. 1, 2, and 6, and to offset the tailstock center as in Figs. 3 and 4.

In most shops a taper attachment is a sound investment because it saves time, assures accuracy and extends the life of lathe centers. It also is advantageous in duplicating tapers of different lengths and in boring internal tapers. Tapering by offsetting the tailstock, although common practice, has several disadvantages. Primarily, the centers must be thrown out of alignment by moving the tail center toward the operator; both lathe centers therefore remain parallel with the lathe bed ways, but the work is positioned at an angle corresponding to the amount of offset. This arrangement results in inade-

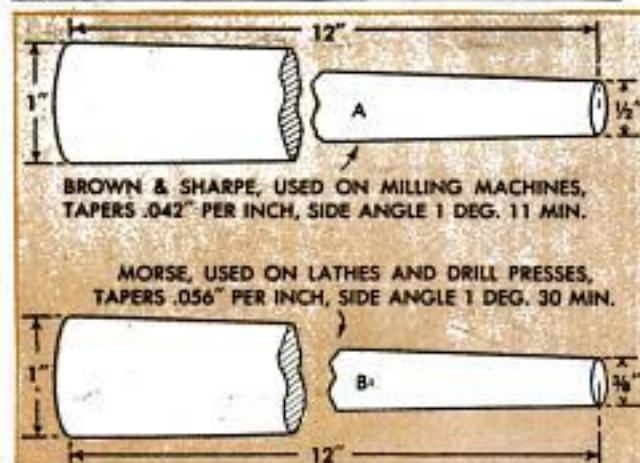

BROWN & SHARPE, USED ON MILLING MACHINES, TAPERS .042" PER INCH, SIDE ANGLE 1 DEG. 11 MIN.

MORSE, USED ON LATHES AND DRILL PRESSES, TAPERS .056" PER INCH, SIDE ANGLE 1 DEG. 30 MIN.

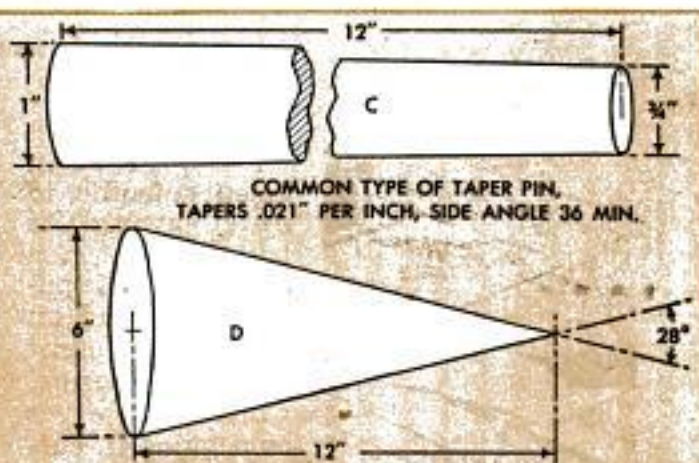

COMMON TYPE OF TAPER PIN, TAPERS .021" PER INCH, SIDE ANGLE 36 MIN.

⑤ SHAPES AND ANGLES OF COMMONLY USED TAPERS

and BORE in a Lathe

Explaining the most common setups for tapering, facing and boring, and the correct way of grinding lathe tools and drills

quate bearing surfaces between the lathe centers and work centers, thus eventually destroying the accuracy of the lathe centers for straight work.

Tapering with the tailstock set over requires a new adjustment with each change in length of taper. An easy and accurate method of determining the amount of taper is to mark off approximately two thirds of the entire tapering length in even inches, as in detail A of Fig. 7, and then "mike" both ends as in detail B until the difference in thousandths of an inch of the estimated length corresponds to the taper per foot desired. For example, assuming that the full length of a Morse taper is $5\frac{7}{8}$ in., an estimating length of 4 in. would call for a difference of .208 in. between the large and small diameters or .052 in. per in. of length.

The difference between the diameters of the two extreme ends of a tapered piece of work, expressed in inches per foot, is known as "taper per foot." Tapers most commonly used in shop practice are the Morse, Brown & Sharpe and pin tapers. Details A, B and C of Fig. 5 show the difference between both ends of each taper based on a 1-in. large diameter and a full 12-in. length. The Morse tapers and the Brown & Sharpe tapers are classified as No. 0, 1, 2, 3, etc., and No. 1, 2, 3, 4, etc., re-

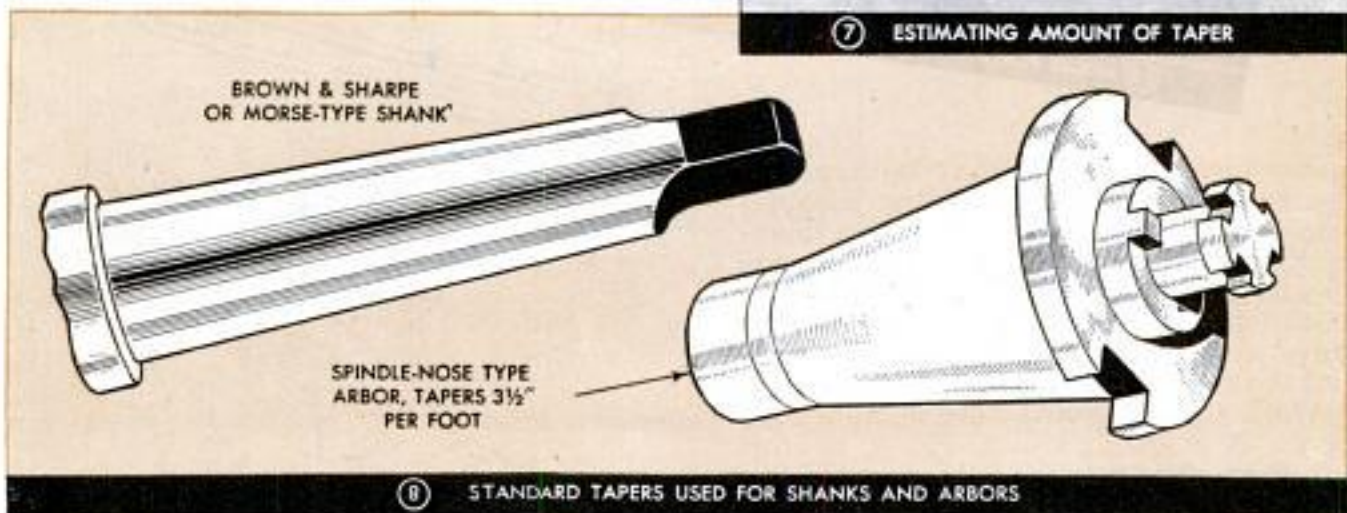
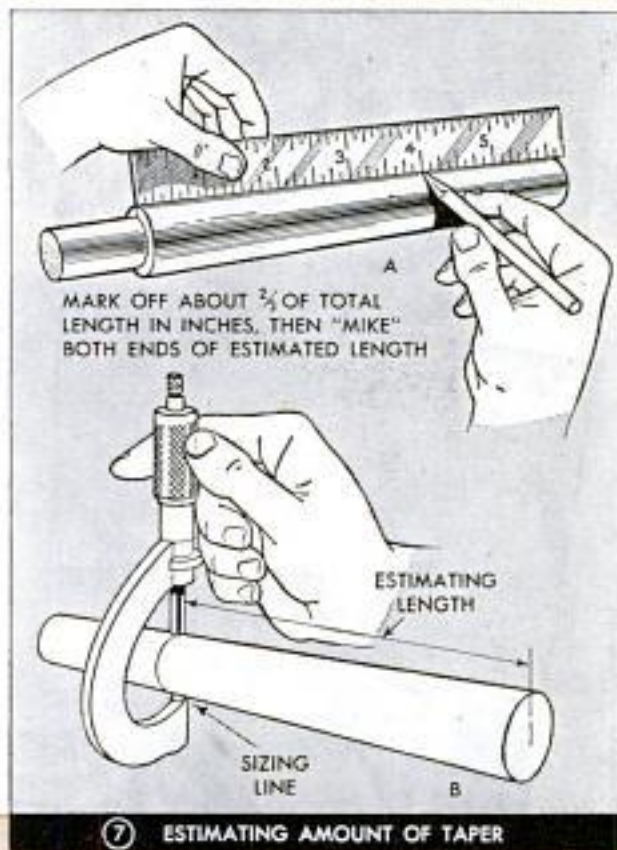
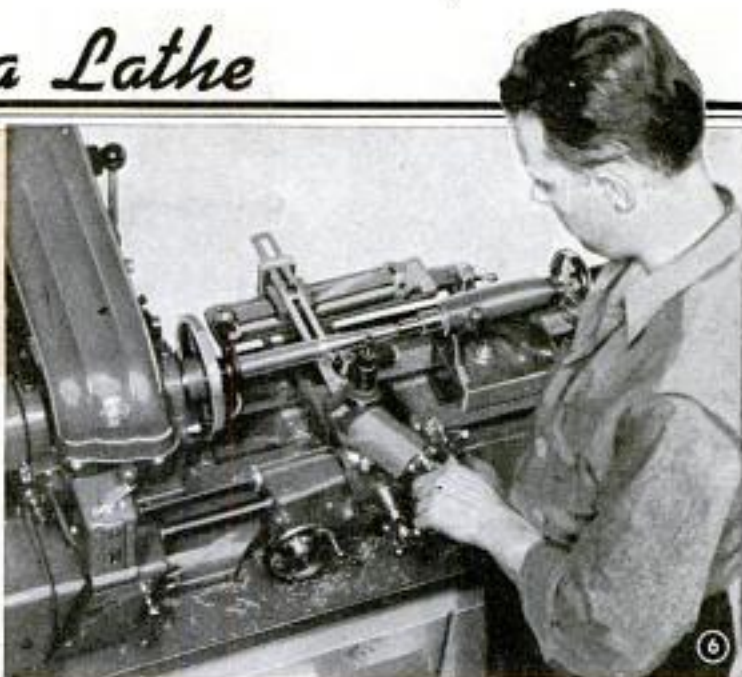



9 WORK HELD ON MAGNETIC CHUCK

chuck is quick-acting and saves much time when a number of parts are to be faced. Short cylindrical work can be held in a 3-jaw universal chuck or a 4-jaw independent chuck, and work of irregular shape can be held on a faceplate as in Fig. 13. Shafting and similar work often is held in a chuck with the aid of a steady rest, or is mounted between centers and rotated with the aid of a faceplate and a lathe dog as in Fig. 10. Work to be drilled, bored or otherwise worked internally should first be faced. In facing operations, the cutting tool is started at zero center and ad-

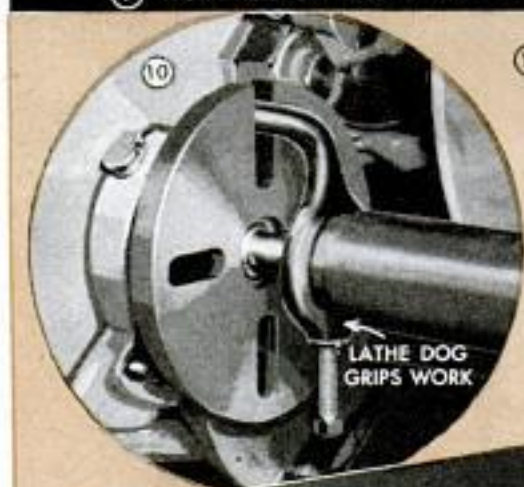

LATHE DOG GRIPS WORK

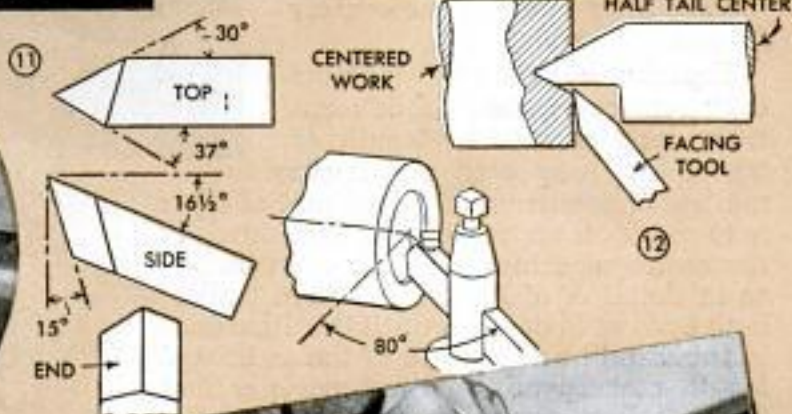

12

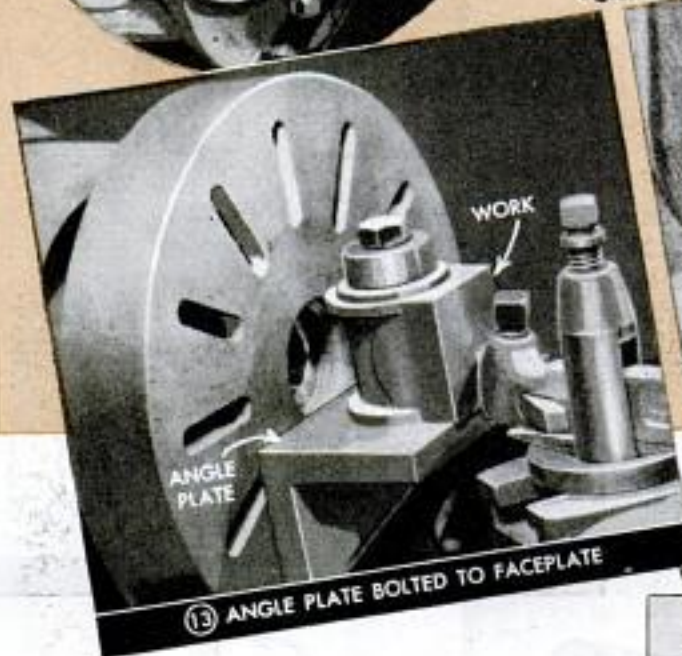

13 ANGLE PLATE BOLTED TO FACEPLATE



14 STEADY REST SUPPORTS WORK FOR END DRILLING

spectively. A taper means both angles combined, the angle remaining constant regardless of length. Based on a 6-in. diameter piece of work, a 6-in. taper corresponds to a 28-deg. included angle and would cone itself out on an exact 12-in. length as indicated in detail D. Fig. 8 shows the standard tapers used for shanks and arbors.

Work to be faced is held in numerous ways. A magnetic chuck, Fig. 9, is ideal for disks. The work is held securely and both sides may be faced accurately. The

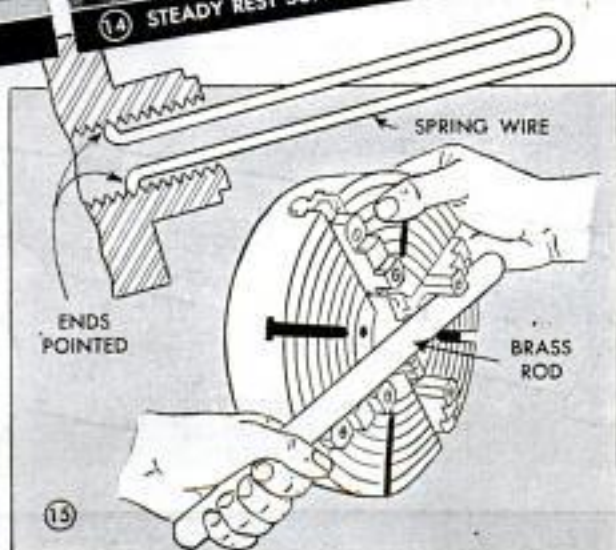

15

vanced toward the full work diameter. Work speed when facing should be kept just below the vibration point; therefore rate of feed should be decreased as the circumference of work increases.

Regular right-hand or left-hand turning tools often are used for facing work held between centers, but better results are obtained in all facing operations if a tool bit is ground especially for this purpose. Fig. 11 shows the various angles of such a tool. A half-center which provides clearance for the tool when facing work held between centers is shown in Fig. 12. When shaping this



16 CROTCH CENTER USED IN CROSS DRILLING

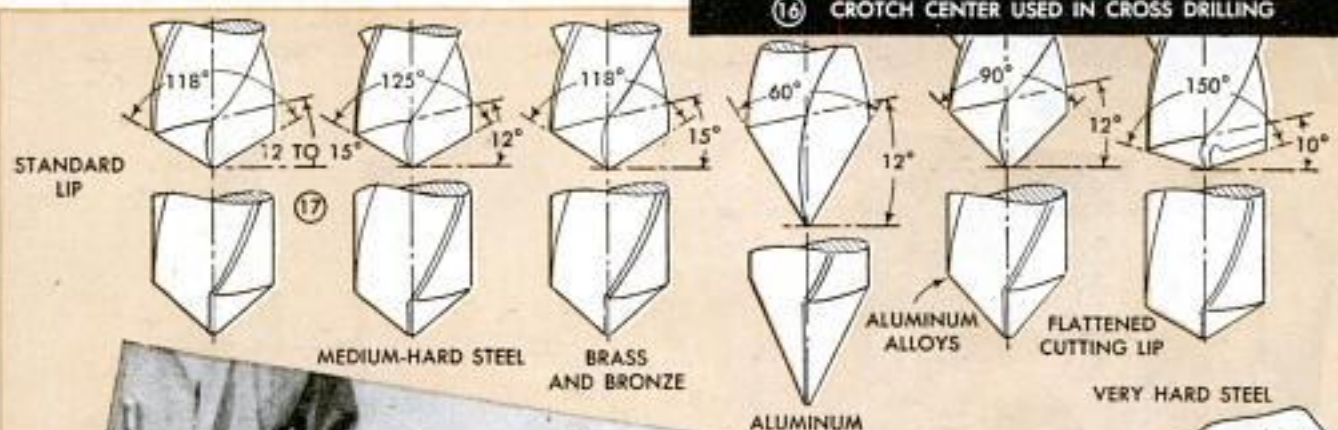

19 DRILLING WITH UNDERSIZE BIT

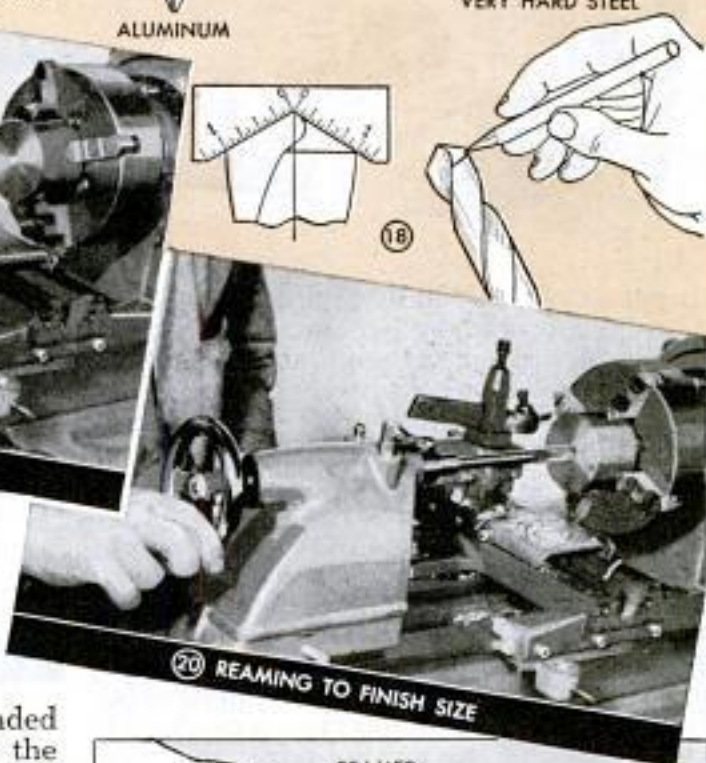

20 REAMING TO FINISH SIZE

center care should be taken to avoid grinding closer than to within $\frac{1}{32}$ in. of the centerline or the center will act as a cutting tool. The point of the tool must set on the centerline of the work to produce a flat cut and to avoid interference with the recommended clearance and rake angle. Depth of the roughing cut should not exceed $\frac{1}{32}$ in. If depth of the finishing cut is held within .010 in. and the correct speed and feed are applied, the surface finish should be satisfactory.

Drilling, boring and reaming all add up to machining a hole. However, a hole cannot be bored unless it has been drilled large enough to clear the boring tool. A drill should cut accurately regardless of how the hole is to be finished. This is especially

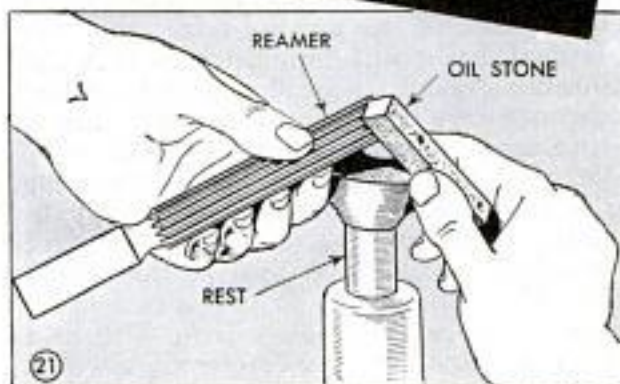



aluminum oxide of 60 grain, K grade, about 6 in. in diameter. It should be operated at no less than 4000 s.f.p.m.

When a hole is to be sized with a reamer, the drill diameter should be $\frac{1}{64}$ in. under that of the reamer; using a still smaller drill and taking an intermediate boring cut is the most practical for maximum accuracy. Generally, the less material removed with the reamer the more accurate the hole. Reamers can be kept in good condition by going over the cutting edges very lightly with an oil stone, Fig. 21, each time they are used. This practice makes



true if a drill is actually to finish a hole, or is to be followed by a reamer. A boring operation will correct any out-of-round or tapering hole resulting from an incorrectly ground drill provided that a sufficient amount of material remains with which to correct the error.

A drill even of the highest grade is only as good as its two lips or cutting edges. Where a substantial amount of drill-point grinding has to be done, there is no substitute for a drill-grinding fixture. Fig. 17 shows how a number of drill points are ground for drilling different materials. Fig. 18 shows how the lip clearance should appear back of the cutting edge, and also a typical drill-point gauge, which is indispensable even to a skilled grinder. The clearance can be more easily determined with the eye than can the length and angle, bearing in mind that both lips may appear to be of the same angle but may vary in length, or vice versa. Grinding of a drill free-hand should be done on the wheel face. Mechanical drill grinding usually is done on the side of the wheel. The best wheel for this purpose is one of vitrified



grinding unnecessary as it removes all fine particles of metal pressed against the cutting edges. This idea also applies to drills. To drill and ream a hole, chuck the work, then face it and make a hole with a small drill. Follow this with an undersize drill, Fig. 19, and then ream it as in Fig. 20.

While it is customary to hold all drills under $\frac{1}{2}$ in. in size in drill chucks, the amateur machinist will get better results by using drills that have Morse-taper shanks, especially for drills over $\frac{1}{4}$ in. in size. Work may be drilled by rotating the drill

rather than the work, as in Fig. 16, which shows a taper-shank drill held in the headstock to cross-drill a cylindrical bar with the aid of a crotch center.

Boring is one of the most common machining operations and requires slightly more practice than turning to do accurate work. The advantage of boring is that any size hole can be produced after drilling a hole large enough to provide clearance for the boring tool. A $\frac{1}{4}$ -in. hole can be bored to a diameter of 6 in. by using larger and more rigid boring tools as the diameter of the bore increases, and it is possible

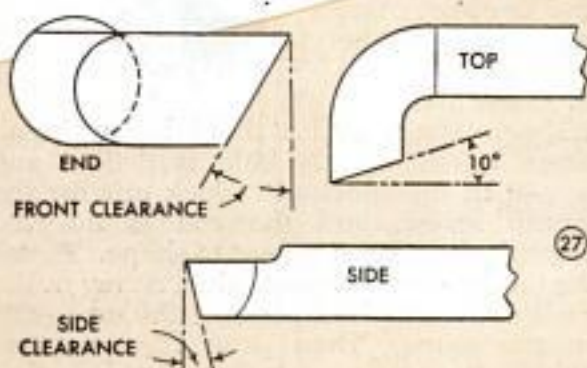
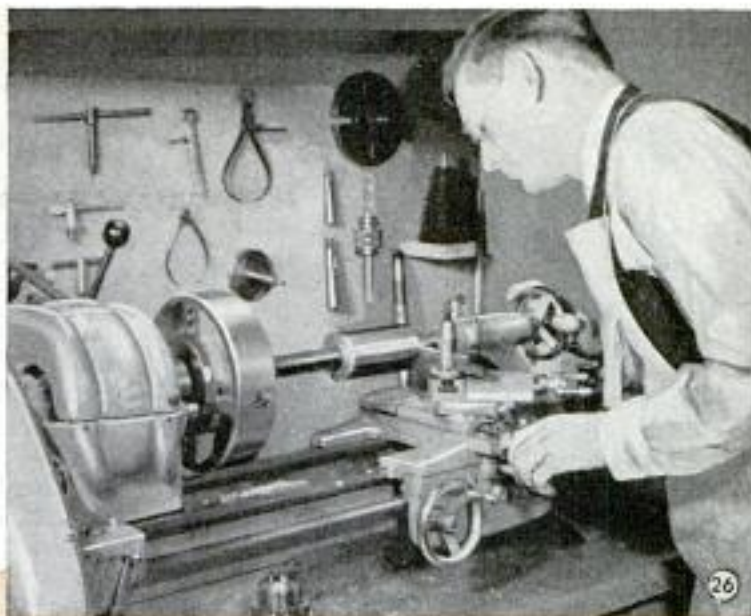

BORING-TOOL ANGLES

Front clearance varies with hole size. Should be not less than 10 deg., may be as much as 20 deg. for small holes. Side clearance—the same as for external tool bits. Back and side rake—about half that of external angles, sometimes less



ance and rake angles recommended for boring tools. All lathe tool bits may be

ground on a 4-in. cup wheel as indicated.

If work is to be turned after boring, it is mounted on a mandrel and the assembly is held between both lathe centers, or it is held by chucking one end as in Fig. 26.

Short bar stock can be turned, drilled or bored when accurately trued in a universal or independent chuck. Long bars, however, require the use of a steady rest, which must be adjusted correctly. After truing the end of the work, place the steady rest close to the chuck, bolt it down and adjust the three bronze jaws so that they barely contact the bar. Then, release the top jaw and slide the steady rest into operating position. After again bolting the rest to the bed, adjust the top jaw with a strip of paper about .001 in. thick, as in Fig. 14, to avoid binding. If the bar does not run true, either it is bent or the chuck is defective.

Chucks should be handled carefully. If a chuck does not screw off the spindle easily, a length of brass bar used as in Fig. 15 will do the trick. The internal threads of the chuck can be cleaned with a length of spring wire shaped and used as indicated.

to work as close as .002 and even .001 in. of the desired size. Also, you can do internal threading with a boring tool as pictured in Fig. 23.

Boring tools are of the plain or inserted type. Fig. 25 shows a plain or solid type tool mounted directly in the tool post. This type usually is intended for small bores but sometimes is made from $\frac{1}{2}$ -in. tool steel to bore holes as large as 3 in. in diameter. Fig. 24 shows a small boring tool of this type, which is supported in a specially made holder. A boring tool having an inserted bit is shown in Fig. 22. This tool provides maximum rigidity and is used in boring large holes. It is economical as the small bit can be replaced. The holder is adjustable vertically to substitute for the rocker adjustment used on other boring tools. Whether the boring tool is of the solid or inserted type the shape of the cutting section is the same. Fig. 27 gives clear-

Shelf for Draftsman's Instruments Swings Under Table

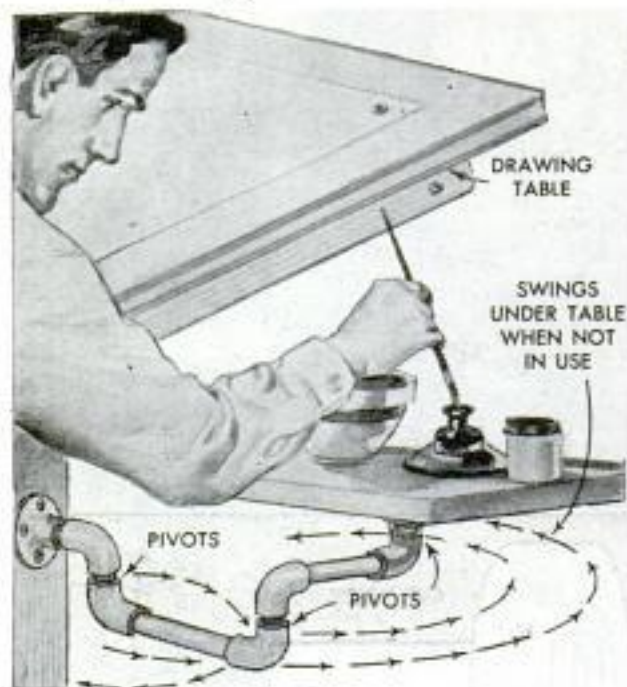

Instead of keeping his drawing instruments and other equipment on a table or chair near his work, one draftsman attached a swinging shelf to his drawing table for holding these articles. The shelf is a piece of hardwood of suitable dimensions, and is attached by pipe and fittings. By leaving two joints loose, the shelf can be swung out of the way when not in use.

J. B. Baucher, Montreal, Can.

Handy Fillet and Radius Gauge Cut From Celluloid

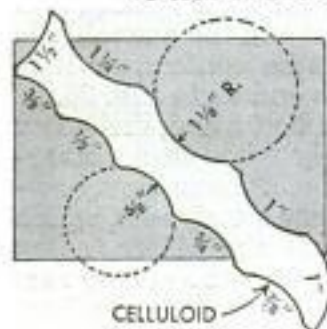

As a timesaver in checking fillets and radii, this handy gauge, which can be cut from celluloid or clear plastic, will be useful to cabinetmakers and metal workers as well as to home craftsmen. The gauge need be only as large as a pocket comb. All radii are laid out by compass, then routed and filed smooth.

Jules Duchin, Bayonne, N. J.

Stain-and-Shellac Mixture Speeds Wood Finishing

The usual two operations of finishing wood by staining and shellacking can be combined easily to save time. To do this, mix boiling water, 1 qt., with the required amount of stain powder, and then add bicarbonate of soda, 1 oz. This will saponify

the water and permit the addition of 4-lb.-cut white shellac, 2 oz. Let the mixture cool, then spray or brush in the usual manner. In storage, this mixture will keep just as well as plain water stain.

Replacing Auto Valve Springs Without Removing Head

The job of replacing auto valve springs without removing the cylinder head is made easier by the use of this little tool, which holds the valve down while the spring is compressed to remove the keeper. The tool consists of the shell of a discarded spark plug and

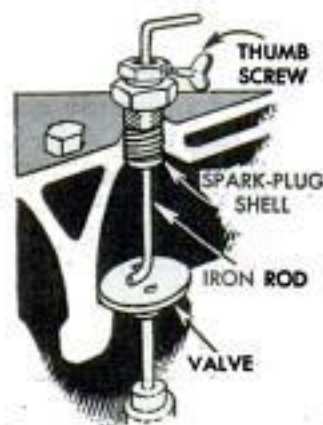

a short length of rod held by a thumb screw as shown. A hole is drilled and tapped in the spark-plug lock nut for the thumb screw, and the rod is inserted through the plug and bent to shape. To use the tool, remove a spark plug, screw in the shell and turn the rod until the end rests on the valve. Then push it down and tighten the screw to lock the rod so that the spring can be compressed.

Spray-Gun Top Can Be Attached To Any Size Glass Jar

If you have a suction-type spray gun you can easily adapt it for use on any kind of glass jar that may be available. Cut a hole in the lid of the jar for the fluid tube and fasten the lid to the regular spray-gun top with a short machine screw. If the fluid tube is too short to reach well into the jar, it can be extended with a short piece of fiber or metal tubing.

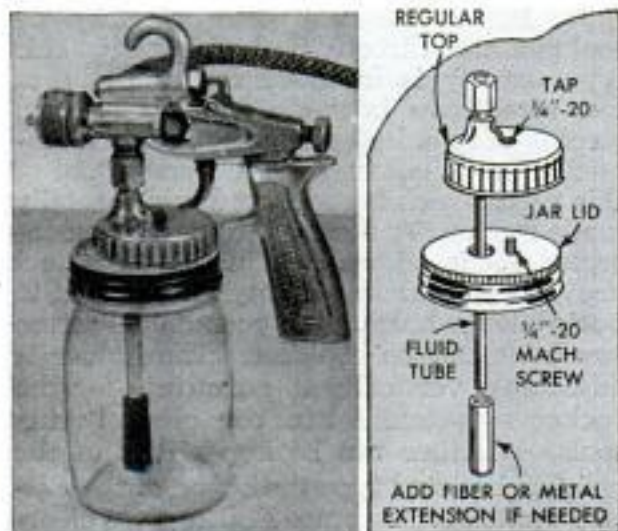

Tapping in Lathe Done With Chuck and Collar

Here is a simple way of using a drill chuck to do light tapping jobs in a lathe. This method is accurate and much faster than hand tapping. To set up the lathe for the work, first turn a metal collar that will slip loosely over the chuck shank, making the collar just wide enough to prevent the chuck from seating firmly so that it can be rotated when placed in the tailstock ram. In use, center the work to be tapped in the lathe chuck and hold the tap in the drill chuck. After starting the lathe to rotate the work, feed the tap into it by advancing the tailstock while you grip the drill chuck with one hand to keep it from rotating. On light work you will find that the chuck can be held as the tap

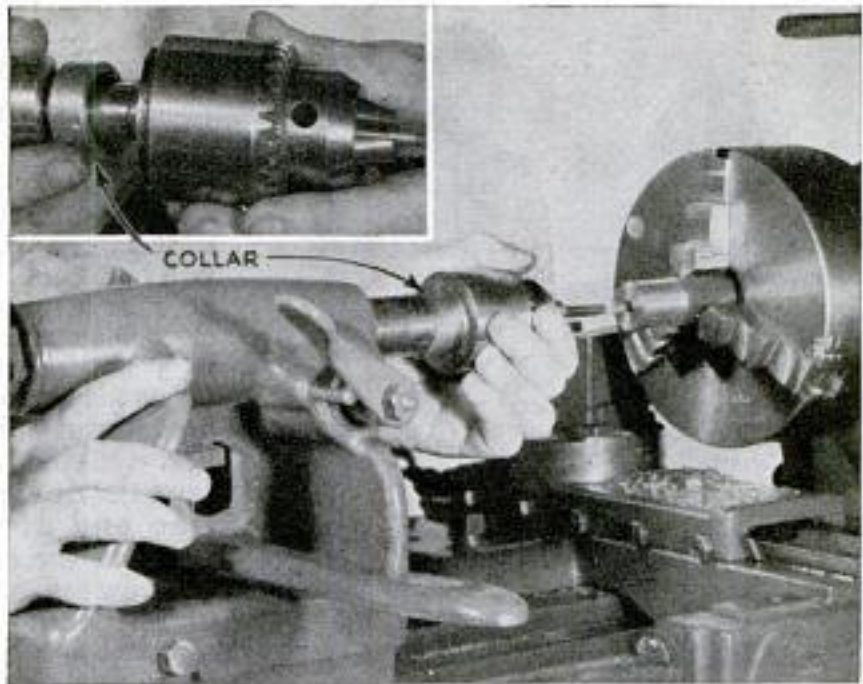

advances into the work, but when the tap reaches the bottom of the hole the chuck will spin.

Samples Wound on Shade Rollers Are Easily Inspected

Merchants will not only save time, but will prevent soiling or damaging their yard goods such as oilcloth by frequent handling, if they show only samples of the goods instead of unwrapping and exhibiting entire bolts. The samples are wound on window-shade rollers, which are held in a frame on the counter. The frame consists of two wooden strips long enough to support the desired number of rollers, and two end pieces that join them as shown in the detail. A length of split garden hose is slipped over the lower edge of each strip to protect the counter and prevent the frame from sliding when the samples are pulled out for display.

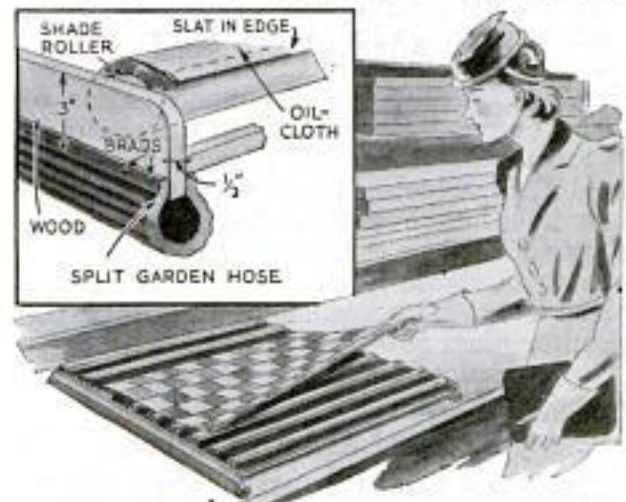

Rubber Ball Forms Shield for Lens of Flashlight Carried in a Toolbox



To avoid damage to the lens of his flashlight when it was tossed around in his toolbox, one mechanic cut the side from a small hollow rubber ball and then slit the edges of the opening so that it could be forced over the lens cap to cover it. This provided a resilient shield that could be taken off or put on with ease.

☐ A light oil generally is more efficient than a heavy oil for a car, since oil must flow to bearings, piston rings and similar parts before its lubricating action can begin, and heavy oils will not flow readily between such closely fitting parts.

Lighted Box Under Counter Top Helps Customers View Negatives



Merchants who accept films for developing and printing can build additional good will among their customers by installing under the glass of a counter top an illuminated box for viewing finished negatives. The box, which can be made either of wood or metal, is fitted with a lamp bulb of low wattage and covered with a sheet of opal glass, which diffuses the light so that negatives held over it can be viewed easily. Vents should be drilled or punched in the box to dissipate heat. The box is held in place by metal hooks slipped between the counter glass and frame as indicated.

Bruce MacIntosh, Galveston, Tex.

Heavy Roller Laid on Leather Belt Squeezes Out Cleaning Solution

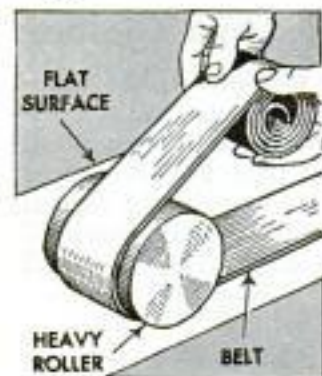

After cleaning grease and dirt from a machine-pulley belt of leather or cotton by immersing it in a naphtha, gasoline or other cleansing solution, it can be dried quickly by extending it on a flat surface and laying

on it a heavy roller such as a length of bar stock of suitable dimension. Then one end of the belt is pulled up, causing the roller to move along and squeeze the belt.

The heaviest roller available should be used in order to squeeze out the liquid.

W. F. Schaphorst, Newark, N. J.

Large Beam Compass Assembled From Pipe Fittings

Pipe fittings are used to make the beam compass shown here, which will be found suitable for laying out circles or arcs of very large diameter as the beam, or horizontal member, can be of any length desired. One end of the beam is threaded to screw into a tee, in one end of which a 4-in. nipple is screwed tightly, the other end being pointed. A pipe cap on a short nipple is screwed into the upper end of the tee as a hold down for pressing the point into the work. Another tee, of 1/4-in. bore, slides on the beam, and a 4 1/2-in. nipple, pointed like the other, is screwed into it. This nipple is threaded so that it can be screwed against the beam to lock the nipple.

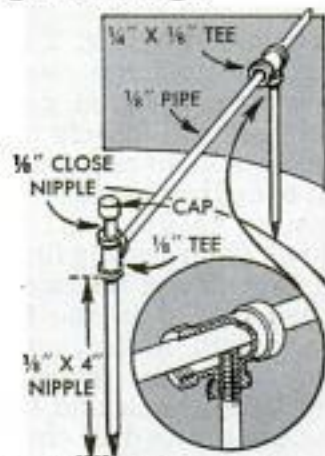

Julian N. Weathers, Sheffield, Ala.

Bulky Freight Is Handled Easily By Using Auto Lift

The owner of a filling station uses his auto lift to load or unload oil drums and other heavy freight. To do this, roll a drum on the lowered lift and raise it to approximately the height of the truck bed. Then back the truck into position, adjust the lift flush with the bed and roll off the drum.

Cpl. Harold A. George, Keesler Field, Miss.

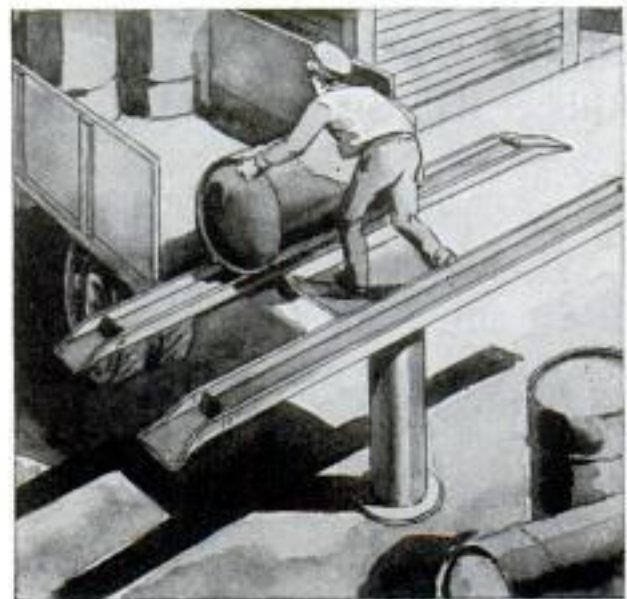

Molding Head on Circular Saw Cuts Recesses

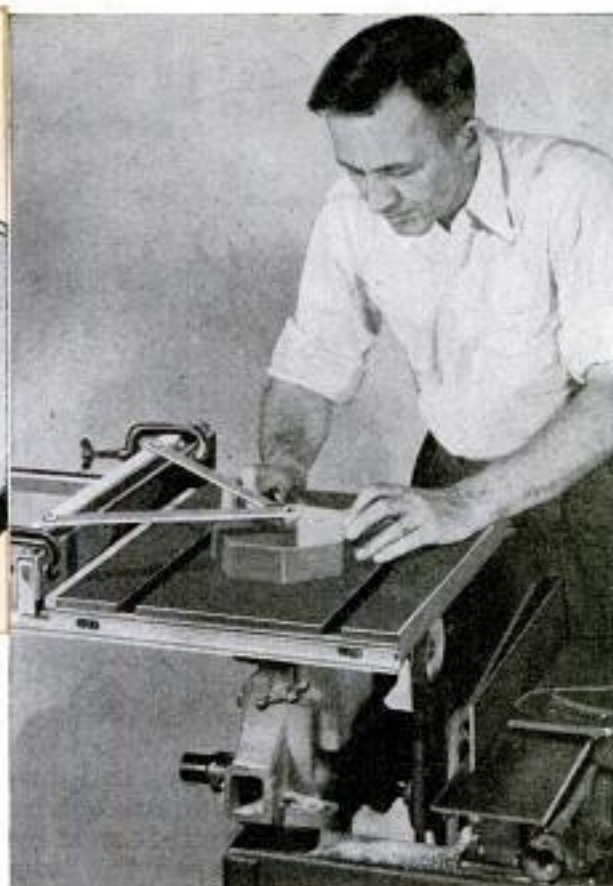
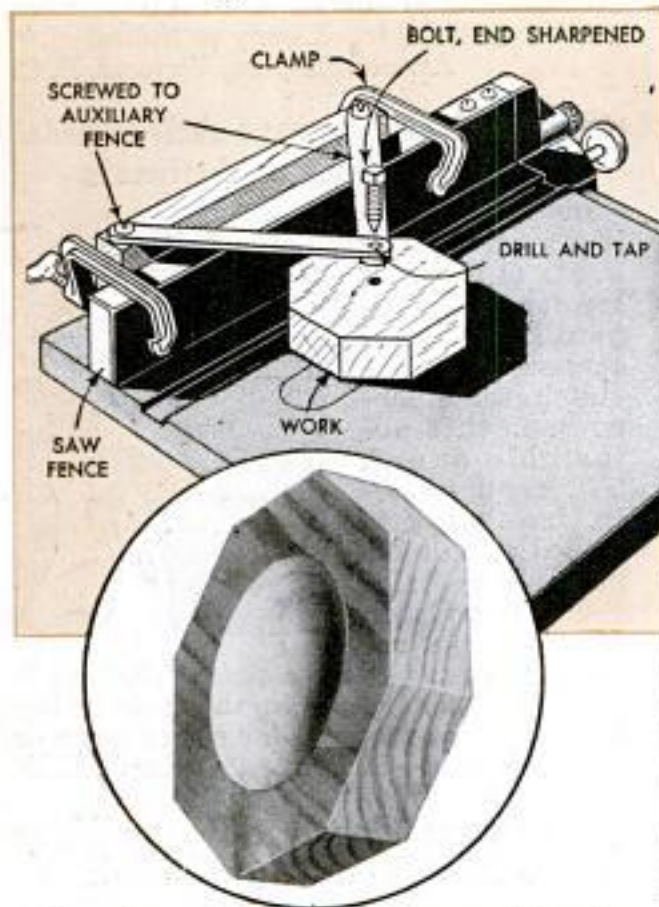

Round recesses in ash trays, small bowls and similar pieces can be cut quickly on a circular saw of the type on which the table or saw blade can be raised and lowered. A molding head is attached to the saw mandrel, although the work can be done with a regular blade. For a pivot on which to rotate the work, a bolt having the end ground to a point is used. It is held directly over the centerline of the molding head by two lengths of flat iron, which are screwed to a board or auxiliary fence. This is clamped to the regular saw fence as shown. With

the work fitted to the pivot, the saw table is lowered gradually until the required depth of cut is reached. Then the work is rotated to complete the recess. This method is faster than lathe work and can be used to good advantage in production runs, as the cut requires a minimum amount of sanding. The average circular-saw molding head will cut a recess of 4-in. diameter by $\frac{3}{4}$ in. deep. Special long knives or larger heads can be used if needed, the shape of the cutter being immaterial so long as the actual cutting end is not too wide.

Printing Warped Envelopes Simplified by Metal Fingers

Feeding envelopes into a platen press by automatic feeder is sometimes difficult because the envelopes do not lie flat, causing

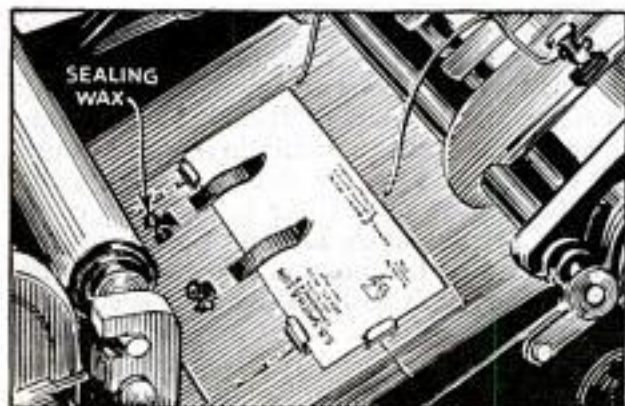

them to slip past the gauge pins. I solved this problem by cutting and bending two lengths of flat clock spring to the shape shown, and then inserting the ends in the tympan sheet, where they are held by sealing wax to act as fingers for work fed against the gauge pins. The fingers guide the envelopes to the gauge pins and hold them even when the press runs at high speed.—G. T. Clayton, Los Angeles, Cal.

☞ If radiators are painted when they are only moderately warm, the finish will last longer than it would if they were painted when either stone cold or very hot, since a moderate heat tends to bake the paint on, but extreme heat cracks the finish.

Knife Blade Set in Contour Pen Cuts Ben Day Speedily

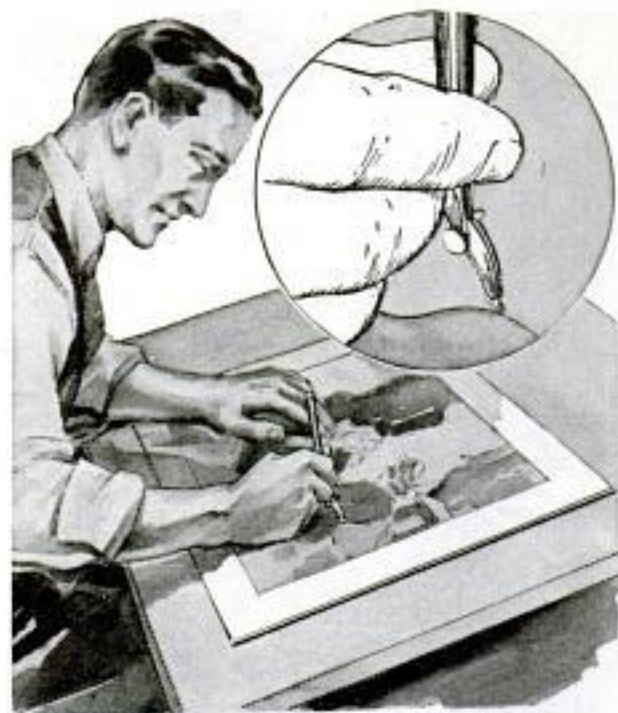

Trimming the edges of Ben Day and similar transparent application patterns can be speeded greatly by using a knife formed by clamping a thin blade between the jaws of a discarded contour pen. Such a knife can be made by grinding down a small blade so that it fits snugly in the pen. Then both blade and pen are cleaned and tinned and sweat-soldered together.

Ronald L. Ives, Tooele, Utah.

Iron Caps Slip Over Long Pipe To Keep It on Truck

In my work as a trucker, I often haul long pipe, rods, etc., that project from both ends of the truck body, and experience considerable difficulty in preventing the material from slipping either forward or backward when traveling over hilly country. The trouble was finally avoided by

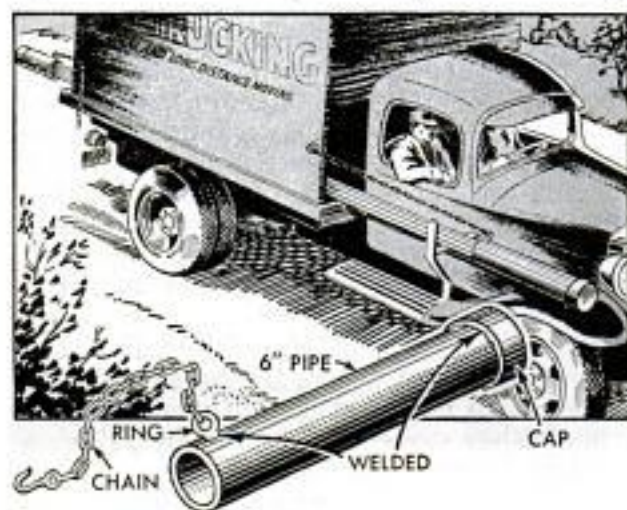

making holders of 6-in. pipe like the one shown. These were slipped over bundles of the material and fitted with chains for attaching to the truck body as indicated.

Arnold Malpass, Victoria, B. C.

Gambrel Hooks Are Adjustable To Suit Various Animals

Instead of having several gambrels of different lengths for suspending animal carcasses of various sizes, a butcher uses this adjustable one. A 5-ft. length of 1½-in. iron pipe is drilled at suitable intervals to take ⅝-in. eyebolts on which hooks are

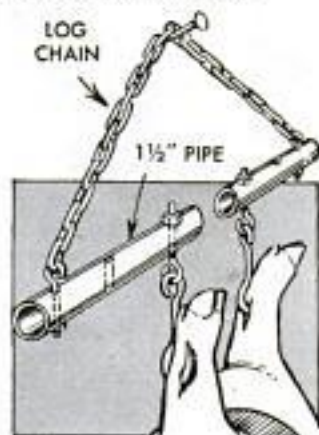

hung for suspending a carcass. The pipe is held by a chain as shown, the eyebolts being spaced as required for either large or small animals.—D. Bruyer, Burbank, S. D.

Whistle on Gasoline-Pump Hose Tells When Tank Is Full

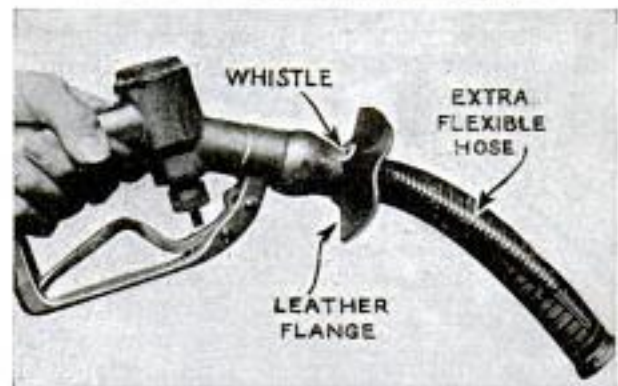

When a motorist tells Dale Watson, owner of a gasoline service station of Lasara, Tex., to "fill 'er up," the service station proprietor does so without looking into the filler hole to see when the tank is full. Air displaced by gasoline as the tank fills sounds a small whistle on one side of the filler hose nozzle. The whistle is mounted on the end of a short flexible hose as indicated. When the gas level in the tank reaches the bottom of the short hose, air cannot enter and the whistle stops. Length of the extra hose is determined by the lengths of the tank filler tubes most commonly serviced. A leather flange at the upper end of the hose nozzle fits over the tank filler tube to help prevent displaced air from escaping without passing through the whistle.

Gene Smith, Raymondville, Tex.



AUTO RADIO CONVERTED FOR A.C. OPERATION

By Joseph Vanella

IF YOU have an idle auto set that employs a non-synchronous vibrator—and most of them do—it is a simple matter to change it over for 110-volt a.c. operation in your home or office. The receiver can be installed in a console cabinet or in a desk drawer as illustrated if sufficient ventilation is provided.

First remove and discard the plug-in vibrator unit. Next, ground point "B" on the power transformer; this is done by simply tracing the lead in the vibrator socket as indicated in Fig. 1, soldering a flexible lead to the socket prong and bringing it out to a spring clip on the metal case as shown in photo A. Now disconnect the 6-volt dynamic speaker, photo B, in the set and substitute a permanent magnet type speaker. Connect a 6.3-volt, 4-amp. filament transformer, as indicated by the dotted lines in Fig. 1, to the input 6-volt "hot" lead at point "C"; the other secondary lead goes to ground on the chassis. If the set uses an 0Z4 rectifier tube, change to a type 6X5. To do this connect a wire from the filament prong lug of one of the other tubes to pin No. 7 on the 0Z4 socket and connect its No. 2 pin to ground. If excessive hum is present, use a 15-hy. 75-ma. choke in place of the resistor at point "D."

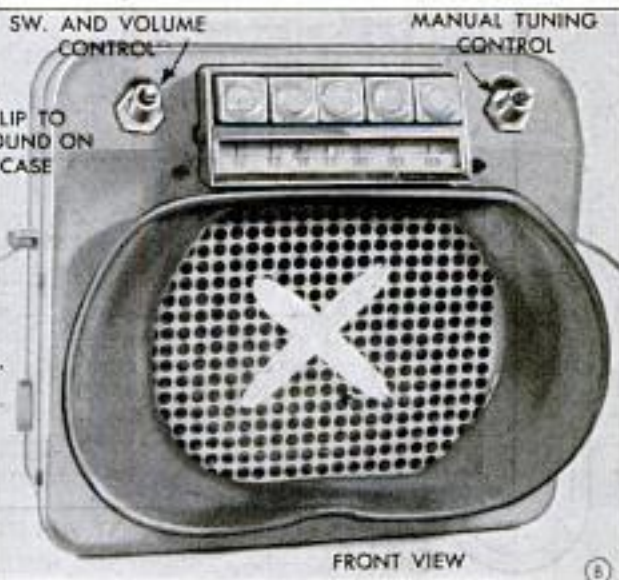
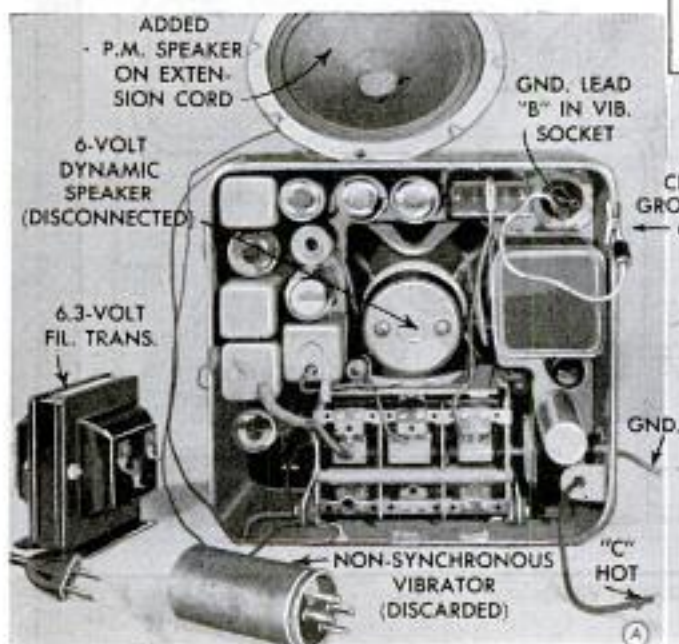
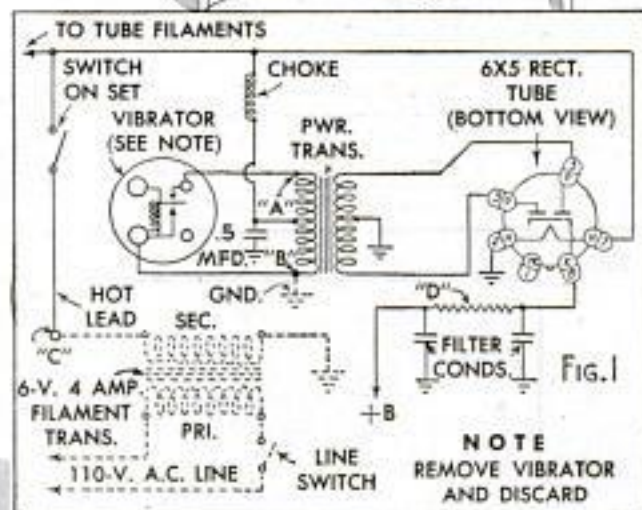
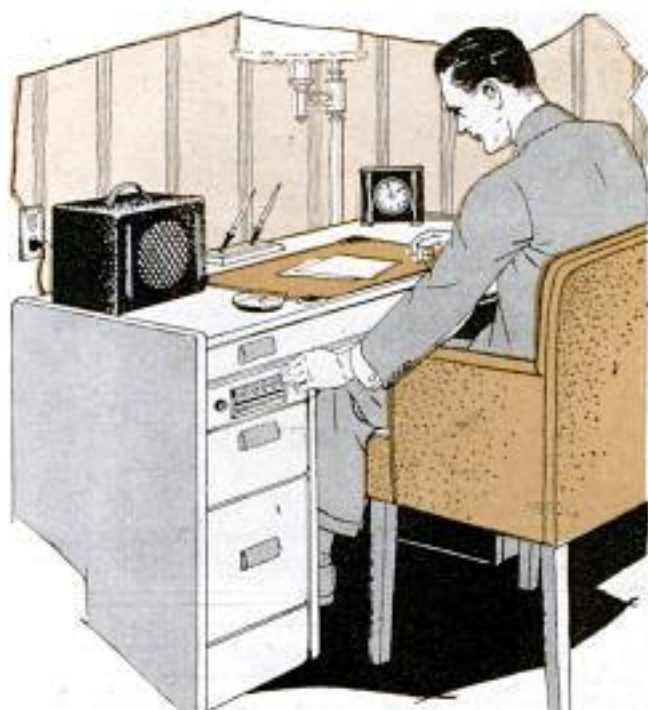

THREE-TUBE EIGHT-WATT "CAKE

By Stan Johnson

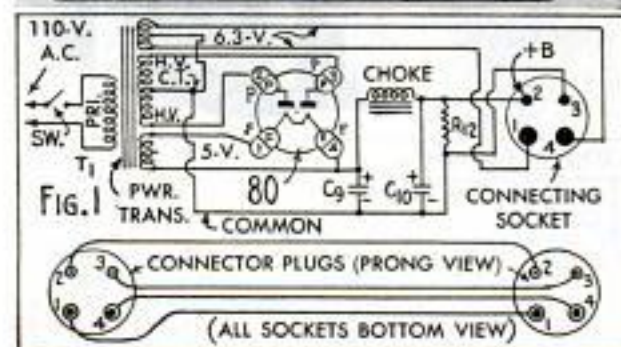
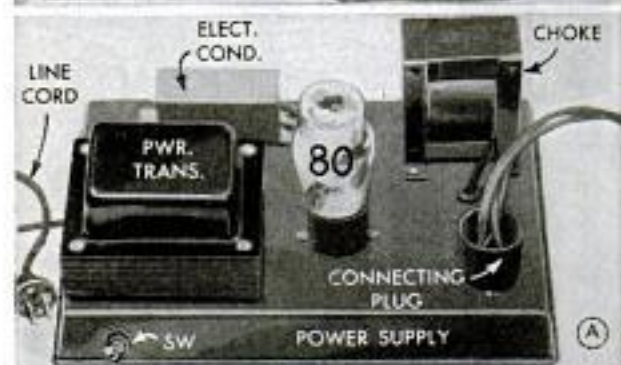
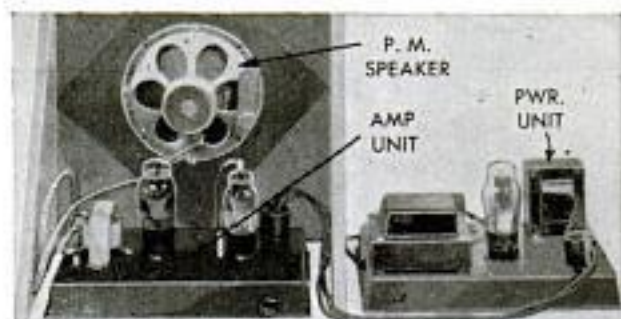

SPLENDID tone quality and plenty of volume are features of this practical and easy to build phono amplifier which is conservatively rated at 8 watts of audio output, or about twice the volume that could be used in the average room of a house. The secret of its excellent tone quality lies in the use of a circuit employing degenerative feedback. Hum and all forms of distortion are thus reduced to a very low value. Only three tubes are employed; a 6V6-G may be substituted for the 6L6-G output tube without any circuit changes. Ordinary gunmetal-finish cake pans are used for the power unit and amplifier proper; any pans of similar dimensions may be employed as chassis bases. Building the amplifier and power supply in two separate units has one important advantage: the 300-volt power supply unit may be used later to power a small amateur transmitter.

The power supply transformer should have three windings: a 6.3-volt winding for the tube heaters, a 5-volt winding for the type-80 rectifier tube, and a high-voltage winding providing about 350 volts each side of the center tap at 100 ma. or more.

A schematic circuit diagram for the power supply unit, photo A, appears in Fig. 1 and the pictorial wiring diagram in Fig.

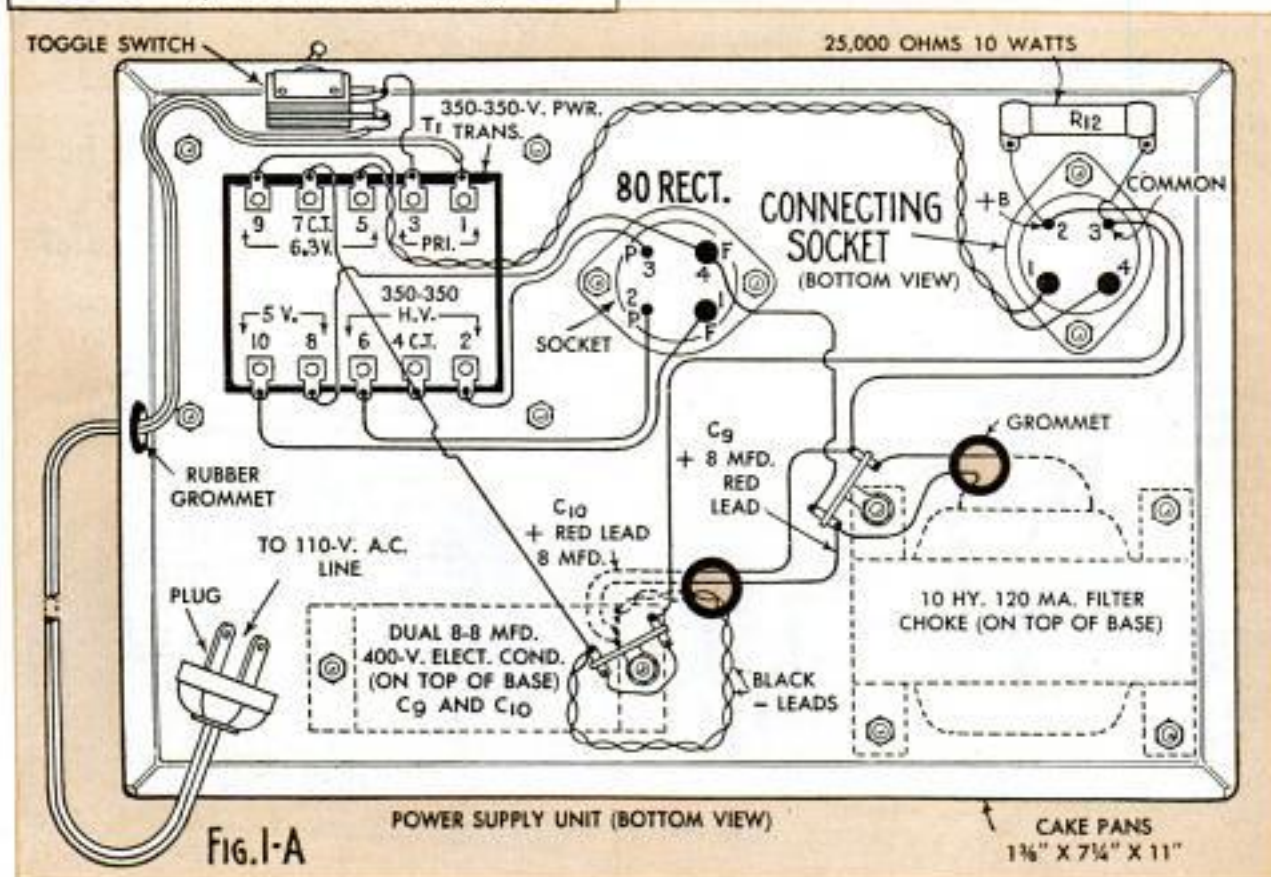

PAN" PHONO AMPLIFIER

1-A. Filter condensers C_9 and C_{10} may be either 8 or 10-mfd. dual electrolytic units. Output voltage leads for the tube heaters, the high voltage B-positive and common ground are brought out to a 4-prong socket. A 4-prong plug-and-cable connector about 2 ft. long is used to couple the power unit to the amplifier.

All parts used in the amplifier unit, photo B, are standard values found in any well stocked experimenter's junk box. The universal output transformer T_2 should be of good quality. The taps selected must match a 4000-ohm load for the tube. A PM speaker any size from 8 to 12 in. may be used. This is mounted on a pressed wood panel 2 ft. square supported by simple wooden end pieces as shown in the photo at upper right. The schematic circuit diagram for the amplifier unit is given in Fig. 2 and the simplified wiring diagram for this unit appears in Fig. 2-A.

To operate, plug your record player, either crystal or magnetic pickup type, into the "phono" jack, set the gain control (R_2) at about half level and switch on the amplifier. If there is a loud howl in the speaker turn off the amplifier and reverse connections 1 and 5 on the speaker output transformer. Detailed student material list R-338 is available from Popular Mechanics radio and electronics department upon receipt of ordinary letter postage.

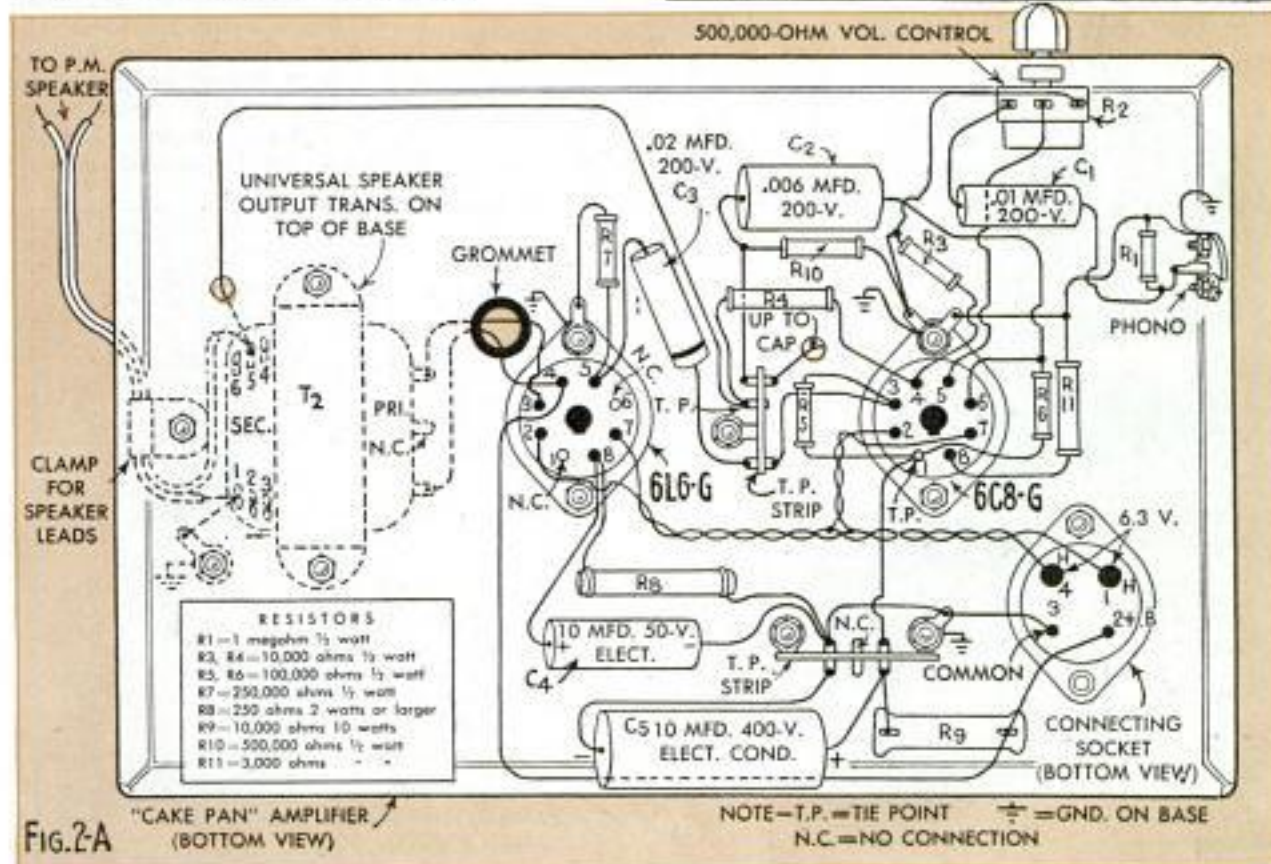
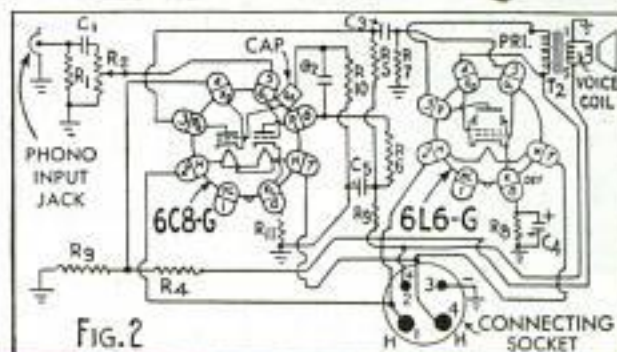
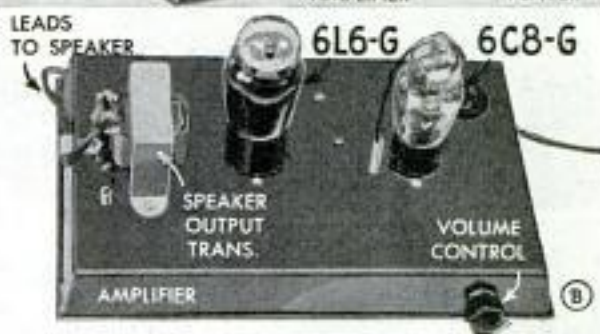

Helpful RADIO HINTS



(A) All soldered connections in radio circuits should be mechanically strong and free from corrosion to be electrically efficient. Rosin core wire solder is used for this purpose; heat the work thoroughly, and avoid the use of acid flux

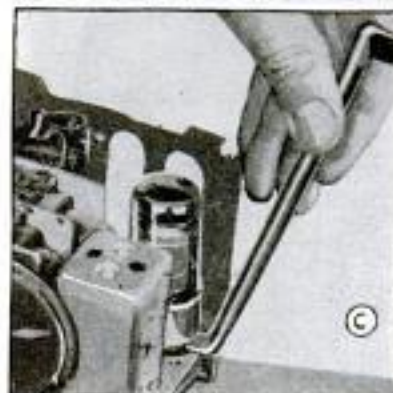

(B) Dust lodged between variable condenser plates may contain minute metal particles that can cause crackling noises when tuning. A pipe cleaner run between the plates as shown will clean them. (C) An offset screw driver is handy for removing tight-fitting tubes from chassis sockets; an ordinary screw driver may be bent for the purpose



(D) Cracks and tears in speaker cones are easily repaired with radio service cement

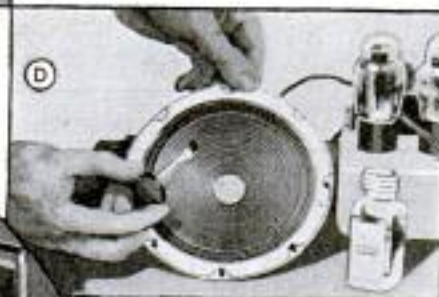

(E) Scotch tape holds associated parts for soldering; (F) Separate on-off toggle switch for small set having combination line switch and volume control but no pilot light. Connected in series with line cord it permits presetting of volume control for desired volume

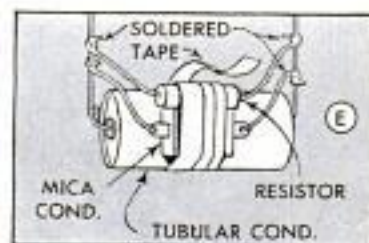
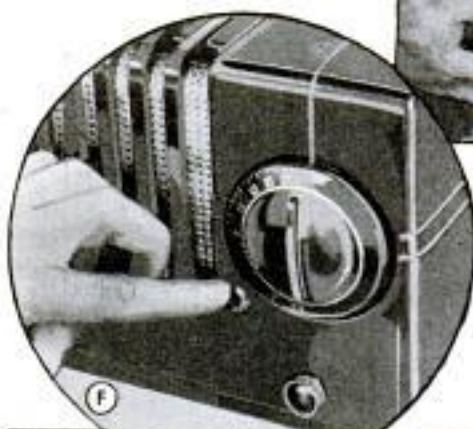

(G) Best signal pickup position for portable set employing extension type loop antenna; (H) Telechron robot timer for turning "on" or "off" radio receiver, light, etc., at predetermined moments; (I) Simple base and panel assembly for student sets

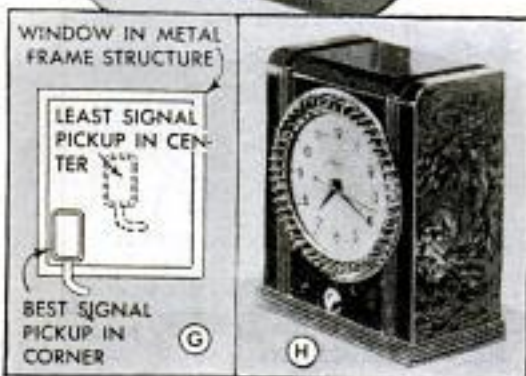

Fighting names

THAT BELONG TOGETHER



"Airacobra, Avenger, Corsair, Hellcat, Lightning, Mustang, Thunderbolt, Black Widow, Wildcat"—these and other equally descriptive fighting names were the scourge of the vaunted Luftwaffe—have ~~all but~~ cleared Jap-infested skies. There's one more name common to all of them that just naturally belongs with such a world's champion team—and that is CHAMPION Spark Plugs.

The Champion Spark Plugs you buy for your car are blood brothers to these aircraft Champions. Naturally they insure an extra measure of performance, economy and dependability in every engine.

CHAMPION SPARK PLUG COMPANY
TOLEDO 1, OHIO

CHAMPION SPARK PLUGS





One of the great dramatic moments in railroading occurred when the Cotton Belt changed the gauge of its 419 miles of track in a single week end. The scene pictured above is our artist's conception of the closing hours of this successful old-time race against time.

CHANGING THE MEASURE OF RAILROADING

It was September in 1886. All along the Cotton Belt, from Bird's Point, Mo., to Texarkana, old spikes came out. Rails were shifted. New spikes sank home under swinging hammers. The entire railroad was changed from narrow to standard gauge over one week end. The Cotton Belt had stepped along with the times.

This railroad is still stepping along. It is one of 83 railroads and major industries where General Motors Diesel locomotives are changing the measure of railroading.

Watch what happens when complete lines and systems are GM Dieselized. Far faster freight hauls. Quicker, more comfortable, and more reliable travel for passengers.

And reduced maintenance by sturdiness that goes a million miles or more without major overhaul!

Yes, the measure of railroading is changing — for the better. And GM Diesel locomotives are helping to bring about this new benefit for the railroads, for the country, and for you.

One More War to Win
Buy MORE Bonds

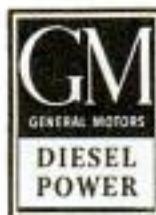

LOCOMOTIVES ELECTRO-MOTIVE DIVISION, La Grange, Ill.

SINGLE ENGINES ... Up to 200 H.P. }
MULTIPLE UNITS ... Up to 800 H.P. } DETROIT DIESEL ENGINE DIVISION, Detroit 23, Mich.

ENGINES 150 to 2000 H.P. CLEVELAND DIESEL ENGINE DIVISION, Cleveland 11, Ohio

Here's how your car feels after MARFAK chassis lubrication

THE REASON WHY: Texaco Marfak lubricant provides a tough, adhesive film that cushions chassis bearings against road shocks, increasing the riding comfort of the car and adding substantially to its life. Marfak maintains its consistency at the outer edges of the bearings, sealing itself in and sealing out grit and dirt.



Fig. 1



Marfak cushions the blow, sticks to the job, doesn't spatter when given the hammer test. Ordinary lubricant spatters in all directions, flying away from the job.

Marfak chassis lubricant is scientifically designed to fully protect bearing surfaces against the destructive action of friction and road shock. You can feel its cushioning effect as you drive. Marfak has cohesive and adhesive qualities that make it cling to bearing surfaces

Fig. 2

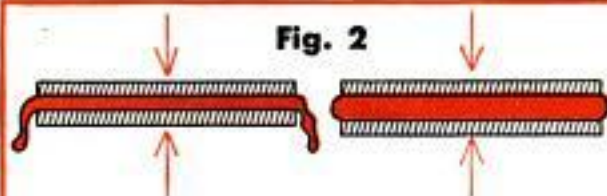

A lubricant that is lacking in cohesive and adhesive qualities squeezes out of the bearings.

The cohesive and adhesive qualities of Marfak chassis lubricant keep it together and sticking to the job.

and resist any tendency to wash-out, jar-out, or squeeze-out, see Fig. 2.

Turn to Marfak protection today!

THE TEXAS COMPANY



Don't miss the TEXACO STAR THEATRE on Sunday nights with JAMES MELTON and famous guest stars. See your newspaper for time and station.

You're welcome at **TEXACO DEALERS**

Let us
MARFAK
your car



Swift action against danger and lawlessness demands constant vigilance on the part of scout car police and utmost reliability in their equipment. That's why thousands of police cars throughout America are equipped with AC Spark Plugs. These plugs are serviced by maintenance crews, the usual practice being to clean and regap them every 3,000 miles, as recommended by AC—worn plugs being replaced promptly with AC's of correct Heat Range for today's fuels. Why not insure utmost reliability in spark plug performance for your engine, by following the same easy method? Your car will start easier, run better and save you money in fuel and oil expense.



CLEAN SPARK PLUGS
SAVE UP TO ONE GALLON
OF GAS IN TEN

AC
SPARK
PLUGS

DON'T LET UP NOW—KEEP ON BUYING
WAR BONDS—LET'S FINISH THE JOB

A Billion Dollars' Worth of Dams

(Continued from page 69)

In still another room, men peer through windows at the behavior of water freighted with bentonite, a colloidal clay that allows currents to be studied. The water coming into a reservoir is cold, therefore dense, and it carries silt, which is heavier than water. Thus it flows right under the still water in a "density current" which may carry it clear down to the dam itself. Can reservoirs be so designed as to be self-scouring, flow the silt-laden water right through and thus increase the useful life of the reservoir?

These engineers deal with true planetary forces, almost incomprehensible in magnitude. Backed up behind Boulder Dam, for example, are nearly 40 billion tons of water, which have sunk the planet's crust about five inches, and will sink it further. Hundreds of small earthquakes and earth-slips in the vicinity are attributed to this.

The silt-laden Colorado once built a delta out into the Gulf of California at about one-third of a mile a year. Now the silt-free stream is instead cutting back and melting away its delta, working upstream about three miles yearly.

Other government departments and other governments have borrowed freely from the resources and the brains of the bureau's engineering division. Several hundred studies are going on all the time.

Since this is a tax-supported public project, its data are open for public use. Savings to taxpayers direct, which are many times the division's budget, are probably matched by savings to private industry, which freely uses the bureau's studies.

Science is the Umpire

(Continued from page 47)

lesser known sports. The styles of experts will be studied at home by television to improve one's own game.

Sports reporters as we know them will fade out almost completely. Bright young experts at the home office desk will cover the game and sports writing may assume an editorial or interpretive slant.

There will be distinct changes even in sports commentating. Radio reporters today cover games from an enclosed remote booth to drown out the noise of the spectators. A noise-cancellation microphone will enable the radio reporter to describe the game as he walks up and down the field. All crowd noises will be kept away by the "lip mike" which was perfected for

(Continued to page 150)

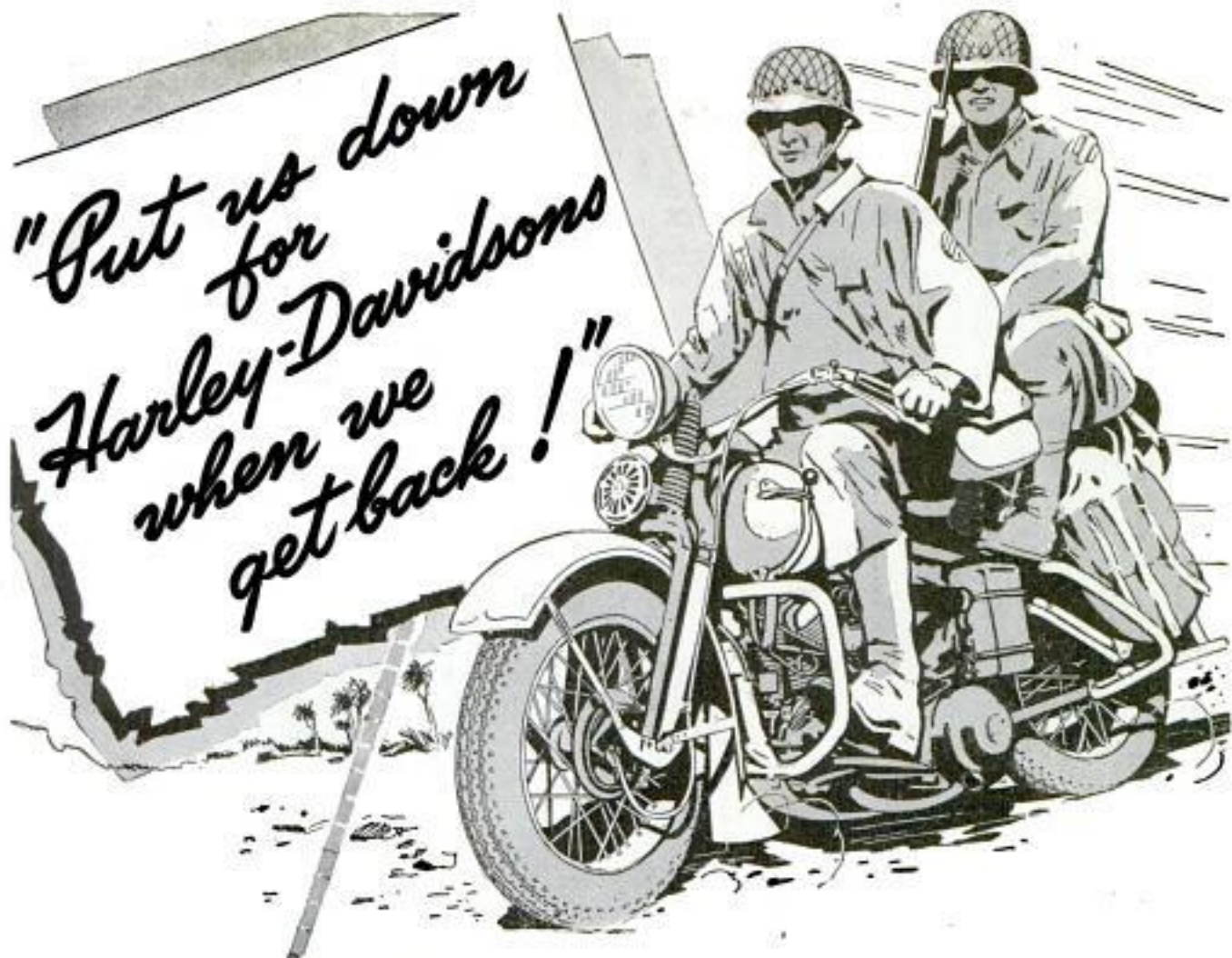

All through this war, thousands of letters have been pouring in from our fighting men on all fronts. In every instance, the letters tell how Harley-Davidsons stand up under severest conditions of heat, cold, mud, rain and snow. Always, the letters end something like this—"Want to get this war over quickly and get back to those good old motorcycling days. A new

Harley-Davidson will be my first buy." Okay, fellows. The new Harley-Davidsons will be ready soon after the shooting is over. And you can count on it that they will have the same stamina, rugged construction and dependability that made them World Champions before the war — world beaters during the war.

HARLEY-DAVIDSON

Motorcycles

HARLEY-DAVIDSON MOTOR COMPANY, Dept. P, Milwaukee 1, Wis.

Please send at once free copy of 24-page "Enthusiast" Magazine, filled with motorcycle action pictures and thrilling stories.

Name.....

Address.....

City..... State.....



SAVE WORK!

...Yet Have Lovelier Floors



Self-Polishing Simoniz Shines with- out Rubbing . . . Gives Longer Lasting Luster

Don't envy others. Your floors can be as brightly spotless as the best of them—and oh so easily! Merely flow Self-Polishing Simoniz onto your floors. No rubbing—no polishing—just let it dry. Then—Presto!—Shimmering loveliness that lasts and lasts. Self-Polishing Simoniz doesn't wash off and have to be replaced every few days. It wears, in fact, much like the original SIMONIZ long famous for enduring beauty on automobiles. Cleaning's so easy, too. A damp cloth whisks off dust and dirt and your floors shine like new again. So, do try Self-Polishing Simoniz—but Soon! Sold by grocery, hardware, drug, paint and department stores everywhere. The Simoniz Company, Chicago, Ill.

SELF-POLISHING
SIMONIZ
FOR FLOORS



use in Army tanks. With the lip mike, a gadget an inch wide and weighing less than two ounces with harness, cord and plug, the future sports radio announcer will be able to keep out all extraneous sound while almost on top of the play.

If you are one of America's 15,000,000 bowlers there are pleasant surprises ahead for you. An automatic pin setter is ready and so is a mechanical "Einstein," a calculator understanding strikes and spares, to keep score.

Fishermen and radar will go down to sea together in the postwar era. Deep-sea boats, A. Paul King of the Beach Haven Tuna Club of New Jersey testifies, will be equipped with electronic detection units that spot schools of fish miles away. American destroyers, using the magic beam, have often blown up schools of fish, believing them to be submarines.

Even such a placid game as chess will be influenced. Arrangements are already under way for American-Russian team matches by short wave.

Science will eliminate the guesswork from almost every sport but one. No progress has as yet been reported on a device to beat the horse races.

"It's Impossible But We'll Try It!"

(Continued from page 81)

Its role then was that of spotter. Once survivors of a disaster were found it could signal a flying boat or surface craft to make the rescue. However, squadron officers had been experimenting with an old parachute harness attached to the end of a line for possible use by an airship in an emergency. Culbertson was carrying this apparatus.

Arriving close to the dye patch, Culbertson dropped a smoke float in the water to mark the location and to signal the PBY. The flying boat came over and had a look but didn't dare risk a landing. For once the surface was too rough for a Catalina.

With the motors throttled back until he just had steerage way against the wind Culbertson settled down close to the surface and moved up to the life raft. The occupant was soaked and shouted that he couldn't last much longer in that sea. "I'll lower a chute harness to you," Culbertson shouted back. "Wave your hand when you have it tied on!" "Right!" came the answer. The harness was lowered out of the airship's opened door. The flyer signaled and three of the crew hauled him up. They dried him out over the cabin heater and gave him hot soup.

Then Ace got a surprise. The rescued

(Continued to page 152)

LIGHTER MOMENTS with
fresh Eveready Batteries



*"I'll have to hang up, dear—one of the boys
wants the phone..."*

"EVEREADY" No. 6 dry cells are still serving in vitally important field telephone equipment for our Armed Forces.

But substantial quantities of these extra-powerful, long-life batteries are available for civilian use—for radios, ignition systems, doorbells, buzzers and other battery-operated devices.

Famous "Eveready" No. 6 dry cells give you dependable performance and a full measure of long, trouble-free service. Ask for them by name at your dealer's.



EVEREADY
TRADE-MARK

The registered trade-marks "Eveready" and "Ignitor" distinguish products of National Carbon Company, Inc.

THE SPHINX USED
TO LOOK DOWN UPON:



PIPES
LIKE
THESE
IN
EGYPT



LHS TODAY, IT'S
STERNCREST
STERLING

IN EGYPT,
AND EVERYWHERE OUR BOYS HAVE GONE

LHS has never turned out better pipes, nor more pipes, in the 50 years of LHS pipe-making. And yet, so great is the demand that dealers' stock are often depleted. But, good news—with war's end, more and more LHS pipes are now available for our civilian friends. Not all models yet, but a big selection, and all pre-war quality and workmanship. Your dealer has them.



\$5

Sterling Silver Band
Model No. 21
Antique Finish

IMPORTED
BRIAR

Also in plain finish.
Dozens of other
handsome models.

Also LHS
Sterncrest 14K
Specially selected
imported briar,
14K gold band.
Plain and antique
finishes. . . \$7.50

AT ALL GOOD DEALERS

KEEP ON BUYING
WAR BONDS



Reg. U.S. Pat. Off.

FREE—"Fountain on Pipes"—Write

L & H STERN, INC., Stern Bldg., 56 Pearl St., Brooklyn 1, N. Y.

man walked forward, thrust out a hand, and said, "Thanks, Pete." Ace said, "Huh?" and looked closer. The man wrapped up in the blanket was a former college wrestling opponent, Frank Baldwin, a Marine Corps pilot.

Ace's dexterous handling of airships comes from much practice in standard maneuvers, then trial in all the situations to which such maneuvers could be adapted. An airship, he maintains, will do practically anything except loop. The cabin begins to fall back into the envelope when you approach the vertical, he explains sadly.

Such pranks are all in the past now. Culbertson has promised to stick strictly to the operations necessary for carrying out his orders. His squadron commander, a good psychologist, exacted that promise after explaining to Ace that unless he calmed down, less competent pilots might get into difficulty trying to imitate him.

So maybe it wasn't Ace who steered his ship right up alongside another airship, away offshore on lonely outer patrol. Urgently, dots and dashes of light began to wink from the arriving airship's signal blinker. Letter by letter, the commander of the other blimp gravely took down the message. It read "Wanta race?"

High Pressure Diver

(Continued from page 53)

used by Browne in the test can be carried on small salvage vessels which do not have decompression rooms. It can also be used in emergencies when a diver has to be brought to the surface in a hurry.

Another Browne creation, welcomed by aviators as well as sailors and divers, is an "escape vest" which carries about a 15-minute supply of oxygen. Tests have shown the vest to be practical for escaping from a submarine at 210 feet, or from bailing out of a plane in the stratosphere. All the pilot or submariner has to do is insert the mouthpiece and keep breathing. In case of ditching, the vest gives a bomber crew more time to escape and also aids in rescuing occupants of a partly submerged plane.

Browne's other inventions include a "damage control vest," similar to the escape vest but permitting work under water for a longer period; a "search board" on which a person can lie face down and peer through a plastic window to locate sunken objects; a plastic and rubber swimming mask which fits over the nose and eyes, taking the place of nose clips and goggles, and a diving helmet made mostly of transparent plastic for amateurs.

(Continued to page 154)

Up in the Air

ABOUT WHAT BATTERY TO BUY?

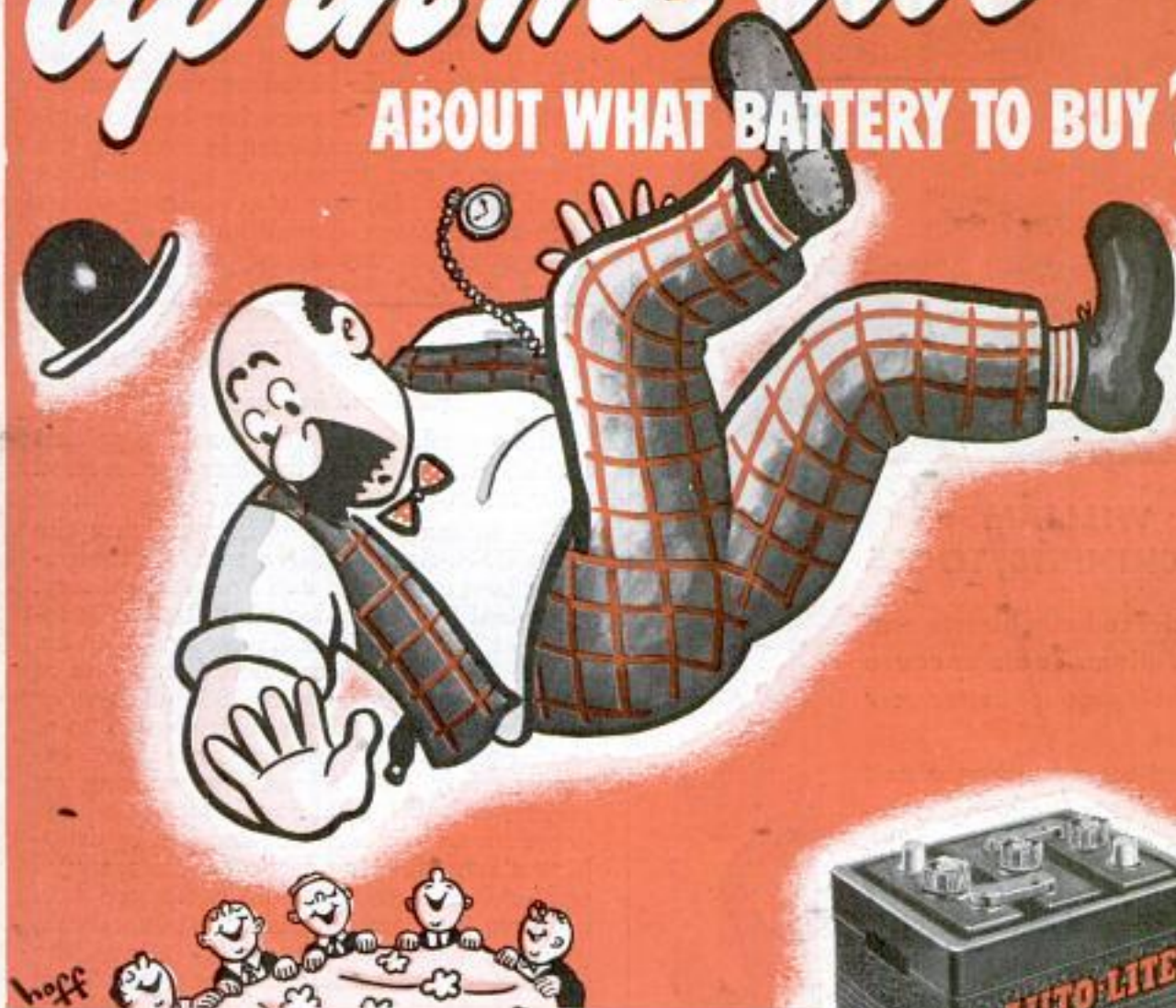

GET THE BATTERY EXPERTS CHOOSE

You can have the help of experts when you buy your next battery. Follow their example. They choose Auto-Lite batteries for service in the million-mile ocean-spanning Clippers, for service with our fighting forces in jeeps, tanks, half-tracs and other vehicles.

AUTO-LITE BATTERY CORPORATION • TOLEDO, 1, OHIO

Manufacturing Plants at: Niagara Falls • Indianapolis • Atlanta • Oakland • Oklahoma City • Toronto

The qualities experts look for in a battery are the same you need in your car battery—long life, quick starts, dependable power and low-cost operation. That's what you get when you buy an Auto-Lite battery—specified as standard equipment by leading automotive engineers.

TUNE IN THE AUTO-LITE radio show starring Dick Haymes, with Helen Forrest, Gordon Jenkins' orchestra. Features stars of stage, screen and radio and 2-way conversations with men and women at the fighting fronts.

AUTO-LITE BATTERIES

ENGINEERED AS A BALANCED UNIT OF THE ELECTRICAL SYSTEM

Preferred
BY
MACHINISTS

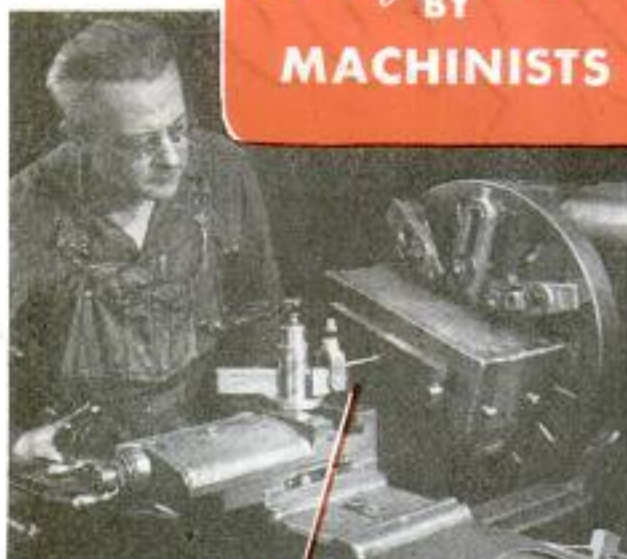

WILLIAMS MACHINISTS' TOOLS

Experienced machinists prefer Williams Tools because they help produce better work easier!

Backed by more than a half century of tool-making experience, you'll find these daily-used shop tools not only well-designed and accurately machined, but rugged and long-lasting because they are drop-forged by Williams.

Write Dept. M-10 for free Tool Data Sheets.

J. H. WILLIAMS & CO.
BUFFALO 7, N. Y.



DROP FORGINGS AND DROP-FORGED TOOLS

Browne has worked with Capt. John Craig and other noted deep-sea divers on many occasions. He helped design a self-contained suit with its own oxygen supply to be used in the Lusitania salvage expedition, which was abandoned just before the war. This suit eliminates the danger of fouling air lines when a diver is working on a wreck. During tests in Lake Michigan, Browne took part in what is believed to be the first radio broadcast under water.

More recently, Browne has helped supply diving equipment used in righting the Normandie and in salvage operations at Pearl Harbor. He predicts that the greatest deep-sea salvage expeditions in history will get under way shortly after the war.

Nine Lives for Battlewagons

(Continued from page 63)

to the vessel. So swiftly was the gallant carrier reconditioned that her men missed their treasured stateside leave.

The mammoth job of hospitalizing the huge U. S. fleet requires some of the nation's best craftsmen and finest machinery. A typical Navy drydock installation is located at Terminal Island, near Los Angeles, where "sick" ships are nosed into one of the two big cruiser docks, 700 feet long, or into the 1100-foot Morreel Drydock, one of the largest in the world and able to accommodate any ship afloat. Resembling an enormous bathtub, Morreel Dock is a huge depression which can be closed off by dropping a large floating section at its seaward end. After a ship has been nudged into position, the floating caisson is pushed into place by a tug and the air is let out, the sinking section sealing off the dock. Then the water can be pumped out of the drydock, leaving the ship high and dry.

In the Terminal Island shop are many highly specialized tools such as a 630-ton machine planer for armor plate. Its smallest casting weighs over 70 tons, yet it is so delicately balanced that special housing must protect it from temperature changes. The nearby optical shop rides on a floating foundation to prevent vibration from disturbing delicate instruments. Steel frameworks are erected in a yard in which, spider-like, walk huge traveling bridge cranes—1000-ton hydraulic giants with fingertip control that a girl can operate. In the riggers' shop, life rafts, cables and other outfitting gear are made. The mold loft makes templates of plywood or paper, to be reproduced in steel, while in the sail loft, the Navy's seamstresses—some old-timers of sailing days—cut and sew canvas.

CASITE

**MAKES HORSEPOWER
LEAP TO LIFE!**



**65¢
A PINT**

**Guarantees Quick Starting in Winter Weather
or Double-Your-Money-Back**

Does your car sputter and cough, refuse to start on cold mornings? Get touch-and-go starting all winter long. Get Casite... a pint in the crankcase every oil change... at service stations, car dealers and garages, everywhere.

THE CASITE CORPORATION • HASTINGS, MICHIGAN

WE GUARANTEE that any motor capable of being started in a warm room will start promptly in the coldest weather when Casite is added to the crankcase according to instructions. If your car fails to start quickly, you get double-your-money-back by filling out guarantee certificate and mailing it to The Casite Corporation, Hastings, Michigan. Maximum refund is \$1.30 per pint, twice the nationally advertised price of Casite.

GIVES BETTER AND SMOOTHER PERFORMANCE ALL-YEAR-ROUND

Make this simple test! See why you

GET MORE HEAT



FROM LESS FUEL



with the genuine ESTATE

HEATROLA HEATER

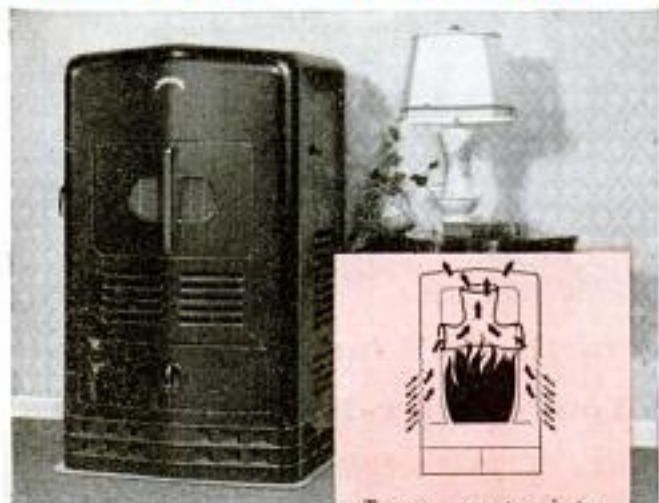

Turns waste into warmth. Only the genuine Estate Heatrola Heater has the Intensi-Fire Air Duct, built directly over the flame.

Before you buy any home heater . . . see the genuine Estate Heatrola Heater . . . the recognized leader for over 20 years. Circulates healthful warmth throughout the rooms...makes less fuel go farther.

THE ESTATE STOVE COMPANY, Hamilton, Ohio

Your best buy is the best you can buy

. . . the genuine

ESTATE *Heatrola* HEATER

FOR COAL, WOOD, OIL

"Fleet Under Two Flags"

(Continued from page 87)

Big 14-inch rifles and 6 and 8-inch guns blasted holes in the airfields. Jap opposition was almost negligible from then on.

The full weight of British sea power employed in the Pacific included an estimated 19 battleships, 8 large carriers, 37 cruisers, 255 destroyers, 50 submarines and hundreds of smaller craft.

Based in Australia, the British Fleet used United States bases and anchorages farther up the line in the Western Pacific. British tankers with fuel from the Middle East refueled British warships; British-made ammunition carried in British bottoms was used to rearm British warships; food from all over the Empire—New Zealand butter, Australian flour and meat, Indian tea—was eaten aboard British ships.

The British fleet train consisted of more than 100 auxiliary ships and its supply line was approximately 5000 miles long—about the same distance that the U. S. Pacific Fleet operates from Pearl Harbor. The British fleet train was made up of repair ships, tankers, supply ships, hospital ships, floating drydocks, tugs, etc., plus some types the U. S. Pacific Fleet does not have.

One of these was an aircraft repair ship. This vessel looks like an aircraft carrier and may operate as such, but its main job is to recondition planes. It carries complete machine shops and spare parts.

Another unusual kind of an auxiliary is the "amenities" ship. This is a converted 10,000-ton passenger liner devoted entirely to recreation. It has a brewery capable of turning out 9000 pints of beer a day. It contains a restaurant, store, cobbler's shop, postoffice and an ice cream shop, or "milk bar" as the British call it. A theater with movies and stage shows is open all hours.

Proud though it is of its own accomplishments in the Pacific, the U. S. Navy welcomed the help of its "senior partner." At the close of the Okinawa operation, Fleet Admiral Nimitz sent a message of congratulation to the British task force commander. He said the successful attacks made on Sakashima were most gratifying and that the British ships were to be congratulated on the "auspicious manner" in which they had initiated operations in the Pacific.

The same idea was expressed later when the King George V dropped hook in Apra harbor. A sun-tanned American boatswain's mate ran into a Liverpool signalman and invited him to have a can of beer.

Tilting his can at the Britisher, he said: "You limeys are O. K. Glad to have you out here with us."



**WHAT A BARGAIN!
A WHOLE YEAR OF WOOD-
WORKING FUN, PROJECTS,
AND IDEAS FOR YOU!**



in **THE Deltagram**

— the popular, plan-packed
homecrafters' magazine . . .

Page after page of practical ideas, projects, news, shop tips, designs — delivered to your home six times a year

A whole year's supply of fascinating woodworking plans and projects — about 68 of them! And all for only 50¢! That's less than ¼¢ per plan!

In addition to all this, The Deltagram is a gold-mine of ideas for more fun from your hobby. You get the latest tips on how to perform operations more easily, more quickly, more safely. You get useful information that's a big help in producing beautiful objects your friends admire.

No wonder woodworking hobbyists everywhere have for thirteen years been calling The Deltagram "the biggest half-dollar's-worth in the hobby field!"

Published by the makers of famous

Delta
MILWAUKEE
Homecraft
Power Tools

Easy to Understand

Every idea, every plan, every shop tip of the many that fill the pages of The Deltagram has been worked out in detail in Delta's own shop.

Step-by-step instructions are complete and are made crystal-clear in words and pictures — so that even the beginner can follow them easily, without costly waste of time and materials.

Subscribe Now

The new subscription year for The Deltagram is just starting. By subscribing right now, you're in time to receive the first new issue.

Paper restrictions limit the number of subscriptions we can accept. So to avoid disappointment, fill out the coupon below and mail it today with coin, postal note, or money order.

Six big, exciting issues

for
only

50¢

One recent issue of The Deltagram contained all this:

- Photographs of seven interesting projects made by Deltagram readers.
- Plans and instructions for a novel cigarette server.
- Plans with numerous illustrations of a child's glider swing.
- Plans and photographs for a beautiful lamp table.
- Plans and pictures for a handsome mahogany panel wastebasket.
- An interesting illustrated story on remodeling an office.
- Plans and photographs for a sturdy and attractive set of juvenile table and chairs.
- Plans for a maple vanity (part of a bedroom set, continued from previous issues).
- Plans for a Gothic wall shelf.
- Several cutout designs for garden ornaments.
- A page of letters from readers.
- A Delta Crafts sheet showing how to make a simple, but useful, mitering jig for the circular saw.

. . . And, remember, this is just one issue out of six!

TEAR OUT COUPON AND MAIL TODAY!

THE DELTA MANUFACTURING COMPANY
630L E. Vienna Avenue, Milwaukee 1, Wisconsin

Enclosed is 50c in payment for a full year's subscription to The Deltagram.

Name.....

Address.....

City..... (.....) State.....

HM-20



STOP DUST

It is no longer necessary to put up with a dirty room every time you sweep the floor. By sweeping with a Dustless brush, which makes its own sweeping compound as it sweeps, you can eliminate up to 97% of germ laden dust in the air between sweepings. You can also do away with costly sweeping compound and cut labor costs. Thousands of factories, shops, offices, schools, and stores now use Dustless sweeping. Get complete facts about this better method of dust control. Write today.



Dustless
DOES MORE FOR LESS



- Dustless
- Speed Sweep
- Speed Wash brushes

MILWAUKEE DUSTLESS BRUSH COMPANY

528 N. 22nd Street • Milwaukee 3, Wisconsin

Grand Slam in Subs

(Continued from page 16)

Japan's famous Fujiyama, covered with snow and big as life, taken through the periscope of a submarine. Another sub surfaced so close to the Jap mainland that crew members could watch a horse race in progress. Winning horses were hastily chosen and book was made on the race.

Subs are always out in front. When the Marines were storming Tarawa, subs were sinking Jap ships in the Marianas; when we invaded Kwajalein and Roi and Namur, subs were making patrols into the Philippines. Long before Admiral Halsey took the powerful Third Fleet into the China Sea, subs had been operating there.

It was the submarine fleet again that weakened Japan's mighty bastion of Truk so that it could be successfully by-passed. Supply ships carrying precious fuel, bombs, spare parts and food to Truk were sunk regularly. When Truk was finally attacked by United States carrier planes, its resistance was surprisingly feeble.

In addition to sinking enemy merchant shipping, subs have played an important role in keeping track of the movements of the Jap fleet. A generous portion of the credit for winning the Battle of Midway has been given the submarines for their valuable reconnaissance work. In the decisive Battle for Leyte Gulf (originally called the Second Battle of the Philippine Sea), it was a lone American sub that spotted a Jap task force cruising at high speed northward from the Singapore area. That was the tipoff. The sub radioed the information to Admiral Halsey, sank a Jap heavy cruiser and damaged another.

After the surface action of that battle, which will go down in history as the greatest of sea battles, American subs hung on the flanks of the crippled Jap fleet—polishing off several warships with torpedoes.

Subs have played an important role in rescuing shipwrecked or shot-down personnel. Many a sailor or flyer owes his life to a curious submarine that came poking along at just the right time.

When the mighty Jap stronghold of Truk was being plastered by carrier aircraft in the summer of 1944, the Tang made one of the most daring rescues of all time. Twenty-two Navy pilots were downed within sight of the Japs. But, dodging treacherous coral reefs and risking fire from shore guns, the Tang went right into the Truk lagoon and picked up the water-logged airmen.

The Harder made a similar daring rescue off a Jap-held island when a lone figure,

(Continued to page 160)

ALWAYS SHARP! ALWAYS READY!

X-ACTO Knives Save Time • Effort • Spoilage

Experts Enthuse Over Renewable Blade Feature

What's your hobby? Plane models? Leather work? Photography? Whatever you need a knife for, you'll do better with a supersharp X-acto. It gets those hard-to-reach places, does a better job . . . quicker.

What's your business? Drafting? Teaching? Commercial art? You'll find X-acto the handiest, most efficient knife you've ever used . . . for paper, wood, rubber, plastics. Industry finds new uses for this versatile wonder knife every day.

What's the reason? X-acto's refillable blades are super-keen, made like a surgeon's scalpel, from specially ground surgical steel. X-acto handles are designed for firm grip and easy cutting control; the blades can't fold under. You've never used a knife so sharp, so safe, so sure!



*Reg. U. S. Patent Off.



Busy Business Man Builds Scale-Model Railroad — Says No Job Too Ticklish for X-acto

Meet Jack Reeder of New York City, owner, builder, and operating crew of the Coldwater Canyon Railroad. Mr. Reeder started this scale-model railroad several years ago, as relaxation from the tension of business. By now it's one of the finest model systems in America.

And here's what he says about X-acto: "Best model knife there is," he says. "Whenever I need a new sharp blade, or a different shape for a special cut, I can switch blades in a jiffy. And another thing, now that I use X-acto knives, I sport no more cut fingers, as I did when I used razor blades."

HELPFUL "HOW TO" BOOKLETS

Full of Ideas • Only 10¢ each

Write for one or all of these interesting booklets, chock full of suggestions for things to make and how to make them.

- (1) How to Build Scale Model Planes.
- (2) Boat Whittler's Handbook.
- (3) Twelve Techniques — The Knife as a Drawing Instrument.
- (4) Commercial Artists' Handbook.

X-acto Crescent Products Co., Inc.
440 Fourth Avenue, New York 16, N. Y.

X-ACTO TOOLS, TOO

Scientifically Accurate—Each Perfect for its Purpose



x-acto^{*} KNIVES & TOOLS

X-acto Knives & Knife Chests From 50¢ to \$5.00

Buy where you see this sign. At better hardware, hobby and gift shops
— or if not available write direct to

X-acto Crescent Products Co., Inc., 440 Fourth Avenue, New York 16, N. Y.

**EASY
TO
HANDLE**



Of the many types of sailing craft some, like the comet riding swiftly before the breeze, are designed for easy handling.

Plumb tools, too, are easy to handle. The hang, the comfortable shape of the shock-absorbing hickory handle, the one-piece steel head correctly weighed for balance are part of Plumb's design. Yes—Plumb tools work better and do the job faster because they are easy to handle. Fayette R. Plumb, Inc., Phila. 37, Penna.



NAIL HAMMER



BALL PEEN HAMMER



HALF HATCHET

PLUMB

HAMMERS • HATCHETS • AXES • SLEDGES

waving a shirt, was spotted on the reef. Was it an American flyer downed at sea—or was it a Jap trick? The skipper of the Harder had to make the decision. He calculated the risks and decided that if a single American life were at stake, it was worth making an effort. So he put his sub in as close as he dared and sent his gunnery officer and three volunteers in a rubber boat to investigate. The man waving the shirt turned out to be an American pilot. Another life was chalked up to the subs.

Along the 1500-mile overwater route from the Marianas to Tokyo, subs have picked up the crew of many a ditched B-29. And in the waters around the Ryukus, shot-down carrier pilots were hauled out of the sea, given dry clothing and hot food and delivered back to their ships.

Even though it made few headlines, the "Silent Service" played a spectacular and brilliant part in the defeat of Japan.

The Big Pit

(Continued from page 5)

drill presses and other tools are powered by individual motors, and the old overhead shaft and belt system is heading rapidly for the scrap pile. Machine shop workers are proudest of their giant planer, powered by a direct current motor which reverses its own direction. Speed is controlled by a rheostat panel, and voltage may be changed by a variable control.

The last word in arc and acetylene welding is found in the welding shop. Here was devised a cable cutter to replace the old process of measuring out cable by hand from a drum. The wire is drawn into the cutter, and pressure on a foot control raises a meter which records in feet the length of cable passing through. In the blacksmith shop are made the big teeth for the shovel buckets, and hammers and drill bits which bite into the earth. Between times in repairing truck bodies and building wedges, carpenter shop workmen construct small houses for the shovel operators. Compact heating units keep them comfortable in chill weather, of which there is a large supply on the range.

Electric motors of all kinds are torn down and rewired in the electrical shop, facilities of which include an electric oven for baking varnish at a 250-degree temperature, maintained evenly by a fan system. In cable repairing, lines are tested at 4000 volts just as in regular operation.

Away from the regular shops is a special garage for Diesel trucks, including the 30-ton dual drive monsters which are the

(Continued to page 162)

Fine for boys . . . and fine for Motors, too!

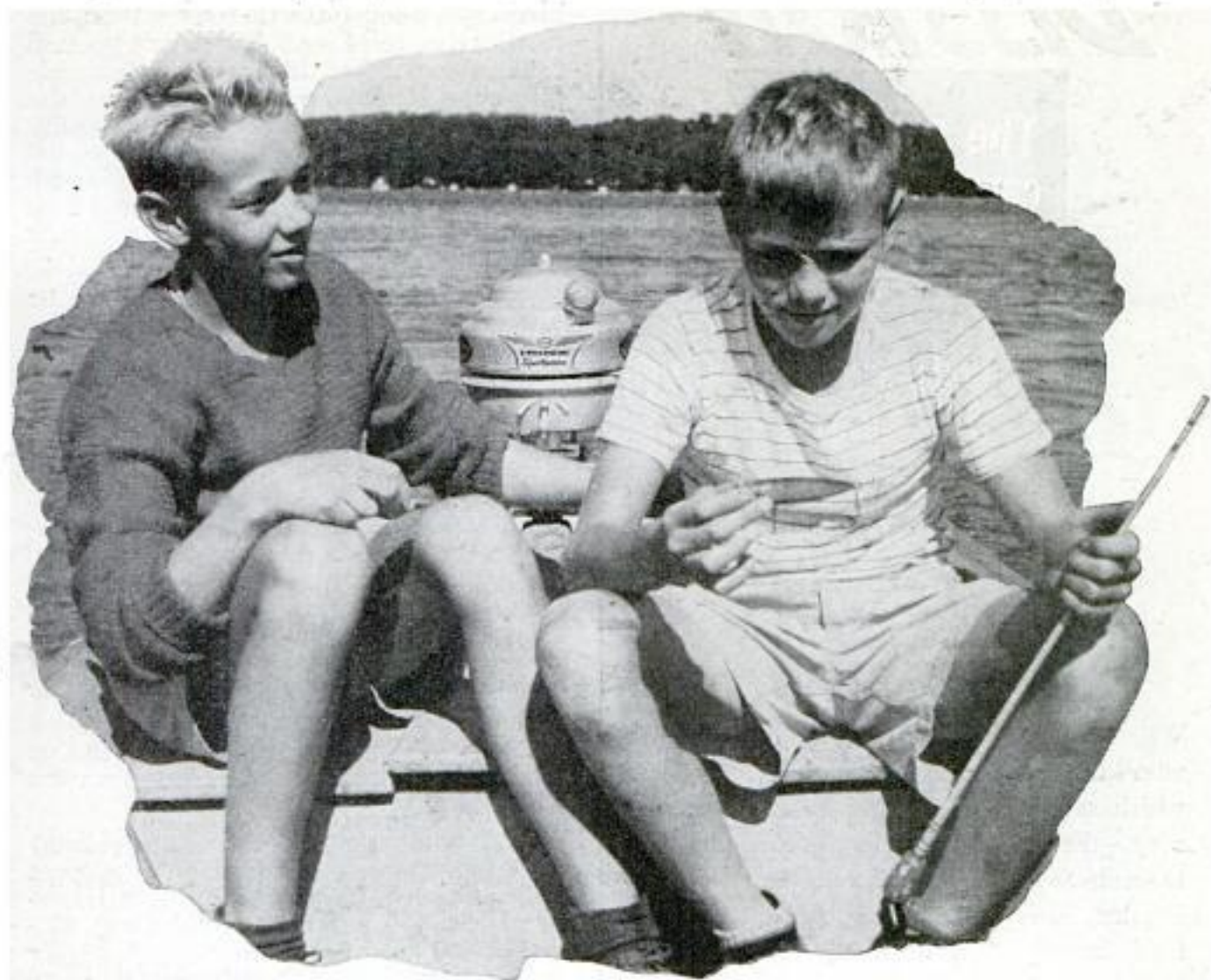

Getting out on boats is a grand thing for boys. It makes them water-wise and "fish-wise", clear-thinking and resourceful in emergencies. It nurtures all the priceless qualities that make for manliness and good sportsmanship.

Getting out on boats is also a great thing for outboards. In fact, it means just about *everything* in developing and perfecting truly fine outboard motors. And this is the overshadowing advantage Evinrude offers. 36 years of *getting out on boats* . . . 36 years of studying, testing, proving and improving countless models on thousands of boats of every type . . . from humble fishing skiffs to spectacular assault craft. Matured, perfected, *completely satisfying performance* is something you can bank on . . . when you choose a postwar Evinrude! EVINRUDE MOTORS, Milwaukee, Wisconsin.

BUY MORE WAR BONDS . . . AND HOLD THEM!

EVINRUDE

OUTBOARD  MOTORS

DISSTON



When you seek legal advice, you ask a man who knows the law. When you want to learn which saw is best, ask the man who knows saws—the carpenter. Most carpenters use Disston Saws. They will tell you they like Disston Saws because these famous saws are faster cutting, they do finer, smoother work and they require less frequent sharpening.

Take care of your Disston Saws and they will continue to serve you well. Many hardware retailers and saw repairmen provide a special saw sharpening service. They will be glad to help you keep your Disston Saw—or other quality make—in good serviceable condition.

If you need a new Disston Saw or other tool for essential work, talk to your local hardware retailer—he may be able to help you.

HENRY DISSTON & SONS, INC.
1011 Tacony, Philadelphia 35, Pa., U. S. A.

ASK FOR YOUR FREE COPY



of the Disston Saw, Tool and File Manual. It tells how to use and care for tools. Ask your Hardware Retailer, or write us for a copy.



granddaddies of the motorized fleet. Built like a plane hangar, the garage is of fiber-board and wooden trestle construction, the trestles connected by bolts. Four 80-pound rails are anchored in concrete alongside pits over which the trucks roll into the shop. Some light trucks which were found unsuitable for ore handling came in too often for repairs, but they weren't wasted. A quick trip to the machine shop, and they were converted into traveling cranes.

A question often asked after a survey of the intensive mining in all the ranges is: "How long is this going to last? Won't the ore give out if this keeps on?"

It's difficult to get an answer. Mining companies are not anxious to open new locations before they're ready to take out the ore, for the reason that, under Minnesota law, such deposits become taxable assets and are taxed just as producing property. Municipal governments which derive the bulk of their revenue from mining taxes worry about the possibility of losing this rich income, but, significantly, you never hear an executive of a big mining company express fears about the supply of ore.

An exceedingly well informed source gave me this estimate of reserves on the Mesabi Range:

High-grade ore (52 percent natural iron) 900,000,000 tons; concentrates (40 percent natural iron), 150,000,000 tons, and low-grade ore (30 percent natural iron), 57,200,000,000 tons. The low-grade ore supply will last for years. Though practically no low-grade ore has been shipped from the range, those vast piles of waste rock will become a rich source of supply when experiments now under way have developed economical processes for extracting the ore from the rock. That they will come in time is doubted by no one in the industry.

Iron miners look with pride at their war-time record of not one labor stoppage. The mining industry employs about 24,000 at the season's peak. Although mining itself ceases in winter because the ore becomes like concrete and won't flow, management attempts to maintain a high year-round employment level, and has been successful in doing just that long before the annual wage became a subject of conversation. The Oliver Iron Mining Company long has operated on an all-year basis, and keeps its employment level stable by maintenance and stripping work in the winter.

Transportation of the ore from the pits by rail and steamer to blast furnaces is another gigantic operation, to be described in a second article in November.

*Signet of Quality
in Pipes*

VanRoy



Under a star-studded sky . . . when impressions are sharply accented . . . try smoking a VanRoy. You will soon realize how profound is the difference between pipes . . . and thank your lucky stars that your smoking-companion is a luxurious VanRoy.



*Pipes illustrated
VanRoy Bard \$5*

VanRoy Company, Inc.
Empire State Building, New York 1, N. Y.



PREFERRED BY ELECTRONIC ENGINEERS

Powering portable sound amplifiers for Pathe newsreel cameras is typical of the many uses for which electronic engineers choose Burgess Batteries. Electronic experts prefer Burgess 2 out of 3! Use the brand experts choose in your radio, flashlight, hearing aid or telephone. **BUY BURGESS!**

BURGESS BATTERY COMPANY, FREEPORT, ILLINOIS.



BURGESS BATTERIES

Recognized By Their Stripes
Remembered By Their Service



SAVE WASTE PAPER

STOKER EMPTIES OWN ASH!

A remarkable stoker already used by thousands of home owners—fits into any furnace or boiler. Manufactured since 1934. So automatic it takes the coal from your present coal bin through a pipe to the furnace, going around corners if necessary. Keeps house at even temperature, empties its own ash in sealed containers, no coal to shovel, no clinkers to dig, only bituminous stoker of its kind on the market. Send for full information NOW!

POCAHONTAS FUEL COMPANY INCORPORATED
344 EAST 131st STREET • CLEVELAND 8, OHIO



ARMSTRONG TOOL HOLDERS

enabled American industry to change to war production "over night." For they are the permanent, multi-purpose tools used by 96 per cent of the machine shops and tool rooms, on lathes, planers and shapers—the tools used to make dies and jigs, to build production machines. They are the tools you will want for your own shop—ARMSTRONG TOOL HOLDERS for industry, ACE Tool Holders for home work shops.

ARMSTRONG BROS. TOOL CO.

"The Tool Holder People"

368 N. Francisco Ave., Chicago 12, U.S.A.



BUILD this GAS ENGINE



No Castings! No Special Tools.

All you need is a lathe and some scrap shafting. Speed and power for midsize cars, boats, etc. Two cycle. 4" bore, 4" stroke. With our unique construction methods you can also design other engines incorporating your own ideas. No casting or pattern worries. Order complete plans and step-by-step instructions NO W—satisfaction guaranteed. Engine Plans, \$1.75. Carburetor plans, 75c. Mailed postpaid on receipt of remittance. R. W. Rowe, Engineering, 2225 Appoline, Detroit 27, Mich.

AUTO ENGINE SPEED CONTROL

GOVERNORS



Give constant or changeable speed to any auto or truck engine, when used for power. Guaranteed. Instructions. Oil ring bearing, \$13.00. Ball bearing, \$19.50. Prepaid.

Agents Wanted: Parts Dealers, Garages, Wreckers, Implement Dealers, General Merchants, etc. Free circulars.



State size of opening and distance between bolt holes.

Also additional carburetor butterflies. In Montreal: 7546 Wiseman St.; Latin America: East Asiatic Co.

CANDEE, Dept. F. 2641 S. Hill, Los Angeles 7, Calif.

POPULAR MECHANICS material

Sky High Proving Ground

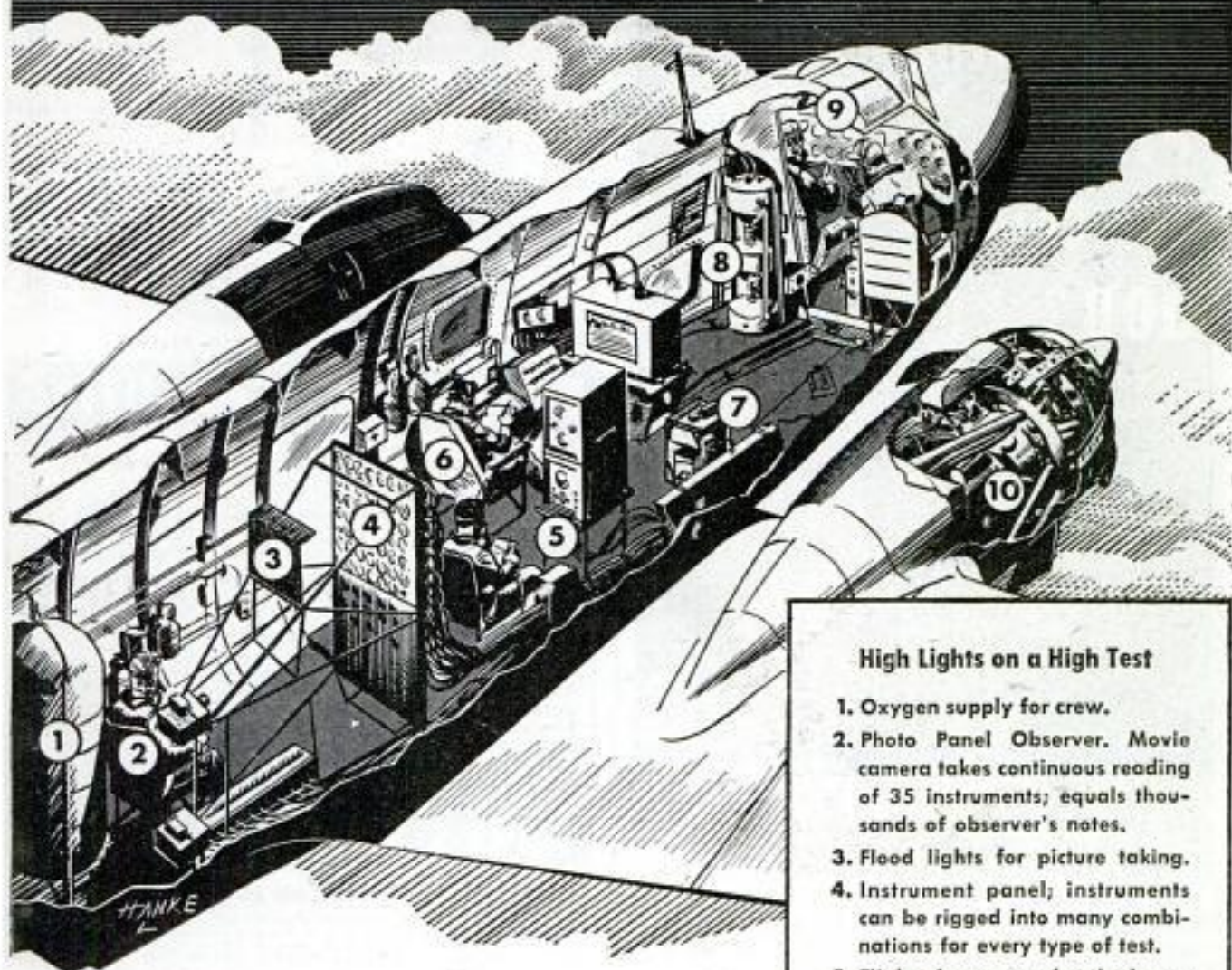

In this Wright Aeronautical flying laboratory, experimental models of Wright Cyclone aircraft engines are put through the grueling grind of flight test. From this continuous research are produced more powerful and more efficient Cyclones for the commercial and military planes of tomorrow.

WRIGHT AIRCRAFT ENGINES

DIVISION OF
CURTISS WRIGHT
FIRST IN FLIGHT



High Lights on a High Test

1. Oxygen supply for crew.
2. Photo Panel Observer. Movie camera takes continuous reading of 35 instruments; equals thousands of observer's notes.
3. Flood lights for picture taking.
4. Instrument panel; instruments can be rigged into many combinations for every type of test.
5. Flight observer and cathode ray detonation (knock) detector.
6. Flight observer at engine operating temperature recorder. Automatically records temperatures 30 times a minute.
7. Radio-equipment bay (cutaway to show cabin interior).
8. Volume meter measures fuel consumed during flight test.
9. Pilot and co-pilot observer.
10. Wright Cyclone with cowling cutaway to show installation.

Send for "ENGINOLOGY" — 25¢

Learn more about aviation's source of power. Enginology explains super-charging, combustion and engine principles in non-technical terms; describes their relation to planes and propellers. Just send 25 cents in U. S. coin to:

Wright Aeronautical Corporation
Dept. PM, Paterson 3, N. J.

**DIEMAKER,
what's the
FILE
for this
JOB?**



RECONVERSION means busy days for diemakers. . . . And a good diemaker must have the ability to select *The right file for the job.*

Because dies are infinite in their variety, their making calls for a wide range of file types, cuts and sizes. Nicholson's manufacture of files for this specialized field covers years and years.

Many Nicholson regular purpose files in the American pattern are suitable for finishing dies with the more liberal specifications. For close tolerances and intricate designs, the slenderer, more pointed and finer cut regular types of Nicholson X.F. Swiss Pattern Files are recommended; and for small dies or extra-fine detail, Die Sinkers Files, Die Sinkers Riffers and Round Handle Needle Files comprise a wide assortment of special shapes and sizes in the famous Nicholson X.F. Swiss Pattern line.

BOOK "FILE PHILOSOPHY" FREE
to diemakers and master mechanics.

P.S. — The file used on the job illustrated above (finishing the female of a punch die not restricted to extra-close tolerance) is a Nicholson Round In Smooth cut.

NICHOLSON FILE CO., 22 Acorn St., PROVIDENCE 1, R. I.
(In Canada, Port Hope, Ont.)

NICHOLSON
FILES FOR EVERY
PURPOSE

NICHOLSON
U.S.A.
MADE IN U.S.A.

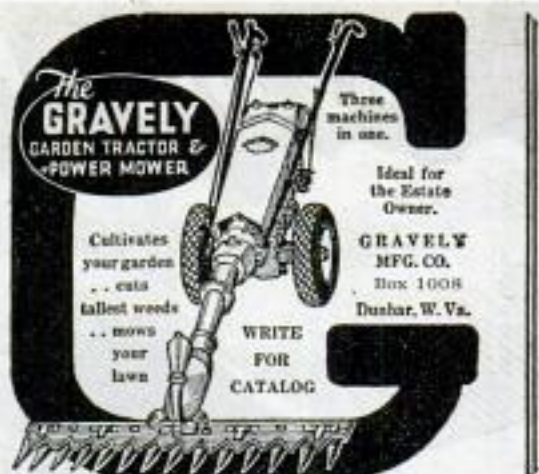

ORDER NOW FOR PREFERRED DELIVERY

SOLDERING Simplified

with this revolutionary gun-type iron

INSTANT HEATING—Fast Handling

The streamlined BAKER Flash will do the work of several ordinary type irons—faster, easier, more economically, instant heating, high or low heat as desired, by control of your "trigger finger". Not only when actually soldering. Non-tiring, protected gun grip and perfect balance for easy, steady application. Unexcelled for work in close places. Operates from standard storage battery or plug-in with 110-volt transformer. Only \$4.75 post paid. With transformer, \$8.95. Send check or money order.



BAKER-PHILLIPS CO., 3051 Lyndale S., Minneapolis 8, Minn.

PAINT STRIPING TOOL

ONLY \$1.00 POST PAID

Try it! See the Added Beauty

With this NEW TOOL (not a brush) everyone can now draw lines with paint, enamel, lacquer, etc. Used on signs, models, toys, signs, imitation tile walls, cabinets, furniture, linoleum floors, etc. Includes boards, sporting goods, home workshop projects, etc.

Send only \$1.00 for complete tool for painting a 3/16" wide stripe. As easy to use as a pencil.



Patented

including adjustable guide, operating instructions, etc. C.O.D. price \$1.50.

Extra interchangeable tips for making 1/64", 1/32", 3/64", 1/16", 3/32" and 1/8" wide stripes lines—.50 each.

Every Painter and Craftsman Should Own One.

Send for your tool and as many additional width tips you need today. Use it. If you are not satisfied that you can do better work, add character as well as beauty to your product or project, return the tool and we'll refund your money promptly.

Paint Dealers: Write for literature, etc.

4234-B Lincoln Ave. WENDELL MFG. CO. CHICAGO 16, ILL.

COLOR CONCRETE WITH CHEMICALS

A business of your own. Big money making Hollywood style pottery and birdbaths without moulds. Washing-wells, stucco-rock, benches, Marbling and cement water-paints. 10c brings sample, literature, pictures. Hollywood CementCraft, 8529 Wonderland Ave., Hollywood 46, California



ONLY \$1.00 EXPANDING SAFETY LEATHER WATCH BRACELET

NEW INVENTION! Fits watches with adjustable dials. Made from the finest Genuine Leather. No other Watch Strap at any price has these Patented advantages. **USED BY THE U. S. NAVY.**

SAFETY WATCH STRAP COMPANY, Dept. 17, 2544-1st Ave., N. Y., 25, N. Y.

() I will pay postman \$1.00 C.O.D. charges & postage.
() I enclose \$1.00. Send Watch Bracelet post-paid and insured. Regulated in size within 2 inches. For perfect fit, mark size of wrist: Small () Medium () Large ()
Name (Print).....
Address.....

Ingenious New Technical Methods

Available Now to Industry in General

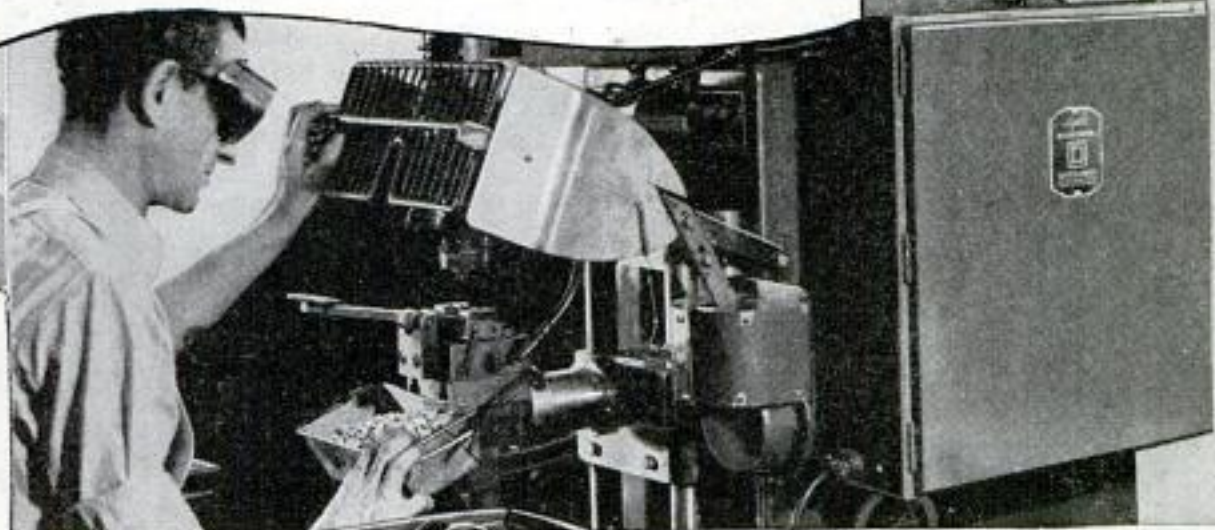

Now! Projection Welding of Two Studs to Housing in One Operation!

The series of P-20 Peer Welders were developed to provide manufacturers of sheet metal and wire products with automatically air operated machines capable of high speed precision projection and general spot welding. They are sturdily constructed, low priced, direct air operated, press type machines.

Shown above, is a Peer P-20 set up with safety guard which is so adjusted that, when lowered, it trips the switch and causes the welder to pass through a complete welding cycle before the machine automatically lifts the guard and stops, ready for the next operation. Other means such as a foot-switch control, can also be used to actuate the welding cycle.

The standard cylinders furnished with these welders provide nominal electrode force up to a maximum of 1000 lbs. Pressures are easily adjusted by the air pressure regulating valve. The welders may be operated with strokes suitable for work at hand within the range of from 0" to 3".

Shown at right, is the wrapper from a package of Wrigley's Spearmint Gum. This famous wrapper will remain empty until conditions permit Wrigley's Spearmint manufacture in quality and quantity for everyone. Wrigley's Spearmint Gum, will, one day, be back as "a help on the job" to workers in industry. Until then, we ask you to remember this wrapper as a guarantee of finest quality and flavor in chewing gum!

*You can get complete information from
Peer Equipment Mfg. Co., 8 Milton St., Benton Harbor, Mich.*

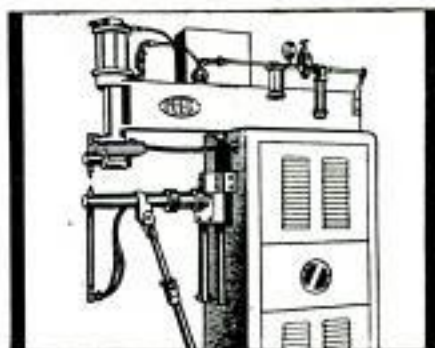

Air Operated Press Type Spot Welder



Remember this wrapper

Z-85

ROGER BOWER,
Director of WOR's "CAN YOU TOP THIS"

Likes "Forecaster!"



"You can't top this Forecaster for a cool, mellow smoke. It registers tops on my pleasure meter, and tops for value."

Roger Bower is typical of the pipe-smoking American who goes for the enjoyment and value in a Forecaster Superb. It's a finely made pipe that gives real smoking pleasure without demanding a premium price. That's just why so many Forecasters are going to servicemen . . . they too find real pleasure and relaxation in a Forecaster smoke. If your dealer is temporarily out of stock, it's because the armed services come first. Keep asking though! Once you own a Forecaster you'll enjoy it always. National Briar Pipe Co., Jersey City, New Jersey.

\$1.50

SIR SHELDON
in natural
briar, \$2.50

NATIONAL
Forecaster
SUPERB

Test-O-Lite *the MODERN TROUBLE SHOOTER*



← **THE NEON GLOW**

... LOCATES TROUBLE INSTANTLY in electric circuits, fuses, cut-outs, motors, radios, appliances. Tests everything electrical from 100 to 550 volts. Indicates hot or grounded wires. Tells AC from DC. Far superior to ordinary clumsy test bulb.

↑ **PUTS "FINGER" ON THE TROUBLE SPOT -- QUICKLY**

Saves precious time. Indispensable in shop or home. Has patented safety features. Vest pocket size with clip. Lifetime guarantee. List \$1.50. Purchase through regular electrical dealers.

L. S. BRACH MFG. CORP.
55 Dickerson St. Newark, N. J.



FUSES



MOTORS



OUTLETS



HUNTER'S COMPASS

Hunting Case, Watch Type, All Metal, Jeweled **\$3.75**

Engineers All Metal Army Type Hand-Sighting LEVELS

\$1.50



PUBLIC SPORT SHOPS

13 S. 16th St., Phila. 2, Pa.

No COD's

WHITENS

CHIPS, CRACKS, DARK SPOTS—Quick! Easy!

So-Lo's PORCELAIN GLAZE

for wash bowls, table tops, refrigerators, bath tubs, toilet seats . . . all porcelain and enameled surfaces. Large jar only 25c.

At Hardware and 10c Stores.

Millions Save with So-Lo Menders

LEPAGE'S GRIPSPREADER MUCILAGE

LEPAGE'S WHITE PASTE

LEPAGE'S GLUE

Electrically Welded Endless

Paramount

**BAND
SAW
BLADES**



Made in widths from 1/8" to 1 1/4"

Make your hand saw do more work for you. The proper width of blade will extend the scope of this important machine. Burrill's Paramount Blades are made from tough Nickel Alloy Steel properly tempered. Teeth accurately set and filed, and all saws carefully straightened. Send order and check today. Delivery will be made as promptly as war conditions permit, from a few days to a week or two. You can obtain these saws at the following prices:

3/8"-3/16"-3/8"-3/8" wide, 5'6" long.....\$.96 each
 3/8"-3/16"-3/8"-3/8" wide, 6'6" long..... .95 each
 3/8"-3/16"-3/8"-3/8" wide, 7'6" long..... 1.10 each

Other sizes at proportional prices

Your satisfaction is guaranteed
BURRILL SAW & TOOL WORKS
 407 E. Main St., Iliou, N.Y.

**SMO-O-OTH
SHAVING!**

HOSPITAL
 MADE IN U. S. A.
 DOUBLE EDGE
HOSPITAL
 RAZOR BLADES
 5 for 25c
 Concave honed

**5 BLADES
FOR 25c**

HOSPITAL
 BRAND
RAZOR BLADES
 NEWARK 2, NEW JERSEY

— After War —

**THE WORLD'S SAFEST ELECTRIC
JIG SAWS** will again carry the name

SYNGRO
 SYNCRO DEVICES, INC.
 Ferndale 20, Michigan

The World's **STRONGEST** Adhesive!

AMAZING Strength



FLEXIBLE, yet quick-drying—and forms a practically unbreakable bond. The only cement of its kind. Exhaustive tests prove all our claims. Unexcelled for adhering metal to metal, cellophane, paper, wood, peat-er's cut, plastic and hundreds of other uses.

STA-FAST Cement

**Almost Impossible
to Pry Apart!**

For Every Kind
 Of Job. Invaluable for me-
 chanics and home craftsmen. A little
 goes a long way. If it's cemented by
 STA-FAST it stays fast. Ex-
 cellent for building of model
 planes, ships, manufacture of
 novelty jewelry, model furni-
 ture. Water resistant, clean.

easy to use. Satisfaction guaranteed or money refunded. At hardware, photographic and artist supply stores, and hobby shops, or direct from us. 1/4 lb. jar mailed for 60c, plus 15c for packing and postage. Order NOW.
AMERICAN WOOD TYPE MFG. CO.
 Dept. PM, 270 Lafayette St., New York 12, N. Y.



**NEXT TIME SAY
BRIGHT STAR**

and you will get a
FLASHLIGHT & BATTERIES

famous since 1909

for **QUALITY,**
STYLE and
SERVICE

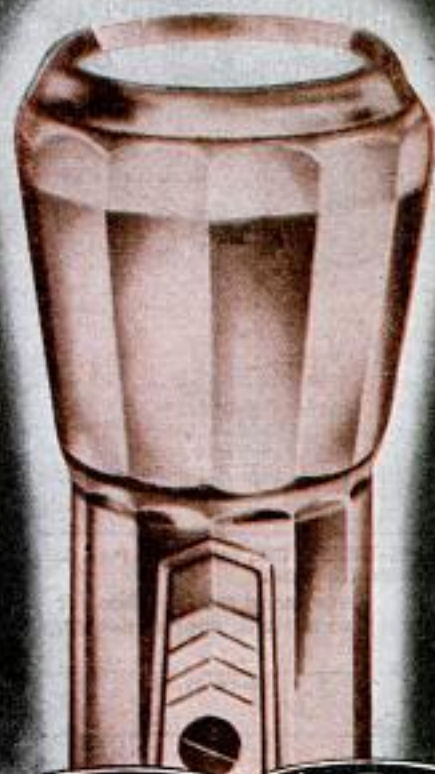

BRIGHT STAR BATTERY CO. CLIFTON N. J.

Say you saw it in *Popular Mechanics!*



Become
TALLER
...instantly!



change to
ELEVATORS
TRADE MARK
HEIGHT-INCREASING SHOES
"YOUR PERSONAL PEDESTAL"
TRADE MARK OF STONE-TARLOW CO., INC.

TALL men are admired. You'll be 1½ inches TALLER the instant you step into a pair of "ELEVATORS". These amazing height-increasing shoes are styled just like any other smart shoes. If your dealer should be temporarily out of the style you want, please try again because he is constantly receiving fresh shipments. The THRILL that comes from being TALLER is worth waiting for! Most Styles, \$12.95 Slightly Higher West.

Write for a free booklet and name of dealer nearest you.

STONE-TARLOW CO., Inc. Dept. P.M. 1
Brockton 68, Mass.

Please send me Free Booklet
and name of nearest dealer.

Name _____
(Please Print)

Address _____

City _____ State _____

KEEP YOURSELF UP-TO-DATE ON
WOOD VENEERS
LUMBER & SUPPLIES

with
**CONSTANTINE'S
MASTER MANUAL**

Published by the leading suppliers to woodworkers, the most complete book ever offered. More than a catalog, contains valuable information on lumber inlays, veneers, wood finishing, etc. 83 inlay border designs in full color, 6 pages of full color inlays plus a wood identification chart showing over 60 rare woods in natural color. Send only 25c today and we will include FREE a year's subscription to our publication, Chips & Chats.

ALBERT CONSTANTINE & SON, INC.
7918 E. 135th Street, New York 54, N. Y.



What paper gadgets,
tied with string
Put addresses on
anything?

Dennison
SHIPPING TAGS
At Stationery Departments Everywhere

STOP LEAKS With So-Lo's
FIX-IRON

Repair furnaces, iron castings, pipe leaks, etc. FIX-IRON is in powder form—mixed with water it hardens into iron itself! 2-oz. jar 10c, 1 lb. can 50c. Many other So-Lo Menders. At Hardware or 10c Stores.

Millions Save with So-Lo Menders

Build: STEAM ENGINE

- A precision built and engineered single cylinder, ¼" scale marine model, with clutch or reverse.
- Send \$2.50 for 14 pages scale drawings, 2 photos, instructions.
- 2 Photos and Description...\$.25
- Rough Castings Kit..... 12.50
- Horizontal Flash Boiler Drawings and Instructions 1.00

THOMPSON ENGINEERING CO. 236 NO. DIVISION BLDG., GRAND RAPIDS 2, MICH.



KRW ARBOR PRESSES BENCH TYPE AND HYDRAULIC
NEEDED IN EVERY SHOP—SAVE TIME AND MONEY—DO BETTER WORK, QUICKER.

No shop is complete without a small arbor press. Pressing and squeezing operations can be done better and faster on a KRW Arbor Press. Stop using vise and sledge hammer methods—they generally deliver spoiled work in the end. KRW Factory-To-You Prices give you greater value for your money. Order today.

KRW Bench Type Arbor Presses, 3 sizes

No. 37-P	½ Ton,	\$13.25*
No. 37-O	1 Ton,	\$23.00*
No. 37-N	3 Ton,	\$33.00*

*Prices F.O.B. Arcade, N. Y. Slightly higher west of Rockies. Stand illustrated extra.



KRW Hydraulic Presses are built in 25, 50, 60 and 75 ton sizes. Prices start at \$198.00*.



K. R. WILSON, Dept. 17, 215 Main St., BUFFALO 3, N. Y.
Builders of Shop Equipment for Ford Dealers Since 1916

SENSATION OF THE DAY—and night!

REX-LITE
TRADE MARK

Powerful...striking in design...built to specifications of U. S. Air Forces... 3-cell flashlight throws a beam approximately 500 feet. Durable all plastic case. Uses standard "D" size batteries.

May be carried on finger, hung on hook or belt, stood on floor. Weight only 4 ozs. without batteries. Three-position switch: steady, signal and safety. Plated reflector.



MAKES A FINE XMAS GIFT!

\$2.65

Sent postage prepaid on receipt of money order... # C.O.D. send \$1 deposit. Write for quantity prices.

AGENTS WANTED
Write for our attractive proposition today!

RANAY CO. Dept. C 21 W. 3rd St. Cincinnati 2, Ohio

REPAIR YOUR OWN ELECTRIC APPLIANCES

NICHROCITE

Mends Heating Elements Easily!

Simply overlap ends, apply Nichrocite Paste and turn on the current—a perfect weld results. Used by big utility companies.

HANDY for HOME or INDUSTRIAL USE

This simple and effective repair material is just the thing for that broken or burned out heating element in your electric iron, stove, toaster or heater. It does the job in a jiffy. Trial Order, \$1.00; 4 ozs., \$2.50; 1 pound, \$8.00.

ARMSTRONG ELECTRIC CO., Box 861-PM, Minneapolis, Minn.

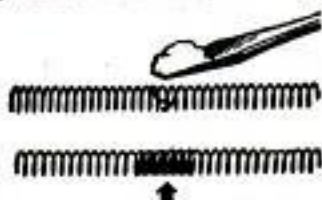

NEW! Sell Popular ALL WOOL Buffalo Check Shirt -

BIG PROFITS FOR YOU!



Every Outdoor man a prospect. Smartest color and style combined with warm snug comfort. Genuine ALL WOOL Buffalo Check Shirts. Full cut, patented storm cuffs. Amazingly low priced, with generous profit for you.

COMPLETE LINE—Leather and wool jackets, raincoats, 250 fast selling shoe styles for men and women. Our salesmen making biggest profits in this field, using Actual Samples we furnish FREE. Write today for FREE SAMPLE OUTFIT.

MASON SHOE MFG. CO., Dept. M-281, Chippewa Falls, Wis.

SEND FOR THIS TIME SAVING **OHMITE** Ohm's Law Calculator



Figures Ohms, Watts, Amperes Volts... Quickly! Any Ohm's Law Problem solved with one setting

of slide. All values direct reading. (4 1/8" x 9")

Sent only 10c in coin to cover cost of handling.

OHMITE MFG. CO., 4930 Flournoy St., Chicago 44, Ill

READY FOR THE TAKEOFF



Before a Millers Falls Plane is ready for a take-off from our plant towards a happy landing in your hands, it receives such a double checking that you'd almost think it was the *other* kind of 'plane.

Such painstaking care helps to explain why Millers Falls fine tools have enjoyed world-wide popularity since 1868. Ask your dealer for the ones you need to improve your work and your pleasure in it.

One Thing in Common—QUALITY!

MILLERS FALLS TOOLS

SINCE 1868

MILLERS FALLS COMPANY GREENFIELD, MASSACHUSETTS

Carhartt

BROWN DUCKS

Give Extra Protection!



• You'll find these new-style 11 oz. heavy Brown Duck Carharts, with coats to match, the ideal work garment for those extra tough jobs. Structural iron and steel workers, foundry men, line-men, electricians, road builders, freight handlers, truck drivers and a host of others swear by their exclusive, extra protection, water repellent features.

They give greater satisfaction, longer wear, real work comfort—are tops in appearance, protection and full cut to fit.

IF YOUR DEALER CAN'T supply you send in your measurements and \$3.50 for either overalls or coat. We'll send them charges prepaid.

WORK CAPS in materials to match. Washable, comfortable, with breather eyelets.



HAMILTON CARHARTT OVERALL CO.
Established 1889

Detroit, Mich. Carhartt Park, Ky.
Atlanta, Ga. Dallas, Texas

On sale at your local dealers

Carhartt

UNION MADE WORK CLOTHES

50 Years a Friend to Organized Labor

Say you saw it in Popular Mechanics!

QUICK FIXER!

Loose bathroom tiles and fixtures, such as towel racks or soap dishes, can be securely reset with **PLASTIC WOOD!**

PLASTIC WOOD

HANDLES LIKE PUTTY • HARDENS INTO WOOD

Fuse Puller — Circuit Tester

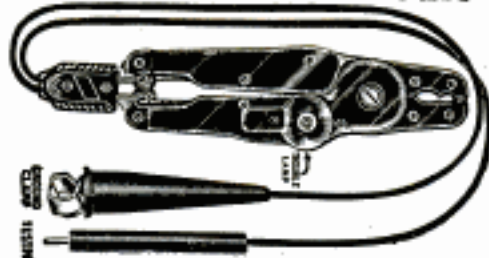

For Home or Factory

TESTS 110-250 VOLTS

When motors stop and lights go out, this tool quickly **LOCATES DEAD CIRCUITS** and safely removes blown Fuse. The Star Test Pocket Plier is made of a Transparent Plastic having in one of the legs a small lamp in series with a resistance and can be used to test 110 to 250 volts circuit. The Plier will pull fuses from 10 to 100 Amperes. Thousands of Electricians find this tool handier than Test Lamps. Price \$2.75 each without Leads, \$1.50 additional for Leads, plus 10c postage. Can be obtained from General Electric or Westinghouse Stores or directly from us. Order NOW. **STAR PLIER CO., 233 Canal St., New York 13, N. Y.**

Sand Casting—Forging—Heat Treating—Case Hardening

BRONZE FOUNDRY



is again available in limited quantity without priority. Orders filled in sequence as received. **INVENTORS—SCHOOLS—CRAFTSMEN** use **FOUNDRYETTE** for making castings quickly for new inventions, for instruction, and general purpose. Order now for early delivery. Three sizes are available capable of making bronze castings of 1½, 3, and 6 pounds weight, aluminum, copper, brass, etc., \$17.50, \$24.00, \$34.50, f.o.b. Kansas City. Domestic gas supply and 110 volt AC or DC energy required for operation. Write for circular.

KANSAS CITY SPECIALTIES CO.
Box 6022, Dept. P-59 Kansas City, Mo.

SHAW and Peppy-Pal "DU-ALL" GARDEN TRACTORS

• 1 to 9 H.P. Circulars on request. War limits production—We supply repairs for all SHAW Tractors sold in our 41 years in business.

BUILD YOUR OWN RIDING TRACTOR—"WAR HORSE"

using old auto parts, powered by 2 H.P. or larger air-cooled engine; or walking type Garden Tractor ½ to 3 H.P. or convert truck or auto into Farm Tractor. Each with steel or rubber tires; will plow, cultivate. Plans for building, in few hours, any one of above, postpaid for \$1.00 (state which wanted) or all 3 for \$2.00. Money Back Guaranteed!

SHAW MFG. CO., 4510 Front St.
Galesburg, Kansas
6680 North 4th St., Columbus, Ohio

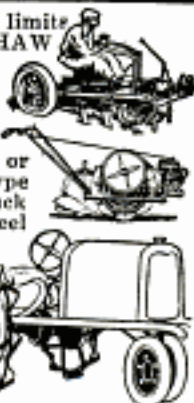

TAPE WORMS
ROUND WORMS
(Ascarids)
HOOK WORMS
WHIP WORMS



...you can free your dog of all these worms

with **PULVEX**
COMBINATION TREATMENT **WORM CAPSULES**

Used by leading breeders. At leading pet, drug, department stores, 50c a package (double size, 75c). Packed two ways: for puppies, for dogs.

YOU WERE WRONG

THE TIME YOU INVITED THE BOSS TO DINNER



Packard Four-Forty, the ignition cable that outlasts and outperforms all others, is *right for the job* when it comes to replacing worn-out or inefficient spark plug wires.

Packard Four-Forty is the ignition cable with the tough protective sheath that resists heat, cold, oil, moisture, corona . . . assures dependable service under the most severe conditions. No other high-tension cable can match it for long life and efficiency.

Packard Electric engineers have put the same high-quality workmanship and materials into other Packard cable products—battery cables, ground straps, lighting wires and primary ignition cables are backed by Packard Electric's years of cable manufacturing experience.

**But... YOU'RE RIGHT
with
PACKARD CABLE!**

Packard ignition cable, spark plug wires and battery cables are the original-equipment choice of leading automobile manufacturers... are serving in cars, trucks, buses, tractors and private and commercial aircraft.

There's a reason for this wide acceptance. Re-wire with Packard—the cable that's *right for the job*.

**PACKARD
CERTIFIED RE-WIRING SERVICE**

This sign means cable service at its best—the right Packard cable and the right methods. Thousands of dealers provide better electrical service as a result of the Packard Certified Re-Wiring Manual and Packard Certified Re-Wiring training films.



Packard

PACKARD ELECTRIC DIVISION
GENERAL MOTORS CORPORATION
WARREN, OHIO



**BUY VICTORY BONDS
FOREMOST BUILDER OF AUTOMOTIVE AND AVIATION WIRING**

RED-ITCHY SKIN?

watch out—it's often

ECZEMA

**'Invisible'
Liquid
Promptly
Relieves
Torture!**



First applications of wonderful soothing Zemo—a Doctor's highly medicated invisible liquid—quickly relieve intense itching burning of Eczema, Psoriasis and similar annoying skin and scalp irritations due to external cause. Zemo also aids healing. Amazingly successful for over 35 years! Apply any time—doesn't show on skin. First trial of clean, stainless liquid Zemo convinces! Buy Extra Strength Zemo for mean cases. At all drugstores.

ZEMO



PROVEN VALUES

Genuine Gerstner Tool Chests have been the choice of the best Craftsmen for 40 years. Free catalog for machinists and toolmakers.
GERSTNER TOOL CHESTS
448 Columbia St. Dayton 7, Ohio



**SEAL OUT
WINTER'S DRAFTS AND DIRT—
CUT FUEL BILLS—WITH**

KALK-KORD

**SEAL CRACKS QUICKLY, EASILY,
WITHOUT TOOLS**

Kalk-Kord, the original non-hardening caulking compound in soft, rope-like form, enables you to effectively seal window and door frames, cracks and crevices, inside or out.

Just press Kalk-Kord into the crack or hole with fingers; no tools required. Kalk-Kord will not harden, check, or crack. It seals tightly and stays tight.

Don't wait till cold weather—use Kalk-Kord to seal out winter's cold right now. It cuts heating bills; saves cleaning of walls and drapes due to soot and dust. Use it also to plug and seal holes in wood or plaster. Kalk-Kord is waterproof and can be painted over at once, if desired.

Packed in convenient rolls, ready for use—neat and clean to work with. Anyone—and everyone—can use Kalk-Kord. Get a box today.

Buy Kalk-Kord at your nearest
Sears-Roebuck retail store, or order by mail from Sears.



PRESSTITE ENGINEERING COMPANY
3978 CHOUTEAU AVE. • ST. LOUIS 10, MISSOURI

Is YOUR WATCH.. a war-time CASUALTY?



- Quick, expert repairing of Swiss and American watches and clocks.
- Free estimate on your watch or clock BEFORE we repair it.
- All work 100% GUARANTEED. Finest in highly skilled workmanship.
- Surprisingly inexpensive prices.

MAIL YOUR WATCH or clock under insured mailing to us. Our experts will send you a FREE repair estimate to put your watch in perfect running condition. Then we'll quickly, skillfully do the job and return your watch or clock insured, C. O. D. plus postage.

You take no risk—your watch and clock covered by fire and theft insurance while in our possession.

EL'GENE WATCH REPAIR COMPANY
6312 Huntington St., Dept. PM-10, Chicago 30

OTTAWA TRACTOR SAW



FREE BOOK
and
Price List

350 CUTS PER MINUTE

Make money sawing wood. Use Ottawa—fastest cutting. Cuts large, small logs easiest way. Falls trees. One man operates. Thousands in use. Built to last with heavy, stiff saw blade. Positive safety clutch control; uses power take-off any tractor.
OTTAWA MFG. CO., D1027 Forest Ave., Ottawa, Kan.

EXPERIMENT WITH BLACK LIGHT!

FUN! THRILLS! PROFITS! See seven page article on this fascinating science in June 1945 issue of Popular Mechanics. We furnish all supplies. Trial Kit of 8 lacquers only \$6.25. Black bulb for testing, \$2.00. Lamps, lacquers, crayons, fabrics, etc. Write for descriptive list and full details today!

BLACK LIGHT PRODUCTS, 450 East Ohio Street
Chicago 11, Illinois

Big Money for Workers In Home or Shop



Licensed Concrete Specialists wanted. No experience needed. Make *Colorglazed* concrete pottery without molds. New, low cost, patented method. Cemetery products, novelties, tiles, etc. Basement leaksealing. Other big pay projects. Booklet, details free. Men only.

NATIONAL POTTERIES COMPANY
542 Lincoln Avenue
Fergus Falls, Minnesota

Say you saw it in *Popular Mechanics!*

MADE FOR IT

Heavy Body 3-IN-ONE Oil helps electric refrigerators and other household equipment give longer, quieter service. Cuts repair bills.



HEAVY BODY

“3-IN-ONE” OIL

POPULAR MECHANICS material

Here's the Big News about New Static-Free F-M Radio

(F-M... "Frequency Modulation"—sensational new method of radio broadcasting)

1.



Not even thunderstorms... or other natural static will mar a Zenith F-M radio's life-like tone. No popping or crackling to annoy you, because all static or interference will be virtually abolished. And only a Zenith will have a new way to increase listening range.

2.



Smooth as satin tonal realism will be a feature of Zenith F-M radios. You'll hear music and voices against a backdrop of velvety silence. No electrical noises, no distorted sounds... just pure, uninterrupted listening pleasure. When you hear it you'll agree it has the touch of genius.

3.



Genuine F-M... not imitation... Zenith collaborated with the originator in bringing F-M to its present peak of perfection. Through long experience in operating its own 50,000 watt F-M station, and through important new Radionic developments, Zenith will have F-M radios with the touch of genius.

4.



No overlapping or fading stations with genuine Zenith F-M. It will be as superior as a sharp photograph is to an out-of-focus snapshot. Each F-M station will tune in with razor-sharp precision and stay on the beam until you turn the dial.

5.



Records come alive! First, Zenith's new way to reproduce record music ends all needle-noise, scratch and rattle. Then, the music goes through the static-free F-M radio circuit. The result—all the hidden beauty never heard in records before, plus the tonal realism of F-M.

For the Best in Radio Keep Your Eye on Zenith

ZENITH
LONG DISTANCE
RADIO

COPYRIGHT 1948, ZENITH RADIO CORP.

RADIO • FM • RADAR • TELEVISION • RADIO-PHONOGRAPHS • HEARING AIDS

Naturally a Leader in F-M
Because
Zenith Concentrates on
RADIONICS
EXCLUSIVELY

Following the discovery of F-M (Frequency Modulation), Zenith joined with the originators in its development. In fact, Zenith's 30 years of concentration on Radionics Exclusively has played a vital part in bringing genuine F-M to its present perfection.

This vast reservoir of experience in Radionics—the science of radio waves—has led to amazing achievements in manufacturing F-M devices for the armed forces. And all Zenith's wartime discoveries will be incorporated in the coming new Zenith F-M Radios and Radio-Phonographs.

When you see and hear them, you'll know instantly that there's a touch of genius in everything Zenith does.

**BUY VICTORY BONDS—
BETTER THAN CASH!**

MAKE ACCURATE PHOTOCOPIES OF ANYTHING! In your own shop —Quickly, Easily—at Low Cost!



The APÉCO PHOTOEXACT
"Copies Anything!"

**BLUE PRINTS
PHOTOGRAPHS
PENCIL SKETCHES
SPECIFICATIONS
TRACINGS; GRAPHS
CHARTS; LETTERS
(over 100 others)**

Photo-Copier
\$55
Copies up to
18" x 22"

Also continuous cabinet models for prints of any length, up to 42" wide.

Make permanent, error-proof photocopies direct from blueprints (without tracings) or get photographic tracings direct from any blueprint, drawing or sketch. Save time, money—expedite work! APÉCO makes copies, 1-a-minute, of anything written, typed, printed, drawn or photographed—even if on both sides. No darkroom or technical knowledge needed. Get facts. Write TODAY on your business letterhead.

AMERICAN PHOTOCOPY EQUIPMENT CO.
2849 N. Clark St., Dept. GF105, Chicago 14, Ill.
(Representatives in principal cities and Canada)

**AMERICA'S MOST WIDELY USED
PHOTOCOPY EQUIPMENT**

SAVE WASTE PAPER

**MILL IT
ON YOUR LATHE**



WITH A

PALMGREN

MILLING ATTACHMENT
(COMPLETE WITH VISE)



Now you can do light milling; cutting keyways, slotting, surfacing, sawing at angles, grinding, tap flutes, recessing, squaring shafts, beveling, grooving and many other important operations right on your lathe. PALMGREN MILLING ATTACHMENT WITH VISE is a necessary fixture for small shops and emergency work in large plants. Adaptable for South Bend, Atlas, Craftsman, Sheldon and other lathes, it has graduated vertical angle adjustments, is easily mounted on cross slide and held by one T-Slot bolt. Every lathe owner should have one... it will quickly pay for itself.

No. 250 Milling Attachment Complete With Vise	Width Jaws	Depth Jaws	Jaw Open	Weight Pounds	Price F.O.B. Plant
	2 1/2"	1 1/16"	2 1/2"	10 1/2"	\$24.75

Order from your dealer or jobber. Send for our Circular No. 600.

CHICAGO TOOL AND ENGINEERING CO.

Mfrs. of PALMGREN PRODUCTS for Over 25 Years

8404 South Chicago Avenue

Chicago 17, Illinois

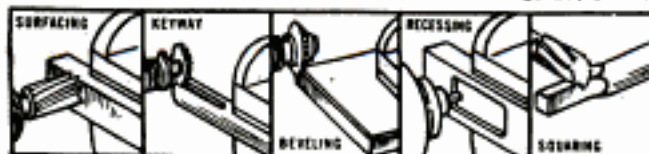

**Makes a Pipe
Welcome Anywhere**



30c the
pocket-
packet

With that RICH, NATURAL, NUTTY Flavor

Write for free booklet, "The Choice of Experience." John Middleton, 1201 Walnut Tobacco St., Phila. 7, Pa.

Custom-made for the Carriage-trade since 1856

**AMAZING MYSTERY
BUTTON**

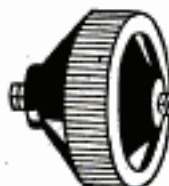

Startles Every body. With this Electronic Button you can make your own Telephone—Amplifier—Detective use. Attach this button to places of earlobe—transmit conversation to another room. Made also transmitted to distant places. Most interesting, electrical apparatus ever discovered. Enables you to perform hundreds of experiments. So tiny it can be concealed in dozens of places. A Pre-War Product. Electronic Button including 2000 word instruction booklet with 20 illustrated experiments postpaid only \$1.00.

Electronic Products Company, Saint Charles, Ill.

**So-Lo's
All-Purpose AUTO CEMENT**

Mends Most Anything



For rubber, metal, cloth—mends auto doors, running boards, windshields, floor mats, also refrigerator doors—rubber to metal and glass, leather to leather. Large tube 10c, jar 25c.

At Hardware or 10c Stores.



Millions Save with So-Lo Menders



BUILDING WITH COMPOSITION

strongly reinforced with cheap wood. Several formulas. Modern, stress-lined roof, walls and gutters in one. How to build a house 22x24, three rooms, as low as \$150 for materials, garage, \$20, 20x20 poultry house, \$50. Farm buildings for a few dollars. Home-made equipment to make wall-high building blocks with inside and outside finish. Also roof, wall and floor tile in color, and durable wallboard of gypsum. Labor saving. Long lasting. No painting. Make doors and windows. Sectional cabins, 100 money-saving ideas. Mixer and saw easily made from an old auto. 40 business plans. Earn \$10 a day. Guaranteed. Illustrated instructions, \$1.00.

MAKE FURNITURE OF COMPOSITION cement, sawdust, asbestos, paper. Some part sawdust and metal. Illustrated instructions to make tables, cabinets, chests, racks, shelves, enclosed stoves, lawn mowers and toys, 500 per cent profit. 50c.

HOW TO MAKE ACCURATE SHOP MACHINES: Band, jig and circular saws, electric drills, sanding wheels, frets, tools, electric wood cutters and many other things from old auto parts and washing machine motors. Illustrated, 50c.

HOME MFG. ENTERPRISES, 80 selected home shop projects. Illustrated, 50c.

Special: All of the booklets described above, \$2.00 postpaid. No C.O.D.

HOME INDUSTRIES, 1318 South 38th Ave., Dept. PM, Omaha 5, Neb.

NEW CHEAP OIL BURNER

**FOR COOKING & HEATING STOVES-FURNACES
HEAT YOUR HOME, COOK YOUR MEALS
WITH CHEAP FURNACE OIL**



**NO MORE SHOVELING COAL OR
ASHES.** New Furnace Starter Vaporizing System Burns Cheap 130 Flash Furnace Oil into Oil Gas heat without clogging up. LIFE-TIME GUARANTEE against defects. \$1.00-BONUS OFFER FOR TESTING. We will let you try it in your own stove or furnace for one month. Get Yours for introducing. Big profits. Be first. Send in your name today.

NORTHWEST MFG. CO., 535-M 5th Ave., Mitchell, So. Dak.



No other ring sets use 26 Basic Designs

No one piston ring design can meet all replacement needs. Sealed Power Individually Engineered Ring Sets are made up from twenty-six (26) basic designs, which permit each set to be specifically engineered to do the best possible job in a particular make of engine with a particular degree of cylinder wear.

These ring sets are engineered to save gas without sacrifice of oil economy, to save oil without inducing friction and cylinder wear. Each set gives *balanced* performance in a particular engine.

Get every drop... and every mile from every drop

PLENTY of motorists feel like "squeezing the hose" to get every last drop of gas. But the best way to get top mileage out of every gallon of gas is to replace worn piston rings with new Sealed Power Piston Rings. They save gas, save oil, restore original power, lengthen engine life!

The men and women of Sealed Power are proud of their product—proud of its 34-year record of preference by leading car, truck and engine manufacturers—proud of the performance of millions of Sealed Power Piston Rings in the engines of war. Your favorite repairman can get a Sealed Power Individually Engineered Ring Set for your car now. Talk to him today! Sealed Power Corporation, Muskegon, Michigan • Windsor, Ontario.

BUY VICTORY BONDS AND KEEP THEM—GET \$4 FOR \$3!

© 1945, Sealed Power Corp.

- Piston Rings
- Pistons
- Cylinder Sleeves
- Valves
- Water Pumps
- Chassis Parts



SEALED POWER PISTON RINGS

BEST IN NEW CARS! ★ BEST IN OLD CARS!

FREE! MOST COMPLETE RADIO PARTS CATALOG



EVERYTHING in RADIO ELECTRONICS for Training, Maintenance or Repair



New R-F Resonance and Coil Winding Calculator No. 37-955. Postpaid, 25c

Parallel Resistance & Series Capacitance Calculator No. X37-960. Postpaid, 25c

NEW

RADIO'S FINEST BOOK VALUES

Specially prepared to aid radio training in schools and industry. Full of valuable data. Send for all six!

- Radio Formulas and Data Book No. 37-752... 10c
- Dictionary of Radio Terms No. 37-751... 10c
- Radio Circuit Handbook No. 37-753... 10c
- Radio Builders' Handbook No. 37-750... 10c
- Simplified Radio Servicing No. 37-755... 10c
- Radio Data Handbook No. 37-754... 25c
- All Six Books No. 37-799... 75c

6 BOOKS FOR 75c

ALLIED RADIO CORP.
833 W. Jackson, Dept. S-K-5, Chicago 7

ALLIED RADIO

Now for EVERY WORK SHOP!

NEW INVENTION Electroplates by BRUSH



Easy to Plate CHROMIUM GOLD, SILVER, NICKEL, COPPER . . . For Pleasure and Profit!

If you have a workshop—at home or in business—you need this new Warner Electroplater. At the stroke of an electrified brush, you can electroplate models and projects—you can replate worn articles, faucets, tools, fixtures, silverware, etc. with a durable, sparkling coat of metal . . . Gold, Silver, Chromium, Nickel, Copper or Cadmium. Method is easy, simple, quick. Everything furnished—equipment complete, ready for use. *By doing a bit of work for others, your machine can pay for itself within a week.* So make your shop complete by getting a Warner Electroplater right away. Send today for FREE SAMPLE and illustrated literature. ACT AT ONCE! Mail Coupon.

WARNER ELECTRIC CO., DEPT. D-4
663 North Wells, Chicago 10, Illinois

FREE Details & Sample!

WARNER ELECTRIC CO., 663 North Wells, Chicago 10, Dept. D-4
Gentlemen: Send Free Sample and Details to:

Name _____
Address _____
City _____ State _____

Build These Cleveland Model "Supervalues"!

Boeing B-29 "Superfortress" 28 1/2" line-controlled model of the greatest of all bombers. Kit AU-200. \$100



Biggest \$1.00 Model in U.S. 8 1/2" Super Condor Soarer. Soars for hours. Kit E-5019. \$100

"Build the Models the Men in the Air Forces Build"

SEE YOUR DEALER FIRST. In ordering direct, add 20c extra for packing-postage.

36" PIPER CUB



CATALOG 5c (Circular free)

The civilian plane that went to war, and did a darn good job. Rubber or gas, leather or true flight. C-D Kit T-94. \$150

CLEVELAND MODEL & SUPPLY CO.
4508E95 Lorain Ave. ★ ★ ★ Cleveland 2, Ohio, U. S. A.

Fix Chairs, Tables, ALL FURNITURE with So-Lo's WOOD GLUE



Easy to use. Dries fast, holds like iron. Fully guaranteed. Large tube 10c. Many other So-Lo Menders. Ask for them. At Hardware or 10c Stores.



Millions Save with So-Lo Menders

110-VOLTS AC from DIRECT CURRENT

with KATO KONVERTERS. Furnish standard 110-v AC from 32, 110, or 220-v. DC. Special motors and generators 25 to 800 cycles. Good deliveries on 5, 7 1/2, 15 & 25 KW, AC generators. Mfg'r of motor generators, frequency changers and high frequency generators.



KATO ENGINEERING CO.
54 Elm Street, MANKATO, MINN., USA

DEXTER UNIVERSAL LATHE CHUCK well-made, accurate, strong, serviceable



IDEAL for Home Workshops Easily attached to standard lathes. Adapters available. 2"-410; 3"-410; 4"-410; 5"-424; 6"-428 Includes inside and outside jaws DANDY FOR XMAS Send Check or Money Order

THE LEAVITT MACHINE COMPANY
ORANGE MASSACHUSETTS

★ ★ 500 PERSONAL LABELS GUMMED Only

COMPLETE NAME AND ADDRESS PRINTED ON EACH!

500 Personal Labels, only 50c Postpaid! Two-colors—handsome blue printing of your complete name and address on attractive white gummed label paper! Use on letters, envelopes, postcards, checks, books, tools, egg cases, etc. HUNDREDS OF USES! Wonderful for those in Service! Order today! FAST SERVICE. Limited supply. Money-back Guarantee.

50c

WESTERN STATIONERY CO., Dept. 237-K, Topeka, Kan.

New OTTAWA WOOD SAW For Tractors

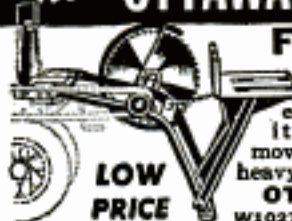

Makes wood sawing fast and easy. Can cut enough wood to pay for itself quickly. Easily moved while attached. Big heavy blade. FREE details. OTTAWA MFG. CO.

LOW PRICE

W1027 Oak Ave., Ottawa, Kans.

*When carrying precious cargo...
you're safer with
Guide Sealed Beam Units*

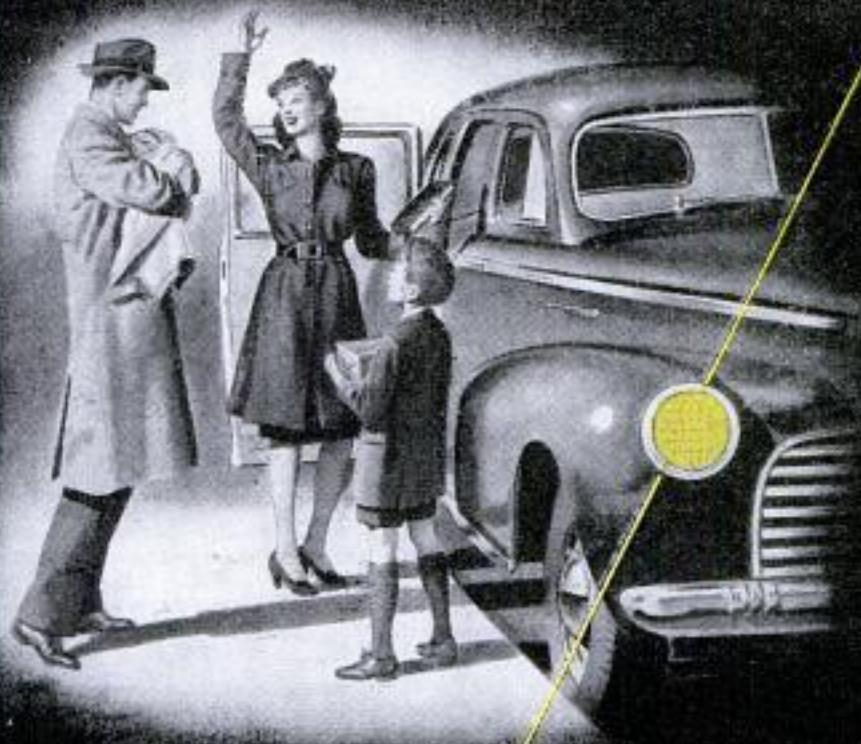

KEEP BUYING
WAR BONDS

Guide Sealed Beam headlamp units are "eyes" at night... the safest, surest system of automotive lighting that science and research have yet been able to develop.

Throughout their long life, your Guide Sealed Beam units maintain the highest standard of safety. They will not grow dim through use. They will not fail, even if a stone or blow should crack the lens. You're safer with Guide.

Next time you need a new Sealed Beam unit, tell your automotive service man you want a Guide unit. It costs no more.



NO DIM-OUT—because Guide Sealed Beam units are sealed against dirt, dust and traffic film. They stay bright for the life of the unit—do not lose their efficiency, as earlier-type headlamps do.

NO BLACK-OUT—because Guide Sealed Beam units provide the double protection of a bulb within the sealed unit. If a lens is cracked they do not fail—they will light the way safely until the damaged unit can be replaced.

GUIDE LAMP DIVISION OF GENERAL MOTORS CORPORATION

LET SAFETY SHARE THE RIDE — REPLACE WITH GUIDE

A true thoroughbred!

Sterling Hall by Briarcraft

For men who appreciate quality



\$3.50

AT BETTER SHOPS...
INDIVIDUALLY BOXED

Expert craftsmen, using carefully selected materials, have fashioned Sterling Hall for men who appreciate "something better".

Its beautifully-grained bowl is alive with a lustrous glow—produced by painstaking finishing methods. And the graceful beauty of the perfectly-proportioned bit and stem attest to the skill of the designer. The bowl angle, wall thickness, pitch and depth of the bore, etc., have all been turned with meticulous precision to insure the utmost in appearance and smoking pleasure. Styled in a full range of handsome models, either with or without an inlaid sterling silver band.

Briarcraft, Inc., 347 Fifth Avenue, New York 18, N. Y.

ELECTRICITY FOR ANY JOB ANYWHERE



Reliable, economical electric service anywhere, anytime, with an Onan Electric Generating Plant. Driven by Onan built, 4-cycle, gasoline engines, these power plants are of single-unit, compact design and sturdy construction. Suitable for all types of service.

Models range from 350 to 35,000 watts, A.C. types from 115 to 460 volts; 50, 60, 180 cycles, single or three-phase; 400, 500 and 800 cycle, single phase; also special frequencies. D.C. types range from 6 to 4000 volts. Dual voltage types available. Write for engineering assistance or detailed literature.

ONAN

D.W. ONAN & SONS, 2510 Royalston Ave., Minneapolis 5, Minn.

5 lbs. HANDY ASSORTMENT \$1.98
FOR MECHANICS—GARAGES
—WORKSHOPS—HOME USE

SCREWS • NUTS • BOLTS • WASHERS • RIVETS • SPRINGS • BRACKETS • MISC.

MORE THAN 1,000 PIECES

5 full pounds—a veritable treasure chest of fastening devices for every practical use. Satisfaction guaranteed. Order now. **\$1.98**

SPECIAL—2 assortments, over 2,000 pieces, for \$3.69.

HUDSON TRADING CORPORATION

The House of Handy Assortments
C-165 West Hubbard St., Chicago 10, Ill.

FREE! Handy List of Special Assortments: FIBER AND BAKELITE WASHERS—RUBBER WASHERS and PADS—FELT WASHERS and PADS—RADIO LUGS, CLIPS and CONNECTORS—SPRINGS—SELF-TAPPING SCREWS—etc.



Complete 520

ENGINES IN STOCK



The G. H. Q. miniature gasoline engine that really operates is still available. Over 100,000 sold to date, 1/5 H. P. Complete with flywheel and propeller, fuel 15 accessories and full instructions. Fully bench tested and ready to run. Power for all models. \$20 complete. Send only \$1.00—Shipped Collect C.O.D. same day. Send for free illustrated Catalog of hundreds of hobby items.

GHQ MOTORS, Dept. BV105, 40 East 21 St., New York 10, N. Y.

New Designs in FRANZITE GRIPS

Modernize Your Gun! Improve Your Score!

Most durable grips made. Positively unbreakable! For Colt, Smith & Wesson, Hi-Standard, Ortigas, Luger & Mausers in a wide choice of beautiful designs in ivory, pearl, walnut, onyx, etc. Low prices. **FREE CATALOG.** Dealers Wanted.

SPORTS, INC., (Mrs.) 5501 Broadway, Dept. P-10, Chicago 40, Ill.

WOOD WORKERS

LUMBER—PLYWOOD AVAILABLE

Harold Hunt wants to send revised No. 14 mailing, 124 pages of woodworking ideas, **UNQUALIFIED BARGAINS** in imported and American woods, supplies. Those already holding this catalog—send for revised sheets.

CRAFTSMAN WOOD SERVICE CO.
2729 S. Mary St., Dept. A-62, Chicago 8, Ill.

only 10¢

ONE-MAN SAWMILL LESS THAN \$110.00

Easy To Turn Trees Into Money

Makes Lumber, ties, shingles, crates, lathe, studding, siding.



BELSAW MODELS

in to 24 feet sawing length. Patented Mechanical Feed, accurate set works and positive dogs. Use tractor or old auto engine for low cost power. Thousands used for commercial sawing. Pays for itself quickly.

Send postcard today for **FREE** booklet, "How To Make Lumber" & Catalog of Woodworking Equipment.
BELSAW MACHINERY COMPANY
Dept. 1811-S 3542 Main Street, Kansas City 2, Mo.



"WONDER" ELECTRIC BUTTON

Most interesting electrical apparatus ever discovered. Make your own Telephone Amplifier, Detector, etc. Transmit your voice or music to distant rooms. Perform hundreds of fascinating experiments. No fee! It can be concealed in dozens of places. Send \$1 now for button and

free 5000 word instruction booklet with 50 illustrated experiments. **SPECIAL OFFER** 6 buttons and booklets sent post-paid for \$5.
BUCK MFG. COMPANY, Box A-28, No. Aurora, Ill.

SMALL BACK ROOM SHOP* DOES BIG JOB WITH *Atlas* EQUIPMENT



Great Production "Race" Creates New Opportunities for Skilled Craftsmen

*The Jaymac Co., moved to Jackson, Mich. in 1937, and set up its shop in the back room of a retail store. From 3 employees the payroll grew to 19, turning out thousands of parts for aircraft and radio equipment. The shop is nearly 100% Atlas-equipped.

All over the nation, shops like the one above will swing into small parts production. And thousands more will be needed in 1946 by big industry to keep assembly lines running smoothly. It is a great opportunity for men with mechanical skill and a sincere ambition to get ahead.

You'll find a sound foundation for such a shop in Atlas tools. Atlas lathes, drill presses, milling machines, and shapers — precision-made for precision work — will help you get started with a minimum investment, and give you the lowest possible operating costs. Check into the possibilities in your community. Send for the latest Atlas catalog today for complete tool specifications, accessories, and prices.



ATLAS PRESS COMPANY
1043 NORTH PITCHER ST., KALAMAZOO 13D, MICHIGAN



Learn to Shoot

Send for
this FREE
booklet!



Many thousands are learning to shoot... or to shoot better... with this fascinating, FREE, 48 page booklet, prepared in cooperation with the National Rifle Ass'n. Covers the authoritative, government-approved, pre-induction Rifle Training Course. Improves the scores of even experienced shooters. Send TODAY.

Mossberg facilities are now 100% on peacetime models. These will be made available as rapidly as possible. You'll find it well worth while to

WAIT for a MOSSBERG

O.F. Mossberg
NEW HAVEN 5, CONN. & SONS, INC.
56510 ST. JOHN STREET

LEO'S SPECIAL!
Immediate Delivery on this
Multitester
\$18.75
WVL 300 Less Leads



Handles AC and DC Voltmeter, DC Milliammeter, High and Low range Ohmmeter. Size 5 1/2 x 8 x 3 1/4. 3" meter with sturdy D'Aronsyal movement. Write for priority information today.



Exclusive
at Leo's

PHONO AMPLIFIER KITS
Complete with tubes, all parts, chassis, diagram, etc. Priority AA-5 or higher. No. 1059..... **\$9.50**

14 Page Radio Parts Flyer. FREE
Tube and Circuit Book..... 10c
Giant Radio Reference Map. 15c
Handy Tube-Base Calculator. 25c

PLACE YOUR ORDER NOW!

Leo is making delivery now on

HALLICRAFTERS

Easy terms, liberal trade-in allowances

TEST EQUIPMENT

We have it or can get it!

Address Leo, W9GFQ, Dept. PM-10, Council Bluffs, Iowa

Wholesale
RADIO LABORATORIES

**V-8
DUALS
AND SINGLES**



A genuine steel pack muffler WITH A BEAUTIFUL MOTORBOAT TONE. Sandee Mufflers feature improvements far in the lead, years ahead of competition. Increases mileage and power, reduces back pressure and gives better performance. Savings in gasoline will pay for a Sandee Muffler.

V-8 FORD AND MERCURY DUALS **\$17.50**

SINGLES—FIT IN PLACE OF REGULAR MUFFLER

Chev., V-8 Ford, Plym., \$5.00 Chry., Olds, Buick, etc., \$7.00

These mufflers will outlast two regular stock replacements. Dealers Wanted

SANDEE MUFFLER CO.
7523 S. WESTERN AVE., LOS ANGELES 44, CALIF.



Collect U.S. ARMY
Shoulder Patches

Fascinating hobby. Great for decorating dens, bars, game rooms. Patches 20c to 50c each. Complete set of 250 for \$50.00. Official patches available for every major Army and Air Corps unit. Send \$1 for sample assortment and illustrated catalogue. Orders from Canada—add 20%.



SPRINGER'S

276 San Francisco St. EL PASO, TEXAS



POCKET ADDING MACHINE

STURDY STEEL construction for lifetime use. Adds, subtracts, aids multiplication. Capacity 999,999.99. A real machine—guaranteed 5 years. Thousands of satisfied users. Send name and address. We ship immediately. On delivery, pay postman \$2.50 (plus C.O.D. and postage charges). If you send \$2.50 with order, we pay postage. Leatherette case 25c additional. Your money back after 10 days trial if not satisfied.

Free Trial **\$2.50**

Send no money

TAVELLA SALES CO., 19-NA West Broadway, New York 7, N.Y.

ONLY FIENDOIL

★ Pours at 40° Below ★

has everything tools and light mechanisms need in an oil— **35¢**

Cleans Metal • Prevents Rust 2 oz. size
Lubricates

At Hardware and Sports Stores
MCCAMBRIDGE & MCCAMBRIDGE CO.
Baltimore 23, Md.

MEND TIRES, BOOTS, HOT WATER BOTTLES

So-Lo RUBBER REPAIR KIT

Saves rubber. Easy to use—just spread on, let dry. Millions sold! Complete Kit, enough for 20 average repairs, 29c. At Hardware or 10c Stores.

Millions Save with So-Lo Menders

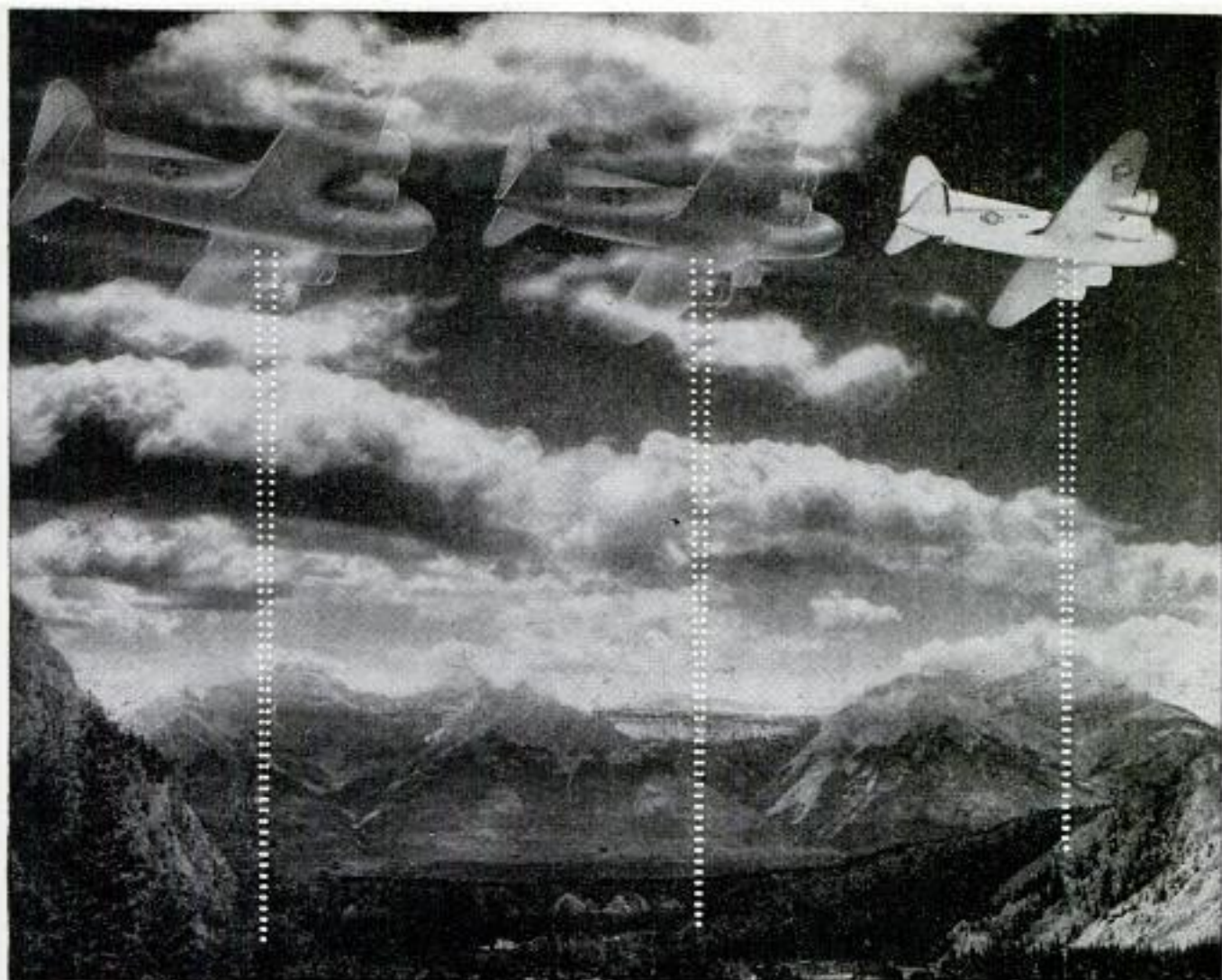

The RCA Radio Altimeter assures that the last mountains have been passed before letting down to the airport in the valley below.

Measuring "every bump on the landscape" —at 20,000 Feet!

A radio altimeter—indicating exact height above land or sea—is another RCA contribution to aviation.

Old-style altimeters gave only the approximate height above sea level—did not warn of unexpected "off-course" mountains.

To perfect a better altimeter was one of science's most baffling problems. So RCA developed an instrument so accurate it "measures every bump on the landscape" from the highest possible altitudes . . . so sensitive it can measure the height of a house at 500 feet . . . and "see" through the heaviest fog or snow.

All the radio altimeters used in Army, Navy and British aircraft were designed and first produced by RCA. This same pioneering research goes into every RCA product. So when you buy an RCA Victor radio, Victrola, television receiver, even a radio tube replacement, you enjoy a unique pride of ownership. For you know it is one of the finest instruments of its kind that science has yet achieved.

Radio Corporation of America, Radio City, New York 20. Listen to *The RCA Show, Sundays, 4:30 P.M., E.T., over the NBC Network.*



The RCA radio altimeter is a major contribution to the safety of commercial flying. The section at the left sends the radio waves to earth and back again while the "box" at the right—timing these waves to the millionth of a second—tells the navigator the plane's exact height in feet.



RADIO CORPORATION of AMERICA

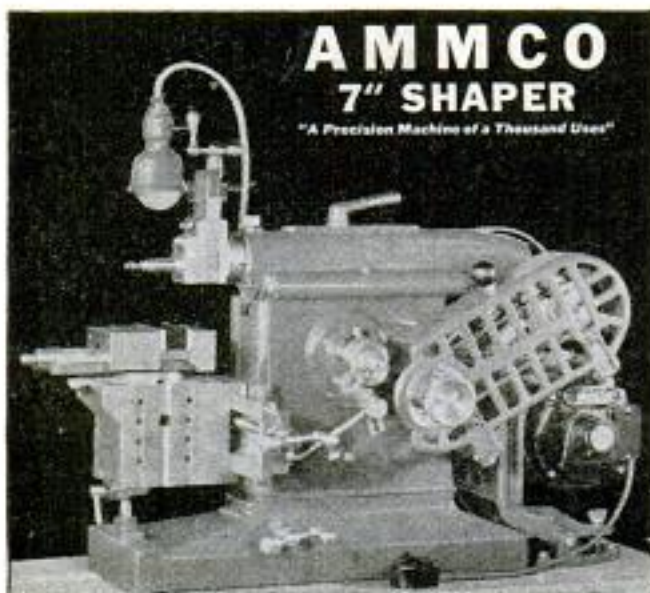

AMMCO 7" SHAPER

"A Precision Machine of a Thousand Uses"

A wide variety of jobs can be done accurately, quickly, easily, and economically on the AMMCO Shaper (7" stroke).

Construction incorporates many features you would expect to find only in larger, more expensive machines... For example: WAYS of ram, tool head, and front face of the main frame are of the "VEE" type, hand scraped to insure accuracy and long life. Available for stationary installation or as portable unit.

Write today for specifications and prices

AMMCO

2140 Commonwealth Ave. North Chicago, Ill.

ADD POWER

to your
CRAFT SKILL

Write on steel... engrave on glass, plastics... slice into wood, linoleum, cardboard, cloth... tool leather... hammer, file, chisel... do "hand quality" work with

BURGESS vibro-tool

Trade Mark Reg. U. S. Pat. Off.

Vibro-Tool complete with 20 ordinary engraving needles **\$7.50**

Vibro-Tool plus complete set of attachments **\$11.70**

We can accept priority rated orders only. Attach check or M. O., or sent C.O.D.



Tools Leather



Carves Wood



Engraves Glass



Slices Cardboard

(HANDICRAFT DIVISION)
BURGESS BATTERY COMPANY

166 N. Wabash Ave., Chicago 1, Ill.

Does More Things Easier and Quicker Than Any Other Tool!

Remains locked to the work with hands removed. Holds anything, any shape, with a grip that never slips. Is actually Hand-Vise, Clamp, Super-Plier, Adjustable End Wrench, Pipe-Wrench, Locking Wrench and Toggle-Press — ALL IN ONE! Light, trim, handsome. Made of fine alloy steel. Zinc plated. 2 sizes—7" and 10".

PETERSEN MFG. CO.

Dept. C-10

DeWitt, Nebr.

WISE-GRIP WRENCH



Gives 1 Hand TON-GRIP



TRADE Old Guns for Brand New GUNS

Trade Guns at KSG, America's Biggest Gun Trading Center, where you get MORE for your merchandise—and buy for less. Large selection 1945 Models (for de-Every right now) and Used Bergains in Rifles, Shotguns, Handguns, from \$3—to the finest. Ship your Guns, Reels, Rods, etc., at once, or describe fully by letter.

"Where other sources fail—KSG comes through by mail!"

KLEIN'S Sporting Goods

Founded for Gent June 1885
507TH So. Halsted St., Chicago 7, Illinois

- Get Your Copy!
- Full "Guaranteed Bergain Catalog"
- and Swap List of new and used guns
- and other "hard-to-find" sports items
- and 25c (refund on first order).

FREE! 40 PAGE HOBBY CATALOG

Over 1000 Items — Over 300 Photos

Our new 40-page catalog—just off the press—is the "bible" of wide-awake modelers. Practically every nationally advertised model is listed and many, many hard-to-get items. Planes, engines, boats, gliders, supplies, etc.

America's Hobby Center, Dept. BC-105, 40 E. 21 St., N.Y. 10, N.Y.

DEVELOP THE POWERFUL INFLUENCE

FEUCHTINGER Method Guaranteed IN YOUR VOICE

DO IT YOURSELF AT HOME

Write for the Voice Book - FREE

Sent only to those over 17 yrs of age

PERFECT VOICE INSTITUTE

Studio 9357 Kimball Hall Bldg., Chicago 4, Ill.

FEET HURT? Try Dr. BARRON'S New Foot Cushion

Many with tired, aching feet have found happy relief! So comfortable—LIKE WALKING ON A PILLOW! Made of fine soft, spongy material, leather covered. So light, flexible—cushions and helps relieve your feet from heel to toes. If you suffer from metatarsal callouses, corns, foot pains or fallen arches, try Dr. Barron's Foot Cushion. Wear in any shoes—helps make walking a pleasure. Doctor says: "I recommend Foot Cushions to foot sufferers." Send only \$1.98 for A PAIR—or will ship C. O. D., plus postage. STATE SHOE SIZE AND IF MAN OR WOMAN, 30 DAY TRIAL GUARANTEE. Money back if you don't get blessed relief!

ORTHO CO., 111 W. 83rd St., Dept. 49-M, New York City 24

Titan Slide Rule

6" diameter. Easily read, clearly marked single index scales. Gives logarithms, reciprocals, squares, square roots, sines, and tangents. Continuous circular calibrations cannot go "off-scale." Invaluable in multiplication, division, proportion, conversion, all mathematical problems. Made of durable heavy pure white Vynylite. Complete with instructions, \$2.95. Leatherette case 75c additional. Money-back guarantee.

PRECISION INSTRUMENT CO.
Box 654, Dept. BA Church St. Annex New York 7, N.Y.

Try this on your boat

There is this about outboard motors: you don't have to *guess* which one will suit you best. For more than 20 years we've said, "Get into a boat and see for yourself." This, together with the testimony of thousands (and thousands) of owners, is the best way we know to impress you with the *quality* of Johnson Sea-Horses.

As for Johnson **DEPENDability**—you learn about that (with more and more amazement and pleasure) as the years go on. • See your Johnson dealer. Look for his name under "Outboard Motors" in your classified phone book. He will be the first to know when Sea-Horses will be available for pleasure use.



JOHNSON MOTORS, 400 PERSHING ROAD
WAUKEGAN, ILLINOIS

JOHNSON SEA-HORSES for **DEPENDability**



THERE IS NO SUBSTITUTE FOR EXPERIENCE



"Don't fret, Mrs. Wattlbottom — Henry will have that fixed in a minute with a little Weldwood Glue!"

When you want to fix things fast... remember Weldwood Glue. It's quick to mix... easy to use... tremendously strong... stain-free... rot-proof... and permanent. At hardware stores, lumber yards, chain stores. United States Plywood Corporation, 55 West 44th Street, New York 18, N. Y.



WELDWOOD

PLASTIC RESIN
WATERPROOF GLUE

BUILD the COMET B-29 SUPERFORTRESS

- **IT'S BIG!**
26½" WINGSPAN!
- **IT'S AUTHENTIC!**
Right down to
the last detail!



SECRET
\$2.50

At your
Comet
Dealer

ONE OF MANY OUTSTANDING COMET MODELS

You'll find your biggest model-building thrills in Comet's ALL BALSA Solid Model of the B-29! A super-kit with many finished and semi-finished parts; finished turrets and blisters of formed plastic; scaled dual wheels, complete decal sheet, many other features! Comet Design makes it easy to build—assures better results!

COMET MODEL AIRPLANE & SUPPLY CO. INC.,
CHICAGO NEW YORK

LETTER LIKE AN EXPERT THIS EASY WAY

STENSO LETTERING GUIDES were invented for all who need to make neat, good looking lettering for posters, scrap books, bulletins or on handicraft. Now a complete set of 8 guides, including a map of the U. S., is available for only \$1.00. Ask for No. 208 at your five and ten, stationery or department store. Stenso guides also sold individually. But if the set of 8 is unobtainable locally, send \$1.00 direct to maker, Stenso Lettering Company, 2510 Elsinore Ave., Baltimore 16, Maryland.



Keep your Plane Irons and Chisels SHARP as NEW!

Unique grinding attachment insures a perfectly straight hollow grind on plane irons and chisels. Results in a sharp, keen, even-cutting edge. Adds life to tools—permits better and faster work. Enables you to do an expert grinding job. Easy to install and use. Endorsed by home craftsmen and carpenters. Satisfaction guaranteed—write for folder.

READ-LEWIS MACHINE CO.
387 Third Ave., Troy, N. Y.



At dealers or sent direct on receipt of \$6.95.

KEEP WARM! SAVE FUEL!

Mortite

● Seal your home against drafts and cold, stop expensive heat leaks! Keep out dust and dirt. Just press MORTITE pliable plastic tape around windows, doors, baseboards, etc. It's easy! It's sure!

A roll covers about 80 ft., enough for 5 windows . . .

At hardware, paint, department stores and lumberyards.

FREE MORTITE J. W. MORTELL CO.
CIRCULAR 522 Burch St. Kankakee, Ill.



\$1.25

Higher cost of
Rockite & Canada



DON'T TRIP!

Keep 'Em Flat with
So-Lo's

LINOLEUM & STAIR TREAD CEMENT

Easy to use. Waterproof. Dries quickly, does permanent job. Many uses. Large tube 10c, jar 25c. Many other So-Lo Menders.

At Hardware or 10c Stores.



Millions Save with So-Lo Menders

SAVE WASTE PAPER

BUILD YOUR OWN MACHINE TOOLS!

Blueprints \$1.00 - Catalog FREE



Detailed construction Blueprints on 6 Lewis metal and wood-working tools prepared for \$1.00. Includes plans for Lewis 10" Shaper, Milling Machine, Drill Press, Vice, 16" Band Saw, 8" Jointer. Plans or semi-finished castings available for these tools save up to 90% of comparable new tool cost.

Illustrated 27-page Catalog sent free with Blueprint Order—describes 20 Lewis tools. WRITE TODAY!

LEWIS MACHINE TOOL CO.

P.O. Box 116, Sta. A, Dept. M-22, Los Angeles 31, California

TRAILER AXLES, HITCHES, AND PARTS

● If you are interested in purchasing trailer axles, hitches, and other trailer parts, contact us promptly. Complete house trailer blueprints, \$1.00. Write for free literature.

HAMMER BLOW TOOL COMPANY, Dept. 110, WAUSAU, WIS.

DO YOU

WANT a permanent business profession of your own? Then BECOME A FOOT CORRECTIONIST. Earnings in this greatly needed profession run as high as \$50-\$100 weekly after a few weeks home training—not medical or chiropody—no further capital needed, no goods to buy. 50th year. Write for free booklet.

Stephenson System of Foot Correction
28 Back Bay, Boston, Mass.

POPULAR MECHANICS

Copyrighted material

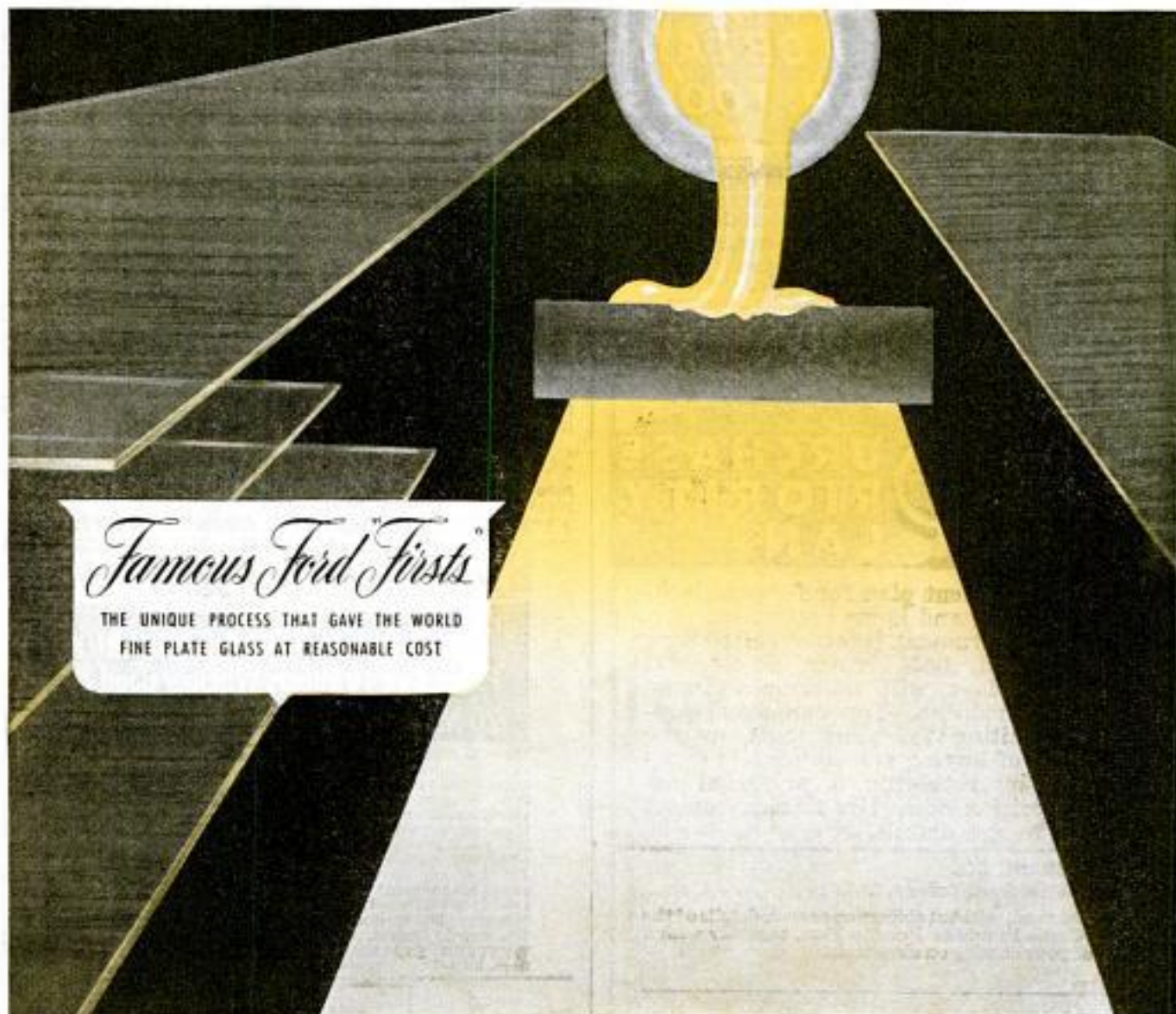

Famous Ford Firsts

THE UNIQUE PROCESS THAT GAVE THE WORLD
FINE PLATE GLASS AT REASONABLE COST

1st

**with a continuous
process of glass making**



In 1923, a red hot ribbon of plate glass began to flow from a furnace in the Ford Rouge plant. Year after year, this ribbon poured out . . . rolled into a long cooling oven . . . moved onto the polishing line to be finished and cut into crystal-clear sheets.

This was the first continuous process of glass making . . . capable of producing more than three miles of plate glass every day.

Started in a limited way in 1920, this process was conceived by Henry Ford to make possible the use of finest quality plate

glass in low priced cars. And it hastened another great Ford "first" . . . safety glass as standard equipment "all around."

Following his usual policy, Mr. Ford made the continuous process available to all Industry without royalties. Thus, throughout the world, people came to enjoy the beauty and utility of plate glass, not only in their automobiles but in their homes as well.

Ford will produce many more such "firsts" in the future—to the lasting benefit of every owner of Ford-built cars and trucks.

EXPECT THE "FIRSTS" FROM FORD!

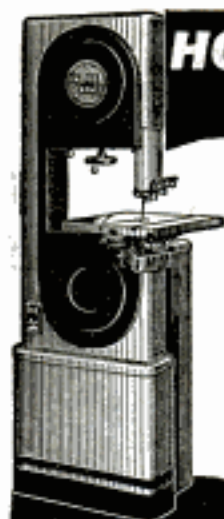

HOW TO OBTAIN SHOP TOOLS

at the earliest possible moment and
PAY FOR THEM OUT OF PATRIOTIC SAVINGS IN WAR BONDS

Own versatile, low-cost, sturdy

Boice-Crane
Band Saws - Saw Jointers
Jig Saws - Spindle Shapers
Belt Sanders - Spindle Sanders
Drill Presses - Lathes
Thickness Planers

Write today for folder on the

*Boice
Crane*

**PURCHASE
PRIORITY
PLAN**

a safe, convenient plan for forward-looking shop men and home craftsmen.

True, government priority restrictions are removed, but civilian power tool delivery delays will continue to exist for many months. You can avoid prolonged waiting for your tools, or the necessity of buying something less satisfactory, by reserving a preferred delivery position now. Use this convenient coupon to get details.

BOICE-CRANE CO.
943 Central Ave., Toledo, Ohio

Please send, without obligation or cost, details of the Boice-Crane Purchase Priority Plan, together with a copy of your catalog on shop tools.

NAME _____

STREET _____

CITY _____

A RARE BARGAIN IN PIPE TOBACCO

Surplus from compounded private formulas—\$3, \$4 and \$5 a lb. mixtures—saved in oak barrels, then aged, seasoned, counter-blended and aromatized—are now available to you at only \$1.00 per ½ lb. Here is a deluxe quality mixture of delicious flavor—guaranteed to give you a new thrill in pipesmoking. Will never cloy or jade the palate. Is always good—always different!



**SMOKE IT AT
OUR RISK!**

Order a trial ½ lb. container of BARGAIN BARREL for \$1. Smoke a few pipefuls. Savor this delightful mixture that always pleases. If you are not fully satisfied, you can return package for complete refund. **Order TODAY!**

Sidney P. Ram, Tobacconist for Connoisseurs
59 W. Monroe St., Dept. DK-642, Chicago 3, Ill.

FOOT PAINS STOPPED

or Your MONEY BACK



TRY 30 DAYS AT OUR RISK

Real Cushion
Increases Circulation
Weight Balancer
Metatarsal Support



PAIR \$1

Air-Cooled ARCH-HEELERS

Get Quick Lasting Relief

Wear Guaranteed Proved ARCH-HEELERS in any shoes for aching feet, metatarsal pains, burning callouses, corns, weak arches. Must please you or Your Money Back. Made of selected leather, specially shaped with soft cushions to gently lift bone joints, release nerve pressure, free blood circulation, align entire foot. Springy. Air cooled. Comfortable, even in tight fitting shoes. Users praise them. "I wouldn't take \$5 for mine!" says one. Pair only \$1.

Send No Money Send name, address and shoe size. Pay postman \$1 plus C.O.D. charge. Or save C.O.D. by sending price with order. Money back if not pleased after 30 days. Send Today.
ARCH HEELER CO., Dept. Z-10 COUNCIL BLUFFS, IOWA

PERSONAL STATIONERY!

Your Name & Address Elegantly Printed on 40 Sheets Whippet Bond & 20 Matching Envelopes... only...

We will elegantly print anyone's name and address, business or personal style, on 40 sheets of crisp, new Whippet Bond Stationery (made by Hammermill), and on 20 matching envelopes—all for only 25¢! Or, if you send \$1.00 for four sets we'll include one extra set FREE of any extra charge—or 5 sets in all postpaid! Same name, or as many as 5 different names on stationery. **Money-Back Guarantee.** Supply limited. Order Now!
WESTERN STATIONERY CO.
Dept. 240-K Topeka, Kansas

25¢
POSTPAID



**PULVEX
FLEA POWDER**

Kills fleas

100% SATISFACTION
...OR MONEY BACK

25¢
AND 10¢

BUILD AN ARC WELDER FROM OLD GENERATOR

For Light or Heavy Work. 75-200 amperes. Complete **PLANS 35c**. Send today and we'll include **FREE** our Big NEW Catalog.

LEJAY MANUFACTURING CO.
1347 LeJay Bldg., Minneapolis, Minn.



Balance 4" x 9" Base. With either 5 **6.00**
Metric or Avoirdupois Weights ...

Catalog with 3500 illustrations of laboratory apparatus sent for 75 cents. Catalog listing 10,000 chemicals, drugs, minerals, etc. and 1100 scientific books sent for 25 cents. 100 scientific books 15¢ each.
LABORATORY MATERIALS CO.
7321 Vincennes Ave. Chicago 21, Ill.

CRESCENT TOOLS
Give Wings to Work

ASK YOUR
HARDWARE
DEALER

WINDOW SIGN LETTERS

For Store Fronts and Office Windows. Anyone can put them on. Samples furnished. Genuine Gold and Silver.
METALLIC LETTER CO., 430 N. Clark St., Chicago 10

GUM GRIPPER

TIGHTENS FALSE TEETH OR NO COST

Amazing NEW Plastic Reliner LASTS FROM 4 to 6 MONTHS



Now—in a jiffy—you can make loose, slipping dental plates fit snug and comfortable. Eat, talk in comfort, laugh freely—“Gum Gripper” enables you to enjoy that feeling of almost having your own teeth again!

● APPLY IT YOURSELF — AT HOME

“GUM GRIPPER” amazing plastic Reliner tightens dental plates quickly, makes them hold firmly and fit like new! Just squeeze from tube, spread evenly, put plate in mouth, wear it while “Gum Gripper” sets in few minutes. No heating necessary.

● USE ON ANY DENTAL PLATE

“Gum Gripper” will not harm denture or irritate gums. Sanitary, tasteless, odorless. Keeps mouth sweet and clean, prevents sore spots. Application of plastic “Gum Gripper” is guaranteed to last 4 to 6 months—or no cost. Can be scrubbed or washed. Rev. A. J. Wigley, Pittsburgh, Pa., writes: “Best material I ever used. I have not refined my lower teeth for 2 months.”

“Best I’ve Ever Used”

SEND NO MONEY—Order a tube today—it’s only \$1.00. Fill out and mail coupon below. You’ll be delighted! Satisfaction guaranteed or your money back.

FREE Generous size package Dental Plate cleaner included free of extra cost. Cleanses dental plates without brushing. Will not harm denture.

GUM GRIPPER 127 N. Dearborn St., Dept. 71-C, CHICAGO

GUM GRIPPER, Dept. 71-C
127 N. Dearborn St., Chicago 2, Ill.

Send me a tube of “Gum Gripper.” You guarantee it to satisfy—or it will not cost me a penny.

I will deposit \$1.00 plus postage with postman when package arrives.

Enclosed is \$1.00—You pay postage.

NAME.....

ADDRESS.....

CITY..... STATE.....

Make Any Article GLOW IN THE DARK with Magic New Discovery!

Don't pay big prices for luminous articles. Make your own! Sell at big profit or keep for your pleasure. With our complete outfit and confidential instructions, it's easy! A stroke of the brush—any article glows in the dark like magic! Lasts indefinitely. Absolutely harmless. Hundreds of uses. Use on ties, flowers, jewelry, house numbers, furniture, pictures, statues, toys, etc. Order NOW! Supply limited. Money-back guarantee.

\$1.00
Send No Money

Complete Lite-Glo Kit, \$1.00. Send name, address, pay postman \$1.00 plus postal charges. Send cash, we pay postage.

LITE-GLO, Dept. 312-LK, Topeka, Kan.

Service Plans:
 COAT SWITCH
 DECORATIONS
 JEWELRY
 GIGS

AVAILABLE for IMMEDIATE DELIVERY!



Radios—
Table Models
Electric Fans
Electric Heaters
Health Lamps

Electric Irons
Electric Roasters
Electric Mixers
Waffle Bakers



Silverware
Cooking Utensils
Carpet Sweepers
Electric Extension Cords
Other Electric Items

Electric Cookers
— 1 or 2-Burner
Electric Broilers



Send Stamped Return Envelope for Prices

JOSEPH WINKLER & CO.
667-671 NO. CLARK STREET
DEPT. BP-10, CHICAGO 10, ILLINOIS

STAR COMET TACKER

For tacking insulation, upholstery, roller shades, shelf paper, decorations, etc. One hand operated. Just squeeze handle, drive twinpoint tacks right where you want them. Tack where you can't swing a hammer. Always ready, no spilled tacks.



Red H Twist Drills

Finest high speed steel, perfect points, supremely accurate. Needed by every mechanic and home craftsman. Set of 29 drills from 1/16" to 3/8" in handy case. Straight shank only. Write for prices and name of nearest distributor. Some territory still available to hustlers.

Essential rated orders must be filled first
STAR PAPER FASTENER CO. Dept. SG Norwalk, Conn.



FLIGHT JACKET INSIGNIA
With your own first name **50¢** each
Come and get 'em, only... **50¢** Postpaid

Dress up your sweater, blouse, or lumber jacket and look just like the men that fly our big bombers. Indicate selection by number and print carefully your first name, or your nick name. Mail with 50c today. Agents Make Money—Take orders. Sell for \$1.00. Illustrated book of all Army Insignia Emblems only 25c.

INSIGNIA MART
703 Broadway, Dept. P, New York 3, N.Y.

SHINE WITHOUT 'POLISH'



New Invention! • Sells Like Wild
Replaces messy pastes, liquids. Simply glide over shoes—and presto!—you have a lustrous, long-lasting shine. No mess. No fuss. No soiled hands. Clean, Handy. **WORKS LIKE MAGIC!** For Men's, Women's and Children's Shoes. Low priced. Lightning seller!

SAMPLES FOR AGENTS Sample offer sent immediately to all who send name at once. A penny postal will do. **SEND NO MONEY**—Just your name. **KRISTEE CO., 686 Bar Street, AKRON, OHIO**



Delicious Meat and Eggs of Your Own!

NOW... You Can Raise Chickens in Your Basement, Garage or Spare Room



COZY HOME All Steel Triple Service BROODER

Large and Roomy
... Dependable

No Extras to Buy —
A Complete Outfit

BROODER ONLY \$12.95

The easy, modern way to start raising chickens. This new, efficient all steel BROODER comes to you set up, ready to use. Just attach feeders and plug it in—automatic heat keeps chicks comfortable. Sanitary wire mesh floor, removable dropping pan. Feed and water troughs at each end. Large size—30" long, 24" wide, 12" high—capacity, 100 baby chicks. Dependable CHROMALOX heating element (or oil heat if specified). Adjustable heat control, pilot light and thermometer also furnished. Heavily galvanized, rust-proof.

Brooder Can Be Used 3 Ways

- 1. On Table**—Ideal for brooding chicks for your own meat and eggs, in your basement or spare room.
- 2. On Floor**—For garage, shed or brooder house. Removing floor and feeders makes a regular floor-type brooder for 200 baby chicks.
- 3. As a Battery**—Up to 4 decks high. Add a brooder at a time for profitable broiler business. 4-deck steel rack given without cost with order for 4 brooders. Free plans for Raising Chicks for Profit.



SPECIAL OFFER A

BROODER and 25 CHICKS
Both for only **\$13.95**

You Save
\$4.00

Assorted heavy chicks, guaranteed live delivery

SPECIAL OFFER B

BROODER and 40 AA ROYAL HEAVY CHICKS
Both for only **\$16.95**

You Save
\$4.50

Your choice of breeds. Famous Campbell strains, noted for quality and fast growth

SPECIAL OFFER C

BROODER and 50 AAAA IMPERIAL CHICKS and 10 SPECIAL MATING COCKERELS
All for only **\$19.95**

You Save
\$5.00

Our highest quality. Your choice of Wh. Leghorn, Wh. Rock, Barred Rock, New Hamps., Bl'k Giants, Buff Orps., Austra-Wh. ORDER NOW—select one of offers above. Chicks shipped prepaid after you receive Brooder, or whenever desired. C.O.D.—no money down. (Or, if full payment sent with order, Brooder also shipped prepaid.) Satisfaction guaranteed.

CAMPBELL'S POULTRY FARMS Dept. 28
Rochelle, Illinois

KEEP ON THE BEAM

HULL STREAMLINE AUTO COMPASS always shows your driving direction. Reliable for years, improved now in performance and accuracy. Limited supply at dealers'. Free circular. Price \$3.50.

HULL MFG. CO.

P. O. Box 246-D11

Warren, Ohio



BUILD THESE PROJECTS

For garden or lawn. Easy to build. Easy to sell. Dotted blueprints Model B-25 Dutch Windmill 50c; Model OSM-40 Old Mill, 85c. Lawn Figure Patterns—Bustle and Gink Dutch Boy, Tulip Girl, Holland Fair, 35c each, all 4—\$1.00. Catalog illustrating many models, send 10c today.

CRAFTSMAN'S MODEL CO., Dept. P-45, 2030 N. 41st St., Milwaukee, Wis.



The positive lock of the Streamline steel tape rule is conveniently located at the rear of the case. This makes it possible to actually take an inside measurement and retain the reading in the same motion. Streamline also has an extra long (7/16") tip for making one-hand measurements beyond arm's reach. Replaceable blade of high grade tempered steel and case chrome plated.

TRADE MARK

MASTER

WOOD AND STEEL TAPE RULES

MASTER RULE MFG. CO., INC.
815 E. 136th St., New York 54, N. Y., Dept. F-10
Branch: P.O. Box 1587, Oakland, Cal.

Enclosed find \$2.65 for the new 6 ft. "Streamline" complete with spare blade.

NAME _____

ADDRESS _____

CITY _____ STATE _____



MICHIGAN TULIPS

BIGGEST BARGAIN IN AMERICA

Darwin, Triumph, Leader and Cottage Tulip Bulbs, marvelous assortment of flaming rainbow colors guaranteed to flower 4 years.

75 BULBS \$1.69

FREE SEND NO MONEY—ORDER NOW—PAY LATER. Bulbs reach you in a few days in plenty of time for fall planting for only \$1.69 plus c.o.d. postage. Cash orders sent prepaid. Free... prompt action brings you 25 quality gladioli bulbs FREE. Act now. Send your name, address to:

MICHIGAN BULB CO., Dept. R-1428
148 Monroe Avenue N. W., Grand Rapids 2, Michigan

Announcing—A New Drill Press Accessory

THE BARRON ROTARY SURFACE SANDER

\$5.95 COMPLETE



Note these Special Features—

Made of Alcoa aluminum. Machined and balanced for smooth operation in drill press chuck. For surface sanding woods, plastics or polishing metal surfaces. Complete with 20 instantly removable sanding cup discs. No messy gluing needed. Leaves an agate smooth, absolutely true surface finish. Does not leave waves, ripples, steps or striations in work piece. The only tool of its kind. Shipped prepaid on 10 DAY MONEY BACK GUARANTEE for \$5.95.



The IMPROVED Barron Multi-Purpose Drill Press Planer.. \$7.50

Not only surface planes toughest woods and plastics to precision limits—but rabbets, routs, tenons, panels, grooves, beads. Will cut rabbets, tenons, panels, etc. to a depth of 1" with special Barron extra long hi-speed cutter blades. Thousands now in use. Made of Alcoa aluminum, machine finished thru-out. Vibrationless. Fits any drill press. Shipped prepaid on 10 DAY MONEY BACK GUARANTEE on receipt of cash, money order or C.O.D. for \$7.50.

Baron ALL-METAL Auxiliary DRILL PRESS Table.. \$8.85



Hard Alcoa aluminum die casting heavily ribbed—machined both sides. Has 234 sq. inch extra large working surface. Equipped with Barron Steel Planer Fence. Can also be used for shaper operations, innumerable other drill press uses. A real buy at \$8.85, express collect.

See Your DEALER . . . Or Write For CATALOG

BARRON TOOL CO., INCORPORATED
369 Architects Bldg. Detroit 1, Mich.

BARRON PRECISION WORK SHOP TOOLS



DRILL-INDEX A compact container for indexing and filing twist drills. Eliminates search. Made entirely of steel in nine sizes. See your dealer or write to
HUOT MFG. CO.
Foot Schultz Bldg. St. Paul 1, Minn.

Fix Scratches, Dents, Nicks the Professional Way!



Get This Handy Kit!

Repair damaged furniture surfaces with new practical kit. Enables anyone to do fast, easy touch-up jobs like a professional cabinet finisher. Makes furniture and cabinets look new. Every home and shop needs this remarkable kit. Pays for itself over and over!

Amazing Results—Easy to Use

Kit includes 23 different items—scratch removers for slight scratches, assorted shades of shellac sticks for deep nicks, bottles of light and dark stains, shining lacquer, alcohol lamp with fuel, stainless steel spatula, touch-up brushes, scratch sticks, steel wool, sandpaper, rubbing liquid. Packed in handy leatherette finish case. Send for it today. Best investment of lifetime. Fully guaranteed. Detailed instructions supplied.

\$3.95
Postpaid

AMERICAN HOUSEHOLD BUREAU
Dept. F, 520 N. Michigan Ave., Chicago, Ill.

MINK Easterns Labradors Yukons \$40.00 EACH

All shipments made subject to 5 days' inspection before acceptance.

The quality of my mink is indicated by the fact that I have netted an average of \$20.00 a pelt on all mink skins sold during the past 5 years.

WHITE, SILVERBLU, and BLACK CROSS MINK
WHITE FACE, PLATINUM SILVER, and PEARL PLATINUM FOX

Priced on Request

BOOK "Domestic Mink" \$1.00

HARRY SAXTON'S MINK RANCH, Bemus Point, N. Y.

MADE FROM IMPORTED BRIAR



\$3.50 to \$10

Enjoy unmatched sweet smoking quality, outstanding fine grains, in modern designs, \$3.50 to \$10. At leading tobacconists everywhere.



Write for FREE illustrated booklet

C. B. WEBER & CO. 141 Cator Ave., Jersey City 5, N.J.

Get This NEW INVENTION CRACKS BLACK WALNUTS BUTTERNUTS, ENGLISH WALNUTS

NO FLYING SHELLS

75% MEATS IN QUARTERS. \$1.50 delivered—send cash, stamps, check, money order. C. O. D. 21 cents extra. Money-back guarantee. Order early—NOW.
POTTER, 140 N. Main, Sapulpa, Okla.



GET THE IMPROVED SUPER DRILL GRINDING ATTACHMENT

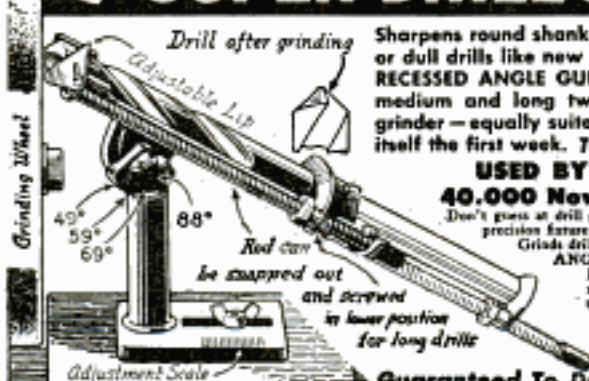

Sharpens round shank drills from 3/32" to 1-1/16" diameter. Grinds old, broken or dull drills like new in four accurate drill point angles—49°—59°—69°—88°. RECESSED ANGLE GUIDES ELIMINATE NEED FOR PROTRACTOR. Grinds short, medium and long twist drills from 1-1/2" up to 11". Attaches to bench or grinder—equally suited for hand or power-operated grinding wheels. Pays for itself the first week. The Grinding Fixture That Gives Rounded Points!

USED BY ARMY—NAVY—AIRCRAFT PLANTS
40,000 Now in Use! Wherever Drills are Needed!

Don't guess at drill grinding. Anyone can be an expert from the start with the Super Grinders. This precision fixture gives a true center, and clearance desired. Does work like the highest priced grinder.

Grinds drills in 25 seconds—Saves drills, time and money. Built for long, hard usage. FOUR ANGLE FEATURE GIVES PROPER POINT TAPERS FOR CLEAN FAST DRILLING IN STEEL, WOOD OR PLASTIC PRODUCTS. No factory, machine shop, home workshop or repair shop should be without the Super Drill Grinder. Delivered with complete instructions.

Mail your check or money order for only \$2.95 with your printed address. The Super Grinder will come by express mail—postage paid.

CRANDALL MFG. CO.

1512 W. Slauson Ave., Dept. FA-10

Guaranteed To Do The Work or Money Refunded

Los Angeles 44, Calif.

ONLY
\$2.95
COMPLETE

DURAPOINT DRILLS for CONCRETE, STONE, GLASS HARDENED STEEL

Style 3 (Standard in sizes over 3/8")



Style R (Standard in sizes 3/8" and under)



PRICE LIST

Diameter	Over-all Length (A)	Net Price Each	Diameter	Over-all Length (A)	Net Price Each
1/8"	3"	\$2.75	5/8	8	\$5.00
	4-1/2	3.00		8	5.25
3/16	3	2.75	11/16	8	5.50
	4-1/2	3.00		8	5.75
1/4	4	2.75	3/4	8	6.25
	5	3.00		10	6.50
5/16	4	3.00	13/16	8	7.00
	5	3.25		10	7.25
3/8	5	3.25	7/8	8	7.75
	7	3.50		10	8.00
7/16	6	3.50	15/16	10	9.00
	8	3.75		12	9.50
1/2	6	4.00	1	10	11.00
	8	4.25		12	11.50
9/16	6	4.25			
	8	4.50			

Sizes to 1 1/4" obtainable at proportionate cost. Drills in 64th's and 32nd's now in stock priced at next larger size in list. Tolerance normally +.005 or -.005. Tolerance to .0001 on special order. Drills below 1/8" on special order. Specify your chuck size.

DURAPOINT SCRIBER, like a pencil, excellent for circular glass cutting, engraving, or drawing on any hard substance, \$2.50 Postpaid.

DURAPOINT TOOL COMPANY, 4342 Umatilla Street, Denver 11, Colorado

Don't Let **SICKNESS** or **ACCIDENT** Rob You of Your Savings... Provide Hospital Care for Yourself and Your Family

Costs only **3c A DAY • EACH ADULT**
1 1/2c A DAY • EACH CHILD

FOR SICKNESS OR ACCIDENT
Hospital Expenses paid (beginning with the first day), up to \$500.00

FOR ACCIDENT
Doctor Expense paid, up to \$135.00 Less of Wages reimbursed up to \$300.00
Loss of Life by Accident \$1000.00

WAR COVERAGE and EXTRA BENEFITS
Childbirth Expense paid, up to \$80.00

Sickness or accident can easily wipe out, in a few weeks, savings it may have taken years to accumulate. Don't let this happen to you. With a Family Mutual Hospitalization policy, you'll be able to pay your hospital bills. In case of accident, you will be reimbursed for your doctor expenses and for loss of time from work. You may choose any hospital in the United States and your own family doctor may attend you. Benefits applying to children are 50% of those paid adults.

MAIL COUPON TODAY — No Agent Will Bother You.

FAMILY MUTUAL LIFE INSURANCE CO., WILMINGTON 99, DEL.

Family Mutual Life Insurance Co., PM-8
601 Shipley St., Wilmington 99, Del.
Please send me without obligation, complete information on your Economical Hospitalization Plan.

NAME _____
ADDRESS _____
CITY _____ STATE _____

The Best Marlin RIFLES SINCE 1870

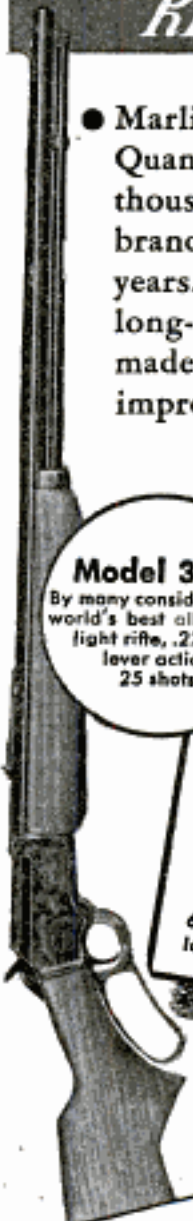

• Marlin Rifles are being made again! Quantities are limited but several thousand sportsmen will soon own brand new Marlins...the best in 75 years. Honest guns—safe, accurate, long-lived. Built to standards that made the name famous with war-improved skills.

Model 39-A
By many considered the world's best all-around light rifle, .22 cal., lever action, 25 shots.

OTHER MARLIN .22 RIFLES

MODEL 81-DL BOLT ACTION .22 CALIBER REPEATER
Dependable patented magazine feeder. Automatic side ejection. 25 shots for vermin and small game.

★
MODEL 80-DL CLIP MAGAZINE .22 REPEATER
8 fast shots for small game. Among rifles recommended for target practice by N. R. A. Man-sized gun at a low price.

★
MODEL AT-DL AUTOMATIC .22 CALIBER RIFLE
6 shots as fast as you can pull the trigger. Ideal for fast-moving small game, vermin.

If you're lucky enough to get a new Marlin, treat it well. It will repay your care with many long years of service.



THE Marlin FIREARMS COMPANY
New Haven, Conn.

THERE'S Profit & Fun in THESE PLANS

only \$1.50

OVER 100 ITEMS
-Worth \$12.35
 IF PLANS BOUGHT SEPARATELY

Have Fun—Make Money

You can surprise yourself with the profitable things you can make from these LeJay plans. No special tools or special experience necessary, and most of your material, particularly old generators, can be found around garages, workshops and scrap yards. Make your own welder and do some paying jobs for the neighbors.

Easy to Follow Plans

Clear illustrations and charts help you every step of the way in making such interesting things as:

- 200 Amp. Generator Welders
- Large Transformer Welders
- Gunsmith's Carbon Welder
- Workshop Spot Welder
- 6, 12, 32, 110-Volt Motors
- Electric Outboard Motor
- Wind-driven Light Plant
- Electric Fences
- Electric Drills
- Bench Grinders
- Electric Scooter
- Armature Rewinding
- Insect Electrocuters
- Electric Bicycle Pusher, etc.

Send No Money—But

Send a postcard with your name and address and a request to send the LeJay Manual C.O.D. and the postman will deliver it to your door. If you are not entirely satisfied after 3 days perusal, send it back and we will refund the \$1.50. Bear in mind, however, that C.O.D. fees have been considerably increased, so if you prefer to save this expense send \$1.50 now, under same guarantee. \$1.75 in Canada.



WELDING GENERATORS
 TRANSFORMER WELDERS



ARMATURE WINDING



ELECTRIC OUTBOARD POWER TOOLS



WIND PLANTS INSECT KILLERS



ELECT. GO-BIKE MOTORS



ELECTRIC SCOOTER ELECTRIC FENCES



LIGHT GENERATORS TRACTOR LIGHTS

3 DAY TRIAL

LEJAY MFG. CO.

47 LEJAY BUILDING,
 MINNEAPOLIS 8, MINNESOTA.

Hi-Speed NUT DRIVING

XCELITE Delux NUT DRIVERS

Color of Handle Indicates Size

The newest idea in nut drivers! Each of seven sizes has different colored handle of shock-proof, fire resistant plastic—easy to spot size needed. Seven sizes (in 32nds) for nuts from 3/16" to 3/8". Supplied in neat, lockable, metal holder. Price \$6.10, no priority required. Ask your dealer—or write Dept. J.

LOCKABLE HOLDER

PARK METALWARE CO., Inc.
 Orchard Park, N. Y.

LOCATES TROUBLE INSTANTLY IN ALL ELECTRICAL DEVICES

In this single unit are combined all the necessary tests for examining every appliance. Checks temperature regulating thermostats under actual working conditions. Tells instant it opens or closes. Controls the heat on solder pots and soldering irons. Prevents over-heating. Tests continuity, open circuits, etc. Checks automatic irons, vacuum cleaners, motors, shavers, all types of bulbs, appliances with 3-way switches, etc. Great time, effort and money saver! ONLY \$9.50 COMPLETE with instructions. WRITE FOR LITERATURE.

Pat. Pend.

FREE New Complete Practical Course in electrical appliance repairing included free with each instrument.
HANLAN CO., 1419-A, West Jefferson, Los Angeles 7, Calif.

PLYWOOD Beautiful aircraft, cabinet and paneling stock now available for prompt shipment without priority. Panel sizes from 6" x 6" up to 48" x 96". Thicknesses from 1/16" through 1". Fir, gum, birch, oak, walnut and mahogany. Reasonably priced! Send 10c Today for Complete Catalog!

CARMEN-BRONSON CO.
 165 E. 3rd St. Dept. 10-B Mt. Vernon, N. Y.

TELESCOPING MEASURING TOOLS

... Measure All Holes, Slots, Etc.—5/16 Inch to 6 inches ... Gives You Outside Micrometer Accuracy on Inside Measurements

FINISH YOUR OWN SET OF FOUR TOOLS

Only \$2.95 C.O.D.

Plus Usual Small Postal Charge

PART OF THE MACHINE WORK ALREADY DONE—ONLY SIMPLE LATHE WORK NECESSARY TO COMPLETE. No special tools required—Threading, Knurling, etc., already done. Kit includes all material (part machined); simple drawings, and detailed instructions. Send \$2.95 cash with order and we pay postage.

ALCO SHOP, Dept. PM-6, 1459 Sunset Blvd., Los Angeles 26, Calif.

BRUSH PLATING OUTFITS

for re-plating articles in the home and shop. No tanks necessary. Free particulars.

GUNMETAL CO., AVE. M, DECATUR, ILLINOIS

TOMBSTONES \$13.69
 Freight Paid.

Interested? Write us now for Free Catalog. Made of best Marble & Granite. Service direct to you by mail. Why wait.

U. S. MARBLE & GRANITE CO.
 A-18 Oneco, Fla.

NEW OTTAWA SAW

World's Fastest 6 H.P. EASY to MOVE

BIG FREE BOOK

Fells trees. Saws big logs, small logs, limbs. Pulley for belt work. Easy to handle, weighs less than lower powered units. FULLY GUARANTEED. Cash in on fuel shortage. Turn wood lots into cash.

OTTAWA MFG. CO., 1027 PINE ST., OTTAWA, KANS.

For Men who Really Know Pipes



MOUTHPIECE TUBE
prevents backflow
of moisture

CONDENSING CHAMBER
traps and holds bitter
juices and sediment

BOWL GUARD
keeps shank
and bowl dry

Patented

REMOVABLE SECTION
eases thorough cleaning

CHAMBER GUARD
bars tobacco fragments
from bit

Royalton
CROWN

150

Selected
Briar

ROYALTON CROWN EMANCIPATES SMOKERS from the annoyance of bitter juices and stray tobacco slugs. These nuisances are imprisoned by the condensing well and other patented safeguards found only in a Royalton Crown . . . This pipe never lets you down—always smokes cool and dry—no matter how often you light up.

HENRY LEONARD & THOMAS, INC. • OZONE PARK 17, NEW YORK

TUNGSTEN CARBIDE

CUTTING TOOLS

For home workshop craftsmen. Set of 6 genuine tungsten carbide tipped tools, with 2 1/4"x3/4" steel shanks. For turning, boring, facing, milling, reaming and finishing.

Set of 6, postpaid \$5.00

Complete set includes 3 tools for cutting steel and cast iron—3 for fibre, hard rubber and non-ferrous materials. Satisfaction guaranteed or money back. Order today.

KWIK-KUT TOOL CO., 13418 Fenkell, Detroit 27, Mich.

KEEP TOOLS SHARP!

GRIND your cutting edges on this 5000 f.p.m. grinder, then hone to razor sharpness on 110 r.p.m. coarse-fine reversible oilstone.

A VERSATILE MACHINE

Useful for many jobs—makes good gem cutter or pottery wheel. Free folder.



CLAUSING MFG. CO. OTTUMWA IOWA

Make your own STORM SASH

No skill required. Inexpensive, unbreakable, lightweight, easily assembled. Installed from inside, no glass required. Mail \$1.00 for complete instructions for Steel Casement or Double Hung Sash, state which.

PARKINSON SASH CO., 18500 Archdale Avenue, Detroit 27, Michigan

Manufacturers please note: I will consider the sale of my patent rights in these inventions. Production items of tremendous potential.



Red-Letter
BARGAIN!

KIT OF 60 CONDENSERS

MALLORY, SPRAGUE, AEROVOX! List Value, \$14.75!

Fresh, guaranteed stock. 600-volt condensers, .001, .002, .005, .01, .02, .05, .1, .25 MFD.

You also get a FREE Neon Tester with each Kit. Make a tremendous saving on this Olson Bargain! Clip this ad, write your name & address in margin. If you send remittance with order, we pay postage. (Send for our Free Catalogs!)

OLSON RADIO WAREHOUSE, 73-J Mill St, Akron 8, Ohio

Our price, only

\$7.50

NEON
TESTER
FREE
with order



NOW AVAILABLE!

Crosman Silent Rifles—America's favorite compressed air rifles for indoor and outdoor shooting are back again! Available in 22 cal. single shot and Magazine Loading Types. At your dealer—or order direct. Ask for Crosman SUPER-PELLS too—the better ammunition for all compressed air rifles. .177 Cal.—\$1.80 per M. .22 Cal.—\$2.00 per M.

CROSMAN ARMS CO., INC. • Rochester 7, N. Y.

If They'll Bite You Can **CATCH 'EM** With The **FISHIN' GADGET** Sets Hook Automatically



The greatest fishing invention since the fishhook! Automatically sets the hook on fish that bite. First day's results insure lifetime use. Will last for years. Made of stainless steel. Use on any line... for any kind of fishing.

See your dealer or send coupon and \$1 bill for your Fishin' Gadget... now!

Money Back
Guarantee



Graham-Campbell Co.
2513 Fidelity Bldg.
Kansas City 6, Mo.

Here is a \$1 Bill. Send me a FISHIN' GADGET quick!

NAME

TOWN

STREET STATE

**NEW CONCEPTS OF
BATTERY LIFE**

P.R. MALLORY & CO. Inc.
MALLORY
Tropical*
DRY
BATTERIES

*REG. U. S. PAT. OFF.

Originally developed by Mallory for the United States Army Signal Corps to solve military problems, Mallory Tropical Dry Batteries are fundamentally different.

Here is bright promise for fascinating commercial development in the future.

P. R. MALLORY & CO., Inc.
INDIANAPOLIS 6, INDIANA

P.R. MALLORY & CO. Inc.
MALLORY

HERE IT IS!

**PHENOMENAL NEW
PRECISION ENGINEERED
CIGARETTE
ROLLER** PATENTED FULLY GUARANTEED

CIG-ROLL-ETT \$1

MAKES PERFECT CIGARETTES EVERY TIME! With Factory Uniformity. **IDEAL CHRISTMAS GIFT**

Works like magic! No tapes! Nothing to get out of order. Beautiful transparent plastic and metal. Entirely NEW in principle and operation. **SAVES 75% OF CIGARETTE COSTS!** Use your favorite cigarette or pipe tobacco. Buy for gifts. For boys in the service.

**JUST 4 INCHES LONG
CLIPS TO POCKET LIKE A FOUNTAIN PEN.**

EASY TO USE!

ORDER NOW from Your Retailer! If he can't supply you, write direct.

SHIPPED POSTPAID ANYWHERE

PLASTICO 1110 E. FIFTH ST.
DAYTON 2, OHIO

New! **BERRY ROTARY DISC SANDER**
WITH PATENTED "FLEX-TOP"

Fits any drill press. Sands perfectly. Produces controlled, uniform surfaces. Finished work has a smooth, satin finish. Patented FLEX-TOP "gives" if surface is irregular. Complete with sanding discs, postpaid



C.O.D. **\$9.95**
USE YOUR DRILL PRESS AS A WOOD PLANER!

BERRY Planer! Planes, panels, tenons, rabbets and routs. Hollow-Ground, High-Speed Steel Cutters insure a smooth, shearing cut. Takes only 30 seconds to plane, parallel and finish an 8" x 24" board. No gouging. No chipping. Complete, postpaid or C.O.D. **\$7.50**

5-day trial offer. Free literature. **ACT TODAY!**
H. J. BERRY MFG. CO., 2297 Scott St., Detroit 7, Mich.

TITLER FOR MOVIES **SUPERIOR UNIVERSAL TITLER KIT**

Movis Fess. Rem or 16mm will welcome the SUPERIOR TITLER KIT. Contains of special 12" lens, complete illustrations & directions for the easy construction of a titler for your covers & four colorful backgrounds. Price complete \$3.00 postpaid. **SUPERIOR BULK FILM CO.**
388-M Randolph St., Chicago, Ill.

NEW! **Ideal Gift for Your Service Man!**

Heavy 10K Solid Gold Souvenir Service Ring of World War II. A beautiful and authentic ring that your service man will be proud to wear and cherish forever. It plainly shows that he is a Veteran of our Armed Forces of World War II. One side of ring shows Allied Flags and World with Shield, other side shows the Great Seal of the U. S. State ring \$10.

Available in all sizes.
Order Your Ring Now!

No. 1541 10K Solid Gold.....\$18.00
Add 20% Fed. Tax (\$3.60)

Solid Sterling Silver.....\$6.67
Add 20% Fed. Tax (\$1.33)

EDWIN W. LANE CO., Dept. PM, 32 W. Randolph St., Chicago 1

**SIGNS EASILY AND EXPERTLY
PAINTED WITH LETTER PATTERNS**

AND SHOWCARDS MANY SIZES & STYLES WRITE FOR FOLDER!

JOHN F. RAHN
1320-31 N. Central Ave.
CHICAGO 51, ILL.

**A TOOLSHOP
IN YOUR HAND!**

•GRIND •DRILL
•POLISH •ROUT
•ENGRAVE •CUT
•CARVE •SAND
•SAW, etc.

HANDEE TOOL OF 1001 USES

The original hand tool and today's finest for work on any metal, alloy, plastic, wood, horn, bone, glass, etc. Fits your hand comfortably, perfectly balanced, weighs only 12 ounces—it's the "non-fatiguing" tool. And Handee's usefulness is as extensive as the number of quick and easy-to-change accessories you own . . . choose from more than 300 in the Chicago line. Operates on AC or DC current at 25,000 r.p.m. With 7 accessories, postpaid.....\$18.50

Write for free new 64-page catalog

CHICAGO WHEEL & MFG. CO.
1101 W. Monroe St. Dept. PM Chicago 7, Ill.

**Power
FOR PENNIES**

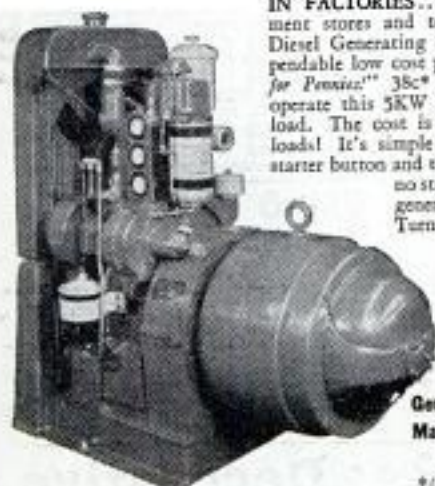

IN FACTORIES...on farms...in department stores and tourist camps Sheppard Diesel Generating Sets are furnishing dependable low cost power—literally "Power for Pennies." 38¢ will buy the fuel to operate this 5KW set for 8 hours at full load. The cost is even less at fractional loads! It's simple to operate! Press the starter button and the power's on. There's no standby charges when you generate your own electricity. Turn it off and the costs stop, too. Install a Sheppard—it will soon pay for itself with savings on your present power bills. Write for information and free literature.

Generating Sets—3 to 30 KW
Marine Engines—3 to 62 HP
Power Units—3 to 50 HP
(at 9¢ per gal.)

R. H. SHEPPARD CO., 2848 Middle St., Hanover, Pa.

Sheppard ALL AMERICAN
Diesels



*the varnish
that boiling
water made famous*

**Super
VALSPAR**

VALSPAR
STANDS UP FINE!

*the Varnish
that won't
turn white*

Whether it's the front door or your hardwood floors—a desk or home woodwork—Super Valspar stands up fine, gives beautiful, lasting protection. Super Valspar gives any wooden surface a finish that you can well be proud of. Millions will tell you, "Super Valspar is the best varnish in the world!"



VALSPAR
PAINTS · VARNISHES · ENAMELS

VALENTINE & CO., INC., 11 E. 36th St., New York, N. Y.

WORKSHOP WISDOM

Improving wallpaper paste



PERHAPS you plan to use extra heavy paper.

Or you want to strengthen paste for paper in rooms where air may get damp—such as in the kitchen or bathroom. To meet these special conditions, make a standard glue mix, using $\frac{1}{2}$ lb. of Casco and 1 lb. water for each pail of liquid paste.

When thoroughly dissolved, stir Casco mix into the paste. It makes paste stronger and more water-resistant. You can use Casco for 1001 jobs. *And here's why so many folks prefer Casco for general wood gluing:*

Unusual strength: Casco Glue sets chemically. Doesn't just "dry out." Casco becomes as strong as wood itself and is highly resistant to dampness, heat, and time.

Easy to mix: You just add cold water and stir. No heating problems.

Economical: You use Casco as you need it. There is no waste.

For water resistant projects and special outdoor jobs, get Cascamite. It's a completely stainfree urea resin adhesive. Casco Glue and Cascamite are available in 10¢, 25¢, and larger sizes at all hardware stores.



WRITE FOR FREE Gluing Guide containing over 40 household gluing hints. Address Casein Company of America, Dept. PM-05, 350 Madison Ave., New York 17, N. Y.

CASCO Powdered Casein GLUE

Sets chemically—hardens permanently!

Always write your name and full address clearly when answering advertisements.



NAMECHAIN

Personalized
KEY CHAIN
Spells
YOUR NAME
in full

DURABLY CONSTRUCTED
IN GOLD PLATE

The Perfect Gift

Each Namechain made to your order . . . up to 16 letters allowed. Individually packed in Gift Box. Orders filled in one day. Sent Postpaid for \$3.50.

Namechain Mfg. Co.
19 E. Pearson St., Dept. R, Chicago 11, ILL.

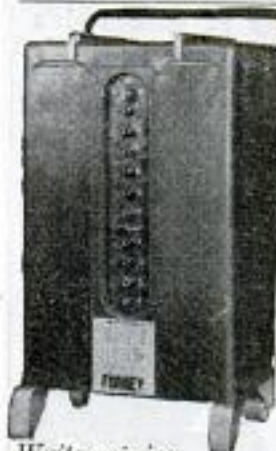

ARC WELDERS

Post War Models now available. Most complete line of welding machines. Any size for any shop. From \$20 to \$200.

Brazing, preheating, cutting, spot welding, arc soldering, pipe thawing. 220, 110, 32 Volt Models.

UNCONDITIONALLY GUARANTEED

Highest grade of materials used in construction.

There is a Forney Product in every town in the U.S.A.

Also have used Welders.

Write or wire, factory direct, **FORNEY MFG. CO., FT. COLLINS, COLO.**



MACHINE SHOP EQUIPMENT

Every man who owns a workshop should have a copy of this new, authentic catalog of Machine Shop Equipment . . . the latest tools made by the biggest manufacturers in the United States. Replete with illustrations, descriptions, prices. Prompt delivery on most tools listed in this catalog. Available at the cost of printing—50¢ a copy—Get yours today! Send check or M.O. to

CENTER TOOL CO.
154 Centre Street, New York 11, N. Y.



RADIO PHONE SET

Dynamic microphones and dynamic receivers of the finest quality. Made to U. S. Army Signal Corps Specifications and passed by Signal Corps Inspectors. Water shock weather and altitude proof. Precise and delicate as a watch; rugged as a tank. Were used on tank and aircraft intercom systems. Part of B-12 equipment. Can be used for record recording, telephone sets, for talking through radio, and many other uses. Inside of earphones make fine loud speakers for pocket radios. Complete set consisting of two receivers, cord set, head band, and dynamic hand microphone for less than regular cost of dynamic mix; \$14.95 post paid.

Electronic Products Co., St. Charles, Ill.



Decorative Decalcomania

Transfers Imported Designs of all Sizes & Types—Flowers, Fruits, Figures, Birds, Dogs, Horse Heads, Ships, Juvenile, Tropical, Chinese, Peasant, Colonial, Patriotic, Inlay, Borders, Initials, etc., for Furniture, Doors, Walls, Trays and what not. **Catalog with 800 illustrations in color sent for 25¢.** Deductible on first order of \$1.00 up. **L. C. WELLS, Dept. PM-510, 25 East 26th St., New York, 10**

POPULAR MECHANICS

1946 FORD *with many advancements* *- now in production!*



There's a Ford in your future!

Here is the most beautiful Ford car ever built—with more improvements than many pre-war yearly models. . . . Under the broad hood there's new and greater power. Plus improved economy in oil and gasoline. . . . Colorful interiors invite you to relax in luxury. Plenty of elbow-room,

knee-room, head-room. New-type springs assure a full-cushioned level ride. Brakes are new hydraulics—extra-large and self-centering—to make stops quick, smooth and quiet. . . . Ask your Ford Dealer about the smartest Ford cars ever built. FORD MOTOR COMPANY



ORDER NOW!

NEW ECHOPHONE EC-1A RADIO RECEIVER

Be one of the first to own this popular communications-type set for short-wave and regular broadcast reception. *Many new features!* Covers entire tuning range from 550 Kc. to 30 Mc. (550 to 9.85 meters) in 3 bands. For 115-125 volts AC-DC. Automatic noise limiter. Built-in PM speaker. Compact and reliable. Complete with tubes. Net... **\$29.50**

F. O. B. Chicago

ALLIED RADIO CORP.

833 W. Jackson Blvd., Dept. 5-KK-5, Chicago 7, Ill.

- Ship ECHOPHONE EC-1A at earliest moment.
- Enclosed \$..... Full Payment
- Send full information on Communications Receivers and Time Payment Plan, without obligation.

Name.....

Address.....

City.....Zone.....State.....

Start a SAW REPAIR BUSINESS!

MAKE A GOOD LIVING IN YOUR OWN BUSINESS—sharpening saws with the Foley Automatic Saw Filer. It makes old saws cut like new again. All hand saws, also band saws and cross-cut circular saws can be filed on this ONE machine.

THERE ARE HUNDREDS OF SAWS TO BE FILED in your own neighborhood, used by farmers, carpenters, homes, schools, factories, etc. W. L. Tarrant writes: "I left my old job last September and in 10 months have filed 2,159 saws. We have a lovely business worked up and can't keep up with the work."

SEND FOR FREE PLAN

Shows how to start this steady cash business. No experience needed, no eyestrain, no canvassing. Send coupon today.



FOLEY Automatic SAW FILER

FOLEY MANUFACTURING CO.
1016-5 Foley Bldg., Minneapolis 13, Minnesota
Send Free Plan on Saw Filing business, no obligation

Name.....
Address.....

SAVE MONEY on your HOME PLANNING BUILDING MODERNIZING REPAIRS



These Practical Books Will Show You How to Do it!



Plan Now — Build When You Can!

Here are fine, practical books to help you in the most important and thrilling event in a lifetime—the planning, building and upkeep of your home. Make your selection and order now.

FAMOUS PLAN BOOKS

Each book contains floor plans, photos and descriptions of completed homes.

- AMERICA'S BEST LOW COST HOMES.** 125 designs of 1 and 2 story houses\$1.00
- DE LUXE SMALL HOMES.** 210 popular designs\$1.00
- OUR FUTURE HOME.**

Set of **FOUR PLAN BOOKS—\$3.50**

Wide selection of residences, summer homes, garage apartments...\$1.00
MODERN HOME & GARDENING. 42 home designs. Information on home improvements, gardening shortcuts, etc...50c

PLANNING • DECORATING • REPAIRS, Etc.

- How to Plan a House** 525 pages.....\$4.50
- House Construction Details** Practical working guide\$3.00
- Painting and Decorating**\$1.50
- Simplified Carpentry Estimating** Rules are arranged for convenient use.....\$3.00
- Carpentry** Popular book for carpenters and apprentices\$2.00
- Steel Square Pocket Book** Describes best methods\$1.00
- Painting, Furniture Finishing & Repairing** Includes renewing of floors\$1.50
- How to Remodel a House** Nothing is omitted \$4.75

- Building Insulation** Helpful guide for home owners, builders...\$3.50
- Concrete Handbook** How to do practical and ornamental work...\$1.50
- The Home Mechanic** Covers simple repairs, upkeep\$2.50
- Blueprint Reading for Building Trades**\$1.25
- Practical Bricklaying**\$1.75
- Practical Instruction for Paper Hanging**.....\$2.00
- Stair Building**.....\$2.00
- Carpentry & Joinery Work** A beginners' text...\$4.00
- Glass & Glazing**.....\$2.00
- Drake's Cyclopaedia of Painting and Decorating**.....\$3.00
- Paintbrush Fun for Home Decoration** Create miracles of color, design\$2.50

BOOKS SENT C.O.D. ANYWHERE IN U. S. A.

You may order on post card and pay postman, plus small charge for delivery in U.S.A. Books sent postpaid if remittance accompanies order. Outside U. S. add 15% to prices shown.

POPULAR MECHANICS PRESS

Dept. 606 • 200 E. Ontario, Chicago 11, Ill.

it's fun! to make
"GOOD PICTURES"

WRITE TODAY FOR THIS 56 PAGE BOOK

IT WILL HELP YOU
 SOLVE MANY PROBLEMS

- SELECTION OF FILM
- EXPOSURE
- DEVELOPING
- ENLARGING
- FLASH PICTURES
- FILTERS & COLOR

Send 25c to
ARGUS, INC.
 Ann Arbor, Mich.
 DEPT. 6

argus

Cameras and Optical Instruments



PLASTICS

Plexiglas, Lucite, Bakelite, Lignolite, Lumarith, Ethocel, Cellulose, Acetate now available in sheets, tubes and strips. Fine assortment of sizes. No priority required. Cements, dyes and other plastics supplies, too! Send 10c today for complete Catalog!

CARMEN-BRONSON CO., Dept. 10-B
 165 E. Third St. Mt. Vernon, N. Y.

BURN YOUR NAME ON TOOLS WITH THE ARKOGRAF

PROTECT YOUR TOOLS FROM THEFT

Write with electricity any pattern design on the hand- and file-set tools and instruments, or any metal like writing on paper with pen or pencil. Thousands used by mechanics, garages, machine shops. Complete Outfit \$3.50—Prepaid Anywhere. Interesting illustrated circular free. Write today. ARKOGRAF PEN CO., 3927 S.E. Stark, Portland 15, Ore.



PATENTS — INVENTIONS

We will purchase patents, inventions, processes for manufacturing in the U. S. A. and abroad. We also offer opportunities for world-wide distribution and sale of your products and inventions.

J. J. BERLINER & STAFF
 212 Fifth Avenue New York 10, N. Y.

GENUINE U.S. BARGAINS



- Genuine Army Folding Litters, used . . . \$7.95
 - Used Cot Mosquito Nets 1.25
 - Used Army Bolo Knives with Scabbard 2.50
 - Slightly Used Army Caisson Wheels with Axles, 26" high, weight per pair with Axle, 322 lbs. \$37.50
- Thousands of Other Bargains in Military, Outdoor & Sport Goods for Hunter, Farmer, Scout. Send 10c for 32-page catalog returned with first order.

A and N SUPPLY CO.
 4720 LESTER ST. RICHMOND, VA.

OCTOBER, 1945

how long will
 your watch run
 without winding
 ?



Croton Waterproof Aquamatic Needs No Winding at all!

Ordinary watches stop running in about 36 hours. But Croton Aquamatic winds by itself—natural motions of your wrist keep it wound. Wear it night and day—it won't "run down".

13.5% MORE ACCURATE, TOO!

In a 30-day comparison test recently completed by an impartial laboratory, Croton Aquamatic achieved astonishing accuracy compared to the average of nine nationally-famous stem-wind watches. Three Croton Self-Winding Aquamatics proved 13.5% more accurate. Wear it when you swim or bathe—it's waterproof. Added features: shock-resistant, unbreakable crystal, sweep second hand, radium dial. All the things a man wants in a 17-jewel watch (plus self-winding) for only \$49.50. Fed. Tax Incl.

P. S. Write for free Booklet K19
 Croton Watch Co., 48 W. 48th St., N. Y. 19

Croton SELF-WINDING

WATERPROOF AQUAMATIC

★ SAVE WASTE PAPER ★

ANCO RAIN-MASTER

"Dead-Locker"

WINDSHIELD WIPER
ARMS and BLADES

BLADE SNAPS ON...
STAYS PUT

FINGER-
TIP
RELEASE

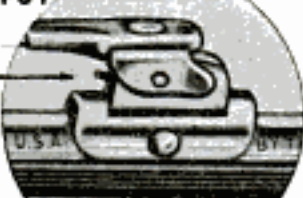

CAN'T FALL OFF
CAN'T BLOW OFF

(A war-born invention—by ANCO—first)
for military aircraft—now for your car.)

DON'T SHOOT YOUR GAS-PUMP MAN!

He's doing the best he can. Sure, he knows how dangerous it is for you to drive your car... in stormy weather... with your dull old windshield wipers that smear and smear. He'd gladly put on for you quickly a pair of keen new ANCO RAIN-MASTER Wiper Blades and Arms. He has them—Newest Models! But he forgets to remind you? Too busy? You can't shoot him for that!



After all, it's *your* car to protect. So you remind *him*. Get RAIN-MASTERS... patented features... original equipment on many makes of high grade cars and trucks... used in war—on our fighting tanks and trucks and ships and bombers too... because ANCO RAIN-MASTERS clean quicker, clean cleaner... last longer. May save you a costly smashup.

Ask for RAIN-MASTER Windshield Wiper Arms and Blades next time you buy gas.

THE ANDERSON COMPANY
Established 1918
GARY, INDIANA

★ SAVE WASTE PAPER ★

KELNOR

AMERICA'S FINEST LINE OF
LIGHTWEIGHT ELECTRIC
**SOLDERING
IRONS**

FOR CRAFTSMEN IN FACTORY
AND HOBBIY SHOPS IF YOUR
DEALER DOES NOT CARRY, WRITE
KELNOR MANUFACTURING CO.,
CENTRAL TOWER,
SAN FRANCISCO 3, CALIFORNIA

REG. U. S. PAT. OFF. PAT. APP. FOR



ANNOUNCING

Diamond Dust Mottoes
New-Different-Artistic-Salable
Best loved Scripture Verses, Artistically lettered-Radiant Colors. Big Values-Excellent profit. Send \$1.00 for \$2.00 Sample Outfit. Big Free Catalogs listing Stationery, Greeting Cards, Plaques, Books, Bibles.

GOLDEN RULE PUBLISHERS North Manchester 3, Ind.

BOYS

Ask Dad to Get
this Great Book
for You!



This big book tells and shows how to make over 450 things—useful articles for the home, toys, furniture, boats, novelties, photo equipment, electrical gadgets, etc. of the more simple, easy-to-make type. Only ordinary tools are needed. No special skill required. Tell Dad to send \$1.50 to address below NOW. We'll send Dad's money back if you and he don't think it's worth double the cost.

POPULAR MECHANICS PRESS
200 EAST ONTARIO STREET
DEPT. 615, CHICAGO 11, ILL.

Handy Mail Order List

Little Library of Useful INFORMATION

5 for \$1.00
12 for \$2.00
25¢ Each

Here at amazingly low cost is the practical help and information you have always wanted. Articles in previous issues of Popular Mechanics have been classified according to subject and are now available in these handy reprint booklets.

- | | | | | | | | | | | | | | | | | | | | | | | | | | | | | | | | | | | | | | | | | | | | | | | | | | | | | | | | | | | | | | | | | | | | | | | | | | | | | | | | | | | | | | | | | | | | | | | | | | | | | | |
|---|-----------------------|-----------------------------------|--------------------------------|--|-------------------------------|-------------------------------|--------------------|-----------------------------|-----------------------------|--------------------------------------|-----------------------------|---------------------------|-------------------------------|------------------------------|-------------------------------|-------------------------|----------------------------|--------------------------------|------------------------------|-------------------------|---------------------------|-------------------------|---|---------------------------------|---------------------------|----------------------------|----------------------------|---------------------------------|------------------------|-------------------------------|---------------------------------|-------------------------------|--------------------------|------------------------------|--------------------------|-------------|------------------|----------------------|---------------------------|-----------------------|----------------|--------------------|-----------------|---------------|------------------|--------------------|-----------|----------------|-----------------|---------------------------|----------------|-----------------|-------------------------|---------------------------|-------------------------------|-----------------------------------|-------------------------------|------------------------|---------------------------------|-----------------------------|-------------------------------|------------------------------|------------------------|-------------------------------|----------------------------|-----------------------------|--------------------|--------------------------|------------------------------|------------------------|----------------------------|----------------------|----------------------------|----------------------------|-----------------------------|---------------------------|-----------------------|------------------------------|-------------------------------|-------------------------------|------------------------------|--------------------------------|-----------------------|----------------------------|--------------------------------|--------------------------|--------------------------|--------------------------------|----------------------------|-----------------------------|--------------------------------|-------------------------------|-----------------|-----------------|--------------------|-----------------|---------------------------|--------------|-----------|-------------------|--------------------|
| How to Use Measuring Tools—
Micrometers, Calipers, etc.—
106. | Power Driven Saws—74. | Drill Presses, Grinders, Etc.—79. | Wood, Metal Turning—Lathes—81. | Filing Machine, Hacksaw, Cutoff
Wheel, Shaper—82. | Lathe Tools You Can Make—101. | Workbenches—Tool Cabinets—47. | Spray Painting—94. | From Pattern to Casting—91. | Tool and Saw Sharpening—92. | Sharpening Drills, Wood Bits—
90. | Successful Wood Turning—32. | How to Read Blueprint—71. | Metal Turning Lathe Kinks—99. | Operating a Metal Lathe—100. | Heat Treating, Hardening—102. | Working With Glass—103. | Servicing Elec. Motors—75. | Electromagnets & Solenoids—44. | Transformer Construction—41. | The Boy Electrician—43. | Soldering and Brazing—17. | Arc and Spot Welders—5. | Electroplating With Nickel, Chromium, Cadmium, Etc.—86. | Plating Leather, Wood, etc.—87. | Lower Your Fuel Costs—31. | Curing Leaky Basements—45. | Fitting Home Game Room—55. | Indoor & Outdoor Fireplaces—88. | Backyard Gardening—39. | Lawn and Garden Novelties—72. | Trellises, Pergolas, Fences—76. | Lawn and Garden Furniture—77. | Playground Equipment—73. | Concrete Garden Furniture—6. | Making Serving Trays—53. | Sanders—80. | House Wiring—89. | Pressure Finders—13. | Hanging Wallpaper—
38. | Built-in Fixtures—78. | Bird Houses—7. | Magazine Racks—49. | Clock Cases—50. | Book Ends—52. | Small Tables—54. | Smoking Stands—56. | Books—28. | Book Cases—59. | Action Toys—66. | High Flying Kites—
67. | Telescopes—20. | Metal Craft—28. | Knots and Ropework—105. | Working With Plastics—61. | Simple Home Improvements—104. | Ridding Home of Insect Pests—107. | Children's Room Furniture—51. | Jigsawed Novelties—57. | Doll House & Doll Furniture—60. | 25 Shelves You Can Make—64. | Novelties Turned on Lathe—62. | Inlay Pictures—Veneering—63. | Wood, Soap Carving—65. | Windmills & Weather-vanes—68. | Lamps from Wood, Metal—69. | Home Work Opportunities—19. | Wood Finishing—40. | Boats—14 ft. Outboard—2. | Boats—24 ft. Sail Dinghy—26. | Boats—21 ft. Sloop—48. | Rowboats, Small Dinghy—83. | Small Sail Boats—84. | Two Outboard Runabouts—85. | Build Own Canoe, Kayak—30. | Build Class-K Ice Yacht—22. | Auto Kinks, Shortcuts—10. | Building Trailers—27. | Motor-Driven Budget Cars—34. | Stop Auto Elect. Troubles—95. | Photo Printers and Dryers—25. | Photo Darkroom Equipment—96. | Trick and Table Top Photos—97. | Cosmetic Formulas—12. | Food Products Formulas—15. | Metal Plating and Coloring—21. | Re-Silvering Mirrors—70. | Chemical Experiments—93. | Log Cabins, Tourist Houses—14. | Trapping Small Animals—33. | Farm and Garden Tractors—8. | Building Extra Attic Rooms—23. | Attractive Basement Rooms—24. | Small Looms—37. | Gem Cutting—42. | Photo Enlargers—1. | Photo Kinks—95. | Cleaning Formulas—
11. | Taxidermy—6. | Magic—29. | Training Dogs—35. | Small Furnaces—36. |
|---|-----------------------|-----------------------------------|--------------------------------|--|-------------------------------|-------------------------------|--------------------|-----------------------------|-----------------------------|--------------------------------------|-----------------------------|---------------------------|-------------------------------|------------------------------|-------------------------------|-------------------------|----------------------------|--------------------------------|------------------------------|-------------------------|---------------------------|-------------------------|---|---------------------------------|---------------------------|----------------------------|----------------------------|---------------------------------|------------------------|-------------------------------|---------------------------------|-------------------------------|--------------------------|------------------------------|--------------------------|-------------|------------------|----------------------|---------------------------|-----------------------|----------------|--------------------|-----------------|---------------|------------------|--------------------|-----------|----------------|-----------------|---------------------------|----------------|-----------------|-------------------------|---------------------------|-------------------------------|-----------------------------------|-------------------------------|------------------------|---------------------------------|-----------------------------|-------------------------------|------------------------------|------------------------|-------------------------------|----------------------------|-----------------------------|--------------------|--------------------------|------------------------------|------------------------|----------------------------|----------------------|----------------------------|----------------------------|-----------------------------|---------------------------|-----------------------|------------------------------|-------------------------------|-------------------------------|------------------------------|--------------------------------|-----------------------|----------------------------|--------------------------------|--------------------------|--------------------------|--------------------------------|----------------------------|-----------------------------|--------------------------------|-------------------------------|-----------------|-----------------|--------------------|-----------------|---------------------------|--------------|-----------|-------------------|--------------------|

Check Titles Wanted, Clip, Mail with Remittance to
POPULAR MECHANICS PRESS, Dept. 605, 200 E. Ontario, Chicago, 11

POPULAR MECHANICS

RIGHT TO THE POINT!

Every "Yankee" spiral screw driver is right to the point. Every part is ingeniously designed to speed work, cut down man-hours. Pains-taking design and simple strength are typical of all "Yankee" fine mechanics' tools . . . whether Tap Wrenches, Vises, Automatic Drills, or Bit Braces.



"YANKEE" SPIRAL SCREW DRIVER No. 130A
A Size for Every Purpose

"YANKEE" TOOLS

make good mechanics better
North Bros. Mfg. Co., Phila. 33, U. S. A.
Established 1880

Makers, also, of "Yankee-Handyman" Tools



Roll Up Your Sleeves — "Head Off" Car Trouble

Yes, take the head off your motor and install new rings, "Rings made by Simplex" — the quickest and easiest way to head off motor trouble. Engineered sets designed especially for your car will stop oil pumping, quiet engine noises, restore lost power and return their cost in gas and oil saved. On sale at Auto Stores everywhere. For the best, be sure to get "Rings made by Simplex."



BUY WAR BONDS AND KEEP THEM

SIMPLEX
PISTON RINGS
SIMPLEX PRODUCTS CORP., CHICAGO, ILL.

Now-Immediate Delivery!

RADIO KITS RADIO PARTS • EQUIPMENT

• Now you can get what you want, and get it quickly! CONCORD has complete stocks of all standard radio parts required for Popular Mechanics Kits in addition to the well known line of Concord Kits. Also every kind of radio part and electronic equipment . . . standard lines, dependable quality, exceptional values. Orders from former Catalogs No. 94 and No. 345. And write for special VICTORY CLEARANCE FLYER, offering thousands of items at money-saving prices. Mail coupon for FREE COPY.

FAST SERVICE!

• Orders shipped in 24 hours from CHICAGO or ATLANTA. Amplifiers, Intercoms, etc. Now available for immediate delivery without priority.

CONCORD RADIO CORP.

LAFAYETTE RADIO CORPORATION
CHICAGO 7, ILL. 901 W. Jackson Blvd. • 265 Peachtree St. ATLANTA 3, GA.

CONCORD RADIO CORPORATION, Dept. P-105
901 W. Jackson Blvd., Chicago 7, Ill.

Please RUSH FREE Concord's Victory Clearance Flyer.

Name.....
Address.....
City..... State.....

Hunting for Help on
MODERNIZING?
— then here's first
aid for you!



LOOK FIRST TO YOUR COMFORT!

Make your modernized home comfortable in coldest weather . . . refreshingly cool in summer . . . by applying Balsam-Wool Sealed Insulation in the attic! Balsam-Wool makes homes more livable . . . provides fuel savings up to 20%.



CREATE EXTRA LIVING SPACE WITH NU-WOOD!

New rooms or partitions are quickly built with sturdy Nu-Wood Insulating Interior Finish—with its beautiful, fade-proof colors and velvety texture. Nu-Wood also insulates and hushes unwelcome noise.



SOLVE DECORATING PROBLEMS— ONCE AND FOR ALL!

Nu-Wood Interior Finish covers old walls and ceilings—comes in a wide variety of pattern combinations. Use with Kolor-Trim moldings—predecorated in harmonizing colors!



DON'T WAIT—START RIGHT NOW!

Ask your lumber dealer for full information about Balsam-Wool Sealed Insulation and about Nu-Wood Interior Finish. For additional information and literature on Balsam-Wool and Nu-Wood, mail the coupon!



WOOD CONVERSION COMPANY
210-10 First National Bank Building
St. Paul 1, Minnesota

Please send me full information on modernizing homes with Balsam-Wool and Nu-Wood. I am a
Home owner Renter Architect Contractor Student

Name.....
Address.....
City..... State.....

Balsam-Wool GUARANTEED SEALED INSULATION
BALSAM-WOOL • Products of Weyerhaeuser • NU-WOOD

★ SAVE WASTE PAPER ★



\$4⁹⁰
complete

"SERVICE PAL"
DELUXE KIT

The answer to your serviceman's "pipe dream". A grand gift—a welcome companion. All three at one special price!

PIPE Genuine Imported Shell Briar. Smart . . . sturdy . . . cool-smoking. Made from the heart of fine, aged Briar. A pipe of superb quality.

POUCH Genuine Leather (choice blue or brown), with slide fastener. Waterproof lining. Holds full pack of tobacco.

TOBACCO Honey Briar Mixture. Mild, aromatic, sweet-smoking. 1/4 lb. package.

Packed ready to ship.
No overseas request needed.
Shipped direct if desired.

Note: For \$1.00 additional, we will include Windproof Lighter with extra Flints.

SACHS PIPES, 5435 Myrtle Ave., Brooklyn 27, N. Y. Est. 1887

SHARPEN YOUR DRILLS WITH THE E-Z DRILL SHARPENER

ONLY \$2.80
Complete with Protractor



This precision fixture was developed for factory use by aircraft tool engineers. Real shop size and not a toy. Sturdily built, attaches to bench or grinder frame. Has new **PROTRACTOR FEATURE** which enables you to adjust quickly for different drill angles. Thousands now in use—home and repair shops, garages, factories, farm shops—wherever accurate holes are drilled. E-Z is simple to operate. Gives faster drilling, perfect hole centers and clearance. Guaranteed to do the work or money back.

SHARPENS ALL ROUND SHANK DRILLS FROM THE SHORTEST TO 11" LONG—3/32" TO 1 1/16" DIAMETER

SAVE MONEY WITH E-Z. Comes complete with instructions, ready to sharpen your dull drills as good as new. Low price of \$2.80 because of our volume business on this wanted precision tool. The E-Z protractor gives you proper angles for cutting extra hard material, ordinary use, for soft material, wood, Plexiglas, Lucite, Plastics. Send check or money order for \$2.80. **WE PAY POSTAGE AND SHIP IMMEDIATELY.** Write for FREE folder giving scientific data on drilling techniques.

FRED F. TEN EYCK, Dept. PB, 758 S. Irolo St. LOS ANGELES 5, CALIF.

MODEL No. 1 is already set for 59° drill angle, no adjustment needed for 99% of drills. Sturdy shop model. Postage paid \$1.98.

Sensational! New! ARC-MELT SOLDERING UNIT

THE RADICALLY NEW UNIT THAT HANDLES ALL TYPES OF INTRICATE WORK!



- This machine was developed to meet an exacting need for speed and accuracy on the most intricate work. The tip (copper-plated carbon rod) gets 'way down into smallest spaces. It may be resharpened repeatedly.
- A precision machine for smallest to heavy-duty work. Shipping weight 32 lbs. Shipped F.O.B. Dayton, send check or specify C.O.D. **\$39.85**

Adjustable wire-stripper adapter also available. Ask for information.

Heat is concentrated only at TIP . . . which becomes red-hot on contact. No current drain!

Fully tested, perfected and **PROVEN** in thousands of actual jobs! **TWENTY-FOUR** heat temperatures instantly! Use with flux, same as ordinary soldering iron. Excellent for etching on metal. Maximum secondary output 5 volts. Complete, compact, efficient . . . fully guaranteed for one year. Orders filled promptly. Order now, or request circular.

WYSE LABORATORIES
211 S. Ludlow St., Dayton 2, Ohio



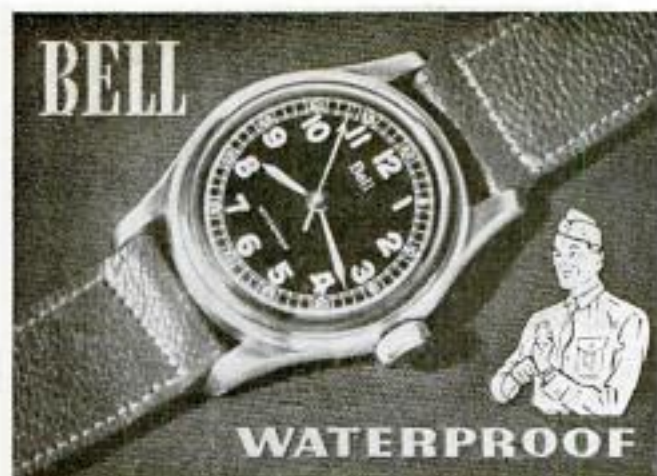

Waterproof, shockproof, anti-magnetic, radium dial and hands, unbreakable crystal, precision tested, sweep second hand.

No. YO 121 15 jewels, stainless steel back	\$39.75
No. YO 212 17 jewels, stainless steel back	\$42.50
No. YO 330 17 jewels, all stainless steel case	\$59.75

Prices Include All Federal Excise Taxes.
Postage Prepaid. Mail Orders Promptly Filled.

Write for Free Illustrated Booklet "YO"

BELL WATCH COMPANY

Time and Life Bldg., Rockefeller Center, New York 20, N. Y.

WOODWORKING IS FUN

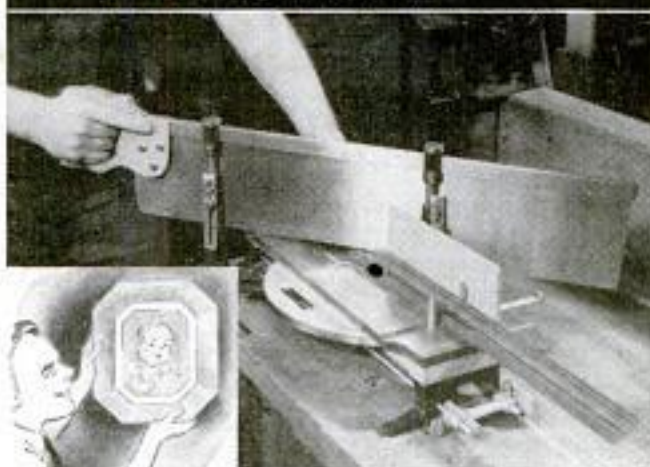

when you have a GOOD MITRE BOX

Nothing gives the craftsman more pride and pleasure in woodworking than the ability to produce neat, close-fitting, accurate joints. That's why a modern Stanley Mitre Box should be in your postwar selection of hobby shop tools.

Stanley Mitre Boxes, complete with back saw, have special features galore: two roller bearings in each saw guide - positive guide stops and depth stop plates - adjustable spurs to keep work from slipping - swivel lever automatically raises front guide and saw when changing swivel position - quadrant graduated in degrees and numbered for sawing 3, 4, 5, 6, 8, 12, and 24-sided figures - length stops for duplication.

Expert Help in Selecting Your Tools

Send for Stanley's free booklet, "The Joy of Accomplishment". It's full of helpful suggestions for the home craftsman, and includes a primary list of tools and a special list of tools to be added as needed. You'll also find the big Stanley textbook: "How to Work with Tools and Wood," constantly useful. It's yours for only \$1.00. Mail coupon today.

STANLEY

THE TOOL BOX OF THE WORLD

MAIL NOW

STANLEY TOOLS,
1105 Elm St., New Britain, Conn.

Please send by return mail -

- The FREE booklet: "The Joy of Accomplishment."
- 188-page book: "How to Work with Tools and Wood." \$1.00 enclosed.

Name.....
Address.....
City..... State.....

★ SAVE WASTE PAPER ★

BUILD THIS TUG BOAT

KIT

\$7.50



Every landlocked sailor will enjoy building this tough SEA GOING TUGBOAT for game room or study. Authentically detailed - 14" long, 7" high. Completely shaped hull - simple to build. Add 25c for packing and shipping. Big catalogue only - 10c. Address Dept. 1.

MARINE MODEL CO., INC., 29 W. 15th St., N. Y. C.

POCKET-PAL Always A Keen Edge

FOR SINGLE OR DOUBLE EDGE BLADES

• HIGH LUS. TRE CHROME FINISH—Secure spring lock in either open or closed position. Handier than a pocket knife—no bulk. Thousands of uses—cuts, scrapes, cleans windshields, rips seams—blade easily replaced. Carry POCKET PAL for a week and you'll be lost without it. Useful. Attractive. A fine gift.

J. A. NELSON MFG. CO.

222 W. Kellogg Blvd., St. Paul, Minn.

\$1.00
POST PAID

In Gold \$5.00





WONDERFUL GIFT ITEM - Ready to Mail - SELLS ON SIGHT! Patented feature (NO PEGS, MAGNETS OR HOLES) makes checkers stay on LIKE MAGIC when held upside down! STUDENTS - NEWSBOYS - WORKERS - HOUSEWIVES - CLUBS - EVERYONE! Make spare money showing this unbelievable item to friends. SEND FOR DETAILS OF PROFITABLE SALES PLAN. (Simply show your sample; take orders on special numbered forms - WE MAIL YOUR PROFIT CHECK PROMPTLY.) Beautifully made to look like REAL LEATHER, Cover Stamped in Gold. MONEY BACK GUARANTEE. ONLY 89c! PRINT YOUR NAME ON COUPON AND WE WILL SEND YOUR SAMPLE C.O.D. OR POSTPAID, AS YOU WISH.

SIDE LINE SALES CO.
Box 150, Dept. B, Hartford 1, Conn.
 SEND FREE INFORMATION, NO OBLIGATION TO ME.
 Send Non-Skid Game C.O.D., 89c, plus postage.
\$1.00 enclosed for Non-Skid Game and mailing cost.

Name.....Age.....
Street & No.....
City.....State.....



KILL RATS easily, quickly with nothing-to-mix, easy-to-use K-R-O Ready-Mixed in Bis-Kit form. A red squill product, K-R-O is safer than poison for use around humans, livestock, pets, and poultry. Two sizes: 35c and \$1. Also K-R-O Powder: 75c, at drug, seed, and hardware stores.



ANYONE CAN DO THIS IF THEY HAVE OUR CHART

SPECIAL OFFER FOR AGENTS

Blue Print 27" x 36" shows how to find length of any rafter; find any angle in degrees, frame any polygon 3 to 16 sides, read board foot and brace tables, octagon scale, rafter tables and many other uses. Can be scaled down for model work as well as full scale framing. Also Chart changing pitches to degrees for use with Radial Saws. Send 50c in Coin or M. O. No Checks or Stamps. **MASON & PARRISH ENGINEERS, 2031-B N. Burdick St., Kalamazoo 61, Mich.**

"My Son's at the Front - I'M SAVING WASTE PAPER"



"In his last letter home my son said: 'So you're saving waste paper! My food, uniforms and all kinds of equipment are shipped in paper.' And he pointed out that supplies for the Pacific have to be double and triple-wrapped in waterproof paper. The climate's so damp, and they have to guard against insects and dry rot..."

Your waste paper is needed now even more than before V-E Day. Set aside a "Salvage Corner" for your waste paper until you bundle it for collection. If you wish any more information, call your local newspaper or Salvage Committee.

REMEMBER - the War Production Board has said that the *only* way to avoid further drastic cuts in civilian paper allotments is for *everyone* to save *every scrap!*

A simple home baler will help you salvage all your wastebasket scraps. For a *free folder* describing how to make and use the home baler, address *Paper Salvage*, Washington 25, D. C.

POPULAR MECHANICS MAGAZINE

This advertisement prepared by the War Advertising Council in cooperation with the War Production Board and the Office of War Information. Space contributed by this publication.

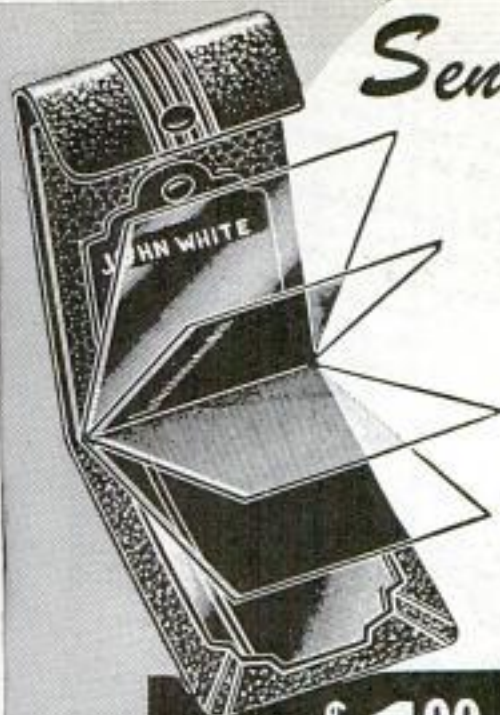

Sensational **VALUE!** GENUINE *Leather* WALLET

For Men and Women... Only \$1.00

Yours for Only \$1.00. Beautifully finished, finely stitched, a perfect gift for everyone. Genuine Leather with 8 Card Windows, Identification Card Pocket and Coin Purse. Take advantage of this Special Offer NOW! Just send \$1.00 plus 20c Federal Tax for each of these handsome wallets!

Free YOUR NAME ENGRAVED IN
22K GOLD

Only **\$1.00** ACT
NOW!

UNITED STATES STATIONERY CO.

487 Broadway, New York 13, N. Y.

Enclosed find \$..... for which send..... wallets to be engraved as attached list of names (print). Be sure to enclose \$1.00 plus 20c Federal Tax for each wallet.

Name.....

Address.....

City..... P. O. Zone No..... State.....



Build a Paying Business Now with this "Simplified" ARC WELDING

Many a war production welder is planning to open up a job welding shop of his own... a good, sound business that he knows will pay off in profits. His choice should be Hobart "Multi-Range" Dual Control Arc Welding with Remote Control...

It's "Simplified" for greater speed and better welding with less effort. No other welder can compare! Try it today!

Write for "Welder's Vest Pocket Guide," a handy booklet containing charts, tables, hints. It's FREE.

Hobart Bros. Co. Box M-195 Troy, Ohio
"One of the World's Largest Builders of Arc Welders"

HOBART
"Simplified"
ARC WELDERS



MAKE EXTRA MONEY AS SHOP AGENT FOR SCHERR TOOLS



THE REED MICROMETER

Measures to 1/10,000", with accurate vernier, in 1, 2 and 3" sizes. A modern tool to be proud of. Burnished thread, for smooth, sensitive measuring and long life. Locknut and ratchet. Accuracy guaranteed. PRICE 1" size, \$6.98 PLUS 10 CENTS POSTAGE. ORDER ONE NOW.

DIAL INDICATOR SET
Reads to .001". Set includes clamp, toolpost holder, inside measuring attachment, three contact points, ball joint back and the precision-built Scherr Dial Indicator \$18.00.

10-DAY MONEY BACK OFFER
All Scherr products carry 10-day money back offer, without conditions. Our tools must prove to you that they are as fine as we know them to be. In ordering, send money order, check, or we'll ship C.O.D. Scherr tools for export now available with metric readings if so ordered.

Your shopmates will be interested in the Scherr line of machinists tools, micrometers, combination squares, surface gages, sine bars and other specialties. Help them to buy. Prices interestingly low. Quality up to the Scherr precision standard. Deliveries immediate. No priority. Ten day examination privilege. Write now for details of the Scherr Shop Agent extra income plan, and description of this desirable line.

SCHERR TOOL CHESTS

A tool chest like this marks a good mechanic. Solid oak, 20x9x13 1/2 in. Separate locks for top section and drawer section. Price \$13.50. Other sizes available. WRITE FOR FULL DATA.



GEO. SCHERR COMPANY, Inc. 200-A LAFAYETTE STREET
NEW YORK 12, N. Y.

Men! DO YOU KNOW THESE FACTS ABOUT SUSPENSORIES?



• Many men are not even aware that a persistent, energy-draining strain on certain delicate and vital cords and muscles can cause them to tire too easily.

This strain affects office workers and laborers alike, particularly as they reach their 30's. It affects the entire system. The result is an ever-increasing fatigue; you feel "all in," fagged out.



Comfortable Support Needed

There is nothing better than a Bauer & Black O.P.C. Suspensory to help you to avoid this fatigue . . . and maintain bodily vigor. It has a soft knitted pouch, so comfortable and easy to wear that you scarcely know you have it on. Soft, elastic leg straps and waist band hold it securely in place regardless of your activity. Buckles for individual adjustment. Once adjusted, slips on or off as easily as your shorts.

Men in all walks of life—bankers, laborers, business executives, skilled mechanics and unskilled laborers—say they feel younger, peppier, less fatigued, thanks to its scientific help.

Go to your druggist today. Ask for a Bauer & Black O.P.C. Suspensory. Regular model, \$1.00—De Luxe model, \$1.25.

SEND FOR FREE BOOK, valuable information about Suspensories, and why so many men in all kinds of occupations now wear them, is given in a frank, interesting booklet, "What Every Man Should Know About Suspensories." Send for it today. There is no obligation. Simply write Dept. S-315.

BAUER & BLACK

Suspensories

Division of The Kendall Company

2500 South Dearborn Street, Chicago 16, Illinois

DIE-LESS DUPLICATING

Many small parts can be formed without dies, to duplicated accuracy of .001" with DI-ACRO Precision Machines,—Benders, Brakes, Shears. Save die expense and time delay. Ideal for experimental and research work, making samples, models, etc., as well as regular production runs.

Write for illustrated circular.
O'Neil-Irwin Mfg. Company
341 8th Ave. South
Minneapolis 15, Minn.



SHEAR

BENDER

BRAKE

CASTING RODS and FLY RODS

Plans \$1; Handle \$3.95; Cork Grip 50c; Line Guide Tip 50c; Line Guide 25c. **NEW**, a rigid Tubular Bait Casting Rod with line guides on the inside (like cut) \$6.95. Also 10-foot Tubular Sectional Still-Fishing Pole with offset handle \$8.95. Taper tempered Steel Bait Casting Rod with line guides and offset handle \$11.95. Cash or pay postman few cents extra if ordered C.O.D. (Retail and wholesale). Is your favorite fish rod handle worn or broken? Mail your handle or broken pieces to us; we will duplicate it of aluminum the same as new. Also rod and reel repairing.



Make Your Own with Our Plans and Aluminum Offset Handle.

Order from this ad, no literature available.

BISHOFF MFG. CO.

Dept. C, 9535 Ohio St., Detroit 4, Mich.

For Your Man's Xmas at home or abroad

To dad or brother, hobby or lover — your gift of a fine pipe will mark you as a "solid sender." The Biltmore Blue Ribbon is a secret-smoker, light in the tooth, cool on the draw . . . a lifetime of pleasure. Many models . . . choice century-old American briar . . . rich-grained, with a craftsmans finish.
Biltmore Pipe Co., 220 Fifth Ave., N.Y.
\$3.50



For a super special gift choose a Biltmore of Imported Algerian Briar, at \$5 \$7.50 \$10

Biltmore
"BLUE RIBBON" PIPES

LAW

STUDY AT HOME for PERSONAL SUCCESS and LARGER EARNINGS. 35 years expert instruction—over 108,000 students enrolled. L.L.B. Degree awarded. All texts furnished. Easy payments. Send for FREE BOOK—"Law and Executive Guidance."

AMERICAN EXTENSION SCHOOL OF LAW
Dept. 58-M 646 N. Michigan Ave., Chicago 11, Ill.

Always write your name and full address clearly when answering advertisements.

MOTORISTS

NOW SAVE MONEY WITH EXTRA MILEAGE



Now you can get up to 30% extra gasoline mileage with a Vacu-matic on your car. Quicker pick-up, smoother running, added power and precious gasoline savings guaranteed.

Automatic Supercharge Principle
Vacu-matic is entirely different! Operates on the Supercharge principle. Saves gas. Automatically provides a better gas mixture. Guaranteed to give up to 30% extra gas mileage, more power and better performance.

FITS ALL CARS

Constructed of six parts, fused into a single unit. Adjusted and sealed at the factory. Very quickly installed by anyone.

AGENTS TRIAL OFFER

Every car, truck, tractor a prospect. Send name, address on postcard for big money making offer and how you get yours for introducing.
Vacu-matic Co., 7617-1254 W. State St., Wauwatosa 13, Wis.

Get The **FACTS** About This **SENSATIONAL** . . .
REAL RADIAL AIRPLANE ENGINE
BUILT IN MINIATURE — WEIGHT ONLY 22 OZ.

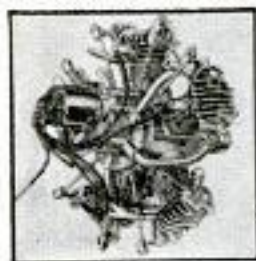

MORTON M-5, REAR

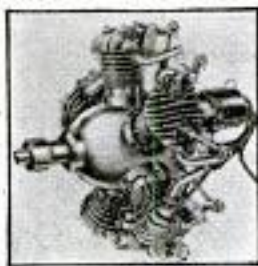

MORTON M-5, FRONT

Now You Can Have a Gas-Powered Model
THAT LOOKS — SOUNDS — FLIES LIKE REAL

The Morton M-5 Five-Cylinder Radial Engine, now in full production, is built in every respect like the real thing. **PRECISION BUILT THROUGHOUT.** Diameter only 5 3/8 inches. Every engine **TEST RUN.** Tough, fast and powerful. You'll be amazed at the **low price of this little marvel!** Send 10c for Illustrated detailed folder on M-5 Engine and Accessories, including 2 and 3 bladed **ALL-METAL, ADJUSTABLE PITCH Propellers.** Also Assembly Chart and parts price list.

MORTON AIRCRAFT CORPORATION, Dept. D 103
 3225 Harney Street, Omaha 2, Nebraska

**HOSPITAL and DOCTOR
 BILLS PAID!**



HOSPITALIZATION PLAN

POLICY PAYS
 Hospital and Doctor Bills
 up to:

\$600 Each Day \$1080.00

HOSPITAL
 Maximum Benefit for Room,
 Board, General Nursing (for
 each insured adult. Includes
 up to 90 days per year for
 Accident and up to 90 days
 per year for Sickness.

\$25 Each Week
LOSS OF TIME \$300
 From work, by Accident
 up to 12 weeks.

DOCTOR EXPENSES \$135.00
 Maximum benefit for additional
 Medical or Surgical
 care while in Hospital due to
 injuries.

\$1000.00
**Accidental Loss of Life,
 Limbs or Entire Sight**
 Many other liberal
 benefits. All as plainly
 stated in Policy.

3¢ costs about
A DAY

Don't go into debt when
 Sickness or Accident strikes.
 Be prepared—protect your-
 self **NOW!** This dependable
 Hospital and Doctor Expense
 Policy **PAYS YOUR BILLS**
FROM THE VERY FIRST
DAY of Hospitalization, ex-
 actly as provided. Also in-
 cluded are additional benef-
 its for **LOSS OF TIME** from
 work while in hospital, due
 to accident disability. Any
 recognized Hospital and any
 Doctor may be selected. Policy
 issued to Individual or
 Family. No red tape—no
 medical examination—no
 agents. Write today—**NOW!**
George Rogers Clark Casualty
Co., Rockford, Ill. Dept. 3511

MAIL COUPON NOW!

George Rogers Clark Casualty Co. Dept. 3511
 Rockford, Illinois

Please rush **FREE** information about Hospital
 and Doctor's Expense Policy.

Name

Address

City & State.....

STOP
Wasteful Leaks
in your
Heating System



EVERY crack, every
 leak, every loose
 connection or part in your furnace,
 boiler, tank, radiators, piping, wastes
 heat, uses up fuel. Seal up those leaks
 quickly, easily, as professional repair
 men do, with Smooth-On No. 1 Iron
 Repair Cement—**NOW.**

Smooth-On is easy to use as putty,
 gives lasting results. Requires no dis-
 mantling, no heat, no special experi-
 ence. Makes tight repairs, for it ex-
 pands slightly as it sets. Has been pop-
 ular for home and shop repairs the
 past 49 years. Get Smooth-On at your
 neighborhood hardware store in 1 3/4-oz.
 or 7-oz. containers or if necessary from
 us. Inexpensive—does not deteriorate.

**FREE HANDBOOK
 ON REPAIRS**

40 Pages of tested, short-cut in-
 structions for ingenious practical re-
 pairs around the home, car and shop.
 170 diagrams. Pocket size. Con-
 veniently indexed. Mail the coupon.



MAIL THIS TODAY

Smooth-On Mfg. Co., Dept. 37,
 570 Communipaw Avenue, Jersey City 4, N. J.

Yes—please mail me my Smooth-On Handbook.

Name

Address

10-43

Free

Do it with SMOOTH-ON

There are two funny things about Wilmer

The first is Wilmer's getup.

The second is that he doesn't care if he does look like a castoff scarecrow.

Because Wilmer's a lot smarter than he looks. While he's making more than he's ever made before, the dough he'd spend for a fancy wardrobe goes right smack into War Bonds . . . and for this Uncle Sam is mighty proud of him.

Naturally, you don't have to look like Wilmer . . . or tramp around in rags . . . to make your country proud of you, and your own future a whole lot more secure.

All you have to do is keep getting those War Bonds—and then forgetting them till they come due. Not bad—that four dollars for every three, and the safest investment in the world!

Why not get an *extra* War Bond today?



BUY ALL THE BONDS YOU CAN . . .
KEEP ALL THE BONDS YOU BUY

POPULAR MECHANICS MAGAZINE

This is an official U. S. Treasury advertisement—prepared under auspices of Treasury Department and War Advertising Council

1. Cleaner, cooler smoke enters your mouth, because—
2. Sensational filter whirl-cools smoke, collects flakes and slugs, absorbs juices.
3. Replace filter when discolored.

Don't Tolerate Tongue Bite. Try Milder Medico Filtered Smoking.

Frank MEDICO FILTERED SMOKING



If your dealer is temporarily out of MEDICO Pipes, remember servicemen come first!

Always write your name and full address clearly when answering advertisements.

NEW! ENGINEERS... DRAFTSMEN... STUDENTS!

MULTI Slide Rule

With **8** ADDITIONAL, EXCLUSIVE TABLES! COMPLETE WITH CASE!



\$1 POST-PAID SIZE 10" LONG x 4" WIDE

FIGURES ANYTHING! ANYONE CAN USE IT!

YES, you get everything that's on an ordinary Slide-Rule PLUS 8 additional EXCLUSIVE tables not found on any other Slide-Rule:

1. Four-place LOGARITHM TABLE
2. VALUE assumed by trigonometric functions
3. Table of NATURAL TRIGONOMETRIC FUNCTIONS
4. Table of TRIGONOMETRIC FORMULAE
5. Table of SLIDE-RULE SETTINGS
6. Table of GENERAL EQUATIONS
7. Long list of common MATHEMATICAL FORMULAE
8. DECIMAL equivalents of a fraction

A genuine technician's scale—not a toy. Full instructions for use. Fits E-ring binder. Tough, sturdy for long wear. Clear legible print. PLASTIC SLIDE INDICATOR. Send only \$1 today. Do not send stamps. Biggest slide rule bargain ever offered. Supply limited. Order at once.

MULTI-SLIDE INSTRUMENT CORPORATION
P. O. BOX 5038, DEPT. B, CHICAGO, ILL.

★ SAVE WASTE PAPER ★



Now THE BATTLE-PROVED "TOUGH-TEST" WATCH

Now available, the watch to wear *all* the time—dress or work or sport—because it was created for military dress wear *plus* battle use (and proved in fox-holes). It's absolutely WATERPROOF, super-SHOCK-TOUGH (shatterproof crystal and sealed-in, shock protected, guaranteed 17 jewel movement) and ANTI-MAGNETIC. Yet it's a handsome dress watch. Now it's available to you at a special low price—but only direct from our New York showroom. Send for detailed, descriptive literature or send \$32.95 (tax included) and we mail watch anywhere in the world with unlimited 30 day money-back guarantee.

LAMONT

Internationally famous

Watches

New York Office—Dept. A
597 Fifth Avenue, New York 17, N. Y.

WORLD'S LOWEST PRICED ADDING MACHINE

VEST POCKET SIZE

FREE TRIAL
ONLY \$2.50
TOTAL
COST
SEND NO MONEY

FREE!!

• Each Baby Calculator enclosed in beautiful rich-looking Leath-ette Case—at no extra cost.



• IDEAL
XMAS
GIFT

Fits vest pocket or purse. Guaranteed Accurate Operated as easily, and as reliable, as machines costing many times as much. *NOT A TOY OR GADGET.* Substantially made of 28-gauge steel—guaranteed for life against defects in construction. Beautiful looking, modernized design. Finished in Rich Maroon and Silver. You positively can't buy a Calculator of equal quality for as little money. *ACCEPTED AS THE FINEST LOW PRICED CALCULATOR FOR OVER 30 YEARS!* Operates with a flick of your finger. Adds, subtracts, multiples, divides—counts up to ten million. Pays for itself over and over in mistakes avoided, and time saved.

MAKES IDEAL GIFT

Baby Calculator makes an ideal gift—for every Gift occasion. Birthday—Graduation—Christmas—Anniversaries. For men, women, children—teachers, business people, home or shop use.

TEN DAY TRIAL—Money Back Guarantee

Because we know that our machine is the very best Calculator to be obtained at this low price, we make this 10 Day Trial offer, on a positive money back guarantee!! Don't buy ANY Calculator without this guarantee! Send only name and address, pay postman \$2.50 plus postage (if cash is sent, we pay postage—you save up to 40c). (Send full cash if outside U.S.) Money back within 10 days if not delighted.

AGENTS WANTED

CALCULATOR MACHINE CO. (Mfrs.)
DEPT. 171, P.O. BOX 1118, CHICAGO, ILL.

USE COUPON

CALCULATOR MACHINE CO. (Mfrs.)
P.O. Box 1118, Dept. 171, CHICAGO, ILL.

Your Calculator is just what I've been looking for. Send one at once (C.O.D.) or (I am enclosing \$2.50).

Name.....
Address.....
City..... State.....

Say you saw it in Popular Mechanics!

PIB ALL-PURPOSE
LIQUID INSULATION



Keeps the "KICK"
in Batteries!

fights corrosion—saves "juice"

PIB, new miracle liquid insulation, makes all types of batteries last longer by fighting corrosion and shorts between terminals. **PIB** insulates motors and wiring in commercial and home shops, moisture-proofs all types of ignitions, helps start rain-installed engines.

PIB is so effective it's used on engines of Army and Navy vehicles during amphibious operations. **PIB** flows easily... penetrates... dries pliable... endures. Use on any gasoline or electric motor... industrial and farm machinery... home appliances, boats, planes.

1 TREATMENT FOR 6-MONTH SAFETY!

1-oz. bottle... 75¢ 4-oz. bottle... \$1.50

Send TODAY for FREE booklet on PIB

U. S. Industrial Chemicals, Inc., Dept. D-4,
60 E. 42nd Street, New York 17, N. Y.

Ask for PIB at service stations—
hardware, electric, dep't stores!



RAPID PLATING EQUIPMENT

Has contributed to nearly every major wartime development, and is now being made available for civilian use. See your dealer or write for catalogue. • BRUSH PLATING KITS • SMALL TANK PLATING UNITS • SPECIAL HEAVY DUTY PLATERS. Complete kits (less batteries) at \$1.50 per kit and up. Unconditionally guaranteed!

RAPID ELECTROPLATING PROCESS, INC.
1414-A SOUTH WABASH AVE., CHICAGO 5, ILL.

Your Rust Troubles are Over CORODEX Rust Remover

is the war-time miracle liquid heretofore sold only to war plants. **CORODEX** positively removes RUST AND CORROSION from iron, steel, brass, bronze, copper, chromium and nickel, regardless of depth, renewing tools, hardware, sports equipment, household utensils, etc., thus salvaging easily, with slight effort, many articles for future use—for a few cents. See notice "NEEDLE'S EYE", December 1944 issue.

• Ask your dealer or send \$1.00 for full quart F.O.B. Chicago. Valuable "MANUAL OF RUST CONTROL" included with order.

ALLIED PRODUCTS COMPANY
1133 NEWPORT AVENUE, CHICAGO 13, ILL.

WAR SURPLUS BARGAINS

* * * * *

SENSATIONAL VALUES FOR QUICK LIQUIDATION



GI BELTS

Of heavy canvas webbing. Adjustable in size. Snap-on buckle. Eyeslets all around. Used, but guaranteed. **A131—EACH..... 98c**

BANDOLEERS



Army Bandoleers of heavy khaki. Used by hunters, boy scouts, etc. Well made, serviceable, guaranteed new. **A129—11 POCKET, EACH..... 49c**



Mess Kits

Regulation Army Mess Kits. Ideal for campers, boy scouts, etc. Slightly used but guaranteed perfect. Two pieces. Folding handle. **A116—EACH..... 69c**



Regular U. S. Gov't issue canteens. Plastic screw top cap chained to body. Slightly used.

A117—METAL BODY, Each..... 69c
A118—PLASTIC BODY, Each..... 69c
A119—Canteen Covers, Each... 35c
A120—Canteen Cups, Each... 25c



U.S. Govt. BOLO KNIFE

Extra heavy. For farm, home or jungle use. Blade of Gov't. Formula cutlery steel. Walnut riveted handle. 3 1/2 inch hilt. 10 1/2 inch blade. You'll find hundreds of uses for a Bolo knife. Blade will take and hold a keen cutting edge. Wt. 2 lbs.

A112—with Army Sheath..... \$4.95

A212—Leather Sheath, extra..... \$1.50



PUP TENTS

Regulation Army Pup Tents of durable, brown canvas. Used, but in good condition. Fine for campers, outdoorsmen, boy scouts, etc. Grand Xmas gift for children.

A100—Tent Only..... \$4.95

A101—Ropes, wooden poles and stakes for above. Per set..... \$1.00



SHIPS BELLS

Purchased from U.S. Maritime Comm. Measures 10 inches high, 9 3/4 inch flare. Big 6 inch clapper. Weight 15 lbs. Fine for farms, clubs, estates, etc. All new. **A841, ONLY... \$9.85**



HEAD NETS

Real protection from insects, etc. Fits over hat. Draw string in set. Celluloid window. For campers, fishermen, etc. **A509, ONLY... 89c**



BLITZ CAN

Standard Gov't. blitz cans. Used and scuffed but guaranteed leak-proof. Measures 18 1/2 x 13 1/2 x 6 1/2 inches. Welded seams. Screw cap. Capacity 5 gal. A splendid bargain. **A542—EACH ONLY..... 85c**



CAVALRY SPURS

Genuine wishbone type cavalry spurs. Nickel-plated brass. **A102, Pair... 98c**
A103 Spur straps per set of four..... 50c



CATHODE RAY TUBE

Purchased from U.S. Gov't. for experimenters in electronics, radar, etc. Slightly used for test work. Guaranteed perfect. Tubes are standard No. 58P1 or 58P4 with 5 inch screen. Each tube tested before shipment. Specify number when ordering. Tube list on request. **EACH, express collect..... \$12.00**



RADIO HEAD PHONES

Extremely sensitive with 4000 ohms resistance. Brand new and fully guaranteed. With moisture-proof cord and phone plug. A splendid value for the radio serviceman and experimenter.

A106—PAIR..... \$2.95

7-LB. RADIO PARTS ASSORTMENT

A "gold mine" for the Radio Service Man. Hundreds of valuable radio parts, including rivets, soldering lugs, sockets, coils, resistors, trimmer condensers, etc. **A130R—7 LBS. \$1.79**

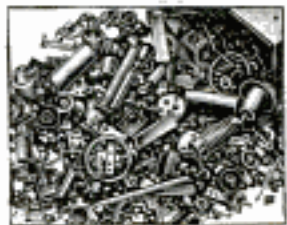

RUBBER CUP WITH LID

Measures 3 5/8 x 3 1/4 inches—of genuine live rubber. Snug fitting lid. Makes fine tobacco humidifier, etc. All guaranteed perfect. **A503—EACH..... 59c**

AMMUNITION BOX

Fine for storing valuables, carrying lunches, etc. Of heavy gauge metal 7 1/2 x 11 x 4 inches. Fire-proof. Hinged lid with folding handle. Olive drab finish. Used, but perfect. A splendid value. **A525—EACH..... 85c**



PLASTICS LUCITE AND PLEXIGLASS

In sheet form. Good workable size. Transparent. For costume jewelry, etc. Easy to work and polish. **A280—5 LB. \$4.75**
A88T.....

CATALAN—ASST. COLORS

Extruded shapes, rounds, half rounds, etc. Easy to machine. Furnished in assorted colors, shapes and lengths. **A281—5 LB. \$4.75**
A88T.....

27 LENSES, ALL NEW, PERFECT. For experimental work in optics. Consists of 27 precision ground and polished prisms and lens elements in assorted diameters and focal lengths. Big variety, positive, negatives, etc. Actual value over \$100.00. **A519—27 PIECES..... \$7.95**



50 LENSES, SEMI-FINISHED

Lenses similar to above but not polished. All are blanked and formed ready for polishing. Negatives, positives, and prisms in Crown and Flint glass. Worth many times this low price. **A520—50—LENSES, ONLY..... \$1.95**

BICYCLE DUFFLE BAG

Heavy canvas pouch. Attach to bicycle for lunches, shopping, books, etc. Has three 11 x 12 inch pockets. Used, and slightly soiled, but in good usable condition. Has oversize flap with two strap fasteners. **A113—EACH..... 98c**

COMB. AIR PILLOW-LIFE BELT

Every outdoorsman, hiker, camper, boy scout, etc., should have one. Made of air tight, waterproofed, rubberized khaki 10 x 40 inches when deflated. Swimmers, boatmen, etc., use them as life-belt or beach raft. Quickly inflated or deflated. Folds compactly for storage. Used, but guaranteed perfect. **A127—EACH..... 98c**



SADDLE BAGS

Made of finest top grain leather. Rivet reinforced seams. Bottom and side gussets. Each canvas lined bag measures 12 x 13 inches.

Fine for motorcyclists. May be separated to make two duffle bags. Used, but perfect. **A151—EACH..... \$7.95**



OFFICERS WATCH COMPASS

Brand new gov't surplus Army-Navy model. Single jewel mounted needle. Silver colored dial. A splendid value. **A174—EACH... \$3.35**



AVIATORS GOGGLES

U. S. Aviator Goggles. Over-size design with sponge rubber shock lining. Curved lenses. Elastic head band. Fine for industrial use, motorcyclists, etc. Hinged nose arch. Slightly used, guaranteed perfect. **A159—PAIR..... \$5.95**

"MIKE" BUTTON

Microphone button for experiments in electronics and other electrical apparatus. Used in telephone, amplifier and detection circuits. Measures 2 1/2 in. Brand new. **A512—EACH... 98c**



ORDER DIRECT FROM THIS AD

Values galore! Hundreds of hard-to-find items for home, shop and outdoors. Make remittances by money-order, bank draft or personal check. Send 25% deposit on C.O.D. orders. No C.O.D.'s on orders for less than \$5.00. Include sufficient postage on parcel-post orders—any overage will be promptly refunded. All quotations F.O.B. Chicago. Used items and materials are guaranteed serviceable and as described. Your money back if not more than satisfied.

BIG ILLUSTRATED CATALOG FREE

STARK'S Dept. PM10
 509 So. State St.
 CHICAGO 5, ILL.



SHIPS LANTERN

Purchased from the Navy. Stands 22 1/2 inches high, 9 1/2 inches wide. Of heavy sheet metal. Windproof ventilation. Mounts on any wall. Burns oil—may be wired for electricity. All new. **A516—EACH... \$12.50**

CORK FLOAT

Measures 5 1/2 by 3 ins. Solid cork. Used as buoy, also for deep sea live bait fishing or Muske-longe boat. White and red finish. New. **A161—EA... 75c**



CAMERA TRIPOD

Purchased from U.S. Gov't. For cameras up to 5x7 in. Extends to 39 inches. Folds to 23 inches. Has 5 1/2 inch brass head with extended threading screw. Extra sturdy design. Adjustable. Brand new. **A159—EACH... \$4.95**

\$75,000 for boy MODEL BUILDERS

8 UNIVERSITY SCHOLARSHIPS

588 CASH AWARDS

36 CONVENTION TRIPS

Here's the biggest news you've read in a long time. You are eligible to try for these awards in the TWO competitions listed below—if you reside in the United States and are between the ages of 12 and 19 inclusive.

1. NAPOLEONIC COACH COMPETITION—316 awards, including two \$5,000 and two \$3,000 scholarships. In this, you build a miniature model Napoleonic Coach to plans we furnish you.

2. MODEL CAR DESIGN COMPETITION—316 awards, including two \$4,000 and two \$2,000 scholarships. All you do is make a solid model automobile embodying your own ideas of motorcar design.

Rules are simple and fair

In both competitions the following regulations will prevail. Boys 12 years old, or older, but not yet 16 by September 1, 1945, compete in the Junior Division. Boys 16 years old, or older, and not yet 20 on September 1, 1945, compete in the Senior Division. All boys within these age limits are eligible to Guild Membership. There are no dues or entrance fees of any kind. Each member shall receive, without charge, an official Guild membership card and button, and a full set of Guild drawings and instructions. Both competitions close July 15, 1946, and are open to all boys within the age limits, including the sons of General Motors employees. In all cases where the son of a General Motors employe qualifies for an award, duplicate awards will be made.

FISHER BODY CRAFTSMAN'S GUILD

An educational foundation sponsored by
Fisher Body Division of General Motors

General Motors Bldg., Detroit 2, Michigan

Gentlemen: Please enroll me in the Fisher Body Craftsman's Guild for 1946, in the

Napoleonic Coach Competition

Model Car Design Competition

Send me full instructions without charge

Name _____

Address _____

City _____ Zone _____ State _____

I was born on the _____ day of _____ 19____

Name of parent or guardian _____

★ SAVE WASTE PAPER ★



"Safety On The Bottom"

Enjoy underwater sports, photography, diving, fishing, boat and dock inspection with

THOMPSON Shallow-Water DIVING APPARATUS

Simple, safe, easy to use. No upsets. Used by professional divers and amateurs.

Send 25¢ for Diving Decompression Calculator

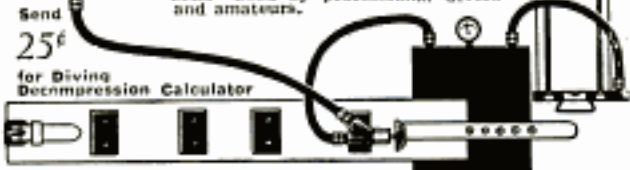

The Thompson Engineering Company
200 N. Division Bldg., Grand Rapids 2, Mich.

RAFTER LENGTHS. A new vest pocket book for the carpenter, estimator. Gives lengths, Side cuts, Plumb cuts, Deductions. For all your rafters to fit any building from one inch wide to forty feet wide. Gives the numbers to cut on the square. Also gives degrees for same cuts for Radial Saws. All standard pitches from 1/4 to 3/4 are given. Just open book to pitch page and there in plain print are your lengths, side cuts, etc. Any one who knows what a jack rafter is can frame a roof correctly if he has this great book. Price one dollar, prepaid.

BUILDERS' TOPICS. Dept. M, Med. Arts Bldg., Seattle 1, Wash. Original teachers of the square in five easy lessons, by mail. Send for FREE list of plan books—Kamp Kabins to Mansions.



RADIO & ELECTRONIC HARDWARE KIT—\$2.00

● Full 2-lb. practical assortment for radio repair shop or home use—all new, hard-to-get items—brass bushings, geared shafts, spacers, springs, standard self tapping screws, bolts, nuts, useful wire, parts. **MONEY BACK** if not pleased. Send \$2 cash, check, M.O.; save C.O.D.

All types Radio and Photo-cell tubes now available—write.

DAVIS & MURPHY, DAVIS BLDG.
5252 Broadway, Chicago 40, Ill.

NEW TOOL READY!

War Industry's Handiest All'Round Machine

Now Available
To Home Shops!

The world-famous Mead Bandsaw—*invented for and used by hundreds of war plants—is at last available to you for home workshop use!* This remarkable machine quickly shapes, sands, carves and polishes wood, metal, plastics! Works equally well on inside cut-out openings or irregular outside edges. Gets at places no other can! Tilting table for bevelling, chamfering. Rust-and-sweat proof top. Ball bearings. Saves time, labor, money on jobs in any home or industrial shop. **Invaluable to home-craftsmen, makers of patterns, tools, dies, signs, costume jewelry, castings, forgings, ornaments, radio and electrical parts, stampings, etc. Nothing else like it.** Sold on 5 Day Trial, money back guarantee. Colored Circular Free!

QUICKLY SHAPES, SANDS, CARVES, GRINDS, PROFILES, CLEANS, SMOOTHS, and POLISHES WOOD! METAL! PLASTICS!

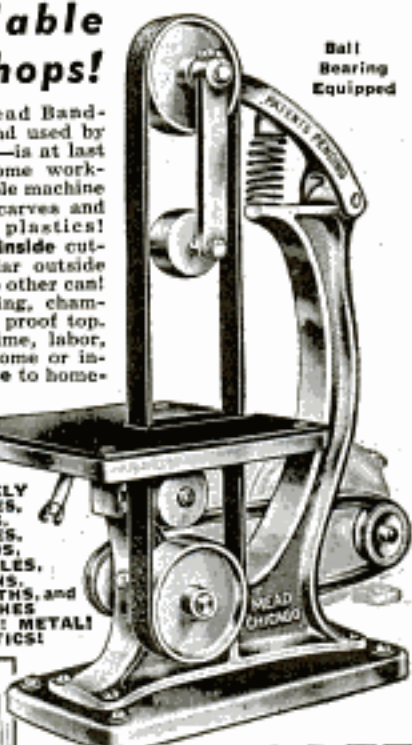

WRITE NOW for **FREE**

Details on "the machine that amazed the experts!" Rush a postcard today for Circular, surprisingly low price. **Hurry!**

MEAD SPECIALTIES CO.
414 N. Knox Ave., Dept. 110, Chicago 41, Ill.

Now A DYNAMIC HEAVY DUTY INDUSTRIAL WELDER

Available Now Without Priorities!

TO SAVE YOU VALUABLE TIME and MONEY!

Designed to Do High-Grade Welding *Inexpensively*

Maintenance men, farmers, mechanics, machine shops, foundries, auto, general repair and job welding shops using the DYNAMIC WELDER find it so indispensable and useful that they cannot afford to be without it. If inexperienced you can easily learn to do a variety of high-grade welding jobs by following the practical, simplified operating and welding instructions furnished.

WORKS ON IRON, STEEL, BRASS, BRONZE and OTHER METALS

Has eight metallic and carbon arc welding heat stages. Does work you would think only possible with a larger, more expensive machine.

READ WHAT USERS SAY...

Repair Shop Owner says, "It will do more than you say"

"I want to say I operate a repair garage and am more than satisfied with the welder. It will do more than you say." C. P., Butler, Ohio

It's the Greatest Portable Outfit

"Now I am equipped for all kinds of welding and I must say it's the greatest portable outfit for welding any man could ever wish to own. I wouldn't sell mine for the cost of plenty welders I have seen which were very high in cost but not in convenience. You may put me on file as a booster of your wonderful welding product." W. J. B., St. John, N. B., Canada

Better Than I Expected

"I have done quite a little welding with my welder and will say it is better than I expected. The price, convenience, and variety of work that can be done with the Dynamic are the attractive points." W. R. P., Portland, Ore.

EASY TO OPERATE!

DYNAMIC SUPERCHARGED WELDER

GET DETAILS ON OUR 10-DAY TRIAL OFFER!

Once you see a DYNAMIC in operation you won't want to be without it. Its simplicity will amaze you. In a year the DYNAMIC only costs you about 6c a day. Comes complete, ready to operate, with helmet, rods, cables, electrode holder and operating instructions, etc. Nothing else to buy. Write today for Free particulars. Act now and get details on our amazingly low priced Dynamic Welder and 10 day trial offer.

DYNAMIC WELDER CO.

13 East 23rd Street—CL

CHICAGO 16, ILLINOIS

FOR ONLY
\$23⁵⁰

COMPLETE

AMAZINGLY SIMPLE TO OPERATE!

This portable Dynamic Welder, easily carried right to the job, can be operated from any convenient, properly wired 110 Volt 60 cycle line. Can also be supplied for 220 Volt 60 cycle operation and for other voltages and cycles at slight additional cost.

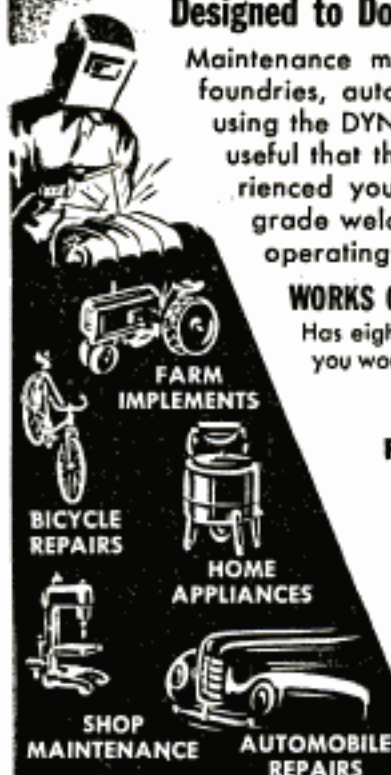

FARM
IMPLEMENTS

BICYCLE
REPAIRS

HOME
APPLIANCES

SHOP
MAINTENANCE

AUTOMOBILE
REPAIRS





**PLAN YOUR
HOME
WORKSHOP
NOW!**

The home workshop you have been dreaming about may become a reality sooner than you think, if you make your plans now. First thing to do is to draw a floor plan to scale showing the locations of all machines, benches, tool cabinets, and shelves. You can then decide on the equipment you want to install.

You will want to include a South Bend 9-inch Lathe. This fine precision tool has long been considered basic equipment for the better shops. No single piece of equipment will give you greater satisfaction or pride. With it you can perform a wide variety of operations (turning, boring, drilling, cutting screw threads, milling, polishing, etc.) on metals of all kinds, wood, plastics, and similar materials.

Although most of these lathes are now shipped on priority orders, non-rated orders are being accepted for post-war delivery. Available in five sizes, 9" to 16" swings. Write for catalog, stating size in which you are interested.



Lathe Builders for 38 Years

SOUTH BEND LATHE WORKS
455 EAST MADISON STREET SOUTH BEND 22, INDIANA

PRINTED BY POPULAR MECHANICS COMPANY, CHICAGO, ILL., U. S. A.

9-INCH LATHE FEATURES

Fine workmanship by highly experienced machine tool craftsmen
Superfinished spindle with large bearings
Belt drive for smooth, quiet operation at high speeds
Back-gear drive for power and low speeds
6, 8, 12 or 16 spindle speeds
Thread cutting range — 4 to 224 per inch, 48 pitches
Precision lead screw for thread cutting
Worm drive and friction clutch for power longitudinal and cross feeds
Three hand-scraped V-ways and a flat way on bed insure perfect alignment of headstock, saddle and tailstock



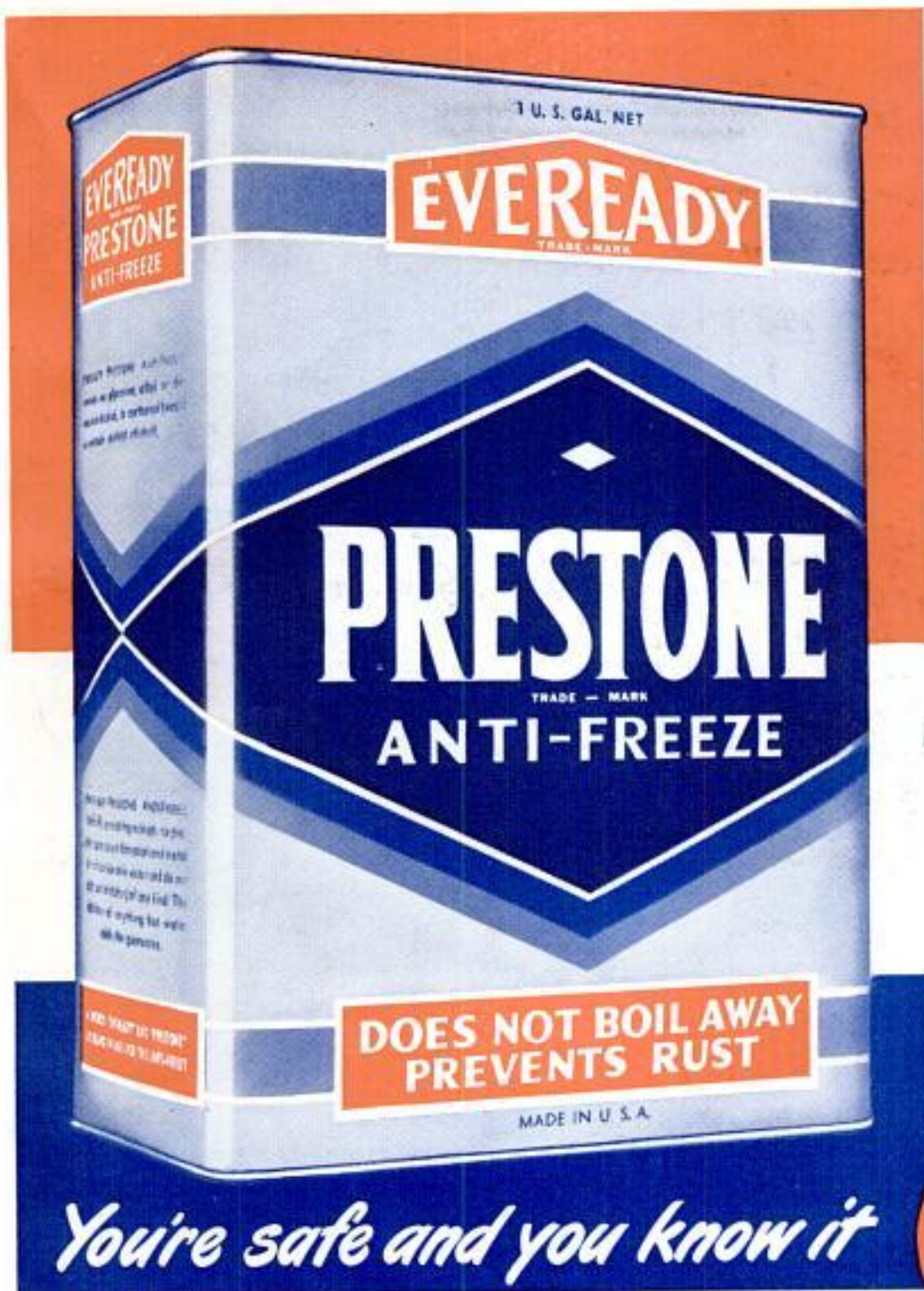

ONE-SHOT ANTI-FREEZE

Protects
the Equipment
of the
Armed Forces

You know these
uses:

- ✓ tanks
- ✓ trucks
- ✓ jeeps
- ✓ bulldozers
- ✓ cranes
- ✓ tractors
- ✓ air compressors
- ✓ P.T. boats
- ✓ landing vehicles
- ✓ gun motor
carriages
- ✓ planes—
Mustang
Lightning
Kittyhawk
Tomahawk
Warhawk
Airacobra

Do you know these?

- anti-aircraft gun
recoils
- aircraft catapults
- sound detection
equipment
- liquid-cooled
machine guns
- anti-aircraft
searchlights
- aerial gunnery
trainers
- hydraulic arresting
gears (aircraft
carriers)
- submarine diesel
engines

O.P.A.
Retail Ceiling Price

\$2.65

per gallon

SAME PRODUCT
SAME PRICE

You're safe and you know it

This year, again, there's a limited supply of "Prestone" anti-freeze—limited due to continued needs of our Armed Forces for one-shot cooling system protection.

The sooner you see your dealer, the better your prospects. "Prestone" anti-freeze will not evaporate, boil away or foam off. It protects against rust and corrosion. One shot lasts all winter — with "Prestone" anti-freeze in your car you're safe and you know it!

How anti-freeze is being distributed this year

To protect the nation's motor vehicles, the War Production Board, with the help of the Anti-Freeze Industry Advisory Committee, set up a state allocation plan for the distribution of all anti-freezes. This plan is intended to assure motorists of some kind of anti-freeze protection. Some "Prestone" brand anti-freeze will be available in all communities.

NATIONAL CARBON COMPANY, INC.
Unit of Union Carbide and Carbon Corporation



The words "Eveready" and "Prestone" are registered trade-marks of National Carbon Company, Inc.



in partnership with progress:



THE NEW
Lifetime[®]
POINT

THE WHITE DOT
ON THE PEN
IDENTIFIES IT!

New "TRIUMPH" Pens

New Finesline Pencils

These are the pens and pencils that are going to the men and women in the Services overseas. Quantities available for civilians are very limited.

Ever wonder why so many men who do things better—who set the pace for progress—use Sheaffer writing instruments? It's because these finest of pens and pencils likewise do things better—look better, stand up better, write better! You'll see how and why this is true—how Sheaffer sets the pace in writing progress—if you will examine a Sheaffer "TRIUMPH" pen or Finesline pencil—compare part-by-part and feature-by-feature with any others. Do this—and let your own good sense of value decide the best writing instruments for you. W. A. Sheaffer Pen Co., Fort Madison, Iowa, U.S.A., and Tor., Can.

VALIANT "TRIUMPH" pen, \$12.50; pencil, \$5; complete set, \$17.50. Other sets, \$3.95 to \$150. Other pens, \$2.75 to \$100. Colors: Golden Brown, Marine Green, Carmine, Grey Pearl and Black. Federal excise taxes additional.

LISTEN EVERY SUNDAY to SHEAFFER'S WORLD PARADE—NBC Complete Network, 3 P.M., E.W.T.; 2 P.M. C.W.T.; 1 P.M. M.W.T.; 12 P.M. P.W.T.



SHEAFFER'S

Copyright 1945, W. A. Sheaffer Pen Co. *Trademark Reg. U. S. Pat. Off.

Copyrighted material