

POPULAR MECHANICS MAGAZINE



WRITTEN SO YOU CAN UNDERSTAND IT

REG'D. TRADE MARK, GREAT BRITAIN, No. 40424

REG. U.S. PAT. OFF. 1957

MARCH
25 CENTS
30c IN CANADA



ROCKET-FIRING LCVP
PAGE 1

SNIPING THE SNIPER

LET'S FINISH THE JOB

Buy Extra War Bonds



DEAN
CORN-
WELL

WHERE HAVE WE MET BEFORE?

IT was at Tarawa — on the beach at Anzio — in Normandy — in bombers over Berlin — in tank battles, dog fights, and on the high seas — on every fighting front.

These are the recent places where the craftsmanship symbolized by this emblem has been meeting up with the men who are winning the war. And every day sees a new meeting on other fronts as the output of Fisher Body factories moves into the battle lines.

Major assemblies for the B-29 and other bombers, delicate aircraft instruments, big guns of various calibers, tanks — the flood of Fisher Body armament knows no end until final victory.

The Army-Navy "E" flies above six Fisher Body plants for excellence in aircraft production and from two others for tank production, while the Navy "E," with five stars, is flown by still another Fisher Body plant for its naval ordnance work.

Into every single piece go the skills and techniques that have always made the Fisher Body coach a symbol of fine craftsmanship throughout the length and breadth of our land.

Every Sunday Afternoon

GENERAL MOTORS SYMPHONY OF THE AIR
NBC Network

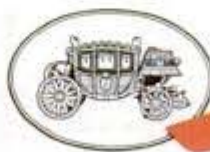

armament
BOX BY

Fisher

D I V I S I O N O F G E N E R A L M O T O R S

Ingenious New Technical Methods

Presented in the hope that they will
prove interesting and useful to you.

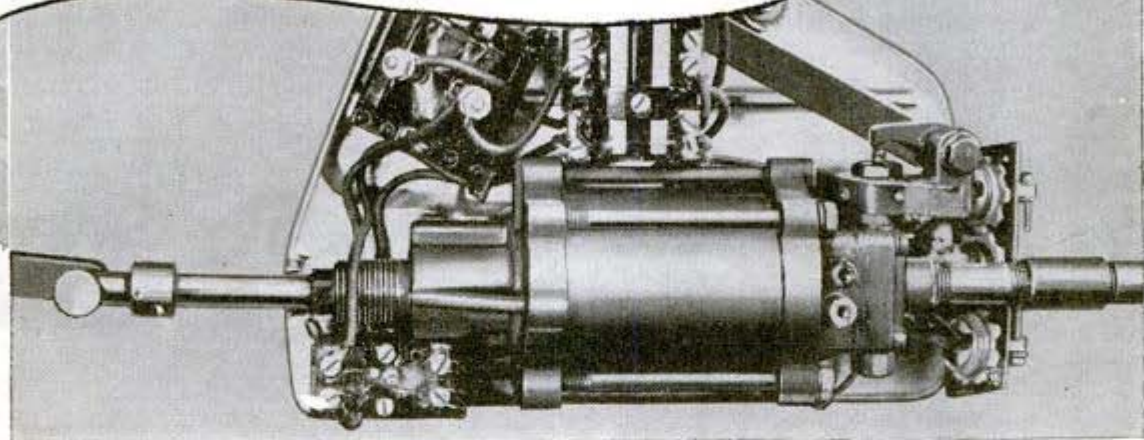

New Electroaire Power Unit Converts Standard Drill Press to Automatic

This exact control over feed and retraction speeds permits ready conversion of a standard drill press with tapping head into an automatic tapping machine, capable of producing Class III threads, even with comparatively unskilled operators. By adjusting speed to conform to the lead pitch of the threads being tapped, the tap will cut without forcing threads, and on the reverse the tap will actually "float" out of the part with no strain against the thread angle.

Air-powered jigs and fixtures can be opened, closed, and indexed by the Electroaire Power Feed. The unit can be set for a predetermined number of cycles so that multiple holes can be drilled in the same piece without ejection, by means of an indexing fixture controlled and synchronized by the Electroaire Unit. One operator can run as many as two or three drill presses, turning out top-quality work with few rejects and with a minimum of tool breakage, thus effecting a great savings in time.

Present stockpiles of finest quality materials used in the manufacture of Wrigley's Spearmint chewing gum are now exhausted—necessitating discontinuance of production. When a supply of proven materials—known to be up to the finest standards of quality—is again available, Wrigley's will resume production—And Wrigley's Spearmint will be back to again help you on your job. In the meantime they are manufacturing a war brand. Wholesale but not excellent enough for the Wrigley brand name.

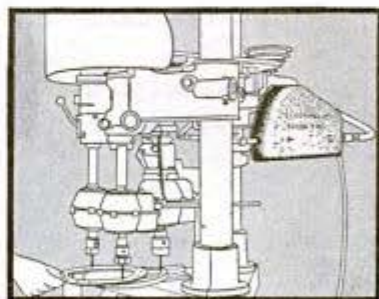

Set up to punch 3 holes simultaneously

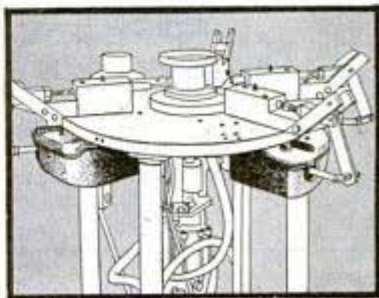

Shows holes being drilled
automatically

You can get complete information from Electroline Manufacturing Company, 1975 East 61st Street, Cleveland 3, Ohio

MARCH, 1945

This One



B57N-AGD-P4FL

Z-58

1A

A MODERN SYLLOGISM

MAJOR PREMISE:

Bell Telephone System serves the American Public.



MINOR PREMISE:

Bell Telephone Laboratories develop the facilities of the Bell System.



CONCLUSION:

Therefore, Bell Laboratories serve the American Public.



And that is the *raison d'être* of the Laboratories. For the Bell Telephone System, the Laboratories carry on research studies in all the sciences and development work in all the engineering arts that relate to electrical communication.

For the Western Electric Company, the manufacturing unit of the System, the Laboratories

develop equipment, prepare specifications for its construction, and engage in various engineering activities.

For the Armed Forces of the United States, under contracts of the Western Electric, the Laboratories have undertaken more than a thousand development projects — many with spectacular effect upon our enemies.



BELL TELEPHONE LABORATORIES explore and invent, devise and perfect for our Armed Forces at war and for continued improvements and economies in telephone service.

Popular Mechanics Magazine

Registered in U. S. Patent Office and Canada

H. H. WINDSOR, Founder

H. H. WINDSOR, Jr., Editor and Publisher

March, 1945

Vol. 83, No. 3

Next Month

OLD-TIMERS in the Coast Guard consider the year-around Greenland patrol just about the toughest assignment in the 155 years that branch of the service has been in existence. When the Germans gobbled up Denmark, they may have figured its Arctic possession, Greenland, would fall plum-fashion into their mitts. About that time Rear Admiral Ed "Iceberg" Smith of the Coast Guard swung into action. The result is one of the epic stories of the war—a fight against blizzards, shifting ice and Nazis to establish weather bases for the Allies along the ferry-plane route to Europe. "Watch Over Greenland" appears in the April issue.

TNT Special

THE bombs dropped on a single 1,000-plane raid would fill a freight train three miles long. Like every other kind of ammunition, from incendiary bullets to rocket shells, those bombs made part of their trip to the enemy via the railroads. How trainmen handle the "TNT Special" from inland storage depots to ports of embarkation is told for the first time in the April issue.

W-A-R Calling

EIGHT to nine million words a day crackle out over the ether waves from Station WAR, the War Department's Signal Center which is the heart of the largest radio network in the world. Remote outposts in the Pacific are only a few minutes away by radio-telegraph. The signal center, vital link in global warfare, is the subject of an April feature.

IN THIS ISSUE

Bazooka Boats Hit the Beaches	1
Ice Crackers of the Coast Guard	11
Bridging the Army's Water Hazards	18
The Rails Are Talking	28
Combing the Sea for Lost Flyers	33
Sharpening the Navy's Camera Eyes	40
Sniping the Sniper	44
Models—Tip-Off to What's Ahead	51
Putting Air to Work	60
Black Gold Rush	65
Aerialists on the Home Front	76
Medics in Dungarees	82

Where-to-Buy-It Index—Page 8A

Tips for Moviemakers

EVERY professional movie cameraman has a bag full of tricks, and most of these so-called tricks come under the heading of "lighting." This applies to both outdoor and indoor scenes. Flood lamps or reflectors can be manipulated to give brilliance and depth to pictures made with an 8 or 16-mm. camera, or to focus attention on the proper spot. Wonders can be accomplished with a spotlight equipped with front flaps, called "barn doors" by Hollywood cameramen. An article in the April issue, "Hollywood Tips for Moviemakers," is filled with helpful hints which will give a professional touch to home movies.

Moving the Earth to Win a War

EARLY in the war an American general remarked that victory would go to the side that could move the most dirt—and he wasn't speaking of propaganda. The U. S. leads the world in the production of giant earth-moving machines such as bulldozers, which perform a thousand vital jobs ranging from clearing a path for advancing infantry to digging a ditch for a pipeline at home. The "dozer" family is featured in "They Move the Earth" next month.

Published monthly by POPULAR MECHANICS COMPANY, 200 East Ontario Street, Chicago (11), Ill., U. S. A. Single copy in the United States, 25 cents; subscription rates in United States and possessions, and countries of the Pan-American Postal Union, 1 year, \$2.50; 2 years, \$4.50; 3 years, \$6.00. Single copy in Canada, 30 cents; subscription rates, 1 year, \$3.00; 2 years, \$5.50; 3 years, \$7.50. To all other countries add \$1.00 a year over United States prices for overseas postage. If you plan to move, notify us at least 60 days in advance so you will not miss an issue. Give both old and new addresses. Entered as Second Class Matter, September 15, 1903, at the Post Office at Chicago, Illinois, under Act of March 3, 1879. Entered as Second Class Matter at Post Office Dept. Canada. Copyright 1945, by Popular Mechanics Company. Copyright under International Copyright Union. All rights reserved under Pan American Copyright Union. Printed in the United States of America



"I'm Not Ready for Reconversion"

NEITHER ARE WE...

He's still giving everything. Until his job is done Universal's job is making the precision optical instruments he needs. We're sticking to that job—100%—until he's ready for us to reconvert.



BECAUSE HIS NEEDS COME FIRST you'll have to wait for **MERCURY II**, the new camera we promised you "soon." It's worth waiting for—the **MERCURY II** is especially designed for color.

UNIVERSAL CAMERA CORP.

NEW YORK • CHICAGO • HOLLYWOOD



*There's only one flag
we're prouder of!*

Peacetime Manufacturers of Mercury, Cinémaster, Corsair Cameras and Photographic Equipment



Tough

BUT

OH SO GENTLE

● Millions of motor cars—long overdue on the scrap heap—are still giving faithful, economical service.

Why? Because their owners took good care of them and replaced worn parts before it was too late.

Play safe and watch your engine—particularly the piston rings. Whenever you see signs of ring wear—smoke, oil-pumping or loss of power—see your motor specialist.

If he recommends new piston rings, it will pay you to install Hastings Steel-Vent rings. They *stop* oil-pumping, *check* cylinder wear, *restore* performance.

HASTINGS MANUFACTURING COMPANY • HASTINGS, MICHIGAN
Hastings Mfg. of Canada, Ltd., Toronto

HASTINGS STEEL-VENT



PISTON RINGS

TOUGH ON OIL-PUMPING **GENTLE** ON CYLINDER WALLS

In Your Mind's Eye

The Secret of MENTAL CREATING

IF you just like to dream, read no further. There comes a time when your fancies *must be* brought into light—and stand the test of every-day, hard realities. Are you one of the thousands—perhaps millions—whose thoughts never get beyond the stage of *wistful wishing*? Do you often come to from a daydream with the sigh, "If only I could bring it about—*make it real*?"

All things begin with thought—it is what follows that may take your life out of the class of those who hope and dream. Thought energy, like anything else, can be dissipated—or it can be made to produce actual effects. *If you know how to place your thoughts* you can stimulate the creative processes within your mind—through them you can assemble things and conditions of your world into a happy life of accomplishment. *Mental creating* does not depend upon a magical process. It consists of *knowing how* to marshal your thoughts into a power that draws, compels and organizes your experiences into a worth-while design of living.

ACCEPT THIS *Free* BOOK

Let the Rosicrucians tell you how you may accomplish these things. The Rosicrucians (not a religious organization), a world-wide philosophical fraternity, have preserved for centuries the ancients' masterful knowledge of the functioning of the inner mind of man. They have taught men and women how to use this knowledge to *recreate their lives*. They offer you a free copy of the fascinating book, "The Mastery of Life." It tells how you may receive this information for study and use. Use coupon opposite.

The ROSICRUCIANS
(AMORC)

SAN JOSE

CALIFORNIA

SCRIBE: M.L.J.
The Rosicrucians (AMORC),
San Jose, California.

Please send free copy of "The Mastery of Life,"
and I shall read it as directed.

Name.....

Address.....

City.....



Business Demands Accountants



... because Accountants Command Business

Accountants are usually in demand—at better than average earnings.

But today—more than ever before—the competent accountant finds his services at a premium.

Business in war has tightened up the reins and is watching costs—prices—every move—striving to operate on that basis of close control so essential to service and profits.

Then, too, business is working under tighter government regulations, with many more records and reports—war production, priorities, more and larger taxes, wage and hour laws, payroll deductions for Defense Bonds, etc., etc.

The Home Study Way to Accountancy Success

Thousands upon thousands of men have trained for Accountancy with LaSalle—at night—at home.

Their success—their progress—is a matter of record.

Whether their goal was a C. P. A. certificate or advancement in business, our files are full of letters reporting income increases far out of line with the time and cost investment.

Note for instance, these six cases out of many we might cite. (Names on request.)

A cost clerk, J. S. H. became, after completing 30 training assignments, cost accountant. Within nine months, only half through the course, he became chief cost accountant with a salary nearly four times what it was when he enrolled. C. K. was an immigrant day laborer. Within a few months he secured a bookkeeping job. Within a year, he secured three raises. In two years, he was in charge of his company's accounting department, although not yet through the training. W. J. F. moved up from store clerk to assistant bookkeeper after the first ten lessons. Now he is office man-

ager. S. W. N. knew nothing about bookkeeping. With 19 months of training he passed the C. P. A. examination on first attempt and opened his own public accounting office. Although a university graduate, P. M. was a grocery clerk at small wages. Today he is Secretary and Credit Manager with an income 300 per cent higher. Already in cost work, G. N. P. within nine months was earning 40% more; within two years, 100% more. The third year his income went up still more. Now he is manager.

These Men Won Success in Ordinary Times —You Have War Opportunities

Remarkable as is the success of these men—you will have an advantage over them—you will be entering accountancy when unusual national conditions work with you for success.

Conditions not only call for more accountants—but offer unusual opportunities for both quick and permanent success. The need for accountants will increase during war and will continue for years afterwards during the difficult post-war adjustment period.

—If You Can Qualify

Ask yourself three questions:

1. Are you ambitious?
2. Have you determination?
3. Can you see and grasp an opportunity?

If you have determination; if you are ambitious; if you can take advantage of circumstances—prove it by investigating. A three-cent stamp, sixty seconds time, and the coupon below will bring you full information regarding Accountancy training and the opportunities to which such training leads. Then you can judge intelligently.

LASALLE EXTENSION UNIVERSITY

A Correspondence Institution

Dept. 364-H • 417 S. Dearborn St. • Chicago 5, Ill.

Opportunities in Accountancy—Check below and we will send you a free copy of "Accountancy, the Profession That Pays," also, information about our training in Higher Accountancy, all without obligation.

Higher Accountancy

Other LaSalle Opportunities: If more interested in one of the other fields of business indicated below, check that:

- | | | |
|--|--|--|
| <input type="checkbox"/> Business Management | <input type="checkbox"/> Effective Speaking | <input type="checkbox"/> Modern Foremanship |
| <input type="checkbox"/> Expert Bookkeeping | <input type="checkbox"/> Law: L.L.B. Degree | <input type="checkbox"/> Business Correspondence |
| <input type="checkbox"/> C. P. A. Coaching | <input type="checkbox"/> Commercial Law | <input type="checkbox"/> Stenotypy |
| <input type="checkbox"/> Traffic Management | <input type="checkbox"/> Industrial Management | <input type="checkbox"/> Modern Salesmanship |



Name Age.....

Present Position

Address City and State

... the next
250 miles
 you drive, add
3 ounces of...



● The next 250 miles on your car — or the miles after that may be the straw that breaks the camel's back. When mileage begins to pile up—that's the time to be sure that lubrication is always efficient. Pyroil maintains a protective covering of oil on cylinder walls—reduces wear—rust—sludge formation and makes starting easier. Put a pint of Pyroil in the crank case—3 ounces in your gas tank every 250 miles.

Manufactured and Guaranteed by Pyroil Company, W. V. Kidder, Founder, 53 Pyroil Building, La Crosse, Wisconsin

PYROIL Adds life to your Car

PYROIL COMPANY,

53 Pyroil Building, La Crosse, Wisconsin

I want my car to last and run properly. Please tell me more about Pyroil and how it can accomplish this for me.

Name

Address

City or Town State

WHERE-TO-BUY-IT INDEX

Manufacturer's name and address appear in parentheses directly after items believed by us to be commercially available

Pigmy flat-tops carry both planes and cargo.....	6
"Snow-eater" melts drifts away in railroad yard.....	6
New Navy "Lib" ranges 3,000 miles on patrol.....	7
Automatic mask for Army pilot regulates oxygen and pressure.....	7
"Inside stuff" on the B-29.....	8
Anti-gravity pants prevent blackout in plane dive.....	10
Chance for inventors to help the Air Forces.....	10
Triple-threat photo plane carries bombs and guns.....	16
Synthetic rubber made of sand defies heat and cold.....	16
Largest tire ever to be retreaded.....	17
Insulation sprayed on like paint (Insul-Mastic Corp. of America, Fulton Bldg., Pittsburgh 22, Pa.).....	17
Nazis use "panzer fist" rockets against tanks.....	26
Car runs on current from buried conductors.....	26
Lockheed "Saturn" designed for versatility.....	27
Penicillin taken like cough drops for throat infections.....	27
Adjustable target tests student's sighting (Paige Training Aids, 28 W. 44th St., New York).....	31
22-foot ship propeller weighs 70,000 pounds.....	32
Unbreakable plastic eyes can be shaped to fit (American Optical Co., Southbridge, Mass.).....	32
"Phone-projector" on food cart for hospital movies.....	32
Three-dimensional maps model invasion terrain.....	38
Robot voice pronounces words as heard by partly deaf.....	38
"Sky freighter" gliders carry heavy payloads.....	39
Tractor's air-conditioned cab keeps out dust, heat, wind.....	39
Outdoor spotwelder hung from crane.....	43
Parachute closes like umbrella for fast descent.....	43
"Fountain pen" marker writes in waterproof colors.....	43
Junk-built truck-locomotive hauls fuel, supplies.....	49
Device eases drilling in awkward positions (Skillsaw, Inc., 5033 Elston Ave., Chicago 30).....	49
Invisible beam shot into sky to measure cloud height.....	49
Tool cleans cylinder of carbon without removing pistons (Stuart Engineering Div., 3349 N. Ashland, Chicago 13).....	50
Sugar suggested as food to raise flyers' ceiling.....	50
Common garlic destroys germs that penicillin won't kill.....	50
Printer labels cellulose tape.....	55
New resin gives rigidity to synthetic rubber.....	55
Streetcar fitted out as traveling library.....	55
Clever Yanks improvise tools and methods for work over.....	56
Explosive-laden Nazi speedboat jettisons pilot near target.....	58
Cabinet tumbles clothes for quick drying (Lovell Manufacturing Co., Erie, Pa.).....	58
Cartridge belt "vanishes" as bullets are used.....	58
Gear shaper cuts all teeth in single operation (Michigan Tool Co., 7171 E. McNichols Rd., Detroit 12, Mich.).....	59
"Lily jig" guides tiny filament into radio tube (Tung-Sol Lamp Works, Newark, N. J.).....	59
Transparent casts for wounded made of Plexiglas.....	59
Notched plier strips, cuts, crimps wire (Aircraft-Marine Products, Inc., 1521 N. 4th St., Harrisburg, Pa.).....	59
Wire-wrapped concrete stronger than steel.....	64
Tablets decontaminate water without changing taste.....	64
Dial eliminates flags in semaphore training (Noble & Noble Publishers, Inc., 72 Fifth Ave., New York 11).....	64
Waterproof tanks hit beach with guns blazing.....	70
Model of "Old Ironsides" took five years to build.....	70
Alkaline salts solution protects tin cans.....	70
Rolling "giants" build runways for heavy planes.....	71
Quick-change fittings convert pump for deep or shallow well (F. E. Myers & Bros. Co., Ashland, O.).....	71
Fast LSM joins fleet for action in Pacific.....	71
Mascots of the Yanks.....	72
Chicken-wire belts carry heat from fields.....	74
Snug paper house costing \$51.20 erected in 59 minutes.....	74
Robot map-maker plots route as it travels.....	74
Surgery jelly absorbs water 300 times its weight.....	75
Legs steady funnel for horizontal filling of drums (Industrial Products Co., 2993 N. 4th St., Philadelphia 33, Pa.).....	75
Geologists "fish" for data with crane and reel.....	75
Plastic mold of metal surface is 2/1,000,000 inch thick.....	75
Circular house has telescoping sections (Designed by Frank J. Zavada, Carnegie Bldg., Pittsburgh, Pa.).....	80
Television in color with two-sided screen.....	81
Armored jeep protects airborne scouts.....	81
"Indoor climate control" for individual rooms.....	87
Floating bridge bends arch into river current.....	88

Craftsman and Shop Notes Index

ART AND ARTIST

Slots in triangle act as lettering guide.....	98
Drawing paper made transparent for tracing work.....	112
Tracing drawings from book without marring pages.....	113

AUTOMOTIVE

Electrolyte height gauge for battery.....	96
Spring under accelerator acts as governor.....	100
Two-ply patches make tire boot.....	102
Stopping vacuum gearshift flutter.....	108
Causes of motor spitting back through carburetor.....	118
Avoiding accidents when inflating truck tires.....	126
Installing bushings in motorcycle connecting rods.....	132
Care of paper gaskets.....	138
Reflector assembly for use on towed car.....	139
Stopping rear main bearing leak.....	139
Grinding compound holds oil line clips.....	140
Guide for drilling brake lining.....	140

CAMPING, HUNTING AND FISHING

Adhesive tape container for fish lines and hooks.....	108
Ladies' compact holds gut fly leaders.....	108
Lead sinker untangles snarled fish line.....	138

FARM

Easy way to drain water pan under grindstone.....	92
Thermostat for electric brooder.....	98

(Continued to page 10A)

"EVEN BETTER THAN I HAD!"



Of course, the I. C. S. Course which Bill is studying has it all over the one the Boss completed. I. C. S. texts constantly are revised in response to student questions and reactions . . . brought up to date on technical advances.

Today's texts embody the experience of more than 53 years, the expenditure of nearly six million dollars. This is the reservoir of Vocational Training knowledge from which every student draws his personalized instruction.

I. C. S. graduates, including many employers, will tell you how good I. C. S. Courses were in their day. But current texts, they find, are better.

Employers have a very real interest in I. C. S. This famous educational system regularly reports the progress of its students to the men for whom they're working. And it regularly receives letters expressing keen appreciation for this service.

I. C. S. training goes on record with these executives — counts in your record. Join the "coming" men! Mail the coupon for your own information as thousands of now successful men did for theirs. Possibly your own employer was one of them.

INTERNATIONAL CORRESPONDENCE SCHOOLS



BOX 5531-K, SCRANTON 9, PENNA.

Without cost or obligation, please send me full particulars about the course *before* which I have marked X:

- Air Conditioning and Plumbing Courses
- Air Conditioning
- Heating
- Plumbing
- Refrigeration
- Steam Fitting
- Chemistry Courses**
- Chemical Engineering
- Chemistry, Analytical
- Chemistry, Industrial
- Chemistry, Mfg. Iron & Steel
- Petroleum Refining
- Plastics
- Pulp and Paper Making
- Civil Engineering, Architectural and Mining Courses**
- Architectural Drafting
- Architecture
- Bridge and Building Foreman
- Building Estimating
- Civil Engineering
- Coal Mining
- Contracting and Building
- Highway Engineering
- Lumber Dealer
- Reading Structural Blueprints
- Sanitary Engineering
- Structural Drafting
- Structural Engineering
- Surveying and Mapping

- Electrical Courses**
- Electrical Drafting
- Electrical Engineering
- Power House Electric
- Practical Electrician
- Practical Telephony
- Telegraph Engineering
- Internal Combustion Engines Courses**
- Auto Technician
- Aviation
- Diesel-Electric
- Diesel Engines
- Gas Engines
- Mechanical Courses**
- Aeronautical Engineering
- Airplane Drafting
- Flight Engineer
- Foundry Work
- Heat Treatment of Metals
- Industrial Engineering
- Industrial Metallurgy
- Mechanical Drafting
- Mechanical Engineering
- Mold-Loft Work
- Patternmaking
- Reading Shop Blueprints
- Sheet-Metal Drafting
- Sheet-Metal Worker

- Ship Drafting
- Ship Fitting
- Shop Practice
- Steel Mill Workers
- Tool Designing
- Welding, Gas and Electric
- Radio Courses**
- Electronics
- Radio, General
- Radio Operating
- Radio Servicing
- Railroad Courses**
- Air Brake
- Car Inspector
- Locomotive Engineer
- Locomotive Fireman
- Railroad Section Foreman
- Steam Engineering Courses**
- Boilermaking
- Combustion Engineering
- Engine Running
- Marine Engineering
- Steam Electric
- Steam Engines
- Textile Courses**
- Cotton Manufacturing
- Rayon Weaving

- Textile Designing
- Woolen Manufacturing
- Business and Academic Courses**
- Accounting
- Advertising
- Arithmetic
- Bookkeeping
- Business Correspondence
- Business Management
- Certified Public Accounting
- College Preparatory
- Commercial
- Cost Accounting
- Federal Tax
- First Year College
- Foremanship
- French
- Good English
- High School
- Higher Mathematics
- Illustrating
- Motor Traffic
- Postal Service
- Salesmanship
- Secretarial
- Sign Lettering
- Stenography
- Traffic Management
- Spanish

Name..... Age..... Home Address.....
 City..... State..... Present Position..... Working Hours..... A.M. to..... P.M.

Canadian residents send coupon to International Correspondence Schools Canadian, Ltd., Montreal, Canada.
 British residents send coupon to I. C. S., 71 Kingsway, London, W. C. 2, England.

DISCOUNT TO DISCHARGED VETERANS—SPECIAL TUITION RATES FOR MEMBERS OF THE ARMED FORCES

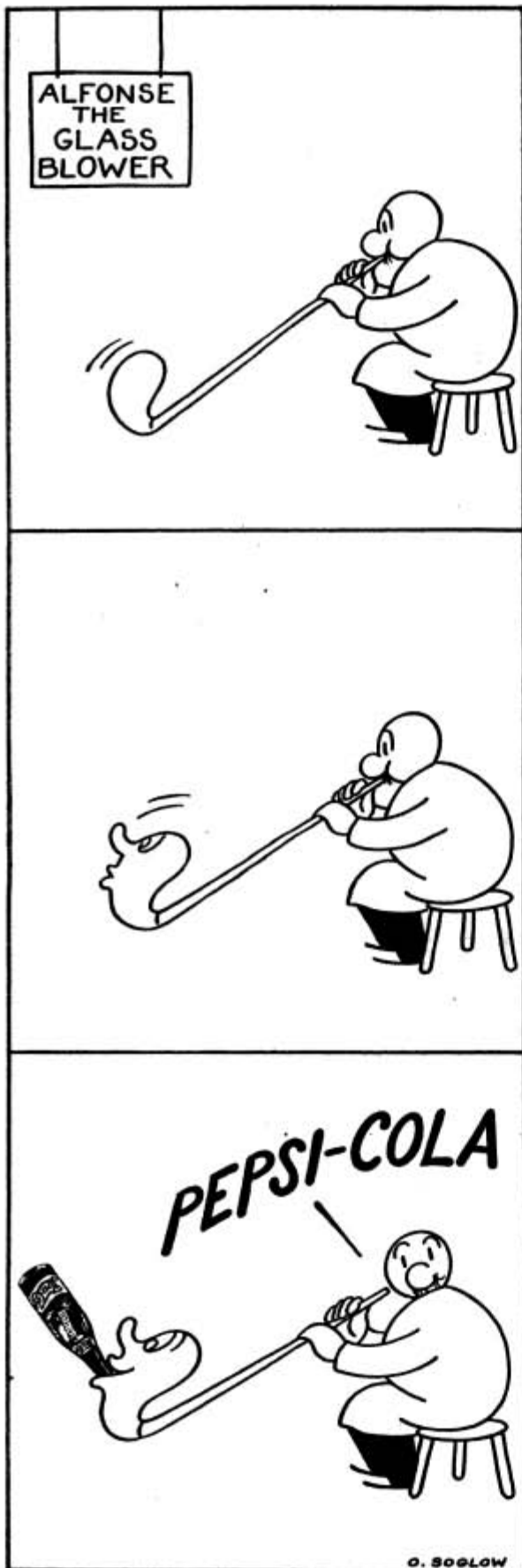

O. SOGLOW

(Continued from page 8A)

Making a limestone spreader.....	129
Cushioning egg containers.....	132
Tractor level for terracing.....	139
Preserving truck and wagon-box floors.....	140
HAND TOOLS	
Self-locking wedge for tool handles.....	93
Fitting compass with automatic pencil.....	98
Using broken blades in hacksaw frame.....	110
Preventing breakage of hacksaw blades.....	128
Utilizing broken hacksaw blades.....	131
How to cut angle iron with hacksaw.....	132
Drills kept in shaving-soap container.....	132
Adjusting wheel on marking gauge.....	133
Sliding parallel has extension pin.....	138
HOME IMPROVEMENTS	
Installing narrow door in wide opening.....	90
Gauge for installing door locks accurately.....	91
Silencing noisy water pump.....	98
Conserving cistern water.....	113
HOUSEHOLD	
Bottle of soapy water handy on picnics.....	90
Magnet in razor handle picks up blade.....	92
Oiling electric-clock motors.....	92
Unusual holders for place cards.....	92
Baking perfectly formed pie shells.....	92
Solving home problems.....	94
Drying rack folds against wall.....	96
Burning sawdust in fireplace.....	96
Plate hanger made from coat hanger.....	96
Bed converted to baby crib with safety gate.....	97
Smoothing tops of canning jars.....	98
Making porcelain repairs.....	99
Repairing cracked firepot in heating stove.....	110
Foot scraper edge shielded with hose.....	110
How to remove decalcomania.....	112
Handy ash tray for card tables.....	112
Snap-on door keeps child out of open bookcase.....	113
LAWN AND GARDEN	
Electric hedge trimmer from vacuum cleaner.....	89
Clips secure wheelbarrow sides.....	102
Cast birds for the lawn.....	109
Home landscaping with evergreens.....	114
Cement tree stump for rock garden.....	119
PHOTOGRAPHY	
Lining up miniature slide projectors.....	120
Flood reflector used as spotlight.....	120
Kitchen sink used to wash prints.....	120
Wooden darkroom sink.....	120
POWER TOOLS	
Making files for use in jigsaw.....	101
Power cordwood saws.....	121
Milling attachment using lathe compound.....	127
Scriber for centering milling machine cutter.....	128
Lathe attachment for cutting small gears.....	133
Hollow-chisel mortising.....	134
RADIO AND ELECTRONICS	
Electronic tubes are "electrical valves".....	141
1945 "Little Giant" student set has push-pull output stage.....	142
De luxe replacement cabinet for small sets.....	144
STORE AND SHOP	
How to make small speed reducer.....	112
Easy way to repair oilcan.....	126
Muslin buffs made softer with cardboard.....	126
Carton cut to form grocery display rack.....	126
Protecting edges of skid boxes.....	128
Shallow holes in soldering iron for dipping wire ends.....	128
Removable cradle to move drums on hand truck.....	138
Receptacle in wire basket for small pieces of waste.....	138
Locating centers on odd-size work.....	140
TOYS, GAMES AND NOVELTIES	
Racing turtle of wood.....	91
Lapel pin jigsawed from plywood.....	97
Child's game uses yarn on track.....	102
Checkers stored inside board.....	108
Woven effects with molding slices.....	111
Pull-string top easy to make.....	112
WOODWORKING	
Sanding stick for use in drill press.....	92
Scrolled corner shelf in leaf design.....	93
Tape aids in laying out spiral cuts.....	96
Wooden stroller with space for extras.....	101
Dummy books hide secret compartment.....	103
Rustic gates, fences and summer house.....	104
Vanity dresser converted to kneehole desk.....	108
Simple stove to keep glue warm.....	110
Blowing shavings from drilled work.....	128
MISCELLANEOUS	
Eraser notched to avoid smudging.....	102
Sealing screw-cap bottles.....	102
Alcohol lamp from oilcan.....	102
Covering wire book bindings to prevent marring.....	108
Preserving leaves and four-leaf clovers.....	110
Stenciling name on pencils.....	110
Salesman has small file case attached to top of car.....	126
Safe way to cut coil springs.....	126
Using masking tape in damp weather.....	128
Hook on ice scraper turns cakes for washing.....	132
Jute rope lasts longer when oiled.....	132
Sharpening pencil-sharpener cutters.....	138
Sickle sections hold logs on sawbuck.....	140
Adapting chair for cripple.....	140

IMPORTANT NOTICE

It is the intention of this magazine to provide its readers with information regarding the latest developments in the mechanical arts. We take no responsibility as to whether the disclosures contained in our articles are covered by patents and advise readers to investigate this subject before making, using, or selling any of the products, machines, or processes described in order to avoid possible liability for patent infringement.

AUDELS REFRIGERATION & AIR CONDITIONING GUIDE.....\$4

New from Cover to Cover—1280 Pages, Fully Illus. Covering basic principles, servicing, operation & repair of household, commercial & industrial refrigeration & air conditioning. A gold mine of essential important facts for engineers, servicemen, usora.

AUDELS CARPENTERS & BUILDERS GUIDES—4 Vols.\$6

A practical illustrated trade assistant on modern construction for carpenters, joiners, builders, mechanics and all woodworkers. 4 vols., 1600 pages, 3700 illustrations, flexible covers. Pocket size. Each volume sold separately \$1.50 a vol.

AUDELS AUTOMOBILE GUIDE.....\$4

A practical quick ready reference book for auto mechanics, service men, operators & owners. Explains theory, construction & servicing of modern motor cars, trucks, buses & auto type Diesel engines. 1340 pages, fully illustrated, 55 chapters. Indexed. A standard book for mechanics. New fluid drive covered.

AUDELS DIESEL ENGINE MANUAL.\$2

A practical, concise treatise with questions and answers on the theory, operation and maintenance of modern diesel engines including General Motors 2 cycle Diesel. 384 pages, fully illus., flexible binding, pocket size. All details plainly brought out, this book is of extreme value to engineers, operators & students.

AUDELS WIRING DIAGRAMS.....\$1

210 Pages. Illustrated. Gives practical facts on wiring of electrical apparatus. It shows clearly how to wire apparatus for practically all fields of electricity. Each diagram is complete & self-explanatory. Highly Endorsed Pocket Companion.

AUDELS PLUMBERS & STEAMFITTERS GUIDES—4 Vols.\$6

A Practical Trade Assistant & Ready Reference. Explains in plain language & by clear illustrations, diagrams, charts, graphs, pictures principles of modern plumbing practice including Marine Pipe Fitting and Air Conditioning. 4 Vols.—1670 Pages—3612 Diagrams. Pocket size. Each Vol. Sold Separately \$1.50 a Vol.

AUDELS SHEETMETAL WORKERS HANDY BOOK.....\$1

Practical inside information. Fundamentals of Sheet Metal Work. 388 pages. Illustrated. 11 sections. Clearly written. Essential & important facts, figures, pointers in everyday language. Ref. Index.

AUDELS SHEETMETAL PATTERN LAYOUTS.....\$4

Developed by Experts for Sheet Metal Workers, Layout Men & Mechanics. A Practical Encyclopedia in 10 Sections, size 7 x 10 x 2—1125 Pages—350 Layouts—1600 Illustrations. 1001 Key Facts. Fully indexed for ready reference in answering your layout problems. Covers all phases of sheet metal work including Pattern Cutting, Pattern Development & Shop Procedure.

AUDELS ANSWERS ON BLUE PRINT READING.....\$2

For Mechanics & Builders. Covers all types of blue print reading including ship & airplane. 376 pages, fully illustrated.

AUDELS NEW MACHINIST & TOOLMAKERS HANDY BOOK...\$4

Covers modern machine shop practice in all its branches. 5 practical books in 1. New from cover to cover. Tells how to set up & operate lathes, screw and milling machines, shapers, drill presses and all other machine tools. 1600 pages, fully illustrated, 5 x 6 1/2 x 2. Indexed. 5 sections. 1—Modern Machine Shop Practice. 2—Blue Print Reading & How to Draw. 3—Calculations & Mathematics for Machinists. 4—Shop Physics. 5—How to Use the Slide Rule. 60 chapters. Easy to read and understand. A shop companion that answers your questions.

AUDELS MATHEMATICS & CALCULATIONS FOR MECHANICS \$2

Mathematics for home study or reference. 700 pages, 550 illus. Practical mathematics from beginning. How to figure correctly. Easy, correct methods covering a complete review. Ill. & Indexed.

AUDELS HANDY BOOK OF PRACTICAL ELECTRICITY.....\$4

For maintenance engineers, electricians & all electrical workers. 1440 Pages, 2600 Illus. Covers important electrical information in handy form—including Marine Wiring, Radio Principles, Welding. Indexed. A Key to a practical understanding of electricity.

AUDELS RADIOMANS GUIDE.....\$4

A key to the practical understanding of radio including Frequency Modulation, Television, etc., Aircraft & Marine Radio. For radio engineers, servicemen, amateurs. 772 pages, 400 illustrations & diagrams. Photos. Review Questions & Answers, Reference Index. Authentic, clear, concise.

AUDELS ELECTRONIC DEVICES...\$2

Tells What You Want to Know About Electric Eye. Easily Understood. Covers photo-electric cells & their applications. Amplifiers, illumination, frequencies, voltage, photocell, tubes, Ohm's Law, wiring diagrams, etc.

AUDELS WELDERS GUIDE.....\$1

A concise, practical text on operation & maintenance of all welding machines for all mechanics. Over 400 pages, illustrated. Covers all methods of electric and acetylene welding including airplane work.

AUDEL, Publishers, 49 W. 23 St., N. Y. 10

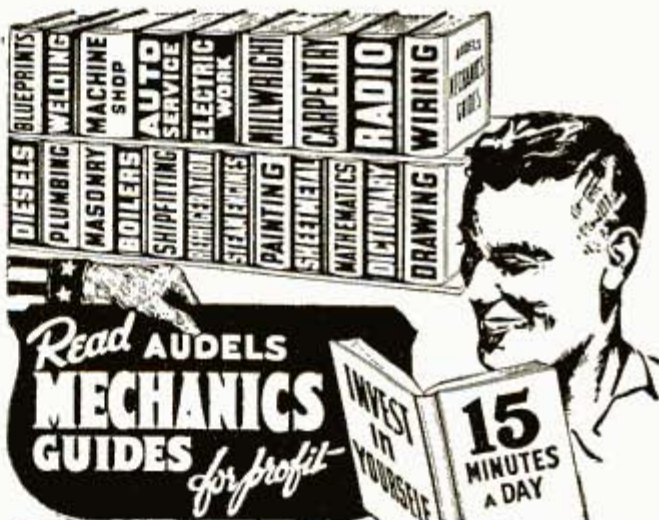

AN AUDEL GUIDE IS A GOOD FRIEND!

Use the brains and experience of others in these Guides of the Trades. Save time and money with right methods, short cuts, labor saving ideas. CHECK NOW! You can look over any Audel Guide in your home. Start the Easy Payments if satisfied.

CUT HERE MAIL ORDER

THEO. AUDEL & CO., 49 W. 23 St., New York 10, N.Y.

Please mail me for 7 days' free examination the books marked (X) below. I agree to mail \$1 in 7 days on each book or set ordered, and to further mail \$1 a month on each book or set ordered until I have paid purchase price.

If I am not satisfied with Guides I will return them.

- Audels REFRIGERATION & Air Conditioning Guide \$4.
- Audels PUMPS, HYDRAULICS & AIR COMPRESSORS 4.
- Audels WELDERS GUIDE 1.
- Audels BLUE PRINT READING 2.
- Audels SHEET METAL WORKERS Handy Book 1.
- Audels SHEET METAL PATTERN LAYOUTS 4.
- Audels AIRCRAFT WORKER 1.
- Audels MATHEMATICS and CALCULATIONS 2.
- Audels MACHINISTS & TOOLMAKERS Handy Book 4.
- Audels DIESEL ENGINE MANUAL 2.
- Audels MECHANICAL Dictionary 4.
- Audels AUTOMOBILE GUIDE 4.
- Audels MARINE ENGINEERS Handy Book 4.
- Audels SHIPFITTERS Handy Book 1.
- Gueths MECHANICAL DRAWING COURSE 1.
- Rogers DRAWING and DESIGN 2.
- Audels MILLWRIGHTS and Mechanics Guide 4.
- Audels CARPENTERS and Builders Guides (4 vols.) 6.
- Audels PLUMBERS and Steamfitters Guides (4 vols.) 6.
- Audels MASONS and Builders Guides (4 vols.) 6.
- Master PAINTER and DECORATOR 2.
- Audels GARDENERS & GROWERS GUIDES (4 vols.) 6.
- Audels ENGINEERS and Mechanics Guides Nos. 1, 2, 3, 4, 5, 6, 7 and 8 complete 12.
- Audels Answers on Practical ENGINEERING 1.
- Hawkins Aids to ENGINEERS EXAMINATION 2.
- Audels WIRING DIAGRAMS 1.
- Audels Handy Book of PRACTICAL ELECTRICITY 4.
- Audels ELECTRICAL POWER CALCULATIONS 2.
- Hawkins ELECTRICAL Guides at \$1. each 10.
- Audels ELECTRONIC DEVICES 2.
- Audels ELECTRIC Dictionary 2.
- Audels RADIOMANS GUIDE 4.
- Audels NEW ELECTRIC LIBRARY at \$1.50 a Volume Vols. I, II, III, IV, V, VI, VII, VIII, IX, X, XI, XII.

Name.....

Address.....

Occupation.....

Employed by..... PM



Building this A. M. SIGNAL GENERATOR gives you valuable experience. Provides amplitude-modulated signals for test and experiment purposes.

Radio Servicing pays many good money for full time work. Many others make \$5, \$10 a week EXTRA fixing Radios in spare time.



Learn Radio

WITH THE 6 BIG KITS OF



J. E. SMITH, President
National Radio Institute
Our 31st Year of Training Men
for Success in Radio

BE A SUCCESS IN RADIO I Will Train You at Home

Here's a *practical* way to learn Radio at home in spare time—to train for a good Radio job, or to start your own spare time or full time Radio Service Business!

Many Beginners Soon Make \$5, \$10 a Week EXTRA in Spare Time

You get Radio EXPERIENCE building real Radio Circuits with kits of standard parts I send. You get solid KNOWLEDGE of Radio, Television, Electronic fundamentals from my easy-to-grasp lessons. You follow the same "50-50" method that has helped hundreds of beginners make \$5, \$10 EXTRA a week in spare time while learning . . . and prepared them for full time Radio jobs at good pay.

Future Looks Bright for Trained Radio Technicians and Operators .

The Radio Repair Business is booming. Profits are large and peacetime prospects are bright. Broadcasting Stations, Aviation Radio, Police Radio, Loudspeaker Systems, Radio Manufacturing all employ trained Radio men at good pay—and many of these fields have a *big backlog* of business built up during the war—*plus* opportunities to expand into new fields opened by wartime developments. You may never see a time again when it will be so easy to get a start in Radio!

MEN I TRAINED AT HOME Get Good Jobs Like These

Averages Over \$60 a Week

"Not long ago I was working 16 hours a day in a filling station at \$10 a week. Now I have my own radio business and average over \$60 a week. The N.R.I. course is fine."—ALBERT C. CHRISTENSEN, 1116—10th Ave., Sidney, Neb.



Fixing Radios Profitable Hobby

"I am doing radio work in my spare time, and find it a profitable hobby. My extra earnings run about \$10 a week. I certainly am glad I took your N.R.I. Course."—FERDINAND ZIRBEL, Chaseley, North Dakota.



Has Good Job in Broadcasting

"The N.R.I. course gave me the strength to tackle jobs without fear of failure. At present I am a member of the engineering staff of a large broadcasting chain."—SERGE A. DESOMOV, 849 First Ave., New York, N. Y.



From Elevator Man to Supervisory Job

"Since taking your Course I have moved up from elevator operator to a supervisory job in our Electronics Division. My investment in N.R.I. training has been returned."



Runs Repair Shop for Sears Roebuck

"I was a barber and not working steadily. After about 30 lessons in your Course, I came with Sears Roebuck and now run their radio service shop here, at a nice steady income."—NORMAN P. FORNOFF, 1923 E. 13th St., Davenport, Iowa.

FIND OUT ABOUT THIS **TESTED WAY**

You build this **MEASURING INSTRUMENT** yourself early in the Course—use it for practical Radio work on neighborhood Radios to pick up **EXTRA** spare time money!

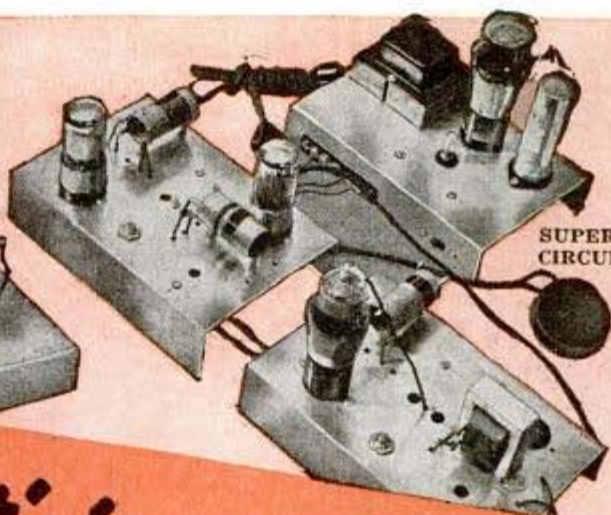
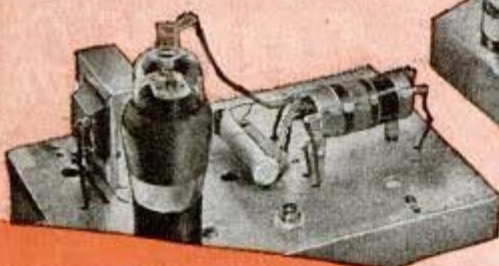

You build this **SUPERHETERODYNE CIRCUIT** that brings in local and distant stations. You get *practical* experience putting this set through fascinating tests!

by Practicing in Spare Time

RADIO PARTS I SEND YOU

Be Ready to Cash In on Jobs Coming with Television, Electronics

Think of the **NEW** jobs that Television, Frequency Modulation, Electronics, other Radio Developments promise for the peacetime future. You have a real opportunity. I will train you to be ready to cash in when amazing wartime developments are released for unlimited peacetime use.

Mail Coupon for My Free Lesson and 64-Page Illustrated Book

I will send you Free, a sample Lesson, "Getting Acquainted with Receiver Servicing," to show you how practical it is to train for Radio in spare time. And with it I'll send my 64-page, illustrated book, "Win Rich Rewards in Radio" FREE. It describes many fascinating jobs in Radio, tells how *you* can get started. No obligation—no salesman will call. Just mail coupon in an envelope or paste it on a penny postal.—**J. E. SMITH**, President, Dept. 5CP, National Radio Institute, Pioneer Home Study Radio School, Washington 9, D. C.

My Radio Course Includes TELEVISION ★ ELECTRONICS FREQUENCY MODULATION

Think of the **NEW** jobs that Television, Frequency Modulation, Electronics and other developments will open after the war! I will train you to be ready to cash in when Victory releases the amazing wartime developments for peacetime uses!

Sample Lesson 64 Page Book BOTH FREE

FREE LESSON gives hints on Receiver Servicing, Locating Defects, Repair of Loudspeakers, I. F. Transformer, Gang Tuner Condenser, etc., 31 Illustrations. Study it—keep it—use it—without obligation! Mail Coupon NOW for your copy!



GET BOTH 64 PAGE BOOK SAMPLE LESSON FREE

MR. J. E. SMITH, President, Dept. 5CP
NATIONAL RADIO INSTITUTE, Washington 9, D. C.

Mail me FREE, without obligation, Sample Lesson and 64-page book, "Win Rich Rewards in Radio." (No salesman will call. Please write plainly.)

Age.....

Name

Address

City..... State.....4FR

(Please include Post Office zone number)

TO GOOD PAY

NEW BOOK *for*



**PATENT GUIDE
FOR THE INVENTOR**
CLARENCE A. O'BRIEN
& HARVEY B. JACOBSON
REGISTERED PATENT ATTORNEYS
WASHINGTON, D. C.



FREE RECORD OF INVENTION

This FREE Record of Invention form enables you to conveniently make a sketch of your invention and have it witnessed in a manner of value to you, should the occasion for evidence arise.

48
PAGES
Over 150
Mechanical
Movements

LATEST FACTS ON INVENTIONS

Is your invention something for the home, the farm, the factory, the store? Would you like to know whether anything like it has ever been invented, and if not, how to protect your invention? Our new 48-page book "Patent Guide for the Inventor" will show you how to proceed with your invention. You'll get a good idea of whether you "have something" or not. Would you like to know how you may judge the marketability of your invention? This book gives you several important tests prepared by authorities. Read of the experiences of Bell, Edison, Westinghouse, and other outstanding, successful inventors who patented and thereby protected their inventions. This book not only tells you how to obtain a patent, it also explains the steps that must be taken afterward to promote the success of your invention. MAIL THE COUPON TODAY to Clarence A. O'Brien & Harvey B. Jacobson, Registered Patent Attorneys, 51-C, Adams Building, Washington 4, D. C.

**CLARENCE A. O'BRIEN
& HARVEY B. JACOBSON**
REGISTERED PATENT ATTORNEYS

INVENTORS

NOW Is the Time to PATENT and SELL Your Invention

Now, more than ever before, is the right time to patent your invention. Why? Because manufacturers everywhere presently engaged in war production are looking ahead to the future by buying up patent rights now, so they will have new and attractive items to make and sell for civilian consumption as soon as the war is over. This is what happened during and after the last war. Hence, the smart thing for you to do is to look ahead to the future too. Protect your invention and yourself by applying for a patent now.

Patent Guide Shows What To Do

Our "Patent Guide for the Inventor" answers many important questions concerning Patents that inventors constantly ask. It tells what facts, details, drawings, sketches, etc. are necessary to apply for a Patent, how to protect your invention through dated and witnessed disclosure; how to do this AT ONCE to safeguard your rights; how Patent Office Records can be checked to determine whether the invention is probably patentable before filing fees need be paid; discusses costs involved and a practical way these can be paid as the application progresses. It tells how some inventors secured financial backing; how many simple inventions have proved large commercial successes, how Patents covering improvements also can be profitably utilized and marketed, tells countless other facts of interest.

Why You Need Expert Assistance

The Patent Laws were enacted for your benefit—to give you protection for the features of your invention which are Patentable. But these features must be legally and concisely set forth in the form of "claims." This phase of the procedure is so complex that the Patent Office advises the Inventor to engage a competent Registered Patent Attorney. We maintain a large staff—carefully trained registered patent attorneys—expert draftsmen—experienced searchers—to serve you. We have been serving inventors for more than 20 years.

Take First Step Now

With the Patent Guide you will receive also Free a "Record of Invention" form which will enable you at once to establish the date of your invention, before you file your Patent application. This step costs you nothing yet may be vital to your success. Remember—in Patent Matters, ACTION is IMPORTANT. Delay can be costly. Mail the coupon in an envelope, or paste it on a penny postcard NOW.

*Worthy of
Your Trust*

Get

**FREE
COPY**

*Mail
Coupon
Today*

CLARENCE A. O'BRIEN & HARVEY B. JACOBSON

CLARENCE A. O'BRIEN & HARVEY B. JACOBSON
Registered Patent Attorneys before the United States Patent Office
51-C Adams Building, Washington 4, D. C.

Please send me your 48-Page "Patent Guide for the Inventor" and your specially prepared "Record of Invention" form FREE. This request does not obligate me.

Name.....

Address.....

City..... State.....

(Please write or print plainly.)

Here is the one quick practical way to

REALLY LEARN RADIO • ELECTRONICS and TELEVISION



**..YOU GET
A COMPLETE
RADIO SET**

SPRAYBERRY RADIO TRAINING

Gives you Both



BE A TRAINED TECHNICIAN

JUST OUT! FREE!

"How to Read Radio Diagrams and Symbols"

... a valuable new book which explains in simple English how to read and understand any Radio Set Diagram. Provides the quick key to analyzing any Radio circuit. Includes translations of all Radio symbols. Send for this FREE book now and along with it I will send you another big FREE book describing my Radio-Electronic training.



GET FREE BOOKS

SPRAYBERRY ACADEMY OF RADIO

F. L. Sprayberry, President
Room 1035, Pueblo, Colorado.

Please rush my FREE copies of "How to MAKE MONEY in RADIO, ELECTRONICS and TELEVISION," and "HOW TO READ RADIO DIAGRAMS and SYMBOLS."

Name..... Age.....

Address.....

City..... State.....

(Mail in plain envelope or paste on penny postcard)

There's only one *right* way to learn Radio Electronics. You must get it through simplified lesson study combined with actual "shop" practice under the personal guidance of a qualified Radio Teacher. It's exactly this way that Sprayberry trains you... supplying real Radio parts for learn-by-doing experience right at home. Thus, you learn faster, your understanding is clear-cut, you acquire the practical "know how" essential to a good-paying Radio job or a Radio business of your own.

A Bright Future Ahead

Now's the right time to start training. Because Radio is surging forward, expanding at a rapid pace... with the promise of spectacular opportunities in Television, Frequency Modulation, Industrial Electronics... in the vast Radio Service and Repair business. When you train with Sprayberry, you need no previous experience. The Course starts right at the beginning of Radio, even shows you how to make spare time profits while learning.

I'll Show You a New, Fast Way to Test Radio Sets Without Mfg. Equipment

The very same Radio parts I supply with your Course for gaining pre-experience in Radio work may be adapted through an exclusive Sprayberry wiring procedure to serve for complete, fast, accurate Radio Receiver trouble-shooting. Thus, you do not have one cent of outlay for manufactured Test Equipment, which is not only expensive but scarce. In every respect, my training is practical, complete... tested and proved for results. It will give you the broad, fundamental principles so necessary as a background, no matter which branch of Radio you wish to specialize in.

MAIL COUPON NOW!

The Insult "CHUMP" Into a CHAMP

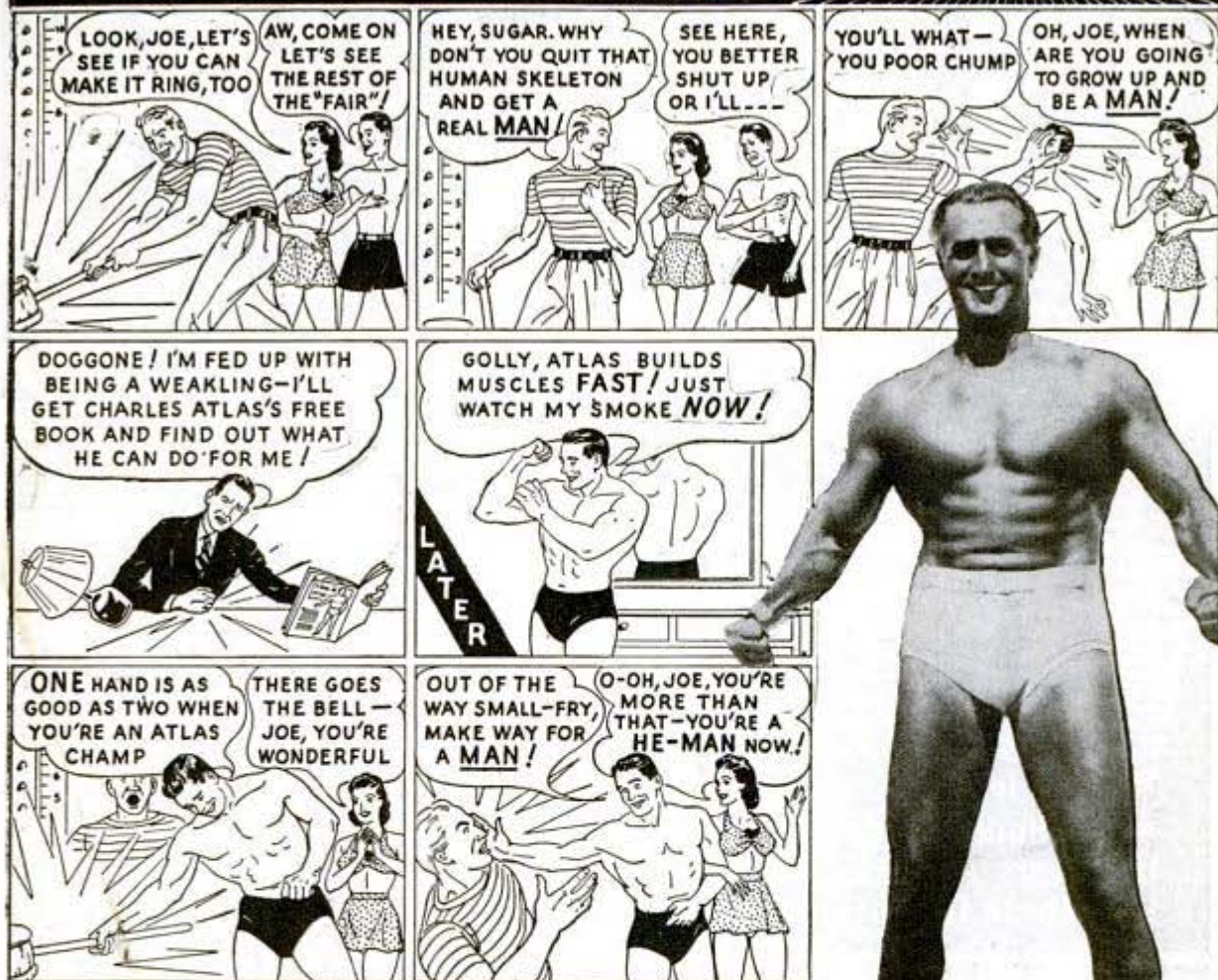

Charles Atlas

—actual photo of the man who holds the title, "The World's Most Perfectly Developed Man."

I Can Make YOU A New Man, Too in Only 15 Minutes A Day!

HAVE YOU ever felt like Joe—absolutely fed up with having bigger huskier fellows "push you around"? If you have, then give me just 15 minutes a day! I'LL PROVE you can have a body you'll be proud of, packed with redblooded vitality! "Dynamic Tension." That's the secret! That's how I changed myself from a scrawny, 87-pound weakling to winner of the title, "World's Most Perfectly Developed Man."

"Dynamic Tension" Does It!
Using "Dynamic Tension" only 15 minutes a day, in the privacy of your own room, you quickly begin to put on muscle, increase your chest measurements, broaden your back, fill out your arms and legs. This easy, NATURAL method will make you a finer specimen of REAL MANHOOD than you ever dreamed you could be!

You Get Results FAST
Almost before you realize it, you will notice a general "toning up" of your entire system! You will have more pep, bright eyes, clear head,

real spring and zip in your step! You get sledge-hammer fists, a battering ram punch—chest and back muscles so big they almost split your coat seams—ridges of solid stomach muscle—mighty legs that never get tired. You're a New Man!

FREE BOOK

Thousands of fellows have used my marvelous system. Read what they say—see how they look before and after—in my book, "Everlasting Health and Strength."

Send NOW for this book—FREE. It tells all about "Dynamic Tension," shows you actual photos of men I've turned from puny weaklings into Atlas Champions. It tells how I can do the same for YOU. Don't put it off! Address me personally. **Charles Atlas, Department 83, 115 East 23rd St., New York 10, N. Y.**



CHARLES ATLAS, Dept. 83, 115 East 23rd St., New York 10, N. Y.

I want the proof that your system of "Dynamic Tension" will help make a New Man of me—give me a healthy, husky body and big muscular development. Send me your free book, "Everlasting Health and Strength."

Name.....
(Please print or write plainly)

Address.....

City..... State.....

Check here if under 16 for Booklet A

INVENTORS

LEARN HOW TO
**PROTECT and SELL
YOUR INVENTION**

GET NEW FREE BOOK



FREE
Invention Record
Know How Successful
Inventors Protect and
Sell Their Inventions

MODERN BUSINESS WANTS INVENTIONS

Practical and novel inventions are in big demand today. The opportunity for quick money is enticing. Sales sources are many if your invention has merit. But, be *sure*—before you place your device in strange hands—that it is fully protected. A United States Patent gives you this protection. *The first step toward inventive success—always is—and always has been, the application for a U. S. Patent. There is no other way to protect your invention in accordance with the laws of this country.*

MAKE THIS RECORD NOW

If you have an invention, and wish to secure it for the future, act at once. Have it dated now and recorded in our office. We will send you this FREE Invention Record Form for the purpose. Fill out the Invention Record Form fully describing the nature of your invention. Make a sketch of its main features. Mail it to us and we will record the date it was received in our office. The earlier the date the better your chance of combating rival inventors who may lay claim to your idea later. *Don't delay a single minute in taking this important step. Your whole future may depend upon it. Mail the coupon for our FREE Invention Record Blank and New FREE Book today!*

HOW WE SERVE YOU AS REGISTERED PATENT ATTORNEYS

The U. S. Patent Office strongly recommends—unless the inventor is familiar with such matters—that he employ the services of a Registered Patent Attorney in the preparation of his Patent Application. We are Registered Patent Attorneys fully qualified to represent you at the Patent Office. We have had long experience in studying hundreds of types of inventions. This gives us the ability to judge your invention and to describe it accurately and convincingly in technical language. It gives us the perception to center arguments upon those details of your invention which, in our judgment, will be looked upon most favorably by the Patent Office Examiner.

Mail the coupon today for our new FREE Book, "How to Protect, Finance and Sell Your Invention," and our FREE Invention Record Form—maybe this step will pave the way to future security for you and your family. Act Today!

McMORROW & BERMAN
Registered Patent Attorneys
1358 Atlantic Building, Washington 4, D. C.

Our new FREE Book is a book every inventor should have. Mail the coupon today for "How to Protect, Finance and Sell Your Invention" and learn . . .

- How to know if there is a prior U. S. patent on your invention.
- How to save steps in getting patent action.
- How to prepare your application for presentation to the Patent Office.
- How you may patent an improvement on something in use now.
- How to obtain funds to patent and promote your invention.
- How to find a buyer or backer for your invention.
- How to protect yourself in making royalty agreements.

McMORROW & BERMAN

REGISTERED PATENT ATTORNEYS

1358 ATLANTIC BUILDING, WASHINGTON 4, D. C.

Send me your new FREE book, "How to Protect, Finance and Sell Your Invention"—and "Invention Record" form at once. I understand that this request does not obligate me.

NAME

ADDRESS

CITY STATE

(Write or print name clearly)



DRAFTING

SPRINGBOARD TO SUCCESS!

MANY men today are using drafting boards to help win this war! • The International Correspondence Schools Courses in Mechanical or Architectural Drafting have fitted many hundreds of ambitious men for better jobs in this well-paid field! • All I. C. S. Courses (covering 400 business and technical subjects) are prepared by leading practical authorities, constantly revised to meet new developments. *Yet the cost of I. C. S. training is surprisingly low.* • It's not too late for you to start—help your country, help yourself! Mail this coupon today!



INTERNATIONAL CORRESPONDENCE SCHOOLS



BOX 5530-K, SCRANTON 9, PENNA.

Without cost or obligation, please send me full particulars about the course before which I have marked X:

- Air Conditioning and Plumbing Courses**
- Air Conditioning
- Heating Plumbing
- Refrigeration Steam Fitting
- Chemistry Courses**
- Chemical Engineering
- Chemistry, Analytical
- Chemistry, Industrial
- Chemistry, Mfg. Iron & Steel
- Petroleum Refining Plastics
- Pulp and Paper Making
- Civil Engineering, Architectural and Mining Courses**
- Architectural Drafting
- Architecture
- Bridge and Building Foreman
- Building Estimating
- Civil Engineering Coal Mining
- Contracting and Building
- Highway Engineering
- Lumber Dealer
- Reading Structural Blueprints
- Sanitary Engineering
- Structural Drafting
- Structural Engineering
- Surveying and Mapping

- Electrical Courses**
- Electrical Drafting
- Electrical Engineering
- Power House Electric
- Practical Electrician
- Practical Telephony
- Telegraph Engineering
- Internal Combustion Engines Courses**
- Auto Technician Aviation
- Diesel-Electric
- Diesel Engines Gas Engines
- Mechanical Courses**
- Aeronautical Engineering
- Airplane Drafting
- Flight Engineer
- Foundry Work
- Heat Treatment of Metals
- Industrial Engineering
- Industrial Metallurgy
- Mechanical Drafting
- Mechanical Engineering
- Mold-Loft Work
- Pattermaking
- Reading Shop Blueprints
- Sheet-Metal Drafting
- Sheet-Metal Worker

- Ship Drafting
- Ship Fitting
- Shop Practice
- Steel Mill Workers
- Tool Designing
- Welding, Gas and Electric
- Radio Courses**
- Electronics
- Radio, General
- Radio Operating
- Radio Servicing
- Railroad Courses**
- Air Brake Car Inspector
- Locomotive Engineer
- Locomotive Fireman
- Railroad Section Foreman
- Steam Engineering Courses**
- Boilermaking
- Combustion Engineering
- Engine Running
- Marine Engineering
- Steam Electric
- Steam Engines
- Textile Courses**
- Cotton Manufacturing
- Rayon Weaving

- Textile Designing
- Woolen Manufacturing
- Business and Academic Courses**
- Accounting Advertising
- Arithmetic Bookkeeping
- Business Correspondence
- Business Management
- Certified Public Accounting
- College Preparatory
- Commercial
- Cost Accounting
- Federal Tax
- First Year College
- Foremanship
- French
- Good English
- High School
- Higher Mathematics
- Illustrating
- Motor Traffic
- Postal Service
- Salesmanship
- Secretarial
- Sign Lettering Spanish
- Stenography
- Traffic Management

Name..... Age..... Home Address.....
 City..... State..... Present Position..... Working Hours..... A.M. to..... P.M.

Canadian residents send coupon to International Correspondence Schools Canadian, Ltd., Montreal, Canada.
 British residents send coupon to I. C. S., 71 Kingsway, London, W. C. 2, England.

DISCOUNT TO DISCHARGED VETERANS—SPECIAL TUITION RATES FOR MEMBERS OF THE ARMED FORCES

**Had Never Written a Line
Sells Article Before
Completing Course**

"Before completing the N.I.A. course, I sold a feature to Screenland Magazine for \$50. That resulted in an immediate assignment to do another for the same magazine. After gaining confidence with successive feature stories, I am now working into the fiction field. Previous to enrolling in the N.I.A., I had never written a line for publication, nor seriously expected to do so."—Gene E. Levant, 116 West Avenue 28, Los Angeles, Cal.



**How do you know
you can't WRITE?**

Have you ever tried?

Have you ever attempted even the least bit of training under competent guidance?

Or have you been sitting back, as it is so easy to do, waiting for the day to come when you will awaken all of a sudden to the discovery, "I am a writer"?

If the latter course is the one of your choosing, you probably never will write. Lawyers must be law clerks. Doctors must be internes. Engineers must be draftsmen. We all know that, in our time, the egg does come before the chicken.

It is seldom that anyone becomes a writer until he (or she) has been writing for some time. That is why so many authors and writers spring up out of the newspaper business. The day-to-day necessity of writing—of gathering material about which to write—develops their talent, their background and their confidence as nothing else could.

That is why the Newspaper Institute of America bases its writing instruction on journalism—continuous writing—the training that has produced so many successful authors.

Learn to Write by writing

NEWSPAPER Institute training is based on the New York Copy Desk Method. It starts and keeps you writing in your own home, on your own time. Week by week you receive actual assignments, just as if you were right at work on a great metropolitan daily. Your writing is *individually* corrected and constructively criticized. Thoroughly experienced, practical, active writers are responsible for this instruction. Under such sympathetic guidance you will find that (instead of vainly trying to copy some one else's writing tricks) you are rapidly developing your own distinctive, self-flavored style—undergoing an experience that has a thrill to it and which at the same time develops in you the power to make your feelings articulate.

Many people who *should* be writing become awestruck by fabulous stories about millionaire authors and therefore, give little thought to the \$25, \$50, and \$100 or more that can often be earned for material that takes little time to write—stories, articles on business affairs, home and shop crafts, and scientific activities, gardening, home making, etc. — things that can easily be turned out in leisure hours, and often on the impulse of the moment.

A chance to test yourself

Our unique **FREE** Writing Aptitude Test tells whether you possess the fundamental qualities necessary to successful writing—acute observation, dramatic instinct, creative imagination, etc. You'll enjoy taking this test. The coupon will bring it, without obligation. Newspaper Institute of America, One Park Avenue, N. Y. 16, N. Y. (Founded in 1925)

NOTICE TO CANADIANS
Newspaper Institute's operations in Canada have been approved by the Foreign Exchange Control Board and to facilitate all financial transactions, a special permit has been assigned to their account with The Canadian Bank of Commerce, Montreal.

Free

Newspaper Institute of America
One Park Avenue, New York 16, N. Y.
Send me, without cost or obligation, your **FREE** Writing Aptitude Test and further information about writing for profit as promised in Popular Mechanics, March.

Mrs. _____
Miss _____
Mr. _____
Address _____
(All correspondence confidential. No salesman will call on you.) 72-C-365

Copyright 1944 Newspaper Institute of America

Say you saw it in Popular Mechanics!

PARKS AIR COLLEGE
PARKS AIRPARK EAST ST. LOUIS, ILL.

18th Year Offers YOU COLLEGE and PROFESSIONAL TRAINING
18th Year Majoring in AVIATION

Accredited by the Illinois Superintendent of Public Instruction. Included since 1938 in Directory of Higher Institutions of Learning, issued by the U. S. Office of Education. U. S. approved since 1929 as a Flight and Ground School.

"G. I. Bill of Rights" educational benefits are sufficient to pay most of, though not all of, direct school expenses for eligible Veterans.

Open to high school graduates with a ranking in the upper two-thirds of their classes.

Three engineering courses majoring in Aviation Operations, Aviation Maintenance, and Aeronautical Design Engineering lead to the Bachelor of Science degree, the Airplane and Airplane Engine Mechanics ratings, and the Private Pilot rating on the two-control personal plane.

Professional Flight Training, leading to the Commercial Pilot rating and the Instrument Pilot rating, is elective for all enrolled engineering students who are physically qualified.

Each course provides 120 weeks, ten terms, of personalized instruction and is completed in 2½ calendar years.

Enrollment limited to 400 students.

Airpark and 21 buildings devoted to school purposes exclusively. Dormitories and dining hall are on the campus.

Spring term, April 2, Summer term, July 9.

Send post card for new 64-page catalog. Address:

Registrar, Dept. PM-3

PARKS AIR COLLEGE, East St. Louis, Ill.

LEARN MONEY-MAKING CARTOONING

IN SPARE TIME — by Easy Picture Chart Method

Same Simplified Method that has helped train creators of "Ferry & Pirates," "Freckles," "Out Our Way," "Winnie Winkle," "Regular Fellows," "Strange As It Seems," "The Neighbors," and many others. Earn while learning. Send 10c for Picture Chart (to test your ability), and full details. (State age.)



THE LANDON SCHOOL, Dept. 4503, Philadelphia 1, Penna.

CHEMISTRY IS OPPORTUNITY!

There's no limit to the chemist's chances for advancement . . . in salary . . . in importance. Experiments develop into giant new industries. Established industries rely on laboratories. I.C.S. training . . . practical . . . thorough . . . opens this great field to you. Instruction papers specially written by noted chemical engineers, consulting chemists, metallurgists. And these big experts are EASY TO UNDERSTAND. Our editors have explained all technical terms simply, clearly. Any person of ordinary intelligence can learn and make rapid progress. You have ambition. We have the training you need. Send now for free booklet! International Correspondence Schools, Box 5532-K, Scranton 9, Pa.

Good Handwriting
HELPS YOU WIN SUCCESS!

It's so important to write a good hand for business and social advancement. Poor legible penmanship often causes costly errors and marks you for failure. Why write a poor hand? It's so easy to learn at home in spare time. Write for our new free booklet today. If you wish, send 10c for a penpoint suitable for shaded writing and your name beautifully written.

THE TAMBLYN SCHOOL OF PENMANSHIP
In Business Since 1895
H-441 Ridge Bldg., Kansas City, Mo., U. S. A.

LAW
STUDY AT HOME for PERSONAL SUCCESS and LARGER EARNING! 8.35 years expert instruction—over 108,000 students enrolled. LL.B. Degree awarded. All texts furnished. Easy payments. Send for FREE BOOK—"Law and Executive Guidance."

AMERICAN EXTENSION SCHOOL OF LAW
Dept. 51-M, 646 N. Michigan Ave., Chicago 11, Ill.

Free Book

MOUNT BIRDS, ANIMALS, FISH
Yes FREE. Explains Taxidermy. Tells how to learn at home by mail to mount birds, animals, heads . . . to TAN skins and furs. Great for MEN and BOYS. Fun! Also earn money in spare time. **WRITE TODAY**—NOW—for free book containing 100 game pictures. State AGE, N.W. School of Taxidermy, Dept. 3373, Omaha, Neb.



LEARN MEAT CUTTING
At Home — In Spare Time

Get into the vital meat industry. Concise, practical Home Training based on 25 years' proven instruction methods used at National's famous resident school. Prepares you for bigger pay as Meat Cuts, Supervisor, market manager or more money in your own store. Go as rapidly as your spare time permits. Diploma. Start NOW to turn your spare hours into money. Send for FREE bulletin today. No obligation.

National School of Meat Cutting, Inc., Dept. U-55, Toledo 4, Ohio

ELECTRICIANS!

Free!

Get This
Book of 150
Valuable Wiring
Diagrams

ACCEPT THIS AMAZING
BOUND VOLUME AS MY
GIFT TO YOU! . . .

Here's one of the greatest "get acquainted" offers ever made. This book of 150 Electrical Shop Prints and Wiring Diagrams is YOURS—absolutely FREE. IT'S an outright gift—you pay nothing to get it and nothing to keep it.

This book is "chuckfull" of valuable charts diagrams, wiring methods and instructions for reading and using wiring shop prints. You'll find its pages packed with the kind of up-to-the-minute electrical information. All the shop prints are full size with full explanatory information. . . they have all been developed and pretested in the big Coyne Training Shops. I WANT YOU TO HAVE THIS BOOK AS MY GIFT AND HERE'S ALL YOU HAVE TO DO TO GET IT:



H. C. Lewis

EXAMINE MY NEW 7 VOLUME SET

Get This Book of 150 Shop Prints Free!

To get your FREE copy of this Shop Print book all you have to do is to let me send you my complete new 7 volume set of electrical books — COYNE PRACTICAL APPLIED ELECTRICITY for 7 days FREE examination. Here's a set of books written for the "beginner" or "oldtimer" in electrical work who is anxious to get ahead.

This 7 volume set covers everything electrical from house wiring to advanced DC & AC motors and equipment. Thousands of "show how" diagrams and photos—the very latest information written in easy to understand language.

A leader in electricity today must "know his stuff." The day of the "one operation" Electrician is going fast—to succeed from now on you must KNOW MANY BRANCHES.

SEND NO MONEY!

The new 7 volume set of practical electrical books is so NEW, so DIFFERENT and so UNIQUE that you have to see the set to really appreciate how much it can mean to you and your future. So here's what I'll do—I'll send you the complete set of 7 volumes (pictured below) at my risk, postpaid for 7 days FREE Examination. I'll also send you the New Coyne Book of 150 Shop Prints & Motor Diagrams as my FREE gift to you TO KEEP REGARDLESS OF WHETHER OR NOT YOU DECIDE TO KEEP THE 7 VOLUME SET COYNE PRACTICAL APPLIED ELECTRICITY.

Keep ALL the books 7 days. If not 100% pleased with the 7 volume set just return it and you owe nothing. If you keep the 7 volumes you can pay for them at the special low rates shown here in the coupon at right.

**Coupon Is Not An Order!
JUST A REQUEST TO SEE
THE BOOKS FREE**

I want to make one point very clear—YOU ARE NOT BUYING THE 7 VOLUME SET WHEN YOU SEND THIS COUPON. You are merely asking to see the books free for 7 days. Offer is limited. Don't put it off—Send the coupon NOW.



FREE BOOK COUPON

H. C. Lewis, Pres., Coyne Electrical School, Dept. 35-R6, 500 S. Paulina Street, Chicago 12, Ill.

Send me the NEW 7 Volume COYNE PRACTICAL APPLIED ELECTRICITY. Also send the Bound Volume of 150 Shop Prints and Diagrams which I am to keep FREE whether I keep the 7 Book Set or not. I'll either return the 7 Book set in 7 days and owe you nothing or pay \$3 within 7 days and \$3 a month until \$21.00 is paid, or I'll send the cash price of \$19.75. You also include FREE one full year of Consultation service and technical bulletins.

NAME _____ Age _____

ADDRESS _____

CITY _____ Zone _____ STATE _____

Check here if you want to pay postman cash price of \$19.75 (you save \$1.25) delivered. Same 7-day examination privilege and Money-Back Guarantee.

7 AMAZING VOLUMES

Cover everything from home wiring to DC-AC Motors and Equipment. Over 8000 subjects—2000 illustrations—5000 facts.

VOL. 1 Electrical Principles & circuits—signal systems—telephony; 450 pages.

VOL. 2 Wiring for Light, Power—Neon, Fluorescent, Aviation Lighting—Household Appliances—Farm Electricity; 460 pages.

VOL. 3 D.C. Motors and Controls, installation, operation and Maintenance, Welding—520 pages.

VOL. 4 A. C. Motors and Controls—Electronics—700 pages.

VOL. 5 Armature & Stator Winding and Repair—350 pages.

VOL. 6 Refrigeration & Air Conditioning; Radio—510 pages.

VOL. 7 Automotive, Diesel and Battery—420 pages.

COYNE ELECTRICAL SCHOOL

Dept. 35-R6, 500 S. Paulina St., Chicago 12, Ill.



A Constructive Approach to the Postwar Life

THE days ahead are a challenge to each and every one of us. What will we make of them? What will they make of us? If we will approach the future with a constructive outlook, with faith and optimism, then we will be better, stronger, more capable men and women for having lived in this period of dynamic change.

We must learn to make decisions. We must have the vision to make up our minds what we want to do — and the determination to act. We must be self-reliant, yet keep our minds open that we may benefit from the experience of others. We must grow and develop. If we stand still, the world that is now dawning will surely pass us by.

Industry has made gigantic strides under the demands of war. With the return of peace, new inventions, new ways of doing things, change and improvement will characterize every phase of production. The world of tomorrow offers priceless opportunity to the man who can foresee its requirements, and who will prepare himself to fulfill them.

FOR almost half a century, since 1905, through peace and war, National Schools has been consistently training ambitious men for careers in the major technical trades, and today offers complete resident technical trade training programs, in:

Radio, Television and Allied Electronics
Electricity and Industrial Electronics
Diesel, Automotive and Allied Mechanics

Trained, skilled men are the dependence of the world in post war research, invention, building and development. At National Schools, it has always been our objective to bring practical, modern technical trade training, the kind of training demanded by progressive industry, to all ambitious men.

Those who are looking ahead and planning ahead are invited to write for our new, illustrated catalog, which, based on many years of vocational counseling and training experience, will be found to be of constructive help in planning a wide variety of technical careers in the postwar world.

★ **NATIONAL SCHOOLS** ★
Figueroa St. at Santa Barbara, Los Angeles 37, Calif.

APPROVED FOR VETERANS



★ PIONEERS OF TECHNICAL TRADE TRAINING SINCE 1905 ★

WHICH OF THESE *Opportunities* INTERESTS *You* MOST?

Accounting & C. P. A.
Air Conditioning
Architecture & Building
Automotive Engineering
Aviation—Practical
Aviation Drafting & Design
Better Foremanship
Bookkeeping
Business Management
Cost Accounting for Mfg.

Diesel Engineering
Drafting & Design
Electrical Engineering
Electricity—Practical
High School Courses
Machine Shop Operations
Mechanical Engineering
Plastics Engineering
Plumbing—Practical
Private Secretary

Radio Operating & Servicing
Railway Training
Refrigeration
Sheet Metal Pattern Drafting
Shipbuilding
Shop Management
Surveying & Topographical
Drafting
Tool Making

THINK! LOOK FORWARD!

Business is making Post-war plans

Men and Women are preparing for the future

WHAT ARE YOU DOING ABOUT YOUR TOMORROWS?

● *Today*, choose the job you want—and prepare for it. Or if you are already engaged in the work you like best, start training *now* for quicker promotion. Acquire the knowledge that will help you to get ahead faster, make more money and have greater security.

Invest part of your spare time in more rapid progress. Start training now, in spare time in your own home. Be ready to grasp your opportunity and step out ahead of those who lack the ability you have attained.

American School, founded in 1897 as an educational institution *not for profit*, can help you to reach your goal just as it has helped others during the past forty-seven years. Give serious thought to the list above. Pick one or more subjects that interest you. Then check the coupon at right, add your name and address and mail it at once. The school will send you details on its training plan and outline of study prepared by specialists. There is no charge, no obligation, so send the coupon immediately.

PRACTICAL, EFFECTIVE HOME - STUDY TRAINING SINCE 1897

Take This First Easy Step

CHECK, CLIP AND MAIL COUPON NOW

AMERICAN SCHOOL, Dept. G345, Drexel at 58th, Chicago 37, Ill.
Without obligation. Please send FREE and postpaid, bulletin and details of the Subjects checked.

- | | | |
|---|---|--|
| <input type="checkbox"/> PLASTICS ENG'R | <input type="checkbox"/> Accounting and C.P.A. | <input type="checkbox"/> Drafting and Design for Men and Women |
| <input type="checkbox"/> Refrigeration and Building | <input type="checkbox"/> Cost Accounting for Manufacturing | <input type="checkbox"/> Radio |
| <input type="checkbox"/> Practical Plumbing | <input type="checkbox"/> Bookkeeping | <input type="checkbox"/> High School |
| <input type="checkbox"/> Automotive Engineering | <input type="checkbox"/> Private Secretary | <input type="checkbox"/> Air Conditioning |
| <input type="checkbox"/> Aviation Drafting | <input type="checkbox"/> Diesel Engineering | <input type="checkbox"/> Shipbuilding |
| <input type="checkbox"/> Aviation | <input type="checkbox"/> Surveying & Topographical Drafting | <input type="checkbox"/> Mechanical Eng. |
| <input type="checkbox"/> Business Mgmt | <input type="checkbox"/> Sheet Metal Pattern Drafting | <input type="checkbox"/> Shop Management |
| <input type="checkbox"/> Railway Training | <input type="checkbox"/> Electrical Engineering | <input type="checkbox"/> Tool Making |
| | | <input type="checkbox"/> Better Foremanship |
| | | <input type="checkbox"/> Machine Shop Operations |

Name..... Occupation.....
Address..... Age.....
City..... State.....

AMERICAN SCHOOL

Dept. G345, Drexel at 58th Street, Chicago 37

HOW YOU CAN BUILD A MIGHTY BODY

Quickly! Easily! Pleasantly
—in 10 minutes a day in your own home

"The World's greatest molder of men"—at last reveals to you in these five complete book-courses (value \$5 each)

1. How YOU Can Build a Mighty ARM!



A. PASSAMONT
First prize for physical perfection.

house of energy. Ferris writes, "I want to add my sincere gratitude to that of thousands of pupils for wonderful results from your course. Your course is by far the best." If you have a narrow, sunken chest I can improve it so that you will be proud to show it off.

Let me give YOU, TOO, such a pair of chain-breaking biceps. The strongest-armed man in the world, George F. Jowett, planned this course for you. His great experience stands as proof that YOU, TOO, can get the arms men respect and women admire.

Complete Arm Course 25c

2. How YOU Can Build a Mighty CHEST!



REX FERRIS
Champion of South Africa, says, "I owe everything to Jowett Methods."

Look at the Herold Chest of this Jowett Pupil. A powerhouse of energy. Ferris writes, "I want to add my sincere gratitude to that of thousands of pupils for wonderful results from your course. Your course is by far the best." If you have a narrow, sunken chest I can improve it so that you will be proud to show it off.

Complete Chest Course 25c

3. How YOU Can Build a Mighty BACK!



CHAS. SCHAFER
an amazing Jowett product. Once a puny weakling. Now versatile athlete.

Look at his rock-like Back now! He says, "You have worked wonders for me. You are head and shoulders above the rest in your profession." Let me help YOU, TOO, build a back of power. Square shoulders with enviable military spread. A spine as strong as a steel shaft.

Complete Back Course 25c

4. How YOU Can Build a Mighty GRIP!



W. BURNS
A Jowett-made Olympic Strength Champion.

YOU, TOO, can have a Manly Grip like this Jowett pupil. What would you give for a forearm like that, with its bone-crushing grip? Fingers strong as steel pincers. A hand like an iron vise. YOU, TOO, can get these symbols of real manliness. I have proved to thousands this is no mere dream. Let me mold a pair of arms like this for you . . . with a grip of might. A handshake that will win friends—success.

Complete Grip Course 25c

5. How YOU Can Build Mighty LEGS



BOB MITCHELL
A Jowett Champion—not in words but by ACTUAL RECORDS.

What would you give to have the all-round he-man strength of Bob Mitchell? It's reasonable to assume that what I have done for thousands, I can do for you. I myself increased my thighs by 8 inches, my calves by 5 inches, by this simple, unbreakable method. I'll help you build legs that are real props of leaping, tireless power!

Complete Leg Course 25c

Last Chancel Get All 5 Picture Courses for \$1.00

Send for them now and learn the "World's Greatest Secrets of Body Building." FREE! Marvelous Photo Book of Famous Strong Men, "Nerves of Steel—Muscles like Iron".

RUSH COUPON NOW

**BOOK WITH PHOTOS OF FAMOUS STRONG MEN
MAIL COUPON NOW**

FREE



George F. Jowett
Champion of Champions

Jowett Institute of Physical Culture
239 Fifth Avenue, Dept. 473-A, New York 1, N. Y.
George F. Jowett: Your proposition looks good to me. Send by return mail, prepaid, the courses checked below, for which I enclose (). Include FREE book of PHOTOS.

- All 5 courses for . . . \$1 Molding Mighty Legs 25c
 Molding a Mighty Arm 25c Molding a Mighty Grip 25c
 Molding a Mighty Back 25c Molding a Mighty Chest 25c
 Send all 5 C.O.D. (\$1 plus postage.) No orders less than \$1 sent C.O.D.

NAME Age

(Print name)

ADDRESS

STUDY AT HOME

With A Chartered Educational Institution

Men with specialized training win higher positions, insure larger earnings, and are bigger successes in business and public life. Opportunities NOW greater than ever before. Send for our 1944 Catalog.

ARTS AND SCIENCES

Courses in Philosophy; Education; Letters; Public Health; Medical Jurisprudence; Psychology; Sociology; Physics; Chemistry; Plastics; Geology; Political Science; Theology; Business and Commerce; Accounting; Mathematics; Statistics; Agriculture.

ENGINEERING

Courses in Electrical, Civil, Mechanical, Drafting, Architectural, Steam, Aeronautical, Radio, Structural, Mining, Industrial, Highway, Petroleum, Marine, Chemical, Diesel, Automobile and Air Conditioning Engineering.

LAW

Complete Professional Law Course includes 21 Hornbook Series college grade textbooks. Courses also in Commercial Law, Patent Law and Medical Jurisprudence.

McKinley-Roosevelt Incorporated, 4610-K, Sheridan Rd., Chicago 40, Ill.

Get into Good Paying AUTO BODY and FENDER WORK



BIG DEMAND in Auto Body and Fender work. Start training now spare time at home for good pay work now and postwar. Practical shop experience included. U.E.I. Training covers metal work, welding, painting, etc. Placement service—or we will show you how to start own shop. Behind U.E.I. TRAINING is a large national organization founded 1927.

Write today for Free Facts—No obligation

AUTO-CRAFTS DIVISION • UTILITIES ENGINEERING INSTITUTE
1314 BELDEN AVENUE, DEPT. 135X, CHICAGO 14, ILLINOIS

DRAFTING SPRINGBOARD TO SUCCESS!

Increased salary, larger responsibilities, a real career instead of just a job—these are to be had by the trained draftsman. I.C.S. makes the way to thorough, practical training open to you. Check up and you'll find that nearly every "big name" American in engineering and production acquired experience at the drafting board. Many of them started by writing for the I.C.S. free booklet. Send for it today! It can be the most important act of your life.

International Correspondence Schools, Box 5532-K, Scranton 9, Pa.

TRAIN Your VOICE! Results GUARANTEED

We build, strengthen the vocal organs—not with singing lessons—but by sound, scientifically correct silent and vocal exercises and absolutely guarantee complete satisfaction with results. Write for Voice Book, FREE. Sent to no one under 17 years old unless signed by parent.

PERFECT VOICE INSTITUTE, Studio 1353, 64 E. Lake St., Chicago 1, Ill.

THERE'S MONEY IN CARTOONS!

RAYE BURNS will teach you HOW to CREATE ORIGINAL CARTOONS at home that you may SELL! Course contains 25 lessons and over 500 illustrations. All for Only \$2.85

Send name and address for free details.
RAYE BURNS SCHOOL, Dept. M, Box 3583, CLEVELAND, OHIO



Wonderful, new device, guides your hand; corrects your writing in a few days. Big improvement in three hours. No failures. Complete outline FREE. Write C. J. Ozment, Dept. 34, St. Louis, Mo.

To Help You Learn

PRACTICAL
EQUIPMENT

RADIO

HOME
MOVIES

ELECTRONICS

Faster • Easier



**Make 133 Fascinating Experiments
In Spare Time At Home**

THINK OF IT—real radio parts and sub-assemblies—EIGHT BIG KITS of them—enough genuine parts to assemble not one but SIX Radio Receiving Circuits that work. You build a SUPER-HET, a SHORT-WAVE, a LONG-WAVE Aviation Band Circuit, a LIGHT BEAM TRANSMITTER, a WIRELESS MICROPHONE, ELECTRIC EYE devices, a RADIO TELEPHONE and scores of other fascinating projects. DeForest's unique "Block System" speeds building of new circuits—gives you valuable "Learn-By-Doing" experience at home—helps you prepare effectively for today's many grand Radio-Electronic opportunities. Get the complete facts! Mail coupon today for big, free book "VICTORY FOR YOU." You also get the colorful KIT FOLDER that tells about some of the many exciting experiments you build from DeForest's "Home Laboratory."

GET INTO RADIO AND ELECTRONICS

See how you may prepare in your spare time at your home—and without interfering with your present position—to get into the vast, Billion Dollar Radio field that needs so many trained men TODAY, and that promises many exciting postwar opportunities. Find out about the opportunities ahead of F. M. Radio, Two-Way Train Radio, Radio Manufacturing, Police Radio, Broadcast Radio, Motion Picture Sound—about the postwar possibilities of Television—about the opportunity to be your own boss in your own Radio Business.

GET FACTS ABOUT THIS MODERN FIELD

... that offers so many real money-making opportunities for the trained man who is on his toes. Mail the coupon NOW—TODAY. Do this! Find out about this NEWER... BRIGHTER future facing you in the grand field of Radio and Electronics. See how DeForest's helps you make your start by means of its effective "A-B-C" Training method.

YOU GET EMPLOYMENT SERVICE

DeForest's also provides its students and graduates with an effective EMPLOYMENT SERVICE that has long-established contacts with employers who use many DeForest's trained men. Mail the coupon today!

VETERANS: Check coupon at right for Special Information

You Use Both
with DeFOREST'S
Plus

**"Learn-By-Seeing" Movies—Add Life
to Lesson Texts**

YOU GET MOVIES—exciting training films which you project in your own home! How much more INTERESTING it is to grasp important fundamentals when right on the wall of your room you are able to see RADIO waves in motion... circuits come to life... Electrons on the march. Thanks to the use of a genuine DEVRY movie projector and 12 reels of exclusive training films, you see Radio-Electronic actions otherwise hidden from the eye. Think how much it will help you, to actually see IN MOTION the principles of what you are learning. DeForest's modern training, alone, provides this valuable aid to learning Radio-Electronics at home.

90 LOOSE-LEAF LESSONS

Where else can you get such a combination of proved major training features as—(A) 90 modern, well-illustrated loose-leaf lessons prepared under the supervision of Dr. Lee DeForest, often called the "Father of Radio"; (B) the use of "Learn-by-Seeing" home movie training films and a genuine DEVRY movie projector; and (C) the use of many practical Radio parts? You be the judge. No obligation.



DeForest's Training Offers
Instruction in Motion Picture
Sound Equipment, FM
Radio and Television



E. B. DeVry, President,
DeForest's Training, Inc., Dept. PM-B3
2535-41 N. Ashland Ave., Chicago 14, Illinois

Please send me—FREE and WITHOUT OBLIGATION—illustrated book, "VICTORY FOR YOU," and Kit Folder.

Name..... Age.....

Address.....

City..... State.....

- If under 16, check here for special information.
- If a veteran of World War II check here.

DeFOREST'S TRAINING, INC.
CHICAGO 14, ILLINOIS



SO IT NEEDS FIXING

By S. T. CHRISTENSEN

the "Fix-it Man"

WELL, I guess I'm the fellow to see, for I've repaired thousands of refrigerators (home and commercial both), vacuum cleaners, radios, washing machines, irons, fans, lamps, mangles, motors, etc. In fact, many of my customers call me their "electrical appliance doctor." And, "doctoring," I might add, has paid me a good substantial income for quite a few years. Funny, in a way, how I got started. Always liked to tinker and by experimenting around I found that most electrical appliances had many things in common. That, regardless of what the appliance was used for, or who the manufacturer was, the basic principles were much the same. From fixing my own appliances to fixing friends' and then for strangers at a fee, seems now to have been but a small step.

What to Charge?

At first, I let the owner decide the charge and, frankly, I was amazed at what I earned per hour. But then, when one figures what initial costs are involved in buying most electrical appliances, one can readily see that spending extra dollars for repairs is well worth while. Before long I was making more in my spare time repairing than from my regular job. The result . . . I went into business for myself. When war came, business boomed, for new appliances were not available.

For a while, repair parts (needed on some

jobs) were a little difficult to get. But that situation seems to have adjusted itself for many repair parts have today the high priority rating of AA2. After all, we must provide for the health and well-being of our civilian population.

The Future Offers

Friends ask me about my future. And, I think I've got a grand one. Age is no handicap in repairing. I have in my files enthusiastic letters from repairmen ranging in age from 18 to 79 years. After the war, we're bound to see hundreds of new products on the market . . . products that the average person never dreamt of. These new products and our old appliances are all going to need at some time or other "fixing." Well, I'll still be the fellow to do it. The field open for appliance repairmen is unlimited. I don't worry at all about too much competition.

If You Are Ambitious

To the contrary, I've prepared a complete course, chuck full of simple, easy to understand photos and drawings and written in the same non-technical language as this article. I know the course is good, because I have hundreds of men all over the country writing to me telling me how the course has helped swell their pockets with cash. If you too want to prepare now for your future, I suggest you read the next page and send me the handy coupon."



**BIG MONEY
INDEPENDENCE**

*A PROFITABLE
LIFETIME
BUSINESS
OF
YOUR OWN!*

LEARN ELECTRICAL APPLIANCE REPAIRING

PREPARE NOW FOR THE FUTURE

If now in war work, start your home appliance repair business NOW in your spare time and be set with a business of your own when the war is over. You don't need elaborate fixtures or expensive equipment to be a successful repairman. Operate from your garage, basement, vacant store, etc. Work as many hours as you wish—the home appliance repairman is his own boss. It is a profitable occupation for on many types of repairs it is not unusual for a repairman to charge on the basis of \$5.00 to \$6.00 per hour. Don't gamble with your future—learn a trade that will always support you. Remember, as long as electrical appliances are used, there will be a need for electrical appliance repairmen.

If you are at all mechanically inclined—can hold and use tools—then you have all of the qualifications required for becoming a big money earning home appliance repairman. It does not matter if you have not had a great deal of schooling or had previous experience along these lines—**WE WILL TEACH YOU.** Age should be no barrier—nor should any minor physical handicap.

New Course Tells All

Profusely illustrated, our new course shows you in simple, easy to understand language and drawings how to make each repair on refrigerators, vacuum cleaners, washing machines, motors, etc. Explains and gives you a working knowledge of electricity, welding, nickel plating, etc. Shows you how to build the power tools you need and how to solicit and keep business coming to you. Not a theory course but an honest to goodness course written by and used by repairmen the country over. Price of course is so low that the savings on your own household appliance repairs will quickly pay for it. Act now! Mail the handy coupon below today.

..... Read What Our Students Say About Course

I really believe your course the best investment a mechanically minded man can make.—Claude E. Allen, Indianapolis, Ind.

I have received your Course in Appliance Repairing and I must say I am well pleased with same. I am only sorry I did not have said Course some years ago. I have learned so much more through this course I would not part with it.—Charles Schwarz, Hamilton, Ohio

The Course in Appliance Servicing arrived a few days ago. Want to take out a few minutes of my valuable time to let you know that this is just what I have been looking for ever since I opened up my Fix-It shop. I must admit that you told the truth when you said that it contains quite a bit more information than I bargained for.—P. J. Bretl, Sebring, Ohio.

I am a mechanic for the Western Union Telegraph Co. Three days after receiving the lessons in refrigeration I earned the exact cost of the course.—Henry S. Lee, Washington, D. C.

I work day times at the shipyard and after 4:00 P.M. I operate from my cellar and garage. I average \$10.00 to \$15.00 clear every day.—Walter Hanby, Brockton, Mass.

GET STARTED TODAY—MAIL THIS COUPON

CHRISTY SUPPLY CO.
2835 N. Central Ave., Dept. D-1903
Chicago 34, Illinois

Please send me free illustrated literature about America's Fastest Growing Industry — **ELECTRICAL APPLIANCE REPAIRING.**

Name.....

Address.....

City..... State.....



GET INTO RADIO



Trained Men Needed Everywhere for Hundreds of Industries and Vast New Opportunities Resulting from Electronic Developments of War. Send For FREE Lesson to Prove How Quick and Easy You Get the Basic Training and EXPERIENCE with National

SHOP METHOD HOME TRAINING

By a Long Established Technical Trade School

Here is the modern, practical, advanced way for you to get ready for F.M., TELEVISION and the wonder world of ELECTRONICS as well as the great field of Radio. **Get in on the ground floor of the big industrial boom that will demand thousands of trained and experienced specialists.** Get your share of the Radio Service business now. Here is a sensationally improved method—a thoroughly proved system of training whereby you study in spare time—odd hours, even minutes—and have the advantage of actual shop experience behind you.

This exclusive shop method of home training comes to you right from one of the world's greatest vocational educational centers—the resident training shops and experimental laboratories of National Schools. It is the sound, practical training based on actual experience of qualified instructors and engineers who have prepared thousands of National graduates now employed in the radio industry.

It is up-to-date—matches the progress constantly being made in modern Radio, Television and Electronics. It is time tested. **National Schools has been training men for higher pay and greater opportunity for more than a third of a century.** Fill out and mail the coupon below for details.

The Age of Electronics is here. Radar, Radio, Communications—other branches of electronic service have been brought to perfection during the war. **These amazing improvements and advances are being turned to better living after the war.** Science says the advances made are beyond imagination.



Electronic technicians are urgently needed to build and service equipment in the field of modern scientific research and agriculture.

Radio communication has spread out to include not only aviation and marine but railroad and bus transportation—even exploration and research.



Here is a powerful force that can be put to use in industry, in commerce—in every home in the Country. America will not stand still. Americans demand the convenience, the service, the luxury that Radio and Radionics can bring them. **Vast new opportunities are swinging wide open for the man who is ready.**

What does this mean to YOU? Where do YOU—PERSONALLY AND INDIVIDUALLY—fit into this picture? Is there a big job waiting for YOU? IS NOW THE TIME FOR YOU TO GET INTO BUSINESS FOR YOURSELF? Don't sit back and see this chance go by. Send in the coupon and see how you can make your start right now.



Make Sure of Your Success and Security After the War

DON'T let your post-war ambitions lag after you get home and hang up your uniform. Don't let YOUR future depend on others. **Carve out a career for yourself.** Never in all history has the returning soldier or sailor been confronted with such a great future if he reaches out and grasps it NOW. Here is a new world opening before him. But don't YOU muffle the opportunity. Get ready now while you are still in uniform. Then when you step into civvies you will be ready to take a good, well paid position or, with little capital, GET INTO BUSINESS FOR YOURSELF. It isn't a bit too soon to start now. Fill out and mail the coupon immediately and examine the NATIONAL SHOP METHOD HOME TRAINING COURSE carefully.

Join the Thousands of Successful National Graduates

National Shop Method Home Training can win a good job for you too. Step into the kind of jobs these National men are holding.



"Due to the thorough training I received at National I have been constantly employed. At present I am with an experimental department of a large aircraft factory."
—LeRoy Murray
Highlands, California.



"Due to my training at National I was selected to instruct in the laboratory work of Navy and Marines."
—R. R. Wright
Blackfoot, Idaho.

"My latest offer was \$5,800.00 as Radio Photo Engineer . . . but I'm doing well where I am now engaged. I am deeply indebted to National."
—Joseph Grumich
Lake Hiawatha, New Jersey.



"I believe National offers the best course to be had . . . Keep up the good work."
—O. K. Ivey
Washington, D. C.



Read what hundreds of other enthusiastic students have written about National Training. Send in your coupon today.

★ **LEARN BY DOING**

TELEVISION ELECTRONICS



Use the Actual Shop Equipment That Comes to You with Your Course

Experience is the best teacher. You learn by experience with the exclusive National Shop Method of Home Training — actually build many circuits and do experiments with the big kits of standard radio parts included in your training equipment at no extra cost to you.

Build a superheterodyne receiver. Make tests and conduct experiments that show you the why and how of electronics. Build visual testers, signal generators and other instruments with the parts and supplies included in your course.

You gain marvelous experience by this method of learning and you have valuable equipment and instruments to use on the job. Mail the coupon and learn what this means to you.

Now!

Free!
GET THESE BOOKS



No Previous Experience Needed

You don't have to know the first thing about radio or electricity. You don't have to be handy with tools. The National SHOP METHOD HOME TRAINING is so direct, simple, practical, that it is like training directly under a skilled, experienced technician—an instructor interested in your progress and future. It is better than that in effect, because you, as a NATIONAL student, have the help and guidance of not one man but a whole staff of experienced shop instructors, ready and anxious to help you.

Get the same practical knowledge that has made possible the amazing progress of thousands of successful men—broadcast engineers, electronics experts, television specialists. Here is sound, fundamental training that is based on actual experience. **LEARN BY DOING**—Working right in your own home with materials and master shop methods developed at one of the world's best equipped and most advanced RADIO TRAINING CENTERS. Get a FREE lesson and opportunity book. USE THE COUPON.



Left: Ellsworth K. Anderson, owner and operator of one of the country's finest radio organizations is a National graduate.

der no obligation when you receive these books. You may keep them for your own use and no salesman will call on you.

Be Sure—Then Go Ahead

Now, right now is the time to grasp the great opportunity of today—a successful career for tomorrow. Get into the big money, rapid advancement, a position of importance. A BUSINESS OF YOUR OWN. The industry is crying for trained men everywhere. A rapidly expanding business—probably the greatest in industrial history—holds out the promise of a rich future—prosperous security. But to win it you must be ready. Well-trained men ONLY are wanted.



See for yourself what National Training can mean to you. Send Coupon for FREE Lesson

What about F. M.

F. M.—Frequency Modulation—one of the greatest developments in radio transmission and reception—is already in operation. The United States Government has already issued applications to 2,000 radio stations to broadcast F. M. "Fasimile," too is constantly progressing. The equipment, like every other type of radio, requires servicing, and it presents another valuable opportunity to the trained radio man. Mail the coupon here that brings you the complete story of this marvelous new system of training in Radio, Television and Electronics. It costs you nothing and may be worth a fortune.



Examine the National Shop Method of Home Training carefully. Be convinced. Study the lesson we send you FREE. No obligation of any sort. Fill out the coupon and mail today.

NATIONAL SCHOOLS
Los Angeles 37, California
Established 1905

One of the Nation's Greatest Vocational Education Centers

National Schools is one of the best established and widely recognized vocational schools in the Country. Thousands of men have been trained here under the direct supervision of the U. S. Government. It is widely recognized for the type of training in which it specializes—thorough practical training based on industrial standards. Only National can provide you with SHOP METHOD HOME TRAINING for National actually has the shops—the laboratories and research departments—the experienced technicians and instructors that can develop and provide the service necessary for such a training method. Fill out and mail the coupon immediately so you can examine the evidence of the value of this course of training. **See for yourself! Decide for yourself!**

MAIL OPPORTUNITY COUPON FOR QUICK ACTION

NATIONAL SCHOOLS, Dept. 3-PM
4000 South Figueroa Street,
Los Angeles 37, California

(Mail in envelope or post on penny post card)

Mail me FREE the books mentioned in your ad including a sample lesson of your course. I understand no salesman will call on me.

NAME..... AGE.....

ADDRESS.....

CITY..... STATE.....

Include your zone number.

Will you be one of the miserable 5,000,000?

Experts say the last gun on V-E Day will blow from 5 to 11 million war jobs sky-high. Will yours be one? If the future is worrying you

Get into REFRIGERATION and AIR CONDITIONING

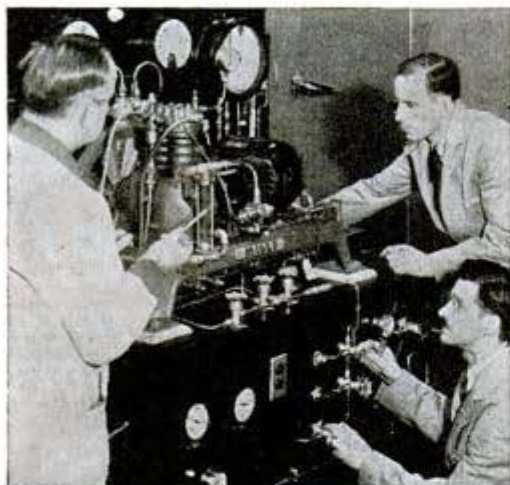

Trade figures show less than 6,000 service experts and repairmen to care for over 20,000,000 domestic and commercial refrigerators now in use—to say nothing of numberless other cooling and air conditioning installations.

Desperate Need for Trained Men. Thousands of good jobs are available for refrigeration and air conditioning service experts **RIGHT NOW.** Many thousands more men will be required after the war, due to revolutionary new applications of cooling, humidifying, heating, in industrial processes.

Vast Expansion Ahead. Air conditioning alone anticipates 500% jump in post-war output. That's only small part of bright job-making picture in this vital field. The opportunities for trained men are terrific.

Train Now for a Key Job. Yes, get ready to pick one of the biggest plums—a key job with bright future and top pay... even a business of your own. We'll give you the practical training you need to be an expert. Over 400,000 men have trained with us in our 28 years.

We'll Train You at Home. No advanced schooling is necessary. We'll train you at home, in your spare time, or in our big Chicago shops, or combine both methods. Our unique system makes everything simple, fascinating, easy to grasp. Use the Convenient I. T. I. pay-as-you-go plan. Get the facts. Write for full details **TODAY.**

For the past 3 years we have been training men and women in fine precision work for the Army, Navy, and Marine Corps exclusively, under Government contract. We are now resuming civilian training.

INDUSTRIAL TRAINING INSTITUTE
2130 Lawrence Ave., Dept. PIC, Chicago, 25, Ill.

Keep that "TICKING" Car



Every operator and mechanic needs AUDELS AUTO GUIDE.

This book saves time, money and worry. Highly endorsed. It presents the whole subject of auto mechanics:

- 1—Basic principles
 - 2—Construction
 - 3—Operation
 - 4—Service
 - 5—Repair
- Handy Size, Easily understood.

NEW FLUID DRIVE, HYDRAULIC SHIFT AND DIESEL ENGINES FULLY COVERED

Over 1500 pages—1540 illustrations showing inside views of modern cars, trucks and buses with instructions for all service jobs.

4 COMPLETE • PAY ONLY \$1. A MONTH ←
ASK TO SEE IT!—To Get This Assistance for Yourself Simply Fill in and Mail Coupon Today.

AUDEL Publishers, 49 West 23rd St., New York
MAIL AUDELS NEW AUTO GUIDE for free examination. If O. K. I will send you \$1 in 7 days; then remit \$1 monthly until price of \$4 is paid. Otherwise I will return it.

Name.....
Address.....
Occupation.....
Employed by.....P.M

ANALYZE HANDWRITING

Qualify for Certified Grapho-Analyst Degree. Earn up to \$100 weekly, up to \$1 hourly spare time, in new uncrowded profession. Graduates in employment and credit fields, police departments, courts, and in private practice as Personal Problem and Vocational Counselors. 3,000 word test lesson and illustrated GRAPHO-ANALYST Free.



ADDRESS A.I.G.A., INC., 120 JOPLIN, MO.

JOIN THE Management!

There's always opportunity in the business world for the man who wants to join the management. Routine jobs are easily filled, but men with the rounded knowledge needed by executives are hard to find. That's where I.C.S. comes in. A pioneer in business training, these schools have graduated thousands who became executives. Through the I.C.S. Business Management Course, experts train you in finance and business law, accounting and production, salesmanship and advertising. Write today for free booklet. International Correspondence Schools, Box 5532-K, Scranton 9, Pa.

Learn BAKING At Home

Baking is one of America's high industries in wages. Nearly depression-proof. Thorough basic home course lays sound foundation. If you have aptitude, write for FREE BOOKLET. "Opportunities in Commercial Baking." National Baking School, 1315 Mich. Ave., Dept. 1353, Chicago 5



LEARN PORTRAIT PAINTING AT HOME



• Good portrait painters who can PRODUCE LIKENESSES earn big money. Prices today are high; sales made before painting begins. We teach students to paint true likenesses. Write for free booklet.

STUART STUDIOS,
121 Monument Circle, Room 635, Indianapolis 9, Ind.
Please send me free book and outline of lessons.
Name.....
Street.....
City.....State.....

INVENTORS

... THE TIME IS RIPE FOR *Action!*



You men . . . and women . . . with ideas for patentable inventions—OPPORTUNITY IS KNOCKING! American industry WANTS your ideas for new products, new processes, time-and-labor saving devices to offer to a public with money to buy after the war is won. You see evidence of this every day in the newspapers . . . MANUFACTURERS

ACTUALLY ARE ADVERTISING FOR IDEAS! And they want them NOW.

Don't wait! Get going now! Have your patent application prepared and prosecuted just as quickly as you can—and be in a position to cash in. Remember—most manufacturers will consider an idea ONLY if you have taken steps to protect it with a patent.

HOW WE HELP INVENTORS

For 46 years, Victor J. Evans & Company, has helped inventors secure strong patents. Our experienced staff does all the work for you—makes the search, prepares the drawings for submission to the United States Patent Office, prepares all necessary papers, pushes the prosecution of your claim to a speedy conclusion. *And reports to you every step of the way.*

Sure—you can do it yourself. But think of the lost time, the travel expense, the lost motion! Many successful inventors use—and recommend—the services of an experienced patent attorney.

You can't go wrong when you select Victor J. Evans & Company—a firm that has helped inventors for nearly 50 years—to handle your patent application for you.

HERE'S THE FIRST THING TO DO...

Send coupon below for FREE BOOKS

that tell you everything you should know about patent procedure . . . outline and illustrate clearly every step you should take . . . illustrate 115 fundamental mechanical movements, information that may help you complete your invention. And they're yours for the asking!

With books we also send FREE Evidence of Invention Form that may help you establish your claim.

MAIL THIS COUPON TODAY FOR QUICK ACTION!

VICTOR J. EVANS & Co.

Merlin M. Evans

REGISTERED PATENT ATTORNEYS

930-C Merlin Building
Washington 6, D. C.

Please send me your books, "Patent Protection" and "When and How to Sell Your Invention"—also important "Evidence of Invention" form, without cost or obligation.

Name

Address

City and State





REFRIGERATION AIR CONDITIONING

Air Conditioning and Refrigeration are among the great industries of today and tomorrow. Installations everywhere—in restaurants, shops, homes, etc., need service. Thousands of businesses are waiting for new installations. The day may come soon when homes, too, will be air conditioned. The Refrigeration and Air Conditioning industries are headed for greater prosperity and men who have the "know how" and experience should ride along.

Train Now Before the Expected EXPANSION Begins

Experts predict large demand for men to install and service Air Conditioning and Refrigeration equipment. . . Rise to the kind of job which requires a competent, trained man who can carry the responsibilities of installing costly equipment and maintaining it. If he knows the answer when he is called in for consultation, his reputation grows and his pay should grow also.

Historic SUCCESSES May Repeat
Do you realize where you might be today if you had been in on the ground floor when some of our great industries began? Men who see ahead are more apt to be the ones who later cash in on the growth of the industry.

Follow This Way to Knowledge

Here is all it will take to get you ready for experience in this modern industry. You just invest a limited amount of your spare time—while you are still on your present job. Through our balanced training, you learn first through home study, how to handle Installation, Maintenance, and Service Work on Refrigeration and Air Conditioning equipment. Then you can get practical experience in our big shops under capable instructors—practical men who will take a personal interest in helping you learn. When you are through you should have the knowledge that enables you to get started in this vast industry.

GET FREE FACTS RIGHT NOW!

It costs you nothing to get all the facts about this great field. Simply mail the coupon below and we'll tell you, without obligation the whole, sensational story of what's ahead in Refrigeration and Air Conditioning. Mail the FREE coupon now.



REFRIGERATION
TRAINING
Since 1927

UTILITIES ENGINEERING INSTITUTE
1314 W. Belden Avenue, Dept. 135, Chicago 14, Ill.

Please send me the FREE FACTS about opportunities in Air Conditioning and Mechanical Refrigeration. I have marked the one that interests me most.

Air Conditioning Mechanical Refrigeration

NAME _____

ADDRESS _____

CITY _____

ZONE _____ STATE _____

Always write your name and full address clearly when answering advertisements.

32A

Write your own Future in Photography

Prepare now for a well-paid position today and a postwar career that is different, fascinating and profitable. Photography offers ever-increasing opportunities for both men and women. FREE book tells how N. Y. I. experts can quickly train you at home or thru resident, day or evening instruction in our up-to-the-minute N. Y. studios. ALL branches of black and white, motion picture and COLOR photography. Write TODAY!

NEW YORK INSTITUTE OF PHOTOGRAPHY
Dept. 49 10 West 33 Street New York 1, N. Y.

Learn to MOUNT BIRDS

Tan SKINS, make up FURS

Be a Taxidermist. Double your hunting fun. We teach you at Home. Mount Birds, Animals, Fish, Heads, common specimens. Fun and profits. Decorate homes and den **WAKE MONEY**. Mount game, tan for others. Big profits in spare time. **WRITE TODAY.** 100 game pictures in **FREE BOOK** Hunters, get your copy. It's Now Free. Send post card. State your AGE.

FREE BOOK **NORTHWESTERN SCHOOL OF TAXIDERMISTRY**
Dept. 3373 Omaha, Nebraska

DRAW CARTOONS BIG MONEY!

EASY . . . PLEASANT WORK!
Let CHAS. H. KUHN, with 25 years actual experience in drawing a daily newspaper cartoon, teach you how to create, draw and sell your work. 52 complete lessons—one sent each week. Professional criticism on every lesson. Write today.

Complete Course Only \$15.00

KUHN SCHOOL OF CARTOONING
420 MURPHY BUILDING Dept. M INDIANAPOLIS 4, INDIANA

LAW STUDY AT HOME

Legally trained men win higher positions and bigger success in business and public life. Greater opportunities now than ever before. Big corporations are headed by men with legal training.

More Ability: More Prestige: More Money
We guide you step by step. You can train at home during spare time. Degree of LL. B. Successful graduates in every section of the U. S. We furnish all text material, including 14-volume Law Library. Low cost, easy terms. Get our valuable 48-page "Law Training for Leadership" and "Evidence" books FREE. Send for them NOW.

LASALLE EXTENSION UNIVERSITY, 417 South Dearborn Street
A Correspondence Institution Dept. 364-L Chicago 5, Ill.

The SUPER SYSTEM

of Natural Physical Training builds health, muscular development, strength, normalizes your bodyweight and makes you full of pep. Let Harry Good, World famous strength athlete be your teacher. Send for free booklet "Building A Better Body." Do you want me to include my book "Fundamentals of Exercise and Strength Building"? Learn the Secrets of Strength Building. For 25c coin (or 30c in U. S. stamps) I will send you this fifty cent book with photos, postpaid.

HARRY GOOD, 3261-M Watson Road, St. Louis 9, Missouri

MONEY for MEN ALL DATA FREE

THE PLASTEX Industry needs manufacturers on small scale and for big production of Lamp and Clock Stands, Art Goods and Novelties in Plaster and Marble imitation. Experience unnecessary. Lge material makes regular 10c store sellers. Rubber moulds furnished for speed production. Small investment brings good returns. Big chain store orders now being placed. Ambitious men have chance for real prosperity. Our Free booklet will interest and benefit you.

PLASTEX INDUSTRIES, Dept. P, 1085 Washington Ave., New York, N. Y.

POPULAR MECHANICS



Be smart— Study Radio Now!

THIS is a radio war — and victory will bring a radio world!

That's why men with foresight and ambition are studying radio now.

In the Armed Forces, radio training makes them eligible for further valuable training — eligible for higher rating and higher pay — eligible for more interesting assignments!

In civil life, well-paid, responsible jobs in radio, television or electronics are opened to trained men.

You can study an I. C. S. Radio Course in your spare time—at low cost — starting right now! Mail this coupon, and we'll send you complete information on the famous I. C. S. personalized teaching method, which has helped thousands of Americans along the highway to success!

This information may well be worth thousands of dollars to you—yet it's yours for a 3c stamp! Mail the coupon today! Don't delay!

INTERNATIONAL CORRESPONDENCE SCHOOLS



BOX 5529-K, SCRANTON 9, PENNA.

Without cost or obligation, please send me full particulars about the course before which I have marked X:

Air Conditioning and Plumbing Courses
 Air Conditioning
 Heating Plumbing
 Refrigeration Steam Fitting

Chemistry Courses
 Chemical Engineering
 Chemistry, Analytical
 Chemistry, Industrial
 Chemistry, Mfg. Iron & Steel
 Petroleum Refining Plastics
 Pulp and Paper Making

Civil Engineering, Architectural and Mining Courses
 Architectural Drafting
 Architecture
 Bridge and Building Foreman
 Building Estimating
 Civil Engineering Coal Mining
 Contracting and Building
 Highway Engineering
 Lumber Dealer
 Reading Structural Blueprints
 Sanitary Engineering
 Structural Drafting
 Structural Engineering
 Surveying and Mapping

Electrical Courses
 Electrical Drafting
 Electrical Engineering
 Power House Electric
 Practical Electrician
 Practical Telephony
 Telegraph Engineering

Internal Combustion Engines Courses
 Auto Technician Aviation
 Diesel-Electric
 Diesel Engines Gas Engines

Mechanical Courses
 Aeronautical Engineering
 Airplane Drafting
 Flight Engineer
 Foundry Work
 Heat Treatment of Metals
 Industrial Engineering
 Industrial Metallurgy
 Mechanical Drafting
 Mechanical Engineering
 Mold-Loft Work
 Patternmaking
 Reading Shop Blueprints
 Sheet-Metal Drafting
 Sheet-Metal Worker

Ship Drafting
 Ship Fitting
 Shop Practice
 Steel Mill Workers
 Tool Designing
 Welding, Gas and Electric

Radio Courses
 Electronics
 Radio, General
 Radio Operating
 Radio Servicing

Railroad Courses
 Air Brake Car Inspector
 Locomotive Engineer
 Locomotive Fireman
 Railroad Section Foreman

Steam Engineering Courses
 Boilermaking
 Combustion Engineering
 Engine Running
 Marine Engineering
 Steam Electric
 Steam Engines
Textile Courses
 Cotton Manufacturing
 Rayon Weaving

Textile Designing
 Woolen Manufacturing

Business and Academic Courses
 Accounting Advertising
 Arithmetic Bookkeeping
 Business Correspondence
 Business Management
 Certified Public Accounting
 College Preparatory
 Commercial
 Cost Accounting
 Federal Tax
 First Year College
 Foremanship
 French
 Good English
 High School
 Higher Mathematics
 Illustrating
 Motor Traffic
 Postal Service
 Salesmanship
 Secretarial
 Sign Lettering Spanish
 Stenography
 Traffic Management

Name..... Age..... Home Address.....
 City..... State..... Present Position..... Working Hours..... A.M. to..... P.M.

Canadian residents send coupon to International Correspondence Schools Canadian, Ltd., Montreal, Canada.
 British residents send coupon to I. C. S., 71 Kingsway, London, W. C. 2, England.

DISCOUNT TO DISCHARGED VETERANS—SPECIAL TUITION RATES FOR MEMBERS OF THE ARMED FORCES

The set of
books
that makes



MASTER MACHINISTS and leads to bigger pay!

This big home-study and reference course gives you the practical facts on machines and methods you need to advance in machine shop work. Take advantage of the other man's experience as found in books, to solve your problems, increase your efficiency, with

The AMERICAN MACHINISTS' LIBRARY

6 volumes—2368 pages—2516 illustrations

(A combined home-study course and reference library)

This library of machine shop practice was written for practical men. It gives you the best methods for every kind of machine shop work. It fully explains lathes, drills, and other machine tools and their operation, automatic screw machines, speeds and feeds, gear design and production, jigs and fixtures, punch and die work, metal surfacing, etc., etc. Plainly written—completely illustrated—the best kind of help to the machine shop man who wants to advance himself.

No money down—special price—easy payments.

EXAMINATION COUPON

McGraw-Hill Book Co., 330 W. 42nd St., N. Y. 18

Send me for ten days' examination the American Machinists' Library. If satisfactory I will send you \$1.50 in 10 days and \$3.00 monthly until the price of \$19.50 is paid. If not wanted, I will return the books postpaid. (To insure prompt shipment write plainly and fill in all lines.)

Name
Home Address
City and State
Position
Name of Company PM-3-43

JUST OUT! NEW FROM COVER TO COVER

AUDELS REFRIGERATION and AIR CONDITIONING GUIDE



4 Books in One! Covering:

- 1—Household Refrigeration
 - 2—Special Refrigeration Units
 - 3—Commercial & Industrial Refrigeration
 - 4—Air Conditioning Systems
- A gold mine of essential important facts for ENGINEERS, SERVICEMEN & USERS.

A Good Book is a Good Friend! Here you have at your fingers' ends a Complete Library in ONE VOLUME, the necessary data you have been looking for on: MODERN UNITS, SYSTEMS & MACHINES, REFRIGERANTS, including Freon, Lockers, Water Coolers, Quick Freezing & Air Conditioning Systems.

1280 Pages, 46 chapters all Fully Illustrated & Indexed for Ready Reference.

ANSWERS YOUR QUESTIONS

Get This Information for Yourself. Mail Coupon Today. No Obligation Unless Satisfied. ASK TO SEE IT.

4 COMPLETE • PAY ONLY \$1. A MONTH ←

AUDELS, Publishers, 49 W. 23rd St., New York 10, N.Y.

MAIL AUDELS NEW REFRIGERATION GUIDE for free examination. If O. K. I will send you \$1 in 7 days; then remit \$1 monthly until price of \$4 is paid. Otherwise I will return it.

Name
Address
Occupation
Employed by PM

ARREST HIM, OFFICER! I'LL HAVE COMPLETE FACTS ON THE OTHER FELLOW TONIGHT!



Secret Service Operator No. 38 is on the job . . . FOLLOW HIM through all the excitement of his chase after the counterfeit gang. Write NOW for

FREE Confidential Reports

No. 38 Made to His Chief!

It may open your eyes to the great opportunity for YOU as a well paid Finger Print Expert. The kind of work you'd like, Excitement! Thrills! A REGULAR MONTHLY salary. REWARD MONEY, 63% of all Identification Bureaus in U.S., employ I.A.S. students or graduates! Write for Free Reports, Finger Print Book, low prices. Easy Terms Offer.

Literature will be sent only to persons stating their age.

INSTITUTE OF APPLIED SCIENCE
1920 Sunnyside Ave., Dept. 1353, Chicago 40, Illinois

924 PAGE AUTHENTIC FORMULARY

10,000 Formulas, Recipes, Trade Secrets for making most any conceivable product. Prepared by experts in simple, non-technical language. Contains profitable business opportunities, supply sources. Valuable references for home, farm or industry. Illustrated. Extra Complete plans: "DDT" Miraculous New Insecticide. One spraying kills all Flies, Mosquitoes, Lice, Fleas, Jap Beetles, etc. List 3 top. Big money maker. \$2.85 postpaid—Canada or Foreign \$3.25 U.S. Funds. (C.O.D. orders accepted for U.S. delivery only.)

Prepare for "After-War-Business"
Especially recommended for Servicemen and War Workers planning a profitable business of their own.
ADAMS BROWN COMPANY . . Dept. 101 . . Chestnut Hill, 67 Massachusetts



LEARN WATCH REPAIRING



AT HOME. By our modern and original system of instruction you can learn every part of the WATCH REPAIRING TRADE AT HOME. Prepare yourself for a well-paying position or start in business after completing our course of instruction. Good watch repairers are in demand and generally earn very good salaries. For particulars apply to the Wisconsin School of Watch Repairing 750 North Milwaukee St., Milwaukee 2, Wis.



Fix Your Own ALARM CLOCKS

New, practical home course. Just out. Makes interesting hobby—profitable too. Save money by doing your own repairing at home. Easy if you know how. Price now only \$1.00. Details FREE. Send postcard.

THIES JEWELRY STORE, Genoa 3, Illinois

Inventions Wanted Patented or Unpatented

Inventions can now be safely sold without patenting expense. If you have a practical, useful idea for sale, either unpatented or patented, write Chartered Institute of American Inventors Dept. 4, 631 Pa. Ave., N. W. Washington, D. C.

ELECTRICITY MEN NEEDED

GOOD JOBS • GOOD PAY • GOOD FUTURE

Through spare time home study you can qualify for a starting job in electrical work and prepare for bigger pay promotions. Or if now employed in this field you can acquire know-how which can win you a bigger, better job. It's not difficult to master principles of equipment used in generating, transmission and use of electricity. Begin now. Send name and address today for FREE information.

AMERICAN SCHOOL, Dept. EE345, Drexel Ave. at 58th St., Chicago 37

Name
Street
City, State

HOW WILL YOU FIT INTO THE POSTWAR WORLD?



LEARN PLASTICS NOW!

Plastics are playing an increasingly important part in almost every industry—improving old products and creating new ones. That is why such a brilliant future is predicted for plastics in the postwar period—offering opportunities to farsighted men and women who *know* plastics. Now is the time for you to prepare for a career in this fast-growing field.

LEARN AT HOME—You can learn plastics in your spare time at home without interrupting your present work. The Plastics Institute has developed a thorough, easy-to-understand course of training, requiring no previous technical experience. It offers complete, authoritative training based on industry requirements.

FASCINATING COURSE—The lessons are readily grasped and practical. Every step is made clear with graphs, diagrams, pictures. Actual specimens of plastics materials are furnished. A bi-weekly bulletin, "Plastics Trends," keeps you posted on new developments.

COMPREHENSIVE—Learn the various phases of plastics from this course . . . materials, designing, molding, fabricating, estimating and plant management. Acquire a basic knowledge of plastics that can be invaluable in preparing you to take your place in this great new industry.

EXCLUSIVELY PLASTICS—The Plastics Institute is America's oldest and largest plastics educational organization which devotes all of its facilities exclusively to plastics. It is held in high esteem by members of the plastics industry. Many of our graduates hold responsible positions in the plastics field.

START YOUR FUTURE—TODAY! Mail the coupon below now! We will send you an interesting booklet filled with valuable information on plastics and tell you how, at small cost, you can prepare for a career in this important industry. Don't put it off! Mail today!

Dept. PM-3, 122 E. 42nd St., New York 17—Dept. PM-3, 221 N. La Salle, Chicago 1—Dept. PM-3, 186 S. Alvarado, Los Angeles 4

SPECIAL RATES FOR SERVICE MEN

Plastics

VETERANS
Ask about
G. I. Training

INDUSTRIES TECHNICAL INSTITUTE

Plastics Industries Technical Institute
221 N. La Salle St., Dept. PM-3, Chicago 1

Mail in Envelope or
paste on penny postcard

Gentlemen: Please send me the booklet "World of Plastics" and information on your training program. I understand there is absolutely no obligation,

Name.....Occupation.....

Street.....Age.....

City.....Zone.....State.....

Veterans: Check here for special information on G.I. Training Privileges.

If under 18: Check here for special booklet.



FREE BOOKLET
Send for It Today!

Do you want

- ..to go to College?
- ..or to enter a Profession?

(Such as Accounting, Architecture, Nursing, Dentistry, Teaching, Social Work, Osteopathy, Beauty Culture, Optometry, Embalming, Chiropractic, Law, Medicine, etc.)

- ..or get an Office Position?

To get anywhere, you practically MUST finish High School FIRST. You can complete our simplified High School Course in SPARE time at home, as FAST as your time and abilities permit. Equivalent to resident school work—prepares you for college, pre-professional examinations, business, industry. Standard texts furnished. Diploma. Credit for H.S. subjects already completed. Single subjects if desired. Low tuition, easy terms. American School, Chicago, est. 1897—endorsed by educators. Finish your high school education NOW. Write TODAY!

High School Course at Home

Many Finish in 2 Years

American School, Dept. H345, Drexel Ave. at 58th St., Chicago 37, Ill.

Gentlemen: Send me FREE information covering special training in subjects checked below. No obligation on my part.

- | | |
|--|--|
| <input type="checkbox"/> High School Course | <input type="checkbox"/> Diesel Engineering |
| <input type="checkbox"/> Cost Accounting for Mfg. | <input type="checkbox"/> Drafting and Design for men & women |
| <input type="checkbox"/> Architecture and Building | <input type="checkbox"/> Plastics |
| <input type="checkbox"/> Automotive Engineering | <input type="checkbox"/> Private Secretary |
| <input type="checkbox"/> Business Management | <input type="checkbox"/> Mechanical Engineering |
| <input type="checkbox"/> Electrical Engineering | <input type="checkbox"/> Aviation <input type="checkbox"/> Radio |
| <input type="checkbox"/> Elec. and Gas Refrigeration | <input type="checkbox"/> Salesmanship |
| <input type="checkbox"/> Air Conditioning | <input type="checkbox"/> Shipbuilding |
| <input type="checkbox"/> Railway Training | |

Name.....

Address.....

Make Money in Postwar Aviation

be an INSTRUMENT TECHNICIAN

Permanently profitable careers will be open to men who become specialists in aircraft instruments, through A.S.A.I. training. For every type of plane—for airlines, commercial, private and military flying—skilled technicians will install, test and repair the extensive instrument sets required by modern aviation. These will be interesting, well paid positions, with a real future

Great networks of global airlines will demand trained specialists for instrument maintenance. NOW is the time to prepare for this growing field, at American School of Aircraft Instruments... the oldest instrument school in America.

VETERANS! SERVICE MEN! CIVILIANS!
Get complete information on A.S.A.I. resident school courses.



SEND TODAY for this interesting 24-page Booklet.

AMERICAN SCHOOL OF AIRCRAFT INSTRUMENTS
5253 W San Fernando Road Los Angeles 28, California

AMERICAN SCHOOL OF AIRCRAFT INSTRUMENTS

Including Accredited Watchmaking School

5253 W San Fernando Road Los Angeles 26, California

Gentlemen: Please send free 24-page book and data on courses checked below without obligation.

- Master Instrument Technician Home Study Instrument Course
 Watchmaking

Name..... Age.....

Address.....

City..... Zone..... State.....

Veteran In Services Civilian P-3

AMERICA'S OLDEST INSTRUMENT SCHOOL



DIVING, CUTTING and WELDING IN UNDERWATER SALVAGE OPERATIONS

by Frank E. Thompson, Jr.

New, fascinating, easy-to-understand book by the famous Manufacturer-operator of salvage equipment who helped our Navy raise ships sunk by Japs at Pearl Harbor! Practical, essential facts for a well-paid, patriotic job.

224 pages . . . Illustrated . . . Indexed . . . \$2.00



CORNELL MARITIME PRESS
241 West 23rd Street New York 11

Learn LANDSCAPE GARDENING!

Prepare for the giant postwar home-building program. A thorough, constructive, interesting home-training for those who wish to become LANDSCAPERS, DESIGNERS, GARDENERS, etc., for profit or pleasure. Write today for FREE INFORMATION, without obligation, to

NATIONAL LANDSCAPE INSTITUTE
Dept. PM-3 756 So. Broadway Los Angeles 14, California



You can learn plain, rapid writing or fancy ornamental writing for social and business advancement, right in your own home during spare time by my Simplified Method. Write for my free book, "How to Become an Expert Penman," which shows what others have accomplished by taking my Courses. Send 10¢ for one of my favorite Pen Points and your name with a beautiful flourished bird written on a card. Write today. T. M. Tevia, Box 25K, Chillicothe, Mo.

"How to Make Money With Simple Cartoons"

A book everyone who likes to draw should have. It is free; no obligations. Simply address

CARTOONISTS' EXCHANGE
Dept. 93 Pleasant Hill, Ohio

STAMMER?

This new 128-page book, "Stammering, Its Cause and Correction," describes the Bogue Unit Method for scientific correction of stammering and stuttering—successful for 44 years. Benj. N. Bogue, Dept. 1822, Circle Tower, Indianapolis 4, Ind.



ARTISTS MAKE MONEY

Find out your ability. Send name, age, occupation and address for Free Vocational Art Test.
ART INSTRUCTION, INC. (Formerly Federal Schools)
3135 Art Instruction Building, Minneapolis, Minnesota

730 SHAVES FROM 1 BLADE

AMAZING NEW BLADE SHARPENER



New sharpener for all makes of double-edge razor blades performs miracles! "Not necessary to change blades," writes one user. Another says, "Have used 1 blade over 730 times." RAZOROLL really sharpens blades because it strokes on leather. Gives keen, smooth shaving edges. No guesswork. Blade held at correct angle and proper pressure—automatically. Just turn crank to sharpen blade. No gears. Well made, handsome, compact, sturdy. Weighs few ounces. Will last years. Makes ideal gift.

Only \$1.00

SEND NO MONEY! Write today. Pay postman only \$1 plus few cents postage. Use RAZOROLL for 5 days and if you're not delighted with smooth, velvet shaves you get, return RAZOROLL, and we'll return your dollar. Hurry—order today. RAZOROLL COMPANY
620 North Michigan Avenue, Dept. 503, Chicago 11, Illinois

Now Any AUTO REPAIR JOB Can Be a "Push-Over" for You!

**IN LESS TIME —
WITH LESS WORK —
AND MORE PROFITS!**

MoToR's new AUTO REPAIR MANUAL shows you how to service and repair ANY part of ANY car! Now you can lick even the toughest jobs when you have this amazing Manual to make your work easier!

Every job on every car built since 1935 is explained as simply as A-B-C. Clear, illustrated instructions lead you step by step. NOW you can tackle ANY job from carburetor to rear end—and do it quick, easy, right, the FIRST time! Just look up make, model, and the job in the quick index of MoToR's AUTO REPAIR MANUAL—and go to work!

ONLY Manual of Its Kind

No wonder this manual is used by the U. S. Army, Navy, trade and technical schools everywhere, and thousands of successful auto servicemen!

To make this great book possible, the engineer-editors of MoToR Magazine condensed all the meat from 150 official factory manuals for you. They dug out all the information you need; made sure every word is crystal-clear; and put "the whole works" into this one great, handy book!

MoToR's AUTO REPAIR MANUAL is a big book: 764 large pages, 8½ x 11 inches, bound in sturdy covers. Nearly 200,000 ser-

vice, repair, adjustment, replacement, tune-up facts on every car built from 1935 to 1942!

Over 1,000 Pictures!

More than 1,000 cutaway photos, diagrams, drawings, charts, SHOW you what the clear text TELLS you! No wonder thousands of men call this amazing book their Auto Repair "Bible"! No wonder it will save YOU countless hours of work—and help you make MORE MONEY from auto repairs!

See for yourself—without cost!—what a work-saver, time-saver, and "life-saver" MoToR's AUTO REPAIR MANUAL will be for you! TRY it FREE—for 7 days. Learn first-hand how it can pay for itself the first few times you use it!



Clear, Pictured Facts on Every Job on Every Car Built Since 1935!

Nearly 200,000 service and repair facts on all these makes:

American	Crosley	La Salle	Packard
Bantam	De Soto	Lincoln	Pierce
Auburn	Dodge	Lincoln	Arrow
Austin	Ford	Zephyr	Plymouth
Buick	Graham	Mercury	Pontiac
Cadillac	Hudson	Nash	Reo
Chevrolet	Hupmobile	Oldsmobile	Studebaker
Chrysler	Lafayette	Overland	Terraplane
Cord			Willys

764 big pages; including 50 pages of carburetor text, charts, illustrations covering all models. Over 500 charts, tables: Tune-up Chart; Valve Measurements; Compression Pressure; Torque Wrench Reading; Starting Motor; Engine Clearances; Generator; Clutch & Brake Specifications; Front End Measurements, etc.; Engines; Electric, Fuel, Cooling, Lubricating Systems; Transmissions; Universals; Front Ends; Wheels; Rear Ends, etc.

**FREE
7-DAY OFFER
SEND NO MONEY**

Just mail coupon below—without money! When the postman brings your book, examine it thoroughly. Make it show you what it's got! Unless you agree this is the greatest time-saver and work-saver you've ever seen—return book in 7 days and pay nothing. Mail coupon today! Address: MoToR Book Department, Desk 1C, 572 Madison Ave., New York 22, New York.



Same FREE 7-Day Offer Applies on MoToR's Truck Repair Manual

For mechanics, truck specialists, service stations, fleet owners. Covers EVERY job on EVERY truck made since 1935! 1400 pictures, 914 pages, 300,000 facts. Used by Armed Forces. Warranted to contain every essential fact you need to know. Strong binding, size 8½x11.

Covers all types Gasoline Engines; Diesels and Hessels-motors. Fuel Systems, Governors, Lubrication Systems, Ignition Systems, Starters, Generators, Clutches, Transmissions, Axles, Torque Dividers, Transfer Cases,

Brakes, Steering, etc., etc.

Also services buses, farm and industrial tractors, contractor and road building equipment, stationary power machinery, etc. (on all parts described in Manual.)

Offered on same FREE 7-Day examination as Auto Repair Manual. Check box in coupon at right.



Published by MoToR, The Leading Automotive Business Magazine. MoToR's manuals assure high standards of repair work.

MoToR Book Dept., Desk 1C, 572 Madison Ave., N. Y. 22

Rush to me at once: (Check box opposite book you want)

MoToR's AUTO REPAIR MANUAL. If O.K. I will remit \$1 in 7 days, and \$1 monthly for 4 months, plus 35c delivery charge with final payment (\$8.35 in all). Otherwise I will return book postpaid in 7 days. (Foreign price, remit \$7 cash with order.)

MoToR's TRUCK REPAIR MANUAL. (Described at left.) If O.K. I will remit \$2 in 7 days, and \$2 monthly for 3 months, plus 35c delivery charge with final payment (\$8.35 in all). Otherwise I will return book postpaid in 7 days. (Foreign price, remit \$11 cash with order.)

Print Name..... Age.....

Print Address

City..... Zone No. (if any).....

State..... Occupation.....

SAVE 35c SHIPPING CHARGE! We pay postage. ENCLOSE full payment (check, m. o.). Same 7-day return-refund privilege.

IF YOU ARE OVER 40 YOU ARE FORTUNATE

Today the middle-aged man has unusual opportunity. Business, industry and government want his experience and skill. Youth—called to the war—is no longer his competition.

To the ambitious man, this is a challenge to serve his country now and to safeguard his future. He can create a permanent place for himself that in normal times his age would block.

But he can't do it by merely wishing—he must work and fight for it, equip himself for these better jobs. And home study training can be a powerful aid. In his spare time, at low cost, he can get quickly the necessary knowledge and skill.

Why not investigate? Ask today for our free 48-page booklet on the field of your choice.

LASALLE EXTENSION UNIVERSITY A Correspondence Institution 417 So. Dearborn St., Dept. 364-R, Chicago 5, Ill.

I want to know whether home study training can help me. Send me your free booklet on the subject I have checked below.

- | | |
|---|--|
| <input type="checkbox"/> Accounting | <input type="checkbox"/> Bookkeeping |
| <input type="checkbox"/> Foremanship | <input type="checkbox"/> Industrial Management |
| <input type="checkbox"/> Law: LL.B. Degree | <input type="checkbox"/> Executive Management |
| <input type="checkbox"/> Traffic Management | <input type="checkbox"/> Business Correspondence |
| <input type="checkbox"/> Business English | <input type="checkbox"/> Salesmanship |

Name.....Age.....

Present Position.....

Address.....

Tomorrow's MONEY MAKING OPPORTUNITY IS HERE Today

Returning Veterans! War Plant Workers! All Men looking to the FUTURE! Get set for life with one of America's greatest industries. Quick cash profits are yours demonstrating AUTOFYRSTOP, the remarkable new combination automatic and manual fire extinguisher and alarm that holds unequalled records. Sells fast to factories, schools, homes. Write for FREE facts. No experience necessary.

AUTOFYRSTOP CO., Dept. M-35
2035 Washington Ave. Philadelphia 46, Pa.

KILLS FIRE BY ITSELF



MECHANICAL ENGINEERING PAYS!

This is the machine age. And back of every machine—every part—are the engineers who designed it, the trained mechanics who built it. No wonder there's high pay... many opportunities to advance... for these indispensable men. Be one of them! Don't stick in a rut! Let I.C.S. show you the way to success! These Schools, famous for more than 50 years, offer authoritative, practical Courses to meet the needs of almost any man in mechanical trades. Mechanical Engineering... Drafting... Mechanical Drawing... Shop Practice. Write today for free booklet.

International Correspondence Schools, Box 5532-K, Scranton 9, Pa.

PRINTING PAYS BIG

Earn up to \$3.50 an hour in your own print shop or prepare for one of the many big pay jobs that are waiting to be filled. Our home study course will prepare you. Practical lessons, Examinations, Diploma. Literature and sample lesson, free.

COMPLETE COURSE ONLY
\$14.50
CASH
TERMS AVAILABLE

Write Dept. V59

International School of Printing, Troy, O.

LEARN MOVIE PROJECTION THEATRE MANAGEMENT



The Motion Picture Theatre Business offers big opportunities for trained men. Get into a fascinating field with a peace time future. Train at home in spare time. Free catalog. Established 17 years.

THEATRE INSTITUTE, 370 Washington St., Elmira, New York

Correspondence Courses in RADIO and ELECTRICAL ENGINEERING

LOW AS
\$25



ELECTRICAL ENGINEERING. Get good grasp of wide electrical field. Modern. Very understandable. Theory made easy. RADIO ENGINEERING. Extra fine course in radio, public address, photo-electric work. Trains you to be super-service man, real vacuum tube technician. Tuition ONLY \$25, either course. Deferred payment plan. Servicemen needed badly.

FREE Write for free copies of school catalogs, student magazine, etc. LINCOLN ENGINEERING SCHOOL, Box 931-P75, Lincoln, Nebr.

ARC WELDER'S GUIDE

FREE!

The most widely distributed booklet in the welding industry. Every welder wants this handy information guide. Tables, charts and valuable welding data you'll use daily.

HOBART

OVER 100 IDEAS!

"Practical Design for Arc Welding"

The trend is toward welded design. You'll find this book a great idea stimulator for new designs. Order your copy today. Learn how others redesigned for faster, lower cost arc welding... today's greatest production tool.



With Individual estimating forms at side \$3.50 of each design. Postpaid

HOBART "One of the World's Largest Builders of ARC WELDERS"

HOBART BROTHERS COMPANY BOX M-351 TROY, OHIO

FREE TRIAL IN YOUR OWN HOME!
Here's the HELP YOU NEED
...Now and After the War!
 Used by Army, Navy, 200 Schools and Big Firms



DO ANY JOB.. EASIER.. QUICKER
MAKE MORE MONEY in the
BIG OPPORTUNITY
FIELDS

SEND NO MONEY
 Select the Books
 YOU Need Now!
 We Ship C.O.D.
 Anywhere in U. S.
 and Will Refund
 Amount Paid if
 Not Satisfactory.

Get ready to meet keener job competition, now and when wartime jobs are over. Get into one of these big opportunity fields. Big money and many other advantages await you if you prepare now. Here is the help you need—EASY—QUICK—AT LOW COST. Thousands of men have already used these famous books. Beginners and experienced men alike have doubled and tripled their earnings with this help. You too, can now get the special knowledge you need for top pay, better jobs, or a business of your own. This is your **GOLDEN OPPORTUNITY.**



MODERN WELDING PRACTICE

Newest book on all types of welding and heat treatment of metals. Written by recognized specialists in training men for production jobs. **Practical and Non-Technical.** Covers everything you need to know. Prepare for best pay jobs now. Price \$4.00.

AIRPLANE WELDING

All metal airplane building offers big opportunities after the war. New 2nd edition of this famous book by J. B. Johnson, Materials Division, Wright Field. The authoritative and practical book on Airplane welding and materials brought right up to date. 420 pages, 193 pictures. \$3.50.



REFRIGERATION—Book of the Hour

NEW PRINTING—ALMOST 1000 PAGES

408 Pictures—17 Diagrams in Colors Makes All Refrigerator Service Maintenance, Repairs Simple as A. B. C.

No new refrigerators being made. Owners will pay big for competent service which will be needed more and more. Get **MODERN GAS AND ELECTRIC REFRIGERATION**, the non-technical guide to all types of refrigerators and get your share of this new profit. Get a job or start your own service business. This book will help you make money anywhere. Price \$5.00.

AIR CONDITIONING



Big air conditioning boom interrupted by war will be bigger than ever in post-war days. Get this non-technical book by international authority and be ready for your share of millions to be spent. Covers whole field. 450 pages. Illustrated. \$3.50.

SHEET METAL LAYOUT

Makes sheet metal layout work so simple that anyone can learn. Get this new instructor and get into the easiest, cleanest and best paying part of all sheet metal work. 143 jobs worked out in drawings and carefully explained. Gives standard for all sheet metal fittings. \$3.00.



15 Million Refrigerators Need Service and Repairs

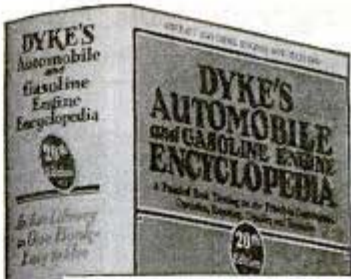

NEW 20th EDITION
Leading Auto Book for Over 32 Years

World's Greatest AUTO BOOK

New Material on Transmissions, Trucks, Tractors, Diesels, Aircraft and Auto Engines

Now with millions of cars needing repairs and thousands of men needed to do the work, you need the famous DYKE Auto Book more than ever before. Brand new 20th Edition covers all principles, construction, repair, adjustments, testing, troubles and remedies of all cars. Over a half million copies of 20 editions of Dyke's have been sold. Gives specifications of old and newer cars. World's biggest book value, \$6.00. This big book, a complete auto library in one volume, has 1483 pages—4600 illustrations and diagrams—weighs 6 lbs.—equal to 4 ordinary books.

AUTO BODY and FENDER REPAIR

Owners will spend big money to keep cars looking new because few new cars available. This is a practical money-making guide, ideal for shop owners and every man who wants a share of the millions to be spent in keeping old cars looking new. Tells how to get a good job or start business of your own with small capital. 325 pages, 232 illustrations. Price \$3.00.

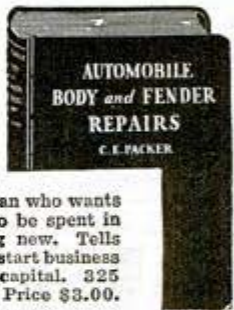

BAILEY'S HANDBOOK



World famous handbook of universal questions and answers for Stationary, Marine and DIESEL engineers and firemen. Prepares for any license examination. Pocket size. \$2.00.

DYKE'S CARBURETOR BOOK

The standard guide for a generation. New edition covers engine tune-up, compression, ignition, carburetion, fuel pump valves, etc. Use this book to specialize in this big field. 244 pages, 549 illustrations. \$3.00.

Mail Coupon to: **Goodheart-Willcox Co., Inc.**
 2009 S. Michigan Ave. Dept. 13 Chicago 16, Ill.

SEND NO MONEY! Mail Coupon

GOODHEART-WILCOX CO.,
 2009 S. Michigan Ave., Dept. 13, Chicago 16, Ill.

Send books checked. C.O.D. I will pay postman, plus few cents charges. If not satisfactory I will return books in 5 days and you will refund money paid. (Outside U.S. or possessions remit with order.)

<input type="checkbox"/> Gas & Electric Refrigeration \$5.00	<input type="checkbox"/> Sheet Metal Layout \$3.00
<input type="checkbox"/> Dyke's Auto Book \$6.00	<input type="checkbox"/> Air Conditioning \$3.50
<input type="checkbox"/> Dyke's Carburetor Book. \$3.00	<input type="checkbox"/> Bailey's Handbook \$2.00
<input type="checkbox"/> Modern Welding \$4.00	<input type="checkbox"/> Body and Fender Repair. \$3.00
<input type="checkbox"/> Airplane Welding \$3.50	<input type="checkbox"/> Aircraft Sheet Metal. \$2.50
	<input type="checkbox"/> Shop Math. (2 vols.) \$3.00

If remittance accompanier order we will pay all postage charges under same return privilege.

Name
 Address
 City State

Increasing your hold on your job and giving yourself a chance for advancement

Few men deliberately plan to work persistently on self-improvement. If progress comes naturally, they're happy; if it doesn't, they worry or ignore the situation. Yet it is possible to pay attention to self-improvement with considerable hope of success. A noticeable degree of advancement is practically assured any one who will make an intelligent and persistent effort. Thousands of men have proved this for themselves, with:



The Croft Library of Practical Electricity

The Croft Library is a complete electrical educator. It is founded on practice—on 20 years of shirt-sleeve experience—on work as it is actually done. It is jammed from cover to cover with the kind of hard-headed facts you want. Written so that the beginner can easily understand it, yet so sound, so thorough, that it is the daily guide of 50,000 highly paid electrical workers and engineers. Croft tells you the things you need to know about motors, generators, armatures, commutators, transformers, circuits, switchboards, distribution systems—electrical machinery of every type—wiring for light and power—wiring of finished buildings—underwriters and municipal requirements—illumination in its every phase—the most improved methods of lighting lamps—and lamp effects, etc.—how to do a complete job, from planning it, to completion.

No money down—easy payments

Fill in and mail the coupon attached and we will send you the entire set of seven volumes for ten days' examination on approval. We take all the risk—you assume no obligation. If you decide to keep the books, send \$3.00 in ten days and the balance at the rate of \$3.00 a month. Send the coupon NOW and see the books for yourself.

MCGRAW-HILL BOOK CO., 330 W. 42nd St., New York 18, N. Y.

Send me for ten days' examination on approval the Croft Library of Practical Electricity, 7 vols. If satisfactory I will send you \$3.00 in 10 days and \$3.00 monthly until the price of \$18.00 is paid. If not wanted, I will return the books postpaid. (To insure prompt shipment write plainly and fill in all lines.)

Name.....
 Home Address.....
 City and State.....
 Position.....
 Company..... PM-3-45

AVIATION Career

DON'T WAIT UNTIL THE WAR IS OVER!

Since 1929 Cal-Aero Technical Institute has been specializing in modern, progressive training for Aeronautical Engineers and Master Aviation Mechanics. Prepare now for your Aviation Career. BE READY! Opportunities are great today and will be greater in tomorrow's Age of Flight. **DISCHARGED VETERANS**—Write us about Aviation Training as provided under "G. I. Bill of Rights."



GRAND CENTRAL AIRPORT
 GLENDALE 1, CALIFORNIA
 (LOS ANGELES COUNTY)

MAIL THIS COUPON TODAY!

Cal-Aero Technical Institute, Grand Central Airport, Glendale 1, California. Send information and illustrated catalogue on Aviation Training. FREE... without obligation... Dept. PM-3

Name..... Birth Date.....
 Street.....
 City..... State.....

"THREE MONKEYS" Cartoon Films



"High light" the HOME MOVIE show. Three leading characters make each film a feature.

50 FT. 8MM. \$1.25 100 FT. 16MM. \$2.50
 Ship Wrecked 1209-A The Auto Race 1213-A
 High and Dizzy 1210-A Midnight Spooks 1214-A
 Screen also a Mickey Mouse, Bosko, Oswald Rabbit and Donald Duck Cartoon for a full evening of delightful HOME entertainment.

See at Your Photo Dealer or Order Direct.
 Catalog and Prices on Request. Write to:
HOLLYWOOD FILM ENTERPRISES, Inc.

6060 Sunset Blvd. Dept. 115 Hollywood 28, Calif.

TRI-STATE COLLEGE

B. S. Degree in 27 Months

Distinguished for technical 2 1/2-year courses in Civil, Electrical, Mechanical, Chemical, Radio, Aeronautical Engineering; Business Administration, Accounting, and Secretarial Science. EX-SERVICE MEN can complete work here in shortest possible time. Special Prep. Dept. Also REFRESHER COURSES. 36-Week Courses in Surveying, Drafting. Low tuition. Low living costs. Cosmopolitan student body. 61st year. Enter Jan., March, June, Sept. Catalog. 435 College Ave. ANGOLA, INDIANA

HIGH SCHOOL AT HOME

Most well-paid positions demand high school training. Without it, or equivalent, you can't advance to the full extent of your abilities in any trade, business or profession. Whatever your age, however you're situated, IT ISN'T NECESSARY TO STRUGGLE UNDER THAT HANDICAP. I.C.S., famous for more than 50 years, enables you to start your own high school in your own home. You're in a class by yourself—study in your spare time—acquire a high school education at astonishingly low cost. Authoritative text! Rapid Progress! Write today for free booklet. International Correspondence Schools, Box 5532-K, Scranton 9, Pa.

CARTOONING

CASH IN on Big Cartoon Market. Become Cartoonists Quickly with NEW, EASY METHOD prepared by successful cartoonists. Learn how to get ideas and quickly originate cartoons for Newspapers, Magazines and Advertisers. No experience necessary. 45 LESSONS covering 93 SUBJECTS. Valuable ideas, cartoon markets, etc. Postpaid anywhere for only—

\$7.85

Sample Lesson Plate and Details Free. NATIONAL ARTISTS BUREAU, Box 4248-A, DALLAS 8, TEXAS

RE-SOLE YOUR SHOES

Easy—at home. Spread on So-Lo. It wears like leather. For all footwear, children's and grownups'. Also mends tires, raincoats, boots—anything of rubber, leather, cloth.

MEND THE HOLE for SPREADS on like butter. Dries tough overnight. Flexible. Non-skid. Waterproof. Won't come off—guaranteed. **So-Lo** AT ANY HARDWARE AND 10c STORE **1¢**

SIMPLE EASY INVENTION TRIMS HAIR AT HOME!

SAVES BARBER BILLS
 Trims hair as it combs! Easy! Quick! Keeps men's, women's children's hair trim, neat, freshly-cut looking all the time! Trims, tapers, thins out uneven hair. Use like ordinary comb. Safe, Simple. No experience required. Fine for legs, underarms! Sells like wild! **SAMPLES FOR AGENTS** Sample offer sent immediately to all who send name at once. A penny postal will do. **SEND NO MONEY.** Just your name. **KRISTEL CO., 683 Bar St., AKRON, OHIO**



DRAFTING

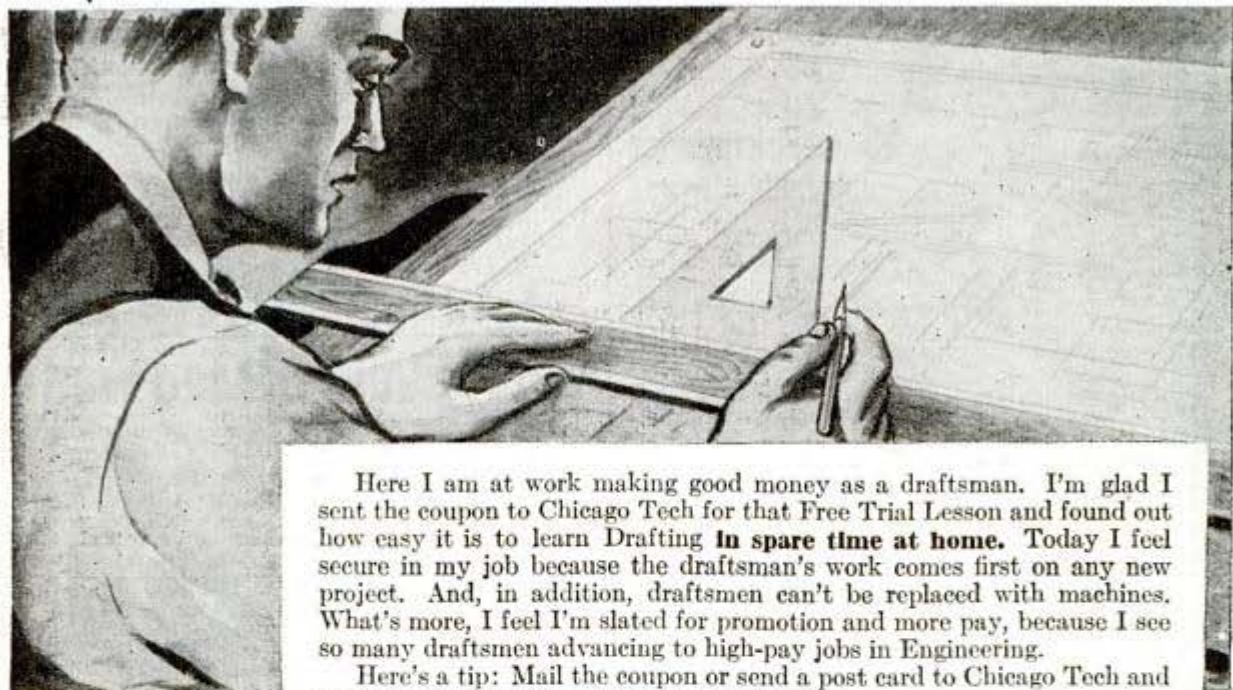

Here I am at work making good money as a draftsman. I'm glad I sent the coupon to Chicago Tech for that Free Trial Lesson and found out how easy it is to learn Drafting **in spare time at home**. Today I feel secure in my job because the draftsman's work comes first on any new project. And, in addition, draftsmen can't be replaced with machines. What's more, I feel I'm slated for promotion and more pay, because I see so many draftsmen advancing to high-pay jobs in Engineering.

Here's a tip: Mail the coupon or send a post card to Chicago Tech and find out about your opportunities in Drafting.

LEARN in Spare Time—at Home!

(Or at the College in Chicago)

A few hours of pleasant home study every week—that's all. No interference with your present job. With Chicago Tech's help, you train yourself step by step. This tested method,—developed over 40 years of C.T.C. progress,—prepares men quickly for good positions in industry.

Get Free Information — Send Coupon

Find out now how you can use your spare time to prepare, in your own home, for these post-war opportunities by use of the Chicago Tech Plan. Same training methods as used in our Chicago school. **Choose the line where you would like to work,—in Drafting, Building Construction, Refrigeration or Air Conditioning.** Mark and mail the coupon or send a post card. No obligation of course. Act today.



FREE TRIAL LESSON

To prove to you how easy it is to learn Drafting at home by the Chicago Tech method we will send you this FREE TRIAL LESSON. No charge for this Lesson, now or later. Fill out and mail Coupon, or send post card today.

DRAWING OUTFIT INCLUDED (with Drafting Courses)

All the tools you need including folding drawing table. With them you can put your ideas on paper quickly and with accuracy. With training, you're all set to master Drafting in months—not years,—at home.

CHICAGO TECHNICAL COLLEGE

C-206 Tech Bldg., 2000 South Michigan Ave., Chicago 16, Ill.

Send INFORMATION PLEASE on Home-Study Training in:

- | | |
|---|--|
| <input type="checkbox"/> Aircraft Drafting | <input type="checkbox"/> Builders' Course |
| <input type="checkbox"/> Machine Drafting | <input type="checkbox"/> Blue Print Reading—Building |
| <input type="checkbox"/> Electrical Drafting | <input type="checkbox"/> Estimating,—Buildings |
| <input type="checkbox"/> Structural Drafting | <input type="checkbox"/> Refrigeration |
| <input type="checkbox"/> Architectural Drafting | <input type="checkbox"/> Air Conditioning |

Name.....Age.....

Address.....

City.....Zone.....State.....

Veterans check here for information about "GI" Training at the College in Chicago.

DRAFTSMEN NEEDED



PREPARE NOW for a BETTER JOB AND GREATER OPPORTUNITIES

If you are ambitious to hold a better job, make more money and have greater opportunities to get ahead, start now to become a draftsman. Or if you are now employed in routine drafting work and want a better job—as a real draftsman, on more important work, at bigger pay, start now to qualify for that job.

Learn at Home in Spare Time

American School has helped thousands to reach higher goals, and can help you. Our practical, up-to-date training plan can provide the know-how that fits men for responsible jobs and opens opportunities. Begin draftsman training now. Check, fill in and mail the coupon below for FREE information—today.

AMERICAN SCHOOL, Dept. DD345, Drexel Ave. at 58th St., Chicago 37, Ill.

Gentlemen: Send me FREE information covering special training in subjects checked below. No obligation on my part.

- | | |
|--|---|
| <input type="checkbox"/> Drafting and Design for Men and Women | <input type="checkbox"/> Electrical Engineering |
| <input type="checkbox"/> Cost Accounting for Mfg. | <input type="checkbox"/> Diesel Engineering |
| <input type="checkbox"/> Architecture and Building | <input type="checkbox"/> High School Course |
| <input type="checkbox"/> Automotive Engineering | <input type="checkbox"/> Plastics |
| <input type="checkbox"/> Business Management | <input type="checkbox"/> Mechanical Engineering |
| <input type="checkbox"/> Railway Training | <input type="checkbox"/> Aviation |
| | <input type="checkbox"/> Shipbuilding |
| | <input type="checkbox"/> Radio |

Name.....

Address.....

Learn RADIO-ELECTRONICS-TELEVISION



12 WEEKS TRAINING IN COYNE SHOPS WHERE YOU "LEARN-BY-DOING"

Trained Radio-Electronics men needed now. They will be needed too when the war is over. Tremendous expansion in Radio, Electronics, Frequency Modulation and Television predicted—a world of new opportunities. Get Radio Training in the Coyne Shops in Chicago now, and BE READY!

Ill Finance Your Training

If you are short of money, you can start now and pay most of your tuition after you graduate. Many earn while learning. Free Lifetime Employment Service to graduates. EXTRA training in INDUSTRIAL ELECTRONICS—no extra cost.

FREE BOOK

Whether you're 16 or up to 40, get the facts. Big illustrated book tells about your future in Radio-Electronics-Television. Mail coupon today.

Men with Physical Disabilities—we have special facilities for you. If you have a physical disability of any kind write me when you send coupon.

H. C. LEWIS, Pres., RADIO-ELECTRONICS DIVISION
COYNE ELECTRICAL SCHOOL
500 S. Paulina St., Dept. 35-3H, Chicago 12, Illinois
Send me FREE BOOK on COYNE RADIO-ELECTRONICS-TELEVISION TRAINING, extra Industrial Electronics course, and details of "Pay-After-Graduation" Plan.

NAME.....

ADDRESS.....

CITY.....ZONE.....STATE.....

START YOUR OWN BUSINESS

GET INTO PLASTICS

SMALL CAPITAL — WORK AT HOME

New miracle Plastics industry offers you unlimited career opportunities. Get started now in your own Plastics business or prepare for postwar plastics employment. Take your place in the new Plastics Era. Now for the first time you get practical training in your own home. This new plan gives you the fundamental technical knowledge covering all branches of the Plastics industry including all types of Plastics materials. This is not a novelty program but a real sound educational plan. The actual practical work consists of working with many different types of Plastics materials—teaching you fabrication, shaping, forming, finishing, cementing methods, mold making, casting, compounding, etc. For full information send this ad with your name in an envelope or paste on a penny postcard.—To Dept. M.

PLASTICS TECH 1845 E. 9th St., Cleveland 14, Ohio

What Every Mason Wants



We have important Masonic books for Blue Lodge, Chapter, Commandery, Scottish Rite, and Shrine.

Our Rituals Are Used the World Over. Send for free catalog of books and rituals for Masons, Odd Fellows, Knights of Pythias, Knights of Columbus, etc. EZRA A. COOK, Publisher, P. O. Box 796, PM, Chicago 90, Ill.

HOW TO GET A BIG PAY JOB IN Real Estate

Write for FREE BOOK!

Tremendous real estate boom predicted. Big-pay, permanent jobs or your own 6-profit business. Salaries up to \$2,500 to \$10,000 a year in property management, brokerage, appraisal, loans, insurance, building. Many make fortunes selling real estate. Thousands of trained men, women, required yearly by real estate firms, insurance companies, banks, Federal agencies. Rush post-card for 32-page QUIZ BOOK—mailed FREE with full details on new and only 5-volume library, MODERN REAL ESTATE PRACTICE! Lane Books, Dept. B-3, 100 East Ohio St., Chicago 11, Illinois.

you can be a well-paid ACCOUNTANT!

Accountants are well paid and in demand. World-famous I.C.S. shows you how to join them. Wide variety of Courses individually tailored. For men or women with no previous experience. For those already in accounting. Instruction papers by well-known Professors of Accountancy, Certified Public Accountants. Excellent preparation for C.P.A. examinations. Home study... low cost... rapid progress. Write for free booklet containing full information.

International Correspondence Schools, Box 5532-K, Scranton 9, Pa.

TIME & MOTION STUDY

DON'T COMPETE WITH 30,000,000 WAR WORKERS. Train with professional engineers for your big pay job now. Approved for "G.I." training. Send for free details and your copy of INDUSTRIAL ENGINEERING BENEFITS. INDUSTRIAL ENGINEERING COLLEGE 4000 Washington, Chicago (24) Illinois

CARTOONING PAYS WELL

Exclusive instruction by a nationally known cartoonist makes it easy to learn at home. Write for details of the course. Please state age. NATIONAL SCHOOL OF CARTOONING 423 Penton Bldg. Cleveland 13, Ohio

BETTER SIGHT

SIGHT-TRAINING technique improved. Everybody gets results now. WRITE: Dept. P-3, "USTI" 4057 Budlong Ave., Los Angeles 37, Calif.

Free SIGHT CHART

Please send me your FREE Sight Chart with instructions.

Name.....

Address.....

THESE BOOKS CAN HELP YOU



TO SUCCESS and HAPPINESS

Good books, skillfully written, can be your Gateway to success and happiness. Gateway books keep you on your toes . . . show you how to do the hardest jobs the easiest way in less time. On the job you're envied because of the extra knowledge you've gained . . . and in your home you're admired because "you're so handy around the house!"

So, take advantage of the knowledge and experience of experts NOW. Let them show and tell you how to make your time pay more money. Prepare now. Study this list of authoritative books . . . choose the ones you want. Remember . . . Gateway books are sold only on a 5-day money back guarantee. You take no chances.

SEND NO MONEY



IF YOU are interested in a future in commercial art or in just dabbling around for your own satisfaction . . . you'll find each of these Gateway books a real help.

- HANDBOOK OF ADVERTISING LAYOUT.** Written and illustrated by one of the country's leading advertising men. It is a practical and sound book for student or professional advertising artist. . . . \$3.00
- FIGURE DRAWING FROM LIFE.** A new, simplified method of drawing the human figure. Actual drawings made from live models were used in the preparation of this outstanding "life" book. . . . \$1.00
- LETTERING and DESIGN.** Covers every style of letter and design used in modern advertising used in national magazines and campaigns. Includes Trademarks, Monograms, Numerals and Package Design—270 pp. . . . \$3.00
- MODERN LETTERING.** . . . \$1.00
- ART OF CARICATURE.** . . . \$2.00
- HOW TO DRAW FUNNY PICTURES.** \$2.00

MECHANICAL

- REFRIGERATION SERVICE ENGINEER.** Includes domestic and commercial types of refrigeration such as used in markets, milk depots, soda fountains, flower shops, etc., as well as in many air conditioning systems and homes. 300 pages, illustrated. . . . \$2.00
- PRACTICAL INSTRUCTION FOR PAPER HANGING.** 200 pages—fully illustrated—shows and tells everything about paper hanging. Now . . . you can redecorate your own home and really be proud of it. Excellent for professional paperhangers. . . . \$2.00
- PRACTICAL ELECTRICITY and HOUSE WIRING.** Discusses basic principles of circuits, wires and insulation, grounding, polarizing, wiring methods, planning your installations, wiring new houses, installing switches, fixtures, etc., wiring houses after they are built, alterations and additions, wiring farm buildings, wiring for motors, and home repairs, etc. 200 pages, 227 illustrations. . . . \$1.50
- MODERN HOMECRAFT.** 240 pages crammed full of ideas for modern furniture . . . and how to make it. Gives working drawings. Make your own furniture and SAVE. 240 pages . . . fully illustrated. . . . \$3.00
- QUICK CONSTRUCTION.** Includes temporary buildings, roof and platform problems, special uses of tools, concrete problems, stairs, shingles, cornices, "Tricks of the Trade" and hundreds of other useful subjects for the amateur or professional carpenter. 250 pages—670 illustrations. . . . \$2.00
- BUILDING—FORMS, STAIRS, ROOFS.** Contains latest information on forms, staircases and roof-building. Top notch book for carpenters or helpers. 210 pages, 497 illustrations . . . \$2.00

13. WOOD FINISHING. Instruction on wood finishes, and problems . . . tools . . . materials . . . repairing, 360 pages and 36 illustrations . . . \$2.00

14. FURNITURE, FURNITURE FINISHING, and DECORATION and PATCHING. New book that covers: 1. Period Furniture; 2. Furniture Decoration; 3. Furniture Finishing; 4. Furniture Patching; 5. Modern Special Finishes, 580 pages and 353 illustrations. . . . \$4.00

15. PLUMBING INSTALLATION and REPAIR. 236 page book explaining how to do repair jobs such as leaky faucets, clogged toilets, drains, traps, vents, sewers, etc. Tells how to cut pipe, make pipe joints, and install fixtures, Tops for the home. 153 illustrations. . . . \$2.00

ELECTRICITY

16. CYCLOPEDIA OF RADIO and ELECTRONICS. A complete non-technical reference book of 1,000 pages, 1,700 headings, 1,178 illustrations, 130 tables, and 105 graphs cover over 500 definite articles. . . . \$5.00

17. ELECTRICAL and RADIO DICTIONARY. Over 3,800 definitions of technical words and terms used in all branches of radio and electricity, 300 pages, 550 illustrations. . . . \$2.50

18. PRACTICAL ELECTRICITY and HOUSE WIRING. Excellent for home repair work. 200 pages, 227 illustrations. . . . \$1.50

19. SLIDE RULE and LOGARITHMIC TABLES. Uses and principles of slide rule and logarithmic tables fully covered. Includes even 10 place log tables, 200 pages. . . . \$1.50

PAINTING AND DECORATING

20. THE MIXING OF COLORS and PAINTS. How to mix colors for interior decorating. Covers house painting, arts, crafts, general paint mixing methods. A handy book

for professional and amateur painters, 302 pages fully illustrated and a big color chart . . . \$2.00

21. PRACTICAL INSTRUCTIONS FOR PAPER HANGING. 200 pages—fully illustrated—shows and tells everything about paper hanging. Now . . . you can redecorate your own home and really be proud of it. Excellent for professional paperhangers. . . . \$2.00

22. SPRAY PAINTING, INDUSTRIAL and COMMERCIAL. Covers principles of spraying technique and latest developments, operating instructions, paints, extenders, materials, finishes, retarding, and a section on National Defense spray painting. 125 fully illustrated pages. . . . \$1.50

23. HOUSE PAINTING METHODS. 400 pages and over 150 illustrations cover the subject of house painting (of any surface) thoroughly . . . includes instructions on use of spray guns, paints, thinners and tricks of the trade. A real time and money saver. \$2.00

24. CYCLOPEDIA OF PAINTING and DECORATING. This new book covers methods, tools and materials for the home and the workshop, including every branch of painting and decorating from A to Z. Any particular job is fully explained with illustrations to clarify the text, whether the reader is interested in finishing walls, floors, furniture, automobiles, boats, houses, or in fact anything which has to do with painting or decorating methods. 350 pages—288 illustrations—

\$3.00 only . . .



GATEWAY PUBLISHING CO.

Dept. P.M.-3, 53 W. Jackson, Chicago 4, Ill.

CHECK, CLIP and MAIL THIS COUPON NOW

GATEWAY PUBLISHING CO.

Dept. P.M.-3, 53 W. Jackson, Chicago 4, Illinois

OK. Send the books I've circled, C.O.D. I'll pay postman cost of books plus a few cents postage. If any book is not entirely satisfactory, I will return in 5 days and you will refund my money.

1 2 3 4 5 6 7 8 9 10 11 12 13 14 15 16 17 18 19 20 21 22 23 24

Save 10%—enclose full cost of book and we will pay the postage—saving you C.O.D. fees . . . approximately 10%. Same money back guarantee.—The Publishers.

Name

Address

City State

INVENTORS

Do Not Delay

Have you ever been startled by seeing a successful article on the market, and exclaimed—"Why, I invented THAT 5 years ago—I didn't think it valuable enough to Patent!"

The Patent Laws were intended for the Protection of the Inventor, and the Inventor who slumbers on his Rights may wake up to find someone else reaping the reward that could have been his.

Write NOW for Information and Record of Invention form FREE. RANDOLPH & BEAVERS, Registered Patent Attorneys, Columbian Bldg., Washington, D. C.

PERSONALIZED SERVICE — REGISTERED PATENT ATTORNEYS

RANDOLPH & BEAVERS

11-D Columbian Bldg., Washington, D. C.

Please send me full particulars on Patents, fees, etc., and "RECORD OF INVENTION" form—FREE.

Name

Street

City State

ELECTRICAL BOOKS

shipped
FREE



**8
BIG BOOKS**

FOR EXAMINATION
**MODERN
ELECTRICITY
INCLUDING RADIO
AND REFRIGERATION**

Here's great news for anyone interested in Electricity. NEW, up-to-date 19th Edition of Applied Electricity with new subjects fully covered, including blueprint reading, electronics, P. M. radio, fluorescent lighting, 8 Big Books FREE for examination!

NEW Edition for
Beginners and
Experts

Over 3700 pages, 2700 illustrations and 134 tables in most complete electrical work ever published. Dynamos, motors, diesel plants, power stations—everything explained for easy understanding.

**BIG FIELD! Big Demand!
Big Pay!**

Men who understand electricity are needed now in all kinds of industries, and will be needed when war production has ended. Practically every business depends on electrical knowledge, and men who know this subject make big money. Learn easily with these new, interesting books. Send coupon for a set for FREE examination. See how they will help you to get ahead faster.

SEND NOW [A year's consulting privileges with our engineers now given to all buyers of this famous Cyclopedia of Electricity.]

AMERICAN TECHNICAL SOCIETY
Vocational Publishers Since 1898

American Technical Society, Dept. E-319, Drexel at 58th St., Chicago 37

Send for 10 days' free use, 8 volume set of New 19th Edition, Applied Electricity, including a certificate entitling me to consulting privileges for one year. I will pay the delivery charges only on the books. If I wish I may return them in 10 days and owe you nothing, but if I keep them, I will send \$2.00 after 10 days, then \$3.00 a month until the total price of only \$34.80 is paid.

NAME

ADDRESS

CITY STATE

Please attach letter stating age, occupation and name and address of employer and have at least one business man as reference. Men in service, also please give home address.

PATENTS AND TRADE MARKS

C. A. SNOW & CO.

Registered Patent Attorneys Since 1875
Write for Free Book and "Certification of Invention" form
427 SNOW BUILDING, WASHINGTON 1, D. C.

PATENT YOUR IDEAS

SEND FOR FREE BOOK

HOW TO OBTAIN A PATENT

Written by Former Member Examining Corps (1922-24) U. S. Pat. Office.
CARL MILLER, Registered Patent Attorney
Former Member Examining Corps U. S. Patent Office
Woolworth Bldg., Dept. 35-A, New York — Bond Bldg., Dept. 35-A, Washington, D. C.

PATENTS Protect Your Idea:

By securing FREE my "PROOF OF INVENTION" folder. *Exceptional Personal Service. Excellent References. Established 1906.*
E. E. VROOMAN, 871 Woodward Bldg., WASH., D. C.

FIX TYPEWRITERS

A Simplified Practical Homestudy Course. Many of our students now have their own Business—Many Repair for others. Repair Shops Swamped. Health or Age no handicap.
WEBER TYPEWRITER MECHANICS SCHOOL
Box 269, Osborn, Ohio

LAW

STUDY AT HOME FOR PERSONAL SUCCESS and LARGER EARNINGS. 35 years expert instruction—over 108,000 students enrolled. LL.B. Degree awarded. All texts furnished. Easy payments. Send for FREE BOOK—"Law and Executive Guidance."
AMERICAN EXTENSION SCHOOL OF LAW
Dept. 81-M, 646 N. Michigan Ave., Chicago 11, Ill.

IS YOUR MIND ASLEEP?

My MIND-STIMULATOR unfolds your Rich, Creative Ability; helps you FIND YOURSELF... the REAL YOU and Real Opportunities to ADVANCE YEARS IN MOSTLY FINANCIAL. Folder **PSYCHOLOGY THAT WORKS** free. Dr. Tibolt, 26M 185 Godfrey Ave., Phila. 20, Pa.

AUDELS Carpenters and Builders Guides

4 vols. \$6



Inside Trade Information for Carpenters, Builders, Joiners, Building Mechanics and all Woodworkers. These Guides give you the short-cut instructions that you want—including new methods, ideas, solutions, plans, systems and money saving suggestions. An easy progressive course for the apprentice and student. A practical daily helper and Quick Reference for the master worker. Carpenters everywhere are using these Guides as a Helping Hand to Easier Work, Better Work and Better Pay. To get this assistance for yourself, simply fill in and mail the FREE COUPON below.

Inside Trade Information On:
How to use the steel square—How to file and set saws—How to build furniture—How to use a mitre box—How to use the chalk line—How to use rules and scales—How to make joints—Carpenters arithmetic—Solving mensuration problems—Estimating strength of timbers—How to set girders and sills—How to frame houses and roofs—How to estimate costs—How to build houses, barns, garages, bungalows, etc.—How to read and draw plans—Drawing up specifications—How to excavate—How to use settings 12, 13 and 17 on the steel square—How to build hoists and scaffolds—skylights—How to build stairs—How to put on interior trim—How to hang doors—How to lay floors—How to paint



THEO. AUDEL & CO., 49 W. 23rd St., New York City
Mail Audels Carpenters and Builders Guides, 4 vols., on 7 days' free trial. If O.K. I will remit \$1 in 7 days, and \$1 monthly until \$6 is paid. Otherwise I will return them. No obligation unless I am satisfied.

Name

Address

Occupation

Reference

New Sickness and Accident Plan Pays \$25 Weekly Benefits

**Cost Only \$12 a Year — Down Payment \$2.50
— Hospital Benefit Included**

Newark, N. J.—The 58-year-old North American Accident Insurance Company of Chicago, announces a new plan that pays \$25 a week for 10 weeks for both stated accidents and sicknesses. Plus an additional \$25 a week for 4 weeks for accidents requiring hospital confinement. Yet the total cost is only \$12 a year. The purpose of this new Premier Limited Double Duty Policy is to bring sickness and accident protection within the reach of men and women who do not have large savings with which to meet sudden doctor or hospital bills, or lost income.

This new plan also has a double-indemnity feature covering travel accidents. You receive \$50 a week if disabled by an accident in a bus, taxicab, street car, train, etc., and \$75 a week if the accident requires hospital confinement. There is another new special feature that pays up to \$25 cash for doctor bills, even for a minor accident such as a cut finger. In case of death by a common accident, the policy pays one thousand dollars cash to your family. Two thousand dollars if caused by a travel accident.

In addition, it covers many common sicknesses such as pneumonia, cancer, appendicitis, etc., paying the weekly benefits whether confined to home or hospital.

The entire cost is only \$12 a year, and that applies to men and women between the ages of 15 and 64 inclusive. Between the ages of 65 and 75 the cost is only \$18 a year. Protects you 24 hours a day. No reduction in benefits regardless of age. No medical examination is required.

Men and women who join the armed forces will receive the full benefits of this protection while in the United States.

North American Accident Insurance Company of Chicago is one of America's great insurance companies, the largest and oldest exclusive health and accident insurance company in this country. It has paid out over \$35,000,000 to grateful policy holders when they needed help most. North American is under the supervision of the Insurance Departments of 47 States and District of Columbia.

Men and women who would like full details about this new plan are urged to write a letter or postcard for a revealing booklet called "Cash or Sympathy." This booklet is absolutely free. It will come by ordinary mail, without charge or obligation of any kind. No one will call to deliver it. We suggest you get a free copy by sending your name and address with postal zone number to Premier Policy Division, North American Accident Insurance Co., 830 Broad Street, Dept. 121, Newark 2, New Jersey.

FREE BOOKLET

North American Accident Insurance Company
830 Broad St., Dept. 121, Newark 2, New Jersey

Gentlemen:

Please mail me a copy of your FREE booklet, "CASH OR SYMPATHY." I understand there is no obligation whatever, and that no one will call on me to deliver this booklet.

NAME.....

ADDRESS.....

CITY..... ZONE No..... STATE.....

**WORLD'S
BEST
WANT AD
MEDIUM**

CLASSIFIED Advertisements



Advertisements in this section, 35 cents per word, each insertion, minimum 10 words, payable in advance
To be inserted under proper classification in April issue, copy should be in our office March 4th
April issue on sale April 1st
Popular Mechanics Magazine, 200 East Ontario Street, Chicago 11, Illinois

AUTOMOBILES, MIDGET CARS

PROFESSIONAL Midget racers, motor-scooters, midget cars, parts. Handbook catalog—50 illustrations, plans—35c. Directory bargain priced used tires, motors, parts, included free! Midwest, 2557 Charlestown, Toledo, Ohio.

STEAM Automobiles! Send 25c for literature listing names 90 different makes steamers once manufactured. Illustrations, descriptions, specifications, Stanley, White, Doble, Lane, Ross steamers, boilers, engines, also photos famous White Racer "Whistling Billy" and world's record holder Stanley Racer. Interesting, educational, ancient steamer history. No cars for sale. Clymers, 2125 W. Pico, Los Angeles 6, Calif.

GARAGE Doors, all types, controlled from dashboard pushbutton. Simple, dependable. Materials inexpensive, obtainable everywhere. Complete "Build Yourself" plans \$1.00, refundable. Free particulars. Kaytor Laboratories, Lynwood, Calif.

ANTIQUÉ Car for sale. 1916 Peerless. Write Mello Hittmiller, Dyersville, Iowa.

FLOYD Clymer's Historical Motor Scrapbook. This humorous, educational, historical scrapbook illustrates, describes hundreds antique and early automobiles, motorcycles. Reg. Oldsmobile, Hupmobile, Metz, Orient, Knox, Winton, Carter, Maxwell, E-M-F, 2-cylinder Ford and Buick, air-cooled Chevrolet, Stanley, White, other steamers, electric. Unusual and steam motorcycles. This is the scrapbook Time Magazine said is a "must." Editions one and two now available but entirely different books. Postpaid \$1.50 each, deluxe edition \$2.50. We mail overseas any time without request and pay postage. Delivery guaranteed. Clymers, 2125 W. Pico, Los Angeles 6, Calif.

PARTS For automobiles and trucks. Generators, differentials, gears, wheels, body parts, etc. Used or reconditioned. Everything you need to keep your car in shape. Write us your problems. We'll help you. H&H Auto Parts, 2949-P Dearborn, Chicago 16, Ill.

REPAIR Your car. Do it yourself. Motor parts for all engines, chassis parts, ignition and carburetor parts, etc. New replacement parts. Genuine and highest quality at manufacturers' retail prices. P.O.B. Chicago. Orders receive priority over inquiries. B & N Engineering Co., Box 3454, Merchandise Mart P.O., Chicago 54, Illinois.

CUSTOMIZE Your automobile. Illustrated, new restyling ideas, instructions, suggestions, specific model changes by simple methods. \$1. Speed Wheel, Box 723-E, Arcadia, California.

BUILD It yourself. Automatic overhead garage doors operated from driver's seat. Used auto parts and other material available everywhere cheap. Use 1/4 h.p. motor. Tried and tested. Be first in your neighborhood to build one. Complete plans \$1.00. McIntosh Projects, 2479 Coolidge Ave., Oakland 1, Calif.

AUTOMOBILE Racing book, fifth edition, well illustrated. Instructions on building bodies, frames, engines. Ford A and B conversions. Plans. AAA rules, specifications. Roadster racing, Indianapolis cars. \$1.00 postpaid, \$1.30 C.O.D. Ray Kuns, Dept. 47, Madisonville, Cincinnati 27, Ohio.

AUTO SUPPLIES AND EQUIPMENT

"UNLOCKEEZ" Is a device that will instantly open any auto lock push button or money refunded. Attention locksmiths, parking lots, garages, car owners. \$2.00 cash or money order. Canada and foreign \$2.50. Unlockeez Lock Device Co., P.O. Box 7218 Sta. G. Los Angeles 37, Calif.

1945 **IGNITION** Supercharger \$3.50. Fast starting, mileage, pep. EG Mfg. Co., 355 E. 149 St., New York.

DEALERS—Mechanics. Auto parts and supplies wholesale. Standard brands. Free list. Auto Parts Distributors, 5920 Cermak Road, Cicero 50, Illinois.

HEAVIEST Truck tires frozen to rim easily removed. Instantly adjusted to any size tire. Made by anyone in a few minutes for less than \$1.00. Complete tire-tool plans sent for a dollar bill. A. E. Silva, 534 - 12th St., Oakland, Calif.

AUTOMOTIVE Engineer tested Vacudex Exhauster on Technology Institute Dynamometer. Reduced back pressure, increased mileage, used less gasoline. Vacudex easily, quickly attached. Satisfaction guaranteed. \$3.75 postpaid. Decker Products Co., Pelham 63, New York.

OPERATE Cars, trucks, tractors, motors, with wood or coal gas, 1/2 cost of gasoline. Extensively used in Europe. Complete detailed instructions \$1.00. W. M. Cross, Lone Rock, Wis.

PRESERVE Your tires with plastic and punctureproof your tires. Details for stamp. Belke, Box 699, Borger, Texas.

EXTRA Miles. 50 miles for each gal. gas used. Tested and proven method. Hundreds of users. Equip your car inexpensively. Simplified diagrams and instructions \$1.50. Astonishing results. Geller, Box 524, Dorris, Calif.

INVENTION Uses kerosene to run motors. Circular on plans. Ruah name. Houston Maupin, Tipp City 38, Ohio.

1,000 MOTORISTS Needed to make gas savings test. Up to 30% savings. For trial test offer write Vacu-matic Carburetor Co., 7617-1168 W. State Street, Wauwatosa, Wis.

V-8 AND Mercury dual muffler sets \$17.50. Genuine steel wool packed mufflers with mellow tone. Gives less back pressure, more power and more gasoline mileage. Also single steel wool pack muffler for any car. Fits in place of regular muffler. Single V-8 Ford, Chev, Plymouth, Pontiac, etc. \$5.00. Buick, Dodge, Chrysler, etc. \$7.00. For 7 years manufacturers of California's best tone mufflers. Sandee Muffler Co., 7523 So. Western Ave., Los Angeles 44, California.

TEST Your own car battery. In car. No testers needed. Simple, interesting. Money-saver. Complete information 25c. Batteryman, 901 South Avenue, Grand Junction, Colorado.

WHIRLGAS Turbinator, \$3, improves carburetor action; increases mileage; quickens acceleration; reduces monoxide. Performance guaranteed. Universities and oil corporation tests. Wrench installs 15 minutes. Give auto make, year. John Hanley, 5719 Loraine, Detroit 8, Mich.

THE Lord is coming! Get guaranteed proofs free. Scheall, 263XA, Duluth, Minnesota.

AMAZING New Moto-Vator injects water-vapor into motor just like newest fighter planes. Burns 15% water; saves 20% to 30% gas; prevents carbon; increases power! Eliminates carbon and valve jobs. Not a gadget. Sensational performance keeps motor like new. Wonderful postwar possibilities. No investment. One low price includes license to install Moto-Vator in your locality. Send 10c for booklet giving complete details. Dept. M, SX Laboratories, P.O. Box 37, Middle Village, Long Island, New York.

HAVING Car trouble? Used, guaranteed auto, truck parts save money. Transmission specialists. Describe needs; immediate reply. Victory, 2439 1/2 Gunnison, Chicago 23.

PLATING Outfits for auto parts. Connect to a battery. No tanks used. Free particulars and proofs. Gunmetal Co., Ave. J, Decatur, Ill.

AUTO TRAILERS

BUILD Your own trailer! Save money! Have every feature you want! Plans for house, sport, camp and utility trailers. Catalog describing 9 models 10c. Jim Dandy, Box 125-A, Wausau, Wisconsin.

MOTORCYCLES, BICYCLES, MOTOR-SCOOTERS AND SUPPLIES

CUSHMAN Motorscooter \$45; motorized bikes as low as \$30; motors \$5 up; plenty non-ratioed 10, 12, 14 inch balloon tires \$1.75 to \$6.50, (mallorder only). Send 25c for big war-bargain catalogue No. 6, just out, listing hundred of bargains in midget cars, motorscooters, motorcycles, motors, parts, etc. (35c by first class mail). Midget Motors Directory, Athens, Ohio.

WE Are in a position to supply you with any parts you need. Now is the time to have your motorcycle repaired. Plenty parts on hand. Contact me for estimate on any job. Guaranteed workmanship. Sam Bernardi, Indian Motorcycle Sales, 1214 Jackson Blvd., Chicago 7, Ill.

MOTOR And motorbike manuals. Containing motorbike, scooter plans, catalog section and tune up information, valve clearance, point gaps, etc., for over 20 motorbike motors including Briggs Stratton. All for \$1.00. Sold only together. Variety Enterprise, Post Office Box 124, Evansville, Ind.

MOTORCYCLE Books—Speed and How to Obtain It, \$1.50. Motorcycling Manual \$2.00. English Motorcycle Service Manual \$1.50. One Man Caravan \$3.00. Clymer's Motor Scrapbook \$1.50. All postpaid. We mail overseas. Clymers, 2125 W. Pico, Los Angeles 6, Calif.

BUILD America's lowest priced motor-scooter speedster. Complete plans and specifications, \$1.00. Big list bargain priced used tires, motors, parts, included free! Motor Supply, Box 1632-C5, Toledo, Ohio.

MOTORCYCLISTS—New and used parts, accessories, all models. Catalog 10c. Henderson catalog 10c additional. Triangle, 2157 Harrison, Chicago.

BUILD Scooters, trailers, midgets, conversions. Large manual \$1.00. Illustrated circulars dime. Craftsmann Books, Box 1153-P2, Milwaukee 1, Wis.

HARLEY Davidson 1942 motorcycles. Army released. Write for details. Charles Stokes, Coldwater, Michigan.

PLANS, Scale drawings, specifications, illustrations for building attractive motor scooter complete \$2.00; plans electrically driven bicycle \$1.50. Postpaid. Clymers, 2125 W. Pico, Los Angeles 6, Calif.

FLOYD Clymer's Motorcycling Manual, 144 pages, 120 illustrations. Complete information, specifications, descriptions, dozens motorcycles. Engines, transmissions, carburetors, square four, two piston singles, sleeve valve engines, overhead camshafts, water cooled motorcycles, spring frames, hydraulic forks, sidescars, riding instructions. Two cycle engines and power bicycles described, illustrated. Just out \$2.00 postpaid. Clymers, 2125 W. Pico, Los Angeles 6, Calif.

MOTORCYCLE Parts, new and used list 10c. Ballak, 811 N. 9th, St. Louis 1, Mo.

MOTORCYCLE Muffler. Steel packed, beautiful tone, seamless, streamline design. \$6.00. Really beauties. Sandee Muffler Co., 7523 So. Western Ave., Los Angeles 44, Calif.

ELECTRIC Motorbike built from your present bicycle. \$1.00 bill brings complete instructions, drawings, specifications. Mowery, Box 994, Lancaster, Pennsylvania.

PARTS, Accessories, pistons, chain Harley Davidson motorcycles. McCann's, P.O. Box 114, El Paso, Texas.

BOYS! All bicycle repair secrets revealed. "Bicycle Repair Manual" 65c. R. G. Klausner, Shelbyville, Ill.

HARLEY Davidson parts, accessories, supplies. Expert service. Cylinder reboring, generator reconditioning. 45" engines \$50.00 and up. Send \$1.85 for U. S. Army Motorcycle Instruction Book, Motorcycle Service Manual and bulletins or 25c for Service Manual and bulletin. Knuth's, 2491 Fondulac Ave., Milwaukee 6, Wis.

SAVE Gasoline, build a motorbike now, send 25c for complete plans. Motorbike Service, 2108 McLean, New Albany, Ind.

PARTS. Complete motor parts list. Pistons, all sizes, chains, sprockets, for Indian, Harley, 10c. Bootz, 622 East Grand, Des Moines 9, Iowa.

TIRES And industrial wheels, suitable for scooters, wheelbarrows, farm equipment, etc. All sizes. Bicycles and accessories. Largest assortment in America. Send dime for list. Cycle Transport Company, 1241 So. Michigan Ave., Chicago 5, Illinois.

AVIATION

AERONCA \$100 Less motor; Waco \$100, wings damaged; Gypsy Moth, \$100 less wings (a builders special); Heath Parasol less wings and motor; Pietenpohl Air-camper, complete. Send 25c for big war-bargain directory listing over 300 used airplanes, crackups, salvage, of every type, located everywhere, some probably near you. (35c by first class mail). Used Aircraft Directory, Athens, Ohio.

THRILLING—Packed with fun and knowledge. 3 foot flying models—Thunderbolt, Warhawk, Lightning, Apache, Avenger, Spit Fire, Hurricane, Alcobra—\$1.75. Dean Model Aviation, 97 Cuthbert Street, Scotia 2, New York.

CUB \$200 (Needs repainting). Curtiss-Robin \$195, Fairchild \$395. Catalog—over 250 aircraft bargains—25c. Lifetime membership in Aviation Club included free! National Aviation, Box 1682-CS, Toledo, Ohio.

FLYING Flea, plans \$1.00. Lightplane manuals, blueprints. Illustrated circular 20c. Craftsmann Books, Box 1153-P1, Milwaukee 1, Wisconsin.

PROPELLERS Of quality, lists free. We fit any motor, airdriven. Airliner 3 blade for sleds, boats, hydrators. Ford aircro conversion diagrams 50c. Hubs \$5.00. Fast delivery. Standard Aero Craft, Ft. Worth, Texas.

PASS CAA examinations. Private pilots multiple choice questions with key. Send \$1. Wisconsin Aeronautics, 1522 Flett, Racine, Wis.

AIRCRAFT Altimeters 8000 meters \$1.95. Revolution indicators 0-2400 r.p.m. \$3.95. Pitch bank indicators electrically illuminated \$2.95. Bosch hand cranking magnetos, worth \$50.00 sacrificed \$4.95. All brand new and guaranteed. Air Transport, Mineola, N. Y.

AIRPLANES—Used \$200 up. Also late models, engines, wings, parts, machinery, books. Cheap. Send 25c for list. Aircraft, 2300 West Flagler, Miami 35, Florida.

A & E Mechanics Manual prepares for "multiple choice" examinations. \$3.00 postpaid or C.O.D. Aviation Publishers, Box 442, Studio City, California.

ELECTRICAL SUPPLIES, EQUIPMENT

ELECTRIC Fans? Make your own. I will sell you a correctly balanced 16 inch aluminum fan blade, half inch bore, \$3.50. All welded guard to fit blade \$3 prepaid. Use ordinary 1/4 hp. electric motor. Ted Riseman, 427 East Jefferson, Springfield, Illinois.

HANDY Pocket size electric circuit tester checks all electrical appliances—Radios, motors, fuses, etc., 90 to 550 volts a.c. or d.c. Distinguishes a.c. from d.c. \$1.00 postpaid. Supreme Electric Mfg., 210-A Roebing St., Brooklyn 11, N. Y.

ELECTRICAL Appliance repair. Open your own shop. Learn house wiring; electric motors, vacuum cleaners, washers, etc. Complete illustrated course shows how. Free booklet. Pacific Training School, Dept. PA-3, 4703 West Pico, Los Angeles 6.

ELECTRIC Kilns; new, prompt delivery, two sizes with temperature dial. M. Fred Keglmeyer, North Wales, Penna., distributor.

1/2 HP. Motor opens 450 pound dashboard controlled garage door within ten seconds. Additional information under "Automobiles."

ELECTRIC Air heaters, electric fly traps. Gardenhour Mfg., Waynesboro, Penna.

COMBINATION Tool marker and soldering iron. \$1.00 postpaid; 20 oz. anvil 50c; small armature growler \$5.00. Catalog 10c refundable. Frazee Electric, Box 5086, San Francisco 1, Calif.

ELEMENTS For electric irons \$1.75 postpaid. Aesco, Box 415, Austin, Texas.

BROKEN—Burned out electrical heating elements quickly repaired. Use new amazing Nichrome Paste, simply overlap ends and turn on current. Family size \$1.00 bill. Satisfaction guaranteed. Advance Electric, Box 861-X, Minneapolis, Minn.

ELECTRIC Pencil: Writes-engraves all metals. \$1.00 postpaid. Beyer Mfg., 4515-H Cottage Grove, Chicago 15.

FLUORESCENT Supplies and many scarce electrical items. Write us your needs. Goodwill, Box 2242, Ft. Worth, Texas.

NOW—Repair your own electrical appliances with Chanite Self-welding Electrical Heating Element Flux. Instructions delivered, price \$1.00. Chanite Sales Company, 914 South Main, Fort Worth, Texas.

BATTERIES, GENERATORS, ETC.

EDISON Batteries. Light. Power. Fifteen year life. Five year guarantee. Complete lighting plants. Free literature. See Jay Company, 321 Yonkers Avenue, Yonkers, New York.

WELDING, SOLDERING, PLATING

MULTIWELD Model "150" production type a.c. welder. 110-220 volts. Hairline control, over 200 heats, 1/16" to 3/16" rods. Garages, shops, farmers, free folder. Phillip Wilson, 309-B Bridge, Streator, Ill.

ACETYLENE Welding outfits like new: arcwelders, acetylene generators. Eagle Welding, Dept. PM, 5065 Broadway, Chicago 40, Ill.

PIPING Layout and fabrication simplified: Practical manual by actual journeymen, explaining trade shortcuts for welded piping \$1.00. Pipe Layout, 3964 Budlong Avenue, Los Angeles 37, California.

PERFECT Welding, brazing, soldering with tested, light-weight "Super-Welder." Ideal for home, farm, office appliances. Beginners become experts quickly with this simple-to-operate outfit. Full instructions. Operates ac-dc, 110 volts. Plug in, flame torch. Complete with metallic arc, flame torch, mask, supplies. Guaranteed. 5 days' free examination. Only \$19.95. Save 25c, send check with order. Super-Welder Mfg. Co., Dept. A, 23 E. 20 St., New York 3, N. Y.

ARC Welders wanted by the thousands. Learn with 516 page lessons manual. Over 500 how-to-do-it photos. \$2.00 copy. Money-back guarantee. Hobartweld, Box M-354, Troy, Ohio.

BUILD D.C. Arcwelder without rewinding armature. Plans \$1.00 each. 25 to 600 amperes from vehicle d.c. motors, light plant generators, automobile starter-generators. Welders Club, AB-3432 Chicago 64. For Sale: Vehicle d.c. motors.

FREE Catalog of welders, welding supplies, generators, fencers, and other electrical items. Write LeJay Company, Minneapolis 8, Minn.

ELECTRIC Welder guaranteed 6 months. Penetrates 16 gauge metal or money back. \$3.95 complete. 110 volts ac-dc. Victory welder complete, less jar, wire, \$1.95. Essay Mfg. Co. H. N. Quincy 69, Mass.

WELDING Rods; all kinds, all sizes. Trial package 25c; literature free. Western Welding Wire Co., 125 So. Santa Fe Ave., Los Angeles 12, Calif.

NEW Model electric welder 110 volt a.c.-d.c.; will weld all metals; easy to use; full directions. Complete with power unit, flame and metallic arc attachments, carbons, fluxes, rods, mask; all for \$19.95. Used by the navy. Magic Welder Mfg. Co., 239-MP2 Canal St., New York City.

RODS, Arc welding, 75 assorted, general purpose, 1/16" 3/32". Guaranteed fine for all a.c. and d.c. welders. One dollar post paid in states. Two for \$1.75. Little Welder Co., 15766 Blackstone, Detroit 23, Mich.

SLIGHTLY Used arc welders. Recommended by R.E.A. Guaranteed. Forney Mfg. Co., Fort Collins, Colo.

WELDING, Cutting, aircraft welding and soldering equipment. Electric arc welders. Superior Oxy-Acetylene Co., Hamilton, Ohio.

MACHINERY, TOOLS AND SUPPLIES

NU-WAY Speed reducer—For electric motors, drills, Circular free. Dealers wanted. Tractor-Lite Mfg. Co., Spirit Lake, Ia.

INDEX Heads for sale. Very inexpensive. Sixty-two different divisions. Used on small lathes, drill press, milling machines, etc. Make gears, hobbs, cutters, etc. Very accurate, and durable. Not a toy. Used by defense schools and hobbyists. Write for free folder. Long's Index Heads, 2117 East B St., Torrington, Wyo.

LAWN Mower sharpener. Simple in design, build it yourself. Plans \$1.00. Winfield Hess, Dover 1, Penna.

MACHINERY, Tools, anything. We buy for you in Chicago. Shepard, 1012 So. Sixth, Maywood, Illinois.

INDUSTRIAL Diamonds \$1.50. Products wanted, models, production. Specialty Machine Shop, 2821 Mitchell St., Racine, Wis.

CONSTRUCT Your own machine tools from Lewis castings, materials and blueprints, supplied complete at a fraction of new tool cost. Mills, shapers, vises, hand saws, jointers, etc., are ideal for a whole range of home or commercial shop work. Send 10c to cover mailing of catalog listing 23 items. Lewis Machine Tool Co., Box 116, Station A, Dept. M-50, Los Angeles 31, California.

NEW High-speed drill sets. No. 1 to No. 60, \$11.30 set, 1/16" to 1/2", \$14.85 set. Will ship c.o.d. promptly. Metal plated stand 25c each with any order. Midwest Surplus Tool, 543 West Lake, Chicago 6.

DRILL Grinder—Grinds drills to factory accuracy. Calipers with direct reading scales. Circle cutters. New tool grinder. Lowest prices. Free literature. Factory; 811-B East 31st, Kansas City 3, Mo.

500 GRINDING Wheels. Marine Engine Business, P.O. Box 17, Sta. A, New Haven, Conn.

TWIN-CYLINDER Air compressors \$17.75. Motors, Hoffman, 6840 Parrish, North College Hill 31, Ohio.

BOATS, OUTBOARD MOTORS, ETC.

COLLAPSIBLE Boats. Handy portable inflatable rubber boats carrying from one to seven men, in both new and used condition, priced at \$19.95 to \$99.50, depending upon size and condition. Write for particulars. Karl Ort, Dept. PM2, York, Penna.

WANTED—Old style Caille straight drive Liberty outboard motor. Leo Whitney, 4800 Cabrillo St., San Francisco 21.

MAKE 16' Rowboat. Blueprint, 30c. Wesho-Uco, Box 51, Detroit, Mich.

FOLDING Kayak plans \$1.00. No catalog. Foldcraft, 4015 Oketo, Chicago.

OUTBOARDS: Latest bulletin available on rebuilt motors. Good used parts most makes and models. Crandall-Hicks Co., 959 Commonwealth Ave., Boston 15, Mass.

OUTBOARD Motor parts, new and used. Too large a stock to list, write us your requirements. Children's swim belts, life preserver cushions. Dixons graphite gear grease, tube 50c, prepaid in U. S. Jiffy trolling plans \$1.00. Outboard Motor Mart, Inc., 315 Atlantic Ave., Boston 10, Mass.

TEN Plywood boat plans 50c. Catalog boat building plans 10c. The Rudder, 15 Murray Street, New York.

SAILKITS 100 Square feet \$13.90, sailboat equipment, motorboat-canoe-kayak-equipment. Rope, canvas, airplane dope, cement, boat paints, carbide lamps, carbide. Army pup tents, blankets, messkits, canteens, knives, cot covers, hammocks, haversacks, holsters, etc. Catalogue. Alan-Clarke, 160 Chambers, New York City.

INBOARD Marine motors, propellers, fittings, conversions. Charles Stokes, Coldwater, Michigan.

FULL Size, cut to shape boat patterns, blueprints. 7 1/2 - 38 feet. Illustrated "Build a Boat" catalog, 10c (coin). "How to Build Boats" book, \$1.00. Cleveland Boat Blueprints Co., Dept. A-66, Cleveland, Ohio.

BOAT Designers are highly paid professionals. Complete course by mail. Catalog. Westlawn, Montriville, N. J.

MARINE Power—Easily convert any Ford motor (domestic and foreign) with Osco parts and kits. Complete catalogue 25c (coin). Osco Motors Corp., 2020 East Orleans Street, Dept. M, Philadelphia 34, Penna.

USED Outboard motor parts. Outboard Exchange, 1194 Remsen Ave., Brooklyn, 12, N. Y.

ENGINES, MOTORS, DYNAMOS

MOTORS, Small d.c. 6 volt, 3000 r.p.m., suitable for operating models and gadgets on intermittent duty. Postpaid \$1.25. Walthers, 247 Erie, Milwaukee.

NEW Kohler electric plants, 115 volts a.c. 1500 watt to 10 k.v.a. E. F. Schmalz, 215 Wyoming Ave., Kingston, Penna.

DUPLEX And Simplex motors. Rotary and semi-rotary. Fractional hp. sizes. Water, air, steam pressures, 40 lbs. and up. Duplex Motors, Burlington, Iowa.

BIG Pay jobs in welding. Complete welding lessons and reference books, 516 pages, 41 lessons \$2.00 copy. Money-back guarantee. Hobartweld, Box 355-M, Troy, Ohio.

WINDING Data, listing 225 motors, single and three phase, \$1.00. Motor Data Co., Box 7631, Kansas City 3, Mo.

MODEL Locomotives, gas, steam engines. Supplies catalogue 25c. Welding rod without flux for aluminum, die cast, pewter. Samples and instructions 25c. Howardo, A3-2417 Ashland, Chicago 14, Ill.

DIESEL And gasoline engines, 5 to 500 horsepower, with or without generators. Power units. New and re-conditioned "Kohler" electric systems. What are your requirements? H. Lesley Phillips, Glenmoore, Chester County, Pennsylvania.

ATHLETIC EQUIPMENT—BODY BUILDING COURSES

HAND Balancing is fun! Teach yourself quickly. W. Power, 923 W. Vine, Kalamazoo, Michigan.

SUPER Ju-Jitsu—lightning attack and defense system. Lick brutes twice your size with only your bare hands! Fear no man! Sensational new home study course now ready. Bargain. Free details. Write—Nelson Company, Dept. 5-02, Chicago 4.

BAR-BELLS, Exercise equipment. Courses, Special offers! Free booklet. Good Barbell Co., 3261-PM Watson Rd., St. Louis (9), Mo.

SPORTING GOODS, GUNS, FISHING TACKLE, ETC.

"WORMOUT" Gets night-crawlers and other worms in broad daylight in less than a minute on top of the ground, alive! No digging, no hard work. Complete kit with 4 oz. bottle and bait moss, only 75c. Full 16 oz. "economy size" \$1.20 at tackle dealers. Circulars on request. Maxine & Co., Waterloo Rd., Cleveland, Ohio.

CASTING Rods—Make your own with our unbreakable offset handle and plans. Handle \$3.50, plans \$1.00. A. C. Bishoff, 9535 Ohio, Detroit 4, Michigan.

GUNS Refined like new by factory methods, as used by leading gun manufacturers. Send for circular. Middletown Metal Finishing Company, 45 River Road, Middletown, Connecticut.

LEARN Gunsmithing at home. Earn money repairing neighborhood's firearms. 25 firearm and gunsmithing textbooks, catalog for 3c stamp. Samworth, Plantersville, South Carolina.

AMMUNITION Available to qualified purchasers. List 10c. Rudolph's, Atchison, Kansas.

ELEVEN Good box traps. Complete blueprints, 30c. Wesho-Uco, Box 51, Detroit, Mich.

USED Guns, bought, sold, exchanged. List stamp. Howe Fur Company, Coopers Mills, Maine.

U.S.N. Machetes, 22" blade, \$5.00. Commando knives, 7" hollow ground blade, leather handle and sheath, \$6.00. Bekirch's Hardware, Winton Road, North Rochester 9, N. Y.

SPORTSMAN'S Encyclopedia, 514 pages, over 1,000 illustrations. All about the outdoors! Camping, fishing, hunting, trapping, scouting. \$3.00 postpaid. Henry Schultz, Route 2, Pascagoula, Mississippi.

ARCHERY Equipment: Catalogue free. Mid-West Archery, 2309-A East 75th, Chicago 49.

THE Lord is coming! Get guaranteed profits free. Scheall, 263XS, Duluth, Minn.

BOWS—Arrows for recreation, hunting, fishing. Beautiful archery instruction book, 70 pages, 50 illustrations, only 50c. Illustrated catalogue free. Archery Sales Service, 617 South State, Chicago.

NETCRAFT Kit—Make landing nets, turtle traps, live nets, hammocks. Dollar bill brings: large, medium, small shuttles (patented), gauges, illustrated instruction booklet. Smaller kit—Medium shuttle, gauge, booklet—50c. Netcraft, Dept. B, Toledo, Ohio.

FIELD GLASSES, MICROSCOPES, TELESCOPES

LENSES, Prisms, optical specialties. Not salvage. Not rejects. Not junk. Highest optical perfection. Nothing like this ever offered before. Fraction original cost. Send for new optical catalog, 10 cents. Ross, 66 W. Broadway, New York City.

MAKE Your own powerful, efficient astronomical telescope. Perfect lenses and instructions. 50X \$1.00, 100X \$2.50, 200X \$3.50, 400X \$5.50. Instructions alone 10c. Carl Jamer, Manorville, N. Y.

TELESCOPE, Powerful army type, 5-power, wide vision. Has scientifically ground 35mm. lens. Length closed, 8 in., open 14 in. Only \$1.00 postpaid. Satisfaction guaranteed. Utica Mail Order Co., 923 Eagle St., Utica, N. Y.

REAL 10 Power telescopes \$1.90. United, 2309-B Lawrence, Toledo, Ohio.

ASTRONOMICAL Telescopes, binoculars, cameras, microscopes; bought, sold, repaired. Send 10c for list of instruments wanted. Rasmussen & Reece, 41 Market, Amsterdam, N. Y.

MAKE Your own efficient compound microscope. Lenses and instructions 50X \$1.00, 100X \$1.50, 200X \$2.00. Instructions alone 10c. Carl Jamer, Manorville, N. Y.

ANTIQUES, RELICS, INDIAN GOODS, CURIOS

INDIAN Stone axe \$1.00, postage extra. 10 arrowheads and flint spear \$1.00. Lists 10c. Williams, 212½ Pine St., Green Bay, Wis.

MUSEUM Supplies, Indian relics, pottery, firearms, fossils, curios, minerals, den decorations. Illustrated catalogue 25c. Museum Supplies, 6601 Oshkosh, Chicago 31, Illinois.

SWORDS, Rapiers, daggers, pistols, armor, illustrated catalog 25c. Robert Abels, 860-A Lexington Ave., New York.

FIVE Stoneage Indian tools 50c. Catalog 5c. Sistershop, Northbranch, Kansas.

MINERALS, Coins, stamps, Indian relics, pistols, old glass. Catalogue 5c. Cowboy Lemley, Las Cruces, New Mexico.

INDIAN Relics, beadwork, coins, curios, minerals, old glass. Catalog 6c. Indian Museum, Osborne, Kansas.

DOGS, PETS, BIRDS, RABBITS

SANITARY Rabbit hutch—Odorless, self-cleaning. No opening doors to clean, feed, water! Most practical, scientific hutch made. Plans, specifications \$1.00. Automatic feeder plans \$1.00. Book, "Angora Care-Management" \$1.00. All three \$2.50. Catalog finest pedigreed Angoras free. Grinsteads, Dept. 15-B, Edwardsville, Illinois.

RAISE Your own meat—also make money raising pigeons. Booklet dime. Gebhardt Farm, Muscatine, Iowa.

BEAUTIFUL, Pure white police dogs. Ansonia Kennels, Moose, N. Dak.

BUILD Your own rabbit hutch. Simple, inexpensive, eliminates dirt, diseases. Instructions, photos, drawings 60 cents. River Hill Rabbitry, Box 644, Eagle River, Wis.

RAISE Rabbits \$9.00 to \$18.00 each. Continuous market. Prices guaranteed. Literature 10c. Hansens Rabbitry, 1347 Miller Ave., Salt Lake City 5, Utah.

TRAINED Springer Spaniel bred. Irish Setter, other hunting puppies, Toys, watch dogs. Bargains. Mrs. Urey, Box 45, Paw Paw, Ill.

STANDARD Rabbit Journal, Milton, Pa. 3 years \$1.00, sample dime.

METAL Dog tags. Your name, address, 25c coin, 5 for \$1.00. Collar plates (3/4x2") 25c. Mail Products, Box 97E, Mendota, Ill.

\$10.00 POUND, Angora rabbit wool, we supply good rabbits, and buy wool. Particulars free. House of Angora, 1848 So. 18th, Springfield 5, Illinois.

RACCOONS, Minks, skunks—bred females. Catalog, 10c. Shady Fur Farm, Springfield, Minnesota.

PUPPIES And supplies; also pedigreed Flemish Giant meat rabbits and supplies; what do you need? Royal Kennels, Chazy, N. Y.

MONEY Raising rabbits. Investigate. Folder 10c. Close Rabbitry, Tiffin, Ohio.

RAISE Giant Chinchilla rabbits. Willow Farm, R15C, Sellersville, Penna.

ST. BERNARD Pups: Champion sired beauties. Franklin Young, R4, Riverhead, Long Island, New York.

MICE, Rabbits, pigs, pigeons. Information 10c. Jim Houck, Tiffin, Ohio.

RAISE Guinea pigs. Make money at home. Big demand. Free booklet. Taylors Guinea Pig Farm, Hapeville, Georgia.

RAISE Rabbits for profit. Magazine puts you in touch with markets. Copy 10c. Booklet describing twenty breeds, and magazine for three months 25c. Address American Small Stock Farmer, Dept. 3, Pearl River, N. Y.

RABBITS: Flemish Giants, New Zealand. Reasonably priced. Franklin Young, Riverhead, Long Island, New York.

RAISE Money-making Angora rabbits. Wool \$9.00 pound. Plenty markets. Particulars free. White's Rabbitry, Marion, Ohio.

SEEDS, PLANTS, NURSERY STOCK

TWENTY Assorted hardy phlox \$1.00 postpaid. Sunnyside Gardens, Madison, Nebraska.

HARDY 4 Year old Colorado Blue Spruce 6 to 10 inches tall; 15 for \$1 or 35 for \$2, 100 for \$4.95 postpaid. Cash with order. Planting instructions. Catalog, Fischer Nursery, Box 36, Bakerstown, Penna.

FARMS, FARM LANDS, REAL ESTATE

160 ACRES—Ozarks—200,000' finest hardwood timber, 5,000 locusts, log house, well, springs, 2 miles village, 20 miles university. Free stock range. Timber worth more than price. Bob Pace, (Owner), Combs, Ark.

FOR Free list, farms, lakeshore resorts, cabins, lots, write Central Minnesota Land Company, Jenkins, Minnesota.

\$5.00 MONTHLY Buys 40 acres, near town; price \$175.00. Free list. Box 425-P, Carthage, Mo.

SELL, Lease, beautiful waterfront home near Acadia National Park. \$7,000. Arthur Pray, Bar Harbor, Maine.

FREE Catalog, farm bargains, 7 mid-west states. Many fully equipped for convenient quick start. Many pictures. Special service to help you locate quickly, if you state requirements, payment plan and general location desired in first letter. United Farm Agency, 7-MP South Dearborn, Chicago 3, Ill.

STROUT'S Spring catalog just out! Bigger than ever! Over 1000 bargains from Maine to Florida and west to Texas, California, Oregon and Washington. Write this minute for this dollar-saving time-saving book. Free. Strout Realty, 255-P 4th Ave., New York 10, N. Y.

CANADIAN Tax sale lands for a dollar an acre and up. Small monthly payments. Farms, timber, hunting and fishing camps, minerals. Limited number of properties. Write at once for free catalogue. Tax Sale Service, Room 613, 73 Queen St. W., Toronto, Canada.

FISH, Hunt, trap, farm, rest, invest, in the incomparable Ozarks. Invaluable how-to mimeo on finding various low cost lands (federal, state, tax, private), Ozarks, Ouachitas, \$1 (refundable). Rent or buy there; vacation or reside there. American Information Service, Box 1156 University Place Station, Des Moines, Ia.

WISCONSIN, Minnesota water frontages \$7 acre, 230-A 40 St., Manhattan Beach, Calif.

WEST'S 1945 Catalogue hundreds farm bargains and business opportunities; including many best buys in Penna., New York, New Jersey, Ohio, Delaware and Maryland. For free copy write West's Farm Agency, HE, Pittsburgh 16, Penna.

ONTARIO Property with lake frontage. Excellent hunting, fishing territory cheap. Inquire C. Greenwood, 3393 Glenwood, Toledo 10, Ohio.

GOOD Farms—Ranches. Washington, Minnesota, Montana, Idaho, Oregon, North Dakota. Dependable crops, favorable climate. Write for literature. Lists describing typical farms. Specify which state. J. W. Haw, 119 Northern Pacific Ry., St. Paul 1, Minn.

HOMESITES \$200.00. On easy payments. In California's loveliest garden spot on wooded shores of Morro Bay, midway between Los Angeles and San Francisco. Wonderful fishing, boating, hunting. Excellent soil, soft water. Grow fruits, vegetables, poultry, etc. Unusual investment opportunity. Free literature. Richard Otto, Dept. M, 6560 Hollywood Blvd., Hollywood 28, California.

OZARK Farm bargains, 5 to 5000 acres. Frank, Mountain View, Mo.

FARM MACHINERY AND SUPPLIES

NEW Farm machinery book. Learn your farm machinery better. A time and money saver. \$1.00 postpaid. Wirtson's, West Burlington, Iowa.

POULTRY AND FARM SUPPLIES

CHICKS: Heavy Red cockerels, \$8.50 per 100. Leghorns—\$2.45. Pure breeds, crossbreeds. Sexed, non-sexed. Write for folder, prices. Amstutz Hatcheries, Box 43, Orrville, Ohio.

CHICKS For broilers \$3.75—100, 200—\$7.00 postpaid. Empire Hatchery, Seward, New York.

YOUR Greatest poultry problem will look simple when you read American Poultry Journal regularly. 500,000 poultrymen do, why not you? Only 25c year, 5 years \$1.00. American Poultry Journal, 539 South Clark, Chicago.

EXPERIMENTAL Farm money-making helps on poultry raising yours for five years only \$1.00; two years, 50c. Order now! Poultry Tribune, Dept. 30, Mount Morris, Ill.

BLUE Egg Araucanas, 50 breeds. Stock. Eggs. List 3c. Empire, Corona, New Mex.

SAVE Money, time—do your own welding, brazing, soldering. Tested, light-work "Super Welder" ideal for fixing chicken coops, tools, appliances, etc. Easy to use. Full instructions. Operates ac-dc, 110 volts. Plugs in anywhere. Complete with metallic arc, flame torch, mask, supplies. Guaranteed, 5 days' free examination. Only \$19.95. Save 2%, enclose check with order. Free for limited time only with every outfit special 95-page booklet, "Poultry for Profit." Super-Welder Mfg. Co., Dept. AA, 23 E. 20 St., New York 3, N. Y.

BIG, Husky, broiler cockerels; \$3.75—100; \$35.00—1000. Quick c.o.d. shipments. Crestwood Hatchery, Sheridan, Penna.

BABY Chicks, champion mated. 52 varieties, 7 hybrids, licensed inspected, bloodtested. Rush postal, large colored book, low prices. Berry's Farm, Route 12, Clarinda, Iowa.

RAISE Turkeys the new way. Write for free information explaining how to make up to \$3000.00 in your own backyard. Address National Turkey Institute, Dept. 3, Columbus, Kansas.

KNOW How to raise poultry for profit. Read Northeastern Poultryman. Every issue packed with helpful hints and practical suggestions. Latest articles on breeding, feeding, and management. Read nationally. Subscribe now, 1 year 65c; 2 years \$1.00. Northeastern Poultryman, 376 Boylston St., Boston 16, Mass.

PROFITABLE OCCUPATIONS

HOMEWORKERS, Make, sell, sell novelties. Beginners samples, instructions, \$1.00. Temple, 224-6th Ave. S., St. Petersburg, Fla.

MAKE \$300 To \$3000 a year in your spare time in your backyard, raising our Owei meat and fur rabbits. Outdoor War Efforts Industry, Owatonna, Minn.

ELECTRICAL Appliance repair. Open your own shop. Learn house wiring; electric motors, vacuum cleaners, washers, etc. Complete illustrated course shows how. Free booklet. Pacific Training School, Dept. 3-AP, 4703 West Pico, Los Angeles 6.

MECHANICALLY Inclined men—Own and operate general appliance repair shop. Complete, illustrated course shows you how. Welding, refrigeration, motor repair, how to get business, etc., all phases covered. Free literature. Christy Supply, Dept. 450, 2835 N. Central Ave., Chicago.

SIMPLIFIED Chemical gardening instructions 50c. Chemicals \$1.00. Gordon, 553 William, Winnipeg, Canada.

ANNOUNCING Home study course in commercial baking. Practical basic training. Good field for those with aptitude. Nearly depression proof. Send for free booklet, "Opportunities in the Baking Industry." National Baking School, 1315 Michigan Ave., Dept. 3431, Chicago 5, Ill.

GROW Ginseng, instructions dime, seeds reasonable. Specialty Farm, Rockford, Minn.

AMATEUR Machinist. 300 pages, 157 illustrations \$2.00. Alvin, 553 William, Winnipeg, Canada.

WELDING Pays. Learn with 1942 trade school text manual, 516 pages. Over 500 photos. \$2.00 copy. Money-back guarantee. Hobartweld, Box M-353, Troy, Ohio.

LADIES Start amazing profitable home work, particulars free. Write Daisy Failing, 885 Elmwood Ave., Providence 7, R. I.

\$2500 YEAR In backyard. Treatise 10c. Moyer, B-252-P, Milton, Penna.

MUSHROOMS Grown in boxes. Instructions 50c. Spawn \$1.00. Gordon, 553 William, Winnipeg, Canada.

PANNING Gold—Hobby or occupation. New 160 page beginner's book. Explains everything. Book and three large blueprints for small equipment \$3.00, c.o.d. if requested. Free literature. Old Prospector, Box 878K85, Oakland 4, Calif.

CASH in leather ornaments. Make at home. Sell on sight. Write now. Vogue Leathers, Fairfield 3, Iowa.

TYPEWRITER Repairing—Original course, simplified home study. Weber Typewriter Mechanics School, Box 269, Osborn, Ohio.

TYPEWRITER Repairmen urgently needed. Earn \$40 to \$50 weekly spare time. Our easy to learn home study course teaches how to repair typewriters. Write for free information. Houston Typewriter Repair Service, P.O. Box 5357C, Houston, 12, Texas.

LOCKSMITHING—Profitable business or hobby! New course teaches you how to pick locks, fit keys, de-code, masterkey, etc. Easy self-instruction lessons. Bargain price. Free details. Write—Nelson Company, Dept. 7-02, Chicago 4.

EXCEPTIONAL Profits raising mink. Finest breeding stock available. Details furnished. Franklin Young, Riverhead, Long Island, New York.

POSTWAR? Prepare now to become associated with us in an essential proven profitable profession. Universal Exterminators, 950 Margate Terrace, Chicago 40, Illinois.

GOLD-STAMPING. Exceptional post-war opportunity. Free booklet. Home City Specialties, Dept. 1273, Springfield, Massachusetts.

ELECTRIC Clocks are every where you go. buildings, homes, parking-lots, factories. Repairs increasing. Our easy to learn course with pictures and drawings teach you how to repair these clocks. Electronic Supply Co., Dept. A, P.O. Box 2350, Houston 1, Texas.

\$40.00 WEEKLY. Made growing mushrooms, fresh, dried. Dominion patent 331583. Free spawn. North American, 169P Yonge, Toronto, Canada.

BOOKS, PERIODICALS, PICTURES, POSTCARDS

KNOWLEDGE, Pleasure, profit through our books, homecraft, woodworking, plastics, refrigeration, airconditioning, building, construction, radio, television, electricity, electronics, mathematics, watchmaking, optics, automobiles, chemistry, farming, fur farming, boat building, hunting, fishing, camping, small arms, photography, occultism, astrology, character reading, music, homemaking. We supply any technical and hobby book. Request free catalogue specific subjects interesting you. Modern Technical Book Co., Dept. MC, 55 West 42nd Street, New York 18.

MAGAZINES—Choose current single copies from list of more than 600 different business, vocational and diversion periodicals. You will profit by being posted on conditions, developments, and opportunities in your line through magazines devoted to it. Write for free price-list. Commercial Engraving Publishing Company, 34C North Ritter, Indianapolis 1, Indiana.

SELF-EXPLAINING Bible; Illustrated circular free. Box 446-P, Minneapolis, Minn.

"PICTURE Yourself Successful!" Learn how to attain success, wealth, happiness! New book tells you! \$1.00, postpaid, or send for interesting free folder. Buse, 878-A Fillmore, Buffalo 12, New York.

BOOKS For sale. Name your favorite—we have it! Cooper, Room 12-PM, 113½ East Lafayette, Tampa 2, Florida.

100 ASSORTED Unused views \$1.00, others 200—\$1.00. Foreign 100—\$2.00. Coltran, 123 Foster, Burlington, Vermont.

MONEY Making ideas in book of formulas, plans, and bargain buyer's guide. Literature free. William Prowell, 618 Wallace Street, York, Penna.

"100,000 POST-WAR Jobs Abroad!"—South America, China, India, Burma, Japan, Russia, Malaya. How, when and where to apply. Post-war U. S. participation in world reconstruction and trade demands thousands of American-trained mechanics, salesmen, technicians, engineers, foremen, laborers and business representatives—every trade needed. Our 15,000-word copyrighted forecast—compiled from business, professional and government sources—lists over 200 big U. S. firms with foreign interests, gives job information, salary brackets, contract tips, application letters, passport information, climatic conditions, etc.—everything needed for your immediate application. \$1.00. Return for refund in 7 days if not satisfied. Pacific Industrial Research Bureau, 202-E Studio Building, Portland 5, Oregon.

THE New illustrated encyclopedia, complete. Thousands of subjects. 1,496 pages. Postpaid \$2.98. John Racksowa, 44 Erwin Place, New Britain, Conn.

WHAT Every Mason wants. We have Masonic books for Blue Lodge, Chapter, Commandery, Scottish Rite and Shrine. Our rituals are used the world over. Send for free catalog of books and rituals for Masons, Odd Fellows, Knights of Columbus, etc. Ezra A. Cook, Publisher, P.O. Box 796, P.M., Chicago 90, Ill.

SAVE Money by writing for our lists of special cut-rate books, many at less than 50% of original price. Pines, Box 32, Flushing, New York.

AVIATION, Photography, radio books. Lists. Shannon, 66A Elm, Nutley 10, N. J.

PIN-UPS, Gorgeous girls, full color. Sample 8x10 and 3½x5½ 10c. Ball Square Company, Dept. 2A, 697 Broadway, Somerville 44, Mass.

GORGEOUS Girl photographs. All different poses. Genuine glossy prints. Big sample assortment—lists \$2.00. Clover, X-31, Hollis 7, N. Y.

PIN-UP Girl photos. 20—\$1.00. 65—\$3.00. 120—\$5.00. Identification bracelet engraved 50c. Army identification brass plate 50c. Print clearly. B. Bonomo, Box 45, Sta. A, Brooklyn 6, N. Y.

ALL Books wanted. State your price. Box 1770, Tampa 1, Florida.

GIRLS Beautiful, assortments \$1.00. Sample 25c. Richman, 121 Carothers Ave., Carnegie, Penna.

25 DIFFERENT Pin-up girls, complete with hangers—\$1.00. Wright, 163-c Carlisle Avenue, Paterson 1, New Jersey.

BEAUTIFUL Pin-up girl pictures. Attractive poses. 24 for \$1. United Arts, 2309-C Lawrence, Toledo, Ohio.

WHOLESALE Directory of ½ million articles. 10c. William Grace, Milledgeville, Georgia.

GLAMOROUS, Fascinating miniature photographic poses of beautiful girls. 24 different 50c. 70 different \$1.00. William Drake, 100 West 43rd Street, New York 18, N. Y. Dept. C.

LOVELY Artistic pin-up girls. Actual photographs, size 3½x4½, 10 for \$1.00. 6 different sets \$5.00. Samples 25c. Murray Wilkins, 417 Hill, London, Canada.

INCREASE Your intelligence! Banish misunderstanding! Revealing book—\$1.00. Redmont Company, P.O. Box 9264, Los Angeles 5, California.

GLAMOROUS Pin-ups! Real photographs! 10—\$1; 25—\$2. Fine Arts, Box 2084-K, San Antonio 6, Tex.

GORGEOUS Pin-ups. 15 beauties only 25c. Richardson, Wyoming 2, Penna.

10 BEAUTIFUL Grand Canyon views 25c. V. Reasor, Medical Lake, Washington.

WRITER'S Instruction books. World's largest collection! List free. Humanity Press, 230 West 42nd St., New York 18.

PIN-UP Parade. 48 pictures, size 6½"x9½". Famous beauties, \$1.00. Dealers wanted. Richardson, Wyoming 2, Pa.

RELIGIOUS Books. Write Bobbitt, 1609 Tenth Avenue, North, Nashville 8, Tenn.

SNAPPY, Gorgeous, full color, 5x7 pin-up girls. 24 for \$1.00. Plastic's, Route No. 5, Muncie, Indiana.

BOOKS, Old, rare, unusual. Current books, magazines, bargain prices. Free catalogue. Banker Book Co., 610 S. Broadway, Room 623-E W. P. Story Bldg., Los Angeles 14, Calif.

BOOKS Found! (Scarce, out-of-print new books) supplied promptly. Send wants. Clifton, Box 1377pm, Beverly Hills, Calif.

FUNNY Books, 10c. 3 books, 25c. Wood Publisher, 921 S. Jackson, Tulsa 5, Okla.

TAILORED Homes—the modern plan book. Ad under Miscellaneous heading.

MACHINIST'S Reference book. Tables, drafting, hardening helps, shop trig. \$1.00 postpaid. G. A. Knudsen, 523-48th St., Brooklyn 20, N. Y.

MAGAZINES (Back dated)—foreign, domestic, arts. Books, booklets, subscriptions, pin-ups, etc. Catalog 10c (refund.) Ciccone's, 863 First Ave., New York 17, N. Y.

BEAUTIFUL Colored pictures. No girls. Lists free. Curtis, Box 1916, Denver, Colo.

SENSATIONAL, New self help books. Security Acres, tells how to create income outdoors. Character at a Glance. If It's Wealth You Desire, each \$1.00. Gold Ahead \$2.50. Interesting details free. White, 528 Brooks, Dallas 8, Texas.

DRUNKENNESS Is a disease which responds to treatment. Medical skill plus human sympathy prove successful with liquor and drug cases. 60 years experience. Write for free booklet. P. M. Nelson, The Keeley Institute, Dwight, Ill.

12 PIN-UP Girls 50c and 3c stamp; foreign 12c extra. Selson, 1919 Girard Ave., Philadelphia 30, Penna.

GORGEOUS Girl photos, books, etc. 15 samples 25c. Richardson, Wyoming, Pa.

REBINDING: We bind magazines, old books, Bibles, hymnals. Heckman Bindery, Dept. D, North Manchester, Indiana.

A RATIONAL View of Life \$1.00. Benjamin Seibert, Urbana, Ohio.

64 ART Cards of gorgeous beauties \$1.00. Reed Novelty, Dept. PM-6, Box 24, Queens Village 9, N. Y.

"PIN-UPS," 180 Gorgeous girl subjects! Huge bargain pack \$1.00. Clover Novelty Company, Dept. 37-DD, Hollis 7, N. Y.

ARTISTIC Girl pictures. Real models. 40 photos for \$1.00 postpaid. All different, postcard size. C. A. Scott, P.O. Box 342, Covington, Ky.

GORGEOUS Full-color pin-ups. 50 different \$1.00. 160 different \$3.00. Samples 10c. Theron Fox, 1024-B Carolyn, San Jose 10, California.

BOOKS. (Out-of-print, new, used) quickly supplied. Many 35c bargains. Catalogue. T. Jankowski, 18870 Marx Ave., Detroit 3, Mich.

GAMES AND ENTERTAINMENT

TWELVE-WAY. 52 Cards, Joker. \$1.00 prepaid. Box 842, Denver, Colo.

MAGIC TRICKS, PUZZLES, JOKEE NOVELTIES

MAGIC Is fun! Send \$2.00 for apparatus to perform 10 different startling tricks. Guaranteed \$5.00 value! Free, with your order, book of "102 Tricks." Robbins Co., 152-P West 42nd St., New York.

ATTRACTIVE Magic kit of 10 tricks \$1.00 postpaid. Kogel's Magic Novelty Co., 6751 Colbert St., New Orleans 19, La.

NEW Magic and fun magazine, 15c. Prize contest. Free luck piece. Phocbus, 945-A Chancellor, Irvington 11, N. J.

84 CARD Tricks and our latest catalog of magic tricks only 25c. Ball Square Company, Dept. 22A, 697 Broadway, Somerville 44, Mass.

BE A mathematical wizard. Send for "Magic in Numbers"—amazing new book of "tricks with figures." 25c coin. Alta Company, Box 1109, Pasadena 1, Calif.

WORLD'S Greatest pocket trick. Educated sponge balls that grow, shrink, multiply and divide. Anyone can do it. Send fifty cents. Singer, 1220-45 Street, Brooklyn, N. Y.

LEARN Ventriloquism. Details free. Earl Gotberg, 15801 Prest, Detroit 27, Michigan.

MAGIC Races, 8 for 25c. Russ Chaney's Hobby World, 1505 Del Norte, St. Louis 17, Mo.

MYSTIFY Your friends with smoke from your finger tips. A sensational trick that never fails. 50c postpaid. Stewart, 107 So. Thomas, Pomona, Calif.

FLOATING Cigarette—Floats in midair. With instructions. Ten cents. J. Eastwood, Box 623, Parkersburg, W. Va.

LEARN Stage, club, and intimate magic by mail. All apparatus furnished free with each lesson. Send \$1.00 for first lesson. Rec, Box 93, College Park Station, Detroit, Mich.

NEW 1945 Magic catalogue free. Eagle Magic Shop, Minneapolis 2, Minn.

CAN You tell—anyone's age or cash in pocket? Never fails—10c tells how. Bob Lees, 6217 W. Wisconsin Ave., Milwaukee 13, Wis.

VENTRILLOQUISM Instruction 25c. Stage money 10c. Parker Publications, Peterboro, Ont., Canada.

VENTRILLOQUISM. Complete instructions only \$1. LeSueur, 77 Wellesley, Toronto, Canada.

NEW Vanishing half dollar 50c. Carlo, 436 Superior, Toledo, Ohio.

TEN Sensational escapes from ropes and shackles 25c. Funmaster Co., Crossville, Tenn.

MAGIC: Big 160 page Illustrated Catalog Latest Magic Goods, 25c. For over 1/3 century we have supplied Professional as well as Beginner. Chicago Magic Co., 2300 N. Mason, Chicago 39.

NEW Scientific discovery in the preparation of playing cards for magic tricks. Even while blindfolded you can instantly detect the face cards. No marks or chemicals used. Instructions for secret, inexpensive preparation of cards, \$1.00. M. Brophy Co., Rentola Bldg., West Duluth, Minn.

FIFTEEN Sealed mysteries — \$1.00. Windsor Magic Mart, 2443 E. 75th Street, Chicago 49, Illinois.

"HITLER'S Last Will." funniest document ever written 25c. Five copies \$1.00. Ace Novelty, Box 101, Richmond, Ind.

JOKEE Tricks, at wholesale. Jobbers, storekeepers, pitchman, salesmen. The fad is sweeping the country. Send for list. Schwamm, 237 East Ninth St., New York City.

WORLD'S Most fascinating puzzle. One dollar. Darden, Box 525, Chicago.

WORLD'S Largest professional magic shop keeps you in touch with latest tricks. To receive mailings send 25c for new catalog. Holden, 220 W. 42nd St., New York.

ENTERTAIN! Mystify! New, bigger magic catalog and 4 secret tricks 25c. Herbert, P-192 N. Clark, Chicago 1.

TEN Professional tricks with equipment \$5.00. Ten amateur tricks \$2.00. Magic package 25c. Magic Den, 612PM Pine, St. Louis, Mo.

6 MAGIC Tricks and clever novelty 10c. Victor Jones, Parma, Missouri.

500 TRICKS You can do! Douglas's famous catalog of 500 tricks, now only 10c. America's fastest service on magic for pocket, parlor, stage, professional, amateur. Douglas Magic Shop, Box 274, Dallas, Texas.

AMAZE Everyone. Answer unspoken questions. Professional "no assistant" mindreading act, \$1.00. Magical Enterprises, Box 111-P, Levering, Mich.

NEW! Simplified card tricks! Amazing self-working bafflers 50c postpaid. James W. Roundtree, 529 Elliott St., River Rouge, Michigan.

LEARN Ventriloquism, 3c stamp brings particulars. Smith, 801 Bigelow, Peoria, Illinois.

BE A magician. Large professional magic catalogue of latest tricks 25c. Ireland, C-109 North Dearborn, Chicago 2.

MAGIC Tricks, puzzles, books, cards, punch boards. Catalog 10c. Specialty, Box 671, St. Louis 1, Mo.

NEW Vanishing key and catalog 25c. Sterling Magic, 345 John R, Detroit, Mich.

EARN Money in any crowd. Call names of strangers, tell unspoken questions. Professional course mind reading, spirit writing, etc., \$1. Henderson, Box 341, San Bernardino, Calif.

OLD STAMPS WANTED

I WILL Pay \$100.00 each for 1924 1c green Franklin stamps, rotary perforated eleven (up to \$1,000.00 each unused). Send 6c today for large illustrated folder showing amazing prices paid. Vernon Baker, (PM-53), Elyria, Ohio.

STAMP COLLECTING

LIBERAL Offer. Thick packet with Seychelles, Gilberts, U. S. commemoratives, Tete, Djibouti, Inini, Congo, Puerto Rico, Philippines, and multitude others. Everything only 10c to approval applicants. Burmaster, 718 1/2 West First St., Los Angeles 12, Calif.

FREE—Solomon Islands "Guadalcanal" (where Marines licked Japs); jungle triangle, Mauritania, Mukden, Cossack, camel, Czechoslovakian independence, French and British Colonies, others—free with approvals. Postage 3c. Quirk Stampco., 1133 N. Main, Tulsa, Okla.

AMAZING Offer! Assortment each of giant stamps, midget stamps, flag stamps, airmail stamps, Free French Colonies, U. S. commemoratives and numerous others. Everything only 10c to approval applicants. Simon, Box 214, Iraan, Texas.

ALASKA Embossed air mail cover with photo stamp. Attractive. Unique. Send 15c stamps or coin. Arctic Cachet Company, Box 118, Ketchikan, Alaska.

FAMOUS Washington bicentennial, complete set, plus eighty year old, high catalog, revenue—only 10c to United States approval applicants. Jarr's, Box 711, Denver 1, Colorado.

POSITIVELY Greatest free offer—Latest Scott's International \$5.00 Stamp Album—covering entire world, contains 38,000 illustrated, descriptive spaces; Scott's 1945 Standard \$9.00 catalogues "Philately's Encyclopedia"—absolutely free to applicants for foreign approvals becoming customers. Thrifty Stamp Service, 1106 East Baseline, San Bernardino, California.

GENEROUS Offer: Over 100 different with Mongolia, Siberia, Southern Rhodesia, Ceylon, other Africa, Latin America, Asia, etc. All only 10c to approval applicants. Herbert Boyd, Box 6081, West Asheville, N. C.

RARE Dollar value! With complete Canadian set, free to approval customers. Large foreign selections. Vogel, 5174 Lake Shore, Port Huron, Michigan.

FREE!—25c Worth of stamps from our first foreign approval selection. Beaumont Stamp Exchange, 2667 McFaddin, Beaumont, Texas.

FREE!—World's only octagonal (eight-sided) stamp and 70 year old Turkey set to approval applicants. Charles Cleaveland, 806 North Humphrey, Oak Park, Ill.

FREE. 30 Different Cossack diamond, "half stamp" triangle, Gobl, others. Approvals included. Send 3c postage. Pilgrim Co., Waverly, Baltimore 18, Md.

FREE! \$1.00 And \$5.00 dues! Complete set free to serious collectors requesting British Colonies and attractive general approvals at moderate prices. Forest D. Wilson, 711 North A Street, Tampa 6, Florida.

FAMOUS Americans, complete set, plus coronations, two colonies complete \$1.60 with approvals. Price, 2521 - 122 St., College Point, N. Y.

FOREIGN Commemoratives, pictorials, etc. on approval at one and two cents each. Mart, Box 67, Holyoke, Mass.

U. S. And foreign stamps packet—includes airmails, commemoratives, pictorials—3c. Approvals. Smith, 237-A 8th Ave., Roselle, N. J.

20 DIFFERENT Early Turkey stamps given to approval applicants sending 3c stamp. Premiums with purchases. Brandwein Stamp Company, 167 West 33 Street, Bayonne, N. J.

50 DIFFERENT Including scarce airmail triangle. 3c to approval service applicants. Avalon Stamp Co., Dept. M, Springfield-8, Mass.

LOOK! 50 Different countries—10c. Northeast, Box 6618, Kansas City, Mo.

FINE Approvals, freshly mounted. Fast, personal service. Tell me what countries you prefer and I'll send them stamps. Skinner, 345 East Ocean, Long Beach 2, Calif.

UNITED States No. 255, No. 324, No. 376, No. 397, No. 413, No. C30, No. C31. Send 50c. Approvals accompany. Whiton-Stamps, Norwalk 4, Connecticut.

JOB Lots. \$1, \$2, \$5. U. S. and foreign in each lot. No approvals or single stamps, everything goes into lots. Troy Huffman, 146 N. Ashland, Chicago 7.

FREE—Your choice any 10 stamps from our first U. S. approval selection. Illustrated list included. Cosmopolitan Stamp Co., 1457 Broadway, Dept. E-3, New York.

200 DIFFERENT Foreign, 30c. Many countries. Jem Stamps, Port Jefferson, N. Y.

GUATEMALA—25 Different 10c. Approvals. E. P. Johnson, P.O. Box 267, Morgan Hill, Calif.

FREE 50 Different stamps to approval applicants enclosing 3c postage. Mangels, 194-13A 111th Rd., St. Albans 12, N. Y.

FRESHLY Mounted approvals for general collectors. Phoenix Stamp Co., Dept. 3-M, 120 West 44th, New York.

CHILE, 50 Different, only 10c with approvals. Paul Rawden, Box 2920, Westville, New Haven, Conn.

STAMPS From 40 countries 10c. No approvals. Eisea, Bowling Green, Ohio.

25 DIFF. Finland 8c with 1/4, 1/2, 1c approvals. Carroll's, 4357A S. Hoover, Los Angeles 37, Calif.

WHAT Have you to offer? A collection? A "shoe box" accumulation? Anything in stamps. We urgently need them. Spot cash paid. Cosmopolitan Stamp Co., 1457 Broadway, Dept. 3-E, New York.

60 DIFFERENT U. S. Includes commemoratives, higher values, airmail. 10c. Charles Stone, 3547 28th St., Astoria 1, N. Y.

MOZAMBIQUE Triangles. Four unused 10c with approvals. Vargo Stamps, Racine, Wisconsin.

BRITISH Colonies and South America on approval. Theo. Stevens, Box 3705, Kercheval Station, Detroit 15, Mich.

PREMIUM Given approval applicants. Arkay Stamp Co., 2136 Fox Ave., Fort Wayne 6, Ind.

FREE! Complete Balkan aviation set with approvals. Beaman, Glenburnie 1, Maryland.

SPECIAL 50 Different Venezuela 50c. Monjar, 1750 Fairmount, Cincinnati, Ohio.

CUBA—31 Large commemoratives, airmail and specials, all different, \$1.00. Pricelist free. Frank Sevilla, Box 1473, Havana.

TWENTY Desirable foreign commemoratives only 5c. Lucas, 7-11 Broadway, New York 4, New York.

500 MIXED Plus 8 Philippines, Porto Rico, Cuba, before 1900—15c. Ajax, Box 2036, Augusta, Georgia.

LATIN-AMERICA. Beautiful pictorial approvals. Foust, 133 Peterboro, Boston 15, Mass.

STAMPS On approval, finest quality, lowest prices. Worth a try. The Stamp Shop, 74B Virginia Rd., Buffalo 21, New York.

100 STAMPS 10c. Approvals applicants. Morris Stamp Co., Box 74, Rockaway, New Jersey.

BY Return mail 125 diff. U. S. \$1.03. G. P. Kunz, 2054 Boulevard, Jersey City 5, N. J.

PENNY Approvals that satisfy. Edw. Feeley, 2927 Wheeler St., Berkeley 5, Calif.

6 MONTHS Subscription 10c! "Stamp Post," Station A, Pasadena 3, Calif.

TWO Mint sets—30 with approvals. Auburn Stamp Co., 1512 Auburn, Cleveland, Ohio.

100 DIFFERENT World-wide 5c—pictorial approvals. Getche, 1040 NE, Eighth, Minneapolis 13.

500 WORLD Mixed including airmails, pictorials 20c. Burns, 153 N. Menard, Chicago 44.

AMERICAN, Foreign, mammoth collection only 25c. Devine, Box 11, La Crescent, Minn.

MINT Canadian approvals. Allison, 712 17th Street, Niagara Falls, New York.

SETS At premium prices. Philately Exchange, 823 1/2 Maple, Santa Monica, Calif.

100 DIFFERENT 10c With approvals. Jacobsen, 59 Nagle Ave., New York 34, New York.

INTERESTING Packet free to approval applicants. Farley Stamps, Pennington Gap, Virginia.

FREE. Haiti victory set to approval applicants. Riedell, Greensburg, Penna.

FREE U. S. price list. Postage 3c. Mark Hanna, 335 - 5th Avenue, Pittsburgh 22, Penna.

FREE United States bargain bulletin. It's different! No approvals accompany. David Chassy, 38 M. Park Row, New York City.

WHOLESALE Price list for dealers only. Thousands of illustrated offers—sets, singles, rarities, collections, packets, etc. (No post cards, please.) Stamp Import Export, 130 West 42nd, New York 18.

FREE — Zanzibar (Jubilee). Abyssinia (Air) plus world wide packet. Send 5c postage, handling. Regent Stamp Company, 330 Flatbush Ave., Brooklyn 17, New York.

IMPORT Your own! Addresses 35c. Souls, Alma Ave., Menominee, Michigan.

KEEP Your collection going! Stamps of the Month Club offers new issues of foreign countries at low cost. Monthly packets and bulletin listing all new issues. Write for bulletin and information. Elm Stamp Company, 2855 Piedmont Road, N.E. Atlanta, Georgia.

U. S. Approvals priced from 1-25 cents. Send stamp. Davis, 172 Clinton Pl., Hackensack, N. J.

25 MINT Varieties plus Chinese Swastika, 5c. Approvals. Rex, 39 Blackstone, Bangor, Maine.

FREE Gifts to purchasers of our approvals. Stamps, 6341 Dennis, Detroit 10.

QUALITY Approvals, reasonably priced, for beginning and intermediate collectors. deValinger, Box 611, Savannah, Georgia.

\$4.80 BRITISH Guiana 1895 10c. Approvals. Gans, 1435 East 67 Place, Chicago 37.

25 DIFFERENT British Colonials, catalog 70c; with approvals 17c. Guy Freese, R.R. 6, South Bend, Ind.

FREE! Approval applicants select 10c worth free. Your choice. Excel, Box 1315, Chicago 90.

50 FREE Pictorial, etc., stamp dictionary, list. Bullard, Newcastle, Maine.

TRIANGLES — Mozambique airmail commemoratives, British Empire commemoratives, U. S. higher values. Bonanza lot, 10c. Approvals accompany. Reuter, 611-C West 40th, Los Angeles 37.

FREE. Complete Cuba tobacco set with approvals. Seminole, Glenburnie-1, Maryland.

AROUND The world—fifty different 5c to approval applicants. Charles Mangels, 19413A 111th Road, St. Albans, N. Y.

SUPERB Assortment U. S. 500 high values, commemoratives, airmails only. Plenty blocks including flags \$2.00. Blackmon, Corcoran, Calif.

FREE Stamps from first approvals. Lowest prices possible. Fedor Stamp Service, 246 Wallington Ave., Wallington, N. J.

STOP—Want something different and unusual in approvals? Kirklands, 7212 Farwell, Chicago 31, Ill.

"PENNY Approvals" my specialty for general collectors. Creek, Box 229, Whittier, Calif.

EXCHANGE Your duplicate stamps with collectors everywhere. Stamp brings particulars. Kurtz, Box 1051, Allentown, Pennsylvania.

BRAZIL 50 Different 20c. Approvals. Reidenbach, Lexington Ave., Troy, New York.

SPAIN—Five large airmails. Send 10c. Approvals. Buchanan, 307 East 23rd, New York.

FIFTY Canadian, Newfoundland, including earlier, commemoratives, 10c. Approvals. Reede, 696 Gerrard, Toronto.

700 MIXED Foreign 50c; 1500—\$1.00. Seiden, 1331 Intervale, New York 59.

LOW Priced United States approvals. Steger, 1165 Downing, Denver 3, Colorado.

WORLD Wide approvals sent on request, references please. Juan Alexis, Box 141, Racine, Wisconsin.

U. S. Approvals. Select copies, used—mint. Kingsbury Stamps, West Burke, Vt.

CARAMBA! Gorgeous Gilberts, oddish Solomons—3c with approvals! Saxon, Valley Stream, N. Y.

SCARCE Grenada bicolored silver jubilee stamp, MacArthur stamp from Australia, Abyssinian wild elephant issue, plus host of others from New Caledonia, Indo-China, Russia, Cuba, Wallis & Futuna, Dutch Indies, China, Philippines, etc., only 5c to approval applicants! Big dime packet list free! Methuen Stamp Service, Inc., Dept. 36, Lawrence, Mass.

EXCHANGE Your duplicate stamps. Details free. C. Bishop, Route 8, Kalamazoo 88, Michigan.

SCARCE 1880 U. S.—Hussey local carrier stamp listed at 15c. Also Costa Rica No. 65 listed at 40c. Both sent free to approval buyers sending 3c postage. Pladon Stamps, 1717-M Idaho, Toledo 5, Ohio.

TURKS Caicos, Grenada, Seychelles, Dominica, Caymans; everything 3c with approvals. Viking, 130(Z) Clinton St., Brooklyn, N. Y.

ZOWIE-E-E! A barrel of fun for only a dime. 500 United States—absolutely unpicked and unsorted—just as received from church missions. Many varieties, including large commemoratives, airmails, high denominations up to \$5.00! Stampdom's biggest package of fun—and you might find something really valuable! Price only 10c to serious approval service applicants. Money back if not delighted. Illustrated bargain lists with each order. Mystic Stamp Company, Department 80, Camden, New York.

20 DIFFERENT—20 Different countries, 3c. approvals. A.B.C. Stamps, 2378-P Miramar, Los Angeles 4, Calif.

19th CENTURY U. S. commems. Civil War revenues, battleship \$5 and \$10 stamps free to U. S. approval applicants. Metropolitan Stamps, 198-C Broadway, New York.

FREE—Pick 25c worth of stamps from our first U. S. approval selection. Approximately 100 stamps to choose from. Excellent value. No obligation to buy. Lists illustrating the most popular U. S. stamps—at prices you can afford—will be included. Don't miss this opportunity! Write today. S. C. Engel Co., 38 Park Row, New York City.

114 DIFFERENT Stamps from far away countries including airmail and Free Fighting French to approval applicants for 10c. Reich Stamp Co., 4647 Kenmore, Chicago 40, Dept. M9.

SPECIAL—Airmails, 21 different, including zeppelin, triangles, Latin-America, 5c with approvals. Continental Co., (Dept. B), Box 606, New Rochelle, New York.

U. S. Price list. Send postage. Stanley Gibbons, 38-P Park Row, New York.

WORLD'S Largest diamond and triangle stamps, free stamp magazine stamps from Fighting Free French, 20 stamps from 20 different countries, pictorials, airmails, big bargain 5c with approvals. Capital Stamps, Dept. 2, Little Rock, Ark.

EXTRAORDINARY Pictorial collection—Nigeria, Southern Rhodesia, Dutch Indies, Martinique, Newfoundland, Philippines, Porto Rico, St. Pierre and Miquelon, Djibouti, Senegal, Ceylon, Yugoslavia, Ivory Coast, Madagascar, Reunion, Wallis and Futuna. Everything only 5c. Imperial Stamps, Box 311, Yonkers 1, N. Y.

118 DIFFERENT Stamps including commemoratives, charities, airmail sets, etc., only 3c to approval buyers. We buy collections. Badger Stamp Co., Milwaukee 3, Wis.

FREE! Complete "United States" stamp catalog with 1,000 illustrations! Send 10c to cover mailing. Harris & Co., 137 Transit Building, Boston, Mass.

FREE! The Stamp Flinder! Send today for the big new edition, fully illustrated, enabling you instantly to identify all difficult stamps! Also fine packet strange, fascinating stamps from Bosnia-Herzegovina, Monaco, Patiala, Cyprus, etc., including maps, ships, animals and strange scenes. All free to approval applicants enclosing 3c postage. Garcelon Stamp Company, Box 900, Calais, Maine.

1000 MIXED U. S. old and new 25c. 2 lbs. \$1.00. Weatherby, Medina, Ohio.

POUND Unpicked U. S. and foreign mixture containing thousands stamps \$1.00. 5 lbs. only \$4.50. Longacre Shop, 100 West 42nd, New York City.

DEALERS—Wholesale list. Postage 3c. Frank, 5031 Queensberry, Baltimore 15, Md.

1000 GRABBAGS 15c Each, 8 different \$1. Special bags. Free French included 25c. Zandy, 630 Bingham, Reading, Pa.

SMOKY Mountain commemorative sheet, largest U. S. stamp issued, and 33 U. S. including commemoratives, airmail, revenues, etc. Catalogs 75c—To approval applicants for 5c. Curhan Stamp Company, Gloucester, Mass.

FREE! Canadian sets, royal visit, George VI, George V, coronation, jubilee, others, to approval applicants. Ensign, Box 118-M, South Orange, N. J.

WEEKLY Stamp Magazine, 26 weeks, 25c. Stamp Journal, Kalamazoo, Mich.

CANADA 100 Different 25c—approvals all countries. Lists. Victoria Stamp Co., London, 4, Canada.

FREE! Leeward Is., Cayman Is., Turks and Caicos plus 60 different mint Geo. VI coronation poster stamps, to approval service applicants sending 3c postage. Tatham Stampco, Springfield-30, Mass.

55 DIFFERENT United States 5c with approvals. Bookman, Box 145-M, Maplewood, N. J.

STAMPS Sent on approval, outstanding quality, low prices. Fred Herzberg, 168 Oak, Elmhurst, Ill.

UNITED States approvals complete coverage, fine quality, attractive prices. Seminole Stamps, Box 436, Coconut Grove, Florida.

80 DIFFERENT United States 10c. Pricelist free. Seidenberg, Baroda, Mich.

DANDY United States approvals. Write immediately. Sullivan, Endicott Arcade, St. Paul, Minnesota.

FREE! Western Hemisphere packet. Postage 3c. Owens, 806 Welsh, Bay City, Michigan.

FREE! British Empire packet. Postage 3c. Williams, 606 Archer, Bay City, Mich.

FREE! Pony Express set (facsimiles). Postage 3c. Roberts, 406 Building, Bay City, Michigan.

EXCELLENT Pictorial approvals. Reasonably priced. Crown Stamp Company, Box 331, Toronto, Canada.

WOW! \$10.00 Worth of fun for only 10c! 500 foreign stamps, unsorted and unpicked (mostly on bits of paper) just as received from the church missions and other sources. Africa, So. America, Australia, China, Philippines, Dutch Indies, and other countries are represented. Includes a few commemoratives, airmails, and stamps cataloging up to 25c or more each! The biggest package of fun in stampdom—and you might find something really valuable! Price only 10c to serious approval applicants! Money back if not delighted. Jamestown Stamp Co., Dept. No. 22, Jamestown, New York.

VICTORY Packet free—Includes stamps from Tanganyika, British Cayman Islands, animal, scarce babyhead, coronation, early Victorian, airmail, map stamps, with big catalogue—all free. Send 5c for postage. Gray Stamp Company, Dept. PM, Toronto, Canada.

COINS, TOKENS, CURRENCY

U. S. Coins. Large cents before 1857, 4 different dates \$1.00. Two cent pieces, 4 different dates \$1.00. Old half dollar before 1837 \$1.25. Civil War notes, 5 different \$1.00. Immediate delivery. Postpaid and insured. James Randall, 341 South Dearborn, Chicago 4, Ill.

RINGLING Brothers circus scrip, complete set 6 \$1.00; 12 wooden nickels \$1.00; both \$1.60. 25 different Indian cents \$1.00. Bargain lists 3c. Bebee Coin Company, 1180 East 63rd Street, Chicago 37, Illinois.

WE Buy Indian pennies, Lincoln pennies, and old rare coins. Highest prices paid. Indian pennies worth up to \$15.00 each. Lincoln pennies up to \$2.00 each. Other rare coins \$5.00 to \$2000.00 each. Send 10c today for new 1945 price catalogue of all wanted U. S. coins. American Rare Coin Co., Dept. 1, Transportation Bldg., Chicago 5.

OLD Money wanted. Will pay \$100.00 for 1894 dime, 5c mint, \$50.00 for 1913 Liberty head nickel (not buffalo). Big premiums paid for all rare coins. Send 4c for large coin folder. May mean much profit to you. Numismatic Co., Dept. 20, Fort Worth, Texas.

10 INDIAN Head cents, different dates, also pricelists, 40c. Schultz, 1053 Richmond, Cincinnati, Ohio.

COMMEMORATIVE Half dollars gold coins for sale. Andrew Kranack, 806 Montiero, Pittsburgh 17, Penna.

WILL Pay \$10.00 each for certain Lincoln pennies! Indianheads \$50.00; dimes \$1,000.00. Catalogue 10c. Federal Coin Exchange, 3-PM, Columbus, Ohio.

FIVE Different coins and lists 25c. Oddehon, Box 482, St. Louis, Mo.

4 ROMAN Coins 2000 years old \$1.00. 30 different foreign coins \$1.00. 100 different \$4.00. 43 mixed Indian cents \$1.00. Lists, approvals. Delmonte, 725 West 172, New York 32.

GET Profit and pleasure in collecting old coins. Send 10c for 56-page illustrated coin catalog. You'll be delighted with it. Send for it now. B. Max Mehl, 370 Mehl Bldg., Fort Worth, Texas. Largest rare coin establishment in U. S. Established 45 years.

TRADE, Buy, sell U. S. coins, foreign gold. Harris, Box 3041, Seattle 14, Wash.

COMMEMORATIVE 1/16. Columbus, Stone Mountain, Texas, Cleveland, \$1.50 each, new. Illustrated catalogue 25c. Norman Shultz, Salt Lake, Utah.

QUICK Service; reasonable prices. United States catalog 10c. Foreign catalog 10c. Ben's Coin Company, 72 West Washington, Chicago 2, Illinois.

FREE! Foreign coin, banknote and coin collectors illustrated catalog to approval service applicants. Send 3c postage. Tatham Coinco, Springfield-125, Mass.

I MAY Have just the scarce U. S. coins you want. Send me list. "Meet me by mail." William H. Kenworthy, Waterville, Maine.

HOBBIES AND COLLECTIONS

DIAMOND Edged 10" circular saw blades for semi-precious stones, tile, brick, etc. Instructions. Each \$2.00. Three \$5.00 postpaid. Leuck Crystal Laboratory, Lincoln, Neb.

COLLECT Foreign military insignias and war prisoners emblems. Sample, prices 15c. Hobbyguild, M-35 West 32nd St., New York.

OLD Cigarette cards, china and dolls. Wanted for cash. Goudie, 11 West 59th St., Kansas City 2, Missouri.

FOREIGN Decoration ribbons, insignia, lists, sample, 20c. Insigniacrafts, 236 28th Avenue N. W., Calgary, Canada.

HOBBIES That pay! List free. Stamp appreciated. Seamans, Box 1922, Portland 11, Oregon.

EXCHANGE Duplicates. Swappers everywhere. List free. Box 2166-M, Denver 1, Colorado.

CARVED, Painted—Fawn, hound, colt, \$1.00 each. "Old Whittier," 1402 Charles, LaCrosse, Wis.

GENUINE Arizona rubies (garnets). Send quarter for packet. Mineral Specimens, Box 2651, Phoenix, Arizona.

UNUSED—130 Different match covers \$1.00. Tomasek, 316 Nuttall, Riverside, Illinois.

100 JEWELRY Stones removed from rings, etc.—from \$2.00 to \$2.40. Lowe's, Box 311, St. Louis 1, Mo.

NEW—15 Different match covers 10c. Box 202, Rochester 1, N. Y.

UNUSED Match book covers. 100 all different \$1.00. 35 Royal Flash covers \$1.00. Free list. Charles Edelman, 1311C East 84, Cleveland 3, Ohio.

CAMERAS AND PHOTO SUPPLIES

PHOTOGRAPHY For pleasure or profit. Learn at home. Practical basic training. Long established school. Write for booklet. American School of Photography, 1315 Michigan, Dept. 3431, Chicago 5.

WILL Buy any movie or still camera regardless of size or condition, describe fully. Write W. K. Crosson, 4515 Grand River, Detroit 8, Mich.

BUILD World's simplest practical enlarger in one evening. Material costs all most nothing. Complete plans \$1.00. Jean Gould, 2227 Clinton Ave., Berwyn, Illinois.

OIL Coloring photographs can be a fascinating hobby or profitable sideline for those with artistic talent. Learn at home. Easy simplified method. Send for free booklet. National Photo Coloring School, 1315 Michigan, Dept. 3431, Chicago 5, Ill.

PHOTOGRAPHS Of all kinds urgently needed. Cash waiting. Free details. Watchtower, Room 21, 411 Central, Newark 7, N. J.

"BIG Bertha" telephoto camera easily made. Trifling cost. Objects miles away photograph close up. Ultra sharp pictures. Telephoto lens and instructions \$2.00. Instructions alone 10c. Carl Jamer, Manorville, N. Y.

USE Any camera with plentiful 35 mm. film! Simple instructions. Rush \$1.00. C. Tirekop, Madeira, Ohio.

BASS Says: War time proves Bass leadership. Amazing selection of finest still cameras—Leica, Contax, new and used still available. Write for quotations. Satisfaction guaranteed or your money refunded. Bass buys 'em, sells 'em, trades 'em. Bass Camera Company, Dept. AG, 179 W. Madison St., Chicago, Illinois.

ENLARGERS—Build your own. Kit of parts, \$6.00. Free particulars. Crescent Engineering, Box 251-P, South Pasadena, California.

HAVE You a camera? Send ten cents for recent number of our big magazine showing how to make better pictures and earn money. American Photography, 116 Camera House, Boston, Mass.

CASH! Spot cash for cameras, lenses, binoculars, movie or still, sound projectors. Send full description by mail, or wire for prompt cash offer. Over 30 years of dependability insures honorable dealings. Bass Camera Company, 179 West Madison Street, Chicago, Illinois.

PHOTO FINISHING

BIGGEST \$1.00 Value in 35 mm. finishing today. 38 exposure fine grain 3 1/2x4 1/2 enlargements; deckled, embossed margins and date; Eighteen exposures 75c; 16 exposure splits 55c; 34 exposure reloads 50c. Special: return this ad with \$2.00 and we will send five 36 exposure reloads. Free mailers. 8 exposure rolls in beautiful, deckled contact finish with embossed wide margin, 25c. Mailbag Film Service, Box 5440A, Chicago 80.

CHOICE Film offers—Roll developed, 8 beautiful enlarged prints (deckled if desired); or 16 brilliant "Lifetime" prints; or 8 sparkling prints plus 2 fadeproof enlargements. Pre-war quality and price—25c. Fast service. Quality guaranteed. Free mailers. Dept. 19, May Studios, La Crosse, Wis.

FILM Developed, 8 album size enlargements or 16 sparkling prints, 25c; 8 snappy 4x6 enlargements, 30c. Reprints each: Contact prints, 2c; album enlargements, 3c; 4x6 enlargements 4c. Crystal Studios, 158-F, Rushford, Minn.

SENSATIONAL Introductory offer! Send snapshots or negative, this ad, and 3c. We'll send you a beautiful "5x5" enlargement and free snapshot folder! Reprints—from your negatives, 16 regular-size or 8 double-size reprints, 25c. Candid rolls—36 exp. 35mm. developed, vaporated, enlarged to 3x4, \$1.00! 18 exp. 60c. Reprints, 3x4, 3c each. We have new, perfect 35mm. film. Low prices. Free mailers, details on request. American Studios, Dept. 264, La Crosse, Wis.

BEAUTIFUL Double-size pictures 3 1/2x5 each, from 116 and 120 negatives, 3 1/2x4 1/2 from all other sizes. All work guaranteed. Overnight service. Roll developed and 8 pictures 30c. Roll 12 pictures 45c. Roll 16 pictures 60c. Enlargements on double weight portrait paper 5x7—30c, 8x10—50c. Copies made from any picture 75c. Pacific Photo Service, Box 666, San Francisco, Calif.

SATISFACTION Or your money back. 8 exposure roll completely finished with 2 prints each regular size 25c or jumbo size 1 each 30c. The old reliable finishers. Pioneer Photo Co., Box 123M, Wichita, Kansas.

ENLARGEMENTS. Eight 5x7 from negative, \$1.00. Six 5x7 from photo, \$1.00. Robert Renshaw, Jr., P.O. Box 478, Chester, Penna.

12 DIFFERENT Glossy snapshots bathing beauties \$1.00. Forman, 882 Lorimer, Brooklyn 22, N. Y.

PHOTOGRAPHY For pleasure or profit. Learn at home. Practical basic training. Long established school. Write for booklet. American School of Photography, 1315 Michigan, Dept. 3431, Chicago 5.

25 REPRINTS 50c. Suburban Studio, PM-3, 1410 Bond, Rockford, Illinois.

15 COPIES Of photo, postal size or smaller 50c. Abbey Studios, St. Louis 3-A, Mo.

EVERY Picture an enlargement! 8 sparkling deckle-edge enlargements and roll developed 25c coin; 116 size or smaller; enlarge reprints 3c. Enlarge Photo, Box 791D, Boston, Mass.

GUARANTEED Reprints 2c. Rolls developed two prints each negative 25c. Photo copied, 12 billfold size prints made, 50c. Summers Studio, Unionville, Mo.

8x10 OIL Colored enlargement from negative \$1.50. Valf, Box 573, Utica 1, N. Y.

100 MINIATURES \$1.00. 1 3/4"x1 1/4". Made from photograph. Gummed, perforated, for stationery, etc. Lang, 1334 Thorndale, Chicago.

16 BEAUTIFUL Deckled prints and enlarging coupon with each roll developed 25c. Owlphoto pm, Weatherford, Okla.

BEAUTIFUL Oil colored enlargements. Your negatives: 8x10, \$2.00; 11x14, \$2.50. From photo 50c extra. Specify colors. Haynescraft, 706 8th, Washington 1, D. C.

ROLL Developed and 8 beautiful enlargements 2 to 6 times larger. Deckled edge—high gloss. Any 8 exposure roll 25c coin. 12 ex. 35c—16 ex. 50c—36 ex. \$1.00. Reprint enlargements 3c each. Alden Photos, 94-3 Astor Sta., Boston 23, Mass.

6-8 EXPOSURE Rolls developed and enlarged mammoth size 30c. Reprints 3c. Thrifty Photos, Box 46, South Gate, Calif.

GLOSSY Contact prints 3c each from any size roll film negative except 35mm. Photo Prints, 136 Maple Ave., Haddonfield, N. J.

PINER Finishing specials 25c. Eight exposure rolls developed with two prints of each or one enlarged print of each negative. Genuine nationally known Moentone Enamel finish. Superior quality since 1899. Moen Photo Service, 452 Moen Bldg., LaCrosse, Wis.

TROUP'S Photo Service, Troup Building, Toccoa, Georgia. 6 or 8 exposure roll film developed and printed 25c.

MOTION PICTURES AND SOUND EQUIPMENT

AMER-A-CINE Camera film, indoor, outdoor. Lowest price. Movies, filters. Free catalog. American Art Service 74, Box 53, Station O, New York 11.

NOW Booking "Messenger." Story of Saint Bernadette. World's greatest Catholic screen photoplay. 8-16mm. silent sound editions; rentals, sales. Circular free. Reed, 312 75th Street, Brooklyn 9, N. Y.

100' 16MM. Used sound film, \$1.00 postpaid. We buy, sell, trade. List of complete subjects upon request. Blackhawk Films, Dept. PM20, Davenport, Iowa.

UNUSUAL Glamour, travel movies. Many in color. "Allure," black-white, 8mm., \$2.00; 16mm., \$4.00. Experimenters, try projecting black-white films in natural color. Iriscope kit, \$5.00. Lists, sample, dime. Jenkins, 392-F Elmira, N. Y.

35 MM. Silent films and projectors. Bedner, 5300 So. Talman, Chicago, Ill.

MOVIE Amateurs! Write for details of America's most progressive home movies club. Home Movies Club, Dept. PM3, 4215 W. 41st Ave., Denver 12, Colo.

I BUY, Sell, swap, rent s.o.f., 8 and 16mm. films. List free. Harvey Iris, Box 539, Brockton, Mass.

HOME Movie Fans—Join Motion Picture Educational Society. Free valuable information. Box 875, Reading, Penna.

8MM-16MM. Films, bought, sold, exchanged. Complete 360' sound subjects \$5.75. Lists. (Sample film 10c.) International-M 2120 Strauss, Brooklyn, New York.

8MM-16MM. Films. Free catalogue (sample film 10c). Parkway Exchange, 1593 Union Street, Brooklyn, New York.

GUARANTEED Fresh movie film! Three spools double 8mm, \$3.45! Six spools single 8mm. for Univex cameras, \$3.50! Processing free! (Limit six each type.) \$1.00 deposit on c.o.d. State make of camera. Eso-S, 4038 Broadway, Kansas City 2, Missouri.

8MM-16MM. Silent-sound films. Complete rental library. All latest subjects. Free catalogue, (sample film 10c). Garden Film, 317 West 50th, New York 19.

CAMERA Film: 100 ft. panchromatic 16mm., Weston 64, \$4.85; 25 ft. double 88 Weston 64, \$1.89; processing included. Movie accessories, chemicals. We do processing. Free circulars. Promader Genera Co., Davenport, Iowa.

"THE World's Greatest Passion Play." 8mm, 16mm, and 35mm. Specify silent or sound. Rent or purchase. Hemenway Film Co., 33-F Melrose St., Boston 16, Mass.

RELIGIOUS Films only. New prints. Screenart, 723-7th Ave., New York.

BETTERPIX Outdoor safety film, 100' 16mm., \$2.50. 25' double 8mm., \$1.25. Free developing. Finished subjects sold, exchanged. Sound library. Better Films, 742 New Lots, Brooklyn 7, N. Y.

SEND Stamp for 16mm., 8mm. catalogue. Sterling's, 679 Northampton, Easton, Pennsylvania.

LEARN Movie production, management. Free catalog. Give age, Theatre Institute, Elmira, N. Y.

SALE—Rent 8-16mm. films. Catalogues 10c. Don Elder's, 739-A Boylston, Boston 16, Massachusetts.

SPECIAL Movie film, 8mm., 25 feet double-Weston 8, \$2.00. Super double X, Pan indoor 60, outdoor 100, 16 mm., \$8.50. Super X Pan indoor 24, outdoor 50, \$5.75. Pan Weston 12, \$5.00. 16 mm. 100 feet Weston 6, \$4.00. Free developing. Exhibitors Film Exchange, 630 9th Ave., New York 19, N. Y.

BASS Says: Leadership in the cine field is apparent in war times. Here ready—your choice of 8 mm. and 16 mm. apparatus. Write for quotations. Your old equipment is worth real money in trade—describe please. Or we buy for cash and pay immediately on receipt. Write to headquarters. Bass buys 'em, sells 'em, trades 'em. Satisfaction guaranteed or your money refunded. Bass Camera Company, Dept. A, 179 W. Madison St., Chicago, Illinois.

USED 16mm. Sound film, bargain price \$3.00 per 400 foot reel. Jack Curry, 919 North 6th Street, Phoenix, Arizona.

FREE, 1945 Movie catalog. Samples 10c. Goodwill Company, Jackson, Tennessee.

RENTAL 16mm. Talking features \$4.95 shorts 75c. 8mm.-16mm. silent, large reel 40c. Movie accessories. Free catalogs. National Cinema, 71 Day Street, New York City.

PROJECTOR 35mm. Sound. Nusslock, 4714 W. Green Tree, Milwaukee 9, Wis.

35MM. Sound features sold, traded. C. Rogers, Postoffice Box 26, East Atlanta, Georgia.

WANTED 16mm., 35mm. silent-sound films. Donachie, 317 5th Street South St. Petersburg 5, Florida.

SOUND-SILENT 8mm., 16mm., 35mm. Bought, sold. Sample 10c. Lists free. Paramount Film Service, Monmouth, Ill.

MOVIE Projectors bought and sold. List 10c. United, 2309-A Lawrence, Toledo, O.

GORGEOUS Girls—Sparkling, adventure, sports, comedy, travel film. Equipment. Big 1945 catalog and sample 10c. Audet, Box 6520-BG, Philadelphia 38, Pa.

MUSIC AND MUSICAL INSTRUMENTS

PLAY Swing piano! Send 10c for instruction bulletin. Christensen Studios, 751 Kimball Hall, Chicago 4, Ill.

POPULAR Piano in 12 lessons. Guaranteed. Kelly School, 1734 30th Avenue, San Francisco 22, California.

GUITAR, Spanish and Hawaiian. Learn by mail. Details. Royal Studios, 178 Boston Road, Springfield 9, Mass.

ACCORDIONS Are available! All sizes and makes. Buy direct. Special discount. Free catalog. Metro Accordion Co., 31 So. Cicero, Chicago.

BEFORE Having your song arranged write for free information. Melodies composed. MacGregor, Hollywood Composer, 5079 Lemon Grove Ave., Hollywood 27, Calif.

VIOLIN Tonepost \$10.00, guaranteed. Dollar knowledge, dime. Patmor, Zion, Illinois.

LEARN Piano in 5 lessons by ear. Play any song—Easiest method known. Amazing results—Complete course \$2. ABC Piano Method. Dept. M3, Mt. Vernon, N. Y., Box 145.

TEACH Yourself to read and write music correctly with the New Crowell Rhythm Tablet—sent post paid for \$1.00. Birkel-Richardson Co., Los Angeles 14, Calif.

NOW Compose tunes to songs you write. New invention automatically creates melodies which you copy on manuscript paper furnished. You get "Compos-a-Tune," musical slide rule, How to Write Professional Songs and Rhyming Dictionary, \$3.00 complete. Guaranteed. Order now. Music Writers Publishing, 535 Fifth Avenue, Studio 10, New York.

PIANISTS—Quickly improve technique, sightreading, accuracy, memorizing, playing through mental-muscular coordination. Free booklet. Broadwell Studios, Dept. 45C, Covina, Calif.

MUSICAL Instruments wanted. Highest cash prices paid for band instruments and violins. Give make, finish, serial number, age, and price desired. No pianos, banjos, or guitars wanted. Write us at once. We will mail you our offer and shipping instructions by return mail. Lyons Band Instrument Company, Dept. 540, 14 West Lake Street, Chicago 1, Illinois.

MELODIES Written and arranged for your lyrics. Complete arranging, scoring and copying service. Analysis report and suggestions \$2.00 per song or lyric. Workmanship guaranteed. Tommy Kilbourne, Box 1253, Bakersfield, California.

NEW! Transposition at a glance. Get this handy pocket size book now! Learn transposition of orchestral instruments, 50c (coin). MacGregor, 5079 Lemon Grove Ave., Hollywood 27, Calif.

MUSIC Composed to songs. Frank Wildt, Music Publisher, Lancaster, Pennsylvania.

ORCHESTRATOR Piano arrangements, songs written, revised. Printing copyrights. Autographing. Songs extracted from recordings. Bell-Tone Music, G.P.O., Box 319, Brooklyn, N. Y.

POEMS Wanted for musical setting. Send poem for immediate consideration. Five Star Music Masters, 630 Beacon Building, Boston.

MUSIC Printing \$5-100, composing, arranging. Auto-Litho Co., Jensen, Fla.

NEW Songs and lyrics wanted for popular radio program and professional promotion. Free examination. Transradio Music, Inc., Dept. P., 1650 Broadway, New York (affiliate of B.M.I.)

WANTED For the armed forces—Your idle band instruments. We pay highest possible prices. Write us name, make, age and model today. Birkel-Richardson Co., Los Angeles 14, Calif.

PHONOGRAPH Record bargains. Latest new and used. Free lists. Melody Music Company, 280 Golden Gate, San Francisco 3, California.

"SONGWRITERS Send for our Publishing Agreement." Mid-West Music Press, 4737 Broadway, Chicago 40.

SONGWRITERS: Collaborate with nationally famous composer of "Boots and Saddles." Send poems for free examination. Get free instructive booklet. Hollywood Harmony House, 126 South La Brea, Studio M-1, Los Angeles, California.

JAZZ Piano. Correspondence or teacher. On approval. Miracle Series, Provident Bldg., Tacoma 2, Wash.

BEFORE Sending your poem to be set to music, know your composer. Free folder. Al. Moquin, 5333 La Cresta Court, Hollywood 38, Calif.

SONGWRITERS: Royalty contract free. Write for details. Puritan Publishing Co., 343 S. Dearborn St., Chicago, Ill.

SONGWRITERS—Amazing information about publishing songs. P. Medary, Williamsburg, Ohio.

HAWAIIAN Guitar orchestrations. Five for \$1.00. List on request. Golden Gate Publications, 5472 Foothill Blvd., Oakland 1, Calif.

SONGWRITERS. Send song poems. Free book—The Key to Your Future. Songwriter's guide, rhymers. Variety, Salem 2, Indiana.

SONGWRITERS! Outstanding proposition. Hibbeler, C6, 2157 N. Avers, Chicago 47.

PRACTICAL Psychology lessons in playing a musical instrument for mechanics, metaphysical students, and physical culturists. 10 lessons Spanish guitar, \$1.00, 10 lessons Hawaiian guitar, \$1.00, 10 lessons for grown-ups—piano—\$1.00. You can't fail. Frank's Musicians Supply, 3311 Herman Ave., San Diego 4, Calif.

SONGWRITERS—Special offer. Edward Madden, 1300 Lodi, Syracuse, N. Y.

WANTED! Lyrics, melodies for songs. We arrange, publish, sell. Superior Song Studios, Passaic, N. J.

LEARN Piano. One hour. Free literature. Ferris, 317P So. Hartford, Breerton, Wash.

SING Beautifully. Modern voice culture. Literature free. Ferris, 317M So. Hartford, Breerton, Wash.

SONGWRITERS: Send poems for free examination. Write for free instructive booklet outlining opportunities. United Music Corporation, Salem, Indiana.

SONGWRITERS—Free booklet "Getting Ahead in Songwriting." Write today. Song Service, 331-C West 46th, New York.

SONGWRITERS! Music composed, arranged. Billy Hannon, 6703 N. Oshkosh, Chicago 30.

SONGS Published—Liberal plan. Barnhart Publications, 1320 48th, Des Moines, Iowa.

SONG Poems wanted. Free examination. McNeil, Master of Music, 510-PM South Alexandria, Los Angeles, Calif.

ACCORDIONS. New and used at wholesale prices. Save up to \$100.00. Buy direct from factory. Del Principe, 307 So. Wabash, Chicago.

WRITE Songs. Big money and reputation. Write for information. J. Gordon Pub Co., 201 N. Hoyne Ave., Chicago.

SONGWRITERS—Send poem for immediate examination and free rhyming dictionary. Richard Brothers, 24 Woods Building, Chicago.

PLAY Violin over night! Miracle chart shows you how. No notes. Melody Masters, Box 805, Rockford, Ill.

RADIOS AND SUPPLIES

HEAD Phones' Latest type—light weight, finest quality, with plug for tuning in on radio, or intercommunication system. Also adaptable for use in making a razor blade or crystal set. Head phones: (No head band—slightly used) \$1.25. Head phones: (No head band—new) \$1.75. Head phones: (With leather covered adjustable head bands—slightly used) \$2.50. Head phones: (With leather covered adjustable head bands—new) \$3.75. Plus 25c for shipping charges—send money order. Quantity limited. Nico Supply Company, 540 N. 17th St., Philadelphia 30, Penna.

YOUR New free catalog is ready! Radionic's Catalog No. 26 lists hard-to-get radio parts. All available for immediate shipment. Send today to: Radionic Equipment Co., Dept. 3D, 170 Nassau St., New York 7, N. Y.

METER Dials, multiple range volt, ohm, milliamperes, any size. Orysen, Pewaukee, Wis.

SUBSTITUTION Instructions covering 200 critical tubes including 50L6, 12SA7, \$1.00. Clifford Jones, 1210P Dudley, Utica 3, N. Y.

JUST Out! Booklet: "All About Crystal Sets." 45c. Amorose, R-4, Hungary Road, Richmond, Virginia.

3 ILLUSTRATED Crystal radio plans 15c. Dick Madsen, Farmington, Utah.

REVISED Plans 18 long distance crystal sets, including "Radiobuilder"—25c. Laboratories, 363-C Hampton, Hayward, Calif.

BUILD A radio, complete kit with tubes, \$10.95, details. Radio, 9418F Avenue "A," Brooklyn, N. Y.

IS Your radio dead for lack of a tube? Send your old tube and 25c coin for examination and we will advise if we can make a replacement adaptor. Radio Tube Service Co., 1613 W. 4th St., Davenport, Iowa.

12SA7 DIRECT Substitute, no rewiring, \$2.85 postpaid, tube substitution chart included. No c.o.d.'s. Ball, 9926 Lorain, Cleveland, Ohio.

MAKE Simple, tubeless, batteryless, distance-getting crystal radios. Crystal and illustrated instructions 25c postpaid. Allen, P-427, Clinton, Missouri.

JUST Out! Crystal set booklet of "Volume Increasing Tips." 45c. Amorose, R-4, Hungary Road, Richmond, Va.

RECORD Player; plays through your radio; simple and easy to make. Detailed plans and instructions only \$1.00. Jay-M Sales Company, P.O. Box 97, West Haven 16, Conn.

TUBELESS Radio made with razor blades! Complete plans, 35c. New Radio, Lohrville, Iowa.

RADIO Tubes, parts, condensers. Free bargain lists. Potter, 1314 McGee, Kansas City, Mo.

PREPARE Now for tremendous opportunities in new fields of radio after the war. Training for federal licenses. Write for particulars. American Radio Institute, 52 East 23 Street, New York 10.

RADIO Service men and experimenters send for our giant radio catalogue. Save dollars. United Radio Co. (1000M), Newark, N. J.

BUSINESS OPPORTUNITIES

LANDSCAPING. Learn landscape designing and gardening for a profitable out-of-door profession. Write National Landscape Institute, Dept. P-3, 756 Broadway, Los Angeles 14, Calif.

MAKE Die metal castings—In your own shop. One dollar brings drawings, explanations. Tractor-Lite Mfg. Co., Spirit Lake, Iowa.

START Home business making statuary, plaques, art goods, novelties, souvenirs, concrete pottery, garden furniture, artificial marble flooring, liquid marble. Make your own flexible molds. Amazing profits. Valuable folder free. Creative Publishers, (PM3), Glencoe, Illinois.

HANDY Men, install dashboard controlled garage door equipment. Excellent post-war business. Additional information under "Automobiles."

GET Into legitimate business waterproofing buildings. Enormous profits. High income taxes force orders. "K" made \$3,000.00, six weeks. Information free. Bryan, 10 E. Pearl St., Cincinnati.

MECHANICALLY Inclined men—Own and operate general appliance repair shop. Complete, illustrated course shows you how. Welding, refrigeration, motor repair, how to get business, etc., all phases covered. Free literature. Christy Supply, Dept. 150, 2835 N. Central Ave., Chicago.

START Your own business at home taking magazine subscriptions. Highest commissions. Write for details and supplies. American Readers Service, Gwynedd, Pa.

START "Soap Factory" at home. No machinery. Amazing opportunity. Literature free. Kemico, SM-3, Park Ridge, Ill.

FREE Yourself from money worries. Be independent. Increase your earnings. Book, "Help Yourself to Postwar Prosperity" shows you how. Limited supply. Get it now. Only \$1.00. National Business Bureau, Department B3, Box 5374, Chicago 7, Illinois.

OPPORTUNITIES Galore. Big mail order magazines. Three months, 25c. Royal Publications, Prospect Heights 2, Illinois.

RAISE Fishworms. Unlimited possibilities. Unfailable plans. Limited. \$1.00. M. Stoner, Chattanooga 6, Tenn.

FREE Plan—Complete mail order enterprise. Small capital. Drop postal order. Chester Bowers, Loyalton, Penna.

BUSINESS Plans and ideas 25c. Details. Spada, 10 Lexington, Wethersfield 9, Conn.

BUILD Profitable real estate business, spare time. Literature free. American, Box 2983, Houston, Texas.

PLAN Post-war prosperity now. Complete plans starting business spare time. One dollar. Information free. G. Schreiner, Batavia 5, Illinois.

POSTWAR Planning, now is the time to start your own business, be ready for the boom. Free literature. Interstate Distributors, P.O. Box 732, Evanston, Ill.

1000 LIVE Names late cash buyers and opportunity seekers, only 50c. Joseph Royer, 82-D Merrimack St., Haverhill, Mass.

KNOW How to cash in on post-war prosperity, save future headaches. Free particulars. Ajax Services, 821 E. Michigan, Ypsilanti, Mich.

OPERATE Profitable credit-collection agency business; earn \$5000-10000 upwards annually; interesting literature free. Write: Extension Service, Department 101, Los Angeles 36.

CIGARETTE Roller, sample, instructions how to make of wood—precut parts available. Mail \$1.00 to Dow, 1348 W. 9th, Erie, Penna.

ELECTRICAL Appliance repair. Open your own shop. Learn home wiring; electric motors, vacuum cleaners, washers, etc. Complete illustrated course shows how. Free booklet. Pacific Training School, Dept. P3-A, 4703 West Pico, Los Angeles 6.

BOOKKEEPERS Earn extra money operating profitable bookkeeping service spare time. A. Schreiner, Batavia 2, Ill.

BOOKKEEPERS, Accountants, double your income, operate a bookkeeping service spare or full time. Send \$1 for textbook, plan and particulars. The Tax-Saver System, Dept. P, Worth Bldg., Fort Worth, Tex.

CIRCULARS Mailed free. Printers, adlets, etc. Our advertising on space—138 mailers. Small or large orders. Harry Bayford, 516 East Main Street, Chattanooga 8, Tenn.

JUMBO Folio containing ventriloquism, chemical gardening, making photo stamps, mushroom culture, frog farming, plaster casting, mindreading, opportunities outdoors, complete \$1.50, separately at 50c. Alvin, 553 William, Winnipeg, Manitoba.

GUARANTEE Your future! Be successful in postwar years. Investigate most unusual selfhelp book ever written. Trebor Sales, 3143 Arcade Building, Seattle 1, Washington.

MAKE Your own Flexible Molds. Statuary. Art Goods. Novelties. Artificial Marble Flooring. Liquid Marble. Literature free. Kemico, 3-M, Park Ridge, Ill.

OPPORTUNITIES, Tips, ideas galore. How magazine. Year 50c, copy 10c. Miller, 5104A Holcomb, Detroit 13, Mich.

CHICAGO Mail or branch office address \$1 monthly. Prompt forwarding. Confidential. Want something in Chicago? We'll buy and ship. Also collections, deliveries, calls, etc. Write for rates on any legitimate service. Faultless Organization, 3439 Michigan, Chicago 16.

OWN A mailorder paper products business. Sell envelopes, tags, labels, boxes, by mail, wholesale. Tremendous demand. Steady profits. No capital necessary. Write Omaha Envelope Service, Dept. 57, 4721 California, Omaha 3, Nebraska.

\$24,000 RICHER; Used "schemes" from "Schemer" Magazine, Alliance, Ohio, 47th year, \$1.00; three months, 25c.

PLAN Now to own your business. Particulars free. Write Frank Buskirk, Box 212-B, Shelbyville, Indiana.

LICENSED Concrete specialists wanted. No experience needed. Make-Colored concrete pottery without molds. New, low cost, patented method. Cemetery products, novelties, tiles, floors, etc. Basement leaksealing. Other money-making projects. Booklet, cost data, details 10c. National Potteries Company, Fergus Falls, Minnesota.

MAKE Plaster Plaques, Statuary, Liquid Marble. Complete instructions, formulas, \$1.00. Ideal Service, RM3, Park Ridge, Ill.

HOW To help yourself to post-war prosperity. Literature free. Harvey Zuehke, Fremont, Wisconsin.

GIANT Mail. Big mail order magazine included. Opportunities galore 10c. The Old Commander, Box 302, Chillicothe, O.

MAKE Flexible molds! Few cents each: Cast plaques, novelties, bookends! Sample, formula, instructions 25c. H. Tooker, 630-K Chestnut, Hamilton, Ohio.

\$.47 PUTS You in life time business. Midwest Drug Co., Dept. 6, Columbus 18, Ohio.

RUBBER-COTE—Liquid rubber for making perfect, lasting, flexible molds, \$3.00 quart, \$10.50 gallon. We also make molds over your patterns. Rubber molds for sale. Morgan Art Co., 4923 Rockville Road, Indianapolis 8, Indiana.

INFORMATION—Locating products (wholesale), etc. Rakes, Box 5931, Chicago 80, Ill.

TAILORED Homes—the modern plan book. Ad under Miscellaneous heading.

MAKE Beautiful, colored liquid marble, soundproof plastic flooring, and flexible molds for novelty casting. Write for free information. Bing Products, 621-A Tremont Street, Boston 18, Massachusetts.

IMMENSE Profits distributing handmade cigars, wholesale, retail. Tremendous demand. Steady business. Valles, New York 13.

PLASTER Casting, moulds, instructions 50c. Casting, moulding compound \$1.50. Alvin, 553 William, Winnipeg, Manitoba.

\$2,000 YEAR Sideline easy, inventing simple items for guaranteed cash markets. Hendrickson, Argyle, Wis.

SEND 10c Today for sample copy "Eagle Mail Order News," fastest growing, 48 or more pages. 505 N. 61st St., Milwaukee 13, Wis.

YOU Too can learn how to make, mold or cast real plastics. Send stamped envelope Box 498, Gainesville, Texas.

"OIL Drilling." New cooperative development plan. Know leasing angles, royalties. Recognize favorable oil lands. Booklets, geological secrets 10c postage. Lynch's, Caddo, Oklahoma.

START Mailorder bookshop—Everything furnished; publisher cooperation. 25c brings booklet, exclusive setup, samples, exciting ideas. General Publications, Ossining, N. Y.

WE Have open machine facilities to manufacture good marketable items such as toys, household and automotive accessories, or what have you. Will consider outright purchase or royalty on sales. Send your proposition to City Machine Company, 868 Tallmadge Avenue, Akron, Ohio.

RECAST Old batteries into new. Latest achievements. Battery Laboratories, Minneapolis.

SHELLCRAFT Art a fascinating, profitable business or hobby. Complete beginners' Shellcraft assortment, containing shells, accessories and simple instructions, \$5.00, postpaid. Or, list and information, 10c. Neptune's Shellcraft Laboratories, Box 1523, Lakeland, Florida.

1000 WOMEN Mail order buyers \$6.00. Our own customers. Trial \$50, \$1.00. Woods Remnants, Bedford, Penna.

FORTIFY Your future now with business of your own conducted in your home or office. Free details tell how. Rush penny postal. Victory Sales Co., Dept. 302, Box 75, College Station, New York City.

SAVE Postage and time. Your name on our mailing list, one year, 25c. Nate Katz, 4254 N. Kimball, Chicago 18, Ill.

YOUR Own products; machinery, experience unnecessary. Details free. McDaniel, 939 East Euclid, Detroit 11, Michigan.

LEARN Mailorder. Five big interesting mail trade magazines teach you quickly. Postpaid, 25c. Lewis Co., 828M Carpenter, Oak Park, Illinois.

INCOME Builders. (Mailorder—direct.) Literature, usable samples, 25c. Superior, Box 801, Clearfield 11, Penna.

GIGANTIC Mails, magazines, catalogs, samples, listing once, 10 cents, three times 25 cents. Waddell's Directory, 309 East 75th, New York 21.

WANT To Make \$100 weekly? No foolin! Write Wilkin, 1348-M North High, Hillsboro, Ohio.

SELL Display signs, pictures, calendars, books, greeting cards, paper novelties! Big profits! Bargain catalog free! Ellico, 438 N. Wells, Chicago.

FISHING Rod holder, adjustable all positions, finest made, regular \$6.00, special \$3.50. Agents, distributors wanted. Steuer, 1377 Haight, San Francisco.

PATHWAYS To progress; wealth. Particulars, stamp appreciated. 313 Fitzsimons Building, Pittsburgh 22, Penna.

YOUR Postwar fortune. Money in mail-order business. Free details. Victory, Box 179F, Dowagiac 3, Mich.

PROFITABLE Spare time, unusual mail business earned \$1400 monthly. Copyrighted instructions \$1.00 postpaid. W. S. Boyd, 331 Fourth, Pittsburgh 22, Penna.

"HOW To Make Simple Molds and Plaster Plaques." Profitable business or hobby! Booklet 25c. Plastercraft, 1406 E. 43rd Street, Cleveland 3, Ohio.

NOW You can have a paying mail order business. Our latest publication shows how with actual opportunities listed. Impressive literature free. Nichols Pub. Service, P.O. Box 831, Pine Bluff 1, Ark.

MAKE And mold genuine plastics. Forty illustrated work-sheets explain methods, processes. Authentic-simplified. \$1. Free circular. Plastics Digest, 3937B Tracy, Kansas City 4, Mo.

COLOR Concrete with chemicals. Big money making Hollywood style pottery, birdbaths, without moulds. Washing-wells, stucco-rock, benches. Marbleing, cement water-paints. 10c brings sample, literature, pictures. Hollywood Cement-Craft, 8527 Wonderland, Hollywood 46, California.

AMBITIOUS? Anxious to get ahead? Write for free details on "From Fifty Cents a Day to Ten Thousand per year." Webb, Box 184-A, Drexel, Missouri.

PLASTICS—Made at home without equipment—perfect castings—formula 50c. Baker, 225 Symington Ave., Toronto, Canada.

RAISING Canaries pays good profits. Valuable bird book—"Its Care, Breeding and Training." Price \$1.00. American Canary, 2839 N. Halsted, Chicago.

IF It's wealth you desire! Read "Gold Ahead." Educational books. Wyatt, Box 333, Hyattsville, Md.

BECOME An "Attritionist Masseur." First improvement over Swedish massage in 100 years! Results unbelievable! Dr. Swearingen, 9128M, Station S, Los Angeles.

MAILORDER Opportunities. Get started now for post-war. Hallenbeck, Roselle, Illinois.

\$10.00 POUND, Angora rabbit wool, we supply good rabbits, and-buy wool. Particulars free. House of Angora, 1848 So. 18th, Springfield 4, Illinois.

NEW Copyrighted booklet mail order plan worth more than \$50,000.00. Will sell for \$1500.00. Free particulars. Robert J. Drummond, 58 Eleventh St., Oakland 7, Calif.

I BOUGHT Financial information worth \$10,000 to me. You can have it too. Send only \$1.00 to F. S. C., 1206 N. Alexandria, Hollywood 27, Calif.

FREE Literature describing mail order and many moneymaking plans. Swentek, 8840 Warren, Dearborn, Mich.

TURN Accounts into cash. Good income; quick results. National Collectors, Newark, Ohio.

MAKE Your own glow in the dark articles. Sell at big profit or keep for your pleasure. Use Lite-Glo—magic new discovery! Hundreds of uses. Complete Lite-Glo kit \$1.00. Cash or c.o.d. Lite-Glo, 1412-(A) Seward, Topeka, Kansas.

START Your own concrete block business. "Cash in" on the tremendous postwar home building boom. Big demand everywhere. Universal Tamper makes all sizes concrete blocks fast—200 blocks per hour. Your normal net profit 5c per block—up to \$10.00 per hour. Easy to operate—no special skill required. Necessary materials available everywhere. Nominal investment, balance out of earnings. Write for details. Universal Tamper, Inc., 1567 No. Adams, Peoria, Illinois.

INCORPORATE Your business. Delaware laws. Many advantages, free details. Tax Research Bureau, Inc., Delaware Trust Building, Wilmington, Delaware.

MONEY Made easily, home or room. Color, health, education need not stop you. Thirty cents coin or stamps will bring you details three dandy plans. Also, fifty cent information sheet, twenty-five cent folio, fifty cent credit coupon and other offers. Ad. Dept. Bargain Specialty Company, Box 635, Modesto, California.

DRUNKENNESS Is a disease which responds to treatment. Medical skill plus human sympathy prove successful with liquor and drug cases. 60 years experience. Write for free booklet. P. M. Nelson, The Keeley Institute, Dwight, Ill.

BOOKKEEPERS. Earn money at home posting journal entries. Ellis Business Service, Cedar Grove, North Carolina.

TYPEWRITER Repairing - Original course, simplified home study. Weber Typewriter Mechanics School, Box 269, Osborn, Ohio.

MAIL Order business course shows you how to make money, spare or fulltime. Teaches professional mail order technique - not penny-snatching schemes. New success catalog free! Write - Nelson Company, Dept. 4-02, Chicago 4.

INSIDE Secrets on making quick cash. Without canvassing. Folder free. Write. Lone Star Service, 1708-B First Ave., Dallas 10, Texas.

5 MOST Read mail order magazines 25c. Education Publishers, Pittsfield, Mass.

LOOKING For a profitable mail order business that can be started with little capital and developed into a paying proposition? Write today for full information. Jackson Publishing Company, Dept. 111, Box 477, Mineral Wells, Texas.

LEARN Electroplating. Complete instructions by a practical plater, with formulas for brass, cadmium, chromium, copper, gold, nickel and silver solutions. Price \$1.00 - money back guarantee. Plater Hyde, P.O. Box 178, National City, California.

SELL Books and courses by mail in your spare time. Siddall, Atascadero, Calif.

VITAMINS, Minerals, health foods. Wholesale prices. Free catalog. National Diet Company, Portland 4, Oregon.

RAISE Giant Chinchilla rabbits. Willow Farm, R15A, Sellersville, Penna.

SIX Complete and different post card plans for starting profitable spare time business. Gordin Publishers, Box 23, Pawtucket, R. I.

VITAMINS - High quality, low price, private label. Gibson Company, Harlan, Iowa.

HOW And where to obtain capital. Fully explained. Particulars free. Star Service, Wapakoneta, Ohio.

MORE Money with your own products. Experience unnecessary. No machinery. Information free. B. Kinford, Wayne, Penna.

SELL Exclusive books of instruction by mail. 80% profit. No bookstore competition. Snappy circulars ready. Rush name! Financial Education, 431F, 728 15th, Denver 2, Colo.

LIQUID Marble; snow-white, multi-colored. Glazed. Unglazed. Composition flooring. Lifetime wear. Any color. No priorities. Flexible molds. Plaster casting. Get into the big money now. Full information given free. Write Compd-Tex, Box 786-R, St. Louis, Mo.

GET Into mail selling. Prepare for future. Start sideline business now. Splendid opportunities. Interesting, profitable propositions immediately available. Progressive Magazine tells how! Free details and premium offer. Sheboygan Publishing Co., Sheboygan, Wisconsin.

CHARTERS: Delaware; best, cheapest; free forms. Colonial Charter Co., Wilmington, Del.

127 WAYS To make money, in home or office, business of your own. Full particulars free. Elite Co., 214 Grand St., New York.

BRUSH Plating outfits connect to a battery. No tanks necessary. Good paying business at home plating autoparts, bathroom fixtures, bicycles, reflectors, silvering mirrors. No shop or experience required. Outfits furnished. Free booklet. Gunmetal Co., Ave. H, Decatur, Ill.

LIQUID Marble - Colorful, glazed! Mold, brush, spray! Composition floors, rubber-lastic molds. Particulars free. Marbleizing Service, Edwardsville, Illinois.

FREE Subscription. Drop postal today. The Mail Order News, Somerville, New Jersey.

MONEYMAKING OPPORTUNITIES

HELP Win the war first! Then man, you'll like silvering mirrors, reflectors! Making sparkling chipped glass nameplates. Outfit prices. Sprinkle, Plater, V60, Marion, Indiana.

MECHANICALLY Inclined men - Own and operate general appliance repair shop. Complete, illustrated course shows you how. Welding, refrigeration, motor repair, how to get business, etc., all phases covered. Free literature. Christy Supply, Dept. 1150, 2835 N. Central Ave., Chicago.

LOOK! 16 Money-making, moneysaving items, including cash bringing plans, magazines, formulas, etc. All for 25c. E. Gieralt, 1405 N. Artesian Ave., Chicago, Ill.

CATALOG Listing hundreds of opportunities 10c. (refundable). Barcus, 1001 N. 13th, Terre Haute, Indiana.

LEARN Money-making secrets. The Mail-order Educator Magazine. Sample copy 10c. National Publishers, Muskegon Heights 13, Mich.

THOUSANDS Of articles wholesale. "Supply Source Directory" 10c. Ideal Service, D-3, Park Ridge, Ill.

LOOKING For a good mail order business? Here's information on one of the easiest and most profitable. Send stamp. P. Scribner, Freeport, Maine.

BOYS, Men, \$1.00 hour anywhere, no selling. Particulars free. Lindsay, 1393 Genesee, Columbus, Ohio.

START Your post war career the mail order way; but first get the 'know-how.' Write: Great Lakes Distributors, Box 97, Flint, Mich.

MONEY Making opportunities. Leading mailorder magazine, 10c. Simon, 1091 First, Wyandotte 2, Mich.

FREE Book "100 Selling Ideas." John D. & Sons, 140 Spruce St., Bridgeport 5, Conn.

BIG Profits for you. Learn the latest in postwar money making opportunities. Circulars free. A. Lencki, P.O. Box 41, North Station, Yonkers, New York.

PLASTICS - Learn to work with Lucite and Plexiglas. It's fascinating. It's profitable. Simplified course of instruction postpaid \$1.00. Materials available. Price list free. Dept. 15, California Plastic Fabricating Institute, 629 W. 9th St., Los Angeles 15, Calif.

FREE Literature describing hundreds of money-making home business opportunities. Tipton, 432 Tacoma, Ottumwa, Iowa.

FREE Formula list! Chemist Robins, 24 South Hamlin, Chicago, Ill.

COLORFUL Plastic jewelry, easily made with sparkling "Wonder-links." Profitable sideline. Dollar starts you! Hughes, 318 Sidell, Danville 3, Illinois.

OPERATE Your own mail order business at home. Details free. George V. Beach, 79 Essex Street, Springfield, Mass.

GAS Machines for home, etc. 30c rates, easy plans \$1.00. Literature. Ideal Spec., Lakewood 5, Rhode Island.

LATEST Best. 100 different single, double ingredient formulas 25c. Satisfaction guaranteed. Hayes, 1215 School, Chicago.

MAKE Money - Have fun! "Tattooing." Steele, 626-AW, 17th, Los Angeles, Calif.

WANT To make \$5000 a year? No bunk. Publications, Bethany 4, Okla.

SELL Names by mail - millions needed. Build a profitable business of your own. Russell Publications, 7-PM Randolph Place, N. W., Washington 1, D. C.

MAKE Fast repeat selling products at home without machinery. Large profits. Pm. Kohn, 506 W. 45th, Chicago 9.

GIANT Big mail! Hundreds of money making propositions, home work offers, including big magazine, all for a dime. Gardenville Publishers, Gardenville 11, N. Y.

AMBITIOUS To enjoy real wealth some day? Amazing book "Gold Ahead" reveals secrets you've been looking for all your life. Particulars free. Write Economy Press, 1554 Sierra Lane, Stockton, Calif.

FREE Literature describing many money making plans. Abbott, Box 44, 210 - 5th Ave., New York City.

CONTEST Books, list free. Pederson, 1609 1/2 East Fifth, Duluth 5, Minn.

"FORTUNES In Sawdust." Build life-long business. Turn this discarded material into cash on kitchen stove. Big demand! Copyrighted plan, formulas 25c. Palmer Company, Station A, Berkeley, California.

"MAIL Order World." Outstanding mail order magazine. Sample copy 10c. Martin's, Box 2414P, Bridgeport 8, Conn.

START Now - Build money making mail order business. Get yourself established. Actual examples explained. Particulars free. Young's Industries, Kent 15, Ohio.

BIG Money manufacturing custom made arch supports. Particulars. Jul Corasen, 2638 Geyer, St. Louis 4, Missouri.

I MAKE Big money in the mail-order business. You can do the same at home with my copyrighted system. Write me. I'll tell you how. F. Little, Box 8, Glen-shaw P.O., Pittsburgh, Penna.

THOUSANDS Of alarm clocks need repairing. Jewelry stores swamped. Our simplified course teaches you how to repair these clocks. Necessary tools and supplies furnished with course. Alarm Clock Repair Service, Dept. B, P.O. Box 1983, Houston, Texas.

RAISE Giant Chinchilla rabbits. Willow Farm, R15B, Sellersville, Penna.

"VARIOUS Opportunity Catalog," copy 10c. P.O. Box 1735, San Diego 12, Calif.

EARN Money evenings, copying and duplicating comic cartoons for advertisers. Adservice, Argyle, Wis.

PUBLISH Your own magazine. Hand-some 52 page format, well edited, illustrated. Cost low as \$1.00 month. Brings you prestige, profits. 10c brings sample, details. National, Ord, Nebr.

LEARN Metascience. Remarkable drug-less healing. No manipulation. No apparatus. Unbelievable simplicity and results. Inexpensive correspondence course. Write Metascience, De Land, Florida.

EARN Money at home! Thousands do! "Home Worker Magazine" tells how. Sample, 25c. Sizemore, Box 7, 4917 North Kostner, Chicago.

LICK After-war layoffs! Start own business home, office. Booklet describing "Collection of 127 Tested Plans" free. Elite Co., 214 Grand St., New York.

CHEMISTRY

SALE: Wholesale laboratory supply house offers surplus stock. Fine chance for experimenters to obtain high-grade chemical glassware, apparatus. Write for list, enclosing postage. Palo-Myers, Inc., 81 Reade Street, New York 7, N. Y.

THE House of Winn, the home of supplies for amateur chemists. See Winn's New Idea chemical kits and apparatus outfits for home experimenting. Send 10c for retail catalog. Established 1931. John H. Winn, Dept. 503, 124 West 23 St., New York.

FREE Catalog: Chemistry, mineralogy, biology, optics. Tracey Laboratories, Evanston, Illinois.

RARE, Unusual chemicals. Send \$1.00 for ten different. Ohio Research Laboratory, Box 6305, Cleveland 1, Ohio.

MICROSCOPIC Stains and preparations at low prices. Catalog 20c. National Scientific Co., 2204 W. North Avenue, Chicago 47, Ill.

CHEMICALS And laboratory apparatus. List free. Peerless Scientific Co., 184 W. Washington, Chicago, Ill.

NEW 32 page chemical apparatus order book. Complete line of chemical glassware, apparatus and chemicals. Send 10c for this book. Standard Science Supply Co., 1232 N. Paulina St., Chicago.

SPECTROSCOPE For quick chemical analysis. \$2.50. Kutting Sons, Campbell, California.

LABORATORY Supplies at wholesale prices: Chemistry, biology, physics. Catalogue 10c. National Scientific Co., 2204 W. North Ave., Chicago. Established 1908.

CHEMISTRY Laboratory apparatus and chemicals for industrial, analytical, and private experimental laboratories. Complete chemical laboratory supply service for correspondence school students. Send 3c for free 48-page catalog of chemicals and apparatus. Dept. M-43, Biological Supply Co., 1178 Mt. Hope Ave., Rochester, New York.

FORMULAS, PLANS, ETC.

"LUMINOUS Paint" shines in dark. Easily made. 100 other formulas, plans - all 25c. Soap-making course (20 formulas) \$1.00. Resilvering mirrors, formula 20c. Ideal Service, 303, Park Ridge, Ill.

PREWAR Tire carcasses everywhere, from these reclaim pure rubber, to make molds, tire plastic, etc. Details for stamp. Betke, Box 699, Borger, Texas.

FORMULAS, Folios, books. Write for literature. F. A. Devoe, Box 243, Ukiah, Calif.

ANY Formula \$2.00 or refund. Case Kowal, Chemist, 1846 Cullerton, Chicago.

FAST Selling products easily made yourself. Big profits! 110 reliable formulas 25c. Honsaker, Masontown, Penna.

MORE Money with your own products. Experience unnecessary. No machinery. Information free. A. Kinford, Wayne, Penna.

LUMINOUS Paint—Three formulas 10c. J. B. M., Box 225, Rockaway, Oregon.

START Profitable business of your own. We supply industrial formulas now used in manufacturing plants, of alkaline metal cleaners, steel treating compounds, cements, rust proofing, etc. Write for free list. Dumble Laboratories, Box 858, Chicago 90, Illinois.

AUTHENTIC Formulary. 924 page illustrated book. Prepared by experts. 10,000 practical tested formulas, recipes, secrets, instructions for easily making most any product. Countless profitable business opportunities. Valuable reference for home, industry. Extra! Complete plans: "D.D.T." miraculous new insecticide. One spraying kills all flies, mosquitoes, lice, jay beetles, etc. Lasts three months. Big money maker. \$2.98 postpaid (c.o.d. U. S. only) foreign \$3.25. Immediate shipment. Adams Brown Company, Dept. 119, Chestnut Hill 67, Mass.

FORMULAS—Latest, best. Analysis. Literature free. Belfort, Engineering Building, Chicago.

REAL Manufacturing formulas. Lists free. Cummings, Chemist, Gordon Ave., Syracuse, N. Y.

HELP WANTED

WANTED—Equipment superintendent for manufacturing and service company, age 35-45, preferably EE, to maintain heavy gas-electric equipment used in contract service to railroads and industry. Responsible for 70 personnel. Vicinity New York City. Write Box 159, Equity, 113 W. 42nd St., New York City. W.M.C. rules observed.

MEN, 20-45 Years, to work on railroad rail testing service cars. Those under 38 must be draft deferred. Job entails constant traveling. Electrical-mechanical experience preferred. Also cooks; salary plus all living expenses. Those now in 100% war work not considered unless released. Write full details to Personnel Dept., Sperry Products, Inc., 1505 Willow Ave., Hoboken, N. J.

WANTED—Assistant service manager. Age 35-45. Gas, electric railroad and industrial equipment. 150 personnel. Part-time travel. Vicinity New York City. Write Box 160, Equity, 113 West 42nd St., New York City. W.M.C. rules observed.

AGENTS WANTED

MAKE Big profits selling the new and absolutely different Magic Renovator Polish for wood, leather, metal. Spectacular demonstration makes quick sales in homes, stores, offices. Mission, Dept. B, Columbus, Kans.

SILVER Plating Liquid. Simply rub-on with a cloth. Like a polish. Easily done at home or in any business place. Cleans, silverplates, polishes, one rubbing. Puts on a genuine 1000 fine pure silverplate finish. A rub-on method, not a dipping process. Renews silverplated tableware and other silvered articles like new. Fills in scratches, covers up worn and brassy spots. Lasting finish, won't come off. Also silverplates onto brass, copper, bronze, zinc, nickel-silver, german-silver, and some other metals. Over 100 other uses in factory, store, office and home. Resilver silverware, jewelry, musical instruments, antiques, art goods, automobile nickel, chromium, light reflectors, heirlooms, and such things. Sales representatives wanted. Details free. NuProcess Products, Dept. 148, Aurora, Illinois.

START Your own business on our capital. Always your own boss. Hundreds average \$3,000 to \$5,000 annual sales year after year. We supply stocks, equipment on credit. 200 home necessities. Selling experience unnecessary to start. Wonderful opportunity to own pleasant, profitable business backed by world wide industry. Write Rawleigh Co., Dept. C-U-PPM, Freeport, Illinois.

LUMINOUS Pictures that glow in the dark. Large manufacturer wants factory representatives; wonderful new items; fast seller; free sample. Madison Mills, 303 Fourth Ave., New York City.

SPARKLING Religious Motives—\$4.00 per 100. Samples 25c. Tabernacle, 1323 High, Springfield, Ohio.

"OUR Family Record" Marriages, births, etc. \$1.00. Nona Frantz, Waterloo, N. Y.

NEW Creations in wood. Circulars free. DeLuxe Creations, 1119 Vidaurri, Laredo 1, Texas.

IDENTIFICATION Plate. Identification tag. Identification stamped dollar. Stanley, Lansing, Mich.

HANDY Hair trimmer. Sells like wild. Trims as you comb. Saves barber bills. Samples sent on trial. Kristee, 140, Akron, Ohio.

SELL Modern wax polish in spare time to friends. \$3.00 per hour. Repeat sales. For free sample can write Modern Household Products, Box 117, Cincinnati 12, O.

GOLD Lacquered window sign, letters. New styles. Absolutely beautiful. Free samples—catalogue. Atlas, 7941 Halsted, Chicago.

SELL Dresses at low prices. Hundreds sensational bargains. Actual samples free. Send dress size, age, Harford, Dept. E-369, Cincinnati, Ohio.

ASPIRINE—150 For 50c, postpaid. Unconditionally guaranteed. Seedless raisins: 12 boxes 50c, postpaid. Creole Products Co., New Iberia, La., U.S.A.

SELL Greetings cards—Make easy money showing gorgeous everyday, birthday, Easter, Mothers' Day cards. Stationery. Over 100 quick sellers. Special offer. Write today for \$1 all occasion assortment on approval. Hedenkamp, 343 Broadway, Dept. 31, New York 13, N. Y.

SKUNKADORA Eliminates 100% all traces of skunk odors! Nothing like it. Whirlwind seller to farmers, trappers, general stores, breeders, etc. Big profits. Send \$1.00 for sample on money back guarantee or write Sparhawk, Sparkill, New York.

BIG Profits taking subscriptions for all magazines. Agents' confidential catalog listing over 2500 periodicals and complete starting supplies free. Pines Subscription Agency, Flushing, New York.

AMBITIOUS School seniors—We want you to sell classmates the "tops" in graduation name cards. Highest commissions! Only firm giving free souvenir chest and card case! Your cards free! Cardalogs going like wildfire! Hurry! Get yours today! Craftcards, Box 235(L), Pittsburgh 30, Pennsylvania.

\$1 STARTS You in business. Sell deluxe five fold ties, 100% wool interlining. Costs you only \$7 per dozen, you make \$5 dozen. Send \$1.00 for special introductory offer two five fold ties. Catalog complete line free. Phillip's Neckwear, 20 West 22nd St., Dept. K-10, New York 10.

AGENTS, it's new, it's hot. Everyone wants Honor Scrolls for loved ones. Sample on trial. We deliver—collect. Condon, Box 157, Upper Darby, Penna.

POWERFUL Mile stretcher: Increase mileage! Increases power! Increase your bank-account! 400% profits. Thermomiles, Peoria 4, Ill.

WRITE Today for free wholesale magazine price list. Good commissions, voluntary repeat sales. Supplies furnished. Start now! Send penny post card to McGregor Magazine Agency, Dept. PM5, Mount Morris, Illinois.

"MAIL Order Trade Directory" tells you where to buy wholesale. 25c brings 1945 edition. Box 693-PM, Canton 1, Ohio.

SELL New-used clothing from home, auto, store. Men's suits 99c, pants 27c, top-coats 44c, dresses 13c, ladies' coats 38c. Other bargains. Catalog free. S&N, 565A Roosevelt, Chicago.

MAGIC Races—At cigarette touch six horses are off. Fast seller. Big profits. 40 races \$1.00. Dime brings samples, wholesale prices. Barkley Co., Dryden 11, Va.

BIG Money taking orders: shirts, ties, socks, pants, jackets, sweaters, shoes, uniforms, etc. Sales equipment free. Experience unnecessary. Nimrod, 4922-AN Lincoln, Chicago.

\$3 FIRE Extinguisher; quick sales, wholesale or direct; liberal profits. "Fire-Killer," 109 N. Franklin, Syracuse 4, N. Y.

90c PROFIT Each \$1 sale! Sell permanent mothproofing solution. Employ agents. Experience unnecessary—we tell you how. A. McKinley, Wayne, Penna.

AGENTS, Big line including food products. Fast selling premium and bargain deals. Low prices. Send card for big outfit offer with gift. Ho-Ro-Co, 2729 Dodier, St. Louis 7, Mo.

BIG Bargains for big profits. Men's used pants 25c, suits \$1.00, topcoats 75c, overcoats \$1.00, shoes 12 $\frac{1}{2}$ c. Over 100 sensational values. Experience unnecessary. Free wholesale catalog. Superior, 1250-OB Jefferson, Chicago 7.

EXCELLENT Sideline for printing salesmen. Decalcomania name plates in small quantities. Also, make money applying initials on automobiles. Free samples. "Ralco," X-164, Boston (18), Mass.

PLATING Outfits for autoparts, reflectors. Connect to a battery. No tanks necessary. Free booklet and particulars. Gunmetal Co., Ave. N. Decatur, Ill.

SCHOOL Seniors—Sell classmates America's most beautiful, distinctive graduation name cards. Positively highest commission. Largest selection. Lowest prices. Free cards and free sample kit. Printcraft, 1423 East Elm Street, Scranton 5, Penna.

AGENTS: Stamping names on pocket-key protectors. Sample check with your name, address, 25c. Stamping outfits. Emblem checks, check-fobs, name plates. Hart Mfg. Co., 303 Degraw St., Brooklyn, N. Y.

MAGIC Cleaner and laundry soap deal. Hotter than a firecracker. Big profits! Sample free. Bestco, 5007 Irving Park, Chicago.

ELITE Collection contains 127 plans for starting own business; home, office. Descriptive booklet free. Elite Co., 214 Grand St., New York.

FREE Water and our concentrates, makes favors, lotions, shampoos, 72 products, labels, bottles furnished. Quilco, E-20030 Russell, Detroit.

HIGH-GRADE SALESMEN

MAKE Unusual spare or full-time profits showing genuine leather jackets, raincoats, 200 style and comfort shoes. Sample outfit free. Rush postcard. Mason Shoe Co., Dept. M-187, Chippewa Falls, Wis.

LEARN Of the newest products in advance of all other sources. Stahl, 1609 Manchester, Middletown 22, Ohio.

SUCCESSFUL, Expanding corporation has opening for aggressive, capable salesman. Splendid postwar opportunity with fast, moving line of essential maintenance materials, including floorings, waterproofings, and paints for industrial and institutions. Factory to consumer. Monroe Company, Quebec Avenue, Cleveland 6, Ohio.

We Have a fine side line for salesman calling on drug stores. Our line includes many items that are scarce. Write Dawn, Inc., 8714 Litzinger, St. Louis 17, Mo.

MAKE Unusual spare or full-time profits showing genuine leather jackets, raincoats, 200 style and comfort shoes. Sample outfit free. Rush postcard to Consolidated Shoe, Dept. S-96, Chippewa Falls, Wis.

PORTRAIT Salesmen or good house to house men; sensational new everlasting portrait on patriotic canvas banner; extra large new commissions and bonus deal; outfit free. Hollywood Co., 787 Lexington, New York 21.

RURAL Salesman: Make more money selling roof coating, paint, oil and grease direct. Write Department RS, Box 392, Dallas, Texas.

SALESMEN. Handle cleaning compounds. Wholesale. Big profits. E. O'Leary, 916 Oak St., Flint 3, Mich.

SALESMEN Wanted. \$200.00 weekly possible. Proof. Roy West, Charleston, W. Va.

ORANGE Concentrate direct from our Florida grove. One quart bottle makes 6 quarts delicious natural orange drink simply by mixing with 5 parts cold water. Rich in vitamin C. Builds up resistance against winter colds. Groceries, restaurants, hospitals big buyers. No investment. Protected territory. Salesmen earn \$100.00 to \$200.00 repeat commission weekly. Sunset Valley, 3357 Clifton, Chicago.

BLADES—Best quality, factory prices. Details free. Ace Blades, Buffalo, N. Y.

EDUCATIONAL AND INSTRUCTION

LEARN To be a landscape architect. Hundreds now manage own business as successful landscapers. Steady income. Home study course—45 illus. lessons. Average student can complete course in 6-12 months. 28th yr. Send for free blkt. American Landscape School, 6316 Grand Ave., Des Moines, Iowa.

MAKE Up to \$25-\$35 week as a trained practical nurse. Learn quickly at home, spare time. Easy tuition payments. Earn while you learn—many earn hundreds of dollars while studying. Easy to understand lessons, endorsed by physicians. High school not required. Our 45th year. Write for free booklet and sample lesson pages. Chicago School of Nursing, Dept. K-3, Chicago.

"HOW To Break and Train Horses"—A book every farmer and horseman should have. It is free; no obligation. Simply address Beery School of Horsemanship, Dept. 1103, Pleasant Hill, Ohio.

LANDSCAPING. Learn landscape designing and gardening for a profitable out-of-door profession. Write National Landscape Institute, Dept. 3-P, 756 Broadway, Los Angeles 14, Calif.

GOOD Jobs and a sound postwar future await you in hotel and institutional field. Men and women—all ages—needed for well-paid positions that offer color, excitement, ever-new and fascinating duties. Record-breaking business in hotels, clubs, institutions, means even greater opportunities. Lewis School receiving calls for managers, assistant managers, stewards, hostesses, purchasing agents, and 53 other types of important positions. These are not temporary jobs, but important positions in an essential business that offers splendid opportunities in war or peace, good times or bad. Previous experience proved unnecessary! No need to leave your job to qualify. A good grade school education, plus Lewis Training, qualifies you at home. In spare time. Our National Placement Bureau helps to place you—and our amazing Certificate Job Plans—actually guarantees you will "make good" when placed. Write today for free book! Lewis Hotel Training School, Room DC-368, Washington 7, D. C. (First and only school of its kind—now in its 29th year.)

HOME Study. Over 300 low cost business, technical and vocational courses, including new course on real estate. Our method stimulates interest, develops initiative, saves months of study and hundreds of dollars. Free bulletin. State subject wanted, DeVoto Schools, 35 Vicente, San Francisco 16, Calif.

WRITE Short stories at home for pleasure and profit. Fame, riches and happiness of achievement are rewards to be realized by students who acquire tested technique. Get free booklet from home study school with 50 years experience. Write today! Blackstone-Sprague, Dept. 13a, 307 North Michigan, Chicago 1.

LEARN To work with plastics. Lucite, Plexiglas, Catalin, etc.—the materials of the future. Complete kit for home craftsmen, including all materials for completing a cigarette box, 2 pins or buckles, pair of earrings, etc., with complete instructions, \$1 postpaid. Kosto-P, 707 20th St. NW, Washington 6, D. C.

DISCOVER I. Q., special abilities, personality strengths. Take simple tests mailed you. Psychologists (Ph.D.) advise suitable jobs, schools, courses \$3. Refund if dissatisfied. Occupational Analysis Clinic, 52H Lincoln, Highland Park, N. J.

LEARN Profitable credit-collection agency business; investigate. Extension Service Advertisement under Business Opportunities.

TRIGONOMETRY Calculator. Trig. functions for 360 degrees. Shows positive and negative values. 79c coin. Reed Mfg., 124 W. 4th, Los Angeles 13.

TEACH Primary child phonics. Instructions \$1.00. Satisfaction guaranteed. Valria Reaser, Medical Lake, Washington.

HORSEMEN—Learn to train and gait. Teach tricks. Free book. Animal Lovers Association, K-111, Tarzana, Calif.

WELDING—Electric arc. Learn profitable trade quickly through actual practice. Individual welder instructions at bare cost of materials. Full particulars free. Valuable welding lessons book 50c. Hobart Welding School, Box M-352, Troy, Ohio.

MEMORIZE Quickly, easily. Simple instructions 25c. Rennacker, 7159 St. Lawrence, Chicago 19.

USED Educational and technical books bought, sold, rented. Catalog free. Educational Exchange, Henagar, Ala.

INVESTIGATOR Training. Phillips Secret Service, 1917-B North Kenneth, Chicago 39, Illinois.

BECOME A doctor of psychology or metaphysics. Teach secret of contentment, happiness. Win degree of Ph.D. or Ms.D. Solve mental worries. Free book. College of Universal Truth, 5153-B North Clark, Chicago.

MONEY. Security and happiness can be yours by following time tested plans for success. Write, Princess, 2026 Klein Rd., Wilmington, N. C.

LEARN To draw funny faces. Write, Funny Faces, Modesto 2, Calif.

MIND Asleep? I'll speed it up. Dr. Tibolt, 32M, 185 Godfrey, Philadelphia 20.

LEARN Photo retouching. Prepare yourself for the future. Short, easy, fascinating course enables you to earn good money at home. Duval-Hurst Studios, 8517-B Sunset Blvd., Hollywood 46, Calif.

GAGWRITING. Complete course includes originating cartoon ideas. \$2.00. Free coaching. Don Frankel, 3623P Dickens, Chicago 47.

SECRET Investigation. Experience unnecessary. Investigators particulars free. George Wagner, M 125 West 86th, New York.

BECOME A finance man. Particulars free. George Lenhoff, Lincoln 8, Nebraska.

COMBINED Shorthand and typing course 25c. Ray T. Johnson, Brookport, Ill.

29 LANGUAGES By Linguaphone. Russian, Spanish, Portuguese—Direct conversational method for mastering any language quickly, easily, correctly at home. Send for free book. Linguaphone Institute, 83 RCA Bldg., New York.

DRUNKENNESS is a disease which responds to treatment. Medical skill plus human sympathy prove successful with liquor and drug cases. 60 years experience. Write for free booklet. P. M. Nelson, The Keeley Institute, Dwight, Ill.

HOME Study course, drugless therapy. Free literature. Institute of Drugless Therapy, Tama, Iowa.

USED Educational books on all subjects sold, rented, also bought and exchanged. Moneyback guarantee. Write today for free catalog and details. Lee Mountain, Pisgah, Alabama.

REFRIGERATION—Air conditioning. Mechanically-minded men! Are you interested in the kind of work which offers a "go-getting" man a real chance to make headway—even own his own business? Then write today for free facts about refrigeration and air conditioning, and how you can start now to get a working foundation for this field in your spare time; how you can get the kind of training which for 18 years has helped so many U.E.I. men "make the grade" in a big way. Utilities Engineering Institute, Dept. 15W, 1314 W. Belden Ave., Chicago 14, Ill.

GOOD "Used" self-instruction educational books on all subjects bought, sold, rented, exchanged. Satisfaction guaranteed. Complete information and 92-page illustrated bargain catalog free. Write—Nelson Company, Dept. 2-02, Chicago 4.

RADIO Writers wanted. Home-study course teaches you the required professional technique for getting your ideas on the air. Pay-as-you-learn terms. Free information. Radio Writing Institute, Studio M, Radio Center, Hollywood 28, Calif.

AUTO Body and fender work, including metal work, welding and spray painting. Look into it! One of the most profitable branches of tremendous auto industry offering chances for good job or your own business. Train in spare time. Write for free facts. Utilities Inst., Dept. 14X, 1316 W. Belden Ave., Chicago.

CARPENTERS. We teach the square in five easy lessons by mail. Our 1/4 size practice square and simplified instructions does the work. Free information, better still send quarter for practice square and partial lesson. Builders' Topics, Medical Arts Bldg., Seattle, Washington.

MEDICAL Laboratory technicians in great demand. We train you in your spare time, in your own home. You can practice while studying. Write for free catalogue. Imperial Technical Institute, Box 973-E, Austin, Texas.

LOCKSMITH Course. Lock picking, key fitting, etc. \$1.00 prepaid. Locksmith, Canadian, Texas.

PLAYS, STORIES, MANUSCRIPTS

NEW Writers needed to rewrite ideas in newspapers, magazines and books. Splendid opportunity to "break into" fascinating writing field. May bring you up to \$5.00 per hour spare time. Experience unnecessary. Write today for free details. No obligation. Postcard will do. Comfort Writer's Service, 210-P South Seventh St., 2, St. Louis, Mo.

WRITERS: Send for free circular P-35, with unified sales plan for placing your work. Otis Adelbert Kline, Literary Agent, Established 1923, 507 Fifth Avenue, New York 17.

WRITERS. Poets, 23 valuable services. Write National Writers Club, 1837 Champa, Denver 2, Colo.

CARTOONING, COMMERCIAL ART, SHOWCARD WRITING, SIGN PAINTING

WRITE Cartoon ideas. Nationally known magazine cartoonist booklet shows how. "Be Funny for Money, 25c." Don's Studio, 518P Wrightwood, Chicago 14.

"LETTER-PERFECT" Process—produces perfect lettering. Experience unnecessary. New! Different! Artype, 8236 Cornell, Chicago 17, Ill.

CARTOONING Course:—30 illustrated lessons, over 500 sketches, complete \$1.00. Rex Cartoon Studio, Box 892, Pasadena, California.

CARTOONING. Sign painting, commercial art instructions complete. Send only \$1.00. Spradlin Sales Co., 2204 North I, Fort Smith, Arkansas.

HOME Cartooning course: 25c. Gerard Studio, 710 Gaston, Fairmount, W. Va.

CARTOONIST'S Magazine. Cartoon hints, lessons and markets. 25c coin postpaid. Hartman, 2438 W. Lincoln 3, Nebr.

CARTOONISTS—Sell your work. 15 illustrated lessons, 10 money making plans, markets. \$1.00. Cartoon Studio, 1402 Charles, LaCrosse, Wis.

POCKET Size cartoon course—22 easy lessons, over 200 sketches including figures and lettering. Prepared by nationally known artist. Mailed postpaid on receipt of 25c in coin. Snack-Pack Co., 34 E. Georgia St., Indianapolis 4, Ind.

ART Instruction. Self taught. Cartoons, Pen and ink. Figure-drawing. Perspective water color. Oil painting. Over 100 illustrations. Send only \$1.00 for complete course. Nothing more to pay. Vondy Publishing Co., 9521 Annetta Ave., Southgate, Calif.

CHALK Talks. Laugh producing program, \$1.00. Catalog 10c. Balda The Cartoonist, Oshkosh, Wisconsin.

ADVERTISING AGENCIES, LETTER WRITERS, FOR ADVERTISERS

ADVERTISE Profitably: \$20.00 reaches 5,000,000 Sunday newspaper readers with 24-word ad. Newspaper, magazine, mailing-list ratebook free. Chicago Advertising Agency, 20-PA West Jackson, Chicago 4.

20 WORDS 30 Newspapers \$2.00. Goodall, 37 Gardner, Vallejo, California.

MAIL Order specialist. Ads, letters, circulars that sell. 24 years success record. Consultation free. Erol Slater, 451 Mount Carmel, Glendale 6, Calif.

ADVERTISE: 24 Words, 149 newspapers \$6.50. Lists free. Advertising Bureau, 4515-C Cottage Grove, Chicago 15.

ADVERTISING Placed, any publication, lowest rates, complete agency service. Skilled advertising—merchandising counsel. Ratelist and booklet, entitled "Advertising Results For Sale" free. Baker Agency, 3302 Dodge, Omaha, Nebraska.

24 WORDS In 90 weeklies \$4.60. H. J. Darnell, 730 Hays, Jackson, Tennessee.

ADS Placed in out of town newspapers and magazines. Low rates. Catalogue free. Ideas that pay. Baker Advertising Agency, Successors Ankrum Agency, 189 W. Madison, Chicago 2.

INCH Display advertisement, 50 magazines, year \$16. Wood's Popular Services, Atlantic City, (N. J.)

FREE—New Advertisers Rate Guide. 44 pages. Includes everything. Lowest rates. E. H. Brown Advertising Agency, Merchandise Mart, Chicago.

BUSINESS SERVICE

BUSINESS Mail service—Send 25c for three Hollywood scenic post cards, write message, address, stamp and return to us for mailing from Hollywood. Letters mailed, 15c. Adele's Novelty Shop, P.O. Box 3535, Terminal Annex, Los Angeles 54, Calif.

FOR New things to buy and sell, read New Products Review. Write Chaffee, 308 Washington, Chicago 6.

NEWPORT Rhode Island, mail forwarded, telegram, errands, etc. Box 86.

\$2.00 MONTHLY Maintains Washington, D. C., office address. Your business, personal mail reforwarded when wanted. Hawkins, (Established 1917), 7-g Randolph Place.

TO Whom it may concern: I will represent you in Cleveland. Personal or business assignments \$1 per hour. James W. Farley, Citizens Bldg., Cleveland 14, Ohio.

SPECIAL SERVICES

DRAFTING: Mechanical, architectural, structural. Job work by mail. Shopmen, millmen, miners, inventors. Send complete information and sketches. Reasonable prices. The Straightway Eng. Co., No. 1 Percy Place, Cambridge, Mass.

NEED Something in New York? Write "Get-It-For-You" Service, 1332 Findlay, New York City 56.

PUBLICITY: Newspaper, magazine, booklets, Publicist, 1009 South Seventh, Waco, Texas.

TYPEWRITERS, DUPLICATORS, OFFICE DEVICES

"PRINTOMATIC" Self-feeding rotary stencil post card printer, complete, \$9.50. All makes duplicator supplies. Literature free. Pittsburgh Typewriter Supply, 336-R Fourth Avenue, Pittsburgh 22, Penna.

8 1/2"x12" STENCIL Duplicator, complete with ink, stencils, paper, \$3.95. Postcard size duplicator \$1.50. Best Company, Box 5802, Cleveland 1, Ohio.

STENCILLESS! "Redigraph Duplicator" \$19.50. Circular 3c. Felker, Box 21, Wilmette, Illinois.

USED Cash-registers, typewriters, paper-cutter, multi-graphs, addressographs, duplicators, folding and adding machines. Shaw Mfg. Co., Galesburg, Kansas.

RUBBER STAMPS, OFFICE SUPPLIES

RUBBER Stamps 25c per line. Laundry stamps \$1.00. Pocket \$1.00. Interesting books, circulars. Parcel Press, 53 Astor Sta., Boston, Mass.

SERVICEMEN'S Kit contains stamp, indelible ink and pad. \$1.20. Excello Sales, Box 500, Shreveport, Louisiana.

YOUR Name, address on de luxe cushion mount rubber stamp. \$1.00—pad 25c. Postpaid. Cash with order. Edgewood Press, Edgewood, Maryland.

PRINTING, MULTIGRAPHING, MIMEOGRAPHING, GUMMED LABELS

SPEEDY, Efficient printing—200 8 1/2"x11 Hammermill bond letterheads, \$1.00 postpaid. 6 1/2 envelopes, statements, business cards same. Race Printing Company, Hudson, New York.

1000 TWO Color shipping labels, \$1.85 postpaid. Samples. Square Deal Press, 1832 West 4th Street, Brooklyn 23, N. Y.

500 ENVELOPES, \$3.00 Postpaid. Business, personal stationery. R&M, 441 Perry, Pontiac 16, Michigan.

POPULAR Mimeo letters (as if typed) for your club or business, 100 copies (300 words) \$1.50, plus postage; additional 100s, 50c. Mail orders filled same day. Multi. Co., 9 Cornhill, Boston.

1,000 ENVELOPES, Letterheads \$5.00. Free samples. Press, 2411 So. University, Denver 10, Colorado.

400 6 1/2"x8 1/2" LETTERHEADS \$1.25. Mango, 555 South 20th, Newark 3, N. J.

BEAUTIFUL Scroll stationery with monogram. Samples, 3c. Keith, Elizabethtown, New York.

\$2.00 POSTPAID—150 8 1/2"x11 Good bond letterheads and 150 6 1/2 envelopes. 500 of each \$5.75 postpaid. Mero Products, Box 344A, Punxsutawney, Penna.

1000 PLATELESS Engraved business cards. \$6.00 value, only \$3.95. Postpaid. Cash with order. Jules Press, 53 West 42nd St., New York 18.

BUSINESS Cards printed reasonable. Samples. Spada, 10 Lexington, Wethersfield 9, Conn.

QUALITY Printing. Lowest prices! Shop orders, shipping tags, automobile forms, noteheds, duplicate forms, statements, invoices, time cards, manifold books, ruled forms, etc. State requirements. Printing Service, 7922 So. Vermont Ave., Los Angeles 44, Calif.

FREE 100 Letterheads, 50 envelopes. Write Print Shop, New Providence, New Jersey.

5000 6x9 CIRCULARS, Dodgers, handbills \$7.50. Samples. Production Printers, Middleburgh, N. Y.

FINE Printing at reasonable prices. Samples. Treaster Printing, Milroy, Pa.

PRINTING Of distinction at really reasonable prices. Samples, helpful suggestions and estimate gladly sent. State needs. Edgewood Press, Edgewood, Md.

MIMEOGRAPHING—Letters, pricelists, formulas, instructions. Lowest prices. Lem's Letter Shop, 5710 Stanton, Detroit 8.

GUMMED Perforated address labels. 3300 for \$1.10. Keller, Michigantown 2, Ind.

MIMEOGRAPHING—Any copy. Reasonable. Mailers Service, Box 606-A, Chicago 90, Ill.

500 3 1/2"x2 1/4" FOUR Line gummed stickers. 25c. Moritz Printery, Saginaw, Mich.

BETTER Grade printing reasonable. Estimates on anything. Economic Press, Leonia, N. J.

MIMEOGRAPHING And multigraphing. 14 years of fine work and fair prices. Free samples and prices. H. Ailsmith, 1500 W. Nedro Avenue, Philadelphia 41, Penna.

PRINTING OUTFITS AND SUPPLIES

INEXPENSIVE Home-made printing press. Details free. Novelty Shop, Downs-ville, Louisiana.

PRINTING Equipment, type and supplies. Send stamp for details or dime for complete illustrated supply book. Kelsey Inc., X-11, Meriden, Conn.

USED Presses, type, supplies. Lists 3c. Turnbaugh Service, Loysville, Penna.

PATENT ATTORNEYS

INVENTORS: Learn now—without obligation—how to protect and sell your invention. Write for free "Record of Invention" form and complete information for making disclosure and establishing date of your invention. We also send our new free "Patent Guide for the Inventor," containing complete information about patent procedure and how to sell inventions; giving illustrations of many successful inventions; over 150 basic mechanical movements. We assure you prompt, confidential service. Yours may be dangerous. Write today for your free "Patent Guide" and "Record of Invention" form. Clarence A. O'Brien & Harvey Jacobson, Registered Patent Attorneys, 51B-C Adams Building, Washington, D. C.

"PATENT-Particulars" and blanks, free. airmail. Sterling Buck, Park-North Avenue, Baltimore 17, Md. Government-registered 38 years.

INVENTORS—First things come first. Your first move toward securing a patent on your invention is acquiring full information on what to do. Our two books "Patent Protection" and "When and How to Sell Your Invention" contain this information and other helpful data. Get them immediately, together with our "Evidence of Invention" form. They cost you nothing, you assume no obligation. Write now to Victor J. Evans & Co., Registered Patent Attorneys, 931-C Merlin Building, Washington 6, D. C.

WHAT Should you invent? Our free book tells you what today's inventive market wants—how to put down, patent, and sell your ideas. Scores of letters in our files attest to the modern demand for inventions—our long experience as Registered Patent Attorneys will help you. Get our free book, "How to Protect, Finance and Sell Your Invention." Also special document free, "Invention Record" on which to sketch and describe your invention. Write today. No obligation. McMor-row & Berman, Patent Attorneys, 134-R Atlantic Building, Washington 4, D. C.

INVENTORS—Before disclosing your invention to anyone send for form "Evidence of Conception"; Schedule of Government and Attorneys' Fees and instructions. Sent free. Lancaster, Allwine & Rommel, Registered Patent Attorneys, 411 Bowen Building, Washington 5, D. C.

PATENTS. Promptness assured. Wilfred E. Lawson, 1524 K Street, N.W., Washington 5, D. C.

PATENT Protection. Write for information. Fees. Record of invention. Free. Randolph & Beavers, 21-C Columbian Bldg., Washington, D. C.

"INVENTOR'S Guide," 100 mechanical movements, free; advises on patenting, selling inventions. Frank W. Ledermann, 154 Nassau Street, New York.

C. A. SNOW & Co., M-427 Snow Bldg., Washington 4, D. C. Registered patent attorneys. Established 1875. Literature mailed on request.

PATENTS Obtained; selling service, information, recording forms free. Labiner, World Building, New York.

PATENTS. Protect your idea by securing free "Proof of Invention" folder. Exceptional personal service. Established 1906. E. E. Vrooman, 371 Woodard Bldg., Washington, D. C.

PATENTS—Trade marks. Preliminary advice, book and disclosure form free. Personal service. Irving L. McCathran, 315 McLachlen Bldg., Washington 1, D. C. Registered Patent Attorney.

FOR INVENTORS

WHAT Should you invent? Our free book tells you what today's inventive market wants—how to put down, patent, and sell your ideas. Scores of letters in our files attest to the modern demand for inventions—our long experience as Registered Patent Attorneys will help you. Get our free book, "How to Protect, Finance and Sell Your Invention." Also special document free, "Invention Record" on which to sketch and describe your invention. Write today. No obligation. McMor-row & Berman, Patent Attorneys, 134-P Atlantic Building, Washington 4, D. C.

SMALL Rubber factory is looking for new items to manufacture postwar. Do you have a patent or a good idea? Perhaps we can help you with design or financing. Reliance Rubber Company, 1515 Powell Street, Oakland 8, California.

WE Locate buyers meritorious patented, unpatented inventions. If will sell, reply immediately. Descriptive booklet, references free. Invention Reporter, 5A-11106 So. Longwood Drive, Chicago.

INVENTORS: Learn now—without obligation—how to protect and sell your invention. Write for free "Record of Invention" form and complete instructions for making disclosure and establishing date of your invention. We also send our new free "Patent Guide for the Inventor," containing complete information about patent procedure and how to sell inventions; giving illustrations of many successful inventions; over 150 basic mechanical movements. We assure you prompt, confidential service. Delays may be dangerous. Write today for your free "Patent Guide" and "Record of Invention" form. Clarence A. O'Brien & Harvey Jacobson, Registered Patent Attorneys, 51A-C Adams Building, Washington D. C.

INVENTION Development—Inventor's consultation, inventions developed, designed, promoted; models constructed, patent advice, patent drawings. Reasonable rates. Address: Invention Development, 17720 Mission Blvd., Granada Hills, California.

PATENT Your ideal Write immediately for two free illustrated books, "Patent Protection" and "When and How to Sell an Invention." 64 pages of valuable information for inventors. No obligation. Address: Victor J. Evans & Co., 932-C Merlin Bldg., Washington 6, D. C.

MANUFACTURERS, Inventors, experimenters. Engineering, designing, drafting facilities available. Confidential. Prompt service. Low fees. International Projects Corp., 277 Broadway, New York City.

HAVE You a practical invention for sale? Write Seymour, 218 South Aurora, Easton 3, Maryland.

INVENTORS! Have you good patentable idea? Write Mr. Metzler, 11 West 42nd, New York.

PUT Your patents to work. Responsible firm of 22 yrs. exper. in pats. and licensing, desires items for development. Prefers ideas adaptable licensing exclusive basis. Will buy outright or take exclusive franchise. Can develop special machinery if necessary. Submit patent or drawings. Explain prospects, competitive products and basis will do business. Faxon, Fidelity Bldg., Benton Harbor, Michigan.

INVENTORS! Submit your idea to the right firm! Over 10,000 concerns need new postwar products, are looking for them right now. Get your invention carefully considered through confidential report to manufacturers. Send brief description of invention, details unnecessary. Edward P. Bishop & Associates, Dept. PM, 4031 Goodwin Ave., Los Angeles 25, California.

WANTED—New products and ideas. Long established concern wants new ideas and products in office appliance and equipment lines and stationers' items—for postwar manufacture and distribution. If you have a new product or idea, whether patented, patent applied for, or merely on paper—send preliminary information (by letter only) to Dept. J, Room 3036, 35 E. Wacker Dr., Chicago 1, Ill.

PATENTED And unpatented inventions promoted. M. Joyce Humphries, 1424 Land Title Bldg., Philadelphia 10, Penna.

RANDOLPH & Beavers; Registered Patent Attorneys, 11-E Columbian Building, Washington, D. C. In order to protect your invention and reap the reward that should be yours, patent your invention without delay, and at the same time have rights to sell as manufacturers convert to civilian production. Write for information and record form today.

INVENTORS: New military and commercial inventions urgently needed by manufacturers. Write for particulars. Chartered Institute, Dept. 4-A, Washington, D. C.

CASH For practical ideas and inventions. Mr. Ball, AB-9441 Pleasant, Chicago.

I SELL Patents. Established in 1900. Charles A. Scott, 773PM Garson Ave., Rochester, N. Y.

MANUFACTURER'S Names, addresses. Any classification. Tupper, 18-A Lyman, Beverly, Mass.

INVENTIONS WANTED

WANTED—Patented, unpatented inventions having profit possibilities, all kinds. If will sell, reply immediately. Descriptive booklet, references, free. Invention Reporter, 5B-11106 So. Longwood Drive, Chicago.

INVENTORS! Have you good patentable idea? Write Mr. Metzler, 11 West 42nd, New York.

ALL Kinds. We have facilities and finances to make and sell your ideas, both mechanical and chemical. Send model, sample, details and wishes. General Sales & Supply Company, 110 East Main St., Madison 3, Wisconsin.

INVENTORS—The Lion Manufacturing Corporation of Chicago, a highly rated concern employing 1,400 people, is interested in inventions for their plant and affiliated companies. Our interest is in patented or patentable electrical or mechanical devices for post-war development in the following fields: Radio and television, sound and recording, household appliances, vending machines, coin operated amusement devices, in fact almost anything of metal or plastic. We invite inventors to send us details concerning their patented inventions. If your invention is not patented, tell us in a general way what you have to offer. If we are interested, we shall inform you how to communicate details without endangering your rights. Lion Manufacturing Corp., 135 South La Salle Street, Dept. G, Chicago 3, Ill.

MANUFACTURER Wants sensible mechanical device or idea with quick sales possibilities in low-priced field. Write Matt, 1412-D Great Northern Building, Chicago 4.

INVENTORS: Learn how we sell your invention. Free booklet. Inventors Patent Exchange, 336-B Palace Building, Hartford 3, Conn.

ANYTHING in building or contracting industry. Nabert Building Corp., 145 Bellevue, Elizabeth, N. J.

WANTED—Patented items for manufacture on royalty basis. Decker Manufacturing Co., Rockford, Illinois.

INVENTORS: Have you a sound, practical invention for sale, patented or unpatented? If so, write Chartered Institute of American Inventors, Dept. 4-D, Washington, D. C.

CASH For inventions, patented, unpatented. Mr. Ball, A-9441 Pleasant, Chicago.

PATENTS FOR SALE

PORTABLE Self elevating derrick, adaptable to 1½ T. line construction truck. Semi self locking trailer hitch, griplink, wt. 12 lbs., withstands 24,000 lbs. tensile strain. Screen door safety latch, stamping. Food chopper, positive feed, no slopping back, simple. George Haniquet, 1256 So. Mariposa St., Glendale 5, Calif.

PNEUMATIC Telescope jack, very compact, lathe manufactured. Guerin, 1237 York Ave., New York.

A FLEXIBLE Adjustable lever drag harrow, No. 2,347,979, royalty basis. Vincent Antal, Owatonna, Minn.

FIRST-AID Kit, compactly designed to be carried like fountain-pen. American, Canadian patents pending. Cash, royalty basis. Cpl. Raymond L. Watkins, 21st General Hospital, APO 362, New York.

MODELS AND MODEL SUPPLIES

HARDWARE, Model makers supplies, engine castings, pulleys, belts, drills, taps, saw mandrels, steel. Screwdriver and catalog 10c. Terek, 6304 Patterson, Chicago 34.

RAILWAY Models, complete line, informative catalog HO and O gauge, 79 pages, 15c. Walther, 247 Erie, Milwaukee, Wisconsin.

MANUFACTURING Dies, stampings, brass, gears and model supplies. Send 10c for catalog. Pierce Model Works, Tinley Park, Ill.

CATALOG 50 Engines, model railroad supplies, 25c refunded. Simonsen Model Supply, A-3054 North Greenview, Chicago 13.

PLANES, Boats, hundreds of hobby items. 40 page catalog free. America's Hobby Center, Dept. B 35, 40 E. 21 St., New York 10, N. Y.

STEAM Engine castings, blueprints, circular 10c. Anton Bohaboy, 2297 Price St., Rahway, New Jersey.

BUILD The famous P.T. boat. A model of 80 feet of fighting fury. Most authentic model kit on market. 130 precision, true-to-scale parts, ready to assemble. No tools needed. Descriptive folder free. Creative Crafts, Winnetka 8, Ill.

ILLUSTRATED Catalogue over 100 model steam, gasoline and locomotive castings and drawings 10c postpaid. Active Products & Supply Co., 53 W. Jackson Blvd., Chicago 4.

WORLD'S Largest selection model engine castings and drawings. Catalogue 10c. Wayne Miller, Suite 200, Engineering Building, Chicago 6.

SHIP Model kits and fittings. Complete line Fisher model yacht equipment. All Boucher Fisher, Marine Model and Ideal kits, fittings and blueprints at standard prices. Most complete stock in New England. James Bliss & Co., Inc., 229 State Street, Boston, Massachusetts.

SHIP Models and yacht supplies complete. Large 64 page catalogue 25c. Bill Wild's, 510 East 11 St., New York City.

MANUFACTURING

WANTED Now! Manufacturers for variety of products. Big directory 25c. Tells who to contact for specifications. Associates, 2557 Charlestown, Toledo, Ohio.

MODELS Of inventions, dies, tools, etc. Danco, 3933 "D" St., Detroit 16, Mich.

MANUFACTURING, Model making, inventions. Baum's Metal Specialties, Kansas City, Mo.

MODELS—Small lot manufacturing. Metals, plastics, etc. Milburn, Burlington, Kentucky.

HOME CRAFTSMEN

CERAMIC Jewelry supplies, bar pins, ear screws, for ceramic and woodworkers, also, glass and sea shell assemblers. Free catalog. Phila. Badge Co., 1007 Filbert St., Philadelphia, Penna.

NEW! Plastic Craftman Kit. Contains generous assortment of both Lucite and Plexiglas pieces. Enough for 15 to 20 useful and artistic items. Kit also includes full directions and plans for making many items, cement and polishing material. Ideal for model builders and home craftsmen. Send \$2.00 plus 20c for postage. B. Paul, 6th and Market Sts., Dept. P, Philadelphia 6, Penna.

BIRD Houses—New construction principle, profitable, easy to obtain material, minimum labor, no painting. Good retail, wholesale market. Plans, selling, mass production ideas \$1.00. Emsco, 749 N. Buchanan, Arlington, Va.

CATALOG: Large line decal transfers. Patterns for jig sawing. New designs easy to make novelty furniture, lawn ornaments, silhouettes, letters and numerals. 100 crafts and hobbies illustrated booklets. Tools. Other lines. 500 articles finely illustrated. Write Wo-Met Shop, Ashburn, Georgia.

PLEXIGLAS Remnants—½" clear sheets. Dollar postpaid bargain assortment on approval. Will trade for 1" translucent rod. Cedar Kraft, Grand Haven, Mich.

REPLACES Sandpaper: Make your own sanding disk, or cover any wood or metal shape with abrasive. Curved surfaces, impossible to cover with sandpaper, are easy to coat with San-Dit. Send \$1.00 for kit and directions. San-Dit, Box 32, Wauwatosa, Wis.

1000 TELUHOW Plans tell how to make 1000 projects. List dime. C. King, E. Kingston, N. H.

NOVELTIES Made from scrap wood, 25 patterns 25c. 15 toy patterns 25c. 15 lawn ornament patterns 25c. Other patterns, 14"-20" high; Dutch boy, Dutch girl, clown, Mexican, pelican, rooster, 10c each; 3 for 25c. Lynds, Medway, Mass.

WOODEN Wheels for toys, grooved or plain, send stamp for sample. Lawrence, M. Dewey, Austin, Minnesota.

ACTION Toy. Ingenious, different. Runs 4 minutes under own power. Scrap materials. Sells readily year around. Blueprints \$1.00. Alta Products, Box 1109, Pasadena 1, California.

LOOKING For good toy patterns? We have them. Attractive modern designs. Ten for \$1.00. Continental Products, 907 Birch, Eau Claire, Wisconsin.

NOVEL Lawn attraction! Two dogs and cat. Full size blueprint 50c. Bee-Gee, 7215 Carolina, Hammond, Ind.

TOY Patterns (action). Friendly puppy; pedaling clown, ducky quack; man sawing wood weathervane. 25c each. Strother, Belington, W. Va.

LARGE Assortment of Lucite and Plexiglas with complete instructions for making many beautiful objects; only \$1 postpaid. Lynds, Medway, Mass.

PLEXIGLAS And Lucite—The amazing crystal-clear plastics! Saw them, drill them, bend them, twist them into hundreds useful articles that are beautifully different. Special one-pound assortment only \$1.00 postpaid; 6 pounds \$5.00! Plexiglas or Lucite sheets 12"x12" (144 square inches) 1/8" \$2.50; 3/16" \$2.75; 1/4" \$3.00. Free directions and project suggestions included. Order these "plastics of tomorrow" today! Carmen-Bronson, 160B East Fourth Street, Mount Vernon, N. Y.

20 WHITTIER Patterns, X-acto knife, enough wood, instructions. \$1.00. "Old Whittier," 1402 Charles, LaCrosse, Wis.

BULLDOZER, Power shovel, earthmover—Build these toys of original design in wood from cuttings. Prints and specifications of set \$1.00. Others available. Earthmover Toys, East Lansing, Mich.

28 LAWN Ornament patterns 25c. Other patterns: 15"-20" high; Dutch girl; Dutch boy, pirate, bull terrier, Mexican girl, Mexican boy, dwarf, penguin, flower girl, 10c each; 3 for 25c. 25 novelty patterns 30c. All 62 full size patterns \$1.00 postpaid. Strother, Box 383-GU, Belington, W. Va.

CASH in leather ornaments. Make at home. Sell on sight. Write now. Vogue Leathers, Fairfield 3, Iowa.

LET Us sell your homecraft products. For further details write National Mak'N'Sel System, 210 Post St., Suite 915, San Francisco 8, California.

SHEBEL Hand Filer, files all saws. Send for circular. A. P. Shebel, 730 S. 2nd St., Milwaukee 4, Wis.

WHITTLE For profit. Patterns, instructions, 10 saleable subjects 25c. Whittier's Studio, 96 Park Place, St. Paul, Minn.

PLYWOOD—Beautiful nonpropriety aircraft, cabinet and paneling stock. Thickness 1/16" through 1"; large, small panels. Fir, gum, birch, mahogany, walnut. Reasonable! Complete lists 10c. Carmen-Bronson, 160B East Fourth Street, Mount Vernon, N. Y.

HOME Craftsman. 4 full size patterns. For doll stroller, cradle, wheel-barrow and doll sulky. \$1.00 postpaid. Lincoln's Craft Shop, Farmington, Conn., Box 71.

MAKE IT YOURSELF

ELECTRIFIED Martin house keeps sparrows away. plans \$1.00. Oigard, 955 W. Central (4), St. Paul, Minnesota.

WATER Softener plans. Up and down flow models \$2.00. Sweigart, 904 Grand, Des Moines 9, Iowa.

GARAGE Doors dashboard controlled. Additional information under "Automobiles."

LOOK! Four corking workshop tool and equipment ideas. Amazing plan tells everything. All for 25c. Ideas & Plans C2, Palmyra, New Jersey.

JEWELRY Supplies. Shell metal and plastic parts for manufacturing. Free illustrated catalogue and detailed instructions on shell jewelry. Florida Supply House, 415 - 12th Street, Bradenton, Fla.

FLUORESCENT Lights. How to make your own 20 watt lights for less than \$1.00 each. Complete, guaranteed detailed instructions \$1.00 M.O. or war stamp. Specialty Sales, Box 1086, Muncie, Ind.

WATCHES, OLD GOLD, JEWELRY, ETC.

PLASTIC Charms for bracelets. \$1.00—100. \$8.00—1000. Free catalogue. P. Bonomo, Box 45, Station A, Brooklyn 6, N. Y.

GEMS, Precious and semi-precious, all genuine, from world wide sources. Deal direct, no overhead, save money. Catalog 10c. Hill Co., Route 7, Salem, Oregon.

NEW Watches, jewelry, diamonds. Write for prices. Orville K. Fast, Reedley, Calif.

COO-COO Clocks, electric and spring wound chime clocks, and hall clock movements serviced and repaired by licensed clockmakers. Write or send us insured mail your clock troubles. Electric Clock Service, Box 1086, Muncie, Indiana.

WATCH Repairing easy learned by our home study course. Watch repairers are in demand and are among the highest paid craftsmen today. Write for free information. Houston Chronometer & Watch Co., P.O. Box 5367C, Houston 12, Texas.

GOLD \$35.00 Ounce—Mail old gold teeth, diamonds, jewelry, watches—receive cash by return mail. Satisfaction guaranteed. Free information. Dr. Weisberg's Gold Refining Company, 1500-Q Hennepin, Minneapolis, Minn.

WATCHES, Materials, tools, jewelry, diamonds—bought—sold. Catalogue, Gales, Box 1000, Chicago.

WATCH And clock repairing—complete practical course in modern horology. 66 illustrated self-instruction lessons. Just out! Low price. Information free. Write Nelson Company, Dept. 8-02-2, Chicago 4.

TOBACCO, SMOKERS' SUPPLIES

FIFTY Quality cigars \$3.50, \$4.00, \$5.50. Continental Cigars, Corning, N. Y.

YOU Can smoke a dry pipe now. Learn this simple process of drying your pipe over night. No heat or special equipment. Guaranteed. Dollar. Clyde Taylor, Route 2, Covington, Ohio.

FREE To pipe smokers—For a new pipe smoking thrill, write us your brand of tobacco and get free package mild, tasty, natural-flavored "Green River." Pete Moberly, Box 987, Owensboro, Kentucky.

FALSE Teeth wearers: Have your pipe rebuilt so that you can smoke comfortably. Send steel of your pipe and one dollar. We will rebuild it so you can hold it securely. Guaranteed. A. C. Bishop, 9535 Ohio, Detroit 4, Michigan.

RAZORS, BLADES, SHARPENING

SHARPEN Safety razor blades with Ingersoll Dollar Strop. 100 shaves out of one blade. \$1.00. Albion, Box 428, Petersburg, Va.

100 DOUBLE-EDGE Blue surgical steel razor blades \$1.50 prepaid. Fully guaranteed. St. Moritz Blade Co., 321 Broadway, Dept. AC, New York 7.

FOR THE HOME

PARTS—Plumbing, heating, stoves, furnaces, boilers, Magic Products, Royal Oak, Mich.

FOR SALE—MISCELLANEOUS

ARMY GOODS (used). Jeep hats and caps 10c, cups 15c, leggings, bayonet scabbards, 25c each; messkits 35c, canteens, cartridge belts, haversacks, holsters, leather or canvas straps, gallon metal cans, polished instrument box 50c each. Raincoats, ponchos, canvas bunk bottoms 2'x7', steel helmets, periscopes and bag, canvas bags, decorating flags, life preservers, aluminum tool boxes, \$1 each; fire hose 5c per ft. Canvas covers any size 5c per sq. ft. Rubber any size or thickness 20c per lb. Pup tents \$2.50. Squad tents \$17.50. Minimum shipment \$1. Via Railway Express. N. Y. Salvage Co., 144 Chambers St., New York City.

SEND \$1.00, Receive prepaid 15 wrenches or 10 clamps used, usable. Maxs Mechanical Store, 150-06 Liberty Ave., Jamaica 4, N. Y.

CUTTERS, Dental burs assorted, reclaimed job-lot, \$1.90 per gross. Wolf, 1934 E. Hartlane, Philadelphia, Pa.

SLIGHTLY Used army raincoats. Small, medium, large. \$3.95 postpaid. Limited supply. Order today. Mears, Hallwood, Va.

LIONEL "0," "00," "027," "072," standard, American Flyer and "HO" gauges. Switches, loco's, freight, passenger cars and accessories. Stamp for list, specifying gauge. Trilior Hobbyist, R.F.D. 260, No. Dartmouth, Mass.

WANTED—MISCELLANEOUS

USED Mercury \$1.19 lb. Beacon Smelting, 93 Federal, Boston, Mass.

TURN Your white elephants and other articles into cash. We buy, trade or sell anything. Write Farmers & Traders Exchange, Dept. C, Chittanooga, N. Y.

WANTED—War work at home, or public typing. No selling. Mrs. B. Kruttschevki, 119 S. George St. Clinton, Ill.

CASH For old buttons. Information free. 230-EA Bowman, South Bend 14, Indiana.

MERCURY—Highest prices. Free containers. Write, Wholesale Terminal, Norwood, Massachusetts.

WANTED Second hand molds, rubber, wood, metal, gelatine. Joseph Webb, 808 1/2 Kanawha Blvd., Charleston, W. Va.

WANTED 3x5 Excelsior press. Bruno, 1144-71, Brooklyn, N. Y.

STEREOSCOPIC Views, Keystone or Underwood. Will pay 5 cents each. Israel Dvorine, 2228 Eutaw Place, Baltimore, Md.

WE'LL Swap, sell, buy anything. Free list. National Swappers Guide, 610 St. Joseph, Evansville, Indiana.

WANT Coin operated machines—all kinds. Describe. Write Adair Company, 6926P Roosevelt, Oak Park, Illinois.

MERCURY (Quicksilver) — Cadmium, bismuth, tungsten, molybdenum, cobalt, vanadium. Write for quotations stating quantity. You'll receive guaranteed prices. Metallurgical Products Co., 35th and Moore Sts., Philadelphia, Pa. Established 1909.

WATCHES Wanted—Broken or usable—all kinds, even Ingersolls. Highest prices paid for jewelry, rings, spectacles, alarm clocks, razors, cigarette lighters, gold teeth, etc. Cash mailed promptly. Lowe's, Holland Bldg., St. Louis 1, Mo.

WE Buy "anything"! Highest prices guaranteed! Justice, Box 150, Chicago 90.

POPCORN Machines, peanut roasters, candy floss, potato chip, caramelpop corn equip. Coin operated vending machines. Northside Company, Indianola, Iowa.

PERSONAL

VITAMIN Guide free. Saves you money. Richardson, Wyoming 2, Penna.

DENTAL Plates and bridges cleaned and sterilized with my brushless cleaner. Make it yourself at small cost. My private formula \$1.00. Satisfaction guaranteed. Dr. Reese, Dentist, Winnetka 236, Ill.

GROOVED Letters correct poor penmanship—few hours. Write, Ozment, 9, St. Louis, Mo.

EXCLUSIVE! Poems, about you, friends, etc. Professionally written. Any subject. Name your own subject, length and form. 3 for \$1.00. Elmer Hill (Editor), 6427 Begole, Detroit, Michigan.

DANIEL Williamson—Please advise address and plans. Parents and sisters.

3 COLOR Bronze keytag, dog identification tag, identification engraved one dollar, three \$2. Metal identification tag stamped 25c coin, five for dollar bill. Stanley, Engraver, Lansing, Mich.

WINDMASTER Cigarette lighter. Beat the match shortage. Satisfaction guaranteed or money back. \$1.79 postpaid. H. A. Welch, Jr., 780 Sunfield, Birmingham 1, Michigan.

YOUR Handwriting will reveal many secrets that you never knew about yourself. Candid analysis, only \$1.00. James Vick, Church Road, Virginia.

LEARN Basic facts "Why Your Feet Hurt." Be sensible! Discard useless remedies! Information. Dulco, 324P, Pitts, Pittsburgh 21, Penna.

KNOWLEDGE Is power. Tell friends the exact day events occur. This dependable formula amazingly figures weekdays accurately any year. Guaranteed. Send 25c in coin to cover printing and postage. Henry Martz, P.O. Box 5352, Paschall Station, Philadelphia 42, Penna.

LIVE Longer, feel better, enjoy life. Free information. Fairchild Company, Mt. Vernon, Ohio.

FALLING Hair, its cause and prevention, is fully explained in an informative and educational pamphlet entitled "How to Keep Your Hair Till Ninety." For free copy write, James Hilton, 4819 Fourth Ave., Brooklyn 20, New York.

ATHLETE'S Foot remedy. Guaranteed satisfaction. \$1.00 bottle, prepaid. Dr. W. J. Renz, D.S.C., P.O. Box 50, Lake Charles, Louisiana.

PSORIASIS, Dry eczema! Rush name for amazing facts, special no-risk offer. Carter-Howell Laboratory, 457 Schenectady Avenue, Dept. L-6, Brooklyn 3, N. Y.

RESEARCH: Heirs, relatives, friends located. Write Chaffee, 308 Washington, Chicago 6.

"SUCCESSFUL Home Treatments for Troubled Feet"—Prescriptions, simple home remedies, illustrated. Postpaid \$1. Grover Publications, 390B Bartlett, San Francisco 10, California.

SLEEP Tight with Sleep-Rite soft waxen earstoppers—that stop noise. Four months supply \$1.00. Guaranteed. Sample 10c. At leading druggists. Accepted American Medical Association. Free "proof." Raymond Dow, 15 Park Row, (1215 AC), New York 7.

PSORIASIS Sufferers: Pixacol has brought relief when everything else failed. Use only as directed. Apply externally, dries quickly, convenient. Try regular \$1 bottle without investing a cent! Write: Pixacol, Box 3583, Cleveland, Ohio.

FREE Psychological talent analysis. Postage required. Dr. Haynes, 706 8th, Washington 1, D. C.

MEXICAN Law practice, A. B. Flota, Box 240, Juarez, Mexico.

GRAY Hair vitamin guaranteed genuine calcium pantothenate. 3 months supply \$1.98. Reliable Products, Box 908, Milwaukee.

DRUNKENNESS Is a disease which responds to treatment. Medical skill plus human sympathy prove successful with liquor and drug cases. 60 years experience. Write for free booklet. P. M. Nelson, The Keeley Institute, Dwight, Ill.

BUY Vitamins direct. Save. Postcard. Matoska Products, White Bear, Minn.

GIRL Photos, beautiful models, only \$1.00 for group. "Little Eve," Box 211, Terre Haute, Indiana.

HAIR Falling? Dandruff? Write Trichologist, 137 Lewis St., Phillipsburg, N. J.

TATTOOING Outfits, designs, colors. Write today. Zela Studio, 728 Lesley, Rockford, Illinois.

MISCELLANEOUS

MEXICAN-AZTEC Featherweight tropical bird picture cards, samples 25c. Bulletin free. Mexican Products Co., 126 N. Main, Tulsa 3, Okla.

ALASKA Scenes in Kodachrome slides. 75c each. Free list. Alaska Film Company, Box 81, Ketchikan, Alaska.

BUY Cigars direct from distributor. Box of 50 regular 15c size Tampa hand made cigars only \$6.75. Send check, money order today. Include 15c handling charge. Special no risk guarantee offer—smoke 2 or 3 cigars at our risk. If not satisfied return balance and money cheerfully refunded. Tampa Quality Cigar Co., 5014 Suwanee Ave., P.O. Box 1836, Dept. A-1, Tampa 3, Florida.

MAGNIFIER, Powerful eye-loop magnifier. Jewelers, inspectors, hobbyists, \$1.00 postpaid. Ador, 52 Mill St., Amityville, N. Y.

FOOL Your friends. Make them believe you are in gay New York. Send 25c for 5 picture postcards. You write message, address, stamp, and return for mailing in New York City. Letters mailed 15c. Fun with loads of laughs. Try it! M. Heller, 250 West 82 St., New York 24, N. Y.

FOXHOLE Radio: Amazing serviceman's pastime gift, batteryless, tubeless, school-boy thrill, made anywhere, anybody. Easy distance-getting instructions. \$2.00. Gadgets, Box 28, Jackson Heights, N. Y.

BIG Mail for you. Latest moneymaking offers, opportunities, catalogs, magazines. Name listed in directory 10c. Ideal Service, 103, Park Ridge, Ill.

COMPLETE Shoe shine unit 30c postpaid. Essential Products, Williamsburg 1, Mo.

FREE Fertile South-American lands! Fifty acre homesteads or large ranches obtainable free. Valuable illustrated information, 25c (refundable). Vallesp, 395-PM Broadway, New York 13.

POSTAL Size ink portrait from clear photo 50c, 5 for \$2.00. No stamps. Other mediums and sizes sent on request. Write, Bus, Kenyon, 119 Cottrell Blvd., Marine City, Mich.

PICTURE Painted from photograph. Paul Fortner, Box 42, Montezuma, Ind.

SURPRISE Your friends. Address your letters, postcards, as from Panama or Canal Zone, send to: "Captain, Box 1590, Panama, Panama Republic." I will re-mail with proper stamp. One for 20c, 5c each additional, 13c extra if airmail. May serve you further? When answer desired send 2c. Send war savings stamps only.

PHOTOCOPY Anything (discharge papers, birth certificates, etc.) 8 1/2" x 11" 25c. Best, 696 Greene Ave., Brooklyn 21, New York.

FAIRY Gardens, gift novelties, clever, different. Free offer. H. Wingfield, Box 673-C, Bemidji, Minnesota.

RECEIVE Moneymaking opportunities, mails, samples, magazines. Your name in several mailing lists, 10c. Rogowski, 3415 Broadway, New York 31.

MAKE Your friends think you are in Nassau, Bahamas, tourist resort. Letters mailed anywhere 20c each postpaid. Simply write message and forward to me. Wm. Cartwright, Box 606, Nassau, Bahamas.

OPPORTUNITY Mail and five multi-color views—dime, George Bryant, 3709-D High, Denver 5, Colo.

ALARM Clocks repaired, bought any condition. Feiker, Box 21, Wilmette, Ill.

POSTAGE Stamp machines—New 1945 models \$30.00 complete. Merchants and operators—write for illustrated catalogue. Parkway, 3046H Tioga, Baltimore 15, Md.

BIGGEST Money in tattooing now! No experience required. Complete instructions with outfits. Send for free literature. Tatuco, 651 South State, Chicago.

TAILORED Homes. Sixty plans one-story houses with selection beautiful colonial, English, Spanish, moderne exteriors—making hundreds of combinations! Price \$1.00. Prepare for rationing and higher building site prices. Avoid rush, plan now! H. P. Jones, 486K Brapdeis Bldg., Omaha, Nebr.

GOOD "Used" self-instruction educational books on all subjects bought, sold, rented, exchanged. Satisfaction guaranteed. Complete information and 92-page illustrated bargain catalog free. Write-Nelson Company, Dept. 2-02-2, Chicago 4.

MAKE Your own Plastroplate printing cuts. Simple, easy process. Adayservice, Argyle, Wisconsin.

THE Lord is coming! Get guaranteed proofs free. Scheall, 283X, Duluth, Minn.

BOYS—Girls, write for free gift. David Berg, 659 Churchill, Bridgeport 29, Conn.

MEXICAN Gift items, price list free. Ray Foster, 909 East River, El Paso, Tex.

MEDICAL Laboratory technicians in great demand. We train you in your spare time, in your own home. You can practice while studying. Write for free catalogue. Imperial Technical Institute, Box 973-J, Austin, Texas.

REPAIR ANY KIND OF RADIO EQUIPMENT

PREPARE NOW FOR A BETTER JOB AT HIGHER PAY IN THE RADIO-ELECTRONIC FIELD.

Complete Basic Radio-Electronic Training for Beginners... FOR ONLY \$5

EASILY WORTH \$50 IF YOU BOUGHT IT AS A COURSE

No girl Radio-Electronic Training doesn't have to be expensive to be good. Actually, A. A. Ghirardi's famous 972-page RADIO PHYSICS COURSE book gives you just the training you need—ALL YOU NEED—easier, better, faster—AT A TOTAL COST OF ONLY \$5 (\$5.50 foreign).

No previous training is necessary. RADIO PHYSICS COURSE book carries you rapidly

through Basic Electricity (over 300 pages) to the latest Radio-Electronic developments. Nothing is omitted or condensed. Each step is made crystal clear by thorough explanations and by more than 500 illustrations. Each section contains Self-Testing Review Questions so you can check your progress every step of the way. There are no lessons to wait for—no monthly payments to make.

★ **More universally used for home study, by more Signal Corps, Navy and civilian schools and colleges than any other book of its kind!**

All you need is a little spare reading time plus a desire to get started NOW to make more money in the rapidly expanding fields of broadcasting, aviation radio, F-M, Television, radio servicing, electronic manufacturing—or any other of Radio-Electronic's fast-growing branches. RADIO PHYSICS COURSE is famous for making it easy for beginners to learn Radio-Electronic fundamentals—at home without an instructor.

You can understand every word without previous training. You'll be pleasantly surprised how easily you'll master the subjects that other books and courses make seem very complicated. Our 5-Day Money-Back guarantee enables you to examine this great book for five full days—and get every cent of your money back if you're not more than satisfied. Send coupon today!

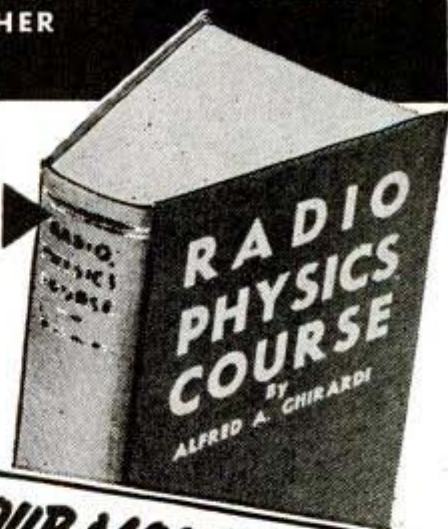

YOUR MONEY BACK
In 5 Days if Ghirardi's RADIO PHYSICS COURSE doesn't teach you EASIER, FASTER, and AT LESS COST than any other Radio-Electronic book or course!

HERE'S HOW TO LEARN MODERN SERVICE WORK

without an instructor!

Ghirardi's MODERN RADIO SERVICING (see below) is the only single, inexpensive book giving a complete course in modern radio repair work. Written so you can understand it without an instructor! Read from the beginning, it takes you step by step through all phases of the work. Used as a reference book, it serves as a beautifully cross-indexed work for "brushing up" on any job that puzzles you. Explains ALL test in-

struments, how they should be used and why (it even gives all data for constructing your own test equipment); Troubleshooting Procedure and Circuit Analysis; Testing and Repair of Components; Installations; Adjustments, etc., etc.—ALSO How to Start a Successful Radio-Electronic Service Business. 1300 pages; 720 Review Questions; 706 Illus. Only \$5 (\$5.50 foreign). 5-Day Money-Back Guarantee!



HERE'S HOW TO REPAIR RADIOS THE EASY WAY

Ghirardi's big 744-page manual size RADIO TROUBLESHOOTER'S HANDBOOK (below at right) isn't a "study" book. You simply turn to it whenever you want to fix a particular trouble in a particular model and make of radio. Its 404-page Case History Section gives full details on common trouble symptoms, their causes and remedies for practically every Radio in use—over 4000 of them! It describes the trouble exactly—tells you exactly how to fix it—without any elaborate testing whatever!

If you like to tinker with radios the HANDBOOK is your "Open, Sesame!" to fast, efficient work. If you are already a radio man it will help you fix two sets in the time normally required for one—repair cheap sets profitably—train new helpers—substitute parts properly, etc. Also, hundreds of pages devoted to I-F alignment peaks; transformer troubles, tube substitutions and dozens of charts, graphs, helpful hints, etc.—all indexed so you can find them fast. Only \$5 complete (\$5.50 foreign) on our 5-Day Money-Back Guarantee

JUST LOOK UP the model radio you want to fix. The Handbook tells exactly what to do—exactly how to do it!

RADIO & TECHNICAL DIVISION

Murray Hill Books, Inc.,
Dept. PM-35, 232 Madison Ave., New York 16, N. Y.

- Enclosed find \$_____ for books checked; or send C.O.D. (U.S.A. only) plus postage. If not fully satisfied, I may return books within 5 days and receive my money back.
- RADIO PHYSICS COURSE \$5 (\$5.50 foreign) MODERN RADIO SERVICING \$5 (\$5.50 foreign)
- RADIO TROUBLESHOOTER'S HANDBOOK \$5 (\$5.50 foreign) MONEY-SAVING OFFER: Modern Radio Servicing AND Troubleshooter's Handbook \$9.50 for the two (\$10.50 foreign)

Name _____
Address _____
City & Dist. No. _____ State _____

MONEY-SAVING OFFER

See coupon for special combination offer on MODERN RADIO SERVICING and TROUBLESHOOTER'S HANDBOOK—over 2040 pages representing a complete service library for only \$9.50! (\$10.50 foreign)



...OR IT WON'T COST YOU A CENT!"
says George F. Jowett
WORLD'S GREATEST BODY BUILDER

Let me prove to YOU that you can put inches of dynamic muscles on your arm! Add inches to your chest! Broaden your shoulders and power-pack the rest of your body. I can do for you what I've done for thousands the world over, including many officers and men now in the U. S. and British Armed Forces!

GIVE ME 10 MINUTES A DAY!
I'll Show You My Secrets Of Body Building

I'll help you learn the "Progressive Power Method" through which I rebuilt myself from a physical wreck to the holder of more strength records than any other living athlete or teacher! No matter how skinny or flabby you are, you can learn my methods right in your own home. Through my proved secrets I show you how to develop your power, inside and out, until YOU are fully satisfied that you are the man you want to be. "The Jowett System," says R. F. Kelly, Physical Director, Atlantic City, "is the greatest in the world!"

PROVE TO YOURSELF IN ONE NIGHT!

Send only 25c for test, course, "Molding a Mighty Arm." Read it the evening it arrives—learn from experience the thrill you can give your muscles! If you want a physique that will

inspire respect from men, and admiration from women... ACT LIKE A HE-MAN! Decide at once! The famous book, "Nerves of Steel—Muscles Like Iron" will be included FREE! Priceless for the strength fan! Full of photos of marvelous power-bodied men who will show you what Jowett has done for them and how he can do the same for you. Reach out... Grasp this Special Offer today!

Jowett Institute of Physical Culture
 230 Fifth Avenue
 Dept. 473-B New York 1, N. Y.

Send for These Five Famous

Courses in Book Form
ONLY 25c EACH
or ALL 5 for \$1.00

FREE! for a limited time only —
ALL 5 GIFTS!
 and Jowett's big Photo Book

Read TWICE as many red-blooded Americans to start on the road to Mighty Strength THIS MONTH as with Coupon-order 1 day FREE at further cost all 5 World Famous Inside Secrets!

- 1 Inside Secrets of "Commando Self Defense Tactics". How to defend yourself against rough and tumble.
- 2 Inside Secrets of "Strong Men Stunts Made Easy". Easy to learn stunts that will amaze your friends.
- 3 Inside Secrets of "The World's Greatest Knock-out Punch". How to deliver it and defend yourself against it.
- 4 Inside Secrets of "Hand-balancing Made Easy". How to stand and walk on your hands.
- 5 Inside Secrets of "Scientific Weight Lifting". How to lift heavy weights with ease.



5 INSIDE STRENGTH SECRETS and PHOTO BOOK of STRONG MEN FREE!



Jowett Institute of Physical Culture
 230 Fifth Avenue, Dept. 473-B, New York 1, N. Y.
George F. Jowett: Your proposition looks good to me. Send by return mail, prepaid, the courses checked, for which I enclose (). Send 5 Secrets and Photo Book FREE.

- All 5 courses for... \$1. Molding Mighty Legs 25c
- Molding a Mighty Arm 25c Molding a Mighty Grip 25c
- Molding a Mighty Back 25c Molding a Mighty Chest 25c
- Send all 5 C.O.D. (\$1 plus postage.) No orders less than \$1 sent C.O.D.

NAME Age

ADDRESS

Please Print Plainly



It's easy to play Cowboy tunes, Hillbilly, Mountain, Barn dance tunes. Simple, Guaranteed method teaches in few minutes how to play sweet music by ear. Most modern method. Surprise your friends! Be the life of the party and always in demand. Entertain at parties, outings, radio, stage, etc. 60 easy lessons, 100 illustrations, Extra Songs.

SEND NO MONEY. Money Back Guaranteed. Pay postman only \$1.00 plus postage or send \$1.00 and we pay postage. Nothing else to buy. GIVEN: Beautiful Billfold with order.

Great American Sales Co. 55 E. Washington St., Dept. 801, Chicago 2, Ill.

ELECTRIFY your career!

There's big money in Electrical Engineering. Be smart—study it NOW. Noted I.C.S. Courses cover the fundamentals and the out-of-the-ordinary things it's necessary for specialists to know. I.C.S. has had more than 50 years of training men for success. The School of Electricity is a separate and complete school giving specialized training—yet enjoying benefits and resources which only a vast institution like I.C.S. affords. And you benefit by the teachings of experts connected with the largest concerns in the field. Send for FREE informative booklet telling what I.C.S. can do for you.

International Correspondence Schools, Box 5532-K, Scranton 9, Pa.

CODE SPEED SHORT CUT

Be an expert. Learn to be a Telegraph or Radio Operator. Thousands of men needed. Intensely interesting work—good pay. Learn at home or wherever you are, quickly, easily with the famous Candler Speed System. Book of particulars Free.

CANDLER SYSTEM CO., Dept. 5-C, Box 928, Denver 1, Colo. U.S.A.

BE INDEPENDENT

BIG DEMAND for plastic articles moulded at home without equipment from cheap ingredients. For our complete plan and instructions send one dollar today. Nothing more to pay.

PLASTICS—Box 4 Postal Station D, Toronto 9, Canada.

JIU-JITSU

If over 15 years old, get together with friends for Jiu-Jitsu club. Learn how to defend yourself, keep healthy and have fun. Send 10c for sample lesson.

MODERN SCHOOL JIU-JITSU, Dept. WW, 5 W. 52nd St., N.Y.C. 19

INDIANA TECHNICAL COLLEGE

Engineering B.S. degree in 27 months. Aeronautical, Chemical, Civil Electrical, Mechanical and Radio Engineering. 1-yr. Radio, Drafting, Govt. approved under G. I. Bill. Prep courses, no added cost. Large industrial center. Earn living expenses. Graduates successful. Enter March, June, Sept., Dec. Catalog. 535 E. Washington Blvd., Fort Wayne 2, Ind.



COMMERCIAL ART DESIGNING ALL IN ONE COMPLETE COURSE CARTOONING

Many of our most successful graduates never studied Art before enrolling with W.S.A. since 1914 our proven, practical method has been training men and women for successful Art Careers. **2 ART OUTFITS** with course. **FREE book—"Art for Pleasure and Profit"** tells all about our step by step training, what graduates say and commercial opportunities for fun in Art.

FREE BOOK gives details!

Washington School of Art, Studio 123P
 1115—15th St., N.W., Washington 5, D. C.

Send me your free booklet and full particulars.

Name..... Age.....
 Address.....
 City..... State.....

IMAGINE THEIR JOY

WHEN THEY FOUND THEY COULD PLAY

This easy as A.B.C. way!



LEARNED QUICKLY AT HOME

"I didn't dream I could actually learn to play without a teacher. Now, when I play for people they hardly believe that I learned to play so well in so short a time."
*L. G. S., Calif.



WOULDN'T TAKE \$1000 FOR COURSE

"The lessons are so simple that anyone can understand them. I have learned to play by note in a little more than a month. I wouldn't take a thousand dollars for my course."
*S. E. A., Kansas City, Mo.



PLAYS AT DANCES

"I have completed your course and your lessons have been most satisfactory. I can play all of the popular songs. I have also earned money playing at dances."
*E.N.J., New York.

PLAYS ON RADIO

"As a proud student I can't keep from telling you that as a result of my course I have a good position playing from KTHS, Hot Springs, Ark., every morning."
*J. S., Okla.



"YOU CAN'T BEAT IT!"

"I am glad to tell anyone about the U. S. School. It is just what they say it is and they will do what they say they will. If you want to learn music you can't beat it."
*W. E. D., N. Mex.

Thousands Have Learned to Play for Less Than 7c a Day

WHAT instrument would you like to play? We'll show you how you can learn to play it—quickly, easily, in spare time at home for less than SEVEN CENTS A DAY! Never mind if you don't know one note of music from another—don't worry about "special talent."

The truth of the matter is that thousands now play who never thought they could! Yes, men and women everywhere are enjoying the thrilling satisfaction of playing the piano, violin, guitar, saxophone or other favorite instrument. Some of them are playing in orchestras and over the radio; others are teaching music, making money in spare or full time. And thousands

are playing for their own enjoyment and the entertainment of their friends.

It all came about when they wrote to the U. S. School of Music for the Free Booklet that shows you how EASY it is to learn music at home this modern way. No tedious scales, no tiresome exercises. You learn to play by playing—start right in almost at once with the melody of a simple tune! It takes only a few minutes a day and the cost is trifling; you save the expense of a private teacher. Does it sound too good to be true? Mail the coupon and get the FREE PROOF! (Our forty-seventh year—Est. 1898.) U. S. School of Music, 73 Brunswick Bldg., New York 10, N. Y.

NOTICE

Please do not confuse the U. S. School of Music method with any system of teaching music "by ear" or by trick charts. Our method teaches you to play by actual notes. . . . not by any "trick" or number system. You are able to pick up any piece of regular sheet music and play by note. And once you've learned to play by note it's just like learning your A-B-C's. It never leaves you—you remember it for life.

SEND FOR FREE → PRINT AND PICTURE SAMPLE

• You'll open your eyes when you find how quickly and easily you can learn to play your favorite instrument. Don't doubt; don't hesitate. Send for the fascinating illustrated booklet that answers all your questions; let the free Print and Picture Sample show you how this method actually works. If interested, mail the coupon NOW.

*Actual pupils' names on request.
Pictures by professional models.

SUCCESSFUL 47TH YEAR

U. S. SCHOOL OF MUSIC

73 Brunswick Bldg., New York 10, N. Y.

I am interested in music study, particularly in the instrument checked below. Please send me your free illustrated booklet, "How to Learn Music at Home."

<input type="checkbox"/> Piano	<input type="checkbox"/> Saxophone	<input type="checkbox"/> Modern Elementary
<input type="checkbox"/> Guitar	<input type="checkbox"/> Trumpet, Cornet	<input type="checkbox"/> Harmony
<input type="checkbox"/> Hawaiian Guitar	<input type="checkbox"/> Reed Organ	<input type="checkbox"/> Clarinet
<input type="checkbox"/> Violin	<input type="checkbox"/> Tenor Banjo	<input type="checkbox"/> Practical Finger Control
<input type="checkbox"/> Piano Accordion	<input type="checkbox"/> Mandolin	<input type="checkbox"/> Other Instrument

Have you Instrument?

Name
(Please Print)

Address

City State

NOTE: If you are under 16 years parent must sign coupon.
Save 2c—Stick coupon on penny postcard.

Learn REFRIGERATION and AIR-CONDITIONING

ARE YOU HANDY WITH TOOLS?

Exceptional opportunity for men of all ages up to 60. The demand for repair and service mechanics in both REFRIGERATION and AIR-CONDITIONING is acute and will continue after the war. You can easily and quickly—

Learn to Be a Service Mechanic at Home or in Our Shops

Our practical, thorough course is easy to grasp and can be studied at home in your spare hours. No previous experience is needed. A common school education is enough. Learn how to start your own business with \$50.00 worth of tools in garage or basement. Open up your own shop or take a well paid job in this active field.

START YOUR OWN REPAIR SHOP

Write for free booklet today. No obligation whatever.

MAIL COUPON TODAY



Send for FREE BOOKLET!

Mechanics Training School

4701 W. Pico, Dept. P-3, Los Angeles 6, Calif.

Dear Sirs: Please send me, without obligation, your free catalog and full details.

Name _____

Address _____

City _____

State _____

MEN! I'll Finance Your Training for a REAL Post War Future in ELECTRICITY



H. C. Lewis

Get Ready for Steady Pay —12 WEEKS TRAINING

After the war—what? Can you step into good-pay peace-time work or is your experience too "one sided"? 12 weeks in the big COYNE shops in Chicago prepares you for the greatest opportunity field, Electricity.

"LEARN-BY-DOING"

Learn power-house work, motors, house-wiring, air conditioning, illumination, maintenance, etc. Also Industrial Electronics included now at no extra cost. Work on actual equipment— "Learn-by-Doing."

EARN WHILE LEARNING

I'll help you get part time work if you need it, to help out with living expenses while training, and let you pay most of the tuition after graduation. Free lifetime job service.

We have facilities for men with Physical Disabilities—If you have a physical disability of any kind, write me when you send coupon.

FREE BOOK gives full details. Send for it now.

MAIL COUPON TODAY FOR FREE BOOK

H. C. LEWIS, Pres., COYNE ELECTRICAL SCHOOL
300 S. Paulina St., Dept. 35-72, Chicago 12, Ill.

Send me BIG FREE BOOK with all details on Coyne Training, "Pay After Graduation" plan, Lifetime Employment Service, and extra course in Industrial Electronics.

Name _____

Address _____

Zone _____

City _____

State _____

LIQUID MARBLE

Make beautiful artificial Marble slabs. Four from liquid state. Glazed or un-glazed. This Marble may be mottled, veined, multi-colored or left in its original snow-white state. The color is actually a part of the Marble, does not fade or wear away. Liquid Marble is unsurpassed on kitchen or bathroom walls. Easy to make and install. **PLASTIC FLOORING.** May be made in any color or combination of colors. Gives a lifetime of wear. Dustproof, Soundproof. Verminproof. Resilient to the tread. Lay out solid from wall to wall or in pattern design of various shaped blocks. **FLEXIBLE MOLDS** for plaster casting. Make your own molds for few cents each. \$1.00 in raw materials will make up to \$25.00 worth of finished goods. (Send no money.) We furnish names of buyers. Write now for free information, and get in on busy season just starting.

COMPO-TEX, Box 786-S, ST. LOUIS, MO. 1

"The Book They're Talking About"

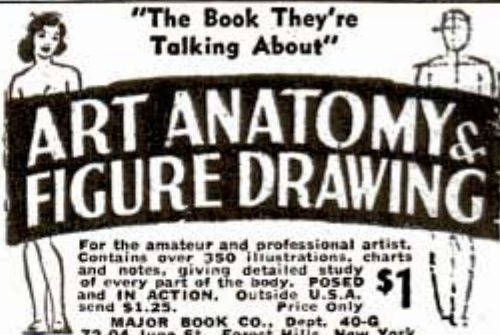

For the amateur and professional artist. Contains over 350 illustrations, charts and notes, giving detailed study of every part of the body. **POSED and IN ACTION.** Outside U.S.A. send \$1.25. Price Only \$1

MAJOR BOOK CO., Dept. 40-G
72-04 Juno St., Forest Hills, New York

INFORMATION

ANY SUBJECT . . . Moderate Rates

THE ROXBYS, 742 S. Hill St., Room 1118, Los Angeles 14

LEARN MACHINIST TRADE TOOL & DIE MAKING

In completely equipped Shops. Also short, special Shop courses for essential War and Post-War Jobs. Learn on actual Shop work. Conducational. Special Counselor for G.I. Training. Write for Free Booklet. Allied School of Mechanical Trades, 1330 S. Michigan, Chicago 5, Ill.

Learn PHOTOGRAPHY at Home

Splendid opportunities. Prepare in spare time. Practical basic training. Long-established school. Send for free book "Opportunities in Photography." No obligation. American School of Photography, 1315 S. Michigan Ave., Dept. 1352, Chicago 5, Ill.

POEMS WANTED

To be set to music. Send your song poem today for free examination by nationally famous hit composer. Our new 6 step plan is most liberal and complete ever offered. Write today for free booklet. SCREENLAND RECORDERS, Dept. PM, Hollywood 28, Calif.

Learn TOOL DESIGN

Qualify quickly as Draftsman or Tool Designer through sparetime home study. Many making \$100 to \$125 a week. Expanding industry calling for more machine and tool designers than available. Good pay jobs waiting. Rush name and kind of job wanted today for full free facts.

OHIO INSTITUTE OF TECHNOLOGY, Box 235, Greenville, Ohio

BOOKS FOUND FREE!

WHAT BOOKS DO YOU WANT?

We quote lowest market prices. No charge for locating Hard-to-Find Books. All books. OLD or NEW mailed POST-FREE. SEARCHLIGHT BOOK CLUB, 22 East 17th St., New York City

JOKE BOOKS For Adults



The kind they like. You will be both a Riot and the Life of the Party with a set of these pocket size joke books. They are full of Entertainment, Fun and Humor. A special assortment of 12 books all different for \$1.00. Print name and address, send cash or stamps to:

TREASURE NOVELTY CO.,
72—5th Ave., Dept. 1203, N. Y. 11, N. Y.

SAVE WASTE PAPER



9 ways to be your own boss!

NOW, more than ever before, is the right time to start a small profitable business of your own... or train yourself for a practical money-making trade in which you can be **INDEPENDENT**. TODAY... take your first step, without cost or any obligation.

Just mail coupon—
and by return mail
you will get full in-
formation on the
courses listed here.

REAL ESTATE

SUCCESS... be a professional man!

Practical training on how to run a profitable real estate business of your own. Illustrated **self-study** lessons on farm and suburban properties, downtown operating. Gain a **working knowledge** of mortgages, listings, sales techniques, appraisals, property management, commercial leasing, contracts, etc. Real estate is the foundation of all wealth! **Rush coupon below** for **NEW** facts you should know about your future in real estate. There's no obligation.

practical REFRIGERATION

Brand New Streamlined Course for quick training. Authoritative step-by-step instruction on servicing household refrigerators... how to install, operate, repair. Easy-to-follow illustrated directions on trouble-shooting, parts replacement, testing. Covers **quick-freeze** units, lockers, water coolers, Freon, air-conditioning systems, etc. **Amazing low price!** Free details, see coupon.

AUTO mechanics

Let this **PRACTICAL, LOW-PRICED** course get you started in the auto repair trade. Good mechanics make big money **NOW**... and have a **great future!** Self-training lessons show you exactly what to do and **how to do it**. It teaches servicing on all makes of cars... adjustments, tune-ups, etc. Clearly written and illustrated by expert engineers. Satisfaction or refund. Mail coupon for **FREE** details.

carpentry—building—estimating

BIG OPPORTUNITIES FOR MEN with the KNOW-HOW! There's a great future in the building trades... for **trained men**. Here are up-to-date lessons on how to plan, build, remodel houses. How-to-do-it instructions on stair building, steel square, roofing, painting and decorating, etc. Send for full information **FREE**... mail coupon below!

what to invent—how to invent

MECHANICAL DRAWING, DESIGNING, BLUEPRINT READING
Practical course for wide-awake practical men. **IDEAS**... how to get them, develop them, protect them and **promote** them! Expert information on how to turn your imagination into money. Plus illustrated self-study lessons on basic mechanical movements and devices. mail coupon below for **FREE** details.

INSURE YOUR FUTURE
Mail This Coupon Today!

On this coupon check the subjects that interest you. Our world-famous copyrighted Success-Catalog will bring complete details. **FREE**... no cost, no obligation.

NELSON COMPANY
321 S. Wabash Ave., Dept. 8C02, Chicago 4, Ill.

watch and clock repairing



Learn at Home—In Your Spare Time
Prepare for a happy future of prosperity, security... and get a big-pay job now. Fascinating, high-grade occupation. You can **EARN WHILE YOU LEARN**. Excellent field for part-time work at home.

Practical Course in HOROLOGY

Thorough self-instruction training in American and Swiss watches, clocks. Special sections on alarm clock repairs. Interesting. **LEARN-BY-DOING** instruction method. **Learn QUICKLY, easily**. No previous experience necessary. **WATCHMAKING IS BASIC TRAINING FOR AIRCRAFT INSTRUMENT WORK** and other scientific precision jobs.

Amazing Low Price! • **Money-Back Guarantee!** Get into this fast-growing field **NOW**... big opportunity... don't delay. Mail coupon below for **FREE** information. No obligation.

locksmithing and key making

PRACTICAL UP-TO-DATE COURSE

How to pick locks, de-code, make master-keys, repair, install service, etc. New, self-instruction lessons for every handy man, home-owner, carpenter, mechanic, service station operator, fix-it shop, hardware dealer, gunsmith.

53 Easy Illustrated Lessons
Low Price! Satisfaction guaranteed or money back. Write now... no obligation!

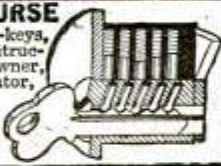

practical RADIO servicing

SELF-INSTRUCTION COURSE
Teaches you the **practical** side of radio... repair, adjustment, operation, alteration, trouble-shooting. No previous knowledge necessary. Large clear illustrations, diagrams, charts, etc. • **INTERESTING STEADY WORK!** Set up a radio repair shop of your own—or prepare for booming industrial electronics. This useful, how-to-do-it course brings you all the fundamentals, including mathematics, review questions, problems, answers. Strictly up-to-date. **Low price**. Coupon below will bring you full information you want immediately. Mail it in today!



MAIL ORDER BUSINESS

Your Big Opportunity!

34-lesson course on proved, tested, up-to-date, profitable methods. Amazing treasure-house of the best mail order plans and practices. How to start your mail order business on a small one-man scale... how to keep it growing more and more profitable month after month. Money-making **FACTS**. Sensational details... **FREE**. Mail coupon below!



FREE! 100-page book... mail this now!

NELSON COMPANY, DEPT. 8C02, 321 S. WABASH AVE., CHICAGO 4, ILL.
Please send me—**Free** and without obligation—illustrated Success-Catalog containing information about the subject (or subjects) I've checked below. No salesman will call.

- | | | |
|---|--|--|
| <input type="checkbox"/> Watch and Clock Repairing. | <input type="checkbox"/> Locksmithing. | <input type="checkbox"/> Refrigeration. |
| <input type="checkbox"/> Practical Radio Servicing. | <input type="checkbox"/> Real Estate. | <input type="checkbox"/> Auto Mechanics. |
| <input type="checkbox"/> Mail Order Business. | <input type="checkbox"/> Carpentry. | <input type="checkbox"/> Inventions. |

NAME _____
ADDRESS _____
CITY _____ ZONE _____ STATE _____

AN INFANT INDUSTRY ... SUDDENLY MATURED PLASTICS

Get In at the Start—and Grow

Plastics is a new industry which the nation's war needs is forcing to quick maturity. Already Plastics are indispensable in practically every branch of the Service—Aircraft, Ordnance, Chemical, Marine, Signal Corps, etc. Opportunities? Nearly everything, from homes to clothing, from gadgets to tools, will be affected by Plastics.

Spare Time Training Now Ready

The time to get started is now. You can prepare at home, in your spare time, to take your place in an infant industry that even now is leaping into prominence. A new, practical training plan is now ready to help you realize your ambitions and build your future security. Act now. Don't delay. Mail this coupon today.

AMERICAN SCHOOL, Dept. P345
Drexel Ave. at 58th St., Chicago 37, Ill.

Send me FREE information covering special training in subjects checked below. No obligation on my part.

- | | |
|--|---|
| <input type="checkbox"/> Plastics | <input type="checkbox"/> Cost Accounting for Mfg. |
| <input type="checkbox"/> Electrical Engineering | <input type="checkbox"/> Automotive Engineering |
| <input type="checkbox"/> Drafting and Design for Men and Women | <input type="checkbox"/> Architecture & Building |
| <input type="checkbox"/> Diesel Engineering | <input type="checkbox"/> Shipbuilding |
| <input type="checkbox"/> Mechanical Engineering | <input type="checkbox"/> Business Management |
| <input type="checkbox"/> Aviation | <input type="checkbox"/> High School Course |
| <input type="checkbox"/> Radio | <input type="checkbox"/> Railway Training |

Name.....

Address.....

SAVE WASTE PAPER

Make Your Own Post War Plans NOW!

Get Started QUICK in

DRAFTING

I Will Train You Until You Get a GOOD PAY JOB! — *Engineer Dobe*

Plan now for a better job and more pay as America changes over to peace-time production. Drafting is the field—now bigger than ever before. And countless thousands of draftsmen and designers must come first—before new production can begin. Get into Drafting. Engineer Dobe will train you at home in your spare time. You'll get experience on actual work—the same kind of jobs you will do for the best paying firms. You will be trained until you are competent, experienced, and are actually holding a position that will bring advancement and pay raises as deserved. Write today for details.

WORKING TOOLS FURNISHED

Professional instruments, drawing table and other tools included and sent when you start.

Previous Experience Not Needed

I train you through practical jobs and give your experience as a reference to employers when you become competent. Lack of previous experience or higher education should not hold you back. Low cost—and monthly payments if desired. Write today for illustrated book and all details. No salesman will call. Give your age to get reply.



Engineer Dobe, Div. 13, Libertyville, Ill.

Send me the Vital Facts on Drafting and Industrial Designing, your FREE BOOK and advertised list of positions for Draftsmen and Designers wanted.

Name..... Age.....

Address.....

City..... State.....

66A

"It is the BEST Handy-Sized Dictionary!"

ACTUAL use proves that WEBSTER'S COLLEGIATE defines all the most commonly used words—is the BEST, 1,300 pages; 110,000 entries; 1,800 pictures; abridged from "the Supreme Authority"—WEBSTER'S NEW INTERNATIONAL DICTIONARY, Second Edition. \$4.00 to \$8.75, depending on bindings. G. & C. Merriam Co., Springfield 2, Mass.



YOU MAY HAVE TO WAIT for your copy of Webster's Collegiate. Paper rationing, plus heavy government needs, plus unprecedented public demand, make it impossible to supply everyone promptly. Your bookseller will do his best to provide your copy with the least delay. Also ask to see:
WEBSTER'S DICTIONARY OF SYNONYMS . . . \$4.00
WEBSTER'S BIOGRAPHICAL DICTIONARY . . . \$6.50

A SIMPLIFIED ART ANATOMY OF THE HUMAN FIGURE
ONLY \$1 POSTPAID
by Charles Carlson. The book they're talking about! One of the most informative books of its kind for both student and professional artists. Charts, notes, and over 350 drawings show detailed studies of every part of the body, posed and in action.
HOUSE OF LITTLE BOOKS, 156-160 Fifth Ave., New York



LANGUAGE IS POWER

... Forge ahead, win special assignments, promotion, better job in global peace time opportunities through ability to speak a foreign language.

MASTER A NEW LANGUAGE quickly, easily, correctly by

LINGUAPHONE

The world-famous Linguaphone Conversational Method brings voices of native teachers INTO YOUR OWN HOME. You learn the new language by LISTENING. It's amazingly simple; thousands have succeeded.

HOME-STUDY COURSES IN 29 LANGUAGES
Send for FREE book—

LINGUAPHONE INSTITUTE

98 RCA Building, New York 20, N.Y. • Circle 7-0830

LINGUAPHONE INSTITUTE,
98 RCA Bldg., New York 20, N.Y.

Send me the FREE Linguaphone Book.

Name.....

Address..... City.....

Language Interested.....

POPULAR MECHANICS

TERRIFIC BARGAINS IN WAR SURPLUS LENSES AND PRISMS

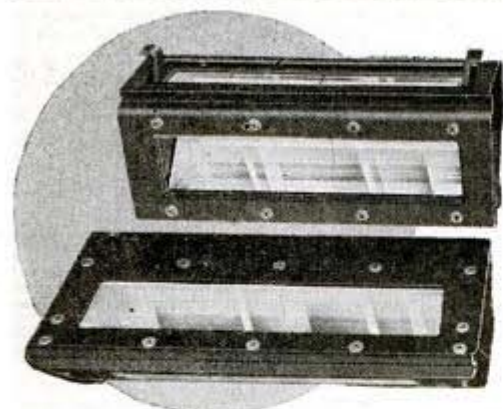

TANK PERISCOPE Complete Set Mounted Components

Rugged, strong, originally constructed for U. S. Tank Corps. Consists of 2 fine Periscope Mirrors mounted in metal and plastic. Only plywood body frame is required to finish this exceptional Periscope. First surface mirror is well protected by glass windows. Set weighs 2 3/4 lbs. Overall length of mount 6 1/2", width 2 1/4". Would normally retail at \$40 to \$50.

Stock No. 700-H.....\$3.00 Complete Set Postpaid

MFG. FOR NAVY'S 7 POWER BINOCULARS

KELLNER EYE-PIECE LENSES . . . you can use in Telescopes, Binoculars, Microscopes, etc. Consist of achromatic eye-lens and a field lens. Focal length 27.5 mms. Comes un cemented with FREE cement and easy directions.

Stock No. 6061-H—Edged.....\$1.25 Postpaid

COMPLETE SET OF LENSES AS ABOVE AND THE PRISMS TO MAKE A MONOCULAR (TELESCOPE) with objective lens of two inch diameter.

Stock No. 5100-H—Monocular Set.....\$5.00 Postpaid

8 MM MOVIE PROJECTING LENS SET—Stock No. 4011-H . . . \$1.20 Postpaid. Consists of 2 Achromatic Lenses, diameter 18 mms. and a focal length when combined of one inch.

35 MM FILM ENLARGING LENS SET—Stock No. 6057-H . . . \$1.50 Postpaid. Consists of 2 Achromatic Lenses to use at a speed of about F.8. These make a good substitute until Anastigmat Enlarging Lenses again become available.

GIANT SIZE ROOF (AMICI) PRISMS 1 1/2 inches wide, 2 3/4 inches long. Weight 3 1/2 ounces. Very limited quantity.

Stock No. 8012-H.....\$7.50 each Postpaid

REDUCING LENS SET—Stock No. 1004-H.....\$1.20 Postpaid. Two big Lenses, 1 3/4" and 2" in diameter. Will make objects look smaller than they actually are.

All Items Finely Ground and Polished but Edges Slightly Chipped or Other Slight Imperfections which We Guarantee Will Not Interfere with Their Use. Come Neatly Packed and Marked.

YOU CAN EASILY MAKE

Telescopes, Magnifiers, Photographic Gadgets and Hundreds of Experiments with these Low Cost Lenses.

To translate millimeter measurements; 25.4 mm. equals one inch.

SPECIALS IN LENS SETS

Big 10 Page Project and Idea Booklet with all sets—describes successful developments—points the way to new experiments.

Set No. 301-H "Our Advertising Special" 15 Lenses for \$1.60 Postpaid. For making your own powerful telescopes, low power microscope, strong magnifiers, drawing projector, photo cells, telephoto lens, dummy focusing camera, Kodachrome viewer, stereoscopic viewer, ground glass and enlarging focusing aids. For experimental optics, portraits of babies and small pets, copying, ultra close-up shots, and many, many other uses.

Set No. 305-H "The Gadgeteer's Delight" 35 Lenses for \$5.00 Postpaid. Contains all the lenses in the above set plus twenty more expensive lenses increasing your field of experiment and gadget making. All our lenses are neatly packed and marked.

Set No. 310-H "The Experimenter's Dream" 60 Lenses and New Complete 50 Page Booklet—\$10.00 Postpaid. Contains all the lenses in the above set plus 25 others that makes this a sensational buy. The variety of lenses in this set will enable you to conduct countless experiments and build a wide variety of optical equipment.

New 50-Page Illustrated Idea Book . . . \$1.00 Postpaid. "Fun with Chipped Edge Lenses" describes a wide variety of uses for our lenses and contains much information especially designed for the homemade construction of optical items.

Scoop! CONDENSING LENS SET for 35 mm. Projectors or Enlargers. Crown optical glass, aplanatic, diameter 52 mm. F.L. 88 mm. Set comprises 2 lenses.

Stock No. 4019-H.....\$2.00 Postpaid

PORRO ABBE PRISMS—Stock No. 3006-H.....25c ea. Postpaid Size 9 mm. x 17 mm. Worth 20 to 40 times above quotation.

PERFECT MOUNTED ACHROMATIC LENSES WITH THREADED MOUNT. Stock No. 6090-H.....\$2.00 Postpaid Lens has diameter of 1 3/4 inches; focal length 5 1/2 inches. Excellent Telescope objective or combine two of these to make a 3 inch focal length projecting lens for a 35 mm. Slide Projector.

TANK PRISMS

90-45-45 degree prisms of huge size—5 3/4" long, 2 1/4" wide, finely ground and polished. Used to build a Periscope . . . excellent also for experiments, classroom demonstrations at high schools, colleges, camera clubs, astronomy clubs. Some of our ingenious customers have used these Prisms to make camera stereo attachments, photometer cube, range finder, etc. Normally, these Prisms would retail from about \$24 to \$30 each.

Stock No. 3004-H—SILVERED TANK PRISM.....Price \$2.00 each Postpaid. Illustrated Booklet on Prisms included FREE.

Stock No. 3005-H—PLAIN TANK PRISM.....Price \$2.00 each Postpaid. This one is excellent for projecting all the colors of the spectrum. Illustrated Booklet on Prisms included FREE.

FOUR TANK PRISMS—Special—\$7.00 Postpaid. This is the most sensational bargain we have ever been able to offer.

Order by Set or Stock No.—Satisfaction Guaranteed

EDMUND SALVAGE COMPANY

27 W. CLINTON AVE., DEPT. 11, P. O. AUDUBON, NEW JERSEY

KEY TO A PRACTICAL UNDERSTANDING OF ELECTRICITY

\$1 PER MO.

• AUDELS HANDY BOOK OF ELECTRICITY

\$4 HANDY SIZE

For Engineers, Electricians, Students and all interested in Electricity. A quick, simplified, ready reference, giving complete instruction and practical information. Easy to understand. A reliable authority and a handy helper that answers your questions.

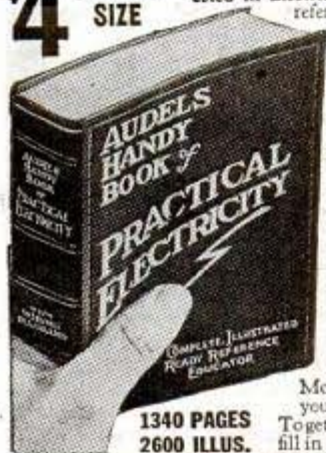

• INSIDE TRADE INFORMATION ON

The Rules and Laws of Electricity—Maintenance of Machinery—A. C. and D. C. Motors—Armature Winding and Repair—Wiring Diagrams—House Lighting—Power Wiring—Cable Splicing—Meters—Batteries—Transformers—Elevators—Electric Cranes—Railways—Bells—Sign Flashers—Telephone—Ignition—Radio Principles—Refrigeration—Air Conditioning—Oil Burners—Air Compressors—Welding, and many Modern Applications explained so you can understand.

1340 PAGES To get this assistance for yourself, simply
2600 ILLUS. fill in and mail the FREE COUPON below.

THEO. AUDEL & CO., 49 West 23rd Street, New York
Please send me "Audels Handy Book of Practical Electricity" for free examination. If satisfactory, I will send you \$1 in 7 days, then \$1 monthly until \$4 is paid. Otherwise I will return it.



READ FOR PROFIT!

Name _____
Address _____
Occupation _____
Reference _____ PM

Learn this Profitable Profession

IN 90 DAYS AT HOME

Money-Making Career Open to Men and Women, 18 to 50

Hundreds of men and women between 18 and 50 make \$10 to \$20 in a single day giving scientific Swedish Massage and Hydro-Therapy treatments. There is big demand from doctors, hospitals, sanatoriums and clubs. Graduates earn large full time incomes from these or in private practice in their own offices. Others make good money from home treatments given in spare time. Learn this interesting, money-making profession in your own home, through our home study course. Same instructors as in our nationally known resident school. You can win independence and prepare for future security by qualifying for your Diploma. Course can be completed in 3 to 4 months. Many earn while they learn. Begin your training at once.

Anatomy Charts & Booklet FREE
Enroll now and we will include, at no extra cost, many needed supplies. Fit yourself to help meet growing demand for massage now and after the war. Send the coupon at once for complete details, Anatomy Charts and 32-Page Illustrated Booklet, FREE, postpaid.



THE COLLEGE OF SWEDISH MASSAGE
Dept. 564C, 100 East Ohio St., Chicago 11, Illinois

Please send me FREE and postpaid, Anatomy Charts, 32-page Booklet and complete details on Home Training.

Name _____
Address _____
City _____ State _____

★ TRAIN for SUCCESS in the Poultry Business



Study at home in spare time. Earn extra while learning.

You Can Make More Money from POULTRY

All signs point to big opportunities ahead for progressive poultry leaders—especially in the post-war period.

Get ready NOW! Proper management means profits ANY season, for life. Our easy, scientific course is NOT expensive. Its small cost should come back to you many times over! Even the first year, your extra profits should be far greater.

Learn at home, the EASY, SCIENTIFIC, and INEXPENSIVE way. Our course covers ALL phases of Poultry raising, including plans for buildings, breeding, hatching, culling, sexing, caponizing, marketing, judging, exhibiting, and many others, etc., as planned by Harry M. Lamon, former Senior Poultryman for the United States Department of Agriculture.

In the past twenty-two years, we have helped thousands of students to establish poultry farms, to increase profits on established plants, to secure positions in the many branches of the Poultry business, and many just to enjoy a small, profitable, breeding plant.

Write TODAY for catalog "How to Raise Poultry for Profit." It fully explains courses and easy payment plan.

NATIONAL POULTRY INSTITUTE

Dept. 50-V, Adams Center, New York

LOOK! Baby Chicks

THOUSANDS WEEKLY ALL YEAR. Finest quality & Layers in 40 breeds. Hybrid Baby Pullets and Cockerels, B. W. D. Tested, Ducklings, Goslings, Baby Turkeys. Mature breeders in 65 breeds. Catalog free. ORDER NOW. Make BIG money raising NABOB QUALITY CHICKS.
NABOB HATCHERIES, BOX M, GAMBIER, OHIO

FIX YOUR RADIO

Learn quickly to repair all radio sets. New, different Comparison method permits you to do expert work almost immediately. No previous radio knowledge needed. Introductory training included. Simple, picture suggestions tell you where to look for faults and how to make the repair. No testers needed for most jobs. Manual \$12x11 in., 72 job-sheets, 16 blueprints. Many hints. 10-day trial. New, 1945 edition. Only \$1.50, postpaid. Money back guaranteed.
SUPREME PUBLICATIONS 9 S. Kedzie Ave. CHICAGO 12, ILL.

A PROFITABLE BUSINESS—PROFESSION You Can Start Anywhere

For an extremely profitable lifetime business, operate a Collection Agency-Credit Bureau. Quickly learned. No capital necessary. Free folder. Write: George H. Cole, Pres., Dept. M, S. A. & K. Bldg., Syracuse, N. Y.

START YOUR OWN SHOP

VETERANS: ASK about G.I. training . . . Men wanted now and after the war for Auto-Diesel, Machinist, Drafting, Refrigeration, Welding, Body & Fender, Aircraft. Earn real money or be independent in your own business. 41,000 graduates. Free booklet. Specify trade.
GREER SHOP TRAINING, Dept. 235, 2017 S. Wabash Ave., Chicago

Learn Public Speaking

At home—in spare time. Many overcome "stage-fright," gain self-confidence and increase earning power, this easy way. Write for free booklet, *How to Work Wonders With Words* and requirements.
North American School, Dept. 1353 1315 Michigan Ave., Chicago 5, Ill.

Learn to Write

Begin today. Write now for our Free Book, "How to Escape a Good Penman." It contains specimens and tells how others learned to write in spare time. Enclose 10c for your name beautifully written and a pen point suitable for slanted writing. Write today.
THE TABLBYN SCHOOL OF PENMANSHIP N441 Ridge Building, Kansas City, Mo.

Prepare for a **BRILLIANT PEACE-TIME CAREER**

Learn AIRCRAFT DESIGNING and ENGINEERING

**Sensational Peace Time Developments
of New Planes Mean
New and Greater Opportunities**

RYAN'S New Home Study Course Trains You In Spare Time

New planes require new plans—plans that you may help perfect. The thousands of new airliners, cargo planes and private planes can't be manufactured until designs and plans are prepared. There'll be a huge need for trained designers and draftsmen to turn out the tons of blue-prints required. You owe it to yourself to see that the study course on which you spend your time is the finest—most practical. So read this advertisement thoroughly—use this coupon—NOW! It may be your passport to a successful career in aviation. Send it Air Mail!

Your Place In The "Age Of Flight"

It is agreed by experts that the aircraft industry will be one of the largest and fastest growing of all future industries. Prepare now for one of these exciting, well-paying positions through home study—THE RYAN WAY. Previous training is unnecessary. You learn at home in your spare time, under individualized supervision. Lessons are so easy and interesting that many earn the coveted Ryan diploma far ahead of schedule.



Free!
Interesting
24-page Illustrated
Book, Full Information
and Costs

Get Training Direct From Industry

R.A.I. training is based on both scientific theory and practical experience. For R.A.I. is affiliated with the famous Ryan School of Aeronautics, where thousands of American pilots have been trained, and with the Ryan Aeronautical Company, pioneer manufacturer of famous planes. Included with your training you get complete Aeronautical Drafting equipment at NO EXTRA COST.

RYAN AERONAUTICAL INSTITUTE (Home Study Affiliate of Ryan School of Aeronautics)
423 Lindbergh Field, San Diego 1, California

Gentlemen: Please send me, without obligation on my part, your FREE 24-page illustrated book, "New Horizons of Opportunity," and full information on R.A.I., including cost of training, and job opportunities.

Name _____ Age _____
Street _____
City _____ State _____



AUTO

BOOKS SENT FREE

ON APPROVAL. Just mail the coupon and we'll send you a complete set of Six Big Auto Books. 20th Edition. Whether you are a mechanic or helper, expert or apprentice, auto owner or driver, take immediate advantage of this FREE EXAMINATION OFFER.

MAKE GOOD MONEY NOW HOLD A PERMANENT JOB

America's autos must be kept in service, now and after the war. Men with "know how" are in demand, at big pay. These books will help you get and hold an important job, or give you a chance to go into business for yourself now or later. Any man who half tries to improve himself can learn auto servicing and repairing by this quick reference method. Use the JIFFY INDEX to find easily understood answer to any auto problem. These wonder books prepared by eleven of America's great automobile engineers. Many hundreds of valuable illustrations. Send the coupon TODAY.

A year's consulting privileges with our engineers now given with these books without extra charge.

Vocational Publishers Since 1898

CAN YOU FIX IT?

These wonder books tell step by step HOW to make difficult repairs and adjustments, how to keep a car at maximum efficiency, including latest improvements in car design and operation. Engine troubles and how to correct them well covered.

6 BIG VOLUMES
2800 pages, 2000 illustrations, wiring diagrams, etc., including Diesel engines. Beautiful modernistic, washable cloth binding.

AMERICAN TECHNICAL SOCIETY, Dept. A319
Drexel Ave. at 58th St., Chicago 37, Ill.

I would like to examine your Six-Volume Set of Auto Books. I will pay the delivery charges only, but if I choose I may return them express collect. If after 10 days' use I prefer to keep them, I will send you \$2 and pay the balance at the rate of only \$3 a month until \$24.80 has been paid. Please include consulting service as offered above.

Name _____
Address _____
City _____ State _____
Please attach letter stating age, occupation and address of employer and of at least one business man as reference. Men in service, also please give home address.

IN SPARE TIME LEARN MUSIC for Pleasure or Profit

...START NOW

● Enjoyment and earnings are rich rewards from musical training, but there is no magical door to success. If you are ambitious to learn and will devote spare time to serious effort, our 40 years of successful instruction experience can lead you to your goal. You can go as fast as your time and talents permit. Ours is the *only* home study school offering all courses required for Bachelor of Music degree. Check courses in which interested and mail coupon NOW for FREE SAMPLE ILLUSTRATED LESSON AND BOOKLET.

UNIVERSITY EXTENSION CONSERVATORY
1525 E. 53rd St., Suite U153, Chicago 15, Ill.

- Piano Violin Cornet Trumpet Saxophone Clarinet
- Guitar Mandolin Voice Ear Training and Sight Singing
- Choral Conducting Public School Music History of Music
- Harmony Advanced Composition Arranging

Name _____
Street _____
City & State _____
Music experience _____ Age _____

Do YOU Want the STRENGTH, POWER and DEVELOPMENT of a CHAMP?

... then let **JOE BONOMO**

Master Builder of Men, show YOU how to build YOUR BODY into MEAT and MUSCLE; and your MUSCLES into SPRINGS of STRENGTH and STEEL.



All my life I've been building big muscles and powerful bodies out of scrawny little ones. I've done it for thousands with my 'Power-Plus' Method, the most original System of Physical Development ever devised; the system that "Proves It With Results"! I'm so sure I can do it for you that I offer my **MONEY-BACK GUARANTEE!** Let me give you the build, strength, energy, vitality you want.

Send NOW for this Amazing, Complete 3 WEEKS "POWER-PLUS" SPEED COURSE
in muscular development for
ARMS, SHOULDERS, CHEST, BACK, LEGS



JACK DEMPSEY says: "I consider your course tops for all round physical development".

Covers every part of your body inside and out. Gives you strength, build, speed and endurance. 18 daily work-out charts, 91 separate Photo-Instructor illustrations, 22 sheets of instructions showing how to do the proven 'Power-Plus' Muscle Builders. 3 illustrated Body Fact Lectures and more. Packed with facts about your body, including diagrams of muscles, nerves, organs. \$5.00 value, but it's yours now, complete for only 97c and a 3c stamp (or send \$1.00 cash, money-order or check), or I'll send complete course COD. Pay postman 97c plus postal charges. **ACT FAST!** Clip and mail coupon to me TODAY!



BERNARR MACFADDEN says: "Your astonishing achievement places you at the head of all your competitors."

FREE For Quick Action! Strong men ACT, but as an inducement to urge you to act fast, if you send coupon at once, I'll send you my famous P. D. Q. Test Dozen. Find out how strong you really are! **RUSH COUPON TODAY.**

JOE BONOMO, Dept. 505-A
1841 Broadway, New York 23, N. Y.

MAIL COUPON NOW! ^{\$5.00} **97c** value only and a 3c stamp

Joe Bonomo, personal
Bonomo Culture Institute,
1841 Broadway
New York 23, N. Y. 505-A

Dear Joe: That's what I want—fast action! Rush me quick, my complete 3 weeks 'Power-Plus' SPEED COURSE. Include FREE your famous P. D. Q. Test Dozen.

I enclose \$1.00 cash. money-order
 Send COD, I will pay postman 97c plus postal charges.

Name..... Age.....
Street.....
City..... Zone..... State.....
(Please print plainly)

Say you saw it in Popular Mechanics!

Do You Make Mistakes in English?

EVERY time you speak or write you show just what you are. Mistakes in English reveal you as a person who lacks education and refinement. Lack of language power prevents you from presenting your thoughts in the strongest possible way. No matter what you do, real command of English will help you to your goal. Stop making mistakes in spelling, punctuation, pronunciation. Increase your vocabulary.



WONDERFUL INVENTION

Only 15 minutes a day with Sherwin Cody's new invention—and you can actually SEE your English improve. It teaches by HAIT—makes it easier to do the RIGHT way. Wonderful self-correcting lessons include spelling, punctuation, grammar and expression.

FREE BOOK ON ENGLISH Lack of language power may easily be costing you thousands of dollars every year. See what Mr. Cody can do for you; it costs nothing to find out. Mail a postal card or letter this very minute for free book, "How You Can Master Good English in 15 Minutes a Day." It will prove a revelation to you. **WRITE NOW.** Address:

Sherwin Cody School of English, 53 Searle Bldg., Rochester 4, N. Y.

MAKE MONEY CASTING AT HOME

.. FREE FACTS SENT ..



Make hundreds of Plastic Casts, quick, easy. Sell output to stores, novelty shops, etc. Enormous profits. No experience. Very little capital needed. Start in basement, garage or workshop. Complete, simple instructions anyone can follow. Start now while merchants are begging for merchandise to sell. Rush.

PLASTIC ARTS STUDIOS, R.R. 4, Dept. 23, Muncie, Ind.

Open Your Own Electric Appliance Repair Shop

Be your own boss! Thousands of electric appliances need service and repairs constantly. Every neighborhood a fertile field. Our complete illustrated course trains you at home in appliance repair, house wiring, motor repairs, etc. Send for **FREE BOOKLET.**

PACIFIC TRAINING SCHOOL

4701 West Pico Dept. AP-3 Los Angeles 6, Calif.

Listen to this Record!



SPEAK SPANISH

FRENCH, GERMAN, OR ITALIAN

Big opportunities awaiting Americans who speak Spanish. Learn as a child learns—"by listening" to these brand-new **CORTINA** recordings.

Only 15 Minutes a Day

Cortinaphone Method famous for 60 years. THOUSANDS have found it the most fascinating, most satisfactory method. Here is the quick, easy way to learn Spanish for **PLEASURE AND BUSINESS. INVESTIGATE!**

Sent on 5 Days Approval



"The Cortinaphone Short-Cut"—tells just what you want to know. Interesting. Get it!

Write Today—NOW!

CORTINA Academy (Language Specialists for 60 Yrs.)
Suite 643, 105 W. 40th St., New York 18, N. Y.

Please send me—without obligation—your free booklet. I am interested in (mark):

SPANISH French Italian German

Name.....
Address.....

KEEP YOUR EYE ON THE JOB AHEAD!

SUPERINTENDENT



If others are getting promotions and you are not, don't discount your ability. There is an easily applied remedy that will bring you to the attention of the top men in your plant.

How to acquire this ability is the subject of a 48 page booklet that is yours for the asking.

It tells how natural ability can be combined with a knowledge of shop practice plus training in the art of handling people. These talents win key positions in industry.

Write to Louis S. Vosburgh

LINCOLN EXTENSION INSTITUTE, INC.
1401 B West 75th St. Cleveland 2, Ohio

The CARE and USE of HAND TOOLS

by R. B. Tolliver

A primer on the care of hand tools for the unskilled beginner. Simple language. Clear illustrations. Precise instructions. Easily understood by those without technical training. Only basic tools are discussed and explained, with emphasis on their safe and efficient use. Thoroughly practical and self-teaching.



\$1.25 at all bookellers or direct from
JOHN WILEY & SONS, Inc.
440 Fourth Ave., New York 16, N. Y.

RADIO

ENGINEERING. Broadcasting, Servicing, Electronics, Aviation, Marine & Police Radio taught thoroughly. 48 weeks' Engineering course equivalent to 3 years' college radio work. All expenses low. Co-educational. Catalog free.

VALPARAISO TECHNICAL INSTITUTE, Dept. D, Valparaiso, Ind.

Be Popular—Learn the **Newest DANCES** in 5 DAYS—or NO COST!



NEW REVISED EDITION of DANCING

Includes the Rhumba, Congo, Samba, Jitterbug . . . Fox Trot, Waltz and Tap Dancing.

All the newest Swing steps—the Rhumba, Congo, Samba, Jitterbug, as well as the Fox Trot, Waltz and basic tap steps—explained with simple, graphic diagrams. **GET MORE FUN OUT OF LIFE!** Swing your way to popularity! Start now and fill your future with Romance! **MAKE THIS FREE TEST!** The new REVISED edition of Betty Lee's book, Dancing, helps you learn correctly and quickly. Be convinced—if not satisfied with results, you will get your money back! And remember, we include two other books—"Tip Top Tapping" and "Swing Steps"—FREE of extra charge. **SEND NO MONEY!** Pay the postman \$1.98 plus a few cents postage. Follow instructions in ALL THREE BOOKS—practice simple dance steps each day and in 5 days if you haven't learned to dance, we will refund your money!



PIONEER PUBLICATIONS, INC.
1790 Broadway, Dept. 943H
New York 19, N. Y.
Send me "Dancing," by Betty Lee, and include 2 free books.
 Ship C.O.D. I will pay on arrival, plus postage.
 I enclose \$1.98. Ship postage prepaid. If in 5 days I do not learn to dance, I may return book and you will refund purchase price.
Name
Address
City State



THE AERO TECH CAMPUS

... covers many acres and thousands of square feet of modern laboratories, shops and classrooms. Many civilians and Servicemen received their start in aviation from here.

...TO VETERANS OR SERVICEMEN

Expand your aviation knowledge by planning now to enroll in Aero Tech's special, advanced courses. This will insure your post-war opportunities in the new "aviation age," which will require trained, alert men by the thousands.

...TO CIVILIANS AND WAR WORKERS

You can do a better job in hastening victory by working in a Los Angeles essential industry and taking Aero Tech courses at the same time. The training is especially laid out for the post-war aviation era—investigate this plan.

GREATLY EXPANDED COURSES

New requirements by airlines, service depots, feeder-lines... and the need for new types of aviation trained men... has created many new courses now offered by Aero Tech. Always up-to-the-minute, Aero Tech steps ahead with special plans for the "aviation age of the future."



Servicing—many types of modern airplanes used for practical shop instruction.



Airport Management—Aero Tech students get actual experience on a leading Los Angeles airport.



Engineering—complete design projects are carried out by Aero Tech students.



Flying—all types of primary, secondary and blind flying instruction for men and women.



Instruments—latest type instruments, gyros, automatic pilots used for training.



Engine overhaul—all modern types of radial and in-line engines used for training.

GET COURSE BULLETINS NOW . . . Winter classes now forming

Thousands secured their start from this institution . . . thousands more will secure a "priority" on their careers by attending Aero Tech in the near future. Send coupon for free bulletins NOW—act today.

Approved by CAA for Aircraft and Engine Mechanics Training

AERO INDUSTRIES TECHNICAL INSTITUTE
Herbert W. Hartley, President
5253 W. San Fernando Rd., Los Angeles 26



Gentlemen: Please send free bulletins, and data on courses checked below.

- Aircraft Mechanics
- Instrument Technician
- Aeronautical Engineering
- Airport Operations
- Flying (all licenses)
- Engine Mechanics

Name _____ Age _____
Street _____
City _____ Zone _____ State _____
Civilian In Services Veteran P-3

● SAVE WASTE PAPER ●



The **BIGGEST** Fish are where you find 'em

"No muskie here", Charley the guide had said . . . and then the old warrior struck . . . smashed the lure like a bolt from the blue . . . and exploded into a battle worth a week of any man's fishing! Which makes the best of guides look sheepish—and proves the truth of the old adage, "the biggest fish are where you find 'em".

For 35 years . . . stalking every variety of game fish in every kind of water . . . fishermen have been finding 'em with Evinrudes. The matchless experience of these Evinrude owners has constantly contributed to the development of features every fisherman wants. With peace, they will again be yours . . . in motors still finer for fishing, and for every other service.

EVINRUDE MOTORS, Milwaukee, Wisconsin.

BUY MORE WAR BONDS



EVINRUDE OUTBOARD MOTORS

Popular Mechanics Magazine

Registered in U. S. Patent Office and Canada

WRITTEN SO YOU CAN UNDERSTAND IT

Vol. 83

MARCH, 1945

No. 3

BAZOOKA BOATS HIT THE BEACHES

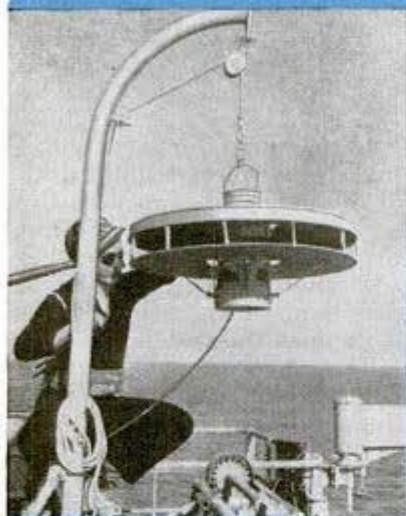

Above, transport's stern light is hooded by metal shield so it can't be spotted by enemy aircraft. Right, portable racks on LCI store rockets until needed in beach assault

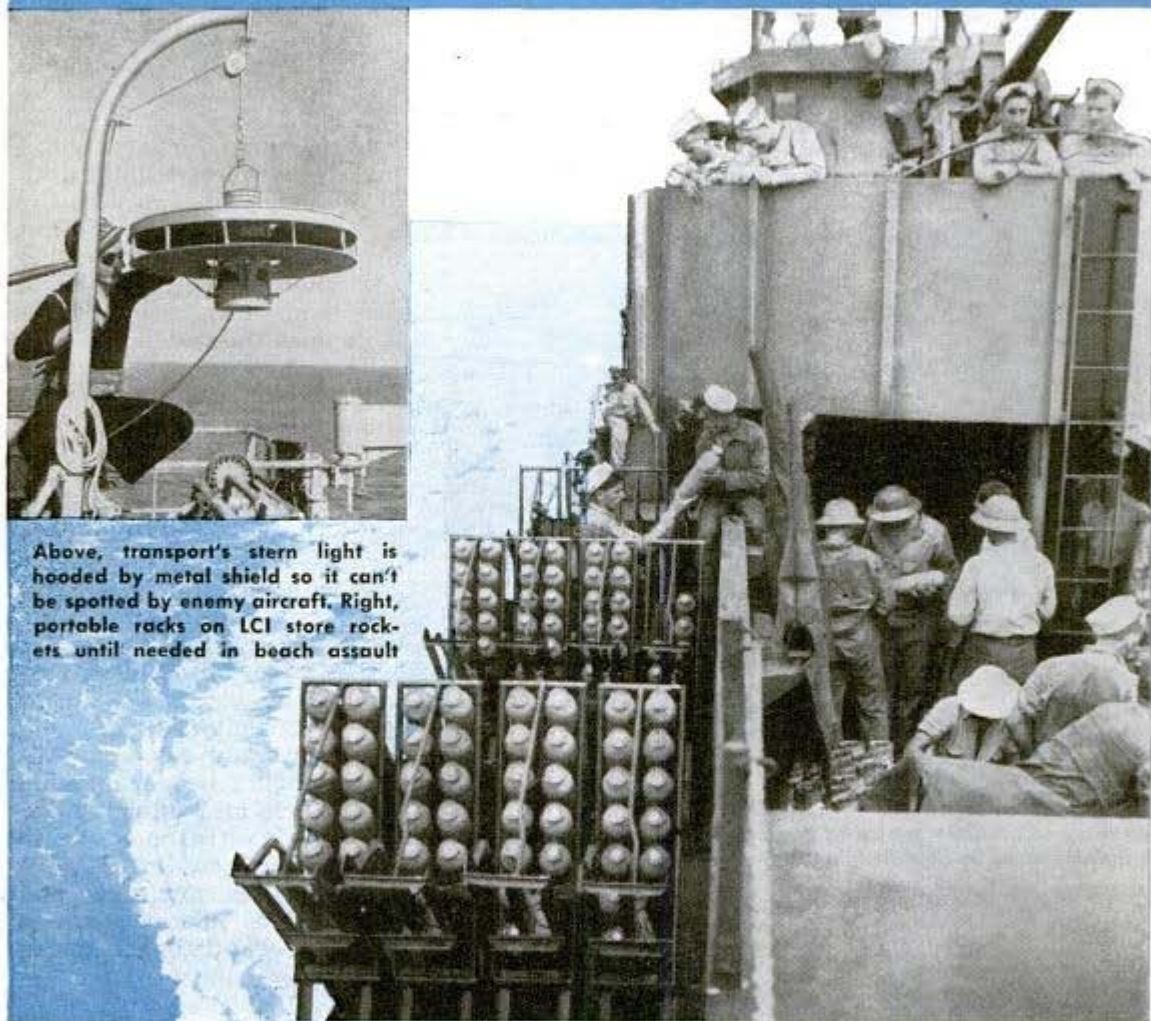

By Thomas E. Stimson, Jr.

THE Japs of almost 100 years ago had never seen anything like the American warships with which Commodore Perry forced the opening of Japanese ports.

And the Japs of today have never before seen anything like the 20th century invasion fleets that we are sending against them.

Vast armadas that extend to all four quarters of the horizon were undreamed of a few years ago. Not only are these invasion fleets of unprecedented size; they

are made up in part of extraordinary new ships especially designed for this type of warfare.

Representative of the peculiar ships that have been evolved for amphibious operations is the LSD, called "LS Dog" in Navy phonetics and meaning Landing Ship, Dock.

One of these 465-foot sea-going dock ships might be compared to an empty apple box in that its exterior walls surround a low central deck. This deck is normally not many feet above the water line and is jam-packed with amphibious vehicles. Ar-



Little boats like the LCVP (above) pack the wallop of a much larger vessel, thanks to the installation of portable rocket-launching racks
Official U. S. Navy photo



Landing boat's crew jumps on board (above) as craft is lowered to the ship's rail. Below, a row of pontoon barges equipped with self-propulsion units is launched by Seabees from the deck of an LST



ring off an invasion beach, the LSD swings open the wide gates that comprise its stern, admits water to its ballast tanks and sinks itself until its central deck is flooded and the amphibious vehicles are water-borne. These vehicles move off under their own power to the beaches, climb to dry land and deliver their cargoes where needed, then return to their dock ship for additional loads of supplies.

Another special-purpose invasion ship is the LST (Landing Ship, Tanks) that carries 120-foot LCTs on deck. These landing craft, loaded with tanks, were placed on the deck of their mother ship with the assistance of huge cranes, but the ship itself has no hoisting equipment strong enough to pick them up again and deposit them in the water.

The LST has its own way of doing that. When it arrives in the combat area and is ready to discharge its tank-carrying craft, it heels far over to one side, sliding some of its craft off the deck and into the water. Other craft are similarly side-launched from the other side of the ship by regulating the water in the ballast tanks.

Some types of landing vessels have bow doors and ramps so that after crossing an ocean they can steer directly to the beach, opening their bows and allowing the men and vehicles inside to move directly to the land. An LST has such bow doors and often moves in to the beach after side-launching its LCTs offshore.

Six hundred ships, including battleships, aircraft carriers, rocket ships, transports, cargo ships, oilers, hospital ships, and even mine sweepers, net tenders, and salvage tugs, were involved in our initial landing in the Philippines. Not all of them, of course, were gathered in one body for the assault, but all were part of the one operation.

The warships that are assigned to an invasion fleet perform several jobs. First they protect the troop and

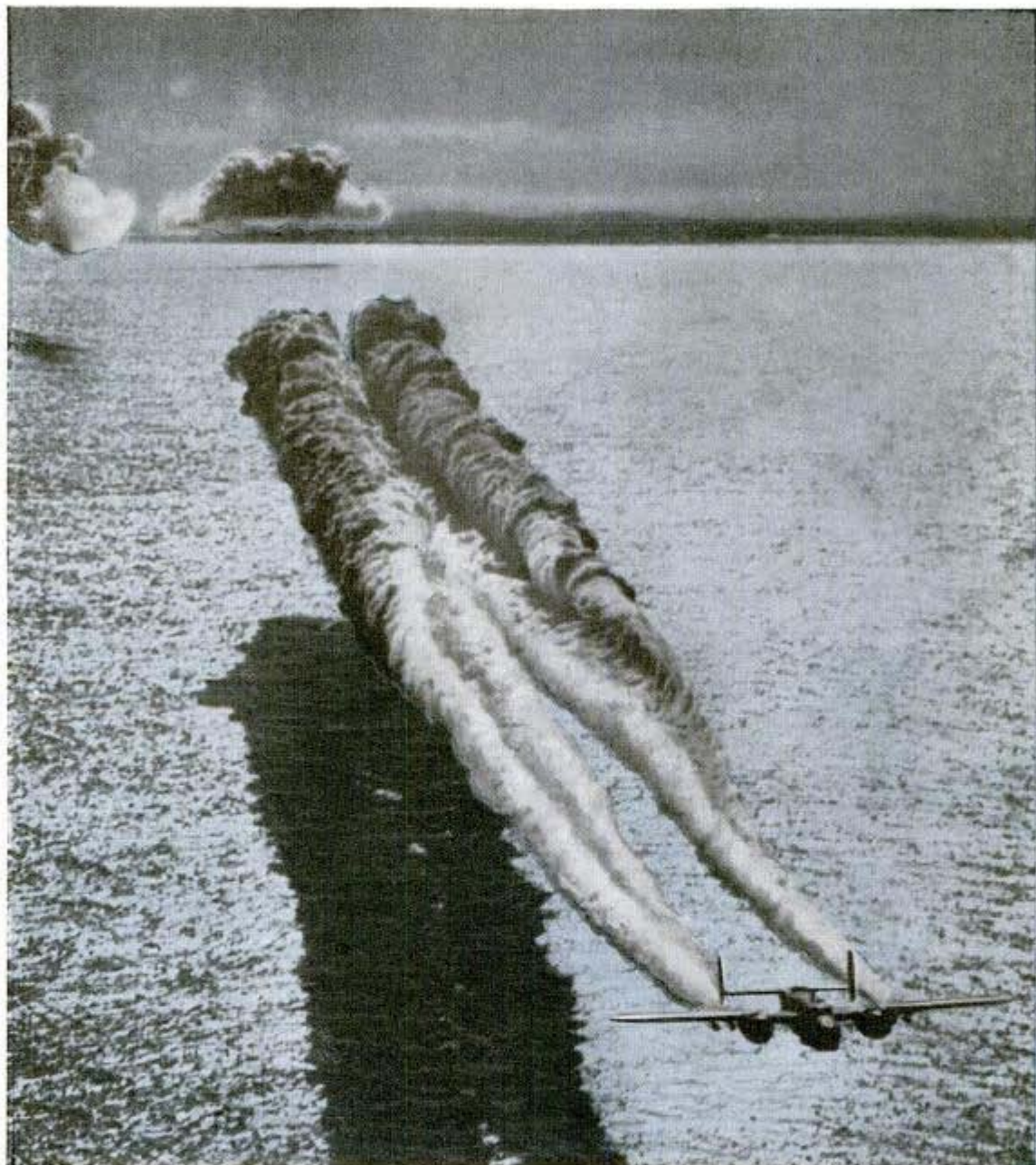

After initial bombardment, plane lays smoke screen off Jap-held beach to cover assault by landing craft

cargo ships during the voyage. Next they soften up the landing point with terrific fire just before the landing occurs. This bombardment is co-ordinated with the work of dive bombers and other aircraft from the carriers and is topped off by the rocket-firing Bazooka Boats that move close inshore and rake the beaches with roaring barrages of hundreds of rockets.

From the initial landing until the beach-head has been secured and extended, the warships act as floating artillery. They turn their guns on specific enemy installations and strong points that are reported to them by radio from spotting parties on shore and in aircraft.

This kind of assignment is new in naval gunnery. The targets often are invisible to the crews and yet they must be hit accurately. Slight errors in range might drop the shells among our own troops. This long range demolition is kept up until the artillery units in the landing force get ashore and take over the job.

An invasion fleet presents a weird appearance at sea. Most of the large deep-water ships are camouflaged in dazzle patterns that may consist of zigzag zebra stripes or of futuristic blocks and swirls of paint. Dazzle camouflage makes it difficult to sight a ship and, once the ship is detected, it is intended to give it the appearance



Quartermaster mans the wheel on the bridge of an attack transport

of moving at a false speed or on some other than its true course.

Some of the landing ships in this convoy may wear tropical camouflage while others are decorated with jungle patterns. Protective tropical camouflage may be a sickly green or a combination of greens and light blues that blend well with the coloring of

western Pacific seas. Jungle camouflage is applied to ships and craft that may spend some time tied to a tropical shore. Jungle camouflage blends in with jungle backgrounds. When moored inshore, such ships may also be concealed under a matting of foliage so that from the air they appear to be part of the shore line.

Nearly all of the invasion ships carry nests of landing craft and small boats on deck. Even the fuel tankers do double duty and may be loaded with PT boats on top of loads of oil and gasoline.

The heart of any invasion fleet is made up of APA and AKA vessels. The APAs are the attack transports, the AKAs are the attack cargo ships. An APA may be a converted passenger liner but most of them are a new special class consisting of Victory ships of some 10,000 tons, turbine driven, with interiors designed to accommodate large numbers of men. They carry considerable anti-aircraft protection. The AKA class is similar but has limited troop capacity and larger cargo spaces.

So many transports are needed in fighting this inter-continental war that the crews of these transports comprise a larger number of men than were in the entire U. S. Navy in 1940. To keep up with the production of ships, these crews were trained ashore at operational training schools which have instruction capacities greater than most major universities. At one of these schools a ship is literally taken apart and placed piece-meal in the different classrooms so that the men can be trained to operate the same devices they will operate at sea.

Even such a prosaic subject as how to load a ship with cargo is an important study, for all invasion ships must be combat loaded. That is, material that will be needed last at a beachhead is the first cargo to go into a ship. Equipment

(Continued to page 158)

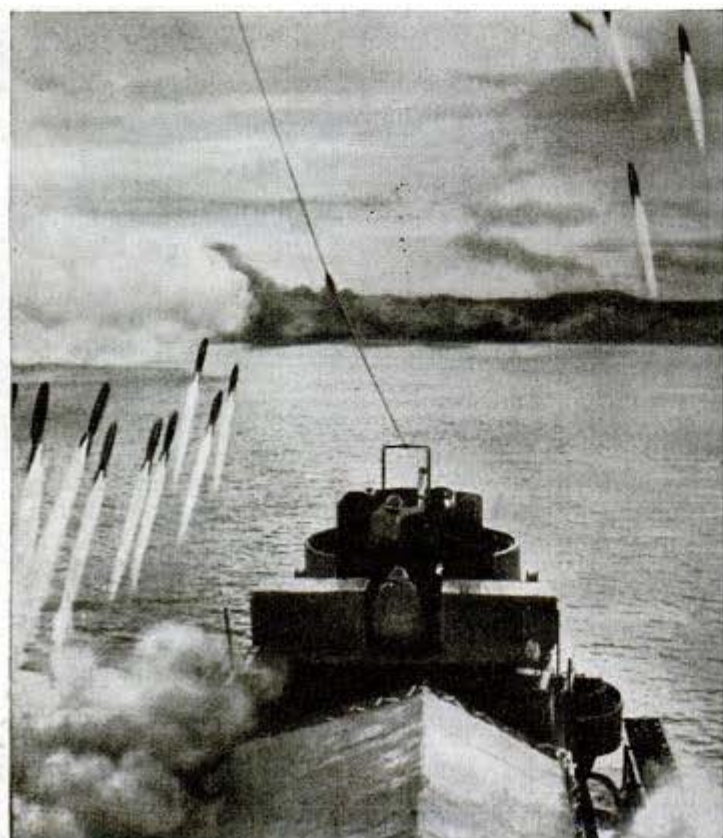

LCI hurls a barrage of rockets at Jap-held Mindoro beaches as first U. S. assault wave approaches shore



Yanks wading through heavy seas onto the beach of a Pacific island after naval bombardment and rocket barrage has smothered Jap shore batteries. Here lessons learned at Anzio and Tarawa saved lives



Official Navy photographs

Rocket craft off Peleliu Island score hits on D-Day. As they blast away at Jap defenses, a wave of Alligators (below) churns toward shore as vanguard for Army and Marine assault units. The tough amphibious tanks approaching the beach obscured by smoke are armed with machine guns and cannon



"Pigmy Flat-Tops" Carry Both Planes and Cargo



Merchant ships have been converted into double-duty "pigmy flat-tops" with flight decks only 380 feet long by the Royal Canadian Navy. While hunting for German submarines on convoy duty, they carry cargo below their flight decks. Before the start of each trip, wheat is usually poured through the flight decks by means of grain funnels while the decks are temporarily cleared of aircraft. The little carriers are so short that flyers use less than 100 feet for takeoffs and landings. Occasionally United States Navy aircraft carriers also are converted to special purposes. Recently a big flat-top left for an unidentified port resembling a floating garage, since its flight deck was packed with trucks, jeeps and other vehicles consigned to U. S. Marines.

Above, merchant ship converted into "pigmy flat-top" with flight deck 380 feet long. At right, loading "pigmy flat-top" with wheat through grain funnels



"Snow-Eater" Melts The Drifts Away In Railroad Yard

Snow disappears in a jiffy in one Boston railroad yard when the "snow-eater" goes to work. This unit is pushed by a locomotive which also supplies the heat to melt the snow as it enters a tank car. A series of rotating disks throws the snow onto a conveyor belt. The tank car holds 14,000 gallons, equal to 18,000 cubic feet of snow.

New Navy "Lib" Ranges 3,000 Miles on Patrol



With the new land-based search plane, the Consolidated Vultee Navy Liberator (PB4Y-2), the Fleet has acquired "three-thousand-mile eyes." It is used for search and photographic missions, antisubmarine patrols and bombing raids. The long narrow wing is its principal resemblance to the old PB4Y-1 Liberator. The new plane, called the Privateer, has a single-rudder tail assembly, a longer fuselage and a different type of armament. It has six gun turrets, each mounting two .50-caliber machine guns, which afford protection from every angle on lone flights. Beneath the

power-operated ball turret in the nose is a small compartment with a bombsight window. The bomb bays are designed to hold several combinations of auxiliary fuel tanks, bombs and depth charges, depending on the mission. The PB4Y-2 can stay in the air 20 hours without refueling. It is powered with four Pratt & Whitney Twin Wasp engines which were redesigned for low fuel consumption and more horsepower at the takeoff. Retractable wing flaps also help the plane to get into the air with its gross weight of from 62,000 to 65,000 pounds. Top speed is more than 250 m.p.h.



'Automatic' Mask for Army Pilot Regulates Oxygen and Pressure

Army Air Force pilots can soar as high as 50,000 feet "into the wild blue yonder" with a minimum of oxygen and pressure worries, wearing a new pressure demand oxygen mask. Its function is to increase the flow of oxygen automatically and deliver it to the pilot under the proper pressure. This enables the pilot to breathe freely and prevents dreaded anoxia. The automatic regulators, which are installed as permanent fixtures at each station in a bomber, supply pure oxygen at 30,000 feet. With the mask, a pilot can function normally for one-half hour at 45,000 feet and at 50,000 feet for short emergency periods. The mask was developed by the aero-medical laboratory at Wright Field in conjunction with industry.

"INSIDE STUFF" ON THE B-29



FROM the bombardier's comfortable seat in the transparent plastic nose all the way back to the tail gunner's position, the Boeing B-29 Superfortress might well be called "the bomber crew's bomber." Its refinements, from pressurized cabin to remote fire control, are designed to bring the crew over the target in fighting trim, to deliver an accurately aimed and deadly blow to the enemy (through the clouds, if necessary), and to enable the crew to fight its way through a swarm of fighters for a safe return to home base.

Flight fatigue, which has plagued bomber crews on long missions at high altitude in the European theater, is reduced to a minimum with the B-29's pressurized interior. Hours of breathing through oxygen masks and cumbersome clothing to protect the men from 50-below-zero cold in the thin air of the stratosphere are eliminated. Oxygen masks, of course, are placed by each station, but they are con-

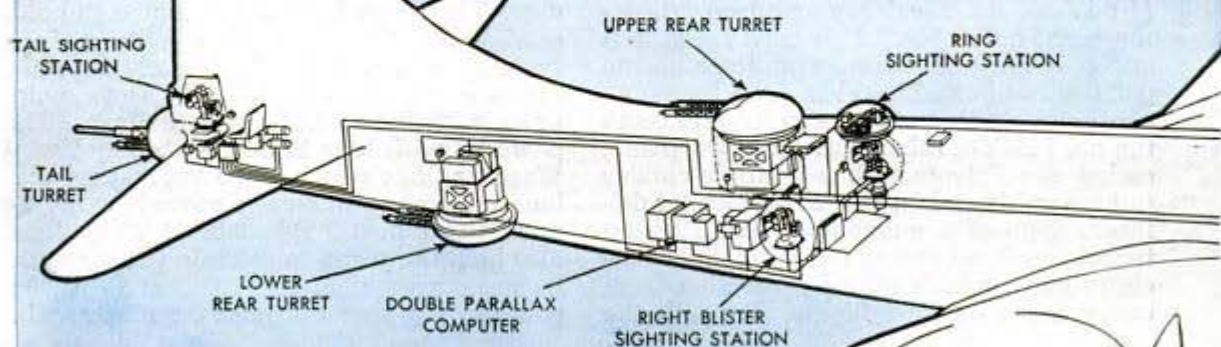

Top, four members of B-29 crew enjoy a few of the comforts of home in rear pressurized cabin equipped with four bunks. Drawing (above) shows sighting stations for the bomber's remote control gunnery system. One gunner can concentrate the fire from three turrets on single target. Left, some of the 30 miles of wire which go into one B-29 to control its 150 electric motors

sidered emergency equipment, like life rafts.

No belly gunner on a B-17 will mourn the loss of that cramped station on the B-29; nor will the Flying Fortress pilot complain about the transfer of numerous gauges and dials to the control panel before the flight engineer on the Superfortress. The "suite at the Ritz"—rear pressurized cabin equipped with four comfortable bunks—gives members of the crew a chance to rest on missions many hours long. This compartment is reached

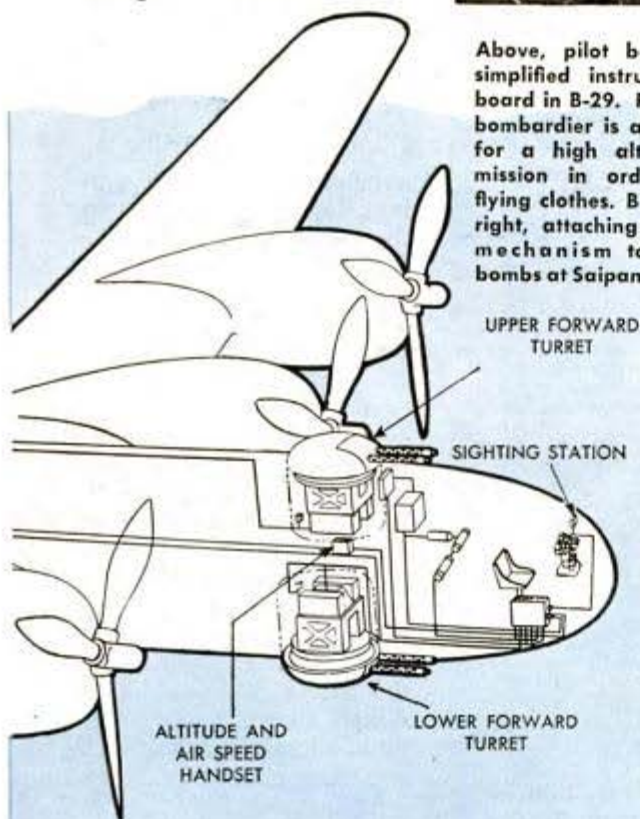

Above, pilot behind simplified instrument board in B-29. Right, bombardier is all set for a high altitude mission in ordinary flying clothes. Below, right, attaching fuse mechanism to the bombs at Saipan base

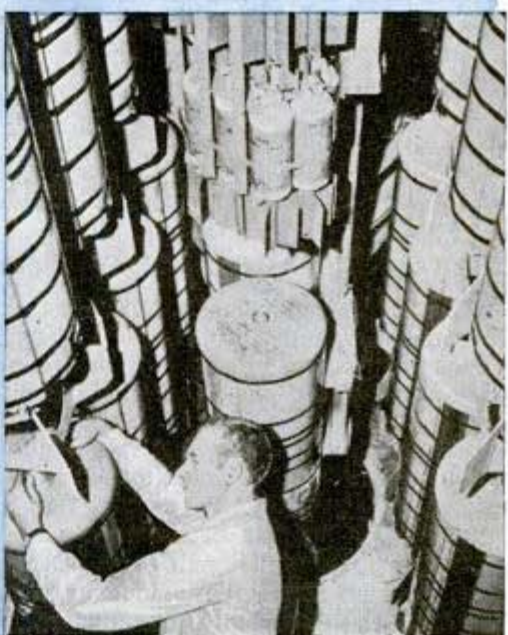

from the forward cabin by a tunnel extending back over the twin bomb bays.

The B-29's remote control gunnery system, with computers between the sighting stations to aim the .50-caliber machine guns in the electrically operated turrets, not only takes the guesswork but much of the drudgery out of being a gunner on a bomber. A chief gunner directs the firing for combat teamwork, and a man at one station can control several turrets. The success of this system has been written in the sky over Japan where the old game of fighters ganging up on a straggling bomber has become a dangerous pastime.

Anti-Gravity Pants Prevent Blackout in a Dive



Top, left, pilot has his anti-gravity pants inflated. Top, right, RCAF officer with the accelerator which tested the suit

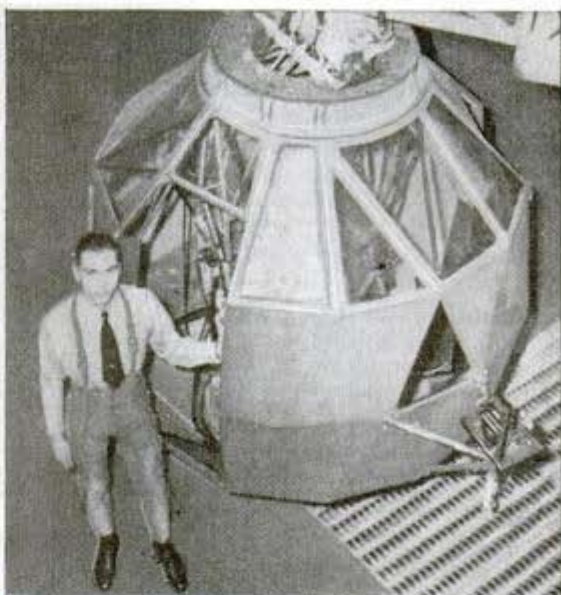

girdle and air bladders over the abdomen and legs. Compressed air from the plane's vacuum system inflates the bladder,



Left, cutaway shows how accurately suit fits body's contours in a sitting position

Pilots don't worry about the danger of "blacking out" in high speed dives and turns when they have their anti-gravity pants on. Used secretly by American and British pilots since 1942, the pneumatic suits have high-waisted, skin-tight pants with built-in suspenders and

and automatic valves control the pressure in relation to the gravity pull. Purpose of the suit is to keep the blood from being driven into the lower extremities and to help the heart pump blood to the brain. According to the RCAF, the pants give Allied flyers a tremendous physical advantage over the enemy in lightning-fast dog fights.

Here's a Chance for Inventors to Help the Air Forces

Among 34 inventions sought by the Air Forces is a small, light-weight gasoline engine of one to five horsepower, capable of operating on 100-octane aviation fuel. According to the National Inventors Council, other Air Force needs for which the public is urged to submit ideas are a high-precision, low-friction bearing that does not involve the use of balls or rollers, a liquid or paste which will prevent the formation of ice on airplane surfaces, a material with the electrical properties and heat

resistant characteristics of mica, a simply installed thrustmeter, a shock absorber that does not require the use of synthetic packing to retain the fluid in the strut, and an automatic ground speed measuring device. For parachute operation, the Air Forces seek a device which will release a parachute from its cargo quickly when the cargo hits the ground; low cost aerial delivery parachutes, improved harness with quick-releasing hardware, new canopy designs, and parachute drop test instruments.

ICE CRACKERS *of the* COAST GUARD



WORKMEN at the shipbuilding yards in Duluth, Minn., and Superior, Wis., shook their heads in wonder at the production schedule early last winter. It didn't make sense. The rush schedule called for the completion of three ocean-going cargo ships early in January. They told each other it was like the man who built a boat in his basement and couldn't get it out.

Between these new cargo ships and the sea lay miles of ice-locked passage, including St. Mary's Canal at Sault Ste. Marie, Mich. No ship had ever made a midwinter passage through the 90-year-old Soo locks.

But the Navy only blinked at the 12-inch blue ice on the upper St. Mary's River. Its Coast Guard icebreaking crews are always on the job keeping open vital waterways—the Hudson, Ohio and Mississippi rivers, and the Great Lakes.

The Coast Guard accepted the 90-year challenge of the Soo locks. The new \$10,000,000 ice cutter Mackinaw was given a chance to make history on its maiden trip. Early in January, this cutter and three other ice-

Down the Mississippi in midwinter, invasion craft follow ice-breaking Coast Guard vessel on way to Gulf. Below, stream of boiling water and axe loosen ice from a buoy being picked up



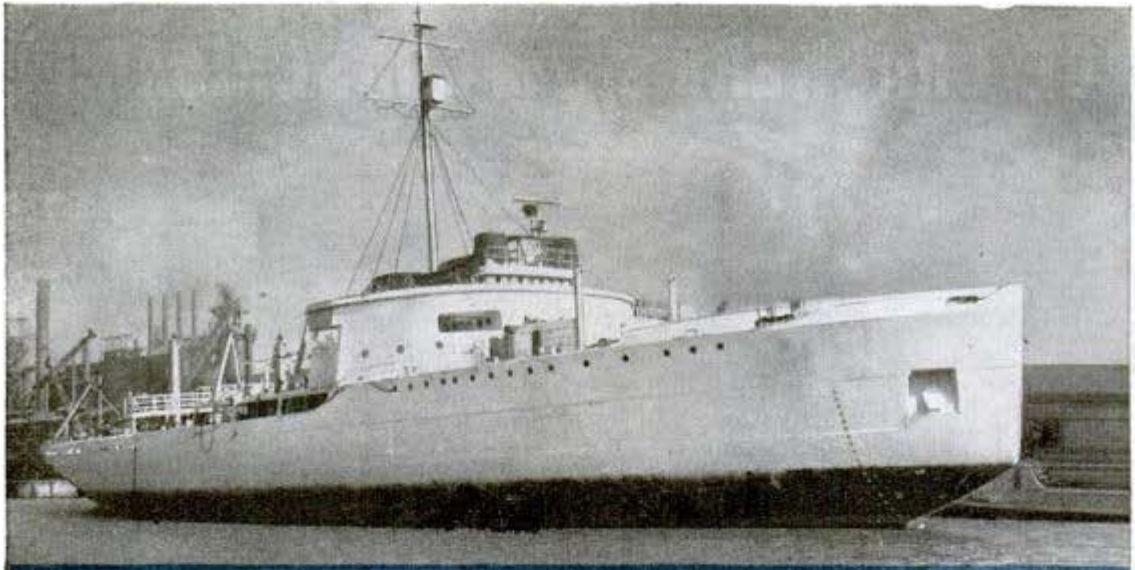

This is the Coast Guard's new \$10,000,000 icebreaker, Mackinaw, which made history with the first winter passage through Soo locks. The 329-foot cutter has one propeller in bow (below), two in stern

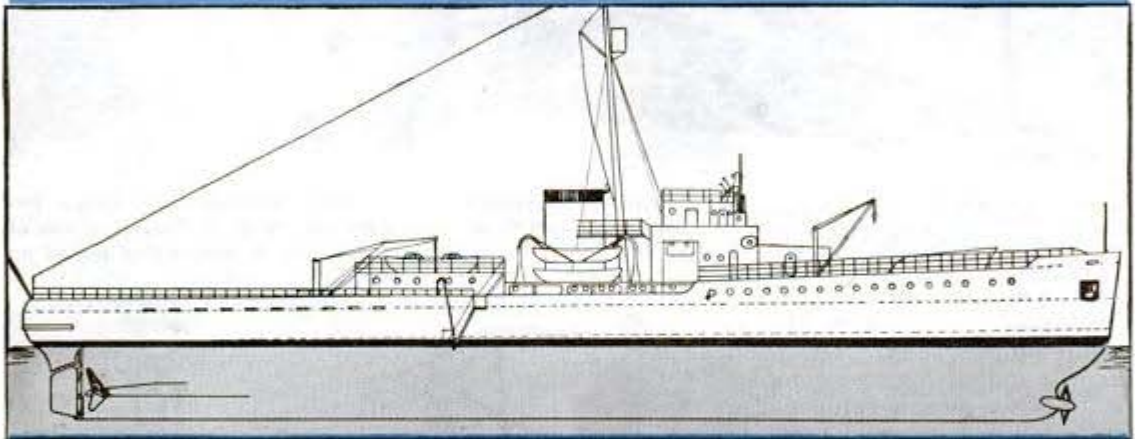

Under a wing pontoon of Coast Guard patrol plane, freighters loaded with war goods can be seen fighting way through ice out of harbor at Buffalo, N. Y. Tug at right is attempting to clear a channel



breakers' smashed a lane through the icy bottleneck from eastern Lake Superior down through the Straits of Mackinac to the open waters of northern Lake Michigan.

Twice during the push through the Straits, it looked as if the ice was going to win out over the Coast Guard; but each time the Mackinaw plunged ahead through windrowed chunks of ice.

The 10,000-horsepower Diesel-driven Mackinaw is said to be the most powerful icebreaker in the world. In addition to two stern propellers, it has one in the bow which agitates the water beneath the ice, making it easier to break. The new 329-foot cutter also has a "rocking-horse" method for freeing itself when lodged in a thick ice floe. This is accomplished by pumps which can dump 400 tons of water from one side of the ship to the other or from fore to aft in two and a half minutes.

Recently, the Mackinaw again made headlines by escorting a 306-foot auxiliary personnel destroyer (originally designed as a destroyer escort) through the lakes and down the Chicago River to Lockport, Ill. Two hundred and sixty miles of the trip was through ice.

Last winter the Coast Guard's icebreaking job was probably the toughest in history, because there was a shortage of icebreakers and personnel and a tremendous increase in water traffic.

In the New York Harbor and Hudson River district, two breakers handle the entire job and keep themselves hopping all winter long. The vessels used are the Mahoning and the Manhattan.

In the harbor and East River there isn't much trouble with ice because of strong tides and the movement of a great number of ships. There are times, of course, when

Making history — cutter leads cargo ships built on Lake Superior through Soo locks early in January on way to the Gulf



Face masks of felt take the bite out of sub-zero winds on winter patrol

the Coast Guard is summoned to dislodge a Liberty or some other vessel.

But on the Hudson above Bear Mountain Bridge things are different. This great stream is navigable all the way up to Albany, a distance of about 150 miles, and the surrounding territory depends to a great extent on river barges and tankers to transport petroleum products.

The Hudson is the particular stamping grounds of the Mahoning, commanded by an ice-wise skipper, Lt. Comdr. Harold Babbitt. The Mahoning goes into action when the first call for help is received at





Mariner uses pressure hose to sluice snow from deck of cutter

the Barge Office from ships or barges having trouble getting through the ice. The big job is to keep the river open from Iona Island down. Iona Island is the Naval Arsenal just below Bear Mountain Bridge at Peekskill. This spot, and the bend in the river at West Point, a few miles north, are

the toughest to keep free of ice. There are pronounced elbows in the river at both these points and the ice tends to pile up on the south banks as it comes down the river.

The Mahoning is a solid, powerfully built vessel especially constructed for icebreaking. Her hull is braced with enough steel to do justice to a battleship while her rounded prow is heavily reinforced. She started working in the Hudson River in 1939 and is of all-welded steel construction, 110 feet long and driven by two powerful General Motors Diesel engines developing 1,300 horses to turn one propeller.

Icebreaking with the Mahoning isn't just a case of pulling back, putting your head down like a fullback and charging the ice. That's all right when the ice isn't too thick. But Hudson River ice often reaches a thickness of 10 or 12 inches, while drift ice will pile up to four feet thick or more.

The Mahoning climbs its rounded prow up on this heavy ice and hangs there. Her weight and vibration finally break the ice and she crashes through. Sometimes such a break will crack the ice for a mile.

Ice that is comparatively thin can open up a seam in a petroleum barge and cause the contents to ignite by friction. The Barge Office issues a daily ice report to all interested parties on the advisability of a trip up or down the river. This report is

Heavy duty icebreaker on North Atlantic patrol carries guns and plane from which this photo was made



based on the report of the Mahoning radioed to New York City from Newburgh every night.

The efficacy of this service is attested by the fact that no ship has ever been crushed or lost because of ice action on the Hudson. However, a few barges that broke their moorings and got caught in the floes have been ground to bits.

Sometimes the Mahoning stands by a ship all night. There was a case last year when a strong ebb tide was bringing a great quantity of ice down the river toward a ship that was tied up at Poughkeepsie. This ice was piling in between the ship and the dock and could easily have crushed her if the Mahoning had not worked all night, breaking up the ice and sending it on its way.

One of the outstanding exploits



Brrr—cutter returning from patrol with ice "camouflage" tossed aboard by heavy seas. Left, ice-coated cabin of an icebreaker on the Hudson River. Below, plow attached to prow of Coast Guard patrol boat Fern breaks ice on Mississippi River to open channel for Great Lakes to Gulf shipping

of the Mahoning took place in February, 1941. The Navy had purchased the world's largest fresh water passenger ship, the Berkshire, from the Hudson River Day Line. This 422-foot, 4,300-ton steamer was tied up at Athens, N. Y., just below Albany, for the winter. The Navy wanted her towed to New York City.

Private tugboat people wagged their heads violently. "Can't be done," they said. "It's impossible for any tug or other boat to get that big baby down those icy channels."

So the Navy, as usual, propositioned the Coast Guard.

When Commander Babbitt and his crew took charge, the betting

(Continued to page 158)





Triple-Threat Photo Plane Carries Bombs and Guns

One reconnaissance plane that can fight its way home is the F-6 version of the P-51 Mustang, the only single-seater photo-reconnaissance craft which can carry a full complement of machine guns and bombs. The F-6 could fight its way to the target area, photograph it, bomb it, photograph the bombed area, and effectively deal with enemy aircraft on the trip home. A variety of cameras can be installed in a special fuselage compartment of the regular production models after they leave the assembly lines, enabling the Mustang to obtain oblique and vertical photographs. While other single-seater fighters must sacrifice either firepower or bomb-carrying capacity when adapted to photo-reconnaissance, the P-51 retains its six machine guns and normal bomb load or long range fuel tanks.

Left, vertical cone is installed in P-51 camera mount. Below, checking camera's sighting aim



Synthetic Rubber Made of Sand Unaffected by Extreme Temperatures

Silicone rubber, a new synthetic which is as pliable as putty yet bounces like rubber, has been developed by the General Electric Company for a variety of wartime uses. This rubber, made from sand and natural gas, loses none of its elastic qualities in temperatures as low as 60 degrees below zero and as high as 575 degrees above. The compound is known chemically as dimethyl silicone. Silicone stands vibration well. It can be squeezed down to two-thirds of its normal thickness between metal plates and afterward will expand to

nearly full thickness. It can be made either hard or soft and is used, among other things, as gaskets for B-29 superchargers, which operate at extremely high temperatures. It also supports the lenses in huge Navy searchlights, which must stand severe vibrations every time a battleship's guns are fired as well as extreme heat from the electric carbon arc.

☐ One set of tires on a B-29 Superfortress survived 160 consecutive landings without the necessity for a change.

Retreading Gives Mammoth Tire a New Life

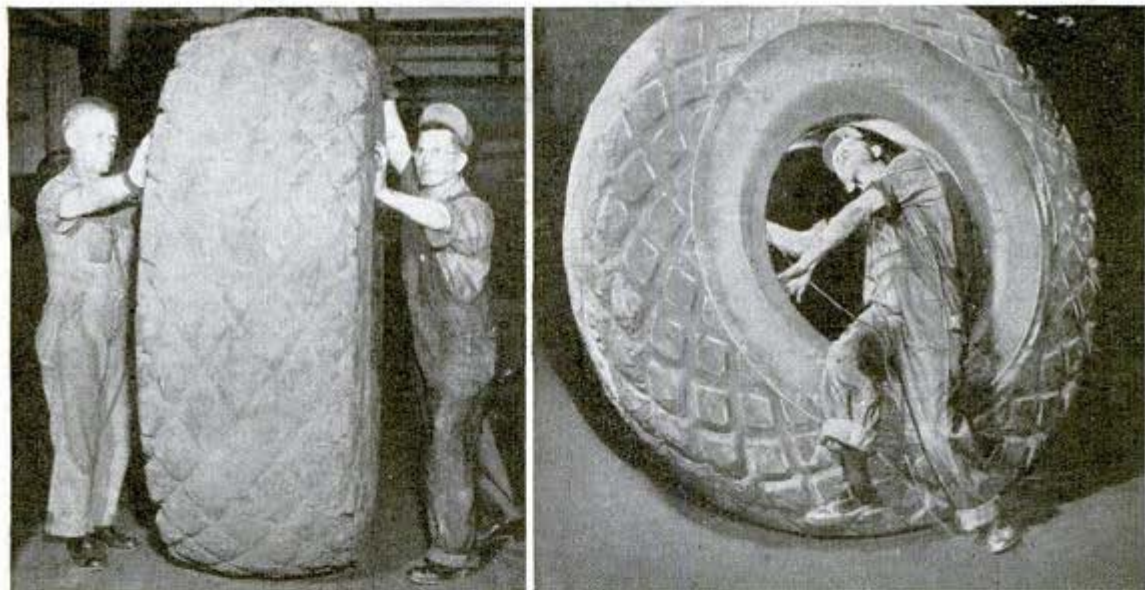

Above, left, largest tire to be given a brand new tread by Goodyear Rubber Company is rolled into receiving room for its face lifting. Then it is thoroughly inspected (above, right) to see if it will stand retreading

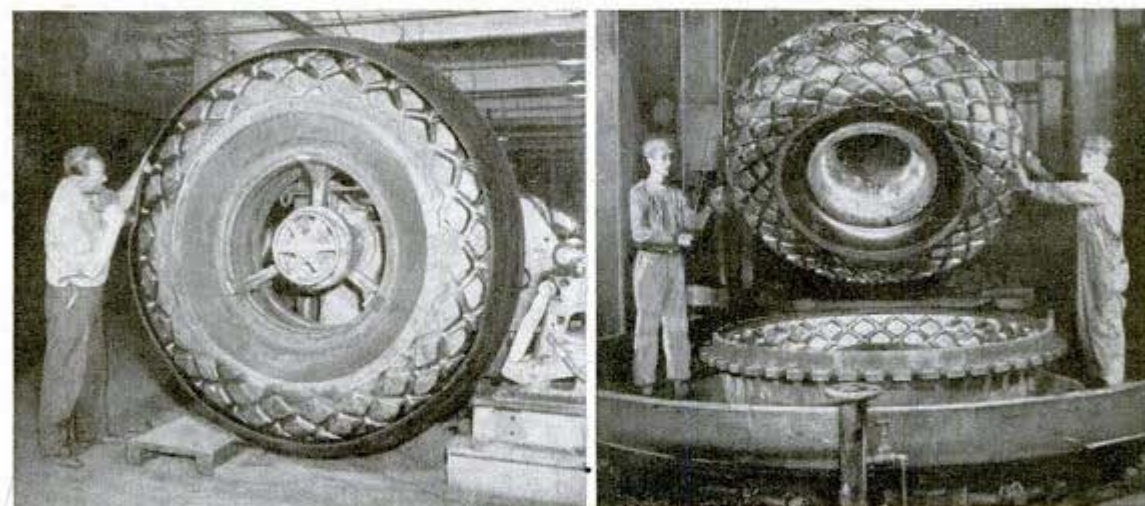

Camelback is applied (above, left) in an endless band to buffed surface. Workman already has started to stitch down the camelback. Curing operations completed (above, right), tire is removed from the mold like new

Insulation Sprayed on Like Paint Sticks to Metal or Wood

Any type of wall, tank or duct, whether made of wood, brick, concrete or metal, can be insulated and weatherproofed with a material sprayed on like paint. The coating, which is applied in a single operation, can be sprayed on to any thickness needed from one-eighth to one-half inch. The base for the insulating and protective material is Gilsonite, a high grade asphalt, which is treated to retain a permanent elasticity at low temperatures. It is made in several forms, and the one used primarily for insulation is impregnated with cork. Those designed for weatherproofing provide some insulation by their sealing properties. One

type is sprayed with varicolored slate granules to form a pleasing protective finish; another is available in several colors which are incorporated in the material. The coating can be applied to homes, industrial buildings, water tanks, tin and galvanized sheet metal ducts, freight cars, or any other object in need of weatherproofing or insulation. It is waterproof and fire resistant.

☐ The leading fishing port of the United States in 1944 was San Pedro, Calif., with a total of 550,000,000 pounds landed; on the Atlantic coast Gloucester, Mass., led with 189,000,000 pounds.

BRIDGING THE ARMY'S

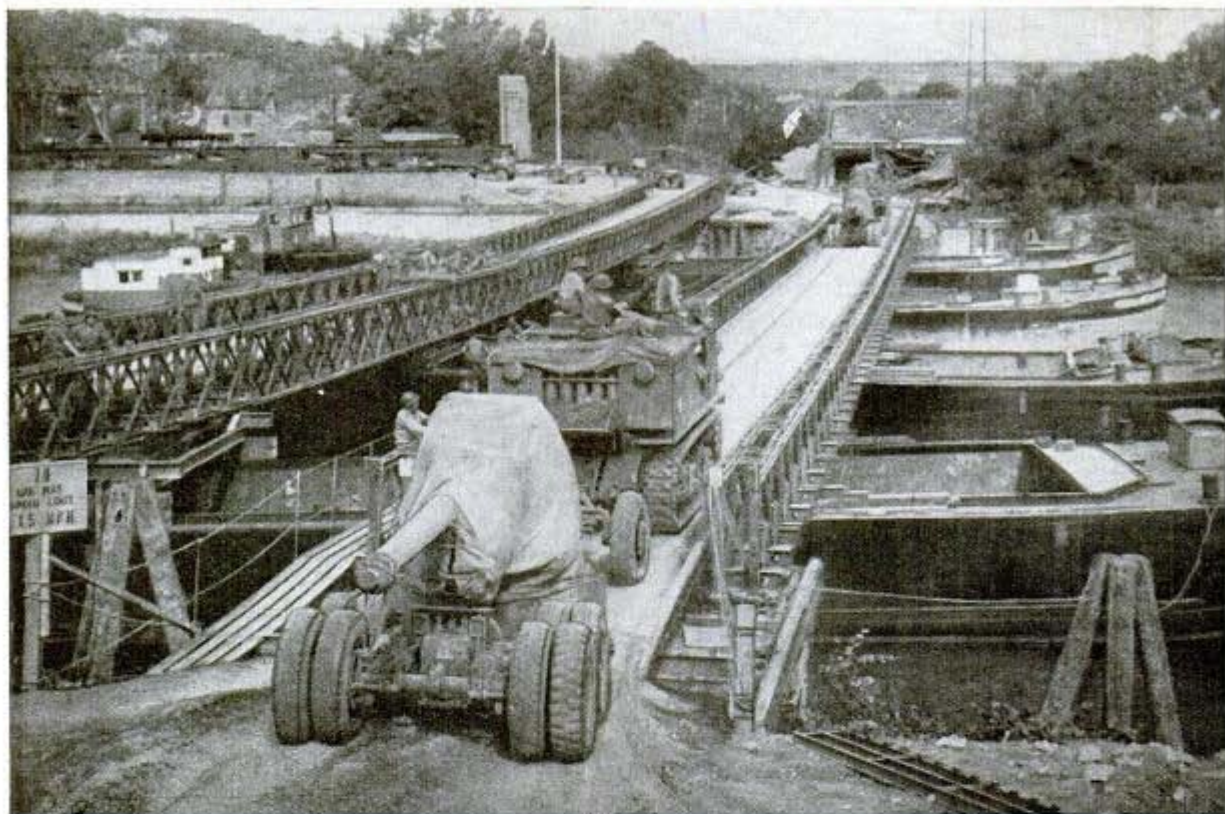

Tractor-drawn 155-mm. gun moves across a Bailey bridge erected on French barges over Seine River

By Staff Sgt. John L. Kent

IN THEIR 80-day retreat across France, the Germans destroyed all bridges to hold up the Allies and give themselves time to reorganize. But for all their frantic efforts, they found the Yanks continually on their heels. In spite of destroyed bridges the Yanks kept coming, for when the Germans blew up bridges the Army's engineers built new ones alongside or brought up portable ones.

Continuous pursuit is the essence of modern mobile warfare. Rivers without bridges or with the bridges destroyed are serious obstacles, since they hold up the pursuing army and give the retreating troops time to reorganize. We did not give the Germans this precious time. Temporary bridges were thrown across streams and rivers by our combat engineers, and larger, permanent ones were erected by engineer general service regiments in rear areas.

Building bridges is a task assigned to the Army's

Corps of Engineers. No other body of men can beat them in spanning rivers in record time, often in the face of enemy fire.

While the engineers have a wide choice of types, there is always a specific type of bridge which fits a particular condition. Sometimes standard construction cannot be followed, and the engineers must substitute and improvise. Wood is used instead of steel. Ponton and assault boat combinations



Engineers use parts of Nazi gun to rebuild bridge on opposite page

WATER HAZARDS



Engineers in makeshift dive suits attach hooks to wrecked bridge parts to raise them from water. Below, span rebuilt with Nazi gun carriage

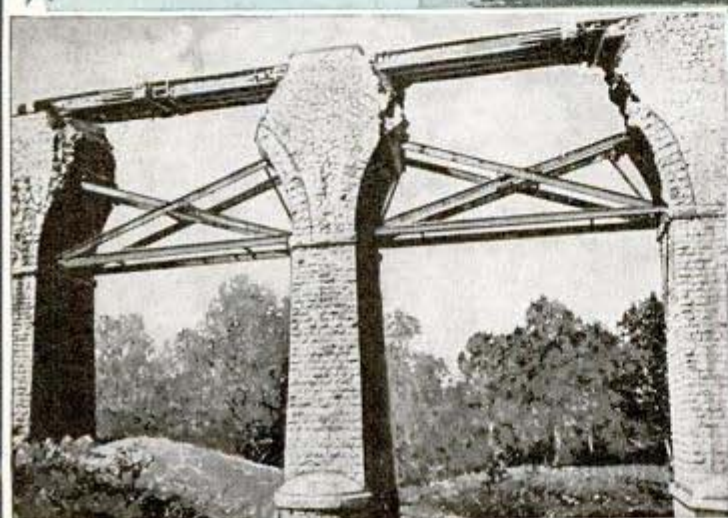

are used. The bridge may be part floating and part fixed. Because of the many expedients they use, engineers are known as "the great improvisers."

In Normandy, the engineers were called on to throw a bridge over the Vire River just below its junction with the Taute-Vire Canal. Time did not permit building anything but a temporary ponton bridge. But even a ponton bridge takes time, especially when the water is deep. Then someone thought of the locks on the canal, several hundred feet down. The gates were raised and the water let out. With the water level



Above, a British prefabricated pier at Normandy made up of small bridges resting on floats. Below, a wilderness bridge on the Alcan highway

only waist high, the engineers waded in, floated the rubber pontons and clamped the steel treadway over them. When the last ponton was bolted and tied, the gates on the downstream lock were shut, and water from the higher lock admitted.

The water floated the bridge higher and higher, until it reached the level of the banks on both sides. The water was then shut off, the ends of the bridge tied and runways built. One hour later trucks were rolling over it.

Army engineers are almost never stumped. In Italy several of them turned divers in order to salvage their own bombed-out floating span from the bottom of the swiftly moving lower Garigliano River, which was under enemy fire at the time. Wearing GI gas masks with a thin rubber hose through which the air was pumped to them from a compression machine on a rubber raft, they went down 25 feet and stood in the rocks and slime of the river



bed for periods of 15 to 20 minutes each. They attached ropes and hooks to the smashed installations, which could then be lifted out of the water by cranes. Soon guns and supplies again were being hauled across the revived bridge toward the astonished Germans.

Many of the engineer units now in France, Italy and Germany received their training in the maneuver area swamps of Louisiana and in the frozen wastelands of Alaska. During the building of the great Alcan highway, seven engineer regiments built hundreds of bridges of all types. The Alcan was a bridgebuilder's nightmare. Unstable ground and frozen shifting foundations made the building of permanent bridges precarious. When the engineers built the first set of bridges in the fall of 1942, they expected all of them to be washed out in the 1943 spring flood—and they were!

But the resourceful engineers had built a duplicate bridge next to each crossing; and left it in sections on the banks, alongside. When the flood receded, the standby bridge was thrown across the stream. Traffic on the Alcan continued.

Our Army's temporary bridges are floating bridges of the assault-boat ponton or pneumatic ponton type. The assault-boat type consists of ordinary army assault boats, resembling rowboats, which are anchored across the stream, over which is laid a wooden or steel treadway. The ponton type uses inflated rubber boats similar to the lifesaving rafts used by our airmen when they are forced down at sea. Special steel clamps and retainers hold the treadway to the pontoons and



Above, overall view of a loaded bridge truck equipped with hydraulic crane. Among assorted construction equipment are two complete trestles

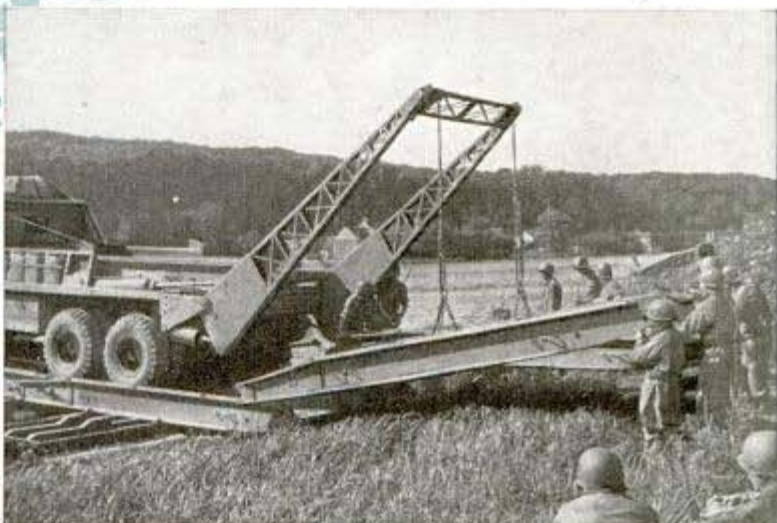

Above, hydraulic truck crane lays final treadway section on ponton bridge over the Seine River. Below, bridging gap left by a blown-out span



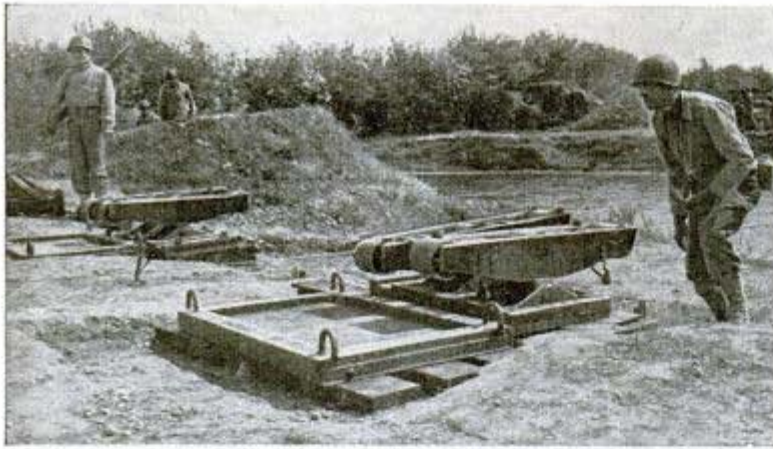

Above, company commander of engineers inspects the rocking rollers of a Bailey bridge. Below, carrying panels which will be joined together

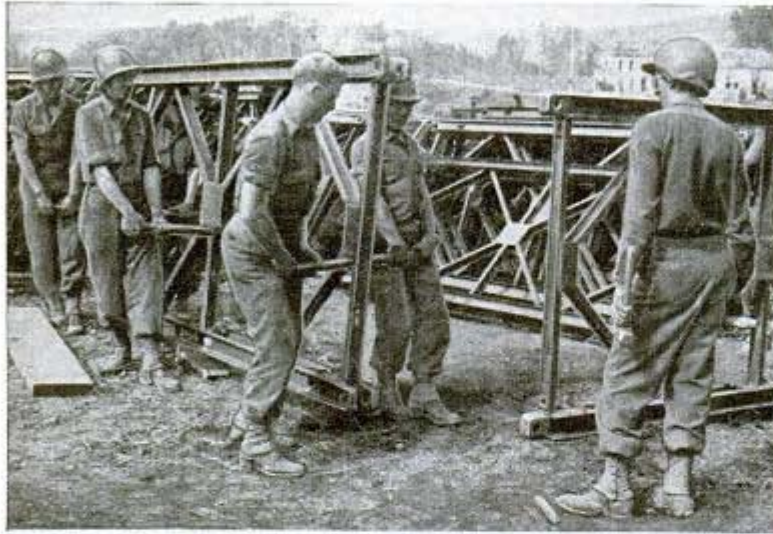

Below, engineer drives pin which holds panels of Bailey bridge together. The spans are prefabricated and can be assembled rapidly at bridge site

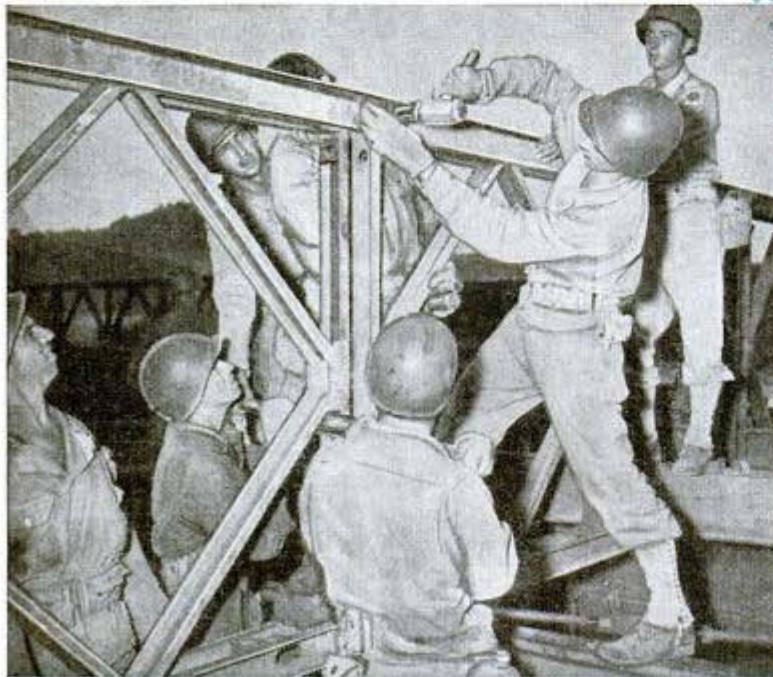

hinges near the ends permit the bridge to give under the load of trucks or tanks moving over it.

In Burma, when neither rubber pontons nor assault boats were available, the resourceful engineers lashed empty oil and gasoline drums together and tied on planking to form a treadway.

In France and Italy our troops are using the 25-ton ponton bridge, which is normally sufficient to meet the needs of an infantry division crossing a river less than 600 feet wide. The bridge is built by an engineer heavy ponton battalion, which also dismantles it when it is no longer needed, and loading it on trucks, holds it in readiness for its next move to some advanced location. The bridge is durable in spite of its temporary nature, and permits the crossing of the trucks of five infantry divisions before requiring repairs.

But the most versatile bridge of this war is the invention of an Englishman—Bailey. The Bailey bridge is a steel fixed bridge of the through truss type. It uses only 29 different parts, completely prefabricated and interchangeable, and like a giant Erector set, can be assembled rapidly in various ways to meet different load and span requirements. The main construction unit is a truss section, 10 feet long and five feet high, called a panel. The strength of the truss may be increased by adding extra panels either alongside the original or above it.

More important at times is the ability to launch this bridge over a stream or ravine from only one side. The bridge is assembled, complete with the 11-foot-wide deck over which the traffic will

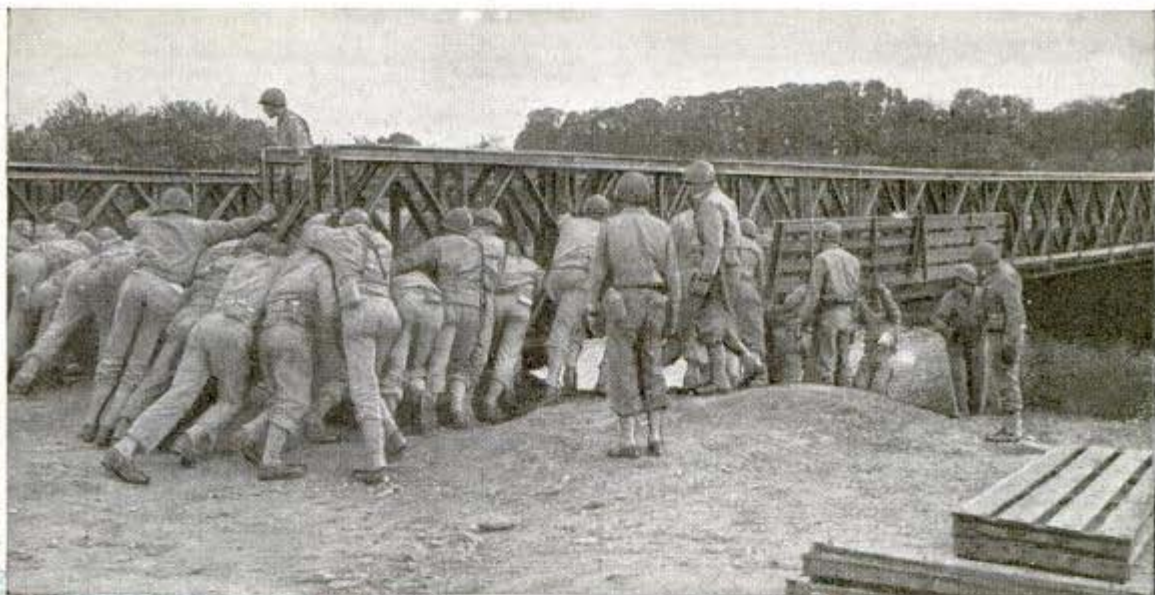

run, on one bank and cantilevered into place with special rocking rollers and winches.

In Italy, sixty such bridges were built in the five days preceding the 5th Army's assault on the Gothic line, for the Germans had destroyed all bridges over the many waterways in central Italy.

Further south, they destroyed all the bridges over the Volturno, and when our forces reached the banks they first had to build bridges before continuing their pursuit. At one location, a wooden trestle bridge was decided upon and work ordered started the following day.

A platoon from the divisional construction battalion was sent out to mark enough trees suitable for timbers for the pile foundation, while another group of officers and non-coms surveyed the site and marked the places where the bridge piers would be built.

Everything was in readiness for the morning. The drivers "buttoned down" the tarpaulins over the hoods

Above, pushing sections of a Bailey together. Below, American engineers make final check on a Bailey built over Volturno River in Italy

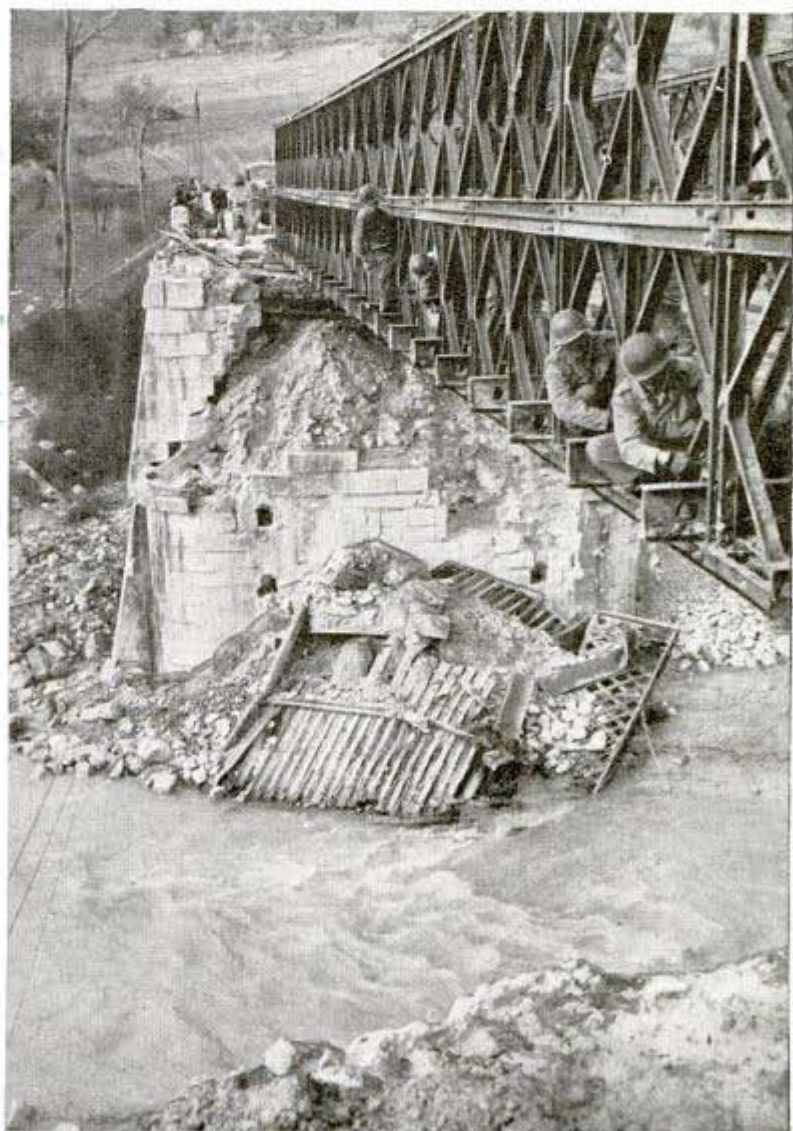

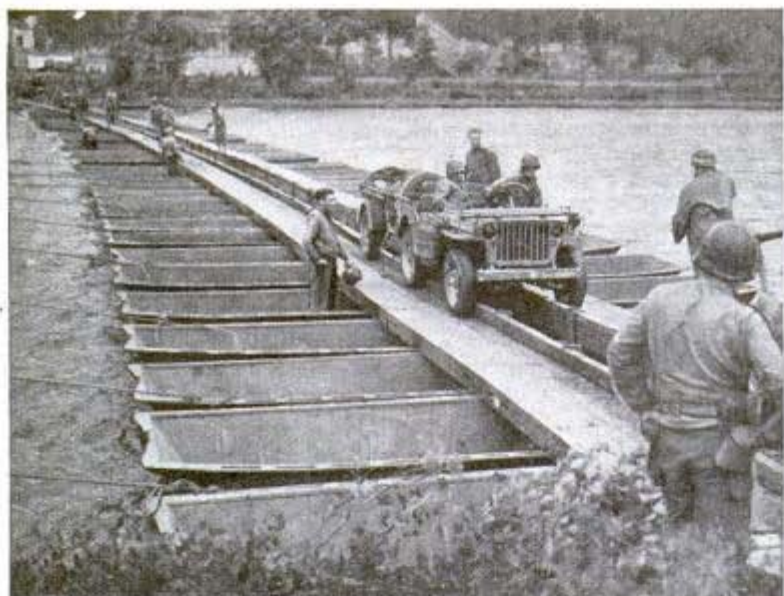

Above, first jeep crosses bridge constructed by Army engineers over the Meuse River in Belgium. They had to fight a raging torrent to build it



British official photo

Above, shoving four tons of chestnut palings into a ditch to form causeway for the tanks which follow. Below, crossing water on ponton rafts



of their vehicles to keep the engines dry should the threatening skies develop rain. With supper over, most of the men turned in. Half an hour later distant thunder and light rain sent the rest into their tents.

The engineers had hardly wrapped themselves in their blankets when the shrill whistles of sergeants and shouts of lieutenants brought them out of their tents. With streams of water running down their glistening raincoats and rivulets of liquid mud eddying around their unlaced shoes, they listened. An order had come through for two of the division's regiments to cross with their antitank companies and vehicles. A light ponton bridge was on the way up from the rear and the battalion was to help build it.

Half an hour later, during the flashes of lightning, one could see hundreds of men cutting trees and clearing an approach to the high bank. At midnight the trucks with the steel pontons and treadways began pulling in. Two of the ponton-carrying trucks failed to arrive, probably lost in the darkness and rain.

The bridge was short several sections, and the major in charge, rapidly



calculating the lengths he had, found that the bridge would not span the river. While looking for a way to stretch the available sections, two of the captains reported that the banks were so steep they would not be able to float the pontoons and build a suitable approach in time. The major and his aides went out to inspect the banks. The far bank, to which they had paid more attention when the preliminary inspection was made earlier in the day, was good, but the bank on their side had a drop too steep for any approach they could build by morning, when the regiments were to cross.

(Continued to page 148)

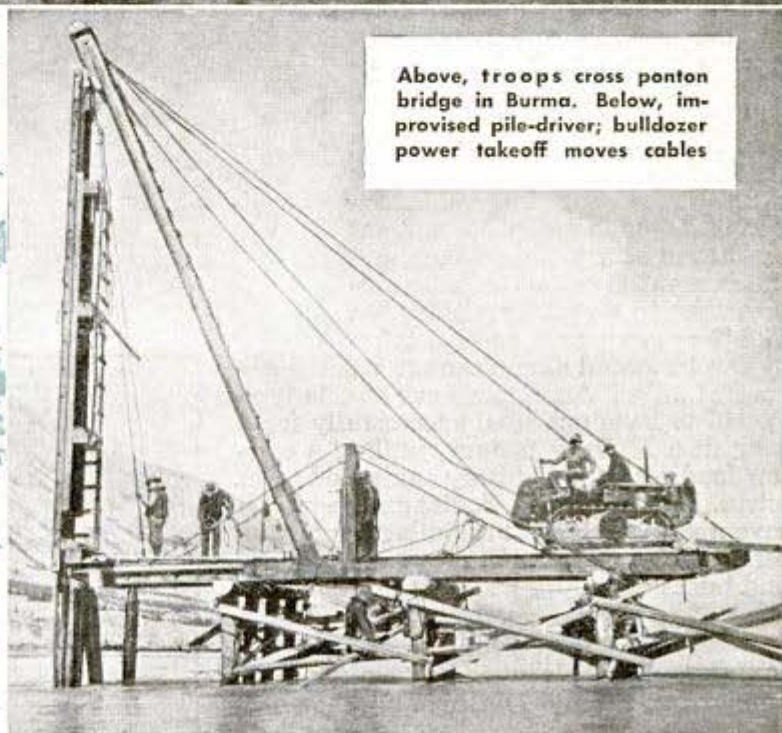

Above, troops cross ponton bridge in Burma. Below, improvised pile-driver; bulldozer power takeoff moves cables

Nazis Fire "Panzer Fist" Rockets Against Tanks



One of the many types of rocket projectiles introduced recently by the German armies is called a "panzer fist." The projectiles, which are small enough to be held by infantrymen, were used against tanks. Another new Nazi weapon is the use of rocket launchers attached to the sides of huge trucks. The latter were reported used in Warsaw to stamp out the uprising of Polish patriots.

Left, German soldiers wield "panzer fist" rockets, apparently as antitank weapon. Below, rocket leaves launcher mounted on truck

Underground Conductors Operate Vehicle

Tass, official Soviet news agency, reports the development of an electric vehicle that operates without the use of a trolley, rails or storage batteries, picking up high-frequency current to power its motor from an electro-magnetic field formed around underground conductors located at intervals along the highway. The 2½-horsepower motor takes in the current by means of a pickup frame and the current is converted from alternating to direct by a rectifier. The Tass story says enough energy can be stored at one time to run the car several miles. An electric car of this type is said to have operated successfully for a year in a Moscow factory, pulling a one-ton load along a roadway underlaid with wires. Dr. G. I. Babat, Soviet engineer who invented the vehicle, has built several passenger car models and believes that trucks and buses operating within a city could be adapted to his system.

☐ One pound of nickel and chromium alloy can be drawn into 90 miles of wire for military communications.



PAPER FOR GI JOE

"Good packaging" is what GI Joe calls it when he opens his food rations out there in the Philippines or on the Western Front. The stuff is as fresh as the day it was packed and it takes many thousands of tons of paper to do the job. Shells and other vital supplies find their way to the front lines in A-1 condition, thanks to the protection of paper. So be sure to turn all your waste paper over to your scrap dealer or some local salvage committee. GI Joe needs it.

SAVE PAPER AND SAVE LIVES

Lockheed "Saturn" Is Designed for Versatility

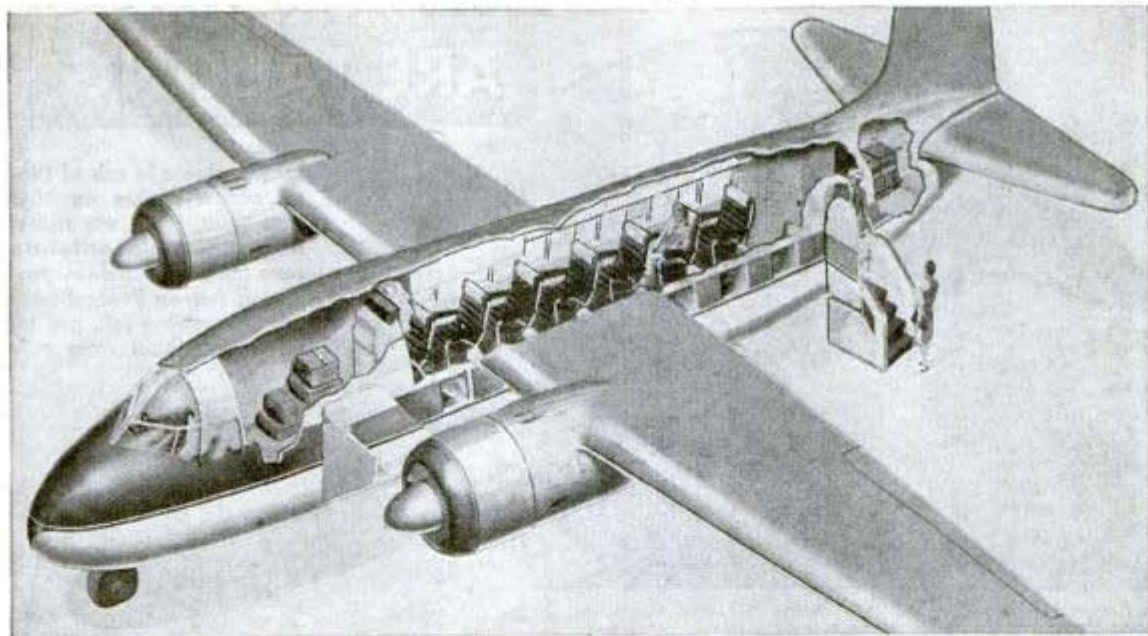

Above, cutaway drawing of Lockheed "Saturn." Right, interior converted to lounge. Below, front-opening nose gives quick access to cargo compartment behind which is movable bulkhead

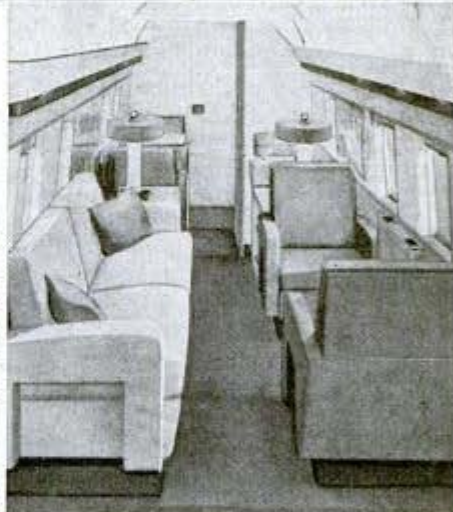
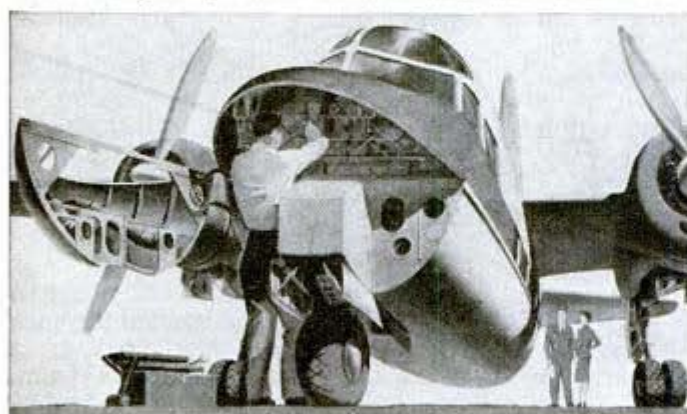

To "bring flying to Main Street," the Lockheed Aircraft Corporation will introduce an airliner designed for short hauls and interurban service after the war. Described as a staunch, swift plane which will give high performance at low cost, the ship will be known as the Saturn, Model 75. Powered by a pair of 9-cylinder Wright engines developing 525 horsepower each on takeoff, it will be a high-wing monoplane carrying 14 passengers, a crew of two, baggage and cargo. To make it ac-

cessible to small airports, its takeoff distance will be 1,055 feet and its landing speed only 73 miles per hour. One of its advantages will be its interchangeable parts, including the dual wheels on the main landing gear, the horizontal and vertical tail surfaces, the elevators and rudders, and the stabilizers and fin. Quick change power plant units also will reduce ground time. Detachable passenger seats and a movable bulkhead permit quick conversion to cargo carrying if necessary.

Penicillin in the Form of Cough Drops Combats Throat Infections

Penicillin in the form of lozenges which resemble cough drops has been used successfully to combat throat and mouth infections, notably trench mouth, according to the British Medical Journal. In some cases, pain, fever and disease germs were

banished in 24 hours. In cases of acute streptococcal tonsillitis, there was "great relief" in 24 hours and within 48 hours all the patients were free of fever. The lozenges are made of gelatin and penicillin plus a preservative.

The RAILS ARE TALKING

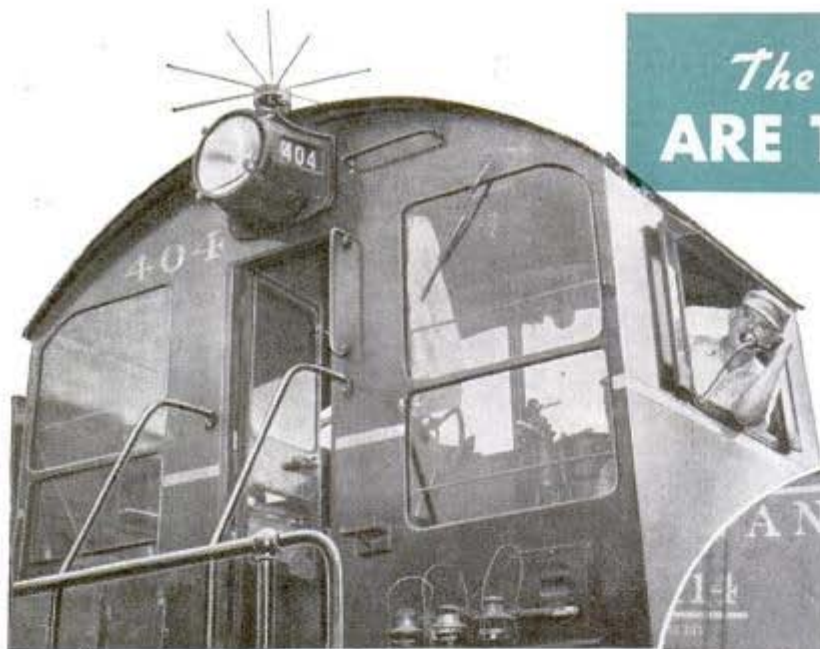

Left, engineer in cab of Diesel switch engine on B&O gets train order via radio-telephone. Note antenna over headlight. Below, projecting bar on Pennsylvania car is receiving coil, picking up radio signal from rails

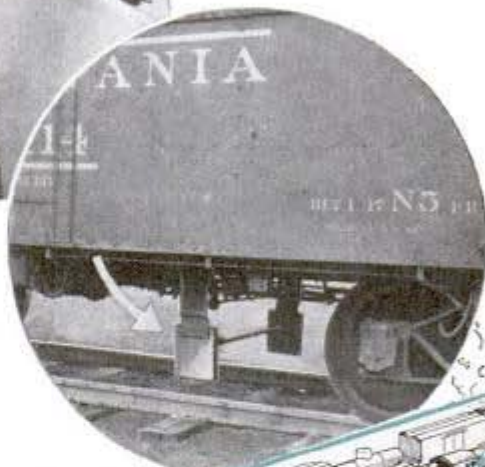

WHENEVER railroadmen get together these days they are spinning radio yarns. Their conversation, however, does not concern the latest exploits of Fibber McGee and Molly or the newest Bob Hope quip. Their stories are "shop talk," for they have to do with the fascinating business of railroadin' by radio.

"Did you hear the one about the station agent at Buda, Ill., and the hotbox on a Burlington Diesel-powered freight?"

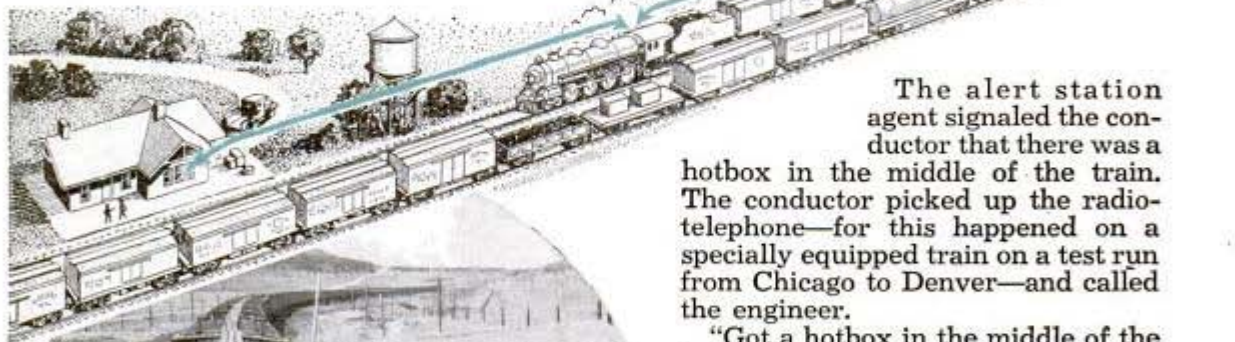

The alert station agent signaled the conductor that there was a hotbox in the middle of the train. The conductor picked up the radio-telephone—for this happened on a specially equipped train on a test run from Chicago to Denver—and called the engineer.

"Got a hotbox in the middle of the train," boomed the voice of the conductor through the loudspeaker in the locomotive cab. "Slow down, and stop at the next station."

The engineer pressed a button on his radio-telephone handset and talked back to the conductor, repeating the instructions. Then a brakeman went back over the top of the train and located the car with the hotbox. The engineer stopped the train at the proper moment so the bad-order car could be set out on a siding with only a few minutes delay.

Although locomotive is almost out of sight, Santa Fe conductor talks by radio to engineer

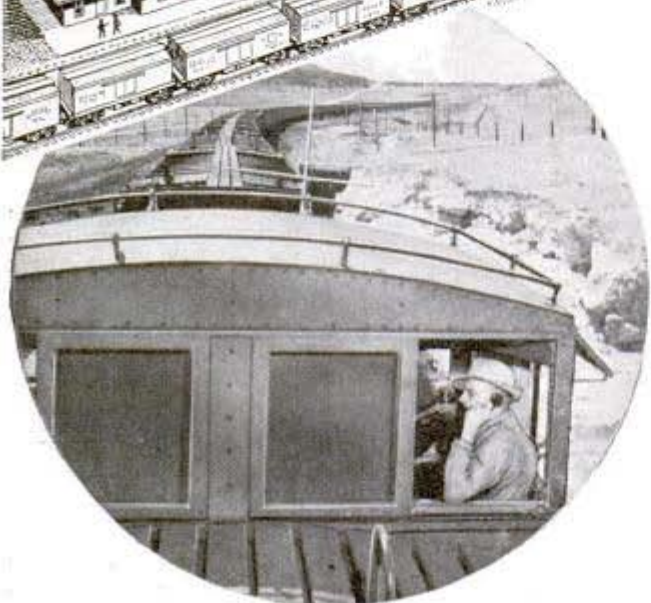

The next day a similar experience with a different ending occurred on an eastbound freight not equipped with radio. Near Ashland, Neb., the conductor was notified of a hotbox. He could not attract the attention of the engineer with hand signals so he had to set the airbrakes. The result was a "pulled" drawbar. That train was delayed two hours, and it held up two other trains for two hours each—a total of six hours delay. But that is only part of the story, for the scores of freight cars composing those trains probably missed many connections costing additional hours of delay.

"And did you hear the one about the Kansas blizzard and the 35-mile gap?"

That happened on the Chicago, Rock Island and Pacific Railroad,

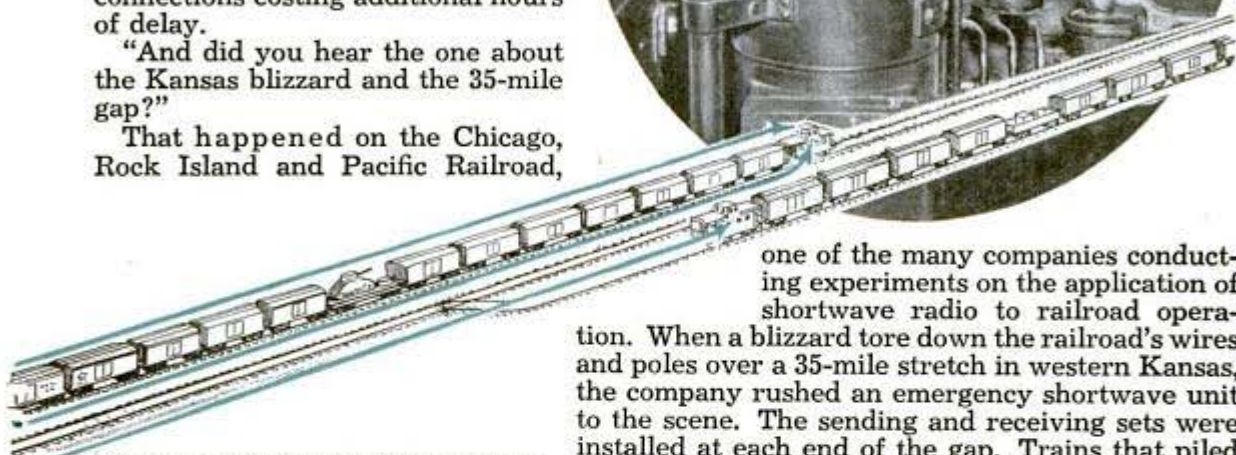

Drawing, based on Union Switch & Signal Co. diagram, shows how train equipped with radio can communicate from end to end, with passing trains, station or signal tower. Upper right, Burlington engineer on Diesel switch engine. Below, installing antenna on top of a Santa Fe Diesel

one of the many companies conducting experiments on the application of shortwave radio to railroad operation. When a blizzard tore down the railroad's wires and poles over a 35-mile stretch in western Kansas, the company rushed an emergency shortwave unit to the scene. The sending and receiving sets were installed at each end of the gap. Trains that piled up during the storm were sent quickly on their way.

Radio-minded railroad officials have put experimental frequency modulation shortwave equipment to work in many other ways. The sets are used not only for communication from caboose to locomotive and for bridging gaps in emergencies, but for com-

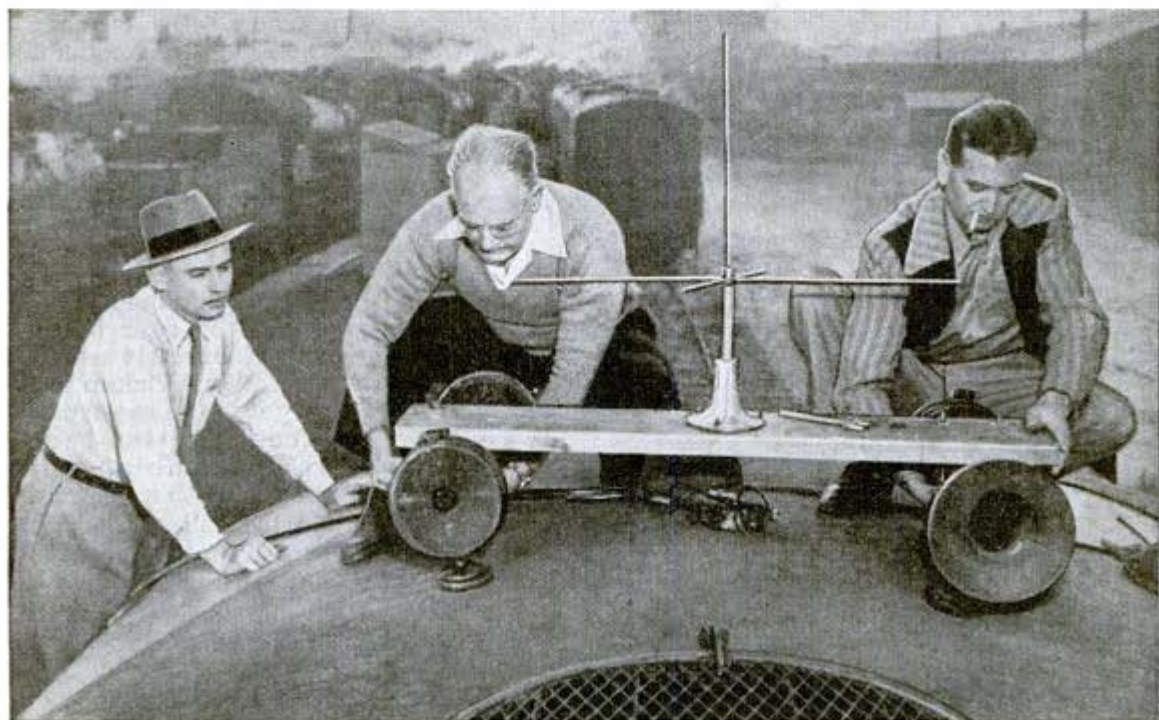



Courtesy Baltimore & Ohio Railroad
Sending train order launching the radio operation of trains in terminal

munication between passing trains, and from trains to wayside towers and stations. Many railroads with Federal Communication Commission permits, issued for experimental purposes, have equipped Diesel switch engines with FM transmitting and receiving units for communication between yardmasters and the engineers. The messages, relayed through centrally located master control stations, greatly facilitate the making up and dispatching of trains. In one yard, two-way radio helps handle 3,000 cars a day.

Some of the railroads have conducted tests on cross-country runs. The Santa Fe equipped a 70-car freight with ultrahigh-

frequency radio-telephone installations for the 2,200-mile trip from Bakersfield, Calif., to Chicago. The purpose was to test end-to-end-of-train communications under varying conditions on a regular freight schedule.

The equipment on the Santa Fe "Spud Special," which was carrying potatoes to Chicago, consisted of low-powered portable transmitters, superheterodyne receiver and power supply at each end of the train, loudspeakers and telephone handsets. A 17½-inch antenna was mounted on the Diesel locomotive and another on the caboose.

The radio was used to make up the train and for all phases of operation en

route. Many times communication was maintained when the engine and caboose were out of sight of each other.

What the trainmen like best about radio on the railroads is the ease with which it can be operated. Veteran railroaders, who were skeptical at first, insist that it is as easy to use as an ordinary telephone.

There are three types of radio or semi-radio systems used on trains: space radio, rail carrier, or induction radio. The space radio system is the conventional type with the radio wave energy traveling through the air. One advantage of this system is that no wayside wires or other conductors along the railroad are required. The principal problem, which remains to be solved, is the allocation of high-frequency channels.

The rail carrier telephone system uses the rails to transmit signals. The current is fed directly into the rails by the output circuit of the transmitter. Pickup coils carry it to the receiver.

The induction radio system combines elements of both space radio and the rail carrier systems. It functions on electronic principles just as



Trainman points to unneeded emergency valve for airbrake as conductor calls engineer
 Santa Fe photo

ordinary radio does, but the transmission path is through the rails and wayside wires as well as space. The wires serve the same purpose as those used in nation-wide radio hookups.

In the induction system the carrier current is fed inductively into the rails by a transmitting loop. The ground provides the return path for the resultant rail current which, in turn, inductively energizes the adjacent line wires. The wires carry the communication over the territory, and the current in these wires sets up a magnetic field. This induces voltage in the rails which is picked up by the receiving coils. Current carried by rails alone has a tendency to diminish, while the wire transmission serves as a booster. An advantage of this system over space radio is that the field of radiation is confined closely to the right of way. It affords a degree of privacy for railroad communications and does not interfere with ordinary radio receiving sets, according to the electronic engineers. Damage to the tracks does not prevent the system from functioning as in the case of the rail carrier system.

The Pennsylvania Railroad is spending a million dollars this year to install induction radio equipment on its busy Middle Division between Harrisburg and Pittsburgh. Two hundred and ten trains, both freight and passenger, pass over the 245 miles of multi-track on this division every day. The Pennsylvania Railroad in collaboration with the Union Switch & Signal Co. has pioneered the development of the induction radio system.

Aside from providing better communication between trains and stations,

Adjustable Target at the End of a Rifle Tests Student's Sighting



Above, soldier aims his rifle while instructor adjusts movable target. Right, closeup of target

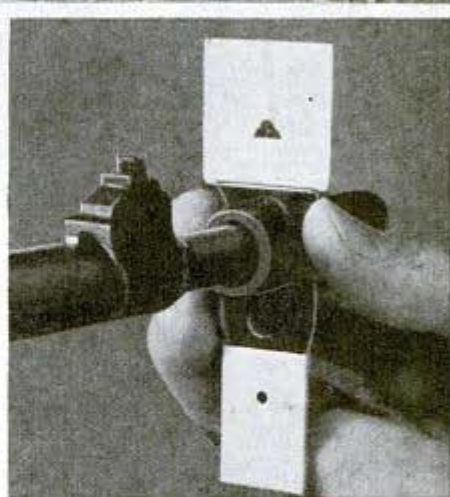

In order to teach sighting on actual rifle sights rather than on the outmoded sighting bar, the Army attaches to the rifle a movable target which to the student appears to be exactly the size of a regulation range target at 200 yards. The instructor adjusts the target up or down, left or right, at the direction of the student until the latter thinks his aim is correct. Then he hands the rifle to the instructor, who looks through the rifle sights to see if the student would have scored a bull's-eye. The target, designed to hold fast in any position, is being made available to rifle clubs.

and between switch engines and yard offices, railroad radio is valuable in expediting routine procedures. It speeds up airbrake tests, the "spotting" of cars under coal chutes, and getting a train under way after the flagman gets aboard. It saves time on sidings, enabling the conductor to notify the engineer the second the caboose is in the clear. The crew of one train can call the attention of the crew on another to hazards like hotboxes and open car doors. Trains on adjacent tracks can be warned of danger along the way. The radio also functions through storm and fog or other conditions that might obscure hand signals. Officials, however, stress the point that radio communication on the railroads serves as a valuable auxiliary and not as a substitute for existing communication systems. When equipment is available after the war, radar is expected to play a similar role with regard to the time-tested safety devices now in use.

22-Foot Ship Propeller Weighs 70,000 Pounds



Six giant ship propellers weighing 70,000 pounds each have been built at the Eddystone, Pa., plant of the Cramp Brass and Iron Foundries division of the Baldwin Locomotive Works. The solid bronze, four-bladed props are 22 feet in diameter and were cast in cement molds. Described as 30 percent larger than any other American-built screws, they utilize 11,000 shaft horsepower on combination ore and oil carriers.

Unbreakable Plastic Eyes Can Be Shaped to Fit

All-plastic artificial eyes can be dropped without breaking, won't corrode like glass, and can be re-shaped if necessary to provide an exact fit. Molded from acrylic resin, one of the newer plastics, the eye is said to be more lifelike than a glass eye. It is made from a realistic photographic reproduction of the iris, the black dot of the pupil being located naturally, deep in the eye, instead of close to the surface as in glass eyes. While the average life of a glass eye is from six months to two years, the new eye is practically unbreakable and will last for years.

"Phono-Projector" on Food Cart for Hospital Movies

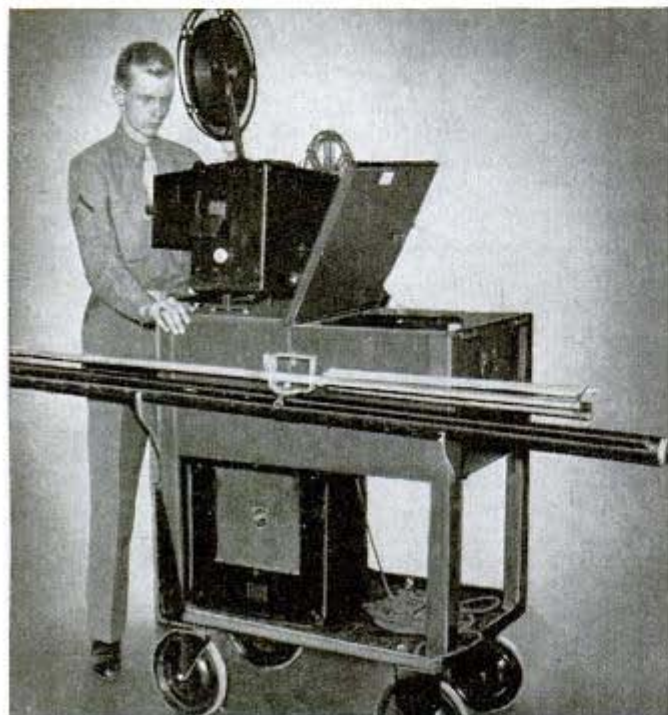

Mounted on a standard food cart, a "phono-projector" unit has been devised to speed up and improve the screening of sound films for bedridden soldiers in Army hospitals. The unit consists of a 16-mm. motion picture projector wired for sound and a phonograph turntable for fading in and out appropriate recordings before and after a movie. Special wiring for a microphone makes the unit adaptable as a public address system. The cart's mobility saves time in moving the equipment from ward to ward and eliminates assembling and disassembling each time it is used. Designer of the "phono-projector" is Pfc. A. W. Johnson, of the William Beaumont General Hospital, El Paso, Tex.

☐ American farmers are using 250,000 miles of single-wire electrified fence.

0-695

COMBING THE SEA FOR LOST FLYERS



SCORES of American flyers were missing at the end of the air-sea battle that accompanied our landing on Saipan. Some of their planes had been shot down during attacks on distant Jap ships, some had been crippled and hadn't been able to make it all the way back to our carriers, and others had run out of fuel.

According to the hard logic of warfare these pilots could be written off. Their loss was a cheap price for the damage that had been done to the enemy.

But military logic didn't have a chance. As soon as the fight was over, destroyers and smaller craft were sent out along the path that the returning aircraft had used. A life raft with a water-soaked pilot on board was found here, another there. When the search ships returned from their sweeps all but a small handful of the missing pilots had been rescued. The rest, presumably, had been killed in action.

Searching for airmen who have been downed at sea is a standard post-battle activity in fleet operations. Surface craft and seaplanes are often used but much of this work is

Navy helicopter uses hydraulic hoist to lift airman in simulated rescue. Below, trailing cloud from smoke pot can be seen miles away





Above, RAF uses hydroplane for rescues in the lakes of the Nile Delta. Below, replenishing helium gas in lighter-than-air ship used in air-sea rescue operations along American coasts

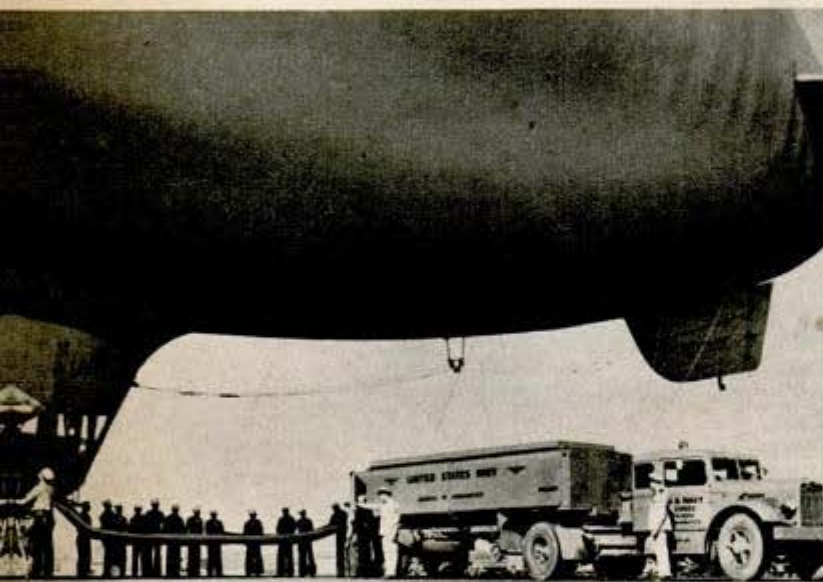

Above, Naval Air Station's crash boat on way to scene of an air-sea accident. These boats are used for rescue work relatively close to shore. Right, men in water learn how to right life raft that has inflated itself while it is upside down. Hundreds of crashed U. S. flyers owe their lives to rubber rafts which kept them afloat on sea

assigned to new air rescue squadrons that use large PBM flying boats equipped with special rescue gear. In combat areas a rescue crew may have to defend itself against attack at any time.

Usually a pilot can get off a brief SOS before he is forced down. Radio direction finders on the ships that pick up his call get bearings on his position and this information goes at once to the rescue squadrons. Some pilots carry small emergency life rafts, tightly packaged, attached to their parachutes. They can leave their aircraft at a safe altitude, parachute to the surface, and inflate the rafts when they touch the water. Other aircraft carry a collapsed rubber raft in a compartment that automatically opens, allowing the raft to inflate itself and pop out, when the pilot pulls a cockpit lever after he has landed on the water. On still larger planes the emergency rafts are thrown overboard after the plane hits.

All pilots on overwater flights also carry their personal "Mae West" rubber life jackets that inflate themselves when a valve is turned. In addition, each man wears a thick backpad that is part of his parachute harness. This backpad opens by means of a zipper and contains cans of drinking water, compressed food, fishing gear, a compass, knife, and other equipment.

A raft is visible at best only four miles away from 1,000 feet of altitude, under conditions of moderate sea and wind. So even after a rescue plane has reached the ap-



proximate area in which the raft is located, after a flight of possibly several hundred miles, the search may only have started. Usually the pilot on the raft sights the rescue plane while it is still some distance away. Then he assists in his own rescue by spreading a colored "sea marker" on the water, making a large patch that is visible from the air. He may ignite a can of chemicals that produces a dense cloud of smoke that can be sighted 10 miles away from moderate altitudes. After dark he fires a Very pistol to signal any plane that he hears, then uses the flashlight that is part of his emergency equipment to help guide the plane.

The crew of a rescue plane often loses sight of a stranded pilot while they are putting their flying boat down on the water, then they must search for him all over again. In high waves the raft will not be visible a few hundred yards away. Sometimes the rescue crew stops the engines of their craft and listens for the sound of the whistle that each flyer carries. The shrill whistle carries farther than does ordinary shouting.

Navy rescue planes have picked up many B-29 crews forced into the ocean on their way back from bombing Japan and once a Catalina flying boat brought 56 survivors of a torpedoed destroyer out of Ormoc Bay in one trip.

An incident where the rescuers themselves had to be rescued occurred after the second Battle of the Philippine Sea. On the third day after a damaged dive bomber sank, its two-man crew, lying sick on a raft, signaled a PBM search plane. Although the water was very rough, the 16 men in the plane voted to attempt a rescue. In landing, a big hole was torn in the bottom of the PBM, causing the craft to spin and crash after it took off with the castaways aboard. The aerologist died from swallowing too much gasoline. This left 17 men trying to occupy a seven-man raft. They took turns treading water, while they beat off sharks with their paddles. Finally, after many hours, four Helldivers, attracted by a Very pistol signal, dropped food and another life raft and kept patrol over them until they were found by one of Admiral Halsey's destroyers.

MARCH, 1945

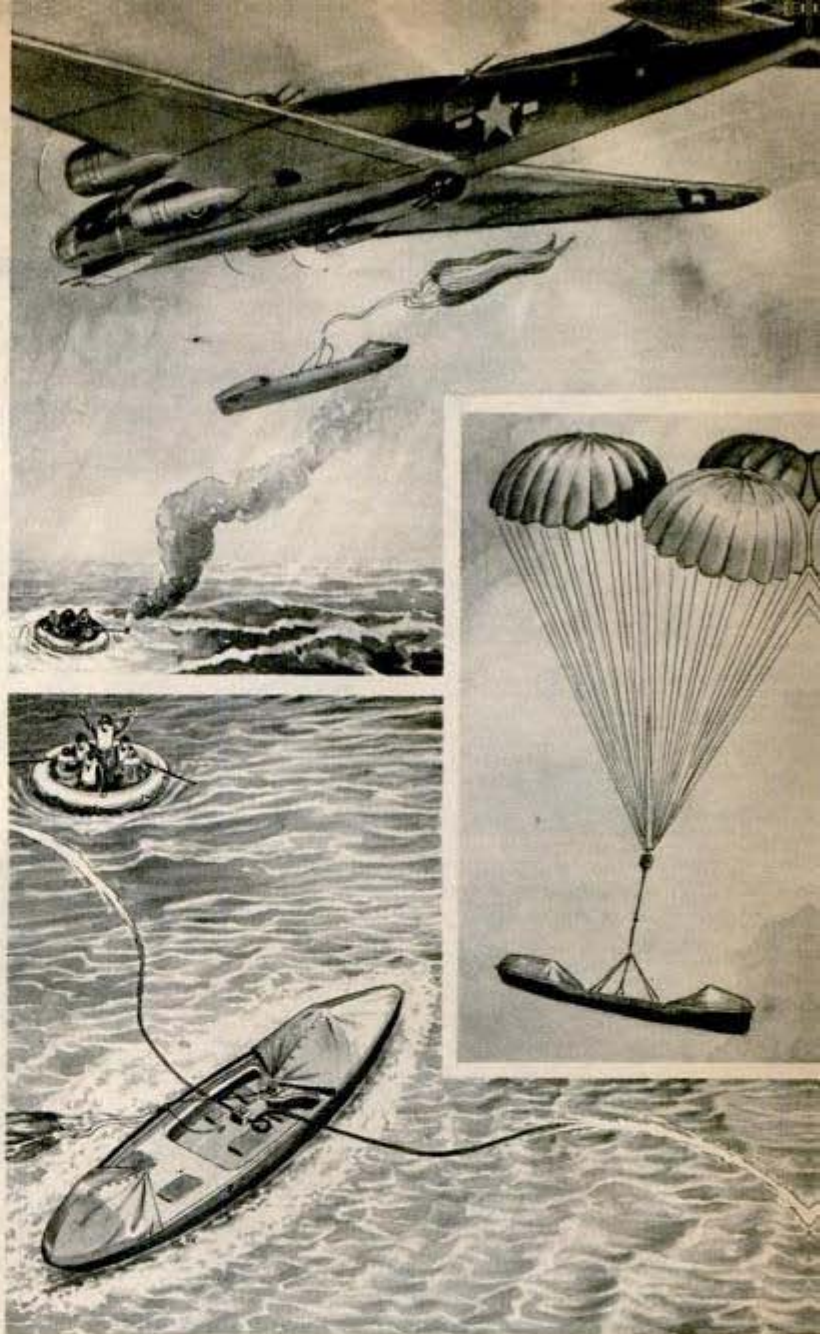

Top, motor sailboat is dropped from bomber by parachutes (inset), which carry it gently to water. As the boat hits the sea, two 150-yard buoyant lines (above) are shot out by rockets, enabling the castaways to pull themselves to the craft. Below, rescued airmen hoist sails of airborne lifeboat and head for shore





Above, larger rafts carry apparatus which distills several quarts of fresh water an hour. Right, lookout in car of blimp scans the surface of the ocean

Comparable to the fleet air-sea rescue operations are the rescue activities conducted along each sea frontier in which the Navy, Coast Guard, and Army cooperate. Pilots who are forced down on the water can be certain of rescue if they get off a radio message describing their plight, and they can be fairly certain they will be rescued even if they send no message. Aircraft on overwater flights normally report their positions at regular intervals. When a scheduled report isn't picked up by a shore radio station, the probable area in which the airplane might

be can be determined by working from the point at which the aircraft last reported.

Fast crash boats are maintained at naval air stations for rescue work not too far from shore. Flying boats, amphibious aircraft, and lighter-than-air blimps perform rescue operations farther at sea. Helicopters are also being assigned to the work. The blimps have performed a number of notable offshore rescues. They are able to remain motionless over life rafts or personnel in the water while a rope ladder is



Below, a PBM flying boat rehearses rescue of airmen from their emergency rubber life rafts





Rescue plane zooms over as occupants of raft burn smokepot signal. Below, receiving plane crash information. Wall chart tells rescue team where to search

dropped down to them. On occasion a member of a blimp's crew has descended the ladder and attached a life line to occupants of a rubber boat who were too exhausted to climb, after which they were hauled up to the airship's cabin.

This coastal rescue work has been placed under direction of the Western Sea Frontier and will be continued after the war.

American rescue operations are based in part on the experiences of Air-Sea Rescue, the Royal Air Force organization that has the task of saving Allied airmen who are forced down in the English Channel. More than 1,000 men, four out of every five who have been "ditched" in the Channel, have been brought ashore by ASR life saving crews. On their busiest day they rescued 118 out of 121 American airmen.

ASR maintains a line of shore stations along the English coast at which high speed launches stand by, their engines kept warm for immediate departure. Additional boats, supplemented by aircraft, are stationed out in the Channel during big raids. The latest procedure that has been tried is the use of a bomber that carries a large lifeboat secured to its fuselage. The lifeboat is dropped from moderate altitude by parachute. A smoke pot begins to burn to show the boat's location, and rockets are fired from each side of the boat, carrying 150-yard-long buoyant life lines. Two outboard engines, a sail, fresh water distillation apparatus, and a cooking stove, in addition to food and other supplies are carried. The boat weighs one and a half tons and has a capacity of 36 people.



Three-Dimensional Maps Model Enemy Terrain

Three-dimensional models of enemy terrain made of a variety of materials are used by the armed forces for studying objectives before invasion or bombing operations. Based on aerial photographs, reconnaissance reports, and prewar maps brought up to date, the relief maps are constructed of molds cast from original models and made of rubber, rubber substitutes, plastic, clay or metals depending on the qualities desired and the availability of ma-



terials. Navy pilots studied rubber relief maps on the aircraft carrier USS Tulagi in a briefing session before D-Day in southern France.

Above, intelligence officer brings rubber maps to briefing session. Left, a terrain model of Attu

Robot Voice Pronounces Words as Heard by Partly Deaf



To enable the physician to listen to words the way a partly deaf person hears them, Acousticon Research laboratories in New York City have perfected an Otometer, which speaks with an unique type of sound. When you speak into the microphone of

this apparatus, the robot repeats your words but pronounces them as they are heard by those who are hard-of-hearing. The Otometer changes "peace" into "goof" and "stitch" into "ook," for example. This is accomplished by taking the high-pitched tones out of each word. The robot voice is able to speak in a dozen of the various distorted tones common to the majority of the hard-of-hearing. It talks in three ways—through a loud speaker, earphones, or through vibrators which transmit sound through the bones. However it speaks, the physician listening in hears the words as the patient does, and then tunes the robot through various zones of amplification to find one where the patient can understand the words. The words come via phonograph records or directly from a microphone into which the physician talks.

"Sky Freighter" Gliders Carry Heavy Payloads



of heavy, bulky battle equipment by air. The CG-10 has clamshell doors for loading cargo from the rear of its extra-large, rounded fuselage. It hauls a larger load than any other American glider, and its fuselage has space for 42 fully armed men or one truck.

Left, two views of cargo glider with twin tail booms. Below, glider has clamshell doors at rear of fuselage which admit truck



"Sky freighter" gliders designed like huge flying wings are being tested by the Army Air Forces for possible war use, though they are expected to be used first in peacetime. The CG-16 is the first American glider equipped with twin tail booms. Its very wide fuselage is divided into two compartments for the delivering



'Cat's' Air-Conditioned Cab Keeps Out Dust, Heat, Wind

Dust, heat and chilling winds no longer bother Gale Rogers of Armel, Colo., a farmer who built an enclosed cab for his Caterpillar tractor and then air-conditioned it. The air inside the cab is constantly circulated by a fan powered by a special belt from the tractor's rear power takeoff. The chimney on top of the cab serves as a ventilator. Lubrication for the blower comes from two lines connected with the tractor's force feed lubrication system.

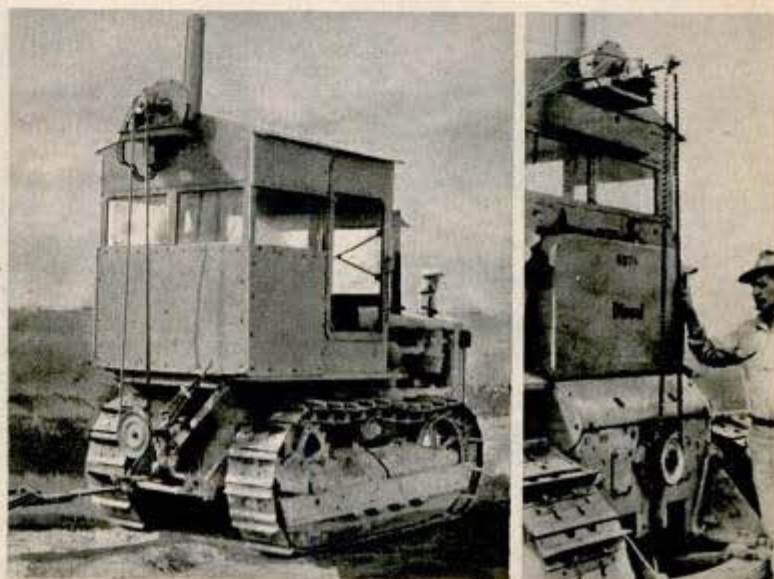

SHARPENING *the* NAVY'S CAMERA EYES



Navy photos

Operator at control board is "dubbing in" sound effects and dialogue for Navy film made on "location." Below, drying aerial film on improved automatic blower in lengths of 50 feet



IF THE 365,000 photographs a year handled by the Navy Office of Public Relations were the only product of naval photographic units, the chances are that such an institution as the Naval Photographic Science Laboratory would not exist.

But the photographs taken by the Navy at the rate of a thousand a day to acquaint the public with its important activities are a minor item. Nine-tenths of naval photography is used for highly technical purposes which play a vital role in the conduct of modern warfare.

These technical purposes include combat photography, identification, mapping, observation, reconnaissance, spotting, training, recruiting, and historical record. Fleet maneuvers are recorded on film for tactical study. The camera captures the flight of projectiles and their ability to penetrate armor plate. Medical research on strange tropical diseases is aided by photographic records in color. Naval cameramen go so far as to record the movements of stars for the Naval Observatory.

POPULAR MECHANICS

There was a time when every new photographic problem—and the war has created hundreds of them—was a headache to the Navy. The need for one center to sift these problems and fill the requests of all bureaus and naval establishments prompted late Secretary of the Navy Knox to order the construction of the photo science laboratory at the Naval Air Station, Anacostia, D. C. It is believed to be the finest institution of its kind in the world.

This three-story laboratory, which is staffed with experts in every field of photography, was designed by engineers of the Eastman Kodak Company. Commander Thorne Donnelly, USNR, officer in charge, stresses the fact that sending out combat photographic units, while important and dramatic, is not the primary function of the laboratory. Its purpose is to improve the quality of stills, color pictures, movies and sound effects. To this end, thousands of tests are conducted on all manner of processes and equipment. For example, every aerial camera that goes into a Navy plane is tested in the laboratory.



Movie crew from the photo science laboratory uses portable equipment. Below, "shooting" training film for Navy divers



Left, checking aerial camera; each one is tested in laboratory before issue to the fleet. Below, giant tanks hold chemicals



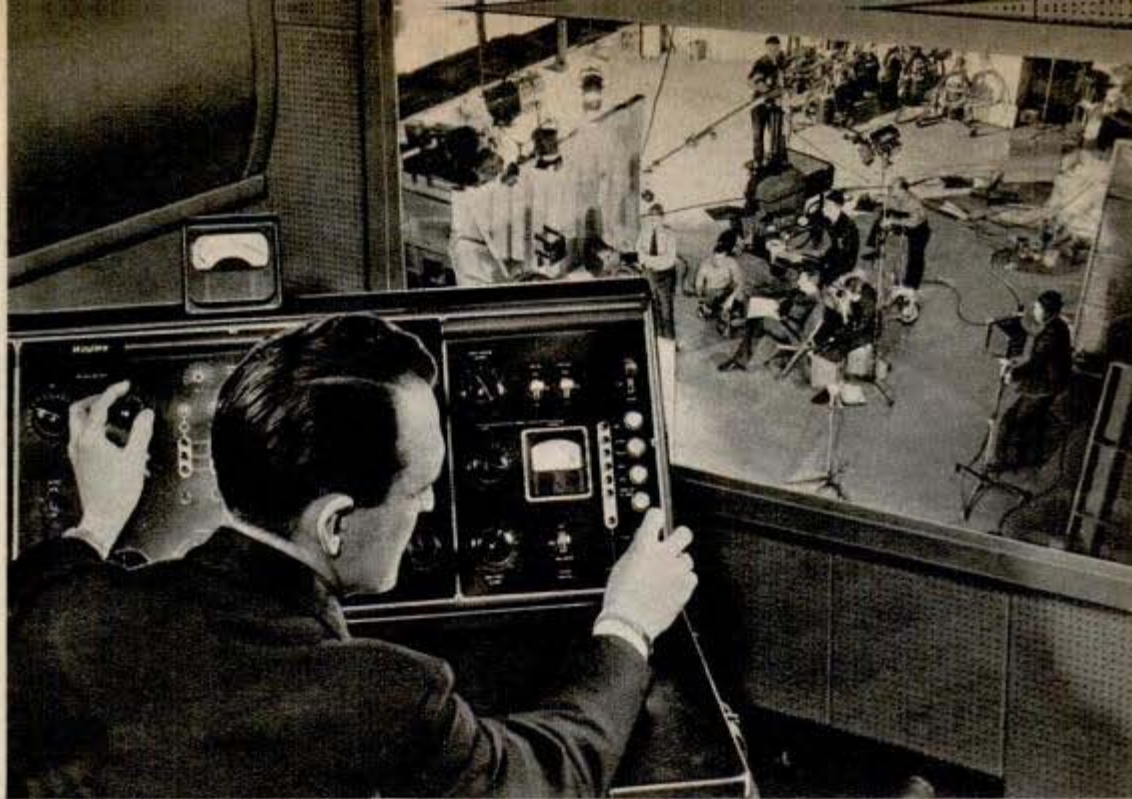

Ex-Hollywood technician regulates sound track as he watches motion picture crew at work on modern sound stage in Anacostia laboratory



Above, testing aerial camera at 90 below zero in "Arctic" room guards against failure on operational flights. Right, drying cabinet on the "assembly line"

Typical research problems concern film defects under tropical conditions, off-color results, or a certain type of lens that is not producing sharp enough images. Filter characteristics are analyzed, also dye solutions, paper, and scores of other pertinent items which can make or mar the finished product.

The staff of about 700 technicians, many of them recruited from the motion picture industry, are constantly making improvements. Despite the emphasis on research and testing, the laboratory's processing division has facilities for developing and printing about one hundred million feet of film a year.

Among laboratory highlights are a 60 by 100-foot sound stage with a 44-foot ceiling, printing equipment with high speed units that turn out 20,000 feet of film in eight hours, the "interpretation" rooms where combat and reconnais-

(Continued to page 154)

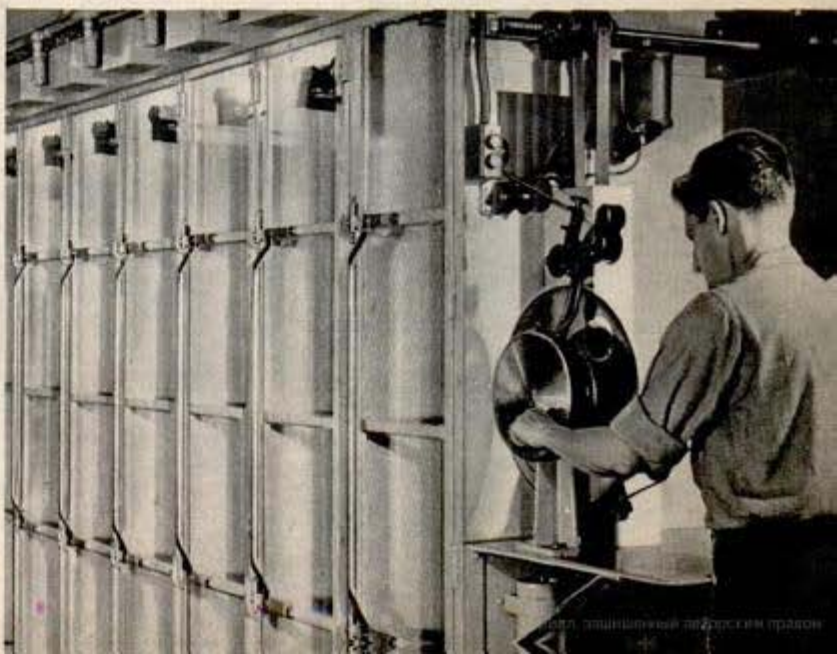

Outdoor Spotwelder Hung From Crane

Already extensively used in inside manufacturing operations, spotwelding moved out of doors recently at the Glenn L. Martin aircraft plant in Baltimore, Md. A portable spotwelder, assembled by Martin engineers, consists of a control and transformer unit and a hydraulically operated welding gun. The unit, which is held over an airplane by a traveler crane, was used to attach a steel part to the baffle of a PBM Mariner exhaust system. Power is supplied by a 500-foot cable with an additional eight-foot line extending from the transformer and control to the welding gun. The welds produced in this manner are said to be of production quality.



Parachute Opens and Closes Like Umbrella for Fast, Driftless Descent

To permit 'chutists to control the speed and general direction of their descent, a parachute rigging which acts much like an umbrella has been devised by A. R. Nailor, a pioneer parachutist in northern Ohio. The parachute can be blossomed and closed

alternately as often as the 'chutist finds it necessary, with an easy pull on the rigging. By dropping free in "steps" the 'chutist can reduce wind drift to a minimum, which would permit him to avoid dangerous landing spots toward which he might be floating. By closing the 'chute frequently he also could hasten his trip earthward—an advantage if dropping into battle or escaping from enemy planes. The control is accomplished with a special attachment which includes a small rubber tubing in the 'chute hem circling the rim, and a pull cord of nylon extending down through the center ring which acts as the hoist attachment.

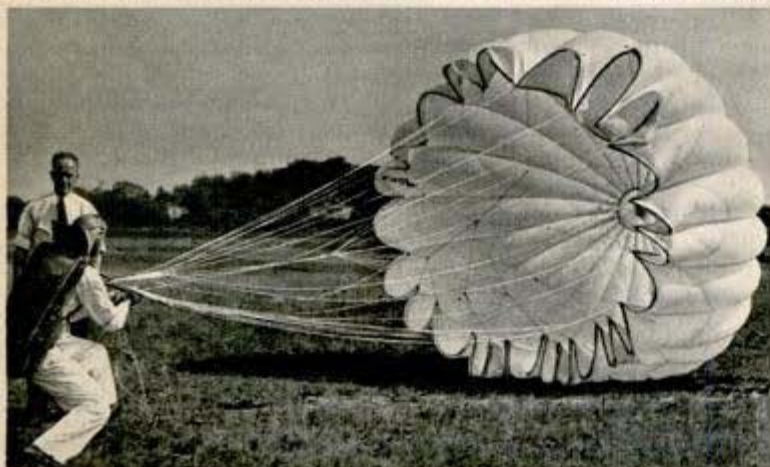

"Fountain Pen" Marker for Parcels Writes in Waterproof Colors

Markers which look and work like fountain pens while using various colors are available for shipping clerks. They can be used to write the address in small or large letters on wet or dry surfaces, including asbestos, aluminum, copper, Cellophane, wax, and textiles. Seven colors are available, all of which are said to be instantly drying and water-, weather-, and abrasion-proof.



File on Quil Markers
1971/1/17

SNIPING THE SNIPER



They're still fighting on Bougainville. This Yank sniper has the "comfort" of sandbags and a roof

THE American countersniper could just see his target, a dark patch in the foliage of a tree that he judged was 700 yards ahead. He raised his sight to that elevation and corrected for a slight side wind. Now he was all set.

His first shot had to kill. Otherwise the crack of his bullet plowing through the air would warn the enemy sniper and then the report of the gun would give away his position. If he missed he might be killed himself a few seconds later.

Through the telescopic sight the target

seemed to dance and jiggle but he knew that this was only the magnification of his own heart beats. Heat waves, too, were swimming across the scene but these would not affect his aim. He lined up the sight's cross-hairs, slowly squeezed the trigger, and fired. Through his sight he saw the target slump, then tumble to the ground.

Some foreign armies depend on sheer mass of fire power in battle but the tradition in the United States Army since the first days of the republic has been to make every shot count. Good shooting, in war

Here's how a bazooka looks when fired in the dark. Launching kicks off a blast from rear as well as from front





Sniper in camouflaged suit fires rifle grenade at a tank

or peace, is a matter of pride with every American who handles a gun.

The best shots in the army are the expert riflemen and the best of these become the army's snipers. Not all expert riflemen can qualify for this dangerous duty. A man-hunting sniper must be a good scout as well as a good shot. Above all he must be calm and patient in the face of danger. A sniper who becomes flustered and exposes himself unnecessarily or who misses too many shots doesn't live long.

The standard assignment of a sniper is to pick off key enemy personnel who expose themselves but in this war the main job of American snipers is that of countersniping. Our enemies are retreating on all fronts. With each withdrawal they usually leave a few good shots behind to hold up our advance. Sometimes this rear guard consists of individual snipers, sometimes of a few suicide machine gun squads.

When that situation occurs in a certain sector of the European front someone usually steps to a field telephone and broadcasts a call for Sergeant Frank Kviatek. "Hardtack," it is explained to him, "there is a Jerry sniper up here who has gotten a couple of our men. Come on over." Ten minutes later, possibly, you hear the single shot that removes the cause of the trouble.

At the last report "Hardtack" Kviatek had 27 notches on his rifle, each representing a German sniper he had killed. Those notches don't include the several dozen enemy soldiers that he has killed with rapid fire weapons, nor the 11 prisoners he has brought in. The Silver

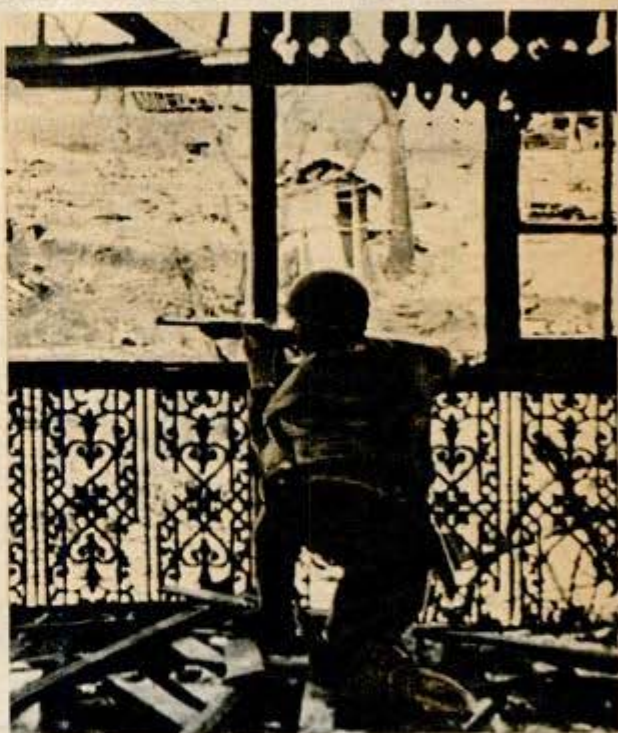

Above, sniper watches from a window for a Jap. Below, bazooka shell hitting U. S. training tank





Huge transparent model of Garand rifle's firing mechanism and breech built at Camp Roberts, Calif.

Star was awarded to him for one day's work in which he wiped out four Germans. First he got two who had command of a crossroads, then he knocked out a German paratrooper captain hidden behind our lines, and last he spotted a sniper who was concealed behind a chimney. With no time for protracted stalking of the latter, he called for a bazooka. The first shell fired

brought down chimney, sniper, and all.

All good snipers know that any one of a dozen things can throw them off their target and that they must compensate for each. They know, for instance, that as the day gets warmer their shots will strike higher than they did in the colder morning. A 15-degree increase in temperature raises a bullet's impact by five inches at 500

yards. A good sniper knows whether he habitually shoots higher, or lower, on a dull day than on a bright day, and he corrects for it. He knows that he must always adjust for more than the actual range in shooting uphill and less than the actual range in downhill shooting.

He has learned to shoot from the left shoulder as well as from the right and this allows him to expose the least amount of his body when shooting from the left side of a protecting object. He knows that

Four Yank riflemen crouch behind barricade, covering troops crossing Seine River on ferry



POPULAR MECHANICS

keeping his ammunition at body temperature makes for the most consistent shooting.

He knows, too, that a man in a prone position head-on makes a target 25 inches wide and that a man's head and helmet form a target about 10 inches tall. He knows that he should aim about 20 inches in front of a walking man in order to hit him, and he knows at what ranges he can be certain of hitting such targets. A good sniper is able to hit a 6-inch disk at 500 yards and kill an enemy at up to 800 or 1,000 yards.

Like the Germans, the Japs are specializing in sniping. The Japs are good at concealment but they are not all crack shots. A favorite stunt of Jap snipers is to lie concealed until our front lines are well beyond them, then open fire on unsuspecting troops. They are usually shot down before they do much harm.

Another stunt of the Jap snipers is to conceal themselves in small caves which are completely sealed except for a small hole through which a rifle can be aimed. These one-man forts could do a lot of damage except that the small firing port limits the sniper's field of fire. Usually the



Trainee hurls a grenade (indicated by arrow) after a tank has crossed his foxhole. Below, sniper covers tank during maneuvers





A soldier aims rifle with telescopic sights from concealed position. In most cases only the muzzle of his gun would be visible

Americans don't bother to shoot it out. When a sniper's cave is located, a flame-thrower merely walks up from one side and burns the sniper out with a burst of fire aimed through the cave's opening.

Not all infantrymen can qualify as expert riflemen or even as sharpshooters, but all of them can shoot proficiently with a number of weapons. Before they go into

mathematical odds of being hit. Entering a house through a door or window, a soldier is taught to make his entry as fast as possible and then immediately get his back to a wall until he has completely inspected the room.

The men learn to step over sills instead of on them to avoid the possibility of setting off a booby trap and they take stairways two or

three steps at a time to reduce the chances of treading on a stair that may be booby trapped. When a man detects such a trap he lets it alone but warns the man behind him.

A man always carries his gun with one hand near the trigger in going through a window so that the rifle can be aimed and fired with the least delay if a target is found. Village fighters know that the whole body below the eyes is blind and so in descending into a basement, they go down with a rush until they are low enough to see any enemy who might be waiting for them. These tricks of their trade plus accurate shooting accomplish two things at the same time—the men get the jump on the enemy, thus keeping alive, and they drive the enemy back toward defeat.

Left, infantryman drops behind sheltering tree trunk to fire at target



Junk-Built "Locomotive" Hauls Fuel, Supplies

Built entirely of salvaged material, a gasoline "locomotive" to pull fuel and other supplies over regulation railroad tracks at the Houma, La., Naval air station was assembled by Frank P. Hatfield, machinist, of Harriman, Tenn. The hybrid machine is a truck with special wheels to fit the rails and can be hooked onto railroad cars that need moving at the station.



Chain Feeds Electric Drill In Awkward Positions

Drilling in hazardous or awkward positions—overhead, head-high, or on ladders—is safe and easy with a new drill attachment which eliminates the need for pushing the drill to maintain pressure. A simple turn of the handle provides the pressure by means of a ratchet and chain arrangement. The operator needs only to guide the tool while controlling the pressure by operating the handle. The attachment can be used on any electric or air drill equipped with a pipe handle.



Invisible Beam Is Shot Into Sky To Measure Cloud Height

Ultraviolet screens made of dark purple glass are used by the Army Signal Corps in a cloud height determining system worked out by the United States Weather Bureau in conjunction with General Electric engineers. The screens filter out all visible light from a powerful little match-shaped mercury lamp, which operates at such high temperatures that the screen occasionally gets hotter than boiling water; therefore it is built in small panes to localize shock caused by exterior temperature changes. A projector shoots the invisible beam up to the cloud base and the ceilometer, actually a photoelectric scanning device, indicates the location of energy reflected from the cloud base. The ceiling height is then computed by triangulation.

Between 620,000,000 and 625,000,000 tons of bituminous coal were mined in 1944, a world's record, exceeding the 1943 output by about 30,000,000 tons.

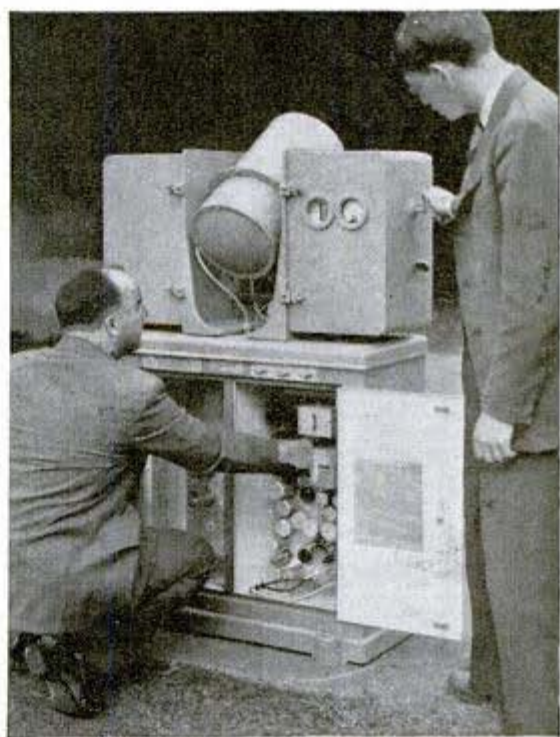

Tool Cleans Cylinder of Carbon Without Removing Piston

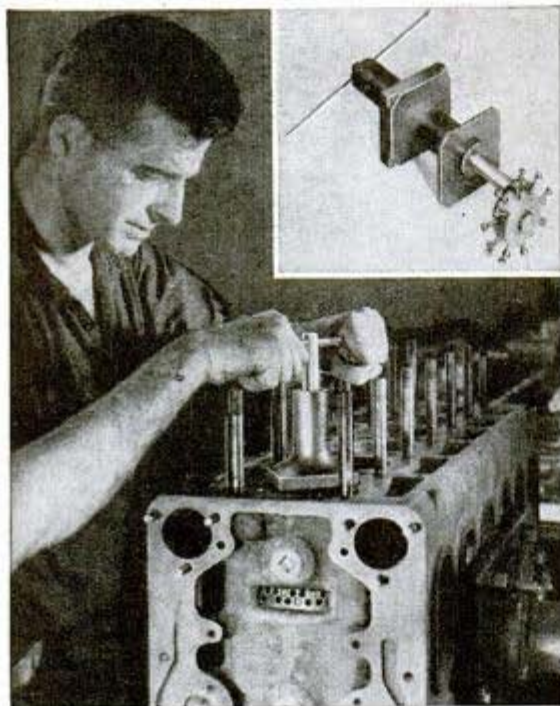

Cleaning the carbon from the air intake ports of the two-cycle Diesel engine is done better and quicker with a carbon removal tool, which operates without removing the pistons or pulling the cylinder sleeves. The tool's head, which carries two rows of eight punches each, is mounted to a shaft by an eccentric cam and is so designed that when it is lowered into position the punches are automatically aligned with the ports to be cleaned. Only four turns of the handle are required to punch the carbon out of all 64 ports in each sleeve, which results in a saving of at least three and a half hours for the whole operation.

Sugar Suggested as "Brain Fuel" To Raise Flyers' Ceiling

To raise their ceiling, airmen should reach for sweets instead of a smoke before high altitude flights, according to experiments reported to the Aero Medical Association by three Harvard University professors. Tests showed for the first time, they reported, that very small amounts of carbon monoxide handicap the human body in the stratosphere, while other tests showed that a flyer's ceiling can be raised a mile if he takes about an ounce and three-fourths of sugar just before taking off. The carbon monoxide—which could come from engine exhaust gas, tobacco smoke or gunfire—is harmful because it reduces the oxygen-carrying ability of the blood and thus might prevent the brain from getting

enough oxygen for proper functioning at high altitudes. Carbon monoxide from three cigarettes would be equal to an altitude of 8,000 feet in its effects on visual sensitivity, the scientists discovered. Sugar, which is almost the only thing the brain can use for fuel, raises the airmen's ceiling by counteracting the lack of oxygen.

Common Garlic Destroys Germs That Penicillin Won't Kill

Allium sativum (better known as garlic) is used as a base for a germ killer called allicin. It will destroy some germs not attacked by penicillin, according to Dr. John Hays Bailey of the Winthrop Chemical Company, Inc., Rensselaer, N. Y. While allicin has only about one percent of the effect of penicillin on some types of bacteria, such as staphylococci found in boils, it stopped the growth of bacillus paratyphosis which penicillin does not destroy.

Printer Labels Cellulose Tape And Adds Laminating Strip

Cellulose tape, which is being used increasingly for labeling wire terminals, parts, accessories and overseas shipments, can be marked easily with a hand-operated

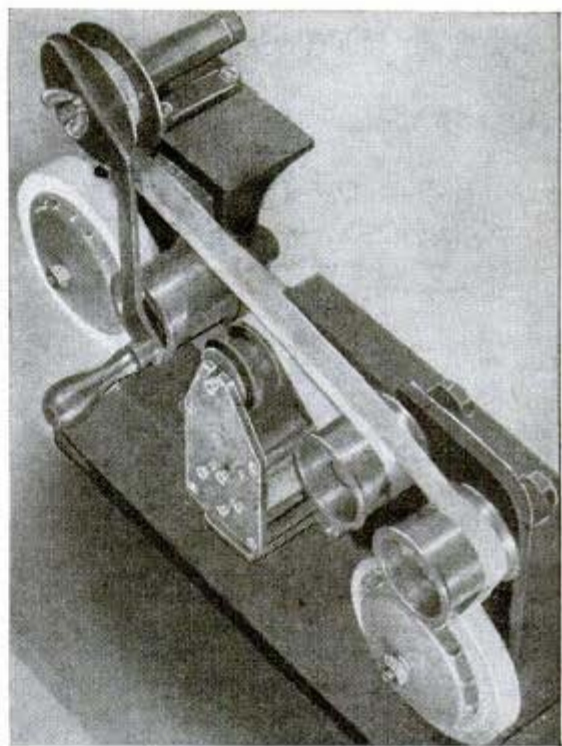

printer with movable type. The unit lays another strip of tape over the printing, a laminating process which seals the ink between the two tapes and gives it resistance against wear, oil, gasoline and salt water.

an 18-foot, transparent acetate plastic model of the new craft in scale. Blueprints of the real ship were used as guides. Plates, duplicating steel slabs to come, were rolled to exact size. Masts and funnels were fabricated precisely. Cargo booms which actually lifted loads were installed. Electrical wiring and pipes of metal were run through the hull in proper places. The various sections and quarters were named with signs.

Then a diagram of the shipyard was painted nearby on the floor. Foremen and assistant foremen by the hundreds were called in to study the model. Then each was referred to the floor layout so he could learn the easiest way to route materials and parts into the section of the hull where his crew would be working.

The Higgins Industries, which had pioneered in building shallow craft for the bayous of New Orleans and Central America before the war, used models to study the underwater action of landing boats when "hitting the beach." A 48-foot tank was installed, with a width of six feet and a depth of three feet. Miniature models of all landing craft were made with motors driven by compressed air. Every type of

beach bottom was fashioned in miniature—coral, sand, or rock. Moving picture machines were set up and as the boats "hit the beach" each was photographed through the plate glass front of the tank. These movies became the standard course of study in landing craft design and operation.

One of the most carefully guarded "mid-gut colonies" in the world is the Taylor Model Basin in Carderock, Md., where every type of naval vessel flying Old Glory first hit the water in exact miniature scale for dynamometer tests which would indicate the probable effect of design and weight on speed. In the same building where American vessels are being tested in miniature, the types of craft constructed by the enemy are being turned out in miniature on a mass-production basis so that crews will recognize the enemy under unfavorable conditions and at great distances.

Even the towing tanks, which actually are miniature canals with the towing machinery suspended above them, are reproduced in transparent lumarith plastic in smaller sizes. They are so light that they can be moved to a table or desk to test the hydrodynamic properties of seaplane hulls



and floats. By observing the deflection resulting from specific loads suspended from the tracks, engineers are able to correct the calculations of deflections of the actual tow tank. One such miniature is used at Langley Field, Va.

Boat builders have for centuries attributed wayward water habits to the individual personality of each craft. Actually, these variations in performance were the result of faulty design. Thanks to tank testing of miniature models during the war, the hundreds of thousands of new seagoing craft perform just as they are supposed to. There are no skittish "Mary Janes" that refuse to take full left rudder working for Uncle Sam.

Tank testing is based on the principle that a boat's performance is governed by water resistance. To test a given hull, it is towed in miniature through the towing tank at definite speeds by known units of power. The resistance set up by the towed model is measured by sensitive instruments

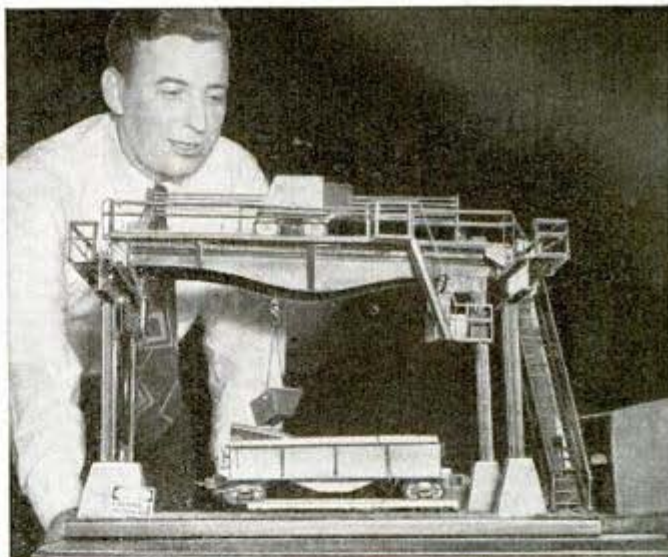

Above, small-scale overhead crane for teaching safety in the mill. Models often are used to emphasize safety rules

from which it is possible to determine the power requirements of the full size hull.

But some corporations have other uses for miniature models—to save the lives of

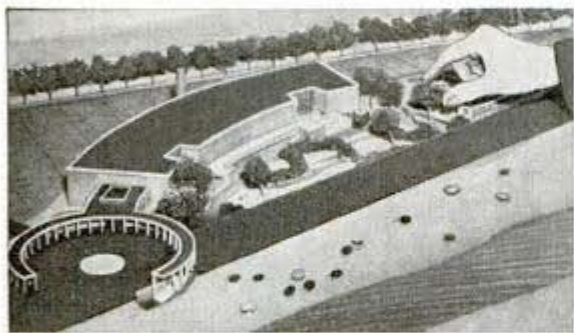

Inset, model of the modern Oceanarium which will be erected at Coney Island. Right, miniature of an entire shipyard which takes up one whole floor of a yard building. This enables operators to devise most economical and efficient work sequence



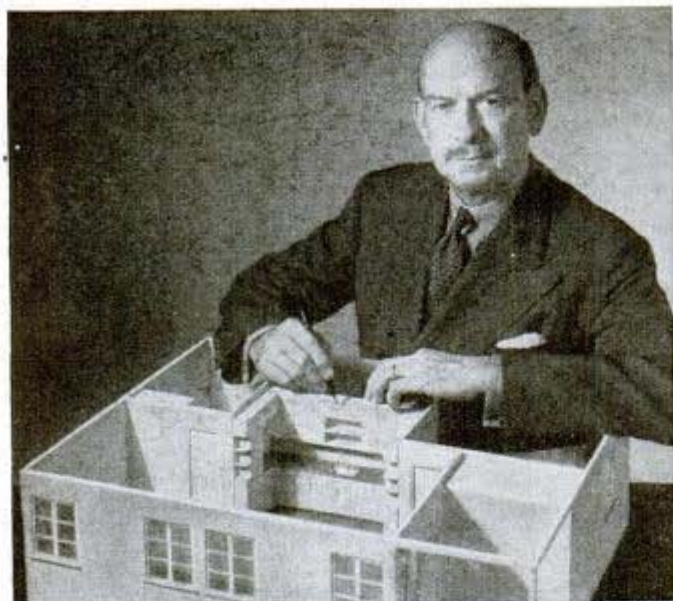

Above, model of prefabricated home designed by Walter Dorwin Teague

workmen. A safety engineer for the Carnegie-Illinois division of U. S. Steel has an accurate scale model of a giant crane by which accidents can be made to order for the eyes of men not familiar with the working hazards.

A. L. Stevens and Associates photo

Another miniature model which aids safety is used by larger coal mines. In small scale, the entire mine is often reproduced. Here safety engineers show miners how to escape in case of an explosion, or where to erect barricades.

Probably more airplanes have been reproduced in model form than any other device, all the way from recognition models to precise scale miniatures tested in tiny wind tunnels. The Glenn L. Martin Company has a model plane which can be taken apart and re-assembled piece by piece, both to teach workers what goes into plane manufacture and to work

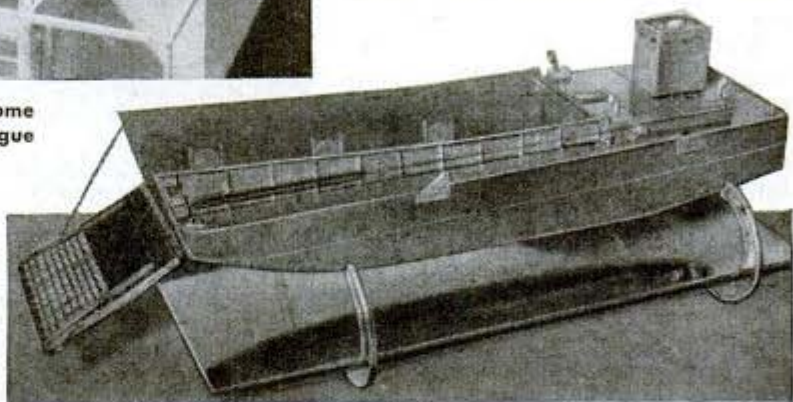

Above, a model of a Higgins boat. Below, facsimile of a city street showing damage and how repair equipment would operate in event of a bombing

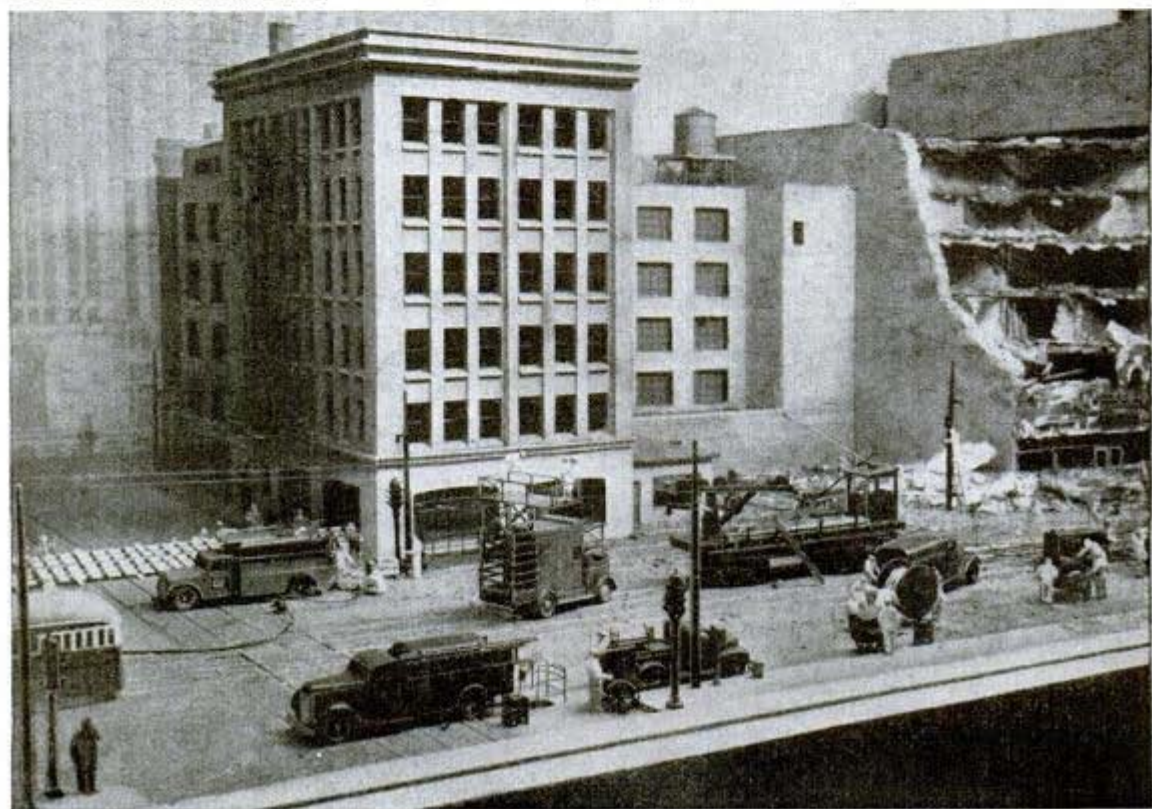

out problems in design for peace as well as war.

The automobile of tomorrow is the miniature of today. Miniature scale models are built by manufacturers to give designers and engineers a "bird's-eye" view of the planned product, a slant more accurate than any sketch can furnish. The manufacturers have used the same system for sizing up the guns and tanks they are producing during the war.

The war uses of models run into the thousands. Accurate reproductions of invasion coasts fix the terrain and defenses in the minds of the servicemen until they feel they have already been ashore at the spot. Models of German villages, both miniature and full-scale, taught our servicemen street and house-to-house fighting and they were familiar with the appearance of Germany before they ever saw the country. In addition, model making provides many a homesick soldier and sailor with a hobby to pass the time at a distant outpost.

On the home front are models of elegant store fronts, store fixtures which will simplify salesmanship, factories which will turn out improved peacetime products, dwellings which will spring up by the hundreds of thousands, schools, museums, docks, apartment groups—in fact, a whole new world already exists in miniature, awaiting the day when it can become as big as reality.

New Resin Gives Rigidity To Synthetic Rubber

A synthetic rubber resin that imparts rigidity to synthetic rubber itself has been developed by the Goodyear Tire and Rubber Company. Although it is unsuited for use in tires, the resin will have importance in wire and cable insulation, safety helmets, golf ball covers, and similar products where hardness, light weight and impact resistance are desired. The resin also eliminates the use of carbon black as a reinforcing agent in certain compounds, making possible the production of synthetic rubber products in color, such as household items, kitchen equipment and toys.

Streetcar Fitted Out as a Library Makes Rounds in City



At top, children boarding traveling streetcar library. Below, choosing books in car, which has bookshelves in place of seats

Books are made available to citizens of Edmonton, Alberta, with a library streetcar. This traveling public library makes its regular rounds on the streetcar system just like the mobile libraries in rural areas. Every week it circulates thousands of books, for both children and adults, in this city of 100,000 population.

☛ Synthetic blood plasma produced as a byproduct in the manufacture of sugar is reported to have been developed in Sweden.



*Clever,
These Yankees!*

Below, a Jeep Laundry built by U. S. Engineers at Castle Shop on Oahu. Clothes are tossed as drum seesaws lengthwise. Power is supplied by back wheel of jacked-up jeep



Nothing is more typical of American ingenuity than the countless on-the-spot inventions by workmen—often with salvaged materials—to make their tasks easier or less costly. The tool above, suggested by a Douglas Aircraft employee, both locates and drills a hole; formerly a tool was used for locating, then the drill was inserted. Use of the drill guide saves almost 10 man-hours per plane

For speedy removal of nails from reclaimed lumber, a multiple nail puller was devised at the R. G. LeTourneau plant in Peoria, Ill. (below). The nails are started by hand, then the board is moved over five hammer heads which, welded to five others on a shaft, rotate at 600 r.p.m., driven by a ½-horsepower motor

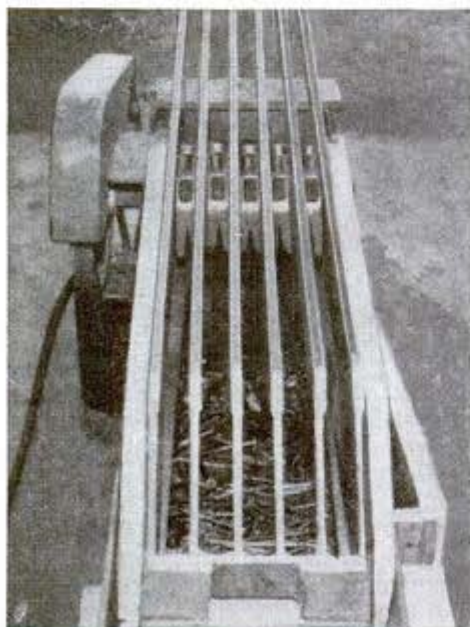

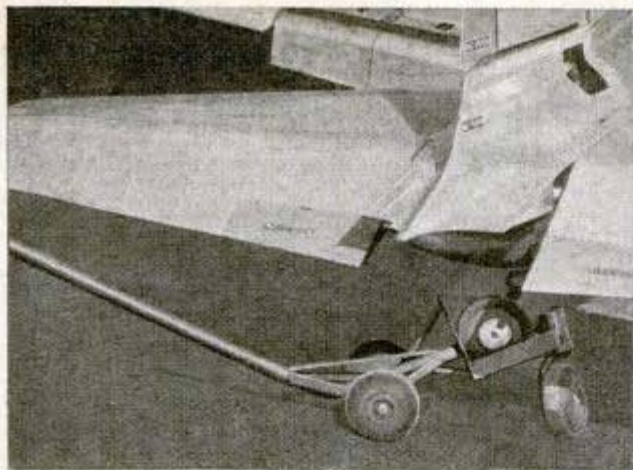

AAF, Cochran Field, Ga.

Above, with an extra wheel inserted below its tail wheel carriage, tail wheel lift dolly is used as a truck. The hydraulic tire remover at right was invented at an AAF depot in Italy. The 8-pronged gadget is placed over the wheel, with the shaft extending down through the hub, and screwed into a disk fitting into hub on other side. It whisks tire off undamaged

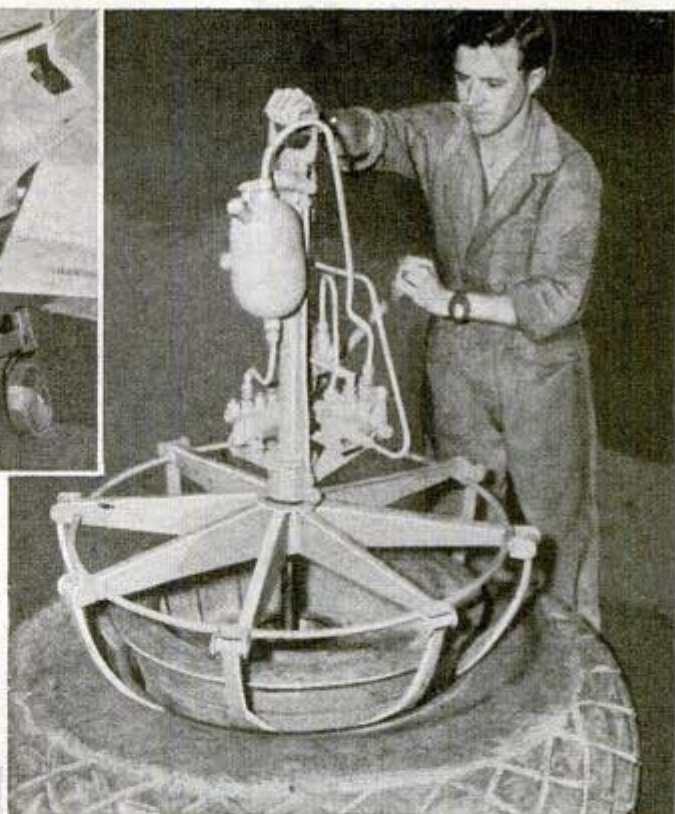

Left, an artillery unit in Italy made a road out of 105-mm. shell cases in order to pull Bofors gun over it and into firing position. Below, a homemade motor boat which was designed and built by a 10th Air Force corporal in India from the discarded belly tank of an RAF Spitfire and other materials which he salvaged

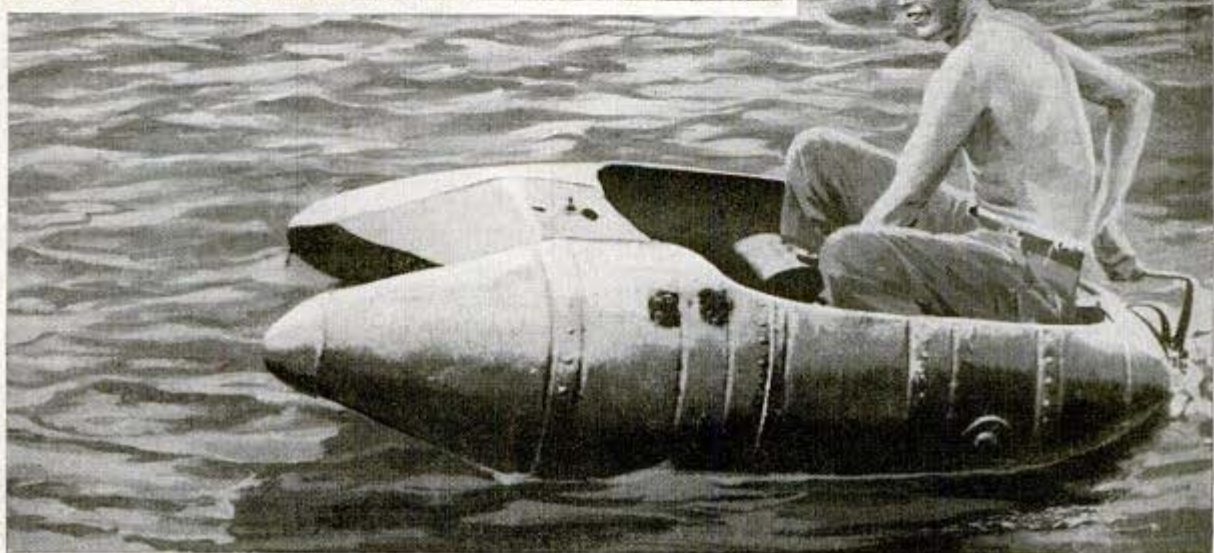

Explosive-Laden Speedboat Jettisons Pilot Near Target

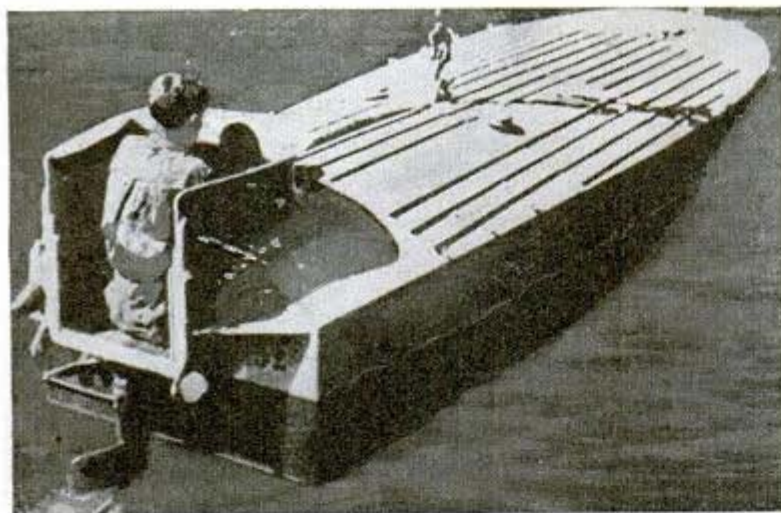

Allied shipping in the English Channel is reported to have been attacked by Nazi speedboats packed with explosives and controlled by one man. When the "suicide boat" comes to within 50 yards of the target, the pilot drops off into the water, after releasing a spring which disengages the floor from the boat. The boat continues on its lethal course and the man uses the floating floor for a raft until picked up by a patrolling ship.

Cabinet Tumbles Clothes For Quick Drying

Fussing with a clothesline in the back yard or basement no longer is necessary if you have an automatic drier that makes the operation entirely mechanical. The clothes simply are dumped into the drier, an automatic dial is turned and soon the clothes are either completely dried or damp-dried, ready for ironing. Uniform drying is assured by an internal mechanism that tumbles the clothes and exposes them to warm air that is free of dust and soot. Temperature of the clothes while drying can be controlled.

☐ Plywood has been produced from timber which had been felled 35 years ago, rot having touched only the outer few inches.

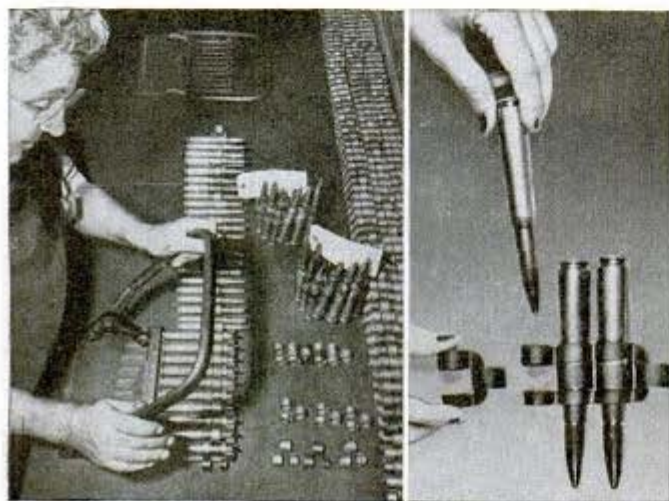

Cartridge Belt "Vanishes" As Bullets Are Used

It looks like ordnance magic. As the flexible belt feeds .50-caliber cartridges into the machine gun breech, it apparently vanishes into the air instead of emerging empty on the other side. The "disappearing belt" actually is a disintegrating belt of breakaway links—simple, interlocking devices that not only hold the cartridges together but are themselves held together by the cartridges. Each pair of links is joined by inserting a cartridge into the tube they form. As

each cartridge is fed into the breech it is withdrawn from the belt, freeing one of the two links which hold it in place and thus bit by bit disintegrating the belt.

Gear Shaper Cuts All Teeth In a Single Operation

Gear cutting is vastly accelerated by a new machine which cuts all gear teeth at the same time. It is capable of rough and semifinish cutting 60 to 100 gears an hour, depending upon the job. Using radially fed form-tool blades with a shear-cutting action, it employs a circular cutter head consisting of a ring with the blades arranged on the inner circumference. When the gear wheel is placed on the work holder in the machine it is automatically clamped and the cutter head lowered into cutting position. Each stroke of the blades is adjustable and the correct sizing of the work is also automatically controlled and adjusted. To sharpen blades or to change over to another type of gear to be cut, the entire inner cutter-head assembly is changed.

"Lily Jig" Guides Tiny Filament Into Miniature Radio Tube

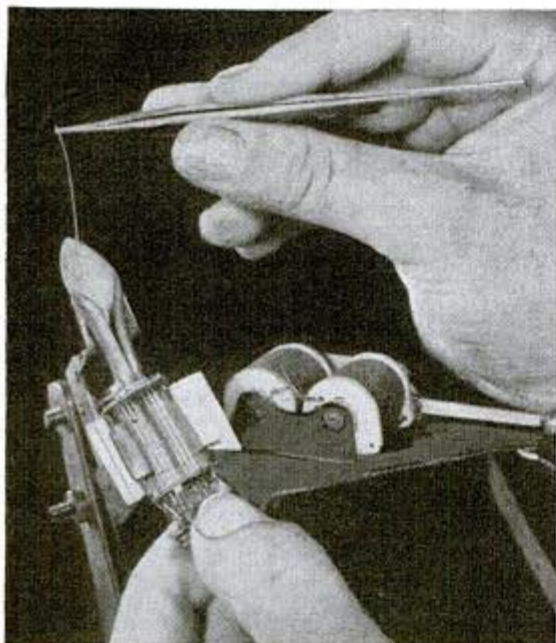

Substituting scientific accuracy for blind chance, a jig shaped like a lily has been devised to assist threading the filament through an almost microscopic hole in a miniature radio tube. Formerly the task was performed laboriously by hand, a slow and delicate process. The new type jig is reliable in getting the filament through the hole and placing it in the proper position where it may be vibrated into place.

Transparent Casts for Wounded Are Made of Plexiglas



Plastic splints and casts, lightweight and far less conspicuous than those of metal or wood, are being tested by Army and Navy medical officers. Neck braces and other supports are easily molded from Plexiglas—the same stuff used to make the transparent noses of big bombers. The plastic aids for wounded veterans were suggested by Clarence A. Renfro, a tool designer at the Consolidated Vultee Aircraft plant in San Diego, Calif.

Plier Strips, Cuts, Crimps Wire

Operating like a pair of pliers, a pocket-size combination tool not only attaches solderless terminals on electric wires but goes through all the steps of preparing the wire for the terminal, since it also can be used to cut the wire and strip its insulation. The proper length to be stripped and terminal stud hole sizes are indicated by the gauge marks notched on the tool, which has molded plastic handles that are fully insulated.

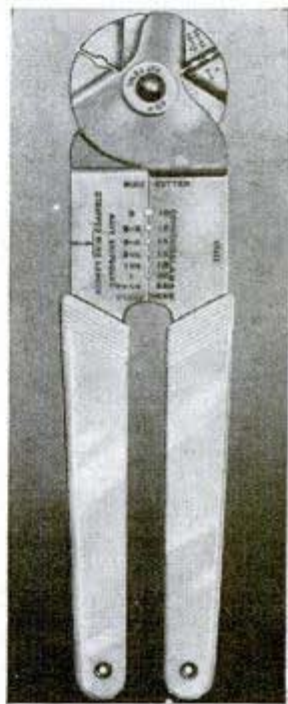

PUTTING AIR TO WORK



This, of course, is the secret of the power in compressed air, and the reason that machinery valued at \$150,000,000 is produced each year to keep air circulating for industrial purposes.

Compressed air drives the drills that are indispensable in the mining of coal and iron; it ventilates shafts and tunnels; it aids in keeping out water when mines are being dug; it operates the vibrator drills that quarry limestone; it helps steer the ships that take these minerals to the blast furnaces; in the blast furnaces, almost three tons of compressed air are necessary to make one

Skilled glass blower blows into hose to seal a 500-watt radio transmitting tube. Below, applying rivets by compressed air

CONSIDERING its importance, man is amazingly accustomed to taking his environment for granted—especially that towering ocean whose bottom he inhabits, the ocean of air.

It's easy to overlook this tenuous sea because its weight, about 15 pounds to the square inch, is equalized by the internal pressures of the body. But let that weight be radically altered, as it is when man swiftly descends into the depths of that more familiar, watery sea, or as it is when he speeds into the rarefied regions of the stratosphere, and man's dependence upon his atmospheric ocean is evident.

In the turbulent mood of a hurricane, air can level a whole countryside, as it did in the first New England hurricane, or can disperse whole fleets—the fate of the storied Spanish Armada. But properly controlled, air can forecast the weather, operate blast furnaces, steer a ship, tear down mountainsides or deliver the mail.

Air that has been compressed to greater than normal density seeks to expand when released.





Compressed Air Institute photo

Air tool (above) is used for carving wood patterns

ton of steel; brakes on the trains that take the steel to munitions plants are air-controlled; and then in the plants, air operates vibrators that help to mold machine parts, and the riveters, grinders, impact wrenches, vises, automatic chucks and other machine tools that fabricate the parts.

On the ship, tank or plane that finally goes into battle, compressed air has its jobs, too—activating landing gear, operating a vessel's ammunition hoists and winches, firing torpedoes.

Air compressors go right into the mines, supplying power for jackhammers, drifters, drills and air-operated hoists. These compact, mobile compressors are mounted on flanged wheels to fit rail tracks, and are built to clear the low ceilings.

Larger tunnels, such as those that carry vehicular traffic under rivers or through mountains, would be untenable were it not for a constant flow of fresh air to the workmen. Great blowers take air under pressure into the most remote crannies of these man-made caverns.

Perhaps the most familiar use of compressed air is in the drilling machine seen in use by pavement repair gangs or in construction through rock foundations. Chat-



Westinghouse photo
Above, the electric fan, elementary method of putting air to work, helps dry clothing



Courtesy Walter Kidde & Co.
Above, a drawing shows how carbon dioxide gas under pressure lowers landing gear in emergency. Below, sandblasting plane parts



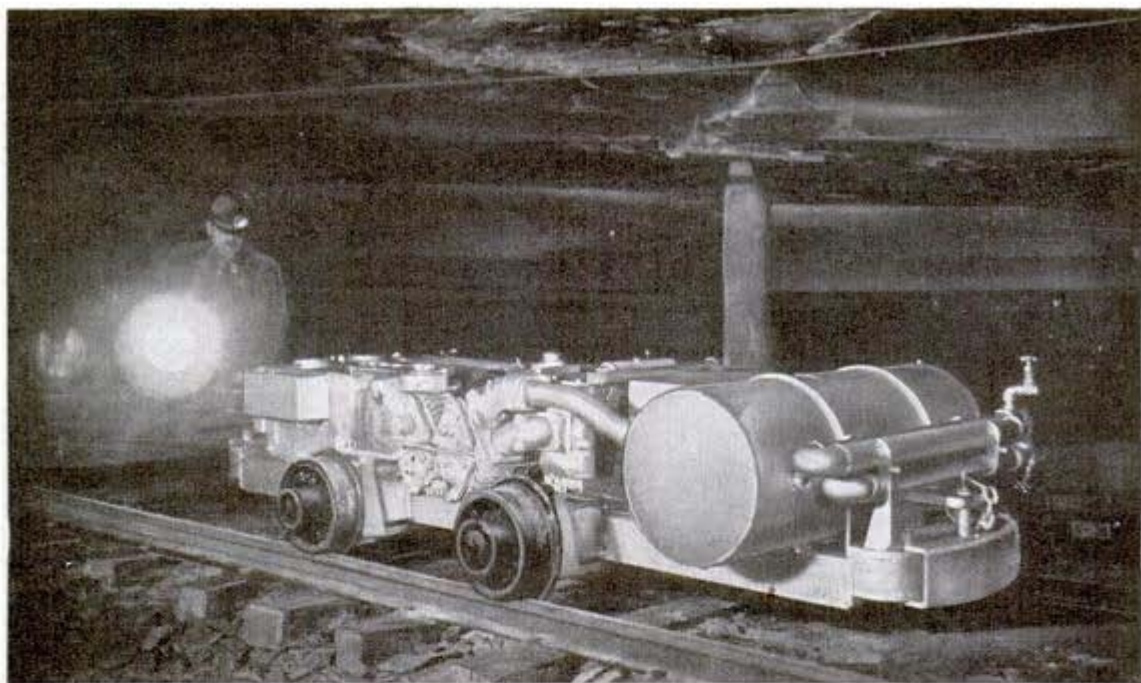

Low-slung, two-stage air compressor plant on flanged wheels is used in bituminous coal mines

tering air drills have been the literal ground breakers in most of the prodigies of road building in modern America.

Industry uses air for almost endless purposes. Blasts of warm air are used to dehydrate food, so that 25,000,000 pounds of nutrition may be shipped without the added weight of some 50,000,000 pounds of water it once contained.

In the finishing of airplanes, ships and vehicles, compressed air sprays on evenly the coats of camouflage paint. One bomber assembly plant constructed a paint-spray-

ing booth large enough to accommodate a four-engined plane, and air circulates through the room at the rate of 700,000 cubic feet a minute. For every pound of paint, 5,250 pounds of air are used.

In a new process developed at Westinghouse Research Laboratories, shiny die blocks of steel emerge from a cooling chamber, air-hardened to the point where they can cut glass. The same company utilizes blasts of air in circuit breakers to blow out powerful electric arcs. These giant breaths extinguish an electric arc rated at 1,500,000 kilovolt amperes.

Many remarkable achievements are being recorded through the application of air tools to wood pattern making. New types of woodcutting tools are light and compact, and give to wood carving the flexibility and beauty of the finest artistic efforts of the sculptor. Besides saving manual effort, air-driven tools vastly increase the productive capacity of their operators.

Compressed air drives a stream of sand against metallic parts to remove roughness and corrosion.

Cowl ventilators which carry refreshing air to holds of ships

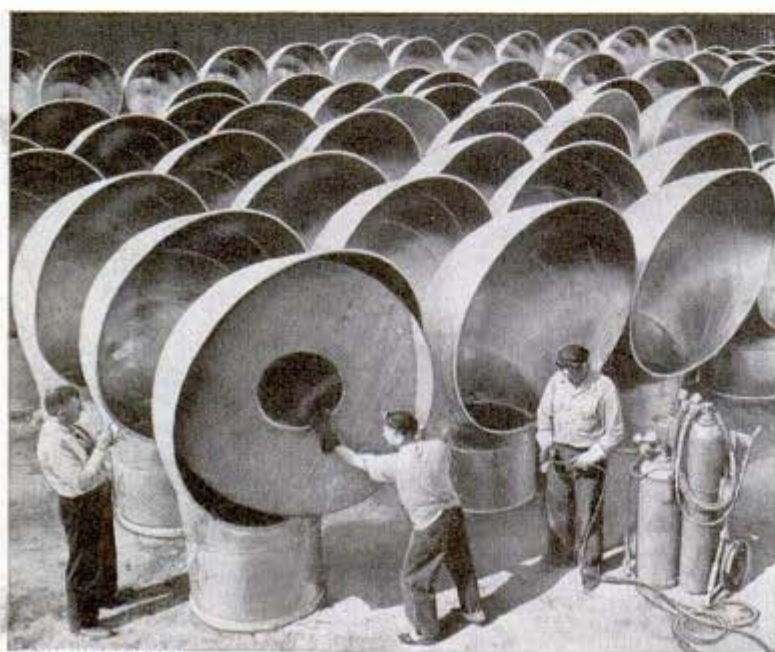

Powell Press photo

At General Electric, an air turbine, believed unique, simulates the actual operation of a steam turbine, except that compressed air instead of steam is used for the driving energy. The air-test turbine has speeded up measurably the developmental work on the buckets and nozzles which largely determine the operating efficiency of a steam turbine. Efficiency of turbine diaphragms has been improved to the point where they

Circuit breaker shown below and at right, partially assembled, "blows out" electric arc rated at 1,500,000 kilovolt amperes

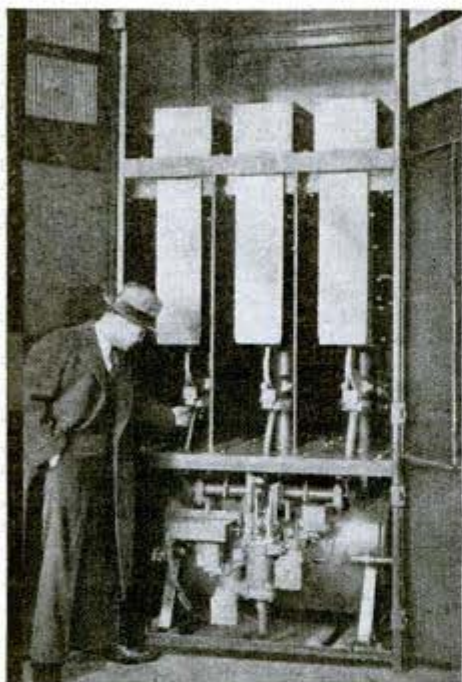
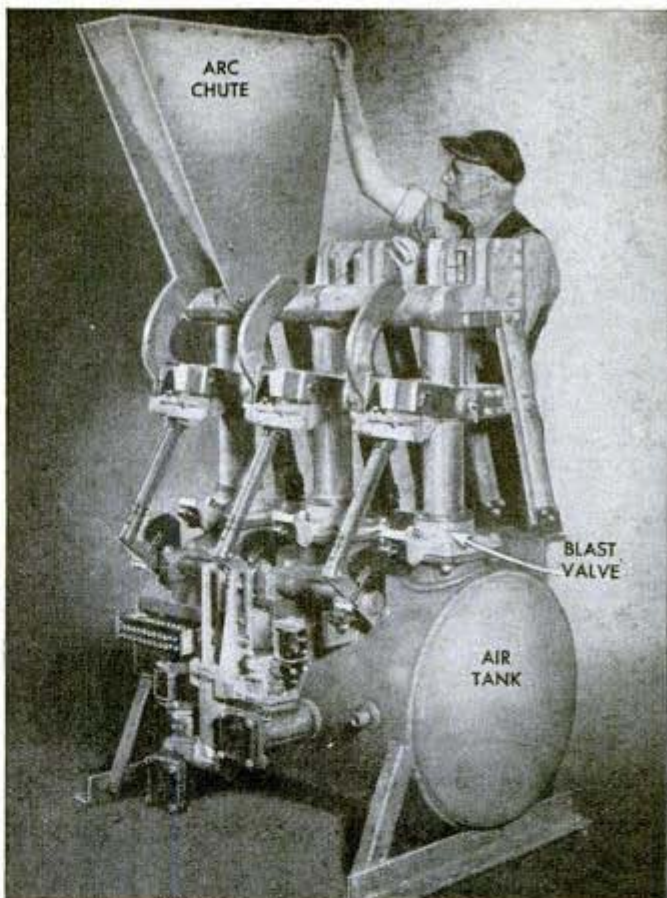

absorb only about 3 percent of the velocity energy of the air or steam driven through them into the bucket wheels. Efficiency of bucket wheels is measured by the amount of "shaft work" they take out of the motivating force—air or steam.

(Continued to page 148)

Below, compressed air activates the drill which pierces rock to pave the way for blasting a highway through mountains



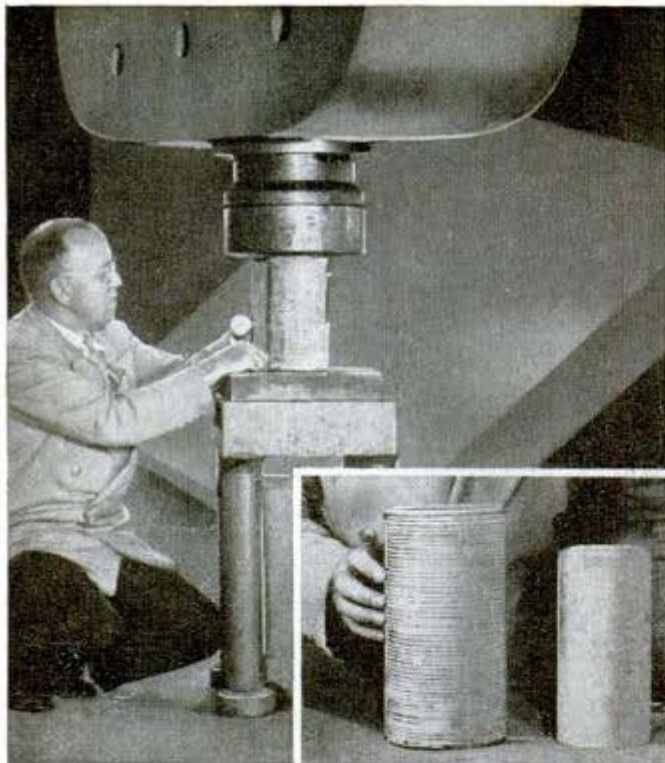

Wire-Wrapped Concrete Is Stronger Than Steel

As light as aluminum and stronger than structural steel, a new type of structural column has been developed at Northwestern University Technological Institute for use in high buildings and long-span arch bridges. The column is made up of 85 percent by volume of concrete and 15 percent by volume of steel. The extremely high strength concrete is wrapped about with a high strength spiral steel wire, which is always under tension, to form a core which is then covered with a fireproofing concrete. It is claimed that an eight-inch core with two inches of fireproofing concrete covering will take a safe load of 1,000,000 pounds; in laboratory tests it carried a load of 2,500,000 pounds without reaching the elastic limit of the steel. The product is said to be easy to manufacture.

Tablets Decontaminate Polluted Water Without Changing Its Taste

"S.C.I. Tablets" made of a special formulation of succinchlorimide are quick-acting water-decontamination pills. One two-grain tablet dissolved in a quart of water kills very large numbers of intestinal pathogenic bacteria within five to 10 minutes at various temperatures in the presence of organic matter. Dysentery ameba cysts are

killed within 20 minutes in a dosage of five two-grain tablets in a quart of water. George F. Reddish, chief bacteriologist at the Lambert Pharmacal Co., of St. Louis, Mo., developer of the tablets, announces that the pills are stable and safe and that they do not change the appearance or taste of water so treated.

Dial Trains Signalmen In Wigwag Code

Semaphore training without the waving of flags is accomplished with a two-way dial that sends on one side and receives on the other. When a letter is dialed the flags are shown in their proper position and the letter appears in a small circle. This training device permits a man to practice receiving by himself. Tests show that it takes twice as long to teach a man to receive messages as it does to send them, since receiving calls for a reversal of the visual image, which is not easy for most people.

Everyone is color-blind at birth and a child is one and a half or two years old before his color vision is fully developed, according to the Better Vision Institute.



Riding "marsh buggy," a cross between a tractor and duck, through Florida swamp in the search for oil

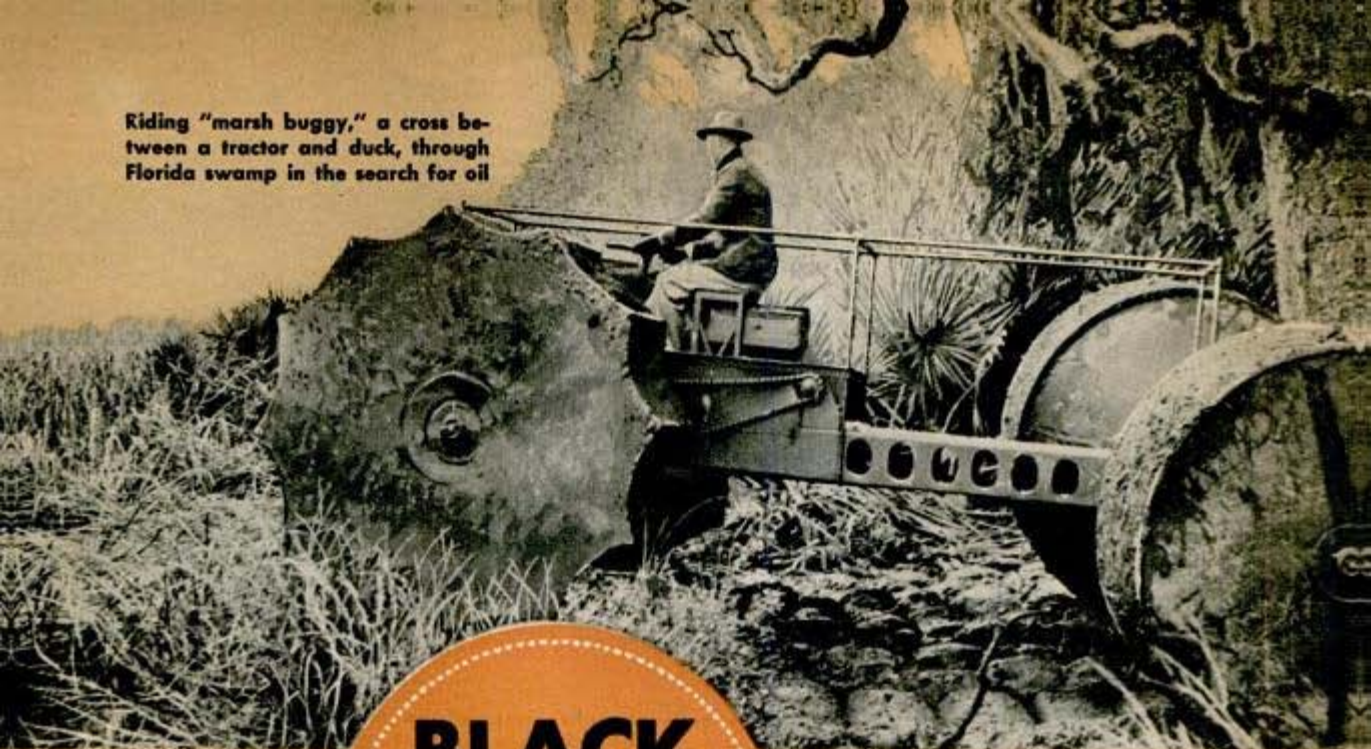

BLACK GOLD RUSH

Below, derrickman guiding drill collar which has just been lifted from the pipe rack to derrick floor. When bit is screwed in the collar will be ready to "go in the hole" to cut rock away

THE biggest treasure hunt in history is on—the search for oil in regions where it is not known to exist. This "wild-cattin'" has attracted not only big oil industries but outside companies and individuals, for the stakes are high.

Known reserves of 20 billion barrels are being depleted by tremendous wartime demands, and by 1950 other reserves of 14 billion barrels must be found to meet domestic needs. Who will find the new oil fields? The answer is the great corporations with their newest scientific devices—and the ordinary guy with a lucky break.

A new subterranean frontier is awaiting those who will look for it. According to the Standard Oil Company of New Jersey, it is composed of more than 750,000 square miles in the United States which have never been explored for oil. This is territory proved favorable to oil deposits. There are some 2,500,000 square miles of oil-bearing type of rock formation in the country.

The black gold rush is founded on the future demands of millions





Man-made "earthquake" recorded by seismograph helps determine depth and angle of rock formations to reveal possible oil traps in earth

of new cars, trucks, tractors, planes, Diesel engines for ships and locomotives, and the new synthetic rubber industry, plus the dozens of new uses discovered for petroleum derivatives during the war. Experts predict a demand of 1,895,000,000 barrels in 1950, an increase of about 150,000,000 barrels over the wartime peak last year.

The postwar gold rush gates will be thrown wide open to prospectors, wildcatters, lease "hounds," investors, oil field workers, veterans, white collar jobholders, laboratory technicians, refinery employees, landowners such as farmers, or anyone with a zest for adventure.

Naturally, most will want to picture themselves as fortunate finders and millionaire owners of oil wells, which is against the law of percentage; but the lightning of luck still strikes in the search for oil.

John Bath, Jr., recently began drilling a water well on his Greece City, Pa., farm and struck oil at 65 feet. Then there is the case of "Dad" Joiner, a hunch player, who discovered the East Texas field, the greatest single oil pool in the world. Instead of drilling in the middle of his field, he picked the extreme edge and hit it. A stone's throw

Setting off explosive charge by remote control to activate seismograph

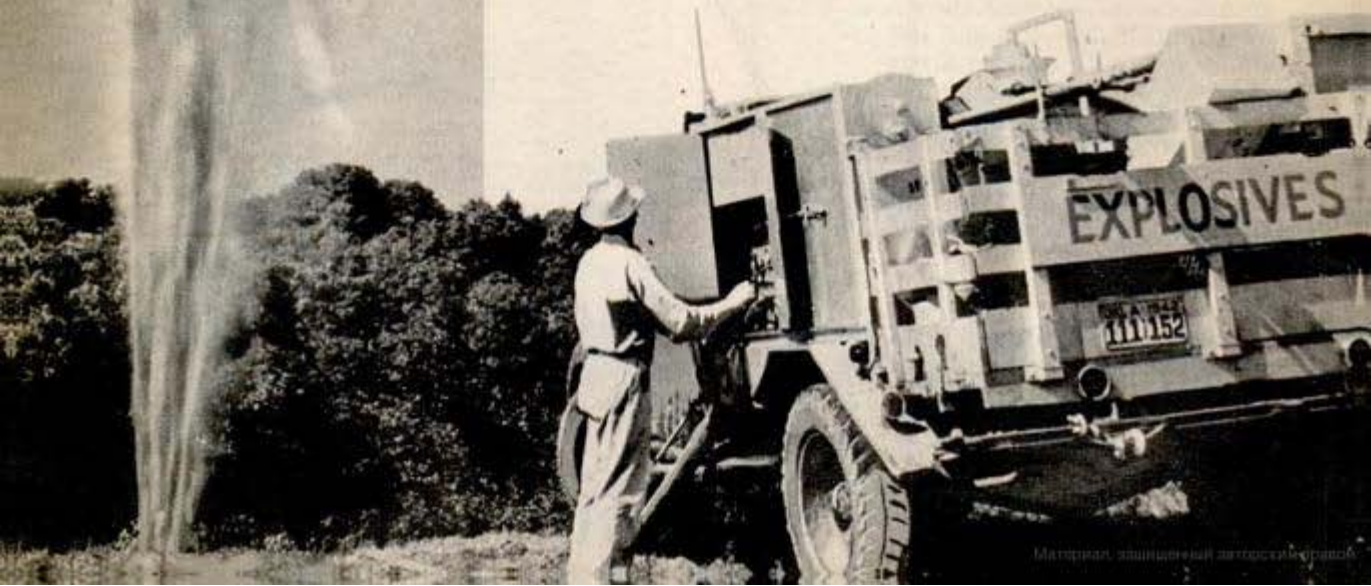

away the under surface was barren of oil.

In Mississippi, the scene of the latest black gold rush, the pupils of the Heidelberg public school are learning the oil business along with their regular lessons. Wells in the schoolyard paid the school \$25,000 down and are putting \$1,000 a month in the bank.

T. D. Lewis, a farmer nearby, has a 14,000-barrel-a-day well on his property. Owners of small farms are buying groceries in Heidelberg stores with \$500 bills and the prosperous storekeepers have the change in the tills.

Strangely, back in 1860 the state geologist wrote a report describing the Mississippi oil formation in excellent detail. But nobody did much about it. Now, at last, the



Above, preparing to run casing gun perforator into hole. Left, reading magnetometer which reveals mass of rock under ground that may form oil basin; gravity meters are used for the same purpose. Midway on derrick below, operator can be seen steadying pipe as rotary helpers on the floor below "stab" the pipe

Heidelberg field is rated as a 100,000,000-barrel find; another at Cranfield is of the same size, and a third at Eucutta is estimated at 50,000,000 barrels. Oil averages \$1.19 a barrel and land that formerly brought \$5 is selling for \$5,000 an acre.

Estimates of the recent strike at West Edmund, 15 miles from Oklahoma City, keep rising until it is expected to be one of the biggest ever discovered. It is now figured at 117,000,000 total future barrels. It was discovered by a Russian, Ace Gutowsky, using a "doodlebug," or homemade divining rod which oil company geologists insist is no good. But these same geologists said the West Edmund prospect was no





Top left, examining the bit that cuts through the rock to drill hole thousands of feet deep. Fast-drilling "fishtail" bit (above) is used until hard formation requires rock bit. Bottom, lifting a long section of pipe from a hole



good, too, and several major companies rejected the field. Now most of them are buying leases from Gutowsky. Everybody hasn't struck it as rich as Gutowsky, yet oil payrolls are up \$500,000 a month in the town favored by the new black gold rush.

The big fellows are doing all right, too. Standard Oil of California set a program of a well a day and exceeded the figure by 50 percent. Out of 135 wells sunk, 110 produced. The Navy, which is floating to victory in a sea of oil, is getting 19,000 barrels a day from 20 new wells in the Elk Hills, Calif., petroleum reserve.

A new oil field in the vicinity of Spring, in southern Texas, was indicated by a successful drilling sponsored by New York City bankers. Phillips Petroleum is

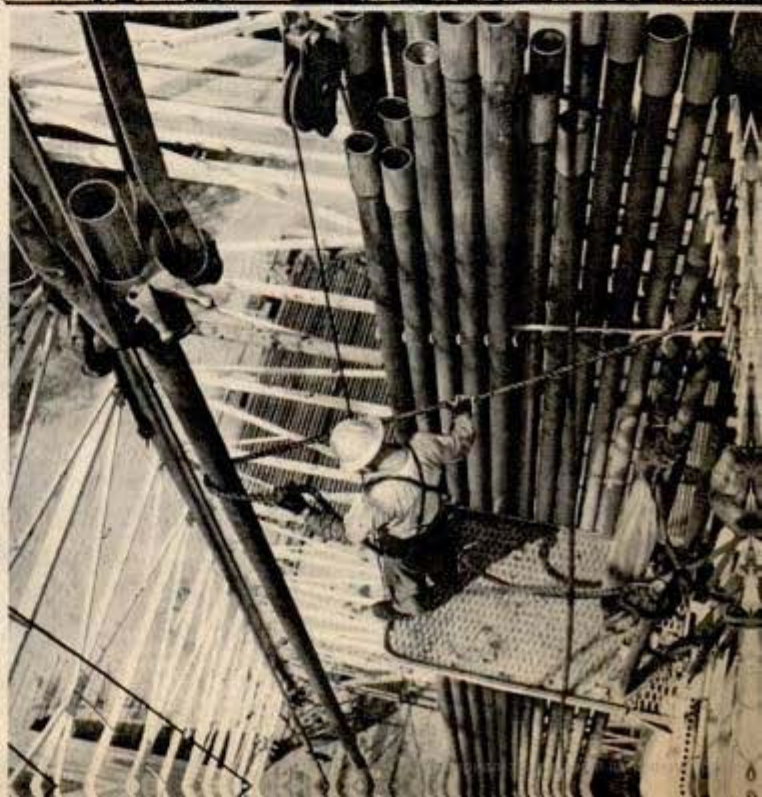

just beginning to develop a new 30,000-acre field in Alberta, Canada. Big-time outfits are exploring in Maryland, Georgia and Alabama.

Florida, long thought to be a likely spot for oil, finally delivered recently for the Humble Oil and Refining Company. The strike was made in the swampy Everglades in southern Florida. The effort and expense to which this company has gone to find oil in Florida and along the Gulf Coast illustrates the revolutionary new devices and methods being employed. Two important tools were submergible barge oil rigs and marsh buggies, engineered to work in muck and water.

The derrick and drilling equipment is mounted on two steel barges, 120 feet long, 24 feet wide, and 10 or 12 feet deep. These barges, six feet apart, are connected with bolted transverse trusses. Towed to the desired drilling location, the sea cocks are opened to fill them with water, and they are sunk to the floor of the bay, lake, canal or river to form a solid foundation for drilling operations.

A third barge carries the boilers, auxiliary boiler plant equipment and electric generators. It is submerged about 150 feet away, usually at right angles to the drilling barge. A steel catwalk connects the boiler barge and the others, serving both as a bridge for personnel and as a support for steam and power lines.



Mast-derrick of rotary drill is mounted on a truck and is used for drilling the seismograph shot holes. At bottom of page, gravity meter is rock "detective"

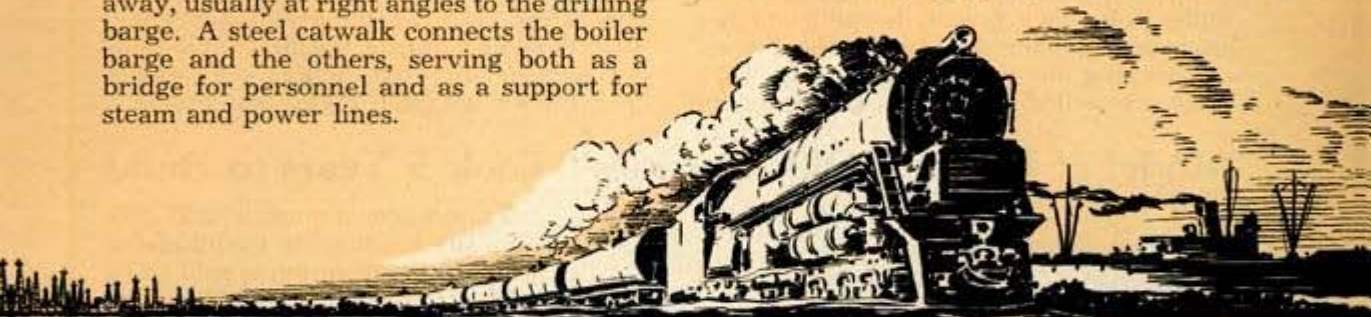

The location for a marine well is marked by two lines of pilings driven in the ground just far enough apart to accommodate the six-foot spread between the twin barges. The barges must be spotted exactly over this location. To hold them in position while they are submerged, each barge is equipped with a heavy pipe which is dropped through a casing sleeve in the bottom of the hull into the clay or sand.

The depth of water in which this operation is practical varies in different areas, depending upon the tides. Eight feet is about the maximum depth in which the barge equipment is normally operated.

The marsh buggy, a combination tractor and duck, is used by prospectors to transport men and tools through the swamps. Its great metal wheels carry them over terrain where the water is too shallow for boats and the muck and mud too deep for ordinary land vehicles. The motor is con-

(Continued to page 150)

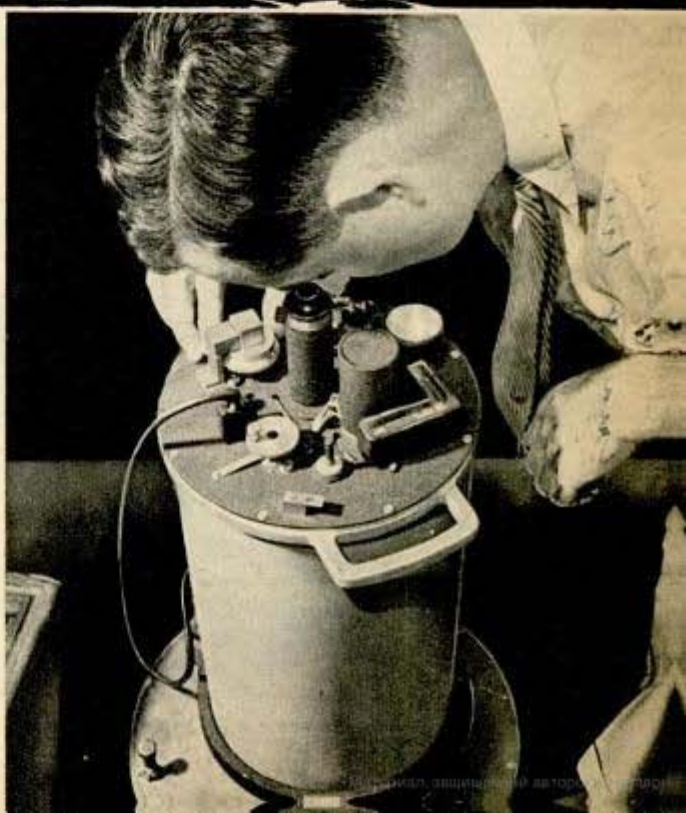

Waterproof Tanks Hit Beach With Guns Blazing

Emerging onto enemy beaches like grotesque, mechanical sea monsters, spouting flame and smoke, Sherman tanks have surprised Axis forces in many an Allied invasion across water barriers. The tanks are capable



of leaving landing ships and going ashore under their own power, keeping engines, crew and powder dry during the "swim" and coming out with guns blazing. Their hulls are sealed with a plastic compound

and paint. Steel exhaust chutes which resemble gigantic periscopes project from the rear of the tanks. The waterproofing must be 100 percent effective, for a little sea spray could upset intercommunication between the tanks. As the final touch, Allied engineers fitted explosive charges, operated at the flick of a switch, which blow off all the waterproof coverings as the tank hits the beach. Crewmen were drowned during the first tank-wading experiments but actual self-landing operations have been highly successful.

Model of Famed "Old Ironsides" Took 5 Years to Build

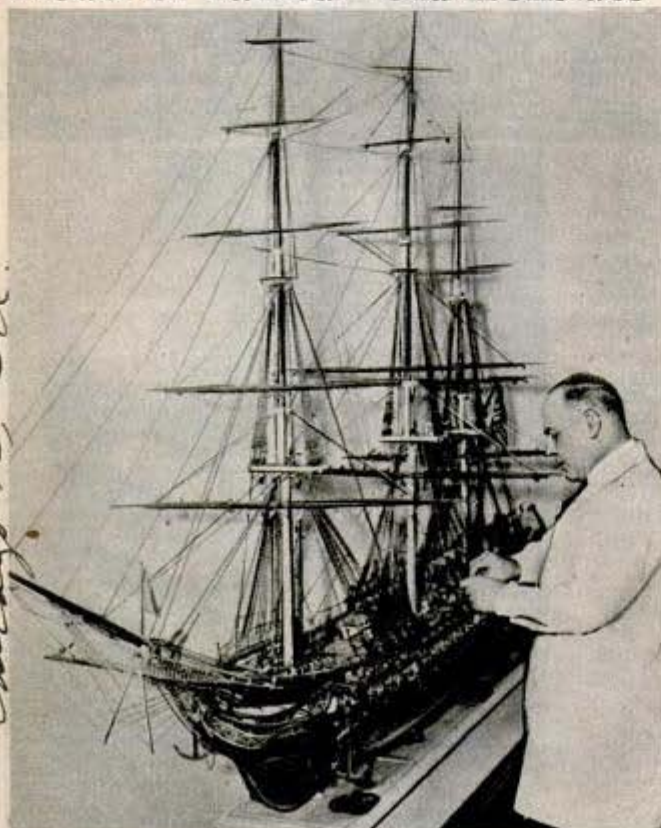

From topmost mast to its 54 cannon, the latest scale model of the warship Constitution is said to be perfect in detail. It took Theodore Morales, Chicago model maker, five years to build the model, which is two more than were required to build the original. The model is 8 feet, 2 inches long and 6 feet high. It is made of mahogany and walnut and copper-lined.

Alkaline Salts Solution Protects Tin Cans

To protect them from outdoor exposure in hot humid weather, tin cans, after being filled and sealed, are dipped into a hot solution of alkaline salts which cleans the surface and forms an invisible film over the tin. No lacquer or enamel is used as in present protective processes. Tests show that this method, developed by Battelle Institute, Columbus, O., effectively delays pinhole corrosion and keeps cans bright and clean.

*Mr. Theodore Morales
1319 Belmont Ave
Chicago 13, Ill.*

"Giants" Pack Soil To Build Runways For Big Planes

When United States Army engineers rebuilt Mather Field, near Sacramento, Calif., to accommodate heavy cargo planes and bombers, they developed two giant pieces of equipment to speed the job. One is an 85-ton pneumatic-tired roller, and the other a sheepsfoot roller with 18-inch feet and a total weight of 38 tons. The rollers, which pack the soil before heavy pavements can be laid, eliminate ordinary methods of excavation and packing by layers.

Top, 76,000-lb. sheeps-foot roller packs subsoil. Right, pneumatic roller carrying ballast

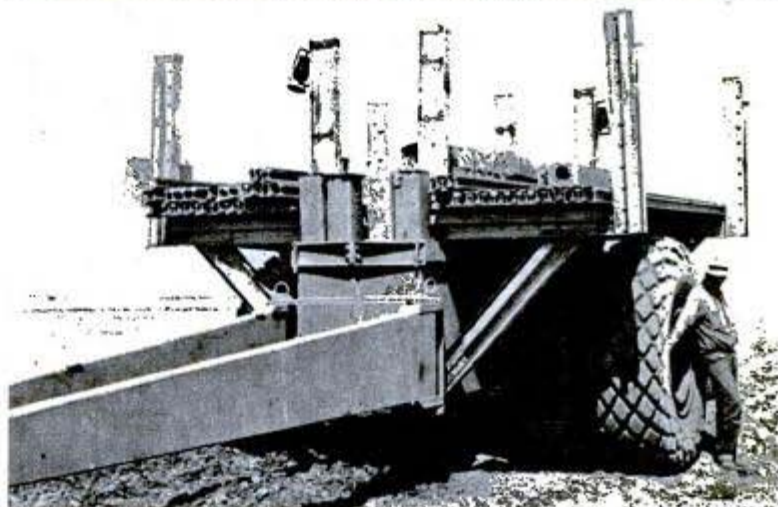

Quickly Changed Fittings Convert Pump for Deep or Shallow Well

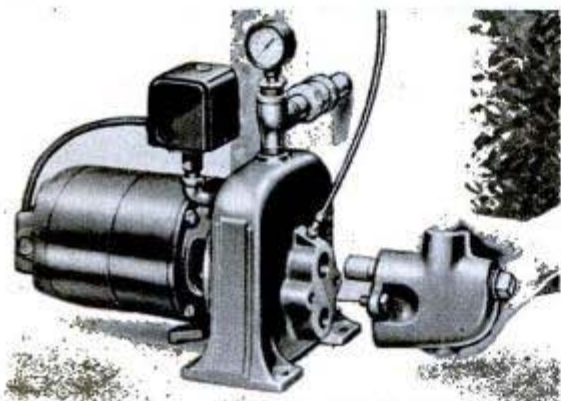

Water can be pumped from a deep or shallow well with a dual-purpose pump which has only one moving part. If the water level changes, the pump is quickly converted by removing tap bolts with ordinary tools and attaching simple fittings. The moving part has no gears to wear out, and the system contains no stuffing box to leak or repack. Only a durable rotary seal ring is subject to wear, and this is easily replaced. All internal parts can be removed as a unit to facilitate servicing, without disturbing suction or discharge piping. The pump is said to be quiet in operation, and it requires no repriming.

Fast LSM Joins the Invasion Fleet for Action Against the Japanese

Newest addition to the "landing ship class" of the United States Navy is the LSM (Landing Ship, Medium) which is designed for duty in the Pacific. This landing ship is 203 feet long and is said to be faster than previous types of landing craft and more easily maneuvered. The tank-carrying LST, largest of the beach vessels, is 328 feet long.



MARCH, 1945

FRIENDS of the YANKS



"Siwash," Marine mascot and veteran of Tarawa, takes time out for refreshments. Below, "Parky," a favorite of 415th Infantry at Camp Carson, Colo.



Leaning out of waist gun position on B-17 (above) is "Lady Moe," a three-foot-high donkey acquired by the crew in Africa on a shuttle mission. She cost them 400 francs. Left, ready for the stratosphere with a special oxygen mask, this police dog has accompanied one crew on several missions



At the sound of "all clear," mongrel pup "Tojo," adopted by five Yanks on jungle island, emerges from air raid shelter located near his "Mutt Manor"



Right, baby wallaby from New Guinea favors high altitude equipment, especially if it happens to include fleece-lined shoes



Left, with a "bring-on-the-Japs" look in her eyes, lion cub "Duchess" goes ashore with Marine



American eagle, Leatherneck mascot at air station, shows a Marine how to look tough



Chicken-Wire Belts Carry Peat From the Fields



Left, peat moss drying in the sun. Above, conveyor takes it to depot. Below, wheel-barrow conveyor gathers it in fields

Canadians have mechanized their peat moss industry. On some of the larger peat bog properties a chicken-wire conveyor belt system for hauling the peat from the field is rigged up on homemade wooden wheelbarrows which can be moved along trenches from which peat moss has been dug. Many peat diggers use various forms of makeshift conveyors to carry the moss to the depot after it has been allowed to dry in the sun.

Snug Paper House Costing \$51.20 Is Erected in 59 Minutes

Made up of panels only an inch thick, a weatherproof paper house developed at the Institute of Paper Chemistry, Appleton,



Wis., took only 59 minutes to set up. The experimental building, which is 16 feet long, eight feet wide and eight feet high, consists only of waterproof paper, except for 49 pounds of glue, metal fasteners, clear plastic windows, and wood window frames. The paper is "fortified" by an inexpensive treatment and is composed entirely of low-cost chipboard made from waste paper and covered with fireproof paint. The insulating quality of the paper and internal design of the panels kept the house comfortably warm during a subzero wave accompanied by wind. The building also withstood driving rains and a windstorm strong enough to damage small farm buildings and blow down trees. The paper house piles into a neat stack of 21 rectangular panels.

Robot Map-Maker on a Jeep Plots Route as It Travels

Known as the odograph, a mechanical map-maker can plot the route of a jeep, tank or truck as the vehicle in which it is mounted speeds along. The device has an electronic magnetic compass, a power pack, and a plotting unit that actually draws the maps, all connected by electrical cables and flexible shafts. Officially called the M-1 Automatic Road Reconnaissance De-

vice, it also can plot the position of an objective relative to a given base, tie gun positions together, and be used in land navigation, reconnaissance tours and the tactical control of movements. Field commanders using the instrument must know both the distance traveled, which the odograph determines by means of a speedometer attached to the transmission, and the direction of travel, which is pointed out by a magnetic compass. The two factors are integrated mechanically in the plotting unit and passed through a robot "brain" to a pencil which draws a map of the route traveled. The odograph can plot to any scale from 1 to 20,000 to 1 to 500,000.

Surgery "Jelly" Absorbs Water 300 Times Its Weight

Gluten sulfate, a jellylike material produced from the action of an acid solution on wheat gluten, absorbs from 100 to 300 times its weight of water. During this process it changes from a cream-colored solid to a clear odorless and tasteless jelly. It has been used by surgeons to absorb body fluids after operations. Other uses, according to the American Chemical Society, include the making of ice cream.

Legs Steady Funnel on Drum To Allow Horizontal Filling



Thanks to a funnel which sprouts legs, it is no longer necessary to upend heavy drums and barrels and fill them in a vertical position. Strong steel legs, slotted to fit the rim of the drum, hold the funnel in a position from which it cannot slip. Both hands are left free for pouring.

MARCH, 1945

Geologists "Fish" for Data With Crane and Reel

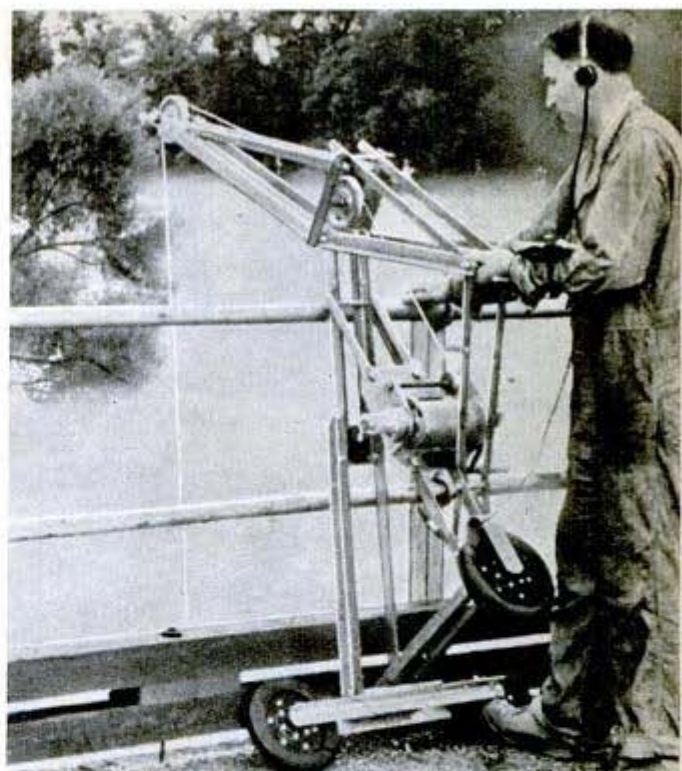

Some members of the Interior Department's geological survey get paid for fishing from rustic bridges. But they search for data, not fish. They are stream-gauging experts and their job is to record vital information about the depth, speed and other characteristics of each stream. They use a specially designed crane and reel.

Plastic Mold of Metal Surface Is 2/1,000,000 Inch Thick

In order to study metal skin structure under a microscope, the metal surface is reproduced in a plastic mold 2/1,000,000 of an inch thick—one thousandth as thick as the Cellophane wrapper on a cigarette package. A very dilute solution of plastic is placed on the surface and then allowed to drain off, leaving a thin coating which follows the hills and valleys of the metal surface. According to Dr. David Harker of the General Electric Research Laboratories, the replicas are strong and tough for their size but must be handled with the utmost delicacy. To remove the mold a small disk of fine wire gauze is placed on it, Cellophane tape is pressed down on the gauze and then the tape is raised from the specimen with the replica stuck to it. The tape is removed by forceps before the mold is placed under the microscope.

75

Aerialists ON THE HOME FRONT



If you are one of those persons who cannot stand atop a stepladder without getting dizzy, the pictures on these pages are not for you—nor are the jobs which they portray. These jobs on lofty perches are just as essential to the home front as the aerial feats of Army and Navy flyers are to the war fronts. Left, workers high above Grand Coulee dam "hitchhiking" on conduit. Below, workman held by safety rope as he performs "routine" job of removing trash gutter from the face of Norris dam

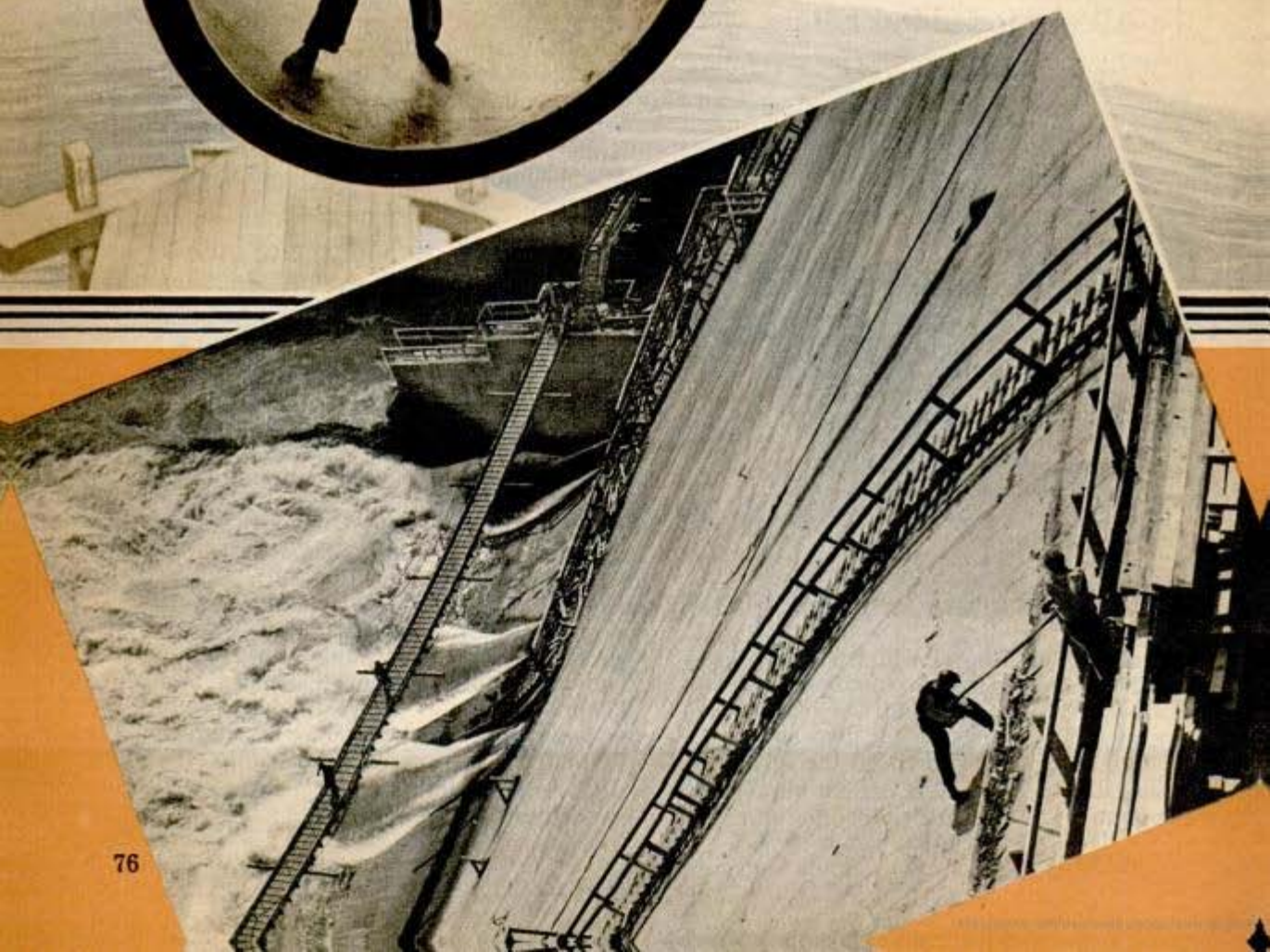

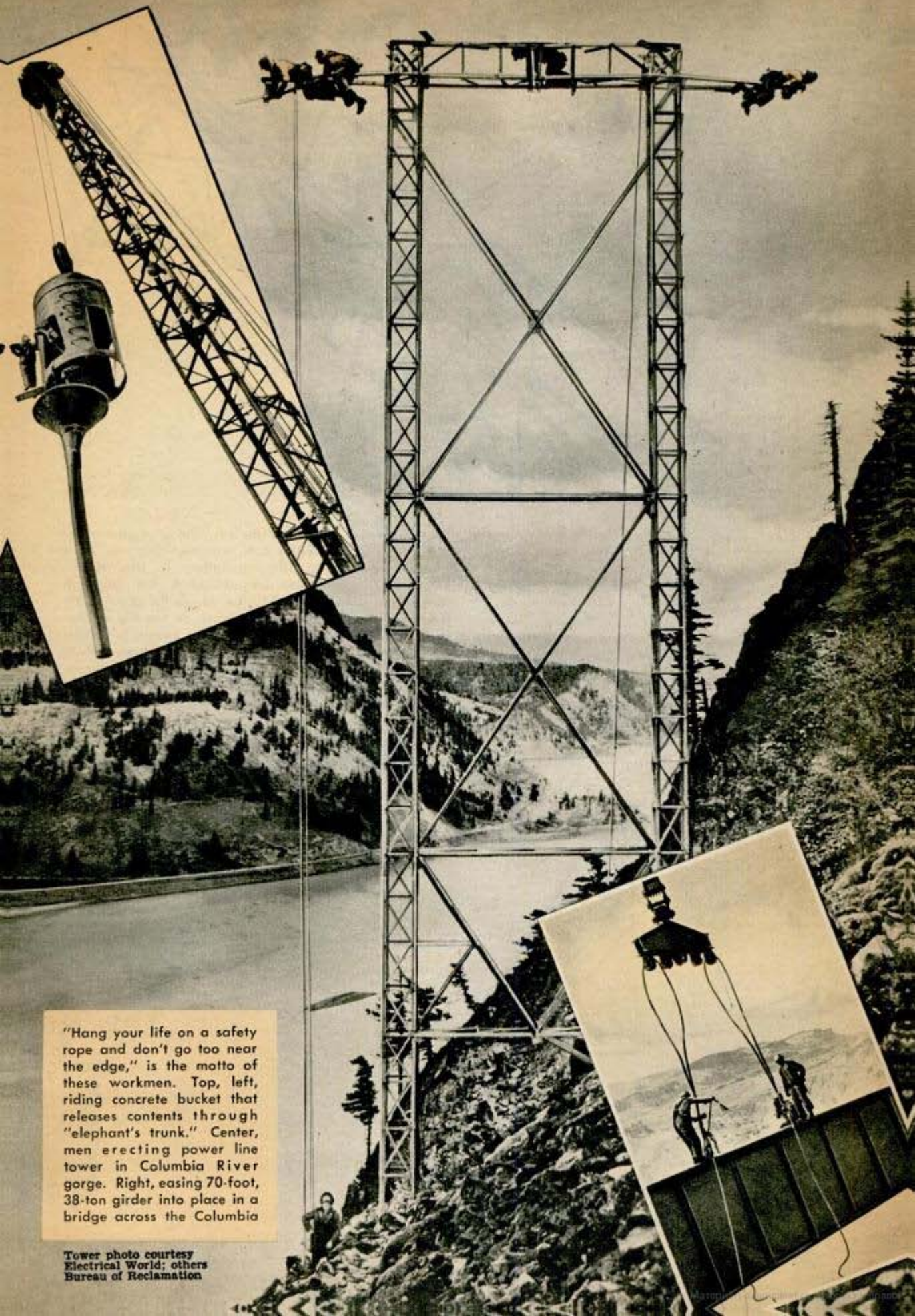

"Hang your life on a safety rope and don't go too near the edge," is the motto of these workmen. Top, left, riding concrete bucket that releases contents through "elephant's trunk." Center, men erecting power line tower in Columbia River gorge. Right, easing 70-foot, 38-ton girder into place in a bridge across the Columbia

Tower photo courtesy
Electrical World; others
Bureau of Reclamation

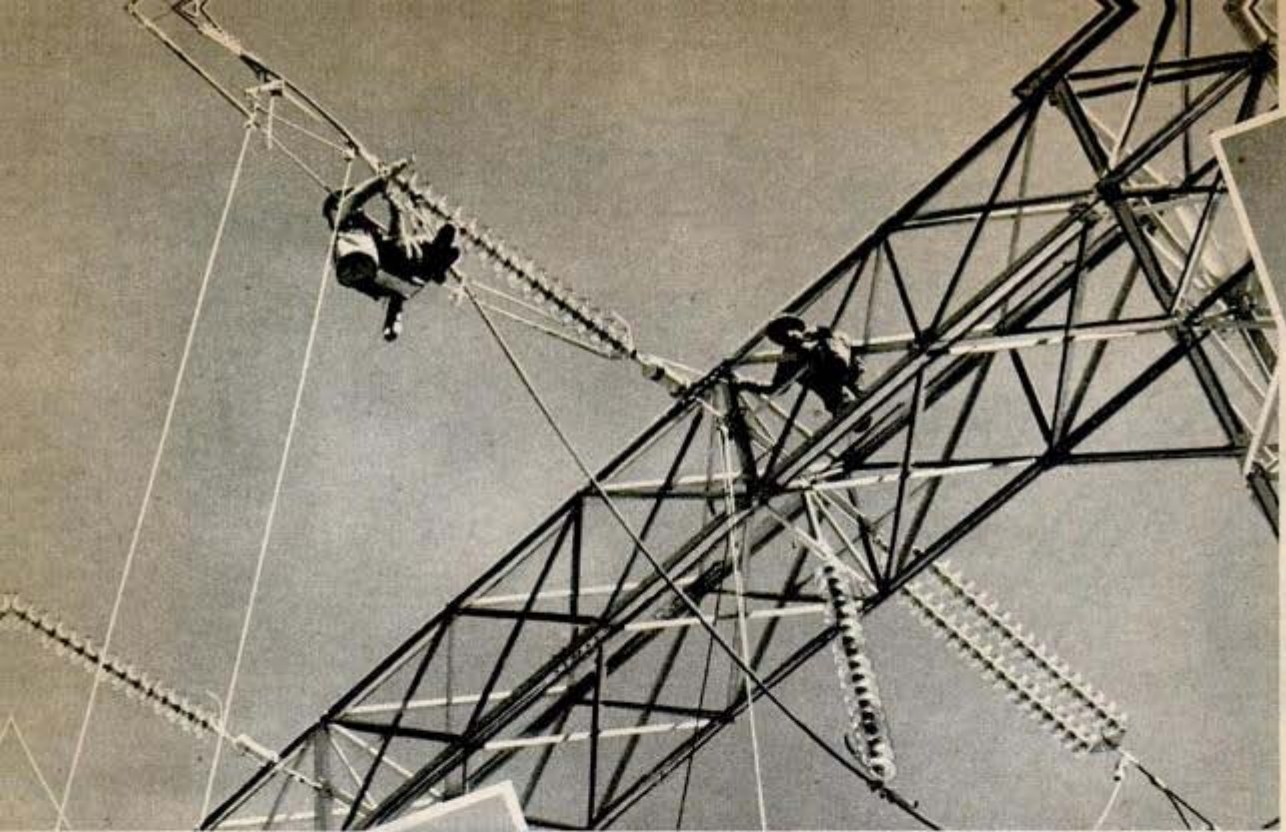

Suspended by ropes and pulleys above a skyscraper tower near Grand Coulee dam, workman "reclines" on a special seat while installing equipment on transmission line in switchyard above dam abutment. The man with foot on guy wire (left) is 270 feet above the ground. He is looking down at fellow workman on the big smokestack on opposite page. The guy wires extend to nearby buildings and are used to brace the steel tower which is built alongside smokestack that is being torn down. Below, jackhammer operator at work on a ridge above Grand Coulee dam could double as mountain climber

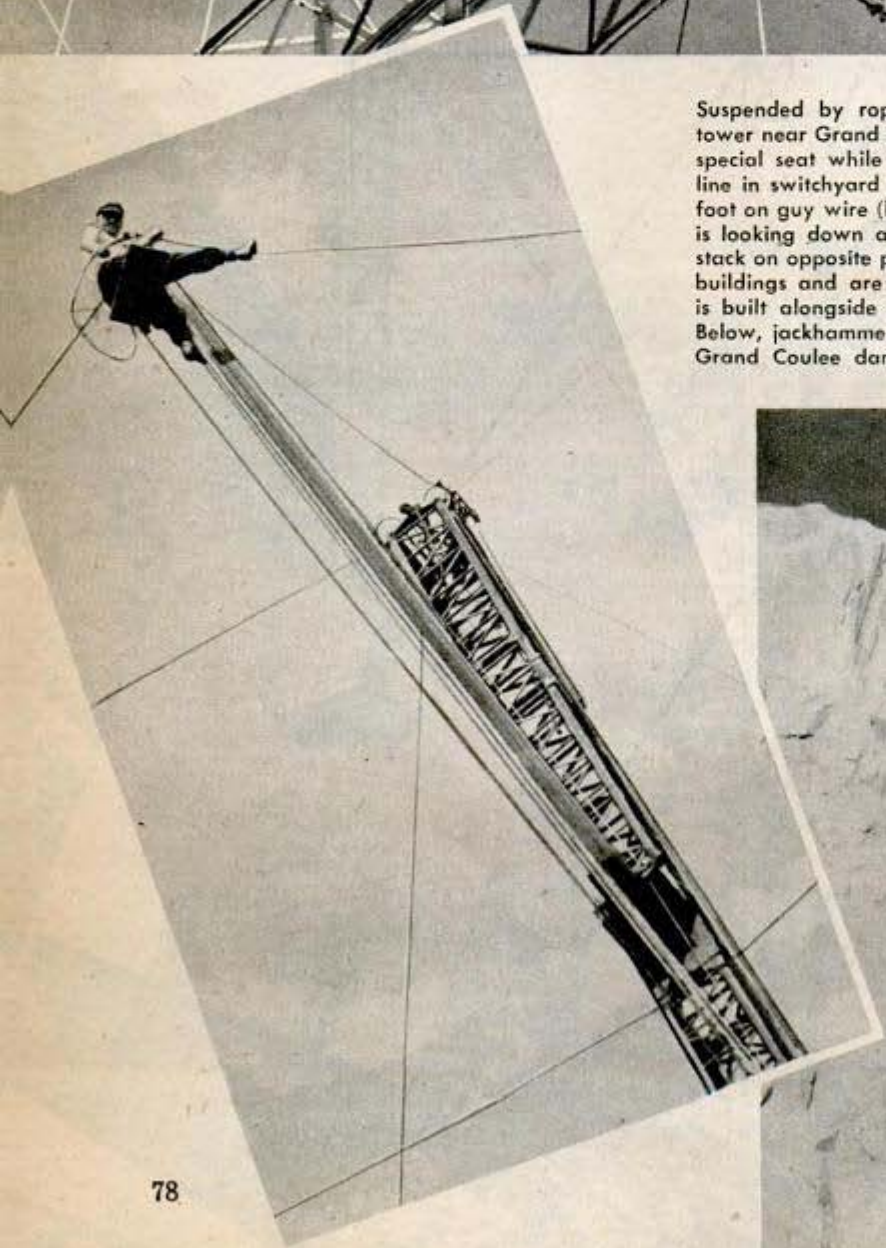

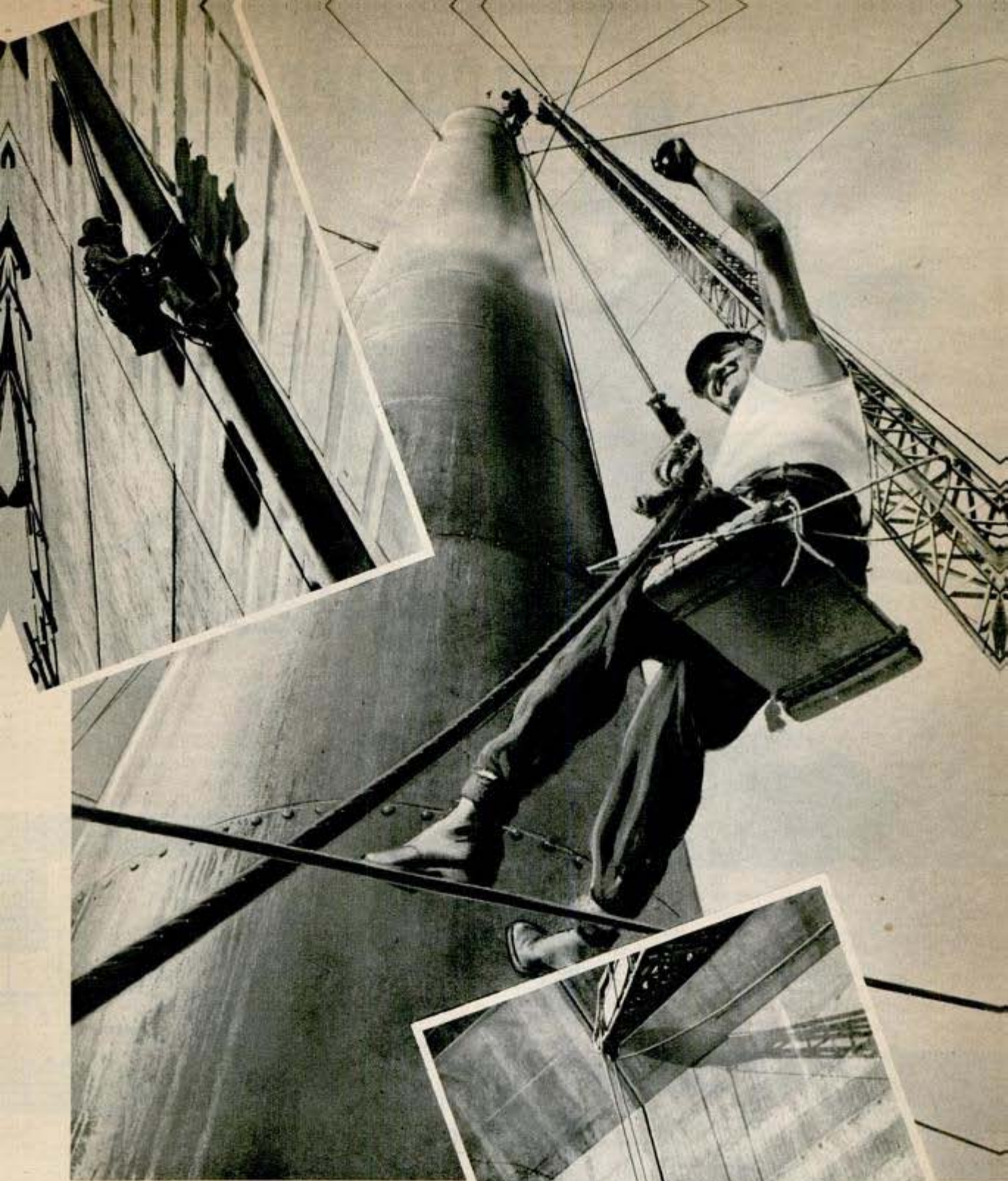

In bosun's chair suspended by block and tackle (top insert), TVA workman cleans and paints embedded steel at navigation lock in dam. Center, smokestack wrecker waves arm to signal for adjustment of guy wire. It took four men just three days to level 180-foot smokestack. Man at work on top of the stack is a welder. Right, if they carve their initials here no one will ever know, for this is side of 550-foot-high dam that holds back the Columbia River. A crane is used to lower workers, who use chisels and patching material

TELESCOPE HOUSE

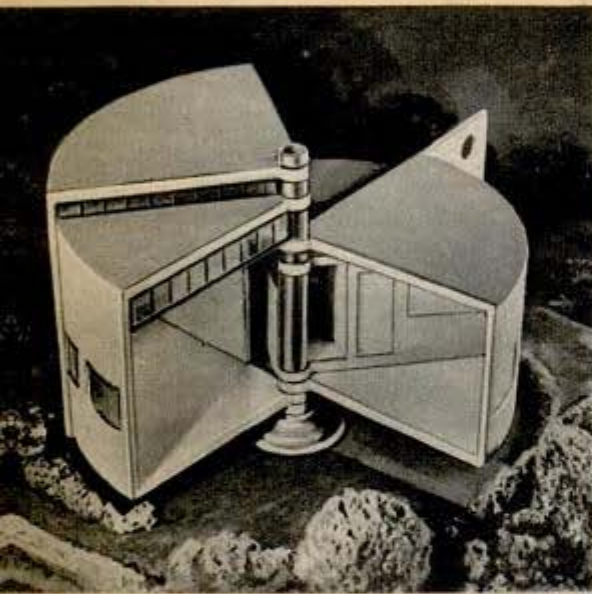
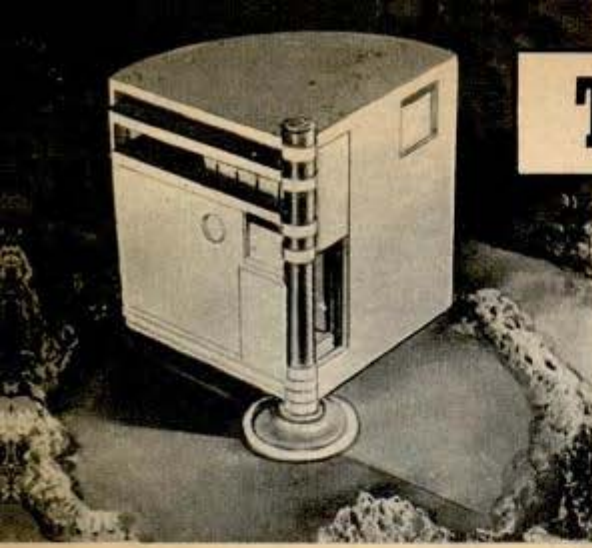

A circular house which expands both vertically and horizontally has been proposed for the postwar market. By telescoping sections, the owner can adjust the size of his home at will. Top, model of house with sections telescoped. Above, model of house expanded into four rooms on one floor

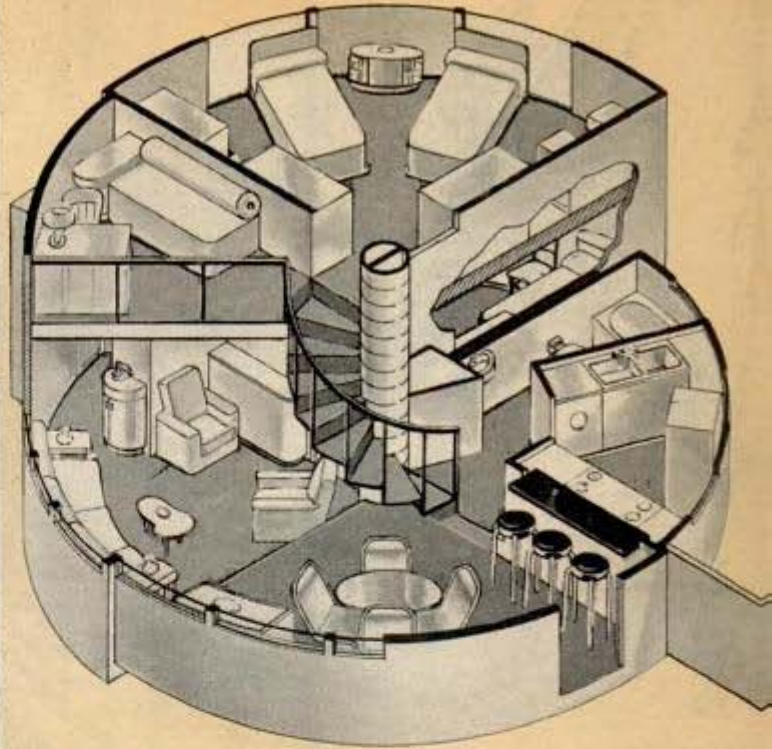

The house is composed of a series of pie-shaped cantilever sections which swing out, fanwise, from central supporting mast. Two-story model (above) has two more bedrooms upstairs

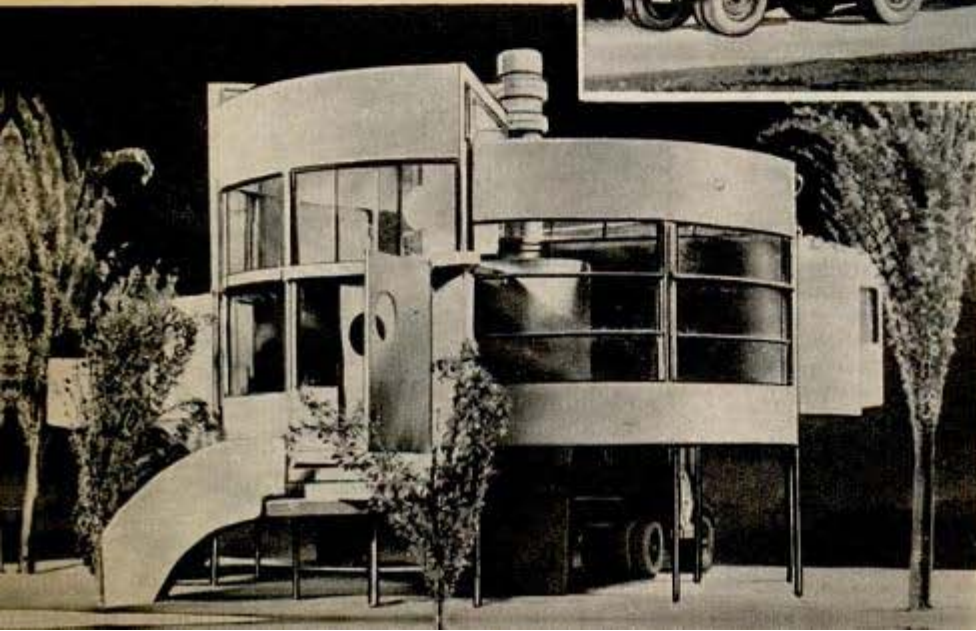
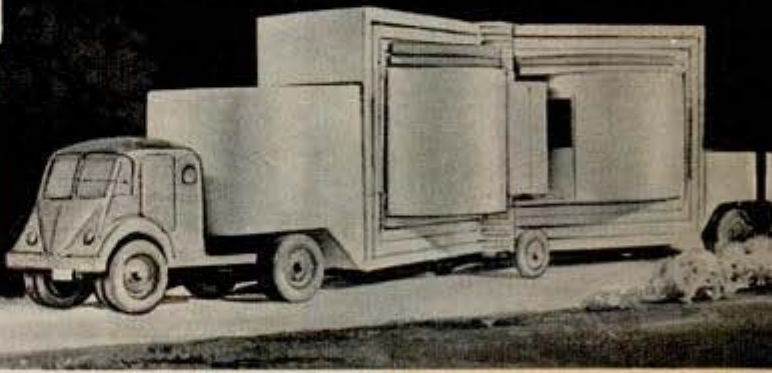

House can be loaded on a trailer (above) for delivery to site. F. J. Zavada, designer, says it may be possible to deliver finished units, fully equipped, direct to owner from factory. Left, exterior view of a model of a telescope house. Utilities are built into the structure as complete units—packaged kitchen, bathroom and living room. Lightweight materials may be used to eliminate much dead weight

Television in Color With a Two-Sided Screen

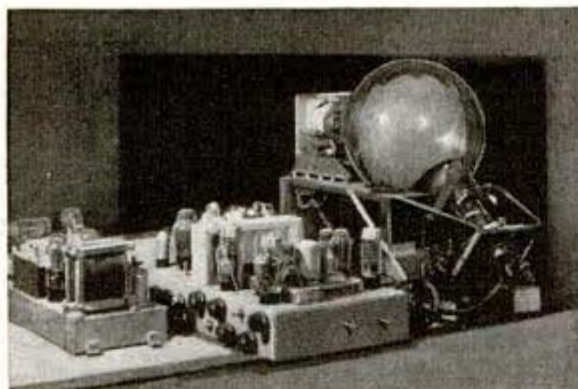

Above and at right, the cathode-ray tube which gives television in color. Below, Fig. 1 shows arrangement of phosphor coatings for two colors. Fig. 2 shows two surfaces on one side of the screen for a 3-color system

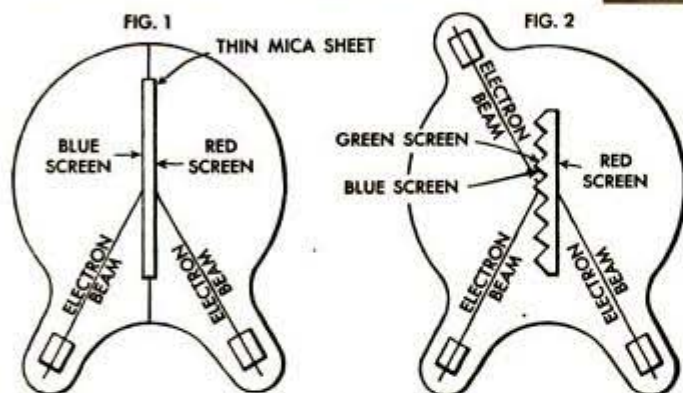

Television pictures in two or three colors are made possible with a new cathode-ray tube, the Telechrome. The picture appears directly on the tube's double-sided transparent screen, and no revolving color disks are necessary as in earlier systems. For the

two-color system, one side of the screen is covered with orange-red fluorescent powder and the other with blue-green powder. Two cathode-ray beams scan opposite sides of the screen, and the images are superimposed to give a picture in natural color. For the three-color system, another beam is required and the back side of the screen is ridged. One side of the ridges is colored green and the other blue. The Telechrome and the color system it employs were developed by John L. Baird, English television engineer. For stereoscopic viewing, colored glasses can be used. Baird has also worked out a system for stereo viewing without the use of glasses, but it is still in the experimental stage.

Armored Jeep Protects Airborne Scouts

"Little Ironsides" may never have a poem written about its exploits but it proved to be a safe and convenient means of transportation for scouts of the 82nd U. S. Airborne Division on the battlefronts of Holland. The paratroopers bounded the open seat of their jeep with steel sides almost as high as their heads, mounted a machine gun next to the driver, installed a two-way radio and put a sheet of iron in front of the radiator, then went zipping over the front on reconnaissance tours.



☞Horses have the largest eyes of any land mammal.

MEDICS IN DUNGAREES



Signal Corps photo

This portable X-ray unit takes the guesswork out of probing for bullets or shell fragments at field hospitals. Generals and Army doctors credit it with saving hundreds of lives. Here it is used for training medical personnel at a field service school in the European Theater of Operations. The 399-pound unit fits into three small trunks. Below, field suction apparatus for mobile surgical team

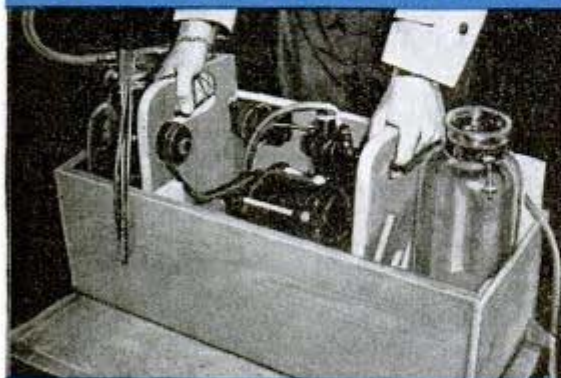

ANYBODY knows you don't have to be a doctor to be a mechanic, but in this man's war it is almost necessary to be a mechanic to place medical miracles within reach of seriously wounded Yanks on the front lines. Fast-moving medical units at the front are as mechanical as a tank battalion, and their equipment—from portable X-rays to collapsible operating rooms—is far more complicated.

The men who are performing these medical wonders within the sound of gunfire, and sometimes within rifle and machine gun range of the enemy, take on the appearance of combat troops. They get mud on their shoes, barbed-wire rents in their trousers, and two-day beards. But to a Yank bleeding to death on a stretcher, they look far better than a Park Avenue surgeon in cut-away and top hat.



Jeep carries medical corpsmen and pulls an emergency trailer

Their mobile operating rooms are moved on two or three trucks or on their backs and are set up in one or more tents. They must be close to the battle line to save the lives of gravely wounded soldiers who would die if they were to be moved even a few miles to a field or evacuation hospital. Semimobile hospitals cannot begin to keep the pace set by such armies as those of Lt. Gen. George S. Patton and Lt. Gen. Courtney H. Hodges during the swift-moving battle in France.

After the break-through at St. Lo and other whirlwind advances in the race across France, mobile medical units followed on the heels of speeding troops. They handle only the most serious cases of head, chest and abdominal wounds.

Litter patients are swung aboard a hospital ship after being transported by landing boat from hospital barge. Note patient with magazine



During the last war, the death rate among such cases was about 70 percent. One medical unit attached to an infantry division in France has kept this front line death rate under 10 percent.

"If proper medical care is to be given wounded men," said a spokesman in the surgeon general's office, "the surgical teams must keep pace with the attack. Medical personnel and equipment that do not arrive in time to be of service are nothing less than impedimenta."

The finest equipment the Army can devise helps the medics in dungarees keep the pace and perform with a high degree of efficiency. The advance auxiliary surgical groups, working in collaboration with evacuation hospitals within the combat zone, travel in their own trucks, supply vehicles, jeeps, planes and on foot. They work in teams organized like firemen and are available for duty wherever they are needed.

The teams, each composed of four officers and 33 enlisted men, can carry a 25-bed surgical hospital on their backs. This includes all of their instruments, tents, dressings, gasoline sterilizers, blood plasma, water, medicines and other supplies. One crew carried such a hospital from Port Moresby to Buna in 40 days, and in Italy, the Western Front and the Philippines surgical units literally carry their hospitals in their hands into areas where roads are impassable. The teams have their own auxiliary power units for electric current; a pint of gasoline sets a portable generator to turning out enough electricity to light a field hospital.

In addition to the "pickaback" hospi-

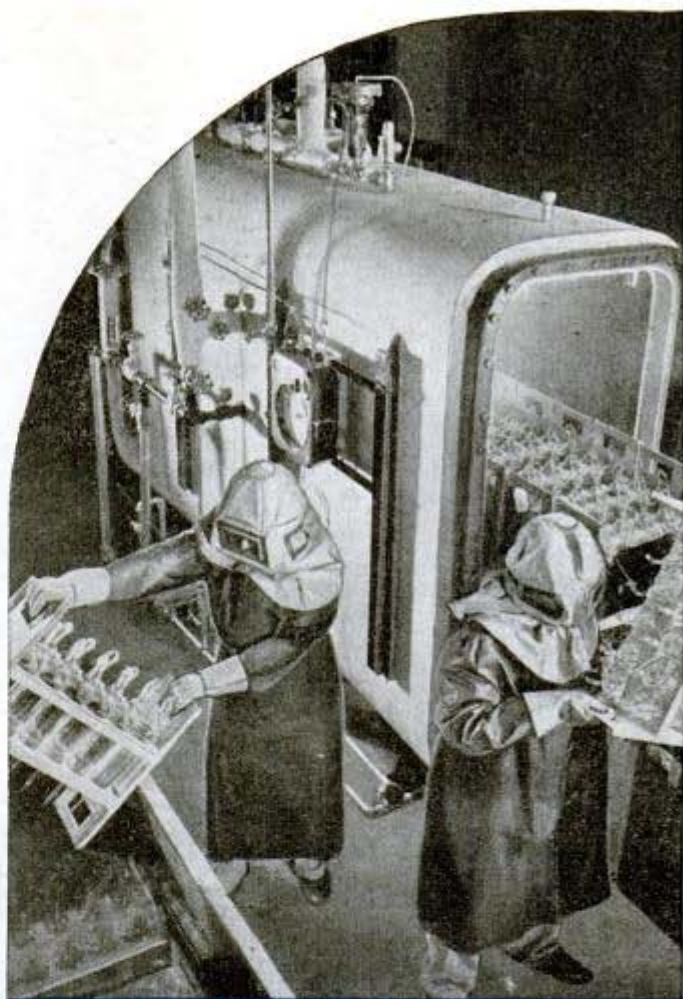

Courtesy William R. Warner & Co.
Intravenous solutions of dextrose and of sodium chloride are sterilized in this autoclave at 240 degrees Fahrenheit. Below, kitchen and refrigerator unit of mobile hospital is formed by two vans back to back. Units like these kept pace during race across France





This dental X-ray is used in well-equipped office on board Navy barracks ship. Below left, plastic vacuum pump is used by Army Medical Corps to extract the venom from snake bite wounds. Below right, wounded veteran from overseas "checks out" of hospital plane

tal, surgical operating trucks are also used on the front lines. These are two-and-one-half-ton, six-wheeled vehicles. The medical teams work in tents attached like two rooms to the rear of the truck, and several teams can work at the same time. The operating rooms have screened windows and are double-walled and lined with white duck to heighten the illumination.

Stairs lead up to the inside of the truck, which is used for storage of supplies, instrument cabinets, sterilizers, and chest pharmacies where the doctors can fill their own prescriptions. With medical teams working around the clock, from 80 to 100 men can be operated on in 24 hours in one of these mobile units.

Other mobile units, not of an emergency nature, include optical and dental vans with complete facilities.

One surgical outfit designed for air transport consists of three operating rooms 16 by 16 feet, complete with screens, floor and roof. This unit can be set up in less than half an hour.

The field instrument that has evoked perhaps the highest praise from our generals, Army doctors, and even the GI Joes, is the portable X-ray machine. It takes the guesswork and the pain out of probing for bullets and shell fragments, and has saved the lives of hundreds of men since its debut in the Tunisian campaign. The machine can be fitted into three small trunks with a total weight of only 399 pounds. Many of these units are flown to the front where they can be set up, ready for use, in 15 minutes.





The operating table in this field hospital is crude, but much of the portable equipment is the last word in medical science. Below, marine on treadmill at naval research hospital



The importance of X-ray examination for military wounds is revealed by a case of air raid injury reported by the Journal of the American Medical Association. A man was brought to a hospital with a thigh injury which at first glance appeared to have been caused by an embedded bomb fragment. But the X-ray pictures showed an unexploded cannon shell

buried in the tissues—an armor-piercing shell that explodes on impact!

Under normal procedures the shell easily might have been exploded during the operation. While the patient was left in happy ignorance of his predicament, a tense surgeon deftly performed the most dangerous and successful operation of his career.

Some of the equipment in the mobile hospital is so new that many of the officers never heard of it in civilian practice. An example is the electrical locator, a scientific “diviner” that locates hidden bits of metal.

It resembles a portable radio, and the dial not only registers the location of shell fragments but it can be used in determining their depth to an accuracy of one-tenth of an inch. The probe, or finder, is about the size of a large fountain pen and is made of stainless metal or Bakelite.

This instrument was first used on a large scale at the Tripler General Hospital in Hawaii after the attack on Pearl Harbor. In one difficult case, the locator was used in the removal of a machine gun bullet lodged in the spinal canal. The doctor who officiated reported that it was doubtful if this bullet would have been found by X-ray alone.

Another miracle-performing instrument is the surgeon’s “radio knife,” an electrical device that prevents excessive loss of blood by sealing small blood vessels as

Military truck teams up with cargo plane to rush containers of blood to the front



they are severed. This is used primarily in brain surgery.

Special medical kits have been developed for parachute troops, for the Arctic, the jungle, and for beachhead operations. The outfit, which is something of a medical marvel in itself, contains a pocket surgical kit, bandages, sulfa drugs, splints, morphine, plasma, iodine, safety pins, clinical thermometer, diagnosis tags, and even an indelible pencil.

After a wounded man has been given first aid, there are special litters, zipper sleeping bags composed of two lightweight mattresses, chemical heating pads, and scores of other things to help make him comfortable. Patients who have ridden in them say that even a jeep ambulance has its advantages.

The Navy has a portable hospital developed for amphibious landings. Every piece is designed so that it can be carried through the water from landing barges to the beach. The largest single piece of equipment is the refrigerator.

The bulk of the work performed by the medical corps is by no means confined to the hospitals. The men must watch over sanitary installations of all kinds and be on constant guard against such diseases as malaria, typhus, yellow fever and dengue. In the South Pacific the chances of a soldier getting malaria are probably five to 10 times greater than his being wounded by the enemy.

In the jungles, medical corpsmen wage a never-ending battle against malaria-bearing mosquitoes. A boon in this fight is DDT, the newest and most effective insecticide ever known. It is so deadly to insects that a mosquito or fly will die if it touches a surface sprayed four months previously. The "mosquito patrol"—consisting of a specially equipped Marine Corps torpedo bomber—on one Pacific island reported complete "air supremacy" with no mosquitoes left.

Helping the doctors at the front to fight diseases like malaria and even common colds, infections, and other menaces to the health of Yanks overseas are an imposing array of new drugs. They include sulfadiazine, penicillin, atabrine and a host of others that have never made the headlines. In one instance, a new method for the treatment of burns saved the lives of all but six of 400 soldiers seared by flaming oil.

When the medics in dungarees get back home, their kits will contain many miracles that will help make America a healthier nation. Meanwhile, they are trying to break their own all-time record: a death rate of about 2 percent among the wounded not killed outright. During World War I, this mortality rate was about 9 percent.

"Indoor Climate Control" For Individual Rooms

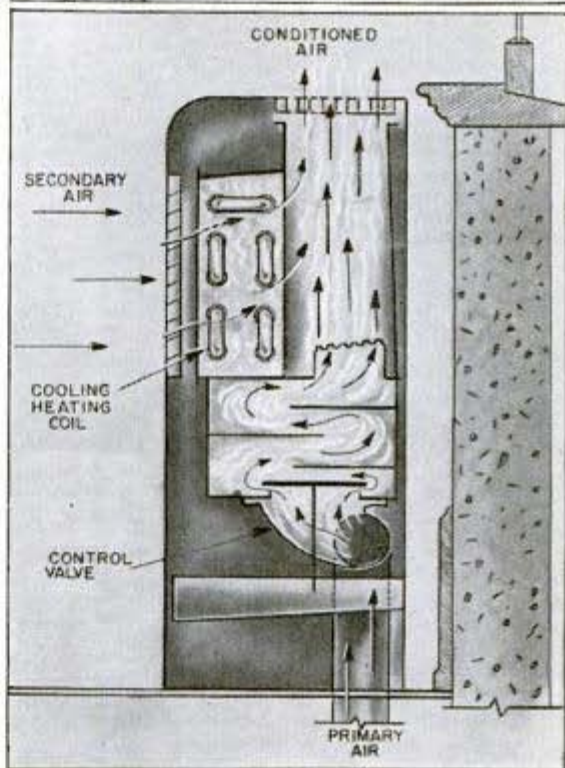
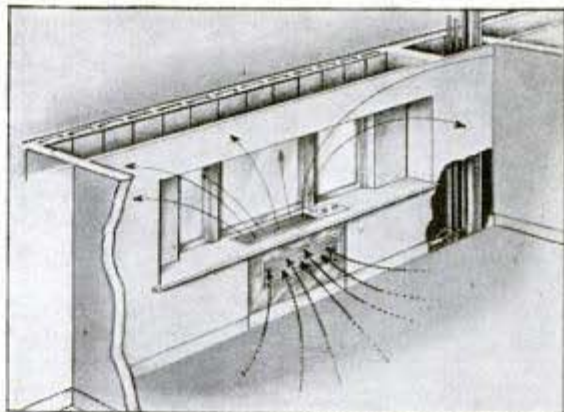

A new system of "indoor climate control" has been devised by the Carrier Corporation for large buildings with many small rooms. The method eliminates return air ducts and reduces the air supply conduits to six inches or less in diameter. "Thinking valves" regulate the heating and cooling action of the unit in each room the year around, and any room supplied from the same central conditioner can be heated or cooled to suit the comfort of the occupant. The central air conditioning apparatus is only about one third the size required by other systems. The key to the system comprises small high-pressure fans which discharge the conditioned air at static pressures and velocities much higher than formerly considered practical.

Floating Bridge Bends Arch Into River Current

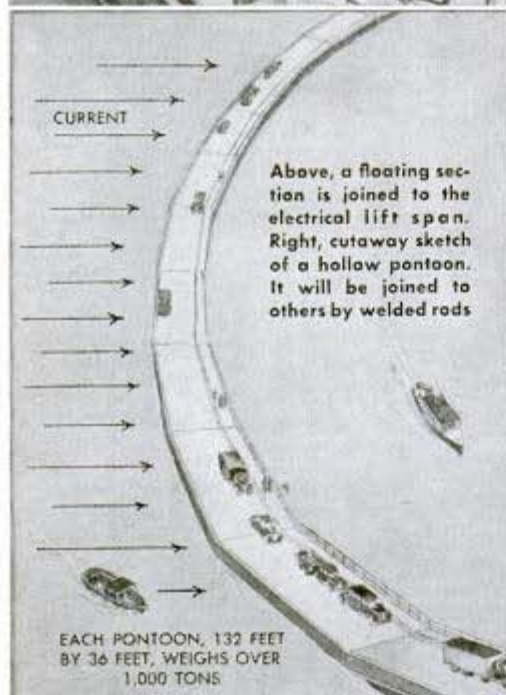
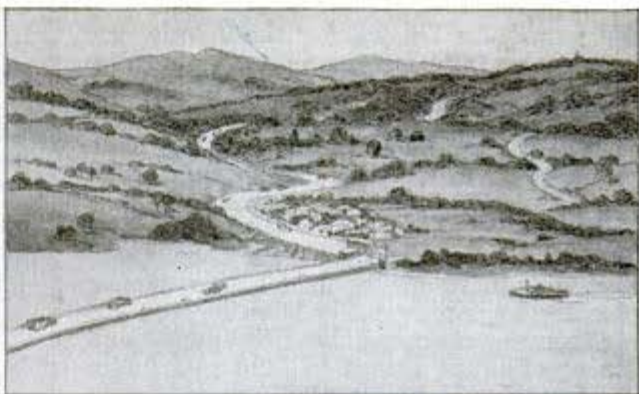
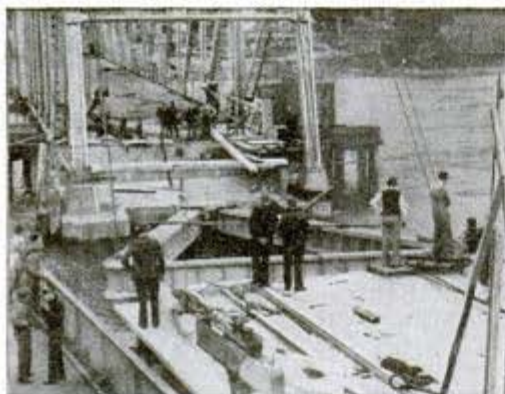

Above, a floating section is joined to the electrical lift span. Right, cutaway sketch of a hollow pontoon. It will be joined to others by welded rods

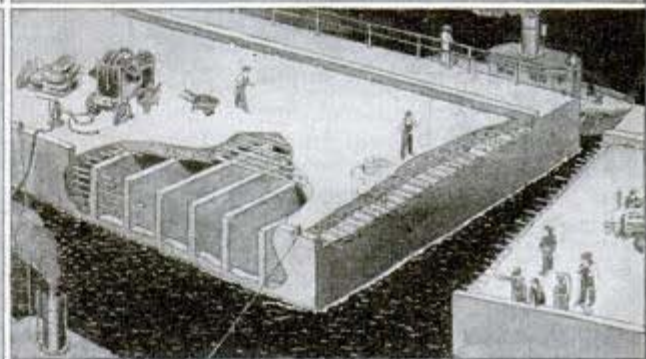

A floating bridge which rests on the water instead of on pillars has been built across the Derwent River at Hobart, Tasmania. The span, which is 3,165 feet long, employs the arched bridge principle but on a horizontal plane. Curving like a great bow upstream, the bridge presses sideways with the push of the current against the bow. It consists of 24 hollow, concrete pontoons, each weighing more than 1,000 tons. Welded together, they make up a 30-foot roadway. At one end ships pass under an electric lift section which can raise to 180 feet

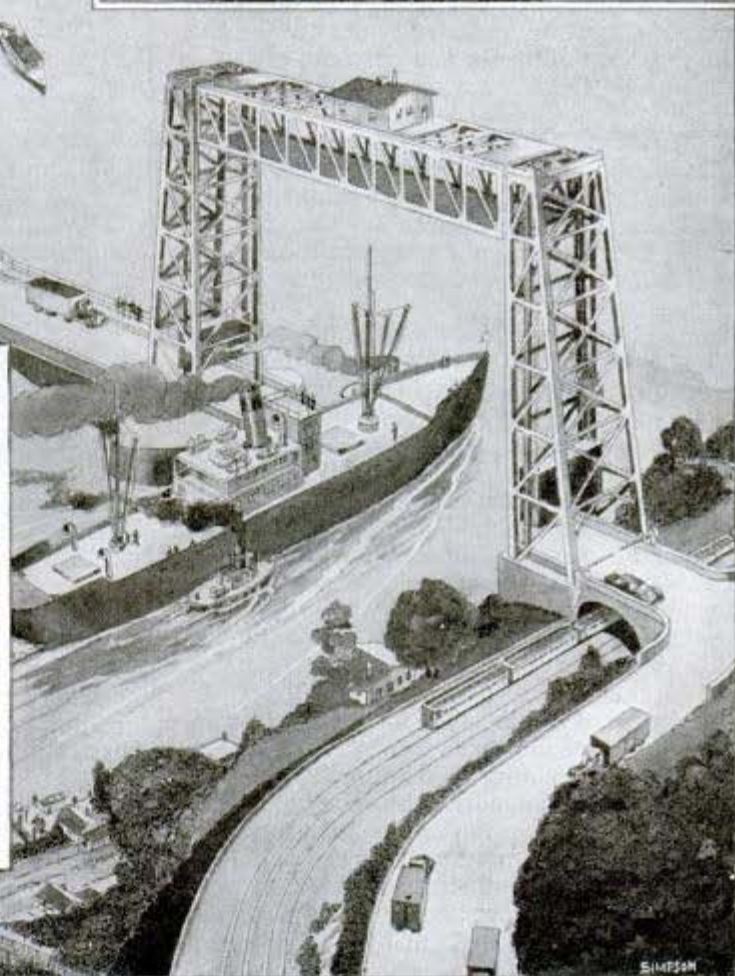

Reprinted W. Make 1947

The CRAFTSMAN

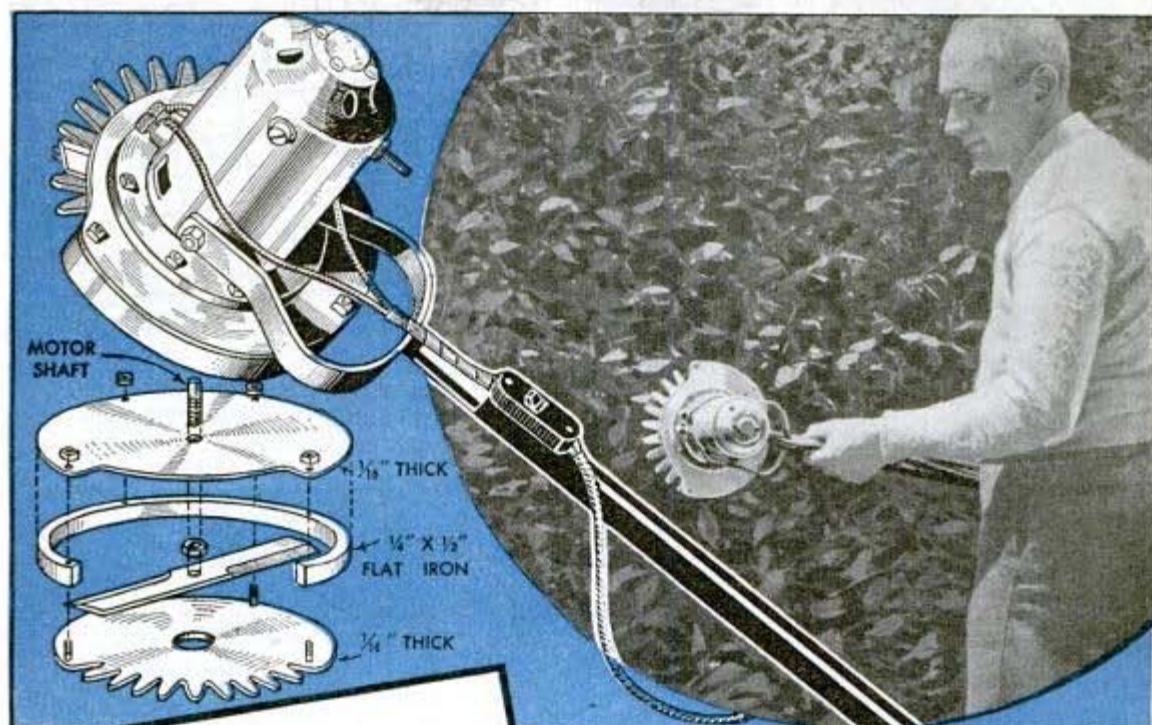

Electric HEDGE TRIMMER

By Bruce E. Stevens

IMPROVED from an old vacuum cleaner, this electric hedge trimmer is fast, efficient and easy to handle. Also, it can be used not only on privets and similar shrubbery, but on weed patches and in other places that cannot easily be clipped by a lawn mower. To convert a vacuum cleaner into a hedge trimmer of this kind, first remove the sweeper housing, including the suction fan. The assembly usually can be taken off merely by removing a few bolts that secure it to the motor housing. Next, substitute a new housing as shown in the illustration. This consists of top and bottom plates, with a flat metal segment between them which forms the side. On the trimmer shown in the illustration, sheet aluminum was used for the plates and spacer in order to assure light weight. However, $\frac{1}{16}$ -in. sheet iron or other similar material can be used for the plates, but the spacer must be of heavier stock so that it

can be drilled for bolts, which hold it in place between the plates. Overall sizes of the plates are not given as they are determined by the particular type of vacuum cleaner you use. The lower plate is serrated nearly halfway along its edge to form teeth between which twigs of shrubbery enter to be cut off by a rotating knife. The width and depth of the teeth and the slots are given in the cross-hatched pattern.

For the knife, you can grind down an old file of suitable size. Dimensions of the knife shown are correct only when the bottom plate is the size given in the pattern. For a plate of a different size, the length of the knife must be varied accordingly, although its thickness need not exceed $\frac{1}{8}$ in. In general, the knife should be long enough to extend to within about $\frac{1}{8}$ in. from the tip of the teeth, and the center hole should fit the motor shaft snugly. To drill a hole in a file, it is necessary first to remove the temper. This is done by heating the file to a dull red and then allowing it to cool gradually. After removing the temper and

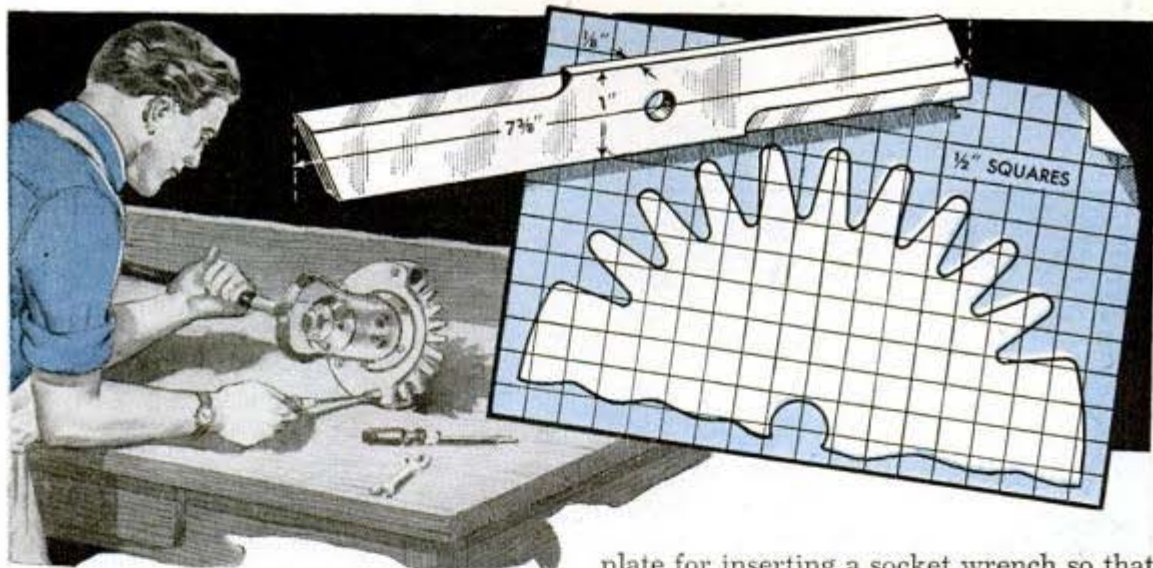

drilling the hole, the file should be ground to a knife edge on opposite sides as shown, so that the cutting edge is toward the bottom plate, taking into consideration the direction in which the blade will move on the motor shaft. Also, it is important to balance the knife to avoid vibration. When the knife is completed, it should be heated to a cherry red and quenched in oil or water to harden it. Two nuts hold the knife on the shaft, one above and one below. A large hole should be drilled in the bottom

plate for inserting a socket wrench so that the lower nut can be tightened whenever needed to prevent the knife from slipping.

The original vacuum-cleaner handle is retained because its length counterbalances the weight of the motor and enables the operator to guide the head without much effort. On some types of vacuum cleaners the switch for the motor is located at the end of the handle. The switch may be left at this location and operated with the right hand; or it may be mounted near the motor, as shown in the illustration, where it will be visible at all times.

Easy Method of Installing Narrow Door in Wide Opening

If you have a door that you would like to use in an opening that is several inches too wide, you can do an attractive job without plastering, which usually leaves a patched effect. If it is necessary to center the door in the opening, install extra studs and attach the door frame to them in the usual manner. Then bridge the space be-

tween the frame and original edges of the opening with $\frac{1}{4}$ -in. plywood, letting it extend back under the full width of the trim as shown in the circular detail. It will be necessary to block out from the sides of the extra studs a distance equal to the thickness of the lath and plaster. If it is not necessary to center the door in the opening, the frame can be set against one side of the opening, thus making it necessary to install only one extra stud. If this is done, the space between the extra stud and the side of the opening is bridged with plywood as before. Plywood also is placed over the plaster an equal distance on the other side to balance the appearance of the door. The plywood should extend under the trim.

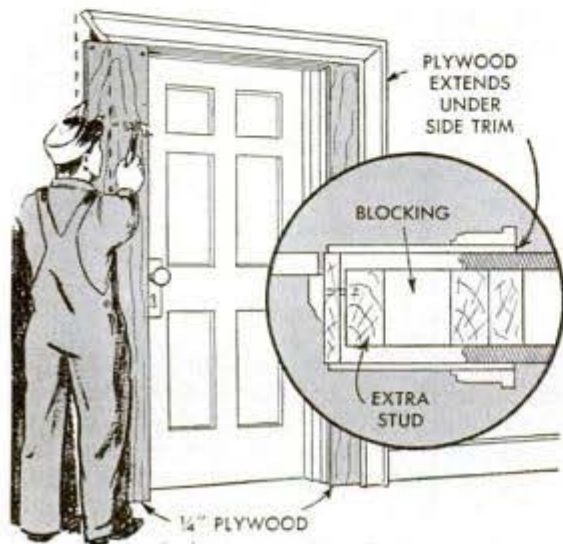

Bottle of Soapy Water Is Handy When Going on a Picnic

Before going on a picnic I dissolve a little soap in a bottle of water and take it along to wash the children's hands. A few paper towels or some pieces of cloth cut about 15 in. square complete the washing kit and save our regular hand towels.

Emily Nelson, Toronto, Ont., Can.

There's Nothing Slow About This Racing Turtle

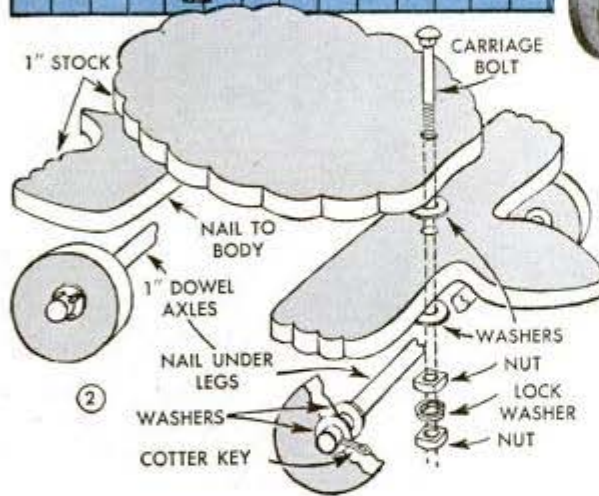
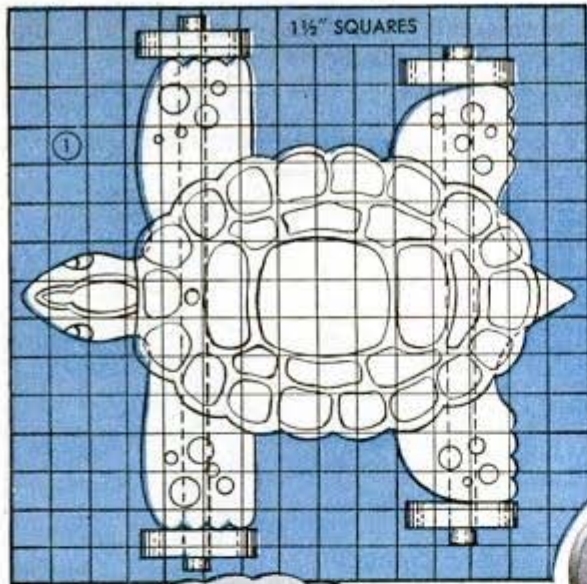

Steered with the feet, this wheeled turtle can be pushed or pulled. If pulled, a rope is tied through a hole in the head. Cut the parts as indicated in Fig. 1 and assemble as in Fig. 2. It's best to use hardwood, which will stand the strain better than softwood. However, if the latter is used, wheels and axles should be made of hardwood. Paint the wheels orange, the legs green with orange spots, and the body orange with green spots. Put a 1-in. spacer between the body and legs to prevent the possibility of pinching the fingers

Gauge Assures Accuracy When Installing Door Locks

When installing one or more door locks of identical type, this gauge will enable you to mark accurately the positions for all mortises, holes and screws with a mere tap of a hammer. In addition to this, its use assures that all locks will be located exactly the same distance from the floor. The gauge consists of a wooden strip long enough to reach from the floor to the desired lock position on the door and a short block screwed to the strip as shown. Screws projecting slightly through the block and strip mark the desired positions on the door. If desired, the gauge can be made adjustable in height by using a strip a little shorter than the distance from the lock to the floor, and attaching a slotted extension piece held by a bolt and wing nut.

☞ Sawdust used with soap and water makes a good hand cleaner to remove grease.



An Easy Way to Drain and Refill Water Pan Under Grindstone



If you have a grindstone of the type that rotates in a water pan that has to be drained after use each time because the stone softens if allowed to remain in water, here is an easy way both to drain and refill it. Drill and tap the lower end of the pan for a small pipe nipple. Then slip a length of hose over this and attach it to a water can. In use, merely raise the can above the level of the pan and the water will run into it. When finished using the stone, lower the can as indicated by the dotted lines and the water will run back into it.

Laurence Slater, Afton, N. Y.

Magnet in End of Razor Handle Helps to Pick Up Blade

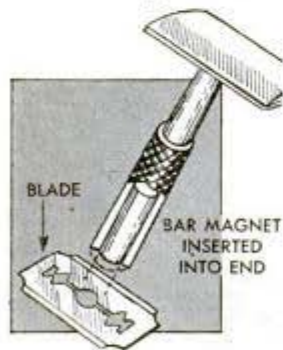

Picking up a safety-razor blade that has been laid on a flat, smooth surface is no trick if you have a small bar magnet in the end of the razor handle. The magnet can be cemented into a hole flush with the end of the handle.

Oiling Electric-Clock Motors

After a few years of service it is not unusual for an electric clock to become noisy. In a particular type of clock the noise will be found to come from inside an enclosed rotor which has a small driving gear projecting from the side and engaging the regular gear train in the works. To stop the noise on this type, place the clock back down with the gear pointing up vertically.

With the clock in this position, place several drops of light machine oil in the little depression around the gear shaft. Then immediately place the clock in a refrigerator. As the air inside the unit cools, it contracts and sucks the oil in through the shaft opening.

G. A. Kauber, Niagara Falls, N. Y.

Novel Place-Card Holders

Colored drinking straws provide unusual holders for place cards if they are slotted to receive the cards. The straws can be cut in half or used whole, and are inserted right into the beverage glasses. A safety-razor blade will be found handy for slotting the straws.—Albert E. Fenn, Chicago.

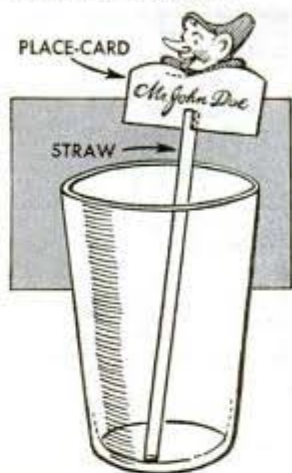

Perfectly Formed Pie Shells

If your pie shells bubble or shrink during baking, bake them between two pie tins of the same size. The tins should be of light material such as tin or aluminum. After 10 min. in the oven, remove the top tin and continue baking until as brown as desired. The result will be a smooth-bottomed shell that is perfectly formed.

Margaret Deutsch, Duluth, Minn.

Sanding Stick for Drill Press

For sanding work having concave curves with small radii, a dowel wrapped with abrasive paper and rotated in a drill press is ideal. One end of the dowel is gripped in the drill chuck and the other end works in the ball-bearing of a roller-skate wheel which is set in a wood block and clamped to the drill-press base.

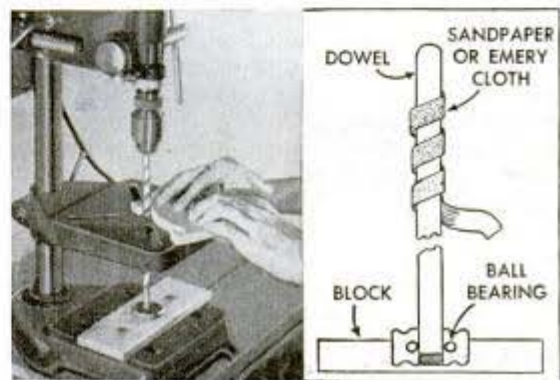

This Corner Shelf Has Scrollsawed Leaf Design

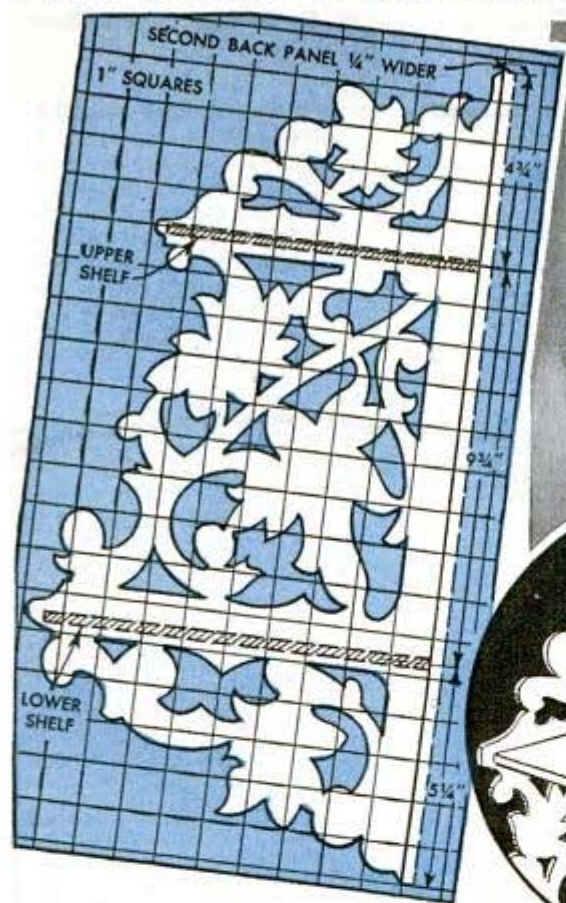

To "brighten the corner" of any room, this scrollsawed shelf in pleasing leaf design is just the thing for holding a small clock or bric-a-brac. Children like it, too, as a handy niche for their small porcelain or carved figures and other trinkets. To make the shelf, first re-draw the design shown in the cross-hatched pattern on heavy paper ruled off into 1-in. squares. Or, if you have a "postcard" projector, you can transfer the design to a large sheet of paper or directly to the wood, and just trace the lines. The most pleasing wood to

use for the sides is oak, maple or walnut about $\frac{1}{4}$ in. thick, but you can use plywood or any other suitable material if you intend to paint it. Because one side of the shelf overlaps the other, as shown in the circular detail, it should be as much wider as the thickness of the stock. The same material may be used for the shelves as for the sides. They first are cut square, then rounded at one corner, and are attached with glue and brads.

Norbert Engels, South Bend, Ind.

Non-Loosening Wedges Hold Small Tools Firmly on Their Handles

If you have trouble keeping a steel wedge from working out of the end of a tool handle, use a wedge like the one shown, which can be made from a flat piece of metal. Slot it in two places to provide three equal parts or tangs. Then bevel or taper the two end tangs on one side and the center tang on the opposite side. When the wedge is driven into the end of a handle, the tangs will bend slightly in opposite directions and thus secure the wedge firmly in place.

Arvid Bohlin, Montoursville, Pa.

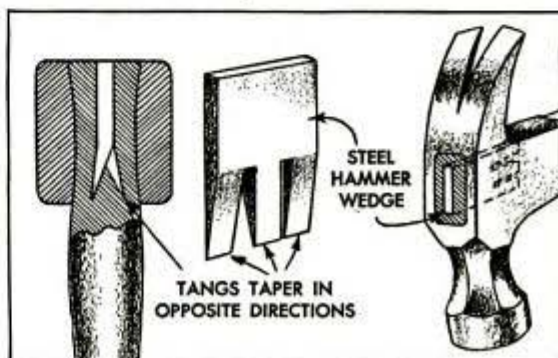

Solving HOME

1: A small accessory cabinet to hook over the edge of a bathtub is convenient for keeping toilet articles within easy reach. The cabinet is made of thin wood and has two rubber-covered hooks to fit the tub. 2: If you store your clothesline in a shopping bag, it is less likely to become entangled. When putting up the line, pay it out of the bag as you go, and when only part of the line is needed, the unused portion is left in the bag, keeping it from being soiled on the ground



1



2

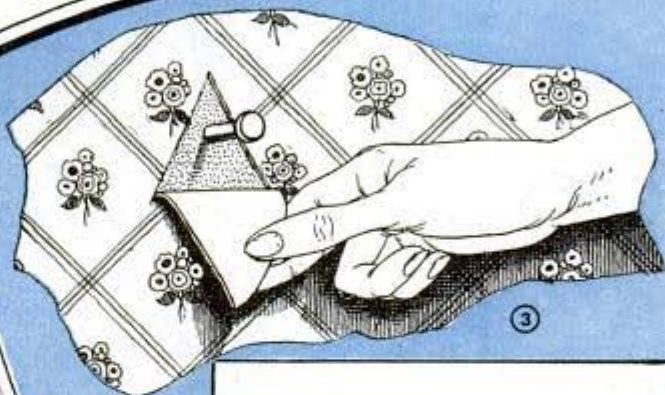

3

3: Before driving a nail in a papered wall to hang a picture, slit the paper and fold down the tab. When the picture and nail are removed the tab can be pasted back in place. 4: To repair utensil handles, use a paste of water glass and chalk colored by lampblack or other powdered dye

PLASTIC REPAIR



4

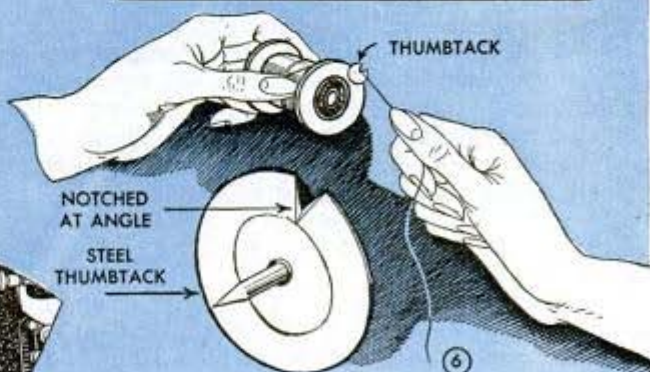

THUMB TACK

NOTCHED AT ANGLE
STEEL THUMB TACK

6

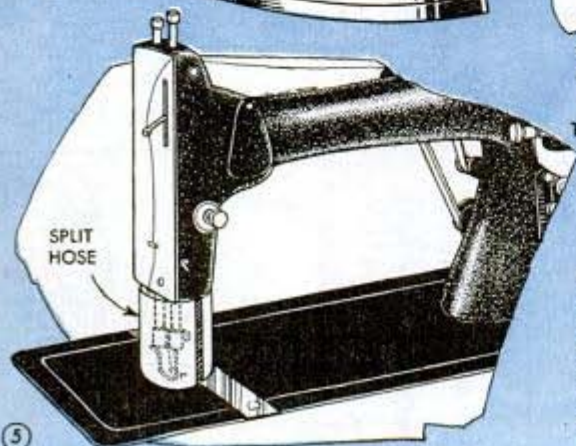

SPLIT HOSE

5

5: To prevent her small child from operating a sewing machine and injuring its fingers on the needle when she had to leave the machine for a few minutes, one mother slit a short piece of hose and slipped it around the needle and foot. 6: A cutter for use on a spool of thread can be made by notching a thumbtack as indicated. The edges of the notch are sharpened

PROBLEMS

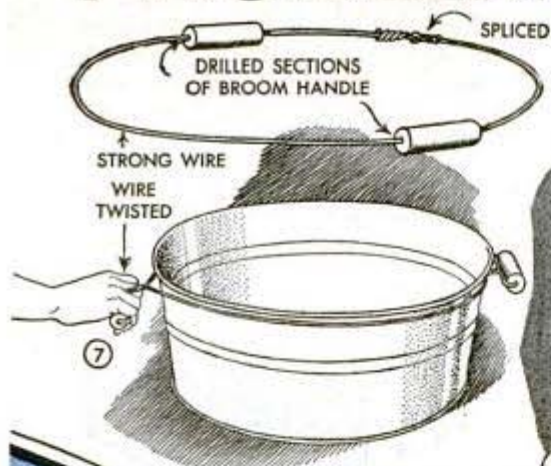

7: If you have a tub or other container with a rim around the top but no handles, here's a way to provide them. String two short handles on a wire, splice the ends together and bring the wire around the tub, just under the rim. Twist the handles to tighten the wire. 8: It's easy to make a pair of clinker tongs. First, cut an L-slot at one end of a length of pipe and bolt or weld a U-prong to it on the side opposite the slot. Next, fit a wood handle over the other end and then insert a rod. Bend the end at right angles to work in the slot as indicated, and then curve it toward the U-prong. A clinker can be gripped securely by twisting the rod

9: For less handling and easier selection of phonograph records, it's a simple matter to show both titles of a record on each side, using gummed labels. 10: A tight metal screw cap on a glass jar can be removed easily if it is held in a flame a few seconds to expand the metal. Use a cloth pad to remove the cap

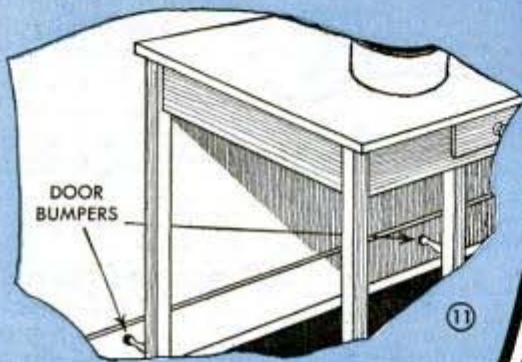
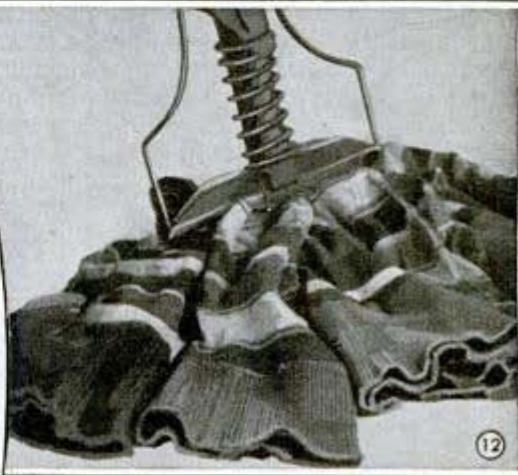

11: If a kitchen table is kept close to a wall, and the edge mars it, two rubber-tipped door bumpers driven into the rear legs will prevent the trouble. 12: Instead of discarding worn socks, save them until you have several pairs. They will provide a good dry mop

Drying Rack Folds Against Wall When Not in Use



Here is a rack for drying towels, garments, etc., that you can fold down out of the way when not in use. It's easy to make, too, because all you have to do is drill a wood strip for as many dowels as required, hinge this to a mounting block and screw the block to a wall. A short wood piece, also hinged to the block, supports the rack in the open position as indicated.

I. M. Fenn, Chicago.

Burning Sawdust in Fireplace

Sawdust is an excellent supplemental fuel for fireplaces. Place the dust in 10-lb. paper bags, packing it down well and folding the top in tightly. When a good fire is going in the fireplace, put the bag of sawdust in the back against the firebrick. The bag will burn away, exposing the dust which burns slowly, thus creating additional heat inexpensively.

Ralph K. Coffman, Arlington, Va.

Gauge to Measure Electrolyte In Storage Battery

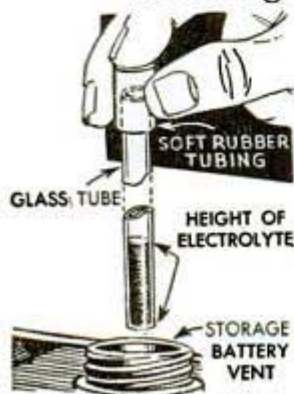

A 6-in. length of $\frac{3}{8}$ -in. glass tubing having a short piece of soft rubber tubing slipped over one end will provide a handy gauge that will eliminate all guesswork as to the height of the electrolyte in your storage battery. To use, merely insert

the tube into the battery cell to the top of the plates. Then place a finger over the upper end on which has been placed the rubber tubing, and withdraw the tube. The height of the liquid in the tube will be the same as its height above the plates in the battery. It will be a good idea to scratch the tube to indicate the liquid height when the battery is full. This will enable you to determine quickly whether or not water should be added to the battery cells.

Spiral Cuts on Wood Spindle Laid Out With Tape

When you have a wood spindle that is to be decorated with spiral cuts or grooves, adhesive tape will enable you to lay them out accurately. First wind a strip of tape spirally around the work, making the



tape the same width as that desired for the grooves. Then wind a second strip of tape of the width desired for the spacing between the grooves, butting the edges of this strip against the edges of the first one. This second strip assures uniform spacing of the grooves. Peeling off the strip of tape first applied to the work gives an accurate guide for making the spiral cuts.

Easy Way to Make Plate Hanger

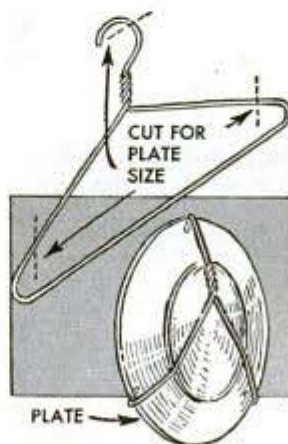

Hangers for decorative dinner plates can be made from wire coat hangers with ease. All that is necessary is to cut the hangers as indicated in the drawing, locating the two lower cuts according to the diameter of the plates. After bending short hooks on the severed ends of the

hanger wires, insert the plates and hang them on nails at the forks where the lower wires of the hangers join.

G. W. Butchart, Owen Sound, Ont., Can.

☞ The glaze will disappear from a grindstone, in which dirt and bits of metal have become embedded, if you hold a piece of ice against it as you turn it slowly.

Picture Lapel Pins Jigsawed From Thin Wood

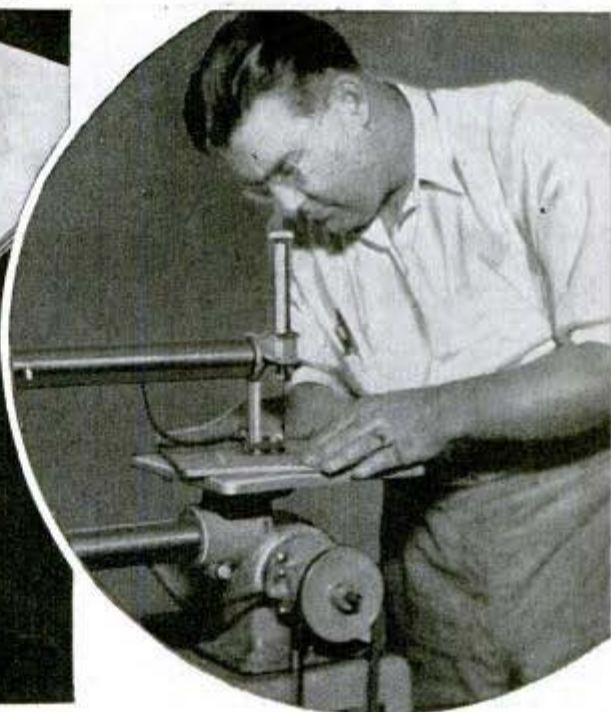

It's easy to glue an attractive picture to thin wood, saw it out and attach a clasp to the back. That's all there is to making colorful lapel pins such as the one shown here. You can select suitable pictures from magazines or you can use photos—even one of the wearer. Plywood or hard-pressed board $\frac{1}{8}$ in. thick is used for the back. After sawing, sand the edges carefully and

then put on the clasp, which can be taken from a discarded brooch. An ordinary safety pin will do if no regular clasp is available. Strong household cement of the imitation-solder type generally will hold it in place securely. A coat of spar varnish or transparent lacquer applied over the entire surface as a protection against moisture will add to the pin's appearance.

Folding Safety Gate Converts Bed to Temporary Baby Crib

Instead of purchasing a baby crib, which the child would soon outgrow, we bought a bed that could be used later and converted it to a crib. To do this, the bed was placed in a corner of the room with the low foot end against one wall as indicated. In this way, it was necessary to close only one side of the bed to keep the baby in it. This was done with a folding safety gate. Wood strips were clamped to the head and foot of the bed for mounting the gate, using cloth between the bed and strips to avoid marring the finish for later use. A hook and eye can be used at the center of the bed rail to keep the child from pushing the gate out at this point. The gate is easy to push to one side when tending the baby.

T. E. Dahl, Yakima, Wash.

☛ To thread a needle with wool thread first twist a tiny piece of cotton on the end of the thread. This makes a smooth end which will allow the thread to slip through the needle without difficulty.

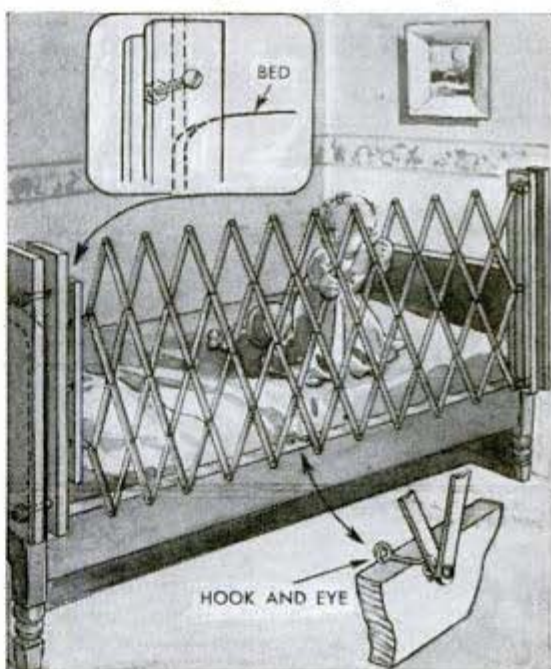

Slots Cut in Draftsman's Triangle Save Time When Lettering

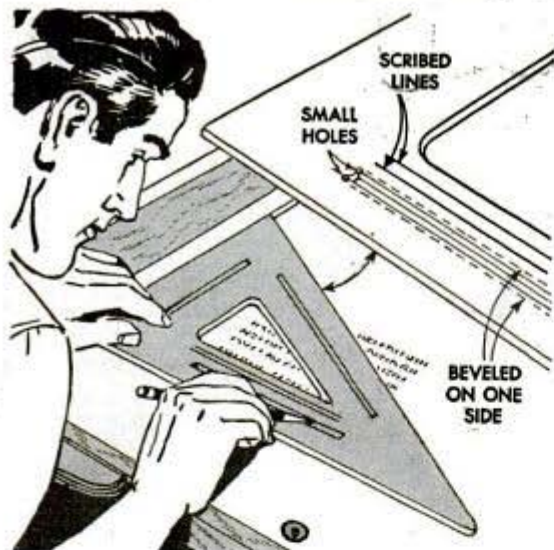

Two or three slots of different widths cut in a triangle will provide a lettering guide that is always at hand, and will make it unnecessary to draw dimension lines. Two scribed lines above each slot will aid in spacing the lettered lines. Before cutting the slots, small holes should be drilled at each corner to prevent splitting the triangle.—J. A. MacDonald, Stamford, Conn.

Water-Pump Thumping Silenced With Rubber Hose

Automatic electric water pumps sometimes thump noisily when the pressure increases too fast for the pipes to accommodate the sudden volume of water. To eliminate this disturbing noise, cut out a 12-in. section of the supply line near the pressure tank and substitute a piece of hose, pushing it a few inches over the pipe ends and securing it with hose clamps. The rubber will expand under the increased pressure and thumping will not occur.

Smoothing Tops of Canning Jars



If you have some glass canning jars on which you cannot use vacuum-type lids because the upper edges of the jars are slightly rough, here is an easy way to smooth them. Tack a strip of waterproof emery cloth of 90 or 100 grit to a smooth board, using a

strip about 4 in. wide and 16 or 18 in. long. Stretch the abrasive taut, place the mouth squarely on the abrasive and rub it back and forth. Use water on the cloth to prevent clogging.—Wm. Fried, Cincinnati, O.

Improving Carpenter's Compass

If you have a compass which uses a short stub pencil that has to be pointed and re-adjusted occasionally, it is easy to fit it with an automatic pencil. Just remove the lead end of a cheap automatic pencil and drill the end of a small dowel so

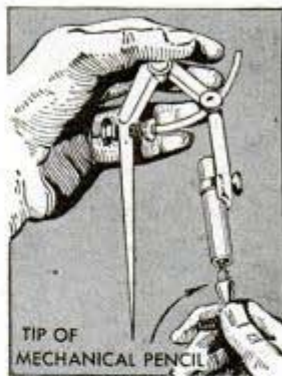

that the pencil can be inserted. The dowel should be of a size that can be substituted for the regular lead pencil in the compass.

Thomas B. Owens, Cleveland, Ohio.

Wafer-Type Thermostat Controls Homemade Electric Brooder

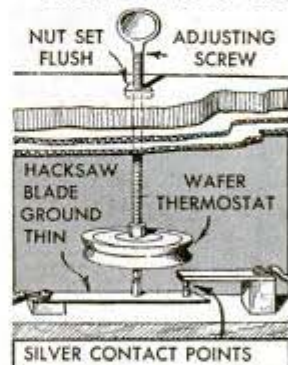

This inexpensive thermostat that anyone can make will solve your problem of controlling a homemade electric brooder, incubator, etc. All you need is a wafer thermostat, which can be purchased or taken from an old water-heated

brooder or incubator. This is attached to the end of an adjusting screw and mounted so that the lower side will press against spring contacts as indicated. The contacts are made from any thin, spring metal. An old hacksaw blade that has been ground thin will do. You can make the contact points from silver wire, or you can use discarded ignition points from a car.

F. Hayward, St. Petersburg, Fla.

WRITE FOR POPULAR MECHANICS!

Readers are paid cash for ideas printed on these pages. You too, may know of a simpler, faster or better way to do some daily chore about the home, farm, office, shop or garage; an aid to amateur photographers, model makers, workshop fans, car owners, hobbyists, etc. Just send a short but complete description plus a sketch or photo to the Homecraft Editor of Popular Mechanics. Checks sent promptly for accepted ideas.

HOW TO MAKE

Reprinted
Home Kinks

Porcelain Repairs

47

ON YOUR SINK, RANGE, REFRIGERATOR

REPAIRING chips and scratches on porcelain or synthetic baked enamel is so simple that no housewife need hesitate to undertake the work. A variety of special patching products is available, usually at dime or hardware stores.

Stick porcelain: As the name implies, this type comes in stick form and is made fluid by heating. Use any thin flexible knife, such as a paring knife, and heat it over a gas or alcohol flame, as shown in Fig. 2, holding the Porcelstix at the end of the knife. Melt off enough to fill the hole and then apply, Fig. 3. Don't worry if you get a little too much on—it dries in five minutes and can be scraped down cleanly and easily with a razor blade. Advantages of this product are speed and a clean, solid patch not easily affected by mild oven heat, cold or fruit juices. Only disadvantage is that white as the stick is,



it is not as white as porcelain enamel. For better color matching, you can go over the patch with white enamel or lacquer.

Porcelain putty: Usually a very good

1 STICK PORCELAIN IS SIMILAR TO STICK SHELLAC. IT MAKES A GOOD PATCH BUT IS NOT AS WHITE AS PORCELAIN ENAMEL

2 HEAT KNIFE TO MELT STICK

3 APPLY MELTED CEMENT

4 USE FLEXIBLE KNIFE

5 SAND OR SCRAPE LEVEL

6 APPLY WITH PENCIL BRUSH

PORCELAIN PUTTY IS LACQUER IN PUTTY FORM. IT SHRINKS SLIGHTLY ON DRYING AND SHOULD STAND OVERNIGHT BEFORE SCRAPING OR SANDING

PORCELAIN GLAZE IS LACQUER IN PASTE FORM. IT IS APPLIED WITH A SMALL BRUSH. SUBSTITUTE PUTTY OR GLAZE CAN BE MADE BY ALLOWING ORDINARY WHITE LACQUER TO STAND IN OPEN DISH UNTIL IT THICKENS

Three ways to patch small chipped places in porcelain are shown in photos above. All methods will give good results with a minimum amount of skill, but don't expect the color of the patch to match the color of the porcelain



USE 5/0 PAPER FOR SANDING

white, this product is knifed into the defect, Fig. 4. It should stand a little above the surrounding surface since it will shrink slightly on drying. Allow plenty of drying time, at least overnight, before scraping or sanding smooth. If you sand smooth, use 5/0 paper backed with a felt or cork block, as shown in Fig. 7. With a little practice, you can get a perfectly level patch with a razor blade, used as shown in Fig. 5.

Porcelain glaze: This is thinner than putty—ideal for very small defects. Just take a brushful and apply, as in Figs. 1 and 6, let dry at least overnight, and then sand or scrape. This is usually the best white. Both putty and glaze can be homemade by taking ordinary lacquer or enamel and pouring off a small quantity in a dish. Let it stand in the open air until it thickens to the desired consistency. You can speed the work by adding dry powder color (zinc white or titanium dioxide) to the lacquer.

General rules: Whatever method you use, make a practice patch before starting actual work. Be sure the surface to be patched is clean. If there is an "island" in the chipped place, pry it out. Warm the

COMPLETE REFINISHING SCHEDULES

REFRIGERATOR EXTERIORS

- 1—Wash thoroughly. Let dry. Wipe with alcohol or lacquer thinner on cloth.
- 2—Sand lightly, 3/0 silicon carbide.
- 3—(If old surface is badly checked or chipped all over.) Apply coat of white primer-surfacer. Sand thoroughly when dry with 3/0 paper, with water as lubricant. (If old surface is good.) Apply coat of white primer. Do not sand.
- 4—Apply first coat of white lacquer enamel.
- 5—Patch all holes with lacquer putty.
- 6—Sand patches smooth.
- 7—Apply second coat of white lacquer enamel. Scuff sand.
- 8—Apply mist coat of straight thinner. Let stand at full gloss.

REFRIGERATOR INTERIORS

- 1—Wash thoroughly. Let dry. Allow refrigerator to come to room temperature.
- 2—Spray or brush one coat of white shellac enamel.

KITCHEN RANGES

Follow same schedule as for refrigerator exteriors, but use air-dry-or-bake synthetic undercoats and top coats. Turn the oven on to bake the various finish coats over and around oven; let other parts air dry until fully hard.

surface slightly with a warm cloth before patching. Do not expect perfection—it is almost impossible to apply a direct patch and get a perfect color match.

Complete refinishing: This is preferably done by spraying. Follow the schedule shown. Do not attempt to spray lacquer or enamel directly over a porcelain finish—always use a primer or surfacer to get necessary bondage between old and new finish. On kitchen ranges, the best product to use is an air-dry-or-bake synthetic. This will bake hard over the oven at normal oven heat, and will air-dry nicely on other parts. For refrigerator interiors, the best product is white shellac enamel. This sticks fairly well without a primer and has a definite advantage in that it dries without odor. Most other lacquers and synthetics will contaminate milk and butter for several days after application.

Spring Under Accelerator Pedal Acts as Governor on Car

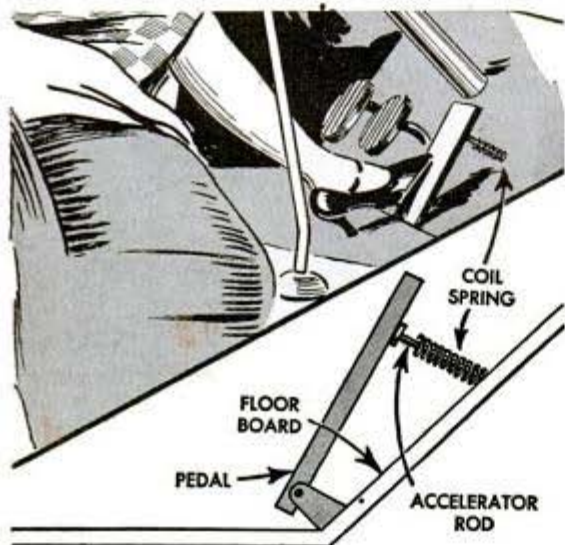

In order to drive a car under a certain speed, yet be able to exceed this speed when necessary, one motorist put a spring under the accelerator pedal as indicated. When the pedal is pushed down under normal foot pressure to contact the spring, the speed of the car will not exceed the predetermined rate. However, harder foot pressure will compress the spring when it is necessary to travel at a higher speed. To install the spring, drive the car at the desired speed and measure the distance from the pedal to the floor. Then cut a compression spring to a length equal to this distance and slip it over the accelerator rod.

E. W. Harmon, Hobart, Ind.

Insulation board of the soft kind makes an excellent backing for archery targets.

WOODEN STROLLER

has space for extras

WHEN mother goes shopping, baby can go along in this wooden stroller, which has a rear compartment for carrying extra blankets or clothing and shopping parcels. When this space is not used, the front panel, which fits in a groove in the sides and bottom, may be lifted out to provide additional room for the child to lie down. Plywood is used for front and rear panels, sides, arm rests and guard rail,

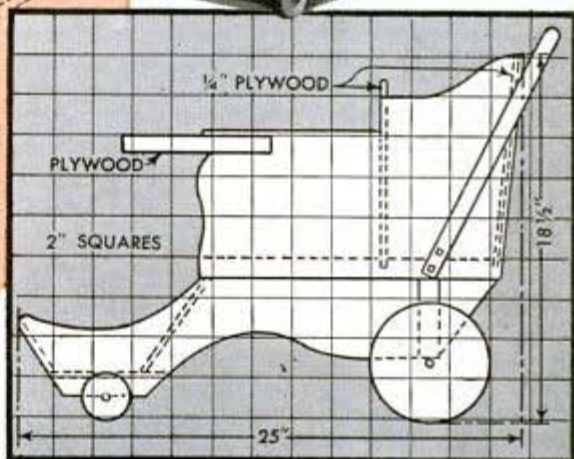
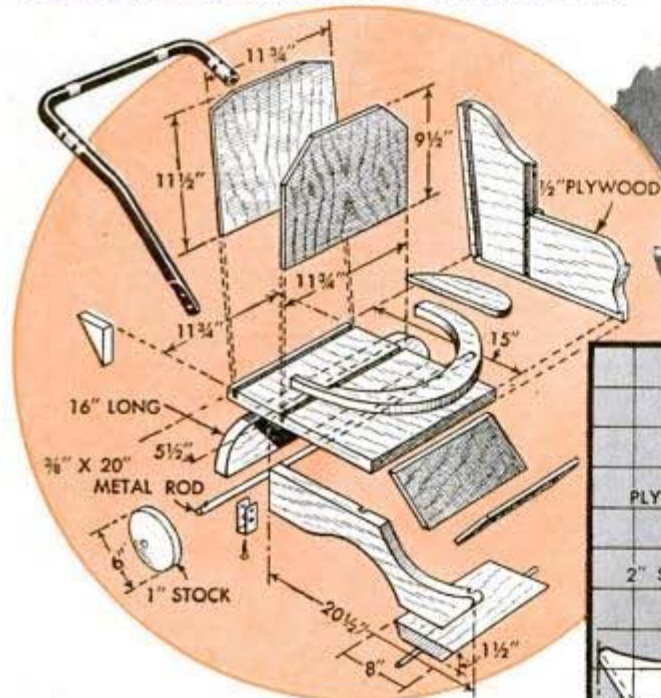

and heavier material for other parts. The stroller is assembled as shown in the cross-hatched pattern. Side pieces, which are grooved as shown, are glued and screwed to the seat after which the rear panel is glued in place. Arm rests and the curved guard rail are attached with screws. A cross support for the axle is screwed to the seat and braced by a triangular piece at each end. The axle, a length of metal rod, is fastened to the support by two U-shaped pieces of flat iron, through which screws are inserted into the axle to keep

the latter from turning. Also, the axles are drilled at the ends to take cotter pins, which hold the wheels in place. Although not shown, washers should be placed over the axles on both sides of each wheel to facilitate revolving. For the handle, a length of 1-in. tubing or flat iron is suitable. This is bent to the shape shown and secured with bolts.

It Is Easy to Convert Pieces of Old Hand Files for Use on a Jigsaw

Satisfactory substitutes for manufactured jigsaw files may be made from straight, round, triangular or square files and from flat files that have parallel sides. Pieces 3/4 in. long are used with one end ground 1/4 in. round for a distance of 1 in. Small files may be set in solder in the end of a

piece of 1/4-in. o.d. metal tubing. For machine use, the files must be made with the teeth cutting on the pull or downward stroke of the saw.

☐ Brown sugar will not become lumpy if it is stored in a mechanical refrigerator.

Tacks Hammered Into Play Board Are Pegs for Yarn Outlines



To most children, a hammer and some tacks will supply hours of amusement. Just supply them with a smooth board about 15 by 20 in. and let them pound tacks into it at random. Then, after they are tired of this pastime, a ball of yarn can be brought out to continue the fun. Looped over the tacks, the yarn can be strung to outline animals, boats and other familiar objects.—Mrs. Hal Geihm, Aurora, Ill.

Tube Patches Used as Tire Boot

A firm, rigid and long-lasting boot for small breaks in tires can be improvised from two equal-size pieces of ordinary tube patching, somewhat larger than the break, cemented together and dried while being pressed in a vise. After the edges have been beveled, the improvised boot is placed over the cut in the usual manner.

Leonard Wright, Kokomo, Ind.

Glue Compound Seals Bottle Containing Volatile Liquid



When a bottle containing volatile liquid is stored for some time the contents are likely to evaporate unless the bottle is sealed. To do this, dip the end of the bottle into a hot solution consisting of liquid flake glue, 4 parts, and glycerine, 1 part. When dry, the

mixture will form a tough film over the cap or cork and neck of the bottle. The film is easy to peel off when the bottle is to be uncorked.

Removable Sides of Wheelbarrow Held by Spring Clips

If your wheelbarrow has detachable sides which sometimes jump out of their stirrups while going over rough ground, they can be secured by means of spring-steel clips. These are shaped as shown and are about $\frac{3}{4}$ in. wide and 4 in. long. The

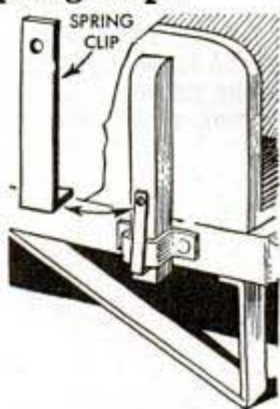

clips are screwed to the cleats of the detachable sides and are bent to fit under the stirrups. When you wish to remove the sides, merely disengage the clips.

Notched Eraser Stops Smudging

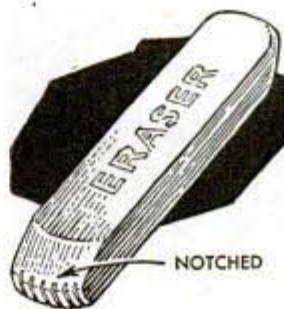

When using a pencil or ink eraser that makes black smudges on the paper, a few notches cut into one end of the rubber about $\frac{1}{8}$ to $\frac{1}{4}$ in. deep will eliminate the trouble. You will find that erasures can

be made faster and neater with less rubbing when an eraser is altered in this way.

Michael Ligocki, Gary, Ind.

Alcohol Lamp From Oilcan

It is an easy matter to make an alcohol lamp from a small oilcan. Just cut off the spout an inch or so above the can, insert a wick and provide a cap to extinguish the light. This can be a piece of tubing closed at one end and attached to the can with a short length of small chain. A tiny vent hole should be drilled in the can close to the screw top.

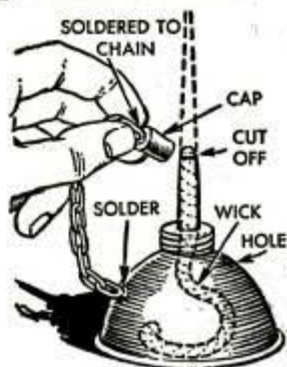

Larry Katz, Brookline, Mass.

Dummy Books Form HIDEAWAY

NO ONE would suspect that what appears to be only a trough of books is really a cleverly disguised hideaway behind which is space for temporary concealment of personal items. The trough, shown in Fig. 1, is made of $\frac{1}{2}$ -in. wood and consists of bottom, back and side pieces, the latter being scrollsawed for appearance. The "books" are all fastened together to form a single unit, which is lifted off, as in the illustration, to disclose the hideaway. Actually, only the covers of old books are used—as many volumes being selected as are needed to fill the trough. After removing the covers, take the smallest one and cut out a section from each side as in Fig. 2, leaving a strip about 1 in. wide along the top and edge adjoining the back. Using the cutout portion as a template, cut all except two of the other covers in the same way. As the two remaining covers are used at the ends, only the right cover of one and the left cover of the other are cut away, the outer covers being left uncut to conceal the hideaway between them. The cut covers are glued to wooden L-shaped blocks

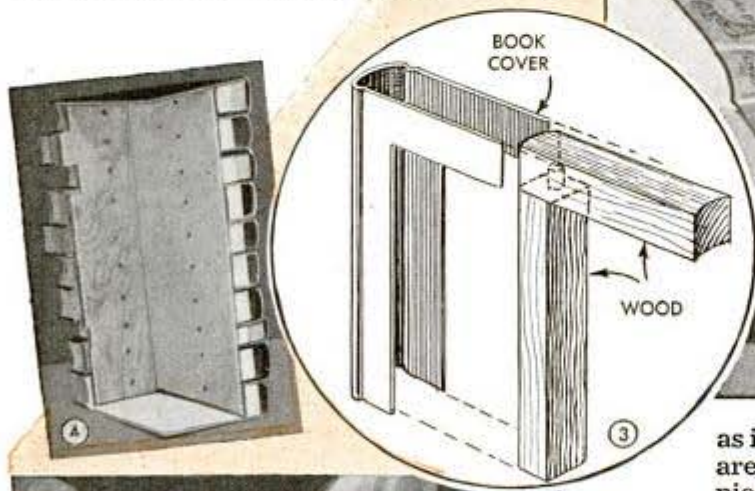

as in Fig. 3 and the imitation books are held together by screwing two pieces of plywood or hard-pressed board to the blocks as shown in Fig. 4. To simulate pages, the top edges of the blocks should be coated with heavy paint. A comb drawn through the paint as shown in Fig. 5 produces the effect of pages. The illusion will be heightened if a fine comb is used on some, a coarser comb on others, and none at all on the rest. To avoid mixing different colors and so ruining the book effect, the comb should be cleaned thoroughly in turpentine or other paint solvent after being used on one "book" and before being used with a different color on another.—Charles and Bertram Brownold, Woodmere, N. Y.

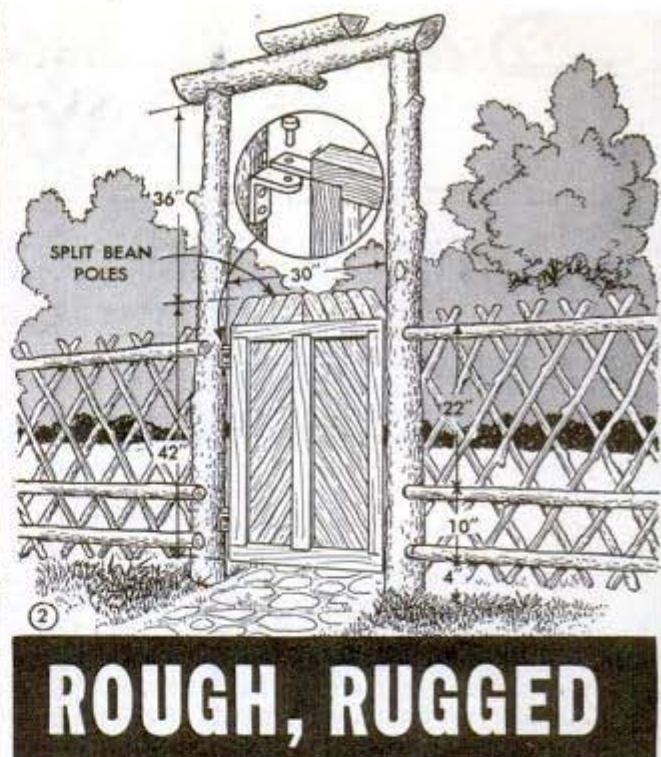

ROUGH, RUGGED

Part 2: Gates, Fences, Summer House

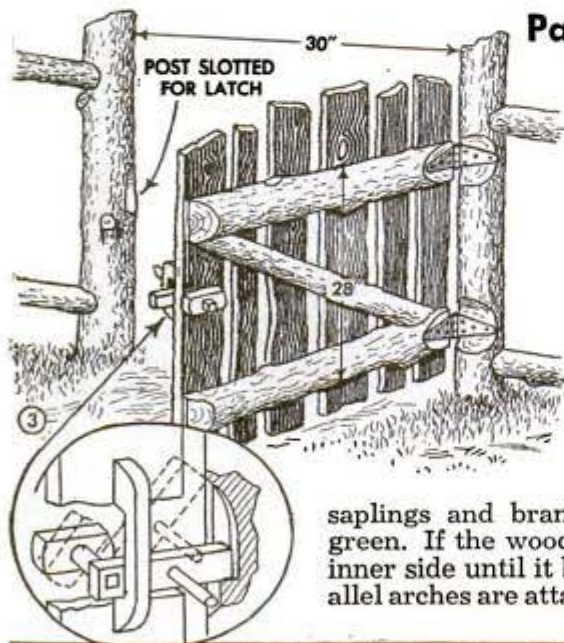

IN BUILDING rustic structures only seasoned material should be used, except members that are to be bent to a curve. These are best handled green and should be bent around a wooden form and allowed to season before installing on the permanent frame. Bark left on the pieces adds to the interest. But if it is of the variety that peels readily when dry, it should be removed. Screws are better than nails for assembling the parts, as they can be tightened if the wood shrinks. Where posts are set into the ground the ends should be tarred or creosoted to forestall decay.

The arched gateway in Fig. 6 is built of saplings and branches, the two arched members being bent green. If the wood selected is difficult to form, shave down the inner side until it bends easily. The short pieces across the parallel arches are attached with raffia or heavy brown cord. Pickets

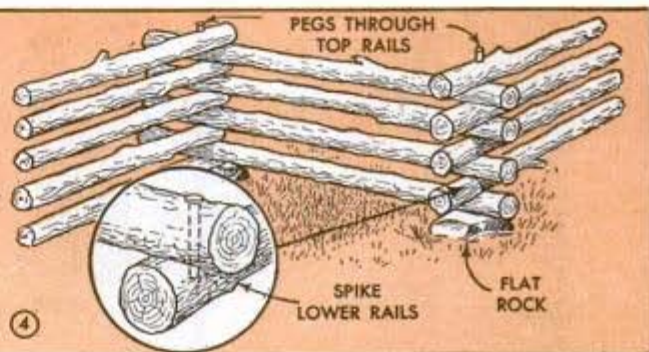
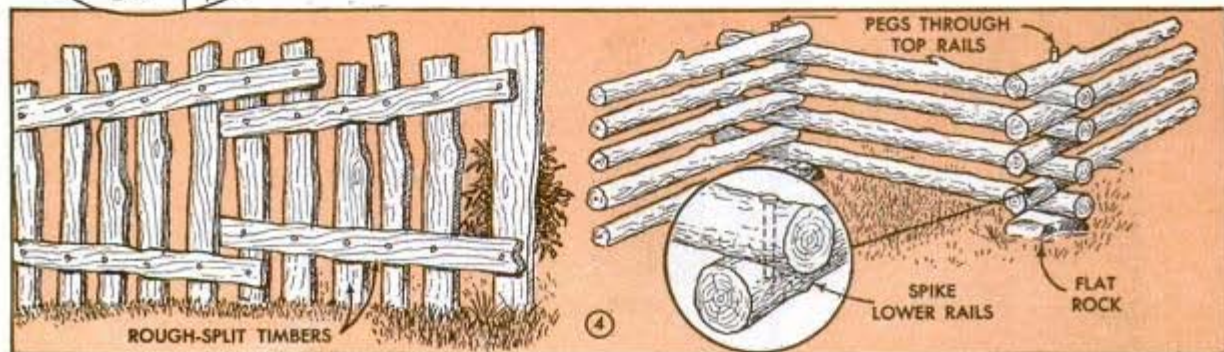

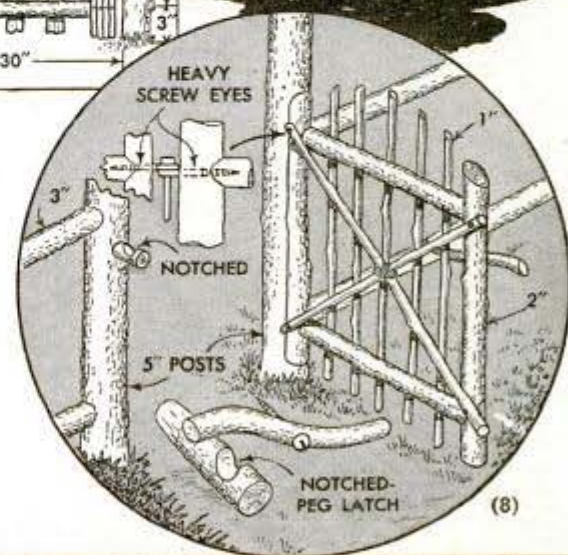
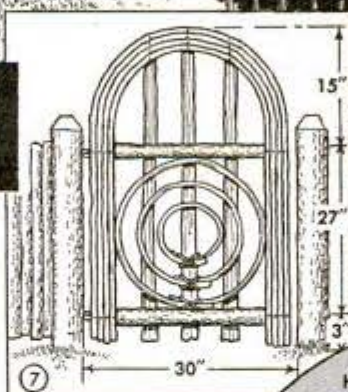
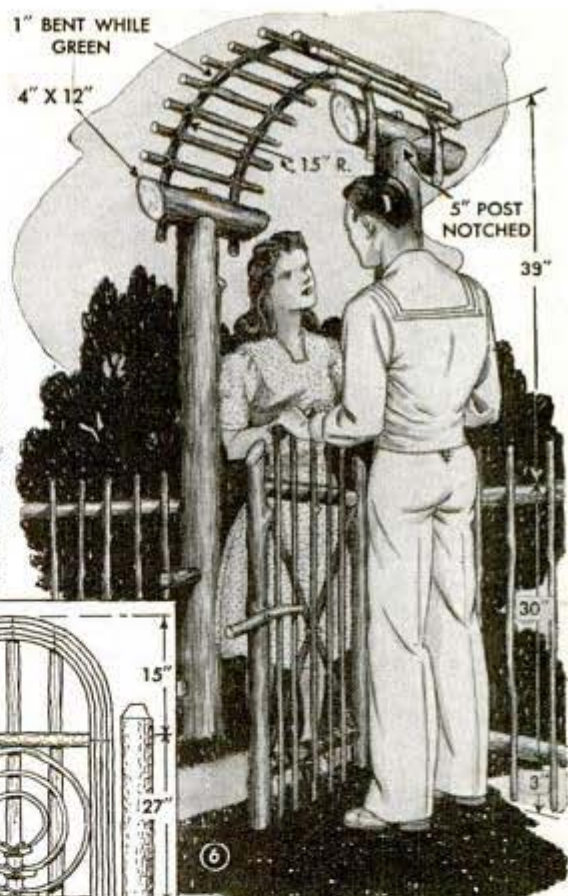
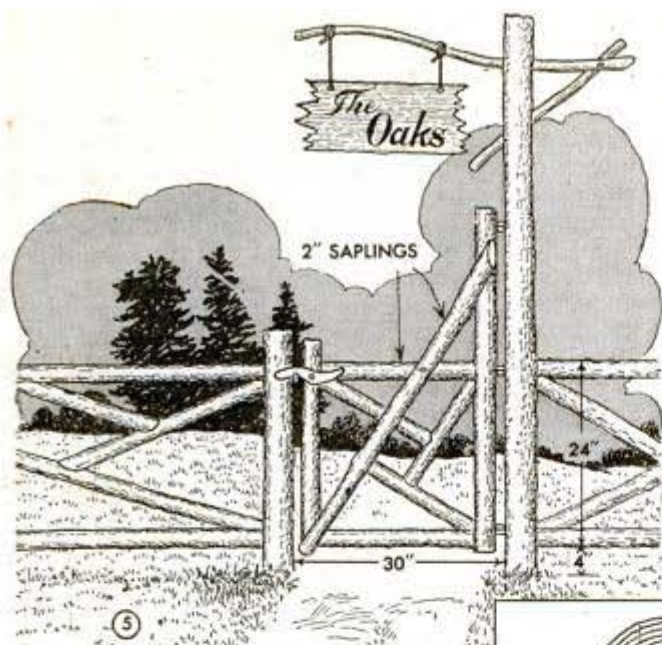

and RUSTIC

are 1-in. sticks nailed in place. If the wood tends to split, small pilot holes should be drilled. A notched peg and pivoted stick serve as a latch for the gate, which is detailed in Fig. 8. Hinges are heavy screw eyes with bolts through them.

An attractive gate suitable for a rail or slab fence is shown in Fig. 3. Rough-hewn slabs with artificial knotholes are nailed to a frame of split saplings and hung on strap hinges. A wooden latch locks in a slot in the gatepost. The herringbone gate in Fig. 2 is an easy project in localities where split stakes are available in quantity. The split members, when nailed with the flat sides against a board frame, form an attractive panel effect. Bolts through metal angle brackets serve as hinges. A commercial latch is used. The diamond-pattern fence adjoining the gate consists of sticks nailed

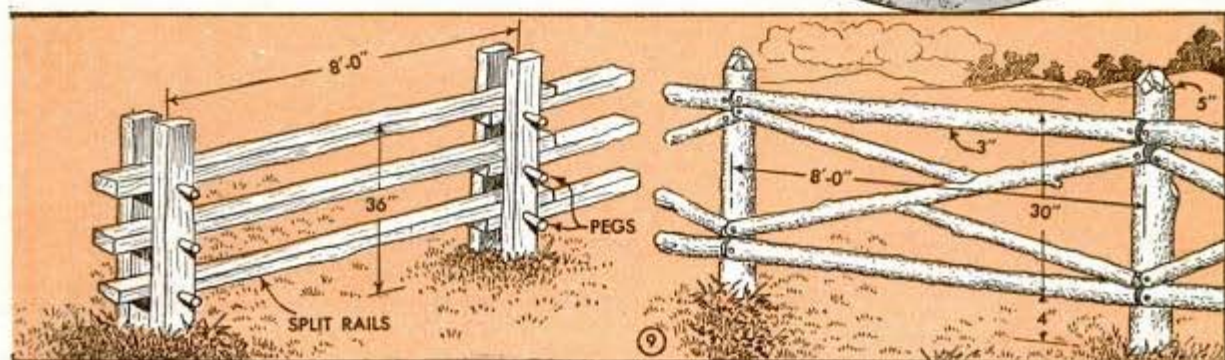

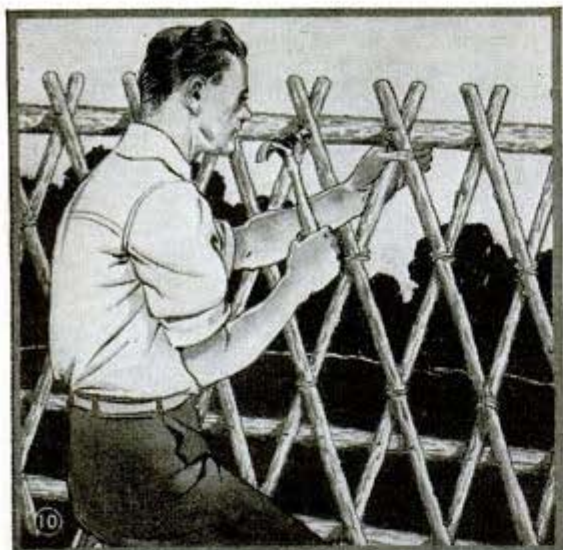

or bound to horizontal members as in Fig. 10. Other pleasing designs in gates are possible with green willow switches, the gate in Fig. 7 being a good example. The willow bends readily to a small radius and is secured to a rustic frame with brads and raffia. A more rugged type of gate, with name plate included, is presented in Fig. 5.

In sections where timber is plentiful the log fence in the right detail of Fig. 9 is a good type. Reminiscent of boyhood days on the farm, the rail or "snake fence" in the right detail of Fig. 4 is an adaptation of the original, but has no stakes at the joints. Instead, it is secured with spikes, which are driven as the rails are laid. The two top rails are held together with hardwood pegs, and each section rests on a flat rock.

A really informal fence is made of rough-split timbers, or slabs assembled as in the left detail of Fig. 4. Discarded telephone poles split to form three-cornered rails are excellent where a ranch or farm-type fence is desired. After the posts are set, you simply lay the rails in between them, one on top of the other, as in Fig. 1. The only white-washed fence in this group is illustrated in the left detail of Fig. 9. The rails are rectangular in section and are spaced a few inches above each other on hardwood pegs.

An unusual arbor for a garden walk is shown in Fig. 11. It is built on substantial corner posts and braced at each side with a diamond-pattern trellis of light sticks. Fig. 12 shows a design for a very unconventional arbor that can be made of odds and ends from a brush pile, once the sturdier posts, plates and rafters are obtained.

With a supply of seasoned and peeled saplings at hand any handyman can build an inexpensive summer house in rustic style like the one in Figs. 14 and 15. Green wood may be used if assembled with lag screws which can be drawn down as the wood shrinks. Smaller pieces are bound with raffia or grass rope, adding to the rustic effect. The sturdy corner posts and other

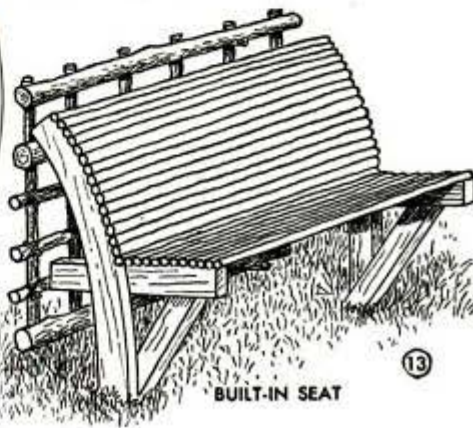
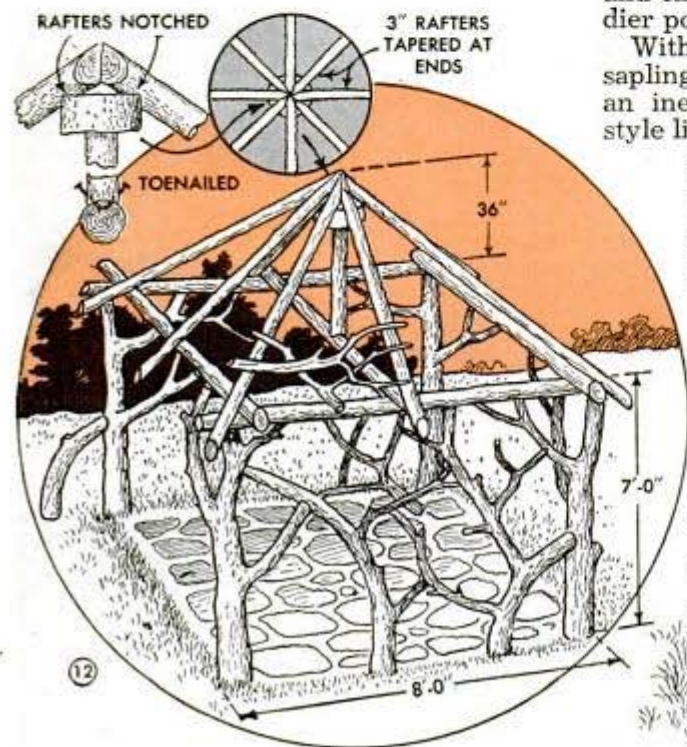
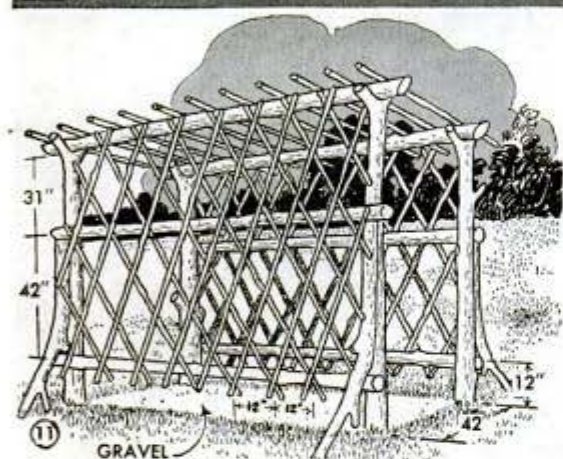

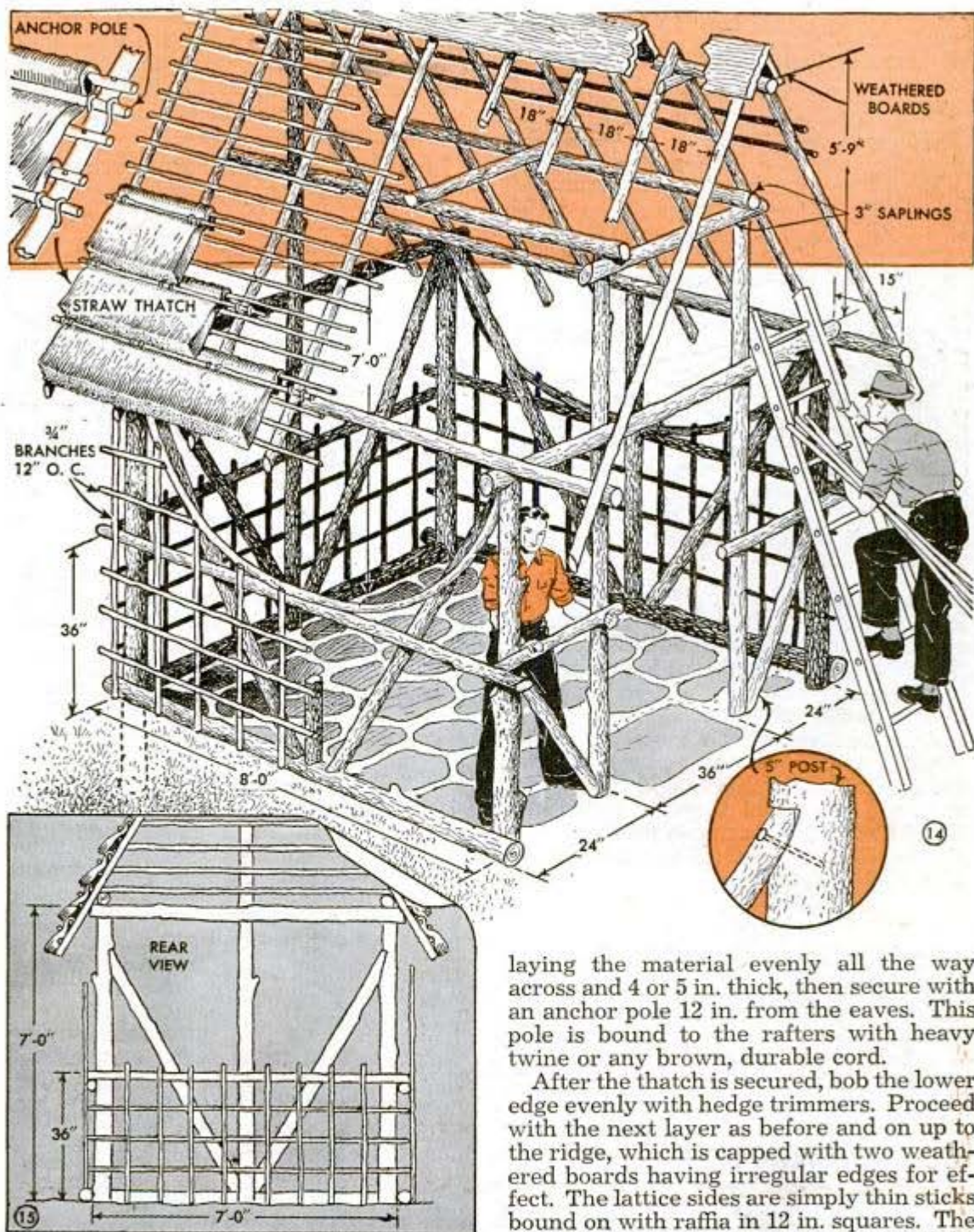

uprights are set 18 in. into the ground. Assemble the "plates" or horizontal members at the eaves and then the diagonal members or braces. The latter are important. After the horizontal beams about 3 ft. above the eaves have been installed, proceed with the rafters and ridge pole. Rafters are "sheathed" with long sticks which may be lapped here and there and on which the thatch is laid. The latter may be oat straw, marsh hay or even fairly straight twigs, such as willow. Start at the bottom,

laying the material evenly all the way across and 4 or 5 in. thick, then secure with an anchor pole 12 in. from the eaves. This pole is bound to the rafters with heavy twine or any brown, durable cord.

After the thatch is secured, bob the lower edge evenly with hedge trimmers. Proceed with the next layer as before and on up to the ridge, which is capped with two weathered boards having irregular edges for effect. The lattice sides are simply thin sticks bound on with raffia in 12 in. squares. The curved member on each side should be bent and bound into place while still green. Lay a flagstone floor, or old brick in basket weave or herringbone pattern and be sure that the surface is at least 2 in. above grade, and crowned, so that water will not accumulate. If permanent seats are preferred to movable furniture, they can be made as shown in Fig. 13, provided, of course, that they are installed before the flooring is laid, as the seat uprights are sunk into the ground.

(To be continued)

Old Vanity Dresser Is Converted To Provide Knee-hole Desk

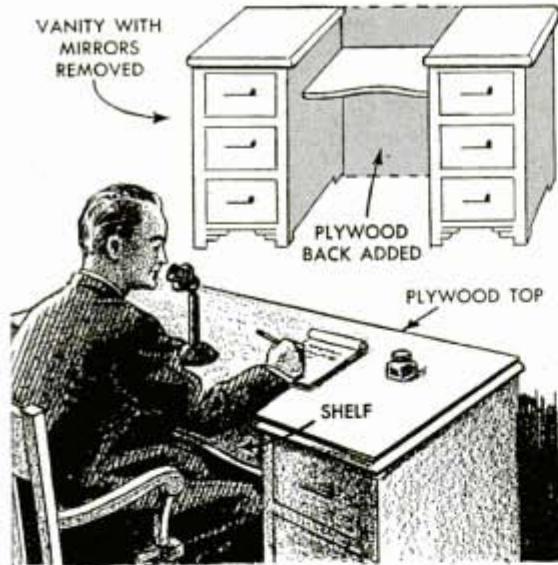

If you have a vanity dresser that is no longer suitable for its regular use, it can be converted into a knee-hole desk for your den or playroom. All that is necessary is to remove the mirrors and install a top. This can be of plywood, hard-pressed board or other suitable material. Attach the top with glue and screws, countersinking the screw heads and filling them with plastic so that they are not visible. Or, if desired, you can use finishing nails, sinking the heads and filling the holes with a suitable plastic.

F. G. Altrichter, Philadelphia, Pa.

Spring Stops Gearshift Flutter

If vacuum gearshifts on Chevrolets flutter or jump out of gear when driving, install a friction spring on the vacuum-cylinder valve rod. Its steadying effect will prevent oscillation and stop the flutter.

Hal Geihm, Aurora, Ill.

Covering Wire Binding on Book Prevents Marring Surfaces



When using a notebook with a spiral wire binding it's a good idea to put a strip of paper or cloth over the binding as indicated. This will shield it so that there is no possibility of scratching the surface of a desk or table. The cloth

can be attached with glue or household cement. If paper is used, it should be of the heavy manila type so that the wires will not wear through it quickly.

Thomas Trail, Baltimore, Md.

Handy Container for Fishlines

An empty adhesive tape container makes an ideal case in which to carry fishlines and hooks. All that is necessary is to punch 2 or 3 small holes in the spindle to receive the hooks, the lines being wrapped around the spindle. If desired, a cork float can be inserted into the end of the case. In this way, lines and hooks can be carried safely in the pocket where they are protected against moisture and also prevented from becoming entangled.—B. W. Savage, Lake, Miss.

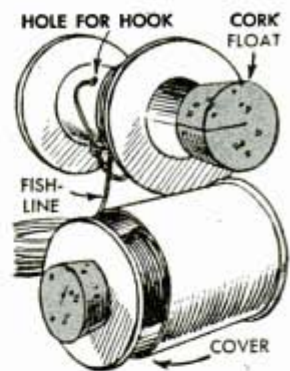

Checkers Stored in Playing Board



One of the most convenient methods of storing checkers is to put them inside the board. As shown in the drawing, the latter consists of two thin pieces separated by square strips on three sides. The board is pivoted

with two screws inside a narrow wood frame, with a friction catch at one end. Pressing one side of the board upward disengages the catch so that the checker compartment is exposed.

Old Compact Holds Fly Leaders

By removing the powder compartment of a lady's compact it can be used as a case for gut fly leaders. If a small powder puff is kept in the compact and moistened occasionally it will keep the leaders pliable and ready for use when wanted.

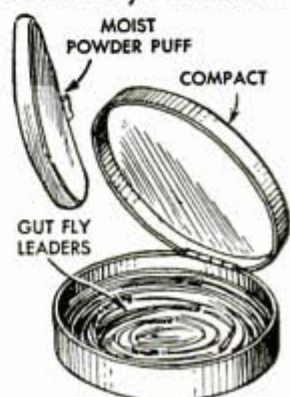



MOLDED BIRDS *for the Lawn*

POSED pertly on their long wire legs, these molded birds add a realistic touch to any lawn or garden. They are cast in cement and are colored with ordinary oil paint. First shape them in wax or modeling clay to provide patterns from which the molds are made. A funnel-shaped piece of clay is added to the underside of the pattern to provide an opening in the mold for pouring and for insertion of the legs. The mold is cast in a box that can be taken apart easily. The box is filled halfway with plaster of paris, after which the pattern is coated with heavy oil, such as motor oil, and is pressed halfway into the plaster, where it remains until the plaster has set. When the pattern is removed, the mold is given two coats of shellac. After the shellac has dried, oil is applied to both pattern and mold, in which the pattern is replaced. Then more plaster is poured to fill the box. When dry, remove the box, separate the mold and then apply shellac to the upper half. Be sure that both halves of the mold are oiled thoroughly before pouring each casting.

Now, mix together portland cement, 3 parts, plaster of paris, 2 parts, and fine sand, 1 part, adding just enough water to form a mixture that can be poured. When pouring the cement, rock the mold gently

to remove air bubbles. Finally, insert two lengths of wire for legs and let the mixture set for 15 min., or until hard. Then remove the casting and submerge it in water for 24 hrs. After a thorough drying, the casting is painted and later coated with spar varnish for luster. The three models shown in the cross-hatched pattern will enable you to make many different species simply by changing the markings and coloring.—Dick Hutchinson, Ithaca, N. Y.

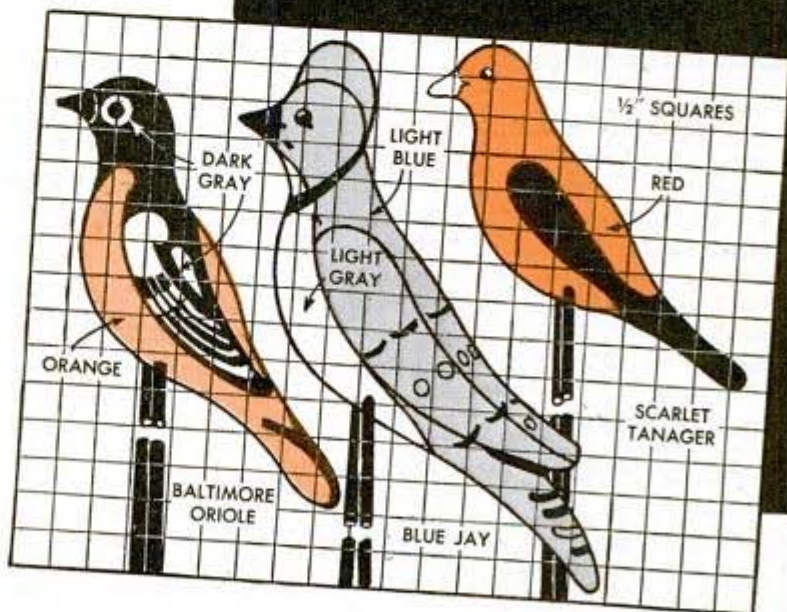

Attachment on Hacksaw Frame To Use Broken Blades

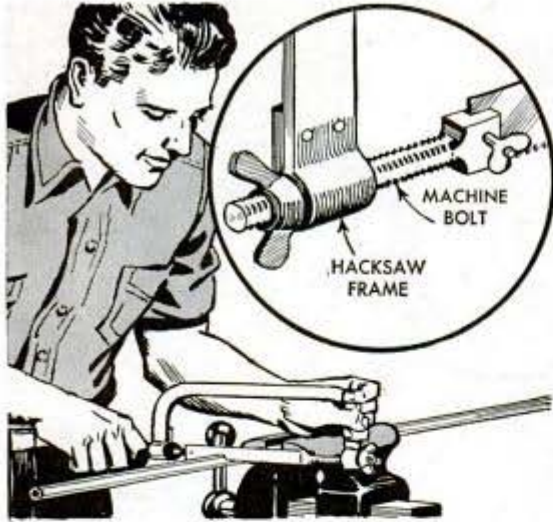

Hacksaw blades that have broken off a few inches from one end can be used if you have a clamp, like the one shown, to hold them in the frame. The clamp is made from a machine bolt by grinding down the head to the shape shown and then slotting it to receive the blade. A thumb screw clamps the blade in the slot. The threaded end of the bolt is squared or otherwise shaped to fit the end of the saw frame and fitted with a wingnut.

Preserving Leaf Collections

One simple method for preserving four-leaf clovers and other leaves is to dry them in a pad or book for about a week, then brush a little clear nail polish over the spot where the leaf is to be mounted. After the leaf has been put in place and the polish dried, another coating of polish should be applied.—V. Beedney, Sioux Falls, S. D.

Cracked Heating Stove Repaired By Using Sheet-Metal Band

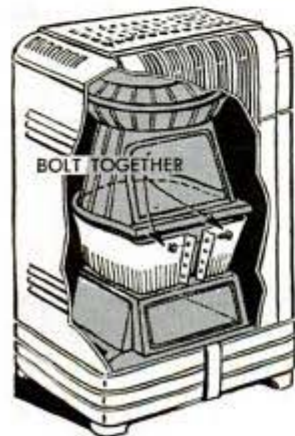

Being unable to replace the cracked firepot on our heating stove, I repaired it by tightly clamping a sheet-metal band around the pot so that cement put in the crack would not fall out. The band was cut to cover the entire outside surface, the ends being bent outward and

drilled for bolts with which the band was drawn tightly around the firepot.

Sadie M. Lasky, Queen City, Mo.

Edge of Foot Scraper Shielded With a Piece of Hose

To avoid any possibility of his children's falling on the sharp edge of a foot scraper, one farmer shielded it with a piece of garden hose as shown. The slight inconvenience of removing and replacing the shield to use the scraper is small cost to pay for safety of the children.

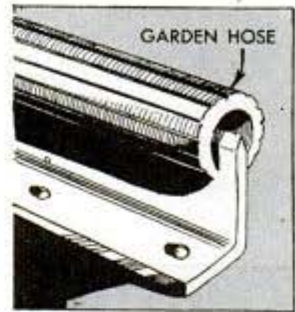

Candle Stove Keeps Glue Warm

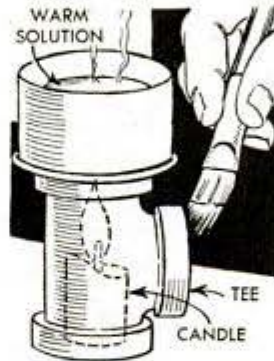

When working in a cool basement or other place where it is necessary to keep glue warm, a simple stove for this purpose can be improvised from a large pipe tee which is set over a short piece of candle as indicated. Used in this way,

the side opening of the tee serves as a flue for the escape of combustion gases from the burning candle.

Ronald Eyrich, Milwaukee, Wis.

Stenciling Your Name on Pencils

It is a simple matter to stencil your name neatly and permanently on pencils. With a typewriter cut a small piece of mimeograph stencil with the desired name and lay it over each pencil in the manner indicated, grasping the edges of the stencil to hold it in good contact. Then, gently dab a cloth pad moistened with ink onto the stencil. Printers' ink thinned down to the consistency of corn syrup is the best. After the pencils have been imprinted, bake them in front of a reflecting or bowl-type electric heater until the ink is dry and hard.

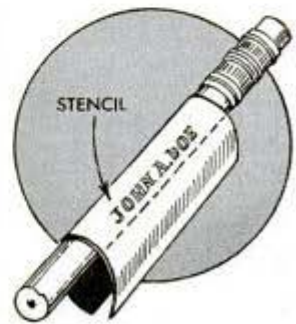

Woven Effects Produced With Molding Slices



Slices of molding can be used to decorate book ends, panels of small screens, desk accessories and shelves, or to cover the sides of window boxes and other articles not usually made of grained or finished wood. Ornate effects can be had by using various kinds of shaped molding, or by staining or painting alternate pieces to give a checkerboard or figured pattern. To begin, cut the molding into slices of a thickness to suit the job. If you use a circular saw, clamp a piece of thin plywood to the table, making a slot in it just wide enough to clear the saw and prevent the slices from falling through. If the molding is sliced with a handsaw, jigs to make straight and miter cuts like those shown in the lower right-hand detail will enable you to do the job accurately. Apply thick glue to the base or surface to be decorated. Then press in the first row of pieces and apply glue to their undersides so that

they will be attached not only to the base but to each other as well. Although it is unnecessary to use pressure if the glue is thick enough, you can clamp the pieces while drying, using a piece of scrap wood and a clamp as shown in the circular detail. By clamping in this way, you can glue the other side of the work while the clamped part is drying. Without this precaution the pieces already applied may be dislodged. If you intend to finish the work in one color only, this may be applied after the pieces have been glued, but in using two or more colors it is better to paint the pieces before gluing them in place to keep the colors from running together.—Charles and Bertram Brownold, Woodmere, N. Y.

Pull-String Top Is Easy to Turn In Your Wood Lathe

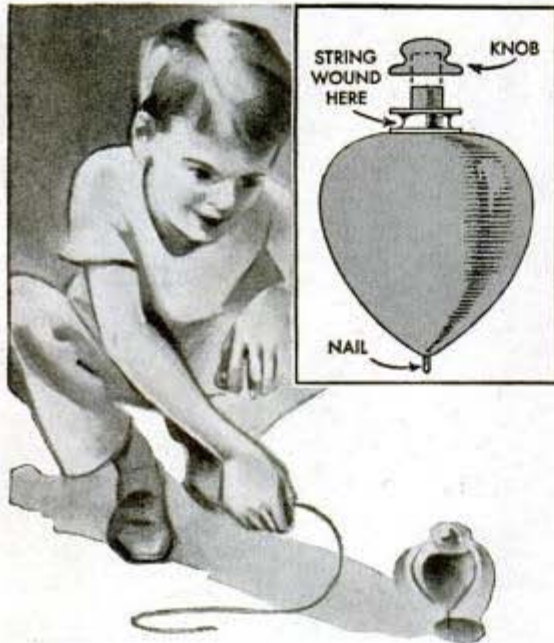

When made correctly this top will spin from 1 to 2 min. It can be turned out in quantities in a lathe. Hardwood is the best wood from which to make the top, but other wood may be used. It can be any diameter desired, but the reel or spool around which the string is wound should be small enough to give the top a good speed. To spin, first wind the string on the reel. Then, holding the top on the floor by the knob, give the string a quick pull and lift off the knob.

A. C. Simonsen, Portland, Oregon.

How to Remove Decalcomania

To remove decalcomania before repainting walls or cabinets, apply a coating of acetone with a cloth, allow this to penetrate for a minute, then rub lightly with fine steel wool. This method avoids scratching the background surface with scraper or sandpaper.—Mildred Anderson, Chicago.

Belt Speed Reducer Made Easily By Using Old Car Water Pump



A speed reducer or countershaft for belt-driven machines is made easily by using a cone pulley and an old water pump from a 1936 model V-8 Ford. Remove the impeller from the pump and then slip the pump over

a short 2-in. pipe nipple screwed into a floor flange. It may be necessary to file one side of the nipple so that the pump can be tilted correctly to line up the shaft. Bolt or weld the pump to the nipple. You can use the regular pump pulley on one end of the shaft and the cone pulley on the other end.—F. W. Becker, Gloversville, N. Y.

Ash Trays on Card-Table Legs Are Always Out of the Way

These handy little ash trays are fastened to the legs of a card table where they are out of the way, yet are within easy reach of the players. Made from 3½-in. lengths of 2-in. metal tubing, which have disks soldered to one end to form the



bottoms, the trays have keyhole slots in the sides near the tops to slip over the heads of screws driven into the table legs. The trays are easy to remove for cleaning, and can be painted or otherwise finished.

Herman R. Wallin, Washington, D. C.

Making Paper Transparent For Tracing Work



For quickly sketching in traced lines in some types of work, one artist makes use of a spot-remover bottle, which has a plush moistening top and is filled with dry cleaner. The plush top is passed over the drawing paper, causing it immediately to become transparent. The tracing is made

before the paper dries, or several applications of the cleaner can be used. After the cleaner evaporates, the paper returns to its normal opaque condition.

Ken Murray, Baltimore, Md.

☞ To make sure that poison medicines are never administered by mistake, fasten the corks or screw caps in place with pieces of adhesive tape, which can be removed easily, yet help to avoid accidental poisoning.

Sink Hookup to Conserve Water From Cistern

In our home the hot-water supply tank is located quite a distance from the sink with the result that considerable water was wasted in draining the pipe line from the tank to the sink each time hot water was wanted at the sink faucet. To save this waste water, which came from a cistern and had to be conserved, especially during dry seasons, a hookup was installed as indicated to return the water to the cistern. A tee and valve in the supply pipe near the sink, as shown, connected to a line leading to a downspout. The pipe could run directly to the cistern if more convenient. In use, the valve is kept open until the cold water runs from the supply pipe, then the valve is closed and the sink faucet opened. — John W. Belsley, Morton, Ill.



Snap-On Door Keeps Small Child Out of Open Bookcase

In order to keep our baby from getting into an open bookcase, I fitted it with a snap-on door that could be put on or taken off easily. The door was a piece of hard-pressed board cut to fit nicely over the

front of the bookcase. You will find that the color of some of this material will harmonize well with the finish on most furniture. The door can be held in place with friction catches at the top and bottom. Screw half of each catch to the door and the other half to the underside of a couple of the shelves where they will be inconspicuous when the door is removed. A decorative knob at the top of the door will aid in handling it.—M. A. Jacobson, Chicago.



Drawings Traced From Book Without Marring Pages

The next time you want to trace a drawing or diagram from a book you can do it without marring the page in any way if you use a piece of clear celluloid. Place this over the drawing and place your tracing paper on top. You can see the drawing through the paper and celluloid and the latter will provide a writing surface to prevent the pencil from creasing the book page. You will find this idea especially handy when you want to copy material from textbooks and magazines or from books in a public library.

House pics from
Rhode Island 87

Dwain Nelson
2320 Coleridge
Utt.

HOME LANDSCAPING

Mr. Peters



Generally, the pyramidal type is used against narrow columns of wall space and beside entrances, while the semi-erect and the lower-growing prostrate forms are best under windows. Broad pyramidal forms are out of place along short foundations. Choose narrow columnars for narrow spaces, and under windows use varieties that will grow no higher than the sills. These should be shearable; therefore avoid using tall spruces and firs. The junipers, arborvitae and dwarf mugo pines (all shearables) supply an abundance of form and color.

What to select: Vigorous conifers cannot be produced cheaply. Propagation is by seeds, cuttings and grafts. Young plants are set in rows close together, and so cultivated. Before crowding begins, they are lifted, the roots are pruned back, and then the trees are transplanted farther apart. This process

By Robert Stahler

IN FORM and color, evergreens are so varied that, if judiciously placed as shown in Figs. 1, 2, 4 and 5, they will beautify almost any landscape without the addition of other kinds of plants. For proper effect, the shape and size of the evergreen should conform generally to the architectural pattern against which it is to be placed. The various shapes are shown in Fig. 9. These are: A, creeping or prostrate; B, globular; C, semi-erect; D, narrow columnar; E, broad columnar; F, narrow pyramidal; G, medium pyramidal; H, broad pyramidal. The pyramidal forms may be bought in tall, medium and low-growing varieties, and are suitable either for group planting as windbreaks and screens, or as single specimens.



with EVERGREENS...

may be repeated four or five times. In catalogs, the symbol X means that the tree has been pruned and transplanted. Thus, the description "XXXX" means that the roots have been pruned four times and the tree transplanted each time. Such a tree will have a compact root system and top growth; it will be thrifty, in contrast to the cheaper tall, sparse specimens that were left to grow at random from their seedling stage. If price is a consideration, buy the small X'd varieties rather than the inferior taller ones. You should specify, too, B&B trees—those having balled and burlapped roots, as shown in Figs. 7 and 11.

A partial list of evergreens includes the following: Arborvitae—perhaps the most adaptable of all. The American varieties do well on ordinary soils that are not too heavy, and are quite hardy. The Chinese varieties are beautiful, but are a risk north

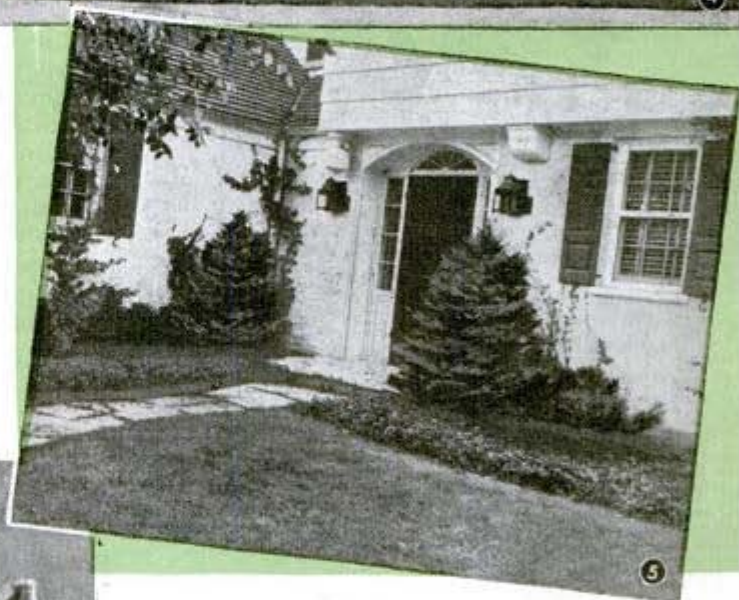

of Pennsylvania. More than fifty forms are under cultivation. Although they grow best in full sun, they will tolerate some shade. Cedars, as a class, are ornamental, but their large size limits their use. The Blue, the Deodar and the Lebanon are the best known. Firs, for the most part, do not thrive in the dust and smoke of cities. The Concolor is the best known of this group. Junipers are a decorative form. They are the least likely to be attacked by insects. Extremely tolerant of shearing, they can be kept within bounds, which is one of the many reasons for their choice in home planting. Generally they are hardy, only a few being somewhat tender. Both the Irish and Swedish junipers are in this class and may show winter damage, the Swedish to a lesser degree. Spruces are mostly tall-growing, and are better fitted for specimen planting and for wind-



CHARACTERISTICS OF CONIFERS				
Group	Type	Average Height (1) (in ft.)	Color	Form (2)
Juniper	Meyer	3	Blue-green	C
	Globe	3½	Lt. green	B
	Savin	—	Dk. green	A
	Pfizer's	3½	Green-grey	C
	Goldenrod	3½	Golden-yellow	C
	Koster's	3	Blue-green	C
	Japanese	—	Blue-green	A
	Andara	—	Silver-green	A
	Spiny Greek	6	Blue	E
	Blue	18	Blue	H
	Chinese columnar	17	Blue-grey	D
	Pyramid	17	Grey-green	F
	Irish	15	Blue-green	D
Swedish	20	Blue-green	D	
Tamarix	—	Bright green	A	
Pine	Dwarf mugo (3)	4	Dark green	B
Cedar (4)	Silver	15	Silver-blue	F
	Concolor red	17	Green	F
	Red	23	Silver-green	F
Arborvitae	American	40	Green	G
	Pyramidal	15	Green	D
	Globe	3	Green	B
	Golden	40	Golden-yellow	D
Spruce	Koster's Blue	40	Blue	H
	Colorado Blue	60	Silver-blue	H
	Shiner (5)	—	—	—
	Black Hills	40	Green	H
	White	70	Green	H
	Norway	100	Green	H
Fir	Concolor	80	Green	H

- (1) In cultivation; wild species may grow taller
 (2) See Fig. 9
 (3) These may be cut back
 (4) Not true cedars
 (5) A species of Colorado Blue. Always buy these balled and burlapped



breaks. The blue color of the Colorado and Koster's (a grafted form of the Colorado) is too intense and striking for combining with other varieties in foundation or group plantings. Hemlocks are graceful trees that often attain great size, and are used mostly for this purpose. Yews are superb for low hedges. The bushy Japanese form is quite hardy, and perhaps is the best of this kind. Fig. 12 shows the characteristic appearance of several of these species.

Where to plant: Before planting, set stakes of the estimated height of the trees you will use, and allow between them the spread you will permit the trees to attain. Set the trees as in Fig. 11, tying the stakes as indicated in the circular detail. After staking, it is a good idea to provide a burlap shield around the newly planted tree, as in Fig. 6, to protect it from being uprooted by the wind. Don't plant too close to the wall of the house; reflected heat burns the foliage, causing it to drop off, Fig. 8, and the light is restricted, resulting in sparse foliage on the rear, or shaded side. Fortunately, most conifers are adaptable to various soil conditions. The common American arborvitae is sometimes found in a swampy environment, yet does well on comparatively dry garden soils. But because conifers are adaptable, they are too often placed on soils wholly unsuitable. In their native habitat, they are mostly residents of slopes, where nature is in the process of soil making. The soil is gritty; mixed into it is the decaying debris of leaves, needles and twigs, called humus. Often the roots are under great rocks, which are prime conservers of moisture. The slopes furnish perfect drainage. Here the trees grow to heights never reached in cultivation.

Preparing the soil: To plant the trees, strip the sod and work the soil deep and fine, Fig. 7. Mix humus and plant foods thoroughly into the soil down to a depth of about 12 in. Damp peat, not soaked, mixes better with the soil than when dry. B&B trees can be set in early winter in many parts of the country, even well into the North, if given the proper depth of mulch, Fig. 3. Spring is the best time to plant, but

mid-summer planting is not recommended.

It is a waste of money to apply nitrogen at planting time. Phosphorus and potash in bone-meal will combine with the soil with little loss by leaching, but nitrogen escapes. Moreover, the shortened root systems are inadequate to supply the moisture needs of the new growth that nitrogen forces. Four to six months can elapse before using nitrogen; if you have used leaf mold for humus, a year may well go by. Peat has almost no food value. If it is the source of humus, apply twelve pounds of dry sheep manure per 100 sq. ft. and work it in, four to six months after planting. Other forms of vegetable or animal nitrogen may be used, but avoid chemicals. To keep the food supply constant, each year apply 15 lbs. of bone meal, 2 lbs. of potash, and 12 to 15 lbs. of sheep manure. Use half of

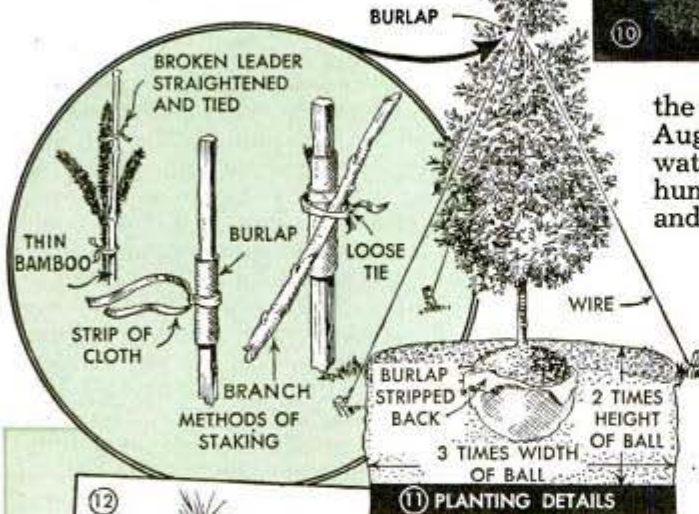
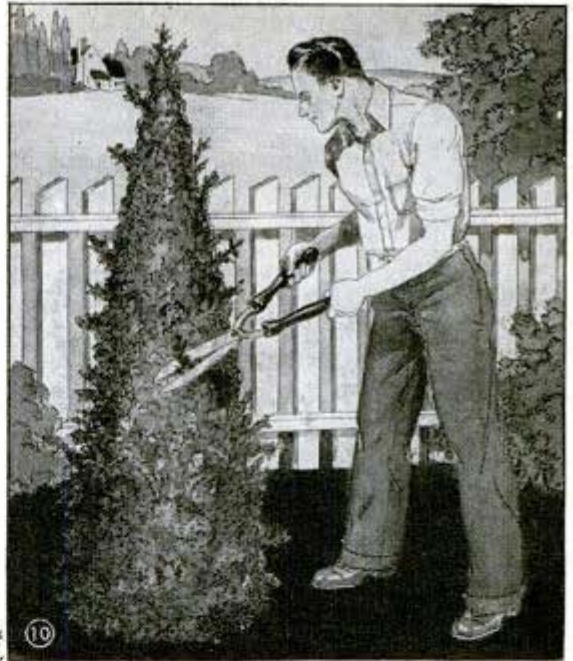

the latter in early spring; half in early August. Work in these materials and water thoroughly. Using plenty of humus not only keeps the soil open and light, but also enables it to retain large quantities of moisture, which is essential for dense foliage, health and vigor.

Fall and spring care: Don't let conifers begin the winter in dry soil. Soak the ground thoroughly to root depth at least. After the first freeze, apply the winter mulch. Remember that evergreens are more or less active at all times, even in winter. If the ground freezes to an appreciable depth, the trees suffer for want of moisture exactly as they would during a summer drouth. Partial damage or complete destruction of the trees results.

In early spring, remove all but an inch of the mulch; then when the ground dries to a workable condition, apply plant foods and work them and the inch of mulch into the soil, the latter to keep the humus supply constant. Cultivate at 10-day intervals, until hot weather begins. Meantime, don't neglect the moisture supply, but, of course, do not flood the soil. Doing so will result in a soured soil. The ideal soil is evenly moist from near the top down to a considerable depth, but not soaking wet. A thorough drenching at 10 to 14-day intervals will, under normal conditions, suffice.

When hot weather sets in, apply the summer mulch, and apply nitrogenous fertilizer in early August.

Pruning: Pruning of conifers consists mostly of shearing to control height and

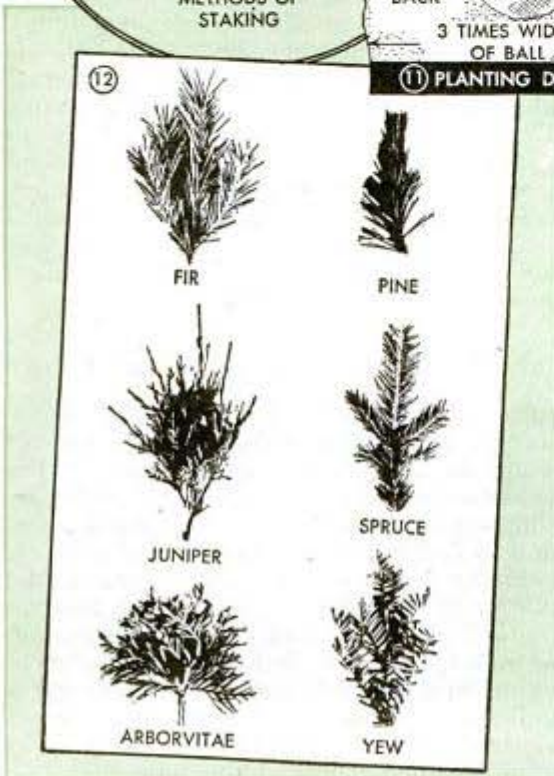



spread. Such work is easily done on dwarf mugo pine, arborvitae, juniper, yew and cypress in spring and early fall. Young specimens of fir and spruce are sometimes pruned by pinching back side branches slightly, Fig. 10. However, it is best to let someone familiar with evergreens do this work for you. Remember that you cannot control height and spread of fir and spruce as you can with ordinary shrubs. Fir and spruce will show a stubby effect if pruned, and their recovery is slow. If the leader is cut in an effort to limit height, the growth is thrown to the sides; if the sides are clipped, the strength goes to the top. A correct balance, which makes for a beautiful pyramid shape, cannot be achieved by using the knife. While any top growth can be cut back, the root system remains intact and constantly extends itself. And as it extends, it throws more strength to the top. It is advisable, therefore, to plant spruce

and fir only where they will have plenty of room to develop. Never prune the low branches of conifers, unless these are dead; they should spread from the ground up.

Insects and disease: Though conifers are a healthy group and are more or less immune to serious insect and disease attack, you should nevertheless be on the alert. In fall look for bagworm nests, which are pendant bags made of bits of leaves bound with silk and suspended by the same material. Remove and burn them. The spruce budworm cuts off the needle-like foliage and weaves it into a web shelter. The larvae of these two insects, also those of the gypsy moth, emerge in spring and attack the foliage. Control is by spraying, Fig. 13. Use a lead arsenate spray applied when the weather warms in early spring; repeat in 10 days.

Aphids or plant lice are of a different type from those found on flowering plants. Many form galls. Spray with a miscible oil in early spring before new growth begins, and only on a sunny day, temperature at 50 degrees or more, with no chance of it dropping within six hours. The oil must dry quickly, else damage will result. Oil sprays are injurious to some junipers whose needles form cup-like depressions.

In hot weather, red spider is most likely to attack. Only about $\frac{1}{10}$ in. long, they are most difficult to see, as are the webs they weave. Treat them with dusting sulphur. Use it weekly, but never within a month after using oil. Borers and beetles have little chance of affecting a healthy evergreen, but may attack a weak one.

Only a few conifers are subject to serious diseases. The white pine is seldom planted, because of white-pine blister rust. Wood rots are more often encountered in forest and other dense growth. If dead wood develops, prune it out with a sharp tool. "Cedar apples," caused by a fungus that produces soft spongy masses of yellow-orange color, may attack junipers and should be carefully cut out.

Preignition Caused by Hot Spot in Combustion Chamber

If your car will not run at high speeds without spitting through the carburetor, likely the trouble is caused by preignition—some part of the combustion chamber becomes sufficiently hot to ignite the fuel charge before the spark occurs at the plug. The trouble probably can be traced to carbon, a valve that does not close tightly, or a plug that operates too hot. First, be sure that the correct type of spark plug is being used. Then, before removing the cylinder head to check for a hot spot, look over the following adjustments which might cause trouble: A too-lean fuel mix-

ture or a clogged fuel line at the carburetor screen. Insufficient cooling due to lack of water in the radiator. A stoppage in the water system, such as a defective pump, or slipping fan belt. Overheated spark plugs due to leakage where they screw into the cylinder head, or a weak or worn fuel pump. If all of these are in order, remove the cylinder head and check for a carbon or metal projection that might be heated to white heat at high speed. Or look for a valve that is burning because it does not close tightly. Likely it is warped or is adjusted incorrectly at the tappet.

EVERLASTING TREE STUMP

"Blooms" in the Rock Garden

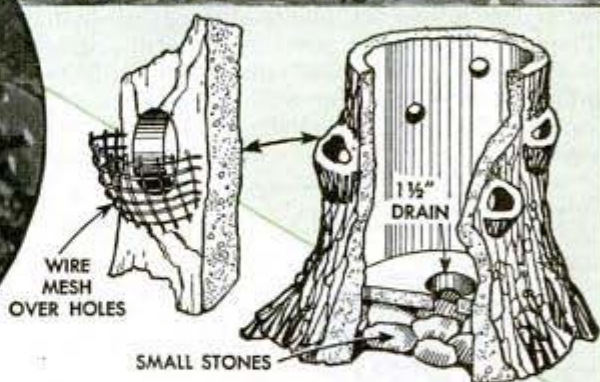
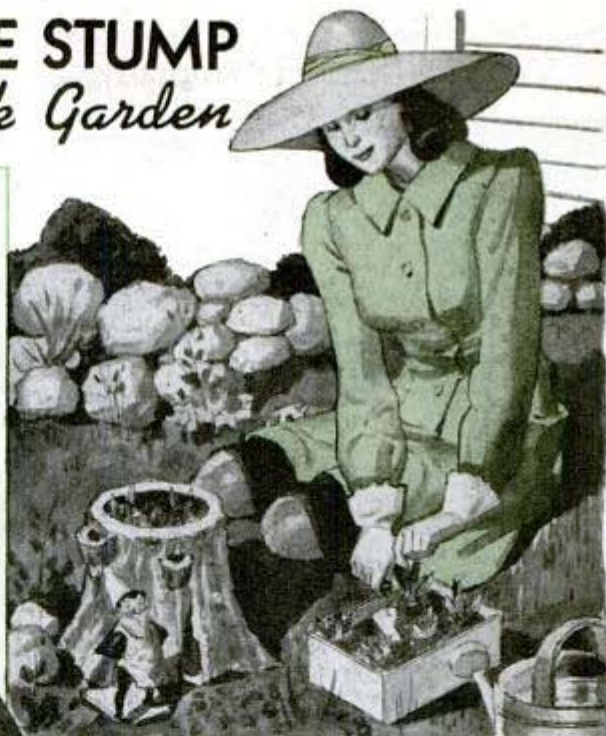
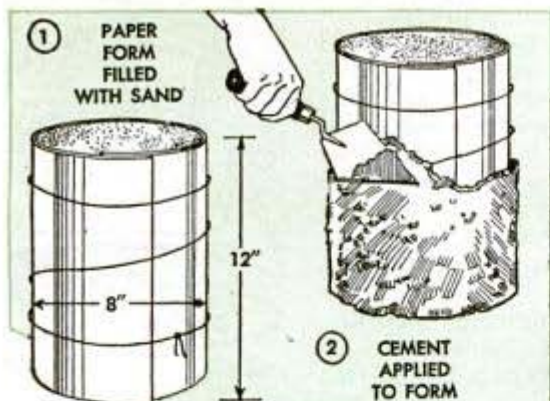

LIKE a real tree stump, this long-lasting one of cement can be "planted" in the rock garden and filled with soil for growing plants and flowers. It is formed by laying cement over a rolled-paper form and adding knot holes as a realistic touch. If you intend to make several stumps, the diameter of the paper forms can be varied. Heavy wrapping or roofing paper is best. The form is tied with twine and then filled with sand, Fig. 1, to support and keep it shaped. A disk of the same paper, cut to fit the top, is laid over the sand, and a 1½-in. layer of cement is troweled over the entire form, including the top, as in Fig. 2. The cement mixture is made of fine, sharp sand, 2 parts, portland cement, 1 part, and water to make a thick paste. After this has set a while, but before it is dry, several openings about 2½ in. in diameter are scooped out at random for knot holes, and in the top, which will be the bottom of the stump, another hole, somewhat smaller, is

made for a drain, as shown in Fig. 3. When the form has set hard enough to handle, it can be turned over and wire mesh pressed into the cement around the knot holes, after which cement is troweled on to form the knots. Bark is simulated by laying on cement in small dabs and troweling them down. It is best to copy these details from a real tree. The stump now can be set out in the garden over a small mound of stones to provide good drainage, and cement applied to represent large roots. As a finish, a thin coat of cream-colored oil paint is applied to the top rim to represent wood, and the trunk is painted as natural as possible in browns and grays. The stump is filled with soil, and small plants and flowers are set out to grow. As the knot holes open into the stump, plants set in them will grow there as well as in the main trunk. If desired, a gnome or other similar garden ornament can be placed near the stump as added attraction.

Special Slide Lines Up Projector Vertically and Horizontally

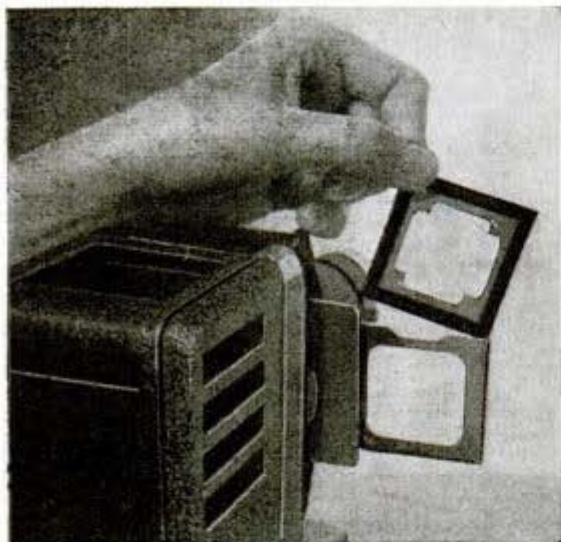

Lining up miniature projectors for both vertical and horizontal slides is simplified by using a special blank slide as shown. There is no need to use two separate ones to determine their positions when projected on the screen. The slide has a mask cut so that the outlines of the horizontal and vertical pictures are shown on the screen.

Flood Reflector Doubles as Spot

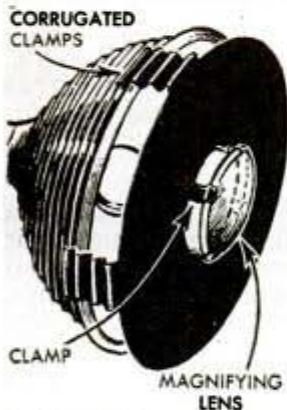

Photoflood lamps can be used as spotlights by attaching a metal shield fitted with an ordinary magnifying lens. The shield, of scrap sheet metal such as an empty oil container, is cut large enough to cover the reflector entirely, leaving four tabs about 2

in. by 4 in. which are bent as shown to clamp over the reflector rim, and are corrugated so as to be adjustable at various distances from the lamp. Four small tabs are left when cutting the opening in the center, and are bent to form clamps to hold the lens in place.—R. Scott, Saltsburg, Pa.

Photos Washed in Kitchen Sink Stopped With Force Cup

The kitchen sink can be used for washing photoprints by attaching a force cup over the drain to keep the running water at constant level. Drill through the handle

socket of the cup so that when water reaches the top of the plunger it will overflow, and then insert a 2-in. wood screw on each side through the plunger bowl at an angle, as shown. Slight pressure on each side will force the screws outward to engage holes in the drain plate, and when the pressure is released, they will return to their original position to clamp the plunger securely. To have a greater depth of water, place a short pipe nipple in the handle socket, being sure that it does not extend as high as the sink edge or the water will overflow onto the floor.



John H. Dunnemin, Grand Rapids, Mich.

Roomy Wooden Darkroom Sink Drains Into Lavatory

For washing prints and films, a roomy, lightweight, portable sink made of common lumber will serve the needs of photography hobbyists who do not have access to fully-equipped darkrooms. Since the sink is lined with rubber matting, there is no danger of leakage, and no plumbing is required because water can be drained from a single vent into a lavatory bowl or laundry tub. Size is optional, though for comfort it should be high enough to permit working without stooping. The one pictured here measures 22 in. wide, 8 in. deep and 5 ft. long, and was made of 3/4-in. stock, with 1 in. by 4 in. legs. For a sink of this width, 36-in. rubber matting should be used, with the surplus laid high on the sides and the corner folds tucked under and tacked to the frame on top to prevent leakage. A drain hole cut through the tank and rubber lining is fitted with a metal drain collar which has a locking nut screwed up from beneath to pull the matting tightly against the frame.

H. M. Tenny, Denver, Colo.



SHOP NOTES

Power CORDWOOD SAWS you can build

By W. C. Lammey

THESE simplified cordwood-saw frames are built principally of hardwood, very little metal being required. The first type, shown in Fig. 1, is intended for very light work such as sawing up tree trimmings, short split lengths of cordwood, etc. Driven by an electric motor of 1/2 hp. or more, or a small gasoline engine, it makes a fast, efficient outfit for this kind of work. In use, you simply support the carriage end of the frame on a sawhorse at a convenient height. Be sure the saw blade runs true and that the teeth are sharp and have a wide set. This latter precaution is very important on any

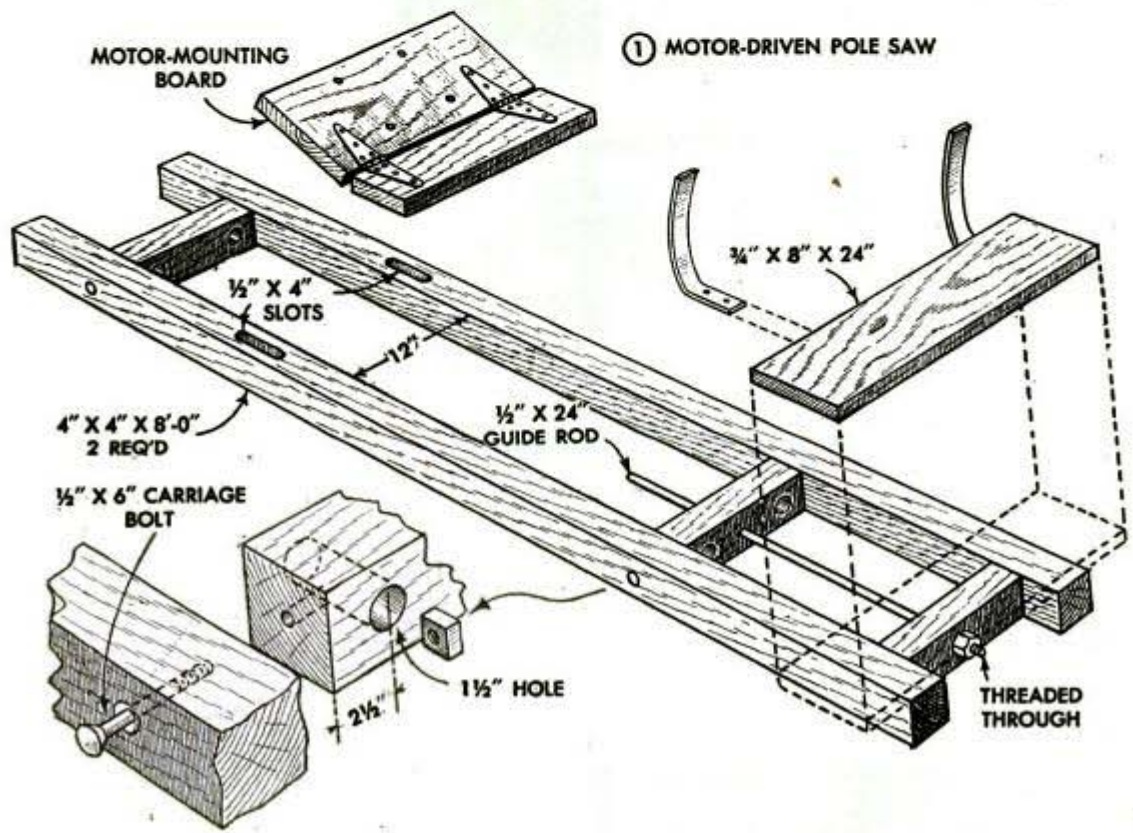
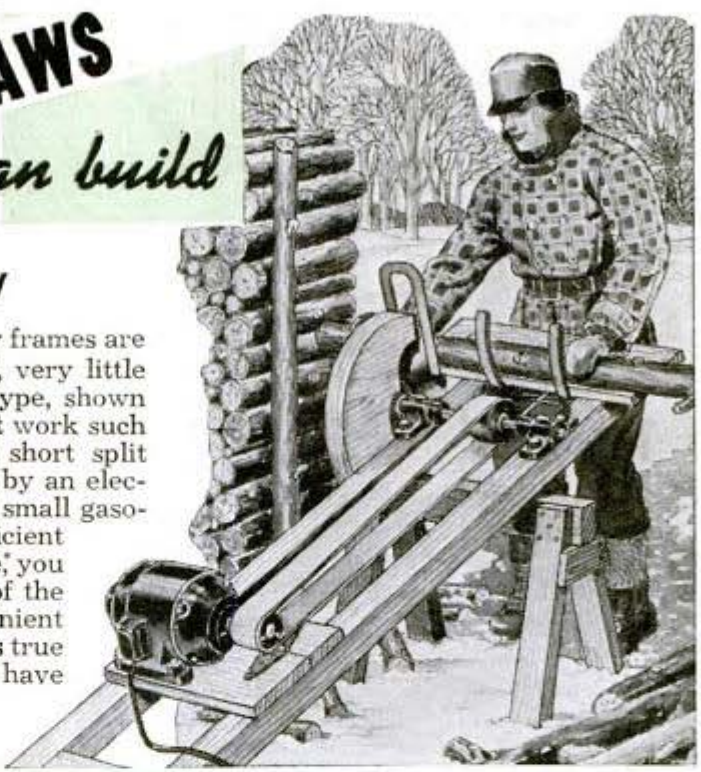

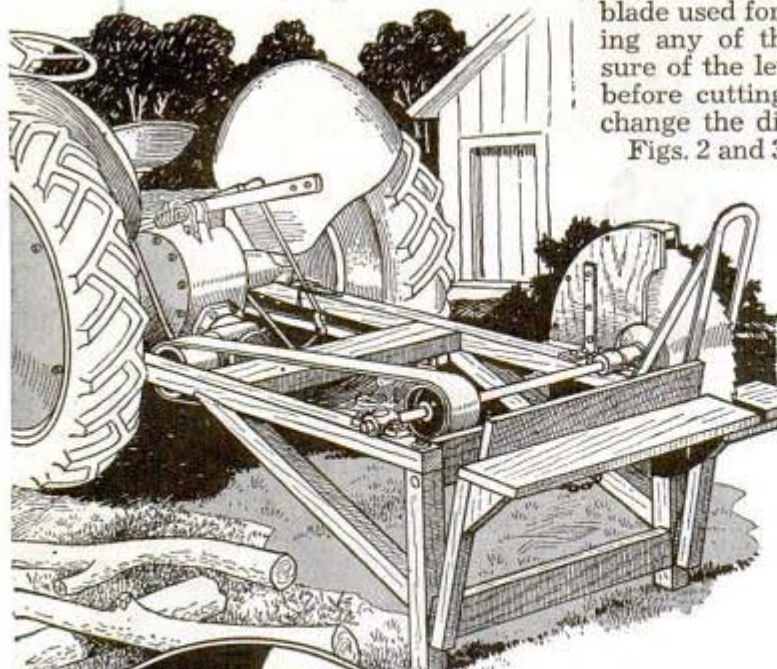

blade used for cutting cordwood. In building any of the saw frames shown make sure of the length of the mandrel at hand before cutting stock as you may have to change the dimensions.

Figs. 2 and 3 detail another type of frame to be attached to popular makes of small tractors. In some cases the saw frame can be bolted to the fender-mounting bosses or implement-mounting pads, which are cast on the rear-axle housings. The original frame was used on a popular tractor equipped with a hydraulic power lift. By using one lift arm and one drawbar link as shown by dotted lines in Fig. 3, the lift can be made to raise and carry the saw frame for transport. Where the lift cannot be used, the saw frame can be supported in the raised position with a chain. When making the frames, cut and fit lengthwise members before the cross members. In this way, you can determine the required length of the latter and avoid any waste of stock. In some instances it may be necessary to cut the saw man-

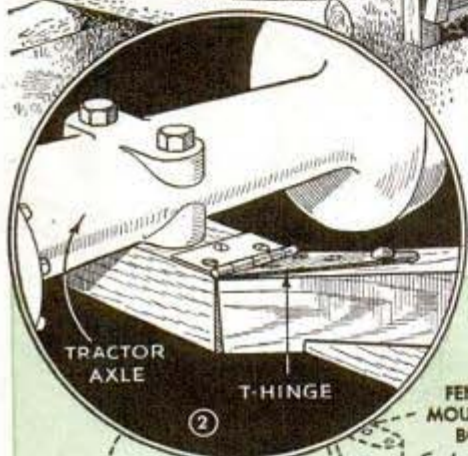

When making the frames, cut and fit lengthwise members before the cross members. In this way, you can determine the required length of the latter and avoid any waste of stock. In some instances it may be necessary to cut the saw man-

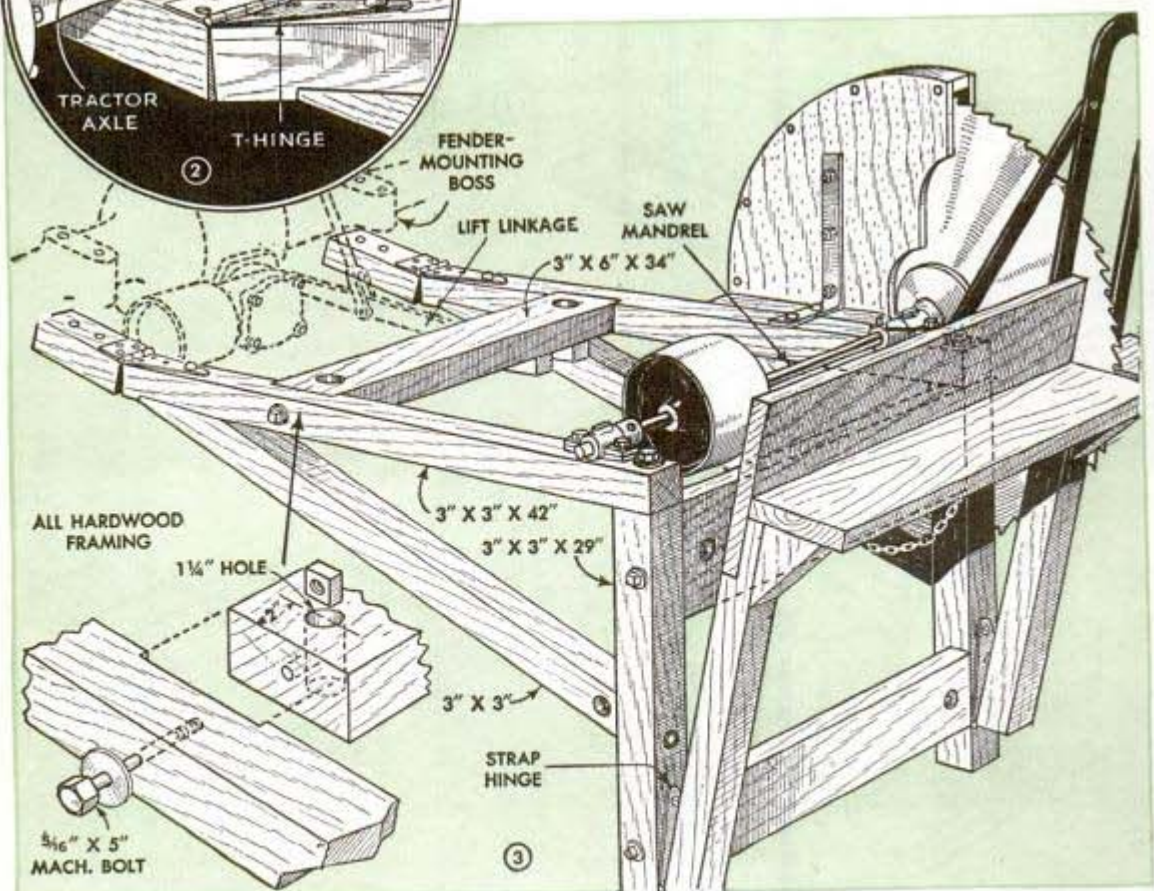

drel to suitable length and have it machined for some distance back from the pulley end so that the pulley can be placed between bearings as in Fig. 3. Be sure that the end of the mandrel shaft does not project more than $\frac{1}{2}$ in. or so beyond the bearing. A projecting shaft end is dangerous as it may catch loose clothing.

A stationary frame for heavier work is detailed in Fig. 4. Although not shown, skids easily are added to this frame if desired. If the mandrel is fitted with a balance wheel, the distance between bearings will be shortened from that shown, and the width dimensions of the frame will have to be altered accordingly. Although it takes somewhat more time to join the frames with the type of bolted joints detailed, the method has the advantage of rigidity and durability. Moreover, if the wood shrinks and the joints loosen, the whole frame can be tightened.

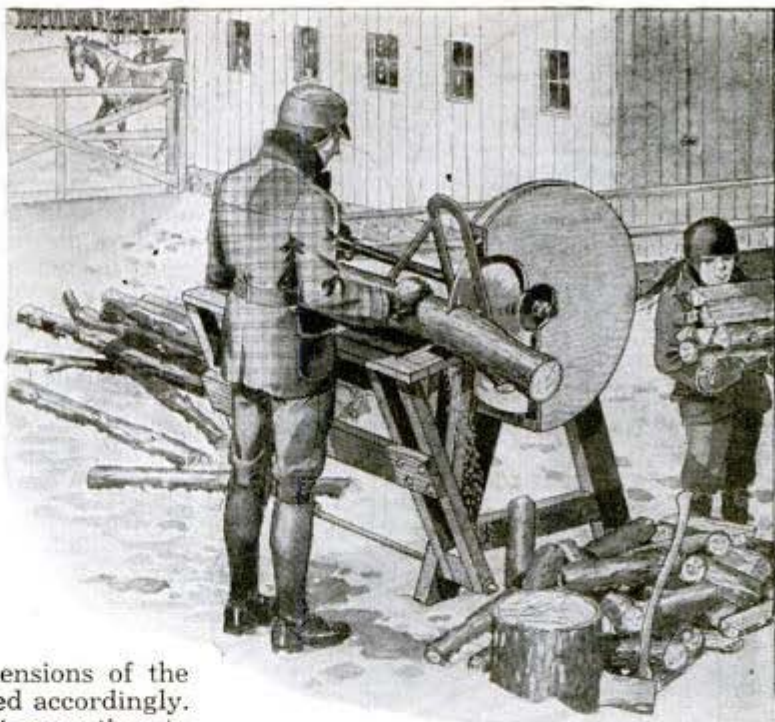

Figs. 5, 6 and 7 show a frame which, with some minor adaptation, can be fitted to the front of almost any tractor having side frames that ordinarily are used for attaching implements. Note that when the saw

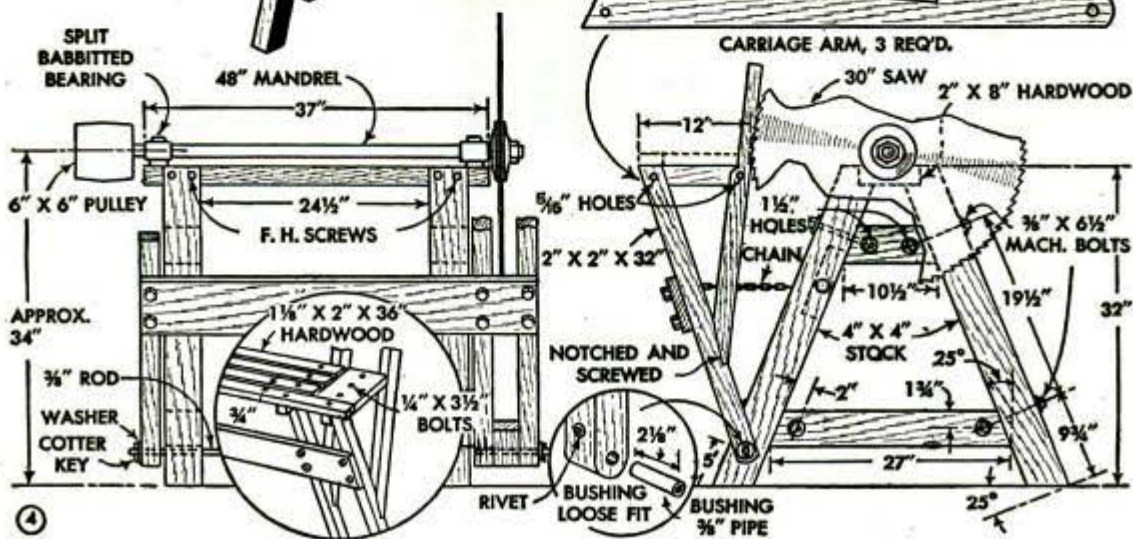
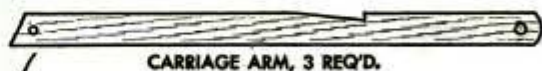
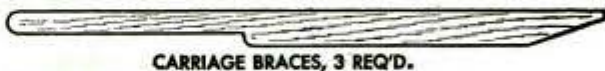

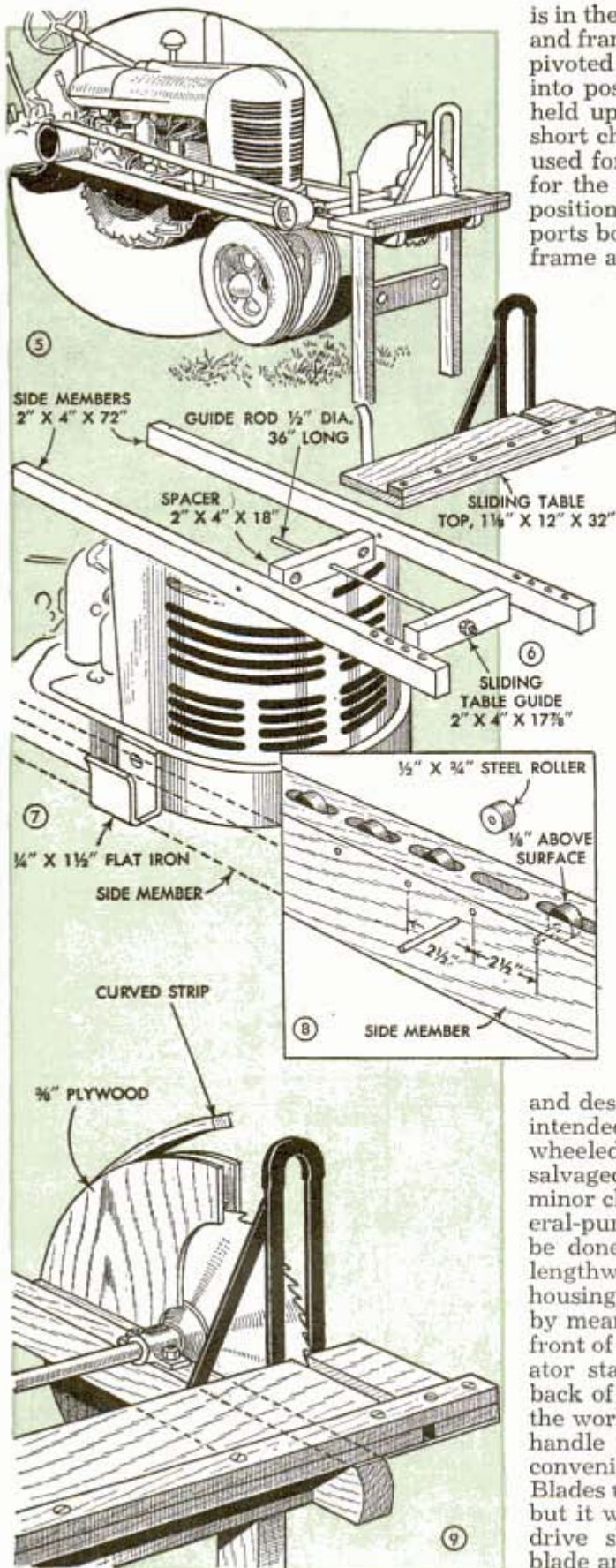

is in the operating position, Fig. 5, the table and frame are supported on legs, which are pivoted to the frame and swing downward into position. For transport, the legs are held up against the frame by means of a short chain or hook. Hardwood should be used for the legs and 2 by 6-in. hardwood for the crosspiece. When in the transport position the frame rests on U-shaped supports bolted to the front end of the tractor frame as in Fig. 7.

Carriage tables that move horizontally can be provided with rollers if desired. Fig. 8 suggests a simple way of fitting these rollers under the carriage. Disks 1/2 in. thick are cut from a piece of 3/4-in. steel shafting with a hacksaw and center-drilled to take a 10d nail loosely so the roller will turn on the nail. Holes are bored and slots chiseled in the frame piece to take the rollers as indicated. A strip of flat iron screwed to the bottom of the carriage board will make a suitable "track." Use hardwood for all frames, and finish with two coats of spar varnish or implement paint to protect the wood. Fig. 9 shows a simple and effective saw guard made from a piece of plywood and screwed to the frame back of the blade. A curved strip is screwed to the plywood edge just outside the circle of the saw teeth. Such a guard does not interfere with removing the blade, yet offers protection against one of the greatest dangers to the operator of a cordwood saw, that of a sliver or small piece of wood or other object falling on the blade when it is running.

Fig. 10 shows a cordwood saw similar to a swinging cut-off saw and designed for heavy work. This saw is intended for mounting on a truck or four-wheeled trailer and can be driven with a salvaged automobile engine. With some minor changes it can be mounted on a general-purpose tractor also. This usually can be done by bolting the rear ends of the lengthwise frame members to the rear-axle housings and supporting the forward ends by means of a cross member bolted to the front of the tractor frame. In use, the operator stands between the frame members back of the saw and swings the blade into the work. The table is stationary. Helpers handle the logs which can be cut to any convenient length for several men to carry. Blades up to 36 in. in diameter can be used, but it will be necessary to shift the upper drive shaft so that the larger-diameter blade and the mandrel will clear the table.

If you use different size blades an adjustable stop should be provided. All shaft bearings should be provided with pressure grease fittings. Only certain of the dimensions are given on the frame. Changes necessary to adapt the design to use of salvaged pulleys, shafting and other parts must be left to the builder as dimensions must be changed to suit what one has at hand or can obtain. Some machining usually has to be done on the saw mandrel to adapt it to use with this design. Don't cut any valuable stock or timbers until you have at hand all the necessary metal parts, including the engine of whatever type used for the drive. Generally, it is necessary to provide an idler pulley on all the longer flat-belt

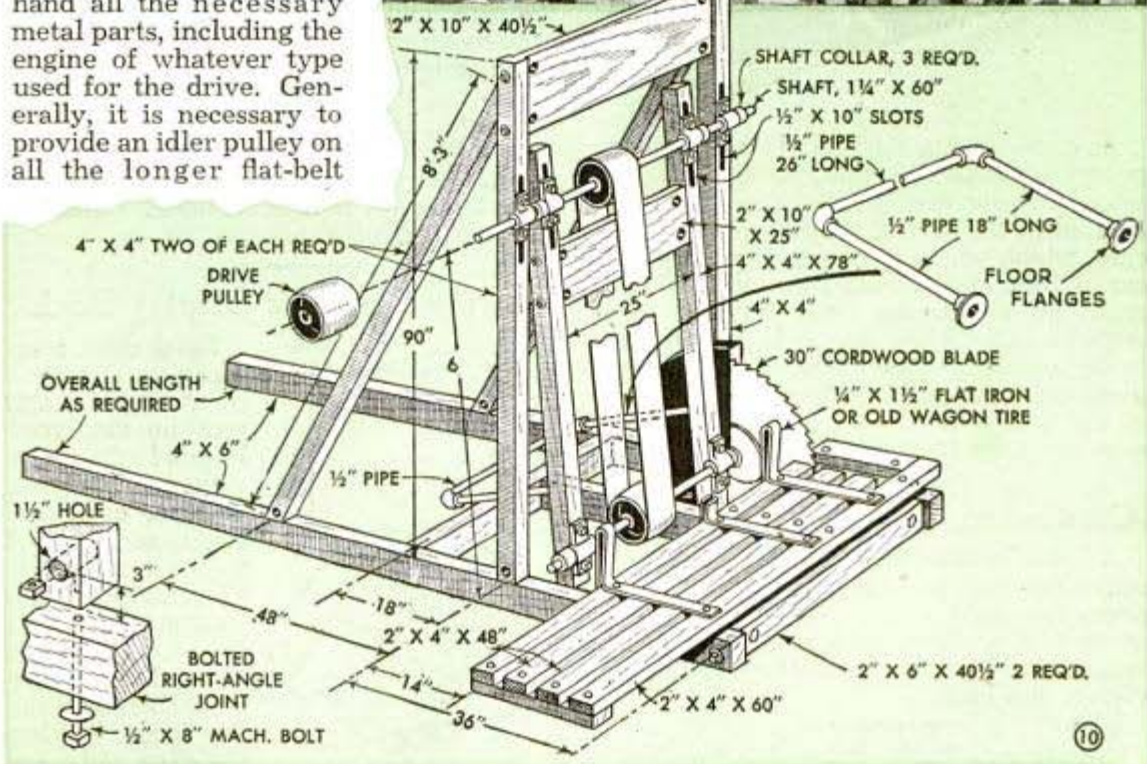

drives. The idler should run on the slack side of the belt nearest the driven pulley and just how it is installed depends on the type of idler and mounting you have or can obtain. When you mount the mandrel on any of the frames that are attached to the tractor, it's a good idea to provide slots so that you can shift it forward or backward. This will enable you to make the proper adjustment for table travel into the saw blade. And of course steel angles are better than wood for making almost any design of cordwood-saw frame.

Two final and important precautions:

Always make certain that the blade is tight on the mandrel before starting, and do not exceed the recommended speeds for the size blade you are using. As an example of the latter, the speed of a 30-in. blade should not exceed 1,500 r.p.m. A speed of 1,200 r.p.m. is safer, while larger diameter blades should run proportionately slower.

Grease-sealed ball bearings with a 1/2-in. hole make excellent collars for a shaper. Because this type of collar remains stationary, the usual burned mark is eliminated from the work.

Salesman's Cardboard File Case Attached to Roof of Car



In order to have his cards and various papers arranged so that he could easily select them as desired while making calls, one salesman used a small cardboard file case, which was attached to the top of his car within easy reach from the driver's seat. To attach the case, buttons were sewed to the fabric lining inside the top to engage buttonholes which were cut in pieces of tape glued to the ends and sides of the case. With this arrangement the case could be removed whenever desired.

Cardboard Softens Muslin Buff

A loose muslin buff can be made much softer for final polishing work by fitting a paper or light cardboard ring between every two or three cloth rings. The paper rings should be about one-third the diameter of the buff.

Small Air Tube Repairs Oilcan

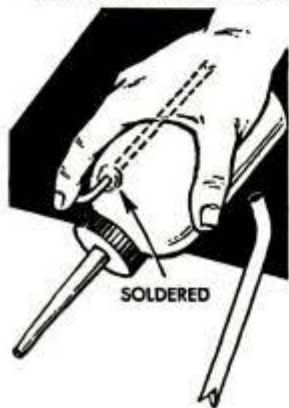

If a large oilcan loses the snap action in the bottom so that oil cannot be forced out, just drill a hole in the can near the top and solder in a small tube as shown. The tube should be notched at the lower end so that it can rest against the bottom

of the can without preventing the entrance of air. In use, hold a finger over the upper end of the tube and then lift it slightly whenever you want oil to leave the can.

John Krill, Youngstown, Ohio.

Lock Rims Chained to Truck Tire For Safety When Inflating

After being injured by a lock rim that flew off while inflating a repaired truck tire, the driver of a road-service car now chains the rim to the wheel as indicated. The chains are passed between the wheel spokes and around the tire and rim where they are fastened by inserting one end link through the other, a bolt being run through the projecting link to secure the chain. It takes only a few minutes to attach and remove the chains, which prevent the lock rim from flying off if it is loosened while the tire is being inflated.



Carton Provides Display Rack

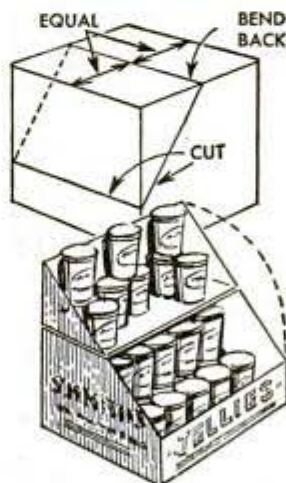

Food cans, soap bars and other packaged goods can be displayed to good advantage right in their own packing cases if the latter are cut to form neat display racks. To do this, cut diagonally across the ends near the corner and then across the front, leaving the top side intact. Then fold the severed portion of

the case back on the top as indicated. This forms a display case with one shelf and an open front.

Safe Way to Cut Coil Springs

When cutting a coil spring, danger from flying pieces can be avoided by running a wire through the spring and tying the ends together to form a loop. This will confine the force of the severed spring within the length of the loop.

George K. McKeowan, Painesville, Ohio.

MILLING ATTACHMENT

uses lathe compound

OCCASIONAL jobs of light milling can be done on the lathe with the use of this simple attachment. The three parts of the unit are standard, and all perform their individual jobs as well as functioning as a unit in the milling attachment. The first item is an angle plate, which should be at least $\frac{1}{2}$ in. thick, and can be either cast or cut from standard angle-iron stock. The work-adjustment part of the attachment is the regular lathe compound, while the work-holding portion is a standard drill-press vise. The method of assembly is apparent



from the photos and drawings. Only a few dimensions are given as the unit will vary, depending on the swing of the lathe, size of compound and drill vise, etc. In planning this for your own lathe, first make a rough side view of the assembly. Start with the lathe centerline, and locate the lower jaw of vise $2\frac{5}{8}$ in. below this. Sketch in the lathe compound as it appears when fully advanced, then locate the angle plate in relation to the top of cross slide. If the lower jaw of the vise is $2\frac{5}{8}$ in. below the centerline, and the compound has the usual $2\frac{1}{2}$ -in. travel, the milling attachment can be raised to center stock as small as $\frac{1}{4}$ in. diameter. Another set of holes in the angle plate for a "low" position will be found useful when swinging large cutters. The low position should be such that the bottom of the drill vise just clears the top of the lathe saddle. One of each pair of holes in the angle plate is drilled oversize or slotted so that the unit can be adjusted with vise jaws exactly horizontal. The top photo shows the set-up for cutting a keyway with a large cutter, the milling attachment being mounted in the low position to the outer face of the angle plate. The lower photo shows a set-up for cutting a flat on a shaft, the milling attachment being mounted in the high position to the inner face of the angle plate. The angle plate mounts on the cross slide in the same position ordinarily occupied by the compound.

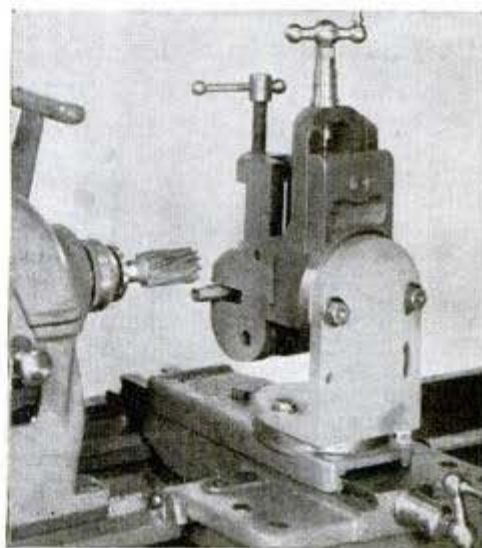
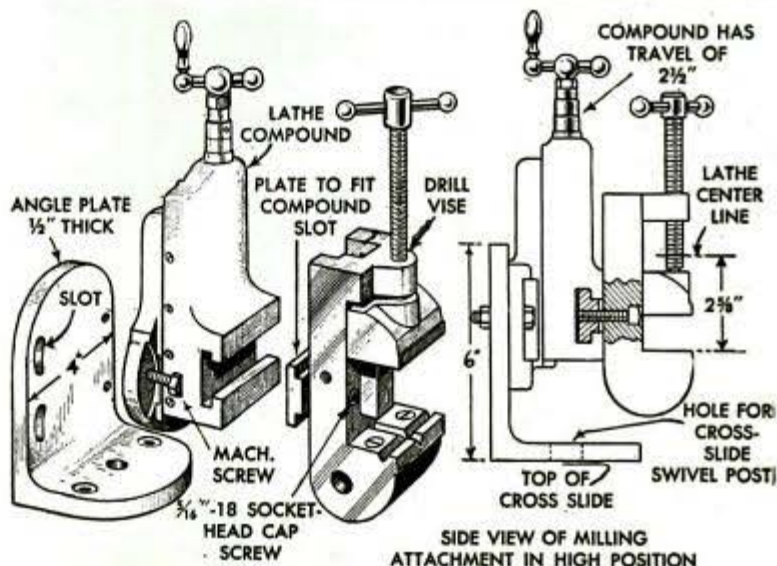

Upper Edges of Large Skid Boxes Shielded Against Wear



Noticing that the upper edges of the canvas-covered skid boxes used in his store wore rapidly by contact with objects being slid into them, one store owner fitted the boxes with wooden shields as indicated. Each shield consists of three strips nailed together to form a groove on the underside as indicated in the upper detail, the edge of the box fitting into the groove to hold the shield in place.

Sticking Tape on Damp Surfaces

If masking tape refuses to stick during damp weather, moisten a cloth in paint thinner, alcohol or similar liquid, and rub the surface of the work with it. This dries out the moisture and gives the tape a good contact.

Small Wells in Soldering Iron To Dip Ends of Wire

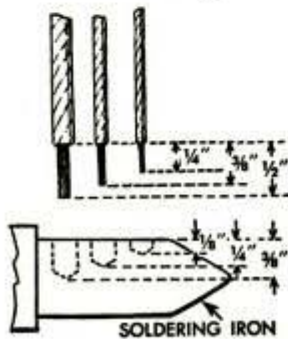

and filled with solder. The iron kept the solder molten and the job was done quickly. The holes were varied in depth as indi-

cated, since some wires had to be coated farther back from the ends than others.

Fred Lettino, Astoria, Long Island, N. Y.

Simple Scriber for Centering A Milling-Machine Cutter

Here is a fixture that will enable you to quickly center the cutter of a milling machine on the work. The fixture consists of a V-block to which is fastened a scriber as indicated, the scriber point being located exactly in line with the center of the block. To use, merely place the fixture over the machine arbor, level it and then scribe your center mark.

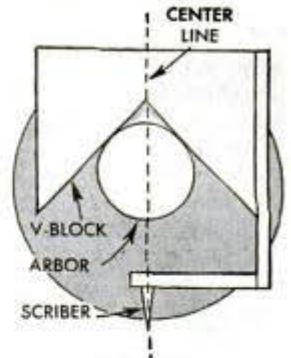

Wm. Slamer, Milwaukee, Wis.

Avoiding Breakage of Saw Blades

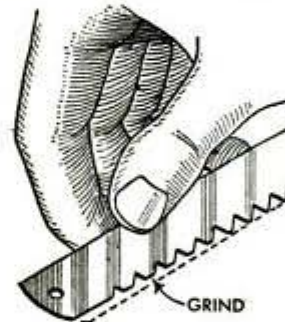

You can avoid breaking teeth from a hacksaw blade when starting a cut if the teeth at the front end are ground down on a slow taper for a distance of about 2 in. as indicated. This allows each succeeding tooth to bite progressively into the work a little deeper than the one ahead.

This treatment is especially effective on extremely hard, high-speed blades.

Russell J. Hunt, Chicago.

Shavings Removed From Work By Blower on Drill Bit

If shavings obscure the layout markings when you are working with wood on a drill press, wrap a piece of tape around the drill so that one end projects about an inch. When the drill rotates, the projecting tape will blow away the shavings.—W. Kraatz, Rialto, Cal.



LIMESTONE SPREADER

Saves Time and Material

HERE'S a practical and inexpensive spreader for handling any finely-ground fertilizing material such as rock or lime phosphate, limestone, etc. It is made almost entirely of wood, only a few pieces of flat iron, rods and bolts being required. It will operate satisfactorily at speeds up to 10 m.p.h. Fig. 1 shows the spreader in use on a truck, but it operates equally well on a rubber-tired tractor trailer or an ordinary farm wagon. About all that is necessary to adapt it is to change the length of the hangers and perhaps the "knocker" or agitator arm.

On a farm wagon, the knocker-arm contacts on the wheel can be clamped to the spokes.

The hopper, Fig. 3, is 12 ft. long overall and is divided into four compartments. The compartments add to the strength of the assembly and also make it easier to keep a uniform amount of material in the hopper. However, the hopper can be made somewhat longer or shorter, and wider at the top and deeper if desired. In any case the inside width at the bottom should be 2½ in. The ends of the lower



①

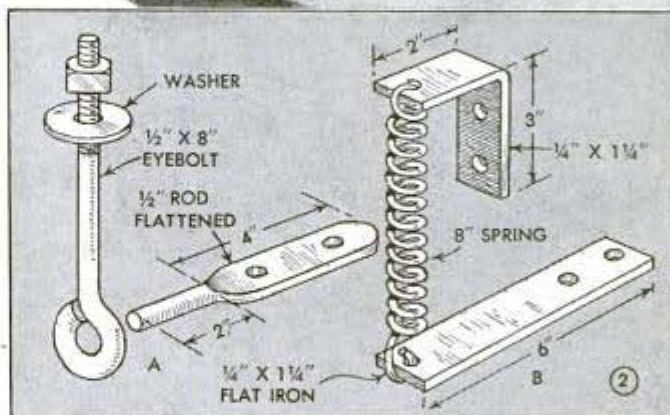

②

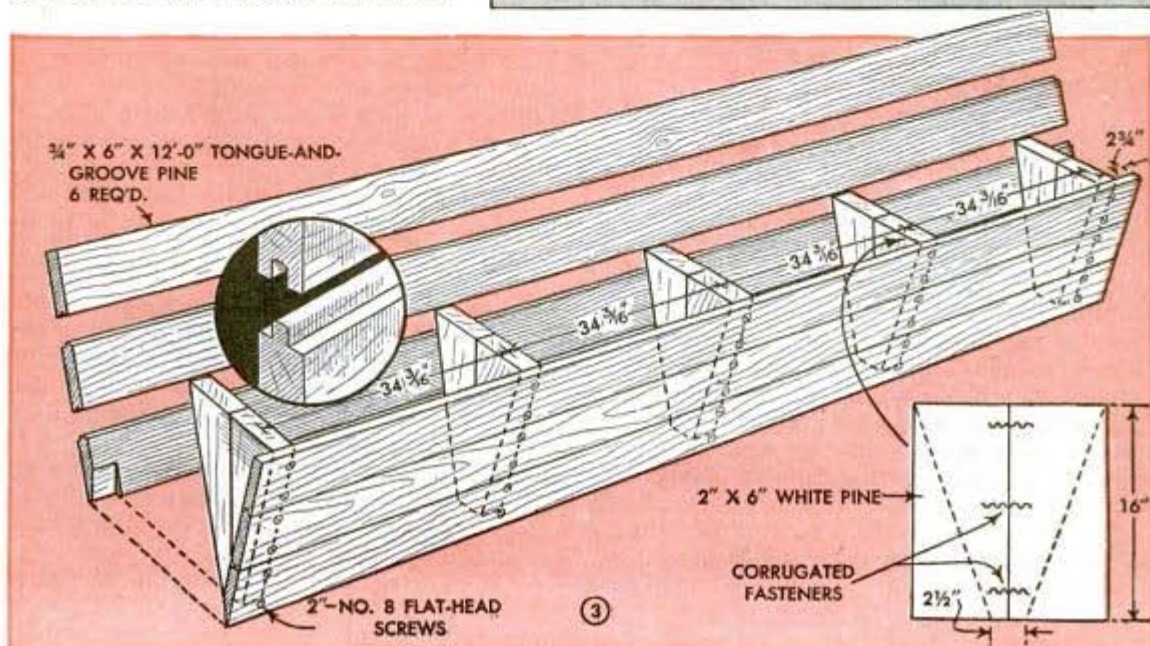

③

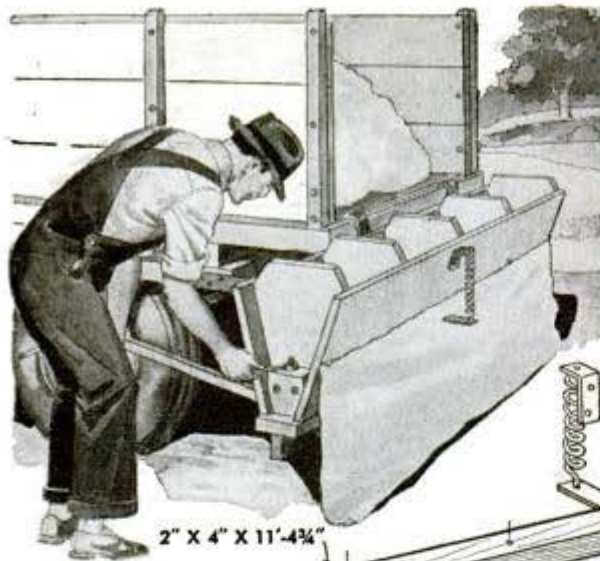

2" X 4" X 11'-4 3/4"

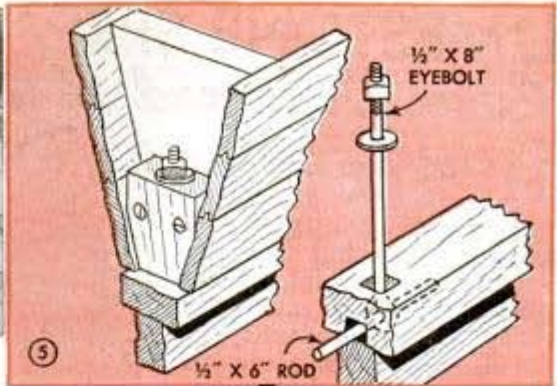

5

1/2" X 6" ROD

1/2" X 8" EYEBOLT

4

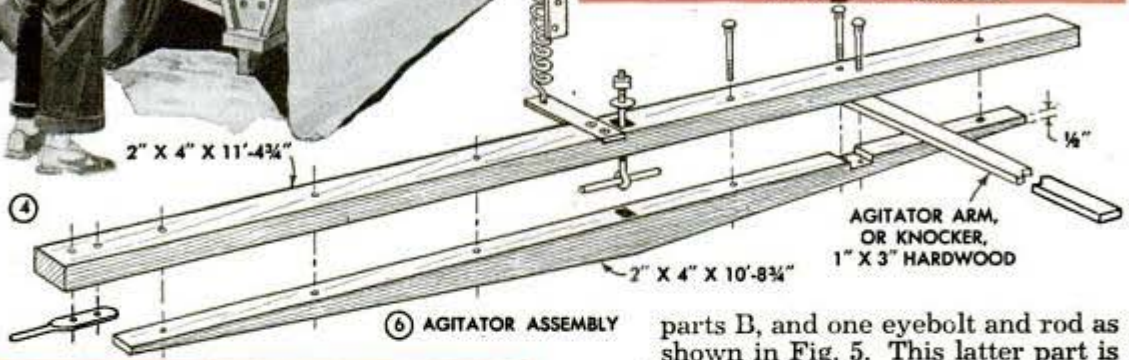

6 AGITATOR ASSEMBLY

AGITATOR ARM, OR KNOCKER, 1" X 3" HARDWOOD

2" X 4" X 10'-8 3/4"

1/4"

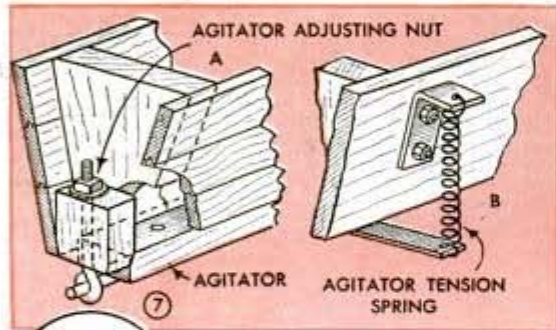

7

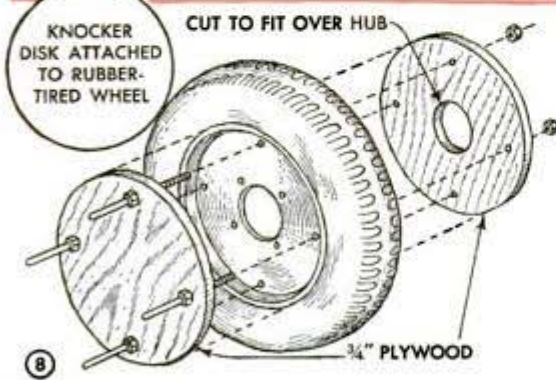

8

boards are notched to take a 2 by 4-in. block as shown. Be sure the partition pieces are all the same size, and before assembling paint all joining edges with an oil paint. Use screws in assembling. They hold much better than nails. Plane the edge of each of the bottom boards flush with the partition pieces so that the bottom of the hopper is square across. Parts shown in Figs. 2 and 5 can be made by a blacksmith or a welder. Two each of parts A in Fig. 2 are required, but only one each of

parts B, and one eyebolt and rod as shown in Fig. 5. This latter part is assembled at the center of the hopper. Parts A and B of Fig. 2 are shown in position in Figs. 6 and 7.

The agitator consists of two lengths of 2 by 4-in. stock assembled with bolts as in Fig. 6. The lower stiffener is tapered from the center toward the ends. Although not essential, the tapers cut down the weight somewhat without weakening the piece. Note, in Fig. 6, the position of the center pivot, which is detailed in Fig. 5. The exact position of the agitator arm is not given as this has to be determined by measurements taken directly from the truck, trailer or wagon on which the spreader is to be used. Once the location is determined the arm is bolted in place as shown in Fig. 4. It's a good idea to use waterproof glue in all joints of the hopper and agitator.

Fig. 8 suggests one way of fitting a knocker disk to a rubber-tired wheel. Of course, the construction of the wheel will determine how the knocker disk is to be attached. On some types of disk wheels it is not necessary to drill holes for the knocker pins as there are equally-spaced openings near the rim. The knocker pins are lengths of 1/2-in. iron rod threaded from one end to such distance that they will pass through the disks and project about 6 in. as indicated. Be sure to cut an opening in the outer wood disk for the valve stem. A similar arrangement can be made for use on wood-wheeled farm wagons, using larger diameter wood disks.

The hopper is supported on hangers as in Figs. 9 and 11. Length of the hanger is not given as this has to be determined by

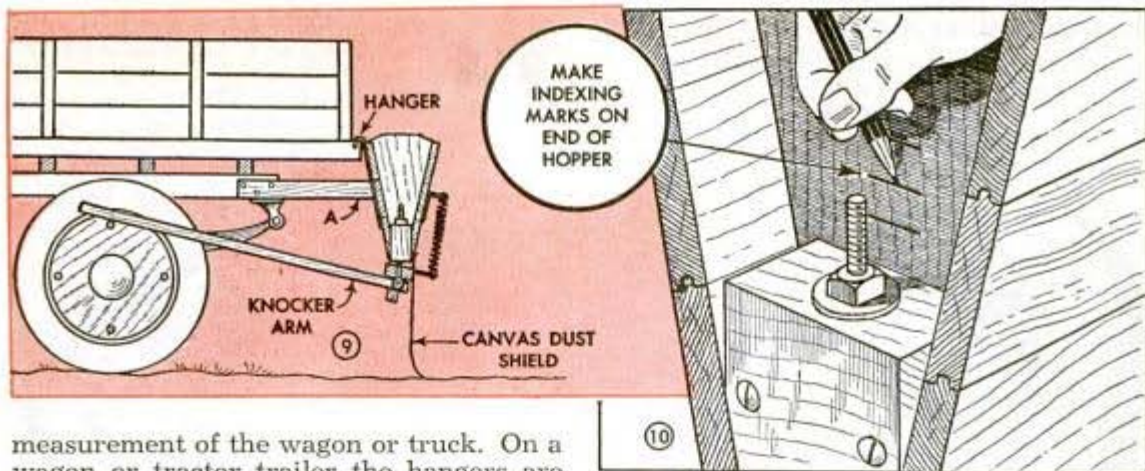

measurement of the wagon or truck. On a wagon or tractor trailer the hangers are simply hooked over the endgate, and on a truck they usually can be hooked to the bed. Ordinarily, the bottom of the hopper should be about 24 in. from the ground and in most cases two braces will be required to hold the hopper level as at A in Fig. 9. Nearly all users fit the hopper with a canvas dust shield as in Fig. 1. This prevents loss of the fine material. The completed spreader should be given two coats of oil paint to prevent warping and shrinking.

To determine the setting for a given amount of fertilizer spread per acre, first draw the agitator snugly against the bottom of the hopper by turning down the nuts on the three eyebolts as in Fig. 4. Then release the nuts a given number of turns until the agitator moves freely without binding when actuated by the knocker assembly. This will give a check setting. Then fill the hopper with a known quantity of fertilizer and drive across the field until the spreader is empty. Measure the distance traveled in feet. Then multiply the width of the hopper by the distance traveled and divide by 43,560. As an example, assume that 300 lbs. of material in the 12-ft. hopper cover a strip 1,820 ft. long; 1,820 ft.

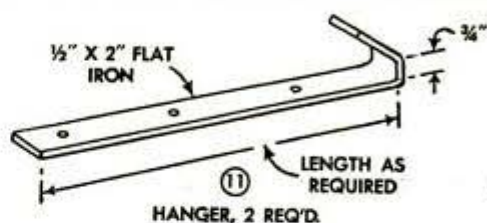

multiplied by 12 ft. equals 21,840 sq. ft.; 21,840 divided by 43,560 equals .501, or approximately one-half acre covered. More or less can be spread by adjusting the agitator. When you have the spreader adjusted for the amount or amounts desired, make index marks at the ends and center of the hopper as in Fig. 10. The marks then will enable you quickly to set the agitator to spread any given amount. Always adjust the center pivot whenever you change the setting of the end pivots.

Constructional details on limestone spreader printed by courtesy of the Agricultural Experiment Station, College of Agriculture, University of Illinois; Englert Engineering Co., Nashville, Tenn.; and Ruhm Phosphate and Chemical Co., Mt. Pleasant, Tenn.

Simple Clamp Holds Broken Hacksaw Blade in Saw Frame

Hacksaw blades often are broken off near the end, and being so hard that they cannot be drilled, are discarded because they cannot be used in the saw frame. However, with a simple clamp like the one shown the blades can be held in the frame. The clamp consists of two pieces of flat metal shaped as indicated, and drilled and tapped for two screws which clamp them over the blade. Notice that the edges of the blade are slotted to fit part way around the screws.

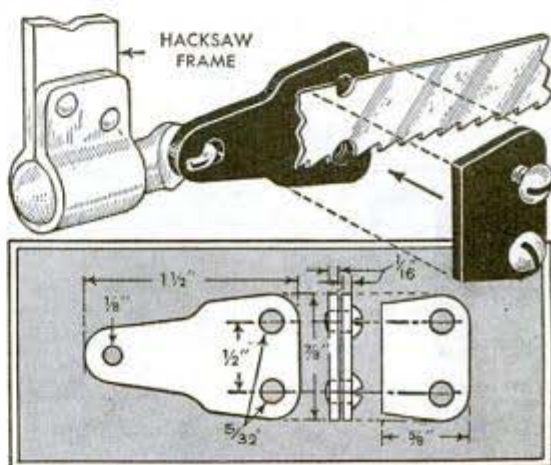

☐ If soap and water do not clean grimy shop windows, try a weak solution of oxalic acid and water. It's best to wear rubber gloves, as the acid may burn the bare hands.

Sharpened Hook on Ice Scraper Turns Cakes for Washing



Much of the labor of turning cakes of ice for washing before delivery can be eliminated by attaching a flat-iron hook to the shank of an ice chisel or scraper. In use, the hook is driven into the top edge of a cake, with the chisel blade held flat against the side as shown. The shank, extending above the cake, then is used as a lever for turning the ice.

Oiling Improves Jute Rope

Jute rope will be flexible, tough and weatherproof if it is soaked in linseed oil. Coil it uniformly in a container—a dishpan will hold up to 50 ft. of $\frac{3}{4}$ -in. rope—and pour a gallon of oil over it. Let it soak overnight. The rope absorbs little of the oil, which then can be used for other purposes. Unlike wetting, which shrinks rope, oiling expands it a little. It is believed that by oiling jute rope, it will give as good service as unoiled manila rope.

Edward Elsas, Kansas City, Mo.

Easy Way of Installing Bushings In Motorcycle Connecting Rods

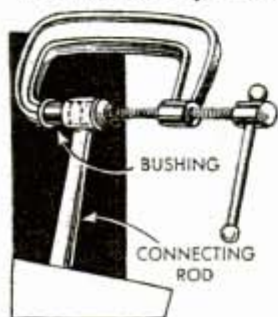

When installing new connecting-rod bushings and wrist pins in a motorcycle engine, it is not necessary to remove the rods from the motor or the motor from the frame, if you use a C-clamp to press

the bushings into place. This method prevents any possibility of distorting the rods and also saves work, as it is necessary to remove only the cylinders and pistons.

W. M. West, Dallas, Tex.

How to Hacksaw Angle Iron

When cutting angle iron with a hacksaw start at the center on the back side as indicated instead of cutting down one side and across the other as is often done. This will save time by requiring fewer strokes of the saw. Also, the saw will cut more smoothly because more of the teeth will be engaged in cutting through both sides of the angle at the same time.

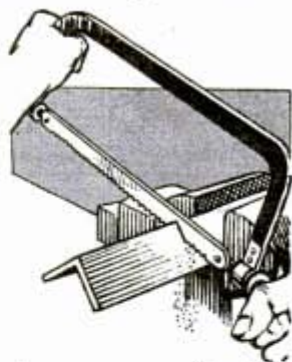

Cardboard Cushions Egg Bucket



Accidental breakage of eggs when carried in a bucket or wire basket was avoided by one farmer who cushioned the container with corrugated cardboard. Three thicknesses of the cardboard were placed in the bot-

tom of the container and two around the sides as indicated. If desired, the cardboard can be glued in place to keep it from falling out.

Small Drills Kept in Container Used for Stick Shaving Soap

An empty shaving-soap container of the type shown provides a handy cover for small drills, taps and similar tools. All you have to do is to fit a piece of fiber or hardwood in the bottom of the container and drill it to take the tools.—P. Soutar, Windsor, Ont., Can.

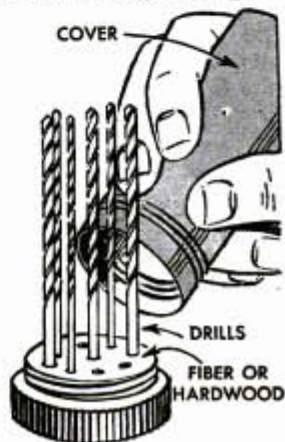

Lathe Attachment to Cut Your Own Small Gears

With this simple attachment and a lathe milling cutter any lathe owner can produce his own gears for experimental purposes, and for other uses where accuracy is not too critical. The attachment is made as shown in the lower detail. The bolt through the center supports the attachment and has the head shaped to fit the T-slot of the lathe cross slide. This bolt also serves as an axle for the gear blank, which is turned by means of a worm and gear assembled as indicated. The arm carrying the worm is attached with one bolt and two pins. Notice that a pin on the underside of the gear is used to engage a small hole in the gear blank for turning the latter. Before setting up the gear blank in the attachment, turn it to correct diameter and thickness. Lay out the tooth positions on a piece of paper and then glue this to the blank. The gear blank is fed into the cutter with the cross slide and should engage the blank at its exact center. This will make a cut with a curved edge, but still produce a gear satisfactory for many uses. After a tooth has been cut, the nut on the supporting bolt is loosened and the blank turned to the next

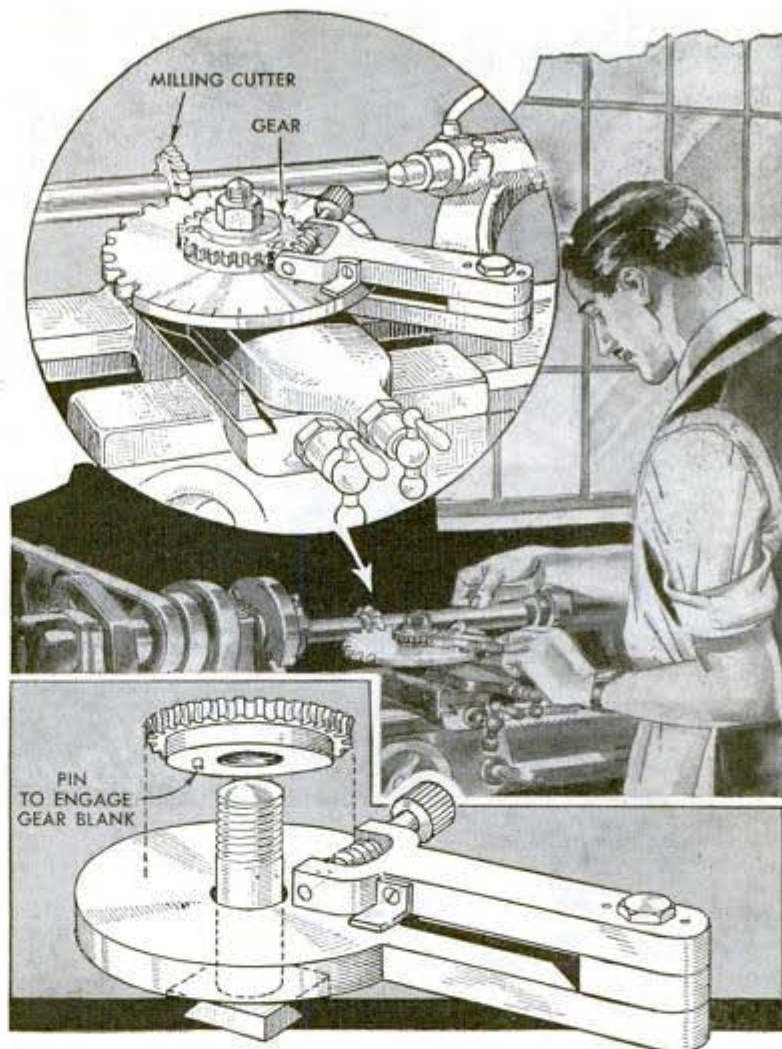

tooth position by means of the worm. A pointer fastened to the worm arm will aid in doing this accurately. Any roughness in cutting can be smoothed with a file.

T. W. Cleaveland, Weston, W. Va.

Adjusting Wheel on Marking Gauge Permits Close Setting

Where extreme accuracy is required in setting a marking gauge, much of the time lost in making the adjustment can be saved by using a gauge like the one shown. Use of a small adjustment wheel permits very fine adjustments to be made with ease, and by loosening two thumbscrews, the scribing rod is moved readily to make wide adjustments. The entire assembly can be made, or a commercial gauge can be fitted with a similar adjusting feature. On a homemade gauge a phonograph needle provides a good scribing point, especially if the gauge is to be used on metal.

Cpl. Frank W. Debski, Salinas, Calif.

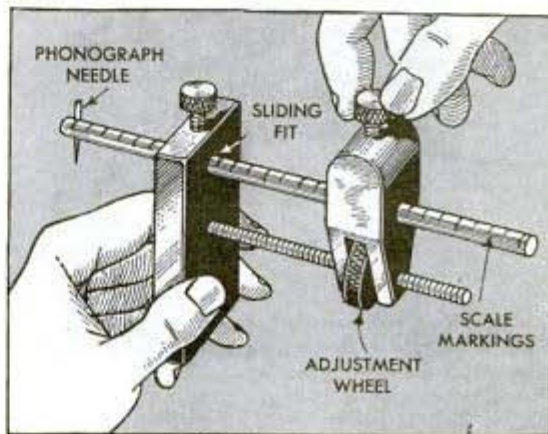

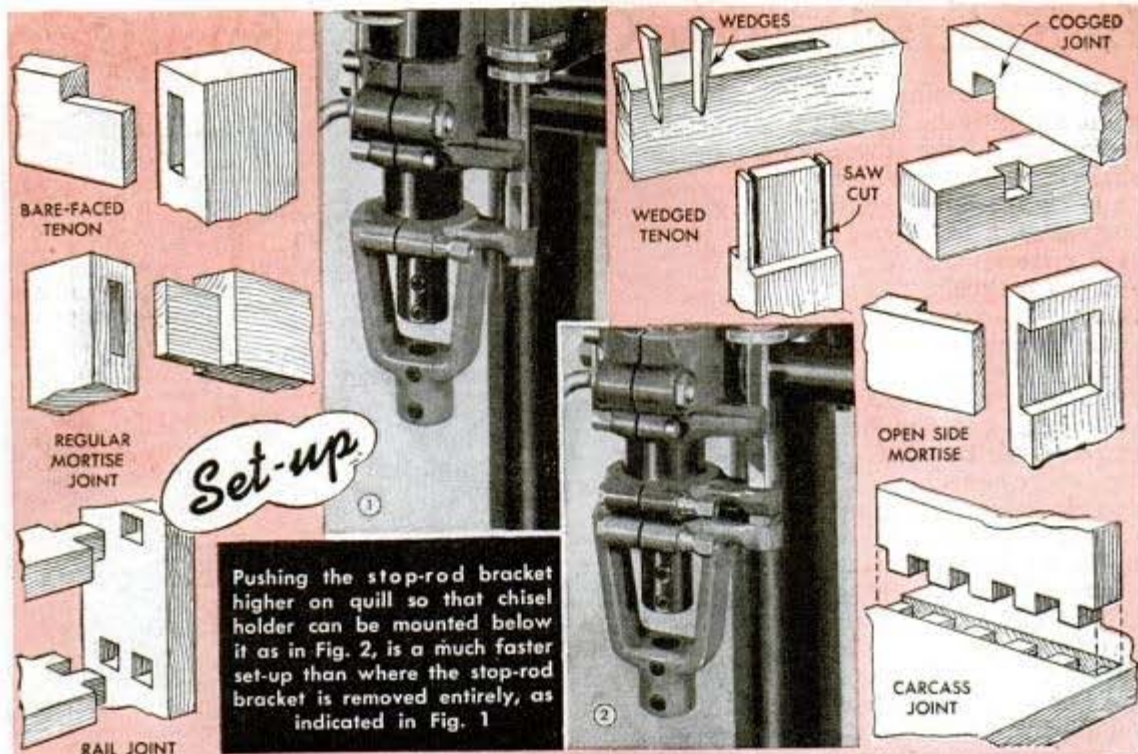

Pushing the stop-rod bracket higher on a quill so that chisel holder can be mounted below it as in Fig. 2, is a much faster set-up than where the stop-rod bracket is removed entirely, as indicated in Fig. 1.



Hollow-Chisel

By Sam Brown

MORTISING on a drill press with the use of a hollow chisel is so fundamentally simple that many craftsmen neglect the finer points of this phase of wood-working. You can do better, faster, cleaner work by observing the simple rules of correct practice.

Set-up: Some drill-press manufacturers advise the removal of the stop-rod bracket. The hollow-chisel holder is then pushed onto the quill and fastened to the stop rod. This set-up, shown in Fig. 1, is practical but involves needless work and time. The best set-up is shown in Fig. 2. Here the stop-rod bracket is not removed but is simply pushed to a higher position on the quill, the chisel holder being mounted below it.

Bit clearance: Most workers adjust bit clearance by sighting across the end of the chisel. This method is very inaccurate. The proper way is to set the clearance at the time the chisel is mounted, allowing about $\frac{1}{32}$ in. between the chisel shoulder and holder, as in



Bit clearance

Set clearance of $\frac{1}{32}$ in. when mounting the chisel. Push bit up tight, then advance chisel to holder

Fence

A fence wholly or partly cut away at center is useless when mortising work with short flats. Correct by turning the fence around and making partial cut on new face, as shown in Fig. 6

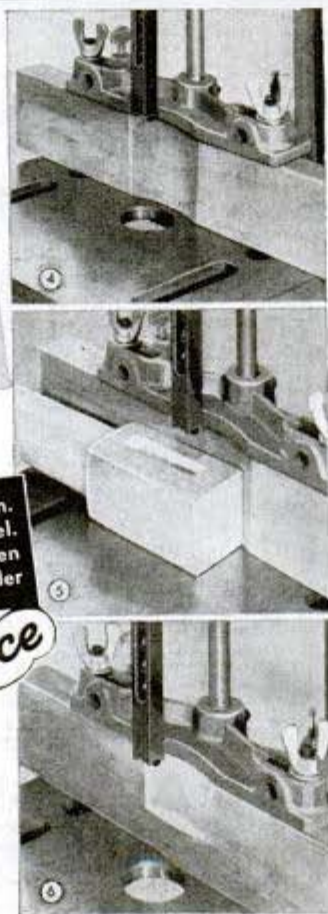



Mortising speeds under 800 r.p.m. result in big chips which jam inside the chisel, causing overheating. Speeds of 1800 to 3000 r.p.m. give a fine chip, easily ejected, as shown below

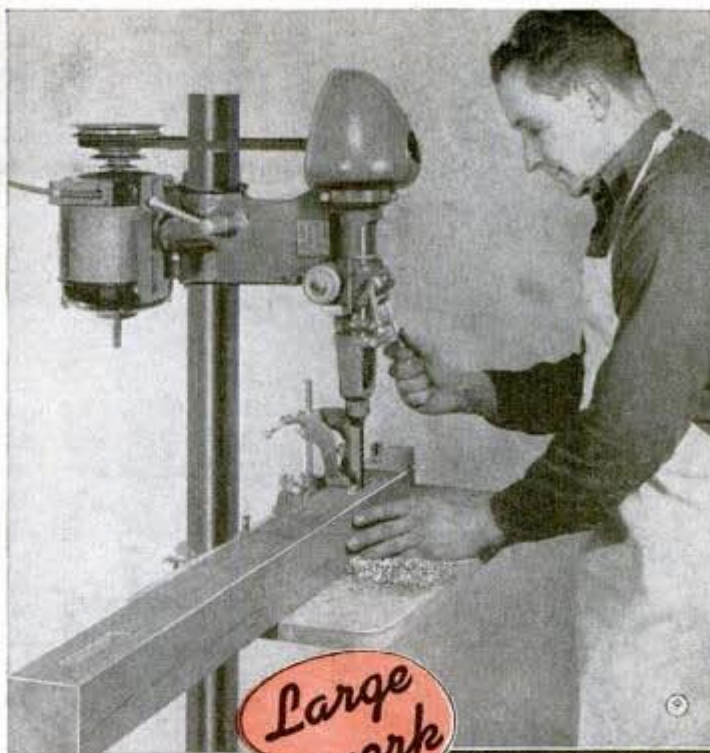

Large work such as storm sash and doors is difficult to hold on standard drill table. An auxiliary wood table with longer fence is better

MORTISING

Fig. 3. The bit is pushed up tightly and fastened, after which the chisel is pushed home to give the clearance. Although $\frac{1}{2}$ in. is nominal clearance, slightly more should be allowed when using chisels over $\frac{1}{2}$ in.

Fence: Some standard mortising fences are wholly or partly cut away at the center as in Fig. 4 to permit their use in routing and shaping operations. This type of fence is unsatisfactory when mortising work with a short square section as the work tends to get out of line, Fig. 5. If you have this type of fence, turn it around and make the cut-out as before, but only part way across, as in Fig. 6.

Speed: A mortising speed of 2400 to 3000 r.p.m. should be used for softwood; 1800 to 2400 for hardwood, when using chisels up to and including $\frac{1}{2}$ in. square. Larger chisels will require a reduction in speed. Too slow speed often causes burning as a slowly rotating bit picks up a big chip, and the stream of big chips has a considerable wedging and heating action when passing through the chisel. Notice in Fig. 7 the large chips and how the chip stream does not clear the work. Fig. 8 shows the result of a higher speed—very fine chips that pass easily through the chisel without binding. An auxiliary table with larger surface and longer fence as in Fig. 9 is almost a necessity when mortising doors and other large work.

Bits and chisels: The standard bit for mortising is a double-flute pattern with knife spurs and no point as shown in Fig. 10. This is a very smooth-cutting bit in softwood and generally is satisfactory for all types of cutting other than production runs in hardwood. The brad-point bit is a heavy-duty style designed especially for production runs in hardwood. The hog-type bit has corrugated edges. It is claimed that this style of bit runs much cooler



Various bit and chisel styles are available. The standard items pictured above are briefly described in text

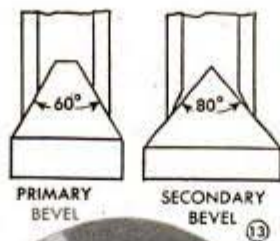

An abrasive cone run in drill press is best equipment for chisel grinding

because of the chip-breaking action of these edges. A standard chisel has one opening, rather high up on the blade, and a hard-wear chisel for production work has two openings, one on either side, for quicker chip relief. A standard chisel can be converted to this style by grinding the second opening, Fig. 11. Chisels also can be obtained in oval, triangular and oblong shapes.

Sharpening bits and chisels: A hollow chisel actually is an arrangement of four ordinary woodworking chisels arranged four-square. Like the woodworking chisel, the cutting angle should be blunter for hardwoods than softwoods. Also, a primary and secondary bevel are used to simplify sharpening. This can be done with a flat file, a cone grinding wheel or wood cone shape covered with 80-grit aluminum oxide or emery paper. Figs. 12 and 13 show the operations. For average work, a primary bevel of 60 degrees is satisfactory. The secondary bevel should be about 80 degrees. The chisel is sharpened on the secondary bevel only, until repeated sharpening makes this bevel longer than one-half the thickness of chisel wall, at which stage the primary bevel is again ground. The ex-

treme corners of the chisel are not touched by the cone and should be pointed up with a square file, as in Fig. 14. Bits are sharpened the same as ordinary woodworking bits, filing the cutting edges through the throat and the spurs from the inside.

Cutting: The one important rule to observe in actual cutting is always to take a cut three-quarters to full chisel width as at A in Fig. 15. It can be seen that since one side of the chisel is open, the chisel tends to lead toward this open side, the work at the same time creeping in the opposite direction. A full chisel stroke as at B minimizes this tendency while a paring cut aggravates it as indicated at C. A good method of working, which eliminates possible tapering at the ends of the mortise, is shown at D where the two end cuts are made first. A continuous running cut, E, is also satisfac-

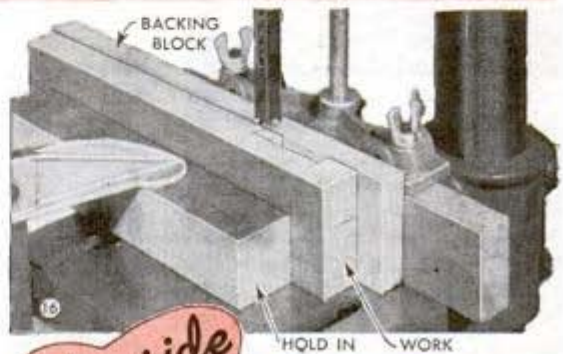
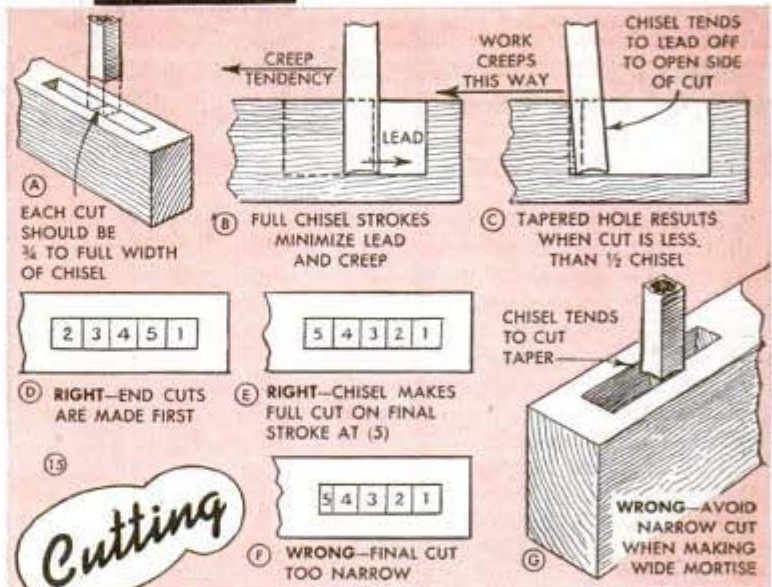

The side mortise

Tendency of chisel to run out in cutting side mortise is prevented by use of backing block



A Make assembly of legs four-square with best surfaces outside. Mark outside facing edges and cut rails after mortises have been made

B Select any one leg and lay out position of mortise on the two sides not marked, taking measurements from the face sides of work

C Arrange legs on bench with all marked (face) sides down and away. The master leg is at front and is used in setting drill press

D Advance chisel to correct depth as indicated by mark on end of master leg. Clamp quill in this position and set stop-rad nuts

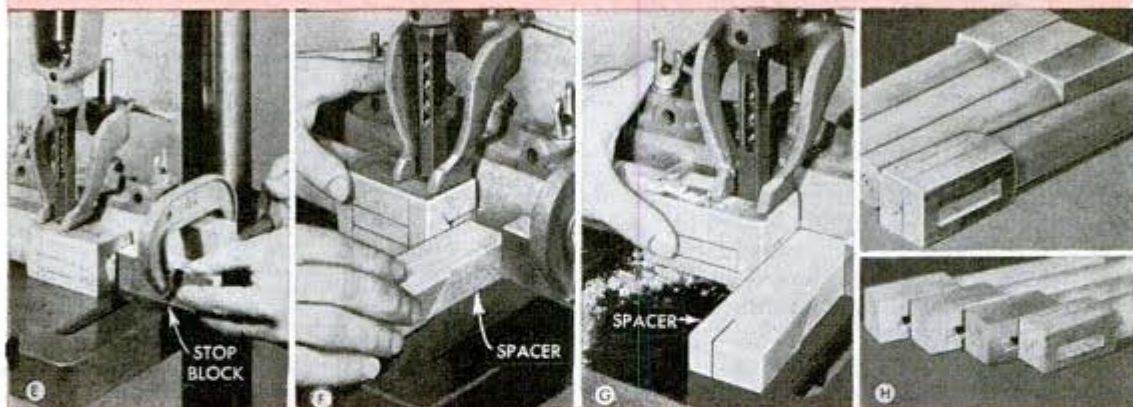

E Advance the chisel to contact work at end of mortise. Adjust fence to suit and clamp a stop block to the fence to limit travel of cut

F Advance chisel to opposite end of mortise. Use spacer block between stop block and end of work. Recheck travel and fence setting

G Cut the mortise. For average work it's best to make the two end cuts first, then clean out the remaining wood between the cuts

H Turn work end for end and replace on bench with marked (face) sides down and away. Cut mortise on top side of remaining pieces

tory providing the final cut is nearly full chisel. The wrong way of working is shown at F, where paring final cut may cause tapering. Similarly, a wide mortise should be made with two or more equal rows, and not one thick and one paring cut as at G.

Side mortise: This is another example where provisions must be made to prevent the natural tendency of the chisel to lead out. In this case a backing block of the same width as work provides solid support, as shown in Fig. 16. Both the work and backing block are held by means of a "hold in" which is clamped in place.

Work schedules: A definite schedule of operations speeds the job and results in clean work. One of the most important schedules in craftwork is concerned with the making of tables, chairs and similar work. A schedule for this is illustrated and described above.

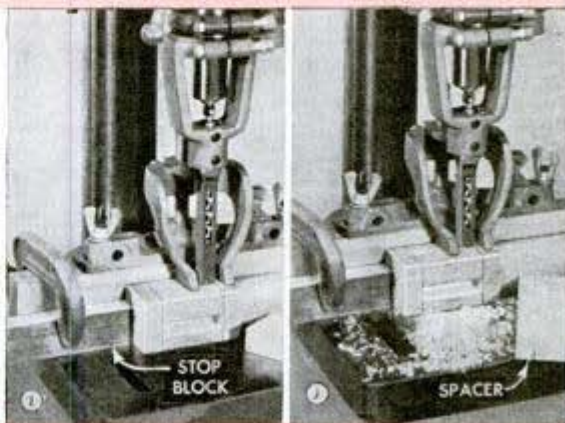

I Pick up the master leg and place it on drill table in the same position as it occupied on bench. Remove the stop block and clamp at opposite end of fence

J Cut the mortise. Repeat on other legs. Note in all cutting that the legs take same position they occupy on bench—always with face sides down and away

Removable Cradles Hold Drums On Warehouse Trucks

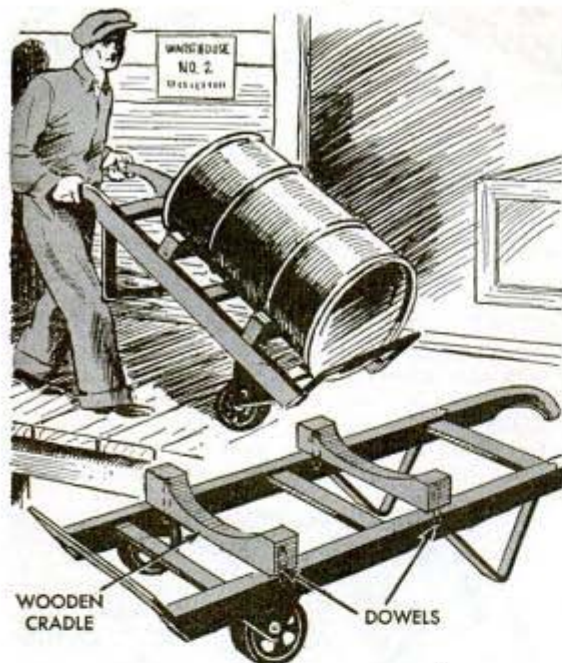

In a warehouse where drums, barrels and boxes had to be moved with the same trucks, removable cradles were made for the trucks so that the drums and barrels could be moved without holding them. The cradles were shaped from blocks of hardwood and were provided with dowels which fitted into holes drilled in the truck side pieces. In this way, the cradles could be put on or taken off in a moment.

A. H. Waychoff, Phoenix, Ariz.

Paper Gaskets Kept From Drying

Paper water-pump gaskets will not dry out when removed from the car if a coat of heavy oil or grease is applied as soon as they are taken out. Such a coating will also eliminate shrinking and curling, so that the gaskets can be used again if new ones are not available.

Honing Pencil-Sharpener Cutters

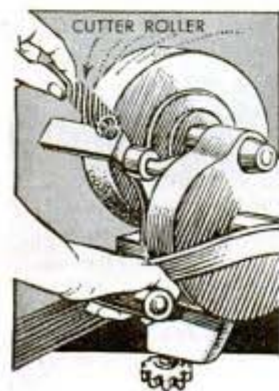

Roller cutters on pencil sharpeners, like other cutting tools, must be sharpened occasionally. To do the job easily, remove the cutters, insert a nail long enough to provide a good grip, and hold one roller at a time against an emery wheel so that the

roller rotates while being sharpened. The roller should be held at an angle, putting the cutting edge of the flutes straight in relation to the wheel, which must, of course, run against the edge, not with it.

W. E. Osmundson, Albert City, Iowa.

Sliding Parallel Has Extension Pin

You can make your own set of sliding parallels and besides add an extension pin that will enable you to obtain measurements beyond the normal range of the gauge. Use tool steel, and when milling or shaping the dovetail, recess a channel, shown at A, on which setscrew B will seat to lock the gauge. Extension pin C is a length of $\frac{5}{8}$ -in. tool steel threaded to screw into the upper surface as shown. Several of these of varying lengths should be made so that a full range of measurements can be obtained by adjusting the height of the pin.

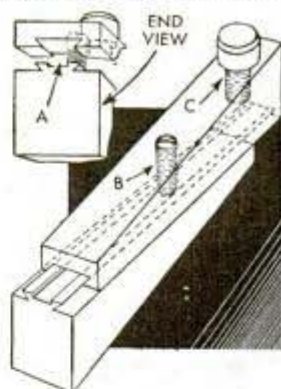

H. D. Chapman, Mt. Rainier, Md.

Sinker Removes Snarls in Fishline



The next time your fishline becomes snarled and knotted, try this simple method of freeing it quickly. Open one eye of a lead sinker and use it as a hook to pick out the tangles and knots.

Receptacle in Wire Waste Basket For Tiny Pieces of Waste

In an office where bits of paper, pencil shavings, etc., passed through wire-mesh waste baskets and were scattered over the floors, the janitor attached receptacles to the baskets to receive these waste particles. The receptacles were clean tin cans cut at the tops to form tongues, which were bent down to hook over the edge of the baskets.



Simple Tractor Level Saves Time in Terracing

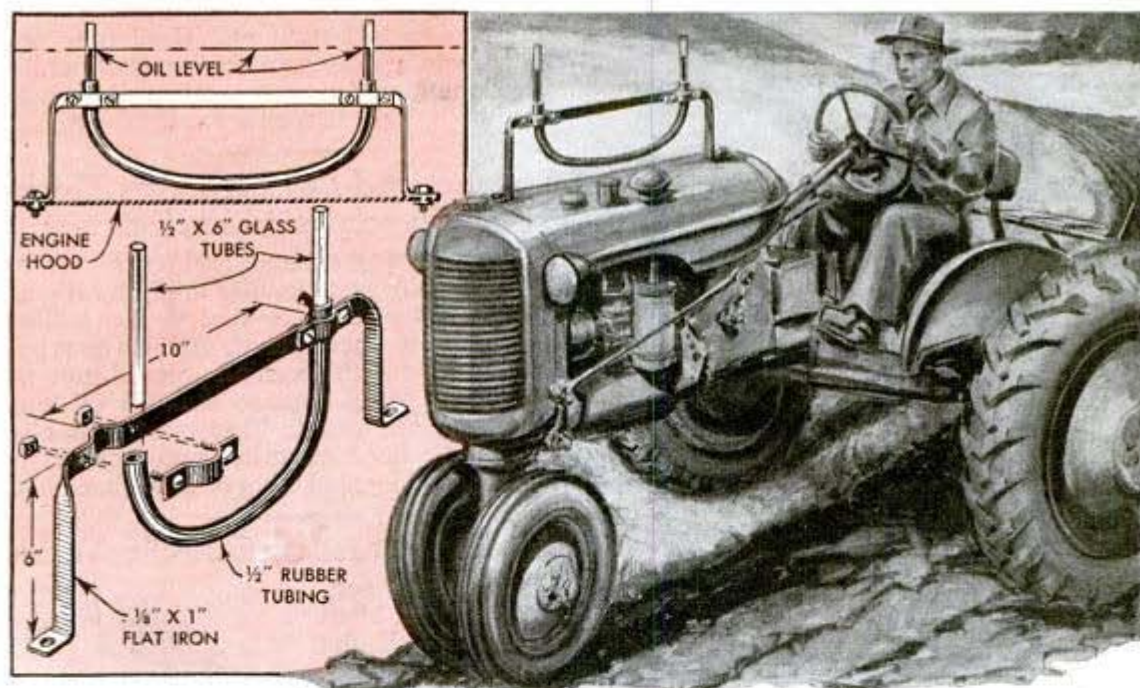

This improvised level enables the tractor driver to lay out terraces across medium slopes quite accurately. To assemble it, drive the tractor onto a level surface and attach the flat-iron bracket to the engine hood, centering it along the length of the hood. Then, assemble and clamp the rubber and glass tubes in place as indicated, and pour in enough No. 20 engine oil to rise about halfway in each tube. Adjust the height of the tubes until the oil level measures exactly the same distance from

the top of each. When laying out a terrace, the driver guides the tractor by watching the level of oil in the tubes. Some farmers using this device make an idle trip across the slope with the tractor moving very slowly to assure an accurate layout before starting to grade. Distance between the tubes is given as 10 in., but this may be more if desired. On some tractors that have low seats a greater distance between the tubes will make the level easier to read.

W. C. Lammey, Sandwich, Ill.

Reflector Assembly Clips on Rear Bumper of Towed Car

In the absence of usable taillights on some wrecked cars, the driver of a tow truck uses a number of red reflectors, which are mounted on a wood strip. This is fitted with a couple of metal clips so that it can be instantly attached to the rear bumper of the towed car. The clips are shaped from spring steel or other springy material and are screwed to the reflector strip as indicated.

Stopping Rear Main-Bearing Leak

When a rear main-bearing leak is caused by seepage past the surfaces of the bearing cap and block, the leak can be stopped by covering both mating surfaces with shellac.

☐ The square pieces of steel used in band-saw guides should be turned over at periodic intervals to equalize wear and prevent cutting deep ridges in the guides.

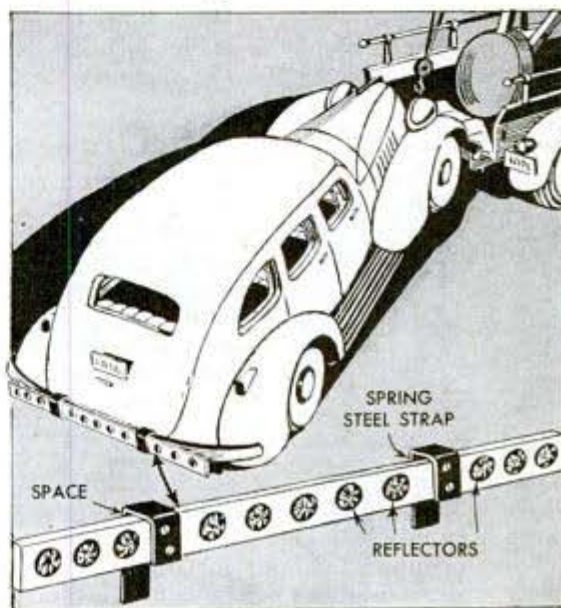

Turning of Small Logs in Sawbuck Avoided With Sickle Sections



To keep small logs from rolling or turning in a sawbuck, screw a couple of sickle sections to the sawbuck as shown so that the logs will rest on them. Sections of the self-sharpening type which have fine teeth along their edges are best for this purpose.

Oil Line Clips Are Held Firmly By Valve Grinding Compound

To keep wire clips and oil line brackets, held by cylinder-head bolts, from turning when screwing down the head, I put a small amount of coarse valve-grinding compound on the under surface of each clip and bracket. Then no matter how tightly I screw the nuts down on them, they remain in place.

Charles Swope, Danville, Pa.

Chair Altered for Injured Person

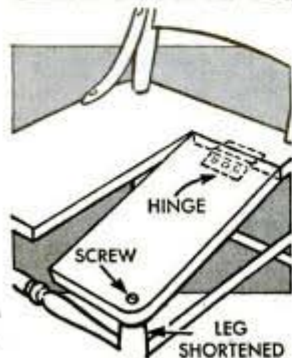

By shortening the upper end of one leg of a chair and then tilting one half of the seat you can adapt it so that a person with a stiff knee or injured hip may sit in it normally against the back rest without discomfort. To determine

how much to shorten the leg, the intended occupant should sit on books or some other elevation placed on the chair

with the injured leg assuming its most comfortable position. The distance from this height to the chair seat will indicate the amount to be cut off. Used thus, the hinge acts merely as a means of attaching the sloping seat section and not as a pivot.

F. B. Veirs, Jr., Oakland, Cal.

Hot Linseed Oil Preserves Floors Of Wagon and Truck Boxes

Floors of wagon boxes and trucks can be preserved by occasionally applying a coat of pure linseed oil, heated to the boiling point and brushed on hot. After a coat has been applied, the vehicle should not be used for several days so that the oil may penetrate the wood. This treatment also makes the floor smoother and less apt to be damaged by shoveling or other hard use.

Center Located on Odd-Size Work

Locating a center of work often is difficult if the width of the work is not readily divisible into halves. A simple way to do it is to lay a rule diagonally across the work with the 1-in. mark at one edge and the 3-in. mark at the other. The

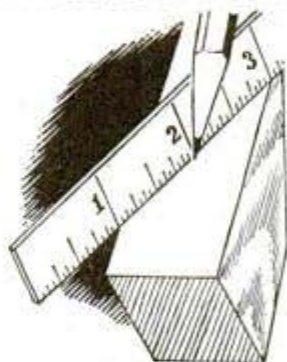

2-in. mark then will accurately locate the center. This method can be used to mark off the work into any number of divisions by moving the rule so that the distance between the edges of the work is divisible by the required number of sections.

Spring-Wire Guide Locates Holes In New Brake Lining

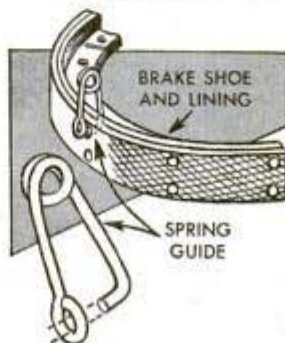

As an aid in positioning holes to be drilled in new brake lining so that they will coincide with the rivet holes in the shoe, bend a piece of spring wire, of the same diameter as the holes, to the shape shown, with an eye at one end

into which the tip, bent at a right angle, will fit. In use, place the brake lining in position, insert the tip of the guide in the rivet hole and press the eye against the lining. Then drill through the eye.

An ELECTRONIC TUBE Is a Valve

By F. L. Brittin

CONTROLLING the flow of current through an electrical circuit as a valve regulates the flow of water through a pipe, the electronic tube is actually an electrical valve. Unlike the water valve, the electronic tube has no moving parts; its action is completely electrical, therefore it operates at the speed of light. Some tubes smoothly regulate the current flow, others can instantly stop or start it.

All electronic tubes are basically the same; the General Electric FG-57 "thyatron" is a commonly used type. Symbol **Fig. 1** shows its heater that heats the cathode which gives off electrons, as illustrated in **Fig. 2**; the dot indicates a gas filled tube. The anode (plate) is the other end of the conductor in the tube; when a positive voltage is applied to it, the plate attracts billions of electrons that are "boiled" off the cathode as in **Fig. 3**, and current then flows through the tube. **Fig. 4**, negatively charged, the plate cannot attract electrons.

Fig. 5 symbols illustrate what the grid (control electrode) does: (1) when more than a certain critical value of negative voltage is applied to the grid, electrons cannot reach the plate; (2) when negative voltage is reduced, electrons flow to the plate; (3) flow stops when plate voltage becomes negative; then cycle repeats. **Fig. 6** illustrates ionization: (1) an electron is knocked out of a neutral gas molecule; (2) a molecule having lost an electron is positive; (3) these positive molecules are called ions; (4) when enough ions form they neutralize the negative field, thus permitting more electrons to reach the plate for greater current-carrying capacity.

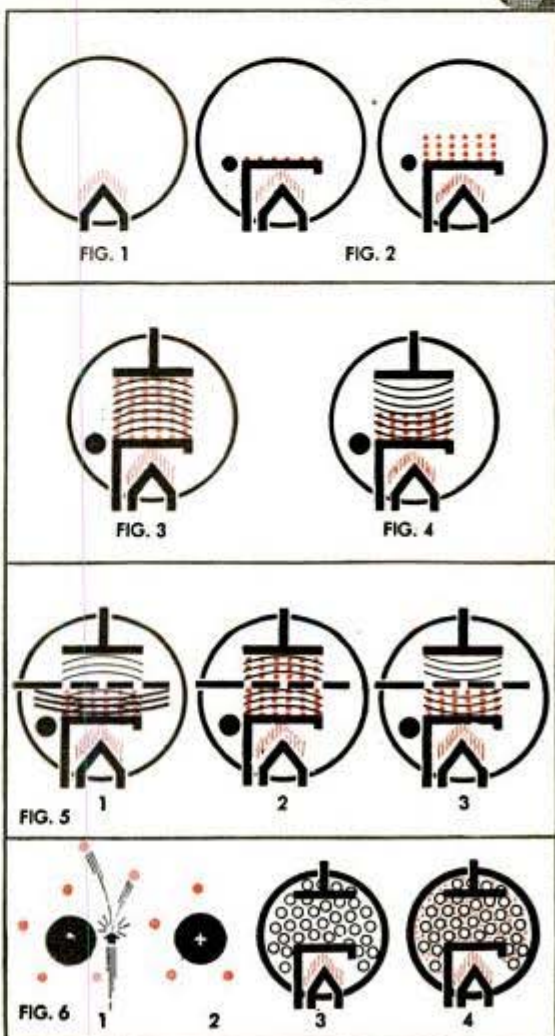
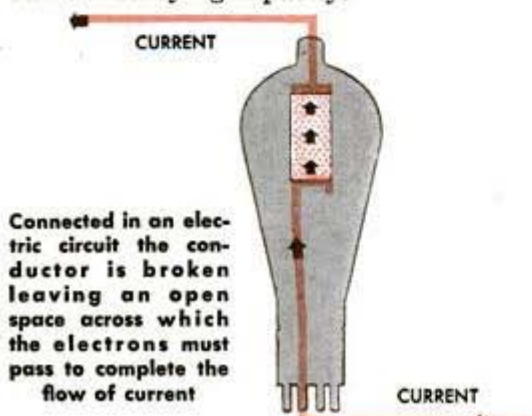

DE LUXE CABINET for Small Set

By C. E. Troutt

ORIGINALLY made to replace a broken plastic radio case, this unusual cabinet may be adapted to any size of table-type receiver chassis, and your own initial can be used to decorate the speaker grille. To produce the two-tone effect, the top, front and bottom may be made of any dark colored scrap hardwood such as mahogany or walnut, and the veneered panels should be of a light color such as aspen or primavera.

Photos A and B show the completed cabinet; an "exploded" rear-view sketch of the assembly appears in Fig. 1, and the front panel details are given in Fig. 2. The $\frac{1}{4}$ -in. front and $\frac{5}{8}$ -in. top pieces should be veneered on both sides to prevent warping; the bottom is 1 in. thick and the sides are of $\frac{3}{4}$ -in. plywood.

Make a template of thin wood for the recessed corners and veining line around the speaker opening. Note that the straight veining lines all stop short of the openings and corner designs. Fasten the template to the back side of the front panel as shown in photo C, then place the work, template down, with one corner of the opening over the pin in the router table. The light veneer being thus cut away, the darker wood will show through. The lace mold, detailed in Fig. 2, is made of a single thickness of dark veneer on the router. Emery boards such as ladies use in manicuring are handy to remove the burrs in the small openings. This mold overlay is glued in place before the top and bottom are attached. Finish with clear lacquer or varnish.

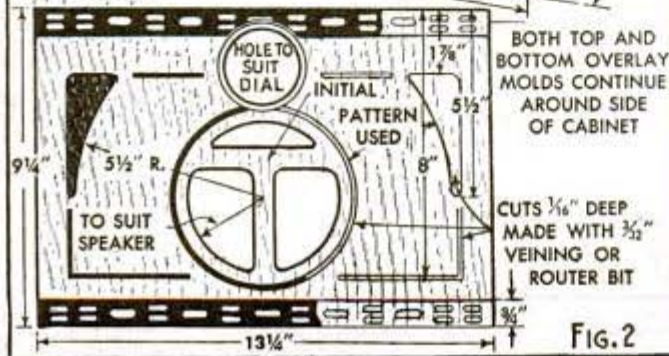
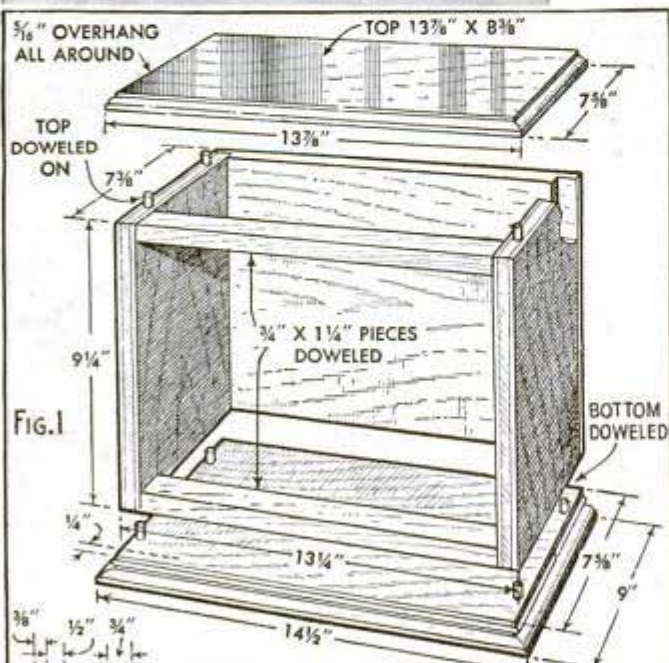
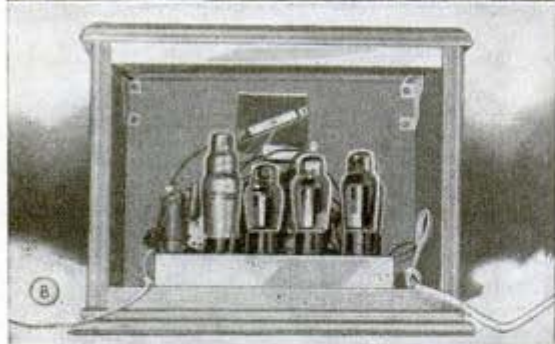

Meet the Men

WHO USE YOUR BATTERIES!



The Navy and Merchant Marine send rapid ship-to-ship messages by battery-powered flasher signal lights when radio might give a ship's position to the enemy.



It's difficult to locate men drifting in the sea! Water-tight battery lights on buoyant lifesaver suits have saved the lives of many torpedoed Merchant seamen.



For emergency communication by voice, the Merchant Marine uses a portable megaphone to broadcast orders and instructions. Dry batteries power the megaphone.



Two men and a bazooka make a winning team! But it takes large quantities of ammunition and dry battery power to keep these portable, hard-hitting weapons firing.



Deadly flamethrowers are blazing the road to Victory! Dry batteries create the spark that sends these efficient weapons into instant, flaming action against the enemy.



The Signal Corps man with a Walkie-Talkie has freedom of speech as long as he has plenty of dry batteries! Handie-Talkies are also powered by war batteries.



When they come Home — Burgess Batteries will be back again, too ...powering flashlights, radios, telephones, instruments and controls for millions of homes, farms and industries throughout America.

BURGESS BATTERIES

IN THE NATION'S SERVICE

BURGESS BATTERY COMPANY, FREEPORT, ILLINOIS

PAY-OFF ON A PURPOSE

Allison's objective for 30 years has been to exact the most work from the fewest ounces of metal. ★ The pay-off on such effort can be appraised in the performance of the 65,000 smooth-running Allison engines powering

Army Air Forces planes on every fighting front. It can be seen in the powerful 24-cylinder Allison "3420's".

★ Allison's rare proficiency in precision with metals will pay off, too, in the planes of peace — emphasizing those qualities which make your flying enjoyable ★ And this same precision will endow any Allison product with the ability to serve you precisely right.

POWERED BY ALLISON

P-38—Lightning
P-39—Airacobra
P-40—Warhawk
A-36 and P-51—Mustang
P-63—Kingcobra

LIQUID-COOLED AIRCRAFT ENGINES

Allison
DIVISION OF

Indianapolis, Indiana



Every Sunday Afternoon

GENERAL MOTORS SYMPHONY OF THE AIR — NBC Network

KEEP AMERICA STRONG
BUY MORE WAR BONDS

"HARLEY-DAVIDSONS *Really* TAKE THE

ROUGH TRAILS!"

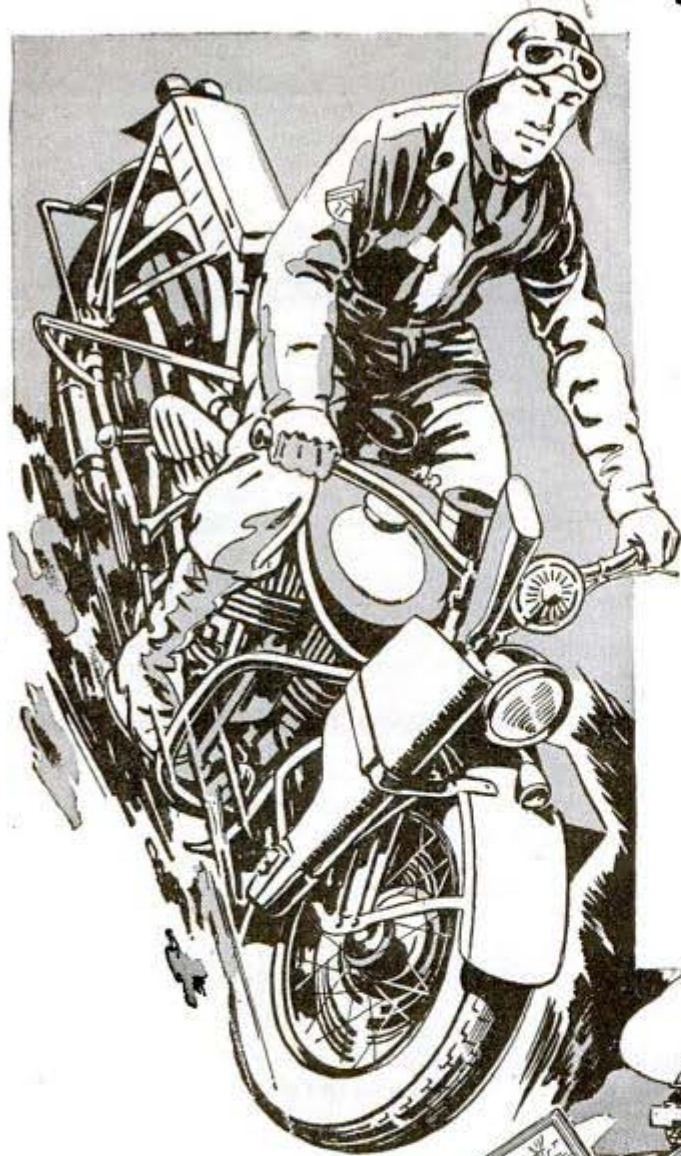

FROM somewhere on the European front comes this letter from Pfc. Dick H. — "In the Signal Corps we use Harley-Davidsons for dispatches and they really take the rough trails. Here it isn't all sunshine, either, so we have plenty tough going. But Harley-Davidsons *get the messages through*. In one of our packing boxes, we found a note from one of your workmen, quote: *We won't quit building till it's over over there* — A friend, unquote. We really like that note and like it fine!"

That's right, Dick — we **WILL KEEP ON BUILDING** — so all you fellows can end the war *quicker* — and come home to enjoy motorcycling days on *your own* Harley-Davidsons.

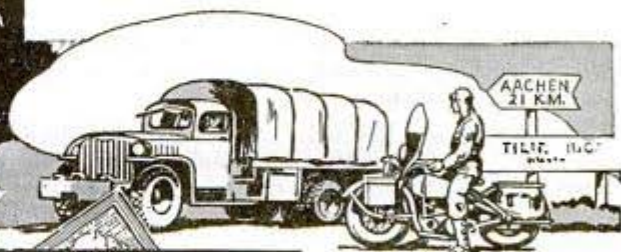

HARLEY-DAVIDSON MOTORCYCLES

HARLEY-DAVIDSON MOTOR CO.
Department P, Milwaukee 1, Wisconsin

Please send at once free copy of 24-page
"Enthusiast" Magazine, filled with motor-
cycle action pictures and thrilling stories.

Name.....

Address.....

City..... State.....



For more Speed
in the "Tight Spots"

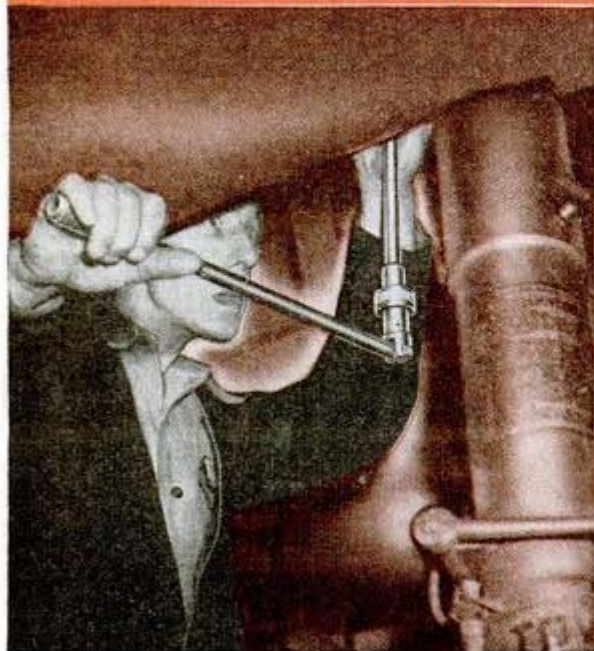

— USE FLEXIBLE, VERSATILE SNAP-ON "COMBINATIONS"

Remember back when "tight spots" were roundly damned as "bad design". Today they are the accepted penalty of *good design* . . . the unavoidable result of packing incredibly high performance into sharply restricted dimensions.

And for the toughest tight spots there are modern Snap-on tools . . . versatile "combinations" that reach into deepest pockets, grip hidden nuts securely, turn them easily, swiftly, solidly. The instant adaptability of Snap-on sockets, handles and ratchets, multiply the range of a compact Snap-on kit into hundreds of speed tools for specialized applications. *And frequently save the cost of specially designed one-job tools!* There are 3,000 Snap-on tools for production, assembly and maintenance operations. Write for catalog of the complete Snap-on line.

SNAP-ON TOOLS CORPORATION, 8062-C 28th Ave., Kenosha, Wis.



Putting Air to Work

(Continued from page 63)

The notable "pontoon tow bridge" spanning a canal from the plant of the Odenbach Shipbuilding Corporation into Lake Ontario uses compressed air to inflate lifting pontoons, which raise the bridge above roadway level to where it can be swung into a dredged bay, to permit exit of ships into the lake.

Beneath many of the city streets are pneumatic tubes which whisk mail, messages and packages from place to place. The Pentagon Building in Washington is equipped with 25 double pneumatic tube lines, each 1,000 feet long. London, Paris, Berlin, New York and Boston have pneumatic conveyor systems under the street to carry mail, 25 miles of tubes under New York streets and six miles under those of Boston. The New York system handles more than 7,000,000 pieces of mail a day.

In certain chemical plants, where reactions are carried on at extremely low temperatures, compressed air, from which the last trace of moisture has been removed, is used to operate valves and other controls that are subjected to freezing temperatures.

Some processes require pressures up to 6,000 pounds per square inch, and alloys of high tensile strength and exceptional resistance to corrosion are necessary for building these machines.

Compressed air is used for such diverse purposes as the agitating of pickles in canneries, spraying insects, regrooving tires, moistening tobacco in cigarette factories, operating milking machines, stopping fires in gas mains, and aerating sewage.

From the diver, fathoms below the surface of the sea, to the airplane pilot, swinging down his landing gear for an emergency landing, air under compression has uses as diverse as the activities of modern, mechanical-minded man.

Bridging the Army's Water Hazards

(Continued from page 25)

Walking over the muddy bank, the major hit on the solution. Ordering two bulldozers brought up, he set them to cutting a deep path in the bank by pushing the earth from the bank into the river.

The rain continued without a letup.

The bulldozers gnawed at the brown earth, which turned to slushy mud when rolled over several times by the blades of the roaring tractors. Little by little the earth was pushed into the river and a val-

(Continued to page 150)

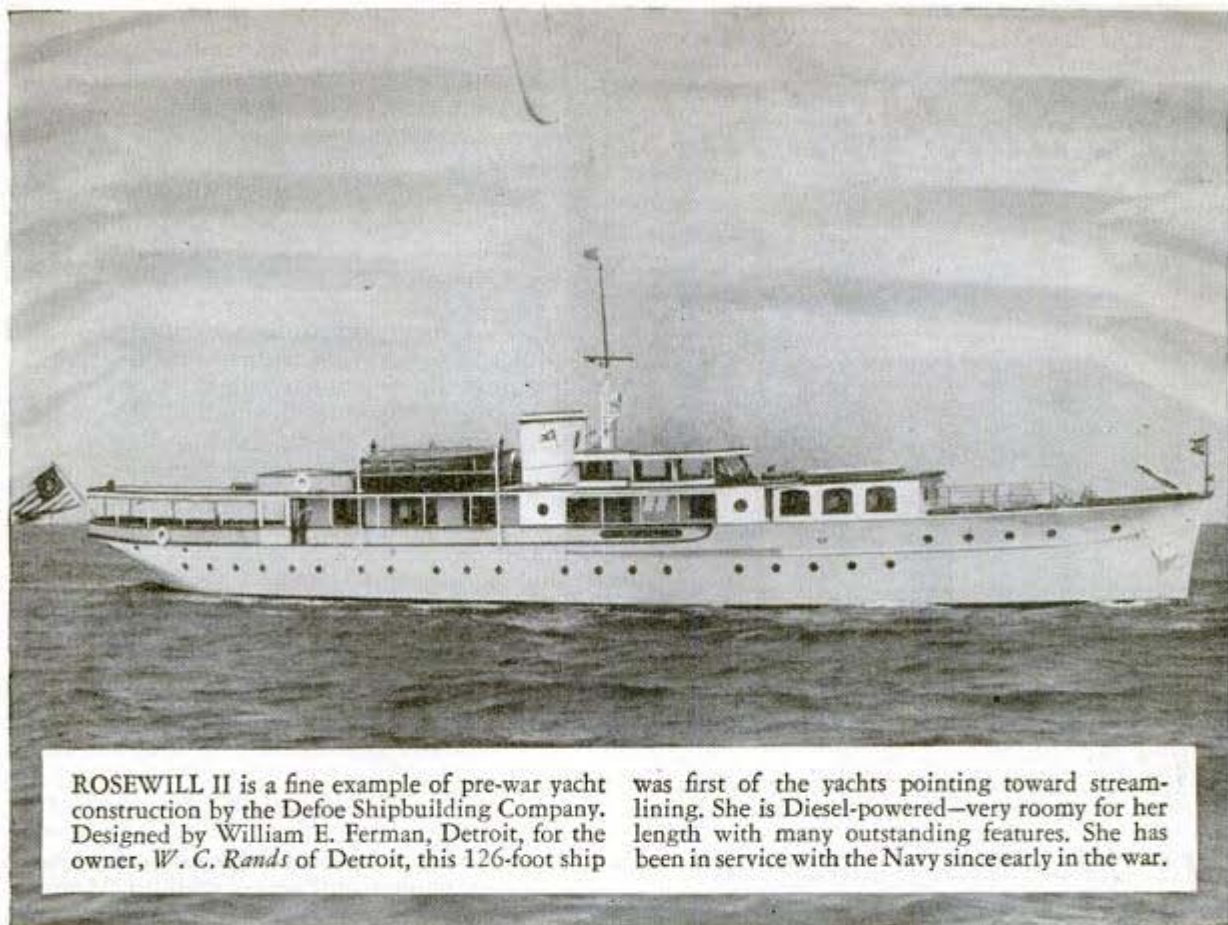

ROSEWILL II is a fine example of pre-war yacht construction by the Defoe Shipbuilding Company. Designed by William E. Ferman, Detroit, for the owner, W. C. Rands of Detroit, this 126-foot ship

was first of the yachts pointing toward streamlining. She is Diesel-powered—very roomy for her length with many outstanding features. She has been in service with the Navy since early in the war.

When It's Clear Sailing Again

In these crucial days every shipbuilder is producing only for Victory. So Defoe's job for the duration is to build fighting ships for the Navy. But some day there'll be clear sailing again for pleasure vessels. Then, it will be anchors aweigh for safer, swifter, more beautiful new yachts, embodying new materials, new power plants, new comforts and economies. One of the most interesting developments for ocean-going yachts will be seen in the advance of instrumentation. This will include the magic of radar, improved radio, electro sounding and gyro-compass control—combining the most perfect ship protection in the history of the sea. Postwar private craft built by Defoe naturally will reflect this organization's forty years of yacht-building experience as well as the new techniques and high standards of precision craftsmanship developed here in record-breaking construction for the Navy. Defoe's Yacht Division invites correspondence and will give individual attention to all inquiries.

CUSTOM YACHT DIVISION

DEFOE SHIPBUILDING COMPANY, BAY

CITY, MICHIGAN

Defoe



Four White Star Renewal Citations
now decorate the Navy "E" Award
won by Defoe workers.

BACK THE ATTACK
—BUY WAR BONDS

SHIPS FOR VICTORY
SERVANTS FOR PEACE

Avoid another winter of...

Frosted Friends



STEP UP HOME COMFORT WITH
BALSAM-WOOL ATTIC INSULATION!



Icy entertainment—freezing guests! Even though fuel must be saved, you can avoid those bone-chilling evenings. It's easy and inexpensive to make your home far more comfortable—now—by installing Balsam-Wool Attic Insulation.

Laid like a rug in your attic, Balsam-Wool will save up to 20% in fuel . . . by keeping precious heat from escaping through the roof. And Balsam-Wool has everything an insulation needs to give you permanent results. It's windproof, moisture-proof and fire resistant . . . proved in thousands of American homes.

GUARANTEED SATISFACTION—Balsam-Wool—"the Aristocrat of Insulation"—is sold under a money-back guarantee of complete satisfaction. See your *lumber dealer* about buying Balsam-Wool on easy monthly payments—or, mail the coupon for complete information.

Balsam-Wool

SEALED ATTIC INSULATION

Balsam-Wool . . . Products of Weyerhaeuser . . . Nu-Wood

WOOD CONVERSION COMPANY
Dept. 210-8, First National Bank Bldg.
St. Paul 1, Minnesota

Please send me more information about modernizing homes with Balsam-Wool and Nu-Wood. I am a home owner , renter , architect , contractor , student .

Name

Address

City State



ley was formed. This valley, extending to the river's edge, was to be the approach. It became longer as the earth piled up in the river in front of the machines. In two hours the river was narrowed by almost 50 feet, the swirling waters eating a little of each bladedful pushed out into the stream.

With 50 feet taken up by the built-up earth embankment, the pontoons available could span the river.

Anchoring the pontoons was troublesome. Floating logs and debris continually hit some of the pontoons, knocking them out of line, and the engineers jumped from one to the other to tighten the bolts holding the treadway to the floating rafts.

The few lights permitted were useless, and more by feel than by sight the engineers bolted the last section and took up the slack on the guy wires and upstream anchor cables.

At dawn the trucks of one regiment arrived and dispersed in the vicinity of the engineers' camp while the damage caused by the rain to the earth runway and approach was repaired. A timber corduroy road, made of logs laid across the roadway, was built.

Precisely at 7:00, while the engineers were milling around their field kitchens drinking coffee, the antitank company with its light trucks and jeeps pulling 37-mm. guns began to cross. The rifle companies and signal trucks followed.

A few hours later the noise of battle on the far side was evidence that our forces had caught up with the enemy—thanks to the engineers!

Black Gold Rush

(Continued from page 69)

nected by chain and sprocket to the huge balloon front wheels which do the driving. Although the driver's seat is near the front, it is the rear wheels which guide the buggy

(Continued to page 152)

**Model Builders
Attention!**



	V	V-2	V-3
Hex	1/2"	3/8"	3/16"
Thread	3/8"-24	1/4"-32	1/4"-32
Thread Length	7/32	7/32	3/32
Weight, Grams	8	3 1/2	2 1/2

Actual Size V-Plug

Champion spark plugs for model gas engines give the same dependable performance as regular Champions. Silliment sealed. Sillimanite insulator. Alloy needlepoint electrodes for easy starting. One piece construction.

CHAMPION

SPARK PLUG COMPANY • TOLEDO 1, OHIO

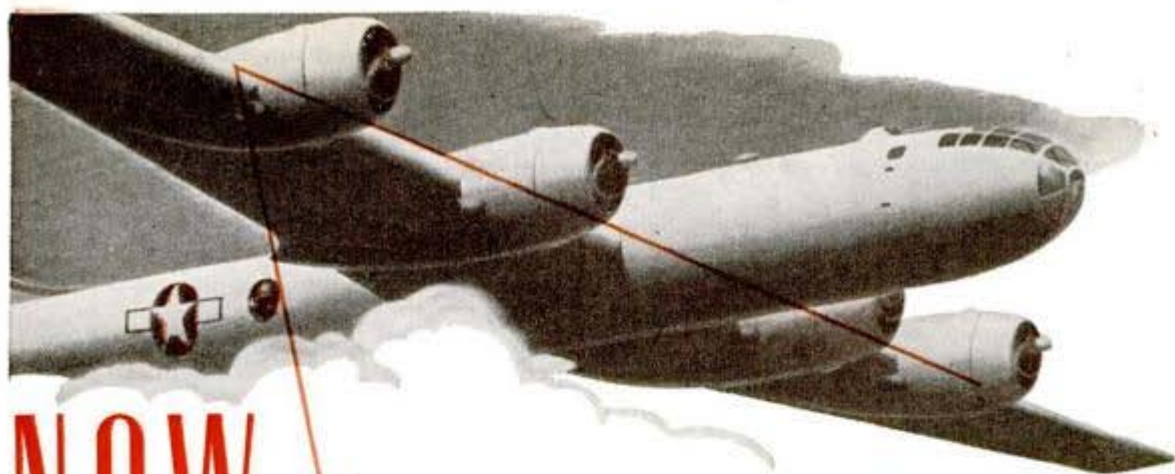

NOW

**... AUTOMOTIVE SPARK PLUGS WITH
AIRCRAFT PRESTIGE AND EFFICIENCY**



Bringing the same performance, dependability and extreme quality to automotive spark plugs that are required of spark plugs for a high-flying Super Fortress is the latest achievement of Champion Spark Plug engineers. Champion's research and engineering background, because it is exclusively devoted to the production of better spark plugs, brought invaluable experience to aviation from the automotive field. But wartime aviation put spark plugs to many extreme tests—stratospheric flight, supercharging, violent temperature fluctuations, 100 octane gas—all of which Champion-Ceramic Aircraft Spark Plugs met with extraordinary success. *Today* these same qualities, the same basic materials, precision manufacturing and design are yours in spark plugs for your car. Demand Champions, the spark plugs with aircraft prestige and efficiency. Champion Spark Plug Company, Toledo 1, Ohio.



Buy War Bonds
More Than Before

DEPENDABLE

**CHAMPION
SPARK PLUGS**

The Best Marlin RIFLES SINCE 1870

● Marlin is ready to produce its outstanding line of accurate, dependable .22's as soon as war contracts permit. They will be the best Marlin in history—built to standards of performance and long life that made the name famous. Now is a good time to look over the Marlin line. Send for catalog today!

**Illustrated: Model 80-DL
CLIP MAGAZINE REPEATER CAL. .22**
8 shots "at a clip" for small fur-bearing game and pests. Recommended for target practice by N.R.A. A man-sized gun at a low price.

Model 81-DL 25-shot Repeater. Bolt action tubular magazine .22 for general purpose hunting of small game, without need of frequent loading.

Model A1-DL Automatic .22. Six quick shots at fast-moving small game, crows, hawks, etc. Shoots regular and high speed .22 long rifle.

Model 39-A. Lever Action Repeater. By many considered world's best all-around light rifle. Only lever action .22 made. All working parts exposed by turning of single hand screw.

THE
Marlin
FIREARMS CO.
NEW HAVEN, CONN

SEND FOR CATALOG
Handsomely illustrated pre-war catalog, with full specifications of Marlin Guns.

THE MARLIN FIREARMS CO.
New Haven, Conn.

Enclosed 3c for mailing catalog of Marlin Guns.

Name _____

Address _____

PM-3

WATCH THE INFANTRY ——— THEY CARRY THE GUNS!

on land and act as a rudder in the water. Land speed ranges from four to a maximum of eight miles an hour; speed in water is appreciably lower.

The balloon wheels are seven feet in diameter, three feet wide, and weigh approximately 500 pounds each. The rear wheels, being smooth, are only six feet in diameter and weigh about 350 pounds. They are three feet wide at the hub and taper to a two-foot width.

Concave sections on the face of the front wheels serve to form traction lugs which enable the buggy to move through mud and slush. Because of their great width the four wheels keep the buggy from sinking in mud and because of their buoyancy they hold up the buggy so that the water level remains about 12 inches below the floor.

An extra feature for extremely difficult operations is a series of two-by-eight-inch wooden paddles which are attached by bolts to special flanges on the front wheels and extend four feet beyond the outer side of the wheels to give extra traction in high marsh grass or water.

Socony-Vacuum and Cities Service have another remarkable drilling operation on a man-made island eight miles off Charlottetown, Prince Edward Island, Canada. Drilling crews battled snow, ice, rain, fog and a 10-foot tide. Before drilling was begun, an island had to be built. Eleven miles of logs were used to construct the walls of a crib and 8,000 tons of rock and concrete were put in it to form a surface area of 9,000 square feet.

Among other innovations being tried are smaller-type portable rigs and well cleaners carried from site to site on trucks.

Standard Oil of New Jersey is experimenting along two lines which may soon change the exploration picture. These are really twin laboratory methods, soil microscopy and geochemistry, both of which are directed toward the discovery of hidden oil by extremely minute variations in the oil and gas content of soil.

This research seeks to make it possible to distinguish the difference between gas and hydrocarbon materials seeping upward from an oil pool and the similar material forming near the soil's surface. If it is successful, the oil prospector of the future may be a chemist in a laboratory. It is even possible that the little fellow, in years to come, will be able to buy an "oil kit" and make his own tests of likely spots. Many of them now depend on doodlebugs and hunches, but there are definite ways in which an oil strike can be indicated without scientific equipment. The simplest of

(Continued to page 154)

Delta Homecraft Power Tools illustrated are Delta Scroll Saw and Delta Lathe.

More Happiness for your money

—greater hobby satisfaction...when you work with quality Delta Homecraft* Power Tools

Trouble-free performance assures you of lots of homecraft fun and healthful recreation...

If you could ask the thousands of Delta homecraft hobbyists the reasons why they prefer Delta Homecraft Power Tools, you would probably get many different, enthusiastic replies. But, taken together, they would all "boil down" into one word — *quality*.

Delta Homecraft Power Tools have always had a reputation for *quality* — "hidden values" in construction that mean you get more for your money.

You can't always see Delta quality with your eyes — and yet you can tell it's there!

For one thing, the *accuracy* of Delta Homecraft Power Tools proves they are

quality tools. You enjoy greater assurance of seeing a project turn out according to the plans.

The *dependability* of Delta Homecraft Power Tools means quality, too. A flick of a switch and they're ready to give you the economical, unflinching performance you expect.

And, because of quality, Delta Homecraft Power Tools are *safe* — meeting the highest safety standards of schools and industry.

To be sure that you enjoy a full measure of the pride and pleasure that comes from using your hands to make good-looking things, include *quality* power tools in your homecraft hobby plans — Delta Homecraft Power Tools!

Right now, save to make your dreams come true — and at the same time, do right by our fighting men — by buying War Bonds.



Delta's "hidden" construction values that give you more for your money:

- 1 Double-sealed ball bearings you don't have to worry about oiling, because they are lubricated for life.
- 2 Precision-bored bearing seats that assure accurate alignment of parts.
- 3 Bearings that are pre-loaded — an extra manufacturing operation that insures longer bearing life.
- 4 Precision-ground shafts, to assure true, accurate performance.
- 5 Dynamically-balanced pulleys, to eliminate annoying, damaging vibration.

HM-23

Free Colorful Delta Book!

Shows you how to get started in homecraft. Illustrates modern shop layouts — in color. Tells how manual hobbies aid mental health. Mail the coupon for your free copy of "Happiness Is In Your Hands."

*Trade Mark Reg. U. S. Pat. Off.



Tear out coupon and mail today!

THE DELTA MANUFACTURING CO.
680C E. Vienna Ave., Milwaukee 1, Wisconsin

Please send me my free copy of "Happiness Is In Your Hands" picturing the ideal creative hobby and telling how to get started in it.

Name.....

Address.....

City..... (.....) State.....

TRANSCONTINENTAL RECORD

Smashed!

by Army-Boeing-Wright

SEATTLE TO WASHINGTON—6 HOURS, 3 MIN., 50 SEC.

MORE THAN 383 MILES AN HOUR

AC Ceramic Aircraft Spark Plugs fired all four of the great Wright "Cyclone" engines which carried the mammoth Boeing-built Army transport 2,323 non-stop miles—and broke the speed record for planes of any size.

Achievements like this demand *utmost reliability*—the quality for which AC Spark Plugs have been known to motorists, operators of buses and trucks, yachtsmen, and farmers since 1908. This same reliability is also now serving our armed forces, in the air, on the ground, and on the water—and is keeping essential transportation on the job all over America.

AIRCRAFT SPARK PLUG →



AC
SPARK
PLUGS

SPEED FINAL VICTORY—BUY WAR BONDS

these is to watch for oil scum in water wells, bubbles in ponds which might indicate the gas is greater in volume than marsh gas, and the presence of tarry sands in stream beds.

A bit more scientific, but not requiring above-average intelligence, is the study of favorable rock formations, a project which may be pursued in most public libraries. In general, a dish or pan-shaped formation with solid rock below is necessary to hold the original oil deposit. These can be detected by outcrops of rock and an examination of their direction to see if they perform the same function as the rim of a pan.

If the outcrops are granite, the time has been wasted because the favorable kind of rock is sedimentary such as would be deposited in a sea bottom, since marine growth was necessary to produce the original oil. Up to this point of general exploration the amateur can get along as well as the oil company geologist. But since the oil-holding basin may be hundreds of miles across, the next job is to plot its shape.

Three scientific methods are most commonly used. A seismograph is used to record shock caused by explosive charges and reflected from solid rock. This gives depth and angle of the rock formation.

The gravity meter and magnetometer are other devices used for much the same purpose. The gravity meter works because the force of gravity is greater as registered near a solid mass of underground rock. The magnetometer is also deflected by such masses.

Not many people realize the United States is one of the few nations in the world where a man can strike oil below the ground and collect on it because of our system of free enterprise concerning mineral rights. After all, what fun would there be in a treasure hunt if you had to give the treasure away?

Sharpening the Navy's Camera Eyes

(Continued from page 42)

sance pictures are studied, and the important still photography division where hundreds of negatives and prints are handled every day.

The still division includes a color section which is equipped to handle the latest processes. Color photography is invaluable in reconnaissance for the detection of camouflage. The Japs are experts at jungle camouflage, but the color camera can make faded foliage stand out like a beacon.

(Continued to page 156)

2200

HORSEPOWER

in each wing

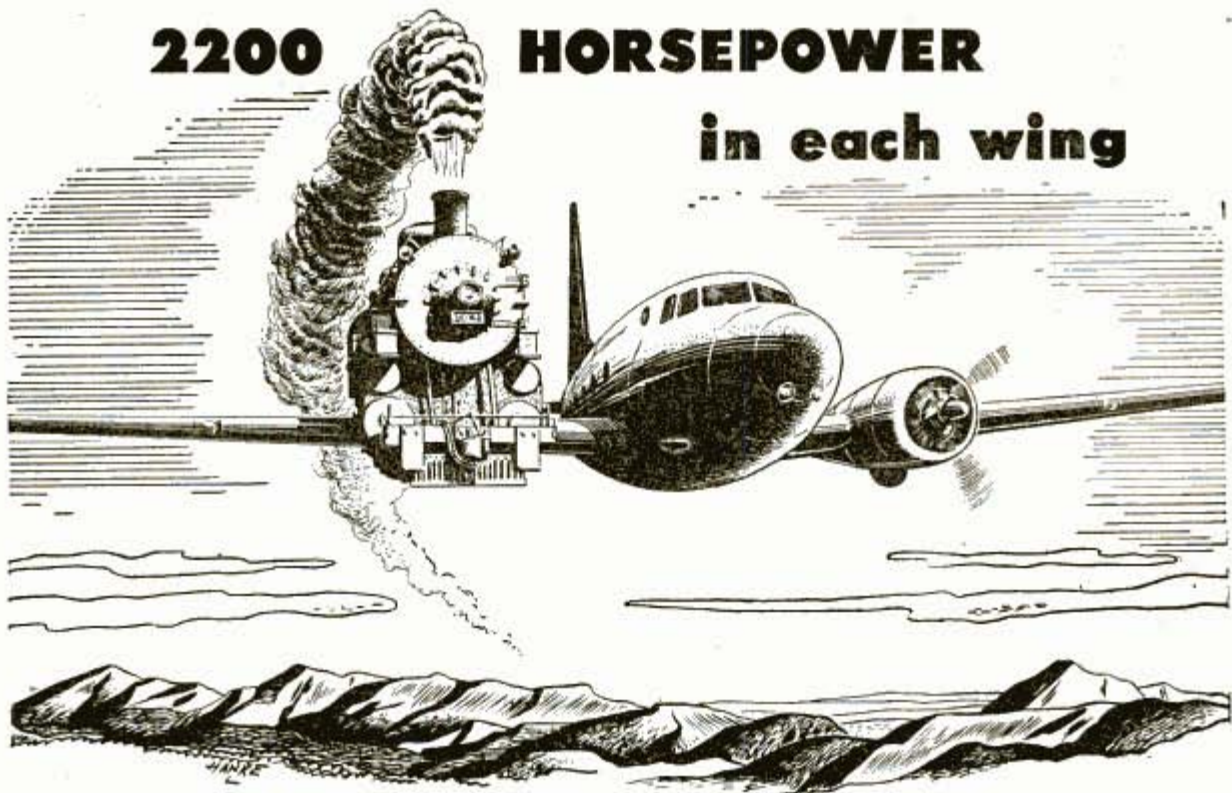

SHOCK ABSORBER: On the power strokes, each piston in a Wright Cyclone has to absorb a blow of 15,000 pounds, or a force equal to the weight of three elephants. The full weight of this force hits a piston face only $6\frac{1}{8}$ inches in diameter.



WEIGHT-KILLER: This is the Wright-designed forged cylinder head which cuts weight from aircraft engines. Stronger than cast aluminum heads, its extra power cuts weight per HP. This cylinder alone will turn out 150 HP, enough to power three training planes.

Equal in power, a locomotive and a Wright Cyclone aircraft engine make an amazing contrast in size and weight. Both develop 2,200 HP. Yet the Cyclone, with its 55-inch diameter and weight of only fractionally over a pound per horsepower, would fit easily into the cab of the 200-ton locomotive.

A vast difference in bulk is one reason why locomotives ride on rails while Cyclones fly. All aircraft power is a specialized field—tremendous power packed into small space at low weight, but Wright engines lead this field, for they are highest in power, lowest in weight. That's why Wright engines have powered leading planes for 25 years.

Write for "ENGINEOLOGY"

a 100-page booklet on the "Why" of engines

A complete, non-technical booklet on engines and their relation to planes and propellers. Describes operating principles of engines. Explains combustion, supercharging, ignition, carburetion. Just send twenty-five cents in stamps or coins to: Wright Aeronautical Corporation, Dept. P.M., Paterson 3, New Jersey.

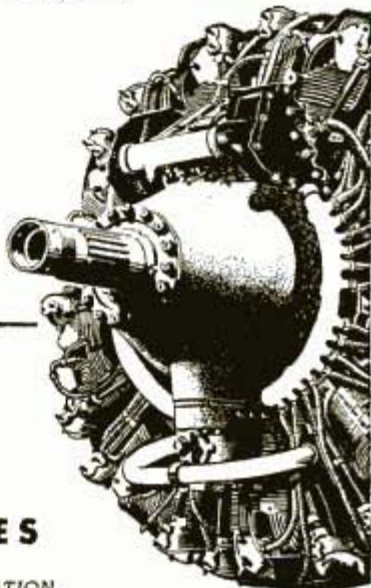

WRIGHT

AIRCRAFT ENGINES

A DIVISION OF CURTISS-WRIGHT CORPORATION

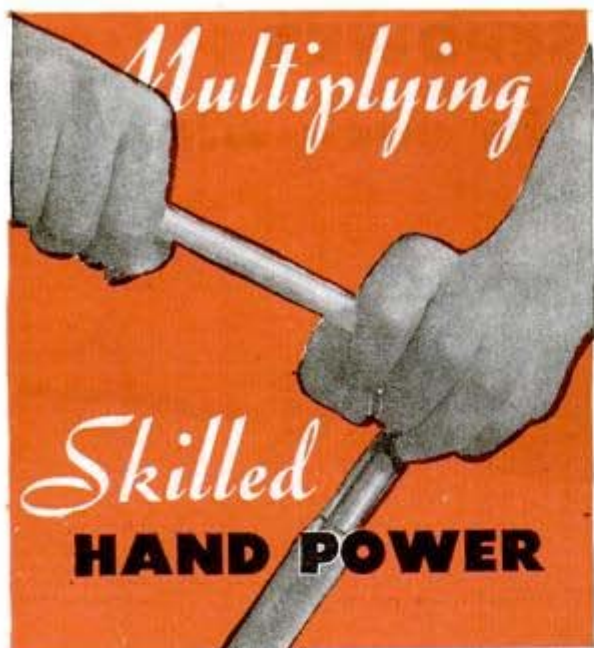

WILLIAMS' "Super-sockets" actually are more than wrenches; they are an extremely flexible system for multiplying the skill and productivity of human hands. "Super-sockets", with their almost endless combinations of handles, parts and different socket types, enable the operator to assemble a special tool to exactly fit the particular job at hand.

Five different patterns, with drives ranging for 1/4" to 1" square, cover every application. They provide the utmost in speed, safety and power. Write Dept. M-3, for free Data Sheets Nos. 4, 9, and 24 describing these time-saving tools.

J. H. WILLIAMS & CO.
BUFFALO 7, N. Y.



DROP FORGINGS AND DROP-FORGED TOOLS

Aerial cameras are tested under all conceivable conditions, from subzero temperatures to tropical conditions of extreme heat and dampness. The aerial division also produces intricate photomosaic maps made of many photographs carefully matched to minimize distortion.

Another important division is devoted to motion picture photography. This division supplies camera crews for special assignments and for making newsreels, in addition to conducting research to improve Navy movies. Along with other producing units, its activities are governed by the "operations" center at the laboratory. Here all approved work orders are received. These may include making training films, recording the launching of a new cruiser, or filming the Battle of the Philippines.

If it is a training film, the subject is often of a restricted nature which could not be entrusted to commercial photographers. Script for the film is prepared in the writers and directors division and a director and camera crew are assigned. If part of the film is to be animated, this will be done in the art and animation division where many former employees of the Disney and Schlesinger studios work. Later, if sound is to be used, that will be taken care of by the sound division. Part of the film may be made in the studio and part on "location" with portable equipment.

Other divisions of the laboratory include the motion picture processing branch, which processes all types of movie film; the graphic arts division, which makes large photolithographic reproductions, photostats and multilithographs; the technical division, where chemicals are analyzed and lenses tested; the supply division, which can produce any one of 3,000 items on a moment's notice; the personnel division, where experienced photographers are trained for special jobs, and a music division which employs an 85-piece Navy symphony orchestra for recordings.

Aside from its primary task of improving methods to pry secrets out of the enemy, the laboratory is making a lasting contribution to the science of photography.

Hydrogen Gas Piped to Divers Replaces Helium or Nitrogen

By mixing hydrogen gas with oxygen, a Swedish engineer has found a substitute for the helium-oxygen mixture used by deep sea divers. The hydrogen mixture, like helium, is said to be nonexplosive. A substitute for nitrogen is desirable for depths of more than 260 feet, below which nitrogen has a narcotic effect on the diver.

"I got a 6½ lb. bass the first time I used the JITTERBUG!"



Jack Holland, Albany, Ga.

"We had fished in the Flint River for about an hour with no luck. I then decided to try a frog Jitterbug I had bought the day before, and boy howdy! I got a 6½ lb. bass, then a 2½ and a 1¾ pounder. This was the first time I had ever used your Jitterbug so I just had to write you. I am a photographer for the Albany Herald so I made a picture of the biggest bass with the Jitterbug I caught it on."—Jack Holland, Albany, Ga.



Write for Catalog
on Jitterbugs and
Hawaiian Wigglers

\$1.21

Frog
Jitterbug

FRED ARBOGAST, 1623 North St., Akron 3, Ohio

DO YOUR DUTY —
BUY WAR BONDS



Here's one thing you can do while you're waiting for restrictions to be lifted on outboard motors:
Ask the owners of Sea-Horses if they aren't glad they paid a little more—to get the best.

It will be the same after the war. Get a Sea-Horse, even if you have to wait for delivery. You'll never be sorry. Years of extra service and top performance *all* the time, will more than repay you for your wait.



If you are interested in selling AND SERVICING Johnson Outboard Motors after the war, write us now — no matter what your location may be.

JOHNSON MOTORS
WAUKEGAN, ILLINOIS



JOHNSON SEA-HORSES

for DEPENDability

MORE POWER TO IT!



P. R. MALLORY & CO. Inc.
MALLORY

Tropical*

**DRY
BATTERIES**

Originally developed by Mallory for the United States Army Signal Corps.

Today war needs claim our output. Tomorrow civilians may expect great things from this fundamentally different battery.

P. R. MALLORY & CO., Inc.
INDIANAPOLIS 6, INDIANA

*TRADE MARK

P. R. MALLORY & CO. Inc.
MALLORY

Ice Crackers of the Coast Guard

(Continued from page 15)

was 5 to 1 the job couldn't be done. With the assistance of the 165-foot Coast Guard cutter Comanche and the small icebreaker Arundel, they went to work. The Comanche tugged, the Arundel broke ice and the more powerful Mahoning lashed herself to the rear of the giant steamer to act as a brake. In case the Comanche got stuck in the ice the Mahoning would reverse her engines and keep the big steamer from running over the Comanche.

The Berkshire is a side-wheel boat with her paddle wheel housings sticking out from the sides of the ship 10 or 15 feet. Ice tended to pile up against these, and the Mahoning would have to break it away.

The trip down the river was a nerve racking journey. Through one narrow gorge the convoy took 12 hours to go one mile! Here the ice had drifted to a depth of four feet and had to be "shaved" away. But the Mahoning and her helpers brought the big ship through.

Commander Babbitt is careful to point out that his crew deserves all the credit for the tough assignments that are completed successfully. Often working in layers of warm clothing, including felt face masks to keep their faces from freezing, the men endure hardships that would make the ordinary civilian shudder.

However, the crew considers the assignment on the Mahoning a "rest." They are mostly Coast Guardsmen who have been sent back from the battle fronts to get them out of combat for a while, and heroes sleep in every bunk. Their heart is in their work, too, for they know the Coast Guard icebreakers are playing an important role in speeding necessary supplies to fighting Yanks overseas.

Bazooka Boats Hit the Beaches

(Continued from page 4)

that is to go ashore with the first few waves of men must be loaded last, on top, where it can be reached at once.

Some of these top priority items seem to have no obvious connection with fighting. Dump trucks may be the most important cargo on one ship; water distillation units or even a saw mill or prefabricated houses may be essential cargo on others.

The reason is that an invasion may bog down if no roads are available for hauling artillery inland, or if no landing strips can be provided for fighting and bombing planes. Dump trucks and other heavy road-

(Continued to page 160)



"You can't beat a Savage, Jim"

"Those rifles and shotguns in the rack are the same ones I'm showing you in these action pictures. I've been using Savage guns for years. They're real game-getters and they'll double your shooting thrills.

"Take a look at that Savage model 99. It has everything I want in a big game rifle. Notice its streamlined design... its lightning-fast lever action. It sure has a real wallop, too. You saw what happened to the buck in the picture! Then there's the Savage model 720 automatic shotgun (that's the gun I'm using in the duck pictures). For 'scatter gun' shooting I consider it first in speed, balance and dependability.

"What about 22's? Sure, Savage made a complete line of 22's and medium power rifles for target and small game shooting. They're accurate and a pleasure to handle, too... real man-sized rifles. Just the thing for 'off season' pest hunting, target shooting or plain and fancy plinking. No sir, Jim, you can't beat a Savage. They're tops!"

Savage Arms Corporation
Plants in Utica, N.Y. and Chicopee Falls, Mass.

WAR PRODUCTION COMES FIRST . . .

 Savage has produced over 2,000,000 military arms, including Browning Cal. .50 aircraft machine guns, Thompson submachine guns, and rifles. Of course, the requirements of our armed forces will continue to come first... but YOUR Savage will be worth waiting for.

MANUFACTURER OF RIFLES AND SHOTGUNS —
LAWN MOWERS AND REFRIGERATION EQUIPMENT

MARCH, 1945



... FOR BIG GAME HUNTING
Savage Model 99 Hi-Power Rifle.
A variety of calibers, including
the famous Savage .300 and
Savage .250-3000.

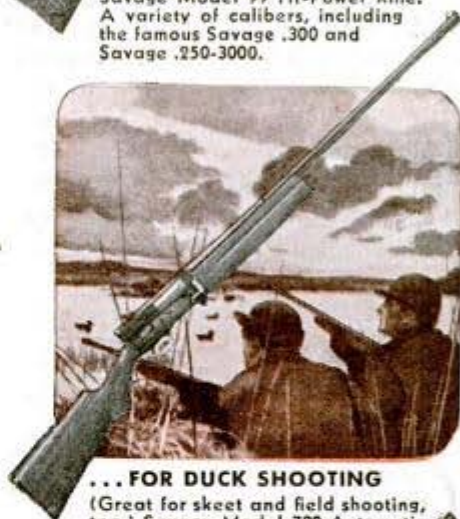

... FOR DUCK SHOOTING
(Great for skeet and field shooting,
too.) Savage Model 720 Automatic
Shotgun, 12 and 16 gauge.



... FOR SPEED SHOOTING
Savage Model 6 — .22 caliber auto-
matic. Three rifles in one... auto-
matic... bolt action repeater...
single shot.



SAVAGE

WORLD FAMOUS FOR
DEPENDABILITY AND
ACCURACY

159

NOW! a model for every type of correctable hearing loss!

Zenith Radionic Hearing Aids with New Neutral-Color Earphone and Cord

SO INCONSPICUOUS
Another Zenith "First!"



● Think of it! No matter what *your* type of correctable hearing loss, you can now get a Zenith model designed to restore you to the world of sound. And it will be *as little noticeable as eyeglasses*—thanks to the Neutral-Color Earphone and Cord which blends with any complexion... enables you to wear a hearing aid with poise and confidence.

Ask the Zenith dispenser near you for a *free* demonstration. Find out about the exclusive external tone control which enables you to adjust your Zenith for different voices and surroundings as easily as you focus binoculars. No obligation! Send coupon for free literature and name of nearest dispenser.



3 NEW



MODELS

Each Complete, Ready-to-Wear

- 1 Standard Model A-2-A.** New, improved model of the famous Zenith standard hearing aid for the person of average hearing loss. Only **\$40**
- 2 Air Conduction Model A-3-A.** A *super-power* instrument with exceptionally wide range of volume control and amazingly fine tone quality. Only **\$50**
- 3 Bone-Conduction Model B-3-A.** A totally new instrument created specially for the very few who cannot be helped by any air conduction aid. Only **\$50**

PASTE ON PENNY POSTCARD AND MAIL

Zenith Radio Corporation, Dept. PM-14
P. O. Box 6940A, Chicago 1, Illinois

Please send me *free* literature about Zenith Radionic Hearing Aids—together with name and address of nearest Zenith dispenser.

Name _____

Address _____

City _____ State _____

COPYRIGHT 1945, ZENITH RADIO CORP.

building equipment are vital for building roads and airports. Construction must start as soon as possible, often while active fighting is still going on only a few hundred yards away.

Water distillation and chlorination equipment is just as necessary. Most western Pacific waters, being untreated, carry the germs of dysentery and other diseases and must be purified for drinking. Prefabricated housing, of course, and the lumber that can be obtained with a saw mill, are needed for erecting hospitals, warehouses, and headquarters facilities after the beach-head has been won.

En route, an invasion fleet never acknowledges coded radio messages transmitted to it nor does it use any of its own transmitters. Radio silence is preserved until the minute of H-hour. From then on the air is literally jammed with messages on scores of frequencies. Hundreds of transmitters that range from portable hand sets to the powerful long range radios of fleet units are then in constant use. The whole vast operation is a secret until that minute, then the whole world learns that the United States has carried the fight to its enemies again.

Get a



THOMPSON BOAT

and—

Get SPEED

Assured by skill and experience in fast boat designing.

Get SAFETY

Thompson Boats are exceptionally seaworthy; plane easily.

Get SPRAY RAIL PROTECTION

This valuable Thompson feature keeps you dry.

Save MONEY

Two big Factories lower costs—save you freight.

Canoes \$83 and up

Rowboats \$60 and up

Outboards \$60 and up

Light Boat for Auto
Six Popular Models of Sail Boats. 12 ft. to 21 ft. long.



THOMPSON BROS. BOAT MFG. CO.
Two Large Factories—Write to Either Place (143)

213 Ann St.
PESHTIGO, WIS.

113 Elm St.
CORTLAND, N. Y.



Catalog Free Save Money

Please state the kind of boat you are interested in

Can You Equal This Home for **1575**

Orders Now Being Taken for Early Postwar Delivery



Act Now!

• First come, first served! Save months of waiting by arranging for your new home now! We ship you the materials—lumber cut-to-fit, ready to erect. Paint, glass, hardware, nails, etc., all included in the price—no extra charges. We pay the freight. Plans furnished—also complete building instructions. No wonder our customers write us that we saved them 30% to 40%, compared with builders' prices. Easy terms—monthly payments. (Present price subject to change.)

Handsome Big **FREE** CATALOGUE

Write for it today and find out how you can have a Liberty Home shipped to you without a long period of waiting.

LEWIS MANUFACTURING CO.
1253 Lafayette Ave., Bay City, Mich.

Send for FREE BOOK of Liberty Homes



QUIETS SWEEPERS

A few drops of 3-IN-ONE Oil works wonders on carpet sweepers. Protects household equipment—makes things run better.

"3-IN-ONE" OIL

in every battle... doing vital jobs... unflinching

that's why there are just a few left for essential jobs at home



BRIGHT STAR BATTERY CO., CLIFTON, NEW JERSEY

For effective Fluid Power Systems

If you have mechanical operations to get done with efficiency and economy, consider Fluid Power.

It is the modern way to transmit power from its source to its job—without shafts, gears, belts or levers.

It moves wherever you want it to go through tubes, and is controlled by valves.

Your Fluid Power system will deliver sure and dependable performance, under all conditions, if it is



Engineered by
PARKER



THE VITAL LINK

in Fluid Power is the Circuit. It goes around corners and into tight places. It must be proof against leak, shock and vibration, and must be pressure-tight.

Parker brings 20 years of experience to the engineering of this Vital Link. We build the valves and fittings, and the tools to handle them.

You'll find it worthwhile to talk with a Parker Fluid Power Engineer. Write to The Parker Appliance Company, 17325 Euclid Ave., Cleveland 12, Ohio.

THE
PARKER
APPLIANCE COMPANY
CLEVELAND • LOS ANGELES
FLUID POWER ENGINEERING

SAVE WASTE PAPER



**a Nicholson file
for every purpose**

3000 kinds, cuts and sizes for every industrial, farm, home and "hobbyist" use. FREE BOOK, "File Philosophy" (48 pages), on kinds, use and care of files.

Nicholson File Co., 22 Acorn St., Providence 1, R.I.
(In Canada, Port Hope, Ont.)

**Red Cross Takes 'Main Street'
To Yanks at the Front**



Above, Red Cross members "shoot the breeze" with a sergeant in Iran as he drinks coffee at mobile snack bar. Below, doughboys hear an impromptu piano program



Diversions which symbolize Main Street to lonely American fighting men are driven right into front-line sectors in clubmobiles, bookmobiles and other vehicles by Red Cross field units. In Iran the portable "jamboree" tours from station to station in a Train Mobile Theater Unit. This consists of two converted box cars built by the soldiers themselves, one for recreation facilities and one for the crew's living quarters. The former includes a movie projector, doughnut machine, ice cream freezer, lending library, newspapers, magazines, and phonographs. Besides its many field services, the Red Cross has collected 10 million pints of blood plasma since the outbreak of the war. Mounting demands for Red Cross services in the war theaters have increased the organization's budget to \$200,000,000 for 1945, a sum the "home front" must provide.

WHOOSH! AND
YOU'RE OUT
IN FRONT—



There's a *Ford* in your future!

▶ You will scarcely know it's running when it idles. Yet when that smooth, soft-spoken motor springs into action, you'll go surging out ahead.

... Yes, it will be fleet—this Ford that will come with peace. Fleet... and smartly styled. A sturdy beauty—rich appearing inside and out—with youthful

lines, suggesting power and smooth riding comfort.

... You'll find this car thrifty and reliable in the finest Ford tradition. It will include many refinements to add to your motoring pleasure.

... This is not wishful thinking. When the green light is given, we will be ready to start

production plans. In the meantime, the full resources and energies of Ford are engaged in turning out war goods to help speed the day of final VICTORY!

FORD MOTOR COMPANY



Amazing Handy ADDING MACHINE

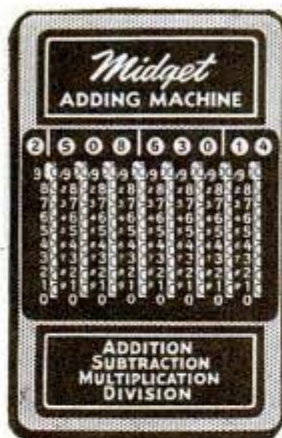

Can Be Carried
in Vest Pocket

ONLY

\$2.50

POSTPAID

**ABSOLUTELY
ACCURATE**

Yet Weighs Only 5 Ounces

- Handles Totals up to \$10,000,000.00.
- Totals appear instantly—as fast as you put the figures down.
- Can be used to subtract, multiply and divide, as well as add.
- Metal construction for years of service.

Haven't you often wished for a handy little device like this . . . that you could take with you ANYWHERE . . . on the road, in the office, at home or in the shop? You can get one now . . . Business man, student, housewife—everyone finds this handy, guaranteed-accurate little machine useful . . . ORDER YOURS TODAY.

SEND NO MONEY

Just send name and address. Then pay postman \$2.50 plus postal charges on delivery. Or send \$2.50 with order and we pay all charges—saving you about 50 cents at the new postal rates.

LEE SPECIALTY CO., Dept. PM-8
Box 3620, Mdse. Mart, Chicago 54, Ill.

MAIL COUPON TODAY

LEE'S SPECIALTY CO., Dept. PM-8,
Box 3620 Mdse. Mart, Chicago 54, Ill.
Please send me one of your MIDGET ADDING MACHINES.

I am enclosing \$2.50 Send C.O.D. plus postage

NAME

ADDRESS

CITY & STATE

PLEASE PRINT PLAINLY

SAVE WASTE PAPER

STOKER EMPTIES OWN ASH!

A remarkable stoker already used by thousands of home owners—fits into any furnace or boiler. Manufactured since 1934. So automatic it takes the coal from your present coal bin through a pipe to the furnace, going around corners if necessary. Keeps house at even temperature, empties its own ash in sealed containers, no coal to shovel, no clinkers to dig, only bituminous stoker of its kind on the market. Send for full information NOW!

POCAHONTAS FUEL COMPANY INCORPORATED
344 EAST 131st STREET • CLEVELAND 8, OHIO

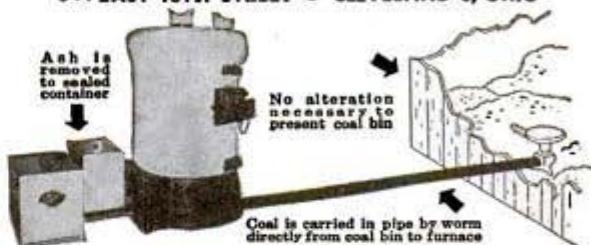

PAINT STRIPING TOOL

ONLY
\$1.00
POST
PAID

Try it! See the Added Beauty

With this NEW TOOL (not a brush) everyone can now draw lines with paint, enamel, lacquer, etc. Used on autos, models, toys, games, imitation tile walls, cabinets, furniture, linoleum floors, signs, bulletin boards, sporting goods, home workshop projects, etc.

Send only \$1.00 for complete tool for painting a 1/16" wide stripe, including adjustable guide, operating instructions, etc. C.O.D. price \$1.25.

As easy to use as a pencil.



Patented

Extra interchangeable tips for making 1/64", 1/32", 3/64", 1/16", 3/32" and 1/8" wide stripe lines—.50c each.

Every Painter and Craftsman Should Own One.

Send for your tool and as many additional width tips you need today. Use it. If you are not satisfied that you can do better work, add character as well as beauty to your product or project, return the tool and we'll refund your money promptly.

Paint Dealers: Write for literature, etc.

WENDELL MFG. CO. 4234-B Lincoln Ave., CHICAGO 18, ILL.

MONEY \$ MONEY \$ MONEY CASH FOR YOUR SPARE TIME

Your spare time is worth money. It's a cinch to make \$\$\$ at club meetings or friendly calls with Everyday Greeting Cards, Birthdays, Anniversaries, "Get Well," etc. They're unique—clever, luxurious, "Diamond Dust" finishes, unusual papers, startling effects. No experience needed. Gives you YEAR ROUND EXTRA INCOME. Send only 60 cents for SAMPLES worth \$1.00—TODAY. ARTISTIC CARD CO., 234 Way Street, Elmira, N. Y.

MAKE BIG MONEY SAWING WOOD NOW!

350 Cuts
a Minute

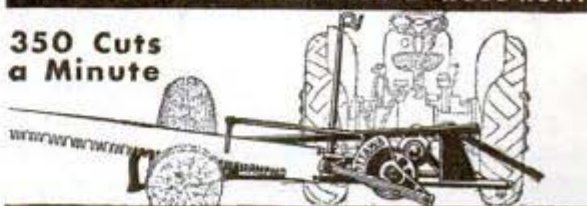

OTTAWA ONE-MAN TRACTOR SAW

Turn wood lots into cash; help save other fuels to win the war. Use Ottawa—fastest cutting; easiest way. Cuts large and small logs, fells trees. Thousands in use. Built to last with special heavy stiff saw blade. Positive safety clutch control, driven from any power take-off.

OTTAWA MFG. CO., D327, Forest Ave., Ottawa, Kansas

FREE BOOK
and
Price List

PORTA-LITE

NEW HANDY ELECTRIC LANTERN
Of 101 Uses!

WEIGHS ONLY 29 OUNCES...
Easy to Carry Long Distances!

OVERALL SIZE 5-1/2 BY 9 INCHES

Postwar PORTA-LITE today... the handiest portable electric lantern, now improved in seven ways! Amazingly light, unusually useful... in home, office, factory, for sportsmen, night workers. Large rubber-grip bail may be hung on arm or belt, over motor in car, or on bumper as emergency light. Bail is adjustable—bright beam may be directed at any angle desired, while changing tire, etc. Uses 2 or 4 flashlight cells, only type replaceable anywhere. New patented circuit prevents corrosion and faulty contacts—adds years to life. Weatherproof switch, tarnish-proof reflector, bulb guard base. Streamlined all-metal case, double-plated, highly polished. ORDER TODAY!

Only \$4.75 POSTPAID

WARNER ELECTRIC CO.
Dept. A-82 360 N. Michigan, Chicago 1

FREE! 40 PAGE HOBBY CATALOG

Over 1000 Items — Over 300 Photos

Our new 40-page catalog—just off the press—is the "bible" of wide-awake modelers. And what is most important, every item is in stock and ready for immediate shipment. Practically every nationally advertised model is listed and many, many hard-to-get items. Planes, engines, boats, gliders, supplies, etc. America's Hobby Center, Dept. BC35, 40 E. 21st, N.Y. 10, N.Y.

NEW CHEAP OIL BURNER

FOR COOKING & HEATING STOVES-FURNACES
HEAT YOUR HOME, COOK YOUR MEALS
WITH CHEAP FURNACE OIL

NO MORE SHOVELING COAL OR ASHES. New Fuelizer Starter Vaporizing System turns Cheap 130 Flash Furnace Oil into Oil Gas heat without clogging up. LIFE-TIME GUARANTEE against defects. \$1.00-BONUS OFFER FOR TESTING. We will let you try it in your own stove or furnace for one month. Get Yours for introducing. Big profits. Be first. Send in your name today.

NORTHWEST MFG. CO., 535-C 5th Ave., Mitchell, So. Dak.

MENDS EVERYTHING

Dishes, glassware, furniture, luggage and toys.



DU PONT DUCO CEMENT

SAVE WASTE PAPER

MARCH, 1945

This was the pipe of yesteryear in CHINA*

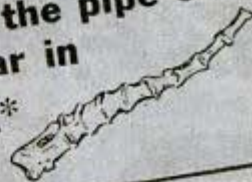

and this is the pipe you'll see today, in China and everywhere

LHS STERNCREST STERLING

Give a master craftsman genuine aged Mediterranean briar, a band of sterling silver, a bit of solid rubber—then, and only then, can he turn out a pipe as fine as Sterncrest Sterling. We number and register every one as your guarantee of pipe perfection.

Model No. 79 Smooth and Antique finish. Dozens of other handsome models

\$5



IMPORTED BRIAR

Sterncrest 14K. \$7.50 solid gold band

Certified Purex . \$3.50

Other LHS Pipes \$10 to \$1.50 AT YOUR DEALERS

*A great percentage of fine LHS pipes have gone overseas to our boys in all parts of the world.



Send for your copy of "Pointers on Pipes"—It's FREE
L. & H. STERN, INC., 56 Pearl Street, Bklyn 1, N. Y.

KEEP ON BUYING WAR BONDS

165

BAZOOKA BEN GETS A "STAY-MOIST" SHAVE

LIFEBUOY SHAVING CREAM'S "STAY-MOIST" LATHER SURE SOFTENS TOUGH WHISKERS FAST

EVEN WITH COLD WATER LIFEBUOY LATHER GIVES SMOOTHER, EASIER SHAVES THAN QUICK-DRYING LATHERS

TRY LIFEBUOY SHAVING CREAM'S HEAVY, "STAY-MOIST" LATHER

120 TO 150 SHAVES IN THE BIG RED TUBE



A Complete Line of 10", 11" and 12" PRECISION LATHES

Quality Lathes built to industrial machine tool standards. Used by Army, Navy, and Marines. Manual 50c. Catalog free.

SHELDON MACHINE CO., Inc.
4266 N. Knox Ave., Chicago 41, USA



DRILL PRESS OWNERS!

HERE'S 1 TOOL WITH 5 DISTINCT USES
THE BARRON MULTI-PURPOSE
ROTARY WOOD PLANNER



PLANES & SURFACES • PANELS & BEADS
ROUTS & GROOVES • RABBETS • TENONS **\$750** COMPLETE

Converts ANY drill press into a time saving, low cost planer, paneler, tenoner, etc. Surface finishes all types of tough grained and knotty surfaces to agree smoothness. Safe! Guaranteed harmless to drill press. Thousands now in use. **SOLD ON MONEY BACK GUARANTEE.** Full refund on 5 day trial. Shipped prepaid on receipt of \$7.50—or C.O.D. YOU RISK NOTHING. Free literature.

ALL METAL AUXILIARY
DRILL PRESS TABLE

Has 234 sq. in. true working surface. Equipped for shaper and many other important workshop uses—a real buy at **\$7.85**



Barron Tool Co., 369 Architects Bldg., Detroit 1, Mich.

BEEES

30 BEEKEEPERS tell their story in free 16-page booklet "DOES BEEKEEPING PAY?"

Two Wonderful Books for Beekeepers "Starting Right with Bees," 96 pages and 184 illustrations. Written for the beginner. Every operation in handling bees explained. "500 Answers to Bee Questions" is a valuable book. Contents classified and indexed. 104 pages. Both books only 50 cents each. **Gleanings in Bee Culture**, monthly magazine largest circulation of any bee magazine.

\$1.00 per year.
(with either of the above books, \$1.25)
Free price list on Root Quality Bee Supplies
THE A. I. ROOT CO., Box 12. MEDINA, O.



FUSE PULLERS



Avoid shocks, burns, infections, etc. A lifetime safety tool.

WRITE FOR LITERATURE

TRICO FUSE MFG. CO. Milwaukee, Wisconsin

INVENTORS, SCHOOLS, CRAFTSMEN BRONZE FOUNDRY



is again available in limited quantity without priority. Orders filled in sequence as received. **INVENTORS—SCHOOLS—CRAFTSMEN** use FOUNDRYETTE for making castings quickly for new inventions, for instruction, and general purpose. Order now for early delivery. Three sizes are available capable of making bronze castings of 1½, 3, and 6 pounds weight, aluminum, copper, brass, etc., \$17.50, \$24.00, \$34.50, f.o.b. Kansas City. Domestic gas supply and 110 volt AC or DC energy required for operation. Write for circular.

KANSAS CITY SPECIALTIES CO.
Box 6022, Dept. P-52 Kansas City, Mo.

Always write your name and full address clearly when answering advertisements.

End damp air with "DRI-AIR"

DRI-AIR Chemical absorbs dampness in basements, game rooms, storerooms. Guards against mildew, rust. Kills musty odors. Complete unit \$5.50, f.o.b. Chicago. Get free folder.

TAMMS SILICA COMPANY
Dept. D-123, 228 N. LaSalle St., Chicago 1, Ill.

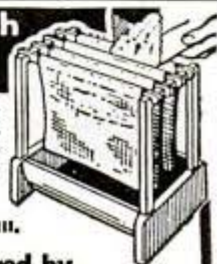

DRI-AIR is featured by
Leading department stores, furniture and hardware dealers everywhere.

THESE
Crescent Pliers
WILL BE BACK
IN HOMEFRONT SERVICE



Here is another Crescent Tool product that someday will be coming back from "the wars." The very popular Crescent Linemen's Side Cutting Pliers made of forged Crestoloy steel.

We do not hesitate to admit that — like other Crescent Tools — military service has made them better, stronger and more serviceable in use.

This tool was designed to meet the needs and rugged use to which it must be applied. Each one is *individually* tested on our specially designed testing machines.

As long as the war lasts, Crescent Tools will be "few and far between." With war's end, they will be available to good mechanics everywhere.

CRESCENT TOOL CO., JAMESTOWN, N. Y.



Crescent No. 1950, Linemen's Side Cutting Pliers. Made of forged Crestoloy Steel in 6, 7 and 8" sizes.

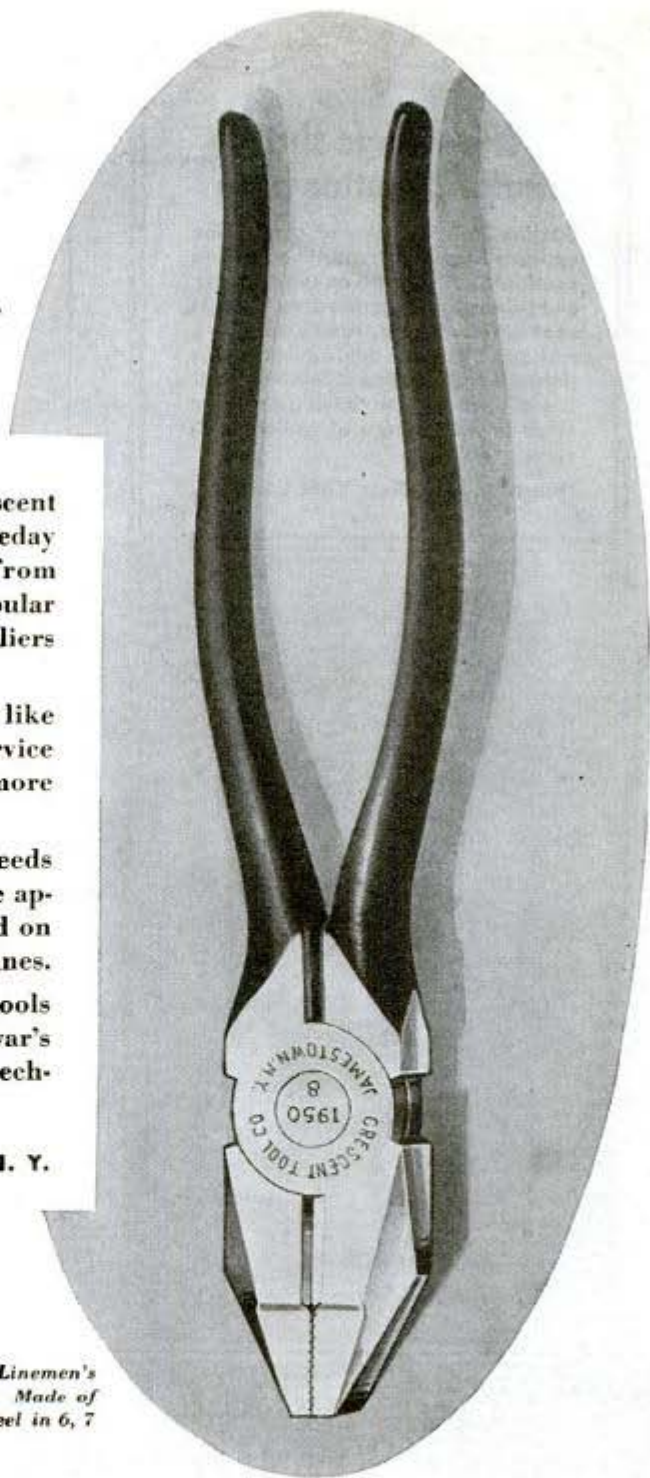

CRESCENT TOOLS

Give Wings to Work



B

The things that make a better pipe

Sterling Hall is a pipe of outstanding appearance and inherently fine smoking qualities... Made with an eye to design and painstaking attention to such details as selection of grain, bowl angle, pitch and depth of bore. Hand-rubbed satin finish. Heavy Sterling Silver band, not just slipped on, but inlaid. At better shops in a full range of models, individually boxed.

Briarcraft, Inc., New York 16, N. Y.

Sterling Hall
by Briarcraft

A pipe of Sterling Quality



\$350
at better shops

GET WORK OUT FASTER

with Steel-Grip Gloves



With no time to be lost, keep war production moving, speed deliveries, save time with Steel-Grip Reinforced Gloves. They handle rough, heavy, jagged materials at breathless pace. Chrome tanned cowhide. Steel ribbon reinforced palm and fingers. Steel thread sewed. Protect against cuts, bruises. Or what's your need? Over 4300 proved Steel-Grip Safeguards may give immediate answer. Used by big industrials since 1910. Write for catalog or state your need today.

INDUSTRIAL GLOVES CO.
647 Garfield Blvd., Danville, Ill.
Canada: Safety Supply Co., Toronto

After War

THE WORLD'S SAFEST ELECTRIC JIG SAWS will again carry the name

SYNGRO

SYNGRO DEVICES, INC.
Ferndale 20, Michigan

110-VOLTS AC from DIRECT CURRENT

with KATO KONVERTERS. Furnish standard 110-v AC from 32, 110, or 220-v. DC. Good deliveries on sizes 350 through 2500 watts on priority orders. Good deliveries on 5, 7½, 15 & 25 KW AC generators. Mfr's of motor generators, frequency changers and high frequency generators.

KATO ENGINEERING CO.
47 Elm Street, MANKATO, MINN., USA



THINGS TO MAKE IN YOUR HOME WORKSHOP

16 Complete Plans — only 10c
Useful, practical, easy-to-build projects — bird houses, lazy chair, etc. Includes photos, drawings.

STANLEY TOOLS
115 Elm Street, New Britain, Conn.

BUILD YOUR OWN

ARC WELDER

For Light or Heavy Work

No rewinding necessary—use coils taken from old auto generators. Works on 110 or 220 A.C. Has 20 different heats. Complete plans and BIG Catalog 35c.

LEJAY MFG. CO.

3347 LeJay Bldg.

Minneapolis, Minn.



SHARPEN YOUR DRILLS WITH THE E-Z DRILL SHARPENER

This precision fixture was developed for factory use by aircraft tool engineers. Real shop size and not a toy. Sturdily built, attaches to bench or grinder frame. Has new PROTRACTOR FEATURE which enables you to adjust quickly for different drill angles. Thousands now in use—home and repair shops, garages, factories, farm shops—wherever accurate holes are drilled. E-Z is simple to operate. Gives faster drilling, perfect hole centers and clearance. Guaranteed to do the work or money back.

SHARPENS ALL ROUND SHANK DRILLS FROM THE SHORTEST TO 11" LONG—3/32" TO 1 1/16" DIAMETER

SAVE MONEY WITH E-Z. Comes complete with instructions, ready to sharpen your dull drills as good as new. Low price of \$2.80 because of our volume business on this wanted precision tool. The E-Z protractor gives you proper angles for cutting extra hard material, ordinary use, for soft material, wood, Plexiglas, Lucite, Plastics. Send check or money order for \$2.80. WE PAY POSTAGE AND SHIP IMMEDIATELY. Write for FREE folder giving scientific data on drilling techniques.

FRED F. TEN EYCK, Dept. P4, 758 S. Irolo St. LOS ANGELES 5, CALIF.

MODEL No. 1 is already set for 59° drill angle, no adjustment needed for 99% of drills. Sturdy shop model. Postage paid \$1.98.



WHEN IT'S AN EXIDE YOU START



A man is known by the company he keeps. You can generally depend upon the services of the dealer who sells only products that are **KNOWN** to be of high quality.

The increasing requirements for batteries by our armed forces need not dislocate home front transportation if everyone cooperates. Regular inspection by your Exide dealer will help you prolong the life of your present battery and put off the day when you must buy a new one.

THE ELECTRIC STORAGE BATTERY COMPANY, Philadelphia 32
Exide Batteries of Canada, Limited, Toronto

BUY TO LAST

**IF
Hearing
WERE
Visual**



Here's what you might expect from improper fitting



But here's what the New Super-TELEX and Scientific Fitting will bring you

Since no two hearing losses are identical, Telex has created a nine-point Scientific Fitting Service for each individual. To recreate near-natural hearing, parts are carefully assembled for your Super-TELEX after each step of the personal analysis has been completed. Through this scientific method of "Personalized" Fitting, normal tones are shaped for individual reception.

TELEX

Hearing Centers from Coast to Coast
CONSULT YOUR TELEPHONE BOOK

TELEX LABORATORIES, 45 Telex Park,
Minneapolis 1, Minn.

Please send me a free copy of your new book,
"New Hearing Through the Miracle of Electronics."

Name.....

Address.....

City..... State.....

Fuse Puller — Circuit Tester



For
Home
or
Factory

TESTS 110-250 VOLTS

When motors stop and lights go out, this tool quickly LOCATES DEAD CIRCUITS and safely removes blown Fuse. The Star Test Pocket Plier is made of a Transparent Plastic Star Test Pocket Plier is made of a small lamp in series with a resistance and can be used to test 110 to 250 volts circuit. The Plier will pull fuses from 10 to 100 Amperes. Thousands of Electricians find this tool handler than Test Lamps. Price \$2.75 each without Leads, \$1.50 additional for Leads, plus 10c postage. Can be obtained from General Electric or Westinghouse Stores or directly from STAR PLIER CO., 233 Canal St., New York 13, N. Y. Order NOW.

BUILD AUTHENTIC SHIP MODELS



Our kits and instructions are complete to the last detail. Clear plans simplify construction. Send \$2. today for SHIP MODELS ILLUSTRATED, WITH A GUIDE TO MODELING—the first book of its kind ever published — of ship models, of real ships, of masts, of rigging, of deck gear, covering all types from whale-boats to PT's from "Slavers" to Corvettes. Many color plates, close-up photos, detailed drawings and actual plans in addition to a salty text and glossary of nautical terms.

Catalogue included with your order.



MARINE MODEL CO.
Dept. A-6, 29 West 15th St.
New York 11, N. Y.

\$2
postpaid

ANYONE CAN DO THIS IF THEY HAVE OUR CHART

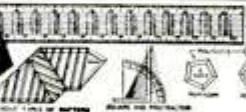

SPECIAL OFFER FOR AGENTS

Blue Print 27" x 36" shows how to find length of any rafter; find any angle in degrees, frame any polygon 3 to 16 sides, read board foot and brace tables, octagon scale, rafter tables and many other uses. Can be scaled down for model work as well as full scale framing. Also Chart changing pitches to degrees for use with Radial Saws. Send 50c in Coin or M. O. No Checks or Stamps. MASON & PARRISH ENGINEERS, 2106-8 N. Burdick St., Dept. D, Kalamazoo 81, Mich.

BUILD YOUR OWN MACHINE TOOLS!

Blueprints \$1.00 - Catalog FREE



Detail construction Blueprints on 6 Lewis metal and wood-working tools postpaid for \$1.00. Includes prints for Lewis 10" Shaper or Milling Machine, Drill Press, Vise, 16" Band Saw, 6" Jointer, 3" Circular Saw. Plain or semi-finished castings available for these tools save up to 80% of comparable new tool cost.

Illustrated 22-page Catalog free with Blueprint Order—describes 25 Lewis tools. WRITE TODAY!

LEWIS MACHINE TOOL CO.
P. O. Box 116, Sta. A, Dept. M-15, Los Angeles 31, California

FALSE TEETH

KLUTCH holds them tighter

KLUTCH forms a comfort cushion; holds dental plates so much firmer and snugger that one can eat and talk with greater comfort and security; in many cases almost as well as with natural teeth. Klutch lessens the constant fear of a dropping, rocking, chafing plate. 25c and 50c at druggists . . . If your druggist hasn't it, don't waste money on substitutes, but send us 10c and we will mail you a generous trial box.

KLUTCH CO., Box 4593-C, ELMIRA, N. Y.

WAR SURPLUS BARGAINS

★ ★ ★ ★ ★

SENSATIONAL VALUES FOR QUICK LIQUIDATION

USED U.S. GOV'T. PUP TENTS

Regulation army pup tents of durable brown canvas. Used, but in good condition. Fine for campers, outdoorsmen, boy scouts, etc. A grand gift for boys.

K100-TENT ONLY, EACH \$4.95

K101-Ropes, wooden poles and stakes for above. Per set \$1.00



HUNDREDS of ITEMS TO CHOOSE FROM

Values galore! Hundreds of hard-to-find items for home, shop and outdoors at tremendous savings. Order early. Ample stocks are on hand to take care of all needs but at these prices they won't last long. Order direct from this ad. Satisfaction guaranteed.

CATALOG PM 3—FREE

CATHODE RAY TUBES

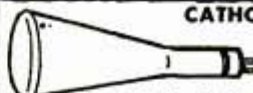

A "find" for experimenters and radio hams. Standard 5 inch

Cathode Ray tubes, ideal for television, scope and experimental work. Slightly used by U.S. Gov't. for test work. Guaranteed to give excellent service. Specify number when ordering.

No. 5BP1 Each
No. 5BP4 Each

\$12.00

CAVALRY SPURS

Genuine wishbone type cavalry spurs, Nickel-plated brass.

K-102, Pair, . 98c

K-103 Spur straps per set of four, 50c



U.S. GOV'T. SURPLUS CAVALRY SWORDS



TO DECORATE YOUR DEN OR LODGE

A collector's item for den or hunting lodge. Of finest tempered steel, double edged, with 35 inch blade, 42 inches long overall. May be cut down for hunting, commando knives, etc. **\$4.95** Complete with scabbard. **K500-EACH, express collect.**

16 mm AIR CORPS FILMS

Air Corps Gunnery training films. Approximate 350-400 feet of action above the clouds. 16mm only. Ready for projection.

K105- \$2.00

PER REEL.

MOSQUITO TENTS

Of marquisette with taped seams. Metal rods and bars included. Covers cot or hammock. Brand new.

K-104 EACH, . \$2.95



U.S. BOLO KNIVES



Extra heavy Bolo Knife with sheath. Of finest tempered steel. Two piece riveted handle. Ideal for jungle and south Pacific use. Fine for hunters, campers, etc.

K112-With Army Sheath \$4.95
K113-With regular Sheath, EACH.

SURPLUS AIR CORPS APPROACH METERS TWO MICRO-AMP. METERS IN ONE

A "buy" for radio servicemen and experimenters in radar, electronics and television. Actually two meters in one. First movement has zero center with 100-0-100 micro amp. range. Second movement has 0-200 micro amp. range. Luminous pointers. Accurately calibrated scale furnished with each meter. Calibrated dial may be superimposed on face of meter. Zero adjustments. Original cost \$40.00 or more.

K114-EACH ONLY.

\$9.85



TARPAULINS

Made of rubber impregnated two-ply balloon cloth. With grommets. Strong, durable and absolutely water-proof. Ideal for farm and factory use.



K107-8x8 feet, each, \$ 4.00
K108-8x10 feet, each, 6.75
K109-10x12 feet, each, 10.00
K110-12x14 feet, each, 14.00
K111-Special sizes to order per sq. yard, 75c



14 INCH BOLT CLIPPERS

Heavy duty type with compound lever jaws. Used but guaranteed perfect. Ideal for farm and factory use.

K115-EACH ONLY. \$2.95



REGULATION ARMY MESS KITS

Regulation Army mess kits. Ideal for campers, boy scouts, etc. Slightly used but guaranteed perfect.

K116-EACH ONLY. 69c



U.S. GOV'T. CANTEENS

Regular U. S. Gov't. issue canteens. Plastic screw top cap chained to body. Slightly used.

K117-METAL BODY 69c

K118-PLASTIC BODY 69c

EACH.

K119-Canteen covers, ea. 35c
K120-Canteen cups, ea. 25c

OPTICAL PRISMS

Finely ground and polished. Two 45 degree angles each 20 mm. by 27 mm.—bottom surface 20 x 40 mm. Regularly used in prism binoculars. Fine for experimental work in optics, etc. A rare buy.

K160 EACH, \$1.50
ONLY.
FOUR FOR ONLY, \$5.50

*** AIR MATTRESSES

6-3 in. AIR CELLS



For campers, outdoorsmen, boy scouts, servicemen, etc. Six separate (slightly used) air chambers provide a 3 inch cushion of air. Measures 24x54 inches—fits cot or sleeping bag. Outer envelope of black, waterproof, rubberized material. Quickly inflated or deflated. Folds compactly. Guaranteed perfect.

K122-EACH, COMPLETE \$10.59

WATERPROOF APRONS

Waterproof, acid and alkali proof. Used by industrial, photographers, florists, chemists, etc. Of salvaged balloon material. Generous cut.

K123-LADIES, each 98c
K124-MENS, each 98c

PER APRON.

1600 FT.—16 mm. STORAGE CANS

Storage cans for 1600 ft. reels of 16 mm. motion picture film. All perfect. Rich maroon finish. A splendid value.

K150-CAN, ONLY, EACH, \$0.49

U.S. INVASION LIFE BELTS



Regulation invasion type life belts. Two independent air chambers. Sparklet cartridges provide instant emergency inflation. Includes hose for manual inflation. Brand new.

K126-EACH ONLY. \$4.95

LENSES, PRISMS, ETC.

Thousands of fine optical lens elements, prisms, etc., of various focal lengths and powers. Ideal for assembling into rifle scopes, projection lenses and other optical systems. Catalog will bring it.

L2PS gives all details. A post card WRITE for L3PM LENS LIST

COMB. AIR PILLOW AND LIFE BELT

Of rubberized khaki 10 x 40 inches in size.

Used as life belt, raft or air pillow. Quickly inflated or deflated. Used but guaranteed water and air tight.

K127 EACH, 98c

BANDO-LEERS



Army Bando-leered heavy khaki. Used by hunters, boy scouts, etc. Slightly used but serviceable.

K128-3 POCKET, EA. 49c
K129-11 POCKET, EA. 69c

ORDER DIRECT FROM THIS AD

Make remittances by money-order, bank draft or personal check. Send 25% deposit on C.O.D. orders. Include sufficient postage on parcel-post orders—any overage will be promptly refunded. All quotations F.O.B. Chicago. Used items and materials are guaranteed serviceable and as described. Your money back if not more than satisfied.

STARK'S 509 So. State St. Dept. PM3 Chicago 5, Ill.

RADIO PARTS ASSORTMENT



A find for radio repair men. Seven pounds of soldering lugs, rivets, grid-leaks, trimmers, coils, etc. Order now!

K130-R, 7 LBS., \$1.79



MOTO-TOOL ★ THE "POCKET-SIZE" MACHINE SHOP

PUT THIS "WAR VETERAN" TO WORK

Long before Pearl Harbor, Dremel Moto-Tools won their spurs by tackling tough jobs in tool rooms and machine shops. Since the war began, Moto-Tools have earned the respect of every branch of the armed forces. And thousands of them helped establish production records in plants such as General Electric, Westinghouse, Remington Arms, Ford, Nash-Kelvinator, Consolidated Aircraft, Northrup, Douglas and many other arsenals.

Only Moto-Tools Have All These Features

A Model 2 Moto-Tool develops a speed of approximately 27,000 rpm. Weighs only 13 oz. Shaped to fit the hand. Sturdily built. Has shock-proof bakelite housing. Balanced for vibrationless operation. Uses 110-120 A.C. or D.C. current.

HOW TO ORDER

Ask your Dealer about Dremel Moto-Tools and accessories. If he does not handle them, send direct to factory. As long as priority ratings are required, ask your War Production Board or your employer for one. Write for FREE CATALOG.

DREMEL MFG. CO.,

27,000 R.P.M.

- Sharpening
- Finishing
- Touching Up
- Sanding
- Drilling
- Marking
- Engraving

A few of the jobs that can be done better and faster with a Moto-Tool.

- Burring
- Grinding
- Polishing
- Sanding
- Burnishing
- Inlaying
- Sawing
- Scoring
- Cleaning
- Routing
- Cutting
- Rasping
- Carving
- Brushing
- Dressing

RACINE, WISCONSIN



MOTO-TOOL KIT

Kit No. 2 with 23 high grade accessories and Model 2 Moto-Tool, in hardwood case. \$23.50
Model 2 Moto-Tool, with 1 accessory. \$16.50

The Guidebook to Rifle MARKSMANSHIP



LEARN to Shoot THIS BOOK FREE

A U. S.-approved program, sponsored by the National Rifle Association, to train citizens in the use of rifles. Send TODAY for above 48-page FREE booklet, and details on how to get expert rifle training.



5653 St. John Street, New Haven 5, Conn.

BURN YOUR NAME ON TOOLS WITH THE ARKOGRAF

PROTECT YOUR TOOLS FROM THEFT

Write with electricity any name or design on the hardest and finest tools and instruments, or any metal, like writing on paper with pen or pencil. Thousands used by mechanics, gunners, machine shops. Complete outfit \$3.50—Prepaid Anywhere. Interesting illustrated circular free. Write today. ARKOGRAF PEN CO., 3927 S.E. Stark, Portland 15, Ore.

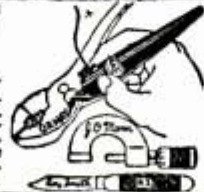

Use Your Drill Press as a Wood Planer!

Planes, Parallels, Finisher—Swiftly planes all wood—leaves knots smooth and finished.

AMAZING SPEED—30 seconds for planing, paralleling and finishing 8"x24" board surface with 1/32" cut or less. 3 high speed steel blades—Double-Screw ADJUSTMENT.

Safe, accurate, a lifetime tool. A perfect paint and varnish remover—blades cut underneath surface.

\$7.50, postage paid. 5-day trial offer. Free literature. ACT TODAY!

H. J. BERRY MFG. CO., 2297 Scott St., Detroit 7, Mich

\$19.95 Full Set



MICROMETERS

Six piece set, in velvet lined leather case. Special price, only \$19.95.

Precision machined in one thousandths, up to 4" outside and 3.75" inside measurements. Guaranteed accurate, easy to read and adjust. Satisfaction guaranteed or money back. Also indicators and gauges. Shipped prepaid on receipt of remittance. On C.O.D. shipments, send deposit of \$2.00.

MICRO PRODUCTS, 211 Jos. Campau, Detroit 7, Mich.

DO YOU

WANT a permanent business profession of your own? Then BECOME A FOOT CORRECTIONIST. Earnings in this greatly needed profession run as high as \$50-\$100 weekly after a few weeks home training—no medical or chiropody—no further capital needed, no goods to buy. 47th year. Write for free booklet.

Stephenson System of Foot Correction
28 Back Bay, Boston, Mass.

★ SAVE WASTE PAPER ★

MICROSCOPES SUPPLIES-ACCESSORIES & SCIENTIFIC INSTRUMENTS

BUY NEW-USED-REPAIRED
BOUGHT-SOLD-EXCHANGED-REPAIRED
SEND FOR FREE LIST

MEDICAL INDUSTRIAL AMATEUR

NATIONAL SCIENTIFIC INSTRUMENT CO. 119 CHAMBERS ST. N.Y.

BLACK on WHITE for BETTER SIGHT

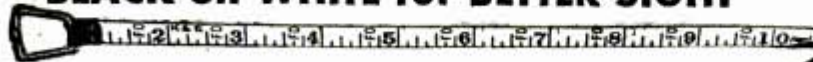

WYTEFACE Steel Tapes have black graduations on a crack-proof white surface. Easy to read in any light, from any angle. Faster measurements with fewer errors. Designed for hard service. Resists abrasion from rails, pipe, rocks, concrete. Protected against rust.

KEUFFEL & ESSER CO.
EST. 1867



NEW YORK • HOBOKEN, N. J.
CHICAGO • DETROIT • ST. LOUIS
SAN FRANCISCO • LOS ANGELES
MONTREAL



Drafting
Reproduction
Surveying Equipment
and Materials
Slide Rules
Measuring Tapes

POPULAR MECHANICS

5 lbs. HANDY ASSORTMENT \$1.98
FOR MECHANICS—GARAGES
—WORKSHOPS—HOME USE

SCREWS • NUTS • BOLTS • WASHERS •
RIVETS • SPRINGS • BRACKETS • MISC.

MORE THAN 1,000 PIECES

5 full pounds—a veritable treasure chest of fastening devices for every practical use. Satisfaction guaranteed. Order now. **\$1.98**
SPECIAL—2 assortments, over 2,000 pieces, for \$3.69.



HUDSON TRADING CORPORATION
The House of Handy Assortments
M-165 West Hubbard St., Chicago 10, Ill.

FREE! Handy List of Special Assortments: FIBER AND BAKELITE WASHERS—RUBBER WASHERS and PADS—FELT WASHERS and PADS—RADIO LUGS, CLIPS and CONNECTORS—SPRINGS—SELF-TAPPING SCREWS—etc.



Titan Slide Rule

6" diameter. Easily read, clearly marked single index scales. Given logarithms, reciprocals, squares, square roots, sines, and tangents. Continuous circular calibrations cannot go "off-scale." Invaluable in multiplication, division, proportion, conversion, all mathematical problems. Made of durable heavy pure white Vinylite. Complete with instructions, \$2.95. Leatherette case 75c additional. Money-back guarantee.

PRECISION INSTRUMENT CO.
Box 654, Dept. K Church St. Annex New York 7, N. Y.

EMPIRE LEVELS

Preferred by MASTER CRAFTSMEN . . .

EMPIRE TORPEDO LEVEL . . . Smallest and handiest accurate Level made. "Cigar-shaped," no sharp corners to tear pocket. Aluminum stock. Has level, plumb and 45° vials, 9" long, only 3 oz. No. 20 . . . \$1.75. No. 151 Aluminum Level, 2 plumbs, 2 levels, 2-45° vials, 18", \$5.00; 24", \$5.50; 28", \$6.25. Order from local dealer. Write for literature.

EMPIRE LEVEL MFG. CO., Dept. P-233 717 S. Sixth St. Milwaukee 4, Wis.

Complete 520

ENGINES IN STOCK



The G. H. Q. miniature gasoline engine that really operates is still available. Over 100,000 sold to date. 1/5 H. P. Complete with flywheel and propeller, fuel 15 accessories and full instructions. Fully bench tested and ready to run. Power for all models. \$20 complete. Send only \$1.00—Shipped Collect C.O.D. same day. Send 25c for illustrated Catalog of hundreds of hobby items.

GHQ MOTORS, Dept. BV35, 40 East 21 St., New York 10, N. Y.

AUTO ENGINE SPEED CONTROL GOVERNORS



\$19.50

Give constant or changeable speed to any auto or truck engine, when used for power. Guaranteed instructions. Oil ring bearing, \$13.00. Ball bearing, \$19.50. Prepaid.

Agents Wanted: Parts Dealers, Garages, Wreckers, Implement Dealers, General Merchants, etc. Free circulars.



Also additional carburetor butterflies. In Montreal: 7546 Wiseman St.; Latin America: East Asiatic Co.

CANDEE, Dept. A. 2641 S. Hill, Los Angeles 7, Calif.

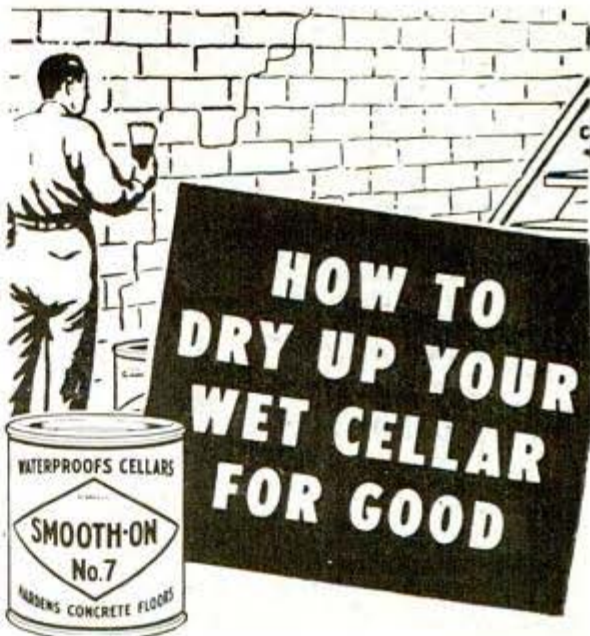

YOU can do it *yourself*—get rid of leaks, dripping, dampness, mustiness—by applying Smooth-On No. 7 Iron Cement to **INSIDE** cellar wall and floor surfaces. You brush it on like paint. Fills in cracks, crevices, pores in concrete, brick, stone. Hardens in 24 hours, expanding slightly, sealing tightly. Inexpensive, for you don't need professional help—and you get a lasting result.

Use it, too, to waterproof troughs, cisterns, tanks, fountains, swimming pool, garage, outbuildings.

Ask for Smooth-On No. 7 at your nearest hardware store—or write us direct if store hasn't it. Comes in 5-, 25-, 50- and 100-lb. sizes. 25 lbs. cover 100 sq. ft.

REPAIR HANDBOOK FREE

Full directions for waterproofing cellars, with instructions for repairing leaky heating and plumbing systems, household equipment, auto parts, etc. 40 pages, 170 diagrams. Pocket size. Just send coupon.



--- Sign and Mail NOW ---

Smooth-On Mfg. Co., Dept. 37,
570 Communipaw Ave., Jersey City 4, N. J.

Please send me Smooth-On Handbook

Name

Address

3-45

Free

Do it with **SMOOTH-ON**

RED-ITCHY SKIN?

watch out—it's often

ECZEMA

**'Invisible'
Liquid
Promptly
Relieves
Torture!**



First applications of wonderful soothing Zemo—a Doctor's highly medicated invisible liquid—quickly relieve intense itching burning of Eczema, Psoriasis and similar annoying skin and scalp irritations due to external cause. Zemo also aids healing. Amazingly successful for over 35 years! Apply any time—doesn't show on skin. First trial of clean, stainless liquid Zemo convinces! Buy Extra Strength Zemo for stubborn cases. At all drugstores.

ZEMO

TRAILER AXLES, HITCHES, AND PARTS

• If you are interested in purchasing trailer axles, hitches, and other trailer parts, contact us promptly. Complete house trailer blue prints, \$1.00. Write for free literature. HAMMER BLOW TOOL COMPANY, Dept. 103, WAUSAU, WIS.



- SEAL OUT DRAFTS
- SAVE FUEL
- BE COMFORTABLE

with

KALK-KORD

THE NON-HARDENING
CAULKING AND SEALING
COMPOUND

You can quickly and easily seal loose windows against drafts with Kalk-Kord—use it around window frames, too, inside and outside.

Neat and clean to use, Kalk-Kord seals cracks without tools—just press in place with fingers. Comes packed in convenient beads or rolls. Will not stain paint or any surface. Does not harden, crack, chip, or shrink. Waterproof and unaffected by temperature changes.

For Sale by Sears, Roebuck retail stores Paint Dept. 30, or by mail from Sears

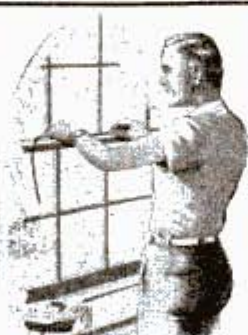

Other Household Uses

- Caulking window and door frames
- Sealing around bathtubs and sinks
- Sealing cracks in plaster, woodwork, masonry
- Sealing around baseboards

Product of

PRESTITE ENGINEERING COMPANY
3978 CHOUTEAU AVE. • ST. LOUIS 10, MO.

FOOT PAINS STOPPED

or Your MONEY BACK



TRY 30 DAYS AT OUR RISK

Heat Cushion
Increases Circulation
Weight Balancer
Metatarsal Support

Air-Cooled ARCH-HEELERS

Get Quick Lasting Relief

Wear Guaranteed Proved ARCH-HEELERS in any shoes for aching feet, metatarsal pains, burning callouses, corns, weak arches. Must please you or Your Money Back. Made of selected leather, specially shaped with soft cushions to gently lift bone joints, release nerve pressure, free blood circulation, align entire foot. Springy. Air cooled. Comfortable, even in tight fitting shoes. Users praise them. "I wouldn't take \$5 for mine!" says one. Pair only \$1.

Send No Money Send name, address and shoe size. Pay postman \$1 plus C.O.D. charge. Or save C.O.D. by sending price with order. Money back if not pleased after 30 days. Send Today.

ARCH HEELER CO., Dept. Z-3, COUNCIL BLUFFS, IOWA

MASCOT SLIDE RULE

• Fits the pocket. Quickly solves any problem in multiplication, division, proportion. Gives the square, the square root, logarithm and reciprocals of all numbers. Trig scales give sines and tangents of numbers. Fine black graduations on white celluloid. Complete with instructions. Price in fabricoid case \$1.00, in leather case \$1.25. Money back if not satisfied. Special offer to agents and dealers.



MONITOR SLIDE RULE—6" Dia.

Made in white Vinylite. Same scales as Mascot Slide Rule. Complete with instructions. Without case, \$2.95. Leatherette case, 75c add'l.

TAVELLA SALES CO., 19-C West Broadway, New York 7, N. Y.

ONE-MAN SAWMILL LESS THAN \$135.00

Easy To Turn Trees Into Money

Makes Lumber, ties, shingles, crates, lath, studding, siding.

Belsaw Models in 10, 14 and 20 feet sawing lengths. Patented Mechanical Feed, accurate set works and positive dogs. Use tractor or old auto engine for low cost power. Thousands used for commercial logging. Pays for itself quickly. Send post card today for FREE booklet, "How To Make Lumber" and Catalog of Woodworking Equipment.

Dept. 1811-N, 3542 Main Street, Kansas City 2, Mo.

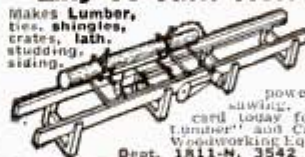

Balance 4" 19" Base. With either \$6.00 Metric or Avirdupuis Weights ... \$6.00

Catalog with 2000 Illustrations of Laboratory Apparatus sent for 25 cents. Catalog listing 10,000 chemicals, drugs, instruments, etc. and 1700 scientific books sent for 25 cents. 100 scientific books 10 cents.

LABORATORY MATERIALS CO.
7321 Vincennes Ave. Chicago 21, Ill.

Make Any Article

GLOW IN THE DARK

with

Magic New Discovery!

Don't pay big prices for luminous articles. Make your own! Sell at big profit or keep for your pleasure. With our complete outfit and confidential instructions, it's easy! A stroke of the brush—any article glows in the dark like magic! Lasts indefinitely. Absolutely harmless. Hundreds of uses. Use on ties, flowers, jewelry, house numbers, furniture, pictures, statues, toys, etc. Order NOW! Supply limited. Money-back guarantee.

Complete LITE-GLO KIT, \$1.00. Send name, address, pay postman \$1.00 plus postal charges. Send cash, we pay postage!

LITE-GLO, Dept. 312-LC, Topeka, Kan.

Service Flags
Light Switch
Decorations
Jewelry
Clocks

\$1.00
Send No Money

★ SAVE WASTE PAPER ★

POPULAR MECHANICS

"THOSE AREN'T SMOKE SIGNALS
POPI! THAT CAR'S WASTING GAS
AND OIL...IT NEEDS BURD
'GRAF-FLOX' PISTON RINGS"



MAKE YOUR CAR A "1946 MODEL" WITH BURD "Graf-Flox" PISTON RINGS

Why drive a sluggish car when you can have new car performance for an investment of a few dollars? Scientific new steps in the production of Burd "Graf-Flox" Piston Rings give them phenomenal self-lubricating qualities. All of the harmful abrasive particles left by grinding are removed by an exclusive method. Then, deeply penetrating colloidal graphite

is applied by a secret process. These steps in making Burd "Graf-Flox" Piston Rings eliminate run-in, assure faster seating, prevent scoring, seizing, scuffing or sticking in grooves. Give your motor a new lease on life... save gas and oil. Mail the coupon for full facts and two free helpful books.

BURD PISTON RING CO., Rockford, Illinois



MAIL THIS COUPON FOR 2 FREE BOOKS

BURD PISTON RING CO., Dept. PM, Rockford, Ill.

Gentlemen:

I'd like a FREE copy of your "Handy Handbook," which tells how to keep my car in good working order. Also send a "Car Economy Record Book" for keeping my mileage costs.

NAME

ADDRESS

CITY..... STATE.....



These
Globe
products
do
precision
work

★
Compact,
Rugged Construction,
Low in Cost!

Immediate Delivery

Detailed literature
free upon request.
Address Dept. P M

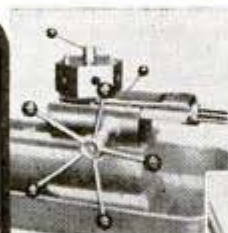

GLOBE HEAVY DUTY BED TURRETS.
Adaptable to any lathe, 4 3/4" travel. Precision built. Rugged construction.

GLOBE CROSS SLIDE. Adaptable to any lathe, 3 1/2" travel. Rugged construction.

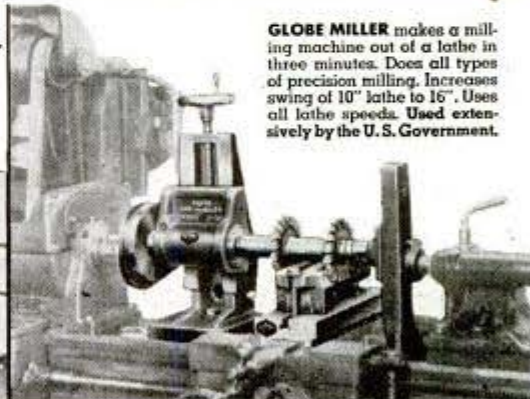

GLOBE MILLER makes a milling machine out of a lathe in three minutes. Does all types of precision milling. Increases swing of 10" lathes to 16". Uses all lathe speeds. Used extensively by the U. S. Government.

IMPORTANT: When ordering or requesting prices on above items, be sure to give: 1. Make and model of lathe. 2. Lathe swing. 3. Power or hand cross lead. 4. State if lathe is equipped with telescoping taper attachment.



GLOBE HAND SCREW MACHINE produces precision parts at high speeds, low cost. Ball Bearing Headstock. 10" swing, 1" capacity, 12 speeds up to 3126 RPM. Exceptionally rugged construction.



MILLING VISE (below) with replaceable jaw plates. Jaws 3 1/2" wide, 3" opening, 1 3/4" deep. Larger sizes available.

DIVIDING HEADS. Precision built. Various sizes available.



Milling arbors, 4", 8", and 12"

WORK HOLDING FIXTURES, hold work of various shapes for milling, drilling, shaping or grinding.

End Mill Holders. Various sizes.

GLOBE PRODUCTS MANUFACTURING CO., 3380 ROBERTSON BOULEVARD, LOS ANGELES 34, CALIFORNIA

MARCH, 1945

175

Pipe companion for your leisure hours

Do you relax by making things and making things work? That's the ideal time to enjoy the mellow, friendly aroma—the rich body of Christian Peper Pouch Mixture.



POCKET-SIZE
PACKAGE
25¢

Christian Peper · St. Louis
Fine Tobaccos Since 1852!

**Now
for EVERY WORK SHOP!**

**NEW
Invention Electroplates
by BRUSH**



**Easy to Plate CHROMIUM
GOLD, SILVER, NICKEL, COPPER
... For Pleasure and Profit!**

If you have a workshop—at home or in business—you need this new Warner Electroplater. At the stroke of an electrified brush, you can electroplate models and projects—you can replat worn articles, faucets, tools, fixtures, silverware, etc. with a durable, sparkling coat of metal... Gold, Silver, Chromium, Nickel, Copper or Cadmium. Method is easy, simple, quick. Everything furnished—equipment complete, ready for use. *By doing a bit of work for others, your machine can pay for itself within a week.* So make your shop complete by getting a Warner Electroplater right away. Send today for **FREE SAMPLE** and illustrated literature. **ACT AT ONCE! Mail Coupon.**
**WARNER ELECTRIC CO., DEPT. A-26
360 North Michigan, Chicago 1, Illinois**

FREE Details & Sample!

WARNER ELECTRIC CO., 360 N. Michigan, Chicago 1, Dept. A-26
Gentlemen: Send Free Sample and Details to:

Name _____
Address _____
City _____ State _____

READY CUT HOMES

Order NOW

Homes \$936 and up, freight paid. Orders filled immediately in essential cases or for preferred post war delivery. Save \$500 on modern production method homes. Much more compared with builders' prices. Anyone can assemble with simple plans furnished. Complete, including paint, hardware, flooring, glass, nails, etc.



Send 25¢ in coin for full color catalog showing 56 modern low-priced homes and floor plans. Complete building plans ready for filing at low cost.

Dept. PM-35
**INTERNATIONAL MILL
& TIMBER CO.**
Bay City, Mich.

**NEW COLOR CATALOG
FOR ONLY
25¢**



**COLLECT U. S. ARMY
Shoulder Patches**

Fascinating hobby. Patches 10c to 50c each. Complete set of 287 for \$56. Official patches available for every major Army and Air Corps unit. Send \$1 for sample assortment of 8 patches and full color patch catalogue.

SPRINGER'S
301 San Francisco St. EL PASO, TEXAS



NEW OTTAWA SAW

**BIG
FREE
BOOK**

**World's Fastest
6 H.P.
EASY TO MOVE**



Falls trees. Saws big logs, small logs, limbs. Pulley for belt work. Easy to handle, weighs less than lower powered units. **FULLY GUARANTEED.** Cash in on fuel shortage. Turn wood lots into cash.
OTTAWA MFG. CO. 327 PINE ST. OTTAWA, KANS.

STOP LEAKS IN BASEMENT WALLS, FLOORS

STOP-IT — Stop those leaks!
End that seepage!
Use **STOP-IT**—amazing quick-setting, waterproof material. Simply mix with water and apply. Sets hard and permanent. At your dealer or write direct.



TAMMS SILICA CO.
Dept. 5-208, 228 N. LaSalle St., Chicago 1, Ill.



DRILL-INDEX A compact container for indexing and filing twist drills. Eliminates search. Made entirely of steel in nine sizes. Available on priority to essential users. See your dealer or write to
HUOT MFG. CO.
Foot Schultz Bldg. St. Paul 1, Minn.



MEN

This Horseshoe Ring, Handmade, Hand-engraved, inlaid with simulated pearl, is a **KNOCKOUT!** Shoe and shank of everlasting Monel Metal is

GUARANTEED 20 YEARS

Supply is limited... rush your order! **SEND NO MONEY.** Pay Postman only \$3.85, plus excise tax and postage. Return for refund in five days if not delighted. State size. Address:

AMERICAN JEWELRY CO., Dept. 162-H, Wheeling, W. Va.

2

Announcing

NOMA'S

\$50,000

FOUNDATION

for Toy Designs

and Ideas

3



AMATEURS OR PROFESSIONALS
— DESIGNERS OR INVENTORS —

Anyone who has ever dreamed up a toy!

Here's your chance! Cash in on Noma Toys' nation-wide search for new, appealing, different toys.

We will consider anything from a rough idea to a complete working model.

There's big money in toy designing
 Write Noma Toy-Design Foundation for full information.

NOMA Electric Corporation
 55 West 13th Street • New York 11, N. Y.

Johnson **HAMMER MOLD & LADLE**



Mold Lead Hammers at home — easily — quickly — economically. Send for Price List 2M.

Made in 7 sizes for 1 to 11 lb. hammers

JOHNSON TOOL COMPANY
 L. H. COOK, Owner • • • EAST PROVIDENCE, R. I.

IT STAYS ON . . . RUST STAYS OFF

FIENDOIL

RUST INHIBITOR



Keep home tools, appliances, corrosive metal protectively coated.

35c Bottle Hdwe. — Sptg. Goods Dealers
 McCambridge & McCambridge Co.
 Baltimore 23, Md.

UTICA TOOLS



ALL TYPES FOR MORE TOOL MILEAGE

Ask Your Dealer

UTICA DROP FORGE & TOOL CORP.
 ★ UTICA, N. Y. ★



SAW FILING

Customer:
 "That's a beautiful job, Pete."

Pete: "Yes, you can't beat the Foley for turning out a perfect cutting saw."

is a Good Business

With the Foley Automatic Saw Filer you can have a fine cash business with steady customers and make a good living. The Foley automatically joints the saw, making all teeth even in size, shape, spacing. The Foley is the only machine that files all hand saws, also band and cross-cut circular saws.

SEND FOR FREE PLAN — Shows how to start a saw repair shop. No canvassing. Send coupon today.

FOLEY Automatic SAW FILER

FOLEY MANUFACTURING CO.
 310-5 Foley Bldg., Minneapolis 13, Minnesota

Send Free Plan on Saw Filing business, no obligation

Name _____
 Address _____



See you saw it in Popular Mechanics!



BATTLE COMPASSES TODAY!



COMPASSES TOMORROW!

the
SHERRILL
Magnetic Director
COMPASS

Victorious war-fare demands accurate direction-finding instruments. While all Sherrill facilities are now devoted to the Armed Services, at war's ends, look for a complete, low-cost line of precision Sherrill Magnetic Directors.



SHERRILL RESEARCH CORP., Peru, Indiana

PALMGREN

No. 000 ANGLE VISE

For MILLING—DRILLING—GRINDING
FITTING—FILING

Solve Difficult Angle Jobs



Quick, accurate setups at any angle. End make-shift methods—time loss—rejections. Ideal for tool rooms or home workshop. Accurately machined and graduated. Once set it stays locked. Jaws hardened steel—plain or grooved. Sizes 1 1/2" to 8" Jaws.

DRILL PRESS VISES

For tool room, machine shop, steel shop, home shop or repair shop. Accurately machined. Best semi-steel castings. Adjusting screw of hardened steel with fine pitch thread and loss bearing. Jaws hardened steel, grooved or plain. Sizes 1 1/2" - 2 1/2" - 4" Jaws.



No. 250 MILLING ATTACHMENT VISE

A most necessary fixture for small shops and even emergency work in large ones. Fits any 8"-9"-10" South Bend, Atlas, Craftsman, Sheldon or other lathes of similar sizes. Has graduated vertical feed screw and 360 degree graduation for vertical angle adjustments. Easily mounted on cross slide and held by one T-slot bolt. Equipped with PALMGREN VISE, 2 1/2" Jaws opening full 2 1/2". Vise has one plain and one grooved jaw for holding round pieces.

MAKES MILLING OPERATIONS POSSIBLE ON ANY LATHE

Width	Depth	Opening	Jaw	Jaw	Jaw	Height	Price
2 1/2"	1-7/16"	2 1/2"	10 1/2"				\$24.75

ORDER DIRECT—Write for Circular No. 347
CHICAGO TOOL AND ENGINEERING CO.
8365 South Chicago Avenue Chicago 17, Ill.

ELECTRICITY FOR ANY JOB ANYWHERE



Reliable, economical electric service anywhere, anytime, with an Onan Electric Generating Plant. Driven by Onan built, 4-cycle, gasoline engine, these power plants are of single-unit, compact design and sturdy construction. Suitable for all types of service.

Models range from 350 to 35,000 watts. A.C. types from 115 to 660 volts; 50, 60, 130 cycles, single or three-phase; 400, 500 and 800 cycle, single phase; also special frequencies. D.C. types range from 6 to 4000 volts. Dual voltage types available. Write for engineering assistance or detailed literature.

ONAN

D.W. ONAN & SONS, 2503 Royalston Ave., Minneapolis 5, Minn.

PICTURE RING \$1.



Exquisite Onyx-like Picture Ring—made from any photo. Send No Money! Mail photo with paper strip for ring size. Pay postman only \$1.00 plus postage. Hand tinted for extra. Photo returned with ring. Money back guarantee. Send photo and ring size now.

Made from Any Photo or Picture! SEND NO MONEY!

POCKET ADDING MACHINE

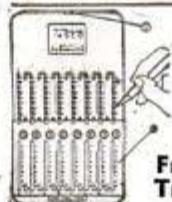

STURDY STEEL construction for lifetime use. Adds, subtracts, aids multiplication. Capacity 999,999.99. A real machine—guaranteed 5 years. Thousands of satisfied users. Send name and address. We ship immediately. On delivery, pay postman \$2.50 (plus C.O.D. and postage charges). If you send \$2.50 with order, we pay postage. Leatherette case 25c additional. Your money back after 10 days trial if not satisfied.

Free Trial \$2.50

Send no money TAVELLA SALES CO., 19-CA West Broadway, New York 7, N. Y.

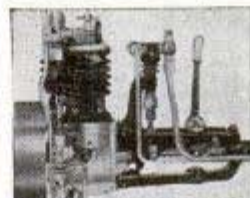

Build: STEAM ENGINE

- A precision built and engineered single cylinder, 1/4" scale marine model, with clutch or reverse.
- Send \$2.50 for 14 pages scale drawings, 2 photos, instructions.
- 2 Photos and Description...\$.25
- Rough Castings Kit.....\$ 12.50
- Horizontal Flash Boiler Drawings and Instructions 1.00

THOMPSON ENGINEERING CO. 206 NO. DIVISION BLDG., GRAND RAPIDS 2, MICH.

WINDOW SIGN LETTERS

For Store Fronts and Office Windows. Anyone can put them on. Samples furnished. Imitation Gold and Silver. METALLIC LETTER CO., 430 N. Clark St., Chicago 10



DEPENDABLE

Genuine Gerstner Tool Chests render complete service to fine tools, day after day. Free Catalog for Machinists and Toolmakers. GERSTNER TOOL CHESTS Dayton 7, Ohio 445 Columbia St.

LEPAGE'S GLUE

LEPAGE'S GRIPSREADER MUCILAGE.

LEPAGE'S WHITE PASTE



For Men who *Really Know Pipes*

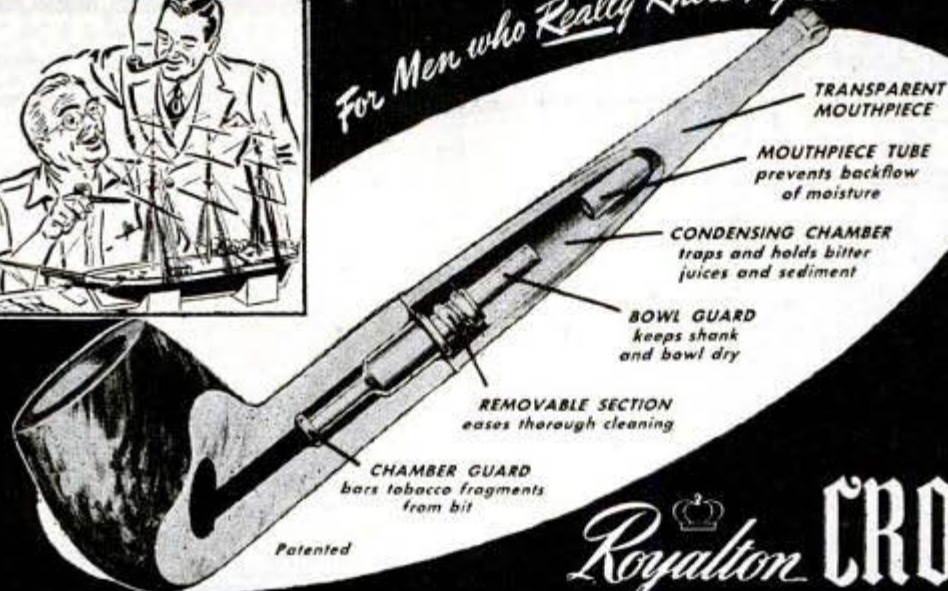

TRANSPARENT MOUTHPIECE

MOUTHPIECE TUBE prevents backflow of moisture

CONDENSING CHAMBER traps and holds bitter juices and sediment

BOWL GUARD keeps shank and bowl dry

REMOVABLE SECTION eases thorough cleaning

CHAMBER GUARD bars tobacco fragments from bit

Patented

\$1.50

Selected Briar

Royalton CROWN

Cool, dry smoking is half the pleasure of a pipe. Royalton Crown redoubles your satisfaction because its patented features 'wring' the smoke dry as it passes from the bowl to the mouthpiece. Every puff is dependably free from strong juices and irritating tobacco shreds. Result: an everlastingly dry pipe in a class by itself for complete smoking contentment.

HENRY LEONARD & THOMAS, INC. • OZONE PARK, NEW YORK

IMPROVED PERFORMANCE

★ Stendier on roughest roads, easier to compensate, still more accurate. You'll want the improved **HULL STREAMLINE AUTO COMPASS** with the new shock-proof mounting bracket. Limited supply at your dealer's. Circular free. Price \$3.50.

HULL MFG. CO., P.O. Box 246-D3, Warren, Ohio



Big Money for Workers In Home or Shop



Licensed Concrete Specialists wanted. No experience needed. Make *Colorglazed* concrete pottery without molds. New, low cost, patented method. Cemetery products, novelties, tiles, etc. Basement leaksealing. Other big pay projects. Booklet, details free. Men only.

NATIONAL POTTERIES COMPANY
542 Lincoln Avenue Fergus Falls, Minnesota

HOLD-E-ZEE AUTOMATIC GRIP SCREWDRIVERS

Hold-E-Zees do the job better, faster. They excel wherever screwdrivers are used. Gripper instantly released by spring action, sliding up out of way when not in use. *High-quality materials throughout.*

Upson Bros., Inc.
86 Exchange St.
Rochester 4, N. Y.

PATENTED

At Leading Dealers Everywhere

Mortite

MANY USES in the HOME

Ever ready, pliable plastic plugger-upper keeps out dust and dirt, mosquitoes, flies, ants, etc. Fills holes and cracks around drainboards, sinks, bathtubs. Use inside or outside. During cold weather, weatherstrips.



EASY TO APPLY

Unrolls like ribbon. Just press into place and it stays put. Does not crack, chip or shrink. Can be painted. A roll covers about 80 feet.

At Hardware, Paint, Dept. Stores and Lumber Yards. \$1.25
Higher west of Rockies and Canada

Free Booklet

J. W. MORTELL CO.

522 Burch St.

Kankakee, Ill.



IT'S EASY and FUN TO BUILD THE NEW LEJAY **FAST FREEZER**

COMPLETE PLANS
FOR BUILDING and
MATERIALS SHOW
YOU HOW!

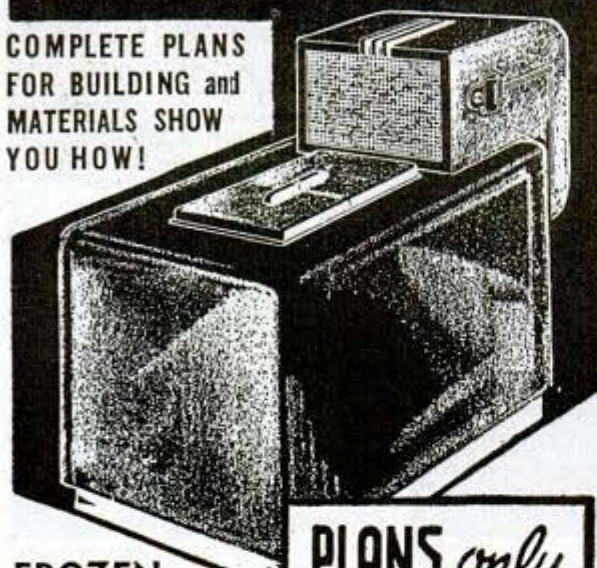

**FROZEN
STORAGE**
From 5° above to
10° below zero
For Fish, Meat, Fruit, etc.

PLANS *only*
\$1.00

5 Sizes—8 to 40 CUBIC FEET CAPACITY

IT'S FUN AND IT'S EASY

to build this Fast Freezer. Our plans cover every detail and you need no expert knowledge of refrigeration or carpentry. Can be built of new or used parts. Operates on any voltage.

MAIL THE COUPON NOW

Clip it to a \$1 bill, check or money order and slip it into an envelope. We will include without extra cost plans for a Milk Cooler, and our Big New Catalog.

LEJAY MANUFACTURING CO.,
447 Lejay Building, Minneapolis 8, Minn.

Gentlemen: Please send me complete plans of your Fast Freezer, for which I attach \$1 bill Money Order Check—add 5c exchange .

NAME.....

ADDRESS.....

CITY.....

STATE.....

LEJAY MFG. CO.

447 LEJAY BUILDING

MINNEAPOLIS 8, MINNESOTA.

★ SAVE WASTE PAPER ★

2 Bushels of Ripe TOMATOES from ONE VINE



2 or 3 vines will produce enough tomatoes for the average family.

New BURGESS CLIMBING TRIP-L-CROP

TOMATO rapidly grows to a height of 10 to 18 feet. Grow on trellis, side of house or barn or as a bush in garden. Beautiful crimson, solid, meaty fruits of best quality, some weighing over 2 lbs. each. The most productive of all tomatoes. Trial packet 10c—3 for 25c, postpaid.

CASH PRIZE CONTEST
Send for FREE Garden Book giving full details about CASH PRIZES to growers of this wonderful tomato.

BURGESS SEED & PLANT CO.
217 C.T., GALESBURG, MICH.

MAGI-GLO LUMINOUS PAINT



**LIKE MAGIC—Make Anything
IN THE DARK**



Get ORIGINAL Magi-Glo.

101 USES: house numbers, clock dials, light switches, dark room equipment, designs on walls, toys, dash boards, costumes, scenery, jewelry.

A stroke of the brush—it glows like magic in the dark. It's fun, easy to use. Lasts indefinitely. Absolutely harmless.

SEND NO MONEY Complete Original Magi-Glo Kit only \$1.29, (C.O.D. plus postage). If not thrilled, money back in 7 days on request.



MAGI-GLO, Dept. 15, 32 W. RANDOLPH CHICAGO 1, ILL.

New OTTAWA WOOD SAW



For Tractors

—Makes wood sawing fast and easy. Can cut enough wood to pay for itself quickly. Easily moved while attached. Big heavy blade. FREE details.

**LOW
PRICE**

OTTAWA MFG. CO.
W327 Oak Ave., Ottawa, Kans.



DURAPPOINT DRILLS...

Drill concrete, glass, hardened steel.
Sizes 1/8" to 1 1/2" inclusive.

Write for price list.

DURAPPOINT TOOL COMPANY
4342 Umatilla Street
Denver 11, Colorado



BUILD WITH CEMENT COMPOSITION

strongly reinforced with cheap wood. Several formulas. Modern stream-lined roof, walls and gutters in cost. How to build a house 22'x34, three rooms, as low as \$100 for materials, garage, \$20, 20x50 poultry house, \$50. Farm buildings for a few dollars. Homemade equipment to make wall-high building blocks with inside and outside finish. Also roof, wall and floor tile in color, and durable wallboard of sawdust. Labor saving. Long lasting. No painting. Make doors and windows. Sectional cabins, 100 non-saving ideas. Mixer and saw easily made from an old auto. 40 Warranted, illustrated instructions, \$1.00.

MAKE FURNITURE OF COMPOSITION cement, sawdust, asbestos, paper. Some part sawn wood and metal. Illustrated instructions to make tables, cabinets, chests, racks, shelves, inclosed stoves, lawn novelties and toys, 500 per cent profit. 50c.

HOW TO MAKE ACCURATE WOODWORKING MACHINES: Band, jig and circular saws; electric drills, sanding wheels, tools, electric weed cutters and many other things from old auto parts and washing machine motors. Illustrated, 50c.

HOME MFG. ENTERPRISES, 50 selected home shop projects, 50c.

Special: All of the booklets described above, \$2.00 postpaid. No C.O.D.

HOME INDUSTRIES, 1318 South 34th Ave., Dept. PM, Omaha 5, Nebr.

POPULAR MECHANICS



Recondition for the Duration-plus

30 million buyers scrambling for the first cars off the production lines! Your chances for a new car, quick, are not so good. Recondition the car you've got for the Duration-plus with "Rings made by Simplex," the longer life rings. Obtainable now at accessory stores and wholesalers. Easily installed by anyone handy with tools.



BUY WAR BONDS AND KEEP THEM

SIMPLEX PISTON RINGS

SIMPLEX PRODUCTS CORP., Cleveland, O.

SALESMAN-AGENTS ATTENTION:

Timely fast selling Specialty—easy to carry. Everybody buys our Clear View Identity Case. The perfect Wallet Insert—4 Plastic pockets with two heavy plastic covers. Metal Spiral bound—fits into Wallet, Vest, or Blouse pocket and Ladies purse. Sells like "Hot Cakes." Price 50c ea. Cost you \$2.80 Doz. Postpaid. Order trial Dozen today. GUARANTEED. Full Sale of 1st order or money refunded for unsold portion. FREE 3 color display card, sample attached, with 1st order.

BEACON SALES CORP., Dept. P-3, 37 S. Wabash, Chicago 3



New Designs in

FRANZITE GRIPS

Modernize Your Gun! Improve Your Score!

Most durable grips made. Positively unbreakable! For Colt, Smith & Wesson, Hi-Standard, Outgias, Luger & Mausers in a wide choice of beautiful designs in ivory, pearl, walnut, onyx, etc. Low prices. FREE CATALOG. Dealers Wanted.

SPORTS, INC., (Mfrs.) 2850 N. Clark St., Dept. P-3, Chicago 14, Ill.



Decorative Decalomania

Transfers Imported Designs of all Sizes & Types—Flowers, Fruits, Figures, Birds, Dogs, Horse Heads, Ships, Juvenile, Tropical, Chinese, Peasant, Colonial, Patriotic, Inlay, Borders, Initials, etc., for Furniture, Doors, Walls, Trays and what not. Catalog with 800 illustrations in color sent for 25c. Deductible on first order of \$1.00 up. L. C. WELLS, Dept. PM-53, 25 East 26th St., New York, 10

BRUSH PLATING OUTFITS

for re-plating articles in the home and shop. No tanks necessary. Free particulars.

GUNMETAL CO., AVE. M, DECATUR, ILLINOIS

Fix Scratches, Dents, Nicks the Professional Way!



Get This Handy Kit!

Repair damaged furniture surfaces with new practical kit. Enables anyone to do fast, easy touch-up jobs like a professional cabinet finisher. Makes furniture and cabinets look new. Every home and shop needs this remarkable kit. Pays for itself over and over!

Amazing Results—Easy to Use

Kit includes 23 different items—scratch removers for slight scratches, assorted shades of shellac sticks for deep nicks, bottles of light and dark stains, shading lacquer, alcohol lamp with fuel, stainless steel spatula, touch-up brushes, scratch sticks, steel wool, sandpaper, rubbing liquid. Packed in handy leatherette finish case. Send for it today. Best investment of lifetime. Fully guaranteed. Detailed instructions supplied.

\$3.95

Postpaid

AMERICAN HOUSEHOLD BUREAU
Dept. F, 520 N. Michigan Ave., Chicago, Ill.

for Global War

Valspar—the Varnish that won't turn white



Valspar—the Paint that does it right

for Home Repairs

VALSPAR

STANDS UP FINE!

An "ocean of Valspar" would hardly exaggerate the amounts used these war years! Millions of gallons of Valspar paints, varnishes and enamels are meeting the toughest of all tests—protecting our armaments and military installations against Arctic blizzards and blazing tropical sun.



People at home who want the best in paints, enamels and varnishes have been using huge amounts of Valspar too. Valspar is the best you can buy. Valspar Varnish never turns white—Valspar paints and enamels give protection . . . lasting beauty . . . make home repairs easy! Ask your dealer for Valspar—today!

Arc Welders, Write HOBART Today!



BOOK FULL OF IDEAS FOR WELDED DESIGN. Complete with work sheets. FREE! Sample pages sent on request. Vol. 1. **ONLY \$3.50** POSTPAID

Prepare yourself for the future with Hobart's new book, "Practical Design for Arc Welding." If you're thinking about a post-war welding business of your own, investigate Hobart before buying any arc welder. Write for full particulars today!

HOBART BROS. COMPANY
Box M-35, Troy, Ohio

HOBART
Simplified
ARC WELDERS



VEST POCKET GUIDE for Arc Welders! Welders can use to solve all kinds of welding problems. **FREE!** Get your copy today!

HOBART "One of the World's Largest Builders of Arc Welders."



HANDEE Tool of 1001 Uses

The original, fit-your-hand tool—today's finest. Does precision work on any metal, alloy, plastic, wood, horn, bone, glass, etc.

A WHOLE TOOLSHOP IN ONE HAND

The sky's the limit with the Handee. Its usefulness is as extensive as the number of quick-and-easy-to-change accessories you own—there are more than 300 in the Chicago line to grind, drill, polish, cut, rout, carve, engrave, sand, saw, etc.

Because it's perfectly balanced and weighs only 12 ounces the Handee is the "non-fatiguing" tool. Operates on AC or DC current at 25,000 r.p.m.

With 7 Accessories, Postpaid **\$18.50** to all who have Priorities.

Free new 64 page Catalog of complete Chicago line.

CHICAGO WHEEL & MFG. CO.

1101 W. Monroe St., Dept. PM Chicago 7, Ill.



WAR SURPLUS BARGAINS!

STARK'S

WAR SURPLUS BARGAINS

\$500,000.00 INVENTORY for QUICK LIQUIDATION

U. S. Gov't, surplus and other items for home, shop, factory, farm and outdoors. New, used and reconditioned. Tremendous savings! All priced for quick sale.

HUNDREDS OF ITEMS to CHOOSE FROM

Pup and Mosquito Tents, Cavalry Swords, Bolo Knives, Radio Tubes, Ski Clothing, Snow Shoes, Bandoleers, Canteens, Mess Kits, Tools, Invasion Life Belts, Slide Rules, Tarpaulins, Air Pillows and Mattresses, BB Shot, Batteries, Optical Prisms and Lens Elements. Hundreds of others! Big, illustrated catalog **FREE!** Write today.

FREE CATALOG

STARK'S Dept. PM3 509 So. STATE STREET CHICAGO 5, ILLINOIS

ITALIAN ACCORDIONS

Hand Made. Very best. Lowest prices. Buy Direct from Factory and Save Money. Send name and address for FREE catalog.

ITALIAN ACCORDION MFG. CO.
323 W. POLK ST., DEPT. PM-15, CHICAGO 7, ILL.

TODAY'S HEAVY-DUTY
Tyson TAPERED ROLLER BEARING
With More Load-Carrying Rollers
TYSON BEARING CORPORATION • MASSILLON, OHIO

Always write your name and full address clearly when answering advertisements.

GET THE IMPROVED SUPER DRILL GRINDING ATTACHMENT



Grinds round shank drills from 3/32" to 1-1/16" diameter. Grinds old drills like new in three different point angles—59°—69°—88°. Grinds short, medium and long twist drills from 2" up to 11". Attaches to bench or grinder. Will grind rounded curve on drill point.

USED BY THE ARMY AND NAVY

Pays for itself the first week

You're an expert from the start with the Super Grinder. Does work like the highest priced grinders. Gives a true center, and desired clearance. Saves drills, time and money. Grinds drills in 25 seconds. No shop should be without the SUPER DRILL GRINDER. Mail your check or money order for \$2.95 with printed address. The Super will come by return mail complete with instructions. Postpaid.

CRANDALL MFG. CO.
Dept. FA-3, 1512 W. Slauson Ave.
Los Angeles 44, Calif.

SUPER JUNIOR

Grinds Std., 59° angle from 3/32" to 1" dia., up to 6" long. Will grind rounded curve on drill point. **ONLY \$1.85**

MONEY BACK GUARANTEE

powerful... efficient

This New DURO 10" Tilting Arbor Saw has many new features and basic improvements

A versatile low-cost machine for cutting metals, woods and plastics, with many exclusive advantages. Entire arbor and tilting mechanism suspended on rugged, extra-heavy precision machined trunnions.

Has capacity up to 3 1/4" depth of cut and a working surface 1080 square inches with regular extensions, or 1395 square inches with special extensions. Distance in front of blade is 14 1/4", and from blade to rip fence with regular extension 17", or 25" with special extension providing greatest possible utility. Cast iron table top is made of close grained and polished surface. Motor mounting is designed for most Standard Motors. Has improved guards and safety features as integral part of unit—also patented accurate improved Rip Fence and Miter Gauge.

Send for Catalog—for full details and prices on the DURO 10-inch Circular Saw. Also lists specifications and prices of complete line of DURO single and multi-spindle Drill Presses, Circular Saws, Jointers, Routers, Shapers, Grinders, Lathes, Scroll Saws, Flexible Shaft Units and Portable Electric Drills.



Available on Priorities Only

DURO TOOLS

MACHINE TOOL DIVISION

DURO METAL PRODUCTS CO., 2670 N. KILDARE AVE., CHICAGO 39, ILL.

ALSO MAKERS OF DURO HAND TOOLS



New 1945 SHOP NOTES Now Ready FOR EVERY MAN WHO USES TOOLS

One of these books is issued each year and is a reprint of articles published in our Shop Notes Department. It contains cream of experience of years, of hundreds of our country's most successful mechanics. Get a copy from your News Dealer, or send 50c to **POPULAR MECHANICS PRESS** Dept. 599 200 E. Ontario Chicago 11, Ill.

★ SAVE WASTE PAPER ★

PLASTAKIT

Make your own ornaments, decorations and jewelry designs out of plastic. Box of 60 pieces including such pieces as boats, anchors, hearts, pilots' wheels, flower baskets, also 2 plastic bases to make your own brooches. All complete, including earclips, glue and pins. Now the latest rage. Send \$2... box sent postpaid. No. C.O.D.'s.

WASHINGTON EMBLEM CO.

Dept. P Box 1067 Providence, R. I.

At these prices you can "OWN your OWN" Scherr Precision Tools

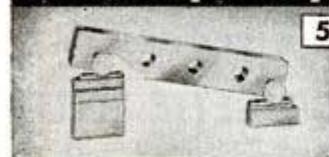

5 IN. SINE BAR

You've always wanted one. Why wait in line at the tool crib every time you have a precision angle job? Get a Scherr 5 in. Sine Bar for only \$19.00. Order today.



DIAL INDICATOR SET

Time-saver in truing up work on lathe, grinder, miller, etc. In hardwood box—clamp, toolpost holder, internal measuring attachment, three contact points, ball joint back and the thoroughly dependable Scherr Dial Indicator—\$18.00.

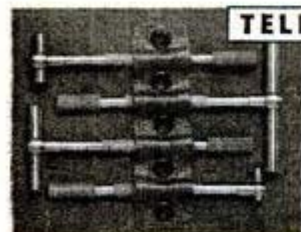

TELESCOPING GAGE

Set of four will give you any inside measurement 5/16" to 2 1/8", to be read off on an outside micrometer. Used with Reed Micrometer, will enable measurements to 1/1000". A Scherr precision tool for only \$9.10, including leatherette case. Quick delivery.



REED MICROMETER

You can easily measure to 1/10,000" with the accurate vernier on this super-precision mike. Burnished thread gives smooth, sensitive measuring and long life. Accuracy guaranteed to Scherr highest standard. 1" size, with locknut and ratchet, \$6.98 plus 10c postage.

The Scherr 10-day money-back offer, without conditions, protects you absolutely. You take no chances in ordering Scherr tools. Neither do we, for we know they're good. In ordering, send money order, check, or we'll ship C.O.D.

GEO. SCHERR COMPANY, Inc. 200-A LAFAYETTE STREET NEW YORK 12, N. Y.

**DOES YOUR BRAKE
PEDAL HIT THE
FLOOR?**

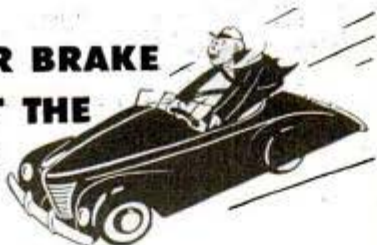

You've got

BUBBLE TROUBLE!

USE

Flare

**HYDRAULIC
BRAKE FLUID**

(By the makers of WAXIDE)

"Bubble Trouble" is dangerous! A bubble in your brake lines is a sure signal of danger. If your brake pedal hits the floor board—get FLARE

Hydraulic Brake Fluid. Blends perfectly with other first-quality fluids—won't freeze at 40° below—or boil at 180° above.

Keep Your Car Fit to the Finish!

FOR CAR BEAUTY
AND CARE USE...
Flare



THE BELL COMPANY, INC.
411-15 NO. WOLCOTT, • CHICAGO 22, ILL.

for EVERY HOBBY SHOP
and HOME CRAFTSMAN!



**NEW
WARNER
Brush
ELECTROPLATER!**

**DECORATE Your MODELS and PROJECTS
with GOLD, SILVER, NICKEL, COPPER**

If you have a hobby—a home workshop—you need this new battery model Warner Electroplater. Easily and quickly, you can electroplate models and projects; you can replat worn articles, faucets, tools, silverware, etc. with beautiful coat of gleaming metal. Equipment includes 10"x14" Control Panel, Variable Voltage Regulator, Work and Brush Terminals, Battery Connectors, Patented NYLON-LUCITE Electrolytic Brush with 4 Anodes. All necessary supplies: Electroplating Compounds for Gold, Silver, Nickel, Copper—also Degreaser, Cleanser, Instruction Book and Wiring Diagram. Get more fun

**The TOOL of
A 101 USES**

Be proud of your work! Electroplate your models. Decorate metal projects. Replate worn objects. It's Easy!

from your hobby, make your workshop complete, order your battery model Warner Electroplater today. ONLY

\$19.75, shipping charge collect.

WARNER ELECTRIC CO.
Dept. A-70, 360 N. Michigan, Chicago 1, Ill.

**DEALERS
Hobby Shops**
Feature this
new tool in
your store.
WRITE FOR
DETAILS!

Just issued!
New, 16-Page Bulletin!
"Hard-to-Find
Radio and Electronic
Parts and Equipment"
Free for the asking
Write immediately to Dept. P-35
Now Known as **LAFAYETTE RADIO CORP.**
as **CONCORD RADIO CORP.**
901 West Jackson Boulevard, Chicago 7, Illinois



INSPECTOR'S LENSES

magnify and leave hands free. Magni-Focuser Binocular Eyeshade magnifies object three times actual size. Sharp focus about ten inches from forehead. Send \$8.50 for ten-day trial. Money-back guarantee. Shipped postpaid. N. L. Huebsch, 83 Yale Street, East Williston, N. Y.



**"WONDER"
ELECTRIC BUTTON**

Most interesting electrical apparatus ever discovered. Make your own Telephone-Amplifier Detectophone. Transmit your voice or music to distant rooms. Perform hundreds of fascinating experiments. So tiny it can be concealed in dozens of places. Send \$1 now for button and free 5,000 word instruction booklet with 60 illustrated experiments. SPECIAL OFFER 6 buttons and booklets sent post-paid for \$5.
BUCK MFG. COMPANY, Box A-28, No. Aurora, Ill.

COLOR CONCRETE WITH CHEMICALS

A business of your own. Big money making Hollywood style pottery and birdbaths without moulds. Washing-wells, stucco-rock, benches. Marbling and cement water-paints. 10c brings sample, literature, pictures. **Hollywood CementCraft, 8529 Wonderland Ave., Hollywood 46, California**

GENUINE U.S. BARGAINS ★ ★

G. D. WOOL BLANKETS (USED). SELECT... \$3.95
Used Late Issue GAS MASK BAGS... .89
U. S. ARMY PUP TENTS (USED)... 3.00
Slightly Used Army CAISSON WHEELS with Axles, 56" high, wt. per pair with axles, 550 lbs. \$35.00
New CONDIMENT CANS... .6 for \$7.75
Thousands of Other Bargains in Military, Outdoor & Sport Goods for Hunter, Farmer, Scout. Send 10c for 32-page catalog returned with first order.

A and N SUPPLY CO.
EST. 1868 4724 LESTER ST. RICHMOND, VA.

HOW TO MAKE CIGARETTE ROLLER

Sample and instructions how to make of wood—easy to sell—badly needed. Mail \$1.00 to

COMMERCIAL SPECIALTY COMPANY, 342 E. 214, Euclid 19, Ohio

Monuments Freight Paid Anywhere in U.S.A.

\$13.69 Up. Guaranteed Genuine Marble & Granite. Deal direct with Us by mail. Save. Write for Free catalog today.
U. S. MARBLE & GRANITE CO. Oneco, Fla.

MAGIC LIQUID Prints Photos

On Wood, Leather, Cloth, Cards Letterheads or almost any surface. Use any snapshot or other negative. Make hundreds of prints without harming negative. Won't wash off. Easy to use. Complete kit for 100 or more photos now only \$1.00 postpaid, or \$1.29 C.O.D. (Canada \$1.50 money order only; no C.O.D.'s). Satisfaction positively guaranteed. Rush order today for the original, big, complete Magic Photo Printing Outfit.
L. & M MFG. CO.
Dept. 333-J, 229 W. Breckinridge, Louisville 3, Ky.

Success WITH Atlas

Andy Langdon at his Atlas lathe in his fine new plant in Glendale, California.

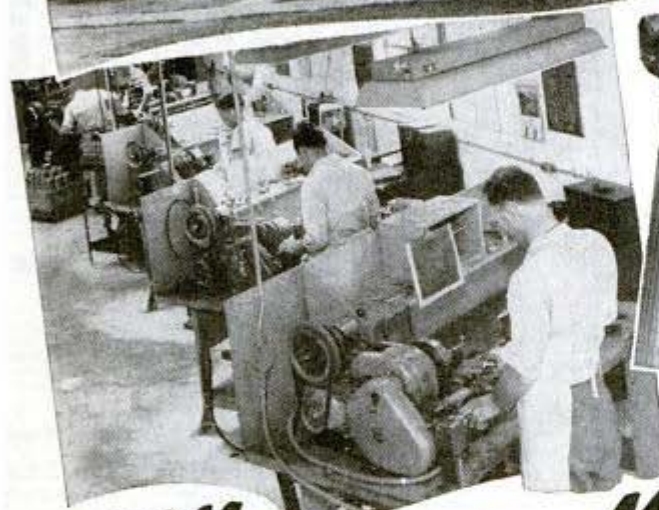

FROM GARAGE SHOP to MODERN PLANT IN THREE YEARS

Three years ago a tool salesman — today owner of a modern new plant, busy on highly precise aircraft tools, with plenty of plans for postwar business — that's the "success story" of Andy Langdon. His interest and skill in machine work came from an Atlas lathe and Atlas drill press in his basement workshop.

He foresaw the need for special precision tools, enlarged his garage, added an Atlas lathe, and started business. Soon he was forced to move to the white building shown

above. But his work and staff kept expanding until he needed to build for himself.

His specialty has been work for Douglas Aircraft on tiny parts only $1/16$ " in diameter to full Atlas lathe capacity with tolerances of $.0005$ ".

SEND FOR LATEST CATALOGS

Are you planning on a home shop after the war with the idea, perhaps, of writing a "success story" of your own in the busy times ahead? We'll gladly send catalogs.

New Atlas pattern service for wood craftsmen. See ad on page 198.



ATLAS PRESS CO.

343 North Pitcher Street, Kalamazoo 13D, Michigan

THE POSTWAR PAINT
for a Glorious Postwar World



PLASTIQUE

AMAZING PLASTIC FINISH The paint of modern science. Resin-based; creates a plastic finish that is tough, fade-proof, waterproof and resistant to gas and fumes. Fun to use on Interior and Exterior. Self-flowing, self-leveling. Amateurs get professional results.

WASHES LIKE TILE

One coat covers any kind of surface—brick, stucco, plaster, wallboard, wood—yes, even old wallpaper. Will not crack, chip, chalk or peel. Cannot be thinned by water. Try it—compare! Per quart. **SPECIAL**

\$1.85
\$5.95
Per Gal.

MONEY-BACK GUARANTEE

If, after using 25% of this plastic finish paint, you are not 100% satisfied, return remainder and receive full refund. Order for cash, postpaid or C.O.D. plus small express charge. **COLORS:** White, Ivory, Cream, Buff, Dusty Rose, Grey, Peach, Blue, Brown, Black and 3 shades of Green. Specify interior or exterior and color—gloss, semi-gloss or flat. Gallon covers 350 square feet.

PLASTIQUE NU-FLO FLOOR FINISH

Eliminates waxing and polishing. Non-skid. Amazing plastic finish. Oil does average kitchen. 12 colors and clear. Per Quart . . .

\$1.95
\$6.75
Gal.

DEALERS—PLASTIQUE PAINTS OFFER YOU A TREMENDOUS POSTWAR FUTURE. WRITE NOW.

NU-FLO PRODUCTS

333 N. MICHIGAN AVE., CHICAGO, I ILL.

AMMCO
7" SHAPER

"A Precision Machine of a Thousand Uses"

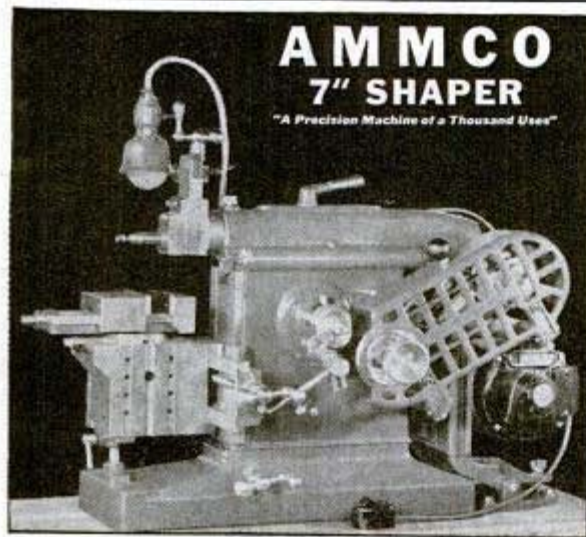

A wide variety of jobs can be done accurately, quickly, easily, and economically on the AMMCO Shaper (7" stroke). Construction incorporates many features you would expect to find only in larger, more expensive machines . . . For example: **WAYS** of ram, tool head, and front face of the main frame are of the "VEE" type, hand scraped to insure accuracy and long life. Available for stationary installation or as portable unit.

Write today for specifications and prices

AMMCO

2140 Commonwealth Ave. North Chicago, Ill.

Trap the Enemy
THAT BORES FROM WITHIN

Dirty engine oil does an "inside job" of destruction—clogging piston rings—causing valves to stick—running up fuel and repair bills.

Keep your oil clean and efficient by installing an AC Oil Filter, similar to those that AC builds by the thousands for the Army. And use AC elements for replacement, no matter what make of oil filter you now have. Your engine will perform better and last longer.



AC

OIL FILTERS

SPEED FINAL VICTORY—BUY WAR BONDS



Peace terms every man should make NOW!

The war is still on . . . and will be for some time to come.

But right now—before the war ends—every man in America has an unprecedented opportunity to make terms with himself for his own peace . . . his peace of mind.

For *now*, as never before, a man should look at his wife and family and say, "What can I offer them for the future?"

Now, as never before, a man should look at tomorrow and say, "How can I best prepare for some unforeseen emergency which might affect my family?"

And *now*, as never before, every man in Amer-

ica has a chance to answer these questions—an opportunity to provide for the future.

That opportunity is War Bonds. No doubt you are buying War Bonds through the Payroll Saving Plan. Arrange to buy *more* War Bonds. All you can afford.

What's even more important—don't cash in those War Bonds before they mature. Stick them away in a safe place—and forget about them till you can reap the full harvest on them.

Now is the time to make your plans for peace of mind. It's something you owe yourself . . . owe your family. Buy War Bonds and hold onto them!

POPULAR MECHANICS MAGAZINE

*This is an official U.S. Treasury advertisement—prepared under auspices of
Treasury Department and War Advertising Council*

PREVENT SMALL FIRES from becoming LARGE FIRES



Help the War Effort

In times of War Emergency, Fire Hazards increase at a terrific rate. Fire is a destructive agent that aids the enemy. Play safe with Fyr-Fyter EQUIPMENT. Opportunity for Salesmen. Write today for our Post-War Sales Plans.

THE Fyr-Fyter CO.
Dept. 90 Dayton 1, Ohio

WAR BONDS

Fyr-Fyter

Selby "Vertical" Barbecue Plans \$1.00

It's easy for you to build a Selby "Vertical" barbecue in your camp, lodge, or yard with these easy-to-follow plans. Forty-nine detailed drawings, precise specifications. Inexpensive to build. A Selby "Vertical" barbecue will add new zest to your outdoor life. Built with any kind of masonry, native rock or brick is particularly attractive. Complete master blueprints \$1.00. Send 12c extra for 1st class mailing.

BARBECUE AL, 1836 Chase Ave., P3, Chicago 26

Wonder-Tone NOISE ELIMINATOR

Just attach to your radio (long, short wave) and enjoy reception free from distracting noises. Send-No-Money Pay Postman 60c plus postage or send 60c and we'll send postpaid. Return in 5 days for refund if not delighted.

WONDER-TONE COMPANY, Dept 50, 7078 N. Clark St., Chicago 26, Ill.

ELECTRIC HEATING ELEMENTS REPAIRED

New amazing NICHROCITE PASTE will do it in a jiffy. Simply overlap ends, apply paste and turn on current. Used successfully by utility companies and others. Family size, \$1; 4 oz. size, \$2.50. Satisfaction guaranteed.

ADVANCE MFG. CO. Box 861-C Minneapolis, Minn.

MRS. BERRY'S POULTRY BOOK

2 BREEDS BERRY'S Champion-Mated, Hand-Picked CHICKS, also SEXED, STARTED, 52 BREEDS, 7 HYBRIDS, All Iowa Inspected, BWD Tested. Over 400 Prizes—30 Shows! LOW PRICES. In Business nearly 50 years. Beautiful POULTRY BOOK FREE, stamps appreciated. BERRY'S POULTRY FARM, Ex. 29, CLARINDA, IOWA

Big Profit AUSTRALIAN WHITES

Sensational MONEY MAKING HYBRID. Customers report broilers 8 weeks, laying 4 1-2 mo. Disease resistant. Heavy Layers. 50,000 chicks weekly. Started pullets. Profit Sharing Plan. FREE Book Write today. BERRY BROS. FARMS, Box 582, ATCHISON, KANS.

LAW STUDY AT HOME FOR PERSONAL SUCCESS and LARGER EARNINGS.

35 years expert instruction—over 108,000 students enrolled. LL.B. Degree awarded. All texts furnished. Easy payments. Send for FREE BOOK—"Law and Executive Guidance."

AMERICAN EXTENSION SCHOOL OF LAW
Dept. 51-M, 646 N. Michigan Ave., Chicago 11, Ill.

do you WORRY?

Why worry and suffer any longer if we can help you? Try a Brooks Patented Air Cushion. This marvelous appliance for most forms of reducible rupture is GUARANTEED to bring YOU heavenly comfort and security—day and night—at work and play—or it costs you NOTHING. Thousands happy. Light, neat-fitting. No hard pads or springs. For men, women, and children. Durable, cheap. Sent on trial to prove it. Not sold in stores. Beware of imitations. Write for Free Book on Rupture, no-risk trial order plan, and proof of results. All Correspondence Confidential.



Brooks Company, 158-D State St., Marshall, Mich.

Greater Pleasure from Your Hobbies with Knives that Respond to Your Touch...X-ACTO

New! No. 83 X-ACTO deluxe all metal knife chest. The finest in knife sets complete with 3 solid aluminum handles and 12 interchangeable blades, in handy wooden chest. Price \$5.00 complete. Other knives and sets from 50c to \$3.50.

Men at work with X-ACTO knives know the joy of using finest surgical steel blades that are always sharp—that always make precision cuts with ease. No matter what the carving or cutting job, be it a frisket, a model airplane, or a piece of 16 ply cardboard, get to know the satisfaction of using X-ACTO for with a twist of the wrist you insert a new blade. Result? A knife that is factory-fresh! For greater pleasure in your work or arts and crafts, get an X-ACTO Knife Chest.



RE-BLADE TO RE-SHARPEN

Write for 32 page Handbook "How to Build Solid Scale Model Warplanes" —10 cents



On sale at Hobby and Model Dealers, Hardware and Dept. Stores or order direct from X-ACTO CRESCENT PRODUCTS CO. 440 Fourth Ave., New York 16, N. Y.

X-ACTO

EVERKEEN knife

LIMITED QUANTITIES

Electric Stoves
1-Burner and 2-Burner



Electric Steam Irons
Automatic Electric Irons
Electric Irons



RADIOS, A.C. & D.C.
Table & Console Models



Electric Room Heaters
Infra-Red Health Lamps
Desk Lamps—Bed Lamps

Electric Food and Cream Mixers
Electric Toasters



Schick Electric
Shavers
and Others



Carpet Sweepers
Electric Vacuum Cleaners



Electric Sandwich Toasters



Electric Roasters All Sizes
Electric Waffle Bakers



Silverware for Home Use
Silverware for Restaurants
Electric Fans, All Sizes
Electric Wire, All Sizes
Heater Elements
Iron Elements
Cooker Elements
Screen Wire All Sizes

Send Stamped Return Envelope for Prices
JOSEPH WINKLER & CO., Dept. AP-3,
667-671 N. CLARK ST. CHICAGO 10, ILL.

INTRODUCING-New Victory Model HANDIWELD ELECTRIC

ARC WELDER

RETAILS
ONLY
\$1.95

FULLY
GUARANTEED



**PLUGS INTO
LIGHT SOCKET**

Victory Model Handiweld Arc Welder operates from 110 volts, A.C. or D.C. current same as other arc welders higher priced; generates tremendous heat to weld all metals. Not a toy welder that uses carbons, but actually uses standard coated rods—sizes 1/16" and 3/32". However, due to Priorities a generous supply of 1/16" rods only are supplied with the welder. Guaranteed not to burn out. Repairs fenders, auto bodies, radiators, machinery parts, etc. Take Victory Model Handiweld anywhere to job, operate right from light socket. You'll find a thousand uses for this welder around your home, garage, workshop, etc. Also in garages, factories, repair shops, tin shops; mechanics, inventors, plumbers, farmers, etc. Order a "Victory Model" Handiweld now.

SEND NO MONEY We'll rush one to you with rods, helmet, op- rating instructions, and all necessary parts with the exception of a large jar and a small piece of extension cord; these most everyone has. Pay postman only \$1.95 plus a few cents postage. If not delighted return Victory Model Handiweld in 5 days from receipt and money paid for it will be refunded promptly. Rush your order now.

KUMFY PRODUCTS, Dept. R-202, CINCINNATI 26, OHIO

COLD PIPE, CONDUIT & Tube Bending Machines

15 Sizes and Types Available

A few of our More Than
12,000 Customers:

Bureau of Ships, Wash. D. C.; Henry J. Kaiser Co., Calif.; Pacific Bridge Co.; Bethlehem-Hingham Shipyard; Standard Oil Co.; E. I. Du Pont de Nemours & Co.; General Electric Co.

Free printed matter on request
AMERICAN PIPE BENDING MACHINE CO., INC.

World's Largest Manufacturers
77 Pearl St., Boston, Mass.



10 IN 1 HANDY TOOL KIT

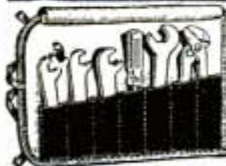

HERE'S the cleverest little tool kit you ever saw. Made to fit your pocket. Think of it—8 wrench sizes —1 screwdriver—and one pair of grip-tight pliers in neat pocket case. Made of the most durable steel. Will give years of service. Just the thing for Radio Repair Men—Auto Mechanics—Vending Machine repair men and countless others. A Lucky Buy makes it possible for us to sell a limited number for \$1.10 prepaid. You will never get a bargain like this again. Send for your set NOW.

LANDAU LABORATORIES
549 W. Randolph St. Chicago 1, Ill.

HUNTING and FISHING



HUNTING and FISHING

is a monthly magazine crammed full of hunting, fishing, camping, dog and boating stories and pictures, invaluable information about guns, fishing tackle, game law changes, best places to fish and hunt—countless ideas that will add more fun to your days afield.

Special Trial Offer

Send 25c in stamps or coin and we will send you Hunting & Fishing for six months.

**HUNTING & FISHING
MAGAZINE**

251 Sportsmen's Bldg., Boston, Massachusetts

DURAPoint GLASS CUTTER

\$2.50
Postpaid

DURAPoint TOOL COMPANY
4342 Umatilla Street, Denver 11, Colorado

New SOLDERING GUN

Copper
Tip Reaches Soldering Heat
in 5 Seconds.

Control button gives high or low heat as desired. Do expert soldering repair work faster, better, easier than with heavier old-style iron. Operates from 6 volt storage battery or hot lead on any car, truck, tractor, etc. (Use proper transformer for 110 volt) Only \$3.75 complete with lead wires and battery clips. Send no money; pay postman plus postal charges or send check or money order to-day and we will mail prepaid. State if interested in sales distributor proposition.

The Metelec Company, 105 E. 16th St., Minneapolis 4, Minn.

**SIGNS EASILY AND EXPERTLY
AND PAINTED WITH LETTER PATTERNS**
AND SHOWCARDS MANY SIZES & STYLES
WRITE FOR FOLDER!

JOHN F. RAHN
1330-31 N. Central Ave.
CHICAGO 31, ILL.

★ SAVE WASTE PAPER ★

POPULAR MECHANICS

THIS **Dustless** BRUSH REDUCES GERM LADEN DUST



*Eliminates
Sweeping Compound*

The "Dustless" brush has a reservoir in its back which holds Arbitrin, a scientifically compounded sweeping fluid. The center row of tufts is connected to the reservoir. During the process of sweeping the Arbitrin feeds through these tufts and moistens every particle of dust it contacts. Instead of floating through the air, the dust is converted into the most efficient sweeping compound.

Tests have proved that "Dustless" sweeping reduces the number of bacteria, normally in the air between sweepings, as much as 97 per cent. The "Dustless" brush also cuts labor and material costs in half.

GUARANTEED—Dustless brushes are used in hundreds of offices, factories, schools, institutions and stores. They are unconditionally guaranteed to meet your requirements. Prompt shipment on AA-5 or higher priority rating. Write for styles, sizes and prices today.



**MILWAUKEE DUSTLESS
BRUSH COMPANY**

528 N 22nd STREET, MILWAUKEE 3, WIS

WOOD WORKERS

LUMBER—PLYWOOD AVAILABLE

Harold Hunt wants to send revised No. 14 catalog, 124 pages of woodworking ideas, UNEQUALLED BARGAINS in imported and American woods, supplies. Those already holding this catalog—send for revised sheets.

CRAFTSMAN WOOD SERVICE CO.
2729 S. Mary St., Dept. A-55, Chicago 8, Ill.

only
10¢



INVENTORS

WE LOCATE BUYERS

for and have many requests from manufacturers for New Inventions of merit, Patented or Unpatented, Cash or Royalty. If will sell, write us today for a FREE PROTECTIVE DISCLOSURE FORM, Descriptive Booklet, References, and Full Particulars of our services to inventors. NO OBLIGATION. A post-card will do. Address:

THE INVENTION REPORTER

50-11106 South Longwood Drive

Chicago 43, Illinois

SHAW and Peppy-Pal DU-ALL GARDEN TRACTORS

• 1 to 9 H.P. Circulars on request. War limits production—We supply repairs for all SHAW Tractors sold in our 41 years in business.

**BUILD YOUR OWN RIDING
TRACTOR—"WAR HORSE"**

using old auto parts, powered by 2 H.P. or larger air-cooled engine; or walking type Garden Tractor ½ to 3 H.P. or convert truck or auto into Farm Tractor. Each with steel or rubber tires; will plow, cultivate. Plans for building, in few hours, any one of above, postpaid for \$1.00 (state which wanted) or all 3 for \$2.00. Money Back Guaranteed!

SHAW MFG. CO., 4503 Front St.
Galesburg, Kansas
6686 North 4th St., Columbus, Ohio

MARCH, 1945



If it isn't a CROTON
it isn't the famous

AQUAMATIC

Self-Winding Waterproof Watch



A dependable timekeeper under all circumstances. Wrist action winds it and keeps it running. Waterproof, shock-resistant, luminous dial, sweep second hand, 17 jewels, \$45. Booklet "T" on request. Croton Watch Co., Inc., 48 West 48th Street, New York 19, N. Y.

Croton

FOR ALL TIME SINCE 1878



SAVE WASTE PAPER



191

\$2000

of Old Line Legal Reserve
LIFE INSURANCE

(at age 21) \$ **178** A MONTH*
ONLY — Other ages in proportion

*One Half Permanent Rate in effect 5th year

Buy as little as \$1500. of this solid protection—or more—at proportionately low rates. *But buy your Postal Policy now!*

Postal Life of New York has specialized for 40 years in insurance by mail and over the counter. The savings due to this direct dealing are passed on to policy holders. Current dividends 9½%. Further savings are made if premiums are paid quarterly, semi-annually or annually.

POSTAL LIFE OF NEW YORK

operates under the rigid New York State Insurance Laws and has paid out over
\$55,000,000.00

to its Policy Holders and Beneficiaries. Postal issues all Standard Policies to men or women, from ages 10-60, at low cost. Send coupon today for rates on this Modified "4" Policy at your age and other details. *Life Insurance is vital!*

CLIP AND MAIL COUPON TODAY

POSTAL LIFE INSURANCE COMPANY

511 Fifth Ave., Dept. M-434
New York 17, N. Y.

Mail me without obligation complete information about your low-cost Modified "4" Policy at my age.

Name

Date of Birth

Occupation

Address
(Street and No., Zone, City and State)

Build These Cleveland Model "Supervalues"!

Boeing B-29 "Superfortress" 26 1/2" line-controlled model of the greatest of all bombers. Kit AU-200. **\$100**



Biggest \$1.00 Model in U.S. 84" Super Condor Soarer, Kit E-5019. **\$100**



SEE YOUR DEALER FIRST. In ordering direct, add 20c extra for packing-postage.

CATALOG 5c (none free)

BLACK WIDOW NIGHT FIGHTER Span 36". An Industrial Training Model. Kit C-D T-155. **\$150**

CLEVELAND MODEL & SUPPLY CO.
4508E25 Lorain Ave. ★ ★ ★ Cleveland 2, Ohio, U. S. A.

NEW TYPE GAS SAVER

Sweeping the Country!



FOR AUTOS—TRUCKS—TRACTORS
New invention easily slips into carburetor vaporizer system. Automatic adjustment. Users report up to 30% saving. Works on super-charge principle. Positive guarantee of satisfaction or double your money back on request.

NEW SALES PLAN—BE FIRST

Easy to sell—big money maker. Don't wait. Send \$1.00 for postpaid demonstrator or order it sent C.O.D. Ten models—so be sure to send make and year of car. Order today.
ONLY \$1.00 Post-paid
Stransky Mfg. Co., Box C1004, Pukwana, S. Dak.

AMAZING MYSTERY BUTTON



Startles Everybody. With this Electronic Button you can make your own Telephone—Amplifier—Detectophone. Attach this button to piece of cardboard—transmit conversation to another room. Music also transmitted to distant places. Most interesting, electrical apparatus ever discovered. Enables you to perform hundreds of experiments. So tiny it can be concealed in dozens of places. A Pre-War Product. Electronic Button including 5000 word instruction booklet with 50 illustrated experiments postpaid only \$1.00.
Electronic Products Company, Saint Charles, Ill.

PRINT ANY PHOTO

on Paper, Cloth, Leather or Wood

SIMPLE, EASY TO USE

Magic liquid takes only 2 minutes to reproduce any snapshot you have on to stationery, handkerchiefs, ties, scarfs, etc. Won't wash off. Won't hurt negative or fabric it's used on. Personalize your belongings! An ideal gift. Complete outfit enough to transfer 100 photos—only \$1.00 postpaid. Sent C.O.D. for \$1.21.

CHRISTY PHOTO SUPPLY, Dept. 1110
2835 N. Central, Chicago 34



WORLD'S LOWEST PRICED ADDING MACHINE

Vest Pocket Size FREE TRIAL

ONLY \$2.50

IDEAL FOR BUSINESS OR PERSONAL USE—GUARANTEED ACCURATE. Not a toy. Operates with only a finger flick. Adds, subtracts, multiplies, divides. Counts up to ten million. Pays for itself over and over. Ideal Gift—for Business, Income Tax and School use. **MONEY BACK GUARANTEE.** Send name and address. Pay postman only \$2.50 plus postage. (Send full cash if outside U. S.) Money back in 10 days if not delighted. **AGENTS WRITE.**

CALCULATOR MACHINE COMPANY (Mrs.)
DEPT. 163, P. O. BOX 1118 CHICAGO, ILLINOIS

Cushman

MOTOR SCOOTER

35 MILES
per HR.
75 MILES
per GAL.



AVAILABLE NOW for service inside war plants.
LATER, for general use.

Want to scoot around **FAST**, at Amazing Low Cost? Then, pick the New Improved **CUSHMAN!** Beats anything you ever saw. Ten times faster than walking! 500 miles on \$1 worth of gas! Built for long, hard use!

So practical, economical and durable that thousands now serve in the nation's great war plants.

POWERFUL 4 H. P. ENGINE. No clutch pedal or gear shift. Floating Drive applies power smooth as Fluid Drive. Hand accelerator controls starting and speed-adjustment. Special springing, long wheel base and balloon tires provide **Smooth Riding.** Low center of gravity and heavy brakes provide **Safety.**

2-wheel and 3-wheel models with 200-lb. and 250-lb.-capacity package boxes.

WRITE! See your dealer who handles the **CUSHMAN**, or send for full details. Be among the first to own a genuine **CUSHMAN** when available outside war plants. Send Now! **CUSHMAN MOTOR WORKS, Dept. M-35, Lincoln, Nebr.**



GEORGE WOLFE

Quick, Mabel! Reach in my pocket for the Weldwood Glue.

WHEN you want to fix things fast...remember Weldwood Glue. It's quick to mix...easy to use...tremendously strong...stain-free...rot-proof...and permanent. At hardware stores, lumber yards, chain stores.



WELDWOOD PLASTIC RESIN
WATERPROOF GLUE

★ SAVE WASTE PAPER ★

*If you are uncertain—
—how to make*
“GOOD PICTURES”

WRITE TODAY FOR THIS 56 PAGE BOOK
IT WILL HELP YOU
SOLVE MANY PROBLEMS



AWARDED TO PLANS & OPTICAL DIVISION

- SELECTION OF FILM
- EXPOSURE
- DEVELOPING
- ENLARGING
- FLASH PICTURES
- FILTERS & COLOR

Send 25c to
ARGUS, INC.
Ann Arbor, Mich.
DEPT. H

argus

Cameras and Optical Instruments



ANN ARBOR MICHIGAN

MARCH, 1945

193

FREE! LATEST, MOST COMPLETE RADIO PARTS CATALOG



EVERYTHING in RADIO and ELECTRONICS for War Training, Maintenance or Repair



New R-F Resonance and Coil Winding CALCULATOR
Easy to use! For fast accurate determination of resonance factors and coil winding data. No. 37-955. Postpaid, 25c.

RADIO'S FINEST BOOK VALUES

Specially prepared to aid radio training in schools and industry. Full of valuable data. Send for all six!

- Radio Formulas and Data Book No. 37-752... 10c
- Dictionary of Radio Terms No. 37-751... 10c
- Radio Circuit Handbook No. 37-753... 10c
- Radio Builders' Handbook No. 37-750... 10c
- Simplified Radio Servicing No. 37-755... 10c
- Radio Data Handbook No. 37-754... 25c
- All Six Books No. 37-799... 75c

ALLIED RADIO CORP.

833 W. Jackson, Dept. 5-C-5, Chicago 7

ALLIED RADIO

FREE TO ALL AUTO OWNERS

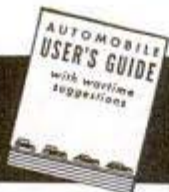

196 Practical Suggestions that will help you to get

- ➔ better gas mileage ➔
- ➔ longer tire life ➔
- ➔ better performance ➔
- ➔ lower upkeep costs ➔

Get a FREE COPY from any General Motors dealer, or use coupon below.

Customer Research Dept., Room 1763
GENERAL MOTORS, DETROIT 2, MICH.

Please send FREE COPY of new edition 64 page "Automobile User's Guide" containing 196 practical suggestions on wartime operation.

Name please print

Address..... please print

City..... Zone State

Make of car now owned..... year model

"YOU ARE UNDER ARREST!"



There's a Thrill in Bringing a Crook to Justice Through Scientific CRIME DETECTION!

I have taught thousands this exciting, profitable, pleasant profession. Let me teach you, too, in your own home. Learn Finger Printing, Firearms Identification, Police Photography and Secret Service Methods thoroughly, quickly and at small cost.

Be A FINGER PRINT Expert

53% of All American Bureaus of Identification employ students or graduates of I.A.S. You, too, can fit yourself to fill a responsible crime detection job with good pay and steady employment. But don't delay—get the details now. Let me show you how easily and completely I can prepare you for this fascinating work, during spare time, in your own home. You may pay as you learn. Write today... Now... Be sure to state age.

FREE!!! Send for Thrilling "BLUE BOOK OF CRIME"

INSTITUTE OF APPLIED SCIENCE
1920 Sunnyside Ave., Dept. 9353, Chicago 40, Ill.

HOUSE PLAN BOOKS...

Do Your Selecting and Planning Now. Build Later.



- America's Best Low-Cost Homes**—Fine selection of 1, 2 story homes. Cost \$1,200 to \$8,100..... \$.50
- De Luxe Small Homes**—210 popular designs, cost \$1,100 to \$10,000..... 1.00
- New American Homes**—66 high class designs. \$3,900 to \$13,000..... 1.00
- New Brick Homes**—4 to 7 rooms. \$3,600 to \$7,400..... .50
- New Small Homes**—62 designs. \$2,300 to \$6,700..... .50
- Artistic Homes**—Selected for unusual features. \$2,600 to \$9,000..... .50
- Colonial Homes**—48 designs..... .50
- Low Budget Homes**—Small, medium size. \$2,100 to \$3,000..... .50
- Spanish and Western Homes**..... .50
- Sunshine Homes**—For warm climates. \$1,900 to \$7,000..... .50
- New Duplex Book**..... .50

Send Your Order to
POPULAR MECHANICS PRESS
200 E. Ontario Chicago 11, Ill.

AMAZING PLASTIC ENAMEL Gives Lasting Beauty to WALLS, WOODWORK & FURNITURE

SUPERIOR Liquid Plastic DRIES TO TOUGH, HIGH-GLOSS FINISH



Applies Easily With Brush.

• A new enamel miracle perfected by Science! It's a true plastic you apply easily with a brush. Beautifies all surfaces. Dries to long-wearing, brilliant white plastic finish. Leaves no brush marks. Non-yellowing, non-scratchable. Can be washed like porcelain.

Guaranteed to be top quality—the finest available.

ORDER NOW ON MONEY-BACK GUARANTEE

• No. 1 for walls, woodwork. No. 2 for furniture. Pure white. Can be tinted with oil colors. \$5.95 per gallon with Special Thinner. Express prepaid or COD if desired.

\$5.95 PER GAL. DELIVERED THIS PRICE FOR U.S. ONLY

SEND YOUR ORDER OR WRITE FOR FREE ILLUSTRATED FOLDER
SUPERIOR PAINT AND VARNISH WORKS
2256 Elston Avenue • Chicago 14, Illinois

YOU WERE WRONG

THE TIME YOU "STOPPED IN" AT THE AUCTION SALE

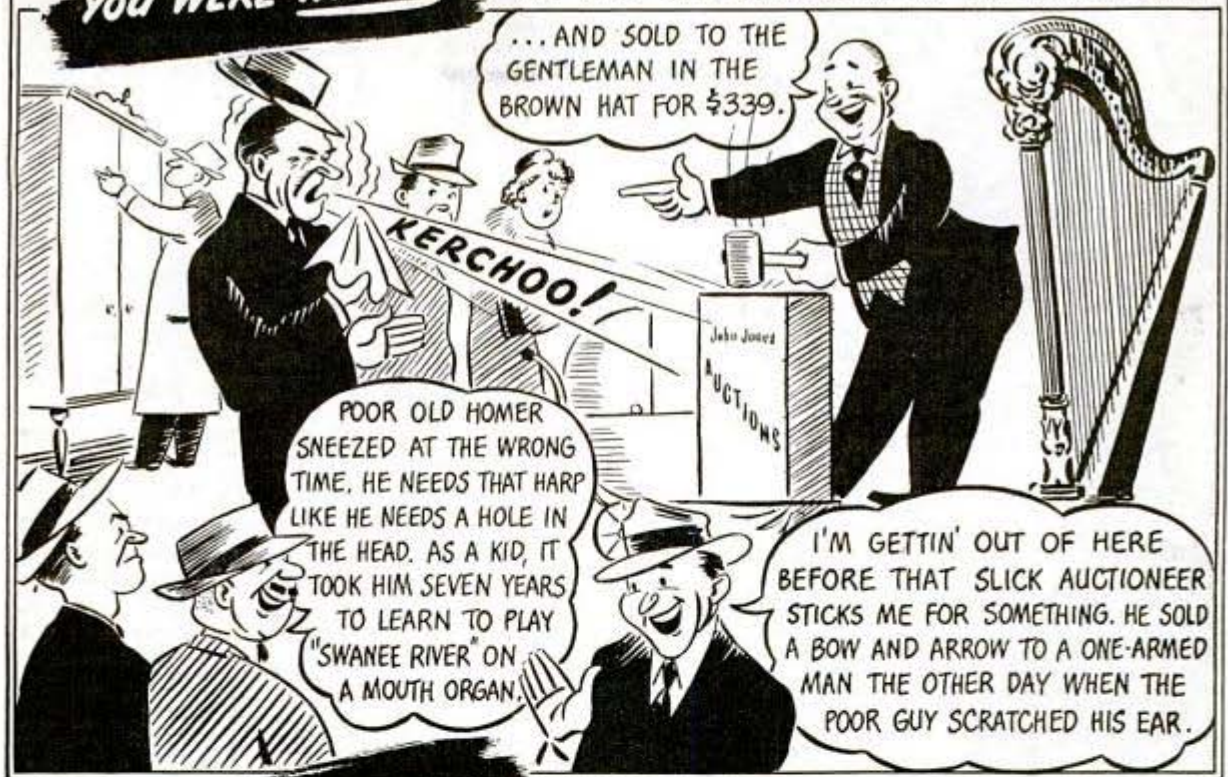

**But... YOU'RE RIGHT
with
PACKARD CABLE!**



Sure as shooting, when you replace worn-out spark plug wires with Packard 440 ignition cable . . . *you're right!* That tough inorganic sheath promises extra protection against electrical breakdown, and extra thousands of miles of high-efficiency service. Heat, cold, oil, moisture, corona and abrasion have been licked by this important Packard de-

velopment to give car owners the best in cable for the best in motor performance.

The same proved superiority that has made Packard 440 ignition cable America's first choice applies to all Packard cable products—battery cables, ground straps, lighting wires and primary ignition cable. Each is designed to do its job well, on the basis of Packard Electric's long years of laboratory research and manufacturing experience. Each reflects the many improvements and refinements that have been developed by Packard Electric in building original-equipment cable for America's leading car manufacturers.

Used to safeguard performance on military aircraft, tanks and combat vehicles of all types, Packard cables have carried out their assignment dependably. Whatever the application, you're *right* with Packard cable.

—PACKARD—

CERTIFIED RE-WIRING SERVICE

This sign means cable service at its best—the right Packard cable and the right methods. Thousands of dealers provide better electrical service as a result of the Packard Certified Re-Wiring Manual and Packard Certified Re-Wiring training films.



Packard
REG. U.S. PAT. OFF.
TRADE MARK

**PACKARD ELECTRIC DIVISION
GENERAL MOTORS CORPORATION
WARREN, OHIO**



KEEP BUYING WAR BONDS

FOREMOST BUILDER OF AUTOMOTIVE AND AVIATION WIRING

Now A DYNAMIC HEAVY DUTY INDUSTRIAL WELDER

TO SAVE YOU VALUABLE TIME and MONEY!

Designed to Do High-Grade Welding Inexpensively

Maintenance men, farmers, mechanics, machine shops, foundries, auto, general repair and job welding shops using the DYNAMIC WELDER find it so indispensable and useful that they cannot afford to be without it. If inexperienced you can easily learn to do a variety of high-grade welding jobs by following the practical, simplified operating and welding instructions furnished.

WORKS ON IRON, STEEL, BRASS, BRONZE and OTHER METALS

Has eight metallic and carbon arc welding heat stages. Does work you would think only possible with a larger, more expensive machine.

READ WHAT USERS SAY...

Repair Shop Owner says, "It will do more than you say"

"I want to say I operate a repair garage and am more than satisfied with the welder. It will do more than you say." C. P., Butler, Ohio

It's the Greatest Portable Outfit

"Now I am equipped for all kinds of welding and I must say it's the greatest portable outfit for welding any man could ever wish to own. I wouldn't sell mine for the cost of plenty welders I have seen which were very high in cost but not in convenience. You may put me on file as a booster of your wonderful welding product." W. J. B., St. John, N. B., Canada

Better Than I Expected

"I have done quite a little welding with my welder and will say it is better than I expected. The price, convenience, and variety of work that can be done with the Dynamic are the attractive points." W. R. P., Portland, Ore.

EASY TO OPERATE!

DYNAMIC SUPERCHARGED WELDER

GET DETAILS ON OUR 10-DAY TRIAL OFFER!

Once you see a DYNAMIC in operation you won't want to be without it. Its simplicity will amaze you. In a year the DYNAMIC only costs you about 6c a day. Comes complete, ready to operate, with helmet, rods, cables, electrode holder and operating instructions, etc. Nothing else to buy. Write today for free priority assistance and particulars on how to qualify for one of these amazingly low-priced welders. Act now while they are still available.

DYNAMIC WELDER CO.

13 East 23rd Street—CC

CHICAGO 16, ILLINOIS

FOR ONLY \$23⁵⁰ COMPLETE

AMAZINGLY SIMPLE TO OPERATE!

This portable DYNAMIC WELDER easily carried right to the job—plugs into any convenient, properly wired 110 volt light circuit.

WORKS OFF 110 VOLT ELECTRIC LIGHT CIRCUIT



BICYCLE REPAIRS



HOME APPLIANCES



SHOP MAINTENANCE



AUTOMOBILE REPAIRS





Motorists! up to 30% EXTRA MILEAGE

from EACH GAS STAMP with a

VACU-MATIC

CARBURETOR *Control*



➔ You can't change gas rationing, but you can make sure that each precious gallon of gasoline is providing you with the maximum mileage of which your car is capable. Now you can get added mileage . . . plus quicker starting and more power! Make this trial test. Install a Vacu-Matic on your car and get up to 30% extra mileage on a money-back guarantee.

AUTOMATIC SUPER-CHARGE PRINCIPLE

• Vacu-Matic is entirely different! It operates on the supercharge principle by automatically adding a charge of extra oxygen drawn free from the outer air, into the heart of the gas mixture. It is entirely automatic and allows the motor to "breathe" at the correct time, opening and closing *automatically*.

PROVEN BY TEST

• In addition to establishing new mileage records on cars in all sections of the country, the Vacu-Matic has proven itself on thousands of road tests and on dynamometer tests which duplicate road conditions and record accurate mileage and horsepower increases. Thousands of motorists now enjoy extra mileage—improved performance with Vacu-Matic.

FITS ALL CARS

• Vacu-Matic is constructed of six parts assembled and fused into one unit, adjusted and sealed at the factory. Nothing to regulate. Any motorist can install in ten minutes. The trial offer coupon will bring all the facts. Mail it today!

AGENTS TRIAL OFFER ➔

• Vacu-Matic offers a splendid opportunity for unusual sales and profits. Every car, truck, tractor and motorcycle owner a prospect. Valuable territories now open. You can obtain one for your own car if you help us introduce it to a friend. Just check and mail the coupon today.

Send this Coupon Today

THE VACU-MATIC COMPANY
7617-1165 W. State St., Wauwatosa 13, Wis.

Please send full particulars about VACU-MATIC, also how I may obtain one for trial on my car. This does not obligate me in any way.

Name

Address

City

State

Check here if interested in Agency Proposition.

NEW *Atlas* PATTERN SERVICE

FULL SIZE PATTERNS for making furniture, household equipment, cabinets, toys are now available through Atlas. They work like templates in airplane construction to save time and insure accurate workmanship.

No. 11 SLATTED ROOF WREN HOUSE

You'll be fascinated with the housekeeping activities of our little feathered friends when they return from the Southland if you have this cozy home ready for them. The step-by-step directions of the Atlas full size pattern will enable you to build this Wren house easily and quickly. Price .20



No. 12 EARLY STARTER GARDEN HOTBED

You can get the jump on other war gardeners by starting your seeds in this ingenious hotbed. It is a most interesting and practical project that will pay extra dividends in usefulness. Price .25



Order patterns by number, inclosing exact cash, check or money order. Price includes mailing costs. Pattern envelopes show many other useful patterns available at low cost.

ATLAS PRESS CO. PATTERN DEPT.
Dept. A-3, P. O. Box 74, Pleasantville, N. Y.

"Not Enough to go Around"

ESSENTIAL INDUSTRIES
get first call on the

BURGESS
vibro-tool
Trade Mark Reg. U. S. Pat. Off.

RIGHT NOW
for
IMPORTANT
MARKING,
CUTTING
and
SPECIAL
APPLICATIONS

WATCH these ADS for Availability
of Vibro-Tool for Craftsmen

(HANDICRAFT DIVISION)
BURGESS BATTERY COMPANY

166 N. Wabash Avenue Chicago 1, Ill.

THE EASY WAY TO KILL RATS!

It's easy to kill rats quickly with *improved* K-R-O Ready-Mixed, now in Bis-Kit form.

No baits to mix. No mess. No bother. Safe around livestock, pets, and poultry.

Each package holds a variety of rat-killing *red squill* baits. Small size—35c. Large—\$1. Satisfaction guaranteed or money refunded. At your drug, seed, or hardware store. The K-R-O Company, Springfield, Ohio.

KILLS RATS ONLY
READY MIXED
BIS-KIT FORM

HARD-TO-GET
RADIO PARTS ★ ★

Real bargains on hundreds of hard-to-get Radio and Electronic parts are listed in our latest FREE bulletin. Thousands of satisfied, steady customers on our lists. Send for your FREE money-saving bulletin today.

NATIONAL ELECTRONIC SUPPLY
77 W. Washington Dept. P.M.-3 Chicago 2, Ill.

Pays HOSPITAL and SURGICAL BILLS for Whole Family

Costs 3c a Day for Adults
Only 1½c a Day for Children

It's here! The new Family Hospital and Surgical Expense Policy you need and want! One policy insures whole family—mother, father, children, anyone from 3 months to 65 years. No medical examination. Pays up to \$510.00 hospital and surgical bills for EACH and EVERY person insured. Pays up to \$100.00 doctor's fees for operations. Pays up to \$50.00 for operating room, medicines, ambulance, etc. Covers sicknesses, accidents, operations, childbirth, female disorders and many other disabilities not covered by other policies. You select your own doctor and hospital. This full-coverage Family Hospital and Surgical Policy issued DIRECT to you at special family rates by big, strong company with over \$3,000,000.00 in assets. Investigate! Send no money, but mail the coupon below quick for full details—sent FREE. No agent will call on you. Act today!

STERLING INSURANCE CO.

A-4862 Sterling Bldg., Chicago 11, Ill.

Send me FREE INSPECTION Offer of Low-Cost Family Hospitalization Plan.

NAME.....

ADDRESS.....

CITY..... STATE.....

GET THIS BOOK



on how to build over 100 Items
for **FUN and PROFIT**

ALL THESE ITEMS CAN BE BUILT
WITH OLD AUTO GENERATORS and
MATERIALS FOUND IN GA-
RAGES and SCRAP YARDS

**LEJAY
MANUAL**

\$1.50

WORTH \$12.35
If Plans Bought
Individually

● **YOU GET A BIG THRILL OUT OF
MAKING THINGS YOURSELF**

Making practical things that work and save money is always fascinating, especially when you can do it in spare time and with spare equipment you may have in your own garage or workshop. If you need a welder, you can make that, too. In fact, the fifty basic plans in the LeJay Manual contain instructions that will enable you to make 100 or more individual items. Think of the extra money you can earn making and repairing things for other people.

● **THESE SIMPLE PLANS AND A FEW
TOOLS ARE ALL YOU NEED**

These plans were made for YOU and others like you, who are not in any sense electrical experts or mechanics. They are simple, yet efficient, and do not need a lot of expensive tools to carry them out. Thousands of amateurs are having fun or making profits with the many things these plans helped them to build. The illustrations shown are only a few of the many things you can make.

● **SENT C. O. D. ON 3 DAYS' TRIAL,
BUT YOU CAN SAVE WITH CASH**

If you will fill in and mail the attached coupon, we will send you the LeJay Manual C.O.D. on three days' trial, guaranteeing to return your \$1.50 if you return the manual. Because of the recent increase in C.O.D. fees, however, you can save money by sending cash in the first instance. The same three-day return privilege applies if you don't care to keep the manual. In Canada, send \$1.75.

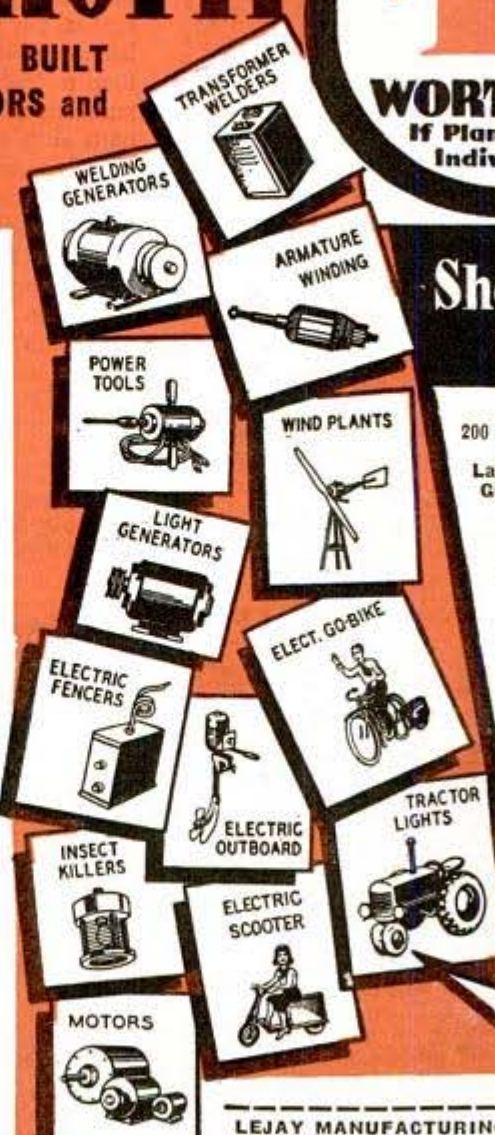

**Shows you how
to build**

- 200 Amp. Generator Welders
- Workshop Spot Welder
- Large Transformer Welders
- Gunsmith's Carbon Welder
- Electric Fencers
- Armature Rewinding
- Bench Grinders
- 6, 12, 32, and 110-Volt Motors
- Wind Driven Light Plant
- Insect Electrocutors
- Electric Bicycle Pusher
- and Many Other Things

**MAIL
COUPON
NOW
\$1.50**

LEJAY MFG. CO
47 LeJay Building
MINNEAPOLIS, MINNESOTA

LEJAY MANUFACTURING CO.,
47 LeJay Building, Minneapolis 8, Minn.

Gentlemen: Please send me C.O.D. your big 1945 LeJay Manual, on the understanding that if, after 3 days trial, I should return the manual, you guarantee to return the \$1.50

purchase price.....
(Canada, \$1.75) If you send check, add 5c exchange.
I enclose \$1.50 for the above manual, same guarantee.....

NAME.....
ADDRESS.....
CITY..... STATE.....

PRECISION-BUILT FOR PRECISION WORK

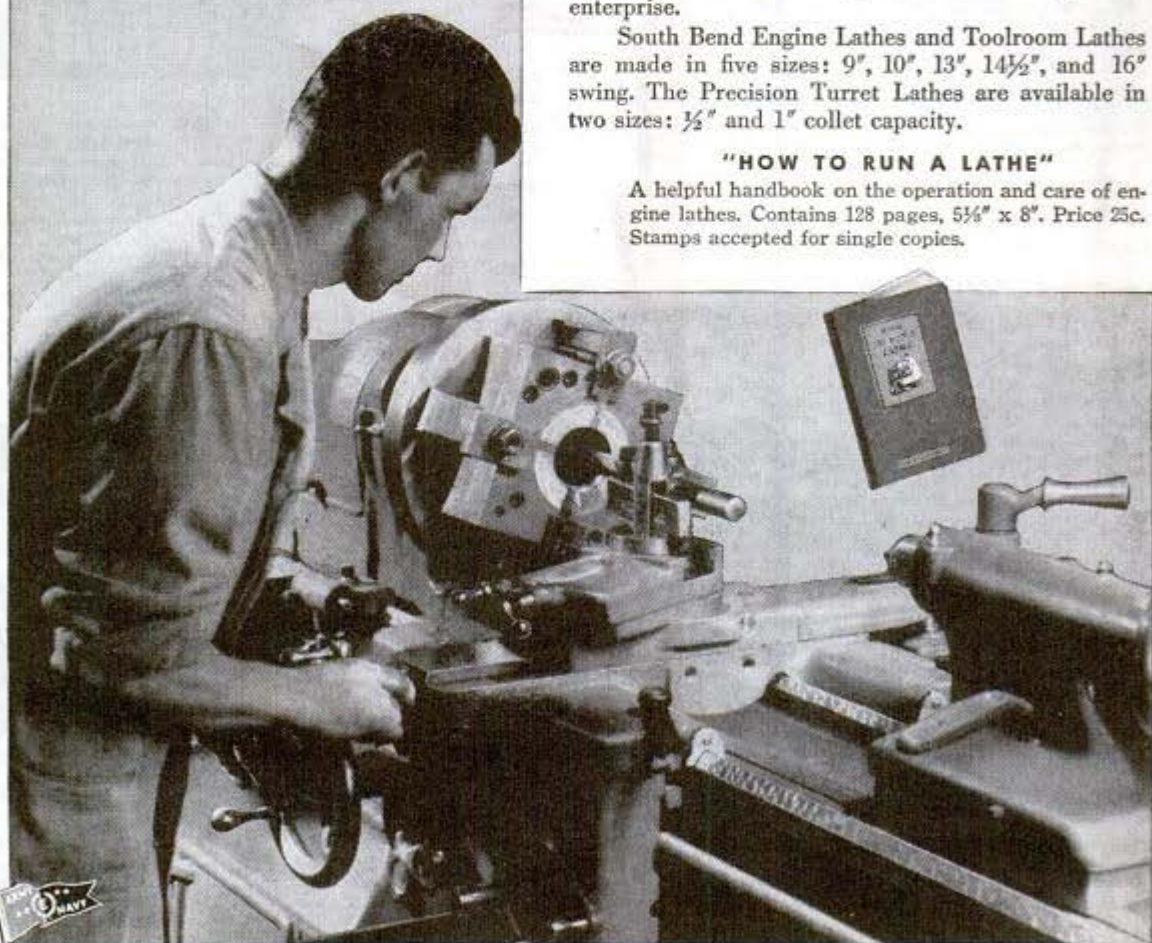

Precision work can be no more exact than the machine on which it is produced. This is why so many war plants, known the world over for the perfection of their products, rely upon precision-built South Bend Lathes for handling operations that demand machining to close tolerances.

While precision is measurable only in the finished work piece, it is the direct result of the lathe's design and construction. Unusually large spindle bearings, belt drive to spindle, hand-scraped bed ways, rigidity, and smooth operation are some of the features that make South Bend Lathes capable of the most exacting precision operations.

Today, as always, our entire factory is devoted exclusively to the production of South Bend Precision Lathes. No other product is made by us. There has been no lowering of quality standards because of war-time restrictions or shortages. The use of substitute materials is negligible, limited only to non-essential parts such as name plates, paint, etc. Improvements have been accelerated.

The performance records that these lathes are setting now on war production work forecast their value for tomorrow when accuracy and production costs become critical competitive factors in post-war enterprise.

South Bend Engine Lathes and Toolroom Lathes are made in five sizes: 9", 10", 13", 14½", and 16" swing. The Precision Turret Lathes are available in two sizes: ½" and 1" collet capacity.

"HOW TO RUN A LATHE"

A helpful handbook on the operation and care of engine lathes. Contains 128 pages, 5½" x 8". Price 25c. Stamps accepted for single copies.

 **SOUTH BEND LATHE WORKS**
455 E. MADISON ST. • SOUTH BEND 22, INDIANA, U. S. A. • LATHE BUILDERS FOR 38 YEARS

PRINTED BY POPULAR MECHANICS COMPANY, CHICAGO, ILL., U. S. A.

LIGHTER MOMENTS with fresh Eveready Batteries

Dated



**"Lucky this is on practice maneuvers and
lucky we had a tailor with us!"**

*"Keep Your Eye on the Infantry—
the Doughboy does it."*

THE CHANCES are that you are having difficulty obtaining "Eveready" flashlight batteries. We want you to understand the reason for this wartime shortage. Practically our entire production is earmarked for the Armed Forces and vital war industries.

After the war "Eveready" batteries will be plentiful again. And for your advanced information they will be even better . . . designed to give longer life, improved service.



The registered trade-mark "Eveready" distinguishes products of National Carbon Company, Inc.

LOST AND FOUND

BUY
U. S. WAR BONDS
AND STAMPS



...it was a package of
Cookies
made with



Candy



RECIPE ON EVERY WRAPPER

CURTISS CANDY COMPANY • Producers of Fine Foods • CHICAGO 13, ILLINOIS