



# POPULAR MECHANICS

## MAGAZINE

WRITTEN SO YOU CAN UNDERSTAND IT

REGD. TRADE MARK, GREAT BRITAIN, No. 40426

REG. U.S. PAT. OFF.

**FEBRUARY**  
**25 CENTS**  
30c IN CANADA

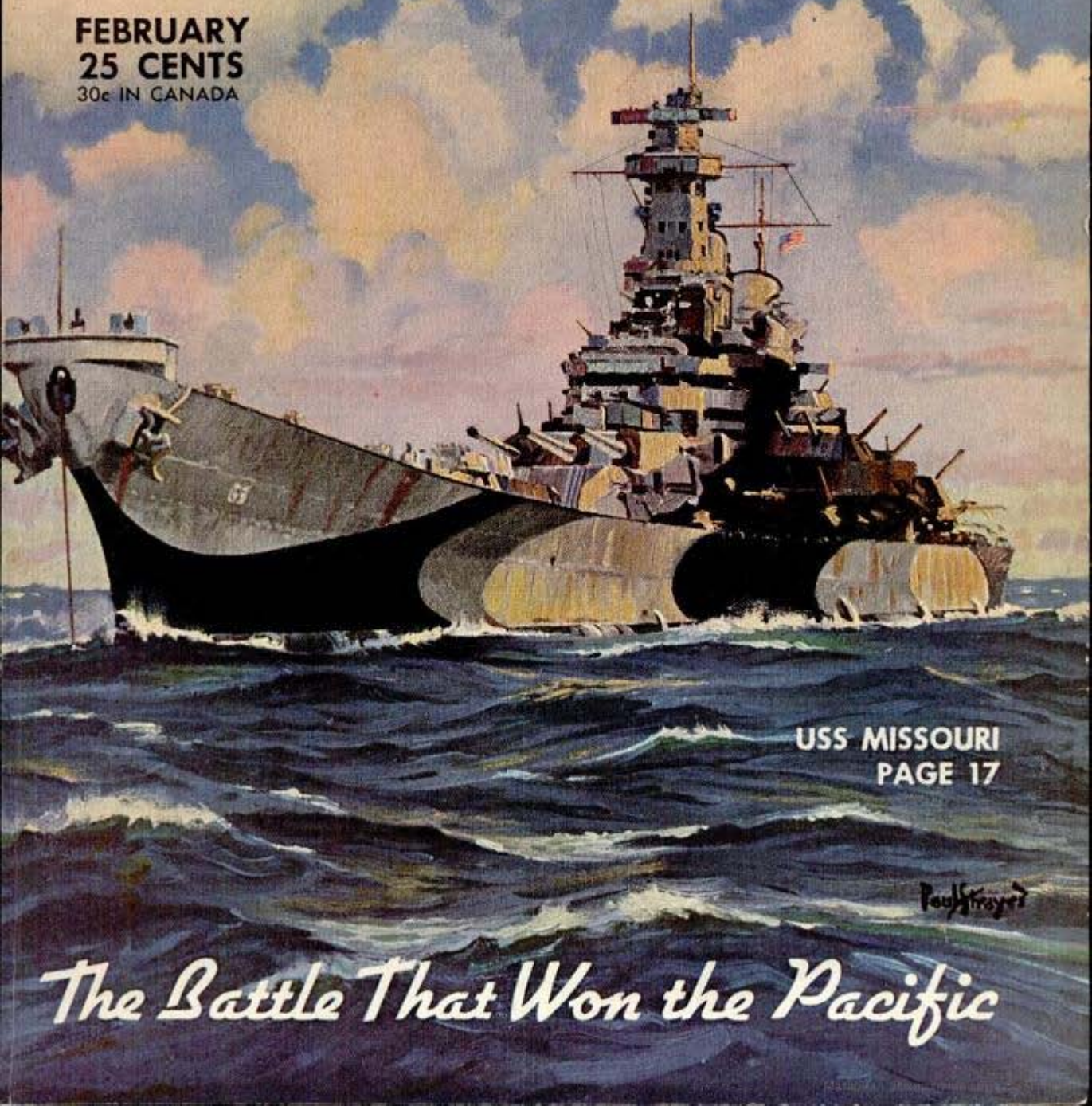

**USS MISSOURI**  
**PAGE 17**

*Paul Strayer*

*The Battle That Won the Pacific*

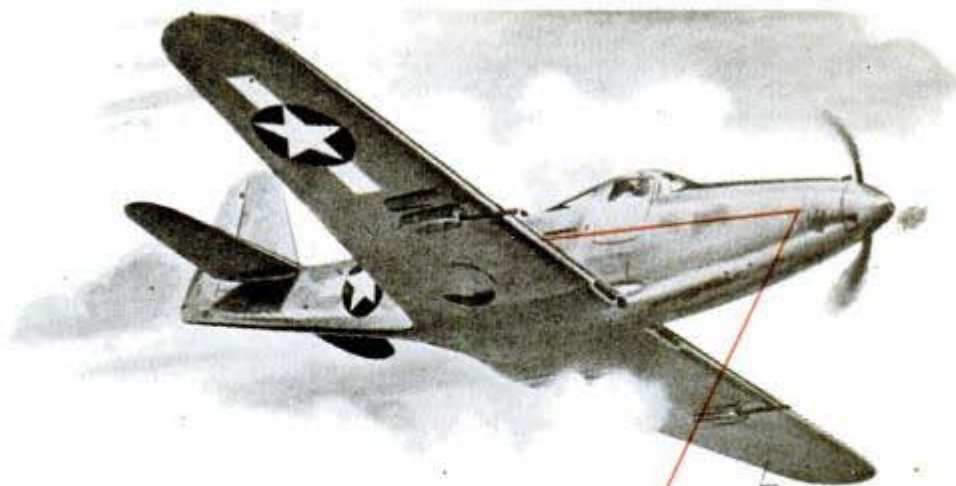

**FROM THE STRATOSPHERE . . . BETTER SPARK PLUGS**

**FOR YOUR CAR!**



For more than four years past, Champion Ceramic Aircraft Spark Plugs have been on active duty with our air forces, setting new records for long life and dependability. Extreme altitudes, extreme temperatures, 100 octane gas, and supercharging required new and revolutionary spark plugs, embodying materials and precision craftsmanship of an exceptionally high order. Today those same basic materials, fundamental design and exceptionally high manufacturing standards are yours, in Champion Spark Plugs, for your present car. Champions bring an extra measure of dependability to every engine. Champion Spark Plug Company, Toledo 1, Ohio.



**DEPENDABLE**  
**CHAMPION**  
**SPARK PLUGS**



**Buy War Bonds  
More Than Before**

# Ingenious New Technical Methods

Presented in the hope that they will  
prove interesting and useful to you.

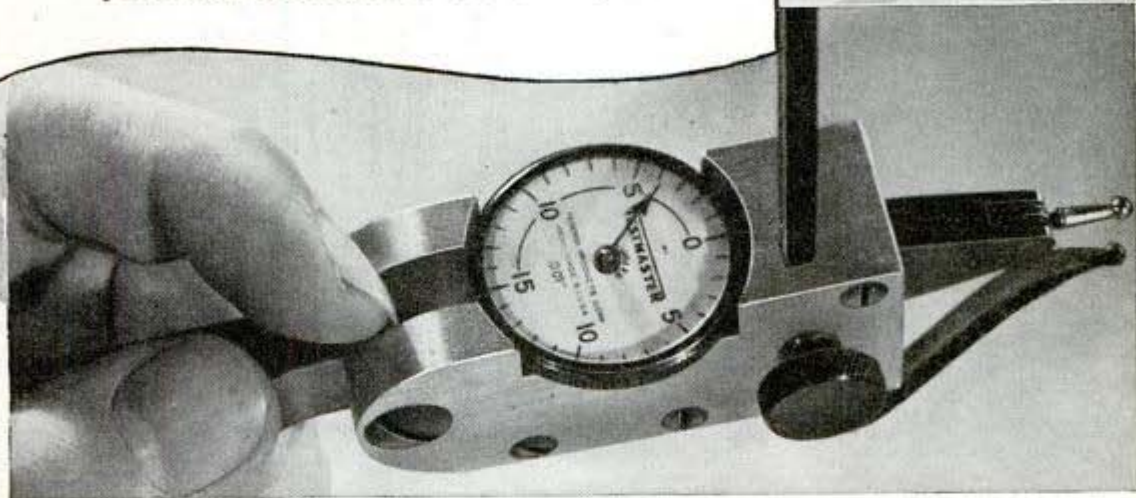

## New Internal Gage Avoids Over Cutting ... Saves Wasted Man Hours

At last a gage that takes the guess work out of checking internal diameters either machine bored, or close ground and lapped. It is called the Keene Internal Gage and is the first accurate method for fast correct checking of internal splines and gears on both minimum and root diameters. The gage is ideal for machining and inspection work, and proves its value in increased production. It can be used with either a master, or micrometers.

This time saving development is constructed of aluminum, is six inches long and weighs only five ounces. Available in models designed to read in thousandths (.001) or in tenths (.0001).

When your gage has been checked the thousandths left to bore, the actual job of machining may become tedious. It is then when Wrigley's Spearmint Gum helps keep you alert and watchful. Chewing gum seems to assist you over the dull spots in the day's work. And Wrigley's Spearmint will aid you in your peacetime job by helping to keep you wide awake and efficient during that part of your work that may seem unimportant, but which actually means perfection to the completed product.

*You can get complete information from Keene Electrical Machinery Co., 542 W. Washington Blvd., Chicago 6, Illinois*

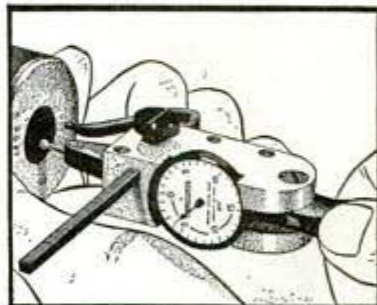

Determining correct setting for gage.

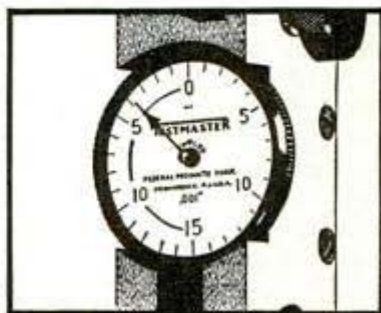

Closeup of dial showing simplicity and fast visibility.





# A MICA MINE

## IN A LABORATORY

War shortages crop up in strange materials. Mica, for instance. Once seen principally in the windows of stoves, and in small boys' pockets, it is now used extensively as electrical insulation. In some war products, it is virtually indispensable: capacitors for radio, spark-plugs for airplane engines, insulators in electronic tubes.

With demand mounting, manufacturers were desperate.

A four-man technical mission flew to London to help ration the world's supply between the United States and Great Britain. The shortage was serious.

The War Production Board, convinced that much mica was classified too low when judged by appearance alone, asked Bell Telephone Laboratories to develop a new method of electrical tests. The Laboratories were able to do this quickly because

of their basic knowledge and experience in this field.

The new tests were made available to manufacturers in this country and abroad—the supply of usable mica was increased 60%—and a difficult situation relieved.

Skill to do this and other war jobs is at hand in Bell Laboratories because, year after year, the Laboratories have been at work for the Bell System.



**BELL TELEPHONE LABORATORIES** *Exploring and inventing, devising and perfecting for our Armed Forces at war and for continued improvements and economies in telephone service.*

# Popular Mechanics Magazine

Registered in U. S. Patent Office and Canada

H. H. WINDSOR, Founder

H. H. WINDSOR, Jr., Editor and Publisher

February, 1945

Vol. 83, No. 2

## Next Month

**T**HE "bridge game" played by Army engineers in Europe and on other fronts has far more variations than the Culbertson variety. They use wood, rubber, steel and lots of Yankee ingenuity to keep our armies on the heels of a retreating foe. In France, the engineers once used the locks of a canal to hold the waters back while they built a temporary pontoon bridge. When neither rubber pontoons nor assault boats were available in Burma, they lashed empty gasoline drums together and tied planking over them. "Bridging the Army's Water Hazards," a March feature by a staff sergeant, gives a new sidelight on mobile warfare.

## Black Gold Rush

**T**HERE'S a postwar frontier of about 500 million acres in this country that has never been explored for oil. This is territory containing rock formations favorable to oil deposits. Heralding the resumption of drilling on a prewar scale is the discovery of the 100-million-barrel Heidelberg field in Mississippi. Get in step with the world's most dramatic industry by reading "Black Gold Rush" in the March issue.

## Air at Work

**D**ID you know that it takes about three tons of compressed air to make one ton of steel? That air instead of steam can be used to drive a turbine? That air goes into battle on ships, tanks and planes doing such jobs as operating landing gear and ammunition hoists? It also milks cows. A March article tells how a nation is "Putting Air to Work."

## IN THIS ISSUE

Death From the Stratosphere	1
The Bombsight That Thinks	7
Mile a Minute on Ice	12
The Battle That Won the Pacific	17
The Car That Runs on Air	29
Around the World in 2,000 Miles	33
Shipyards Sign Talk	40
They Bring 'Em Out Alive	44
Mapping the Navy's Battleground	50
The Latest in Color Photography	60
War Wonders for You	65
The Army's Navy to the Rescue	72
Lifting Father Knickerbocker's Face	76
Coming Down	82

Where-to-Buy-It Index—Page 8A

## The Art of Counter-Sniping

**S**OMEWHERE on the Western Front a U. S. Army officer speaks into a field telephone: "There's a Jerry up here sniping at our men. Send one of our experts to take care of him." The expert is a counter-sniper picked from the cream of our riflemen. He usually shoots only once, for he can hit a 6-inch disk at 500 yards. He is ambidextrous with his rifle, is an expert at camouflage, a good scout, and is calm in the face of danger. He has a bag full of tricks that make him the Nemesis of enemy snipers. Read "Sniping the Sniper," an outstanding March feature.

## Landscaping With Evergreens

**M**ANY an American has stared enviously at an evergreen tree growing out of a rocky mountainside, especially if he has a pampered and yellowed specimen in his front yard at home. The evergreen tree on the mountain thrives because the rocks conserve moisture and the slope gives perfect drainage. An authoritative article in next month's Craftsman section contains the "do's" and "don'ts" of evergreen selection, planting, fertilization and care the year around.

Published monthly by POPULAR MECHANICS COMPANY, 200 East Ontario Street, Chicago (11), Ill., U. S. A. Single copy in the United States, 25 cents; subscription rates in United States and possessions, and countries of the Pan-American Postal Union, 1 year, \$2.50; 2 years, \$4.50; 3 years, \$6.00. Single copy in Canada, 30 cents; subscription rates, 1 year, \$3.00; 2 years, \$5.50; 3 years, \$7.50. To all other countries add \$1.00 a year over United States prices for overseas postage. If you plan to move, notify us at least 60 days in advance so you will not miss an issue. Give both old and new addresses. Entered as Second Class Matter, September 15, 1903, at the Post Office at Chicago, Illinois, under Act of March 3, 1879. Entered as Second Class Matter at Post Office Dept. Canada. Copyright 1945, by Popular Mechanics Company. Copyright under International Copyright Union. All rights reserved under Pan American Copyright Union. Printed in the United States of America

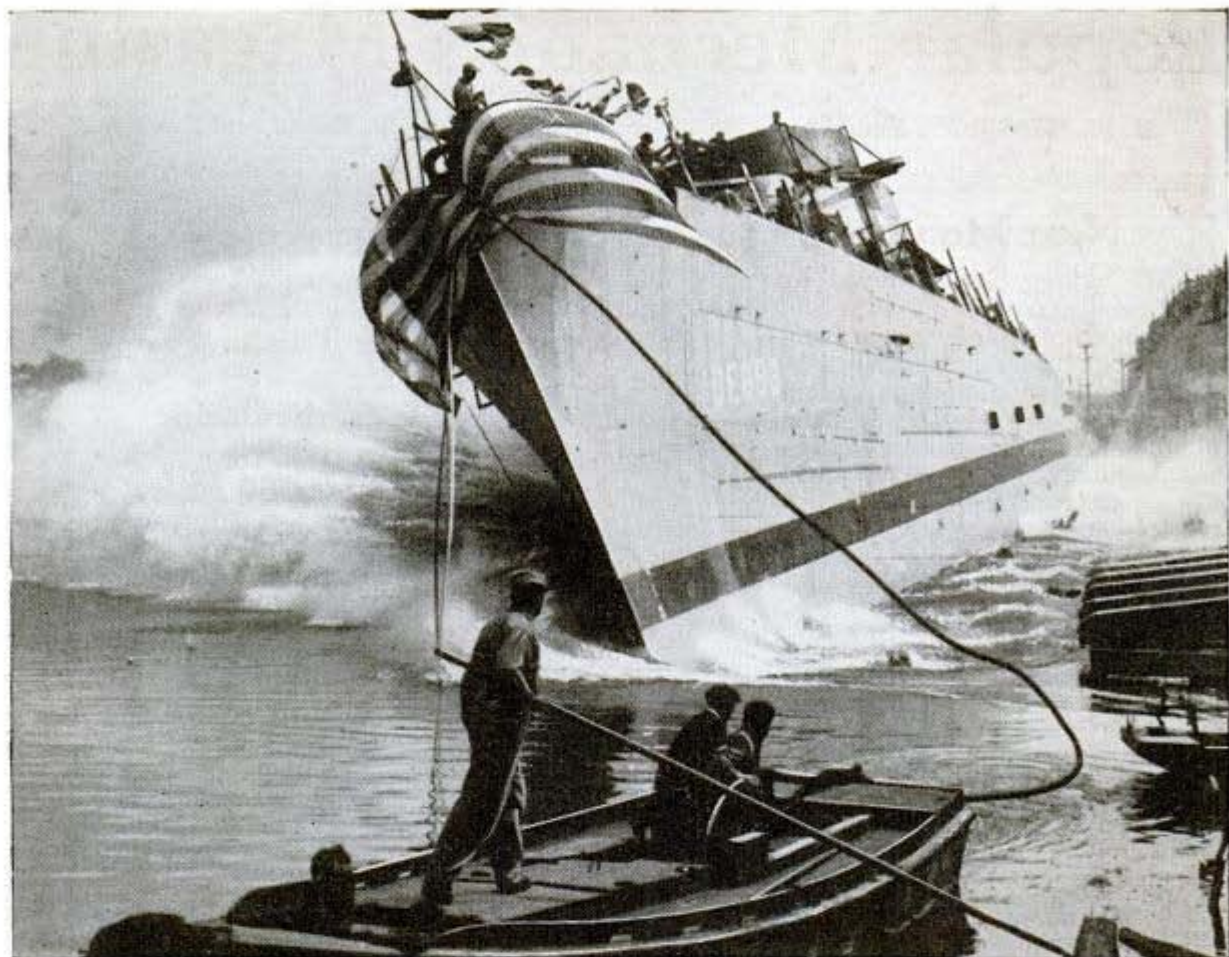

*A Destroyer-Escort hitting the water from the Defoe launching ways*

## When We've Launched Our Last Warship

After the nations of the world stack arms and the last warship has been sent from our ways, this company, in stride with the leaders of American industry, will be ready for conversion to peace. More than that, we will be prepared to translate the advancements and economies taught by war into epoch-making new products for better living for Americans. As it has for more than 40 years, the Defoe Shipbuilding Company will construct large yachts and commercial vessels. But the major expansion will come in the new Housing Division which will manufacture and distribute low-cost units and component parts for American homes and farms. The industries of this country should turn the experience, new techniques and materials developed by war work toward advancing the standard of living throughout the world. The large-scale program of the Housing Division will be Defoe's contribution to mobilization of American war industries for peace time production and employment.

HOUSING DIVISION  
 DEFOE SHIPBUILDING COMPANY, BAY CITY, MICHIGAN

**Defoe**

SHIPS FOR VICTORY  
 SERVANTS FOR PEACE

BACK THE ATTACK  
 —BUY WAR BONDS

*Four White Star Renewal Citations  
 now decorate the Navy "E" Award  
 won by Defoe workers.*



When sending small coins thru the mails  
For samples, books and such,  
Use Texcel Tape to hold them fast—  
It sticks with just a touch.

*(Texcel holds and holds—the "stick-um's" bonded on!)*

And if a sharp knife slips and cuts  
The oilcloth through and through,  
Some Texcel Tape stuck underneath  
Will make it look like new.

*(Texcel mends securely—the "stick-um's" bonded on!)*



For bundling checks, for packaging,  
For holding scores of things,  
Use Texcel Tape—no muss or fuss  
With glue or bits of strings.

*(Texcel means no gummy edges—the "stick-um's" bonded on!)*



Yes, Texcel is an improved tape  
Whose "stick-um's" bonded on.  
It won't come off, it won't dry out,  
It's one, like grass and lawn.



**T**oday most Texcel Tape that's made  
Is being used for war.  
Buy Bonds and Stamps 'til Victory  
Returns it to your store.

Made by  
Industrial Tape Corporation  
A Division of  
Johnson & Johnson  
New Brunswick, N.J.

# Texcel Tape

REG. U.S. PAT. OFF.

CELLOPHANE TAPE — STICKS WITH A TOUCH

FEBRUARY, 1945

5A



**KNOWLEDGE  
THAT HAS  
ENDURED WITH THE  
PYRAMIDS**



## **A SECRET METHOD FOR THE MASTERY OF LIFE**

**W**HENCE came the knowledge that built the Pyramids and the mighty Temples of the Pharaohs? Civilization began in the Nile Valley centuries ago. Where did its first builders acquire their astounding wisdom that started man on his upward climb? Beginning with naught they overcame nature's forces and gave the world its first sciences and arts. Did their knowledge come from a race now submerged beneath the sea, or were they touched with Infinite inspiration? From what concealed source came the wisdom that produced such characters as Amenhotep IV, Leonardo da Vinci, Isaac Newton, and a host of others? Today it is known that they discovered and learned to interpret certain *Secret Methods* for the development of their inner power of mind. They learned to command the inner forces within their own beings, and to master life. This secret art of living has been preserved and handed down throughout the ages. Today it is extended to those who dare to use its profound principles to meet and solve the problems of life in these complex times.



**AMENHOTEP IV**  
Founder of Egypt's  
Mystery Schools

### **This Sealed Book—FREE**

Has life brought you that personal satisfaction, the sense of achievement and happiness that you desire? If not, it is your duty to yourself to learn about this rational method of applying natural laws for the mastery of life. To the thoughtful person it is obvious that everyone cannot be entrusted with an intimate knowledge of the mysteries of life, for everyone is not capable of properly using it. But if you are one of those possessed of a true desire to forge ahead and wish to make use of the subtle influences of life, the Rosicrucians (not a religious organization) will send you *A Sealed Book* of explanation without obligation. This *Sealed Book* tells how you, in the privacy of your own home, without interference with your personal affairs or manner of living, may receive these secret teachings. Not weird or strange practices, but a rational application of the basic laws of life. Use the coupon, and obtain your complimentary copy.

*Use this  
coupon for  
FREE  
copy of book*

-----  
SCRIBE H. A. N.  
The Rosicrucians (AMORC)  
San Jose, California

Please send free copy of *Sealed Book*, which I shall read as directed.

NAME \_\_\_\_\_

ADDRESS \_\_\_\_\_

CITY \_\_\_\_\_

## **The ROSICRUCIANS**

**SAN JOSE (AMORC) CALIFORNIA**





# WHITE COLLAR or OVERALLS—



## Which will YOU wear after the war?

**H**UNDREDS of thousands of white collar workers have put on war overalls for the duration. Millions of both white collar and overall workers have put on uniforms. Hosts of home women are patriotically taking jobs.

After the war, millions will be coming back from army, navy and air force to civilian jobs; great war materials factories will be re-converting to civilian production; old peace-time functions of business will be springing up—where will you fit in the situation?

If you are wise, you will look ahead and prepare. You will not wait on chance. You will analyze the probable conditions in peace employment, decide where your likes and aptitudes fit best, and get ready. You will decide whether your best opportunities lie in production or office or store. You will determine whether you wish to work for someone else or develop a business of your own. You will train now to be above the average and, therefore, surer to get the opportunity you want after the armistice.

Nor will you wait very long. Nobody knows when this war will end or how soon this problem will hit you in the face.

### We Can Help You Decide

If you have some question either about postwar opportunities or about your own fitness for some particular one, probably we can help you. In our 36 years, over one million adults have enrolled for our training, we have built training courses for many

major fields of commerce and industry, and we have gathered a wealth of information about job opportunities and requirements. That information is at your service.

### We Can Help You Prepare

And when you have decided what field of work offers most to you for a life career, we can help you prepare for it—quickly, economically, thoroughly, in your spare time and without any interference with your present work—if it is in the list below. A 48-page booklet on the field of your choice, discussing the field and our training for it, has been prepared to help answer your questions. The coupon below or your letter will bring it to you, without cost or obligation.

Do not delay. Whether the war lasts six months or three years, now is the time to make sure your preparation for postwar success shall not be “too little and too late.”

## La Salle Extension University A Correspondence Institution

DEPT. 264-R

417 S. Dearborn St., CHICAGO 5

I want to pick my career for after the war and get ready for it now. Send me your free booklet on the field I have checked below and full information about your training in that field.

- |   |  |
|---|--|
| <input type="checkbox"/> Foremanship          | <input type="checkbox"/> Industrial Management   |
| <input type="checkbox"/> Bookkeeping          | <input type="checkbox"/> Accounting              |
| <input type="checkbox"/> Business Law         | <input type="checkbox"/> Law: LL.B. Degree       |
| <input type="checkbox"/> Executive Management | <input type="checkbox"/> Traffic Management      |
| <input type="checkbox"/> Salesmanship         | <input type="checkbox"/> Business Correspondence |
| <input type="checkbox"/> Business English     | <input type="checkbox"/> Stenotypy               |

Name.....Age.....

Present Job.....

Address.....

# Here's How You Can **STOP** wearing out your Car with **COLD WEATHER** **"DRY STARTS"**



During cold weather low viscosity winter oil quickly drains off of hot cylinder walls. When you stop your car—cylinders and pistons quickly become cold and dry of oil. When you start—*metal rubs metal* causing rapid wear. A pint of Pyroil in the crank-case gives winter oil the property of clinging to metal surfaces. It reduces wear—it prevents rusting and corrosion and "gumming." Ask your service man for Pyroil!

Manufactured and Guaranteed by  
Pyroil Company, W. V.  
Kidder, Founder, 52  
Pyroil Bldg., La Crosse,  
Wisconsin.

## PYROIL

ADDS LIFE TO YOUR CAR



### PYROIL COMPANY

52 Pyroil Bldg., La Crosse, Wisconsin

I want my car to last and run properly. Please tell me more about Pyroil and how it can accomplish this for me.

Name .....

Address .....

City or Town..... State.....

## WHERE-TO-BUY-IT INDEX

Manufacturer's name and address appear in parentheses directly after items believed by us to be commercially available

Gyro loops with pilot to show attitude of plane.....	5
"Super-finished" reflectors throw beam 20 miles.....	5
Gunpowder made from lower grade paper pulp.....	5
Glass "blanket" helps insulate airliner.....	6
Jets of air reduce smoke in coal-burning boilers.....	6
British Navy's Firefly is deadly fighter-scout.....	11
Searchlight under plane's wing spots subs at night.....	11
Fire escape opens up as box falls from window (Metal Portable Fire Escape Co., Murray Bldg., Grand Rapids, Mich.).....	15
Oil coating adds strength to steel.....	15
Black Widow has 4-gun slinger in top turret.....	16
GI's have form-fitting sleeping bag.....	16
U. S. railroads set new records in 1944.....	16
Drafting tools of plastics turned out in a jiffy (Perceles Bros., Inc., S. 7th and W. Arthur Ave., Milwaukee, Wis.).....	16
Gauge squares saw bits to avoid marking wood (American Saw Mill Machinery Co., Hackettstown, N. J.).....	25
Long-handled jaws remove overhead tube lamps (C-B Tool Co., Lancaster, Pa.).....	25
B-29 gunnery "brain" aims six guns at once.....	26
Car without foot pedal has controls in steering post.....	27
Rocket boats lay smoke screen for landings.....	28
Telephone "eavesdropper" records two-way messages (Dictaphone Corp., Graybar Bldg., New York).....	28
Sponge bank for soap scraps produces cleansing foam (Minute Mop Co., 17 East 23rd St., Chicago 16).....	28
One-man power saw is light and self-contained.....	31
Dial computes withholding tax (Bordeaux Co., West Springfield, Mass.).....	31
Superdestroyer packs punch of prewar cruiser.....	32
2,000-mile-an-hour wind tunnel tests aircraft models.....	32
"Featherweight" aluminum drums carry gas to China (Aluminum Co. of America).....	32
Radio beam guides Nazis attacking through smoke.....	32
Spanish train takes curves at 80 m.p.h.....	38
Collapsible cotton duck tanks hold fuel for front lines.....	38
Mosquito plane wars on subs with 6-pound shells.....	39
Plastic tube pipes fumigant into insect-infested sacks (Dow Chemical Co., Midland, Mich.).....	39
"Octopus" welder speeds laying of pipe line.....	43
Guam-Midway cable restored.....	43
Six-ton bomb penetrates target before exploding.....	49
Re-inker restores old typewriter ribbon (Display Equipment Co., Box 144, Adrian, Mich.).....	49
Four-cannon "Tempest" chases Nazi robot bombs.....	54
"Arabian" water bag keeps contents cool and pure.....	54
Camera photographs waves of heat and sound.....	55
Plug-in conveyor unloads coal at rate of ton a minute.....	55
Landlubber air school.....	56
Bus acts as mobile terminal for feeder air lines.....	58
Wrench with torque control avoids "burning" of threads.....	58
Terminal locks wire to wire in solderless connection (L. S. Brach Manufacturing Corp., Newark 4, N. J.).....	58
Machine prints ticket while customer waits.....	59
Tiny heater warms up big one to start engines in Arctic.....	59
Flywheels test brakes of heavy airplanes.....	59
Steel oxygen tank withstands 20-mm. shell.....	64
Spring snubbers for truck and tractor seats.....	64
New glass made without sand resists hydrofluoric acid.....	70
Pipe-line plan increases latex output 40 percent.....	70
Mobile cradles up-end planes for easier storage (Scott Aviation Corp., Lancaster, N. Y.).....	70
Boxcars with plywood walls are lighter and sturdier.....	71
Colored pictures now speedily transmitted by radio (Finch Telecommunications, Inc., Passaic, N. J.).....	71
Dehydration of penicillin speeded by "radio heat".....	75
Wool fiber for mothproof clothing made from peanuts.....	75
Robot cook makes sandwiches on conveyor system.....	81
Boxes dropped 10,000 feet land with contents intact (American Iron and Steel Institute, 350 Fifth Ave., New York 1).....	81
B-29 model lays smoke screen while riding on cable.....	81
Paratrooper jumps with first aid for isolated crash victims.....	87
Garbage bag snaps shut to keep out insects (Arbee Food Products Co., Kansas City 17, Kans.).....	87
Wrench signals on reaching desired torque.....	87
Cloth-paper runway is rolled out on airfield.....	88
Phone wires carry high fidelity television broadcasts.....	88
Direct sound recorder for home movie film (Miles Reproducer Company, Inc., 812 Broadway, New York 3).....	141

## Craftsman and Shop Notes Index

ART AND ARTIST	
Vacuum cup improves pantograph.....	92
Clip to keep penholder on ink bottle.....	96
Tracing designs on dark surfaces.....	116
Simple holder for artist's pencils.....	116
AUTOMOTIVE	
Cold cream jar replaces filter bowl.....	93
Loosening corroded battery terminals.....	104
Simple repair for broken oil lines.....	116
Preventing bus door from opening accidentally.....	120
Speedometer troubles located.....	131
Tow-truck spotlight used as taillight.....	131
Cage in which to inflate heavy truck tires.....	130
Distributor cap gaskets from jar rubbers.....	130
Car records clamped inside glove compartment.....	130
Strap through arm rest closes car door.....	138
Installing motorcycle drive chain.....	139
Soldering cast-iron cylinder heads.....	140
FARM	
Nails prevent birds roosting on beams.....	91
Stick and nails hold shed windows open.....	121
Building a buckrake and stacker.....	122
Horseshoes used as lifting handles on harrow.....	139

(Continued to page 10A)

**T**raining is essential to advancement in any field—and it's important to have it on record.

International Correspondence Schools' sound and practical training goes on record—and counts in the record. I. C. S. regularly reports the progress of its students to their employers, regularly receives letters expressing appreciation for this service.

A typical employer communication notes: "I have every I. C. S. report on my men filed with their personal records, the records which help to determine any action taken in regard to those men."\*

**YOU** want your record to show you have *trained* for promotion.

**YOU** want your employer to know that you have *prepared* yourself for larger responsibilities. Then *act* now to obtain that training.

I. C. S. Courses cover more than 400 business and technical subjects.

The coupon brings full information.

\*Name furnished on request



## INTERNATIONAL CORRESPONDENCE SCHOOLS



BOX 5520-K, SCRANTON 9, PENNA.

Without cost or obligation, please send me booklet and full particulars about the course *before* which I have marked X:

### Air Conditioning and Plumbing Schools

- Air Conditioning
- Heating  Plumbing
- Refrigeration  Steam Fitting

### Chemistry Schools

- Chemical Engineering
- Chemistry, Analytical
- Chemistry, Industrial
- Chemistry, Mfg. Iron & Steel
- Plastics
- Pulp and Paper Making

### Civil Engineering, Architectural and Mining Schools

- Architectural Drafting
- Architecture
- Bridge and Building Foreman
- Bridge Engineering
- Building Estimating
- Civil Engineering  Coal Mining
- Contracting and Building
- Highway Engineering
- Lumber Dealer
- Sanitary Engineering
- Structural Drafting
- Structural Engineering
- Surveying and Mapping

### Electrical Schools

- Electrical Drafting
- Electrical Engineering
- Power House Electric
- Practical Electrician
- Practical Telephony
- Telegraph Engineering

### Internal Combustion Engines School

- Auto Technician  Aviation
- Diesel-Electric
- Diesel Engines  Gas Engines

### Mechanical Schools

- Aeronautical Engineering
- Airplane Drafting
- Flight Engineer
- Foundry Work
- Heat Treatment of Metals
- Industrial Engineering
- Industrial Metallurgy
- Mechanical Drafting
- Mechanical Engineering
- Mold-Loft Work
- Patternmaking
- Reading Shop Blueprints
- Sheet-Metal Drafting
- Sheet-Metal Worker

- Ship Drafting
- Ship Fitting
- Shop Practice
- Steel Mill Workers
- Tool Designing
- Welding, Gas and Electric

### Radio School

- Electronics
- Radio, General
- Radio Operating
- Radio Servicing

### Railroad School

- Air Brake  Car Inspector
- Locomotive Engineer
- Locomotive Fireman
- Railroad Section Foreman

### Steam Engineering Schools

- Boilermaking
- Combustion Engineering
- Engine Running
- Marine Engineering
- Steam Electric
- Steam Engines

### Textile School

- Cotton Manufacturing
- Rayon Weaving

- Textile Designing
- Woolen Manufacturing

### Business and Academic Schools

- Accounting  Advertising
- Arithmetic  Bookkeeping
- Business Correspondence
- Business Management
- Certified Public Accounting
- City Letter Carrier
- College Preparatory
- Commercial
- Cost Accounting
- Federal Tax
- First Year College
- Foremanship
- French  Good English
- High School
- Higher Mathematics
- Illustrating
- Motor Traffic
- Post Office Clerk
- Railway Postal Clerk
- Salesmanship  Secretarial
- Spanish
- Stenography
- Traffic Management

Name..... Age..... Home Address.....

City..... State..... Present Position..... Working Hours..... A.M. to..... P.M.

Canadian residents send coupon to International Correspondence Schools Canadian, Ltd., Montreal, Canada.  
British residents send coupon to I. C. S., 71 Kingsway, London, W. C. 2, England.

**DISCOUNT TO DISCHARGED VETERANS—SPECIAL TUITION RATES FOR MEMBERS OF THE ARMED FORCES**

**HAND TOOLS**

Tire valve serves as blowtorch valve.....	97
Improving a cutting knife.....	97
Metal spinning suggestions.....	106
Cotter pin used as driver to start screws.....	114
Hacksaw blade marks center of turning blank.....	114
Doorknob used as tap wrench.....	116
Splitting wedges made from angle iron.....	121
Jig for honing plane blades.....	121
Mass inspection with precision instruments.....	132
Gaspipe lengthens reach of claw hammer.....	140

**HOUSEHOLD**

Solving home problems.....	94
Identifying individual toiletry items.....	96
Rack on closet door holds extra trousers.....	102
Sand box ash tray.....	103
Making a furnace cement.....	104
Plywood form for drying sweaters.....	106
Chemical dehumidifier dries basement.....	107
Test tube holds pipe cleaners in rack.....	114
Brackets to support corner shelves.....	114
Cleaning scorched oven with ammonia.....	129

**OFFICE**

Nail polish improves pen threads.....	92
Fountain pen counterweighted to protect point.....	97
Sealing gummed paper roll against moisture.....	104
File-card holders from envelopes.....	131

**PHOTOGRAPHY**

Match books hold photos.....	97
Photographing flash bulb to check shutter speed.....	117
Cleaning film negatives.....	117
Speeding ferrotyping.....	118
Photo mounts used as enlarging easels.....	118
Two photofood diffusers.....	118
Films identified by punched holes.....	118

**POWER TOOLS**

Clamp to hold round work for crosscutting.....	90
Dust cover for buffing wheels.....	96
Front-closing collet chuck.....	119
Mounting drill press for long work.....	138
Grinder head made from pipe fittings.....	140

**RADIO AND ELECTRONICS**

Direct sound recording on 16-mm. home movie film.....	141
High-quality ten-watt phono-radio amplifier.....	142
Renewing the A-battery in portable receivers.....	144

**STORE AND SHOP**

Nonflitting work bench.....	114
Blackboard panel keeps check on deliveries.....	128
Compensating for worn threads in bench vise.....	130
Bench stool swings aside when not in use.....	131
Tongs for removing small articles from show window.....	131

**TOYS, GAMES AND NOVELTIES**

Horse race quills game.....	91
Three gifts for Navy men.....	93
Toy shopping cart.....	104
Model propeller made from nut.....	104
Preventing loss of wing nuts on table tennis set.....	104
Ranch-style salad service.....	105
Mouse favor from peanut.....	116

**WOODWORKING**

Lamps for the nautical-minded craftsman.....	89
Easy way to make mortises for small work.....	92
Plywood pieces spliced to make large panel.....	92
Template locates rung holes in chair legs.....	92
Bracket to support doors for planing.....	96
Wood inlay simulated with dye.....	96
Making rustic furniture.....	98
Getting snug fit on door trim.....	102
Overlapping work fastened together without splitting.....	102
Tiny chisels for model makers.....	113
Cutting jigsawed items following template.....	114
Mailbox has hinged lid to hold magazines.....	115
Bar clamp made from pipe and fittings.....	116
Spring frees binding tailstock.....	120
Drill-press jig locates holes.....	129
Plug cutter made from drill rod.....	139

**MISCELLANEOUS**

Eyeglasses protected with Cellophane covers.....	90
Rubber bands hold loose rubbers on shoes.....	91
Keeping razor blades sharp.....	96
Preventing snag from tangling in rope.....	97
Guide aids in reading printed tables.....	97
Cleaning generator of gasoline stove.....	102
Avoiding breakage of glass funnel.....	102
Protecting wrist watch against perspiration.....	102
Brush from match cleans fingernails.....	104
Repairing ball ear on water pail.....	107
Improvised vacuum bottle.....	107
Wick in oilcan spout to apply thin film of oil.....	107
Starting a gem collection.....	108
Wetting agent helps steel treatment.....	139
Swab for oiling steel tape held on reel.....	139
Clips make testing easier.....	149

**IMPORTANT NOTICE**

It is the intention of this magazine to provide its readers with information regarding the latest developments in the mechanical arts. We take no responsibility as to whether the disclosures contained in our articles are covered by patents and advise readers to investigate this subject before making, using, or selling any of the products, machines, or processes described in order to avoid possible liability for patent infringement.

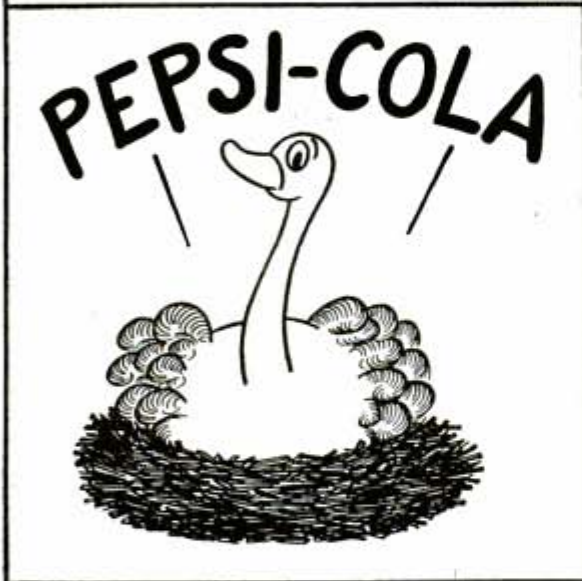
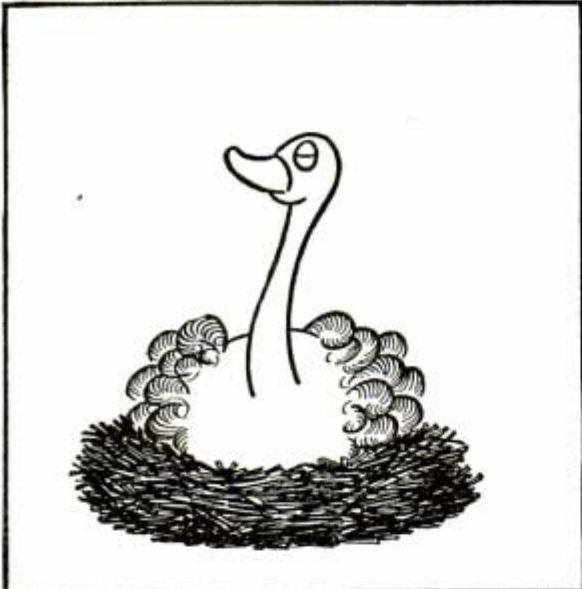

O. SOGLOW

## AUDELS REFRIGERATION & AIR CONDITIONING GUIDE... \$4

New from Cover to Cover—1280 Pages, Fully Illus. Covering basic principles, servicing, operation & repair of household, commercial & industrial refrigeration & air conditioning. A gold mine of essential important facts for engineers, servicemen, users.

## AUDELS CARPENTERS & BUILDERS GUIDES—4 Vols. ....\$6

A practical illustrated trade assistant on modern construction for carpenters, joiners, builders, mechanics and all woodworkers. 4 vols., 1600 pages, 3700 illustrations, flexible covers. Pocket size. Each volume sold separately \$1.50 a vol.

## AUDELS AUTOMOBILE GUIDE... \$4

A practical quick ready reference book for auto mechanics, service men, operators & owners. Explains theory, construction & servicing of modern motor cars, trucks, buses & auto type Diesel engines. 1540 pages, fully illustrated, 55 chapters, Indexed. A standard book for mechanics. New fluid drive covered.

## AUDELS DIESEL ENGINE MANUAL. \$2

A practical, concise treatise with questions and answers on the theory, operation and maintenance of modern diesel engines including General Motors 2 cycle Diesel. 384 pages, fully illus., flexible binding, pocket size. All details plainly brought out, this book is of extreme value to engineers, operators & students.

## AUDELS WIRING DIAGRAMS.....\$1

210 Pages. Illustrated. Gives practical facts on wiring of electrical apparatus. It shows clearly how to wire apparatus for practically all fields of electricity. Each diagram is complete & self-explanatory. Highly Endorsed Pocket Companion.

## AUDELS PLUMBERS & STEAMFITTERS GUIDES—4 Vols. ....\$6

A Practical Trade Assistant & Ready Reference. Explains in plain language & by clear illustrations, diagrams, charts, graphs, pictures principles of modern plumbing practice including Marine Pipe Fitting and Air Conditioning. 4 Vols.—1670 Pages—3612 Diagrams. Pocket size. Each Vol. Sold Separately \$1.50 a Vol.

## AUDELS SHEETMETAL WORKERS HANDY BOOK. ....\$1

Practical inside information. Fundamentals of Sheet Metal Work. 388 pages. Illustrated. 11 sections. Clearly written. Essential & important facts, figures, pointers in everyday language. Ref. Index.

## AUDELS SHEETMETAL PATTERN LAYOUTS.....\$4

Developed by Experts for Sheet Metal Workers, Layout Men & Mechanics. A Practical Encyclopedia in 10 Sections, size 7 x 10 x 2—1125 Pages—350 Layouts—1600 Illustrations, 1001 Key Facts. Fully indexed for ready reference in answering your layout problems. Covers all phases of sheet metal work including Pattern Cutting, Pattern Development & Shop Procedure.

## AUDELS ANSWERS ON BLUE PRINT READING.....\$2

For Mechanics & Builders. Covers all types of blue print reading including ship & airplane. 376 pages, fully illustrated.

## AUDELS NEW MACHINIST & TOOLMAKERS HANDY BOOK... \$4

Covers modern machine shop practice in all its branches. 5 practical books in 1. New from cover to cover. Tells how to set up & operate lathes, screw and milling machines, shapers, drill presses and all other machine tools. 1600 pages, fully illustrated, 5 x 6 1/2 x 2. Indexed. 5 sections. 1—Modern Machine Shop Practice. 2—Blue Print Reading & How to Draw. 3—Calculations & Mathematics for Machinists. 4—Shop Physics. 5—How to Use the Slide Rule. 60 chapters. Easy to read and understand. A shop companion that answers your questions.

## AUDELS MATHEMATICS & CALCULATIONS FOR MECHANICS \$2

Mathematics for home study or reference. 700 pages, 550 illus. Practical mathematics from beginning. How to figure correctly. Easy, correct methods covering a complete review. Ill. & Indexed.

## AUDELS HANDY BOOK OF PRACTICAL ELECTRICITY.....\$4

For maintenance engineers, electricians & all electrical workers. 1440 Pages, 2600 illus. Covers important electrical information in handy form—including Marine Wiring, Radio Principles, Welding. Indexed. A Key to a practical understanding of electricity.

## AUDELS RADIOMANS GUIDE.....\$4

A key to the practical understanding of radio including Frequency Modulation, Television, etc., Aircraft & Marine Radio. For radio engineers, servicemen, amateurs. 772 pages. 400 Illustrations & Diagrams. Photos. Review Questions & Answers, Reference Index. Authentic, clear, concise.

## AUDELS ELECTRONIC DEVICES... \$2

Tells What You Want to Know About Electric Eye. Easily Understood. Covers photo-electric cells & their applications. Amplifiers, illumination, frequencies, voltage, photocell, tubes, Ohm's Law, wiring diagrams, etc.

## AUDELS WELDERS GUIDE.....\$1

A concise, practical text on operation & maintenance of all welding machines for all mechanics. Over 400 pages, illustrated. Covers all methods of electric and acetylene welding including airplane work.

**AUDEL, Publishers, 49 W. 23 St., N. Y. 10**



## AN AUDEL GUIDE IS A GOOD FRIEND!

Use the brains and experience of others in these Guides of the Trades. Save time and money with right methods, short cuts, labor saving ideas. CHECK NOW! You can look over any Audel Guide in your home. Start the Easy Payments if satisfied.

# CUT HERE MAIL ORDER

THEO. AUDEL & CO., 49 W. 23 St., New York 10, N.Y.

Please mail me for 7 days' free examination the books marked (X) below. I agree to mail \$1 in 7 days on each book or set ordered, and to further mail \$1 a month on each book or set ordered until I have paid purchase price.

If I am not satisfied with Guides I will return them.

- Audels REFRIGERATION & Air Conditioning Guide \$4.
- Audels PUMPS, HYDRAULICS & AIR COMPRESSORS 4.
- Audels WELDERS GUIDE . . . . . 2.
- Audels BLUE PRINT READING . . . . . 2.
- Audels SHEET METAL WORKERS Handy Book . . . . . 1.
- Audels SHEET METAL PATTERN LAYOUTS . . . . . 4.
- Audels AIRCRAFT WORKER . . . . . 1.
- Audels MATHEMATICS and CALCULATIONS . . . . . 2.
- Audels MACHINISTS & TOOLMAKERS Handy Book . . . . . 4.
- Audels DIESEL ENGINE MANUAL . . . . . 2.
- Audels MECHANICAL Dictionary . . . . . 4.
- Audels AUTOMOBILE GUIDE . . . . . 4.
- Audels MARINE ENGINEERS Handy Book . . . . . 4.
- Audels SHIPFITTERS Handy Book . . . . . 1.
- Gueths MECHANICAL DRAWING COURSE . . . . . 1.
- Rogers DRAWING and DESIGN . . . . . 2.
- Audels MILLWRIGHTS and Mechanics Guide . . . . . 4.
- Audels CARPENTERS and Builders Guides (4 vols.) . . . . . 6.
- Audels PLUMBERS and Steamfitters Guides (4 vols.) . . . . . 6.
- Audels MASONS and Builders Guides (4 vols.) . . . . . 6.
- Master PAINTER and DECORATOR . . . . . 2.
- Audels GARDENERS & GROWERS GUIDES (4 vols.) . . . . . 6.
- Audels ENGINEERS and Mechanics Guides . . . . . 12.
- Nos. 1, 2, 3, 4, 5, 6, 7 and 8 complete . . . . . 12.
- Audels Answers on Practical ENGINEERING . . . . . 1.
- Hawkins Aids to ENGINEERS EXAMINATION . . . . . 2.
- Audels WIRING DIAGRAMS . . . . . 1.
- Audels Handy Book of PRACTICAL ELECTRICITY . . . . . 4.
- Audels ELECTRICAL POWER CALCULATIONS . . . . . 2.
- Hawkins ELECTRICAL Guides at \$1. each . . . . . 10.
- Audels ELECTRONIC DEVICES . . . . . 2.
- Audels ELECTRIC Dictionary . . . . . 4.
- Audels RADIOMANS GUIDE . . . . . 4.
- Audels NEW ELECTRIC LIBRARY at \$1.50 a Volume . . . . . 4.
- Vols. I, II, III, IV, V, VI, VII, VIII, IX, X, XI, XII.

Name.....

Address.....

Occupation.....

Employed by..... PM



**J. E. SMITH, President**  
National Radio Institute  
Our 31st Year of Training Men  
for Success in Radio

**I WILL SEND  
A SAMPLE  
to PROVE I can Train You  
BE A RADIO**

**Good Jobs Like These  
Go To Men I Train**



**Farmer Made \$600. Extra**—"About six months after I enrolled I started making extra money in radio. I am a farmer and just work on radios evenings and stormy days. That brought me a profit of \$600. in the last year."—**BENNIEL ARENDS, RFD 2, Alexander, Iowa.**



**\$50 a Week From Own Shop**—"Am making over \$50 a week profit from my own shop. Have another N.R.I. graduate working for me. I like to hire N.R.I. men because they know radio."—**NORMAN MILLER, Hebron, Neb.**



**Runs Repair Shop for Sears Roebuck**—"I was a barber and not working steadily. After about 30 lessons in your Course, I came with Sears Roebuck and now run their radio service shop here, at a nice steady income."—**NORMAN P. FORNOFF, 1929 E. 13th St., Davenport, Iowa.**



**\$50 a Month in Spare Time**—"I have a spare time Radio and Electrical business of my own which has been very profitable, due to the efficient training I received from your Course. Last year I averaged over \$50 a month."—**FRED H. GRIFFIE, Route 3, Newville, Pa.**



**Transmitter Network Engineer**—"I began my N.R.I. training while 16 years old and still in high school. Am now transmitter engineer here for one of the big networks."—**THEODORE CAMPBELL, Johnstown, Pa.**



**RADIO SERVICING** (picture above) pays technicians good money, spare or full time. **RADIO OPERATORS** (picture at right) find interesting work in U. S. Broadcasting and other types of stations.

*Get Into a Busy Field With  
a Bright Peacetime Future*

**YOU MAY NEVER SEE A BETTER TIME  
TO GET STARTED IN RADIO**

I will send you my Lesson "Getting Acquainted with Receiver Servicing" FREE, to show you how practical it is to train for Radio at home in spare time. It's a valuable Lesson. Study it—keep it—use it—without obligation! And with this Lesson I'll send my 64-page, illustrated book, "Win Rich Rewards in Radio" FREE. It describes many fascinating jobs Radio offers, tells how N.R.I. gives you practical Radio experience at home with **SIX BIG KITS OF RADIO PARTS** I supply!



**My Radio Course Includes  
TELEVISION ★ ELECTRONICS  
FREQUENCY MODULATION**

Think of the NEW jobs that Television, Frequency Modulation, Electronics, and other developments will open in the future! I will train you to be ready to cash in when amazing wartime developments are converted to new civilian uses.

**A TESTED WAY TO**

# LESSON FREE

## at Home in Spare Time to

# TECHNICIAN



### Many Opportunities Ahead for Trained Radio Technicians and Operators

The future looks bright for capable, well-trained Radio Technicians and Operators. The Radio Repair Business is booming. Profits are large and prospects are bright. Think of the new boom in Radio Sales and Servicing that's coming when new Radios are again available—when Frequency Modulation and Electronics can be promoted—when Television starts its new era of expansion!

Broadcasting Stations, Aviation Radio, Police Radio, Loudspeaker Systems, Radio Manufacturing all give good jobs to trained Radio men—and most of these fields have a big backlog of business that built up because of the war, plus opportunities to expand into new fields opened by wartime developments. You may never see a time again when it will be so easy to get a start in Radio!

### Many Beginners Soon Make \$5, \$10 a Week EXTRA in Spare Time

The day you enroll for my Course I start sending you EXTRA MONEY JOB SHEETS that help show how to make EXTRA money fixing Radios in spare time while still learning. I send you SIX big kits of Radio parts as part of my Course. You LEARN Radio fundamentals from my illustrated, easy-to-grasp lessons—PRACTICE what you learn by building real Radio Circuits—and USE your knowledge to make EXTRA money!

### Mail Coupon for FREE Lesson and Book

The opportunity now offered beginners to get started in Radio may never be repeated. So take the first step at once. Get my Lesson and 64-page illustrated book FREE. No obligation—no salesman will call. Just mail Coupon in an envelope or pasted on a penny postal.—J. E. SMITH, President, Dept. 5BP, National Radio Institute, Washington 9, D.C.

## GOOD FOR BOTH 64 PAGE BOOK SAMPLE LESSON FREE

J. E. SMITH, President, Dept. 5BP  
National Radio Institute, Washington 9, D. C.

Mail me FREE, without obligation, Sample Lesson and 64-page book, "Win Rich Rewards in Radio." (No salesman will call. Please write plainly.)

Name ..... Age .....

Address .....

City ..... Zone ..... State ..... 4FR

### You Build These and Other Radio Circuits with 6 Big Kits I Send



MEASURING INSTRUMENT (above) you build early in Course. Use it in practical Radio work to make EXTRA money. Vacuum tube multimeter, measures A.C., D.C. and R.F. volts, D.C. currents, resistance, receiver output.

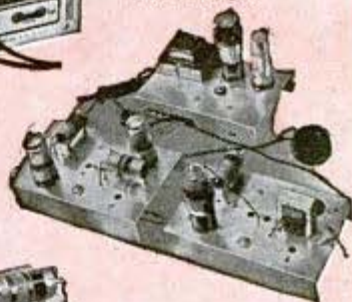

SUPERHETERODYNE CIRCUIT (above) Pre-selector, oscillator, mixer-first detector, i.f. stage, diode detector-a.v.c. stage, audio stage. Bring in local and distant stations on this circuit you build yourself!



A.M. SIGNAL-GENERATOR (above) Build it yourself! Provides amplitude-modulated signals for test and experimental purposes. Gives valuable practice!



**GOOD PAY**

# NEW BOOK *for*

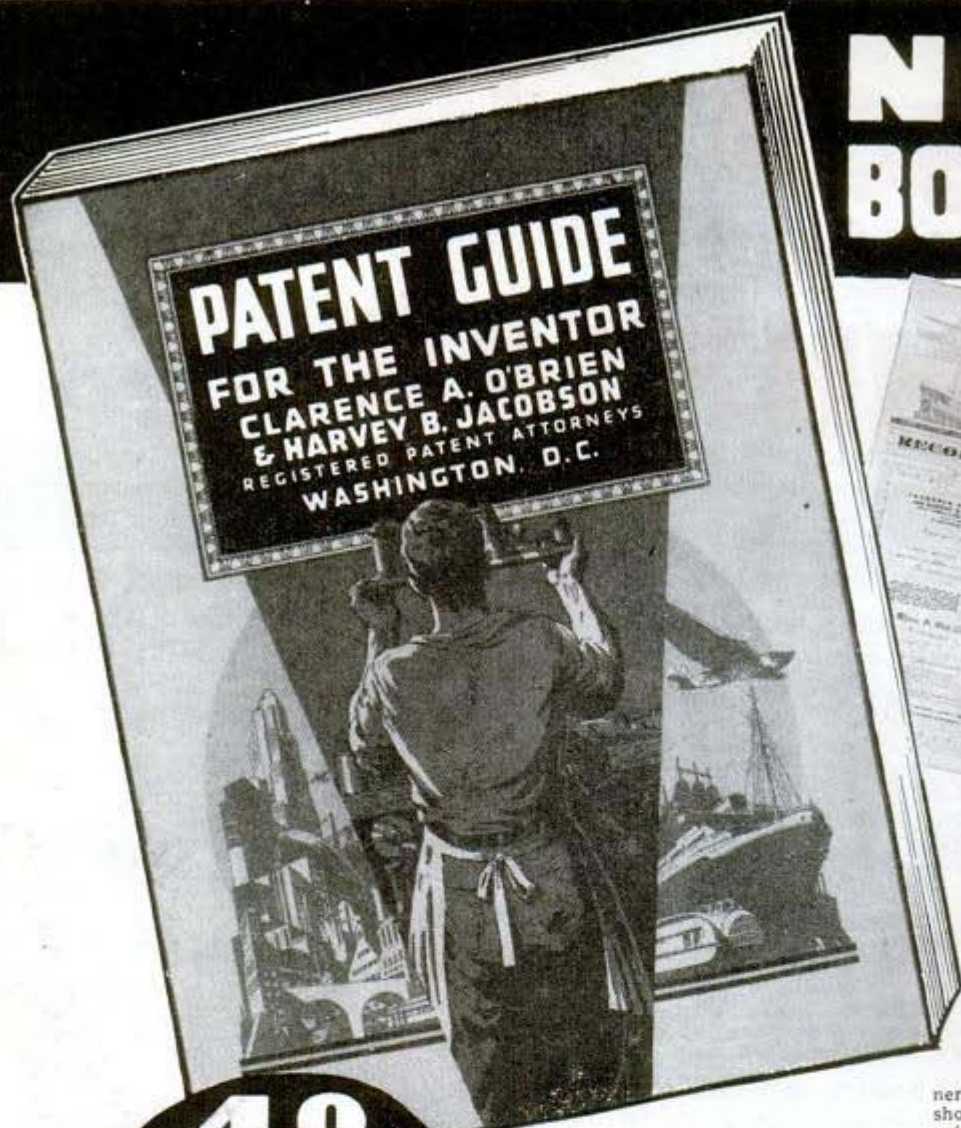

## FREE RECORD OF INVENTION

This FREE Record of Invention form enables you to conveniently make a sketch of your invention and have it witnessed in a manner of value to you, should the occasion for evidence arise.

**48**  
**PAGES**  
*Over 150*  
*Mechanical*  
*Movements*

## LATEST FACTS ON INVENTIONS

Is your invention something for the home, the farm, the factory, the store? Would you like to know whether anything like it has ever been invented, and if not, how to protect your invention? Our new 48-page book "Patent Guide for the Inventor" will show you how to proceed with your invention. You'll get a good idea of whether you "have something" or not. Would you like to know how you may judge the marketability of your invention? This book gives you several important tests prepared by authorities. Read of the experiences of Bell, Edison, Westinghouse, and other outstanding, successful inventors who patented and thereby protected their inventions. This book not only tells you how to obtain a patent, it also explains the steps that must be taken afterward to promote the success of your invention. MAIL THE COUPON TODAY to Clarence A. O'Brien & Harvey B. Jacobson, Registered Patent Attorneys, 51-B Adams Building, Washington 4, D. C.

**CLARENCE A. O'BRIEN  
& HARVEY B. JACOBSON**  
REGISTERED PATENT ATTORNEYS



# INVENTORS

## NOW Is the Time to PATENT and SELL Your Invention

Now, more than ever before, is the right time to patent your invention. Why? Because manufacturers everywhere presently engaged in war production are looking ahead to the future by buying up patent rights now, so they will have new and attractive items to make and sell for civilian consumption as soon as the war is over. This is what happened during and after the last war. Hence, the smart thing for you to do is to look ahead to the future too. Protect your invention and yourself by applying for a patent now.

### Patent Guide Shows What To Do

Our "Patent Guide for the Inventor" answers many important questions concerning Patents that inventors constantly ask. It tells what facts, details, drawings, sketches, etc. are necessary to apply for a Patent, how to protect your invention through dated and witnessed disclosure; how to do this AT ONCE to safeguard your rights; how Patent Office Records can be checked to determine whether the invention is probably patentable before filing fees need be paid; discusses costs involved and a practical way these can be paid as the application progresses. It tells how some inventors secured financial backing; how many simple inventions have proved large commercial successes; how Patents covering improvements also can be profitably utilized and marketed, tells countless other facts of interest.

### Why You Need Expert Assistance

The Patent Laws were enacted for your benefit—to give you protection for the features of your invention which are Patentable. But these features must be legally and concisely set forth in the form of "claims." This phase of the procedure is so complex that the Patent Office advises the Inventor to engage a competent Registered Patent Attorney. We maintain a large staff—carefully trained registered patent attorneys—expert draftsmen—experienced searchers—to serve you. We have been serving inventors for more than 20 years.

### Take First Step Now

With the Patent Guide you will receive also Free a "Record of Invention" form which will enable you at once to establish the date of your invention, before you file your Patent application. This step costs you nothing yet may be vital to your success. Remember—in Patent Matters, ACTION is IMPORTANT. Delay can be costly. Mail the coupon in an envelope, or paste it on a penny postcard NOW.

*Worthy of  
Your Trust*

*Get*

**FREE  
COPY**

*Mail  
Coupon*

*Today*

## CLARENCE A. O'BRIEN & HARVEY B. JACOBSON

CLARENCE A. O'BRIEN & HARVEY B. JACOBSON  
Registered Patent Attorneys before the United States Patent Office  
51-B Adams Building, Washington 4, D. C.

Please send me your 48-Page "Patent Guide for the Inventor" and your specially prepared "Record of Invention" form FREE. This request does not obligate me.

Name.....

Address.....

City..... State.....

(Please write or print plainly.)

# SPRAYBERRY RADIO TRAINING

*Gives you Both*



**FULL RADIO SET  
SUPPLIED FOR  
SHOP PRACTICE!**

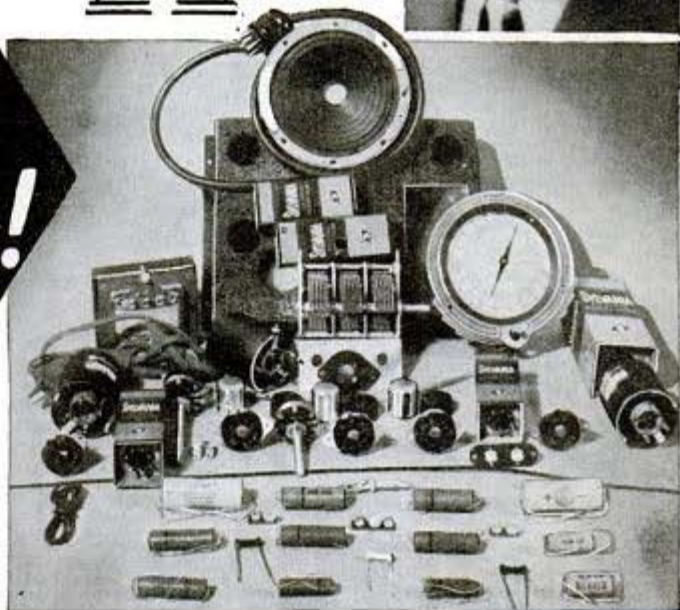

## HERE'S THE ONE PRACTICAL WAY TO TRAIN FOR BIG EARNINGS AHEAD IN RADIO-ELECTRONICS & TELEVISION

**JUST OUT! FREE!**

**"How to Read Radio Diagrams and Symbols"**

... a valuable new book which explains in simple English how to read and understand any Radio Set Diagram. Provides the quick key to analyzing any Radio circuit. Includes translations of all Radio symbols. Send for this FREE book now and along with it I will send you another big FREE book describing my Radio-Electronic training.



**GET FREE BOOKS**

### SPRAYBERRY ACADEMY OF RADIO

F. L. Sprayberry, President  
Box 5000, Pueblo, Colorado.

Please rush my FREE copies of "How to MAKE MONEY in RADIO, ELECTRONICS and TELEVISION," and "HOW TO READ RADIO DIAGRAMS and SYMBOLS."

Name..... Age.....

Address.....

City..... State.....

(Mail in plain envelope or paste on penny postcard)

The offer I make you here is the opportunity of a lifetime. It's your big chance to get ready for a wonderful future in the swiftly expanding field of Radio-Electronics INCLUDING Radio, Television, Frequency Modulation and Industrial Electronics. Be wise! NOW'S the time to start. No previous experience is necessary. The Sprayberry Course starts right at the beginning of Radio. You can't get lost. It gets the various subjects across in such a clear, simple way that you understand and remember.

### I'll Show You a New, Fast Way to Test Radio Sets Without Mfg. Equipment

The very same Radio Parts I supply with your course for gaining pre-experience in Radio Repair work may be adapted through an exclusive Sprayberry wiring procedure to serve for complete, fast, accurate Radio Receiver trouble-shooting. Thus under Sprayberry methods you do not have one cent of outlay for manufactured Test Equipment which is not only expensive but scarce.

### Prepares You for a Business of Your Own or Good Radio Jobs... Civilian or Military

My training will give you the broad, fundamental principles so necessary as a background no matter which branch of Radio you wish to specialize in. I make it easy for you to learn Radio Set Repair and Installation Work. I teach you how to install and repair Electronic Equipment. If you enter the Army, Navy or Marines, my training will help you win higher rating and better pay.

# 15 Minutes a Day!

Give me just this  
and I'll prove I can make you  
**A NEW MAN!**

I'M "trading-in" old bodies for new! I'm taking men who know that the condition of their arms, shoulders, chests and legs—their strength, "wind," and endurance—is not 100%. And I'm making NEW MEN of them. Right now I'm even training hundreds of soldiers and sailors who KNOW they've got to get into shape FAST!

## Only 15 Minutes a Day!

Are you ALL MAN—tough-muscled, on your toes every minute, with all the up-and-at-'em that can lick your weight in wildcats? On do you need the help I can give you—the help that has already worked such wonders for other fellows, everywhere?

All the world knows I was ONCE a skinny, scrawny 97-lb. weakling. And NOW it knows that I am the holder of the title, "The World's Most Perfectly Developed Man." How did I do it? How do I work miracles with the bodies of other men in only 15 minutes a day? The answer is "Dynamic Tension," the amazing method I discovered and which changed me from a 97-pound weakling into the champion you see here!

In just 15 minutes a day, right in the privacy of your own home, I'm ready to prove that "Dynamic Tension" can lay a new outfit of solid muscle over every inch of your body. Let me put new, smashing power into your arms and shoulders—give you an armor-shield of stomach muscle—strengthen your legs into real columns of surging stamina. If lack of exercise or wrong living has weakened you inside, I'll get after that condition, too, and show you how it feels to LIVE!

*Charles Atlas*

—actual photo of the man who holds the title, "The World's Most Perfectly Developed Man."

### Charles Atlas—America's Greatest "Builder of Men"

Among all the physical instructors and "conditioners of men" ONLY ONE NAME STANDS OUT. That name is Charles Atlas!

In every part of the country Charles Atlas is recognized as "America's Greatest Builder of Men." Thousands upon thousands have put their physical development into his capable hands!

And now that the call is for men capable of helping America meet and conquer any national emergency, many thousands of others (even those already in their country's Army and Navy) are calling upon Charles Atlas to build the kind of men America vitally needs!



**MAIL THIS COUPON NOW!**

**FREE** This Famous Book that Tells You How to Get a Body that Men Respect and Women Admire

My book, "Everlasting Health and Strength," tells you exactly what "Dynamic Tension" can do. And it's packed with pictures that SHOW you what it does. RESULTS it has produced for other men. RESULTS I want to prove it can get for YOU! If you want to learn how you can actually become a NEW MAN, right in the privacy of your own home and in only 15 minutes a day, then man!—get this coupon into the mail to me as fast as your legs can get to the letterbox! CHARLES ATLAS, Dept. 82, 115 East 23rd St., New York 10, N.Y.

**CHARLES ATLAS, Dept. 82**  
115 East 23rd St., New York 10, N. Y.

I want the proof that your system of "Dynamic Tension" will help make a New Man of me—give me a healthy, husky body and big muscular development. Send me your free book, "Everlasting Health and Strength."

Name .....

(Please print or write plainly)

Address .....

City .....

State .....

Check here if under 16 for Booklet A.

# INVENTORS

LEARN HOW TO  
**PROTECT and SELL**  
**YOUR INVENTION**

**GET NEW FREE BOOK**



**FREE**

**Invention Record**  
**Know How Successful**  
**Inventors Protect and**  
**Sell Their Inventions**

Our new FREE Book is a book every Inventor should have. Mail the coupon today for "How to Protect, Finance and Sell Your Invention" and learn . . .

- How to know if there is a prior U. S. patent on your invention.
- How to save steps in getting patent action.
- How to prepare your application for presentation to the Patent Office.
- How you may patent an improvement on something in use now.
- How to obtain funds to patent and promote your invention.
- How to find a buyer or backer for your invention.
- How to protect yourself in making royalty agreements.

## MODERN BUSINESS WANTS INVENTIONS

Practical and novel inventions are in big demand today. The opportunity for quick money is enticing. Sales sources are many if your invention has merit. But, be *sure*—before you place your device in strange hands—that it is fully protected. A United States Patent gives you this protection. *The first step toward inventive success—always is—and always has been, the application for a U. S. Patent. There is no other way to protect your invention in accordance with the laws of this country.*

## MAKE THIS RECORD NOW

If you have an invention, and wish to secure it for the future, act at once. Have it dated now and recorded in our office. We will send you this FREE Invention Record Form for the purpose. Fill out the Invention Record Form fully describing the nature of your invention. Make a sketch of its main features. Mail it to us and we will record the date it was received in our office. The earlier the date the better your chance of combating rival inventors who may lay claim to your idea later. *Don't delay a single minute in taking this important step. Your whole future may depend upon it. Mail the coupon for our FREE Invention Record Blank and New FREE Book today!*

## HOW WE SERVE YOU AS REGISTERED PATENT ATTORNEYS

The U. S. Patent Office strongly recommends—unless the inventor is familiar with such matters—that he employ the services of a Registered Patent Attorney in the preparation of his Patent Application. We are Registered Patent Attorneys fully qualified to represent you at the Patent Office. We have had long experience in studying hundreds of types of inventions. This gives us the ability to judge your invention and to describe it accurately and convincingly in technical language. It gives us the perception to center arguments upon those details of your invention which, in our judgment, will be looked upon most favorably by the Patent Office Examiner.

Mail the coupon today for our new FREE Book, "How to Protect, Finance and Sell Your Invention," and our FREE Invention Record Form—maybe this step will pave the way to future security for you and your family. Act Today!

## McMORROW & BERMAN

REGISTERED PATENT ATTORNEYS

1357 ATLANTIC BUILDING, WASHINGTON 4, D. C.

Send me your new FREE book, "How to Protect, Finance and Sell Your Invention"—and "Invention Record" form at once. I understand that this request does not obligate me.

NAME .....

ADDRESS .....

CITY..... STATE.....

(Write or print name clearly)

**McMORROW & BERMAN**  
Registered Patent Attorneys

1357 Atlantic Building, Washington 4, D. C.

# INTERNATIONAL CORRESPONDENCE SCHOOLS

OFFER YOU LOW-COST

# SPECIAL TRAINING

FOR SUCCESS IN MODERN BUSINESS AND INDUSTRY

## TECHNICAL COURSES

### Air Conditioning and Plumbing Schools

Air Conditioning  
Heating Plumbing  
Refrigeration  
Steam Fitting

### Aviation School

Aeronautical Engineering  
Aircraft and Engine  
Mechanic  
Airplane Drafting  
Commercial Pilot  
Flight Engineer  
Private Pilot  
Weather Observing

### Chemistry Schools

Chemical Engineering  
Chemistry, Analytical  
Chemistry, Industrial  
Chemistry, Iron and Steel  
Petroleum Refinery  
Operator  
Plastics  
Pulp and Paper Making

### Civil Engineering, Architectural and Mining Schools

Architecture  
Architectural Drafting  
Bridge and Building  
Foreman  
Bridge Engineering  
Building Estimating  
Civil Engineering  
Coal Mining  
Contracting and Building  
Highway Engineering  
Lumber Dealer  
Reading Structural  
Blueprints

Sanitary Engineering  
Structural Drafting  
Structural Engineering  
Surveying and Mapping

### Electrical Schools

Electrical Drafting  
Electrical Engineering  
Electronics  
Power House Electric  
Practical Electrician  
Practical Telephony  
Radio, General  
Radio Operating  
Radio Servicing  
Telegraph Engineering

### Internal Combustion Engines School

Automobile Technician  
Diesel—Electric  
Diesel Engines  
Gas Engines

### Mechanical Schools

Foundry Work  
Heat Treatment of Metals  
Industrial Engineering  
Inventing and Patenting  
Mechanical Drafting  
Mechanical Engineering  
Mold-Loft Work  
Patternmaking  
Reading Shop Blueprints  
Sheet Metal Drafting  
Sheet Metal Worker  
Ship Drafting  
Ship Fitting  
Shop Practice  
Tool Designing  
Welding, Gas and Electric

### Railroad School

Air Brake Car Inspector  
Locomotive Engineer  
Locomotive Fireman  
Railroad Section Foreman  
Steam Engineering  
Schools  
Boilermaking  
Combustion Engineering

Engine Running  
Marine Engines  
Steam Electric  
Steam Engineering

### Textile School

Cotton Manufacturing  
Rayon Weaving  
Textile Designing  
Woolen Manufacturing

## BUSINESS and ACADEMIC SCHOOLS

### Academic Schools

Arithmetic  
College Preparatory  
Commercial High School  
First Year College  
French Good English  
High School  
Higher Mathematics  
Illustrating

Commercial  
Cost Accounting  
Federal Tax Course  
Foremanship  
Postal Service  
Salesmanship Secretarial  
Spanish Stenography  
Traffic Management

### Business School

Accounting  
Advertising Bookkeeping  
Business Correspondence  
Business Management  
Cert. Pub. Accounting

### Home Economics

Advanced Dressmaking  
Foods and Cookery  
Home Dressmaking  
Professional Dressmaking  
Tea Room and Cafeteria  
Management

If you can read and write,  
and are willing to study,

**WE CAN TEACH YOU!**

• Special service and attention are always given to the student who may need extra help in order to understand.

REASONABLE TERMS  
MAY BE ARRANGED



The successful man DOES today what the failure INTENDS to do tomorrow. Mail this coupon NOW!

Special Tuition Rates for Members of the Armed Forces  
INTERNATIONAL CORRESPONDENCE SCHOOLS  
BOX 5521-K, SCRANTON 9, PENNA.

Please send complete information on following subject:

(Write above Technical, Business or General Educational Subject in which you are interested.)

Name \_\_\_\_\_ Age \_\_\_\_\_

Home Address \_\_\_\_\_

City \_\_\_\_\_ State \_\_\_\_\_

Present Position \_\_\_\_\_ Working Hours \_\_\_\_\_ A.M. \_\_\_\_\_ P.M.

# AVIATION

## Career



Never was it more opportune for you to get into Aviation! In preparation for future peacetime activity, a change in the name of this school has been made to **CAL-AERO TECHNICAL INSTITUTE**, simplifying and coordinating relative operations. — **SAME SCHOOL—SAME MANAGEMENT—SAME LOCATION—SAME PERSONNEL—SAME SPECIALIZED TRAINING** in Aeronautical Engineering and Master Aviation Mechanics incorporating all the latest developments and methods to insure a thorough foundation for your future career in Aviation. Flight training is restricted to the training of Army Air Force cadets for the duration.

Created during the war, the name "Cal-Aero" emerges symbolic of the highest standards of Aviation Training. Having trained more than 20,000 pilots and 7,500 ground-crew men for the Army Air Forces, at the same time training thousands of civilians for the production front, the schools under the personal direction of Major C. C. Moseley, since 1929, have been honored by citations for distinguished service in the training of these men. It is but natural, in view of the co-related activities and planning for the post-war period, under this same personal direction by Major C. C. Moseley, that the technical phase of Aviation Training should come under this distinguished new name.

### CAL- TECHNICAL

MAJOR C. C. MOSELEY



### AERO INSTITUTE

PRES. SINCE 1929

FORMERLY CURTISS-WRIGHT TECHNICAL INSTITUTE

LOCATED ON ITS OWN AIRPORT

IN THE HEART OF THE AIRCRAFT INDUSTRY

GRAND CENTRAL AIR TERMINAL  
GLENDALE 1, CALIFORNIA  
(Los Angeles County)

### MAIL THIS COUPON TODAY!

Registrar, Cal-Aero Technical Institute, Grand Central Air Terminal, Glendale (1), California. Please send information and profusely illustrated catalogue on Aviation Training. FREE... without obligation... Dept. PM-2.

NAME \_\_\_\_\_  
STREET \_\_\_\_\_  
CITY \_\_\_\_\_  
STATE \_\_\_\_\_  
BIRTH DATE \_\_\_\_\_

"CAL-AERO" AVIATION'S HONORED SCHOOL OF AERONAUTICS

Say you saw it in Popular Mechanics!

## Do You Make Mistakes in English?

EVERY time you speak or write you show just what you are. Mistakes in English reveal you as a person who lacks education and refinement. Lack of language power prevents you from presenting your thoughts in the strongest possible way. No matter what you do, real command of English will help you to your goal. Stop making mistakes in spelling, punctuation, pronunciation. Increase your vocabulary.



### WONDERFUL INVENTION

Only 15 minutes a day with Sherwin Cody's new invention—and you can actually SEE your English improve. It teaches by HABIT—makes it easier to do the RIGHT way. Wonderful self-correcting lessons include spelling, punctuation, grammar and expression.

**FREE BOOK ON ENGLISH** Lack of language power may cost you thousands of dollars every year. See what Mr. Cody can do for you; it costs nothing to find out. Mail a postal card or letter this very minute for free book. "How you can Master Good English in 15 Minutes a Day." It will prove a revelation to you. **WRITE NOW.** Address:

Sherwin Cody School of English, 52 Searle Bldg., Rochester 4, N. Y.

## ANY BOOK IN PRINT!

Delivered at your door. We pay postage. Standard authors, new books, popular editions, fiction, reference, medical, mechanical, children's books, etc. —all at guaranteed savings. Send card now for Clarkston's 1945 Catalog.

**FREE** Write for our great illustrated book catalog. A short course in literature. The buying guide of 300,000 book lovers. **FREE** if you write **NOW—TODAY!**

CLARKSON PUBLISHING COMPANY  
Dept. PM45 1253 S. Wabash Ave. Chicago, Ill.

## LEARN MONEY-MAKING CARTOONING

IN SPARE TIME — by Easy Picture Chart Method

Some Simplified Method that has helped train creators of "Terry & Pirates," "Freckles," "Out Our Way," "Winnie Winkle," "Big'lar Sellers," "Strange As It Seems," "The Neighbors," and many others. Earn while learning. Send 10c for Picture Chart (to test your ability), and full details. (State age.)



THE LONDON SCHOOL, Dept. 4502, Philadelphia 1, Penna.

## Learn Penmanship

You can learn plain, rapid writing or fancy ornamental writing for social and business advancement, right in your own home during spare time by my Simplified Method. Write for my free book, "How to Become an Expert Penman," which shows what others have accomplished by taking my Courses. Send 10c for one of my favorite Pen Points and your name with a beautiful flourish bird written on a card. Write today. T. M. Tevis, Box 258, Chillicothe, Mo.

## LAW

### STUDY AT HOME

Legally trained men win higher positions and bigger success in business and public life. Greater opportunities now than ever before. Big corporations are headed by men with legal training.

**More Ability: More Prestige: More Money**

We guide you step by step. You can train at home during spare time. Degree of LL. B. Successful graduates in every section of the U. S. We furnish all text material, including 14-volume Law Library. Low cost, easy terms. Get our valuable 48-page "Law Training for Leadership" and "Evidence" books **FREE**. Send for them **NOW**.

LASALLE EXTENSION UNIVERSITY, 417 South Dearborn Street  
A Correspondence Institution Dept. 264-L Chicago 5, Ill.

## ANALYZE HANDWRITING

Qualify for Certified Grapho-Analyst Degree. Earn up to \$100 weekly, up to \$1 hourly spare time, in new uncrowded profession... Graduates in employment and credit fields, police departments, courts, and in private practice as Personal Problem and Vocational Counselors. 3,000 word test lesson and illustrated GRAPHO-ANALYST Free.

**Free**

ADDRESS A.I.G.A., INC., 120 JOPLIN, MO.

## JOIN THE Management!

There's always opportunity in the business world for the man who wants to join the management. Routine jobs are easily filled, but men with the rounded knowledge needed by executives are hard to find. That's where I.C.S. comes in. A pioneer in business training, these schools have graduated thousands who became executives. Through the I.C.S. Business Management Course, experts train you in finance and business law, accounting and production, salesmanship and advertising. Write today for free booklet.

International Correspondence Schools, Box 5525-K, Scranton 9, Pa.

POPULAR MECHANICS

# Choose YOUR POST-WAR FUTURE *Now*

You'll Need "ALL-AROUND" Training to Meet New Conditions!

Get Ready QUICK—in 1 of these 2 Opportunity Fields!



## ELECTRICITY in its Many Branches...

Electricity is a permanent necessity in war or peace. Be ready for the opportunities in such branches as Power Plant Work, Motors, Armature Winding, Industrial and House Wiring, Maintenance, etc., with COYNE shop training.



This big fire-proof building is occupied entirely by the Coyne Electrical School.

## RADIO-ELECTRONICS... A great field

now, even greater growth ahead. Prepare for a real Radio career. Learn construction, operation, trouble-shooting on Radio Receivers, Public Address Systems, Sound Picture Units, FM, Photo-Cells, Television—the practical COYNE way.

# "LEARN-BY-DOING"-12 WEEKS TRAINING

*I'll Finance Your Training*

Where will YOUR JOB be after the war? Many "one-operation" jobs that pay well today may no longer exist in peace time. Plan for steady pay and advancement by training NOW, while there's still time! Come to the big shops of COYNE in Chicago, for "all-around" training in Electricity or Radio-Electronics—the 2 great opportunity fields of today and tomorrow. I'll finance most of your training.

## TRAIN ON ACTUAL EQUIPMENT!

My famous "Learn-by-Doing" method gives you practical experience on full-size equipment. Not by correspondence, but actual shop work. You are trained right here in the Coyne shops, that has been training men and young men for over 46 years.

## START NOW—PAY LATER! LIFETIME JOB SERVICE TO COYNE GRADUATES

Don't let lack of money hold you back. My "Pay-Tuition-after-Graduation" plan has helped thousands. Coupon brings details. Many earn while learning, to help take care of living expenses while here. Men from 16 up to 40, with or without experience, Coyne training is for you!

First I train you for a good job and future, then assist you in getting located. As a Coyne graduate, use this service whenever you need it—no charge. Also FREE review privileges at any time. Get the facts!



## INDUSTRIAL ELECTRONICS

Included With Either Course—No Extra Charge  
Special training in the new wonder field of INDUSTRIAL ELECTRONIC CONTROLS—Ignitron, Pilotron, Ultra-High-Frequency, etc. A necessity in many types of jobs. Makes you more valuable to employer, leads to opportunities for bigger pay. This valuable EXTRA TRAINING included with either my Electrical or Radio Course, without extra cost.

We have facilities for men with physical disabilities. If you have a physical disability of any kind write me when you send the coupon.

PICK FIELD YOU LIKE—SEND FOR BIG BOOK



FREE *H. C. Lewis*



Some men prefer Electricity, others Radio-Electronics. Whichever interests you most, we will train you in 12 short weeks at Coyne—on full-size equipment, by my famous "Learn-by-Doing" method. I have a big, fully illustrated book on each course, and will send you the one you want, without the slightest cost or obligation. Simply check below, then mail coupon in envelope or paste on postcard. No salesman will call. You are the sole judge. Don't delay. Your future is at stake. Rush coupon to me—TODAY.

# COYNE ELECTRICAL SCHOOL

H. C. LEWIS, Pres.

Founded 1899

500 So. Paulina Street, Dept. 25-72, CHICAGO 12, ILL.

H. C. LEWIS, Pres.,  
COYNE ELECTRICAL SCHOOL  
500 S. Paulina St., Dept. 25-72, Chicago 12, Ill.

Send me your BIG FREE BOOK—for the course checked below. Also full details of your "Pay-After-Graduation" plan.

ELECTRICITY  RADIO-ELECTRONICS

NAME.....

ADDRESS.....

CITY.....ZONE.....STATE.....

The set of  
books  
that makes



## MASTER MACHINISTS and leads to bigger pay!

This big home-study and reference course gives you the practical facts on machines and methods you need to advance in machine shop work. Take advantage of the other man's experience as found in books, to solve your problems, increase your efficiency, with

### The AMERICAN MACHINISTS' LIBRARY

6 volumes—2368 pages—2516 illustrations  
(A combined home-study course and reference library)

This library of machine shop practice was written for practical men. It gives you the best methods for every kind of machine shop work. It fully explains lathes, drills, and other machine tools and their operation, automatic screw machines, speeds and feeds, gear design and production, jigs and fixtures, punch and die work, metal surfacing, etc., etc. Plainly written—completely illustrated—the best kind of help to the machine shop man who wants to advance himself.

No money down—special price—easy payments.

#### EXAMINATION COUPON

McGRAW-HILL BOOK CO., 330 W. 42nd St., N. Y. 18

Send me for ten days' examination the American Machinists' Library. If satisfactory I will send you \$1.00 in 10 days and \$2.00 monthly until the price of \$19.50 is paid. If not wanted, I will return the books postpaid. (To insure prompt shipment write plainly and fill in all lines.)

Name .....  
Home Address .....  
City and State .....  
Position .....  
Name of Company ..... PM-2-45

## AUDELS Carpenters and Builders Guides

4 vols. \$6



Inside Trade Information for Carpenters, Builders, Joiners, Building Mechanics and all Woodworkers. These Guides give you the short-cut instructions that you want—including new methods, ideas, solutions, plans, systems and money saving suggestions. An easy progressive course for the apprentice and student. A practical daily helper and Quick Reference for the master worker. Carpenters everywhere are using these Guides as a Helping Hand to Easier Work, Better Work and Better Pay. To get this assistance for yourself, simply fill in and mail the FREE COUPON below.

#### Inside Trade Information On:

How to use the steel square—How to file and set saws—How to build furniture—How to use a mitre box—How to use the chalk line—How to use rules and scales—How to make joints—Carpenters arithmetic—Solving mensuration problems—Estimating strength of timbers—How to set girders and sills—How to frame houses and roofs—How to estimate costs—How to build houses, barns, garages, bungalows, etc.—How to read and draw plans—Drawing up specifications—How to excavate—How to use settings 12, 13 and 17 on the steel square—How to build hoists and scaffolds—skylights—How to build stairs—How to put on interior trim—How to hang doors—How to lath—lay floors—How to paint



THEO. AUDEL & CO., 49 W. 23rd St., New York City

Mail Audels Carpenters and Builders Guides, 4 vols., on 7 days' free trial. If O.K. I will remit \$1 in 7 days, and \$1 monthly until \$6 is paid. Otherwise I will return them. No obligation unless I am satisfied.

Name .....  
Address .....  
Occupation .....  
Reference ..... PM

★ SAVE WASTE PAPER ★

## PARKS AIR COLLEGE

18th Year Offers YOU COLLEGE and PROFESSIONAL TRAINING  
Majoring in AVIATION

Accredited by the Illinois Superintendent of Public Instruction. Included since 1938 in Directory of Higher Institutions of Learning, issued by the U. S. Office of Education. U. S. approved since 1929 as a Flight and Ground School.

"G. I. Bill of Rights" educational benefits are sufficient to pay most of, though not all of, direct school expenses for eligible Veterans.

Open to high school graduates with a ranking in the upper two-thirds of their classes.

Three engineering courses majoring in Aviation Operations, Aviation Maintenance, and Aeronautical Design Engineering lead to the Bachelor of Science degree, the Airplane and Airplane Engine Mechanics ratings, and the Private Pilot rating on the two-control personal plane.

Professional Flight Training, leading to the Commercial Pilot rating and the Instrument Pilot rating, is elective for all enrolled engineering students who are physically qualified.

Each course provides 120 weeks, ten terms, of personalized instruction and is completed in 2½ calendar years.

Enrollment limited to 400 students.

Airpark and 21 buildings devoted to school purposes exclusively. Dormitories and dining hall are on the campus.

Winter term, January 8, Spring term, April 2.

Send post card for new 64-page catalog. Address:

Registrar, Dept. PM-2

PARKS AIR COLLEGE, East St. Louis, Ill.

## Learn to MOUNT BIRDS



### Tan SKINS, make up FURS

Be a Taxidermist. Double your hunting fun. We teach you at Home. Mount Birds, Animals, Fish, Heads, common specimens. Fun and profits. Decorate home and **MAKE MONEY**. Mount game, tax for others. Big profits in spare time. WRITE TODAY.

100 game pictures in FREE BOOK  
Hunters, get your copy. It's  
Now Free. Send post card. State your AGE.  
NORTHWESTERN SCHOOL OF TAXIDERMISTRY  
Dept. 3372 Omaha, Nebraska

FREE BOOK

## "How to Make Money With Simple Cartoons"

A book everyone who likes to draw should have. It is free; no obligations. Simply address

CARTOONISTS' EXCHANGE

Dept. 92 Pleasant Hill, Ohio

## LAW

STUDY AT HOME for PERSONAL SUCCESS and LARGER EARNINGS. 35 years expert instruction—over 108,000 students enrolled. LL.B. Degree awarded. All texts furnished. Easy payments. Send for FREE BOOK—"Law and Executive Guidance."

AMERICAN EXTENSION SCHOOL OF LAW  
Dept. 50-M, 646 N. Michigan Ave., Chicago 11, Ill.

## LEARN WATCH REPAIRING



AT HOME. By our modern and original system of instruction you can learn every part of the WATCH REPAIRING TRADE AT HOME. Prepare yourself for a well-paying position or start in business after completing our course of instruction. Good watch repairers are in demand and generally earn very good salaries. For particulars apply to the Wisconsin School of Watch Repairing 759 North Milwaukee St., Milwaukee 2, Wis.

## HIGH SCHOOL AT HOME

Most well-paid positions demand high school training. Without it, or equivalent, you can't advance to the full extent of your abilities in any trade, business or profession. Whatever your age, however you're situated, IT ISN'T NECESSARY TO STRUGGLE UNDER THAT HANDICAP. I.C.S., famous for more than 50 years, enables you to start your own high school in your own home. You're in a class by yourself—study in your spare time—acquire a high school education at astonishingly low cost. Authoritative texts! Rapid Progress! Write today for free booklet. International Correspondence Schools, Box 5526-K, Scranton 9, Pa.



# PLASTICS

THE GREAT *New* FIELD OF OPPORTUNITY  
PLASTICS ENGINEERS AND TECHNICIANS NEEDED  
IN NOT ONE BUT MANY CLASSES OF INDUSTRY

● Leaders in science and industry have long been saying, "Keep your eye on Plastics." But now the time for action has arrived. The future of huge possibilities has already begun. Developments in Plastics for hundreds of wartime uses have set the pace for revolutionary changes in peacetime production of thousands of products.

**THIS IS YOUR  
BIG CHANCE**

Today there's a big need in vital war production for those who are trained in Plastics. From one to a hundred articles made of Plastics must be supplied for every man in our fighting forces. Start training now in Plastics Engineering, in spare time in your own home. Fit yourself for a responsible, well-paid position. Help to win Victory. And at the same time you will be preparing for even greater opportunities when the war is over.

There is scarcely an industry in which these so-called "miracle materials" will not play an important part. After the war many old materials, methods and skills will be replaced. Acquire the all-important "know how." Be in a position to step into one of the key jobs.

**YOU CAN LEARN  
WHILE YOU EARN**

Turn at least part of your leisure time into money. Qualify at home for a larger income in an interesting career. Build greater security for your future in a vocation that looms large on the horizon of the new industrial era. Hours you might otherwise waste can put you well on your way toward lasting success.

It's easy to find out about Plastics training. To get details and outline of study prepared by specialists, and about the school that has helped thousands to success during the past 46 years, write us or check and mail the coupon. Send today. The sooner you take this easy step, the sooner you will reach your goal and reap the rich rewards.

**AMERICAN SCHOOL OFFERS  
COMPLETE TRAINING SERVICE  
IN MANY SUBJECTS**

You who have not completed high school or have missed vocational training in college, and who cannot spare time to go away to school, can complete your education in your choice of many subjects. Several of these are listed in the coupon at right. Check the subject in which you are interested, fill in your name and address, clip and mail the coupon today.

PRACTICAL, EFFECTIVE HOME - STUDY TRAINING SINCE 1897

**Take This First Easy Step**

**CHECK, CLIP AND MAIL COUPON NOW**

AMERICAN SCHOOL, Dept. G245, Drexel at 58th, Chicago 37, Ill.  
Without obligation. Please send FREE and postpaid, bulletin and details of the Subjects checked.

- |  |   |  |
|--|---|--|
| <input type="checkbox"/> PLASTICS ENG'R            | <input type="checkbox"/> Accounting and C.P.A.              | <input type="checkbox"/> Drafting and Design for Men and Women |
| <input type="checkbox"/> Refrigeration             | <input type="checkbox"/> Cost Accounting for Manufacturing  | <input type="checkbox"/> Radio                                 |
| <input type="checkbox"/> Architecture and Building | <input type="checkbox"/> Bookkeeping                        | <input type="checkbox"/> High School                           |
| <input type="checkbox"/> Practical Plumbing        | <input type="checkbox"/> Private Secretary                  | <input type="checkbox"/> Air Conditioning                      |
| <input type="checkbox"/> Automotive Engineering    | <input type="checkbox"/> Diesel Engineering                 | <input type="checkbox"/> Shipbuilding                          |
| <input type="checkbox"/> Aviation Drafting         | <input type="checkbox"/> Surveying & Topographical Drafting | <input type="checkbox"/> Mechanical Eng.                       |
| <input type="checkbox"/> Business Mgmt             | <input type="checkbox"/> Sheet Metal Pattern Drafting       | <input type="checkbox"/> Shop Management                       |
| <input type="checkbox"/> Railway Training          | <input type="checkbox"/> Electrical Engineering             | <input type="checkbox"/> Tool Making                           |
|  |   | <input type="checkbox"/> Better Foremanship                    |
|  |   | <input type="checkbox"/> Machine Shop Operations               |

Name.....Occupation.....  
Address.....Age.....  
City.....State.....

**AMERICAN SCHOOL**

Dept. G245, Drexel at 58th Street, Chicago 37

# FREE!

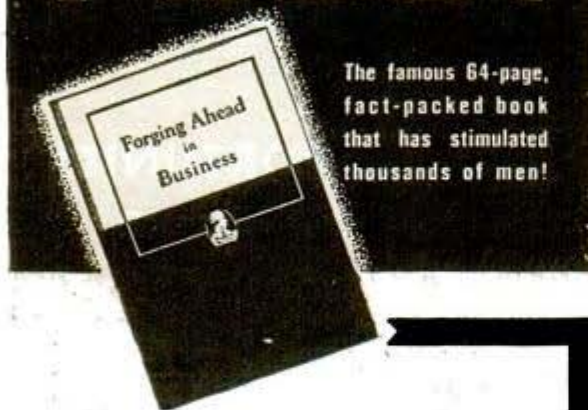

The famous 64-page, fact-packed book that has stimulated thousands of men!

"Forging Ahead in Business" is a practical, thoughtfully-written book with "punch" and common sense on every page. It carries a message of vital importance to every man who wants to make more money, get a better job and improve his station in life.

#### Partial Contents:

- Law of Success
- Highway of Achievement
- Forging a Career
- Making Decisions
- Organized Knowledge
- Failure and Success

#### Noted Contributors

Among the prominent men who have contributed to the Institute's training plan, which is described in "Forging Ahead in Business," are: Thomas J. Watson, President, International Business Machines Corp.; Clifton Slusser, Vice President, Goodyear Tire & Rubber Co.; Frederick W. Pickard, Vice President and Director, E. I. du Pont de Nemours & Co.

Simply return the coupon below, and your FREE copy of "Forging Ahead in Business" will be mailed to you.

#### MAIL COUPON TODAY

ALEXANDER HAMILTON INSTITUTE  
Dept. 221, 71 West 23rd Street, New York 10, N. Y.  
In Canada: 54 Wellington Street, West, Toronto 1, Ont.  
Please mail me, without cost, a copy of the 64-page book—"FORGING AHEAD IN BUSINESS."

Name.....  
Firm Name.....  
Business Address.....  
Position.....  
Home Address.....

★ SAVE WASTE PAPER ★

# STUDY AT HOME

With A Chartered Educational Institution

Men with specialized training win higher positions, insure larger earnings, and are bigger successes in business and public life. Opportunities NOW greater than ever before. Send for our 1944 Catalog.

## ARTS AND SCIENCES

Courses in Philosophy; Education; Letters; Public Health; Medical Jurisprudence; Psychology; Sociology; Physics; Chemistry; Plastics; Geology; Political Science; Theology; Business and Commerce; Accounting; Mathematics; Statistics; Agriculture.

## ENGINEERING

Courses in Electrical, Civil, Mechanical, Drafting, Architectural, Steam, Aeronautical, Radio, Structural, Mining, Industrial, Highway, Petroleum, Marine, Chemical, Diesel, Automobile and Air Conditioning Engineering.

## LAW

Complete Professional Law Course includes 21 Hornbook Series college grade textbooks. Courses also in Commercial Law, Patent Law and Medical Jurisprudence.  
McKinley-Roosevelt Incorporated, 4610-K, Sheridan Rd., Chicago 40, Ill.

#### DEVELOP THE POWERFUL INFLUENCE



FEUCHTINGER Method Guaranteed  
IN YOUR VOICE

DO IT YOURSELF AT HOME

Write for the Voice Book - FREE

Sent only to those over 17 yrs of age

PERFECT VOICE INSTITUTE

STUDIO 9352

64 E. LAKE ST. CHICAGO, ILL.

## Learn LANDSCAPE GARDENING!

Prepare for the giant postwar home-building program. A thorough, constructive, interesting home-training for those who wish to become LANDSCAPERS, DESIGNERS, GARDENERS, etc., for profit or pleasure. Write today for FREE INFORMATION, without obligation, to

**NATIONAL LANDSCAPE INSTITUTE**  
Dept. P-2 756 So. Broadway Los Angeles 14, California

## you can be a well-paid ACCOUNTANT!

Accountants are well paid and in demand. World-famous I.C.S. shows you how to join them. Wide variety of Courses individually tailored. For men or women with no previous experience. For those already in accounting. Instruction papers by well-known Professors of Accountancy, Certified Public Accountants. Excellent preparation for C.P.A. examinations. Home study . . . low cost . . . rapid progress. Write for free booklet containing full information.

International Correspondence Schools, Box 5524-K, Scranton 9, Pa.

## CARTOONING PAYS WELL

Exclusive instruction by a nationally known cartoonist makes it easy to learn at home. Write for details of the course. Please state age.

**NATIONAL SCHOOL OF CARTOONING**  
423 Penton Bldg. Cleveland 13, Ohio



Begin today. Write now for our Free Book, "How to Become a Good Penman." It contains specimens and tells how others learned to write in spare time. Enclose 10c for your name beautifully written and a pen point suitable for shaded writing. Write today.

**THE TAMBLYN SCHOOL OF PENMANSHIP**  
N441 Ridge Building, Kansas City, Mo.

## BETTER SIGHT

SIGHT-TRAINING technique improved. Everybody gets results now. WRITE: Dept. P-2 "USTI" 4057 Budlong Ave., Los Angeles 37, Calif.



Please send me your FREE Sight Chart with instructions.

Name.....  
Address.....

# Now You can Use.



## ALL OF THESE RADIO PARTS

to help You learn

# RADIO

## FASTER-EASIER AT HOME

YOU CAN BUILD **133** FASCINATING EXPERIMENTS.

You get both radio parts and "Learn-by-Seeing" movies to help you grasp the fundamentals of Radio-Electronics faster... easier... from DeForest's. Send for DeForest's big, free book "VICTORY FOR YOU!" Learn how—at home—in your spare time—you get real Radio experience with these many Radio parts and sub-assemblies. DeForest's practical equipment system (as pictured above) saves time... speeds experiments. You quickly build Radio Receiving Circuits that work... a device for Light Beam Transmission, Electric Eye Circuits, a Radio Telephone, and scores of other fascinating projects. Learning Radio at home is practical, effective, and so interesting—with DeForest's "Home Laboratory."

### YOU ALSO USE "LEARN-BY-SEEING" MOVIES

Think of the help you can get from the use of this genuine DeVRY Motion Picture Projector and exciting Radio TRAINING FILMS. You'll likely be surprised how much faster... easier... home movies can help you understand the fundamentals of Radio. SEE the principles of what you're learning—in action, ANIMATED! Peer into moving parts otherwise hidden from the eye.

You build and operate these interesting Radio-Electronic circuits in your own home:

- 3 Tube Superheterodyne Radio Receiver ... Long-Wave Aviation Band Radio Receiver ... Short-Wave Radio Receiver ... Radio Telephone ... Wireless Microphone ... Photo Electric Cell Control ... Vacuum Tube Voltmeter ... Public Address System ... Hearing Aid Amplifier ... Intercommunicating System ... Radio Code Transmitter ... Electron Coupled Oscillator ... Tuned Radio Frequency Receiver and many other projects.

You get the big Radio home-training advantage of movies—exclusively from DeFOREST'S. So act now! Mail the coupon today!

### YOU GET "ALL THREE" WITH DeFOREST'S

Where else can you get such a combination of *proven* major training features as—(1) 90 modern, loose-leaf lessons prepared under the supervision of Dr. Lee DeForest, often called the "Father of Radio;" (2) the use of "Learn-by-Seeing" home training films and a genuine 16mm. DeVRY movie projector; and (3) the use of many Radio parts to build 133 practical radio experiments in leisure time.

### YOU BE THE JUDGE

See how DeForest's Training has helped many to good pay jobs in Radio-Electronics—others to preferred military classifications—still others to interesting, profitable businesses of their own. See how you can prepare for a bright future now—in your spare time at home—then get started in Radio-Electronics with the help of DeForest's effective EMPLOYMENT SERVICE.

Mail the coupon below for illustrated book "VICTORY FOR YOU"—also colorful Kit Supplement. You be the judge. No obligation. Mail the coupon today.

**DeFOREST'S TRAINING INCLUDES INSTRUCTION IN MOTION PICTURE SOUND EQUIPMENT, FM RADIO AND TELEVISION**



DeFOREST'S HOME MOVIES HELP YOU LEARN FASTER—EASIER

See Radio Circuits in Action—Electrons on the March—with this genuine DeVRY Projector

**DeFOREST'S TRAINING, INC.**  
CHICAGO 14, ILLINOIS

DeFOREST'S TRAINING, INC., Dept. PM-B2  
2535-41 N. Ashland Ave., Chicago 14, Illinois, U.S.A.

Please send me—FREE and WITHOUT OBLIGATION—illustrated book, "VICTORY FOR YOU," showing how I can prepare for Radio with your Home Movies and Laboratory Kits.

Name..... Age.....

Address.....

City..... State.....

If a veteran of World War II check here.



## SO IT NEEDS FIXING

By S. T. CHRISTENSEN  
*the "Fix-it Man"*

**W**ELL, I guess I'm the fellow to see, for I've repaired thousands of refrigerators (home and commercial both), vacuum cleaners, radios, washing machines, irons, fans, lamps, mangles, motors, etc. In fact, many of my customers call me their "electrical appliance doctor." And, "doctoring," I might add, has paid me a good substantial income for quite a few years. Funny, in a way, how I got started. Always liked to tinker and by experimenting around I found that most electrical appliances had many things in common. That, regardless of what the appliance was used for, or who the manufacturer was, the basic principles were much the same. From fixing my own appliances to fixing friends' and then for strangers at a fee, seems now to have been but a small step.

### What to Charge?

At first, I let the owner decide the charge and, frankly, I was amazed at what I earned per hour. But then, when one figures what initial costs are involved in buying most electrical appliances, one can readily see that spending extra dollars for repairs is well worth while. Before long I was making more in my spare time repairing than from my regular job. The result . . . I went into business for myself. When war came, business boomed, for new appliances were not available.

For a while, repair parts (needed on some

jobs) were a little difficult to get. But that situation seems to have adjusted itself for many repair parts have today the high priority rating of AA2. After all, we must provide for the health and well-being of our civilian population.

### The Future Offers

Friends ask me about my future. And, I think I've got a grand one. Age is no handicap in repairing. I have in my files enthusiastic letters from repairmen ranging in age from 18 to 79 years. After the war, we're bound to see hundreds of new products on the market . . . products that the average person never dreamt of. These new products and our old appliances are all going to need at some time or other "fixing." Well, I'll still be the fellow to do it. The field open for appliance repairmen is unlimited. I don't worry at all about too much competition.

### If You Are Ambitious

To the contrary, I've prepared a complete course, chuck full of simple, easy to understand photos and drawings and written in the same non-technical language as this article. I know the course is good, because I have hundreds of men all over the country writing to me telling me how the course has helped swell their pockets with cash. If you too want to prepare now for your future, I suggest you read the next page and send me the handy coupon."



**ESTABLISH  
YOURSELF IN  
A PROFITABLE  
LIFETIME  
BUSINESS  
- BIG MONEY  
- INDEPENDENCE**

# LEARN ELECTRICAL APPLIANCE REPAIRING

## NO EXPERIENCE NEEDED

If you are at all mechanically inclined—that is to say—can hold and use tools—then you have all of the qualifications required for becoming a big money-earning home appliance repairman. It does not matter if you have not had a great deal of schooling or had no previous training along these lines. Age is no barrier . . . nor is any minor physical handicap.

### Read What Other Students Say

I really believe your course the best investment a mechanically minded man can make.—*Claude E. Allen, Indianapolis, Ind.*

Your course on Appliance Servicing is the most complete and up-to-date I have heard of.—*Frank Kremen, Tarentum, Penn.*

I have received your Course in Appliance Repairing and I must say I am well pleased with same. I am only sorry I did not have said Course some years ago. I have learned so much more through this course I would not part with it.—*Charles Schwarz, Hamilton, Ohio.*

The Course in Appliance Servicing arrived a few days ago. Want to take out a few minutes of my valuable time to let you know that this is just what I have been looking for ever since I opened up my Fix-It shop. I must admit that you told the truth when you said that it contains quite a bit more information than I bargained for.—*P. J. Brett, Sebring, Ohio.*

I am a mechanic for the Western Union Telegraph Co. Three days after receiving the lessons in refrigeration I earned the exact cost of the course.—*Henry S. Lee, Washington, D. C.*

## PREPARE FOR THE FUTURE

If now in war work, start your home appliance repair business in your spare time and be set with a business of your own when the war is over. You don't need elaborate fixtures or expensive equipment to be a successful repairman. Operate from your garage, basement, vacant store, etc. Work as many hours as you wish . . . the home appliance repairman is his own boss. It's a profitable occupation for on many types of repairs it is usual for a repairman to charge on the basis of \$5.00 to \$6.00 an hour! *Prepare today and make sure of tomorrow's future.*

## New Course Helps All

Profusely illustrated, our new course shows you in simple, easy to understand language and drawings how to make each repair on refrigerators, vacuum cleaners, washing machines, motors, etc. Explains and gives you a working knowledge of electricity, welding, nickel plating, etc. Shows you how to build the power tools you need and how to solicit and keep business coming to you. Not a theory course but an honest to goodness course written by and used by repairmen the country over. Price of course is so low that the savings on your own household appliance repairs will quickly pay for it. Act now!

### Mail Coupon for FREE LITERATURE

**CHRISTY SUPPLY CO.,  
2835 N. CENTRAL AVE., DEPT. D-1803,  
CHICAGO 34, ILLINOIS**

Please send me all the facts about America's Fastest Growing Industry—Electrical Appliance Repairing.

Name .....

Address .....

City..... State.....

# DRAFTSMEN NEEDED



**PREPARE NOW for a  
BETTER JOB  
AND GREATER  
OPPORTUNITIES**

If you are ambitious to hold a better job, make more money and have greater opportunities to get ahead, start now to become a draftsman. Or if you are now employed in routine drafting work and want a better job—as a real draftsman, on more important work, at bigger pay, start now to qualify for that job.

## Learn at Home in Spare Time

American School has helped thousands to reach higher goals, and can help you. Our practical, up-to-date training plan can provide the know-how that fits men for responsible jobs and opens opportunities. Begin draftsman training now. Check, fill in and mail the coupon below for FREE information—today.

AMERICAN SCHOOL, Dept. DD245, Drexel Ave. at 58th St., Chicago 37, Ill.

Gentlemen: Send me FREE information covering special training in subjects checked below. No obligation on my part.

- |  |  |
|--|--|
| <input type="checkbox"/> Drafting and Design for Men and Women | <input type="checkbox"/> Electrical Engineering                  |
| <input type="checkbox"/> Cost Accounting for Mfg.              | <input type="checkbox"/> Diesel Engineering                      |
| <input type="checkbox"/> Architecture and Building             | <input type="checkbox"/> High School Course                      |
| <input type="checkbox"/> Automotive Engineering                | <input type="checkbox"/> Plastics                                |
| <input type="checkbox"/> Business Management                   | <input type="checkbox"/> Mechanical Engineering                  |
| <input type="checkbox"/> Railway Training                      | <input type="checkbox"/> Aviation <input type="checkbox"/> Radio |
|  | <input type="checkbox"/> Shipbuilding                            |

Name.....

Address.....

# Keep that "TICKING" Car



588 PAGES  
1500 ILLUSTRATIONS

Every operator and mechanic needs AUDELS AUTO GUIDE.

This book saves time, money and worry. Highly endorsed. It presents the whole subject of auto mechanics:

- 1—Basic principles
  - 2—Construction
  - 3—Operation
  - 4—Service
  - 5—Repair
- Handy Size. Easily understood.

## NEW FLUID DRIVE, HYDRAULIC SHIFT AND DIESEL ENGINES FULLY COVERED

Over 1500 pages—1540 illustrations showing inside views of modern cars, trucks and buses with instructions for all service jobs.

ASK TO SEE IT!—To Get This Assistance for Yourself Simply Fill in and Mail Coupon Today.

**4 COMPLETE • PAY ONLY \$1. A MONTH** ←

AUDEL Publishers, 49 West 23rd St., New York MAIL AUDELS NEW AUTO GUIDE for free examination. If O.K. I will send you \$1 in 7 days; then remit \$1 monthly until price of \$4 is paid. Otherwise I will return it.

Name.....

Address.....

Occupation.....

Employed by..... PM

To Mechanically Inclined Men:

# REFRIGERATION AIR CONDITIONING



Get ready for your share of the success many will enjoy installing, servicing and maintaining Refrigeration and Air Conditioning equipment. Get practical training by home study balanced with actual practice using real shop equipment. U.E.I., established 1927. Be the boss in your own shop or prepare for employment opportunities. Write for details TODAY.

UTILITIES ENGINEERING INSTITUTE

Dept. 5-4 1314 W. Belden Avenue Chicago 14, Ill.



# DRAW CARTOONS BIG MONEY!

**EASY . . . PLEASANT WORK!**  
Let CHAS. H. KUHN, with 25 years actual experience in drawing a daily newspaper cartoon, teach you how to create, draw and sell your work. 52 complete lessons—one sent each week. Professional criticism on every lesson. Write today.

Complete Course Only \$15.00

**KUHN SCHOOL OF CARTOONING**  
420 MURPHY BUILDING Dept. M INDIANAPOLIS 4, INDIANA

# Get the Knack of Managing Men

Every superintendent or foreman can develop into an outstanding employee by acquiring the knack of managing men.

How to combine the essentials of shop engineering with the art of handling people is covered in a 48 page booklet that outlines the basic problems in every industry. Address Louis S. Vosburgh.

**LINCOLN EXTENSION INSTITUTE, INC.**  
West 75th St. at Detroit, Cleveland, Ohio

# IMPROVE YOUR PLAYING



**PIANISTS**—Send for FREE Booklet showing how you may greatly improve your technique, accuracy, memorizing, sightreading and playing thru Mental-Muscular Coordination. Quick results. Practice effort minimized. Used by famous pianists, organists, teachers and students. No obligation.

BROADWELL STUDIOS, Dept. 155B, Covina, Calif.

# CHEMISTRY IS OPPORTUNITY!

There's no limit to the chemist's chances for advancement . . . in salary . . . in importance. Experiments develop into giant new industries. Established industries rely on laboratories. I.C.S. training . . . practical . . . thorough . . . opens this great field to you. Instruction papers specially written by noted chemical engineers, consulting chemists, metallurgists. And these big experts are EASY TO UNDERSTAND. Our editors have explained all technical terms simply, clearly. Any person of ordinary intelligence can learn and make rapid progress. You have ambition. We have the training you need. Send now for free booklet! International Correspondence Schools, Box 5528-K, Scranton 9, Pa.

# LEARN MEAT CUTTING At Home—In Spare Time



Prepare for a REAL opportunity NOW—and for even greater opportunities when you are well. Thousands of Meat Cutters, Clerks, Apprentices, Managers, Inspectors, Supervisors etc., needed by Meat Stores, Super Markets, Packing Houses, Processing Plants, Hotels and Restaurants. Whether you are a beginner or experienced you can learn easily and quickly AT HOME how to develop and use your REAL ABILITIES as Meat Cutter, Market Manager or Market Owner. Know how to figure percentages—CUT MORE PROFIT—merchandise. Be an expert Meat Cutter and get the extra earnings of an expert. Make more money in a store of your own. Instructions based on 30 years experience and "Learn by Doing" training methods used at National's famous Resident School of Meat Cutting. GUARANTEED. Endorsed by leading meat men. Diploma. This vital field pays better NOW than ever before—and at the same time offers you security of a peace-time future. Investigate! Send for FREE bulletin today! No obligation.

National School of Meat Cutting, Inc., Dept. U-54, Toledo 4, Ohio

Send me your FREE Bulletin. (No Salesman Will Call)

I work in a market.  I own my own store.  I know nothing about meat cutting.

Name.....

Street.....

City and State.....

# GET INTO RADIO ELECTRONICS & TELEVISION NOW!

**Hundreds of Industries Need Radio and Television Men Now and for Great Future Demands**

The man trained in electronics is wanted not only in Radio and Television, but in Aviation, Transportation, Communications, ... in the designing, engineering and operation of hundreds of industries today and for years to come. Learn how great the field is for YOU... How you may GET INTO BUSINESS FOR YOURSELF. Mail the coupon now.



**Send for FREE Lesson and Prove to Yourself How Quick and Easy You Get Ahead in Radio by the NEW**

## SHOP METHOD HOME TRAINING



**Learn by Doing!**  
Use real Radio Equipment Furnished with your Course

Experience is the best teacher. You learn by experience with the exclusive National Shop Method of Home Training—actually build many circuits and do experiments with the big kits of standard radio parts included in your training equipment at no extra cost to you.

Build a superheterodyne receiver. Make tests and conduct experiments that show you the why and how of electronics. Build an audio oscillator, signal generators and other instruments with the parts and supplies included in your course.

**"F.M." Means Future Money**  
Frequency Modulation (F.M.) is here to stay. Thousands of F.M. licenses have been granted by the government F.C.C. all over the country. Learn what this means to you.

Get ready for TELEVISION. Get your share of the RADIO SERVICE Business. Here is a sensationally improved way for you to get the right training—a thoroughly proved system whereby you study in spare time—odd hours, even minutes—and have the advantage of actual shop experience behind you.

This exclusive shop method of home training comes to you right from one of the world's greatest vocational educational centers—the resident training shops and experimental laboratories of National Schools. It is the sound, practical training based on actual experience of qualified instructors and engineers who have prepared thousands of National graduates now employed in the radio industry.

It is up-to-date—matches the progress constantly being made in modern radio, television and electronics. It is time tested. National Schools has been training men for higher pay and greater opportunity for more than a third of a century. Fill out and mail the coupon below for details.

**Shop Method Training Wins Good Jobs**



Joseph Grunich, Lake Hiawatha, New Jersey.

"My latest offer was \$3,800.00 as Radio Photo Engineer... but I'm doing well where I am now engaged. I am deeply indebted to National."

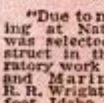

Due to my training at National I was selected to instruct in the laboratory work of Navy and Marines.

"I believe National offers the best course to be had. Keep up the good work."



Read what hundreds of other enthusiastic students have written about National Training. Send in your coupon today.

"I believe National offers the best course to be had. Keep up the good work."

**Be Sure in Post-War**

Now, right now, is the time to prepare for SUCCESS AND SECURITY in the great expansion after the war. The field is wide open. Trained men will get the preference in the broadcasting stations—in industry—will make quick progress with small capital in their own business. Soldiers, sailors and marines make use of your free time to get ready for the future. Study while still in uniform. Thousands of men in the armed forces have trained at National Schools under U. S. Government sponsorship.

**See for Yourself**

Now, right now, is the time to grasp the great opportunity of today—a successful career for tomorrow. Get into the big money, rapid advancement, a position of importance. A BUSINESS OF YOUR OWN. The industry is crying for trained men everywhere. A rapidly expanding business—probably the greatest in industrial history—holds out the promise of a rich future—prosperous security. But to win it you must be ready. Well-trained men ONLY are wanted.

Examine the National Shop Method of Home Training carefully. Be convinced. Study the lesson we will send you FREE. No obligation of any sort. Fill out the coupon and mail it today.



**GET THESE 2 BIG BOOKS FREE!**  
Learn for yourself just how easy this SHOP METHOD HOME TRAINING gives you the practical, down-to-earth experience you can never get from theory alone.

**NATIONAL SCHOOLS**  
LOS ANGELES 37, CALIFORNIA EST. 1905

**MAIL OPPORTUNITY COUPON FOR QUICK ACTION**

National Schools, Dept. 2-PM  
4000 South Figueroa Street, Los Angeles 37, California  
(Mail in envelope or paste on penny post card)  
Mail me FREE the two books mentioned in your ad including a sample lesson of your course. I understand no salesman will call on me.

NAME..... AGE.....  
ADDRESS.....  
CITY..... STATE.....  
Include your zone number

It's YOUR future—Make the most of it!



Start now to earn the bigger pay in electrical repair

WAS there ever such an opportunity to get started in electrical maintenance and repair—and at top-notch wages? Are you ready—with experience and ability—to cash in on it? Others are getting just the sort of background needed—quick! practical!—to handle the great variety of electrical maintenance and repair work; TODAY—from this well-known electrical library. You can too!

## THE LIBRARY OF ELECTRICAL MAINTENANCE AND REPAIR

5 vols., 1826 pages, 1724 illustrations

Gives you the "know-how" to tackle any wiring or motor job. Five books show you HOW—to install all types of motor and generator units—to inspect and repair motor starters and generators—to diagnose motor and generator troubles—to figure new winding for old cores—DC and AC windings—to test armature windings—test induction motors, etc., etc. One book is full of trouble-shooting charts that show quickly symptoms, causes, specific remedies, etc.

Take the first step toward improving YOUR future—Mail this coupon TODAY

No money down—special price—easy payments—FREE trial

McGraw-Hill Book Co., 330 W. 42 St., New York 18, N.Y.

Send me for ten days' free examination the Electrical Maintenance and Repair Library. If satisfactory I will send you \$1.00 in 10 days and \$2.00 monthly until the price of \$15.00 is paid. If not wanted I will return books postpaid. (To insure prompt shipment write plainly and fill in all lines.)

Name .....

Home Address .....

City and State .....

Position .....

Name of Company .....

## Do you want

- .. to go to College?
- .. or to enter a Profession?
- (Such as Accounting, Architecture, Nursing, Dentistry, Teaching, Social Work, Osteopathy, Beauty Culture, Optometry, Embalming, Chiroprody, Law, Medicine, etc.)
- .. or get an Office Position?

To get anywhere, you practically MUST finish High School FIRST. You can complete our simplified High School Course in SPARE time at home, as FAST as your time and abilities permit. Equivalent to resident school work—prepares you for college, pre-professional examinations, business, industry. Standard texts furnished. Diploma. Credit for H.S. subjects already completed. Single subjects if desired. Low tuition, easy terms. American School, Chicago, est. 1897—endorsed by educators. Finish your high school education NOW. Write TODAY!

## High School Course at Home Many Finish in 2 Years

American School, Dept. H245, Drexel Ave. at 58th St., Chicago 37, Ill.

Gentlemen: Send me FREE information covering special training in subjects checked below. No obligation on my part.

- |  |  |
|--|--|
| <input type="checkbox"/> High School Course          | <input type="checkbox"/> Diesel Engineering                      |
| <input type="checkbox"/> Cost Accounting for Mfg.    | <input type="checkbox"/> Drafting and Design for men & women     |
| <input type="checkbox"/> Architecture and Building   | <input type="checkbox"/> Plastics                                |
| <input type="checkbox"/> Automotive Engineering      | <input type="checkbox"/> Private Secretary                       |
| <input type="checkbox"/> Business Management         | <input type="checkbox"/> Mechanical Engineering                  |
| <input type="checkbox"/> Electrical Engineering      | <input type="checkbox"/> Aviation <input type="checkbox"/> Radio |
| <input type="checkbox"/> Elec. and Gas Refrigeration | <input type="checkbox"/> Salesmanship                            |
| <input type="checkbox"/> Air Conditioning            | <input type="checkbox"/> Shipbuilding                            |
| <input type="checkbox"/> Railway Training            |  |

Name .....

Address .....

★ SAVE WASTE PAPER ★

## "YOU ARE UNDER ARREST!"



There's a Thrill in Bringing a Crook to Justice Through Scientific **CRIME DETECTION**

I have taught thousands of men and women this exciting, profitable, pleasant profession. Let me teach you, too, in your own home. Prepare yourself in your leisure time to fill a responsible, steady, well-paid position in a very short time and at very small cost. What others have done, you too, can do.

## 53% of All American Identification Bureaus

Be A FINGER PRINT Expert

Employ students or graduates of I.A.S. This fascinating work is easy to learn and the training is inexpensive. You, too, can fit yourself to fill a responsible crime detection job with good pay and steady employment. But don't delay—get the details now. Let me show you how easily and completely I can prepare you for this fascinating work, during spare time, in your own home. You may pay as you learn. Write today for free Crime Book.

## FREE! "THE BLUE BOOK OF CRIME"

It's a thriller. Tells about some of the most interesting crimes ever perpetrated and how they were solved through the very methods taught by I.A.S. Send now—be sure to state age. **INSTITUTE OF APPLIED SCIENCE** Dept. 1352, 1920 Sunnyside Ave., Chicago 40, Illinois

## PRINTING PAYS BIG

◆ It offers trained men a peace-time future of opportunity and security. **COURSE ONLY \$14.50** CASH. Our home study course will train you. Ask for literature and free lesson. **TERMS AVAILABLE** International School of Printing, Troy, O. DEPT. 258A

## MECHANICAL ENGINEERING PAYS!

This is the machine age. And back of every machine—every part—are the engineers who designed it, the trained mechanics who built it. No wonder there's high pay... many opportunities to advance... for these indispensable men. Be one of them! Don't stick in a rut! Let I.C.S. show you the way to success! These Schools, famous for more than 50 years, offer authoritative, practical Courses to meet the needs of almost any man in mechanical trades. Mechanical Engineering... Drafting... Mechanical Drawing... Shop Practice. Write today for free booklet.

International Correspondence Schools, Box 5527-K, Scranton 9, Pa.

## THERE'S MONEY IN CARTOONS!

RAYE BURNS will teach you HOW to CREATE ORIGINAL CARTOONS at home that you may SELL! Course contains 26 lessons and over 600 illustrations. All for Only... **\$2.85**

Send name and address for free details. RAYE BURNS SCHOOL, Dept. M, Box 3583, CLEVELAND, OHIO

PLAY GUITAR LIKE THE **COWBOYS DO...** **8 1/2** A LESSON

Just out—very latest guaranteed, simple, easy method. Play cowboy songs the Western way in a few minutes by ear. Surprise and amaze your friends. Be in big demand at parties, camps, public entertainments, on the radio, etc. 12 Complete Lessons. **SEND NO MONEY** Pay postman only \$1.00 plus postage and C.O.D. charges, or send \$1.00 and get EXTRA SONGS all postpaid. (Canada, \$1.25 money order only.) Nothing else to buy. Positive money back guarantee. Cash order today. **WESTERN RANGER STUDIOS, Dept. 152, Hutchinson, Kans.**

POPULAR MECHANICS



# HOW WILL YOU FIT INTO THE POSTWAR WORLD?



## LEARN PLASTICS NOW!

Plastics are playing an increasingly important part in almost every industry—improving old products and creating new ones. That is why such a brilliant future is predicted for plastics in the postwar period—offering opportunities to farsighted men and women who *know* plastics. Now is the time for you to prepare for a career in this fast-growing field.

**LEARN AT HOME**—You can learn plastics in your spare time at home without interrupting your present work. The Plastics Institute has developed a thorough, easy-to-understand course of training, requiring no previous technical experience. It offers complete, authoritative training based on industry requirements.

**FASCINATING COURSE**—The lessons are readily grasped and practical. Every step is made clear with graphs, diagrams, pictures. Actual specimens of plastics materials are furnished. A bi-weekly bulletin, "Plastics Trends," keeps you posted on new developments.

**COMPREHENSIVE**—Learn the various phases of plastics from this course . . . materials, designing, molding, fabricating, estimating and plant management. Acquire a basic knowledge of plastics that can be invaluable in preparing you to take your place in this great new industry.

**EXCLUSIVELY PLASTICS**—The Plastics Institute is America's oldest and largest plastics educational organization which devotes all of its facilities exclusively to plastics. It is held in high esteem by members of the plastics industry. Many of our graduates hold responsible positions in the plastics field.

**START YOUR FUTURE—TODAY!** Mail the coupon below now! We will send you an interesting booklet filled with valuable information on plastics and tell you how, at small cost, you can prepare for a career in this important industry. Don't put it off! Mail today!

Dept. PM-2, 122 E. 42nd St., New York 17—Dept. PM-2, 221 N. La Salle, Chicago 1—Dept. PM-2, 186 S. Alvarado, Los Angeles 4

### SPECIAL RATES FOR SERVICE MEN

*Plastics*

**VETERANS**  
Ask about  
G. I. Training

### INDUSTRIES TECHNICAL INSTITUTE

Plastics Industries Technical Institute  
221 N. La Salle St., Dept. PM-2, Chicago 1

Mail in Envelope or  
paste on penny postcard

Gentlemen: Please send me the booklet "World of Plastics" and information on your training program. I understand there is absolutely no obligation.

Name.....Occupation.....

Street.....Age.....

City.....Zone.....State.....

Veterans: Check here for special information on G.I. Training Privileges.

If under 18: Check here for special booklet.

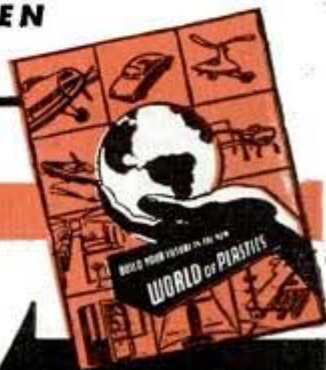

**FREE BOOKLET**  
Send for It Today!

**MEN** *whether you are* **16 or 40**

**Come to COYNE for a great future in**



# RADIO-ELECTRONICS

**"Learn-by-Doing" on Real Radio Apparatus!**



Prepare for a great **Peace time** future and a good job in **Radio-Electronics** now. Coyne "LEARN BY DOING" training covers latest developments in this field. Prepare quickly, easily. Fascinating well paid work in **maintenance, installation and servicing Radio-Electronic equipment.**

### TELEVISION

If you have an all-around Radio-Electronic training, there are great opportunities for you. Tremendous expansion in Radio-Electronics, Frequency Modulation and Television predicted after the war—a world of new opportunities. Get ready for a **Peace time future** and a good job **NOW** with practical Coyne Radio Training.

### Many Branches If You Have All-around Training

Why be satisfied with a narrow, no-future line when by putting in a short time in my Shops, you can qualify for unlimited opportunities in **RADIO-ELECTRONICS**, today's fast-growing field! These pictures show only a few of the big jobs for trained Radio-Electronics Men.

### I'LL FINANCE YOUR TRAINING!

Don't let lack of money hold you back. You can **GET TRAINING** first—then pay your tuition in **EASY MONTHLY PAYMENTS STARTING 60 DAYS AFTER YOUR TRAINING PERIOD IS OVER.** I also help you get part-time work to help pay living expenses while training if you need it, and give you Lifetime Job Service as a Coyne graduate.

### SEND FOR FREE BOOK

Fully illustrated with big pictures of my Shops—facts about your future. Mail coupon now. No obligation. No salesman will call. Act today!

H. C. LEWIS, Pres.  
**RADIO-ELECTRONICS DIVISION  
COYNE ELECTRICAL SCHOOL  
500 S. Paulina St., Dept. 25-3H, Chicago 12**

We have facilities for men with physical disabilities. If you have a physical disability of any kind write me when you send the coupon.

H. C. LEWIS, Pres., Radio-Electronics Div.  
**COYNE ELECTRICAL SCHOOL  
500 S. Paulina St., Dept. 25-3H, Chicago 12, Illinois.**  
Send **FREE BOOK**, "Your Future in Radio-Electronics" and details of easy "Pay-After-Graduation" plan.

NAME.....AGE.....  
ADDRESS.....  
CITY.....STATE.....

★ SAVE WASTE PAPER ★

## MUSIC LESSONS

**COMPLETE CONSERVATORY HOME STUDY COURSES**  
40 years of successful training in Piano, Violin, Cornet, Trumpet, Saxophone, Clarinet, Guitar, Mandolin—Voice, Ear Training and Sight Singing, Choral Conducting, Public School Music—History of Music, Harmony, Advanced Composition, Arranging. The only home study school teaching all courses leading to degree, Bachelor of Music.

**MAIL COUPON NOW**  
**UNIVERSITY EXTENSION CONSERVATORY** 1525 E. 53rd St., Suite U142, Chicago 15, Ill.

Send catalogue and illustrated lesson for ..... course.  
Name .....  
Street .....  
City, State .....  
Give experience..... Age.....

## Get into Good Paying AUTO BODY and FENDER WORK

**BIG DEMAND** in Auto Body and Fender work. Start training now spare time at home for good pay work now and postwar. Practical shop experience included. U. E. I. Training covers metal work, welding, painting, etc. Placement service—or we will show you how to start own shop. Behind U. E. I. TRAINING is a large national organization founded 1927.

Write today for **Free Facts—No obligation**  
**AUTO-CRAFTS DIVISION • UTILITIES ENGINEERING INSTITUTE**  
1314 BELDEN AVENUE, DEPT. 125X, CHICAGO 14, ILLINOIS

## Good Handwriting HELPS YOU WIN SUCCESS!

It's so important to write a good hand for business and social advancement. Poor illegible penmanship often causes costly errors and marks you for failure. Why write a poor hand? It's so easy to learn at home in spare time. Write for our new free booklet today. If you wish, send 10c for a penpoint suitable for shaded writing and your name beautifully written. **THE TABLBYN SCHOOL OF PENMANSHIP**  
In Business Since 1895 H-441 Ridge Bldg., Kansas City, Mo., U. S. A.

**Fix Your Own ALARM CLOCKS**  
New, practical home course. Just out. Makes interesting hobby—profitable too. Save money by doing your own repairing at home. Easy if you know how. Price now only \$1.00. Details FREE. **THIS JEWELRY STORE, Genoa 3, Illinois**

**Get into the BAKING BUSINESS**  
Bakers make good money! Now 7th Industry in wages! Nearly depression-proof. New home study Baking Course qualifies you. Common school education sufficient. If you're ambitious, write for **FREE BOOK**, "Opportunities in Baking." National Baking School, 1315 Michigan, Dept. 1352, Chicago 5, Ill.

**Become a Doctor of PSYCHOLOGY**  
Win the degree of Ps.D. Teach the secret of contentment, happiness. Solve mental worries. Experience the revelation of truth. Chartered college. Individual help. Write for **FREE BOOK** **COLLEGE OF UNIVERSAL TRUTH**, 5153-B North Clark St., Chicago.

**INFORMATION ANY SUBJECT . . . Moderate Rates**  
**THE ROXBYS, 742 S. Hill St., Room 1118, Los Angeles 14**

**A SIMPLIFIED ART ANATOMY OF THE HUMAN FIGURE**  
ONLY 51c POSTPAID  
by Charles Carlson. The book they're talking about! One of the most informative books of its kind for both student and professional artists. Charts, notes, and over 350 drawings show detailed studies of every part of the body, posed and in action. **HOUSE OF LITTLE BOOKS, 156-160 Fifth Ave., New York**

**DRAFTING SPRINGBOARD TO SUCCESS!**  
Increased salary, larger responsibilities, a real career instead of just a job—these are to be had by the trained draftsman. I.C.S. makes the way to thorough, practical training open to you. Check up and you'll find that nearly every "big name" American in engineering and production acquired experience at the drafting board. Many of them started by writing for the I.C.S.—free booklet. Send for it today! It can be the most important act of your life.  
**International Correspondence Schools, Box 5522-K, Scranton 9, Pa.**

# CALLING ALL INVENTORS



**PATENT THE INVENTIONS**  
*the Post-war World Will Need!*

**A SIMPLE LITTLE IDEA MAY BE FOUNDATION FOR SUCCESS**

You don't have to be an Edison or a Marconi. Simple inexpensive little everyday items are always in demand. Even now, you may be thinking up ways of making tomorrow's automobiles safer . . . or of some simple household appliance that will prove the heart's desire of every housewife.

## THE FIRST THING TO DO . . .

is to put your idea on paper . . . and get it into the hands of a reliable Registered Patent Attorney—QUICKLY before someone with possibly the same idea beats you to it!

## LET EVANS HELP YOU . . .

For nearly 50 years, Victor J. Evans & Co., have successfully helped thousands of inventors se-

cure strong patents . . . saved them time, trouble and money. Their long experience covers every phase of patent office procedure . . . experience that is helpful and important to inventors in the preparation and prosecution of their claims.

## ADVICE FROM THE PATENT OFFICE

Rule 17 of "RULES OF PRACTICE IN THE UNITED STATES PATENT OFFICE" reads in part as follows: . . . "An applicant or assignee of the entire interest may prosecute his own case, but he is advised, unless familiar with such matters, to employ a competent registered attorney or registered agent as the value of patents depends largely upon the skillful preparation of the specifications and claims . . ."

They contain valuable information that will start you off right. Here's everything you'll want to know NOW. These books explain types of patents . . . how to safely submit necessary details of your invention . . . what to do as your authorized attorneys . . . suggestions on financing and selling . . . and, in addition, illustrate 115 Mechanical Movements.

GET THESE  
FREE BOOKS

*Now*



**MAIL THIS COUPON TODAY**

Books will be sent you absolutely *Free*  
...plus valuable "Evidence of Invention"  
form... *also Free*

**VICTOR J.  
EVANS & Co.**

**REGISTERED PATENT ATTORNEYS**

930-B Merlin Building, Washington 6, D. C.

Please send me your books, "Patent Protection" and "When and How to Sell Your Invention"—also important "Evidence of Invention" form, without cost or obligation.

Name .....

Address .....

City and State .....

## Choose Your Road to a Postwar Aviation Career



### START TRAINING NOW AT AERO TECH



Select one of the six modern courses available at Aero Tech. Train where complete shops, laboratories and classrooms have started many civilians and servicemen on successful aviation careers.

#### ... TO VETERANS OR SERVICEMEN

Expand your aviation knowledge by planning now to enroll in Aero Tech's special, advanced courses. This will insure your post-war opportunities in the new "aviation age," which will require trained, alert men by the thousands.

#### ... GREATLY EXPANDED COURSES

New requirements by commercial aviation, world-wide airlines, service depots, feeder lines... have created many new courses now offered by Aero Tech. Always up-to-the-minute, Aero Tech steps ahead with special plans for the "aviation age of the future."

#### GET COURSE BULLETINS NOW...

##### New classes now forming

Thousands secured their start from this institution... thousands more will secure a "priority" on their careers by attending Aero Tech in the near future. Send coupon for free bulletins NOW—act today!

#### AERO INDUSTRIES TECHNICAL INSTITUTE

Herbert W. Hartley, President

5253 W. San Fernando Rd., Los Angeles 26, Calif.

Approved by CAA for Aircraft and Engine Mechanics Training



AERO INDUSTRIES TECHNICAL INSTITUTE  
5253 W. San Fernando Road, Los Angeles 26, Calif.

Gentlemen: Please send free bulletins, and data on courses checked:

- |  |  |
|--|--|
| <input type="checkbox"/> Master Aircraft and Engine Mechanic | <input type="checkbox"/> Master Aircraft Instrument Technician |
| <input type="checkbox"/> Airline Maintenance Engineer        | <input type="checkbox"/> Aeronautical Engineer                 |
| <input type="checkbox"/> Airline Flight Engineer             | <input type="checkbox"/> Airport Management                    |

Name \_\_\_\_\_ Age \_\_\_\_\_

Street \_\_\_\_\_

City \_\_\_\_\_ Zone \_\_\_\_\_ State \_\_\_\_\_

Civilian  In Service  Veteran  P-2

## LIQUID MARBLE

Make beautiful artificial Marble slabs. Pour from liquid state. Glazed or un-glazed. This Marble may be mottled, veined, multi-colored or left in its original snow-white state. The color is actually a part of the Marble, does not fade or wear away. Liquid Marble is unsurpassed on kitchen or bathroom walls. Easy to make and install. **PLASTIC FLOORING.** May be made in any color or combination of colors. Gives a lifetime of wear. Dustproof, Soundproof, Verminproof. Resilient to the tread. Lay out solid from wall to wall or in pattern design of various shaped blocks. **FLEXIBLE MOLDS** for plaster casting. Make your own molds for few cents each. \$1.00 in raw materials will make up to \$25.00 worth of finished goods. (Send no money.) We furnish names of buyers. Write now for free information, and get in on busy season just starting.

COMPO-TEX, Box 786-S, ST. LOUIS, MO. 1

"The Book They're Talking About"

For the amateur and professional artist. Contains over 350 illustrations, charts and notes, giving detailed study of every part of the body. **POSED \$1** and IN ACTION. Outside U.S.A. send \$1.25. Price Only  
MAJOR BOOK CO., Dept. 40-F  
72-04 Juno St., Forest Hills, New York

## ACCOUNTANT

BECOME AN EXPERT

Executive Accountants and C. P. A.'s earn \$2,000 to \$10,000 a year. Thousands of firms need them. We train you thoroughly at home in spare time for C. P. A. examinations or executive accounting positions. Previous experience unnecessary. Personal training under supervision of staff of C. P. A.'s. Placement counsel and help. Write for free book, "Accountancy, the Profession that Pays."  
**LASALLE Extension University, 417 So. Dearborn St.**  
**A Correspondence Institution Dept. 264-H Chicago 5, Ill.**

## STAMMER?

This new 128-page book, "Stammering, Its Cause and Correction," describes the Bogue Unit Method for scientific correction of stammering and stuttering—successful for 44 years. Benj. N. Bogue, Dept. 1821, Circle Tower, Indianapolis 4, Ind.

GET THIS FREE BOOK!

## FIX TYPEWRITERS

A Simplified Practical Homestudy Course. Many of our Students now have their own Business—Many Repair for others. Repair Shops Swamped. Health or Age no handicap.  
**WEBER TYPEWRITER MECHANICS SCHOOL**  
Box 269, Osborn, Ohio

## ELECTRICITY MEN NEEDED

GOOD JOBS • GOOD PAY • GOOD FUTURE

Through spare time home study you can qualify for a starting job in electrical work and prepare for bigger pay promotions. Or if now employed in this field you can acquire know-how which can win you a bigger, better job. It's not difficult to master principles of equipment used in generating, transmission and use of electricity. Begin now. Send name and address today for FREE information.

**AMERICAN SCHOOL, Dept. EE245, Drexel Ave. at 58th St., Chicago 37**

Name .....

Street .....

City, State .....

# Get the big rewards in **REFRIGERATION** **AND** **AIR CONDITIONING**

**OPPORTUNITIES GALORE**

## **IN THIS VITAL MAN-FAMISHED FIELD**

**YOU** figure it out... Over 20,000,000 domestic and commercial refrigerators in use — and today, according to reliable sources, only about 8,000 experienced service mechanics to keep them in shape, where normally 20,000, and more, are employed.

**Industry Needs Trained Men, Now.** With such a situation as that, and with millions of home mechanical-refrigerators out of use for lack of repairs and parts, is it any wonder the industry, today, is pleading and begging for competent service and repair men? Literally thousands of steady jobs at good pay are available **RIGHT NOW.**

## **More Trained Men Will Be Needed After The War.**

Vital war-needs and speed-up requirements have created startling new applications of cooling, humidifying, and the like, in industrial processes where they hadn't been used before. Leading authorities say civilian uses after the war are bound to force tremendous expansion in the refrigeration and air conditioning field. Quick Freeze, alone, is one example. Over 100 manufacturers are prepared to enter this field immediately after the war. Air Conditioning manufacturers expect a post-war jump of 500% in sales to a yearly volume of around \$300,000,000. *All of this means* new equipment to be installed, serviced, and repaired — and thousands of *new jobs* for men who are properly trained.



**Train Now.** Yes, **NOW** is the time to prepare for a successful career in this vital, growing field. Be ready to step into a good job with good pay and a bright future by the time V-E Day starts blowing from 5,000,000 to 11,000,000 war-production jobs sky-high, as predicted by Labor leaders.

**We'll Train You At Home In Your Spare Time.** We'll train you at home, in your spare time, or if you prefer, in our big Chicago shops — the largest and most completely equipped refrigeration and air conditioning training shops and laboratories in the country; — or we'll combine both methods. Our simple, easy, step-by-step training system makes everything clear. You'll be amazed and delighted at how quickly you catch on, how easily you acquire the fine points, practical skill, and broad, technical "know-how" that makes the expert.

Proof of the soundness of our methods, and the high quality of our instruction, is the fact that for the past three years we have been exclusively training men and women in fine precision aircraft instrument work for the Army and Navy, under Government contract.

**Easy-Pay Plan.** Yes, no need to cramp yourself or lay out any big sum. Thousands of men in top-pay jobs today used I. T. I.'s easy pay-as-you-go plan to help them through — and so can you.

**Quit Any Time.** You can stop your Training at any point and any time you wish; and pay only for the actual time your Training was in force.

**Get The Facts.** Get the full facts about the many opportunities in refrigeration and air conditioning for properly trained men, now and after the war; and about I. T. I.'s unique and easy-to-grasp training that has helped so many men into key jobs in this Industry. Fill out the coupon and mail **TODAY.** No obligation.

## **INDUSTRIAL TRAINING INSTITUTE**

**2130-58 Lawrence Avenue Dept. P1B Chicago 25, Illinois**

Gentlemen: Without obligation on my part, send me at once full details about I. T. I.'s practical thorough training in Refrigeration and Air Conditioning.

## **USE COUPON**

NAME \_\_\_\_\_  
ADDRESS \_\_\_\_\_ CITY \_\_\_\_\_ STATE \_\_\_\_\_

# LIKE AVIATION?

... Then You'll Want This Book

**Free!**

To anyone sincerely interested in Aviation as a career ...

Let RYAN Fit You For One Of Aviation's Important Peace-Time Jobs... Be an **AIRCRAFT DRAFTSMAN**



Aviation industry leaders at Ryan have proven with direct-from-the-industry methods of instruction that they can train you thoroughly—yet quickly in part of your spare time. **Home Study You'll Enjoy**... You learn at home under individualized supervision. With this new "abridged" course, higher education or special experience is not necessary. Complete Aeronautical Drafting equipment included with your training at NO EXTRA COST. The low R.A.I. tuition, payable in easy monthly payments, covers everything. This illustrated book gives you full information on the most practical way to enter Aviation. So use this coupon—now—there is no obligation—it'll take but a minute—make it your first step toward a successful career in Aviation. To save time send it air mail.

**RYAN**  
Aeronautical Institute  
422 Lindbergh Field, San Diego 1, California

Gentlemen: Please send me, without any obligation on my part, your FREE 24-page illustrated book, "New Horizons of Opportunity," and full information on R.A.I., including cost of training, and job opportunities.

NAME \_\_\_\_\_ Age \_\_\_\_\_  
STREET \_\_\_\_\_  
CITY \_\_\_\_\_ STATE \_\_\_\_\_

Say you saw it in Popular Mechanics!

## Learn REFRIGERATION and AIR-CONDITIONING

### ARE YOU HANDY WITH TOOLS?

Exceptional opportunity for men of all ages up to 60. The demand for repair and service mechanics in both REFRIGERATION and AIR-CONDITIONING is acute and will continue after the war. You can easily and quickly—

### Learn to Be a Service Mechanic at Home or in Our Shops

Our practical, thorough course is easy to grasp and can be studied at home in your spare hours. No previous experience is needed. A common school education is enough. Learn how to start your own business with \$50.00 worth of tools in garage or basement. Open up your own shop or take a well paid job in this active field.

**START YOUR OWN REPAIR SHOP**

Write for free booklet today. No obligation whatever.

MAIL COUPON TODAY



Send for FREE BOOKLET!

**Mechanics Training School**  
4701 W. Pico, Dept. P-2, Los Angeles 6, Calif.

Dear Sirs: Please send me, without obligation, your free catalog and full details.

Name \_\_\_\_\_  
Address \_\_\_\_\_  
City \_\_\_\_\_ State \_\_\_\_\_

## THIS GREAT BOOK

**HOW TO BREAK and TRAIN HORSES**



**FREE!**

Every farmer, every lover of horseflesh should have a copy of it. This amazing book tells how to know horses—how to break them—how to train them—how to make money as a master horseman. Write for it today—FREE, together with my special offer of a course in Animal Breeding without cost to you. If you are interested in Gaiting and Riding the saddle horse, check here  Do it today—now. You'll never regret it.

**BERRY SCHOOL OF HORSEMANSHIP**  
Dept. 1102 Pleasant Hill, Ohio

## KNOW THIS IMPORTANT SUBJECT

We Will Send Enlarged and Revised Second Edition on Money-Back Guarantee

**Plastics**

435 Pages ONLY  
203 Illustrations \$3.75  
50 Tables

The hundreds of war-time uses of Plastics are a forecast of even greater developments offering big opportunities to those who prepare for them by study. In this book a noted Plastics authority gives you the basic information you should have. Send name and complete address for your copy. Pay postman only \$3.75 plus postage on arrival, or enclose \$3.75 and we will pay postage. If you are not satisfied, return book in 5 days and we will refund your money at once.

**AMERICAN TECHNICAL SOCIETY, Department P-219**  
Drexel at 58th Street Chicago 37, Illinois

## Correspondence Courses in RADIO and ELECTRICAL ENGINEERING

LOW AS \$25



**ELECTRICAL ENGINEERING.** Get good grasp of wide electrical field. Modern. Very understandable. Theory made easy.  
**RADIO ENGINEERING.** Extra fine course in radio, public address, photo-electric work. Trains you to be super-service man, real vacuum tube technician. Tuition ONLY \$25, either course. Deferred payment plan. Servicemen needed badly.  
**FREE LINCOLN ENGINEERING SCHOOL, Box 931-P-74, Lincoln, Nebr.**

## INDIANA TECHNICAL COLLEGE

Engineering B.S. degree in 27 months. Aeronautical, Chemical, Civil Electrical, Mechanical and Radio Engineering. 1-yr. Radio, Drafting, Govt. approved under G. I. Bill. Prep courses, no added cost. Large industrial center. Earn living expenses. Graduates successful. Enter March, June, Sept., Dec. Catalog. 525 E. Washington Blvd., Fort Wayne 2, Ind.

## ARTISTS MAKE MONEY

Find out your ability. Send name, age, occupation and address for Free Vocational Art Test.  
**ART INSTRUCTION, INC. (Formerly Federal Schools)**  
2135 Art Instruction Building, Minneapolis, Minnesota

## START YOUR OWN SHOP

**VETERANS: ASK** about G.I. training. - Don't wait! Now and after the war for Plastics, Auto-Diesel, Machinist, Drafting, Refrigeration, Welding, Body & Fender, Aircraft. Earn real money or be independent. Write for free booklet. Specify trade.  
**GREER SHOP TRAINING, Dept. 225, 2017 S. Wabash Ave., Chicago**

## Learn to Service & Repair

### ELECTRICAL APPLIANCES

Open your own electrical appliance service shop. Complete illustrated course covering house wiring, motor repairs, house appliance repair. Send today for FREE BOOKLET without obligation.

**PACIFIC TRAINING SCHOOL**  
4701 W. Pico Dept. AP-2 Los Angeles 6, Calif.

## Inventions Wanted Patented or Unpatented

Inventions can now be safely sold without patenting expense. If you have a practical, useful idea for sale, either unpatented or patented, write **Chartered Institute of American Inventors**  
Dept. 4, 631 Pa. Ave., N. W. Washington, D. C.

# AUTO REPAIR MEN!

# Are You Short-Handed for Mechanics?

**Are You LOSING MONEY on Work You Can't Handle?  
— LOSING TIME on Hard-to-Do Jobs?**

**SEE HOW THIS AMAZING MANUAL IS  
"WORTH 2 EXTRA MEN" IN YOUR SHOP!**



## You Can Do ANY Basic Repair Job on ANY Car Built Since 1935!

No need to keep on losing money on jobs you just don't have time, or enough hands, to do! It's like adding "2 mechanics" to your shop when you put **MoToR's AUTO REPAIR MANUAL** on the job!

With this book on hand you can repair anything from carburetor to rear end—more quickly and easily! Just look up make, model, and job in the quick index in this great book—and go to work! Clear, illustrated instructions lead you step by step.

To make such an amazing book possible, engineer-editors of **MoToR Magazine** collected and "broke down" 150 official factory shop manuals for you, spotted all vital repair information you need, dove-tailed it all into ONE handy, easy-to-understand book.

### No Other Manual Like It!

This **BIG** book—over 764 pages, 8½ x 11 inches, bound in sturdy fabric—brings you nearly 200,000 service, repair, adjustment, replacement, tune-up facts on every car built from 1935 to 1942. More than 1,000 cut-away photos, diagrams, drawings show you exactly **WHAT** to do, **HOW**

to do it! Used by U. S. Army, trade, technical schools, thousands of auto servicemen.

The **PARTIAL** Table of Contents shown here can only give you an idea of all the thousands of jobs this book covers. Hundreds of "war-timely" pointers on maximum mileage and performance with minimum fuel consumption. Full wheel alignment data to prevent tire waste and wear.

### SEND NO MONEY

Just mail coupon below—without money! When postman brings book, pay him nothing. First make it show you what it's got! Actually try it out on a few extra-tough jobs. See for yourself how its quick index, easy instructions, and clear pictures can save you time, trouble and money—how the book can pay for itself! The first few days you use it!

Unless you agree this is the greatest time and work-saver you've ever seen—return book in 7 days and pay nothing. Mail coupon today! **MoToR Book Dept., Desk 1B, 572 Madison Avenue, New York 22, N. Y.**

### Nearly 200,000 Service and Repair Facts on All These Makes:

American	Ford	Oldsmobile
Bantam	Graham	Overland
Auburn	Hudson	Packard
Austin	Hupmobile	Pierce
Buick	Lafayette	Arrow
Cadillac	La Salle	Plymouth
Chevrolet	Lincoln	Pontiac
Chrysler	Lincoln	Reo
Cord	Zephyr	Studebaker
Crosley	Mercury	Terraplane
De Soto	Nash	Willys
Dodge		

764 pages; 50 pages of carburetor text, charts, illustrations, covering all models.

Over 500 charts, tables covering important specifications, clearances, measurements, arranged in handy form, including: Tune-up Chart; Valve Measurements; Compression Pressure; Torque Wrench Readings; Starting Motor; Engine Clearances; Main & Rod Bearing Journal Dimensions; Generators; Clutch & Brake Specifications; Front End Measurements, etc.

Detailed, pictured instructions on Engines; Electric, Fuel, Cooling, Lubricating Systems; Transmissions; Wheels; Front Ends; Universals; Rear Ends, etc., etc.

## FREE 7-DAY OFFER



**MoToR Book Dept., Desk 1B, 572 Madison Ave., New York 22, N. Y.**

Rush to me at once: (check box opposite book you want).

**MoToR's AUTO REPAIR MANUAL.** If O.K. I will remit \$1 in 7 days, and \$1 monthly for 4 months, plus 35c delivery charge with final payment (\$5.35 in all). Otherwise I will return book postpaid in 7 days. (Foreign price, remit \$7 cash with order.)

**MoToR's TRUCK REPAIR MANUAL** (Described at left.) If O.K. I will remit \$2 in 7 days, and \$2 monthly for 3 months, plus 35c delivery charges with final payment (\$8.35 in all). Otherwise I will return book postpaid in 7 days. (Foreign price, remit \$11 cash with order.)

Print Name \_\_\_\_\_ Age \_\_\_\_\_

Print Address \_\_\_\_\_

City \_\_\_\_\_ Zone No. (if any) \_\_\_\_\_

State \_\_\_\_\_ Occupation \_\_\_\_\_

**SAVE 35c!** Check here if enclosing full payment (check, postal note, or money-order) WITH coupon. We pay 35c shipping costs. Same 7-day return privilege, for full refund.



Same **FREE 7-Day Offer** Applies on **MoToR's**

### TRUCK REPAIR MANUAL

Covers all types Gasoline Engines; Diesels, Hesselmanns, Fuel Systems, Governors, Lubrication, Ignition Systems, Starters, Generators, Clutches, Transmissions, Axles, Torque Dividers, Transfer Cases, Brakes, Steering, etc. Check box in coupon at right.

Published by **MoToR, The Leading Automotive Business Magazine.** **MoToR's** manuals assure high standards of repair work.

## Make Money in Postwar Aviation be an INSTRUMENT TECHNICIAN

Permanently profitable careers will be open to men who become specialists in aircraft instruments, through A.S.A.I. training. For every type of plane—for airlines, commercial, private and military flying—skilled technicians will install, test and repair the extensive instrument sets required by modern aviation. These will be interesting, well paid positions, with a real future

Great networks of global airlines will demand trained specialists for instrument maintenance. NOW is the time to prepare for this growing field, at American School of Aircraft Instruments... the oldest instrument school in America.

**VETERANS! SERVICE MEN! CIVILIANS!**  
Get complete information on A.S.A.I. resident school courses.



**SEND TODAY for**  
this interesting 24-page Booklet

**AMERICAN SCHOOL OF AIRCRAFT INSTRUMENTS**  
5253 W San Fernando Road Los Angeles 26, California

### AMERICAN SCHOOL OF AIRCRAFT INSTRUMENTS

Including Accredited Watchmaking School

5253 W San Fernando Road Los Angeles 26, California

Gentlemen: Please send free 24-page book and data on courses checked below without obligation

Master Instrument Technician  Home Study Instrument Course  
 Watchmaking

Name \_\_\_\_\_ Age \_\_\_\_\_

Address \_\_\_\_\_

City \_\_\_\_\_ Zone \_\_\_\_\_ State \_\_\_\_\_

Veteran  In Services  Civilian  P-2

AMERICA'S OLDEST INSTRUMENT SCHOOL

## JUST OUT! NEW FROM COVER TO COVER

# AUDELS REFRIGERATION

and AIR CONDITIONING GUIDE



**4 Books in One! Covering:**  
Basic principles, Servicing, Operation, Repair of  
1—Household Refrigeration  
2—Special Refrigeration Units  
3—Commercial & Industrial Refrigeration  
4—Air Conditioning Systems  
A gold mine of essential important facts for ENGINEERS, SERVICEMEN & USERS.  
A Good Book is a Good Friend! Here you have at your fingers' ends a Complete Library in ONE VOLUME, the necessary data you have been looking for on MODERN UNITS, SYSTEMS & MACHINES, REFRIGERANTS, including: Freon, Lockers, Water Coolers, Quick Freezing & Air Conditioning Systems.  
1280 Pages, 46 chapters all Fully Illustrated & Indexed for Ready Reference.

**ANSWERS YOUR QUESTIONS**  
Get This Information for Yourself. Mail Coupon Today. No Obligation Unless Satisfied, ASK TO SEE IT.

**4 COMPLETE • PAY ONLY \$1. A MONTH**

**AUDEL, Publishers, 49 W. 23rd St., New York 10, N.Y.**  
MAIL AUDELS NEW REFRIGERATION GUIDE for free examination. If O.K. I will send you \$1 in 7 days; then remit \$1 monthly until price of \$4 is paid. Otherwise I will return it.

Name \_\_\_\_\_

Address \_\_\_\_\_

Occupation \_\_\_\_\_

Employed by \_\_\_\_\_ P.M.

## ★ TRAIN for SUCCESS in the Poultry Business



Study at home in spare time. Earn extra while learning...

## You Can Make More Money from POULTRY

All signs point to big opportunities ahead for progressive poultry leaders—especially in the post-war period.

Get ready NOW! Proper management means profits ANY season, for life. Our easy, scientific course is NOT expensive. Its small cost should come back to you many times over! Even the first year, your extra profits should be far greater.

Learn at home, the EASY, SCIENTIFIC, and INEXPENSIVE way. Our course covers ALL phases of Poultry raising, including plans for buildings, breeding, hatching, culling, sexing, caponizing, marketing, judging, exhibiting, and many others, etc., as planned by Harry M. Lamon, former Senior Poultryman for the United States Department of Agriculture.

In the past twenty-two years, we have helped thousands of students to establish poultry farms, to increase profits on established plants, to secure positions in the many branches of the Poultry business, and many just to enjoy a small, profitable, breeding plant.

Write TODAY for catalog "How to Raise Poultry for Profit." It fully explains courses and easy payment plan.

## NATIONAL POULTRY INSTITUTE

Dept. 50-U, Adams Center, New York

## LOOK! Baby Chicks



THOUSANDS WEEKLY ALL YEAR. Finest quality & Layers in 40 breeds, Hybrid Baby Pullets and Cockerels, B. W. D. Tested, Ducklings, Goslings, Baby Turkeys. Mature breeders in 65 breeds. Catalog free. ORDER NOW, Make BIG money raising NABOB QUALITY CHICKS, NABOB HATCHERIES, BOX M, GAMBIER, OHIO



## LEARN TO DANCE \$100

Don't be a wallflower! Be popular. With these 3 books even a child can learn by following the illustrated charts that show you how to teach yourself the latest steps, quickly and easily to dance. Fox Trot, Waltz, Rhumba, Swing Steps, Tap dancing and many others. Pin a \$1 bill to this ad and we'll ship the 3 books prepaid in plain wrapper. MONEY-BACK GUARANTEE.

BULKI, Dept. D-47, Box 382, G. P. O., New York 1

## 924 PAGE AUTHENTIC FORMULARY



10,000 Formulas, Recipes, Trade Secrets for making monetary convertible product. Prepared by experts in simple, non-technical language. Countless profitable business opportunities, supply sources. Valuable reference for home, farm or industry. Illustrated. Extra! Complete plans: "D.D." Marijuana New Invention. One spray-ing kills all Flies, Mosquitoes, Lice, Fleas, Jay Nestles, etc. Lasts 2 mos. Big money maker. \$2.98 postp'd—Canada or Foreign \$3.25 U.S. Funds. (C.O.D. orders accepted for U.S. delivery only.)

Prepare for "After-War-Business" Especially recommended for Servicemen and War Workers planning a profitable business of their own. ADAMS BROWN COMPANY • Dept. 101 • Chestnut Hill 67 Massachusetts

## MONEY for MEN ALL FREE

THE PLASTEX Industry needs manufacturers on small scale and for big production of Lamp and Clock Stands, Art Goods and Novelties in Plastex and Marble imitation. Experience unnecessary. The material makes regular 10¢ store sellies. Rubber moulds furnished for speed production. Small investment brings good returns. Big chain store orders now being placed. Ambitious men have chance for real prosperity. Our Free booklet will interest and benefit you.

PLASTEX INDUSTRIES, Dept. P, 1085 Washington Ave., New York, N.Y.



# BETTER JOBS-BETTER PAY FOR SKILLED MEN!

**QUICK TRAINING BOOKS  
SHIPPED FREE** for Examination

NOW is the time for every ambitious man to prepare for a better job at bigger pay with American Technical Society's easy-to-understand self-training books. All sets interestingly prepared by long-experienced experts and profusely illustrated. Spare time reading can give you the "know how" that brings more money. Use the jiffy index to find out what you need to know in a hurry. Any set of books sent free for examination.



**8  
BIG BOOKS  
APPLIED  
ELECTRICITY**

**MEN** who understand electricity are needed in all kinds of industries. This New 19th Edition of 8 big books contains over 3700 pages, 2700 illustrations and 134 tables. Latest subjects fully covered. Includes electronics, F.M. radio, arc welding, blueprint reading and many up-to-date subjects. **Total price only \$34.80. Sent on trial.**

## BUILDING, ESTIMATING and CONTRACTING

**8 Volumes.** This big set should make it easy for any carpenter to become a contractor. Invaluable to builders. Architectural drawing and design, estimating, concrete forms, building, heating, painting, decorating and many other subjects well covered. **Total price only \$34.80. Sent on trial.**



## MODERN SHOP PRACTICE

**New Edition — 8 Big Volumes**

3000 pages with nearly 3000 illustrations, and a big binder of nearly 800 pages of original shop tickets and 1200 illustrations in addition to the 8 volumes. Among subjects covered are mechanical drawing, tool making, pattern making, foundry work, machine shop practice and management, and hundreds of other subjects which can fit you for a better job. **Total price only \$34.80. Sent on trial.**

## DIESEL ENGINEERING

**6 Volumes.** Over 2500 pages. Hundreds of illustrations. **Total price \$24.80. Sent on trial.**

## AUTOMOBILE ENGINEERING 20th Edition — 6 Volumes

Whether you are expert or beginner, you will find great value in these books which tell, step by step, how to make repairs, and keep cars at maximum efficiency. 2800 pages, 2000 illustrations, wiring diagrams, data sheets, etc. **Total price \$24.80. Sent on trial.**



## PRACTICAL AVIATION

**6 Volumes Prepared by Experts**

The most complete and best illustrated set of Aviation instruction and reference books we have ever published. It covers whole range of subjects from first principles of flight through late types of engines, instruments, meteorology, gliding. **Total price \$19.80. Sent on trial.**

## DRAFTING

For beginners or experts in machine trades, compiled by well-known engineers and written so you can understand every word. Contains hundreds of blueprints, charts and diagrams which will help you to acquire "know how" and prepare for a good job. **5 Volumes, 1600 pages. Total price only \$19.80. Sent on trial.**

**ANY SET SHIPPED *free!***

**FOR EXAMINATION.** All you need do to get any set for FREE examination is to fill in and mail the coupon and give required information. Read the generous offer in coupon and send today.

## AMERICAN TECHNICAL SOCIETY

Vocational Publishers Since 1898

Dept. X219, Drexel at 58th Street, Chicago 37, Illinois

## SEND COUPON TODAY

**AMERICAN TECHNICAL SOCIETY, Dept. X219**  
Drexel at 58th Street, Chicago 37, Ill.

Send for 10 days' free use, the following set of books:

I will pay the delivery charges only, and if fully satisfied, will send you \$2.00 in 10 days and then \$1.00 a month until the total price of \$..... is paid. If I return the books in 10 days I will owe you nothing. You are to include a Year's Consulting Privileges with your engineers without extra charge.

Name .....

Address .....

City .....

State .....

Please attach letter stating age, occupation and name and address of employer, and at least one business man's name as reference. Men in service, also please give home address.

## Sells Story 4 Months After Enrolling

"About 4 months ago I came across the Newspaper Institute advertisement in a magazine. I wrote for and later passed their writing Aptitude Test. Since I have been studying the N.I.A. Course, I have already added to my earnings. It has been one of the happiest experiences of my life. Anyone actually interested in learning to write, will find N.I.A. training a thoroughly practical way."—Alexander Pathe, Cleveland, Ohio.



# Why Can't You Write?

It's much simpler than you think!

SO many people with the "germ" of writing in them simply can't get started. They suffer from inertia. Or they set up imaginary barriers to taking the first step.

Many are convinced the field is confined to persons gifted with a genius for writing.

Few realize that the great bulk of commercial writing is done by so-called "unknowns." Not only do these thousands of men and women produce most of the fiction published, but countless articles on business affairs, home and shop crafts, local and club activities, gardening, sports, home-making, etc., as well.

Such material is in constant demand. Every week thousands of checks for \$25, \$50 and \$100 go out to writers whose latent ability was perhaps no greater than yours.

### The Practical Method

Newspaper work demonstrates that the way to learn to write is by writing! Newspaper copy desk editors waste no time on theories or ancient classics. The story is the thing. Every copy "cub" goes through the course of practical criticism—a training that turns out more successful authors than any other experience.

That is why Newspaper Institute of America bases its writing instruction on the Copy Desk Method. It starts and keeps you writing in your own home, on your own time. And upon the very same kind of actual assignments given daily to metropolitan reporters. Thus you learn by doing, not by studying the individual styles of model authors.

Each week your work is analyzed constructively by practical writers. Gradually they help to clarify your own distinctive style. Writing soon becomes easy, absorbing. Profitable, too, as you gain the "professional" touch that gets your material accepted by editors. Above all, you can see constant progress week by week as your faults are corrected and your writing ability grows.

### Have You Natural Ability?

Our Writing Aptitude Test will reveal whether or not you have natural talent for writing. It will analyze your powers of observation, your imagination and dramatic instinct. You'll enjoy taking this test. There is no cost or obligation. Simply mail the coupon below, today. Newspaper Institute of America, One Park Avenue, New York 16, N. Y. (Founded 1925)

### NOTICE TO CANADIANS

Newspaper Institute's operations in Canada have been approved by the Foreign Exchange Control Board, and to facilitate all financial transactions, a special permit has been assigned to their account with The Canadian Bank of Commerce, Montreal.

**Free** Newspaper Institute of America, One Park Avenue, New York 16, N. Y. Send me, without cost or obligation, your Writing Aptitude Test and further information about writing for profit as promised in Popular Mechanics, February.

Mr. \_\_\_\_\_  
Mrs. \_\_\_\_\_  
Miss \_\_\_\_\_  
Address \_\_\_\_\_  
(All correspondence confidential. No salesman will call on you.) 72-B-595  
Copyright 1944 Newspaper Institute of America

★ SAVE WASTE PAPER ★

## OSWALD RABBIT

Cartoon Home Movies

Oswald, the great "fun maker," delights his audience from beginning to end of every film.

OSWALD FEATURES  
50 Ft. 8MM. .... \$1.25  
100 Ft. 16MM. .... \$2.50

Dr. Oswald ..... 9-A  
Fairyland, Express ..... 11-A  
Radio Bug ..... 18-A  
Magic Wand ..... 21-A

For an evening of enjoyable HOME entertainment show an OSWALD feature, also a Mickey Mouse, Donald Duck and 3 Monkey film.

See At Your Photo Dealer Or Order Direct.  
Catalog And Prices On Request. Write To—

HOLLYWOOD FILM ENTERPRISES, INC.

6060 Sunset Blvd. Dept. 115 Hollywood 28, Calif.



## ELECTRIFY your career!

There's big money in Electrical Engineering. Be smart—study it NOW. Noted I.C.S. Courses cover the fundamentals and the out-of-the-ordinary things it's necessary for specialists to know. I.C.S. has had more than 50 years of training men for success. The School of Electricity is a separate and complete school giving specialized training—yet enjoying benefits and resources which only a vast institution like I.C.S. affords. And you benefit by the teachings of experts connected with the largest concerns in the field. Send for FREE informative booklet telling what I.C.S. can do for you. International Correspondence Schools, Box 5523-K, Scranton 9, Pa.

## LEARN AT HOME TO MOUNT BIRDS

**Animals, Heads, Fishes, Pets; to TAN.**  
Be a Taxidermist. Profit and FUN.  
Hunters, save your valuable TROPHIES. Mount ducks, squirrels, everything. Learn to TAN for leather and furs. Wonderful HOBBY Have a HOME MUSEUM.—BIG PROFITS mounting for others. INVESTIGATE NOW.  
**FREE BOOK** With 100 fine game pictures. NOW absolutely FREE. Write TODAY.  
Send Postal TODAY for FREE BOOK. State AGE. N. W. SCHOOL OF TAXIDERMY, Dept. 3372, Omaha, Neb.

## JOKE BOOKS For Adults

The kind they like. You will be both a Riot and the Life of the Party with a set of these pocket size joke books. They are full of Entertainment, Fun and Humor. A special assortment of 12 books all different for \$1.00. Print name and address, send cash or stamps to:  
TREASURE NOVELTY CO.,  
72—5th Ave., Dept. 1202, N. Y. 11, N. Y.

**Learn Public Speaking** At home—in spare time. Many overcome "stage-fright," gain self-confidence and increase earning power, this easy way. Write for free booklet, *How to Work Wonderful WUA Words* and requirements.  
North American School, Dept. 1352  
1315 Michigan Ave., Chicago 5, Ill.



Wonderful, new device, guides your hand; corrects your writing in a few days. Big improvement in three hours. No failures. Complete outline FREE. Write C. J. Ozment, Dept. 34, St. Louis, Mo.

## What Every Mason Wants

We have important Masonic books for Blue Lodge, Chapter, Commandery, Scottish Rite, and Shrine.  
Our Rituals Are Used the World Over. Send for free catalog of books and rituals for Masons, Odd Fellows, Knights of Pythias, Knights of Columbus, etc.  
EZRA A. COOK, Publisher, P. O. Box 796, PF, Chicago 90, Ill.

# THESE BOOKS CAN HELP YOU...



## Through the GATEWAY TO SUCCESS

If you're the type of man who wants to make more money . . . and you've got the **ambition and gumption** to get ahead . . . and you want the better pay jobs, then these books will help you . . . and faster, too.

Gateway books are easy to understand . . . they're written in conversational language by prominent authorities. Thousands of

fellows (and the records prove it) have surged ahead because they used their spare time to better themselves.

Study this list of exceptional books, then check the coupon for the ones you want. You'll soon see that these books can be **YOUR Gateway to Success**. When you send your order, ask for our new illustrated catalog . . . it's absolutely **FREE**.

## Just out . . . "QUICK CONSTRUCTION" do the HARDEST jobs the EASIEST way in LESS time

No carpentry job is too tough when you have this practical guide to Quick Construction. It's written by a Union carpenter . . . a man who has built himself up the hard way . . . from apprentice to **THE** authority on carpentry problems. His well rounded knowledge and knack for explaining things, makes H. H. Siegel's new book the outstanding one in its field.

Quick Construction covers these and many more subjects . . . Roof & Platform problems; plumbing and measuring; job-made tools; saw-horses; hiecky, checks and concrete piles; circular stair forms; squaring and mitering cuts; circles, segments and kerfing; window frames, flashing, sills, and stools, carpenter made furniture; tricks of the trade, farm problems and plenty of short cuts. 250 pages and **\$2.00** all for only . . .

## CHECK THIS LIST OF MONEY-MAKING BOOKS

2. **CARPENTRY CRAFT PROBLEMS.** How to make frames, sills, beams, porches, window and door frames. 700 illustrations. 302 pages. . . . **\$2.00**
3. **BUILDING—FORMS, STAIRS, ROOFS.** Contains latest information on Forms, staircases and roof-building. Top notch book for carpenters or helpers. 210 pages, 495 illustrations. . . . **\$2.00**
4. **WOOD FINISHING.** Instruction on wood finishes, and problems . . . tools . . . materials . . . repairing. 360 pages and 353 illustrations. . . . **\$2.00**
5. **FURNITURE, FURNITURE FINISHING, DECORATION and PATCHING.** New book that covers: 1. Period Furniture; 2. Furniture Decoration; 3. Furniture Finishing; 4. Furniture Patching; 5. Modern Special Finishes. 580 pages and 353 illustrations. . . . **\$4.00**
6. **THE MIXING OF COLORS and PAINTS.** How to mix colors for interior decorating. Covers house painting, arts, crafts, general paint mixing methods. A handy book for professional and amateur painters. 302 pages fully illustrated and a big color chart. . . . **\$2.00**
7. **ELECTRIC and OXY-ACETYLENE WELDING.** 280 page book with instructions on arc, spot, butt and flash electric welding; gas welding and cutting; hand forging; thermite welding; brazing and soldering. 86 illustrations. . . . **\$1.50**
8. **PLUMBING INSTALLATION and REPAIR.** 236 page book explaining how to do repair jobs such as leaky faucets, clogged toilets, drains, traps, vents, sewers, etc. Tells how to cut pipe, make pipe joints, and install fixtures. 153 illustrations. . . . **\$2.00**
9. **CYCLOPEDIA OF RADIO and ELECTRONICS.** A complete non-technical reference book covering radio transmission and reception, sound pictures, short wave, public address systems, television, photo-cells. 1700 headings, 1060 pages, 1178 illustrations, 130 tables, and 105 graphs. . . . **\$5.00**
10. **PRACTICAL ELECTRICITY and HOUSE WIRING.** This new book discusses these very important subjects; Dictionary of common electrical devices, basic principles of circuits, wires and insulation, grounding, polarizing, wiring methods, planning your installations, wiring new houses, installing switches, fixtures, etc., wiring houses after they are built, alterations and additions, wiring farm buildings, wiring for motors, & home repairs, etc. 190 pages, 208 illustrations. . . . **\$1.50**

11. **SLIDE RULE and LOGARITHMIC TABLES.** How to use a slide rule for all purposes. Includes polyphase and circular rules, logarithms and tables . . . even includes 10 place log tables. Fully illustrated. 200 pages. . . . **\$1.50**
12. **SPRAY PAINTING, INDUSTRIAL and COMMERCIAL.** Covers principles of spraying technique and latest developments, operating instructions, paints, extenders, materials, finishes, lettering, and a section on National Defense spray painting. 125 fully illustrated pages. . . . **\$1.50**
13. **HOW TO DRAW FUNNY PICTURES.** **\$2.00**
14. **ART OF CARICATURE.** . . . **\$2.00**
15. **FIGURE DRAWING FROM LIFE.** . . . **\$1.00**
16. **MODERN LETTERING.** . . . **\$1.00**
17. **HANDBOOK OF ADVERTISING.** LAYOUT . . . by Don May . . . **\$3.00**

### PAINTING & DECORATING CYCLOPEDIA

350 Pages • 288 Illust.  
Only **\$3.00**

18. This new book covers methods, tools and materials for the home and the workshop, including every branch of painting and decorating from A to Z. Any particular job is fully explained with illustrations to clarify the text, whether the reader is interested in finishing walls, floors, furniture, automobiles, boats, houses, or in fact anything which has to do with painting or decorating methods. . . . **\$3.00**

### REFRIGERATION SERVICE MANUAL

19. This NEW book covers refrigeration problems in practically every operation of field service and shop operations. Includes domestic and commercial types, such as used in markets, milk depots, soda fountains, flower shops, etc., as well as in many air conditioning systems and homes. . . . **\$2.00**

## CHECK, CLIP AND MAIL THIS COUPON NOW

### GATEWAY PUBLISHING CO.

Dept. P.M.-2, 53 W. Jackson, Chicago 4, Illinois

OK. Send the books I've checked, C.O.D. I'll pay postman cost of books plus a few cents postage. If any book is not entirely satisfactory, I will return in 5 days and you will refund my money.

- |  |        |  |        |
|--|--------|--|--------|
| <input type="checkbox"/> Quick Construction . . . . .                                      | \$2.00 | <input type="checkbox"/> The Slide Rule . . . . .                                      | \$1.50 |
| <input type="checkbox"/> Carpentry Craft Problems . . . . .                                | 2.00   | <input type="checkbox"/> Spray Painting . . . . .                                      | 1.50   |
| <input type="checkbox"/> Building, Forms, Stairs, Roofs . . . . .                          | 2.00   | <input type="checkbox"/> How to Draw Funny Pictures . . . . .                          | 2.00   |
| <input type="checkbox"/> Furniture Finishing . . . . .                                     | 2.00   | <input type="checkbox"/> Art of Caricaturing . . . . .                                 | 2.00   |
| <input type="checkbox"/> Furniture, Furniture Finishing, Decoration and Patching . . . . . | 4.00   | <input type="checkbox"/> Figure Drawing from Life . . . . .                            | 1.00   |
| <input type="checkbox"/> The Mixing of Colors and Paints . . . . .                         | 2.00   | <input type="checkbox"/> Modern Lettering . . . . .                                    | 1.00   |
| <input type="checkbox"/> Electric Welding . . . . .  | 1.50   | <input type="checkbox"/> Handbook of Advertising Layout . . . . . by Don May . . . . . | 3.00   |
| <input type="checkbox"/> Plumbing Installation and Repair . . . . .                        | 2.00   | <input type="checkbox"/> Cyclopedic of Painting & Decorating . . . . .                 | 3.00   |
| <input type="checkbox"/> Cyclopedic of Radio and Electronics . . . . .                     | 5.00   | <input type="checkbox"/> Refrigeration Service Manual . . . . .                        | 2.00   |
| <input type="checkbox"/> Practical Electricity & House Wiring . . . . .                    | 1.50   |  |        |

Save 10%—enclose full cost of book and we will pay the postage—saving you approximately 10%. Same money back guarantee.—The Publishers.

Name . . . . .

Address . . . . .

City . . . . . State . . . . .

# INVENTORS

## Do Not Delay

Have you ever been startled by seeing a successful article on the market, and exclaimed—"Why, I invented THAT 5 years ago—I didn't think it valuable enough to Patent!"

The Patent Laws were intended for the Protection of the Inventor, and the Inventor who slumbers on his Rights may wake up to find someone else reaping the reward that could have been his.

Write NOW for Information and Record of Invention form FREE. RANDOLPH & BEAVERS, Registered Patent Attorneys, Columbian Bldg., Washington, D. C.

PERSONALIZED SERVICE — REGISTERED PATENT ATTORNEYS

## RANDOLPH & BEAVERS

11-D Columbian Bldg., Washington, D. C.

Please send me full particulars on Patents, fees, etc., and "RECORD OF INVENTION" form—FREE.

Name .....

Street .....

City ..... State .....

# KEY TO A PRACTICAL UNDERSTANDING OF ELECTRICITY

**4** HANDY SIZE

**1** \$1 PER MO.

### • AUDELS HANDY BOOK OF ELECTRICITY

For Engineers, Electricians, Students and all interested in Electricity. A quick, simplified, ready reference, giving complete instruction and practical information. Easy to understand. A reliable authority and a handy helper that answers your questions.

### • INSIDE TRADE INFORMATION ON

The Rules and Laws of Electricity—Maintenance of Machinery—A. C. and D. C. Motors—Armature Winding and Repair—Wiring Diagrams—House Lighting—Power Wiring—Cable Splicing—Meters—Batteries—Transformers—Elevators—Electric Cranes—Railways—Bells—Sign Flashers—Telephone—Ignition—Radio Principles—Refrigeration—Air Conditioning—Oil Burners—Air Compressors—Welding, and many Modern Applications explained so you can understand.

1340 PAGES  
2600 ILLUS.

To get this assistance for yourself, simply fill in and mail the FREE COUPON below.

THEO. AUDEL & CO., 49 West 23rd Street, New York

Please send me "Audels Handy Book of Practical Electricity" for free examination. If satisfactory, I will send you \$1 in 7 days, then \$1 monthly until \$4 is paid. Otherwise I will return it.

Name .....

Address .....

Occupation .....

Reference .....



READ FOR PROFIT!



## DIVING, CUTTING and WELDING

### IN UNDERWATER SALVAGE OPERATIONS

by Frank E. Thompson, Jr.

New, fascinating, easy-to-understand book by the famous Manufacturer-operator of salvage equipment who helped our Navy raise ships sunk by Japs at Pearl Harbor! Practical, essential facts for a well-paid, patriotic job.

224 pages . . . Illustrated . . . Indexed . . . \$2.00



CORNELL MARITIME PRESS  
241 West 23rd Street New York 11

# PATENTS AND TRADE MARKS

## C. A. SNOW & CO.

Registered Patent Attorneys Since 1875  
Write for Free Book and "Certification of Invention" form  
427 SNOW BUILDING, WASHINGTON 1, D. C.

SAVE WASTE PAPER

## PATENT YOUR IDEAS

SEND FOR FREE BOOK



Written by Former Member Examining Corps (1923-24) U. S. Pat. Office.  
CARL MILLER, Registered Patent Attorney  
Former Member Examining Corps U. S. Patent Office  
Woolworth Bldg., Dept. 25-A, New York — Bond Bldg., Dept. 25-A, Washington, D. C.

## PATENTS Protect Your Idea:

By securing FREE my "PROOF OF INVENTION" folder. Exceptional Personal Service. Excellent References. Established 1906.

E. E. VROOMAN, 871 Woodward Bldg., WASH., D. C.

## LEARN MOVIE PROJECTION THEATRE MANAGEMENT

The Motion Picture Theatre Business offers big opportunities for trained men. Get into a fascinating field with a peace time future. Train at home in spare time. Free catalog. Established 17 years.

THEATRE INSTITUTE, 370 Washington St., Elmira, New York

## LEARN PORTRAIT PAINTING AT HOME

• Previous art training or talent NOT necessary. The Stuart System teaches you, in 11 easy-to-follow lessons, to (1) locate features *exactly* to correspond to model's features, (2) outline head and face to correspond to model's outline, (3) make each feature a true portrait of that feature in the model, (4) produce shadows and shading that *exactly* correspond to that of model's face, (5) mix flesh paint tints that are like living flesh. Our students' portraits look alive. You, too, can make *exact* charcoal and oil likenesses. Send for free booklet today.

### STUART STUDIOS,

121 Monument Circle, Room 625, Indianapolis 9, Ind.

Please send me free book and outline of lessons.

Name .....

Street .....

City ..... State .....



# DRAFTING

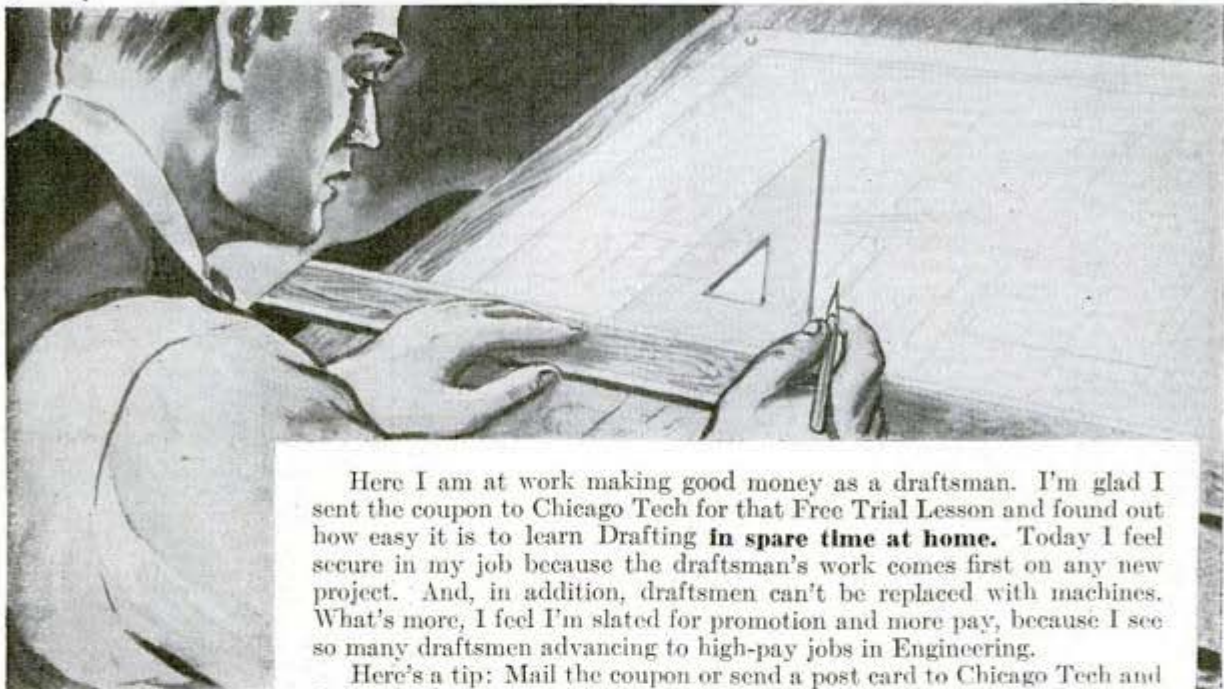

Here I am at work making good money as a draftsman. I'm glad I sent the coupon to Chicago Tech for that Free Trial Lesson and found out how easy it is to learn Drafting **in spare time at home**. Today I feel secure in my job because the draftsman's work comes first on any new project. And, in addition, draftsmen can't be replaced with machines. What's more, I feel I'm slated for promotion and more pay, because I see so many draftsmen advancing to high-pay jobs in Engineering.

Here's a tip: Mail the coupon or send a post card to Chicago Tech and find out about your opportunities in Drafting.



## LEARN in Spare Time—at Home!

(Or at the College in Chicago)

A few hours of pleasant home study every week—that's all. No interference with your present job. With Chicago Tech's help, you train yourself step by step. This tested method,—developed over 40 years of C.T.C. progress,—prepares men quickly for good positions in industry.

### Get Free Information—Send Coupon

Find out now how you can use your spare time to prepare, in your own home, for these post-war opportunities by use of the Chicago Tech Plan. Same training methods as used in our Chicago school. **Choose the line where you would like to work,—in Drafting, Building Construction, Refrigeration or Air Conditioning.** Mark and mail the coupon or send a post card. No obligation of course. Act today.

## FREE TRIAL LESSON

To prove to you how easy it is to learn Drafting at home by the Chicago Tech method we will send you this **FREE TRIAL LESSON**. No charge for this Lesson, now or later. Fill out and mail Coupon, or send post card today.

### DRAWING OUTFIT INCLUDED (with Drafting Courses)

All the tools you need including folding drawing table. With them you can put your ideas on paper quickly and with accuracy. With training, you're all set to master Drafting in months—not years,—at home.

## CHICAGO TECHNICAL COLLEGE

B-206 Tech Bldg., 2000 South Michigan Ave., Chicago 16, Ill.

Send **INFORMATION PLEASE** on Home-Study Training in:

- |   |  |
|---|--|
| <input type="checkbox"/> Aircraft Drafting      | <input type="checkbox"/> Builders' Course            |
| <input type="checkbox"/> Machine Drafting       | <input type="checkbox"/> Blue Print Reading—Building |
| <input type="checkbox"/> Electrical Drafting    | <input type="checkbox"/> Estimating,—Buildings       |
| <input type="checkbox"/> Structural Drafting    | <input type="checkbox"/> Refrigeration               |
| <input type="checkbox"/> Architectural Drafting | <input type="checkbox"/> Air Conditioning            |

Name..... Age.....

Address.....

City..... Zone..... State.....

Veterans check here for information about "GI" Training at the College in Chicago.

**WORLD'S  
BEST  
WANT AD  
MEDIUM**

# CLASSIFIED Advertisements



Advertisements in this section, 35 cents per word, each insertion, minimum 10 words, payable in advance  
To be inserted under proper classification in March issue, copy should be in our office February 4th  
March issue on sale March 1st  
Popular Mechanics Magazine, 200 East Ontario Street, Chicago 11, Illinois

## AUTOMOBILES, MIDGET CARS

**STEAM Automobiles!** Send 25c for literature listing names 90 different makes steamers once manufactured. Illustrations, descriptions, specifications, Stanley, White, Doble, Lane, Ross steamers, boilers, engines, also photos famous White Racer "Whistling Billy" and world's record holder Stanley Racer. Interesting, educational, ancient steamer history. No cars for sale. Clymers, 2125 W. Pico, Los Angeles 6, Calif.

**REPAIR Your car.** Do it yourself. Motor parts for all engines, chassis parts, ignition and carburetor parts, etc.; new replacement parts. Genuine and highest quality at manufacturers' retail prices. P.O.B. Chicago. Personalized technical advice concerning your mechanical problems \$1.50, postpaid. B & N Engineering Co., P.O. Box 3494, Merchandise Mart, Chicago 54, Illinois.

**FLOYD Clymer's Historical Motor Scrapbook.** This humorous, educational, historical scrapbook illustrates, describes hundreds antique and early automobiles, motorcycles, Reo, Oldsmobile, Hupmobile, Metz, Orient, Knox, Winton, Carter, Maxwell, E-M-F, 2-cylinder Ford and Buick, air-cooled Chevrolet, Stanley, White, other steamers, electric, Unusual and steam motorcycles. This is the scrapbook Time Magazine said is a "must." Editions one and two now available but entirely different books. Postpaid \$1.50 each, deluxe edition \$2.50. We mail overseas any time without request and pay postage. Delivery guaranteed. Clymers, 2125 W. Pico, Los Angeles 6, Calif.

**PROFESSIONAL Midget racers, motor-scooters, midget cars, parts.** Handbook catalog—50 illustrations, plans—25c. Directory bargain priced used tires, motors, parts, included free! Midwest, 2557 Charlestown, Toledo, Ohio.

**MODERN Steam car.** 160 pages, 100 illustrations. Interesting, practical book on steam automobiles. Complete information early and latest makes, models. U. S., foreign makes described. Boilers, generators, engines, valves illustrated, described. Article by Stanley, early steam advertisements. How to drive and care for steam automobiles. Unusual, informative book. Postpaid \$2.00. Clymers, 2125 W. Pico, Los Angeles 6, Calif.

**BUILD It yourself.** Automatic overhead garage doors operated from driver's seat. Used auto parts and other material available everywhere cheap. Use 1/4 h.p. motor. Tried and tested. Be first in your neighborhood to build one. Complete plans \$1.00. McIntosh Projects, 2479 Coolidge Ave., Oakland 1, Calif.

**FAREWELL To Model "T".** Humorous book with cartoons, illustrations, description car, engine, chassis, first and last Model T Fords manufactured. Folder includes page on German Jet Propulsion Opel automobile. \$1.50 complete postpaid. Clymers, 2125 W. Pico, Los Angeles 6, Calif.

**AUTOS of yesterday—set.** 20 actual glossy photographs 1900-15 model automobiles. 25c each set, 5—\$1, postpaid. Order 5 sets, \$1, receive packet invasion scenes free. Lloyds, 1411-U Northwest 17th, Oklahoma City 6.

**POWER AND Speed!** World's most famous motor book. 110 large pages. 200 illustrations racing automobiles, motorcycles, airplanes. World's speed record chart, articles by world's famous speed kings Cobb, Eyeston, Campbell, Bonneville record details, photos British racers. Describes cams, compression, valves, superchargers, International racing teams. German Auto-Union, Italian, French, British racer specifications, drawings. \$2.50 postpaid. Clymers, 2125 W. Pico, Los Angeles 6, Calif.

**CUSTOMIZE Your automobile.** Illustrated, new restyling ideas, instructions, suggestions, specific model changes by simple methods. \$1. Speed Wheel, Box 723-E, Arcadia, California.

**SIR Malcolm Campbell's book of famous motorists!** 208 pages, 42 beautiful photographs world famous racing automobiles, drivers. Campbell describes famous race tracks, his American records, European road races, his competitors. Interesting, sensational, \$2.00 postpaid, deluxe edition \$3.00. Clymers, 2125 W. Pico, Los Angeles 6, Calif.

**120 OCTANE Fuels in your car.** Most perfect fuels available. Obtainable most places throughout country. Easy to make equipment to burn them in your car. Won't harm motor. Perfect performance. Complete instructions with pictures, \$1.00. Earl Behling, Box 955, Inglewood, Calif.

**CAR Owner's Economy Handbook—**by Austin Elmore—world famous automotive mileage record holder and test engineer. Mr. Elmore tells you in his book, how to get longer life, greater mileage, from your car, and how to drive most efficiently and with greatest safety. \$1.25. Mileage Research Laboratories, 5058 Alhambra Ave., Los Angeles 32, California.

**MORE Speed and power from your car.** Written by a race car builder. Send make, model with \$1.00. H/P Automotive Engineers, 840 Hovey, Rockford, Illinois.

**GARAGE Doors, all types, controlled from dashboard pushbutton.** Simple, dependable. Materials inexpensive, obtainable everywhere. Complete "Build Yourself" plans \$1.00, refundable. Guaranteed. Free particulars. Kaytor Laboratories, Lynwood, Calif.

**AUTOMOBILE Racing book, fifth edition, well illustrated.** Instructions on building bodies, frames, engines. Ford A and B conversions. Plans. AAA rules, specifications. Roadster racing, Indianapolis cars. \$1.00 postpaid, \$1.30 C.O.D. Ray Kuns, Dept. 47, Madisonville, Cincinnati 27, Ohio.

## AUTO SUPPLIES AND EQUIPMENT

**1,000 MOTORISTS Needed to make gas savings test.** Up to 30% savings. For trial test offer write Vacu-matic Carburetor Co., 7617-1143 W. State Street, Wauwatosa, Wis.

**WANTED Airframe pads from cushions of wrecked cars.** Allen Streamlined Bag Co., 216 Summit St., Elgin, Illinois.

**AUTOMOTIVE Equipment, supplies, accessories, reliners, tire and tube repair materials for service stations.** P.O. Box 1833, Cabanne Station, St. Louis 12, Mo.

**EXTRA Miles.** 50 miles for each gal. gas used. Tested and proven method. Hundreds of users. Equip your car inexpensively. Simplified diagrams and instructions \$1.50. Astonishing results. Geller, Box 524, Dorris, Calif.

**OPERATE Cars, trucks, tractors, motors, with wood or coal gas.** 1/2 cost of gasoline. Extensively used in Europe. Complete detailed instructions \$1.00. W. M. Cross, Lone Rock, Wis.

**V-8 AND Mercury dual muffler sets \$17.50.** Genuine steel wool packed mufflers with mellow tone. Gives less back pressure, more power and more gasoline mileage. Also single steel wool pack muffler for any car. Fits in place of regular muffler. Single V-8 Ford, Chev, Plymouth, Pontiac, etc., \$5.00. Buick, Dodge, Chrysler, etc., \$7.00. For 7 years manufacturers of California's best tone mufflers. Sandee Muffler Co., 7523 So. Western Ave., Los Angeles 44, California.

**TEST Your own car battery, in car.** No testers needed. Simple. Interesting. Money-saver. Complete information 25c. Batteryman, 901 South Avenue, Grand Junction, Colorado.

**INVENTION Uses kerosene to run motors.** Circular on plans. Rush name. Houston Maupin, Tipp City 36, Ohio.

**WHIRLGAS Turbinator, \$3, improves carburetor action; increases mileage; quickens acceleration; reduces monoxide.** Performance guaranteed. Universities and oil corporation tests. Wrench installs 15 minutes. Give auto make, year. John Hanley, 5719 Loraine, Detroit 8, Mich.

**1945 IGNITION Supercharger \$3.50.** Fast starting, mileage, pep. EG Sales Mfg. Co., 355 E. 149 St., New York.

**ATTENTION: Run your car on (natural or artificial gas) without alteration to carburetor or gasoline system.** Plans \$1.15. Circular free. Harper's Machine Shop, 218-22nd Street, Dunbar, W. Va.

**NEW, Metal radiator grills; 1937 Buick \$16.00 pair; 1937 Ford \$12.00.** Antila Grill, 3125 South 53 Court, Chicago 50.

**YOUR Old pistons metallized and ground to any size desired.** Stahl Machine Company, Tiffin, Ohio.

**"UNLOCKEEZ" Is a device that will instantly open any auto lock operated by a push button or money refunded.** Attention locksmiths, parking lots, garages, car owners. \$2.00 cash or money order. Canada and foreign \$2.50. Unlockeez Lock Device Co., P.O. Box 7218 Sta. G, Los Angeles 37, Calif.

**THE Lord is coming! Get guaranteed profits free.** Scheall, 283XA, Duluth, Minnesota.

**AMAZING New Moto-Vator injects water-vapor into motor just like newest fighter planes.** Burns 15% water; saves 20% to 30% gas; prevents carbon; increases power! Eliminates carbon and valve jobs. Not a gadget. Sensational performance keeps motor like new. Wonderful postwar possibilities. No investment. One low price includes license to install Moto-Vator in your locality. Send 10c for booklet giving complete details. Dept. M, SX Laboratories, P.O. Box 37, Middle Village, Long Island, New York.

**VAPOR-MATIC Guarantees you increased gasoline mileage or your money back.** Thoroughly tested and approved. Easily installed. Guaranteed because it really works. \$1.00 complete. Give make, year, number of cylinders. United Carburetor Company, 756 South Broadway, Los Angeles 14, California.

**HAVING Car trouble? Used, guaranteed auto, truck parts save money.** Transmission specialists. Describe needs; immediate reply. Victory, 2439 1/2 Gunnison, Chicago 25.

**ANTI-FREEZE, Noncorrosive, inexpensive, manufacture yourself.** Details for stamp. Betke, Box 699, Borger, Texas.

**PLATING Outfits for auto parts.** Connect to a battery. No tanks used. Free particulars and proofs. Gunmetal Co., Ave. J, Decatur, Ill.

## AUTO TRAILERS

**BUILD Your own trailer! Save money! Have every feature you want! Plans for house, sport, camp and utility trailers.** Catalog describing 9 models 10c. Jim Dandy, Box 125-A, Wausau, Wisconsin.

## MOTORCYCLES, BICYCLES, MOTOR-SCOOTERS AND SUPPLIES

**FLOYD Clymer's Historical Motor Scrapbook \$1.50 postpaid.** This is the book Time Magazine said is a "must." 250 early motorcycles, automobiles illustrated, described. See our advertisements under Automobiles. Clymers, 2125 W. Pico, Los Angeles 6, Calif.

**BUILD Scooters, trailers, midgets, conversions.** Large manual \$1.00. Illustrated circulars dime. Craftsmann Books, Box 1153-P2, Milwaukee 1, Wis.

**MOTORCYCLISTS—New and used parts, accessories, all models.** Catalog 10c. Henderson catalog 10c additional. Triangle, 2157 Harrison, Chicago.

**MOTORBIKE Manual.** Contains motorbike, scooter plans. Catalog section. Easy to build. \$1.00. Variety Enterprise Co., Box 5, Station A, Evansville, Ind.

**"MODERN Motorcycle Mechanics."** New enlarged second edition comprising 500 pages, 250 illustrations. Available shortly. Nicholson Brothers, Saskatoon, Canada.

**ELECTRIC Motorbike built from your present bicycle.** \$1.00 bill brings complete instructions, drawings, specifications. Mowery, Box 994, Lancaster, Pennsylvania.

**PARTS, Accessories, pistons, chain** Harley Davidson motorcycles. McCann's, P.O. Box 114, El Paso, Texas.

**FLYING Clymer's Motorcycling Manual.** 144 pages. 120 illustrations. Complete information, specifications, descriptions dozens motorcycles. Engines, transmissions, carburetors, square four, two piston singles, sleeve valve engines, overhead camshafts, water cooled motorcycles, spring frames, hydraulic forks, sidecars, riding instructions. Two cycle engines and power bicycles described, illustrated. Just out \$2.00 postpaid. Clymers, 2125 W. Pico, Los Angeles 6, Calif.

**BUILD America's lowest priced motor-scooter Speedking.** Complete plans and specifications, \$1.00. Big list bargain priced used tires, motors, parts, included free! Motor Supply, Box 1682-CS, Toledo, Ohio.

**BUILD Your own, new, motor scooter.** Design by original motor scooter inventor. Complete blue prints and material specifications \$1.50. Automotive Division, Elmore Project Engineering Laboratories, 5058 Alhambra Ave., Los Angeles 32, Calif.

**PROFESSIONAL Midget racer with Ace 4-cylinder motor \$65 less body; factory motorscooters \$45 up; motorcycles \$30 up; gasoline engines \$5 up; plenty small unrationed balloon tires \$1.75 to \$6.50; mail-order only. Send 25c for big war-bargain catalogue Number 5. Midget Motors Directory, Athens, Ohio.**

**PLANS, Scale drawings, specifications, illustrations for building attractive motor scooter complete \$2.00; plans electrically driven bicycle \$1.50. Postpaid. Clymers, 2125 W. Pico, Los Angeles 6, Calif.**

**WANTED—Motorscooters, motorcycles, motors, parts of all kinds. Name your own price. Write: Midget Motors Directory, Athens, Ohio.**

**BOYS! All bicycle repair secrets revealed. "Bicycle Repair Manual" 65c. R. G. Klausner, Shelbyville, Ill.**

**PARTS, Complete motor parts list. Pistons, all sizes, chains, sprockets, for Indian, Harley, 10c. Bootz, 623 East Grand, Des Moines 9, Iowa.**

**HARLEY Davidson parts, accessories, supplies. Expert service. Cylinder rebor-ing, generator reconditioning. 45" engines \$85.00 and up. Send \$1.85 for U. S. Army Motorcycle Instruction Book, Motorcycle Service Manual and bulletins or 25c for Service Manual and bulletin. Knuth's, 2491 Fondulac Ave., Milwaukee 6, Wis.**

**TIRES And industrial wheels, suitable for scooters, wheelbarrows, farm equipment, etc. All sizes. Bicycles and accessories. Largest assortment in America. Send dime for list. Cycle Transport Company, 1241 So. Michigan Ave., Chicago 5, Illinois.**

**SAVE Gasoline, build a motorbike now, send 25c for complete plans. Motorbike Service, 2108 McLean, New Albany, Ind.**

#### AVIATION

**B-29 Super Fortress—20 actual photographs, official Boeing releases, contained neat mailing package. 25c each packet, 5—\$1, postpaid. Order 5 packets, \$1, receive packet invasion scenes free. Lloyds, 1411-R Northwest 17th, Oklahoma City 6.**

**AIR Navigation stud'ys—Any question answered. Save time and money—What course to study. What book and where to get it—Fee, \$1 sent with question. P.O. Box 1891, Los Angeles 53, Calif.**

**FLYING Flea, plans \$1.00. Lightplane manuals, blueprints. Illustrated circular 20c. Craftsmen Books, Box 1153-PI, Milwaukee 1, Wisconsin.**

**CUB \$200 (Needs repainting), Curtiss-Robin \$195, Fairchild \$395. Catalog—over 250 aircraft bargains—25c. Lifetime membership in Aviation Club included free! National Aviation, Box 1682-CS, Toledo, Ohio.**

**CIVILIAN Flying opening up! "Operating a Flying Club" tells how to start a good paying business without capital. How to expand; get business; where to buy government surplus airplanes for little cash. Valuable trade secrets. Author formerly with CAA. \$1.00 brings your copy by return mail. Satisfaction guaranteed. Merritt Wells Pub. Co., Gladstone 1, N. J.**

**BOWLUS Sailplane \$100 with trailer; Pietenol Aircraft; Waco-10, wings damaged \$100; Travelair \$125; Curtiss Robin \$175. Send 25c for catalogue of these and hundreds of other war-bargains located everywhere, some probably near you. Used Aircraft Directory, Athens, Ohio.**

**AIRMAN, Monthly aviation newsmagazine. It's different! Latest civil and military aeronautical development by designers, manufacturers, test pilots. Illustrated. Trial offer: One year, \$1.00. Airman, 614 Howard, Elmira, N. Y.**

**AIRPLANES—Used \$250 up. Also late models, engines, wings, parts, machinery, books. Cheap. Send 25c for list. Aircraft, 2300 West Flagler, Miami 35, Florida.**

**PROPELLERS Of distinction—We fit any motor, lists free. Special 3 blade Air-liner type for sleds and boats. Ford A hubs \$5.00. Ford aircooled conversion diagrams 50c. Fast delivery. Standard Aero Craft, Ft. Worth 1, Texas.**

#### ELECTRICAL SUPPLIES, EQUIPMENT

**ELECTRICAL Appliance repair. Open your own shop. Learn house wiring; electric motors, vacuum cleaners, washers, etc. Complete illustrated course shows how. Free booklet. Pacific Training School, Dept. PA-2, 4703 West Pico, Los Angeles 6.**

**BROKEN—Burned out electrical heating elements quickly repaired. Use new amazing Nichrome Paste, simply overlap ends and turn on current. Family size \$1.00 bill. Satisfaction guaranteed. Advance Electric, Box 861-X, Minneapolis, Minn.**

**ELECTRIC Air heaters, electric fly traps. Gardenhour Mfg., Waynesboro, Penna.**

**MANUAL, "Know Your Multispeed Motors," explains in every detail this type of electric motor. \$2.00 or descriptive literature sent free. Electric Generator Mfg. Co., 1333 N. Dale St., St. Paul 3, Minn.**

**WANTED Men for electrical business, own locality or Louisville, Estes, Box 155, St. Matthews Branch, Louisville 7, Ky.**

**HANDY Pocket size electric circuit tester checks all electrical appliances, radios, motors, fuses, etc. 90 to 550 volts a.c. or d.c. Distinguishes a.c. from d.c. \$1.00 postpaid. Supreme Electric Mfg., 210-A Roebing St., Brooklyn 11, N. Y.**

**MAKE Electric hammers! Quick, easy! Circular on plans. Rush name. Houston Maupin, Tipp City 43, Ohio.**

**ALL Midget a.c. motors sold. Have left midget d.c. motors back geared to 4 r.p.m. Shaft speed 1250 r.p.m., 110 volts. Ideal for timing devices, displays, models. Length 5 1/2", height 2 1/2", width 3". Very powerful. A real buy at \$3.00 postage paid. McLaren Products Co., 114 N. W. 1st St., Evansville 8, Ind.**

**FREE Catalog of motors, welders, generators, fencers and other electrical items. Write LeJay Company, Minneapolis 8, Minnesota.**

**NOW—Repair your own electrical appliances with Chanite Self-welding Electrical Heating Element Flux. Instructions delivered, price \$1.00. Chanite Sales Company, 914 South Main, Fort Worth, Texas.**

**ELECTRIC Pencil: Writes—engraves all metals. \$1.00 postpaid. Beyer Mfg., 4515-H Cottage Grove, Chicago 15.**

**ELECTRIC Automobile heaters! Starts cold motors quickly. Saves gasoline, operates from light current. Postpaid \$1.95. Harris Machinery, Minneapolis, Minn.**

**ELECTRIC Soldering iron and tool marker combination \$1.00. Growler \$5.00. Spot welder \$5.00. 30 amp. a.c.-d.c. welder close-out \$3.50. Frazee Electric, Box 5086, San Francisco 1, Calif.**

**GARAGE Doors dashboard controlled. Additional information under "Automobiles."**

#### ELECTRIC FENCING

**ELECTRIC Fence controls for sale. Mechanically reconditioned. Guaranteed. 6 volt d.c. \$7.95 and \$9.95. 110 volt a.c. \$12.95. Horan & Son, 211 No. 7th St., St. Louis, Mo.**

#### BATTERIES, GENERATORS, ETC.

**THE Battery with fifteen lives, six volt Willard for electric fences, ignition, etc., stand by service \$8.95. Will ship c.o.d. M. C. Solon, 2410 E. 8th St., Duluth 5, Minn.**

**EDISON Batteries. Light. Power. Fifteen Year life. Five year guarantee. Complete lighting plants. Free literature. See Jay Company, 321 Yonkers Avenue, Yonkers, New York.**

#### WELDING, SOLDERING, PLATING

**MULTIWELD Model "150" heavy transformer a-c welder, 110-220 volts. Hair-line control, over 200 heats, 1/16" to 3/16" rods. Garages, shops, farmers—free folder. Phillip Wilson, 309-E Bridge, Streator, Ill.**

**WELDING Rods; all kinds, all sizes. Trial package 25c; literature free. Western Welding Wire Co., 125 So. Santa Fe Ave., Los Angeles 12, Calif.**

**ARC Welders wanted by the thousands. Learn with 516 page lessons manual. Over 500 how-to-do-it photos. \$2.00 copy. Money-back guarantee. Hobartweld, Box M-254, Troy, Ohio.**

**NEW Model electric welder 110 volt a.c.-d.c.; will weld all metals; easy to use; full directions. Complete with power unit, flame and metallic arc attachments, carbons, fluxes, rods, mask; all for \$19.95. Used by the navy. Magic Welder Mfg. Co., 239-MP2 Canal St., New York City.**

**RODS, Arc welding. 75 assorted, general purpose, 1/16", 3/32". Guaranteed fine for all a.c. and d.c. welders. One dollar post paid in states. Two for \$1.75. Little Welder Co., 15766 Blackstone, Detroit 23, Mich.**

**NEW Transformer a.c. welders \$20.00 to \$100.00. Chicago a.c. welding rod, any quantity. Catalog. Frazee Electric, Box 5086, San Francisco 1, Calif.**

**SLIGHTLY Used arc welders. Recommended by R.E.A. Guaranteed. Forney Mfg. Co., Fort Collins, Colo.**

**BUILD A.C. arc welder 100, 200, 300 amperes. Plans \$1.00 each. Welders Club, AB-3432, Chicago 54.**

**A.C.-D.C. 1/8" Welding rods. Coated mild steel (without priority). 50 pound cartons \$5.00 l.o.b. Welders Club, AB-3432, Chicago 54.**

**WELDING, Cutting, aircraft welding and soldering equipment. Electric arc welders. Superior Oxy-Acetylene Co., Hamilton, Ohio.**

**SUPER Welder—For home, farm, factory. Makes every beginner an expert. Improved on type used by Navy. Fully equipped with Metallic Arc and Flame Torch handles, carbons, rods, fluxes, mask, etc. Complete directions. Operates ac-dc, 110 volts. No extra wiring needed. Guaranteed. \$19.95. Save 25c, send check with order. Super Welder Manufacturing Co., Dept. A, 23 East 20 Street, New York.**

#### MACHINERY, TOOLS AND SUPPLIES

**CLOSING Out. Machinery. Tools. Motors. Garage, welding supplies. Hardware, sporting, electrical goods. Miller planner, cutters, lathe, chucks, indexer. Woodworking, saws, dados. Scarce pre-war articles. No lists, write your wants, enclose stamps for reply. Zeidler's, Rockwell, Iowa.**

**PATTERN And model supplies, hardware, tools, castings, pulleys, belts, taps, saw mandrels. Catalog 10c refunded. Terek Sons, 6304 Patterson, Chicago 34.**

**CONSTRUCT Your own machine tools from Lewis castings, materials and blueprints, supplied complete at a fraction of new tool cost. Mills, shapers, vises, band saws, jointers, etc., are ideal for a whole range of home or commercial shop work. Send 10c to cover mailing of catalog listing 23 items. Lewis Machine Tool Co., Box 116, Station A, Dept. M-49, Los Angeles 31, California.**

**BUILD \$500 Precision milling machine from drill press. No castings needed. Plans and drawings \$1. Rhodes Engineering Laboratory, 40 Oak St., Ramsey, New Jersey.**

**HANDY Assortment, bolts, nuts, and washers, used for every practical purpose. 5 full lbs. \$1.49 prepaid. No c.o.d. C. Dittman, 3245 Bailey Ave., Buffalo, N. Y.**

**EXPERIMENTERS—400 Valuable springs, 75 kinds, all sizes, 10,000 uses. \$2.00. Jumbo assortment, \$3.85. Naco, 29-B Lancaster, West Hartford, Conn.**

**USED High speed drills, taps, reamers, countersinks, lathe bits, tool steel milling tools. Bargains Tool Co., 205 Hill Ave., Portsmouth, Va.**

**DECIMAL Equivalent chart, 12"x18". 50c. Fay, 8, Ardsley Court, Newark 2, N. J.**

**CONCRETE Building block machines and molds. Easy payments. Catalog free. Concrete Machine Co., 5129 South Compton Ave., St. Louis 11, Mo.**

**UNIVERSAL Tools. Dandy 8 piece set: CeeTee pliers, vise-grips, channellocks, adjustable wrench, needle-nose plier, diagonal cutters, hammer, screwdriver—\$14.85. Remit with order. Other tools needed? Dealers Tool Supply, 1527 Grand, PM, Kansas City, Mo.**

**GRIND Drills any twist in three different point angles like factory. Sold at large chain stores or factory \$2.95 prepaid. Guaranteed. 1512 West Slauson, Los Angeles 44, California.**

**IT'S New—Foot pedal starter and reverse. Controls motors on lathes, drills, etc. Circular free. Factory. Tractor-Lite Mfg. Co., Spirit Lake, Iowa.**

**TWIN-CYLINDER Air compressors \$17.75. Motors. Hoffman, 6840 Parrish, North College Hill 31, Ohio.**

**DRILL Grinder**—Original patented precision sharpener. Grinds drills to factory accuracy. Calipers with direct reading scales. Circle cutters. New tool grinder. Lowest prices. Free literature. Factory, 811-B East 31st, Kansas City 3, Mo.

**INDEX Heads** for sale. Very inexpensive. Sixty-two different divisions. Used on small lathes, drill press, milling machines, etc. Make gears, hobbs, cutters, etc. Very accurate, and durable. Not a toy. Used by defense schools and hobbyists. Write for free folder. Long's Index Heads, 2117 East B St., Torrington, Wyo.

#### BOATS, OUTBOARD MOTORS, ETC.

**OUTBOARD** Motor parts, new and used. Too large a stock to list, write us your requirements. Children's swim belts, life preserver cushions. Dixons graphite gear grease, tube 50c, prepaid in U. S. Sifty trolling plates \$1.00. Outboard Motor Mart, Inc., 315 Atlantic Ave., Boston 10, Mass.

**TEN Plywood boat plans** 50c. Catalog boat building plans 10c. The Rudder, 15 Murray Street, New York.

**SAILKITS** 100 Square feet \$13.90, sailboat equipment, motorboat-canoe-kayak equipment. Rope, canvas, airplane dope, cement, boat paints, carbide lamps, carbide. Army pup tents, blankets, messkits, canteens, knives, cot covers, hammocks, haversacks, holsters, etc. Catalogue. Alan-Clarke, 100 Chambers, New York City.

**OUTBOARDS:** Latest bulletin available on rebuilt motors. Good used parts most makes and models. Crandall-Hicks Co., 959 Commonwealth Ave., Boston, Mass.

**MAKE 16' Rowboat.** Blueprint, 30c. Wesho-Uco, Box 51, Detroit, Mich.

**INBOARD** Marine motors, propellers, fittings, conversions. Charles Stokes, Coldwater, Michigan.

**FULL** Size, cut to shape boat patterns, blueprints. 7½ - 38 feet. Illustrated "Build a Boat" catalog, 10c (coin). "How to Build Boats" book, \$1.00. Cleveland Boat Blueprints Co., Dept. A-66, Cleveland, Ohio.

**BOAT** Designers are highly paid professionals. Complete course by mail. Catalog. Westlawn, Montville, N. J.

**MARINE** Power—Easily convert any Ford motor (domestic and foreign) with Osco parts and kits. Complete catalogue 25c (coin). Osco Motors Corp., 2020 East Orleans Street, Dept. M, Philadelphia 34, Penna.

**USED** Outboard motor parts. Outboard Exchange, 1194 Remsen Ave., Brooklyn, 13, N. Y.

#### ENGINES, MOTORS, DYNAMOS

**MODEL** Locomotives, gas, steam engines. Supplies catalogue 25c. Welding rod without flux for aluminum, die cast, pewter. Samples and instructions 25c. Howardco, A3-2417 Ashland, Chicago 14, Ill.

**BIG** Pay jobs in welding. Complete welding lessons and reference books. 516 pages. 41 lessons. \$2.00 copy. Money-back guarantee. Hobartweld, Box 255-M, Troy, Ohio.

**WINDING** Data, listing 225 motors, single and three phase, \$1.00. Motor Data Co., Box 7631, Kansas City 3, Mo.

#### ATHLETIC EQUIPMENT—BODY BUILDING COURSES

**HAND** Balancing is thrilling! Easily learned. W. Power, 923 W. Vine, Kalamazoo, Michigan.

**BOYS!** Become strong, athletic. Course, boys' paper, inspiring athletic stories—25c. Young America, 20 Penn Ave., West Reading, Penna.

**SUPER** Ju-Jitsu—lightning attack and defense system. Lick brutes twice your size with only your bare hands! Fear no man! Sensational new home study course now ready. Bargain. Free details. Write —Narbon Company, Dept. 5-02, Chicago 4.

**BAR-BELLS.** Exercise equipment. Courses. Special offers! Free booklet. Good Barbell Co., 3261-PM Watson Rd., St. Louis (9), Mo.

#### SPORTING GOODS, GUNS, FISHING TACKLE, ETC.

**INDIAN** Trapping and fishing secrets, handbook 50c. Chief Blackbird, 679-P Dupont North, Minneapolis, Minn.

**DEVON'S** Gold or silver in any quantity. 1½, 1¼, 1½, 4½ inch. The price is right. Victor G. Flebotte, 51 State St., Springfield 3, Mass.

**GUNS** Refinished like new by factory methods, as used by leading gun manufacturers. Send for circular. Middletown Metal Finishing Company, 45 River Road, Middletown, Connecticut.

**BUILD** Powerful, accurate bow gun. 1000 inch-pounds muzzle energy. Will kill largest game. Plans and drawings \$1.00. Rhodes Engineering Laboratory, 40 Oak St., Ramsey, New Jersey.

**AMMUNITION** Available to qualified purchasers. List 10c. Rudolph's, Atchison, Kansas.

**BUILD** A paddleboard: Easy to make, wonderful water sport riding. Will hold up to 300 pounds. Complete plans \$1.00. Dan's, 1507 Kenneth Road, Glendale, Cal.

**RIFLES**—22 Reising Automatic with Redfield sights and 1,000 long rifle cartridges; \$70.00; also Reising 45 Automatic Carbine and 200 factory reloads, \$72.50. Both new guns. Extra .45 reloads, \$2.25 box of fifty. E. C. Morrison, 322½ S. Sixth, Springfield, Ill.

**SPORTSMAN'S** Encyclopedia, 514 pages, over 1,000 illustrations. All about the outdoors! Camping, fishing, hunting, trapping, scouting, \$3.00 postpaid. Henry Schultz, Route 2, Pascagoula, Mississippi.

**ARCHERY** Equipment: Catalogue free. Mid-West Archery, 2209-A East 75th, Chicago 49.

**THE** Lord is coming! Get guaranteed proofs free. Scheall, 263XS, Duluth, Minn.

**LEARN** Gunsmithing at home. Earn money repairing neighborhood's firearms. Catalog 25 firearm and gunsmithing textbooks for 3c stamp. Samworth, Plantersville, South Carolina.

**ELEVEN** Good box traps. Complete blueprints, 30c. Wesho-Uco, Box 51, Detroit, Mich.

**BOWS**—Arrows for recreation, hunting, fishing. Beautiful archery instruction book, 70 pages, 50 illustrations, only 50c. Illustrated catalogue free. Archery Sales Service, 617 South State, Chicago.

**NETCRAFT** Kit:—Make landing nets, turtle traps, live nets, hammocks. Dollar bill brings: large, medium, small shuttles (patented), gauges, illustrated instruction booklet. Smaller kit:—Medium shuttle, gauge, booklet—50c. Netcraft, Dept. B, Toledo, Ohio.

#### FIELD GLASSES, MICROSCOPES, TELESCOPES

**REAL** 10 Power telescopes \$1.90. United, 2309-B Lawrence, Toledo, Ohio.

**MICROSCOPES.** Telescopes, binoculars; all scientific, chemical, laboratory apparatus—bought, sold, exchanged, repaired. Highest prices paid. Trial will show we know our business. Catalog 15c. Harry Ross, 64 W. Broadway, New York City.

**MAKE** Your own powerful, efficient astronomical telescope. Perfect lenses and instructions. 50X \$1.00. 100X \$2.50. 200X \$3.50. 400X \$5.50. Instructions alone 10c. Carl Jamer, Manorville, N. Y.

**ASTRONOMICAL** Telescopes, binoculars, cameras, microscopes; bought, sold, repaired. Send 10c for list of instruments wanted. Rasmussen & Reece, 41 Market, Amsterdam, N. Y.

**MAKE** Your own efficient compound microscope. Lenses and instructions 50X \$1.00. 100X \$1.50. 200X \$2.00. Instructions alone 10c. Carl Jamer, Manorville, N. Y.

#### ANTIQUES, RELICS, INDIAN GOODS, CURIOS

**INDIAN** Relics, coins, bills, gems, crystals, curios, etc. Illustrated catalog 5c. 100 ancient arrowheads \$3.00. H. Daniel, Hot Springs, Ark.

**MUSEUM** Supplies, Indian relics, pottery, firearms, fossils, curios, minerals, den decorations. Illustrated catalogue 25c. Museum Supplies, 6601 Oshkosh, Chicago 31, Illinois.

**SWORDS,** Rapiers, daggers, pistols, armor, illustrated catalog 25c. Robert Abels, 860-A Lexington Ave., New York.

**FIVE** Stoneage Indian tools 50c. Catalog 5c. Sistershop, Northbranch, Kansas.

**20 GENUINE** Indian arrowheads. \$1.00. Cat. Geo. Holder, Glenwood, Ark.

**MINERALS,** Coins, stamps, Indian relics, pistols, old glass. Catalogue 5c. Cowboy Lemley, Las Cruces, New Mexico.

**INDIAN** Relics, beadwork, coins, curios, minerals, old glass. Catalog 6c. Indian Museum, Osborne, Kansas.

#### DOGS, PETS, BIRDS, RABBITS

**BEAUTIFUL** Registrable collie pups \$14. Rosevale Ranchlet, New Liberty, Illinois.

**STANDARD** Rabbit Journal, Milton, Pa. 3 years \$1.00, sample dime.

**RAISE** Rabbits for us. We pay \$9.00 to \$18.00 each. Continuous market. Price guaranteed. Literature 10c. Hansens Rabbitry, 1347 Miller Ave., Salt Lake City 5, Utah.

**FANCY** And utility pigeons—Catalog 5c. William Howe, Princeton, Illinois.

**METAL** Dog tags. Your name, address, 25c coin, 5 for \$1.00. Collar plates (¾x2") 35c. Mail Products, Box 97E, Mendota, Ill.

**\$10.00** POUND, Angora rabbit wool, we supply good rabbits, and buy wool. Particulars free. House of Angora, 1848 So. 18th, Springfield 5, Illinois.

**RACCOONS,** Minks, skunks—bred females. Catalog, 10c. Shady Fur Farm, Springfield, Minnesota.

**PUPPIES** And supplies; also pedigreed Flemish Giant meat rabbits and supplies; what do you need? Royal Kennels, Chazy, N. Y.

**FARM** Raised registered Irish Setter puppies. Write Earl Bond, Albert Lea, Minnesota.

**MONEY** Raising rabbits. Investigate. Folder 10c. Close Rabbitry, Tiffin, Ohio.

**RAISE** Giant Chinchilla rabbits. Willow Farm, R15C, Sellersville, Penna.

**LEARN** All about Angora rabbits—wool brings \$9.00 pound. Book tells everything. "Angora Care-Management" regular \$1.50, special \$1.00. Catalog Angoras free. Grinsteads, Dept. 15, Edwardsville, Illinois.

**ST. BERNARD** Pups: Champion sired beauties. Franklin Young, R4, Riverhead, Long Island, New York.

**MICE,** Rabbits, pigs, pigeons. Information 10c. Jim Houck, Tiffin, Ohio.

**RAISE** Guinea pigs. Make money at home. Big demand. Free booklet. Taylors Guinea Pig Farm, Hapeville, Georgia.

**RAISE** Rabbits for profit. Magazine puts you in touch with markets. Copy 10c. Booklet describing twenty breeds, and magazine for three months 25c. Address American Small Stock Farmer, Dept. 3, Pearl River, N. Y.

**RABBITS:** Flemish Giants, New Zealand. Reasonably priced. Franklin Young, Riverhead, Long Island, New York.

**RAISE** Moneymaking Angora rabbits. Wool \$9.00 pound. Plenty markets. Particulars free. White's Rabbitry, Marion, Ohio.

#### SEEDS, PLANTS, NURSERY STOCK

**DAHLIAS**—Ask for book—400 varieties. Springfield Dahlia Farm, R. 2, Box P, Grand Rapids, Mich.

#### FARMS, FARM LANDS, REAL ESTATE

**FARM** Bargains. Free catalog, 7 mid-west states. Many fully equipped for convenient quick start. Many pictures. Special service to help you locate quickly, if you state requirements, payment plan and general location desired in first letter. United Farm Agency, 7-MP South Dearborn, Chicago 3, Ill.

**OZARKS** Guide, Lonsdale, Arkansas. For homeseekers, sportsmen, folklorists. Year, \$1.00.

**"EVERY** Good book on country living." Free 16 page money-saving catalogue. A treasury of expert advice and knowledge. Covers home gardening to full time farming for profit and pleasure. Country Bookstore, Noroton 27, Conn.

**FARM** Catalog mailed free. Hundreds of bargains New York, Connecticut, New Jersey and 23 other states Maine to Fla., west to Texas, California and Oregon. Strout Realty, 255-P 4th Ave., New York City 10.

**WEST'S** 1945 Catalogue hundreds farm bargains and business opportunities; including many best buys in Penna., New York, New Jersey, Ohio, Delaware and Maryland. For free copy write West's Farm Agency, HE, Pittsburgh 16, Penna.

**ONTARIO** Property with lake frontage. Excellent hunting, fishing territory cheap. Inquire C. Greenwood, 3393 Glenwood, Toledo 10, Ohio.

**GOOD** Farms—Ranches. Washington, Minnesota, Montana, Idaho, Oregon, North Dakota. Dependable crops, favorable climate. Write for literature, lists describing typical farms. Specify which state. J. W. Haw, 119 Northern Pacific Ry., St. Paul 1, Minn.

**HOMESITES** \$200.00. On easy payments. In California's loveliest garden spot on wooded shores of Morro Bay, midway between Los Angeles and San Francisco. Wonderful fishing, boating, hunting. Excellent soil, soft water. Grow fruits, vegetables, poultry, etc. Unusual investment opportunity. Free literature. Richard Otto, Dept. M, 6586 Hollywood Blvd., Hollywood 28, California.



\$5.00 MONTHLY Buys 40 acres, near town; price \$175.00. Free list. Box 425-P, Carthage, Mo.

OKARK Farm bargains. 5 to 5000 acres. Frank, Mountain View, Mo.

#### FARM MACHINERY AND SUPPLIES

**BUILD AT HOME**—Your own garden tractor. Complete blue prints and material specifications \$1.50. Automotive Division—Elmore Project Engineering Laboratories, 5058 Alhambra Ave., Los Angeles 32, California.

**TRACTOR** Light, practically indestructible, rugged welded construction, special sealed beam lamp \$9.80 each. Ted Riseman, 427 East Jefferson, Springfield, Ill.

**NEW FARM** machinery book. Learn your farm machinery better. A time and money saver. \$1.00 postpaid. Wirtson's, West Burlington, Iowa.

#### POULTRY AND FARM SUPPLIES

**RAISE Poultry** for profit! Learn how others succeed. Read America's leading poultry magazine. Subscribe! Two years, 50c; five years, \$1.00. Poultry Tribune, Dept. 30, Mount Morris, Ill.

**YOUR** greatest poultry problem will look simple when you read American Poultry Journal regularly. 500,000 poultrymen do, why not you? Only 25c year, 5 years \$1.00. American Poultry Journal, 537 South Clark, Chicago.

**BABY** Chicks, champion mated. 52 varieties. 7 hybrids, licensed inspected, bloodtested. Rush postal, large colored book, low prices. Berry's Farm, Route 12, Clarinda, Iowa.

**RAISE** Turkeys the new way. Write for free information explaining how to make up to \$3000.00 in your own backyard. Address National Turkey Institute, Dept. 3, Columbus, Kansas.

**KNOW** How to raise poultry for profit. Read Northeastern Poultryman. Every issue packed with helpful hints and practical suggestions. Latest articles on breeding, feeding, and management. Read nationally. Subscribe now. 1 year 65c; 2 years \$1.00. Northeastern Poultryman, 376 Boylston St., Boston 16, Mass.

#### PROFITABLE OCCUPATIONS

**ELECTRICAL** Appliance repair. Open your own shop. Learn house wiring; electric motors, vacuum cleaners, washers, etc. Complete illustrated course shows how. Free booklet. Pacific Training School, Dept. AP-2, 4703 West Pico, Los Angeles 6.

**FOR** An extremely profitable lifetime business, operate a collection agency-credit bureau. Easily learned. Free folder. Cole Associates, Syracuse, N. Y.

**HOMEWORKERS**, Make, sell, shell novelties. Beginners samples, instructions, \$1.00. Temple, 224-6th Ave. S., St. Petersburg, Fla.

**EXCLUSIVE** Permanent—Could start sparetime. Enclose stamps. South, S-1026 Gunderson, Oak Park 34, Illinois.

**PANNING** Gold for vacation expenses or occupation. Free literature on book for beginners and equipment. Old Prospector, Box 878K75, Oakland 4, Calif.

**MUSHROOMS** Grown in boxes. Instructions 50c. Spawn \$1.00. Gordon, 553 William, Winnipeg, Manitoba.

**MECHANICALLY** Inclined men—Own and operate general appliance repair shop. Complete, illustrated course shows you how. Welding, refrigeration, motor repair, how to get business, etc., all phases covered. Free literature. Christy Supply Dept. 449, 2835 N. Central Ave., Chicago.

**WELDING** Pays. Learn with 1942 trade school text manual. 516 pages. Over 500 photos. \$2.00 copy. Money-back guarantee. Hobartweld, Box M-253, Troy, Ohio.

**LEARN** Wood carving. Instructions 25c. Karving Kraft, Box 221, Clovis, New Mex.

**"FROG Raising"** New book tells how. Profitable. Marlboro House, 1035 Marlborough, Detroit 15, Michigan.

**TYPEWRITER** Repairing—Original course, simplified home study. Weber Typewriter Mechanics School, Box 269, Osborn, Ohio.

**ANNOUNCING** New home study course in commercial baking. Good field. Nearly depression proof. Common school education sufficient. Send for free booklet "Opportunities in the Baking Industry" and requirements. National Baking School, 1315 Michigan, Dept. 3431, Chicago.

**TYPEWRITER** Repairmen urgently needed. Earn \$40 to \$50 weekly spare time. Our easy to learn home study course teaches how to repair typewriters. Write for free information. Houston Typewriter Repair Service, P.O. Box 5357C, Houston, 12, Texas.

**LOCKSMITHING**—Profitable business or hobby! New course teaches you how to pick locks, set keys, de-code, masterkey, etc. Easy self-instruction lessons. Bargain price. Free details. Write—Nelson Company, Dept. 7-02, Chicago 4.

**SEABEES**, Send for set of sensational Seabee cards. Free. Pety Studio, 3310 West 65 Street, Chicago 29, Ill.

**EXCEPTIONAL** Profits raising mink. Finest breeding stock available. Details furnished. Franklin Young, Riverhead, Long Island, New York.

**POSTWAR?** Prepare now to become associated with us in an essential proven profitable profession. Universal Exterminators, 950 Margate Terrace, Chicago 40, Illinois.

**GOLD-STAMPING**. Exceptional postwar opportunity. Free booklet. Home City Specialties, Dept. 1273, Springfield, Massachusetts.

**ELECTRIC** Clocks are everywhere you go. buildings, homes, parking-lots, factories. Repairs increasing. Our easy to learn course with pictures and drawings teach you how to repair these clocks. Electronic Supply Co., Dept. A, P.O. Box 2350, Houston 1, Texas.

**\$40.00 WEEKLY**. Made growing mushrooms, fresh, dried. Dominion patent 331583. Free spawn. North American, 169P Yonge, Toronto, Canada.

#### BOOKS, PERIODICALS, PICTURES, POSTCARDS

**YOUR** Opportunity—We supply all technical, hobby books. Plastics, refrigeration, airconditioning, optics, electronics, automobiles, electricity, television, chemistry, mathematics, woodworking, building, construction, watchmaking, homecraft, farming, sports, photography, occultism, magic, character reading, home-making, etc. Request free catalogue specific subjects interesting you. Modern Technical Book Co., Dept. MMC, 55 West 42nd St., New York 18.

**MAGAZINES**—Choose current single copies you need from our list of more than 600 different business, vocational and diversion periodicals. You will profit by being posted on conditions, developments and opportunities in your line through magazines devoted to it. Write now for free price-list. Commercial Engraving Publishing Company, 34C North Ritter, Indianapolis 1, Indiana.

**BOOKS**—Tell us your wants. Chapbooks, 6 Girard, Rochester 10, N. Y.

**PIN-UP** Girls—Two new selections, each containing 10 gorgeous lovelies. "Interesting poses," actual photographs size 2½" x 3½", just like you'd take with your camera. 25c each selection, 5—\$1, postpaid, mailed in envelope. (Order 5 selections, each series, \$2, receive packet invasion scenes free.) Lloyds, 1141-Q Northwest 17th, Oklahoma City 6.

**BOOKS**—For architects, artists, craftsmen, collectors. Send for catalog. B. R. Arterraft, Box 6827, Baltimore 4, Md.

**PIN-UPS**. All kinds. Write. Novelty Studios, 301-A Eldred, Battle Creek 21, Mich.

**MACHINIST'S** Reference book. Tables, drafting, hardening helps, shop trig. \$1.00 postpaid. G. A. Knudsen, 523-48th St., Brooklyn 20, N. Y.

**SAVE** Money by writing for our lists of special cut-rate books, many at less than 50% of original price. Pines, Box 32, Flushing, New York.

**MAGAZINES** (Back dated)—foreign, domestic, arts. Books, booklets, subscriptions, pin-ups, etc. Catalog 10c (refundable.) Cicerone's, 863 First Ave., New York 17, N. Y.

**BEAUTIFUL** Pin up girl pictures. Attractive poses. 24 for \$1. United Arts, 2309 Lawrence, Toledo, Ohio.

**ACTUAL** Photos of army maneuvers. 8" x 30" for framing. Sample 10c war stamp. 205 Hill Ave., Portsmouth, Va.

**MEN:** Girl pictures, various kinds. Sample lists, 10c. Variety, 1242 Lilac Place, Los Angeles 26, Calif.

**BEAUTIFUL** Colored pictures. No girls. Lists free. Curtis, Box 1916, Denver, Colo.

**MODERN** Steam car \$2.00. Floyd Clymer's Historical Motor Scrapbook \$1.50 postpaid. See our advertisements under Automobiles and Motorcycles. Clymers, 2125 W. Pico, Los Angeles 6, Calif.

**VIEWCARDS!** 20 Assorted Chicago scenes 25c. Satisfaction guaranteed. Arlie Long, Forty-Four, Arkansas.

**BOOK** That shows how to understand yourself and others. Key to success, happiness, wealth. Health, educational and other books. Literature free. Premiums. J. Henry Schlake Specialties, Box 813, Cincinnati 1, Ohio.

**25 HOLLYWOOD'S** Best postcards 25c. 25 beautiful homes of movie stars 25c. 25 famous California scenic views 25c. 25 gorgeous colorful glamour girls 25c. "Secragra"—System of 1000 codes 25c. All five —\$1.00. "Postapuz!" game free! Postapress, Box 3150, Hollywood.

**UNUSUAL** Pin-ups! Real photographs! 10—\$1; 25—\$2. Fine-Arts, Box 2084-K, San Antonio 6, Tex.

**OUTSTANDING** Books! Sample and lists 25c. "Association," Box 2501-P, Los Angeles.

**PICTURE** Yourself successful—Free information. New original idea—brings more dollars to you. W. H. Cook, 102 Walnut, Hot Springs, Ark.

**50 ARTISTIC** Pictures \$1.00. Lists 10c. Western Sales, Jillstreet Blvd., Los Angeles 14.

**WHAT** Every Mason wants. We have Masonic books for Blue Lodge, Chapter, Commandery, Scottish Rite and Shrine. Our rituals are used the world over. Send for free catalog of books and rituals for Masons, Odd Fellows, Knights of Columbus, etc. Ezra A. Cook, Publisher, P.O. Box 796, P.F., Chicago 90, Ill.

**TEXAS** Viewcards, 3—10c. Information free. Box 7PM, Naples, Texas.

**PHOTOS** Of beautiful models, 3¼x5½. Attractive, good selection. You'll be pleased. 35 for \$1.00. Richardson's Studio, Wyoming, Penna.

**DAZZLING**, Glamorous "pin-ups," "world beater assortment." Not 6, not 12, but 15! (5x7) beauties, only 35c. National Distributors, Dept. M, Box 57, Muskegon Hts., Mich.

**PICTURE** Post cards for hotels, resorts and advertising purposes; produced from your photograph. 4154A Fifth Street, Philadelphia 40.

**"100,000 POST-WAR** Jobs abroad"—South America, Asia, Africa. How, when and where to apply. 15,000-word, copyrighted forecast—\$1.00. Return for refund in 7 days if not satisfied. Pacific Industrial Research Bureau, 202-P Studio Building, Portland 5, Oregon.

**SENSATIONAL**. New self help books, Security Acres, tells how to create income outdoors. Character at a Glance. If It's Wealth You Desire, each \$1.00. Gold Ahead \$2.50. Interesting details free. White, 528 Brooks, Dallas 8, Texas.

**1280 PAGE** Illustrated encyclopedia. Postpaid \$2.98. John Racksowa, 44 E. Win Place, New Britain, Conn.

**DRUNKENNESS** is a disease which responds to treatment. Medical skill plus human sympathy prove successful with liquor and drug cases. 60 years experience. Write for free booklet. P. M. Nelson, The Keeley Institute, Dwight, Ill.

**OLD**, Rare and unusual books, sold and exchanged. New current books and magazines at bargain prices. Free catalogue. Banker Book Co., 610 S. Broadway, Suite 623, Los Angeles 14, Calif.

**12 PIN-UP** Girls 50c and 3c stamp; foreign 12c extra. Selson, 1919 Girard Ave., Philadelphia 30, Penna.

**GORGEOUS** Girl photos, books, etc. 15 samples 25c. Richardson, Wyoming, Pa.

**REBINDING:** We bind magazines, old books, Bibles, hymnals. Heckman Binder, Dept. D, North Manchester, Indiana.

**A RATIONAL** View of Life \$1.00. Benjamin Seibert, Urbana, Ohio.

**64 ART** Cards of gorgeous beauties \$1.00. Reed Novelty, Dept. PM-6, Box 24, Queens Village 9, N. Y.

**"PIN-UPS,"** 180 Gorgeous girl subjects! Huge bargain pack \$1.00. Clover Novelty Company, Dept. 37-DD, Hollis 7, N. Y.

**ARTISTIC** Girl pictures. Real models. 40 photos for \$1.00 postpaid. All different, postcard size. C. A. Scott, P.O. Box 342, Covington, Ky.

**GORGEOUS** Full-color pin-ups, 50 different \$1.00. 160 different \$3.00. Samples 10c. Theron Fox, 1024-B Carolyn, San Jose 10, California.

**"POOLIES"** Contains cartoons, gags, stories. 10c. Alstone, 406, Lunenburg, Mass.

**PIN-UPS**, Gorgeous girls, full color. Sample 8x10 and 3¼x5½ 10c. Arthur Fowler, Room 1, 697 Broadway, Somerville 43, Mass.

**SELF-EXPLAINING** Bible: Illustrated circular free. Box 446-P, Minneapolis, Minn.

**BOOKS**. (Out-of-print, new, used) quickly supplied. Many 35c bargains. Catalogue. T. Jamkowski, 18870 Marx Ave., Detroit 3, Mich.

## GAMES AND ENTERTAINMENT

**COMEDY** Scripts catalog free! Kleinman, 25-31-B 30th Road, Long Island City 2, New York.

**TWELVE-WAY.** 52 Cards, Joker. \$1.00 prepaid. Box 842, Denver, Colo.

**GOOD** Luck midget Bible, postage stamp size, carry always. 25c postpaid. Grover Publications, 390B Bartlett, San Francisco 10, California.

### MAGIC TRICKS, PUZZLES, JOKER NOVELTIES

**JOKES, Tricks,** at wholesale. Jobbers, storekeepers, pitchman, salesmen. The lad is sweeping the country. Send for list. Schwamm, 237 East Ninth St., New York City.

**AMAZE,** Mystify, entertain. Two magic boxes and dollar trick given. Dime brings details. Astral Guild, 1000 Stelzer, Columbus 3, Ohio.

**MAGIC** Is fun! Send \$2.00 for apparatus to perform 10 different startling tricks. Guaranteed \$5.00 value! Free, with your order, book of "102 Tricks." Robbins Co., 152-P West 42nd St., New York.

**NOVEL** Trick with illustrated list, puzzles, novelties, only 10c. Elton Johnson, 2406 Anson Road, Dallas 9, Texas.

**MAGIC:** Big 168 page illustrated Catalog Latest Magic Goods, 25c. For over 1/3 century we have supplied Professional as well as Beginner. Chicago Magic Co., 2300 N. Mason, Chicago 39.

**LEARN** Ventriloquism. Be popular. Details free. Gotberg, 15801 Prest, Detroit 27, Michigan.

**EASY** Money daily with astounding unbelievable trick. Worth dollars. Only 25c. Twenty big-profit circulars free. United Profit Builders, 305-M West 8th, Los Angeles 14, Calif.

**WORLD'S** Most fascinating puzzle. One dollar. Darden, Box 525, Chicago.

**1/2 LB.** Novelties, funcards, tricks. Two dimes. Air-Age, Box 5033, Chicago 7.

**MAGIC** Envelope 10c. Insert blank paper—pull out dollar bills. Astonish your friends. Magic Mart, 1423 Palou, San Francisco 24, Calif.

**MAGIC** Liquid transfers pictures off funnies, newspapers, etc., to handkerchiefs, cloth, paper. Lotsafun. 50c bottle, \$3.10 postpaid. No stamps. National Specialty Service, Manassas, N. J.

**WORLD'S** Largest professional magic shop keeps you in touch with latest tricks. To receive mailings send 25c for new catalog. Holden, 220 W. 42nd St., New York.

**SEND** 25c For \$1.00 worth of magic tricks and latest catalog. Ball Square Company, 697 Broadway, Somerville 44, Mass.

**TRICKY** Match box, it turns around! It stands up! and it opens, most weird, uncanny magic novelty trick, complete, ready to do. 25c. Magic Shop, 2463-M Kensington Ave., Philadelphia, Penna.

**QUALITY** Magic since 1907. Five professional catalogs. 5 for \$1.00. Thayer's, P.O. Box 1785, Wilshire-LaBrea Station, Los Angeles 36, Calif.

**FREE** Amazing new pocket trick. Prepaid to you for the asking. Bergex Company, 742 Market Street, San Francisco, California.

**TEN** Professional tricks with equipment \$5.00. Ten amateur tricks \$2.00. Magic package 25c. Magic Den, 612PM Pine, St. Louis, Mo.

**BRAND** New magic and fun magazine, 15c. Contains exciting cash prize contest. Real fun. Phoenix, 945-A Chancellor, Irvington 11, N. J.

**VENTRILQUISM.** Complete instructions only \$1. Lesueur, 77 Wellesley, Toronto, Canada.

**6** MAGIC Tricks and clever novelty 10c. Victor Jones, Parma, Missouri.

**ENTERTAIN!** Mystify! New, bigger magic catalog and 4 secret tricks 25c. Herbert, P-192 N. Clark, Chicago 1.

**500** TRICKS You can do! Douglas' famous catalog of 500 tricks, now only 10c. America's fastest service on magic for pocket, parlor, stage, professional, amateur. Douglas Magic Shop, Box 274, Dallas, Texas.

**AMAZE** Everyone. Answer unspoken questions. Professional "no assistant" mindreading act. \$1.00. Magical Enterprises, Box 111-P, Levering, Mich.

**NEW!** Simplified card tricks! Amazing self-working bafflers 50c postpaid. James W. Roundtree, 529 Elliott St., River Rouge, Michigan.

**LEARN** Ventriloquism, 3c stamp brings particulars. Smith, 801 Bigelow, Peoria, Illinois.

**BE** A magician. Large professional magic catalogue of latest tricks 25c. Ireland, C-109 North Dearborn, Chicago 2.

**MAGIC** Tricks, puzzles, books, cards, punch boards. Catalog 10c. Specialty, Box 671, St. Louis 1, Mo.

**NEW** Vanishing key and catalog 25c. Sterling Magic, 345 John R, Detroit, Mich.

**EARN** Money in any crowd. Call names of strangers, tell unspoken questions. Professional course mind reading, spirit writing, etc., \$1. Henderston, Box 341, San Bernardino, Calif.

### COINS, TOKENS, CURRENCY

**FIVE** Foreign bills, 25c; twenty-five different \$1.00. Beffel, Box 37, Ottawa, Ill.

**35** INDIAN Heads mixed \$1.00. Morgan quarters 35c. 2500 coins. Large illustrated list. Send 3c postage. Leo Greenstreet, Union, Mo.

**WILL** Pay \$10.00 each for certain Lincoln pennies! Indianheads \$50.00; dimes \$1,000.00. Catalogue 10c. Federal Coin Exchange, 2-PM, Columbus, Ohio.

**THREE** Coins 15c. 10 Austrian bills 10c. Oddehon, Box 482, St. Louis, Mo.

**OLD** Money wanted. Do you know that coin collectors pay up to \$100.00 for certain U. S. cents? And high premiums for all rare coins? We buy all kinds. Send 4c for large coin folder. May mean much profit to you. Numismatic Co., Dept. 20, Fort Worth, Texas.

**4** ROMAN Coins 2000 years old \$1.00. 30 different foreign coins \$1.00. 100 different \$4.00. 43 mixed Indian cents \$1.00. Lists, approvals. Delmonte, 725 West 172, New York 32.

**START** A collection, twenty different dated Indian head cents \$1.00. E. Walton, 7 Water, Boston, Mass.

**10** INDIAN Head cents, different dates, also pricelists, 35c. Schultz, 1053 Richmond, Cincinnati, Ohio.

**GET** Profit and pleasure in collecting old coins. Send 10c for 56-page illustrated coin catalog. You'll be delighted with it. Send for it now. B. Max Mehl, 370 Mehl Bldg., Fort Worth, Texas. Largest rare coin establishment in U. S. Established 45 years.

**TRADE,** Buy, sell U. S. coins, foreign gold. Harris, Box 3041, Seattle 14, Wash.

**COMMEMORATIVE** 1/2c. Columbus, Stone Mountain, Texas, Cleveland, \$1.50 each, new. Illustrated catalogue 25c. Norman Shultz, Salt Lake, Utah.

**FREE!** Large illustrated price list of coin albums, coin books and other supplies for coin collectors. James Randall, 341 South Dearborn, Chicago 4, Illinois.

**QUICK** Service; reasonable prices. United States catalog 10c. Foreign catalog 10c. Ben's Coin Company, 72 West Washington, Chicago 2, Illinois.

**FREE!** Foreign coin, banknote and coin collectors illustrated catalog to approval service applicants. Send 3c postage. Tatham Coinco, Springfield-125, Mass.

**I** MAY Have just the scarce U. S. coins you want. Send me list. "Meet me by mail." William H. Kenworthy, Waterville, Maine.

### OLD STAMPS WANTED

**I** WILL Pay \$100.00 each for 1924 1c green Franklin stamps, rotary perforated eleven (up to \$1,000.00 each unused). Send 6c today for large illustrated folder showing amazing prices paid. Vernon Baker, (PM-52), Elyria, Ohio.

### STAMP COLLECTING

**FINE** Approvals, freshly mounted. Fast, personal service. Tell me what countries you prefer and I'll send their stamps. Skinner, 345 East Ocean, Long Beach 2, Calif.

**STAMPS** From 40 countries, including Fiji 10c. No approvals. Eisea, Bowling Green, Ohio.

**U. S.** And foreign stamps on approval. Rudolph Peckinpugh, 2115 Collingwood, Toledo 2, Ohio.

**POSITIVELY** Greatest free offer—Latest Scott's International \$5.00 Stamp Album—covering entire world, contains 38,000 illustrated, descriptive spaces; Scott's 1945 Standard \$5.00 catalogues "Philately's Encyclopedia"—absolutely free to applicants for foreign approvals becoming customers. Plymouth, A-9, Bell, California.

**FREE** Mint set! Complete set of 5 mint Lebanon free to serious collectors requesting British Colonies and attractive general approvals at moderate prices. Glen D. Wilson, 711 North A Street, Tampa 6, Fla.

**BRITISH** Coronations list free. What else do you need? Johnston's, Conshohocken 3, Penna.

**CUBA** "Retro" complete to approval applicants sending 3c postage. Wm. Thiem, 98 Strong Street, Rochester, N. Y.

**FREE!** 25c Worth of stamps from our first foreign approval selection. Beaumont Stamp Exchange, 2667 McPaddin, Beaumont, Texas.

**STOP**—Want something different and unusual in approvals? Kirklands, 7212 Farwell, Chicago 31, Ill.

**FINE** Picked assortment 30 U. S. airmails and revenues. 10c to U. S. approval applicants. Atwater Stamp Company, P.O. Box 1583M, Miami 35, Florida.

**SCRIBBLE** A line—United States approvals—right price, real nice. Jarr, Box 711, Denver 1, Colorado.

**LIFETIME** Subscription 25c! Philatelic Shopping News, 2660PM Rochester, Detroit 6, Michigan.

**GUATEMALA**—26 Different 10c with Quetzal bird airmail. Approvals. E. P. Johnson, P.O. Box 267, Morgan Hill, Calif.

**APPROVALS**—Honest, dependable service. United States Foreign. Gobrecht, 205 Anderson, Joliet, Illinois.

**UNITED** States foreign approvals. Floyd Smith, 90E College, Oberlin, Ohio.

**"PENNY** Approvals" my specialty for general collectors. Creek, Box 229, Whittier, Calif.

**SPAIN,** 50 Different, only 10c with approval selection. Paul Rawden, Box 2920, Westville, New Haven, Conn.

**EXCHANGE** Your duplicate stamps with collectors everywhere. Stamp brings particulars. Kurtz, Box 1051, Allentown, Pennsylvania.

**100** DIFFERENT World-wide 3c. Pictorial approvals. Getche, 1040 N.E. Eighth, Minneapolis 13.

**U. S.** army-navy set 10c. U. S. and foreign approvals. Yokums, Box 1327, San Antonio 6, Texas.

**U. S.** And foreign stamps. Packet includes airmails, commemoratives, pictorials—3c. Approvals. Smith, 237-A 8th Avenue, Roselle, N. J.

**FREE**—Zanzibar (Jubilee). Abyssinia (air) plus world wide packet. Send 5c postage, handling. Regent Stamp Company, 330 Flatbush Ave., Brooklyn 17, New York.

**60** DIFFERENT U. S. Includes commemoratives, higher values, airmail, 10c. Charles Stone, 3547 28th St., Astoria 1, N. Y.

**FLAG** Stamp free with U. S. commemorative approvals. Wenigman, 1906 Summerdale, Chicago.

**\$20.00** CAT. U. S. foreign, for only \$1.00. Feils, 3001 Lafayette, Omaha 2, Nebr.

**UNITED** States best mixtures 50c lb. Canada 90c. Mission, 4512 North Racine, Chicago.

**1,500** ALL-WORLD, Large variety, \$1. Missions Outlet, Rev. Marshall, Paterson 1, N. J.

**FREE** Bolivia airs. and postage set to serious approval applicants. Dolin, 31 Park Row, New York 7, N. Y.

**80** PAGES Special offers, all United States, free. Postage 3c. Spencer Anderson, 65 Nassau, New York City 7.

**PICTORIAL** Foreign variety packet, 25 different 10c with approvals. Southwest Stamps, Box 117, Long Beach 1, Calif.

**U. S.** Commemoratives, 75 different, 25c. Crystal Stamp Co., Racine, Wis.

**60** DIFFERENT France and colonies 20c with approvals. Howard Davis, 866 Union, Warren, Ohio.

**INVESTORS**—New issues, big discounts. Feils, 3001 Lafayette, Omaha 2, Nebr.

**FLAG** Set! And 50 different used commemoratives—\$1.00. Redelings, 1325 Gardner, Los Angeles 45.

**60** DIFFERENT U. S. commemoratives including famous Americans, Columbian, Army, Navy, hinges, approvals, all 25c. Ray Bovard, 309 East 3d Ave., Cheyenne, Wyoming.

**ABYSSINIA-ETHIOPIA** 30 Var. for \$1.00. All originals. From the world's best stock of this difficult country. Expert comments on your Abyssinia collection gratis. New England Stamp Co., Est. 1893, 71 Bramfield, Boston 8, Mass.

**10** DIFFERENT U. S. airmails 10c. Approvals. Wamsuta Stamp Co., Box 1065, Providence 1, R. I.

**RUSSIA!** Complete subway set 25c. Many others. Naumkeag Stamp, Newton Lower Falls 62, Mass.

**HURRY! Hurry!** United States and foreign collections consisting of 300 different stamps only 35c. Price list of collection specials included. Frontier Stamp, 1697 Broadway, New York 19.

**SPECTACULAR** Approval service for collectors using International Junior or Modern albums. Loewy, Aberdeen, Maryland.

**TOP** Prices for collections to \$5000. Feils, 3001 Lafayette, Omaha 2, Nebr.

**FREE!** Sensationally interesting money saving stamp magazine. Philatelist, Aberdeen, Maryland.

**BRAZIL** 50 Different 20c. Approvals. Reidenbach, Lexington Ave., Troy, New York.

**700 MIXED** Foreign 50c: 1500—\$1.00. Seiden, 1331 Intervale, New York 59.

**FREE—Your** choice any 10 stamps from our first U. S. approval selection. Illustrated list included. Cosmopolitan Stamp Co., 1457 Broadway, Dept. E, New York.

**SCARCE** U. S. seconds. Approvals. Slightly defective, bargain prices. Hernefeld, 551 Clinton, Newark 8, N. J.

**ALBUMS**, Collections, wholesale and job lots, also stamps on approval. Pkeigwin Company, Vineland, N. J.

**25 AIRMAILS—Dandy** approvals, list 25c. George Davis, Webster, Mass.

**LOW Priced** United States approvals. Steger, 1165 Downing, Denver 3, Colorado.

**SPAIN—Five** large airmails. Send 10c. Approvals. Buchanan, 307 East 23rd, New York.

**WHAT Have you to offer? A collection? A "shoe box" accumulation? Anything in stamps. We** urgently need them. Spot cash paid. Cosmopolitan Stamp Co., 1457 Broadway, (Times Square), New York.

**DEAD Jap** admiral and general stamps; giant diamond, etc., 3c. Approvals. Kommer, 2354-31 Avenue, San Francisco 16, California.

**UNITED States** No. 221, No. 223, No. 233, No. 306, No. 601 (mint), No. 614 (mint), No. 629, No. 754, No. 759, No. 832. Send 50c. Approvals accompany. Whitton-Stamps, Norwalk 4, Connecticut.

**OPPORTUNITY!** New issue service at cost plus small commission. Gorgeous new stamps are sent in complete sets as issued. Send 10c for new Haiti issue. Evden 4, Box 396, Niagara Falls, N. Y.

**NOVA Scotia**, scarce 1860 issue, only 10c to serious approval applicants. Richard Haubrich, Route 3, Kenosha, Wisconsin.

**STAMPS Priced** to satisfy. Ask for our super approval bargains. References please. Edwin F. Russell, 13 1/2 East Montgomery St., Johnstown, New York.

**SUPER Special—United States** packet 53 all different including scarce Olympic games issue. All for 10c to serious approval applicants. Detroit Postage Co., Detroit 21, Michigan.

**PRE-CANCELS** Wanted for cash or commemoratives in exchange. Carpenter's Stamp Co., Manti, Utah.

**50 DIFFERENT** Europe 5c with approvals. Gans, 1435 East 67 Place, Chicago 37.

**272 DIFFERENT** U. S. commemoratives. Lists free. Henderson, 962-72nd St., Brooklyn 28, N. Y.

**FRESHLY Mounted** approvals for general collectors. Phoenix Stamp Co., Dept. 3M, 120 West 44th, New York.

**FIFTY** Canadian, Newfoundland, including earlies, commemoratives, 10c. Approvals. Reede, 696 Gerrard, Toronto.

**SPECIAL Album** free. The United States flag series for twelve overrun nations is the most unique, remarkable, impressive, and beautiful set of stamps ever issued. It fairly cries for a special album worthy of it, such as we have published. It's a very fine album of 34 pages. Cover designed by a famous artist. Arrangement artistic and practical, telling the history of each honored nation.—It is free to sincere approval applicants. Just send 10c for mailing expenses and state whether you desire approvals of the United States or foreign stamps or both. Approval Headquarters, Globus Stamp Company, 268 Fourth Ave., New York City 10, Dept. 201.

**FRESHLY Mounted** approvals! Drost, 2174 So. 92nd, Milwaukee 14, Wis.

**BEGINNERS** Beautiful British Colonies and South America on approval. Theo. Stevens, Box 3705 Kercheval Station, Detroit 15, Mich.

**WORLD Wide** approvals sent on request, references please. Juan Alexis, Box 141, Racine, Wisconsin.

**200 DIFFERENT**, Including Sudan, Persia, Siam, 20c to approval applicants. L. Hague, 318 Bellelita, Newark, Ohio.

**FREE U. S. price** list. Postage 3c. Mark Hanna, 335 - 5th Avenue, Pittsburgh, Pa.

**AIRMAILS**, 100 Different \$1.00, 200 different \$3.00. Paltra, 2664 Concourse, New York 58.

**FREE Stamps** with approvals. Robert Smith, 801 Market, McKeesport, Penna.

**U. S. Approvals**. Select copies, used—mint. Kingsbury Stamps, West Burke, Vt.

**SENSATIONAL!** Variety packet 275 stamps off paper: 100 different Canada, 50 British Empire, 100 foreign, Canadian pre-cancelled. All for one dollar (in bill). If by moneyorder add 15 cents. No approvals. Stamp Shop, 242 Logan, Winnipeg, Man., Canada.

**NOTICE!** I have a good supply of foreign stamps, better than average condition, free of paper. Will sell in mixture at 25c per 100. \$1.00 per 500. Satisfaction guaranteed. Sgt. Karr Ross, MB, NOB, Key West, Florida.

**CARAMBA!** Gorgeous Gilberts, oddish Solomons—3c with approvals! Saxon, Valley Stream, N. Y.

**SCARCE** Grenada bicolored silver jubilee stamp, MacArthur stamp from Australia, Abyssinian wild elephant issue, plus host of others from New Caledonia, Indo-China, Russia, Cuba, Wallis & Futuna, Dutch Indies, China, Philippines, etc., only 5c to approval applicants. Big dime packet list free! Methuen Stamp Service, Inc., Dept. 36, Lawrence, Mass.

**UNITED States** collection of 50 different mint commemoratives in very fine un-hinged condition from 1920 to 1939. Price only \$2.00 with your request for United States approvals. Fort Orange Stampco, Albany, New York.

**LOW Priced** U. S. approvals. Postage paid both ways. Kaiser Stamp Co., 302 E. Hurley St., St. Paul, Minn.

**FREE 15** Different U. S. commemorative stamps to anyone sending 3c postage. Benjamin Bren, Station A, Box 141, Manchester, Conn.

**FOREIGN Approvals**. Fairly priced. Brandann, 1912 - 3rd Ave. So., Minneapolis 4, Minn.

**MOZAMBIQUE** Triangles, four unused 10c with approvals. Vargo Stamps, Racine, Wisconsin.

**25 DIFF.** Finland 8c with 1/4, 1/2, 1c approvals. Carroll's, 7454 W. 45th, Los Angeles 37, Calif.

**EXCHANGE** Your duplicate stamps. Details free. C. Bishop, Route 8, Kalamazoo 88, Michigan.

**50 DIFFERENT** Latin America—25c. Northeast, Box 6818, Kansas City, Mo.

**TRIANGLES—Mozambique** airmail commemoratives, British Empire commemoratives, scarce U. S. higher values. Bonanza lot, 10c with approval request. Reuter, 611-C West 40th, Los Angeles 37.

**HAWAII—Three** rare old Hawaiian stamps, only 10c with approvals. Western Stamps, Box 4042, Los Angeles 24, Calif.

**SCARCE 1880** U. S.—Hussey local carrier stamp listed at 15c. Also Costa Rica No. 65 listed at 40c. Both sent free to approval buyers sending 3c postage. Pladon Stamps, 1717-M Idaho, Toledo 5, Ohio.

**"THE Best"**—United States and Philippine Island approvals. Largest varieties. America's lowest selling prices. Stamp Company, Allen, Albany 3, New York.

**8 ATTRACTIVE** Airmails 3c, with approvals and lists. Gaydos, Kenosha, Wis.

**TURKS** Caicos, Grenada, Seychelles, Dominica, Caymans; everything 3c with approvals. Viking, 130(2) Clinton St., Brooklyn, N. Y.

**ZOWIE-E-E!** A barrel of fun for only a dime. 500 United States—absolutely un-picked and unsorted—just as received from church missions. Many varieties, including large commemoratives, airmails, high denominations up to \$6.00! Stampdom's biggest package of fun—and you might find something really valuable! Price only 10c to serious approval service applicants. Money back if not delighted. Illustrated bargain lists with each order. Mystic Stamp Company, Department 80, Camden, New York.

**20 DIFFERENT—20** Different countries, 3c, approvals. A.B.C. Stamps, 2318-P Miramar, Los Angeles 4, Calif.

**19th CENTURY** U. S. commems. Civil War revenues, battleship \$5 and \$10 stamps free to U. S. approval applicants. Metropolitan Stamps, 198-C Broadway, New York.

**FREE—Pick** 25c worth of stamps from our first U. S. approval selection. Approximately 100 stamps to choose from. Excellent value. No obligation to buy. Lists illustrating the most popular U. S. stamps—at prices you can afford—will be included. Don't miss this opportunity! Write today. S. C. Engel Co., 38 Park Row, New York City.

**114 DIFFERENT** Stamps from far away countries including airmail and Free Fighting French to approval applicants for 10c. Reich Stamp Co., 4647 Kenmore, Chicago 40, Dept. M9.

**SPECIAL—Airmails**, 21 different, including zeppelin, triangles, Latin-America, 5c with approvals. Continental Co. (Dept. B), Box 806, New Rochelle, New York.

**U. S. Price** list. Send postage. Stanley Gibbons, 38-P Park Row, New York.

**WORLD'S Largest** diamond and triangle stamps, free stamp magazine, stamps from fighting Free French, 20 stamps from 20 different countries, pictorials, airmails, big bargain 5c with approvals. Capital Stamps, Dept. 2, Little Rock, Ark.

**100 DIFFERENT** 10c With approvals. Jacobsen, 59 Nagle Ave., New York 34, New York.

**EXTRAORDINARY** Pictorial collection—Nigeria, Southern Rhodesia, Dutch Indies, Martinique, Newfoundland, Philippines, Porto Rico, St. Pierre and Miquelon, Djibouti, Senegal, Ceylon, Jugoslavia, Ivory Coast, Madagascar, Reunion, Wallis and Futuna. Everything only 5c. Imperial Stamps, Box 311, Yonkers 1, N. Y.

**118 DIFFERENT** Stamps including commemoratives, charities, airmail sets, etc., only 3c to approval buyers. We buy collections. Badger Stamp Co., Milwaukee 3, Wis.

**FREE! The Stamp Finder!** Send today for the big new edition, fully illustrated, enabling you instantly to identify all difficult stamps! Also fine packet strange, fascinating stamps from Bosnia-Herzegovina, Monaco, Patiala, Cyprus, etc., including maps, ships, animals and strange scenes. All free to approval applicants including 3c postage. Garcelon Stamp Company, Box 900, Calais, Maine.

**1000 MIXED** U. S. old and new 25c. 2 lbs. \$1.00. Weatherby, Medina, Ohio.

**FREE! Complete "United States"** stamp catalog with 1,000 illustrations! Send 10c to cover mailing. Harris & Co., 137 Transit Building, Boston, Mass.

**PENNY Approvals**, that satisfy. Neil Gronberg, Box 5441-P, Philadelphia 43, Penna.

**DEALERS—Wholesale** list. Postage 3c. Frank, 5031 Queensberry, Baltimore 15, Md.

**FOUND** Unpicked U. S. and foreign mixture containing thousands stamps \$1.00. 5 lbs. only \$4.50. Longacre Shop, 100 West 42nd, New York City.

**1000 GRABBAGS** 15c Each. 8 different \$1. Special bags, Free French included 25c. Zandy, 630 Bingham, Reading, Pa.

**SMOKY** Mountain commemorative sheet, largest U. S. stamp issued, and 33 U. S. including commemoratives, airmail, revenues, etc. Catalogs 75c—To approval applicants for 5c. Curhan Stamp Company, Gloucester, Mass.

**FREE!** Canadian sets, royal visit, George VI, George V, coronation, jubilee, others, to approval applicants. Ensign, Box 118-M, South Orange, N. J.

**WEEKLY** Stamp Magazine, 26 weeks, 25c. Stamp Journal, Kalamazoo, Mich.

**CANADA** 100 Different 25c—approvals all countries. Lists. Victoria Stamp Co., London, 4, Canada.

**FREE!** Leeward Is., Cayman Is., Turks and Caicos plus 60 different mint Geo. VI coronation poster stamps, to approval service applicants sending 3c postage. Tatham Stampco, Springfield-30, Mass.

**55 DIFFERENT** United States 5c with approvals. Bookman, Box 145-M, Maplewood, N. J.

**STAMPS** Sent on approval, outstanding quality, low prices. Fred Herzberg, 168 Oak, Elmhurst, Ill.

**UNITED States** approvals complete coverage, fine quality, attractive prices. Seminole Stamps, Box 436, Coconut Grove, Florida.

**60 DIFFERENT** United States 10c. Pricelist free. Seidenberg, Baroda, Mich.

**DANDY** United States approvals. Write immediately. Sullivan, Endicott Arcade, St. Paul, Minnesota.

**FREE!** Western Hemisphere packet. Postage 3c. Owens, 806 Welsh, Bay City, Michigan.

**FREE!** British Empire packet. Postage 3c. Williams, 606 Archer, Bay City, Mich.

**FREE!** Pony Express set (facsimiles). Postage 3c. Roberts, 406 Building, Bay City, Michigan.

**EXCELLENT** Pictorial approvals. Reasonably priced. Crown Stamp Company, Box 331, Toronto, Canada.

**WOW! \$10.00** Worth of fun for only 10¢! 500 foreign stamps, unsorted and unpicked (mostly on bits of paper) just as received from the church missions and other sources. Africa, So. America, Australia, China, Philippines, Dutch Indies, and other countries are represented. Includes a few commemoratives, airmails, and stamps cataloging up to 25¢ or more each! The biggest package of fun in stampdom—and you might find something really valuable! Price only 10¢ to serious approval applicants! Money back if not delighted. Jamestown Stamp Co., Dept. No. 22, Jamestown, New York.

**VICTORY Packet free**—Includes stamps from Tanganyika, British Cayman Islands, animal, scarce babyhead, coronation, early Victorian, airmail, map stamps, with big catalogue—all free. Send 5¢ for postage. Gray Stamp Company, Dept. PM, Toronto, Canada.

#### HOBBIES AND COLLECTIONS

**GENUINE Arizona rubies** (garnets). Send quarter for packet. Mineral Specimens, Box 2651, Phoenix, Arizona.

**WANTED:** Old cigarette cards. Write Charles Bray, East Bangor, Penna.

**UNUSED—130** Different match covers \$1.00. Tomasek, 316 Nuttall, Riverside, Illinois.

**HOBBY-HAVEN Magazine.** Six issues 25¢. Holocheer, Dwight, Ypsilanti, Mich.

**MINERAL Sets.** Large specimens, scratch plate, description. 29 specimens \$2.00. 20 specimens \$1.25. Postpaid. Kenneth Knapp, Tulunga, Calif.

**"AGE OF Flight"** luggage sticker packet. U. S., Canada, Alaska, Hawaiian, airlines. Postal reserves your set. Air-Age, Box 5033, Chicago 7.

**MINERALS—Ten** pretty specimens 50¢; ten unusual river rocks \$1.00. Bjork, Box 291, Grand Junction, Colo.

**BIG Money** for your spare time by starting a hobby club locally in affiliation with national organization. Write, Hobbies, 131 W. 42nd St., New York City 18.

**FOOL'S Gold**—From famous gold camp. 10¢ per sample. Also mineral specimens from famous local mines. Martin's Snap Shop, 506 Harrison Ave., Leadville, Colo.

**COLLECTORS!** Exchange duplicates. Stamp brings particulars. Box 2166, Denver 1, Colorado.

**100 JEWELRY Stones** removed from rings, etc.—from \$2.00 to \$3.40. Lowe's, Box 311, St. Louis 1, Mo.

**NEW—15** Different match covers 10¢. Box 202, Rochester 1, N. Y.

**UNUSED Match book covers.** 100 all different \$1.00. 35 Royal Flash covers \$1.00. Free list. Charles Edelman, 1311C East 84, Cleveland 3, Ohio.

#### CAMERAS AND PHOTO SUPPLIES

**PHOTO Folder** bargains. All sizes stocked. Order your introductory assortment today. \$6.00 worth—\$5.00; \$14.00 worth—\$10.00. (Cash.) Fast service. Pan-American Press (PM), San Antonio 5, Tex.

**SCOOP!** Cameras. Candid type Sterling cameras. Snapshot and time exposures. Uses standard 127 film. Orders filled same day received. \$3.98 plus 46¢ federal tax. The Pabsc Co., Box 603, G.P.O., New York 1, N. Y.

**USE** Any camera with plentiful 35 mm. film! Simple instructions. Rush \$1.00. C. Tirekop, Madeira, Ohio.

**GLAMOUR Girls!** Kodachrome slides 2—\$1, 5—\$2; 35mm. negatives 10—\$1; 35mm. transparencies, unmounted 15—\$1; pin-up photographs 10—\$1. Fine Arts, Box 2084-K, San Antonio 6, Tex.

**A NEW photo business** that is sweeping the country. Direct positive photo studios. Tremendous profits. Photo experience not necessary. Headquarters for direct positive equipment. Herman Millman, Dept. DPS, 1094 Flatbush Ave., Brooklyn 26, New York.

**BASS Says:** War time proves Bass leadership. Amazing selection of finest still cameras—Leica, Contax, new and used still available. Write for quotations. Satisfaction guaranteed or your money refunded. Bass buys 'em, sells 'em, trades 'em. Bass Camera Company, Dept. AG, 179 W. Madison St., Chicago, Illinois.

**MAKE Money** in photography. Learn quickly at home. Easy plan. Booklet free. American School of Photography, 1315 Michigan, Dept. 3431, Chicago 5, Ill.

**OIL Color** photographs for pleasure and profit. Easy, step by step method only \$1.00. Send today. Wm. Greener, St. Johns, Michigan.

**OIL Coloring** photographs a fascinating hobby or profitable business. Learn at home. Easy simplified method. Send for free information. National Photo Coloring School, 1315 Michigan, Dept. 3431, Chicago 5, Ill.

**"BIG Bertha"** telephoto camera easily made. Trifling cost. Objects miles away photograph close up. Ultra sharp pictures. Telephoto lens and instructions \$2.00. Instructions alone 10¢. Carl Jamer, Manorville, N. Y.

**ENLARGERS**—Build your own. Kit of parts, \$6.00. Free particulars. Crescent Engineering, Box 251-P, South Pasadena, California.

**HAVE** You a camera? Send ten cents for recent number of our big magazine, showing how to make better pictures and earn money. American Photography, 116 Camera House, Boston, Mass.

**CASH!** Spot cash for cameras, lenses, binoculars, movie or still, sound projectors. Send full description by mail, or wire for prompt cash offer. Over 30 years of dependability insures honorable dealings. Bass Camera Company, 179 West Madison Street, Chicago, Illinois.

#### PHOTO FINISHING

**KODAK Snapshots** movie stars, taken in Hollywood. Lana Turner, Ann Sheridan, etc. 12 different \$1.00, 25 different \$2.00. Forman, 882 Lorimer, Brooklyn 22, N. Y.

**8x10 "BRILLIANTONE"** Enlargements 35¢, three \$1.00. Reischling, 418 Dunning, San Antonio 4, Texas.

**FRESH 35mm. Film,** 25 feet \$1.00 postpaid. Taylor Brown, 2112 Farnam, Davenport, Iowa.

**GUARANTEED Reprints** 2¢. Rolls developed two prints each negative 25¢. Photo copied, 12 billfold size prints made, 50¢. Summers Studio, Unionville, Mo.

**100 MINIATURES** \$1.00. 1 1/2"x1 1/2". Made from photograph. Gummed, perforated, for stationery, etc. Lang, 1334 Thorndale, Chicago.

**BEAUTIFUL Oil** colored enlargements. Your negatives: 8x10, \$2.00; 11x14, \$2.50. From photo 50¢ extra. Specify colors. Haynescraft, 708 8th, Washington 1, D. C.

**ROLL Developed** and 8 beautiful enlargements 2 to 8 times larger. Dekeled edge—high gloss. Any 8 exposure roll 25¢ coin. 12 ex. 35¢—16 ex. 50¢—36 ex. \$1.00. Reprint enlargements \$3 each. Alden Photos, 94-3 Astor Sta., Boston 23, Mass.

**ENLARGEMENTS.** Eight 6x7 from negative, \$1.00. Six 5x7 from photo, \$1.00. Robert Renshaw, Jr., P.O. Box 478, Chester, Penna.

**PROFESSIONAL 8x10 Copy** of any photo 50¢; Goldtone finished \$1.00. Arden Studios, Franklin Park, Illinois.

**YOUR Photographs** beautifully oil colored. Any size 60¢ each. Two for \$1.00. Dorothy Briney, Goodell, Iowa.

**6-8 EXPOSURE** Rolls developed and enlarged mammoth size 30¢. Reprints 3¢. Thrifty Photos, Box 46, South Gate, Calif.

**50 REPRINTS** \$1.00. Suburban Studio, PM2, 1410 Bond, Rockford, Illinois.

**ROLLS Developed,** 2 prints each negative 25¢. Reprints 2¢. Royal Photos, 1718 North Sixth, Harrisburg, Penna.

**SENSATIONAL Introductory offer!** Send snapshot or negative, this ad, and 3¢. We'll send you a beautiful 7"x5" enlargement! Or, Kodak roll developed with 16 guaranteed dekeled-edge Velox fadeproof prints or 8 double-size prints, 25¢! Special! From your negatives, 16 regular-size or 8 double-size reprints, 25¢! Candid rolls—36 exp. 35mm. developed, vapo-rated, enlarged to 3x4, \$1.00! 18 exp. 60¢. Reprints, 3x4, 3¢ each. We have new perfect 35mm. film. Low prices. Free mailers, details on request. American Studios, Dept. 413, LaCrosse, Wis.

**GLOSSY Contact** prints 3¢ each from any size roll film negative except 35mm. Photo Prints, 136 Maple Ave., Haddonfield, N. J.

**PHOTOGRAPHY** For pleasure and profit. Prepare at home. Write for information. American School of Photography, 1315 Michigan, Dept. 3452, Chicago 5, Ill.

**ROLLS Developed** and printed, 25¢; reprints, 2¢; 5x7 enlargements, 15¢; 8x10, 25¢. Davis Studio, Guthrie, Okla.

**FINER Finishing** specials 25¢. Eight exposure rolls developed with two prints of each or one enlarged print of each negative. Genuine nationally known Moentone Enamel finish. Superior quality since 1898. Moen Photo Service, 452 Moen Bldg., LaCrosse, Wis.

**8 PRINTS.** All enlarged to nearly postcard size, from your roll or negative, 25¢. Willard Studios, Box 3535A, Cleveland 18, Ohio.

**FREE!** Send negative, this ad for beautiful 4x6 enlargement. (Stamp appreciated). 16 sparkling prints, 2 Hollywood enlargements from roll or negatives 25¢. Lifetime Studios, Dept. A-939, Des Moines, Iowa.

**BIGGEST \$1.00 Value** in 35 mm. finishing today. 36 exposure fine grain 3 1/2"x4 1/2" enlargements; dekeled, embossed margin and date. Eighteen exposures 75¢; 16 exposure splits 55¢; 36 exposure reloads 50¢. Special: return this ad with \$2.00 and we will send five 36 exposure reloads. Free mailers, 8 exposure rolls in beautiful, dekeled contact finish with embossed wide margin, 25¢. Mailbag Film Service, Box 5440A, Chicago 80.

**TROUP'S Photo Service,** Troup Building, Toccoa, Georgia. 6 or 8 exposure roll film developed and printed 25¢.

#### MOTION PICTURES AND SOUND EQUIPMENT

**HOME Movie** fans—Join Motion Picture Educational Society. Free valuable information. Box 875, Reading, Penna.

**PROJECT** Black-white movies, slides in full color. Sensational! Unbelievable! Genuine Birch-Field Iriscope Kit for experimental use only \$5.00, prepaid U.S.A. Jenkins, 392-F, Elmira, N. Y.

**35MM. Sound** films. Reasonable. Stamps for lists. Mertz Films, Springfield, Ill.

**35MM. Silent** films. Features—shorts. Bedner, 5300 So. Talman, Chicago.

**MOVIE Projectors** bought and sold. List 10¢. United, 2309-A Lawrence, Toledo, O.

**GORGEOUS** Girls, adventure, sports, travel, comedy films. Equipment. Big 1945 catalog—3¢ stamp. Audet, Box 6520-BG, Philadelphia 38, Penna.

**8MM-16MM. Films,** bought, sold, exchanged. Complete 360' sound subjects \$5.75. Lists. (Sample film 10¢.) International-M 2120 Strauss, Brooklyn, New York.

**100' 16MM. Used** sound film, \$1.00 postpaid. We buy, sell, trade. List of complete subjects upon request. Blackhawk Films, Dept. PM19, Davenport, Iowa.

**BARGAINS** In 16mm. sound films, projectors, supplies for outright sale. Rentals. Harris, 303 West 42nd Street, New York 18.

**8MM-16MM. Films.** Free catalogue (sample film 10¢). Parkway Exchange, 1593 Union Street, Brooklyn, New York.

**GUARANTEED** Fresh movie film! Three spools double 8mm. \$3.45! Six spools single 8mm. for Univex cameras, \$3.50! Processing free! (Limit six each type.) \$1.00 deposit on c.o.d. State make of camera. Eso-S, 4038 Broadway, Kansas City 2, Missouri.

**SOUND—Silent** 8mm., 16mm., 35mm. Bought—sold. Free lists. Sample 10¢. Paramount Film Service, Monmouth, Ill.

**MOVIE Amateurs!** Our club plan entitles you to receive free, 8mm. and 16mm. film subjects, latest releases of war pictures, comedies, sports and other thrills. Send for free list of titles and club plan. Home Movies Club, Dept. P.M.2, 4215 W. 41st Ave., Denver 12, Colo.

**FINEST** Movie screens, inexpensive, make them yourself. Free literature. Snow White Screen Company, Danville, Illinois.

**8MM-16MM. Silent-sound** films. Complete rental library. All latest subjects. Free catalogue, (sample film 10¢). Garden Film, 317 West 50th, New York 19.

**CAMERA Film:** 100 ft. panchromatic 16mm., Weston 64, \$4.85; 25 ft. double 88 Weston 64, \$1.89; processing included. Movie accessories, chemicals. We do processing. Free circulars. Promader General Co., Davenport, Iowa.

**\$1 BRINGS "Surprise"** assortment 8mm. colorful titles! Guaranteed. LeMoine Films, Nevada, Missouri.

**"THE World's Greatest Passton Play."** 8mm, 16mm. and 35mm. Specify silent or sound. Rent or purchase. Hemenway Film Co., 33-F Melrose St., Boston 16, Mass.

**FREE 1945 Movie** catalog. Samples 10¢. Goodwill Company, Jackson, Tennessee.

**RELIGIOUS** Films only. New prints. Screenart, 723-7th Ave., New York.

**8MM. Movies** bought, sold, exchanged. List dime. Address, Values, Woodbury, Conn.

**8-16MM. Castle** official, others, shorts, features, arts; silent sound. Big discounts. Catalogue stamp. Reed, 312 75 Street, Brooklyn 9, N. Y.

**BETTERPIX** Outdoor safety film, 100' 16mm., \$2.50. 25' double 8mm., \$1.25. Free developing. Finished subjects sold, exchanged. Sound Library. Better Films, 742 New Lots, Brooklyn 7, N. Y.

SEND Stamp for 16mm., 8mm. catalogue. Sterling's, 679 Northampton, Easton, Pennsylvania.

LEARN Movie projection, management. Free catalog. Give age. Theatre Institute, Elmira, N. Y.

SALE—Rent 8-16mm. films. Catalogues 10c. Don Elder's, 739-A Boylston, Boston 16, Massachusetts.

SPECIAL Movie film, 8mm., 25 feet double-Weston 8, \$2.00. Super double X, Pan indoor 60, outdoor 100, 16 mm.—\$6.50. Super X Pan indoor 24, outdoor 50, \$5.75. Pan Weston 12, \$5.00. 16 mm. 100 feet Weston 6, \$4.00. Free developing. Exhibitors Film Exchange, 630 9th Ave., New York 19, N. Y.

BASS Says: Leadership in the cine field is apparent in war times. Here ready—your choice of 8 mm. and 16 mm. apparatus. Write for quotations. Your old equipment is worth real money in trade—describe please. Or we buy for cash and pay immediately on receipt. Write to headquarters. Bass buys 'em, sells 'em, trades 'em. Satisfaction guaranteed or your money refunded. Bass Camera Company, Dept. A, 179 W. Madison St., Chicago, Illinois.

#### MUSIC AND MUSICAL INSTRUMENTS

POPULAR Piano in 12 lessons. Guaranteed. Kelly School, 1734 30th Avenue, San Francisco 22, California.

JAZZ Piano. Correspondence or teacher. On approval. Miracle Series, Provident Bldg., Tacoma 2, Wash.

MUSIC Arranged. Songs published. Frank Wildt, Music Publisher, Lancaster, Penna.

FREE Budget valuable songwriting information. Publishing Professionals, 339, Mill Valley, California.

BEFORE Sending your poem to be set to music, know your composer. Free folder. Al Moquin, 5333 La Cresta Court, Hollywood 38, Calif.

WE Will compose beautiful melodies for your poems for \$5.00. Glenn Snell, Route 1, Youngstown, Ohio.

SONGWRITERS: For publication information write to Pleasant Music, 51 Davis St., Oakville, Conn.

SONGWRITERS—Write for amazing free publishing information! Alton Brand, Sycamore, Illinois.

SONGS Published. Radio license. National Songwriters, 6603B Sunset, Hollywood, Calif.

SONG Poems wanted to be set to music. Examination free. Harry Reynolds, 232 W. 97th St., Los Angeles, Calif.

SONGWRITERS: Royalty contract free. Write for details. Puritan Publishing Co., 243 S. Dearborn St., Chicago, Ill.

SONGWRITERS—Amazing information about publishing songs. P. Medary, Williamsburg, Ohio.

HAWAIIAN Guitar orchestration. Five for \$1.00. List on request. Golden Gate Publications, 5472 Foothill Blvd., Oakland 1, Calif.

GUITARS, Band instruments, bought, sold. List free. Rudolph's, Atchison, Kans.

ACCORDIONS Are available. All sizes and makes. Buy direct. Special discount. Free catalog. American Accordion Co., 31 S. Cicero, Chicago.

DO You want to publish your song? Information free. Mid-West Music Press, 4737 Broadway, Chicago 40, Ill.

SONGWRITERS. Send song poems. Free book—The Key to Your Future. Songwriter's guide, rhymers, Variety, Salem 2, Indiana.

SONGWRITERS! Outstanding proposition. Hibbeler, C5, 2157 N. Avers, Chicago 47.

BEFORE Having your song arranged write for free information. Melodies composed. MacGregor, Hollywood Composer, 6079 Lemon Grove Ave., Hollywood 27, Calif.

SONGWRITERS—Your poem, melody or idea made into complete professional song—\$3.00. Sholl, 2222 N. 5th St., Harrisburg, Penna.

NEW Songs and lyrics wanted for popular radio program and professional promotion. Free examination. Transradio Music, Inc., Dept. P., 1650 Broadway, New York (affiliate of B.M.I.)

NEW! Transposition at a glance. Get this handy pocket size book now! Learn transposition of orchestral instruments. 50c (coin). MacGregor, P.O. Box 628, Hollywood 28, Calif.

POEMS Wanted for musical setting. Send poem for immediate consideration. Five Star Music Masters, 630 Beacon Building, Boston.

MUSIC Composed, music printed. Reginald Belcher, Chatham, New Jersey. Established 1910.

MUSICAL Instruments wanted. Highest cash prices paid for band instruments and violins. Give make, finish, serial number, age, and price desired. No pianos, banjos, or guitars wanted. Write us at once. We will mail you our offer and shipping instructions by return mail. Lyons Band Instrument Company, Dept. 539, 14 West Lake Street, Chicago 1, Illinois.

PIANISTS—Quickly improve technique, sightreading, accuracy, memorizing, playing through mental-muscular coordination. Free booklet. Broadwell Studios, Dept. 45B, Covina, Calif.

MAKE Music yourself! English flute, (plastic), chromatic, instructions and music free \$1.50. Easy-thrilling. Professional instrument (plastic-wood) \$3.50. Hargall, 299 Madison Ave., New York.

AMAZING New method! Play songs first lesson. Hawaiian guitar free! National Institute, 212E Exchange Building, Spokane, Wash.

PRACTICAL Psychology lessons in playing a musical instrument for mechanics, metaphysical students, and physical culturists. 10 lessons Spanish guitar, \$1.00. 10 lessons Hawaiian guitar, \$1.00. 10 lessons for grown-ups—piano—\$1.00. You can't fail. Frank's Musicians Supply, 3311 Herman Ave., San Diego 4, Calif.

PLAY Violin! Magic chart shows you, quickly, easily. No notes. Melody Masters, Box 805, Rockford, Ill.

POEMS Set to music. Clarion Music Service, 5320 Kenwood Ave., Chicago 15.

SONGWRITERS—Special offer. Edward Madden, 1300 Lodi, Syracuse, N. Y.

GUITAR, Spanish and Hawaiian. Learn by mail. Details. Royal Studios, 178 Boston Road, Springfield 9, Mass.

SONGWRITERS! Make your own break on Broadway! Times Square Music Publications, 1589 Broadway, New York.

WANTED! Lyrics, melodies for songs. We arrange, publish, sell. Superior Song Studios, Passaic, N. J.

LEARN Piano. One hour. Free literature. Ferris, 317P So. Hartford, Bremer-ton, Wash.

SING Beautifully. Modern voice culture. Literature free. Ferris, 317M So. Hartford, Bremer-ton, Wash.

SONGWRITERS: Send poems for free examination. Write for free instructive booklet outlining opportunities. United Music Corporation, Salem, Indiana.

SONGS Arranged and scored. Song poems set to music. Analysis report \$2.00. Satisfaction guaranteed. Tommy Kilbourne, Box 1253, Bakersfield, California.

SONGWRITERS—Free booklet "Getting Ahead in Songwriting." Write today. Song Service, 331-C West 46th, New York.

SONGWRITERS! Music composed, arranged. Billy Hannon, 6703 N. Oshkosh, Chicago 31.

SONGS Published—Liberal plan. Barnhart Publications, 1320 48th, Des Moines, Iowa.

SONG Poems wanted. Free examination. McNeil, Master of Music, 610-PM South Alexandria, Los Angeles, Calif.

ACCORDIONS. New and used at wholesale prices. Save up to \$100.00. Buy direct from factory. Del Principe, 307 So. Wabash, Chicago.

WRITE Songs. Big money and reputation. Write for information. J. Gordon Pub Co., 201 N. Hoyne Ave., Chicago.

SONGWRITERS—Send poem for immediate examination and free rhyming dictionary. Richard Brothers, 24 Woods Building, Chicago.

#### RADIOS AND SUPPLIES

SUBSTITUTION Instructions covering 200 critical tubes including 50L6, 12SA7, \$1.00. Jones, 1210P Dudley, Utica 3, N. Y.

BUILD A radio, complete kit with tubes, \$9.95, details. Radio, 9418 Avenue "A," Brooklyn, N. Y.

TUBE Problems solved. 6SA7 or any 6-volt 3-amp in series with any tube drawing 12-amp as 12SA7, etc. 25L6 replaces 50L6 and 35L6. Transformer made of old speaker fields and audio transformer coils in 30 minutes. Sells for \$4.50 installed. Complete plans \$2. Mission Radio Laboratories, 204 Pine, Columbus, Kans.

CRYSTAL Radio receivers. Crystal detectors, crystals, coils, condensers, tuners, diagrams. Illustrated catalog sent free. Hulet, 29 East 39th, New York.

TUNING Arm dials twenty times sharper than ordinary dial. Make easily from scrap wood. "Sketch-plans" 25c. "Arts-Crafts," Blacksburg, Virginia.

BURNED Out radio tubes bought. We pay 5c each for 12 volt series, 3c others. Must be unbroken as to prongs, base and glass. Mail immediately. Brooks Radio Service, 3608 North Main, Houston 9, Texas.

REVISED Plans 18 long distance crystal sets, including "Radiobuilder"—25c. Laboratories, 363-C Hampton, Hayward, Calif.

12SA7 DIRECT Substitute, no rewiring. \$2.85 postpaid, tube substitution chart included. No c.o.d.'s. Ball, 9926 Lorain, Cleveland, Ohio.

MAKE Simple, tubeless, batteryless, distance-getting crystal radios. Crystal and illustrated instructions 25c postpaid. Allen, P-427, Clinton, Missouri.

JUST Out! Crystal set booklet of "Volume Increasing Tips." 45c. Amorose, R-4, Hungary Road, Richmond, Va.

FOXHOLE Radio: Amazing serviceman's pastime gift, batteryless, tubeless, school-boy thrill, made anywhere, anybody. Easy distance-getting instructions. \$2.00. Gadgets, Box 28, Jackson Heights, N. Y.

RECORD Player; plays through your radio; simple and easy to make. Detailed plans and instructions only \$1.00. Jay-M Sales Company, P.O. Box 97, West Haven 16, Conn.

TUBELESS Radio made with razor blades! Complete plans, 35c. New Radio, Lohrville, Iowa.

RADIO Tubes, parts, condensers. Free bargain lists. Potter, 1314 McGee, Kansas City, Mo.

PREPARE Now for tremendous opportunities in new fields of radio after the war. Training for federal licenses. Write for particulars. American Radio Institute, 52 East 23 Street, New York 10.

RADIO Service men and experimenters send for our giant radio catalogue. Save dollars. United Radio Co. (1000M), Newark, N. J.

#### BUSINESS OPPORTUNITIES

EXPERIENCED Bookkeepers, accountants, college men, teachers, may earn \$500 to \$5000 fees as cost consultants, installing new modern practical cost system. Learn direct from Philadelphia firm of successful professional cost consultants and industrial analysts. Practical, profitable. Ten comprehensive parts or lessons, \$10.00 per lesson. Write or register through W. C. Moore, 111 Oak Terrace, Merchantville, N. J.

SELL Display signs, pictures, calendars, books, greeting cards, paper novelties! Big profits! Bargain catalog free! Ellico, 438 N. Wells, Chicago.

LICENSED Concrete specialists wanted. No experience needed. Make Coloredized concrete pottery without molds. New, low cost, patented method. Cemetery products, novelties, tiles, floors, etc. Basement leaksealing. Other money-making projects. Booklet, details free. Men only. National Potteries Company, Fergus Falls, Minnesota.

FISHING Rod holder, adjustable all positions, finest made, regular \$6.00, special \$3.50. Agents, distributors wanted. Steuer, 1377 Haight, San Francisco.

START "Soap Factory" at home. No machinery. Amazing opportunity. Literature free. Kemico, SM-2, Park Ridge, Ill.

OWN A mailorder paper products business. Sell envelopes, tags, labels, boxes, by mail, wholesale. Tremendous demand. Steady profits. No capital necessary. Write Omaha Envelope Service, Dept. 55, 4721 California, Omaha 3, Nebraska.

SUCCESS Sure! Start own business now; insure post-war independence! 180-page volume shows way; dozens successful home-money-making plans detailed in big free brochure. Co-Operative Service, Box 253 Niagara Square Station, Buffalo, New York.

ELECTRICAL Appliance repair. Open your own shop. Learn house wiring; electric motors, vacuum cleaners, washers, etc. Complete illustrated course shows how. Free booklet. Pacific Training School, Dept. P2-A, 4703 West Pico, Los Angeles 6.

LANDSCAPING. Learn landscape designing and gardening for a profitable out-of-door profession. Write National Landscape Institute, Dept. P-2, 756 Broadway, Los Angeles 14, Calif.

\$8,000.00 IN 350 Sales to mechanical homeworkers. Names, addresses, \$10.00. Inquiries, 900, \$10.00. Both lists \$18.50. Hoffmann, 6840 Parrish, North College Hill 31, Ohio.

**BOOKKEEPERS** Earn extra money operating profitable bookkeeping service spare time. A. Schreiner, Batavia 1, Ill.

**HARDWARE** Business is one of the most interesting and profitable of them all. Be independent. You can start your own retail store with small investment and no previous experience. 15,000-word, copyrighted booklet tells you how. \$1.00 postpaid. C. R. Divan, P.O. Box 325, Santa Monica, Calif.

**GET** Ready to start your own postwar business. Make venetian blinds. Practical and simple. Illustrated instruction book \$1.00. Elwert, 6900 North Ashland, Chicago 26.

**MAKE** Your own Flexible Molds. Statuary, Art Goods, Novelties, Artificial Marble Flooring, Liquid Marble. Literature free. Kemico, 2-M, Park Ridge, Ill.

**REALTY** Business. How to buy, sell farms, properties, business. Gives every angle of salesmanship. Book 50c. Free particulars. Mell Specialties, DeMotte, Indiana.

**PATHWAYS** To progress; wealth. Particulars, stamp appreciated. 313 Fitzsimons Building, Pittsburgh 22, Penna.

**YOUR** Postwar fortune. Money in mail-order business. Free details. Victory, Box 179F, Dowagiac 3, Mich.

**1000** LIVE Names of opportunity seekers 50c. All late cash buyers. Joseph Royer, 83-D Merrimac St., Haverhill, Mass.

**MILLIONS** Wasted yearly! Make big income recharging dry cell batteries. New easy approved method invented. Develop permanent post war business; home or shop. Make clean up during present shortage. Build simple inexpensive equipment yourself. We tell you how to buy and sell large quantities. Rich Engineering Co., Dept. B, 3033 Main, Kansas City, Mo.

**PROFITABLE** Spare time, unusual mail business earned \$1400 monthly. Copyrighted instructions \$1.00 postpaid. W. S. Boyd, 331 Fourth, Pittsburgh 22, Penna.

**"HOW** To Make Simple Molds and Plaster Plaques." Profitable business or hobby! Booklet 25c. Plastercraft, 1406 E. 43rd Street, Cleveland 3, Ohio.

**FREE** Literature explains money-making business. Write Successful-Income Builders, Hollywood 28, California.

**RUBBERFLEX**—Airlastex molding liquid. "The Real McCoy." Makes molds overnight. Sample pint with directions \$1.50. Gallon \$9.00. Agents wanted. 20th Century Products, 3151-11 Southport, Chicago.

**NOW** You can have a paying mail order business. Our latest publication shows how with actual opportunities listed. Impressive literature free. Nichols Pub. Service, P.O. Box 831, Pine Bluff 1, Ark.

**PLAN** Now to own your business. Particulars free. Write Frank Buskirk, Box 212B, Shelbyville, Ind.

**PLASTICOAT**—Genuine "Bakelac" clear, ivory, white. Covers, protects everything. Sample pint \$1.25. Gallon \$6.00. 20th Century Products, 3151-B Southport, Chicago.

**HOG** And poultry remedies for rural salesmen packaged under your own brand name (in small lots). Big profits! Permanent business. Near Chemical Co., Minneapolis 4, Minn.

**MAKE** And mold genuine plastics. Forty illustrated work-sheets explain methods, processes. Authentic-simplified. \$1. Free circular. Plastics Digest, 3937B Tracy, Kansas City 4, Mo.

**MAKE** Strange new plastic at 5c gallon. Sells 50c. Makes floors, walls, roofs. Amazing profits. Bays Laboratory, Oklahoma City 9.

**SIXTY** Page mail order magazine and big mail, ten cents. Parrett, 571 Winthrop, New Haven, Conn.

**COLOR** Concrete with chemicals. Big money making Hollywood style pottery, birdbaths, without moulds. Washing-wells, stucco-rock, benches. Marbling, cement water-paints. 10c brings sample, literature, pictures. Hollywood Cement-Craft, 8527 Wonderland, Hollywood 46, California.

**FREE** Circulars, sell on sight novelties, nice profits. Murray, 615 Main, Latrobe, Penna.

**RESTRICTED** Territory. Full or spare time. Manifold and salebooks. Burke's Business Bureau, 11 Main St., Asbury Park, N. J.

**MONEY-MAKING** Business, free! Literature. Write, Successful Income Builders, Hollywood 28, California.

**AMBITIOUS?** Anxious to get ahead? Write for free details on "From Fifty Cents a Day to Ten Thousand per year." Webb, Box 184-A, Drexel, Missouri.

**RUBBER-COTE**—Liquid rubber for making flexible molds. \$3.00 qt., \$10.50 gal. Instructions. Morgan Art Co., 4923 Rockville Rd., Indianapolis 8, Ind.

**INTERESTED** In mailorder? Amazing information free. Dan Smith, 72-P Southbourne, Boston 30, Mass.

**PLASTICS**—Made at home without equipment—perfect castings—formula 50c. Baker, 225 Symington Ave., Toronto, Canada.

**EXTRA** Income—Now and post-war. Assure your financial future. Write for positive proof. Willis, Box 1041, Wilmington 90C, Del.

**LEARN** More about your job, business or profession. Read the "inside" trade journals. Complete lists free. Dunbar Service, New Brunswick, N. J.

**MAIL** Order business—Post war opportunity. Big profits. "National Guild" tells you what sells; who buys; how to reach them. Helps you start almost for nothing. Write "Nmog," Sparta 2, New Jersey.

**ONLY** Highest qualified business men with some surplus capital to engage in sideline business of your own. Make big returns with small advertisements. Read Mail Selling Is Money Business. Write: Houston Maupin, Tipp City 46, Ohio.

**INDUSTRIAL** X-ray, a vast new postwar profession. Find out how to qualify. Rush name for facts. Ohio Institute of Technology, Box X-222, Greenville, Ohio.

**OVER** 100 Ways to make money in home or office for self. Full particulars free. Howell, 1320 St. Andrew (4), New Orleans 13, La.

**MAIL** Order laxative business for sale. \$500. Harry R. Dean, Box 900-M, Galveston, Texas.

**FIVE** Big mailorder magazines 20c. Lewis Company, 828M Carpenter, Oak Park, Ill.

**OVER** 150 Present; post-war opportunities. Local; mail; travel; invention; others. Write, Central Enterprises, Simpson 1, Kansas.

**EXCEPTIONAL** Opportunities in inside secrets mail order plans. Free booklet. Peltam Specialties, Crown Point, Ind.

**LASTING** Growing business for you. Start at home. Put up in cans or fruit jars. Drain pipe cleaner that really cleans plumbing drains. Sell to stores. Start dealers working. Full information and formula \$1.00. Herman Kramer Co., 1309 South Cheyenne, Tulsa 5, Oklahoma.

**MAIL** Order cosmetic business for sale. \$400.00. Harry R. Dean, Box 900-M, Galveston, Texas.

**POSTWAR** Security. Start a profitable business of your own. Chatham, 7729-PM South Park, Chicago 19.

**EARN** Extra cash, spare or full time. Joseph Mail Service, Keene, N. H.

**START** Home business making statuary, plaques, art goods, novelties, souvenirs, concrete pottery, garden furniture, artificial marble flooring, liquid marble. Make your own flexible molds. Amazing profits. Valuable folder free. Creative Publishers, (PM2), Glenoco, Illinois.

**RAISING** Canaries pays good profits. Valuable bird book—"Its Care, Breeding and Training." Price \$1.00. American Canary, 2839 N. Halsted, Chicago.

**MECHANICALLY** Inclined men—Own and operate general appliance repair shop. Complete, illustrated course shows you how. Welding, refrigeration, motor repair, how to get business, etc., all phases covered. Free literature. Christy Supply, Dept. 149, 2835 N. Central Ave., Chicago.

**NEW** 1945 Edition Mail Order Trade Directory. Get yours now. 25c. Details free. Macklyn, Box 6900, Pittsburgh 12, Penna.

**PRODUCE** Perfect monuments. Printed outline of mold and lettering instructions \$1.00. Weldon, Box 634, Detroit Lakes, Minnesota.

**MAIL** Order business for sale. \$1000. Harry R. Dean, Box 900-M, Galveston, Texas.

**IF** It's wealth you desire! Read "Gold Ahead." Educational books. Wyatt, Box 333, Hyattsville, Md.

**BECOME** An "Attritionist Masseur." First improvement over Swedish massage in 100 years! Results unbelievable! Dr. Swearingen, 9128M, Station 8, Los Angeles.

**MAILORDER** Opportunities. Get started now for post-war. Hallenbeck, Roselle, Illinois.

**\$10.00** POUND, Angora rabbit wool, we supply good rabbits, and buy wool. Particulars free. House of Angora, 1848 So. 18th, Springfield 4, Illinois.

**A** 20th Century business is a money business. Operate your own. Details 10c. Jenks 20th Century Enterprise, 635 No. Liberty, Spartanburg, S. C.

**NEW** Copyrighted booklet mail order plan worth more than \$50,000.00. Will sell for \$1500.00. Free particulars. Robert J. Drummond, 58 Eleventh St., Oakland 7, Calif.

**BE** Your own postwar employer. Establish office service system in your community. Interesting dignified, profitable profession. Prospectus \$2.00. Helwig & Olson, 646 Broadway, Gary, Indiana.

**NEED** Capital? Employ methods that never fail. Booklet, Research, 208C Lenox, Duluth, Minn.

**MONEY** Making secrets exposed, including big mail, 25c. E. Medved, Yukon, Pennsylvania.

**I** BOUGHT Financial information worth \$10,000 to me. You can have it too. Send only \$1.00 to F. S. C., 1206 N. Alexandria, Hollywood 27, Calif.

**LEARN** How to build a mail order business of your own. Many successful mail order businesses have been built up from very small beginnings, starting on a small capital, using a room at home for office, growing from profits. Our course of 24 big lessons in "Modern Mail Merchandising" gives real fundamentals of mail selling; tells how you may start by following proved procedures. Mail order business booming as never before. Get our illustrated brochure describing our practical course; see what this grand industry may offer you. Mail Enterprises, Inc., 316 Fox Building, Detroit 1, Michigan.

**FREE** Literature describing mail order and many moneymaking plans. Swentek, 8840 Warren, Dearborn, Mich.

**TURN** Accounts into cash. Good income; quick results. National Collectors, Newark, Ohio.

**FOOD** Product easily made, delicious, appetizing. Formula 50c. Box 666, Springfield, Mass.

**MAKE** Your own glow in the dark articles. Sell at big profit or keep for your pleasure. Use Lite-Glo—magic new discovery! Hundreds of uses. Complete Lite-Glo kit \$1.00. Cash or c.o.d. Lite-Glo, 1412-(A) Seward, Topeka, Kansas.

**BE** Independent. Our home business plans used successfully nation wide. Free literature. Applied Industries, 953-M East Michigan Avenue, Ypsilanti, Michigan.

**START** Your own concrete block business. "Cash in" on the tremendous postwar home building boom. Big demand everywhere. Universal Tampo makes all sizes concrete blocks fast—200 blocks per hour. Your normal net profit 5c per block—up to \$10.00 per hour. Easy to operate—no special skill required. Necessary materials available everywhere. Nominal investment, balance out of earnings. Write for details. Universal Tampers, Inc., 1567 No. Adams, Peoria, Illinois.

**MONEY** Made easily, home or room. Color, health, education, need not stop you. Thirty cents coin or stamps will bring you details three dandy plans. Also, fifty cent information sheet, twenty-five cent folio, fifty cent credit coupon and other offers. Ad. Dept. Bargain Specialty Company, Box 635, Modesto, California.

**DRUNKENNESS** Is a disease which responds to treatment. Medical skill plus human sympathy prove successful with liquor and drug cases. 60 years experience. Write for free booklet. P. M. Nelson, The Keeley Institute, Dwight, Ill.

**BOOKKEEPERS.** Earn money at home posting journal entries. Ellis Business Service, Cedar Grove, North Carolina.

**INCORPORATE** Your business. Delaware laws. Many advantages, free details. Tax Research Bureau, Inc., Delaware Trust Building, Wilmington, Delaware.

**TYPEWRITER** Repairing—Original course, simplified home study. Weber Typewriter Mechanics School, Box 269, Osborn, Ohio.

**MAIL** Order business course shows you how to make money, spare or fulltime. Teaches professional mail order technique—not penny-snatching schemes. New success catalog free! Write—Nelson Company, Dept. 4-02, Chicago 4.

**INSIDE** Secrets on making quick cash. Without canvassing. Folder free. Write. Lone Star Service, 1708-B First Ave., Dallas 10, Texas.

**EARN** Money with textile painting course. Free details. George Gundrum, LeRoy, Michigan.

5 MOST Read mail order magazines 25c. Education Publishers, Pittsfield, Mass.

**INFORMATION**—Locating most any article. (Dime.) Rakes, Box 5931-A, Chicago 80.

**MADE** \$24,000; Used "schemes" from "Schemer" Magazine, Alliance, Ohio. 47th year, \$1.00; 3 months, 25c.

**LOOKING** For a profitable mail order business that can be started with little capital and developed into a paying proposition? Write today for full information. Jackson Publishing Company, Dept. 111, Box 477, Mineral Wells, Texas.

**PERMANENT** Substantial income manufacturing newest, badly needed civilian goods. Investment small. Profits immense! Stamp brings "Messenger" listing modern analyses and certified formulas. Miller, Chemist, Tampa 6, Florida.

**LEARN** Electroplating. Complete instructions by a practical plater, with formulas for brass, cadmium, chromium, copper, gold, nickel and silver solutions. Price \$1.00—money back guarantee. Plater Hyde, P.O. Box 176, National City, California.

**SELL** Books and courses by mail in your spare time. Siddall, Atascadero, Calif.

**VITAMINS**, Minerals, health foods. Wholesale prices. Free catalog. National Diet Company, Portland 4, Oregon.

**RAISE** Giant Chinchilla rabbits. Willow Farm, R15A, Sellersville, Penna.

**SIX** Complete and different post card plans for starting profitable spare time business. Gordin Publishers, Box 23, Pawtucket, R. I.

**VITAMINS**—High quality, low price, private label. Gibson Company, Harlan, Iowa.

**HOW** And where to obtain capital. Fully explained. Particulars free. Star Service, Wapakoneta, Ohio.

**MORE** Money with your own products. Experience unnecessary. No machinery. Information free. B. Kinford, Wayne, Penna.

**SELL** Exclusive books of instruction by mail. 80% profit. No bookstore competition. Snappy circulars ready. Rush name! Financial Education, 431F, 728 15th, Denver 2, Colo.

**START** Mailorder bookshop—Everything furnished; publisher cooperation. 25c brings booklet, exclusive setup, samples, exciting ideas. General Publications, Ossining, N. Y.

**LIQUID** Marble; snow-white, multi-colored. Glazed. Unglazed. Composition flooring. Lifetime wear. Any color. No priorities. Flexible molds. Plaster casting. Get into the big money now. Full information given free. Write Compo-Tex, Box 786-R, St. Louis, Mo.

**OPERATE** Profitable credit and collection agency business; earn \$5000-\$10000 upwards annually; interesting literature free. Write Educational Extension Service, Department 101, Wilshire-Labrea Station, Los Angeles.

**AGENTS**—To mail our literature. Good profits. Home business. Maywood, 1133 Broadway, New York.

**GET** Into mail selling. Prepare for future. Start sideline business now. Splendid opportunities. Interesting, profitable propositions immediately available. Progressive Magazine tells how! Free details and premium offer. Sheboygan Publishing Co., Sheboygan, Wisconsin.

**CHARTERS**: Delaware; best, cheapest; free forms. Colonial Charter Co., Wilmington, Del.

**127 WAYS** To make money, in home or office, business of your own. Full particulars free. Elite Co., 214 Grand St., New York.

**BRUSH** Plating outfits connect to a battery. No tanks necessary. Good paying business at home plating autoparts, bathroom fixtures, bicycles, reflectors, silvering mirrors. No shop or experience required. Outfits furnished. Free booklet. Gunmetal Co., Ave. H, Decatur, Ill.

**EXTRA** Income—Plenty mail selling opportunities. Write Katz, 4254 N. Kimball, Chicago.

**LIQUID** Marble—Colorful, glazed! Mold, brush, spray! Composition floors, rubber-lastic molds. Particulars free. Marbleizing Service, Edwardsville, Illinois.

**FREE** Subscription. Drop postal today. The Mail Order News, Somerville, New Jersey.

#### **MONEYMAKING OPPORTUNITIES**

**MAKE** Money by mail. Particulars for stamp. Mullen, Box 514-B, Atlantic City, N. J.

**THOUSANDS** Of articles wholesale. "Supply Source Directory" 10c. Ideal Service, D-2, Park Ridge, Ill.

**GROW** Dwarfed trees few inches high for yourself or sell. Instructions 15c. Charles McGuire, P.O. Box 628, Dept. G, Seattle 11, Wash.

**FREE** Literature describing many money-making plans. Midwest Distributing Co., 2617 South Greenwood, Fort Smith, Arkansas.

**HELP** Win the war first! Then man, you'll like silvering mirrors, reflectors! Making sparkling chipped glass nameplates. Outfit prices. Sprinkle, Plater, V60, Marion, Indiana.

**ALASKA** Specialty mail order business starting plan. New! Different! Original! Sound profit-maker! Write Climax, 1210 South Harding, Chicago 23, Illinois.

**THE** Manufacture of novelties offers splendid opportunity for permanent, post war business, easily learned, no expensive equipment needed, start in any community, ship anywhere, orders waiting—big profits. Literature free to adults only. Plastex Products, 330 Balboa, San Francisco 18, Calif.

**MAKE** Dollars tattooing. Details 3c. Steele, 234B South Main, Los Angeles.

**HOMEWORKERS**—Castwood plastic gifts, plaques, novelties; any mold, natural wood color. Sample gallon (20 pounds) with instructions \$4.00. 20th Century Products, 3151-A Southport, Chicago.

**MAKE** Plaster Plaques, Statuary, Liquid Marble. Complete instructions, formulas, \$1.00. Ideal Service, RM2, Park Ridge, Ill.

**CASH** In leather ornaments. Make at home. Sell on sight. Write now. Vogue Leathers, Fairfield 3, Iowa.

**DOLLARS** Daily selling year-around necessity to corporations, business firms, stores, home and car owners. This excellent product, full particulars, 50c post-paid. Paragon Products, Box 142, Dept. O, Oil City, Penna.

**HURRY** Dollars galore. No canvassing. Central Mail Service, Willow Springs, Missouri.

**MONSTER** Mail, magazine, adsheets, circulars. Opportunities. 10c. Harvey Teeple, (PM), Decatur, Indiana.

**ICE** Cream candy—Latest rage. Home manufacturing. Formula 10c. LaPlant, Menominee, Michigan.

**TOOL** Designing pays big. Home study course. Low cost. Easy terms. Free booklet. Ohio Institute of Technology, Box 223, Greenville, Ohio.

**MECHANICALLY** Inclined men—Own and operate general appliance repair shop. Complete, illustrated course shows you how. Welding, refrigeration, motor repair, how to get business, etc., all phases covered. Free literature. Christy Supply Dept. 1149, 2835 N. Central Ave., Chicago.

**MAKE** Money mailing our imprint circulars. You make 50c on each dollar order. Sample circulars for stamp. Vinciguerra, 41-20 55th St., Woodside, Long Island, N. Y.

**"FORTUNES** In Sawdust." Build lifelong business. Turn this discarded material into cash on kitchen stove. Big demand! Copyrighted plan, formulas 25c. Palmer Company, Station A, Berkeley, California.

**FORTIFY** Your future with a business conducted in your home or office. Over 100 tested plans. Free details tell how. Rush penny postal. Victory Sales, Dept. M49, Box 75, College Station, New York City.

**OPERATE** Your own mail order business at home. Details free. George V. Beach, 79 Essex Street, Springfield, Mass.

**DISCOVER** Profitable opportunities through creative mind training. Dr. Tibbitt, 17M, 185 Godfrey, Philadelphia 20.

**FREE** Literature describing many money-making plans. Abbott, Box 44, 210 5th Ave., New York City 10, N. Y.

**120 WAYS** To make money. One of the greatest moneymaking books ever published. Price \$1.00. Fresco Service, Box 714, Baltimore 3, Md.

**INFORMATION** Locating most any article. (Dime.) Rakes, Box 5931-B, Chicago 80.

**"MAIL** Order World." Outstanding mail order magazine. Sample copy 10c. Martin's, Box 2414P, Bridgeport 8, Conn.

**MONEY?** Sure, with Selected Opportunities 25c from Seaman, Box 1922-D, Portland 11, Oregon.

**PLASTIC** "Wonder-links" for handmade costume jewelry. Profitable sideline! Free details. Beginner's outfit, \$1 (refundable). Hughes, 218 Sidell, Danville 3, Illinois.

**START** Now—Build money making mail order business. Get yourself established. Actual examples explained. Particulars free. Young's Industries, Kent 15, Ohio.

**BIG** Money manufacturing custom made arch supports. Particulars. Jul Corssen, 2638 Geyer, St. Louis 4, Missouri.

**I** MAKE Big money in the mail-order business. You can do the same at home with my copyrighted system. Write me. I'll tell you how. F. Little, Box 8, Glenshaw P.O., Pittsburgh, Penna.

**THOUSANDS** Of alarm clocks need repairing. Jewelry stores swamped. Our simplified course teaches you how to repair these clocks. Necessary tools and supplies furnished with course. Alarm Clock Repair Service, Dept. B, P.O. Box 1983, Houston, Texas.

**RAISE** Giant Chinchilla rabbits. Willow Farm, R15B, Sellersville, Penna.

**"VARIOUS** Opportunity Catalog." copy 10c. P.O. Box 1735, San Diego 12, Calif.

**EARN** Money evenings, copying and duplicating comic cartoons for advertisers. Adservice, Argyle, Wis.

**CATALOG** Listing hundreds of opportunities 10c. (refundable). Barcus, 1901 N. 13th, Terre Haute, Indiana.

**PUBLISH** Your own magazine. Handsome 52 page format, well edited, illustrated. Cost low as \$1.00 month. Brings you prestige, profits, 10c brings sample, details. National, Ord, Nebr.

**LEARN** Metascience. Remarkable drugless healing. No manipulation. No apparatus. Unbelievable simplicity and results. Inexpensive correspondence course. Write Metascience, De Land, Florida.

**EARN** Money at home! Thousands do! "Home Worker Magazine" tells how. Sample, 25c. Sizemore, Box 7, 4917 North Kostner, Chicago.

**LICK** After-war layoffs! Start own business; home, office. Booklet describing "Collection of 127 Tested Plans" free. Elite Co., 214 Grand St., New York.

#### **CHEMISTRY**

**FREE** Chemical catalogue. Enclose 3c postage. Greenwood, 398 Broadway, New York.

**THE** House of Winn, the home of supplies for amateur chemists. See Winn's New Idea chemical kits and apparatus outfits for home experimenting. Send 10c for retail catalog. Established 1931. John H. Winn, Dept. 502, 124 West 23 St., New York.

**FREE** Catalog: Chemistry, mineralogy, biology, optics. Tracey Laboratories, Evanston, Illinois.

**NEW** 32 Page chemical apparatus order book. Complete line of chemical glassware, apparatus and chemicals. Send 10c for this book. Standard Science Supply Co., 1233 N. Paulina St., Chicago.

**SPECTROSCOPE** For quick chemical analysis \$2.50. Kutting Sions, Campbell, California.

**LABORATORY** Supplies at wholesale prices: Chemistry, biology, physics. Catalogue 10c. National Scientific Co., 2204 W. North Ave., Chicago. Established 1908.

**CHEMISTRY** Laboratory apparatus and chemicals for industrial, analytical, and private experimental laboratories. Complete chemical laboratory supply service for correspondence school students. Send 3c for free 48-page catalog of chemicals and apparatus. Dept. M-43. Biological Supply Co., 1176 Mt. Hope Ave., Rochester, New York.

#### **FORMULAS, PLANS, ETC.**

**START** Profitable business of your own. We supply industrial formulas now used in manufacturing plants, of alkaline metal cleaners, steel treating compounds, cements, rust proofing, etc. Write for free list. Dunbar Laboratories, Box 858, Chicago 90, Illinois.

**LIST** Formulas imitation diamond, etc. Rush name. Forest Galloup, 3 Lakeview, Mich.

**"LUMINOUS** Paint" shines in dark. Easily made. 100 other formulas, plans—all 25c. Soap-making course (20 formulas) \$1.00. Resilvering mirrors, formula 20c. Ideal Service, 302 Park Ridge, Ill.

**CANDIED** Apples, caramel corn, barbecue sauce recipes, all for \$1. Zehnder Sales, Phillipsburg, N. J.

**ARTIFICIAL** Tiling, marble flooring. \$1.00. Universal Sales, Wortendyke, New Jersey.

**MORE** Money with your own products. Experience unnecessary. No machinery. Information free. A. Kinford, Wayne, Penna.

**MAKE** Bleach water formula \$1.00. Capotosto, 1707 Cranston St., Cranston 9, R. I.

ANY Formula \$2.00 or refund. Case Kowal, Chemist, 1846 Cullerton, Chicago.

**SPECIALISTS** Compositions, plastics, adhesives, paints, polishes, household products. Literature free. Rapid Chemical Service, Edwardsville, Illinois.

**MAKE** Fast selling products at home. No machinery. Wonderful profits. Literature free. Kemico, 17, Park Ridge, Illinois.

**AUTHENTIC** Formulary, 924 page illustrated book. Prepared by experts. 10,000 practical tested formulas, recipes, secrets, instructions for easily making most any product. Countless profitable business opportunities. Valuable reference for home, industry. Extra! Complete plans: "D.D.T." miraculous new insecticide. One spraying kills all flies, mosquitoes, lice, jap beetles, etc. Lasts three months. Big money maker. \$2.98 postpaid (c.o.d. U. S. only) foreign \$3.25. Immediate shipment. Adams Brown Company, Dept. 110, Chestnut Hill 67, Mass.

**PLASTICS**, Vegetable, luminous, etc. Particulars free. Philhart Laboratories, 6 South Xanthus, Tulsa 4, Oklahoma.

**FORMULAS** - Latest, best. Analysis. Literature free. Bellfort, Engineering Building, Chicago.

**REAL** Manufacturing formulas. Lists free. Cummings, Chemist, Gordon Ave., Syracuse, N. Y.

#### HELP WANTED

**PLASTIC** And chemical opportunity. Exceptional position open for plastic chemist who understands the manufacture of urea-formaldehyde resins. Unusually attractive compensation and working conditions. Unlimited future to capable person. Brody & Watson Co., 18 Ames Street, Cambridge, Mass.

#### AGENTS WANTED

**AMBITIOUS** School seniors—We want you to sell classmates the "tops" in graduation name cards. Highest commissions! Only firm giving free souvenir chest and card case! Your cards free! Cardalogs going like wildfire! Hurry! Get yours today! Craftcards, Box 235(L), Pittsburgh 30, Pennsylvania.

**SELL** Greeting cards—Make easy money showing gorgeous everyday, birthday, Easter, Mothers' Day cards. Stationery. Over 100 quick sellers. Special offer. Write today for \$1 all occasion assortment on approval. Hedenkamp, 343 Broadway, Dept. 11, New York 13, N. Y.

**SKUNKADORA** Eliminates 100% all traces of skunk odors! Nothing like it. Whirlwind seller to farmers, trappers, general stores, breeders, etc. Big profits. Send \$1.00 for sample on money back guarantee or write Sparhawk, Sparkill, New York.

**BIG** Profits taking subscriptions for all magazines. Agents' confidential catalog listing over 2500 periodicals and complete starting supplies free. Pines Subscription Agency, Flushing, New York.

"MAIL Order Trade Directory" tells you where to buy wholesale. 25c brings 1945 edition. Box 693-PM, Canton 1, Ohio.

**SELL** New-used clothing from home, auto, store. Men's suits 99c, pants 27c, top-coats 44c, dresses 13c, ladies' coats 38c. Other bargains. Catalog free. S&N, 565A Roosevelt, Chicago.

**GREETING** Cards. Personal stationery. Wholesale. Graydons, Box 4152, Denver 9, Colorado.

**SILVER** Plating liquid. Simply rub-on with a cloth. Like a polish. Anyone can do it. Cleans, silverplates, and polishes with one rubbing. Puts on genuine 1000 fine silverplate. Renews silverplated ware and many other articles like new. Silverplates onto brass, copper, bronze, zinc, nickel-silver, german-silver, etc. Enduring finish, won't wash or brush off. Satisfaction or money-back guarantee on every bottle. Sales distributors wanted. Details mailed free. NuProcess Products, Dept. 133, Aurora, Illinois.

**EARN** Big commissions selling our simplified bookkeeping systems. Columbia Bookkeeping Systems, 319 Dell Ave., Pittsburgh 16, Penna.

**WHOLESALE** Directory of 1/2 million articles, sent postpaid for only 10c. W. T. Grace, Milledgeville, Georgia.

**MAKE** Money by mail — "National Guild" tells you what sells; who buys; how to reach them. Helps you start almost for nothing. Get true facts. Write "Nmog," Sparta 3, New Jersey.

**STRANGE** "Dry" window cleaner. Sells like wild. Replaces messy rag, liquids. Simply glide over glass. Samples sent on trial. Friskite, 139, Akron, Ohio.

**BIG** Money being made selling sensational Colt cushion cradle arch supports to women, men. Flexible, leather-covered airform rubber cushions, supports tired, aching feet. Extra large profits, cash bonus. Free sales kit. Write Colt Shoes, 659 Atlantic, Boston.

**MAGIC** Races—At cigarette touch six horses are off. Fast seller. Big profits. 40 races \$1.00. Dime brings samples, wholesale prices. Barkley Co., Dryden 11, Va.

**SELL** Dresses at low prices. Hundreds sensational bargains. Actual samples free. Send dress size, age. Harford, Dept. D-359, Cincinnati, Ohio.

**LOOK** Here! Wanted—Men and women to start in business on our capital. Sell some 200 farm-home products. Thousands our dealers now make quick sales, big profits. For particulars write Rawleigh Co., Dept. B-192-PPM, Freeport, Ill.

**CALL** On friends with greeting card assortments; Easter, birthday, other occasions. Personal stationery; gift wrappings. Big profits. Experience unnecessary. Samples on approval. Wallace Brown, 225 Fifth Avenue, Dept. N-4, New York 10.

**EVERYDAY**, Birthday and patriotic greeting cards. 4154g Fifth Street, Philadelphia 40.

**BIG** Money taking orders; shirts, ties, socks, pants, jackets, sweaters, shoes, uniforms, etc. Sales equipment free. Experience unnecessary. Nimrod, 4922-AN Lincoln, Chicago.

**SELL** Rayo for colds, headaches, rheumatics. Other products. Free, 5 samples, interesting literature. Big demand. Large profits. Rayo Chemical Corp., 334 Union Avenue, Brooklyn 11, N. Y.

**AGENTS**—Coin money—It's new, it's hot. Everyone wants radiant "Wonderlette" colored paintings of loved ones. We deliver, collect. Condon, Box 157, Upper Darby, Penna.

**\$3 FIRE** Extinguisher; quick sales, wholesale or direct; liberal profits. "Fire-Killer," 109 N. Franklin, Syracuse 4, N. Y.

**90c PROFIT** Each \$1 sale! Sell permanent mothproofing solution. Employ agents. Experience unnecessary—we tell you how. A. McKinley, Wayne, Penna.

**AGENTS**. Big line including food products. Fast selling premium and bargain deals. Low prices. Send card for big outfit offer with gift. Ho-Ro-Co, 2729 Dodier, St. Louis 7, Mo.

**POWERFUL** Mile stretcher! Increases mileage! Increases power! Increase your bank-account! 400% profit. Thermomiles, Peoria 4, Ill.

**GOLD** Lacquered window sign, letters. New styles. Absolutely beautiful. Free samples—catalogue. Atlas, 7941 Halsted, Chicago.

**BIG** Bargains for big profits. Men's used pants 25c, suits \$1.00, topcoats 75c, overcoats \$1.00, shoes 12 1/2c. Over 100 sensational values. Experience unnecessary. Free wholesale catalog. Superior, 1250-CB Jefferson, Chicago 7.

**SCHOOL** Seniors—Sell classmates America's most beautiful, distinctive graduation name cards. Positively highest commission. Largest selection. Lowest prices. Free cards and free sample kit. Printcraft, 1423 East Elm Street, Scranton 5, Penna.

**EXCELLENT** Sideline for printing salesmen. Decalcomania name plates in small quantities. Also, make money applying initials on automobiles. Free samples. "Ralco," X-164, Boston (18), Mass.

**AGENTS**: Stamping names on pocket-key protectors. Sample check with your name, address, 25c. Stamping outfits. Emblem checks, check-fobs, name plates. Hart Mfg. Co., 303 Degraw St., Brooklyn, N. Y.

**PLATING** Outfits for autoparts, reflectors. Connect to a battery. No tanks necessary. Free booklet and particulars. Gunmetal Co., Ave. N. Decatur, Ill.

**MAGIC** Cleaner and laundry soap deal. Hotter than a firecracker. Big profits! Sample free. Bestco, 5007 Irving Park, Chicago.

**ELITE** Collection contains 127 plans for starting own business; home, office. Descriptive booklet free. Elite Co., 214 Grand St., New York.

**WHOLESALE** Sources. 500,000 articles. Free directory. Maywood, 1133 Broadway, New York.

**FREE** Water and our concentrates, makes favors, lotions, shampoos, 72 products, labels, bottles furnished. Qualco, E-20030 Russell, Detroit.

**SELL** Quinlan's improved auto polish. It's different. Two quart size \$1.00 postpaid. Guaranteed. Will trust agents. J. Quinlan, Shandaken, N. Y.

#### HIGH-GRADE SALESMEN

**SALESMEN**. Handle cleaning compounds. Wholesale. Big profits. E. O'Leary, 916 Oak St., Flint 3, Mich.

**MAKE** Unusual spare or full-time profits showing genuine leather jackets, raincoats, 200 style and comfort shoes. Sample outfit free. Rush postcard to Consolidated Shoe, Dept. S-91, Chippewa Falls, Wis.

**SALESMEN** Wanted. \$200.00 weekly possible. Proof. Roy West, Charleston, W. Va.

**MAKE** Unusual spare or full-time profits showing genuine leather jackets, raincoats, 200 style and comfort shoes. Sample outfit free. Rush postcard. Mason Shoe Co., Dept. M-186, Chippewa Falls, Wis.

**ORANGE** Concentrate direct from our Florida grove. One quart bottle makes 6 quarts delicious natural orange drink simply by mixing with 5 parts cold water. Rich in vitamin C. Builds up resistance against winter colds. Groceries, restaurants, hospitals big buyers. No investment. Protected territory. Salesmen earn \$100.00 to \$200.00 repeat commission weekly. Sunset Valley, 3357 Clifton, Chicago.

**SALESMAN**: Have real money-making opening. Fits into war program. Old progressive firm. Dept. "F," Box 392, Dallas, Texas.

**BLADES**—Best quality, factory prices. Details free. Ace Blades, Buffalo, N. Y.

#### EDUCATIONAL AND INSTRUCTION

**HORSEMEN**—Learn to train and gait. Teach tricks. Free book. Animal Lovers Association, KP111, Tarzana, Calif.

**LANDSCAPING**. Learn landscape designing and gardening for a profitable out-of-door profession. Write National Landscape Institute, Dept. 2-F, 756 Broadway, Los Angeles 14, Calif.

**SUREHAND** Shorthand 30-day course produces quickest beginners and most rapid accurate stenographers. Textbook 25c. Jesse L. Cook, Bartow, Florida.

**MATHEMATICS**; Arithmetic; algebra, geometry, trigonometry, calculus, physics, preparation electrician, plumber, stationary, architect, surveyor, engineer licenses. Mondell Institute, 230 West 41st, New York.

**LEARN** To draw funny faces in 5 short evenings. Grand hobby. Loads of fun. Money-making possibilities. Illustrated folder free. Write Funny Faces, Modesto 2, Calif.

**BECOME** A finance man. Particulars free. George Lenhoff, Lincoln 8, Nebraska.

**SENSATIONAL** New magic shorthand and typing course, even a ten year old child can understand it. 25c postpaid. Falk, McCarty, Rt. 6, Waco, Texas.

**HUNDREDS** of helpful books. Catalog free. Popular Mechanics Press, (C-43), 200 E. Ontario, Chicago.

**COMBINED** Shorthand and typing course 25c. Ray T. Johnson, Brookport, Ill.

**HOME** Study. Over 300 low cost business, technical and vocational courses, including new course on real estate. Our method stimulates interest, develops initiative, saves months of study and hundreds of dollars. Free bulletin. State subject wanted. DeVoto Schools, 25 Vicente, San Francisco 16, Calif.

**TRIGONOMETRY** Is easy with Quick Trig calculator. Simply set the slides and read the answer. 75c postpaid. Reed Mfg. Co., 124 W. 4th, Los Angeles 13, Calif.

**PLASTIC** Engineering pays big. Home study course. Low cost. Easy terms. Free booklet. Ohio Institute of Technology, Box P-224, Greenville, Ohio.

**USED** Educational and technical books bought, sold, rented. Free catalog. Educational Exchange, Henagar, Ala.

"IF It's wealth you desire"—Write Box 2501-P, Los Angeles.

**LEARN** To be a landscape architect. Hundreds now manage own business as successful landscapers. Steady income. Home study course—45 illus. lessons. Average student can complete course in 8-12 months. 28th yr. Send for free bklet. American Landscape School, 6315 Grand Ave., Des Moines, Iowa.

**WRITE** Short stories at home for pleasure and profit. Fame, riches and happiness of achievement are rewards to be realized by students who acquire tested technique. Get free booklet from home study school with 50 years experience. Write today! Blackstone-Sprague, Dept. 12a, 307 North Michigan, Chicago 1.



**GOOD Jobs** and a sound postwar future await you in hotel and institutional field. Men and women—all ages—needed for well-paid positions that offer color, excitement, ever-new and fascinating duties. Record-breaking business in hotels, clubs, institutions, means even greater opportunities. Lewis School receiving calls for managers, assistant managers, stewards, hostesses, purchasing agents, and 55 other types of important positions. These are not temporary jobs, but important positions in an essential business that offers splendid opportunities in war or peace, good times or bad. Previous experience proved unnecessary! No need to leave your job to qualify. A good grade school education, plus Lewis Training qualifies you at home, in spare time. Our National Placement Bureau helps to place you—and our amazing Certified Job Plan—actually guarantees you will "make good" when placed. Write today for free book! Lewis Hotel Training School, Room DB-368, Washington 7, D. C. (First and only school of its kind—Now in its 29th year.)

**29 LANGUAGES** By Linguaphone. Russian, Spanish, Portuguese—Direct conversational method for mastering any language quickly, easily, correctly at home. Send for free book. Linguaphone Institute, 83 RCA Bldg., New York.

**MEN! Women!** Learn profitable profession in 90 days at home! Make \$40-\$75 week. Swedish Massage graduates in big demand. Work full or spare time. Win independence, security. Write for booklet and free details. College of Swedish Massage, Dept. P-45, Chicago, Illinois.

**WELDING**—Electric arc. Learn profitable trade quickly through actual practice. Individual welder instructions at bare cost of materials. Full particulars free. Valuable welding lessons book 50c. Hobart Welding School, Box M-252, Troy, Ohio.

**"HOW To Break and Train Horses"**—A book every farmer and horseman should have. It is free; no obligation. Simply address Beery School of Horsemanship, Dept. 1102-C, Pleasant Hill, Ohio.

**MAKE Up to \$25-\$35 week** as a trained practical nurse. Learn quickly at home, spare time. Easy tuition payments. Earn while you learn—many earn hundreds of dollars while studying. Easy to understand lessons, endorsed by physicians. High school not required. Our 45th year. Write for free booklet and sample lesson pages. Chicago School of Nursing, Dept. K-2, Chicago.

**SECRET Investigation.** Experience unnecessary. Investigators particulars free. George Wagner, M 125 West 86th, New York.

**LOOK Ahead!** Are you "all set" for a permanent job in the years to come? Only properly trained men will get and hold top positions with best pay. Pick air conditioning, refrigeration, heating, ventilation, welding, electricity, radio or electronics—fastest growing, most promising industries. Prepare now, train in a few months instead of years. Low tuition, liberal terms. Earn part expenses. Big book free. Milwaukee School of Engineering, Box 644, Milwaukee, Wis.

**PROFESSIONAL, Amateur cartoon, gag writers.** Good commission for class jokes. Instructive details mailed free. Monroe, 1728 Pine Street, Tampa 7, Fla.

**DRUNKENNESS** is a disease which responds to treatment. Medical skill plus human sympathy prove successful with liquor and drug cases. 60 years experience. Write for free booklet. P. M. Nelson, The Keeley Institute, Dwight, Ill.

**HOME Studycourse, drugless therapy.** Free literature. Institute of Drugless Therapy, Tama, Iowa.

**USED Educational books** on all subjects sold, rented, also bought and exchanged. Moneyback guarantee. Write today for free catalog and details. Lee Mountain, Pisgah, Alabama.

**REFRIGERATION**—Air conditioning. Mechanically-minded men! Are you interested in the kind of work which offers a "go-getting" man a real chance to make headway—even own his own business? Then write today for free facts about refrigeration and air conditioning, and how you can start now to get a working foundation for this field in your spare time; how you can get the kind of training which for 18 years has helped so many U.E.I. men "make the grade" in a big way. Utilities Engineering Institute, Dept. 15W, 1314 W. Belden Ave., Chicago 14, Ill.

**GOOD "Used"** self-instruction educational books on all subjects bought, sold, rented, exchanged. Satisfaction, guaranteed. Complete information and 92-page illustrated bargain catalog free. Write—Nelson Company, Dept. 2-02, Chicago 4.

**NEW Writers** needed to rewrite ideas in newspapers, magazines and books. Splendid opportunity to "break into" fascinating writing field. May bring you up to \$5.00 per hour spare time. Experience unnecessary. Write today for free details. No obligation. Postcard will do. Comfort Writer's Service, 210-P South Seventh St., 2, St. Louis, Mo.

**RADIO Writers** wanted. Home-study course teaches you the required professional technique for getting your ideas on the air. Pay-as-you-learn terms. Free information. Radio Writing Institute, Studio M, Radio Center, Hollywood 28, Calif.

**AUTO Body and fender work,** including metal work, welding and spray painting. Look into it! One of the most profitable branches of tremendous auto industry offering chances for good job or your own business. Train in spare time. Write for free facts. Utilities Inst., Dept. 14X, 1316 W. Belden Ave., Chicago.

**LEARN Profitable credit and collection agency business;** investigate Educational Extension Service Advertisement under Business Opportunities.

**CARPENTERS.** We teach the square in five easy lessons by mail. Our 1/4 size practice square and simplified instructions does the work. Free information, better still send quarter for practice square and partial lesson. Builders' Topics, Medical Arts Bldg., Seattle, Washington.

**MEDICAL Laboratory technicians** in great demand. We train you in your spare time in your own home. You can practice while studying. Write for free catalogue. Imperial Technical Institute, Box 973-E, Austin, Texas.

**LOCKSMITH Course.** Lock picking, key fitting, etc. \$1.00 prepaid. Locksmith, Canadian, Texas.

#### PLAYS, STORIES, MANUSCRIPTS

**MANUSCRIPT Revision, collaboration.** Ghostwriting. Pay after results. When inquiring, give some details. Lathrop, Box 361-F, Junction City, Kansas.

**WRITERS, Poets, 23 valuable services.** Write National Writers Club, 1837 Champa, Denver 2, Colo.

**WRITERS:** Send for free circular P-25, with unified sales plan for placing your work. Otis Adelbert Kline, Literary Agent, Established 1923, 507 Fifth Avenue, New York 17.

#### CARTOONING, COMMERCIAL ART, SHOWCARD WRITING, SIGN PAINTING

**LEARN Cartooning** from a professional. New method course, 18 chapters, 300 illustrations, pens, pencils, paper included, \$1.00 complete. Defense stamps accepted. Chesley, 1450-P Broadway, Buffalo 12, N. Y.

**CARTOONING, Sign painting, commercial art instructions** complete \$1.00. Spradlin Sales Co., 2204 North L, Fort Smith, Arkansas.

**CARTOONING Course:**—30 illustrated lessons, over 500 sketches, complete \$1.00. Rex Cartoon Studio, Box 892, Pasadena, California.

**CARTOONIST'S Magazine.** Cartoon hints, lessons and markets. 25c coin postpaid. Hartman, 2438 W. Lincoln 3, Nebr.

**CARTOONISTS**—Sell your work. 15 illustrated lessons, 10 money making plans, markets, \$1.00. Cartoon Studio, 1402 Charles, LaCrosse, Wis.

**POCKET Size cartoon course**—22 easy lessons, over 200 sketches including figures and lettering. Prepared by nationally known artist. Mailed postpaid on receipt of 25c in coin. Snack-Pack Co., 34 E. Georgia St., Indianapolis 4, Ind.

**ART Instruction.** Self taught. Cartoons. Pen and ink. Figure-drawing. Perspective water color. Oil painting. Over 100 illustrations. Send only \$1.00 for complete course. Nothing more to pay. Vondy Publishing Co., 9521 Annetta Ave., Southgate, Calif.

**WRITE Cartoon ideas.** Nationally known magazine cartoonist booklet shows how. "Be Funny for Money, 25c." Ullah Studios, 518P Wrightwood, Chicago 14.

**CHALK Talks.** Laugh producing program, \$1.00. Catalog 10c. Balda The Cartoonist, Oshkosh, Wisconsin.

#### ADVERTISING AGENCIES, LETTER WRITERS, FOR ADVERTISERS

**ADVERTISE:** 24 Words, 149 newspapers \$6.50. Lists free. Advertising Bureau, 4516-C Cottage Grove, Chicago 15.

**ADVERTISING Placed,** any publication, lowest rates, complete agency service. Skilled advertising—merchandising counsel. Ratelist and booklet, entitled "Advertising Results For Sale" free. Baker Agency, 3302 Dodge, Omaha, Nebraska.

**24 WORDS** in 90 weeklies \$4.60. H. J. Darnell, 730 Hays, Jackson, Tennessee.

**SALES Counselor** for busy manufacturer or studious inventor. Develops marketing plans, organizes and directs sales-force and promotional activities. P.O. Box 199, Marietta, Ohio.

**ADVERTISING Placed** everywhere lowest rates. Reliable guidance on publications, expert assistance on ads without charge. Newspaper, magazine, mailing-list ratebook free. Chicago Advertising Agency, 20-P West Jackson, Chicago 4.

**20 WORDS** 30 Newspapers \$2.00. Good-all, 37 Gardner, Vallejo, California.

**ADS Placed** in out of town newspapers and magazines. Low rates. Catalogue free. Ideas that pay. Baker Advertising Agency, Successors Ankrum Agency, 189 W. Madison, Chicago 2.

**INCH Display advertisement,** 50 magazines, year \$16. Wood's Popular Services, Atlantic City, (N. J.)

**FREE—New Advertisers Rate Guide,** 44 pages. Includes everything. Lowest rates. E. H. Brown Advertising Agency, Merchandise Mart, Chicago.

#### BUSINESS SERVICE

**RESEARCH.** Business opportunities, imports, exports, etc. on South and Central America. Reasonable fees. Latin American Research Bureau, 305 W. 8 St., Los Angeles 14, Calif.

**HOLLYWOOD, California,** mailing address; reforwarding service, single letters 25c, monthly service \$2.00. Dan's, 1507 Kenneth Road, Glendale, Calif.

**SEATTLE, Wash.** Your mail re-forwarded daily \$2.00 month. Bank reference. Chas. McGuire, P.O. Box 628, Dept. G, Seattle 11, Wash.

**\$2.00 MONTHLY** maintains Washington, D. C. office address. Your business, personal mail reforwarded when wanted. Hawkins, (Established 1917), 7-I Randolph Place.

**CRADLE** of the Confederacy mail address. Month \$2.00. Single letter 25 cents. Honest System, Box 2231, Montgomery, Ala.

**SAN FRANCISCO** Mail address. Forwarding or consultant service. \$2.00 per month. Single letters 25c. Anco, 1191 Market St.

**INCORPORATING** Your business? Write for valuable information free, before you go ahead; we save you money. Murdock Company, 131 West 42nd St., New York City 18.

**TO Whom it may concern:** I will represent you in Cleveland. Personal or business assignments \$1 per hour. James W. Farley, Citizens Bldg., Cleveland 14, Ohio.

#### SPECIAL SERVICES

**ANY Problem?** What do you want to find out? Chaffee, 308 Washington, Chicago 6.

**TUCSON, Arizona.** Mailing address. Personal, business. Reliable representation. Lawrence, Box 5185.

#### TYPEWRITERS, DUPLICATORS, OFFICE DEVICES

**TYPEWRITERS, Cash register, multi-graph, printing presses.** Bartlett-86, Atlanta, Missouri.

**8 1/2" x 11" STENCIL Duplicator** complete with ink, stencils, paper, \$3.75 postpaid. 9" x 12" blue printer complete with blue print paper, tracing paper, developer, \$3.50, postpaid. Best Company, Box 5802, Cleveland 1, Ohio.

**USED Cash-registers, typewriters, paper-cutter, multigraphs, addressographs, duplicators, folding and adding machines.** Shaw Mfg. Co., Galesburg, Kansas.

**"PRINTOMATIC"** Self-feeding rotary stencil post card printer, complete, \$9.50. All makes duplicator supplies. Literature free. Pittsburgh Typewriter Supply, 336-R Fourth Avenue, Pittsburgh 22, Penna.

#### RUBBER STAMPS, OFFICE SUPPLIES

**KNOB Handle, cushioned, 3 lines 30c. 3-40c.** Stamp Works, Centerport, N. Y.

**SERVICEMEN'S Kit** contains stamp, indelible ink and pad, \$1.20. Exello Sales, Box 500, Shreveport, Louisiana.

**YOUR Name,** address on de luxe cushion mount rubber stamp, \$1.00—pad 25c. Postpaid. Cash with order. Edgewood Press, Edgewood, Maryland.

**3 LINE, Cushioned, indexed, 35c.** Signatures \$1.50. Stamprite, Wauwatosa, Wis.

**ONE Line 20c, 2-35c, 3-50c, 4-65c.** Stamp Works, Auburn, Nebraska.

## PRINTING, MULTIGRAPHING, MIMEOGRAPHING, GUMMED LABELS

**PRINTING** Of distinction at really reasonable prices. Samples, helpful suggestions and estimate gladly sent. State needs. Edgewood Press, Edgewood, Md.

**PRINTING**, Commercial advertising, low rates, fast service, good workmanship. Danzig Printing, 178 Clinton Street, New York City.

**MIMEOGRAPHING**—Letters, price lists, formulas, instructions. Lowest prices. Lem's Letter Shop, 5710 Stanton, Detroit 8.

**MIMEOGRAPHING**—Send stamp for trial offer. News-Messenger, So. Lancaster, Mass.

**FAST** Printing, low prices. Samples, estimates free. Wilson Printing, Dowagiac 3, Michigan. Special: 1,000 No. 88 business cards, 3 line limit, \$2.25.

**\$1.00 POSTPAID**—200 8½x11 Letterheads or 6¼ envelopes. Benneville, 907 West Roosevelt, Philadelphia 40, Penna.

**PRINTED** Postcards. For business or personal use. Attractively printed with name and address. 50—35c. 100—60c. 150—75c. postpaid. Printercraft, 1830 Wood, LaCrosse, Wis.

**GUMMED** Perforated address labels. 300 for \$1.10. Keller, Michigantown 2, Ind.

**INTRODUCTORY** Special—One thousand 6¼ Hammermill bond envelopes printed, \$2.90, f.o.b. Samples for stamp. Star Printers, 918 Pinecrest, East Grand Rapids 6, Michigan.

**BUSINESS**, Personal printing. 100 each letterheads, envelopes, \$1.95 postpaid. Samples. Artpress, Riverdale Box 61, Dayton 5, Ohio.

**5000 LOTS** Envelope slip, \$4.85; 6x9 circulars, \$8.98; folders, booklets, catalogs, postcards, stationery—lowest prices. Immediate service. Samples. Goodprint, Harrisonburg, Va.

**ANYTHING** Printed, reasonable. Color work. Samples. Excelsior Printers, Weatherford, Texas.

**QUALITY** Printing—1000 6¼ envelopes, \$3.75; No. 10, \$4.85. Free price list, samples. Joseph Adams, 30 W. Washington, Chicago 2.

**400 5½x8½ LETTERHEADS** \$1.25. Mango, 555B South 20th, Newark 3, N. J.

**200 8½x11 HAMMERMILL** Letterheads \$1.00 postpaid. Envelopes same. Race Printing, Hudson, N. Y.

**SPECIAL** \$3.50—250 Each 8½x11 letterheads, 6¼ envelopes, 5½x8½ statements—White Hammermill bond. Shiretown Press, Plymouth, Mass.

**\$2.00 POSTPAID**—150 8½x11 Good bond letterheads and 150 6¼ envelopes. 500 of each \$3.75 postpaid. Mero Products, Box 344, Punxsutawney, Penna.

**LETTERHEADS**, Envelopes. High speed precision printing. Better work, lowest prices, prompt service. Free samples. Production Printers, Middleburgh, N. Y.

**1000 ENVELOPES**, Letterheads, statements, cards, labels, \$3.98. Chase's, Escalante, Utah.

**DISTINCTIVE** Printing reasonably priced. Free samples. Cramer, Box 993, Chicago.

**WE** Specialize in printing. Shop orders, shipping tags, automobile forms, noteheads, duplicate forms, statements, invoices, time cards, manifold books, and all types of ruled forms. State requirements. Printing Service, 7922 So. Vermont Ave., Los Angeles 44, Calif.

**ENVELOPES**, Letterheads printed 200—\$1.00 postpaid. Samples. Weedman Press, Madisonville, Kentucky.

**PRINTING**—Mimeographing, free estimates, samples. Wabash Print Shop, 1444 Webster, Wabash, Indiana.

**PHOTOCOPIY** Anything 8½x11, 25c—18x22—\$1.00. Quotations, samples. Scholler, 1407 Howard, Pittsburgh 12, Penna.

**200 BOND** Letterheads or 200 6¼ envelopes \$2.25. Estimates on other printing. Foster Sign & Printing Company, 4020 Cottage Grove Ave., Chicago 15, Illinois.

**3000—6x9 CIRCULARS** \$5.85 postpaid to 4th zone. Education Publishers, Pittsfield, Mass.

**SPECIAL**, 1000 6¼ Envelopes printed. 5 lines, \$3.00. Girardin, 10860 Whitehill, Detroit 24, Mich.

**MIMEOGRAPHING**—Any copy. Reasonable. Mallers Service, Box 606-A, Chicago 90, Ill.

**500 3½x2¼ FOUR** Line gummed stickers, 25c. Moritz Printery, Saginaw, Mich.

**BETTER** Grade printing reasonable. Estimates on anything. Economic Press, Leonia, N. J.

**MIMEOGRAPHING** And multigraphing. 14 years of fine work and fair prices. Free samples and prices. H. Allsmith, 1500 W. Nedro Avenue, Philadelphia 41, Penna.

## PRINTING OUTFITS AND SUPPLIES

**BARGAINS**—Presses, type, supplies. Send stamp. 8 Walden, Cambridge, Mass.

**5x7 PRINTING** Outfit, lot of type. Russell Zellers, Mingoville, Penna.

**TYPE**, Ink, 25c outfits. List for stamp. Murelok, Box 748, Dayton 1, Ohio.

**PRESSES**, Type, paper, cabinets, cutters. Bargain lists 3c. Levinson, Box 918, New York 8.

**PRINT** At home. 10c will bring a complete catalog of presses, type and supplies. P. Peiffer & Company, 6 Columbia St., Newark, N. J.

**USED** Presses, type, supplies. Lists 3c. Turnbaugh Service, Loysville, Penna.

**INEXPENSIVE** Home-made printing press. Details free. Novelty Shop, Downsville, Louisiana.

**PRINTING** Equipment, type and supplies. Send stamp for details or dime for complete illustrated supply book. Kelsey Inc., X-11, Meriden, Conn.

## PATENT ATTORNEYS

**INVENTORS: Learn now—without obligation**—how to protect and sell your invention. Write for free "Record of Invention" form and complete information for making disclosure and establishing date of your invention. We also send our new free "Patent Guide for the Inventor," containing complete information about patent procedure and how to sell inventions; giving illustrations of many successful inventions; over 150 basic mechanical movements. We assure you prompt, confidential service. Delays may be dangerous. Write today for your free "Patent Guide" and "Record of Invention" form. Clarence A. O'Brien & Harvey Jacobson, Registered Patent Attorneys, 51B-B Adams Building, Washington, D. C.

**INVENTORS**—First things come first. Your first move toward securing a patent on your invention is acquiring full information on what to do. Our two books "Patent Protection" and "When and How to Sell Your Invention" contain this information and other helpful data. Get them immediately, together with our "Evidence of Invention" form. They cost you nothing, you assume no obligation. Write now to Victor J. Evans & Co., Registered Patent Attorneys, 931-B Merlín Building, Washington 6, D. C.

**WHAT** Should you invent? Our free book tells you what today's inventive market wants—how to put down, patent, and sell your ideas. Scores of letters in our files attest to the modern demand for inventions—our long experience as Registered Patent Attorneys will help you. Get our free book, "How to Protect, Finance and Sell Your Invention." Also special document free, "Invention Record" on which to sketch and describe your invention. Write today. No obligation. McMorro & Berman, Patent Attorneys, 134-L Atlantic Building, Washington 4, D. C.

**INVENTORS**—Before disclosing your invention to anyone send for form "Evidence of Conception"; Schedule of Government and Attorneys' Fees and instructions. Sent free. Lancaster, Allwine & Rommel, Registered Patent Attorneys, 411 Bowen Building, Washington 5, D. C.

**PATENTS**, Promptness assured. Wilfred E. Lawson, 1524 K Street, N.W., Washington 5, D. C.

**FREE** "Fortunes Are Built on Ideas" answers your patent, trademark questions. Registered Patent Attorney since 1920. John J. Lynch, 361K Irving Ave., Brooklyn 27, N. Y.

**PATENT** Protection. Write for information. Fees. Record of invention. Free. Randolph & Beavers, 21-C Columbian Bldg., Washington, D. C.

**"INVENTOR'S** Guide." 100 mechanical movements, free; advises on patenting, selling inventions. Frank W. Ledermann, 184 Nassau Street, New York.

**C. A. SNOW** & Co., M-427 Snow Bldg., Washington 1, D. C. Registered patent attorneys. Established 1875. Literature mailed on request.

**PATENTS** Obtained; selling service, information, recording forms free. Labiner, World Building, New York.

**PATENTS**, Protect your idea by securing free "Proof of Invention" folder. Exceptional personal service. Established 1906. E. E. Vrooman, 871 Woodard Bldg., Washington, D. C.

**PATENTS**—Trade marks. Preliminary advice, book and disclosure form free. Personal service. Irving L. McCathran, 315 McLachlen Bldg., Washington 1, D. C. Registered Patent Attorney.

## FOR INVENTORS

**PATENTED** And unpatented inventions promoted. M. Joyce Humphries, 1424 Land Title Bldg., Philadelphia 10, Penna.

**WHAT** Should you invent? Our free book tells you what today's inventive market wants—how to put down, patent, and sell your ideas. Scores of letters in our files attest to the modern demand for inventions—our long experience as Registered Patent Attorneys will help you. Get our free book, "How to Protect, Finance and Sell Your Invention." Also special document free, "Invention Record" on which to sketch and describe your invention. Write today. No obligation. McMorro & Berman, Patent Attorneys, 134-M Atlantic Building, Washington 4, D. C.

**LARGE** California plastics organization, now successfully manufacturing and merchandising scores of art, gift, and household ware items through department, drug and novelty stores, is interested in adding new items to its line. Inventors are invited to submit ideas for new plastic or metal products, fabricated or molded suitable for large quantity production. Also interested in electronic or radio products. Write giving full details. Precision Specialties Co., 210 N. Western Avenue, Los Angeles 4, California.

**SELL** Your inventions, ideas! Verified list of manufacturers buying inventions, ideas for new products. Send \$1.00 today. S. Hahn, 645 Bergen Avenue, Jersey City 4, N. J.

**RANDOLPH** & Beavers: Registered Patent Attorneys, 11-E Columbian Building, Washington, D. C. In order to protect your invention and reap the reward that should be yours, patent your invention without delay, and at the same time have rights to sell as manufacturers convert to civilian production. Write for information and record form today.

**INVENTORS: Learn now—without obligation**—how to protect and sell your invention. Write for free "Record of Invention" form and complete instructions for making disclosure and establishing date of your invention. We also send our new free "Patent Guide for the Inventor," containing complete information about patent procedure and how to sell inventions; giving illustrations of many successful inventions; over 150 basic mechanical movements. We assure you prompt, confidential service. Delays may be dangerous. Write today for your free "Patent Guide" and "Record of Invention" form. Clarence A. O'Brien & Harvey Jacobson, Registered Patent Attorneys, 51A-B Adams Building, Washington D. C.

**MANY** Years of experience in designing inventions of metal construction. I would accept a commission for perfecting a worth while invention and developing a model for practical production. Designer, Box 144, Catskill, N. Y.

**EXHIBIT** And perhaps sell your invention at World's Invention Exposition, April 16 to 28, Chicago, at Stevens Hotel, world's largest. Thousands of manufacturers will attend to inspect new devices. Inventors need not come in person, since we will have demonstrators there. Small rates for display. Send for free folder World's Invention Exposition, Offices: 750 So. Wabash Avenue, Chicago 5, Ill.

**PATENT** Your idea! Write immediately for two free illustrated books, "Patent Protection" and "When and How to Sell an Invention." 64 pages of valuable information for inventors. No obligation. Address: Victor J. Evans & Co., 932-B Merlín Bldg., Washington 6, D. C.

**WE** Locate buyers meritorious patented, unpatented inventions. If will sell, reply immediately. Descriptive booklet, references, free. Invention Reporter, 5 A-11236 So. Fairfield, Chicago.

**YOUR** Product idea—is wanted. Leading manufacturers are eagerly seeking sound, practical, new product ideas. If you have one, investigate (before submitting your idea) what this organization can do for you as special counsel to a group of prominent companies located in the very heart of war time production. Investigation costs nothing—incurs no obligation. The Howard Crawford Company, 2015 Book Tower, Detroit 26, Michigan.

**INVENTORS:** New military and commercial inventions urgently needed by manufacturers. Write for particulars. Chartered Institute, Dept. 4-A, Washington, D. C.

**CASH** For practical ideas and inventions. Mr. Ball, AB-9441 Pleasant, Chicago.

HAVE Your inventions and ideas beautifully tried and designed for greater sales appeal. Send us your sketch, quotation free, quick service, reasonable rates. John Tjaarda & Associates, 818 Fisher Building, Detroit.

**I SELL Patents.** Established in 1900. Charles A. Scott, 773PM Garson Ave., Rochester, N. Y.

**MANUFACTURER'S Names, addresses.** Any classification. Tupper, 18-A Lyman, Beverly, Mass.

### INVENTIONS WANTED

**MANUFACTURER** Wants sensible mechanical device or idea with quick sales possibilities in low-priced field. Write Matt, 1412-D Great Northern Building, Chicago 4.

**INVENTORS:** Learn how we sell your invention. Free booklet. Inventors Patent Exchange, 336-B Palace Building, Hartford 3, Conn.

**INVENTORS**—The Lion Manufacturing Corporation of Chicago, a highly rated concern doing an annual business of \$20,000,000 is interested in inventions for their plant and affiliated companies. Our interest is in patented or patentable electrical or mechanical devices for post-war development in the following fields: Radio and television, the sound and recording, household appliances, vending machines, coin operated amusement devices, in fact almost anything of metal or plastic. We invite inventors to send us details concerning their patented inventions. If your invention is not patented, tell us in a general way what you have to offer. If we are interested, we shall inform you how to communicate details without endangering your rights. Lion Manufacturing Corp., 135 South LaSalle Street, Dept. D, Chicago 3, Ill.

**INVENTORS!** Have you good patentable ideas? Write Mr. Metzler, 11 West 42nd, New York.

**WANTED**—Patented, unpatented inventions having profit possibilities, all kinds. If will sell, reply immediately. Descriptive booklet, references free. Invention Reporter, B-11236 So. Fairfield, Chicago.

**ANYTHING** in building or contracting industry. Nabert Building Corp., 145 Bellevue, Elizabeth, N. J.

**PATENTED** Inventions for manufacturers. McConnell-Petermann, 16114 Burt, Detroit 19, Mich.

**WANTED**—Patented items for manufacture on royalty basis. Decker Manufacturing Co., Rockford, Illinois.

**INVENTORS:** Have you a sound, practical invention for sale, patented or unpatented? If so, write Chartered Institute of American Inventors, Dept. 4-D, Washington, D. C.

**ALL Kinds.** We have facilities and finances to make and sell your ideas, both mechanical and chemical. Send model, sample, details and wishes. General Sales & Supply Company, 110 East Main St., Madison 3, Wisconsin.

**CASH** For inventions, patented, unpatented. Mr. Ball, A-9441 Pleasant, Chicago.

### PATENTS FOR SALE

**FIRST-AID Kit,** compactly designed to be carried like fountain-pen. American, Canadian patents pending. Cash, royalty basis. Cpl. Raymond L. Watkins, 21st General Hospital, APO 362, New York.

**KETCHUP Spoon.** A novelty. Patentable. Prevents splattering and helps clean nearly empty bottle. Write Bernard Cwiklinski, 133 Weimar, Buffalo 6, N. Y.

**A FLEXIBLE** Adjustable lever drag harrow. No. 2347, 979, royalty basis. Vincent Antal Omatonna, Minn.

**SWIVEL** Trolley staging snap. Patent pending. Attached or removed instantly. Prevents fish twisting off. Won't slide along line. Extremely simple. Cash or royalty. Write C. Fowler, 569A 5th Ave., Chula Vista, Calif.

**I HAVE** Several excellent inventions for postwar production. Royalty basis. Inventor, Box 144, Catskill, N. Y.

**MICROMETER** Tolerance indicator patent, attachable or integral, suitable mail order. W. Drucker, 85-31 104 Street, Richmond Hill, N. Y.

### MODELS AND MODEL SUPPLIES

**BUILD** The famous P.T. boat. A model of 80 feet of fighting fury. Most authentic model kit on market. 130 precision, true-to-scale parts, ready to assemble. No tools needed. Descriptive folder free. Creative Crafts, Winnetka 8, Ill.

**MANUFACTURING.** Model making, inventions. Baum's Metal Specialties, Kansas City, Mo.

**ILLUSTRATED** Catalogue over 100 model steam, gasoline and locomotive castings and drawings 10c postpaid. Active Products & Supply Co., 53 W. Jackson Blvd., Chicago 4.

**BLUE Prints** for horizontal, vertical, uniflow steam engines \$2.00 postpaid. Anton Bohaboy, 2297 Price St., Rahway, N. J.

**PLANES, Boats,** hundreds of hobby items. 40 page catalog free. America's Hobby Center, Dept. B 25, 40 E. 21 St., New York 10, N. Y.

**RAILWAY Models,** complete line, informative catalog HO and O gauge, 79 pages, 15c. Walthers, 247 Erie, Milwaukee, Wisconsin.

**WORLD'S Largest** selection model engine castings and drawings. Catalogue 10c. Wayne Miller, Suite 200, Engineering Building, Chicago 6.

**COMPLETE Kits:** Ship models—coach models—covered wagon. All parts cut to fit—no shaping required—tack hammer only tool needed. Everything included, sails, wire and rigging. Send 3c for catalog. Miniature Ship Models, Dept. R, Perkasie, Penna.

**SHIP Models** and yacht supplies complete. Large 64 page catalogue 25c. Bill Wild's, 510 East 11 St., New York City.

**SHIP Model kits** and fittings. Complete line Fisher model yacht equipment. All Boucher, Fisher, Marine Model and Ideal kits, fittings and blueprints at standard prices. Most complete stock in New England. James Bliss & Co., Inc., 220 State Street, Boston, Massachusetts.

### MANUFACTURING

**MODELS**—Small lot manufacturing. Metals, plastics, etc. Milburn, Burlington, Kentucky.

**ALUMINUM** Foundry. Patterns and castings made. Lowell Robbins, Rapid City, S. D.

### HOME CRAFTSMEN

**PLEXIGLAS** And Lucite—The amazing crystal-clear plastics! Saw them, drill them, twist them, bend them into hundreds useful articles that are beautifully different. Special one pound package assortment \$1.00 postpaid; 6 pounds \$5.00; 25 pounds \$18.75. Pound assortment 12" square rods—strips \$1.25. Polished 23" round rods 3/8" diameter 50c each, dozen \$5.00; 1/2" 75c, dozen \$7.50. Masked sheets 12"x12" (144 square inches!) 1/8" thickness \$2.50; 3/16" \$2.75; 1/4" \$3.00. Free directions and project suggestions included. Order these "plastics of tomorrow" today! Carmen-Bronson, 160B East Fourth Street, Mount Vernon, N. Y.

**LARGE** Assortment of Lucite and Plexiglas with project plans to make many beautiful objects, only \$1.00 postpaid. Lynds, Medway, Mass.

**CELLULOID**—Beautiful assortment. Mottles, opaques, onyx, pearls. Used by ring makers everywhere. One pound assortment—pieces approximately 30 sq. in. each. Price \$1.00. Please add 10c for postage. Craft Service, 337 University Ave., Rochester 7, New York.

**SHAG Rugs.** Make for yourself or to sell. Sample work, complete instructions for 50c. Box 25, Lookout, Calif.

**TOY Patterns** (action). Friendly puppy; peddling clown; ducky quack; man sawing wood weathervane. 25c each. Strother, Belington, W. Va.

**WHITTLE** For profit. Patterns, instructions, 10 saleable subjects 25c. Whittler's Studio, 96 Park Place, St. Paul, Minn.

**PLYWOOD**—Beautiful nonpriority aircraft, cabinet and paneling stock. Thickness 1/16" through 1"; large, small panels. Fir, gum, birch, mahogany, walnut. Reasonable! Complete lists 10c. Carmen-Bronson, 160B East Fourth Street, Mount Vernon, N. Y.

**28 LAWN Ornament** patterns 25c. Other patterns: 15"-20" high; Dutch girl; Dutch boy, pirate, bull terrier, Mexican girl, Mexican boy, dwarf, penguin, flower girl, 10c each; 3 for 25c. 25 novelty patterns 30c. All 62 full size patterns \$1.00 postpaid. Strother, Box 283-GP, Belington, W. Va.

**SHEBEL** Hand Filer, files all saws. Send for circular. A. P. Shebel, 730 S. 2nd St., Milwaukee 4, Wis.

**NEVER**—Before-published, 4-page plan tells how to make your own bench knife money can't buy; "no-tip" paint can holder; handy swing tray; locking caliper ruler. 16 photo illustrations. 25c. Ideas & Plans, B2, Palmyra, New Jersey.

**LET Us** sell your homecraft products. For further details write National Mak'N'Sel System, 210 Post St., Suite 915, San Francisco 8, California.

**MOTION Wheel** drawings with set up instructions \$1.00. Gage, 21 Eldert St., Brooklyn, N. Y.

**BULLDOZER,** Power shovel, earthmover—Build these toys of original design in wood from cuttings, prints and specifications of set \$1.00. Others available. Earthmover Toys, East Lansing, Mich.

**WHITTLES**—Softwood subjects, 23 patterns, instructions, 50c. Cartoon Studio, 1402 Charles, LaCrosse, Wis.

**HOME Craftsman.** 4 full size patterns. For doll stroller, cradle, wheel-barrow and doll sulky. \$1.00 postpaid. Lincoln's Craft Shop, Farmington, Conn., Box 71.

**AMAZING** Lawn garden ornament patterns. Send self-addressed, stamped envelope for free folder. B. Reitz, 13820 Wentworth Ave., Chicago 27, Ill.

**NOVELTIES** Made from scrap wood. 25 patterns 25c. 15 toy patterns 25c. 15 lawn ornament patterns 25c. Other patterns, 14"-20" high; clown, Mexican, Dutch boy, Dutch girl, pelican, rooster, 10c each, 3 for 25c. Lynds, Medway, Mass.

**49 LAWN Ornament** patterns, some 21" high. 20 novelty patterns, 20 silhouette patterns, 89 patterns \$1.00. Modern Woodcraft, Saginaw, Mich.

### MAKE IT YOURSELF

**BEAUTIFUL** Combination table lamp and revolving book-case. Requires small space. Excellent for den, dormitory, library. Easily constructed. Working plans complete \$1.00. Allens, 78 Beechwood Road, East Braintree 84, Massachusetts.

**PLEXIGLAS-LUCITE.** Free, 1/2 lb. with our instructions for making lamps, trays, picture frames, etc., for only \$1.00. Glaslite, 3722 Beverly Blvd., Los Angeles 4, Calif.

**JEWELRY** Supplies. Shell metal and plastic parts for manufacturing. Free illustrated catalogue and detailed instructions on shell jewelry. Florida Supply House, 415 - 12th Street, Bradenton, Fla.

**BAROMETER,** Make your own for a dime. Drawing and instruction 25c. Hoens, 2311 Bellevue, Maplewood 17, Mo.

**GARAGE** Doors dashboard controlled. Additional information under "Automobiles."

**FLOUORESCENT** Lights. How to make your own 20 watt lights for less than \$1.00 each. Complete, guaranteed, detailed instructions \$1.00 M.O. or war stamp. Specialty Sales, Box 1086, Muncie, Ind.

### WATCHES, OLD GOLD, JEWELRY, ETC.

**LADIES'** And men's watches repaired. Your watch guaranteed to look and run like new. Dials refinished, etc. Prices reasonable. Send us your watch for free estimate. Carlson Watch Repairs, 5104 Argyle Street, Chicago, Illinois.

**LOVELY** Lucite cross and chain adds glamour to any woman. Stunning, inexpensive, gets the raves. \$2.00. Free circular. Bible Artists, Box 28, Jackson Heights, N. Y.

**COO-COO** Clocks, electric and spring wound chime clocks, and hall clock movements serviced and repaired by licensed clockmakers. Write or send us insured mail your clock troubles. Electric Clock Service, Box 1086, Muncie, Indiana.

**WATCH** Repairing easy learned by our home study course. Watch repairers are in demand and are among the highest paid craftsmen today. Write for free information. Houston Chronometer & Watch Co., P.O. Box 5367C, Houston 12, Texas.

**GOLD \$35.00 Ounce**—Mail old gold teeth, diamonds, jewelry watches—receive cash by return mail. Satisfaction guaranteed. Free information. Dr. Weisberg's Gold Refining Company, 1500-Q Hennepin, Minneapolis, Minn.

**WATCHES,** Materials, tools, jewelry, diamonds—bought—sold. Catalogue. Gales, Box 1000, Chicago.

**WATCH** And clock repairing—complete practical course in modern horology. 66 illustrated self-instruction lessons. Just out! Low price. Information free. Write Nelson Company, Dept. 8-62-2, Chicago 4.

### TOBACCO, SMOKERS' SUPPLIES

**FREE** To pipe smokers—For a new pipe smoking thrill, write us your brand of tobacco and get free package mild, tasty, natural-flavored "Green River." Pete Moberly, Box 987, Owensboro, Kentucky.

**PIPE Cleaners**—Instructions for making superior, lifetime cleaner that anybody can make in few minutes. Dime. Clyde Taylor, Route 2, Covington, Ohio.

### RAZORS, BLADES, SHARPENING

**RAZOR** Strop dressing—smooth shave 35c (coin). Wanted dealer. S. Schultz, 114 Baggott St., Zeigler, Ill.

100 **DOUBLE-EDGE** Blue surgical steel razor blades \$1.50 prepaid. Fully guaranteed. St. Moritz Blade Co., 321 Broadway, Dept. AA, New York 7.

**SIXTY** Double-edge blades, \$1.00. Free plastic razor. Geuthe, 1123 Broadway, New York 10.

### SURVEYING INSTRUMENTS

**GUARANTEED** Factory rebuilt transits and levels for sale (cash or terms) or rent (with purchase option). We will repair, trade, or buy old instruments. Ship prepaid for estimate and valuation. For complete information, write for list M102. Warren-Knight Co., (Manufacturers of Transits and Levels), 138 N. 12th St., Philadelphia 7, Penna.

### FOR THE HOME

**WASHING** Machine parts, most makes, models; wringer rolls, belts, supplies. Write for prices. General, 7203 Lozier, Van Dyke, Mich.

### FOR SALE—MISCELLANEOUS

**LIONEL** "0," "00," "027," "072," standard, American Flyer and "HO" gauges. Switches, loco's, freight, passenger cars and accessories. Stamp for list, specifying gauge. Trilior Hobbyist, R.F.D. 260, No. Dartmouth, Mass.

**ARMY** Goods (used). Jeep hats and caps 10c, canteens 50c, cups 15c, mess kits 35c, leggings 25c, pup tents \$2.50 alum. tool boxes \$2.00, 1 gallon metal cans \$1.00, cartridge belts \$1, knapsacks \$1, helmet liners only \$1, felt rubber bottom boots \$4, pilot boots \$4, raincoats \$1, ponchos \$1, parkas sheepskin \$12.50, canvas covers 5c per foot, all sizes. No c.o.d. Minimum shipment \$1 via railway express. N. Y. Salvage Co., 144 Chambers St., New York City.

**WHOLESALE** List of unusual tropical merchandise and sample 25c. Barrington Smith Co., Halfwaytree—20, Jamaica, B. W. I.

### WANTED—MISCELLANEOUS

**INVENTOR** Wants financial assistance to perfect the magnetic motor. Write J. Smith, 218 W. Newton St., Boston 16, Mass.

**STEREOSCOPIC** Views, Keystone or Underwood. Will pay 5 cents each. Israel Dvorine, 2328 Eutaw Place, Baltimore, Md.

**WE'LL** Swap, sell, buy anything. Free list. National Swappers Guide, 610 St. Joseph, Evansville, Indiana.

**WANT** Coin operated machines—all kinds. Describe. Write Adair Company, 6926P Roosevelt, Oak Park, Illinois.

**TYPEWRITERS**, Printing presses, radios, record players, anything. Bartlett-86, Atlanta, Missouri.

**MERCURY** (Quicksilver)—Cadmium, bismuth, tungsten, molybdenum, cobalt, vanadium. Write for quotations stating quantity. You'll receive guaranteed prices. Metallurgical Products Co., 35th and Moore Sts., Philadelphia, Penna. Established 1909.

**WATCHES** Wanted—Broken or usable—all kinds, even Ingersolls. Highest prices paid for jewelry, rings, spectacles, alarm clocks, razors, cigarette lighters, gold teeth, etc. Cash mailed promptly. Lowe's, Holland Bldg., St. Louis 1, Mo.

**WE** Buy "anything"! Highest prices guaranteed! Justice, Box 150, Chicago 90.

**POPCORN** Machines, peanut roasters, candy floss, potato chip, caramelpopcorn equip. Coin operated vending machines. Northside Company, Indianola, Iowa.

### PERSONAL

**FOR** Better health try super potency "Vi-D-Mins." Nine important vitamins, twenty essential minerals. Fifty day supply \$2.95. Circular free. Delfe Company, 3960 Avondale, Chicago 41, Illinois.

**MIDGET** Bible. Size of postage stamp. Only 10c; three for 25c. Delmarr's, Crescent Beach, B. C. Canada.

**VITAMINS** At money saving prices. Literature free. Watson Company, 3119 Troost, Kansas City 3, Mo.

**"TITHING** To Riches." Soul satisfying religious booklet 50c. Money back guarantee. Bobbitt, 1809 Tenth Avenue, North, Nashville 8, Tenn.

**FREE** Psychological talent analysis. Postage required. Dr. Haynes, 706 8th, Washington 1, D. C.

**SCIENTIFIC** Analysis of your handwriting 50c (coin). Cunningham, 81 Bailey, Lawrence, Mass.

**PIN-UPS**. All kinds. Write. Novelty Studios, 301-A Eldred, Battle Creek 21, Mich.

**MEXICAN** Law practice. A. B. Flota, Box 240, Juarez, Mexico.

**ATHLETE'S** Foot remedy. Guaranteed by manufacturer \$1.00 bottle prepaid. Dr. W. J. Renz, P.O. Box 50, Lake Charles, Louisiana.

**PSORIASIS**. Dry eczema! Rush name for amazing facts, special no-risk offer. Carter-Howell Laboratory, 457 Schenectady Avenue, Dept. L-5, Brooklyn 3, N. Y.

**PICTURE** Painted from photograph. Paul Fortner, Box 42, Montezuma, Ind.

**SLEEP** Tight—Sleep-Rite ear stoppers stop noise. Guaranteed. Trial 10c. Four months supply \$1.00. Accepted American Medical Association. Circular. Raymond Dow, 15 Park Row (1215AA), New York 7.

**HEIRS**, Relatives, others located. Birth, census, estate research. Chaffee, 308 Washington, Chicago 6.

**GRAY** Hair vitamin guaranteed genuine calcium pantothenate, 3 months supply \$1.98. Reliable Products, Box 908, Milwaukee.

**ARCH** Supports. Send \$1.00 and shoe size. Money back guarantee. Blair Company, 4520 Sheridan Road, Chicago 40, Ill.

**DRUNKENNESS** Is a disease which responds to treatment. Medical skill plus human sympathy prove successful with liquor and drug cases. 60 years experience. Write for free booklet. P. M. Nelson, The Keeley Institute, Dwight, Ill.

**GROOVED** Letters make your penmanship beautiful—few hours. Ornament, 9, St. Louis, Mo.

**BUY** Vitamins direct. Save. Postcard. Matoska Products, White Bear, Minn.

**GIRL** Photos, beautiful models, only \$1.00 for group. "Little Eve." Box 211, Terre Haute, Indiana.

**PERSONALIZED** Pencils—Individual or firm name imprinted gold. Economical for school and office. Dozen 50c, 3 dozen \$1.00, gross \$3.00 cash, delivered. Pencil Market, 611 - 15th St., Knoxville 16, Tenn.

**BUY** Vitamins, half price. Vitamin guide free. Richardson, Wyoming, Penna.

**HAIR** Falling? Dandruff? Write Trichologist, 137 Lewis St., Phillipsburg, N. J.

**TATTOOING** Outfits, designs, colors. Write today. Zeis Studio, 728 Lesley, Rockford, Illinois.

### MISCELLANEOUS

**PHOTOSTATS** (Photographic permanent copies) of your discharge papers, birth certificates, legal documents, newspaper clippings, music manuscripts, keepsake photographs, drawings, etc. Protect your valuable documents against loss, fire, theft, etc., by having additional legal, permanent photostats. All material copied covered by valuable papers insurance for your protection. Prompt service. Satisfaction guaranteed. 50c per copy—3 for \$1.00. (Established 1932). Hollywood Photocopy Service, 1606 Cauhenga Blvd., Hollywood 28, California.

**SOLID** Silver fortune money clip—of pure sterling silver, with a real silver dollar part of design. Practical, sturdy—a real "good luck" piece; makes ideal gift. Price, \$10.00 (federal tax included). Send check or money order and clip will be sent postpaid. If c.o.d., you pay postage. Money back in ten days if dissatisfied. Cyril Chesses, Inc., Dept. 2, 545 Fifth Ave., New York 17, N. Y.

**POSTAGE** Stamp machines—New 1945 models \$30.00 complete. Merchants and operators—write for illustrated catalogue. Parkway, 3046H Tioqa, Baltimore 15, Md.

**BIGGEST** Money in tattooing now! No experience required. Complete instructions with outfits. Send for free literature. Tatuco, 651 South State, Chicago.

**YOUR** Post war home? Design your own home. Send rough sketches and we will make finished drawings. Free estimates. Danco, 3933 D. St., Detroit 16, Mich.

**FLORIDA** Souvenir coconuts mailed anywhere in U.S.A. \$1.00 each. Miami Merchandise Mart, 1621 Douglas Rd., Miami 35, Florida.

**AMAZE** Everyone. Tell anyone's age and amount of loose change in his pocket. Call anyone by their first name. Entertaining, enlivens parties! Complete instructions 15c. Ira Smith, 153 Liberty, San Francisco 10, Calif.

**CRUCIFIXES** 10c. Charms 2c. Send dollar bill, (bonanza package). Joseph Donat Derosier, 304 River Street, Woonsocket, Rhode Island.

**FREE**, Fertile South-American lands! Fifty acre homesteads or 25,000 acre livestock ranches obtainable free. Valuable illustrated information, 25c (refundable). Vallesp, 395-F Broadway, New York 13.

**RECEIVE** Mails, literature, opportunities. Your name in numerous mailing lists 10c. Howard, 396 Broadway, New York.

**POCKET** Key protectors. Your name, address, stamped on metal identification key protector. 25c. Walls, 318 West 71st, Los Angeles 3.

**UNFINISHED** Wall plaques 2½c up. Write, Oman, 642 Broadway, St. Paul 1, Minn.

**PRINT** Photos on handkerchiefs! Directions 10c. Parker Publications, Peterboro, Ont., Canada.

**RECEIVE** Moneymaking opportunities, mails, samples, magazines. Your name in several mailing lists, 10c. Rogowski, 3415 Broadway, New York 31.

**\$7.50 GENTLEMAN'S** Genuine leather billfold for only \$3.75. Quantity limited. Act quick. Send check or money order. Money refunded if not pleased. L. Y. Perkins Co., 41 Egremont Rd., Brookline 46, Mass.

**BUY** High potency vitamins direct, save 40%. Vitamin booklet free. Schreiner Drug Co., Batavia 1, Illinois.

**RARE** Garden, field and tree seeds. List free. Valley Gardens, 126 N. Main, Tulsa 3, Okla.

**HAWAIIAN** Coconuts from famous Wai-kihi make fine souvenirs. Postpaid, \$1.00 each. Mills, 2312 Kaala Ave., Honolulu 5, Territory Hawaii.

**ALMANACS** Are scarce. Send 13c, stamps or coins for famous Trail Blazers Almanac. Dept. B31, Bloomington, Ill.

**BECOME** Worldwide traveler in few seconds. Souvenir luggage labels, windshield stickers, those hard to get kind from everywhere, fascinating romantic scarce "hard to get" originals. Package (5) assorted 25c. Special 25 all different \$1.00. Send stamps or coin. Stop speculating. Buy wholesale. Our 16 page catalog lists 1001 items, (10c). Lewis Novelty Co., 565-Kearny St., (Dept. PM), San Francisco.

**BIG** Mail for you. Latest moneymaking offers, opportunities, catalogs, magazines. Name listed in directory 10c. Ideal Service, 102, Park Ridge, Ill.

**TEST** Locks—Be safe! 5 master keys open 90% of locks. \$1.00. National Service, 322-A Union Ave., Brooklyn 11, N. Y.

**HOW** To drill glass. Special tools unnecessary. Full information. Send \$1.00 bill to Harry Shootz, 326 East Liberty Street, Charlestown, Jefferson County, West Virginia.

**LUMINOUS** Nursery wall decorations. Fascinating cut-outs glow in darkness. Complete set 35c. Sample and circulars on other luminous items 3c. Luminovettes, 469 Irving Ave., Brooklyn, N. Y.

**SQUARE** Dance instructions, calls, 25 sets, \$1.00. Rayburn, Lonsdale, Arkansas.

**POSTCARDS**. Letters sent from Canada in your own handwriting 25c, 50c. Write to C. Marr, 21 East Pender, Vancouver, B. C.

**PIN-UPS**. All kinds. Write. Novelty Studios, 301-A Eldred, Battle Creek 21, Mich.

**TAILORED** Homes. Sixty plans one-story houses with selection beautiful colonial, English, Spanish, moderne exteriors—making hundreds of combinations! Price \$1.00. Prepare for rationing and higher building site prices. Avoid rush, plan now! H. P. Jones, 486K Brandeis Bldg., Omaha, Nebr.

**GOOD** "Used" self-instruction educational books on all subjects bought, sold, rented, exchanged. Satisfaction guaranteed. Complete information and 92-page illustrated bargain catalog free. Write—Nelson Company, Dept. 2-02-2, Chicago 4.

**MAKE** Your own Plastoplate printing cuts. Simple, easy process. Adayservice, Argyle, Wisconsin.

**THE** Lord is coming! Get guaranteed proofs free. Scheall, 263X, Duluth, Minn.

**BOYS**—Girls, write for free gift. David Berg, 659 Churchill, Bridgeport 29, Conn.

**MEXICAN** Gift items, price list free. Ray Foster, 909 East River, El Paso, Tex.

**SERVICE** Station driveway "service signals" again available. Free literature. Knipp, Long Beach 4, California.

**MEDICAL** Laboratory technicians in great demand. We train you in your spare time, in your own home. You can practice while studying. Write for free catalogue. Imperial Technical Institute, Box 973-J, Austin, Texas.

# IMAGINE! MUSIC LESSONS

## for less than 7¢ a day



Thousands have learned to play this quick, easy short-cut way, right at home—AND YOU CAN, TOO!



**PLAYS FROM START.** I can play my favorite instrument even though I'm only at the beginning. How can I ever express my joyful gratitude. "F. R. O., III.



**PLAYS ON RADIO.** As a proud student I can't keep from telling you that as a result of my course I have a good position playing from KTHS every morning. "J. S. Heavener, Okla.

IT'S grand fun learning music this amazing, home-study, "Print and Picture" way. Instead of tedious exercises, you learn to play real tunes by note, almost from the start. First printed instructions tell you how to play a tune. Next a picture shows you how. Then you play it yourself and hear how it sounds. You go from simple tunes to more advanced pieces. And sooner than you ever dared hope you're thrilled to find that you can play almost any popular number by note.

And just think! You can study any instrument you like for less than 7¢ a day.

That includes valuable sheet music, printed Instructions, diagrams, and our Personal Advisory Service.

If you really want to learn music . . . to win new popularity . . . get more fun out of life . . . send for our Free Illustrated Booklet and "Print and Picture" Sample. See how easy it is to learn this modern, short-cut money-saving way. Check instrument you want to play. Mail coupon now! U. S. School of Music, 72 Brunswick Bldg., New York 10, N. Y. Forty-seventh year. (Est. 1898.)

### SIMPLE AS A-B-C

Yet it's from the famous "Merry Widow" Waltz.



\*Actual pupils' names on request. Pictures by professional models.

## SUCCESSFUL 47TH YEAR

U. S. School of Music, 72 Brunswick Bldg., New York 10, N. Y.  
Please send me Free Booklet and Print and Picture Sample.  
I would like to play instrument checked below.

(Do you have instrument? .....

Piano	Guitar	Clarinet	Tenor Banjo
Violin	Piano Accordion	Mandolin	Modern
Hawaiian	Saxophone	Practical Finger	Elementary
Guitar	Trumpet, Cornet	Control	Harmony

Name.....  
(Please Print)

Street.....

City..... State.....

NOTE . . . If you are under 16 years of age parent must sign this coupon.

SAVE 2¢ — Stick coupon on penny postcard.

# Design for Arc Welding

This \$3.50 Investment may SAVE you HUNDREDS of dollars.

100 pages of designs and redesigns for arc welding on 5 days approval.

It's the costs that have turned manufacturers to welded design. This book will prove to you in five days the value of "Simplified" arc welding over more costly methods. DESIGNERS! ENGINEERS! PRODUCTION MANAGEMENT! Order your copy today! Saves many times its cost. \$3.50 postpaid. HOBART BROS. CO., BOX M-251, TROY, OHIO

Compiled by one of America's Foremost Authorities on Arc Welding. Every design from an actual product presented in flexible form for varying applications.

## Hobart

"One of the World's Largest Builders of Electric Arc Welders."

### HUNTING and FISHING

is a monthly magazine crammed full of hunting, fishing, camping, dog and boating stories and pictures, invaluable information about guns, fishing tackle, game law changes, best places to fish and hunt—countless ideas that will add more fun to your days afield.

**Special Trial Offer**  
Send 25c in stamps or coin and we will send you Hunting & Fishing for six months.

**HUNTING & FISHING MAGAZINE**  
251 Sportsmen's Bldg., Boston, Massachusetts

---

### LAW

STUDY AT HOME for PERSONAL SUCCESS and LARGER EARNINGS. 35 years expert instruction—over 108,000 students enrolled. L.L.B. Degree awarded. All texts furnished. Easy payments. Send for FREE BOOK—"Law and Executive Guidance."  
AMERICAN EXTENSION SCHOOL OF LAW  
Dept. 50-M, 646 N. Michigan Ave., Chicago 11, Ill.

### AIR CONDITIONING and REFRIGERATION

Be ready for profitable postwar Opportunities. Learn Air Conditioning and Refrigeration in our modern laboratories. Complete Refrigeration course, 3 months; Air Conditioning, 6 months; for the man who wants his own business. Moderate tuition—earn part expenses. Write NOW!

**MILWAUKEE SCHOOL OF ENGINEERING "42nd Year"**  
PM-245 N. Broadway and East State, Milwaukee, Wis.

*New FREE BOOK*

### ALARM CLOCKS

THOUSANDS OF ALARM CLOCKS NEED REPAIRING. Cash in on this flood of work. Jewelry stores swamped. Watchmakers too busy repairing watches. Easy to learn course with illustrations, pictures, tools and necessary material furnished with course.

Write for free information.  
**ALARM CLOCK REPAIR SERVICE**  
P. O. Box 1983 Houston 1, Texas

## LEARN ABOUT THE GREAT OPPORTUNITY FIELD ELECTRONICS!

THE PRACTICAL BOOK FOR RADIO and ELECTRICAL MEN

**7 DAYS FREE TRIAL**  
Brandnew! Practical! Simplified! THE quick, easy way to get a knowledge of Electronics—greatest of all job opportunities.

**SEND NO MONEY! SEE OFFER IN COUPON!**  
Big new 400 page manual on Electronic work. Handy for job use—full of easy-to-follow diagrams, Radio men, Electricians, Mechanics—build on your present knowledge to get a better job! Send coupon TODAY!  
**FREE with Manual!** 1 yr. Personal Counsel by mail on your Electronic problems from Coyne staff. ALSO FREE—1 year subscription to Coyne Technical News.

**ELECTRONICS**  
For the RADIO MAN and ELECTRICIAN

H. C. LEWIS, Pres., COYNE ELECTRICAL SCHOOL, Dept. 25-R5, 500 S. Paulina St., Chicago 12, Ill.  
Send me postpaid your big new manual, ELECTRONICS for the Radio Man and Electrician. I'll either return book within 7 days or send \$4.95 in full payment.

NAME.....  
ADDRESS.....  
CITY.....STATE.....  
OCCUPATION.....AGE.....

## Learn this Profitable Profession

IN 90 DAYS AT HOME

### Money-Making Career Open to Men and Women, 18 to 50

Hundreds of men and women between 18 and 50 make \$10 to \$20 in a single day giving scientific Swedish Massage and Hydro-Therapy treatments. There is big demand from doctors, hospitals, sanatoriums and clubs. Graduates earn large full time incomes from these or in private practice in their own offices. Others make good money from home treatments given in spare time. Learn this interesting, money-making profession in your own home, through our home study course. Some instructors as in our nationally known resident school. You can win independence and prepare for future security by qualifying for your Diploma. Course can be completed in 3 to 4 months. Many earn while they learn. Begin your training at once.

**Anatomy Charts & Booklet FREE**  
Enroll now and we will include, at no extra cost, many needed supplies. Fit yourself to help meet growing demand for massage now and after the war. Send the coupon at once for complete details. Anatomy Charts and 32-Page Illustrated Booklet, FREE, postpaid.

**THE COLLEGE OF SWEDISH MASSAGE**  
Dept. 564B, 100 East Ohio St., Chicago 11, Illinois  
Please send me FREE and postpaid, Anatomy Charts, 32-page Booklet and complete details on Home Training.

Name.....  
Address.....  
City.....State.....

**FREE TRIAL IN YOUR OWN HOME!**

**Here's the HELP YOU NEED**

**...Now and After the War!**

Used by Army, Navy, 200 Schools and Big Firms



**DO ANY JOB.. EASIER.. QUICKER**  
**MAKE MORE MONEY** *in the*  
**BIG OPPORTUNITY**  
**FIELDS**

**SEND NO MONEY**  
 Select the Books  
 YOU Need Now!  
 We Ship C.O.D.  
 Anywhere in U. S.  
 and Will Refund  
 Amount Paid if  
 Not Satisfactory.

Get ready to meet keener job competition, now and when wartime jobs are over. Get into one of these big opportunity fields. Big money and many other advantages await you if you prepare now. Here is the help you need—EASY—QUICK—AT LOW COST. Thousands of men have already used these famous books. Beginners and experienced men alike have doubled and tripled their earnings with this help. You, too, can now get the special knowledge you need for top pay, better jobs, or a business of your own. This is your **GOLDEN OPPORTUNITY**.



**MODERN WELDING PRACTICE**

Newest book on all types of welding and heat treatment of metals. Written by recognized specialists in training men for production jobs. **Practical and Non-Technical.** Covers

everything you need to know. Prepare for best pay jobs now. Price \$4.00.

**AIRPLANE WELDING**

All metal airplane building offers big opportunities after the war.

New 2nd edition of this famous book by J. B. Johnson, Materials Division, Wright Field. The authoritative and practical book on Airplane welding and materials brought right up to date. 420 pages, 193 pictures. \$3.50.

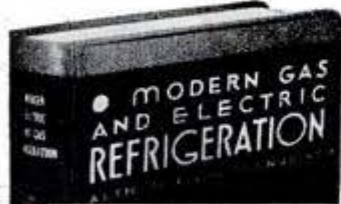

**REFRIGERATION—Book of the Hour**

**NEW PRINTING—ALMOST 1000 PAGES**

**408 Pictures—17 Diagrams in Colors Makes All Refrigerator Service Maintenance, Repairs Simple as A. B. C.**

No new refrigerators being made. Owners will pay big for competent service which will be needed more and more. Get **MODERN GAS AND ELECTRIC REFRIGERATION**, the non-technical guide to all types of refrigerators and get your share of this new profit. Get a job or start your own service business. This book will help you make money anywhere. Price \$5.00.

**AIR CONDITIONING**



Big air conditioning boom interrupted by war will be bigger than ever in post-war days. Get this non-technical book by international authority and be ready for your share of millions to be spent. Covers whole field. 450 pages. Illustrated. \$3.50.

**SHEET METAL LAYOUT**

Makes sheet metal layout work so simple that anyone can learn. Get this new instructor and get into the easiest, cleanest and best paying part of all sheet metal work. 143 jobs worked out in drawings and carefully explained. Gives standard for all sheet metal fittings. \$3.00.



**15 Million Refrigerators Need Service and Repairs**



**NEW 20th EDITION**  
**Leading Auto Book for Over 32 Years**

**World's Greatest AUTO BOOK**

**New Material on Transmissions, Trucks, Tractors, Diesels, Aircraft and Auto Engines**

Now with millions of cars needing repairs and thousands of men needed to do the work, you need the famous DYKE Auto Book more than ever before. Brand new 20th Edition covers all principles, construction, repair, adjustments, testing, troubles and remedies of all cars. Over a half million copies of 20 editions of Dyke's have been sold. Gives specifications of old and newer cars. World's biggest book value, \$6.00. This big book, a complete auto library in one volume, has 1483 pages—4600 illustrations and diagrams—weighs 6 lbs.—equal to 4 ordinary books.

**AUTO BODY and FENDER REPAIR**

Owners will spend big money to keep cars looking new because few new cars available. This is a practical money-making guide, ideal for shop owners and every man who wants a share of the millions to be spent in keeping old cars looking new. Tells how to get a good job or start business of your own with small capital. 325 pages, 232 illustrations. Price \$3.00.



**BAILEY'S HANDBOOK**



World famous handbook of universal questions and answers for Stationary, Marine and DIESEL engineers and firemen. Prepares for any license examination. Pocket size. \$2.00.

**DYKE'S CARBURETOR BOOK**

The standard guide for a generation. New edition covers engine tune-up, compression, ignition, carburetion, fuel pump valves, etc. Use this book to specialize in this big field. 244 pages, 549 illustrations. \$3.00.

Mail Coupon to: **Goodheart-Willcox Co., Inc.**  
 2009 S. Michigan Ave. Dept. 11 Chicago 16, Ill.

**SEND NO MONEY! Mail Coupon**

**GOODHEART-WILCOX CO.,**  
 2009 S. Michigan Ave., Dept. 11, Chicago 16, Ill.

Send books checked, C.O.D. I will pay postman, plus few cents charges. If not satisfactory I will return books in 5 days and you will refund money paid. (Outside U.S. or possessions remit with order.)

- Gas & Electric Refrigeration . . . . . \$5.00
- Dyke's Auto Book . . . . . \$6.00
- Dyke's Carburetor Book . . . . . \$3.00
- Modern Welding . . . . . \$4.00
- Airplane Welding . . . . . \$3.50
- Sheet Metal Layout . . . . . \$3.00
- Air Conditioning . . . . . \$3.50
- Bailey's Handbook . . . . . \$2.00
- Body and Fender Repair . . . . . \$3.00
- Aircraft Sheet Metal . . . . . \$2.50
- Shop Math. (2 vols.) . . . . . \$3.00

If remittance accompanies order we will pay all postage charges under same return privilege.

Name . . . . .  
 Address . . . . .  
 City . . . . . State . . . . .

For Best Opportunities  
Now and After the War *Get into*

# DRAFTING

**LEARN AT HOME FROM ENGINEER**

Avoid the scramble for ordinary jobs when industry changes over to peacetime production. Act now to get a better job with more pay and pleasant working conditions. The field for draftsmen is bigger than ever, for Drafting is a basic profession and all new products start with the draftsman or designer in war or peace. Get into Drafting now. I will train you at home, in your spare time, to get experience on actual work—the same kind of jobs you will do with the best paying firms. I will train you until you are competent, experienced and holding a position that will bring advancement and pay raises as deserved.

All working tools, table and professional instruments sent you when you start. Previous training, experience or higher education not necessary. The cost is reasonable for this practical training from a successful engineer and you can pay for it monthly. Write today for full details and illustrated book. No salesman will call on you. Give your age to get reply.

**I Will Train You Until You Get a GOOD PAY JOB And I'll furnish all WORKING TOOLS**

**MAIL COUPON FOR VITAL FACTS**

Engineer Dobe, Div. 12, Libertyville, Ill.

Send me the Vital Facts on Drafting and Industrial Designing, your Free Book and advertised list of positions for Draftsmen and Designers wanted.

Name..... Age.....

Address.....

City..... State.....

## DRAW for MONEY

**Be An ARTIST!**

**Trained Artists Are Capable of Earning \$30 - \$50 - \$75 A WEEK**

**Learn At Home In Your Spare Time for A Fascinating Hobby and Profitable Postwar Career!**

It's pleasant and interesting to study Art the W.S.A. way. **COMMERCIAL ART, DESIGNING and CARTOONING**—all in ONE complete course. No previous Art experience necessary—we teach you step by step—hundreds have profited by our practical method since 1914. **TWO ART OUTFITS FURNISHED. FREE BOOK "Art for Pleasure & Profit"**—tells all about our course, describes our method of instruction—what our graduates say—and commercial opportunities for you in Art.

**FREE BOOK gives details!**

WASHINGTON SCHOOL OF ART  
Studio #22P; 1115 15th St., N. W., Wash. 5, D. C.

Send me your booklet and full particulars about your course.

Name..... Age.....

Address.....

City..... State.....

NOTE. After reading the book described below, pass it on to your service man or woman. They like it MUCH for after-war plans for jobs and independence. Welcome gift.

# How to Make Money by Mail

Down-to-earth facts, directions (illustrated) for running business profitably, using expertly for your good fortune the employees, trains, planes which Gov't places at your disposal **CHEAP**. Get orders by mail, ship by express or freight or mail, get out of the kindergarten... 2nd printing of this book now selling. It's YOUR winner.

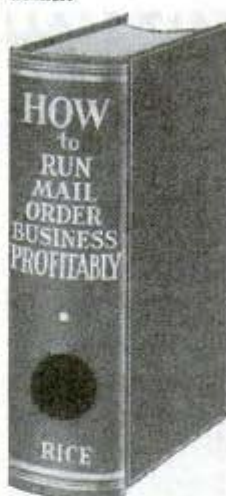

**THE EASY WAY** to start new or expand your present occupation. **Do it NOW.**

Extraordinary plain, simple skill, know-how. No theory. Fact story of rich experience of author E. Rice day-by-day. How many times have we heard: "I wish I had some money, this would sure be a fortune," or "why can't I make more money?" or "I wish I knew how to sell this gadget myself," or "why should my boss do this when I know too how the money is made"... **Listen, you do not need money** to start this live way. It's method automatically pays all bills same day rendered, no bank loans, pay as you go, no borrowing from relatives or friends, no salesman. Also no worry, quickly a home of your own all paid for. **Rice paid off \$5000 in mortgages** a year after using this idea.

**44 Years of PROOF**

**Sounds fishy?** Sure, but this has been done steadily for 44 years, depression or no depression, by the author; that is why he wrote this book to pass the good word along. **Make it go with anything you have** which is salable. Rice did it with poultry when living in one room in a city lodging house. **Turn your city or country home, your work, your hobby, into money.** How to get orders at cost of only 5¢ for each \$100 taken in. The popular error to avoid in trying for sales. Business won free while others have to pay for it. How to conceive the money-getting advertisement... Profitable changes from ordinary ads and methods. Not usual cut-and-dried pattern, 60 adventures, a dictated book in everyday talk, no dictionary writing.

Take a chance on this book being worth a fortune to you and yours and send \$2.50. Book mailed same day order is received. Or ask two friends to chip in 33 cents each with your \$4c to get this book. Hundreds of buyers whose letters we show you declare emphatically its superlative goodness. Follow its easy pattern for success. Cloth-bound, 512 pp., 8 1/2 by 5 1/2. Best seller, 2nd edition now selling. Cut out the \$2.50 **HOW BOX** here, pin or stick it to sheet of paper bearing your name and address, mail in envelope with money order or check for \$2.50 to

**HOW \$2.50**

**HOWARD ST. HOUSE, Melrose 76d, Massachusetts**

52 BREEDS

**MRS. BERRY'S POULTRY BOOK**



**BERRY'S Champion-Mated, Hand-Picked CHICKS, also SEXED, STARTED, 52 Breeds, 7 HYBRIDS, All Iowa Inspected, BWD Tested, Over 400 Prizes—30 Show!** **LOW PRICES.** In Business nearly 50 years, **Beautiful POULTRY BOOK FREE,** stamps appreciated. **BERRY'S POULTRY FARM, Rte. 29, CLARINDA, IOWA**

**FIBRE ARMS AND LEGS!**

Light, correctly fitted, strong and comfortable. Natural appearance. Braces for all deformities. Scientific design. Fair Terms. **BUCHSTEIN-MEDCAL 610-3rd Av. S., Minneapolis, Minn.**



**Bia Profit AUSTRALIA-WHITES**

**Sensational MONEY MAKING HYBRID.** Customers report hollers 8 weeks, laying 4 1-2 mos. Disease resistant. **Hardy Layers, 60,000 chicks weekly.** Started pullets. **Profit Sharing Plan. FREE Book.** Write today. **BERRY BROS. FARMS, Box 582, ATCHISON, KANS.**

**RADIO ENGINEERING, Broadcasting, Servicing, Electronics, Aviation, Marine & Police Radio** taught thoroughly. 48 weeks' Engineering course equivalent to 3 years' college radio work. All expenses low. Co-educational. Catalog free. **VALPARAISO TECHNICAL INSTITUTE, Dept. D, Valparaiso, Ind.**

## Win SUCCESS in PHOTOGRAPHY

**QUALIFY AT AMERICA'S LARGEST, OLDEST SCHOOL**

Top-ranking experts coach you individually in Commercial, News, Portrait, Motion Picture or Color Photography. Learn at home or through resident courses in N. Y. Free book gives full details. Write TODAY!

**NEW YORK INSTITUTE OF PHOTOGRAPHY**

Dept. 49 10 West 33 Street New York, 1, N. Y.



# "Let me show YOU too, HOW TO MAKE YOURSELF COMMANDO -TOUGH

inside and out... in double quick time  
—OR IT WON'T COST YOU A CENT!"

says *George F. Jowett*

whom experts call the  
**WORLD'S GREATEST BODY BUILDER**

Thousands of Jowett pupils are in the U. S. and British forces knocking Japs and Nazis slap-happy with their swift, powerful bodies. Let me prove to YOU how in double quick time I get out inches of dynamic muscles on your arms! Add inches to your chest! Broaden your shoulders! And power-pack the rest of your body—so quickly it will amaze you! My methods can give you the surprising endurance of a panther. I have done it for thousands the world over. Give me a fighting chance to do it for you.



"The Jowett System is the greatest in the world!" says R. F. Kelly, Physical Director of YMCA, Washington, D. C.

## Give me 10 Minutes a Day Learn My Time Tested Secrets of Strength

I'll teach you the "Progressive Power Method" through which I rebuilt myself from a physical wreck the doctors condemned to die at 15, to the holder of more strength records than any other living athlete or teacher! "Progressive Power" has proven its ability to build the strongest, handsomest men in the world. And I stand ready to show you on a money back basis—that no matter how flabby or puny you are, I can do the same for you right in your own home. Through my proven secrets I bring to life new power in you inside and out, until YOU are fully satisfied you are the man you want to be. **MY TIME TESTED METHODS RE-BUILD YOU.**

### PROVE TO YOURSELF IN ONE NIGHT

Send only 25c in full payment for my test course "Moulding A Mighty Arm." Try it for one night! Experience the thrilling strength that will surge through your muscles.

### READ WHAT THESE FAMOUS PUPILS SAY ABOUT JOWETT



**A. PASSANONT**, Jowett-trained athlete who was named America's first prize-winner for Physical Perfection.

**REX FERRIS**, Champion Strength Athlete of South Africa. Says he, "I owe everything to Jowett methods!" Look at this chest!—then consider the value of the Jowett Courses!



## BUILD A BODY YOU'LL BE PROUD OF

Send for These  
**FIVE Famous Courses**  
NOW in **BOOK FORM**  
**ONLY 25c EACH**  
or **ALL 5 for \$1**

At last, Jowett's world-famous muscle-building courses, are available in book form to all readers of this publication at an extremely low price of 25 cents each! All 5 for only \$1.00. You owe it to your country, to your family, and to yourself, to make yourself physically fit now! Start at once to improve your physique by following Jowett's simple, easy method of muscle-building!

### 10-DAY TRIAL OFFER!

Think of it—all FIVE of these famous course-books for only ONE DOLLAR—or any one of them for 25c. If you're not delighted with these famous muscle-building books—if you don't actually FEEL results within ONE WEEK, send them back and your money will be promptly refunded! Don't let this opportunity get away from you! And don't forget—by sending the **FREE GIFT COUPON** at once you receive a **FREE** copy of the famous Jowett book, "Nerves of Steel, Muscles of Iron."

**JOWETT INSTITUTE OF PHYSICAL CULTURE**  
230 Fifth Ave., Dept. 472, New York 1, N. Y.



# FREE! ALL 5 GIFTS!

for a limited time only—  
and Jowett's big Photo Book

I want TWICE as many red-blooded Americans to start on the road to Mighty Strength THIS MONTH, so, with coupon-order, I offer FREE of further cost, all 5 World Famous Inside Secrets!

- ① *Inside Secrets* of "Commando Self Defense Tactics". How to defend yourself against rough and tumble.
- ② *Inside Secrets* of "Strong Man Stunts Made Easy". Easy-to-learn tricks that will amaze your friends.
- ③ *Inside Secrets* of "The World's Greatest Knock-out Punch". How to deliver it and defend yourself against it.
- ④ *Inside Secrets* of "Hand-balancing Made Easy". How to stand and walk on your hands.
- ⑤ *Inside Secrets* of "Scientific Weight Lifting". How to lift heavy weights with ease.



MAIL ORDER-COUPON NOW and get my...

## 5 INSIDE STRENGTH SECRETS and PHOTO BOOK of STRONG MEN FREE!



Jowett Institute of Physical Culture  
230 Fifth Avenue, Dept. 472, New York 1, N. Y.  
George F. Jowett: Your reputation looks good to me. Send by return mail, prepaid, the course checked, for which I enclose ( ). Send 5 Secrets and Photo Book FREE.

- All 5 courses for..... \$1
- Molding a Mighty Arm 25c
- Molding a Mighty Back 25c
- Molding a Mighty Chest 25c
- Molding a Mighty Grip 25c
- Molding a Mighty Leg 25c
- Send all 5 C.O.D. (\$1 plus postage.) No orders less than \$1 sent C.O.D.

NAME..... Age.....  
Please Print Plainly

ADDRESS.....

# 4 WAYS To Be Your Own Boss!

NOW, more than ever before, is the **right time** to start a small profitable business of your own... or train yourself for a practical money-making trade in which you can be **independent**. TODAY take your first step, without cost or obligation. Just mail coupon—and by return mail you will get full information on the courses listed here.

## watch and clock repairing



**Learn at Home—In Your Spare Time**  
Prepare for a happy future of prosperity, security... and get a big-pay job now. Fascinating, high-grade occupation. You can **EARN WHILE YOU LEARN**. Excellent field for part-time work at home.

### Practical Course in HOROLOGY

Thorough self-instruction training in American and Swiss watches, clocks. Special sections on alarm clock repairs. Interesting. **LEARN-BY-DOING** instruction method. **LEARN QUICKLY, easily**. No previous experience necessary. **BASIC TRAINING FOR AIRCRAFT INSTRUMENT WORK** and other scientific precision jobs.

**Amazing Low Price! • Money-Back Guarantee!** Get into this fast-growing field NOW... big opportunity... don't delay. Mail coupon below for **FREE** information. No obligation.

## locksmithing and key making

### PRACTICAL UP-TO-DATE COURSE

How to pick locks, de-code, make master-keys, repair, install service, etc. New, self-instruction lessons for every handy man, home-owner carpenter, mechanic, service station operator, fix-it shop, hardware dealer, gunsmith.

**53 Easy Illustrated Lessons**  
Low Price! Satisfaction guaranteed or money back. Write now... no obligation!

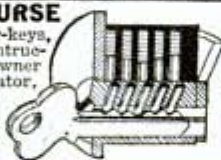

## practical RADIO servicing



### SELF-INSTRUCTION COURSE

Teaches you the **practical** side of radio... repair, adjustment, operation, alteration, trouble-shooting. No previous knowledge necessary. Large clear illustrations, diagrams, charts, etc. **INTERESTING STEADY WORK!** Set up a radio repair shop of your own—or prepare for booming industrial electronics. This useful, how-to-do-it course brings you all the fundamentals, including mathematics, review questions, problems, answers. Strictly up-to-date. Low price. Coupon below will bring you full information you want immediately. Mail it in today!

# MAIL ORDER BUSINESS

## Your Big Opportunity!

34-lesson course on proved, tested, up-to-date, **profitable** methods. Amazing treasure-house of the best mail order plans and practices. How to start your mail order business on a small one-man scale... how to keep it growing more and more profitable month after month. Money-making **FACTS**.

**WRITE FOR COMPLETE DETAILS ON ANY OF THESE COURSES.** Send Coupon for World-Famous Copyrighted Success-Catalog—IT'S FREE!  
**NELSON CO., Dept. 8B02, 321 S. Wabash Ave., Chicago 4, Ill.**

## FREE details... mail coupon!

**NELSON CO., Dept. 8B02, 321 S. Wabash Ave., Chicago 4, Ill.** Please send me—FREE and without obligation—illustrated Success-Catalog containing information about the course (or courses) I have checked below. No salesman will call.

Watch and Clock Repairing.  Locksmithing and Key Making.  
 Practical Radio Servicing.  Mail Order Business.

NAME \_\_\_\_\_  
ADDRESS \_\_\_\_\_  
CITY \_\_\_\_\_ STATE \_\_\_\_\_

★ SAVE WASTE PAPER ★

# MAKE MONEY CASTING AT HOME

FREE FACTS SENT



Make hundreds of Plastic Casts, quick, easy. Sell output to stores, novelty shops, etc. Enormous profits. No experience. Very little capital needed. Start in basement, garage or workshop. Complete, simple instructions anyone can follow. Start now while merchants are begging for merchandise to sell. Rush.  
**PLASTIC ARTS STUDIOS, R.R. 5, Dept. 22, Muncie, Ind.**

# Learn TOOL DESIGN

Quality quickly as Draftsman or Tool Designer through sparetime home study. Many making \$100 to \$125 a week. Expanding industry calling for more machine and tool designers than available. Good pay jobs waiting. Rush name and kind of job wanted today for full free facts.

**OHIO INSTITUTE OF TECHNOLOGY, Box 225, Greenville, Ohio**

# REFRIGERATION

Repair and improve all refrigerators. Large manual tells how. Charts and pictures to help you. Price only \$1.00, postpaid. Money back guarantee. **SUPREME PUBLICATIONS, 9 S. Kedzie Ave., Chicago 12, Ill.**

# BOOKS FOUND FREE!

WHAT BOOKS DO YOU WANT?

We quote lowest market prices. No charge for locating Hard-to-Find Books. All books. OLD or NEW mailed POST-FREE. **SEARCHLIGHT BOOK CLUB, 22 East 17th St., New York City**

**MAGIC LIQUID MAKES PHOTOS APPEAR**  
On Scarfs, Ties, Stationery, Etc.

Reproduce any snapshot on cloth, leather, wood, paper. Simply apply liquid. Like magic photo appears within 2 minutes in broad daylight. Harmless to negative. Won't wash off. Full colors included. Complete kit for 100 photos only \$1.29. Send no money, just name. Pay postman \$1.29 plus few cents postage on delivery. Or send cash with order and get postpaid. (Canada \$1.50 money order only.) Order today.

**L. & M. Mfg. Co., Dept. 333-H, 229 W. Breckenridge, Louisville 6, Ky.**

# IS YOUR MIND ASLEEP?

My **MIND-STIMULATOR** unfolds your Rich, Creative Personality; helps you **FIND YOURSELF**... the **REAL YOU** and Real Opportunities to **ADVANCE YEARS IN MONTHS** financially. Folder **PSYCHOLOGY THAT WORKS** free. Dr. Tibbitt, 19A 185 Godfrey Ave., Phila. 20, Pa.

## Learn PHOTOGRAPHY at Home

Splendid opportunities. Prepare in spare time. Easy plan. No previous experience needed, common school education sufficient. Send for free booklet "Opportunities in Photography", particulars and requirements.

**American School of Photography**  
1315 Michigan Ave., Dept. 1352, Chicago 5, Ill.

# Make BIG MONEY in Coming REAL ESTATE BOOM!

**PREPARE NOW** for a big pay, permanent job or your own 6-Profit business in the predicted post-war real estate boom! Salaries up to **\$2,500.00 to \$10,000.00** a year in property management, brokerage, appraisal, loans, insurance, building. Dignified, pleasant work. Many make fortunes in real estate. Thousands of trained men, women required yearly by real estate firms, insurance companies, banks, Federal agencies, etc. **Coming real estate boom** means even bigger demand for workers, greater earnings, larger profits. Rush post-card or coupon for **FREE 32-Page QUIZ BOOK** and full details on Modern Real Estate Practice—first and only complete, popular-priced home training and reference library in this entire field. **Hurry!**

**Get in the Swim NOW**

**JOB SEEKERS!  
REALTORS!  
OWNERS!  
BUILDERS!  
INVESTORS!**

**RUSH COUPON OR POST-CARD FOR 32-Page FREE BOOK!**

**LANE BOOKS, INC.**

100 E. Ohio St., Dept. B-2, Chicago 11, Illinois  
Send me **FREE, POSTPAID** and **WITHOUT OBLIGATION**, your 32-Page **QUIZ BOOK** and complete details on Modern Real Estate Practice.

Name \_\_\_\_\_  
Home Address \_\_\_\_\_

# SENSATIONAL NEW EASY WAY TO SHOOT TROUBLE on Electrical and Radio Jobs!

**JUST OFF THE PRESS!**

**500 Shop Prints and How to Use Them**  
 — Plus Many Other Practical Features  
 — All in This BIG Money-Making Book

**Try it 7 DAYS FREE!**

Now at last — a practical book on TROUBLE SHOOTING for every Electrical and Radio man! Hundreds and hundreds of shop prints and wiring diagrams, with **easy-to-understand** instructions on how to read and use them. A streamlined course based on a new, time-saving method of shooting trouble.

A big **Electrical, Radio and Electronic Dictionary**. A special section on how to get **spare time jobs**. ALL THIS in one great volume—"The **COYNE ELECTRICAL AND RADIO TROUBLE SHOOTING MANUAL**". Coupon brings it for 7 DAY FREE TRIAL!



CREATED AND GUARANTEED BY

**COYNE**

For 46 Years — the Famous "LEARN-BY-DOING" School

## FREE WITH MANUAL

**1 Year Technical Service by Coyne Staff**

Act now and I'll include certificate entitling you to 1 full year of personal counsel from the Coyne Staff—technical advice by mail on any Electrical or Radio problem when you own this book. A real help in your daily work.

**ALSO FREE** 1 yr. subscription to Coyne Technical News — latest facts on Electrical and Radio progress, illustrated and explained.

## 7 DAY FREE TRIAL COUPON!

**H. C. LEWIS, Pres., COYNE ELECTRICAL SCHOOL**  
 500 S. Paulina St., Dept. 25-R6, Chicago 12, Illinois  
 O. K.—send me your new COYNE ELECTRICAL AND RADIO TROUBLE SHOOTING MANUAL, postpaid. Within 7 days after it comes I'll either return it or send you \$3, and then \$3 a month until total of \$8.95 is paid. Coyne pays shipping charges.

Name.....  
 Address.....  
 City..... State.....  
 Occupation..... Age.....

**SAVE 10%** Send cash price, \$8.00, if pre-day free trial and return privilege.

## 4 GREAT BOOKS IN 1



"STEP-BY-STEP" Method of Shooting Trouble



500 Prints, Diagrams — How to Read and Use



DICTIONARY of 1200 Electrical, Radio Terms



SPARE TIME WORK—to make extra money quick

### Step-by-Step Method Saves Time, Errors

Coyne, America's famous "Learn-by-Doing" Electrical School, has developed an utterly new way to locate the cause of any breakdown. This new "Step-by-Step" Method is fully described in the Coyne Trouble Shooting Manual. **Not obtainable anywhere else.** You'll be amazed at how quickly YOU can solve problems in your work—how much time, how many mistakes this training will save!

### Imagine! 500 Prints in One Book!

Why pay up to 25c for a single wiring diagram or blueprint, when this remarkable Manual gives you over 500 full-sized prints (in black and white, for easy reading.) Includes D.C. and A.C. Motors, Armatures, Switchboards; Electronic Controls; Radio Receivers; Auto Ignition; Refrigeration and Air Conditioning, etc. with full instructions. Also Dictionary of 1200 Technical Terms, and Spare Time Job information that helps you pay for your book easily.

### Special Introductory Offer SEND NO MONEY

Let me send you this big 8 1/2 x 11 inch, handsomely bound Manual FREE FOR 7 DAY TRIAL. I don't want a penny if you're not convinced it's the most practical, helpful book you've ever seen. Simply mail "NO MONEY" Coupon. Put the Manual to work on your job. If not delighted, return at my expense after 7 days and you'll owe me nothing. Don't delay. Your copy is waiting. Rush Coupon TODAY!

**COYNE** H. C. LEWIS, Pres. Dept. 25-R6  
 ELECTRICAL SCHOOL  
 500 S. Paulina Street, Chicago 12, Illinois

# CASH

This New, Absolutely FREE Service Helps You Find Buyers! FOR YOUR IDEAS OR INVENTIONS!

You can now reach prospective buyers of your ideas and inventions at *absolutely no cost* to you. The Nation-Wide Bureau of Ideas offers an amazingly simple way for you to cash in on your ideas for new, useful gadgets, mechanical devices, processes or methods.

### IT WORKS LIKE THIS

All you do is describe your idea and what it does. The Bureau briefs your description and places it before its subscribers, well-rated firms of all types. These companies are in the market for worthwhile ideas and pay well for those they use.

### YOU PAY NO FEES—BUY NOTHING

If a company is interested in your idea, the Nation-Wide Bureau of Ideas puts them in touch with you. From then on, you handle all details with prospective buyers. The Bureau charges you nothing, now or later—it acts purely as a clearing-house and neither buys nor sells any ideas.

### YOU GET FULL PROTECTION

You need not disclose actual details of your idea to the Bureau. If you believe your idea is patentable, have someone witness a dated description or sketch of the details. Keep this to prove priority if patent application is made later.

### DELAY IS COSTLY—ACT NOW!

The sooner your ideas are placed before prospective buyers, the better your chances. Those who supply the ideas American business needs right now, will benefit.

To get your free forms and instructions, just tear out this ad, write your name and address in the margin and mail *today*. Valuable folder, "Ideas That Pay," telling how to develop marketable ideas, will also be sent. Return this ad immediately—it may be the most important step you have ever taken.



Send Your Name to

**NATION-WIDE BUREAU OF IDEAS**

**MORTON MANUFACTURING CO.**  
NATION-WIDE BUREAU OF IDEAS  
353 N. Leamington Ave., Chicago 44, Ill.

**START YOUR OWN BUSINESS**

## GET INTO PLASTICS

### SMALL CAPITAL — WORK AT HOME

New miracle Plastics industry offers you unlimited career opportunities. Get started now in your own Plastics business or prepare for postwar plastics employment. Take your place in the new Plastics Era. Now for the first time you get practical training in your own home. This new plan gives you the fundamental technical knowledge covering all branches of the Plastics industry including all types of Plastics materials. This is not a novelty program but a real sound educational plan. The actual practical work consists of working with many different types of Plastics materials—teaching you fabrication, shaping, forming, finishing, cementing methods, mold making, casting, compounding, etc. For full information send this ad with your name in an envelope or paste on a penny postcard.—To Dept. M.

➤ **PLASTICS TECH** 1845 E. 9th St., Cleveland 14, Ohio

## CARTOONING

CASH IN on Big Cartoon Market. Become Cartoonists Quickly with NEW, EASY METHOD prepared by successful cartoonists. Learn how to get ideas and quickly originate cartoons for Newspapers, Magazines and Advertisers. No experience necessary. 45 LESSONS covering 93 SUBJECTS. Valuable ideas, cartoon markets, etc. Postpaid anywhere for only—

\$2.85

Send name and address for free details.  
NATIONAL ARTISTS BUREAU, Box 4248-A, DALLAS 8, TEXAS

## LEARN MACHINIST TRADE TOOL & DIE MAKING

In completely equipped Shops. Also short, special Shop courses for essential War and Post-War Jobs. Learn an actual Shop work. Coeducational. Special Counselor for G.I. Training. Write for Free Booklet. Allied School of Mechanical Trades, 1330 S. Michigan, Chicago 5, Ill.



## ITALIAN ACCORDIONS

Hand Made. Very best. Lowest prices. Buy Direct from Factory and Save Money. Send name and address for FREE catalog. ITALIAN ACCORDION MFG. CO. 323 W. POLK ST., DEPT. PM-14, CHICAGO 7, ILL.



## LANGUAGE IS POWER

... Forge ahead, win special assignments, promotion, better job in global peace time opportunities through ability to speak a foreign language.

**MASTER A NEW LANGUAGE quickly, easily, correctly by**

## LINGUAPHONE

The world-famous Linguaphone Conversational Method brings voices of native teachers INTO YOUR OWN HOME. You learn the new language by LISTENING. It's amazingly simple; thousands have succeeded.

**HOME-STUDY COURSES IN 29 LANGUAGES**

Send for FREE book—

## LINGUAPHONE INSTITUTE

98 RCA Building, New York 20, N.Y. • Circle 7-0830

LINGUAPHONE INSTITUTE,  
98 RCA Bldg., New York 20, N.Y.

Send me the FREE Linguaphone Book.

Name .....  
Address..... City.....  
Language Interested.....

# FREE

## THIS AMAZING NEW BOOK FOR 7 DAY TRIAL!

# HOW TO MAKE AND FIX THINGS FOR YOUR HOME!

### NOW — IT'S EASY! BIG, NEW COMPLETE GUIDE HAS EVERYTHING BEGINNER OR EXPERT NEEDS TO KNOW!

Now you can make the things you've wanted . . . do the repairing and redecorating that needs doing—and have fun, too! For here is "It's Fun To Make It Yourself," an amazing new guide that simplifies every step in wood and metal working . . . shows you short-cuts that save time, money, labor. See how easily you can follow the amazingly simple picture-instructions. Mail coupon now for 7-Day FREE examination. Send no money!

#### Here's How to Beat High Prices, Scarcities!

Even if you've never handled tools in your life—you can follow the simplified picture-direction in this new kind of book. So easy you can't possibly go wrong . . . thanks to its easy-to-understand, non-technical language and over 2000 helpful pictures!

Imagine saving \$10 to \$50 by making a nest of tables yourself. Or framing your own pictures. Imagine repairing and renewing old furniture—at practically no cost. Or adding a handsome rustic bench to your garden. Just one article you make—or one repair job you do—with the help of this book can easily save you many times the cost of the entire volume. So mail coupon now for your FREE examination. No Obligation!



IT'S FUN to make a collapsible bed tray, scores of other things.

*Simplified, Step-by-Step Methods of One of America's Leading Authorities*

# It's Fun... TO MAKE IT YOURSELF!

384  
BIG  
PAGES —  
COMPLETE  
INDEX

#### Look at this Partial List of Things You Can Make and Do!

##### MAKING

- Nest of Tables
- Medicine Cabinet
- Combined Cabinet and Bookshelves
- Fire Screen
- Double Step-ladder
- Desk Chair
- Table Lamp
- China Cabinet
- Modern Sideboard
- a Burglar-proof Hinge
- a Shelf Bracket
- Objects of Metal
- Rustic Garden Bench
- Rose Pergola
- Greenhouse
- Furniture Repairs
- Panelling a Room
- Replacing Sash Cords
- Lifting Flooring

- Draught Prevention
- Picture Framing
- Glass Cutting
- Fitting & Replacing Window Panes
- Fitting Hinges
- Fitting Shelves
- Converting Spare Room into Workshop
- Using Garage as Workshop
- Choice and Care of Tools
- Wax Polishing, Fuming, etc.
- Choice of a Lathe
- Sheet-Tin Work
- Bent Wire Work
- Etching on Brass
- Copper and Steel
- Paperhanging
- Interior Painting
- Graining

And many other things you'll have FUN making and doing with help of this new book!

2000 PHOTOS AND DIAGRAMS MAKE EVERY STEP AS EASY AS A-B-C!



**Household Utility Items**—Make ironing boards, step-ladders, kitchen tables, workstands, clothes driers, utility cabinets, etc.



**Things Decorative, Useful**—Have fun making book-ends, coffee tables, hearth rails, etc. You'll get real pleasure in seeing them finished in your home.



**For Garden**—Make a 2-light garden frame for plants—or beautify with rustic seats and benches, rose pergolas, bird feeding tables, even complete greenhouse, etc.



**Nursery Needs**—Make hard-to-get things like a baby's folding crib, medicine cabinets, work stands, lamps, cake tins, ash trays, etc.



**New Rooms For Old**—Add new life to old rooms! Imagine the difference a new combination book case and cabinet, a nest of tables, or new wall paper would make!

## Examine 7 Days FREE!

### Send No Money! Mail Coupon NOW!

There never has been a book like "It's Fun To Make It Yourself." 384 BIG pages, over 2000 photographs, working diagrams, sketches—all the facts you should know about building and equipping your home workshop; selecting, manipulating, sharpening, caring for your tools; joints, jointing; finishing woodwork; wood turning; wood, metal construction projects; how to do home repairs, maintenance; fundamentals of house-painting; plastering, paperhanging; 50-page section of things to make for garden.

#### MAIL COUPON NOW!

Once you go through this practical guide you

wouldn't give it up for many times its small price. Let us send "It's Fun To Make It Yourself" for one week's free examination. Then, if you're delighted with it (as we're sure you will be) send only \$1—and one month later pay small balance of only \$1.95 (plus few cents postage).

If, for any reason, you decide not to keep book, return it and owe nothing. You have everything to gain, nothing to lose, by mailing FREE Examination Coupon NOW to Book Presentations, 31 West 57th Street, New York 19, New York.

#### FREE EXAMINATION COUPON

##### BOOK PRESENTATIONS

31 W. 57th Street, New York 19, N. Y. PM-2

Without obligation, send me immediately (prepaid for a week's free examination), IT'S FUN TO MAKE IT YOURSELF, 384 pages, over 2000 How-To-Do-It Illustrations, indexed, handsome cloth binding. At end of week I will return book and owe nothing. Or I will keep it and send \$1 then; and \$1.95 one month later (plus a few cents postage charges).

Check here if you desire beautiful Deluxe Edition bound in special-finish Simulated Leather — gorgeously grained, stamped in genuine gilt. Only \$1 extra.

NAME ..... (Please Print Plainly)

ADDRESS .....

CITY ..... STATE .....

(Please List Zone Number — if any)  
 CHECK HERE AND SAVE MORE. SHIPPING WEIGHT 3 lbs. Send full cash with this coupon and we will stand shipping costs. Same return privileges!

## MAIL FREE EXAMINATION COUPON TODAY!



**TIE UP YOUR FUTURE**  
with these Growing Industries

# REFRIGERATION AIR CONDITIONING

Air Conditioning and Refrigeration are among the great industries of today and tomorrow. Installations everywhere—in restaurants, shops, homes, etc., need service. Thousands of businesses are waiting for new installations. The day may come soon when homes, too, will be air conditioned. The Refrigeration and Air Conditioning industries are headed for greater prosperity and men who have the "know how" and experience should ride along.

## Train Now Before the Expected EXPANSION Begins



Experts predict large demand for men to install and service Air Conditioning and Refrigeration equipment... Rise to the kind of job which requires a competent, trained man who can carry the responsibilities of installing costly equipment and maintaining it. If he knows the answer when he is called in for consultation, his reputation grows and his pay should grow also.

**Historic SUCCESSES May Repeat**  
Do you realize where you might be today if you had been in on the ground floor when some of our great industries began? Men who see ahead are more apt to be the ones who later cash in on the growth of the industry.

### Follow This Way to Knowledge

Here is all it will take to get you ready for experience in this modern industry. You just invest a limited amount of your spare time—while you are still on your present job. Through our balanced training, you learn first through home study, how to handle Installation, Maintenance, and Service Work on Refrigeration and Air Conditioning equipment. Then you can get practical experience in our big shops under capable instructors—practical men who will take a personal interest in helping you learn. When you are through you should have the knowledge that enables you to get started in this vast industry.

### GET FREE FACTS RIGHT NOW!

It costs you nothing to get all the facts about this great field. Simply mail the coupon below and we'll tell you, without obligation the whole, sensational story of what's ahead in Refrigeration and Air Conditioning. Mail the FREE coupon now.

**REFRIGERATION  
TRAINING**  
Since 1927

**UTILITIES ENGINEERING INSTITUTE**  
1314 W. Beiden Avenue, Dept. 125, Chicago 14, Ill.

Please send me the FREE FACTS about opportunities in Air Conditioning and Electric Refrigeration. I have marked the one that interests me most.

Air Conditioning     Electric Refrigeration

NAME \_\_\_\_\_  
ADDRESS \_\_\_\_\_  
CITY \_\_\_\_\_ ZONE \_\_\_\_\_ STATE \_\_\_\_\_

# YOUR FORMULA TO SUCCESS

Any one of these 500 proven formulas, recipes and processes can be your first step to real success. Take your choice of one of the most successful collections ever assembled. Make your own: Adhesives, Metal, Glass and Wood-Craft, Paints, Photographic Supplies, Inks, Household Aids and many other products—useful in office, factory, home and workshop. Save as much as 1000% on store prices.

Formerly \$1.00, now, only 25c postpaid. Send U. S. Stamps, money order or coin.

**NATIONAL PLANS INSTITUTE**  
P. O. BOX 25P, STATION N, NEW YORK 23, N. Y.

**25c**  
68 PAGES  
32,000 WORDS  
MONEY-BACK GUARANTEE



**JIU-JITSU** If over 15 years old, get together with friends for Jiu-Jitsu club. Learn how to defend yourself, keep healthy and have fun. Send 10c for sample lesson.  
**MODERN SCHOOL JIU-JITSU, Dept. WW, 5 W. 52nd St., N.Y.C. 19**



**CODE-RECEIVING SPEED**  
Learn to send and receive Radio Code with greater speed. Stop nervous tension. Have confidence. Be proficient. Same system used by radiotelegraph specialists. Thousands of operators needed. Rush name for FREE book.  
**CANDLER SYSTEM CO., Dept. 5-B, Box 322, Denver 2, Colo., U. S. A.**

**RAISE GUINEA PIGS**  
**MAKE MONEY.** Thousands needed—War demand great. We supply breeders and buy the young. Write today for FREE illustrated bulletin. **RESEARCH SUPPLY CO., Dept. F-9, 2436 W. York St., Phila. 32, Pa.**

**TOMBSTONES \$13.69**  
Freight Paid.  
Interested! Write us now for Free Catalog. Made of best Marble & Granite. Service direct to you by mail. Why wait.  
**U. S. MARBLE & GRANITE CO. Oneco, Fla. A-18**

**Be Popular—Learn the Newest DANCES in 5 DAYS—or NO COST!**

**NEW REVISED EDITION OF DANCING**  
includes the Rhumba, Congo, Samba, Jitterbug . . . Fox Trot, Waltz and Tap Dancing.

All the newest Swing steps—the Rhumba, Congo, Samba, Jitterbug, as well as the Fox Trot, Waltz and basic tap steps—explained with simple, graphic diagrams. **GET MORE FUN OUT OF LIFE!** Swing your way to popularity! Start now and all your future with Romance! **MAKE THIS FREE TEST!** The new REVISED edition of Betty Lee's book, *Dancing*, helps you learn correctly and quickly. Be convinced—if not satisfied with results, you will get your money back! And remember, we include two other books—"Tip Top Tapping" and "Swing Steps"—FREE of extra charge. **SEND NO MONEY!** Pay the postman \$1.98 plus a few cents postage. Follow instructions in ALL THREE BOOKS—practice simple dance steps each day and in 5 days if you haven't learned to dance, we will refund your money!



**PIONEER PUBLICATIONS, INC.**  
1790 Broadway, Dept. 942H  
New York 19, N. Y.

Send me "Dancing," by Betty Lee, and include 2 free books.  
 Ship C.O.D. I will pay on arrival, plus postage.  
 I enclose \$1.98. Ship postage prepaid. If in 5 days I do not learn to dance, I may return book and you will refund purchase price.

Name \_\_\_\_\_  
Address \_\_\_\_\_  
City \_\_\_\_\_ State \_\_\_\_\_

**TWO BOOKS Included FREE**

# SENSATIONAL WAR BARGAINS IN LENSES & PRISMS

All Lenses New, Finely Ground and Polished, Edges Very Slightly Chipped. Come Neatly Packed and Marked—A Salvage Bargain!

## YOU CAN EASILY MAKE

Telescopes

Magnifiers

Photographic Gadgets

and HUNDREDS OF EXPERIMENTS with these Low Cost LENSES

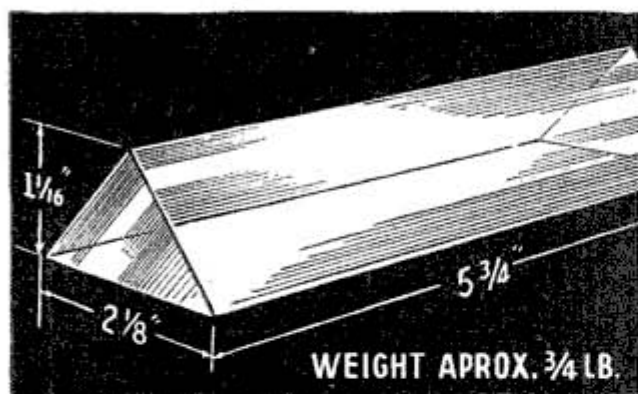

## TANK PRISMS

In order that the tank driver shall not get shot in the face, two of these Silvered Prisms are used to make a periscope. We have secured a number of these that are very slightly chipped, making possible their sale at a very low price. They are 90-45-45 degree prisms of huge size— $5\frac{3}{4}$ " long,  $2\frac{1}{8}$ " wide, finely ground and polished.

You can use these Prisms to make Periscopes to see over the heads of crowds, to photograph fish under water, to view high or low gauges, etc. Also excellent for experiments, classroom demonstrations at high schools, colleges, camera clubs, astronomy clubs. Some of our ingenious customers have used these Prisms to make camera stereo attachment, photometer cube, range finder, etc.

Normally, these Prisms would retail from about \$24 to \$30 each.

## SPECIALS IN LENS SETS

Big 10 Page Project and Idea Booklet with all sets—describes successful developments—points the way to new experiments.

**Set No. 301-H "Our Advertising Special" 15 Lenses for \$1.60 Postpaid.** For making your own powerful telescopes, low power microscope, strong magnifiers, drawing projector, photo cells, telephoto lens, dummy focusing camera, Kodachrome viewer, stereoscopic viewer, ground glass and enlarging focusing aids. For experimental optics, portraits of babies and small pets, copying, ultra close-up shots, and many, many other uses.

**Set No. 305-H "The Gadgeteer's Delight" 35 Lenses for \$5.00 Postpaid.** Contains all the lenses in the above set plus twenty more expensive lenses increasing your field of experiment and gadget making. All our lenses are neatly packed and marked.

**Set No. 310-H "The Experimenter's Dream" 60 Lenses and New Complete 50 Page Booklet—\$10.00 Postpaid.** Contains all the lenses in the above set plus 25 others that makes this a sensational buy. The variety of lenses in this set will enable you to conduct countless experiments and build a wide variety of optical equipment.

**New 50-Page Illustrated Idea Book . . . \$1.00 Postpaid.** "Fun with Chipped Edge Lenses" describes a wide variety of uses for our lenses and contains much information especially designed for the homemade construction of optical items.

**PORRO ABBE PRISMS—Stock No. 3006-H . . . 25c each Postpaid.** Size 9 mm x 17 mm . . . another war bargain. Normal prices would be 20 to 40 times above quotation. At this exceptionally low price, you should purchase a few of these, even though you have no immediate need for them. Such a bargain will not be available long.

Stock No. 3004-H . . . SILVERED TANK PRISMS—Price \$2.00 each Postpaid.

Stock No. 3005-H . . . PLAIN TANK PRISM—Price \$2.00 each Postpaid. This one is excellent for projecting all the colors of the spectrum—a beautiful sight.

FOUR TANK PRISMS—Special—\$7.00 Postpaid. . . . This is a sensational bargain opportunity.

### MFG. FOR NAVY'S 7 POWER BINOCULARS

**KELLNER EYE-PIECE LENSES . . .** you can use in Telescopes, Binoculars, Microscopes, etc. Consist of achromatic eye-lens and a field lens. Focal length 27.5 mms. Comes uncemented with FREE cement and easy directions.

Stock No. 6061-H—Edged . . . \$1.25 Postpaid

**COMPLETE SET OF LENSES AS ABOVE AND THE PRISMS TO MAKE A MONOCULAR (TELESCOPE)** with objective lens of two inch diameter.

Stock No. 5100-H—Monocular Set . . . \$5.00 Postpaid

**MICROSCOPE OBJECTIVE LENS SET—Stock No. 6093-H . . . \$2.00 Postpaid.** 2 Cemented Achromatic Lenses (color corrected) which may be combined to make a microscope objective lens with a focal length of  $\frac{1}{2}$  inch. Use these to make a microscope for microphotography.

**8 MM MOVIE PROJECTING LENS SET—Stock No. 4011-H . . . \$1.20 Postpaid.** Consists of 2 Achromatic Lenses, diameter 18 mms. and a focal length when combined of one inch.

**35 MM FILM ENLARGING LENS SET—Stock No. 6057-H . . . \$1.50 Postpaid.** Consists of 2 Achromatic Lenses to use at a speed of about F.8. These make a good substitute until Anastigmat Enlarging Lenses again become available.

Order by Set or Stock No.—Satisfaction Guaranteed

## EDMUND SALVAGE COMPANY

27 W. Clinton Ave., Dept. 11, P. O. Audubon, N. J.

# Do YOU want the STRENGTH, POWER and DEVELOPMENT of a CHAMP?

... then let

**JOE BONOMO**

Master Builder of Men, show YOU how to build YOUR BODY into MEAT and MUSCLE; and your MUSCLES into SPRINGS of STRENGTH and STEEL.



All my life I've been building big muscles and powerful bodies out of scrawny little ones. I've done it for thousands with my "Power-Plus" Method, the most original System of Physical Development ever devised; the system that "Proves It With Results"! I'm so sure I can do it for you that I offer my **MONEY-BACK GUARANTEE!** Let me give you the build, strength, energy, vitality you want.

**Send NOW for this Amazing, Complete 3 WEEKS "POWER-PLUS" SPEED COURSE**  
in muscular development for  
**ARMS, SHOULDERS, CHEST, BACK, LEGS**



**JACK DEMPSEY** says: "I consider your course one of the best for all round physical development."

Covers every part of your body inside and out. Gives you strength, build, speed and endurance. 18 daily work-out charts, 91 separate Photo-Instructor illustrations, 22 sheets of instructions showing how to do the proven "Power-Plus" Muscle Builders. 3 Illustrated Body Fact Lectures and more. Packed with facts about your body, including diagrams of muscles, nerves, organs. \$5.00 value, but it's yours now, complete for only 97c and a 3c stamp (or send \$1.00 cash, money-order or check), or I'll send complete course COD. Pay postman 97c plus postal charges. **ACT FAST!** Clip and mail coupon to me TODAY!



**BERNARR MACFADDEN** says: "Your astonishing physical achievement places you at the head of all your competitors."

**FREE For Quick Action!**

Strong men ACT, but as an inducement to urge you to act fast, if you send coupon at once, I'll send you my famous P. D. Q. Test Dozen. Find out how strong you really are! **RUSH COUPON TODAY.**

**JOE BONOMO, Dept. 503-A**  
1841 Broadway, New York 23, N. Y.

**MAIL COUPON NOW!**

\$5.00 value only  
**97c** and a 3c stamp

Joe Bonomo, personal  
Bonomo Culture Institute,  
1841 Broadway  
New York 23, N. Y.

503-A

Dear Joe: That's what I want—fast action! Rush me quick, my complete 3 weeks "Power-Plus" SPEED COURSE. Include FREE your famous P. D. Q. Test Dozen.

I enclose \$1.00  cash,  money-order  
 Send COD, I will pay postman 97c plus postal charges.

Name..... Age.....

Street.....

City..... Zone..... State.....  
(Please print plainly)

## ARE YOU THINKING OF BUYING A FARM OR COUNTRY HOME?

Don't do it until you send for my "Have-More" Plan to read and examine free—it may save you hundreds of dollars and many heartbreaking mistakes.

Tells how to have a place that will pay for itself!

My "Have-More" Plan is the true story of how my family and I moved from the city to a little two-acre place in the near-by country to find a "little land and a lot more living" and how I've kept a regular full-time job. Tells how we grow most of our own food in spare time—have fun doing it—have better health—more sunshine and fresh air—more peace and quiet—more security and independence—in fact, more of just about everything that makes life worth living!

My "Have-More" Plan contains over 50,000 words, 73 illustr., many actual photos of our own place.

It tells the how of all our shortcuts, ideas, labor-saving methods—how it takes us only an hour or so of spare time a day to have tender chicken to eat, plenty of eggs, wonderful garden with a lot less work, delicious rabbit meat at only 8c a pound, rich milk, butter, cream from our miniature dairy, tasty ham, pork, bacon, sausage, geese, turkeys, squab, honey bees, fruit trees instead of shade trees, luscious grapes, berries—how we use new, easier preserving methods, including quick freezing.

Best of all, my Plan tells you how to choose the right kind of place—how to save hundreds of dollars in buying and financing—how to avoid costly mistakes.

The "Score-Card" of what to look for is worth more by itself than the whole price of the Plan—which is only \$1.00.

Honestly, if you're thinking of buying or building (or if you already have a place), my Plan can be the biggest dollar's worth you ever got—and I'll send it to you to look over and examine free. If you don't like it—if you don't agree it's worth many times one dollar—just send it back and owe me nothing. If you keep it—just send me one dollar, full price—I know you're going to be delighted—so drop me a postcard now—Yours for "a little land and a lot more living." **ED ROBINSON, Box 2702, Noroton, Conn.** (Of course, if you'd prefer to send your dollar now, that would be fine—save me a lot of record keeping. I'll gladly refund your dollar if you're not delighted.)

### TIME & MOTION STUDY

**DON'T COMPETE WITH 30,000,000 WAR WORKERS.** Train with professionals for your big pay job now. Approved for "G.I." training. Send for free details for Ind. Eng. benefits.

**INDUSTRIAL ENGINEERING COLLEGE**  
4000 Washington, Chicago (24) Illinois

## Pays HOSPITAL BILLS for Whole Family

**Costs 3c a Day for Adults**  
**Only 1½c a Day for Children**

It's here! The new Family Hospital and Surgical Expense Policy you need and want! One policy insures whole family—mother, father, children, anyone from 3 months to 65 years. No medical examination. Pays up to \$510.00 hospital and surgical bills for EACH and EVERY person insured. Pays up to \$100.00 doctor's fees for operations. Pays up to \$50.00 for operating room, medicines, ambulance, etc. Covers sicknesses, accidents, operations, childbirth, female disorders, and many other disabilities not covered by other policies. You select your own doctor and hospital. This full-coverage Family Hospital and Surgical Policy issued DIRECT to you at special family rates by big, strong company with over \$3,000,000.00 in assets. Investigate! **SEND NO MONEY**, but mail the coupon below quick for full details—sent FREE. No agent will call on you. Act today!

#### STERLING INSURANCE CO.

A-4861 Sterling Bldg., Chicago 11, Ill.

Send me your FREE INSPECTION Offer of **LOW-COST** Family Hospitalization Plan.

NAME.....

ADDRESS.....

CITY..... STATE.....

★ SAVE WASTE PAPER ★



# "The Supreme Authority"

IS WORTH WAITING FOR

Be Sure  
You Get the  
**MERRIAM-Webster**



**WEBSTER'S  
NEW INTERNATIONAL  
DICTIONARY**  
*Second Edition*  
UNABRIDGED

**D**EMAND is heavy and paper rationed but better to wait for your copy of the MERRIAM-Webster than accept a substitute. Ask for the genuine Webster—the MERRIAM-Webster—identified by the circular trade-mark. Contains 3,350 pages, illustrations for 12,000 terms, and a total of 600,000 entries—122,000 more than any other dictionary. Order now from your bookseller or stationer. He will get your copy as soon as he can.

G. & C. MERRIAM CO., SPRINGFIELD 2, MASS.

Listen to this Record!



# SPEAK SPANISH FRENCH, GERMAN, OR ITALIAN

Big opportunities awaiting Americans who speak Spanish. Learn as a child learns—"by listening" to these brand-new CORTINA recordings.

**Only 15 Minutes a Day**

Cortinaphone Method famous for 60 years. THOUSANDS have found it the most fascinating, most satisfactory method. Here is the quick, easy way to learn Spanish for PLEASURE AND BUSINESS. INVESTIGATE!

**Sent on 5 Days Approval**



"The Cortinaphone Short-Cut"—tells just what you want to know. Interesting. Get it!

**Write Today-NOW!**

CORTINA Academy (Language Specialists for 60 Yrs.)  
Suite 642, 105 W. 40th St., New York 18, N. Y.

Please send me—without obligation—your free booklet. I am interested in (mark):

SPANISH     French     Italian     German

Name .....

Address .....

**LEARN HOW EASILY  
YOU CAN FLY!**



THIS BOOKLET,  
"HOW TO FLY  
A PIPER CUB",  
HAS OVER 50  
STEP-BY-STEP  
PHOTOS  
AND  
DESCRIP-  
TIONS.



IT SHOWS YOU  
HOW TO TAKE OFF,  
CLIMB AND LAND.  
GET YOUR COPY-  
STUDY IT,  
THEN  
TAKE  
LESSONS.

For booklet send 10c in stamps or coin for postage-handling. Piper Aircraft Corporation, Department PM25, Lock Haven, Pennsylvania.

16mm. SOUND FILM—"The Construction of a Light Airplane." For distribution points, write: Supervisor, Audio-Visual Aid, Extension Services, Pennsylvania State College, State College, Pennsylvania.



**PIPER CUB**

POINTS THE WAY TO WINGS FOR ALL AMERICANS



**F**ISHING'S more fun than fighting . . . as twelve million fighting Americans will fervently agree. *Keeping on* producing everything *they* need is all that counts today. That is why the Evinrude you want for happy peacetime use may not be ready as quickly as you, and we, would like. All we can promise is . . . it will be *worth waiting for!* Evinrude Motors, Milwaukee, Wis.

# EVINRUDE



OUTBOARD MOTORS

**SPEED THE DAY . . . FOR THEM — FOR YOU . . . BUY MORE WAR BONDS**

# Popular Mechanics Magazine

REGISTERED IN U. S. PATENT OFFICE AND CANADA

WRITTEN SO YOU CAN UNDERSTAND IT

Vol. 83

FEBRUARY, 1945

No. 2

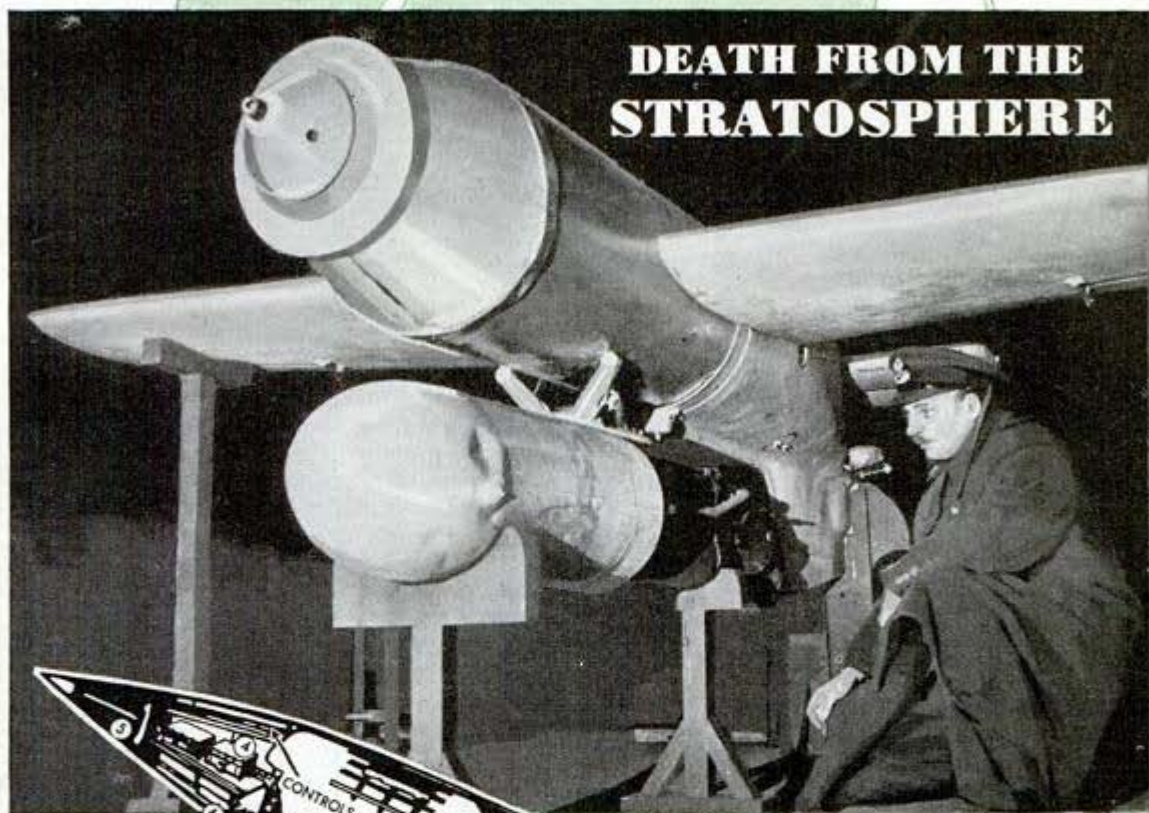

## DEATH FROM THE STRATOSPHERE

Above, radio-controlled glider bomb is released from plane miles from target

**W**ORST of all was the terrifying suddenness with which it struck. They couldn't see it coming. They couldn't even hear it—until too late. Without warning, the ground trembled as if from a local earthquake and a roaring blast beat on their ear drums, followed by an eerie, rumbling "whoosh." Most of the people were knocked flat but those close to the explosion were killed or mangled. Twisted fragments of metal littered the area and when the dazed survivors stumbled to the wreckage they found a deep crater, perhaps 30 feet in diameter, from which protruded the finned tail of a curious cylindrical missile the size of a small airplane fuselage.

A shudder rippled through the onlookers. They knew then that the fantastic stratosphere rocket, another monstrous perversion of German science, had

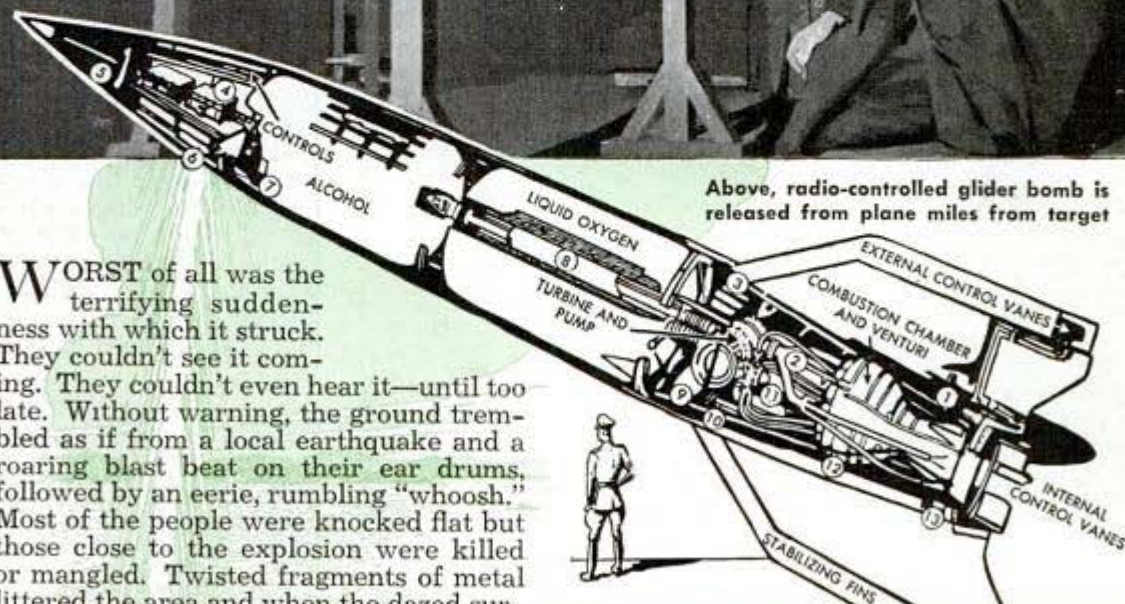

**DIAGRAM OF V-2:** (1) electric motor; (2) alcohol supply from pump; (3) air bottles; (4) radio guiding equipment; (5) central exploder tube; (6) nitrogen bottles; (7) pitch and azimuth gyros; (8) alcohol delivery pipe to pump; (9) hydrogen peroxide tank; (10) permanganate tank; (11) oxygen distribution from pump; (12) alcohol pipes for subsidiary cooling; (13) electro-hydraulic servo motors

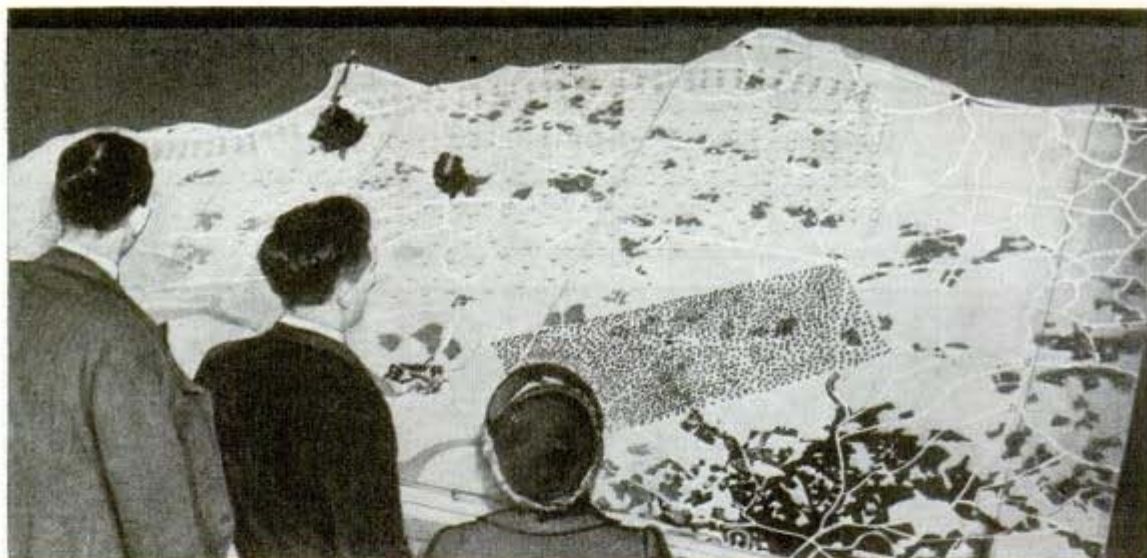

Huge model of southern England coast defenses shows guns near shore, searchlights (white dots), and balloon barrage (rectangle of black dots) which lie between London and the coast

paid them a lethal visit. It seemed to be the handiwork of demons—a wingless, self-propelled projectile which, fired into space at supersonic speeds, would plunge at random like a vengeful meteor upon a peaceful countryside or city.

To Allied scientists this new manifestation of indiscriminate warfare—known as V-2—is a “considerable technical achievement” but less destructive than the Nazis must have hoped it would be. True, numerous civilians were killed and wounded after the bombardment began to rain on

England last autumn. And of the 1,100,000 English homes, hospitals, churches and schools reported damaged by “V bombs” since last June, many were victims of V-2.

But as to military effectiveness V-2 was regarded as no more destructive than V-1, the “buzz bomb” with wings. V-2 penetrates deep into the earth and thus concentrates much of its damage around its own self-made crater. V-1, which is cheaper and much less complicated to build, but carries the same amount of explosives (one ton), digs hardly any hole but scatters glass and shrapnel over a greater radius.

Recently, the Germans launched over the Western Front what is believed to be a new type of rocket. This barrage weapon has been called a V-1½ for it is said to combine features of both the V-1 and V-2.

The V-2 is the weirdest-looking of World War II's surprise weapons. It resembles a metal telegraph pole 46 feet long and five feet in diameter, and it behaves like a gigantic Roman candle gone berserk. Weighing 13½ tons at takeoff, it climbs upward to 70 miles above the earth before it starts its descent. When it strikes, it plows under more than half its length



Artist's conception of portable launching ramp for V-2

before it is detonated with a noise that can be heard almost 20 miles.

Unlike the gas turbine method of jet propulsion in airplanes, V-2 does not breathe air but derives all its power from the fuel it carries and therefore can travel outside the earth's atmosphere. It is made up of six principal parts: an explosive-packed warhead in the sharply pointed nose; a control compartment; two large fuel tanks, one containing about 7,000 pounds of alcohol and the other 11,000 pounds of liquid air; a turbine and pump assembly with a



Inspecting turbo pumps of wrecked V-2; fuel pump is at left, liquid air pump right. Left, Allied soldiers remove parts of V-2 found in field in Belgium



generator to drive the turbine; a large combustion chamber, and two sets of control vanes, one for the inside and one for the outside.

The V-2 is launched in a vertical position from a concrete platform or hard surface, according to the British Air Ministry. To keep the fuels from exploding, hydrogen peroxide and potassium permanganate

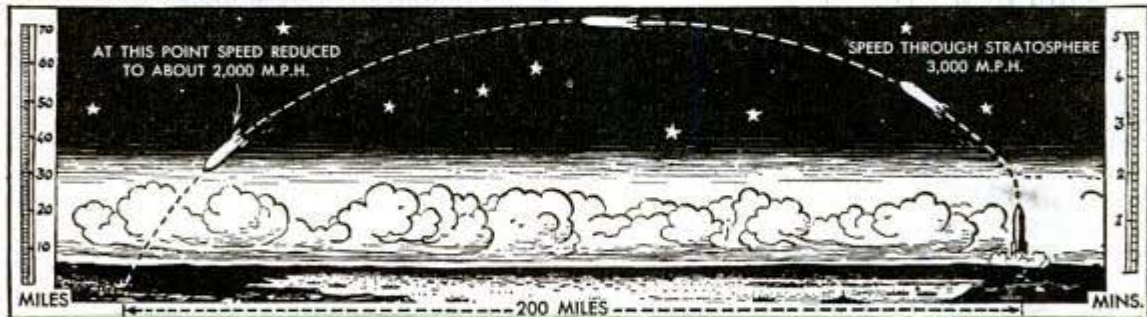

Stratosphere path of V-2 which travels 200 miles in about four minutes. At takeoff it weighs 13½ tons

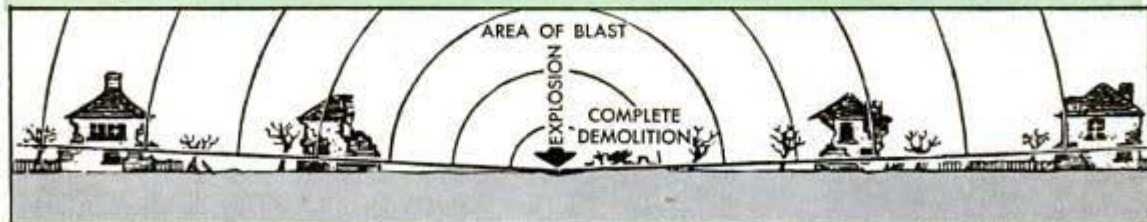

Drawings from London Daily Mail

Blast area of V-1 (above) is greater than the V-2 (below) which digs deep crater when rocket explodes

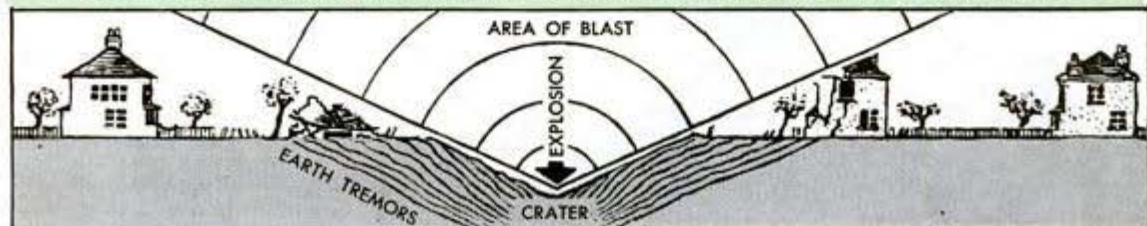

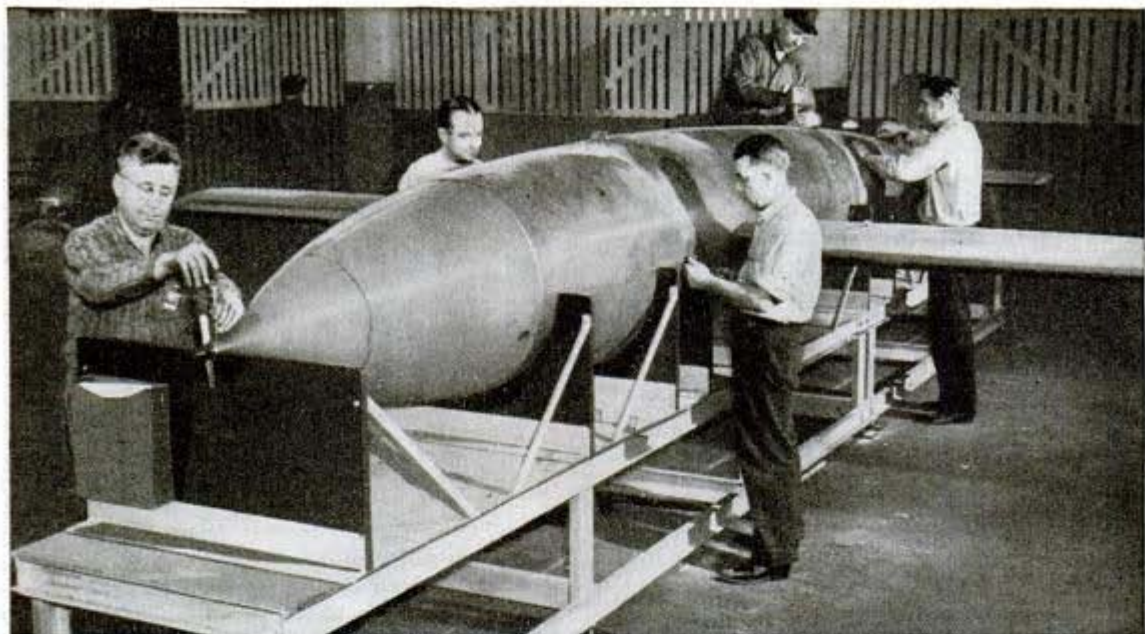

This robot bomb built for the U. S. Army Air Force is 27 feet long and has a wing span of 17 feet

are mixed with the highly explosive combination of alcohol and liquid air. Pipes carry these four liquids into a turbine and pump assembly where they are blended and released under pressure through 18 jets into the forward end of the combustion chamber. The fine spray is ignited electrically from a safe distance and the hot gases rush out through jets at the rear of the chamber.

A gyroscope control within the rocket operates the control vanes. Photographs of the V-2's climb reveal a zigzag path which might be caused by a radio control that holds the rocket inside a set course for the first few miles.

About one minute after launching, the fuel supply is cut off, either by remote ra-

dio control or by pre-set automatic instruments. The point at which the fuel is cut off determines the range. Its maximum range is believed to be about 200 miles.

The speed of the V-2 is about 3,000 miles an hour during the climb into the stratosphere, and this probably diminishes to 2,000 miles an hour when the fuel is cut off. On its downward flight it becomes heated by friction to such an extent that by night it looks like a dull red comet. By day all that can be seen from the ground is the vivid flash that accompanies the blast.

Against V-2 ordinary air defenses are obviously useless. The specially built Bofors guns along the English coast, the balloon barrages girdling London, and the alert fighter planes—all of which were used successfully against V-1—simply cannot cope with this man-made bolt of lightning.

As a defense, Allied airmen attacked German oil storage deposits and what were believed to be the V-2 launching bases in the Netherlands and the railroads leading to them. Stories about secret launchings filtered through from the Dutch. In roped-off areas the Germans dug wells 80 feet deep and as large as tennis courts. Along the

(Continued to page 158)



This Nazi V-1 robot bomb landed intact in a U. S. Army camp

## Gyro Loops With Pilot to Show Plane's Attitude

Aerobatic maneuvers, including loops and rolls, can be performed with a high degree of safety with a Sperry attitude gyro. The dial, which looks like a free-rolling ball in a frame, tells the position of an airplane with reference to the earth's surface throughout 360 degrees of roll and pitch. With this instrument, a pilot can perform complicated maneuvers on instruments alone without having to see where the ground is. The indicator is divided into hemispheres, the upper half white luminescent and the lower half black.

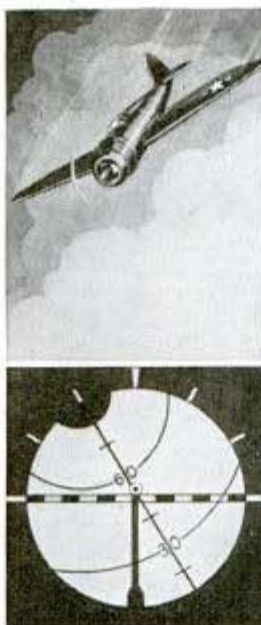

## "Super-Finished" Reflectors Throw Beam Twenty Miles

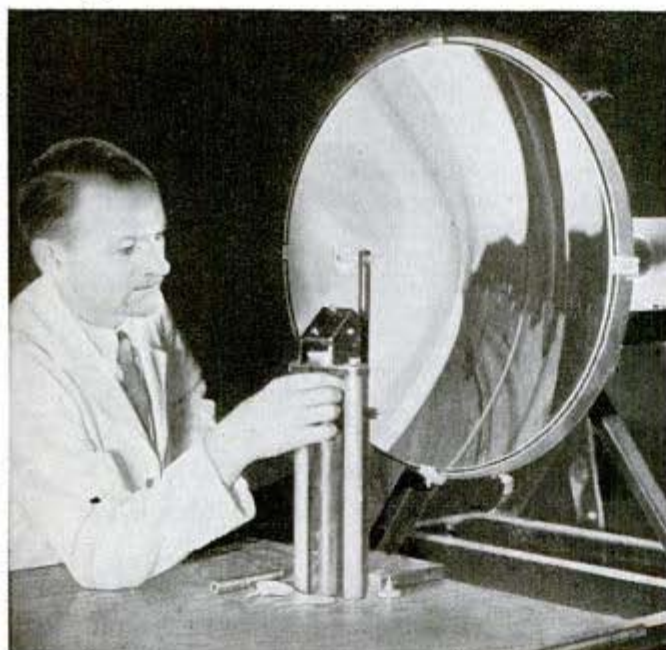

Reflectors built by the Chrysler Corporation are so precisely cut and polished from a tough metal alloy they are capable of throwing 30,000,000-candlepower Navy searchlight beams more than 20 miles. To accomplish this, a parabolic reflector must be shaped and finished to such a high degree of accuracy that it will gather the maximum amount of light directed at it and reflect this light in concentrated parallel beams. The Chrysler method of polishing the metal is known as "super-finishing." An electronically controlled machine produces a 24-inch parabolic shape which is polished until the inside surface is so accurate that a reflection from it will not deviate more than 8/1,000 inch in two miles. The reflectors resist corrosion or tarnishing.

## Gunpowder From Lower Grade Paper Pulp in New Sulphate Process

Smokeless powder can be produced from the same low cost wood pulp used in wrapping paper and bags, as a result of a new sulphate process developed by the Western Cartridge Company, East Alton, Ill. While wood is not a new source of cellulose in the production of nitrocellulose, basic material of rifle and cannon powder, the process permits the use of woods of a lower grade, faster growing and much more plentiful

than the type used in the older sulphite process. Chief difference between the two processes is that sulphite pulp is produced by treating wood chips with acids whereas sulphate pulp is produced by treating wood chips with alkalis. In the latter process the amount of pulp required to produce enough powder for a single carbine cartridge would make a piece of wrapping paper large enough to wrap a lemon.

# Glass Fiber "Blanket" Helps to Insulate Airliner

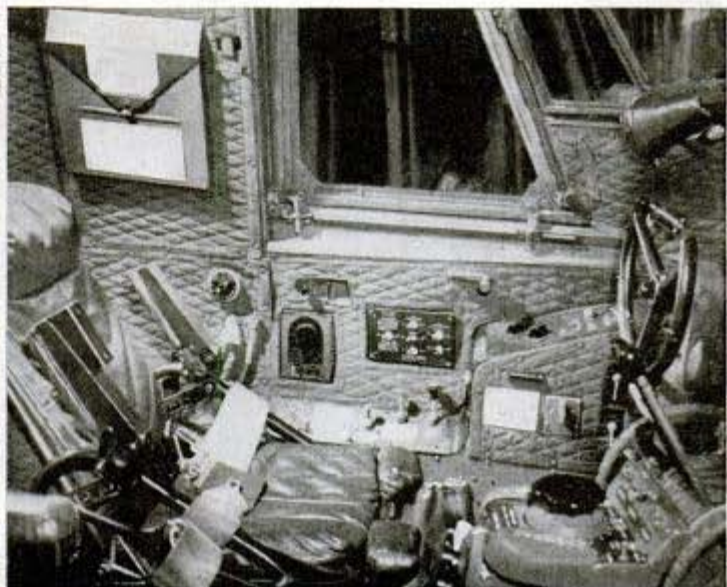

Top, right, pilot's seat in a C-46 next to quilted Fiberglas. Top, installing the cloth in a B-29 fuel cell. Above, insulating a window

Insulation against high-altitude cold by means of a glass fiber "blanket" has been perfected by Curtiss-Wright engineers. In the C-46 Commando cargo transports and their peacetime successor, the CW-20 commercial airliner, the insulation helps to keep the interior comfortable even when the outside temperature is 40 degrees below zero. The "blanket" consists of minute glass fibers, .0002 inch in diameter, fabricated into a soft, silk-like covering half an inch thick. The "blanket" results in a weight saving of more than 200 pounds per airplane of the Commando size over materials like kapok or other vegetable fibers. Resin-impregnated glass fiber cloth also is used as a protective lining for fuel cell cavities in the wings of the B-29 Superfortress. Because of its high impact strength, it prevents "flowering" of the metal walls of the fuel cell cavity if struck by a bullet, thus safeguarding the self-sealing rubber cell against jagged metal edges.

## Overfire Air Jets Quell Smoke in Coal-Burning Boilers

Plumes of smoke from coal-burning boilers may soon be a thing of the past, thanks to overfire air jets developed by the Bituminous Coal Institute, 60 East 42nd Street, New York City. The device eliminates al-

most all smoke and provides better fuel utilization. When jets of air, forced by steam, are mixed turbulently with the gases given off by the burning coal, the smoke that normally passes up the stack

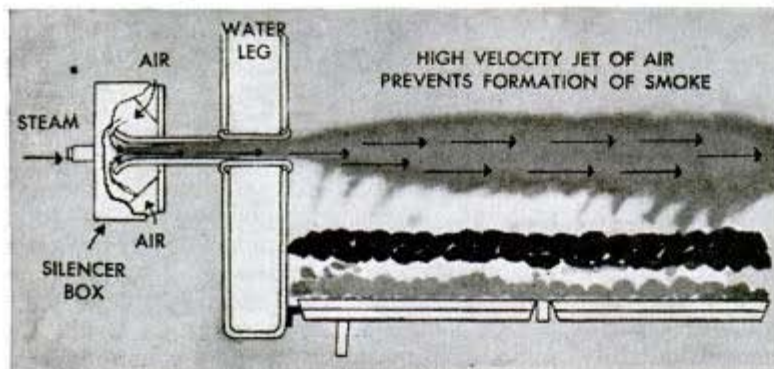

is also consumed. Actual operational tests show a 20 percent saving in coal with the air jets; one home heater gave 50 percent more heat and one-third less ashes. Kitchen ranges utilizing the principle are in limited production. The \$110 unit cost of the air jets is low enough to encourage installation even on old boilers.



# THE BOMBSIGHT THAT THINKS



Nearing target, bombardier makes few simple adjustments—the Norden bombsight's "brain" does the rest

## By Wayne Whittaker

**R**ECENTLY, at one of the several plants in the U. S. which manufacture the Norden bombsight for the armed forces, one of these delicate instruments failed to pass its final test. This test is so exacting that allowance is made for curvature of the earth and the distance the earth travels between the time a bomb is released and when it strikes the ground.

The puzzled engineers sent the bombsight back for a recheck of some of its 2,300 parts. Finally the imperfection was located. One part was found to have a tolerance of  $1/3,000$  of an inch instead of  $1/5,000$ ! The Air Technical Service Command demands and gets perfection in its bombsight, of which photographs were released a few

weeks ago. Every B-29 flying over Japan is equipped with the Norden bombsight.

On a bombing mission which consumes many hours of flying time, the bombsight is used for less than 30 seconds. But those

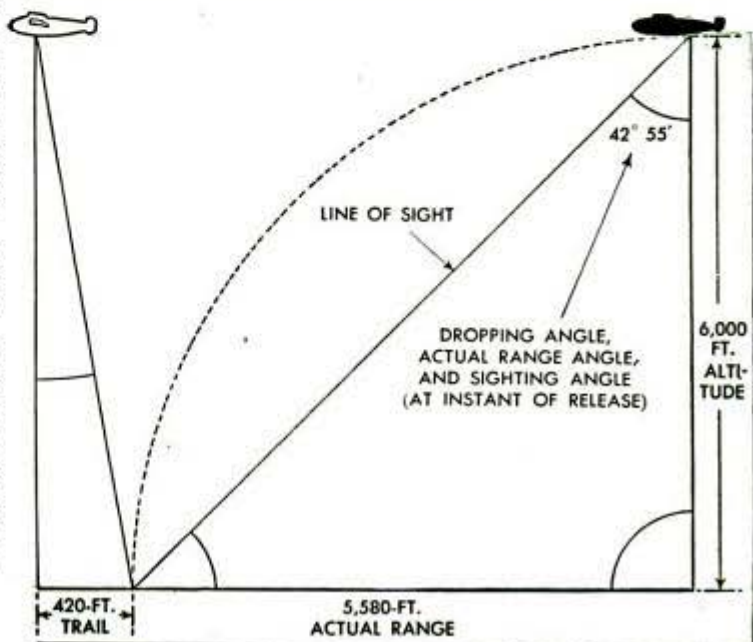

Here are elements of bombing problem solved by computer



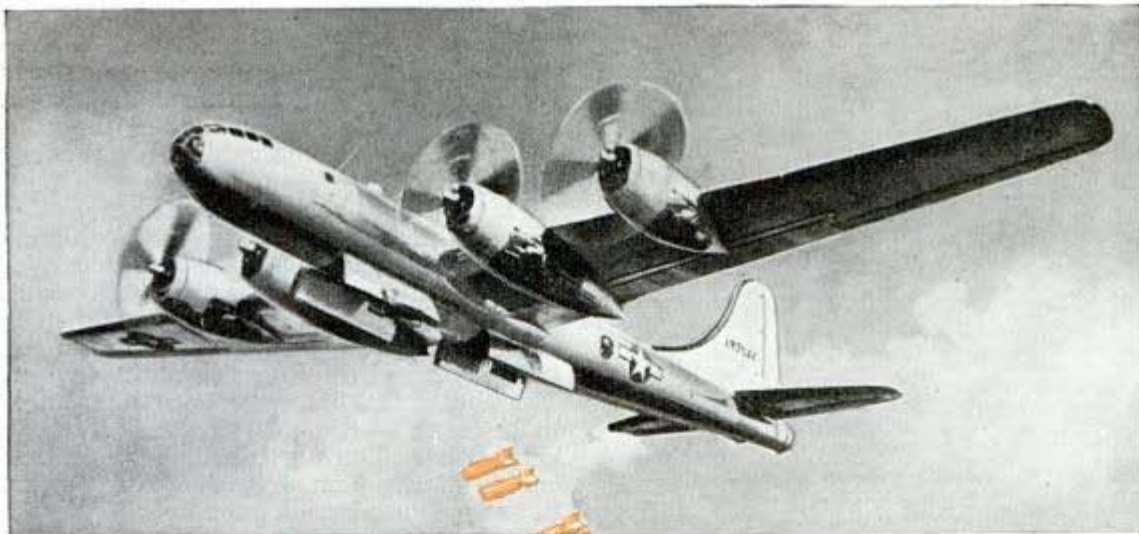

This Superfortress and all of her sister ships now attacking Japan are equipped with Norden bombsights

is "fed" the proper information, it solves the mathematical problems of the bombardier and provides the correct answer by fixing the exact instant for releasing the bombs. Information which must be supplied to the bombsight includes air and ground speed of the plane, altitude, drift, wind velocity and weight of the bomb. Much of this information is set up on the computer long before the actual bombing run, so the bombardier has only a few last second vertical and horizontal adjustments to make to keep the crosshairs on target.

The type of bomb, whether a 500-pounder or a blockbuster, and the altitude of the bomber over the target determine the dropping angle. This is registered on a dropping angle scale on top of the bombsight. Another factor which must be set up on the bombsight is the "trail." This represents the horizontal distance between the actual trajectory and a theoretical trajectory in a vacuum.

The stabilizer controls the horizontal flight of the plane, maintaining constant altitude, while the automatic pilot controls yawing and the bombsight gyro establishes a vertical line between the plane and earth. This provides a right angle triangle which enables the computer to determine the instant for releasing the bombs.

Let's follow a bombardier from the briefing at the base until "Bombs away!" over the target. At the briefing, he jots down the altitude from which the attack will be made, weight of the bombs that are to be dropped, possible wind directions and velocity. When he climbs into his station in the nose of the bomber he consults previously prepared charts and sets up the bombing problem on the computer.

Before reaching the target the bombardier checks

**Forty direct hits on aircraft plant at Nagoya testify to the accuracy of our famed bombsight**



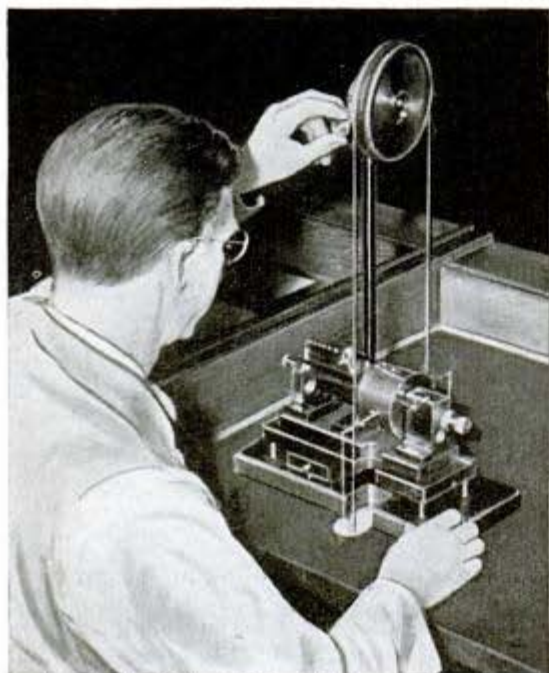

Courtesy Victor Adding Machine Co.  
Ball drop fixture with chain is used for spot check of ball bearings which are vital part of bombsight

the settings by following an object on the ground to simulate the actual target. Adjustments are made to keep the crosshairs on the object. As the bomber nears the real target the flak gets heavier and the pilot changes the course of the plane about every 15 seconds.

Finally, the bombardier throws the switches for the bomb bay doors and informs the pilot that he is ready to take over for the bombing run. The pilot switches on the automatic flight control which then is controlled by the bombardier through the bombsight and the final run is under way. The time of this final run—ranging from 10 to 30 seconds—depends on the skill of the bombardier. During this time the steady course of the bomber makes it a perfect target for anti-aircraft guns below.

With the course knob, the bombardier directs the plane in a predetermined course toward the target. He hooks up the automatic release switch and clutches in the motor drive of the telescope which puts the computer into operation. This sets into motion a series of mechanisms which solve the bombing problem and release the bombs

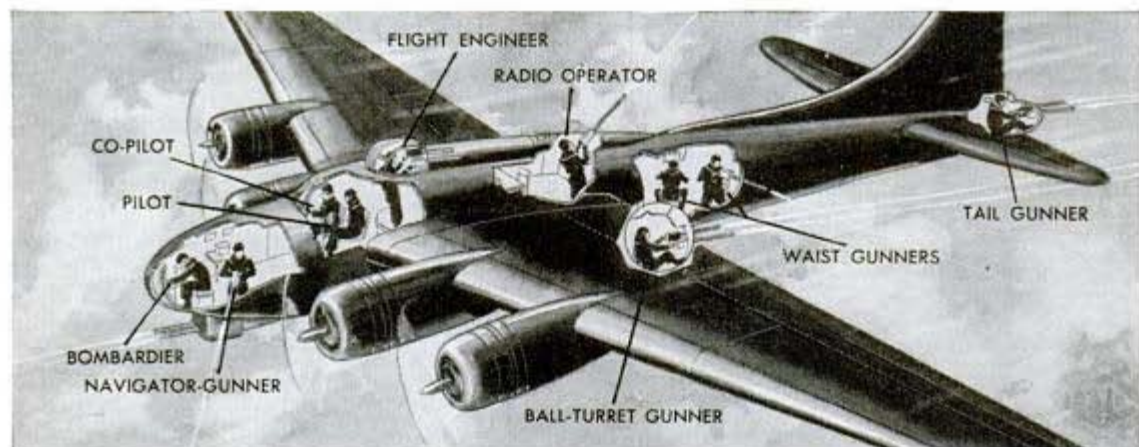

Cutaway shows how 10-man "team" on B-17 functions during bombing run. Below, brush test for the bombsight ball bearings; brush must move the wheel

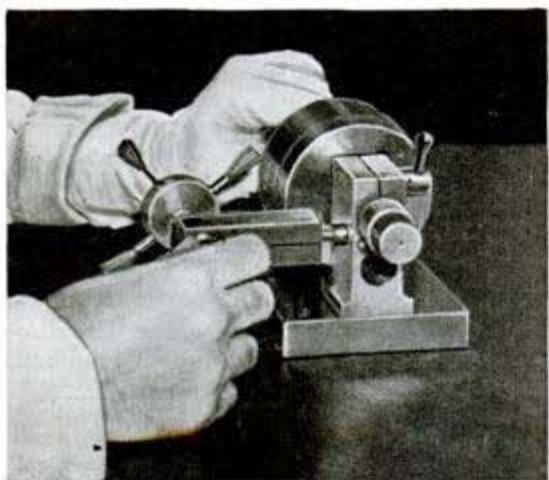

at the proper moment. This release takes place automatically when one fixed and one moving pointer meet on the dropping angle scale. The moving pointer is advanced by the computer in exact ratio to the ground speed, and before the two pointers meet the bombardier can make his last corrections. The perfectly synchronized movement of the telescope gives a bombardier the feeling that he is sighting at the target from a fixed platform instead of a speeding bomber. He knows that an error of one degree at 20,000 feet will cause the bombs to miss the target by 349 feet.

The seconds drag by until suddenly there is a click from the bomb release and the bombardier shouts into the interphone: "Bombs away!"

As the crew watches the bombs arcing

(Continued to page 160)

# Royal Navy's Firefly Is a Deadly Fighter-Scout

Armed with four 20-mm. cannon and a camera for vertical photography, the British Royal Navy's Firefly is used on aircraft carriers both for reconnaissance and pursuit operations. Powered with a Rolls-Royce Griffon engine which develops more than 2,000 horsepower, the plane has a hydraulically controlled wing

Right, Firefly in flight. Below, Firefly with its wings folded

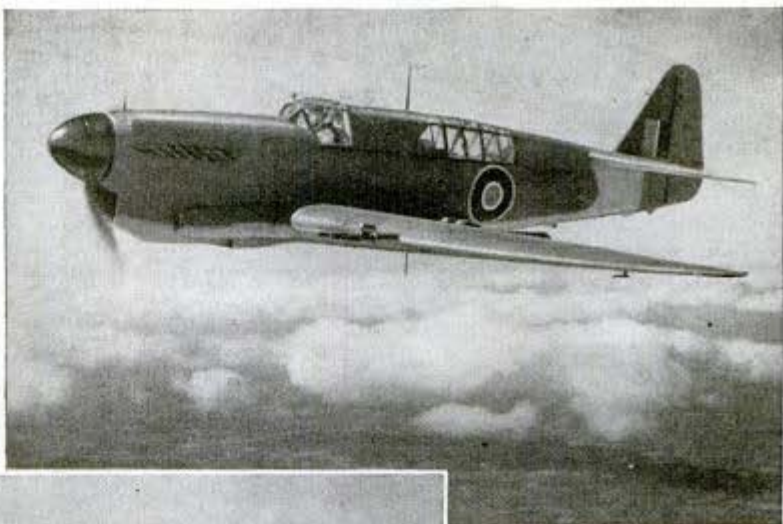

flap which may be extracted from its position in the trailing edge of the wing and swung out to give varying positions for takeoff, cruising or landing. The Firefly, which carries a crew of two, saw its first action in the Atlantic. When Allied bombers attacked the Tirpitz in Norway, Fireflies shot down German aircraft attempting to interfere.

## Searchlight Under Wing of Plane Spots Subs at Night

Powerful searchlights attached to the wings of Liberator bombers of the Royal Air Force Coastal Command are used to hunt submarines at night. They light up the sea for miles, making it unsafe for U-boats, which usually surface at night, to recharge their batteries. So effective were these searchlights in the Battle of the Atlantic, they were long on the list of restricted secret weapons.

## Airplanes "Herd" Ducks Away From Fields

Small airplanes are used by the U. S. Fish and Wildlife Service to "herd" ducks away from grain fields to refuges. When the planes fly low over a field the ducks take to the air. The pilots drive them in the desired direction by swooping across the rear of the flocks.





Above, stern-steering iceboat hikes sharply. Hiking is the sailing trick of bringing the windward runner into the air. Below, iceboaters push their craft in preparation for leaping aboard when the sails fill. Both can easily fit into the roomy cockpit located in the rear of the mast



## By Ross M. Dick

**S**PEEDS up to 60 miles an hour, split second thrills, spills and bruises. When you've known all four, you've experienced real iceboating. It is a sport which goes back to the 18th century in this country and through the years it always has had its following. Only in the decade prior to 1940 did it begin to gain wide popularity. Then, an estimated 25,000 Americans went boating on ice surfaces in scores of localities.

While iceboats aplenty are being sailed today, the sport's devotees are storing up ideas for designs and regattas after the war, when the daring, physically fit men now in the armed forces or busy in wartime industry can

once more give week ends to whizzing smoothly over frozen ponds, rivers and lakes.

Iceboats are of two general types: the stern steerer and the front steerer. Both are three-runner boats. In the stern steerer, which was conventional for a long time, the single steering runner is at the stern, back of the runner plank on which the two parallel runners are mounted at opposite ends, while in the front steerer the steering runner is at the bow, ahead of the runner plank.



Above, sheepskin jacket and heavy mitts protect iceboater from cold winds. Left, front-steering racing boat hiking



Within the last decade there has been considerable experimenting with a four-runner boat—front and rear runners mounted parallel at opposite ends of two runner planks. The steering lines may be attached to the front runners, the rear runners, or all four. There also are the “scooter” boats, regular small sailboats on which runners have been mounted on the bottom planking; and motor powered boats, propelled by airplane propellers.

Below, children sail a simple boat with boxlike cockpit





Above, riders cling to runner plank as boat speeds over the ice



Debutante III (above), a champion with 610 sq. ft. of sail, is said to have hit 100 m.p.h. Below, "skeeter" boats



Iceboat construction basically is simple. Complexity of design and construction has developed from the desire to increase speed and maneuverability and reduce mechanical factors that contribute to accidents.

The "skeeter" boat, a development of the 1930's and influential in spreading the sport's popularity, may be built for as little as \$30 to \$40 by economizing on materials. The large racing yachts may cost several thousand dollars. Spruce, strong but lightweight, is recommended for the hull, runner plank, mast and boom. Stainless steel, hot rolled cast iron and aluminum are good runner materials. A yacht duck, close woven and of 10-ounce weight, makes a good sail, one that won't stretch out of shape too easily or be sluggish in a light breeze.

The size of iceboats may vary considerably. For racing, the sail area distinguishes them. The Northwestern Ice Yachting association, principal midwestern organization in the sport, specifies the following classes: Class A, sail limit of 350 square feet; Class B, 250 square feet; Class C, 175 square feet; Class E (skeeter), 75 square feet. While the skeeter hull ranges from 14 to 20 feet in length, Class A boats may run to 40 feet.

The sail area determines the power of a boat; the more sail, the more power. Large sail area, however, is not the sole guaranty of a boat's speed. The sail plan may



vary considerably. There may be only the one mainsail, or two sails—the mainsail and a jib. Some of the large yachts carry a sail spread of 750 feet. One man can operate the smaller boats, while it requires two for the more complex craft.

The sport can be extremely dangerous. A capsizing boat will pitch the occupant headlong across the ice or trap him under the hull or sail. An icy bath is the result if the rider is thrown clear upon hitting bad ice or a patch of open water. Bracing to stay in a rocketing boat in a high wind brings severe bruises.

It is an established fact that iceboats will travel two to six times the wind velocity. In fact, wind velocity of 50 miles an hour is considered too extreme, as the frail craft cannot stand the strain. Iceboat racers of the late 19th century used to race trains along the shore of the Hudson river. The boats, at claimed speeds of up to 100 miles an hour, quickly would outdistance the trains. Iceboats have been officially recorded at 140 miles an hour, some authorities declare, although others scoff at claims above 60 miles an hour.

"Flickering" and "hiking" provide the greatest thrills of the sport. Flickering occurs when pressure is released from the steering runner, causing it to slip and the boat to go into a spin. This is common in a stern steerer when she "hikes" too far. Hiking occurs when the helmsman manipulates his craft so as to cause the windward runner to rise into the air. Without careful handling, hiking can result in capsizing.

Anyone adept at sailboating or driving an automobile should be able to learn to handle an iceboat with practice. While an iceboat acts many times as fast as a sailboat and has certain characteristics a sailboat does not have, fundamentally it goes through the same motions. Iceboat steering, especially at high speed, requires the same quick reactions needed in guiding a speeding automobile, and, as with other skills, can be learned best through riding with an experienced helmsman.

If you have never had a ride on the ice, put it down now as one of the "musts" in your postwar recreational plans.

## Portable Fire Escape Opens Up As Box Falls From Window

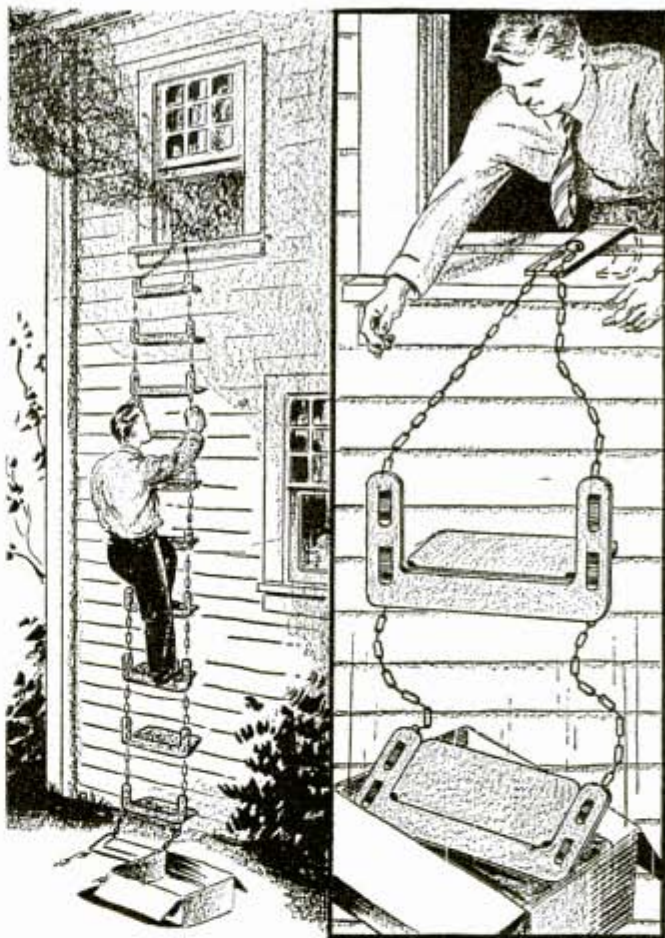

Capable of supporting 1,880 pounds, a portable, metal fire escape can be hung from a window with its hook anchored on the sill. The fire escape is stored in a carton. When needed, the top of the carton can be opened, the hook anchored to the sill, and the carton dropped to the ground, permitting anyone to climb down safely. The fire ladder consists of metal yoke steps 10 inches wide and 4½ inches deep locked to parallel chains. It is manufactured in three sizes suited to two, three or four story buildings.

## Oil Coating Adds Strength to Steel While Water Weakens It

With a micromachine and a photographic registering apparatus, Swedish engineers discovered that a coating of crude oil, paraffin or even gasoline increases the resistance of steel and other metals to rupture. Tests also revealed that water weakens both metals and glass. As a demonstration, three glass rods were weighted at one end with equal weights; a rod that had been moistened with water broke almost at once, a rod that was dry broke after a few minutes, while a third that had been dipped in paraffin withstood the weight without breaking.

## Black Widow 4-Gun Turret "Plugs Into" Nacelle Top



To give the P-61 Black Widow a deadly stinger, four .50-caliber machine guns are installed in a revolving drum in the crew nacelle. The turret, which costs approximately \$16,000, is electrically operated. The P-61 is the most powerful of the Army Air Force's night fighters.

## U. S. Railroads Set New Records For Freight and Passengers

Records that may stand for many years were set by American railroads in 1944. Freight traffic amounted to 740 billion ton-miles, an increase of 1.8 percent over 1943, and passenger miles were estimated at 96 billion by the Association of American Railroads. Leveling off of traffic during the latter part of 1944 indicates that the peak for World War II may have been reached. Freight car loadings totaled 43,500,000 cars with an average capacity of 50.9 tons, also a record, and the average load of freight per train was 1,144 tons. Passenger traffic increased 9.3 percent over 1943 and was four and one-fifth times

greater than in 1939. More than 10,700,000 troops were moved in special cars. The railroads set these records with about the same number of locomotives and freight cars they had before the war.

## Drafting Tools Made of Plastic Are Turned Out in Jiffy

Drafting instruments, which must have tolerances of from .001 to .005 inch, are now produced by thermoplastic molding. This process was devised in the face of threatened shortages in slide rules, protractors, scales and other instruments needed by the armed forces and war industries. A triangular relief facet scale made of celluloid-faced boxwood required two to three years for the wood to become seasoned and the celluloid to set. Some of the plastic instruments using Lucite, Plexiglas and Polystyrene, are made by an injection molding process in 24 hours.

## GI's Form-Fitting Sleeping Bag Covers Him Like a Tent

Even in the cradle, GI Joe never was bundled up as thoroughly as in the Army's weather-resistant, form-fitting sleeping bag. Only the face remains exposed when the big sack is sealed up. The bag is protection against rain, snow, cold, damp and other hazards of outdoor living.





*The BATTLE  
that WON  
the PACIFIC*

**T**HE Second Battle of the Philippine Sea last October, in which the United States Navy defeated the Japanese Imperial Navy as soundly as Notre Dame might beat Podunk Tech, can almost be reduced to football terminology. Perhaps Admiral "Wild Bill" Halsey, who played fullback for the Naval Academy years ago, thought of it that way.

Stretching along a 1,500-mile front, the scrimmage line was marked by the thousands of islands of the Philippine archipelago and the blue water around it. West of this line were the Japanese warships with their strange, pagoda-like superstructures; east of this line were the

U. S. Navy photos

The image of a battleship painted on flight deck of doomed Jap carrier did not fool U. S. flyers

The mighty USS Missouri, our newest battleship of the Iowa class, fires salvo from 16-inch guns



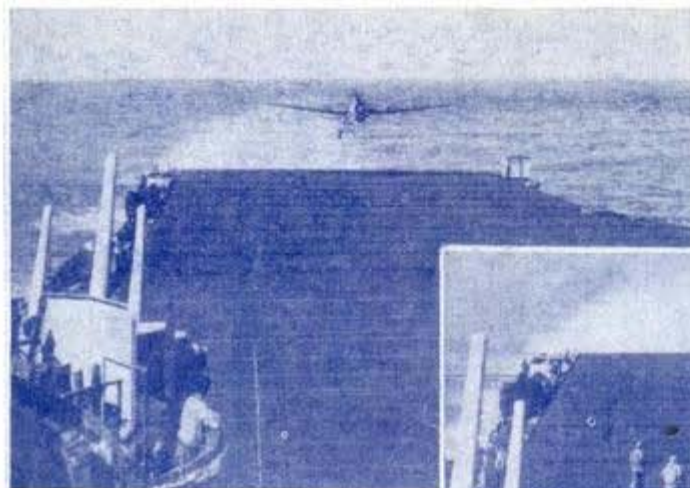

With one wheel shot away during attack on Jap Fleet, torpedo plane pilot brings his ship in for landing on U. S. carrier. Below, flight deck crew rushes toward plane after successful landing by lucky pilot



powerful, sleek, fast ships of the United States Third and Seventh Fleets.

For weeks the two forces had been shifting into position—the United States Navy anxious to get on with the game, the Japs stalling for time, cautiously waiting for a moment most advantageous to themselves.

The Japs had been so well scouted that the United States admirals knew how the Nips would line up and what plays they would probably use. When and where they would try for a touchdown was not clear.

As it turned out, the Japs tried four plays—all of them failing in spite of the fact that the overall strategy was carefully planned, well timed and cleverly executed. First they threw a forward pass in the form of

land-based aircraft at our carriers, but this was batted down. They tried an end run around Luzon but were thrown for a loss by Admirals Halsey and Mitscher. They tried an off-tackle smash through Surigao Strait but this attempt was stopped cold by Admirals Kinkaid and Oldendorf. Finally they tried a straight power play through the center of the line, the San Bernardino Strait. This play was the most successful because the Japs found a hole and did some damage. But in the end this try also was thrown back to the line of scrimmage.

The results added up to a decisive defeat for the Japanese Navy. Final score in ships sunk was heavily in the favor of the United States Navy, and even more lopsided when ships possibly sunk or damaged are figured. Sports writers might have used such verbs as "steamrollered," "lambasted" or "crushed" in their descriptive "leads." Admiral Halsey called it "catastrophic."

The great sea battle of October, 1944, is probably the last full-scale naval battle to be fought in the Pacific for many years to come. Previous sea bat-

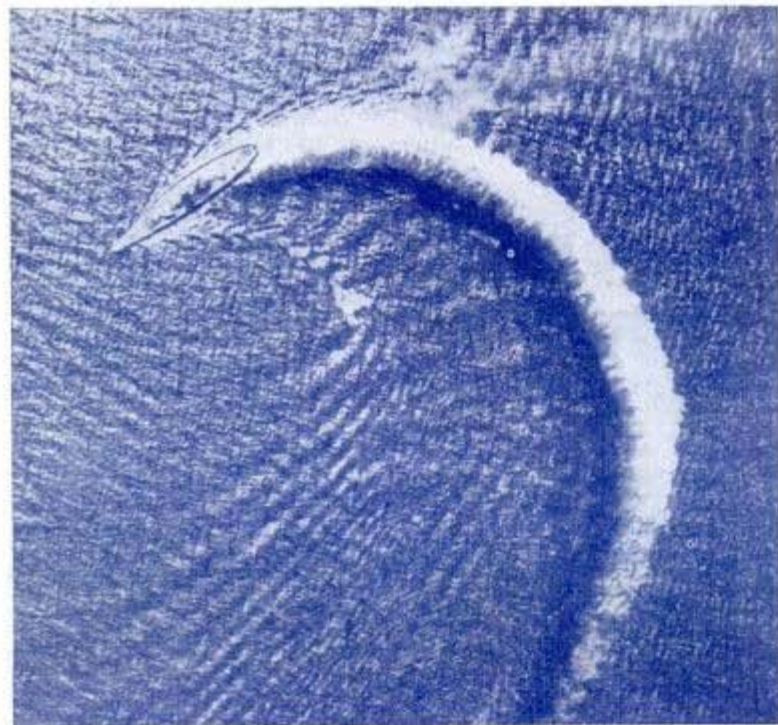

Jap battleship maneuvers desperately during Sulu Sea battle

tles in World War II in the Pacific set the stage for this final battle by somewhat reducing the Japanese Fleet and heightening the desperation of the Japanese high command. The Battle of the Coral Sea checked the Japanese advance toward Australia; the Battle of Midway saved the Hawaiian Islands from invasion; the Battle of Guadalcanal nailed our position securely in the Solomons; and the First Battle of the Philippine Sea insured the capture of the Marianas—thus giving the United States bases from which to launch further attacks against the Philippines, the China coast and the Japanese homeland.

But the Second Battle of the Philippine Sea overshadowed the other four in scope and import. Most of Japan's heavy ships—battleships, carriers and cruisers—have been either sunk or crippled. The Japanese Navy still possesses nuisance value but its strength is no longer

that of a first or even second-rate power.

We are too close to the sweat and blood of battle to understand the full significance of this greatest naval engagement of World War II. There is no doubt, however, that history will rank it in importance with such



Avenger crew examines battle scars on fuselage and parachute pack

The Second Battle of the Philippine Sea paved the way for landing operations like this on enemy shores



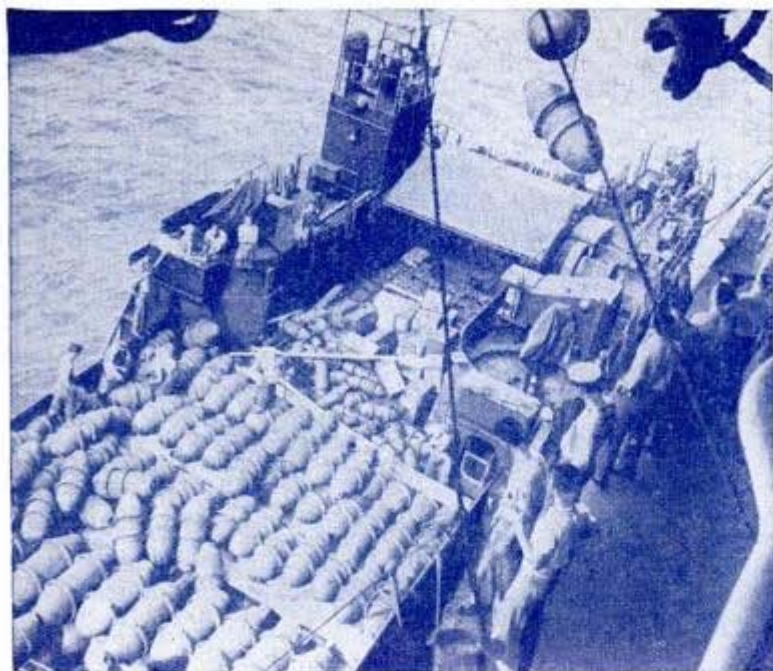

Bombs are loaded aboard an aircraft carrier at sea for delivery to the Japs on Formosa. Below, official Navy chart shows disposition of the U. S. and Jap fleets during the battle in and about the 1,000-mile archipelago

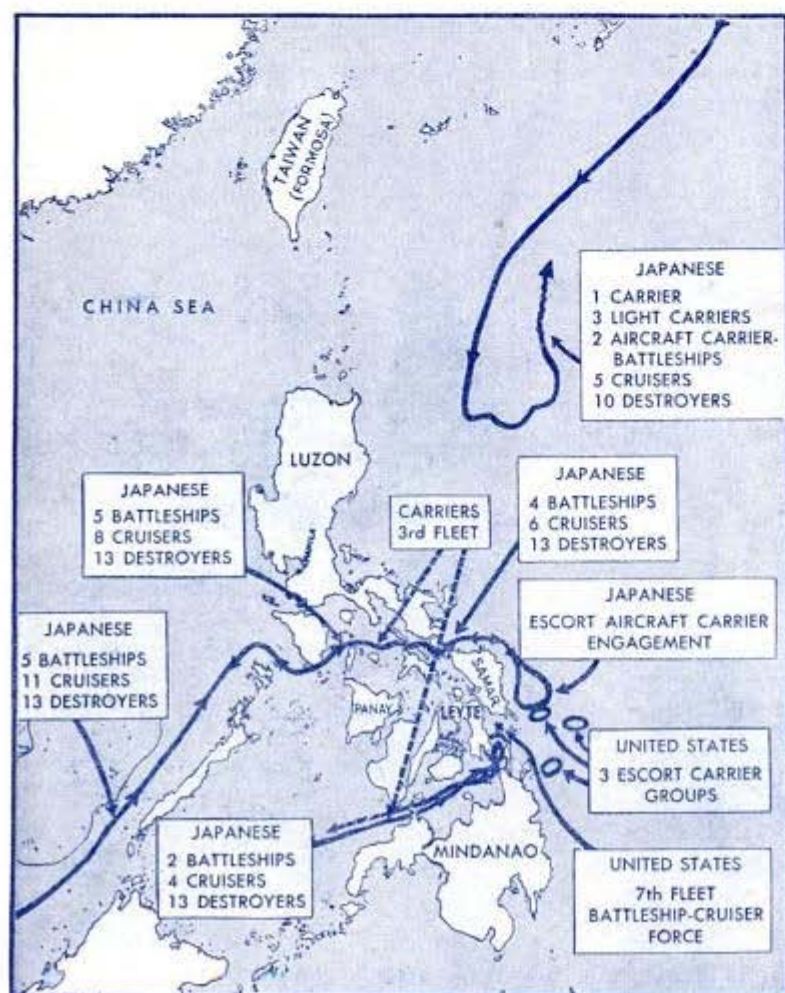

decisive sea engagements as Trafalgar and Jutland. At Trafalgar the British Navy licked a combination of the French and Spanish navies and paved the way for the defeat of Napoleonic France. At Jutland, even though it lost heavily, the British Navy crippled the German Navy and thus insured victory for the Allies. The Second Battle of the Philippine Sea, in which more ships were involved, vastly more fire power employed, new weapons used, and more ships damaged and sunk than in any other great sea battle, marked the beginning of the end for the Japanese Empire.

Even though the Japanese Navy was decisively defeated, the strategy and planning might have worked if we had been unlucky or unprepared. But our seagoing admirals were too experienced, our submariners too alert, our pilots too well trained, our gunners too keen eyed, our equipment too plentiful and too good. In sheer weight of iron and steel—plus skill, courage and experience—the All Americans of the Pacific league topped the best the Bushido bush leaguers could offer.

This is how the Japs figured: (1) General MacArthur had just made a landing on Leyte Island with vulnerable LST's and transports unloading men and supplies on the beach; (2) Admiral Kincaid's Seventh Fleet, which had furnished air cover and shore bombardment for the landing, was probably low on fuel and ammunition; (3) Admiral Halsey's mighty Third Fleet, which had been rampaging through the Philippines, Formosa and the Ryukyus, was also probably short of oil, bombs and torpedoes. It

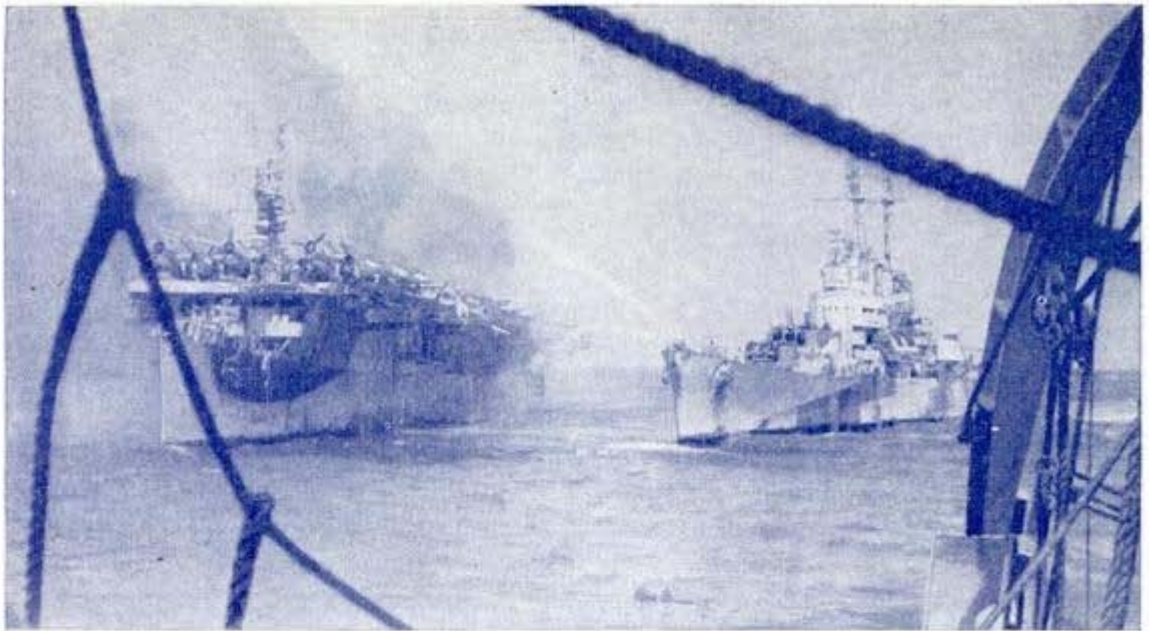

**Cruiser pours water into USS Princeton, light carrier set aflame by Jap bombs and later sunk**

is even possible that the Japs may have believed some of their own outrageous propaganda which cackled that a sizable portion of the Third Fleet had been sunk off Formosa in September.

At any rate, the Japanese admirals figured that this was the time to shoot the works—literally and figuratively—using the classic Japanese naval maneuver of a pincer movement on its objective.

On October 21 or thereabouts, heavy

units of the Japanese Imperial Navy which had been based down around Singapore, out of range of American bombers, started moving north. Submariners reported what they saw in their periscopes and Admirals Halsey and Kinkaid lined up their fleets along the eastern shores of the Philippines in defensive formation.

The Japs received their first surprise on October 22 when an American submarine, stalking the Imperial Fleet, sank a couple

**Jap battlewagon Yamato shudders under direct hits from dive bombers of the U. S. carrier force**





**Ships stand by to rescue crew as fires explode magazine of the Princeton**

of heavy cruisers and damaged a third. Then and there the Japs must have known that a certain amount of tactical surprise had been lost. But the signals had been called and the plays were under way.

As the heavy Jap ships plowed northward and wheeled toward the Philippines,

damaged that she was sunk by one of our own torpedoes. The Japs had figured on sinking not one but many United States carriers with their bombs and aerial torpedoes. Thus the first phase of the attack failed—the forward pass the Japs had attempted was incomplete.

Jap planes based on Luzon and the Visayan Islands attacked Admiral Halsey's carriers. This was a battle royal in which United States carrier-based planes fought off wave after wave of determined Jap planes. It was one of the strongest shore-based air attacks ever launched against our naval forces and more than 150 of the enemy planes were shot down.

Only one of our carriers, the USS Princeton, was sunk. And only then through a piece of tough luck. One of the Jap bombs crashed through the flight deck and started a bad fire below. Before the blaze could be brought under control, it spread to the magazine, which exploded with a terrific blast. The ship was so badly

badly

**Jap survivors from battle in Surigao Strait cling to debris alongside PT boat. Note alert men with guns**

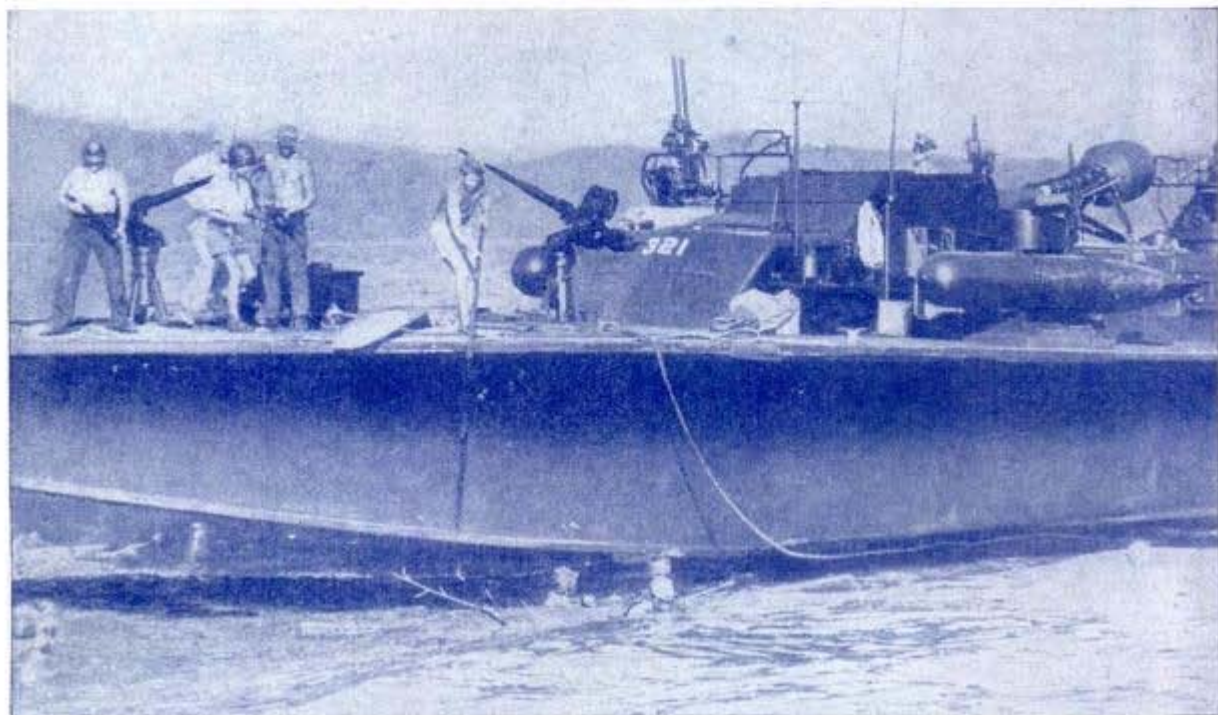



Meanwhile search planes from Admiral Halsey's carriers had picked up the Jap ships approaching from the South China Sea. The enemy force had been split into two groups—one in the Sulu Sea to the south, heading for the Surigao Strait; the other in the center, speeding through the Sibuyan Sea toward the San Bernardino Strait. The Japs had picked the two best east-west passages through the Philippine Islands.

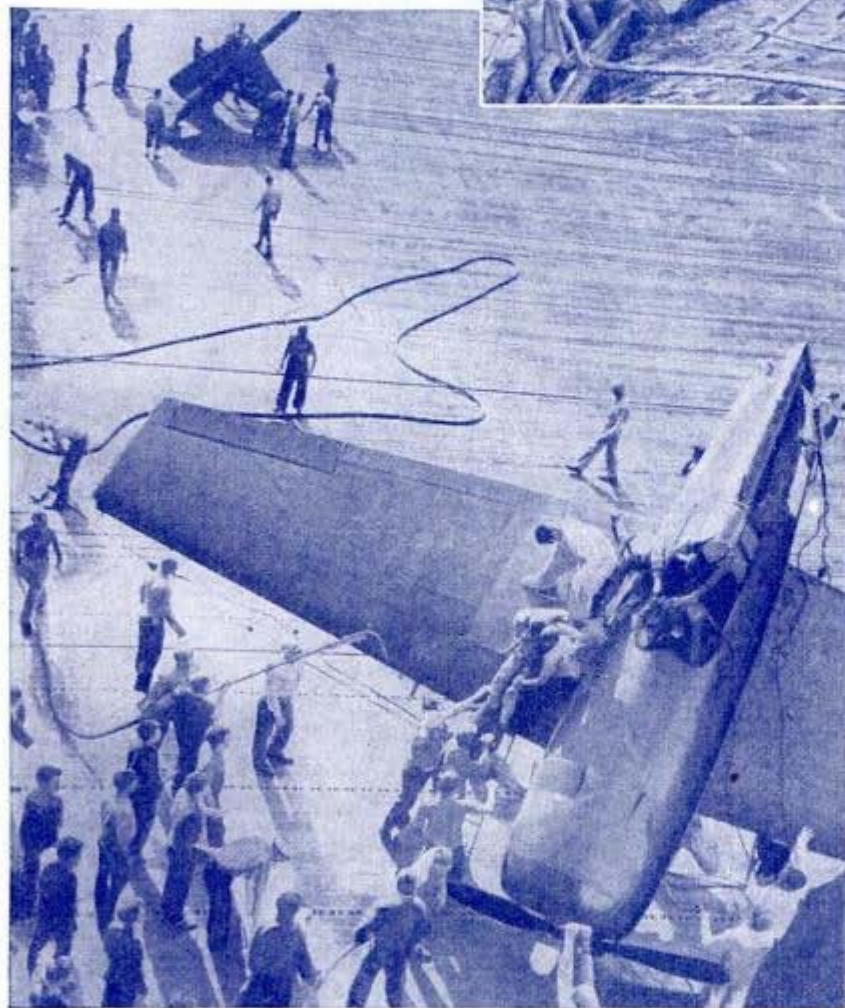

Natives help PT's pick up survivors. Left, assisting the pilot from plane after crash landing

cruisers and 13 destroyers. The two forces contained just about everything the Japs had in the way of fast, heavy, gun-toting warships outside their shipyards.

As a veteran carrier commander, Admiral Halsey knew that the best way to slow up such power was to tackle it before it reached the open water beyond the Philippine archipelago. Maneuvering through the green-fringed jungle islands and hidden reefs of the Philippines, even for Japanese officers who once swarmed through them disguised as fishermen, would be tricky business at best. So, on October 23, Admiral Halsey threw his Hellcats, Avengers and Helldivers at both enemy forces, inflicting damage on many ships.

The southern force was grouped for speed and maneuverability and consisted of two battleships (the Yamashiro and Fuso), two heavy cruisers, two light cruisers and seven or eight destroyers. The force in the center of the line bristled with heavy fire power and consisted of five battleships (the Kongo, Haruna, Nagato, Mushashi and Yamato—the two latter being big, modern, 45,000-ton battlewagons similar to our Iowa class ships), eight heavy

But where were the Japanese carriers? Six carriers had been either sunk or damaged by Admiral Spruance's Fifth Fleet in the First Battle of the Philippine Sea on June 19. But there were still a couple more running loose that had not taken part in that action and perhaps some of the cripples had been patched up. In addition, the Japs were supposed to have converted a couple of ISE class battleships into carriers by mounting flight decks aft

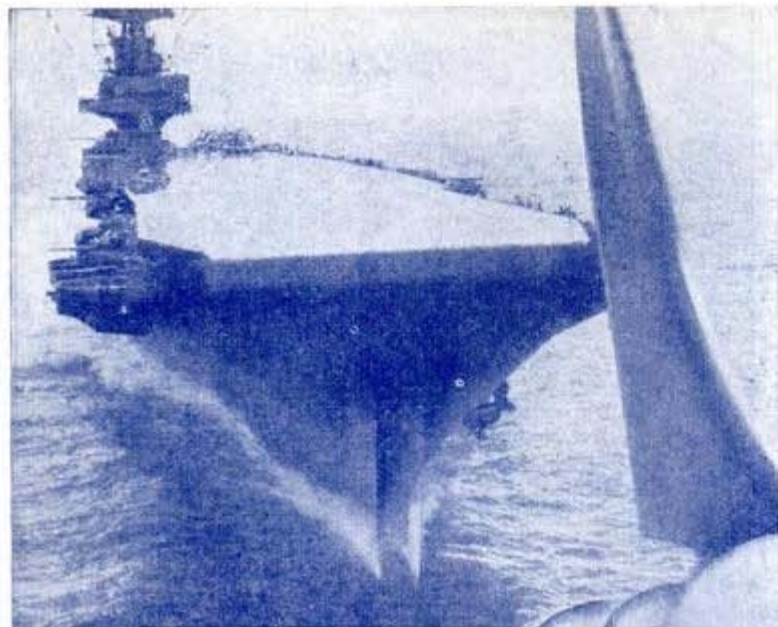

Tail gunner's view of flat-top USS Enterprise a moment after the takeoff

of the forward turret—making an odd-looking battleship-carrier. But where were they?

A Navy search plane, flying lonely patrol hundreds of miles from its base, radioed the answer. It had spotted a Japanese carrier force consisting of four carriers (the Zuikaku, Chitose, Chiyoda and Zuiho),

that they offered no effective air opposition.

"Just like sitting ducks..." was the verdict of United States pilots who sank the four carriers and bombed and torpedoed the other ships. The end run had been caught behind the line of scrimmage and thrown for a loss.

The new United States carriers Wasp,

two converted battleship-carriers (of the ISE class), six cruisers and six destroyers about 200 miles northeast of Luzon. Here was a serious flank attack, a hidden ball play, an end run.

Believing that the two enemy forces threading their way through the Philippines had been sufficiently battered and slowed down so that Admiral Kinkaid's Seventh Fleet could handle them, Admiral Halsey ordered the bulk of his strength to cruise north at full speed during the night of October 23-24. He met the astonished Jap carrier force at dawn the next day. The Nips were taken so completely by surprise

Escort carriers in thick of battle—fighters are rushed from deck to attack Japs blasting sister ship



Hornet and Lexington, named for gallant ships sunk in previous sea engagements with the Japs, were among the Halsey carriers that hit the enemy carrier force that morning.

Meanwhile, Admirals Kinkaid and Ouldendorf, with their Seventh Fleet battleships, cruisers, destroyers and PT boats, waited for the Japs to sortie through Surigao Strait. This was the attempt to get into Leyte Gulf and wreak havoc on General MacArthur's beachhead. It was an off-tackle smash and required precise timing and speed of execution.

The Japs decided to make a run for it on the night of October 23-24. As they came through the narrow Surigao Strait, in some places only 12 miles across, they ran into a withering cross fire from the United States warships that lay in ambush. The California, Pennsylvania, Tennessee, Maryland and West Virginia, all old battleships that were raised out of the mud at Pearl Harbor, got their revenge that night. The Japs could stand the concentrated hail of steel only 40 minutes and then turned tail and ran. Every ship was either sunk or badly damaged. The off-tackle smash had been stopped cold.

In the power play through the center of the line, where the Japs had concentrated their greatest surface strength and fire power, they were doing better. The force of Japanese battleships, cruisers and destroyers, which had been attacked by carrier planes in the Sibuyan Sea, had continued on through the San Bernardino Strait on the night of October 23-24 and the next day had attacked escort carriers of the Seventh Fleet which had been posted to guard the entrance to Leyte Gulf. This was the other prong of the pincer that hoped to crack open General MacArthur's beachhead.

It was a weird battle and one of the most unevenly matched in the history of sea power. Japanese 16-inch guns slugging away at little, thin-skinned CVE's whose heaviest armament is a 5-incher. Japanese heavy cruisers dueling with American destroyers half their size. But the CVE's had daring fighter and torpedo pilots aboard, and the destroyer skippers had guts. The CVE's and destroyers fought a losing battle but never before has American courage been displayed to better advantage.

The CVE's yelled for help. Elaborate Navy codes were discarded in the urgency of the moment and plain-language appeals crackled out across the Philippine Sea to Admiral Halsey. He immediately broke off his engagement with the Jap carriers—thus missing an opportunity to wipe out every ship in the force. He raced his ships

(Continued to page 150)

## Gauge Squares Bits on Saw To Avoid Marking Wood

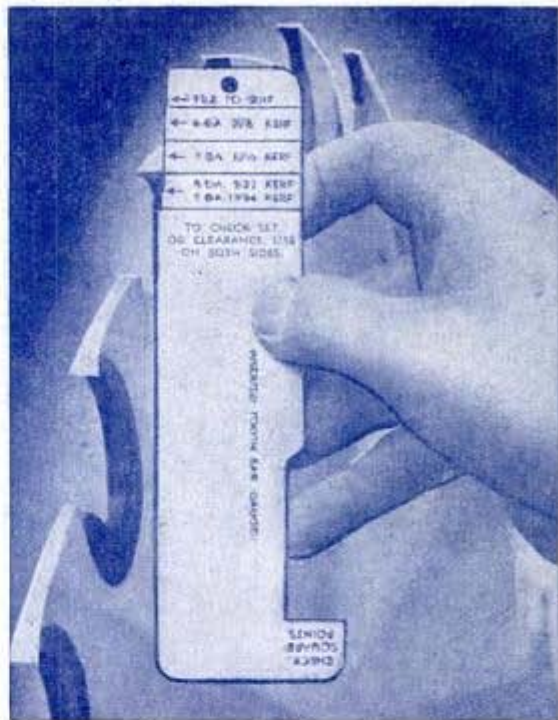

To facilitate the checking of saw bits on inserted-tooth saws, a new gauge just developed squares the saw bits with the saw and shows immediately whether the bit is set to do the same amount of work as the others. Unless the bits are exactly uniform, the lumber will be marked and an inferior sawing job will result.

## Mechanical Jaws on Long Handle Remove Overhead Tube Lamps

Burned-out fluorescent tubes in overhead fixtures can be removed while standing on the floor by using a long-handled "changer." The one-man unit has cork-padded jaws which grip the lamp without damaging it. A twist of the handle clamps the jaws around the tube and disengages it from the socket, permitting it to be lowered to the floor.



# B-29 Gunnery "Brain" Aims Six Guns at Once



At a single sighting position in the pressurized cabin of a B-29, a gunner can direct the fire of six of the bomber's 10 .50-caliber machine guns by remote control. This central electrical control system made it possible recently for a lone Superfortress to win a four-hour battle against 79 Jap fighters. By shifting the control of gun turrets between the sighting stations, the bomber is pro-

Between gunner and turret is computer that aims B-29 guns

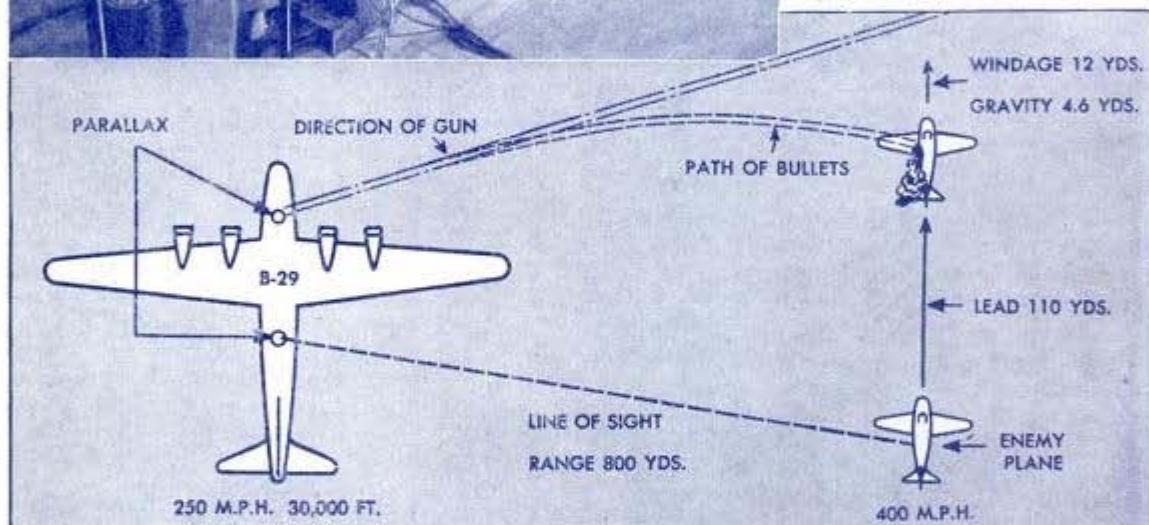
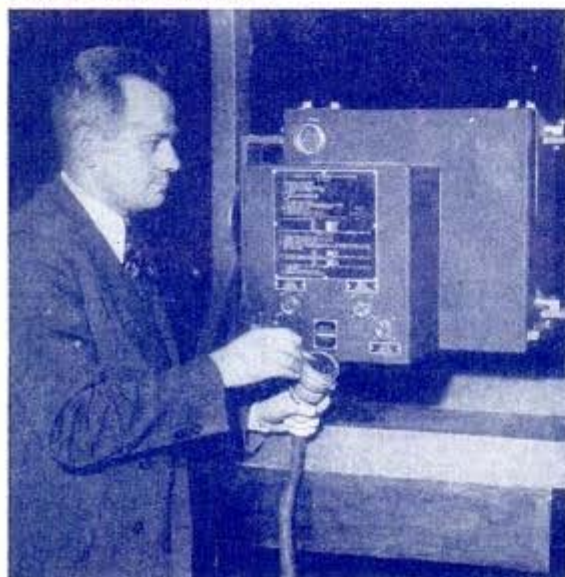

Diagram shows the problem solved by electronics and mechanical computer to hit speeding fighter plane. This brain-like computer (below left) is housed in the small black box. Right, sighting through B-29 nose  
Courtesy General Electric Co.



ected from all angles by concentrated fire.

The system permits a variety of combinations for the control of the B-29's five turrets, two of which are on top of the fuselage, two on the underside and one in the tail. The turrets can be controlled individually or in combinations of two or three under the direction of the chief gunner. There are two machine guns in each turret. Between the sighting stations are several computers—the electronic "brains" of the system—which aim the guns at a point in space where bullets and enemy plane will meet. Ballistic factors which are solved by the computer in a split second include lead, windage, gravity and parallax.

Information that must be relayed to the computer by electrical impulses includes range and speed of the enemy plane, its angle from the B-29, air density and speed of the bomber. First, the gunner catches an enemy plane in his sight and registers the size on an instrument. Then he focuses a circle of dots on the image of the plane and keeps it there by moving the sight. Range is computed by instruments from the size of the plane and the size of the luminous circle in the sight. Speed of the enemy fighter is estimated on the basis of range and the movement of the sight necessary to keep it within the circle of dots.

The altitude, outside temperature and speed of the B-29 are relayed to the computer by the navigator. The air density, used to figure windage, is determined from altitude and temperature. A bomber moving 250 miles an hour at 30,000 feet will curve the path of a bullet 12 yards.

The computer must also compensate for gravity. At 30,000 feet a .50-caliber bullet will drop 4.6 yards in a range of 800 yards. While the bullet is traveling this distance a fighter plane going 400 miles an hour would move forward 110 yards. The computer determines the lead, pointing the guns well ahead of where the gunner is focusing his sights.

The distance between the sight and the guns, necessitating a parallax correction, is compensated for by the computer which angles the aim of the guns toward the

## Car Driven Without Foot Pedal Has Controls in Steering Post



By replacing foot controls with a steering wheel device, Brooks Stevens and Harry Krueger, Milwaukee industrial designers, have modified an automobile so that the legless can drive. Instead of an accelerator and brake and clutch pedals on the floorboard, the car has a rod connected with the brakes and accelerator and operated through the steering column. The only restriction is that the car to which the device is attached have some form of automatic shift. When the wheel is slowly pulled up, the shift starts operating; when the wheel is slowly depressed, braking is effected. During this manipulation the wheel is never moved more than four inches in all.

gunner's position. Electrical parts that move the guns include electronic equipment and a series of motors which respond instantly and accurately to quick movements of the sight. Motors on the turrets are powerful enough to lift a 200-pound weight suspended from the ends of the guns.

Advantages of the remote control system include concentrated and accurately directed firepower, elimination of cumbersome oxygen masks and high altitude suits for the gunners, and reduction of aerodynamic drag caused by ball turrets. Also, if a gunner is wounded, it permits one of his teammates to take over his turret.

The electronic gunnery system, developed by engineers of the General Electric Co., Boeing Aircraft and the AAF, helped make it possible for the B-29's to fly 14 unescorted bombing missions against Japan before a single bomber was shot down.

## Rocket Boats Lay Smoke Screen for Landings



One of the highly effective members of that large World War II family—the landing ships—which has been little publicized is the Navy's LCS (landing craft, support). During amphibious operations the LCS is equipped to lay smoke screens for the protection of other landing craft. It is also capable of firing rockets.

Left, smoke pours from rear of LCS during maneuvers off Norfolk, Va.

## Telephone "Eavesdropper" Records Two-Way Messages

Electronic voice recorders speed up business transactions by taking down two-way telephone conversations. The telephone is placed on a plastic stand which contains an induction coil. The recorder may be equipped with two cylinders which operate automatically, one taking over a few seconds before the first is filled. With a hand microphone the machine can be used for ordinary dictation or for recording conferences. One company uses the telephone attachment for taking rush orders from salesmen.



## Sponge "Bank" for Scraps of Soap Gives Cleansing Foam When Wet



To utilize soap that has become too small for ordinary use, a sponge pouch now on the market acts as a "bank" for the scraps. The soap scraps or chips are put into a cloth lined pocket which prolongs the life of the sponge. When wet, the sponge releases soapy foam that may be used to clean walls, windows, rugs and upholstery or wash dishes, sinks, bathtubs and even pets. It is made of cellulose.

☐ The average American farmer has 27 acres of woodland, enough to grow lumber for a new six-room house every year.

*Perrymobile*  
*Los Angeles Inventor*

# The CAR that RUNS on Air

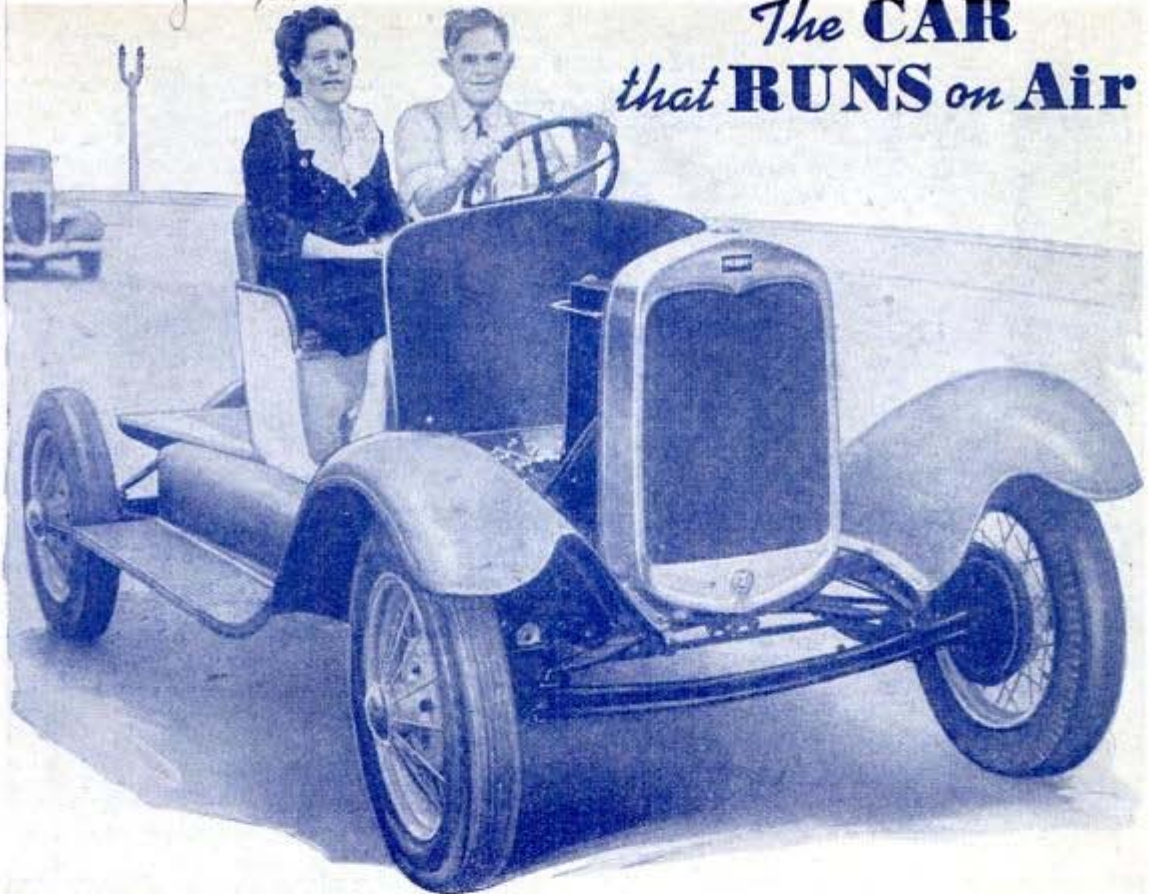

Compressed air and vapor supply power for the "Perrymobile" that travels 60 miles on a gallon of butane

**P**OSTWAR motorists may climb into their automobiles, step on the air instead of the gas, and glide away swiftly and silently at 60 miles to the gallon with never a gear to shift or clutch to shove.

That's the prospect presented by Frank R. Perry, Los Angeles inventor, who has built a revolutionary car called a "Perrymobile."

Untried commercially, it's a novel combination of steamer and compressed air powered automobile. The motive power comes from a secret liquid, which vaporizes at a much lower temperature than water, and compressed air which serves as an ever-ready starting and reserve source of power.

Perry says he has driven several thousand miles with his machine which is mounted on an old Ford chassis. The Perrymobile weighs only 700 pounds—about 1,300 pounds less than standard automobiles powered by the conventional internal combustion engines. The engine installation alone weighs only 140 pounds.

The 30-horsepower four-cylinder engine is turned over by pressures instead of by the explosions that move the pistons of an

ordinary auto engine. The Perrymobile engine is essentially the same as a steam engine. Inside each cylinder is a piston which moves up and down and is connected to the crankshaft.

The secret non-inflammable liquid, which boils at about 150 degrees Fahrenheit, is heated by a burner which uses anything from butane gas to crude oil. The car will travel 60 miles at 30 miles an hour on



The only floorboard pedal is the brake; a control on steering column regulates both speed and power

FEBRUARY, 1945

*3506 W. 85th - Inglewood, Calif.*  
*L.A.*

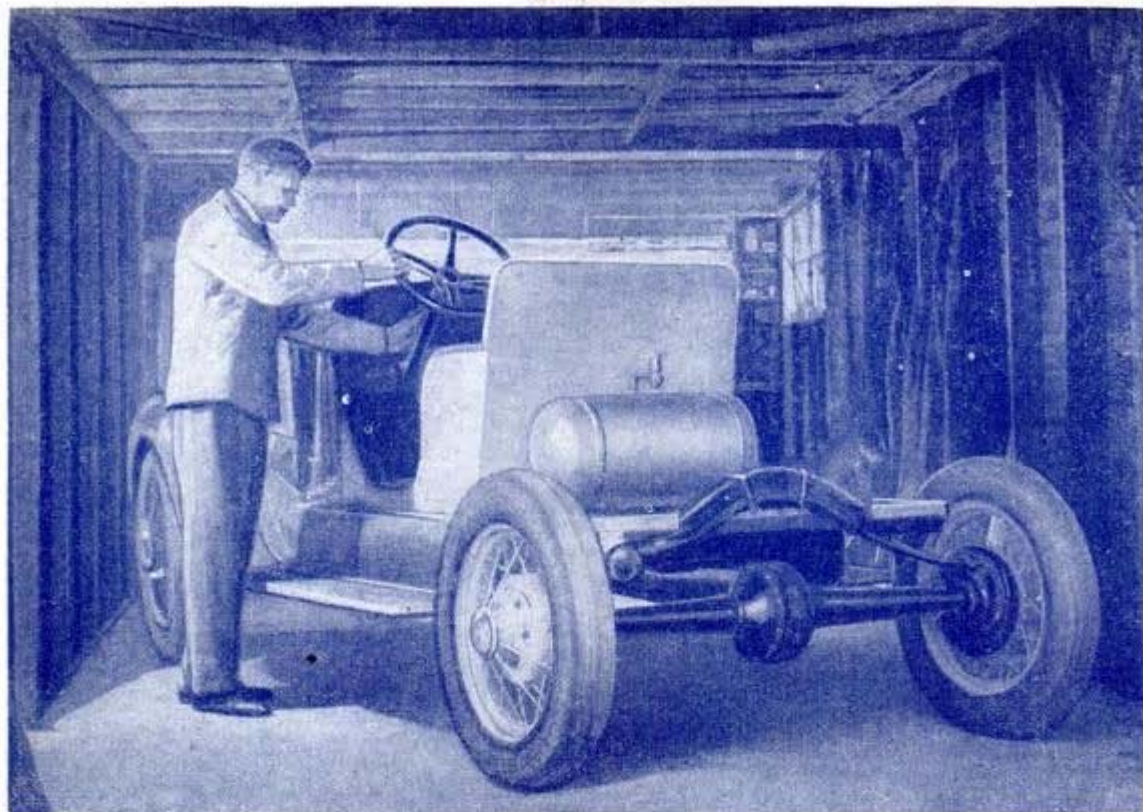

Built on an old Ford chassis, the air-vapor car carries enough butane in its fuel tank to run 600 miles

one gallon of butane, the inventor claims. He says this fuel costs about 8½ cents a gallon. (He sets the top speed at "better than 70.") Only one quart of the secret liquid is required in the boiler because it is exhausted as vapor into the radiator, condensed and returned to the boiler.

The vapor passes through an intake valve into the top of the cylinder, and with a pressure of about 150 pounds per square

inch pushes the piston down just as steam would do. At the bottom of the stroke the vapor exhausts through a port cut through the cylinder wall. As the piston starts up again a valve at the top of the cylinder lifts so the piston travels upward against no air pressure. At the top of the stroke more vapor is admitted which starts the piston down again.

Each of the four pistons supplies power to the rear wheels every time it is pushed down. This affords "two-cycle" operation instead of the conventional "four-cycle" shift in which each piston gets a shove only every second time it travels downward. Thus, Perry's four cylinders put out as many power impulses as an eight-cylinder auto engine.

The compressed air part of the power for the Perymobile comes from a tank under the seat. That tank is kept full of compressed air supplied by a small air pump connected

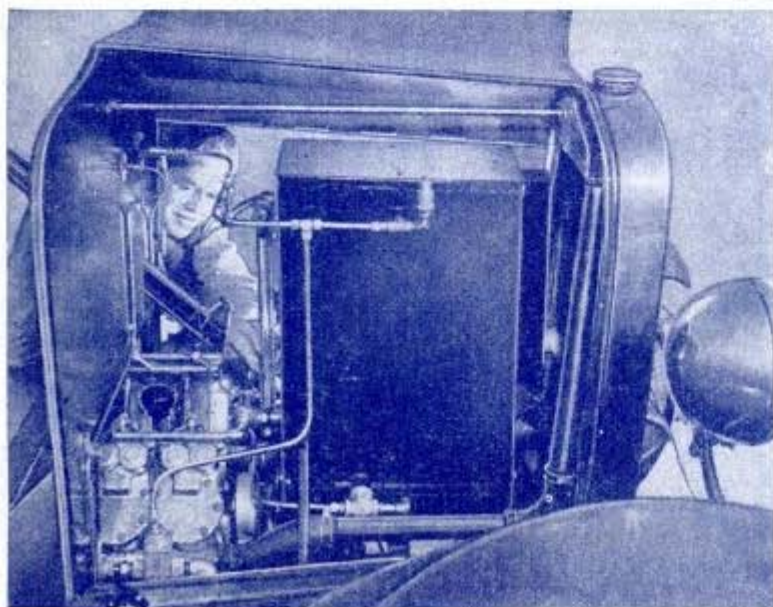

Oblong steel box houses boiler; four cylinders form a V



*Precision Parts, Ltd.*  
 2025 Gwynne St.  
**One-Man, Bow-Type Power Saw**  
 Is Light and Self-Contained

*Novel, Lumber Canada*

by a belt with the engine. The compressed air, which flows through the boiler into the cylinders, is used for a quick start and until sufficient vapor pressure has been built up to run the engine.

To operate this revolutionary automobile, you first open the fuel valve under the hood and the burners catch fire from a pilot light. Then you get in the car and pull down the throttle lever on the right side of the steering column. Compressed air from the tank flows into the cylinders and the car starts to move.

After you have driven a few blocks the flame in the boiler has built up sufficient vapor pressure so you can turn off the air. The pump quickly restores the pressure in the air tank. Heat in the boiler is regulated by an automatic valve.

Suppose you are driving out into the country and come to a long sloping downgrade. You close the throttle, just as you would in an ordinary car, and the flame goes low in the boiler, for no pressure is being used. Even while the engine is idling, air is pumped into the tank to maintain a constant pressure. To back up, a control on the left of the steering column changes position of the cams for reversing.

The inventor compares his single control for regulating speed and power to the control lever of an electric motor. The smooth operation of the Perrymobile is due to the fact that the power output is the same at all speeds—from 1 r.p.m. to 2,000. On a gasoline engine the horsepower is in direct ratio to the r.p.m.'s.

Even at full power with the throttle valve wide open, Perry says his engine runs so cool that the paint has never blistered on the cylinders. This makes the car adaptable to extremes of climate for the liquids in it do not freeze unless the mercury drops to 30 below zero. The engine turns over slowly. At 40 miles an hour it revolves only 800 times a minute compared with 2,000 or more for most present-day cars.

Other advantages of the Perrymobile, according to the inventor, are the "parts it does without." These include clutch, carburetor, spark plugs, distributor, coils, battery, fan, gear box and self starter. The car, of course, is equipped with brakes. Perry estimates that it will require less than one quart of lubricating oil a year. The Perrymobile makes no noise, smoke or smell. So smooth is its operation, he reports, that in a blindfold test it is impossible to tell when the car starts moving.

It cost Perry about \$400 to build his lightweight automobile, but he says it should sell for much less if it gets into mass production—about \$250. He believes the air-vapor engine can be used on helicopters and boats as well as automobiles.

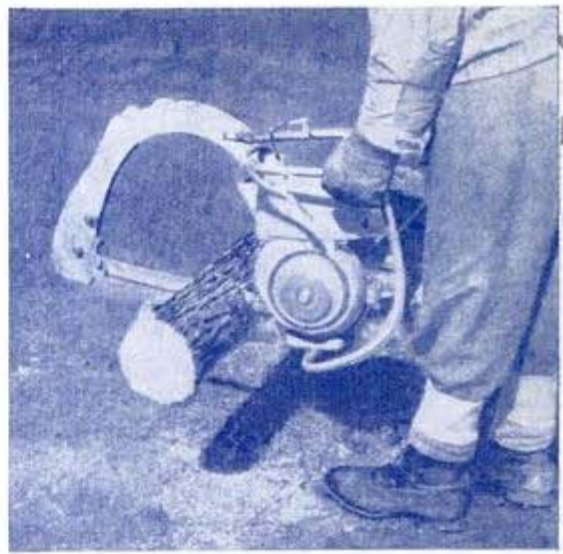

Self-contained and weighing only 38 pounds, a bow-type power chain saw which works equally well on soft or hard wood can be operated by one man. With an attachment for two-man operation, the saw can be used for felling or crosscutting. Its motor is air cooled and develops 3½ h.p.

### Dial Computes Withholding Tax On Nearest Dollar of Income



What you should have deducted from your paycheck for federal income taxes in 1945 is determined simply and quickly with a large circular dial. The calculator automatically gives the correct amount of tax for from one to 10 dependents. All that is necessary is to turn the outside dial showing the amount of salary to an indicating slot where the amount of tax is shown.

# Superdestroyer Packs Punch of Prewar Cruiser



Ready to help the Navy deliver a death blow to Jap sea power is a new 2,200-ton superdestroyer of the Allen M. Sumner class. This warship packs such a lethal

punch that it would have been classed as a cruiser in World War I. In addition to its superior firepower, the superdestroyer has higher speed and great maneuverability.

## 2,000-Mile-an-Hour Wind Tunnel Tests Aircraft Models

Wind velocities more than twice the speed of sound can be produced in the Army Air Forces' new supersonic tunnel at Wright Field, O. The largest supersonic tunnel for aeronautical research in the world, it is capable of a maximum airspeed that would correspond to about 2,000 miles per hour at sea level. The test section of

the tunnel is fitted with an assortment of scales, gauges and other measuring devices which record lift, drag, side force, rolling, yawing and pitching movements of any airfoil under test. The tunnel also has two concave mirrors 36 inches in diameter for making photographs of the "invisible" shock waves that form at high speeds.

## "Featherweight" Aluminum Drum Carries Gas to China



More than 30 pounds lighter than conventional drums, a 21-pound aluminum gasoline drum has been developed for the Air Transport Command of the China-Burma-India run. The container makes it possible to carry hundreds of thousands more gallons of gasoline per month to the 14th and 20th Air Forces fighting in Asia.

## Radio Beam Guides Germans Attacking Through Smoke

Captured German field manuals reveal that both a radio beam system and rockets are used to guide troops attacking under cover of smoke screens. A portable radio beam projector operated from the rear defines a path 65 feet wide, along which Nazi signal corps men with lightweight receivers move as guides to the riflemen and grenade throwers slogging blindly forward through the artificial fog. Rockets fired toward the objectives trail guide lines behind them for about 1,000 feet. When the attackers come to the end of the lines, they can launch more rockets to carry the guide lines another thousand feet forward and thus keep infantrymen from straying.

**H**OW about a trip around the world, or at least a reasonable facsimile of it, for your first vacation after the war?

Now wait a minute!

You don't need to be a millionaire, nor do you need to waste weeks in ocean crossings. You can drive your own car and be home again two weeks from the time you started. You need spend no more than you would spend while touring at home.

In two weeks you can visit steaming tropical jungles, play in the snow that covers the tops of extinct volcanoes 15,000 feet high, take pictures of pyramids that compare with those of Egypt, inspect cities that rival those of Europe in beauty and architecture, and drive through narrow, crowded streets that are reminiscent of the Orient. You can do all this and more on a jaunt through Mexico after V-day.

American vacationists were just becoming aware that a trip south of the border resembled a vestpocket journey around

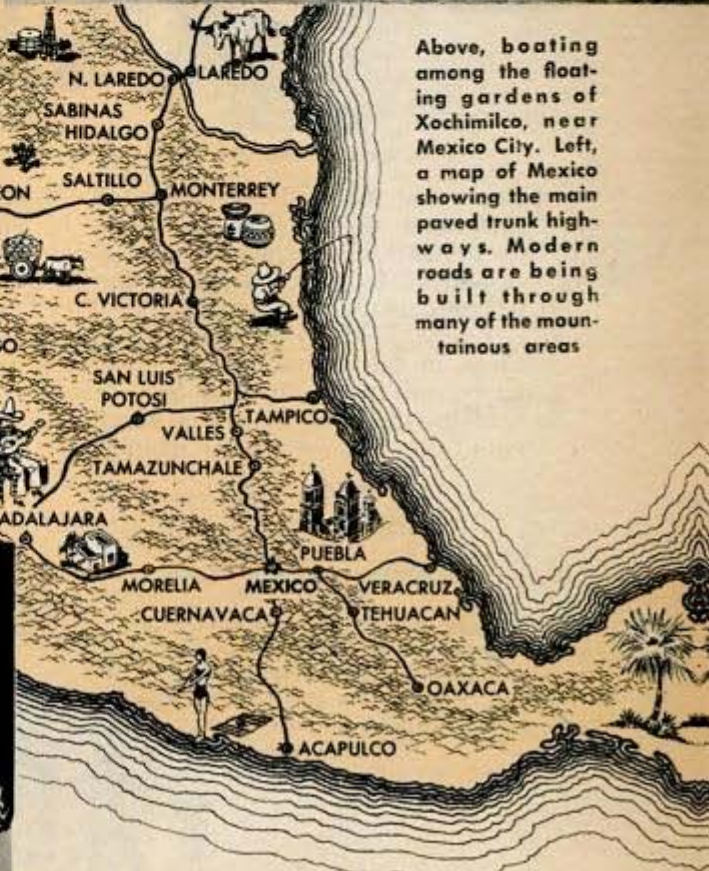
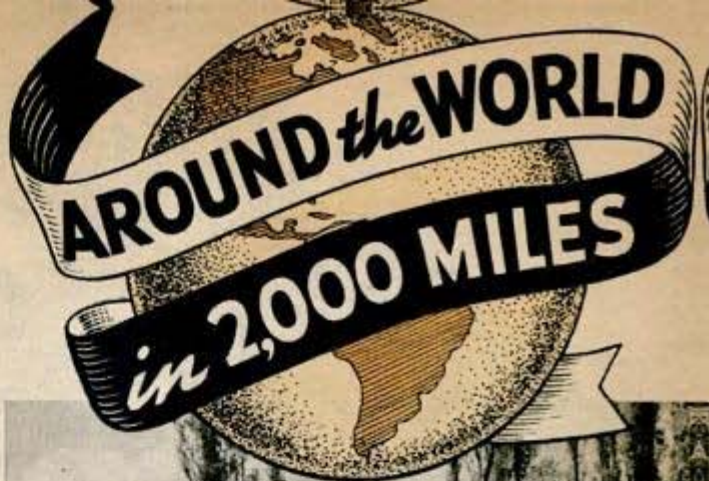

Above, boating among the floating gardens of Xochimilco, near Mexico City. Left, a map of Mexico showing the main paved trunk highways. Modern roads are being built through many of the mountainous areas



Left, Mexican girl weaving a rug. Though many areas of Mexico show little of the influence of modern living, the country is expanding its industry rapidly



Above, stone carvings on the wall of the ancient temple of Quetzalcoatl, which is near Mexico City

the world when the war started. In the meantime Mexico has continued to improve its highway system and today you can drive to many parts of the republic without leaving pavement.

Traffic laws in Mexico are similar to those in the United States, distances are measured in kilometers, and gasoline is sold by the liter at prices about equal to what we are accustomed

to paying. Traffic signs, of course, are in Spanish. "Alto" means "stop," "camino sinuoso" means "winding road," and "conserve su derecha" means "keep to the right." Pamphlets that contain many useful phrases, including interpretations of highway signs, can be obtained at the border and at gasoline stations. Modern hotels and auto courts, at all of which English is spoken,



SCHOOL

Mexicans board a highway bus. The man at the left is carrying a grass raincoat on his shoulder. Some of the raincoats in Mexico are made of palm leaves



are found on the roads most apt to be frequented by tourists.

The peso is the Mexican equivalent of our dollar and one dollar in U. S. currency can be exchanged for \$4.85 in Mexican currency. Living costs have been quite low in Mexico in the past because of this favorable exchange but prices have been rising and today a visitor can expect to spend nearly as much as he would in the United States for comparable accommodations and services. All foreign goods are expensive in Mexico but goods of native manufacture, such as shoes and other leatherwork, silver jewelry, glassware and textiles, are quite inexpensive.

Mexico City is about as far from Laredo, Tex., as is Chicago from New York. You can make the drive in two days, although three days gives you more leisure to enjoy the sights. From Mexico City you can drive, still on paved roads, to Veracruz on the Gulf Coast, to Acapulco on the Pacific, south to Oaxaca, or northwest to Guadalajara. A round trip to Mexico City plus interesting side excursions is 2,000 miles or less from Laredo.



MAXIMUM SPEED

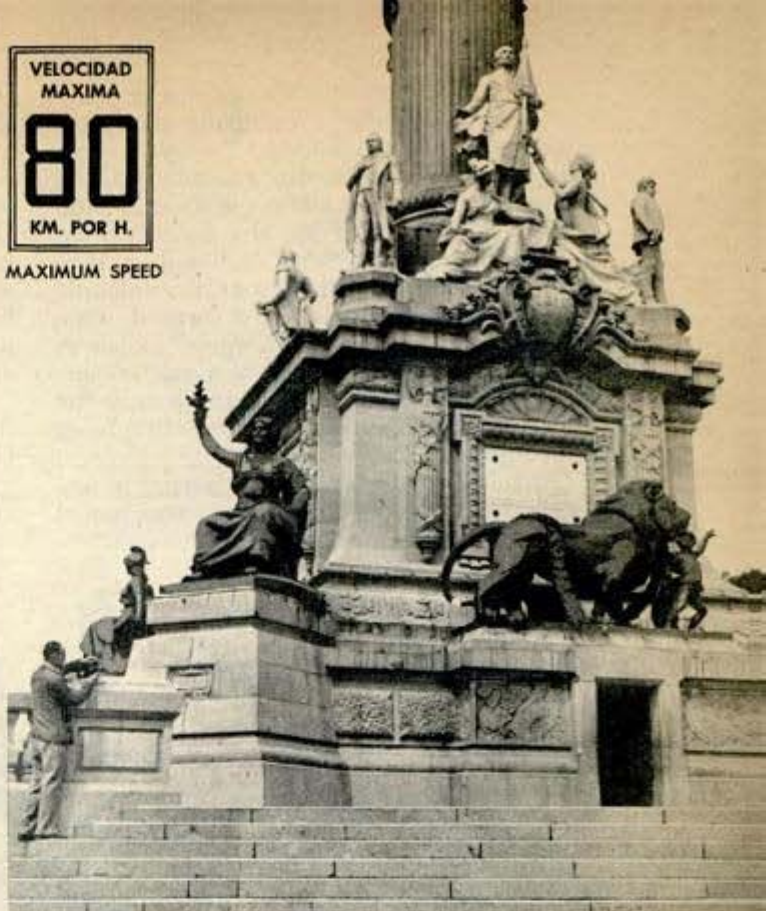

Above, a tourist photographs some statuary in Mexico City. The country is dotted with numerous landmarks worth visiting and photographing, including the two year old volcano at Paricutin



Above, Pyramid of the Sun in background of the old amphitheater near Mexico City. Right, wind charger at highway-railroad crossing in mountain pass charges batteries of electric train warning signal. Traffic signs are in Spanish; distances are measured in kilometers; gasoline in liters



STOP



A scientific curiosity that is worth visiting is the new Paricutin volcano about 150 miles west of Mexico City. Two years ago a native farmer felt the ground shaking under him, then ran when smoke and sand began shooting up from the field that he had been plowing. Sand and molten lava poured forth and within a month a volcanic cone 800 feet high had been formed. One river of lava, moving at a speed of seven feet per hour, flowed down to a small nearby village and covered it, leaving only the tower of the village church projecting from the cooling rock.

During the volcano's early period of activity the noise of its eruptions was heard

100 miles away, the ground shook constantly in its vicinity, and material amounting to some 10 million tons per day was erupted. A rain of cinders and ash fell over the adjoining country. In the city of Uruapan, 15 miles away, 80 tons of cinders were shoveled from the roof of one hotel alone. Now about 2,000 feet high, Paricutin has somewhat reduced its activity. It is under continuous observation by Mexican and American volcanologists.

Mexico is typical of most foreign lands in that it is not nearly as industrialized as the United States, even though it is rapidly expanding its industry. It has its own iron and steel mills, extensive textile mills, a

Below, a typical market scene in a small Mexican town. For many of these towns time seems to have little meaning. Life exists as it has for ages



Left, lava flowing from the Paricutin volcano has blotted out this village except for the church tower

large cement industry, and is preparing to become self-sufficient in many manufactured items. Primarily an agricultural nation, Mexico is busy with an agricultural education program by which it is hoped the production of some crops may be doubled. Large irrigation and drainage projects are being completed in some areas.

In keeping with its industrial program, Mexico is planning to utilize much of the petroleum tonnage that it shipped abroad in the past and it is also preparing to harness more of its rivers for additional electric power. One outstanding project is a hydroelectric plant that will generate



Above, family of Mexican Indians grinding corn and toasting tortillas at home

150,000 horsepower from the melting snows of an extinct volcano that overlooks the Valley of Mexico.

Industrial activity so far is centered in a few of the larger cities. The bulk of the rural population, consisting of native Indian races, is still virtually untouched by the modern age. The serape is the usual cold-weather overcoat in the country, and a shaggy covering made of palm leaves is worn as protection against rain. Plowing is usually done with

(Continued to page 150)

Left, automobile ferry on a side road. Below is a typical crossroads scene

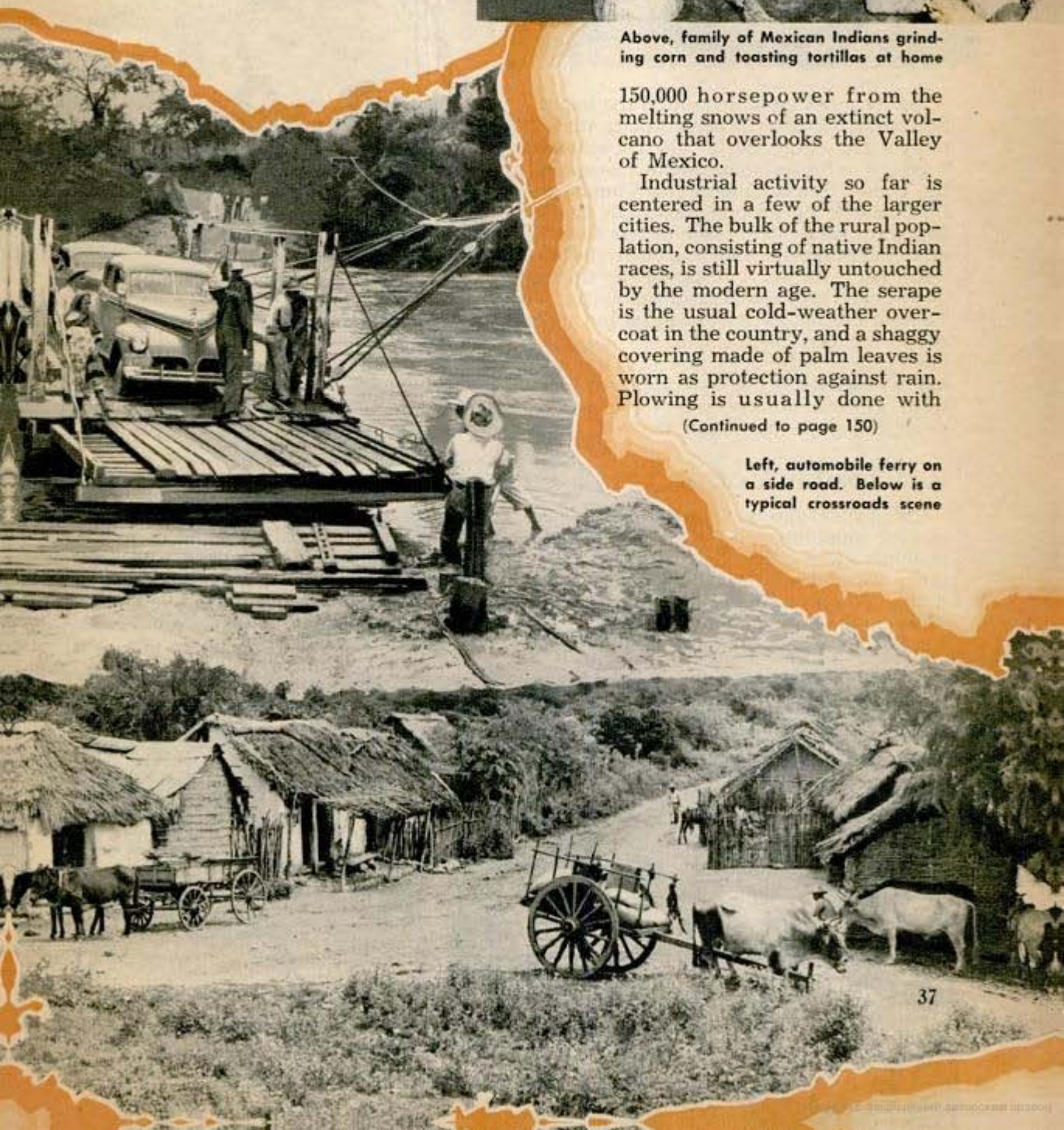

# Spanish Train Goes 80 M.P.H. Around Curves



Left, the speedy Diesel-powered Spanish train viewed from rear. Below, the Swedish M-locomotive for use on steep grades

Eighty miles an hour around the mountain bends! That's the performance turned in by a low-slung, beetle-like Diesel train tried out in Spain, according to a report by the United States Chamber of Commerce. Besides roaring around mountain curves which ordinary trains take at less than 32 miles per hour, the train was clocked at 105 miles per hour on a straightaway during its test runs between Madrid and Zaragoza. To hold the lightweight train on the rails, Alejandro Goicoechea, Spanish designer, lowered the center of gravity until it is only half as high as any ordinary train. Axles were eliminated and wheels suspended separately with the result that car floors



are only 12 to 14 inches above the rails. Another powerful foreign engine unveiled recently was the Swedish State Railways' new 3,600-horsepower electric M-locomotive, which was designed for pulling trains on lines with heavy gradients in the northern part of Sweden.

## Collapsible Cotton Duck Tanks Hold Fuel for Front Lines

Collapsible gasoline tanks simplify the task of supplying jeeps, trucks and tanks pushing ahead to Berlin and Tokyo. The tanks are made of cotton duck impregnated with synthetic resins of the rubbery type. The containers come in 750, 1,000, 2,700 and 3,000-gallon sizes. The 750 and 1,000-gallon

tanks are transportable. Fitted with rigid plywood frames, they may be set up on the ground or mounted on flatcars when petroleum tank cars are not available. Four 2,700-gallon containers can carry approximately the same amount of gasoline as an ordinary tank car.

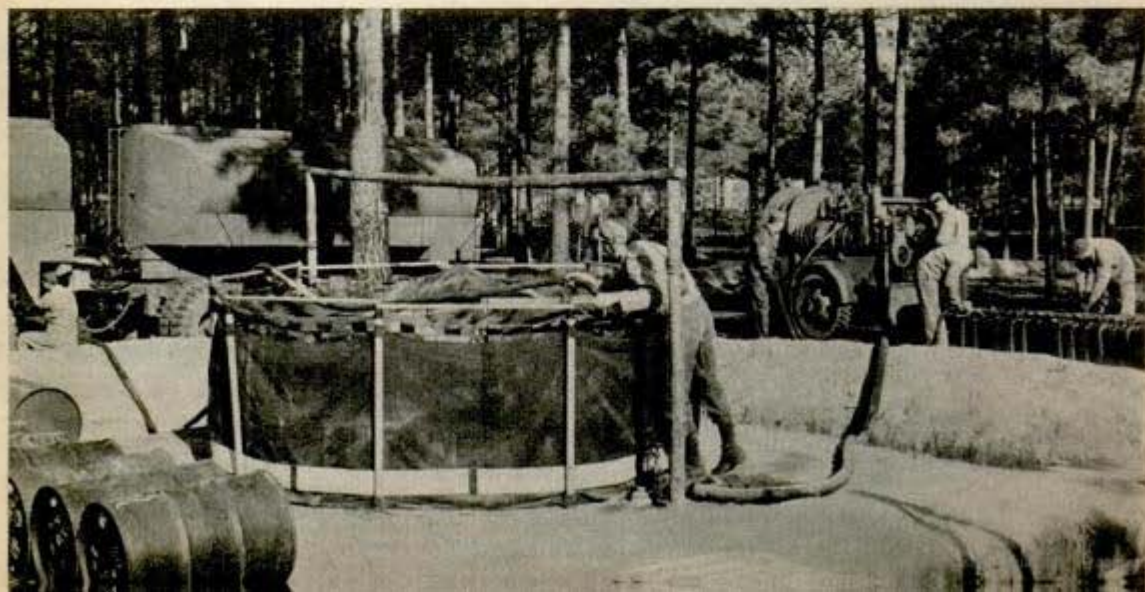



## Mosquito Wars on U-Boats With 6-Pound Shells

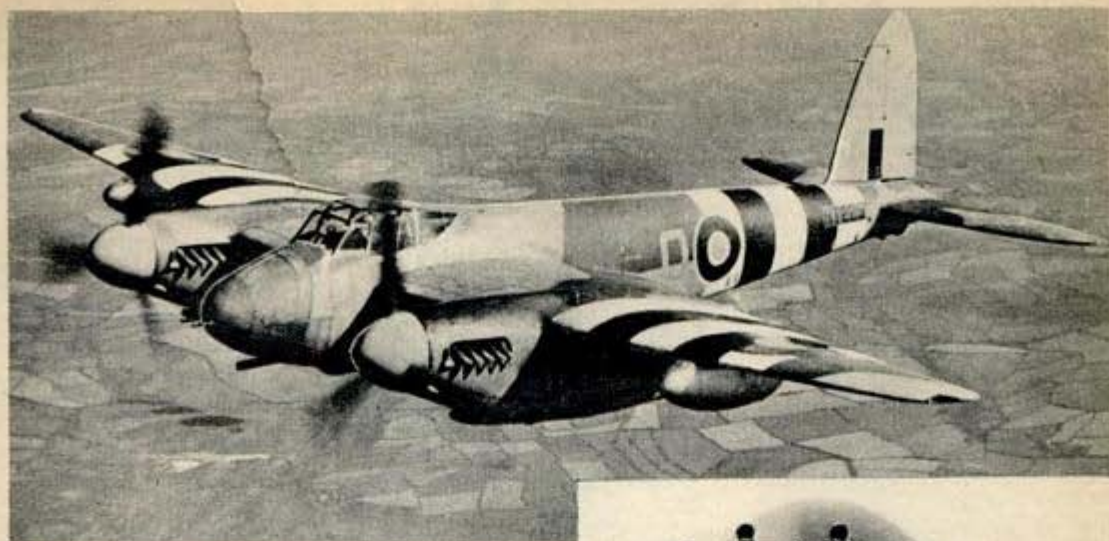

Top, a Mosquito in flight. Note 6-pounder under the nose. Right, crewman holds 6-lb. shell

U-boat commanders now have cannon from the air as well as cannon from the sea to worry about. The six-pounder cannon slung under the fuselage of the R.A.F.'s Mosquito plane can fire shells, at the rate of one a second, big enough to sink a submarine. It has proved so effective that U-boats now travel with an escort of flak ships, armed trawlers and fighter planes right up to their home port. Even there they are sometimes attacked by Mosquitoes as they lie at their moorings. The Mosquitoes likewise use their 6-pounders, which are sisters to the antitank gun employed against German Tiger tanks, to attack destroyers, tankers, and other Nazi craft, in one instance even making a direct hit on an enemy plane in the air. When the 6-pounder is fired, the aircraft suffers a slight jerk which does not affect the accuracy of the pilot's aim. The Mosquito also carries four .303-caliber machine guns.



## Plastic Tube Pipes Fumigant Into Insect-Infested Sacks



Dow Chemical Company photo

By creating a "death chamber" with a tarpaulin, large stocks of warehouse bags can be rid of insects without moving a bag. First, the end of a plastic tube is placed as close to the center of the pile of bags as possible, then the bags are carefully covered with a plastic-coated, gasproof tarpaulin. The plastic tube feeds gas from a can of methyl bromide under the tarpaulin, and under normal conditions the process should kill all insects in the bags in 12 hours. The gas does not affect the germinating power of seeds and the method is applicable to freight cars, ships and docks.



Above, two clasped hands mean "Hold it!"—signal usually given when only one crane is involved

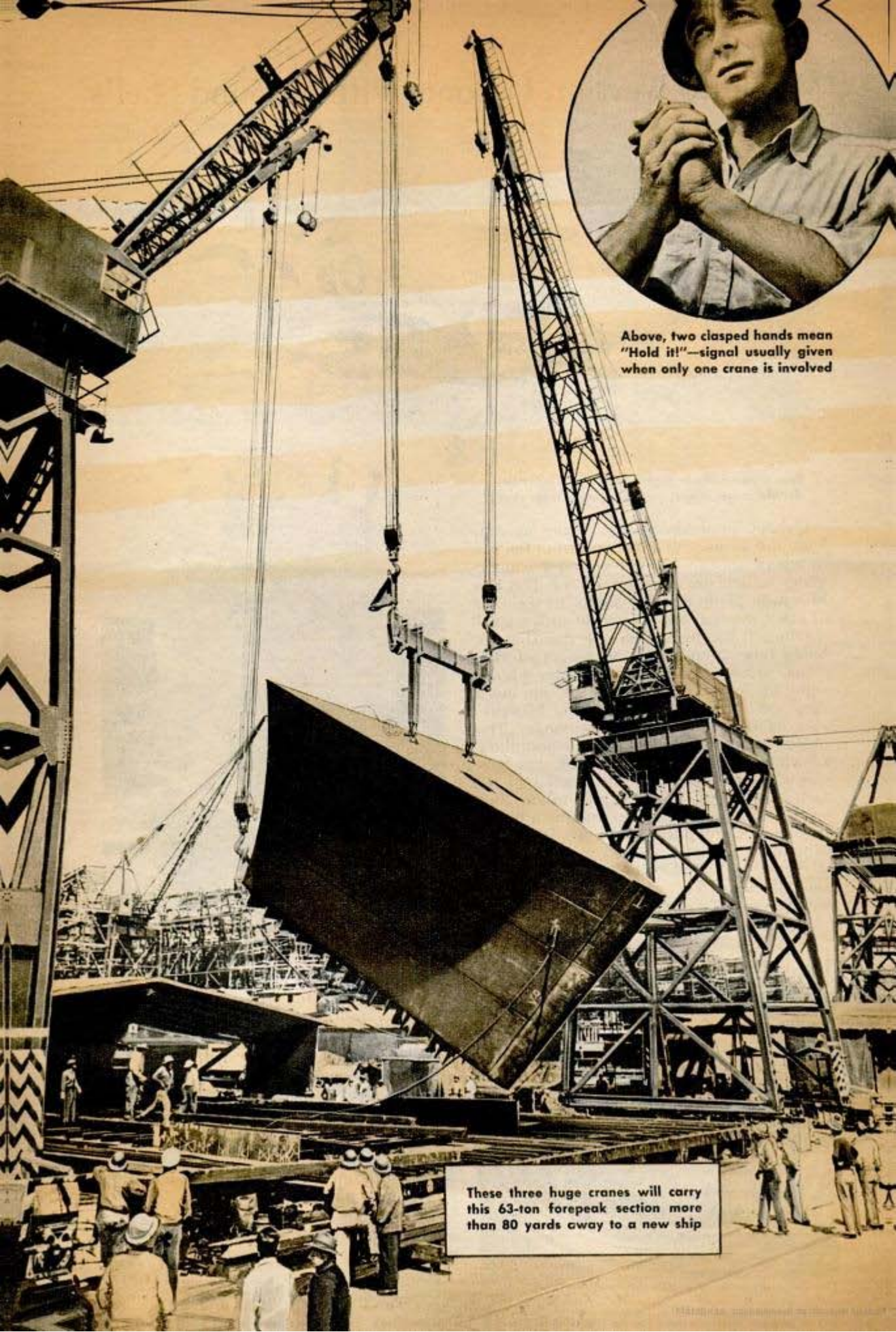

These three huge cranes will carry this 63-ton forepeak section more than 80 yards away to a new ship

Right, complicated rigging gear like this at California Ship Corporation's Los Angeles yard makes it possible for huge gantry cranes to accomplish difficult lifts. Below, in shipyard sign talk crossed arms mean someone is injured and a stretcher should be lowered by the crane to pick him up



At right, a signalman's right hand means "swing to left." His left hand means "travel forward"



Below, by thumbs down, signal crane operator is told to lower boom



## Shipyard SIGN TALK

**A**LERT and nimble rigger signalmen have the dangerous job of acting as an extra pair of eyes for the men who operate the huge gantry cranes which facilitate the prefabrication of ship sections. The cranes carry the sections to the shipways, where they are assembled like giant jig-saw puzzles, instead of being laboriously fabricated on the ways. By a system of visual hand signals, the riggers tell the crane operators, who ordinarily can't see their loads or hear anything above the din, how to maneuver their loads safely into the ship being assembled.

Clenched hands, for example, mean "Hold everything!" while rolling the hands as if they were turning a wheel directs the craneman to travel forward or roll the crane on its tracks. If a worker

Crane operator (right) works speedily and safely by reading hand signals of workmen far away



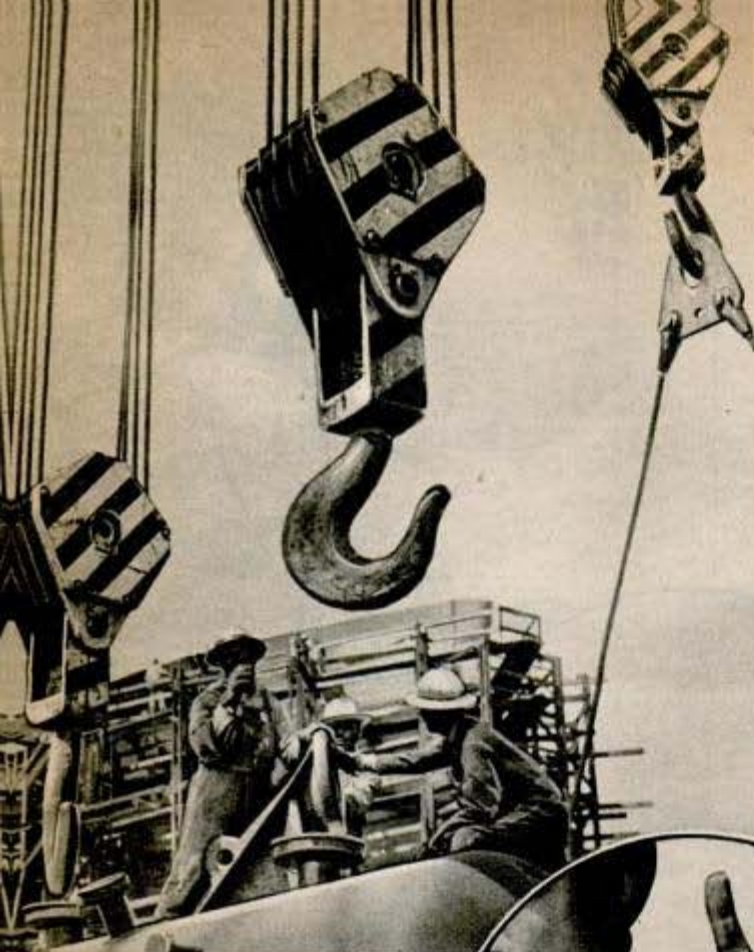

stilt-legged cranes, each of which weighs 140 tons and has a 45-ton boom capacity. The cranes work singly or in pairs. The 85-foot boom can reach 120 feet above track level.

The riggers' work is heavy, fast and hazardous. They must tie and untie loads and, like deaf mutes, use their fingers and hands to guide the loads through tight places, usually leaping and climbing about with the agility of acrobats. Sometimes they must guide a cranky 10-ton load past a clutter of obstacles to the bottom of the hold.



Above, rubbing the palm means "take it easy." Below, riggers and machinists lowering turbine gear assembly into ship, coached by signals from above



Above, crane hoists about to lift a ship's boiler. Right, circle means "hold" (of ship), three fingers, No. 3 hold. Below, "load-goes-to-deck" sign



is hurt on the ship, the signalman calls for a stretcher by crossing his arms over his chest. The crane operator lowers a steel stretcher into the ship and lifts out the injured man.

Steel decks, bulkheads and machinery, as well as bolts, paint, wire and pipe, are hoisted into place by the

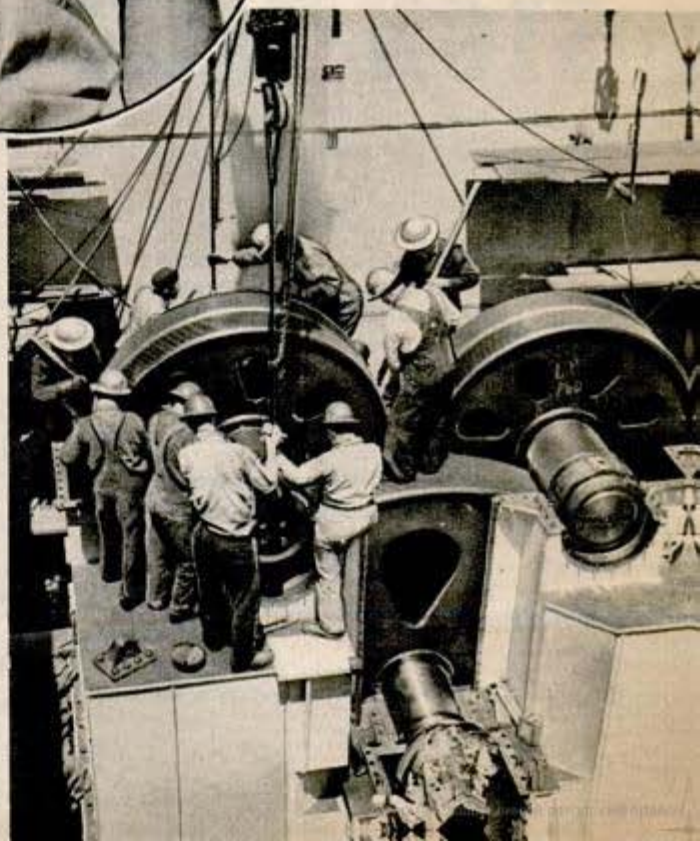

# "Octopus" Welder Speeds Laying of Pipeline



Laying hundreds of miles of pipeline to carry natural gas from Texas to West Virginia was speeded up with a pressure-welding process to join sections of 24-in. pipe. Before welding, the beveled end is cleaned of rust with a portable grinder (above) mounted on a self-centering spindle within pipe. Top right, ring of fire from 365 burner jets in the welding head surrounds abutting ends of pipe when lowered. Hydraulic rams close twin clamps which seize abutting pipe ends. The hydraulic leads, gas and oxygen hoses, and connections for lines in water cooling system give the unit appearance of an octopus. Center, pipeline crosses a river. It has 24-hour capacity of 207 million cubic feet of gas. Below, welding head suspended from tractor's side boom

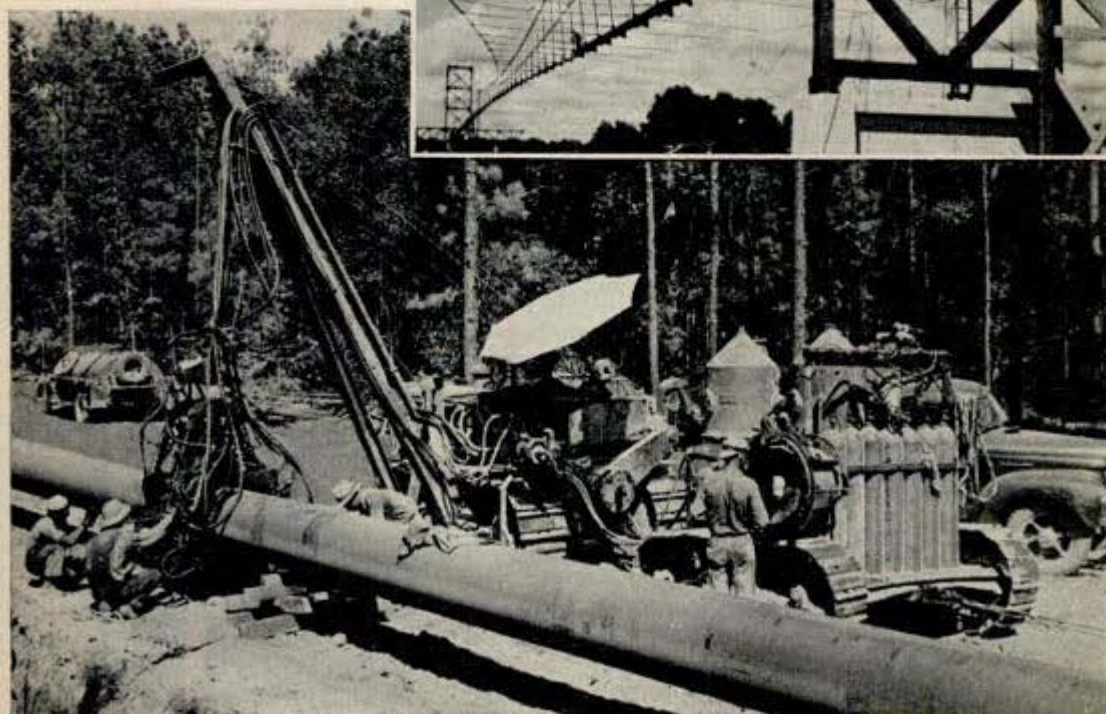
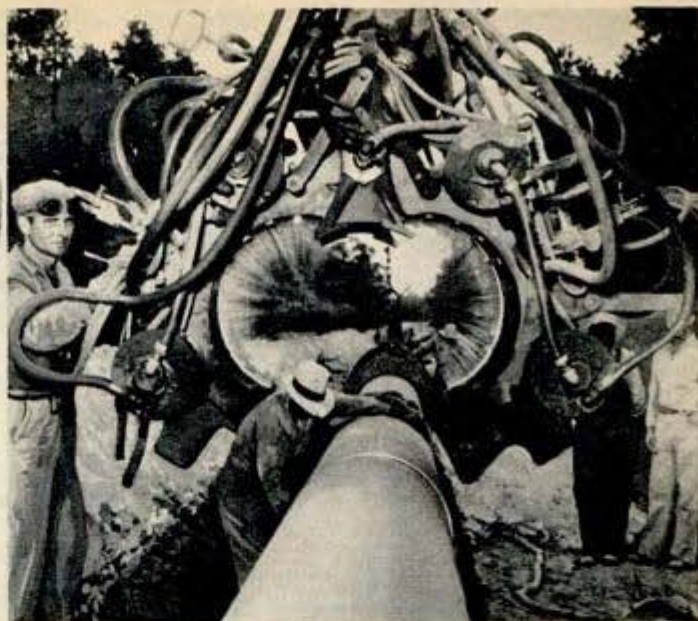

# They BRING 'EM OUT ALIVE



Above, rescue team enters experimental coal mine at Bruce-ton, Pa., after simulated disaster. The men wear electric cap lamps, protective caps, safety-toed shoes, breathing apparatus, etc. Left, the team emerging from the mine after practice rescue. An all-service gas mask is worn by the "vic-tim." This mine is a "proving ground" for engineers who specialize in mining safety. Below, reviving canary affected by gas in a mine. An oxygen tank is at the right. Bituminous Coal Institute photo

**T**HE war that never ends is the battle for life deep in the coal mines. There is no armistice with the underground forces of nature. Terrific explosives are set off in this war. Deadly poison gas imperils the miners. Booby traps in the way of rock falls and hundreds of other hazards beset their paths. The subterranean war has its thunder and crackle resembling distant shell fire and the miner, like the soldier, has trained ears which instantly warn him to seek safety.

Today Uncle Sam's army of miners, mine owners and safety technicians has achieved the immediate objective of keeping the mines working safely to produce the materials of warfare. But it is anxious to expand and intensify its campaign against mine hazards in peacetime, when worn or outmoded equipment can be replaced. The campaign will be led from the office of R. R. Sayers, director of the Bureau of Mines, Washington, D. C., and from the "proving ground" of the mine safety army—a novel experimental station at Bruce-ton, Pa.

In the Bruce-ton "torture chamber,"





Wearing oxygen-breathing masks, men (above) come out of mine with samples of dust and poisonous gases created by blasting. Lower right, holding anemometer, safety man checks ventilating efficiency

Below, practicing building temporary blockade which is used if ventilating system is damaged  
Bureau of Mines photo

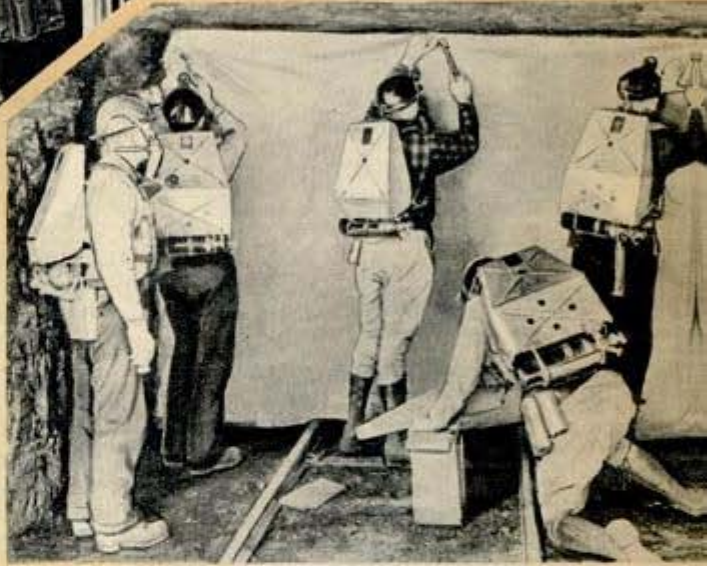

mine disasters are made to order. Great explosions are manufactured. Gusts of flame flash and clouds of choking smoke roll through subterranean chambers and passages.

Equipped with gas masks and other safety devices and employing test tubes, chemicals, axes, picks, muscles and brains, the experimenters live in constant peril. What they learn saves the lives of other soldiers in the army of miners scattered across the face of the nation.

Fires are set in veins of coal. Then barricades are erected against them, science, mathematics and chemistry are employed and soon the flames are smothered.

Electrical equipment is placed in a gas "death chamber" of steel. If a spark ignites the gas, a report goes from the Bureau of Mines to the manufacturer: "Not permissible." As mining mechanism develops in this country, so does the danger from sparks of electricity. The public thinks of a piece of coal as an object which burns slowly and provides heat. But to the mine safety expert it's dynamite.

Safety technicians point out that a teaspoonful of coal, powdered so as to expose its surface to a maximum of oxygen, can be converted to a blinding and often fatal blast if it is ignited by the flame of a match or candle.





Safety experts try out telephone used by mine rescuers after disasters

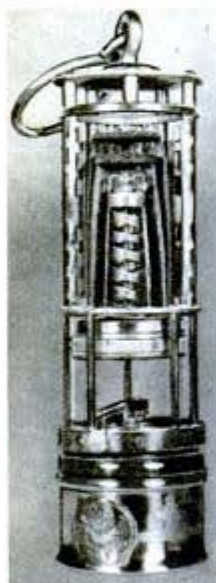
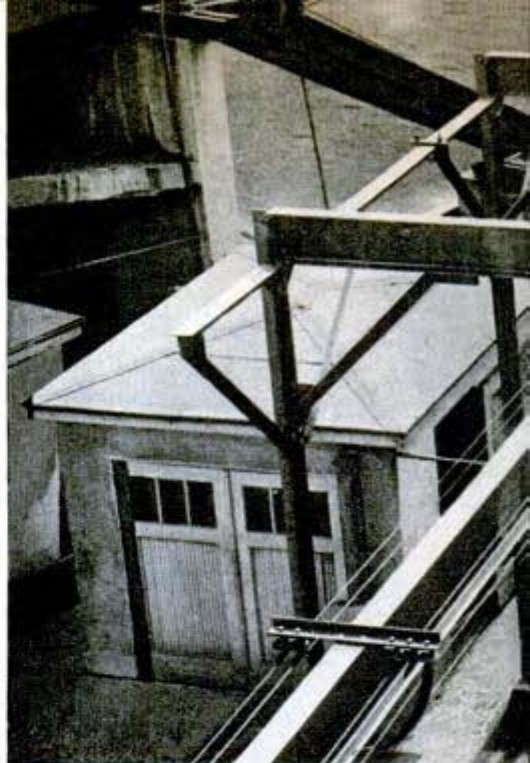

Research by the Bureau of Mines proves that the application of rock dust, or finely powdered rock, to the interior of coal mines helps prevent coal dust explosions and also lessens the chance of coal dust "picking up" or carrying forward a gas explosion to other parts of a mine. It also has been found that the application of water, or water plus a wetting agent, keeps coal dust from being thrown into a cloud. Many coal mines in the United States now are "rock-dusted" and many use water or wetting solutions to curb explosion dangers.

Thousands of dust samples from bituminous mines are tested annually by the Bureau of Mines to ascertain whether they contain sufficient rock dust to prevent their starting or spreading an explosion.

Various gases also are encountered in coal mines—carbon dioxide, hydrogen sulfide and methane; and, under some circumstances, carbon monoxide, sulfur dioxide and others. The most dangerous is methane, which is odorless, tasteless and invisible. This gas, liberated by coal beds, is found in thousands of coal mines of the United States and is highly explosive in certain concentrations in air—5 to 15 percent. Accumulations of methane in air generally are the source of explosions in coal mines.

Left, cutaway view of flame lamp used for methane test. Safety of explosives is tested by detonating them in gas-filled chamber

When ignited, methane explodes with great heat and violence, killing men, destroying equipment and, in some cases, wrecking the interior of the mine. Once started, an explosion may be carried to many parts of the mine by stirring up and igniting coal dust.

Extensive tests by the Bureau of Mines have revealed that adequate ventilation will prevent methane from accumulating in dangerous percentages and amounts. Methane is detected by a flame safety lamp, tested and approved by the Bureau of Mines, or with a permissible methane indicator operated

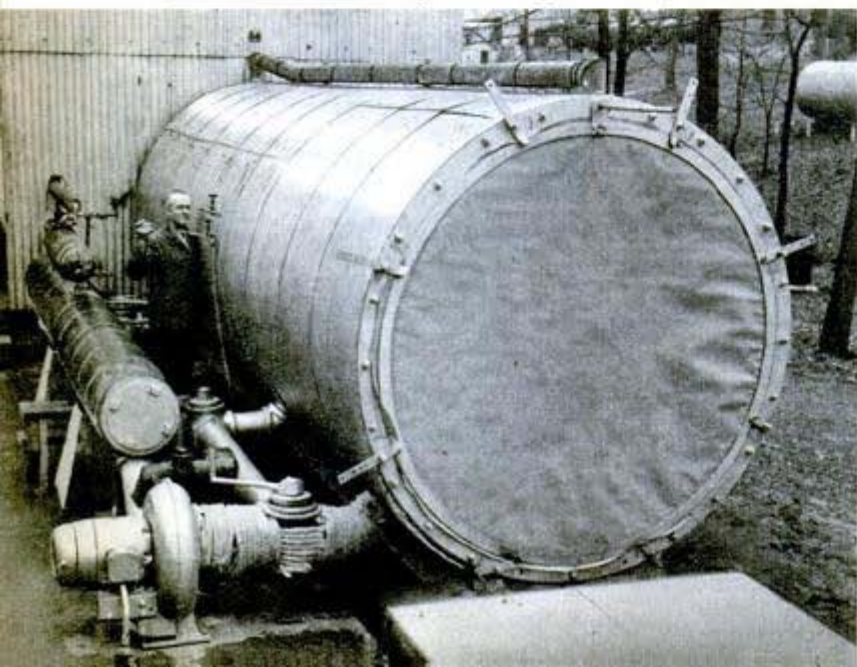



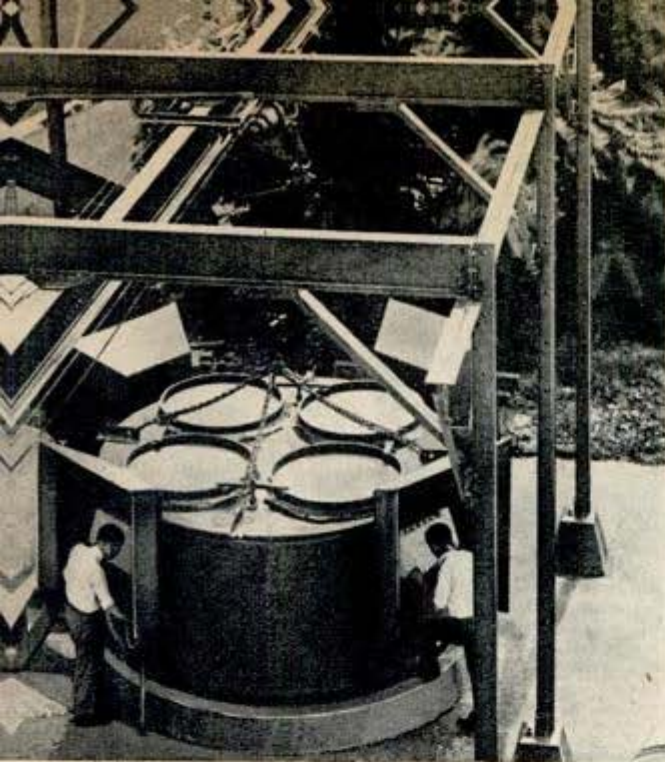

dustrial plants. They have miles of electric wiring and haulage tracks, electric locomotives, and electrical switches. The Bureau of Mines constantly carries on research aimed at curbing shock, fire and ignition dangers created by the use of electricity underground and in combating hazards which accompany the operation of mechanical equipment.

Over a period of years, manufacturers of electrical equipment have developed coal cutting machines, drills, loaders and other machinery which will not ignite gas or

(Continued to page 152)

Left, electrical equipment is operated in this chamber packed with explosive gas. If the gas is not ignited, and other tests are passed, equipment is "permissible"

electrically. The flame safety lamp roughly indicates the percentage of methane in the air through the varying height of a guarded flame—the higher the flame, the higher the percentage of methane.

The introduction of mechanical equipment to coal mines has increased production but it also has increased the hazards for workers. Modern underground coal mines are like surface in-

Right, testing a special "hard hat" for insulation against electrical shock. Below, rock duster dusting mine roof and walls

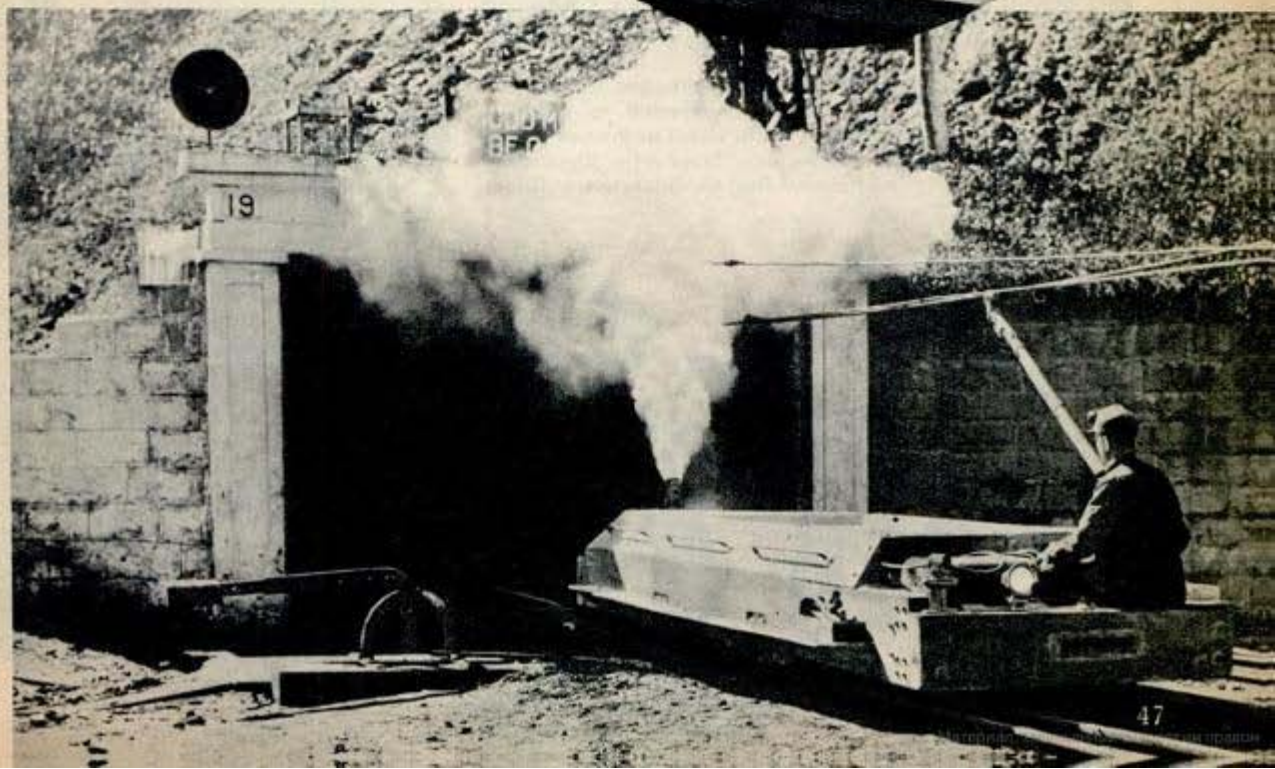

# GUAM IS ON THE WIRE

After a "blackout" of 2½ years, the Guam-Midway cable has been restored to serve the Navy's advanced operations base on Guam. The task involved hauling sections of the line (right) over the bow of the Restorer, cable repair ship, for examination. The 2,670-mile cable was severed before the Battle of Midway as a security step



From this room (left) on the Restorer, engineers can localize a faulty spot in the cable to a five-mile area, though the ship may be 2,000 miles away. Below, bow of the Restorer with its large cable sheaves reeling in two separate cables. Grappling hooks were strung over these sheaves when the ocean was dragged to find the cable, which is world's second longest

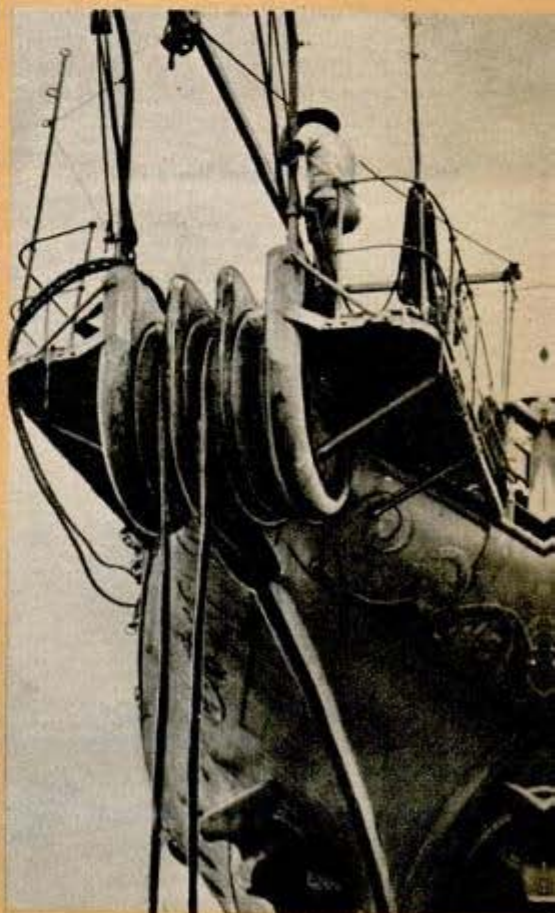

After the cable was dragged ashore (below) enough was allowed to reach a Quonset hut which serves as the new Guam office for the line. Later Adm. Chester W. Nimitz moved fleet headquarters to Guam



# Huge Bomb Drills Into Target Before Exploding

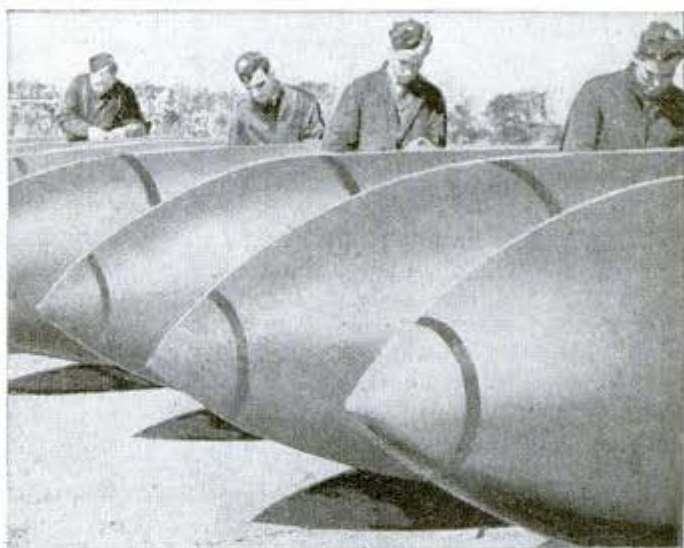
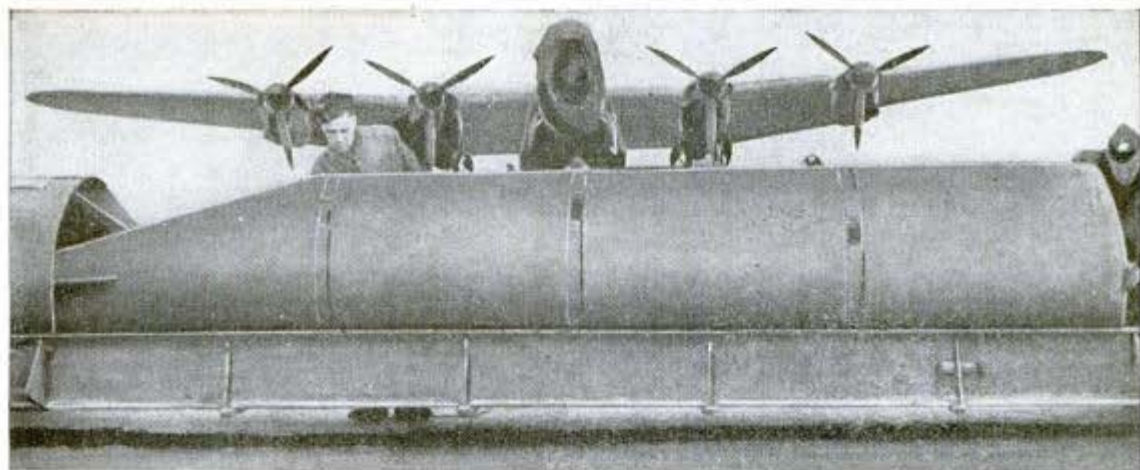

At top, one of the original six-ton "blockbusters" is readied for loading into a Lancaster bomber. The new six-tonner, lower right, has a sharply pointed nose and can pierce 12 feet of concrete before exploding

Described as the "most destructive air weapon ever used," a six-ton bomb which combines tremendous penetrating power with a blast like an earthquake is being

used by the Allies. The missile drills its way deep into the target, then sets off a giant charge of powerful explosive. The delayed action bombs pierced 144 inches of concrete in the Nazi submarine pens at Brest before they exploded; at St. Leu Desserant, where the Germans stored flying bombs, limestone caves were so completely collapsed they looked as if they had been undermined by an earthquake.

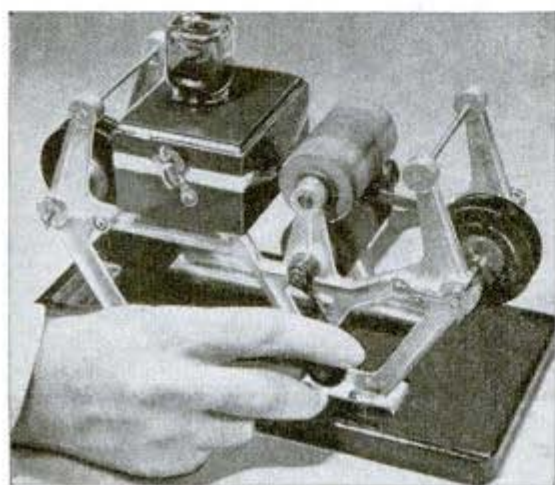

## Re-Inker for Typewriter Ribbon Makes Old One Like New

Typewriter and other business machine ribbons can be quickly and easily re-inked with a hand operated roller unit that doubles their life. The device was developed so that ribbons will not have to be discarded when they are only dried and not actually worn out. Both sides of the ribbon are inked simultaneously by the machine.

# MAPPING



WAVE at work on negative of ocean depths in hydrographic office. Right, placing floating signal marker for use by sounding boats

By Thomas E. Stimson, Jr.

THE South Seas are studded with islets and reefs that the world never got around to charting accurately, and this oversight became a serious matter early in the war when the Navy took up its task of helping kick the Japs out of the South Pacific.

Without reliable charts warships hardly dare to operate at high speeds, especially at night. Without precise information boards of strategy can't plan offensive operations. Not even a rendezvous for transshipping fuel can be scheduled ahead if sizes and depths of possible anchoring places are unknown.

Yet, miraculously, at the exact times that accurate charts of the waters off Guadalcanal or Tulagi or a dozen other areas were desperately needed, flag officers were able to distribute freshly printed charts to

Dead reckoning device makes record of courses and distances run

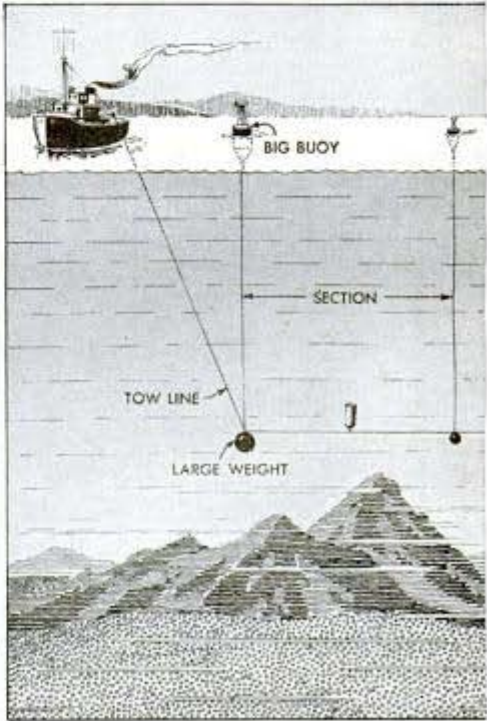
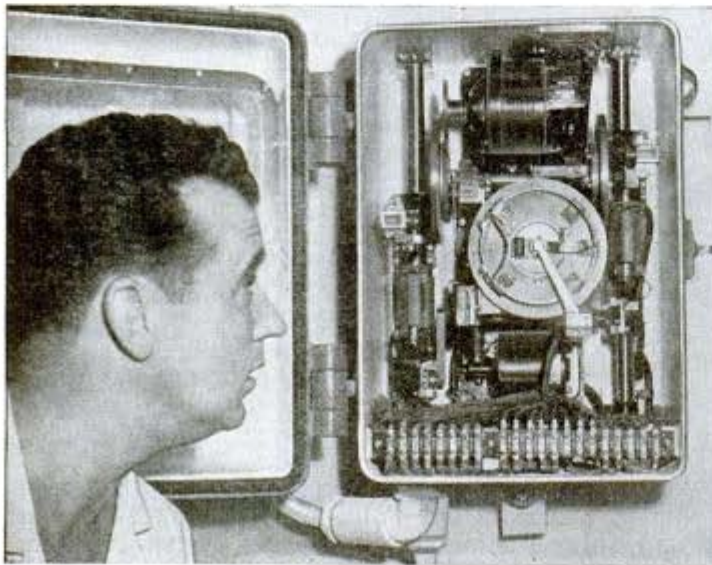

# the NAVY'S BATTLEGROUND

ship commanders. The story of how those charts were prepared, on the spot, makes a thrilling chapter in Navy history.

Details of the story are contained in the logs of the "Pathfinder," the "Oceanographer," the "Hydrographer," and other vessels of a special Navy squadron. These survey craft often poked their noses into Jap-held waters ahead of our fighting ships. They have been bombed, attacked by surface vessels, submarines and shore batteries, yet always they brought back information on which the advance against the enemy could be based.

The history of the "USS Oceanographer," now honorably retired from service, is typical of the work that the survey ships have been performing. Once the \$3,000,000 pleasure yacht of J. P. Morgan, the 300-foot ship began her naval career by sinking a submarine during the first World War. In the present war she was sent into the South Pacific and for 16 months performed dangerous and audacious solitary missions. The American attack on Bougainville was made with the aid of charts that her crew had compiled only a few days before. To gain necessary information, her

men often landed on Jap-held islands. During her duty 15 large navigational charts were completed on board, as well as a survey that covered 5,800 square miles of ocean. A representative task was the locating and noting of hundreds of coral heads and hidden dangers in the neighborhood of a 20-mile-long atoll. Once the "Oceanographer" discovered and surveyed a new channel that made possible a 120-mile shortcut.

Left, taking bearings on headland of island. Below, wire drag is towed by two small vessels

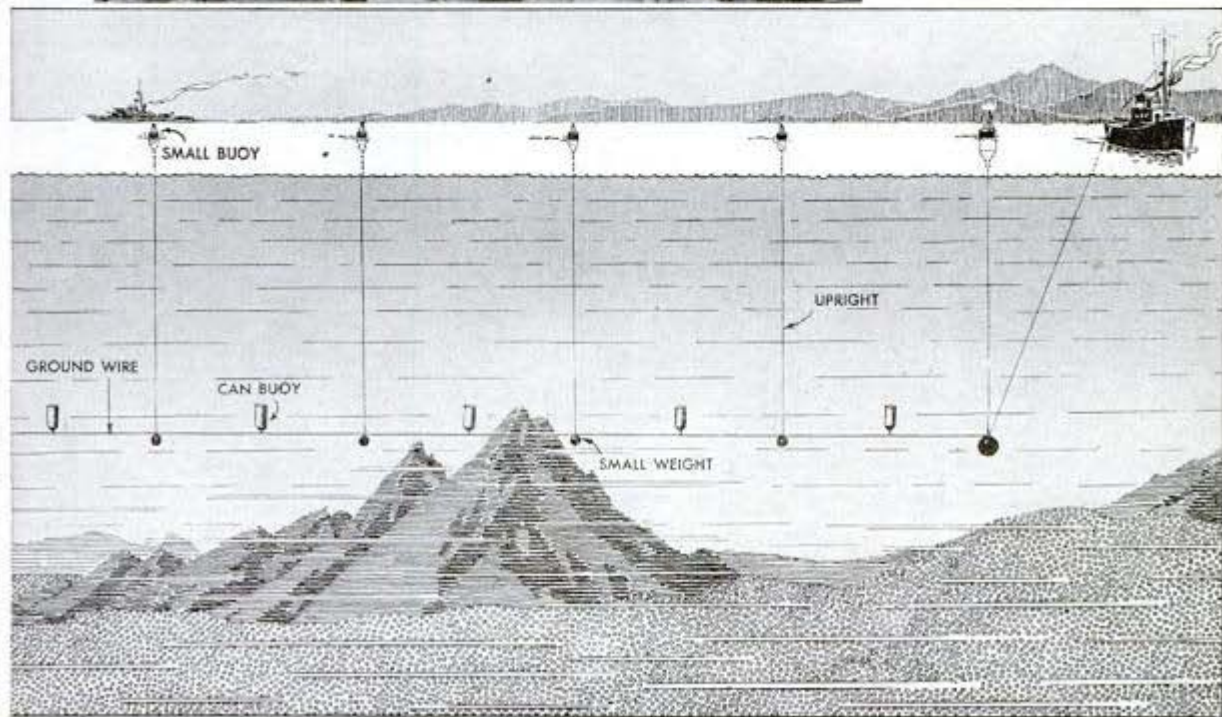



to be sure, yet the work must be done at the fastest possible speed. Sometimes a ship dares work only in the dark of the moon to escape detection by Jap aircraft or coastal patrols. During daylight hours she may lie camouflaged under the steep shore of some island. When running a line of soundings in deep water a survey ship often steers a zigzag course to minimize the possibility of a torpedo hit. On occasion the survey men have used a PT boat for a fast ex-

**Left, aerial photographs assist in making of chart. Below, examining photo with stereoscopic instrument**

(U. S. Navy Photos)

Ordinarily, underwater exploration is a leisurely and painstaking occupation. A survey vessel must proceed slowly to avoid wrecking herself among the obstacles she is charting. Measurements of depths and distances must be made with great care.

But the stress of war made the charting of the South Pacific an entirely different kind of adventure. Observations must still be made accurately,

These buoys are used by survey ships to mark danger spots

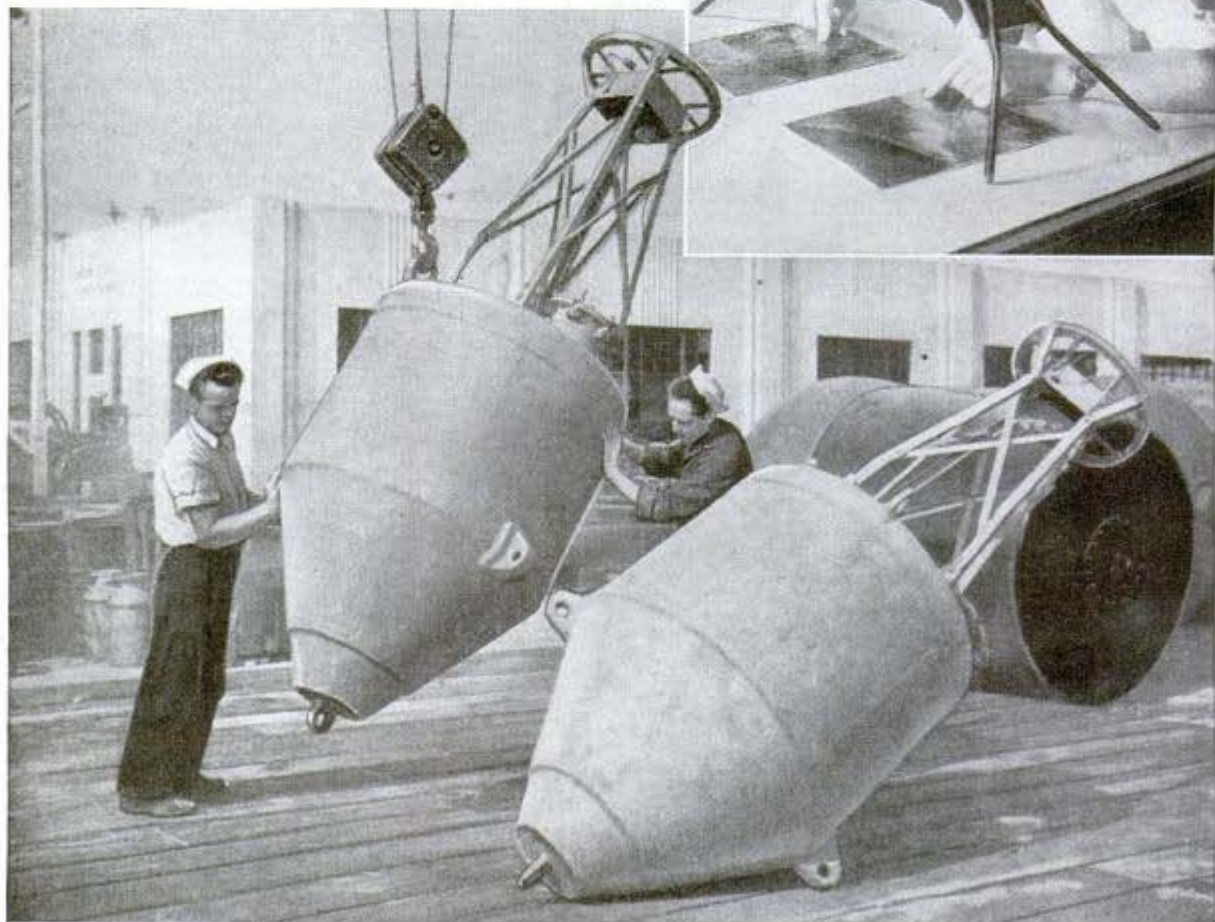

ploration trip right up to the entrance to a Jap base; other times they work from rubber life rafts, after dark, in shallow waters. An accepted hazard has been the possibility of being bombed by our own aircraft, for a pilot might disbelieve recognition signals flashed to him by an unknown ship deep in Jap territory.

When the war began, the best charts of some Pacific areas were mere sketches that had been made at the beginning of the century. Detailed maps had never been prepared because there was no commerce in the islands to attract



Divers on way to inspect underwater obstruction

the job was to place markers on reefs and rocks that couldn't be removed and to install other buoys for marking safe channels into protected anchorages. Sometimes old French buoys were salvaged and repainted but more often the men had to improvise their own markers from any materials that could be found. Many of the buoys that are now

in service consist of empty mine cases with sheet metal flags attached. Brand new amphibious "alligator" landing craft and weatherbeaten

native catamarans worked side by side in anchoring buoys.

(Continued to page 148)

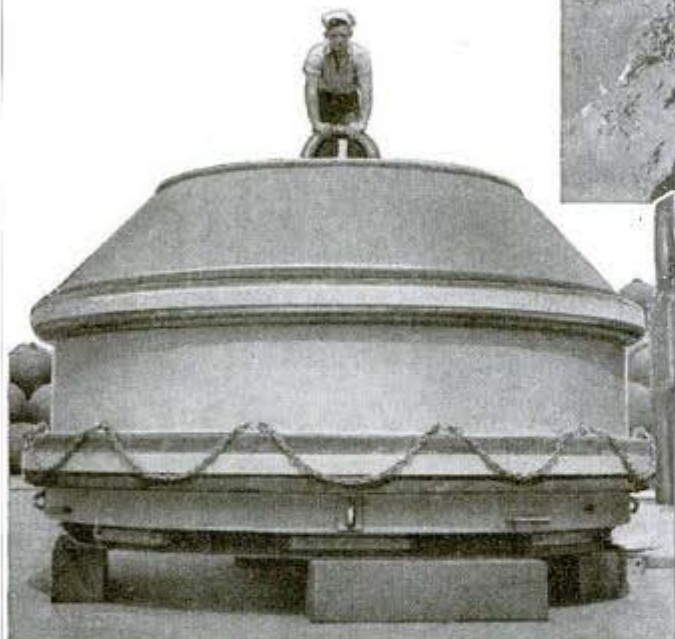

This giant buoy is now marking a channel in the Pacific. Right, crane picks up one of the steel ball floats that mark course

large ships. The main land masses were known and that was about all.

The Navy secured survey vessels in a hurry by taking over Coast and Geodetic Survey Service vessels, by building some, and by rebuilding others. Each was outfitted with drafting rooms so that cartographers could prepare their charts on board, and with photolitho and printing shops so that the finished maps could be reproduced in colors for immediate distribution to the fleet.

Each ship carried a deep-sea diver and TNT for him to use in blasting coral heads or submerged wrecks that might be blocking a channel. Each, too, was outfitted for buoy tending service. Part of

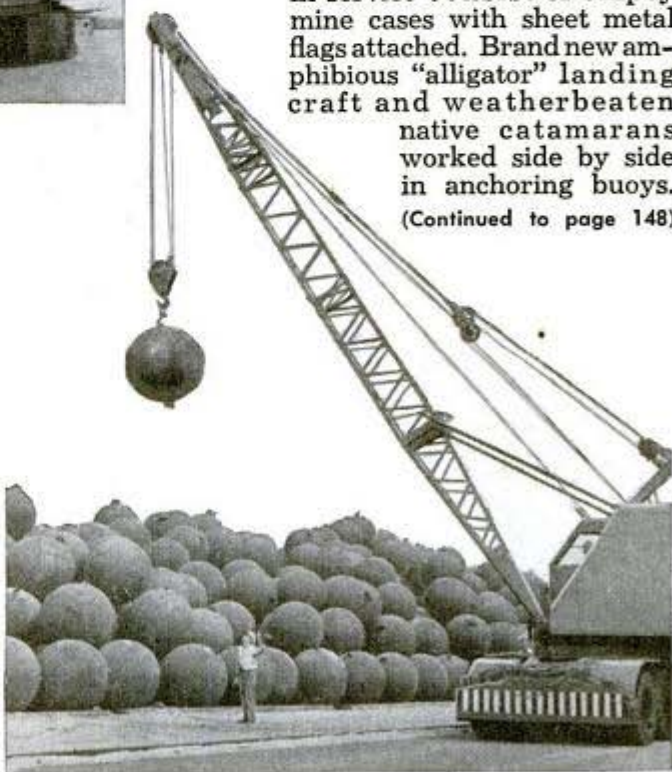

## 4-Cannon "Tempest" Chases Nazi Robot Bombs

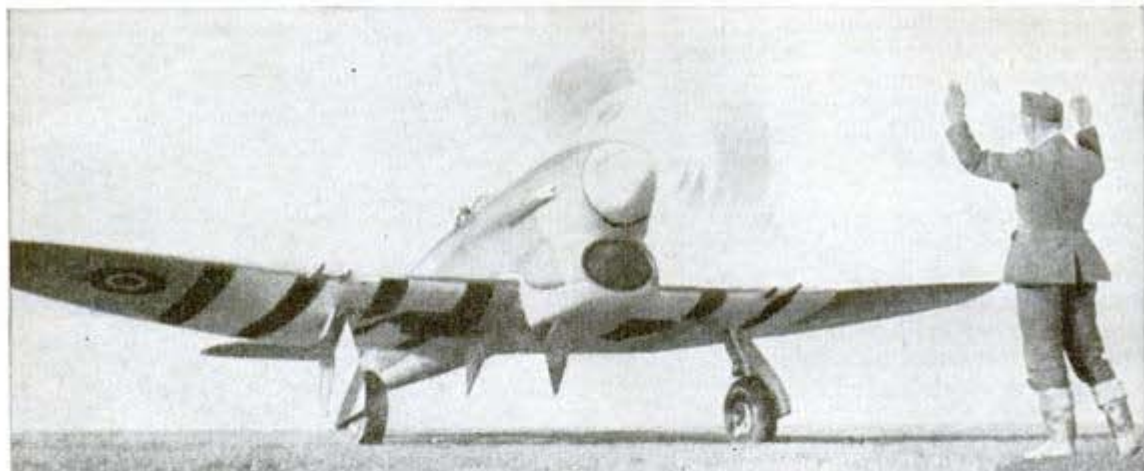

Extremely fast, highly maneuverable and easy to fly, Britain's Hawker "Tempest" is known as the "dream fighter" among R.A.F. pilots. The Tempest, a successor to the Hawker Hurricane and Typhoon, broke into headlines when it was credited with knocking 600 flying bombs out of the sky, the best record for pursuit planes. Before D-Day it was hailed as an effective ground straffer when it softened

up German fortifications in France; later it operated successfully out of Belgian bases, specializing in fighting Messerschmitts and the Luftwaffe's swallow-tailed jet plane. The Tempest is a low-wing monoplane resembling the Typhoon but with the elliptical wing of the Spitfire and a high tail fin rising in a Flying Fortress curve. Powered by a 2,200-h.p. Napier Sabre engine, it carries four 22-mm. cannons.

## "Arabian" Water Bag Keeps Its Contents Cool and Pure



Borrowing an idea from the Arabs, U. S. Army engineers designed a collapsible 36-gallon water container. It is made of heavy duck covered with a synthetic plastic resin that permits a slight seepage of water through the bag. Evaporation keeps the water cool in the same manner as the Arabian desert water bag. A cone-shaped hood fits over the top to keep out dust and germs, and five faucets are located two inches above the bottom of the bag to avoid any possible sediment. The container, made by the United States Rubber Company, is 21 inches in diameter and 26 inches in depth.

## Frozen Milk for Hospital Ships Tastes Like Fresh Product

Frozen concentrated milk, produced by research workers at Pennsylvania State College, can hardly be distinguished from fresh milk when diluted with hot water. The new product was developed for possible use on hospital ships. By adding an equal amount of water to a frozen block, coffee cream is produced; doubling the amount of water yields milk. The manufacturing process involves three steps: evaporation, preliminary freezing to a mushy consistency, then quick freezing at 10 degrees below zero after packaging.



# Camera Photographs Waves of Heat and Sound

By means of a flash-light capable of exposures of four millionths of a second, a photographic technique which can take pictures of heat waves, sound waves and other invisible air disturbances has been developed by General Electric engineers. The technique depends on a new electronic device which not only supplies the illuminating flash at the right instant but also gives an exposure duration so brief that light from the flash has time to travel only a thousand feet. Two types of apparatus are used—the Schlieren method, in which photographs are made with a highly specialized type of optical system which requires infinitely fine manipulation and adjustment, and the shadowgraph method, in which shadowgraphs are made by using nothing more than a film holder, the disturbance to be studied, and a light spark source with extremely sensitive controls. The latter pictures show only the boundary conditions between regions of sharp variations in density or pressure, while in the Schlieren technique, where the sensitivity is many times greater, gradual variations can be recorded. The Schlieren apparatus

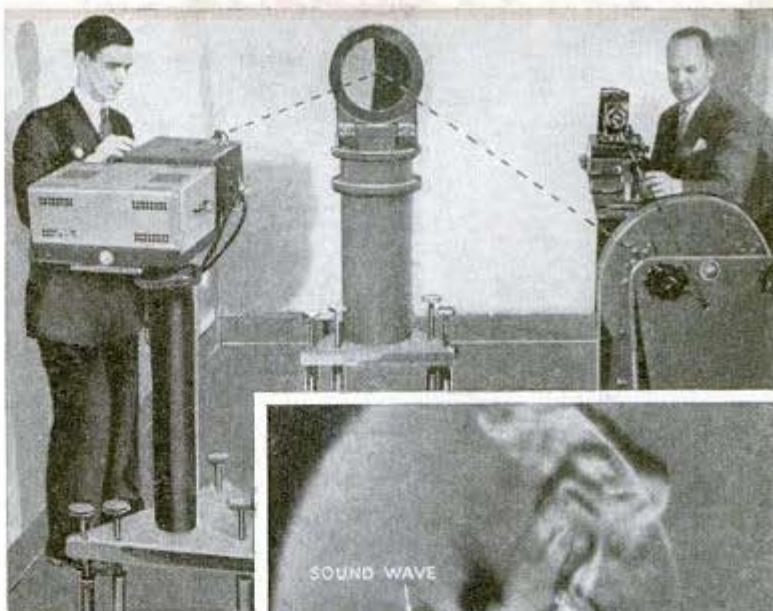

Above, in taking photo light goes from its source at left to mirrors and then to camera held by man. Right, sound wave from a gun blast as it is photographed passing amid heat waves generated by a soldering iron

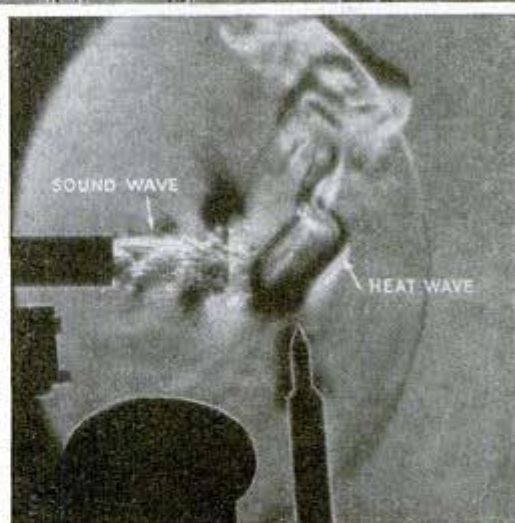

can show the breath coming from the nostrils, while the shadowgraphic method is usually adequate only for stronger disturbances. Either system can be employed to photograph sound waves or shock waves, provided an exposure of sufficiently short duration is obtained.



## Plug-In Conveyor Unloads Coal at Ton a Minute

Coal can be shifted from truck to bin at the rate of a ton a minute by a portable conveyor which plugs into any convenient electrical outlet and needs only two men, at most, to operate it. Its 15-inch width fits into any window. Powered by a 1-h.p. motor, the conveyor requires only two cents worth of current to unload 10 tons and can be carried on the fenders of a truck.

# LANDLUBBER *Air School*

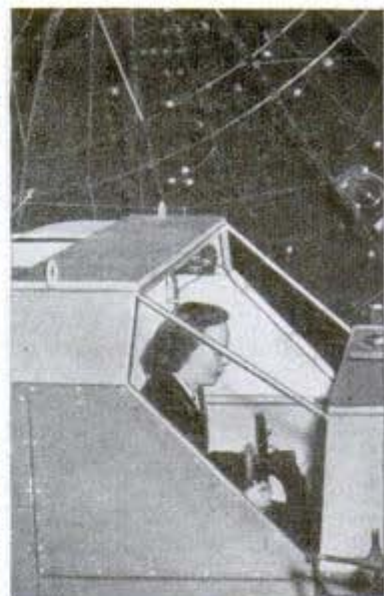
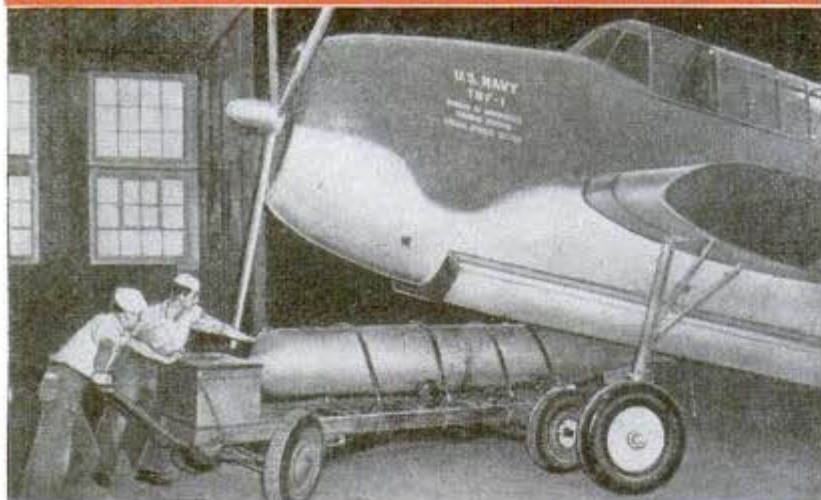

Huge mock-ups and complicated devices are used to speed up the training of naval air crews under conditions which simulate the real thing. At Alameda, Calif., trainees (above) wheel a torpedo under a full-size wooden mock-up of a TBF. Right, to practice his accuracy on a moving target, overhead turret gunner looks through viewing window of a motion picture machine in which he sees a Jap plane coming in to attack him. His hand grips turn the trainer just as if he were operating a turret and the picture of the plane turns red when he is in position to score a hit

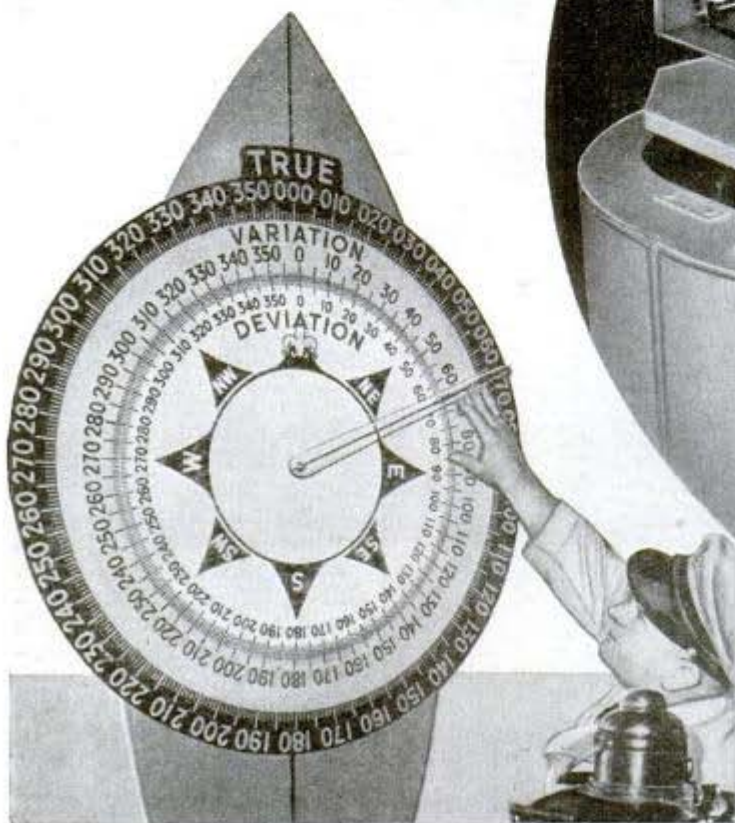

Left, cardboard compass on which corrections may be made so that a true steering course can be determined from magnetic compass

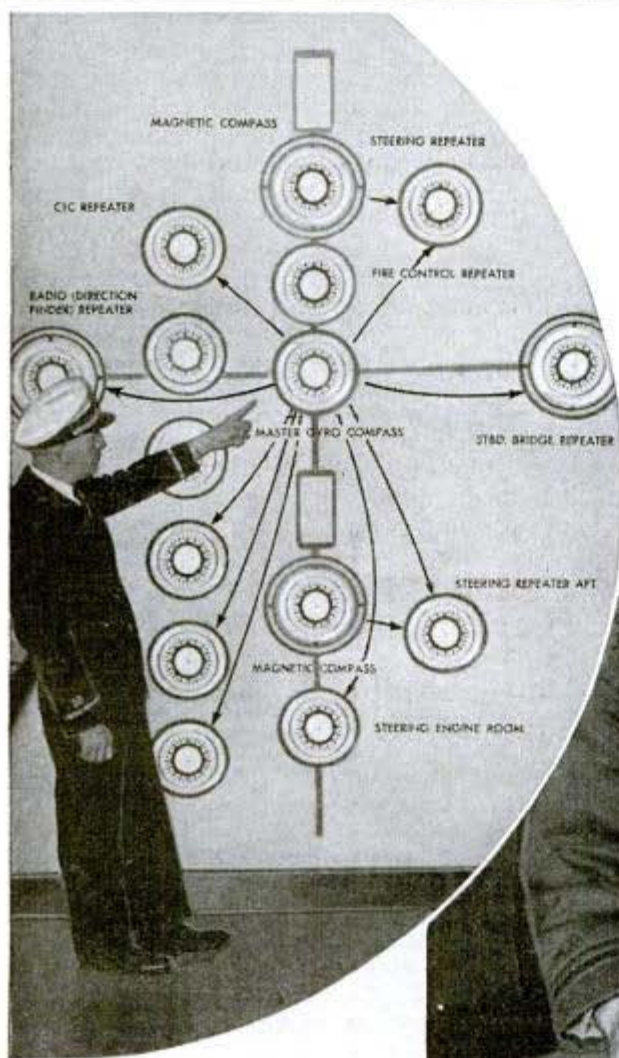

Upper left, student navigator takes a star sight in a navigational trainer, while a WAVE operates pilot's controls. The trainer is mounted high above the floor of a tall room and the ceiling contains lights which represent the stars. Student navigator gives his pilot courses to fly; their competence is recorded on a paper chart. Above them the stars rotate on a wire framework. Trainees attach spinner and arming-wire (above) to bomb secured to shackle under SBD's wing. Below, celestial compass that tells directions by stars is mounted on model plane base for a class lecture



Above, a diagram at Treasure Island Operational Training School shows types, number and location of compasses on warship

## Bus Acts as Mobile Terminal for Feeder Air Lines

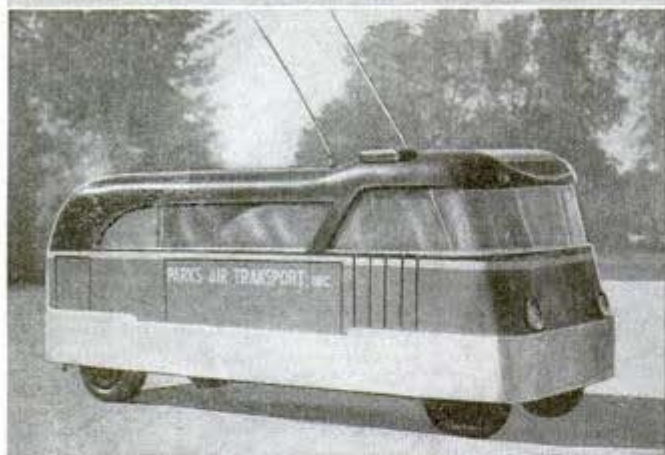
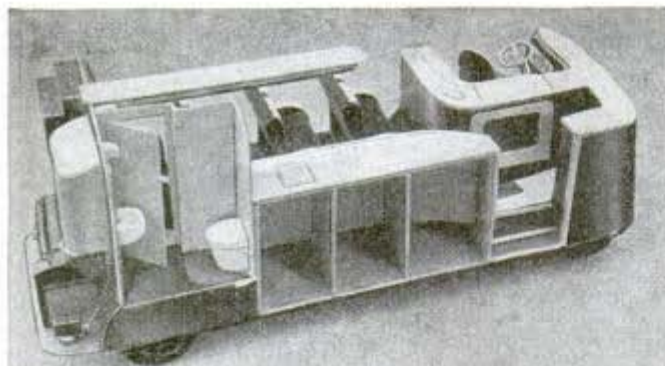

A local bus which could double as a mobile terminal has been designed by Oliver L. Parks, president of Parks Air Transport, Inc., East St. Louis, Ill., for possible use in an air line feeder system. The bus would drive right up to the airplane wherever it stops, deliver and take off passengers, mail and cargo and in general serve as the air depot. The bus Mr. Parks proposes to install includes a two-way radio and everything from a ticket sales counter to toilet facilities. Among the special accommodations the design calls for are a loudspeaker and radio system enabling control of airport ground traffic or public announcements by the driver; a refrigerator for refreshments; recording floor scales to weigh passengers and baggage; an air conditioning unit; floodlights on roof to illuminate area between plane and bus, and a telephone plug-in. Chief purpose of the bus is to speed feeder air line schedules by eliminating delays at the airport, such as taxiing the plane into position.

## Wrench With Torque Control Avoids 'Burning' Threads

To prevent stretching or "burning" of threads, a  $\frac{3}{8}$ -inch impact wrench which operates with controlled torque has been developed by the Aro Equipment Corporation, Bryan, O. This pneumatically powered tool is capable of both forward and reverse rotation and has a calibrated ad-

justing screw on the side of the motor which permits the operator to set any bolt or nut to any desired tension. The control is made possible by a roller clutch impacting mechanism having only four parts.

## Terminal Locks Wire to Wire In Non-Vibrating Connection

To save time, space and materials, an electric terminal block provides a solderless, vibration proof, wire to wire connection. The block is a connector strip with almost any desired number of terminal posts, each capable of handling from two to eight wires in the smaller ranges. The binding stud has a slotted channel, the wires being held in this channel between a top clamp or shoe built into the nut, and a lower clamp or shoe which is secured to the base. This arrangement locks every wire to a wire in a low-

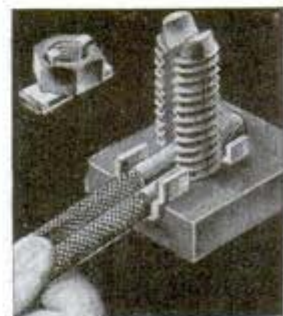
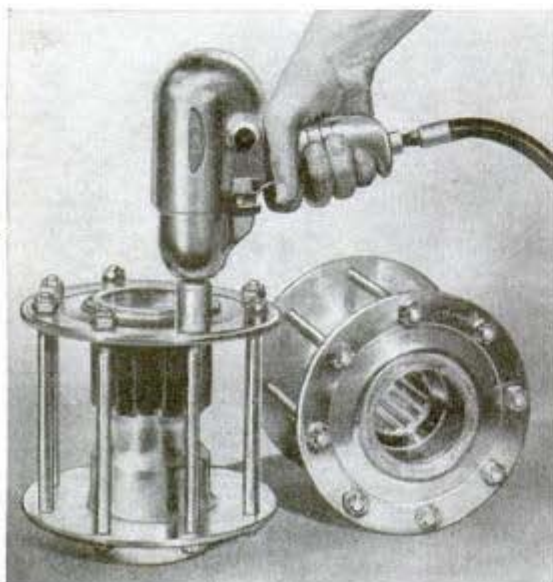

resistant connection, without danger of loose strands getting away. No lock nuts, lock washers, double nut arrangement, lugs or other accessories are required. The block obviates soldering, crimping, pressing or insulating, and no special tools other than the regular socket wrench or pliers need be used.

### Machine Prints Ticket While Customer Waits

To ease ticket problems of railroads, a machine has been developed which will print tickets automatically and do the company's bookkeeping while the ticket buyer waits. The invention eliminates the necessity of maintaining a stock of tickets for various destinations on the same road. Designed primarily for local or point to point tickets, it looks like a small cash register and can print up to 100 different stops. The tickets, two inches square, show the points between which they will be honored, the amount paid, whether it is one way or round trip, date of sale, identification of the salesman and serial number. Besides printing tickets, the machine tabulates all records for the ticket seller. The cost of printing 1,000 tickets, including paper, is less than 20 cents.

## Tiny Heater Warms Up Big One To Start Engines in Arctic

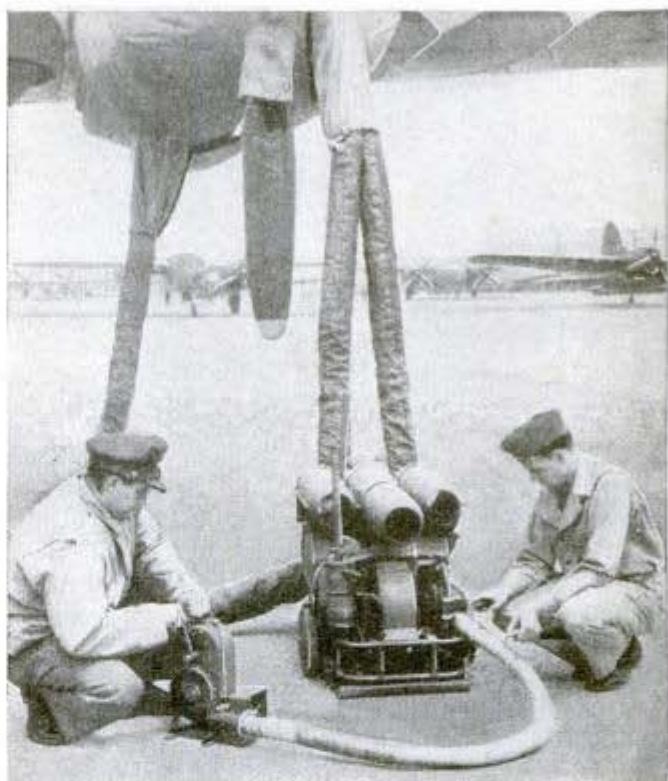

In the Arctic a tiny, manually operated heater is used by the Air Technical Service Command to heat up the big heater which in turn warms aircraft engines before they will start. The new heater was invented because the severe cold freezes up the large ground heater.

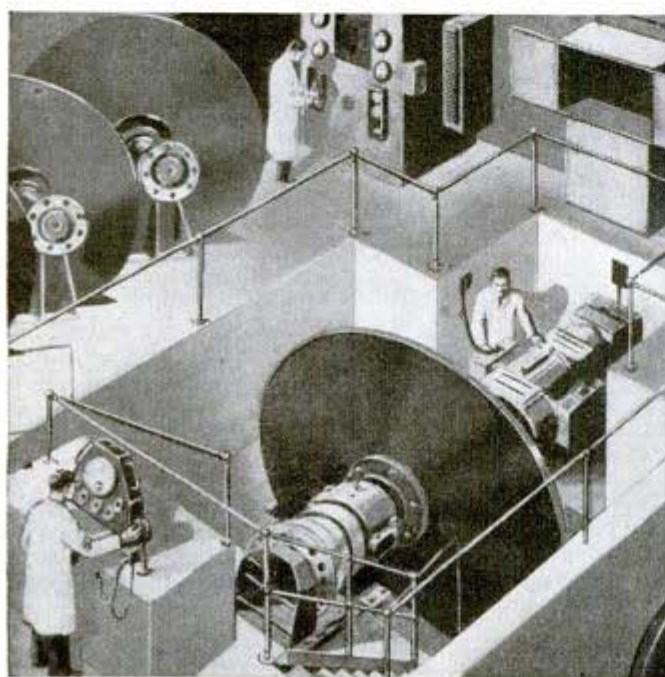

### Flywheels Test Brakes In Trial "Landing"

To try out the braking systems of the heaviest British aircraft, under all working conditions, the "landing" of a plane is simulated by flywheels in a laboratory. The test apparatus has a range of flywheels geared to shafts. A wheel corresponding to the size of the brake to be tested is fitted to the machine for each test. By using the largest size, the kinetic energy—40 million foot pounds—of a 53-ton airplane landing up to 100 miles an hour is reproduced. Decelerations, stopping times, temperatures, and rates of wear and tear are recorded during the braking runs. The machine has aided greatly in evolving the best braking systems for bombers, troop-carriers and transport planes.

## The LATEST in COLOR



Above, photographer checks lenses to be used in color camera. Below, comparing fidelity of finished color test prints with original shades of color on color wheel. Color film now can be processed in the home



**T**RUE-TO-LIFE color films and color papers that you can easily develop and print in your own home darkroom are on the market in limited amounts and will be available everywhere after the war.

With the new color films you can take natural color photographs with almost any camera, then process the film into positive color transparencies. These transparencies in turn can be used like negatives for making contact prints or enlargements on color paper. The results are astonishingly lifelike, reproducing all the colors and shades of the original scene.

Processing your own color photos is not difficult, although it takes a longer time and requires more precise time and temperature control than does the developing of

# PHOTOGRAPHY

black and white photographs. One hour is about the minimum time for developing either film or paper, the first 15 minutes being spent in darkness.

At present the color materials are more expensive than are black and white film or paper. A 4x5-inch sheet of color film costs about one dollar, as does an 8x10-inch sheet of the material on which color prints are made. With quantity production these prices may drop considerably.

Eastman's Kodachrome type transparencies and



Above, photographer uses four flash bulbs to make color picture. Left, cross-section of Gasparcolor printing paper showing layers of emulsion coating base materials. Below, making enlargements on color paper

YELLOW LAYER	(BLUE SENSITIVE)
YELLOW FILTER LAYER	
MAGENTA LAYER	(GREEN SENSITIVE)
CYAN LAYER	(RED SENSITIVE)
BASE	

papers are processed only in special laboratories. Gasparcolor, Inc., and Ansco are producers of the photographic color materials that can be processed in most home darkrooms. Ansco's materials include color film and "Printon" color paper, most of which is going to the armed forces. Gasparcolor printing material also is on priority.

These new materials, both transparencies and papers, all make use of a multilayer photographic emulsion, each layer of which is sensitive to a different part of the light spectrum. Such an emulsion may consist of blue-sensitive, green-sensitive and red-sensitive layers, or variations of these colors. The three colors and their combinations satisfactorily reproduce all of the colors of the spec-





Placing test strip of filter emulsion in spectroscope to analyze color

trum. A yellow filter layer below the top emulsion stops blue light from affecting the emulsion layers below it.

This idea was outlined in 1862 by the French researcher du Hauron, who visualized a "tri-pack" with filters in between, permitting red, blue, and violet-green light images of the same scene to be photographed in one exposure. Laid one over the other, the three dye images would reproduce the colors of the scene that was photographed. Practically all color photography has been based on some variation of this idea. Until the advent of the present "monopack" papers the most practical ways of making color prints were the wash-off relief process and the carbonyl process.

All of the color materials are of the reversal type; that is, each is developed first as a negative, after which additional processing converts or reverses the negative to a positive. This is why, after the first development step, the balance of the process can be done in subdued white light. This feature, too, permits partial processing and inspection, after which the material may be dried and then stored or shipped for completion of the processing at a later time.

Overexposure on a reversal film or paper produces a light, thin image, while underexposure produces a heavy, dark image, just the opposite of ordinary black and white photography. Color prints normally have black borders unless the borders are especially exposed to white light at the time the print exposure is made.

Anso's Printon and Gasparcolor's paper are both of the monopack type but there the similarity ends. Printon employs the principle of dye-coupling. Dye-forming sub-

stances in the layers of emulsion produce separate color images in reaction to a color-developing fluid during processing. These layers of dyes form the finished positive color print.

Gasparcolor's process is based on dye-destruction. Azo dyes are incorporated into the layers of emulsion during manufacture. After a print has been made on the paper from any color transparency the paper is then developed like any black and white print, in darkness. A negative silver image is created in each of the layers of emulsion. A dye bleach bath is then used to remove the dye wherever the negative silver image occurs, followed by an additional bleach to remove the silver. The untouched dyes that remain form a positive color photograph.

Preparing to measure foot-candles of light that are transmitted by color transparency film laid on top of contact printer

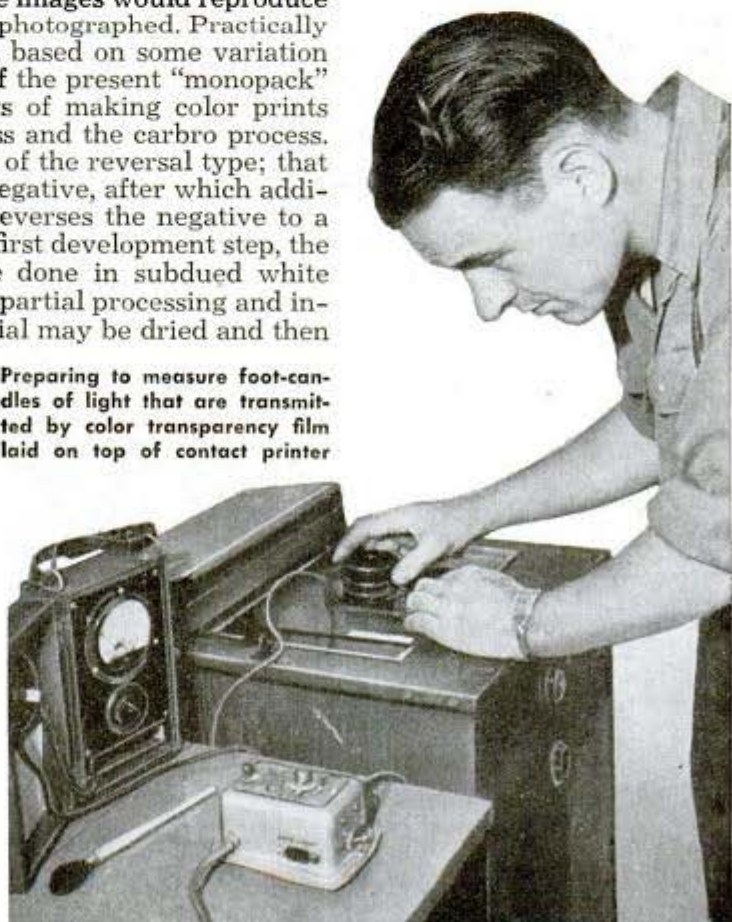



The Gasparcolor method produces bright, brilliant pictures, which have exceptionally sharp detail and also create an impression of three dimensions. The dyes are permanent.

Ordinary darkroom equipment plus a few incidentals are all that is needed for processing color pictures. Film transparencies may be developed in tanks or trays. Dry chemicals for processing color materials must be mixed with distilled water, filtered, and should be used at a common temperature.

For making enlargements on color papers the best results are achieved with condenser-type enlargers. All of the color papers require the use of a filter pack in the enlarger to screen out ultraviolet light from the enlarger lamp and to correct the color balance of the light. Additional filters may be added to the filter pack to compensate for shades of color in the transparency that are not quite correct. A light meter that reads in foot-candles is recommended for gauging correct exposure.

Color photography has become an important tool in many branches of science and is widely used by the armed forces, especially in aerial photography for the detection of camouflage. Color pictures also are used in hospitals for studying tropical diseases.

The Gasparcolor process was developed by Dr. Bela Gaspar in Europe, principally in Belgium, before the war. Laboratory records and other details of the process were brought to the United States by microfilm before the war began. The Gaspar organization is continuing its research in this country and other domestic photographic material concerns are also doing considerable research. Improvements such as increasing the sensitivity of color emulsions and eliminating some of the processing steps may result.



Compact kit contains two cameras, film holders, bulbs, lenses, etc.

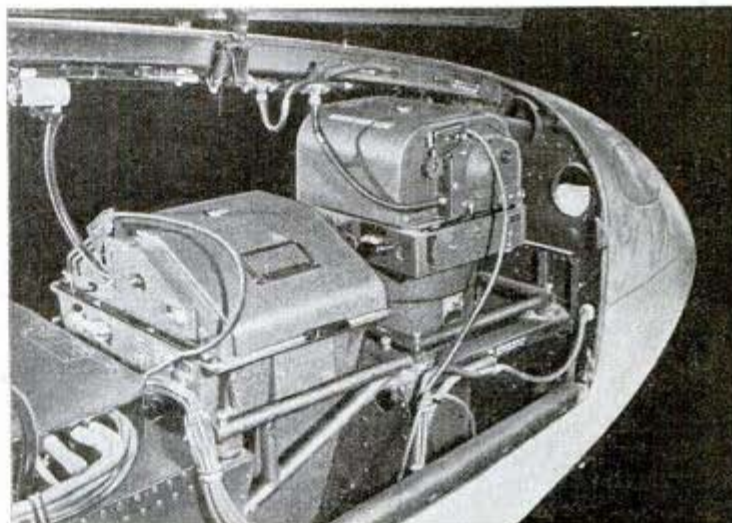

Above, installation of aerial cameras in nose of Lockheed P-38  
Below, floodlamps on lazy tongs are raised and lowered easily



## Steel Oxygen Tank Stands Up Under Cannon Fire

An oxygen cylinder for aircraft which will withstand cannon fire without exploding has been developed by the Firestone Steel Products Company. Some of these cylinders, made of stainless steel, are shaped like chubby watermelons, while others look like stovepipes with caps on either end. The first of their kind, they are applicable to planes from the B-29 to the smallest fighter. Earlier type cylinders were shatterproof against .50-caliber machine gun bullets, but the new ones won't explode even when pierced by a 20-mm. shell.

Left, oxygen cylinders hang like balloons from assembly line before being inspected and stacked by plant crew

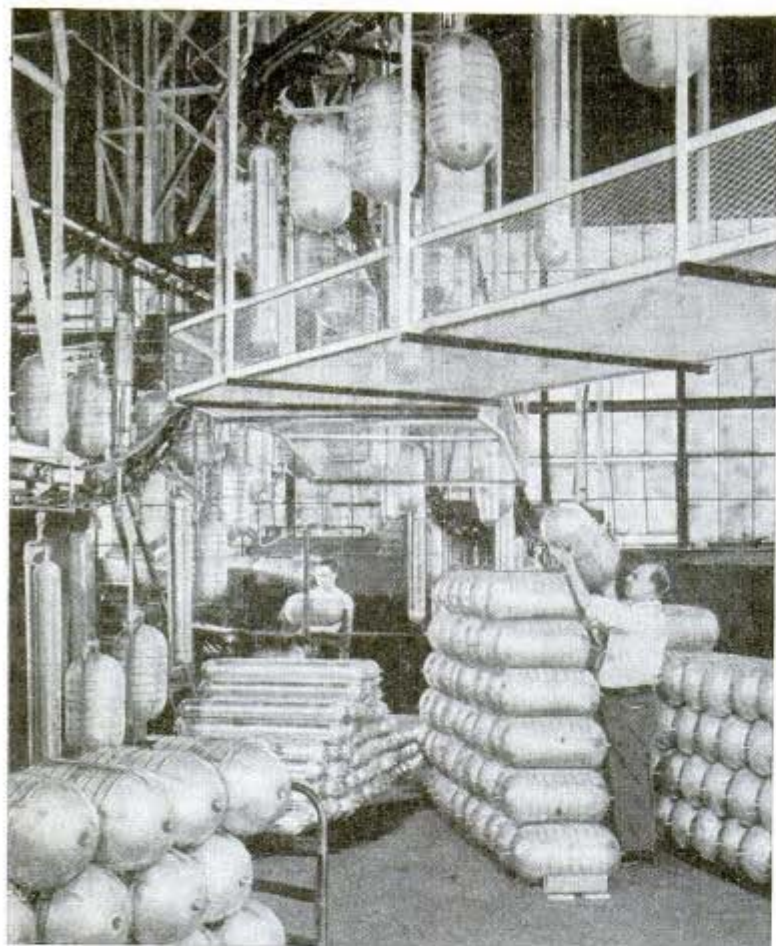

## Spring Snubbers Ease Bouncing of the Seats on Trucks and Tractors

Snubbers for seat springs may eliminate most of the jolts and bounces in truck and tractor driving. The Monroe Auto Equipment Company, Monroe, Mich., worked out an experimental "suspension seat" by providing snubbers which check the compression and extension of the spring.

### Aluminum Economically Made From Clay

Aluminum can be made from clay by a new and economical process developed by TVA chemical engineers. After the clay is percolated with sulphuric acid, forming sulphate salts of aluminum and iron, manganous acid removes the iron which caused previous difficulties. Other impurities are then removed and the final product is electrolyzed to produce aluminum. Loss of chemicals by earlier methods made the production of aluminum from clay uneconomical.



# WAR WONDERS *for* YOU



Cutaway drawing shows what postwar summer cottages may be like, if modeled after sturdy Quonset huts (below) built by the Army and Navy Great Lakes Steel Corp.

**P**ERHAPS you already have envisioned walkie-talkie radios, like those developed for the Army, in use after the war for home-office or field-home communication, or even as a convenience for the housewife who wants to summon her golf-loving husband home to supper just as he is sinking a tough putt on the 15th green.

Maybe you've heard about the way the tough Army jeeps are being tested for use on the farm, as fire engines and for a host of other peacetime purposes. Some of your friends right now may be thinking of buying, for duck hunting, fishing, boating, or as a swimming float, one of the air-filled rubber boats that were originally designed



and built especially for the Navy or AAF.

And undoubtedly you've wished for some of the waterproof matches, the shaving soap that lathers nicely in the coldest

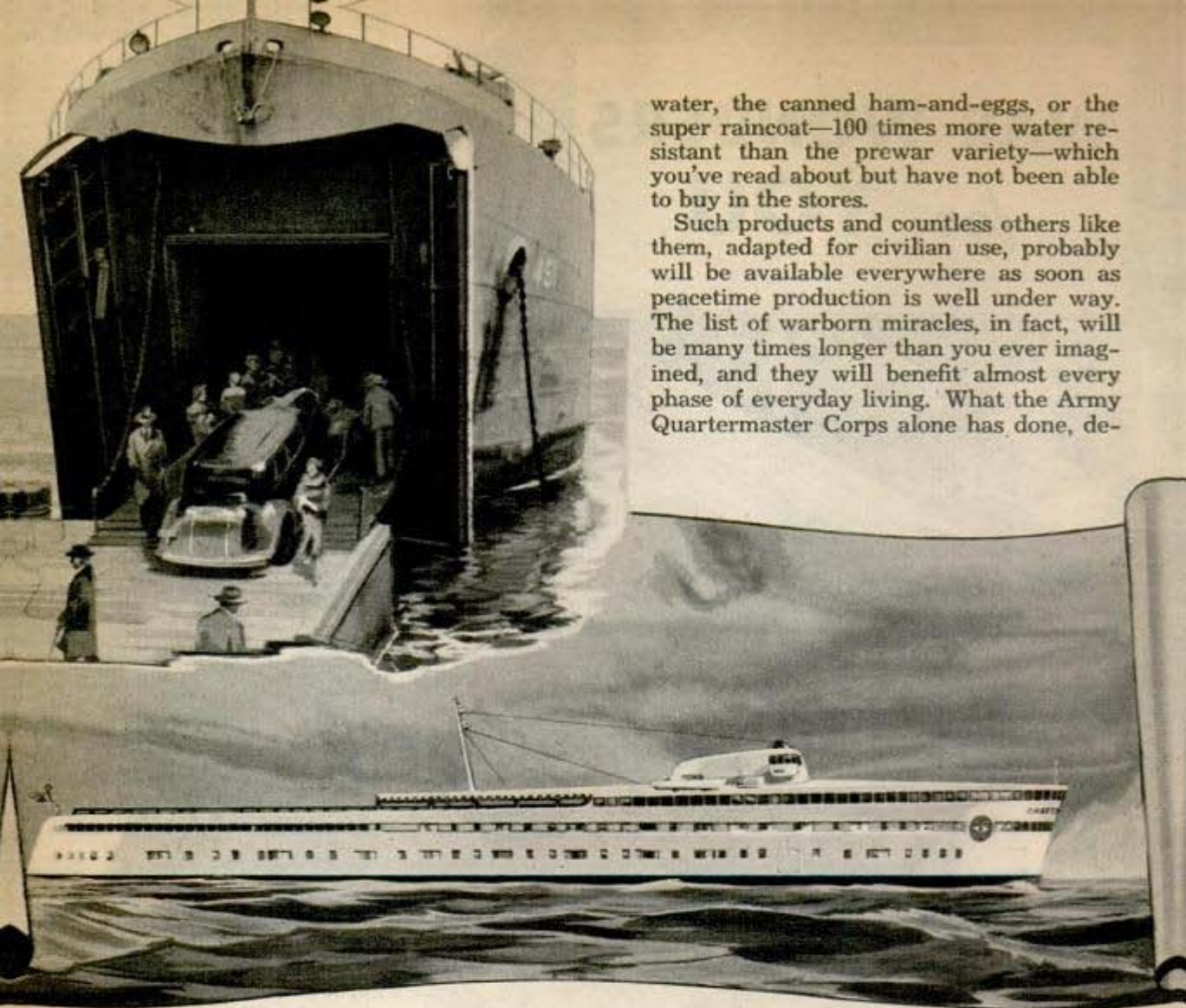

Above, bow and side view of SS Chattanooga, cruise liner which will have Plexiglas pilot house and cargo doors like a landing ship. Below, instead of welding, metal is bonded to metal by resin cement  
U. S. Stoneware Co.



water, the canned ham-and-eggs, or the super raincoat—100 times more water resistant than the prewar variety—which you've read about but have not been able to buy in the stores.

Such products and countless others like them, adapted for civilian use, probably will be available everywhere as soon as peacetime production is well under way. The list of warborn miracles, in fact, will be many times longer than you ever imagined, and they will benefit almost every phase of everyday living. What the Army Quartermaster Corps alone has done, de-

clares Maj. Gen. Edmund B. Gregory, quartermaster general, will revolutionize the life of the average individual after the war, affecting his clothing, his food, his housing, his personal luxuries, and even his recreation.

Take, for example, just a few of the chemical items produced or procured by the Quartermaster Corps. The waterproof matches can withstand several hours of soaking in water and still be usable. A new germicidal rinse may be a boon in kitchens and restaurants; as it's now made for the Army, a few ounces will make a 25-gallon can of water into a disinfectant powerful enough to kill all the bacteria on the mess kits of a company of 200 soldiers when boiling water is not available.

The Army also has a new nontoxic, non-inflammable insecticide, sprayed from a handy dispenser under pressure generated by freon gas. Just four seconds of spraying will knock out all the insect pests in any confined space.

The Army's new all-purpose soap is



Portable stoves developed for the Army may be popular with campers after the war. Below, many civilians will want the GI soap which can be used for shaving and washing and is equally efficient in any type of water

equally efficient in hot or cold, salt or fresh water, and can be used for washing hands and face, bathing, shaving, washing clothes and even items of equipment. Another special preparation—cold climate “dubbing”—can be applied to shoes and other articles of leather apparel so that they will be soft, pliable, non-cracking and waterproof, regardless of low temperatures and bad weather. A newly developed square candle, made of wax mixed with sawdust, is an adequate substitute for a small stove or fire. It is used by soldiers where large fires would be dangerous or impracticable.

Some of the greatest advances have been made by the armed services in clothing and they are expected to be incorporated in post-war materials and fabrics. The Army’s “five-harness sateen,” which is woven five times, is probably the toughest cloth ever made, with other fabrics running close behind in wear and snag tests. Work clothes and children’s play

Below—will the hardy jeep become a farmer in peacetime?





Goodyear photo

Rubber life rafts similar to those used by Army and Navy flyers are already being sold for hunting and fishing. The boat rolls up into a neat package, as shown at the right

clothes, made of these materials, will have wide appeal. Composition Army shoe soles are said to outlast four ordinary soles. Then, there are unbreakable nylon shoestrings, plastic buttons, and even ambidextrous gloves. If you lose one, you buy only one to replace it.

Development work by the armed services in cold weather clothing may have far-reaching effects on winter garments. It has been found, for instance, that several light layers of cotton and wool keep a man warmer than fur, and manufacturers already are reported to be styling coats made of this material for both men and women. Army raincoat material and cloth for windbreakers are better than any other fabrics ever made for these purposes.

Not only has the war fostered new foods, like precooked cereal with milk and sugar (just add water) and butter that won't melt or turn rancid, but it has speeded progress in dehydration, quick-freezing and concentrating. Before the war no combination foods with meat had been successfully dehydrated. Now such foods are fairly common on the menus of service men.

It is obvious that many vast improvements in all forms of



Below, featherweight plastic all-year screens will be available after the war. Made of Lumarith, they are said to transmit 90 percent of ultraviolet rays

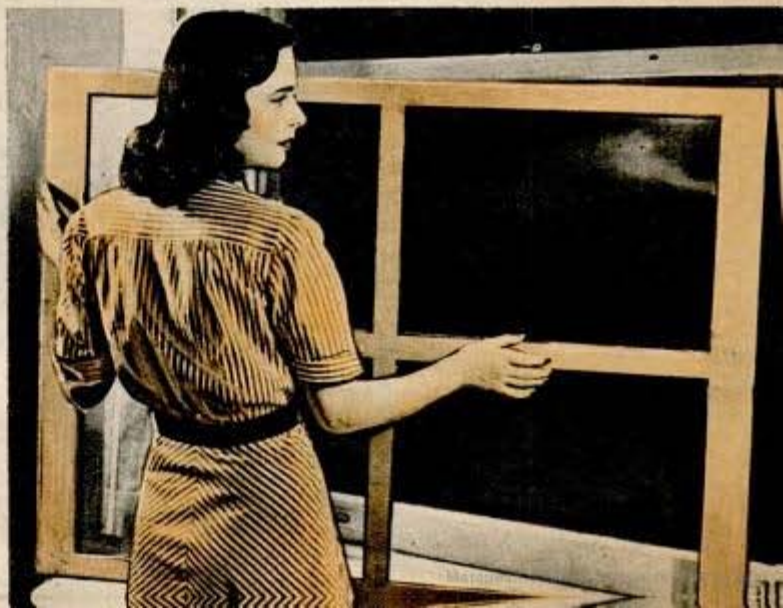



Navy coats (above) will be adapted for civilians. At left is winter jacket with face mask. At right is a parka which is both overcoat and raincoat. Below, a Handie-Talkie radio relays golf score to press room

transportation will be direct results of wartime progress. Air lines already have ordered fleets of new four-motored cargo and passenger planes, with four and five-mile-a-minute speeds, that will have pressurized cabins, scientifically advanced soundproofing, and other new comforts.

There has been widespread speculation as to the effect war developments will have on water travel. Some authorities predict that vehicles like the Army's amphibious trucks will come into civilian use. Already the war influence is having a definite effect on shipbuilding design, an outstanding example being the completion of plans for a 250-foot, 300-passenger, streamlined, luxury cruise liner, the SS Chattanooga, which will be built by the Ingalls Shipbuilding Corporation for travel on the Tennessee River after the war.

Along with ship-to-shore tele-

(Continued to page 154)





## New Glass Made Without Sand Resists Acid Attack

Hydrofluoric acid, which disintegrates ordinary glass, corrodes most metals and produces dangerous burns, has met its match in a new glass made without sand. Since hydrofluoric acid instantaneously attacks and soon disintegrates sand, the major ingredient of the new glass is phosphorus pentoxide which by itself instantly reacts with water with almost explosive violence. To test its acid-resisting property, Dr. E. D. Tillyer, research director of the American Optical Company, which makes the glass, immersed a piece of the new composition in a bath of hydrofluoric acid for 500 hours. At the end of that time the glass was substantially transparent and to the naked eye showed no obvious attack. During the same period a piece of ordinary glass made of sand, lime and soda was converted into a chalky mass by the acid. The discovery is expected to simplify the handling of hydrofluoric acid, which is being used extensively in scientific experimentation, in many industrial operations and as a catalyst in oil refining and synthetic rubber manufacture.



Left, top, sandless glass lens at right stays transparent after acid attack but other lens turns opaque. Left, chemist spraying acid against a protective hood

## Pipe-Line Plan for Making Latex Increases Rubber Output 40%

Manufacturing rubber latex by a continuous polymerization process—that is, by connecting the tanks to one another by pipe-lines—has increased the output of synthetic rubber plants in this country 40 percent. The new method supplants the older so-called batch type of operation in making GR-S rubber, which results from

polymerizing or uniting the molecules of butadiene and styrene. Large glass-lined tanks known as reactors are used and their temperatures are carefully controlled. Instead of handling each reactor as a separate unit, the reactors are connected by pipe-lines to form a continuous chain. Pumps admit the ingredients in a steady stream.

## Mobile Cradles Up-End Planes for Better Use of Storage Space



Using wheel cradles to up-end planes so they can be stacked closer together makes better use of storage space. The cradles, mounted on casters, also provide an easy means of moving planes, which can be loaded onto the cradle by one person with a small ramp which lifts up and forms a bar to lock the wheels into place.

### Save That Paper!

How many old magazines and dated newspapers and piles of other "useless" paper do you have lying around the house? Know who needs them badly? The army and navy men who package guns, equipment and supplies for shipment to the fighters across the oceans. Bundle up your paper scrap and turn it over to the salvage drive!



# Lighter, Sturdier Boxcars Have Plywood Walls

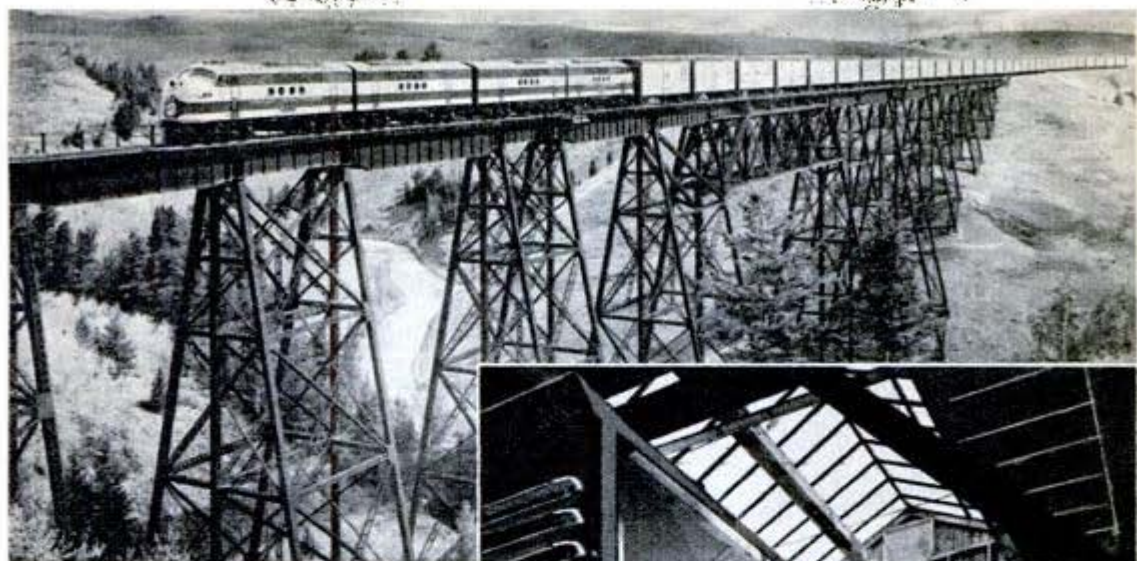

Above, train of plywood-steel boxcars crosses Montana bridge. Right, car is given plywood sheathing wall

One thousand boxcars made of plywood and steel have been built by the Great Northern Railway at its Duluth and St. Cloud, Minn., shops. They are a combination of steel, Douglas fir plywood and lumber, the steel comprising the underframe, end sills, roof ribs and bracings, and the plywood furnishing the sides of the car. The plywood is treated with a patented "sealer" before being applied to prevent warping. The steel used is lighter than that in ordinary cars and results in a weight saving of approximately two tons per car. On an average freight train this will reduce by at least 200 tons the weight pulled by the locomotive. The cars also are equipped with special high speed trucks, wrought steel wheels, and nonharmonic springs. Painted a brilliant orange to dis-

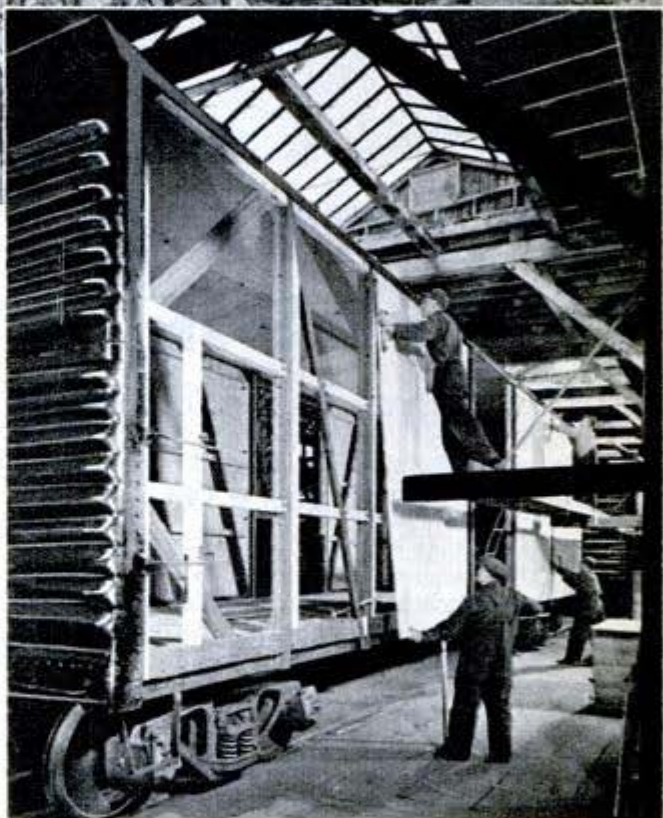

tinguish them from ordinary equipment, they will be used for the rapid transportation of lumber, newsprint and other high class heavy commodities.

## Colored Pictures Now Are Speedily Transmitted by Radio

Full-color pictures can be transmitted by radio with the same speed as black and white photographs by a recently patented process. The pictures are sent and received in the form of three-color separation films which are developed and printed in the customary way for making full-color prints. For transmission, a color picture is placed on a cylindrical drum for line by line scanning by a photoelectric eye. A

color disk, containing triangular sections of the three primary colors—red, yellow and blue—is placed between the scanning eye and the picture. Each color in turn is filtered out. The scanner selects and transmits impulses for the three colors, which are recorded in their proper order by the exposure of films on a receiving drum. The technique is basically the same as for sending news photographs or maps by facsimile.

Army rescue craft swings alongside raft. Soldiers on the rope net are ready to assist survivors into boat



## The **ARMY'S NAVY** to the **RESCUE**

THE CARIBBEAN division of the Army's Air Transport Command has its own small navy, a "Splinter Fleet," and operates Catalina flying boats on trips to bases from Florida to Puerto Rico.

On a houseboat named "Silver Wedding," it keeps headquarters for Army boatmen, and on dots of islands in the Caribbean Sea soldiers in sailor suits pursue a single duty of dissipating the dangers of a 1,000-mile flight over water.

When Air Transport Command planes, or planes of any other command or Allied nation or commercial company, drone the distance



Ship's captain directs rescue; injured flyer will be placed on a litter. Left, from a radio station on houseboat go emergency messages



from South Florida to Puerto Rico or Trinidad—first leg of air journeys to far continents—an ATC navy serves as convoy along the airways.

This miniature navy's system of "check points," rescue boats, PBY Catalina flying boats, grid charts and search plans makes the first overwater leg of the ATC southern route a journey over friendly territory. A forced landing is never far from immediate rescue. Below the northern border of Brazil the rescue system is taken up by ATC's South Atlantic division.

An unconventional but effective organization of air-sea rescuers has been fashioned by combining radio communications, boats, airplanes—and a method.

The method, based on co-operation with other services, carries out the idea of putting a series of life nets under men who fly the route—safeguards that provide psychological comfort as well as actual value. Between Miami, Morrison Field, West Palm Beach, and other Army, Navy and commercial fields in Florida, and Puerto Rico or Trinidad, the organization maintains four check points and one rescue station. At each place the Army has a rescue boat that can cruise about 600 miles at 21 knots to pick up survivors of any plane that ditched in the sea.

The four check points are so called because at each a radio operator is on duty constantly to “check” by voice every airplane that flies over the route. As a C-54 or a B-24 flies north or south above the small bare islands below, a GI radioman in his wood shack or tent listens for:

“Check Three. This is Army 3327 on course. Over.”

To which the solitary GI replies: “Roger. Over and out.” Then he makes a notation that Army 3327 has passed safely by.

If Army 3327 fails to report to Check Four or exceeds her estimated time of arrival or calls in distress, a radioman down the line notifies Station WZXD at Boat Company headquarters, and calls the solitary GI at Check Three to ask the check time of Army 3327. By determining when and where the plane reported last, headquarters localizes the search area.



While he keeps glasses fixed on distant raft, lookout on PBY rescue plane reports find to pilot over the interphone

Thus, if a plane reports to Check Three, and fails to talk to Check Four, searchers know it must be down between those two points. In such instance, the division air-sea rescue office alerts all check points and other rescue agencies in the Caribbean and institutes by radio a search plan which is based on co-ordinated understandings between ATC, the Navy, Civil Air Patrol and Great Britain's RAF.

Search plans are exact. They are all based on a grid chart, which has been carefully superimposed on a map of the water and island area from Florida to Puerto Rico. Each grid square is designated by horizontal lettered lines and vertical and diagonal numbered lines.

Chart forms basis for rescue plans, each identified by code, so rescue units can cover specified areas

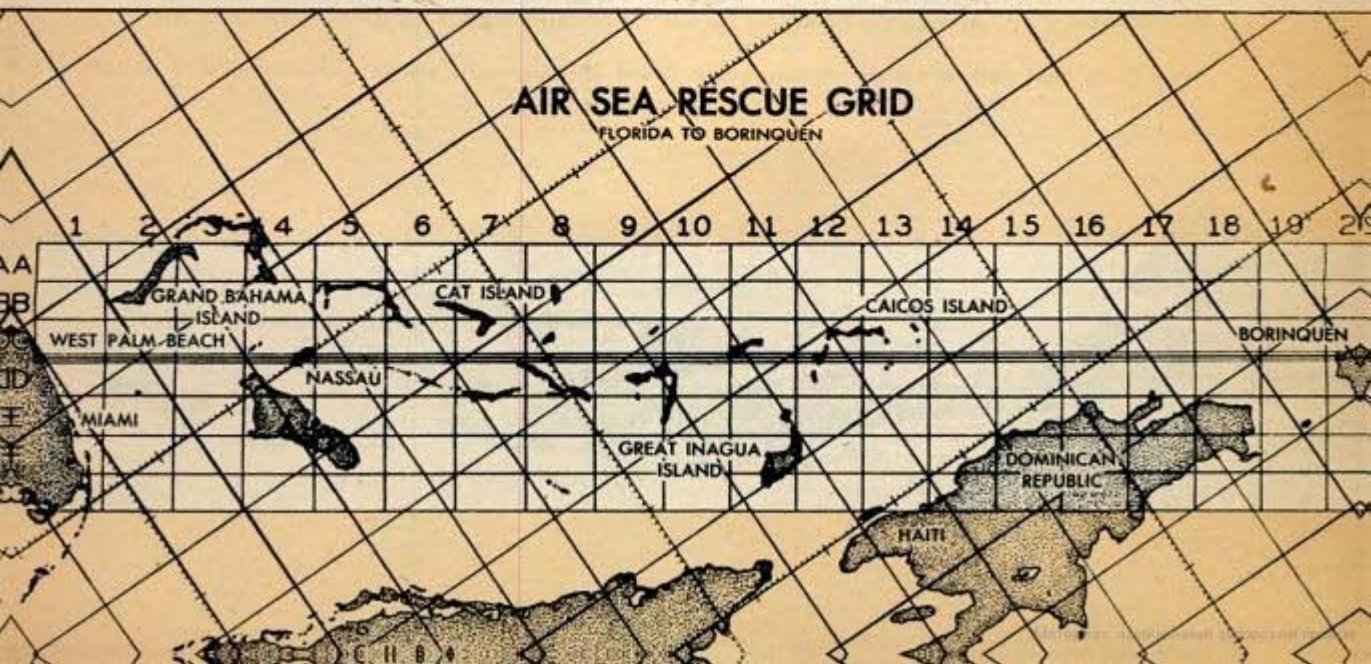

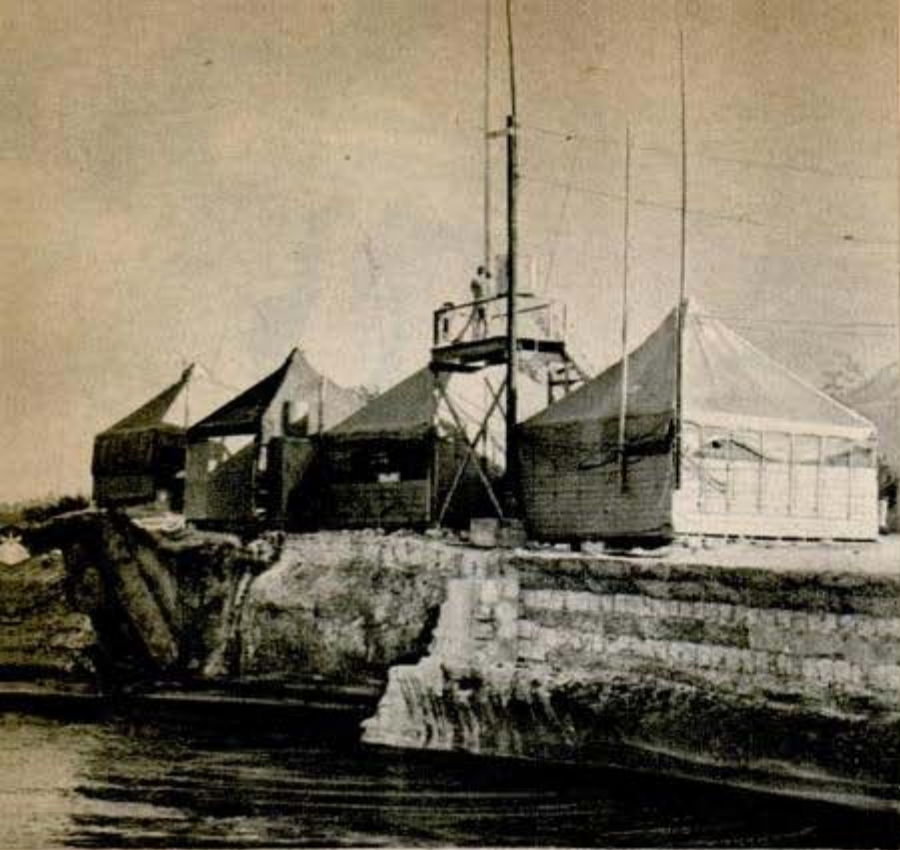

On South Caicos Island, rescue station is built on the edge of a cliff

A radio message is sent out: "Request you institute Aztec plan." Immediately each search agency examines its grid chart and learns which predetermined square area of the Caribbean it will cover. Each square is 26 by 42 miles. Should a plane ditch in another area, other plans such as Camel or Cobra would move the searchers to other squares of the grid.

As soon as a search plan has been put into effect, division headquarters asks Foreign Operations of all ports of aerial embarkation in South Florida to alert crews and to fly subsequent flights over the course taken by the missing aircraft at 1,000 feet altitude until the search is concluded. Radio operators of cargo planes and bombers are instructed to stand by on

the emergency radio frequency over the area.

When wreckage or survivors are spotted in a grid area, the air-sea rescue officer requests change of plans by a message such as: "Request you cancel Aztec plan and concentrate on Dog Three."

When survivors are located, the nearest rescue boats are dispatched to take them aboard. At top speed they follow instructions of a plane which circles the survivors. If the rubber raft that holds the downed airmen contains its "Gibson Girl" radio after the concussion and scramble of ditching, the boat takes a fix on the small radio's signal. Each ATC boat is equipped with a Bendix aircraft-type radio compass, which can "home" on a Gibson Girl radio 50 miles distant and speed

directly to that raft. The moment the tired airmen are spotted, soldiers throw a rope net over the side, ease up to the yellow raft and help the exhausted flyers up the net. Wounded men are fastened to a wire stretcher while still in the raft and hoisted aboard to a well appointed dispensary below decks. Then, while under way either to sheltered water where a PBY can land and pick up the wounded, or off to home base, the airmen are given food and first aid.

The system involves a bookful of occupational specialties from marine engine maintenance man to combination medical specialist and oiler, and all sorts of codes, numbers, mess and supply problems are natural with an Army organization that operates like a navy with its own air arm.

Army flying boat rests at anchor off Mayaguana Island awaiting radio call to search for ditched aircraft



At Palm Beach, the Army's navy headquarters is a houseboat donated to ATC by a Navy commander of that city. The houseboat holds a complete short-wave radio station in its forward wheelhouse, quarters for 40 men, a mess hall, PX, kitchen, officers' mess, orderly room, and tiled bathrooms. This is the center of the communications network.

Men of the air-sea rescue service are stationed on the islands of Cat Cay, Nassau, Great Exuma, Mayaguana, and South Caicos. At Cat Cay, about 50 miles south of Palm Beach, GI radio representatives live where the rich sported before the war. On the walls of its Casino are scrawled the names of princes and playboys. At Great Exuma, the Army sailors live with the Navy, eat Navy chow, and work in closest co-operation with the other service. Two sailors and two soldiers alternate shifts in the base weather station, and their readings are sent out for Army, Navy and civilian weather bureaus.

Each air-sea rescue station has its all-important weathermen, whose observations are indispensable for hurricane warnings and other weather forecasts of the fickle Caribbean.

Men on Mayaguana live in a half dozen tents. Fifteen to 18 of them constitute the white population of an island that has few natives. They are alert day and night to man their boat at the call of distress.

The morale problem could be serious, but it is not. A supply ship calls monthly with food stocks and heavy supplies. Weekly a PBY takes off from Morrison Field with mail, ice cream, fresh fruits, vegetables, eggs, and other perishable foods.

The air-sea rescue service has located several survivors of planes that have been forced down, and has picked up flyers forced down in the vicinity of the various check and rescue points.

Probably the most unusual mission undertaken by the ATC rescue boat concerned a plane that had ditched in shallow water near an island. It was spotted by scores of aircraft flying the route and was reported as a new crash. Finally, a boat was dispatched to dismantle and salvage the plane to reduce the overflow of false alarms from that area of the Caribbean.

American flying men have been lifted from yellow life rafts in rough tropic seas by ATC soldier-sailors. The rescue of one man is checked off as worth all the hardship and troubles.

The rescue service gets high praise from the crews who fly the route. One veteran ATC radio operator said: "Just knowing you can talk to somebody down there every hour to say you're doing fine helps an awful lot."

## Dehydration of Penicillin Speeded by "Radio Heat"



Production of penicillin, the life-saving drug, is speeded up with an all-electronic drying system that reduces a 24-hour operation to just 30 minutes. The dehydration of penicillin has been a stumbling block in its production because ordinary heat methods destroy the drug. The radio-frequency heating units, developed by Radio Corporation of America, consist of a vacuum chamber in which are placed rotators that spin at 3,000 revolutions a minute. Metal belts between the circling rows of rotators serve as electronic plates. The drug can be boiled in a moderate vacuum at 50 degrees Fahrenheit without harmful effects. It was formerly dehydrated by "freeze-drying" with Dry Ice in a vacuum chamber.

## Wool Fiber Made From Peanuts Yields Mothproof Clothing

Peanuts are the base for a textile which will yield warm, inexpensive, mothproof clothing, according to David Trail, research scientist for Imperial Chemical Industries in England. The company has developed a synthetic wool fiber made from peanut protein after oil for industrial uses has been extracted. The fiber can be mixed with real wool, cotton and rayon for manufacture of inexpensive textiles. Trail says the fiber has cold-resisting properties, is mothproof and will hold dyes.

# Lifting FATHER KNICKERBOCKER'S FACE



Photo by Edward Ratcliffe

A billion-dollar "face lifting" is in store for Manhattan (top). Proposed advertising sign for postwar uses balloon for orange

By Allen W. Elliott

THE greatest single face-lifting job ever attempted on any city is scheduled for postwar New York City—in fact, it's already under way. More than \$1,270,000,000 is expected to be spent on new construction within three and one-half years from the day marking "all quiet" on the European front.

Father Knickerbocker, if his mythical spirit still haunts the skyscraper cliffs of the great city, would feel like Rip Van Winkle were he to witness the face lift that is in store. Broadway will become a fantastic canyon of color with huge signs enlivened by motion and three-dimensional effects.

Enough modern apartments will be constructed to house all the inhabitants of a medium-sized city. New roads, docks,

schools, hospitals, tunnels, airports and other projects, some single items costing tens of millions, will spring up, partly to keep returned war veterans working and

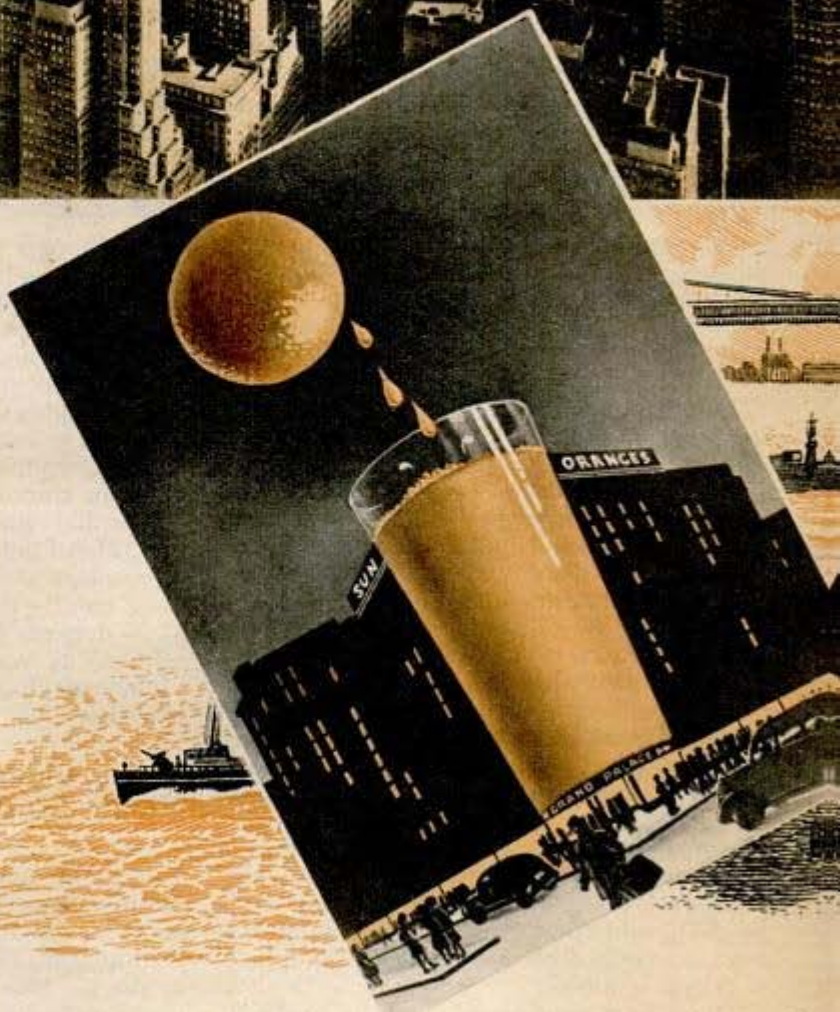

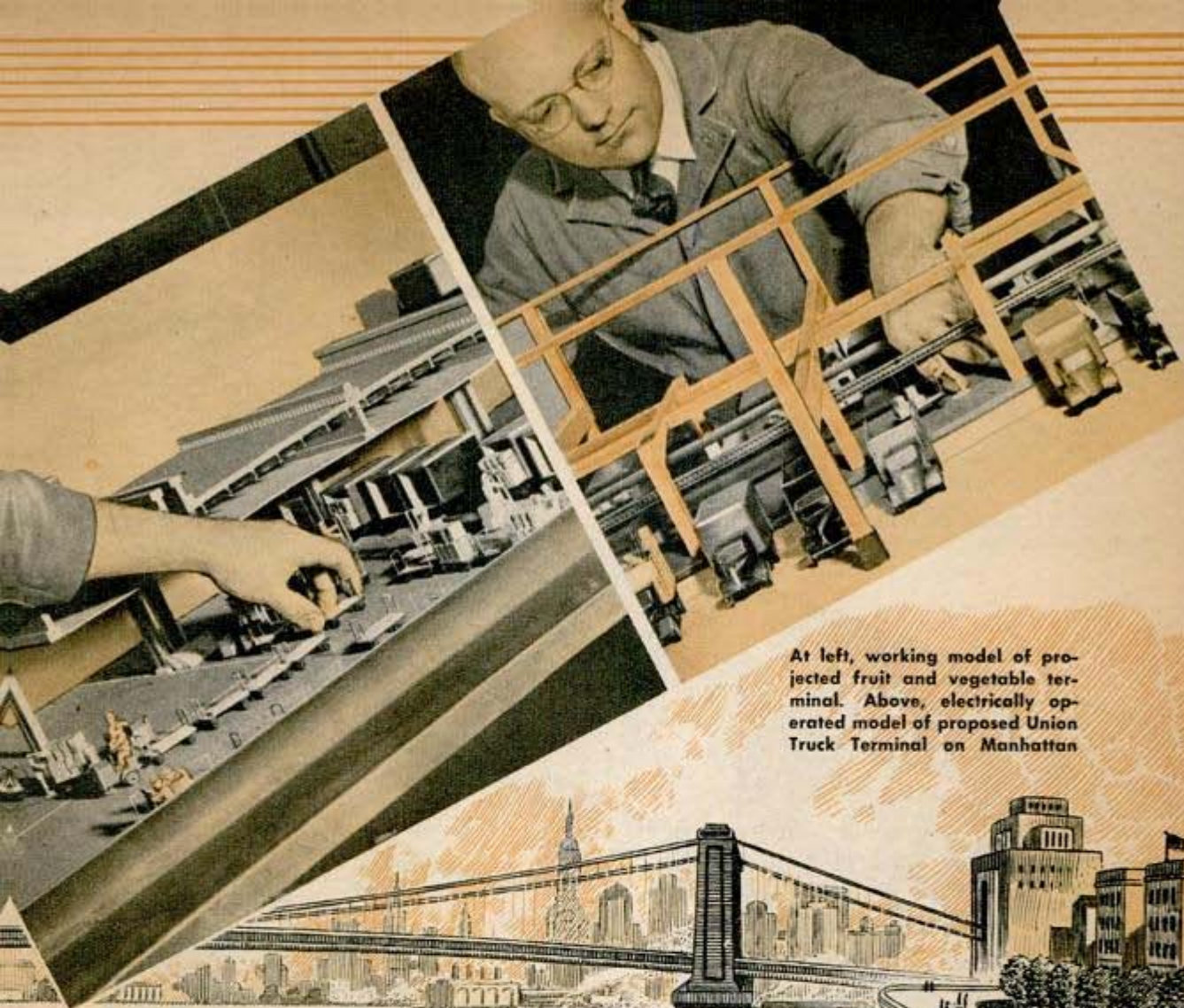

At left, working model of projected fruit and vegetable terminal. Above, electrically operated model of proposed Union Truck Terminal on Manhattan



Right, section of Brooklyn-Queens connecting highway, part of postwar plan. Below, model of traffic ramp to replace 210-foot elevator for automobiles from Queensborough Bridge to Welfare Island

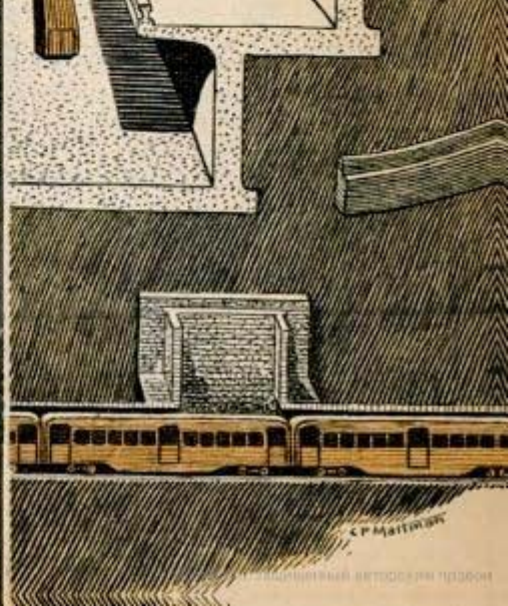
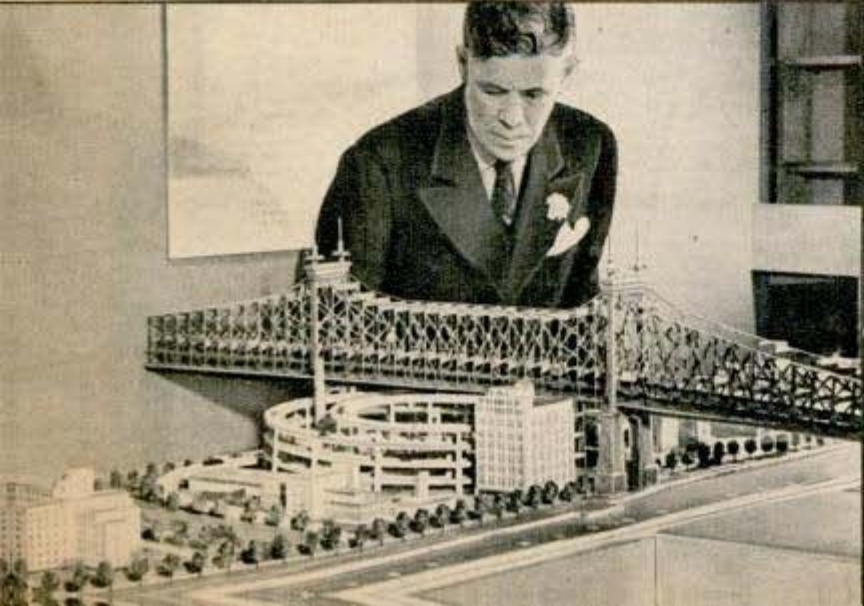

CP Maitland



Top, the tip of Manhattan as planned, with new ferry buildings and extension of recently finished East River Drive

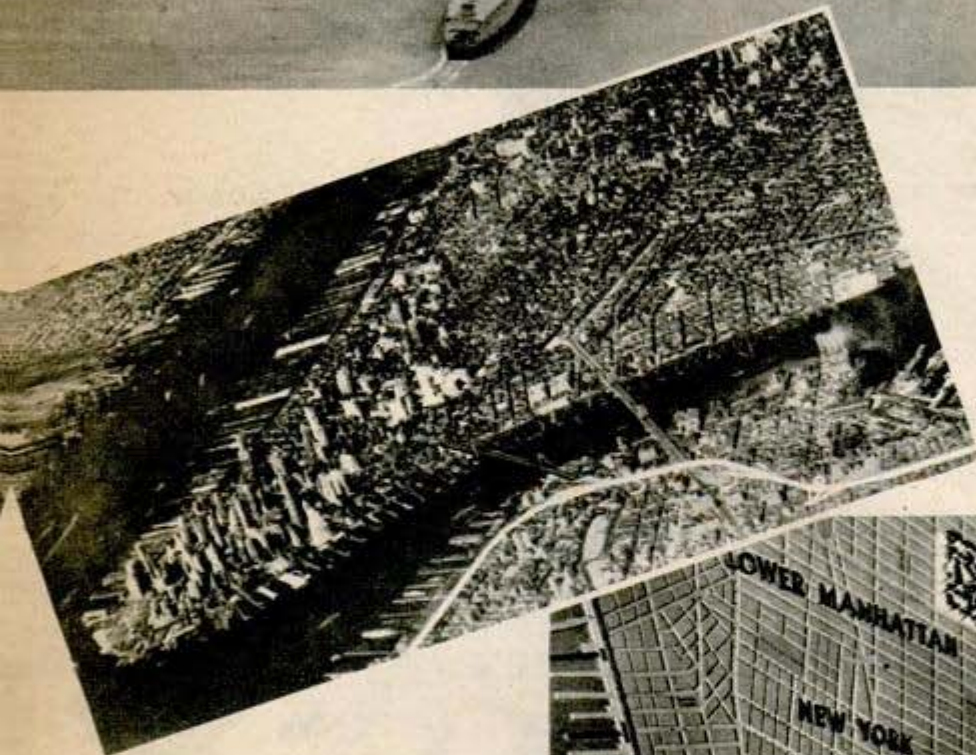

Arrivals by air may catch the view, at left, of lower Manhattan as it is today

At upper end of relief map is the \$50,000,000 "Stuyvesant Town" housing project, below it two other city house projects

partly to catch up with the wartime lag in civic construction which usually amounts to \$100,000,000 a year. The city planning commission has budgeted \$198,317,593 for 1945, and seeks \$147,308,861 more from the U. S. government.

One project alone will give an idea of the "city within a city" of apartments to spring up as soon as priorities on materials are lifted. This is the Metropolitan Life Insurance Company's \$50,000,000 "Stuyvesant Town" to be located in the lower East Side of Manhattan. A short distance away, the city will build its twin housing de-

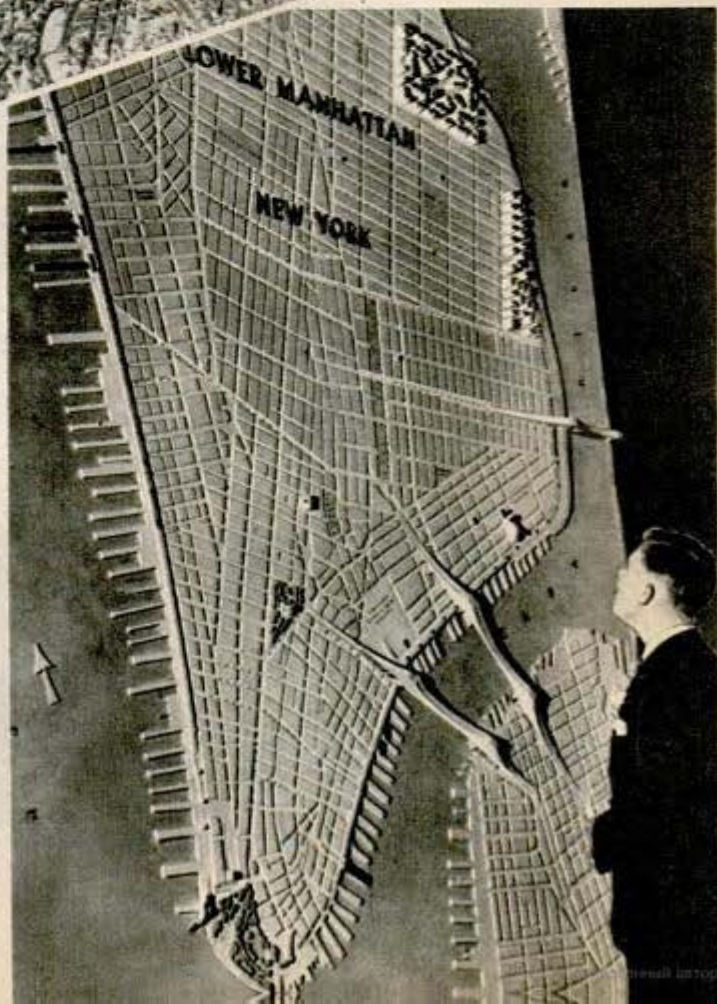



velopment, Lillian Wald and Jacob Riis Houses, to cost around \$20,661,000. Other community and apartment projects raise the total contemplated expenditures well above \$100,000,000.

It is estimated that 1,250,000 persons will be kept busy producing materials for all this construction and about 250,000 will be employed on the construction work itself.

Private enterprises have filed plans since D-day in Normandy for over \$70,000,000 worth of building construction.

Mayor LaGuardia is battling to get construction going to complete the Brooklyn-Battery tunnel, halted by the war. Location of the Manhattan approaches and exits of this tunnel at the tip of the island has resulted in one of the most noticeable changes, the face lifting of ancient Battery Park, which got as far as wrecking of the old aquarium, a colonial-day fort. The changes mostly stopped there, because of the war emergency, but the picturesque spot will look a lot different at the end of the postwar works program. A huge sundial will occupy the site of the aquarium and, on the Hudson River side, a modern ventilating tower for the tunnel will rise above the entrance and exit of the tubes. New structures will house the Marine and Aviation divisions of the police department as well as a



Harlem River Drive, the white area above Triborough Bridge, will be one of first projects. Fragrant soap bubbles as big as a man are suggested for animated sign (left). Traffic at east end of Washington Bridge ravel in orderly threads below





*James Gallagher, Brooklyn Technical High School  
Custodian-Engineer, 29 7th Avenue St., Brooklyn, N.Y.*

## Robot Cook Makes Sandwiches on Mass Basis

To eliminate the "elbow grease" from sandwich-making on a mass basis, a high school in metropolitan New York put into operation a sandwich-making machine with a kind of assembly line system. This robot cook prepares 3,500 sandwiches for the students in an hour. Bread is fed into the machine at two points. The pieces pass under a container, which spreads butter, jelly, marmalade, or cream cheese, and out come sandwiches.

Right, two high school officials run the sandwich maker they devised



## Boxes Dropped 10,000 Feet Land With Contents Intact

Bottles of blood plasma can be tossed out of an airplane at an altitude of 10,000 feet or more, plummet down without a parachute and land intact, if they are packaged correctly. The bottles are surrounded by a packing material like excelsior and put in a wooden box which is tied together with a special kind of steel wire. The wire is made of a strong alloy steel and applied by a simple, hand operated machine which binds the wires together into a strong, twisted tie. When the box hits the ground,

it bounces end-over-end about 30 feet back into the air. Whether it has dropped 100 feet or 10,000 feet the impact and resulting bounce are about the same, since the wire binding acts as a shock absorber, giving a little and absorbing most of the bursting effect produced by the fall. In this manner plasma has been delivered to beleaguered troops by the Allies for more than a year; parachutes could have been spotted by the enemy or drifted into enemy hands. Each box weighs about 100 pounds.

## B-29 Model Lays Smoke Screen While It Rides on 100-Yard Cable



Troops at Camp Lee, Va., are trained to advance under a screen of smoke laid by a B-29 model equipped with spray tanks. The 12-pound model runs along a sloping 100-yard cable, and has been used for training units up to 250 men. Tear gas has also been used with the model, which was built by the camp's chemical warfare service unit. Experiments have been conducted with a smoke bomb dropped by a trip wire release from the miniature B-29.

☐ Only 14,000 patents were issued during the first six months of last year, a drop of about 7,000 patents from the same period in 1939. This was the lowest number of patents taken out since the first 10 years of this century.

# COMING DOWN



Above, paratroopers landing on Noemfoor Island. B-17 keeps watch overhead. Below, pilot chute which opens first, jerking open big chute

**P**OSSIBLY you have enjoyed second-hand thrills reading about the experiences of paratroopers and the thousands of daring airmen who parachuted to safety during the war. Perhaps you failed to realize that the parachute may have an important part in your own life before long.

The great, white floating blossom which spells safety in the sky is likely to be as familiar to the average American as a fishing pole, a shotgun or a picnic lunch basket.

The postwar years will greatly increase civilian plane ownership and sky riding. Parachutes have become so simplified and efficient in operation that Uncle Sam may require most civilians to wear them while in

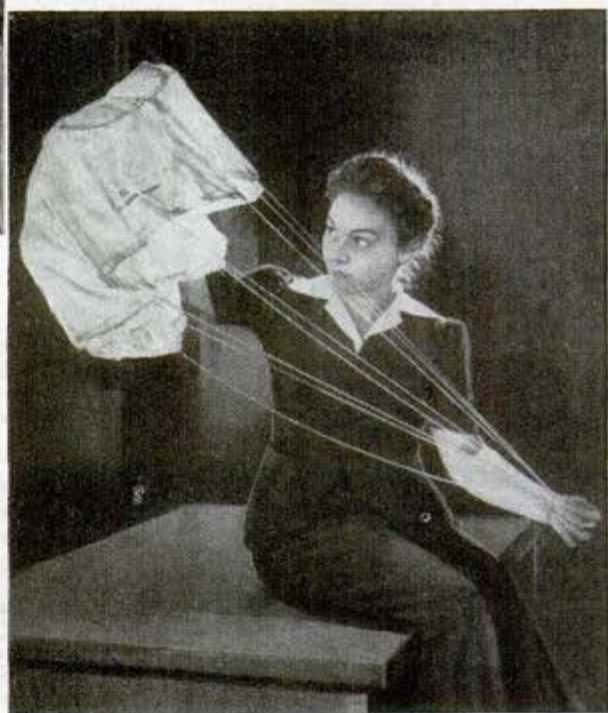



Above, attaching shroud cords to the straps of a parachute

the air. "Hitting the silk" will be almost as commonplace as flying itself—only it may be called "hitting the nylon" because nylon has proved better in many ways than silk. "Hitting the nylon" is likely to become a sport or a diversion like skiing, skating or picnicking.

The parachute industry itself bloomed from four companies to 28 during the early months of the war. It made more chutes in a wartime week than a prewar year. The industry has established meticulous standards of manufacture and testing which have made the parachute safe and fostered scientific research which has condensed the chute from a bulky nuisance to a trim necessity.

Before the war, a standard chute was a cumbersome, leg-banging or back-humping load of 26 pounds. Now, even with additional safety features, the Pioneer Parachute Company, Inc., of Manchester, Conn., has reduced the weight of a standard parachute to a snug 18 pounds.

FEBRUARY, 1945



Above, nylon threads are woven into parachute shroud lines. Below, suspension rig determines how harness innovations fit under body weight



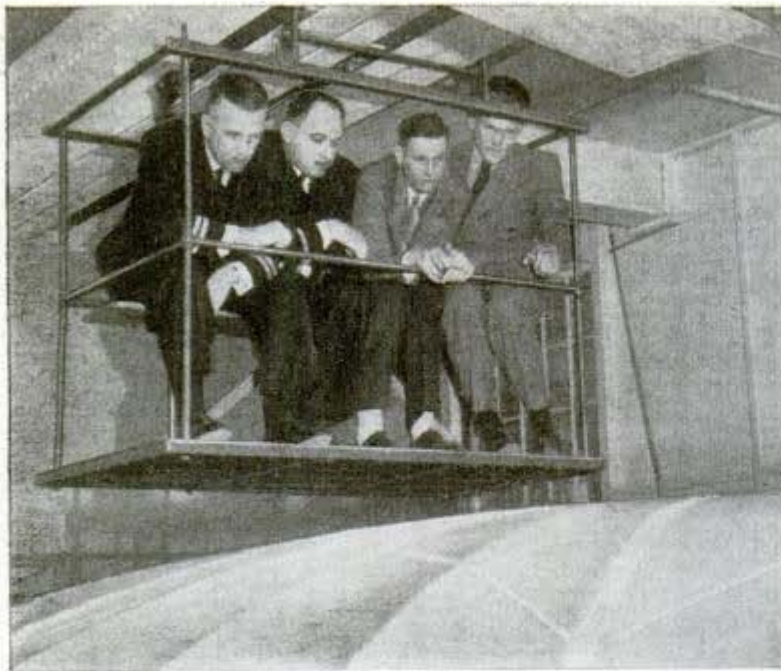

the 185-pound man to the 105-pound wife or the 70-pound child. This will probably be a modified version of the standard 24-foot diameter military chute now in use. Above 225 pounds, a 28-foot chute may be required.

Small children may have diminutive chutes, but the standard, 24-foot job is generally necessary since a man might accidentally put on the adjustable harness of the smaller chute intended for a woman or child, with unfortunate results. It is interesting to note that in the event a family of three were to bail out because of engine trouble at 5,000 feet, the 70-pound child would reach the ground in about six minutes, 24 seconds and the 105-pound wife in five minutes, 12 seconds, but the 185-pound man in four minutes, 37 seconds.

In the case of the child, it is likely that a static line would be used to trip



RIGHT

WRONG

Above, watching the canopy tester and awaiting bursting of chute. Left, if chutist is oscillating during descent, correct way to land is with feet together to distribute shock. Below, nylon chutes ready to ship

According to Lyman H. Ford, vice-president of the company, the postwar civilian parachute will weigh around 15 pounds and will be no more of a burden to carry than a picnic blanket. Like the military parachute, it will be foul-proof and fool-proof.

"Today," he says, "any person who can step out of a plane and pull a rip cord can parachute safely. It isn't necessary to count 10 or any other number. You don't have to be an acrobat. Or a daredevil, either. Landing is just like jumping from a height of six feet or so. A bend of the knees, a roll and that's all there is to it."

There is likely to be only one size parachute in the civilian plane to care for the needs of ordinary passengers ranging in weight from



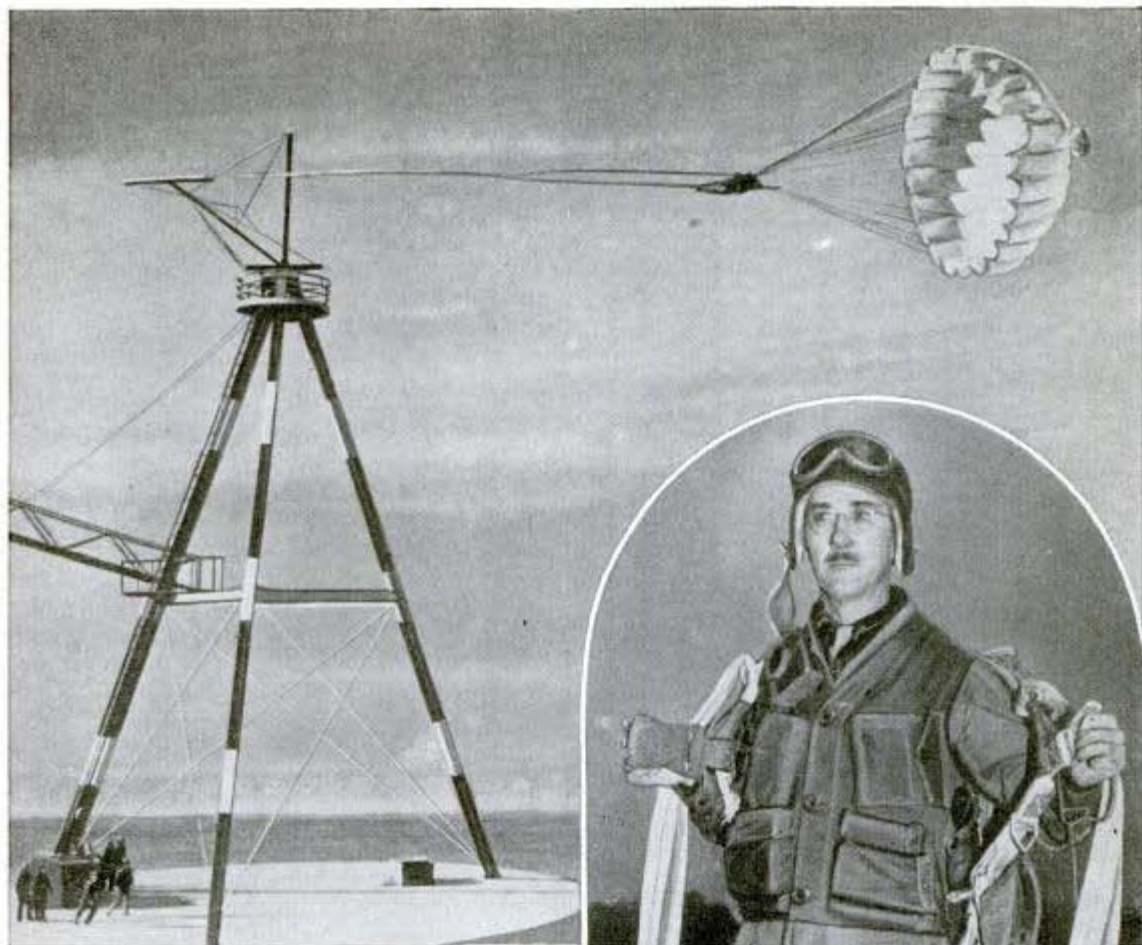

Above, a test tower at Pioneer plant whirls chute at 300 miles an hour before the rip cord is pulled

the parachute. A static line is a rope attached to the plane and to the rip cord device on the chute so the chute will be released automatically when the end of the line is reached as a person bails out. The same arrangement is possible for the family dog or cat, with the animal wearing a parachute on its back and a harness attached around its body and anchored by the four legs.

For very small children or babies, a parachute harness without a chute may be worn. Instead of the chute, there will be snaps and webbing attached which can be snapped onto the harness of the chute worn by mother, father, or older brother or sister. Such an arrangement would preclude the possible loss of an infant from the arms of an adult when the usual yank of the blossoming chute transmits itself into a jerk on the harness.

The 24-foot wartime chute, with its 65 square yards of fabric and 800 feet of cord, has been made of white nylon until recently when the camouflaged parachute was invented to evade Japanese jungle snipers. The camouflage patterns are so attractive that the family chute may be



Above, life vest for stranded flyers. Below, examining vent through which air escapes as chute descends



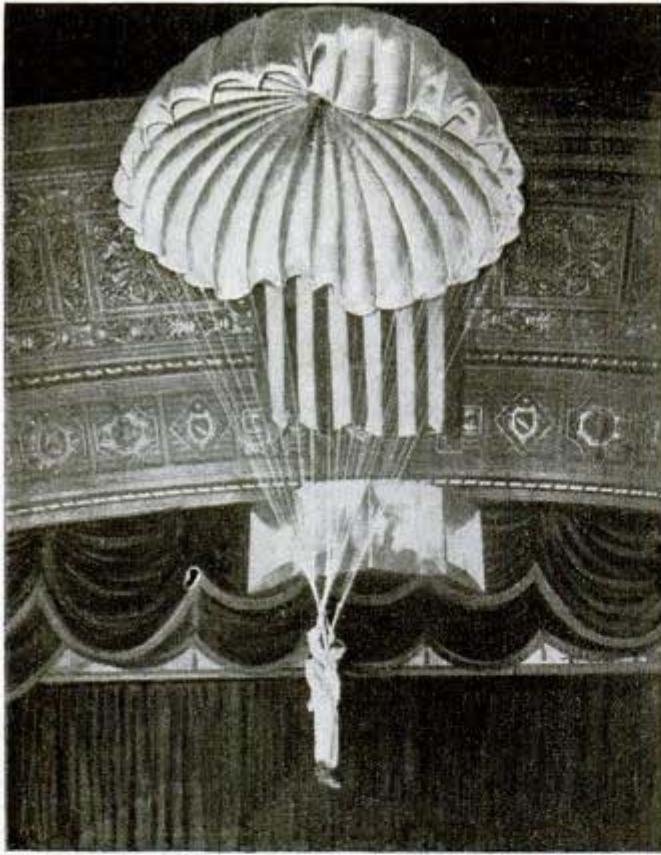

Above, world's record for low leap—82 feet by Carl Rupert in a theater. Below, modern chutes are repeatedly inspected. Here a completed chute is examined under fluorescent lights



colored to match plane interiors or to avoid necessity of repeated washings, since a chute is often soiled when it hits the ground.

If you have an idea that people are lucky to be alive after they bail out, consider Joe Crane, parachute expert for the Pioneer company. As a stunt parachuter and tester, Crane has made 688 jumps. In all this time he has broken his left ankle twice, sprained his right ankle and cracked a few teeth, although he has leaped with four parachutes open at one time, deliberately landed atop buildings, jumped at night, blinded by searchlights, and has taken chances no civilian will ever face.

Crane, who is president of the National Parachute Jumpers' Association, says that a jump in a modern parachute requires only a cool head, some common sense and the necessity of keeping your mind on your business.

"It's a lot more interesting than it looks from the ground," he says. "A parachute really bobs like a cork in the air currents. Some actually go up for a time, instead of down, if rising currents catch them.

"By pulling cords a surprising maneuverability can be attained and once, as a stunt, I agreed to land on top of a friend after bailing out 2,000 feet from where he stood on a flying field. I didn't do so, but it was because he sidestepped just as I hit the ground where he had stood. Another time I brought down a basket of eggs, unbroken."

Test towers, hydraulic canopies and mechanical "fabric detectives" are among the scientific devices which have put daring jumpers like Crane and Ford behind desks, serving our military flyers and preparing for the civilian needs of the future.

The test tower at Pioneer is a huge steel structure which whirls parachutes around at speeds up to 300 miles an hour or more, opening them with the tremendous force they are likely to meet when used by airmen on speedy warplanes. A high-speed motion picture machine, faster than the eye, records what happens when the rip cord is pulled, when the chute catches the air and when the great canopy blooms into graceful lines of safety.



To determine where a chute is most likely to fail under stress, it is spread over a canopy which uses hydraulic pressure to give even force. The strain is gradually increased until the fabric splits. Trained observers, stationed on a platform above the canopy, watch the fault develop. In another test, a parachute is laid flat on the floor and the strain is applied slowly to the ropes.

The "fabric detective" is a machine which tests the porosity of the material used in the parachute canopy. It automatically records the number of cubic feet of air per square foot per minute that flow through the fabric under a given differential in pressure. Before the fabric is approved for use it must meet rigid and specified maximum and minimum porosities.

Thanks to these men and machines, the time may soon come when you may be talking the language of parachutes—discussing bridles and cones, D-rings and drifts, fillings and flaps, oscillation and peaks, pull-offs and streamers.

But you won't need to remember all these things—just remember to pull the rip cord when the time comes.

### Paradoctor Jumps With First Aid For Isolated Crash Victims



Medical officers are trained as rescue parachutists with the Army's 2nd Air Force. Wearing a football helmet and a kind of catcher's mask, and weighted with bundles and first-aid kits, the paradoctors are prepared to jump into isolated places to minister to the survivors of crashes.

### Bag for Garbage Snaps Shut To Keep Out Insects



Garbage is neatly disposed of in a paper container suspended from a special metal frame which can be attached to a cupboard door or drawer. Equipped with crossbars and spring, the bag seals tightly to keep unpleasant odors in and insects out. It is made of heavy wax-covered paper, and the frame is available in either screw-on or hang-on models.

### Wrench Signals Eye, Ear, Hand On Reaching Desired Torque



A three-sensory wrench developed by the P. A. Sturtevant Co., Addison, Ill., operates according to sight, sound, and feel, with a trigger finger that can be set at any signaling point. When the desired torque is reached, the sensory action of the wrench sounds a loud, clicking signal, imparts a strong impulse to the hand, and visibly indicates the torque on a dial.

# Cloth-Paper Runway Is Rolled Out on Airfield



Above, the underside of P.H.S. Note black surface showing that the asphalt coating has been cut back. A new roll of P.H.S. is being started



Above, laying cloth-paper runway on a new landing strip. Below, threading "stamp licker" with new roll of P.H.S.

Air Force Engineers who seemingly worked miracles in building over 100 airfields in France between D-day and Oct. 12 were using P.H.S. (prefabricated Hessian surfacing), a new type of easily transportable runway which is laid by machinery in rolls three feet wide and 300 feet long. P.H.S. consists of a cloth layer between two paper layers, thoroughly impregnated with bitumen. It will only support a load that the original dry soil will take, but it excludes water and keeps the sub-grade dry. The sub-grade is graded, compacted with the sheepfoot roller, and then rolled smooth. Finally P.H.S. is applied by the "stamp licker" machine towed behind a truck. The material is unrolled, the under surface moistened by a solvent and passed

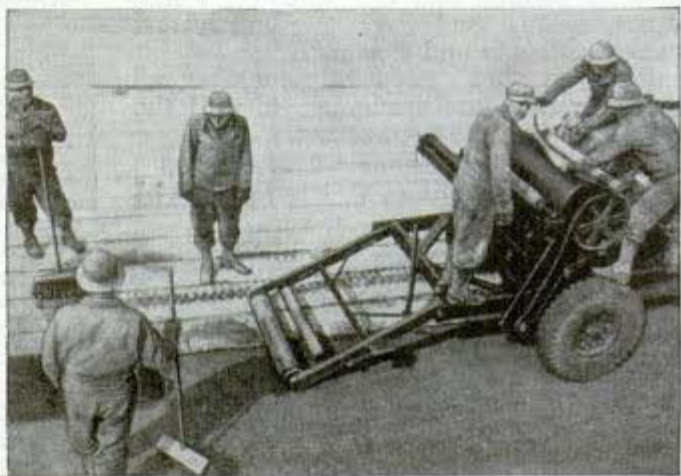

through rollers, the last one pressing it against the ground. Each strip overlaps and sticks to the preceding one. Rolling follows to keep the surface precise. After grading, the process takes about 15 hours for a runway 120 by 3,600 feet. This type of runway will carry planes up to fighter-bomber weight without undue damage.

## Phone Wires Carry High Fidelity Television Broadcasts

High fidelity transmission of television over standard telephone wires has been developed by the Packard Manufacturing Corporation. For the new, simpler method of video transmission, coaxial cables are not required, according to Homer Capehart, president of the company. In a demonstration Capehart showed that when the coaxial cable customarily used is replaced with a twisted wire—a common lamp cord—there is no change in the clarity or definition of the picture. The same results were achieved when the twisted wire was

replaced with a single wire. Capehart said this development, still a technical secret, makes nation-wide television broadcasts practical via existing telephone lines and eliminates the need for installing coaxial cable systems at approximately \$10,000 per mile. A Capehart method of recording television programs for rebroadcast in the same manner that radio programs now are transcribed also has been developed. This was achieved by increasing the sensitivity of recording beyond the 8,500-cycle maximum attained by present methods.



## A Pair of NAUTICAL LAMPS

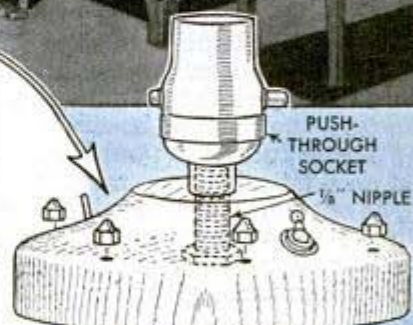
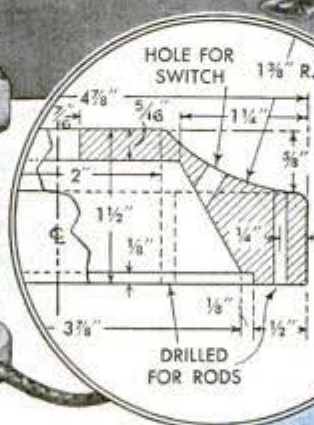
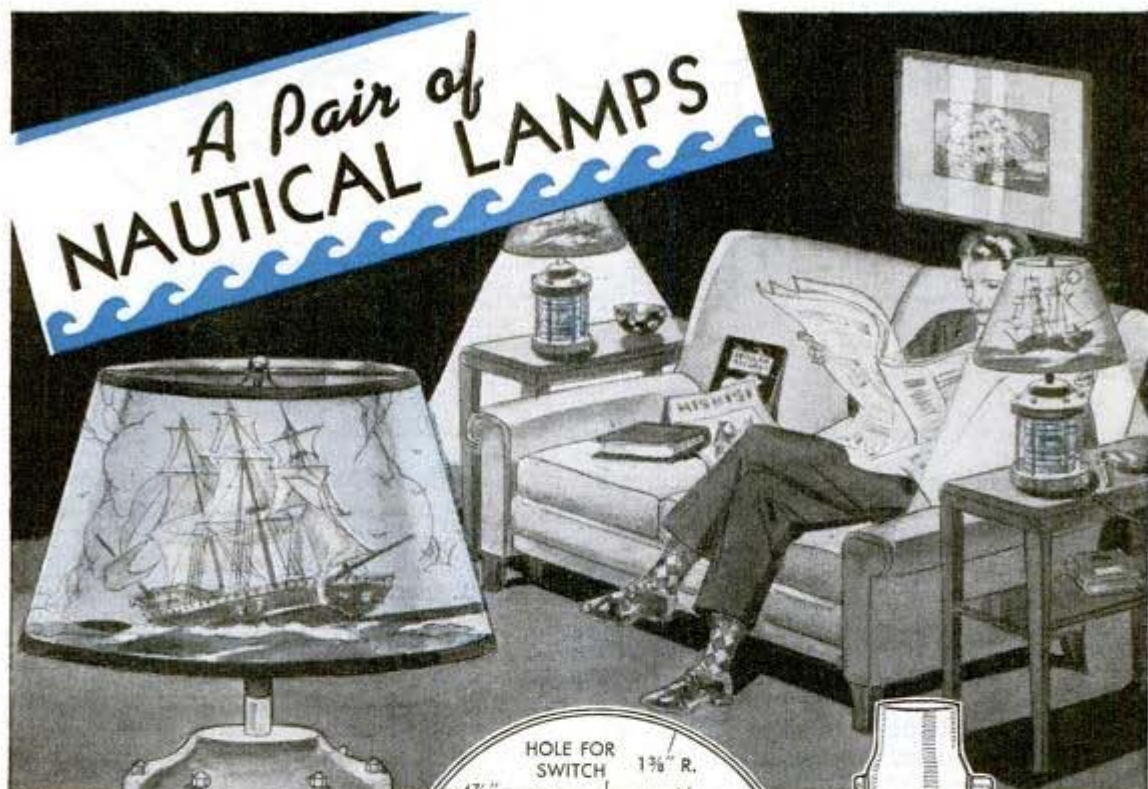

By D. C. Cline

**J**UST the thing for the nautical-minded craftsman, these lamps, of the lighted-base type, represent port and starboard running lights of a sailing vessel. Tops and bottoms can be made of metal, plastic or hardwood. The latter can be worked easily, is less expensive and takes various finishes to suit the individual taste.

First, the bottom is turned to the dimensions shown in the rectangular detail, and recessed to fit the edge of the lens. Then holes are drilled for the wire and the rods which hold the assembly together, the holes being counterbored for nuts on the rods. Dimensions of the top are given in

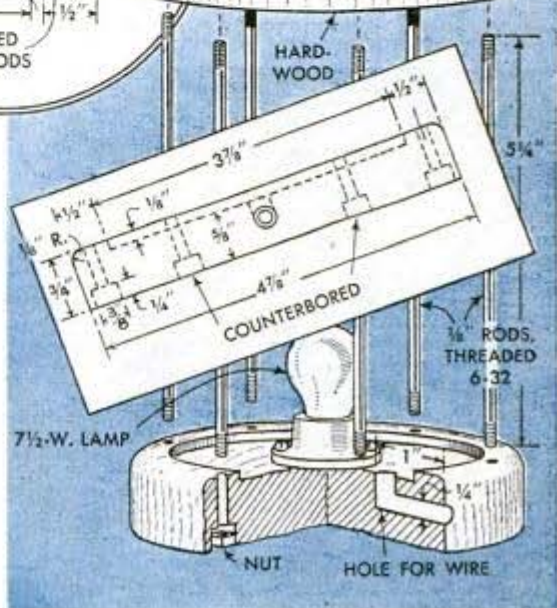

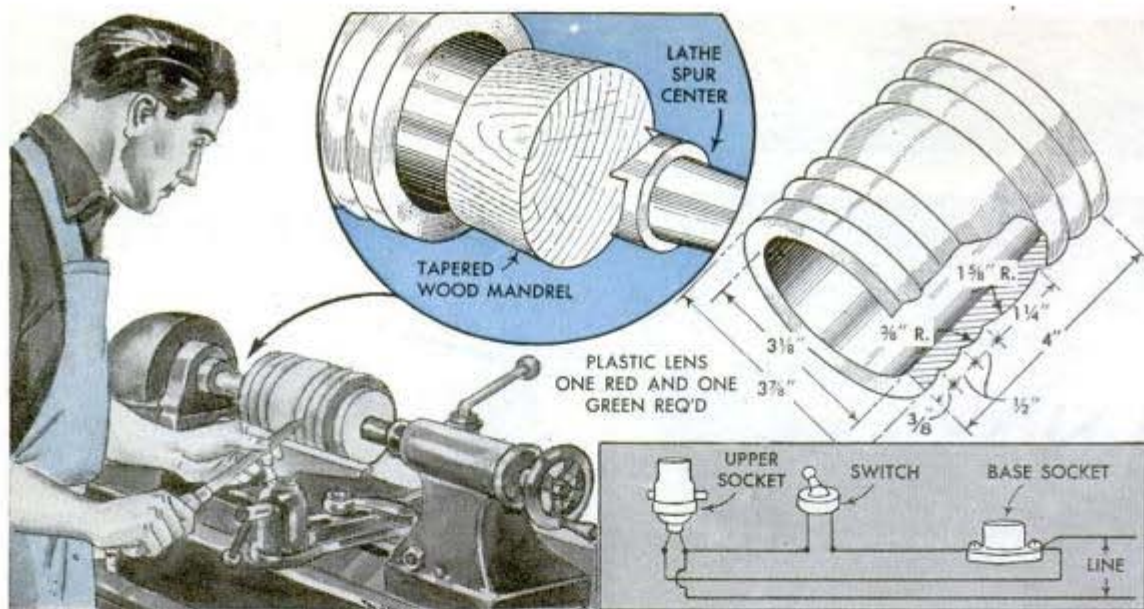

the circular detail. This, too, is recessed for the lens, and holes are drilled for the rods, toggle switch and the nipple that supports the lamp socket. Holes for the rods must align with those in the bottom.

For the lenses, choice of material is varied. They can be made of translucent, colored plastic tubing, or glass lenses, known as Fresnel lenses, can be obtained in many sizes, shapes and colors from marine supply houses. If you intend to use glass lenses, you should get them first and then turn the top and bottom to suit.

If plastic tubing is used for lenses, it is held on a tapered wood mandrel for turning, as shown. When turning, care should be taken to avoid excessive heating of the chisels, which destroys their temper and edge. When turning some plastics, there is

more tendency for the chisel to dig in and spoil the work than in turning wood. After the lenses have been turned, they are sanded with 0/7-grit wet sandpaper and then polished to a high luster on a buffing wheel with plastic-polishing rouge. Then the inside is sanded—also with a fine-grit paper—to give a frosted effect so that, in use, the small lamp inside will transmit a glow without actually being seen.

Sockets now can be wired as shown in the wiring diagram. Note that a toggle switch controls both the lamp inside the lens and the one above, and that the latter can be controlled separately by a push-through switch which leaves only the lens illuminated as a night light. All parts now are assembled, and the rods are tightened in place with acorn nuts.

## Holder Clamps Round Work for Cutting Off on Band Saw

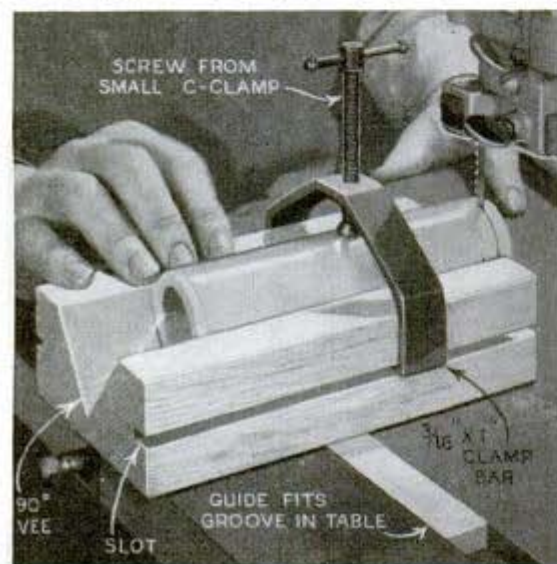

Metal or plastic cylinders and rods can be crosscut accurately with this jig. It is made from a hardwood block measuring about  $1\frac{3}{4}$  by  $3\frac{1}{2}$  by 6 in. A guide strip fastened to the underside fits in a slot in the band-saw table. The clamp is made from flat iron which is drilled and tapped to take a screw from a small C-clamp.

## Cellophane Protects Eyeglasses

Eyeglasses can be protected from splatters while painting if covers of Cellophane are slipped over the lenses. Wrappers of the type used on cigarette packages are convenient for this purpose. The same method also is effective to protect the lenses of goggles from damage by abrasive particles when using an emery wheel.

—E. M. Fellows, Morrison, Ill.

# "Horse Race" Adds Excitement to Quoits Game

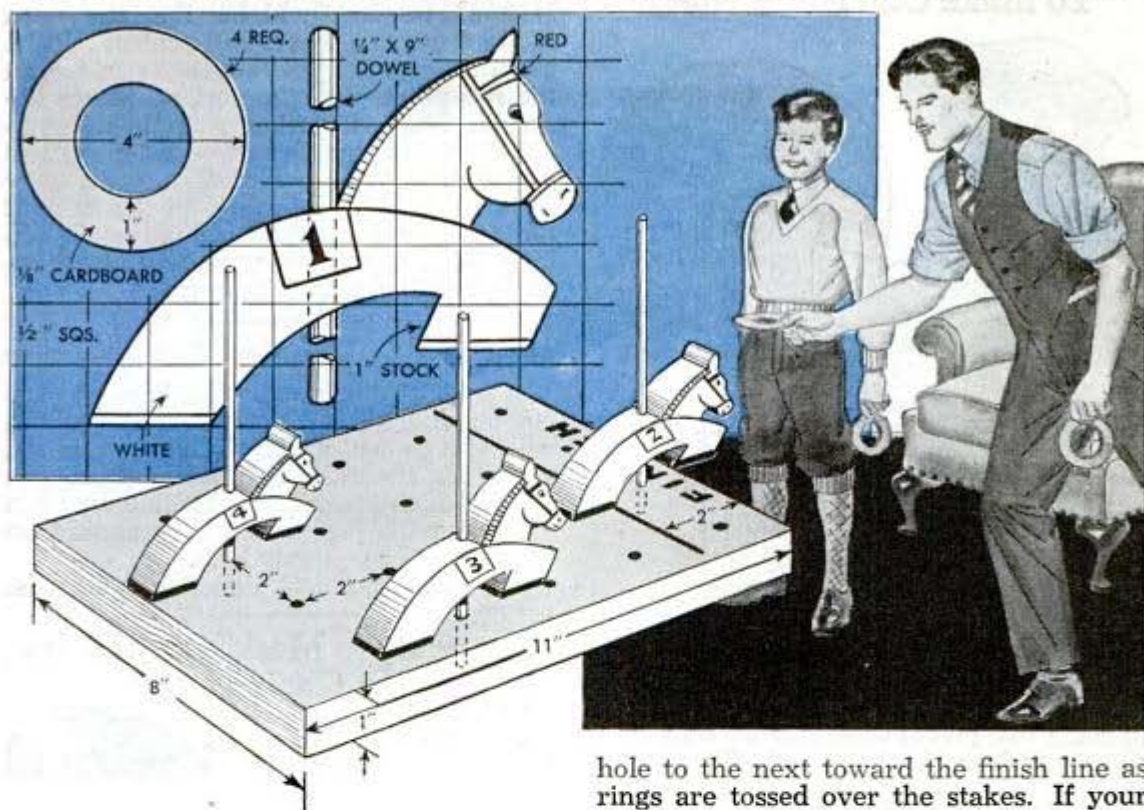

This easy-to-make game, which combines the thrills of a horse race with the fascination of quoits, assures a good time at any party. Also, the game is excellent for stay-at-home evenings when members of the family can vie with one another. The horses are moved progressively from one

hole to the next toward the finish line as rings are tossed over the stakes. If your opponent rings your horse, you move it forward. Therefore, your chances of winning the game depend not only upon your own skill in tossing the rings, but also upon your opponent's poor aim. For a more exciting game, or to provide entertainment for several players, a larger board can be made to accommodate more horses.

## Elastic Bands on Heels Prevent Rubbers From Pulling Off

If your rubbers are so loose-fitting that they come off easily, especially in snow or mud, slip a couple of wide rubber bands over your shoes at the heels, as shown, before putting on the rubbers. In most cases sufficient friction will be provided between

the shoe and rubber, at the point where the pull is greatest, to keep the rubber in place.  
—G. E. Hendrickson, Argyle, Wis.



## Nails Prevent Birds Roosting On Beams in Barns

If you would like to keep birds from roosting on beams in your barn or garage, just drive three rows of nails in the upper surfaces of the beams as indicated. Nails in the center row should be driven vertically and those in the outside rows should be driven at an angle to overhang slightly the sides of the beam.



## Two Pieces of Plywood Spliced To Make One Large Panel

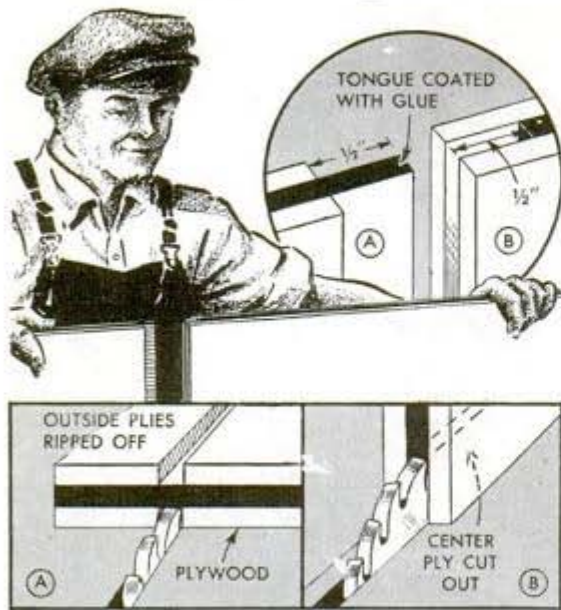

When a plywood panel larger than any available is needed, one can be made by splicing two pieces together. To do this, a tongue is formed on the end of one piece as at A, and the end of the other piece is grooved as at B. On  $\frac{1}{4}$ -in. plywood, the groove can be made by cutting out the center ply on a circular saw, and the tongue can be shaped by cutting away the two outside plies. The panel is assembled by coating the tongue with glue and pressing it into the groove. Wood plastic or filler can be used to fill any small cracks at the splice line. After the glue has dried, the joint is sanded smooth and the panel used without any danger of its warping or buckling.—Michael Ligocki, Gary, Ind.

## Replacing Broken Fuel Filter Bowl

On finding that the glass filter bowl between the fuel pump and the carburetor had been broken, one motorist used an empty cold cream jar as a substitute. The jar, stronger than the original, gives good service.—Jos. Schafsack, Long Island, N. Y.

## Easy Way to Mortise Railings

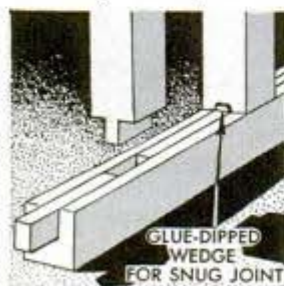

Where numerous small mortises for vertical strips are necessary in making railings for cribs, playpens, etc., you can do the job neatly and quickly by grooving both the

rail pieces. After this has been done, a thin filler strip is cut to fit snugly in the groove. It should be slightly higher than the depth of the groove so that it will project a little. Then the mortise positions are marked on the rail pieces and the vertical pieces inserted. Next, the filler strip is cut into lengths to fit snugly between the vertical pieces and glued or nailed in place, after which it is planed flush with the rail. If the tenons on the vertical pieces fit too loosely in some places, wedges can be driven in beside them as indicated.

## Nail Polish Repairs Pen Threads

Stripped threads on a fountain-pen cap often can be improved by coating them with nail polish, which should be allowed to dry for several hours before the cap is put on. If the ventilation holes have been plugged with the polish, they should be opened or the pen may leak.

—C. J. Bennett, Vancouver, Canada.

## Template to Mark Rung Holes In Chair Legs

When boring rung holes in chair legs and similar turnings the holes can be located accurately in duplicate work by using a template like the one shown. It is merely a paper sleeve which slips snugly over the work and has the drilling positions marked on it. In use, hold the sleeve flush with the same bead or undercut portion of each duplicate turning. Then the drilling positions can be transferred from the template to the work with an awl or sharp nail.



## Vacuum Cup for Pantograph

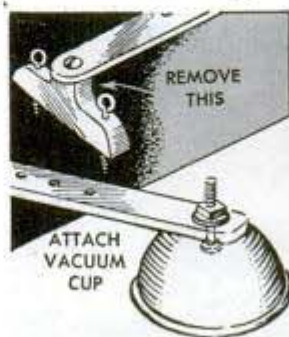

Often having occasion to use a pantograph on a surface where it was inconvenient or impossible to anchor it with screws in the usual way, one artist substituted a vacuum cup for the attachment cleat. The cup permitted

attachment of the instrument to any hard, smooth surface without marring it.

—A. H. Waychoff, Phoenix, Ariz.

# 3 Navy-Style GIFTS for men

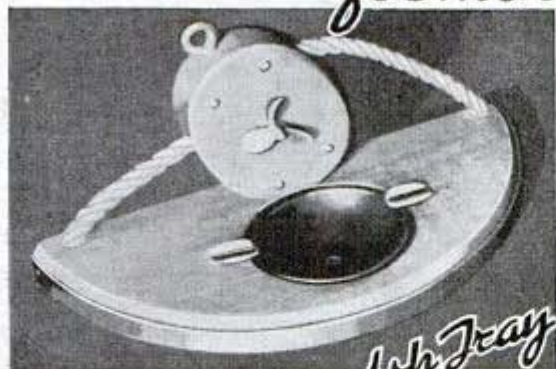

*Ash Tray*

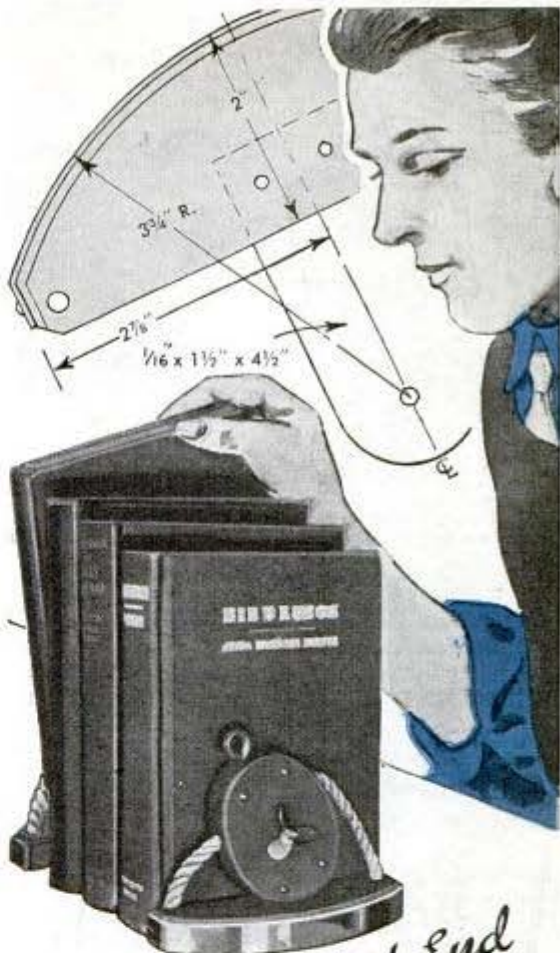
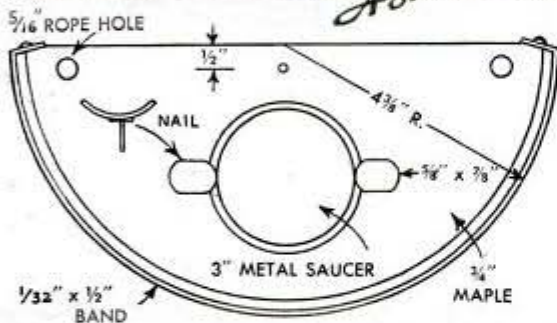

*Book End*

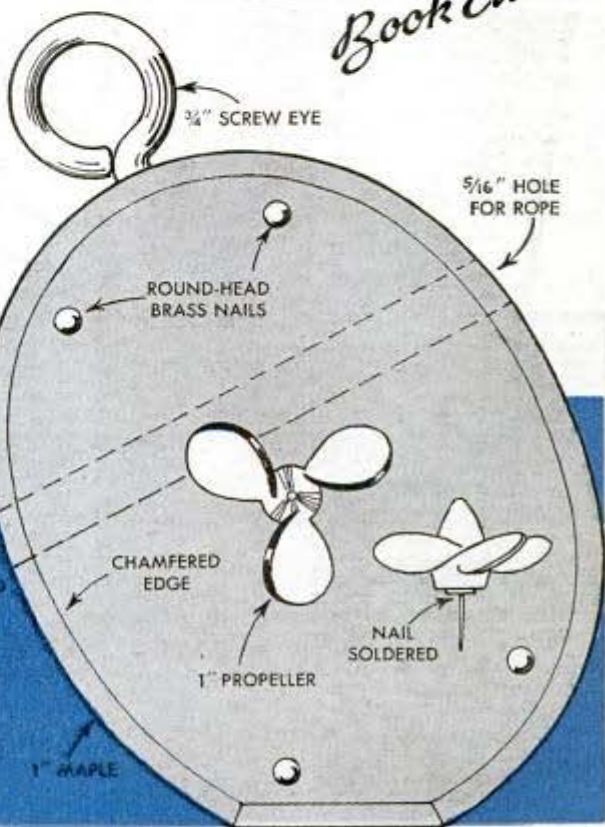

These three gift items all have the same motif, and will add a distinctive nautical touch to any room. Although brass is preferable, other metal will do for trim, but nails and metal parts should match. Use hardwood having a close grain. If desired, you can match it to the furniture of the room in which the pieces are to be used. If you make all three pieces, be sure to use the same size rope. Felt should be glued to the underside of the bookends and ash tray as these may be placed on polished table surfaces

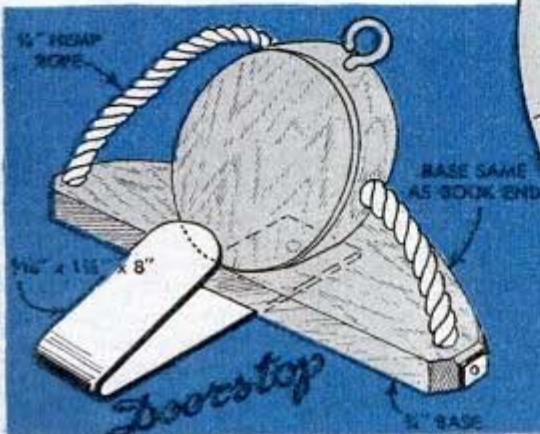

*Doorstop*

# Solving HOME



1—If you have no mixing faucet on your laundry tubs or kitchen sink, it is easy to improvise one from a length of garden hose which has an opening cut in the center. On faucets that have threaded ends, use hose connectors

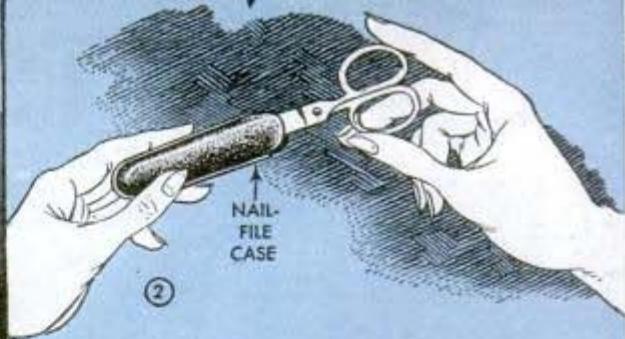

2—To carry scissors safely in your bag, slip a nail-file case over the pointed end

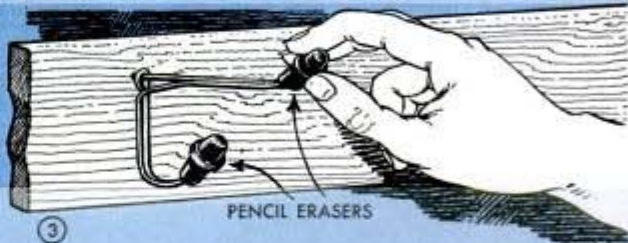

3—When it is necessary to hang several garments on a clothes hook, slip a couple of erasers over the hook ends and you can remove one garment without all of the others sliding off



5—To give rice a quick and thorough cleaning, put it in a bowl partly filled with water and stir with an egg beater of the rotary type



4—Clay flowerpots that have been broken can be repaired neatly by using an adhesive that consists of fine brick dust and ordinary household cement mixed to the consistency of a thick paste

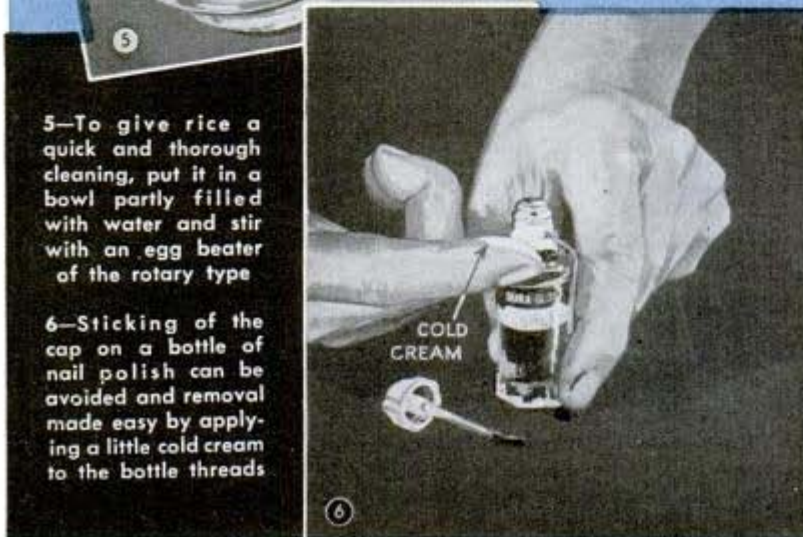

6—Sticking of the cap on a bottle of nail polish can be avoided and removal made easy by applying a little cold cream to the bottle threads



# PROBLEMS

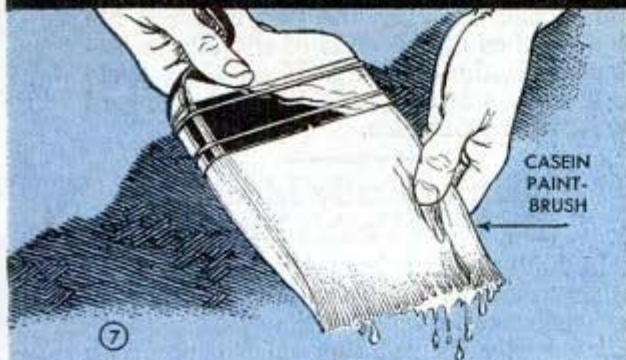

7—Be sure a casein paintbrush is free of water, otherwise the first brushful will be diluted

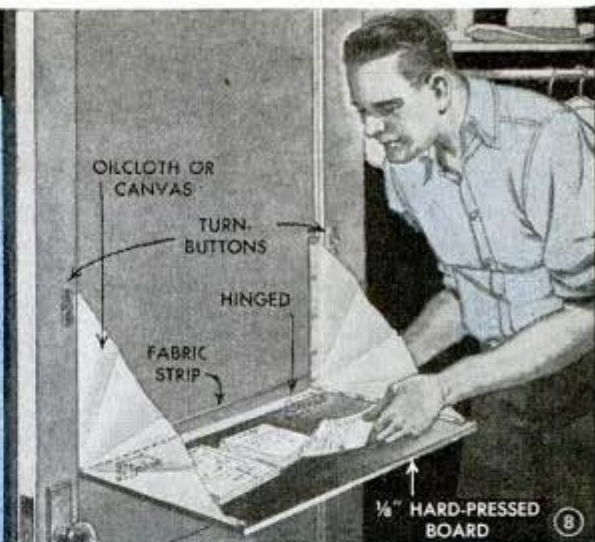

8—Hinged to a closet or pantry door, and held with canvas or oilcloth at the ends, a shelf of hard-pressed board provides a handy compartment for bills and receipts, and serves also as a writing surface when making notes



9—If you have rubber casters on some of your furniture and they make black marks on the floors, just wrap adhesive tape (not friction tape) around the casters to act as tires

10—A small child in your home can be prevented from tampering with the fire in a heating stove or from getting burned against it if you merely set the play pen around it as indicated



11—An easy way to use soap scraps is to dry them thoroughly and then run them through a food chopper; resulting powder is handy in dishpan



12—To remove a cork from a bottle, pour in a little ammonia and leave it for 48 hours. The ammonia will eat away the cork so that it can be shaken out

## Hinged Bracket Supports Door For Planing the Edges



When trimming or rehanging doors you will find a bracket like the one shown a great help in supporting them for drilling or planing the edges. The bracket is made from two pieces of hardwood with a notch cut at a slight angle in the inner ends to form jaws, and the two parts are hinged on the bottom so that the weight of the door, pressing on the joint, will force the jaws tightly together. The bottom of the bracket is recessed so that the hinge pin will not mar the floor. By inserting a wedge between the door and one jaw, the bracket may be used on doors of various thicknesses.

## To Keep Dust Off Buffing Wheels

Oiled silk covers used on refrigerator dishes will serve as protective hoods for fine buffing wheels. One of these covers snapped over a wheel after use will prevent dust and oil from accumulating on it.

## Clip Keeps Pen on Ink Bottle



If you are troubled by having your penholder roll around and mar your work, here is an easy way to keep it right on the ink bottle where it al-

ways will be on hand. Cut a strip of spring brass or steel about  $\frac{1}{2}$  in. wide and bend it so that it will clip snugly to the sides of the bottle. To keep the pen in place file two notches at the ends of the clip as indicated in the drawing. If an old bicycle trouser clip is available it can be shaped to serve the purpose.

## Toiletries Easily Identified By Nail Polish Initials

In households where toothbrushes and other toiletries belonging to different persons often are confused, they can be identified easily by painting on the name or initials with colored nail polish. This method also is effective for cold cream jars, combs, hair brushes, powder boxes and other articles.

## Wood Inlay Simulated With Dye

An excellent method of imitating strip inlays on work is to use penetrating water dye. First the inlay is laid out in pencil and all but the part to be inlaid is "stopped out" with waterproof varnish. After this has dried, the wood is sponged with the dye. When dry the work is sanded to remove the varnish and smooth the surface. The "inlay" may be made with more than one color of dye, allowing each to dry before applying the next.—Ken Murray, Baltimore, Md.

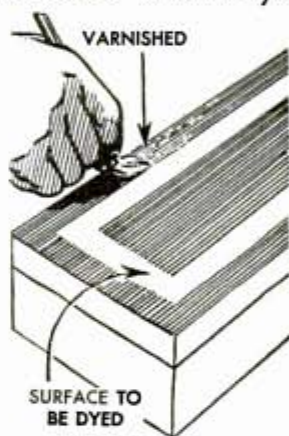

## Proper Care of Razor Blade Keeps It Sharp Longer



The secret of making your safety-razor blades last longer is to keep them dry when not in use. Invisible rusting of the cutting edges dulls them more than actual shaving. Wiping them dry on a towel or dipping them in alcohol are good methods, but are time consuming and therefore often are not used. A better way is to dry them between two blotters. Hinge these together with a piece of tape at one

end. After shaving, remove the blade and place it between the blotters for a moment. Then move it to a dry place between the blotters and leave it there until used again.

—W. F. Schaphorst, Newark, N. J.

## Weighted Cap Protects the Point Of a Fountain Pen



When a fountain pen rolls off a desk or is accidentally dropped it usually strikes on the point, which then is damaged. To avoid this, cement a piece of lead to the inside of the cap as indicated. Then if the pen drops, the weight

is sufficient to make the cap end strike the floor first and protect the point. Be sure to see that the pen point clears the lead when the cap is screwed into place.

—Herman R. Wallin, Washington, D. C.

## Improved Valve for Blowtorch

I made a handy blowtorch relief valve by cutting off a metal tire valve to a length of 2 in. and then threading the lower end so that it could be screwed into a hole drilled in the top of my blowtorch, soldering around the base of the valve for rigidity. Now I can fill the torch with air from a compressor, or release the air quickly and, at the same time, put out the flame without closing the needle valve.

—John D. Reynolds, Liberty, N. Y.

## Attaching Flag to Tube Support Prevents Tangling in Rope

Flags will be less likely to tangle in the rope on the flagpole if they are attached to a rigid support instead of directly to the halyard as is usually done. Such a support can be made from a length of light metal tubing slightly longer than the width of the flag. Two eyes, spaced to meet the grommets in the flag, are welded or soldered to the tube to take snap hooks as shown, and the ends of the tube are crimped to grip the rope.

—Bernard A. Peltier, Port Huron, Mich.

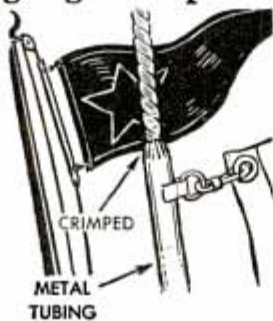

## It's Easy to Read the Printed Data In Tables With This Guide

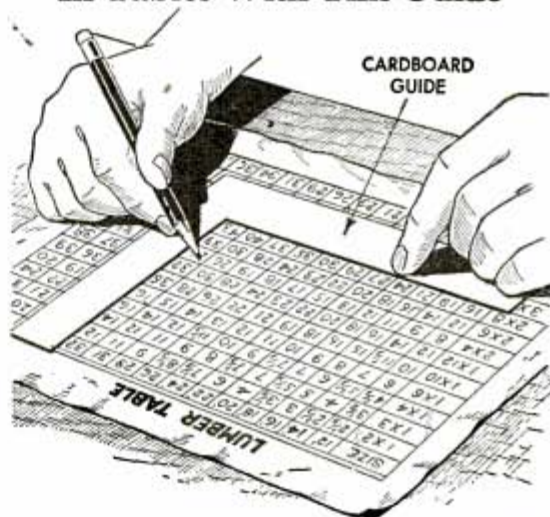

Anyone who has to use printed tables will find this guide handy. Cut to an L-shape from cardboard and used as indicated, the guide prevents any possibility of accidentally taking data from the wrong line or column. If desired, a square piece of celluloid can be used by painting a band along the right and lower edges. Colored nail polish, which adheres well to celluloid and dries quickly, can be used for painting.

## Rounded Corner Improves Knife



A knife used on paper, leather, cloth and similar cutting jobs will work better if the corner of the cutting edge is rounded and then sharpened. A right angle will gather and push particles

of the material ahead of it, resulting in a tear, or the accumulated particles are apt to cause the knife to skip and not cut.

## Photo Easel From Match Books

From the barracks comes this suggestion for making a handy easel for snapshots. Take two empty match books, fold the covers back to form a support, and insert the photo between the strike strip and the match stubs.



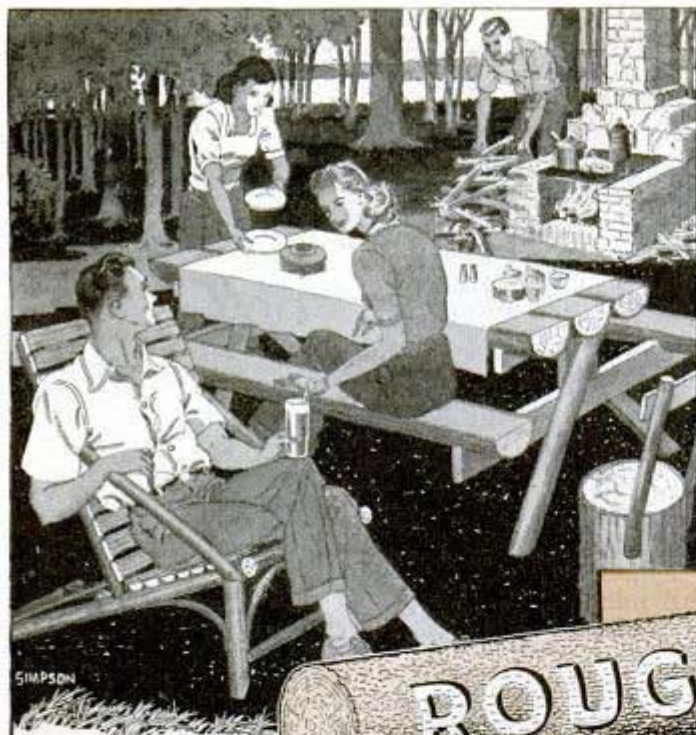

the furnace room in winter or a sunny spot in summer. Also, it's better to use screws than nails as screws are less likely to loosen and pull out. This is especially true in regard to slats used as seats and backs where constant flexing of the slats tends to loosen nails.

Fig. 1 shows a chair of easy but substantial construction. Two short legs are mortised into saplings that form the seat frame and serve as a rear support. To assure rigidity and tight joints, hardwood wedges are inserted into saw cuts in the tenons, as shown in the circular detail, to spread the tenons when

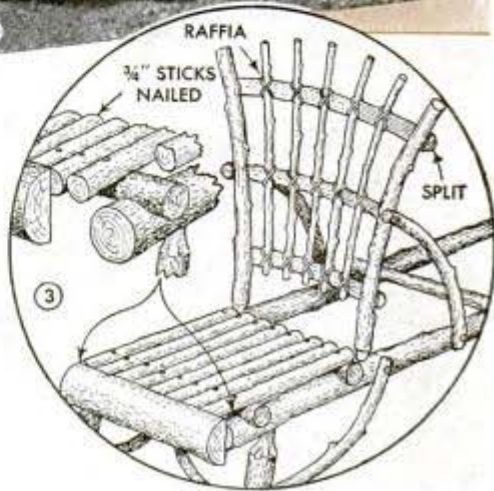
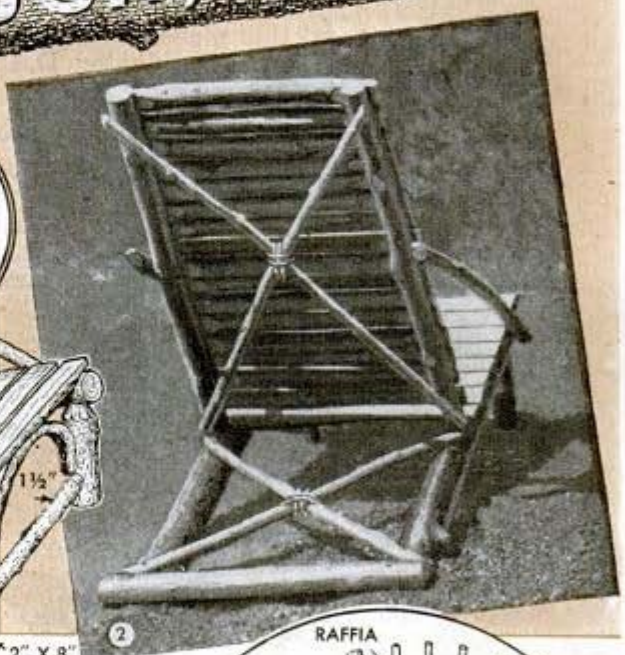
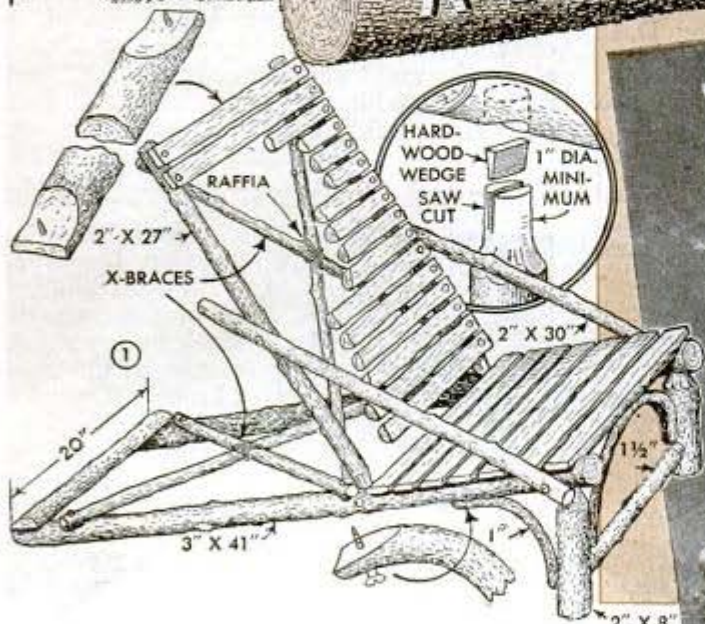

### Part I: Chairs, Benches and Tables

WITH the simple ruggedness of the tree trunks and branches of which it is made, rustic furniture is appropriate for lawn, porch or cottage, and will withstand the weather indefinitely. Additional protection can be provided by applying spar varnish not only over the raw wood but also over the bark to prevent moisture from seeping between it and the wood. As green wood shrinks considerably, which results in loosening of the joints, only seasoned wood should be used except where sticks or branches are to be bent. These should be curved around a form and left to season for a few weeks in a warm, dry place such as

they are forced into holes drilled in the frame. After the legs have been mortised, nails or screws can be driven through the frame and into the tenons. Seat and back are split saplings flattened at the ends to fit snugly on the frame where they are screwed in place. To provide concave surfaces for greater comfort, these pieces may be shaped with a drawknife before fastening in place, and left slightly roughened rather than plane-smooth for rustic effect. Two X-braces, shown in Fig. 2, are used as reinforcements to prevent twisting. These are bound with raffia,

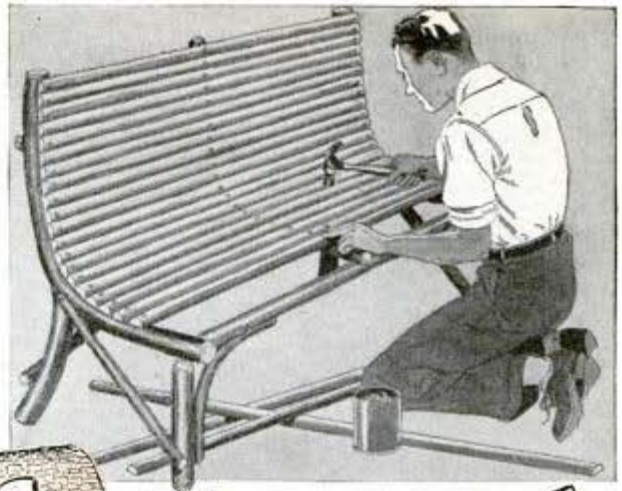

# AND RUSTIC

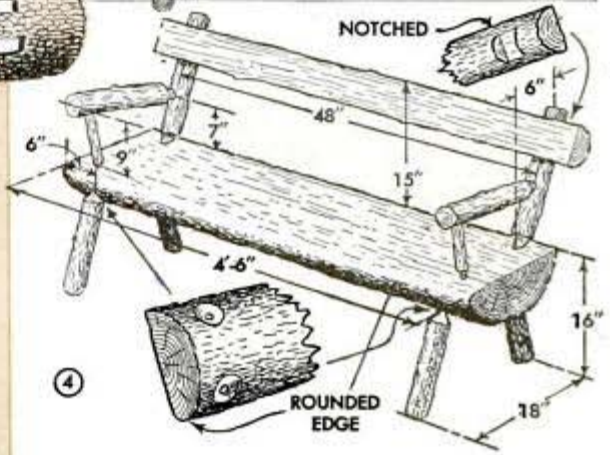

rawhide or stout cord at the intersections, and are screwed to the frame. Arms, which serve as additional supports for the back, are fastened with countersunk screws concealed with plugs.

A similar chair is shown in Fig. 3. Saplings form the frame and, as in the chair shown in Fig. 1, two legs are attached by wedge-spread tenons and reinforced by curved braces on sides and front. Sticks forming the seat are nailed to cross members that fit notches in the frame, and split molding covers the ends. On this chair, arms are omitted, a brace being substituted on each side to support a fan-shaped back. This is made of narrow pieces bound with raffia or stout cord to cross members screwed on curved uprights. The chair shown in Fig. 11 has willow whips for the seat and back to provide resiliency. Net sizes of all parts are shown in the cross-hatched drawing, Fig. 10. Ends of the stretchers are cut concave to fit the round contour of the legs against which they are butted and screwed, as shown in the detail

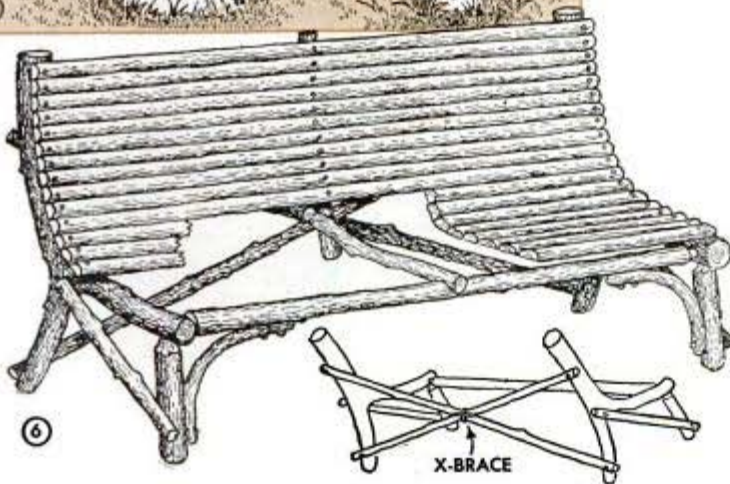
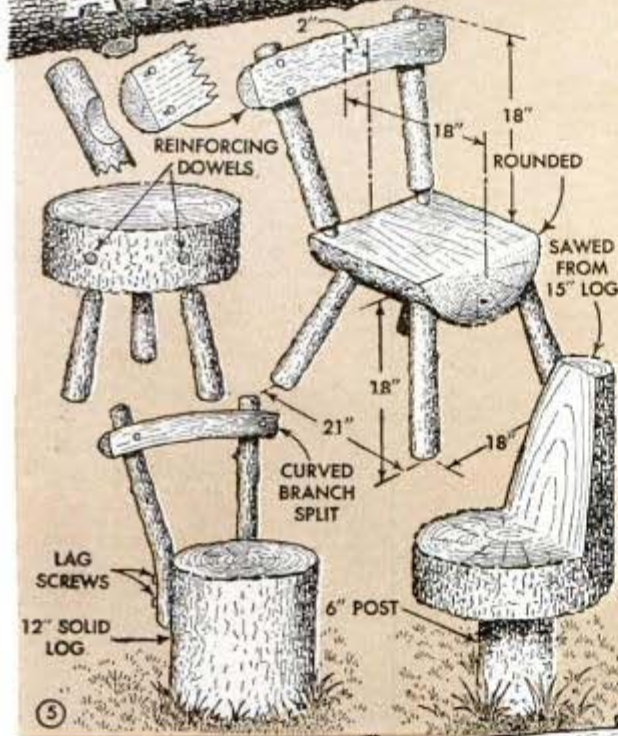



screws driven into counterbored holes, which are plugged. Curved braces may be added for additional support if desired. A back rest is notched as shown and screwed to upright supports, which are drilled for tenons on the arms. For variation, the back and arms may be omitted to make a bench.

Chairs and stools to match the settee are shown in Fig. 5. On the four-legged chair, the back rest is set into notches in the uprights, but the same construction may be followed as for the settee. If wood used for the three-legged stool has a tendency to split easily when dry,  $\frac{1}{2}$ -in. wooden dowels may be inserted in holes drilled across the grain and secured with waterproof

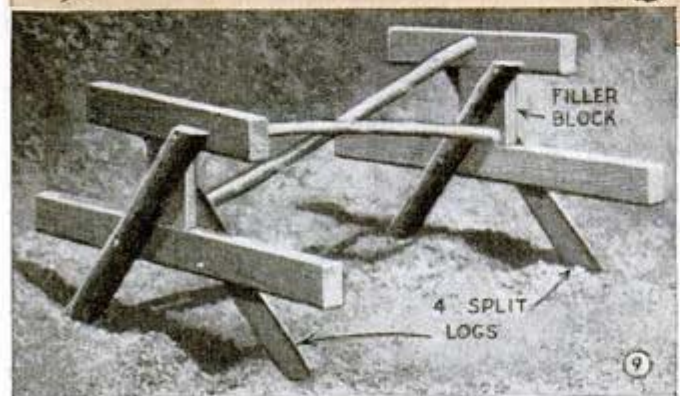
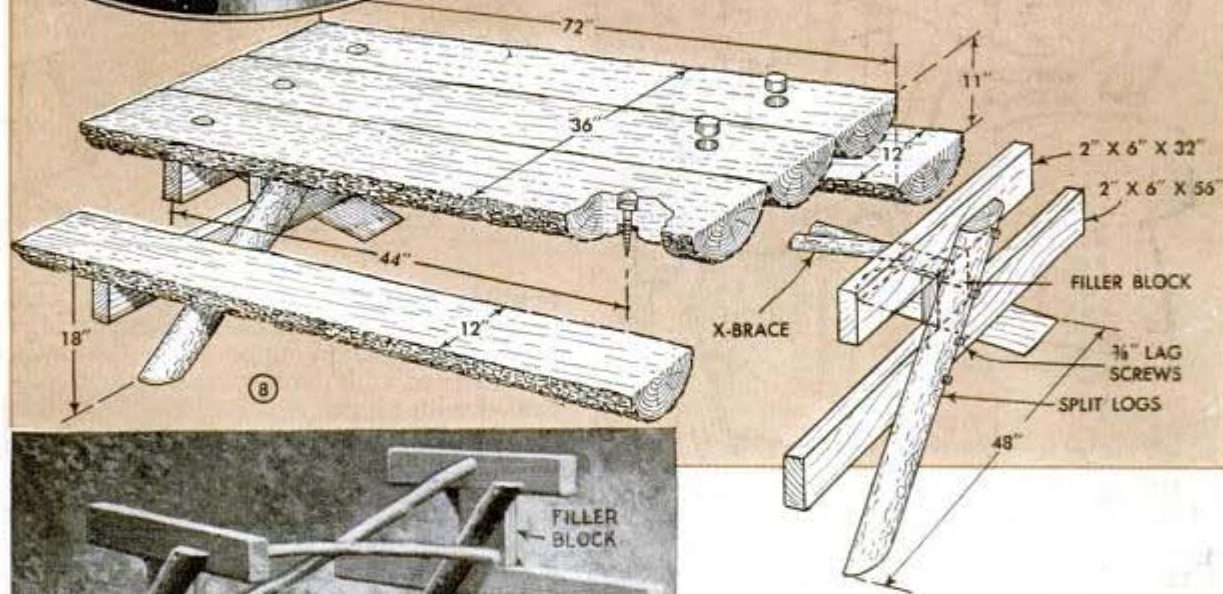

of Fig. 11. A diagonal brace, attached to front and rear legs, wedges a center rail securely for attachment of willow whips. These are nailed to inside surfaces of the frame as indicated in the circular detail.

For the settee, Fig. 4, a large split log about 9 or 10 in. in diameter is rounded at the edge and smoothed for a seat. Legs are set tightly in holes drilled at the desired angle in the underside, and secured with

glue. The two chairs or stools shown at the bottom of Fig. 5 illustrate what can be done with conveniently situated tree stumps. Edges of seats should be rounded to prevent snagging clothes.

Another settee can be made as illustrated in Fig. 6. Crotched limbs, as nearly alike as possible, are cut for back supports and rear legs, and set aside to season. When the wood is thoroughly dried, holes are drilled for front legs, which are secured by wedges and screws as suggested for the chair shown in Fig. 1, and a suitable piece is inserted to form a front rail. Curved braces are screwed to front legs and rail, and an X-brace is attached as shown in the detail.

Before the seat slats are nailed on, holes should be drilled for the nails to prevent splitting the dried frame.

Split-log slabs are excellent for a fixed, outdoor table that will survive years of hard use. Large posts, well creosoted to prevent decay, are sunk into the ground below the frost line so that they will not heave. They are slotted as shown in Fig. 7 to take 2 by 6-in. crosspieces, which support half logs that form the top. Shallow logs or slabs are best for this purpose, and should be sawed or planed straight on each edge to fit together closely. Screws driven through the slabs into the crosspieces should be countersunk and plugged so as not to be noticeable. A similar table with built-on benches is shown in Fig. 8. The crosspieces that support the table and benches are mounted on split-log legs with a filler block

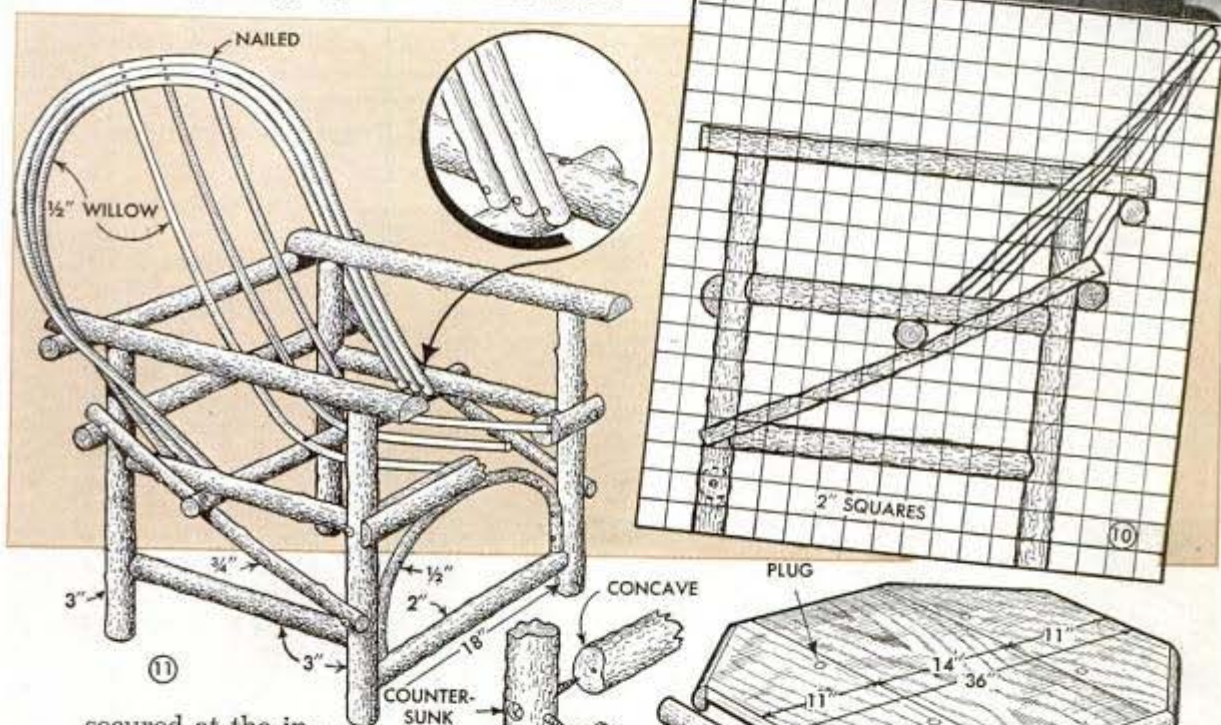

secured at the intersection by a bolt. An X-brace, consisting of 3-in. saplings, is screwed to the crosspieces as shown in the photograph, Fig. 9. Another table, of lighter construction, is shown in Fig. 12. As finished lumber is used for the top, this table is suitable for indoor use in cottages and camps. Legs are glued into holes drilled in a 1 by 3-in. frame. Then the top is screwed to the frame, holes for the screws being countersunk and plugged, and bark-covered, split pieces are nailed along the edge for a molding. Curved braces support legs and frame, and four short spreaders join the stretchers.

(To be continued)



## A Folding Rack on Closet Door Holds Your Extra Trousers

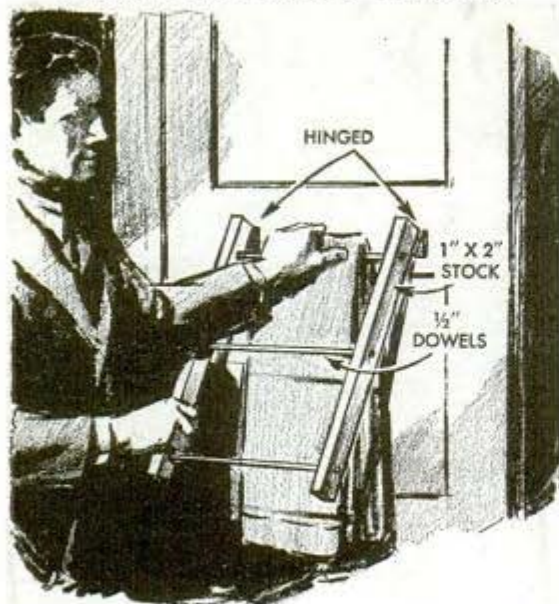

Where closet space is limited, summer slacks or other extra trousers may be hung over the bars of a rack attached to the inside surface of the door. The rack is made by gluing lengths of dowel into holes drilled in side members, and is fastened to the door by small hinges at the top which permit the rack to be raised for hanging garments. The rack may be made as long as desired with as many cross bars as needed.

## Beveling Edges of Door Jambs To Make Casings Fit Tightly

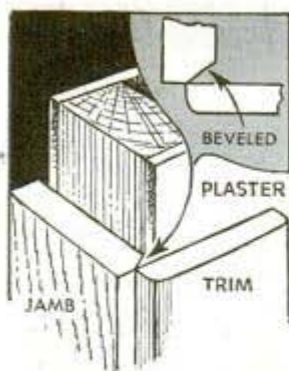

In fitting door frames, here's a good stunt one carpenter uses to make the trim boards fit tightly against an unevenly plastered wall. Before nailing the jambs and header in place, he bevels the inner edges of them slightly, so that

when the trim is applied, the bevel will tend to draw it inward tightly against the wall.—Pvt. Wayne C. Leckey, Aurora, Ill.

## Welding Torch Removes Carbon From Stove Generator

Having a job of repairing a gasoline stove on which the generator was clogged with carbon, I burned the carbon out with a welding torch. To do this, I first turned on enough flame to ignite the carbon inside

the generator and then turned off the acetylene gas and let the oxygen burn with the carbon until the generator was clean.

—Edward Harris, Hagersville, Ont., Can.

## Work That Has Narrow Overlap Fastened Without Splitting

When two pieces of wood are overlapped at the edges and the lap is not enough to permit nailing or screwing them at the lap without splitting, they can be fastened with a screw and a staple as shown. Drive the staple into the exposed edge of one piece and then drive a screw through the staple into the other piece.—N. G. Near, Newark, N. J.

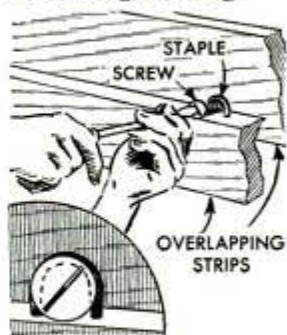

## Rubber Cushions Glass Funnel To Prevent Breakage



Pushed over the neck of a glass funnel, a small inner-tube patch or similar piece of rubber will act as a cushion between the funnel and the container on which it is used to prevent chipping or breaking the funnel. The hole in the rubber should be a tight

fit over the funnel neck so that it will not slip off easily when the funnel is lifted.

—Herman Klein, Pittsburgh, Pa.

## Cellophane Protects Wrist Watch Against Perspiration

Finding that perspiration from his wrist was damaging his watch, one workman eliminated the trouble with a small piece of Cellophane, which he slipped between the watch and his wrist. The Cellophane projected slightly at each side of the watch and thus prevented moisture from coming in contact with it.





# Sand Box ASH TRAY

Convenient to clean, this attractive ash tray can be made from either plastic or hardwood. The body is cut from a 4½-in. plastic cylinder and the top is turned from a piece of ½-in. sheet plastic. Body is half filled with silica sand, which usually is obtainable at any building-supply dealer. Cigarette butts are removed by lifting the tray, and the sand itself needs changing only about every tenth cleaning. If desired, the sand can be cleaned by blowing on it to remove ashes while it is being poured from one container to another. Wire mesh used for the tray is spun or hammered to shape over a hardwood form, after which the surplus is cut off with a chisel as shown in the lower left photo

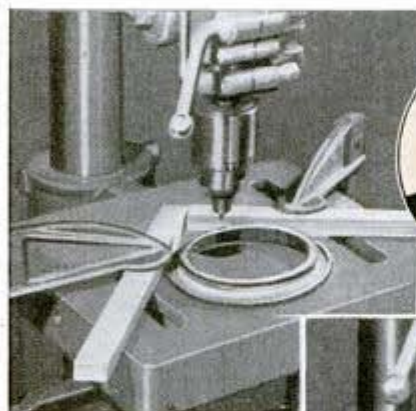

USE THIS SETUP FOR ROUTING TRAY GROOVE



CUT SLOTS IN BOX BODY TO TAKE PINS IN LID

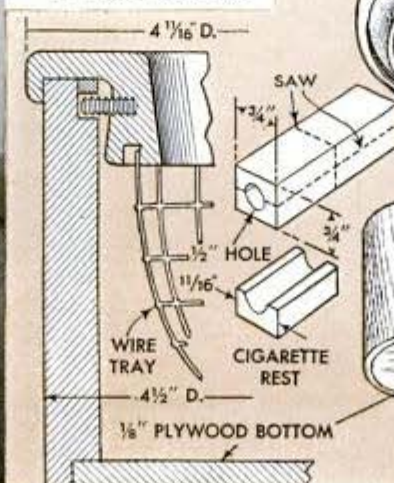
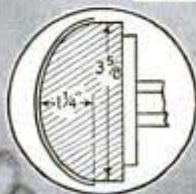

CIGARETTE REST 3-48 R.H. MACH. SCREW TO HOLD WIRE  
1/4" WIRE MESH PIN

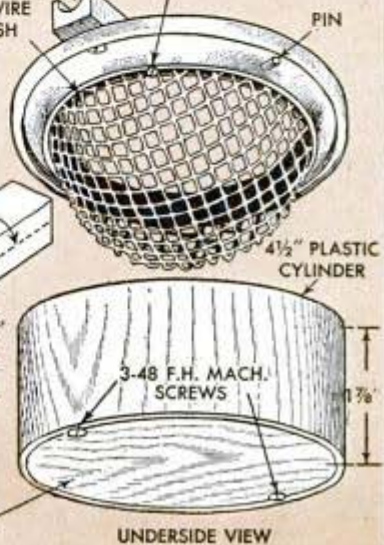

## Shopping Cart for a Little Girl Made From a Tin Can

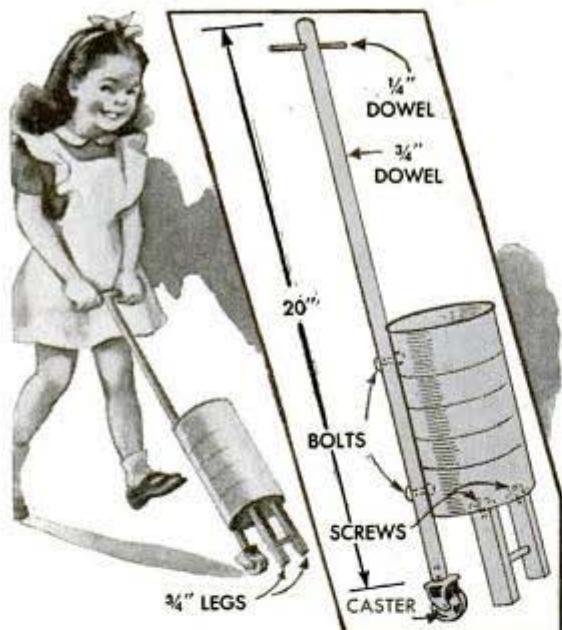

The little feminine member of your family will feel quite grown-up if she has this shopping cart when she goes to the store with mother. It is made from a large tin can which is bolted to a dowel handle having a caster at the lower end. A small dowel run through the handle at the upper end serves as a hand grip, and two short legs nailed to the bottom of the can help support the cart in a vertical position.

—Harold Gluck, Bronx, N. Y.

## Matchstick Provides a "Brush" To Clean Your Fingernails

Grimy fingernails can be effectively cleaned with a "brush" made by cutting off the head of a match and flattening the end. For best results, place the flattened end in warm water, rub against a cake of soap and dip it into powdered pumice.

—James Garmon, Los Angeles, Calif.

## Model Propeller Easily Assembled

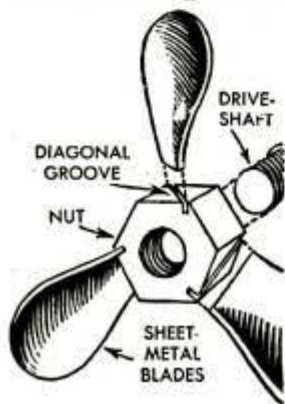

Propellers for model boats can be made very simply as shown in the illustration. Saw a groove diagonally across three sides of a hexagon nut that will fit the boat's driveshaft, and insert blades cut from light sheet metal thick

enough to fit the grooves snugly. If very thin metal is used, or the saw cuts are wide, the ends of the blades can be folded over and tapped to form a slight bead that will hold the blades fast. The blades then can be bent out to give the desired pitch.

## Ammonia Frees Battery Terminal

For removing corroded battery terminals that are stuck tightly to the post, apply a small amount of ordinary household ammonia, letting it soak in for a few minutes. The terminal then can be lifted off easily, after which it should be wiped clean and dry.—Hal Geihm, Aurora, Ill.

## Paraffin Seals Gummed Paper Roll Against Effect of Moisture

Rolls of gummed paper are sometimes moistened by humidity so that the layers adhere in a solid mass that cannot be used. To avoid penetration by atmospheric moisture, coat the sides of the roll with a thin layer of melted paraffin, which seals the edges, yet allows the roll to be unwound as used.



—Pfc. Andrew Vena, New York City.

## Mix Your Own Furnace Cement

A good furnace cement, which also can be used in fireplaces, is made by mixing wet fire clay, 100 parts, manganese dioxide, 3 parts, silver sand, 3 parts, and powdered asbestos, 1/2 part. After mixing, enough water is added to give the material a doughy consistency.

## Preventing Loss of Wing Nuts On Table Tennis Net

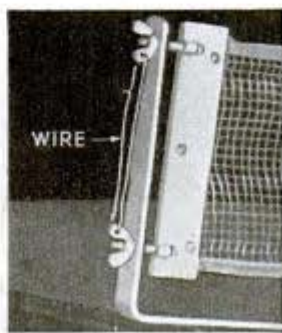

The wing nuts to tighten our table tennis net often were removed and lost or misplaced by the small children. To prevent this trouble, I drilled a small hole in one wing of each nut and wired the nuts together as shown in the photo. This prevented the children from disturbing them, but permitted an adult to remove them whenever necessary.

—R. F. Bertrand, Dearborn, Mich.



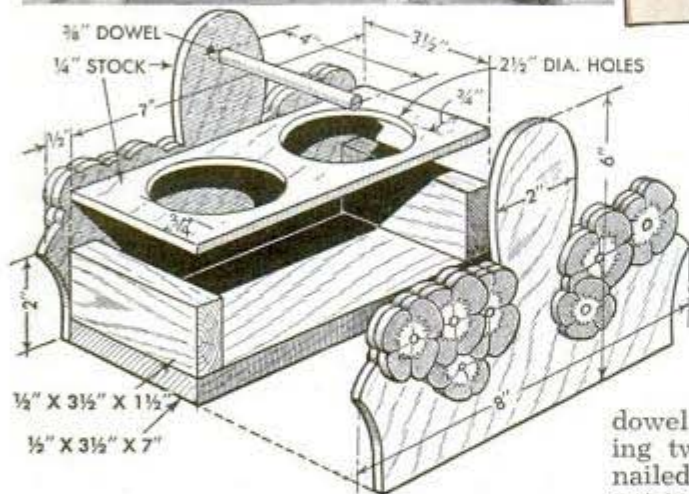
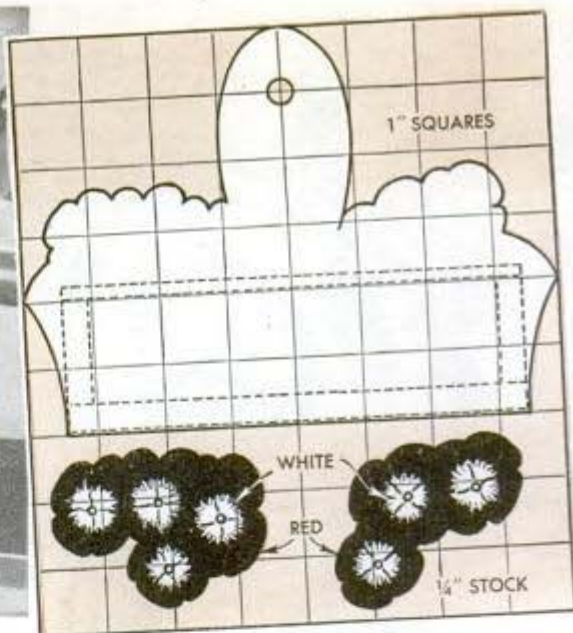

when bought, the designs on the wheel and handles should be painted to match it.

For the sandwich or cracker trough, hard-pressed board or  $\frac{1}{4}$ -in. wood is glued and nailed in a V-slot cut in a base of  $\frac{1}{2}$ -in. stock, as shown. The roosters are jigsawed

from  $\frac{1}{2}$ -in. stock according to the cross-hatched pattern. Their dowel legs are glued in holes drilled in the base as shown in the circular detail, so that their heads overhang the trough. Feet are painted on the base, and a triangular piece is nailed at each end.

The sauce and dressing basket has two sides jigsawed to the size and shape indicated in the cross-hatched pattern and nailed to a base and end blocks. A length of dowel serves as a handle, and a tray, having two circular cutouts to hold jars, is nailed on the end blocks. Plywood flowers, cut to coincide exactly with the outline of the basket sides, are glued in place as overlays. Except for any painted decorations, all pieces may be left in natural finish by applying a coat of varnish or transparent lacquer. Or they may be painted in bright colors as suggested in the illustration.

## Ventilated Plywood Form Aids Rapid Drying of Sweaters

Sweaters will be less likely to lose their shape if they are dried on this plywood or pressed-board form, which permits air circulation and rapid drying. The arms, piv-

oted by bolts, can be moved down to put the sweater on the form and raised for drying. After sawing out the parts, sandpaper the edges smooth to prevent "snagging" and damaging the sweater, and apply a coat of varnish to make the form water resistant.

—Paul Komroff, Flushing, N. Y.

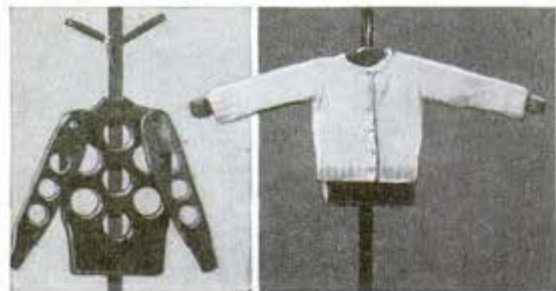

## Hints on Spinning Metal

The following suggestions will make metal spinning easier and more successful: For lubricating the disk, cook a half-and-half mixture of yellow soap and tallow, letting it harden before use. Yellow soap

applied to the edge of the shell when trimming it will give better results. Maple and gumwood make the best spinning forms, and when several shells must be spun on the same form, it will last longer if yellow soap first is applied and spun over it. Removing a deep-spun shell is easier if tallow is applied to the form before spinning. When spinning steel always use a brass tool and brass or wood back stick, but in spinning brass or copper, steel tools and steel or wood back sticks should be used, and these metals should be annealed before spinning. An old file ground and polished smooth makes an ideal back stick.

—Cpl. M. R. Baun, Randolph Field, Tex.

### Light Oil Film Applied to Shaft By Means of Wick in Can



When it is necessary to apply a very light film of oil, such as when lubricating a small shaft, the job can be done easily by using a wick in the oilcan spout. An ideal wick for this purpose is obtained by inserting

a pipe cleaner into the spout, allowing about a quarter of an inch of the cleaner to project. If the spout is too large to hold the wick in position the cleaner can be folded at the lower end to increase the diameter sufficiently so that the wick will be firmly wedged in the spout.

### Fruit Jar and Cardboard Carton Used as "Vacuum Bottle"

Here is a simple way to improvise an insulated container in which to keep beverages hot or cold. Set a ½-gal. fruit jar inside a large oatmeal carton and then pack crumpled paper or other suitable insulating material between the sides of the jar and the carton. Be sure to use a rubber ring on the jar so that there will be no possibility of the contents leaking out. If desired, some of the insulating material can be glued to the underside of the carton lid to provide better insulation.



### Dampness in Basement Removed With Calcium Chloride



When exposed in an open mesh bag, calcium chloride, due to its affinity for water, will readily extract moisture from the air and ultimately liquefy. It therefore is ideal as an aid in keeping basements and other damp places dry. A bag of 25 lbs. will last all summer in an average basement. An easy way of using the chemical is to pour it into a mesh bag, such as one of cheese-cloth, suspended from a simple frame like the one shown. A pan or other container should be placed under the bag to catch the drippings. The rate of absorption can be accelerated by using a small electric fan to blow air over the exposed chemical. Liquid from the pan can be utilized for sprinkling coal or ashes to help prevent dust in the basement.

—G. J. Issakoff, Sioux City, Ia.

### Simple Repair for Water Pail

If one of the bail ears on a pail breaks, a repair can be made by using a window-shade fastener. Just bend the arm of the fastener back, shape the fastener to the curvature of the pail and attach it with rivets. Or, you can scrape and sand off any finish that may be on the fastener and solder it in place.—E. R. Gorton, Maryville, Mo.





# START A GEM

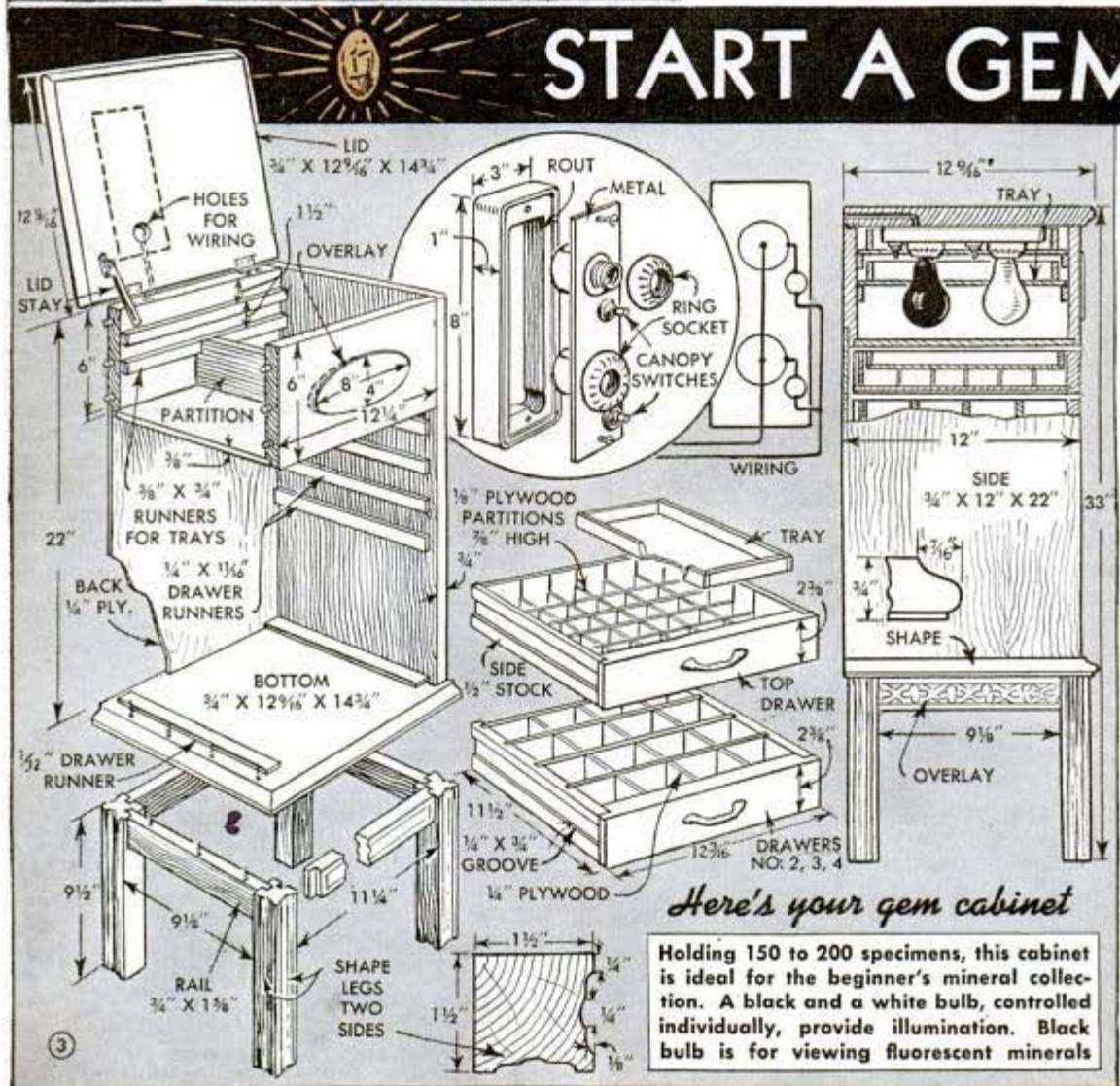

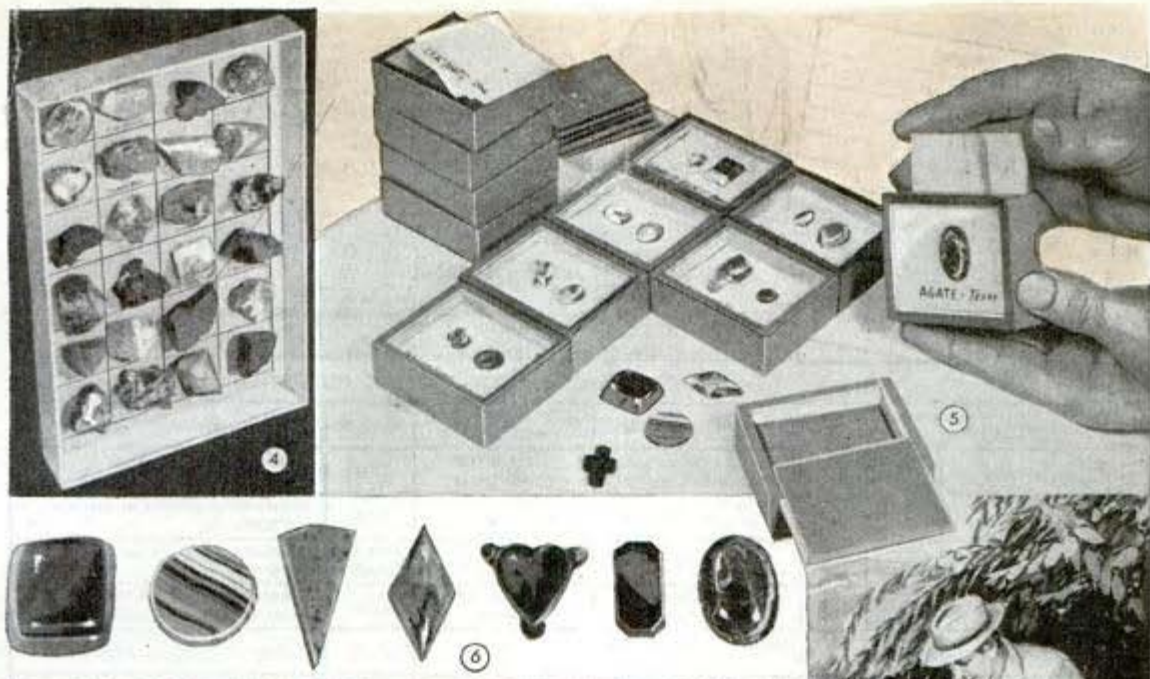

# COLLECTION

By Sam Brown

**I**F YOU are looking for a new hobby, try mineral collecting. You can go at it in one of two ways. You can merely collect minerals or you can collect and then cut and polish those rated as semi-precious gems. Stones are available at nominal cost, but it is more fun prospecting for your own. Almost any beach or river bed will yield stones suitable for cutting.

**The gem cabinet:** Like any other hobby, gem collecting is most enjoyable when you can display your work. A small cabinet for this purpose is pictured in Figs. 1 and 2, and is detailed in Fig. 3. The hinged lid carries a white bulb and a black bulb, the latter for viewing fluorescent minerals. Two sliding trays in the upper part of the cabinet provide room for 16 individual gem mounts. The top drawer has a tray and 36 compartments. The second, third and fourth drawers have 16 compartments each for larger specimens, and the large bottom drawer is plain. However, the arrangement can be altered to suit, but this plan will be found very satisfactory, as it provides accommodations for 150 to 200 specimens.

**Individual mounts:** Cut and polished stones look best in individual mounts and should be mounted on white cards together with a small piece of the raw material if available. A good type of mount is shown in Figs. 5 and 7. The slide bottom permits ready removal of the stone. Rubber cement is used to mount the stone on a white card, which then is pushed up from the underside of the mount until it is tight against

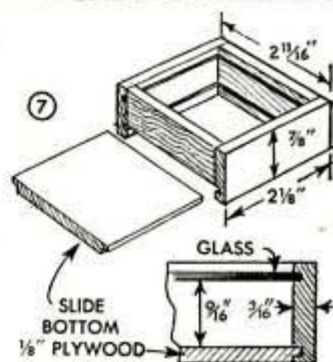

MOHS' HARDNESS SCALE		
No.	Mineral	Comparative Mat'l
1	Talc	Lead - 1½
2	Gypsum	Fingernail
3	Calcite	Copper coin
4	Fluorite	Iron - 4-5
5	Apatite	Knife blade
6	Feldspar	File - 6-7
7	Quartz	Garnet
8	Topaz	Steel - 5-8½
9	Corundum	Silicon carbide - 9½
10	Diamond	

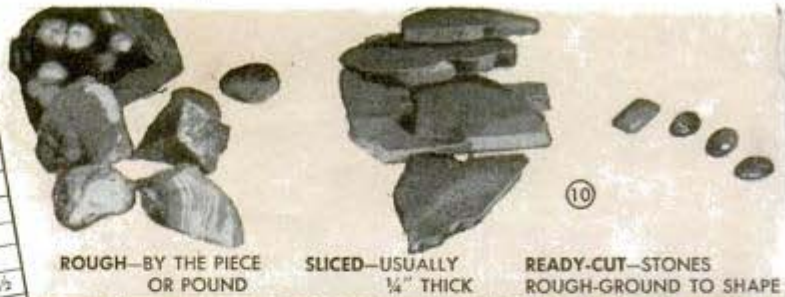

Buy gem material any of three ways

11 SELECTED CABOCHON CUTTING GEM MATERIALS

Name of Mineral	Hardness 1	Spec. gravity	Color 2	Transparency and luster 3	Cost 4	Remarks
Agate, banded	7	2.7	Usually red-brown and white in bands	Translucent glassy luster	Low	Best known agate. Usually very attractive coloring
Agate, moss	7	2.7	Red, green or gray	Translucent glassy to waxy	Low	Shows moss growth in interesting patterns
Agate, scenic	7	2.7	All colors	Translucent glassy	Low to med.	Inclusions resemble flowers, trees, etc.
Agate, Sweetwater	7	2.7	Gray, with dark inclusions	Translucent waxy	Low	Sweetwater, Wyo. A moss agate—water worn pebbles
Amazonite	6½	2.5	Green, lightly streaked with white	Opaque glassy	Med.	Variety of feldspar. Nice color
Azurite	3½	3.7	Deep blue	Opaque waxy	Med.	Too soft for rings. Tends to undercut
Chlorastrolite	5½	3.2	Green with white markings	Translucent to opaque-glassy	High to v. high	Water worn pebbles. Often chatoyant 5
Chrysocolla	3	2.2	Green or green-blue	Translucent to opaque-glassy	Med.	Rather soft. Very nice blue color
Dinosaur bone	7	2.6	Usually red, brown or black	Usually opaque waxy	Low	Bone replaced by agate or jasper. Often nicely marked
Jade, American	6½	3.1	White to green	Translucent glassy	Med. to high	Oregon (grossularite). California (vesuvianite). Good cutting
Jasper, breccia	7	2.6	Mixture of various colors	Opaque waxy	Low	Attractive coloring. Also "puddingstone"
Jasper, poppy	7	2.6	Usually red with yellow markings	Opaque waxy	Low	Attractive coloring. Also known as orbicular jasper
Labradorite	6	2.5	Gray, with blue play of color	Opaque glassy	Med.	Excellent play of blue color. Labrador, Canada 6
Lapis lazuli	5½	2.6	Deep blue or green-blue	Opaque to translucent-glassy	High	Cheap specimens usually in gray matrix 7
Malachite	3½	3.8	Bright green	Opaque glassy	Med. to high	Often banded or with radial fibrous structure
Moonstone	6½	2.6	Translucent white	Translucent glassy	Med.	Usually double cut to display marked opalescence 8
Opal	5½	2.0	Various. Usually white or black	Translucent glassy	High to v. high	Precious varieties show beautiful play of colors 6
Petrified wood	7	2.7	All colors	Translucent waxy to glassy	Low	Also agatized wood. Interesting patterns, nice colors
Rose quartz	7	2.6	Pink	Translucent glassy	Med.	Often opalescent. Valuable when asteriated 9
Sagenite	7	2.6	Red-brown hairs in clear quartz	Transparent glassy	Med.	Also rutilated quartz or Venus's-hairstone
Smithsonite	5	4.2	Green or blue	Translucent glassy	High	Nice color. Green variety also known as banomite
Tiger-eye	7	2.6	Yellow-brown, sometimes red or blue	Opaque glassy	Med.	Chatoyant. Principal locality, South Africa 5
Thomsonite	5	2.3	White, gray, red or brown	Transparent to opaque-glassy	High	Popular with mottled or eye markings in red or green
Turquoise	6	2.6	Green to sky blue	Opaque waxy	High	Sky blue color is most desirable
Variscite	4½	2.5	Apple green to blue-green	Translucent to opaque-glassy	Med. to high	Cheap specimens in slate gray matrix 7

NOTES

- Based on the ability of one mineral to scratch another. See Mohs' scale above. No. 7 will scratch No. 6, etc.
- Some variation in color should be expected.
- Glassy indicates luster of glass; Waxy, somewhat lower.
- Most gems listed are inexpensive. Low indicates 2 oz. for 25 cents, from which you can cut three or four ring-size cabochons. Medium, 1 oz.; High, ¼ to ½ oz.; Very high, less than ¼ oz. for 25 cents.

- Chatoyant—a rippling play of light on the surface of the stone. Same effect often seen in wood.
- Play of color—a changing play of color on the surface or interior of stone. Most pronounced in opal, which shows flashes of red, blue, green and other colors.
- Matrix—the slate, shale or other material in which some gems are found. Sometimes attractive, usually not.
- Opalescence—a play of light without color inside the stone. Most pronounced in moonstone.
- Asteriated—showing starlike light when viewed under good light. Star rubies and sapphires are best examples.





the glass. Corrugated cardboard is used as a filler. Two very simple mounts are shown in Fig. 8. One of these is a cigarette box with the top cut out and covered with black gummed tape after the stone is mounted; the second is an ordinary penny matchbox treated in a similar manner.

**Minerals:** Start your collection by purchasing two or three ordinary mineral assortments. Some of these are already boxed, Fig. 4, and can be obtained for as little as one dollar for 24 specimens. These usually are not cutting material, but are colorful and a worthwhile



1—Break large stone into small pieces. Further trimming can often be done by pinching off the pieces with a pair of pliers

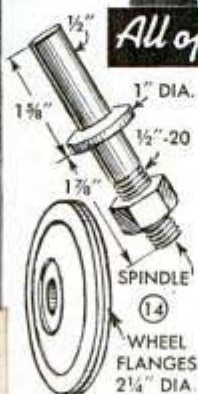

*All operations can be done on drill press*

part of your collection. You will certainly want a set of eight or 10 fluorescent minerals. These are just ordinary stones when viewed under ordinary light, but under the black bulb they glow in brilliant colors. Likely, you will want a set of minerals illustrating Mohs' scale of hardness, Fig. 9. Then there are many unusual minerals that add considerable interest to any collection: natural stone crosses and beautiful masses of rock quartz crystals; lodestone



2—If diamond saw is available, trim stone by sawing. Use plenty of water. Hold stone steady. Speed 2400 r.p.m.



3—Grind base of stone flat on 100-grit wheel. Use plenty of water. Speed 1200-2400. Repeat operation on 220 wheel



4—Mark outline of stone, using pointed piece of aluminum



5—Grind outline and shape roughly on 100-grit wheel. Use plenty of water. Speed 1200-2400. Watch out for chipping (see text)

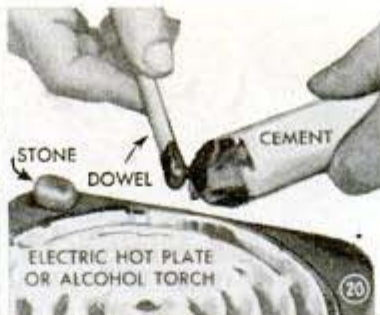

6—Cement the stone to a dowel stick. Use regular lapidary cement. Both stone and cement must be hot for good adhesion



7—Further smooth the stone, using 100 and 220-grit wheels in succession. Keep wheel wet to avoid burning. Speed 1200-2400

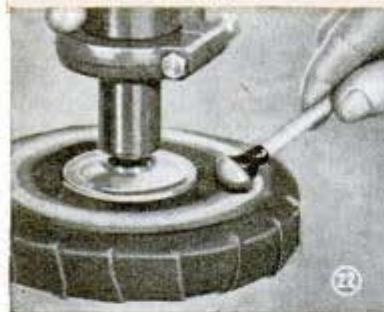

8—Dry-sand on 220-grit cloth backed with felt on wood wheel. Speed 1200. Use moderate pressure, but avoid getting stone hot



9—Mix polishing abrasives with clay flour and water to form a paste. Use F-grit silicon carbide for first polish; tripoli for final



10—Polish on felt wheels. Keep wheel wet with tiny trickle of water. Speed 1200. Use moderate to heavy pressure (see text)

(magnetite), which is strongly magnetic; Iceland spar, which shows two images of anything viewed through it; selenite, which can be bent without breaking.

**Cutting materials:** Minerals suitable for cutting because of their color or sparkle are called gem stones. A selected list of cutting materials is given in Fig. 11; most of these are inexpensive and readily obtainable. These stones are intended for cutting en cabochon. Cabochon gems usually are round or oval, but may be almost any shape, Fig. 6, so long as they are not facet-cut like diamonds or other transparent stones. Cutting material includes all minerals which look attractive when cut and polished; you can pick up pebbles from any beach that will rate as semi-precious gem stones. Most popular with beginners are agate, petrified wood, tiger-eye and jasper. All of these except tiger-eye occur in a wide variety of brilliant colors and markings so that a good collection can be based on these alone. The most expensive stone in the list is opal. There are cheap varieties of this—common opal—but gem quality indicates a stone which flashes red, blue and green patches of color as it is turned in the hand. A few of the stones, such as variscite, turquoise and lapis lazuli, occur in matrix; that is, the actual gem stone is embedded in a valueless mass of slate, shale or other mineral.

Sometimes the matrix polishes nicely and the whole thing makes an attractive gem stone; usually, however, the matrix is not attractive.

You can buy cutting material in three forms, as shown in Fig. 10. Rough cutting stock averages one dollar per pound; sliced material costs about 50 cents for a 3 by 3-in. slice, and ready-cut gem stones about 50 cents each. It is a good idea to experiment with all three since each has its good points in money value or workability.

**Gem cutting and polishing:** Complete accessory equipment for gem cutting and polishing is illustrated in Fig. 12. Of these items, the diamond saw (diamond grains embedded in the rim of a copper disk) is the most expensive, costing several dollars in the 6-in. size. The rest of the items can be purchased at a total of about five dollars. The actual gem-cutting machine can be almost any type of motor-driven spindle. One of the best spindles for this work is a drill press. If this is fitted with a simple cooling system (water), it is ideal for the various cutting and polishing operations, Fig. 13. The only other extra equipment needed is a spindle as in Fig. 14, and even this is a standard drill-press accessory (grinding or shaping arbor). The feed pan used to hold and control splash of water can be obtained from any farm store for about fifty cents.

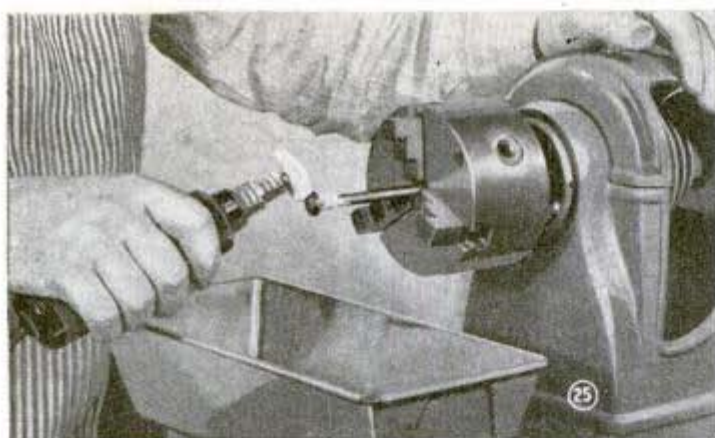

Figs. 15 to 24 inclusive show the cutting and polishing operations. With a little experience, it takes about 40 min. from rough stone to finished gem. Make your first job an agate. Break or saw the rough stock to get pieces suitable for gem cutting. In operation 5, Fig. 19, keep a bevel ground on the stone in advance of the side cutting. If you grind right down to the outline on the 100-grit wheel, you may chip the edges. In Fig. 20, use a stick somewhat smaller than the stone. Heat the stick and cement together over a hot plate or torch. When the cement begins to melt, twist it off onto the stick. Have the stone hot before you press it into the cement—it should be just as hot as you can hold. Good adhesion usually will be obtained if both stone and cement are hot. Moisten your fingers and mold the warm cement around the bottom of the stone, but keep it clear of the edges. Let cool 10 min. or dip in cold water to set cement. Operation 8—this is done dry. The sanding cloth should be backed with something that has a slight amount of "give." Felt is standard, but a piece of carpeting or several layers of canvas will do. Use moderate pressure, but stop frequently to avoid overheating the stone. Operation 10—use heavy pressure in the rough-buffing operation with F-grit silicon carbide grains. The felt buff must be fairly hard and of the proper combination to assure smoothness. The removal of tiny flats requires a hard buff and hard pressure. Don't try buffing with a loose muslin buff—you may get a mild degree of polish but the surface will be lumpy. Have the abrasive in a dish and apply to stone every 10 seconds. Get the stone as smooth as possible with the F-grit before you change buffs for the final polish. This can be done with tripoli or any of the special buffing powders formulated especially for this work.

It is easy to tell when the stone is pol-



*Gem cutting can be done with a wide variety of power tools*

ished perfectly. It has a glasslike appearance, you can see your face in it, and the image of a lamp bulb or window is bright and sharp. If it does not satisfy you, go back one or two steps and try again. Never rush the polishing schedule; never say, "I can take that out in the next operation." What you can do in a few seconds by sanding takes several minutes on the buffing wheel.

**Other tool setups:** You can grind and cut gems on almost any kind of spindle. The lathe, the bench grinder, and buffing heads can be used. If you have a belt sander, use it with a 220-grit belt, as in Fig. 26. Round cabochons are ground readily with a lathe; cement the stone to a metal rod, then grind with a hand grinder, Fig. 25, and polish with a rag and abrasive with the lathe in motion.

### Tiny Chisels for Model Makers

Tiny chisels for model work can be made by soldering small pieces of razor blades to iron nails after filing a flat surface on the nail for attaching the blade.—R. Salzer, Baldwin, N. Y.



## Workbench Kept From Tipping If Legs Are Set at Angle



In building a workbench, if you set the two front legs inward at the top, the bench will not be so apt to tip forward when work held in a vise is pulled or pounded toward you. The legs should be tilted just enough so that the lower ends do not project beyond the bench.

## Production Jigsawing Speeded When Template Is Used

A handy template for jigsawing duplicate pieces may be made by placing a sheet of stencil paper or other heavy paper between two layers of wood before they are sawed. Use of this template eliminates the bother of tracing the pattern each time and shows just where the pattern is placed on the wood.—G. James, Louisville, Ky.

## Corner Shelves Supported Safely By Sections of Curtain Rod

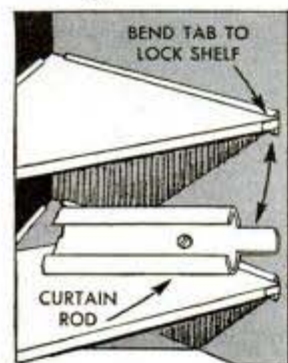

When you want to put up corner shelves of either glass or wood, sections cut from a flat, telescoping curtain rod will provide good supports or brackets. One end of each section is shaped to provide a projecting tongue,

then the sections are screwed to the wall, the shelves inserted and the tongues bent around the corners of the shelves.

—Ronald Eyrich, Milwaukee, Wis.

## Cotter Pin Used to Start Screws In Hard-to-Reach Places

When starting a screw where it is difficult to reach with the fingers, a cotter pin with the ends of the legs ground down as shown will hold the screw and serve as a driver to start it. If three or four pins of different sizes are prepared, you will always have a

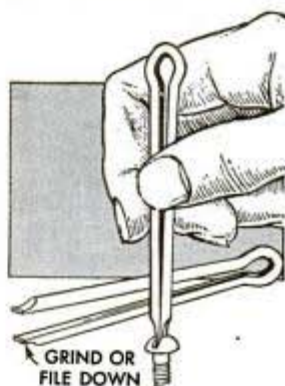

driver for starting a screw of any size. If desired, you can fit handles to the pins.

—L. E. Shepard, Toledo, Ohio.

## Center Marked on Turning Blank With Hacksaw Blade



Centering the ends of lathe work can be done quickly with an old hacksaw blade. This is placed diagonally across the work and is tapped lightly with a hammer to make the two intersecting lines as indicated.

## Test Tube Fits in Pipe Rack To Hold Cleaners

Pipe smokers can keep cleaners handy with the rest of their accessories by inserting small test tubes in their pipe racks as indicated. In some cases, it may be necessary to enlarge the openings in the racks to take the tubes, or to make new openings in the racks. If desired, these can be corked to keep out dust and dirt.

—Kenneth Schwartz, White Plains, N. Y.



# Wood Mailbox Has Hinged Lid for Magazines

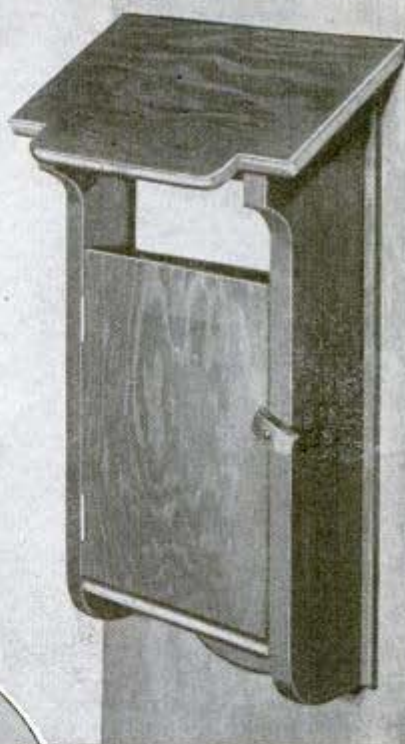
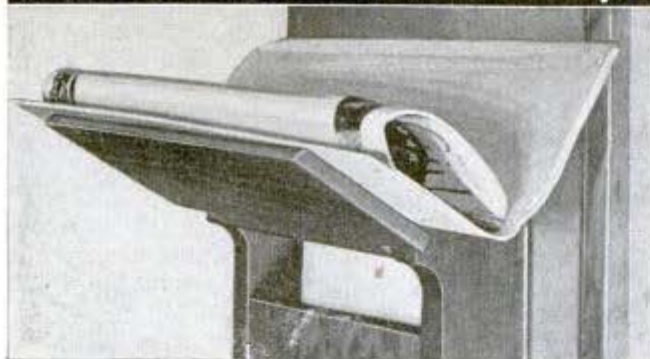

**S**IMPLE, neat appearance and a false, hinged lid that opens to provide a rack for holding small packages, newspapers and magazines, combine to make this wooden mailbox thoroughly practical as well as attractive. Wood used in its construction may be maple, white pine or waterproof plywood, but ordinary plywood will, of course, be unsuitable when exposed to rain or snow. All parts except the hinges are butted

CUTTING LIST—NET SIZES	
BACK	—1 pc. $\frac{1}{4}$ " x 7" x 14"
SIDES	—2 pcs. $\frac{9}{16}$ " x $3\frac{1}{8}$ " x $13\frac{1}{8}$ "
TOP	—1 pc. $\frac{3}{8}$ " x $3\frac{9}{16}$ " x $5\frac{1}{2}$ "
LID	—1 pc. $\frac{3}{8}$ " x $4\frac{7}{8}$ " x $8\frac{1}{4}$ "
BOTTOM	—1 pc. $\frac{3}{8}$ " x $2\frac{1}{4}$ " x $5\frac{1}{2}$ "
DOOR	—1 pc. $\frac{3}{8}$ " x $5\frac{5}{16}$ " x $7\frac{1}{4}$ "

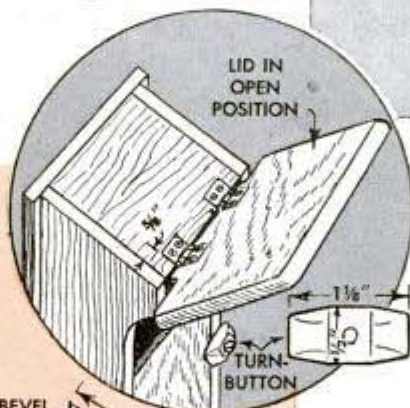

and nailed, with a little waterproof glue added here and there if desired for extra durability.

The various pieces are cut to the net sizes as shown in the cutting list. For ease in hand-sawing and sanding, the side pieces can be nailed together and worked as one piece. Hinge gains are mortised by chisel, or they can be routed on a drill press with a  $\frac{1}{8}$ -in. router bit. Notice that the lower edge of the lid is beveled inward to provide a stop for the false lid, which is hinged on it to swing down. A wooden turnbutton can be made, according to the dimensions in the circular detail, to lock the door.

If a bright finish is desired, a brown-orange stain should be used. This is followed by two coats of spar varnish or three coats of clear lacquer. Two screws driven through the back panel secure the box to a porch post or wall. Knobs, of course, may be fastened to the door and lid, but they are not necessary. Leave the false lid open the first day the box is installed to acquaint the mailman with its use.

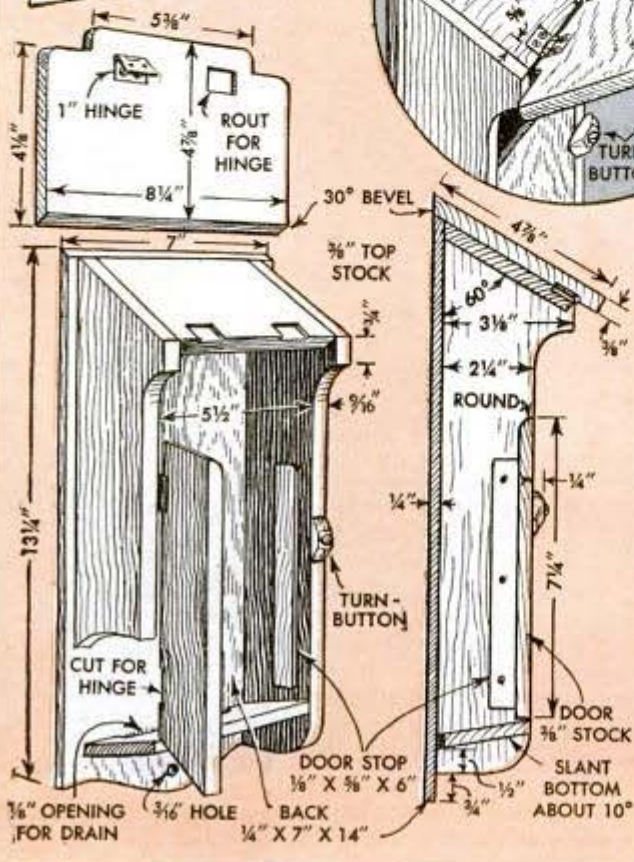

## Pipe and Fittings Are Assembled To Provide Strong Bar Clamps

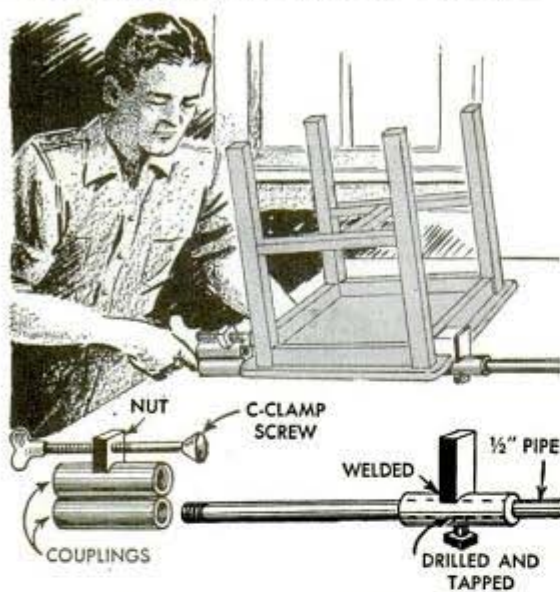

Inability to purchase a bar clamp need not bother the woodworker because a very strong one can be made from a length of pipe and a few fittings. First cut a piece of 1/2-in. pipe to the desired length and then weld two couplings together to screw on one end. To this assembly weld a large nut to take the screw from a C-clamp. Over the other end of the pipe slip a coupling from which the threads have been reamed. Weld a small steel block to the coupling, and drill and tap the coupling opposite the block to take a setscrew. This permits adjusting the clamp to any width.

—Sgt. Don Brooks, San Francisco, Calif.

## Tracing Designs on Dark Surfaces

The difficulty of tracing designs through carbon paper onto dark surfaces is overcome by using a "carbon" paper which makes light colored lines. This is done by going over the surface of a white sheet of paper with a yellow or other light-colored pencil, entirely covering the sheet, and then using it for a carbon in the ordinary manner.—Frank Shore, New York City.

## Repair Your Flexible Oil Line With Cloth Strips and String



If the flexible oil line on your car breaks and you cannot immediately replace it, a repair that will last for some time can be made easily. To do this,

wrap the line with several layers of cloth strips which have been dipped in varnish, preferably the Bakelite type. After several layers of the soaked cloth strips have been tightly wrapped spirally over the break and well beyond it, apply a spiral wrapping of strong string. This should be wrapped in the direction opposite that in which the cloth was wrapped. If there is any question as to the strength of the repair, apply additional layers of varnish soaked cloth strips and another wrapping of cord.

—Stephen J. Butler, Brighton, Colo.

## Mouse Favor Made From Peanut

Realistically poised to run into a hole, this amusing mouse favor will attract immediate attention at your parties. Its body is a peanut and the tail and feet are pieces of yarn. The ears are shaped from paper and are glued in tiny slits made in the peanut shell. Eyes and mouth are inked on.



—Benj. Nielsen, Aurora, Nebr.

## Doorknob Used as Tap Wrench

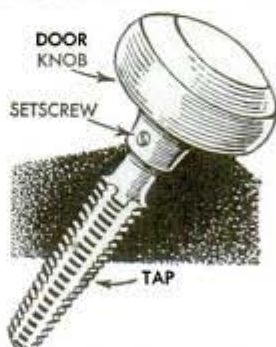

If you have misplaced your small tap wrench, or do not have one, just use a doorknob. The squared socket in the hub will fit over the shoulder of most small taps and will provide a handle for turning them into the holes. If desired, the doorknob can be fastened to the tap by driving in the setscrew.

—M. A. Jacobson, Chicago.

## Simple Holder for Artist's Pencils

One artist who experienced trouble in keeping his pencils close at hand on the drawing board improvised a holder from a whisk broom. The broom was screwed to the edge of the drawing board and the ends of straws tied as shown.



# Camera Shutter Checked by Photo of Flash Bulb

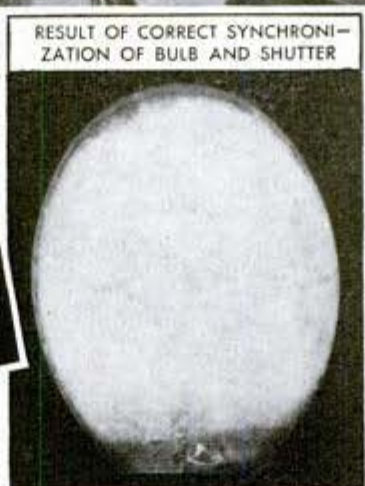
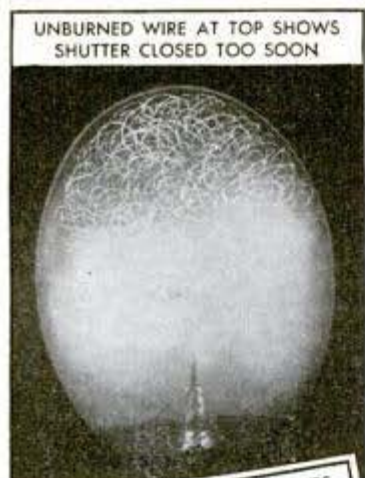

Cameras having shutter speeds of 1/200 sec. or more can be checked for synchronization of shutter and flash simply by photographing the bulb while it is being fired. If the shutter closes too early, the resulting photo will show some of the fine wire inside the bulb unburned around the top and edges. If the shutter has closed too late, the photo will show the outer edges of the bulb filled with flame and the center burned out as indicated by a dark spot at the center. Correct synchronization is indicated when the photo shows the bulb completely filled with flame, with little or no unburned wire visible, and no burned-out spot in the center. To make the check, the flash gun, with the reflector removed and a bulb in place, is set up in front of the lens, and the bulb is focused sharply on the ground glass with the image as large as possible. After focusing, the shutter speed is set at 1/200 sec. and the lens opening is stopped down to f:32 or smaller if

possible. A red filter should be put over the lens to help reduce the extreme overexposure resulting from the bulb being fired so close to the lens. Any slow-speed film having good latitude and anti-halation properties may be used; one having a Weston rating of less than 64 daylight is preferable. Also it is a good idea to turn your face as the bulb is fired because there is always a possibility that the bulb might shatter. Any error in the synchronization of the shutter and bulb can be corrected by changing the small adjustment screw of the magnetic tripper that operates the shutter. This adjustment varies with different flash equipment, but as a general rule it will be found that tightening the screw will result in speeding up the shutter action.

—Duard Ferguson, Los Angeles, Calif.

## How to Clean Film Negatives

After a negative has been about two-thirds washed, pass it through a solution made by mixing 1 fl. oz. glacial acetic acid with 100 fl. oz. water. Dip the negative in this solution for a few seconds and then complete the washing in the usual manner. The film will dry without any scum or surface markings. The acid may be used repeatedly until no longer effective.

## Ferrotyped Prints Dried by Heat When Placed Over Gas Burners



Drying glossy prints can be speeded up considerably by the use of a dishwashing rack inverted over the lighted burners of a gas stove. Place the ferrotyping plate on the rack so that the heat will warm the prints. Of course, only a low flame must be used or the prints will be scorched.

## Photo Mount Serves as Substitute For Enlarging Easel

Inexpensive cardboard photo mounts, available in all print sizes, can be used as enlarging easels. The cutout portion allows a border of about  $\frac{1}{4}$  in. on all sides, and, being sealed at the top, prevents the paper from being pushed beyond the margins. Also, the white inner surface will serve as the focusing screen. Pencil or ink lines



should be ruled on it as a guide to show how far to either side the paper should be placed. The mount is cemented to a piece of wood for stability. After the enlarging paper is inserted, the open end or front of the mount is held by a thumbtack at each corner pressed into the wood so that the heads overlap the mount.

## Two Kinds of Photoflood Diffuser That Can Be Made Easily

Here are two types of photoflood diffuser that can be improvised in a few minutes. The one illustrated in Fig. 1 consists of a tin can lid soldered to the wire clamp of a discarded lamp shade. The bright side of the lid should face the lamp so as to direct light back into the reflector.

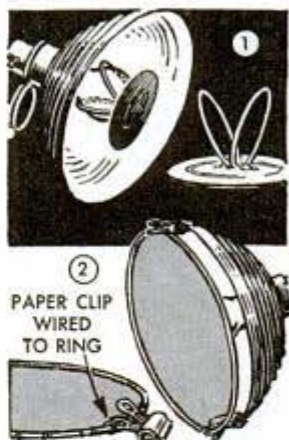

The diffuser shown in Fig. 2 is made by gluing a circular piece of cotton, silk or other porous material over a wire loop. The lower rim of a lamp shade will do, or a coat hanger may be bent into a ring. To avoid wrinkling the cloth, slits may be cut along the edge to facilitate folding it over the ring. Two spring paper clips then are wired to the ring to attach the diffuser.

## Roll-Film Emulsion Is Identified By Holes Punched in Leader

Holes punched in the leaders of 35-mm. film serve to identify the emulsion speed or type of film, especially when several kinds of bulk film are loaded on spools not otherwise marked. For instance, one hole may be used to indicate a specified film speed or a type of emulsion, as ortho, pan or infrared; two holes, a different speed or type; or holes can be punched according to a pattern, as one above another. By keeping a record of the code, the operator can tell in a moment what kind of film is contained in any cartridge not otherwise marked.

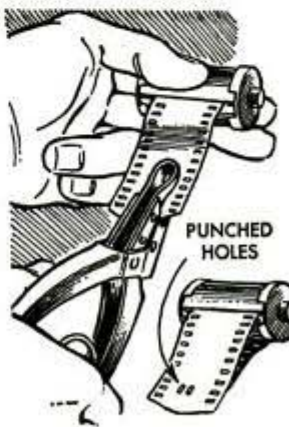



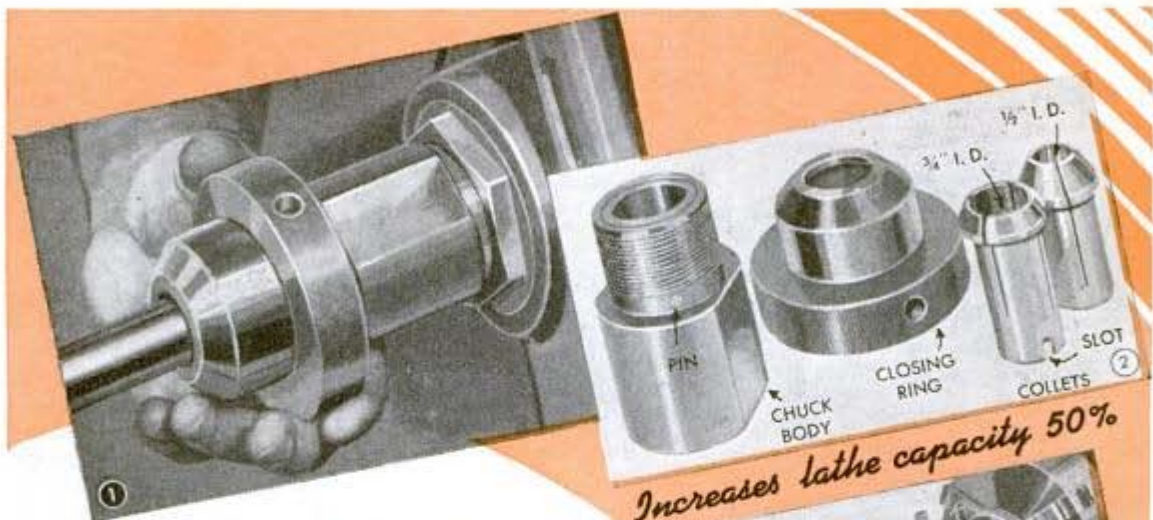

*Increases lathe capacity 50%*

## Front-Closing COLLET CHUCK

WHEN made accurately, this collet chuck is "on the nose" for precision. Also, it has the advantage of taking stock up to the full capacity of the hollow through a lathe spindle. Thus, while the familiar drawbar collet chuck has a maximum capacity of  $\frac{1}{2}$  in. when used in the average small lathe, the front-closing type will take  $\frac{3}{4}$ -in. stock.



As can be seen in Fig. 2, the chuck consists of only two parts—body and closing ring—plus as many collets as you want to make. The preferable range of collets is between  $\frac{1}{2}$ - and  $\frac{3}{4}$ -in. internal diameter,

leaving the smaller sizes for the drawbar collet. To begin, first make the chuck body according to the dimensions in Fig. 4. Be sure that the spindle nose thread is a tight fit so that it will not come loose by the action of unscrewing the closing ring. Then fit the chuck body on the lathe spindle and bore and ream the collet hole.

In making the closing ring, first it is turned to external shape, then rechucked and the internal thread and 60-deg. included angle at the nose are cut. The

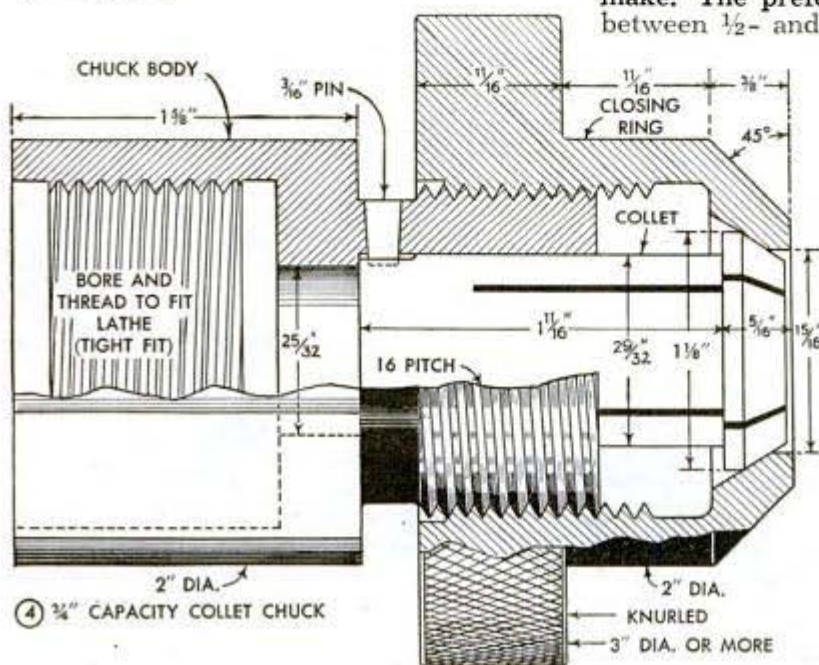

④  $\frac{3}{4}$ " CAPACITY COLLET CHUCK

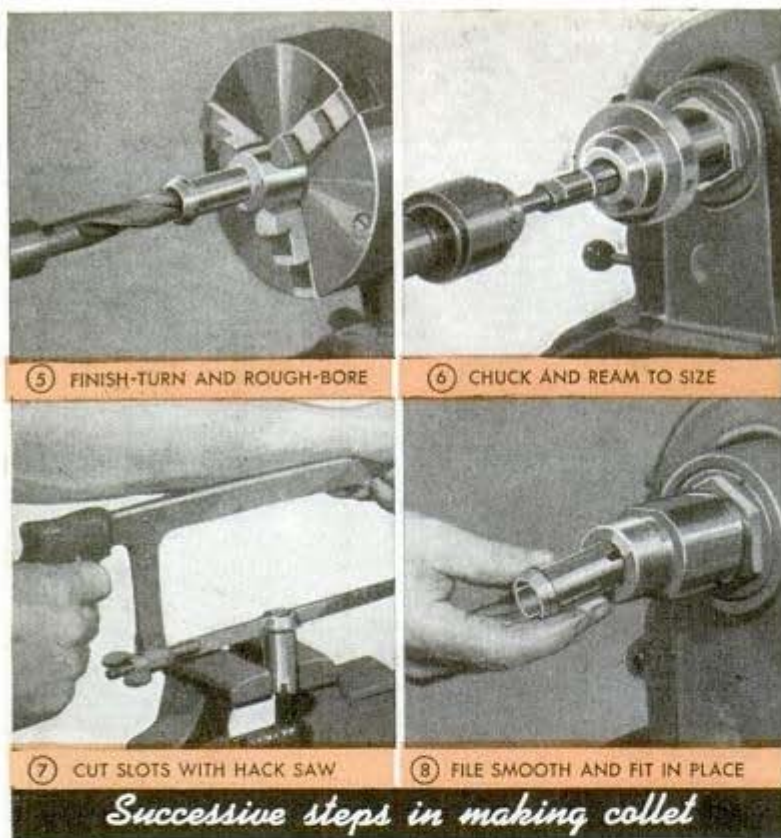

flat reamer and use it to take a light finishing cut.

Make the collets from a good grade of tool steel. Turn the outside first, "miking" the straight stem for a close fit in the chuck body. Rough-bore the internal hole as shown in Fig. 5, then cut off. Cut a slot at the end of the collet to fit over the pin in the chuck body, then fit the collet in place, Fig. 6, and ream to net size. Remove the collet and slot with a hacksaw as in Fig. 7. Run the slots almost to the end for a 1/2-in. collet; less for larger sizes. Go over the hacksaw cuts with a fine file to remove burrs. Fig. 8 shows the finished collet being fitted in place. It is indexed by means of the pin, thus assuring that it fits in the same position in which it was bored. Screwing on the closing ring closes the collet and holds the work

internal nose angle can be worked by feeding the lathe compound at 30 deg. as shown in Fig. 3, using a conventional boring bar as cutting equipment. However, for a smooth finish, it is best to make up a special

firmly for turning, Fig. 1. Hand pressure alone is sufficient for average work. If stock is available, it is a good idea to make the closing ring somewhat larger at the knurl to obtain a better gripping surface.

## Handle for Opening Bus Door Held With Leather Strap

After having the bus doors accidentally opened by passengers who leaned on the operating mechanism or held onto the operating handle when the bus was overcrowded, one driver prevented this trouble

by securing the handle with a leather strap. This was attached to the bus as indicated and slit near the outer end to slip over the handle. A flip of the hand removed the strap to open the doors.



## Spring Prevents Tailstock Binding

Sometimes the tailstock slide plate of a small woodturning lathe binds under the ways and cannot be moved without much time-wasting effort. To avoid this annoyance, one workman fitted an auto valve spring over the clamping bolt as shown. When the bolt was loosened for moving the tailstock, the spring expanded and pushed down on the slide plate, preventing it from turning and binding against the ways.

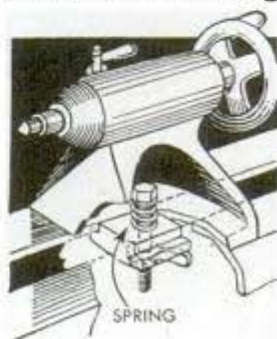

## Lightweight Wedges for Splitting Made From Angle Iron



Disliking to carry a number of heavy steel wedges when splitting light logs in the woods, one workman made a number of lightweight wedges from angle iron. These were ground or sawed to the shape shown. When splitting large logs, these wedges are ideal to finish the split once it is started with a heavy wedge, and are much better than the usual wooden wedge.

## Locating Speedometer Trouble

When your speedometer fails to operate, you can locate the trouble by removing the cable at the speedometer head, jacking up one of the rear wheels, starting the motor and putting the car in high gear. If the cable does not turn, it should be removed for inspection. However, if it turns, the trouble is in the speedometer head, which then should be serviced.

## Jig Holds Plane Iron for Honing

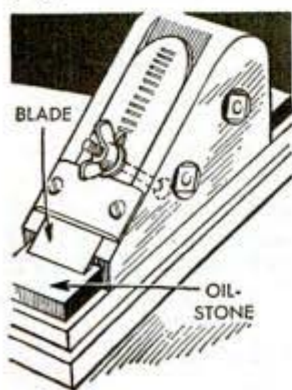

Assuring a keen, straight edge at the proper bevel, this wooden jig for honing plane blades fits over an oilstone. A recess as deep as the blade thickness is made on the sloping face, and a piece of flat iron is screwed across it to hold the blade,

which is secured by a wing nut on a bolt running through the block and counter-sunk into the underside. The jig, about 7¼ in. long overall, can be made of one piece of hardwood; or, if it is assembled from several pieces, these are reinforced by flat-head bolts through the body, the nuts being recessed and ground flush.

—Robert J. Gilmartin, Bronx, N. Y.

## Windows Held at Desired Level By Stick and Nails

Rather than use props of various lengths to keep shed or poultry-house windows open at a desired position for ventilation, you can do it easily with one stick and a few nails. Just drive

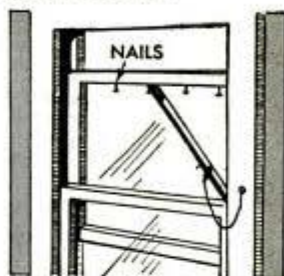

the nails into the underside of the top sash and prop the stick between any one of them and the lower sash as shown. The stick can be kept handy by fastening it to the frame by a cord.—Mrs. Pearl M. French, Norridgewood, Me.

## Tow-Truck Spotlight Converted To Taillight With Red Lens

When towing a damaged car at night, one garageman installs the tow truck's spotlight at the rear to throw light on the towed car so that it can be seen easily by motorists at the rear. The spotlight lens is covered with a red celluloid or Cellophane disk, which is fitted with four lengths of cord or small leather straps. These are looped at the free ends to take a strap and buckle which attaches the red disk to the spotlight as indicated. It takes only a moment to attach or remove the disk.

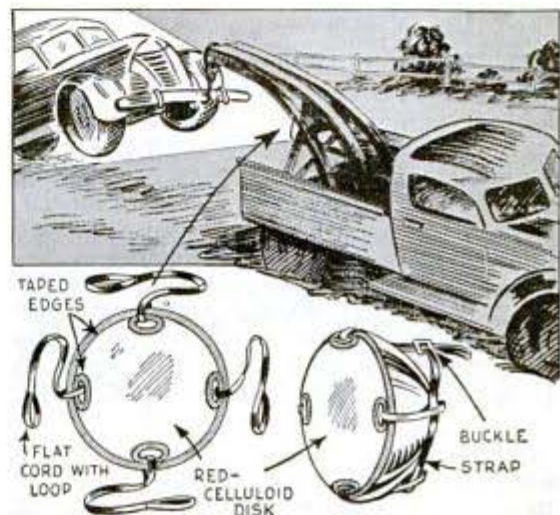

## Building Your Own

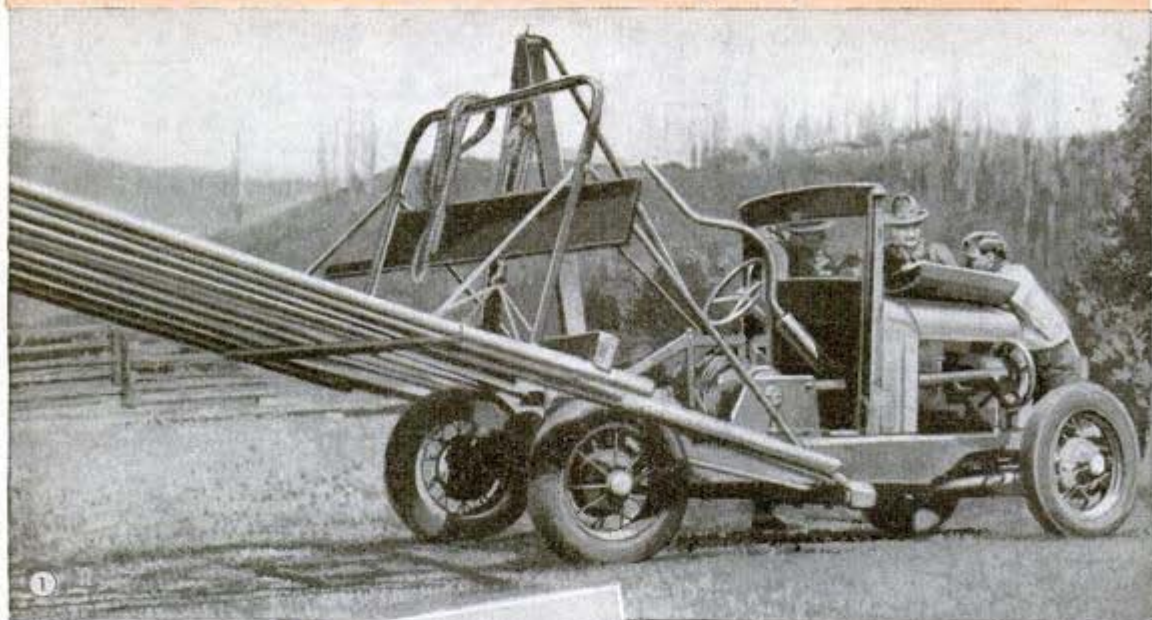

Photos courtesy  
Agricultural Extension  
Service, State College of Washington

**B**UCKRAKES mounted on old trucks and cars or on tractors are great time and labor savers, in many cases enabling one man to do the work of two or three men by the usual methods of haying. Thus they reduce labor and equipment costs. Besides being used in haying, the rakes are handy in many other harvesting operations, such as bringing grain shocks to a thresher, hauling corn shocks to a shredder, etc. And where distances are not too great they are used to take hay directly from field to barn, which reduces handling and results in less shattering of the foliage. Also, the hay is not bunched and twisted so that it is easier to mow. Some farmers put hay in the barn singlehanded with the

rakes. When this is done, slings are used instead of forks, taking an entire load at one operation. Usually, three or four loads are put into the barn between mowings. And some farmers even pull the hay into the barn with the rakes as they start their return trips to the fields.

A rake should have a capacity of 700 to 1,000 lbs. per load, a speed of at least 8 m.p.h., and a width to pass easily through average gates and lanes. Usually, a width of 10 ft. with 12 teeth is about right. A power lift is practically a "must" as it is very difficult to provide enough leverage to lift a load of 1,000 lbs. manually, especially as you should be able to raise the load at least 4 ft. above the ground at the ends of the rake teeth.

Choice of a power unit is a matter of using the type of unit most readily available. Old trucks are better than cars because they are stronger, but cars are used more extensively as they are easier to obtain. Tractors are used in some cases, but this work is hard on the front tires and wheel bearings, which in many tractors are not heavy enough to stand up under the loads. However, some farmers get around this trouble by mounting an old car chassis in front of the tractor to carry the load as shown in Fig. 14. Regardless of the unit selected, the motor and chassis should be in fair condition, or at least be such that it can be put in a good, usable condition at

# BUCKRAKE or STACKER

③ TYPE OF RAKE USED ON TRUCK OR AUTO CHASSIS

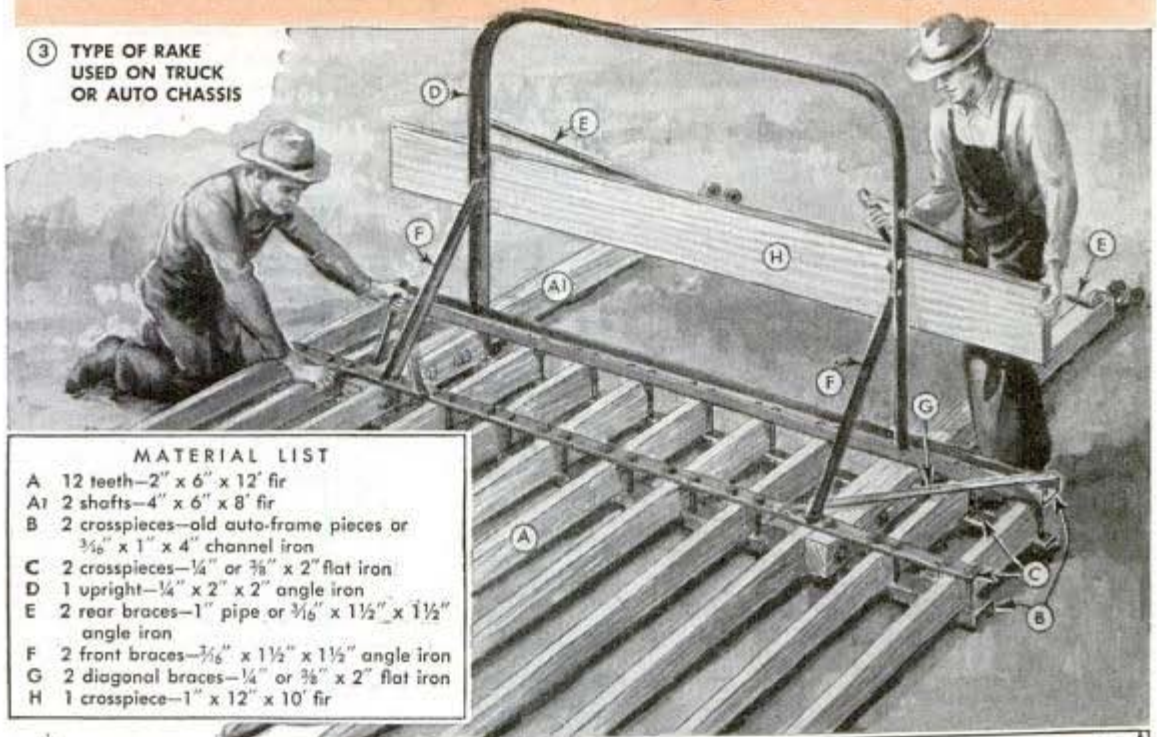

### MATERIAL LIST

- A 12 teeth—2" x 6" x 12' fir
- A1 2 shafts—4" x 6" x 8' fir
- B 2 crosspieces—old auto-frame pieces or 3/8" x 1" x 4" channel iron
- C 2 crosspieces—1/4" or 3/8" x 2" flat iron
- D 1 upright—1/4" x 2" x 2" angle iron
- E 2 rear braces—1" pipe or 3/16" x 1 1/2" x 1 1/2" angle iron
- F 2 front braces—3/16" x 1 1/2" x 1 1/2" angle iron
- G 2 diagonal braces—1/4" or 3/8" x 2" flat iron
- H 1 crosspiece—1" x 12" x 10' fir

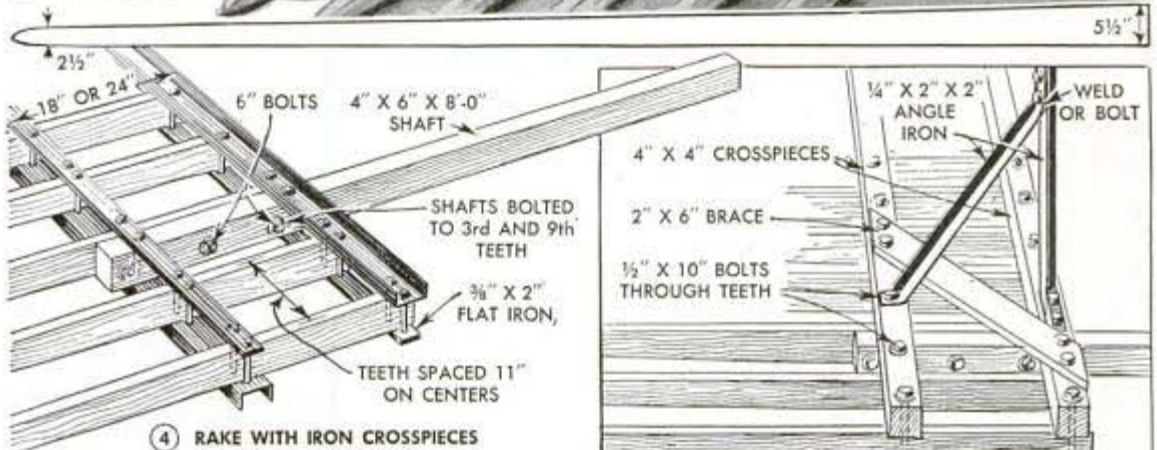

④ RAKE WITH IRON CROSSPIECES

⑤ RAKE WITH WOOD CROSSPIECES

a reasonable cost. Also, it is best to select a make and model for which parts can be obtained easily. Although an "orphaned" car may be purchased cheaply, it may prove exceedingly costly if you experience a breakdown during harvest season and cannot obtain parts quickly.

Since the rake is mounted on the rear end, the car is run in reverse to pick up the load, then driven forward to haul it. Some builders object to the slow reverse speed, and to avoid it change the gears so that the car can be driven backward. On some cars and trucks this is accomplished by merely turning over the rear axle end for end. This causes the differential ring gear to mesh with the drive pinion on the side opposite to its normal position and thus

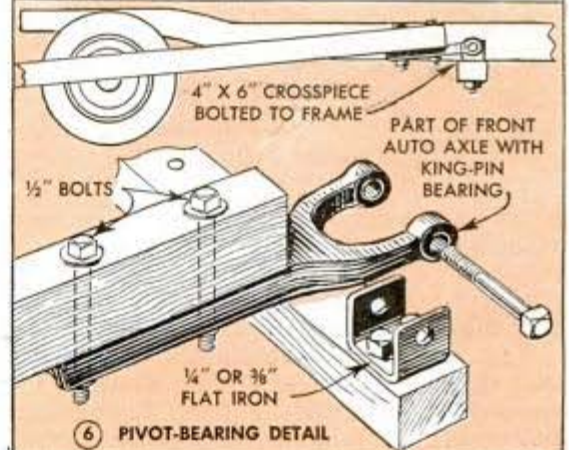

⑥ PIVOT-BEARING DETAIL

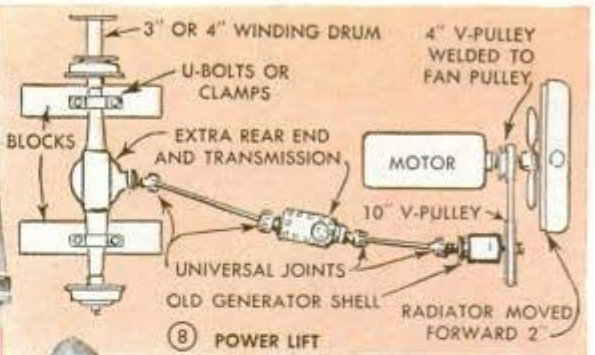
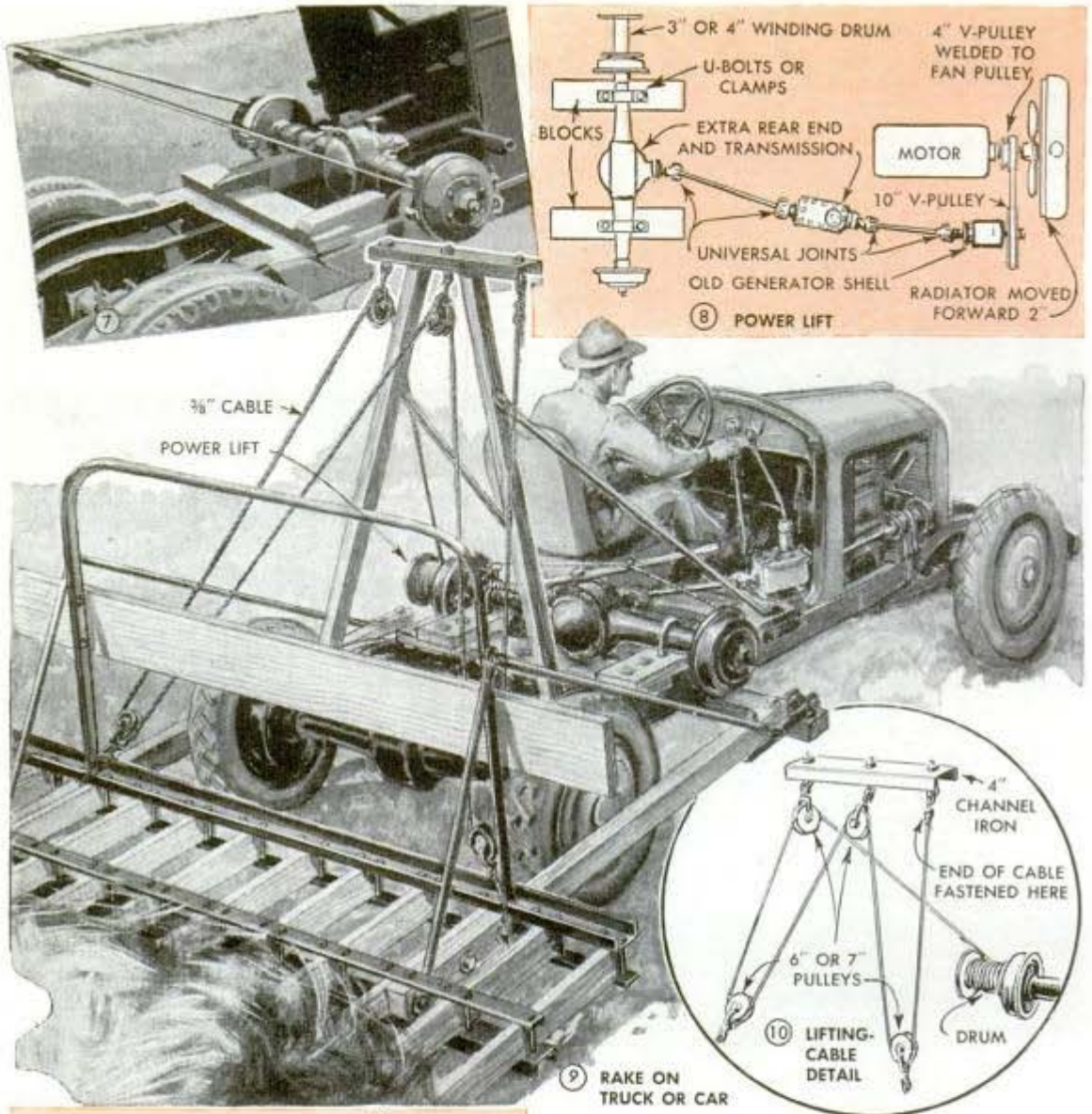

9 RAKE ON TRUCK OR CAR

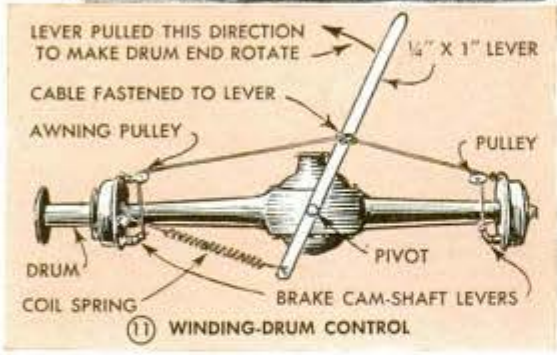

11 WINDING-DRUM CONTROL

reverses the rotating direction of the rear wheels so that the car has three speeds in reverse. When this change is made the steering wheel should be rearranged so that the driver faces the direction of travel.

Figs. 1, 2 and 9 give general views of a unit mounted on a car chassis showing locations of the rake, hoisting tripod and power lift. Installation on a truck chassis

would be similar. General assembly of the rake is shown in Fig. 3. All bracing and supporting members should be of metal if available. Often, parts of old car frames can be utilized as in Fig. 4, although hardwood can be used as in Fig. 5, but makes the rake heavier and gives it a rather bulky appearance. The teeth should be made of strong, warp-resistant wood. Fir 2 by 6's are used for this purpose, and are tapered from full width at the back to 2½ in. at the front. Of course, other wood can be used, some farmers using poles cut from their own timber. If this is done, the poles should be stored in a dry place for several months and fastened down to avoid warping. In mounting the rake on the car, the load should be kept as nearly over the rear axle as possible by placing the hoisting tripod directly above it. The shafts that carry the rake should be of sound stock for

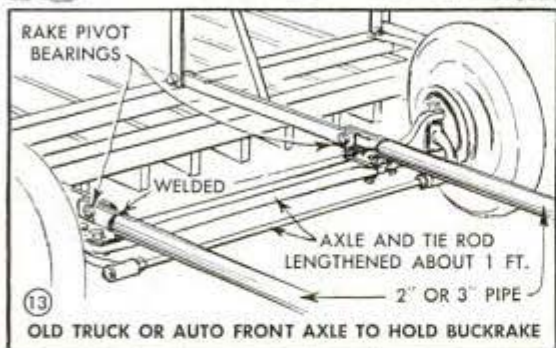
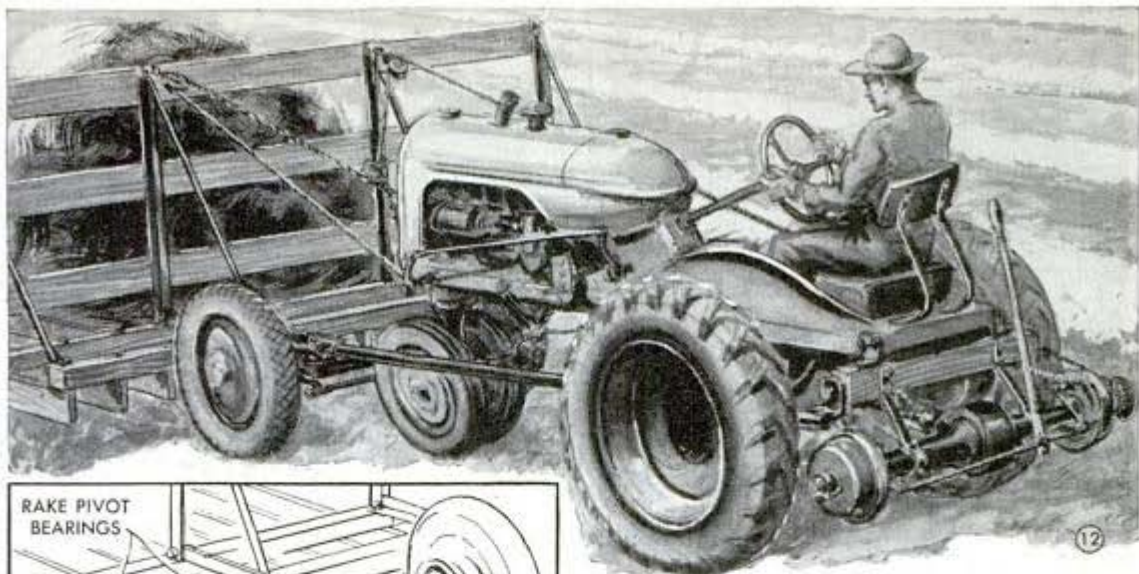

strength. They are pivoted to a crosspiece which is clamped to the underside of the chassis. Fig. 6 shows one way of using part of an old car front axle as a pivot bearing.

After completing and mounting the rake unit on the car, you are ready for a power lift. The most popular lift consists of an old car rear-axle assembly mounted just behind the driver's seat and driven from the fan belt at the front end of the car motor. The general arrangement is shown in Figs. 7 and 8. Likely it will be necessary to block up the axle on the frame to keep the drive linkage as straight as possible. A transmission in the drive gives variable lift speeds, and an old generator shell at the pulley end of the drive provides a good ball-bearing support. A small winding drum is attached to one of the projecting

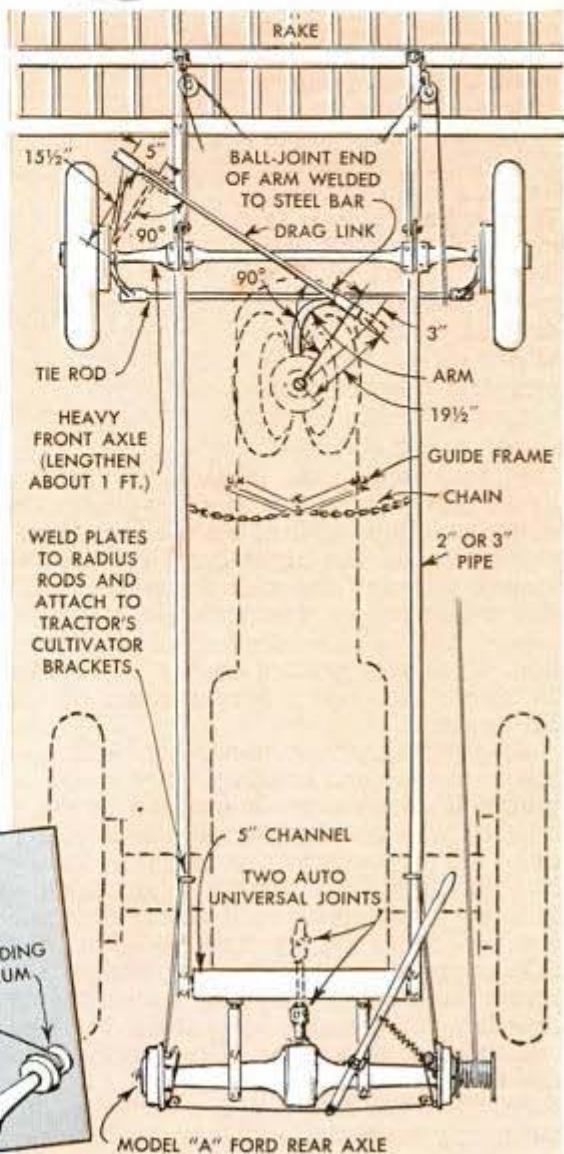

14 PLAN VIEW OF TRACTOR BUCKRAKE

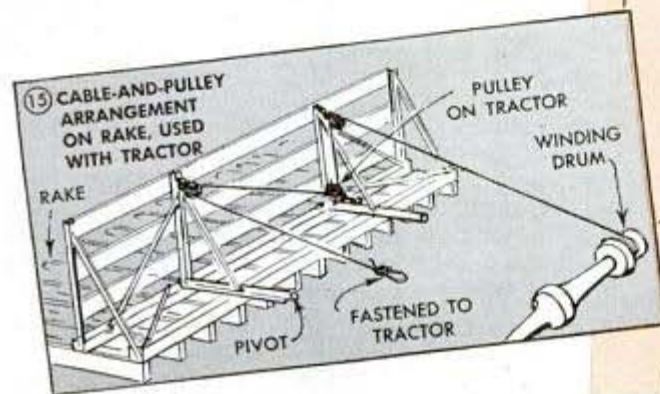

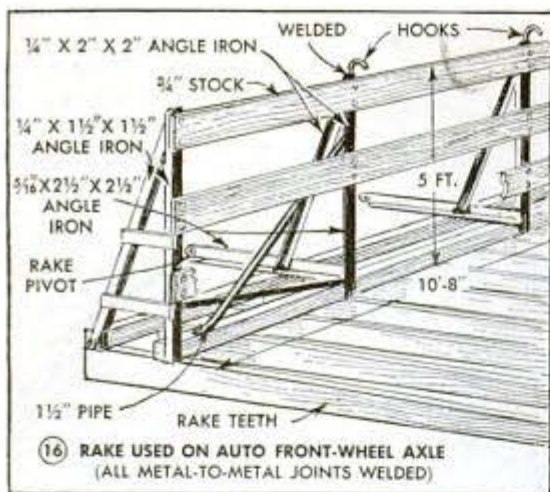

16 RAKE USED ON AUTO FRONT-WHEEL AXLE  
(ALL METAL-TO-METAL JOINTS WELDED)

axles. Fig. 11 shows how the drum is controlled. A lever is pivoted to the differential housing, and a small cable, run over pulleys fastened to the brake housings, is attached to the lever and to the brake cam levers. When the lever is moved to the left the brake is set in the right-hand brake drum, locking the axle, which causes the axle carrying the drum to rotate. When the lever is released a spring at the lower end pulls it back, setting the brake and making the winding-drum side of the axle inoperative. At the same time, the brake on the right-hand side is released, allowing the axle to rotate. With this arrangement, the rake teeth can be raised or lowered to any desired height and held by merely pulling on the lever. Fig. 10 shows the pulley arrangement of the lifting cable.

As previously mentioned, overloading of the front tires and bearings when a rake is mounted on a tractor is avoided by some farmers who use the front axle and wheels of an old car to carry the weight as shown in Figs. 12 and 14. Long pipe shafts running from the tractor rear axle or drawbar are welded to the car axle to which the rake supporting members are pivoted. On some tractors, it may be necessary to lengthen the car axle by cutting it in two and welding in a piece. The steering arm and drag link also are lengthened if necessary. Then the drag link is attached to the steering gear of the tractor so that the car wheels turn with the front wheels of the tractor. The method of doing this will, of

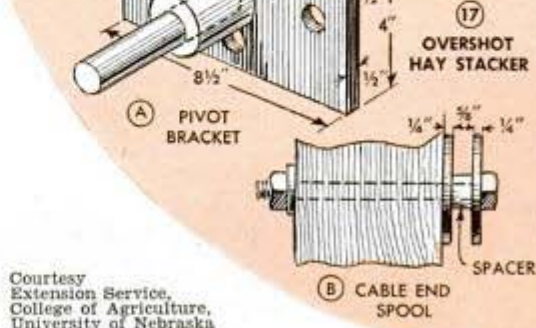
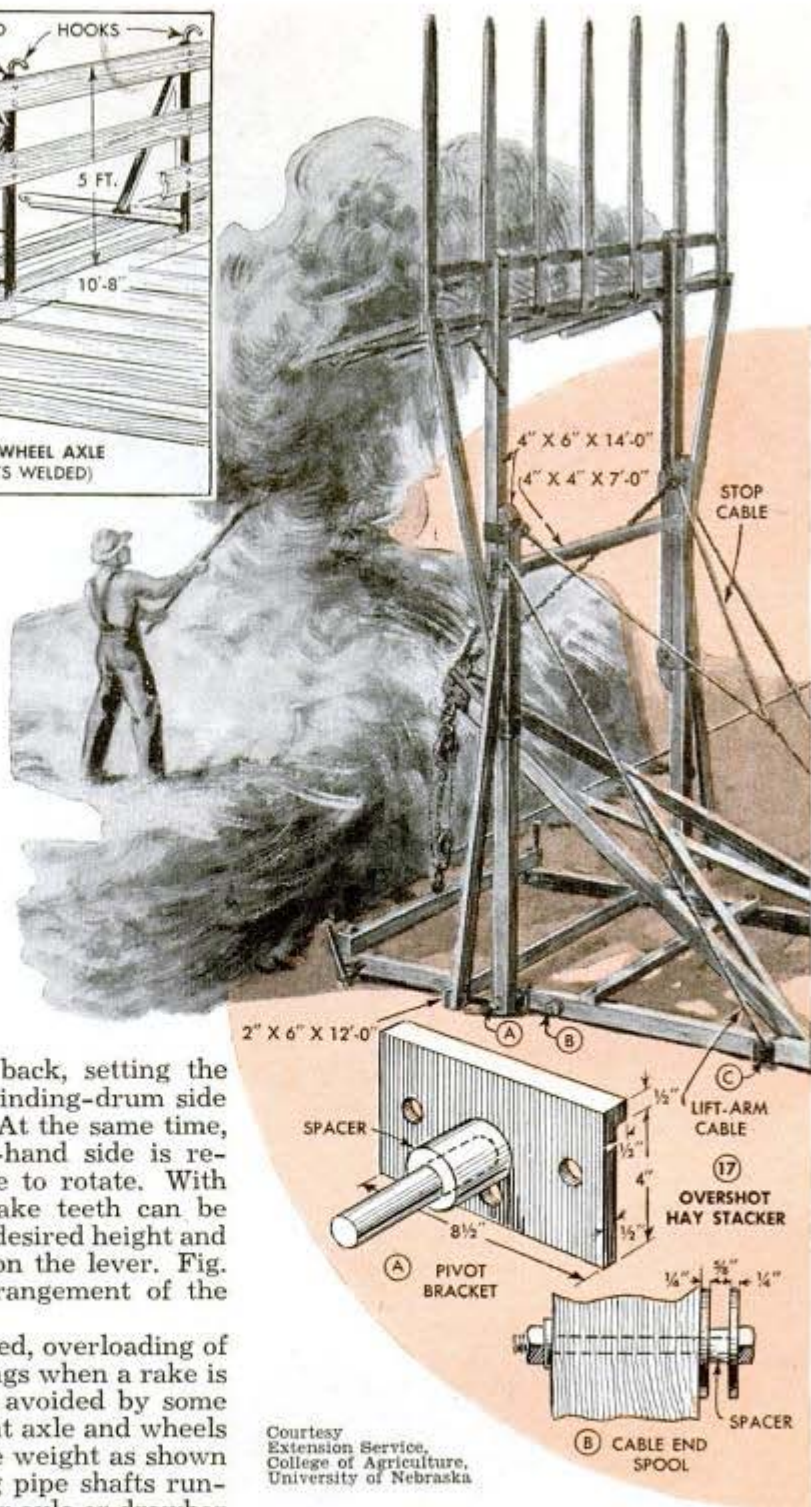

17 OVERSHOT HAY STACKER

Courtesy Extension Service, College of Agriculture, University of Nebraska

course, depend on the steering mechanism of the tractor. On the tricycle or dual-purpose type, it usually is possible to attach the drag link by means of a curved arm, which is welded or otherwise attached between the front wheels so that it turns with them. The various angles of this arm and the one on the car axle are given in Fig. 14. A V-shaped guide frame or stabilizer is attached to the tractor frame as in Fig. 14 to



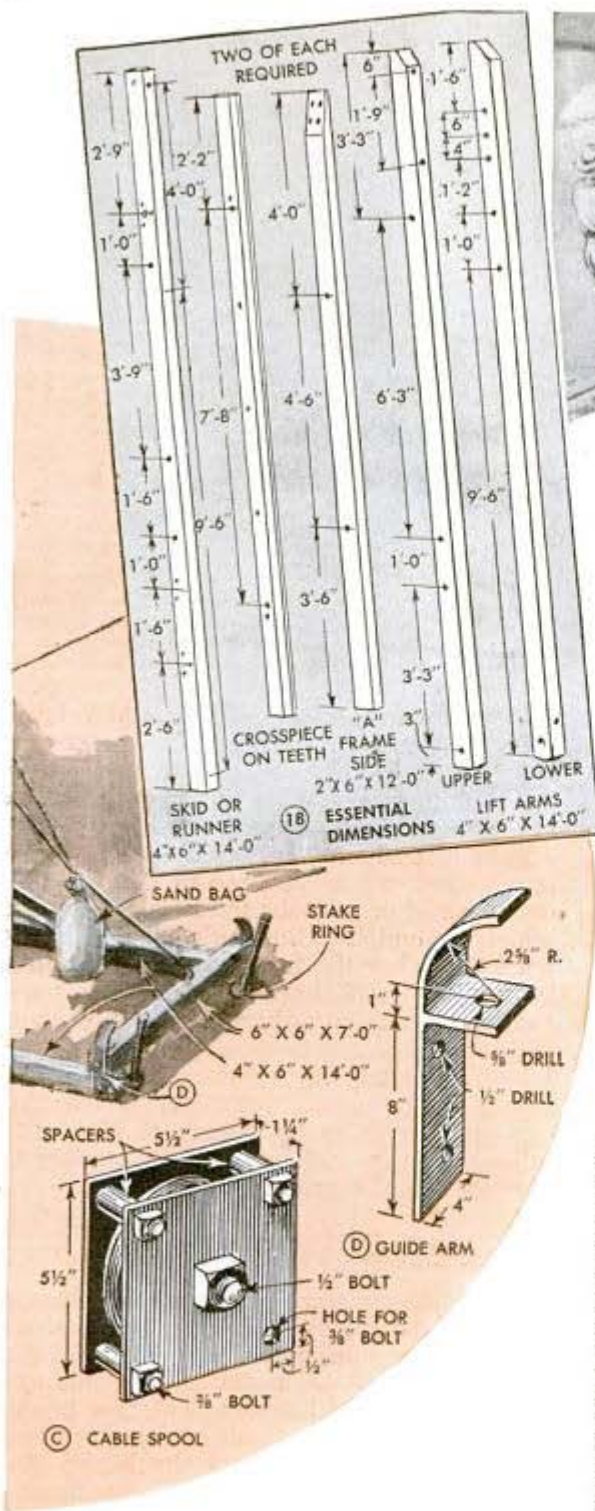

the axle is placed at the rear of the tractor, mounting it on the drawbar or other convenient place. This may make it necessary to use a couple of universal joints in the drive. Arrangement of the lifting cable and pulleys is shown in Fig. 15, the center pulley being fastened to some part of the tractor front. Notice in Fig. 13 that when mounted on a tractor the rake supporting shafts are very short. On this installation, the rake is not lifted bodily as on the car, but instead the teeth are merely tilted upward at the front. Fig. 16 shows construction of a rake for tractor mounting.

Since use of a buckrake usually means that hay is stacked, an overshot stacker will make the job much easier. The one shown in Fig. 17 is strong and fairly easy to make. Dimensions and bolt-hole locations of all wood parts except the teeth are given in Fig. 18. The teeth along with general construction details are shown in Fig. 19. Each lift arm consists of two pieces, which are held together by means of U-shaped slides, detailed in Fig. 19, at the end of each piece. These slide to permit extension adjustment of the arms. Use of lift-arm cables as indicated in Fig. 17 permits this adjusting to be done automatically. As the stacker rises with a load, the cables, being attached to each skid and to the lower end of each upper part of the lift arms, cause the latter parts of the arms to rise and thus extend the height of the stacker. Then, as the stacker is lowered, the cables let the upper parts of the lift arms work down to shorten the stacker in its lowered position. There are two advantages in using this automatic extension arrangement. It assures that the stacker will always be high enough to complete a stack of hay without making frequent adjustments, and it allows high stacks to be made without requiring excessive energy to lift the stacker in its extended position at ground level. The advantage of this latter feature is apparent when you consider that it is much easier to lift a given weight

keep the car axle centered when backing. The chain should be long enough to allow a movement up and down of at least 8 in. The guide should be attached just back of the tractor front wheels as indicated. On a tractor, the power take-off usually can be utilized to drive the lifting mechanism, which is an old car rear-axle assembly arranged as on the car installation. However,

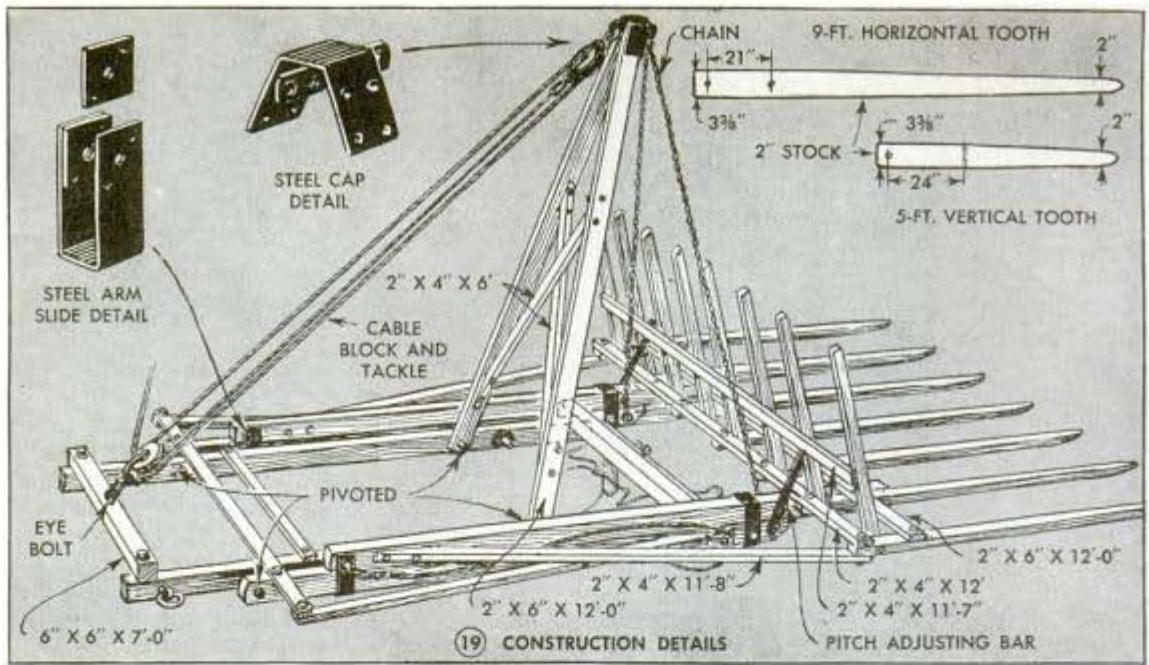

at the end of a short arm in a horizontal position than a long one. Notice how the lift-arm cables are run over pulleys, C, Fig. 17, and fastened at the ends to cable-end spools, B. Extended height of the stacker can be adjusted by shortening or lengthening the cables at the spools. Pivot brackets, A, attach the lift arms to the skids, and guide arms, D, prevent the arms from coming down on top of the skids. An old wagon tire will provide metal for the guide arms, which can be made by your local blacksmith or welding shop.

A stop cable to check travel of the stacker just past the vertical position is attached at the front end of the skid assembly and near the tops of the lower members of the lift arms. A sand bag near the lower end of

this cable serves as a weight to help in lowering the stacker. If available, a strong spring would be better as it would check the travel of the stacker with a snap action and thus aid in dislodging the load.

A block and tackle raises the stacker and is attached to the rear end of the skid assembly and to a V-shaped hoisting frame, which is pivoted to the skids, a chain being used to anchor the frame at the front end. Notice in Fig. 19 that the pitch of the vertical teeth can be adjusted by metal bars. This adjustment is necessary to control release of the hay at various heights of the stack. Large metal rings attached near the ends of the skids by means of eye bolts take long stakes with which the stacker is anchored to the ground.

## Careful Check on Deliveries Is Possible With This Panel

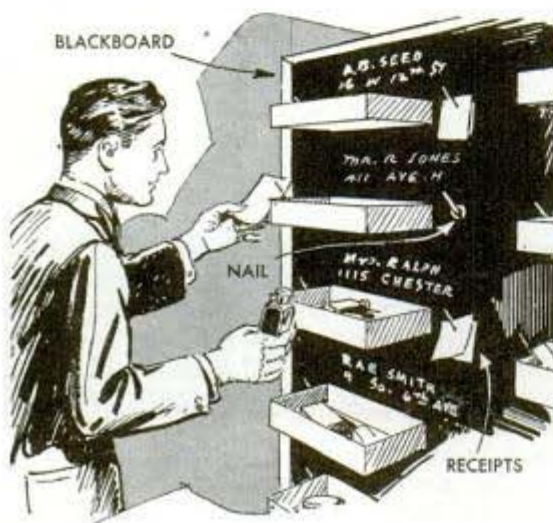

This delivery panel keeps each delivery separate and shows at a glance whether an order is being delivered or the receipt for it is already in. A number of boxes are attached to a blackboard, and nails or hooks are placed on both sides of each box. When an order is put in one of the boxes, the customer's name is written on the blackboard above it and the receipt placed on the hook at the left. The delivery boy picks up the order and the receipt, then, on returning from the delivery, he hangs the signed receipt on the hook at the right.

When penning strange pigs together, spray them with a solution of dip disinfectant so that they all have the same odor and they will be less likely to fight.

# Holes Spaced Accurately With a Drill-Press Jig

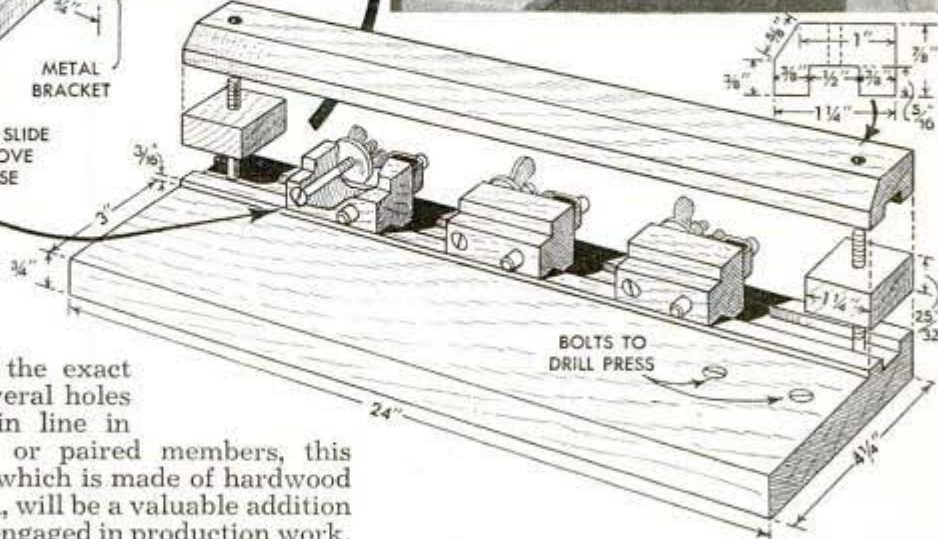
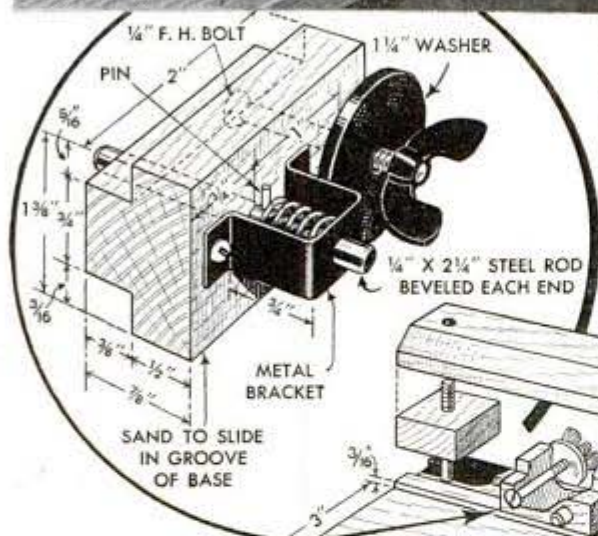
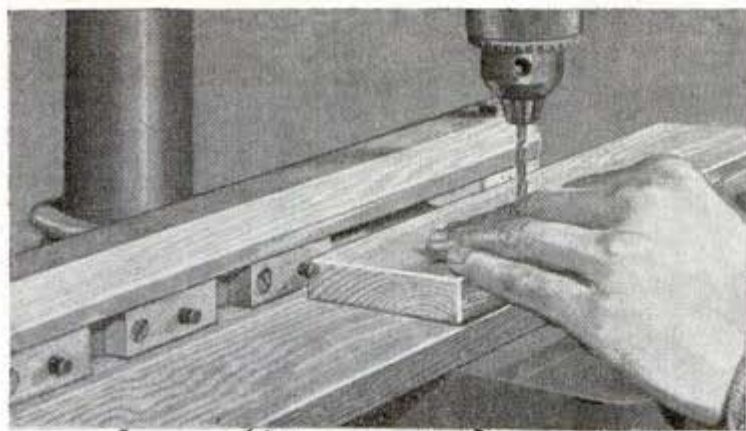

For locating the exact positions of several holes to be drilled in line in identical parts or paired members, this drill-press jig, which is made of hardwood and scrap metal, will be a valuable addition to many shops engaged in production work. It can be installed or removed quickly as it is attached to the drill-press table with bolts and wing nuts. Consisting of a base and a rail as long as required, the jig is fitted with a number of stop blocks that can be moved along a channel and locked at any predetermined position. The blocks are locked in place by wing nuts that tighten large washers against the base and rail. Being extra large, the washers will have to be made specially. Each block has a sliding pin projected beyond its face by a light compression-type coil spring. In use, the work is placed against the fence so that all stop pins are pushed in. Then it is slid along the fence until the first pin is released, which provides a stop for drilling

the first hole, the work being pulled back to butt snugly against the pin. For the other holes, the work is advanced and butted against succeeding pins. The work may be moved either left or right according to the prearrangement of the stops.

—Charles E. Troutt, Atlanta, Ga.

## Ammonia Removes Oven Scorch

Ovens scorched when pie or other confections run over may be cleaned by leaving a cloth saturated with ordinary household ammonia over the spot for a couple of hours, after which the scorched material will wipe off.

—Mrs. Hal Geihm, Aurora, Ill.

## Truck Tires Inflated Inside Cage To Prevent Injuring Workmen

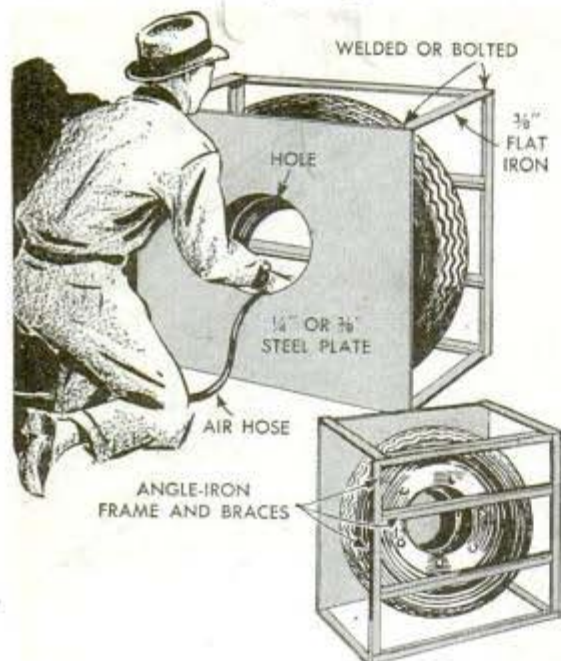

After one of his tire repairmen had been seriously injured while inflating a newly repaired truck tire because one of the lock rims flew off, the owner of a fleet of trucks made a cage like the one shown in which to house the tire while inflating it. The cage is welded together from angle iron, the front consisting of a steel plate with a large opening through which the air hose is inserted.—John Krill, Youngstown, Ohio.

## Emergency Car Distributor Gasket

Rubber distributor cap gaskets of the Ford V-8 type can be replaced by ordinary canning jar rubbers. These are about the same size and are less expensive than the standard gaskets, which often are difficult to obtain.

## Hardening of Tool Steel Aided By Wetting Agent



Users of tool steels sometimes dip the pieces before hardening in a saturated solution of boric acid to reduce the amount of decarburization during heating. Unless the work is absolutely clean, wetting may not be complete.

However, a few drops of some wetting agent in each quart of the acid solution will insure complete and uniform wetting. Such

agents are available at chemical-supply houses and photo-supply stores; or some hair-washing preparations may be used.

## Spring Used to Take Up Play In Worn Threads of Vise

Much of the time wasted in using a vise that has play in the movement of the jaw because of worn screw threads can be avoided by using a compression spring as shown.

The spring keeps the threads on the screw in contact with those inside the vise so that the slightest movement of the handle is transmitted to the jaw.—H. C. Kenly, Summit, N. J.

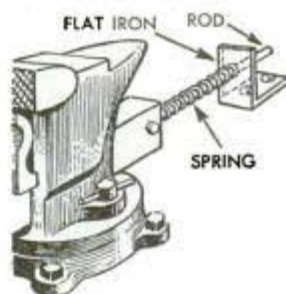

## Auto Records and Ration Books Clamped in Glove Compartment

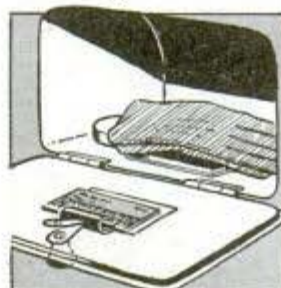

One motorist who had trouble in keeping his car ration books and tire inspection records at hand in the car clamped them to the door of the glove compartment. To do this, a spring paper clip was fastened to the inside surface of the compartment door. On some cars this can be done by slipping one side of the paper clip under the nut that holds the knob in place. In this position, the papers are out of the way, yet are kept safely stored and conveniently at hand.

—Anson W. Tiffany, Kingsley, Pa.

## Oil Swab Carried on Tape Reel

To keep a steel tape free of rust and in good condition under all working conditions, it should be wiped occasionally with an oil-soaked swab. To avoid carrying an oily cloth for this purpose in his tool bag, one carpenter

removed the threaded filler neck and cap from an empty oilcan and soldered it to his tape reel to serve as a housing in which to carry the cloth.—Opie Read, Jr., Chicago.



# Stool Pivoted on Bench Swings Out of the Way

Always at hand when needed yet easily swung out of the way when not in use, this workbench stool is comfortable, and it is easy to make from a few pieces of pipe and some fittings. Although different sizes of pipe are indicated, the stool could be made from any scrap pipe available. However, the tees through which the seat standard slides and those that pivot on the support pipe next to the bench will have to be large enough to permit a sliding fit. Floor flanges are used to attach the stool to the bench and the seat to the standard, the latter also having a flange at the lower end to serve as a foot. A spring under the seat raises the foot off the floor when not in use to permit easy swinging of the assembly. When a person sits on the seat, his weight compresses the spring, pushing

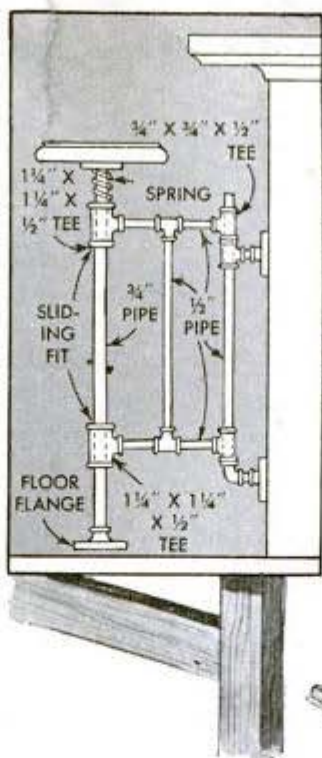

the foot to the floor. Thus there is no strain to pull the stool from the bench.

—Thos. H. Duffy, Altoona, Pa.

# “Tongs” to Remove Small Articles From Show Window

Removing small articles from the front of a show window without disturbing the rest of the display is a simple matter if you use this little gadget. It consists of a spring



clothespin, which has one leg screwed to the end of a suitable handle. The free leg is operated to pick up articles by a trigger at the other end of the handle, the trigger and clothespin being connected by a strong cord or thin wire. If desired, a pistol grip may be provided at the trigger end of the handle to make it easy to hold.

—Paul V. Repasy, Franklin Park, N. J.

# File-Card Holder From Envelope

When a number of small cards on the same subject must be filed together, a holder that will keep the cards grouped can be made easily from an envelope. All that is necessary is to cut the envelope from one



corner to another as indicated. This forms a three-cornered pocket for the cards. Either old or new envelopes can be used.

—J. Paul Stevens, Taos, N. Mex.

# Mass Inspection with Illuminated magnifier



when they subsequently develop. An incorrect analysis of the raw materials may cause uncertainty in machining operations and may result in incorrect heat treatment, which is highly critical. Although a few precision inspection instruments are entirely mechanical, most of them incorporate optical or electrical features, or both. In general, all are designed for ease of operation so that the average shop worker can learn to use them within a relatively short time. In this article the most commonly used devices for inspection will be considered.

**Illuminated magnifiers:** The small instrument shown in Fig. 1 is an illuminated magnifier having a wide field range with



by H. J. Chamberland

**Q**UALITY control in mass production assures that a hundred or a hundred thousand parts are identical in respect to internal structure, strength, resistance to wear, surface and dimensional accuracy. To be effective, quality control must start with raw materials because it simplifies locating and correcting troubles if and



③ *Shadowgraph*



④ *X-ray film magnifier*

either a 2 or 3-in. achromatic lens, which transmits light without decomposing it into primary colors. Two electric lamps, one on either side of the lens and under a shield that prevents glare to the worker, illuminate the parts being examined. The magnifier can be used for bench inspection as shown or may be taken to any machine or place where electrical connections are available. Such a low-cost inspection instrument is ideal to set cutting tools, observe cutting action and read fine graduations.

# Precision Instruments

With its 3-power lens, minute errors in welding and riveting, and cracks in hardened steel can be detected, after which more effective instruments may be used for further examination. The lens sets at a high eye point for convenience in working and relief of eye strain. Detail A of Fig. 2 shows a 7-power (7X) photomicrograph of a series of minute cracks. Detail B shows a 300X photo of a similar pattern.

The illuminated magnifier shown in Fig. 4 is strictly a bench model particularly designed to study X-ray films, technically known as "radiographs." Illumination in this case is a fluores-



⑥ Shop microscope

for observation. Although this instrument has many applications, in this case it is used to control the setting operation on bandsaw teeth. The machine that sets the teeth automatically stops if an error of .002 in. is exceeded.

**Shop microscope:** Fig. 6 shows a very popular shop microscope for inspecting routine work which is in process or has been finished. It magnifies 40X and may be carried in one's pocket. A self-contained battery supplies ample illumination. In use, the device is placed on a surface that is to be inspected and the illuminator but-



⑦ Toolmaker's microscope

cent light. A rheostat controls its intensity, the telescopic mount is adjustable to individual vision and the size of the equipment permits inspection of 14 by 17-in. films. While intended for a special purpose, the instrument has other applications within its range of 2½ magnifications.

**Shadowgraph:** The instrument shown in Fig. 3 is a shadowgraph. It consists of an illuminated microscopic lens of predetermined power. This directs the image of the object in its field onto a mirror which in turn reflects the image onto a white screen



⑧ Brinell hardness tester

## ⑨ Electric comparator



ton is pressed. The resulting light casts a deep shadow which is highly effective for the study of all surface characteristics. The instrument has a direct reading scale to measure cracks, flaws, impressions and projections to an accuracy within .00025 in. (one-quarter of a thousandth inch). It has hundreds of applications for extremely fine inspection, such as measuring impressions of Brinell hardness-testing instruments such as shown in Fig. 8. It is regularly used to inspect wear, blowholes in castings, welds, deposits of metals or paints, etc.

**Toolmaker's microscope:** The toolmaker's microscope shown in Fig. 7 is a somewhat finer instrument than the shop model in Fig. 6, and has about the same magnifying power, but a variety of objectives and eyepieces is available to meet individual requirements. Unlike laboratory-type microscopes, it shows the objects and movements in their natural aspect and direction, instead of being reversed. Fig. 5 is a 50X photomicrograph of the surface of a brass alloy. To use a toolmaker's microscope, the operator places the object to be examined on the microscope table and clamps it in position, then focuses on the part directly under the cross line in the microscope tube. The table can be moved longitudinally and transversely by two mi-

cometer screws with readings in .0001 in. By moving the object under the cross line in the tube, the distance between any two points is measured by the readings of the micrometer screws. This microscope is adapted to inspection of gauges, fine threads, complicated outlines involving radii and angles, etc. In reality the instrument is like a vernier micrometer, caliper or protractor, enlarged 40 times its normal size.

**Electric comparator:** The instrument shown in Fig. 9 is an electro-mechanical device for dimensional inspection on a production basis. It is finely calibrated and is in reality a high-production micrometer because it is from ten to a hundred times more accurate and is also much faster to use than any type of regular micrometer. Instruments of this kind are designed to calibrate in thousandths, ten

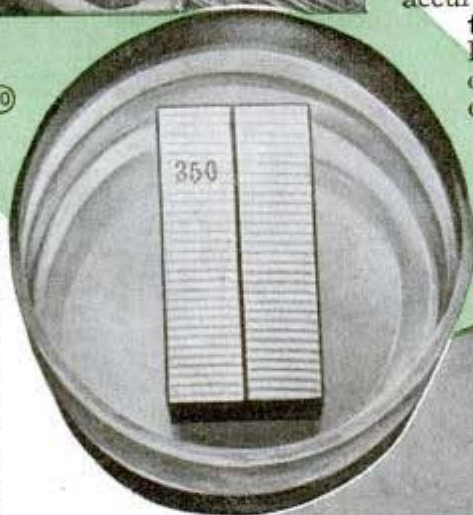

## Monochromatic light and optical flats



thousandths and one-hundred millionths of an inch. With the instrument shown, however, the change from one reading to another is instantaneous by the turn of a switch. Thus this special comparator does the work of several others of limited capacity. The operator can master precision measuring after a few hours of instruction.



**Monochromatic light and optical flats:** Measuring to millionths of an inch, monochromatic (one-color) light is used in connection with optical flats, Figs. 10 and 11. Although originally used in the laboratory, this equipment has become popular in many inspection departments and tool rooms. About a month of special training is necessary for an uninitiated worker to become proficient in measuring accurately with this equipment. Unlike white light, which contains all the colors of the spectrum—each one of different wave length—monochromatic light emits only one color having rays of the same wave length. When this light is directed through a

## ⑫ Profilometer

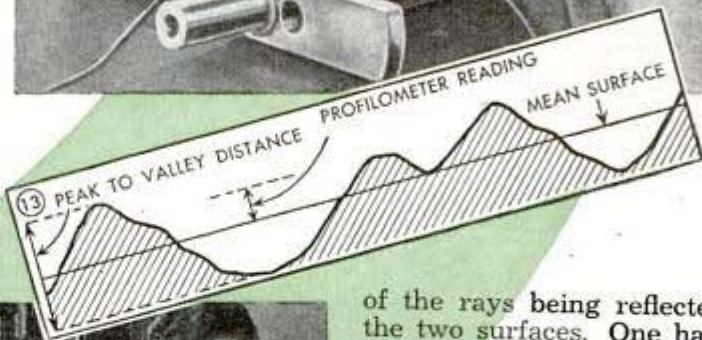

## ⑬ Mobile inspection unit

quartz optical flat placed on the work to be measured, the rays reflected from the bottom of the flat and the top surface of the work cause dark interference bands as shown in Fig. 10, owing to a thin "wedge" of air between the two surfaces. The bands repeat themselves each time the width of the wedge of air is increased by a vertical distance equal to one half the wave length

of the rays being reflected from the two surfaces. One half wave length of ray from a helium light source is about eleven millionths inch. If the wedge of air becomes narrower, indicating that the two flat surfaces are more nearly parallel, the distance between the bands increases—and vice versa. The bands are at right angles to the wedge; the straighter they are, the finer is the degree of flatness accuracy of the work. If the bands are concave or U-shaped when the point of the wedge is closest to the observer, the surface of the work is low in the center and high at the ends. If the surface is high in the center and low at the ends, the bands are convex. Thus it is relatively easy to determine the degree of accuracy of any flat surface when compared to a master part of known accuracy if both are observed simultaneously. Monochromatic light is produced by using cadmium, helium, sodium, etc., helium being generally used for the purpose.

**Profilometer:** The profilometer, Fig. 12, is an instrument used to study or inspect surface finish on a production basis. It performs electrically rather than optically, and is quite simple to operate after a few hours of practice. On any fine surface finish there still remains a range of peaks and valleys of microscopic size. The purpose of the

## 15 Metalloscope

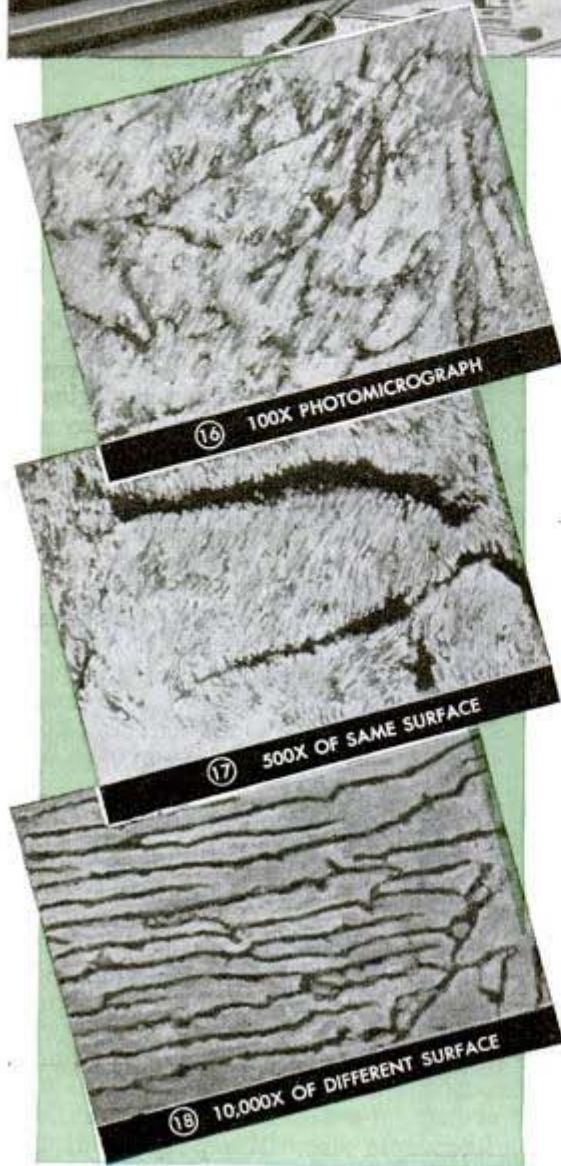
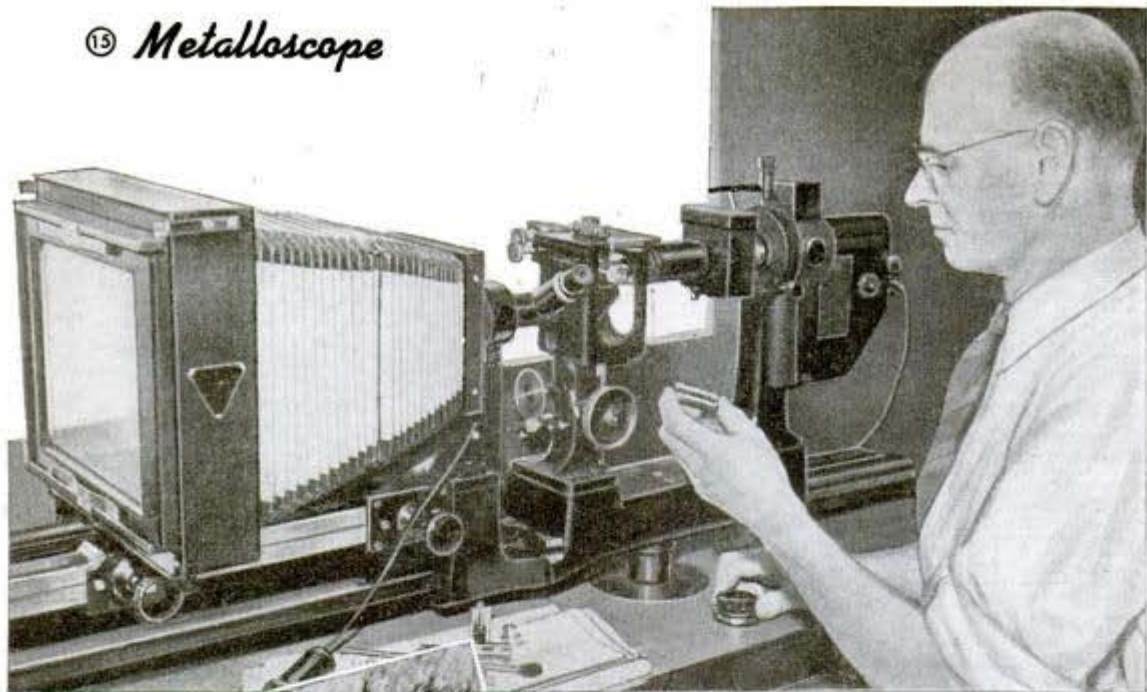

16 100X PHOTOMICROGRAPH

17 500X OF SAME SURFACE

18 10,000X OF DIFFERENT SURFACE

profilometer is to measure these minute deviations rapidly in terms of micro-inches—millionths of an inch. The tracer member in the operator's hand is fitted with a fine diamond point. As this point travels over the surface being tested, the microscopic high and low spots cause vertical displacements of the point, which in turn cause similar variations of current in a coil located in a magnetic field inside the tracer head. As the varying current is too small to operate a meter directly, it is amplified so that it can be measured by the meter. Fig. 13 shows a profilometer reading.

**Mobile inspection unit:** Mobile inspection, Fig. 14, is a recent innovation in quality control. This practice eliminates placing instruments in many parts of a plant and also saves considerable time. The inspector can wheel the unit to any machine to check gauges and other tools as well as parts being machined. The one shown is a cabinet on wheels and is equipped with an illuminated magnifier, electric comparator, monochromatic light, master flat and several surface flats, a full set of gauge blocks, and various instruments to increase the value of gauge blocks. Pull-out desk space and drawers also are provided for keeping production records and making necessary notations.

**Metalloscope:** The metalloscope, Fig. 15, is an instrument designed for visual observation and photography of internal structure or formation of metals and alloys. Basically, it consists of an inverted microscope and a camera with 40-in. bellows extension and a series of objectives and eyepieces, etc. The microscope may, of

course, be used separately. Illumination is provided by an arc lamp and transformer for use with alternating current, or a motor-driven 10-amp. carbon arc for use with direct current. The metalloscope is so designed that any one fairly well trained in photography can do surprisingly effective research work in a reasonable length of time. Specimens may be examined or photographed from 25 to 2,000 times actual size.

Most important is the preparation of the surface to be examined; this work is called etching and is done as follows: Specimens of hardened steel must be tempered to a blue color to bring out the so-called carbide structure. With other specimens this step is disregarded. Specimens to be compared should be of identical size and are clamped together after being aligned in order to produce an even surface, which is first rough-ground with a coarse-grain wheel and then finish-ground with a fine-grain wheel. It is next dry-polished with No. 1 abrasive cloth at right angles to the grinding marks, then repolished with No. 00 cloth at right angles to the previous polishing operation. After this, the surface is finely wet-polished with 400 aluminum-oxide lapping compound and subsequently with lavigated alumina. After cleaning the finished surface with kerosene and wiping it dry with chamois, the specimens are ready to be examined or photomicrographed. Fig. 16 shows the appearance of a surface etched as above outlined and magnified 100 times and Fig. 17 shows the same surface magnified 500 times. Fig. 18 shows a 10,000X photomicrograph of another surface, and 100,000X magnification is within the range of the recently developed electron microscope.

**Cyclograph:** Shown in Fig. 19 is another production testing instrument, called a cyclograph, which is used to inspect or classify structures, depth of case, brittleness, castings, forgings, chemical content, thickness of tubing, plating, etc. It does the work of the metalloscope, but it is electronic rather than optical in operation and utilizes no photographic equipment. It is also a comparator instrument, and is as easy to operate as a radio. In use, a reading is made of a master specimen, this being etched as previously outlined. Then the instrument is calibrated according to the depth of case, structure, brittleness or other requirements, including allowable error. After such adjustments, parts by the hun-

## 19 Cyclograph

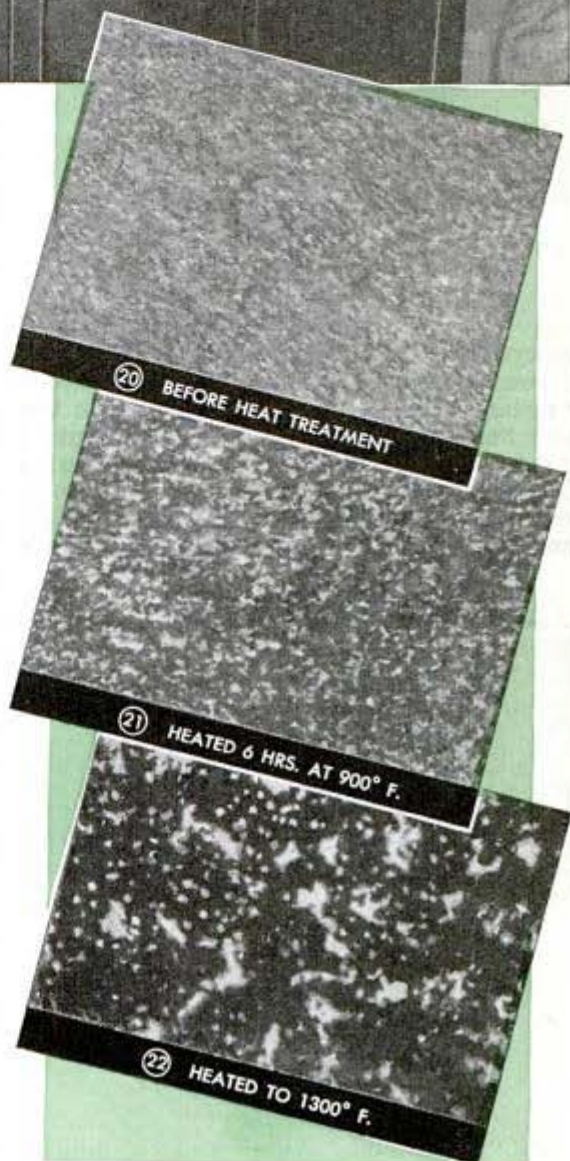

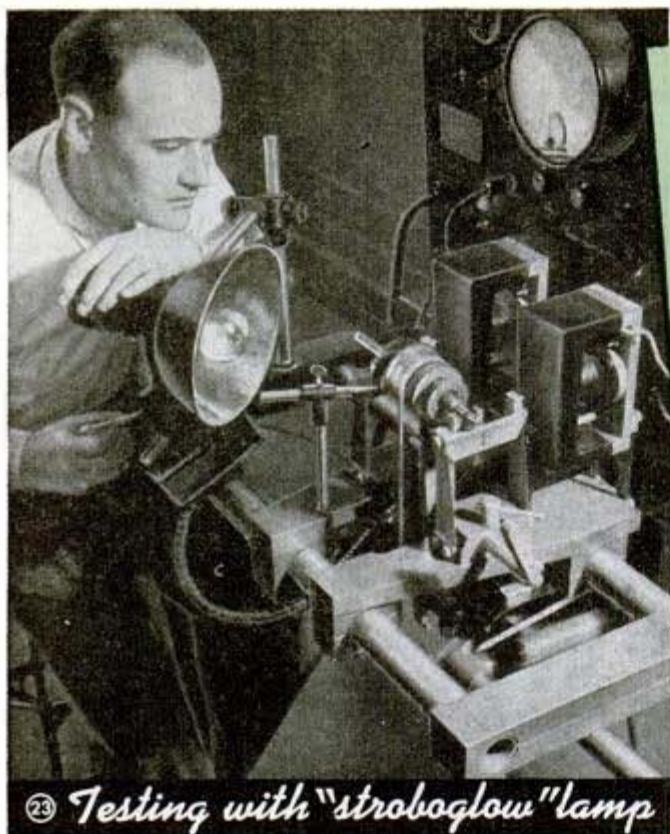

23 Testing with "stroboglow" lamp

dreds or thousands can be inspected as fast as they can be handled, being placed in a purposely designed coil. The operator need only observe the slightly-enlarged pattern or cyclogram appearing on the cathode-ray screen, then compare this pattern with the master pattern. The cyclograph is an inspection instrument for the full output of production, whereas the metaloscope is for specimen inspection of less than 5 percent of total production. It is obvious that some of these precision testing and inspec-

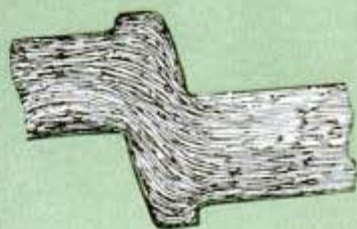

24

tion devices are not within reach of a small plant, but frequently private laboratories provide facilities so that production on a small scale can be controlled as efficiently as mass production in a large plant. Figs. 20 to 22 show how internal structure of steel changes with varying heat treatment and Fig. 24 shows how the

structural or flow lines in a forging look when highly magnified; note that they follow the bend in the metal as water follows a bend in the brook.

**Testing balance with "stroboglow" lamp:** Fig. 23 shows how parts rotating at high speed are electrically tested for balance, the amount of error and location thereof being indicated on a meter. In this case, the indicator point shows a piece of putty on the rotor, which a stroboglow lamp makes visible while the rotor is turning.

## Auto Door Is Pulled Shut by a Strap Through Arm Rest

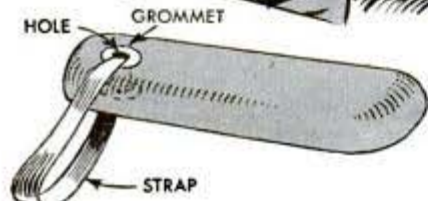

Grasping a strap inserted through the arm rest to close a wide car door is easier than reaching for the window crank or door lever. For this purpose a strap can be inserted through a hole drilled in the arm rest as shown. Metal or rubber grommets should be placed at top and bottom of the hole before attaching the strap.

## Drill Press Set at Edge of Bench For End-Boring Long Work

End-boring long work can be done with a bench-type drill press mounted at the extreme edge of the workbench with the head swung out a quarter turn. The work is then rested on the floor and the drill brought to bear on the end.

## Wooden-Plug Cutter Is Turned From Drill Rod

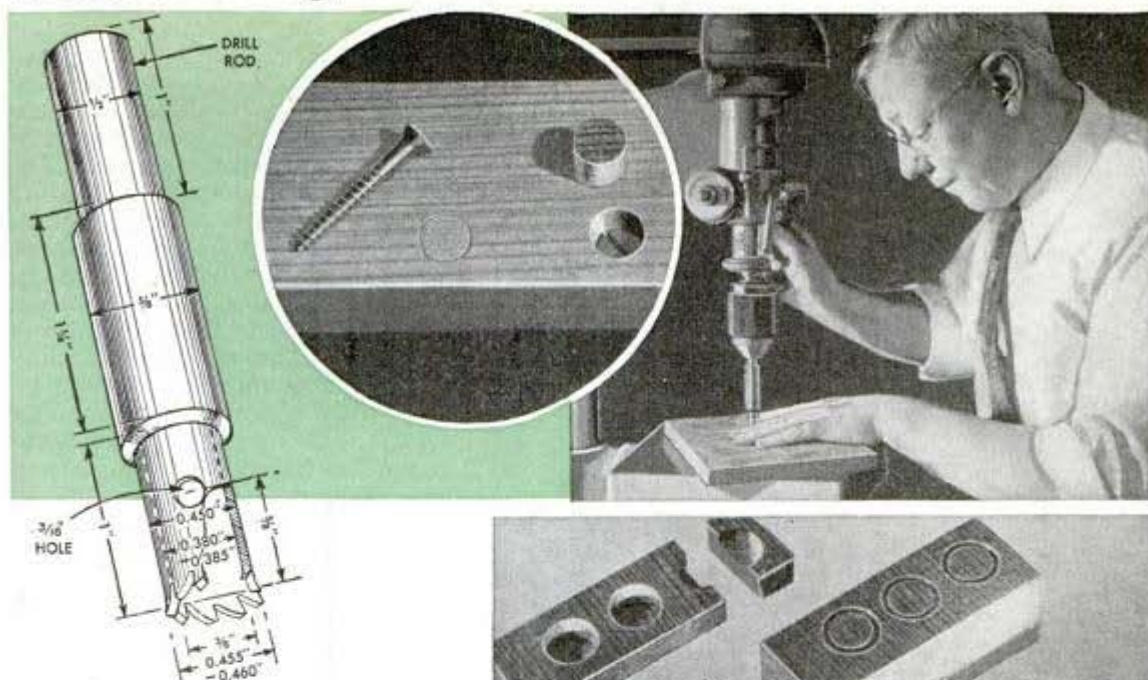

Wooden plugs for covering screws or dowel ends in fine cabinet work can be made by a cutter turned from drill rod. One end of the rod is turned to fit the drill-press chuck, and the other end is turned to suit the plug. Outside diameter for a  $\frac{3}{8}$ -in. plug would be .0455 to .0460 in. Next, a hole is drilled to a depth of 1 in. and is bored to the plug diameter as shown by the dotted lines. Then it is enlarged to within  $\frac{1}{8}$  in. from the end for plug clearance. The outside diameter is slightly reduced over the same distance for tooth relief. Teeth, cut with a three-cornered file, should be  $\frac{3}{32}$  to  $\frac{1}{8}$  in. deep and

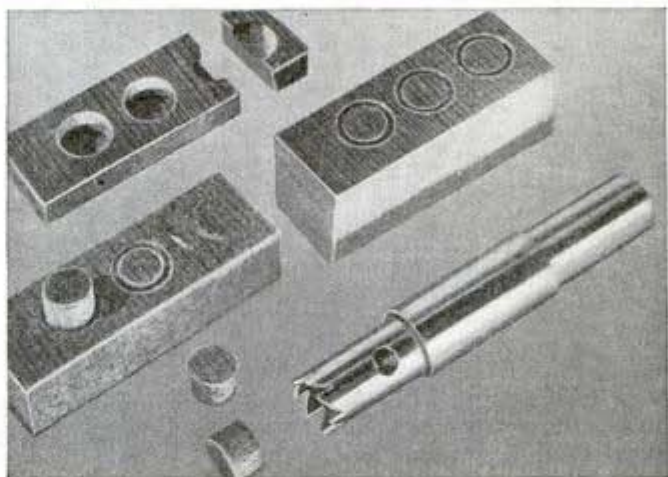

slightly coarser than crosscut teeth. A hole is drilled crosswise for inserting a wire to push out plugs that break off inside the cutter. After machining, the cutting end should be hardened.

—Walter E. Burton, Akron, Ohio.

## Horseshoes on Sections of Harrow Make Them Easy to Lift

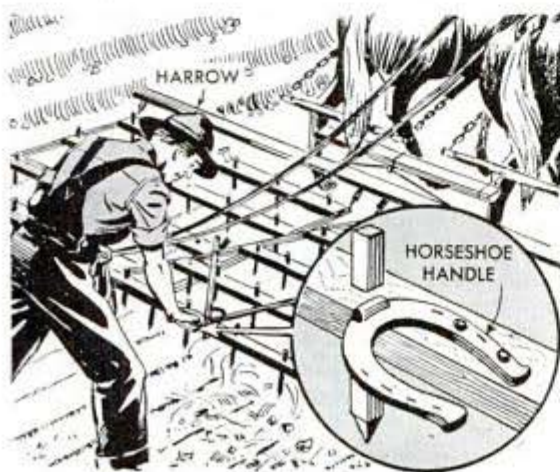

Lifting the sections of a harrow to free them of accumulated weeds and dry clods is made easier if a horseshoe is attached to each section to serve as a lifting handle. Nail holes in the shoes are enlarged to take bolts with which they are attached.

## Fitting Motorcycle Drive Chain

Fitting a new, secondary drive chain around the countershaft sprocket of a motorcycle can be simplified by fastening one end of the new chain to the end of the old one before removing it from the front sprocket. Then, as the old chain is pulled through, the new one will follow in its place.—I. J. Stretten, Detroit, Mich.

# Inexpensive Grinder Head From Pipe Fittings

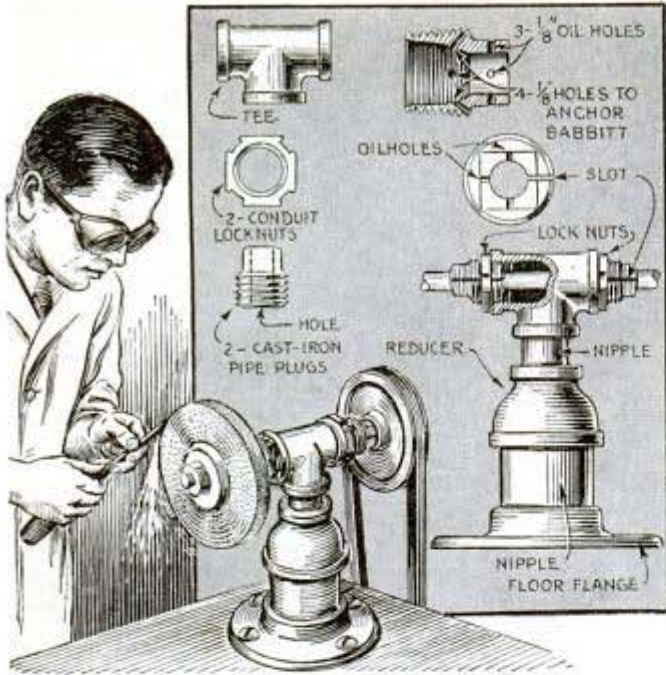

A few standard pipe fittings can be assembled to make an inexpensive grinder head. Any size fittings can be used. After the base is assembled, the bearings are made from pipe plugs screwed into a tee at the top of the base. A  $\frac{1}{2}$ -in. hole first is drilled through each plug to take the spindle. Then, located around the plug, four  $\frac{1}{8}$ -in. holes are drilled for anchoring the babbitt. Also, oil-holes are drilled through the walls at the end of the plug. This may be done after pouring the babbitt; or, if the holes are drilled previously, the babbitt can be pierced later. The plugs then are slotted lengthwise along one side to allow for bearing take-up and secured in place with conduit lock nuts. These may have to be retapped to fit the plug threads.

—Roy L. Rhoades, Madison, Wis.

## Pipe Slipped Over Hammer Pulls Nails Above Your Head

When one carpenter is dismantling a scaffold or doing some other job in which it is necessary to pull nails that are out of reach from the ground, he slips a piece of pipe over the end of the hammer, enabling him to pull the nail as shown. This method is particularly handy when nails are located so that a claw bar is ineffective.



## Solder Will Adhere to Cast Iron Coated With Blue Vitriol

Solder will adhere permanently to a cracked cast-iron cylinder head to seal it tightly if, after the crack has been cleaned thoroughly with gasoline and chiseled smooth along its full length, a small amount of blue vitriol is dissolved in water and applied to it. The vitriol will coat the surface with a fine film of copper, making a base to which solder adheres readily.

## Test Prods Are Handled More Easily When Clips Are Used at Tips

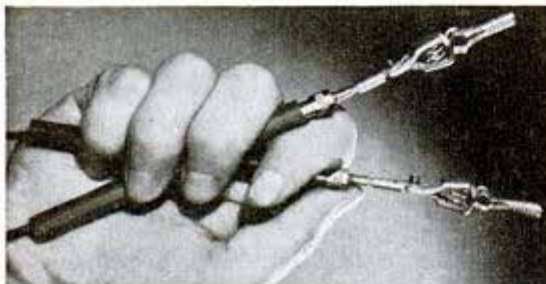

Electrical testers are much handier to use if detachable clips of the type shown are placed at the ends of the prods. Generally, at least one prod of the tester can be clipped to the object that is being tested while the other is used for probing, and on many jobs both of the prods can be clipped on, which will leave the hands free for other work.

—R. Boettinger, Englewood, N. J.



## DIRECT RECORDING ON HOME MOVIE FILM

**R**ECORDING and reproducing sound on 16mm. film instantaneously without processing, just like you would cut a phonograph record on a blank disk and switch to playback, this portable unit provides synchronized sound for home movie films.

The unit includes a recording head, microphone, built-in audio amplifier, speaker, film reel mechanism and motor housed in a portable case. The "Filmgraph" unit is also supplied without amplifier and speaker for those who wish to employ separate equipment. To make a movie sound track, the picture is thrown on the screen and a script is written to explain and coincide with the action. The recording unit, placed near the projector, provides the takeup reel, as shown in photo B. A recording needle cuts a groove on the "shiny" side of the film close to the sprocket holes as it passes under the stylus. When used for straight recording on special auxiliary film, photo A, a number of script rehearsals may be made and played back until satisfactory for the final recording on the picture film. Up to 40 sound tracks may be made across the special film.

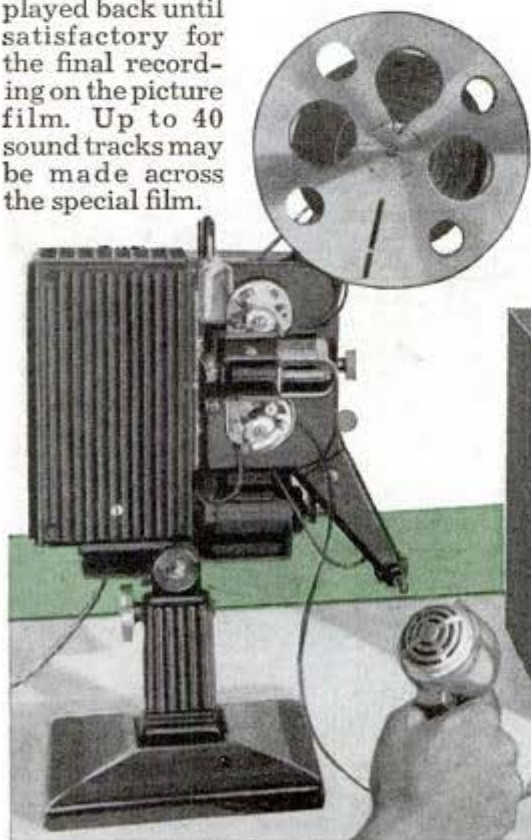
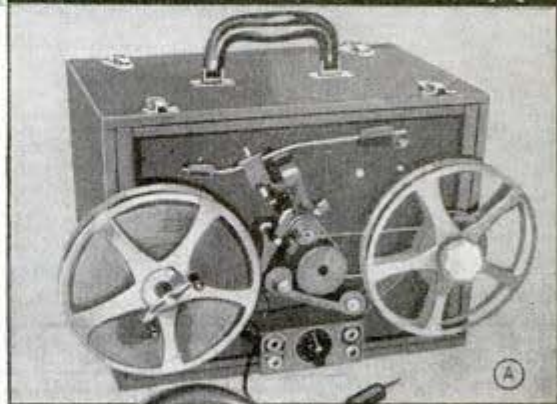

RECORDING SOUND TRACK ON 16MM. FILM

# HIGH-QUALITY TEN-WATT

By C. H. Trapp



TONE quality often sought and seldom attained is an outstanding feature of this electronic power amplifier unit which has been designed for critical experimenters interested in the reproduction of high grade recorded music, and for use with FM as well as standard AM broadcast tuners.

Although the materials specified are parts that almost any advanced radio student or experimenter has on hand, they should be of good quality. Bass reproduction is built into the unit and is not obtained by the usual type of treble attenuation which results in a booming unnatural tone. With filament adjustment either 2A3 or 6A3 tubes may be employed in the push-pull resistance-coupled circuit, which includes phase inverter, and a simple form of feed back that prevents distortion and reduces hum level to a minimum.

The sheet metal chassis base is detailed in Fig. 1; many experimenters will have salvaged metal bases that will meet the requirements. A schematic circuit diagram appears in Fig. 2, and a simplified pictorial wiring diagram in Fig. 3. Check both diagrams for parts values. The unit is not difficult to build as all mechanical and

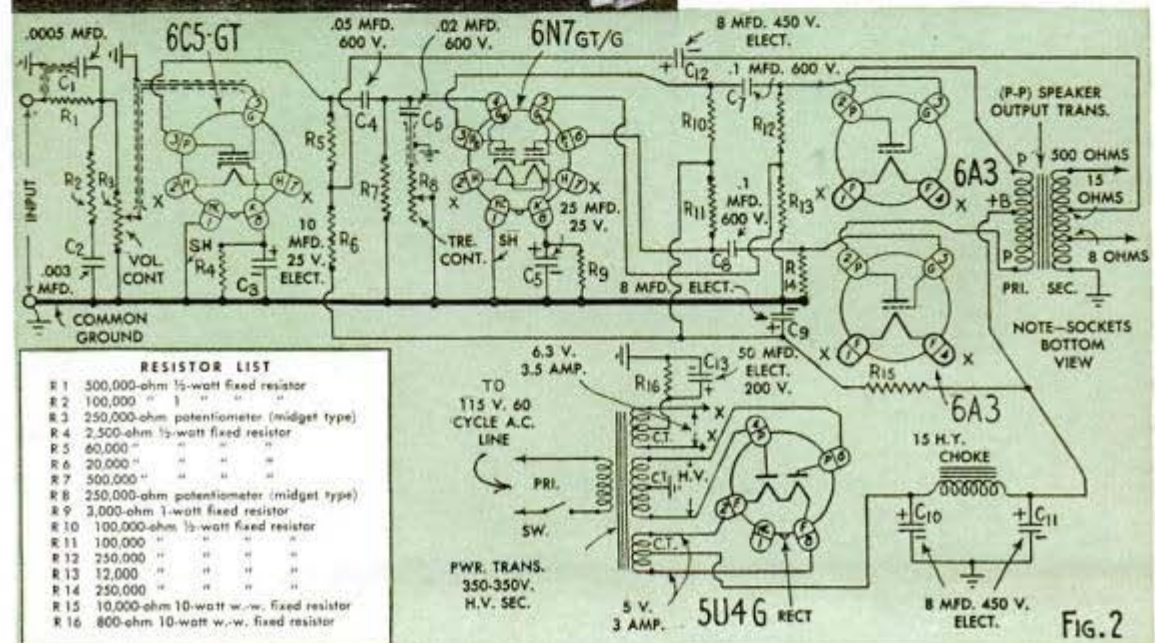
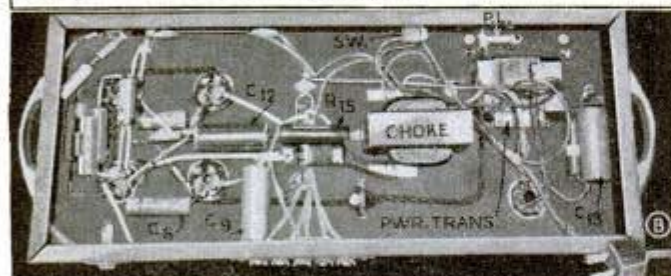
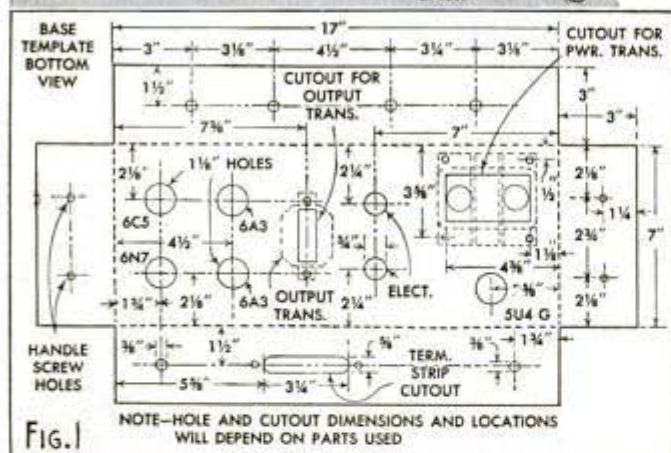



# PHONO-RADIO AMPLIFIER

electrical details are clearly shown in Fig. 3 and photos A, B and C. A large permanent-magnet speaker should be used for best results. The speaker output transformer shown happened to be a type with terminals out the bottom. Yours may have a different terminal arrangement that may necessitate bringing the leads down through the top of the base to the terminal strip shown at rear. The electrolytic filter condensers  $C_{10}$  and  $C_{11}$  can be of higher capacity and voltage rating if desired. The writer suggests two 24-mfd. 300-volt electrolytic condensers in series for each position, as this combination will carry a surge of 750 volts.

As in any electronic device, all connections should be well soldered. Use shielded single conductor wire where specified, and make all soldered ground connections to the metal shield just as indicated. The feed back loop from the 15-ohm secondary tap on the 5,000-ohm P-P speaker output transformer flattens out the frequency response curve, but it can be omitted for greater gain. Detailed student material list R-331 is available from Popular Mechanics radio and electronics department upon receipt of postage.

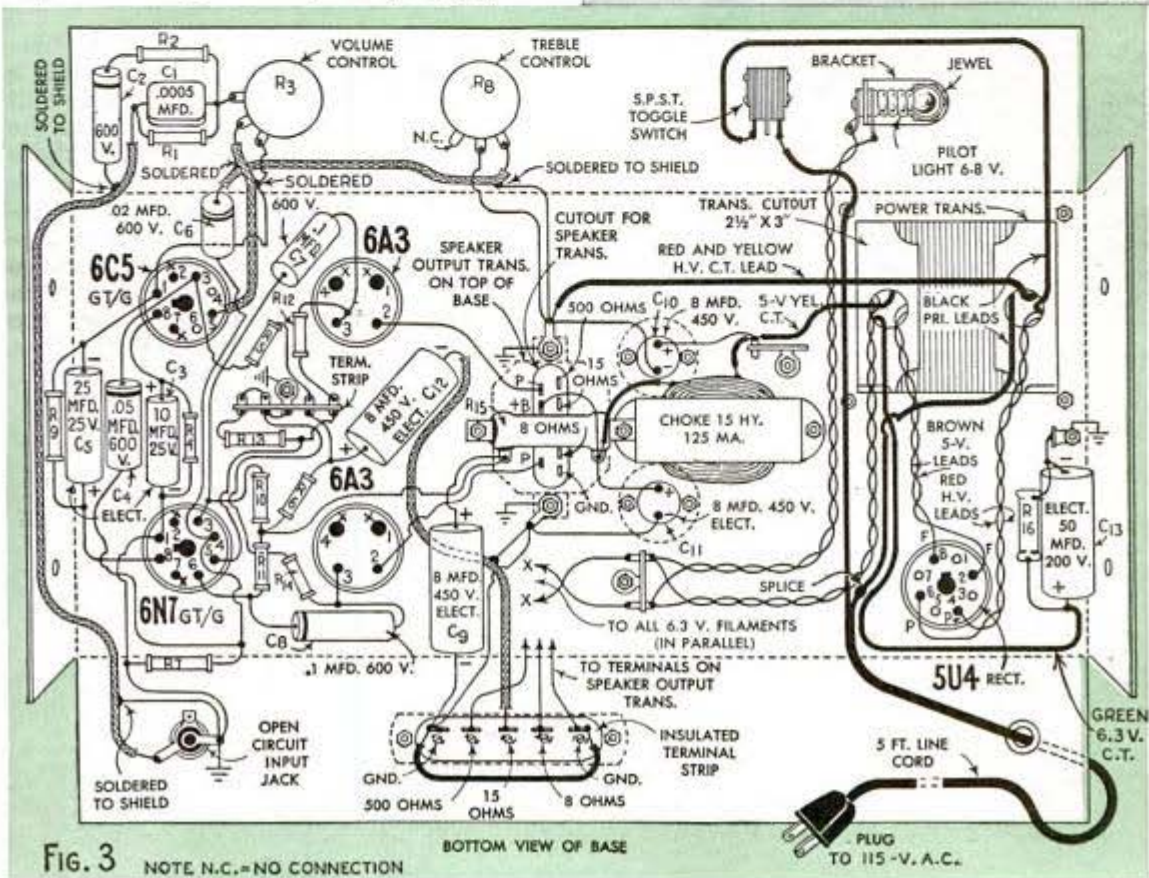
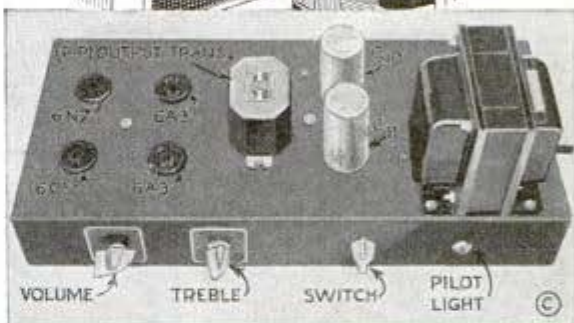

# Renewing the A-Battery in Portable Receivers

By Walter E. Burton



WHEN the A-battery in your portable radio receiver goes dead and you cannot buy a new one, you can substitute a homemade flashlight cell unit that will furnish the same voltage. The useful life of such a battery probably will not be quite as long as the standard A-battery but reasonable service will be obtained.

Take the dead A-battery apart and discard all but the cardboard jacket and the insulated top piece bearing the jacks into which the set wires are plugged. Four standard 1½-volt flashlight cells having about the same diameter as the old cells are connected in parallel to furnish the original 1½-volt output and approximate amperage.

A handy clip-in arrangement, detailed in Fig. 1, provides a simple means for quickly replacing the cells without making soldered connections. The top and bottom metal plates are cut from tin can material. The hole in the top plate should be at least ½ in. in diameter; a square sheet of ⅛-in. pressed board or similar insulating material slightly smaller than the inside of the cardboard jacket is riveted to this top plate. A small hole is drilled for a machine screw in the bottom plate, and a short coil spring is fastened to this bolt and to another bolt in the center of the insulating material as shown in photo B. The negative spring should not touch the positive top plate. Flexible insulated wires connect the positive and negative to the jacks. If necessary, remove the cardboard casings on the cells; the metal cell containers are negative, therefore the casings are not required. The complete assembly is illustrated in photo A and the sketch above.

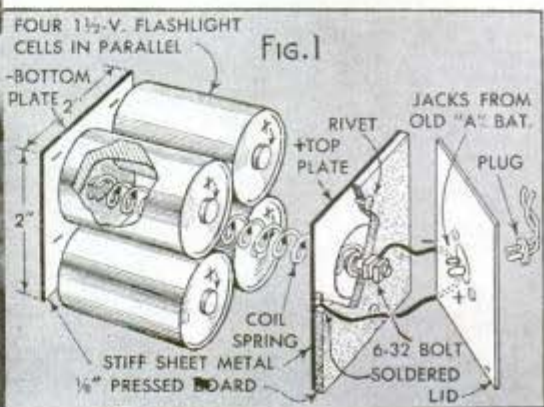
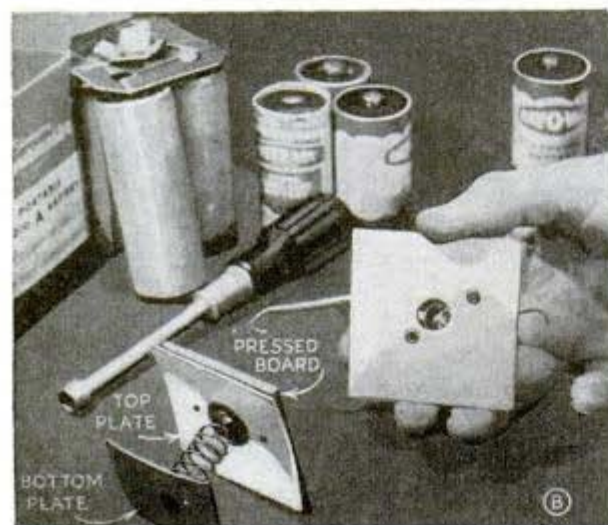

# See the Difference..

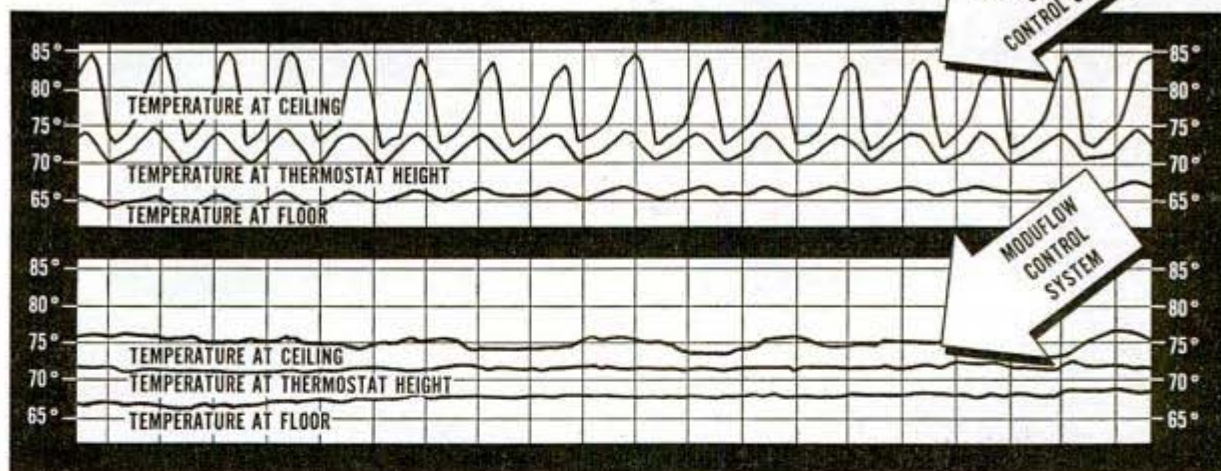

## BETWEEN MODUFLOW AND CONVENTIONAL HEATING *Control* SYSTEMS

THE CHARTS above are actual temperature recordings taken from two identical houses. One was equipped with ordinary "on and off" heating controls. The other was equipped with MODUFLOW, Honeywell's remarkable new heating control system. Compare the ups and downs of the old system with the smooth, even comfort of MODUFLOW. Moduflow eliminates wasteful overheating and drafty, cold floors . . . Every home can afford the greater comfort and efficiency of Moduflow.

### HOW *Moduflow* WORKS

Moduflow operates on an entirely new principle. It can be used with most automatic heating plants, either hot water, warm air or steam. Shown here is a warm air system. The heavy black lines show the simple additions required. Room temperature is controlled by the Moduflow Thermostat while temperatures of the warm air supply are governed by the bulb in the duct. The Reset Panel, operating at the command of these instruments, controls the burner and fan. Air at the right temperature is continuously circulated. Send coupon for the complete story of Moduflow.

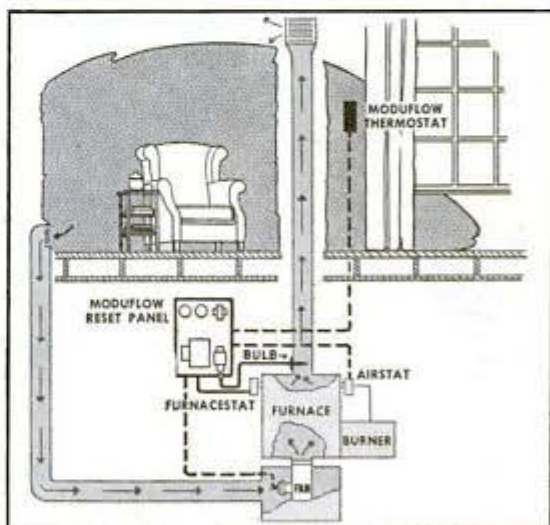

**Free!** SEND FOR THIS BOOKLET

**Minneapolis-Honeywell Regulator Co.**  
 2907 Fourth Avenue South  
 Minneapolis 8, Minnesota

Please send my free copy of "Heating and Air Conditioning the Postwar Home"

Name \_\_\_\_\_  
 Address \_\_\_\_\_  
 City \_\_\_\_\_ State \_\_\_\_\_



Another great day in railroading was heralded in January, 1888, when the Atlantic Coast Line ran the first de luxe vestibule Pullman train from New York to Jacksonville, Florida.

## IT'S A GREAT NEW DAY FOR RAILROADING

Today powerful GM Diesel locomotives on the Atlantic Coast Line whisk Florida's fresh fruits and vegetables to major American markets in a matter of hours. This is possible because these locomotives haul heavy trains faster and stay on their job longer with few stops for service.

**O**NE thing is certain—Americans will have an entirely new level of transportation, post-war. Two factors will make this inevitable:

*The amazing achievements of the railroads under the stress of war.*

*The new and exciting prewar records for rapidity, regularity of service, safety and comfort the railroads had established with General Motors locomotives.*

American railroads are in a favored position to lead in this fine new service because a most vital tool which makes it possible is fully developed and thoroughly proved. Already General Motors Diesel passenger and freight locomotives are operating on more than 100 million miles, annually, of regularly scheduled service. Yes, it's a great new day for railroading—with even greater days ahead.

**ON TO  
FINAL VICTORY  
BUY MORE  
WAR BONDS**

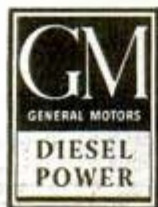

LOCOMOTIVES . . . . . ELECTRO-MOTIVE DIVISION, La Grange, Ill.

ENGINES . . 150 to 2000 H.P. . . CLEVELAND DIESEL ENGINE DIVISION, Cleveland II, Ohio

ENGINES . . 15 to 250 H.P. . . . . DETROIT DIESEL ENGINE DIVISION, Detroit 23, Mich.



# RAY-O-VAC

## *Leakproof*

### FLASHLIGHT BATTERIES

## *Stay Fresh*

FOR WHEN YOU NEED THEM—  
EVEN FOR YEARS AND YEARS

# 10¢

COST NO MORE THAN  
ORDINARY BATTERIES

#### **For Your Flashlight... After Victory**

They stay fresh—that's why every week for the past 2 years millions of these sealed-in-steel Leakproof batteries have gone to our fighting men. Leakproofs are not now available to civilians.

**RAY-O-VAC COMPANY**  
MADISON 4, WIS. 

THE FAITHFUL  
**HEART**  
OF YOUR FUEL  
SYSTEM



# AC FUEL PUMPS

Pulsing steadily, hundreds of times a mile, your AC Fuel Pump is the strong, reliable heart of your fuel system. It has given you long, faithful service because of its inbuilt quality and scientific design.

You can prolong that faithful service indefinitely, if you insist upon an AC when you replace your present pump with a new or rebuilt one.

BUY WAR BONDS • BRING VICTORY QUICKER

## Mapping the Navy's Battlegrounds

(Continued from page 53)

Aerial photographs form the basis of modern cartography. After a mapping plane brings back photographs of an area that is under study, one of the survey boats moves into the district and determines the exact latitude and longitude of various prominent points on shore. Sometimes these fixes can be made by shooting the sun in the daytime; other times they must be made by means of star observations during the night, if Japs are suspected to be close. Concealment during survey operations helps prevent the Japs from suspecting where the Marines may land next.

Learning the latitude and longitude of shore points provides an accurate scale for the aerial photograph and serves to orient the photograph with true north. Meanwhile the survey ship determines the depths offshore by means of fathometer readings, and it uses its underwater sound gear to detect underwater obstructions.

Approaches to anchorages and the channels leading into them are swept by means of a wire drag. In this operation a weighted cable is stretched between two small boats and is allowed to sink to a depth that would be safe for large ships. If the cable catches on an obstruction, a diver goes down to determine whether to blast away the obstruction or to mark it on the surface.

While this work proceeds a master chart that incorporates all the needed features of the original aerial photograph as well as the numerous notes and observations of the survey crew is being prepared in the ship's drafting room. Data is added to the chart as rapidly as the new information is obtained. Drafting a chart is a punishing job on a tropical night when every door and port is shut on a blacked-out ship.

It was assumed early in the war that the Japs had charted much of the Pacific years earlier in preparation for battle but this seems not to be the case. From evidence captured at their bases it appears that the Japs relied on old charts plus what local knowledge they could gather. In many cases this became a handicap to them and an advantage to us.

As the scene of battle shifts closer to the Jap homeland, American survey vessels are working far to the north and west of the areas in which they started to hang up road signs that point the way to Tokyo. These days they are charting waters that the Japs always regarded as their own, and are mapping islands that the Japs have held as secret, unapproachable possessions.

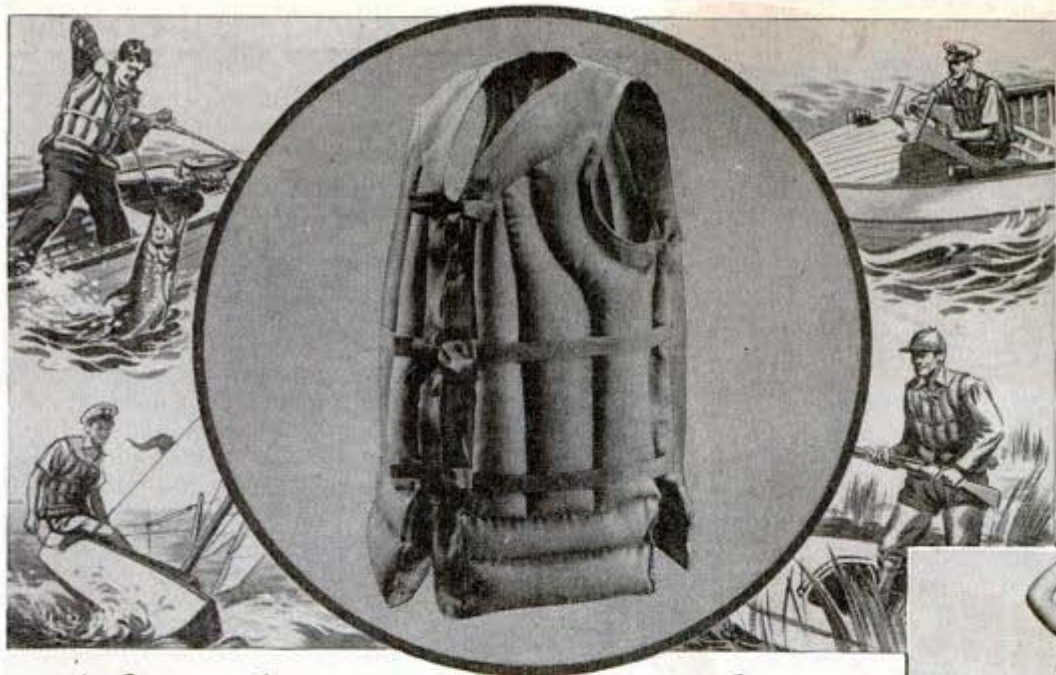

## After the war—more safety for all—in or on the water!

On the oceans of the world Ta-pat-co life-save equipment is doing its part in winning the war. Aboard fighting ships, transports and vessels of the merchant marine it is a protector of marine, sailor, and G. I. Joe.

What strange and dramatic stories these Ta-pat-co life-save vests might tell if they could speak. They are doing the job they were made to do.

After the war a Ta-pat-co life-save vest can be yours. Unique in their features of construction and built to "never let you down," all water sport can be more enjoyable — more safe. AMERICAN PAD AND TEXTILE COMPANY, GREENFIELD, OHIO.

# Ta-pat-co

LIFE-SAVE EQUIPMENT

*Made as if our lives depended on it.*

**STAY-A-FLOAT**

**SAFETY FOR YOUR CHILDREN!**

No one need worry about Johnny or Jane when they paddle about or wade in a STAY-A-FLOAT. For beach, river or pool this vest gives them perfect protection. It is inexpensive. After the war it will be with you again.

When your dealer shows you outdoor equipment bearing this label, buy it with confidence and you'll own it with pride.



FOR ASKING!

### 100 DO'S and DONT'S TO MAKE VACATIONS SAFER and HAPPIER

Written by a Canadian guide, this fascinating book tells how men who know the woods, fields and streams do things.

#### IT TELLS HOW TO

- build a fire without matches
- use your watch as a compass
- forecast weather from wind
- tell the weight of fish
- keep game birds from spoiling
- tell the height of a tree
- check thirst without water
- light matches when wet
- do 100 things in unusual ways

IT IS YOURS FOR THE ASKING

### JUST MAIL COUPON

TA-PAT-CO,  
GREENFIELD, OHIO

Please send me a copy of "Outdoors with Ta-pat-co" as soon as it comes from the press.

Name \_\_\_\_\_

Address \_\_\_\_\_

City \_\_\_\_\_ State \_\_\_\_\_

IN **BURMA**

this is the pipe they  
used to smoke



... and this is the pipe  
you see today—everywhere—



Our service men are in Burma, and on all the far-flung battle-fronts of the world—along with them have gone the same mellow LHS pipes they puffed in the states. That's the reason you may not always find just the LHS model or style you want, but if it's an LHS, it's "the sign of the perfect pipe."



\$5

DOZENS OF  
HANDSOME MODELS

Model No. 6  
Antique Finish  
Also Smooth Finish

**IMPORTED BRIAR**

Other LHS Pipes of Imported Briar  
Sterncrest Ultrafine . . . \$10.00  
Sterncrest 14K . . . . . 7.50  
Certified Purex . . . . . 3.50  
AT ALL GOOD DEALERS



Send for your copy of "Pointers on Pipes"—FREE  
L. & H. STERN, INC., Dept. Z, 56 Pearl St., Bklyn 1, N.Y.

## The Battle That Won the Pacific

(Continued from page 25)

south and drove the Japanese heavy units back into the San Bernardino Strait.

The Japs had sunk two of our CVE's, two destroyers and one destroyer escort. For a time they had threatened to break through to Leyte Gulf and it was nip and tuck. But this enemy thrust had been halted by the Seventh Fleet and thrown back by the Third Fleet.

By the morning of October 25 the surface action was over. The crippled Jap warships were fleeing for safety in the way they had come. Most of them had been hit or damaged, most of them had been slowed up and many were trailing oil. All day long, as the beaten enemy forces retreated through the Sibuyan Sea and the Surigao Strait, they were attacked again and again by United States carrier planes. On succeeding days the fleeing ships suffered further damage as they tried to find refuge in Philippine harbors.

When the Second Battle of the Philippine Sea was over, the official box score, as announced from Pacific Fleet Headquarters in Pearl Harbor, was as follows:

### JAPANESE IMPERIAL NAVY

24 ships sunk  
13 ships possibly sunk  
21 ships damaged

### UNITED STATES NAVY

6 ships sunk  
Several ships damaged

The figures do not tell the whole story. The Japanese Fleet is no longer a threat. It has a certain nuisance value, but that is about all. The United States Navy will be able to convoy its long lines of shipping to the forward areas with destroyers—releasing carriers, battleships and cruisers for raids in waters around Japan proper.

What happened at Pearl Harbor is about to be brought home to Japan's cities a hundredfold. The Second Battle of the Philippine Sea made it possible.

## Around the World in 2,000 Miles

(Continued from page 37)

oxen, the people in some areas using wooden plows, and burros are almost universally used for carrying farm products to market.

Much of Mexico is mountainous and in the past this rough terrain was a hindrance to travel. Communities have existed practically side by side for centuries with little interchange of ideas. Each community

(Continued to page 152)



**ONE OF THE  
FIRST YANKS**

**to Ride a Harley-Davidson  
Into Germany!**

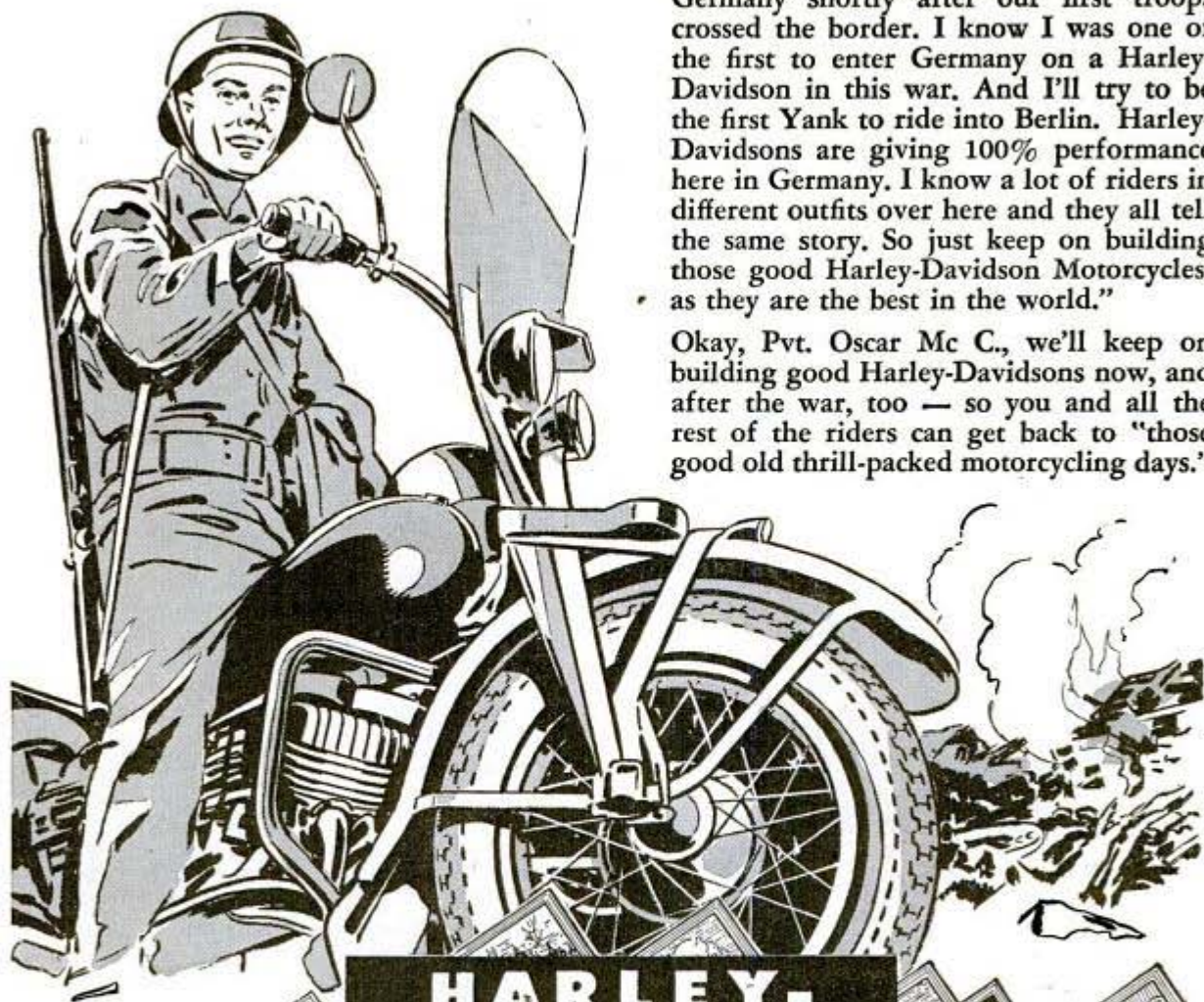

Pvt. Oscar Mc C., writes: "I cannot state the date due to censorship regulations, but I rode my Army 45 Harley-Davidson into Germany shortly after our first troops crossed the border. I know I was one of the first to enter Germany on a Harley-Davidson in this war. And I'll try to be the first Yank to ride into Berlin. Harley-Davidsons are giving 100% performance here in Germany. I know a lot of riders in different outfits over here and they all tell the same story. So just keep on building those good Harley-Davidson Motorcycles, as they are the best in the world."

Okay, Pvt. Oscar Mc C., we'll keep on building good Harley-Davidsons now, and after the war, too — so you and all the rest of the riders can get back to "those good old thrill-packed motorcycling days."

**HARLEY-  
DAVIDSON  
MOTORCYCLES**

HARLEY-DAVIDSON MOTOR CO.  
Dept. P, Milwaukee 1, Wisconsin

Please send at once free copy of 24-page  
ENTHUSIAST MAGAZINE, filled with motor-  
cycle action pictures and thrilling stories.

Name.....

Address.....

City..... State.....



**SEND COUPON  
NOW**



**ARTIST  
with a  
FILE**

It is indeed an art to lathe-file a piece of work to proper dimensions; or to bench-file a precision part to micrometer measurements. Such skill is rarely achieved from practice alone . . . you've got to have *The right file for the job.*

That sound precept helps to explain why there are more than 3000 kinds, cuts and sizes in the Nicholson line of files—each of which can do a certain job on a certain type of metal better, faster or more economically.

An "M.F." (Master of Files) is a much sought "artist" these days!

**NICHOLSON FILE CO., 22 Acorn St., Providence 1, R. I., U. S. A.**  
(In Canada, Port Hope, Ont.)

**NICHOLSON**  
**FILES** FOR EVERY  
PURPOSE

NICHOLSON  
U.S.A.  
MADE IN U.S.A.

still builds its homes in its own individual way, still dresses in its own traditional costume, and engages in its own special kind of agriculture. A visitor may pass through three or four distinctly different kinds of civilization in a day of automobile driving. In one region the houses have brush walls and palm thatch roofs, while in another the walls of a house consist of sun dried adobe brick, with burned tile for roofs.

Mexico has been providing the United States with quantities of strategic war materials, including henequin and other fibers, minerals, rubber and castor beans, all of which flow north over Mexico's extensive railroad system. Portions of the Mexican railways are being improved by means of funds provided by the United States, one purpose of the rehabilitation being to insure dependable rail transportation all the way from Texas to the Guatemalan border.

The country still needs additional arteries of transportation and these are being provided by extending the highway system. The Pan American Highway is now completed as far as Oaxaca, 250 miles southeast of Mexico City, and the link from Oaxaca to Guatemala is scheduled for completion in 1945.

Another recently completed modern highway joins Guadalajara and San Luis Potosi and then continues eastward to connect with the Pan American Highway. Sections of the proposed west coast road from Nogales to Guadalajara are being worked upon and when completed this project will allow American tourists to drive to Mexico City over one highway and return north via another. The Mexican Health Department has undertaken a three-year sanitation program that would remove most health risks in the regions touched by the Pan American Highway and other major roads. At present some of the local water supplies are of dubious purity and tourists drink bottled water to be on the safe side.

## They Bring 'Em Out Alive

(Continued from page 47)

dust if the equipment is maintained properly. The Bureau tests this equipment in a gallery filled with explosive gas. If it fulfills all safety requirements, it is rated as "permissible."

Safety progress in mining has been speeded by the development of protective equipment such as a self-contained oxygen-breathing apparatus, which is worn when exploratory crews are examining workings which have been abandoned or

(Continued to page 154)

THE **NUT** THAT  
UNTHREADED

*Locks* ON  
STUDS!

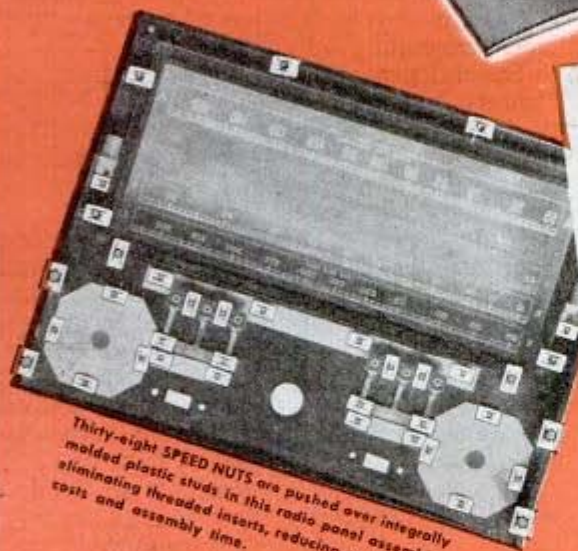

Thirty-eight SPEED NUTS are pushed over integrally molded plastic studs in this radio panel assembly, eliminating threaded inserts, reducing mold costs and assembly time.

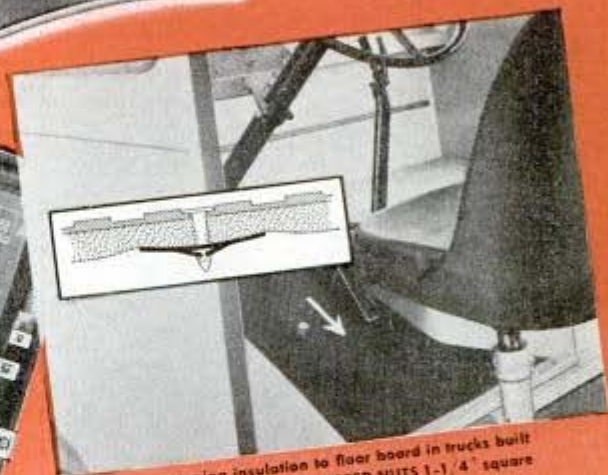

In fastening insulation to floor board in trucks built by the White Motor Co., SPEED NUTS 1-1/4" square pushed over No. 11 nails eliminate large washers or retaining strips.

● Just a push and it locks! It's just as simple and easy as that! For this unique spring steel fastener needs only to be pushed over rivets, nails, tubing, wire, integral die cast or plastic studs to lock parts firmly together. Threads are unnecessary because the spring prongs of the nut provide a friction lock on even the smoothest of chrome surfaces.

But easy attachment is not the only advantage gained by using Push-On type SPEED NUTS. Costly threaded inserts, drilling and tapping are eliminated—

molding costs reduced—assembly speeded up—and vibration loosening prevented. These fasteners are available in many sizes and shapes . . . rectangular, square, round, or they may be specially designed to fit your particular requirements.

If you want to improve the attachment of name plates, emblems, trim strips, grilles, or other light-weight parts, write now for samples of Push-On type SPEED NUTS, giving *stud diameter* and any other pertinent assembly details.



THE BASIC PRINCIPLE  
of Spring-Tension Lock is  
Embodied in all Speed Nut Designs

**TINNERMAN PRODUCTS, INC.**  
2023 FULTON ROAD, CLEVELAND 13, OHIO

In Canada: Wallace Barnes Co., Ltd., Hamilton, Ontario  
In England: Simmonds Aerocessories, Ltd., London

*Speed Nuts*  
PATENTED Trade Mark Reg. U. S. Pat. Off.  
**FASTEST THING IN FASTENINGS**



**HE HAS  
YOUR BATTERY**

Men's lives depend on supplies by air when advance combat units are cut off in enemy territory! Battery-powered parachute lights quickly guide these fighting men to essential food, ammunition and medical equipment. Batteries help light the way to Victory on every fighting front—that's why they are not available here at home. Use your batteries sparingly... keep them cool and dry. Burgess Battery Company, Freeport, Illinois.

*Think Twice Before You Travel!*



**BURGESS  
BATTERIES**

IN THE NATION'S SERVICE



for some other reason may contain poisonous gases or are deficient in oxygen.

A self rescuer is carried by many miners. It gives the wearer protection against certain gases likely to be found after a fire or an explosion.

An all-service gas mask guards against limited percentages of a wide range of toxic gases, including carbon monoxide. It is a valuable aid in fire-fighting and other emergency work but is too bulky to be carried by miners in routine work.

Electric cap lamps are worn for underground illumination by miners. These lamps can be used safely in any atmosphere, insofar as ignition of explosive gas is concerned.

Special protective hats, "hard hats" or "safety hats," which have passed "drop" tests and other tests at the Bureau of Mines are recommended. Safety-toed shoes have special toe caps of steel which protect the wearer's toes from falling objects.

Safer types of explosives are becoming increasingly popular in coal mines. Black powder and dynamite, both of which generally are fired with flame-ignited fuses, have caused tragic explosions and fires. Better explosives, which have flames of short duration and less heat, are now fired electrically. Wartime explosive improvements are expected to prove valuable.

Obviously, any profession which depends upon the firing of explosives requires something of the courage and skill of a soldier trained for modern warfare. To illustrate what the miners face in their daily toil, consider this: They set off about 200,000,000 pounds of explosives in this country's mines every year.

## War Wonders for You

*(Continued from page 69)*

phones and other conveniences formerly found only in ocean liners, this ship will have a front end opening similar to that employed on the Navy LST's (landing ships, tanks) so that both automobiles and passengers may embark and disembark on electrically-operated gangplanks. The pilot house will be built entirely of transparent plastic in the same general design as used on the "blisters" of bombing planes. This will give the pilot a full 360-degree range of vision and is regarded as an important safety factor.

The use of prefabricated steel buildings by the armed services has resulted in numerous improvements, and a Detroit manufacturer, the Great Lakes Steel Corporation, already has a program for using

*(Continued to page 156)*

Delta Homecraft Power Tools illustrated are Delta Band Saw, Delta Lathe, Delta Circular Saw, and Delta Drill Press.



# Homecraft Happiness

...Why you enjoy more of it when you use

## Delta Homecraft Power Tools

Typical advantages that Delta quality construction gives you:

- 1 Double-sealed ball bearings you don't have to worry about oiling, because they are lubricated for life.
- 2 Precision-bored bearing seats that assure accurate alignment of parts.
- 3 Bearings that are pre-loaded — an extra manufacturing operation that insures longer bearing life.
- 4 Precision-ground shafts, to assure true, accurate performance.
- 5 Dynamically-balanced pulleys, to eliminate annoying, damaging vibration.

**"Hidden values" in construction help assure you of trouble-free performance**

In one word, *quality* is the reason why famous Delta Homecraft Power Tools help you enjoy a full measure of the fun homecraft offers you.

You can't always see Delta quality with your eyes. It doesn't make Delta tools look much different than other makes of power tools.

Yet, *quality is there!*

**Accuracy Tells!**

Because of quality, you can count on Delta Homecraft Power Tools for *accuracy*.

You enjoy greater assurance of parts that fit together according to plan, to form finished work that has a look of expert craftsmanship.

**Dependability Tells!**

Because of quality, Delta Homecraft Power Tools are dependable.

They're always ready to go at the flick of a switch—ready to give you the economical, reliable performance you have a right to expect.

**Safety Tells, Too!**

And, because of quality, Delta Homecraft Power Tools are *safe* — meeting the highest safety standards of schools and industry.

You feel free to let other members of your family share in the happiness of your hobby.

**Be Sure You Get Quality!**

Before you buy *any* power tools — when they are again available — be sure to learn about all the advantages of Delta Homecraft Power Tools that mean more for your money.

Right now, invest your money in War Bonds! When peace comes, reinvest your accumulated savings wisely in Delta Homecraft Power Tools.



HM-22

**Free Colorful Delta Book!**

"Happiness Is In Your Hands," shows you how to get started in homecraft. Contains a reprint of a Reader's Digest article telling how manual hobbies aid mental health. For your free copy, fill in the coupon and mail today.



THE DELTA MANUFACTURING CO.  
6808 E. Vienna Avenue, Milwaukee 1, Wisconsin

Please send me my free copy of "Happiness Is In Your Hands" picturing the ideal creative hobby and showing how to get started in it.

Name.....

Address.....

City..... (.....) State.....

THE EFFECTIVENESS OF  
**fluid power**  
DEPENDS ON  
**THIS**

**VITAL LINK**

ENGINEERED BY **parker**

Be sure of the Circuit—the “vital link” between the source of fluid power and the device that applies it.

The Circuit carries fluid power around corners and into tight places—wherever you want it to go. It must be leakproof, vibration-proof, able to stand high pressures and resist corrosion.

Engineering fluid power circuits is a Parker job. Years of experience have showed us how to design them, how to build the necessary valves and fittings and how to plan sure-working installations.



**THE PARKER COUPLING** is the key to the vital link, engineered and designed by Parker—protected against leakage and vibration, precision-made, quick to install, quick to service.

Ask a Parker Fluid Power Engineer how you can use this modern form of power on your machines of today or tomorrow. No obligation—just write to The Parker Appliance Company, 17325 Euclid Ave., Cleveland 12, Ohio.

THE  
**PARKER**  
APPLIANCE COMPANY  
CLEVELAND • LOS ANGELES  
**FLUID POWER ENGINEERING**

designs similar to the Army and Navy Quonset huts for farm and home structures. Easy to erect, strong and well-insulated, these units are expected to have a range of usefulness in several directions. Advances also have been made in central heating systems as a result of large scale tests in Army and Navy installations.

Sportsmen may live in their proverbial paradise in the postwar years, at least in regard to their equipment, if manufacturers adopt improvements and new devices found in Army and Navy paraphernalia. Some of these are mosquito-proof, featherweight pup tents; tiny, one-pound stoves that will burn for hours on a single filling of gasoline; Halazone tablets that purify river and creek water; new type sleeping bags, and floating match boxes.

In the medical field, there are warborn advances that range all the way from the Westinghouse “candid” X-ray camera, which has been used to examine as many as 2,000 WAVES per day, to bags which utilize a small vial of methyl bromide in sterilizing clothing and bed coverings in half an hour.

Nylon clotheslines, paint brushes with rayon bristles that won't wear easily, non-breakable milk bottles and plastic dishes are other warborn items likely to become familiar on the civilian market. Nylon rope has proved seven times as strong as hemp, easier to tie and untie, and fray resistant.

You can make the list include pianos that are 150 pounds lighter, as developed for Army camps, and plastic musical instruments that are lighter and cheaper, the first of which was the Army bugle.

In some cases, more or less serious difficulties may be encountered in adapting war products to civilian uses, but many of them, like the rubber boats, already are available and others will appear on the market rapidly.

## Lifting Father Knickerbocker's Face

(Continued from page 80)

the Hudson River, terminal for the largest transatlantic lines.

Among the novel features of the postwar program will be three terminals, two accommodating helicopters, planned by the Port of New York Authority. One is a bus terminal in the Times Square district, with elevated overpasses to clear traffic to and from New Jersey and the west side New York City highways. The other will be a 1,000-foot truck terminal with novel loading features for exchange of cargo near

(Continued to page 158)

# New Thousands Now Wear a Hearing Aid

*Thanks to the*

## NEW ZENITH NEUTRAL-COLOR EARPHONE and CORD



SO INCONSPICUOUS  
Another Zenith "First"

### ...Have you tried Its New "Look of Youth" on You?

**A**NOTHER great Zenith advancement is encouraging *new thousands* to discover the blessings of a hearing aid!

The Zenith Radionic Hearing Aid brought the *cost* of better hearing within reach of all. Now the new Neutral-Color Earphone and Cord brings a new standard of *smart appearance* that enables you to wear a hearing aid with poise and confidence.

This Zenith ensemble is actually *as little noticeable as eyeglasses!* Its streamlined, complexion-tinted plastic earphone is light in weight, comfortable. Its translucent plastic cord is perspiration-proof, fray-proof, kink-proof ... gives less friction or clothing noise than any fabric-covered cord.

Ask the Zenith dispenser near you for a *free* demonstration of the smart looking, superbly performing Zenith. No obligation! Send coupon below.

### Why Its Fine Quality Costs You So Little

If only a few Zeniths were made, each would cost many times more, yet have less precision quality—as Zenith proved when its precision mass production lowered the cost of a \$200 radio to \$29 and made it an *even finer* instrument. Now Zenith combines this production with a sales method which *eliminates* salesmen's huge commissions and other high sales costs ... to bring you an *even finer* hearing aid than our original \$50,000 model.

**CANADIANS!** The Zenith Radionic Hearing Aid (Air Conduction) with *Neutral-Color Earphone and Cord* is available in Canada—*direct by mail only*—at \$40 (Canadian currency). No extra charge for shipping, duties, taxes! Write Dept. PM-15, Zenith Radio Corporation of Canada, Ltd., P. O. Box 30, Windsor, Ontario.

**FREE! Illustrated Descriptive Literature** Gives complete information on advantages of the three new Zenith Radionic Hearing Aids. Mail coupon *now!*

### A New Zenith Model for Every Type of Correctable Hearing Loss

**1 Model A-2-A.** New improved model of the famous nationally popular standard Zenith for the person of average hearing loss. New, patented "Prentiss Tube" brings clarity and volume range with low battery consumption! Complete **\$40**—ready to wear, only . . .

**2 Model A-3-A.** New Air Conduction Zenith . . . A brand new, *super-power* instrument with tremendous volume in reserve to assure maximum clarity and tone quality even under the most difficult conditions! This special model **\$50** complete, ready to wear, only

**3 Model B-3-A.** New Bone-Conduction Zenith. A new, powerful precision instrument created specially for the very few who cannot be helped by any air conduction aid. Exclusive Zenith "Stator Mount" Headband automatically warns when headband pressure exceeds normal adjustment! **\$50** Complete, ready to wear, only . . .

#### NEW ZENITH RADIONIC HEARING AIDS

(All 3 models complete with Radionic Tubes, Crystal Microphone, Magnetic Receiver, Batteries and Battery Case)



BY THE MAKERS OF

**ZENITH**  
RADIO

RADIONIC PRODUCTS EXCLUSIVELY—  
WORLD'S LEADING MANUFACTURER

ZENITH RADIO CORPORATION, CHICAGO, ILLINOIS

COPYRIGHT 1945, ZENITH RADIO CORP.

#### PASTE ON PENNY POSTCARD AND MAIL

ZENITH RADIO CORPORATION, Dept. PM-15  
P. O. Box 6940A, Chicago 1, Illinois

Please send me *free* literature about Zenith Radionic Hearing Aids—together with name and address of nearest Zenith dispenser.

Name .....

Address .....

City ..... State .....

Physicians check here for special literature.

# MILLERS FALLS TOOLS

SINCE  
1868

## One thing in common — QUALITY!

There are hundreds of Millers Falls Tools for thousands of jobs. . . . From the simplest screw driver to the finest precision tool, they have one thing in common — **QUALITY**. Experienced craftsmen of the past took pride in the unvarying quality of Millers Falls tools. Countless thousands of new craftsmen now depend upon them. Your dealer's supply of Millers Falls Tools is increasing in size and variety. Ask him or write for complete details.



**MILLERS FALLS COMPANY**  
**Greenfield • Massachusetts**

Holland Tunnel. In both cases the roof will have a landing area for helicopters.

The third terminal will be like nothing else ever devised. New-type car floats equipped with platform conveyors and tracks on both sides will dock with railroad express and freight cars at a quarter-mile terminal on Manhattan's lower East Side. Shipments will move to the bulkhead, to be picked up on portable conveyors. Then they will be sorted and moved quickly to hundreds of trucks. This terminal will handle mostly perishable fruit and vegetables.

Problems of cargo movements are being worked out by Port of New York Authority engineers on electrically operated, three-dimensional models. The same is true of the Manhattan Union Truck Terminal, first of four to be built.

Finally there will come the blossoming of Broadway. The trend toward cigarette signs which smoked, coffee pot signs which steamed and great neon-decked thermometers and weather forecasters will continue until roofs and building faces of the bright light district will drip with orange juice and flash with time-telling clocks. Cartoon figures in lights will put on animated shows, cats and dogs will scamper across signs and towers will be shaped like cigars and cigarettes until the canyon of color around which the theatrical center flourishes will be a show itself.

The proponent of the new Broadway is Douglas Leigh, now a navy lieutenant, who controls 65 percent of the sign space on Broadway. Leigh inaugurated the new trend toward three-dimensional, animated signs which was stopped by the blackout and lack of construction materials. He is ready with some startling postwar signs, notably rooftops shaped into gigantic perfume bottles, cereal boxes and so on.

Out-of-town visitors will unembarrassedly stretch their necks to see the sights overhead, for New Yorkers will be doing the same thing.

## Death From the Stratosphere

(Continued from page 4)

concrete sides they laid heavy steel rails almost vertically. Then they brought in what appeared to be giant artillery shells on wooden trailers drawn by horses. When the projectiles were set off, the blast sounded like a prolonged thunderclap. Immense heat was generated around the shaft and during some launchings it was said that the ground for acres around the site was scorched and a number of the launching crew killed.

(Continued to page 160)





Ralph Conrad and father with bass and walleyes caught on a Jitterbug in the Susquehanna River.

## "A Swell Surface Bait" say Sunbury, Pa., Anglers

"Dear Fred: Here are some pictures of bass and walleyes caught on your red and white Jitterbug in the north branch of the Susquehanna River. The largest walleye weighed 7½ lbs. and measured 29½ inches. My father caught the largest bass. It weighed 6 lbs. and measured 21 inches. We both think the Jitterbug is a swell surface bait. We also catch quite a few on the Hawaiian Wigglers. Yours for better fishing."

—Ralph Conrad, Sunbury, Pa.



Write for  
Literature

FRED ARBOGAST  
1622 North St., Akron 3, Ohio



QUALITY . . . WORTH WAITING FOR

### THERE WILL BE A SLIGHT PAUSE . . .

One of these days, restrictions will be lifted on outboard motor sales for pleasure use.

While Johnson has the facilities to build a major share of all outboard motors manufactured, there will definitely be some lag between the lifting of restrictions and full deliveries of all Sea-Horse models.

How long? That depends on many things, including army and navy requirements. There has been, there still is and there will be a large army and navy demand for *Sea-Horses*.

The qualities that make Sea-Horses suitable for war—ruggedness, smooth performance, and **DEPENDABILITY**—are qualities worth waiting for. To get these qualities, you may have to wait a while after restrictions are lifted; but you'll have them for **YEARS** of satisfaction thereafter.

**DEALERSHIPS:** If you are interested in selling AND SERVICING outboard motors after the war, write us now—no matter what your location may be. **JOHNSON MOTORS, WAUKEGAN, ILLINOIS**

DO YOUR DUTY



BUY WAR BONDS

THERE IS  
NO SUBSTITUTE FOR  
EXPERIENCE

# JOHNSON SEA-HORSES for **DEPENDABILITY**

## FOR IMPROVED LATHE PERFORMANCE

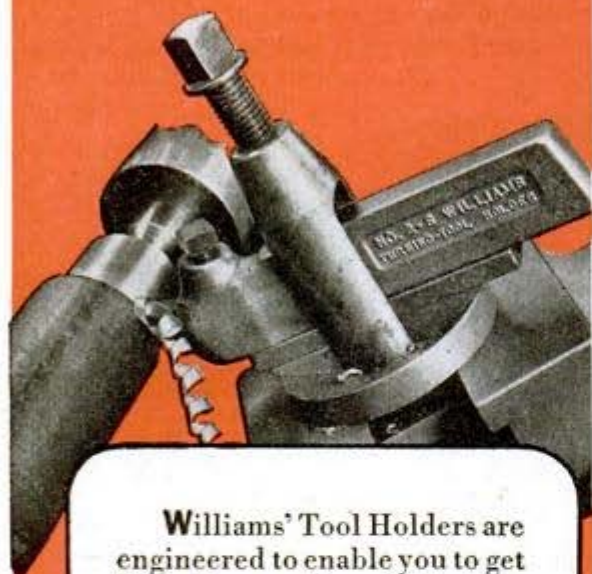

Williams' Tool Holders are engineered to enable you to get from the machine all that the builder built into it. There's a type for every regular operation of lathe, planer and shaper ... many incorporating design advantages found in no other holders.

Compare the performance you get with Williams' Tool Holders. Meanwhile, write Dept. M-2 for your free copy of Williams' Tool Holder Data Sheets, loaded with helpful information on grinding, set-up and use of cutting tools.

**J. H. WILLIAMS & CO.**  
BUFFALO 7, N. Y.



**DROP FORGINGS AND DROP-FORGED TOOLS**

Another source reported the Nazis also use a portable, adjustable launching ramp, consisting of a tracked vehicle towed by a big truck. The electric firing mechanism is housed within the armored flash shield. Hydraulic jacks on which the platform rests absorb the recoil. Jets of water cool the platform during the firing operation.

Swedish sources have indicated the Nazis were constructing launching sites high in the Norwegian skiing slopes, presumably for firing V-3, which is rumored to be a larger and improved version of V-2, intended for spanning the Atlantic Ocean. Most Allied scientists nevertheless hold that the stratosphere rocket, in its present development, cannot be used against the United States with enough success to make it worthwhile.

But if the rocket is only a spite weapon now, strategists admit that in a future war a super-rocket, carrying really heavy explosives, might not only prove to be the decisive weapon but could conceivably annihilate entire areas of civilization as well.

As for peacetime, big things are predicted for V-2 adaptations. G. Edward Pendray, secretary of the American Rocket Society, says that after the war giant rockets will swish mail and express across the United States in a matter of minutes and that rockets will be sent into the stratosphere to gather data which will enable meteorologists to forecast the weather two weeks in advance. J. B. S. Haldane, British scientist, believes that perfected versions of V-2 could be used to photograph the sun, the moon and other heavenly bodies.

Meanwhile, the United States has developed a controllable "buzz bomb" which is reported as highly successful. It is said to be a speedy, winged robot which travels on ordinary low-test gasoline but it will not be used in this war, the Air Force says, unless our inhuman enemy "asks for it."

### The Bombsight That Thinks

(Continued from page 10)

down toward the target, the pilot switches off the automatic controls and quickly changes the course of the plane. If everything has gone well, the happy report of "bombs on target" is echoed and re-echoed over the interphone.

That is when high precision workmanship pays off. The personal thrill of "bombs on target" is not for the crew alone, but for the workers back in the Victor Adding Machine Company plant in Chicago where Norden bombsights are made for the Army Air Force.

(Continued to page 162)

# More Power in Cyclones on Deck than in Carrier's Turbines Below!

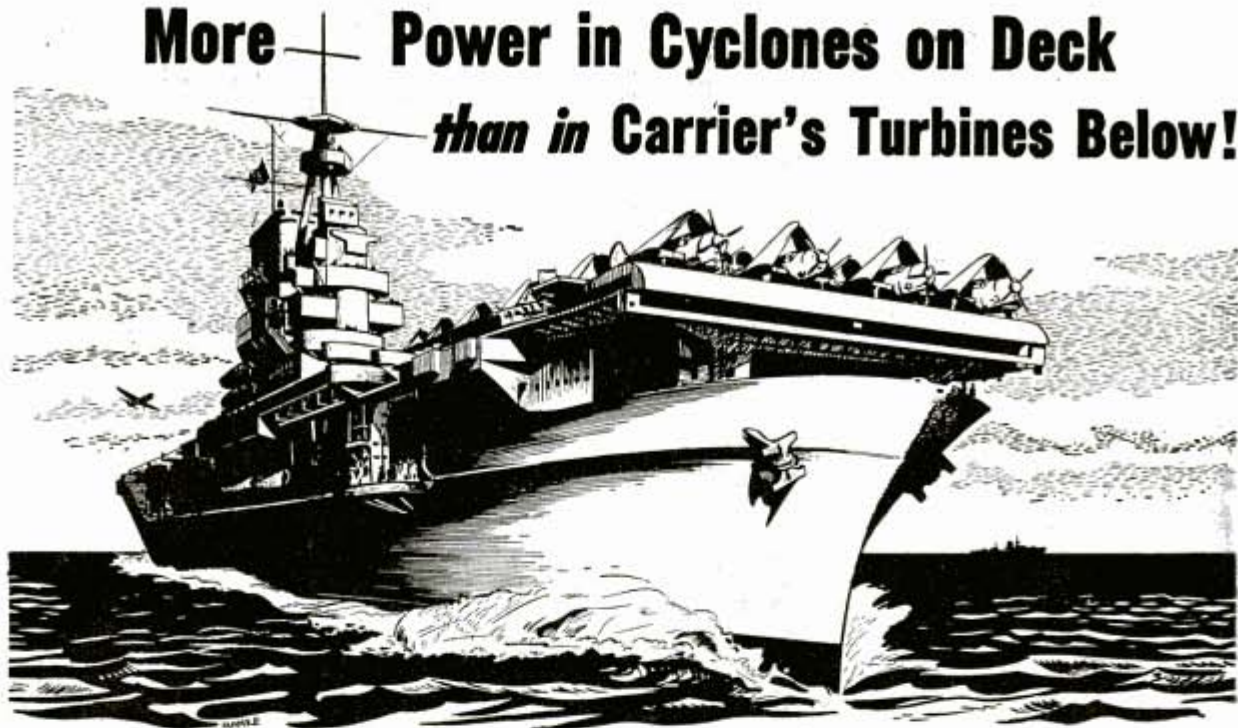

Surging into the wind at 30 knots, this 20,000-ton carrier is driven by massive turbines which can turn up more than 100,000 horsepower. On deck, there's a 1,700 HP Wright Cyclone in each Curtiss Helldiver and Grumman Avenger. Mighty as the carrier is, a normal number of these single-engined planes aboard may total 50,000 more horsepower in combined form than the turbines below.

Weight, size and power are the three critical points of an aircraft engine. It must be light to permit flight, compact to cut drag, powerful to carry heavy planes at high speed. Wright Cyclones come from 25 years of work on such problems. That's why it takes such a few Cyclones to equal the power of a carrier.



**LIGHTEST:** The Cyclone 9 of 1,350 HP in new FM-2 Wildcat is first service engine under a pound per HP. It weighs only 0.97 lbs. per HP.



**TOUGH:** A Cyclone 9 in a Douglas SBD-3, with oil line and 4 of 9 cylinders shot out of action, kept right on running to bring pilot and plane safely home.

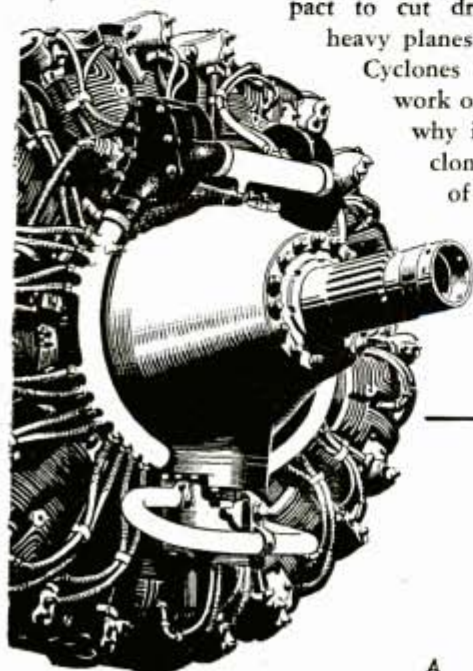

### Write for "ENGINOLOGY"

a 60-page booklet on the whys of engines

A complete, non-technical booklet on engines, propellers, and aircraft. Describes operating principles of engines and planes. Explains combustion, supercharging, ignition, carburetion. Just send twenty-five cents in stamps or coins to: Wright Aeronautical Corporation, Dept. P. M., Paterson 3, New Jersey.



# WRIGHT AIRCRAFT ENGINES

A DIVISION OF CURTISS-WRIGHT CORPORATION

## WOODWORKING IS FUN



...when  
you have a  
**GOOD  
PLANE**

A proper assortment of fine tools chosen from the Stanley line will put real fun into making things in your postwar home workshop. For example, the Stanley "Bailey" Plane—one of Stanley's 64 types of planes—will lend even your first efforts the touch of the expert. Like other Stanley Tools, this plane is better designed and balanced. It takes and holds a keener edge. And it is made to last!

### Expert Help in Selecting Tools

Stanley has a free booklet for you, "The Joy of Accomplishment". Crammed full of helpful suggestions, it contains: a primary list of tools, a list of tools to be added as needed, and a list of project plans. You'll also find the big Stanley textbook, "How to Work with Tools and Wood", mighty useful. It's yours for only \$1.00. Mail the coupon today.



**STANLEY**  
TRADE MARK

**THE TOOL BOX  
OF THE WORLD**

**MAIL NOW**

The Stanley Works  
125 Elm St., New Britain, Conn.

Please send by return mail—

- FREE booklet: "The Joy of Accomplishment"  
 The 188-page book: "How to Work with Tools and Wood". \$1 enclosed.

(In Canada: Send order to Stanley Tool Co. of Canada, Ltd., Roxton Pond, Quebec.)

Name.....

Address.....

City..... State.....

The precision with which this plant operates is a story in itself. Gauges, accurate to within 20 millionths of an inch, the shadowgraph which magnifies an image 100 times, and the watchmaker's care with which the parts are made and tested leave nothing to chance. The profilometer, for instance, measures the smoothness of surfaces within one tenth of a micro-inch—or the thickness of a human hair split lengthwise 30,000 times. The optical flats which employ the light wave measuring system show dark interference bands which are exactly 11.7 millionths of an inch apart.

Elaborate precautions are made to keep dust out of the parts. The spotless plant is airconditioned and the workers on the assembly lines wear special lint free coats. Ball bearings are handled with white kid gloves so that no perspiration shall mar their perfection, and they are oiled with drops from a hypodermic needle.

The fact that the Norden bombsight is being made on an assembly line and is today in mass production is a new high for American industry. To complicate this procedure, improvements are being constantly incorporated into the sight. One of the newest improvements on which engineers are now at work will increase the forward angle of the telescope.

A high altitude bombsight made specially for the B-29s is now in production. The altitude at which the Superfortress attacks necessitated a few changes in the computer in gear ratios to compensate for height.

By this time our enemies probably have taken captured Norden bombsights apart and studied them, just as we have studied theirs. Our engineers, however, are confident that it would be impossible for them to get our sight into production before the end of the war. Besides, the Germans are conceded to have a pretty good bombsight of their own, particularly in regard to its optical system. But the computer and other refinements on the Norden make it the best of them all.

## Epsom Salts in Synthetic Rubber Makes Tires Run Cooler

Magnesium sulphate—well known as epsom salts—is the key material in a process which reduces the danger of heat failure of heavy duty synthetic rubber tires. Latex, to which zinc oxide had been added to make the tires cooler-running, could not be made to coagulate or harden until chemical engineers discovered a magnesium sulphate process which results in quick coagulation of equal parts of synthetic rubber latex and zinc oxide.

# Success WITH Atlas

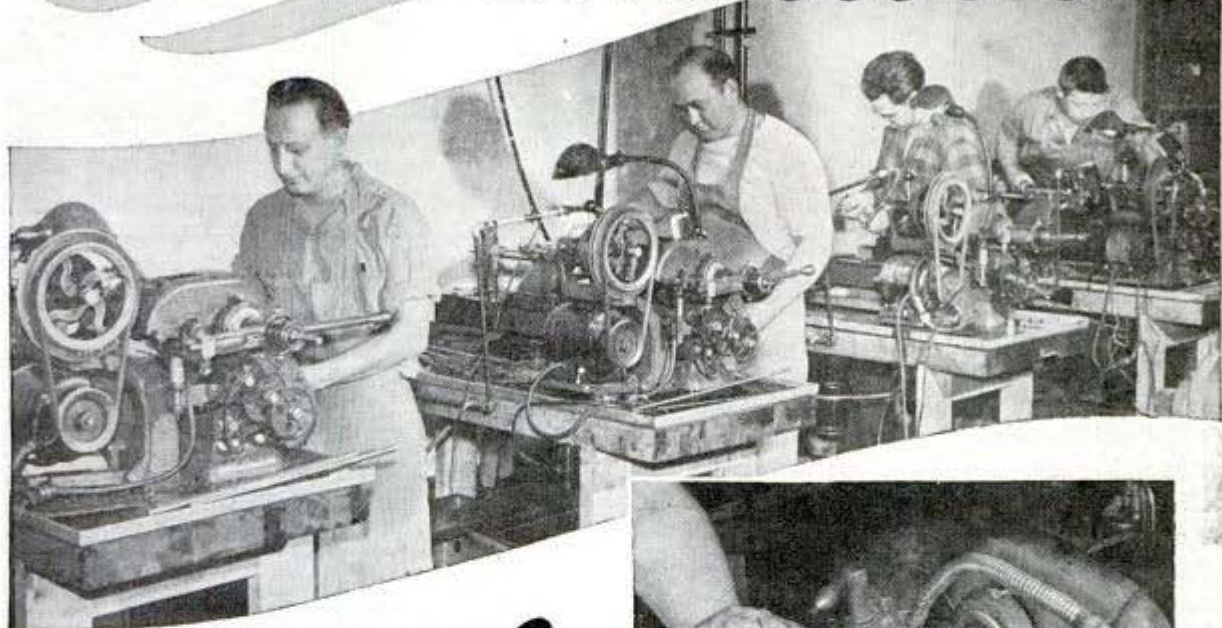

**OVER 500,000  
VITAL WAR PARTS  
FROM  
PLANT STARTED  
WITH ONE ATLAS LATHE**

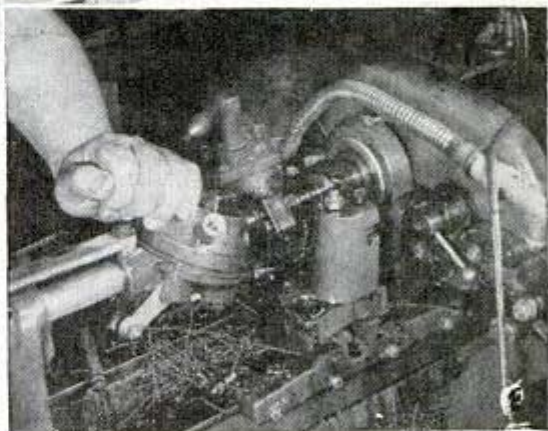

Poppit Valves for hydraulic controls in Mitchell Bombers and North American Mustangs and precision parts for oxygen regulating units are but a few of the 98 individual jobs handled by the Precision Machine Works, Chicago, where over 500,000 vital war parts have been made with Atlas equipment.

"Our shop started with a single Atlas lathe shortly after Pearl Harbor," reports Mr. L. W. Skuse, Pres. and Treas. "Since that time we have purchased about 26 lathes and 9 drill presses from

you. We have used your lathes as straight bench lathes, turret lathes, hand screw machines and have machined practically all types of material."

America always has been — and will be in the busy postwar days — a land of opportunity for men with vision and courage and mechanical ability. If you have thought of and planned for a shop of your own for commercial or personal use, you can build it soundly with Atlas lathes, drill presses, milling machines, and shapers. Send for latest catalogs.



**ATLAS PRESS COMPANY**

243 N. PITCHER ST., KALAMAZOO 13D, MICHIGAN

NEW ATLAS PATTERN SERVICE FOR WOOD CRAFTSMEN — See ad on page 189



# Carhartt

## OVERALLS

... A Clear Track Favorite  
On Any Job

● Carhartt Master Cloth overalls have been a big favorite with railroad men the country over for more than half a century—a great tribute to the better wear and fit of these famous work clothes—and to the traditions of the Carhartt family for building the best work garments money can buy. You'll find that, regardless of your work, Carhartt's give you those "extras" that make them a better buy on every count.

At the Better Dealers Everywhere.

THE HAMILTON CARHARTT OVERALL CO.

Established 1889

Detroit  
Atlanta

Dallas  
Carhartt Park

THIS LABEL IS YOUR PROTECTION

**Carhartt**

FOR OVER 50 YEARS A FRIEND TO ORGANIZED LABOR

**BENJAMIN H. G. PELLETS**

MADE IN U.S.A.

AVAILABLE FROM FACTORY

and dealers.—Cal. .22 at \$2.00 M., Cal. .177 at \$1.80 M. Place your order now for a NEW Benjamin Air Rifle or Benjamin Air Pistol. Write today for illustrated folder of POSTWAR MODELS and POSTWAR PRIORITY PLAN. BENJAMIN AIR RIFLE CO., 812 MARION ST., ST. LOUIS 4, MO.



## HELP MAKE THE OLD THINGS DO!

Mends dishes, glassware, furniture, toys and luggage.

**DU PONT**  
REG. U.S. PAT. OFF.

## DU PONT DUCO CEMENT

REG. U.S. PAT. OFF.

### KNOW YOUR WAY ALWAYS

★ With a HULL STREAMLINE AUTO COMPASS, you drive any road with assurance. No backtracking. Hull's pre-war excellence is more outstanding than ever. Circular on request. Price \$3.50.



HULL MFG. CO., P.O. Box 246-D2, Warren, Ohio

Com-  
plete \$20

### ENGINES IN STOCK



The G. H. Q. miniature gasoline engine that really operates is still available. Over 100,000 sold to date. 1/5 H. P. Complete with flywheel and propeller, fuel 15 accessories and full instructions. Fully bench tested and ready to run. Power for all models. \$20 complete. Send only \$1.00—Shipped Collect C.O.D. same day. Send 25c for illustrated Catalog of hundreds of hobby items.

GHQ MOTORS, Dept. BV25, 40 East 21 St., New York 10, N. Y.

### New Designs in FRANZITE GRIPS

Modernize Your Gun! Improve Your Score! Most durable grips made. Positively unbreakable! For Colt, Smith & Wesson, Hi-Standard, Ortgies, Luger & Mausers in a wide choice of beautiful designs in ivory, pearl, walnut, onyx, etc. Low prices. FREE CATALOG. Dealers Wanted.

SPORTS, INC., (Mfrs.) 2850 N. Clark St., Dept. P-2, Chicago 14, ILL.

MAKE MONEY! Sell Warm LEATHER Jackets

Hundreds of prospects near you; sportsmen, workers in lumber yards, warehouses, stock rooms, war plants, etc. Men of action demand their snug warmth, free-action comfort, sturdy construction.

**COMPLETE LINE**

Leather and wool jackets, work shirts, 250 shoe styles for men and women. Liberal Commissions. Write today for FREE SALES OUTFIT.

VICTOR THOMAS SHOE CO.

Dept. V-96 610 W. Van Buren St.

Chicago, Ill.



### THERE'S PROFIT in ELECTRICITY—LEARN from PRACTICAL ELECTRICS, \$1.00



Whether you want to enter the electrical field as a profession—or whether you want to know more about fixing electrical gadgets around the house, you will find Practical Electrics a profitable investment. You can find the right answers quickly. It gives you the

fundamentals of electricity, electrical circuits, motors, transformers, electrical symbols, trouble shooting, etc.—all in plain, simple, understandable language. Send \$1.00 today for a copy of Practical Electrics, the ready reference book of electricity.

AUTOPOWER, INC., 2125 PINE STREET, ST. LOUIS, MISSOURI

*Famous Ford Firsts*

THE DEVICE THAT HELPED MAKE FLYING  
INDEPENDENT OF WEATHER AND MAPS

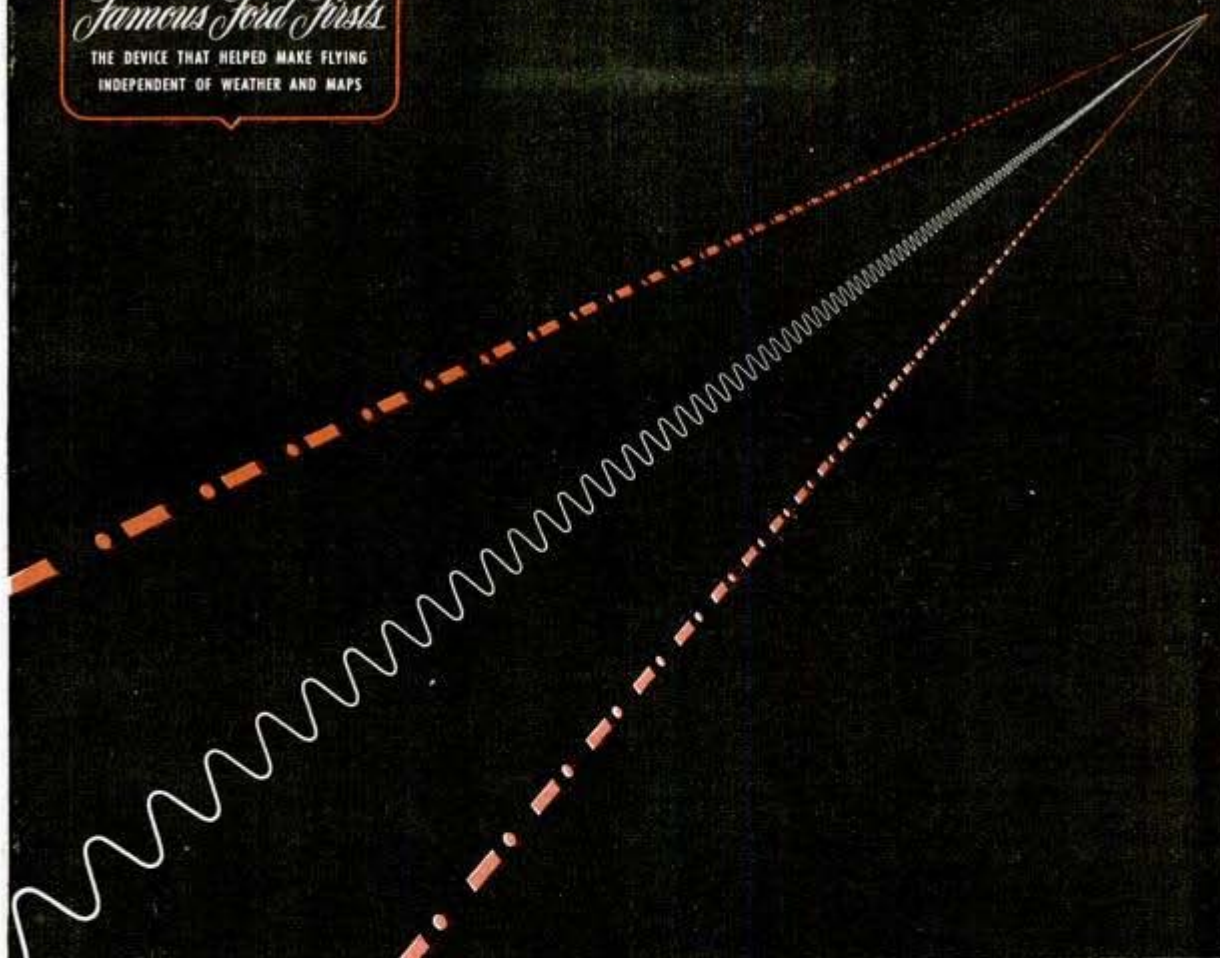

**1<sup>st</sup>**

with a radio beam  
for planes!



Eighteen years ago the first radio range system was set up by Ford. And a Ford plane made a daring round-trip flight through a snow-storm from Dearborn to Dayton, guided solely by radio.

The original Ford radio beacon was essentially that in use today. Two sending loops were set at an acute angle, transmitting signals alternately. From one was beamed the letter "A" . . . dot-dash. From the other, the letter "N" . . . dash-dot. These signals interlocked to give the pilot's "on course" hum.

Basic patents have been issued

to Ford on this greatest navigation aid. But in the interest of safer air travel, Ford has made these patents available to the air transport industry without charge.

The radio beacon is just one of many important "firsts" resulting from the Ford desire to benefit the greatest number of people in the most effective way.

Naturally, Ford-built cars and trucks have profited fully by this seeking for new and better things. And with the pioneering spirit more alive than ever at Ford today, you can continue to "expect the firsts from Ford."

**EXPECT THE "FIRSTS" FROM FORD!**

FEBRUARY, 1945

only **10¢** for this handy  
**WOODWORKING TOOL**

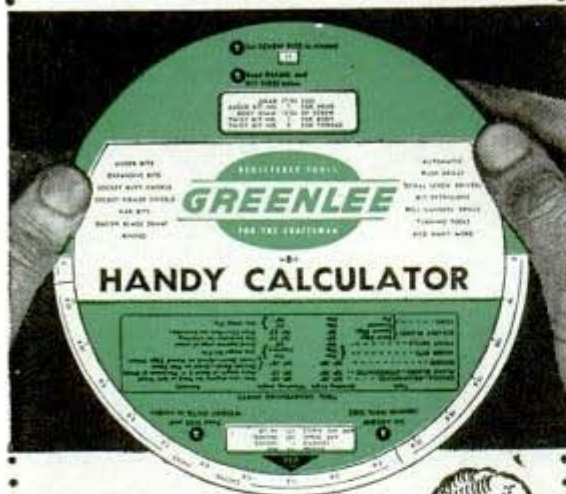

"Worth the price  
of five anyway,"



writes a user. You'll agree when you see how this popular, easy-reading calculator swiftly solves your woodworking problems. Just set the dial... convert linear feet to board feet... get slope per foot in degrees... compare hardness, weights, shrinkage, warping, working ease of various woods. More, too: bit sizes for head, body, thread of screws... nail specifications... tool sharpening hints... protractor. 6" diameter, fits your tool kit. Heavily varnished cardboard. Special wartime offer by the makers of famous GREENLEE tools for craftsmen—10¢. Send coupon in next mail. Greenlee Tool Co., Rockford, Illinois.



Send for yours now!

GREENLEE TOOL COMPANY, 2102 COLUMBIA AVENUE  
ROCKFORD • ILLINOIS

Enclosed is 10c. Send your "Handy Calculator" by return mail.

Name \_\_\_\_\_

Address \_\_\_\_\_

City \_\_\_\_\_

State \_\_\_\_\_

**5 lbs. HANDY ASSORTMENT \$1.98**  
—FOR MECHANICS—GARAGES—  
—WORKSHOPS—HOME USE

**SCREWS • NUTS • BOLTS • WASHERS •  
RIVETS • SPRINGS • BRACKETS • MISC.**

**MORE THAN 1,000 PIECES**

5 full pounds—a veritable treasure chest of fastening devices for every practical use. Satisfaction guaranteed. Order now. **\$1.98**  
**SPECIAL—2 assortments, over 2,000 pieces, for \$3.69.**

**HUDSON TRADING CORPORATION**  
*The House of Handy Assortments*  
F-165 West Hubbard St., Chicago 10, Ill.



**FREE!** Handy List of Special Assortments: FIBER AND BAKELITE WASHERS—RUBBER WASHERS and PADS—FELT WASHERS and PADS—RADIO LUGS, CLIPS and CONNECTORS—SPRINGS—SELF-TAPPING SCREWS—etc.

**AMAZING MYSTERY  
BUTTON**



Startles Everybody. With this Electronic Button you can make your own Telephone—Amplifier—Detectaphone. Attach this button to piece of cardboard—transmit conversation to another room. Music also transmitted to distant places. Most interesting, electrical apparatus ever discovered. Enables you to perform hundreds of experiments. So they can be concealed in dozens of places. A Free-War Product. Free-Electronic Button including 5000 word instruction booklet, with 50 illustrated experiments postpaid only \$1.00.

Electronic Products Company, Saint Charles, Ill.

**ONE-MAN SAWMILL LESS THAN \$135.00**  
Easy To Turn Trees Into Money

Makes Lumber, ties, shingles, studs, siding.

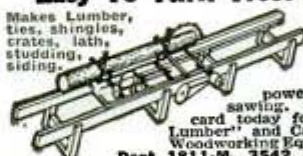

Belsaw Models in 10, 14 and 20 feet sawing lengths. Patented Mechanical Feed, accurate set works and positive dogs. Use tractor or old auto engine for low cost power. Thousands used for commercial sawing. Pays for itself quickly. Send post card today for FREE booklet, "How To Make Lumber" and Catalog of BELSAW MACHINERY CO. Woodworking Equipment.

Dept 1811-M, 3542 Main Street, Kansas City 2, Mo.

**TRAILER AXLES, HITCHES, AND PARTS**

• If you are interested in purchasing trailer axles, hitches, and other trailer parts, contact us promptly. Complete house trailer blue prints, \$1.00. Write for free literature. HAMMER BLOW TOOL COMPANY, Dept. 102, WAUSAU, WIS.

**DO YOU** WANT a permanent business profession of your own? Then BECOME A FOOT CORRECTIONIST. Earnings in this greatly needed profession run as high as \$50-\$100 weekly after a few weeks home training—not medical or chiropractic—no further capital needed, no goods to buy. 47th year. Write for free booklet.

Stephenson System of Foot Correction  
28 Back Bay, Boston, Mass.

**SHAW and "Peppy-Pal" GARDEN TRACTORS**  
"DU-ALL"

• 1 to 9 H.P. Circulars on request. War limits production—We supply repairs for all SHAW Tractors sold in our 41 years in business.

**BUILD YOUR OWN RIDING TRACTOR—"WAR HORSE"**

using old auto parts, powered by 2 H.P. or larger air-cooled engine; or walking type Garden Tractor 1/2 to 3 H.P. or convert truck or auto into Farm Tractor. Each with steel or rubber tires; will plow, cultivate. Plans for building, in few hours, any one of above, postpaid for \$1.00 (state which wanted) or all 3 for \$2.00. Money Back Guaranteed!

**SHAW MFG. CO., 4502 Front St.**  
Galesburg, Kansas  
668G North 4th St., Columbus, Ohio

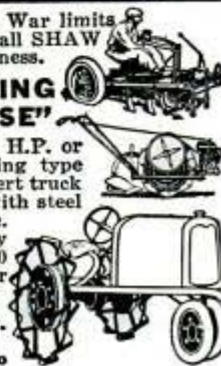



# STOKER EMPTIES OWN ASH!

A remarkable stoker already used by thousands of home owners—fits into any furnace or boiler. Manufactured since 1934. So automatic it takes the coal from your present coal bin through a pipe to the furnace, going around corners if necessary. Keeps house at even temperature, empties its own ash in sealed containers, no coal to shovel, no clinkers to dig, only bituminous stoker of its kind on the market. Send for full information NOW!

**POCAHONTAS FUEL COMPANY INCORPORATED**  
344 EAST 131st STREET • CLEVELAND 8, OHIO

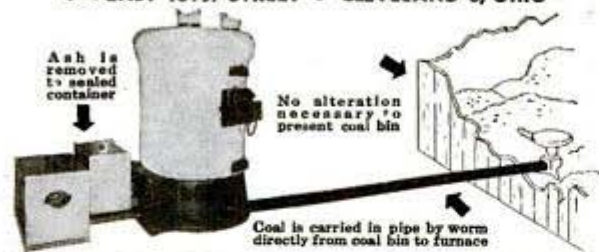

## PRINT ANY PHOTO on Paper, Cloth, Leather or Wood

**SIMPLE, EASY TO USE**

Magic liquid takes only 2 minutes to reproduce any snapshot you have on to stationery, handkerchiefs, ties, scarfs, etc. Won't wash off. Won't hurt negative or fabric it's used on. Personalize your belongings! An ideal gift. Complete outfit enough to transfer 100 photos—only \$1.00 postpaid. Sent C.O.D. for \$1.21.

**CHRISTY PHOTO SUPPLY, Dept. 1010**  
2835 N. Central, Chicago 34



## GENUINE U.S. BARGAINS ★ ★

- O. D. WOOL BLANKETS (USED), SELECT... \$3.95
  - Used Late Issue GAS MASK BAGS..... .89
  - U. S. ARMY PUP TENTS (USED)..... 3.00
  - Slightly Used Army CAISSON WHEELS with Axles, 56" high, wt. per pair with axles, 560 lbs..... \$35.00
  - New CONDIMENT CANS..... 6 for \$7.50
- Thousands of Other Bargains in Military, Outdoor & Sport Goods for Hunter, Farmer, Scout. Send 10c for 32-page catalog returned with first order.

**A and N SUPPLY CO.**

4724 LESTER ST. RICHMOND, VA.

# FREE VITAMIN SAMPLES

**HY-PANOL**—Amazing New Combination of Vitamins AND Minerals gives you Daily Minimum known requirement of BOTH.

lets). Then take the ten FREE tablets. If you are not enthusiastic about the benefits to be gotten from the use of HY-PANOL, return the bottle unopened within ten days and your payment of \$1.95 plus postage will be refunded in full by next mail. The samples are absolutely FREE. After taking the samples if you decide to keep the large bottle, you owe nothing as the \$1.95 you give the postman is payment in full. Rush your name and address today on a penny postcard. See for yourself what this new combination of Vitamins and Minerals can do for you.

**HYGEA VITAMIN CO., 2017 S. Michigan Ave.**  
Dept. 92, Chicago, Illinois

# IF HEARING WERE VISUAL

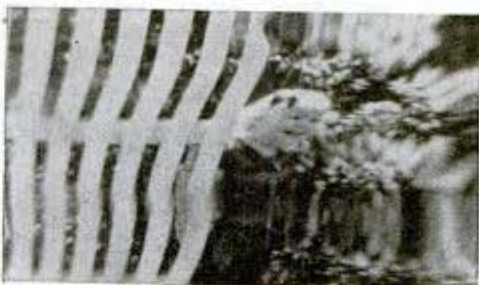

*Here's what an improperly fitted Hearing Aid will give you*



*And here's what a "personalized" fitting with the New Super-TELEX will give you*

Experience near-natural hearing as recreated for you by the New Super-TELEX. To use a Telex is to know the thrill of restored hearing through scientific "personalized" fitting. Test the New Super-TELEX... FREE. You'll know then why a Telex can realistically fit your hearing need now and for years to come.

# TELEX

*Hearing Centers from Coast to Coast*  
Consult Your Telephone Book

**TELEX LABORATORIES, 44 Telex Park**  
Minneapolis, Minn.

Please send me a copy of your new book, "New Hearing Through the Miracle of Electronics."

Name .....

Address .....

City..... State.....

# YELLO-BOLE

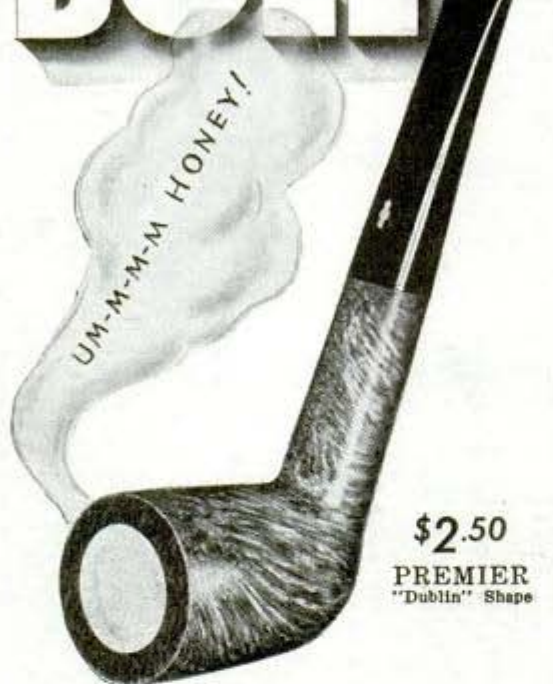

\$2.50

PREMIER  
"Dublin" Shape

# HONEY

**cures your smoke**

Honey is sprayed and brushed into Yello-Bole Pipes. It blends gently with the tobacco—so that the pleasant, mild flavor of it joins with the tobacco-flavor and aroma, forming the most enjoyable, satisfying smoke ever imagined in the most wishful hopes for "the perfect" pipe smoke. You don't have to get used to a Yello-Bole. You'll find it enjoyable from the start. Army and Navy needs come first of course—but your dealer is being supplied.

**YELLO-BOLE PREMIER \$2.50**  
**YELLO-BOLE IMPERIAL \$1.50**  
**YELLO-BOLE STANDARD \$1**



**YELLO-BOLE**

A NAME TO REMEMBER, WHEREVER YOU ARE—  
AND WHEN YOU COME HOME

# SYNGRO

**Torpedoes the Axis!**

Syncro Electric Jig Saws are busy torpedoing the Axis in the shape of SYNCRO-machined parts for submarines, bombers, tanks, guns, etc. Meanwhile Syncro research guarantees better Syncro Saws for you after Victory!

SYNGRO WORLD'S GREATEST SAWS



SYNGRO DEVICES, INC.  
3265 Bermuda Ave.  
Ferndale 20, Michigan

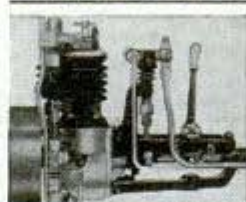

**Build: STEAM ENGINE**

- A precision built and engineered single cylinder, 1/4" scale marine model, with clutch or reverse.
- Send \$2.50 for 14 pages scale drawings, 2 photos, instructions.
- 2 Photos and Description...\$ .25
- Rough Castings Kit.....12.50
- Horizontal Flash Boiler Drawings and Instructions 1.00

**THOMPSON ENGINEERING CO.** 206 NO. DIVISION BLDG., GRAND RAPIDS 2, MICH.

## MASCOT SLIDE RULE

● Fits the pocket. Quickly solves any problem in multiplication, division, proportion. Gives the square, the square root, logarithm and reciprocals of all numbers. Trig scales give sines and tangents of numbers. Fine black graduations on white celluloid. Complete with instructions. Price in fabricoid case \$1.00, in leather case \$1.25. Money back if not satisfied. Special offer to agents and dealers.



**MONITOR SLIDE RULE — 6" Dia.**

[ Made in white Vinylite. Same scales as Mascot Slide Rule. Complete with instructions. Without case, \$2.95. Leatherette case, 75c addn'l. ]

**TAVELLA SALES CO., 19-B West Broadway, New York 7, N. Y.**

## Big Money for Workers In Home or Shop



LICENSED CONCRETE SPECIALISTS wanted everywhere. No experience needed. Make **Colorglazed** pottery. No molds or costly tools. U.S.-Canada patent method. Ceramic products, novelties, tiles, etc. Guaranteed basement leaksealing. Other big pay projects. Booklet, details Free. Men only. **NATIONAL POTTERIES COMPANY**  
542 Lincoln Avenue Fergus Falls, Minnesota

## SEND FOR THIS TIME SAVING OHMITE Ohm's Law Calculator



Figures Ohms, Watts, Amperes Volts... Quickly! Any Ohm's Law Problem solved with one setting

of slide. All values direct reading. (4 1/8" x 9")  
Send only 10c in coin to cover cost of handling.  
**OHMITE MFG. CO., 4931 Flournoy St., Chicago 44, Ill.**

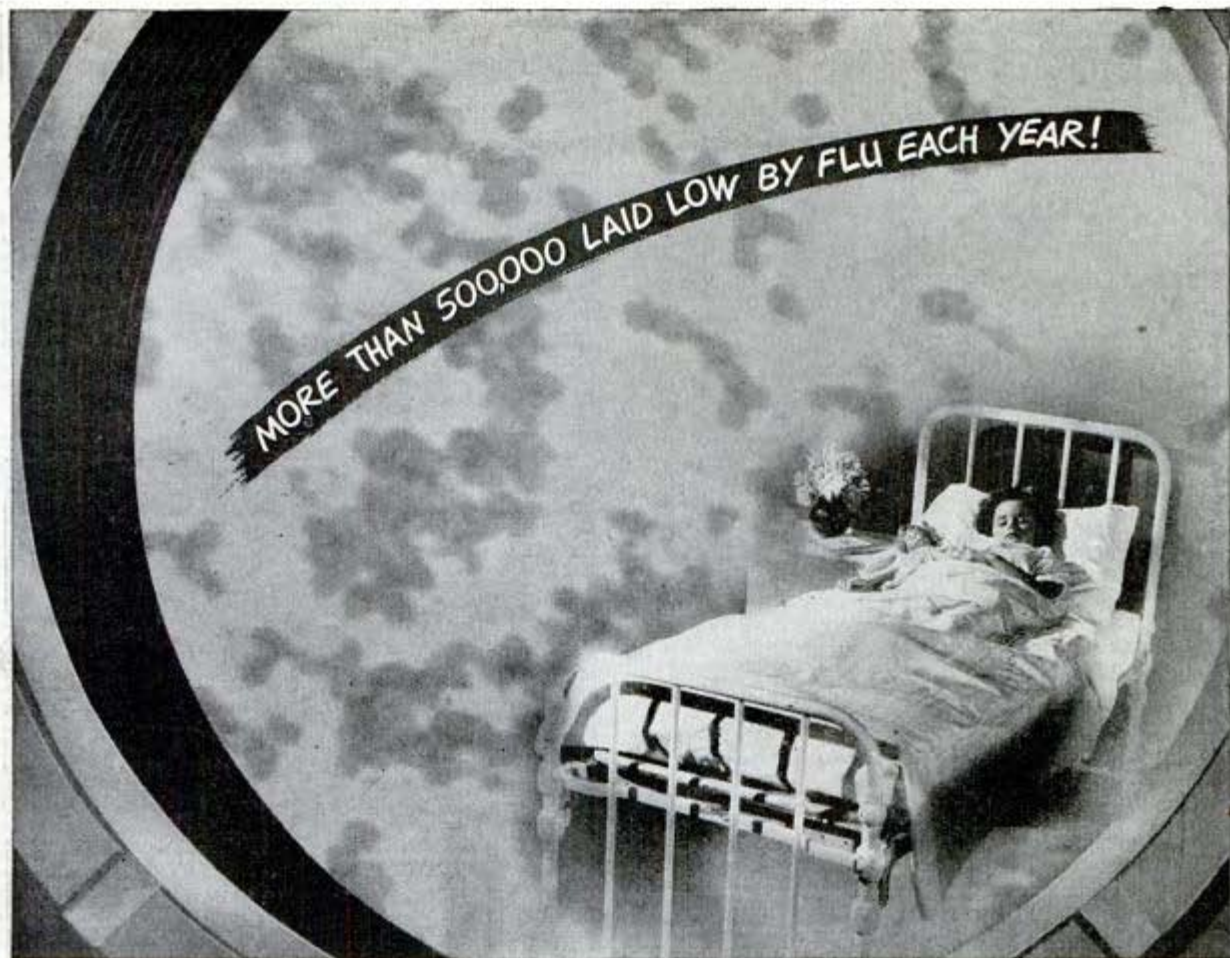

## ***to destroy 'em you have to see 'em***

Microscopes are gunsights in Medicine's battle on bacteria.

Optical microscopes, however, were not powerful enough to "draw an accurate bead" on the deadly virus that caused influenza.

But today, medical men have seen what no optical microscope could bring into focus — the infinitesimal influenza virus that previously had lain craftily camouflaged among larger cells.

This revelation came about through the Electron Microscope, developed by scientists at RCA Laboratories. And now, having been seen, influenza may be forced to unconditional surrender, saving the lives of thousands each year.

Here is but one facet of the genius shown by scientists behind RCA

research . . . the "ever-onward" research that saves lives or creates a better radio with equal skill . . . the "there-when-you-need-it" research that gave super-secret equipment to the United Nations . . . the "way-ahead" research that goes into everything made by RCA.

When you buy an RCA radio or phonograph or television set or any RCA product, you get a great satisfaction . . . enjoy a unique pride of ownership in knowing that you possess the very finest instrument of its kind that science has yet achieved.



### **They see what human eyes have never seen before!**

Drs. Arthur W. Vance and James Hillier, scientists at RCA Laboratories, with Mr. E.W. Engstrom, Research Director (standing), examine the RCA Electron Microscope that has useful magnification up to 100,000 diameters.

## **RADIO CORPORATION of AMERICA**

PIONEERS IN PROGRESS



# POWERFUL LIQUID

Promptly Soothes Torture  
and Aids Healing of

# SKIN RASHES

**'Invisible'**  
—Doesn't  
Show  
On  
Skin



To quickly relieve itching, burning of simple skin rashes, eczema, psoriasis, ringworm symptoms and similar skin irritations due to external cause — apply wonderful medicated *liquid Zemo* — a Doctor's formula backed by 35 years' success. Zemo also aids healing!

Apply clean, stainless, *invisible Zemo* any time — it won't show on skin. First trial convinces! In 3 different sizes.

## ZEMO

## DRILL PRESS OWNERS!

HERE'S 1 TOOL WITH 5 DISTINCT USES  
THE BARRON MULTI-PURPOSE  
ROTARY WOOD PLANER



PLANES & SURFACES • PANELS & BEADS \$7.50  
ROUTS & GROOVES • RABBETS • TENONS COMPLETE

Converts ANY drill press into a time saving, low cost planer, paneler, tenoner, etc. Surface finishes all types of tough grained and knotty surfaces to agree smoothness. Safe! Guaranteed harmless to drill press. Thousands now in use. SOLD ON MONEY BACK GUARANTEE. Full refund on 5 day trial. Shipped prepaid on receipt of \$7.50 — or C.O.D. YOU RISK NOTHING. Free literature.

Barron Tool Co., 389 Architects Bldg., Detroit 1, Mich.

ALL METAL AUXILIARY  
DRILL PRESS TABLE

Has 234 sq. in. true working surface. Equipped for shaping and many other important workshop uses — a real buy at \$7.95



## PAINT STRIPING TOOL

ONLY  
\$1.00  
POST PAID

Try it! See the Added Beauty

With this NEW TOOL (not a brush) everyone can now draw lines with paint, enamel, lacquer, etc. Used on autos, models, toys, games, imitation tile walls, cabinets, furniture, linoleum floors, signs, bulletin boards, sporting goods, home workshop projects, etc.

Send only \$1.00 for complete tool for painting a 1/16" wide stripe, including adjustable guide, operating instructions, etc. C.O.D. price \$1.25.

As easy to use as a pencil.



Extra interchangeable tips for making 1/8", 1/32", 3/64", 1/16", 3/32" and 1/8" wide stripe lines — .50¢ each.

Every Painter and Craftsman Should Own One.

Send for your tool and as many additional width tips you need today. Use it. If you are not satisfied that you can do better work, add character as well as beauty to your product or project, return the tool and we'll refund your money promptly.

Patent Dealers: Write for literature, etc. 4234-B Lincoln Ave. WENDELL MFG. CO. CHICAGO 15, ILL.



### DURABILITY

Genuine GERSTNER Tool Chests are built for many more years of satisfying service. Free Catalog for Machinists and Toolmakers. GERSTNER TOOL CHESTS 445 Columbia St. Dayton 7, Ohio

# SINKS AND BATHTUBS

FIX THOSE OFFENSIVE CRACKS!

## WITH Centraz TILE POINT

REPAIRS CRACKS  
BETWEEN TILE WORK  
AND BATHTUB  
OR SINK... BETTER



OVER SINK



OVER BATHTUB

DRIES WHITE  
SMOOTH GLASS-  
LIKE FINISH

Pint 35¢

(40¢ WEST OF ROCKIES)



See Your Hardware  
and Paint Dealer  
**CHRISTY COMPANY, Inc.**  
1417 PINE STREET • ST. LOUIS 3, MO.

## IT STAYS ON . . . RUST STAYS OFF

# FIENDOIL

### RUST INHIBITOR

Keep home tools, appliances, corrosive metal protectively coated.

35¢ Bottle Hdwe. — Sptg. Goods Dealers  
McCambridge & McCambridge Co.  
Baltimore 23, Md.



★ SAVE WASTE PAPER ★

**FREE Catalog**

Class pins, club pins, rings and emblems. Finest quality. Reasonable prices from 55¢ up. Write today. Dept. N, Metal Arts Co., Rochester 5, N.Y.



### ELECTRIC HEATING ELEMENTS REPAIRED

New amazing NICHROCITE PASTE will do it in a jiffy. Simply overlap ends, apply paste and turn on current. Used successfully by utility companies and others. Family size, \$1; 4 oz. size, \$2.50. Satisfaction guaranteed.

ADVANCE MFG. CO. Box 861-C Minneapolis, Minn.

## AUTO ENGINE SPEED CONTROL GOVERNORS



Give constant or changeable speed to any auto or truck engine, when used for power. Guaranteed. Instructions. Oil ring bearing, \$13.00. Ball bearing, \$19.50. Prepaid. Also additional carburetor butterflies. In Montreal: 7546 Wiseman St.; Latin America: East Asiatic Co.

Agents Wanted: Parts Dealers, Garages, Wreckers, Implement Dealers, General Merchants, etc. Free circulars.



CANDEE, Dept. A. 2641 S. Hill, Los Angeles 7, Calif.  
POPULAR MECHANICS

# MAKE MORE MONEY sharpening lawnmowers on the IDEAL LAWNMOWER SHARPENER

## BUILD A BUSINESS OF YOUR OWN

Prepare for the future. Make real money sharpening lawnmowers. Build a business of your own that will produce a steady profitable income. Lawnmowers have to be kept sharp to operate properly. You can cash in on this volume business if you start now.

The Ideal Lawnmower Sharpener makes old, dull lawnmowers cut like new. NO experience necessary. Easy to operate. Just set the mower in the sharpener, make a few simple adjustments, the machine does the rest. Sharpens like magic to perfect edge in just a few minutes. Write today for complete details and order as soon as possible to avoid disappointment.

- NO EXPERIENCE NEEDED
- EASY TO OPERATE
- KEEN EDGE IN 20 MINUTES



**THE FATE-ROOT-HEATH CO.**  
1245 BELL ST., PLYMOUTH, OHIO

SEND FOR DESCRIPTIVE LITERATURE  
TELLS HOW TO BUILD A LAWNMOWER SHARPENING BUSINESS

## Big Demand for Wood! Prices Never as High! QUICK PROFITS with OTTAWA

Log Saw of  
the Future  
TODAY!

# OTTAWA 6 H-P LOG SAW

### FELLS TREES • SAWS LOGS Buzzes Up Poles and Limbs

Unbeatable combination! 3 in 1 machine. Does everything you need fast and easy. You can turn wood lot into cash quickly and profit by present high prices.

**USE ENGINE FOR BELT JOBS**—When not sawing wood, use the engine to grind feed, pump water, etc. Pulley furnished.

**THOUSANDS IN USE EVERYWHERE**



### Speed Up Production!

Thousands NOW making more money with an OTTAWA LOG SAW. You can beat the labor shortage with this powerful machine. Saws the human way, only many times faster. Starts easy in any weather.

### 350 Saw Strokes per Minute

Air cooled motor—a blessing in winter. No shut-downs or strikes. Many exclusive OTTAWA features. Uncle Sam needs you to help relieve the nation wide fuel shortage. No priority needed when you buy an OTTAWA. Plan to get yours at once!

**What Users Say** "My 6 H-P Ottawa is a mighty magnet of power and energy. It is always ready to work in any kind of weather and makes log sawing a pleasure. It is easy to operate profitably and economically."—Edward Androus, California.

**FREE Big Catalog** Write today for your FREE copy of the Ottawa Catalog. Contains complete information of the "6" and other Ottawa Saws.

OTTAWA MANUFACTURING COMPANY, 1427 PINE STREET, OTTAWA, KANSAS

Now  
for EVERY WORK SHOP!

# NEW Invention Electroplates by BRUSH



**Easy to Plate CHROMIUM  
GOLD, SILVER, NICKEL, COPPER  
... For Pleasure and Profit!**

If you have a workshop—at home or in business—you need this new Warner Electroplater. At the stroke of an electrified brush, you can electroplate models and projects—you can replate worn articles, faucets, tools, fixtures, silverware, etc. with a durable, sparkling coat of metal... Gold, Silver, Chromium, Nickel, Copper or Cadmium. Method is easy, simple, quick. Everything furnished—equipment complete, ready for use. *By doing a bit of work for others, your machine can pay for itself within a week.* So make your shop complete by getting a Warner Electroplater right away. Send today for FREE SAMPLE and illustrated literature. ACT AT ONCE! Mail Coupon. **WARNER ELECTRIC CO., DEPT. A-25  
360 North Michigan, Chicago 1, Illinois**

**FREE Details & Sample!**

WARNER ELECTRIC CO., 360 N. Michigan, Chicago 1, Dept. A-25  
Gentlemen: Send Free Sample and Details to:

Name \_\_\_\_\_

Address \_\_\_\_\_

City \_\_\_\_\_

State \_\_\_\_\_

# Mortite

**UTILITY TAPE**

**BETWEEN YOU  
and the COLD**

New pliable plastic stops heat leaks—saves fuel. Weatherstrips windows, doors, baseboards, casements. Keeps out dust and dirt. Plugs cracks around drainboards, bathtubs, etc.



Use inside or outside. Can be painted.

**EASY TO APPLY**

Unrolls like ribbon. Just press into place and it stays put. Does not crack, chip or shrink. A roll covers about 80 feet, enough for 5 windows.

**At your Dealer's . . . . \$1.25**

Higher West of Rockies and Canada

Circular Free

**J. W. MORTELL CO.**

522 Burch St.

Kankakee, Ill.



## Fuse Puller — Circuit Tester

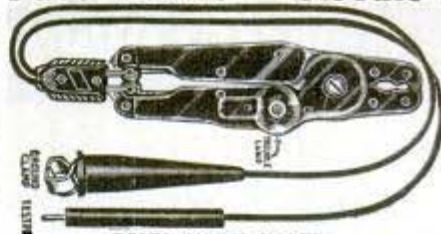

For  
Home  
or  
Factory

TESTS 110-250 VOLTS

When motors stop and lights go out, this tool quickly **LOCATES DEAD CIRCUITS** and safely removes blown Fuse. The Star Test Pocket Plier is made of a Transparent Plastic having in one of the legs a small lamp in series with a resistance and can be used to test 110 to 250 volts circuit. The Plier will pull fuses from 10 to 100 Amperes. Thousands of Electricians find this tool handier than Test Lamps. Price \$2.75 each without Leads, \$1.50 additional for Leads, plus 10c postage. Can be obtained from General Electric or Westinghouse Stores or directly from us. Order NOW. **STAR PLIER CO., 233 Canal St., New York 13, N. Y.**



## SHIP MODELS ILLUSTRATED

with a guide to  
modeling



\$2

POSTPAID

is the first book of its kind ever published — of ship models, of real ships, of masts, of rigging, of furniture, of deck gear — covering many types of vessels from whale-boats to PT's from "Slavers" to Corvettes. It incorporates many color plates, closeup photos, detailed drawings and actual construction plans, in addition to a salty text covering ship model building and a glossary of nautical terms. Send for it today. We'll include our catalogue of ship model kits and supplies.

**MARINE MODEL CO. DEPT. A-5** 29 WEST 15th STREET  
NEW YORK CITY

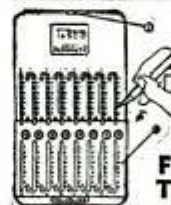

## POCKET ADDING MACHINE

STURDY STEEL construction for lifetime use. Adds, subtracts, aids multiplication. Capacity 999,999.99. A real machine—guaranteed 5 years. Thousands of satisfied users. Send name and address. We ship immediately. On delivery, pay postman \$2.50 (plus C.O.D. and postage charges). If you send \$2.50 with order, we pay postage. Leatherette case 25c additional. Your money back after 10 days trial if not satisfied.

Free  
Trial \$2.50

Send no money

**TAVELLA SALES CO., 19-BA West Broadway, New York 7, N. Y.**

## BUILD ARC WELDER FROM OLD GENERATOR

For Light or Heavy Work. 75-200 amperes. Complete **PLANS** 35c. Send today and we'll include FREE our Big NEW Catalog.

**LEJAY MANUFACTURING CO.**  
1347 LeJay Bldg., Minneapolis, Minn.



# LEPAGE'S GLUE

LEPAGE'S MODEL AEROPLANE GLUE

LEPAGE'S LIQUID SOLDER



## IS YOUR INVENTION ON THE POST WAR CALENDAR ?

If you have a metal product, patented or patent pending, or an invention beyond the idea stage on which you can furnish clear sketches and written description, write us fully about it. We may have an interest in common. Your rights will be scrupulously respected.



152 W. SLAUSON  
LOS ANGELES 3  
CALIFORNIA

### NATIONAL MACHINE PRODUCTS

PRECISION  
CRAFTSMEN

## Fix Scratches, Dents, Nicks the Professional Way!



### Get This Handy Kit!

Repair damaged furniture surfaces with new practical kit. Enables anyone to do fast, easy touch-up jobs like a professional cabinet finisher. Makes furniture and cabinets look new. Every home and shop needs this remarkable kit. Pays for itself over and over!

### Amazing Results—Easy to Use

Kit includes 23 different items—scratch removers for slight scratches, assorted shades of shellac sticks for deep nicks, bottles of light and dark stains, shading lacquer, alcohol lamin with fuel, stainless steel spatula, touch-up brushes, scratch sticks, steel wool, sandpaper, rubbing liquid. Packed in handy leatherette finish case. Send for it today. Best investment of lifetime. Fully guaranteed. Detailed instructions supplied.

\$3.95

Postpaid

**AMERICAN HOUSEHOLD BUREAU**  
Dept. F, 520 N. Michigan Ave., Chicago, Ill.

## 110-VOLTS AC from DIRECT CURRENT

with **KATO KONVERTERS**. Furnish standard 110-v AC from 32, 110, or 220-v. DC. Good deliveries on sizes 350 through 2500 watts on priority orders.

Good deliveries on 5, 7½, 15 & 25 KW AC generators. Mfg'r's of motor generators, frequency changers and high frequency generators.

**KATO ENGINEERING CO.**  
46 Elm Street, MANKATO, MINN., USA



## A BUSINESS FOR YOU

Learn how you too can obtain a valuable, exclusive franchise for handling **STAMINITE** protective coatings, waterproofer, **NON-SLIPPERY** Floor Wax, and **PLASTIC BASE** speed drying, transparent coatings for wood and linoleum floors and surfaces **IN or OUT**. If you can qualify for local Distributorship (small stock requirement) you'll prosper greatly. Write **TODAY!**

**THE STAMINITE CORP., DEPT. B., 109 WATER ST., NEW HAVEN, CONN.**

## BUILD YOUR OWN MACHINE TOOLS!

Blueprints \$1.00 - Catalog FREE



Detail construction Blueprints on 6 Lewis metal and wood-working tools postpaid for \$1.00. Includes prints for Lewis 10" Shopper or Milling Machine, Drill Press, Vice, 16" Band Saw, 6" Joiner, 8" Circular Saw. Plain or semi-finished castings available for these tools save up to 80% of comparable new tool cost.

Illustrated 28-page Catalog-post free with Blueprint Order—describes 20 Lewis tools. **WRITE TODAY!**

**LEWIS MACHINE TOOL CO.**  
P. O. Box 116, Sta. A, Dept. M-14, Los Angeles 31, California

## NEW! FUNDAMENTALLY DIFFERENT!



Originally developed by Mallory for the United States Army Signal Corps.

Now, output is devoted to war needs. At war's end, these batteries will offer outstanding advantages for civilian use.

**P. R. MALLORY & CO., Inc.**  
**INDIANAPOLIS 6, INDIANA**





**YOU enjoy  
better  
smoking!**

In the Smokemaster pipe, an ordinary pipe cleaner, inserted in the stem, *works while you smoke*. As smoke is drawn through the stem, the pipe cleaner under the smoke passage, absorbs moisture as fast as it forms.

The smoke always has a clean, dry passage. You enjoy your favorite tobacco at its very best—uncontaminated by rank, biting juices.

Smokemaster, made to Briarcraft standards, is a fine-looking pipe too—one you'll be proud to own.

In many popular shapes, of Native Briar. At leading dealers.



Pat. No.  
2,166,537

Moisture is absorbed by  
pipe cleaner inserted in  
the stem.

Smokemaster Custom-made \$7.50  
Smokemaster Standard \$7

Briarcraft, Inc., 347 Fifth Ave., New York 16, N.Y.

**Briarcraft  
Smokemaster**

★ SAVE WASTE PAPER ★

**Test-O-Lite** the MODERN TROUBLE SHOOTER



← THE NEON GLOW

... LOCATES TROUBLE INSTANTLY in electric circuits, fuses, cut-outs, motors, radios, appliances. Tests everything electrical from 100 to 550 volts. Indicates hot or grounded wires. Tells AC from DC. Far superior to ordinary clumsy test bulb.

↑ PUTS "FINGER" ON THE TROUBLE SPOT -- QUICKLY

Saves precious time. Indispensable in shop or home. Has patented safety features. Vest pocket size with clip. Lifetime guarantee. List \$1.50 (Priority A7 required) Purchase through regular electrical dealers.



FUSES



MOTORS



OUTLETS

**L. S. BRACH MFG. CORP.**  
55 Dickerson St. Newark, N. J.



**Titan Slide Rule**

6" diameter. Easily read, clearly marked single index scales. Gives logarithms, reciprocals, squares, square roots, sines, and tangents. Continuous circular calibrations cannot go "off-scale." Invaluable in multiplication, division, proportion, conversion, all mathematical problems. Made of durable heavy pure white Vinylite. Complete with instructions, \$2.95. Leatherette case 75c additional. Money-back guarantee.

PRECISION INSTRUMENT CO.  
Box 654, Dept. H Church St. Annex New York 7, N. Y.

**TRAIN**

**Your VOICE!**

**Results GUARANTEED**

We build, strengthen the vocal organs—not with singing lessons—but by sound, scientifically correct silent and vocal exercises and absolutely guarantee complete satisfaction with results. Write for Voice Book, FREE. Sent to no one under 17 years old unless signed by parent.

PERFECT VOICE INSTITUTE, Studio 1352, 64 E. Lake St., Chicago 1, Ill.

Now You Can be  
**TALLER**  
than "SHE" is!

Adler Elevator Shoes make you almost 2 INCHES TALLER. "Confidentially", and comfortably, the instant you put them on. Worn and praised by thousands. Look like any other stylish shoes—no high heels! Write for amazing catalog, mailed in plain wrapper. Adler, 122 E. 42nd St., New York 17, N. Y., Dept PM-1.

Yes, You can get a genuine  
"Simplified"  
**ARC WELDER**

Send for complete delivery information. State Your Priority No. and Type of Welding you do.

**Quicker and Stronger Welds**

are possible with only the latest developed welding equipment. And the latest developed is the Hobart "Simplified" Arc Welder... the same arc welder that has played such an important part in the all out production for "VICTORY." Hobart equipment is available to you now, and we'll be glad to send you complete information on request. Write us today!

HOBART BROS. CO., BOX M-25, TROY, O.

**HOBART "Simplified" ARC WELDERS**

with the Original and Exclusive Remote Control



HOBART "One of the World's Largest Builders of Electric Arc Welders."



# husky, accurate

## A New Low-Cost 18" Drill Press That Can Really Take It

This New Duro 18" Drill Press has been designed and built to handle a much heavier load continuously than ordinary low-priced units. Has many new features including: special design for quick-changing of belts; head casting slotted to provide take-up when wear develops from movement of quill; six-spline telescopic self-aligning spindle that reduces play; heavy ribbed cast iron table and base with large machined surface and grooves for collecting coolant; base provided with "T" slots for bolting jigs; improved simplified depth gauge. Efficient production foot feed available. Specifications include:  $\frac{3}{4}$ " capacity. No. 2 Morse Taper. 4 New Departure Ball Bearings. Speed range 425 to 2030 R.P.M. Spindle travel—5". Drills to center of 18" circle. Maximum distance from base to spindle—49". Maximum distance from table to spindle—19". Overall Height—68". Size of overall base—18" x 28½". Diameter of column—3½". Weight of Model A3088 (as illustrated) less motor, 350 lbs. Also available in bench model.

**Send for Catalog**—showing low-cost single and multiple-spindle Drill Presses, Metal-Cutting Band Saws, Circular Saws, Jointers, Routers, Shapers, Grinders, Lathes, Scroll Saws, Flexible Shaft Units, and Portable Electric Drills. Gives full specifications and prices.

Available on Priorities only

# DURO TOOLS

## MACHINE TOOL DIVISION

DURO METAL PRODUCTS CO., 2665 N. KILDARE AVE., CHICAGO 39, ILL.

ALSO MAKERS OF DURO HAND TOOLS

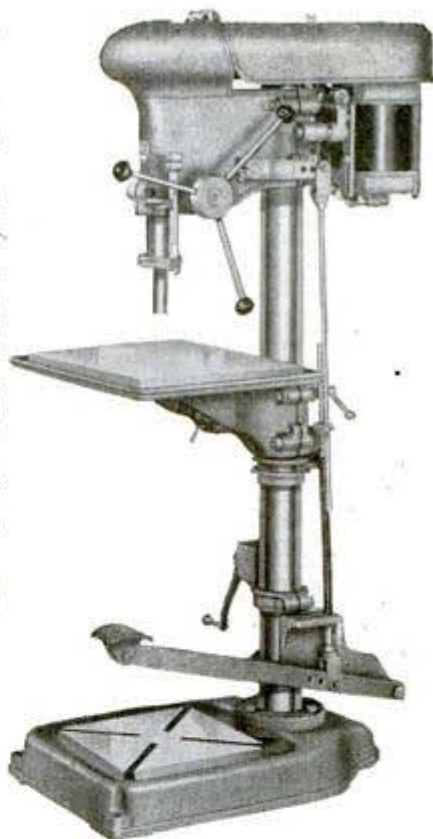

## PICTURE RING \$1.



Exquisite Onyx-like Picture Ring—made from any photo. **Send No Money!** Mail photo with paper strip for ring size. Pay postman only \$1.00 plus postage. Hand tinted 25c extra. Photo returned with ring. Money back guarantee. Send photo and ring size now. **PORTRAIT RING CO., Dept. F-44, CINCINNATI, O.**

Made from  
Any Photo  
or Picture!  
**SEND NO MONEY!**

# INVENTORS

## WE LOCATE BUYERS

for and have many requests from manufacturers for New Inventions of merit. Patented or Unpatented, Cash or Royalty. It will sell, write us today for a FREE PROTECTIVE DISCLOSURE FORM, Descriptive Booklet, References, and Full Particulars of our services to inventors. NO OBLIGATION. A post-card will do. Address:

### THE INVENTION REPORTER

5C-11236 South Fairfield Avenue

Chicago 43, Illinois

## MAKE BIG MONEY SAWING WOOD NOW!

350 Cuts  
a Minute

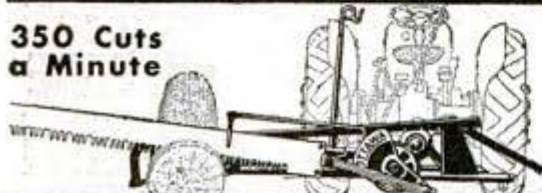

## OTTAWA ONE-MAN TRACTOR SAW

Turn wood lots into cash; help save other fuels to win the war. Use Ottawa—fastest cutting; easiest way. Cuts large and small logs, fells trees. Thousands in use. Built to last with special heavy stiff saw blade. Positive safety clutch control, driven from any power take-off.

**OTTAWA MFG. CO., D227, Forest Ave., Ottawa, Kansas**

**FREE BOOK**  
and  
Price List

## If you are uncertain— —how to make "GOOD PICTURES"

WRITE TODAY FOR THIS 56 PAGE BOOK

IT WILL HELP YOU  
SOLVE MANY PROBLEMS

- SELECTION OF FILM
- EXPOSURE
- DEVELOPING
- ENLARGING
- FLASH PICTURES
- FILTERS & COLOR

Send 25c to  
**ARGUS, INC.**  
Ann Arbor, Mich.  
DEPT. R



## argus

Cameras and Optical Instruments



**YOU NEED**

**BURGESS**  
vibro-tool  
Trade Mark Reg. U. S. Pat. Off.

**Indispensable**  
FOR ALL TYPES  
of Craft work

120 VIBRATING  
STROKES PER  
SECOND

Writes on steel. Engraves on glass, plastics. Slices into wood, linoleum, rubber, cardboard, cloth. Tools leather. Hammers, files, chisels. See your dealer or, post-paid on receipt of check or money order. Circular free

Only **\$7.50**  
Complete with 20 Engraving Needles (Special attachments extra)

(HANDICRAFT DIVISION)  
**BURGESS BATTERY COMPANY**  
166 N. Wabash Avenue Chicago 1, Ill.

**USE THE**

**NEW**

*Streamline*

for more accurate measuring

Redesigned for craftsmen who take pride in good tools, the new Streamline performs many workbench jobs and simplifies accurate measuring - both in the home workshop and on the job.

**Check these features:**  
Entirely new design, but same high quality materials...  
Longer tip for more accurate "reach" measurements...  
Simplified construction for quicker, easier cleaning and oiling... Easier to insert spare blade... Less frictional wear on tape and smoother operation... Larger braking surface holds blade steady... Graduations, on all edges and both sides, are visible from any angle... Lever lock on back of case for convenient inside measuring.

Master Rule Mfg. Co., Inc., Dept. F-2  
815 E. 136th St., New York 54, N. Y.  
Branch: 541 S. Spring St., Los Angeles, Calif.  
Enclosed find \$2.65 for 6 ft. Streamline steel tape rule and spare blade.

Name.....  
Address.....  
City..... State.....

**MASTER**  
WOOD and TAPE RULES

**Build These Cleveland Model "Supervalues"**

Build this realistic 20 1/2" line-controlled gas model of the greatest of all bombers. Kit UA-200. **\$100**

Biggest \$1.00 Model in U.S. 8 1/2" Super Condor Soarer. Kit E-5019. **\$100**

**SEE YOUR DEALER FIRST.** In ordering direct, add 20c extra for packing-postage.

**CATALOG 5c** (none free)

**BLACK WIDOW NIGHT FIGHTER**  
Span 36". An Industrial Training Model. Kit C-D T-155. **\$150**

**CLEVELAND MODEL & SUPPLY CO.**  
4508E15 Lorain Ave. Cleveland 2, Ohio, U. S. A.

The Dennison Handy Helper says:  
**Wilful Destruction, Plain Misuse or Careless Loss Has No Excuse**

GUARD LOOSE LEAF RECORDS WITH  
**Dennison**  
GUMMED REINFORCEMENTS  
At Stationery Departments Everywhere

**Burpee's**  
**BEST VEGETABLES**

Special--to get acquainted, we'll mail you these 5 full-size 10c-Packets seeds for just 10c--Tomato, Radish, Carrot, Beet, Lettuce. Send dime today!

Burpee's Seed Catalog FREE--all the best Flowers, Vegetables.

**W. ATLEE BURPEE CO.**  
511 Burpee Building, Philadelphia 32, Pa.  
(or) 511 Burpee Building, Clinton, Iowa

**5PKTS. 10c**

**TOMBSTONES**  
**DIRECT TO YOU \$9.95 UP**

Genuine beautiful **ROCK-DALE** Monuments, Markers. Satisfaction or MONEY BACK. Freight paid. Free catalog. Compare our prices

**ROCKDALE MONUMENT CO., Dept. 385, JOLIET, ILL.**

**EASY TERMS**

★ **SAVE WASTE PAPER** ★

**RATIONED MOTORISTS**

Now Get **EXTRA** **GASOLINE MILEAGE**

Now you can get up to 30% extra gasoline mileage with a Vacu-matic on your car. Quicker pick-up, smoother running, added power and precious gasoline savings guaranteed.

**Automatic Supercharge Principle**  
Vacu-matic is entirely different! Operates on the Supercharge principle. Saves gas. Automatically provides a better gas mixture. Guaranteed to give you to 30% extra gas mileage, more power and better performance.

**FITS ALL CARS**  
Constructed of six parts, fused into a single unit. Adjusted and sealed at the factory. Very quickly installed by anyone.

**AGENTS TRIAL OFFER**  
Every car, truck, tractor a prospect. Send name, address on postcard for big money making offer and how you get yours for introducing.

**Vacu-matic Co., 7617-1140 W. State St., Wauwatosa 13, Wis.**

**INTRODUCING-New Victory Model  
HANDIWELD ELECTRIC  
ARC WELDER**

RETAILS ONLY  
**\$1.95**



**PLUGS INTO  
LIGHT SOCKET**

Victory Model Handiweld Arc Welder operates from 110 volts, A.C. or D.C. current same as other arc welders higher priced; generates tremendous heat to weld all metals. Not a toy welder that uses carbons, but actually uses standard coated rods—sizes 1/16" and 3/32". However, due to Priorities a generous supply of 1/16" rods only are supplied with the welder. Guaranteed not to burn out. Repairs fenders, auto bodies, radiators, machinery parts, etc. Take Victory Model Handiweld anywhere to job, operate right from light socket. You'll find a thousand uses for this welder around your home, garage, workshop, etc. Order a "Victory Model"

your home, garage, workshop, repair shops, plumbers, farmers, Handiweld now.

**SEND NO MONEY** We'll rush one to you with rods, helmet, operating instructions, and all necessary parts with the exception of a large jar and a small piece of extension cord; these most everyone has. Pay postman only \$1.95 plus a few cents from receipt and money paid for it will be refunded promptly. Rush your order now.

**KUMFY PRODUCTS, Dept. P-202, CINCINNATI 26, OHIO**



**MEN**

This Horseshoe Ring, Handmade, Hand-engraved, inlaid with simulated pearl, is a **KNOCKOUT!** Shoe and shank of everlasting Monel Metal is

**GUARANTEED 20 YEARS**

Supply is limited... rush your order! **SEND NO MONEY.** Pay Postman only \$3.85, plus excise tax and postage. Return for refund in five days if not delighted. State size. Address:

**AMERICAN JEWELRY CO., Dept. 161-H, Wheeling, W. Va.**

Always write your name and full address clearly when answering advertisements.



**BUILD WITH CEMENT COMPOSITION**

strongly reinforced with cheap wood. Several formulas. Blown iron-lined roof, walls and gutters in one. How to build a house 22x24, three rooms, as low as \$100 for materials, garage, \$20, 20x50 poultry house, \$50. Farm buildings for a few dollars. Homemade equipment to make walk-in building blocks with inside and outside finish. Also roof, wall and floor tile in color, and durable wallboard of sawdust. Labor saving. Long lasting. No painting. Make doors and windows. Sectional cabins. 100 money-saving ideas. Mixer and saw easily made from an old auto. 40 War-Guaranteed, illustrated instructions, \$1.00.

line plans. Earn \$10 a day.

**MAKE FURNITURE OF COMPOSITION** cement, sawdust, asbestos, paper. Some racks, shelves, increased sinks, lawn novelties and toys, 500 per cent profit. 50c.

**HOW TO MAKE ACCURATE WOODWORKING MACHINES:** Band, jig and circular saws; electric drills, sanding wheels, tools, electric wood cutters and many other things from old auto-parts and washing machine motors. Illustrated, 50c.

**HOME MFG. ENTERPRISES,** 50 selected home shop projects, 50c.

Special: All of the booklets described above, \$2.00 postpaid. No C.O.D.

**HOME INDUSTRIES, 1318 South 39th Ave., Dept. PM, Omaha 5, Nebr.**

**SIGNS AND SHOWCARDS** EASILY AND EXPERTLY PAINTED WITH LETTER PATTERNS. MANY SIZES & STYLES. WRITE FOR FOLDER! **JOHN F. RAHN** 1830-31 N. Central Ave. CHICAGO 51, ILL.

**So-Lo SAVES RUBBER**

**AND MOST ANYTHING MADE OF LEATHER AND CLOTH**

- Spreads Like Butter
- Dries Hard Overnight
- Flexible—Non-Skid
- Waterproof—Won't Come Off

**Longer Life for TIRES**



Easy to fix cuts, bruises, worn spots in tires *at home.* Keeps out grit and water. Add hundreds of miles wear to your tires with SO-LO.

**Re-Sole Your Own SHOES**



Easy—at home. Spread on So-Lo like butter. Wears like leather. Use it for all footwear, children's and grownups'. Also use So-Lo for raincoats, boots, etc. Guaranteed to SAVE!

**1,001 Repairs in the Home, Auto, Farm, Factory and Shop**



Mend It with So-Lo FOR ONLY **1¢** EACH



**So-Lo**

**AT ANY HARDWARE AND 10c STORE**

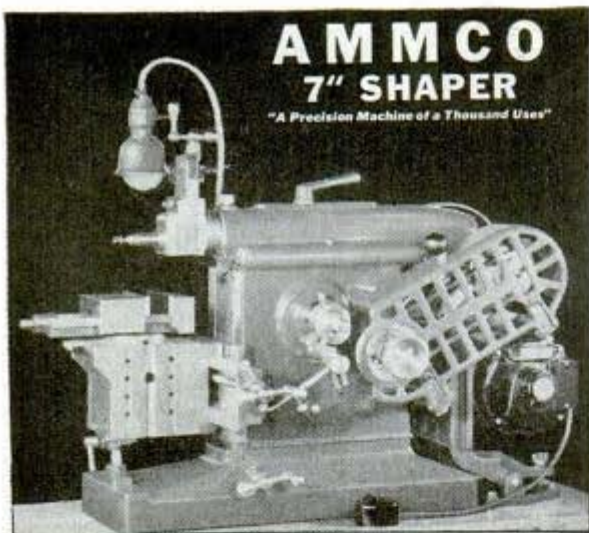

# AMMCO 7" SHAPER

"A Precision Machine of a Thousand Uses"

A wide variety of jobs can be done accurately, quickly, easily, and economically on the AMMCO Shaper (7" stroke).

Construction incorporates many features you would expect to find only in larger, more expensive machines... For example: WAYS of ram, tool head, and front face of the main frame are of the "VEE" type, hand scraped to insure accuracy and long life. Available for stationary installation or as portable unit.

Write today for specifications and prices

## AMMCO

2140 Commonwealth Ave. North Chicago, Ill.

- SEAL OUT DRAFTS
  - SAVE FUEL
  - BE COMFORTABLE
- with

## KALK-KORD

THE NON-HARDENING  
CAULKING AND SEALING  
COMPOUND

You can quickly and easily seal loose windows against drafts with Kalk-Kord—use it around window frames, too, inside and outside.

Neat and clean to use, Kalk-Kord seals cracks without tools—just press in place with fingers. Comes packed in convenient beads or rolls. Will not stain paint or any surface. Does not harden, crack, chip, or shrink. Waterproof and unaffected by temperature changes.

For Sale by Sears, Roebuck retail stores Paint Dept. 30, or by mail from Sears

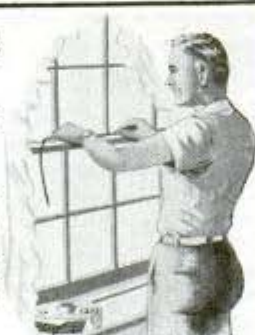

### Other Household Uses

- Caulking window and door frames
- Sealing around bathtubs and sinks
- Sealing cracks in plaster, wood-work, masonry
- Sealing around baseboards

Product of

**PRESSTITE ENGINEERING COMPANY**  
3978 CHOUTEAU AVE. • ST. LOUIS 10, MO.

## WISE-GRIP WRENCH

Gives Your Hand a  
**TON-Grip!**

Does more things, easier and quicker, than any other tool! Remains locked to the work with hands removed. Holds anything, any shape, with a grip that never slips. Is actually Hand-Vise, Clamp, Super-Plier, Adjustable End-Wrench, Pipe-Wrench, Locking-Wrench and Toggle-Press—ALL IN ONE! Light, trim, handsome. Made of fine alloy steel. Zinc-plated. 2 sizes—7" and 10".

Sold through Tool Jobbers and Dealers.

PETERSEN MFG. CO., Dept. C-2, DeWitt, Nebr.



## COLD PIPE, CONDUIT & Tube Bending Machines

15 Sizes and Types Available

A few of our More Than  
12,000 Customers:

Burns of Ship, Wash. D. C.; Henry J. Kaiser Co., Calif.; Pacific Bridge Co.; Bethlehem-Hingham Shipyard; Standard Oil Co.; E. I. Du Pont de Nemours & Co.; General Electric Co.

Free printed matter on request

AMERICAN PIPE BENDING MACHINE CO., INC.

World's Largest Manufacturers

77 Pearl St., Boston, Mass.





### TRICO KLIPLOK CLAMPS

FOR FUSE CLIPS

Lock fuses and clips together. Eliminate burnt fuses, premature blowings, wasted power.

**WRITE FOR LITERATURE**

TRICO FUSE MFG. CO. Milwaukee, Wisconsin

Externally  
Caused

## PIMPLES

ACNE, BLACKHEADS, OILY SKIN, RED PATCHES Discouraged by soaps and salves? **SEBOLINE** applied nightly often shows improvement in a week. **Money Back** if not completely satisfied after 2 weeks. **Skin Specialist Prescription. SENT ON TRIAL.** You risk nothing. **FREE** Send for Free Booklet at Once. Don't suffer embarrassment any longer. **WRITE TODAY.** Seboline Lab., Dept. HH, P.O. Box 350, Independence, Mo.

## MANY NEVER SUSPECT CAUSE OF BACKACHES

This Old Treatment Often  
Brings Happy Relief

Many sufferers relieve nagging backache quickly, once they discover that the real cause of their trouble may be tired kidneys.

The kidneys are Nature's chief way of taking the excess acids and waste out of the blood. They help most people pass about 3 pints a day.

When disorder of kidney function permits poisonous matter to remain in your blood, it may cause nagging backache, rheumatic pains, leg pains, loss of pep and energy, getting up nights, swelling, puffiness under the eyes, headaches and dizziness.

Don't wait! Ask your druggist for Doan's Pills, used successfully by millions for over 40 years. They give happy relief and will help the 15 miles of kidney tubes flush out poisonous waste from your blood. Get Doan's Pills.

## ELECTRICITY FOR ANY JOB ANYWHERE



Reliable, economical electric service anywhere, anytime, with an Onan Electric Generating Plant. Driven by Onan built, 4-cycle, gasoline engines, these power plants are of single-unit, compact design and sturdy construction. Suitable for all types of service.

Models range from 350 to 35,000 watts. A.C. types from 115 to 660 volts; 50, 60, 180 cycles, single or three-phase; 400, 500 and 800 cycle, single phase; also special frequencies. D.C. types range from 6 to 4000 volts. Dual voltage types available. Write for engineering assistance or detailed literature.

### ONAN

D. W. ONAN & SONS, 2502 Royalston Ave., Minneapolis 5, Minn.

## INVENTORS, SCHOOLS, CRAFTSMEN BRONZE FOUNDRY



is again available in limited quantity without priority. Orders filled in sequence as received. **INVENTORS—SCHOOLS—CRAFTSMEN** use **FOUNDRYETTE** for making castings quickly for new inventions, for instruction, and general purpose. Order now for early delivery. Three sizes are available capable of making bronze castings of 1½, 3, and 6 pounds weight, aluminum, copper, brass, etc., \$17.50, \$24.00, \$34.50, f.o.b. Kansas City. Domestic gas supply and 110 volt AC or DC energy required for operation. Write for circular.

**KANSAS CITY SPECIALTIES CO.**

Box 6022, Dept. P-51

Kansas City, Mo.

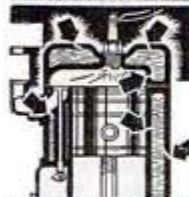

## REPAIR CRACKED BLOCKS AND HEADS—

External and internal leaks in blocks, cylinders and valve ports quickly and easily with **LUSCO PLASTIC SEAL**. **90 day Service Guaranteed** or your money back. Send money order or check for full pint—sufficient for average repair. **\$3.00** Postpaid

**C. F. LUSK CO., 4620 EUCLID AVE., CLEVELAND 3, OHIO**

## Wonder-Tone NOISE ELIMINATOR

Just attach to your radio (long, short wave) and enjoy reception free from distracting noises. **Send-No-Money Pay Postman** 60c plus postage or send 60c and we'll send postpaid. Return in 5 days for refund if not delighted.

**WONDER-TONE COMPANY, Dept 49, 7078 N. Clark St., Chicago 26, Ill.**



# 2 Bushels of Ripe TOMATOES from ONE VINE

2 or 3 vines will produce enough tomatoes for the average family.

## New BURGESS CLIMBING TRIP-L-CROP

**TOMATO** rapidly grows to a height of 10 to 18 feet. Grow on trellis, side of house or barn or as a bush in garden. Beautiful crimson, solid, meaty fruits of best quality, some weighing over 2 lbs. each. The most productive of all tomatoes. Trial packet 10c—3 for 25c, postpaid.

**CASH PRIZE CONTEST**  
Send for FREE Garden Book giving full details about CASH PRIZES to growers of this wonderful tomato.

**BURGESS SEED & PLANT CO.**  
217 C.T., GALESBURG, MICH.

## FOR YOU AND YOUR FAMILY

### SPIEGELS BIG SPRING AND SUMMER CATALOG

SEND FOR YOUR COPY TODAY!



This big 658-page catalog is divided into 5 complete Shopping Sections.

- A Fashion-Right Store for Women
- A Complete Department Store for Children
- A Men's Wear and Sporting Goods Store
- A Style-Conscious Home Furnishings Store
- Complete Hardware—Farm—Auto Store
- Over 40,000 Items of Merchandise

Here at Spiegels you have three convenient ways to buy—Cash, 30-Day Charge or Time Payment. This new catalog gives full details of these three plans.

As you undoubtedly know, there is an extreme shortage of paper and for this reason the number of catalogs we were able to print for this coming season has been limited. This makes it most important that we send catalogs only to substantial people who are interested in shopping at Spiegels.

For this reason, we are asking you to be sure to fill out all the questions on the attached Catalog Request Coupon. Your answers will be kept strictly confidential.

CHICAGO SPIEGEL ILLINOIS

## CATALOG REQUEST COUPON

Be sure to answer all questions below and mail to SPIEGEL INC., 1061 W. 35th ST., CHICAGO 9, ILLINOIS, to get your copy of the new big Spiegel Spring and Summer Catalog. If married, answers must apply to husband.

1. What kind of work do you do? \_\_\_\_\_

2. Date hired by \_\_\_\_\_ 3. How long have you lived present employer? \_\_\_\_\_ at present address? \_\_\_\_\_  
(month) (year)

4. Do you own your home? \_\_\_\_\_ Rent? \_\_\_\_\_ Room \_\_\_\_\_ Room \_\_\_\_\_  
at home? \_\_\_\_\_ outside? \_\_\_\_\_

Name \_\_\_\_\_

Address \_\_\_\_\_

Town \_\_\_\_\_ State \_\_\_\_\_

BE SURE TO ANSWER ALL QUESTIONS M20-11



# HANDEE

Tool of 1001 Uses

The original, fit-your-hand tool—today's finest. Does precision work on any metal, alloy, plastic, wood, horn, bone, glass, etc.

## A WHOLE TOOLSHOP IN ONE HAND

The sky's the limit with the Handee. Its usefulness is as extensive as the number of quick-and-easy-to-change accessories you own—there are more than 300 in the Chicago line to grind, drill, polish, cut, rout, carve, engrave, sand, saw, etc.

Because it's perfectly balanced and weighs only 12 ounces the Handee is the "non-fatiguing" tool. Operates on AC or DC current at 25,000 r.p.m.

With 7 Accessories, Postpaid **\$18.50** to all who have Priorities.

Free new 64 page Catalog of complete Chicago line.

**CHICAGO WHEEL & MFG. CO.**  
1101 W. Monroe St., Dept. PM Chicago 7, Ill.



# PALMGREN

## No. 000 ANGLE VISE!

For MILLING—DRILLING—GRINDING  
FITTING—FILING

Solve Difficult Angle Jobs

Quick, accurate setups at any angle. End make-shift methods—time loss—rejections. Ideal for tool rooms or home workshop. Accurately machined and graduated. Once set it stays locked. Jaws hardened steel—plain or grooved. Sizes 1 1/2" to 8" Jaws.



## DRILL PRESS VISES

For tool room, machine shop, school shop, home shop or repair shop. Accurately machined. Best semi-steel castings. Adjusting screw of hardened steel with fine pitch thread and long bearing. Jaws hardened steel, grooved or plain. Sizes 1 1/2" • 2 1/2" • 4" Jaws.



## No. 250 MILLING ATTACHMENT VISE

A most necessary fixture for small shops and even emergency work in large ones. Fits any 8"•9"•10" South Bend, Atlas, Craftsman, Sheldon or other lathes of similar sizes. Has graduated vertical feed screw and 360 degree graduation for vertical angle adjustments. Easily mounted on cross slide and held by one T-slot bolt. Equipped with PALMGREN VISE. 2 1/2" Jaws opening full 2 1/2". Vise has one plain and one grooved jaw for holding round pieces.

## MAKES MILLING OPERATIONS POSSIBLE ON ANY LATHE

Width	Depth	Opening	Jaw	Jaw	Jaw	Height	Price
2 1/2"	1-7/16"	2 1/2"	10 1/2"				\$24.75

ORDER DIRECT—Write for Circular No. 347  
**CHICAGO TOOL AND ENGINEERING CO.**  
8365 South Chicago Avenue Chicago 17, Ill.



# READY CUT HOMES

## Order NOW

Homes \$998 and up. Freight paid. Orders filled immediately in essential cases or for preferred post-war delivery. Save \$500 on modern production method homes. Much more compared with builders' prices. Anyone can assemble with simple plans furnished. Complete including paint, hardware, roofing, glass, nails, etc.



NEW COLOR CATALOG FOR ONLY **25¢**

Dept. PM-25  
**INTERNATIONAL MILL & TIMBER CO.**  
Bay City, Mich.

# 10 IN 1 HANDY TOOL KIT



HERE'S the cleverest little tool kit you ever saw. Made to fit your pocket. Think of it—8 wrench sizes—1 screwdriver—and one pair of grip-tight pliers in neat pocket case. Made of the most durable steel. Will give years of service. Just the thing for Radio Repair Men—Auto Mechanics—Vending Machine repair men and countless others. A Lucky Buy makes it possible for us to sell a limited number for **\$1.50** prepaid. You will never get a bargain like this again. Send for your set NOW.

**LANDAU LABORATORIES**  
549 W. Randolph St. Chicago 1, Ill.

## WHEN YOU BUY FLASHLIGHT BATTERIES ASK FOR "EVEREADY" FRESH DATED BATTERIES

The word "Eveready" is the registered trade-mark of National Carbon Co., Inc.

# WINDOW SIGN LETTERS

For Store Fronts and Office Windows. Anyone can put them on. Samples furnished. Imitation Gold and Silver. **METALLIC LETTER CO., 430 N. Clark St., Chicago 10**

# New OTTAWA WOOD SAW



## For Tractors

Makes wood sawing fast and easy. Can cut enough wood to pay for itself quickly. Easily moved while attached. Big heavy blade. FREE details. **OTTAWA MFG. CO.**  
W227 Oak Ave., Ottawa, Kans.

LOW PRICE

# Make Any Article GLOW IN THE DARK with Magic New Discovery!



Don't pay big prices for luminous articles! Make your own! Sell at big profit or keep for your pleasure. With our complete outfit and confidential instructions, it's easy! A stroke of the brush—any article glows in the dark like magic! Lasts indefinitely. Absolutely harmless. Hundreds of uses. Use on ties, flowers, jewelry, house numbers, furniture, pictures, statues, toys, etc. Order NOW! Supply limited. Money-back guarantee.

**\$1.00**  
Send No Money

Complete Lite-Glo Kit, \$1.00. Send name, address, pay postman \$1.00 plus postal charges. Send cash, we pay postage.

**LITE-GLO, Dept. 317-LB, Topoka, Kan.**

These  
Globe  
products  
do  
precision  
work

★  
Compact,  
Rugged Construction,  
Low in Cost!

Immediate Delivery

Detailed literature  
free upon request.  
Address Dept. P.M.

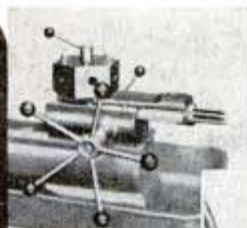

**GLOBE HEAVY DUTY BED TURRETS.**  
Adaptable to any lathe. 4 1/4" travel. Precision built. Rugged construction.



**GLOBE CROSS SLIDE.** Adaptable to any lathe. 3 1/2" travel. Rugged construction.



**IMPORTANT:** When ordering or requesting prices on above items, be sure to give: 1. Make and model of lathe. 2. Lathe swing. 3. Power or hand cross feed. 4. State if lathe is equipped with telescoping taper attachment.

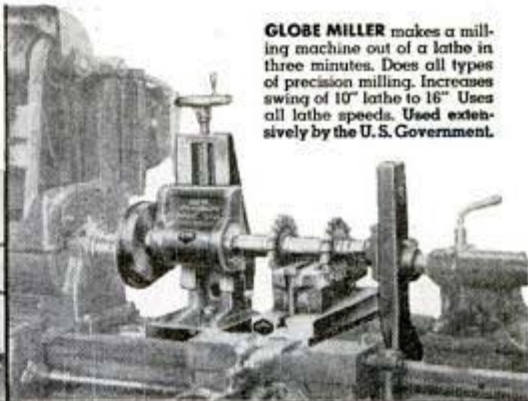

**GLOBE MILLER** makes a milling machine out of a lathe in three minutes. Does all types of precision milling. Increases swing of 10" lathe to 16" Uses all lathe speeds. Used extensively by the U. S. Government.



**GLOBE HAND SCREW MACHINE** produces precision parts at high speeds, low cost Ball Bearing Headstock. 10" swing, 1" capacity, 12 speeds up to 3125 RPM. Exceptionally rugged construction.



**MILLING VISE** (below) with replaceable jaw plates. Jaws 3 1/2" wide, 3" opening, 1 3/4" deep. Larger sizes available.

**DIVIDING HEADS.** Precision built. Various sizes available.



Milling arbors. 4", 8", and 12"



**WORK HOLDING FIXTURES,** hold work of various shapes for milling, drilling, shaping or grinding.

End Mill Holders. Various sizes.

GLOBE PRODUCTS MANUFACTURING CO., 3380 ROBERTSON BOULEVARD, LOS ANGELES 34, CALIFORNIA

WE MEND MEN BY AUTO-MATIC

**FIBRE-LITE ARMS & LEGS**

With Soft Adjustable COMFORT SOCKETS. TRUSSES, BRACES, SOX, SUPPORTS.



Cash or Terms. Give Full Details.

WORMAN CO., 310-P, THIRD AV. SO. MINNEAPOLIS-15, MINN. U. S. A.

**LAW**

STUDY AT HOME for PERSONAL SUCCESS and LARGER EARNINGS. 35 years expert instruction—over 108,000 students enrolled. LL.B. Degree awarded. All texts furnished. Easy payments. Send for FREE BOOK—"Law and Executive Guidance."

AMERICAN EXTENSION SCHOOL OF LAW  
Dept. 50-M, 646 N. Michigan Ave., Chicago 11, Ill.

in every battle...  
doing vital jobs...  
unfailingly...



that's why there are just a few left for essential jobs at home

BRIGHT STAR BATTERY CO., CLIFTON, NEW JERSEY

For Faster, Handier Work

**THE DUAL-PURPOSE**



"Combination Detachable" Screwdriver

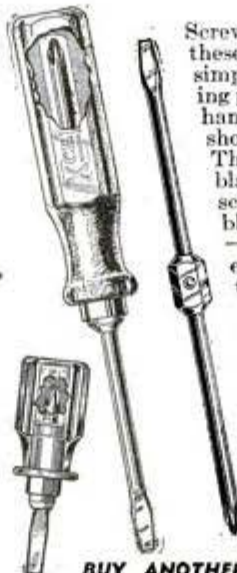

Screwdriving is a pleasure with one of these Xcelite tools—and it certainly simplifies the job. The "grip fits," giving plenty of turning pressure. And the handle is genuine Xcelite plastic, shock-proof, fire-resistant and tough. The shaft is special tool steel, with blades accurately machined to fit the screw. One end provides a standard blade; the other end a Phillips blade—the shaft is quickly changed from end to end and is securely held in the handle by a special ball-lock. Supplied in three popular sizes—also in stubby type, AA-5 or better priorities required—sales restricted. Price \$1.45 with 1 blade extra blades \$.75 each. Ask your dealer or write Dept. J.

**PARK METALWARE COMPANY, Inc.**

Orchard Park, N. Y.

★

BUY ANOTHER WAR BOND—KEEP THEM ALL

# Amazing Handy ADDING MACHINE

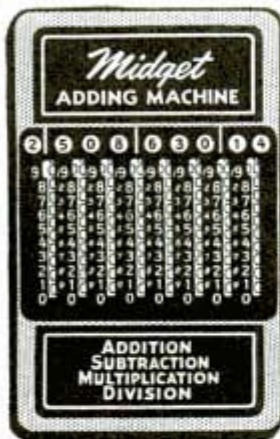

Can Be Carried  
in Vest Pocket

ONLY  
**\$2.50**

POSTPAID

**ABSOLUTELY  
ACCURATE**

Yet Weighs Only 5 Ounces

- Handles Totals up to \$10,000,000.00.
- Totals appear instantly—as fast as you put the figures down.
- Can be used to subtract, multiply and divide, as well as add.
- Metal construction for years of service.

Haven't you often wished for a handy little device like this . . . that you could take with you ANYWHERE . . . on the road, in the office, at home or in the shop? You can get one now . . . Business man, student, housewife—everyone finds this handy, guaranteed-accurate little machine useful . . . ORDER YOURS TODAY.

**SEND NO MONEY**

Just send name and address. Then pay postman \$2.50 plus postal charges on delivery. Or send \$2.50 with order and we pay all charges—saving you about 50 cents at the new postal rates.

**LEE SPECIALTY CO., Dept. PM-7**  
Box 3620, Mdse. Mart, Chicago 54, Ill.

**MAIL COUPON TODAY**

LEE'S SPECIALTY CO., Dept. PM-7,  
Box 3620 Mdse. Mart, Chicago 54, Ill.  
Please send me one of your MIDGET ADDING MACHINES.  
 I am enclosing \$2.50       Send C.O.D. plus postage

NAME .....

ADDRESS .....

CITY & STATE .....

PLEASE PRINT PLAINLY



Better skis make for better skiing! Choose Northland Skis, designed and produced by men who know good skis. Built for action, balanced for control, Northlands are the choice of world famous skiers.

★ Offered FREE for the First Time

Get Northland's famous 48 page Ski Manual FREE. Edited by Hannes Schneider—full of helpful skiing tips—82 illustrations. Send postcard today. (Offer does not apply in Canada.)

**NORTHLAND SKI MFG. CO.**

World's Largest Ski Manufacturers

95 MERRIAM PARK • SAINT PAUL 4, MINNESOTA

**'730 SHAVES FROM 1 BLADE'**

**AMAZING NEW  
BLADE SHARPENER**



New sharpener for all makes of double-edge razor blades performs miracles! "Not necessary to change blades," writes one user. Another says, "I have used 1 blade over 730 times." RAZOROLL really sharpens blades because it strops on leather. Gives keen, smooth shaving edges. No guesswork. Blade held at correct angle and proper pressure—automatically. Just turn crank to sharpen blade. No gears. Well made. Handsome. Compact, sturdy. Weighs few ounces. Will last years. Makes ideal gift.

Only  
**\$1.00**

**SEND NO MONEY!** Write today. Pay postman only \$1 plus few cents postage. Use RAZOROLL for 5 days and if you're not delighted with smooth, velvet shaves you get, return RAZOROLL and we'll return your dollar. Hurry—order today. **RAZOROLL COMPANY**  
620 North Michigan Avenue, Dept. 502, Chicago 11, Illinois

**Tyson** TODAY'S HEAVY-DUTY  
TAPERED ROLLER BEARING  
With More Load-Carrying Rollers  
TYSON BEARING CORPORATION • MASSILLON, OHIO



**TRAILER BUILDERS' PARTS CATALOG**

We'll save you money on everything. Largest and most complete trailer builders' supply house in the United States. Member TRAILER COACH MFRS.' ASSOC. Send 10c for parts catalog. **NATIONAL TRAILER EQUIPMENT CO.**  
Complete Plans and Building Instructions, 25c 719 N. Seventh St. Milwaukee 3, Wis.

**do you WORRY?**

Why worry and suffer any longer if we can help you? Try a Brooks Patented Air Cushion. This marvelous appliance for most forms of reducible rupture helps hold nearly every rupture securely and gently—day and night—at work and at play. Thousands made happy. Light, neat-fitting. No hard pads or stiff springs to chafe or gouge. Made for men, women and children. Durable, cheap. Sent on trial to prove it. Never sold in stores. Beware of imitations. Write for Free Book on Rupture, no-risk trial order plan, and proof of results. All Correspondence Confidential.



**Brooks Company, 158-D State St., Marshall, Mich.**



for EVERY HOBBY SHOP!  
and HOME CRAFTSMAN!

NEW  
WARNER  
Brush  
ELECTROPLATER!

DECORATE Your MODELS and PROJECTS  
with GOLD, SILVER, NICKEL, COPPER

If you have a hobby—a home workshop—you need  
this new battery model Warner Electroplater. Easily  
and quickly, you can electroplate models and projects; you can

replate worn articles, faucets, tools, silverware, etc. with beautiful coat of gleaming metal. Equipment includes 10" x 14" Control Panel, Variable Voltage Regulator, Work and Brush Terminals, Battery Connectors, Patented NYLON-LUCITE Electrolytic Brush with 4 Anodes. All necessary supplies: Electroplating Compounds for Gold, Silver, Nickel, Copper—also Degreaser, Cleanser, Instruction Book and Wiring Diagram. Get more fun

from your hobby, make your workshop complete, order your battery model Warner Electroplater today. ONLY charge collect.

WARNER ELECTRIC CO.  
Dept. A-69, 360 N. Michigan, Chicago 1, Ill.

STOP LEAKS IN BASEMENT WALLS, FLOORS

STOP-IT—Stop those leaks! End that seepage! Use STOP-IT—amazing quick-setting, waterproof material. Simply mix with water and apply. Sets hard and permanent. At your dealer or write direct. Send for free booklet, "Household Hints in War Time."

TAMMS SILICA CO.  
Dept. S-207, 228 N. LaSalle St., Chicago 1, Ill.

PIN-UP GIRLS FOR ADULTS

(pocket size). Thrilling . . . breath-taking, life-like beauties that will make your heart skip a beat. The kind you like! 10 different PIN-UPS sent for 60c or 25 assorted for \$1. Shipped prepaid in plain wrapper. No C.O.D.'s. Send cash or money order. No stamps. NUDKI, Dept. P-214 Box 126, G.P.O., N.Y.C. 1

NEW TYPE GAS SAVER

Sweeping the Country!



FOR AUTOS—TRUCKS—TRACTORS  
New invention easily slips into carburetor vaporizer system. Automatic adjustment. Users report up to 30% saving. Works on super-charge principle. Positive guarantee of satisfaction or double your money back on request.

NEW SALES PLAN—BE FIRST  
Easy to sell—big money maker. Don't wait. Send \$1.00 for postpaid demonstrator or order it sent C.O.D. Ten models—so be sure to send make and year of car. Order today.  
ONLY \$1.00 Post-paid  
Stransky Mfg. Co., Box 1004, Pukwana, S. Dak.

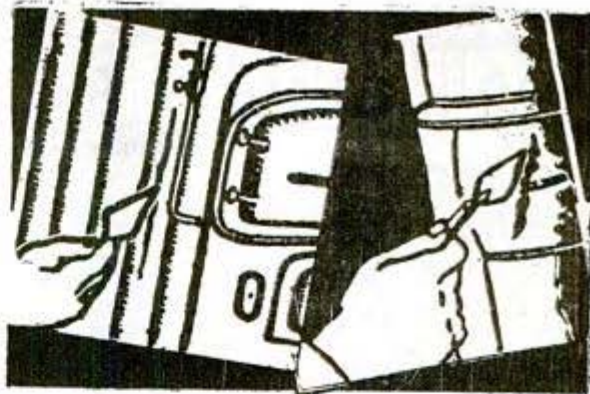

REPAIR LEAKS AND CRACKS  
YOURSELF with  
SMOOTH-ON



No. 1

YOU'LL find it easy to repair your plumbing and heating systems, autos, household equipment, utensils, tools, etc. with Smooth-On No. 1 Iron Repair Cement. Stops leaks, seals cracks, tightens loose bolts, screws, fixtures.

Easy to use—requires no heat, no special experience. Applied like putty, hardens like metal. Get a 1 3/4-oz. or 7-oz. container of Smooth-On at your neighborhood hardware store. Or if necessary, write us direct.

Repair Handbook FREE

40 pages. 170 diagrams. Clear, complete, simple directions for all types of home repairs. Conveniently indexed. Short-cuts. New ideas. Free for your name and address on the coupon.



MAIL THIS TODAY

Smooth-On Mfg. Co., Dept. 37,  
570 Communipaw Ave., Jersey City 4, N. J.  
Yes—I want the Smooth-On Handbook

Name .....  
Address .....  
2-45 .....

Free

Do it with SMOOTH-ON

# GUM GRIPPER

**TIGHTENS  
FALSE TEETH**

**OR NO  
COST**

**Amazing  
NEW  
Plastic  
Reliner**

**LASTS FROM 4 to 6 MONTHS**



NOW...in a jiffy—you can make loose, slipping dental plates fit snug and comfortable. Eat, talk in comfort, laugh freely—for "Gum Gripper" enables you to enjoy that feeling of almost having your own teeth again!

**● APPLY IT YOURSELF — AT HOME**

"GUM GRIPPER" amazing plastic Reliner tightens dental plates quickly, makes them hold firmly and fit like new! Just squeeze from tube, spread evenly, put plate in mouth, wear it while "Gum Gripper" sets in few minutes. No heating necessary.

**● USE ON ANY DENTAL PLATE**

"Gum Gripper" will not harm denture or irritate gums. Sanitary, tasteless, odorless. Keeps mouth sweet and clean, prevents sore spots. Application of plastic "Gum Gripper" is guaranteed to last 4 to 6 months—or no cost. Can be scrubbed or washed. Rev. A. J. Wigley, Pittsburgh, Pa., writes: "Best material I ever used. I have not relined my lower teeth for 2 months."

**"Best I've  
Ever Used"**

**SEND NO MONEY**—Order a tube today—it's only \$1.00. Fill out and mail coupon below. You'll be delighted! Satisfaction guaranteed or your money back.

**FREE** Generous size package Dental Plate cleaner included free of extra cost. Cleanses dental plates without brushing. Will not harm denture.

**GUM GRIPPER** 127 N. Dearborn St., Dept. 71, CHICAGO

**GUM GRIPPER, Dept. 71**  
127 N. Dearborn St., Chicago 2, Ill.

Send me a tube of "Gum Gripper." You guarantee it to satisfy—or it will cost me a penny.

I will deposit \$1.00 plus postage with postman when package arrives.

Enclosed is \$1.00—You pay postage.

NAME.....

ADDRESS.....

CITY..... STATE.....

**DRILL-INDEX** A compact container for indexing and filing twist drills. Eliminates search. Made entirely of steel in nine sizes. Available on priority to essential users. See your dealer or write to

**HUOT MFG. CO.**  
Foot Schultz Bldg. St. Paul 1, Minn.

**SAVE WASTE PAPER**

## SHARPEN YOUR DRILLS WITH THE E-Z DRILL SHARPENER

ONLY \$2.80

Complete with Protractor

TOOL STEEL LIP

DRILL V HOLDER - ADJUSTING WHEEL - PEDESTAL - PROTRACTOR

INCREASE CLEARANCE

DECREASE CLEARANCE 2 3/4"

LOCK NUT

This precision fixture was developed for factory use by aircraft tool engineers. Real shop size and not a toy. Sturdily built, attaches to bench or grinder frame. Has new PROTRACTOR FEATURE which enables you to adjust quickly for different drill angles. Thousands now in use—home and repair shops, garages, factories, farm shops—wherever accurate holes are drilled. E-Z is simple to operate. Gives faster drilling, perfect hole centers and clearance. Guaranteed to do the work or money back.

**SHARPENS ALL ROUND SHANK DRILLS FROM THE SHORTEST TO 11" LONG—3/32" TO 1 1/16" DIAMETER**

**SAVE MONEY WITH E-Z.** Comes complete with instructions, ready to sharpen your dull drills as good as new. Low price of \$2.80 because of our volume business on this wanted precision tool. The E-Z protractor gives you proper angles for cutting extra hard material, ordinary use, for soft material, wood, Plexiglas, Lucite, Plastics. Send check or money order for \$2.80. **WE PAY POSTAGE AND SHIP IMMEDIATELY.** Write for FREE folder giving scientific data on drilling techniques.

**FRED F. TEN EYCK,** Dept. P3, 758 S. Irolo St. LOS ANGELES 5, CALIF.

MODEL No. 1 is already set for 59° drill angle, no adjustment needed for 99% of drills. Sturdy shop model. Postage paid \$1.98.

# WANTED TOY TRAIN CATALOGS

- AMERICAN FLYER:** All before 1924 and for 1929 and 1930.
- IVES:** All before 1924.
- LIONEL:** All before 1923.

Send list of what you have and describe fully to Museum, Dept. H, 140 W. Ontario St., Chicago



**Just issued!**  
New, 16-Page Bulletin!

"Hard-to-Find  
Radio and Electronic  
Parts and Equipment"

Free for the asking

Write immediately to Dept. P-25

Now Known **LAFAYETTE RADIO CORP.**  
as **CONCORD RADIO CORP.**  
901 West Jackson Boulevard, Chicago 7, Illinois

# HAIR CAN NOW BE SAVED

"GIVE YOUR HAIR A CHANCE" is the amazing book by J. W. KING, Sc. B. on dandruff, baldness, thinning and graying hair. Much usable information.—Ohio State Medical Journal. Best investment.—Science Education. Debunks hair fads.—Scientific American. Scientific fact.—Sunset Magazine. Without commercial bias.—Teaching Biologist. Book of a scientist.—Home Acres. Enormous assistance.—Pictorial Review. Practical.—Science News Letter.

Send only \$2.00 today for postpaid copy of this new, authentic instruction on how to save your hair. 6th printing. Prompt refund if not helped.

**THE BRADNER PUBLISHING CO. (EST. 1933)**  
Dept. 61, Kendall Square, Cambridge 42, Mass.





## RE-RING YOUR OWN CAR

Complete sets of Simplex Piston Rings are engineered and packaged so that any handyman can easily recondition his own car.

Rings are unbreakable and each packed in separate envelopes and marked for the groove in which it is to be placed. Complete detailed installations with each set.

Ask in your local store for "Rings made by Simplex"—they last longer.



BUY WAR BONDS AND KEEP THEM

## SIMPLEX PISTON RINGS

SIMPLEX PRODUCTS CORP., Cleveland, O.

## MAGI-GLO LUMINOUS PAINT



**LIKE MAGIC—Make Anything  
IN THE DARK**

**GLOW**

A stroke of the brush—it glows like magic in the dark. It's fun, easy to use. Lasts indefinitely. Absolutely harmless.

**SEND NO MONEY** Complete Magi-Glo Kit only \$1.25. Send name, address, pay postman plus postal charges. Send cash, we pay postage. Satisfaction or Money Back.

**MAGI-GLO, Dept. 10, 32 W. RANDOLPH  
CHICAGO 1, ILL.**

## ARMSTRONG TOOL HOLDERS

enabled American industry to change to war production "over night." For they are the permanent, multi-purpose tools used by 96 per cent of the machine shops and tool rooms, on lathes, planers and shapers—the tools used to make dies and jigs, to build production machines. They are the tools you will want for your own shop after the war—ARMSTRONG TOOL HOLDERS for industry, ACE Tool Holders for home work shops.



**ARMSTRONG BROS. TOOL CO.**

"The Tool Holder People"

368 N. Francisco Ave., Chicago 12, U.S.A.

## BUILD THESE PROJECTS

For garden or lawn. Easy to build. Easy to sell. Detailed Blueprints Model B-25 Dutch Windmill \$60; Model OM-60 Old Mill \$86. Lawn Figure Patterns—Sunbonnet Girl, Dutch Boy, Tulip Girl, Holland Fair, 30¢ each, all 4—\$1.00. Catalog illustrating many models, send 10¢, today.

**CRAFTSMAN'S MODEL CO., Dept. P-81, 2030 N. 41st St., Milwaukee, Wis.**



**Balance 4" x 9" Base. With either 56.00  
Metric or Avoirdupois Weights ...**

Catalog with 3000 illustrations of laboratory Apparatus sent for 75 cents. Catalog listing 10,000 chemicals, drugs, minerals, etc. and 1700 scientific books sent for 25 cents. 100 scientific book, 10 cents.  
**LABORATORY MATERIALS CO.,  
7321 Vincennes Ave., Chicago 21, Ill.**

## SIMPLE EASY INVENTION TRIMS HAIR AT HOME!

**SAVES  
BARBER BILLS**

Trims hair as it comb! Easy! Quick! Keeps men's, women's children's hair trim, neat, freshly-cut looking all the time! Trims, tapers, thins out uneven hair. Use like ordinary comb. Safe. Simple. No experience required. Fine for legs, underarms! Sells like wild!

**SAMPLES FOR AGENTS** Sample offer sent immediately to all who send name at once. A penny postal will do. **SEND NO MONEY.** Just your name.  
**KRISTEE CO., 682 Bar St., AKRON, OHIO**

★ **SAVE WASTE PAPER** ★

# MAKE MORE MONEY

APPLYING OR SELLING  
**CORKSTONE  
PLASTIC FLOORING**  
**EASY  
TO  
APPLY**



Here's your opportunity to get into business for yourself applying or selling Corkstone, the economical, top-grade plastic flooring. Act without delay!

**MAKE MORE MONEY  
APPLYING OR SELLING**

## Lasting CAULKING COMPOUND

Easy to apply, extra profitable. America's #1 Fuel Saver. Now you can guarantee every job. No priming required. You'll do better selling or applying Lasting Caulking Compound. Available in Gun & Knife grades.



## Lasting PAINT PRODUCTS

Plenty of profit for you in selling our fine quality paints for residences, factories, ships, railroads, institutions. Also full line of industrial finishes. First choice of master painters from coast to coast.

## Dealers & Agents Wanted

**WRITE FOR DETAILS OF OUR PROPOSITION**

We believe in teamwork and cooperation. We'll help you get started. No cash. No obligation. Act today!

## LASTING PRODUCTS COMPANY

**MANUFACTURERS OF PAINTS, PUTTIES, PLASTICS  
FRANKLINTOWN ROAD PLANT, BALTIMORE-23, MARYLAND**

# WAR SURPLUS BARGAINS

HUNDREDS OF SENSATIONAL VALUES

DECORATE YOUR DEN OR LODGE  
MAKE YOUR OWN HUNTING KNIFE



U.S. GOV'T  
CAVALRY  
SWORD

**TEMPERED STEEL—DOUBLE EDGE**  
Genuine U. S. Cavalry Swords for den or hunting lodge. Makes finest hunting—commando knives, etc. Tempered steel blade, 42 inches long overall. With sheath. Guaranteed value. Quantity limited. hurry. Each, express collect, **\$4.95**

### WRITE FOR THIS BARGAIN CATALOG

For quick liquidation! Items for home, shop and outdoors—for hobbyists, experimenters, and laymen. Waterproof Tarpaulins, all sizes; Army Slide Rules, brass bound; Bolo Knives; Wishbone Type Cavalry Spurs; Mess Kits; Pup Tents; Canteens; Canteen Covers and Cups; Mosquito Tents; Cavalry Swords; Invasion Life Saving Belts; Three and Eleven Pocket Bandoleers; Bolt Clippers; Copper-Coated Steel BB Shots; Men's and Ladies' Waterproof Aprons; Cathode Ray and other types of Transmitting Tubes; Air Pillows and Air Mattresses; Assorted Screws; Bolts, Nuts and Washers; Storage Cans for 800 ft. 16 mm. film; Optical Prisms for experimenters; Negative and Positive Lenses for rifle scopes, projection work, etc.; Special Aviation Type Approach Indicator Meters—two meters in one, milliamperage readings. Big FREE catalog gives all details and prices. Satisfaction guaranteed.

## CATHODE RAY TUBES

A find for experimenters and hams. Standard 3 inch cathode ray tubes Nos. 5BP1 or 5BP4 ideal for scope, television and experimental work. Slightly used by U. S. Gov't for test work. Guaranteed to give excellent service. Bargain list of other tubes on request. Specify number when ordering. Express collect.



EACH ONLY **\$12.00**

## HEADPHONES

They're hard to get but we've got 'em. Made for use in tank corps helmets. 4000 ohms. With moisture proof cord and phone plug. Express collect.

PER SET **\$2.95**

WRITE FOR BARGAIN CATALOG PM2 TODAY

**STARK'S** Dept. PM2, 509 S. State St. CHICAGO 5, ILLINOIS

## BRUSH PLATING OUTFITS

for re-plating articles in the home and shop. No tanks necessary. Free particulars.

**GUNMETAL CO., AVE. M, DECATUR, ILLINOIS**

## PREVENT SMALL FIRES FROM BECOMING LARGE FIRES



A recent frightful increase in fire hazards has stepped up the demand for fire protection equipment to a new high. Fyr-FYTERS have a very high rating in the fire equipment field, while the demand exceeds the supply just now. This backlog of business will necessitate a greatly increased sales force for our coming sales program expansion. If you want a postwar selling job, write us today. Tell us about yourself in confidence. We may have just the money-making opportunity you are seeking.



THE Fyr-FYTER CO.  
Dept. 30 Dayton 1, Ohio

# Fyr-Fyter

## BUILD a BOAT



- Row Boat—12 Foot
- Dinghy—8 Foot
- Training Ship—6 Foot
- See Sled—9 Foot
- Outboard—12 Foot
- Cruiser—18 Foot
- Bicycle Boat—Kayak
- Row Boat—Sectional
- Dinghy—8 Foot
- Canoe—16 Foot
- Sailing—12 Foot
- Outboard—Rurubout
- Pentons ice Yacht

### FOR PLEASURE OR PROFIT DESCRIBES 17 LOW COST BOATS

Get this outstanding book and build a boat at home for your own use or to sell at a profit. You can do it. Just the boat you've always wanted—power, sail or row boat—17 different kinds and sizes.

Order BUILD A BOAT on postal card and pay only \$1.50 plus postage on delivery. Return in 5 days if not pleased and get money back. Or send \$1.50 with order and we'll pay postage. (Outside U. S. \$1.70 with order.) Order today.

**POPULAR MECHANICS PRESS**  
Dept. 598, 200 E. Ontario, Chicago, 11

Say you saw it in  
**POPULAR MECHANICS**



# MOTO-TOOL ★ THE "POCKET-SIZE" MACHINE SHOP

## PUT THIS "WAR VETERAN" TO WORK

Long before Pearl Harbor, Dremel Moto-Tools won their spurs by tackling tough jobs in tool rooms and machine shops. Since the war began, Moto-Tools have earned the respect of every branch of the armed forces. And thousands of them helped establish production records in plants such as General Electric, Westinghouse, Remington Arms, Ford, Nash-Kelvinator, Consolidated Aircraft, Northrup, Douglas and many other arsenals.

**Only Moto-Tools Have All These Features**  
A Model 2 Moto-Tool develops a speed of approximately 27,000 rpm. Weighs only 1 1/2 oz. Shaped to fit the hand. Sturdily built. Has shock-proof bakelite housing. Balanced for vibrationless operation. Uses 110-120 A.C. or D.C. current.

### HOW TO ORDER

Ask your Dealer about Dremel Moto-Tools and accessories. If he does not handle them, send direct to factory. As long as priority ratings are required, ask your War Production Board or your employer for one. Write for FREE CATALOG.

27,000  
R.P.M.

- Sharpening
- Finishing
- Touching Up
- Sanding
- Drilling
- Mortising
- Engraving



A few of the jobs that can be done better and faster with a Moto-Tool.

- Burring
- Grinding
- Polishing
- Burnishing
- Inlaying
- Sawing
- Scoring
- Cleaning
- Routing
- Cutting
- Rasping
- Carving
- Brushing
- Dressing

**DREMEL MFG. CO., Dept. T-115-B, RACINE, WISCONSIN**



### MOTO-TOOL KIT

Kit No. 2 with 23 high grade accessories and Model 2 Moto-Tool, in hardwood case. **\$23.50**  
Model 2 Moto-Tool, with 1 accessory. **\$16.50**

# Anyone Can Build.. ARC WELDERS with these Plans

## WE SHOW YOU HOW

Here are six plans that will enable you to save money on your own welding and to make money on outside jobs. On top of that, a knowledge of welding is a valuable asset anywhere.

**Plan 8:** Arc Welder from old auto generator. Single or dual hook up. Output 75 to 200 amps.

**Plan 29:** Portable transformer Arc Welder for use on 110 or 220 A.C. Output 80 to 125 amps.

**Plan 50:** Transformer Arc Welder for use on 110 or 220 A.C. Has 16 different heats, 35-85 amperes. No rewinding necessary. Uses coils taken from old auto generator.

**Plan 30:** Spot Welder capable of welding up to 1/4" for operations on 110 A.C.

**Plan 32:** Spot Welder for handling light sheet metals. Operates on car battery. Simple to build.

**Plan 46:** Carbon electrode welder for light welding, brazing and soldering. Operates on car battery.

### PLANS SIMPLE—

### NO EXPERIENCE NEEDED

All details clearly shown and described; no hard work or previous experience required for a perfect job. Our valuable catalog of many Electrical Supply Bargains will be sent FREE with plans.

Send only 98c for complete set of 6 Plans and get started on a fascinating and money-making project.

Total value of plans, if purchased separately, \$1.85.



## LEJAY MFG. CO.

2347 LeJay Building  
MINNEAPOLIS 8, MINN.



America's oldest industry—the fishing industry—has benefited in peace and in war from AC's easy plan for maintaining spark plug efficiency. Regular cleaning and adjustment, by AC methods, have helped thousands of the fishing industry's motor trucks to speed their perishable cargoes to market or cannery. Worn plugs, of course, are promptly replaced with AC's for utmost reliability. Thus, another of America's essential industries shows you how to conserve your transportation,—have your spark plugs cleaned and adjusted every 3,000 miles, and install AC's—of the right Heat Range for today's driving—when the old plugs have served their term.



CLEAN SPARK  
PLUGS SAVE UP  
TO ONE GALLON  
OF GAS IN TEN

# AC SPARK PLUGS

SPEED FINAL VICTORY — BUY WAR BONDS

★ SAVE WASTE PAPER ★

## HOW RUPTURE MISERY MAY DISAPPEAR

Don't go on day after day suffering the tortures of a clumsy truss that presses on your hips and back, gouches your flesh, slips and slides and leaves your rupture  **Dangerously Unprotected.**

Get the truth about rupture care and how the newly patented Vita-Pneumatic Nature-Ade (U.S. Pat.) appliance with its unique features can help your rupture, misery disappear. Write at once for FREE booklet containing much valuable information.

PNEUMATIC APPLIANCE, 103 PARK AVE., N. Y. 17, N. Y., DEPT. 45-E

## NEW CHEAP OIL BURNER

FOR COOKING & HEATING STOVES-FURNACES  
HEAT YOUR HOME, COOK YOUR MEALS  
WITH CHEAP FURNACE OIL



**NO MORE SHOVELING COAL OR ASHES.** New Fuelizer Starter Vaporizing system turns Cheap 130 Flash Furnace Oil into Oil Gas heat without clogging up. **LIFE-TIME GUARANTEE** against defects. \$1.00-BONUS OFFER FOR TESTING. We will let you try it in your own stove or furnace for one month. Get Yours for introducing. Big profits. Be first. Send in your name today.

NORTHWEST MFG. CO., 535-B 5th Ave., Mitchell, So. Dak.

FEBRUARY, 1945

187

# "YANKEE"



## TOOLS

### also make friends

Vast throngs of new shop workers, trained in war industries, have been using "Yankee" Fine Mechanics' Tools for the first time . . . mastering fresh trade skills which will stand them in good stead in the peace years to come. They have learned what skilled mechanics and old-time factory men have long known . . . that "Yankee" Tools complete innumerable tasks *faster, easier, and better*. Because of the great demand for these tools during the war emergency, your dealer may not always be able to take care of your needs, but keep asking for "Yankee" by name. For half a century, the ingenuity of "Yankee" Tools has set a high record in speed and accuracy. The war has served to underscore that record.

"YANKEE" SPIRAL SCREW DRIVER NO. 130A  
A Size for Every Purpose

# "YANKEE" TOOLS

make good mechanics better

North Bros. Mfg. Co., Phila. 33, U.S.A.

Established 1880

Makers, also, of "Yankee-Handyman" Tools

## REMOVES ALL FINISHES

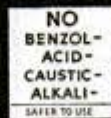

New type semi-paste remover quickly lifts off paint, enamel, varnish, shellac, lacquer, bakelite and other synthetic resin finishes. (Removes emulsified resin water paints, too.) Stays wet longer — stays put on upright or overhead surfaces — strips clean, quick. One coat usually enough (apply with brush or spray). Contains no benzol, acid, caustic, alkali, or wax — harmless to hands, bristles, surface stripped. All sizes (pint 65c) at paint and hardware stores.

FREE CIRCULAR

"How to Remove Paints, Varnishes, Lacquers, etc." Also describes other Savogran Products: Heavy Duty Cleaner, Crack Filler, Wood Putty, Remover & Bleacher (renews floors), Paint Brush Cleaner, Coldfoam Soapless Soap Powder.

THE SAVOGRAN CO.  
DEPT. 17, BOSTON 10, MASS.

It's Orange!



# SAVOGRAN STRYPEEZE

IN EVERY WELL-EQUIPPED HOME WORKSHOP

Say you saw it in Popular Mechanics!

## STAR Staple GUN

For tacking insulation, upholstery, roller shades, shelf paper, decorations, etc. One hand operated. Just squeeze handle, drive twinpoint tacks right where you want them. Tack where you can't swing a hammer. Always ready, no spilled tacks.



## Red H Twist Drills

Finest steel, perfect points, supremely accurate. Needed by every mechanic and home craftsman. Set of 29 drills from 1/16" to 1/2" in handy case. Write for prices and name of nearest distributor.

Some territory still available to hustlers.

Essential rated orders must be filled first

STAR PAPER FASTENER CO. Dept. SG Norwalk, Conn.

## GET THE IMPROVED SUPER DRILL GRINDING ATTACHMENT



Sharpens drills from 3/32" up to 1-1/16" diameter. Grinds old drills like new in 3 different drill point angles—59°—69°—88°. Will grind short, medium and long twist drills up to 11".

Pays for itself the first week

WHEN YOU GRIND DRILLS WITH THE SUPER GRINDER YOU'RE AN EXPERT FROM THE START.

Machine shops pronounce it a time saver, does work like the highest priced grinders, gives a perfect center, clearance desired, and three different point tapers. Saves time—grinds drill perfectly in 25 seconds.

NO MACHINE SHOP SHOULD BE WITHOUT THE SUPER GRINDER. Just mail your check or money order for \$2.95, complete, and your address—the SUPER GRINDER will come to you quickly, postage paid.

ONLY  
\$2.95  
COMPLETE!

CRANDALL MFG. CO.  
Dept. FA-2, 1512 W. Slauson  
Los Angeles 44, Calif.

MONEY  
BACK  
GUARANTEE

## NEW *Atlas* PATTERN SERVICE

FULL SIZE PATTERNS for making furniture, household equipment, cabinets, toys are now available through Atlas. They work like templates in airplane construction to save time and insure accurate workmanship.

### NO. 3 STEP-SAVER KITCHEN UNIT

This is a handy piece of furniture for any kitchen. It's the same height as the usual "working" shelf. Note the toe-room, tray storage compartment, and generous shelves for oversize appliances that are so hard to put away. The Atlas pattern will help you make it quickly and easily. Price \$ .50.



### NO. 56 FOLDAWAY GARDEN CHAIR

The whole family will enjoy this comfortable chair during the pleasant summer months outdoors. It is also handy in the basement game room as it takes up little space when folded. This is a real fascinating project. Price \$ .25.



Order patterns by number, inclosing exact cash, check or money order. Price includes mailing costs. Pattern envelopes show many other useful patterns available at low cost.

**ATLAS PRESS CO. PATTERN DEPT.**  
Dept. A-3, P. O. Box 74, Pleasantville, N. Y.



## "WONDER" ELECTRIC BUTTON

Most interesting electrical apparatus ever discovered. Make your own Telephone Amplifier, Detectophone. Transmit your voice or music to distant rooms. Perform hundreds of fascinating experiments. So tiny it can be concealed in dozens of places. Send \$1 now for button and free 5,000 word instruction booklet with 50 illustrated experiments. SPECIAL OFFER 6 buttons and booklets sent post-paid for \$5.

BUCK MFG. COMPANY. Box 124. No. Aurora, Ill.

## Modern Wonder Plastic \$1.00 POST PAID LUCITE KIT

Complete supply of Lucite plastic sheets, attractive designs, instructions for cutting, shaping, bending, cementing. Make your own Lucite novelties, costume jewelry. Ideal gifts for Xmas, birthdays, etc. EARN MONEY AT HOME. Sell to your friends, \$15 to \$20 worth from \$1 Kit. Satisfaction guaranteed or money refunded. Get a supply of the Wonder Plastic NOW! Send your name and address with \$1 to Plastic Homecraft Co., Dept. P, 4617 West Washington Boulevard, Los Angeles 16, California.



## Decorative Decalomania

Transfers Imported Designs of all Sizes & Types—Flowers, Fruits, Figures, Birds, Dogs, Horse Heads, Ships, Juvenile, Tropical, Chinese, Peasant, Colonial, Patriotic, Inlay, Borders, Initials, etc., for Furniture, Doors, Walls, Trays and what not. Catalog with 800 illustrations in color sent for 25c. Deductible on first order of \$1.00 up. L. C. WELLS, Dept. PM-52, 25 East 26th St., New York, 10

★ SAVE WASTE PAPER ★

# WORKSHOP WISDOM

## How to make a good crack-filler

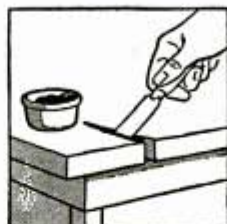

HERE'S a low-cost filler for building up loose joints, filling gouges or cracks in furniture—and hundreds of other uses.

Mix 1 measure of Casco Glue Powder with 1 measure of water and let stand for 15 minutes.

Then add it to a dry mixture of 1½ measures of sifted sawdust, ½ measure of flour, ½ measure of whiting. Mix to a heavy paste, using ¼ measure of denatured alcohol to smooth the filler.

Round the filler off slightly above the work to allow for slight shrinkage. Finish off with sandpaper when dry.

## Casco Glue has a 4-point advantage

**Unusual strength.** Casco Glue hardens and sets chemically to form a bond of remarkable strength and toughness.

**Greater durability.** This glue is highly resistant to dampness, heat, and age.

**Easy to mix.** Casco Glue mixes readily with cold water . . . no heating problems.

**Economical.** A little Casco goes a long way. Mix it as you need it. The powder, if tightly covered, lasts indefinitely.

For special outdoor jobs and water projects, specify Cascamite—the completely waterproof plastic adhesive.

You can get both Casco Glue and Cascamite in 10c, 25c, and larger sizes at all hardware stores.

Write a post card today for free Casco Project Booklets and free Gluing Guide containing 80 household gluing hints. Address: Casein Company of America, Dept. P-2, 350 Madison Ave., New York 17, N.Y.



## CASCO Powdered GLUE

Casein

"Sets chemically—hardens permanently"



**Be the "LIFE O'the PARTY"**  
Have fun. Be the center of attraction everywhere with this easy-to-play Song Flute. Sweet Flute-like tone. Play alone, or in group, with singers, guitar or other instruments. Anyone can quickly master it.

**... EASY TO PLAY.** Yes, almost as easy as whistling a tune. Just blow for tone, finger for notes, you can't miss. Eight tone holes give full chromatic scale. Low price. Carry in pocket or purse.

**Get this FREE PLAYING GUIDE**

Send coupon for interesting playing guide with complete playing instructions and music. See how easy it is. Amaze your friends. Ideal Xmas gift. At all good music stores. But mail coupon today. 379

**\$1**



**MAIL TODAY**

**CONTINENTAL MUSIC CO., INC.** Dept. 229  
630 So. Wabash Ave., Chicago 5, Ill.  
Please send free Song Flute playing guide and name of nearest dealer. No obligation.

Name \_\_\_\_\_  
(Write address, town, state in margin)

**THIS Dustless BRUSH  
REDUCES GERM LADEN DUST**



*Eliminates  
Sweeping Compound*

The "Dustless" brush has a reservoir in its back which holds Arbitrin, a scientifically compounded sweeping fluid. The center row of tufts is connected to the reservoir. During the process of sweeping the Arbitrin feeds through these tufts and moistens every particle of dust it contacts. Instead of floating through the air, the dust is converted into the most efficient sweeping compound.

Tests have proved that "Dustless" sweeping reduces the number of bacteria, normally in the air between sweepings, as much as 97 per cent. The "Dustless" brush also cuts labor and material costs in half.

**GUARANTEED**—Dustless brushes are used in hundreds of offices, factories, schools, institutions and stores. They are unconditionally guaranteed to meet your requirements. Prompt shipment on AA-5 or higher priority rating. Write for styles, sizes and prices today.



**MILWAUKEE DUSTLESS  
BRUSH COMPANY**

528 N 22nd STREET, MILWAUKEE 3, WIS

**HERE'S THE  
HOSPITALIZATION PLAN  
YOU'VE BEEN LOOKING FOR!**

**3c**  
ONLY **3c** A DAY GIVES  
YOU THESE REMARKABLE  
BENEFITS IN CASE OF  
SICKNESS OR ACCIDENT

Don't wait for trouble to strike! Many a man's savings of years have been wiped out by a few weeks of misfortune. Take out our liberal hospitalization policy now and know that your doctor and hospital bills will be paid. Only 3 cents a day gives you a freedom of mind worth far more. Individuals or whole families (to age 70) are eligible, and you may go to any U. S. or Canadian hospital, under any physician's care.

MAIL COUPON TODAY. No agent will bother you.

Family Mutual Life Insurance Co. PM-6  
601 Shipley St., Wilmington 99, Del.  
Please send, without obligation to me, complete information on your Economical Hospitalization Plan.

NAME \_\_\_\_\_  
ADDRESS \_\_\_\_\_  
CITY \_\_\_\_\_ STATE \_\_\_\_\_

**A HOT COMBINATION!  
POCKET-SIZE HOTPLATE WITH  
"HEATAB" FIRE TABLETS**



COMPACT  
STOVE & HEATABS  
\$1.00

There's nothing else like this sensational COOKIT—so compact you can carry both stove and miracle fuel in your pocket or glove compartment of your car! It's amazing how many ways people are using this famous COOKIT both indoors and out.

Hundreds of uses for mechanics, hobbyists, repairmen in factories, shops, homes, and home workshops. Great for camping, hunting, fishing. Heat all foods—fry or boil—start camp and picnic fires. Handiest portable heating method for homemakers, doctors, dentists, chemists and others. Used extensively by all branches of armed forces—a "swell" gift for friends and relatives in service—Speaker COOKIT complete with hotplate and supply of HEATABS only \$1.00 at your dealer's; or order direct—\$1.00 postpaid. . . . (In Canada \$1.55).

J. W. SPEAKER CORPORATION  
3059 N. Weil St., Milwaukee 12, Wisconsin  
Canadian Speaker Corp., Ltd., Montreal



**Speaker  
HEATABS** **FIRE TABLETS**

TRADE-MARK REGISTERED

POPULAR MECHANICS



# X-acto

## EVERKEEN KNIFE

### Makes Modeling Easy!

There's no better knife for airplane modeling than X-ACTO. Makes your toughest job seem easy. Designed to get into the most difficult grooves and corners with accuracy. The blades are interchangeable . . . just slip in a different blade for each type of carving . . . a slight turn of the handle releases the blade. You'll make better models in less time with X-ACTO everkeen knives.

No. 1 X-ACTO knife for light delicate work, complete with one blade. 50c

No. 2 X-ACTO knife for heavy carving . . . complete with one blade. 50c

No. 62 Double Set handles 12 blades. \$2.00 . . . No. 82 Fitted wooden chest 3 handles and 12 blades, \$3.50.

At your dealer or order direct.



X-ACTO CRESCENT PRODUCTS CO.  
440 - 4th AVENUE, NEW YORK 16, N. Y.

AMATEURS GET  
"PRO" RESULTS WITH

One coat of

# PLASTI-COTE

AAA

the paint of tomorrow—today!

AMAZING RESIN-BASED  
LIQUID PLASTIC PAINT—

WASHES  
LIKE  
TILE

Plasti-Cote AAA is a triumph of modern chemistry—a resin-based paint that lets you give your home, Interior and Exterior, a beautiful plastic finish that is tough, fade-proof, waterproof, and resistant to gas and fumes. This remarkably durable paint is self-leveling and leaves no brush marks. So, amateurs get the same fine results as a master painter. It's really fun to apply—and helps you cut your decorating bill almost in two.

ONE COAT of Plasti-Cote AAA covers any kind of surface—wood, wallboard, brick, stucco, plaster, even old wallpaper. It has exceptional hiding properties and does not chip, chalk, crack, or peel. Plasti-Cote AAA, being a true plastic, *cannot be thinned by water*. Its smooth, porcelain-like surface stands innumerable washings,

ONLY

**\$7.50**

PER GAL.

MONEY-BACK  
GUARANTEE



Use 25% of this liquid plastic paint. If not delighted with results, return remainder and receive full refund. Order for cash, postpaid; or C.O.D., plus small express charge. COLORS: White, Ivory, Cream, Buff, Dusty Rose, Peach, Grey, Blue, Brown, Black, and 3 shades of Green. Specify color and whether Interior or Exterior—gloss, semi-gloss or flat. Gal. covers 300 sq. ft.

## Use PLASTI-COTE FLOOR FINISH

New Plastic Beauty-Treatment Banishes Waxing—  
Makes Floors Gleam and Sparkle

Plasti-Cote Floor Finish banishes waxing and polishing, gives hard glossy, durable finish to linoleum, rubber, concrete, asphalt, tile, cork, wood—all surfaces. Non-skid. Resists alcohol, boiling water, cigarette burns—even lye. Apply it yourself. Qt. does average kitchen. 12 colors and clear. **\$8.60 per gal.**

## Let PLASTI-COTE CAR ENAMEL

Give Your Car a Gleaming  
Factory-Fresh Lustre

Here's a car enamel that's different from any other you've ever tried—a real plastic paint that is flexible and covers better and wears longer. One coat covers the old finish. Withstands road tar, oil, sun, salt water, salt air, alcohol, boiling water, sleet, and snow. Quart does average car. Easy to apply. **\$2.95 per quart.**

DEALER INQUIRIES INVITED

# CELLO-NU PRODUCTS

333 N. MICHIGAN AVE., CHICAGO 1, ILL.

★ SAVE WASTE PAPER ★

## FREE! LATEST, MOST COMPLETE RADIO PARTS CATALOG



EVERYTHING in RADIO and  
ELECTRONICS for War Training,  
Maintenance or Repair

New R-F Resonance and  
Coil Winding CALCULATOR

Easy to use! For fast accurate determination of resonance factors and coil winding data. No. 37-955. Postpaid, 25c.

### RADIO'S FINEST BOOK VALUES

Specially prepared to aid radio training in schools and industry. Full of valuable data. Send for all six!

Radio Formulas and Data Book No. 37-752 . . . 10c

Dictionary of Radio Terms No. 37-751 . . . 10c

Radio Circuit Handbook No. 37-753 . . . 10c

Radio Builders' Handbook No. 37-750 . . . 10c

Simplified Radio Servicing No. 37-755 . . . 10c

Radio Data Handbook No. 37-754 . . . 25c

All Six Books No. 37-799 . . . 75c

**ALLIED RADIO CORP.**

833 W. Jackson, Dept. 5-B-5, Chicago 7

# ALLIED RADIO



6  
BOOKS FOR  
**75c**



# SUCCESS!

## How to Get Along in this World

Here, gathered together for the first time, are 5000 gems of worldly wisdom on how to live joyously, successfully... how to handle people, make money, be happy. Written out of actual experience by the best brains of mankind... during the past four thousand years! To-the-point, workable instructions on getting ahead. Only \$1. Included are lessons on how to use these quotations in your daily life. Clip and mail coupon below for FREE details today.

## Short-Cut Mathematics

COMBINED WITH  
*Practical Mechanics Simplified*

Be a "master mind." Learn how to juggle figures, do baffling tricks with numbers. Add long columns of figures this lightning-quick, short-cut way. Multiply 4 figures by 4 figures without old-fashioned multiplication. Here are speedy, simplified systems used by stage "wizards," expert accountants, engineers. Only \$1. Course includes illustrations, problems, answers. Mail coupon below!

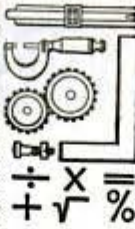

## SUPER JU JITSU

### Now... get tough DOUBLE-quick!

Fear no man. The bigger they come the harder they fall. Super Ju Jitsu is easy to learn. Big illustrated self-instruction course shows you how to disarm, disable and capture an armed attacker—with only your bare hands! Get amazing details at once—mail coupon below.



## MAGIC AND CARD TRICKS

HOW to PERFORM for FUN and MONEY. Mystifying stunts made easy. Secrets of magic revealed in new illustrated course. Teaches tricks with coins, handkerchiefs, balls, ropes, etc. Shows you how to protect yourself from card sharks... their card manipulations exposed! Get the "inside" information on baffling stage performances. Learn how to be a magician and entertain friends. Mail coupon for FREE details.



## CARTOONING MADE EASY

New Self-Instruction Course. Learn how to draw funny pictures for money—caricature, comic strip, gag-cartoon, political and editorial cartoon, etc. Practical simplified method takes out all the mystery. Step-by-step lessons for home-study. Excellent SPARE-TIME training for pleasure and profit. FREE interesting details on request. Just send name and address on coupon below.



## how to write better letters

Make your letters CLICK! Learn to put warmth and sparkle into business and social correspondence. Practical brass-tacks instruction on writing successful job-getting application letters, exciting keen-witted friendly letters, etc. ACTUAL EXAMPLES show tested ways of packing your letters with vitamins. Fascinating details on request...FREE. Just mail coupon below today!



NELSON CO., Dept. 1802, 321 S. Wabash Ave., Chicago 4, Ill. Write today for complete details on any of these SELF-INSTRUCTION COURSES. Send coupon below for the world-famous copyrighted Success-Catalog—it's FREE, on request.

### FREE details... mail coupon!

NELSON CO., Dept. 1802, 321 S. Wabash Ave., Chicago 4, Ill. Please send me—FREE and without obligation—illustrated Success-Catalog containing information about the course (or courses) I have checked below. No salesman will call.

- |  |  |
|--|--|
| <input type="checkbox"/> Success               | <input type="checkbox"/> Magic and Card Tricks       |
| <input type="checkbox"/> Short-Cut Mathematics | <input type="checkbox"/> Cartooning Made Easy        |
| <input type="checkbox"/> Super Ju Jitsu        | <input type="checkbox"/> How to Write Better Letters |

NAME \_\_\_\_\_  
 ADDRESS \_\_\_\_\_  
 CITY \_\_\_\_\_ STATE \_\_\_\_\_

# FOOT PAINS STOPPED

or Your MONEY BACK



## Air-Cooled ARCH-HEELERS

### Get Quick Lasting Relief

Wear Guaranteed Proved ARCH-HEELERS in any shoes for aching feet, metatarsal pains, burning callouses, corns, weak arches. Must please you or Your Money Back. Made of selected leather, specially shaped with soft cushions to gently lift bone joints, release nerve pressure, free blood circulation, align entire foot. Springy. Air cooled. Comfortable, even in tight fitting shoes. Users praise them. "I wouldn't take \$5 for mine!" says one. Pair only \$1.

Send No Money Send name, address and shoe size. Pay postman \$1 plus C.O.D. charge. Or save C.O.D. by sending price with order. Money back if not pleased after 30 days. Send Today.  
ARCH HEELER CO., Dept. Z-2, COUNCIL BLUFFS, IOWA

## CRESCENT TOOLS

Give Wings to Work

ASK YOUR  
HARDWARE  
DEALER



## FIGHTER PLANES

Latest pictures of your favorite U. S. PLANES. Large assortment of FIGHTERS — BOMBERS — TRANSPORTS ACTION PHOTOS

ALL REAL PHOTOGRAPHS  
HIGH GLOSS FINISH

Black Widow P-41 Night Fighter  
We also have finest selection of authentic PIN UP PHOTOS of your favorite MOVIE STARS with latest poses. Rush \$5 for one or 7 for \$1.00 postpaid (No COD's) FREE list MOVIE STARS and PLANE PHOTOS with each order  
DANIEL'S PHOTO SERVICE, Box 1316 Wilshire, La Brea St., Los Angeles, Calif.

## BURN YOUR NAME ON TOOLS WITH THE ARKOGRAF

PROTECT YOUR TOOLS FROM THEFT Write with electricity any name or design on the handle and finest tools and instruments of any metal. Like writing on paper with pen or pencil. These marks used by mechanics, garages, machine shops. Complete outfit \$3.50—Prepaid Anywhere. Interesting illustrated circular free. Write today. ARKOGRAF PEN CO., 3927 S.E. Stark, Portland 15, Ore.

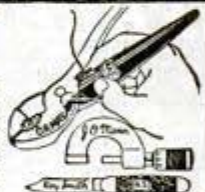

# WORLD'S LOWEST PRICED ADDING MACHINE

VEST POCKET SIZE

FREE TRIAL  
ONLY  
\$2.50  
TOTAL COST  
SEND NO MONEY

## IDEAL FOR INCOME TAX

Fits vest pocket or purse. Guaranteed accurate. Operated as easily, and as reliable, as machines costing many times as much. Not a toy. Substantially made of 28-gauge steel—guaranteed for life against defects in construction. You positively can't buy a calculator of equal quality for as little money. ACCEPTED AS THE FINEST LOW PRICED CALCULATOR FOR OVER 30 YEARS! Operates with a flick of your finger. Adds, subtracts, multiplies, divides—counts up to ten million. Pays for itself over and over in mistakes avoided, and time saved. MAKES IDEAL GIFT.

Sold on a positive money back guarantee. Send only name and address, pay postman \$2.50 plus postage (send full cash if outside U.S.). Money back within 10 days if not delighted. AGENTS WANTED!

CALCULATOR MACHINE CO. (Mfrs.)

Dept. 162, P. O. Box 1118, Chicago, Illinois

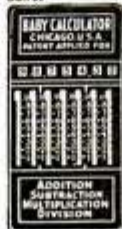

# Royalton CROWN

For Men who Really Know Pipes

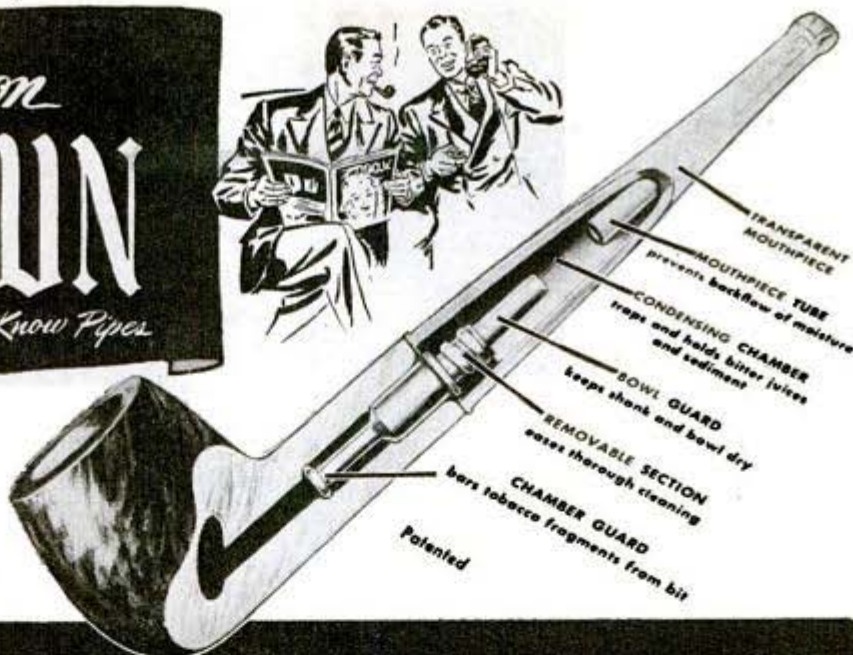

Even the choicest tobacco loses its savor in a pipe that allows bitter juices to seep into the mouthpiece. Steady smokers heartily approve the Royalton Crown pipe because it is uniquely equipped to trap unwanted moisture and slugs. No pipe of its kind possesses the Royalton Crown features—the condensing well and other patented safeguards—that keep bowl and mouthpiece enduringly dry... Smoking luxury within reach of every man.

\$1.50

Selected Briar

HENRY LEONARD & THOMAS, INC. • OZONE PARK, NEW YORK

## REPAIR FURNITURE WITH HIDE GLUE



## FRANKLIN Liquid Hide GLUE

USED BY FURNITURE MANUFACTURERS

Ready to use, no mixing, no heating means no chilled joints. Choice of fine craftsmen everywhere.

LOOK FOR THIS DISPLAY AT YOUR HARDWARE DEALER

or send 30 cents for 1/4-pint to The Franklin Glue Co., Columbus 3, Ohio



## FREE BOOK Tells How To

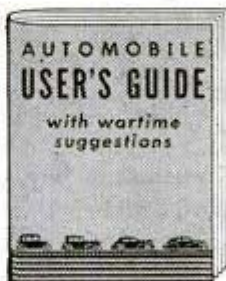

- get better gas economy
- prolong tire life
- preserve exterior finish
- keep your car in the best operating condition.

You can get a FREE COPY from any General Motors dealer or by writing:

Customer Research Dept., Room 1763  
GENERAL MOTORS, DETROIT 2, MICH.  
Please send FREE COPY of new edition 64-page  
"Automobile User's Guide"—containing 196  
practical suggestions on wartime operation.

Name..... please print

Address..... please print

City..... Zone State

Make of car now owned..... year model

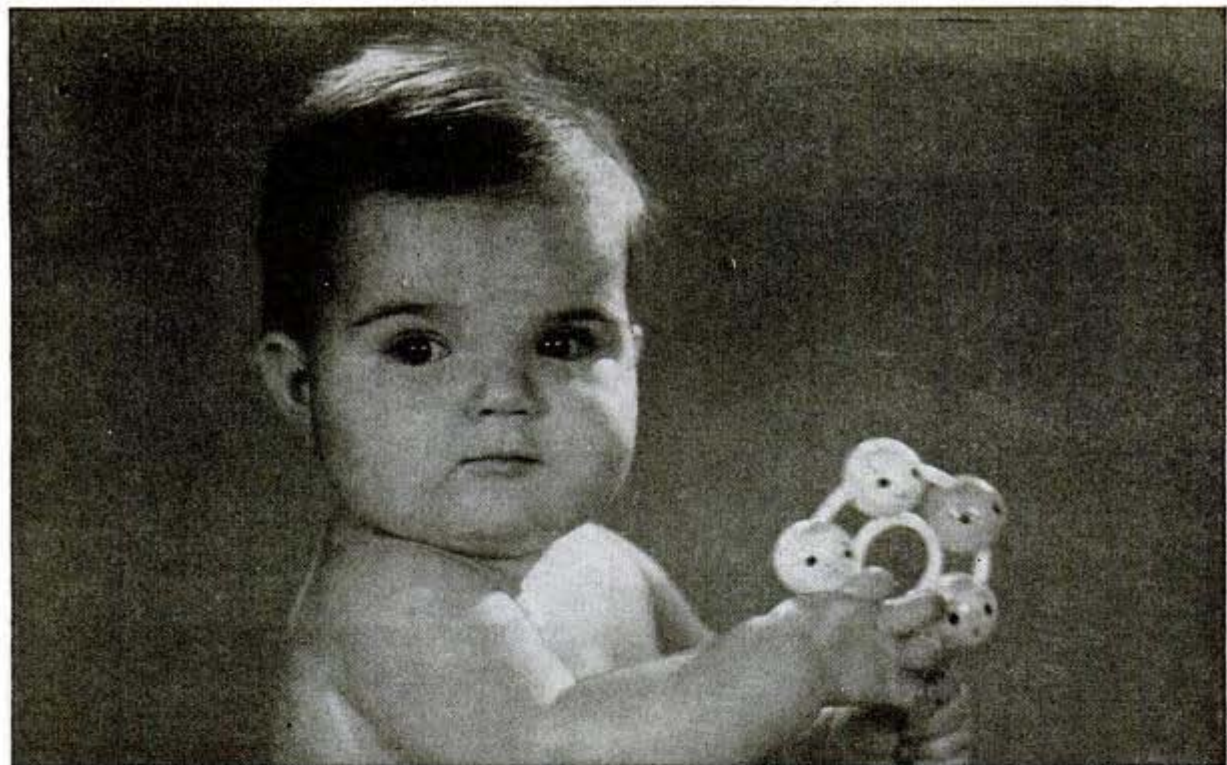

# WAR BOND MAN — CLASS OF '63

**Someday you'll want** to see that boy, or girl, of yours off to college . . . and *right now* is not too early to start making plans.

Maybe your youngster, like so many other American boys, will work his way through school . . . but even in that case you'll want to be in a position to give him a little help if he needs it.

**By what you put aside** in War Bonds *today* you can help *make sure* he gets the same chance as other boys, *tomorrow*.

Chances are you're already on the Payroll Savings Plan. Saving as you've never been able to save before. This is fine *provided you keep on saving*.

But take your dollars out of the fight—and you will be hurting yourself, your boy's future, and your country..

Try to buy more bonds than you ever have before. And *hold on to them* . . .

**For every three dollars** you invest today, you get *four dollars back when your Bonds come due*.

## POPULAR MECHANICS MAGAZINE

*This is an official U. S. Treasury advertisement—prepared under auspices of Treasury Department and War Advertising Council*

★

★

# HOW MANY TIMES HAVE YOU SAID . . .

*"Gee!*  
**I WISH  
I COULD  
PLAY LIKE  
THEY DO"**

● You *can* play a wind instrument, and play it well, as there's only one line of notes to follow! Don't be content to sit back and listen—*make music yourself* and be one of the popular group. Anyone who can whistle a tune can play a new Conn. The fingering is simple and the scale comes easily because of exclusive, patented Conn features and advanced design. Plan now to make music your hobby . . . and be sure you get a genuine CONN as soon as they are available.



## SEND FOR FREE BOOKS

**TEEN-AGERS**—send for "Fun and Popularity Through Music."

**PARENTS**—send for "Music, The Emotional Outlet for Youth." See your local Conn dealer, or write direct to C. G. CONN LTD., Dept. 231, Elkhart, Indiana.



**WORLD'S LARGEST MANUFACTURERS OF BAND INSTRUMENTS**



## KRW ARBOR PRESSES BENCH TYPE AND HYDRAULIC

NEEDED IN EVERY SHOP—SAVE TIME AND MONEY—DO BETTER WORK, QUICKER.

No shop is complete without a small arbor press. Pressing and squeezing operations can be done better and faster on a KRW Arbor Press. Stop using vise and sledge hammer methods—they generally deliver spoiled work in the end. KRW Factory-To-You Prices give you greater value for your money. Order today.

**KRW Bench Type Arbor Presses, 3 sizes**  
 No. 37-P 1/2 Ton, \$13.25\*  
 No. 37-O 1 Ton, \$23.00\*  
 No. 37-N 3 Ton, \$33.00\*  
 \*Prices F.O.B. Arcade, N. Y. Slightly higher west of Rockies. Stand illustrated extra.



**KRW Hydraulic Presses** are built in 25, 50, 60 and 75 ton sizes. Prices start at \$198.00\*.



**K. R. WILSON, Dept. 17, 215 Main St., BUFFALO 3, N. Y.**  
 Builders of Shop Equipment for Ford Dealers Since 1916



## SAW FILING

You can have a good, steady, cash business of your own reconditioning saws with the Foley Automatic Saw Filer, which makes old saws cut like new again. The Foley is the ONLY machine that files all hand saws, also band and circular saws. Easy to operate—no eyestrain.



**SEND FOR FREE PLAN**—shows how to start in spare time—no canvassing. Send coupon today—no salesman will call.



### FOLEY Automatic SAW FILER

**FOLEY MANUFACTURING CO.**  
 216-5 Foley Bldg., Minneapolis 13, Minnesota  
 Send Free Plan on Saw Filing business, no obligation

Name \_\_\_\_\_

Address \_\_\_\_\_

SAVE WASTE PAPER

## Use Your Drill Press as a Wood Planer!



Planes, Parallels, Finishes—Swiftly planes all wood—leaves knots smooth and finished. **AMAZING SPEED**—30 seconds for planing, paralleling and finishing 8"x24" board surface with 1/32" cut or less. 3 high speed steel blades—Double-Screw ADJUSTMENT. Safe, accurate, a lifetime tool. A perfect paint and varnish remover—blades cut underneath surface. \$7.50, postage paid. 5-day trial offer. Free literature. **ACT TODAY!**



**H. J. BERRY MFG. CO., 2297 Scott St., Detroit, Mich.**

## FUN AND PROFIT FROM YOUR HOME WORKSHOP



New 1945 "WHAT TO MAKE" is now ready. One of these books is issued each year and is a reprint of articles which have been published in our "Craftsman" Department. Hundreds of ideas that can be used around your home workshop in one handy, 224-page volume. Get book from your News Dealer or send 50c to

**POPULAR MECHANICS PRESS**  
 Dept. 596 200 E. Ontario Chicago 11

## WALTON TAP EXTRACTORS

LIST PRICES  
 \$1.50—\$5.00  
 IMMEDIATE DELIVERY



**BROKEN TAPS — Out In A Jiffy**

Salvages expensive parts. Simple and easy to use. Full instructions.

**THE WALTON COMPANY, 102 Allyn Street, Hartford, Conn.**



## New 1945 SHOP NOTES Now Ready FOR EVERY MAN WHO USES TOOLS

One of these books is issued each year and is a reprint of articles published in our Shop Notes Department. It contains cream of experience of years, of hundreds of our country's most successful mechanics. Get a copy from your News Dealer, or send 50c to

**POPULAR MECHANICS PRESS**  
 Dept. 597 200 E. Ontario Chicago 11, Ill.

# Now A DYNAMIC HEAVY DUTY INDUSTRIAL WELDER

## TO SAVE YOU VALUABLE TIME and MONEY!

This portable DYNAMIC WELDER—easily carried right to the job—plugs into any convenient properly wired 110 volt light circuit—works on IRON, STEEL, BRASS, BRONZE, AND OTHER METALS—has 8 metallic and carbon arc welding heat stages—does work you would think only possible with a larger more expensive machine. Once you see a DYNAMIC in operation, you won't want to be without it. Its simplicity will amaze you. In a year the DYNAMIC only costs you about 6c a day. Helmet, rods, cables, holder and operating instructions, etc., furnished.

### DYNAMIC SUPERCHARGED WELDER

DESIGNED TO DO HIGH GRADE WELDING INEXPENSIVELY—Maintenance Men; Farmers; Mechanics; Machine Shops; Foundries; Auto, General Repair and Job Welding Shops; all using the DYNAMIC find it so indispensable and useful that they cannot afford to be without it. If inexperienced, you can easily learn to do a variety of high grade welding jobs by following the practical, simplified operating and welding instructions furnished.

Member of the Chicago Association of Commerce

**DYNAMIC WELDER CO. • 13 East 23rd St., CB, Chicago 16, Ill.**

FOR ONLY

# \$23.50

COMPLETE...

Write today for free priority assistance and particulars on how to qualify for one of these amazingly low-priced welders. Act now while they are still available. Get details on our 10 day trial offer.

FARM IMPLEMENTS

BICYCLE REPAIRS

SHOP WORK

HOME APPLIANCES

AUTOMOBILE REPAIRS

# AUTO-LITE SPARK PLUGS

IN SERVICE ON EVERY FRONT

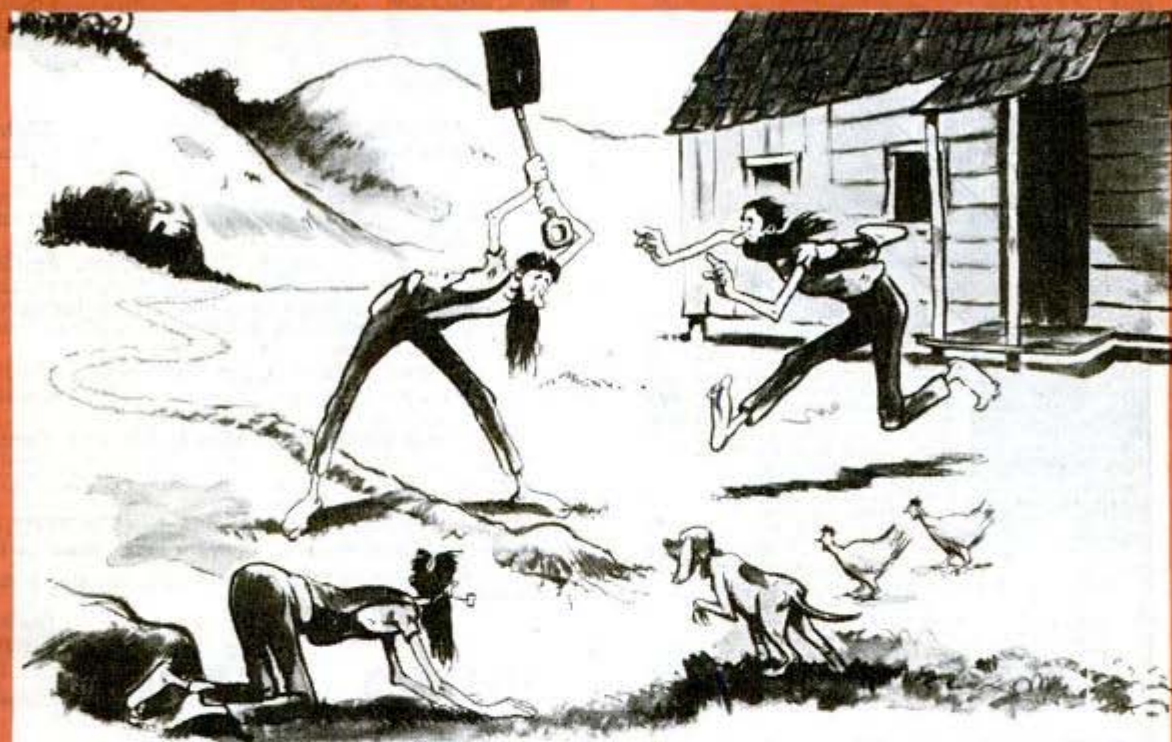

"Hold 'er, Luke—'tain't no mole . . . Uncle Rafe's playin' he's a Undergroun' Movement"

## "PLUG-CHEK" HELPS UNCOVER GAS WASTE QUICK

Gas-wasting plugs can be spotted quickly and accurately the "Plug-Chek" way. This Auto-Lite Inspection Service helps put the finger on faulty or improper plugs, may add as much as 12% to gas mileage, according to tests by the American Automobile Association.

Stop in today at your friendly Auto-Lite Spark Plug Dealer and have your spark plugs inspected the "Plug-Chek" way. Possibly all they need is cleaning or regapping. But if new spark plugs are needed, ask for Auto-Lites . . . the ignition engineered spark plug.

THE ELECTRIC AUTO-LITE COMPANY  
TOLEDO, 1 • Merchandising Division • OHIO  
BACK THE ATTACK—BUY WAR BONDS

Tune in the  
**AUTO-LITE**

Radio Show  
STARRING

**Dick Haymes**

HELEN FORREST • GORDON JENKINS'  
ORCHESTRA

Every Tuesday Night • NBC

Featuring men and women on  
the fighting fronts



**UGLY  
BLACKHEADS  
OUT  
in SECONDS  
with**

**VACUTEX  
BLACKHEAD  
EXTRACTOR  
\$1.00**



**EVEN  
THESE  
EASILY**

Blackheads are ugly, offensive, embarrassing. They clog pores, mar your appearance, invite criticism. Now your blackheads can be removed in seconds, scientifically, and easily, without injuring or squeezing the skin. VACUTEX creates a gentle vacuum around the blackhead, cleans out hard-to-reach places in a jiffy. Germ laden hands never touch the skin. Simply place the direction finder over your blackhead, draw back extractor... and it's out. Release extractor and blackhead is ejected. VACUTEX does it all! Don't risk infection, order today!

**SAFE • SURE  
SANITARY  
DAINTY  
FAST  
PLEASANT**

**10 DAY TRIAL COUPON**  
Balco Products Co., Dept. A-3202  
19 West 44th St., New York 18, N. Y.

Enclosed find \$1.00. Send me Vacutex postpaid. My dollar will be refunded if I am not delighted.

Ship C. O. D. I will pay postman \$1 plus postage.

NAME.....  
ADDRESS.....

**COLOR CONCRETE WITH CHEMICALS**

A business of your own. Big money making Hollywood style pottery and birdbaths without moulds. Washing-wells, succo-rock, benches. Marbling and cement water-paints. 10c brings sample, literature, pictures. Hollywood CementCraft, 8529 Wonderland Ave., Hollywood 46, California

**Economical!  
Speedy!**

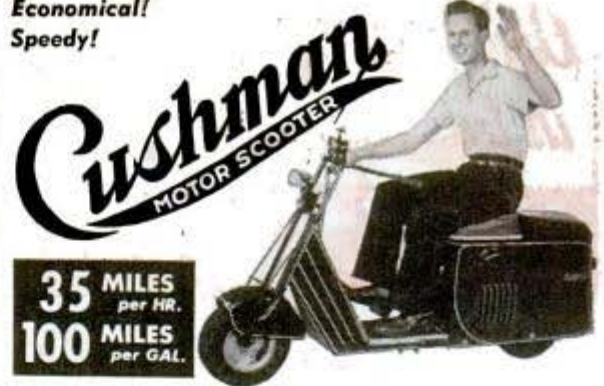

**35 MILES  
per HR.  
100 MILES  
per GAL.**

You can't beat the New Improved CUSHMAN Motor Scooter for low-cost speedy transportation! Ten times faster than walking! 500 miles on \$1 worth of gas!

Developed to the Nth degree by rigorous war-time service. Now even sturdier, more dependable, more comfortable than ever before.

Powerful 4 H. P. engine. Floating drive. Applies power as smoothly as Fluid Drive. To start, travel any speed or stop, merely touch hand accelerator. Improved springing, long wheel-base, balloon tires. Electrically welded all-steel frame.

3 models—as illustrated... or with 200-lb. capacity side car... or Package-Kar with 250-lb. capacity front delivery box.

**AVAILABLE NOW** for service inside war plants. Later—to individuals. Get the complete story now—be among the first to own a genuine CUSHMAN, when available.

**WRITE!** See your dealer who handles the CUSHMAN, or send for full details, photos, low prices. Send NOW!

CUSHMAN MOTOR WORKS, Dept M-25, Lincoln, Nebr.

**STOP  
RADIO STATIC**



The ALL WAVE radio filter is guaranteed to help you get perfect radio reception. Eliminates all hums, clicks, crackles, etc., caused by electric razors, vacuum cleaners, motors and other electrical appliances. The ALL WAVE is a scientific and compact radio filter that can be used on any make electric radio. To connect, just put your radio plug thru the ALL WAVE's slotted opening and into any wall outlet. 15 DAY FREE TRIAL. Sent C.O.D. for \$1.50 plus postage. Cash orders sent postpaid. Rush order—supply limited. Vogue Eliminator Co., 7759 S. Halsted, Dept. AW-1002, Chicago 20, Ill.

Say you saw it in Popular Mechanics!

**MAKE EXTRA MONEY AS SHOP AGENT FOR SCHERR TOOLS**



**THE REED  
MICROMETER**

Measures to 1/10,000", with accurate vernier, in 1, 2, and 3" sizes. A modern tool to be proud of. Burnished thread, for smooth, sensitive measuring and long life. Locknut and ratchet. Accuracy guaranteed. PRICE 1" size, \$6.98 PLUS 10 CENTS POSTAGE. ORDER ONE NOW.



**SCHERR DIAL TEST INDICATORS**

Read to 1/1000" at a glance. Invaluable for speeding machine set-up and for testing. Universal ball joint for use at any angle. Write for full details today.

**10-DAY MONEY BACK OFFER**

All Scherr products carry 10-day money back offer, without conditions. Our tools must prove to you that they are as fine as we know them to be. In ordering, send money order, check, or we'll ship C.O.D.

Your shopmates will be interested in the Scherr line of machinists tools, micrometers, combination squares, surface gages, sine bars and other specialties. Help them to buy. Prices interestingly low. Quality up to the Scherr precision standard. Deliveries immediate. No priority. Ten day examination privilege. Write now for details of the Scherr Shop Agent extra income plan, and description of this desirable line.

**SCHERR TOOL CHESTS**

A tool chest like this marks a good mechanic. Solid oak, 20 x 9 x 13 1/4 in. Separate locks for top section and drawer section. Price \$13.50. Other sizes available. WRITE FOR FULL DATA.



**GEORGE SCHERR CO., INC., 200A LAFAYETTE ST., NEW YORK 12, N. Y.**



Over 100 Valuable Ideas  
in this Amazing



# LEJAY MANUAL

HOW TO BUILD

PRICE **\$1.50**



TRANSFORMER  
WELDERS

WELDING  
GENERATORS



ARMATURE WINDING

ELECTRIC  
OUTBOARD

POWER  
TOOLS



WIND PLANTS

ELECT. GO-BIKE



MOTORS

INSECT  
KILLERS



ELECTRIC  
SCOOTER

ELECTRIC  
FENCERS



LIGHT GENERATORS



TRACTOR  
LIGHTS

## THERE'S LOTS OF ENJOYMENT IN THESE PROJECTS

Making practical things that work and save money is always fascinating, especially when you can do it in spare time and with spare equipment you may have in your own garage or workshop. If you need a welder, you can make that, too. In fact, the fifty basic plans in the LeJay Manual contain instructions that will enable you to make 100 or more individual items. Think of the extra money you can earn making and repairing things for other people.

## LEARN HOW TO BUILD

200 Amp. Generator Welders

Workshop Spot Welder

Large Transformer Welders

Gunsmith's Carbon Welder

Electric Fencers

Armature Rewinding

Bench Grinders

6, 12, 32 and 110-Volt Motors

Wind Driven Light Plant

Insect Electrocutors

Electric Bicycle Pusher

and Many Other Things

## PLANS EASY TO FOLLOW

These plans were made for YOU and others like you, who are not in any sense electrical experts or mechanics. They are simple, yet efficient, and do not need a lot of expensive tools to carry them out. Thousands of amateurs are having fun or making profits with the many things these plans helped them to build. The illustrations shown are only a few of the many things you can make.

WORTH  
**\$12.35**  
IF PLANS  
BOUGHT  
INDIVIDUALLY

**100  
BUILD  
YOUR  
OWN  
ITEMS  
\$1.50**

IT'S EASY and FUN  
TO BUILD

# THE NEW LEJAY FAST FREEZER

COMPLETE PLANS  
FOR BUILDING  
AND MATERIALS  
SHOW YOU  
HOW!

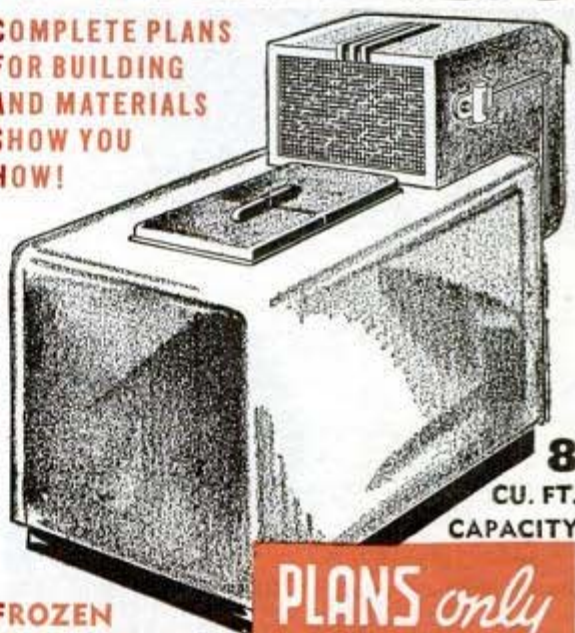

**8**  
CU. FT.  
CAPACITY

FROZEN  
STORAGE

From 5° above to  
10° below zero  
For Fish, Meat, Fruit

PLANS *only*  
**\$1.00**

## IT'S FUN AND IT'S EASY

to build this Fast Freezer. Our plans cover every detail and you need no expert knowledge of refrigeration or carpentry. Can be built of new or used parts. Operates on any voltage.

## MAIL COUPON NOW

for our Special Combination Offer of the Fast Freezer plans and the 1945 LeJay Manual for only \$2.25, or specify which of the two items you require at quoted price.

## LEJAY MFG. CO.

### SAVE ON THIS COMBINATION OFFER

LEJAY MANUFACTURING CO.,

447 LeJay Building, Minneapolis 8, Minn.

Gentlemen: Please send me both the LeJay Manual for 1945 (\$1.50) and the plans for your New Fast Freezer (\$1.00), for which I enclose \$2.25 in Cash  Check  Money Order  I need only the LeJay Manual and enclose \$1.50  I need only the Fast Freezer Plans and enclose \$1.00

NAME.....

ADDRESS.....

CITY..... STATE.....

**LEJAY MFG. CO.**

47 LEJAY BUILDING,  
MINNEAPOLIS - 8 - MINN.

**30 DAY  
TRIAL**

# *POST-WAR PRODUCTION will demand Precision Machining*

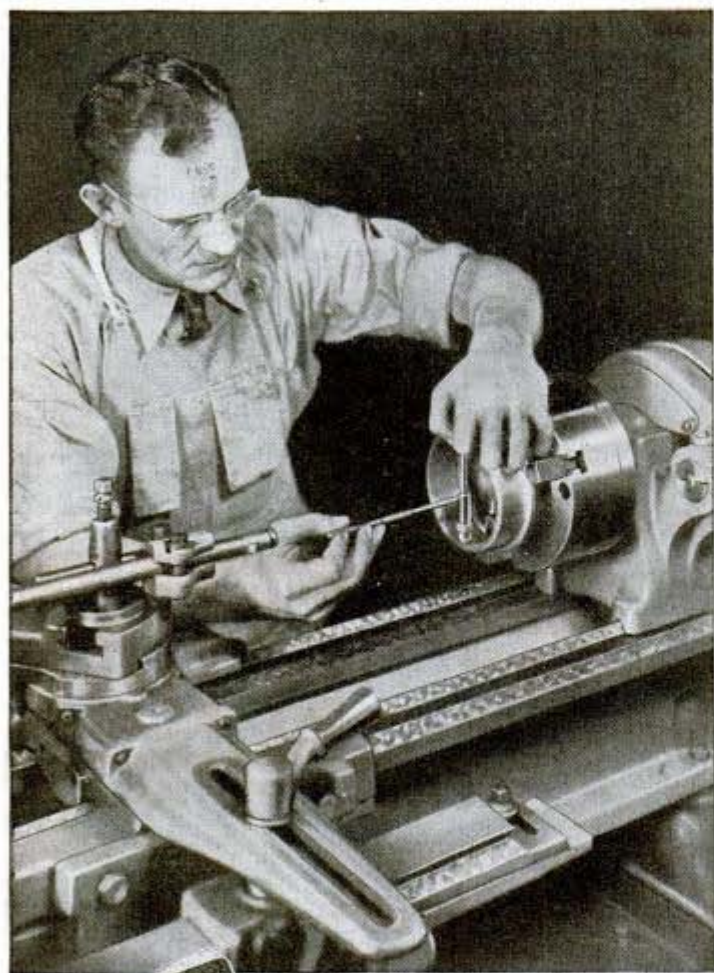

Manufacturing costs must be kept within reason in order to meet the keen competition that is sure to come with the post-war period. Then, if ever, shop machinery will be needed that can operate with unquestionable precision. There will be no margin for loss of time, labor, and material resulting from the use of inaccurate, obsolete machines.

South Bend Lathes are designed and built to provide the extreme accuracy required for efficient production. Throughout the war they have been performing hundreds of essential war production operations with toolroom precision. Their war-time record stands as a recommendation worthy of careful consideration when peace-time plans are made. Substantial savings in capital investment, power consumption, floor space, and labor costs often result from their selection.

Today, South Bend Lathes are better in every way. All of our facilities are still devoted to their manufacture. Improvements have been accelerated to meet war production needs. Their smooth, vibration-free operation at high speeds permits finish turning and boring with such precision that subsequent grinding, honing, or lapping operations can often be eliminated.



## **"HOW TO RUN A LATHE"**

A useful handbook for machinists, apprentices, and shop students. Contains complete information on the operation and care of engine lathes, grinding cutter bits, turning, facing, boring, tapering, drilling, reaming, tapping, thread-cutting, etc. Consists of 128 pages, 5 $\frac{1}{4}$ " x 8", and 365 illustrations. Send 25c for your copy.

South Bend Engine Lathes and Toolroom Lathes are made in five sizes: 9", 10", 13", 14 $\frac{1}{2}$ ", and 16" swing. The Precision Turret Lathes are available in two sizes:  $\frac{1}{2}$ " and 1" collet capacity. Write today for your copy of our Catalog.

**SOUTH BEND LATHE WORKS**  
455 EAST MADISON STREET • SOUTH BEND 22, INDIANA  
LATHE BUILDERS FOR 38 YEARS



PRINTED BY POPULAR MECHANICS COMPANY, CHICAGO, ILL., U. S. A.



## WINTER IS ROUGH ON HORSEPOWER

● Outside, it's bitter cold. The service station phone never stops ringing. All over town, people are wailing, "My car won't start!"

Too bad. This trouble could have been avoided . . . with Casite.

**Casite Guarantees Summer Starting  
in Winter Weather  
or Double-Your-Money-Back**

Casite keeps oil from congealing . . . speeds oil flow. Result: a fast, sure start, even in coldest weather.

Casite cleans out motors, keeps them clean. And everyone knows a clean motor runs better and lasts longer.

Casite is sold by service stations, car dealers and garages everywhere, for only 65¢ a pint. Get Casite today and start *every* day!

**THE CASITE CORPORATION  
HASTINGS, MICHIGAN**

### Guarantee

We guarantee that any motor capable of being started in a warm room will start in the coldest weather when Casite is added to the crankcase . . . Add Casite according to instructions. If your car fails to start, you get double your money back by filling out guarantee certificate and mailing it to The Casite Corporation, Hastings, Michigan. Maximum refund is \$1.30 per pint, which is twice the nationally advertised price of Casite.



# CASITE

**CLEANS OUT MOTORS  
KEEPS MOTORS CLEAN**

**IT'S A PRIVILEGE TO BUY WAR BONDS**



SEIBERLING  
TIRES  
S

TO BE SURE



OF QUALITY

## Choose the Name You Can Trust in Rubber!

Today, *all* tires are manufactured from GRS (Government Rubber, Styrene).

*All* manufacturers of tires start with this same new, wartime plastic.

Extra safety and mileage in today's tires, therefore, can come *only from extra skill in tire building—from superior compounding and craftsmanship.*

That's why the name that is "signed" to the new tires you buy is far more important now than it ever has been before.

Twenty-four years devoted to building the BEST in tires have given Seiberling a rich background of achievement in rubber research and a priceless reputation for honesty in the making and marketing of fine quality tires.

You can select today's Seiberling Tire with complete confidence—with the knowledge that it is the finest synthetic tire you can buy . . . for it bears *The Name You Can Trust in Rubber.*

# SEIBERLING

*Experts in Rubber*



*We invite you to inspect this SUPERIOR SYNTHETIC TIRE*

In your vicinity there is an Independent Seiberling Dealer who will be glad to show you this latest Seiberling achievement. You'll find it a good looking tire—one that will give you the maximum in safety and mileage—and worth waiting for, if you must.

SEIBERLING  
TIRES



RETAILED ONLY BY FREE,  
INDEPENDENT BUSINESS  
MEN DISPLAYING THIS  
SIGN OF QUALITY