

Two Days in the Hornet's Nest

POPULAR MECHANICS

MAGAZINE

WRITTEN SO YOU CAN UNDERSTAND IT

FILED TRADE MARK GREAT BRITAIN NO. 40426

REG. U.S. PAT. OFF.

JANUARY
25 CENTS
30c IN CANADA

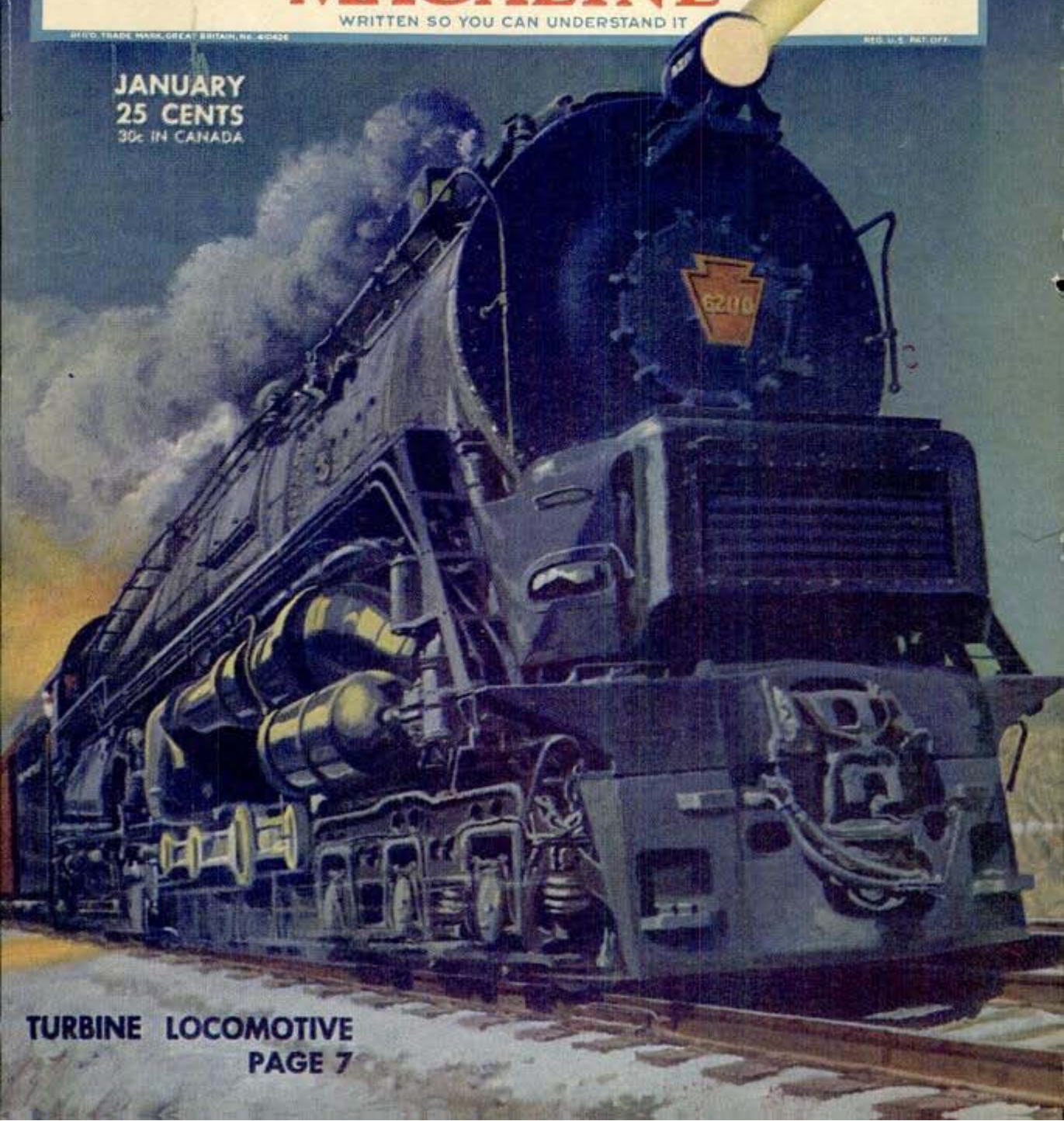

TURBINE LOCOMOTIVE
PAGE 7



MESSAGES GOT THROUGH

ON THE "BANANA NET"

THERE is many an exciting story about how amateur radio operators now in the services have helped extend the lines of victory around the world. There's the one about the "Banana Net"—the name the boys gave to the radio network down in the Panama jungle. As the G. I.'s have it, "it rains continually during the rainy season but only once a day in the dry season". The "Banana Net" is just one link in the vast network set up by the AACS—Army Airways Communications System. The AACS safeguards tens of thousands of lives by relaying weather reports, coordinating information on enemy ship and plane movements and by bringing home or locating flying ships that are down or in trouble.

The ranks of the far-flung AACS are filled with one-time amateur radio operators. Amateurs have always found in Hallicrafters equipment the perfection they themselves have been seeking. For these exacting technicians Hallicrafters made superior equipment long before the war. As a matter of fact thousands of pieces of privately owned Hallicrafters equipment were drafted into the services right along with the amateurs who once operated them. After the war Hallicrafters will have a new kind of radio ready. You will want the radio man's radio—the radio that has an amazing range and performance on all bands, short wave and regular broadcast. There will be a set for you in our post-war line.



This is Hallicrafters new Model SX-28A, latest version of the famous Super Skyrider. It is a 15-tube communications receiver operating on a frequency range of 500 kc to 42 Mc, continuous in 6 bands including the regular broadcast band.



BUY A WAR BOND TODAY!

hallicrafters RADIO

THE HALLICTRAFTERS CO. • MANUFACTURERS OF RADIO AND ELECTRONIC EQUIPMENT • CHICAGO 16, U. S. A.

Ingenious New Technical Methods

Presented in the hope that they will
prove interesting and useful to you.

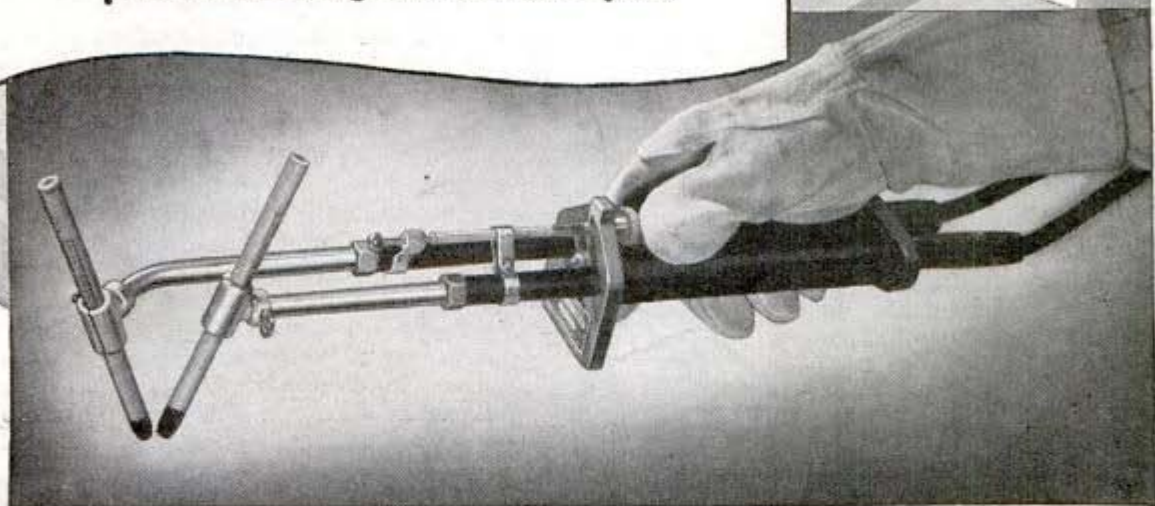

NEW 9000° ARC TORCH CAN BE USED FOR WELDING AND BRAZING ALL FERROUS AND NON-FERROUS METALS AND ALLOYS

Now an arc torch that makes it possible to do most jobs *electrically* that previously were thought possible only with gas. This attachment for arc welders provides an independent source of heat by means of two carbons. It is capable of producing intense heat, approximately 9000° F., over 2000° hotter than an oxyacetylene flame. Pure heat, no oxygen or gas to contaminate the weld. No pressure to force the molten metal away or blow holes in light sections.

Developed to capitalize to the fullest on the time-saving advantages of electric welding, the new Mid-States 9000° arc torch can be used with any AC or DC electric welder. It opens up new horizons of service in this field, never before possible with an electrically operated instrument.

New uses are being found every day for products that have been familiar to us for years. Wrigley's Spearmint Gum, always enjoyed for its chewing satisfaction, is now proving with the fighting men overseas many benefits which will be useful to you in peacetime. One of the big factors in mass production is the alertness and efficiency of the man on the job. The chewing of Wrigley's Spearmint will help keep you alert and wide-awake during those work periods that, while seemingly dull and monotonous, call for watchfulness in order to get perfection in the final assembly.

You can get complete information from Mid-States Equipment Co., 2429 So. Michigan Ave., Chicago 16, Illinois

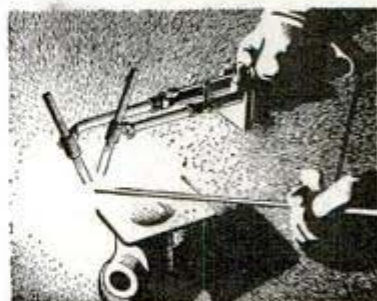

For BRAZING Steel, Cast Iron, Malleable Iron, Copper, Brass, Bronze, and other ferrous and non-ferrous metals.



For HEATING to Straighten or Bend, etc.

JANUARY, 1945

This One



9XBZ-8RK-82Q5

165

1A

BELL TELEPHONE LABORATORIES

Exploring and inventing, devising and perfecting for our Armed Forces at war and for continued improvements and economies in your telephone service

RESearch, in the Bell Telephone System, has always been an expanding activity, growing with the scientific knowledge of the times and contributing to that knowledge.

The telephone, itself, was invented in the laboratory where Alexander Graham Bell was carrying on researches in speech and hearing and laying the foundation for the electrical transmission of speech. As time went on the telephone research program expanded to cover every science which gives any promise of improved telephony.

These researches and development studies now include electrical communication of speech—both by wire and by radio—the transmission of pictures (television)—and many important projects for war.

There Is No End to Progress

Every new research gives rise to new inventions and to new lines for development and design. New inventions indicate new lines for more research. In the early years, this work was carried in part by the American Telephone and Telegraph Company and in part by the Western Electric Company, the manufacturing unit of the Bell System.

For many years, however, the work has been assigned to a specialized unit, Bell Telephone Laboratories, Incorporated. Theirs is the responsibility for the technical future of the telephone industry.

The policies and procedures of Bell Telephone Laboratories are distinguished by two characteristics. In the first place the Laboratories design for service. The consideration is not the profit of a manufacturer, but the production of equipment which will give the best service at the lowest annual cost when all factors are considered, such as first cost, maintenance, operation, and obsolescence. The Laboratories make no profit and the equipment they design is owned and used by the telephone companies; and the emphasis is upon that use.

Organized Co-ordinated Research

In the second place the Laboratories design always with reference to the complete communication system in which the equipment is to play a part.

Reliable, economical telephone service, which is the product of its efforts, is not so much an assemblage of excellent apparatus as it is an excellent

assembly of co-ordinated equipment—all designed to work together.

4600 People in Bell Laboratories

Bell Laboratories contributions to the Armed Forces derived in large part from the technical background that the Laboratories had acquired through their steadily maintained program of research. The Laboratories had special knowledge and skill which could instantly be diverted to war problems.

At the time of Pearl Harbor, over a quarter of the 4600 people in the Laboratories had twenty or more years of service. This breadth of background made possible many engineering developments outside the strict field of communication and these have been of value to the Armed Forces. So far the Armed Forces and the O.S.R.D. have engaged the Laboratories on over a thousand major projects.

Most of the Laboratories developments, of course, have been in the field of electrical communication. Communication, not simply between individuals as in ordinary telephony, but between mechanisms—as in the electrical gun director.

Leader in Electronic Development

The Laboratories techniques and electronic researches have produced many secret weapons for our country's Armed Forces. In World War I, they pioneered by developing radio telephone systems for talking between planes and between planes and ground stations. They also contributed methods and devices for locating enemy planes, submarines, and artillery.

In this war, Bell Laboratories have pioneered in the field of electronics. The Western Electric Company, which manufactures the designs of the Laboratories, is the largest producer of electronic and other war communication equipment in the United States and is now engaged almost exclusively in the manufacture of this equipment.

In war, Bell Telephone Laboratories devote their work to the needs of our Armed Forces. In peace, they are constantly exploring and inventing, devising and perfecting for continued improvements and economies in telephone service. Centralized research is one of the reasons this country has always had "the most telephone service and the best at the least cost to the public."

BELL TELEPHONE LABORATORIES



Popular Mechanics Magazine

Registered in U. S. Patent Office and Canada

H. H. WINDSOR, Founder

H. H. WINDSOR, Jr., Editor and Publisher

January, 1945

Vol. 83, No. 1

Next Month

IMAGINE a football game with a scrimmage line 1,500 miles long. On one side of this line are two U. S. teams, and on the other side three Jap teams. The teams are composed of the fastest and most powerful warships in the world. Reduced to terms of football, the Second Battle of the Philippine Sea makes crystal-clear reading, and contains more trick plays and grandstand thrills than an Army-Navy game. The Japs tried four major plays—each of which ended in disaster. In the February issue, a correspondent with the Fleet gives a play-by-play account of "The Battle That Won the Pacific."

War Wonders

DON'T think for a minute that the jeep is the only Army product which will be at your disposal in postwar years. There are walkie-talkies for radio calls to the folks from the 15th green, rubber boats for sportsmen, and a thousand little things like waterproof matches, shaving soap that lathers in the coldest water and a super raincoat. Unbreakable shoestrings are an item. Read "War Wonders for You" next month.

Mexico Calling

WHEN you get that shiny new car after the war (which we hope will travel about 35 miles on a gallon of gas) a vacation trip to Mexico should be in order whether your home is in Maine or Texas. Modern roads are being built south of the border to bring Mexico's beauties within reach of American tourists. A preview of what you will find is told next month in "Around the World in 2,000 Miles."

IN THIS ISSUE

Gangplank to Hitler's Doorstep	- -	1
Whirlwind on Rails	- - -	7
Human Takeoff at 130 M.P.H.	- -	12
Torture Tests for Sky Rangers	- -	18
Two Days in the Hornet's Nest	- -	27
Teaching the GI Way	- - -	33
Giving Depth to the Movies	- - -	44
Seven Trillion Dollar Treasure	- -	50
Trackless Railroad	- - -	56
One-Bulb Pictures	- - -	60
It's All Electric but the Horses	- -	65
Flying the Power Midgets	- - -	76
Sharper Eyes for Stargazers	- - -	82

Where-to-Buy-It Index—Page 8A

The Latest in Color Photography

WITH the new color films which will be available after the war, you can take photographs in natural color with almost any camera. It won't be a rich man's hobby either, for quantity production of the color materials may reduce prices to a fraction of prewar figures. After the film is processed into positive color transparencies you can make your own prints or enlargements on color paper. Some of the prints have exceptionally sharp detail and create an impression of three dimensions. A February article brings you up to date on color photography.

The Army's Navy to the Rescue

IN A wood shack on one of the small islands that dot the Caribbean Sea a radio man talks to the pilot of a C-54 en route from Florida to Puerto Rico. He makes a note that this plane, identified by number, has safely passed by. The island is a "check point" for the Army's Air Transport Command, and is part of a rescue system which maintains its own small navy and operates Catalina flying boats. A February article reveals a little known chapter of the ATC.

Published monthly by POPULAR MECHANICS COMPANY, 200 East Ontario Street, Chicago (11), Ill., U. S. A. Single copy in the United States, 25 cents; subscription rates in United States and possessions, and countries of the Pan-American Postal Union, 1 year, \$2.50; 2 years, \$4.50; 3 years, \$6.00. Single copy in Canada, 30 cents; subscription rates, 1 year, \$3.00; 2 years, \$5.50; 3 years, \$7.50. To all other countries add \$1.00 a year over United States prices for overseas postage. If you plan to move, notify us at least 60 days in advance so you will not miss an issue. Give both old and new addresses. Entered as Second Class Matter, September 15, 1903, at the Post Office at Chicago, Illinois, under Act of March 3, 1879. Entered as Second Class Matter at Post Office Dept. Canada. Copyright 1945, by Popular Mechanics Company. Copyright under International Copyright Union. All rights reserved under Pan American Copyright Union. Printed in the United States of America

TWO GREAT NAMES

for the new age of color photography

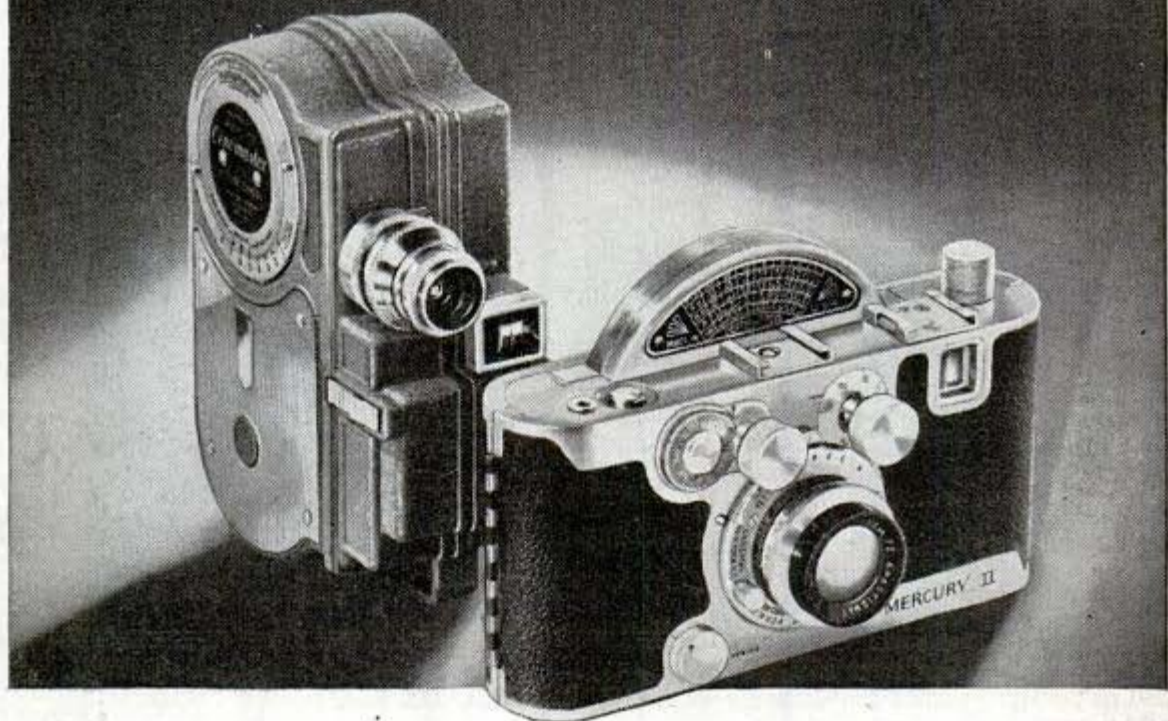

Universal **CINÉMASTER**

The famous Cinémaster 8 mm. Movie Camera and Projector will soon be available. Thanks to Universal's wartime experience in producing precision optical instruments for the armed forces, Cinémaster will boast many important new improvements.

There will be no finer 8 mm. camera and projector on the market!

Watch for preview announcement of a complete line of Cinémaster Home Movie Equipment.

BUY THAT EXTRA WAR BOND TODAY!

Universal **MERCURY II**

The new MERCURY II is the world's first candid camera specially designed for the new color films. It will give you color shots that are sharp, clear and color-true in every part of the picture—both foreground and background—and do it every time. It will give you better color shots at only a fraction of the usual cost. MERCURY II will use any make of 35 mm. film in color or black-and-white, in standard cartridges. And it will be one of the fastest candid cameras ever made!

Look for the Mercury name, too, on a full line of fine precision cameras, accessories and equipment.

COLOR FILMS ARE ONLY THE BEGINNING . . . *New Universal Cameras are specially designed for surer, better, easier results with the new type films.*

UNIVERSAL CAMERA CORP.

NEW YORK • CHICAGO • HOLLYWOOD



Manufacturers of Mercury, Cinémaster, Corsair Cameras and Photographic Equipment

Ann Sheridan gets as much
pleasure from her

Motorola Radio



... as you'll get from her
performance in WARNER BROS'.
happiness hit
"The DOUGHGIRLS"

Many of America's stars of stage, radio and screen enjoy the brilliant performance of Motorola Radio. These are experts who know good performance when they hear it.

On battle fronts throughout the world, Motorola Military Radio has performed brilliantly. The famous "Handie Talkie," an exclusive development of Motorola Radio Engineers, is affectionately called the "fight-

ingest radio" in the army. These same engineers, pioneers in electronics before the war and through it, will have exciting new developments in F-M and A-M radio for your Home and Car.

You have a right to expect improved radio performance in your Post War set and you can depend on Motorola to deliver it soon after Victory in Europe!

GALVIN MANUFACTURING CORPORATION • CHICAGO 51
"HANDIE TALKIE" ANOTHER MOTOROLA FIRST!

 **Motorola**  **Radio**
FOR HOME & CAR



F-M & A-M HOME RADIO • AUTO RADIO • AUTOMATIC PHONOGRAPHS • TELEVISION • F-M POLICE RADIO • RADAR • MILITARY RADIO

THE GREATEST
POWER ON
EARTH !



The Magic of Mind

WERE the great personages of the past victims of a stupendous hoax? Could such eminent men of the ancient world as Socrates, Pericles, and Alexander the Great have been deluded and cast under the spell of witchcraft—or did the oracles whom they consulted actually possess a *mysterious faculty of foresight*? That the *human mind can truly exert an influence over things and conditions* was not a credulous belief of the ancients, but a known and demonstrable fact to them. That there exists a wealth of infinite knowledge just beyond the border of our daily thoughts, which can be aroused and commanded at will, was not a fantasy of these sages of antiquity, but a dependable aid to which they turned in time of need.

It is time you realized that the rites, rituals and practices of the ancients were not superstitions, but subterfuges to conceal the marvelous workings of natural law from those who would have misused them. Telepathy, projection of thought, the materializing of ideas into helpful realities, are no longer thought by intelligent persons to be impossible practices, but instead, *demonstrable sciences*, by which a greater life of happiness may be had.

One of America's foremost psychologists and university instructors, says of his experiments with thought transference and the powers of mind—"The successes were much too numerous to be merely

lucky hits and one can see no way for guessing to have accounted for the results." *Have you* that open-minded attitude of today which warrants a clear, positive revelation of the facts of mind which intolerance and bigotry have suppressed for years? *Advance with the times*; learn the truth about your inherited powers.

Let this free book explain

The Rosicrucians (NOT a religious organization) have been leaders in introducing the ancient wisdom of mental phenomena. Established throughout the world for centuries, they have for ages expounded these truths to those thinking men and women who sought to make the utmost of their natural faculties. Use the coupon below—avail yourself of a pleasing book of interesting information which explains how you may acquire this most *unusual and helpful knowledge*.

The ROSICRUCIANS (AMORC)

USE THIS COUPON

Scribe E.M.K.
The Rosicrucians, AMORC,
San Jose, California.

I am sincerely interested in knowing more about this unseen, vital power which can be used in acquiring the fullness and happiness of life. Please send me, without cost, the book, "THE MASTERY OF LIFE," which tells me how to receive this information.

Name _____

Address _____

State _____

TO THE MAN WHO WANTS SUCCESS

after the WAR!

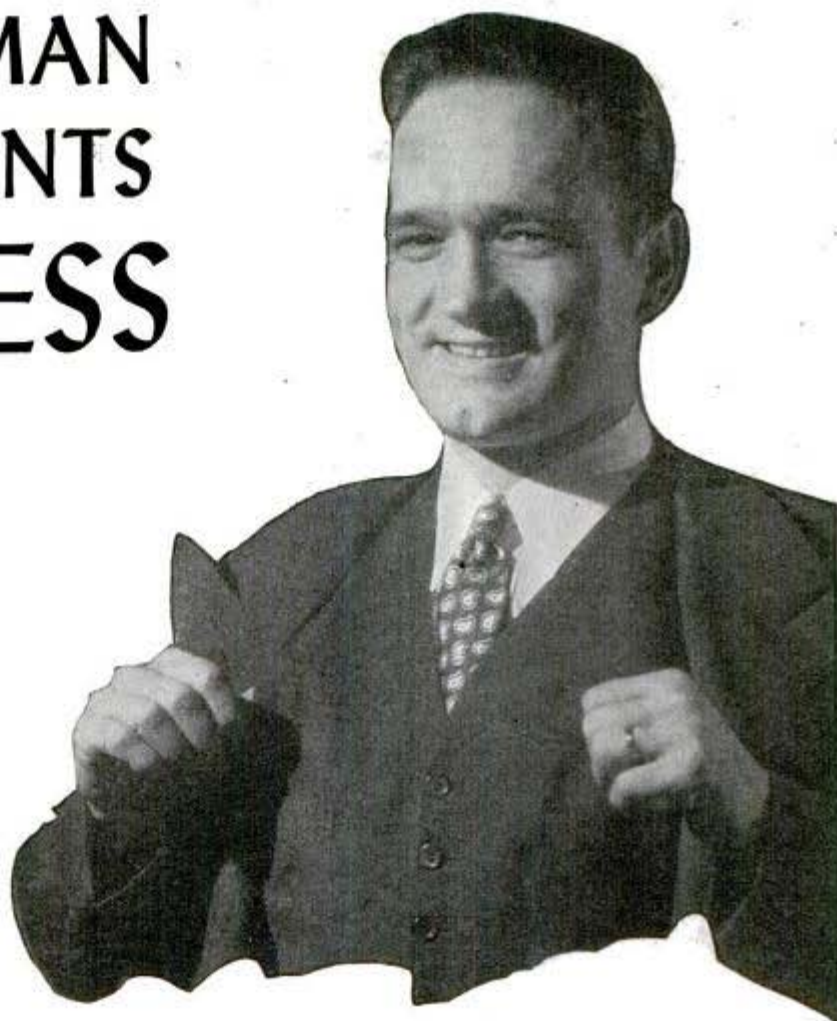

If you want success and security when peace comes, prepare for it now. Make sure that you have the trained ability that employers will want and pay for in the post-war adjustment.

As business converts back to civilian goods, there will be urgent call for accountants, bookkeepers, salesmen, sales and credit correspondents, traffic managers, marketing men, secretaries, office managers and legally trained executives.

For 36 years, LaSalle has been training adults in their spare time for such positions.

It knows how. It can train you—quickly, thoroughly, at moderate cost, without interruption to your present work.

Mark the coupon below for our free booklet about the field of your interest. It costs nothing to get the facts and they may lead you to larger security and success—now and after the armistice whistles blow.

LASALLE EXTENSION UNIVERSITY

A Correspondence Institution

417 SOUTH DEARBORN STREET, DEPT. 164-R, CHICAGO 5, ILLINOIS

I am interested in knowing what your training is and how it can help me in the post-war adjustment. Please send me your free booklet on the field I have marked at right.

- Accounting
- Bookkeeping
- Salesmanship
- Business English

- Law: LL.B. Degree
- Business Law
- Office Management
- Business Correspondence
- Stenotypy: machine shorthand

- Traffic Management
- Executive Management
- Foremanship
- Industrial Management

Name.....Age.....

Position.....Address.....

City and State.....

THE NEXT TIME YOU BUY GAS SAY . . . "ADD PYROIL PLEASE"



Pyroil increases lubrication efficiency. It protects your pistons and cylinders from excessive wear. It reduces destructive friction and permits quicker starting even in coldest weather. It prevents sludges and carbon formation. Three ounces in your gasoline every two or three hundred miles—a pint in the crank case does all this for you. Say—"Add Pyroil, please"—and add life to your car.

Manufactured and Guaranteed by Pyroil Company, W. V. Kidder, Founder, 51 Pyroil Bldg., La Crosse, Wis.

PYROIL
ADDS LIFE TO YOUR CAR
Keep Buying Bonds



PYROIL COMPANY

51 Pyroil Bldg., La Crosse, Wisconsin

I want my car to last and run properly. Please tell me more about Pyroil and how it can accomplish this for me.

Name
Address
City or Town State

WHERE-TO-BUY-IT INDEX

Where no name and address appear directly under an item, the product is not believed by us to be commercially available

Service station on wheels for planes	5
Guns' range extended by firing at top of roll	6
Inactive ships kept rustproof	6
Midjet tank built by Yanks	6
New planes for war and peace	14
Imitation Jap cruiser is bombing target	16
Conveyor speeds delivery of tomatoes	16
Superfuel better than 100-octane gas	16
Gas tank salvaged from plane becomes miniature taxi	17
Treating fibers makes runless hose, non-shrink wool	17
Machine removes fuzz from peaches	17
Non-flying kite measures wind velocity	26
Pathfinder planes mark target with colored smoke	26
Grenade launcher casts fishing line	26
Angle adapter gives drill press versatility	32
Nobur Mfg. Co., 910 N. Orange Drive, Los Angeles 38, Calif.	32
More powerful vaccine through ultra-violet process	32
Michael Reese Hospital and Ill. Dept. of Public Health, Chicago	32
"Exploded view" of parts makes assembly simple	32
Tempo, Inc., 230 E. Ohio St., Chicago 11	32
Camera "freezes" spilled milk in weird designs	38
Anti-glare goggles help spot submarines	38
1100-lb. automobile gets 40 miles to the gallon	38
Bamboo pipeline saves metal on China front	39
"Speed bomb" aids in checking plane instruments	39
Preview—postwar developments for the home	40
Armed transport fights own battles	42
Cloth "sweats" fresh water from sea water	42
Army ducks lay smoke screen	42
Electronic "brain" closes window	43
Wires measured to millionth of an inch	43
Floating monitor helps fight pier fires	43
Big guns of industry	48
Giant camera speeds airplane designing	49
Concrete tanks wound with wire for reinforcement	49
Redesigned B-29 will be postwar Stratocruiser	54
Plywood tubing has many uses	55
Plymold Corp., Lawrence, Mass.	55
Postwar refrigerator has built-in freezer	55
Admiral Corp., 3800 Cortland St., Chicago 47	59
Students practice bombing without leaving ground	59
Stratosphere food warmer for B-29 crews	64
10,000 h.p. gas turbines predicted for aircraft	64
Screwdriver with offset shank speeds war work	64
Mechanical Research Co., 601 Failing Bldg., Portland 4, Ore.	70
Insulating material expands five-fold	70
Kimberly-Clark Corp., 8 S. Michigan Ave., Chicago 3	70
Electronic device tests hardness of metals	70
Allen B. Du Mont Laboratories, Passaic, N. J.	70
Improved plastics for postwar products	70
Turret head quadruples usefulness of drill press	70
Chicago Drilllet Corp., 919 N. Michigan Ave., Chicago 11	71
Chemical protects tanks and pipes from scale	71
Calgon, Inc., Hagan Bldg., 323 Fourth Ave., Pittsburgh 22, Pa.	71
Twin ducks carry P-38 planes from ship to shore	71
Electronic control speeds milling operation	71
Modeling marine life in glass	72
Parachute acts as brake in landing glider	74
Rotary cooker turns out 200 steaks per hour	74
Groetchen Mfg. Co., 126 N. Union Ave., Chicago 6	75
One-man bazooka fires 4.5-inch rocket	75
New plating slows corrosion on electrical instruments	75
No-accident home has built-in safety features	80
Plane drops "pararaff" to shipwrecked flyers	81
Sprayer for stripping wall paper attached to garden hose	81
Mistic Manufacturing Co., 255 McCormick Pl., Cincinnati 19, O.	86
Aerial trams for wounded also carry supplies	86
Slide rule gives decimal point to 19 places	86
Pickett & Eckel, 53 W. Jackson Blvd., Chicago 4	87
2,000,000-volt X-ray units penetrate 12 inches of steel	87
Bombs with spikes stick where they hit	87
Floating hotels for Navy personnel	88
Rolling magnet picks up nails from road	88
Celluloid lettering scale	144
Frederick Post & Co., Box 803, Chicago 90	

Craftsman and Shop Notes Index

ART AND ARTIST	
Transparent rule on board aids draftsman	92
Tracing cloth on triangle for testing drawing pen	98
Non-tip base for India ink bottle	102
Tightening artist's canvas on frame	112
Improving crow quill pen	118
Straight lines inked with ordinary pen	118
AUTOMOTIVE	
Cotter pin removes valve core	92
Protecting bottom of water can in garage	104
Rubber heel made into pedal pad	114
Cleaning gear-shift air filter	130
Springs prevent swaying of towed car	130
Limiting spread of inner tube cuts	131
Adjustable drag chain for tank trucks	137
Water expands shrunken gasket	137
Shield protects car when filling fuel tank	138
Tool for straightening radiator fins	138
Preventing damage to threads on wash-rack hose	140
CAMPING, HUNTING AND FISHING	
Lightweight ice scooter	93
Tin can oven toasts marshmallows	96
Oar and paddle rack	115
ELECTRICAL	
Simple time switch made from alarm clock	96
Rubber cushion protects porcelain wall sockets	112
Polarity test paper	112

(Continued to page 10A)

"Why, he knows all about me!"

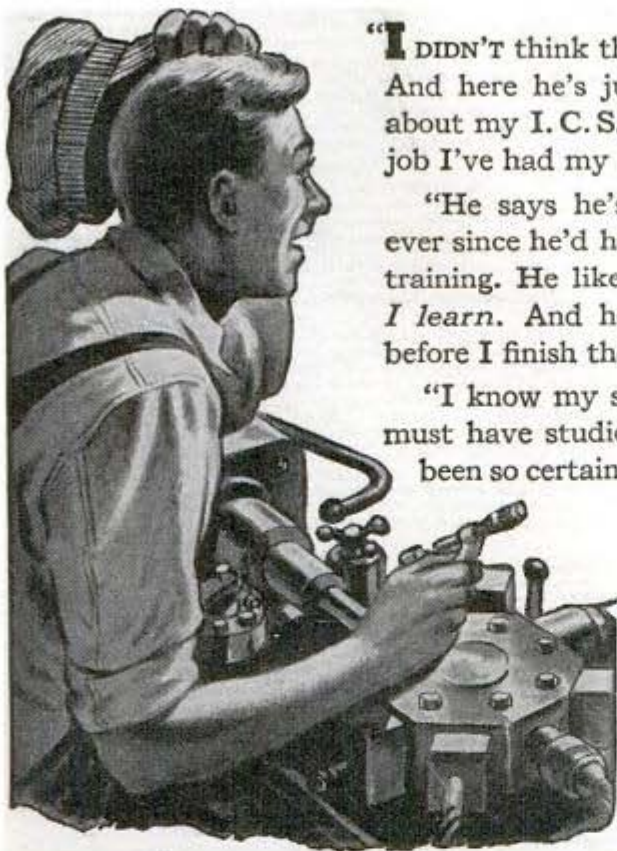

"I DIDN'T think the boss knew my name. And here he's just stopped by to talk about my I. C. S. Course and the bigger job I've had my eye on.

"He says he's had *his eye* on me ever since he'd heard I was getting that training. He likes the idea of my applying what I learn as *I learn*. And he says there'll be good news for me even before I finish the course.

"I know my studies showed in my work. But I guess he must have studied with I. C. S. himself or he couldn't have been so certain about just where I was getting my training."

Quite possibly the boss is an I. C. S. graduate. Thousands of employers are. Whether he is or isn't, however, he knows about your studies. I. C. S. regularly reports student progress to superiors. Letters of employer appreciation for this service are a regular part of our mail. So are student and graduate letters telling us of advancements—600 a month on an average. There *must* be a connection. Mail the coupon for full information.

INTERNATIONAL CORRESPONDENCE SCHOOLS



BOX 5511-K, SCRANTON 9, PENNA.

Without cost or obligation, please send me booklet and full particulars about the course *before* which I have marked X:

- | | | | |
|---|--|--|---|
| <p>Air Conditioning and Plumbing Schools</p> <p><input type="checkbox"/> Air Conditioning</p> <p><input type="checkbox"/> Heating <input type="checkbox"/> Plumbing</p> <p><input type="checkbox"/> Refrigeration <input type="checkbox"/> Steam Fitting</p> <p>Chemistry Schools</p> <p><input type="checkbox"/> Chemical Engineering</p> <p><input type="checkbox"/> Chemistry, Analytical</p> <p><input type="checkbox"/> Chemistry, Industrial</p> <p><input type="checkbox"/> Chemistry, Mfg. Iron & Steel</p> <p><input type="checkbox"/> Plastics</p> <p><input type="checkbox"/> Pulp and Paper Making</p> <p>Civil Engineering, Architectural and Mining Schools</p> <p><input type="checkbox"/> Architectural Drafting</p> <p><input type="checkbox"/> Architecture</p> <p><input type="checkbox"/> Bridge and Building Foreman</p> <p><input type="checkbox"/> Bridge Engineering</p> <p><input type="checkbox"/> Building Estimating</p> <p><input type="checkbox"/> Civil Engineering <input type="checkbox"/> Coal Mining</p> <p><input type="checkbox"/> Contracting and Building</p> <p><input type="checkbox"/> Highway Engineering</p> <p><input type="checkbox"/> Lumber Dealer</p> <p><input type="checkbox"/> Sanitary Engineering</p> <p><input type="checkbox"/> Structural Drafting</p> <p><input type="checkbox"/> Structural Engineering</p> <p><input type="checkbox"/> Surveying and Mapping</p> | <p>Electrical Schools</p> <p><input type="checkbox"/> Electrical Drafting</p> <p><input type="checkbox"/> Electrical Engineering</p> <p><input type="checkbox"/> Power House Electric</p> <p><input type="checkbox"/> Practical Electrician</p> <p><input type="checkbox"/> Practical Telephony</p> <p><input type="checkbox"/> Telegraph Engineering</p> <p>Internal Combustion Engines School</p> <p><input type="checkbox"/> Auto Technician <input type="checkbox"/> Aviation</p> <p><input type="checkbox"/> Diesel-Electric</p> <p><input type="checkbox"/> Diesel Engines <input type="checkbox"/> Gas Engines</p> <p>Mechanical Schools</p> <p><input type="checkbox"/> Aeronautical Engineering</p> <p><input type="checkbox"/> Airplane Drafting</p> <p><input type="checkbox"/> Flight Engineer</p> <p><input type="checkbox"/> Foundry Work</p> <p><input type="checkbox"/> Heat Treatment of Metals</p> <p><input type="checkbox"/> Industrial Engineering</p> <p><input type="checkbox"/> Industrial Metallurgy</p> <p><input type="checkbox"/> Mechanical Drafting</p> <p><input type="checkbox"/> Mechanical Engineering</p> <p><input type="checkbox"/> Mold-Loft Work</p> <p><input type="checkbox"/> Patternmaking</p> <p><input type="checkbox"/> Reading Shop Blueprints</p> <p><input type="checkbox"/> Sheet-Metal Drafting</p> <p><input type="checkbox"/> Sheet-Metal Worker</p> | <p><input type="checkbox"/> Ship Drafting</p> <p><input type="checkbox"/> Ship Fitting</p> <p><input type="checkbox"/> Shop Practice</p> <p><input type="checkbox"/> Steel Mill Workers</p> <p><input type="checkbox"/> Tool Designing</p> <p><input type="checkbox"/> Welding, Gas and Electric</p> <p>Radio School</p> <p><input type="checkbox"/> Electronics</p> <p><input type="checkbox"/> Radio, General</p> <p><input type="checkbox"/> Radio Operating</p> <p><input type="checkbox"/> Radio Servicing</p> <p>Railroad School</p> <p><input type="checkbox"/> Air Brake <input type="checkbox"/> Car Inspector</p> <p><input type="checkbox"/> Locomotive Engineer</p> <p><input type="checkbox"/> Locomotive Fireman</p> <p><input type="checkbox"/> Railroad Section Foreman</p> <p>Steam Engineering Schools</p> <p><input type="checkbox"/> Boilermaking</p> <p><input type="checkbox"/> Combustion Engineering</p> <p><input type="checkbox"/> Engine Running</p> <p><input type="checkbox"/> Marine Engineering</p> <p><input type="checkbox"/> Steam Electric</p> <p><input type="checkbox"/> Steam Engines</p> <p>Textile School</p> <p><input type="checkbox"/> Cotton Manufacturing</p> <p><input type="checkbox"/> Rayon Weaving</p> | <p><input type="checkbox"/> Textile Designing</p> <p><input type="checkbox"/> Woolen Manufacturing</p> <p>Business and Academic Schools</p> <p><input type="checkbox"/> Accounting <input type="checkbox"/> Advertising</p> <p><input type="checkbox"/> Arithmetic <input type="checkbox"/> Bookkeeping</p> <p><input type="checkbox"/> Business Correspondence</p> <p><input type="checkbox"/> Business Management</p> <p><input type="checkbox"/> Certified Public Accounting</p> <p><input type="checkbox"/> City Letter Carrier</p> <p><input type="checkbox"/> College Preparatory</p> <p><input type="checkbox"/> Commercial</p> <p><input type="checkbox"/> Cost Accounting</p> <p><input type="checkbox"/> Federal Tax</p> <p><input type="checkbox"/> First Year College</p> <p><input type="checkbox"/> Foremanship</p> <p><input type="checkbox"/> French <input type="checkbox"/> Good English</p> <p><input type="checkbox"/> High School</p> <p><input type="checkbox"/> Higher Mathematics</p> <p><input type="checkbox"/> Illustrating</p> <p><input type="checkbox"/> Motor Traffic</p> <p><input type="checkbox"/> Post Office Clerk</p> <p><input type="checkbox"/> Railway Postal Clerk</p> <p><input type="checkbox"/> Salesmanship <input type="checkbox"/> Secretarial</p> <p><input type="checkbox"/> Spanish</p> <p><input type="checkbox"/> Stenography</p> <p><input type="checkbox"/> Traffic Management</p> |
|---|--|--|---|

Name..... Age..... Home Address.....
 City..... State..... Present Position..... Working Hours..... A.M. to..... P.M.

Canadian residents send coupon to International Correspondence Schools Canadian, Ltd., Montreal, Canada.
 British residents send coupon to I. C. S., 71 Kingsway, London, W. C. 2, England.

DISCOUNT TO DISCHARGED VETERANS—SPECIAL TUITION RATES FOR MEMBERS OF THE ARMED FORCES

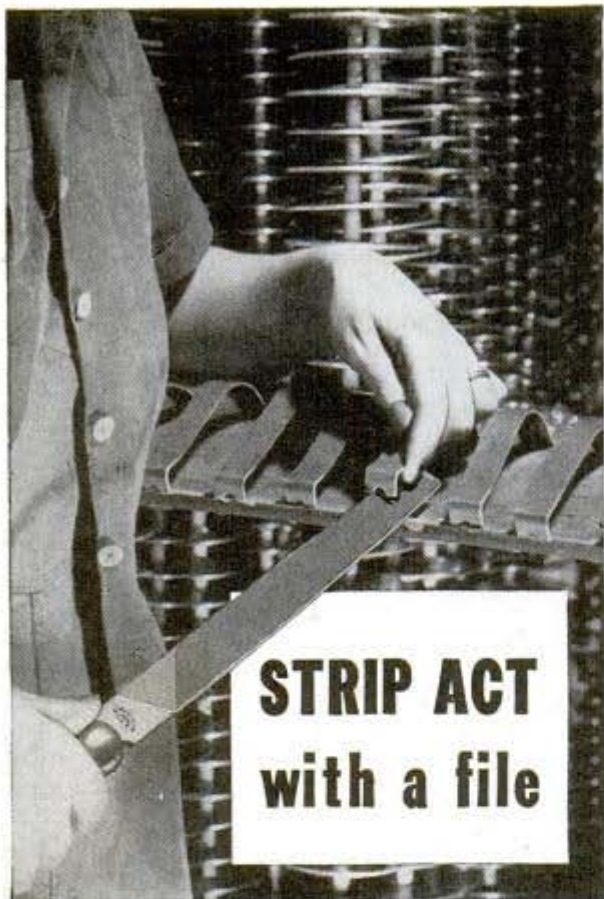

STRIP ACT with a file

YES, industry has its "strip acts." The one illustrated here helps to make airplane and other vital war-product parts strong and dependable.

It is part of a plating operation which provides aluminum alloys with a "diamond-hard" finish impervious to rust and tremendously resistant to surface wear. So tenacious is the anodizing solution that *only a file* can strip the residue from the racks which hold the parts while being dipped.

Stainless steel, chromium and other modern metals and alloys issue an unending challenge to shop tools. Nicholson manufacture and research are constantly meeting it where files are concerned. File steels, tooth structure, hardening—all have made such progress that Nicholson Files, in thousands of kinds, cuts and sizes, are recognized by mechanics throughout the world as the very highest in quality and modern design.

FREE BOOK, "FILE PHILOSOPHY"—an intensely interesting and informative handbook (48 pages) for production and purchasing heads, foremen, key mechanics, "hobbyists."

NICHOLSON FILE CO., 22 Acorn St., Providence 1, R. I., U. S. A.
(Also Canadian Plant, Port Hope, Ont.)

NICHOLSON FILES

FOR EVERY
PURPOSE

NICHOLSON
U.S.A.
MADE IN U.S.A.

(Continued from page 8A)

FARM

Dual-steering bobsled has many uses.....	98
Repairing leaky watering tank.....	129
Rattrap safety release for implement trip rope.....	130
Honey boxes secured in hives by horse-collar clips.....	138
Holding cordwood on sawhorse.....	140

HAND TOOLS

Hole in hammer head aids in clinching nails.....	92
Large clamp improvised from screw jack.....	96
Note pad on yardstick is handy.....	102
Blue chalk in box keeps tools from rusting.....	104
Protecting and resurfacing grindstones.....	129
Bit guides aid in reboring holes.....	140

HOME IMPROVEMENTS

Forced draft for heating plant.....	101
Counterweighted basement door easy to open and close.....	104
Paint magic for your walls.....	106
Repairing leaky flue in steam boiler.....	114
Wall brackets from light fixtures.....	119

HOUSEHOLD

Keeping dogs from upsetting garbage can.....	92
Solving home problems.....	94
Reducing soap waste.....	98
Repairing laundry tubs.....	100
Pin-up lamp shade from glass brick.....	101
Paper pots for starting plants.....	105
Strips keep rain from windows.....	114
Nail polish mends torn curtain.....	115

OFFICE

Ruler guides aid in drawing uniform lines.....	91
Inserting paper and carbons in typewriter.....	96
Cleaning typewriter keys with blotter.....	100
Reglazing tracing paper after erasure.....	102
Identifying bundles of file cards.....	112
Mimeograph ink thinned with oil.....	118
Removing dust from mimeograph stencil.....	130
Index tabs protected with lacquer.....	138

PHOTOGRAPHY

Lantern slides from your negatives.....	120
Tapeline determines exposure for close-ups.....	123
Camera on pivoted platform for making stereo photos.....	123

POWER TOOLS

Chamfering small work on belt sander.....	105
Small metal-turning lathe.....	125
Tips on taps.....	132
Pulleys removed from shaft by bar clamps.....	137
Facing several small pieces of round stock.....	137

RADIO AND ELECTRONICS

Speaker replacements in small sets.....	141
"Seven Seas" a.c.-d.c. short-wave three tuber.....	142
Control panels for meters and electronic testing equipment.....	144

STORE AND SHOP

Leaky oilcan repaired with hose washer.....	130
Counter racks save time in store.....	131
Tilting table displays wallpaper.....	131
Clips hold carton open.....	138
Notches on oilcan identify viscosity of oil.....	140

TOYS, GAMES AND NOVELTIES

Whittling deer in five poses.....	103
A pair of play telephones.....	104
Game boards made faster with wax paper.....	118

WOODWORKING

Humpty-dumpty rocking chair.....	89
Wooden tidbit dishes of novel design.....	91
Guide block aids in cutting mortises by hand.....	92
Small cabinets for hobby collections.....	97
Smoking stand for your easy chair.....	99
Holder for work gloves.....	113
Sturdy table for cottage.....	115
Six styles in band-sawed block ends.....	116
Adjustable boring jig for lathe.....	139

MISCELLANEOUS

Repairing alarm clock springs.....	92
Arm sling placed to avoid neck strain.....	93
Improvised pencil clip.....	93
Repairing worn bearings on clocks.....	96
Using scrap pieces of sponge.....	98
Portable signaling blinker from photo-flash gun.....	102
Rifle shell acts as pocket sewing kit.....	102
Foot operated stop for large door.....	104
Small flashlight illuminates music at night.....	112
Fitting lids of plastic containers.....	112
Reducing needle pressure on records.....	113
Preventing envelopes sealing before use.....	114
Key ring in grommet helps attach flag.....	114
Using shovel as gauge in determining grade line.....	118
Easy way to locate center of circle.....	118
Collections displayed in inverted jars.....	122
Craft quiz.....	124
Spelling board for conversing with deaf-blind.....	128
Mousetrap holds ribbon badges for lettering.....	128
Scraper for cleaning bevel gears.....	129
Retrieving linotype matrices.....	130
Lumber crayon improved by wrapping.....	140

IMPORTANT NOTICE

It is the intention of this magazine to provide its readers with information regarding the latest developments in the mechanical arts. We take no responsibility as to whether the disclosures contained in our articles are covered by patents and advise readers to investigate this subject before making, using, or selling any of the products, machines, or processes described in order to avoid possible liability for patent infringement.

AUDELS REFRIGERATION & AIR CONDITIONING GUIDE....\$4

New from Cover to Cover—1280 Pages, Fully Illus. Covering basic principles, servicing, operation & repair of household, commercial & industrial refrigeration & air conditioning. A gold mine of essential important facts for engineers, servicemen, users.

AUDELS CARPENTERS & BUILDERS GUIDES—4 Vols.\$6

A practical illustrated trade assistant on modern construction for carpenters, joiners, builders, mechanics and all woodworkers. 4 vols., 1600 pages, 3700 illustrations, flexible covers. Pocket size. Each volume sold separately \$1.50 a vol.

AUDELS AUTOMOBILE GUIDE....\$4

A practical quick ready reference book for auto mechanics, service men, operators & owners. Explains theory, construction & servicing of modern motor cars, trucks, buses & auto type Diesel engines. 1540 pages, fully illustrated, 55 chapters. Indexed. A standard book for mechanics. New fluid drive covered.

AUDELS DIESEL ENGINE MANUAL.\$2

A practical, concise treatise with questions and answers on the theory, operation and maintenance of modern diesel engines including General Motors 2 cycle Diesel. 334 pages, fully illus., flexible binding, pocket size. All details plainly brought out, this book is of extreme value to engineers, operators & students.

AUDELS WIRING DIAGRAMS.....\$1

210 Pages. Illustrated. Gives practical facts on wiring of electrical apparatus. It shows clearly how to wire apparatus for practically all fields of electricity. Each diagram is complete & self-explanatory. Highly Endorsed Pocket Companion.

AUDELS PLUMBERS & STEAMFITTERS GUIDES—4 Vols.\$6

A Practical Trade Assistant & Ready Reference. Explains in plain language & by clear illustrations, diagrams, charts, graphs, pictures principles of modern plumbing practice including Marine Pipe Fitting and Air Conditioning. 4 Vols.—1070 Pages—3442 Diagrams. Pocket size. Each Vol. Sold Separately \$1.50 a Vol.

AUDELS SHEETMETAL WORKERS HANDY BOOK.....\$1

Practical inside information. Fundamentals of Sheet Metal Work. 388 pages. Illustrated. 11 sections. Clearly written. Essential & important facts, figures, pointers in everyday language. Ref. Index.

AUDELS SHEETMETAL PATTERN LAYOUTS.....\$4

Developed by Experts for Sheet Metal Workers, Layout Men & Mechanics. A Practical Encyclopedia in 10 Sections, size 7 x 10 x 2—1125 Pages—350 Layouts—1600 Illustrations, 1001 Key Facts. Fully indexed for ready reference in answering your layout problems. Covers all phases of sheet metal work including Pattern Cutting, Pattern Development & Shop Procedure.

AUDELS ANSWERS ON BLUE PRINT READING.....\$2

For Mechanics & Builders. Covers all types of blue print reading including ship & airplane. 376 pages, fully illustrated.

AUDELS NEW MACHINIST & TOOLMAKERS HANDY BOOK...\$4

Covers modern machine shop practice in all its branches. 5 practical books in 1. New from cover to cover. Tells how to set up & operate lathes, screw and milling machines, shapers, drill presses and all other machine tools. 1600 pages, fully illustrated, 5 x 8 1/2 x 2. Indexed. 5 sections. 1—Modern Machine Shop Practice. 2—Blue Print Reading & How to Draw. 3—Calculations & Mathematics for Machinists. 4—Shop Physics. 5—How to Use the Slide Rule. 60 chapters. Easy to read and understand. A shop companion that answers your questions.

AUDELS MATHEMATICS & CALCULATIONS FOR MECHANICS \$2

Mathematics for home study or reference. 700 pages, 550 illus. Practical mathematics from beginning. How to figure correctly. Easy, correct methods covering a complete review. Ill. & Indexed.

AUDELS HANDY BOOK OF PRACTICAL ELECTRICITY.....\$4

For maintenance engineers, electricians & all electrical workers. 1440 Pages, 2600 Illus. Covers important electrical information in handy form—including Marine Wiring, Radio Principles, Welding. Indexed. A Key to a practical understanding of electricity.

AUDELS RADIOMANS GUIDE.....\$4

A key to the practical understanding of radio including Frequency Modulation, Television, etc., Aircraft & Marine Radio. For radio engineers, servicemen, amateurs. 772 pages. 400 Illustrations & Diagrams. Photos. Review Questions & Answers, Reference Index. Authentic, clear, concise.

AUDELS ELECTRONIC DEVICES...\$2

Tells What You Want to Know About Electric Eye. Easily Understood. Covers photo-electric cells & their applications. Amplifiers, illumination, frequencies, voltage, photocell, tubes, Ohm's Law, wiring diagrams, etc.

AUDELS WELDERS GUIDE.....\$1

A concise, practical text on operation & maintenance of all welding machines for all mechanics. Over 400 pages, illustrated. Covers all methods of electric and acetylene welding including airplane work.

AUDEL, Publishers, 49 W. 23 St., N. Y. 10



AN AUDEL GUIDE IS A GOOD FRIEND!

Use the brains and experience of others in these Guides of the Trades. Save time and money with right methods, short cuts, labor saving ideas. CHECK NOW! You can look over any Audel Guide in your home. Start the Easy Payments if satisfied.

CUT HERE MAIL ORDER

THEO. AUDEL & CO., 49 W. 23 St., New York 10, N.Y.

Please mail me for 7 days' free examination the books marked (X) below. I agree to mail \$1 in 7 days on each book or set ordered, and to further mail \$1 a month on each book or set ordered until I have paid purchase price.

If I am not satisfied with Guides I will return them.

- Audels REFRIGERATION & Air Conditioning Guide \$4.
- Audels PUMPS, HYDRAULICS & AIR COMPRESSORS 4.
- Audels WELDERS GUIDE 1
- Audels BLUE PRINT READING 2
- Audels SHEET METAL WORKERS Handy Book 1
- Audels SHEET METAL PATTERN LAYOUTS 4
- Audels AIRCRAFT WORKER 1
- Audels MATHEMATICS and CALCULATIONS 2
- Audels MACHINISTS & TOOLMAKERS Handy Book 4
- Audels DIESEL ENGINE MANUAL 2
- Audels MECHANICAL Dictionary 4
- Audels AUTOMOBILE GUIDE 4
- Audels MARINE ENGINEERS Handy Book 4
- Audels SHIPFITTERS Handy Book 1
- Gueths MECHANICAL DRAWING COURSE 1
- Rogers DRAWING and DESIGN 2
- Audels MILLWRIGHTS and Mechanics Guide 4
- Audels CARPENTERS and Builders Guides (4 vols.) 4
- Audels PLUMBERS and Steamfitters Guides (4 vols.) 6
- Audels MASONS and Builders Guides (4 vols.) 6
- Master PAINTER and DECORATOR 2
- Audels GARDENERS & GROWERS GUIDES (4 vols.) 6
- Audels ENGINEERS and Mechanics Guides Nos. 1, 2, 3, 4, 5, 6, 7 and 8 complete 12
- Audels Answers on Practical ENGINEERING 1
- Hawkins Aids to ENGINEERS EXAMINATION 2
- Audels WIRING DIAGRAMS 1
- Audels Handy Book of PRACTICAL ELECTRICITY 4
- Audels ELECTRICAL POWER CALCULATIONS 2
- Hawkins ELECTRICAL Guides at \$1. each 10
- Audels ELECTRONIC DEVICES 2
- Audels ELECTRIC Dictionary 2
- Audels RADIOMANS GUIDE 4
- Audels NEW ELECTRIC LIBRARY at \$1.50 a Volume Vols. I, II, III, IV, V, VI, VII, VIII, IX, X, XI, XII.

Name.....

Address.....

Occupation.....

Employed by..... PM



Building this A. M. SIGNAL GENERATOR gives you valuable experience. Provides amplitude-modulated signals for test and experiment purposes.

Radio Servicing pays many good money for full time work. Many others make \$5, \$10 a week EXTRA fixing Radios in spare time.



Learn Radio

WITH THE 6 BIG KITS OF



J. E. SMITH, President
National Radio Institute
Our 31st Year of Training Men
for Success in Radio

BE A SUCCESS IN RADIO I Will Train You at Home

Here's a *practical* way to learn Radio at home in spare time—to train for a good Radio job, or to start your own spare time or full time Radio service business!

Many Beginners Soon Make \$5, \$10 a Week EXTRA in Spare Time

You get Radio EXPERIENCE building real Radio Circuits with kits of standard parts I send. You get solid KNOWLEDGE of Radio, Television, Electronic fundamentals from my easy-to-grasp lessons. You follow the same "50-50" method that has helped hundreds of beginners make \$5, \$10 EXTRA a week in spare time while learning . . . and prepared them for full time Radio jobs at good pay.

Future Looks Bright for Trained Radio Technicians and Operators

The Radio Repair Business is booming. Profits are large and peacetime prospects are bright. Broadcasting Stations, Aviation Radio, Police Radio, Loudspeaker Systems, Radio Manufacturing all employ trained Radio men at good pay—and many of these fields have a *big backlog* of business built up during the war—*plus* opportunities to expand into new fields opened by wartime developments. You may never see a time again when it will be so easy to get a start in Radio!

MEN I TRAINED AT HOME Get Good Jobs Like These



\$200 a Month in Own Business
"For several years I have been in business for myself making around \$200 a month. Business has steadily increased. I have N. R. I. to thank for my start."—A. J. FROEHNER, 300 W. Texas Ave., Goose Creek, Texas.



\$600 Before Graduating, Kits Helped
"From your Experimental Kits I learned how electricity worked, how to connect the three stages of a Radio together, also the practical basis for the operation of different parts of a set. I made about \$600 or \$700 before I graduated."—S. G. PIERSON, Box 71, Dry Creek, W. Va.



Chief Operator Broadcasting Station
"Before I completed your lessons, I obtained my Radio Broadcasting Operator's license and immediately joined Station WMPG where I am now Chief Operator."—HOLLIS F. HAYES, 327 Madison St., Lapeer, Michigan.



Radio Service Manager of 4 Stores
"I was working in a garage when I enrolled with N. R. I. I am now Radio Service Manager for M. . . Furniture Co. for their 4 stores."—JAMES E. RYAN, 119 Pebble Court, Fall River, Mass.



\$10 a Week in Spare Time
"I repaired some Radios when I was on my tenth lesson. I made \$600 in a year and a half, and have made an average of \$10 a week—just spare time."—JOHN JERRY, 300 So. H. St., Exeter, California.

FIND OUT ABOUT THIS **TESTED WAY**

You build this **MEASURING INSTRUMENT** yourself early in the Course—use it for practical Radio work on neighborhood Radios to pick up **EXTRA** spare time money!

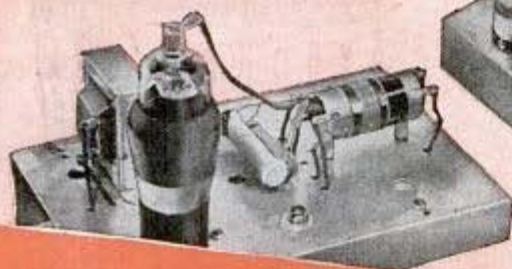

You build this **SUPERHETERODYNE CIRCUIT** that brings in local and distant stations. You get practical experience putting this set through fascinating tests!

by Practicing in Spare Time

RADIO PARTS I SEND YOU

Be Ready to Cash In on Jobs Coming with Television, Electronics

Think of the **NEW** jobs that Television, Frequency Modulation, Electronics, other Radio Developments promise for the peacetime future. You have a real opportunity. I will train you to be ready to cash in when amazing wartime developments are released for unlimited peacetime use.

Mail Coupon for My Free Lesson and 64-Page Illustrated Book

I will send you Free, a sample Lesson, "Getting Acquainted with Receiver Servicing," to show you how practical it is to train for Radio in spare time. And with it I'll send my 64-page, illustrated book, "Win Rich Rewards in Radio" FREE. It describes many fascinating jobs in Radio, tells how you can get started. No obligation—no salesman will call. Mail coupon in an envelope or paste it on a penny postal.—**J. E. SMITH, President, Dept. 5AP, National Radio Institute, Washington 9, D. C.**

My Radio Course Includes

TELEVISION ★ ELECTRONICS

FREQUENCY MODULATION

Think of the **NEW** jobs that Television, Frequency Modulation, Electronics, and other developments will open after the war! I will train you to be ready to cash in when Victory releases the amazing wartime developments for peacetime uses!

Sample Lesson

64 Page Book

BOTH FREE

FREE LESSON gives hints on Receiver Servicing, Locating Defects, Repair of Loudspeakers, I. F. Transformer, Gang Tuner Condenser, etc., 31 illustrations. Study it—keep it—use it—without obligation! Mail Coupon NOW for your copy!



GET BOTH 64 PAGE BOOK SAMPLE LESSON FREE

MR. J. E. SMITH, President, Dept. 5AP
NATIONAL RADIO INSTITUTE, Washington 9, D. C.

Mail me FREE, without obligation, Sample Lesson and 64-page book, "Win Rich Rewards in Radio." (No salesman will call. Please write plainly.)

Age.....

Name

Address

City..... State.....4FR

(Please include Post Office zone number)

TO GOOD PAY

NEW BOOK *for*

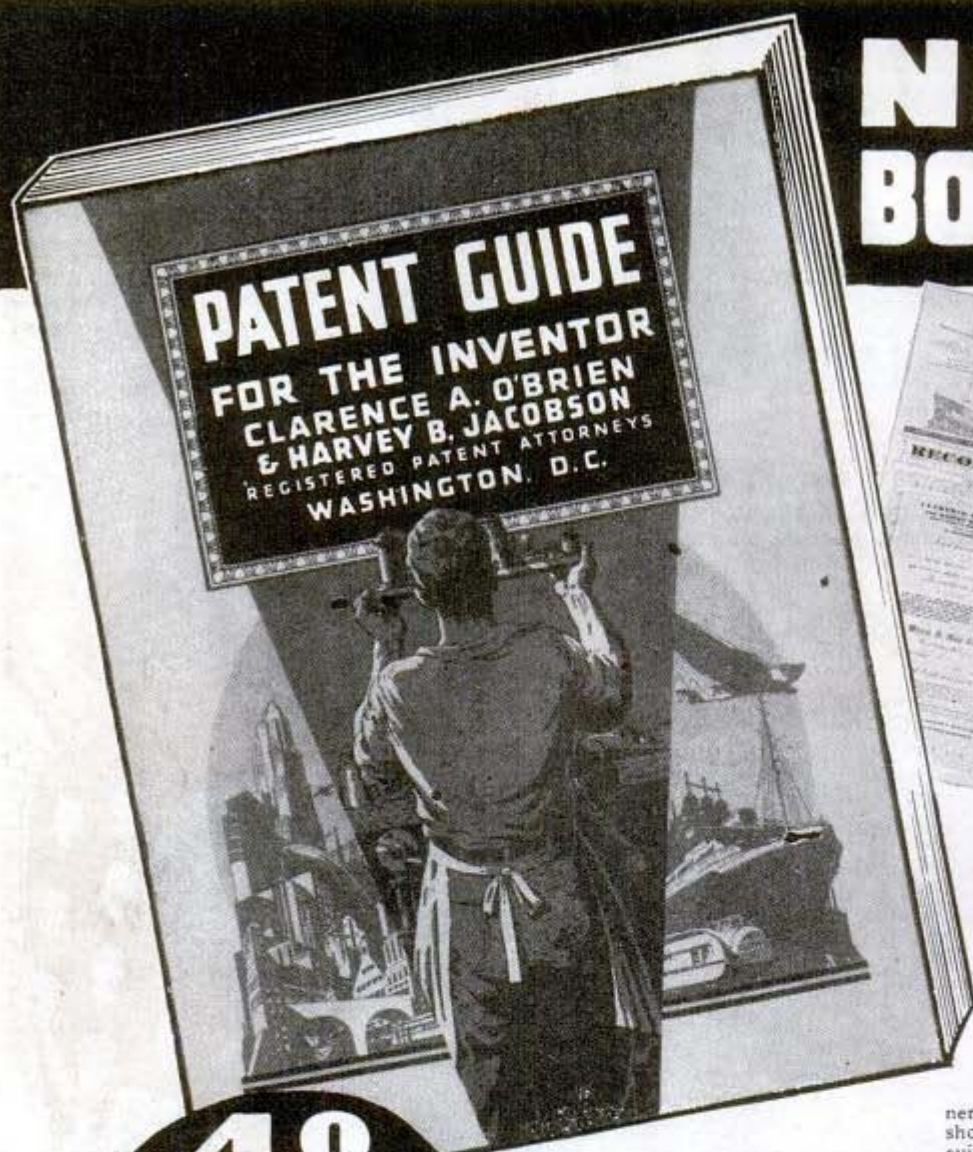

FREE RECORD OF INVENTION

This FREE Record of Invention form enables you to conveniently make a sketch of your invention and have it witnessed in a manner of value to you, should the occasion for evidence arise.

48
PAGES
Over 150
Mechanical
Movements

LATEST FACTS ON INVENTIONS

Is your invention something for the home, the farm, the factory, the store? Would you like to know whether anything like it has ever been invented, and if not, how to protect your invention? Our new 48-page book "Patent Guide for the Inventor" will show you how to proceed with your invention. You'll get a good idea of whether you "have something" or not. Would you like to know how you may judge the marketability of your invention? This book gives you several important tests prepared by authorities. Read of the experiences of Bell, Edison, Westinghouse, and other outstanding, successful inventors who patented and thereby protected their inventions. This book not only tells you how to obtain a patent, it also explains the steps that must be taken afterward to promote the success of your invention. MAIL THE COUPON TODAY to Clarence A. O'Brien & Harvey B. Jacobson, Registered Patent Attorneys, 51-A Adams Building, Washington 4, D. C.

**CLARENCE A. O'BRIEN
& HARVEY B. JACOBSON**
REGISTERED PATENT ATTORNEYS

INVENTORS

NOW Is the Time to PATENT and SELL Your Invention

Now, more than ever before, is the right time to patent your invention. Why? Because manufacturers everywhere presently engaged in war production are looking ahead to the future by buying up patent rights now, so they will have new and attractive items to make and sell for civilian consumption as soon as the war is over. This is what happened during and after the last war. Hence, the smart thing for you to do is to look ahead to the future too. Protect your invention and yourself by applying for a patent now.

Patent Guide Shows What To Do

Our "Patent Guide for the Inventor" answers many important questions concerning Patents that inventors constantly ask. It tells what facts, details, drawings, sketches, etc. are necessary to apply for a Patent, how to protect your invention through dated and witnessed disclosure; how to do this AT ONCE to safeguard your rights; how Patent Office Records can be checked to determine whether the invention is probably patentable before filing fees need be paid; discusses costs involved and a practical way these can be paid as the application progresses. It tells how some inventors secured financial backing; how many simple inventions have proved large commercial successes; how Patents covering improvements also can be profitably utilized and marketed, tells countless other facts of interest.

Why You Need Expert Assistance

The Patent Laws were enacted for your benefit—to give you protection for the features of your invention which are Patentable. But these features must be legally and concisely set forth in the form of "claims." This phase of the procedure is so complex that the Patent Office advises the Inventor to engage a competent Registered Patent Attorney. We maintain a large staff—carefully trained registered patent attorneys—expert draftsmen—experienced searchers—to serve you. We have been serving inventors for more than 20 years.

Take First Step Now

With the Patent Guide you will receive also Free a "Record of Invention" form which will enable you at once to establish the date of your invention, before you file your Patent application. This step costs you nothing yet may be vital to your success. Remember—in Patent Matters, ACTION is IMPORTANT. Delay can be costly. Mail the coupon in an envelope, or paste it on a penny postcard NOW.

*Worthy of
Your Trust*

Get

**FREE
COPY**

*Mail
Coupon
Today*

CLARENCE A. O'BRIEN & HARVEY B. JACOBSON

CLARENCE A. O'BRIEN & HARVEY B. JACOBSON
Registered Patent Attorneys before the United States Patent Office
51-A Adams Building, Washington 4, D. C.

Please send me your 48-Page "Patent Guide for the Inventor" and your specially prepared "Record of Invention" form FREE. This request does not obligate me.

Name.....

Address.....

City..... State.....

(Please write or print plainly.)

SPRAYBERRY RADIO TRAINING

Gives you Both



FULL RADIO SET SUPPLIED FOR SHOP PRACTICE!

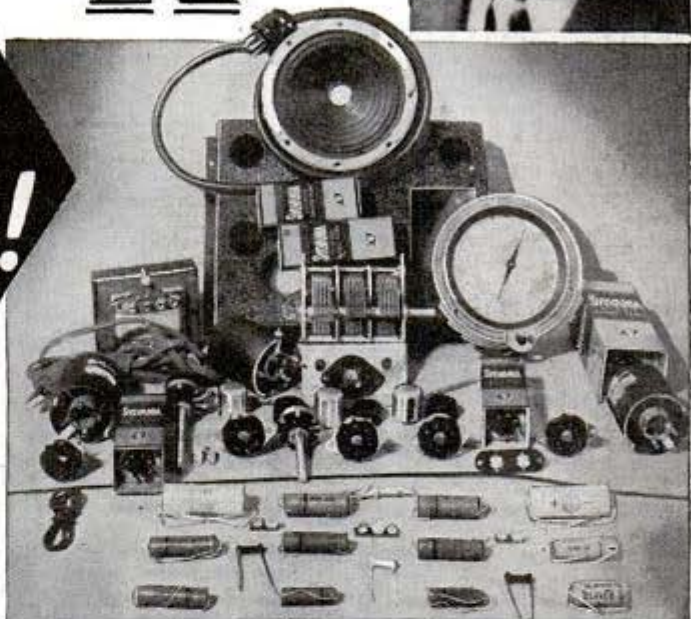

HERE'S THE ONE PRACTICAL WAY TO TRAIN FOR BIG EARNINGS AHEAD IN RADIO-ELECTRONICS & TELEVISION

JUST OUT! FREE!

"How to Read Radio Diagrams and Symbols"

... a valuable new book which explains in simple English how to read and understand any Radio Set Diagram. Provides the quick key to analyzing any Radio circuit. Includes translations of all Radio symbols. Send for this FREE book now and along with it I will send you another big FREE book describing my Radio-Electronic training.



GET FREE BOOKS

SPRAYBERRY ACADEMY OF RADIO

F. L. Sprayberry, President
Box 500RN, Pueblo, Colorado.

Please rush my FREE copies of "How to MAKE MONEY in RADIO, ELECTRONICS and TELEVISION," and "HOW TO READ RADIO DIAGRAMS and SYMBOLS."

Name..... Age.....

Address.....

City..... State.....

(Mail in plain envelope or paste on penny postcard)

The offer I make you here is the opportunity of a lifetime. It's your big chance to get ready for a wonderful future in the swiftly expanding field of Radio-Electronics INCLUDING Radio, Television, Frequency Modulation and Industrial Electronics. Be wise! NOW'S the time to start. No previous experience is necessary. The Sprayberry Course starts right at the beginning of Radio. You can't get lost. It gets the various subjects across in such a clear, simple way that you understand and remember.

I'll Show You a New, Fast Way to Test Radio Sets Without Mfg. Equipment

The very same Radio Parts I supply with your course for gaining pre-experience in Radio Repair work may be adapted through an exclusive Sprayberry wiring procedure to serve for complete, fast, accurate Radio Receiver trouble-shooting. Thus under Sprayberry methods you do not have one cent of outlay for manufactured Test Equipment which is not only expensive but scarce.

Prepares You for a Business of Your Own or Good Radio Jobs... Civilian or Military

My training will give you the broad, fundamental principles so necessary as a background no matter which branch of Radio you wish to specialize in. I make it easy for you to learn Radio Set Repair and Installation Work. I teach you how to install and repair Electronic Equipment. If you enter the Army, Navy or Marines, my training will help you win higher rating and better pay.

BILL, YOU SURE HAVE A SWELL BUILD! DID YOU TRAIN FOR A LONG TIME?

ABSOLUTELY NOT! THE ATLAS DYNAMIC TENSION SYSTEM MAKES MUSCLES GROW FAST!



Here's the Kind of MEN I Build!

Charles Atlas

An actual untouched photo of Charles Atlas, holder of the title, "The World's Most Perfectly Developed Man."



J. G. O'BRIEN
Atlas Champion Cup Winner
This is an ordinary snapshot of one of Charles Atlas' California pupils.

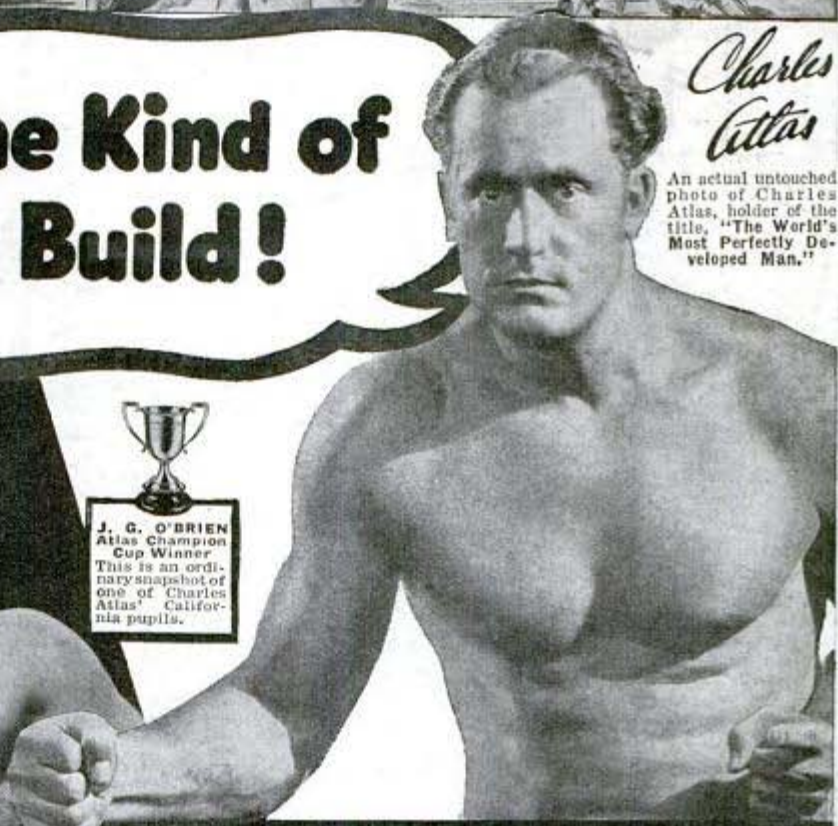
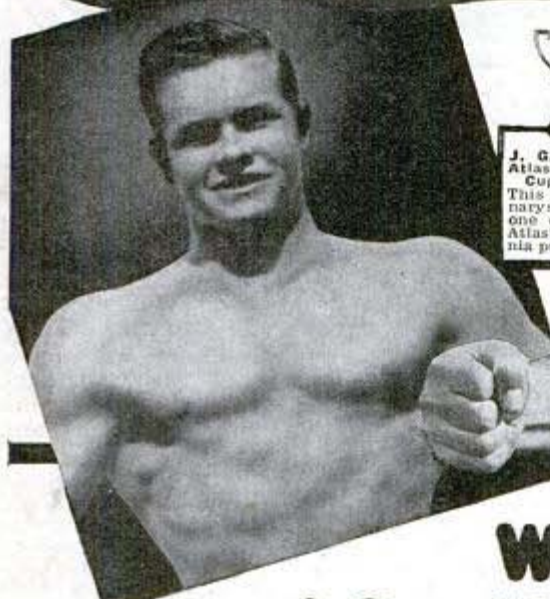

Will You Let Me PROVE I Can Make YOU a New Man?

Only 15 Minutes a Day

I DON'T care how old or young you are, or how ashamed of your present physical condition you may be. If you can simply raise your arm and flex it I can add **SOLID MUSCLE** to your biceps—yes, on each arm—in double-quick time! Only 15 minutes a day—right in your own home—is all the time I ask of you! And there's no cost if I fail.

I can broaden your shoulders, strengthen your back, develop your whole muscular system **INSIDE and OUTSIDE!** I can add inches to your chest, give you a vise-like grip, make those legs of yours lithe and powerful. I can shoot new strength into your old backbone, exercise those inner organs, help you cram your body so full of pep, vigor and red-blooded vitality that you won't feel there's even "standing room" left for weakness and that lazy feeling! Before I get through with you I'll have your whole frame "measured" to a nice, new, beautiful suit of muscle!

What's My Secret?

"Dynamic Tension!" That's the ticket! The identical natural method that I myself developed to change my body from the scrawny, skinny-chested weakling I was at 17 to my present super-man physique! Thousands of other fellows are becoming marvelous physical specimens—my way. I give you *no gadgets or contraptions to fool with*. When you have learned to develop your strength through "Dynamic Tension" you can laugh at artificial muscle-makers. You simply utilize the **DORMANT** muscle-power in your own God-given body—watch it increase and multiply double-quick into real, solid **LIVE MUSCLE**.

My method—"Dynamic Tension"—will turn the trick for you. No theory—every exercise is practical. And, man, so easy! Spend only 15 minutes a day in your own home. From the very start you'll be using my method of "Dynamic Tension" almost unconsciously every minute of the day—walking, bending over, etc.—to **BUILD MUSCLE and VITALITY**.

FREE BOOK "Everlasting Health and Strength"

In it I talk to you in straight-from-the-shoulder language. Packed with inspirational pictures of myself and pupils—fellows who became **NEW MEN** in strength, my way. Let me show you what I helped **THEM** do. See what I can do for **YOU!** For a real thrill, send for this book today. **AT ONCE, CHARLES ATLAS, Dept. 81, 115 East 23rd Street, New York 10, N. Y.**



**CHARLES ATLAS, Dept. 81
115 East 23rd Street, New York 10, N. Y.**

I want the proof that your system of "Dynamic Tension" will help make a New Man of me—give me a healthy, husky body and big muscular development. Send me your free book, "Everlasting Health and Strength."

Name.....
(Please print or write plainly.)
Address.....
City..... Zone No.....
(if any)..... State.....
 Check here if under 16, for Booklet A.

INVENTORS

LEARN HOW TO
PROTECT and SELL
YOUR INVENTION

GET NEW FREE BOOK



FREE
Invention Record
**Know How Successful
Inventors Protect and
Sell Their Inventions**

Our new FREE Book is a book every inventor should have. Mail the coupon today for "How to Protect, Finance and Sell Your Invention" and learn . . .

- How to know if there is a prior U. S. patent on your invention.
- How to save steps in getting patent action.
- How to prepare your application for presentation to the Patent Office.
- How you may patent an improvement on something in use now.
- How to obtain funds to patent and promote your invention.
- How to find a buyer or backer for your invention.
- How to protect yourself in making royalty agreements.

MODERN BUSINESS WANTS INVENTIONS
Practical and novel inventions are in big demand today. The opportunity for quick money is enticing. Sales sources are many if your invention has merit. But, be sure—before you place your device in strange hands—that it is fully protected. A United States Patent gives you this protection. *The first step toward inventive success—always is—and always has been, the application for a U. S. Patent. There is no other way to protect your invention in accordance with the laws of this country.*

MAKE THIS RECORD NOW If you have an invention, and wish to secure it for the future, act at once. Have it dated now and recorded in our office. We will send you this FREE Invention Record Form for the purpose. Fill out the Invention Record Form fully describing the nature of your invention. Make a sketch of its main features. Mail it to us and we will record the date it was received in our office. **The earlier the date the better your chance of combating rival inventors who may lay claim to your idea later. Don't delay a single minute in taking this important step. Your whole future may depend upon it. Mail the coupon for our FREE Invention Record Blank and New FREE Book today!**

HOW WE SERVE YOU AS REGISTERED PATENT ATTORNEYS

The U. S. Patent Office strongly recommends—unless the inventor is familiar with such matters—that he employ the services of a Registered Patent Attorney in the preparation of his Patent Application. We are Registered Patent Attorneys fully qualified to represent you at the Patent Office. We have had long experience in studying hundreds of types of inventions. This gives us the ability to judge your invention and to describe it accurately and convincingly in technical language. It gives us the perception to center arguments upon those details of your invention which, in our judgment, will be looked upon most favorably by the Patent Office Examiner.

Mail the coupon today for our new FREE Book, "How to Protect, Finance and Sell Your Invention," and our FREE Invention Record Form—maybe this step will pave the way to future security for you and your family. Act Today!

McMORROW & BERMAN

REGISTERED PATENT ATTORNEYS

1356 ATLANTIC BUILDING, WASHINGTON 4, D. C.

Send me your new FREE book, "How to Protect, Finance and Sell Your Invention"—and "Invention Record" form at once. I understand that this request does not obligate me.

NAME

ADDRESS

CITY STATE

(Write or print name clearly)

McMORROW & BERMAN
Registered Patent Attorneys
1356 Atlantic Building, Washington 4, D. C.



DRAFTING

SPRINGBOARD TO SUCCESS!

MANY men today are using drafting boards to help win this war! • The International Correspondence Schools Courses in Mechanical or Architectural Drafting have fitted many hundreds of ambitious men for better jobs in this well-paid field!

• All I. C. S. Courses (covering 400 business and technical subjects) are prepared by leading *practical* authorities, constantly revised to meet new developments. *Yet the cost of I. C. S. training is surprisingly low.* • It's not too late for *you* to start—help your country, help yourself! Mail this coupon *today!*



INTERNATIONAL CORRESPONDENCE SCHOOLS



BOX 5512-K, SCRANTON 9, PENNA.

Without cost or obligation, please send me booklet and full particulars about the course *before* which I have marked X:

- | | | | |
|---|---|---|---|
| <p>Air Conditioning and Plumbing Schools</p> <ul style="list-style-type: none"> <input type="checkbox"/> Air Conditioning <input type="checkbox"/> Heating <input type="checkbox"/> Plumbing <input type="checkbox"/> Refrigeration <input type="checkbox"/> Steam Fitting <p>Chemistry Schools</p> <ul style="list-style-type: none"> <input type="checkbox"/> Chemical Engineering <input type="checkbox"/> Chemistry, Analytical <input type="checkbox"/> Chemistry, Industrial <input type="checkbox"/> Chemistry, Mfg. Iron & Steel <input type="checkbox"/> Plastics <input type="checkbox"/> Pulp and Paper Making <p>Civil Engineering, Architectural and Mining Schools</p> <ul style="list-style-type: none"> <input type="checkbox"/> Architecture <input type="checkbox"/> Bridge and Building Foreman <input type="checkbox"/> Bridge Engineering <input type="checkbox"/> Building Estimating <input type="checkbox"/> Civil Engineering <input type="checkbox"/> Coal Mining <input type="checkbox"/> Contracting and Building <input type="checkbox"/> Highway Engineering <input type="checkbox"/> Lumber Dealer <input type="checkbox"/> Sanitary Engineering <input type="checkbox"/> Structural Drafting <input type="checkbox"/> Structural Engineering <input type="checkbox"/> Surveying and Mapping | <p>Electrical Schools</p> <ul style="list-style-type: none"> <input type="checkbox"/> Electrical Drafting <input type="checkbox"/> Electrical Engineering <input type="checkbox"/> Power House Electric <input type="checkbox"/> Practical Electrician <input type="checkbox"/> Practical Telephony <input type="checkbox"/> Telegraph Engineering <p>Internal Combustion Engines School</p> <ul style="list-style-type: none"> <input type="checkbox"/> Auto Technician <input type="checkbox"/> Aviation <input type="checkbox"/> Diesel-Electric <input type="checkbox"/> Diesel Engines <input type="checkbox"/> Gas Engines <p>Mechanical Schools</p> <ul style="list-style-type: none"> <input type="checkbox"/> Aeronautical Engineering <input type="checkbox"/> Airplane Drafting <input type="checkbox"/> Flight Engineer <input type="checkbox"/> Foundry Work <input type="checkbox"/> Heat Treatment of Metals <input type="checkbox"/> Industrial Engineering <input type="checkbox"/> Industrial Metallurgy <input type="checkbox"/> Mechanical Drafting <input type="checkbox"/> Mechanical Engineering <input type="checkbox"/> Mold-Loft Work <input type="checkbox"/> Patternmaking <input type="checkbox"/> Reading Shop Blueprints <input type="checkbox"/> Sheet-Metal Drafting <input type="checkbox"/> Sheet-Metal Worker | <ul style="list-style-type: none"> <input type="checkbox"/> Ship Drafting <input type="checkbox"/> Ship Fitting <input type="checkbox"/> Shop Practice <input type="checkbox"/> Steel Mill Workers <input type="checkbox"/> Tool Designing <input type="checkbox"/> Welding, Gas and Electric <p>Radio School</p> <ul style="list-style-type: none"> <input type="checkbox"/> Electronics <input type="checkbox"/> Radio, General <input type="checkbox"/> Radio Operating <input type="checkbox"/> Radio Servicing <p>Railroad School</p> <ul style="list-style-type: none"> <input type="checkbox"/> Air Brake <input type="checkbox"/> Car Inspector <input type="checkbox"/> Locomotive Engineer <input type="checkbox"/> Locomotive Fireman <input type="checkbox"/> Railroad Section Foreman <p>Steam Engineering Schools</p> <ul style="list-style-type: none"> <input type="checkbox"/> Boilermaking <input type="checkbox"/> Combustion Engineering <input type="checkbox"/> Engine Running <input type="checkbox"/> Marine Engineering <input type="checkbox"/> Steam Electric <input type="checkbox"/> Steam Engines <p>Textile School</p> <ul style="list-style-type: none"> <input type="checkbox"/> Cotton Manufacturing <input type="checkbox"/> Rayon Weaving | <ul style="list-style-type: none"> <input type="checkbox"/> Textile Designing <input type="checkbox"/> Woolen Manufacturing <p>Business and Academic Schools</p> <ul style="list-style-type: none"> <input type="checkbox"/> Accounting <input type="checkbox"/> Advertising <input type="checkbox"/> Arithmetic <input type="checkbox"/> Bookkeeping <input type="checkbox"/> Business Correspondence <input type="checkbox"/> Business Management <input type="checkbox"/> Certified Public Accounting <input type="checkbox"/> City Letter Carrier <input type="checkbox"/> College Preparatory <input type="checkbox"/> Commercial <input type="checkbox"/> Cost Accounting <input type="checkbox"/> Federal Tax <input type="checkbox"/> First Year College <input type="checkbox"/> Foremanship <input type="checkbox"/> French <input type="checkbox"/> Good English <input type="checkbox"/> High School <input type="checkbox"/> Higher Mathematics <input type="checkbox"/> Illustrating <input type="checkbox"/> Motor Traffic <input type="checkbox"/> Post Office Clerk <input type="checkbox"/> Railway Postal Clerk <input type="checkbox"/> Salesmanship <input type="checkbox"/> Secretarial <input type="checkbox"/> Spanish <input type="checkbox"/> Stenography <input type="checkbox"/> Traffic Management |
|---|---|---|---|

Name..... Age..... Home Address.....

City..... State..... Present Position..... Working Hours..... A.M. to..... P.M.

Canadian residents send coupon to International Correspondence Schools Canadian, Ltd., Montreal, Canada.

British residents send coupon to I. C. S., 71 Kingsway, London, W. C. 2, England.

DISCOUNT TO DISCHARGED VETERANS—SPECIAL TUITION RATES FOR MEMBERS OF THE ARMED FORCES

PATENT YOUR INVENTION

These FREE BOOKS TELL YOU HOW!

They're the same books that have guided thousands of inventors to strong patents . . . helped them cash-in on their ideas.



1 "PATENT PROTECTION" explains fully the steps you must take . . . and the steps we take for you—to determine if your invention is probably patentable; the proper course to follow in applying for a patent; explains the 4 types of patents; illustrates 115 Mechanical Movements (just what you may need to complete your invention); answers your every question. An understandable, helpful book—full of money-making, money-saving suggestions!

2 "WHEN AND HOW TO SELL YOUR INVENTION" contains practical suggestions to help you solve your problem of financing, partnerships, assignment and outright sale of your invention. Based on observations of Victor J. Evans & Company's staff of Registered Patent Attorneys, during nearly 50 years of dealing with thousands of successful inventors.

NEW IDEAS FOR POST-WAR NEEDED NOW!

The tremendous demand for post-war merchandise, methods and machines presents a rare opportunity to men like you in the months ahead.

GET BUSY. . . read these valuable books . . . put your ideas down in black and white . . . get them into our hands quickly! We will handle all the difficult details of determining the possible patentability of your invention . . . will save you time, trouble and money. **JUST MAIL THE COUPON NOW**—In addition to the books, we'll send you also FREE the valuable "Evidence of Invention" form for use in establishing your claim.

FOLLOW THE ADVICE OF THE U. S. PATENT OFFICE

Rule 17 of RULES OF PRACTICE IN THE UNITED STATES PATENT OFFICE reads in part as follows: . . . "an applicant or assignee of the entire interests may prosecute his own case, but he is advised, unless familiar with such matters, to employ a competent registered attorney or registered agent, as the value of patents depends largely upon the skillful preparation of the specifications and claims. . . ."

64 Pages OF FACTS FOR INVENTORS
Plus
"Evidence of Invention" Form
All 3 Free!

VICTOR J. EVANS & Co.
 REGISTERED PATENT ATTORNEYS
 930-A Merlin Building, Washington 6, D. C.

Please send me your books, "Patent Protection" and "When and How to Sell Your Invention"—also important "Evidence of Invention" form, without cost or obligation.

Name
 Address
 City and State



Learn RADIO- ELECTRONICS- TELEVISION



RADIO TESTING AND SERVICING—Students learning to locate troubles with modern radio analyzers.



ELECTRONIC CIRCUIT TESTING—Instructor showing students use of large Cathode Ray Oscilloscope.

TRAIN FOR A GOOD JOB NOW that will also be a GOOD JOB IN PEACE-TIME

Don't be caught napping. Prepare for a good essential job now that will still be a good job with a real future when the war is over. If you are not a trained man you may have to compete with millions of other untrained men. Get into a field that offers real opportunities in war times, peace-times—good-times and bad-times. Tremendous expansion in Frequency Modulation and Television is predicted after the war. Radio-Electronics trained men are needed today—they will be needed too when peace comes.

Real Opportunities for the Radio Trained Man

Prepare for jobs as assembler, inspector and tester—Radio sales or service and installation work, electronics, television, sound work, aircraft-radio, auto-radio, etc. Many opportunities in the vast Radio-Electronics field.

GET MY BIG NEW BOOK

It tells all about my big Chicago shops and my plans to help you get ahead. Packed with facts and pictures of students at work in my shops. Mail coupon for this Big New Book now! Coupon will also bring details on how I'll Finance Your Training . . . facts on how I help you "Earn-While-Learning" . . . information on FREE EMPLOYMENT SERVICE FOR LIFE . . . and other plans to help you. ACT NOW TO MAKE SURE YOU GET MY GENEROUS OFFER. Sending for this interesting free book can be your first big step to success. No obligation. No salesman will call. Mail coupon today.



H. C. Lewis

"Learn by Doing"

RIGHT HERE in the SHOPS of COYNE-12 Weeks Training

All Finance Your Training

We train you on real Radio, Television and Sound equipment. Whether or not you have had Radio experience you need Coyne all-around Radio-Electronics training. We give you—RIGHT HERE IN THE COYNE SHOPS IN CHICAGO—the actual practice and experience you'll need in this great field. And because we cut out all useless theory and only give that which is necessary you get a practical training in a few weeks. Right now I'm including extra training in Industrial Electronics at no extra cost.

EARN WHILE LEARNING

If you need part-time work to help pay living expenses while at school, we will help you get it. After you graduate, life-time employment service will be available to you. Every Coyne graduate also receives a Life Membership, with free technical and business service and privilege of review at any time without additional tuition charge.

PREPARE FOR JOBS LIKE THESE

Frequency Modulation (FM)
Radio Manufacturing
Radio Set Serviceman
Television Servicing
Electronics Maintenance
Public Address Systems, etc.

**EXTRA
COURSE**
NO EXTRA COST

Industrial Electronics
Special extra course to help you get ready for the better jobs in this new wonder field . . . no additional tuition cost IF YOU ACT NOW!

THE HOME OF
COYNE



We have facilities for men with physical disabilities. If you have a physical disability of any kind write me when you send the coupon.

H. C. Lewis, Pres. Founded 1899
COYNE ELECTRICAL SCHOOL
RADIO-ELECTRONICS DIV.
500 So. Paulina Street Dept. 15-3H CHICAGO 12, ILLINOIS

H. C. LEWIS, Pres., Radio-Electronics Div.,
COYNE ELECTRICAL SCHOOL
500 S. Paulina St., Dept. 15-3H,
Chicago 12, Ill.

Dear Mr. Lewis: Send me your Big Free Radio-Electronics Book and all the facts . . . also full details of your "Pay-after-Graduation" plan.

NAME.....

ADDRESS.....

CITY.....ZONE.....STATE.....



Know Electricity as Experts Know It—and Get an Expert's Pay!

What about your future? Who is safe today? Surely not the man who is contented to stand still! Know your job thoroughly—prepare yourself for jobs ahead. To do just this thousands of men have used

The Croft Library of Practical Electricity

The Croft Library is a complete electrical educator. It is founded on practice—on 20 years of shirt-sleeve experience—on work as it is actually done. It is planned from cover to cover with the kind of hard-headed facts you want. Written so that the beginner can easily understand it, yet so sound, so thorough, that it is the daily guide of 29,000 highly paid electrical workers and engineers. Croft tells you the things you need to know about motors, generators, armatures, commutators, transformers, circuits, switchboards, distribution systems—electrical machinery of every type—wiring for light and power—wiring of finished buildings—underwriters and inspectors' requirements—illumination in its every phase—the most improved methods of lighting—lamps and lamp effects, etc.—how to do a complete job, from planning it, to completion.

No money down — easy payments

Fill in and mail the coupon attached and we will send you the entire set of seven volumes for ten days' examination on approval. We take all the risk—no money no obligation. If you decide to keep the books, send \$3.00 in ten days and the balance at the rate of \$3.00 a month. Send the coupon NOW and see the books for yourself.

EXAMINATION COUPON

McGraw-Hill Book Co., 330 W. 42nd St., N. Y. 18

Send me for ten days' examination on approval the Croft Library of Practical Electricity, 7 vols. If satisfactory I will send you \$3.00 in 10 days and \$3.00 monthly until the price of \$18.00 is paid. If not wanted, I will return the books postpaid. (To insure prompt shipment write plainly and fill in all times.)

Name

Home Address

City and State

Position

Name of Company

Keep that Car "TICKING"



Every operator and mechanic needs AUDELS AUTO GUIDE.

This book saves time, money and worry. Highly endorsed. It presents the whole subject of auto mechanics:

- 1—Basic principles
- 2—Construction
- 3—Operation
- 4—Service
- 5—Repair

Handy Size, Easily understood.

NEW FLUID DRIVE, HYDRAULIC SHIFT AND DIESEL ENGINES FULLY COVERED

Over 1500 pages—1540 illustrations showing inside views of modern cars, trucks and buses with instructions for all service jobs.

ASK TO SEE IT!—To Get This Assistance for Yourself Simply Fill in and Mail Coupon Today.

4 COMPLETE • PAY ONLY \$1. A MONTH ←

AUDEL Publishers, 49 West 23rd St., New York
MAIL AUDELS NEW AUTO GUIDE for free examination. If O.K. I will send you \$1 in 7 days; then remit \$1 monthly until price of \$4 is paid. Otherwise I will return it.

Name

Address

Occupation

Employed by

**HOW TO
BREAK
and
TRAIN
HORSES**

THIS GREAT BOOK FREE!

Every farmer, every lover of horseflesh should have a copy of it. This amazing book tells you how to know horses—how to break them—how to train them—how to make money as a master horseman. Write for it today—FREE, together with my special offer of a course in Animal Breeding without cost to you. If you are interested in Gaiting and Riding the saddle horse, check here Do it today—now. You'll never regret it.

BEERY SCHOOL OF HORSEMANSHIP
Dept. 1101 - - Pleasant Hill, Ohio

you can be a well-paid ACCOUNTANT!

Accountants are well paid and in demand. World-famous I.C.S. shows you how to join them. Wide variety of Courses individually tailored. For men or women with no previous experience. For those already in accounting, instruction papers by well-known Professors of Accountancy, Certified Public Accountants. Excellent preparation for C.P.A. examinations. Home study, low cost, rapid progress. Write for free booklet containing full information.

International Correspondence Schools, Box 5516-K, Scranton 9, Pa.

LEARN WATCH REPAIRING

AT HOME. By our modern and original system of instruction you can learn every part of the **WATCH REPAIRING TRADE AT HOME.** Prepare yourself for a well-paying position or start in business after completing our course of instruction. Good watch repairers are in demand and generally earn very good salaries. For particulars apply to the **Wisconsin School of Watch Repairing** 759 North Milwaukee St., Milwaukee 2, Wis.

LEARN MONEY-MAKING CARTOONING

IN SPARE TIME — by Easy Picture Chart Method

Same Simplified Method that has helped train creators of "Terry & Pirates," "Freckles," "Out Our Way," "Winnie Winkle," "Regular Fellers," "Strange As It Seems," "The Neighbors," and many others. Earn while learning. Send 10c for Picture Chart (to test your ability), and full details. (State age.)

THE LONDON SCHOOL, Dept. 4501, Philadelphia 1, Penna.

Get into the BAKING BUSINESS

Bakers make good money! Now 7th Industry in wages! Nearly depression-proof. New home study Baking Course qualifies you. Common school education sufficient. If you're ambitious, write for FREE BOOK "Opportunities in Baking."

National Baking School, 2315 Michigan, Dept. 1351, Chicago 5, Ill.

Learn to Write

Begin today. Write now for our Free Book, "How to Become a Good Penman." It contains specimens and tells how others learned to write in spare time. Enclose 10c for your name beautifully written and a pen point suitable for slanted writing. Write today.

THE TAMBLYN SCHOOL OF PENMANSHIP
N441 Ridge Building, Kansas City, Mo.

Big Profit AUSTRALIAN WHITES

Sensational MONEY MAKING HYBRID. Customers report broilers 8 weeks, laying 4 1-2 mos. Disease resistant. **Hardy Layers.** 50,000 chicks weekly. Started pullets. Profit Sharing Plan. FREE Book. Write today.

BERRY BROS. FARMS, Box 582, ATCHISON, KANS.

STOP RADIO STATIC

The ALL WAVE radio filter is guaranteed to help you get perfect radio reception. Eliminates all hums, clicks, crackles, etc., caused by electric razors, vacuum cleaners, motors and other electrical appliances. The ALL WAVE is a scientific and compact radio filter that can be used on any make electric radio. To connect, just put your radio plug thru the ALL WAVE's slotted opening and into any wall outlet. **15 DAY FREE TRIAL.** Sent C.O.D. for \$1.50 plus postage. Cash orders sent postpaid. Rush order—supply limited. Vogue Eliminator Co., 7759 S. Halsted, Dept. AW-902, Chicago 20, Ill.

PLASTICS

THE GREAT *New* FIELD OF OPPORTUNITY
PLASTICS ENGINEERS AND TECHNICIANS NEEDED
IN NOT ONE BUT MANY CLASSES OF INDUSTRY

● Leaders in science and industry have long been saying, "Keep your eye on Plastics." But now the time for action has arrived. The future of huge possibilities has already begun. Developments in Plastics for hundreds of wartime uses have set the pace for revolutionary changes in peacetime production of thousands of products.

THIS IS YOUR BIG CHANCE

Today there's a big need in vital war production for those who are trained in Plastics. From one to a hundred articles made of Plastics must be supplied for every man in our fighting forces. Start training now in Plastics Engineering, in spare time in your own home. Fit yourself for a responsible, well-paid position. Help to win Victory. And at the same time you will be preparing for even greater opportunities when the war is over.

There is scarcely an industry in which these so-called "miracle materials" will not play an important part. After the war many old materials, methods and skills will be replaced. Acquire the all-important "know how." Be in a position to step into one of the key jobs.

YOU CAN LEARN WHILE YOU EARN

Turn at least part of your leisure time into money. Qualify at home for a larger income in an interesting career. Build greater security for your future in a vocation that looms large on the horizon of the new industrial era. Hours you might otherwise waste can put you well on your way toward lasting success.

It's easy to find out about Plastics training. To get details and outline of study prepared by specialists, and about the school that has helped thousands to success during the past 46 years, write us or check and mail the coupon. Send today. The sooner you take this easy step, the sooner you will reach your goal and reap the rich rewards.

AMERICAN SCHOOL OFFERS COMPLETE TRAINING SERVICE IN MANY SUBJECTS

You who have not completed high school or have missed vocational training in college, and who cannot spare time to go away to school, can complete your education in your choice of many subjects. Several of these are listed in the coupon at right. Check the subject in which you are interested, fill in your name and address, clip and mail the coupon today.

AMERICAN SCHOOL

Dept. G145, Drexel at 58th Street, Chicago 37

PRACTICAL, EFFECTIVE HOME - STUDY TRAINING SINCE 1897
Take This First Easy Step

CHECK, CLIP AND MAIL COUPON NOW

AMERICAN SCHOOL, Dept. G145, Drexel at 58th, Chicago 37, Ill.
Without obligation. Please send FREE and postpaid, bulletin and details of the Subjects checked.

- | | | |
|--|---|--|
| <input type="checkbox"/> PLASTICS ENG'R | <input type="checkbox"/> Accounting and C.P.A. | <input type="checkbox"/> Drafting and Design for Men and Women |
| <input type="checkbox"/> Refrigeration | <input type="checkbox"/> Cost Accounting for Manufacturing | <input type="checkbox"/> Radio |
| <input type="checkbox"/> Architecture and Building | <input type="checkbox"/> Bookkeeping | <input type="checkbox"/> High School |
| <input type="checkbox"/> Practical Plumbing | <input type="checkbox"/> Private Secretary | <input type="checkbox"/> Air Conditioning |
| <input type="checkbox"/> Automotive Engineering | <input type="checkbox"/> Diesel Engineering | <input type="checkbox"/> Shipbuilding |
| <input type="checkbox"/> Aviation Drafting | <input type="checkbox"/> Surveying & Topographical Drafting | <input type="checkbox"/> Mechanical Eng. Shop Management |
| <input type="checkbox"/> Aviation | <input type="checkbox"/> Sheet Metal | <input type="checkbox"/> Tool Making |
| <input type="checkbox"/> Business Mgmt | <input type="checkbox"/> Pattern Drafting | <input type="checkbox"/> Better Foremanship |
| <input type="checkbox"/> Railway Training | <input type="checkbox"/> Electrical Engineering | <input type="checkbox"/> Machine Shop Operations |

Name.....Occupation.....
Address.....Age.....
City.....State.....

Will you be one of the miserable 5,000,000?

Experts say the last gun on V-E Day will blow from 5 to 11 million war jobs sky-high. Will yours be one? If the future is worrying you

Get into REFRIGERATION and AIR CONDITIONING

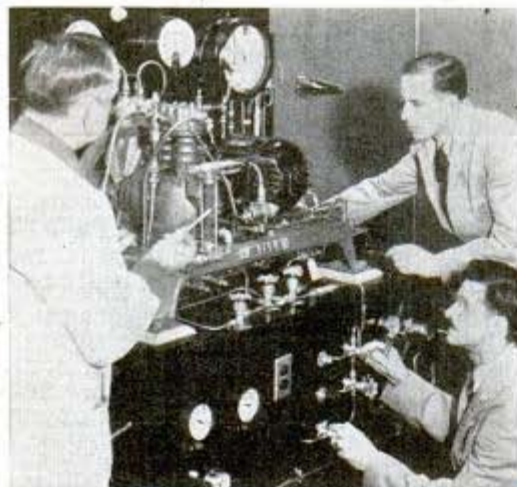

Trade figures show less than 6,000 service experts and repairmen to care for over 20,000,000 domestic and commercial refrigerators now in use—to say nothing of numberless other cooling and air conditioning installations.

Desperate Need for Trained Men. Thousands of good jobs are available for refrigeration and air conditioning service experts **RIGHT NOW**. Many thousands more men will be required after the war, due to revolutionary new applications of cooling, humidifying, heating, in industrial processes.

Vast Expansion Ahead. Air conditioning alone anticipates 500% jump in post-war output. That's only small part of bright job-making picture in this vital field. The opportunities for trained men are terrific.

Train Now for a Key Job. Yes, get ready to pick one of the biggest plums—a key job with bright future and top pay... even a business of your own. We'll give you the practical training you need to be an expert. Over 400,000 men have trained with us in our 28 years.

We'll Train You at Home. No advanced schooling is necessary. We'll train you at home, in your spare time, or in our big Chicago shops, or combine both methods. Our unique system makes everything simple, fascinating, easy to grasp. Use the Convenient I. T. I. pay-as-you-go plan. Get the facts. Write for full details **TODAY**.

For the past 3 years we have been training men and women in fine precision work for the Army, Navy, and Marine Corps exclusively, under Government contract. We are now resuming civilian training.

INDUSTRIAL TRAINING INSTITUTE

2130 Lawrence Ave. Dept. P1A, Chicago, 25, Ill.

WHY NOT BE AN EXPERT ACCOUNTANT? YOU CAN!

MORE and more opportunities—that is Accountancy's appeal to ambitious people like YOU! Government, industry, thousands of firms, are needing trained accountants. C. P. A.'s and executive accountants earn \$2,000 to \$10,000 yearly; new conditions are steadily increasing the demand! LaSalle trains you at home in your spare time; among our alumni are over 10 per cent of the C. P. A.'s in United States. Training prepares you for C. P. A. examinations or executive accounting positions. Staff of C. P. A.'s personally supervises every phase of your training. You do not need previous experience, for we start you from the beginning. Numerous new opportunities now waiting in Governmental and industrial lines warrant your considering this subject carefully! So act now—investigate LaSalle Accountancy training's possibilities without delay.

Write today for free 48-page booklet, "Accountancy, the Profession That Pays"

LASALLE Extension University • A Correspondence Institution

DEPT. 164-H

417 South Dearborn Street, CHICAGO 5, ILLINOIS

ARC WELDER'S GUIDE
FREE!

The most widely distributed booklet in the welding industry. Every welder wants this handy information guide. Tables, charts and valuable welding data you'll use daily.

OVER 100 IDEAS!
"Practical Design for Arc Welding"

The trend is toward welded design. You'll find this book a great idea stimulator for new designs. Order your copy today. Learn how others redesigned for faster, lower cost arc welding... today's greatest production tool.

With Individual estimating forms at side of each design. **\$3.50** Postpaid

HOBART "One of the World's Largest Builders of ARC WELDERS"

HOBART BROTHERS COMPANY BOX M-151 TROY, OHIO

For Good Jobs TODAY...
TOMORROW... LEARN

RADIO ELECTRONICS

DeFOREST'S A-B-C WAY!



THE fast-moving Opportunity Field of Radio-Electronics needs many trained men! Let DeFOREST'S show you how to get ready to take advantage of the breaks—the good jobs—the satisfying pay checks of today—and the bright postwar opportunities of tomorrow. Write for DeFOREST'S big, free book—"VICTORY FOR YOU" and colorful kit supplement.

Consider Radio's Many Fields

See how you may cash in on a vast field that includes F.M. Radio, Communication Radio, Electronics, Broadcast Radio, Motion Picture Sound, Radio Sales and Service—or a Radio business of your own.

Start a Business of Your Own

See how DeFOREST'S has helped many get their start in Radio-Electronics—helped them to good pay jobs in one of our most promising industries—others to preferred military classifications with higher ratings, better pay. Helped others to full or part-time sales and service businesses of their own.

Employment Service!

DeFOREST'S also provides an effective EMPLOYMENT SERVICE which has long-established contacts with many employers who use DeFOREST'S trained Radio-Electronic men.

Mail the coupon Now—Today!

See how DeFOREST'S can help YOU get started toward this fascinating work by means of its effective "A-B-C" Training Method—in your spare time.

VETERANS: Check coupon below for special information.



A "LEARN-BY-DOING" FROM PRACTICAL EQUIPMENT
Make 133 interesting Radio-Electronic experiments at home—from 8 BIG KITS of Radio parts and assemblies. Quickly build Radio Receiving Circuits that operate... a Light Beam Transmitter... Wireless Microphone... Radio Telephone... "Electric Eye" Devices. Scores of other fascinating projects.

B GET INTERESTING, LOOSE-LEAF LESSONS—
90 modern, well-illustrated loose-leaf lessons, prepared under the supervision of one of the world's foremost Radio authorities, Dr. Lee DeForest, often called "The father of Radio!"

The Billion Dollar Radio-Electronic Industry, with its Manufacturing, Servicing, Broadcasting, Communications, and many other promising fields, invites your careful consideration. See how DeFOREST'S helps you prepare for a good pay job, or a business of your own in one of America's most promising, interesting fields.

DeFOREST'S TRAINING INCLUDES INSTRUCTION IN MOTION PICTURE SOUND EQUIPMENT, FM RADIO AND TELEVISION

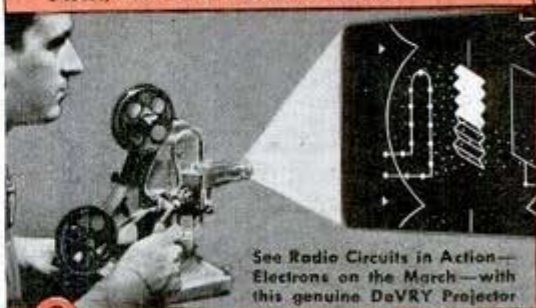

See Radio Circuits in Action—Electrons on the March—with this genuine DeVRY Projector

C USE "LEARN-BY-SEEING" MOVIES
with a genuine DeVRY 16mm. Movie Projector and Films to help you learn Radio faster... easier. See hidden Radio action come to life! Radio waves in motion—*Electrons on the march...*

E. B. DeVry, President
DeFOREST'S TRAINING, INC.
2535-41 N. Ashland Ave., Dept. BPM-1
Chicago 14, Illinois, U.S.A.

Please send me your "VICTORY FOR YOU" book and KIT FOLDER, FREE.

Name..... Age.....
Address.....
City..... State.....

If under 16, check here for special information.
 If a veteran of World War II, check here.

READ WHAT THESE MEN SAY ABOUT DeFOREST'S TRAINING

"I have obtained employment with the Mfg. Company. They speak highly of DeForest's students and state they have had excellent results with your men whom they have employed."
Clifford Taylor, Mass.

"As a result of DeForest's Training, I am doing very well. If my income doesn't range between \$50.00 and \$75.00 per week, I figure something is wrong."
Lyle Rielly, Wisconsin

"But the credit must go to you and your employment service for placing me in this job when I really needed one. I shall always be grateful for the help and guidance given me by you and DeForest's Training. Thanks a million."
Earl Eschelberger, Illinois.

"I cannot impress too strongly on anyone who may be considering taking your course the value of both the training and the employment service that goes with it. This service is not merely an empty promise, but a truly conscientious effort that continues until its job of preparing you is done."
Philip Cummins, New Jersey.

"I am amazed at the many subjects I have learned with DeForest's. I also want to praise your motion picture lessons. It is truly amazing, how well the action of electricity is brought out. I feel safe in saying that no book could ever establish effectively those principles and actions so well in my mind."
Yale Schorr, Texas.

DeFOREST'S TRAINING, INC.
CHICAGO, 14, ILLINOIS



SELLS 95 STORIES AND NOVELETTES

"The introduction you gave me to your editor friend, resulting in my present assignment to do a complete novel for him monthly, is doubly appreciated, since I finished my N.I.A. training some time ago and, consequently, have no call on your services. To date now, I have sold 95 stories and novelettes to 20 national magazines."—Darrell Jordan, P. O. Box 279, Friendship, N. Y.

Why Don't You Write?

It's much simpler than you think!

SO many people with the "germ" of writing in them simply can't get started. They suffer from inertia. Or they set up imaginary barriers to taking the first step.

Many are convinced the field is confined to persons gifted with a genius for writing.

Few realize that the great bulk of commercial writing is done by so-called "unknowns." Not only do these thousands of men and women produce most of the fiction published, but countless articles on business affairs, home and shop crafts, local and scientific activities, gardening, homemaking, etc., as well.

Such material is in constant demand. Every week thousands of checks for \$25, \$50 and \$100 go out to writers whose latent ability was perhaps no greater than yours.

The Practical Method

Newspaper work demonstrates that the way to learn to write is by writing! Newspaper copy desk editors waste no time on theories or ancient classics. The story is the thing. Every copy "cut" goes through the course of practical criticism—a training that turns out more successful authors than any other experience.

That is why Newspaper Institute of America bases its writing instruction on the Copy Desk Method. It starts and keeps you writing in your own home, on your own time. And upon the very same kind of actual assignments given daily to metropolitan reporters. Thus you learn by doing, not by studying the individual styles of model authors.

Each week your work is analyzed constructively by practical writers. Gradually they help to clarify your own distinctive style. Writing soon becomes easy, absorbing. Profitable, too, as you gain the "professional" touch that gets your material accepted by editors. Above all, you can see constant progress week by week as your faults are corrected and your writing ability grows.

Have You Natural Ability?

Our Writing Aptitude Test will reveal whether or not you have natural talent for writing. It will analyze your powers of observation, your imagination and dramatic instinct. You'll enjoy taking this test. There is no cost or obligation. Simply mail the coupon below, today. Newspaper Institute of America, One Park Avenue, New York 16, N. Y. (Founded 1925)

NOTICE TO CANADIANS

Newspaper Institute's operations in Canada have been approved by the Foreign Exchange Control Board, and to facilitate all financial transactions, a special permit has been assigned to their account with The Canadian Bank of Commerce, Montreal.

Free Newspaper Institute of America, One Park Avenue, New York 16, N. Y.

Send me, without cost or obligation, your Writing Aptitude Test and further information about writing for profit as promised in Popular Mechanics, January.

Mr. _____
Mrs. _____
Miss _____
Address _____
(All correspondence confidential. No salesman will call on you.) 72-A-815

Copyright 1944 Newspaper Institute of America

LEARN Refrigeration AND Air Conditioning

★ Train now for immediate future and POST-WAR

A real opportunity for good earnings awaits reliable, ambitious, mechanically-minded men who prepare NOW and get into Refrigeration and Air Conditioning. Thousands of war-worn mechanical units need servicing RIGHT NOW; new equipment must be properly installed, intelligently serviced after the war.

A GOOD field for GOOD earnings

Start now and train in your spare time. It need not interfere with your present work. Here is a Balanced plan of practical training that offers you home-study followed by actual practice with real equipment. Since 1927 U.E.I. has been training thousands of men to get better pay in this growing field. Get this "Know How" that leads to opportunities for employment or a business of your own after the war. Write for FREE complete details TODAY.

UTILITIES ENGINEERING INSTITUTE
Dept. 115 1314 W. Belden Ave. Chicago 14, Ill.

DRAFTING SPRINGBOARD TO SUCCESS!

Increased salary, larger responsibilities, a real career instead of just a job—these are to be had by the trained draftsman. I.C.S. makes the way to thorough, practical training open to you. Check up and you'll find that nearly every "big name" American in engineering and production acquired experience at the drafting board. Many of them started by writing for the I.C.S. free booklet. Send for it today! It can be the most important act of your life.

International Correspondence Schools, Box 5513-K, Scranton 9, Pa.

MAGAZINES BUSINESS VOCATIONAL DIVERSION

Profit by keeping better posted on conditions, developments and opportunities in your line, through magazines devoted to it. Choose current single copies from our LIST of over 600 different periodicals—more than 175 fields. Write now for free price-list.

Commercial Engraving Publishing Company
34C North Ritter Indianapolis 1, Indiana

LAW STUDY AT HOME for PERSONAL SUCCESS and LARGER EARNINGS, 35 years expert instruction—over 108,000 students enrolled. LL.B. Degree awarded. All texts furnished. Easy payments. Send for FREE BOOK—"Law and Executive Guidance."

AMERICAN EXTENSION SCHOOL OF LAW
Dept. 49-M, 646 N. Michigan Ave., Chicago 11, Ill.

—Train at Home in Your Spare Time
The fascinating field of Art offers commercial opportunities to men and women. COMMERCIAL ART, CARTOONING, DESIGNING all in one complete course. TWO ART OUTFITS furnished. Learn to draw step-by-step. Trained Artists are capable of earning \$30, \$50, \$75 a week. Write today for full information in FREE BOOK, "Art for Pleasure and Profit." Mail coupon today.

FREE BOOK gives details

Washington School of Art, Studio 121P
1115-15th St., N. W., Washington 5, D. C.

Name _____ Age _____
Address _____
City _____ State _____

GET INTO RADIO ELECTRONICS & TELEVISION NOW!

Hundreds of Industries Need Radio and Television Men Now and for Great Future Demands

The man trained in electronics is wanted not only in Radio and Television, but in Aviation, Transportation, Communications, ... in the designing, engineering and operation of hundreds of industries today and for years to come. Learn how great the field is for YOU... How you may GET INTO BUSINESS FOR YOURSELF. Mail the coupon now.



Send for FREE Lesson and Prove to Yourself How Quick and Easy You Get Ahead in Radio by the NEW

SHOP METHOD HOME TRAINING



Learn by Doing!
Use real Radio Equipment Furnished with your Course



Experience is the best teacher. You learn by experience with the exclusive National Shop Method of Home Training—actually build many circuits and do experiments with the big kits of standard radio parts included in your training equipment at no extra cost to you.

Build a superheterodyne receiver. Make tests and conduct experiments that show you the why and how of electronics. Build an audio oscillator, signal generators and other instruments with the parts and supplies included in your course.

"F.M." Means Future Money
Frequency Modulation (F.M.) is here to stay. Thousands of F.M. licenses have been granted by the government P.C.C. all over the country. Learn what this means to you.

Get ready for TELEVISION. Get your share of the RADIO SERVICE business. Here is a sensationally improved way for you to get the right training—a thoroughly proved system whereby you study in spare time—odd hours, even minutes—and have the advantage of actual shop experience behind you.

This exclusive shop method of home training comes to you right from one of the world's greatest vocational educational centers—the resident training shops and experimental laboratories of National Schools. It is the sound, practical training based on actual experience of qualified instructors and engineers who have prepared thousands of National graduates now employed in the radio industry.

It is up-to-date—matches the progress constantly being made in modern radio, television and electronics. It is time tested. National Schools has been training men for higher pay and greater opportunity for more than a third of a century. Fill out and mail the coupon below for details.

Shop Method Training Wins Good Jobs



Joseph Grumich, Lake Hiawatha, New Jersey.

"My latest offer was \$5,800.00 as Radio Photo Engineer . . . but I'm doing well where I am now engaged. I am deeply indebted to National."

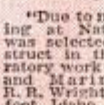

R. R. Wright, Blackfoot, Idaho.

"Due to my training at National I was selected to instruct in the laboratory work of Navy and Marines."



G. K. Ivey, Washington, D. C.

"I believe National offers the best course to be had. . . . Keep up the good work."

Be Sure in Post-War

Now, right now, is the time to prepare for SUCCESS AND SECURITY in the great expansion after the war. The field is wide open. Trained men will get the preference in the broadcasting stations—in industry—will make quick progress with small capital in their own business. Soldiers, sailors and marines make use of your free time to get ready for the future. Study while still in uniform. Thousands of men in the armed forces have trained at National Schools under U. S. Government sponsorship.

See for Yourself

Now, right now, is the time to grasp the great opportunity of today—a successful career for tomorrow. Get into the big money, rapid advancement, a position of importance, A BUSINESS OF YOUR OWN. The industry is crying for trained men everywhere. A rapidly expanding business—probably the greatest in industrial history—holds out the promise of a rich future—prosperous security. But to win it you must be ready. Well-trained men ONLY are wanted.

Examine the National Shop Method of Home Training carefully. Be convinced. Study the lesson we will send you FREE. No obligation of any sort. Fill out the coupon and mail it today.



GET THESE 2 BIG BOOKS FREE!
Learn for yourself just how easy this SHOP METHOD HOME TRAINING gives you the practical, down-to-earth experience you can never get from theory alone.

NATIONAL SCHOOLS

LOS ANGELES 37, CALIFORNIA EST. 1905

MAIL OPPORTUNITY COUPON FOR QUICK ACTION

National Schools, Dept. 1-PM
4000 South Figueroa Street, Los Angeles 37, California

(Mail in envelope or paste on penny post card)

Mail me FREE the two books mentioned in your ad including a sample lesson of your course. I understand no salesman will call on me.

NAME..... AGE.....

ADDRESS.....

CITY..... STATE.....

Include your zone number



SO IT NEEDS FIXING

By S. T. CHRISTENSEN

the "Fix-it Man"

WELL, I guess I'm the fellow to see, for I've repaired thousands of refrigerators (home and commercial both), vacuum cleaners, radios, washing machines, irons, fans, lamps, mangles, motors, etc. In fact, many of my customers call me their "electrical appliance doctor." And, "doctoring," I might add, has paid me a good substantial income for quite a few years. Funny, in a way, how I got started. Always liked to tinker and by experimenting around I found that most electrical appliances had many things in common. That, regardless of what the appliance was used for, or who the manufacturer was, the basic principles were much the same. From fixing my own appliances to fixing friends' and then for strangers at a fee, seems now to have been but a small step.

What to Charge?

At first, I let the owner decide the charge and, frankly, I was amazed at what I earned per hour. But then, when one figures what initial costs are involved in buying most electrical appliances, one can readily see that spending extra dollars for repairs is well worth while. Before long I was making more in my spare time repairing than from my regular job. The result . . . I went into business for myself. When war came, business boomed, for new appliances were not available.

For a while, repair parts (needed on some

jobs) were a little difficult to get. But that situation seems to have adjusted itself for many repair parts have today the high priority rating of AA2. After all, we must provide for the health and well-being of our civilian population.

The Future Offers

Friends ask me about my future. And, I think I've got a grand one. Age is no handicap in repairing. I have in my files enthusiastic letters from repairmen ranging in age from 18 to 79 years. After the war, we're bound to see hundreds of new products on the market . . . products that the average person never dreamt of. These new products and our old appliances are all going to need at some time or other "fixing." Well, I'll still be the fellow to do it. The field open for appliance repairmen is unlimited. I don't worry at all about too much competition.

If You Are Ambitious

To the contrary, I've prepared a complete course, chuck full of simple, easy to understand photos and drawings and written in the same non-technical language as this article. I know the course is good, because I have hundreds of men all over the country writing to me, telling me how the course has helped swell their pockets with cash. If you too want to prepare now for your future, I suggest you read the next page and send me the handy coupon."



**ESTABLISH
YOURSELF IN
A PROFITABLE
LIFETIME
BUSINESS
- BIG MONEY
- INDEPENDENCE**

LEARN ELECTRICAL APPLIANCE REPAIRING

NO EXPERIENCE NEEDED

If you are at all mechanically inclined—that is to say—can hold and use tools—then you have all of the qualifications required for becoming a big money-earning home appliance repairman. It does not matter if you have not had a great deal of schooling or had no previous training along these lines. Age is no barrier . . . nor is any minor physical handicap.

Read What Other Students Say

I really believe your course the best investment a mechanically minded man can make.—*Claude E. Allen, Indianapolis, Ind.*

Your course on Appliance Servicing is the most complete and up-to-date I have heard of.—*Frank Kremen, Tarentum, Penn.*

I have received your Course in Appliance Repairing and I must say I am well pleased with same. I am only sorry I did not have said Course some years ago. I have learned so much more through this course I would not part with it.—*Charles Schwarz, Hamilton, Ohio.*

The Course in Appliance Servicing arrived a few days ago. Want to take out a few minutes of my valuable time to let you know that this is just what I have been looking for ever since I opened up my Fix-It shop. I must admit that you told the truth when you said that it contains quite a bit more information than I bargained for.—*P. J. Brel, Sebring, Ohio.*

I am a mechanic for the Western Union Telegraph Co. Three days after receiving the lessons in refrigeration I earned the exact cost of the course.—*Henry S. Lee, Washington, D. C.*

PREPARE FOR THE FUTURE

If now in war work, start your home appliance repair business in your spare time and be set with a business of your own when the war is over. You don't need elaborate fixtures or expensive equipment to be a successful repairman. Operate from your garage, basement, vacant store, etc. Work as many hours as you wish . . . the home appliance repairman is his own boss. It's a profitable occupation for on many types of repairs it is usual for a repairman to charge on the basis of \$5.00 to \$6.00 an hour! *Prepare today and make sure of tomorrow's future.*

New Course Helps All

Profusely illustrated, our new course shows you in simple, easy to understand language and drawings how to make each repair on refrigerators, vacuum cleaners, washing machines, motors, etc. Explains and gives you a working knowledge of electricity, welding, nickel plating, etc. Shows you how to build the power tools you need and how to solicit and keep business coming to you. Not a theory course but an honest to goodness course written by and used by repairmen the country over. Price of course is so low that the savings on your own household appliance repairs will quickly pay for it. Act now!

Mail Coupon for FREE LITERATURE

CHRISTY SUPPLY CO.,
2835 N. CENTRAL AVE., DEPT. D-1703,
CHICAGO 34, ILLINOIS

Please send me all the facts about America's Fastest Growing Industry—Electrical Appliance Repairing.

Name

Address

City..... State.....

Choose Your Road to a Postwar Aviation Career



START TRAINING NOW AT AERO TECH



Select one of the eight modern courses available at Aero Tech. Train where complete shops, laboratories and classrooms have started many civilians and servicemen on successful aviation careers.

... TO VETERANS OR SERVICEMEN

Expand your aviation knowledge by planning now to enroll in Aero Tech's special, advanced courses. This will insure your post-war opportunities in the new "aviation age," which will require trained, alert men by the thousands.

... GREATLY EXPANDED COURSES

New requirements by commercial aviation, worldwide airlines, service depots, feeder lines... have created many new courses now offered by Aero Tech. Always up-to-the-minute, Aero Tech steps ahead with special plans for the "aviation age of the future."

GET COURSE BULLETINS NOW...

New classes now forming

Thousands secured their start from this institution... thousands more will secure a "priority" on their careers by attending Aero Tech in the near future. Send coupon for free bulletins NOW—act today!



Approved by CAA for Aircraft and Engine Mechanics Training

AERO INDUSTRIES TECHNICAL INSTITUTE
Herbert W. Hartley, President
5253 W. San Fernando Rd., Los Angeles 26, Calif.



AERO INDUSTRIES TECHNICAL INSTITUTE
5253 W. San Fernando Road, Los Angeles 26, Calif.

Gentlemen: Please send free bulletins, and data on courses checked:

- | | |
|---|--|
| <input type="checkbox"/> Aircraft Mechanics | <input type="checkbox"/> Airport Management |
| <input type="checkbox"/> Instrument Technician | <input type="checkbox"/> Flying (all licenses) |
| <input type="checkbox"/> Aeronautical Engineering | <input type="checkbox"/> Engine Mechanics |
| <input type="checkbox"/> Flight Engineer | <input type="checkbox"/> Dispatcher |

Name _____ Age _____

Street _____

City _____ Zone _____ State _____

Civilian In Service Veteran P-1

★ SAVE WASTE PAPER ★

Write your own Future in Photography

Prepare now for a well-paid position today and a postwar career that is different, fascinating and profitable. Photography offers ever-increasing opportunities for both men and women. FREE book tells how N. Y. I. experts can quickly train you at home or thru resident, day or evening instruction in our up-to-the-minute N. Y. studios. Start now. ALL branches of black and white, motion picture and COLOR photography. Write TODAY!

NEW YORK INSTITUTE OF PHOTOGRAPHY
Dept. 49 10 West 33 Street New York 1, N. Y.

LEARN AT HOME TO MOUNT BIRDS

Animals, Heads, Fishes, Pets; to TAN.
Be a Taxidermist. Profit and FUN.
Hunters, save your valuable TROPHIES. Mount ducks, squirrels, everything. Learn to TAN for leather and furs. Wonderful HOBBY Have a HOME MUSEUM. BIG PROFITS mounting for others. INVESTIGATE NOW!
FREE BOOK With 100 fine game pictures. NOW absolutely FREE. Write TODAY.
Send Postal TODAY for FREE BOOK. State AGE.
N. W. SCHOOL OF TAXIDERMY, Dept. 3371, Omaha, Neb.

CHEMISTRY IS OPPORTUNITY!

There's no limit to the chemist's chances for advancement... in salary... in importance. Experiments develop into giant new industries. Established industries rely on laboratories. I.C.S. training... practical... thorough... opens this great field to you. Instruction papers specially written by noted chemical engineers, consulting chemists, metallurgists. And these big experts are EASY TO UNDERSTAND. Our editors have explained all technical terms simply, clearly. Any person of ordinary intelligence can learn and make rapid progress. You have ambition. We have the training you need. Send now for free booklet
International Correspondence Schools, Box 5514-K, Scranton 9, Pa.

924 PAGE AUTHENTIC FORMULARY

10,000 Formulas, Recipes, Trade Secrets for making most any conceivable product. Prepared by experts in simple, non-technical language. Countless profitable business opportunities, supply sources. Valuable reference for home, farm or industry. Illustrated. Extra Complete plans: "DDT" Miraculous New Insecticide. One spraying kills all Flies, Mosquitoes, Lice, Jap Beetles, etc. Lasts three months. Big money maker. \$2.98 postpaid—Canada or Foreign \$3.25 U.S. Funds. (C.O.D. orders accepted for U.S. delivery only.)



Prepare for "After-War-Business" Especially recommended for Servicemen and War Workers planning a profitable business of their own.

ADAMS BROWN COMPANY . . Dept. 10 . . Chestnut Hill 67, Massachusetts

Get the Knack of Managing Men

Every superintendent or foreman can develop into an outstanding employee by acquiring the knack of managing men.

How to combine the essentials of shop engineering with the art of handling people is covered in a 48 page booklet that outlines the basic problems in every industry. Address Louis S. Vosburgh.

LINCOLN EXTENSION INSTITUTE, INC.
West 75th St. at Detroit, Cleveland, Ohio

EARN MONEY PAINTING PORTRAITS



No previous training or talent necessary. Unique Stuart System teaches you, by mail, in 11 simple, easy-to-follow lessons, to make exact charcoal and oil likenesses. Detailed guidance for your every step. Send for free book today.

STUART STUDIOS, 121 Monument Circle, Rm. 615, Indianapolis 9, Ind.
Please send me free book and outline of lessons.

Name _____

Street _____

City _____ State _____

PLASTICS

ADVERTISING	BUSINESS MACHINES	PHONOGRAPH RECORDS	GARDEN TOOLS	BEAUTICIAN MACHINES	RAILROAD
INSTRUMENTS	DECORATING	TOYS	CLOTHING	GEARS	BOATS
OGRAPHY	HARDWARE	MUSICAL INSTRUMENTS	HOME APPLIANCES	TELEPHONES	GAMES
TERS	ELECTRICAL	FURNITURE	TOOLS	PACKAGING	SPORTS
YARD	MODELS	REFRIGERATION	MOTORS	PRINTING	MOVIES
VERY	PLUMBING	MACHINERY	FIXTURES	TEXTILES	WIRE
VARE	GAMES	DISPLAYS	DENTISTRY	SIGNS	WIRE
ING	AIR CONDITIONING	SURGICAL APPLIANCES	BUILDING MATERIALS	KITCHEN UTENSILS	WIRE
E	MARINE	AUTOMOTIVE	RADIO	AIRCRAFT	WIRE

Be a part of this Great Industry!

Plastics are playing an increasingly important part in almost every industry—improving old products and creating new ones. That is why such a brilliant future is predicted for plastics in the postwar period—offering opportunities to farsighted men and women who *know* plastics. Now is the time for you to prepare for a career in this fast-growing field.

LEARN AT HOME—You can learn plastics in your spare time at home without interrupting your present work. The Plastics Institute has developed a thorough, easy-to-understand course of training, requiring no previous technical experience. It offers complete, authoritative training based on industry requirements.

FASCINATING COURSE—The lessons are readily grasped and practical. Every step is made clear with graphs, diagrams, pictures. Actual specimens of plastics materials are furnished. A bi-weekly bulletin, "Plastics Trends," keeps you posted on new developments.

Dept. PM-1, 122 E. 42nd St., New York 17—Dept. PM-1, 221 N. La Salle, Chicago 1—Dept. PM-1, 186 S. Alvarado, Los Angeles 4

COMPREHENSIVE—Learn the various phases of plastics from this course . . . materials, designing, molding, fabricating, estimating and plant management. Acquire a basic knowledge of plastics that can be invaluable in preparing you to take your place in this great new industry.

EXCLUSIVELY PLASTICS—The Plastics Institute is America's oldest and largest plastics educational organization which devotes all of its facilities exclusively to plastics. It is held in high esteem by members of the plastics industry. Many of our graduates hold responsible positions in the plastics field.

START YOUR FUTURE—TODAY! Mail the coupon below now! We will send you an interesting booklet filled with valuable information on plastics and tell you how, at small cost, you can prepare for a career in this important industry. Don't put it off! Mail today!

SPECIAL RATES FOR SERVICE MEN

Plastics

INDUSTRIES TECHNICAL INSTITUTE

Plastics Industries Technical Institute
221 N. La Salle St., Dept. PM-1, Chicago 1

Mail in Envelope or
paste on penny postcard

Gentlemen: Please send me the booklet "World of Plastics" and information on your training program. I understand there is absolutely no obligation.

Name.....Occupation.....

Street.....Age.....

City.....Zone.....State.....

Veterans: Check here for information about G.I. Training Privileges.

If under 18: Check here for special booklet.

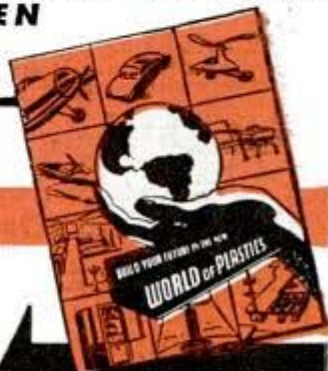

FREE BOOKLET
Send For It Today!

150 ELECTRICAL SHOP PRINTS



Only
\$1

Full Size 8½ x 11 in.
Large, clear type

Rich, Library Cover to stand wear

The goal of every expert Electrician and Radio Man is to have a full kit of Shop Prints and Wiring Diagrams. Many fellows buy such prints a few at a time, paying 10c to 25c per print. Now here's a handy collection of 150 of these useful Shop Prints—at a BIG SAVING.

- New Electrical Ideas
- Wiring Techniques for Controls
- Wiring for Welders, Motors, etc.
- Armature Winding Diagrams
- House Wiring Circuits
- Radio Circuits

Some of the most complex electrical circuits illustrated and described in easy to follow instructions. Page after page of down-to-earth "Show how" practical, working illustrations to show you just what you want to know about D.C. and A.C. Motors, starters and controls.

Full Size Diagrams

Complete Explanations

Every diagram is large, clear—amazingly easy to understand. By means of the most unique illustrations you are given a step-by-step explanation of major electrical principles of Motors, Generators, Trouble Shooting, Welding Systems, Transformers, Radio Circuits, Frequency Modulation as well as many valuable Trouble-Shooting Ideas.

Coyne Laboratory-Tested Book

Every diagram in this book has been tested in the great Coyne School Laboratories. Whether you're an "old hand" or a beginner, you should have this practical book in your working kit. It will be worth many times the low price of \$1.00. Send for this great book TODAY. It will make you more valuable to your company—better prepared for the coming severe post-war competition for jobs.

ORDER NOW Paper shortage limits quantity of these great books available. To be sure of getting a copy order **yours immediately**. Simply fill out the coupon below and drop in an envelope with a \$1 bill, money order or check. (Sent C.O.D. if you prefer). **BUT DO IT NOW!**

H. C. LEWIS, President
COYNE ELECTRICAL SCHOOL

500 S. Paulina St., Dept. 15-R4, Chicago 12, Ill.

SUPPLY LIMITED — ORDER NOW!

H. C. LEWIS, Pres., COYNE ELECTRICAL SCHOOL, Dept. 15-R4, 500 South Paulina Street, Chicago 12, Ill.

I enclose \$1.00 (cash, money order, check) — Please send me a copy of "150 Coyne Shop Prints and Motor Diagrams." I understand that if I am not satisfied I can return the book within 5 days and my money will be refunded.

Name _____

Address _____

Town _____ Zone _____ State _____

If you want book sent C.O.D.—(you pay postman \$1.00 plus small C.O.D. fee), check here — same satisfaction or money back agreement.

★ SAVE WASTE PAPER ★

MEN WANTED!

GOOD MONEY NOW and
a Bright POST-WAR FUTURE

War plant workers... returning Veterans... Others! If you want to enjoy a FINE INCOME NOW, with even greater opportunities after the War ends, write us today! We are a nationally known manufacturer of Fire Fighting equipment... including "AUTOFYRSTOP," the amazing combination fire extinguisher and alarm that holds unequalled records. Our products sell FAST and in QUANTITIES to factories, schools, stores, homes. NO EXPERIENCE NEEDED. Write for FREE FACTS!

AUTOFYRSTOP CO., Dept. M-15, 2035 Washington Ave., Philadelphia 46, Pa.



Show Donald Duck CARTOON FILMS

At Your Xmas Home Movie Entertainments Every DONALD DUCK Home Movie a laugh riot from start to finish.

Get These Features
100 Ft. 8MM. \$3.00
200 Ft. 16MM. \$6.00

Fast & Furious. 1452-B
The Fireman. 1453-B
Donald's Day Off. 1454-B
The Flying Trapeze. 1455-B

Give and show also a Mickey Mouse, 3 Monkeys, Bosko and Oswald Rabbit feature for grand Holiday entertainment.

See at your Photo Dealers, or order direct. Catalog and prices on request. Write to:

HOLLYWOOD FILM ENTERPRISES, INC.

6060 Sunset Blvd. Dept. 115 Hollywood 28, Calif.

JOIN THE Management!

There's always opportunity in the business world for the man who wants to join the management. Routine jobs are easily filled, but men with the rounded knowledge needed by executives are hard to find. That's where I.C.S. comes in. A pioneer in business training, these schools have graduated thousands who became executives. Through the I.C.S. Business Management Course, experts train you in finance and business law, accounting and production, salesmanship and advertising. Write today for free booklet. International Correspondence Schools, Box 5517-K, Scranton 9, Pa.

INVENTORS

WE LOCATE BUYERS

for Practical, Saleable inventions. Patented, Unpatented, Cash, Royalty. Many requests waiting. Inventors wishing to sell, write us immediately. DESCRIPTIVE BOOKLET, Protective Disclosure Form, References, and Full Particulars, FREE ON REQUEST. A Post-Card will do! Address:

THE INVENTION REPORTER

5C-11236 So. Fairfield Ave. Chicago 43, Ill.

A SIMPLIFIED ART ANATOMY OF THE HUMAN FIGURE
ONLY 51 POSTPAID
by Charles Carlson. The book they're talking about! One of the most informative books of its kind for both student and professional artists. Charts, notes, and over 350 drawings show detailed studies of every part of the body, posed and in action. HOUSE OF LITTLE BOOKS, 156-160 Fifth Ave., New York

MONEY MEN ALL FREE
DATA
THE PLASTEX Industry needs manufacturers on small scale and for big production of Lamp and Clock Stands, Art Goods and Novelties in Plastex and Marble imitation. Experience unnecessary. Lat material makes regular 10c store sellers. Rubber moulds furnished for speed production. Small investment brings good returns. Big chain store orders now being placed. Ambitious men have chance for real prosperity. Our Free booklet will interest and benefit you.
PLASTEX INDUSTRIES, Dept. P, 1095 Washington Ave., New York, N.Y.

SENSATIONAL WAR BARGAINS IN LENSES & PRISMS

All Lenses New, Finely Ground and Polished, Edges Very Slightly Chipped. Come Neatly Packed and Marked—A Salvage Bargain!

YOU CAN EASILY MAKE

Telescopes

Magnifiers

Photographic Gadgets

and HUNDREDS OF EXPERIMENTS with these Low Cost LENSES

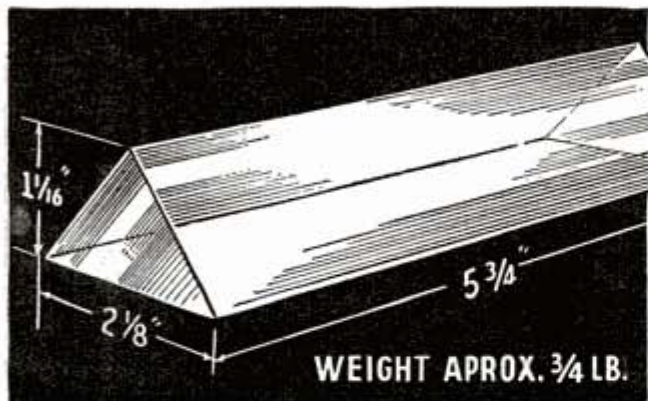

WEIGHT APROX. 3/4 LB.

TANK PRISMS

In order that the tank driver shall not get shot in the face, two of these Silvered Prisms are used to make a periscope. We have secured a number of these that are very slightly chipped, making possible their sale at a very low price. They are 90-45-45 degree prisms of huge size—5 3/4" long, 2 1/8" wide, finely ground and polished.

You can use these Prisms to make Periscopes to see over the heads of crowds, to photograph fish under water, to view high or low gauges, etc. Also excellent for experiments, classroom demonstrations at high schools, colleges, camera clubs, astronomy clubs. Some of our ingenious customers have used these Prisms to make camera stereo attachment, photometer cube, range finder, etc. And here's an excellent, unique gift idea. For 5c we supply 100 gold letters with which you can turn one of our Silvered Prisms into a desk name plate in 5 minutes of easy work.

Normally, these Prisms would retail from about \$24 to \$30 each.

SPECIALS IN LENS SETS

Big 10 Page Project and Idea Booklet with all sets—describes successful developments—points the way to new experiments.

Set No. 301-H "Our Advertising Special" 15 Lenses for \$1.60 Postpaid. For making your own powerful telescopes, low power microscope, strong magnifiers, drawing projector, photo cells, telephoto lens, dummy focusing camera, Kodachrome viewer, stereoscopic viewer, ground glass and enlarging focusing aids. For experimental optics, portraits of babies and small pets, copying, ultra close-up shots, and many, many other uses.

Set No. 305-H "The Gadgeteer's Delight" 35 Lenses for \$5.00 Postpaid. Contains all the lenses in the above set plus twenty more expensive lenses increasing your field of experiment and gadget making. All our lenses are neatly packed and marked.

Set No. 310-H "The Experimenter's Dream" 60 Lenses and New Complete 50 Page Booklet—\$10.00 Postpaid. Contains all the lenses in the above set plus 25 others that makes this a sensational buy. The variety of lenses in this set will enable you to conduct countless experiments and build a wide variety of optical equipment.

New 50-Page Illustrated Idea Book . . . \$1.00 Postpaid. "Fun with Chipped Edge Lenses" describes a wide variety of uses for our lenses and contains much information especially designed for the homemade construction of optical items.

PORRO ABBE PRISMS—Stock No. 3006-H . . . 25c each Postpaid. Size 9 mm x 17 mm . . . another war bargain. Normal prices would be 20 to 40 times above quotation. At this exceptionally low price, you should purchase a few of these, even though you have no immediate need for them. Such a bargain will not be available long.

Stock No. 3004-H . . . SILVERED TANK PRISMS—Price \$2.00 each Postpaid.

Stock No. 3005-H . . . PLAIN TANK PRISM—Price \$2.00 each Postpaid. This one is excellent for projecting all the colors of the spectrum—a beautiful sight.

FOUR TANK PRISMS—Special—\$7.00 Postpaid.

. . . This is the most sensational bargain we have ever been able to offer.

MFG. FOR NAVY'S 7 POWER BINOCULARS

KELLNER EYE-PIECE LENSES . . . you can use in Telescopes, Binoculars, Microscopes, etc. Consist of achromatic eye-lens and a field lens. Focal length 27.5 mms. Comes uncemented with FREE cement and easy directions.

Stock No. 6061-H—Edged . . . \$1.25 Postpaid

COMPLETE SET OF LENSES AS ABOVE AND THE PRISMS TO MAKE A MONOCULAR (TELESCOPE) with objective lens of 2" diameter.

Stock No. 5100-H—Monocular Set . . . \$5.00 Postpaid

8 MM MOVIE PROJECTING LENS SET—Stock No. 4011-H . . . \$1.20 Postpaid. Consists of 2 Achromatic Lenses, diameter 18 mms. and a focal length when combined of 1".

35 MM FILM ENLARGING LENS SET—Stock No. 6057-H . . . \$1.50 Postpaid. Consists of 2 Achromatic Lenses to use at a speed of about F.8. These make a good substitute until Anastigmat Enlarging Lenses again become available.

Order by Set or Stock No.—Satisfaction Guaranteed

EDMUND SALVAGE COMPANY

27 W. Clinton Ave., Dept. 11, P. O. Audubon, N. J.

Men, get into

INDUSTRIAL ELECTRONICS

Grow With America's Great New Industry

Get hooked up with the newest and perhaps the fastest growing industry this country has ever seen.

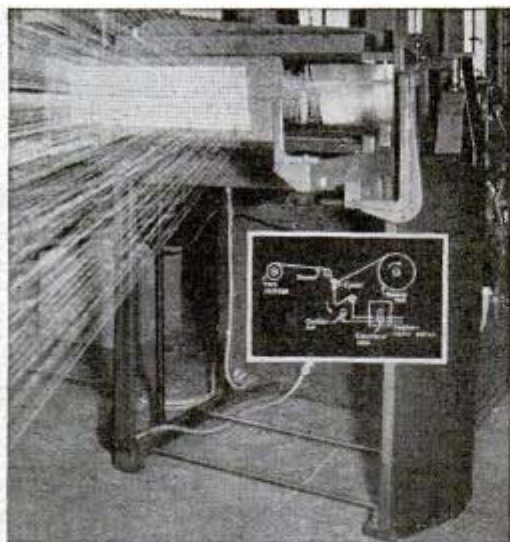

Electronic detector stops motor if any one of 500 threads breaks

Revolutionary—Amazing. Industrial Electronics is revolutionizing production processes of all kinds. Wheels turn or stand still at its signal. Lights go on or off at the flick of its sensitive "fingers". Giant printing presses, shears, punch presses, and the like, are absolutely controlled by it.

Going to Town. With ability to do all these things and more, is it any wonder Industrial Electronics is forging to the front by leaps and bounds? All the big industries are opening wide their doors to it. Why? Because this amazing new force cuts costs tremendously.

Trained Men Are Needed—to install and service this Industrial Electronics equipment. In fact, right now there are not nearly enough such trained men. And thousands upon thousands more will be needed after the war.

Train for a Key Job NOW. Yes, get ready NOW. Be among the first to land a key job with top pay in this exciting new industry. This institution, a pioneer in practical technical home training, will give you the "know-how" you need. Our methods must be right, for during the past 3 years we have been training men and women in fine precision work for the Army, Navy, and Marine Corps exclusively, under Government contract.

We Will Train You in Your Spare Time. We will train you at home in your leisure time, or in our big Chicago shops, or combine both methods. No advanced schooling or previous experience is necessary. Our methods are geared to the man who must work for a living. They make everything simple, fascinating, easy to grasp. Get the facts. Write for full details TODAY.

INDUSTRIAL TRAINING INSTITUTE
2130 Lawrence Ave., Dept. P1A, Chicago 25, Ill.

Do you want

- .. to go to College?
- .. or to enter a Profession?
- (Such as Accounting, Architecture, Nursing, Dentistry, Teaching, Social Work, Osteopathy, Beauty Culture, Optometry, Embalming, Chiropragy, Law, Medicine, etc.)
- .. or get an Office Position?

To get anywhere, you practically MUST finish High School FIRST. You can complete our simplified High School Course in SPARE time at home, as FAST as your time and abilities permit. Equivalent to resident school work—prepares you for college, pre-professional examinations, business, industry. Standard texts furnished. Diploma. Credit for H.S. subjects already completed. Single subjects if desired. Low tuition, easy terms. American School, Chicago, est. 1897—endorsed by educators. Finish your high school education NOW. Write TODAY!

High School Course at Home

Many Finish in 2 Years

American School, Dept. H145, Drexel Ave. at 58th St., Chicago 37, Ill.

Gentlemen: Send me FREE information covering special training in subjects checked below. No obligation on my part.

- | | |
|--|--|
| <input type="checkbox"/> High School Course | <input type="checkbox"/> Diesel Engineering |
| <input type="checkbox"/> Cost Accounting for Mfg. | <input type="checkbox"/> Drafting and Design for men & women |
| <input type="checkbox"/> Architecture and Building | <input type="checkbox"/> Plastics |
| <input type="checkbox"/> Automotive Engineering | <input type="checkbox"/> Private Secretary |
| <input type="checkbox"/> Business Management | <input type="checkbox"/> Mechanical Engineering |
| <input type="checkbox"/> Electrical Engineering | <input type="checkbox"/> Aviation <input type="checkbox"/> Radio |
| <input type="checkbox"/> Elec. and Gas Refrigeration | <input type="checkbox"/> Salesmanship |
| <input type="checkbox"/> Air Conditioning | <input type="checkbox"/> Shipbuilding |
| <input type="checkbox"/> Railway Training | |

Name.....

Address.....

AUDELS Carpenters and Builders Guides

4 vols. \$6



Inside Trade Information for Carpenters, Builders, Joiners, Building Mechanics and all Woodworkers. These Guides give you the short-cut instructions that you want—including new methods, ideas, solutions, plans, systems and money saving suggestions. An easy progressive course for the apprentice and student. A practical daily helper and Quick Reference for the master worker. Carpenters everywhere are using these Guides as a Helping Hand to Easier Work, Better Work and Better Pay. To get this assistance for yourself, simply fill in and mail the FREE COUPON below.

Inside Trade Information On:

How to use the steel square—How to file and set saws—How to build furniture—How to use a mitre box—How to use the chalk line—How to use rules and scales—How to make joints—Carpenters arithmetic—Solving mensuration problems—Estimating strength of timbers—How to set girders and sills—How to frame houses and roofs—How to estimate costs—How to build houses, barns, garages, bungalows, etc.—How to read and draw plans—Drawing up specifications—How to excavate—How to use settings 12, 13 and 17 on the steel square—How to build hoists and scaffolds—skylights—How to build stairs—How to put on interior trim—How to hang doors—How to lay—lay floors—How to paint



THEO. AUDEL & CO., 49 W. 23rd St., New York City

Mail Audels Carpenters and Builders Guides, 4 vols., on 7 days' free trial. If O.K. I will remit \$1 in 7 days, and \$1 monthly until \$6 is paid. Otherwise I will return them. No obligation unless I am satisfied.

Name.....

Address.....

Occupation.....

Reference.....PM



Now ANY AUTO REPAIR JOB Can Be "Duck Soup" For You!

MoToR's New AUTO REPAIR MANUAL
Shows You How to Service and Repair
ANY Part of ANY Car!

FREE 7-DAY OFFER!

NOW you can "polish off" the HARDEST jobs the EASIEST way! MoToR's AUTO REPAIR MANUAL is ready to show you how to repair anything from carburetor to rear end—with the least possible amount of time and effort!

Suppose plain-talking car engineers from every auto plant in America got together and showed you all the things you needed to know about repairing and servicing the cars they had designed and manufactured! That's really what you get in this big manual! Right at your fingertips, the main "dope"

from 150 Official Factory Shop Manuals, covering every make car built since 1935!

Easy to use, too! Quick-index leads you to right page in jiffy! Just follow simple instructions step-by-step.

SEE HOW MUCH YOU GET!

764 pages, 8½ x 11 inches, bound in sturdy covers. 200,000 service, repair, adjustment, replacement, tune-up facts on all makes and models, 1935 to 1942. More than 1000 cut-away photos, diagrams, drawings show you exactly WHAT to do and HOW to do it. Used by U. S. Army, trade and technical schools everywhere, thousands of auto servicemen.

Now YOU—without cost—can see for yourself what a wonderbook MoToR's Auto Repair Manual really is. TRY it—FREE for 7 days! Learn first-hand how it can pay for itself the first few times you use it.

SEND NO MONEY 7-Day Free Examination

Just mail coupon at right, without money! When the postman brings your book, pay him nothing. First make it show you what it's got! Unless you agree this is the greatest time-saver and work-saver you've ever seen—return book in 7 days and pay nothing. Mail coupon today! Address: MoToR Book Dept., Desk 1A, 572 Madison Ave., New York 22, N. Y.

Published by MoToR, The Leading Automotive Business Magazine. MoToR's manuals assure high standards of repair work.

Covers All These Makes!

American
Bantam
Auburn
Austin
Buick
Cadillac
Chevrolet
Chrysler
Cord
Crosley
De Soto
Dodge
Ford
Graham
Hudson
Hupmobile
Lafayette
La Salle

Lincoln
Lincoln
Zephyr
Mercury
Nash
Overland
Oldsmobile
Packard
Pierce
Arrow
Plymouth
Pontiac
Reo
Studebaker
Terraplane
Willys

USED BY
U. S.
ARMY

Clear, Pictured Facts on Every Job on Every Car Built Since 1935!

Nearly 200,000 service and repair facts on all 31 makes, 764 big pages; including 50 pages of carburetor test, charts, illustrations, covering all models. Over 500 charts, tables; Tune-up Chart; Valve Measurements; Compression Pressure; Torque Wrench Reading; Starting Motor; Engine Clearances; Generator; Clutch and Brake Specifications; Front End Measurements, etc.; Engines; Electric, Fuel, Cooling, Lubricating Systems; Transmissions; Universals; Front Ends; Wheels; Rear Ends, etc.

Same FREE 7-Day Offer Applies on MoToR's TRUCK REPAIR MANUAL

For mechanics, truck specialists, service stations, fleet owners. Covers EVERY job on EVERY truck made since 1936! 1400 pictures, 914 pages. 300,000 facts. Used by Armed Forces.

All types Gasoline Engines, Diesels, Hesselman, Fuel Systems, Governors, Lubrication Systems, Ignition Systems, Starters, Generators, Clutches, Transmissions, Axles, Torque Dividers, Transfer Cases, Brakes, Steering, etc. ALSO SERVICES buses, farm and industrial tractors, contractor and road building equipment, stationary power machinery, etc. (on all parts described in Manual.) Check box in coupon at right.



MAIL COUPON NOW FOR 7-DAY FREE TRIAL

MoToR Book Dept., Desk 1A, 572 Madison Ave., New York 22, N. Y.
Rush to me at once: (check box opposite book you want).

MoToR's AUTO REPAIR MANUAL. If O. K. I will remit \$1 in 7 days, \$1 monthly for 4 months, plus 35c delivery charge with final payment (\$5.35 in all). Otherwise I will return book postpaid in 7 days. (Foreign price, remit \$7 cash with order).

MoToR's TRUCK REPAIR MANUAL. (Described at left.) If O. K., I will remit \$2 in 7 days, and \$2 monthly for 3 months, plus 35c delivery charges with final payment (\$8.35 in all). Otherwise I will return book postpaid in 7 days. (Foreign, remit \$11 cash with order).

Print Name _____ Age _____

Print Address _____

City _____ Zone No. _____

State _____ (if any)

Occupation _____

SAVE 35c! We pay postage if you ENCLOSE full payt., (check, M.O.). Same 7-day return-refund privilege.

The set of
books
that makes



MASTER MACHINISTS and leads to bigger pay!

This big home-study and reference course gives you the practical facts on machines and methods you need to advance in machine shop work. Take advantage of the other man's experience as found in books, to solve your problems, increase your efficiency, with

The AMERICAN MACHINISTS' LIBRARY

6 volumes—2368 pages—2516 illustrations
(A combined home-study course and reference library)

This library of machine shop practice was written for practical men. It gives you the best methods for every kind of machine shop work. It fully explains lathes, drills, and other machine tools and their operation, automatic screw machines, speeds and feeds, gear design and production, jigs and fixtures, punch and die work, metal surfacing, etc., etc. Plainly written—completely illustrated—the best kind of help to the machine shop man who wants to advance himself.

No money down—special price—easy payments!

EXAMINATION COUPON

McGraw-Hill Book Co., 330 W. 42nd St., N. Y. 18

Send me for ten days' examination the American Machinists' Library. If satisfactory I will send you \$1.50 in 10 days and \$3.00 monthly until the price of \$19.50 is paid. If not wanted, I will return the books postpaid. (To insure prompt shipment write plainly and fill in all lines.)

Name
Home Address
City and State
Position
Name of Company PM-1-45

EVERY MARINE ENGINEER CAN USE THIS BOOK

JUST OUT! **New From Cover To Cover**

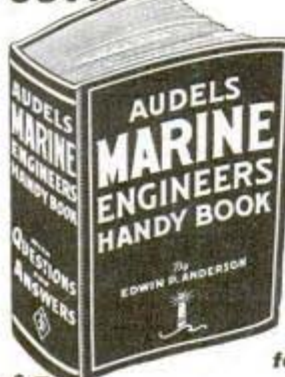

AUDELS MARINE ENGINEERS Handy Book

Entirely modern, Practical Treatise for Marine Engineers (all grades), Firemen, Oilers, Machinists and Students with Calculations and Questions and Answers for Examinations.

LATE INFORMATION in a Handy Form covering all branches of modern Marine Engineering with step-by-step solutions on hundreds of problems. —Tables and Data—Fully Indexed—Easy to Understand—Size 6 3/4 x 5 x 1 3/4.

Indispensable
for Upgrading Examinations
and Ready Reference.

\$4 COMPLETE
PAY \$1 A
ONLY 1 MO.
1280 PAGES—FULLY ILLUSTRATED
ASK TO SEE IT—Get this information
for yourself—
Clip this coupon and mail today!

AUDELS, Publishers; 49 W. 23 St., New York 10, N.Y.

Mail AUDELS MARINE ENGINEERS Handy Book (Price \$4) on 7 days free trial. If O.K., I will remit \$1 in 7 days and \$1 monthly until \$4 is paid. Otherwise, I will return it.

Name
Address
Occupation
Employed by PM

PARKS AIR COLLEGE

18th Year Offers YOU COLLEGE and PROFESSIONAL TRAINING
Majoring in AVIATION

Accredited by the Illinois Superintendent of Public Instruction. Included since 1938 in Directory of Higher Institutions of Learning, issued by the U. S. Office of Education. U. S. approved since 1929 as a Flight and Ground School.

"G. I. Bill of Rights" educational benefits are sufficient to pay most of, though not all of, direct school expenses for eligible Veterans.

Open to high school graduates with a ranking in the upper two-thirds of their classes.

Three engineering courses majoring in Aviation Operations, Aviation Maintenance, and Aeronautical Design Engineering lead to the Bachelor of Science degree, the Airplane and Airplane Engine Mechanics ratings, and the Private Pilot rating on the two-control personal plane.

Professional Flight Training, leading to the Commercial Pilot rating and the Instrument Pilot rating, is elective for all enrolled engineering students who are physically qualified.

Each course provides 120 weeks, ten terms, of personalized instruction and is completed in 1 1/2 calendar years.

Enrollment limited to 400 students.

Airpark and 21 buildings devoted to school purposes exclusively. Dormitories and dining hall are on the campus.

Winter term, January 8, Spring term, April 2.

Send post card for new 64-page catalog. Address:

Registrar, Dept. PM-1

PARKS AIR COLLEGE, East St. Louis, Ill.

TRAIN

Your VOICE!

Results GUARANTEED

We build, strengthen the vocal organs—not with singing lessons—but by sound, scientifically correct silent and vocal exercises and absolutely guarantee complete satisfaction with results. Write for Voice Book, FREE. Sent to no one under 17 years old unless signed by parent.

PERFECT VOICE INSTITUTE, Studio 1351, 64 E. Lake St., Chicago 1, Ill.

Learn Penmanship

You can learn plain, rapid writing or fancy ornamental writing for social and business advancement, right in your own home during spare time by my Simplified Method. Write for my free book, "How to Become an Expert Penman," which shows what others have accomplished by taking my Courses. Send 10c for one of my favorite Pen Points and your name with a beautiful flourished bird written on a card. Write today. T. M. Tevis, Box 25K, Chillicothe, Mo.

TRI-STATE COLLEGE

B. S. Degree in 27 Months

Distinguished for technical 2 3/4-year courses in Civil, Electrical, Mechanical, Chemical, Radio, Aeronautical Engineering; Business Administration, Accounting, and Secretarial Science.

EX-SERVICE MEN can complete work here in shortest possible time. Special Prep. Dep't. Also REFRESHER COURSES. 36-Week Courses in Surveying, Drafting. Low tuition. Low living costs. Cosmopolitan student body. 61st year, Enter Jan., March, June, Sept. Catalog.

415 College Ave. ANGOLA, INDIANA

Fix Your Own ALARM CLOCKS

New, practical home course. Just out. Makes interesting hobby—profitable too. Save money by doing your own repairing at home. Easy if you know how. Price now only \$1.00. Details FREE. Send postcard.

THIES JEWELRY STORE, Genoa 3, Illinois

ELECTRICITY MEN NEEDED

Electricians are needed everywhere. Demand is growing. Good pay now and bright future for trained men in this live, expanding vocation. Learn at home, in spare time, from old established school. Write for FREE Bulletin. No obligation.

AMERICAN SCHOOL
Dept. EE145 Drexel at 58th St. Chicago 37

FREE TRIAL IN YOUR OWN HOME!
Here's the HELP YOU NEED
... Now and After the War!
 Used by Army, Navy, 200 Schools and Big Firms



DO ANY JOB.. EASIER.. QUICKER
MAKE MORE MONEY in the
BIG OPPORTUNITY
FIELDS

SEND NO MONEY
 Select the Books
YOU Need Now!
 We Ship **C.O.D.**
 Anywhere in U. S.
 and Will Refund
 Amount Paid if
 Not Satisfactory.

Get ready to meet keener job competition, now and when wartime jobs are over. Get into one of these big opportunity fields. Big money and many other advantages await you if you prepare now. Here is the help you need—**EASY—QUICK—AT LOW COST.** Thousands of men have already used these famous books. Beginners and experienced men alike have doubled and tripled their earnings with this help. You too, can now get the special knowledge you need for top pay, better jobs, or a business of your own. This is your **GOLDEN OPPORTUNITY.**



MODERN WELDING PRACTICE

Newest book on all types of welding and heat treatment of metals. Written by recognized specialists in training men for production jobs. **Practical and Non-Technical.** Covers

430 Pages
 277 Illus.
 Practical and Non-Technical

everything you need to know. Prepare for best pay jobs now. Price \$4.00.

AIRPLANE WELDING

All metal airplane building offers big opportunities after the war.

New 2nd edition of this famous book by J. B. Johnson, Materials Division, Wright Field. The authoritative and practical book on Airplane welding and materials brought right up to date. 420 pages, 193 pictures. \$3.50.

AIR CONDITIONING



Big air conditioning boom interrupted by war will be bigger than ever in post-war days. Get this non-technical book by international authority and be ready for your share of millions to be spent. Covers whole field. 450 pages. Illustrated. \$3.50.

SHEET METAL LAYOUT

Makes sheet metal layout work so simple that anyone can learn. Get this new instructor and get into the easiest, cleanest and best paying part of all sheet metal work. 143 jobs worked out in drawings and carefully explained. Gives standard for all sheet metal fittings. \$3.00.



15 Million Refrigerators Need Service and Repairs

REFRIGERATION—Book of the Hour

NEW PRINTING—ALMOST 1000 PAGES

408 Pictures—17 Diagrams in Colors Makes All Refrigerator Service Maintenance, Repairs Simple as A. B. C.

No new refrigerators being made. Owners will pay big for competent service which will be needed more and more. Get **MODERN GAS AND ELECTRIC REFRIGERATION**, the non-technical guide to all types of refrigerators and get your share of this new profit. Get a job or start your own service business. This book will help you make money anywhere. Price \$5.00.



NEW 20th EDITION
Leading Auto Book for Over 32 Years

World's Greatest AUTO BOOK
New Material on Transmissions, Trucks, Tractors, Diesels, Aircraft and Auto Engines

Now with millions of cars needing repairs and thousands of men needed to do the work, you need the famous DYKE Auto Book more than ever before. Brand new 20th Edition covers all principles, construction, repair, adjustments, testing, troubles and remedies of all cars. Over a half million copies of 20 editions of Dyke's have been sold. Gives specifications of old and newer cars. World's biggest book value, \$6.00. This big book, a complete auto library in one volume, has 1483 pages—4600 illustrations and diagrams—weighs 6 lbs.—equal to 4 ordinary books.

AUTO BODY and FENDER REPAIR

Owners will spend big money to keep cars looking new because few new cars available. This is a practical money-making guide, ideal for shop owners and every man who wants a share of the millions to be spent in keeping old cars looking new. Tells how to get a good job or start business of your own with small capital. 325 pages, 232 illustrations. Price \$3.00.



BAILEY'S HANDBOOK

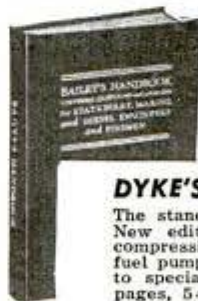

World famous handbook of universal questions and answers for Stationary, Marine and DIESEL engineers and firemen. Prepares for any license examination. Pocket size. \$2.00.

DYKE'S CARBURETOR BOOK

The standard guide for a generation. New edition covers engine tune-up, compression, ignition, carburetion, fuel pump valves, etc. Use this book to specialize in this big field. 244 pages, 549 illustrations. \$3.00.

Mail Coupon to: **Goodheart-Willcox Co., Inc.**
 2009 S. Michigan Ave. Dept. 12 Chicago 16, Ill.

SEND NO MONEY! Mail Coupon

- GOODHEART-WILCOX CO.,**
 2009 S. Michigan Ave., Dept. 12, Chicago 16, Ill.
- Send books checked, C.O.D. I will pay postman, plus few cents charges. If not satisfactory I will return books in 5 days and you will refund money paid. (Outside U.S. or possessions remit with order.)
- Gas & Electric Refrigeration . . . \$5.00
 - Dyke's Auto Book . . . \$6.00
 - Dyke's Carburetor Book . \$3.00
 - Modern Welding . . . \$4.00
 - Airplane Welding . . . \$3.50
 - Sheet Metal Layout . . . \$3.00
 - Air Conditioning . . . \$3.50
 - Bailey's Handbook . . . \$2.00
 - Body and Fender Repair. \$3.00
 - Aircraft Sheet Metal . . \$2.50
 - Shop Math. (2 vols.) . . \$3.00
- If remittance accompanies order we will pay all postage charges under same return privilege.

Name
 Address
 City State

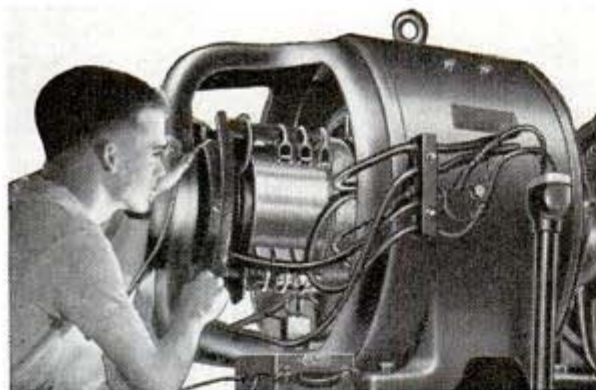

STUDY AT HOME

With A Chartered Educational Institution

Men with specialized training win higher positions, insure larger earnings, and are bigger successes in business and public life. Opportunities NOW greater than ever before. Send for our 1944 Catalog.

ARTS AND SCIENCES

Courses in Philosophy; Education; Letters; Public Health; Medical Jurisprudence; Psychology; Sociology; Physics; Chemistry; Plastics; Geology; Political Science; Theology; Business and Commerce; Accounting; Mathematics; Statistics; Agriculture.

ENGINEERING

Courses in Electrical, Civil, Mechanical, Drafting, Architectural, Steam, Aeronautical, Radio, Structural, Mining, Industrial, Highway, Petroleum, Marine, Chemical, Diesel, Automobile and Air Conditioning Engineering.

LAW

Complete Professional Law Course includes 21 Hornbook Series college grade textbooks. Courses also in Commercial Law, Patent Law and Medical Jurisprudence.
McKinley-Roosevelt Incorporated, 4610-K, Sheridan Rd., Chicago 40, Ill.

Learn LANDSCAPE GARDENING!

Prepare for the giant postwar home-building program. A thorough, constructive, interesting home-training for those who wish to become LANDSCAPERS, DESIGNERS, GARDENERS, etc., for profit or pleasure. Write today for FREE INFORMATION, without obligation, to

NATIONAL LANDSCAPE INSTITUTE
Dept. P-1 756 So. Broadway Los Angeles 14, California



DRAW CARTOONS BIG MONEY!

EASY . . . PLEASANT WORK!
Let CHAS. H. KUHN, with 25 years actual experience in drawing a daily newspaper cartoon, teach you how to create, draw and sell your work. 52 complete lessons—one sent each week. Professional criticism on every lesson. Write today.

KUHN SCHOOL OF CARTOONING
420 MURPHY BUILDING Dept. M INDIANAPOLIS 4, INDIANA

LEARN MOVIE PROJECTION THEATRE MANAGEMENT

The Motion Picture Theatre Business offers big opportunities for trained men. Get into a fascinating field with a peace time future. Train at home in spare time. Free catalog. Established 17 years.

THEATRE INSTITUTE, 370 Washington St., Elmira, New York

HIGH SCHOOL AT HOME

Most well-paid positions demand high school training. Without it, or equivalent, you can't advance to the full extent of your abilities in any trade, business or profession. Whatever your age, however you're situated, IT ISN'T NECESSARY TO STRUGGLE UNDER THAT HANDICAP. I.C.S., famous for more than 50 years, enables you to start your own high school in your own home. You're in a class by yourself—study in your spare time—acquire a high school education at astonishingly low cost. Authoritative texts! Rapid Progress! Write today for free booklet.

International Correspondence Schools, Box 5518-K, Scranton 9 Pa.



Wonderful, new device, guides your hand; corrects your writing in a few days. Big improvement in three hours. No failures. **Complete outline FREE.** Write C. J. Ozment, Dept. 34, St. Louis, Mo.

Learn ELECTRICITY 12 WEEKS TRAINING ON REAL MOTORS, GENERATORS, ETC.

Trained Electrical men are needed now. It's not how young you are, or how old you are. The question is, have YOU the training to hold a good war-time job today—and a good job with a real future, after the war.

COYNE TRAINING is easy, practical. Located in Chicago, heart of vast war industries. Coyne has behind it 45 years of experience in training successful men. Mail coupon now!

"Learn-by-Doing" in the Great Coyne Shops

Get ready for a big future the quick Coyne Way—by actual work on full-size electrical equipment, not by correspondence. Learn house-wiring, motors, power plants, switchboards, auto electricity, etc. Be an "All-Round Electrical Man"—for big opportunities.

Train First—Pay Later

My "Pay-Tuition-After-Graduation" plan enables you to get training first, and pay for your tuition in easy payments after graduation. If you need part-time work to help defray expenses while here, I'll help you get it.

Lack of Experience No Bar!

Many of my students have never had Electrical experience. Others have had experience in one or two branches but realize they need all-around training for the better jobs. So whether or not you have had electrical experience you need Coyne training.

Get My Free Book!

Let me send you my big illustrated book showing how I help you get the training you need for a good Electrical job. It's FREE—no obligation—no salesman will call. Send the coupon today!

H. C. LEWIS, Pres.
COYNE ELECTRICAL SCHOOL
500 South Paulina Street,
Dept. 15-72, Chicago 12, Ill.

We have facilities for men with physical disabilities. If you have a physical disability of any kind write me when you send the coupon.

INDUSTRIAL ELECTRONICS Now Included!

No extra cost for valuable extra training in this big field of new opportunities!



H. C. Lewis



H. C. LEWIS, President,
COYNE ELECTRICAL SCHOOL,
500 S. Paulina St., Dept. 15-72, Chicago 12, Ill.

Send me your Free Book. Tell me about your SPECIAL INDUSTRIAL ELECTRONICS TRAINING at no extra cost, and your "Pay-Tuition-after-Graduation" offer.

NAME.....

ADDRESS.....

CITY.....ZONE.....STATE.....

Have You Heard About My "HAVE-MORE" PLAN?

How to Raise Your Own Delicious Meat, Eggs, Vegetables, Etc. in Your Spare Time on as Little as 3/4 Acre of Land!

"A Little Land
and a Lot of Living"



Less Than
ONE ACRE
of Land!

**Let Me
Tell You How
We Do These Things
The EASIEST, LATEST, Most
PRACTICAL Ways at Our Small Place.**

Maybe you already are raising your own food—or at least part of it. Maybe you are even a full-time farmer. Or maybe you are a city-dweller just hoping and planning ahead.

Whatever your situation, I think you'll be interested in my Plan, because it's really a story—the true story of our place, of my family and me. It's the story of how we moved to the country outside of New York City . . . How I kept my regular job and how we've gone in for "back-yard farming" in our spare time!

If you are already doing something like this you'll want to "compare notes" with me. Maybe I can give you some new ideas . . . short cuts . . . help you get better results. If you are not yet doing it, but are planning to, you'll find my Plan very helpful. It will tell you how to look for the right kind of place near your job, how to get started the easiest, most inexpensive way. My Plan will show you lots of short cuts, help you avoid many mistakes.

"One Hour or So a Day"

Some people may think this sort of thing takes a lot of hard unpleasant work. That is not so! It does take some time—but really not very much. We take care of the chores at our place in only one hour or so a day on the average! It does take some work, but it's not unpleasant—it's fun! And it does not take much land—even a fairly large city lot can be enough!

The secret, of course, is doing things the easiest, most practical ways, taking advantage of all the modern, scientific, labor-saving methods that have been developed in recent years! And it is these new, easier, better methods that my Plan tells you about! See right hand side of this page for list of things my Plan covers.



Mrs. Robinson and our son, Jack. The home-raised goose I'm holding weighed 10 1/4 lbs. at 10 weeks of age. All the food it ate was stale bread and grass growing around our place.

Healthful, Relaxing

Not only is it fun to have a garden, and to raise lots of the other foods you need—it's healthful. Really fresh vegetables, milk, eggs, meat, etc., have more vitamins and other health giving qualities in them. They taste much better—and, of course, raising your own you can have all you want, without worrying about ration points!

Being outdoors around the place is healthful, too. The whole family eats better, sleeps better, feels better and gets along together better. Your children, if you have any, have more wholesome surroundings. This "way of life" is really the soundest foundation for family happiness.

Saves on Food Bills and Ration Points

Food prices are very high now—everybody knows that! So, just figure out how much you'd save if you raised 50% to 75% of all the food you buy! Not only that—it doesn't take any ration points to raise your own! You can have more food, better food, and save money doing it!

Security Against Hard Times

Maybe you'd like to retire some day. If there's a postwar depression, you might even lose your job. I hope not, but it might happen, and if it did, wouldn't it be swell to have a place where you could raise most of your food, where you could get by with very little cash income? Wouldn't it be a good idea to know how to do these things even if you never have to? I can tell you it sure gives me a feeling of independence and security and I'm sure it would do the same for you!

Well, I guess you can see I'm pretty well "sold" on this whole idea. It's fun, it's healthful, it saves you money, you eat better, you feel secure and independent. That's why I've told the whole story about it in my "Have-More" Plan, and why I'm offering my Plan for sale. (Price \$1.00.) I wish I could give it away to everybody that might be interested, but of course I can't, and after all one dollar isn't very much.

So, if you're interested either to "compare notes" with me or to plan ahead—then send me your name and address and one dollar and I'll send you my Plan by return mail.

Right now is an excellent time of year to start.

Yours for "a little land and a lot of living!"—
Ed Robinson

Box 2701, Noroton, Conn.

NOT A BOOK!

50,000 WORDS • 73 PICTURES, DIAGRAMS

My "HAVE-MORE" Plan tells, by clear-cut diagrams, pictures, easy-to-read directions, tables, charts, etc., how we have applied the easiest, most practical, labor-saving methods to having such things at our place. You can easily do the same.

How to choose—to rent or buy—the right kind of a place of your own, near your job. (If you don't already have a place.)

A wonderfully bountiful garden with half the work.

Broilers and roasters—at about 16 cents a pound.

Fresh eggs—7 minutes a day.

Delicious rabbit meat—at 8 cents a pound.

Milk, butter, cheese from your own miniature dairy.

Pigs are easy—why pay to have garbage removed?

Geese, turkeys, squabs, ducks—easy, interesting, delicious.

A lovely flower garden for mother.

New amazingly easy ways of preserving foods—they taste far better, too.

75 pounds of honey—only 8 hours' work.

Extra income selling your surplus crops.

Fruit instead of shade trees.

Grapes, berries—your investment back each year.

Etc., Etc., Etc.

What My Plan Tells You about any one of these things can easily be worth several times the price of the whole Plan (which is \$1.00). So even if you are interested in only one or two of the subjects you need not hesitate to order my Plan. Besides, if for any reason you aren't more than satisfied with it, I'll gladly refund your dollar without question!

DO YOU WANT TO SEE MY PLAN?

If you do, just put a dollar bill or dollar money order (if bank check, \$1.05) in an envelope with your name and address and turn it over to Uncle Sam's mailman. I'll send your copy of my Plan by return mail. If for any reason you aren't pleased with it, let me know and I'll refund your money without delay and without question. Address:

Ed. Robinson, Box 2701, Noroton, Conn.

Your Name.....

Address.....

"I'll show YOU how to make yourself COMMANDO-TOUGH

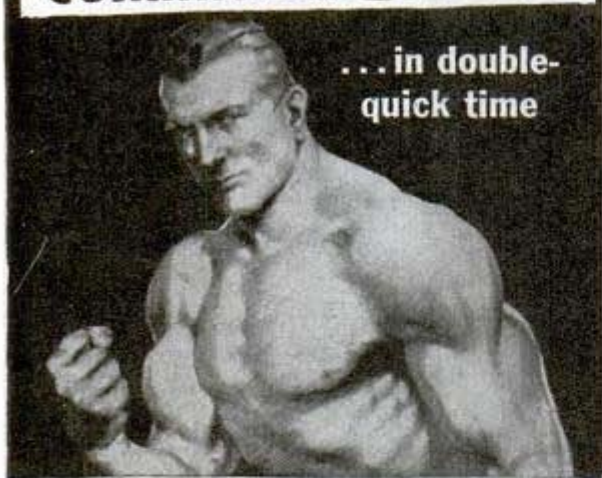

...in double-quick time

...OR IT WON'T COST YOU A CENT!"

says *George F. Jowett*

WORLD'S GREATEST BODY BUILDER

Let me prove to YOU that you can put inches of dynamic muscles on your arms! Add inches to your chest! Broaden your shoulders and power-pack the rest of your body. I can do for you what I've done for thousands the world over, including many officers and men now in the U.S. and British Armed Forces!

GIVE ME 10 MINUTES A DAY!

I'll Show You My Secrets Of Body Building

I'll help you learn the "Progressive Power Method" through which I rebuilt myself from a physical wreck to the holder of more strength records than any other living athlete or teacher! No matter how skinny or flabby you are, you can learn my methods right in your own home. Through my proved secrets I show you how to develop your power, inside and out, until YOU are fully satisfied that you are the man you want to be. "The Jowett System," says R. F. Kelly, Atlantic City, Physical Director, "is the greatest in the world!"

If you want a physique that will inspire respect from men, and admiration from women... ACT LIKE A HE-MAN! Decide at once! The famous book, "Nerves of Steel—Muscles Like Iron" will be included FREE! Priceless for the strength fan! Full of photos of marvelous power-bodied men who will show you what Jowett has done for them and how he can do the same for you. Reach out... Grasp this Special Offer today!

Jowett Institute of Physical Culture
230 Fifth Avenue
Dept. 471
New York 1, N. Y.

PROVE TO YOURSELF IN ONE NIGHT!

Send only 25c for test Course, "Molding a Mighty Arm." Read it the evening it arrives—learn from experience the thrill you can give your muscles!

SEND FOR THESE FIVE FAMOUS COURSES IN BOOK FORM

ONLY 25c EACH
or ALL 5 for \$1.00

This
Book
Free!



BOOK WITH PHOTOS OF FAMOUS STRONG MEN
MAIL COUPON NOW

FREE



Jowett Institute of Physical Culture
230 Fifth Avenue, Dept. 471, New York 1, N. Y.

George F. Jowett: Your proposition looks good to me. Send by return mail, prepaid, the courses checked below, for which I enclose (), include FREE book of PHOTOS.

- George F. Jowett
Champion of Champions
- All 5 courses for . . . \$1
 - Molding a Mighty Arm 25c
 - Molding a Mighty Back 25c
 - Molding a Mighty Grip 25c
 - Molding a Mighty Chest 25c
 - Molding a Mighty Leg 25c
 - Send all 5 C.O.D. (\$1 plus postage.) No orders less than \$1 sent C.O.D.

NAME Age.....
(Print name)

ADDRESS



DIVING, CUTTING and WELDING IN UNDERWATER SALVAGE OPERATIONS

by Frank E. Thompson, Jr.

New, fascinating, easy-to-understand book by the famous Manufacturer-operator of salvage equipment who helped our Navy raise ships sunk by Japs at Pearl Harbor! Practical, essential facts for a well-paid, patriotic job.

224 pages . . . Illustrated . . . Indexed . . . \$2.00



CORNELL MARITIME PRESS
241 West 23rd Street New York 11

LIQUID MARBLE

Make beautiful artificial Marble slabs. Pour from liquid state. Glazed or un-glazed. This Marble may be mottled, veined, multi-colored or left in its original snow-white state. The color is actually a part of the Marble, does not fade or wear away. Liquid Marble is unsurpassed on kitchen or bathroom walls. Easy to make and install. **PLASTIC FLOORING.** May be made in any color or combination of colors. Gives a lifetime of wear. Dustproof, Soundproof. Verminproof. Resilient to the tread. Lay out solid from wall to wall or in pattern design of various shaped blocks. **FLEXIBLE MOLDS** for plaster casting. Make your own molds for few cents each. \$1.00 in raw materials will make up to \$25.00 worth of finished goods. (Send no money.) We furnish names of buyers. Write now for free information, and get in on busy season just starting.

COMPO-TEX, Box 786-S, ST. LOUIS, MO. 1

INFORMATION

ANY SUBJECT . . . Moderate Rates

THE ROXBYS, 742 S. Hill St., Room 1118, Los Angeles 14

Correspondence Courses in
RADIO and ELECTRICAL ENGINEERING LOW AS **\$25** PER MONTH

ELECTRICAL ENGINEERING. Get good grasp of wide electrical field. Modern. Very understandable. Theory made easy.

RADIO ENGINEERING. Extra fine course in radio, public address, photo-electric work. Trains you to be super-service man, real vacuum tube technician. Tuition ONLY \$25, either course. Deferred payment plan. Servicemen needed badly.

FREE Write for free copies of school catalogs, student magazines, etc.
LINCOLN ENGINEERING SCHOOL, Box 931-P-73, Lincoln, Nebr.

CARTOONING

PAYS WELL Exclusive instruction by a nationally known cartoonist makes it easy to learn at home. Write for details of the course. Please state age.

NATIONAL SCHOOL OF CARTOONING
423 Penton Bldg. Cleveland 13, Ohio



It's so important to write a good hand for business and social advancement. Poor legible penmanship often causes costly errors and marks you for failure. Why write a poor hand? It's so easy to learn at home in spare time. Write for our new free booklet today. If you wish, send 10c for a penpoint suitable for shaded writing and your name beautifully written.

THE TAMBLYN SCHOOL OF PENMANSHIP
In Business Since 1895
H-41 Ridge Bldg., Kansas City, Mo., U. S. A.

MECHANICAL ENGINEERING PAYS!

This is the machine age. And back of every machine—every part—are the engineers who designed it, the trained mechanics who built it. No wonder there's high pay . . . many opportunities to advance . . . for these indispensable men. Be one of them! Don't stick in a rut! Let I.C.S. show you the way to success! These Schools, famous for more than 50 years, offer authoritative, practical Courses to meet the needs of almost any man in mechanical trades. Mechanical Engineering . . . Drafting . . . Mechanical Drawing . . . Shop Practice. Write today for free booklet.

International Correspondence Schools, Box 5519-K, Scranton 9, Pa.

It's Simple TO DECORATE

- FURNITURE
- FLOORS
- HOUSES
- PLAYROOMS
- BOATS
- AUTOS

EASILY . . . QUICKLY . . . CHEAPLY
WITH THIS
AUTHORITATIVE BOOK



PAINT and PUTTER with . . . The Assurance of a CRAFTSMAN!

. . . because this modern book shows you methods to follow, tools to use, and materials you need for decorating your home or putting in your work-shop.

Any particular job fully explained in conversational language . . . with the help of clear illustrations.

FINISHING WALLS for instance . . . demonstrates color stippling, blending and mottling, Period finishes, calcimining methods.

AUTOMOBILES made like new because this handy book tells and shows you how to

enhance the beauty of your car . . . helps make it last longer.

HOUSES—paint them yourself and easily too. Discover the "tricks of the trade" that turn work into fun . . . and save you money while you do it.

FURNITURE made like new. Those small pieces of furniture you're ready to throw out can be made like new . . . pieces you'll show instead of hide.

IDEAS—You'll get thousands of ideas on decorating . . . Ideas that are fun . . . Ideas that mean an EXTRA income for you. 350 pages, 288 illus. . . . \$3.00

**MONEY BACK
GUARANTEE**

SEND TODAY

**REFRIGERATION
SERVICE MANUAL**

Today's Best Seller Only **\$2.00**

Written by H. P. Manly, refrigeration authority, this NEW book covers refrigeration problems in conversational language so that it's 300 pages and 138 diagrams and illustrations can't miss being a real HELP TO YOU. Covers practically every operation in field service and shop operations which may be required. Includes domestic types of refrigeration, and fully and completely explains the commercial types in small and medium sizes, such as used in markets, milk depots, soda fountains, flower shops, etc., as well as in many air conditioning systems. . . . **\$2.00**

CHECK THIS LIST OF MONEY-MAKING BOOKS

2. CARPENTRY CRAFT PROBLEMS. How to make forms, sills, beams, porches, window and door frames. 700 illustrations. 302 pages. . . . \$2.00

3. BUILDING—FORMS, STAIRS, ROOFS. Contains latest information on Forms, staircases and roof-building. Handy book for carpenters or helpers. 210 pages, 495 illustrations. . . . \$2.00

4. WOOD FINISHING. Instruction on wood finishes, and problems . . . tools . . . materials . . . repairing. 360 pages and 353 illustrations. . . . \$2.00

5. FURNITURE, FURNITURE FINISHING, DECORATION and PATCHING. New book that covers: 1. Period Furniture; 2. Furniture Decoration; 3. Furniture Finishing; 4. Furniture Patching; 5. Modern Special Finishes. 580 pages and 353 illustrations. . . . \$4.00

6. THE MIXING OF COLORS and PAINTS. How to mix colors for interior decorating. Covers house painting, arts, crafts, general paint mixing methods. A handy book for professional and amateur painters. 302 pages fully illustrated and a big color chart. . . \$2.00

7. ELECTRIC and OXY-ACETYLENE WELDING. 280 page book with instructions on arc, spot, butt and flash electric welding; gas cutting and cutting; hand forging, thermite welding; brazing and soldering. 86 illustrations. . . . \$1.50

8. PLUMBING INSTALLATION and REPAIR. 236 page book explaining how to do repair jobs such as leaky faucets, clogged toilets, drains, traps, vents, sewers, etc. Tells how to cut pipe, make pipe joints, and install fixtures. 153 illustrations. . . . \$2.00

9. CYCLOPEDIA of RADIO and ELECTRONICS. A complete non-technical reference book covering radio transmission and reception, sound pictures, short wave, public address systems, television, photo-cells. 1700 readings, 1000 pages, 1178 illustrations, 139 tables, and 105 graphs. . . . \$5.00

10. THE SLIDE RULE and LOGARITHMIC TABLES. How to use a slide rule for all purposes. Includes polyphase and circular rules, logarithms and tables . . . even includes 10 place log tables. Fully illustrated, 260 pages. . . . \$1.50

11. PRACTICAL ELECTRICITY and HOUSE WIRING. This new book discusses these very important subjects; Dictionary of common electrical devices, basic principles of cir-

cuits, wires and insulation, grounding, polarizing, wiring methods, planning your installations, wiring new houses, installing switches, fixtures, etc.; wiring houses after they are built, alterations and additions, wiring farm buildings, wiring for motors, & home repairs, etc. 190 pp., 208 ill. \$1.50

12. SPRAY PAINTING, INDUSTRIAL and COMMERCIAL. Covers principles of spraying technique and latest developments, operating instructions, paints, extenders, materials, finishes, lettering, and a section on National Defense spray painting. Authoritative—concise. 125 fully illustrated pages. . . . \$1.50

13. MODERN HOMECRAFT. Make and finish your own furniture. Working drawings and photographs, step-by-step instructions for modern furniture. Complete in every detail. 240 pages for only . . . \$3.00

14. HOUSE PAINTING METHODS. Covers brick, wood, cements, iron and steel surfaces, equipment, paint mixing, tinting, oils, thinners, driers and removers. Tells how to estimate paint costs, etc. 400 pages and 150 illustrations. . \$2.00

CHECK, CLIP AND MAIL THIS COUPON NOW

GATEWAY PUBLISHING CO.

Dept. P.M.-1, 53 W. Jackson, Chicago 2, Illinois

OK. Send the books I've checked, C.O.D. I'll pay postman cost of books plus a few cents postage. If any book is not entirely satisfactory, I will return in 5 days and you will refund my money.

- | | | |
|--|--|---|
| <input type="checkbox"/> Refrigeration Service Manual . . . \$2.00 | <input type="checkbox"/> Cyclopedia of Painting & Decorating, \$3.00. | <input type="checkbox"/> Plumbing Installation and Repair. . . 2.00 |
| <input type="checkbox"/> Carpentry Craft Problems 2.00 | <input type="checkbox"/> Cyclopedia of Radio and Electronics 5.00 | <input type="checkbox"/> The Slide Rule and Logarithmic. . . 1.50 |
| <input type="checkbox"/> Building—Forms, Stairs, Roofs . . . 2.00 | <input type="checkbox"/> Practical Electricity and House Wiring 1.50 | <input type="checkbox"/> Commercial 1.50 |
| <input type="checkbox"/> Wood Finishing 2.00 | <input type="checkbox"/> Modern Homecraft 3.00 | <input type="checkbox"/> House Painting Methods. 2.00 |
| <input type="checkbox"/> Furniture, Furniture Finishing, Decoration and Patching. 4.00 | | |
| <input type="checkbox"/> The Mixing of Colors and Paints. . . . 2.00 | | |
| <input type="checkbox"/> Electric and Oxy-Acetylene Welding 1.50 | | |

Save 10%—enclose full cost of book and we will pay the postage—saving you approximately 10%. Same money-back guarantee.—The Publishers

Name

Address

City Zone State

INVENTORS

Do Not Delay

Have you ever been startled by seeing a successful article on the market, and exclaimed—"Why, I invented THAT 5 years ago—I didn't think it valuable enough to Patent!"

The Patent Laws were intended for the Protection of the Inventor, and the Inventor who slumbers on his Rights may wake up to find someone else reaping the reward that could have been his.

Write NOW for Information and Record of Invention form FREE. RANDOLPH & BEAVERS, Registered Patent Attorneys, Columbian Bldg., Washington, D. C.

PERSONALIZED SERVICE — REGISTERED PATENT ATTORNEYS

RANDOLPH & BEAVERS

11-D Columbian Bldg., Washington, D. C.

Please send me full particulars on Patents, fees, etc., and "RECORD OF INVENTION" form—FREE.

Name

Street

City



HUNTING and FISHING

is a monthly magazine crammed full of hunting, fishing, camping, dog and boating stories and pictures, invaluable information about guns, fishing tackle, game law changes, best places to fish and hunt—countless ideas that will add more fun to your days afield.

Special Trial Offer

Send 25c in stamps or coin and we will send you Hunting & Fishing for six months.

HUNTING & FISHING MAGAZINE

251 Sportsmen's Bldg., Boston, Massachusetts

PATENTS Protect Your Idea: By securing FREE my "PROOF OF INVENTION" folder. Exceptional Personal Service. Excellent References. Established 1906. E. E. VROOMAN, 871 Woodward Bldg., WASH., D. C.



COMPLETE CONSERVATORY HOME STUDY COURSES

40 years of successful training in Piano, Violin, Cornet, Trumpet, Saxophone, Clarinet, Guitar, Mandolin—Voice, Ear Training and Sight Singing, Choral Conducting, Public School Music—History of Music, Harmony, Advanced Composition, Arranging. The only home study school teaching all courses leading to degree, Bachelor of Music.

MAIL COUPON NOW

UNIVERSITY EXTENSION CONSERVATORY 1525 E. 53rd St. Suite U124, Chicago 15, Ill.

Send catalogue and illustrated lesson for course.

Name

Street

City, State

Give experience Age

ELECTRIFY your career!

There's big money in Electrical Engineering. Be smart—study it NOW. Noted I.C.S. Courses cover the fundamentals and the out-of-the-ordinary things it's necessary for specialists to know. I.C.S. has had more than 50 years of training men for success. The School of Electricity is a separate and complete school giving specialized training—yet enjoying benefits and resources which only a vast institution like I.C.S. affords. And you benefit by the teachings of experts connected with the largest concerns in the field. Send for FREE informative booklet telling what I.C.S. can do for you. International Correspondence Schools, Box 5515-K, Scranton 9, Pa.

CARTOONING

CASH IN on Big Cartoon Market. Become Cartoonists Quickly with NEW, EASY METHOD prepared by successful cartoonists. Learn how to get ideas and quickly originate cartoons for Newspapers, Magazines and Advertisers. No experience necessary. 45 LESSONS covering 40 SUBJECTS. Valuable ideas, cartoon markets, etc. Postpaid anywhere for only—



Send name and address for free details. NATIONAL ARTISTS BUREAU, Box 4248-A, DALLAS 8, TEXAS

RADIO ENGINEERING, Broadcasting, Servicing, Electronics, Aviation, Marine & Police Radio taught thoroughly. 48 weeks' Engineering course equivalent to 3 years' college radio work. All expenses low. Co-educational. Catalog free.

VALPARAISO TECHNICAL INSTITUTE, Dept. D, Valparaiso, Ind.

PATENTS AND TRADE MARKS

C. A. SNOW & CO.

Registered Patent Attorneys Since 1875

Write for Free Book and "Certification of Invention" form

427 SNOW BUILDING, WASHINGTON 1, D. C.

PATENT YOUR IDEAS

SEND FOR FREE BOOK → HOW TO OBTAIN A PATENT

Written by Former Member Examining Corps (1922-24) U. S. Pat. Office.

CARL MILLER, Registered Patent Attorney
Former Member Examining Corps U. S. Patent Office

Woolworth Bldg., Dept. 15-A, New York — Bond Bldg., Dept. 15-A, Washington, D. C.

An Audel Guide!

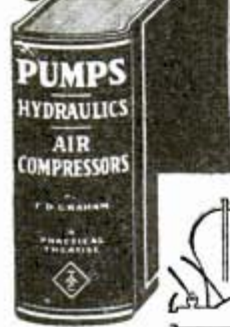

PUMPS-HYDRAULICS-AIR COMPRESSORS

JUST OUT! 3 BOOKS IN ONE—OVER 1650 PAGES, 1654 ILLUSTRATIONS, WITH QUESTIONS AND ANSWERS. COMPLETE PRACTICAL CONCISE INFORMATION FOR ALL ENGINEERS AND OPERATORS.

PART 1—PUMPS—850 Pages: All types—Centrifugal—Rotary—Reciprocating Pumps: Their Theory, Construction, Operation and Calculations. Air and Vacuum Chambers—Power Pumps—Air Pumps—Jet Condensers—Surface Condensers—Condenser Auxiliaries—Condenser Operation—Calculations—Cooling Ponds—Cooling Towers—Water Supply—Hydraulic Rams—Special Service Pumps—Automotive Fire Pumps—Dredges—Codes. 942 Illustrations.

PART 2—HYDRAULICS—320 Pages: Hydraulic Physics—Drives—Machine Control—Accumulators—Elevators—Hydraulic Airplane Control—Automobile Brakes—Shock Absorbers—Presses—Turbines. Many new uses explained. 310 Illustrations.

PART 3—AIR COMPRESSORS—406 Pages: Compression of Air—Compressor Classification—Parts, Types—Inter and After Coolers—Regulating Devices—Installation—Lubrication—Operation—Maintenance—Blowers—Super-Chargers—Pneumatic Hand Tools—Ready Reference Index and Tables. 402 Illustrations.

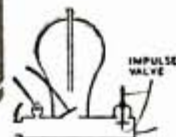

Free Examination

TO GET THIS ASSISTANCE FOR \$4 COMPLETE YOURSELF SIMPLY FILL IN AND MAIL YOUR ORDER TODAY 4 PAY \$1 A MONTH ONLY \$1 MO.

AUDEL, Publishers, 49 West 23 St., New York 10, N. Y. Send postpaid AUDELS PUMPS, HYDRAULICS, AIR COMPRESSORS (\$4). If I decide to keep it, I will send you \$1 within 7 days; then remit \$1 monthly until purchase price of \$4 is paid. Otherwise, I will return it promptly.

Name

Address

Occupation

Employed by P. M.

POPULAR MECHANICS

Here I Am At WORK

Making

GOOD MONEY

thanks to this

Free

TRIAL
LESSON
IN



DRAFTING

Yes, this free lesson proved that drafting is easy, mighty interesting work . . . convinced me I didn't need special talent to get into this well-paid profession . . . proved beyond a doubt that Drafting by the fascinating C.T.C. method can be mastered easily AT HOME IN SPARE TIME.

So I enrolled. I learned Drafting at home—in my spare time. Today I feel secure in my new job because Draftsmen always come first on any new project in manufacturing and industry. In addition, Draftsmen can't be replaced with machines. What's more, I feel I'm slated for promotion and more pay because I see so many draftsmen advancing to high-pay jobs in Engineering. And, as a draftsman, I have a peacetime future as well as a good job now.

Here's a tip: Mail the coupon or drop a card for the free trial lesson. Do this today—and find out about your opportunities in Drafting.

LEARN in Spare Time — At Home! (Or at the College in Chicago)

A few hours of pleasant home study every week—that's all. No interference with your present job. With Chicago Tech's help, you train yourself step by step. This tested method,—developed over 40 years of C.T.C. progress,—prepares men quickly for good positions in industry.

Get Free Information — Send Coupon

Find out now how you can use your spare time to prepare, in your own home, for these post-war opportunities by use of the Chicago Tech Plan. Same training methods as used in our Chicago school. Choose the line where you would like to work, in Drafting, Building Construction, Refrigeration or Air Conditioning. Mark and mail the coupon or send a post card. Act today.

DRAWING OUTFIT INCLUDED (with Drafting Courses)

All the tools you need including folding drawing table. With them you can put your ideas on paper quickly and with accuracy. With training, you're all set to master Drafting in months—not years,—at home.

CHICAGO TECHNICAL COLLEGE

A-206 Tech Bldg., 2000 South Michigan Ave., Chicago 16, Ill.

Send INFORMATION PLEASE on Home-Study Training in:

- | | |
|---|--|
| <input type="checkbox"/> Aircraft Drafting | <input type="checkbox"/> Builders' Course |
| <input type="checkbox"/> Machine Drafting | <input type="checkbox"/> Blue Print Reading—Building |
| <input type="checkbox"/> Electrical Drafting | <input type="checkbox"/> Estimating,—Buildings |
| <input type="checkbox"/> Structural Drafting | <input type="checkbox"/> Refrigeration |
| <input type="checkbox"/> Architectural Drafting | <input type="checkbox"/> Air Conditioning |

Name.....Age.....

Address.....

City..... Zone..... State.....

Veterans check here for information about "GI" Training at the College in Chicago.

**WORLD'S
BEST
WANT AD
MEDIUM**

CLASSIFIED Advertisements



Advertisements in this section, 25 cents per word, each insertion, minimum 10 words, payable in advance. To be inserted under proper classification in February issue, copy should be in our office January 4th. February issue on sale February 1st. Popular Mechanics Magazine, 200 East Ontario Street, Chicago 11, Illinois

AUTOMOBILES—MIDGET CARS

GASOLINE Age. 360 pages. Wonderful book history automobile business in America. Start of Dodge Brothers, Ford, Nash, Durant, Chrysler, Willys, others described. Illustrations. Contains list of over 1500 American makes automobiles once manufactured. \$3.00 postpaid. Clymers, 2125 W. Pico, Los Angeles 6, Calif.

CUSTOMIZE Your automobile. Illustrated, new restyling ideas, instructions, suggestions, specific model changes by simple methods. \$1. Speed Wheel, Box 723-E, Arcadia, California.

SEE Our advertisements under Motorcycles Classification. Clymers, 2125 W. Pico, Los Angeles 6, Calif.

GARAGE Doors, all types, controlled from dashboard pushbutton. Simple, dependable. Materials inexpensive, obtainable everywhere. Complete "Build Yourself" plans \$1.00, refundable. Guaranteed. Free particulars, Kaytor Laboratories, Lynwood, Calif.

1944 IGNITION Supercharger \$3.50. Fast starting, mileage, pep. EG Sales Mfg. Co., 355 E. 149th St., New York.

AUTOMOBILE Books. "Racing photo album" 110 photos, exciting crashes, world's greatest race cars, drivers described. \$1.50. "Saga Roaring Road" 181 pages, 16 pictures. Start: Fred Wagner's early racing experiences with world famous drivers, cars described. Read about Rickenbacker, Murphy, Burman, DePalma, Ford "999", Oldfield's Benz \$2.50. Automobile racing book \$1.10. Prices include reprints, illustrations, drawings army Jeep and German BMW war motorcycles. All postpaid. Clymers, 2125 W. Pico, Los Angeles 6, Calif.

PROFESSIONAL Midget racers, motor-scooters, midget cars. Parts, plans. Handbook catalog—50 illustrations, plans—20c. Midwest, 2557 Charlestown, Toledo, Ohio.

INTERESTING, Educational, illustrated English "Motor" magazine on foreign automobiles. 50c postpaid. Clymers, 2125 W. Pico, Los Angeles 6, Calif.

REPAIR Your car. Do it yourself. Motor parts for all engines, chassis, parts, etc. New replacement parts. Genuine and highest quality at manufacturers' retail prices. P.O.B. Chicago. Personalized technical advice concerning your mechanical problems, \$1.50 postpaid. Send information on state registration card for proper identification of vehicle. B & N Engineering Co., Box 3454, Merchandise Mart, P.O. Chicago 54, Illinois.

AUTOMOBILE Racing book, fifth edition, well illustrated. Instructions on building bodies, frames, engines. Ford A and B conversions. Plans. AAA rules, specifications. Roadster racing. Indianapolis cars. \$1.00 postpaid. \$1.30 C.O.D. Ray Kuns, Dept. 47, Madisonville, Cincinnati 27, Ohio.

CAR Owner's Economy Handbook—by Austin Elmore—world famous automotive mileage record holder and test engineer. Mr. Elmore tells you in his book, how to get longer life, greater mileage, from your car, and how to drive most efficiently and with greatest safety. \$1.25. Mileage Research Laboratories, 5058 Alhambra Ave., Los Angeles 32, California.

FLOYD Clymer's Historical Motor Scrapbook. This humorous, educational, historical scrapbook illustrates, describes hundreds antique and early automobiles, motorcycles. Reg. Oldsmobile, Hupmobile, Metz, Orient, Knox, Winton, Carter, Maxwell, E-M-F, 2-cylinder Ford and Buick, air-cooled Chevrolet, Stanley, White, other steamers, electrics. Unusual and steam motorcycles. This is the scrapbook Time Magazine said is a "must." Editions one and two now available but entirely different books. Postpaid \$1.50 each, deluxe edition \$2.50. We mail overseas any time without request and pay postage. Delivery guaranteed. Clymers, 2125 W. Pico, Los Angeles 6, Calif.

FAREWELL To Model "T". Humorous book with cartoons, illustrations, description car, engine, chassis, first and last Model T Fords manufactured. Folder includes page on German Jet Propulsion Opel automobile. \$1.50 complete postpaid. Clymers, 2125 W. Pico, Los Angeles 6, Calif.

AUTO TRAILERS

BUILD Your own trailer! Save money! Have every feature you want! Plans for house, sport, camp and utility trailers. Catalog describing 9 models 10c. Jim Dandy, Box 125-A, Wausau, Wisconsin.

AUTO SUPPLIES AND EQUIPMENT

ATTENTION: Invention, new method for repairing synthetic inertubets, any size rip repaired, guaranteed to prevent further ripping. Make your own material in few minutes. Send \$1.50 for samples and complete process revelation. My invention sold strictly on guaranteed basis. Redwood Tire & Repair Shop, 2599 El Camino Real, Redwood City, Calif.

"TIRE Trouble Detector." Saves tires; automobiles, trucks, trailers. Patent pending. Cash and royalty. Inventor, Box 57, "Colvin," Syracuse, N. Y.

AUTO Parts, all makes. Bargains. Rankin, Glover Bldg., Kansas City, Missouri.

YOUR Old pistons metallized and ground to any size desired. Stahl Machine Company, Tiffin, Ohio.

1,000 MOTORISTS Needed to make gas savings test. Up to 30% savings. For trial test offer write Vacu-matic Carburetor Co., 7617-1129 W. State Street, Wauwatosa, Wis.

CRANKSHAFT Refacing. Simple device. Instructions \$1.00. John Richard, 4544 So. St. Louis Ave., Chicago, Ill.

INVENTION Uses kerosene to run motors. Circular on plans. Rush name. Houston Maupin, Tipp City 36, Ohio.

"UNLOCKEEZ" Is a device that will instantly open any auto lock operated by a push button or money refunded. Attention locksmiths, parking lots, garages, car owners. \$2.00 cash or money order. Canada and foreign \$2.50. Unlockeez Lock Device Co., P.O. Box 7318 Sta. G, Los Angeles 37, Calif.

THE Lord is coming! Get guaranteed proofs free. Scheall, 263XA, Duluth, Minnesota.

UNIVERSITY And oil corporation tests prove Whirlgas Turbulator, \$3, increases mileage and horsepower. Users report savings high as 40%. Wrench installs 15 minutes. Give auto make, year. John Hanley, 5719 Loraine, Detroit 8, Mich.

GASOLINE Mileage gauge indicates as you drive and analyzes motor trouble when idling. Write for free literature. Industrial Engineering, 1155 South Kenmore, Los Angeles 6, California.

AMAZING New Moto-Vator injects water-vapor into motor just like newest fighter planes. Burns 15% water; saves 20% to 30% gas; prevents carbon; increases power! Eliminates carbon and valve jobs. Not a gadget. Sensational performance keeps motor like new. Wonderful postwar possibilities. No investment. One low price includes license to install Moto-Vator in your locality. Send 10c for booklet giving complete details. Dept. M, SX Laboratories, P.O. Box 37, Middle Village, Long Island, New York.

GASOLINE Saving device. Chevrolet 1932-1942. Walert Company, 3429 No. 10th St., Milwaukee 6, Wis.

EXTRA Miles. 50 miles for each gal. gas used. Tested and proven method. Hundreds of users. Equip your car inexpensively. Simplified diagrams and instructions \$1.50. Astonishing results. Geller, Box 54, San Bruno, Calif.

VAPOR-MATIC Guarantees you increased gasoline mileage or your money back. Thoroughly tested and approved. Easily installed. Guaranteed because it really works. \$1.00 complete. Give make, year, number of cylinders. United Carburetor Company, 766 South Broadway, Los Angeles 14, California.

USED New and rebuilt parts for all cars, transmission, rear end, mufflers, etc. Write for prices. Great Western Auto Parts, 2928 No. Western Ave., Chicago.

HAVING Car trouble? Used, guaranteed auto, truck parts save money. Transmission specialists. Describe needs; immediate reply. Victory, 2439 1/2 Gunnison, Chicago 25.

ANTI-FREEZE, Noncorrosive, inexpensive, manufacture yourself. Details for stamp. Betke, Box 699, Borger, Texas.

V-8 AND Mercury dual muffler sets \$20.00. Genuine steel wool packed mufflers with mellow tone. Gives less back pressure, more power and more gasoline mileage. Also single steel wool pack muffler for any car. Fits in place of regular muffler. Single V-8 Ford Chev. Plymouth, Pontiac, etc., \$5.00. Buick, Dodge, Chrysler, etc. \$7.00. For 7 years manufacturers of California's best tone mufflers. Sandee Muffler Co., 7523 So. Western Ave., Los Angeles 44, California.

PLATING Outfits for auto parts. Connect to a battery. No tanks used. Free particulars and proofs. Gunmetal Co., Ave. J, Decatur, Ill.

MOTORCYCLES, BICYCLES, MOTOR-SCOOTERS AND SUPPLIES

PROFESSIONAL Midget racer with Ace 4-cylinder motor, \$65 less body; factory motorscooters \$45 up; motorcycles \$30 up; gasoline engines \$5 up; unrationed small balloon tires \$1.75 to \$6.50; mailorder only. Send 25c for free War-Bargain Directory Number 5, just out. Midget Motors Directory, Athens, Ohio.

100 MILES Gallon! Motor-scooters, motorcycles, Whizzer bicycle engines, midget automobiles, gasoline engines. No priority necessary. Catalog 10c. Clymers, 2125 W. Pico, Los Angeles 6, Calif.

400x7 WHEELS And 4 ply tire and tube complete with Timken roller bearings and axle. Hub dia. 1 3/4", 4 3/4" length. Axle 7/16", length 7". Price \$10.95. Limited quantity available. American Moto-Scoot Company, 1319 West Carroll Ave., Dept. M, Chicago 7, Ill.

MOTORCYCLISTS—New and used parts, accessories, all models. Catalog 10c. Henderson catalog 10c additional. Triangle, 2157 Harrison, Chicago.

BOOK "Speed—How to Obtain It" 160 pages, illustrated, instructions, cams, balance, timing, valves, pistons, racing technique. World's greatest speed tuning book. \$1.50 postpaid. Clymers, 2125 W. Pico, Los Angeles 6, Calif.

BUILD Your own, new, motor scooter. Design by original motor scooter inventor. Complete blue prints and material specifications \$1.50. Automotive Division, Elmore Project Engineering Laboratories, 5058 Alhambra Ave., Los Angeles 32, Calif.

CONVERT Your bicycle into motorbike. Complete illustrated instructions for 50c. L. D. Blythe, White City, Kans.

BUILD America's lowest priced motor-scooter Speedking! Complete plans and specifications \$1.00. Big list bargain priced used motors, parts, etc., included free. Midwest Supply, Box 1682-CS, Toledo, O.

ENGLISH "Motorcycling" Magazine. Interesting, educational, foreign motorcycles. Racing, new-old models, advertisements. 50c sample copy. Clymers, 2125 W. Pico, Los Angeles 6, Calif.

PARTS. Complete motor parts list. Pistons, all sizes, chains, sprockets, for Indian, Harley, 10c. Boots, 622 East Grand, Des Moines 9, Iowa.

BOOKS! "Modern Motorcycle Mechanics and Speed Tuning," 435 pages maintenance Harley, Indian, Villiers, all British motorcycles \$2.50; with drawings, specifications, illustrations U. S. Army Jeep, German BMW war motorcycles \$3.00; "Motorcyclist's Workshop" \$1.50; "Two Stroke Motorcycles" \$1.50; "Speed—How to Obtain It" \$1.50; "Historical Motorcycling Facts" \$1.00; "Automobile Racing" \$1.10; Motorcycle instruction manual "Questions—Answers" \$1.10. All postpaid. Clymers, 2125 W. Pico, Los Angeles 6, Calif.

PLANS, Scale drawings, specifications, illustrations for building attractive motor scooter complete \$2.00; plans electrically driven bicycle \$1.50. Postpaid. Clymers, 2125 W. Pico, Los Angeles 6, Calif.

MOTORCYCLE Muffler, Steel packed, beautiful tone, seamless streamline design, \$6.00. Really beauties. Sandee Muffler Co., 7523 So. Western Ave., Los Angeles 44, Calif.

MOTORBIKE Manual, containing easy to read motorbike and scooter plans, helpful hints and catalog section \$1.00. Variety Enterprise Company, Station A, Box 5, Evansville, Ind.

WANTED: Old motorcycles; motors, Any make. Priced reasonable. Not for resale. Randall Goff, Barrington, R. I.

PARTS, Accessories, pistons, chain for Harleys and Indians. McCann's, P.O. Box 114, El Paso, Texas.

WANTED—Motorscooters, motorcycles, motors, parts of every kind. Name your own price. Write: Midget Motors Directory, Athens, Ohio.

MOTORCYCLE Cams ground for speed and power. Harleys \$25.00, Indians \$15.00, all models. Send your old cams. Satisfaction guaranteed. Harold Schaller, 247 West Main, Turlock, California.

"MODERN Motorcycle Mechanics" New enlarged second edition comprising 500 pages, 250 illustrations. Available shortly. Nicholson Brothers, Saskatoon, Canada.

HARLEY Davidson parts, accessories, supplies. Expert service. Cylinder rebor-ing, generator reconditioning, 45" engines \$85.00 and up. Send \$1.85 for U. S. Army Motorcycle Instruction Book, Motorcycle Service Manual and bulletins or 25c for Service Manual and bulletin. Knuth's, 2491 Fondulac Ave., Milwaukee 6, Wis.

BUILD Scooters, trailers, midgets, conversions. Large manual \$1.00. Illustrated circulars dime. Craftsmann Books, Box 1153-P2, Milwaukee 1, Wis.

TIRES And industrial wheels, suitable for scooters, wheelbarrows, farm equipment, etc. All sizes. Bicycles and accessories. Largest assortment in America. Send dime for list. Cycle Transport Company, 1241 So. Michigan Ave., Chicago 5, Illinois.

SAVE Gasoline, build a motorbike now, send 25c for complete plans. Motorbike Service, 2108 McLean, New Albany, Ind.

AVIATION

BOWLUS Sailplane \$100 with trailer; Travelair biplane \$125; Curtiss Robin \$175; Aerona \$290; Waco-10, wings damaged \$100. Send 25c for catalogue of these and hundreds of other war-bargains located everywhere, some probably near you. Used Aircraft Directory, Athens, Ohio.

AIR Mechanics Manual by Zweng covers aircraft and engines. Multiple choice examinations \$3.00 postpaid. Pan American Navigation Service, 12021 Ventura Blvd., North Hollywood, Calif.

MODEL Supplies: Biview Class C motor, \$24, new; electric jig-saw, \$12.50; 14" and 10" propellers, 40c; S.A.E. 70 oil, 50c quart; Miss Tiny kit, \$3.00; ready to fly gas models—American Ace with New Rogers "35," \$49.00; Bayridge Mike with Rogers 29 new motor, \$44.00. Remit with order. R. Blazek, Lidgerwood, N. D.

PROPELLERS Of quality, quick service, 2 and 3 blades, all sizes. Lists free. Ford aircoil conversion diagrams 50c. Standard Aircraft, Ft. Worth, Texas.

LIGHTPLANE Manuals blueprints four new designs now ready. New illustrated circulars 2 dimes. Craftsmann Books, Box 1153-P1, Milwaukee 1, Wis.

PROPELLERS For snow sleds, air boats, catalogue free. Banks Propellers, R.F.D. 7, Ft. Worth, Texas.

CUB \$200 (Needs repainting); Curtiss Robin \$195; Fairchild \$395. Catalog over 250 listings, 25c. National Aviation, Box 1682-CS, Toledo, Ohio.

AIRPLANES—Used \$250 up. Also late models, engines, wings, parts, machinery, books. Cheap. Send 25c for list. Aircraft, 2300 West Flagler, Miami, Florida.

BATTERIES, GENERATORS, ETC.

EDISON Batteries. Light. Power. Fifteen year life. Five year guarantee. Complete lighting plants. Free literature. See Jay Company, 321 Yonkers Avenue, Yonkers, New York.

ELECTRICAL SUPPLIES—EQUIPMENT

HANDY Pocket size electric circuit tester checks all electrical appliances, radios, motors, fuses, etc. 90 to 550 volts a.c. or d.c. Distinguishes a.c. from d.c. \$1.00 postpaid. Supreme Electric Mfg., 210-A Reobling St., Brooklyn 11, N. Y.

FREE Catalog of motors, welders, generators, fencers and other electrical items. Write Le-Jay Company, Minneapolis 8, Minnesota.

NOW—Repair your own electrical appliances with Chantite Self-welding Electrical Heating Element Flux. Instructions delivered, price \$1.00. Chantite Sales Company, 914 South Main, Fort Worth, Texas.

ELECTRIC Pencil: Writes-engraves all metals. \$1.00 postpaid. Beyer Mfg., 4515-H Cottage Grove, Chicago 15.

MAKE Electric hammers! Quick, easy! Circular on plans. Rush name. Houston Maupin, Tipp City 43, Ohio.

ELECTRIC Automobile heaters! Starts cold motors quickly. Saves gasoline, operates on light current. Postpaid \$1.95. Harris Machinery, Minneapolis, Minn.

ELECTRIC Soldering iron and tool marker combination \$1.00. Growler \$5.00. Spot welder \$5.00, 30 amp. a.c.-d.c. welder close-out \$3.50. Frazee Electric, Box 5086, San Francisco 1, Calif.

REPAIR Electric heating elements with Nichrome paste. See our ad page 173. Advance Mfg. & Dist. Co.

ELECTRICAL Appliance repair. Open your own shop. Learn house wiring; electric motors vacuum cleaners, washers, etc. Complete illustrated course shows how. Free booklet. Pacific Training School, Dept. PA-1, 4703 West Pico, Los Angeles 6.

ELECTRIC One burner hot plates; 600 watt nichrome wire burner, sturdy, will stand plenty of wear, looks good on breakfast table and for regular cooking use. Made without cord—any standard cord will fit. Each \$3.00 or \$15.00 for 6 or more. Standard 6 foot cord sets 75c each or \$7.20 per doz. f.o.b. Chicago. 25¢ deposit on c.o.d.'s. Fort Dearborn Specialty Outlet, Dept. PM, 82 W. Washington St., Chicago 2, Ill.

ATTENTION Farmers, electricians, factories, stores. Buy electrical supplies at wholesale prices. State needs. Wilson, 461 Winthrop Road, Union, N. J.

GARAGE Doors dashboard controlled. Additional information under "Automobiles."

NEW Kohler electric plants—Other electric plants, new and used, from 350 watts and up. E. F. Schmaltz, 215 Wyoming Ave., Kingston, Penna.

QUANTITY New electric heaters 14" bowl type, and two burner electric stoves a.c. or d.c., 120 volts, \$7.95 each, plus shipping and postage, 30c. No. C.O.D. Jeannette Electric, 159 W. 23rd Street, New York 11, N. Y.

ELECTRICAL Trouble shooter; finds leaks, opens and grounds in anything electrical. Indispensable to electric shops, garages, car owners. Free literature. Factory, 811 East 31st, Kansas City 3, Mo.

WELDING, SOLDERING, PLATING

NEW Transformer a.c. welders \$20.00 to \$100.00. Chicago a.c. welding rod, any quantity. Catalog. Frazee Electric, Box 5086, San Francisco 1, Calif.

ARC Welders wanted by the thousands. Learn with 516 page lessons manual. Over 500 how-to-do-it photos. \$2.00 copy. Money-back guarantee. Hobartweld, Box M-154, Troy, Ohio.

MULTIWELD Model "150" heavy duty a.c. welder, 110-220 volts. Over 200 heats, 1/16" to 3/16" rods. Garages, shopmen, farmers—free literature. Phillip Wilson, 309-E Bridge, Stretor, Ill.

ARC Electric welder used by electricians, plumbers, industrial plants, navy. Welds everything. Literature. Sine Equipment, P376W, Quakertown, Penna.

ACETYLENE Welding outfits like new; arcwelders, Eagle Welding, Dept. PM, 5085 Broadway, Chicago 40, Ill.

SLIGHTLY Used arc welders. Recommended by R.E.A. Guaranteed. Forney Mfg. Co., Fort Collins, Colo.

BUILD A.C. arcwelder 100, 200, 300 amperes. Plans \$1.00 each. Welders Club, AB-3432, Chicago 54.

NEW Model electric welder 110 volt a.c.-d.c.; will weld all metals; easy to use; full directions. Complete with power unit, flame and metallic arc attachments, carbons, fluxes, rods, mask; all for \$19.95. Used by the navy. Magic Welder Mfg. Co., 239-MP1 Canal St., New York City.

A.C.-D.C. 1/8" Welding rods. Coated mild steel (without priority). 50 pound cartons \$5.00 f.o.b. Welders Club, AB-3432, Chicago 54.

BUILD D.C. Arcwelder without rewinding armature. Plans \$1.00 each. 25 to 600 amperes from vehicle d.c. motors, light plant generators, automobile starter-generators. Welders Club, AB-3432 Chicago 54. For Sale: Vehicle d.c. motors.

FARMERS, Garagemen, repairmen, manufacturers: Guaranteed 110/220 volt a.c. welder, 20 to 160 amperes continuous output, complete supplies, \$135.00 f.o.b. Chicago. Welds heavy production, light maintenance, repairs. Others, \$68.00 to \$245.00. Circulars, supplies. Williams Sales Company, Box 4100, Portland 8, Ore.

WELDING, Cutting, aircraft welding and soldering equipment. Electric arc welders. Superior Oxy-Acetylene Co., Hamilton, Ohio.

SUPER Welder—For home, farm, factory. Makes even beginner an expert. Improved on type used by Navy. Fully equipped with Metallic Arc and Flame Torch handles, carbons, rods, fluxes, mask, etc. Complete directions. Operates ac-dc, 110 volts. No extra wiring needed. Guaranteed. \$19.95. Save 2%. Send check with order. Super Welder Manufacturing Co., Dept. A, 23 East 20 Street, New York, N. Y.

MACHINERY, TOOLS AND SUPPLIES

HARDWARE, Model makers supplies, engine castings, pulleys, belts, drills, taps, saw mandrels, steel. Screwdriver and catalog 10c. Terek, 6304 Patterson, Chicago 34.

CONSTRUCT Your own machine tools from Lewis castings, materials and blueprints, supplied complete at a fraction of new tool cost. Mills, shapers, vises, band saws, jointers, etc. are ideal for a whole range of home or commercial shop work. Send 10c to cover mailing of catalog listing 23 items. Lewis Machine Tool Co., Box 116, Station A, Dept. M-48, Los Angeles 31, California.

EXPERIMENTERS — 400 Valuable springs, 75 kinds, all sizes. 10,000 uses. No junk. \$2.00. Naco, 29 Lancaster, West Hartford, Connecticut.

SHOPCRAFT Tools—All forged steel-alloy adjustable 6" end wrench, 10" adj. pipe wrench, 6" diagonal cutting pliers, 6" slip joint pliers, 16 oz. claw hammer and nail set, 3 plastic hdez. unbreakable 6", 4", and stubby size screw drivers. Set of 9 tools, \$9.25. Send money order or check to Marcosa Supply, Plymouth Road, Stamford, Conn.

STAINLESS Steel scrap 3/16" to 3/8" hex and rounds assortments, prepaid \$1.00 or \$5.00. Industrial Engineering, 1155 South Kenmore, Los Angeles 6, California.

TWIN-CYLINDER Air compressors \$17.75. Motors. Hoffman, 6840 Parrish, North College Hill 31, Ohio.

CONCRETE Building block machines and molds. Easy payments. Catalog free. Concrete Machine Co., 5129 South Compton Ave., St. Louis 11, Mo.

LATHES, Millers, attachments, chucks, micrometers, indicators. Machine Supply, Newfane, Vermont.

DRILL Grinder—Original patented precision sharpener. Grinds drills to factory accuracy. Calipers with direct reading scales. Circle cutters. New tool grinder. Lowest prices. Free literature. Factory, 811-B East 31st, Kansas City 3, Mo.

STEEL Beam trammels for draftsmen, engineers, mechanics. Circular free. Clair Company, Box 92M, Blythebourne Station, Brooklyn, N. Y.

INDEX Heads for sale. Very inexpensive. Sixty-two different divisions. Used on small lathes, drill press, milling machines, etc. Make gears, hobbs, cutters, etc. Very accurate and durable. Not a toy. Used by defense schools and hobbyists. Write for free folder. Long's Index Heads, 2117 East B St., Torrington, Wyo.

BOATS, OUTBOARD MOTORS, ETC.

SAIL Kits 100 square feet \$8.95, boat supplies, canvas, canvas cement, glue, airplane dope, marine paints, hardware, etc. Bilge pumps, carbide lamps, sleeping bags, zippers any length. Catalog. Alan-Clarke Co., 100 Chambers, New York City.

COLLAPSIBLE Boats. Handy portable inflatable rubber boats carrying from one to seven men, in both new and used condition, priced at \$129.50 to \$99.50, depending upon size and condition. Write for particulars. Karl Ort, Dept. PM1, York, Penna.

TEN Plywood boat plans 50c. Catalog boat building plans 10c. The Rudder, 15 Murray Street, New York.

FOLDING Kayak plans \$1.00. No catalog. Foldcraft, 4015 Oketo, Chicago.

FULL Size, cut to shape boat patterns, blueprints. 7 1/2 - 38 feet. Illustrated "Build a Boat" catalog, 10c (coin). "How to Build Boats" book, \$1.00. Cleveland Boat Blueprints Co., Dept. A-66, Cleveland, Ohio.

ASA Gallupe of Fort Fairfield, Maine, wishes to buy your Evinrude or Johnson.

OUTBOARDS—Save 1/2. Good used parts, all makes and models. Bargains re-build motors. Crandall Hicks Co., 959 Commonwealth, Boston, Mass.

BOAT Designers are highly paid professionals. Complete course by mail. Catalog. Westlawn, Montville, N. J.

MARINE Power—Easily convert any Ford motor (domestic and foreign) with Osco parts and kits. Complete catalogue 25c (coin). Osco Motors Corp., 2020 East Orleans Street, Dept. M, Philadelphia 34, Penna.

USED Outboard motor parts. Outboard Exchange, 1194 Remsen Ave., Brooklyn, 12, N. Y.

ENGINES, MOTORS, DYNAMOS

NEW 1/40 H.P. reduction motors, 110 volt, a.c.-d.c. Dremel Sales, 1101 Cleveland, Racine, Wis.

MODEL Locomotives, gas, steam engines. Supplies catalogue 25c. Welding rod for aluminum, die cast, pewter. Samples and instructions 25c. Howardco, A2-2417 N. Ashland, Chicago, Ill.

BIG Pay jobs in welding. Complete welding lessons and reference books. 516 pages. 41 lessons. \$2.00 copy. Money-back guarantee. Hobartweld, Box 155-M, Troy, Ohio.

FOR Sale—Kohler 110 volt, 1500 watt d.c. lighting plant, 4 cyl. motor, rad. Manual starting. Just rebuilt, \$250.00. About 1000 feet No. 4 and No. 6 covered electric wire, used, in 25' to 100' lengths, 5c per foot. 10% off for entire lot. Concrete mixer, 1 bag size, side loader with 2 cyl. gas engine drive. Running condition, \$265.00. Wanted: 1/2" bench drill press, late type, 1/2 h.p. 110 or 220 volt a.c. elec. motor, or 3/4 h.p. electric portable belt sander, power lawn mower. P.O. Box 1344, Lake Charles, La.

AUTHORIZED By W.P.B. to sell inventory of new a.c. and d.c. midjet motors—Both geared to 4 r.p.m. Shaft speed 1250 r.p.m. 110 volts. Ideal for timing devices, displays, models. Bargain price a.c. motor \$2.00. Length 3", height 2 1/2", width 2 1/2". d.c. \$3.00. Length 5 1/2", height 2 1/2", width 3". Add 25c for postage. McLaren Products Company, 114 N.W. First Street, Evansville 8, Ind.

WINDING Data, listing 225 motors, single and three phase, \$1.00. Motor Data Co., Box 7631, Kansas City 3, Mo.

ATHLETIC EQUIPMENT—BODY BUILDING COURSES

SUPER Ju-Jitsu—lightning attack and defense system. Lick brutes twice your size with only your bare hands! Fear no man! Sensational new home study course now ready. Bargain. Free details. Write—Nelson Company, Dept. 5-02, Chicago 4.

DEFEAT A boxer. Secret ju-jitsu defense. Complete instructions, 10c. Dr. Malcolm Smith, 1104 Union Ave., Montreal 3, Canada.

HAND Balancing easily learned. Write, W. Power, 923 W. Vine, Kalamazoo, Mich.

BECOME Muscular! Hoist 200 pounds overhead one arm! Learn weightlifting positions, expert's secrets, "knack"! Small men out-lift large! Show you're strongest: lift 200. Secure "Knack of Lifting." \$1.98. Ansonge, 619 Watson-P. Grand Rapids, Michigan.

BAR-BELLS, Exercise equipment. Courses, Special offers! Free booklet. Good Barbell Co., 3261-PM Watson Rd., St. Louis (9), Mo.

SPORTING GOODS, GUNS, FISHING TACKLE, ETC.

SPORTSMAN'S Encyclopedia, 514 pages, over 1,000 illustrations. All about the outdoors! Camping, fishing, hunting, trapping, scouting. \$3.00 postpaid. Henry Schultz, Route 2, Pascagoula, Mississippi.

AMMUNITION Available to qualified purchasers. List 10c. Rudolph's, Atchison, Kansas.

ARCHERY Equipment: Catalogue free. Mid-West Archery, 2209-A East 75th, Chicago 49.

THE Lord is coming! Get guaranteed proofs free. Scheall, 263XS, Duluth, Minn.

LEARN Gunsmithing at home. Earn money repairing neighborhood's firearms. Catalog 25 firearm and gunsmithing textbooks for 3c stamp. Samworth, Plantersville, South Carolina.

TRAP Fox and coyote; on bare ground or deep snow. Learn modern tricks to outwit the sly furbearers. Free illustrated circular. Q. Bunch, Welch, Minn.

ELEVEN Good box traps. Complete blueprints. 30c. Wesho-Uco, Box 51, Detroit, Mich.

BOWS—Arrows for recreation, hunting, fishing. Beautiful archery instruction book, 70 pages, 50 illustrations, only 50c. Illustrated catalogue free. Archery Sales Service, 617 South State, Chicago.

USED Guns, bought, sold, exchanged. List stamp. Howe Fur Company, Coopers Mills, Maine.

NETCRAFT Kit:—Make landing nets, turtle traps, live nets, hammocks. Dollar bill brings; large, medium, small shuttles (patented), gauges, illustrated instruction booklet. Smaller kit:—Medium shuttle, gauge, booklet—50c. Netcraft, Dept. B, Toledo, Ohio.

FIELD GLASSES, MICROSCOPES, TELESCOPES

REAL 10 Power telescopes \$1.90. Supply limited. United 2309B Lawrence, Toledo, Ohio.

LENSES, War surplus, introductory offer four for one dollar postpaid. Industrial Engineering, 1155 South Kenmore, Los Angeles 6, California.

ACHROMATIC Telescope objective. 3" diameter, 15" effective focus. Coated surfaces. Mounted in aluminum cell. Ideal for telescopes, spotting, television and projection. Only \$13.50 each, postpaid. Remit with order. General catalog 15c. Ross, 70 West Broadway, New York.

MAKE Your own powerful, efficient astronomical telescope. Perfect lenses and instructions. 50X \$1.00, 100X \$2.50, 200X \$3.50, 400X \$5.50. Instructions alone 10c. Carl Jamer, Manorville, N. Y.

ASTRONOMICAL Telescopes, binoculars, cameras, microscopes; bought, sold, repaired. Send 10c for list of instruments wanted. Rasmussen & Reece, 41 Market, Amsterdam, N. Y.

MAKE Your own efficient compound microscope. Lenses and instructions 50X \$1.00, 100X .50, 200X \$2.00. Instructions alone 10c. Carl Jamer, Manorville, N. Y.

ANTIQUES, RELICS, INDIAN GOODS, CURIOS

INDIAN Relics, coins, bills, gems, crystals, curios, etc. Illustrated catalog 5c. 100 ancient arrowheads \$3.00. H. Daniel, Hot Springs, Ark.

BIRDPOINT And list 15c. Seven fine birdpoints, \$1.00. Paul Summers, Stamford, Texas.

FIVE Stoneage Indian tools 50c. Catalog 5c. Sistershop, Northbranch, Kansas.

MUSEUM Supplies, Indian relics, firearms, fossils, curios, minerals, den decorations. Illustrated catalogue 25c. Museum Supplies, 6601 Oshkosh, Chicago 31, Illinois.

20 GENUINE Indian arrowheads, \$1.00. Cat. Geo. Holder, Glenwood, Ark.

MINERALS, Coins, stamps, Indian relics, pistols, old glass. Catalogue 5c. Cowboy Lemley, Las Cruces, New Mexico.

INDIAN Relics, beadwork, coins, curios, minerals, old glass. Catalog 6c. Indian Museum, Osborne, Kansas.

DOGS, PETS, BIRDS, RABBITS

ENGLISH And Boston bull puppies. Catalogue 10c. Challenger Kennels, Jackson Center, Ohio.

BEAUTIFUL, Pure white police dogs. Ansonia Kennels, Mose, N. Dak.

RACCOONS, Minks, skunks—bred females. Catalog, 10c. Shady Fur Farm, Springfield, Minnesota.

PUPPIES And supplies; also pedigreed Flemish Giant meat rabbits and supplies; what do you need? Royal Kennels, Chazy, N. Y.

FARM Raised registered Irish Setter puppies. Write Earl Bond, Albert Lea, Minnesota.

WILD Geese, ducks, peafowl, pigeons, rabbits, pheasants. Prices free. Jewell Game Farm, Danville, Ill.

MONEY Raising rabbits. Investigate. Folder 10c. Close Rabbitry, Tiffin, Ohio.

RABBITS, Most breeds. Write needs. Bay Farms, Box 59, Hayward, Calif.

RAISE Giant Chinchilla rabbits. Willow Farm, R15C, Sellersville, Penna.

LEARN All about Angora rabbits—wool brings \$9.00 pound. Book tells everything. "Angora Care-Management" regular \$1.50, special \$1.00. Catalog Angoras free. Grinsteads, Dept. 15, Edwardsville, Illinois.

ST. BERNARD Pups: Champion sired beauties. Franklin Young, R4, Riverhead, Long Island, New York.

MICE, Rabbits, pigs, pigeons. Information 10c. Jim Houck, Tiffin, Ohio.

RAISE Guinea pigs. Make money at home. Big demand. Free booklet. Taylors Guinea Pig Farm, Hapeville, Georgia.

RAISE Rabbits for profit. Magazine puts you in touch with markets. Copy 10c. Booklet describing twenty breeds, and magazine for three months 25c. Address American Small Stock Farmer, Dept. 3, Pearl River, N. Y.

RABBITS: Flemish Giants, New Zealand. Reasonably priced. Franklin Young, Riverhead, Long Island, New York.

SEEDS, PLANTS, NURSERY STOCK

DAHLIAS—Ask for book—400 varieties. Springhill Dahlia Farm, R. 2, Box P, Grand Rapids, Mich.

FARMS, FARM LANDS, REAL ESTATE

NEW Winter catalog, selected farm bargains, 7 midwest states, sent to you free! Many equipped. Many illustrated with picture. Special service to those stating general location desired, and payment plan. Write today! United Farm Agency, 7-MP South Dearborn, Chicago 3, Ill.

\$5.00 MONTHLY Buys 40 acres, near town; price \$175.00. Free list. Box 425-P, Carthage, Mo.

FARM Catalog mailed free. Hundreds of bargains New York, New Jersey, Connecticut and 23 other states Maine to Fla., west to Texas, California and Oregon. Strout Realty, 255-P 4th Ave., New York City 10.

GOOD Farms—Ranches, Washington, Minnesota, Montana, Idaho, Oregon, North Dakota. Dependable crops, favorable climate. Write for literature. Lists describing typical farms. Specify which state. J. W. Haw, 119 Northern Pacific Ry., St. Paul 1, Minn.

FREE Fertile South-American lands! Fifty acre homesteads or 25,000 acre livestock ranches. Valuable illustrated information, 25c (refundable). Valles, 395-PJ Broadway, New York 13.

OZARKS Guide, Lonsdale, Arkansas. Magazine for homeseekers, sportsmen. Year, \$1.00.

WEST'S Fall catalogue; new big catalogue of hundreds of farm bargains; including many best buys in Penna., New York, Ohio, Delaware and Maryland. For your copy, absolutely free, write to West's Farm Agency, Dept. HE, Pittsburgh 16, Penna.

"EVERY Good book on country living." Free 16 page money-saving catalogue. A treasury of expert advice and knowledge. Covers home gardening to full time farming for profit and pleasure. Country Bookstore, Noroton 27, Conn.

OZARK Farm bargains. 5 to 5000 acres. Frank, Mountain View, Mo.

HOMESITES \$200.00. On easy payments. In California's loveliest garden spot on wooded shores of Morro Bay, midway between Los Angeles and San Francisco. Wonderful fishing, boating, hunting. Excellent soil, soft water. Grow fruits, vegetables, poultry, etc. Unusual investment opportunity. Free literature. Richard Otto, Dept. M, 6560 Hollywood Blvd., Hollywood 28, California.

FARM MACHINERY AND SUPPLIES

BUILT At home—Your own garden tractor. Complete blue prints and material specifications \$1.50. Automotive Division—Elmore Project Engineering Laboratories, 5058 Alhambra Ave., Los Angeles 32, California.

NEW Farm machinery book. Learn your farm machinery better. A time and money saver. \$1.00 postpaid. Wirtson's, West Burlington, Iowa.

POULTRY AND FARM SUPPLIES

BABY Chicks, champion mated. 52 varieties. 7 hybrids, licensed inspected, blood-tested. Rush postal large colored book, low prices. Berry's Farm, Route 12, Clarinda, Iowa.

RAISE Turkeys the new way. Write for free information explaining how to make up to \$3000.00 in your own backyard. Address National Turkey Institute, Dept. 3, Columbus, Kansas.

YOUR Greatest poultry problem will look simple when you read American Poultry Journal regularly. 500,000 poultrymen do, why not you? Only 25c year, 5 years \$1.00. American Poultry Journal, 535 South Clark, Chicago.

KNOW How to raise poultry for profit. Read Northeastern Poultryman. Every issue packed with helpful hints and practical suggestions. Latest articles on breeding, feeding, and management. Read nationally. Subscribe now. 1 year 65c; 2 years \$1.00. Northeastern Poultryman, 376 Boylston St., Boston 16, Mass.

POULTRY Raisers—Increase poultry profits with experimental farm advice. Latest tested helps. Subscribe now! Two years 50c; five years \$1.00. Poultry Tribune, Dept. 30, Mount Morris, Ill.

PROFITABLE OCCUPATIONS

MAKE \$300 To \$3000 a year in your spare time in your backyard, raising our Owei meat and fur rabbits. Outdoor War Efforts Industry, Owatonna, Minn.

WELDING Pays. Learn with 1942 trade school text manual, 516 pages. Over 500 photos. \$2.00 copy. Money-back guarantee. Hobartweld, Box M-153, Troy, Ohio.

GROW Ginseng, instructions dime, seeds reasonable. Specialty Farm, Rockford, Minn.

FOR An extremely profitable lifetime business, operate a collection agency-credit bureau. Easily learned. Free folder. Cole Associates, Syracuse, N. Y.

"FROG Raising." New book tells how. Profitable. Marlboro House, 1035 Marlborough, Detroit 15, Michigan.

TYPEWRITER Repairing—Original course, simplified home study. Weber Typewriter Mechanics School, Box 269, Osborn, Ohio.

MUSHROOMS Grown in boxes. Instructions 50c, spawn \$1.00. Gordons, 553 William, Winnipeg, Manitoba.

ANNOUNCING New home study course in commercial baking. Good field. Nearly depression proof. Common school education sufficient. Send for free booklet "Opportunities in the Baking Industry" and requirements. National Baking School, 1315 Michigan, Dept. 3431, Chicago.

MECHANICALLY Inclined men—Own and operate general appliance repair shop. Complete, illustrated course shows you how. Welding, refrigeration, motor repair, how to get business, etc., all phases covered. Free literature. Christy Supply Dept. 448, 2835 N. Central Ave., Chicago.

LOCKSMITHING—Profitable business or hobby! New course teaches you how to pick locks, fit keys, de-code, masterkey, etc. Easy self-instruction lessons. Bargain price. Free details. Write—Nelson Company, Dept. 7-02, Chicago 4.

CAMERALESS Photography, photo stamps. Instructions \$1.00. Alvin, 553 William, Winnipeg, Manitoba.

BANISH Post-war worries! Become a distributor of nationally known merchandise. 25c brings you big directory of manufacturers, products. Tells who to contact for samples. Associated, 2557 Charlestown, Toledo, Ohio.

PANNING Gold—Hobby or occupation. New 160 page beginner's book. Explains everything. Book and three large blueprints for small equipment \$3.00. C.O.D. if requested. Free literature. Old Prospector, Box 878K44, Oakland 4, Calif.

HOMEWORKERS. Make, sell, shell novelties. Beginners samples, instructions, \$1.00. Temple, 2152 Tangerine, St. Petersburg, Fla.

SEABEES. Send for set of sensational Seabee cards. Free. Petyt Studio, 3310 West 65 Street, Chicago 29, Ill.

GROW Green vegetable in cellar, six days. Sell restaurants. Complete instructions, pound seed, \$2.00. Temple, 2152 Tangerine, St. Petersburg, Fla.

SIMPLIFIED Chemical gardening. Instructions 50c. Chemicals 50c. Alvin, 553 William, Winnipeg, Manitoba.

YOUR Own business: Clean chimneys without climbing on roof. Uncrowded field, essential. \$25 to \$40 a day. Outfit and complete instructions shipped for \$25. Hoffman Supply, Box 861, Spokane, Wash.

ELECTRICAL Appliance repair. Open your own shop. Learn home wiring; electric motors, vacuum cleaners, washers, etc. Complete illustrated course shows how. Free booklet. Pacific Training School, Dept. 1-AP, 4703 West Pico, Los Angeles 6.

PLASTICS. Plaster casting plaques, molds. Instructions 50c. Alvin, 553 William, Winnipeg, Manitoba.

TYPEWRITER Repairmen urgently needed. Earn \$40 to \$50 weekly spare time. Our easy to learn home study course teaches how to repair typewriters. Write for free information. Houston Typewriter Repair Service, P.O. Box 5357C, Houston, 12, Texas.

EXCEPTIONAL Profits raising mink. Finest breeding stock available. Details furnished. Franklin Young, Riverhead, Long Island, New York.

POSTWAR? Prepare now to become associated with us in an essential proven profitable profession. Universal Exterminators, 950 Margate Terrace, Chicago 40, Illinois.

\$2500 YEAR In backyard. Treatise 10c. Moyer, B-252-P, Milton, Penna.

GOLD-STAMPING. Exceptional post-war opportunity. Free booklet. Home City Specialties, Dept. 1273, Springfield, Massachusetts.

ELECTRIC Clocks are every where you go. Buildings, homes, parking-lots, factories. Repairs increasing. Our easy to learn course with pictures and drawings teach you how to repair these clocks. Electronic Supply Co., Dept. A, P.O. Box 2350, Houston 1, Texas.

\$40.00 WEEKLY. Made growing mushrooms, fresh, dried. Dominion patent 331563. Free spawn. North American, 169F Yonge, Toronto, Canada.

BOOKS, PERIODICALS, PICTURES, POSTCARDS

MAGAZINES—Business, vocational, diversion. Profit by being better posted on conditions, developments and opportunities in your line, through magazines devoted to it. Choose current single copies from our list of over 600 different periodicals—more than 175 fields. Write now for free price-list. Commercial Engraving Publishing Company, 34C North Ritter, Indianapolis 1, Indiana.

SAVE Money by writing for our lists of special cut-rate books, many at less than 50% of original price. Pines, Box 32, Flushing, New York.

KNOWLEDGE Is power. Amazing book bargains. Free colorful catalogue. Continental Publications, 79-02 Woodside Ave., Elmhurst, New York.

MODERN Steam car \$2.00. Floyd Clymer's Historical Motor Scrapbooks, \$1.50 postpaid. See our advertisements under Automobiles and Motorcycles. Clymers, 2125 W. Pico, Los Angeles 6, Calif.

ASHAMED! Read "Character," 100 pages, illustrated. \$1.00. Starr, 106 North Seventh, Allentown, Penna.

IF It's money you want? Then read the new book, Gold Ahead. Free literature. Thompson Co., Baldwin, Michigan.

1280 PAGE Illustrated encyclopedia. Postpaid \$2.98. John Rackowa, 44 Erwin Place, New Britain, Conn.

AMERICA'S Leading livestock journal. Send \$1.00 year's subscription. Three years for \$2.00. Free magnetic breeding calculator with each subscription. Breeder's Gazette, Box PM-1, Spencer, Ind.

DRUNKENNESS Is a disease which responds to treatment. Medical skill plus human sympathy prove successful with liquor and drug cases. 60 years experience. Write for free booklet. P. M. Nelson, The Keeley Institute, Dwight, Ill.

BACK Number magazines, supplied. Cavalier, 618 Carroll Street, Brooklyn, N. Y.

LOVELY Pin up girls, actual photographs. Size 3 1/4 x 4 1/4. 10 for \$1.00. 4 different sets \$3.00. Samples, 25c. Murray Wilkins, 417 Hill, London, Canada.

INDIANS. All Americas. Authoritative. 485 pages. \$1.25. Boedecker, Willow Springs, Illinois.

TEXAS V-weards 3, 10c. Details free. Box 7, Naples, Texas.

UNUSUAL Pin-ups! Real photographs! 10—\$1. Fine-Arts, Box 2084-K, San Antonio 6, Tex.

PIN Ups. All kinds. Write Novelty Studios, 301C Eldred, Battle Creek 21, Mich.

BEAUTIFUL Colored pictures. No girls. Lists free. Curtis, Box 1916, Denver, Colo.

OLD. Rare and unusual books, sold and exchanged. New current books and magazines at bargain prices. Free catalogue. Banker Book Co., 610 S. Broadway, Suite 623, Los Angeles 14, Calif.

YOUR Opportunity—we supply all technical, hobby books. Plastics, refrigeration, airconditioning, radio, optics, electronics, automobiles, electricity, television, chemistry, watchmaking, building, construction, watchmaking, homecraft, farming, etc. Request free catalogue specific subjects interesting you. Modern Technical Book Co., Dept. MC, 55 West 42nd St., New York 18.

10 BEAUTIFUL Grand Canyon views 25c. V. Reasor, Medical Lake, Washington.

OUTSTANDING Arizona postcard views—ten, 25c; twenty-five, 50c. Dot-Mor Distributors, 3120-C North Stone, Tucson, Arizona.

BOOKFINDERS—319 So. Marengo, Pasadena, Calif. Rare books and courses.

OUTSTANDING Books! Lists and sample 25c. Barnes, 2501-P, Los Angeles.

WHAT You don't know about George Washington \$5.00. Knight Publishing Co., Leonardtown, Maryland.

WHAT Every Mason wants. We have Masonic books for Blue Lodge, Chapter, Commandery, Scottish Rite and Shrine. Our rituals are used the world over. Send for free catalog of books and rituals for Masons, Odd Fellows, Knights of Columbus, etc. Ezra A. Cook, Publisher, P.O. Box 796 P.A., Chicago 90, Ill.

12 PIN-UP Girls 50c and 3c stamp; foreign 12c extra. Selson, 1919 Girard Ave., Philadelphia 30, Penna.

BOOKS You are looking for—occultism, astrology, magic, character reading, graphology, money-making, photography, music, sport, entertainment, farming, handicraft, homemaking, public speaking, etc. All technical, hobby books. Request free catalogue specific subjects interesting you. Modern Technical Book Co., Dept. MMC, 55 West 42nd St., New York 18.

GORGEOUS Girl photos, books, etc. 15 samples 25c. Richardson, Wyoming, Pa.

100 ASSORTED Unused views \$1.00. Others 20c—\$1.00. Foreign 100—\$2.00. Coltran, 123 Foster, Burlington, Vermont.

REBINDING: We bind magazines, old books, Bibles, hymnals. Heckman Bindery, Dept. D, North Manchester, Indiana.

A RATIONAL View of Life \$1.00. Benjamin Selbert, Urbana, Ohio.

64 ART Cards of gorgeous beauties \$1.00. Reed Novelty, Dept. PM-6, Box 24, Queens Village 9, N. Y.

"PIN-UPS," 180 Gorgeous girl subjects! Huge bargain pack \$1.00. Clover Novelty Company, Dept. 37-DD, Hollis 7, N. Y.

ARTISTIC Girl pictures. Real models. 40 photos for \$1.00 postpaid. All different, postcard size. C. A. Scott, P.O. Box 342, Covington, Ky.

BACK-DATED Magazines, foreign, domestic, arts. Catalog 10c (refunded.) Cicerone's, 863 First Ave., New York 17, N. Y.

FREE Catalog, lowest prices, domestic and foreign magazines, newspapers, professional and trade journals by subscription. Agents wanted. Sutherland Magazine Agency, Dept. M, Ringgold, Virginia.

WRITER'S Instruction books. World's largest collection. List free. Humanity Press, 220 West 42nd St., New York 18.

GORGEOUS Full-color pin-ups. 50 different \$1.00. 160 different \$3.00. Samples 10c. Theron Fox, 1024-B Carolyn, San Jose 10, California.

"FOOLIES" Contains cartoons, gags, stories, 10c. Alstone, 406, Lunenburg, Mass.

PIN-UPS, Gorgeous girls, full color. Sample 8x10 and 3 1/2 x 5 1/2 10c. Arthur Fowler, Room 1, 697 Broadway, Somerville 43, Mass.

SELF-EXPLAINING Bible: Illustrated circular free. Box 446-P, Minneapolis, Minn.

BOOKS. (Out-of-print, new, used) quickly supplied. Many 35c bargains. Catalogue, T. Jamkowski, 18870 Marx Ave., Detroit 3, Mich.

GAMES AND ENTERTAINMENT

LEARN To draw funny faces. Write Funny Faces, Modesto 16, California.

CHARACTER Reading—Fourteen illustrated chapters. Eyes, nose, mouth, head analyzed. Valuable-informative. Postpaid \$1. Grover Publications, 390 H Bartlett, San Francisco 10, Calif.

COMEDIAN'S Scripts! Catalog free! Kleinman, 25-31-B 30th Road, Long Island City 2, New York.

THREE Playing card games. 25c pre-paid. Box 842, Denver 1, Colo.

MAGIC TRICKS, PUZZLES, JOKER NOVELTIES

BE A mathematical wizard. Mystify and amaze your friends. New collection of numerical tricks, illusions, problems, jokes and mind-reading stunts just off the press. Stage secrets exposed. Anyone can learn. Send 25c coin for "Magic In Numbers." Alta Company, Box 1109, Pasadena 1, Cal.

THREE Precision wooden puzzles that defy efforts to take them apart. \$1.00. Continental, 3158 Penobscot Bldg., Detroit.

FLOATING Cigarette—Floats in midair. With instructions. Ten cents. J. Eastwood, Box 623, Parkersburg, W. Va.

MAGIC Is fun! Send \$2.00 for apparatus to perform 10 different, startling tricks. Guaranteed \$5.00 value! Free, with your order, book of "102 Tricks." Robbins Co., 152-P West 42nd St., New York.

FOOL Your friends, pretend you are traveling. List 10c. Martin-50, D-203 Myrtle, New Bedford 4, Mass.

BOYS—"Transfer liquid" powder—Just add water and transfer comics, etc., from newspaper. Only 10c and stamp—or dozen packages postpaid 60c. Berent's, 4300 Hampton Blvd., Norfolk, Va.

QUALITY Magic since 1907. Five professional catalogs. 5 for \$1.00. Thayer's, P.O. Box 1785, Wilshire-LaBrea Station, Los Angeles 36, Calif.

FREE Amazing new pocket trick. Prepaid to you for the asking. Bergez Company, 742 Market Street, San Francisco, California.

TEN Professional tricks with equipment \$5.00. Ten amateur tricks \$2.00. Magic package 25c. Magic Den, 612PM Pine, St. Louis, Mo.

YEAR'S Cleverest trick. Send dime. Box 333, South Pasadena, Calif.

MAGIC Trick free. List. Gorsline, 216 So. Center, Corry, Penna.

LEARN Ventriloquism. Write for free details. Gotberg, 15801 Prest, Detroit 27, Michigan.

11 FIRE Eater's stunts—50c. Manly, 1315-PM Ferris, Los Angeles 22, Calif.

BRAND New magic and fun magazine, 15c. Contains exciting cash prize contest. Real fun. Phoebe, 945-A Chancellor, Irvington 11, N. J.

800 MAGIC Tricks, books and secrets now in stock. New 1944 lists free. Magic Store, Minneapolis 2, Minn.

AMAZE, Mystify, entertain. 64 magical mysteries explained and illustrated catalogue, dime. Wholesale prices wanted. The Astral Guild, 1000 Stelzer Road, Columbus 3, Ohio.

TRANSFER Pictures off funnies, newspapers, etc., to paper, cloth handkerchiefs. 50c bottle. No stamps. National Specialty Service, Manassas, N. J.

"BREATHAKING" Chinese ring illusion. 50c. Box 18, Lefferts Station, Brooklyn, N. Y.

VENTRILLOQUISM. Complete instructions only \$1. Lesueur, 77 Wellesley, Toronto, Canada.

SEND 25c For \$1.00 worth of magic tricks and our latest catalog. Ball Square Company, 697 Broadway, Somerville 44, Mass.

6 MAGIC Tricks and clever novelty 10c. Victor Jones, Parma, Missouri.

ENTERTAIN! Mystify! New, bigger magic catalog and 4 secret tricks 25c. Herbert, P-192 N. Clark, Chicago 1.

NEW Vanishing half dollar 50c. Carlo, 436 Superior, Toledo, Ohio.

MAGIC — Jokers — puzzles. Illustrated lists 3c stamp. Jokerhammel, Leighton, Penna.

MAGICIANS' Headquarters. 216-page catalog, pocket, parlor, professional tricks. 25c. Kanter's, M-1311 Walnut, Philadelphia 7, Penna.

500 TRICKS You can do! Douglas' famous catalog of 500 tricks, now only 10c. America's fastest service on magic for pocket, parlor, stage, professional, amateur. Douglas Magic Shop, Box 274, Dallas, Texas.

TRICKY Match box, it turns around! It stands up! and it opens. most weird, uncanny magic novelty trick, complete, ready to do. 25c. The Magician 2463-M, Kensington Ave., Philadelphia, Penna.

LEARN Ventriloquism, 3c stamp brings particulars. Smith, 801 Bigelow, Peoria, Illinois.

AMAZE Everyone. Answer unspoken questions. Professional "no assistant" mindreading act. \$1.00. Magical Enterprises, Box 111-P, Levering, Mich.

NEW! Simplified card tricks! Amazing self-working bafflers 50c postpaid. James W. Roundtree, 529 Elliott St., River Rouge, Michigan.

WORLD'S Largest professional magic shop keeps you in touch with latest tricks. To receive mailings send 25c for 1943 catalog. Holden, 220 W. 42nd St., New York.

BE A magician. Large professional magic catalogue of latest tricks 25c. Ireland, C-109 North Dearborn, Chicago 2.

MAGIC Tricks, puzzles, books, cards, punch boards. Catalog 10c. Specialty, Box 671, St. Louis 1, Mo.

NEW Vanishing key and catalog 25c. Sterling Magic, 345 John R., Detroit, Mich.

EARN Money in any crowd. Call names of strangers, tell unspoken questions. Professional course mind reading, spirit writing, etc., \$1. Henderson, Box 341, San Bernardino, Calif.

COINS, TOKENS, CURRENCY

GET Profit and pleasure in collecting old coins. Send 10c for 66-page illustrated coin catalog. You'll be delighted with it. Send for it now. B. Max Mehl, 370 Mehl Bldg., Fort Worth, Texas. Largest rare coin establishment in U. S. Established 45 years.

INDIAN Head penny with list 10c. Charles Banker, Salina, Kansas.

OLD Money wanted. Will pay fifty dollars for nickel of 1913 with Liberty head (no buffalo). We pay cash premiums for all rare coins. Send 4c for large coin folder. May mean much profit to you. Numismatic Co., Dept. 20, Fort Worth, Texas.

MEXICAN Coin and list, 10c. Silver peso 50c. Half peso, 30c. Paul Summers, Stamford, Texas.

FIVE Foreign bills, 25c; twenty-five different, \$1.00. Beffel, Box 37, Ottawa, Ill.

WILL Pay \$10.00 each for certain Lincoln pennies! Indianheads \$50.00; dimes \$1,000.00. Catalogue 10c. Federal Coin Exchange, 1-PM, Columbus, Ohio.

12 WOODEN Nickels \$1.00. 25 different Indian cents \$1.00. Bargain lists 3c. 1945 large retail catalogue 15c. Copyrighted premium list 6c. Bebee Coin Company, 1180 East 63rd, Chicago 37, Illinois.

FOREIGN Coin 10c. \$5 worth coins \$2.50. Oddehon, Box 482, St. Louis, Mo.

FOREIGN Coin and coin information 10c. Willard, 3132 Mersington, Kansas City 3, Mo.

TRADE, Buy, sell U. S. coins, foreign gold. Harris, Box 3041, Seattle 14, Wash.

WANT To buy, Indian and scarce Lincoln cents. Send 10c for buying price list. Hansan's, 1326 Main, Kansas City 6, Mo.

COMMEMORATIVE \$1.25. Columbus, Stone Mountain, Texas, Cleveland, \$1.50 each, new. Illustrated catalogue 25c. Norman Shultz, Salt Lake, Utah.

FREE! Large illustrated price list of coin albums, coin books and other supplies for coin collectors. James Randall, 341 South Dearborn, Chicago 4, Illinois.

QUICK Service: reasonable prices. United States catalog 10c. Foreign catalog 10c. Ben's Coin Company, 72 West Washington, Chicago 2, Illinois.

10 INDIAN Head cents, different dates, also pricelists, 40c. Schultz, 1053 Richmond, Cincinnati, Ohio.

FREE! Foreign coin, banknote and coin collectors illustrated catalog to approval service applicants. Send 3c postage. Tatham Coinco, Springfield-125, Mass.

I MAY Have just the scarce U. S. coins you want. Send me list. "Meet me by mail." William H. Kenworthy, Waterville, Maine.

OLD STAMPS WANTED

I WILL Pay \$100.00 each for 1924 1c green Franklin stamps, rotary perforated eleven (up to \$1,000.00 each unused). Send 6c today for large illustrated folder showing amazing prices paid. Vernon Baker, (FM-51), Elyria, Ohio.

STAMP COLLECTING

SCARCE Grenada bicolored silver jubilee stamp, MacArthur stamp from Australia, Abyssinian wild elephant issue, plus host of others from New Caledonia, Indo-China, Russia, Cuba, Wallis & Futuna, Dutch Indies, China, Philippines, etc., only 5c to approval applicants. Big dime packet list free! Methuen Stamp Service, Inc., Dept. 36, Lawrence, Mass.

OPPORTUNITY! Gorgeous lot with triangles, diamonds, giants, midgets, flags, airmails, and railroad stamps. Also Guiana, Djibouti, Mongolia, Columbia, New Caledonia, etc.! Everything only 10c to approval applicants. Evden 3, Box 396, Niagara Falls, N. Y.

VATICAN City, Eritrea, Falkland Islands, Mauritius, Nyassaland, Selangor, African airmail, Kenya, Tanganyika, South America, Asia, British Colonies. Many others. Swell packet, 5c to approval applicants only. Kenwood Stamp Co., 321-M Burchett, Glendale 3, California.

UNITED States No. 33, No. 182, No. 306, No. 324, No. 425 (mint), No. 453, No. 643 (mint), No. C21, No. R40c, No. R52c. Send 50c. Approvals accompany. Whiton-Stamps, Norwalk, Connecticut.

FREE—World's only octagonal (eight-sided) stamp and 70 year old Turkey set to approval applicants. Charles Cleveland, 806 North Humphrey, Oak Park, Ill.

UNITED States collection of 50 different mint commemoratives in very fine un-hinged condition from 1920 to 1939. Price only \$2.00 with your request for United States approvals. Fort Orange Stampco, Albany, New York.

FAMOUS Washington bicentennial, complete set, plus eighty year old, high catalog, revenue—only 10c to United States approval applicants. Jarr, Box 711, Denver 1, Colorado.

BOY, Oh boy!—10 gorgeous "model" stamps that pack a thrill!—only 5c with approvals. Estates (Box 46PM), Foxlake, Wis.

FINE Approvals, freshly mounted. Fast, personal service. Tell me what countries you prefer and I'll send their stamps. Skinner, 345 East Ocean, Long Beach 2, Calif.

AMAZING Offer! Assortment each of giant stamps, midget stamps, flag stamps, airmail stamps. Free French Colonies, U. S. commemoratives and numerous others. Everything only 10c to approval applicants. Simon, Box 214, Iraan, Texas.

STAMPS From 40 countries, including Fiji, 10c. No approvals. Elsea, Bowling Green, Ohio.

SPECTACULAR Approval service for collectors using International Junior or Modern albums. Lowey, Aberdeen, Maryland.

LAST Chance! Five attractive mint sets, including colorful complete sets only 10c. Approvals. Barton, Box 321, Elizabeth, N. J.

LOW Priced U. S. approvals. Postage paid both ways. Kaiser Stamp Co., 302 E. Hurley St., St. Paul, Minn.

500 DIFFERENT Foreign stamps and Mexican banknote only 50 cents. Nagle, 1101 Marion, Reading, Penna.

60 DIFFERENT United States. Includes commemoratives, higher values, airmail, 10c. Charles Stone, 3547 28th St., Astoria, 1, N. Y.

FREE! Super stamp mixture to approval applicants enclosing 5c postage. International Stamp Co., Hallettsville, Texas.

PERSONAL Attention and quick service with each order of approvals. Kirklands, 7212 Farwell, Chicago 31, Illinois.

FREE 15 Different U. S. commemorative stamps to anyone sending 3c postage. Benjamin Bren, Station A, Box 141, Manchester, Conn.

FRESHLY Mounted approvals for collectors using Scott's International Junior album. Phoenix Stamp, 120 West 44th, New York, Dept. 3-M.

100 STAMPS 10c. Approvals. 1000 different \$4.25. Morris Stamp Co., Box 74, Rockaway, N. J. Dept. 104.

MINT Cayman Islands, Malta and Hong Kong jubilees, 5c with approvals. Smith, 237-A 8th Avenue, Roselle, N. J.

200 DIFFERENT Foreign. 30c. Many countries. Jem Stamps, Port Jefferson, N. Y.

SURPRISE Mint set, 10c. Fine approvals. Norien Stamps, 1417 East 34 Street, Brooklyn 10, N. Y.

FIGHTING Free French packet free to approval applicants. Postage 3c. Gelburd Stamps, 1214 Shakespeare, Bronx, New York.

100 DIFFERENT World-wide 3c. Pictorial approvals. Getche, 1040 N.E. Eighteenth, Minneapolis 13.

500 MIXED Airmails, 200 different \$5. Shoenbach's, Box 180, New York 19.

CHILE, 50 Different, only 10c with approval selection. Paul Rawden, Box 2920, Westville, New Haven, Conn.

80 PAGES Special offers, all United States, free. Postage 3c. Spencer Anderson, 65 Nassau, New York City 7.

FAMOUS Americans complete, 85c. Flags. 60c. Erickson, 736 Cottage, St. Paul 6, Minn.

TWENTY Desirable foreign commemoratives only 5c. Ridgeaway, 316 57th Street, Brooklyn 20, New York.

FOREIGN Approvals. Fairly priced. Brandann, 1912 - 3rd Ave. So., Minneapolis 4, Minn.

FREE United States price list. Postage 3c. Mark Hanna, 335 - 5th Avenue, Pittsburgh, Penna.

BETTER Grade stamps. Pictorials, airmails, covers. References. Mehde, Amiret, Minn.

50 FREE, Pictorial, etc., stamp dictionary. List. Bullard, Newcastle, Maine.

MOZAMBIQUE Triangles, four unused 10c with approvals. Vargo Stamps, Racine, Wisconsin.

25 DIFF. Finland 8c with 1/4, 1/2, 1c approvals. Carroll's, 745A W. 45th, Los Angeles 37, Calif.

FREE! Haiti victory set to approval applicants. Riedell, Greensburg, Penna.

ELEVEN Beautiful Liberian officials 20c. Approvals sent. Prall, Hackettstown, N. J.

GREECE Three colored charity complete snakes (3) free. Write Thomas & Co., 129 State St., Hammond, Ind.

25 STAMPS From 25 countries 3c with approvals. Beaumont Stamp Exchange, 2567 McFaddin, Beaumont, Texas.

WE Pay return postage. Low priced scarce foreign. Southern Stamp Co., Box 70, Miami, Florida.

SPAIN—Five large airmails. Send 10c. Approvals. Buchanan, 307 East 23rd, New York 10.

U. S. Beginners list. Write Mayer, 786 East 149, Bronx 55, N. Y.

"U. S. Only approvals." Request them today. Reasonable. Box 488, Minneapolis.

PICTORIALS—Low and medium priced. Attractive series of general approvals. Elmo Masters, Clifton and Kernan, Baltimore 7, Md.

EXCHANGE Your duplicate stamps. Details free. C. Bishop, Route 8, Kalamazoo 88, Michigan.

MINT Canadian approvals. R. A. Allison, 712 - 17th Street, Niagara Falls, N. Y.

COMPLETE Set Washington bi-centennials 10c. U. S. approval applicants. Davis, 172 Clinton Place, Hackensack, N. J.

SCARCE—United States imperforate! Free! When requesting our low-priced attractive U. S.—foreign approvals. Samuel Fapp, Ferguson 21, Mo.

SELECT United States approvals. Thomson, 40-60 Elbertson, Elmhurst, New York.

100 DIFFERENT U. S., regardless of catalog value, including airmails, commems, coils, hi-values, only \$1.00. Fred Quatsak, 1242 Kelton, Pittsburgh 16, Pa.

100 DIFFERENT, 25 South America, 25 Canada, 50 worldwide. Commemoratives, pictorials—25c. Winneshiek, LaCrosse, Wisconsin.

ARMY-NAVY Set 10c. United States and foreign approvals accompany. Yokums, Box 1327, San Antonio 6, Texas.

100 AIRMAILS, Approvals and list \$1.00. George Davis, Webster, Mass.

50 DIFFERENT Latin America—25c. Northeast, Box 6618, Kansas City, Mo.

LIVELY. Indispensable stamp publication. 6 months subscription 10c! "Stamp Post." Station A, Pasadena 3, Calif.

CORONATIONS! Crown colonies. One country complete 10c. Approvals. Millhiser, 7724 Abbott, Pittsburgh, Penna.

9 TRIANGLES—10c, worth 40c. Approvals. Thompson, Box 435, Merrimac, Mass.

1945 BARGAIN 5c, approvals. Cornetta Bros., 228 West 25th, New York 1, N. Y.

(U. S. Offer)—Double value! Send 25c, 50c or \$1.00 take double the amount of your own choice in stamps from our high grade first U. S. approval selection. Free price list. Cosmopolitan Stamp Co., 1457 Broadway, (Dept. 112), New York.

100 STAMPS From 25 countries—10c with approvals. D. John, 7933 Clyde, Chicago 17.

UNITED States approvals. Select copies, used—mint. Kingsbury Stamps, West Burke, Vermont.

LARGE United States commemoratives, 30 different 15c. Henderson (M), 902 - 72nd Street, Brooklyn 28, N. Y.

375 DIFFERENT Stamps including Montenegro, 30c. Approvals. Best, Box 139, Bangor, Maine.

POSITIVELY Greatest free offer—Latest Scott's International \$5.00 Stamp Album—covering entire world, contains 36,000 illustrated, descriptive spaces; Scott's 1945 Standard \$5.00 catalogues "Philately's Encyclopedia"—absolutely free to applicants for foreign approvals becoming customers. Thrifty Stamp Service, 1106 East Baseline, San Bernardino, California.

TRIANGLES—Mozambique airmail-commemoratives, British Empire commemoratives, scarce U. S. higher values. Bonanza lot, 10c, with approval request. Reuter, 611-C West 40th, Los Angeles 37.

1000 MIXED U. S., old and new, 25c. Kolona, Troy 3, Ohio.

HAWAII—Three rare old Hawaiian stamps, only 10c with approvals. Western Stamps, Box 4042, Los Angeles 24, Calif.

SPECIAL—Request approvals, enclose 10c, keep 30c worth premium. Lon's, 1360-J Pacific, St. Paul 6, Minnesota.

SCARCE 1880 U. S.—Hussey local carrier stamp listed at 35c. Also Costa Rica No. 65 listed at 40c. Both sent free to approval buyers sending 3c postage. Pladon Stamps, 1717-M Idaho, Toledo 5, Ohio.

PRIVATE Collection—excellent—3,430 foreign, catalog approximately \$245.00. State best offer. Booher, 1132 Banning, Wilmington, California.

NEW Issues, cost plus 10%. Advise your countries complete information. Callahan, 512 Van Ness, San Francisco 2, Calif.

50 DIFFERENT Near East 10c with approvals fourteen countries. Champion, Box 4725A Florence Branch, Los Angeles 1, Calif.

FREE U. S. 20c clipper stamp with approvals. Stanley, the Stamp Man, 3120 South Adams Ave., Milwaukee 7, Wis.

100 ALL Different airmails \$1.00. Monjar, 1750 Fairmount, Cincinnati, Ohio.

EGYPT No. 205-07, Mint (Scott's cat. Nos.) Catalog value of this set of three stamps 75c but in order to introduce our stamps to discriminating collectors, we are offering this rare set to approval applicants for only 45c. Lawrence Stamp Co., P. O. Box 3507, Oklahoma City 6, Okla.

SPLendid Offer! Gilberts, Seychelles, Solomons, U. S. commemoratives, Anzac commemoratives, Bolivia commemoratives, liberated countries and multitude other stamps. Everything only 10c to approval applicants. Stav, 147 Victoria, Kamloops, B.C., Canada.

"THE Best"—United States and Philippine Island approvals. Largest varieties. America's lowest selling prices. Stamp Company, Allen, Albany 3, New York.

CANADA War set 10 var. 10c with interesting approvals. Rheame, 8949 Routhier, Montreal 12, Canada.

NEWFOUNDLAND 20 Different to approval applicants sending 10c war stamp. Neumann & Co., 1506 West Oklahoma Ave., Milwaukee 7, Wisconsin.

8 ATTRACTIVE Airmails 3c, with approvals and lists. Gaydos, Kenosha, Wis.

FOR Service and low prices on United States approvals write John Steger, 1165 Downing, Denver 3, Colorado.

EXOTIC Solomons, gorgeous Gilberts, etc.—3c with approvals! Saxon, Valley Stream, N. Y.

TURKS Caicos, Grenada, Seychelles, Dominica, Caymans; everything 3c with approvals. Viking, 130(Z) Clinton St., Brooklyn, N. Y.

LIBERAL Prices paid for stamp collections, job lots, etc. PKeigwin Company, Vineland, N. J.

ZOWIE-E-E! A barrel of fun for only a dime. 500 United States—absolutely unpicked and unsorted—just as received from church missions. Many varieties, including large commemoratives, airmails, high denominations up to \$5.00! Stampdom's biggest package of fun—and you might find something really valuable! Price only 10c to serious approval service applicants. Money back if not delighted. Illustrated bargain lists with each order. Mystic Stamp Company, Department 80, Camden, New York.

PICTORIAL Foreign variety packet, 25 different, 10c, with approvals. Southwest Stamps, Box 117, Long Beach 1, Calif.

20 DIFFERENT—20 Different countries, 3c, approvals. A.B.C. Stamps, 2318-P Miramar, Los Angeles 4, Calif.

ALASKA Embossed air mail cover with photo stamp. Attractive. Unique. Send 15c stamps or coin. Arctic Cachet Company, Box 118, Ketchikan, Alaska.

19th CENTURY U. S. commems, Civil War revenues, battleship \$5 and \$10 stamps free to U. S. approval applicants. Metropolitan Stamps, 198-C Broadway, New York.

FREE—Pick 25c worth of stamps from our first U. S. approval selection. Approximately 100 stamps to choose from. Excellent value. No obligation to buy. Lists illustrating the most popular U. S. stamps—at prices you can afford—will be included. Don't miss this opportunity! Write today. S. C. Engel Co., 38 Park Row, New York City.

114 DIFFERENT Stamps from far away countries including airmail and Free Fighting French to approval applicants for 10c. Reich Stamp Co., 4647 Kenmore, Chicago 40, Dept. M9.

SPECIAL—Airmails, 21 different, including zeppelin, triangles, Latin-America, 5c with approvals. Continental Co., (Dept. B), Box 606, New Rochelle, New York.

FREE! Approval applicants select 10c worth free—your choice. Excel, Box 1315, Chicago 90.

U. S. Price list. Send postage. Stanley Gibbons, 38-P Park Row, New York.

FREE, Complete Cuba tobacco set with approvals. Seminole, Glenburnie-1, Maryland.

WORLD'S Largest diamond and triangle stamps, free stamp magazine, stamps from fighting Free French, 20 stamps from 20 different countries, pictorials, airmails, big bargain 5c with approvals. Capital Stamps, Dept. 2, Little Rock, Ark.

100 DIFFERENT 10c With approvals. Jacobsen, 59 Nagle Ave., New York 34, New York.

EXTRAORDINARY Pictorial collection—Nigeria, Southern Rhodesia, Dutch Indies, Martinique, Newfoundland, Philippines, Porto Rico, St. Pierre and Miquelon, Djibouti, Senegal, Ceylon, Jugoslavia, Ivory Coast, Madagascar, Reunion, Wallis and Futuna. Everything only 5c. Imperial Stamps, Box 311, Yonkers 1, N. Y.

FINAL Clearance—500 mixed approval remnants, etc.—\$1.00. Beacon Sales, Maynard, Mass.

118 DIFFERENT Stamps including commemoratives, charities, airmail sets, etc., only 3c to approval buyers. We buy collections. Badger Stamp Co., Milwaukee 3, Wis.

FREE! The Stamp Finder! Send today for the big new edition, fully illustrated, enabling you instantly to identify all difficult stamps! Also fine packet strange, fascinating stamps from Bosnia-Herzegovina, Monaco, Fataala, Cyprus, etc., including maps, ships, animals and strange scenes. All free to approval applicants inclosing 3c postage. Garcon Stamp Company, Box 900, Calais, Maine.

1000 MIXED U. S. old and new 25c. 2 lbs. \$1.00. Weatherby, Medina, Ohio.

FREE! Complete "United States" stamp catalog with 1,000 illustrations! Send 10c to cover mailing. Harris & Co., 137 Transit Building, Boston, Mass.

PENNY Approvals, that satisfy. Neil Gronberg, Box 5441-P, Philadelphia 43, Penna.

DEALERS—Wholesale list. Postage 3c. Frank, 5031 Queensberry, Baltimore 15, Md.

POUND Unpicked U. S. and foreign mixture containing thousands stamps \$1.00, 5 lbs. only \$4.50. Longacre Shop, 100 West 42nd, New York City.

1000 GRABBAGS 15c Each. 8 different \$1. Special bags, Free French included 25c. Zandy, 630 Bingham, Reading, Pa.

SMOKY Mountain commemorative sheet, largest U. S. stamp issued, and 33 U. S. including commemoratives, airmail, revenues, etc. Catalogs 75c—To approval applicants for 5c. Curhan Stamp Company, Gloucester, Mass.

FREE! Canadian sets, royal visit, George VI, George V, coronation, jubilee, others, to approval applicants. Ensign, Box 118-M, South Orange, N. J.

WEEKLY Stamp Magazine, 26 weeks, 25c. Stamp Journal, Kalamazoo, Mich.

WOW! \$10.00 Worth of fun for only 10c! 500 foreign stamps, unsorted and unpicked (mostly on bits of paper) just as received from the church missions and other sources. Africa, So. America, Australia, China, Philippines, Dutch Indies, and other countries are represented. Includes a few commemoratives, airmails, and stamps cataloging up to 25c or more each! The biggest package of fun in stampdom—and you might find something really valuable! Price only 10c to serious approval applicants! Money back if not delighted. Jamestown Stamp Co., Dept. No. 22, Jamestown, New York.

DANDY United States approvals. Write immediately. Sullivan, Endicott Arcade, St. Paul, Minnesota.

FREE! Western Hemisphere packet. Postage 3c. Owens, 806 Welsh, Bay City, Michigan.

FREE! British Empire packet. Postage 3c. Williams, 606 Archer, Bay City, Mich.

FREE! Pony Express set (facsimiles). Postage 3c. Roberts, 406 Building, Bay City, Michigan.

CANADA 100 Different 25c—approvals all countries. Lists. Victoria Stamp Co., London, 4, Canada.

FREE! Leeward Is., Cayman Is., Turks and Caicos plus 60 different mint Geo. VI coronation poster stamps, to approval service applicants sending 3c postage. Tatham Stampco, Springfield-30, Mass.

55 DIFFERENT United States 5c with approvals. Bookman, Box 145-M, Maplewood, N. J.

STAMPS Sent on approval, outstanding quality, low prices. Fred Herzberg, 168 Oak, Elmhurst, Ill.

UNITED States approvals complete coverage, fine quality, attractive prices. Seminole Stamps, Box 436, Coconut Grove, Florida.

60 DIFFERENT United States 10c. Pricelist free. Seidenberg, Baroda, Mich.

LATIN-AMERICA Only—65 diff., including airmails, pictorials, commems—10c with approvals. "Crescent Stamps," London, Canada.

VICTORY Packet free—Includes stamps from Tanganyika, British Cayman Islands, animal, scarce babyhead, coronation, early Victorian, airmail, map stamps, with big catalogue—all free. Send 5c for postage. Gray Stamp Company, Dept. PM, Toronto, Canada.

EXCELLENT Victorial approvals. Reasonably priced. Crown Stamp Company, Box 331, Toronto, Canada.

HOBBIES AND COLLECTIONS

NEW Hobby catalogue 10c. Mexican glass miniature animals, twenty different \$2.00, ten dishes \$1.00; framed leather picture 4x7" \$1.00. Quivira Specialties, Topeka, Kansas.

SEMPIPRECIOUS Stones, how to cut and polish, equipment, etc. Book \$1.00. Home Lapidary Shop, Madera, Calif.

CUTE! 5" Hand carved fawn—painted \$1.00. Cartoon Studio, 1402 Charles, La Crosse, Wis.

LEARN To draw funny faces. Write Funny Faces, Modesto 15, California.

MEMBERSHIP Free. National Hobby Club, Box 1113, Rochester 2, N. Y.

COLLECTORS! Exchange duplicates. Stamp brings particulars. Box 2166, Denver 1, Colorado.

100 JEWELRY Stones removed from rings, etc.—from \$2.00 to \$2.40. Lowe's, Box 311, St. Louis 1, Mo.

NEW—15 Different match covers 10c. Box 202, Rochester 1, N. Y.

UNUSED Match book covers, 100 all different \$1.00. 35 Royal Flash covers \$1.00. Free list. Charles Edelman, 1311C East 84, Cleveland 3, Ohio.

CAMERAS AND PHOTO SUPPLIES

BASS Says: War time proves Bass leadership. Amazing selection of finest still cameras—Leica, Contax, Korelle reflex, new and used still available. Write for quotations. Satisfaction guaranteed or your money refunded. Bass buys 'em, sells 'em, trades 'em. Bass Camera Company, Dept. AG, 179 W. Madison St., Chicago, Illinois.

OIL Coloring photographs a fascinating hobby or profitable business. Learn at home. Easy simplified method. Send for free information. National Photo Coloring School, 1315 Michigan, Dept. 3431, Chicago 5, Ill.

GLAMOUR Girls! Kodachrome slides 2—\$1, 5—\$2; 35mm. negatives 10—\$1; 35mm. transparencies, unmounted 15—\$1; pin-up photographs 10—\$1. Fine Arts, Box 2084-K, San Antonio 6, Tex.

MAKE Money in photography. Learn quickly at home. Easy plan. Booklet free. American School of Photography, 1315 Michigan, Dept. 3431, Chicago 5, Ill.

CAMERAS. Lenses, projectors, bought, sold, and traded. Binoculars and field glasses also traded. Advise what you have or what you want. Knoxville Company, Dept. PM, Traffic Station Box 7, Minneapolis 3, Minn.

"BIG Bertha" telephoto camera easily made. Trifling cost. Objects miles away photograph close up. Ultra sharp pictures. Telephoto lens and instructions \$2.00. Instructions alone 10c. Carl Jamer, Manorville, N. Y.

OIL Color photographs for pleasure and profit. Easy, step by step method only \$1.00. Send today. Wm. Greener, St. Johns, Michigan.

ENLARGERS—Build your own. Kit of parts, \$6.00. Free particulars. Crescent Engineering, Box 251-P, South Pasadena, California.

HAVE You a camera? Send ten cents for recent number of our big magazine, showing how to make better pictures and earn money. American Photography, 116 Camera House, Boston, Mass.

CASH! Spot cash for cameras, lenses, binoculars, movie or still, sound projectors. Send full description by mail, or wire for prompt cash offer. Over 30 years of dependability insures honorable dealings. Bass Camera Company, 179 West Madison Street, Chicago, Illinois.

PHOTO FINISHING

BEAUTIFUL Double-size pictures 3 1/2x5 each, from 116 and 120 negatives, 3 1/4x4 1/2 from all other sizes. All work guaranteed. Overnight service. Roll developed and 8 pictures 30c. Roll 12 pictures 45c. Roll 16 pictures 60c. Enlargements on double weight portrait paper 5x7—30c, 8x10—60c. Copies made from any picture 75c. Pacific Photo Service, Box 666, San Francisco, Calif.

SENSATIONAL Introductory offer! Send snapshot or negative, this ad, and 3c. We'll send you a beautiful 7"x5" enlargement! Or, Kodak roll developed with 16 guaranteed deckled-edge Velox fadeproof prints or 8 double-size prints, 25c! Special! From your negatives, 16 regular-size or 8 double-size reprints, 25c! Candid rolls—36 exp. 35mm. developed, vaporated, enlarged to 3x4, \$1.00! 18 exp. 60c. Reprints, 3x4, 3c each. We have new, perfect 35mm. film. Low prices. Free mailers, details on request. American Studios, Dept. 413, LaCrosse, Wis.

100 MINIATURE Photos \$1.00 1 3/8"x1 3/8". Made from snaps or negative. Gummed for stationery, etc. Photo Stamps, 1334 Thorndale, Chicago.

GLOSSY Contact prints 3c each from any size roll film negative except 35mm. Photo Prints, 136 Maple Ave., Haddonfield, N. J.

SIX 8x10" Enlargements \$1.00, three 55c. Ten 5x7" enlargements \$1.00, four 50c. Either size colored 25c each extra. Photos copied 25c. Empire Photos, Adams Center, N. Y.

BEAUTIFUL 8x10 Enlargement from your photo or negative 45 cents. Originals returned unharmed. Quick service. Photo Lab., 3122 N. Clark St., Chicago 14, Ill.

PHOTOGRAPHY For pleasure and profit. Prepare at home. Write for information. American School of Photography, 1315 Michigan, Dept. 3432, Chicago 5, Ill.

EIGHT Exposure roll finished 20c. Studio, 1410 Bond, Rockford, Illinois.

ENLARGEMENTS. Eight 5x7 from negative, \$1.00. Six 5x7 from photo, \$1.00. Robert Renshaw, P.O. Box 478, Chester, Penna.

5x7 ENLARGEMENTS—12 for \$1.00, rolls 6 and 8 exp.—25c. Sky-Line, Box 450, St. Louis 3, Mo.

ROLLS Developed and printed, 25c; reprints, 2c; 5x7 enlargements, 15c; 8x10, 25c. Davis Studio, Guthrie, Okla.

8 BEAUTIFUL Enlarged prints (nearly postcard size) or 16 regular prints 25c. 35mm. rolls enlarged 3 1/4x4 1/2, \$1.00. Burton Studios, 55-M, Roscoe, New York.

BEAUTIFUL Oil colored enlargements. Your negatives: 8x10, \$2.00; 11x14, \$2.50. From photo 50c extra. Specify colors. Haynescraft, 802 20th, Washington 6, D. C.

FINER Finishing specials 25c. Eight exposure rolls developed with two prints of each or one enlarged print of each negative. Genuine nationally known Moentone Enamel finish. Superior quality since 1898. Moen Photo Service, 452 Moen Bldg., LaCrosse, Wis.

PHOTOGRAPHS Beautifully oil colored. Any size 60c. Two for \$1.00. Snapshots tinted, 3 for 25c. Dorothy Briney, Goodell, Iowa.

8 PRINTS. All enlarged to nearly postcard size, from your roll or negative, 25c. Willard Studios, Box 3535A, Cleveland 18, Ohio.

FREE! Send negative, this ad for beautiful 4x6 enlargement. (Stamp appreciated). 16 sparkling prints, 2 Hollywood enlargements from roll or negatives 25c. Lifetone Studios, Dept. A-939, Des Moines, Iowa.

16 BEAUTIFUL Deckled prints and enlarging coupon with each roll developed 25c. Owlphoto pm, Weatherford, Okla.

BIGGEST \$1.00 Value in 35 mm. finishing today. 36 exposure fine grain 3 1/4x4 1/2 enlargements; deckled, embossed margin and date. Eighteen exposures 75c; 16 exposure splits 55c; 36 exposure reloads 50c. Special: return this ad with \$2.00 and we will send five 36 exposure reloads. Free mailers, 8 exposure rolls in beautiful, deckled contact finish with embossed wide margin, 25c. Mailbag Film Service, Box 5440A, Chicago 80.

TROUP'S Photo Service, Troup Building, Toccoa, Georgia. 8 or 8 exposure roll film developed and printed 25c.

MOTION PICTURES AND SOUND EQUIPMENT

8MM-16MM. Films, bought, sold, exchanged. Complete sound subjects \$5.75. Lists. (Sample film 10c.) International-M, 2120 Strauss, Brooklyn, New York.

MOVIE Amateurs! Our club plan entitles you to receive free, 8mm. and 16mm. film subjects, latest releases of war pictures, comedies, sports and other thrills. Send for free list of titles and club plan. Home Movies Club, Dept. P.M.1, 4215 W. 41st Ave., Denver 12, Colo.

16MM. Film, equipment, Artistic Productions, 5920 Cermak Rd., Cicero 50, Ill.

8MM-16MM. Silent-sound films. Complete rental library. All latest subjects. Free catalogue, (sample film 10c). Garden Film, 317 West 50th, New York 19.

RELIGIOUS Films only. New prints. Screenart, 723-7th Ave., New York.

ANSKO 8-16mm. Camera films. Other bargains. Nowatka, 257 Main, Passaic, N. J.

MOVIES. 8mm., 16mm., war, comedy glamour. Lists free with glamour sample dime. Keeleys, 34-PM, Corning, N. Y.

MOVIE Camera film. 100' outdoor 16mm. \$2.25. 100' indoor \$4.25, developing included. Ambassador, 479-A Quincy Street, Brooklyn, N. Y.

35MM. Sound features sold, traded. C. Rogers, Postoffice Box 26, East Atlanta, Georgia.

8MM-16MM. Films. Free catalogue (sample film 10c). Parkway Exchange, 1593 Union Street, Brooklyn, New York.

SACRIFICING 16-35mm. silent and sound projectors, films, and equipment. Entertainments, Atlanta, Indiana.

100' 16MM. Used sound film. \$1.00 postpaid. We buy, sell, trade. List of complete subjects upon request. Blackhawk Films, Dept. PM18, Davenport, Iowa.

MOVIE Projectors bought and sold. List 10c. United 2309-A Lawrence, Toledo, O.

FREE. 1945 Film and supply catalog. Samples, 10c. Goodwill Company, Jackson, Tennessee.

35MM. Silents, sounds. New listings. Hoosierland, 1734 Noble, Anderson, Ind.

8MM. Movies bought, sold, exchanged. List dime. Address, Values, Woodbury, Conn.

SOUND—Silent 8mm., 16mm., 35mm. Lists free. Sample 10c. 35mm. sound sample 15c. Paramount Film Service, Monmouth, Illinois.

21 EXCLUSIVE Pretty girl movies! Many in color! Latest releases, "Allure," "Beauty Brevities," "Starlet Revue," "Cinderella," 8mm. \$2.00 each; 16mm. \$4.00. In color, 8mm. \$7.50; 16mm. \$14.75. Also Iriscope kits, \$5.00. Complete lists, sample, dime. Jenkins, 392-F, Elmira, N. Y.

35MM. Silents, like new. Features. Shorts. Bedner, 5300 So. Taiman, Chicago.

GORGEOUS Girls—New glamorous sparkling "Allure" and "Whistle Girls." 8mm.—50 ft. \$2.00; 16mm.—100 ft. \$4.00 each. Comedy, travel, adventure, sports. Equipment accessories. New 1945 catalogue 3c stamp. Audet, Box 6520-BG, Philadelphia 38, Penna.

8-16MM. Castle official, others, shorts, features, arts; silent sound. Big discounts. Catalogue stamp. Reed, 312 75 Street, Brooklyn 9, N. Y.

COMEDIES. Glamour, sample, dime. Zientek, 1129 Monroe Circle, Baltimore 25, Maryland.

SEND Stamp for 16mm., 8mm. catalogue. Sterling's, 679 Northampton, Easton, Pennsylvania.

35MM. Sound features and shorts. A. Savarese, Woodcliff Lake, New Jersey.

GUARANTEED Fresh movie film! Three spools double 8mm., \$3.45! Six spools single 8mm. for Univex cameras \$3.50! Dalite loading! Processing free! (Limit six each type.) Will ship c.o.d. on \$1.00 deposit. Eso-S Pictures, 4038 Broadway, Kansas City 2, Missouri.

BETTERPIX Outdoor safety film, 100' 16mm., \$2.50. 25' double 8mm., \$1.25. Free developing. Finished subjects sold, exchanged. Sound library. Better Films, 742 New Lots, Brooklyn 7, N. Y.

LEARN Movie projection, management. Free catalog. Give age. Theatre Institute, Elmira, N. Y.

SALE—Rent 8-16mm. films. Catalogues 10c. Don Elder's, 739-A Boylston, Boston 16, Massachusetts.

SPECIAL Movie film, 8mm., 25 feet double-Weston 8, \$2.00. Super double X, Pan indoor 60, outdoor 100, 16 mm.—\$6.50. Super X Pan indoor 24, outdoor 50, \$5.75. Pan Weston 12, \$5.00. 16 mm. 100 feet Weston 6, \$4.00. Free developing. Exhibitors Film Exchange, 630 9th Ave., New York 19, N. Y.

BASS Says: Leadership in the cine field is apparent in war times. Here ready—your choice of 8 mm. and 16 mm. apparatus. Write for quotations. Your old equipment is worth real money in trade—describe please. Or we buy for cash and pay immediately on receipt. Write to headquarters. Bass buys 'em, sells 'em, trades 'em. Satisfaction guaranteed or your money refunded. Bass Camera Company, Dept. A, 179 W. Madison St., Chicago, Illinois.

RENTAL 16mm. Talking features \$4.95, shorts 75c. 8mm.-16mm. silent, large reel 40c. Movie accessories. Free catalogs. National Cinema, 71 Dey Street, New York City.

I BUY, Sell, swap, rent s.o.f. 8 and 16mm. films. List free. Harvey Iris, Box 539, Brockton, Mass.

MUSIC AND MUSICAL INSTRUMENTS

MUSICAL Instruments wanted. Highest cash prices paid for band instruments and violins. Give make, finish, serial number, age, and price desired. No pianos, banjos, or guitars wanted. Write us at once. We will mail you our offer and shipping instructions by return mail. Lyons Band Instrument Company, Dept. 538, 14 West Lake Street, Chicago 1, Illinois.

PLAY Violin! Magic chart shows you, quickly, easily. No notes. Melody Masters, Box 895, Rockford, Ill.

"HOW To Sing Beautifully." Self coaching course. Easy to learn. Particulars free. Barcus, 1001 North 13th, Terre Haute, Indiana.

GUITARS, Band instruments, bought, sold. List free. Rudolph's, Atchison, Kans.

PIANISTS—Quickly improve technique, sightreading, accuracy, memorizing, playing through mental-muscular coordination. Free booklet. Broadwell Studios, Dept. 45A, Covina, Calif.

POEMS Set to music. Clarion Music Service, 5320 Kenwood Ave., Chicago 15.

HEAR "Your song" on record. Sung and played professionally. "Carolyn"—Hollywood Music Co., 6019 Hollywood Blvd., Hollywood 28, Calif.

POEMS Wanted for musical setting. Send poem for immediate consideration. Five Star Music Masters, 630 Beacon Building, Boston.

SONGWRITERS—Special offer. Edward Madden, 1300 Lodi, Syracuse, N. Y.

NEW Songs and lyrics wanted for popular radio program and professional promotion. Free examination. Transradio Music, Inc., Dept. P, 1650 Broadway, New York. (Affiliate of B.M.I.)

BEFORE Having your song arranged write for free information. Melodies composed. MacGregor Hollywood Composers, 5079 Lemon Grove Ave., Hollywood 27, Calif.

LEARN Piano in 5 lessons by ear. Play any song—Easiest method known. Amazing results—Complete course \$2. ABC Piano Method, Dept. M1, Mt. Vernon, N. Y., Box 145.

GUITAR, Spanish and Hawaiian. Learn by mail. Details. Royal Studios, 178 Boston Road, Springfield 9, Mass.

SWEETEST Harmony teaching. Complete course \$5.00 (7 lessons). Prof. Gara, 519 W. 31, Los Angeles 7, Calif.

SONGS Printed. Complete edition. 1000 copies, \$46.00 up. Midwest Music Press, 4737 Broadway, Chicago 40.

HAWAIIAN Guitar. World's simplest, amazingly easy method. Inexpensive. Guitar free! First National Studios, Exchange Building, Spokane, Washington.

MUSIC Arranged to songs. Frank Wildt, Music Publisher, Lancaster, Pennsylvania.

SONGWRITERS! Make your own break—on Broadway! Times Square Music Publications, 1589 Broadway, New York.

SONGWRITERS: Amazing information about publishing songs. P. Medary, Williamsburg, Ohio.

ACCORDIONS Are available. All sizes and makes. Buy direct. Up to 65% discount. Free catalog. American Accordion Co., 31 South Cicero, Chicago.

WANTED! Lyrics, melodies for songs. We arrange, publish, sell. Superior Song Studios, Passaic, N. J.

"HOW To Write and Publish That Song" \$2.00 m.o. Knight Publishing Company, Leonardtown, Maryland.

SONGWRITERS! Amazing offer. Hibeler, C5, 2157 No. Avers, Chicago 47.

LEARN Piano. One hour. Free literature. Ferris, 317P So. Hartford, Bremer-ton, Wash.

NEW! Transposition at a glance. Get this handy pocket size book now! Learn transposition of orchestral instruments, 50c (coin). MacGregor, P.O. Box 828, Hollywood 28, Calif.

SING Beautifully. Modern voice culture. Literature free. Ferris, 317M So. Hartford, Bremer-ton, Wash.

SONGWRITERS: Send poems for free examination. Write for free instructive booklet outlining opportunities. United Music Corporation, Salem, Indiana.

SONGS Arranged and scored. Song poems set to music. Analysis report \$2.00. Satisfaction guaranteed. Tommy Kilbourne, Box 1253, Bakersfield, California.

SONGWRITERS—Free booklet "Getting Ahead in Songwriting." Write today. Song Service, 331-C West 46th, New York.

SONGS, Poems set to music \$6, arranged, recorded \$3 up, printed, copyrights. Free booklet (stamp). Urab-P, 245 West 34th, New York 1.

GOOD Music composed to good words. Song printed. Reginald Belcher, Chatham, New Jersey. Established 1910.

PHONOGRAPH Records, slightly used. 20 cents each. Chas. Hoodwin Co., 4419 Broadway, Chicago, Illinois.

SONGWRITERS! Music composed, arranged. Billy Hannon, 6703 N. Oshkosh, Chicago 31.

SONGS Published—Liberal plan. Barnhart Publications, 1320 48th, Des Moines, Iowa.

SONGWRITERS: You can arrange your songs for orchestras. 20 modern lessons \$2.00. Money back guarantee. Brokel College, 64-P East Jackson, Chicago.

SONGWRITERS: Royalty contract free. Write for details. Puritan Publishing Co., 343 S. Dearborn St., Chicago, Ill.

SONG Poems wanted. Free examination. McNeil, Master of Music, 510-PM South Alexandria, Los Angeles, Calif.

ACCORDIONS. New and used at wholesale prices. Save up to \$100.00. Buy direct from factory. Del Principe, 307 So. Wabash, Chicago.

SONGWRITERS Wanted; prices, details, free book. Variety, 2 Salem, Ind.

WRITE Songs. Big money and reputation. Write for information. J. Gordon Pub Co., 201 N. Hoyle Ave., Chicago.

SONGWRITERS—Send poem for immediate examination and free rhyming dictionary. Richard Brothers, 24 Woods Building, Chicago.

RADIOS AND SUPPLIES

REVISED Plans 18 long distance crystal sets, including "Radiobuilder"—25c. Laboratories, 363-C Hampton, Hayward, Calif.

BUILD Improved, extra-loud crystal set. Easy instructions. 20c. Amorose, R-4, Hungary Road, Richmond, Va.

SUBSTITUTION Instructions covering 200 critical tubes including 60L6, 12SA7, 1.00. Jones, 1210P Dudley, Utica 3, N. Y.

MAKE Simple, tubeless, batteryless, distance-getting crystal radios. Crystal and illustrated instructions 25c postpaid. Allen, P-427, Clinton, Missouri.

CRYSTAL Radio receiver kit, \$2.75. Sensitive Silverite crystals, 25c. Radio phones, \$2.95. Illustrated catalog including three diagrams, free. Hewlett, 29 East 39th, New York.

JUST Out! Crystal set booklet of "Volume Increasing Tips." 45c. Amorose, R-4, Hungary Road, Richmond, Va.

TELEPLEX "Morse code" teaching machine. Excellent condition. Dumont, 418 Middle Highway, Barrington, R. I.

FOXHOLE Radio: Amazing serviceman's pastime gift, batteryless, tubeless, school-boy thrill, made anywhere, anybody. Easy distance-getting instructions. \$2.00. Gadgets, Box 28, Jackson Heights, N. Y.

HEAD Phones: Finest quality, adjustable leather covered head bands, complete with plug for tuning in on radio or inter-communication system. Also adaptable for use in making a razor blade or crystal set. Slightly used sets \$1.78. New sets complete \$3.68. Send money order. Quantity limited. Nico Supply Co., 546 N. 17th St., Philadelphia 30, Penna.

ANY Radio tube substituted. Use adapter. Send for prices. Robertson, 2326 South Robinson, Oklahoma City 9, Okla.

RECORD Player: plays through your radio; simple and easy to make. Detailed plans and instructions only \$1.00. Jay-M Sales Company, P.O. Box 97, West Haven 16, Conn.

TUBELESS Radio made with razor blades! Complete plans, 35c. New Radio, Lohrville, Iowa.

RADIO Tubes, parts, condensers. Free bargain lists. Potter, 1314 McGee, Kansas City, Mo.

PREPARE Now for tremendous opportunities in new fields of radio after the war. Training for federal licenses. Write for particulars. American Radio Institute, 52 East 23 Street, New York 10.

RADIO Service men and experimenters send for our giant radio catalogue. Save dollars. United Radio Co. (1000M), Newark, N. J.

BUSINESS OPPORTUNITIES

FREE Literature describing mail order and many moneymaking plans. Swentek, 8840 Warren, Dearborn, Mich.

SHARPEN Scissors for doctors, barbers, housewives, etc. Mail \$1.00 for complete instructions to Sterling Service, Box 481, Hopkins Road, Richmond, Virginia.

SELL By mail. Make big money. Be established after the war. Reliable firm offers most astounding all profit plan ever known. Quarters pour in daily, all yours. Second plan—Dollars daily, same mail. Enormous profits. Over \$100 weekly possible. Postal gets details, but 25c (stamps accepted) for circulars, etc., starts you getting quarters immediately, all yours. Impossible to lose. Profit Builders, 305-A West 8th, Los Angeles 14, Calif.

ELECTRICAL Appliance repair. Open your own shop. Learn home wiring; electric motors, vacuum cleaners, washers, etc. Complete illustrated course shows how. Free booklet, Pacific Training School, Dept. P1-A, 4703 West Pico, Los Angeles 6.

TURN Accounts into cash. Good income; quick results. National Collectors, Newark, Ohio.

CHICAGO Mail address. \$1 monthly. Write Paulless, 3439 Michigan, Chicago.

RAISE Worms. Interesting, profitable. Details free. M. Stoner, Chattanooga 6, Tenn.

WORLD'S Most mystifying novelty. Actually spellbounds people. Costs 1c, sells 35c. Wire or write. Tropical Enterprises, Box 142, St. Petersburg 1, Florida.

IMPRINT Circulars. New 2-color samples free. Fowl Printing Co., Muncie 4, Indiana.

1000 MONEYMAKING Ideas. No investment required. Satisfaction guaranteed. 150 pages. \$1.98 postpaid. Lynch's, Caddo, Okla.

WORK For yourself at home, selling books, courses, etc., by mail. Write D. Foster, Box 1069, Glendale 5, California.

FOOD Product easily made, delicious, appetizing. Formula 50c. Box 666, Springfield, Mass.

MAKE Your own glow in the dark articles. Sell at big profit or keep for your pleasure. Use Lite-Glo—magic new discovery! Hundreds of uses. Complete Lite-Glo kit \$1.00. Cash or c.o.d. Lite-Glo, 1412-(A) Seward, Topeka, Kansas.

"\$2,000,000.00 LETTER." Gardner's letter and brand new beginner's plan circular, free. Raymond Dowe, 17 Park Row, New York 7.

\$1.00 IMPRINTS. Details 3c. Mission, 4183 Emerald, Oakland 9, California.

SELL By mail. Many live opportunities. Write for literature. Ben Wade, 1423 Palou, San Francisco 24, Calif.

FREE Literature. Earn money, exclusive novelty items not found in stores, sell on sight. Excellent mail order items. Write today. Murray, 615 Main St., Latrobe, Penna.

GET Into victory and prosperity. Local or mail business. Make 300% profit. Dime brings proof. Central, Simpson 1, Kansas.

ANYONE Can make flexible molds, plaster casts, and liquid marble with our simple instructions. Complete instructions \$1.95. Bing Products, 621 Tremont Street, Boston 18, Massachusetts.

MOLD Perfectly lettered monuments. Cost fifty cents. Bring \$12.50. Cemeteries full of business. Instructions \$1.00. Richard Gardens 19, Martin, Tennessee.

OWN A mail-order paper products business. Sell envelopes, tags, labels, boxes, by mail, wholesale. Tremendous demand. Steady profits. No capital necessary. Write Omaha Envelope Service, Dept. 47, 4721 California, Omaha 3, Neb.

WANT To make \$100 weekly? No foolin'! Write Paul A. Wilkin, 1348-M North High, Hillsboro, Ohio.

OWN A real business, full or part time. Idea received Reader's Digest reward. 25 cents brings information. Baby Exchange, 514 E Broadway, Glendale 5, Calif.

HOME Mail order business pays big profits. Prospectus tells how. Church, 814 N. 24th St., Billings, Montana.

BE Independent. Our home business plans used successfully nation wide. Free literature. Applied Industries, 953-M East Michigan Avenue, Ypsilanti, Michigan.

5000 WOMEN Mail buyers. \$25.00. Our own customers. 1000, \$6.00. Guaranteed accurate. Woods Remnants, Bedford, Penna.

MAKE And mold genuine plastics. Forty illustrated work-sheets explain methods, processes. Authentic—simplified \$1. Free circular. Plastics Digest, 3937B Tracy, Kansas City 4, Mo.

WE Start you in business at home. Sparetime, earning \$10-\$25 weekly, selling by mail. Joseph Driscoll Sales Service, Denver, Colo. Box 2771A.

START Home business making statuary, plaques, art goods, novelties, souvenirs, concrete pottery, garden furniture, artificial marble floorings, liquid marble. Make your own flexible molds. Amazing profits. Valuable folder free. Creative Publishers, (P.M.I.), Glencoe, Illinois.

START Your own concrete block business. "Cash in" on the tremendous post-war home building boom. Big demand everywhere. Universal Tamper makes all sizes concrete blocks fast—200 blocks per hour. Your normal net profit 5¢ per block—up to \$10.00 per hour. Easy to operate—no special skill required. Necessary materials available everywhere. Nominal investment, balance out of earnings. Write for details. Universal Tamper, Inc., 1567 No. Adams, Peoria, Illinois.

WE Have open machine facilities to manufacture good marketable items such as toys, household and automotive accessories, or what have you. Will consider outright purchase or royalty on sales. Send your proposition to City Machine Company, 863 Tallmadge Avenue, Akron, Ohio.

START "Soap Factory" at home. No machinery. Amazing opportunity. Literature free. Kemico, SM-1, Park Ridge, Ill.

QUICK Cash. New amazing products. Make them yourself. Formulas \$2.00. Details free. Mero, Box 344A, Punxsutawney, Penna.

WONDERFUL Opportunity for operators of sandwich shops, soda fountains and small cafes. Sensational new sandwich, easily served. No smoke, no grease. Write today for free information and start making big money with the sandwich that is different. Haskell D. Boyer, P.O. Box 1486, Fort Worth 1, Texas.

ORDER-BY-MAIL Advertising and selling of valuable goods, service, and information is big profit, free, independent enterprise. Men and women qualified to conduct any business can secure substantial income. Big income requires considerable investment. The mail order business is no exception. But it can be built up gradually. The system of building is everything. "Mail Selling Is Money Business" in few pages tells all. Gives the urge to carry through to big money returns. Details free. Rush name. Houston Maupin, Tipp City 44, Ohio.

MONEY Made easily, home or room. Color, health, education need not stop you. Thirty cents coin or stamps will bring you details three dandy plans. Also, fifty cent information sheet, twenty-five cent folio, fifty cent credit coupon and other offers. Ad. Dept. Bargain Specialty Company, Box 635, Modesto, California.

LICENSED Concrete specialists wanted everywhere. No experience needed. Make Colorglazed pottery without molds or costly tools. U. S.-Canada patented method. Cemetery products, novelties, tiles, etc. Guaranteed basement leak sealing. Other moneymaking projects. Booklet, details free. Men only. National Potteries Company, Fergus Falls, Minnesota.

MAKE Your own Flexible Molds. Statuary, Art Goods, Novelties, Artificial Marble Flooring, Liquid Marble. Literature free. Kemico, 1-M, Park Ridge, Ill.

DRUNKENNESS Is a disease which responds to treatment. Medical skill plus human sympathy prove successful with liquor and drug cases. 60 years experience. Write for free booklet, P. M. Nelson, The Keeley Institute, Dwight, Ill.

BOOKKEEPERS. Earn money at home posting journal entries. Ellis Business Service, Cedar Grove, North Carolina.

INCORPORATE Your business. Delaware laws. Many advantages, free details. Tax Research Bureau, Inc., Delaware Trust Building, Wilmington, Delaware.

POSTWAR Planning, now is the time to start your own business and be ready for the boom. Full description free. Elite, Box 177-A, Des Moines, Iowa.

LANDSCAPING. Learn landscape designing and gardening for a profitable out-of-door profession. Write National Landscape Institute, Dept. P-1, 756 Broadway, Los Angeles 14, Calif.

UPHOLSTERING Pays. Easy learned. Low cost illustrated course shows you how. Write Upholstering, Dept. 235, Lombard, Illinois.

MECHANICALLY Inclined men — Own and operate general appliance repair shop. Complete, illustrated course shows you how. Welding, refrigeration, motor repair, how to get business, etc., all phases covered. Free literature. Christy Supply, Dept. 148, 2835 N. Central Ave., Chicago.

NEW! Unusual business. Publish fair, convention, anniversary souvenir books. Earnings to \$1200. Part time. Write Pummer, P.O. Box 99, Westfield, Mass.

GET into legitimate business waterproofing buildings. Enormous profits. High income taxes force orders. K made \$3,000, six weeks. Information free. Bryan, 10 E. Pearl, Cincinnati.

TYPEWRITER Repairing — Original course, simplified home study. Weber Typewriter Mechanics School, Box 269, Osborn, Ohio.

MAIL Order business course shows you how to make money, spare or fulltime. Teaches professional mail order technique —not penny-snatching schemes. New success catalog free! Write—Nelson Company, Dept. 4-02, Chicago 4.

"PROFITABLE Mail Selling." New mail order business development idea and plan book for beginners, established operators. Shows how to build permanent, profitable with small capital. This valuable handbook postpaid quarter, no stamps, now. Greb, 10029 - 85 Ave., Edmonton, Alberta, Canada.

BE Your own boss. Learn how to make money in a business of your own. Plan, complete instructions 25 cents. Pionka, Box 333, Station D, Cleveland, Ohio.

OWN Your own business. Make money at home. Amazing new insulating storm sash saves 30% heat losses. Thirty minutes to make. Saves more, costs less. For free information write System, Box 453, Waterville, Maine.

YOU Too can learn how to make, mold or cast real plastics. Send stamped envelope Box 498, Gainesville, Texas.

ELECTRIC Ironing cords with indicator light. Peanut vending machines. Automobile radiator propeller ornaments. Iron-So-Ezee Company, Mt. Washington, Ohio.

FORTIFY Your future now with business of your own conducted in your home or office. Free details tell how. Rush penny postal. Victory Sales Co., Dept. 302, Box 75, College Station, New York City.

LEARN Mailorder. Five big interesting trade magazines teach you quickly. Postpaid, 25c. Lewis Co., 828M Carpenter, Oak Park, Ill.

5 MOST Read mail order magazines 25c. Education Publishers, Pittsfield, Mass.

NEW Mail order course hits the spot! Shows how to make dollars not dimes by mail. Contains four proven money making plans. Write today! Rehkop, 308 E. Commercial, Springfield 14, Mo.

PATENT My invention for share. Wicks, Rt. 2, Box 1632, Delapso Heights, Calif.

INTERESTED in mailorder? Amazing information sent to you free. Dan Smith, 72 Southbourne, Boston 30, Mass.

INSIDE Secrets on making quick cash. Without canvassing. Folder free. Write. Lone Star Service, 1708-B First Ave., Dallas 10, Texas.

EARN Money with textile painting course. Free details. George Gundrum, LeRoy, Michigan.

OPERATE Paying mail order business in your own home. Free details. Myatt's Service, Box 192, Pittsboro, N. C.

INFORMATION—Locating most any article. (Dime.) Rakes, Box 5931-A, Chicago 80.

1000 LIVE Names of opportunity seekers. 50c. All late cash buyers. Joseph Royer, 82-D Merrimack St., Haverhill, Mass.

MADE \$24,000; Used "schemes" from "Schemer" Magazine. Alliance, Ohio. 47th year, \$1.00; 3 months. 25c.

CAPITAL Seekers—Interested in raising \$25,000 or more should write to Amster Leonard. Fox Bldg., Detroit 1, Michigan.

SELL Unusual, practical information by mail. Big profits. Most everybody a prospect. Free literature. Ritter Sales, 616 Franklin, Sioux Falls, S. Dak.

BE Independent with 300 business opportunities information free. Clark System, Ellwood City, Penna.

DEALERS Wanted. Get in business for yourself. Manifold and sales books. Burke's Business Bureau, 11 Main St., Asbury Park, N. J.

I WILL Pay cash for mailorder article or service. Advertiser, Box 844, St. Louis, Mo.

FORTIFY The future: Start your own business. 127 tested plans. Free descriptive booklet. General Sales, Box 511-C, Burlingame, Calif.

INDUSTRIAL X-ray a vast new post-war profession. Find out how to qualify. Rush name for facts. Ohio Institute of Technology, Box X-206, Greenville, Ohio.

START Fine, money-making business! Information free! Rayco, Box A-124, Newport News, Virginia.

MAKE Soap, candy, hundreds other items. Sell locally or by mail. A. Barnes, 1416 North Mosley, Wichita, Kansas.

LOOKING For a profitable mail order business that can be started with little capital and developed into a paying proposition? Write today for full information. Jackson Publishing Company, Dept. 111, Box 477, Mineral Wells, Texas.

PERMANENT Substantial income manufacturing newest, badly needed civilian goods. Investment small. Profits immense! Stamp brings "Messenger" listing modern analyses and certified formulas. Miller, Chemist, Tampa 6, Florida.

LEARN Electroplating. Complete instructions by a practical plater, with formulas for brass, cadmium, chromium, copper, gold, nickel and silver solutions. Price \$1.00—money back guarantee. Plater Hyde, P.O. Box 178, National City, California.

ESTABLISH Home business. Money making business starters 25c. Des Moines Home Service, Box 855PM, Des Moines 4, Iowa.

SELL Books and courses by mail in your spare time. Siddall, Atascadero, Calif.

"100,000 POST-WAR Jobs abroad!"—South America, Asia, Africa. How, when and where to apply. 15,000-word, copyrighted forecast—\$1.00. Return for refund in 7 days if not satisfied. Pacific Industrial Research Bureau, 202-P Studio Building, Portland 5, Oregon.

VITAMINS, Minerals, health foods. Wholesale prices. Free catalog. National Diet Company, Portland 4, Oregon.

MAIL Order education. Four magazines, other opportunities. Three months, 25c. Commodore, 101-D, Forest Park, Illinois.

LOCAL Representatives wanted in every community. Act as agent for all leading magazines. We furnish needed supplies free. Send name and address to American Readers Service, Gwynedd, Penna.

GIANT Mail, big mail order magazine included. Opportunities galore. 10c. The Old Commander, Box 302, Chillicothe, O.

PLASTICS — Made at home without equipment—perfect castings—formula 50c. Baker, 225 Symington Ave., Toronto, Can.

AMERICA'S Most needed commodity will make you independent in your spare time. Tremendous profits. No capital required. Send 25c for sample merchandise and full particulars. Stanford Company, 10967 Wellworth, Los Angeles 24, Calif.

RAISE Giant Chinchilla rabbits. Willow Farm, R15A, Sellersville, Penna.

SIX Complete and different post card plans for starting profitable spare time business. Gordin Publishers, Box 23, Pawtucket, R. I.

WANT To make \$5,000 yearly? No bunk. Publications, Bethany 4, Oklahoma.

VITAMINS—High quality, low price, private label. Gibson Company, Harlan, Iowa.

HOW And where to obtain capital. Fully explained. Particulars free. Star Service, Wapakoneta, Ohio.

MORE Money with your own products. Experience unnecessary. No machinery. Information free. B. Kinford, Wayne, Penna.

MAKE Girls novel name pins, simple, low cost. Complete instructions 25c. Melco Novelties, 323 Hayward St., Woodstock, Ill.

SELL Exclusive books of instruction by mail. 80% profit. No bookstore competition. Snappy circulars ready. Rush name! Financial Education, 431F, 728 15th, Denver 2, Colo.

START Mailorder bookshop—Everything furnished; publisher cooperation. 25c brings booklet, exclusive setup, samples, exciting ideas. General Publications, Ossining, N. Y.

RUBBERFORM — Plastic; waterproof elastic flexible mold making liquid. Sample pint with instructions \$1.25 postpaid. Gallon \$7.00. Plastic Products, 1410-13, Belmont, Chicago.

LIQUID Marble; snow-white, multi-colored. Glazed. Unglazed. Composition flooring. Lifetime wear. Any color. No priorities. Flexible molds. Plaster casting. Get into the big money now. Full information given free. Write Compo-Tex, Box 786-R, St. Louis, Mo.

COLOR Concrete with chemicals. Big money making Hollywood style pottery, birdbaths, without molds. Washing, wells, stucco-rock, benches. Marbling, cement water-paints. 10c brings sample, literature, pictures. Hollywood Cement-Craft, 8527 Wonderland, Hollywood 46, California.

OPERATE Profitable credit and collection agency business; earn \$5000-\$10000 upwards annually; interesting literature free. Write Educational Extension Service, Department 101, Wilshire-Labrae Station, Los Angeles.

AGENTS—To mail our literature. Good profits. Home business. Maywood, 1133 Broadway, New York.

GET Into mail selling. Prepare for future. Start sideline business now. Splendid opportunities. Interesting, profitable propositions immediately available. Progressive Magazine tells how! Free details and premium offer. Sheboygan Publishing Co., Sheboygan, Wisconsin.

CHARTERS: Delaware; best, cheapest; free forms. Colonial Charter Co., Wilmington, Del.

"HOW To Make Simple Molds and Plaster Plaques." Profit in popular novelties! Booklet 25c. Plastercraft, 1406 E. 43rd St., Cleveland 3, Ohio.

127 WAYS To make money, in home or office, business of your own. Full particulars free. Elite Co., 214 Grand St., New York.

BRUSH Plating outfits connect to a battery. No tanks necessary. Good paying business at home plating autoparts, bathroom fixtures, bicycles, reflectors, silvering mirrors. No shop or experience required. Outfits furnished. Free booklet. Gunmetal Co., Ave. H, Decatur, Ill.

EXTRA Income—Plenty mail selling opportunities. Write Katz, 4254 N. Kimball, Chicago.

LIQUID Marble—Colorful, glazed! Mold, brush, spray! Composition floors, rubber-lastic molds. Particulars free. Marbleizing Service, Edwardsville, Illinois.

FREE Subscription. Drop postal today. The Mail Order News, Somerville, New Jersey.

MONEYMAKING OPPORTUNITIES

THE Manufacture of novelties and utility goods offers splendid opportunity for a permanent, post war business. Easily learned, no expensive equipment needed, start in any community, ship anywhere, orders waiting. Large profits. Literature free to adults. Plastex Products, 332 Balboa, San Francisco 18, Calif.

DRAFTSMEN And designers will be needed in great numbers in the post-war period. Learn how to qualify quickly. Rush name. Ohio Institute of Technology, Box 207, Greenville, Ohio.

FREE Literature describing many moneymaking plans. Midwest Distributing Company, 2617 South Greenwood, Fort Smith, Arkansas.

"749 MONEYMAKING Home Business Opportunities," 25c! Hirsch Enterprises, Spring Valley 2, N. Y.

MOLDMAKING—Plaster Casting. Complete formulas—fully illustrated. \$1.00. Ideal Service, RM-1, Park Ridge, Ill.

SEND 25c For twelve practical moneymaking plans, mailorder magazine and big mail. Romola King, 700 North Mont Clair, Dallas 11, Texas.

INFORMATION Locating most any article. (Dime.) Rakes, Box 5931-B, Chicago 80.

"MAIL Order World." Outstanding mail order magazine. Sample copy 10c. Martin's, Box 2414P, Bridgeport 3, Conn.

GAS Machines for home, etc. 30c rates, easy plans \$1.00. Literature, Ideal Spec., Lakewood 5, Rhode Island.

HELP Win the war first! Then man, you'll like silvering mirrors, reflectors! Making sparkling chipped glass nameplates. Outfit prices. Sprinkle, Plater, V60, Marion, Indiana.

THOUSANDS Of articles wholesale. "Supply Source Directory" 10c. Ideal Service, D-1, Park Ridge, Ill.

NATIONWIDE Selling by mail taught in practical mail order course. Free literature. Habermann (S), Box 1642 Perry Square Station, Erie, Penna.

10c BRINGS Many moneymaking magazines, offers, ideas. Simon, 1091 First, Wyandotte 2, Mich.

WANT Financial independence? I've helped hundreds. Dr. Tibolt, 25M 185 Godfrey, Philadelphia 20.

MECHANICALLY Inclined men — Own and operate general appliance repair shop. Complete, illustrated course shows you how. Welding, refrigeration, motor repair, how to get business, etc., all phases covered. Free literature. Christy Supply Dept. 1148, 2835 N. Central Ave., Chicago.

MAMMOTH Mails, receive latest offers, bargains, opportunities, samples, catalogs, etc., name listed in our directory 10c. 3 listings 25c. National Distributors, Box 57, Muskegon Hts. 13, Mich.

OPERATE Your own mail order business at home. Details free. George V. Beach, 79 Essex Street, Springfield, Mass.

MONEY? Sure, with Selected Opportunities 25c from Seaman, Cox 1923-D, Portland 11, Oregon.

"FORTUNES In Sawdust." Build lifelong business. Turn this discarded material into cash on kitchen stove. Big demand! Copyrighted plan, formulas 25c. Palmer Company, Station A, Berkeley, California.

LEARN Wood carving. Instructions 25c. Karving Kraft, Box 221, Clovis, New Mex.

GIANT Big mail! Hundreds of money making propositions, home work offers, including big magazine, all for a dime. Gardenville Publishers, Gardenville 11, N. Y.

SELL Office supplies by mail. Samples, moneymaking information for 25c, refundable. Edgar W. Thomas, Barnesville, O.

PLASTIC "Wonder-links" for handmade costume jewelry. Profitable sideline! Free details. Beginner's outfit, \$1 (refundable). Hughes, 218 Sidell, Danville 3, Illinois.

START Own business. Cleaning upholstered furniture, automobiles, rugs. No equipment required. Secret process. Information free. Renovators, G.P.O. Box 619, New York.

MAIL Our new 50% commission circular for steady profits. 250 \$1.00. Sample free. Omaha Envelope Service, Dept. 50, 4721 California, Omaha 3, Nebr.

167 Names and addresses of mail order magazines 10c. Val, Box 5776, Tampa 5, Fla.

START Now—Build money making mail order business. Get yourself established. Actual examples explained. Particulars free. Young's Industries, Kent 15, Ohio.

START Now. Be set for post war. Make "Sta-Cress" new garment hanger invention. Saves on pressing and tailor bills. Use scrap material, \$1.00 seller. Pay inventor 1c each royalty. Model and instructions \$2.00 postpaid. Higgins, Box 295, Sta. P, Milwaukee, Wis.

INVESTIGATE—Co-Operative mail promotion service for profitable opportunities. Russell Johnson, Clarkfield, Minnesota.

BIG Money manufacturing custom made arch supports. Particulars. Jul Corssen, 2638 Geyer, St. Louis 4, Missouri.

I MAKE Big money in the mail-order business. You can do the same at home with my copyrighted system. Write me. I'll tell you how. F. Little, Box 8, Glenshaw P.O., Pittsburgh, Penna.

THOUSANDS Of alarm clocks need repairing. Jewelry stores swamped. Our simplified course teaches you how to repair these clocks. Necessary tools and supplies furnished with course. Alarm Clock Repair Service, Dept. B, P.O. Box 1983, Houston, Texas.

RAISE Giant Chinchilla rabbits. Willow Farm, R15B, Sellersville, Penna.

"VARIOUS Opportunity Catalog," copy 10c. P.O. Box 1735, San Diego 12, Calif.

EARN Money evenings, copying and duplicating comic cartoons for advertisers. Advice, Argyle, Wis.

CASH From your back yard, basement or bedroom. No experience necessary. Send for free details. Challenge Association, 87 Somerset, Springfield, Mass.

CATALOG Listing hundreds of opportunities 10c. (refundable). Barcus, 1001 N. 13th, Terre Haute, Indiana.

SPECIAL Training—for entering successful business. You start small, grow big. We tell you what to start, what to pay, what to sell, who will buy. Ask for bulletin No. 12. It's free. Edgar W. Thomas, Barnesville, Ohio.

PUBLISH Your own magazine. Hand-some 52 page format, well edited, illustrated. Cost low as \$1.00 month. Brings you prestige, profits. 10c brings sample, details. National, Ord, Nebr.

LEARN Metascience. Remarkable drugless healing. No manipulation. No apparatus. Unbelievable simplicity and results. Inexpensive correspondence course. Write Metascience, De Land, Florida.

EARN Money at home! Thousands do "Home Worker Magazine" tells how. Sample, 25c. Sizemore, Box 7, 4917 North Kostner, Chicago.

LICK After-war layoffs! Start own business; home, office. Booklet describing "Collection of 127 Tested Plans" free. Elite Co., 214 Grand St., New York.

FORMULAS, PLANS, ETC.

AMAZING Profits! Make fast selling products at home—build steady repeat business. Information free. A. Kinford, Wayne, Penna.

REMOVE, Prevent rust. Eight guaranteed formulas \$1.00. Hamilton, 650-A South 20th, Newark 3, New Jersey.

"LUMINOUS Paint" shines in dark. Easily made. 100 other formulas, plans—all 25c. Soap-making course (20 formulas) \$1.00. Resilvering mirrors, formula 20c. Ideal Service, 301, Park Ridge, Ill.

MAKE Bleach water formula \$1.00. Capotosto, 1707 Cranston St., Cranston 9, R. I.

NEED A chemist? Formulas. Research. Consulting Scientific Company, Swarthmore, Pennsylvania.

MAKE Fast selling products at home. No machinery. Wonderful profits. Literature free. Kemico, 17, Park Ridge, Illinois.

PLAN A profitable business of your own. We supply industrial formulas, now used in manufacturing plants, of alkaline metal cleaners, cements, rust proofing, etc. Write for free list. Dunbar Laboratories, Box 858, Chicago 90, Illinois.

START Home manufacturing business, authentic formulas. Personalized service given. Church, 814 N. 24th St., Billings, Montana.

BURGOO, Kentucky's famous formula. Made by Campbell Doggins, Burgoon Prince, delicious for home or cafes; hot seller, \$1.00. Box 949, Lexington, Ky.

AUTHENTIC Formulary. 924 page illustrated book. Prepared by experts. 10,000 practical tested formulas, recipes, secrets, instructions for easily making most any product. Countless profitable business opportunities. Valuable reference for home, industry. Extra! Complete plans: "D.D.T." miraculous new insecticide. One spraying kills all flies, mosquitoes, lice, jay beetles, etc. Lasts three months. Big money maker. \$2.98 postpaid (c.o.d. U. S. only) foreign \$3.25. Immediate shipment. Adams Brown Company, Dept. 110, Chestnut Hill 67, Mass.

LUMINOUS Paint—Three formulas 10c. J. B. M., Box 225, Rockaway, Oregon.

10,000 FORMULAS. Recipes, trade secrets for making numerous products. Over 900 pages chock full of money-making ideas. Business opportunities galore! Edited by expert chemists. Easy to read and understand. Start your own manufacturing business! Complete volume—\$1.75 postpaid. Write! Grand Supply Company, Dept. M, 2506 52nd Street, Kenosha, Wisconsin.

PLASTICS, Vegetable, luminous, etc. Particulars free. Philhart Laboratories, 6 South Xanthus, Tulsa 4, Oklahoma.

FORMULAS—Latest, best. Analysis. Literature free. Belfort, Engineering Building, Chicago.

REAL Manufacturing formulas. Lists free. Cummings, Chemist, Gordon Ave., Syracuse, N. Y.

CHEMISTRY

THE House of Winn, the home of supplies for amateur chemists. See Winn's New Idea chemical kits and apparatus outfits for home experimenting. Send 10c for retail catalog. Established 1931. John H. Winn, Dept. 501, 124 West 23 St., New York.

FREE Catalog: Chemistry, mineralogy, biology, optics. Tracey Laboratories, Evanston, Illinois.

NEW 32 Page chemical apparatus order book. Complete line of chemical glassware, apparatus and chemicals. Send 10c for this book. Standard Science Supply Co., 1232 N. Paulina St., Chicago.

CHEMISTS: Specialized non-technical brochures on chemistry for bench and home chemists. Something unique. Literature free. Lankton Chem-Research Bureau, RI, Box 78, East Lansing, Mich.

SPECTROSCOPE For quick chemical analysis \$2.50. Kutting Sons, Campbell, California.

LABORATORY Supplies at wholesale prices: Chemistry, biology, physics. Catalogue 10c. National Scientific Co., 2204 W. North Ave., Chicago. Established 1908.

CHEMISTRY Laboratory apparatus and chemicals for industrial, analytical, and private experimental laboratories. Complete chemical laboratory supply service for correspondence school students. Send 3c for free 48-page catalog of chemicals and apparatus. Dept. M-43, Biological Supply Co., 1176 Mt. Hope Ave., Rochester, New York.

HELP WANTED

WANT A civil service job? Follow the Civil Service Leader weekly listing of government jobs open. \$1 for 6 months subscription. 97A Duane St., New York City 7.

MEN, 20-30 Yrs., draft deferred, to work on rail testing service cars. Job entails constant traveling. Electrical-mechanical experience preferred. Also dining car cooks. Salary plus living expenses. W.M.C. rules apply. Sperry Products, Inc., 1505 Willow Ave., Hoboken, New Jersey.

\$200,000,000.00 ESTIMATED 1945 Volume advertising specialties. Join the H-Men. Calendars, thermometers, leather goods. \$126 earned in day. Hewlett, Huntington Station, New York.

AGENTS WANTED

AMBITIOUS School seniors—We want you to sell classmates the "tops" in graduation name cards. Highest commissions! Your cards free! Cardalogs going like wildfire! Hurry! Get yours today! Craft-cards, Box 235(L), Pittsburgh 30, Penna.

BIG PROFITS taking subscriptions for all magazines. Agents' confidential catalog listing over 2500 periodicals and complete starting supplies free. Pines Subscription Agency, Flushing, New York.

SKUNKADORA Eliminates 100% all traces of skunk odors! Nothing like it. Whirlwind seller to farmers, trappers, general stores, breeders, etc. Big profits. Send \$1.00 for sample on money back guarantee or write Sparhawk, Sparkill, New York.

AGENTS—Coin money—It's new, it's hot. Everyone wants radiant "Wonderlette" colored paintings of loved ones. We deliver, collect. Condon, Box 157, Upper Darby, Penna.

MAKE Good money selling art novelties in spare time. Rich Company, 299 Madison Ave., New York.

PROFITS Selling novelty fun cards, novelties, etc. Samples 10c. National Specialties, Box 301-M, Cincinnati 1, Ohio.

1000 **BLADES**, \$4.50; Dolls, dozen \$13.50; combs, gross \$3.50; aspirin, gross boxes \$1.95; payment with order. Catalogs free. Mills Sales, 901 Broadway, New York.

\$3 FIRE Extinguisher; quick sales, wholesale or direct; liberal profits. "Fire-Killer," 109 N. Franklin, Syracuse 4, N. Y.

90c PROFIT Each \$1 sale! Sell permanent mothproofing solution. Employ agents. Experience unnecessary—we tell you how. A. McKinley, Wayne, Penna.

STRANGE "Dry" window cleaner. Sells like wild. Replaces messy rags, liquids. Simply glide over glass. Samples sent on trial. Kristee 138, Akron, Ohio.

SELL Dresses at low prices. Hundreds sensational bargains. Actual samples free. Send dress size, age. Harford, Dept. C-359, Cincinnati, Ohio.

CALL On friends with greeting card assortments; Easter, birthday, other occasions. Personal stationery; gift wrappings. Big profits. Experience unnecessary. Samples on approval. Wallace Brown, 225 Fifth Avenue, Dept. M-4, New York 10.

AGENTS. Big line including food products. Fast selling premium and bargain deals. Low prices. Send card for big outfit offer with gift. Ho-Ro-Co, 2729 Dodier, St. Louis 7, Mo.

START Your own business on our capital. Always your own boss. Hundreds average \$3,000 to \$5,000 annual sales year after year. We supply stocks, equipment on credit. 200 home necessities. Selling experience unnecessary to start. Wonderful opportunity to own pleasant, profitable business backed by world wide industry. Write Rawleigh Co., Dept. A-U-PPM, Freeport, Illinois.

LUMINOUS Pictures that glow in the dark. Large manufacturer wants factory representatives; wonderful new item; fast seller; free sample. Madison Mills, 303 Fourth Ave., New York City.

BIG PROFITS. Big demand—War production find. Here's a money maker. Rustoff Co., Box 177, Des Moines, Iowa.

ABRAHAM Lincoln operated a saloon. We have reproduction of license issued 1833. Every tavern will want one. Agents prices. Sample 25 cents. Select, Little Falls, N. J.

SELL Rayo Balm for colds, headaches, rheumatics. Other products. 5 free samples. Rayo Chemical Corp., 334 Union Avenue, Brooklyn 11, N. Y.

AGENTS—300% Profit selling gold color window letters; stores and offices. Free samples. Metallic Letter Co., 438-B North Clark, Chicago.

TAKE Orders for new sensational plastic lifetime reproductions of any photo or negative. Amazingly beautiful. Big earning opportunity. Part or full time. Get details quickly. Quaker Photo, 914 Walnut St., Philadelphia 7, Penna.

SILVERWARE Made like new again. Right in your own home, or place of business, by yourself or any employee, simply by rubbing the worn or tarnished piece with a soft cloth, saturated with NuSilver, the 17-year-old trademark patented Silver Plating and Polishing Liquid. Simple, quite inexpensive, anyone can do it. Follow simple directions on each bottle. Contains and deposits genuine 1000 fine silver, on Silverware, Sterling Silver, Brass, Copper, Bronze and Zinc metal surfaces, leaving a brilliant silver-color finish that lasts for a year or more. Won't wash off. Does not adhere to iron and steel metal surfaces. Guaranteed non-injurious to the finest ware, jewelry, etc. Unsurpassed for cleaning diamonds, rings, brooches, all precious stones and jewelry. Does not change color of gold. Used and endorsed by jewelers, musical instrument makers, antique, hardware and automotive trade. A miracle silverware-renewing product for Eating Places, large and small. Excellent to clean and fill in scratches on nickel and chrome plating. Removes rust quickly no matter how old. Wonderful for all automobile trim and headlight reflectors. Works miracles on electriclight, bathroom, kitchen fixtures, doorknobs, etc. Has a thousand wonderful uses besides renewing worn-through and tarnished silverware. Sold successfully in stores and by agents with an unqualified money-back guarantee on every bottle. To introduce to more users, one bottle will be sent postpaid for \$1.00. Representatives are wanted to sell wholesale and retail by a most astounding personal demonstration on their own ware to Eating Places, Dealers and Homes, for fulltime, sparetime or sidelining. Confidential prices and full details will be sent with one bottle to try out fully postpaid for \$1.00. NuProcess Products, Dept. 126, Aurora, Ill.

TRANSFER Comics, actors—liquid 25c. A. Veneziano, 259 Linwood St., New Britain, Conn.

200 **BUSINESS** Ideas, plans, schemes, rare formulas, exposés. Formico Service, 314 Kiefaber, Dayton, Ohio.

POWERFUL Mile stretcher! Increases mileage! Increases power! Increase your bank-account! 400% profit. Thermomiles, Peoria 4, Ill.

PHOTOSTAMPS—No investment, large commissions, dignified work, easy to sell, no large samples, selling field large, all classes buyers, repeat orders come soon. Aristo, Dept. P, 1, Plainfield, N. J.

GOLD Lacquered window sign, letters. New styles. Absolutely beautiful. Free samples—catalogue. Atlas, 7941 Halsted, Chicago.

BIG Bargains for big profits. Men's used pants 25c, suits \$1.00, topcoats 75c, overcoats \$1.00, shoes 12½c. Over 100 sensational values. Experience unnecessary. Free wholesale catalog. Superior, 1250-CB Jefferson, Chicago 7.

SCHOOL Seniors—Sell classmates America's most beautiful, distinctive graduation name cards. Positively highest commission. Largest selection. Lowest prices. Free cards and free sample kit. Printcraft, 1423 East Elm Street, Scranton 5, Penna.

EXCELLENT Sideline for printing salesmen. Decalcomania name plates in small quantities. Also, make money applying initials on automobiles. Free samples. "Ralco," X-164, Boston (18), Mass.

AGENTS: Stamping names on pocket protectors. Sample check with your name, address. 25c. Stamping outfits, Emblem checks, check-fobs, name plates. Hart Mfg. Co., 303 Degraw St., Brooklyn, N. Y.

PLATING Outfits for autoparts, reflectors. Connect to a battery. No tanks necessary. Free booklet and particulars. Gunmetal Co., Ave. N. Decatur, Ill.

MAGIC Cleaner and laundry soap deal. Hotter than a firecracker. Big profits! Sample free. Bestco, 5007 Irving Park, Chicago.

ELITE Collection contains 127 plans for starting own business; home, office. Descriptive booklet free. Elite Co., 214 Grand St., New York.

WHOLESALE Sources. 500,000 articles. Free directory. Maywoode, 1133 Broadway, New York.

FREE Water and our concentrates, makes flavors, lotions, shampoos. 72 products, labels, bottles furnished. Qualco, E-20030 Russell, Detroit.

HIGH-GRADE SALESMEN

SELL Warm leather jackets to friends, neighbors. Make money spare or full time. Also rubber raincoats, 200 styles shoes. Sales outfit free. Experience unnecessary. Mason, Dept. M-185, Chippewa Falls, Wis.

ADVERTISING Book matches—World's largest "direct selling" book match factory offers advance cash earnings calling on every type of business. Men or women. Experience unnecessary. Full, part time. Low prices. High quality. Quick deliveries. Powerful patriotic display. Special designs for army camps and naval stations. Repeats. Sales kit free. Match Corporation of America, 3433 West 48th Pl., Dept. E-1, Chicago 32.

SALESMEN For patented adjustable metal hole cutter for machinists or any metal cutting requirements. Fine commission. Complete information. Frayn Company, Box 1005, Redwood City, California.

YOURS Free! Latest issue Opportunity Magazine, Salesman's Guide, inspiring, constructive. Shows how to make money selling and how to build your own business. Send name, address and tell us what you have sold or are selling. Illustrated copy will be sent free. Opportunity Magazine, Dept. 17, 620 N. Michigan, Chicago 11, Ill.

CALENDAR Salesmen. Southern states. Earn \$25.00 daily. Write: Clyde O. Jackson, Salisbury, N. C.

ADVERTISING Salesmen—New complete line calendars, novelties, quality pencils. Liberal commissions and bonus. Best selling season starting. State experience, references. Klein Advertising Company, Quincy 5, Illinois.

SELL Warm leather jackets to friends, neighbors. Make money spare or full time. Also rubber raincoats, 200 styles shoes. Sample outfit free. Experience unnecessary. Consolidated, Dept. S-81, Chippewa Falls, Wis.

GOVERNMENT And state tax laws make our complete-simple bookkeeping system necessary. Record Systems, 2222 Lawrence, Chicago 25, Illinois.

ORANGE Concentrate direct from our Florida grove. One quart bottle makes 6 quarts delicious natural orange drink simply by mixing with 5 parts cold water. Rich in vitamin C. Builds up resistance against winter colds. Groceries, restaurants, hospitals big buyers. No investment. Protected territory. Salesmen earn \$100.00 to \$200.00 repeat commission weekly. Sunset Valley, 3357 Clifton, Chicago.

SALESMAN: Have real money-making opening. Fits into war program. Old progressive firm. Dept. "F," Box 392, Dallas, Texas.

BLADES—Best quality, buffalo, N. Y. Details free. Ace Blades, Buffalo, N. Y.

EDUCATIONAL AND INSTRUCTION

LEARN To be a landscape architect. Hundreds of men and women now manage their own businesses as successful landscapers. Earn a steady, comfortable income in this healthful outdoor profession. Also interesting hobby! Practical home study course—45 clearly illustrated lessons in landscape design, plant materials, horticulture, construction, drafting, garden design, etc. Average student can complete course in 8 to 12 months. 28th year. Send today for free booklet—"Success Through Landscape Training." American Landscape School, 6314 Grand Avenue, Des Moines, Iowa.

GOOD Jobs and a sound postwar future await you in hotel and institutional field. Men and women—all ages—needed for well-paid positions that offer color, excitement, ever-new and fascinating duties. Record-breaking business in hotels, clubs, institutions, means even greater opportunities. Lewis School receiving calls for managers, assistant managers, stewards, hostesses, purchasing agents, and 55 other types of important positions. These are not temporary jobs, but important positions in an essential business that offers splendid opportunities in war or peace, good times or bad. Previous experience proved unnecessary! No need to leave your job to qualify. A good grade school education, plus Lewis Training qualifies you at home, in spare time. Our National Placement Bureau helps to place you—and our amazing Certified Job Plan—actually guarantees you will "make good" when placed. Write today for free book! Lewis Hotel Training School, Room DA-368, Washington 7, D. C. (First and only school of its kind—Now in its 29th year.)

PLASTICS Engineers and workers in great demand. Rush name for free information on home study courses. Ohio Institute of Technology, Box P-208, Greenville, Ohio.

"HOW To Break and Train Horses"—A book every farmer and horseman should have. It is free; no obligation. Simply address Beery School of Horsemanship, Dept. 1101-C, Pleasant Hill, Ohio.

WANT A new job, happier work at better pay? If you are not happy, making progress, you are not in your right work! Our grand new book, "Find the Job That Fits You," outlines winning procedures in finding and getting the one job for which you are best fitted by natural talents, interests and aptitudes—the one job in which you will find greatest happiness, success. Book sent postpaid, only \$1.98. Money refunded if not satisfied. Descriptive literature free. Byron Publications, Gunnison 3, Utah.

SUREHAND Shorthand in 30 days, guaranteed high-school graduates. Most rapid readable system. Textbook 25c. Jesse L. Cook, Bartow, Florida.

WELDING—Electric arc. Learn profitable trade quickly through actual practice. Individual welder instructions at bare cost of materials. Full particulars free. Valuable welding lessons book 60c. Hobart Welding School, Box M-152, Troy, Ohio.

INTERESTING, Highly paid, uncrowded profession. Men trained for the work of motion picture projection seem to have no trouble in stepping into good positions. There is a demand for trained men; your business is to train men. Capable instructors, fully equipped theatre booth, Western Electric and RCA sound equipment. Learn this work under actual working conditions, and be able to operate a show. Day and evening classes. Hollywood Sound Institute, Inc., 1040-A North Kenmore, Los Angeles 27, California.

WRITE Short stories at home for pleasure and profit. Fame, riches and happiness of achievement are rewards to be realized by students who acquire tested technique. Get free booklet from home study school with 50 years experience. Write today! Blackstone-Sprague, Dept. 11a, 307 North Michigan, Chicago 1.

DRUNKENNESS is a disease which responds to treatment. Medical skill plus human sympathy prove successful with liquor and drug cases. 60 years experience. Write for free booklet. P. M. Neilson, The Keeley Institute, Dwight, Ill.

LANDSCAPING. Learn landscape designing and gardening for a profitable out-of-door profession. Write National Landscape Institute, Dept. P-2, 756 Broadway, Los Angeles 14, Calif.

REFRIGERATION—An air conditioning. Mechanically-minded men! Are you interested in the kind of work which offers a "go-getting" man a real chance to make headway—even own his own business? Then write today for free facts about refrigeration and air conditioning, and how you can start now to get a working foundation for this field in your spare time; how you can get the kind of training which for 18 years has helped so many U.E.I. men "make the grade" in a big way. Utilities Engineering Institute, Dept. 15W, 1314 W. Belden Ave., Chicago 14, Ill.

MAGIC Shorthand and typewriting. Complete home study course in short, quick lessons. Now for the first time you can learn how to write shorthand with very little effort. 25c. Central Sales Service, Box 90, 210 5th Ave., New York City, N. Y.

MEN! Women! Get into Swedish massage. Make up to \$40-\$70 week! Learn at home. Booklet free. College of Swedish Massage, Dept. MC-45, Chicago.

HOME Studycourse, drugless therapy. Free literature. Institute of Drugless Therapy, Tama, Iowa.

USED Educational books on all subjects sold, rented, also bought and exchanged. Moneyback guarantee. Write today for free catalog and details. Lee Mountain, Pisgah, Alabama.

NEW Writers needed to rewrite ideas in newspapers, magazines and books. Splendid opportunity to "break into" fascinating writing field. May bring you up to \$5.00 per hour spare time. Experience unnecessary. Write today for free details. No obligation. Postcard will do. Comfort Writer's Service, 210-P South Seventh St., 2, St. Louis, Mo.

GOOD "Used" self-instruction educational books on all subjects bought, sold, rented, exchanged. Satisfaction guaranteed. Complete information and 92-page illustrated bargain catalog free. Write—Nelson Company, Dept. 2-02, Chicago 4.

MAKE Up to \$25-\$35 week as a trained practical nurse. Learn quickly at home, spare time. Easy tuition payments. Earn while you learn—many earn hundreds of dollars while studying. Easy to understand lessons, endorsed by physicians. High school not required. Our 45th year. Write for free booklet and sample lesson pages. Chicago School of Nursing, Dept. K-1, Chicago.

BECOME A finance man. Particulars free. George Lenhoff, Lincoln 8, Nebraska.

INVESTIGATOR Training. Phillips Secret Service, 1917-B North Kenneth, Chicago 39, Illinois.

BECOME An "Attritionist Masseur." First improvement over Swedish massage in 100 years! Results unbelievable! Dr. Swearingen, 9128M, Station 8, Los Angeles.

BECOME A doctor of psychology or metaphysics. Teach secret of contentment, happiness. Win degree of Ps.D. or Ms.D. Solve mental worries. Free book. College of Universal Truth, 5153-B North Clark, Chicago.

NON-RESIDENT High school, college, professional degrees. Bulletin free. Capital City College, Washington-5, D. C.

HEALTH And happiness can be yours! Read this great book "Cause and Cure of Colds." With 308 pages written for your health's sake. Order now. \$1.00 postpaid. Satisfaction guaranteed. Robert Ripley, Homer, N. Y.

USED Educational and technical books bought, sold, rented. (2500 books wanted.) Free catalog. Educational Exchange, Hengsar, Ala.

GET "Set now." When the war-time job boom ends, only properly trained men will get and hold permanent positions with top pay. Pick air-conditioning, refrigeration, heating, ventilating, welding, electricity, radio or electronics—fastest growing, most promising industries. Prepare now, train in a few months instead of years. Low tuition, liberal terms. Earn part expenses. Big book free. Milwaukee School of Engineering, Box 644, Milwaukee, Wis.

HOW To trisect angles. Ruler and compass only. Illustrated publication \$1.25. Pure Science Research Associates, Box 310, Moscow, Idaho.

MATHEMATICAL Resultants without figuring. Write Claude Beaver, 1016 So. Westlake Ave., Los Angeles 6, California.

SHORTHAND In 6 weeks at home. Famous Speedwriting system, no signs or symbols. Easy to learn and use. Fast preparation for a job. Surprisingly low cost. 70,000 taught by mail. Used in leading offices and civil service. Write for booklet. Speedwriting Institute, 338 Ridge Bldg., Kansas City 6, Mo.

RADIO Writers wanted. Home-study course teaches you the required professional technique for getting your ideas on the air. Pay-as-you-learn terms. Free information. Radio Writing Institute, Studio M, Radio Center, Hollywood 28, Calif.

REAL Estate. Low cost home study course for all states. Unlimited opportunities. Big earnings. Free bulletin. DeVoto Schools, 35 Vicente, San Francisco 16, Calif.

EARN Certified Grapho-Analyst degree analyzing handwriting. Students report earnings up to \$1.00 an hour sparetime. \$75.00 weekly full time. Graduates in employment, credit agencies, police departments, courts, business and in private practice as personal problem and vocational advisors. Fully illustrated Grapho-Analyst and 3000 word illustrated lesson free. Institute, (AP), Joplin, Missouri.

AUTO Body and fender work, including metal work, welding and spray painting. Look into it! One of the most profitable branches of tremendous auto industry offering chances for good job or your own business. Train in spare time. Write for free facts. Utilities Inst., Dept. 14X, 1316 W. Belden Ave., Chicago.

LEARN Profitable credit and collection agency business; investigate Educational Extension Service Advertisement under Business Opportunities.

RADIO Engineering, broadcasting, servicing electronics, aviation, marine and police radio taught thoroughly. All expenses low. Co-educational. Catalog free. Valparaiso Technical Institute, Dept. C, Valparaiso, Ind.

CARPENTERS. We teach the square in five easy lessons by mail. Our 14 size practice square and simplified instructions does the work. Free information, better still send quarter for practice square and partial lesson. Builders' Topics, Medical Arts Bldg., Seattle, Washington.

MEDICAL Laboratory technicians in great demand. We train you in your spare time, in your own home. You can practice while studying. Write for free catalogue. Imperial Technical Institute, Box 973-E, Austin, Texas.

LOCKSMITH Course. Lock picking, key fitting, etc. \$1.00 prepaid. Locksmith, Canadian, Texas.

PLAYS, STORIES, MANUSCRIPTS

WRITERS: Send for free circular P-151, with Unified Sales Plan for placing your work. Otis Adelbert Kline, Literary Agent, Established 1923, 507 Fifth Avenue, New York 17.

IMPORTANT—Join National Poetry Group, 25 West 3rd Street, New York 12.

CARTOONING, COMMERCIAL ART, SHOCARD WRITING, SIGN PAINTING

CARTOONING Course:—30 illustrated lessons, over 500 sketches, complete \$1.00. Rex Cartoon Studio, Box 892, Pasadena, California.

BEST Complete cartoon course with artists kit—\$2.00. Membership Cartoonists Association free. Cartoon Publishers, West Springfield, Mass.

POCKET Size cartoon course—22 easy lessons, over 200 sketches including figures and lettering. Prepared by nationally known artist. Mailed postpaid on receipt of 25c in coin. Snack-Pack Co., 34 E. Georgia St., Indianapolis 4, Ind.

ART Instruction. Self taught. Cartoons. Pen and ink. Figure-drawing. Perspective water color. Oil painting. Over 100 illustrations. Send only \$1.00 for complete course. Nothing more to pay. Vondy Publishing Co., 9521 Annetta Ave., Southgate, Calif.

LEARN Cartooning from a professional, new method course, 18 chapters, 300 illustrations, pens, pencils, paper included, \$1.00 complete. Chesley Studio, 1450P Broadway, Buffalo 12, N. Y.

SIGN Painting and commercial art instructions \$1.00. Spradlin Sales Co., 2204 No. L St., Fort Smith, Arkansas.

YOUR Name cleverly drawn in cartoon, \$1. State hobby or profession. Holt Scott, Box 126, Somerville, Tennessee.

AMATEUR And semi-professional cartoonists and artists, cash in on your ability. Write Hamilton, Box 4FA, Woolsey Sta., Astoria, N. Y.

CARTOON Course, gag, anatomy, business courses. Also drawing set. All for \$3.00 postpaid. Hartman, 2438 W. Lincoln, Nebraska.

PEN Drawings from objects or photographs. Sanden, 716 - 21st, Bellingham, Wash.

FREE Cartoon course. You pay only the postage. Send 30c in stamps. Associated Publishers Cartoon Syndicate, 611 S. Harrison, Fort Wayne, Ind.

FUNNY Faces, comic faces, learn to draw them. It's simple, easy, lots of fun. Details free. Funny Faces, 3 - 924B Faust Ave., Modesto 2, California.

WRITE Cartoon ideas. Nationally known magazine cartoonist booklet shows how. "Be Funny for Money, 25c." Ullsh Studios, 518P Wrightwood, Chicago 14.

CHALK Talks. Laugh producing program. \$1.00. Catalog 10c. Balda The Cartoonist, Oshkosh, Wisconsin.

ADVERTISING AGENCIES, LETTER WRITERS, FOR ADVERTISERS

ADVERTISE: 24 Words, 149 newspapers \$6.50. Lists free. Advertising Bureau, 4515-C Cottage Grove, Chicago 15.

ADVERTISE Profitably: \$20.00 reaches 5,000,000 Sunday newspaper readers with 24-word ad. Newspaper, magazine, mailing-list ratebook free. Chicago Advertising Agency, 20-PA West Jackson, Chicago 4.

CIRCULARS Mailed to opportunity seekers. Trial 500 \$1.00. Vinciguerra, 41-20 55th St., Woodside, Long Island, N. Y.

LOW Cost clinic for mail order ads. Over 75 tests, you receive written diagnosis. Send stamp for low introductory offer. Robert Alexander & Co., Sebring, Ohio.

MAIL Order specialist. Ads, letters, circulars that sell, 24 years success record. Consultation free. Slifer, 451 Mount Carmel, Glendale 6, Calif.

20 WORDS 30 Newspapers \$2.00. Good-all 37 Gardner, Vallejo, California.

24 WORDS In 90 weeklies \$4.60. H. J. Darnell, 730 Hays, Jackson, Tennessee.

ADS Placed in out of town newspapers and magazines. Low rates. Catalogue free. Ideas that pay. Baker Advertising Agency, Successors Ankrum Agency, 189 W. Madison, Chicago 2.

INCH Display advertisement, 50 magazines, year \$16. Wood's Popular Services, Atlantic City, (N. J.)

FREE—New Advertisers Rate Guide. 44 pages. Includes everything. Lowest rates. E. H. Brown Advertising Agency, Merchandise Mart, Chicago.

BUSINESS SERVICE

PHILADELPHIA Mailing address in business section or highest calibre personal representation. Christian, college graduate, highly rated, excellent business and political connections. Legitimate contacts only. Modest cost. Art Dyer, 5214 Walnut St., Philadelphia 39.

HOLLYWOOD Business, sales, publicity representation. Mailing and forwarding. Formerly with chambers of commerce, better business bureaus, etc. Write Jeff Daniels, P.O. Box 2266, Hollywood, California.

TO Whom it may concern: I will represent you in Cleveland. Personal or business assignments \$1 per hour. James W. Farley, Citizens Bldg., Cleveland 14, Ohio.

NEWPORT, Rhode Island, mail forwarded, telegrams, errands, etc. Box 86.

DETROIT, Mich. Mail forwarded. Confidential. 25c per item. ADJ Service Bureau, Suite 2120, 1150 Griswold St.

HOLLYWOOD, California, mailing address: Reformatting service, single letters 25c, monthly service, \$2.00. Dan, 1507 Kenneth Road, Glendale, Calif.

OREGON Mailing address—Coast resort; letter 25c; month \$2.00. J.B.M., Box 225, Rockaway, Oregon.

MIAMI Forwarding address for business or personal use. \$1.00 per month or 10c per letter. Miami Merchandise Mart, 1631 Douglas Rd., Miami 35, Florida.

TWIN CITY reformatting service. \$2.00 monthly. Steffen, 810 Pioneer Building, St. Paul, Minn.

MAIL Letters from 10,000 lake state. Prompt forwarding. \$2.00 monthly, 25c individual letter. R. Hamstad, St. Peter, Minnesota.

\$2.00 MONTHLY Maintains Washington, D. C., office address. Your business, personal mail forwarded when wanted. Hawkins, (Established 1917), 7-e Randolph Place.

SPECIAL SERVICES

NEED Something in New York? Write "Get-It-For-You" Service, 1332 Findlay, New York City 56.

TYPEWRITERS, DUPLICATORS, OFFICE DEVICES

8½" x 11" STENCIL Duplicator complete with ink, stencils, paper, \$3.75 postpaid. 9" x 12" blue printer complete with blue print paper, tracing paper, developer, \$3.50, postpaid. Best Company, Box 5802, Cleveland 1, Ohio.

POSTAL Scales, guaranteed accurate. Capacity ½ oz. to ½ pound, \$1.50 postpaid. W. Grace, Milledgeville, Ga.

TYPEWRITERS, Mimeograph, multi-graph machines, presses, and supplies. Dixigraph, King, N. Car.

USED Cash-registers, typewriters, paper-cutter, multigraphs, addressographs, duplicators, folding and adding machines. Shaw Mfg. Co., Galesburg, Kansas.

"PRINTOMATIC" Self-feeding rotary stencil post card printer, complete, \$9.50. All makes duplicator supplies. Literature free. Pittsburgh Typewriter Supply, 336-R Fourth Avenue, Pittsburgh 22, Penna.

RUBBER STAMPS, OFFICE SUPPLIES

SIGNATURE Stamps, daters, numberers, rubber type sets, sign and chart printers. Prices on request. Ideal Rubber Stamp Company, Box 83, Detroit 8, Mich.

3 LINE, Cushioned, indexed, 35c. Signatures \$1.50. Stamprite, Wauwatosa, Wis.

ONE Line 20c. 2—35c. 3—50c. 4—65c. Stamp Works, Auburn, Nebraska.

PRINTING, MULTIGRAPHING, MIMEOGRAPHING, GUMMED LABELS

ENVELOPES, Letterheads printed 200—\$1.00 postpaid. Samples. Weedman Press, Madisonville, Kentucky.

\$2.00 POSTPAID: 150 8½" x 11 Good bond letterheads and 150 6¾ envelopes. 500 of each \$5.75 postpaid. Mero Products, Box 344A, Punksutawney, Penna.

500—\$2.25. LETTERHEADS, Envelopes. Mango, 555A South 20th, Newark 3, N. J.

GUMMED Perforated address labels, 3300 for \$1.00. Keller, Michigantown 2, Ind.

SHIPPING Labels for parcel post. Printed in two colors, gummed, 250—\$1.00, postpaid. Sample free. Schaffer Press, 1295 Gates Ave., Brooklyn 21, New York.

100 PERSONAL Letterheads, 100 envelopes to match. Rippletone \$1.25. Clarion Press, Richland, Iowa.

EMBOSSER Business cards reasonable. Samples. Spada, 10 Lexington, Wethersfield 9, Conn.

100 8½" x 11 LETTERHEADS, 6¾ Envelopes, \$1.50. Samples free. Farleyprint, Woodway, Virginia.

500 2x3½ BUSINESS Cards \$1.50. 500 bond letterheads and envelopes, both for \$5.50 prepaid. Money-back guarantee. Magic Press, 5214 Walnut St., Philadelphia 39, Penna.

250 \$1.00 LETTERHEADS, Envelopes, statements, 1,000 \$2.75. Paramount Press, Atlanta, Missouri.

ENVELOPE Printing bargain—1000 6¾, \$3.90; No. 10, \$5.00. Postpaid. Guaranteed quality. Joseph Adams, 30 W. Washington, Chicago 2.

250 CARDS, Envelopes or letterheads \$1.50. Grinnell Press, Glen Elyn, Illinois.

DISTINCTIVE Business, personal stationery, office supplies. Armagh Stationery Products, Milroy, Penna.

150 LETTERHEADS, Envelopes, 98c. Good printing cheap! Samples. Joseph Johnson, 1382-A Fifth Ave., New York 29.

100 8½" x 11 LETTERHEADS And 100 envelopes \$1.00 postpaid. Benneville, 907 West Roosevelt, Philadelphia 40, Penna.

LOW Prices—Fast, quality service. Estimates, samples free. Wilson Printers, Dowagiac 2, Mich.

PRINTING—Mimeographing, free estimates, samples. Washah Print Shop, 1444 Webster, Washah, Indiana.

PHOTOCOPIY Anything 8½" x 11, 25c—18x22—\$1.00. Quotations, samples. Scholler, 1407 Howard, Pittsburgh 12, Penna.

200 8½" x 11 HAMMERMILL Letterheads, \$1.00 postpaid. Envelopes, invoices, business cards same. Race Printing Company, Hudson, N. Y.

200 BOND Letterheads or 200 6¾ envelopes \$1.25. Estimates on other printing. Poster Sign & Printing Company, 4020 Cottage Grove Ave., Chicago 15, Illinois.

3000—6x9 CIRCULARS \$5.85 postpaid to 4th zone. Education Publishers, Pittsfield, Mass.

SPECIAL, 1000 6¾ Envelopes printed, 5 lines, \$3.00. Girardin, 10860 Whitehill, Detroit 24, Mich.

250 8½" x 11 16 LB. Bond letterheads, or 6¾ envelopes; \$1.25. Lung, Huntertown, Indiana.

MIMEOGRAPHING—Any copy. Reasonable. Mailers Service, Box 606-A, Chicago 90, Ill.

BETTER Grade printing reasonable. Estimates on anything. Economic Press, Leonia, N. J.

MIMEOGRAPHING And multigraphing. 14 years of fine work and fair prices. Free samples and prices. H. Allsmith, 1500 W. Nedro Avenue, Philadelphia 41, Penna.

500 3½" x 2¼ FOUR Line gummed stickers, 25c. Moritz Printery, Saginaw, Mich.

PRINTING OUTFITS AND SUPPLIES

TYPE 25c, Cases 25c, inks 25c. Other attractive items. Outfits, Murelco, Box 748, Dayton 1, Ohio.

PRINT At home. 10c will bring a complete catalog of presses, type and supplies. P. Peiffer & Company, 6 Columbia St., Newark, N. J.

USED Presses, type, supplies, Lists 3c. Turnbaugh Service, Loydsville, Penna.

INEXPENSIVE Home-made printing press. Details free. Novelty Shop, Downs-ville, Louisiana.

PRINTING Equipment, type and supplies. Send stamp for details or dime for complete illustrated supply book. Kelsey Inc., X-11, Meriden, Conn.

PATENT ATTORNEYS

INVENTORS: Learn now—without obligation—how to protect and sell your invention. Write for free "Record of Invention" form and complete information for making disclosure and establishing date of your invention. We also send our new free "Patent Guide for the Inventor," containing complete information about patent procedure and how to sell inventions; giving illustrations of many successful inventions; over 150 basic mechanical movements. We assure you prompt, confidential service. Delays may be dangerous. Write today for your free "Patent Guide" and "Record of Invention" form. Clarence A. O'Brien & Harvey Jacobson, Registered Patent Attorneys, 51B-A Adams Building, Washington 6, D. C.

PATENTS. Promptness assured. Wilfred E. Lawson, 1524 K Street, N.W., Washington 5, D. C.

INVENTORS—First things come first. Your first move toward securing a patent on your invention is acquiring full information on what to do. Our two books "Patent Protection" and "When and How to Sell Your Invention" contain this information and other helpful data. Get them immediately, together with our "Evidence of Invention" form. They cost you nothing, you assume no obligation. Write now to Victor J. Evans & Co., Registered Patent Attorneys, 931-A Merlino Building, Washington 6, D. C.

WHAT Should you invent? Our free book tells you what today's inventive market wants—how to put down, patent, and sell your ideas. Scores of letters in our files attest to the modern demand for inventions—our long experience as Registered Patent Attorneys will help you. Get our free book, "How to Protect, Finance and Sell Your Invention." Also special document free, "Invention Record" on which to sketch and describe your invention. Write today. No obligation. McMorro & Berman, Patent Attorneys, 134-K Atlantic Building, Washington 4, D. C.

PATENT Protection. Write for information. Fees. Record of invention. Free. Randolph & Beavers, 21-C Columbian Bldg., Washington, D. C.

INVENTORS—Before disclosing your invention to anyone send for form "Evidence of Conception"; Schedule of Government and Attorneys' Fees and instructions. Sent free. Lancaster, Allwine & Rommel, 411 Bowen Building, Washington 5, D. C.

"INVENTOR'S Guide," 100 mechanical movements, free; advises on patents, selling inventions. Frank W. Ledermann, 154 Nassau Street, New York.

C. A. SNOW & Co., M-427 Snow Bldg., Washington 1, D. C. Registered patent attorneys. Established 1875. Literature mailed on request.

PATENTS Obtained; selling service, information, recording forms free. Labiner, World Building, New York.

PATENTS. Protect your idea by securing free "Proof of Invention" folder. Exceptional personal service. Established 1906. E. E. Vrooman, 871 Woodard Bldg., Washington, D. C.

PATENTS—Trade marks. Preliminary advice, book and disclosure form free. Personal service. Irving L. McCathran, 315 McLachlen Bldg., Washington 1, D. C. Registered Patent Attorney.

FOR INVENTORS

WHAT Should you invent? Our free book tells you what today's inventive market wants—how to put down, patent, and sell your ideas. Scores of letters in our files attest to the modern demand for inventions—our long experience as Registered Patent Attorneys will help you. Get our free book, "How to Protect, Finance and Sell Your Invention." Also special document free, "Invention Record" on which to sketch and describe your invention. Write today. No obligation. McMorro & Berman, Patent Attorneys, 134-H Atlantic Building, Washington 4, D. C.

INVENTORS: Learn now—without obligation—how to protect and sell your invention. Write for free "Record of Invention" form and complete instructions for making disclosure and establishing date of your invention. We also send our new free "Patent Guide for the Inventor," containing complete information about patent procedure and how to sell inventions; giving illustrations of many successful inventions; over 150 basic mechanical movements. We assure you prompt, confidential service. Delays may be dangerous. Write today for your free "Patent Guide" and "Record of Invention" form. Clarence A. O'Brien & Harvey Jacobson, Registered Patent Attorneys, 51A-A Adams Building, Washington D. C.

PATENT Your idea! Write immediately for two free illustrated books, "Patent Protection" and "When and How to Sell an Invention." 64 pages of valuable information for inventors. No obligation. Address: Victor J. Evans & Co., 932-A Merlino Bldg., Washington 6, D. C.

MECHANICAL Drafting, blueprints. Send sketch. Free quotation. Hamilton, 650-A South 20th, Newark 3, New Jersey.

I SELL Patents. Established in 1900. Charles A. Scott, 737PM Garson Ave., Rochester, N. Y.

INVENTORS: New military and commercial inventions urgently needed by manufacturers. Write for particulars. Chartered Institute, Dept. 4-A, Washington, D. C.

INVENTORS: Let our 16 years experience help you streamline your invention for greater sales appeal. Send details for quotation to: Industrial Design Service, Commercial Building, Rockford, Ill.

PATENT And unpatented inventions promoted. M. Joyce Humphries, 1424 Land Title Bldg., Philadelphia 10, Penna.

CASH For inventions or practical ideas. Write Herbert Seymour, 218-PM S. Aurora, Easton 3, Maryland.

INVENTION Development — Inventor's consultation, inventions developed, designed, promoted; models constructed, patent advice, patent drawings. Reasonable rates. Address: Invention Development, 1770 Mission Blvd., Granada Hills, Calif.

WE Locate buyers meritorious inventions, patented, unpatented, cash, royalty. Many requests on hand. Serious thinking inventors, write immediately. Descriptive booklet, references, free. Invention Reporter, 5A-11236 So. Fairfield, Chicago.

SMALL Rubber factory is looking for new items to manufacture postwar. Do you have a patent or a good idea? Perhaps we can help you with design or financing. Reliance Rubber Company, 1515 Powell Street, Oakland 8, California.

MANUFACTURER'S Names, addresses. Any classification. Tupper, 18-A Lyman, Beverly, Mass.

CASH For practical ideas and inventions. Mr. Ball, AB-9441 Pleasant, Chicago.

INVENTIONS WANTED

INVENTIONS Wanted—Patented or unpatented. Developed or undeveloped. As engineers, manufacturers and market analysts, we know what new products industry needs. If your idea is not patented write for details on your protection. Your idea may make you a fortune. Mason, Lesh and Beall, 441 No. Beverly Drive, Beverly Hills, Calif.

INVENTORS—The Lion Manufacturing Corporation of Chicago, a highly rated concern doing an annual business of \$20,000,000 is interested in inventions for their plant and affiliated companies. Our interest is in patented or patentable electrical or mechanical devices for post-war development in the following fields: Radio and television, sound and recording, household appliances, vending machines, coin operated amusement devices, in fact almost anything of metal or plastic. We invite inventors to send us details concerning their patented inventions. If your invention is not patented, tell us in a general way what you have to offer. If we are interested, we shall inform you how to communicate details without endangering your rights. Lion Manufacturing Corp., 135 South LaSalle Street, Dept. A, Chicago 3, Ill.

WANTED—Patented items for manufacture on royalty basis. Decker Manufacturing Co., Rockford, Illinois.

INVENTORS: Have you a sound, practical invention for sale, patented or unpatented? If so, write Chartered Institute of American Inventors, Dept. 4-D, Washington, D. C.

MANUFACTURER Interested post-war patented articles. In volume and popular priced fields. Write Suite 2, 7043 Lawdale, Houston 12, Texas.

INVENTORS: Learn how we sell your invention. Free booklet, "Selling Your Invention." Inventors Patent Exchange, 336-B Palace Building, Hartford 3, Conn.

WANTED—Inventions having profit possibilities. Patented, unpatented, cash, royalty. Inventors wishing to sell, reply immediately. Descriptive booklet, references, free. Invention Reporter, 5B-11236 So. Fairfield, Chicago.

INVENTORS! Have you good, patentable idea? Write Mr. Metzler, 11 West 42nd, New York.

ALL Kinds. We have facilities and finances to make and sell your ideas, both mechanical and chemical. Send model, sample, details and wishes. General Sales & Supply Company, 110 East Main St., Madison 3, Wisconsin.

CASH For inventions, patented, unpatented. Mr. Ball, A-9441 Pleasant, Chicago.

MANUFACTURER Wants sensible mechanical device or idea with quick sales possibilities in low-priced field. Write Matt, 1412-D Great Northern Building, Chicago 4.

PATENTS FOR SALE

PATENT. Sept. 1944 issue. One man placing of wallboard panels on ceilings. Iron pipe construction. Light weight. Will answer manufacturers only. Chas. A. McPherson, Edgar, Mont.

AUTOMOBILE Parts and accessories. McConnell-Petermann, 16114 Burt, Detroit 19, Mich.

ATTENTION. Cash or royalty. Always moist antenna. Home or car. Five claim patent. Wilbur White, 312 State Street, Salamanca, New York.

PATENT. Sell outright. Garden rake and marker combined, to space rows for planting. Can be punched and formed from sheet metal. Inexpensive to make. E. Ernst, 1857 E. Pacific St., Philadelphia 34, Penna.

MANUFACTURING

PRODUCTION Time now available for lathe and shaper work. Duane Machine Co., Box 335, Lorain, Ohio.

MODELS—Small lot manufacturing. Metals, plastics, etc. Milburn, Burlington, Kentucky.

MODELS AND MODEL SUPPLIES

ILLUSTRATED Catalogue over 100 model steam, gasoline and locomotive castings and drawings 10c postpaid. Active Products & Supply Co., 53 W. Jackson Blvd., Chicago 4.

MODEL Electric cannon. Photograph, blueprints \$1.00. Hamilton, 650-A South 20th, Newark 3, New Jersey.

CATALOG 50 Engines, model railroad supplies, 25c refunded. Simonsen Model Supply, A-3054 North Greenview, Chicago 13.

RAILWAY Models, complete line, information catalog HO and O gauge, 79 pages, 15c. Walthers, 247 Erie, Milwaukee, Wisconsin.

PLANES, Boats, hundreds of hobby items. Catalog free. America's Hobby Center, Dept. B 15, 40 E. 21 St., New York 10, N. Y.

SHIP Models and yacht supplies complete. Large 64 page catalogue 25c. Bill Wild's, 510 East 11 St., New York City.

MODEL Steam and gasoline engines, castings and drawings. Literature 10c. Wayne Miller, 205 W. Wacker Drive, Chicago 6.

SHIP Model kits and fittings. Complete line Fisher model yacht equipment. All Boucher, Fisher, Marine Model and Ideal kits, fittings and blueprints at standard prices. Most complete stock in New England. James Bliss & Co., Inc., 220 State Street, Boston, Massachusetts.

HOME CRAFTSMEN

FLOATING Art colors are back again! They float on water—form brilliant, swirling patterns. Decorate wooden, paper, metal objects—candles, bottles, bric-a-brac, etc.—by dipping! Weatherproof, permanent marbled finish. Create vivid original patterns of striking beauty! Set of six colors—red, white, blue, black, green, yellow—only \$1.00 postpaid. Instructions included. Satisfaction guaranteed! Carmen-Bronson, 160B East Fourth Street, Mount Vernon, N. Y.

NOVELTIES Made from scrap wood, 25 patterns 25c, 15 toy patterns 25c, 15 lawn ornament patterns 25c. Other patterns, 14"-20" high; clown, Mexican, Dutch boy, Dutch girl, pelican, rooster, 10c each, 3 for 25c. Lynds, Medway, Mass.

MAKE Your own locking calliper rule; handy swing tray; "no-tip" paint can holder; bench knife. Money can't buy. Never-before-published, 4-page plan tells how—16 photo illustrations. 25c per copy. Ideas & Plans, A2, Palmyra, New Jersey.

HERALDIC Insignia patterns \$2 set. Distinctive designs—various sizes. IHB, P.O. Box 508, Annapolis, Maryland.

28 LAWN Ornament patterns 25c. Other patterns: 15"-20" high; Dutch girl; Dutch boy, pirate, bull terrier, Mexican girl, Mexican boy, dwarf, penguin, flower girl, 10c each; 3 for 25c. 25 novelty patterns 30c. All 62 full size patterns \$1.00 postpaid. Strother, Box 383-GN, Belington, W. Va.

PLEXIGLAS, Lucite, catalin, dollar assortment. Homecrafters, 81 Duke Street, Toronto, Canada.

PLEXIGLAS—The amazing crystal-clear plastic. Saw it, drill it, bend it, twist it into hundreds of useful articles that are beautifully different. Special 1 pound package assortment \$1 postpaid; 7½ pounds \$5. Free instructions and project suggestions included! Order today! Carmen-Bronson, 160-B East Fourth Street, Mount Vernon, N. Y.

ACTION Toy. Ingenious, different. Runs 4 minutes under own power. Scrap materials. Easy to build. Sells like hotcakes. Blueprints \$1.00. Alta Products, Box 1109, Pasadena 1, California.

STAINLESS Steel scrap, generous shipment \$1.00 postpaid. Industrial Engineering, 1155 South Kenmore, Los Angeles 6, California.

TOYS. Build the Earthmover Line of wood toys from cuttings. Bulldozer, power shovel, and Earthmover prints and specifications \$1.00. Others available. Earthmover Toys, East Lansing, Mich.

49 LAWN Ornament patterns, some 21" high, 20 novelty patterns, 20 silhouette patterns, 89 patterns \$1.00. Modern Woodcraft, Saginaw, Mich.

LUMBER, Walnut, cherry, oak, cut to order. Sample lot \$1.00. Jason E. Lyon, Harrisonburg, Va.

THE Shebel Filer files all saws. Send for circular. A. P. Shebel, 730 S. 2nd St., Milwaukee 4, Wis.

TOY Patterns (action). Friendly puppy; peddling clown; ducky quack; man sawing wood weathervane. 25c each. Strother, Belington, W. Va.

WHITTLES' — Softwood subjects, 10 patterns, instructions, 25c. Cartoon Studios, 1402 Charles, LaCrosse, Wis.

CATALOG: Large line decal transfers. Patterns for jig sawing. New designs easy to make novelty furniture, lawn ornaments, silhouettes, letters and numerals. 100 crafts and hobbies illustrated booklets. Tools. Other lines, 500 articles finely illustrated. Write Wo-Met Shop, Ashburn, Georgia.

MAKE IT YOURSELF

JEWELRY Supplies. Shell metal and plastic parts for manufacturing. Free illustrated catalogue and detailed instructions on shell jewelry. Florida Supply House, 415 - 12th Street, Bradenton, Fla.

THREE-WAY Telegraph signal sets. No machining, just assemble. Night blinker, telegraph and wire less sound signals. Twin set includes all parts for two instruments. Codes and operating instructions \$3.89. Nothing like it near the price. Fully guaranteed. Magill, Germantown Manor, Philadelphia 19, Penna.

BUILD Substantial rocking horse. Easy to make. Good seller at big profits. Send 25c in coin for plans to G. Wayman, 6213 So. 33rd Ave., Omaha, Nebr.

BAROMETER, Make your own for a dime. Drawing and instruction 25c. Hoene, 2311 Bellevue, Maplewood 17, Mo.

PUT Two-inch solid wood arrow through half-inch solid metal washer! Amaze, amuse! Barrels of fun, bushels of money! Instructions \$1. George Gillespie, Galax, Virginia.

GARAGE Doors dashboard controlled. Additional information under "Automobiles."

BUILD It yourself. Automatic overhead garage doors operated from drivers seat. Used auto parts and other material available everywhere cheap. Use ¼ h.p. motor. Tried and tested. Be first in your neighborhood to build one. Complete plans \$1.00. McIntosh Projects, 2479 Coolidge Ave., Oakland 1, Calif.

SHELLWORKERS. Rehabilitation hospitals, send for wholesale price list. Plastic and metal jewelry findings, seashells and supplies. Shell Novelty Co., Box 1664, Fort Myers, Florida.

FLOUORESCENT Lights. How to make your own 20 watt lights for less than \$1.00 each. Complete, guaranteed, detailed instructions \$1.00 M.O. or war stamp. Specialty Sales, Box 1086, Muncie, Ind.

WATCHES, OLD GOLD, JEWELRY, ETC.

MAN'S Massive ring, roaring lion's head, real knockout ring with plenty of punch. Handsome, sterling silver ring designed especially for a "He" man. Send \$5 (tax included) ring will be sent postpaid or pay postman on arrival. Three sizes, large, medium, small. Jewelry Craftsmen, Providence 3, R. I.

LOVELY Lucite cross and chain adds glamour to any woman. Stunning, inexpensive, gets the raves. \$2.00. Free circular. Bible Artists, Box 28, Jackson Heights, N. Y.

COO-COO Clocks, electric and spring wound chime clocks, and hall clock movements serviced and repaired by licensed clockmakers. Write or send us insured mail your clock troubles. Electric Clock Service, Box 1086, Muncie, Indiana.

WATCH Repairing easy learned by our home study course. Watch repairers are in demand and are among the highest paid craftsmen today. Write for free information. Houston Chronometer & Watch Co., P.O. Box 5367C, Houston 12, Texas.

GOLD \$35.00 Ounce—Mail old gold teeth, diamonds, jewelry, watches—receive cash by return mail. Satisfaction guaranteed. Free information. Dr. Weisberg's Gold Refining Company, 1500-Q Hennepin, Minneapolis, Minn.

WATCHES, Materials, tools, jewelry, diamonds — bought — sold. Catalogue. Gales, Box 1000, Chicago.

WATCH And clock repairing—complete practical course in modern horology. 66 illustrated self-instruction lessons. Just out! Low price. Information free. Write Nelson Company, Dept. 8-02-2, Chicago 4.

TOBACCO, SMOKERS' SUPPLIES

SMOKING Cigarettes: Antiseptically de-nicotized quality cigarettes that satisfy the desire while reducing the habit. Make an ideal gift. Sample pack \$1.00, carton \$5.00. Ringel Laboratories, Box 215, Madison, Wis.

AMAZING! Make cigarettes like magic! New, patented, jewel-like cigarette roller. Precision engineered. Makes perfect cigarettes with factory uniformity. Just 4 inches long. Clips in the pocket like a fountain pen. Beautiful transparent plastic and metal. Easy to use. No tapes. Nothing to get out of order. Saves 75% of cigarette costs. Use your favorite cigarette or pipe tobacco. Buy for gifts, for boys in service. Just \$1.00 postpaid anywhere. Order now. Cig-Roll-Ett Co., 420 Kenilworth Avenue, Dayton 5, Ohio.

RAZORS, BLADES, SHARPENING

80 SINGLE Edge razor blades \$2.00. 100 double edge razor blades \$2.00. Satisfaction guaranteed prepaid. Varner Sales Co., 1722 Stanfield St., Chattanooga 6, Tenn.

100 DOUBLE-EDGE Blue surgical steel razor blades \$1.50 prepaid. Fully guaranteed. St. Moritz Blade Co., 321 Broadway, Dept. R, New York 7.

FOR THE HOME

REPAIR Parts—Stoves, furnaces, boilers, heaters. Magic Products, Royal Oak, Mich.

WASHING Machine parts, most makes, models; wringer rolls, belts, supplies. Write for prices. General, 7303 Lozier, Van Dyke, Mich.

FOR SALE—MISCELLANEOUS

SELSYN Motors: 110 volt, 60 cycle, a.c. navy surplus. Can be used for remote control, beam antennas, bingo, signaling, wind indicators. Many other uses. Very high torque. Original cost \$130.00 pair, our price \$25.00 pair. Guaranteed new—original packing. Met Exchange, 323 Canal St., New York.

ARMY Goods (used). Jeep hats and caps 10c, canteens 50c, cups 15c, mess kits 35c, leggings 25c, signal flags and case 75c, pup tents \$2.50, new type helmets \$4, liners only \$1, pilot sheepskin lined leather boots \$4, raincoats \$1, ponchos \$1, parkas, sheepskin or pile \$12.50, canvas covers 5c per foot, all sizes. Minimum shipment \$1. Via railway express. N. Y. Salvage Co., 144 Chambers St., New York City.

WIRE Name on bluebird 49c. Nuway, 1519 West 3rd Ave., Vancouver, B. C., Can.

SELF-WINDING Extension reels equipped with 16 feet No. 18 electric cord. Suitable for factory or garage. These reels manufactured by Vacuum Cleaner Corporation of America on special order. Closing out at \$2.25 each postpaid. Radio Reel Co., 1116 Rust Building, Tacoma 2, Wash.

WANTED—MISCELLANEOUS

WANTED—New ideas on good printing, novelty or paper specialty items by well-established firm with facilities to produce in quantity. Will accept new items on any arrangement of mutual interest, whether patented or not. Write complete details in first letter. Petersen Press, 825-827 W. College Avenue, Appleton, Wisconsin.

MERCURY (Quicksilver) — Cadmium, bismuth, tungsten, molybdenum, cobalt, vanadium. Write for quotations stating quantity. You'll receive guaranteed prices. Metallurgical Products Co., 35th and Moore Sts., Philadelphia, Penna. Established 1909.

SHUT in wants work, to do at home. Assembling, addressing, or? Stanley Fitz, 6340 Perkins, Detroit 10, Michigan.

WANTED: Very small single stage steam turbine, base 4 1/2 by 2 1/2 or 3 inches, 1/16 or 1/8 horse power, for 1/4 or 1/8 inch steam pipe. S. W. Jolley, Dighton, Kansas.

WATCHES Wanted—Broken or usable—all kinds, even Ingersolls. Highest prices paid for jewelry, rings, spectacles, alarm clocks, razors, cigarette lighters, gold teeth, etc. Cash mailed promptly. Lowe's, Holland Bldg., St. Louis 1, Mo.

WE'LL Swap, sell, buy anything. Free list. National Swappers Guide, 1100 E. Chandler, Evansville, Indiana.

WE Buy "anything"! Highest prices guaranteed! Justice, Box 150, Chicago 90.

WANTED Old Swiss and disc type music boxes, mechanical figures. Lloyd Kelley, Hanover, Mass.

POPCORN Machines, peanut roasters, candy boss, potato chip, caramelpop corn equip. Coin operated vending machines. Northside Company, Indianola, Iowa.

PERSONAL

NEW Vitamin restores gray hair to natural color. Satisfaction or money back. Veach & Co., Palestine, W. Va.

SLEEP-RITE Earplugs stop noise. Guaranteed 10c. Accepted by American Medical Association. Raymond Dowe, 17 Park Row, New York 7.

MOVIE Stars beautifully life colored photos, interesting, pleasing, 20 for 25c. Satisfaction guaranteed. O. P. Meyers, Box 246, Glendale, California.

KNOWLEDGE Is power. Tell friends the exact day events occur. This dependable formula amazingly figures weekdays accurately any year. Guaranteed. Send 25c in coin to cover printing and postage. Henry Marta, P. O. Box 3352, Paschall Station, Philadelphia 43, Penna.

YOUR Favorite photo on three beautiful plastic match cases \$1.50. Photostamp Service, B120M, Arkansas, Wis.

SUCCEED Post-war! Find what you're best fitted for. Write Occupations, 52 Lincoln, Highland Park, N. J.

ARCH Supports. Send \$1.00 and shoe size. Money back guarantee. Blair Company, 4520 Sheridan Road, Chicago 40, Ill.

DRUNKENNESS Is a disease which responds to treatment. Medical skill plus human sympathy prove successful with liquor and drug cases. 60 years experience. Write for free booklet. P. M. Nelson. The Keeley Institute, Dwight, Ill.

HELP Your body to good health, new pep and joy of life by drinking Vitality Health Cocktails. Made from articles of food readily obtainable anywhere. Two complete formulas 10c. Delfa Co., 3960 Avondale, Chicago 41, Illinois.

SAFETY First: Safe-Vu gives clear vision through eyeglasses and windshields in rain or snow. 25 and 50 cents. Marvo Products, Box 217, Muskego, Okla.

PRETEND Visiting New York. Souvenir, evidence: 25c. Haller, 436 N. Y. Ave., Brooklyn 25, N. Y. Details free. Write: Any year.

YOUR Handwriting will reveal many things that you never knew about yourself. Candid, general analysis, \$1.00. James Vick, Church Road, Virginia.

PSORIASIS Sufferers: Pixacol has brought relief when everything else failed. Use only as directed. Apply externally, dries quickly, convenient. Try regular \$1 bottle without investing a cent! Write: Pixacol, Box 3583, Cleveland, Ohio.

GROOVED Letters make your penmanship beautiful—few hours. Ozment, 9, St. Louis, Mo.

LEARN Character at a glance! Know friends, enemies! Employers, employees, need this. Used everywhere. Scientific proven system. Information. Dulco, 324P Pitt, Pittsburgh 21, Penna.

BUY Vitamins direct. Save. Postcard. Matoska Products, White Bear, Minn.

FALLING Hair, its cause and prevention, is fully explained in an informative and educational pamphlet entitled "How to Keep Your Hair Till Ninety." For free copy write, James Hilton, 4819 Fourth Ave., Brooklyn 20, New York.

GIRL Photos, beautiful models, only \$1.00 for group. "Little Eve," Box 211, Terre Haute, Indiana.

MEXICAN Law practice. A. B. Flota, Box 240, Juarez, Mexico.

PERSONALIZED Pencils—Individual or firm name imprinted gold. Economical for school and office. Dozen 50c, 3 dozen \$1.00, gross \$3.60, cash, delivered. Pencil Market, 611 - 15th St., Knoxville 16, Tenn.

BUY Vitamins, half price. Vitamin guide free. Richardson, Wyoming, Penna.

HAIR Falling? Dandruff? Write Trichologist, 137 Lewis St., Phillipsburg, N. J.

TATTOOING Outfits, designs, colors. Write today. Zeis Studio, 728 Lesley, Rockford, Illinois.

MISCELLANEOUS

SENSATIONAL Bargain! 9 piece gold shell set \$3.00. Set consists of: 2 earrings, 2 bobbins, brooch, spray, necklace, bracelet, lapel. Gold shells are the rarest and best shells found in the tropical waters of the Bahamas. Send payment with order to—L. L. Russel & Co., Box 295, Nassau, Bahamas.

MANUFACTURERS! We have mail order market for electrical and mechanical products. Quote distributor proposition. Box 5086, San Francisco 1, Calif.

SAFETY Fold razor blade scrapers again available. 25c postpaid. Alto Sales Co., 222 West Kellogg, St. Paul, Minn.

LUMINOUS Nursery wall decorations. Fascinating cut-outs glow in darkness. Complete set 35c. Circulars, sample 3c. Luminovettes, 469 Irving, Brooklyn, N. Y.

MEXICAN Importations. Bulletin free. Featherwork greeting and place cards. Samples 25c. Mexican Products Co., 126 N. Main, Tulsa 3, Okla.

BIG Mail for you. Latest moneymaking offers, opportunities, catalogs, magazines. Name listed in directory 10c. Ideal Service, 101, Park Ridge, Ill.

FREE—Illustrated movie photo catalogue, listing movie stars, bathing suit poses, candid photos, band leaders, vocalists, etc. Send ten cents to cover handling and mailing which will be refunded with order. Irving P. Klaw, 209 East 14 St., New York City 3.

100% PURE Horseradish and extra hot pepper relish. 12 oz. of each \$1 postpaid. Quality Foods, Pawhuska, Okla.

TAILORED Homes. Sixty plans one-story houses with selection beautiful colonial, English, Spanish, moderne exteriors—making hundreds of combinations! Price \$1.00. Prepare for rationing and higher building site prices. Avoid rush, plan now! H. P. Jones, 488K Brandeis Bldg., Omaha, Nebr.

GOOD "Used" self-instruction educational books on all subjects bought, sold, rented, exchanged. Satisfaction guaranteed. Complete information and 92-page illustrated bargain catalog free. Write—Nelson Company, Dept. 2-02-2, Chicago 4.

MAKE Your own Plastoplate printing cuts. Simple, easy process. Adayservice, Argyle, Wisconsin.

UNUSUAL Novelties. Samples 10c. Modern, Box 2, Sta. B, New York 2.

RECEIVE Free mails, valuable moneymaking opportunities, samples, magazines. Your name inserted in several mailing lists. 10c. Rogowski, 3415 Broadway, New York 31.

INFORMATION For treasure seekers. Write. Wyss, 104 1/2 Francis, St. Joseph, Mo.

PHOTOSTAT Copies of discharge papers, letters, drawings, etc., up to 8 1/2" x 11". 25c postpaid. (Original returned unharmed.) R & N. Service, 8316 5th Ave., Brooklyn 9, N. Y.

ALARM Clocks—Repaired, bought, sold. Write Earl Feiker, Wilmette, Illinois.

LUGGAGE Tags. Your name and address on metal tag. For all purposes of identification. 35c, three one dollar. Olson, Janesville, Wisconsin.

BUILD Your new post-war home yourself! Save 1/3 to 1/2! Easy instructions. 25c coin brings plans and particulars. William Jackson, A.B. 1713 Howard, Port Huron, Michigan.

MAGNIFIER. Powerful eye-loop magnifier. Jewelers, inspectors, hobbyists, \$1.00 postpaid. Ador, 52 Mill St., Amityville, N. Y.

PIPE And tobacco \$2; 25 quality cigars \$5; 50, \$10; wallets \$2; fountain pens \$2; safety razor and shaving brush \$2; 100 double edge blades \$2; cash with order. James Gallo, 15-06 150th Street, Whitestone, New York.

GIGANTIC Malls, magazines, catalogs, samples, listing once, 10 cents, three times 25 cents. Waddell's Directory, 309 East 75th, New York 21.

THE Lord is coming! Get guaranteed proofs free. Scheall, 263X, Duluth, Minn.

BOYS—Girls, write for free gift. David Berg, 659 Churchill, Bridgeport 29, Conn.

METAL Dog tags. Your name, address, 25c coin, 5 for \$1.00. Collar plates (3/4x2") 35c. Mail Products, Box 97E, Mendota, Ill.

MEXICAN Gift items, price list free. Ray Foster, 909 East River, El Paso, Tex.

ALASKA Scenes in Kodachrome slides, 75c each. Free list. Alaska Film Company, Box 81, Ketchikan, Alaska.

SERVICE Station driveway "service signals" again available. Free literature. Knipp, Long Beach 4, California.

INFORMATION—How to locate most any article made in the United States. Postal brings information. Mission, 4182 Emerald, Oakland, California.

BIGGEST Money in tattooing now! No experience required. Complete instructions with outfits. Send for free literature. Tatuco, 651 South State, Chicago.

MEDICAL Laboratory technicians in great demand. We train you in your spare time, in your own home. You can practice while studying. Write for free catalogue. Imperial Technical Institute, Box 973-J, Austin, Texas.



Learn by Mail to Mount Birds

Animals, Game-Heads, Fish, Pets, to Tan Skins

Men, Boys! Be a **Taxidermist**. Learn at home in spare time. Easily, quickly learned. **Grand Fun**. A wonderful, profitable hobby, for expert hunters, also for amateurs, even young boys. Mount wild-game, although wild-game is not necessary. Use common, domestic specimens, squirrels, pigeons, even frogs. This famous, reliable school in business more than 35 years. **More than 300,000 delighted students.** Think of that!

Hunters Save Your Trophies — Have a Home-museum Be a Taxidermy Artist

You will be **THRILLED** and **DELIGHTED**. You learn **QUICKLY**, easily **AT HOME**. Your friends will be amazed. Hunters from near and far will bring their **TROPHIES** to be mounted. You can earn fine **profits in spare time**. Many students earn \$50 to \$100 a month, in season. **Rush the coupon today**, and learn all about wonderful taxidermy. **DO IT NOW!**

Save your own hunting trophies. Have a lifelong hobby. Have a home museum that you are proud of, and that makes you popular and well-known far and wide. **BOYS**, wild-game is **not** necessary. Use common specimens, squirrels, pigeons, owls, domestic birds and animals. **It's wonderful**. Inquire **today**. **Kill fewer game-birds. Double your fun and pleasure.**

Fun — Fascination — Profit

And so easily learned in spare time. Wild-game is growing scarce. Help preserve it. Shoot only a **FEW** fine ducks and other game-birds. **MOUNT THEM** for home and den, and have **MORE FUN** and **PLEASURE** than killing the legal limit every day. **Help preserve the wild-game.**

Remember you learn to mount expertly, **birds, animals, game-heads, fish, pets, to tan skins and furs**. Investigate! You will be delighted. Send for **free book today**. "Eat your trophies and have them too."

THE N. W. SCHOOL OF TAXIDERM, 3371 Elwood Bldg., Omaha 8, Nebr.

FREE BOOK!

Yes **FREE**, 44 pages, with 100 unique pictures of taxidermy work. No other book in the world like this. It will amaze and thrill you. **Ask today for your free copy. State your AGE.**

Send the Coupon!

Write name plainly in coupon or margin, or a **post card** will do. **Rush your request, as free books may be exhausted quickly. Decide now. Don't wait a moment. State your age.**

FREE BOOK

Northwestern School of Taxidermy, 3371 Elwood Bldg., Omaha, Neb. Send me your free illustrated book, "How to Mount Game". Also tell me how I may learn this fascinating art easily and quickly by mail. No obligation. State your age.

Name _____ Age _____

Address _____



PLUMBERS & STEAM FITTERS

Audels Plumbers and Steamfitters Guides

4 Vols. \$6



A practical, illustrated, Reference Library and Study-Course for Master Plumbers, Journeymen and Apprentice Steamfitters, Gas Fitters and Helpers, Sheet Metal Workers, Draughtsmen, Master Builders, Engineers and all Building Trade Students. This valuable set of handy, pocket-size Guides explains in practical concise language and well-done illustrations all the principles, advances and short cuts of the Plumbing and Heating trade — based on modern practice. Contains careful, detailed instructions on how to figure and estimate various jobs. Use **FREE COUPON** below to examine, without obligation, this valuable work.

INSIDE TRADE INFORMATION ON:

Soldering, tinning. Joint wiping, bending, beating. Pipe—iron—steel, threading. Mathematics, tables, physics. Materials—iron, steel, copper, brass, lead, tin, antimony, etc. Sheet metal—galvanized—plate. Sanitation, syphonage, tanks. Drainage, sewage, purification. Fixtures—bath—kitchen. Pipe fittings, soil pipe, tools. Laying out work. Roughing. Bore-d fittings, flanges, joints. Pipe bending, examples. Elbows. Heating, ventilation, air conditioning, refrigeration. Water supply, mains, wells, tanks. Gas-fittings. Sheet metal work, problems, methods. Brazing, heating, lead burning. Welding, various useful methods. Blacksmithing, forges, tools. Air Conditioning.

THEO. AUDEL & CO., 49 W. 23rd St., New York City

Mail Audels Plumbers Guides, 4 vols., on 7 days' free trial. If O. K. I will remit \$1 in 7 days, and \$1 monthly until \$6 is paid. Otherwise I will return them. No obligation unless I am satisfied.

Name _____
Address _____
Occupation _____
Reference _____ P.M.



CAN YOU FIX IT?

These wonder books tell step by step **HOW** to make difficult repairs and adjustments, how to keep a car at maximum efficiency, including latest improvements in car design and operation. Engine troubles and how to correct them well covered.

6 BIG VOLUMES

2800 pages, 2000 illustrations, wiring diagrams, etc., including Diesel engines. Beautiful modernistic, washable cloth binding.

AMERICAN TECHNICAL SOCIETY, Dept. A119
Drexel Ave. at 58th St., Chicago 37, Ill.

I would like to examine your Six-Volume Set of Auto Books. I will pay the delivery charges only, but if I choose I may return them express collect. If after 10 days use I prefer to keep them, I will send you \$2 and pay the balance at the rate of only \$3 a month until \$24.80 has been paid. Please include consulting service as offered above.

Name _____
Address _____
City _____ State _____

Please attach letter stating age, occupation and address of employer and of at least one business man as reference. Men in service, also please give home address.

AUTO

BOOKS SENT FREE

ON APPROVAL. Just mail the coupon and we'll send you a complete set of Six Auto Books, 20th Edition. Whether you are a mechanic or helper, expert or apprentice, auto owner or driver, take immediate advantage of this **FREE EXAMINATION OFFER.**

MAKE GOOD MONEY NOW HOLD A PERMANENT JOB

America's autos must be kept in service, now and after the war. Men with "know how" are in demand, at big pay. These books will help you get and hold an important job, or give you a chance to go into business for yourself now or later. Any man who half tries to improve himself can learn auto servicing and repairing by this quick reference method. Use the **JIFFY INDEX** to find easily understood answer to any auto problem. These wonder books prepared by eleven of America's great automobile engineers. Many hundreds of valuable illustrations. Send the coupon **TODAY.**

A year's consulting privileges with our engineers now given with these books without extra charge.

Vocational Publishers Since 1898



SUCCESS!

How to Get Along in this World

Here, gathered together for the first time, are 5000 gems of worldly wisdom on how to live joyously, successfully . . . how to handle people, make money, be happy. Written out of **actual experience** by the best brains of mankind . . . during the past four thousand years! To-the-point, **workable** instructions on getting ahead. Only \$1. Included are lessons on **how to use** these quotations in your daily life. Clip and mail coupon below for **FREE** details today.

Short-Cut Mathematics

COMBINED WITH
Practical Mechanics Simplified

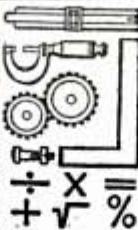

Be a "master mind." Learn how to juggle figures, do baffling tricks with numbers. Add long columns of figures this lightning-quick, short-cut way. Multiply 4 figures by 4 figures without old-fashioned multiplication. Here are speedy, simplified systems used by stage "wizards," expert accountants, engineers. Only \$1. Course includes illustrations, problems, answers. Mail coupon below!



SUPER JU JITSU

Now.. get tough DOUBLE-quick!

Fear no man. The bigger they come the harder they fall. Super Ju Jitsu is easy to learn. Big illustrated self-instruction course shows you how to disarm, disable and capture an armed attacker—with only your bare hands! Get amazing details at once—mail coupon below.

MAGIC AND CARD TRICKS



HOW to PERFORM for FUN and MONEY
Mystifying stunts made easy. **Secrets of magic** revealed in new illustrated course. Teaches tricks with coins, handkerchiefs, balls, ropes, etc. Shows you how to protect yourself from card sharks . . . **their card manipulations exposed!** Get the "inside" information on baffling stage performances. Learn how to be a magician and entertain friends. Mail coupon for **FREE** details.

CARTOONING MADE EASY

New Self-Instruction Course

Learn how to draw funny pictures for money—caricature, comic strip, gag-cartoon, political and editorial cartoon, etc. **Practical simplified** method takes out all the mystery. Step-by-step lessons for home-study. Excellent **SPARE-TIME** training for pleasure and profit. **FREE** interesting details on request. Just send name and address on coupon below.



how to write better letters

Make your letters **CLICK!** Learn to put warmth and sparkle into business and social correspondence. **Practical brass-tacks** instruction on writing successful job-getting application letters, exciting keen-witted friendly letters, etc. **ACTUAL EXAMPLES** show tested ways of packing your letters with vitamins. Fascinating details on request . . . **FREE.** Just mail coupon below today!

NELSON CO., Dept. 1A02, 321 S. Wabash Ave., Chicago 4, Ill.
Write today for complete details on any of these **SELF-INSTRUCTION COURSES.** Send coupon below for the world-famous copyrighted Success-Catalog—it's **FREE**, on request.

FREE details . . . mail coupon!

NELSON CO., Dept. 1A02, 321 S. Wabash Ave., Chicago 4, Ill.
Please send me—**FREE** and without obligation—illustrated Success-Catalog containing information about the course (or courses) I have checked below. No salesman will call.

- | | |
|--|--|
| <input type="checkbox"/> Success! | <input type="checkbox"/> Magic and Card Tricks |
| <input type="checkbox"/> Short-Cut Mathematics | <input type="checkbox"/> Cartooning Made Easy |
| <input type="checkbox"/> Super Ju Jitsu | <input type="checkbox"/> How to Write Better Letters |

NAME _____

ADDRESS _____

CITY _____

STATE _____

Become a REAL ESTATE Specialist

Tremendous opportunities! National Housing Administration Survey reveals 12,600,000 homes needed. Vast shifts of industrial population, government loans to returning veterans, widespread urge to "buy something real," higher incomes on farms, in towns, cities—all mean tremendous expansion in real estate business. Prepare **NOW** to cash in on big profits. You can learn—in spare time at home. No need to give up your present job. Start in "on the side"—then build up good full time business as your own boss; pleasant outside work, your own working hours.

Our practical home-study course prepares you for this money-making, big-future business. No previous experience needed. Free book describes course—tells how you can quickly learn to make excellent income. Write for free book at once. No cost; no obligation; no salesman will call. **School of Real Estate Training, Dept. 52, 12 East 46 St., New York 17, N. Y.**

Inventions Wanted

Patented or Unpatented

Inventions can now be safely sold without patenting expense. If you have a practical, useful idea for sale, either unpatented or patented, write **Chartered Institute of American Inventors**
Dept. 4, 631 Pa. Ave., N. W. Washington, D. C.

Learn to Service & Repair ELECTRICAL APPLIANCES

Open your own electrical appliance service shop. Complete illustrated course covering house wiring, motor repairs, house appliance repair. Send today for **FREE BOOKLET** without obligation.

PACIFIC TRAINING SCHOOL

4701 W. Pico

Dept. AP-1

Los Angeles 6, Calif.

LAW

STUDY AT HOME for PERSONAL SUCCESS and LARGER EARNINGS. 35 years expert instruction—over 108,000 students enrolled. L.L.B. Degree awarded. All texts furnished. Easy payments. Send for **FREE BOOK**—"Law and Executive Guidance."

AMERICAN EXTENSION SCHOOL OF LAW
Dept. 49-M, 646 N. Michigan Ave., Chicago 11, Ill.

Learn Public Speaking

At home—in spare time. Many overcome "stage-fright," gain self-confidence and increase earning power, this easy way. Write for free booklet, *How to Work Wonders With Words* and requirements.

North American School, Dept. 1351
1315 Michigan Ave., Chicago 5, Ill.

INDIANA TECHNICAL COLLEGE

Engineering B.S. degree in 27 months. Aeronautical, Mechanical, Chemical, Civil Electrical, Mechanical and Radio Engineering. Govt. approved for G.I. bill. Prep courses, no added cost. Large industrial center. Earn living expenses. Graduates successful. Enter March, June, Sept. and Dec. Catalog. **515 E. Washington Blvd., Fort Wayne 2, Indiana.**



JOKE BOOKS For Adults

The kind they like. You will be both a Riot and the Life of the Party with a set of these pocket size joke books. They are full of Entertainment, Fun and Humor. A special assortment of 12 books all different for \$1.00. Print name and address, send cash or stamps to:

TREASURE NOVELTY CO.,
72—5th Ave., Dept. 1201, N. Y. 11, N. Y.

BETTER SIGHT

SIGHT-TRAINING technique improved. Everybody gets results now. **WRITE:** Dept. P-1, "USTI" 4057 Budlong Ave., Los Angeles 37, Calif.



Please send me your **FREE** Sight Chart with instructions.

Name

Address



Three months after taking your course I STARTED TO PLAY FOR DANCES

"Before I took it I didn't know a note of music"

writes Miss Rosie Montemurro of Vancouver, B. C., Canada

• "Words cannot express my feelings to the U. S. School of Music. Before I took your course I didn't know one note of music. Three months later I started to play for dances. It has a clear explanation in every lesson." *Miss Rosie Montemurro.*

You, too, can learn your favorite instrument quickly, easily, for ONLY 7c A DAY

This letter is typical of many we have from pupils. Thousands who didn't know a note are now playing their favorite instruments—thanks to this simple home study method of learning music for *only 7c a day.*

Learning music this famous "Print and Picture" way is easy as A-B-C! No long-winded explanations. No tiresome exercises. You play real tunes by note right from the start. If interested, send for Free Booklet and "Print and Picture" Sample. Mail coupon today, to: U. S. School of Music, 71 Brunswick Bldg., New York 10, N. Y.

See how easy it is!

"My country 'tis of thee, sweet land of liberty"



★
Look at the music. The first note is "C". Follow the dotted line to the keyboard and locate "C" on the piano. Find other notes the same way. Strike notes as indicated and you'll play the melody of America.



SUCCESSFUL 47TH YEAR

U. S. School of Music
71 Brunswick Bldg., New York 10, N. Y.

Please send me Free Booklet and Print and Picture Sample. I would like to play instrument checked below.

Piano	Saxophone	Clarinet
Guitar	Trumpet, Cornet	Tenor Banjo
Hawaiian Guitar	Modern	Mandolin
Violin	Elementary	Practical
Piano Accordion	Harmony	Finger Control

Name..... Have You Instrument?.....

Address.....

City..... State.....

Save 2c—Stick Coupon on Penny Postpaid

Get into Good Paying AUTO BODY and FENDER WORK



BIG DEMAND in Auto Body and Fender work. Start training now spare time at home for good pay work now and postwar. Practical shop experience included. U.E.I. Training covers metal work, welding, painting, etc. Placement service—or we will show you how to start own shop. Behind U.E.I. TRAINING is a large national organization founded 1927.

Write today for Free Facts—No obligation

AUTO-CRAFTS DIVISION • UTILITIES ENGINEERING INSTITUTE
1314 BELDEN AVENUE, DEPT. 115X, CHICAGO 14, ILLINOIS

STAMMER ?

This new 128-page book, "Stammering, Its Cause and Correction," describes the Bogue Unit Method for scientific correction of stammering and stuttering—successful for 44 years. Benj. N. Bogue, Dept. 1820, Circle Tower, Indianapolis 4, Ind.

GET THIS
FREE
BOOK!

Learn TOOL DESIGN

Qualify quickly as Machine or Tool Designer through sparetime home study. Many making \$100 to \$125 a week. Expanding industry calling for more machine and tool designers than available. Good pay jobs waiting. Rush name and kind of job wanted today for full free facts.

OHIO INSTITUTE OF TECHNOLOGY, Box 500, Greenville, Ohio

ARTISTS MAKE MONEY

Find out your ability. Send name, age, occupation and address for Free Vocational Art Test.

ART INSTRUCTION, INC. (Formerly Federal Schools)
1135 Art Instruction Building, Minneapolis, Minnesota

FIX TYPEWRITERS

A Simplified Practical Homestudy Course. Many of our Students now have their own Business. Many Repair for others. Repair Shops Swamped. Health or Age no handicap.
WEBER TYPEWRITER MECHANICS SCHOOL
Box 269, Osborn, Ohio



ELECTRICIANS! RADIO MEN!

Earn More Money!

Get this new
GIANT SIZE



**ELECTRICAL
and RADIO
TROUBLE
SHOOTING
MANUAL**
GUARANTEED BY
COYNE

Yours 5 Days Free

**OVER
500**

**Large Size
Electrical
and Radio
Shop Prints
-How to read
and use them**

Needed by war workers, maintenance men, beginners, old timers! Nothing else like it. Saves time, helps boost your pay... **4 GREAT BOOKS IN ONE!**
1. New Step-by-Step Trouble Shooting Course. 2. 500 Shop Prints. 3. Electrical Radio Dictionary. 4. Spare Time Jobs.

FREE! 1 yr. Technical Counsel by mail from COYNE staff, on trouble-shooting problems.

SEND NO MONEY! See offer below. Satisfaction guaranteed by famous COYNE "Learn - by - Doing" Electrical School. Rush coupon now!

H. C. LEWIS, Pres., Dept. 15-R6
COYNE ELECTRICAL SCHOOL
500 S. Paulina St., Chicago 12, Ill.
Send, with all shipping charges paid, your new COYNE Electrical and Radio Trouble Shooting Manual. Within 5 days after getting it I'll either return it or send \$3, then \$3 monthly until total of \$8.95 is paid. (1) Cash price \$8.00—you save over 10%. Same 5-day free trial and return privilege.

NAME.....
ADDRESS.....
CITY..... STATE.....

DRAFTSMEN NEEDED

Now



Industry is clamoring for more draftsmen for the job can't start until plans are drawn. Buildings, airplanes, machines, guns, tanks, bridges, all start on the drafting board, so it's no wonder that every good draftsman has a fine job. Yes, more draftsmen are needed NOW. The pay is good and the opportunities for advancement great.

Learn at Home in Spare Time

Begin now to turn spare hours into money. Be a draftsman, the connecting link between a mechanic and an engineer. Enjoy the wonderful opportunities for promotion that exist now. No experience or artistic talent is needed. You don't have to leave your present job while learning. Use spare time.

American School, Dept. DD145, Drexel Ave. at 5th St., Chicago 37, Ill.

Gentlemen: Send me FREE information covering special training in subjects checked below. No obligation on my part.

- | | |
|---|--|
| <input type="checkbox"/> Drafting and Design for Men and Women | <input type="checkbox"/> Electrical Engineering |
| <input type="checkbox"/> Cost Accounting for Mfg. Architecture and Building | <input type="checkbox"/> Diesel Engineering |
| <input type="checkbox"/> Automotive Engineering | <input type="checkbox"/> High School Course |
| <input type="checkbox"/> Business Management | <input type="checkbox"/> Plastics |
| <input type="checkbox"/> Railway Training | <input type="checkbox"/> Mechanical Engineering |
| | <input type="checkbox"/> Aviation <input type="checkbox"/> Radio |
| | <input type="checkbox"/> Shipbuilding |

Name.....

Address.....

KEY TO A PRACTICAL UNDERSTANDING OF ELECTRICITY



AUDELS HANDY BOOK OF ELECTRICITY

\$4 HANDY SIZE

For Engineers, Electricians, Students and all interested in Electricity. A quick, simplified, ready reference, giving complete instruction and practical information. Easy to understand. A reliable authority and a handy helper that answers your questions.

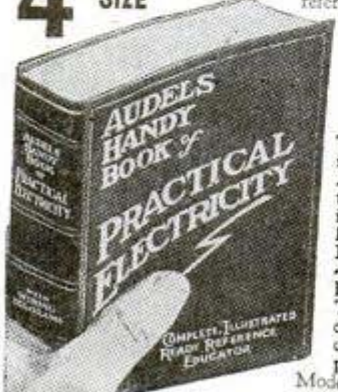

INSIDE TRADE INFORMATION ON

- The Rules and Laws of Electricity~Maintenance of Machinery~A. C. and D. C. Motors~Armature Winding and Repair~Wiring Diagrams~House Lighting~Power Wiring~Cable Splicing~Meters~Batteries~Transformers~Elevators~Electric Cranes~Railways~Bells~Sign Flashers~Telephone~Ignition~Radio Principles~Refrigeration~Air Conditioning~Oil Burners~Air Compressors~Welding, and many Modern Applications explained so you can understand.

1340 PAGES
2600 ILLUS.

To get this assistance for yourself, simply fill in and mail the FREE COUPON below.

THEO. AUDEL & CO., 49 West 23rd Street, New York
Please send me "Audels Handy Book of Practical Electricity" for free examination. If satisfactory, I will send you \$1 in 7 days, then \$1 monthly until \$4 is paid. Otherwise I will return it.

Name.....
Address.....
Occupation.....
Reference..... P M



READ FOR PROFIT!

Law!

LEARN AT HOME

Are you adult, alert, ambitious, willing to study? Investigate LAW! We guide you step by step—furnish all texts, including 14-volume Law Library. Training prepared by leading law professors and given by member of bar. Degree of LL. B. conferred. Low cost, easy terms. Send NOW for Free, 48-page "Law Training for Leadership."

LASALLE Extension University, 417 So. Dearborn St. A Correspondence Institution Dept. 164-L Chicago 5, Ill.

IMPROVE YOUR PLAYING



PIANISTS—Send for FREE Booklet showing how you may greatly improve your technique, accuracy, memorizing, sightreading and playing thru Mental-Muscular Coordination. Quick results. Practice effort minimized. Used by famous pianists, organists, teachers and students. No obligation.

BROADWELL STUDIOS, Dept. 155A, Covina, Calif.

HOW TO GET A BIG PAY JOB IN Real Estate

Write for FREE BOOK!

Tremendous real estate boom predicted. Big-pay, permanent jobs of your own profit business. Salaries up to \$2,500 to \$10,000 a year in property management. brokerage, appraisal, loans, insurance, building. Many make fortunes selling real estate. Thousands of trained men, women, required yearly by real estate firms, insurance companies, banks, Federal agencies. Rush post-card for 32-page QUIZ BOOK—mailed FREE with full details on new and only 5-volume library, MODERN REAL ESTATE PRACTICE! Lane Books, Dept. B-1, 100 East Ohio St., Chicago 11, Illinois.

What Every Mason Wants



We have important Masonic books for Blue Lodge, Chapter, Commandery, Scottish Rite, and Shrine.

Our Rituals Are Used the World Over. Send for free catalog of books and rituals for Masons, Odd Fellows, Knights of Pythias, Knights of Columbus, Elks, etc. EZRA A. COOK, Publisher, P. O. Box 796, PJY, Chicago 90, Ill.

START YOUR OWN SHOP

Men wanted now and after the war for Plastics, Auto-Diesel, Machinist, Drafting, Refrigeration, Welding, Body & Fender, Aircraft. Earn real money or be independent in your own business. Free booklet. Specify trade. State whether interested in Home Study or Practical Shop Training. GREER, Dept. 215, 2017 S. Wabash Ave., Chicago

Learn PHOTOGRAPHY at Home

Splendid opportunities. Prepare in spare time. Easy plan. No previous experience needed, common school education sufficient. Send for free booklet "Opportunities in Photography", particulars and requirements.

American School of Photography
1315 Michigan Ave., Dept. 1351, Chicago 5, Ill.

COLOR CONCRETE WITH CHEMICALS

A business of your own. Big money making Hollywood style pottery and birdbaths without moulds. Washing-wells, stucco-rock, benches, Marbling and cement water-paints. 10c brings sample, literature, pictures. Hollywood CementCraft, 8529 Wonderland Ave., Hollywood 46, California

SUIT YOURS AS A BONUS

And Big Money in Spare Time, Too

We want you to wear this fine made-to-measure suit! Make it yours by sending a few orders, and earn BIG CASH PROFITS in spare time. Your suit will help you get more orders with scores of rich, quality fabrics, tailored-to-measure to newest styles. Also Ladies' Tailored Suits—complete line. Write today for FREE S&HP. No experience, no money needed. For quick action tell us about yourself. J. C. FIELD & SON
Harrison and Throop Sts., Dept. N-1716, Chicago, Ill.



**START
YOUR OWN
BUSINESS**

GET INTO PLASTICS

SMALL CAPITAL — WORK AT HOME

New miracle Plastics industry offers you unlimited career opportunities. Get started now in your own Plastics business or prepare for postwar plastics employment. Take your place in the new Plastics Era. Now for the first time you get practical training in your own home. This new plan gives you the fundamental technical knowledge covering all branches of the Plastics industry including all types of Plastics materials. This is not a novelty program but a real sound educational plan. The actual practical work consists of working with many different types of Plastics materials—teaching you fabrication, shaping, forming, finishing, cementing methods, mold making, casting, compounding, etc. For full information send this ad with your name in an envelope or paste on a penny postcard.—To Dept. M.

➔ **PLASTICS TECH** 1845 E. 9th St.,
Cleveland 14, Ohio

To Mechanically Inclined Men:

REFRIGERATION AIR CONDITIONING



Get ready for your share of the success many will enjoy installing, servicing and maintaining Refrigeration and Air Conditioning equipment. Get practical training by home study balanced with actual practice using real shop equipment. U.E.I. established 1927. Be the boss in your own shop or prepare for employment opportunities. Write for details TODAY.

UTILITIES ENGINEERING INSTITUTE

Dept. S-3 1314 W. Belden Avenue Chicago 14, Ill.

THERE'S MONEY IN CARTOONS!

RAYE BURNS will teach you HOW to CREATE ORIGINAL CARTOONS at home that you may SELL! Course contains 26 lessons and over 600 illustrations. All for Only \$2.85

Send name and address for free details.

RAYE BURNS SCHOOL, Dept. M, Box 3583, CLEVELAND, OHIO

Pays HOSPITAL BILLS for Whole Family

**Costs 3c a Day for Adults
Only 1½c a Day for Children**

It's here! The new Family Hospital and Surgical Expense Policy you need and want! One policy insures whole family—mother, father, children, anyone from 3 months to 65 years. No medical examination. Pays up to \$10,000 hospital and surgical bills for EACH and EVERY person insured. Pays up to \$100.00 doctor's fees for operations. Pays up to \$50.00 for operating room, medicines, ambulance, etc. Covers sicknesses, accidents, operations, childbirth, female disorders, and many other disabilities not covered by other policies. You select your own doctor and hospital. This full-coverage Family Hospital and Surgical Policy issued DIRECT to you at special family rates by big, strong company with over \$3,000,000.00 in assets. Investigate! SEND NO MONEY, but mail the coupon below quick for full details—sent FREE. No agent will call on you. Act today!

STERLING INSURANCE CO.

A-486 Sterling Bldg., Chicago 11, Ill.

Send me your FREE INSPECTION Offer of LOW-COST Family Hospitalization Plan.

NAME _____
ADDRESS _____
CITY _____ STATE _____

Do YOU Want the STRENGTH, POWER and DEVELOPMENT of a CHAMP?

... then let

JOE BONOMO

Master Builder
of Men, show
YOU how to build
YOUR BODY into
MEAT and MUS-
CLE; and your
MUSCLES into
SPRINGS of
STRENGTH and
STEEL.



All my life I've been building big muscles and powerful bodies out of scrawny little ones. I've done it for thousands with my "Power-Plus" Method, the most original System of Physical Development ever devised: the system that "Proves It With Results"! I'm so sure I can do it for you that I offer my **MONEY-BACK GUARANTEE!** Let me give you the build, strength, energy, vitality you want.

Send NOW for this Amazing, Complete 3 WEEKS "POWER-PLUS" SPEED COURSE

in muscular development for

ARMS, SHOULDERS, CHEST, BACK, LEGS



JACK DEMPSEY says:

"I consider your course order or check), or I'll send complete course COD. Pay postman 97c plus postal charges. ACT FAST! Clip and mail coupon to me TODAY!"

Covers every part of your body inside and out. Gives you strength, build, speed and endurance. 18 daily work-out charts, 91 separate Photo-Instructor illustrations, 22 sheets of instructions showing how to do the proven "Power-Plus" Muscle Builders, 3 illustrated Body Fact Lectures and more. Packed with facts about your body, including diagrams of muscles, nerves, organs. \$5.00 value, but it's yours now, complete for only 97c and a 3c stamp (or send \$1.00 cash, money-order or check), or I'll send complete course COD. Pay postman 97c plus postal charges. ACT FAST! Clip and mail coupon to me TODAY!



BERNARR MACFADDEN says:

"Your astonishing achievement places you at the head of all your competitors."

FREE For Quick Action!

Strong men ACT, but as an inducement to urge you to act fast, if you send coupon at once, I'll send you my famous P.D.Q. Test Dozen. Find out how strong you really are! **RUSH COUPON TODAY.**

JOE BONOMO, Dept. 501-A
1841 Broadway, New York 23, N. Y.

MAIL COUPON NOW!

\$5.00 value only
97c and a
3c stamp

Joe Bonomo, personal
Bonomo Culture Institute,
1841 Broadway,
New York 23, N. Y. 501-A

Dear Joe: That's what I want—fast action! Rush me quick, my complete 3 weeks "Power-Plus" SPEED COURSE. Include FREE your famous P. D. Q. Test Dozen.

I enclose \$1.00 cash, money-order
 Send COD, I will pay postman 97c plus postal charges.

Name _____ Age _____

Street _____

City _____ Zone _____ State _____
(Please print plainly)



DANCE IN 5 DAYS . . . OR NO COST!
LEARN NEWEST STEPS—INCLUDING RHUMBA, SAMBA, CONGA and JITTERBUG, FOX TROT and WALTZ.

Let dancing open the door to Romance and Happiness for you! This sensational new book helps you learn the latest steps, quickly, easily. A revolutionary book that offers a shortcut to dancing. **MAKE THIS TEST!** Send today for Betty Lee's amazing book—it's packed full of diagrams and tells in simple language how to do the Jitterbug, Rhumba, Conga, Samba and other exciting new dances

—also the ever-popular Waltz, Fox Trot, and many old-time favorites. **SEND NO MONEY!** Act now, and we'll send you as a gift, 2 additional books **FREE** of any extra charge, "Tip Top Tapping," and "Swing Steps." And remember—if not satisfied with results in 5 days you may return the book and your money will be refunded.



PIONEER PUBLICATIONS, INC.
 1790 Broadway, Dept. 941H
 New York 19, N. Y.
 Send me by return mail, in plain wrapper "Dancing," by Betty Lee, and include 2 free books.
 Ship C.O.D. I will pay on arrival, plus postage.
 I enclose \$1.98. Ship postage prepaid. If in 5 days I do not learn to dance, I may return book and you will refund purchase price.
 Name.....
 Address.....
 City..... State.....

NOTE. After reading the book described below, pass it on to your service man or woman. They like it **MUCH** for after-war plans for jobs and independence. Welcome gift.

How to Make Money by Mail

Down-to-earth facts, directions (illustrated) for running business profitably, using expertly for your good fortune the employees, trains, planes which Gov't places at your disposal **CHEAP**. Get orders by mail, ship by express or freight or mail, **get out of the kindergarten**. . . 2nd printing of this book now selling. It's **YOUR** winner.



THE EASY WAY to start new or expand your present occupation. **Do it NOW.**

Extraordinary plain, simple skill, know-how. No theory. Fact story of rich experience of author E. Rice day-by-day. How many times have we heard: "I wish I had some money, this patent would earn me a fortune," or "why can't my crop pay better?" or "I wish I knew how to sell this gadget myself," or "why should my boss alone do this when I know too how the money is made?" **Listen, you do not need money** to start this Rice way. His method **automatically** pays all bills same day rendered, no bank loans, pay as you go, no borrowing from relatives or friends, no salaried. Also no worry, quickly a home of your own all paid for. **Rice paid off \$5000 in mortgages** a year after using this idea.

44 Years of PROOF

Sounds fishy? Sure, but this has been done steadily for 44 years, depression or no depression, by the author: that is why he wrote this book to pass the good word along. **Make it go with anything you have** which is salable. Rice did it with poultry when living in one room in a city lodging house. **Turn your city or country home, your work, your hobby into money.** How to get orders at cost of only \$4 for each \$100 taken in. The popular error to avoid in trying for sales. Business won free while others have to pay for it. How to conceive the money-getting advertisement. Profitable changes from ordinary ideas and methods. Not usual cut-dried pattern, 60 adventures, a dictated book in everyday talk, no dictionary writing.

Take a chance on this book being worth a fortune to you and yours and send \$2.50. Book mailed same day order is received. Or ask two friends to chip in 83 cents each with your \$4 to get this book. Hundreds of buyers whose letters we show you declare emphatically its superlative goodness. Follow its easy pattern for success. Cloth-bound, 312 pp., 8 1/2 by 5 1/2. Best seller, 2nd edition now selling. Cut out the \$2.50 **HOW BOOK** here, pin or stick it to sheet of paper bearing your name and address, mail in envelope with money order or check for \$2.50 to



HOWARD ST. HOUSE, Melrose 76d, Massachusetts

LOOK! Baby Chicks
THOUSANDS WEEKLY ALL YEAR. Finest quality & Layers in 40 breeds. Hybrid Baby Pullets and Cockerels, B. W. D. Fuzzed, Ducklings, Baby Turkeys, Maters. Catalog free. Order in 65 breeds. Catalog free. **ORDER NOW.** Make BIG money raising NABOB QUALITY CHICKS.
NABOB HATCHERIES, BOX - M, GAMBIER, OHIO

RADIO REPAIR HINTS
 "Radio Servicing Made Easy." New large manual tells how. Hints, pictures, diagrams to help you. Size: 8 1/2 x 11 in. **25¢**
 Supreme Publications, 9 S. Kedzie Ave., Chicago 12, ILL.

LEARN MEAT CUTTING At Home - In Spare Time
 Prepare for a REAL opportunity NOW—and for even greater opportunities when war is won! Thousands of Meat Cutters, Clerks, Apprentices, Managers, Inspectors, Supervisors etc., needed by Meat Stores, Super Markets, Packing Houses, Processing Plants, Hotels and Restaurants. Whether you are a beginner or experienced you can learn easily and quickly AT HOME how to develop and use your REAL ABILITIES as Meat Cutter, Market Manager or Market Owner. Know how to figure percentage—**CUT MORE PROFIT**—merchandise. Be an expert Meat Cutter and get the extra earnings of an expert. Make more money in a store of your own. Instructions based on 30 years experience and "Learn by Doing" training methods used at National's famous Resident School of Meat Cutting, GUARANTEED. Endorsed by leading meat men. Diploma. This vital field pays better NOW than ever before—and at the same time offers you security of a peace-time future. Investigate! Send for FREE bulletin today! No obligation.

National School of Meat Cutting, Inc., Dept. U53, Toledo 4, Ohio
 Send me your FREE Bulletin. (No Salesman Will Call)
 I work in a market. I own my own store. I know nothing about meat cutting.
 Name.....
 Street.....
 City and State.....

The Steady Pay Profession Good Times or Bad!

SCIENTIFIC CRIME DETECTION



It Is Easy to Learn!
 I will teach you this fascinating science during your spare time at home. It pays to be an expert in Finger Printing, Firearms Identification, Police Photography and Secret Service Methods. I have trained hundreds of men and women now successfully serving in identification bureaus throughout America. You, too, may quickly prepare yourself to become a well-paid valued officer of the law, often sharing in the generous rewards offered for wanted criminals.

FREE! 53 PER CENT

"BLUE BOOK OF CRIME"
 This book is full of exciting information on scientific crimedetection. It will show how You can get started in a grand career. Now, at amazingly low cost. Clip coupon now... Mail it today.

INSTITUTE OF APPLIED SCIENCE
 1920 Sunnyside Ave., Dept. 1351 Chicago 40, Ill.

INSTITUTE OF APPLIED SCIENCE
 1920 Sunnyside Ave., Dept. 1351, Chicago 40
 Gentlemen: Without any obligation on my part, send me the "Blue Book of Crime," and complete list of Identification Bureaus employing your students or graduates, together with your low prices and Easy Terms Offer. (Literature will be sent ONLY to persons stating their age.)

Name.....
 Address.....
 Age.....

★ TRAIN for SUCCESS in the Poultry Business



Study at home in spare time. Earn extra while learning.

You Can Make More Money from POULTRY

All signs point to big opportunities ahead for progressive poultry leaders—especially in the post-war period.

Get ready NOW! Proper management means profits ANY season, for life. Our easy, scientific course is NOT expensive. Its small cost should come back to you many times over! Even the first year, your extra profits should be far greater.

Learn at home, the EASY, SCIENTIFIC, and INEXPENSIVE way. Our course covers ALL phases of Poultry raising, including plans for buildings, breeding, hatching, culling, sexing, caponizing, marketing, judging, exhibiting, and many others, etc., as planned by Harry M. Lamon, former Senior Poultryman for the United States Department of Agriculture.

In the past twenty-two years, we have helped thousands of students to establish poultry farms, to increase profits on established plants, to secure positions in the many branches of the Poultry business, and many just to enjoy a small, profitable, breeding plant.

Write TODAY for catalog "How to Raise Poultry for Profit." It fully explains courses and easy payment plan.

NATIONAL POULTRY INSTITUTE
Dept. 50-T, Adams Center, New York

ELECTRICAL BOOKS

shipped FREE

8 BIG BOOKS

FOR EXAMINATION MODERN ELECTRICITY INCLUDING RADIO AND REFRIGERATION

Here's great news for anyone interested in Electricity. NEW, up-to-date 19th Edition of Applied Electricity with new subjects fully covered, including blueprint reading, electronics, P. M. radio, fluorescent lighting. 8 Big Books FREE for examination!

NEW Edition for Beginners and Experts

Over 3700 pages, 2700 illustrations and 134 tables in most complete electrical work we have published. Dynamotors, diesel plants, power stations, transmission—everything explained for easy understanding.

BIG FIELD! Big Demand! Big Pay!

Men who understand electricity are needed now in all kinds of industries, and will be needed when war production has ended. Practically every business depends on electrical knowledge, and men who know this subject make big money. Learn easily with these new, interesting books. Send coupon for a set for FREE examination. See how they will help you to get ahead faster.

SEND NOW

A year's consulting privileges with our engineers now given to all buyers of this famous Cyclopedia of Electricity.

AMERICAN TECHNICAL SOCIETY
Vocational Publishers Since 1898

American Technical Society, Dept. E 119, Drexel at 58th St., Chicago 37

Send for 10 days' free use. 8 volume set of New 19th Edition, Applied Electricity, including a certificate entitling me to consulting privileges for one year. I will pay the delivery charges only on the books. If I wish I may return them in 10 days and owe you nothing, but if I keep them, I will send \$2.00 after 10 days, then \$3.00 a month until the total price of only \$29.80 is paid.

NAME
ADDRESS
CITY STATE

Please attach letter stating age, occupation and name and address of employer and have at least one business man as reference. Men in service, also please give home address.

AVIATION Career



Never was it more opportune for you to get into Aviation! In preparation for future peacetime activity, a change in the name of this school has been made to CAL-AERO TECHNICAL INSTITUTE, simplifying and coordinating relative operations. — SAME SCHOOL — SAME MANAGEMENT — SAME LOCATION — SAME PERSONNEL — SAME SPECIALIZED TRAINING in Aeronautical Engineering and Master Aviation Mechanics incorporating all the latest developments and methods to insure a thorough foundation for your future career in Aviation. Flight training is restricted to the training of Army Air Force cadets for the duration.

Created during the war, the name "Cal-Aero" emerges symbolic of the highest standards of Aviation Training. Having trained more than 20,000 pilots and 7,500 ground-crew men for the Army Air Forces, at the same time training thousands of civilians for the production front, the schools under the personal direction of Major C. C. Moseley, since 1929, have been honored by citations for distinguished service in the training of these men. It is but natural, in view of the co-related activities and planning for the post-war period, under this same personal direction by Major C. C. Moseley, that the technical phase of Aviation Training should come under this distinguished new name.

CAL - AERO

TECHNICAL INSTITUTE

MAJOR C. C. MOSELEY PRES. SINCE 1929
FORMERLY CURTISS-WRIGHT TECHNICAL INSTITUTE

LOCATED ON ITS OWN AIRPORT

IN THE HEART OF THE AIRCRAFT INDUSTRY

GRAND CENTRAL AIR TERMINAL
GLENDALE 1, CALIFORNIA
(Los Angeles County)

MAIL THIS COUPON TODAY!

Registrar, Cal-Aero Technical Institute, Grand Central Air Terminal, Glendale 1, California. Please send information and profusely illustrated catalogue on Aviation Training. FREE ... without obligation ... Dept. PM-1

NAME

STREET

CITY

STATE

BIRTH DATE



"CAL-AERO" ... AVIATION'S HONORED SCHOOL OF AERONAUTICS

9 BIG BUILDING BOOKS



SHIPPED
FREE FOR
EXAMINATION

Learn to draw plans, estimate, be a live-wire builder, do remodeling, take contracting jobs. These 9 practical, profusely illustrated books cover subjects that will help you to get more work and make more money. Architectural design and drawing, estimating, steel square, roof framing, construction, painting and decorating, heating, air-conditioning, concrete forms and many other subjects are included.

BETTER JOBS — BETTER PAY

Keep busy now at good pay, and be prepared for after-war building boom. Big opportunities are always for MEN WHO KNOW HOW. These books supply quick, easily understood training and handy, permanent reference information that helps solve building problems.

Coupon Brings Nine Books FREE For Examination

AMERICAN TECHNICAL SOCIETY Vocational Publishers since 1898
Dept. G119 Drexel at 58th Street Chicago 37, I. I.

You may ship me the Up-to-Date edition of your nine big books, "Building, Estimating, and Contracting" without any obligation to buy. I will pay the delivery charges only, and if fully satisfied in ten days, I will send you \$2.00, and after that only \$3.00 a month, until the total price of only \$29.80 is paid. I am not obligated in any way unless I keep the books.

Name.....
Address.....

City..... State.....
Please attach a letter stating your age, occupation, employer's name and address, and that of at least one business man as a reference. Men in service, also please give home address.

Learn REFRIGERATION and AIR-CONDITIONING

ARE YOU HANDY WITH TOOLS?

Exceptional opportunity for men of all ages up to 60. The demand for repair and service mechanics in both REFRIGERATION and AIR-CONDITIONING is acute and will continue after the war. You can easily and quickly—

Learn to Be a Service Mechanic at Home or in Our Shops

Our practical, thorough course is easy to grasp and can be studied at home in your spare hours. No previous experience is needed. A common school education is enough. Learn how to start your own business with \$50.00 worth of tools in garage or basement. Open up your own shop or take a well paid job in this active field.

START
YOUR OWN
REPAIR SHOP

Write for free booklet today. No obligation whatever.

MAIL COUPON TODAY



Send for FREE BOOKLET!

Mechanics Training School

4701 W. Pico, Dept. P-1, Los Angeles 6, Calif.

Dear Sirs: Please send me, without obligation, your free catalog and full details.

Name.....

Address.....

City..... State.....

"The Book They're Talking About"

ART ANATOMY & FIGURE DRAWING

For the amateur and professional artist. Contains over 350 illustrations, charts and notes, giving detailed study of every part of the body. POSED and IN ACTION. Outside U.S.A. send \$1.25. Price Only \$1

MAJOR BOOK CO., Dept. 40-E
72-04 Juno St., Forest Hills, New York

PRINTING PAYS BIG

It offers trained men a peace-time future of opportunity and security. Our home study course will train you. Ask for literature and free lesson.

COURSE ONLY \$14 CASH TERMS AVAILABLE

International School of Printing, Troy, O.
DEPT. 258A

CODE-RECEIVING SPEED

Learn to send and receive Radio Code with greater speed. Stop nervous tension. Have confidence. Be proficient. Same as step used by radiotelegraph specialists. Thousands of operators needed. Rush name for FREE book.

Dept. 5-A, Box 328, Denver 1, Colo., U. S. A.

CANDLER SYSTEM CO.

JIU-JITSU

If over 15 years old, get together with friends for Jiu-Jitsu club. Learn how to defend yourself, keep healthy and have fun. Send 10c for sample lesson.

MODERN SCHOOL JIU-JITSU, Dept. W, 5 W. 52nd St., N.Y.C. 19

Look Way Ahead In Your Fascinating Career as an INSTRUMENT TECHNICIAN



1945 46 47 48

More and more Instrument Technicians will be needed to repair, test, calibrate and build more instruments... in use on more private and commercial planes. Work with all types of instruments, including the automatic pilot, sensitive altimeter and directional gyro. Train now to become a specialist in this well-paid, interesting field, through A. S. A. I.'s practical resident course—or if you prefer, start with the Home Study Course. A. S. A. I. also offers complete training in Watchmaking.

SERVICE MEN! VETERANS!

Ask about Full Benefits available to you under G. I. Bill of Rights. As a technically trained specialist you will be eligible for the real opportunities in postwar aviation. Now is the time to plan your career!



GET THIS FREE BOOK—The complete 24-page story of the A. S. A. I. Resident and Home Study training programs—send the coupon for your copy today!

AMERICAN SCHOOL OF AIRCRAFT INSTRUMENTS
Including Accredited School of Watchmaking
5253 W. San Fernando Road, Los Angeles 26, Calif.

AMERICAN SCHOOL OF AIRCRAFT INSTRUMENTS
5253 W. San Fernando Road, Los Angeles 26, Calif.

Gentlemen: Please send free 24-page book and data on courses checked below, without obligation.

Home Study Instrument Course Watchmaking
 Master Instrument Technician

Name..... Age.....
Address.....
City..... Zone..... State.....
Civilian In Services Veteran P-1

AMERICA'S OLDEST INSTRUMENT SCHOOL

NOW! Enjoy Learning to Speak **SPANISH** at Home Only 15 Minutes a Day!

Learn as a child learns — by LISTENING to native instructors on these brand new **CORTINA RECORDS!**



Right in your living room your instructors talk to you in everyday Spanish — just like any native would, on the streets, in shops, in offices of any Latin American city.

Doing business is much more profitable and enjoyable when you speak Spanish.



How much more the pleasures South of the Rio Grande will mean to you when you really understand the language.

DO YOU realize how much it can mean to you to speak and understand Spanish?

A whole new world of opportunities is opening up south of the Rio Grande. Take advantage of these opportunities there, or cash in on them here at home! Millions of dollars are invested — more millions are being laid out every week — to develop the endless industrial, mining, farming, engineering and other resources of Mexico, Cuba, Panama, Central and South America. The immense volume of business and travel with our 100,000,000 Spanish-speaking neighbors is calling for men and women who can speak their language, be friends with them instead of merely "foreigners"!

It's today's biggest chance. And right here in the United States there are countless openings for correspondents, sales agents and managers, clerks, mechanics, secretaries, stenographers, engineers, men and women who know Spanish, who can talk with customers

when they arrive and correspond with them when they've gone back home!

The Air Lines are fast bringing about a whole new world for you, as an American. Within a very short time you won't be satisfied with going to "the mountains" or "the lake" or "the shore." You'll be going to see new places, meet different people, do more interesting things.

Let your knowledge of Spanish bring you a richer, more satisfying life!

When you speak Spanish you open the doors to this new world. You're part of it. And the simplest, surest way to begin speaking Spanish—to learn it quickly, right in the privacy and relaxation of your own home—is the Cortina way. You begin to understand Spanish almost at once. In an amazingly short time—you are actually speaking Spanish.

And to prove it to you we invite you to look into this offer:



New Cortina Recordings by Native Instructors on 15 Big Symphonic Size Discs
Fifteen large Cortina discs, 30 recordings in all, bring you interesting conversations in everyday Spanish. Every word clear as a bell, and in Spanish that is a pleasure to listen to.

SENT ON 5 DAYS' APPROVAL

Free Book Describes Full Details

READ the free book we will send you describing the CORTINA method, and all about our 5-day approval offer.

This is the simplest way to speak Spanish. You learn by listening. Instead of struggling with complicated textbooks—instead of losing time going to and from classes, you learn at home, relaxed and at ease in as little as 15 minutes a day. Your teachers never lose patience with you. There's no one to hustle you or hold you back!

The EASIEST Way to Learn the EASIEST of All Languages!

—and this is the finest time to learn it! Remember, Spanish means greater social advantages too. Everyone should know at least one foreign language.

And you'll be amazed how quickly you can pick up ordinary Spanish conversation! Business and commercial terms soon become second nature to you.

Today, when Spanish, the most important foreign language in the world, can mean so much financial gain, travel and cultural pleasures, why not see what the Cortina Method can do for you? You risk nothing.

The CORTINA Academy has been teaching languages successfully for 60 YEARS. And it will do for you personally what it has done for thousands of others—if you will give it a chance. Without obligation, send the coupon TODAY for your free copy of the 32-page booklet, "The Cortina Short-Cut."

FRENCH, GERMAN, ITALIAN

Also Taught Courses are as effective in teaching you as the Spanish course described here.

CORTINA ACADEMY

Established in 1882

Dept. 641, 105 West 40th St., New York 18, N. Y.

CORTINA ACADEMY. (Language Specialists for 60 Years)
Dept. 641 105 West 40th St., New York 18, N. Y.

Please send me—without obligation—your free book "The Cortina Short-Cut" and full facts about your special "Proof in 5 Days" Offer.

(Check language in which you are interested)

SPANISH FRENCH GERMAN
 ITALIAN ENGLISH

Name

Address

City State

Make Your Own Post War Plans NOW!

Get Started QUICK in

DRAFTING



I Will Train You Until You Get a **GOOD PAY JOB!** — *Engineer Dobe*

Plan now for a better job and more pay as America changes over to peace-time production. Drafting is the field — now bigger than ever before. And countless thousands of draftsmen and designers must come first—before new production can begin. Get into Drafting. Engineer Dobe will train you at home in your spare time. You'll get experience on actual work—the same kind of job you will do for the best paying firms. You will be trained until you are competent, experienced, and are actually holding a position that will bring advancement and pay raises as deserved. Write today for details.

Previous Experience Not Needed

I train you through practical jobs and give your experience as a reference to employers when you become competent. Lack of previous experience or higher education should not hold you back. Low cost—and monthly payments if desired. Write today for illustrated book and all details. No salesman will call. Give your age to get reply.

WORKING TOOLS FURNISHED

Professional instruments, drawing table and other tools included and sent when you start.



MAIL COUPON FOR VITAL FACTS

Engineer Dobe, Div. 11, Libertyville, Ill.

Send me the Vital Facts on Drafting and Industrial Designing, your FREE BOOK and advertised list of positions for Draftsmen and Designers wanted.

Name, Age,

Address,

City, State,

This exciting, fascinating game teaches you how to speak another language while you play!



LEARN A LINGO is Fun Yes, by playing this game with your friends you will soon speak another language.

LEARN A LINGO is Easy If you can read English you can speak another language by associating pictures with words.

LEARN A LINGO is Quick You speak new words immediately. Any age can play Learn-a-Lingo.

ORDER TODAY! — MAILABLE OVERSEAS

Roger Stephens, Publ., 119 E. 19th St.,

Enclosed you will find \$..... New York 3, N. Y.

Please send at once..... copies of Learn-a-Lingo.

Name
 Address
 City State,

Check Language desired
 Spanish French
 Italian Portuguese

MAKE MONEY CASTING AT HOME

FREE FACTS SENT



Make hundreds of Plastic Casts, quick, easy. Sell output to stores, novelty shops, etc. Enormous profits. No experience. Very little capital needed. Start in basement, garage or workshop. Complete, simple instructions anyone can follow. Start now while merchants are begging for merchandise to sell. Rush.
PLASTIC ARTS STUDIOS, R.R. 4, Dept. 21, Muncie, Ind.

HOW TO HELP YOURSELF TO POST-WAR PROSPERITY

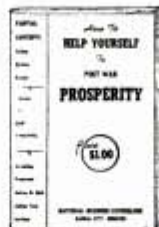

Partial Contents

How I Can Start a Business of My Own. Selling by Mail. Creating and Making Things to Sell. Inventions. Patents. . . . Formulas.

Every worker, serviceman and high school student will be interested in the new book just off the press. Tells how to make easy money part time or full time or how to get in own business. Hundreds of proven ideas are jam-packed within the pages of this book of golden opportunities. Thousands sold. Send only \$1 now for complete book.

BOOKMEN AGENTS

SALESMEN write today for fast moving profitable deal.
NATIONAL BUSINESS COUNSELORS
 Dept. 301 Box 8111 Kansas City, Mo.

ANALYZE HANDWRITING

Qualify for Certified Grapho-Analyst Degree. Earn up to \$100 weekly, up to \$1 hourly spare time, in new uncrowded profession. . . . Graduates in employment and credit fields, police departments, courts, and in private practice as Personal Problem and Vocational Counselors. 3,000 word test lesson and illustrated GRAPHO-ANALYST Free.



ADDRESS A.I.G.A., INC., 120 JOPLIN, MO.

LEARN MACHINIST TRADE TOOL & DIE MAKING

In completely equipped Shops. Also short, special Shop courses for essential War and Post-War Jobs. Learn on actual Shop work. For FREE BOOK, write Dept. PM-15, Allied School of Mechanical Trades, 1340 S. Michigan, Chicago 5, Ill.

Always write your name and full address clearly when answering advertisements.



LANGUAGE IS POWER

... Forge ahead, win special assignments, promotion, better job in global peace time opportunities through ability to speak a foreign language.

MASTER A NEW LANGUAGE quickly, easily, correctly by

LINGUAPHONE

The world-famous Linguaphone Conversational Method brings voices of native teachers INTO YOUR OWN HOME. You learn the new language by LISTENING. It's amazingly simple; thousands have succeeded.

HOME-STUDY COURSES IN 29 LANGUAGES

Send for FREE book—

LINGUAPHONE INSTITUTE

98 RCA Building, New York 20, N. Y. • Circle 7-0830

LINGUAPHONE INSTITUTE,
 98 RCA Bldg., New York 20, N. Y.

Send me the FREE Linguaphone Book.

Name
 Address City,

Language Interested,

1920

Mr. A. G. HOFFMAN
President

1945

Mr. E. F. HOFFMAN
Vice-President

MIDWEST RADIO CORPORATION BEGINS ITS

Silver Anniversary Year

This year of 1945 marks the 25th Anniversary of the Midwest Radio Corporation. It has been a quarter-century of pioneering, of progress, of achievement, of leadership in the field of radio. Very few radio manufacturers can match the unbroken record of continuous manufacture and of faithful adherence to high quality standards which MIDWEST RADIO has established and maintained for the past twenty-five years.

Since its establishment in 1920, Midwest Radio Corporation has figured prominently in the pioneering of many outstanding radio developments. Among them: Single dial, 3-gang condenser battery sets . . . all electric radios . . . superheterodyne . . . screen grid . . . amplified and resonant AVC . . . dual speakers . . . 2400 meters band . . . shielded switching . . . noise-reducing antenna system . . . push button tuning . . . ceramic porcelain insulation . . . reinforced capacitors . . . pre-balanced coil assembly . . . acousti-sonic louvres . . . 9-Band dial . . . and others too many to mention.

Today—although still engaged exclusively in the production of electronic and radio instruments for our Armed Forces—Midwest is planning new and finer radios for the post-war period. And when the new MIDWEST RADIOS are again available you may be sure that you can once again save up to 50% by buying on the famous MIDWEST factory-to-you plan.

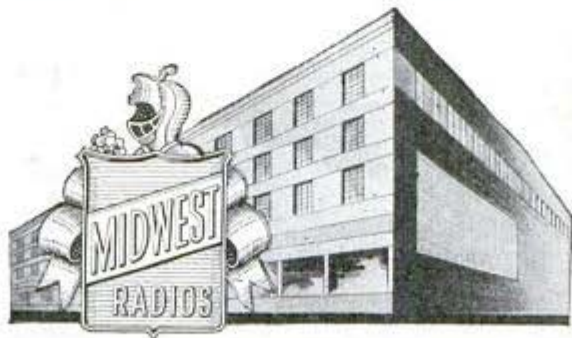

MIDWEST RADIO CORPORATION

DEPT. 15M...ESTABLISHED 1920...CINCINNATI 2, OHIO

INVENTORS!

ONLY \$15 FOR A 24" x 36" **NOTARIZED BLUEPRINT** (DRAWN FROM YOUR OWN SKETCHES)

of your INVENTION or IDEA

Protect your invention while establishing commercial value, developing a model or obtaining technical information. Expedite patenting procedure by making clear to your patent attorney the inventive elements of your idea and gain wider claim for your benefit. A Professional Drawing enhances the value of any invention and helps gain interest and confidence of your employer, financial backer, manufacturer. Put our years of experience in preparing patent drawings, to work for you. Let Draftsmen Associates accurately illustrate the novelty of your invention. Enclose only the initial payment of \$5.00 with your rough sketch and full instructions to start preparation of your drawing, or write for Free Sample Notarized Blueprint and full information. Use coupon below today.

FREE SAMPLE

DRAFTSMEN ASSOCIATES, Dept. B-1,
299 Madison Avenue, New York 17, N. Y.

Enclosed find sketch and description together with \$5.00 for preparation of a Notarized Blueprint.

NAME.....
ADDRESS.....
CITY.....
STATE.....

Check here if you merely desire information and a free sample notarized blueprint.

Learn AIRCRAFT DESIGNING & ENGINEERING

Development of Helicopters, Jet-Propelled Planes and Flying Wings Means New and Greater Opportunities

RYAN'S New Home Study Course Trains You in Spare Time



New planes require new plans—plans that you may help perfect. New airliners, cargo planes and private planes can't be built until plans are prepared, and there'll be a huge need for trained designers and draftsmen to do the work.

Prepare now for one of these exciting, well-paying positions through home study—THE RYAN WAY. Previous training is unnecessary. You learn at home in your spare time under individualized supervision. Lessons are so easy and interesting that many earn the coveted Ryan diploma far ahead of schedule.

RYAN Aeronautical Institute
(Home Study Affiliate of Ryan School of Aeronautics)
421 Lindbergh Field, San Diego 1, California

Please send me, without any obligation on my part, your FREE 24-page illustrated book, "New Horizons of Opportunity," and full information on R.A.I., including cost of training, and job opportunities.

Name..... Age.....
Street.....
City..... State.....

FREE 24-Page Booklet

DIRECT-FROM-INDUSTRY TRAINING
You owe it to yourself to see that the study course on which you spend your time is the finest—most practical. R.A.I. is affiliated with both a famous flight school and aircraft manufacturer. So use this coupon—NOW! It may be your passport to a successful career in aviation. Send Air Mail! No salesman will call on you.

INTRODUCING-New Victory Model HANDIWELDED ELECTRIC ARC WELDER

RETAILS ONLY \$1.95

FULLY GUARANTEED



PLUGS INTO LIGHT SOCKET
Victory Model Handiwelded Arc Welder operates from 110 volts, A.C. or D.C. current same as other arc welders higher priced; generates tremendous heat to weld all metals. Not a toy welder that uses carbons, but actually uses standard coated rods—sizes 1/16" and 3/32". However, due to priorities a generous supply of 1/16" rods only are supplied with the welder. Guaranteed not to burn out. Repairs fenders, auto bodies, radiators, machinery parts, etc. Take Victory Model Handiwelded anywhere to job, operate right from light socket. You'll find a thousand uses for this welder around your home, garage, workshop. Also in garages, factories; mechanics, inventors, plumbers, farmers, etc. Order a "Victory Model" Handiweld now.

SEND NO MONEY We'll rush one to you with rods, helmet, operating instructions, and all necessary parts with the exception of a large jar and a small piece of extension cord; these most everyone has. Pay postman only \$1.95 plus a few cents postage. If not delighted return Victory Model Handiweld in 5 days from receipt and money paid for it will be refunded promptly. Rush your order now.

KUMFY PRODUCTS, Dept. N-202, CINCINNATI 26, OHIO

Always write your name and full address clearly when answering advertisements.

Learn this Profitable Profession

IN 90 DAYS AT HOME

Money-Making Career Open to Men and Women, 18 to 50

Hundreds of men and women between 18 and 50 make \$10 to \$20 in a single day giving scientific Swedish Massage and Hydro-Therapy treatments. There is big demand from doctors, hospitals, sanatoriums and clubs. Graduates earn large full time incomes from these or in private practice in their own offices. Others make good money from home treatments given in spare time. Learn this interesting, money-making profession in your own home, through our home study course. Same instructors as in our nationally known resident school. You can win independence and prepare for future security by qualifying for your Diploma. Course can be completed in 3 to 4 months. Many earn while they learn. Begin your training at once.

Anatomy Charts & Booklet FREE

Enroll now and we will include, at no extra cost, many needed supplies. Fit yourself to help meet growing demand for massage now and after the war. Send the coupon at once for complete details, Anatomy Charts and 32-Page Illustrated Booklet, FREE, postpaid.

THE COLLEGE OF SWEDISH MASSAGE
Dept. 564A, 100 East Ohio St., Chicago 11, Illinois

Please send me FREE and postpaid, Anatomy Charts, 32-page Booklet and complete details on Home Training.

Name.....
Address.....
City..... State.....

730 SHAVES FROM 1 BLADE!

AMAZING NEW BLADE SHARPENER



New sharpener for all makes of double-edge razor blades performs miracles! "Not necessary to change blades," writes one user. Another says, "I have used 1 blade over 730 times." RAZOROLL really sharpens blades because it strokes on leather. Gives keen, smooth shaving edges. No guesswork. Blade held at correct angle and proper pressure—automatically. Just turn crank to sharpen blade. No gears. Well made. Handsome, compact, sturdy. Weighs few ounces. Will last years. Makes ideal gift.

Only \$1.00

SEND NO MONEY! Write today. Pay postman only \$1 plus few cents postage. Use RAZOROLL for 5 days and if you're not delighted with smooth, velvet shaves you get, return RAZOROLL, and we'll return your dollar. Hurry—order today. **RAZOROLL COMPANY**
620 North Michigan Avenue, Dept. 501, Chicago 11, Illinois

PIN-UP GIRLS FOR ADULTS

(pocket size). Thrilling . . . breath-taking, life-like beauties that will make your heart skip a beat. The kind you like! 10 different PIN-UPS sent for 50c or 25 assorted for \$1. Shipped prepaid in plain wrapper. No C.O.D.'s. Send cash or money order. No stamps. NUDKI, Dept. P-165
Box 126, G.P.O., N.Y.C. 1



BOOKS FOUND FREE!

WHAT BOOKS DO YOU WANT?

We quote lowest market prices. No charge for locating Hard-to-Find Books. All books, OLD or NEW mailed POST-FREE. **SEARCHLIGHT BOOK CLUB, 22 East 17th St., New York City**

5¢ EACH LITTLE BLUE BOOKS
Send postcard for our free catalogue. Thousands of bargains. Address: **HALDEMAN-JULIUS CO., Catalogue Dept.**
Desk M-1057, GIRARD, KANSAS

★ SAVE WASTE PAPER ★

JUST OUT! NEW FROM COVER TO COVER

AUDELS REFRIGERATION and AIR CONDITIONING GUIDE



4 Books in One! Covering:
Basic principles, Servicing, Operation, Repair of
1—Household Refrigeration
2—Special Refrigeration Units
3—Commercial & Industrial Refrigeration
4—Air Conditioning Systems
A gold mine of essential important facts for ENGINEERS, SERVICEMEN & USERS.
A Good Book is a Good Friend! Here you have at your fingers' ends a Complete Library in ONE VOLUME, the necessary data you have been looking for on: MODERN UNITS, SYSTEMS & MACHINES, REFRIGERANTS, including Freon, Lockers, Water Coolers, Quick Freezing & Air Conditioning Systems, 1250 Pages, 46 chapters all Fully Illustrated & indexed for Ready Reference.

ANSWERS YOUR QUESTIONS
Get This Information for Yourself. Mail Coupon Today. No Obligation Unless Satisfied. ASK TO SEE IT.

4 COMPLETE • PAY ONLY \$1. A MONTH

AUDEL, Publishers, 49 W. 23rd St., New York 10, N.Y.

MAIL AUDELS NEW REFRIGERATION GUIDE for free examination. If O. K. I will send you \$1 in 7 days; then remit \$1 monthly until price of \$4 is paid. Otherwise I will return it.

Name _____
Address _____
Occupation _____
Employed by _____

NEW—JUST OFF THE PRESS ELECTRICIANS HANDBOOK

A Book Every Electrical Worker Needs

Here's a BRAND NEW, up to the minute Electricians Handbook. A book electrical workers need for reference on the job. Over 5,000 electrical facts—wiring diagrams—essential electrical formulas—latest code rules, tables, charts, and wiring methods. Includes Industrial Electronics data. A PRACTICAL BOOK EVERY ELECTRICAL WORKER CAN USE EVERY DAY. Pocket size, flexible leatherette cover to stand every day hard usage.

Electricians Handbook

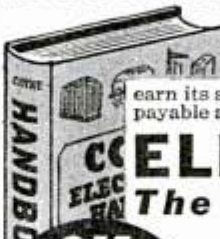

See this book FREE for 7 days. It's a book electricians have been waiting for—350 pages "chuckfull" of VALUABLE ELECTRICAL DATA that can earn its small cost many times over. Price \$2.75, payable after 7 days' FREE inspection.

ELECTRONICS The QUICK Way To BIGGER PAY

GET THESE BOOKS 7 DAYS FREE

To get ahead in Electricity NOW and in the future you should know ELECTRONICS. It is the big pay field for Electrical workers. Coyne's new 400 page book—just off the press is especially written for busy electricians who want practical "on the job" simplified electronic information. This is no text book—it's a practical book written for practical men. Electricians should find this book a "GOLD MINE" of EASY TO FOLLOW electronic data. Priced at only \$4.95—payable after 7 days' FREE inspection.



SEND NO MONEY

See both of these books FREE for 7 days. Here's my offer. I'll send either or both books to you for 7 days' inspection at my expense. If you decide you don't want the books, send them back and you owe nothing; if you keep either or both you can pay as outlined in the coupon. Don't delay! SUPPLY LIMITED due to paper restrictions—send that coupon NOW!

COYNE ELECTRICAL SCHOOL

H. C. LEWIS, President
500 S. Paulina St., Dept. 15-R5, Chicago 12, Ill.

Send me the books checked below on 7-day free trial. I'll either return them in 7 days or pay for them according to the plan I select as outlined below.

- Coyne Electricians Handbook: 1 Volume. Price \$2.75 after 7 days FREE examination.
- Electronics for Electricians and Radiomen: 1 Volume. Price \$4.95 after 7 days Free examination.

SPECIAL PAYMENT PLAN
If you keep both books you can send \$2.00 in 7 days and pay \$2 monthly until \$7.70 is paid.

NAME _____
ADDRESS _____
CITY _____ ZONE _____ STATE _____
 If you want books sent C. O. D.—you pay postman cash price (shown above) check here. Same 100% satisfaction guarantee.



"You learn a lot about outboards ... in 35 years"

Canny old-timers know it's a fact. Owning motors, being shipmates with them, keenly comparing all types and makes . . . a fellow sure learns a lot about outboards in 35 years!

It's equally true of a manufacturer — with knowledge multiplied by engineering, building and testing hundreds of thousands of motors through this span of years. The result is *know-how* . . . a matchless "all-star feature" that reflects in every phase of operation . . . constantly rewarding the owner with extra dividends of fine performance . . . without a nickel of added cost!

The great Storm Boat Motors that serve on every fighting front are the product of 35 years of Evinrude *know-how*. When peacetime motors can again be built, this same *know-how* will be a priceless part of every motor that carries the Evinrude name.

EVINRUDE MOTORS, Milwaukee 9, Wis.

EVINRUDE

OUTBOARD MOTORS



EVERY DOLLAR YOU INVEST HELPS SPEED VICTORY...BUY MORE BONDS

0 673

Popular Mechanics Magazine

REGISTERED IN U. S. PATENT OFFICE AND CANADA

WRITTEN SO YOU CAN UNDERSTAND IT

Vol. 83

JANUARY, 1945

No. 1

GANGPLANK *to* HITLER'S DOORSTEP

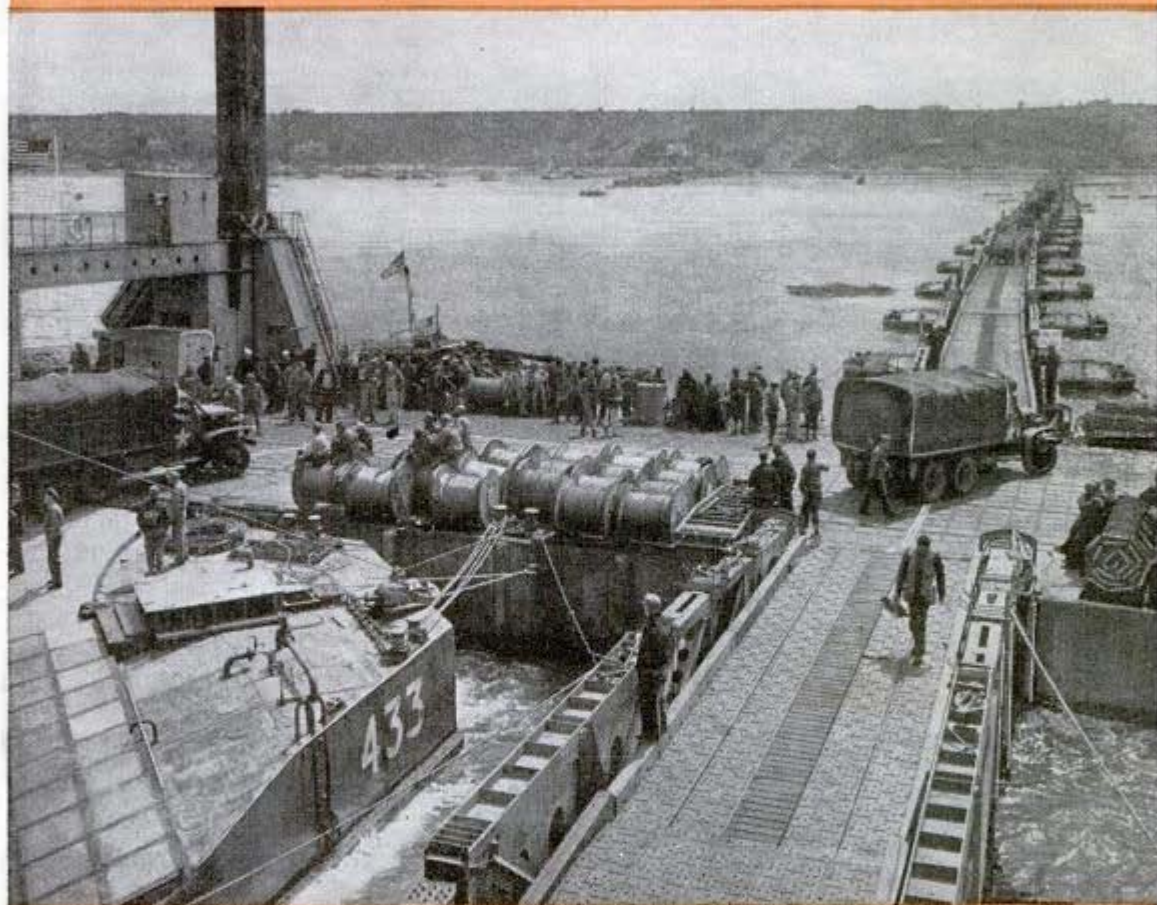

Cargo rolls from ships to floating harbor's pier, from which it will be transported to Omaha beach

By Wayne Whittaker

"**A**CH HIMMEL! It looks like Noah's Ark with the roof blown off and a Bofors mounted amidships!"

The eyes of German reconnaissance must have popped on D-day if they saw one strange segment of the invasion armada inching its way across the English Channel.

Aside from the ark-like ships, the like of which had never been seen on any sea, there were 200-foot floating monsters of steel, and long sections of what appeared to be bridges resting on queer-looking pontoons. All were being towed by tugs through the choppy waters at four knots.

Then, adding insult to mystery, Nazi reconnaissance might have spotted 60 decrepit freighters and warships heading toward the invasion coast. They looked out of place among the sleek invasion craft and modern warships, but they seemed to know where they were going.

Martial history was in the making, for the invasion forces advancing against the heavily fortified beaches of Normandy were bringing their own harbors with them. This feat, which has been called the eighth wonder of the world, will be recorded as one of the greatest military engineering achievements despite the fact that it was not an unqualified success.

JANUARY, 1945

1

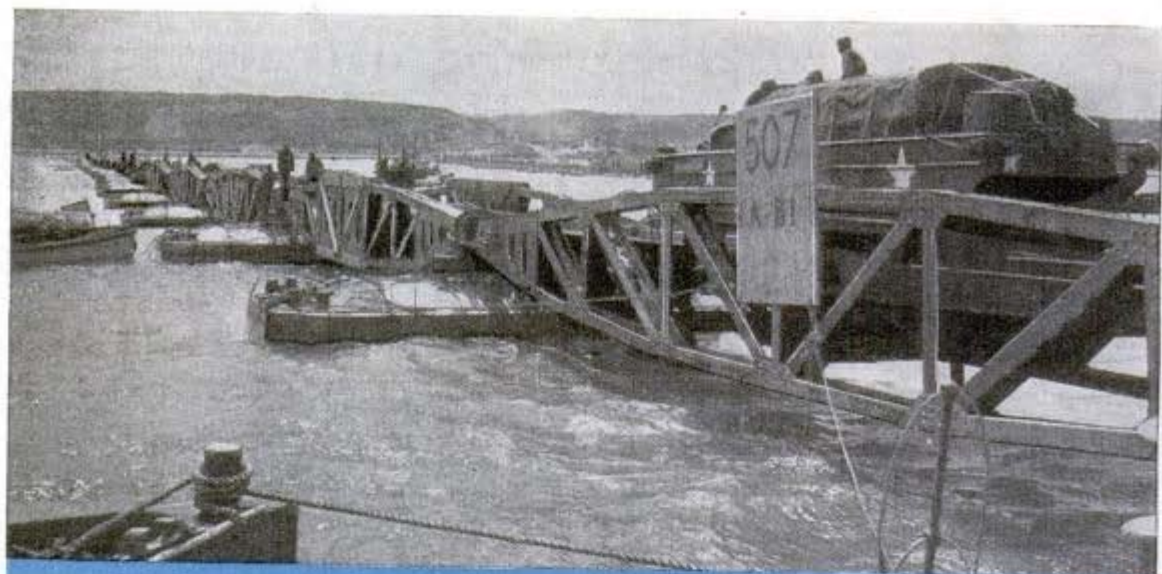

Supplies stream steadily ashore over pontoon bridgeway linking floating harbor with the beach



Above, one sector of breakwater created by line of sunken ships near "U. S. Mulberry" harbor off the Normandy coast. Below, panoramic view of Omaha beach before the Mulberry was set up. Barrage balloons hover over mighty assemblage of shipping as Allies pour an unending flow of supplies ashore



The building of the pre-fabricated ports was one of the most closely guarded of invasion secrets. Everything pertaining to the project was in code. It was decided at the Quebec conference in 1943 that there should be two synthetic harbors—one for the British and one for the American forces—to be known as “Mulberries.”

Each of the harbors was designed to move an estimated 12,000 tons of supplies and 2,500 vehicles per day for the first 90 days of fighting.

The plan for the ports was prepared by a joint committee of technical experts working under the Joint Anglo-American Chiefs of Staff, and the units were constructed in England and Scotland.

The general plan called for a system of breakwaters in the lee of which were to be piers with docking facilities for the rapid unloading of the big LSTs, Liberty ships and other craft. The requirements—breakwaters and piers—were conventional enough, but the units that formed them are the most revolutionary in the history of ports. The breakwaters consisted of three elements: concrete caissons (“phoenixes”), floating breakwaters, sunken ships (“gooseberries”).



Tugs jostle the concrete caissons into position. Note anti-aircraft gun mounted amidships. Below, aerial view before storm wrecked harbor

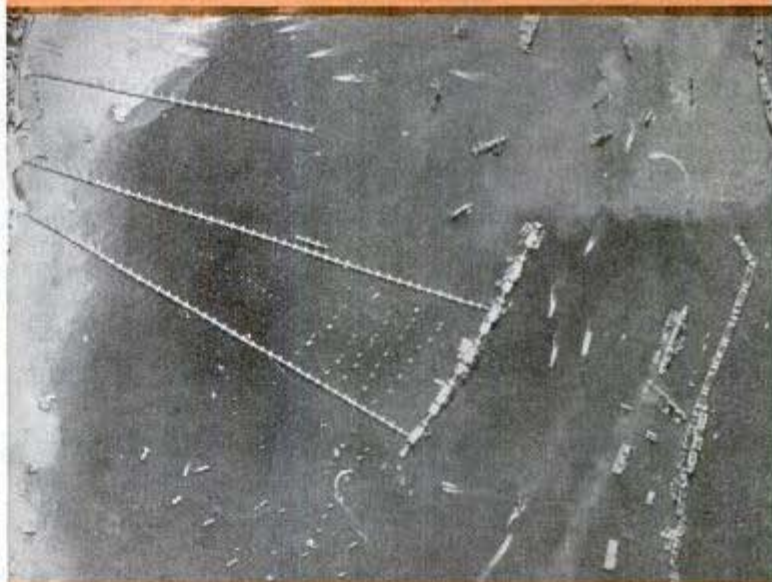

Below, railroad cars rolling from the mouth of an LST onto the beach. Depth of water near shore greatly facilitated unloading of big LSTs

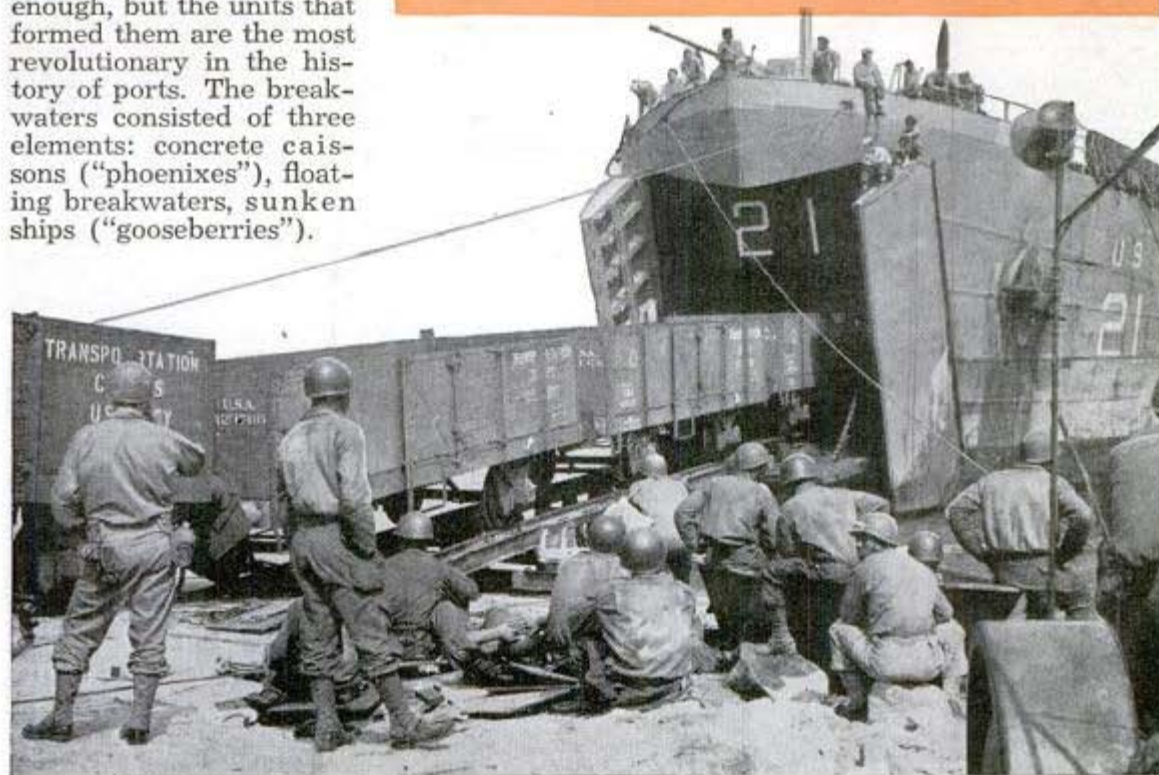

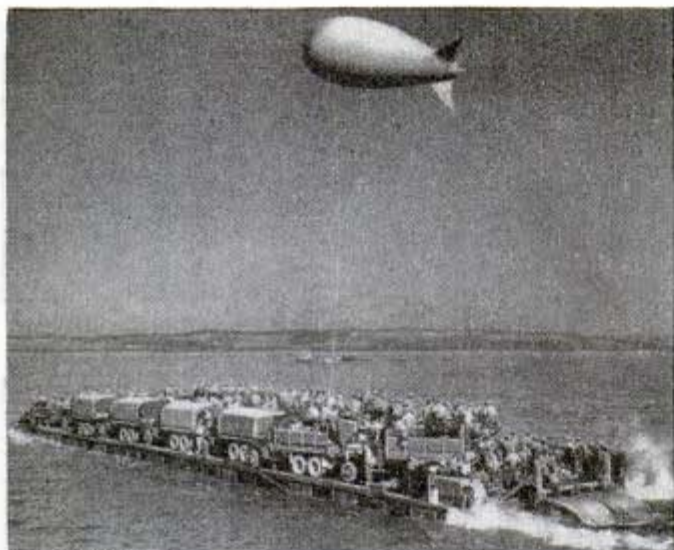

U. S. Navy photo
Barrage balloon flies over Navy "Rhino ferry" made of pontoons

"Obtaining those 60 ships just to take out and sink was no mean task in itself," said Capt. H. Hickling of the Royal Navy, who worked on the project from its inception. "At first the Admiralty turned us down cold, particularly in view of the fact that we were then on the last lap of licking the U-boats."

The ships earmarked for sinking included several antiquated battleships and

cruisers. In the lineup of blockships, which were to furnish more than four miles of breakwater, were 22 United States freighters and obsolete warships.

The blockships were sunk parallel to the beaches in 30 to 40 feet of water and were all in place by D-day plus three. These ships, with the upper parts of their hulls and superstructures above water, inspired German claims of "scores of Allied freighters sunk."

The concrete caissons, or phoenixes, which resembled roofless arks, were built in six sizes. The largest caissons had a displacement of 6,044 tons. They were sunk in water up to 33 feet in depth. The caissons were shaped like an inverted T with the interior divided into cells. The T construction helped give them equilibrium while afloat. Valves in the outer walls served as sea cocks. Space at the ends of each caisson was decked over to form quarters for the crew during the tow across the channel. The caisson's "superstructure" consisted of a platform amidships on which was mounted a 40 mm. Bofors. These weapons, along with those on the decks of the sunken ships, formed a vital part of the port defenses.

Ships unloading at pierhead directly onto Army trucks. Piers went up and down with the 21-foot tide

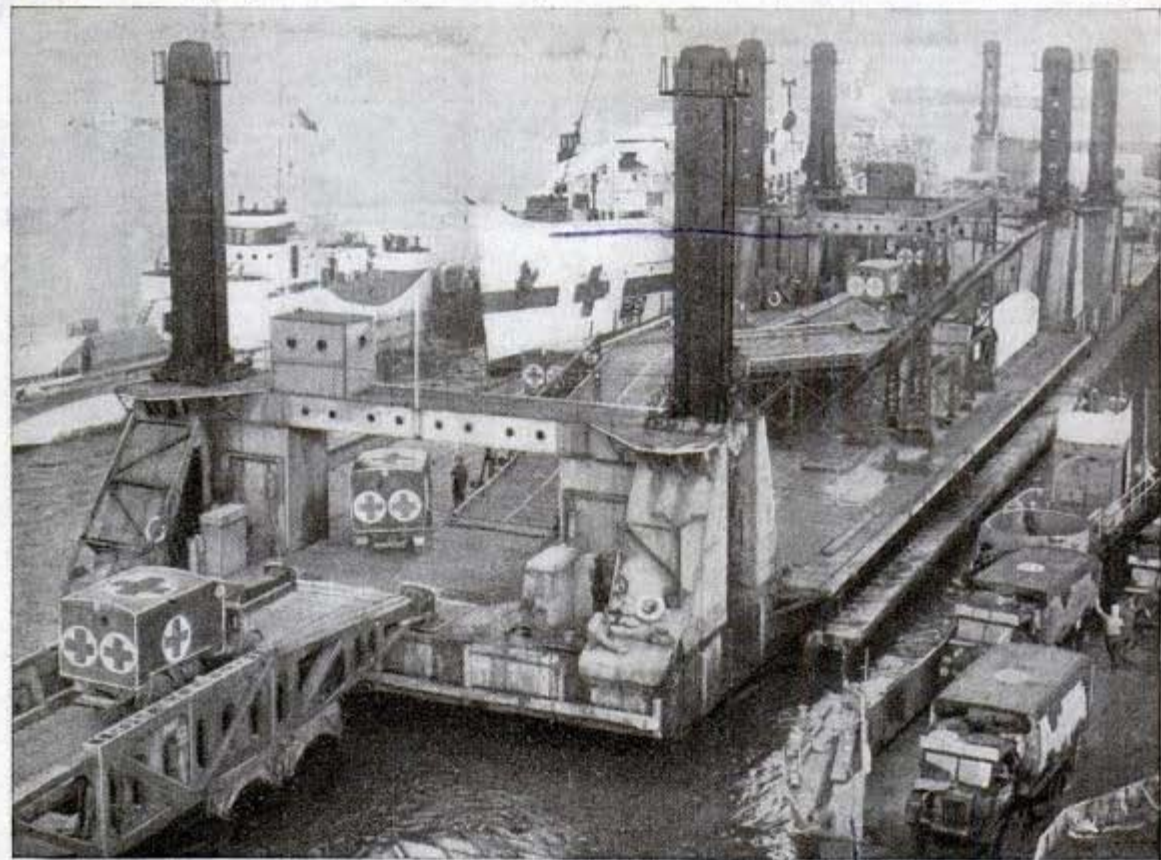

H.M.S. Roberts
Page 365, The Spher 9/16/44

Range of Guns Extended by Firing at Top of Roll



When the British monitor, Roberts, was bombarding German coastal forts during the invasion of Normandy, some of the 15-inch shells began falling short, although the guns were being fired at maximum

range. But it was noticed that the ship was rolling from earlier salvos, so the fire control officer decided to time the firing with the apex of the roll. This gave the guns increased elevation to exceed normal range.

dome - 461 Eighth Ave, N.Y.C.

Interior of Inactive Ships Is Kept

Rustproof by Air-Drying Units

Many years are added to the usefulness of reserve and inactive ships by the Navy's rustproofing technique. Based on the knowledge that steel doesn't rust in the desert, the dehumidifying technique keeps the air inside the ships very dry by means of mechanical units. A thin film of rust preventive is used to preserve metals and machinery, while mildew and decay pre-

ventives are used to preserve wood, life jackets, cordage and other nonmetallic equipment. Silica gel or activated alumina is used in the driers which take the moisture out of the air. Two beds of these compounds are employed. When one becomes saturated with moisture, electric heat dries it out, making it ready for use while the other is being operated.

338

0642

Bureau of Ships - U.S.N.B.

"Jeep Model" Tank Built by Yanks Near Front

With pieces of captured German vehicles, as well as French and American parts, ordnance men of the American 9th Air Force Command built a midget tank. Although this midget weighs four tons, it has the agility of a jeep. The tank was used to creep behind hedge-rows in France, and can crawl in and out of craters or make an about-face with ease. It holds 3 men.

Three-man crew of "home-made" baby tank used in France includes a gunner

0681

"Service Station on Wheels" Feeds Oil to Planes

Most of the 146 caissons were built in specially excavated tidal basins. When the lower part of a caisson was completed, a channel was dredged to the crude dry dock and the "ship" was floated out.

One difficult engineering problem was the construction of portable pier equipment that would withstand a 21-foot tide. The piers consisted of steel roadways supported on special floats. These floats were designed to sit down on rock or sand as the tide receded. Sections of the pier were towed across the channel in lengths of 480 feet.

The pierhead consisted of a steel barge, or platform, about 200 feet long and 60 feet wide, partially supported by steel columns resting on the sea bottom. The columns supported only enough of the load to anchor and steady the structure. They extended above the pierhead, and an ingenious arrangement of sheaves, cables and power-driven winches raised or lowered it with the tide.

It required 500 tows from ports scattered all along the coast of England and Scotland to assemble the 600 harbor units, which weighed about a million tons. A fleet of more than 150 tugs towed the ports across the channel—by far the greatest towing job in history. One large tug would handle either one caisson, a unit of six bridge sections, or one pierhead.

A timing schedule for the arrival of various units along the beaches was carefully worked out. At noon on D-day plus one the blo or gooseberry units, began ing at the two American b Omaha and Utah. Omaha be the site of our prefa port. The caissons were se to arrive on D-day plus 7 were maneuvered into flooded and sunk.

Moorings for many of t ing breakwaters were D-day plus one about 3,20 shore. The installation 200-foot steel giants, whi cruciform in shape, began day. They were placed of the caissons and bl One arm of the floats v with air and the other th water to give them stabi

On D-day plus 12, Jur worst gale in 40 years ble



Quick servicing for plane engines is possible with a "service station on wheels"—a small trailer unit which holds two barrels of oil and requires only one operator. The unit can supply aircraft with motor oil at a rate of six gallons a minute from barrels sealed to insure against sabotage. The barrels are tilted by a lever that locks the barrel and also acts as a brake on the trailer to facilitate loading of the barrels by one man.

Armstrong Equipment Co., 9339 Santa Anita

0670

WHIRLWIND on RAILS

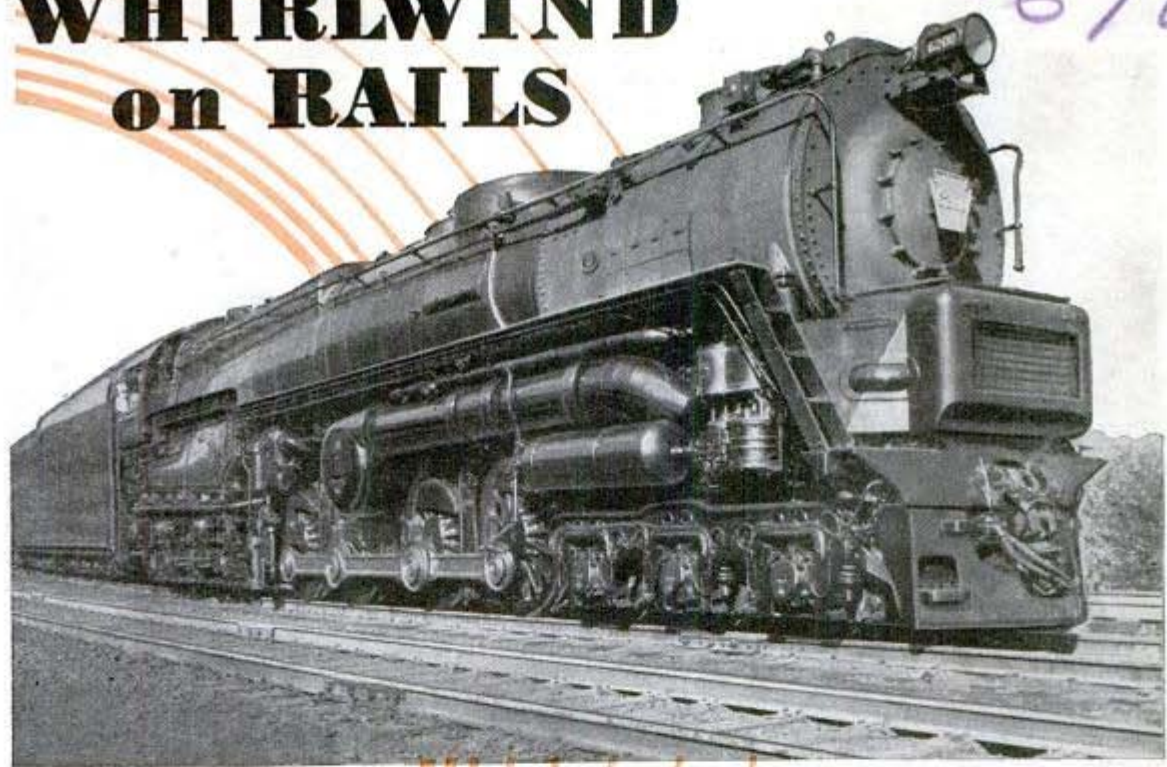

By
Roderick M. Grant

First thing new in locomotives since the Diesel-electric, Pennsylvania's "6200" has direct steam turbine drive. Pistons and cylinders are absent. Inset below shows control lever which is forward and reverse throttle

ALL ALONG the line from Philadelphia to Pittsburgh and Chicago folks glanced from their kitchen windows curiously as the big engine lumbered past.

What was this, anyway? Was the Pennsylvania putting a million-pound rocket on rails? The brand new giant rolled by with a steady "who-oosh" strangely devoid of resemblance to the pulsating "chuff-chuff" of the conventional iron horses whose faces had been familiar along this road for a hundred years.

Those who looked sharply noticed another peculiarity about this newcomer. There was no plume of steam escaping from the cylinders as the pistons pounded in and out at mile-a-minute tempo. In fact there were no pistons, nor cylinders. And the bright steel driving rods, unlike those of

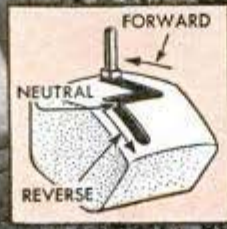
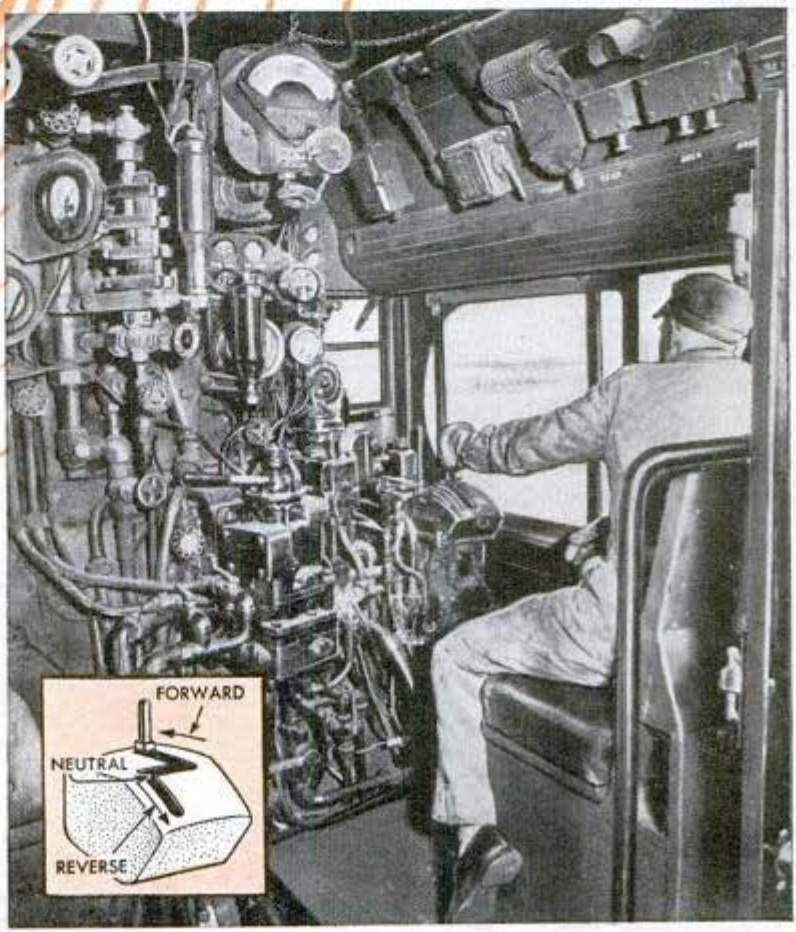

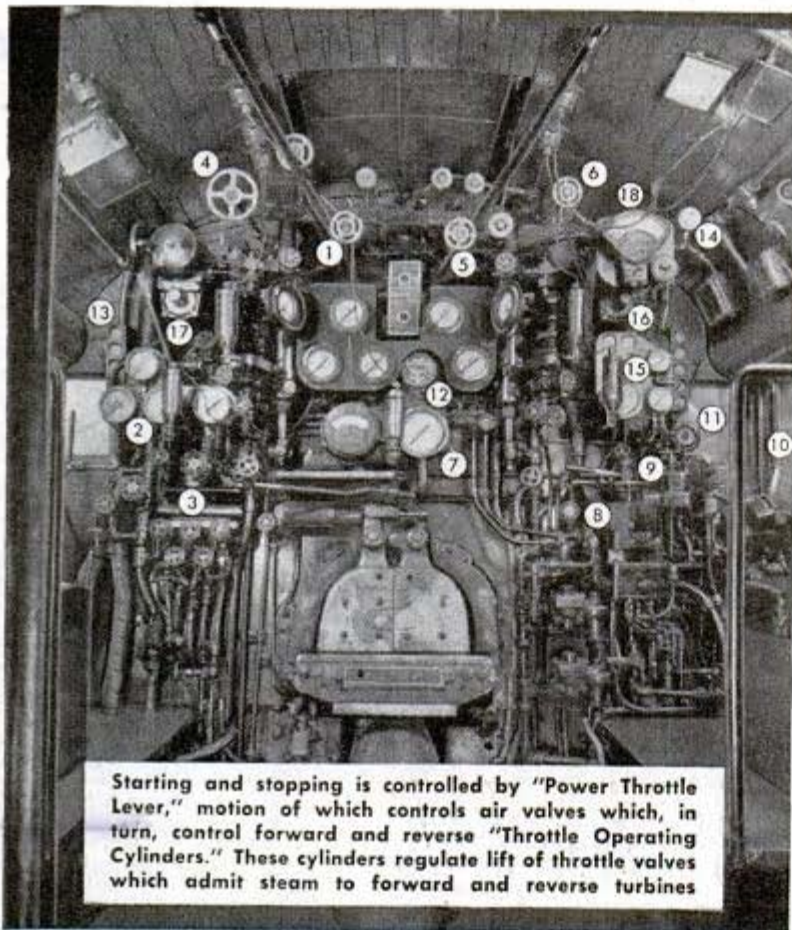

Starting and stopping is controlled by "Power Throttle Lever," motion of which controls air valves which, in turn, control forward and reverse "Throttle Operating Cylinders." These cylinders regulate lift of throttle valves which admit steam to forward and reverse turbines

- | | |
|-------------------------------|--|
| 1—STOKER VALVE | 11—FEED WATER OPERATING VALVE |
| 2—STOKER GAUGES | 12—FEED WATER GAUGE |
| 3—STOKER VALVES | 13—CAB SIGNAL INDICATOR |
| 4—INJECTOR STEAM VALVE | 14—TEST GAUGES |
| 5—MECHANICAL LUBRICATOR VALVE | 15—OIL PRESSURE GAUGES |
| 6—OIL PUMP VALVE | 16—POWER THROTTLE OPERATING CYLINDER (FORWARD) |
| 7—MAIN STEAM GAUGE | 17—POWER THROTTLE OPERATING CYLINDER (REVERSE) |
| 8—AUTOMATIC AIR BRAKE VALVE | 18—POWER THROTTLE GAUGE |
| 9—STRAIGHT AIR BRAKE VALVE | |
| 10—POWER THROTTLE LEVER | |
- Cab diagram from Baldwin Locomotive Works

two center driving axles. These gears operate continuously in an oil bath and mesh with so little friction that 97 percent of the turbine's power reaches the driving wheels. Since the conventional locomotive is notoriously inefficient in its utilization of the energy in coal, despite tremendous engineering improvements in the last generation, the potentialities of this fundamentally new type of coal-burning steam engine are vast but unknown. Exactly what No. 6200, designated type S-2 by the Pennsylvania, will do is an unknown quantity to be solved in road tests just beginning.

Designed to develop 6,900 shaft horsepower, the S-2 has capacity to pull a full length passenger train at 100 miles an hour and high class heavy freight trains at high speeds. Completed recently at Philadelphia, the engine was sent into service on the Chicago-Crestline, O., division to determine its adaptability to high speed passenger and freight hauls. That division is the scene

Below, the turbine locomotive on running test rack at Altoona

the traditional steam locomotive, remained on a true horizontal line as they revolved with the wheels; while above them was a huge horizontal tube, akin to nothing in the experience of veteran railroaders. What kind of engine was this, anyway?

No. 6200, just starting out on her career, is America's first direct drive steam turbine locomotive. Instead of harnessing the power of steam to the reciprocating pistons in the cylinders, the turbine shaft feeds power in steady flow to heat treated alloy steel reducing gears on

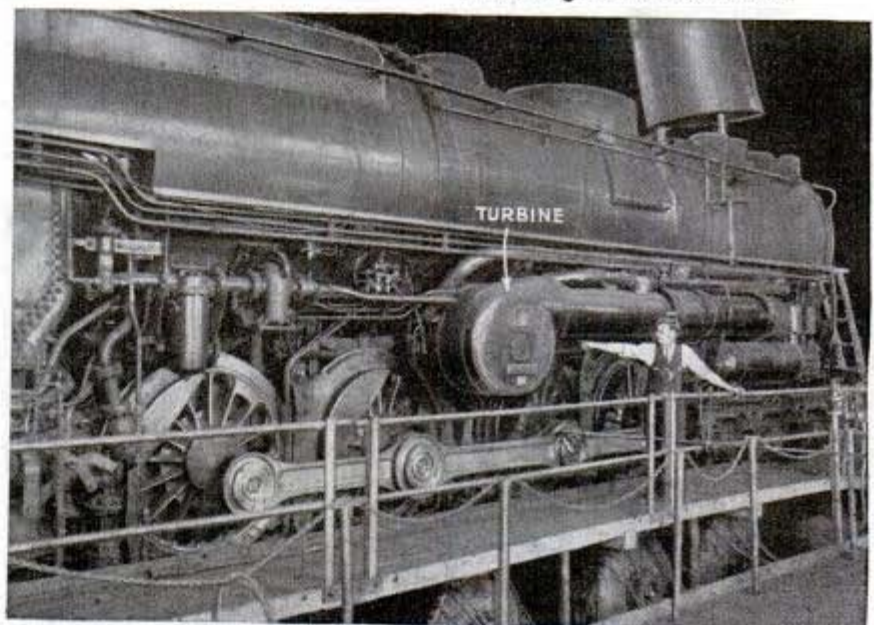

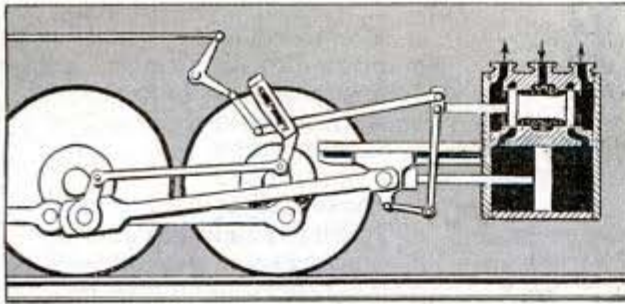

Diagram shows the typical valve and cylinder arrangement of a conventional type steam engine

where world records in train speed have been set.

One of the first things you notice about the turbine locomotive is its quietness. There is no snorting as it gets under way with the smoothness of an electric drive, no chugging as it speeds down the track in a vibrationless glide. At rest, it is virtually silent; moving, its steady hiss of steam is that of a giant breathing.

The engine was designed and built by the Baldwin Locomotive Works and the Westinghouse Electric and Manufacturing Company, in collaboration with the Pennsylvania Railroad. The purpose was to eliminate the reciprocating parts of the conventional steam locomotive, obtain a uniform flow of power to the driving wheels and secure the economies inherent in a turbine for railroad motive power.

The turbine shaft is rotated by the pressure of jets of steam against the vanes of the turbine wheel, and its power is transmitted continuously to the driving wheels

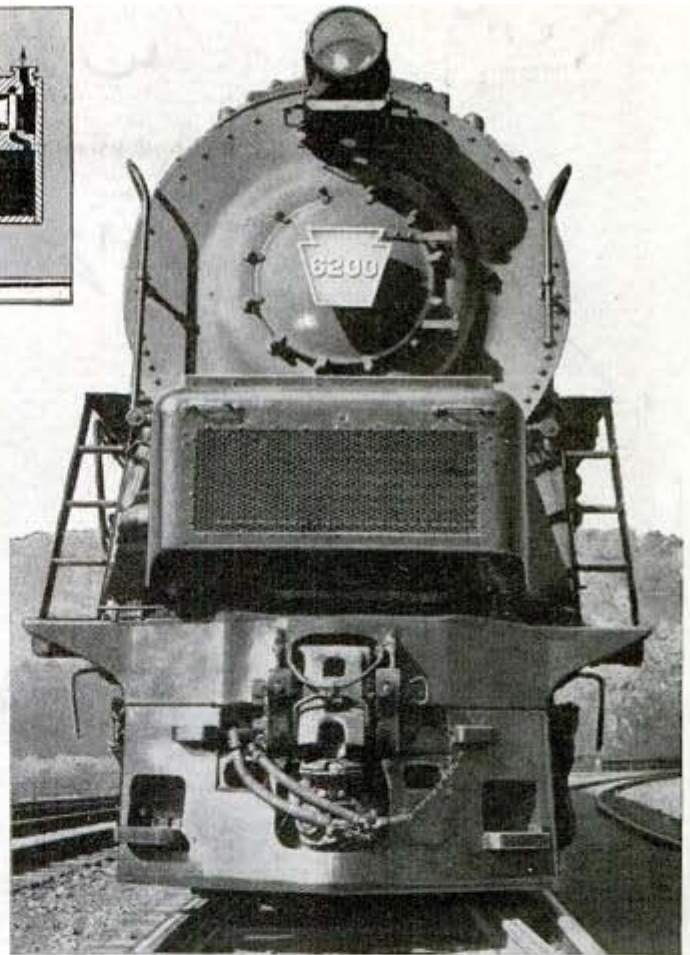

The "radiator" on No. 6200's nose cools compressed air pumps

through speed reducing gears. In operation the turbine engine is the simplest ever constructed. Forward and reverse movements are controlled by a single lever actuating special pneumatic control apparatus. Automatic devices make it impossible to handle the mechanism incorrectly.

Cutaway drawing reveals turbine and gears which deliver power to center pairs of drive wheels; connecting rods drive front and rear pairs. Exhaust steam flows forward through long tube

Courtesy Westinghouse

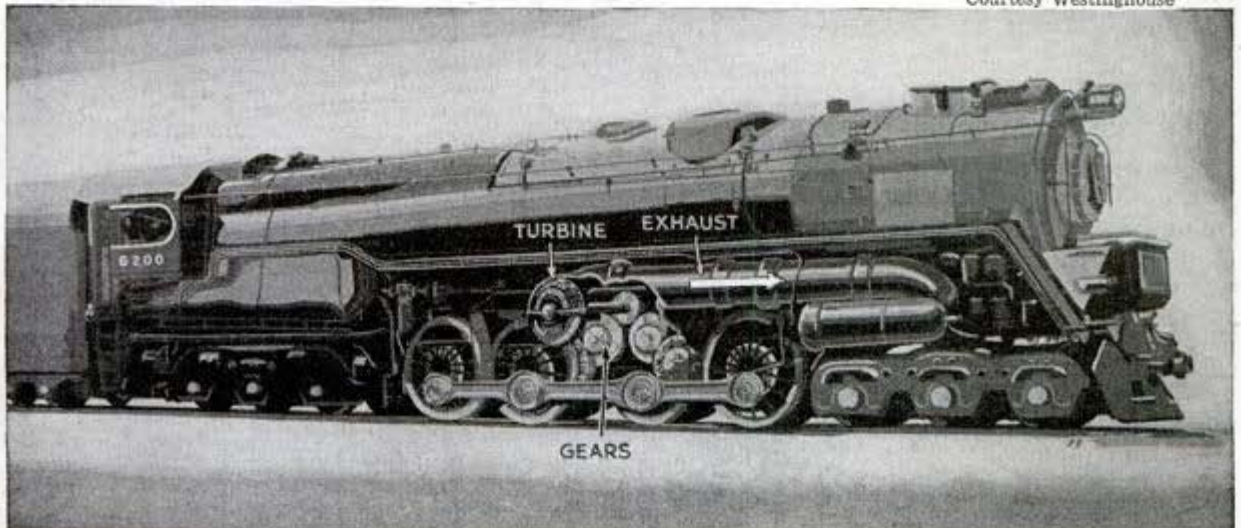

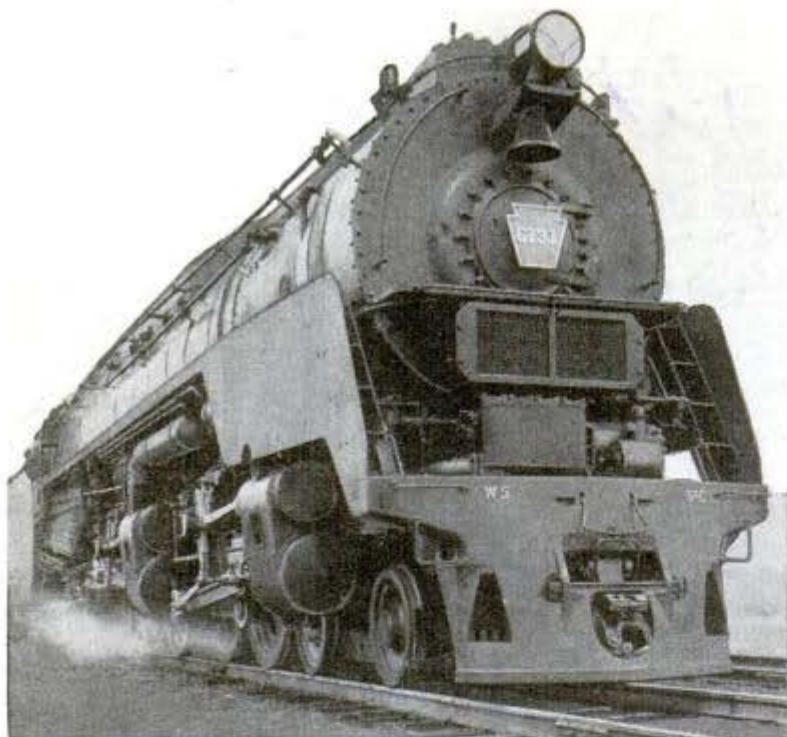

The Pennsylvania has pioneered several new types recently: at top, the new four-cylinder freight hauler; center, the world's longest and fastest passenger engine; bottom, the "T-1" streamline passenger locomotive

At rest, the engineer's control lever stands in neutral. To go forward, he moves it slightly to the right and then forward, rather like the automobile gearshift. To reverse, he moves it left and back.

There are separate turbines for forward and reverse travel. The main, or forward drive turbine is mounted at the right side of the locomotive and accounts for less than one percent of the engine's total weight of nearly a million pounds. It is only about 3 feet 9 inches in diameter. The smaller turbine, on the left side, is designed for reverse speeds up to 22 miles an hour and is brought into operation by engaging a clutch.

The forward turbine contains more than 1,000 chromium steel blades,



some of them less than one inch long. From the conventional boiler, carrying 310 pounds of steam pressure and fired by mechanical stoker, steam travels through the entire battery of turbine blades, expending all its energy but about 15 pounds, which produces a non-pulsating draft through the firebox and boiler.

The whirling turbine shaft imparts its power directly to two center pairs of driving wheels.

International News Photo
235 E. 45th St.

Robot Tank Can Fire a Bomb Charge By Remote Radio Control

Connecting rods from these wheels transmit the power to two additional pairs of drive wheels. Thus the S-2 has a 6-8-6 wheel arrangement: six leading wheels, eight drivers and six trailing wheels. It has roller bearings throughout.

Together with its tender, the S-2 is 123 feet long—only 17 feet shorter than the Pennsylvania's No. 6100, rated the world's longest passenger engine, familiar to many as an exhibit at the New York World's Fair in 1939-1940.

The S-2's colossal tender carries 18,000 gallons of water and 37½ tons of coal—44% more fuel than even No. 6100 holds.

Product of years of research, the Pennsylvania's new "baby" is frankly an experiment but one of the most significant in a long line. Several other new types of steam engines have been introduced in the last five years, notably the "6100," the new four-cylinder "Q-2" freight haulers and the "T-1" streamlined steam passenger engines introduced two years ago.

Several turbo-electric locomotives have been developed in Europe, and one was tried experimentally in this country several years ago. Pennsylvania's No. 6200 is the first in America to omit the electric generator and harness the turbine directly to the wheels. Railroad men throughout the world are watching this new 100-mile-an-hour whirlwind on rails with keen interest.



Much larger than the unsuccessful "doodle-bug" remote control tank used by the Nazis in Italy is the German radio-controlled "bomb tank" employed more recently. This robot tank is driven close to Allied positions, whereupon the driver gets out and by radio directs the machine to a place nearer the lines. At that point he releases bomb charges which are fired from a front compartment and then directs the robot back to him. The Allies captured many of these tanks intact and smashed others as they approached.

Electrical "Brain" Shuts Off Current When Lamp Starts to Flicker

To prevent the flickering of fluorescent lamps during their dying hours, Westinghouse engineers have devised a tiny electrical "brain" which fits into the lamp receptacle and automatically shuts off the current when the lamp has passed its useful

stage. This is done by adding a resistor to the starter, a small, glow-discharge tube which heats up when the lamp begins to function unevenly, activating a bimetal switch which halts the tube's operation almost immediately.

Bureau Public Rel.
War Dept.

HUMAN TAKEOFF at 130 MILES an HOUR

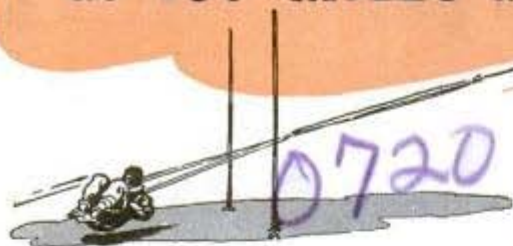

Maj. H. C. Hodges
A.C. Army Air Corps

"THE only sensation is a smooth whirl of air around you and then the ground disappears underneath. If I hadn't heard the wind I wouldn't have known I was moving."

Those were the words of Lt. Alexis Doster, the first man in history to be picked off the ground by an airplane in the same manner that mail sacks are lifted into the air. Lt. Doster rode a nylon rope into the sky behind a Stinson monoplane traveling at 130 m.p.h. That was on Sept. 5, 1943.

Since then three other men have been picked off the ground by light planes. After the fourth successful test conducted recently in secret, the "human pickup" was pronounced practical by the Air Technical Service Command at Wright Field. It may make possible a revolutionary means of rescue for stranded airmen forced down in inaccessible locations.



Sgt. Harry C. Conway, second man to demonstrate human pickup, is ready for takeoff in special harness which holds his knees against his chest. He wears a winter flying suit

Below, Lt. Alexis Doster, first aerial hitchhiker, takes off with little shock as plane hook catches pickup loop suspended between the poles. Note the tension of the observers



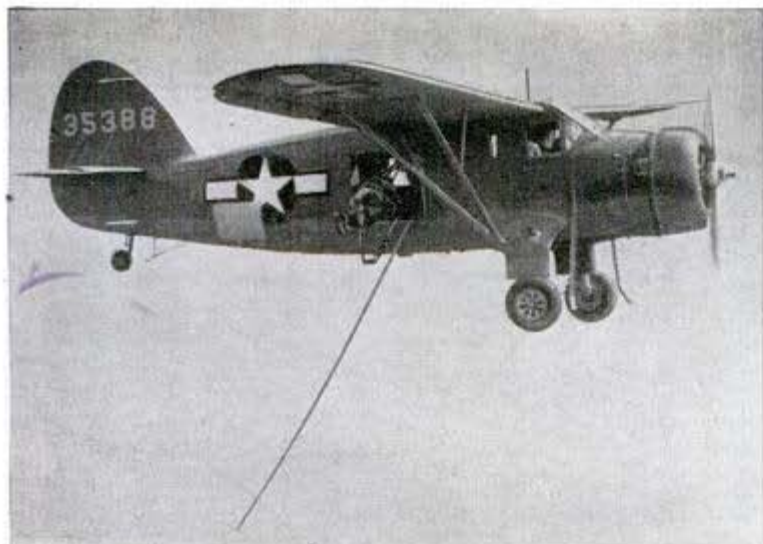

Man climbs in doorway of plane after rope is reeled. Right, dangling from plane in midair after knee strap is unsnapped

The first human pickup followed a year of experimentation by Army Air Force engineers at Wright Field. This included the development of special equipment and 126 trial pickups of cargo, dummies, and live sheep. The Aero-Medical Laboratory, Parachute and Glider branches, all took an active part in the project.

A standard parachute harness with additional supporting straps was worn by Lt. Doster for the first pickup. Inside the cabin of the plane was a reel with 185 feet of $\frac{1}{2}$ -inch nylon rope. At the free end of the rope was a hook. The hook was held by a release mechanism at the end of a long wooden pole used to guide the hook into the pickup loop. This loop hung above the ground between two poles to permit the plane to make contact.

Special braking equipment pays out the nylon rope to avoid any jerking effect until the subject is moving at the same speed as the plane. At the moment of contact a man is lifted into the air about eight inches and gains altitude like a glider while the plane climbs. Reeling in by electric motor begins as the plane levels off. Two minutes and 45 seconds after the man leaves the ground he is in the plane.

Experiments are continuing with the goal of eventually using a cargo plane or fighter. A rescue kit, to be dropped by parachute, contains pickup loop, poles and a harness.

Sgt. Conway climbs aboard $2\frac{3}{4}$ minutes after takeoff



NEW PLANES *for* WAR



Murderous attack planes, luxurious transports and giant cargo ships are some of the latest models turned out by U. S. aircraft engineers. The A-26 Invader (above and at right) is the most versatile and the fastest of American-built attack bombers. Its all-purpose nose permits it to be rapidly adapted for special missions. At bottom, P-61 Black Widow has four .50-caliber machine guns in a top revolving turret plus a 20-mm. cannon, giving it more firepower than most other fighters

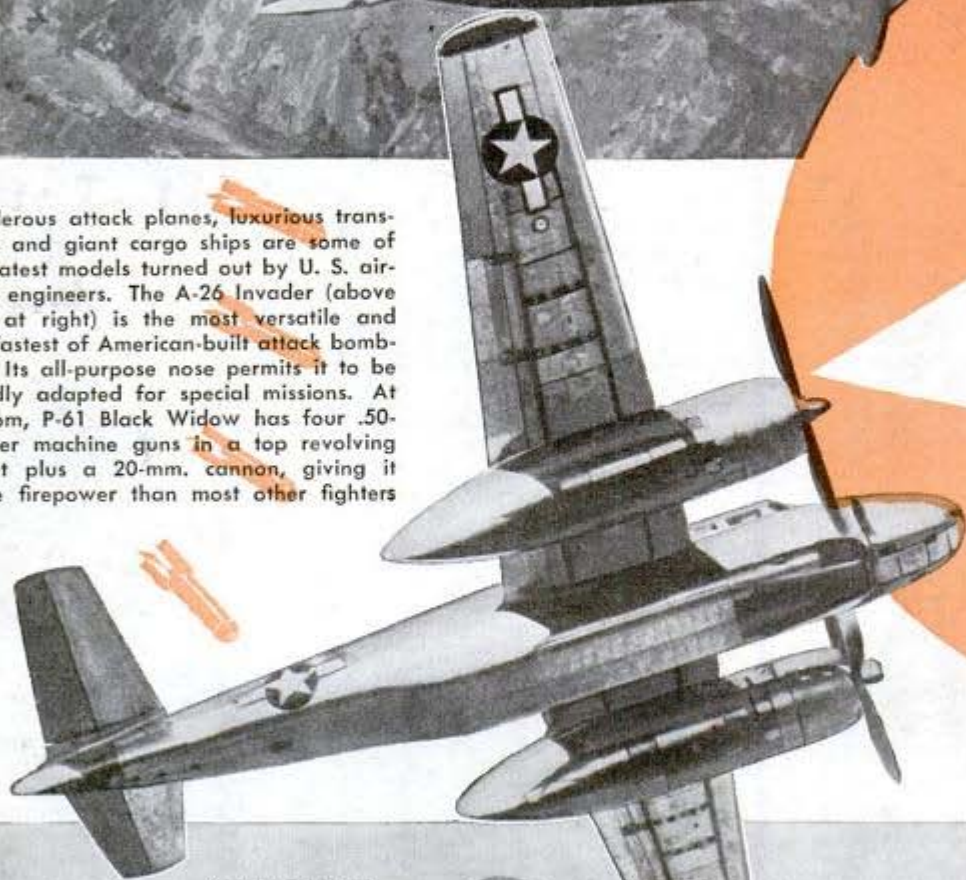

4 GUN TURRET

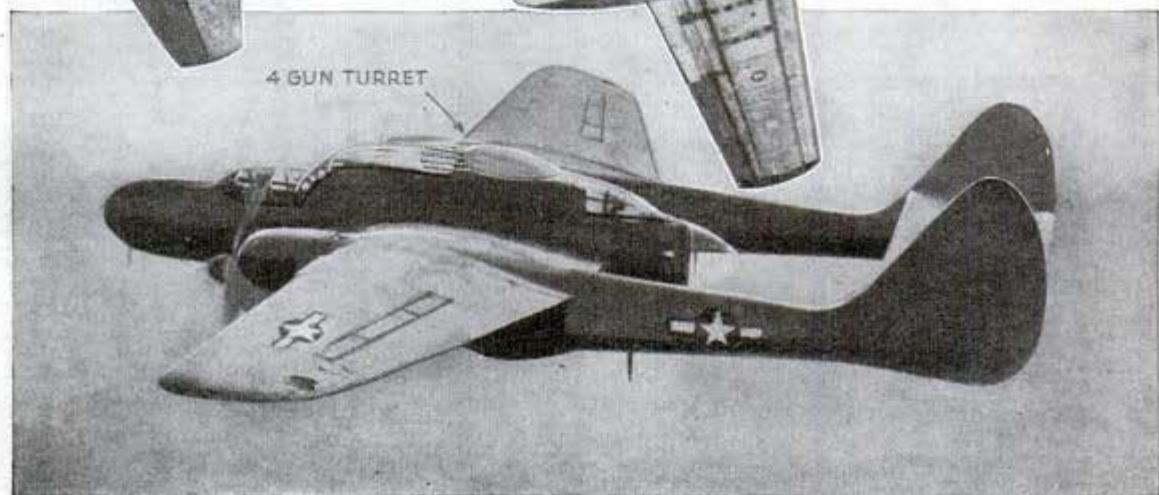

- and PEACE

0630

Pan American Airways has ordered 26 of these DC-7 Clippers which will carry 108 passengers at over 300 miles per hour



Below, the new hinged nose cone in commercial version of the Curtiss Commando, which has a new "waistline" and recessed cockpit with better visibility. Right, sketch of interior. Biggest twin-engine transport, the postwar Commando has already been flown

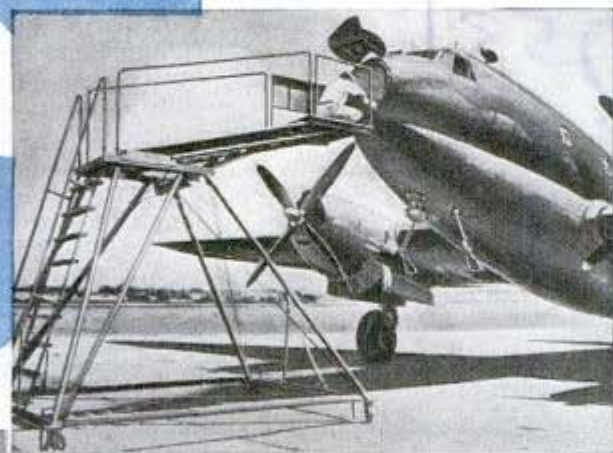

Below, Fairchild C-82, U. S. Army freight carrier which opens at rear



*Muroc Army Air Base
Muroc, Calif.*
Skeleton "Cruiser" Is Practice Bombing Target

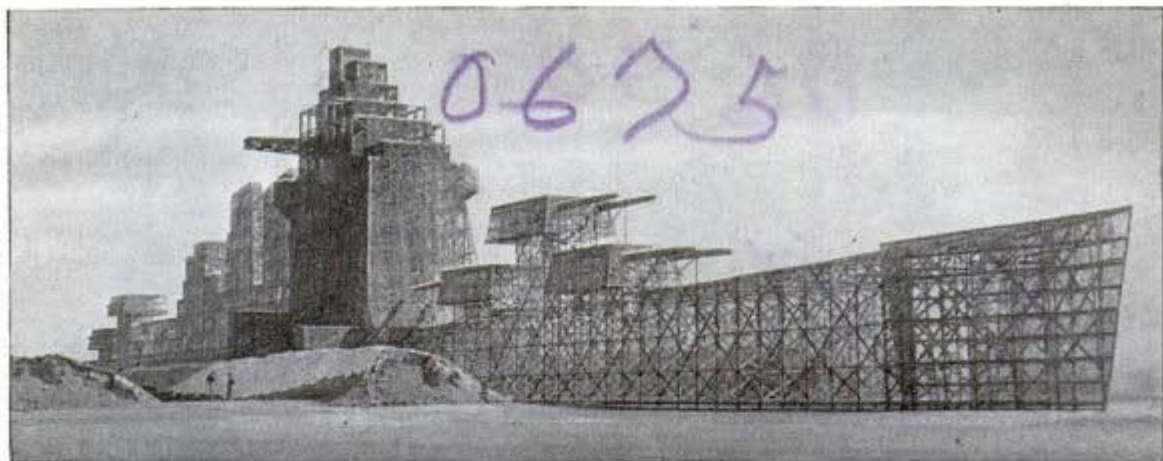

Of all the Japanese cruisers belabored by Allied bombers none has received nearly as many direct hits as the skeleton of one planted in the center of a California desert. The naked-looking reproduction is made

of lumber and chickenwire and serves as a target for dive bombing and skip bombing by flyers of the Air Forces' "finishing school" at the Muroc air base. The flyers learn to hit vital parts of Jap ships.

H. J. Heinz Plant Pitt, Penn.
"Roller Coaster" Conveyor Speeds Delivery of Tomatoes



To hurry the unloading of bushel baskets of vegetables for canning, the H. J. Heinz plant in Pittsburgh, Pa., has constructed a super-conveyor belt which has almost as many twists and grades as a roller coaster. Starting at the main loading platform on the street, the baskets, carried by steel arms hanging from the conveyor, move across the yard and into the plant building with their loads and out via another route after they have been emptied. The baskets are used for all fruit and vegetable products received at the plant.

0472
Superfuel Developed for Heavy Bombers Surpasses 100-Octane Gas

To rebuild chemically 100-octane aviation gasoline into 100-octane-plus is like improving on perfection. This has been accomplished by American chemists, according to the Petroleum War Council, and the superfuel is so potent that it will permit maximum bombing of distant targets. It is designed for use in superbombers, such as the Boeing B-29 and Consolidated B-32, and the latest types of fighter planes. Tests conducted in standard military aircraft show that the superfuel gives maximums

in sustained speed, short takeoffs, combat radius and load carrying. To produce the improved high-octane gasoline, scientists and technicians worked for two years analyzing its composition. Infrared, ultraviolet and mass spectrographic processes were used. The new gasoline can be produced by 80 percent of the refineries now turning out 100-octane fuel when military authorities give the "go ahead" signal. It is said that it will permit the bombing of Japan on a "suburban service schedule."

Pvt. Albert M. DeCaprio
N. Haverly, Contractor

Salvaged Gas Tank Taxi for Antiaircraft Crews

Christened the "tin swish," a motorized auxiliary gasoline tank from a P-39 serves as a makeshift taxi for crewmen at an antiaircraft firing point of the Panama Coast Artillery command. The one-man contraption looks like a cross between a land-locked torpedo and a miniature airplane without wings. Except for the discarded tank, through which its inventor, Pvt. Albert De Caprio, cut a hole for a cockpit, all the main parts were salvaged from "rat" target planes shot down in ack-ack drills. These include the three-point landing gear on which the belly is mounted, the bullet-riddled two-cylinder engine hitched to the fuselage nose, the six-volt battery, the fins, the rudder, the dual tail wheels, the twin contra-revolving propellers recovered from the ocean and a bullet-peppered, five-quart gas

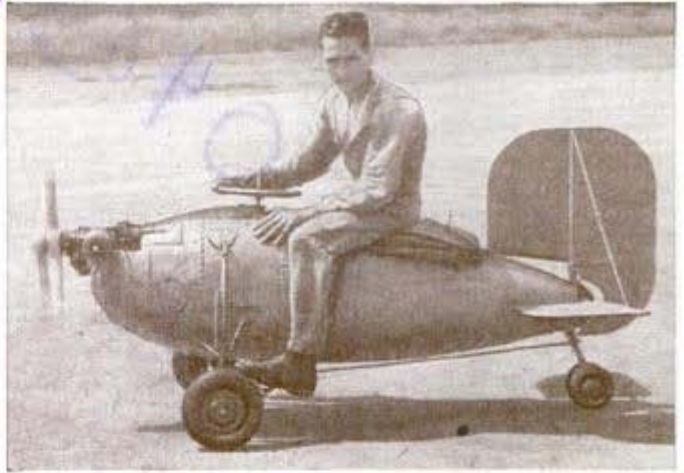

tank that keeps the vehicle in locomotion for one hour. The ignition coil came from a motorcycle, the front wheels from a "rat" plane catapult, and the steering wheel from the pulley of a power generator.

Runless Hose, Non-Shrink Wool Made by Treating Fibers

Stockings that won't run, wool that won't shrink, serge trousers that won't shine, wool trousers that won't lose their crease, and cotton and wool with double their usual wearing quality are possible as a result of developments in the chemical treatment of fibers by the Monsanto Chemical Company, St. Louis, Mo. The technique involves treating either the surface or the heart of the fibers without affecting the feel or texture

of the material. In some cases the treatment involves the deposit of a submicroscopic film of plastics. To prevent runs in stockings it involves the deposit of silica or submicroscopic grains of sand which prevent the fibers from slipping out of the positions into which they were knitted. The research into chemical treatment of textiles also will bring greater water-repellent qualities for many fabrics.

Machine Removes Fuzz From Peaches With Line of Rotating Brushes

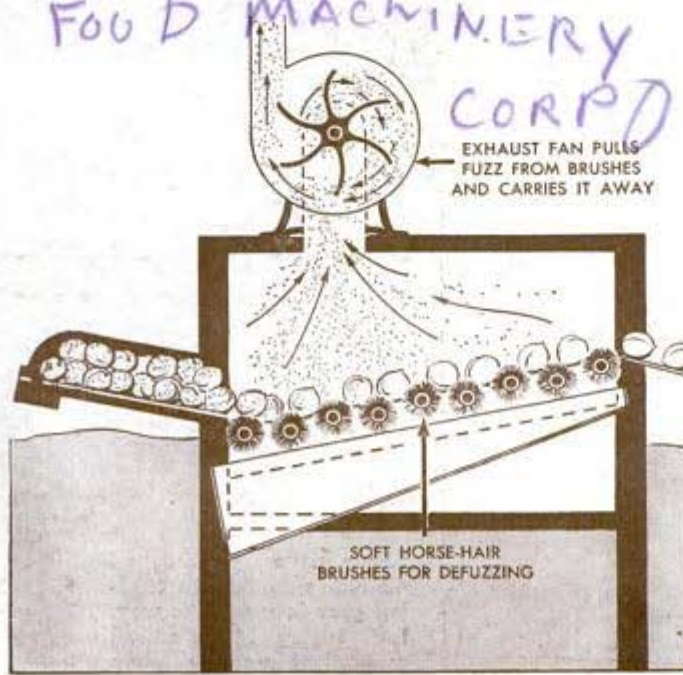

A "facial massage" for peaches is provided by a "de-fuzzer" introduced by the Food Machinery Corporation, Hoopston, Ill. This five- by six-foot device, which includes horsehair brushes, conveyor belts and an exhaust fan, scrubs the rosy cheeks of 15 tons of peaches every hour by moving them in single file over the soft, rotating brushes. The fan, located at the top of the compartment, sucks the fuzz up and out through an opening.

American soldiers in New Guinea play night baseball by the light from 60-inch arc searchlights attached to coconut tree poles and directed upward on white board reflectors placed at the top of the poles, with four 750-watt floodlights around home plate.



TORTURE TESTS *for* SKY RANGERS

By Allen Warren Elliott

Complete 1,600-horsepower engine (above) is hoisted to nacelle of Pan American Clipper

THE THICK metal skin and plate glass and plastic eyes of the huge B-29, the world's first pressurized bomber, are being tested by Boeing engineers. Sure, it will fly, but how much punishment can it take? What will collapse first? Better find out in the laboratory instead of over Tokyo.

Tremendous air pressure is exerted against the tip of the plane. Suddenly there is an ear-shattering crash. The long nose turns inside out, like the finger of a lady's glove.

Part of the nose is re-designed and the new one installed. This time the blowers pump the

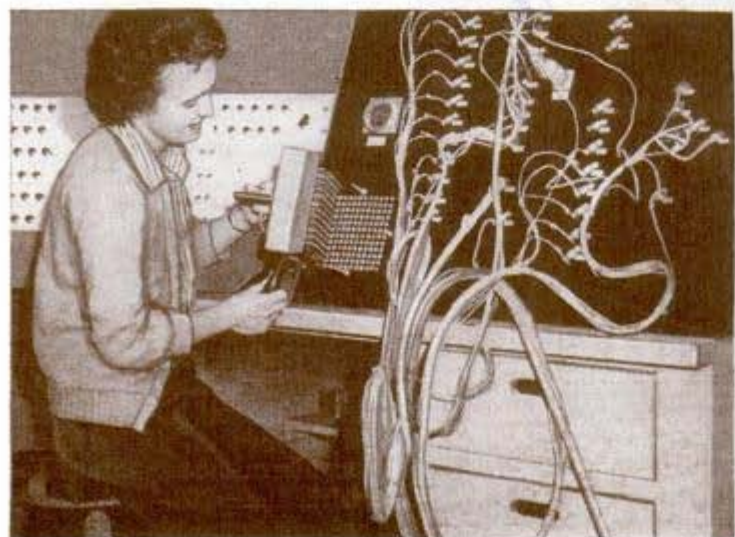
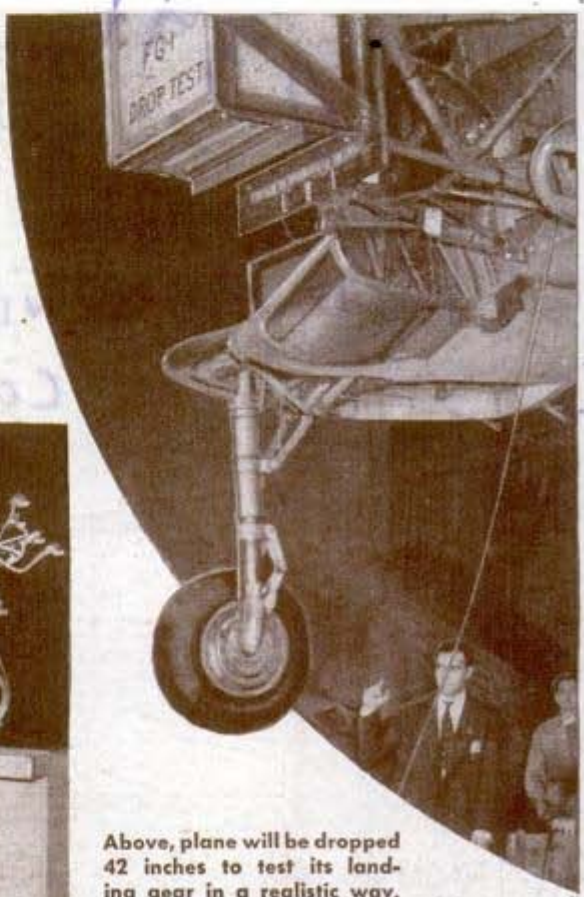

Above, plane will be dropped 42 inches to test its landing gear in a realistic way. Left, testing 144 electrical connections in one operation

one, N.Y. 16 N.Y.

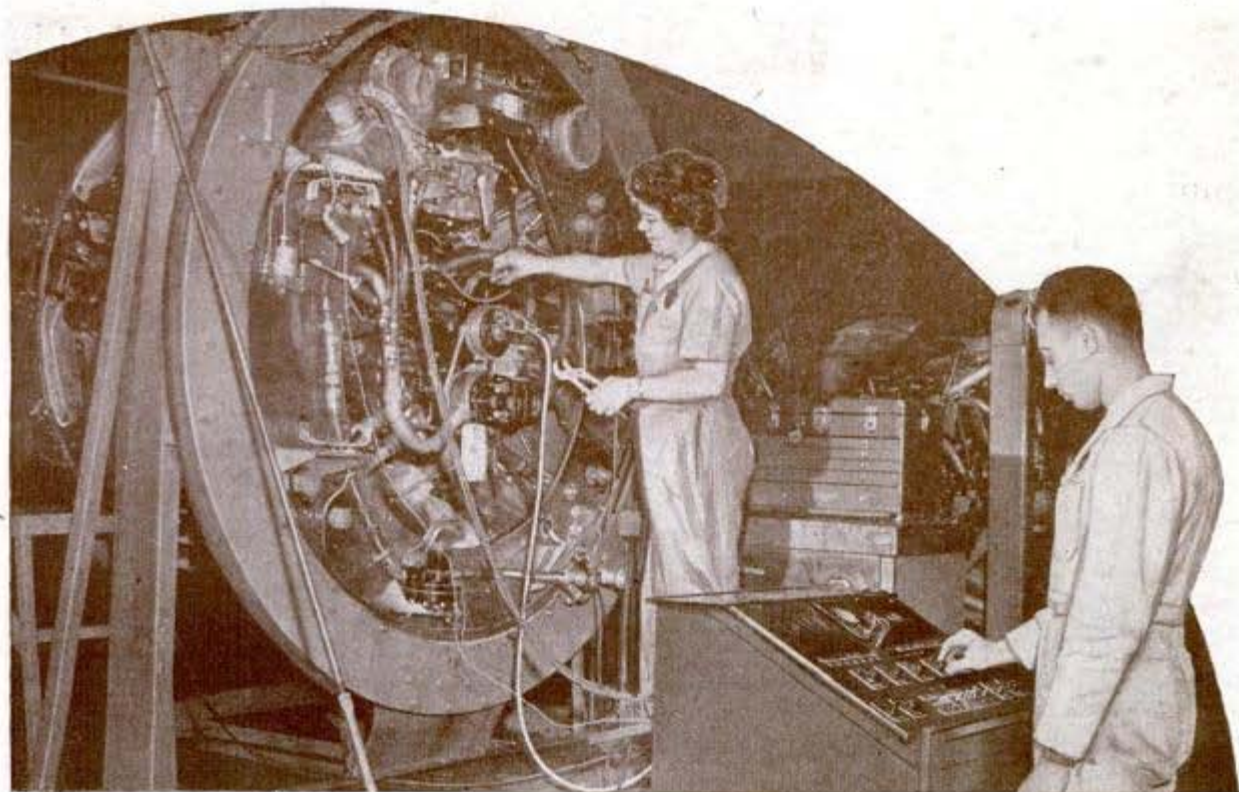

Pan American Airways photo

Above, check box tests all electrical wiring and accessories before the Clipper's engine is installed. Below, naval air experimental station crew at Philadelphia prepares landing gear drop test



U. S. Navy photo

cabin full, pitting their power against the resistance of the spherical lines which equalize pressure. The air strains the cabin. The word goes out: "Everybody clear! Steady now! The window is holding!" And—wham!—the cabin itself blows up. Never mind, this was expected, an engineer tells you. It's torture testing.

Okay then, someone says, let's have another fuselage pressurized and bring on the 20-mm. gun. Someone else asks: "Ready? Fire a burst into the skin near the nose!" Air escapes with a hiss, but the gauges show the ship can take it. "Blast that window!" The cabin deflates. "Let's have a crack at the tail gunner's compartment!" Chunks fly. The Boeing engineers read their dials and smile.

Finally a B-29 gets a high pressure test in the air. The blowers are at it again. The nose gunner leans against the plastic "fish bowl." Bang! Out goes the window, gunner and all, tumbling into space, the plastic window a glinting jewel catching the sun, the man a plunging black speck swaying under a parachute.

The engineers—there are 3,600 at Boeing—go to work again. Sections of the plane are pounded, crushed, stretched, bent, burned, blasted and pierced. In the end there is success and a turning point in the war. But many of man's mechanical birds die before they are born; only the fit live.

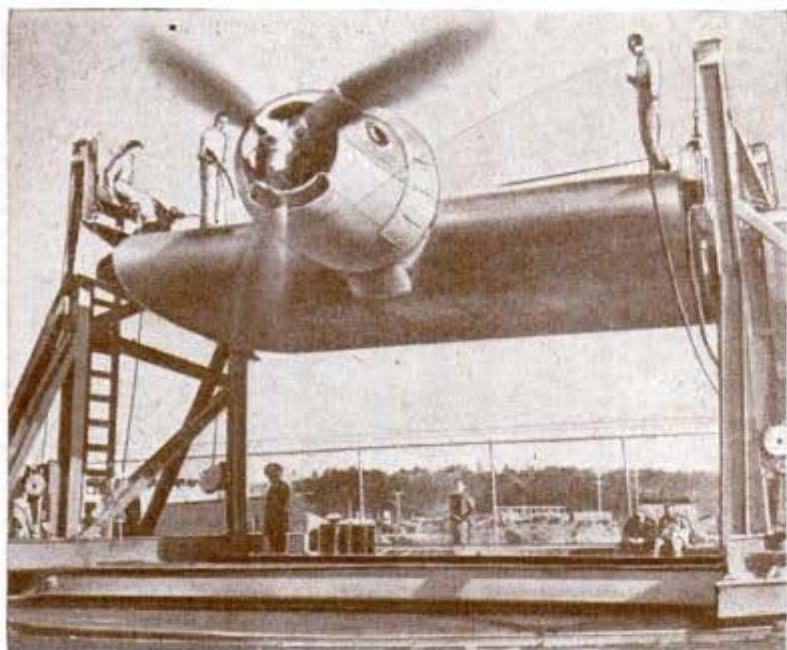

Boeing's engine test laboratory is mounted on wheels which run on a track, permitting the engine to be shifted to take advantage of wind

Let's go to the Glenn L. Martin plant in Maryland and see them crack the wing of a Navy "Mariner" patrol bomber. The torture test takes only six seconds, but it takes around 25 weeks to prepare for the wing test. What it costs would set you up for life.

During the six-month wait for the crucial six seconds, 150 drawings have to be made, 11,099 man-hours spent in design, 31,395 man-hours in construction and wing preparation and 2,118 man-hours in actual operation of the test apparatus, which requires 77 experts drilled in special roles.

Concrete foundations are laid, a 50-ton steel framework erected and the wing, in three sections, is moved by four cranes and

strain on the inverted wing.

"The next load is 100 percent," states the test conductor over the public address system. "Prepare to load at the next light signal."

This may be the payoff. It is 100 percent of ultimate design strength. Now the strain is going up. Computers are plotting data. The wing is losing its gull-like grace.

Somebody says the wing is holding a load equal to 100 standard passenger automobiles. But the test must reach the maximum load imposed by centrifugal force in

Directional gyros (right) are given a "rocking chair" operational test at a Sperry plant



the pull-out from a dive.

Men pump the jacks. Others tighten turnbuckles. Still others adjust tension jacks. Some 258 strain-gauge measurements are taken, using fine-resistance wire 1/1000 inch thick. Seven miles of other wire connect the strain gauges. The movements of the wing are observed from 21 stations.

The wing is now like a spring compressed under a 100-ton weight. The metal skin begins to wrinkle. The six crucial seconds are ticking off. Warning cries go up.



OWI photo

Above, engineers figure their calculations as to probable performance of a new plane. Left, engineers about to install over 100 strain gauges on the pilot's enclosure of a pressure test specimen



There is a sharp explosion. A shower of rivets, bolts and metal fragments fills the room as everybody ducks. A steel safety frame catches the bulk of the shattered wing. The announcement comes:

"The wing stood up under 238,000 pounds!"

There is a happy babble of voices.

You ask: "Why go to all this expense and trouble? The ship flies all right."

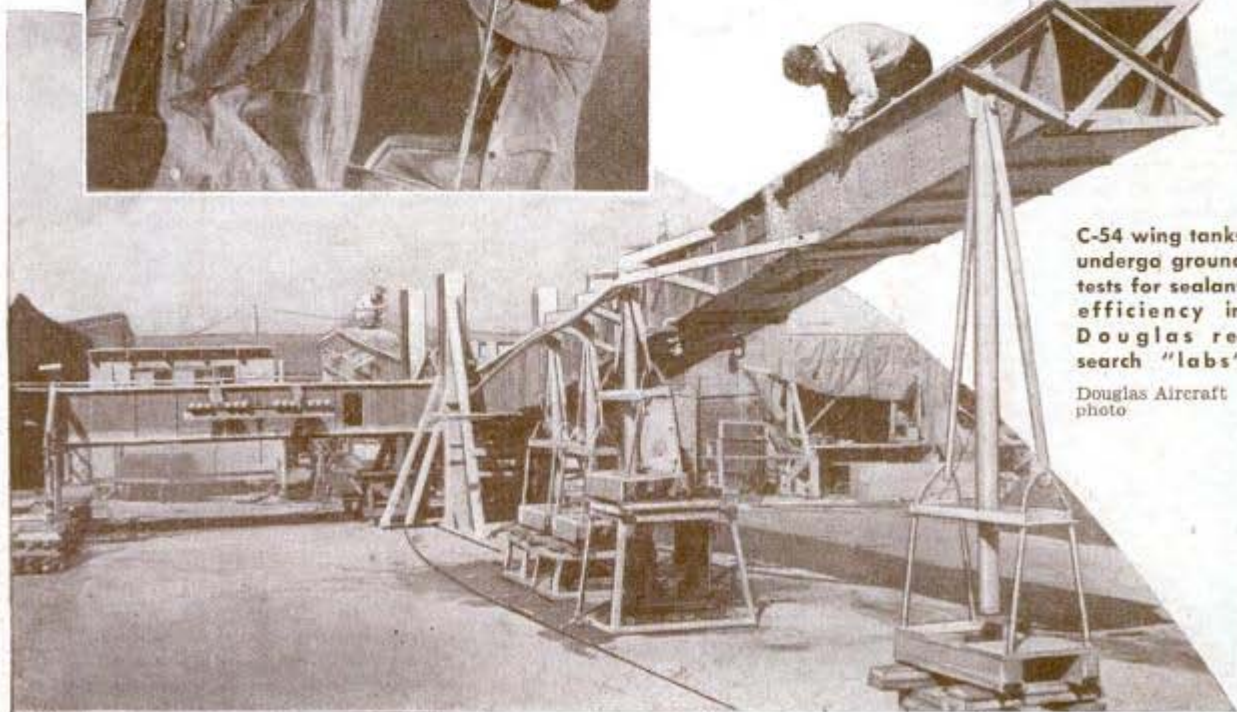

C-54 wing tanks undergo ground tests for sealant efficiency in Douglas Aircraft research "labs"

Douglas Aircraft photo

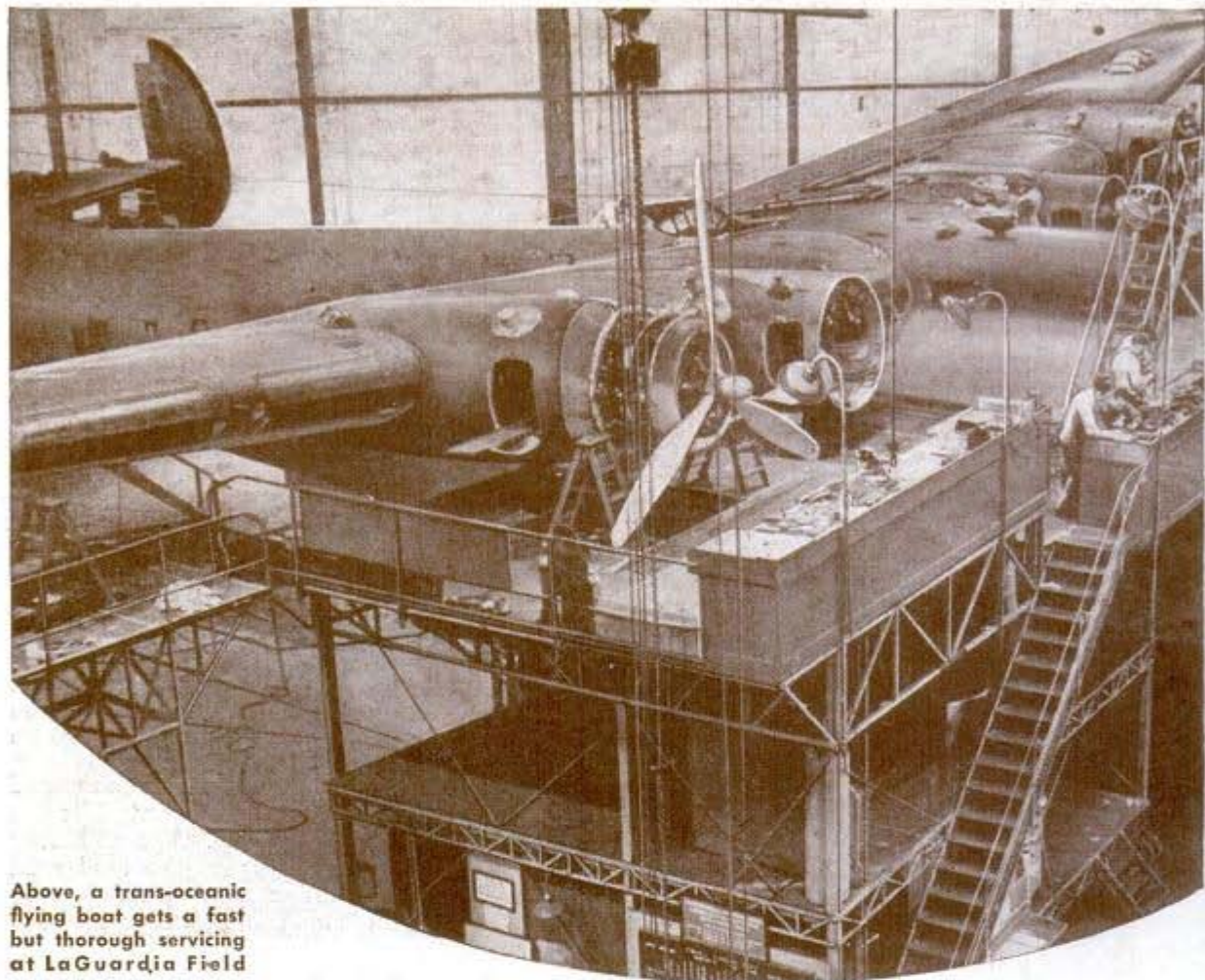

Above, a trans-oceanic flying boat gets a fast but thorough servicing at LaGuardia Field

The answer: "The Mariner has complied with exacting Navy specifications, but war often demands 'better-than-specification' performance. Lives may depend on an airplane's ability to carry a few hundred extra pounds of food, medicine, or munitions. Pilots of Mariners have had to rescue ship-

wreck survivors, packing them into already fully loaded airplanes. The amount such a flying boat can be safely overloaded depends mainly on the strength of its wing. Where lives are concerned, we take no chances."

Where lives are concerned they take no chances at the air experimental station in Philadelphia Navy yard—unless it's necessary to risk their own in behalf of pilot safety.

In comes a new fighter plane. Looks nice, acts sweet, but how will its landing gear stand the jolt if a pilot, worn out fighting Japs, sets her down heavily on a carrier's deck? The way they find out is to load one of the ships to the limit, suspend it in the laboratory, and



Left, master control table of the Martin wing test. Data and observations are phoned to it
Glenn L. Martin photo

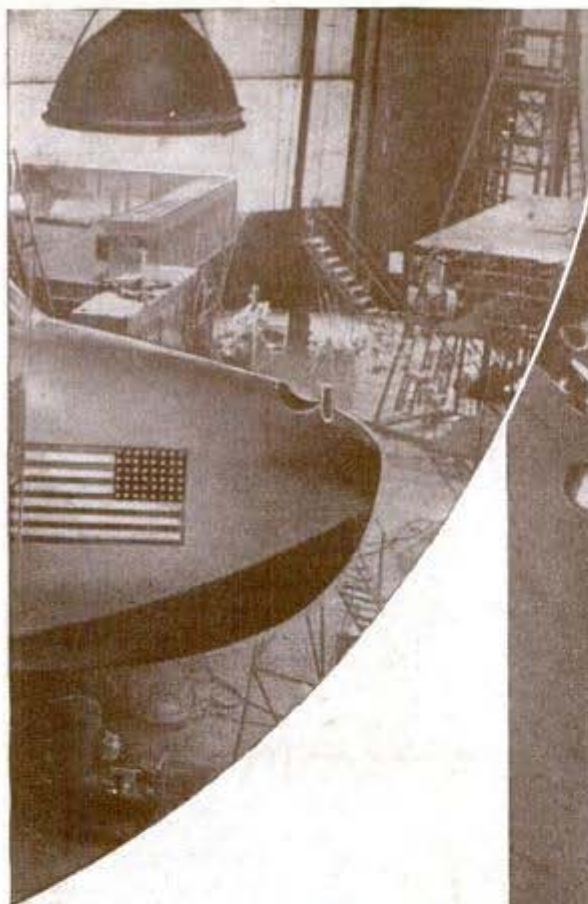

then let it drop with a crash to a concrete floor.

Suppose the pilot fumbles a landing and the plane noses over? To find out what will happen, they suspend a fuselage slanting nose downward and — smack! — it does a header onto the hard floor.

A separate section of the station tests textiles for parachutes, for parachute harness webbings, glider cords, flyer's clothing. Machines test yarns as thin as a hair and as thick as a pencil. Magnetos get the vibration test, a "rough ride" which lasts 300 hours while a motor jiggles the mechanism ceaselessly. In fact, at the naval air experimental station everything that goes into a Navy plane is subjected to strenuous tests of speed, heat, cold, vibration or other ordeals.

In scores of test cells around the country, aircraft engines take their first breath of high octane gas and air and come to roaring life. Then they are torn down to the last part and each part is carefully

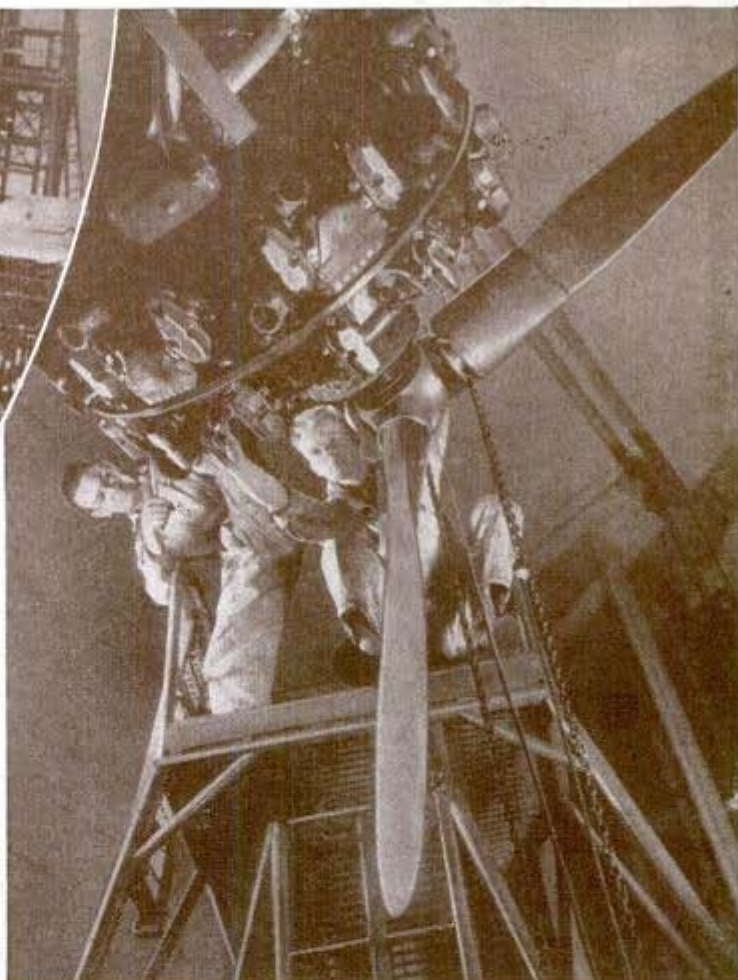

Above, engine is adjusted before being tested on a horizontal engine stand. Below, oleo strut is tested at 65 degrees below zero



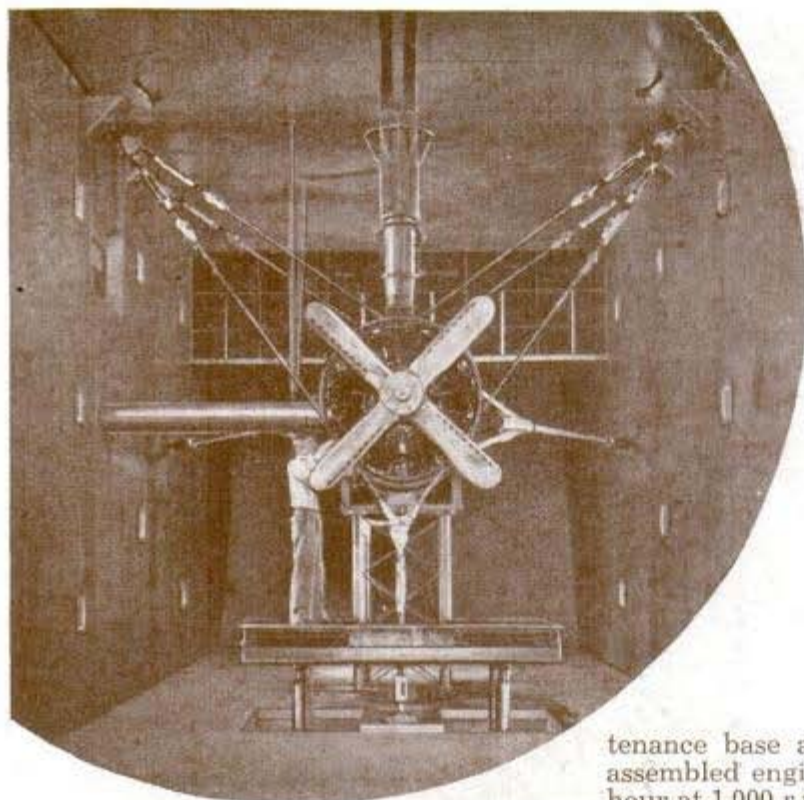

Studebaker-built Cyclone engine (above) about to get test run in a large cell made for special jobs

examined. If it passes this check-up, the engine is put together again and shipped to an airplane plant where a fuselage is waiting. The engine test laboratory at the Boeing plant in Seattle is mounted on

wheels which run on a track, permitting the engine to be shifted to take advantage of wind from any direction.

No military plane gets more rigorous tests than does the passenger transport plane. United Air Lines puts out what they call a "new" plane every 725 hours. The planes are not new, but such rigid tests are conducted, such careful overhaul accomplished that "new" efficiency is obtained from perfect or brand new parts. The 14-cylinder, twin-row Pratt & Whitney Wasp engines are given thorough test runs after disassembly, cleaning and reassembly at United's central main-

tenance base at Cheyenne, Wyo. Newly assembled engines are run in for the first hour at 1,000 r.p.m.; for the second hour at 1,400 r.p.m.; for the third hour at 1,600 r.p.m., and for the fourth hour at 1,800 r.p.m. The engine then is checked and run for the fifth and sixth hours at 1,900 to 2,500 r.p.m.

But the story of the torture tests of the B-29 is the epic of the aviation industry because this craft took off almost "from drawing board to sky." More than 8,000

Planes (below) are loaded for drop tests which determine strength of landing gear and fuselages

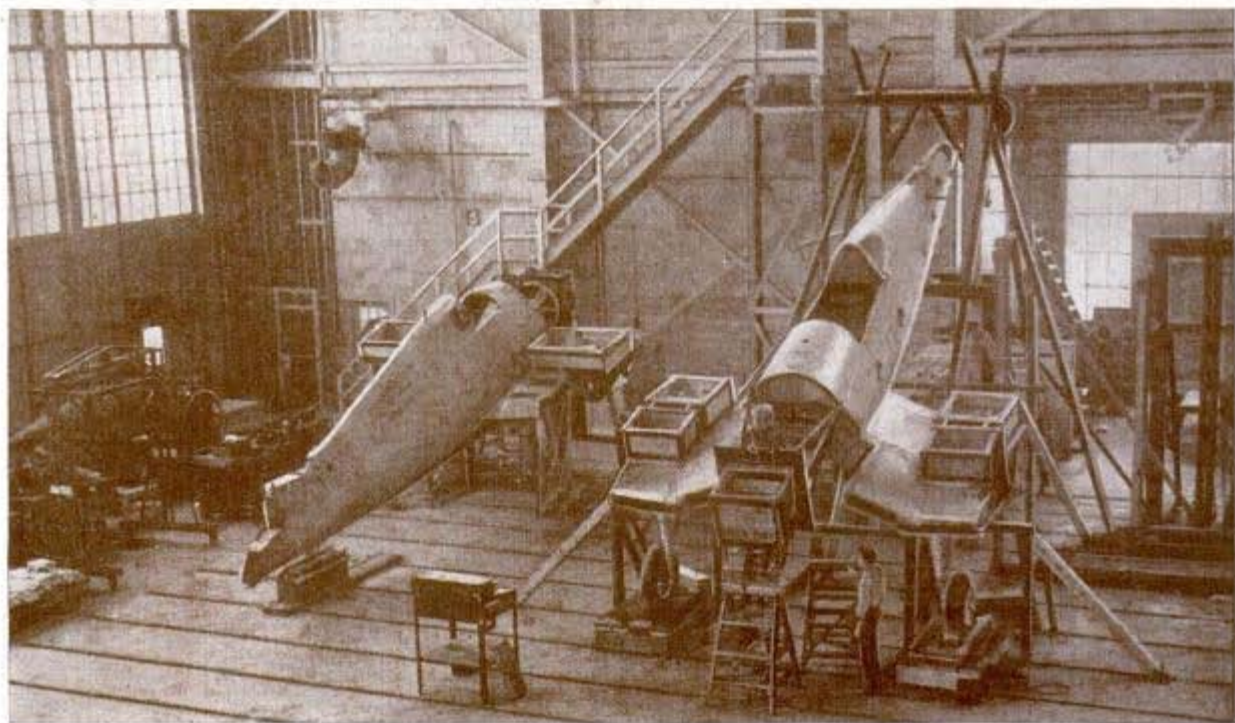

hours of scale model tests were made in wind tunnels. Models of parts were tried out in other planes. Yet there were plenty of gremlins left.

The 50 tons of one test plane made a belly-landing at around 100 miles an hour when a tiny screw came loose, jamming an electrical control. The plane made it all right and lived to fly again.

The first test plane ever to take to the air was not so lucky. It crashed, killing the whole crew who had spent months on the job of building her. A second had a narrow escape from the same fate. Two more were deliberately destroyed in torture tests.

The final tests of the assembled equipment, only three weeks before the B-29 went to war, were so strenuous that it was called "the battle of Kansas." Thousands of technicians went from war plants all over the country to a blizzard-swept Kansas airfield. In three weeks' time they did several months' normal work, installing and testing equipment in frantic haste.

Both the men and the plane took plenty of punishment before the B-29 job was through, but now American airmen are flying them over the towering Himalayas on the China supply route with more comfort than some folks back home enjoy.

That is what torture tests for man-made birds make possible—and safe.

Below, wing test diagram. Wing, in upside-down position, is broken by pulling down with the two hydraulic jacks



Above, de-nitrogenized trainees, in full flying equipment, enter Boeing strato-chamber. Below, massive wing spars of the Boeing Flying Fortress

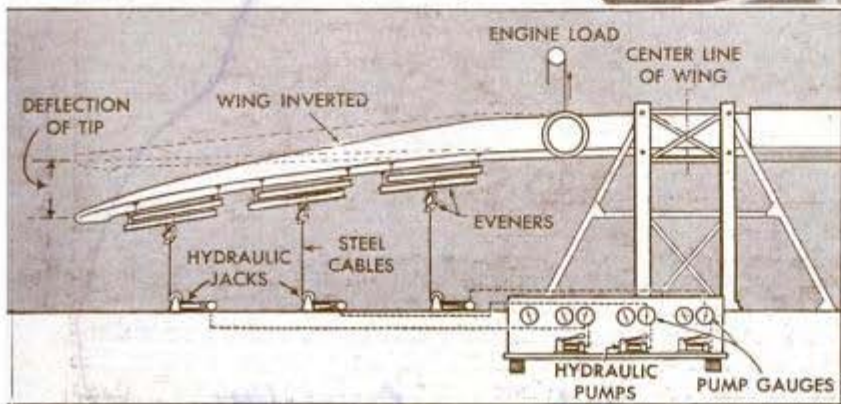
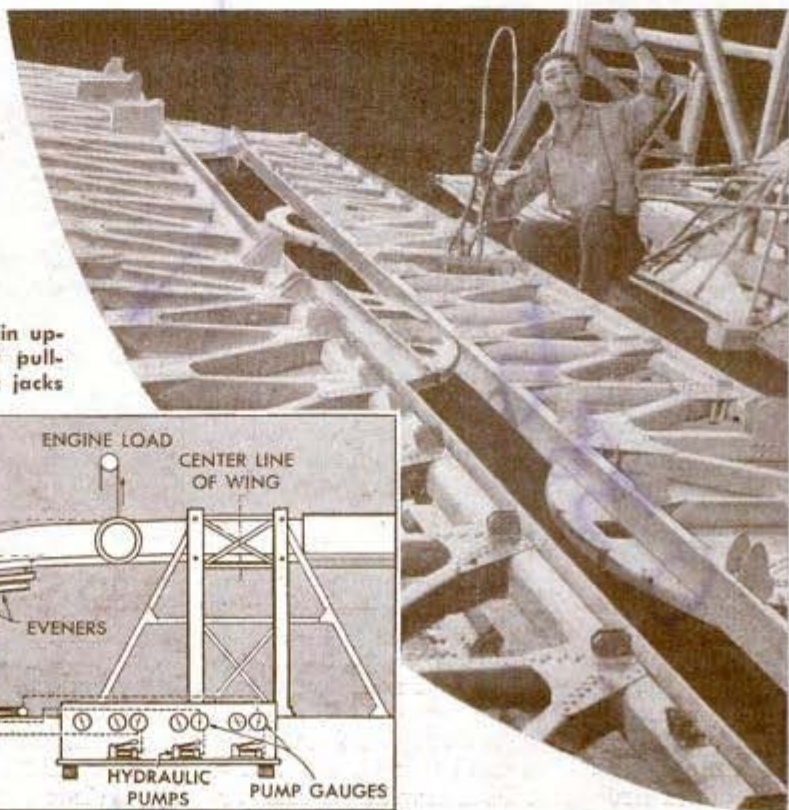

4611
3111 Road, Arlington, Va.
Kite That Never Flies Measures Wind Velocity

U.S. Army
 47, 48, 49
 Chemical Warfare Service
 B3
 SKY-MARKER Development
 C. H. BREEDLOVE

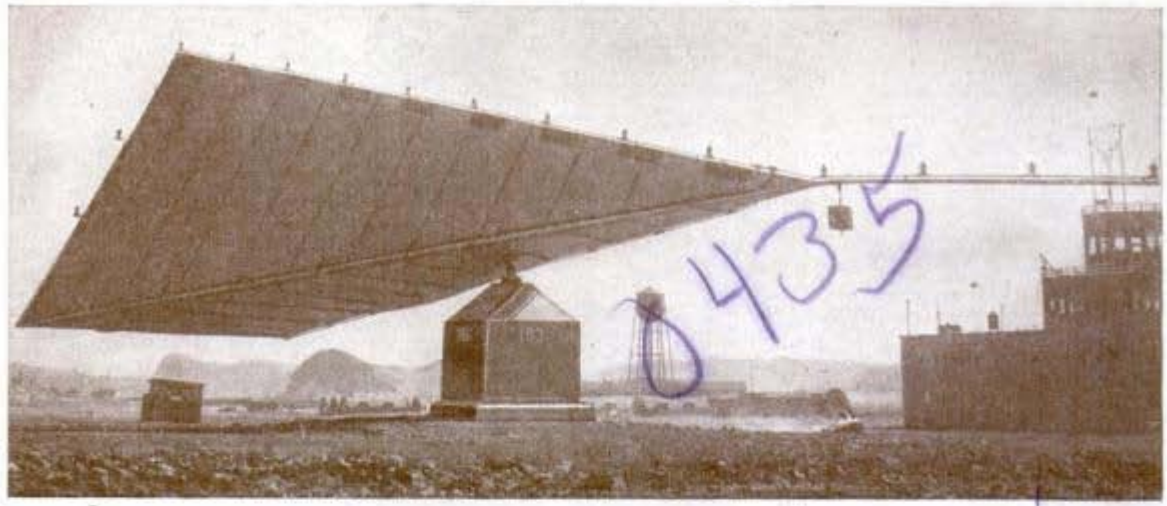

On the bleak, exposed coast of Newfoundland the direction and velocity of the wind may greatly determine the extent of military operations. Since it is the hop-off spot for air and naval craft en route to the United Kingdom, and the site of an eternal vigil against German submarines, the Newfoundland base is of high strategic importance. But more than that, it is invaluable as a "weather outpost" for the North American continent. A huge and novel wind gauge there in the shape of a monster kite is one of the devices utilized by the military weathermen in their efforts to assure that Allied flyers and seamen are prepared for any of the vagaries of climate that may ensue.

Pathfinder Marks Bomb Target With Colored Smoke

Targets which cannot be seen with the naked eye are bombed accurately through the clouds by means of the Pathfinder navigation instrument, which "sights" the target, and colored smoke bombs, which mark it for the bombardiers. One plane in each formation of bombers carries the instrument and a technically trained crew to operate it. When the target is located by the instrument, the Pathfinder plane drops colored smoke bombs, if it is daytime, or colored smoke flares, if it is at night. This leaves a ring of colored smoke in the clouds through which bombardiers drop their "eggs." Details of the working of the Pathfinder instrument, which was invented by the Office of Scientific Research and Development, have been kept secret, except for the fact that it is the "eyes" of the plane from altitudes as high as 25,000 feet. The technique has been used also in the landing of paratroopers. Planes with Pathfinder

equipment go ahead of the troop carrier aircraft to select a suitable place for the paratroopers to drop, beyond the range of enemy anti-aircraft fire, and guide them to the exact spot with colored smoke.

Grenade Launcher Casts Line For Yanks Fishing in Pacific

Deep sea fishing, wartime style, at an Air Force base in the Mariana islands is accomplished by adapting the line-carry-



ing wooden float to a regulation grenade-launching rifle and shooting it out into the surf. The discharge of the combination hunting-fishing weapon carries the baited hook and line 200 yards.

Thomas P. Whittemore
 Paducah, Ky.
 POPULAR MECHANICS

Lt. William McKechney, U.S.N.R.
6634 No. Newguard, Chicago, Ill.

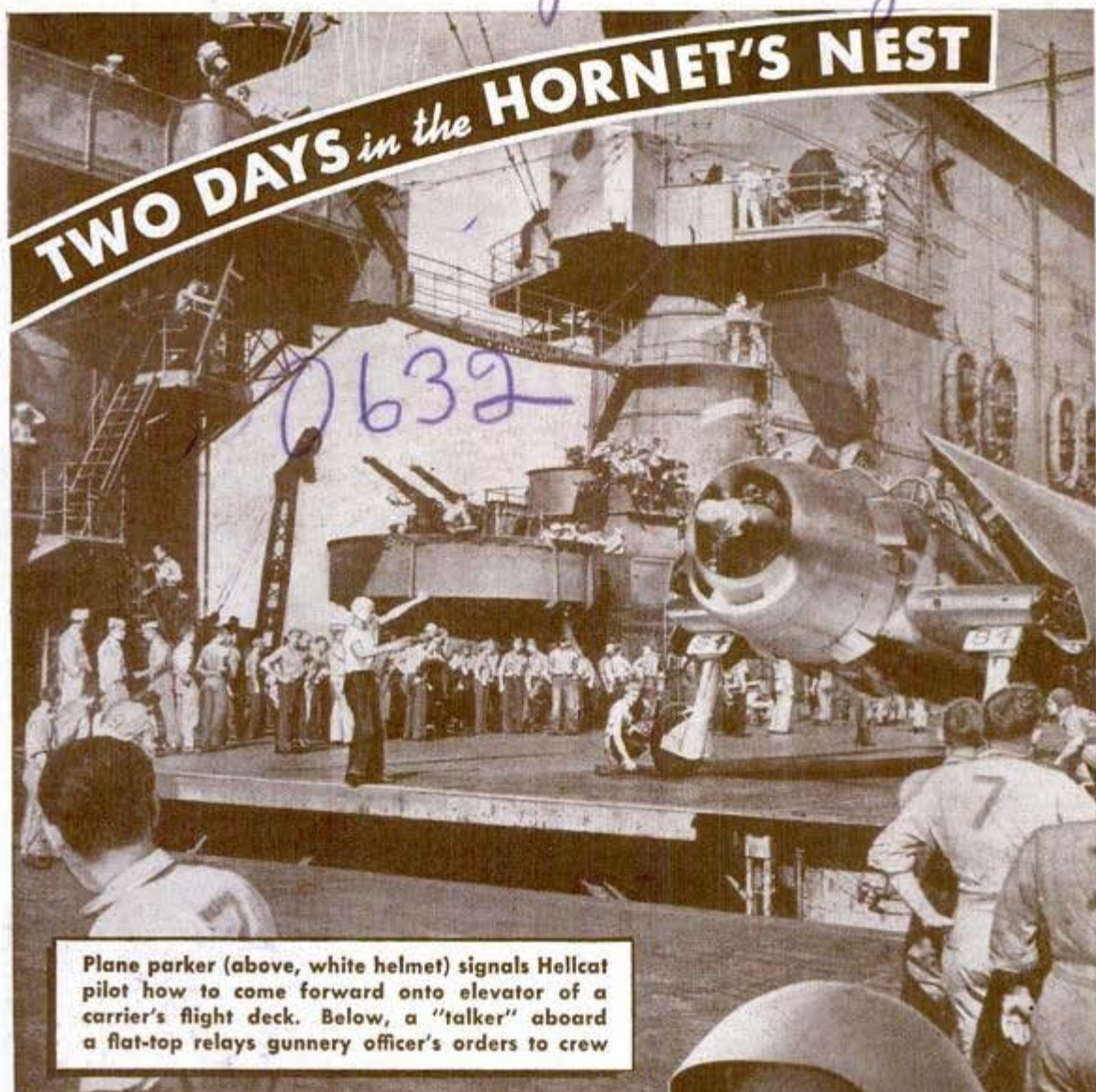

Plane parker (above, white helmet) signals Helicat pilot how to come forward onto elevator of a carrier's flight deck. Below, a "talker" aboard a flat-top relays gunnery officer's orders to crew

By Lt. William McKechney

U. S. Naval Reserve

FOUR days before the Battle of the Eastern Philippines, in which our carrier, the new U.S.S. Hornet, helped intercept and shatter a Jap fleet racing to the aid of the beleaguered garrisons on Saipan, our task group was in the Bonin Islands bombarding Jap air fields. Suddenly Vice Adm. Marc Mitscher, directing the task force supporting the army and marines invading Saipan, ordered us to a rendezvous near Saipan. There we were to join other task groups and hunt a mammoth enemy force reported steaming toward them from the Philippines.

We reached the designated point the following morning but it was

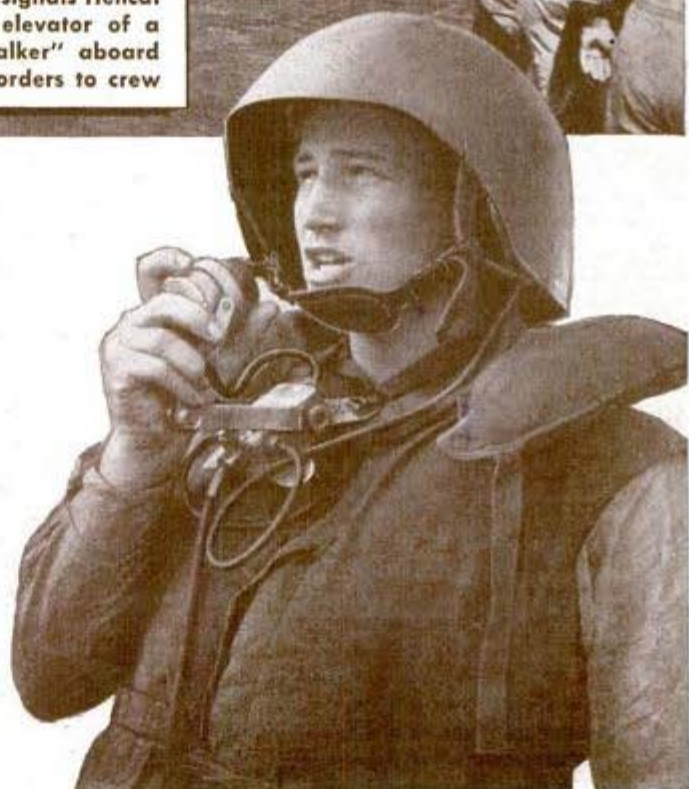

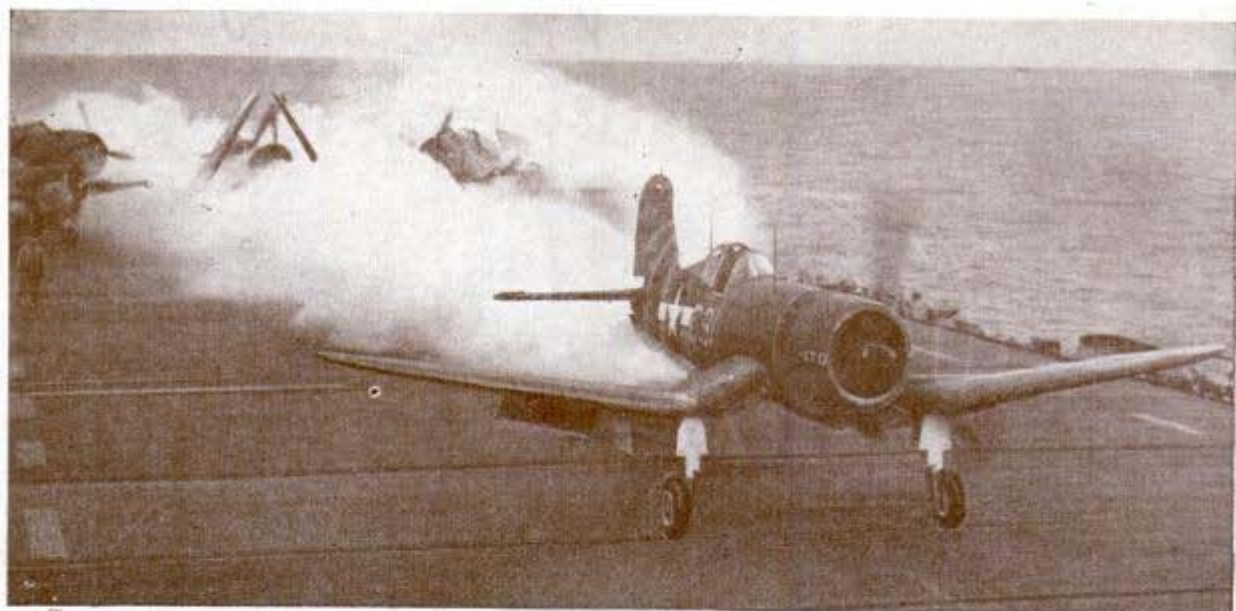

Aided by a jet engine attachment for takeoff, a Corsair roars across the deck



Director 2 from which I controlled the after 5-inch batteries.

On the flight deck the plane handlers were already scurrying around, re-spotting fighters, bombers and torpedo planes so that the maximum number could take off at a given moment. The pilots were running toward their planes from the ready room,

Above, "full face" portrait of U.S.S. Hornet. Right, "caulking off"—some carrier crewmen napping in the nets of a catwalk

not until the night of June 18 that a Coronado flying boat notified us the Jap armada had been sighted only 350 miles away. We scented action, and an undercurrent of excitement was at once noticeable. Up to this time our carrier, which was of the 26,000-ton Essex class, had been exposed only to some prowling Jap night fighters.

At 10:20 a.m. June 19 I was in my room writing a letter when I heard over the loudspeaker the boatswain's pipe whistling, "Attention all hands!" My guess was that it was just a false alarm but nevertheless I leaped from my cabin, grabbed for the ladder and started for my battle station in

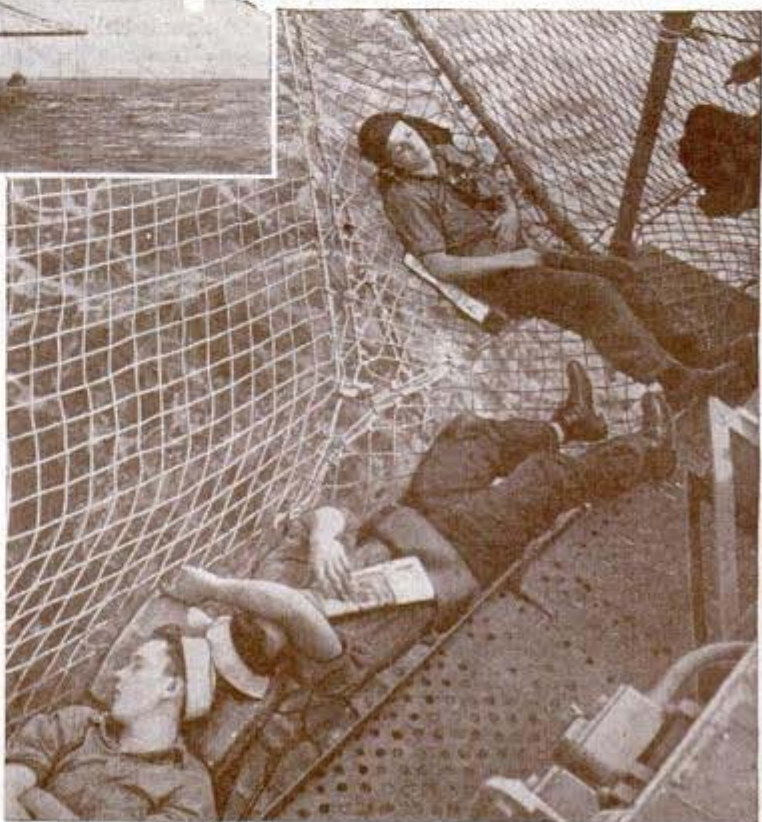

while the plane captains stood by to warm engines.

Climbing the narrow ladder leading from the flight deck to "sky aft," I noticed the motors on the 40-mm. guns had been started and the 5-inchers had been trained to starboard. I scaled the final barrette, entered the control station and relieved the officer on watch.

"There's nothing phony about this one," he yelled above the din. Jap planes had been sighted about 275 miles west. I manned my phones and established communication with gun crews and plotting room. Over another

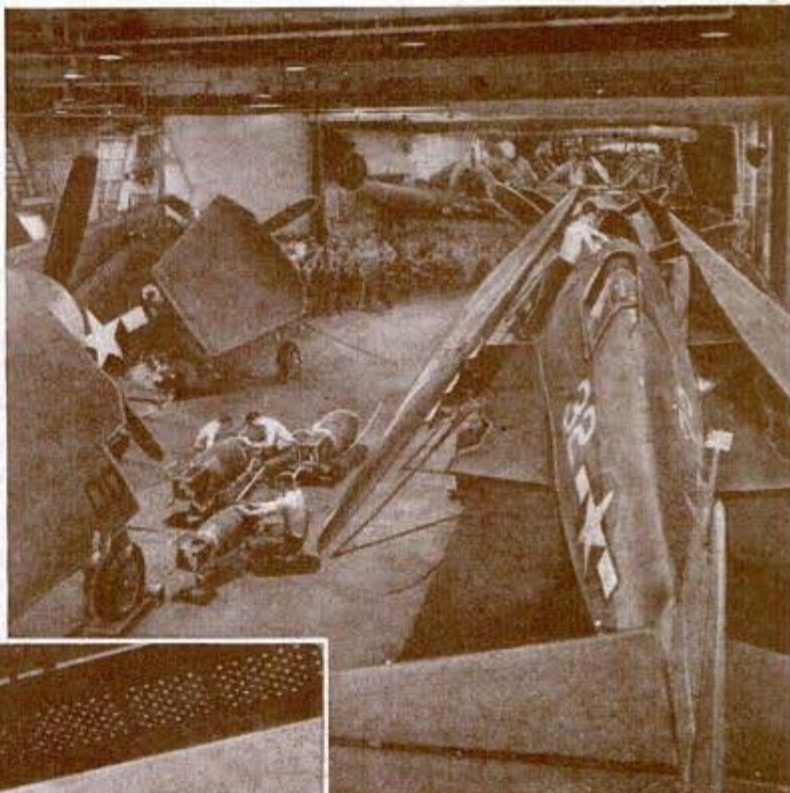

In the midst of Hellcats, ordnancemen work on bombs. Left, with wheels, hook and flaps down, Hellcat comes in to land

station. One by one our planes began to streak down the deck and weave into the sky.

I told my gun crews to check their motors, fuse-setters and ammunition train, and ordered the men on the open mounts to put on their protective clothing and helmets. We tried to appear

casual and trade wisecracks. Suddenly our carrier's C.I.C. man (combat information center) cried, "Second group of bogeys sighted!" The Japanese were on their way in! Soon he told us our fighters had "tally-hoed Raid 1." They had contacted the first wave of 50 or 60 enemy dive bombers and fighters.

Then a lookout shouted, "Gunfire on the starboard beam!" I could make out a tiny

casual and trade wisecracks. Suddenly our carrier's C.I.C. man (combat information center) cried, "Second group of bogeys sighted!" The Japanese were on their way in! Soon he told us our fighters had "tally-hoed Raid 1." They had contacted the first wave of 50 or 60 enemy dive bombers and fighters.

Then a lookout shouted, "Gunfire on the starboard beam!" I could make out a tiny

Profile of the 26,000-ton Hornet, second U. S. carrier to bear the name during World War II





Marine honor guard and bandmen await a visiting flag officer who is arriving by plane

dot no bigger than a fly going into a steep dive over a fellow carrier. Instantly I said, "All hands on alert," into my speaker and ordered my crews to throw their guns into automatic.

Ten or twelve thousand yards to the west the sky was spotted with angry black puffs

as the target carrier's ack-ack tried to defend it from the plummeting dive bomber. Seconds later the bomber burst into flames, veered off the target out of control and exploded in the ocean. A terrific geyser of water spouted near the carrier.

About noon, during a fifth attack, a lookout startled us once more with the cry, "Gunfire to port!" Soon we made out two bogeys about 23,000 yards away, headed hell-for-leather in our direction at very low altitude. Our pickets, two destroyers, were bracketing them with shell bursts but the ragged evading course of the Japs thus far had prevented anyone getting a good solution on them.

At 16,000 yards it was apparent they were going to make a run on our carrier. Just then one of our fighters appeared, dove right through our own ack-ack onto the back of one of the Japs with guns spurting, and sent him slanting into the water, a

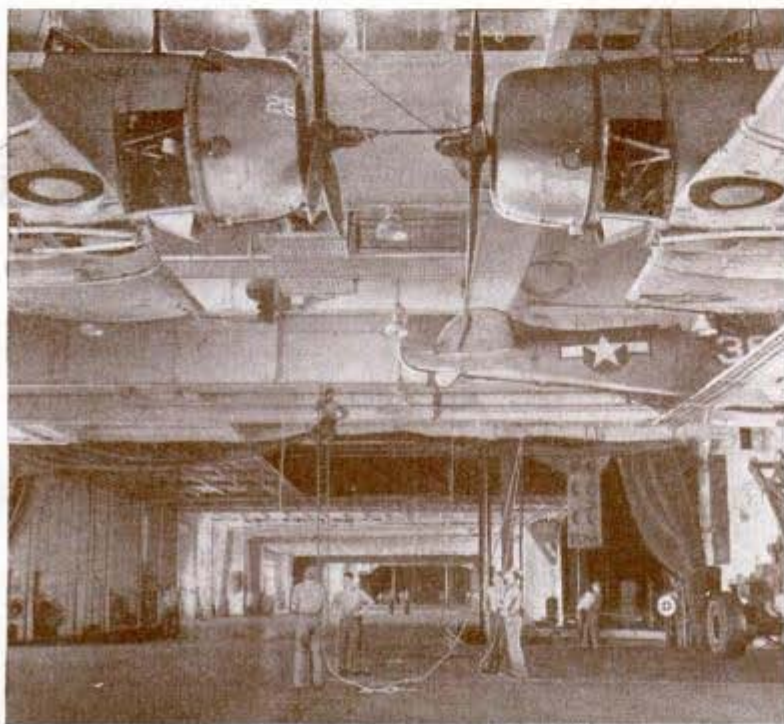

Hangar deck of a large carrier showing spare planes overhead

blazing comet. At 14,000 yards I told the port battery to stand by. When the range closed to 12,000, I ordered, "Commence firing!" Almost the instant we opened up, the lone Jap—hit many times by our task group—fell in flames several thousand yards out.

At 3 p.m. the last attacker was shot down, but we stayed at battle stations until after sundown. The returning flyers were jubilant. Our carrier had lost only three fighters, while our pilots had accounted for between 50 and 60 enemy planes. The overall score for our task force planes was 369 Japs shot down against a loss of only 27.

Early next morning all carriers sent out search planes after the fleeing Japs. They were sighted at 3 p.m. 275 miles west. All ships immediately were ordered to launch two strikes with the idea of crippling the fleet so it couldn't slip away from us that night. The first wave was launched at 4 p.m. and as a matter of safety the crew

(Continued to page 154)

Below, Jap torpedo plane braves curtain of carrier antiaircraft fire near Truk. It crashed shortly after picture was taken

U. S. Navy photos



Above, with wings folded, a warbird goes to roost in the hangar deck, while other F6F Grummans wait their turn on flight deck. Below, Helldiver being taken aboard carrier at a U. S. port

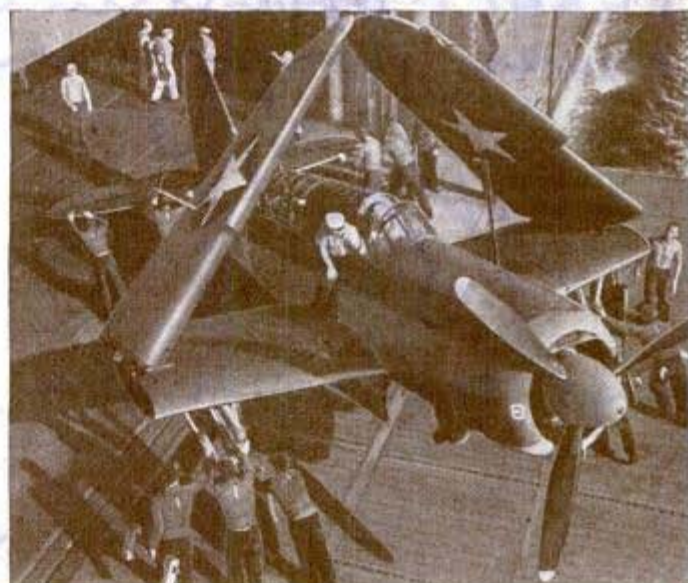

Angle Adapter for Drill Press Gives Versatility

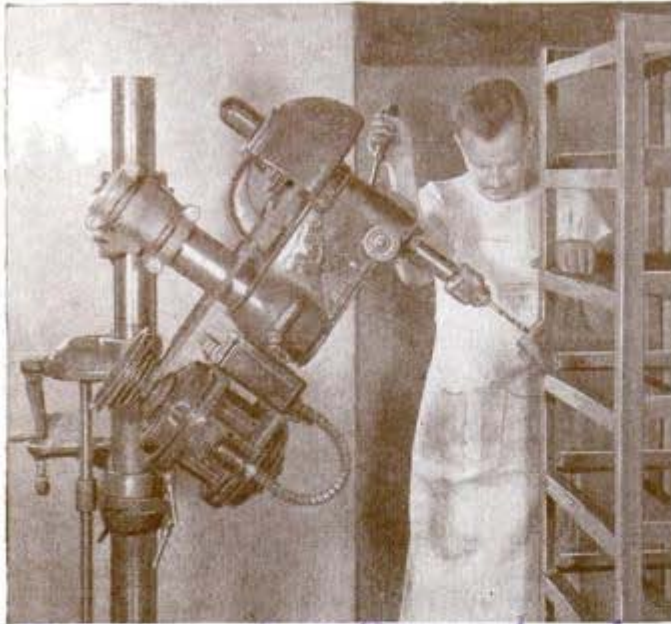

Drill presses can be converted into multiple-purpose machines by an angle adapter which permits working at any angle and height. Fitting almost any drill press with a round tubular column, the unit prepares a drill press for angle drilling, polishing, buffing, sanding, rotary filing, wire brushing, tapping, reaming, burring, grinding and honing. Besides angle and height adjustment, the adapter allows horizontal and vertical control. It also affords a more comfortable position for the operator and encourages faster work.

Left, adapter permits operator to adjust drill press to whatever angle and height is desired

FRANCE *Oppenheimer of Michael Reese Hospital in Chicago* Germs Killed by Ultraviolet Light Provide More Powerful Vaccine

More powerful vaccines are likely to result from the development of a method of killing germs almost instantly with ultraviolet light, says a report to the Journal of the American Medical Association. Bacteria and viruses, numbering about one billion in a teaspoon of fluid, are killed in less than one second when exposed to a specially constructed ultraviolet lamp. Vaccines prepared from light-killed bacteria for typhoid fever, pneumonia type 1, and

Salmonella enteritidis, one of the germs that causes food poisoning, were prepared by research scientists, who said they appeared to be equal or superior in antigenic potency to vaccines prepared by heat-killing the same bacterial suspensions. They asserted that rabies vaccine produced by the new technique consistently induced a higher degree of immunity in mice than vaccines in which the germs had been killed by phenol.

Temp INC. 230 E Ohio, Chicago, Ill 'Exploded View' of Engine Parts Makes Complicated Assembly Simple

0540 By eliminating all guesswork and tinkering, a visual aid known as an "exploded view" makes assembly of a complicated engine part quick and easy. The "view," a photographic chart, shows all parts in a machine individually down to the last nut and bolt and makes plain their exact inter-relationship, which helps to simplify maintenance problems for mechanics. In a test case at the Bendix Aviation plant in Chicago, Jack Butler, an 11 year old boy, assembled the 500-odd parts of an injection carburetor fuel regulator in approximately 90 minutes.



TEACHING the GI WAY

0523

TWO French language experts visited a class of GI's who had graduated from a nine-month course in that tongue conducted under the Army Specialized Training Program at the University of Chicago.

To their astonishment, they found the top third of the class had a better command of French than most candidates for university master degrees under conventional methods of teaching, that the middle third was as good as the best candidates for bachelor degrees, and that the bottom third did as well as the average candidates for bachelor degrees after four years of study.

This accomplishment didn't surprise the Army instructors, nor does it surprise many leading educa-

MR. N.B. MOORE
1362 N. Dearborn
Chicago 10,
Ill.



Above, aerial gunners are trained by the use of electrically geared guns which fire at motion picture projected targets, presided over by WAVES. Below, left, training aid for teaching signal recognition. Below, toy vehicles help in training GI's to regulate troop traffic

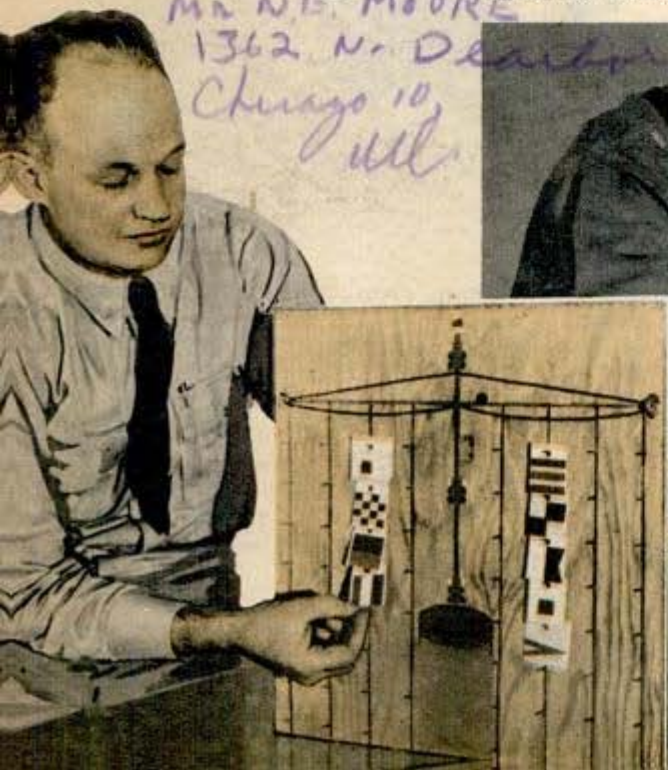

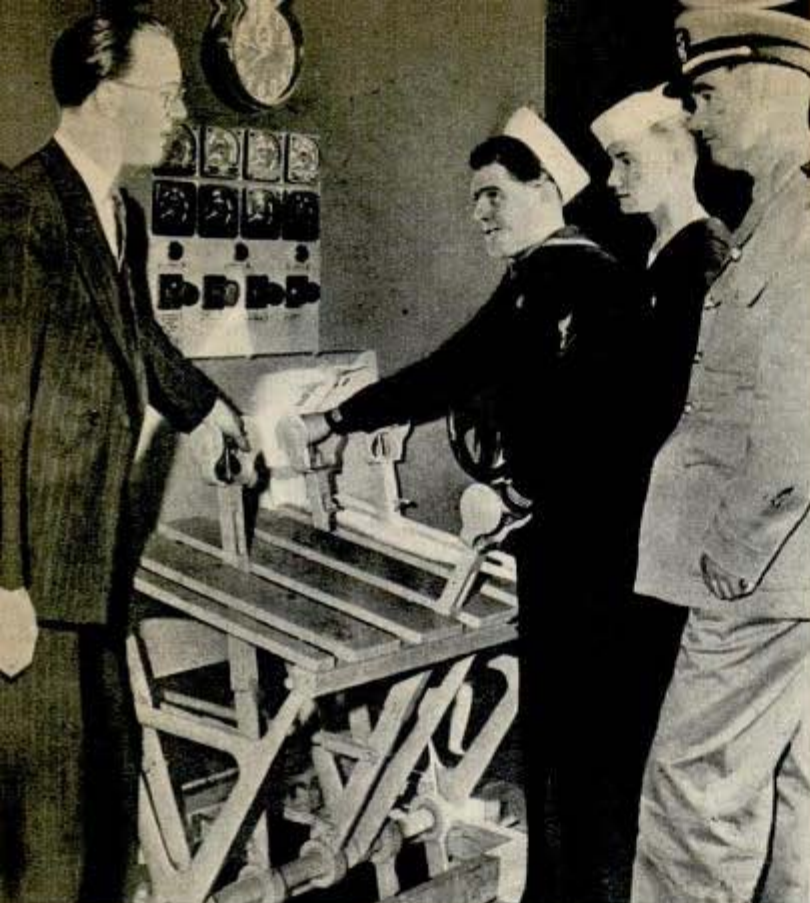

Above, simulated equipment for teaching ship operation. Right, miniature German M-IV tank with hatch door being opened to show its construction

tors, for similar results are being attained in hundreds of other foreign language classes of the specialized training divisions of the Army and Navy.

With new techniques, practically every foreign tongue or dialect is being taught the men in the service with incredible speed and thoroughness. The Army alone teaches about 40 languages. The Navy has a program which includes one school in Boulder, Colo., where students get a good working knowledge of



classes, even an illiterate can read and write. The Navy has more than 550 different schools to give the types and degrees of training its men require.

A vast, speeded-up teaching and training program was necessary to turn out the millions of specially trained men needed quickly by both the Army and Navy in World War II. So traditional teaching



Left, miniature ward tent and pyramidal tent aid training at Camp Robinson, Ark.

methods have been combined with new and improved techniques involving the use of a seemingly endless variety of teaching aids, including sound and silent movies, film strips, slides, recordings, charts, diagrams, mechanical devices of all sorts, cut-away and transparent models, miniatures of equipment, large scale models, topographic models, even toys and sand tables.

Probably the best term to describe the Army and Navy teaching system is audio-visual education. It is said that 95 percent of all learning is absorbed through the eyes and ears. This is the basis for most of the new teaching techniques.

Take the teaching of foreign languages, for example. Students start speaking the language from the first class day and actually live the scenes which might take place in a foreign land through movies and the acting out of playlets. There is frequent use of recordings and sound motion pictures in the language being studied. There are few students in each group and many teachers are rotated among the groups. Natives are brought in to converse with the students whenever possible.

So effective have recordings become in language instruction that they can be used to teach the essentials of a foreign tongue in 8 to 12 hours. Sometimes soldiers on troopships in an invasion fleet learn the rudiments of the language of the country they will invade while they are en route, using only recordings and guide books. In classroom studies, the students cut their own records for review.

Probably the most versatile and widely used of all teaching aids is the motion picture, with which might be combined the

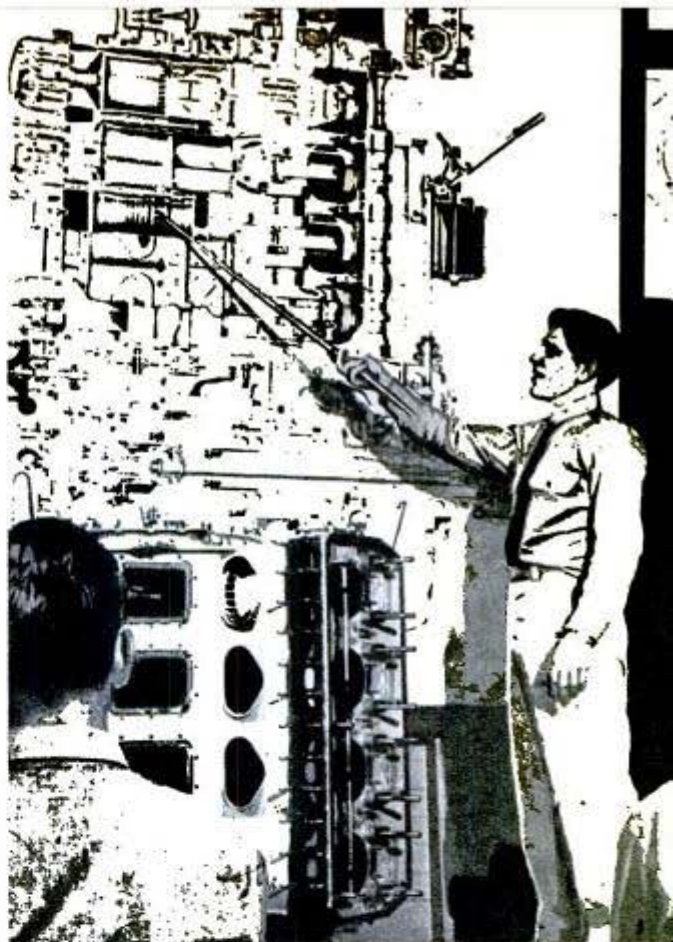

Above, charts supplement real equipment in teaching engine operation to a class of naval trainees

film strip (a succession of stills), film bulletins and slides. Most of the movies are sound, and some of them are in color, though silent films often are used independently or in conjunction with recordings. Thousands of subjects are covered, one War Department basic field manual alone listing more than 700 pages of films.

Below is oversize model of slide rule used in teaching slide rule operation in radio training
U. S. Navy photo

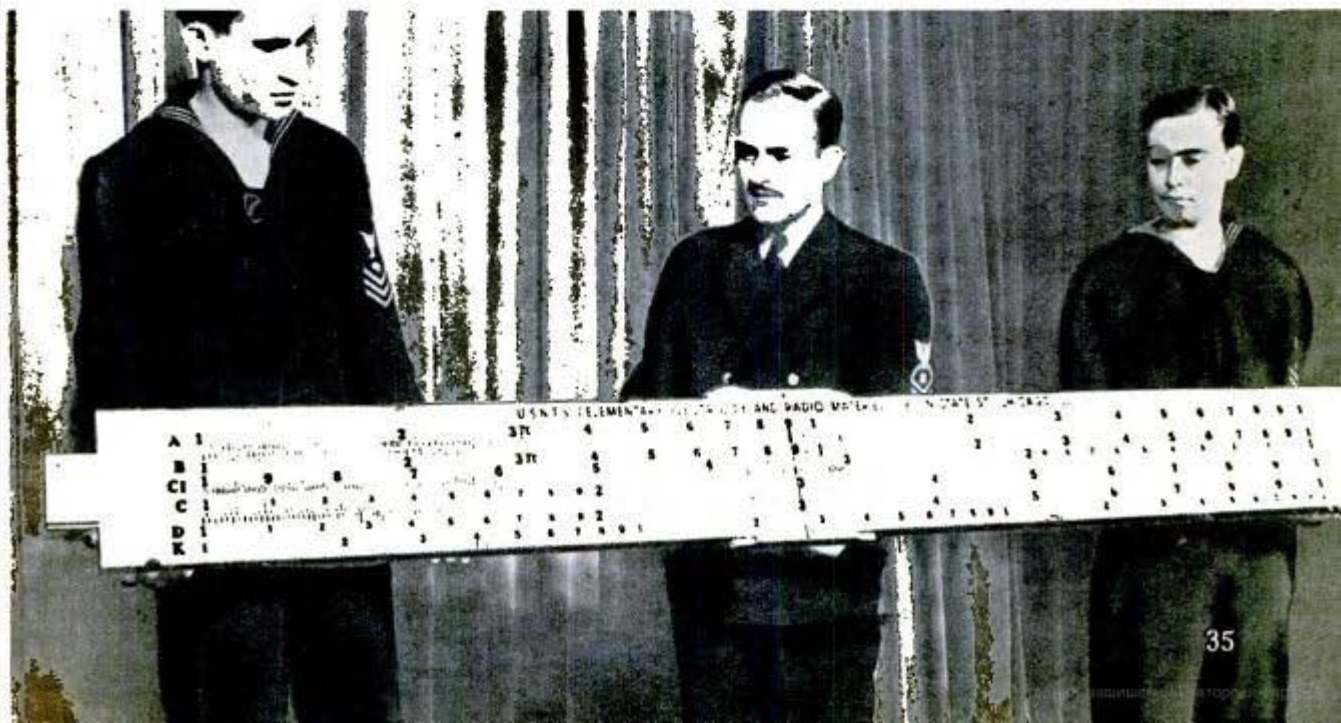

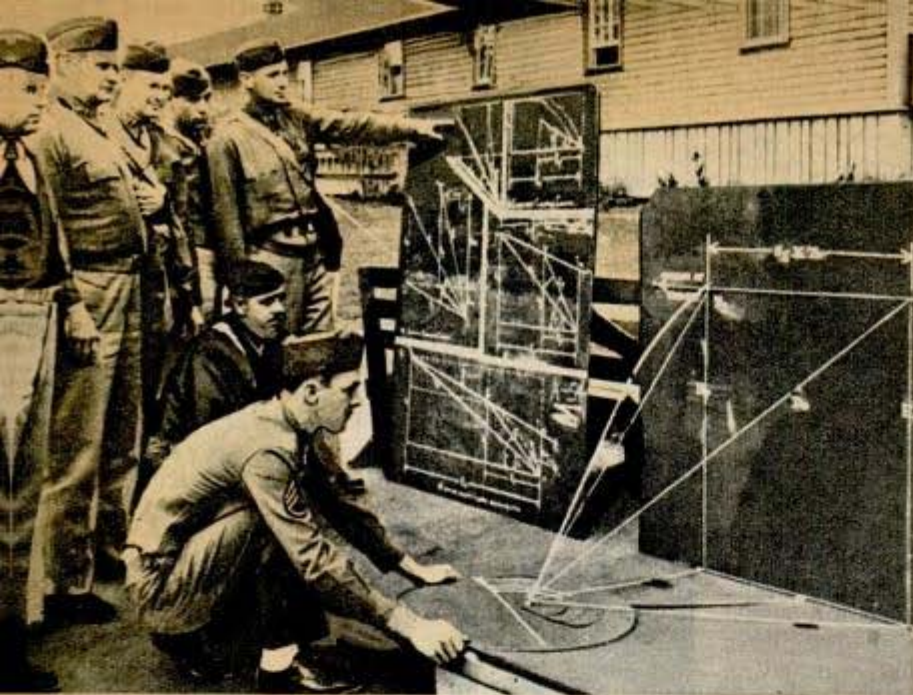

This visual set-up helps to teach the operation of the anti-aircraft director. Device at right illustrates some ack-ack firing problems

Motion pictures enable students to learn up to 35 percent more in a given time, and tests show that the facts learned are remembered up to 55 percent longer, according to the training division of the Bureau of Naval Personnel.

The types of movies used range from animated cartoons and Hollywood-staged productions to highly technical subjects which show, for example, how to use a slide rule. In addition, movies have been combined with mechanical and electrical devices to achieve unusual effects and re-

sults. Student aerial gunners at the Lakehurst Naval Air Station are trained by the use of electrically-gearred guns which fire at motion picture projected targets.

Toy-like, small-scale models of tanks, guns, ships, buildings and other equipment have been found especially useful in many fields of study. The complex problems of supplying the modern army are "solved" and explained in Army Quartermaster Schools where piers, camouflaged warehouses, ships and highways were used in tiny model form, along with miniatures of trucks and other vehicles. To teach military maneuvers and systems of regulating military traffic, the Army uses complicated topographic models in which sand, water, clay, plasticene, sponge, paper, cardboard, wood and metal are used for various types of construction. The theory and methods of bridge construction are taught with miniatures scaled one inch to one foot.

In some model work, the terrain is formed on a canvas, and tiny tanks, scout cars, artillery pieces and men, made of metal, are propelled by man-powered magnets beneath the canvas. Sometimes the

Below, officer candidates learn to use ack-ack information board to check on enemy aircraft

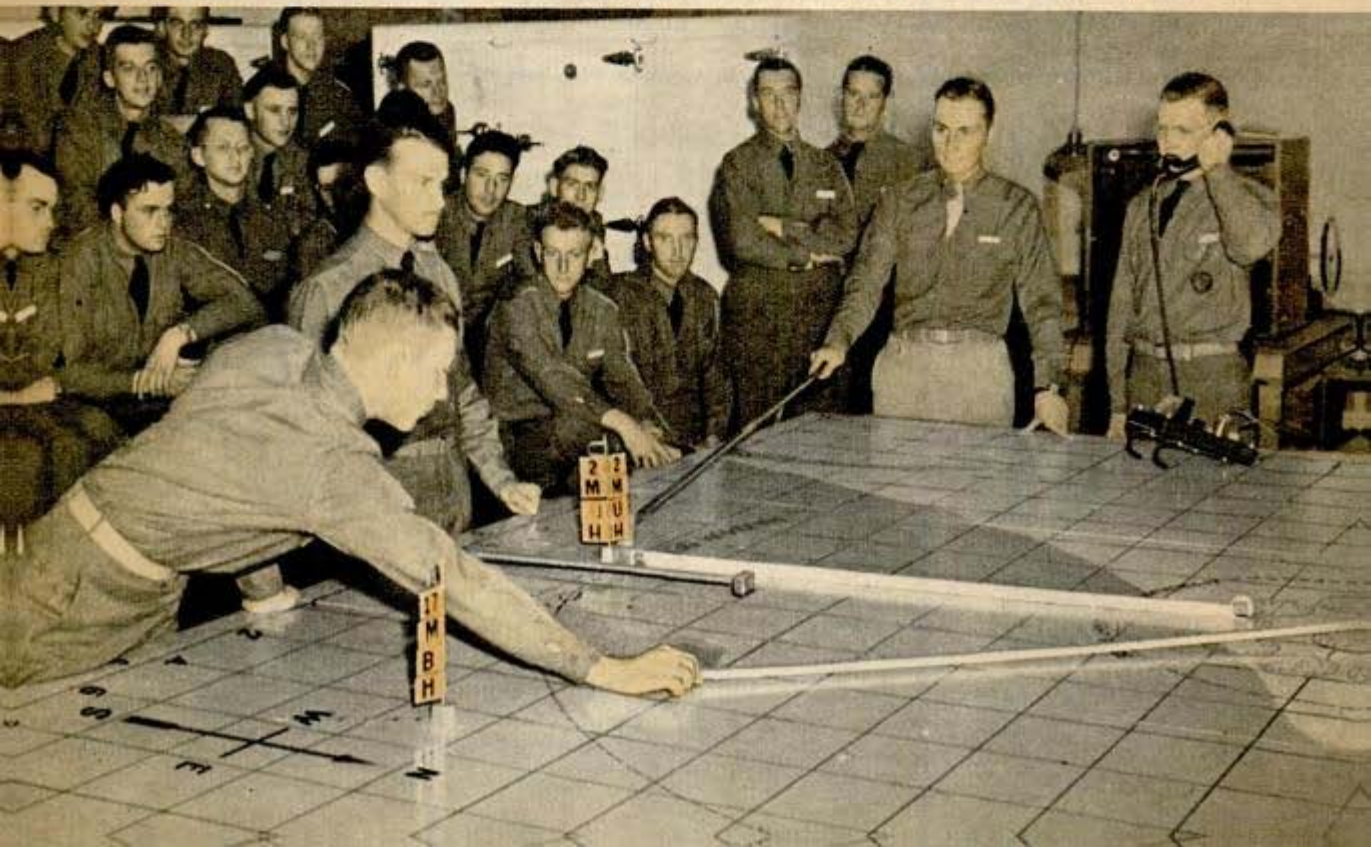

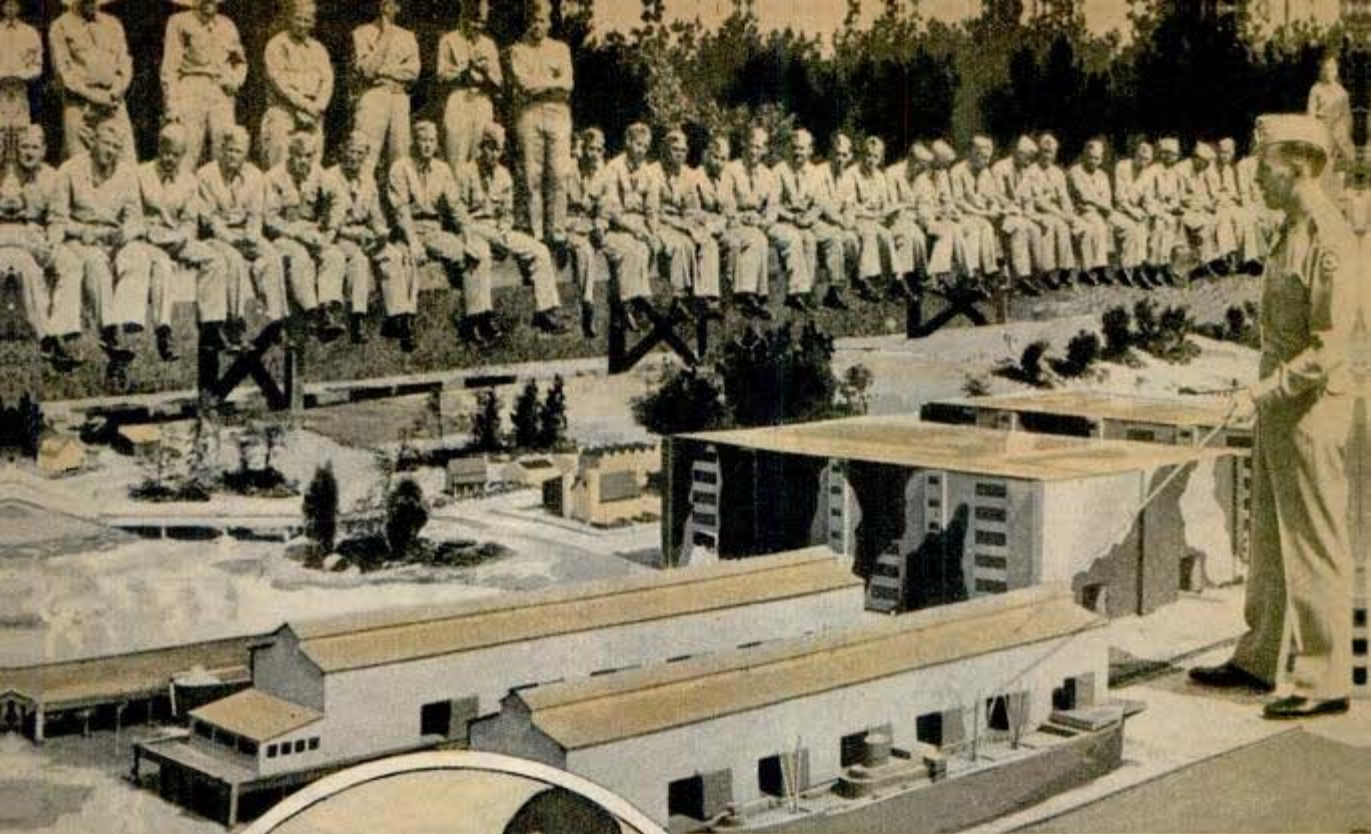

Army Signal Corps photo

Above, miniature theater of operations for solving problems at a quartermaster school. Left, model tanks for identification study



The Navy has a fully equipped and staffed training aids development center. Drafting and design rooms, a complete woodworking shop, engineering department and illustrating division are operated by skilled layout men, engineers and mechanics, woodworkers, metal workers and pattern makers.

One of the latest products of this center is a ship-to-shore demonstration panel for specialized am-

(Continued to page 156)

models are several times actual size. A wooden model of one machine gun is enlarged three times, but functions the same and has the same number of parts as the gun it represents.

Considerable use, too, is made of cutaway models of equipment and mechanical training devices. The latest full-sized models of valves, pumps and other types of equipment are made of crystal-clear plastics which are machined to size and accurately shaped.

A model sewage treatment plant is used to teach construction and operation to students at U. S. Army engineers school



David M. ...

Camera "Freezes" Spilled Milk in Weird Designs

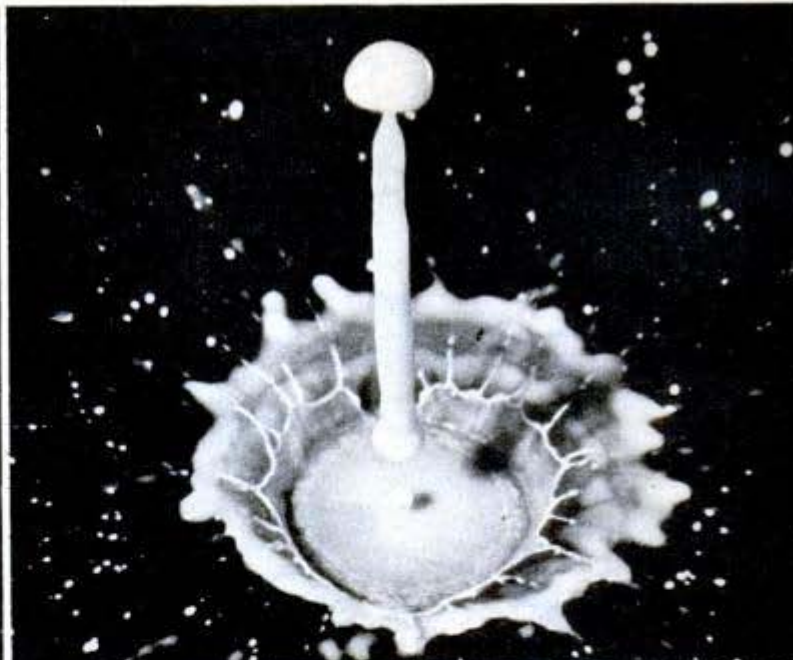

Left, milk overflowing around glass; above, a drop of milk is "frozen" by the camera as it hits flat surface

One person who does not cry over spilled milk is the man behind a stroboscopic camera with a high speed shutter. The result is "frozen" milk in fantastic patterns. A camera with a shutter speed of 1/30,000 second gives the spilled milk a semi-solid appearance.

Anti-Glare Goggles Reveal Submarines When the Lenses Are Rotated

Goggles which can control light are helping the Navy lick the submarine menace. Developed by the American Optical Company specifically to locate underwater craft, the goggle is equipped with a pair of special anti-glare lenses. When the lenses are rotated by hand in an arc of 180 degrees, blimp and plane crews find it possible to spot submarines or periscopes otherwise obscured by water or light reflections. The rotation is accomplished by a

sliding bar in the upper part of the goggle frame. The range of rotation is enough to eliminate concealing glare for any position of the observer with respect to the sun and water. In any adjustment the lenses transmit the same amount of useful light but cut out reflections. The goggle also has been used successfully to locate survivors from torpedoed ships, to spot enemy planes from airplane carriers and to protect the eyes against glare when scanning sunny skies.

"Gadabout Auto" Weighing 1,100 Pounds Gets 40 Miles to the Gallon



The "Gadabout," a 3-passenger automobile built largely of aluminum, magnesium and Duralumin on an 80-inch wheelbase, has been developed by the Detroit Industrial Designers' Association as a postwar possibility. Weighing only 1,100 pounds, it is powered by a two-cycle, air-cooled engine with a fuel injection system instead of a carburetor and gets 40 miles to a gallon of gasoline. A steel tube at bumper height surrounds the body.

Ray Russell Pres., Detroit Industrial Designers Ass.

660 Y T... #62751

GI's "Bamboo Inch" Saves Metal Pipe On Chinese Front

Native wood found growing in a wild bamboo thicket was used by U. S. Army Engineers to build a 600-foot water line down a mountain slope back of the ground fighting in Yunnan Province, China. Calling their span the "Bamboo Inch," the soldiers cut large bamboo stems, joined and caulked them, fashioned bamboo trestles to support the line across the defiles and suspend it over jagged rocks, and then watched spring water flow from the spring to their mess hall. The bamboo eliminated the need for 678 pounds of metal pipe and the cargo space required to bring it from this country.

Upper right, bamboo line is supported by a bamboo trestle. Right, engineers knock pith from bamboo



Vultee - Sandberg

"Speed Bomb" Trailed by Plane Helps Eliminate Testing Hazards

Airspeed instruments on new aircraft are checked at a safe altitude with an airspeed "bomb" lowered by cable and winch. It is accurate at speeds in excess of 300 miles an hour. Formerly, airspeed instruments were calibrated by flying the plane at danger-

ously low altitudes over a speed course on the ground. The bomb, developed by Consolidated Vultee Aircraft Corporation, resembles a metal lure used by fishermen. It has a streamlined lead body, a static pressure head for a nose, and four stabilizing tail fins. The bomb is 12 inches long and weighs 25 pounds. Airspeed indicators must be adjusted on new planes because the pitot-static tubes from which they receive pressure impulses are situated in the turbulent air close to the body of the aircraft. It is almost impossible for engineers to estimate the effect of this air on the tube. The trailing airspeed bomb sends accurate electrical impulses to a special indicator on the plane through connecting wires, and from this indicator the plane's regular airspeed instruments are calibrated.

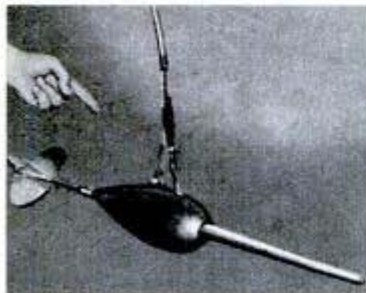

*Only News
Photos*
Preview-

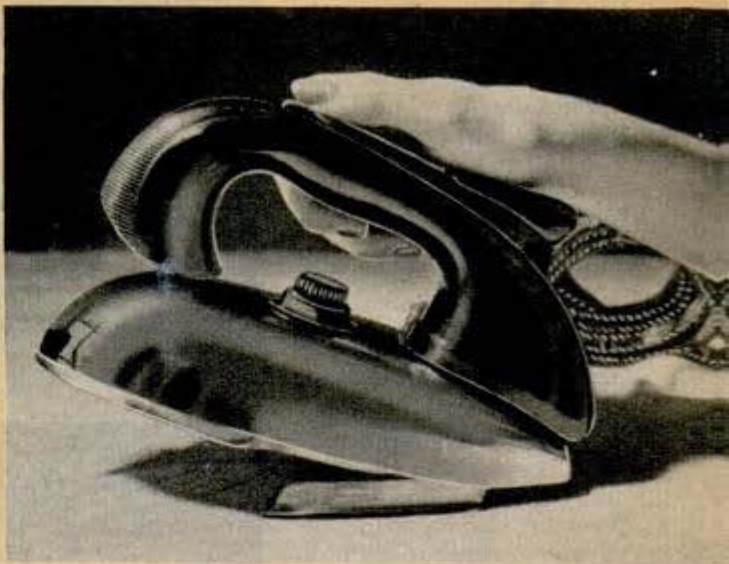

Here's a preview of what's promised you—postwar.

Loaded with a few ice cubes and a little salt, the midget refrigerator (upper left) will cool a quart of liquid in a few minutes. It's known as a "Fahr-heitor" and is designed to save space in your postwar refrigerator. The stream-lined iron (above) is called a "never-lift" because it springs back on its own "heels" and does not have to be lifted by the housewife during the entire ironing process



The small television receiving unit (in circle) is a far cry from bulky prewar devices. Incorporated in this set, designed by Barnes & Reinecke, will be a radio and a wire recorder which records broadcasts on magnetized wire instead of phonograph records. Below, that yen to put your feet on the desk is satisfied by this chair of revolutionary type made of tubular steel. It raises the feet above head level





D625

The plastic cups and saucers (above) were made originally for the Navy. They will not break as easily as china cups and they won't topple over if stacked up high. The new cups are said to be "nontiltable." The table model radio set of unusual design (upper right) has the tuning dial in a band around the speaker. It was designed by a student at California Institute of Technology. It is a compact radio and said to be efficient



Right, it looks like a radio and stove combination at first glance and is exactly that. This is how your "airtronic" high frequency cooker is going to look. Simple dials control the voltage and a cake can be made to rise in four seconds. Instead of cooking in the conventional way from the outside surface inward, food cooks uniformly inside and out. Airtronic units were developed for quick heating of plastic molding materials



*Arbomex Devel Corp.
131 E 3rd St
Dayton, Ohio*



Left, inflated "upholstery" for chair is made of flexible plastic. Frame consists of an aluminum ring with four legs which support cushion. When deflated and taken apart it fits into a briefcase

*Bureau of Ships
U.S. Navy*

Transport Fights Own Battle Carrying Troops



Able to defend itself from attack by air or sea, the Navy's newest combat transport is designed as a complete fighting unit within itself. The ship, with the official Navy designation BD-1, incorporates many revolutionary features developed from experience in amphibious operations. Many of our landing craft are equipped with rocket-launching devices. The heavily armed and expertly camouflaged ship carries a large number of fully equipped men.

Chicago News Photo 326 W Mack

Cloth "Sweats" Drinking Water in Life Raft Experiment

Drinking water was "sweated" from a cloth by Air Force volunteers cast adrift off Hawaii to test new life raft equipment. One of the crew held the solar still in position as the sea water entered through the funnel and tube in his hand and soaked the heavy black cloth under a large shield in a square frame which he held to his chest. The steam resulting from the heat of the sun on the damp cloth condensed on the shield and trickled down into the fresh water retaining tube. The raft contained a canopy for protection from the sun. The men also experimented with a new type of mirror for signaling.

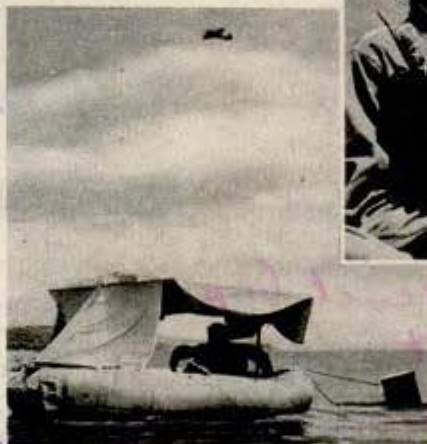

Above, soldier holds the still in position while it creates fresh water. Left, men on sun-shaded raft signal to a plane

Daily News Press Wire N.Y. N.Y.

"Ducks" Equipped to Throw Smoke Screen to Hide Troops on Beach



Smoke generators which spout artificial fog are mounted on ducks, the Army's amphibious trucks, to cover their operations and hide troops on beachheads. The GI designation is "Smoke Drake." The amphibious vehicles haul three tons of supplies and travel at five knots through water and 40 miles an hour on land. These vessels carried thousands of tons of equipment into France.

See with ... Piqua, Ohio

Electronic "Brain" Closes Window When It Rains

Lazy people will be delighted to learn that a window has been invented which will close automatically when it rains. It is in use at the Lear Aviation plant at Piqua, O. Motivating power is a Lear midget motor with reduction gears or power unit plus a Lear linear actuator. The company has kept the nature of the "brain" a secret, except to say that control is exercised through an electronic relay.

Right, window with electronic device that shuts it when rain comes down

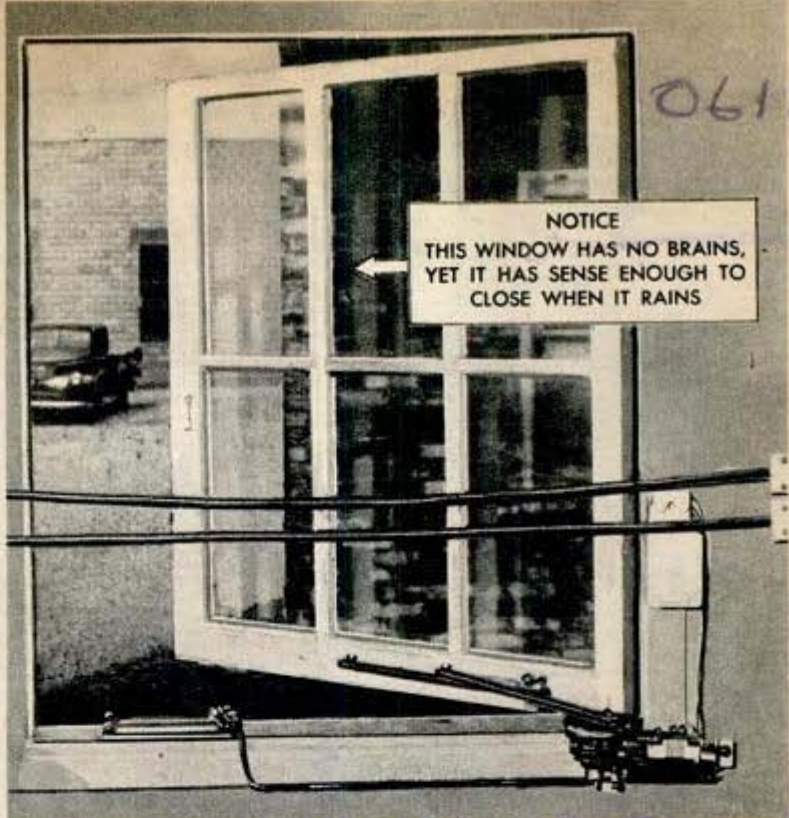

E. D. Reilly G. E. works

Wires Measured in Plastic Mold To Millionth of an Inch

Fine wires are measured to a millionth of an inch in the General Electric works laboratory. The method consists of molding a plastic block with a series of V-shaped grooves in its upper surface. Short pieces of wire are placed in the grooves, molding powder is poured over the wires and pressure and heat are applied until the whole block is hard. The powder grips the wires firmly so the block can be sawed across the wires without distorting them. The face of the block, which exposes a cross section of the wires, is then carefully polished and examined under a microscope with a micrometer eyepiece. Two threads are visible. Moving them until they seem to touch diametrically opposite parts of the cross section of the wire, the diameter is determined to a millionth of an inch.



Coast Guard Phila, Pa

'Floating Monitor' Combats Pier Fires With Water Spray

A "floating monitor" has been devised to help the Coast Guard fight fires under piers. The device, which looks like a toy boat, is floated near or under the blazing pier, where it sprays water into the air with great pressure. It is jet-propelled and operated by remote control from the fire boat.



GIVING DEPTH to the MOVIES

HOLLYWOOD will pay you one million dollars in cold cash if you can devise a satisfactory third-dimensional effect for motion pictures. Possibly you could get a better price than that.

The vivid impression of depth and distance that you get when looking at pictures through a stereoscope is the effect the cinema industry would like to duplicate on the screen. Hundreds of schemes have been proposed for creating this illusion and hundreds of engineers have worked on the problem without success.

One way to achieve it, of course, is to project a double picture on the screen and provide the audience with stereoscopic spectacles. Another way, demonstrated as far back as 1912, is to tint alternate frames of a motion picture in red and green and to provide the audience with spectacles that have a red filter for one eye and a green filter for the other. The spectators see one frame with one eye, the next with the other, obtaining stereoscopic vision. A polaroid screen and

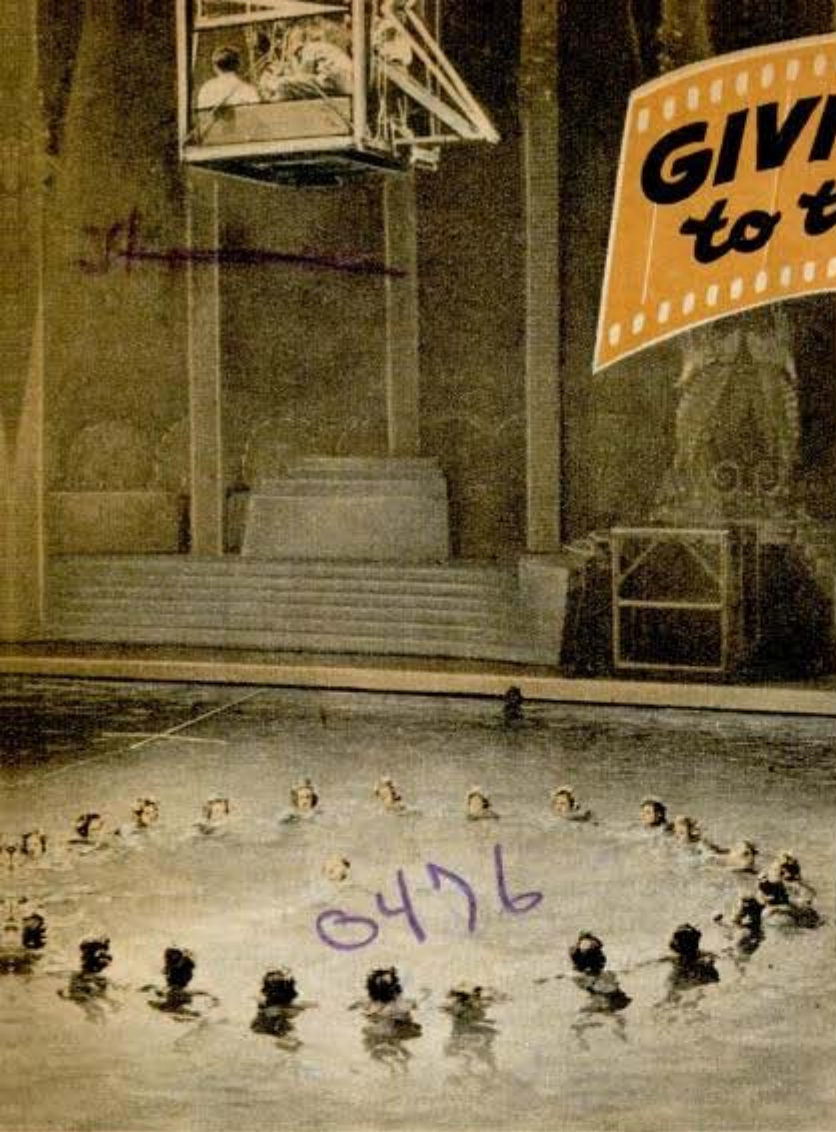

Above, scaffolding suspended from roof gives camera a bird's eye view of girl swimmers. Below, model of city streets will correct errors in perspective before full sized set is built

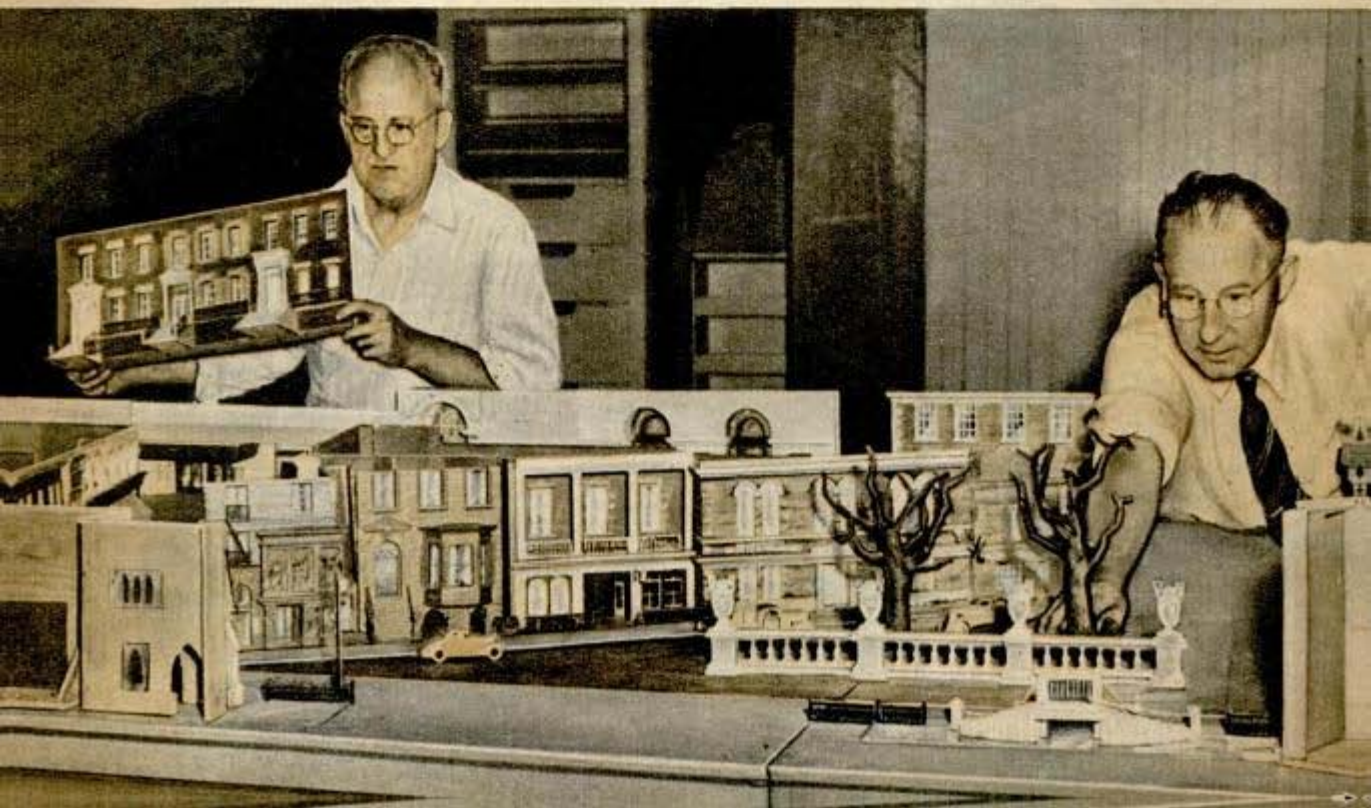

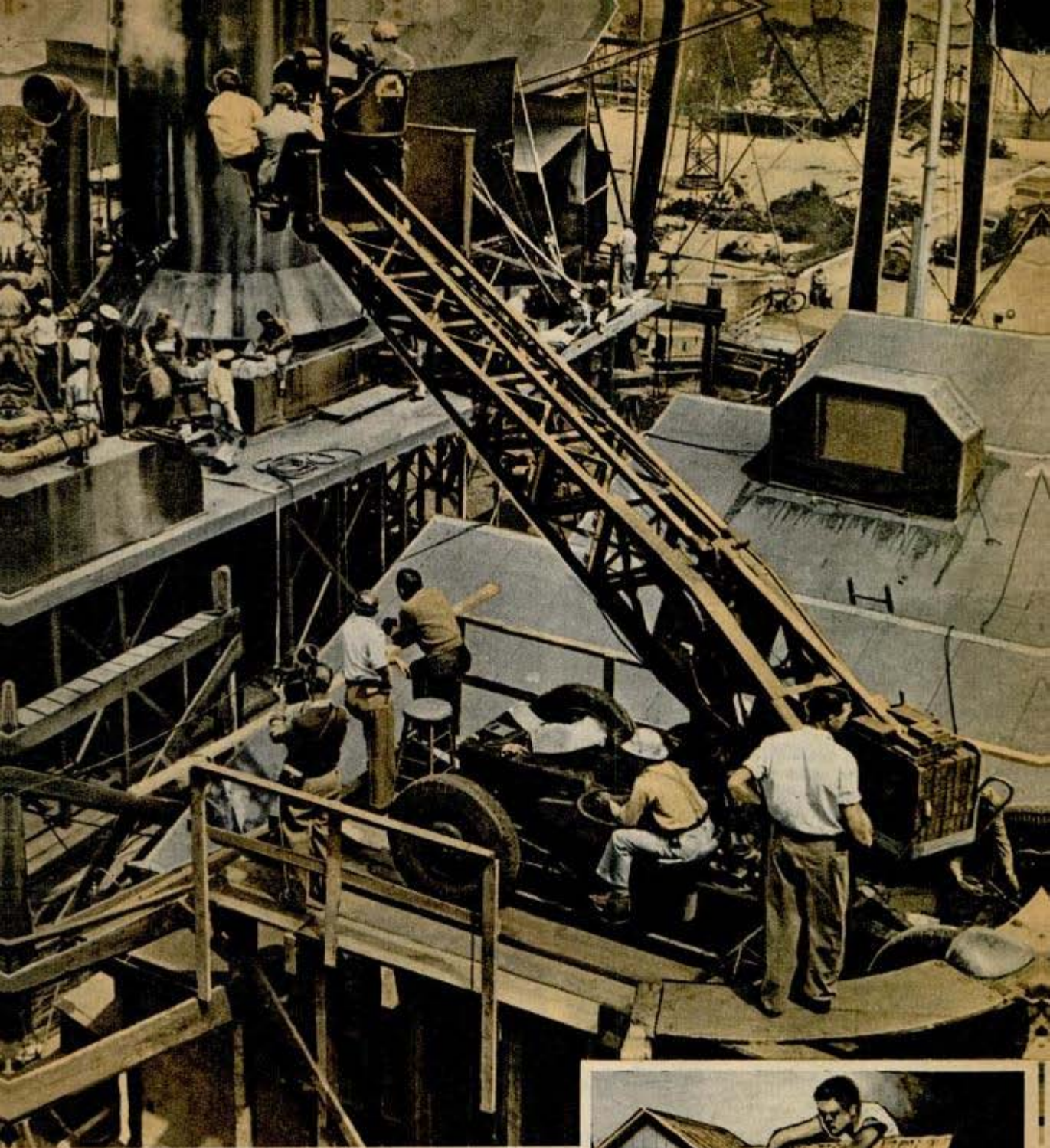

Crew on end of camera boom films synthetic shipboard scene. Right, scaled down buildings will give an illusion of depth

polaroid spectacles give the same effect. All of these methods work but none has been adopted. Audiences find it too much of a nuisance to wear spectacles in the theater.

The Army Air Forces get a kind of third dimension in motion pictures that are used for training aerial gunners. The screen is curved in the form of a paraboloid. Five different motion pictures are projected on different parts of the concave screen simultaneously, producing one complete composite picture. Even this arrangement doesn't provide a perfect sense of depth. The projection apparatus,

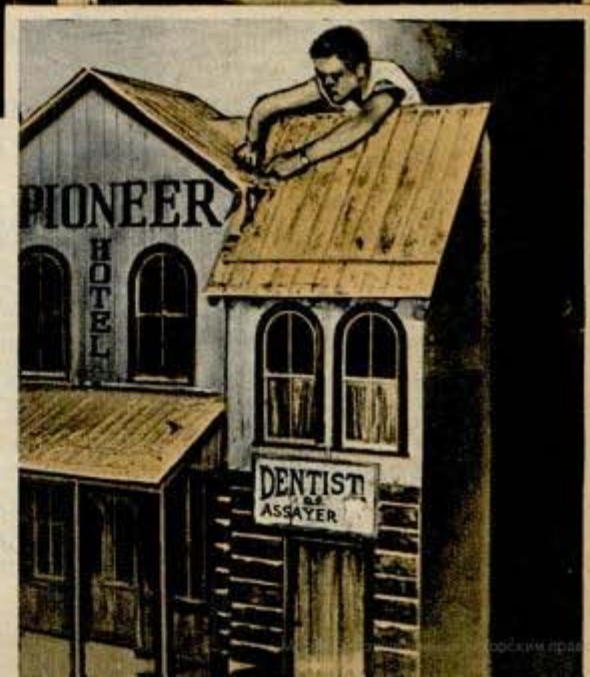



Above, side lighting for actors comes from standards to which a dozen or more lights are attached. Right, the concave projection screen in background provides three-dimensional illusion for aerial films used in training Air Force gunners. Below, touching up model of old house. In background of set it will seem to be some distance from camera



consisting of five synchronized projectors, would be too complicated for ordinary theater use.

As much as the studios would like to produce stereoscopic movies, they are doing quite well without them. During the last few years the movie technicians have developed methods that provide an impression of three dimensions that is quite realistic.

Ten years ago motion pictures seemed to be just as flat as the screens on which they were projected, though occasionally a scene would appear in which each actor seemed to stand out in relief. A third-dimensional quality had been achieved by accident. Cameramen studied the causes, then changed their lighting systems. Flat lighting from behind the camera was dropped and now actors are lighted from the sides as well as from the back and front to model them and make them stand out more sharply from their surroundings.

Sharpness of the film image, all by itself, helps create the third-dimensional illusion and so the new fine grain film that the studios are using



contributes to the effect. Color film is more third-dimensional than black and white because the colors themselves sharply separate all the objects in the scene. Recent improvements in color include the use of single strips of film of the Kodachrome type that may be exposed in any motion picture camera. The expectation is that after the war practically all motion pictures will be filmed with this color "monopack."

Another way in which the effect of three dimensions has been approached is to increase the depth of focus at which pictures are filmed so that more of the scene from foreground to infinity is seen in sharp detail.

Like three dimensions, a method of achieving universal focus has been sought for a long time. One idea was a split lens with half of it focused on the foreground and the other half focused on infinity; another idea was a lens that moved or vibrated back and forth, alternately placing the

foreground and then the background in sharp focus and giving an over-all effect of sharpness. Mechanical difficulties seem to have precluded wide use of these devices.

Greater depth of focus is being obtained through use of new fast film emulsions that are more sensitive to light, allowing smaller diaphragm openings that provide the depth to be used. The new so-called coated lenses that transmit more light than do untreated lenses also allow smaller apertures to be used, and the coated lenses likewise reduce halation and lens flare, helping to provide sharper film images. The newest professional cameras have improved shutters that stay open longer, then chop off more sharply than did the older shutters. More light is admitted to the film during each exposure, again allowing the use of a smaller aperture that increases the depth of focus.

These are the mechanics of the three-dimensional effect; there is also an art in simulating it. In Hollywood it is often best to film an exterior scene inside a sound stage instead of outdoors. Houses, lawns, and streets are assembled indoors. Even distant mountains and villages are provided for backgrounds, or seascapes that stretch out to the horizon. The camera records a realistic picture of a scene that appears to be miles in depth, though actually occupying no more than 100 feet or so of stage.

The effect is achieved by following the laws of perspective. Robert O'Dell, one of the art directors of Paramount, explains that objects such as houses that are to appear in the middle distance may be built in three dimensions, but scaled down to a half or a tenth of their normal size to create the illusion of distance. Mountains or other background scenery are often painted on canvas backdrops, shaded to match the shadows that will be cast by objects in the foreground and painted in neutral tones with a lack of sharp definition to match the impression one usually receives of distant scenery. Tremendously enlarged photographs are printed on sensitized canvas for use as backdrops.

(Continued to page 160)



Above, mountains painted on canvas backdrop are expertly shaded so that shadows conform with shadows in foreground



Above, miniature of hall's ornate walls and ceiling, suspended in the air in front of the camera, appears to be full sized in finished movie. Below, photo of house used as set background

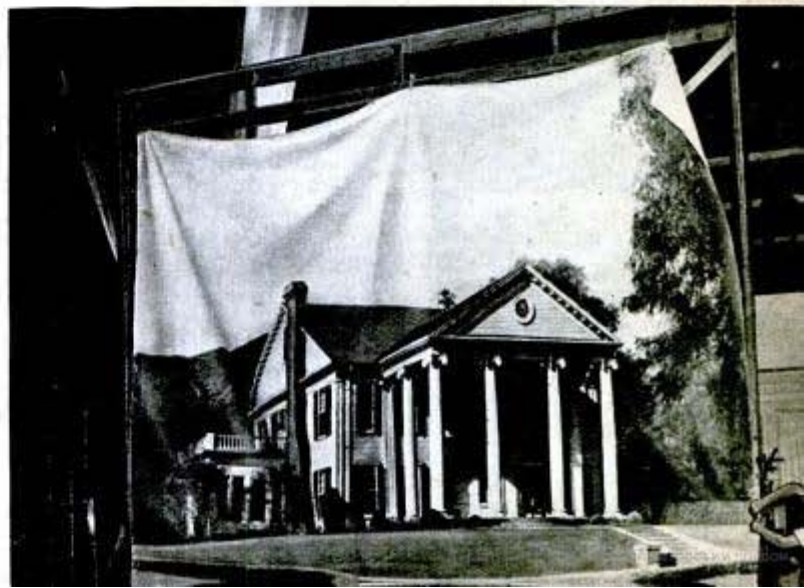

0579



BIG GUNS of INDUSTRY

*mark
Coip
York
Pa*

Though they look like death-dealing weapons, these instruments are some of the big guns of industry—machine tools used to prepare the real fighting weapons for the front. Above is machine tool used to finish off crankcases and cylinders for engines and to machine gun mount cradles

Right, water-cooled condensers for industrial refrigeration



Below, steel shafts which bore the holes in the cylinders of powder presses and ammonia compressors

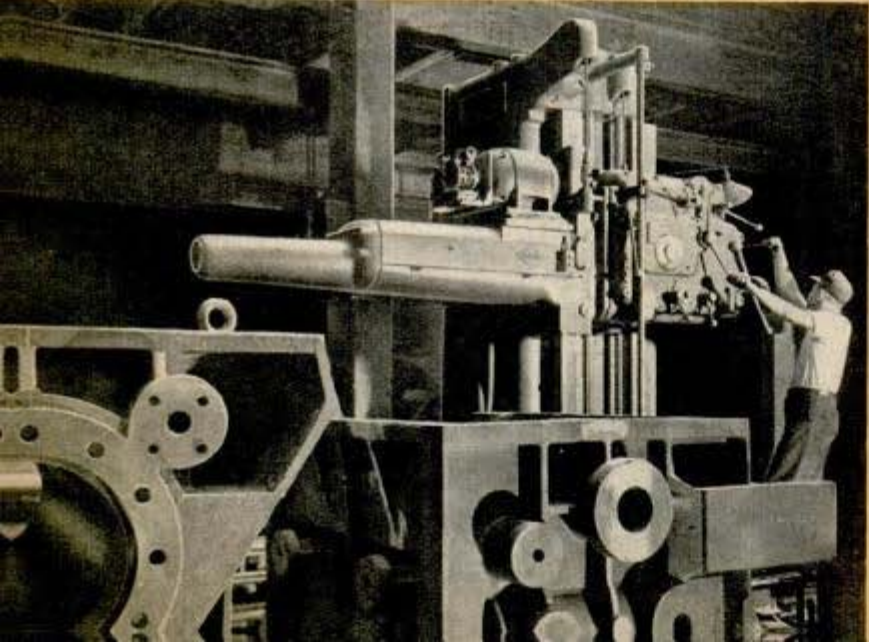

Rocket gun? No, the boring mill at left is used for machining gun mounts and milling high altitude chambers

Vultee - Fort Worth, Tex.

"Boxcar" Camera Speeds Airplane Designing

Three persons can work inside the giant engineering camera in the plaster pattern shop of Consolidated Vultee Aircraft Corporation's Fort Worth, Tex., plant. The camera has a base 8 by 14 feet and its box is 36 feet high. This huge camera, which is believed to be the only piece of air-conditioned photographic equipment, photographs seven square feet of surface. Full-sized master design layouts drawn by engineering draftsmen are photographed one-half size on film held to the top of the camera by a vacuum. The film is printed on 4- by 8-foot sensitized photographic paper or transparent tracing cloth. This paper or cloth is then developed, fixed and washed in the same fashion as ordinary photographs are processed. The camera eliminates countless hours of tracing in the production of blueprints, and is one of the many photographic aids which speed war production.

Photographing a full-sized master design layout in Consolidated Vultee Aircraft's Fort Worth plant with giant box camera. It is said to be the world's largest box camera. Three persons can work inside the air-conditioned box which is speeding the preparation of aircraft blueprints

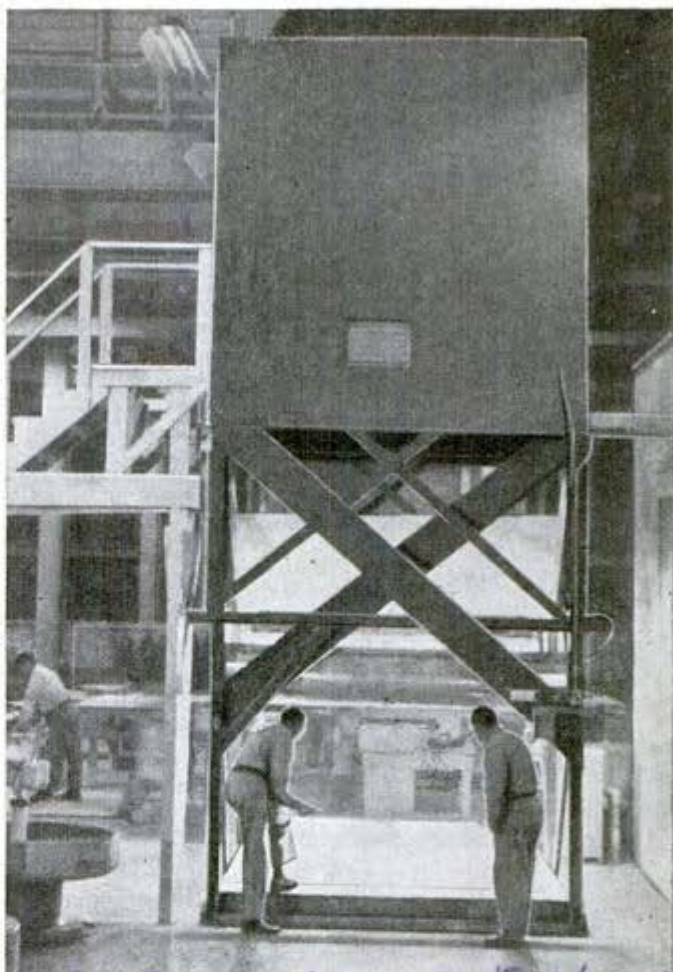

"Merry-Go-Round" Winds Wire Around Huge Tanks

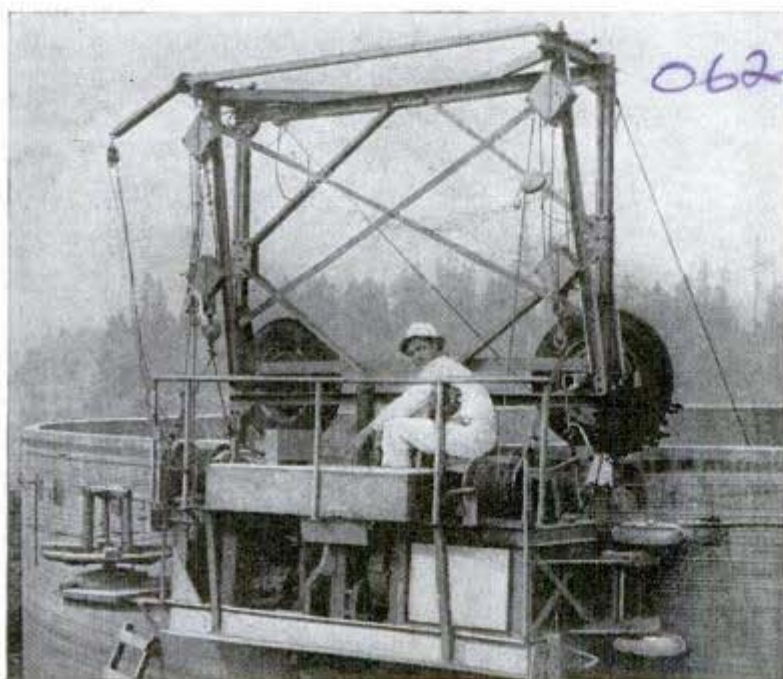

Heavy wire is wound spirally around concrete tanks with a "merry-go-round" machine that travels around and around the rim. The wire, which is stressed to 150,000 pounds per square inch, prevents the tank from cracking due to shrinkage of the concrete or from pressure within. This method of reinforcement is said to save 88 percent of the steel ordinarily used in reinforcing.

Motorized wire-winding machine travels around rim of a concrete tank at rate of three miles an hour. Wires prevent cracks

SEVEN TRILLION DOLLAR



By Roderick M. Grant

THERE are several good reasons for boasting that America is the most powerful nation on earth. One of the reasons is coal.

For coal is power, and heat, and a treasure house of chemicals, and we have more of it in our mines than all the rest of the world. In our spendthrift way we dig upwards of 600,000,000 tons of coal every year and think nothing of it unless a war or a strike comes along and threatens us with empty bins in midwinter. As a matter of fact we can afford to be spendthrift. We have coal to burn.

In 200 years we have dug over 20 billion tons of bituminous coal alone. Yet 98 percent of our reserves lie in the ground. We have more than 3,175,000,000,000 tons of anthracite, bituminous, lignite and intermediate grades still in the mines, worth above seven trillion dollars wholesale. A comfortable bank balance. The next generation may see the end of our petroleum and natural gas. We have coal for 3,000 years.

Top, Caterpillar tractor and shovels in strip mine. Below, cleaning coal in cone at a Hudson Coal Co. (Pa.) mine

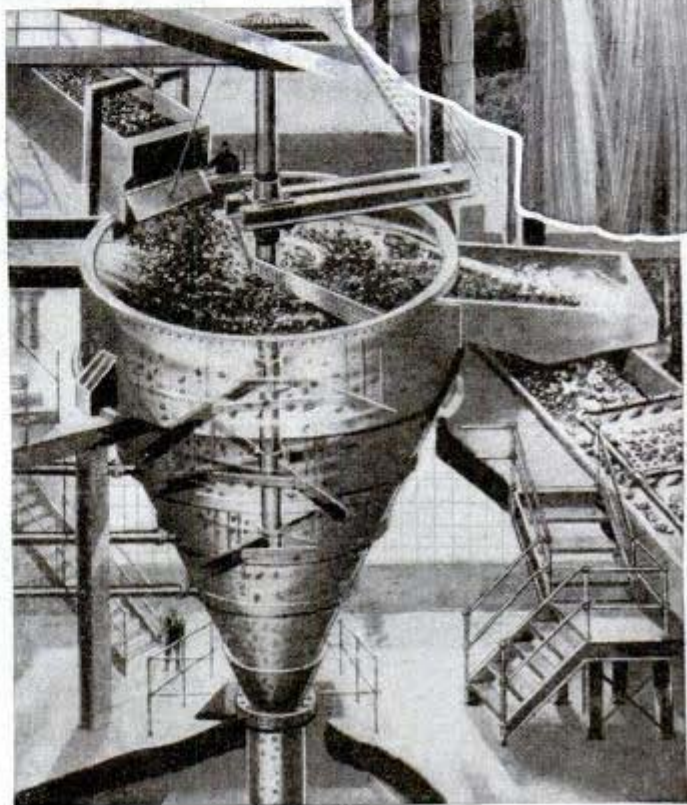

TREASURE

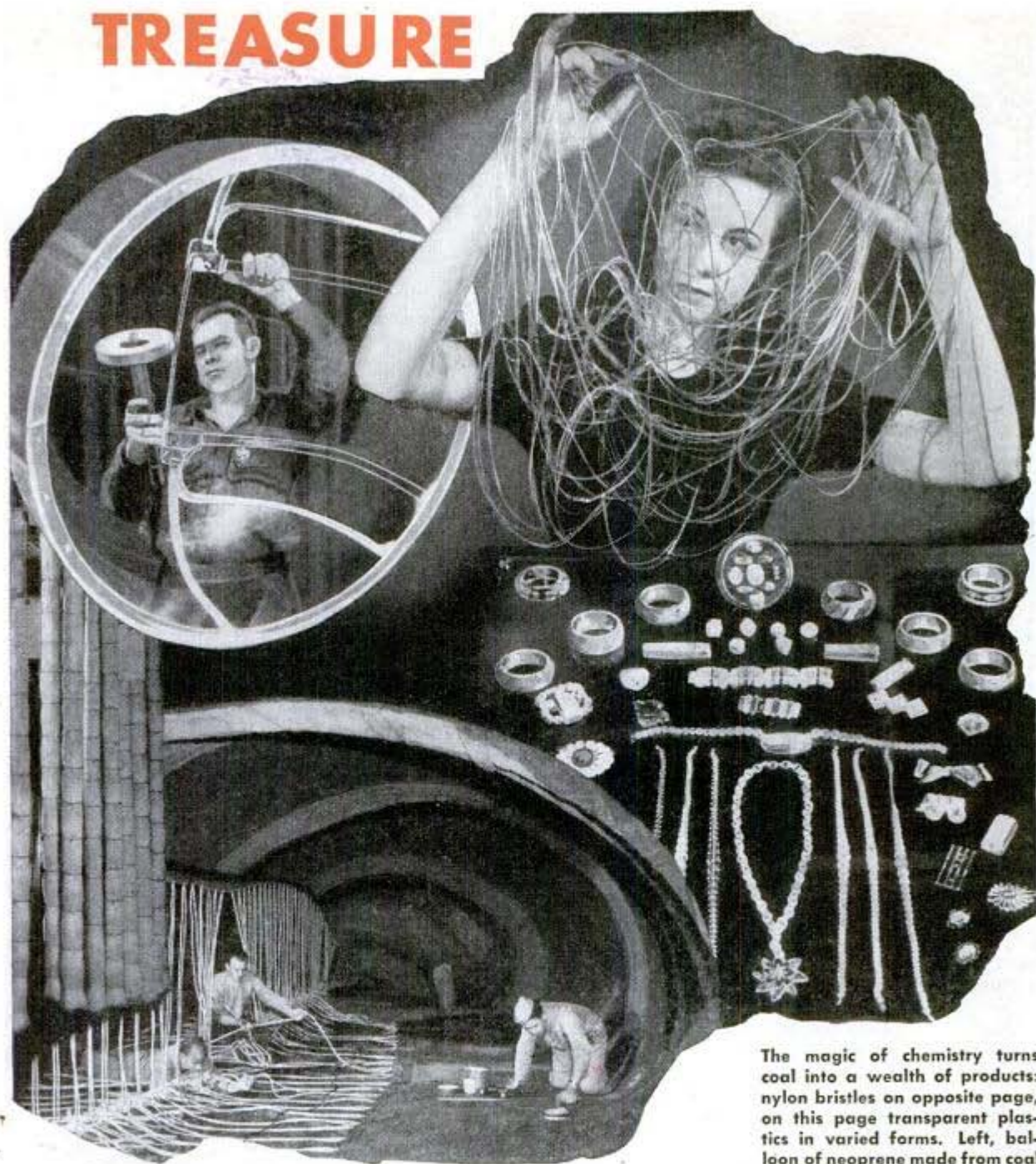

The magic of chemistry turns coal into a wealth of products: nylon bristles on opposite page, on this page transparent plastics in varied forms. Left, balloon of neoprene made from coal

Primarily, of course, coal is energy. Our railroads alone burn 115 million tons a year, and 53 percent of their freight cars carry nothing but coal. More than half the nation's mechanical energy is derived from coal, 65 percent of our electricity has its origin in the coal mines, and coal is the staff of life to our gigantic steel industry which is dependent on coke from 100 million tons of coal a year. It takes a ton of coal to make a ton of steel.

Prodigious as is the quantity burned for power, coal is going high hat over its chemical importance. The coal tar from coke

ovens eventuates in such end-products as TNT and aspirin, sulfa drugs and vitamins and insect poison, paints and paint removers, perfumes and plastics and parachutes. The once-wasted gases and liquors and coal tar distilled in coke ovens are so precious today that a drastic cutback in steel production would have a serious effect on industries dependent upon the by-products of coke.

Bituminous (60-75 percent carbon), the coal of power, of heat and chemicals, is mined in 25 states and represents 90 percent of our coal tonnage. Anthracite (90



percent carbon) constitutes less than one-tenth of our production and is used principally for heating and cooking in the northeastern states. Most of the coal workings are underground, with West Virginia and Pennsylvania the leading producers; one Pennsylvania pit has a 1,200-mile underground railroad with 500 electric locomotives moving coal in 24,000 cars to shafts where it is hoisted to the surface. Destined to be

Automatic dumper upturns a carload of "black diamonds"
 Bituminous Coal Institute photos

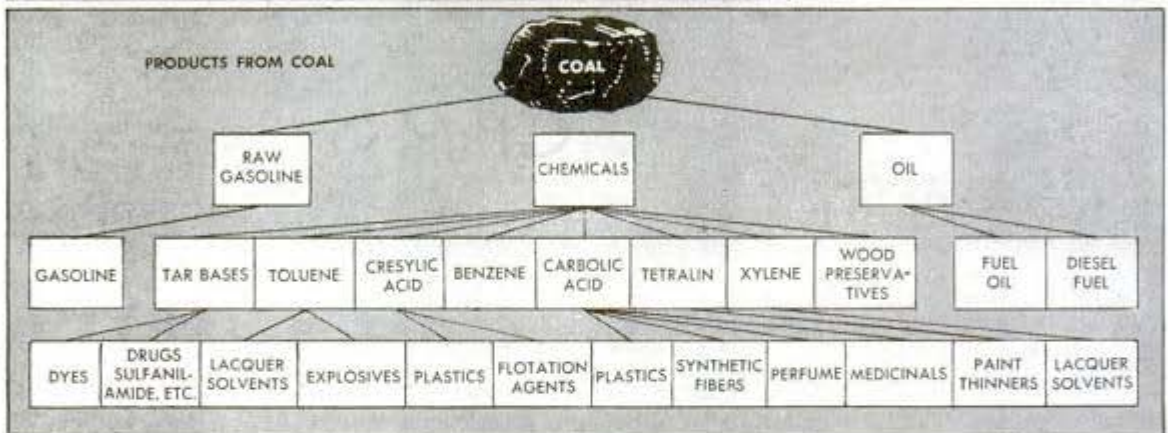

The wide range of coal derivatives is shown in this Bureau of Mines chart
 Coal traveling down chutes and moving belts is sorted by hand at tippie

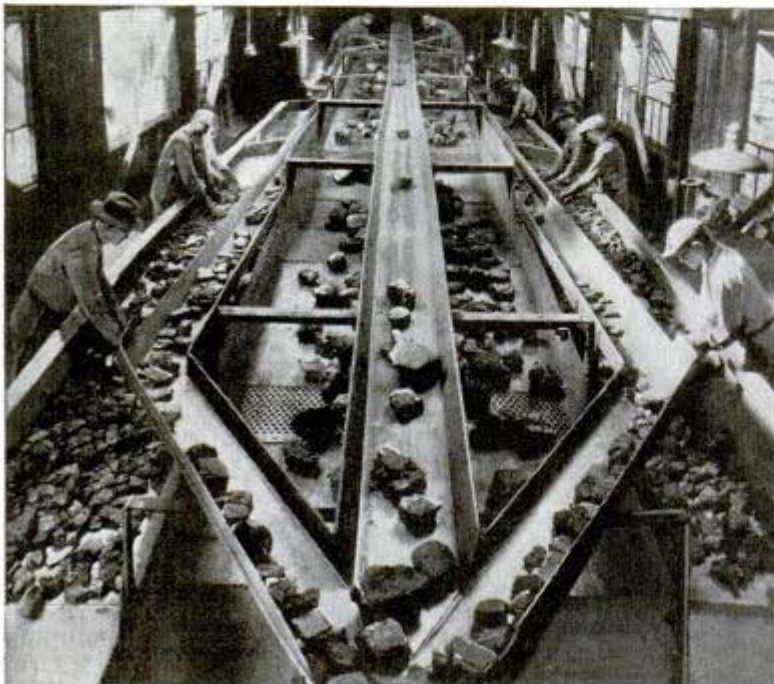

the biggest producer in the world is the Robena mine, south of Pittsburgh, a wartime development which at full capacity will deliver 20,000 tons daily. Most of this goes to the Clairton coke ovens, where every 45 seconds an oven disgorges 12 tons of white-hot coke, while the by-product gases, coal tar and ammonia liquors are piped away to be processed into 200,000 different products.

A 330-foot coal seam near Cologne, Germany, is the world's thickest. But there are profitable seams only a few inches thick, particularly in strip (surface) mining. Colossal electric shovels, some with booms 325 feet long, make it possible to shovel away 50 feet of soil profit-



ably to reach coal seams less than three feet thick. Probably the most powerful is the gigantic shovel in an eastern Ohio strip mine; it can scoop up every minute a 60-ton bite of soil.

There are still thousands of miners toiling with pick and shovel in underground labyrinths. There are still subterranean coal carts drawn by mules that never see daylight until they retire. But the mining companies have spent more than \$20,000,000 a year for the last 20 years on mechanical equipment and safety apparatus, and today bituminous coal is mechanically extracted in nine out of ten mines, loaded mechanically in two of every five.

Since it costs about as much to transport coal as to mine it, the

(Continued to page 150)

Coal of various sizes, consigned to various destinations, is loaded direct from the mine trestle into railway coal cars

Bituminous coal is extracted mechanically in nine out of ten mines. Below, power saw cuts into horizontal vein of coal



Boeing Co. Sec. 14, Wash. D.C.

Stratocruiser to Span Oceans With 100 Riders

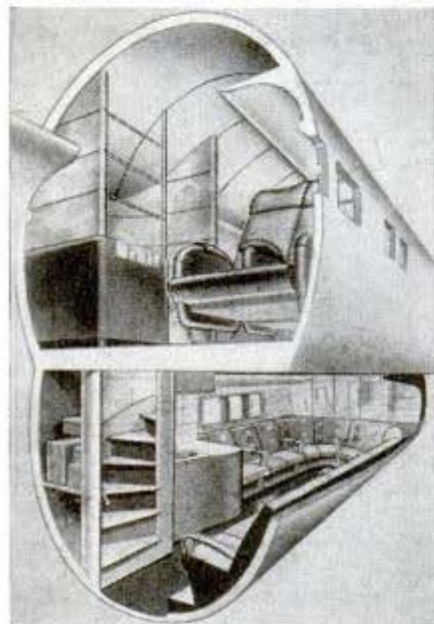
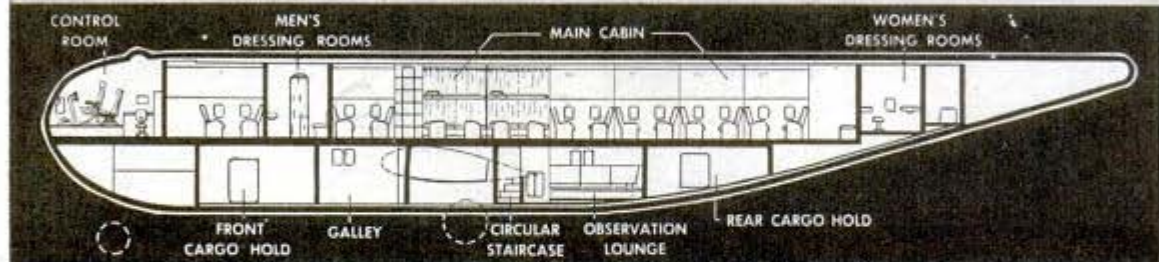

First of the postwar super-transport actually built in a military version is the two-deck Boeing Stratocruiser, an adaptation of the B-29. It will be powered by four engines of 3,500 horsepower each at takeoff (the largest ever made). Cruising speed will be 340 miles an hour and the operating range will be 3,500 miles. There is room for 100 passengers

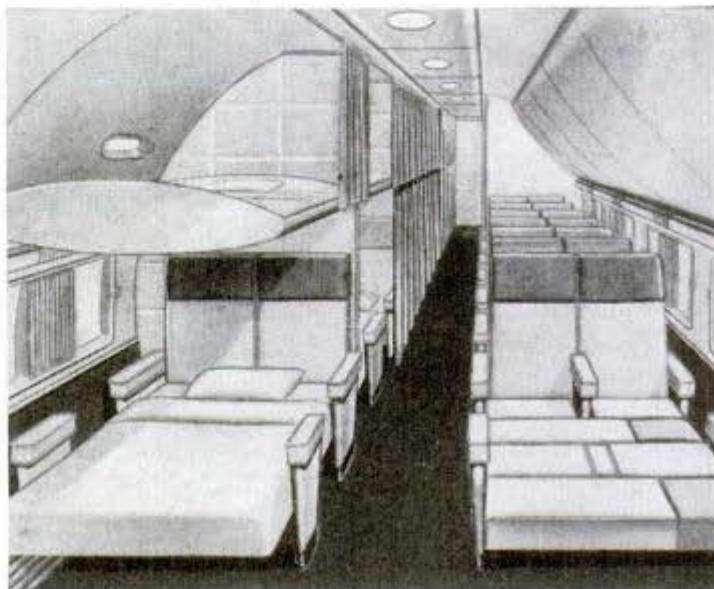

Above, cutaway shows day seats convertible to berths in upper deck and cocktail lounge below. Right, 36 roomy berths in the main cabin

*Swissburg Chas. F. ...
Lewistown, Pa.*

Tubes of Plywood Make Clock Cases Or Stepladders

Many new postwar products will be made of plywood tubing which is lightweight, strong and decorative, and which lends itself to a thousand different applications. Beautiful grain effects make it suitable for clock cases, lamp bases and similar items. It can be used for radio masts, stepladders and as reinforcing members in prefabricated construction. One manufacturer predicts sectional radio masts that will telescope from 90 to six or eight feet. The tubing is made in sizes ranging from less than an inch in diameter to a foot, and wall thicknesses vary depending on strength requirements. War uses of the product, which is made of various types of wood, include sectional poles, radio masts, and some rugged floats.

Clock case (top) is made of plywood tubing, samples of which are shown along with it. Stepladder (right) built of lightweight tubes shows another of the many postwar uses

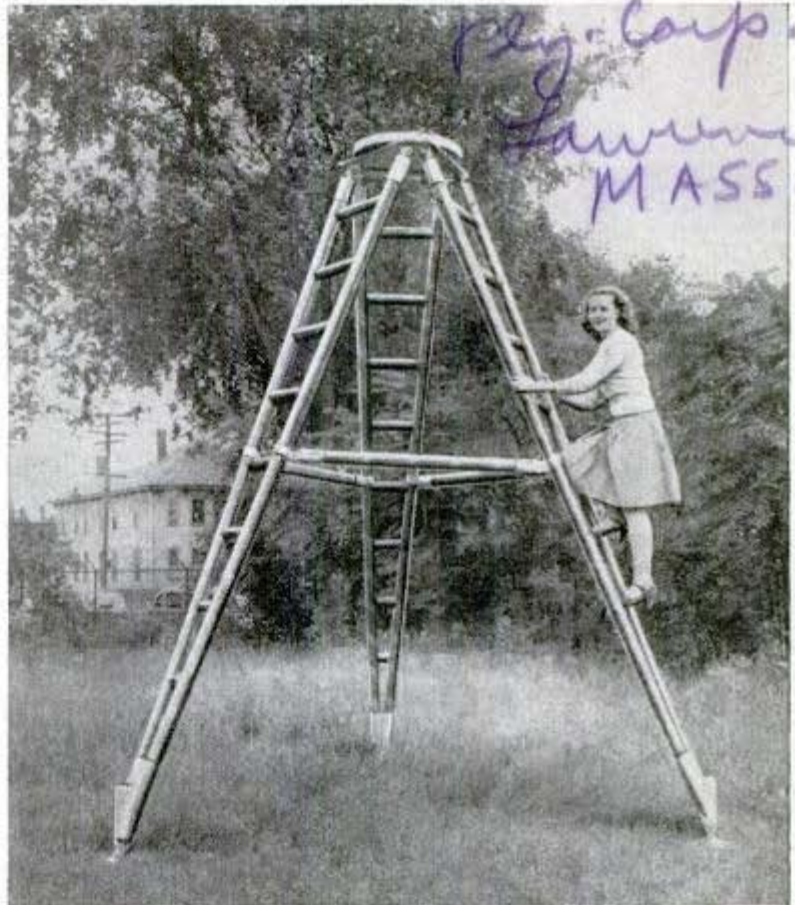
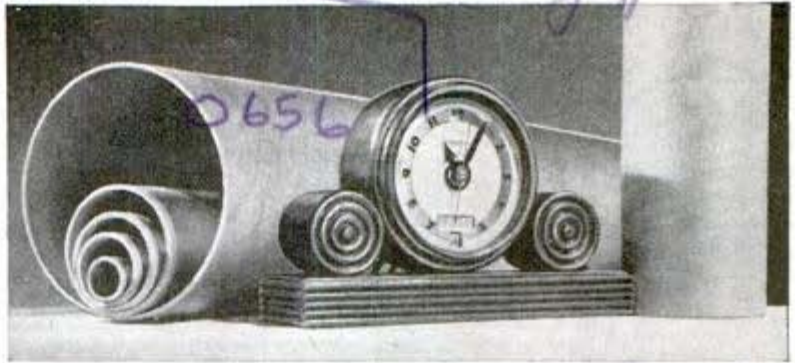

0348

Sanitary and Frostless Refrigerator Will Have Built-In Freezing Unit

For keeping food fresh for months and freezing your own food at home, a refrigerator with a built-in freezer and without a frost-covered evaporator will be marketed in the postwar period by the Admiral Corporation. The freezer, a separate compartment, will have room to store two bushels of frozen foods and will maintain a temperature of 22 to 32 degrees below freezing. There also will be a large purified moist cold air compartment for the storing of regular foods and no defrosting will be required. The top and back panels of the moist compartment will be chilled to the right degree to insure high humidity, preventing frost. The food will be kept fresh and wholesome for a longer time by

a Sterilamp, which destroys bacteria on exposed surfaces and in the surrounding air by ultra-violet ray action.

U.S. Bureau of Mines Horizontal Drill for "Dry" Wells

Drilling holes horizontally from a chamber at the foot of a shaft sunk deep in the ground is the latest method for the recovery of oil from partly depleted fields. At an experimental project in Pennsylvania, the first two horizontal holes are nearly half a mile long. A 10-foot shaft was dug 388 feet down and a 27-foot circular chamber was constructed at the base. Equipment was lowered and the holes were drilled through portholes in the concrete walls.

*Admiral Corp. 3800
Counthold Sh. Chicago 47, Calif. 55*

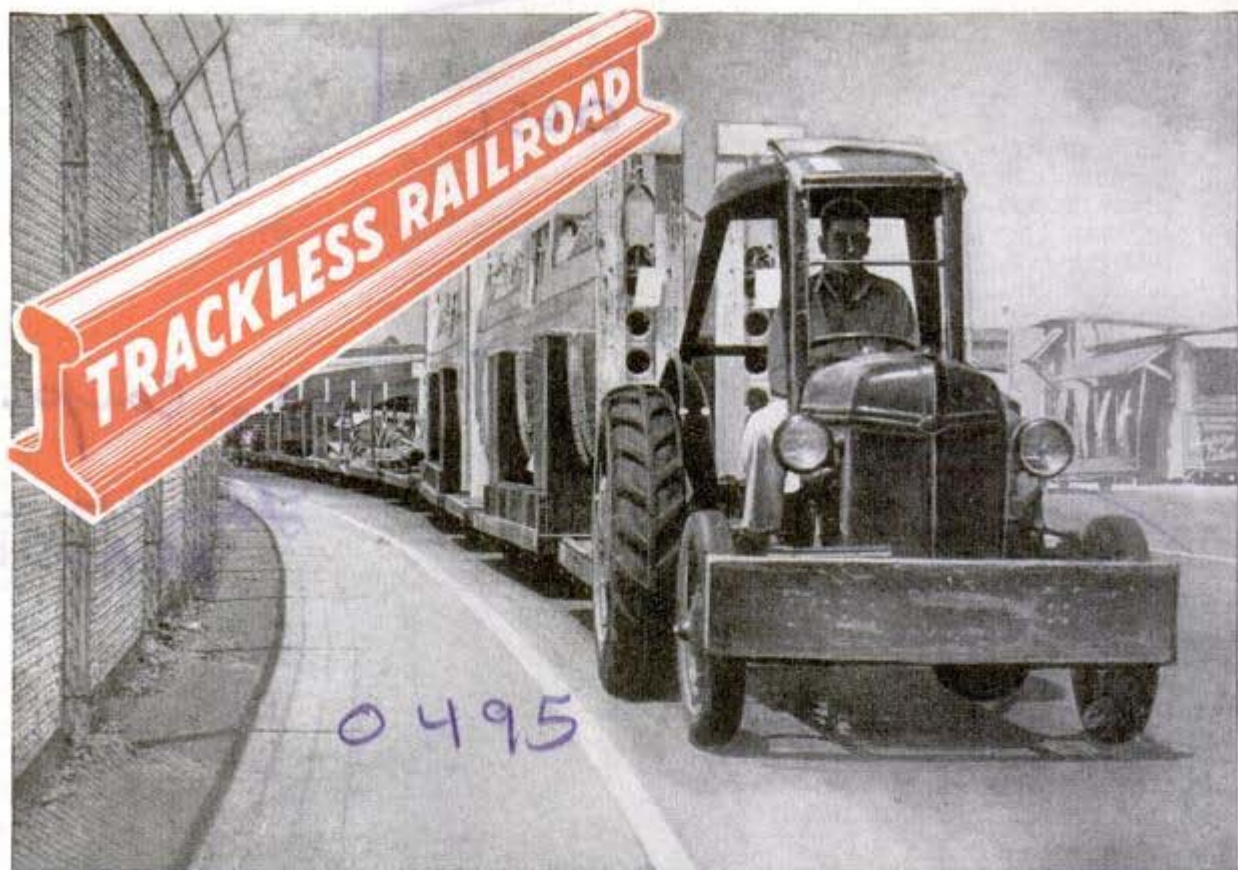

Above, "trackless train" delivering sub-assemblies from Convair plant to final assembly line at San Diego. Below, dispatch supervisor hangs tag on board showing that truck has just left Plant 1 for assembly line



DOWN at the San Diego plants of the Consolidated Vultee Aircraft Corporation the "move men" are helping fewer people build more airplanes than anyone dreamed was possible a few years ago.

The "move men" make up the transportation gang. They operate their own indoor-outdoor railroad, using trackless trains made up of tractor units and trailers. They have their own control towers in the form of control points, their own freight handling yards, their own system of tickets, and hundreds of stations.

They even have their own time tables. A routing tag attached to a bundle of aircraft parts may read "Deliver to Station 2510 at 10:21 a.m." The color of the tag shows the building in which the station is located. A paper flag attached to the tag tells the day of delivery by its color, and the design of the flag indicates the shift during which the de-

Art., Los Angeles, 27, Calif.

livery time occurs. Convair's entire system of manufacture is based on punctual deliveries all through the plants.

Most manufacturing establishments stock-pile all small parts and sub-assemblies as they are completed. Units that are needed on the assembly lines are then removed from these reservoirs. Convair has eliminated all stock bins and stock rooms with one or two unimportant exceptions. Parts that are manufactured are picked up at once and begin to move to the places where they will be used in larger assemblies.

Conceived and put into operation by H. L. Smith, general supervisor of production control, the system is one of the reasons why Consolidated Vultee claims the best man-hour efficiency record of any aircraft plant in the United States. A couple of years ago it took 1,000 workers more than a week to turn out one B-24 bomber. Today the same 1,000 workers are building a B-24 in one shift with time left over to start another.

This method has the advantage of allowing a plant to operate at full speed on practically no inventory. Construction changes or even a complete switch to a new design can be made almost at once and there never are expensive stock piles of excess parts on hand.

Too, all the confusion and unavoidable mistakes in trying to keep track of parts in storage are eliminated, an important factor because some 1,200,000 different kinds of parts for four models under pro-

Below, an example of one of Convair's many odd-looking "trackless trains" used to transport equipment



Trays full of small parts are moved from station to station by a "lifting dolly" (above) at Consolidated Vultee Aircraft. Below, a truck hauls wing center section of a Liberator bomber from a sub-assembly plant



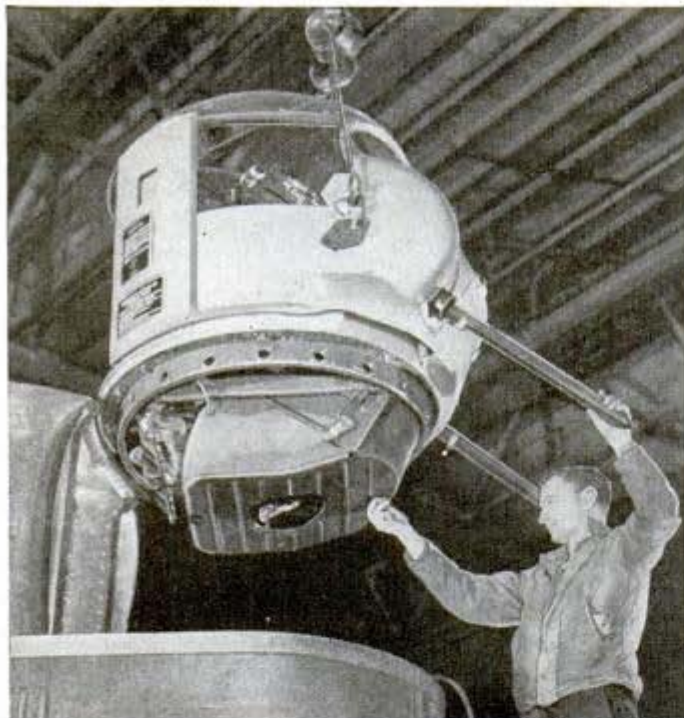

Overhead crane (above) lowers a nose machine gun turret into a B-24. Right, monorail crane takes sub-assembled hull of a Catalina PBY-5A flying boat to a final assembly line at Consolidated. Below, a small "lifting dolly" picks up a huge Pratt & Whitney engine for transfer to the Consolidated plant's final assembly line for installation in a Liberator. The company's intricate and efficient transportation system allows it to operate at full speed without stock piles



duction would need to be kept on hand.

Smith's control of scheduling extends even to suppliers of materials and parts whose plants are possibly thousands of miles from San Diego. He tells them how much to ship and when to ship it, by air, rail, or truck, so that the goods will reach the assembly plants precisely as needed. Movements en route are checked by telegraph.

Each operation of each department inside the plants is plotted ahead of time by the production control department. Full schedules are prepared for each working day in a 26-day cycle, the orders go out to the control cen-

ters, and the "move men" deliver the materials on schedule.

What happens if there is a breakdown in transportation? Wouldn't a delay in the delivery of even one necessary part hold up the whole manufacturing process? The answer is no, because a delay or shortage is detected in the records before it actually occurs. Threat of a shortage is observed at a control point. At the same time that the cause of delay is being found and remedied, additional parts that were scheduled for later delivery are speeded up and moved along in time to maintain the schedule. The system works so well that on a typical day there were paper

shortages of only three parts out of the hundreds of thousands that were being manufactured and assembled, and actual shortages of none.

The rolling stock used around the plants includes 37 gasoline-operated tractor units, 34 standard trailers, 45 specially-built trailers, 56 car loaders, 36 battery-operated elevator trucks, 113 hand jack trucks, 131 power scooters and 650 bicycles. In addition, much floor space is served by overhead conveyors.

The flow of materials through the plants runs like this: Finished aircraft parts in the fabrication buildings are inspected, are loaded into pans or metal tubs for convenience in handling, are weight-counted and then are moved through inventory control centers where each batch of parts is provided with a routing tag that indicates its destination and time of delivery. The loaded containers move over a roller conveyor to a freight assembly point, where they are picked up by a switch engine in the form of a car loader and are deposited on the proper trailers of an inter-building trailer train. This train pulls out on schedule to make the rounds of buildings at the different plants. One or more trailers are left at each building, and the tubs are removed by car loaders and are then transported by elevator truck or hand truck to the station shown on the routing tag.

Consolidated Vultee has other plants in other parts of the country, where it is turning out cargo versions of the B-24, flying boats, special Model 39 four-motored transports, and the new giant B-32 bomber, details of which are a military secret.

JANUARY, 1945

*Efficient and Business
Machines Corp. 55 Liberty
St. N.Y.C.*

Students Get the Feel of a Bomb Run Without Leaving the Ground



Student bombardiers in the Navy and the Air Forces are given the illusion of making an actual bombing run in a realistic but stationary mock-up of a bombardier's compartment, known officially as the 7A-3 Horizontal Bombing and Dead Reckoning Trainer. The trainer, fitted with regulation instruments, affords practice in bombing accuracy, intercommunication procedure, dead-reckoning navigation, evasive action and other problems of actual combat flight. An optical projector on the floor below the student shows him the image of an actual target area. The image moves according to the altitude and speed set for a particular problem and gives the effect of drift according to a desired crosswind. Mechanical devices reproduce the noise and vibration of the bomber's engines and a refrigerating system produces below-freezing temperatures to accustom the student to working in flying clothes. He releases his bombs exactly as if he were on a real bombing mission. An instructor at a control desk just outside the mock-up keeps track of the instrument settings made by the student and can stop, or "freeze," the trainer at any moment to emphasize a point or analyze errors. After an interval representing the falling of the bombs, a ring and spot of light are flashed onto the target to indicate the point at which the bombs theoretically landed.

ONE-BULB PICTURES



GET the flash bulb away from the camera—that's the rule on which many photographers base techniques which enable them to get around the wartime shortage of bulbs. By aiming the flash gun from a strategic position, one bulb often can be made to do the work of two and in some cases one bulb will produce artistic, "contrasty" effects superior to those obtained with multiple flashes.

All that is needed is a piece of insulated wire long enough to extend the cord which connects the shutter tripper to the battery case from its usual 12 to 15 inches to a total of from three to five feet. In addition to this cord, which frees the bulb from the camera attachment, the photographer can make use of available secondary lighting sources, such as incandescent and window light. Newspapers, white cardboard, bright walls and other light-reflecting materials also will help. Add to these ingredients an alert imagination and you will have an enlarged photographic world to explore with your flashlamp.

After discovering that a "roving bulb" often gives the details, highlights and crispness of multiflash photography,

Above, flash gun was held behind camera on ring apron so as to improve flesh tones. At upper right, flash gun was high, taking advantage of reflecting towel and wall. Below, roving flash gun highlights fast-moving legs



FLASH GUN BEHIND CAMERA



Mr. Warren Elliott, 7, Park Ave.
N.Y. 16, N.Y.

many fans will go a step further and use a 20-foot extension cord and auxiliary socket and reflector for the single bulb. When bulbs become more plentiful, many also will use multiflash with a new appreciation of lighting values gained through one-bulb operation.

If the camera is usually used without a tripod, a



Left, prize-winning one-bulb photo taken with flash aimed from above to catch rope. Above, preparing for an off-the-camera shot. Below, lighting emphasizes building and ramp



three-foot cord is long enough for the one-bulb system. To obtain the extra lighting effects, the flash gun is kept attached to the camera until preliminaries are completed. Then the photographer disconnects the flash gun and moves it above, below or to either side of the lens and backward or forward from the camera. The reflector may be tilted up or down.

When a tripod is used, a five-foot cord will practically double the opportunities to angle-light the subject. Also, the area of movement permitted by this cord will allow photographers who customarily make two shots at different apertures to in-

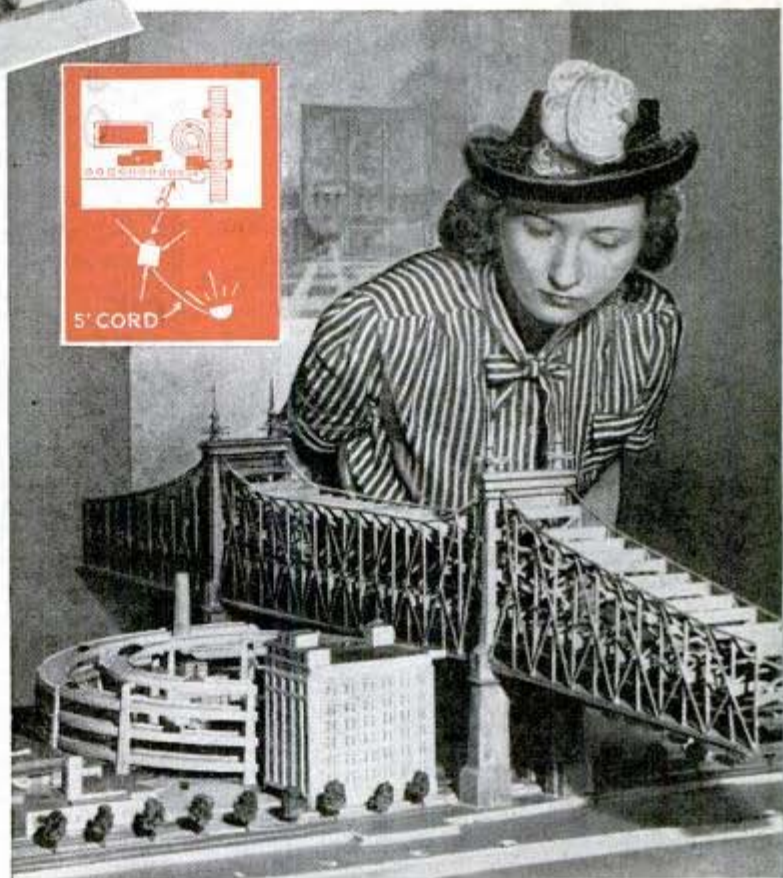



Above, experimenting with placement of light. Below, reflective surface gives two-bulb evenness here

sure a good negative, to walk forward or backward up to 10 feet, thereby controlling the density of the negative by the distance of the light from the subject without disturbing the aperture. This leeway is advantageous, too, in trying two one-bulb shots of the same subject with entirely different lighting.

Here are some "don'ts" in regard to one-bulb operation listed by Philip Sperry, chief of the phototechnical division of the Wabash Photolamp Corp.:

Don't forget that the cord is not too firmly attached to the tripod; unless you are careful, you can jerk it loose. Don't forget that where the camera formerly directed your light automatically, your hand is doing the job now. Be sure the reflector is aimed exactly where you want it.

Don't forget that when you begin to move your flash bulb around you are more likely to shine the flash into your lens; a lens shade is handy. And don't get the light too close to the subject merely because it's easier to do so with a free-moving flash gun.

The farther the light is held to one side the greater is the resulting contrast and the darker the shadows are likely to be. Unless a bizarre effect is sought, the bulb ordinarily should be held above the lens. Even lighting is accomplished by holding the flash equidistant from portions or sections of the subject.

Sperry also warns beginners against aim-



ing the flash gun at the brightest and therefore most prominent feature of the subject, such as the face. He says this leads to overexposure of the face with details blasted out and underexposure of the garments, which usually are darker and have less reflective quality.

"Another common mistake is to anchor a

subject too close to a wall," he asserts, "unless it is alongside a wall which will reflect light and give a three-dimensional effect. A good rule of thumb is to leave a space equivalent to the height of the subject between the subject and the background, thereby eliminating harsh shadows which usually prevail in close-to-wall exposures."

To obtain multiple-light depth and tonal qualities with only one bulb, the open flash is suggested as a solution. This requires a comparatively long exposure to capture incandescent or indoor daylight, followed by the flash of the single bulb. To the combinations which can be made of fixed incandescent or daylight sources, the flash gun's removal from the camera adds a light source whose distance and angles can be controlled.

The mobility of the flash permits one bulb to be used either as the principal light, with flash gun held fairly close, or as fill-in light, with the gun held at some distance and the reflector removed or the bulb covered by some thin but opaque material, like a handkerchief.

For one-bulb efficiency in general the standard reflector is better than the narrow-beam type which "spots" the light, or the wide and shallow type which spreads illumination over a wide area. The reflector should be between 2½ and 4 in. deep. It should be kept clean and the flash

bulb centered in the reflector. An easy way to check this is to look at the bulb and reflector from a head-on position. When it is centered, the entire reflection of the bulb's bulge can be seen clearly in the shiny surface of the reflector.

Shot at left was made with gun fixed to camera outdoors; right, extension bulb was indoors, camera outside



With gun at photographer's right, flash was made to travel upward, catching both men but subduing unimportant details



*Public Relations
Oahu, Hawaii*

"Stratosphere" Galley for B-29 Keeps Meals Hot for Crew



Piping hot meals can be served to cold, tired Superfortress crews any time they get hungry, thanks to a specially-designed galley only two feet high. The food tray warmer, which keeps pre-cooked meals hot in high-altitude cold, was developed after it was discovered that food cannot be cooked practically at 10,000 feet or higher. Inside its insulated cabinet is a thermostatic heat system which plugs into the plane's electric circuit. It contains six metal trays for holding pre-cooked meat, vegetables and soup, each in a separate compartment; 12 metal cups for fruit juices and coffee; and drawers for bread, rolls, fruit, silverware and straws. Complete, standardized menus of energy-producing foods are prepared for packing in the warmers.

Sky Map Assists Lost Pilots

To eliminate lengthy computations by fighter pilots in a hurry to return to their carrier or land base, a three-part air navigation instrument which takes bearings automatically has been proposed by Dr. T. A. Jaggard of the University of Hawaii. The device consists of a mirror, a lens, and a small star map showing each star in its correct relation to the other stars. By adjusting the mirror so that it reflects images of the actual stars onto the stars of the printed map, and then looking through the lens, the pilot can determine his field of vision. Next, by referring to a special graphic chart and to his watch, he can read almost immediately his exact location in latitude and longitude. By the usual method it takes several minutes to do the figuring, and an error made by a tired pilot may have serious results.

*176. A.I.A.T.
H.I.Q.*

gation instrument which takes bearings automatically has been proposed by Dr. T. A. Jaggard of the University of Hawaii. The device consists of a mirror, a lens, and a small star map showing each star in its correct relation to the other stars. By adjusting the mirror so that it reflects images of the actual stars onto the stars of the printed map, and then looking through the lens, the pilot can determine his field of vision. Next, by referring to a special graphic chart and to his watch, he can read almost immediately his exact location in latitude and longitude. By the usual method it takes several minutes to do the figuring, and an error made by a tired pilot may have serious results.

*Science
Oct 1944*

10,000 H. P. Gas Turbines Predicted for Aircraft

Gas turbine engines capable of 10,000 horsepower may be used in aircraft within the next decade, according to G. W. Vaughan, president of the Wright Aeronautical Corp. Vaughan pointed out that in the high power range the gas turbine offers a large saving in weight and fuel consumption for long range operation and high altitudes. On a giant transport plane the gas turbine engine could mean a saving of as much as 8,000 pounds over current engine types, which would permit 40 or more extra passengers per flight or four more tons of cargo, he said. He added that this might mean reductions in both passenger fares and cargo rates.

*MERECO
101 FALLING CREEK*

Screwdriver Has Offset Shank

By employing a new principle, a war worker in Kaiser's Swan Island shipyards, Portland, Ore., has invented a screwdriver with an offset shank and a rotating handle which greatly speeds up his work. Operated by an easy twist of the wrist, the tool exerts tremendous pressure for tightening screws.



0499

IT'S ALL ELECTRIC *but the HORSES*



0488

This business of betting which horse can run the fastest around a race track—a diversion so old that even George Washington was an addict—has reached the status of a billion dollar a year industry in the United States.

Like all giant American industries, its growth has been made possible by Yankee ingenuity in making machines do the work. Human nature with respect to gambling is the same as it was in Washington's day. It's the electrical devices which have made the difference.

Today, nearly everything on a race track runs mechanically—except the horses. Race tracks employ the biggest adding machines in the world, the biggest timepieces in the world and some of the most accurate cameras in the world—to add and calculate the money, to find out how fast the horses run and to decide beyond the possibility of human error which horse won.

The more the public feels the human element has been removed from management of the horses by use of gadgets and machines, the more it risks its money. And the more machines are installed, the more money can be handled efficiently.

So great has this industry grown in

Crowding the rail, a field of two year olds is off to a flying start. Right, operator of "Totalisator" signals for a "crash test" of all mutuel machines to make certain they are in order. Below, cluster of loudspeakers tells fans who is ahead

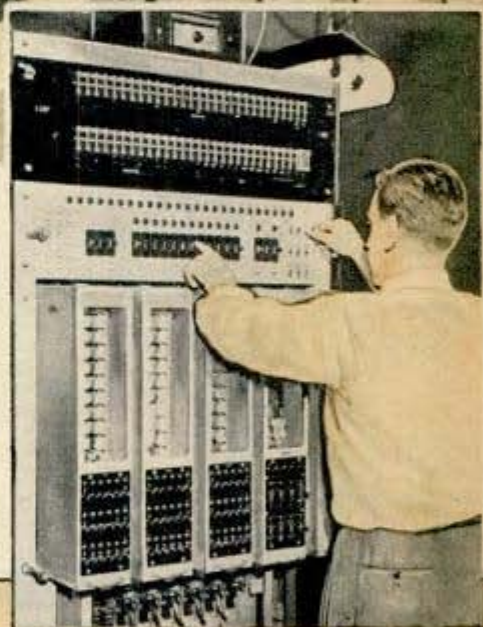

allan Warren Elliott

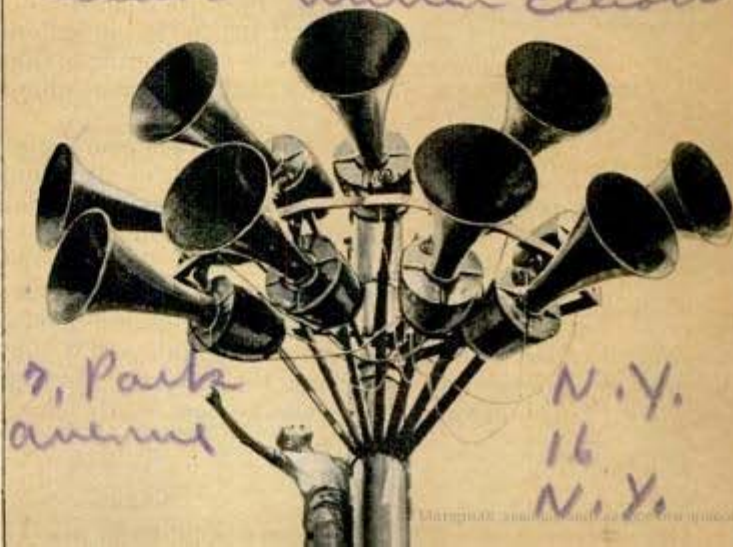

7, Park Avenue

*N.Y.
16
N.Y.*



This typical photo-finish picture was developed, fixed, enlarged, printed and delivered to placing judges in 38 seconds. Below, photoelectric eye catches finish for Teletimer. Camera views slit revealing revolving drum

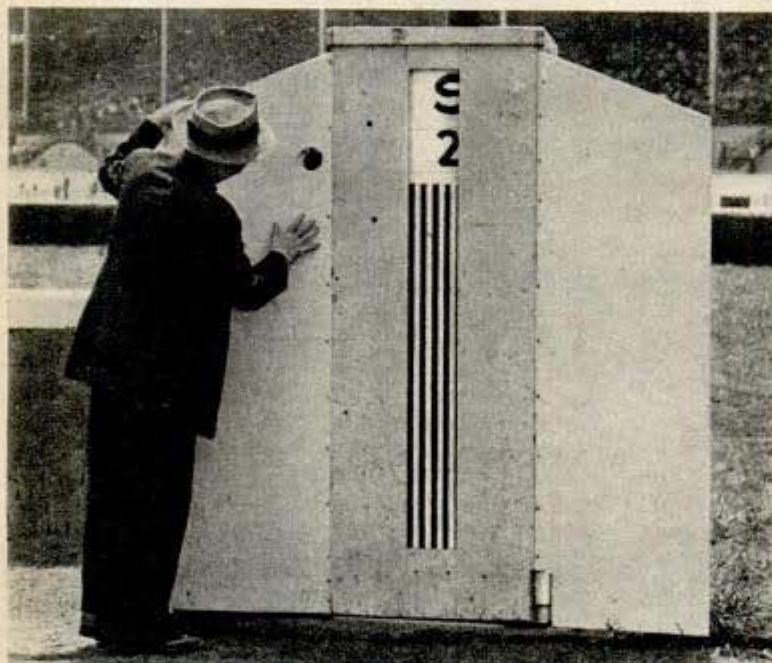

New York, for example, that the cash drawers of a race track contain \$1,100,000 in sorted currency every morning before the opening of business. This is merely for the making of change for the first races.

Most of the money taken in on these races is in one or two dollar denominations. If a long-shot won the first or second race and a daily double of, say, \$400 results, it would take so long to hand out small currency that the races would be delayed. Most of the bets are for two dollars, also, and if the gigantic adding machine called a Totalisator were not employed, it would be physically impossible to register the bets and still find time to run the horses.

At a race track like Belmont Park, in New York, more than \$500,000, mostly in small bets, is often wagered within 23 minutes between races. While this is going on, the great calculating machines continually add up the totals electronically for win, place and show and automatically flash them every 90 seconds in clusters of lights on a mutuel board extending as long as some city blocks.

Simultaneously, a score or more of expert calculators figure the winning odds on from three to 30 horses, changing them every 90 seconds as the board flashes new totals.

It takes 730 employees to handle the torrent of money which sometimes reaches \$3,000,000 a day. It takes electrical equipment weighing over 100,000 pounds, including 300 ticket machines and the relays and circuits which carry the totals and flash them to the tote board facing the grandstand. It takes between 600 and 700 miles of wire just to hook up the ticket machines, the adding devices and the tote board where the figures are shown in 3,624 electric lights.

The Totalisator is so completely electrical that, unlike a mechanical adding machine, it does not carry figures, but merely combinations of electrical relays, which in turn light

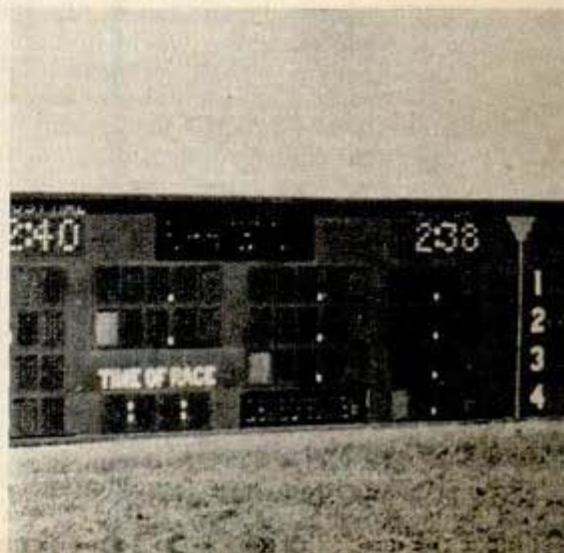

certain electric bulbs. Only in the bulbs is the result reduced to readable figures.

The giant device is set in motion when a bettor pays for a ticket. The seller punches a key on a machine. An impulse speeds to a row of distributing boxes which set up circuits. In a jiffy this impulse, a weak one, reaches the distributing boxes and finds out if they are too busy with other bets. If they are, the weak impulse dies when it can't crowd in and nothing further happens. The ticket machine does not work.

If there is room for one more bet at that instant, the weak impulse enters, is magnified, registers the bet and in 1/30,000 second flashes back to the ticket machine which then operates.

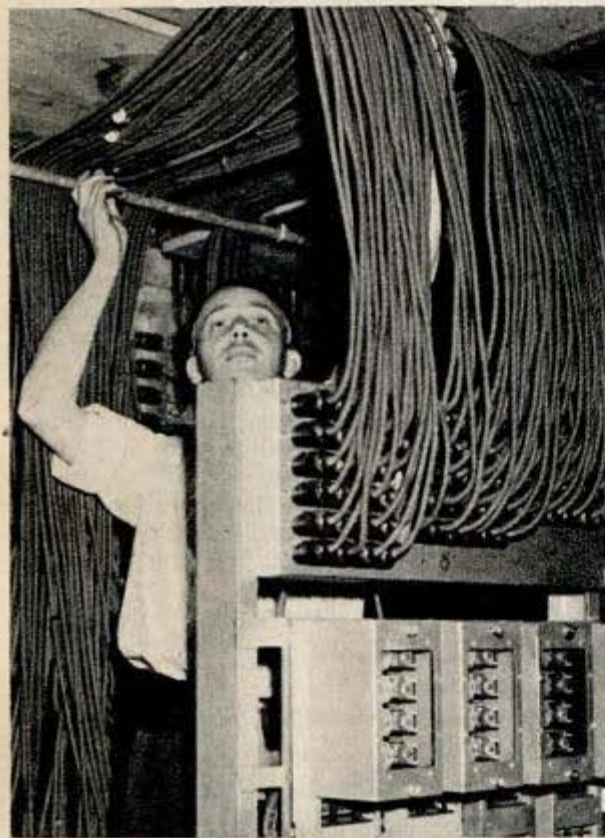

Starter holds a "baton" containing starting button. Cables at left lead to mutuel board

The ticket machine now acts as a printing press, printing a fresh ticket each time. To prevent counterfeiting, one section of the type, with a code known only to one man, is replaced just before each race. The code is an erratic and meaningless combination of figures and letters.

Smaller but just as remarkable is the Photochart camera. This camera can photograph the finish of a race, the film can be removed, developed, fixed, washed, an 8 by 10 print exposed, developed, fixed, washed and delivered by messenger to the stand of the placing judges in 38 seconds. The judges can

Below, view of infield mutuel board which is part of the largest adding machine in world



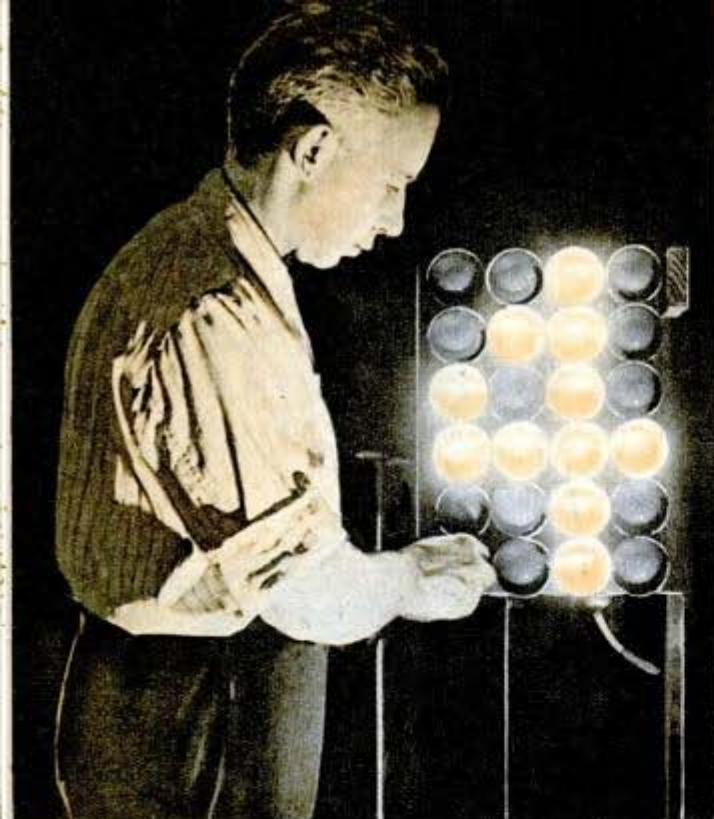

Operator of tote board flashes figure "4" to test section of bulbs—there are 3,624 in the entire board

examine the print before the horses slow down, turn and run back to the finish line.

In this arrangement nearly everything moves—film, horses and a revolving drum set behind the finish line so that only a strip of it shows. Film and drum are synchronized to the speed of average race horses at the finish, about 37 miles per hour.

The camera, set on the top of the grandstand, 247 feet from the revolving drum at

the finish line, has no shutter. A slit $\frac{8}{1,000}$ inch wide opens as soon as the device begins to operate. This slit permits only a three-inch section of the revolving drum and a three-inch section of the race track to register on the film. As each horse crosses the line, he is photographed in continuous, three-inch sections. The name of the track, the number of the race and the date are shown on the drum and repeated on the film as the horses speed past the line.

The timing of the races is accomplished by a Teletimer. A photoelectric eye is set at the start and finish of a race. The first horse to break the invisible beam starts the machine working at the beginning of a race. The same thing occurs at the finish to stop it.

An operator is stationed at a telephone behind the photoelectric unit at the start, so that if an unruly horse breaks out of the starting gate, setting off the Teletimer, notice can be given to reset the device for the real start. As in the Totalisator, there is no room for tampering or human error since the time of a race, by fractions of the distance, is not reproduced in figures in the machine, but is merely carried in relays until the machine is impelled to post the figures by flashing on electric bulbs in the tote board.

The starting gate is another successful attempt to remove the human element from the operation of races. Here horses are taught to stand in stalls with doors closed in their faces until a bell is rung. When the starter presses a button in his lofty perch above the track, the bell clangs and an electrical contact is broken. This releases a magnetic lock which has held the gates

Tube at left holds photoelectric cell to register start of race. Right, Teletimer operator checking board

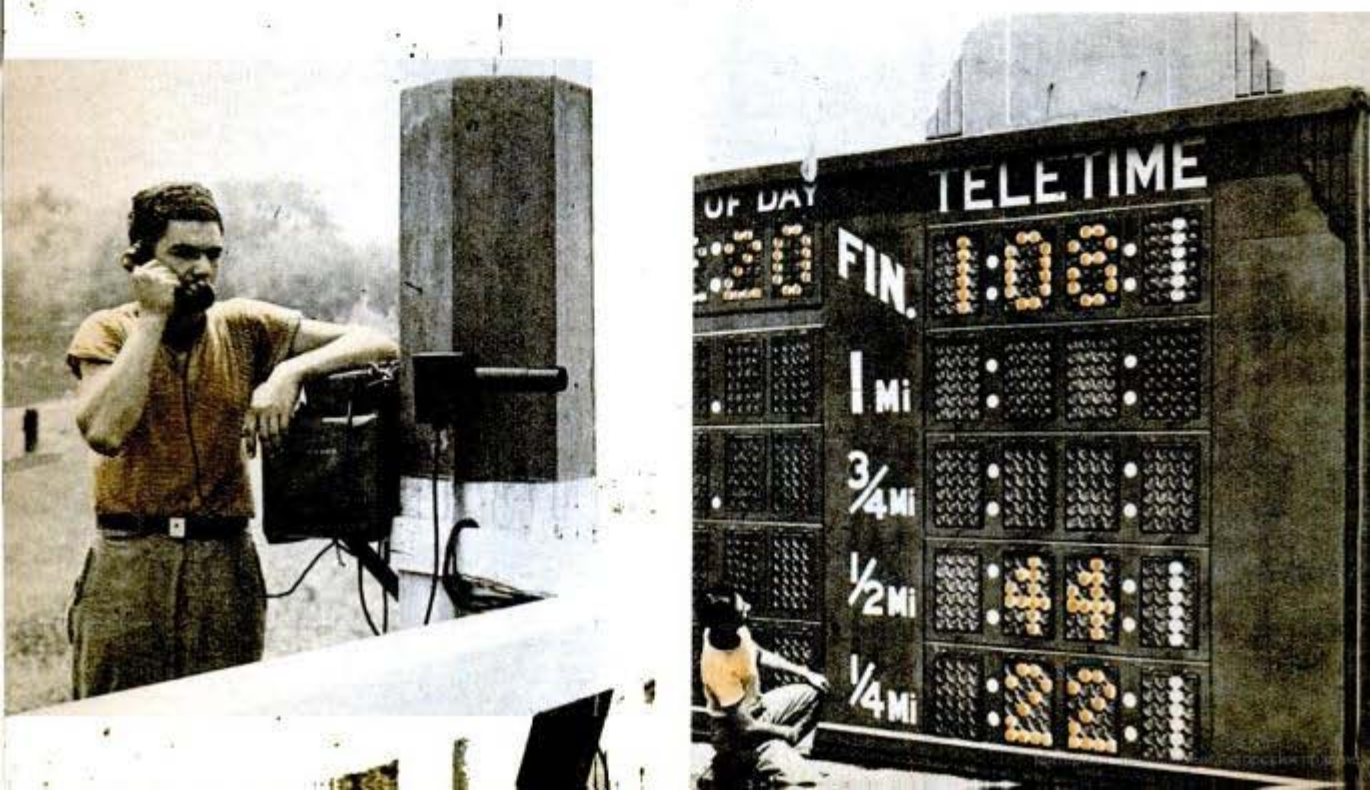



Starting gates work on principle of magnetic lock. When gate is released, bar drops and springs pull doors back

closed and they are flipped back, out of the way, by springs.

Opening of the gate is usually a signal for an outburst of wild yells by the jockeys who startle the horses into a fast run. The riders must keep an eye on a flag held by a man near the starting gate. Unless he drops the flag the start is not official.

Mechanical devices and gadgets have their places in the lives of these jockeys, too. Electric "hot boxes" are available in the jockey rooms to sweat down their weight. Heat, ultraviolet, diathermy and other machines which tend to eliminate soreness and the effects of injuries are constantly employed.

Other methods of automatically safeguarding the public's money include a system of identification by photographs and distinc-

(Continued to page 162)



Above, demonstrating how gates are closed on horses. The bar above controls a catch which holds them shut. Note padding which protects nervous thoroughbreds. Left, a jockey selects numbered blanket for horse



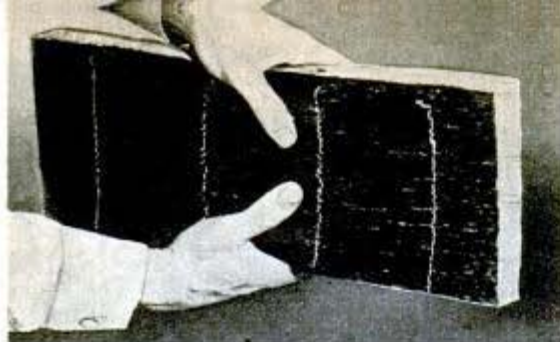

Insulation Opens Like Accordion To Five Times Its Bulk

Insulation material, which is compressed to save shipping space, expands like an accordion to more than five times its bulk when installed. A special process for obtaining dead-air spaces makes this new insulation thicker when expanded.

Hard Metals Get "Screen Test" With Electronic "Projector"

Hours spent in making chemical tests are saved by checking the hardness of metals with an electronic cyclograph, which does the job in seconds. A piece of metal of known type and hardness is first dropped into a small magnetic coil attached to the cyclograph and a reading is made on two cathode ray screens. Using this reading as a guide, any number of pieces of metal can be inserted into the coil and checked with

70 *Passaic, N.J.*

the instrument. In cases where the kind and hardness of metal are not known, it can be identified by placing it in the coil, taking a reading and referring to specially designed charts. The cyclograph helps to eliminate soft shell cases which, if fired, would ruin the gun.

Better Chairs and Sagless Hose Promised in Super-Plastics

Super-plastics turned to civilian uses after the war will result in furniture which will not break under sudden blows, plastic combs which will not crack or become soft when heated, and rayon stockings which will not sag at the knees and ankles, according to predictions made at a joint meeting of the Society of Rheology and the Polytechnic Institute of Brooklyn. As an example of the newer plastic materials, polythene, a waxlike substance produced from coal and oil, was cited for its outstanding toughness and resistance to stresses. During the war it is used to make vital radio and radar parts; in the postwar period it will be used for television sets, telephones, radios, and other equipment.

Drill Press With Turret Head Is Four Times More Useful

By attaching a turret head, the usefulness of a drill press can be quadrupled. The turret head can be used for all drill press operations—drilling, counter-boring, sinking, reaming and spot-facing—when the tools can be held and driven in an ordinary drill chuck. The head is attached easily and a new tool can be brought into position quickly by fingertip control. Only the tool in working position rotates. It is held in position rigidly to avoid slipping.

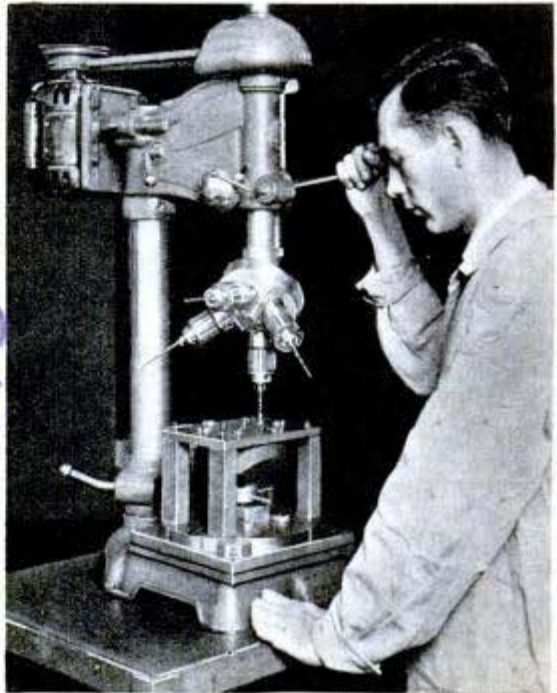

Ala. 1. Ave of Chicago 3.

Chicago 949 N. W. 16th St.

*Press Ass. Inc. 51 Rocky Center
Pleasant N.Y. N.Y. 05876*

Twin Ducks Form Catamaran for Carrying P-38



P-38 fighter planes are transported from ship to shore overseas aboard "ducks" which are lashed in pairs, to form cata-

marans. This method of unloading from vessels makes it possible for planes to be delivered to remote airports ready to fly.

*Calgon Inc. Hagen Bldg. 323 Fifth
Pills. 22 Pa.*

Minerals in Water "Locked" to Protect Tanks and Pipes

Lime-scale deposits and rust inside hot water tanks and in pipes are eliminated with a chemical which ties up the minerals in water so they cannot form a scale. The chemical is made from food-grade phosphoric acid, and it takes only one-fourth of a pound for each 6,000 gallons of water. A simple feeder, made from pipe fittings, can be attached to the main water line of an ordinary hot water heater. A removable plug or gate valve is used at the top.

Electric Control Speeds Milling From 13½ Hours to 5 Minutes

Five minutes rather than 13½ hours are now required to machine aluminum spar beams used as internal supports for airplane wings, thanks to General Electric's Thy-mo-trol, an electronic control installed on a traveling-carriage milling machine in a Cleveland aircraft plant. The machine provides four cutters which operate at speeds of 3,600 and 10,800 revolutions per minute. The Thy-mo-trol automatically adjusts the speed of the carriage along the table, providing low speeds for heavy cuts and high speeds for light cuts and thus greatly reducing the time required to perform the various milling and beveling operations on each spar beam.

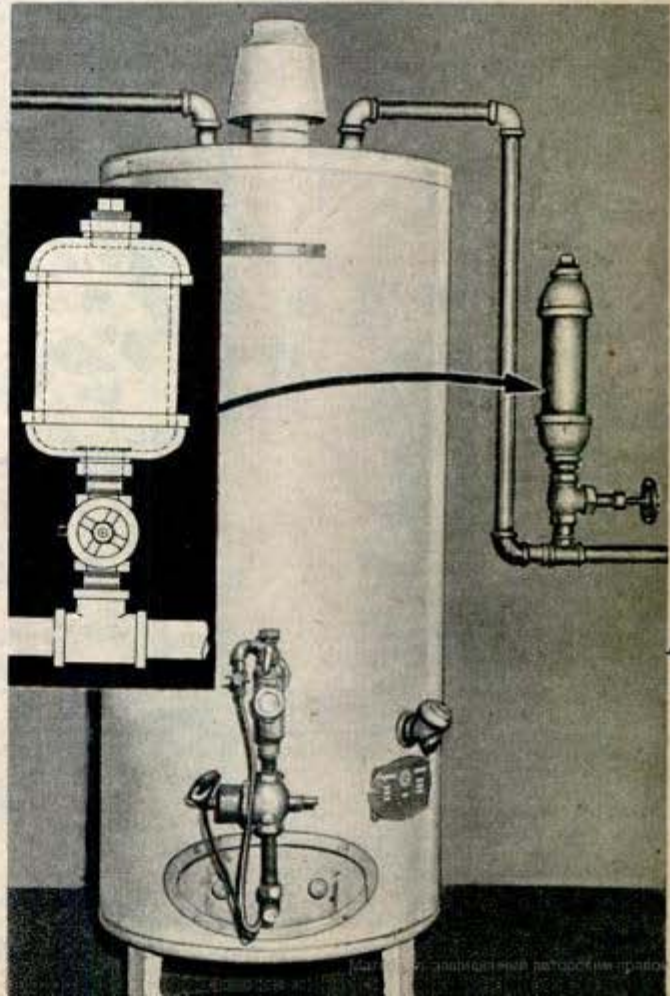

0446

Machining works, lines 3910, with Palmer St. Chicago

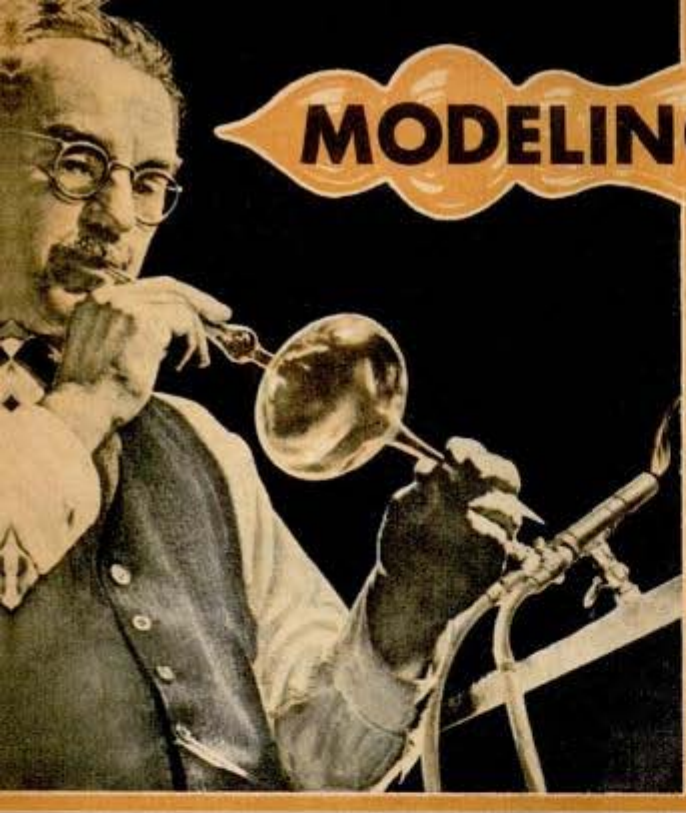

MODELING MARINE LIFE

*Blown by
Herman Mueller*

*American Museum of Natural History
New York City*

Herman Mueller is forever blowing glass bubbles in complicated shapes. Some of his blown-glass gems depict marine life forms magnified many, many times and are displayed by New York's American Museum of Natural History. He works almost entirely from water-color drawings or sketches and a single model sometimes requires 100 different views. Scientifically accurate to the smallest detail, the models are blown from glass tubes an inch in diameter, or glass rods a quarter inch thick. They are painted with an air brush

Below, nucleus (left of center) and other particles inside the larger glass "egg" of this single-celled animal were blown separately before being attached with adhesive or wire



What appears to be fancy lace work (above) is another protozoan model blown out of glass from drawings

Below, a protozoan model with hundreds of spicules looks difficult but is one of the easiest to make

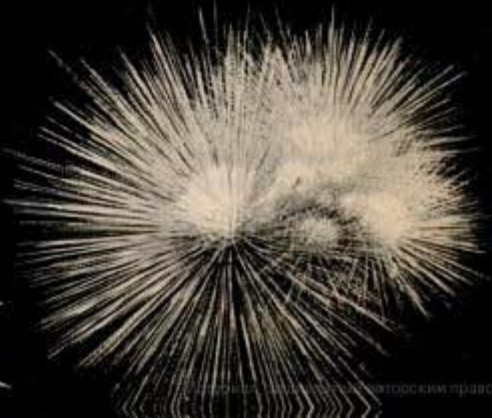

0561

in GLASS

Right, Mueller fits tentacles on a Cephalodiscus model. Colorings are sometimes natural but often go according to an arbitrary chart so that by following one color through various organisms a student can trace the development of the skeleton, nervous structure, circulatory system and any other parts

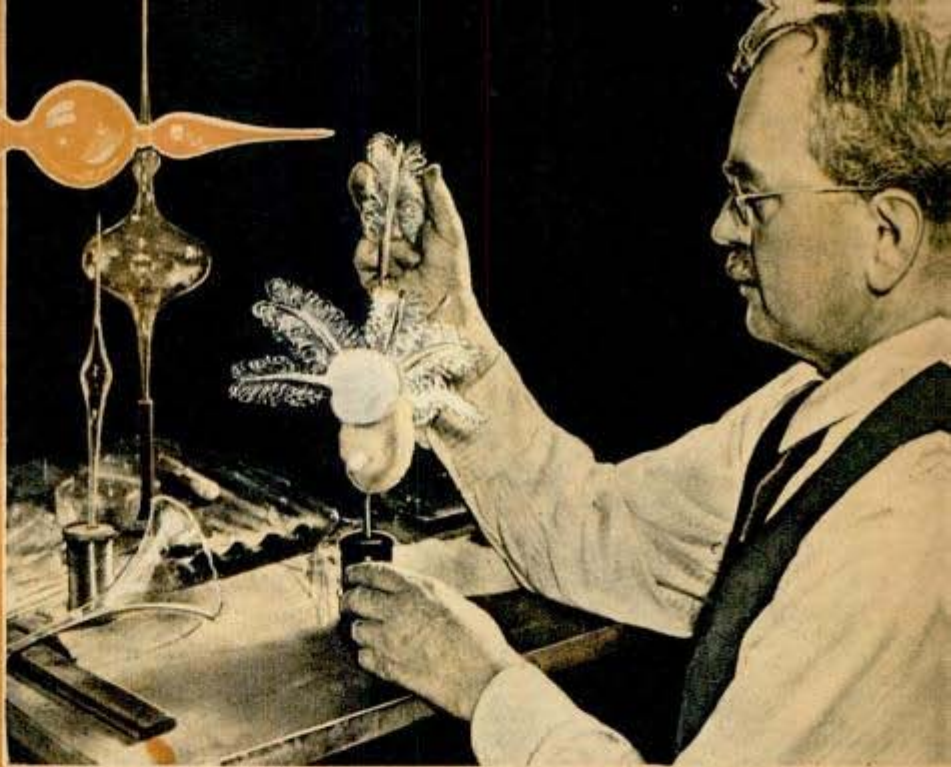

Left, a Canary Islands protozoan which has spicules all over its surface. The organism is shown half-denuded so the part underneath is visible

Below—frozen lightning? No, just another radiolarian, a tiny organism barely visible to the eye, but which, like the other marine models, has been magnified tremendously in the glass reproduction

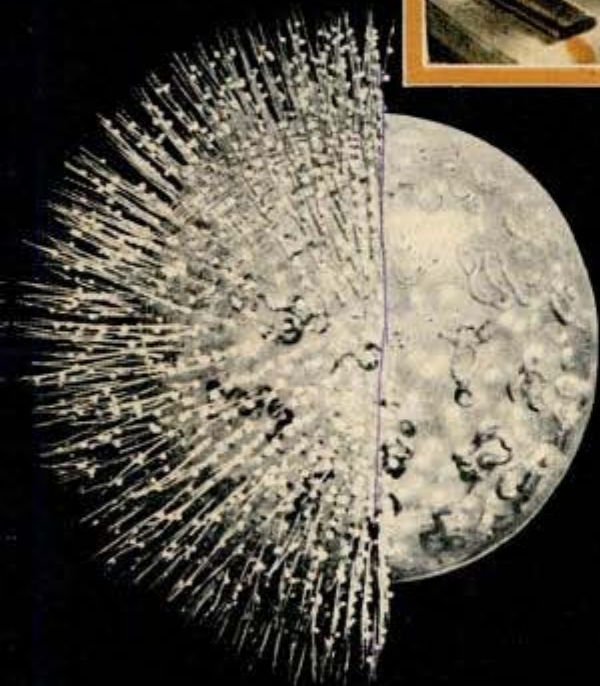

Actually this rotifer (below) is about as big as a mote of dust seen in a sunbeam, perhaps 1/50 of an inch long. The glass model, about six inches long, enlarged this marine animal eight million times

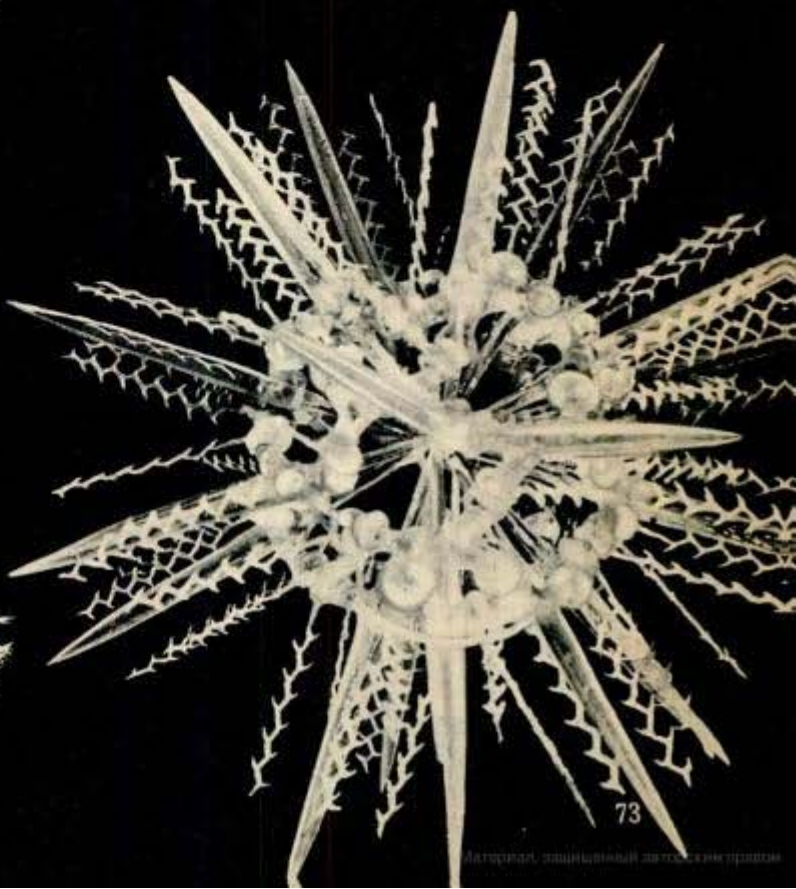
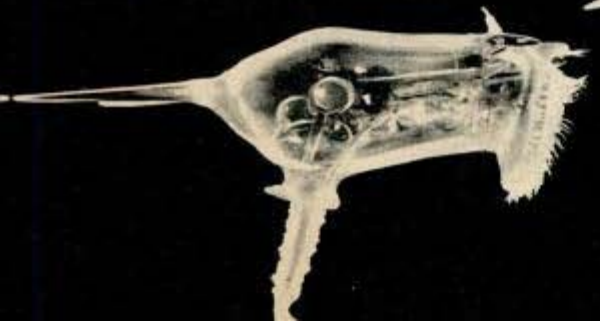

Parachute Acts as Brake in Landing Giant Glider

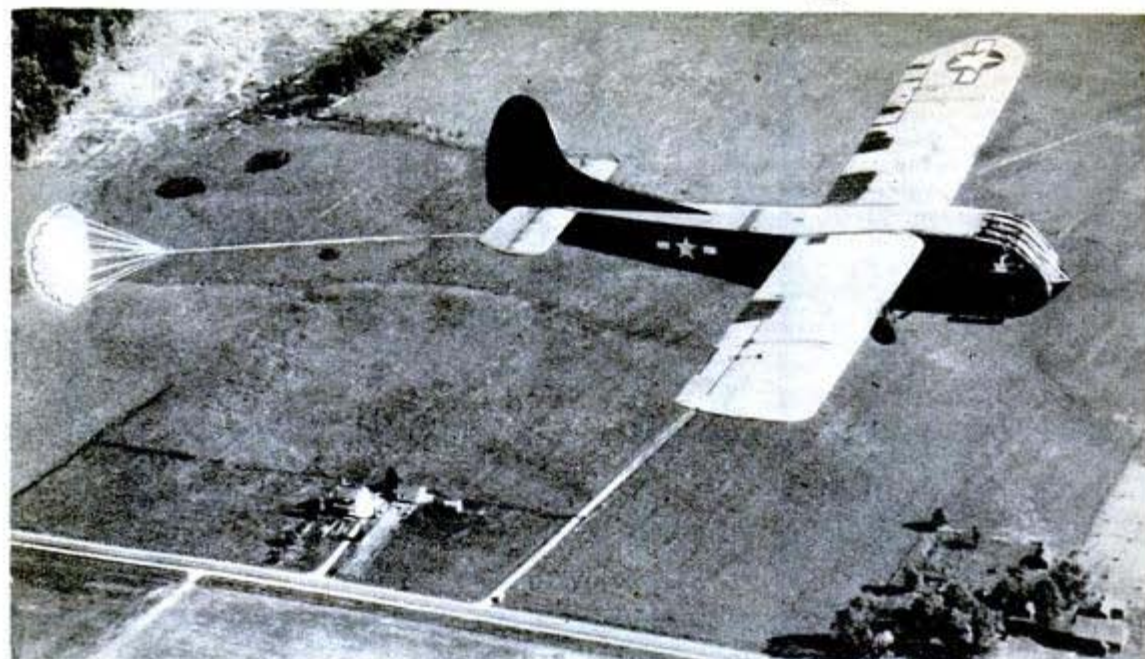

Giant troop-carrying gliders can land in smaller areas and with less danger of cracking up when they are equipped with a parachute "air brake." Ten-foot nylon drag parachutes were used in successful

tests conducted recently at the Clinton County Army Air Base, Wilmington, Ohio. The parachute can be kept open during the entire landing operation, or released at any time by controls in the cockpit of the glider.

Greeth Mfg. Co. 126 N. Union Ave. Chicago, Ill.

Steaks Pop Out of Rotary Cooker Like Automatic Toaster

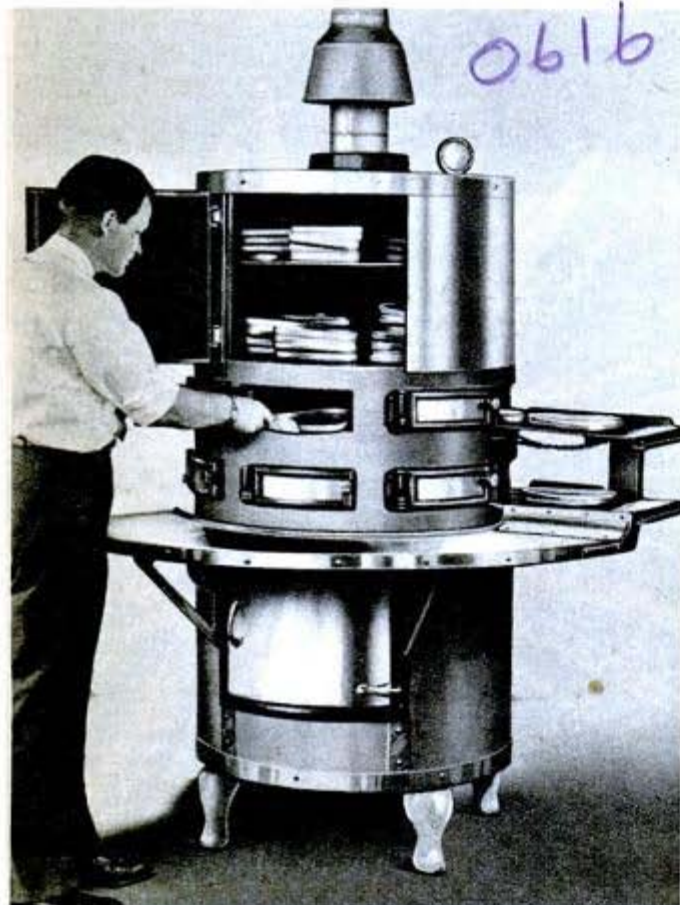

0616

"Cooking with gas" is given a revolutionary twist with a rotary cooker employing reflected heat. Designed for restaurant use, it can turn out 200 steaks an hour and cooks chicken in only eight minutes. There are compartments for cooking meat either rare, medium or well done, and when the meat is done it is automatically ejected "toaster style" onto a ramp where it can be picked up for serving. Casseroles are preheated in an upper compartment kept at a temperature of about 450 degrees. By reducing the temperature, this space can also be used for baking or roasting. The cooking chamber, which has six compartments, is kept at a temperature of 850 degrees. Specially constructed fire brick encircles the gas burner, and the heat is reflected from the bricks to the food. The intense heat seals the vitamin-rich juices in meat, and the process is said to eliminate smoke, grease and odor. The inside of the cooker never has to be cleaned. It is 63 inches high and weighs 1,200 pounds.

Ⓢ Lignin extract, which is obtained in abundance in Canada as a by-product of the pulp and paper industry, has been used successfully as a stabilizing material in road construction in Quebec.

0312

One-Man Bazooka Is Fired by Remote Control

Light enough to be carried and fired by one man, the Rocket Launcher M-12, a new type bazooka, was designed as the infantryman's artillery. The big brother of the original bazooka is more than two inches larger and packs as much destructive punch as a 105-mm. howitzer. The equipment consists of a four-foot tube and a tripod on which the tube is mounted when ready for firing. The 4.5-inch projectile for the 35-

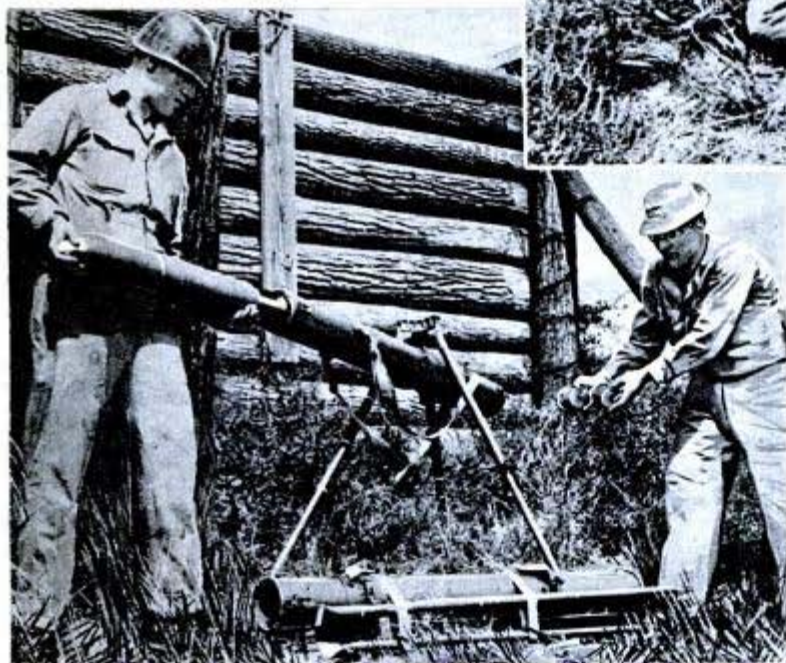

pound gun is three feet long to provide a maximum wallop for enemy gun emplacements. The gun is easily set up for quick use by unstrapping its tripod mount and fastening the rocket launcher on it. Wires lead to a safe distance where the battery to detonate it is located. After they tumble over backward upon being fired, the rocket launchers and tripods can be picked up and used over again.

New Plating Slows Corrosion on Electrical Instruments

Bright Alloy, a three-metal, weather-resistant plating process which scientists have sought since the last century, has been developed by Westinghouse. From copper, tin and zinc the process evolves a compound which provides a tough, protective coating for instruments in war machines. The coating not only resists corrosion and tarnish, which are very difficult to combat in tropical regions, but its nonmagnetic quality also improves the electrical performance on which the calculations of the fighter pilot or the beachhead radio operator depend. The process permits much thinner coatings than do conventional anticorrosives. After the war Bright Alloy probably will be used to cover many items of general hardware subject to corrosion.

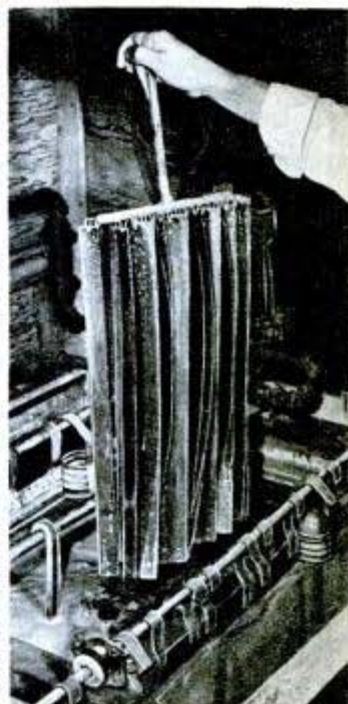

FLYING *the* POWER MIDGETS



Above, model builders and their planes. Below, a speed plane which holds 112 mile an hour record has deep rooted stub wings and enclosed engine

THE flying of powered model airplanes is a 25 million dollar a year sport in the United States today and enthusiasts who have flown their tiny aircraft at better than 100 miles per hour confidently expect to reach speeds above 200 miles per hour within the next 12 months.

A world record of 112 miles per hour was recently set by a bullet-like "Williams-Clark Special" that has a wing span of 18 inches and a gross weight of two pounds. The model is powered by a 12 ounce, one cylinder aircooled engine that develops one horsepower at 16,000 r.p.m. Its hollow balsa wood wing and fuselage are built up of tiny

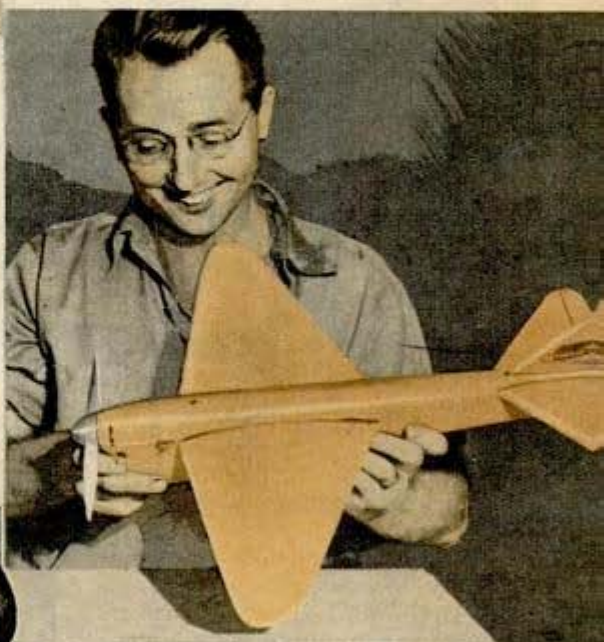

planks $\frac{3}{4}$ inch wide and $\frac{1}{16}$ inch thick. Its speed record is equivalent to a scale speed of 1,700 miles per hour in a full sized version of the model, an absurdity that nevertheless indicates the skill and care with which

Cutaway model of a free flight plane that shows the interior construction

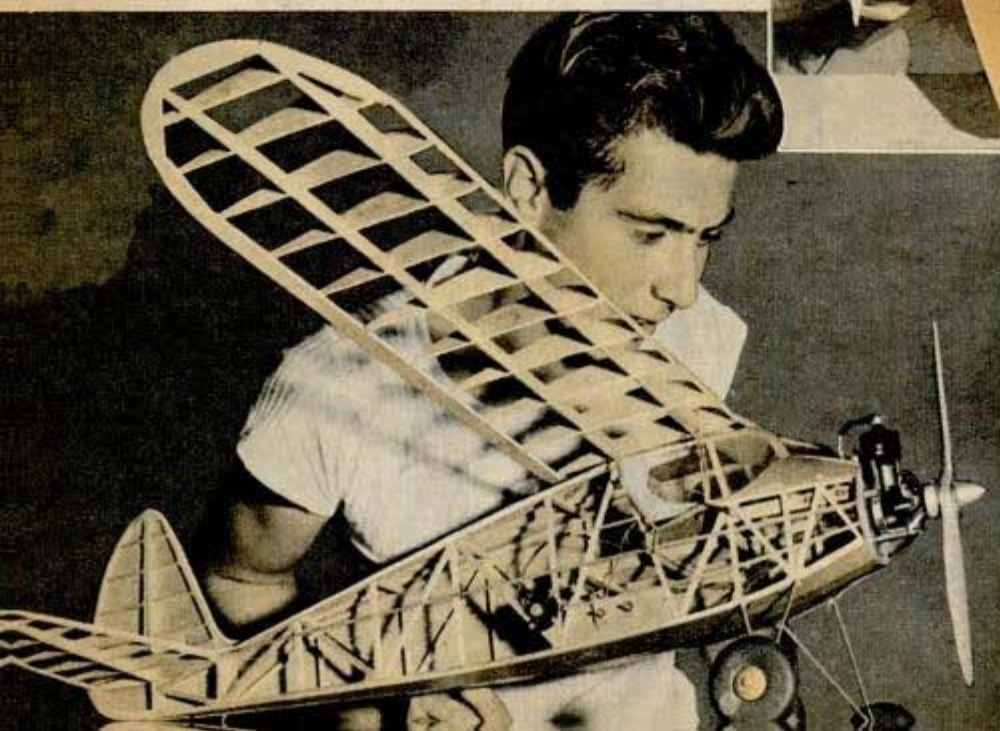



Above, flying wing's landing gear retracts into hull due to centrifugal pull when it is flown on a control wire. Right, interior of tiny motor

model racing planes are designed and built.

Model racing enthusiasts suggest that it is entirely possible that the research they are doing with models will contribute to the efficiency and speed of tomorrow's large aircraft. They point out that a scale model of a German Messerschmitt has been clocked at 106 miles per hour, an indication of the efficiency of this particular plane, but that models with tapering, deep rooted wings designed by themselves are considerably faster than models of Messerschmitts or other fast combat planes.

Model speed planes are flown at the ends of two 70-foot piano wires that the operator holds in his hands and by means of which he can dive or climb the plane while it travels in a circle around him. Several planes can be flown from the center of the same circle and can be made to dog fight, perform loops, and fly upside down. Even greater speeds than the present record have been made by attaching the control lines to the end of a four-foot rod that the operator whirls around his head in slingshot fashion.

Free flight models that rise off the ground or that are launched by hand compete for endurance records instead of for speed. An automatic timer cuts the engine at the end of 20 seconds of flight, after which the plane glides gently toward the earth. Miniature free flying planes have remained aloft

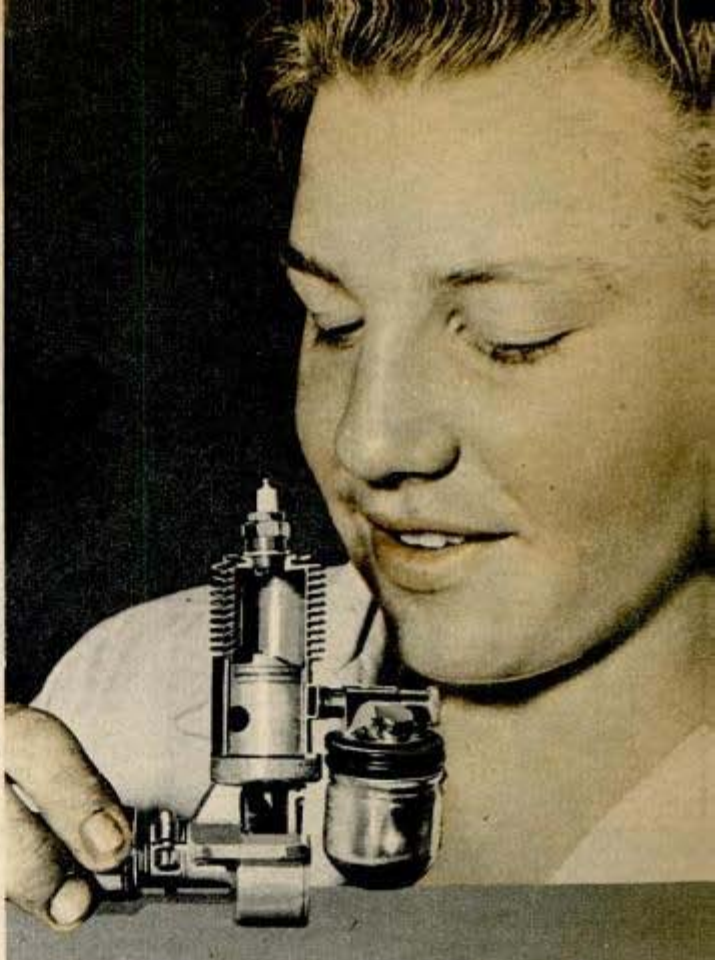

Launching model plane at start of endurance test





Above, substituting a propeller of a different pitch. Some propeller tip speeds reach 45,000 feet a minute



Left, record breaking speed plane. Note the air scoop below propeller which admits carburetor and cooling air to the enclosed engine

Below, high speed scale model of Messerschmitt that does 106 miles per hour, held above its takeoff dolly from which it rises into the air



plane consists of a glider with a commercial firecracker attached under the fuselage. The fuse end of the fire cracker is opened up so that the powder burns like a squib instead of exploding when ignited. A large cracker of the "half inch steel turning" type provides a few seconds of terrific thrust during which time the rocket plane attains a speed of around 100 miles per hour, after which it glides gently to the ground.

Moderately large models that are controlled during flight by means of radio signals were being experimented with before the war and work will be resumed on this type when material is available.

Model builders have their own national organization, the Academy of Model Aeronautics, whose chapters consist of various local clubs. One such chapter, the Los Angeles Aero Modelers, has several hundred members ranging in age from 10 to 60 years. The Aero Modelers maintains its own model airport, laid out with flight and contest areas, spectators' parking, public address system, and other facilities.

The club holds semiannual contests for both free flight

for more than an hour when caught by an uprising thermal current.

Dozens of odd types of aircraft have been built, including gliders with wing spans of up to seven feet, flying wings, helicopters of various designs that rise off the ground under their own power, wing flapping ornithopters, and tail-first aircraft. Jet propulsion aircraft are of current interest and many builders are working on designs for free and controlled flight. One simple rocket



endurance records and wire controlled speed flying. Each type of competition is divided into three classes based on the engine displacements of the models. War bonds and similar prizes go to the winners of the events. Spectators pay 10 cents for admission. For safety, no one except contestants and judges is allowed on the field. A two pound model flying 50 miles per hour is a dangerous missile and could knock a man down. A person might be killed or gravely injured if hit by a model plane flying above 100 miles per hour.

Some "speed jobs" are valued at more than \$500 but most model builders assemble their planes from factory kits that sell for only a few dollars. The cost of a free flight miniature airplane, including engine, may total \$25, while the cost of a controlled speed plane is about \$75. Lightweight balsa wood is a universal material. Bamboo paper doped with nitrate is a practical covering for the wings and fuselages of free flight model planes.

(Continued to page 158)

Below, this model lands on one wheel and skid. Elimination of other wheel reduces wind drag and increases the speed

Twin boom endurance plane (above) similar to P-38 Lightning is ready for launching test. Below, weighing model plane. This one has a gross weight of just under fifteen ounces



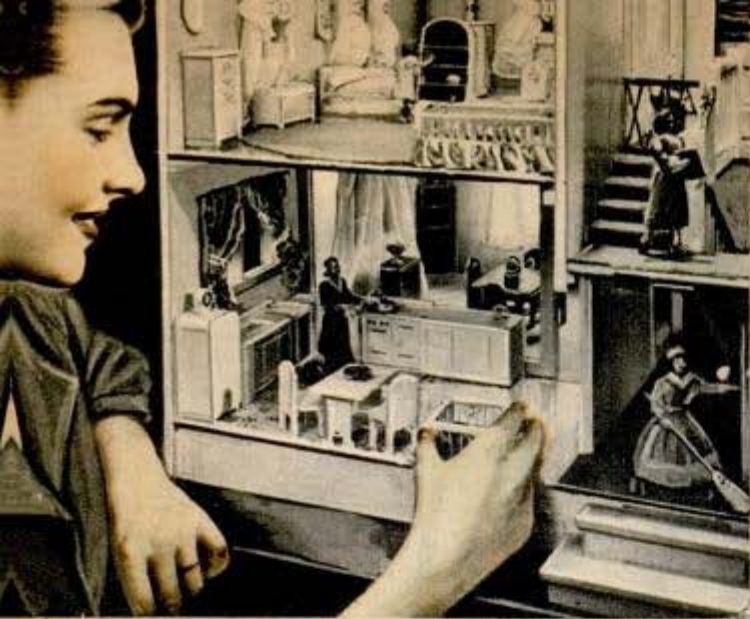

National Safety Council, 20 N. Wacker Drive, Chicago 6, Ill.
BUILT-IN Safety
 0627

Every year accidents in the home reap a death toll of 32,500. The miniature house shown here stresses safety features for your home—from the outside steps of not over three risers (unless handrail is provided) to a locked cabinet in the bathroom for storing poisonous medicines. The kitchen (above) features rounded corners on cupboards and counters, doors that slide, non-skid floor and well-lighted work area. The nursery (right) has a cabinet for storing those toys that grownups trip over. Below, furniture in the bedroom is arranged to prevent stumbling accidents, and carpets in all rooms are sized to be slip-proof. This no-accident home was built by the National Safety Council



0579
N.A. So Lakehurst N.J.

Plane Drops "Pararaft" to Shipwrecked Flyers

Two steps make up the Navy's sea-air rescue system for flyers forced down in the ocean. First, a plane throws the castaways an AR-1 unit for their protection and then they are picked up by either a blimp or helicopter. The AR-1 consists of two containers connected with about 20 feet of floating line. A "pararaft" with paddles is stowed in one container; in the other is a small amount of survival equipment. In a recent demonstration it took the "survivors" only 70 seconds to inflate the raft and paddle in the direction of safety.



Shuss a T.B.F.
Hellcat drops line and two containers holding a "pararaft" and other survival equipment to "castaways" in practice rescue. Left, helicopter drops tow line so sailor can pull himself up from life raft

Mister MAYER Co. 255 McCornie Pl.

Spray for Stripping Wall Paper Attached to Garden Hose

Wall paper is easily peeled off in large strips down to the bare walls, once it has been watered with a sprayer which can be attached to the garden hose. The hose's regular nozzle is removed and the special spray nozzle is screwed tightly in place. Then the water is turned on about one-eighth of the way and when all the air is out of the hose a fine mistlike spray of water can be seen coming from the tiny hole in the nozzle. Holding the nozzle 15 to 18 inches away from the surface of the ceiling or wall, the sprayer moves the nozzle over the paper slowly enough to dampen it thoroughly but fast enough so that the mist will not form drops of water and fall. After repeating the operation two or three times, the paper can be peeled off. When the mist is too fine or the nozzle stops up, new holes can be opened up with a very fine needle.



0522
Concord, Ohio

SHARPER EYES *for* STARGAZERS



Space between the stars is filled with clouds of dark obscuring matter which astronomers must penetrate. Below, box on telescope tube at Mt. Wilson Observatory holds camera

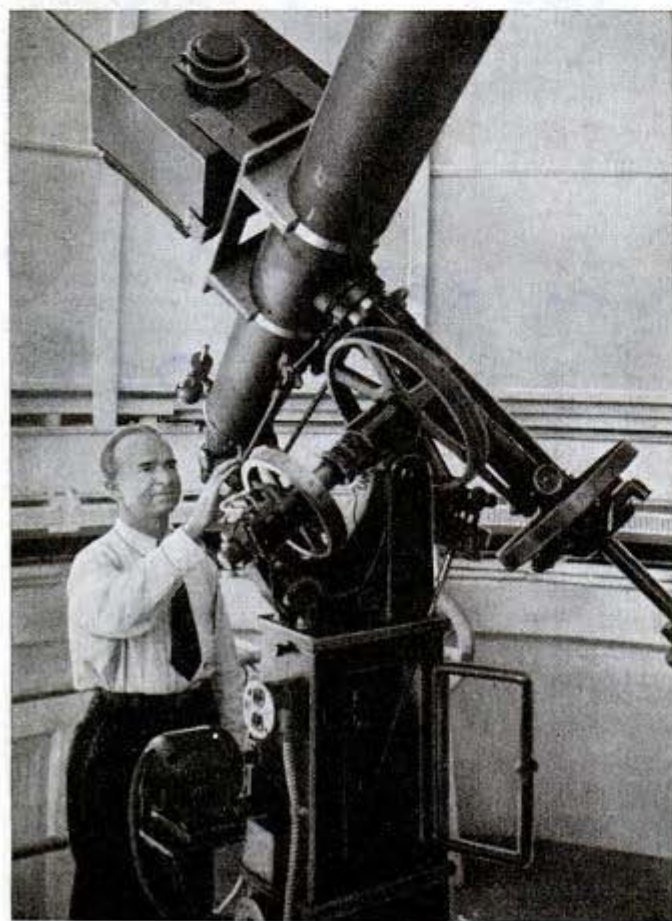

By Robert S. Richardson

WHAT new wonders will the 200-inch telescope reveal?"

Not many years ago that was one of the biggest questions in science. Today the answer seems more remote than ever. Work on the 200-inch is halted. The machine shops that once turned out instruments for astronomy now are the source of secret weapons for the Allies.

However, we already know many wonders that the 200-inch would have revealed. Owing to improvements in optics and photography, the 100-inch telescope of the Mt. Wilson Observatory has more than surpassed the gains expected of the 200-inch. These gains can be applied to the 200-inch when finally completed. Some of these improvements have been achieved by simple methods that amateurs could use on their home-made telescopes.

How these phenomenal improvements have been possible is easy to see if you think of a telescope, not as a device for magnify;

1244 N. Holliston Ave. 01
Pasadena 6, Calif.

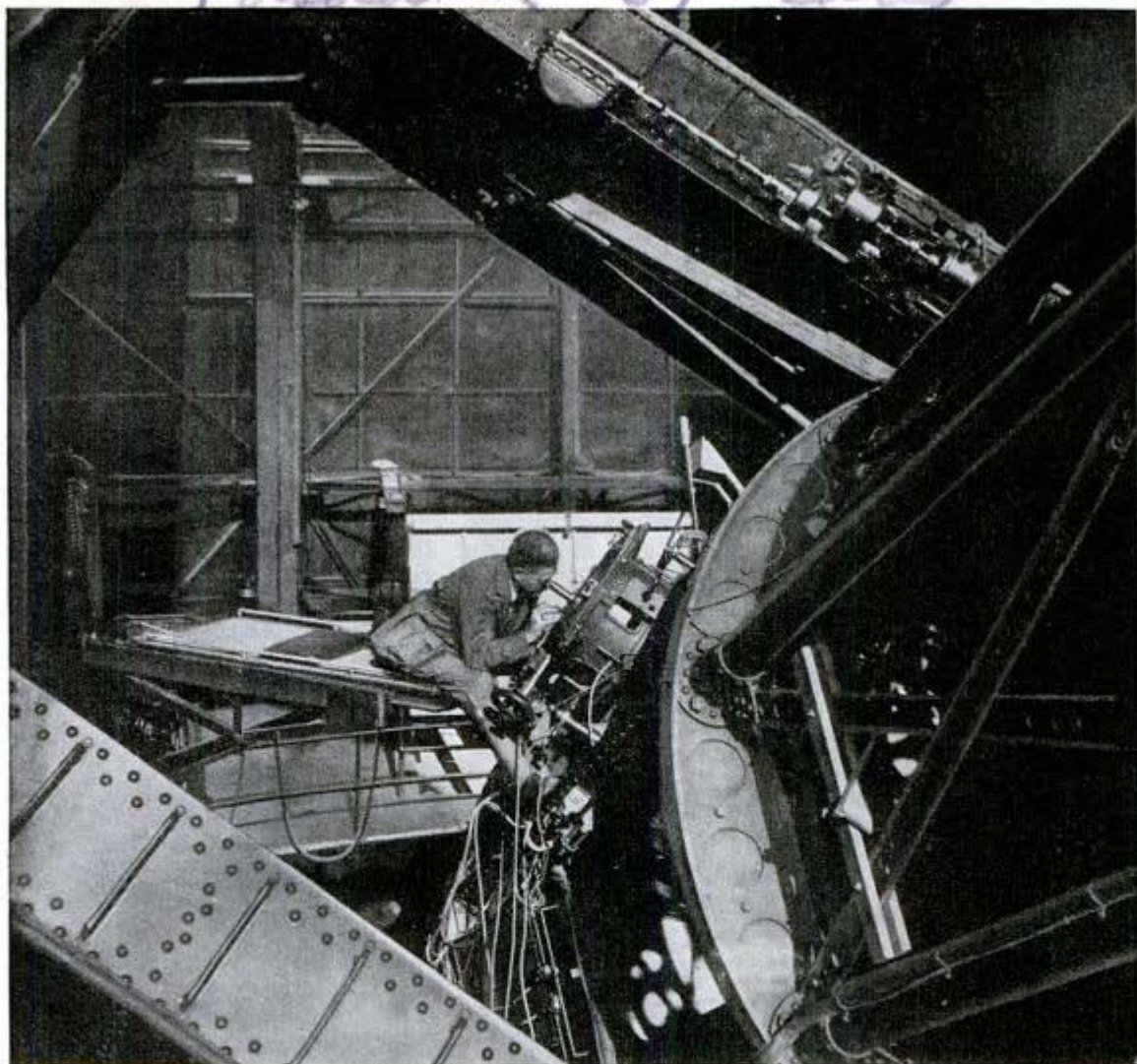

ing distant objects, but as a device for gathering more light from distant objects than your eye can grasp. An astronomer never thinks of his telescope as a magnifying glass; he thinks of it as a giant camera. A telescope might be compared to a water funnel that catches light instead of raindrops at the wide end and gathers them into a narrow stream where they emerge at the bottom. If you wanted to catch more raindrops you would build a bigger funnel, and the most obvious way to catch more light would be to build a bigger telescope.

Another way to improve a telescope is to make the most of every ray of light. A telescope is an inefficient sort of a funnel that lets a lot of the light escape before it ever reaches the eye or photographic plate.

An astronomer spends very little time merely looking through his telescope. He does spend a great deal of time working with various optical in-

Largest telescope in use today is the 100-inch (above) on Mt. Wilson. Work on 200-inch telescope on Mt. Palomar, Calif. (below), has been suspended for duration
Photo by Edison R. Hoge, Mt. Wilson Observatory

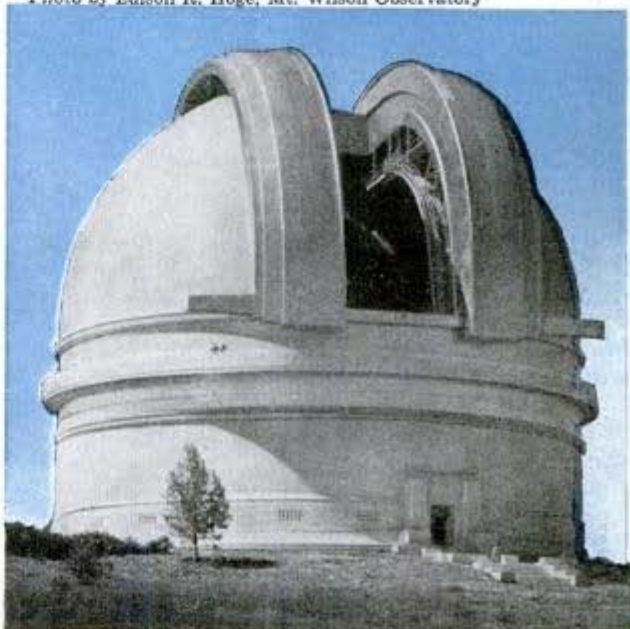

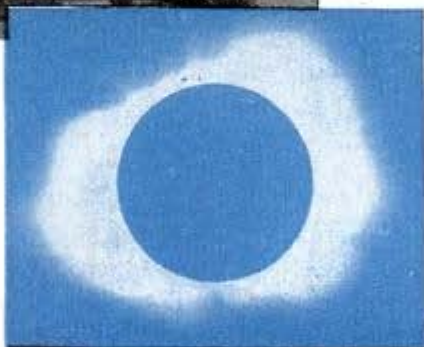

Image of sun is projected from high tower to disk in the foreground. Right, a total eclipse

struments which he attaches to it. By far the most important of these instruments is the spectrograph, which spreads the white light of a star out into a rainbow colored strip or spectrum. From studying the spectrum of a star an astronomer can tell you its temperature, the chemicals in its atmosphere, how fast it is moving toward or away from us—even the distance of the star from the earth!

In order to photograph the spectrum of a star, its faint light may have to traverse as many as six air-glass surfaces. The clearest lens will not transmit all the light that strikes it. Usually about 5 percent is lost by reflection. This means that

Baking blue sensitive plates in oven reduces time of exposures



perhaps 25 percent is lost before it reaches the photographic plate.

Astronomers have found a way of increasing the transparency of their lenses by coating them with a metallic film. If a film of lithium or calcium fluoride four-millionths of an inch thick is deposited upon the surface of a lens it will then transmit light practically 100 percent. Remember those intensely black spots that appear on a soap bubble when it is blown up so big and thin it is about to burst? Those spots appear black because all the light striking there is going on through the bubble. None is being reflected back to your eye. The same principle applies to a lens coated with a non-reflecting film.

As an example of what can be found with the spectrograph, there is a star invisible to the unaided eye in the direction of the Pleiades or Seven Sisters known to astronomers as RW Tauri. This star is one of the most curious objects in the heavens, for it has a

ring around it. Not a ring composed of cold meteoric fragments, but a ring of fiery scarlet hydrogen gas.

Nobody has ever actually seen this flaming ring for it is beyond the reach of the most powerful telescope. But from the spectrum of RW Tauri we know it must be there.

Photography has so completely superseded the eye that almost the only time an astronomer bothers to look through his telescope is when he takes a peek to make sure it is still pointed in the right direction. Suppose the proper exposure time on a faint cluster of stars with the 100-inch telescope is four hours. Because the 200-inch is twice as big and therefore has four times as much mirror surface or light gathering power, we should expect the proper exposure time with it to be about one hour. But if instead of building a telescope twice as big we could speed up the photographic plate four fold virtually the same result would be attained by a much simpler and cheaper method.

This is what has been accomplished in the case of photographic emulsions sensitive to red and the invisible infra-red light. As every camera fan knows, the advantage of using a red sensitive plate is that it will penetrate or "see" through haze that would be like a blank wall to a blue sensitive plate.

(Continued to page 148)

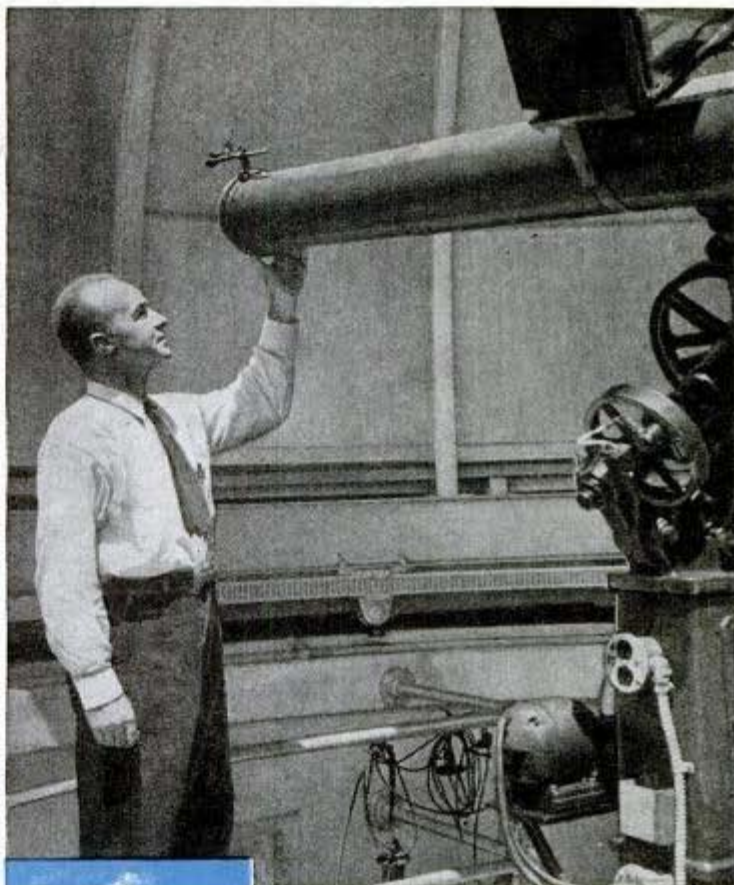

Inspecting lens coated with thin non-reflecting metallic film which transmits nearly 100 percent of light. Loss was formerly about 25 percent. Below, massive framework of 100-inch telescope hides giant mirror near the base

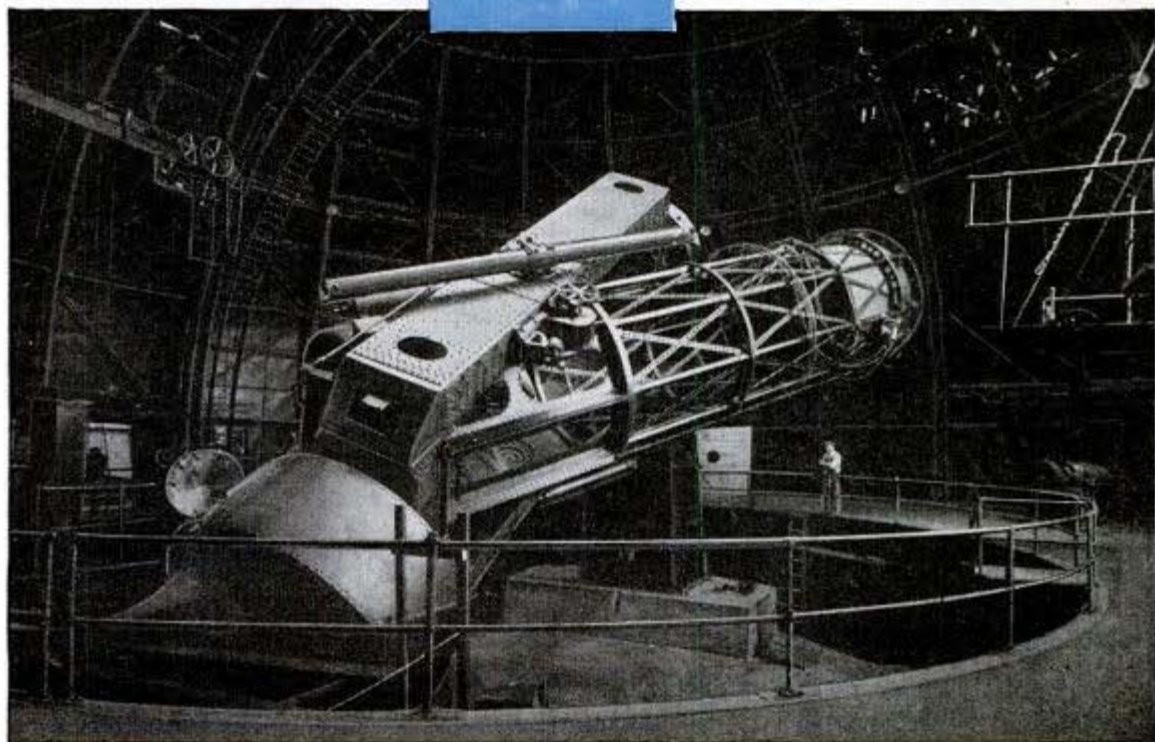

Camp Hale, Colo.

Aerial Trams for Wounded Also Carry Supplies

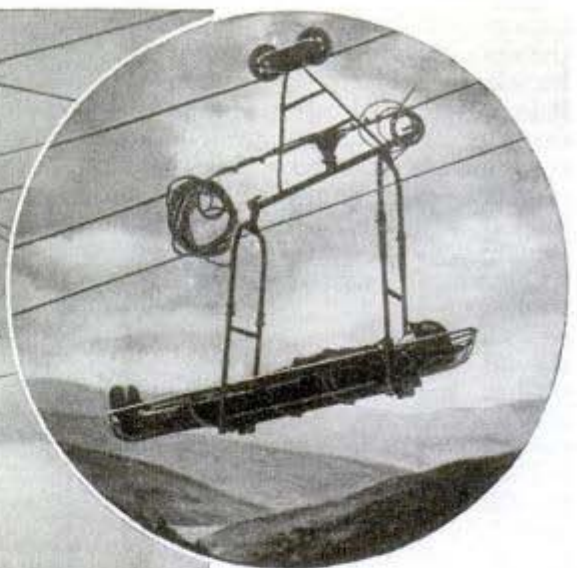
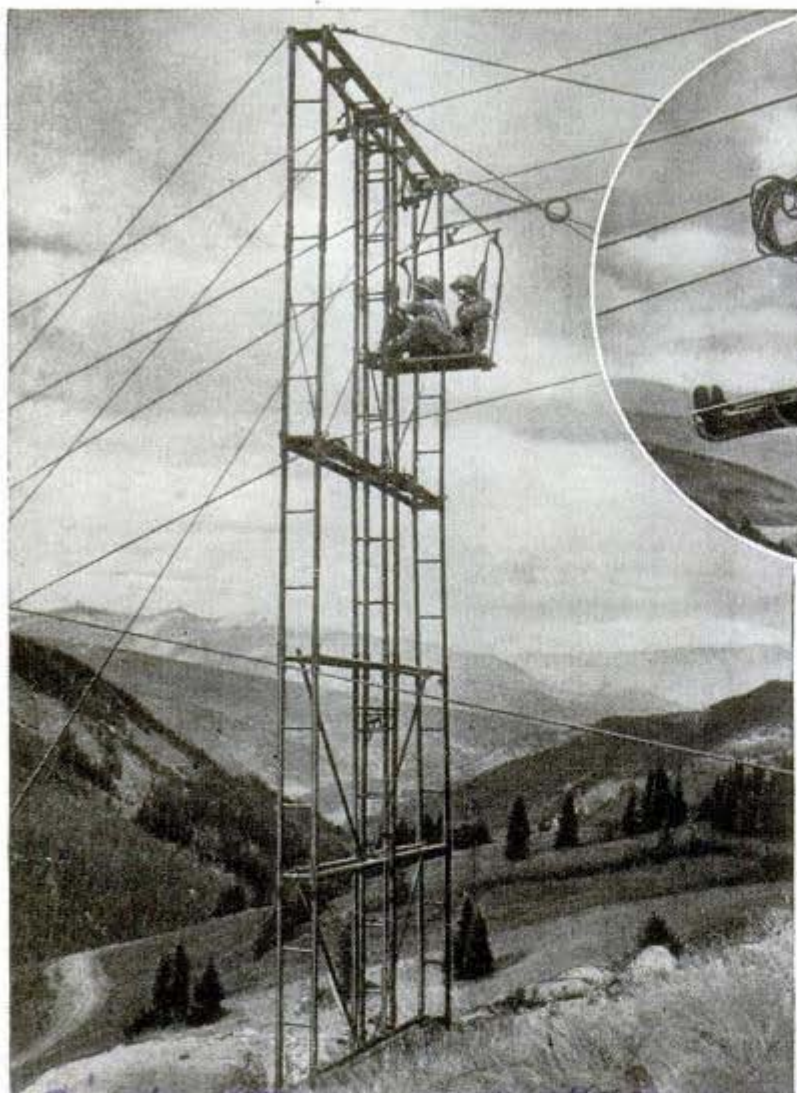

Mountain fighters operating in terrain too rough for pack animals are linked to base positions with an aerial tramway. This lightweight tramway, recently demonstrated by the mountain warfare section of the Army's Engineer Board at Camp Hale, Colo., carries wounded soldiers, ammunition, food, guns or other vital cargo. The wounded are carried on litters. The towers can be taken down quickly and moved to new positions.

Slide Rule Places Decimal Point in Problem of 19 Digits

Since the invention of the slide rule 300 years ago, placing the decimal point has been a stumbling block. A recently devel-

oped decimal point locator and slide rule not only "points off" up to 19 places, but with one setting gives the square root, cube root and logarithm. Persons with limited mathematical knowledge can use it.

FOUR READINGS WITH ONE SETTING OF HAIRLINE

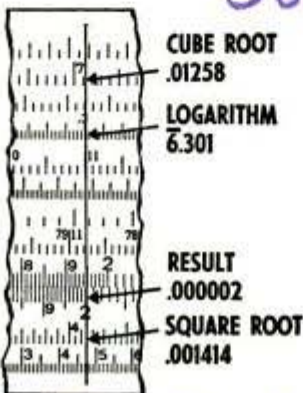
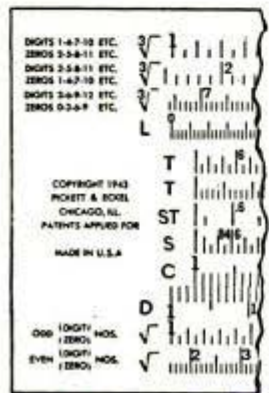

0665

0469

Noses and Ears Made of Plastic Are Flexible and Lifelike

Similar to the flexible plastic in "glass" belts and suspenders, a new material for making noses, ears, fingertips and other parts of the human body has a texture similar to skin and can be colored to blend with the complexion of the individual. It already has been used successfully on scores of persons, including a war worker with a mutilated ear, a taxi driver whose nose was disfigured, and a woman who lost an index fingertip.

X-Ray Through 12 Inches of Steel Made With 2,000,000-Volt Units

Two-million-volt X-ray tubes, twice as powerful as those now used for the examination of metal sections, can penetrate a foot of steel to produce satisfactory pictures. The high-voltage tubes greatly reduce the amount of time required to make an exposure. One 2,000,000-volt unit, developed by the Machlett Laboratories, Inc., Springdale, Conn., is sealed like an electric light bulb. This eliminates pumping to maintain the high vacuum within, and is said to achieve extremely fine focusing. A unit of the same voltage, built by General Electric, weighs 5,000 pounds and also makes pictures through a foot of steel. Formerly, it took about four and a half hours to make a picture through an eight-inch steel casting with a million-volt unit. With the new unit an exposure can be made in three and a half minutes. It is predicted that the new precision tube brings to the field of X-ray radiography the same sort of improvement in definition that the electron microscope brought to the field of optics.



Right, R. R. Machlett, president, and his company's new 2,000,000-volt tube. Below, a 2,000,000-volt outfit made by the General Electric Co.

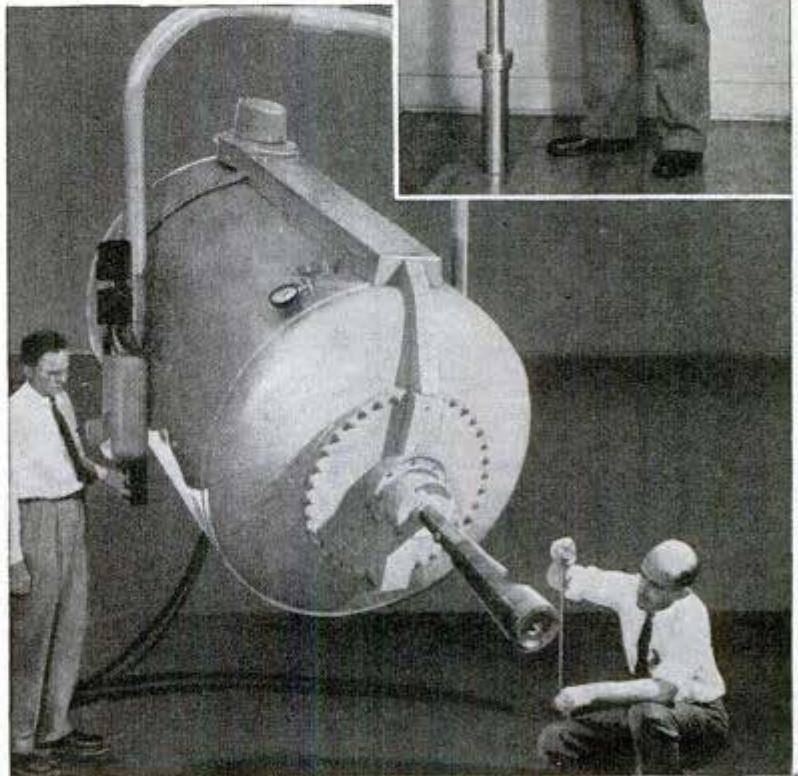

"Darts" Are Bombs And Target Is Japs

Playing a lethal dart game with 100-pound spike bombs as darts and Japanese railways and bridges as targets is a favorite sport of Air Force flyers in the India-Burma theater. Ordinary bombs showed a tendency to ricochet and explode harmlessly a few feet away from the target, so the airmen took the nose fuse out of each bomb and replaced it with a long spike made from an old axle. The flyers continued to make the bombs by hand until the new weapons began to arrive in quantity from this country.

Chicago Tribune 8/19/44

Microphone and Film Show Hidden Illness While Listening to Heart

Subtle changes in the body's circulation which signify the beginning of an illness are recorded by a heart-sound detector developed at the Du Pont laboratories in Wilmington, Del. The instrument, which is portable and easy to operate, flashes signs of trouble long before the patient himself notices any symptoms and before real damage has been done. These disturbances,

which do not necessarily mean something is wrong with the heart, are too slight to be noticed by the electrocardiograph and often too faint even to be caught by standard blood-pressure measurements. The meter consists of a sensitive microphone strapped to the patient's chest and a dial or a photographic film on which the microphone's "pick up" is registered.

0296

Mr. Chester Hope 345 W. 86th St.
N. Y. City

Floating Hotels Towed Overseas for Mechanics

Ships which will serve as hotels large enough to house 800 mechanics each are being built by the Navy for use in any part of the globe. The sea-going boarding houses, known as auxiliary personnel lighters, have no motive power of their own and are towed to overseas ports, where skilled shipfitters, carpenters, machinists, electricians, metalsmiths and painters live in them while operating repair shops 24 hours a day. Besides three decks of sleeping quarters, each ship includes a 15-bed hospital, a dental clinic, a cafeteria, public utilities, a post exchange, recreation rooms, a super laundry, and a Butcher Boy band saw which



U. S. Navy photo

Above, signalman tidies up a 4-tiered bunk aboard a Navy barracks ship. Left, exterior view of the "floating hotel"

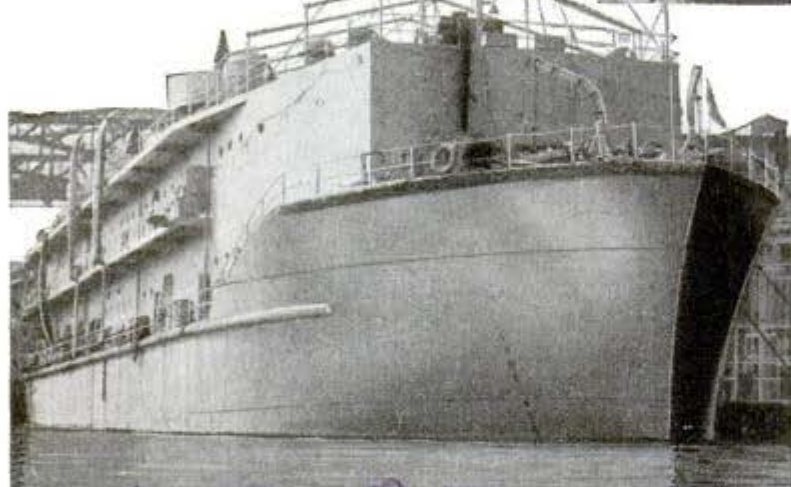

cuts sides of beef into steaks and roasts. The lighters are armed with 20 mm. anti-aircraft guns and machine guns and also carry two motor-driven whaling boats. Some of the ships may be used as floating barracks for troops "island-hopping" in the Pacific.

Honolulu R. Transit Co. Honolulu

Rolling Magnet Made of Scrap Picks Up Nails From Road



To reduce punctures in valuable tires in Honolulu, the Rapid Transit Company joined with a Westinghouse engineer to invent a gasoline-electric-magnetic scrap-retriever made largely of material from the storeroom and scrap pile. Welded to the trailer-like chassis of the retriever is a small, air-cooled gasoline motor, an electric generator converted from a Westinghouse motor which was in service in 1905, and some magnet coils salvaged from old street car equipment. Turning at 1,310 revolutions per minute, the generator produces direct current at 200 volts to energize the magnet coils. When the current is turned off, metal scraps collected drop off and are easily swept up.



Fairyland ROCKING CHAIR

By E. J. Tangerman

ALL the king's men couldn't put Humpty Dumpty together, but you can do it easily with a few hand tools and some spare time. As the chair is to be carved, 1-in. white pine is suitable, although maple, while more difficult to carve, is stronger and more attractive.

The only extensive carving job is the back, which is glued up to size from standard widths and sawed, leaving ear and thigh projections. Outlining cuts

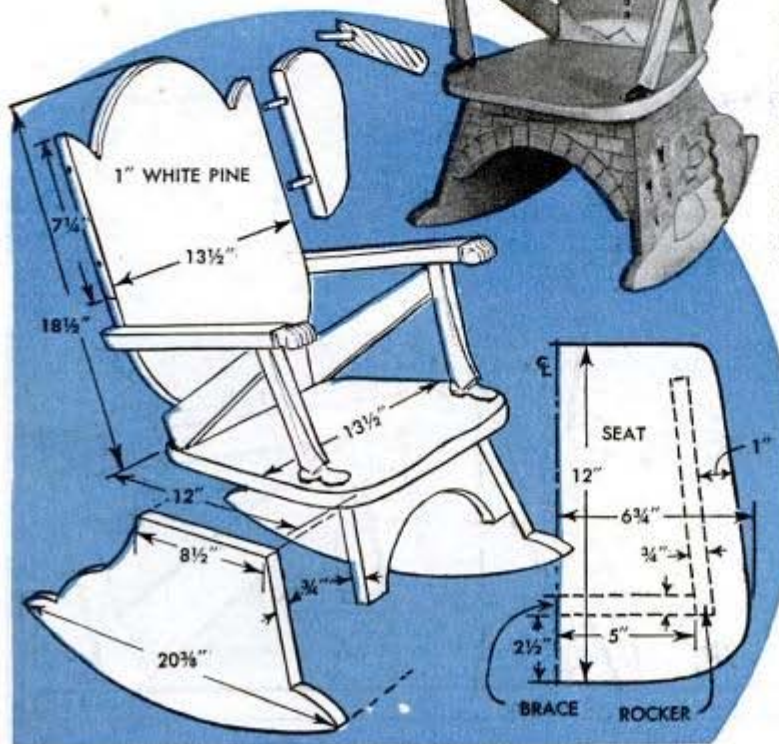

for the features are made with a V-gouge, but the carving should be not deeper than 1/8 in. to avoid causing discomfort to the chair's occupant. Holes for eyes and mouth are drilled and the latter is cut out with a scrollsaw and smoothed to shape with a rasp. Ears are set forward at an angle and are assembled with dowels and glue. The back is attached to the seat with dowels, glue and screws, the lower edge being beveled to set at a comfortable angle.

Now the rockers and brace are joined to the seat. The rear rocker tips should be separated about 8 3/4 in. and the front tips about 12 in. so that the chair does not "walk" across the floor or tip over so easily. The bottom edges are shaped to bear flat on the floor. Screws driven through the seat



are countersunk and covered with wooden plugs. The picture design is outlined with a small gouge on each side and across the brace.

Shoes are whittled and the arms are rounded on top, the ends being carved to resemble closed hands. Leg sections are tapered toward the edge to simulate a trouser crease, and the thigh is fitted by tongue-and-groove joints. In setting the lower legs, the dowel holes should be drilled so that the legs will tilt outward as shown.

After the chair has had a coat or two of linseed oil, it is painted by rubbing in oil pigment mixed with drier. Details can be brushed on, but the color should be rubbed off until only a tint remains, to allow the grain to

show and to avoid a pasty, painted appearance. However, the black hats, white gloves and candy-striped shirt should be solid color. The pigment should dry for about a week before final finishing. Then two or three coats of hard wax may be applied, rubbed in well between coats to protect the chair from the knocks and hard usage to which nursery furniture is usually subjected. For buttons and decorations on the sides and back, ornamental tacks can be used, and a piece of costume jewelry or colored glass will serve as a tie pin as indicated.

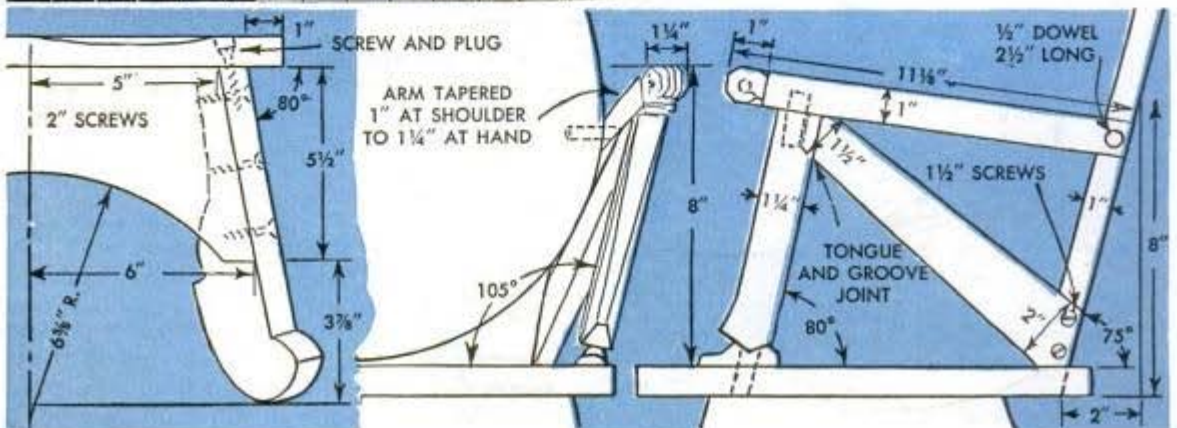
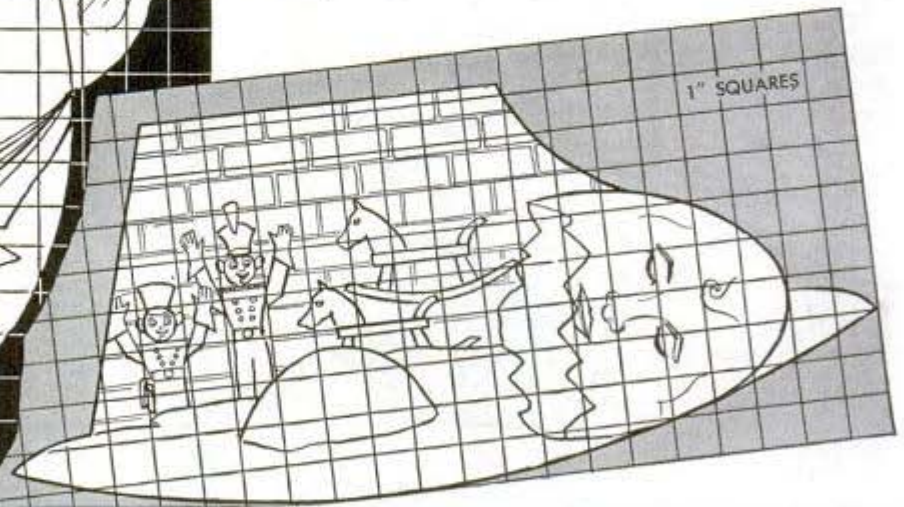
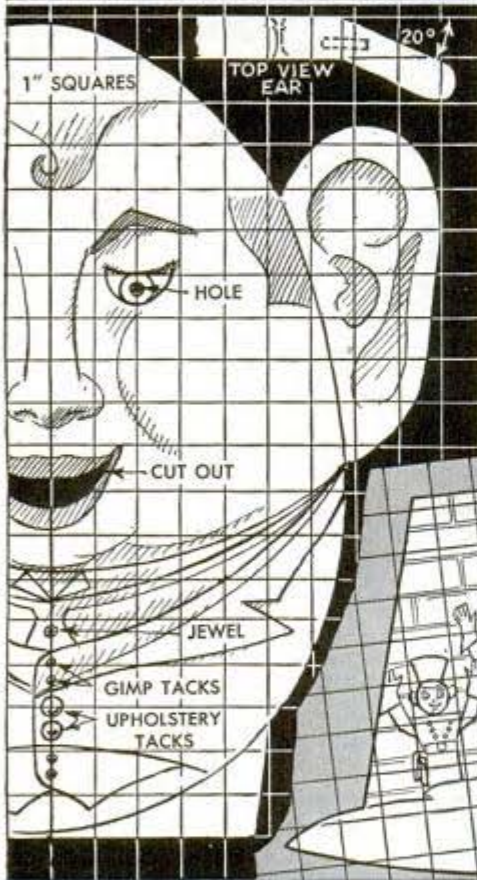

Two Wooden Tidbit Dishes of Unusual Design

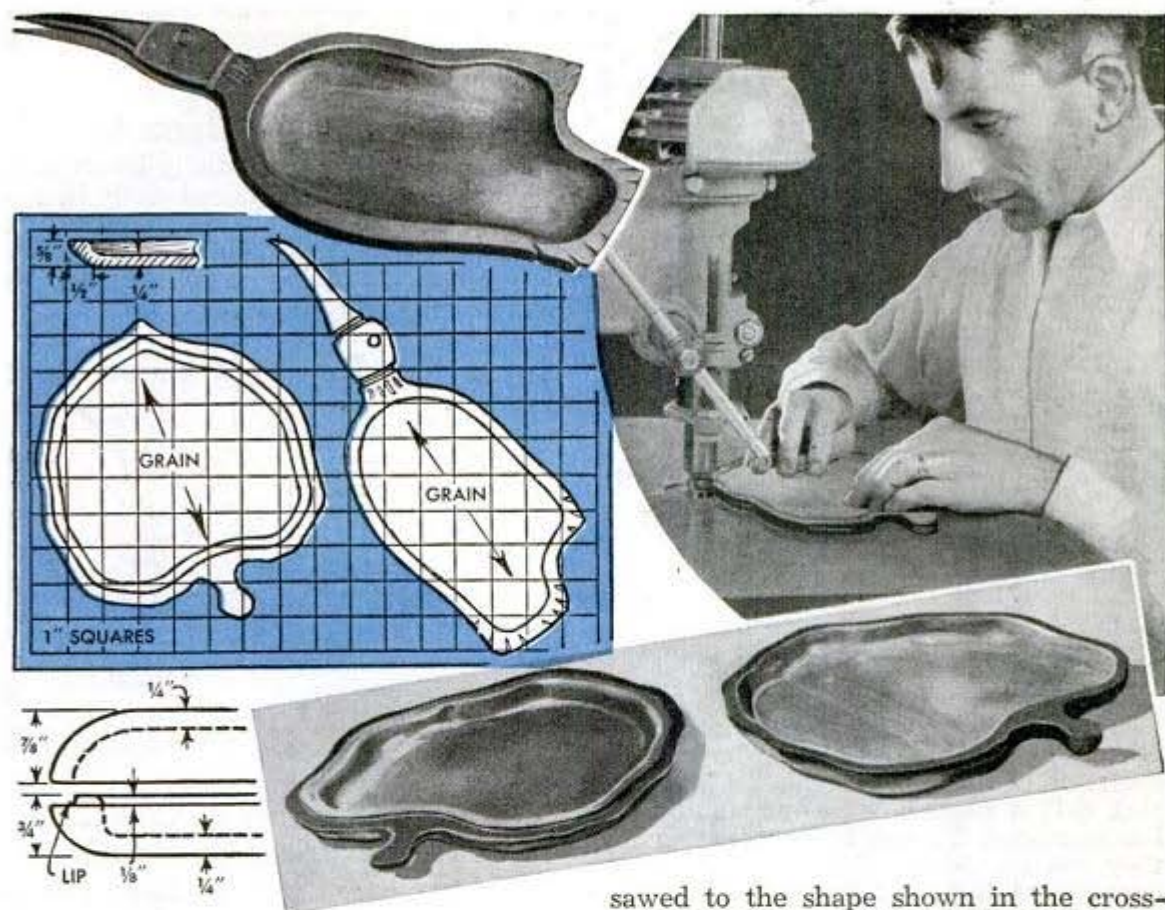

To many an outdoorsman, this curlew dish will bring back memories of salt marsh or windswept dune. The Puritan-style double dish, on the other hand, has a homely, rustic appeal. Both dishes are suitable for serving nuts, candy and other tidbits, or they may be used as cigarette trays. Any close-grained wood may be used, but maple, whitewood, mahogany or birch are especially attractive. The dishes are jig-

sawed to the shape shown in the cross-hatched detail, and the edges are undercut. Holes are drilled to rough out the hollow, which then is routed to shape, and a gouge is used for finishing. On the double dish, a lip is left on one section, and the other is recessed to fit so that both sections nest together snugly. After they are sanded, the dishes may be stained and varnished or waxed. However, the inner surface of the double dish should be lighter in color than the outer surface for pleasing contrast.

Guides on Ruler Aid in Drawing Uniform Lines on Paper

When you want to draw a number of uniformly spaced lines, two strips of gummed paper on your ruler will enable you to do the job quickly and accurately. The strips are stuck to the ruler as indicated and then cut so that when the ends touch the line above, the ruler is in position for drawing the next line. When the lines must be of uniform length, a couple of pieces of rubber tubing slit along one side and slipped over the ruler edge will serve as stops. Of course, the paper strips will serve the same purpose, but the pieces of tubing provide adjustable stops that can be set for lines of different length by merely sliding them along the edge of the ruler.

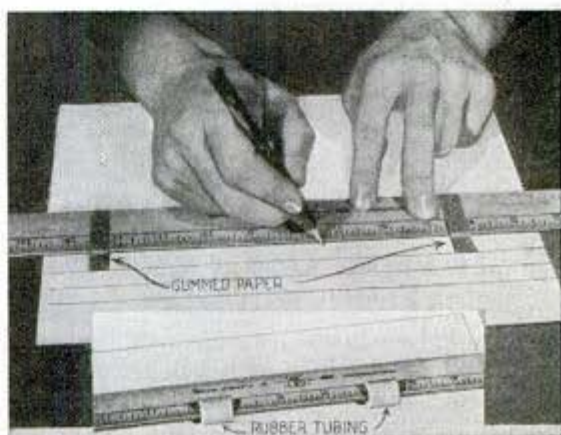

Hole Drilled in Hammer Head Used for Clinching Nails



When nails are clinched to provide greater holding power, they should be bent as indicated in the upper detail. To facilitate this, drill a small hole in one side of the hammer head. Then, if long nails are used, they can be given a double bend in one operation, as indicated, and the points driven back into the wood across the grain, leaving no points projecting on which clothing or hands can be caught.

Hinged Cover Prevents Dogs Upsetting Garbage Can

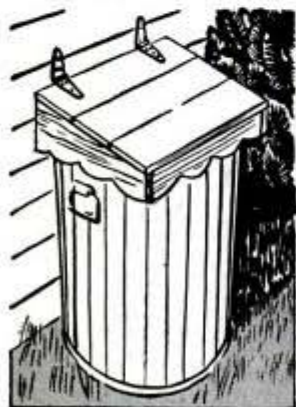

You can keep dogs or other small animals from upsetting your garbage can by hinging a wooden cover to the side of a building and setting the can under it. Put skirt pieces on the front and sides of the cover and the can cannot be pushed over.

Ruler Taped Under Glass Desk Helps Draftsman Draw Lines

To help him in ruling measured lines and yet keep the surface of his board free for unhampered use of the straightedge, one draftsman fastens a plastic rule to the un-

derside of the ground glass of his transparent table with cellulose tape. The same idea can be adapted to use with a mimeoscope in drawing lines or measuring on a duplicating stencil.

Repairing Broken Alarm Springs

Alarm-clock springs usually break near the ends and can be repaired easily by removing the spring, heating to draw the temper and then forming a new eye or hook. A piece only half as long as the original spring will make a workable repair.

Cotter Pin Removes Valve Core

When there is no tool at hand for removing a valve core from a tire, do the job with a cotter pin. Spread the legs of the pin slightly, insert it into the valve stem and then squeeze the legs against the core to unscrew it.

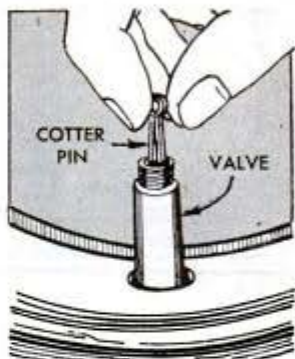

Guide Block Aids in Chiseling True Mortises by Hand

When cutting mortises by hand, an accurate job can be done easily if you use a block to guide the chisel. After boring a number of holes to remove most of the waste stock, clamp the work and block in a vise as indicated. The inner edge and top surface of the block must be at a true right angle, and the upper surface of the block must be directly in line with the intended edge of the mortise. Now, to get the mortise accurate, all you have to do is hold the chisel flat against the block as you cut away the remaining waste stock.

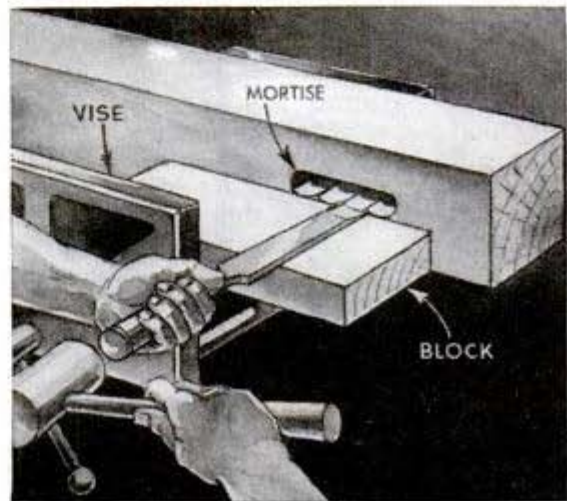

Mono-Runner Ice Scooter Gives Thrilling Ride

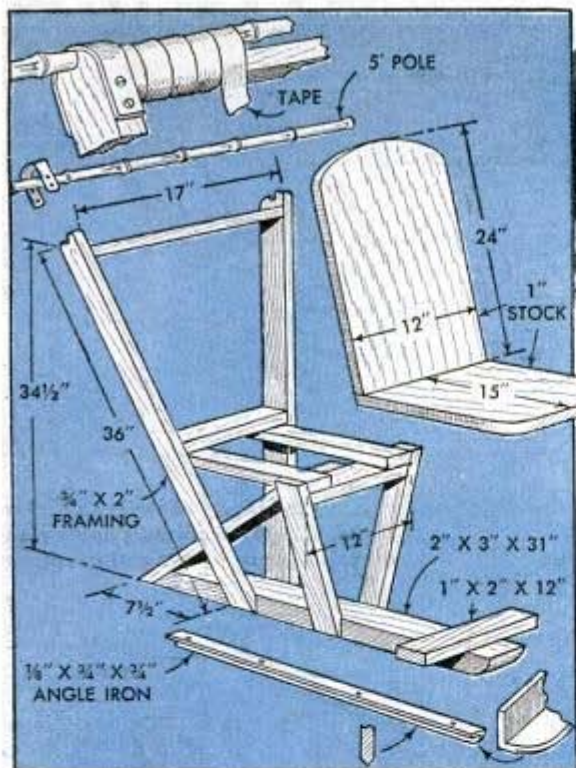

Pushed by two skaters, this lightweight scooter skims over the frozen pond to give its passenger a swaying ride. The frame is so sturdily braced that it will support even a heavy person safely, and the single angle-iron runner, which is rounded at the forward end and beveled along the lower edge

as shown, is designed to slip over the ice with the least possible friction. A bamboo pole for pushing the scooter is set in notches in the corner posts where it is held with galvanized-iron straps and tape.

Arm Sling Placed Over Shoulder to Avoid Neck Strain

When it is necessary to carry one's arm in a sling for several days, the weight of the arm, if suspended in the usual manner as shown in Fig. 1, sometimes causes strain

on the neck which may become quite painful. A better way is shown in Fig. 2. Here the sling is carried around the body and over the shoulder opposite the injured arm so that the neck is free of strain.

—Mrs. Hal Geihm, Aurora, Ill.



Eraser and Paper Clip Hold Pencil In Your Pocket

An ordinary pencil can be held in your pocket by an improvised clip which can be put on in a moment. This consists of a paper clip secured by an eraser of the type shown, slipped over the end of the pencil. —Wm. Swallow, Brooklyn, N. Y.



Solving HOME



If the weight of bed clothes on a patient's feet causes discomfort, it is easy to provide an emergency support by using a card table on the foot of the bed as shown at the left



If a waxed-paper container lacks a metal edge to tear the paper, glue abrasive paper at one end as above

The next time you have to dry small garments quickly and the usual artificial heat is unavailable, just place them on a rack above a floor lamp as at the right. A small rack from a refrigerator is ideal



Lack of a ring mold need not hinder your culinary efforts because you can improvise one by inverting a cup inside a pan of suitable size as shown below. The cup should not have a handle to interfere

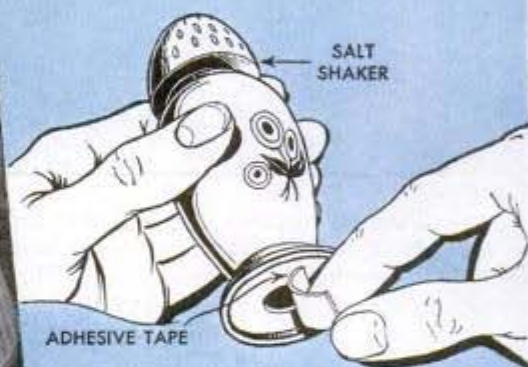

Because it is less likely to work loose, a strip of tape is better than a cork for stoppering the hole in a salt shaker

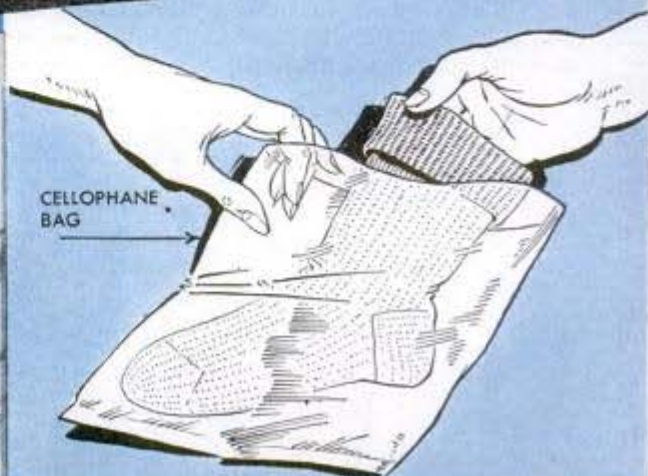

Cellophane bags such as those used in 1-lb. tobacco cartons, are handy to store woolen socks and other small articles of clothing that are likely to be damaged by moths

PROBLEMS

An endless clothesline is easier to operate from an upper floor if you attach the pulley in the center of the window as shown at the right instead of fastening it at one side

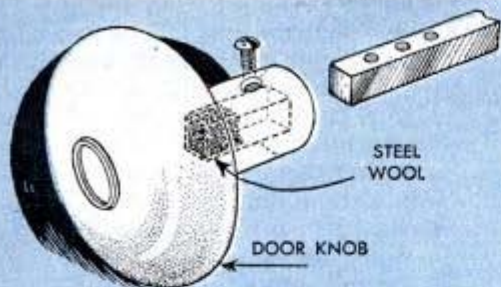

Loosening of the screw in a door knob can be avoided by putting steel wool in the socket as shown above

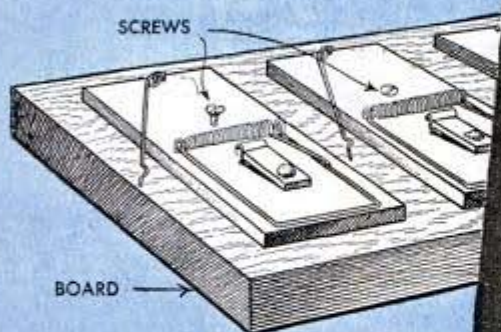

Set mouse or rat traps in gangs by screwing them to a block as above; they can't be dragged and baiting can be done easier



It's easy to remove a cork from a bottle if you use a button tied to a string. Insert the button and then tip the bottle to move the cork into the neck. Now, pull out the button and the cork together

Paint spots on your linoleum and no remover at hand? Nail-polish remover will do the trick. Just put a little on a cloth, and rub the spots as below. They will disappear in a very short time

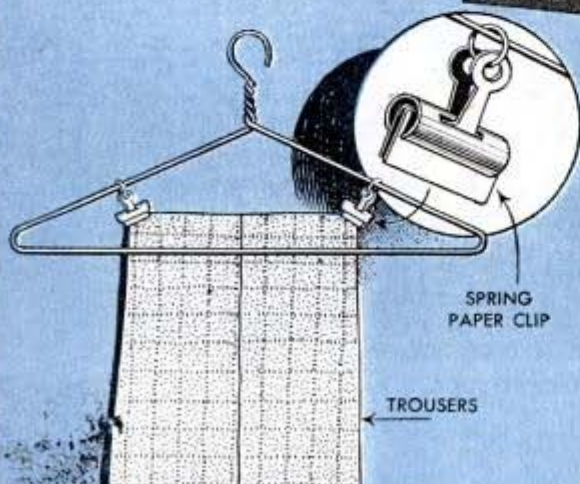

Fastened to a wire clothes hanger with rings as above, spring type paper clips will enable you to put your trousers on the same hanger as the coat without wrinkling them

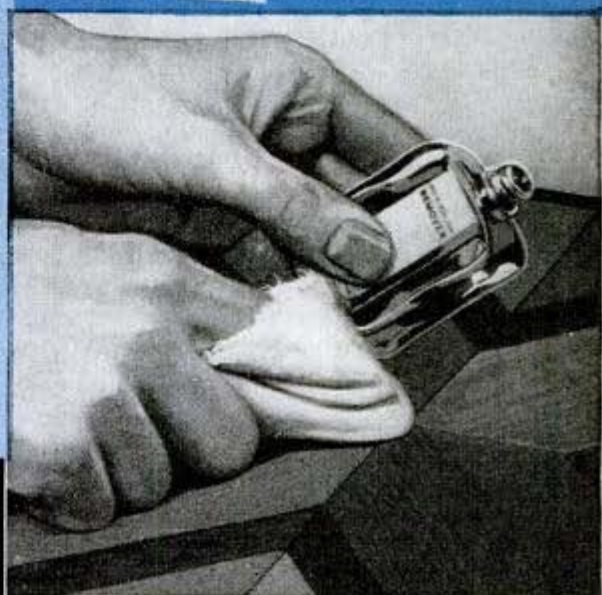

Strong Clamp for Wide Work Improvise From Screw Jack



With a screw type jack and a length of chain you can improvise a strong clamp that will have many uses. As shown here, the clamp was used to straighten warped parts of a diving board. A clamp of this type also would be handy when gluing up large panels, for straightening heavy pipe, etc. When used on planed or sanded work, blocks of wood should be placed under the jack and chain to prevent damaging the edges of the work.—R. R. Busch, Chicago.

Plugging Rat Holes With Cement

Rat holes in stone or cement basements can be filled quickly by using a funnel to which an extra length of spout has been soldered. This is placed as far in the hole as possible and a very thin cement mixture, of high cement content, is poured in to fill the hole.

—Victor Dieffenbach, Bethel, Pa.

Simple Time Switch From Clock

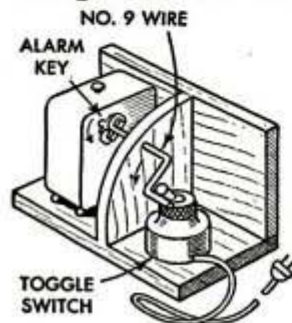

An effective switch for turning on lights or appliances at a given time can be made easily by using an alarm clock and an ordinary toggle switch. The clock and switch are mounted on a right-angle frame,

after which a piece of heavy wire bent to the shape shown is attached to the alarm key and run through a wood bearing so

that the crank end moves the switch toggle when the alarm key turns. Thus when the alarm goes off at the designated time the alarm key turns the crank, throwing the switch and closing the electrical circuit.

Cleaning Cigarette-Lighter Wheel To Assure Quick Ignition

Cigarette lighters often fail to work because soft material from the flint clogs the file wheel. When this occurs, clean out the wheel with a "file card," a strip of heavy canvas material having short lengths of wire projecting through it, about 30 to the inch. This is available at most hardware stores.—S. A. Pease, Wauwatosa, Wis.

Worn Pinion Bearings in Clock Held in Position by Plates

Clocks in which the pinion-bearing holes have worn as indicated in the upper detail often can be repaired by riveting small plates over the holes to keep the shafts in their original positions.

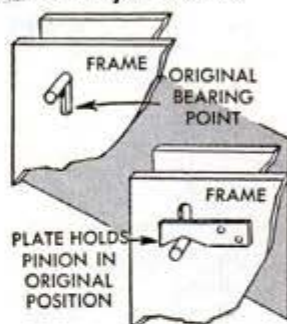

A careful examination of how the small gears mesh will enable you to determine whether or not the original position of the pinion was at the top or bottom of the elongated hole.

—Geo. A. Childs, Somerville, Mass.

Large Tin Can Serves as Oven For Toasting Marshmallows



To toast marshmallows to a golden brown in a campfire, without scorching, use a large tin can as an oven. Remove the ends of the can and place it on the fire so the flames do not reach the marshmallows.

Inserting Carbons in Typewriter

Inserting a number of carbon sheets in a typewriter is easier if a large envelope is placed over the sheets at one end. They can be lined up straight with the bottom of the envelope and then rolled into the typewriter, envelope and all, far enough to slip off the envelope.

—Pvt. Sam Greenberg, Atlanta, Ga.

Dual-Steering Bobsled Turns in a Short Radius

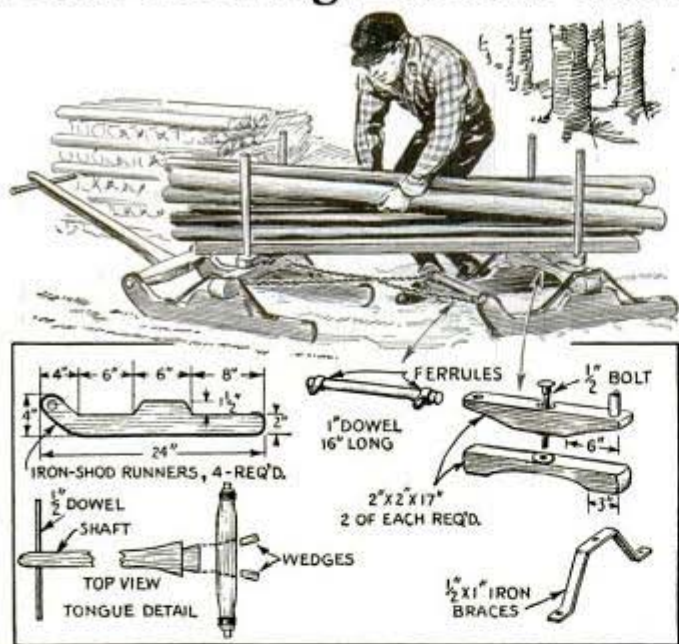

This handy little sled, which steers at the rear as well as the front, will have many uses around the farm because it can be turned in a very short radius. Also, if desired, it can be fitted with a steering wheel and a wide plank and used for coasting. And, since the bobs are connected by two crossed chains, which are responsible for the dual steering feature, the sled can be adjusted easily to suit the length of the load. The sled consists of four iron-shod runners assembled in pairs or bobs as shown, and then pivoted to two bolsters which carry the load. A tongue assembled as indicated in the lower left-hand detail is pivoted between the runners of the front bob so that it may be raised in pulling.

—Edwin C. Norlin, Chicago.

Brick Enclosure Keeps Sand Clean

You can provide children with a neat sand pile and at the same time keep the sand clean for odd cement jobs if you make an enclosure about 8 ft. square for the sand, the enclosure consisting of three or four layers of mortared brick. A floor of loosely fitted bricks keeps the sand from being mixed with dirt.

Scrap Pieces of Sponge Salvaged By Using Them in 'Sponge Bag'

Instead of discarding worn sponges, or the small pieces that break off as the sponge wears, save them in a coarse mesh sack or bag. When you have enough almost to fill the bag, sew it together at the top and use it in the same way that you would a regular sponge. Such a bag will



be especially handy on rough work, such as removing calcimine, where a good sponge would wear out rapidly. When the mesh bag wears, the scrap sponges can be put into another one.

Tracing-Cloth Strip on Triangle For Testing Inking Pen



In order to have paper always at hand for testing his drawing pen for width of line, or to start the flow of ink after refilling it, one artist taped a strip of tracing cloth to his triangle as indicated. In this position, the cloth is not in the way, yet is always close to his work when needed.

—Iver Johnsen, Jr., Michigan City, Ind.

Bottle Cap Improves Soap Dish

Much soap is wasted by the water at the bottom of a soap dish. This waste can be reduced by cementing an inverted bottle cap to the dish to hold the soap off the wet bottom as shown.

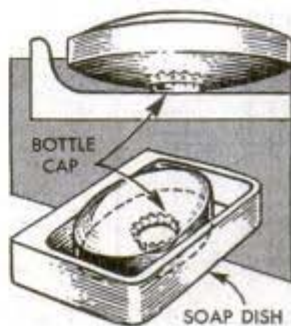

A SMOKING STAND

at your easy chair

By Wallace W. Buffmire

ALTHOUGH designed for smokers, this little table, shown in Figs. 1 and 2, also serves with equal propriety as an end or chairside table. As a smoking stand it is particularly useful, since it has a large drawer to hold accessories. By dividing it into sections as shown in detail B of Fig. 4, various brands of cigarettes as well as matches and other items can be kept neatly separated.

Walnut, oak or any other hardwood is suitable. The top and sub-top first are cut square to facilitate accurate routing of grooves for the sides as shown in Fig. 5. Grooving should be completed before the top is turned to the dimensions given in Fig. 3. Then all necessary turning is done, a hole is drilled through the sub-top for the tenon of the standard shown in Fig. 9, and the edges are beveled as shown in the details of Fig. 3. Round the edges of the side members and sand all surfaces smooth before assembling and gluing.

The drawer is constructed as shown in detail A of Fig. 4, all parts being glued and clamped together. Note that knobs are placed at both ends so that the drawer may be pulled from either side. The standard is turned as in Fig. 6 according to the pattern, Fig. 9, three slots being cut equidistant about $\frac{1}{4}$ in. deep in the lower end

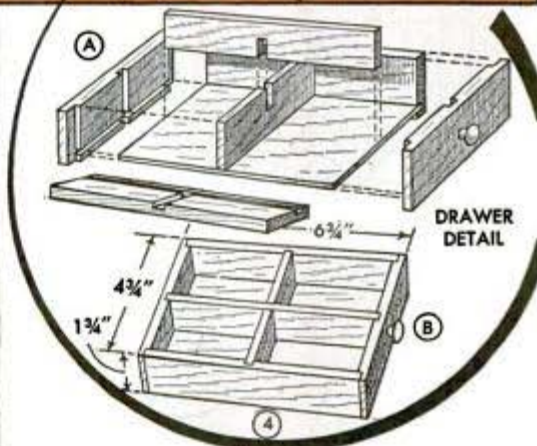
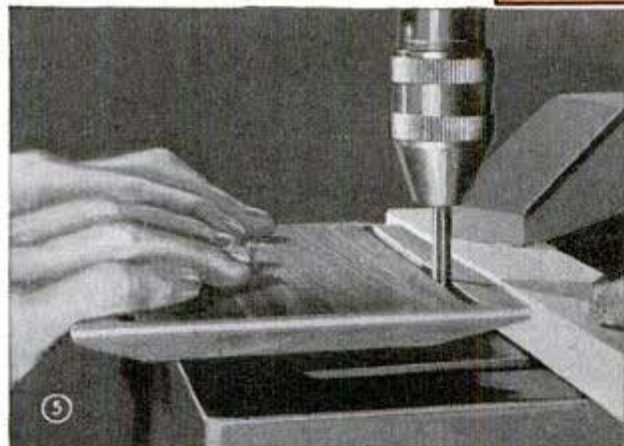
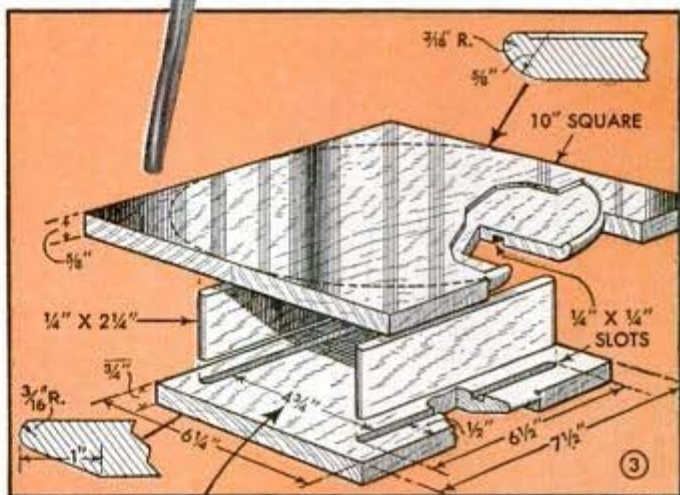

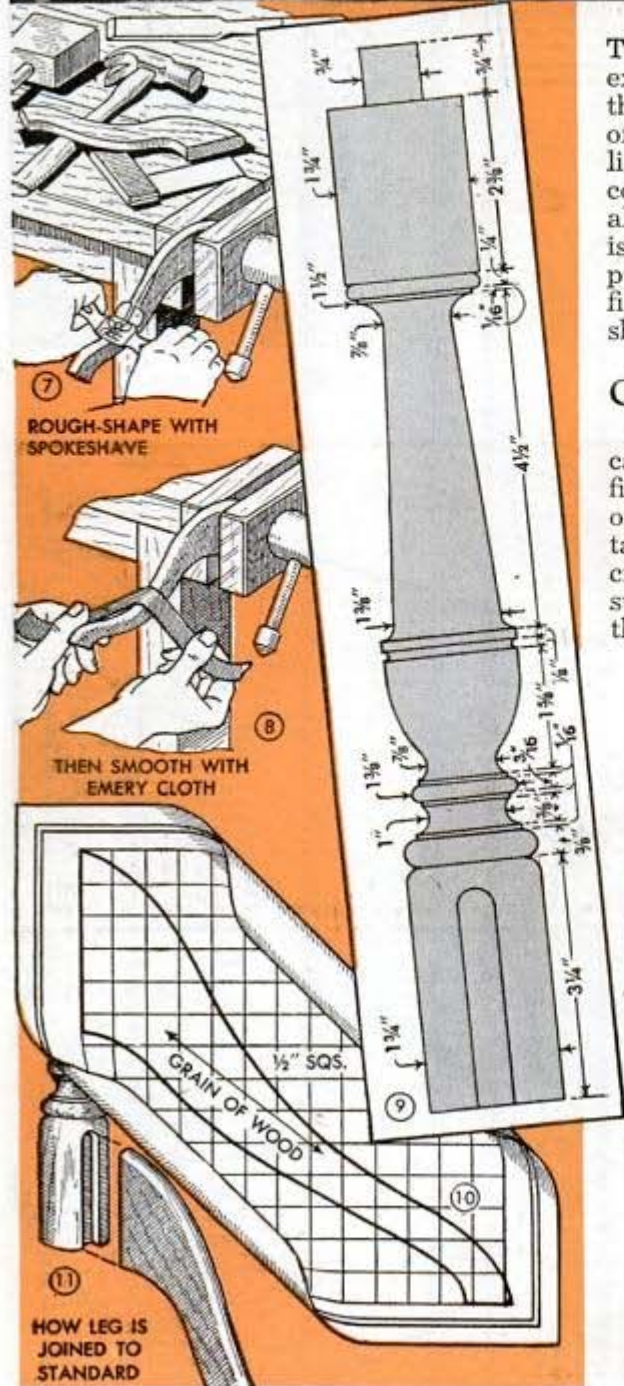
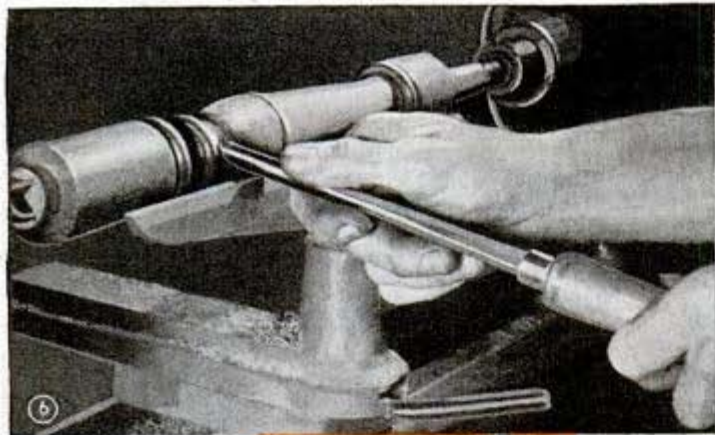

for inserting the legs, Fig. 11. Their design is shown in Fig. 10. The grain should run lengthwise, and the edges are chamfered with a spokeshave, Fig. 7, then rounded and smoothed by using strips of fine emery cloth as in Fig. 8. The standard is glued in place, care being taken to set the top level, and, when dry, the bottom edges of the legs can be trimmed so that the table will stand true.

For finishing, apply a stain and filler combination, allowing it to remain on the wood until the gloss has disappeared.

Then, with a piece of burlap, wipe off the excess, rubbing across the grain, and allow the stain to dry for 24 hrs. Two thin coats of lacquer sealer are applied and sanded lightly between coats, after which several coats of clear gloss lacquer are put on and allowed to dry for a day each. If a dull finish is desired the table is rubbed with fine pumice and water, but for a gloss finish, fine pumice and oil, such as paraffin oil, should be used.

Cement to Repair Laundry Tubs

Cracked and leaky laundry tubs often can be made practically as good as new by filling the cracks with a cement consisting of litharge and glycerin, which are obtainable at most paint stores. Likely the cracks will have to be grooved on their surfaces in order to work the cement into them. This can be done with a small, sharp chisel and a hammer. Cracks that reach through the tubs should be grooved on both sides, and all of them should be cleaned thoroughly of dried soap or grease residue, which would prevent the cement from making a good bond. The tang of a small file can be ground down to provide an ideal tool for cleaning the cracks. After the cracks have been prepared, mix the cement to a consistency slightly thinner than window putty. Force the cement into the cracks with a putty knife, working it in thoroughly and smoothing it to make a neat job. Allow the cement to dry at least 24 hrs. before using the tubs.

—J. R. Magill, Washington, D. C.

Blotter Cleans Typewriter Keys

Rapid cleaning of typewriter keys can be done by placing a blotter in the machine and striking each key with the ribbon released for stencil cutting. Each key is struck several times until it leaves a clear impression.

Forced Draft in Furnace From Circulating Fan

One home owner makes the blower on the forced-air circulating system of his furnace do double duty by also providing forced draft. As shown in the drawing, a pipe tapped into the circulation system between the blower and furnace carries air to the burner. This is a 6-in. length of 4-in. steel pipe which projects through the grates into the firebox. Three rows of eight $\frac{1}{2}$ -in. holes distribute the air through the fuel bed. To control the amount of air entering the burner, dampers are installed in the pipes as indicated. Once the air flow is adjusted, the fuel will burn thoroughly, producing maximum heat and forming clinkers that can be removed easily through the fire door. The grates are covered with a steel disk to keep the fine fuel

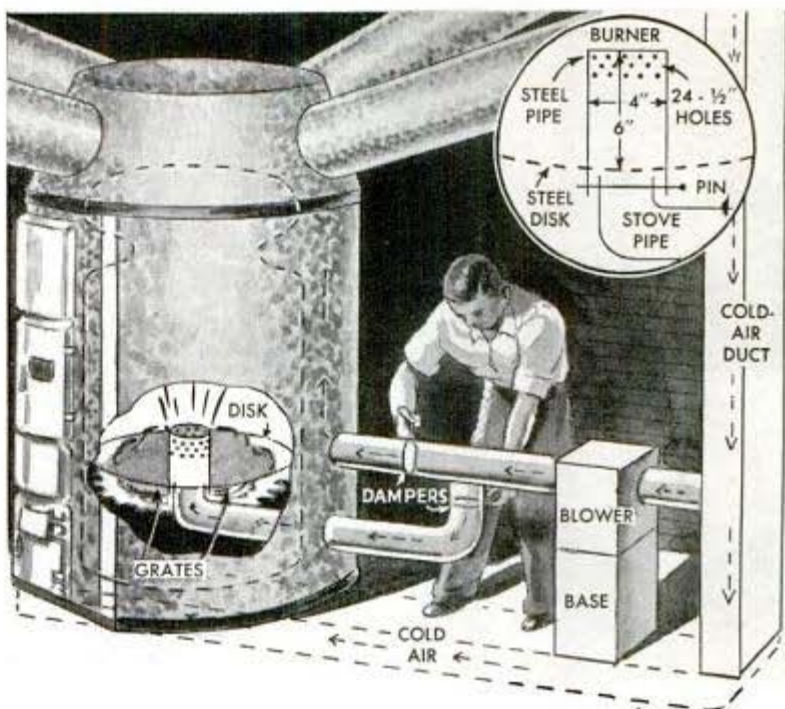

from falling through them. All openings below the grates should be sealed or dust may escape.—A. J. Rich, Aurora, Nebr.

Glass Brick Provides Shade for a Kitchen Pin-Up Lamp

You can have an unusually neat pin-up lamp that provides excellent illumination for your kitchen or dinette for the price of

a glass brick, a bulb and a socket. The brick is of the type used as a vase, having an opening in one end as indicated in the large circular detail. To assemble the lamp, mount the socket in the center of a wood block by means of a $\frac{1}{8}$ -in. pipe nipple as shown in the small circular detail. The block, which serves as a base, should be just slightly larger than the brick, and has a short piece of spirally grooved molding attached to the underside near the outer edge to rest against the wall and serve as a brace. The lamp is supported on the wall by two screw hooks, which are fastened to the block to engage L-hooks or screw-eyes driven into the wall. The lamp is wired with an extension cord to a nearby wall outlet. It may be necessary to drive three or four short nails into the base to project into the opening of the brick and prevent vibration from working it off the base. The nails will be invisible from the outside. Or, the base surface could be grooved to take the brick.

—A. W. Elliott, New York, N. Y.



Portable Code-Signaling Blinker Uses Photo-Flash Gun

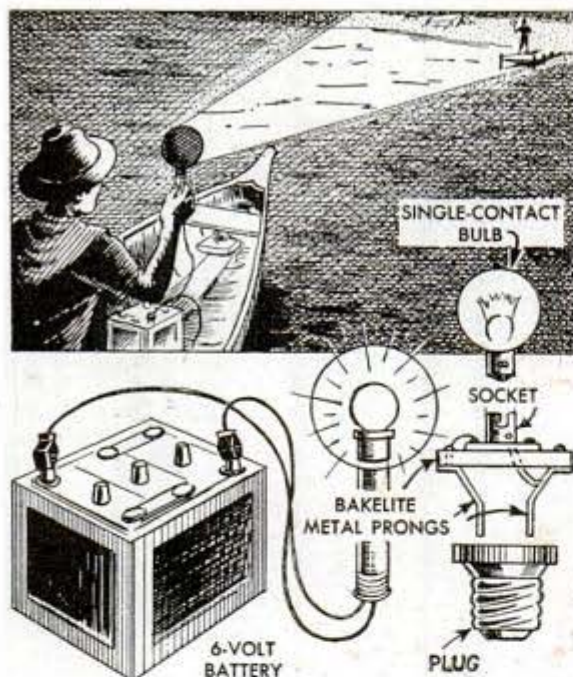

Boy Scouts and other boys' groups desiring a code blinker will find this one ideal and inexpensive. Under normal conditions, it will be visible over several miles of water or flat terrain. A small photo-flash gun and a 6-volt battery, wet or dry, are all you need to make it. To start, substitute a single-contact auto bulb for the flash bulb. To do this, mount the auto-bulb socket on a Bakelite disk, which is then fitted with two metal prongs as shown for insertion into a common receptacle plug which is screwed into the gun socket. Use a couple of short wires to connect the socket to the prongs as shown. In making the alteration, be sure that the bulb is high enough to center in the gun reflector. Next, drill a small hole in the bottom cap of the gun for two wires which connect the gun to the battery. In most guns, one wire can be soldered to the case and the other to the switch. However, your particular type of gun will determine the method of wiring it. If the switch on the gun is not suitable for closing and opening rapidly with thumb pressure, you can devise a simple spring contact for the purpose. Now, put a couple of spring clips on the projecting ends of the wires for connection to the battery and you are ready to try out the blinker.

—L. B. Robbins, Harwich, Mass.

Reglazing Paper After Erasure

Erasing on tracing cloth or paper generally takes away its finish and makes the erased portion so thin it will not take a

good line. However, difficulty can be avoided if a glaze-stick made from a piece of soapstone is rubbed over the erased surface. This restores the glaze so that the spot will take ink readily without blotting and permits fine, sharp lines to be drawn.

—J. H. Newberg, Brevard, N. C.

Small Note Pad on Yardstick Is Always at Hand

You will always have paper available for taking down notes when figuring a job if a note pad is attached to a yardstick as shown. To do this, screw a short section of telescoping curtain rod to the yardstick and then slip strips of paper, cut to the proper size, into it. When a strip of paper is filled, it is easily removed to expose a clean strip.

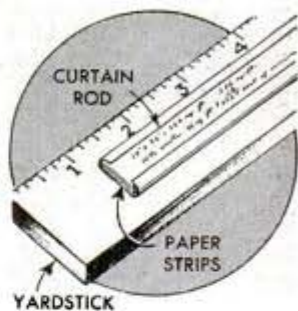

Sewing Kit for Your Pocket From a Rifle Cartridge

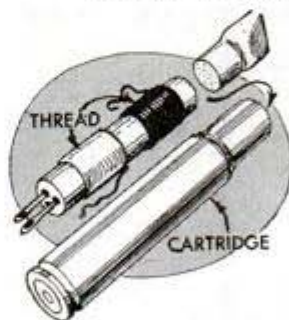

A 30-30 rifle cartridge with a small, round piece of wood to slip inside it will provide a handy sewing kit to carry in your pocket. A couple of yards of black and white thread can be wound around the

wood, which also is drilled lengthwise for the insertion of two needles. A tightly fitting stopper, either cork or one whittled from wood, completes the kit.

—Floyd McCracken, San Diego, Calif.

Non-Tip Base for Ink Bottle

Have you ever spilled India ink over your work because the bottle was small and easily tipped? Such accidents can be avoided if you cement a heavy base to the bottom of the bottle. A glass caster cup, fastened with rubber cement, is ideal.



Whittle This Deer in Five Poses



HERE is an attractive little figure that even the most inexperienced carver can make with ease. Most of the work can be done on a jigsaw to produce a blank, which then is chamfered along the edges. The legs are now rounded and tapered toward a blunt point at the hoof. In general, the wood grain should follow the line of the legs which are fragile and likely to break off if the grain runs across them. The only careful carving required is around the ears, which are rounded at the back, undercut at the base in front to give them a forward tilt, and then hollowed out at the front. Head and body shapes are practically the same in all poses, most of which are obtained by changing the angle of the neck and shape of the legs. After the figures are carved, they should be sanded carefully and finished by shellacking and waxing or varnishing.

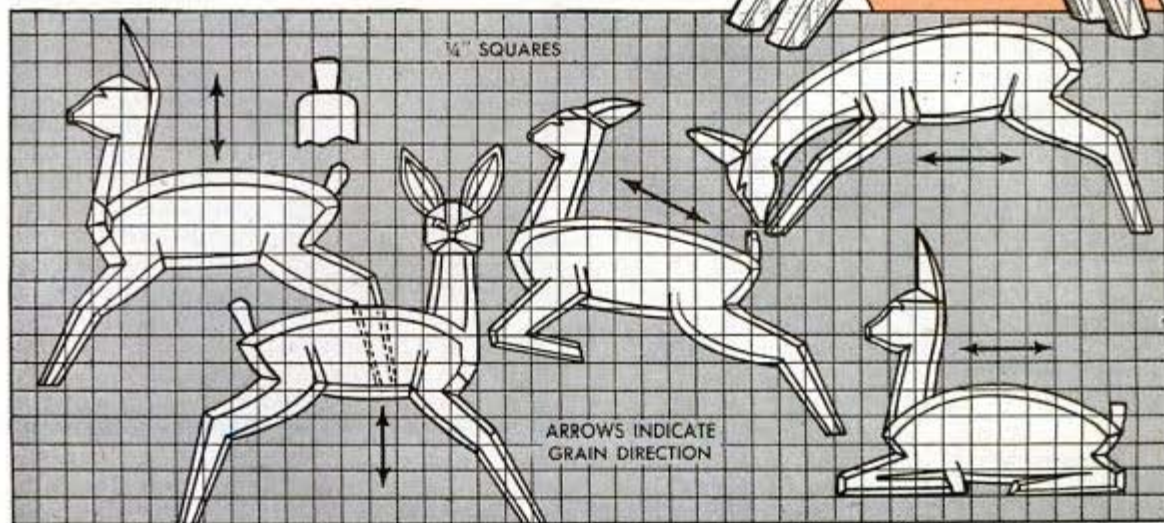
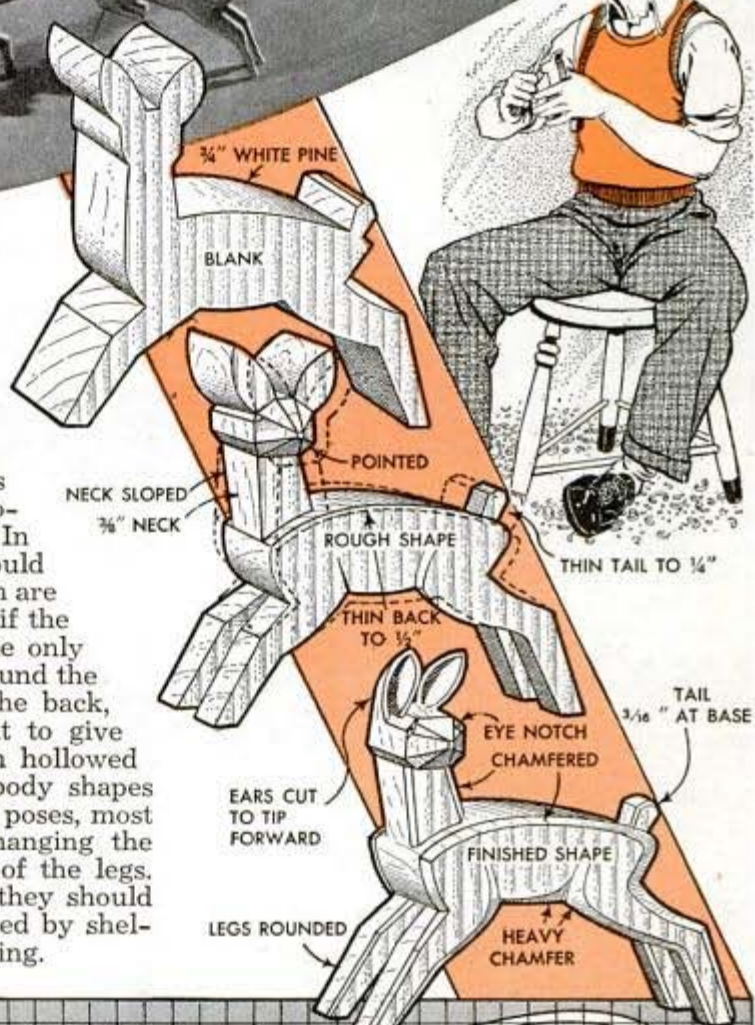

Counterweighted Basement Door Is Easy to Open and Close

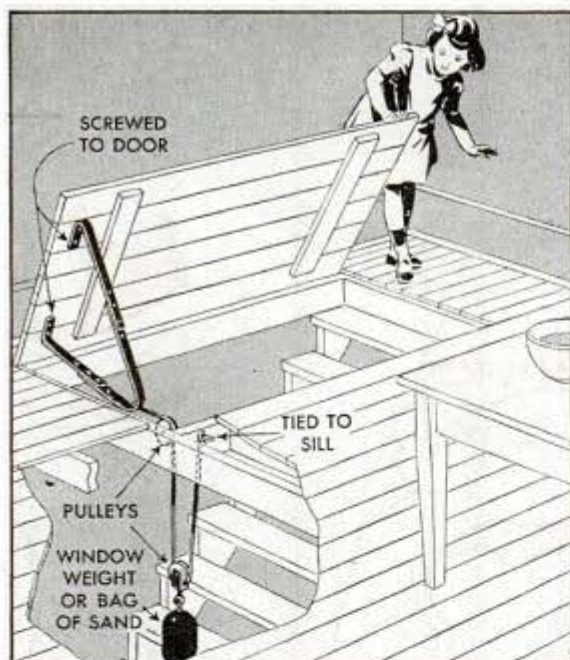

If you have a heavy trap door to your basement, here is a simple method of counterweighting it so that it can be opened or closed easily. Just bend a piece of flat iron to a long V-shape and screw this to the door near one end. At the lower end of the iron attach a rope and run this over a pulley attached to one of the sills, then through another pulley carrying the counterweight and on to a sill where the rope is tied. The weight will depend on your door; usually a window-sash weight will be sufficient, or you can use a sandbag.

—J. Frank Watson, Wheatland, Wyo.

How to Prevent Rusting of Tools

Excess moisture, which often rusts the tools in a tool box, will be absorbed by a few cones of carpenter's blue chalk kept in the box. Drying the chalk thoroughly in an oven every two months will renew its effectiveness.

Play Telephones Are Made From Paper Cups and String

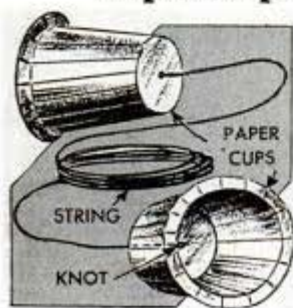

Children will have a lot of fun with this simple set of play telephones, which will transmit their voices for a distance of several feet. All you need is a couple of stiff paper cups of the

type shown and a suitable length of string. A tiny hole to receive the string is punched in the bottom of each cup, the string inserted and knotted. In use, when the string is held taut by pulling lightly on the cups, speaking into one of the cups sets up vibrations which are transmitted through the string and reproduced in the bottom of the other cup. Of course, the string must not touch anything to dampen the vibrations.

—H. R. Alley, Northbrook, Ill.

Ammonia Cleans Lettering Pens

Those who use lettering pens can avoid the annoyance of India ink drying on them in a heavy crust by dipping the points after use in a bottle of dilute ammonia. The pens should be shaken vigorously to remove the surface moisture.

Bottom of Garage Water Can Shielded Against Wear

Sliding a water can on the floor of a garage or on the concrete around a filling station soon wears a hole in the bottom of the can. To help avoid this, the owner of one garage puts a rubber shield on the can. The shield is cut from an old inner tube and is tied on the bottom of the can with a stout cord so it can be replaced easily.



Stop on Garage Door Operated Without Stooping or Bending

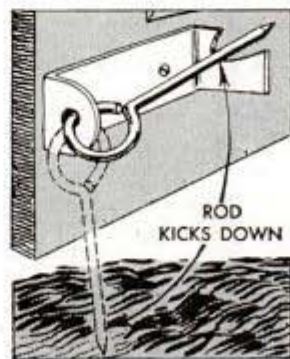

When you need a stop to keep a garage or other large door open, this one is positive in action, can be made at practically no cost and can be operated with your foot. The stop consists of a metal bracket shaped as shown to take a length of $\frac{1}{4}$ or $\frac{3}{8}$ -

in. iron rod which is pointed at one end and has an eye formed on the other. In use, the rod can be dropped into position with the toe of your shoe. When you want to release the stop, push slightly on the door and flip the rod back onto the bracket with your foot.

Paper Pots Made in Quantities to Start Plants

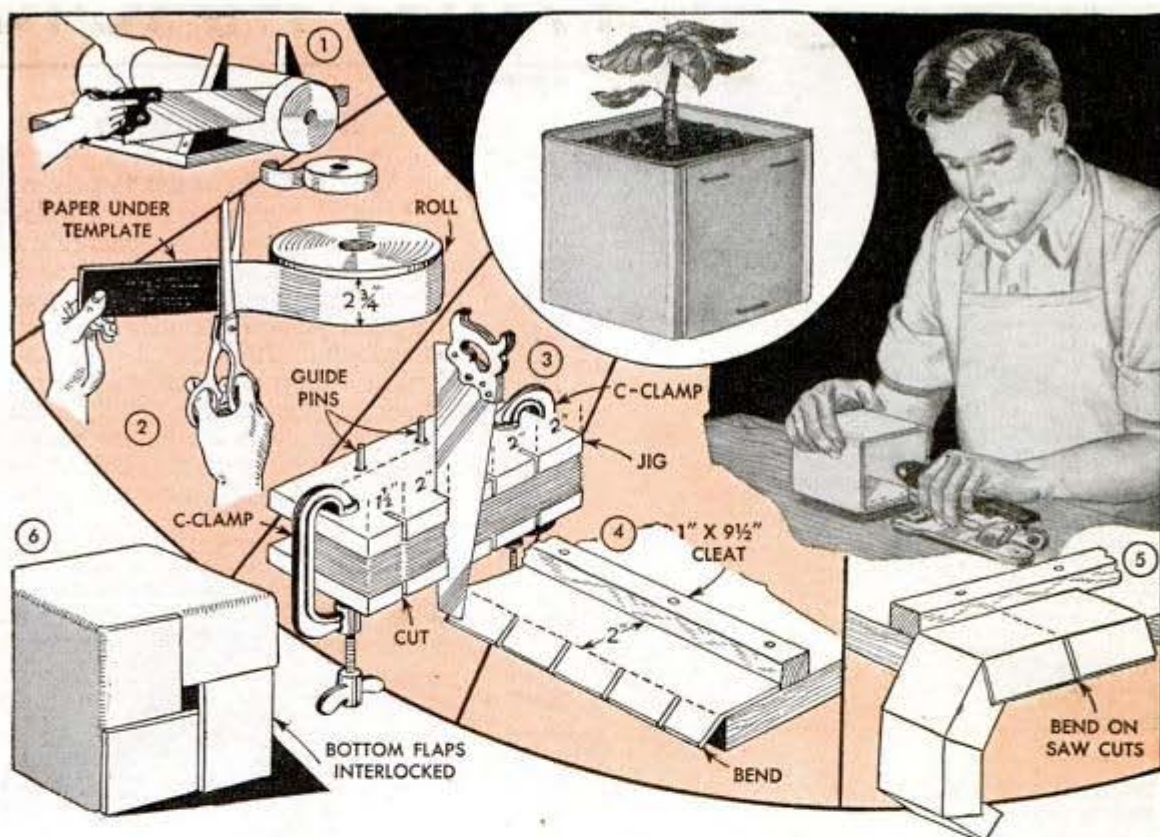

Making a number of pots for starting plants indoors is a simple job if you have a roll of building paper, preferably the red rosin type. To begin, saw from one end of the roll a slice $2\frac{3}{4}$ in. wide as in Fig. 1 if you want pots 2 in. square, or $4\frac{1}{4}$ in. wide for pots 3 in. square. Then, using a template, unroll the slice and cut the paper into strips $9\frac{1}{2}$ in. long for 2-in. pots or $14\frac{1}{2}$ in. long for the larger size as in Fig. 2. Three

or four dozen of these strips can be slotted to form the bottom flaps if you use a hand saw and a clamp as indicated in Fig. 3. The slotted edge of each strip is folded down as shown in Fig. 4, and then is folded crosswise as in Fig. 5. This done, ends of the strips are overlapped and stapled or glued together to form the pot, which is completed by folding over and interlocking the flaps at the bottom as in Fig. 6.

Jig Aids in Chamfering Small Work on Your Belt Sander

Clamped to the fence of a belt sander, a simple trough-shaped jig with sides at 90-degree angles will enable you to sand chamfers quickly and accurately. It is particularly suited for very small work that is difficult and dangerous to chamfer on a jointer or shaper. In use, the work is pushed into the guide, which has a narrow opening at the bottom, and is held in contact with the belt. It is impossible to overcut the work, and the fence can be reset as needed to utilize the full width of the sanding belt.

Ⓜ A narrow strip of rind from a slab of bacon may be used temporarily to pack a water pump on a car when regular packing cannot be obtained. A coat of graphite will improve this emergency packing.

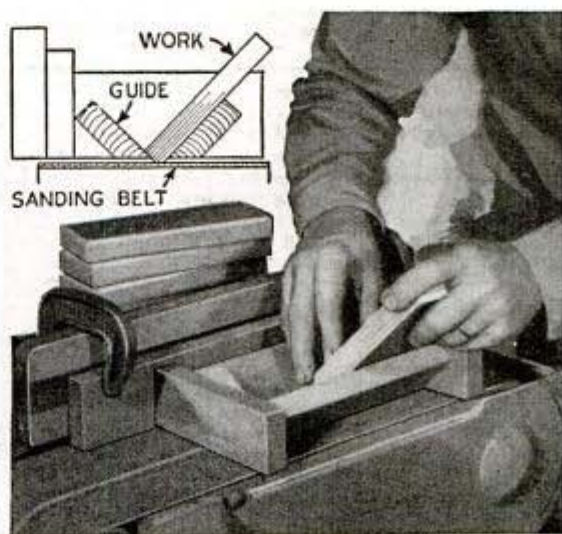

PAINT MAGIC

By Sam Brown



TREATMENT OF WALLS BEFORE PAINTING is important and should not be neglected. Torn paper in corners can be patched easily with gummed tape

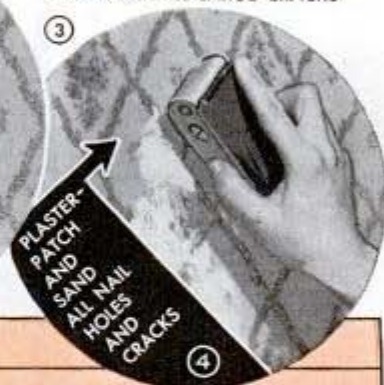
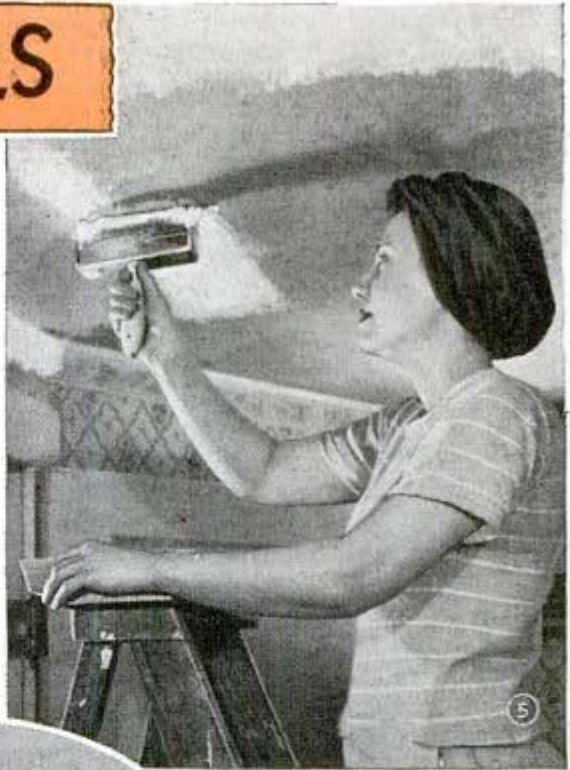

TABLE No. 1		CHARACTERISTICS OF WALL PAINTS					
Kind of Paint	Where Used	How to Thin and Apply	Coverage		General Features		
			Cost per 100 sq. ft.	Drying Time			
POWDER-FORM WATER PAINTS	Calcimine	Ceilings, walls—Any firm, dry surface. Walls should be glue-sized	5 lbs. with ½ gal. water covers 300 sq. ft.	10c	1 hr.	Cheapest. Excellent for all ceilings. Not durable. Not washable. Cannot be double coated. Washes off easily with warm water	
	Casein Wall Paint	Ceilings, walls—Can be applied on almost any surface. Suitable for upper part of both or kitchen	Powder form—Thins with water. Do not size unless walls are very porous	5 lbs. with 1 gal. water covers 500 sq. ft.	12c	1-2 hrs.	Smoother, longer lasting than calcimine. Will stand mild washing after 30 days. Takes second coat okay
PASTE-FORM WATER PAINTS	Casein Wall Paint	Ceilings, walls—Can be applied on almost any surface. Suitable for upper part of both or kitchen	Paste form—Thins with water. No sizing required. Apply with brush, roller or spray gun	1 gal. with ½ gal. water covers 600 sq. ft.	37c	1-2 hrs.	One coat will cover most surfaces. No primer needed. Best paint for light reflecting value. Tends to be lumpy and is harder to mix smooth than resin base
	Resin-Base Wall Paint	Ceilings, walls—Can be applied on almost any surface. Suitable for upper part of both or kitchen	Paste form—Thins with water. No sizing required. Apply with brush, roller or spray gun	1 gal. with ½ gal. water covers 600 sq. ft.	48c	1-2 hrs.	Most durable, most washable of water-mixed paints. High hiding. Can be second coated. Excellent light reflection. Mixes easily
READY-MIXED OIL PAINTS	Flat Wall Paint	All interior walls	Use at can consistency. Thin with turpentine if needed. Apply with brush or spray. Needs undercoat except on surfaces previously painted	500-600 sq. ft. per gal.	42c	4-18 hrs.	More durable, washable than any water mix paint. Pleasing flat surface
	Semi-Gloss Paint	Excellent for woodwork and for walls in kitchen and bath	Use at can consistency. Thin with turpentine if needed. Apply with brush or spray. Needs undercoat except on surfaces previously painted	500-600 sq. ft. per gal.	60c	Overnight	Best for kitchen or bath where frequent washing is necessary. Usually requires undercoats which add to cost. Too "hard" for living and bedroom walls
	Gloss Enamel	Excellent for woodwork and for walls in kitchen and bath	Use at can consistency. Thin with turpentine if needed. Apply with brush or spray. Needs undercoat except on surfaces previously painted	500-600 sq. ft. per gal.	65c	24-48 hrs.	

for Your WALLS

Treatment of walls before painting: Water-mix paints can be applied on almost any clean, dry surface. Finishing over wallpaper is popular, but don't depend too much on one coat to hide the pattern. A weak pattern can be covered nicely but strong designs usually show through, not so much because the paint is at fault but because certain wallpaper colors either bleed into or repel water-mix paint. An example is paper with gold or silver metallic printing. Often it is necessary to coat such a paper with a pigmented wall size before the water paint will take. On the average, 50 percent of all papers will cover with one coat; 45 percent will require two coats and 5 percent will require a primer coat. All loose edges of paper should be pasted down, Fig. 2. Don't tear them off, as a torn edge will be plainly visible. An exception is corners, where it usually is necessary to strip the paper



APPLICATION is simple with either brush or roller. Use masking tape to set off the borders

back about an inch. Patch the corner with two strips of 2-in. wide gummed-paper tape, turning the corner $\frac{1}{4}$ in. with the first strip and butting right into the corner with the second as in Fig. 1. Wet the plaster before applying tape and run the tape through water to get it really wet.

All cracks and nail holes should be patched and sanded smooth, Figs. 3 and 4. The finer spachtling compound is better than patching plaster for this work.

Painting procedure: Ceilings come first. Paint can be applied with brush or roller, Fig. 5. Determine the type of border you

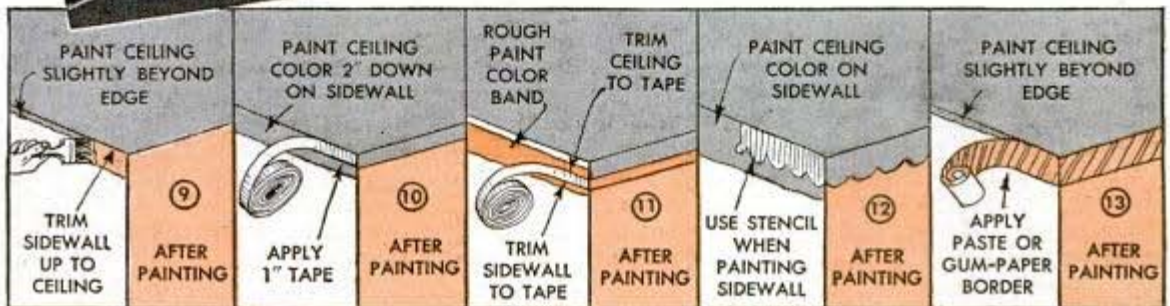
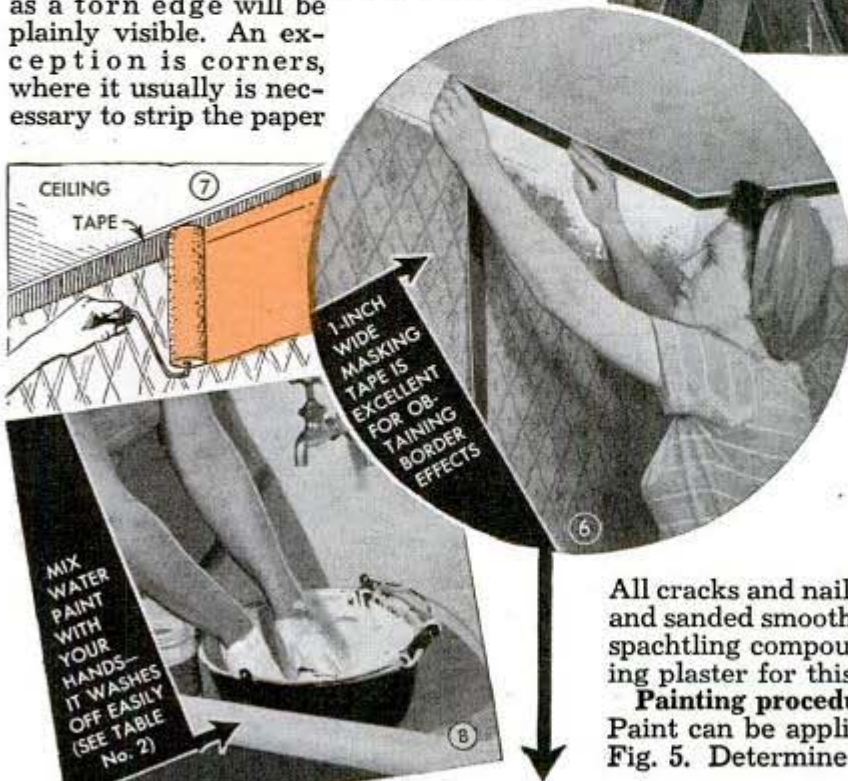

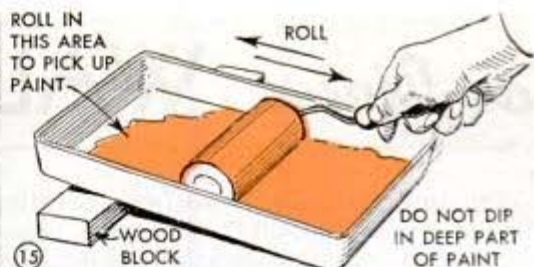

A FLAT TRAY OR PAN IS ESSENTIAL

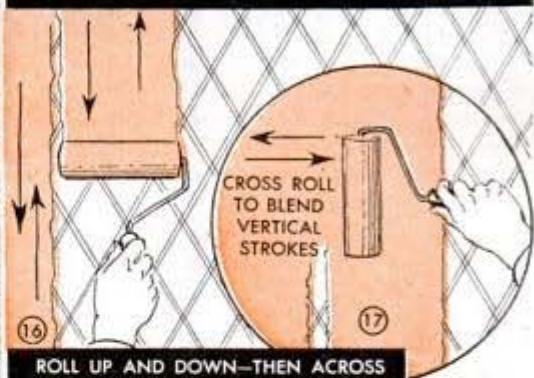

ROLL UP AND DOWN—THEN ACROSS

ROLLER COATER is faster and smoother than a brush. Use as above; practice with the coater a little before you start on actual work

want before starting so that you will know whether or not to extend the ceiling color down the sidewall. Cheap masking tape is excellent for laying off borders as in Figs. 6 and 7. Two 8-ft. strips can be used several times and thus cover a whole room. Various ideas for borders are shown in Figs. 9 to 13. Mix the paint in a pan or pail as in Fig. 8, following the proportions given in Table No. 2. The roller coater, Fig. 14, is much faster and smoother than brushing. Break in your roller by washing in warm water and rolling dry on newspaper to remove loose fuzz. A flat tray (you can buy paper ones) is essential, Fig. 15. Apply paint with vertical strokes, leaving a slight space between the paint strips as in Fig. 16, then roll crosswise as in Fig. 17 to blend. Don't load the roller with too much paint until you have had a little practice, and don't press heavily on a roller freshly filled with paint. To reach low spots in the surface, increase pressure as the roller becomes dry. Don't worry about sags in the paper, as they will flatten out when the paint dries.

Special colors: You can buy water-mix colors in solid deep tones. Use these to tint white or any of the light pastel shades the color you desire. Mix the tinting color in a separate container with a little water, Fig.



18, then add gradually to the slightly thinned paint. A casein base product will mix with a resin base product. Add water gradually, stirring as you go, especially if you are using a casein paint, which will be lumpy and hard to mix if all the water is poured in at once. If you are going to brush on the paint, it is a good idea to add a small quantity of glycerin. This holds the coat open (wet) longer so that you have plenty of time to paint a strip and still have a wet edge for a smooth blend when you paint the adjoining strip. If you can't get glycerin, use boiled linseed oil, and work it in while the paint is in paste form. It emulsifies nicely with the paste but is hard to work in after the paint has been thinned.

Spray application: Water paints spray nicely but are dusty. Be sure everything is out of the room before you start. Cover the floor with newspapers. Mask all trim with masking tape as in Fig. 19, and then use a shield while spraying, Fig. 20. Go over all woodwork and glass with a damp rag as soon as dust has settled. Dusting is held to a minimum by using the paint as thick as the gun will take. It can be sprayed with exceptionally heavy body by using a pressure feed gun coupled to a small compressor. Don't try to spray the ceiling unless you have suitable equipment, Fig. 21.

Mottle finishes: These are attractive, especially if the surface is a little too rough to look nice in a single flat color. First, apply a



IF YOU SPRAY, use paint at heaviest body gun will handle to minimize dusting. Use masking tape for clean edges. Go over woodwork with damp rag as soon as paint dust has settled

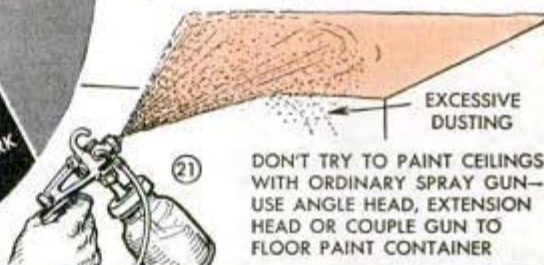

DON'T TRY TO PAINT CEILINGS WITH ORDINARY SPRAY GUN—USE ANGLE HEAD, EXTENSION HEAD OR COUPLE GUN TO FLOOR PAINT CONTAINER

ground coat of water-mix paint, Fig. 22, let dry overnight, then mottle with roller or sponge as shown in Figs. 23 to 28. A two-color mottle usually is the most attractive. Rules for using color are given in Table No. 3. Do a couple of practice panels on paper or wallboard before you start.

News roll: The ground coat for this is preferably a pigmented wall paint or other hard-finish undercoat. Applied over a water-mix paint base, the effect tends to be soft and fuzzy. This makes a nice finish and is easy to do as shown in Figs. 29 to 31. The news roll makes a good base for a mottle finish when redecorating.

Spatter finish: This is obtained by tapping the surface with a fiber brush loaded with paint as in Figs.

MIXING PROPORTIONS FOR PASTE WATER PAINT			TABLE No. 2	
Surface or Finish	Method of Application	Water		Other Ingredients
		Per qt.	Per gal.	
Paper, Wall-board, Plaster, Flat Paint	Brush	16 oz. (1 pt.)	4 pts.	Recommended but not essential: 2 oz. glycerin per gal. of paste for smoother brushing and slower drying. Boiled linseed oil can also be used.
Oil Paint—All Non-porous Surfaces	Brush	12 oz. (¾ pt.)	3 pts.	
All Surfaces	Roller	12 oz.	3 pts.	
All Surfaces	Spray (suction feed)	12 oz.	3 pts.	None
All Surfaces	Spray (pressure feed)	8 oz.	2 pts.	None
Sponge or Roller Mottle	Sponge or roller	10 oz.	1 qt. 8 oz.	4 oz. glycerin per gal. of paste
Streak Glaze	Brush on—wipe with cloth	24 oz.	3 qts.	None
Flat Stipple	Brush	8 oz.	2 pts.	1 pt. spar varnish per gal. of paste. Add water last
News Roll *	Brush on—wipe with newspaper	18 oz.	2 qts. 8 oz.	6 oz. glycerin per gal. of paste

* Works best over ground coat of pigmented wall size

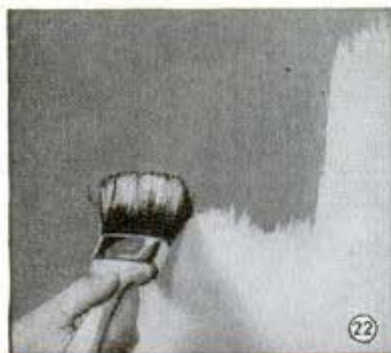

GROUND COAT is required for all two-tone finishes. Let water paint dry overnight before applying color coat

32 and 33, or by snapping the color onto the wall as shown in Fig. 35. A widely spaced spatter in two colors is effective if the paint dots are brushed out with a dry brush before they dry hard. Fig. 34 shows the result.

Streak glaze: It is a simple matter for anyone to imitate the appearance of wood grain with this finish, which is easy to apply. First, apply a coat of white or cream water paint and allow it to dry overnight. Then, brush on a thin coat of colored water paint and immediately wipe the color with a crumpled soft cloth. You will get the streaked, wood grain effect shown in Fig. 36. Although any colored paint can be used over a white or cream ground coat, good color combinations for this finish are brown over a cream ground coat, or green over a white ground coat. It may take a little practice



ROLLER MOTTLE—Pick up color on roller, Fig. 23, then apply roller to wall, being careful not to overlap. Two times over makes a heavier mottle, as shown in Fig. 25. Use a stippling roller, not a roller coater



SPONGE MOTTLE—Trim sponge so that it has a flat side. Dip in water to soften, then wring dry. Press onto the color slab, Fig. 27, then transfer the paint to the wall. Two color mottles are very effective



NEWS ROLL—Use a pigmented ground coat for this, not water paint. When dry, apply color coat of water paint. Crumple a sheet of newspaper, Fig. 29, and roll this over the fresh paint, Fig. 30. Change the paper as often as may be necessary. Fig. 31 shows a heavier pattern obtained by double rolling



SPATTER FINISH—This novel effect can be obtained in three or four different ways, as shown above and described in the text. Two or more complementary colors may be spattered on one ground coat if desired

to produce the desired effect, but if any particular area does not please you, just apply a new coat of colored paint and try wiping again. You will find that it is not necessary to wipe in continuous strokes from the ceiling to the floor as the strokes can be blended together easily.

Flat stipple: Mix the paint for this according to Table No. 2. This is a single-coat finish and does not require the ground coat common to other novelty finishes described. Just brush it on, let it stand about 5 min., and then stipple. This can be done with a brush, preferably a stippling brush if available, by merely tapping the surface with the face or bristle end of the brush.

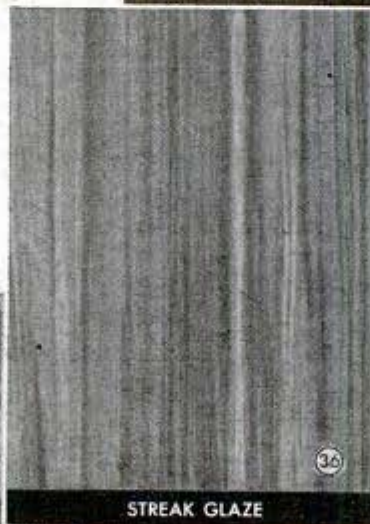

STREAK GLAZE

Or, it can be done with a wood float as shown in Fig. 37. The float is merely applied to the surface and then pulled straight out as indicated. The mild texture is effective in a single color, or it can be highlighted by applying a thin coat of contrasting color and immediately wiping with a cloth.

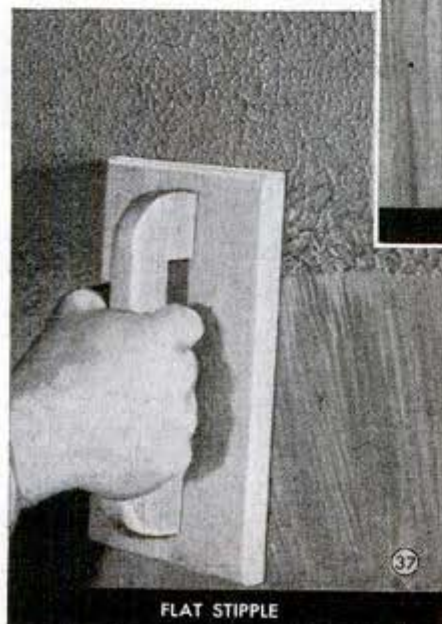

FLAT STIPPLE

COLORS FOR TWO-TONE FINISHES

TABLE No. 3

Finish	General Rules	Examples
Mottle or Spatter	Tints of same color	Light blue over dark blue
	Any color on cream or white	Blue over cream
	Contrasting colors (Not too strong)	Rose over blue-green
	Two mottle coats are usually more pleasing	White and light blue over orange
News Roll	Any color on cream or white	Green over white
	Complementary colors	Orange over blue
Streak Glaze	Any color on white or cream	Brown over cream Green over white

Tape Small Flashlight to Trumpet To Illuminate Music at Night



When marching at night or when playing where the light is poor, musicians often can avoid eye strain by attaching small flashlights to their instruments to illuminate the music. On trumpets and cornets, the flashlight can be taped to the back curve of the instrument as shown.

Metal Corner Pieces and Wedges Tighten Artist's Canvas on Frame

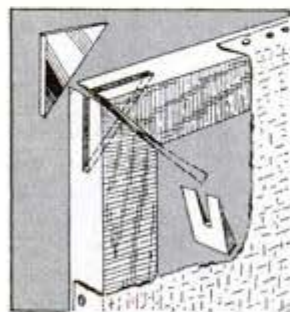

A good way to expand the frame of an artist's canvas is to cut diagonal slots through the mitered corners, insert a triangular piece of sheet metal to fit each slot and then slip over it, from the inside of the frame, a wooden wedge in which a cut as thick as the metal has been made. After tacking on the canvas and squaring the frame, tap the wedges lightly to force apart the joints and expand the frame.

Chemical Test for Polarity

A simple polarity test of an electrical circuit which will indicate the negative terminal quickly is prepared by soaking filter paper in a solution of 1 gram of phenolphthalein dissolved in a small quantity of alcohol, to which has been added 100 c.c. of 10 percent solution of potassium chloride. After it has dried, the paper is cut

into small strips which are used for the test. When a strip of the paper is placed in contact with each terminal, the paper at the negative terminal will show a bright red stain.—Arthur Beiser, New York City.

Fitting Lids of Plastic Containers

Small plastic boxes containing pencil leads and similar articles frequently have loose-fitting lids that may come off unexpectedly and spill the contents. If a small nick is made in the box with the point of a knife as shown the lid will fit tightly. Press the knife point into the plastic, then give it a slight turn in order to raise the surface at one point.

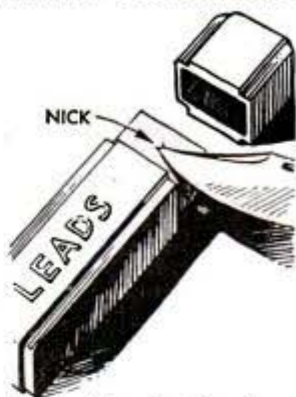

Bundles of File Cards Identified By Lettering on the Edges



Packages of file cards can be identified easily in storage if they are marked along the edge according to date, subject or other classification used. In order to mark them, hold or clamp the edges together firmly and print the necessary information on them with ink or colored pencil. —Mildred Anderson, Chicago.

Cushioning Porcelain Socket Against Breakage

Porcelain sockets of the type shown often are broken accidentally when they are mounted because one of the screws was pulled down too tightly, especially if the mounting surface is slightly uneven. To avoid this trouble, slip a piece of inner-tube rubber under the socket before driving the screws. The rubber will allow the socket to adjust itself to any slight irregularity.



Your Gloves Always at Hand in This Holder

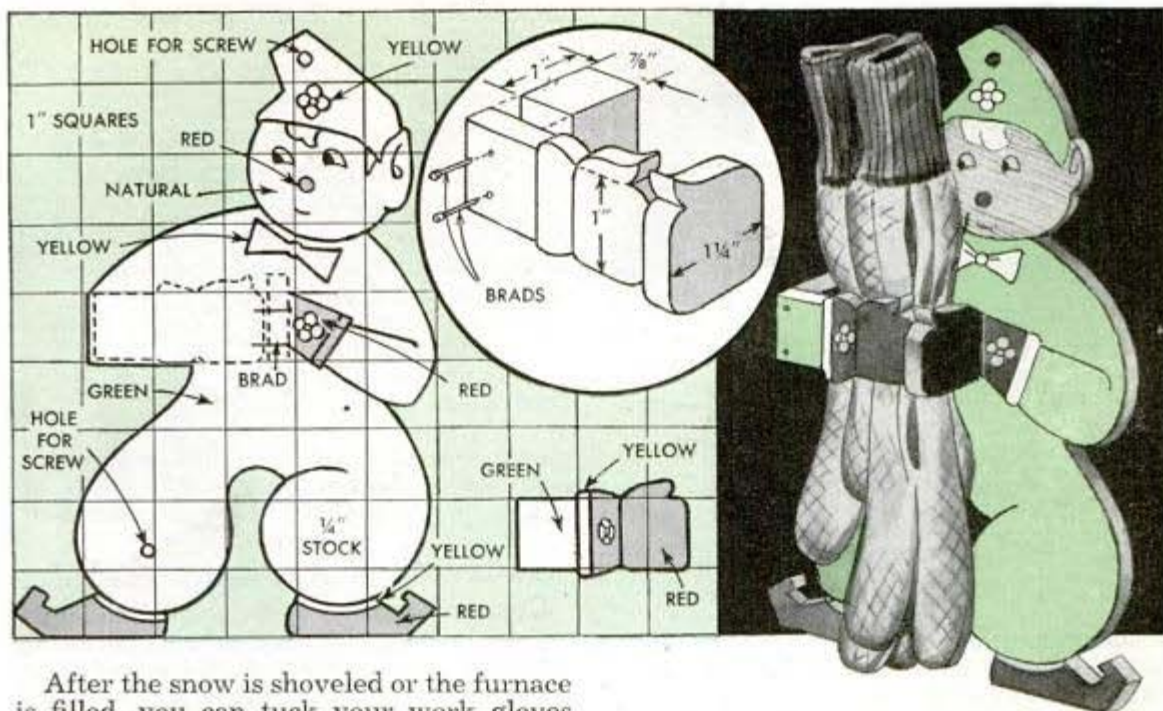

After the snow is shoveled or the furnace is filled, you can tuck your work gloves away in the crook of this little figure's arms where they will be handy for the next day's work. The figure is traced on plywood or hard-pressed board and jigsawed, and the right arm and left hand are assembled as shown in the circular detail. Small holes

through one leg and the peak of the cap permit screwing the figure to a wall or other convenient place. Suggestions for painting are given, although the figure may be finished in any color combination.

—R. L. Fairall, La Crescenta, Calif.

Counterweighting Pickup Arm Reduces Record Wear

Some phonograph pickup arms are so heavy that they cause excessive record wear even with ordinary steel needles, and especially when a long-life sapphire needle is used. By reducing the arm's weight, record wear will be reduced without noticeably affecting the tone quality. This can be done by counterweighting the pickup arm as shown. To determine the weight needed, a beam scale is improvised. This consists of a stick, such as a length of

dowel, with a piece of string tied at each end and equidistant from the center. One of these is tied to the pickup arm at the needle position and the other holds an envelope or piece of paper in which BB shot or similar small weights can be placed. The beam is supported at the center by a looped string. Then, by filling the container until it exactly balances the arm, the weight of the latter can be found by weighing the shot. If they weigh more than 1 oz., the pickup arm probably is too heavy. To reduce its weight to about 1 oz., the arm should be counterbalanced in a specific proportion. This is determined by measuring the distance from needle to pivot and from pivot to a point on the mount where a weight can be placed so as not to strike any object when the arm moves. If the former distance is five times the latter, a counterweight of 5 oz. is required to reduce the weight of the pickup by 1 oz. This counterweight, which can be made from sheet lead or other suitable material, is attached by a metal strap screwed to the arm as shown.

—Willard Allphin, Danvers, Mass.



Rain Kept From Soiling Windows With Strips Nailed to Roof



On summer cottages and other buildings not fitted with eaves, small strips of wood nailed above windows in the manner shown prevent rain water from running down to soil them. When only light rains are falling, the strips are sufficient to turn all the water to either side of the windows so that it does not drop onto the panes.

Rubber Heel Serves as Pedal Pad



A rubber heel will make a serviceable and easily replaced substitute for a worn rubber pad covering the clutch or brake pedal of your car. Drill two holes through the heel and the pedal plate and insert bolts to hold them together.

Wax Paper Prevents Sticking Of Envelope Flaps

In humid climates or when carried in your pocket, envelopes sometimes become sealed. To avoid this trouble, I arrange them with pieces of wax paper next to the adhesive on the

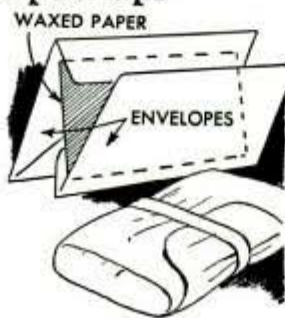

flaps as shown. A number of envelopes can be prepared in this way and then bundled in waxed paper. The paper can be used repeatedly without replacing it.

—Pfc. Andrew Vena, New York, N. Y.

Key Ring on Grommet of Flag Provides Easy Attachment

When you can't place a snap fastener in the grommet of a flag because the latter is set in too far for the snap to engage, place a split key ring in the grommet and attach the fastener to the ring.

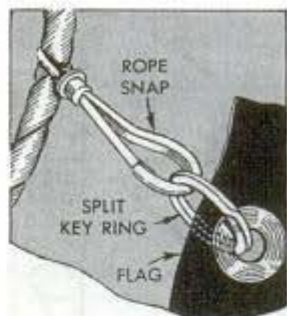

Common Bleach Removes Ink

Common bleaching solutions of the laundry variety can be used as an eradicator that will remove inks of all kinds except indelible. It is convenient to place the remover in an empty bottle of the type which has a glass rod attached to the cork, since this can be used in applying the eradicator.

Wooden Plugs Stop Leak in Boiler Of Home Heating Plant

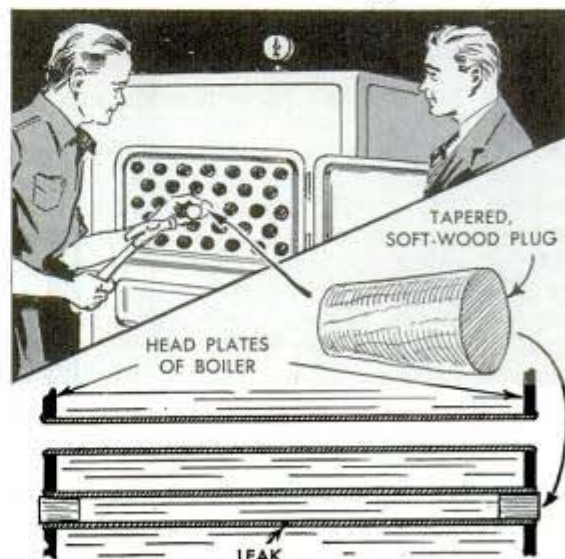

Having a leak suddenly develop in one of the flues of his horizontal steam boiler, one home owner repaired it temporarily by carefully driving tapered softwood plugs into the ends of the flue. As soon as the flue filled with water from the leak the plugs swelled tightly in place and were kept wet so that there was little danger of their becoming ignited under a medium fire in the boiler.

Reinforced X-Legs Make Cottage Table Sturdy

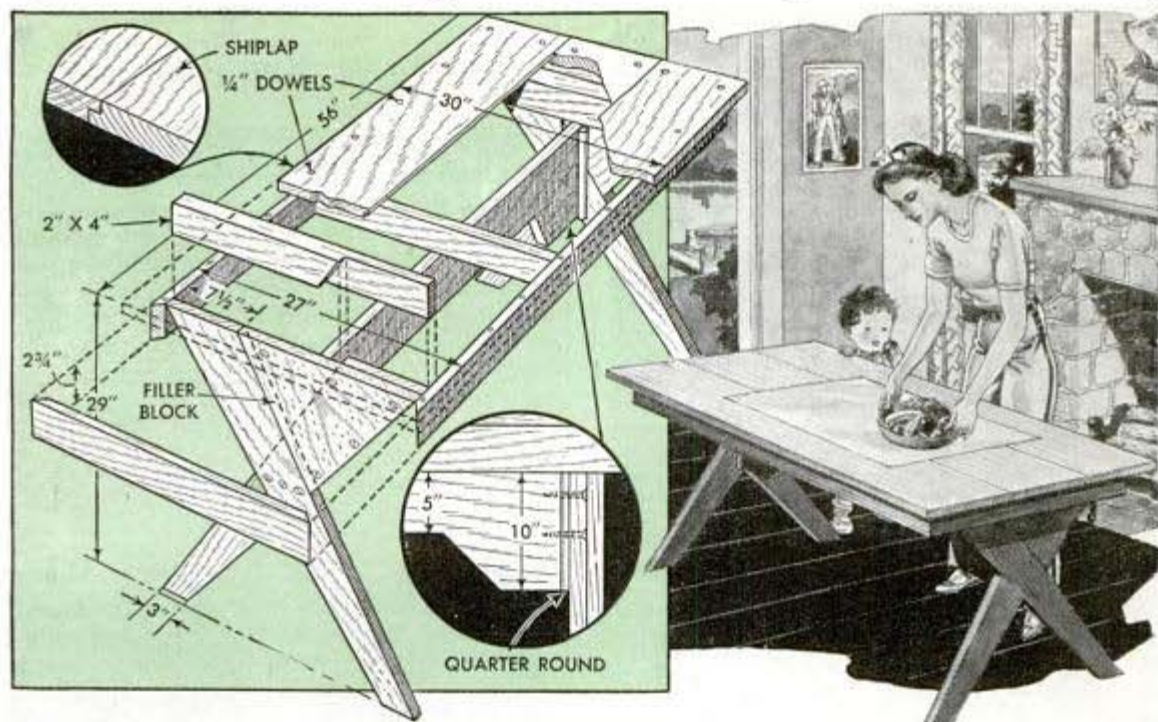

Built of pine or other common lumber, this sturdy table is doubly reinforced for use in cabins or summer cottages. Construction is simplified by using X-type, tapered legs, which are made flush across the table ends by a triangular filler block. A cross brace, cut as shown in the lower detail, assures rigidity. Seasoned lumber should be used for the top, which is dow-

eled in place. If unseasoned lumber is used, the boards may shrink and leave openings. Therefore, they should be nailed on temporarily until completely shrunk, after which dowels are substituted for the nails. After the table has been well sandpapered, the application of two coats of shellac and one or two of liquid wax will prevent stains from soaking into the grain.

Rack Holds Oars and Paddles Upright to Prevent Damage

Instead of leaning oars and paddles in a corner of the boat house as is often done, you can set them in a neat rack like the

one shown, where they are less likely to become nicked or split. The rack has a wire holder for each oar and paddle and butt blocks into which the ends fit. The wire holder shown at B, bent from heavy-gauge wire, is shaped so that an oar shaft can be pushed into it and retained by spring action. Instead of using a wire holder, the oars can be retained by a block, like that shown in detail C, equipped with wooden latches pivoted to drop across the slots. Butt block C is slotted for oar handles and block A is recessed to take the ends of paddles.—Pfc. Harry Mack, St. Louis, Mo.

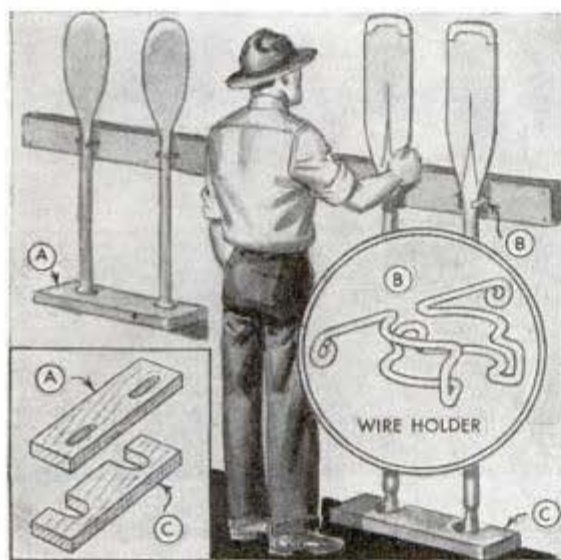

Nail Polish Mends Torn Curtain

You can make an almost invisible mend for tears in net curtains by applying a thin coat of colorless nail polish to the tear and pressing the frayed edges together with the fingers until the polish dries. Curtains mended in this way should not be stretched after laundering them.

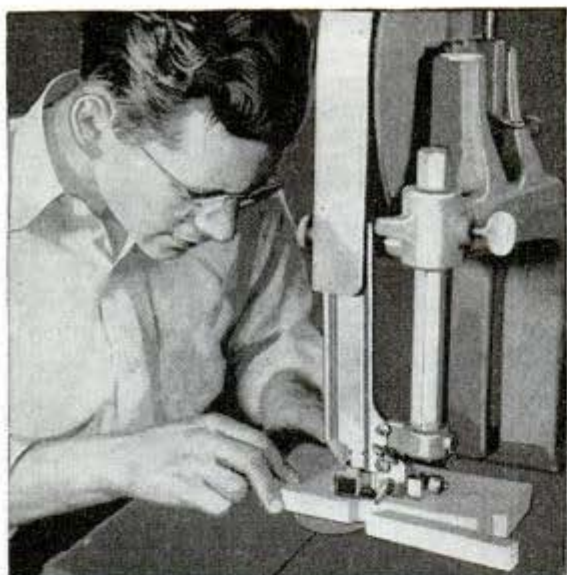

Six Styles in

By W. T. Warde

ATTRACTIVE book ends like these make ideal gifts, as the design can be suited to the recipient's tastes—even to his initial. For instance, instead of the spaniel you can use a likeness of another dog—a bulldog is particularly effective. The horse-head book ends are made of three laminations, the long curve of neck and mane being cut first, after which the pieces are glued together and the head and inside of the neck cut as one piece. In the spaniel

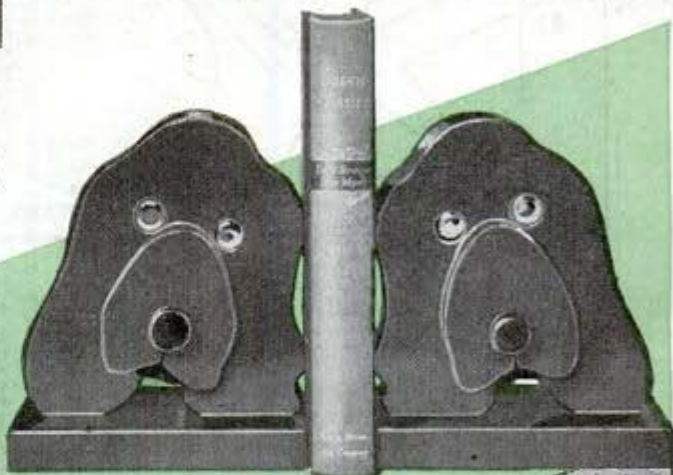
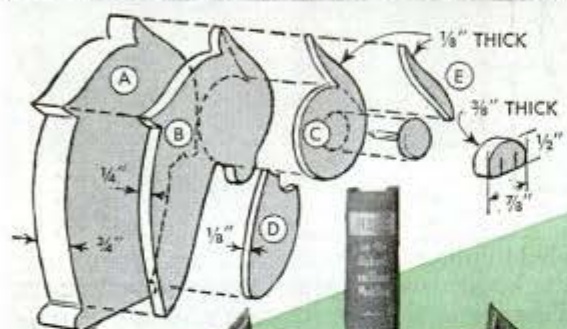

PLASTIC BUTTON OR UPHOLSTERY TACK

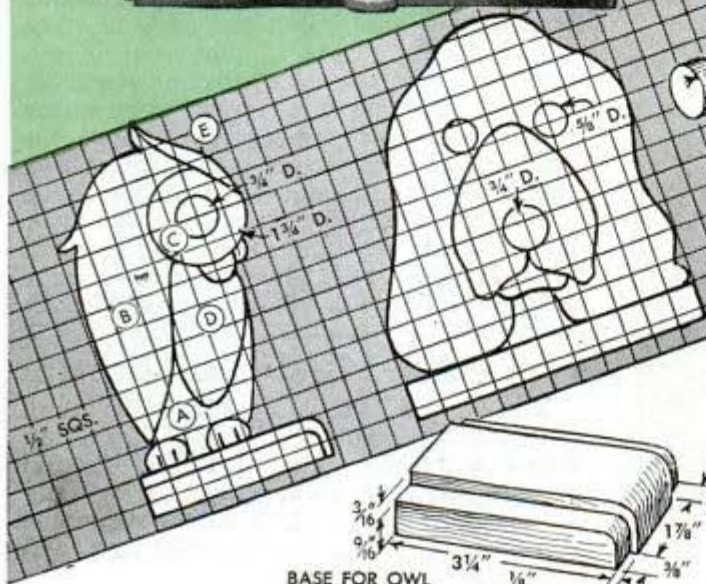
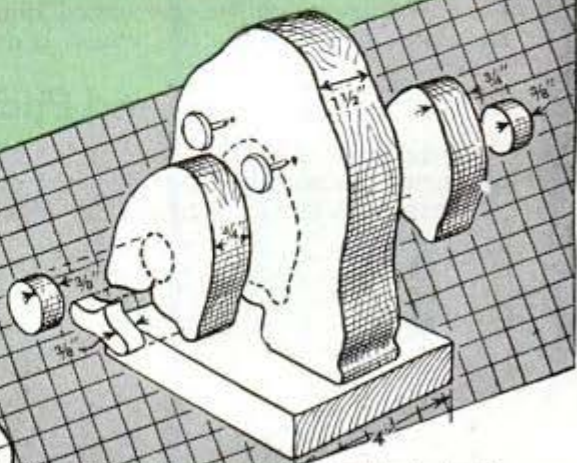
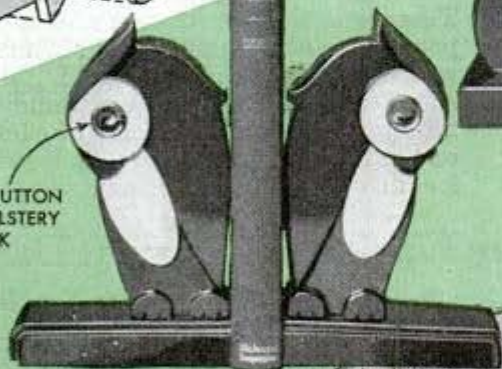

BASE FOR OWL



SUGGESTION FOR BULLDOG BOOK ENDS

BAND-SAWED BOOK ENDS

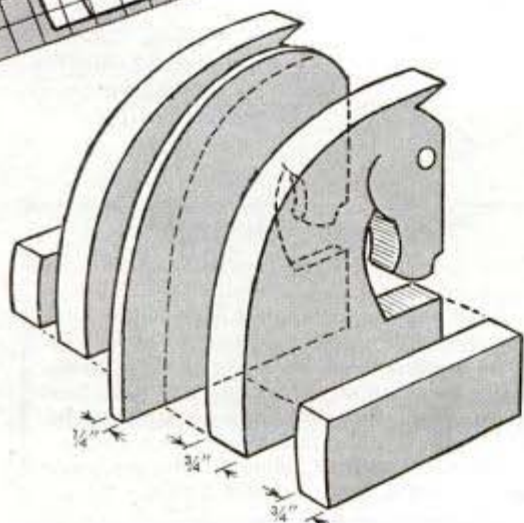
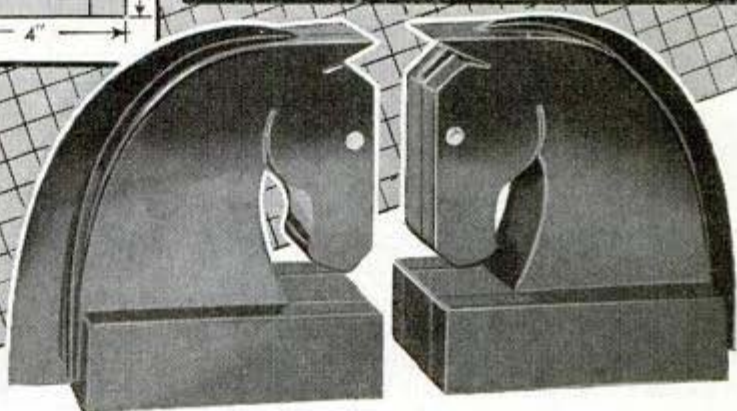
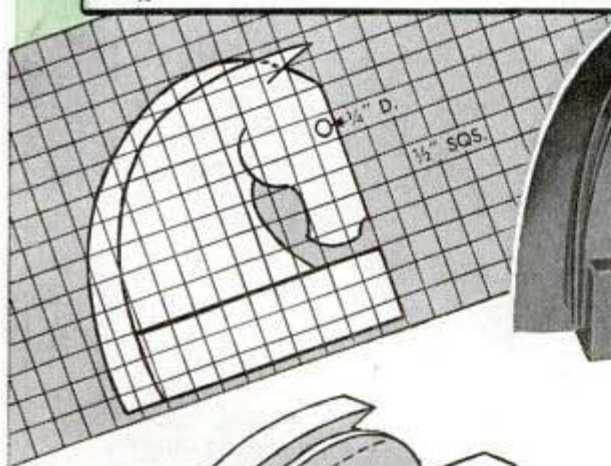
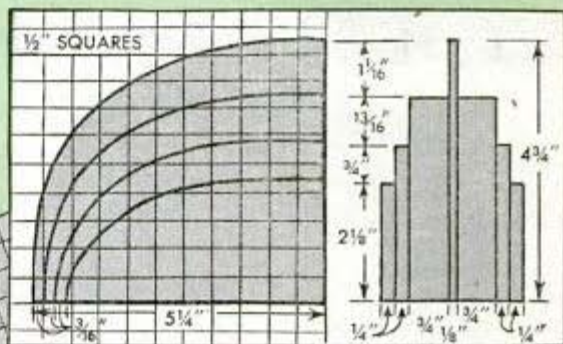
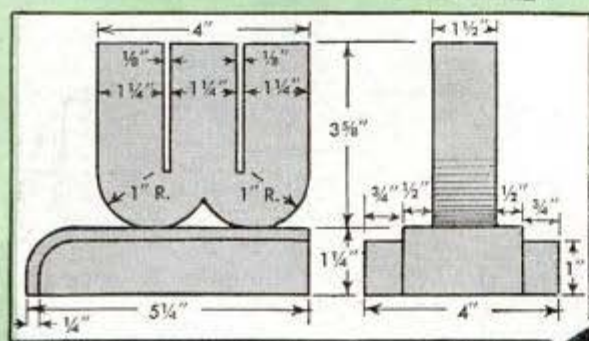
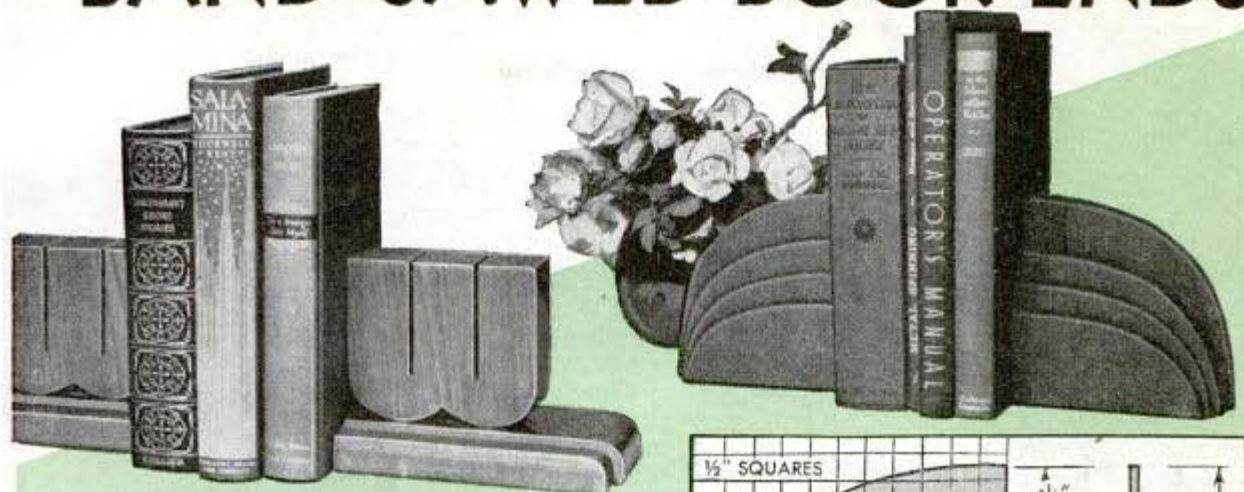

and owl designs, all inside curves are cut in pairs, and after these are glued in place, the contour of the body or head is cut. The completed book ends can be left in natural finish, some unusual effects being obtainable with just the grain. Or they can be enameled, the horse-head in black, the spaniel in golden brown with a black nose, and the owl in brown, white and black. The curved design can be dusted with fine sand while the paint is wet and then spray-painted with any desired color. For eyes use transparent plastic, either solid pieces or separate small lenses, holes for their insertion being drilled all the way through after assembly. Finally, holes are cut in the underside of the base and filled with melted lead to add weight, the bottom then being covered with felt.

Blade of Shovel Used as a Gauge To Determine Grade Level



Inconvenience of having a low chalkline in the way, or of having it covered by dirt when making a grade, can be avoided simply by raising the line above the predetermined level of the grade a distance equal to the length of a shovel blade. The grade level now can be determined by lowering or building it up until the shovel will just pass between the grade and line.

—Michael Ligocki, Gary, Ind.

Oil Thins Mimeograph Ink

When mimeograph ink will not flow freely through the stencil because the ink has thickened, it will make better copies if a small amount of light motor oil is added as a thinner, taking care not to add so much that the ink will "creep" through the paper. Other solvents are not practical as they tend to break down the pigments of the ink.

—Corp. Darrell Roberts, Flora, Miss.

Center of Circle Located Easily With a Postcard

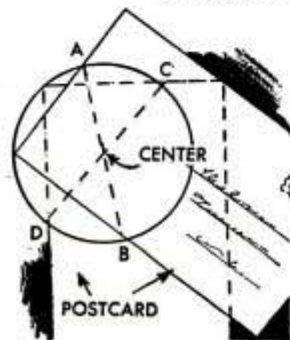

The next time you want to locate the center of a circle and have no instrument at hand for the purpose, just use a postcard or other card that has one side and end at true right angles. Place the card on

the circle with the true corner just touching it as shown, and mark positions A and B. Then swing the card a little and mark positions C and D. Now, draw lines from A to B and C to D. The center of the circle will be at the point where the lines intersect.—N. Bogoch, Winnipeg, Man., Can.

"Crow Quill" Is Easier to Use When Inserted in Penholder

If your work requires the use of a crow-quill pen, cramped fingers caused by gripping the small holder of the pen can be avoided by cutting off the holder and inserting it into a regular penholder. In some cases it may be necessary to wedge or glue the pen in place.—C. T. MacFarlane, Moncton, New Brunswick, Can.

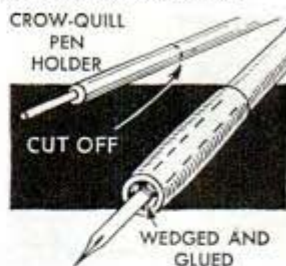

Wax Paper Smooths Game Board

Faster, smoother play can be obtained in such games as caroms, crokinole and shuffleboard by rubbing the playing surface with waxed paper. This makes the playing surface smooth and slick so that shooters will slide more easily.

Using Regular Pen Point to Ink Straight Lines on Paper



With an ordinary writing pen, an extra pen point and a ruler you can ink straight lines as easily as with a ruling pen. To do this, insert the extra pen point up, into the holder as shown, to serve as a guide which will follow the edge of the ruler.

WHAT HAVE YOU DONE?

Have you solved some troublesome everyday problem of a mechanical nature pertaining to your home, work or occupation, your hobby, play or recreation? If so, why not send us a short description accompanied by a sketch or a photograph? Many other readers may benefit from what you have done. We pay promptly for accepted material and return that which we cannot use. Address Homecraft Editor, Popular Mechanics Magazine, 200 E. Ontario Street, Chicago, Illinois.

From LIGHT FIXTURE to WALL BRACKET

TURNING a light fixture into an attractive wall bracket like that shown in Fig. 5 is a simple project in home decoration. All you need is a ceiling-fixture canopy, plaster of Paris, a brass ornament, some thin wood, a hack saw and a few brads. First, the ornament is soldered to the tip of the canopy. Then three wooden disks are cut so that the second projects $\frac{1}{2}$ in. beyond the bottom disk, and the top extends $\frac{1}{4}$ in. over the second, as in Fig. 1. This one should be

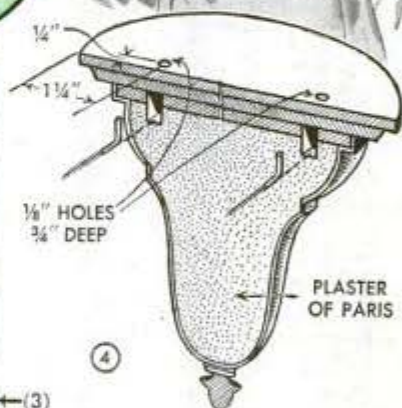
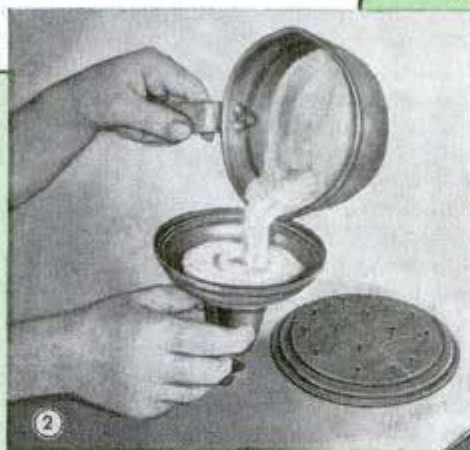
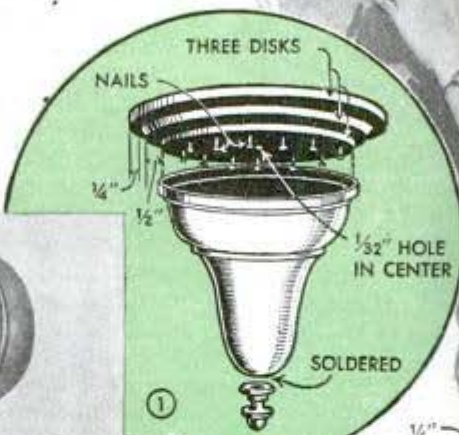

beveled. The disks are lined up by drilling a $\frac{1}{32}$ -in. hole through the centers and inserting a small nail, and then are glued, after which they should be shellacked. Next, brads are driven into the bottom disk as a key for the plaster. This should be thin, and poured to within $\frac{1}{4}$ in. of the canopy's edge, as in Fig. 2. The top section is pressed in place and the plaster allowed to set for 24 hrs. When it is hard, a center line is scribed across the top disk and over the canopy and the assembly is cut into halves as in Fig. 3. Light-gold bronze then is applied to top and backs, after which the brass is buffed and the complete unit is lacquered. The brackets hang on two screw hooks which engage holes drilled through the top as in Fig. 4, and slots are cut through the plaster and lower disk to meet them.

—Otto Merker, Chicago.

LANTERN

LANTERN slides made from your own negatives show fine shadow details and delicate gradations of tone better than paper prints because, unlike paper prints, slides are viewed by direct instead of reflected light. To make lantern slides, any good negative can be used. In projecting images to the slides, it is advisable to use an enlarger having double extension bellows, Fig. 1, to decrease the image to the desired size. However, an enlarger not so equipped can be used if a portrait lens is employed as in Fig. 3 to shorten the focal length. Sometimes it may be necessary to mount the lens and portrait attachment on a cardboard tube in order to reduce the picture to required proportions. In any case, as the projected scene most likely will come into focus only a few inches below the lens, books can be used to elevate the easel, Fig. 2, if the enlarger housing cannot be lowered sufficiently. Instead of using your regular easel, which is too large for the working space, a smaller one, designed for this kind of work, can be made as shown in Fig. 4. For focusing, a 2-in. square card as thick as the slide plate will do. This is set in place on the easel, which then is moved around on the book platform until the desired portion of the negative is positioned for printing. However, the picture should not be composed in the form of a square because the mask, Fig. 5, which is bound with the print in making the slide, has a rectangular opening.

In making the exposure, remember that slide plates are extremely high speed—almost three times as fast as bromide paper. Therefore, exposure time is critical. It should be computed as accurately as possible before making the print by using ordinary bromide paper as test strips and dividing by three the time required for printing these. Also, it is advisable not to

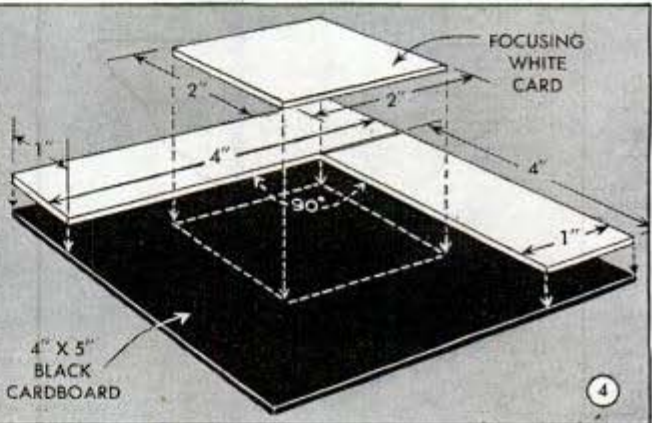

SLIDES *from Your* NEGATIVES

By ALEXANDER MAXWELL

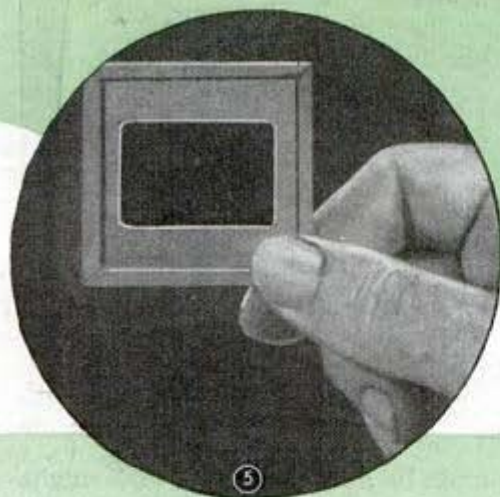

stop down the lens beyond $f:8$, otherwise dust in the enlarger or bubbles in the condensers may be brought into focus. To prevent movement of the enlarger caused by manipulating the switch, and to avoid overexposure by a possible delay in turning off the light, a piece of black cardboard should be used as a safety shield as in Fig. 2.

In developing the print, temperature should be carefully maintained at 68 deg. F. or as close to this point as possible. If it falls below 60 deg., action will be retarded, and if it rises much above this point, the emulsion may loosen. All solutions—developer, wash and hypo—must be of uniform temperature. Any standard bromide-paper developer can be used, diluted according to directions enclosed with the package of plates. Instead of using a standard tray, you will find a 3-in. glass ash tray, like that shown in Fig. 6, ideal for this purpose as only a little solution is needed to cover the plate. The tray should be rocked gently and continuously throughout development to break up air bubbles and prevent dust from settling on the emulsion.

After development, the print is washed and fixed in the same way as paper prints, except that greater care must be taken to avoid exposing the emulsion to the direct flow of wash water, which may tear it. If the print is to be left untinted, it may be dried and bound now. However, beautiful effects can be obtained by coloring the picture with a liquid dye or toner, sev-



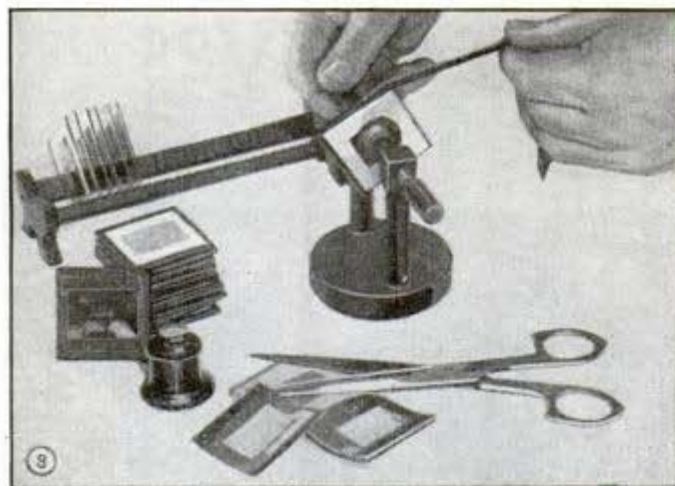

eral varieties of which are available at most photo-supply shops. The dye is applied with a camel's-hair brush as in Fig. 7, a puddle being allowed to remain for 10 or 15 min. on the print, which then is immersed in clean water to clear the light portions. After drying the print, a second dye wash of a different color may be applied and even a third may be added for special effects. Care must be taken, of course, to avoid getting the dye on a sink or table as it leaves a stain difficult to remove. Prints can be dried rapidly by being immersed in alcohol which, on evaporating, takes with it much of the wash water. Then

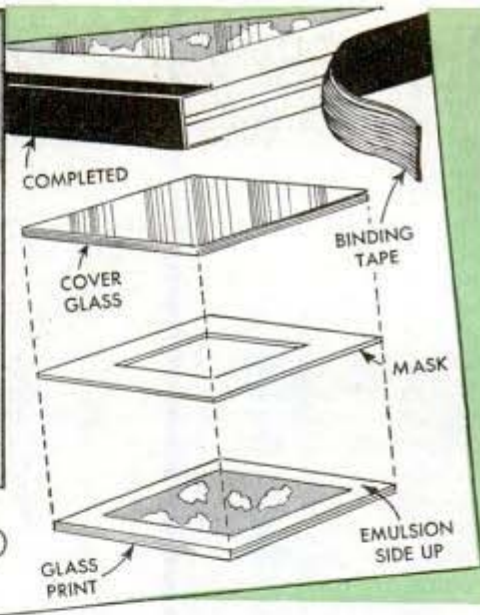

they should be allowed to stand overnight edgewise in a rack as in Fig. 8, to give the emulsion time to harden, after which they are ready for assembling into slides.

Before binding, dust specks and lint are removed with a soft brush. Then the mask is placed silvered side up, and the cover glass is laid on top as in Fig. 9. The assembly is held in a vise as in Fig. 8 while binding tape is applied around the edges to hold the parts together.

Filling of Display Jars Simplified by Paper-Backed Cotton

For displaying various collections, such as insects, rocks and minerals, inverted display jars of the type shown are ideal. Before placing the specimens on the cotton, lay a sheet of paper under it to provide a smooth surface, so that when the specimens are placed in the jar, more cotton or other filling can be packed into it to keep the

display securely in place, after which the paper is removed. If labels are needed, they may be pasted to the inside of the jar before it is filled. If desired, specimens can be placed on opposite sides of the jars and thus utilize more of the display surface. When this is done the jars should be placed so they can be viewed from both sides.

These display jars generally can be obtained in many sizes from biological or bottle-supply houses.

—John Karlovic, Chicago.

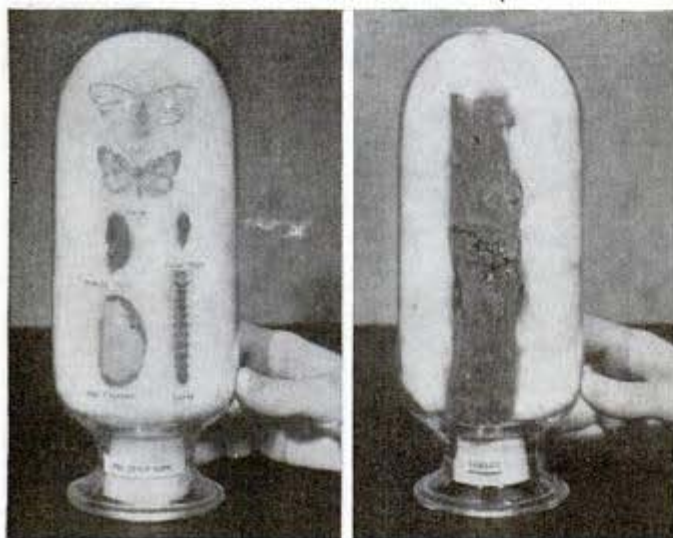

Metallic-Powder Finishes

Professional looking finishes with bronze or other powdered metallic paints are possible if the surface to be covered first is coated with a good grade of plain varnish, left to dry until tacky and then dusted freely with the powder. A soft powder puff or piece of cotton makes a good applicator. After the varnish has hardened, the surface should be buffed gently with the same puff.

—Jack Bronte, Nevada City, Calif.

Tapeline Determines Exposure for Close-Ups

If you use an exposure meter, here's a faster and more accurate method of determining exposure for close-ups than multiplying by factors or counting extra stops to compensate for the change in f values. These are correct as marked on the lens only at distances equal to or greater than ten times the lens's focal length, because with the lens racked out for close-ups, the light reaching the plate is less at the longer extension. All you have to know is the focal length of your lens. To find this, focus on some distant object and measure the bellows extension from the front of the lens to the ground glass. If the distance is 8 in., you have a lens of 8-in. focal length.

Assuming that you are using an 8-in. lens, with the bellows racked out 14 in., to determine the correct exposure, use the meter in the usual manner. At 130 lumens of light, the meter will appear as in the top diagram. Then, substituting the focal length of the lens (8 in.) as the f value (in this case f 8 on the meter scale), read the exposure that appears opposite the figure corresponding to the bellows extension—which is 14 in. in this case, read as f 14. The correct exposure, under the given con-



NORMAL SETTING



SETTING FOR CLOSE-UP



ditions, is now indicated as 1/12 sec. and not, as before, as 1/40 sec. Now rotate the scale until the figure representing the lens's focal length (as f 8 for 8 in.) has taken the place of the figure representing the bellows extension (14 in.), as shown in the lower diagram. With the scale so set, the light reading is now correctly shown as 40 lumens instead of 130 as before, and all the f stop figures will be positioned to read correctly for a close-up at the determined bellows extension.

Camera Set on Pivoted Platform to Make Stereo Photos

Set on a pivoted platform, any camera can be used for making pairs of stereo negatives. Perfect positioning is assured because the camera and platform are firmly attached to the tripod, being moved only laterally for the required separation. Two

pieces of wood of identical dimensions are used and the four metal links, which provide the shifting movement, also must be identical in size, the holes being drilled through all of them at once to assure uniformity. A distance of about 1½ in. be-

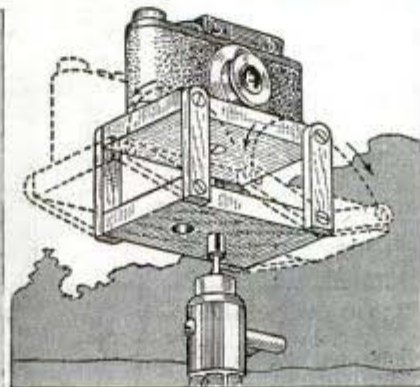

tween holes in the links provides a separation of approximately 2½ in. in the picture. The camera can be attached to the upper platform with a countersunk stove bolt reached by a screwdriver through a hole drilled as shown. A nut soldered to a large washer and countersunk in the under surface of the lower platform engages the tripod stud.

CRAFT QUIZ

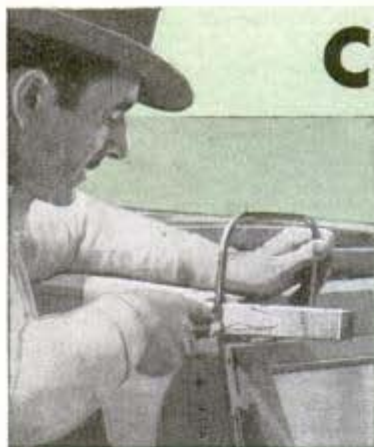

1. He is using a—
 (a) Hack saw (c) Curve saw
 (b) Keyhole saw (d) Coping saw



2. This wood will require—
 (a) Sanding (c) Stain
 (b) Filler (d) Backing

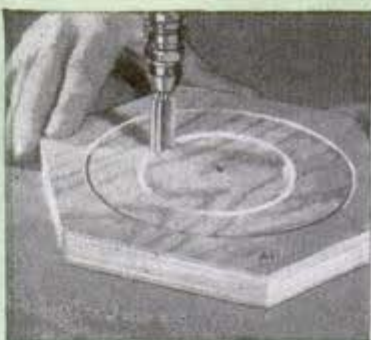

3. Best speed for this job is—
 (a) 5,000 r.p.m. (c) 10,000 r.p.m.
 (b) 1,000 r.p.m. (d) 4,000 r.p.m.



4. This knife is used to cut—
 (a) Basswood (c) Thin brass
 (b) Linoleum (d) Cloth



5. For this cutout you can use—
 (a) Basswood (c) Oak
 (b) Yellow pine (d) Walnut

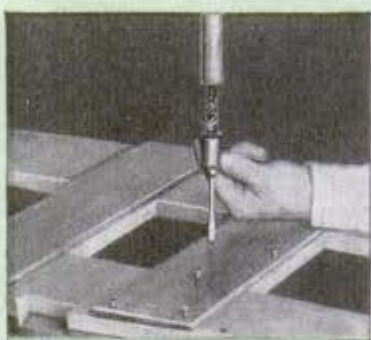

6. Best size screws for this job—
 (a) No. 0 (c) No. 20
 (b) No. 14 (d) No. 6



7. This worker is using a—
 (a) Spokeshave (c) Trimmer
 (b) Drawknife (d) Scraper

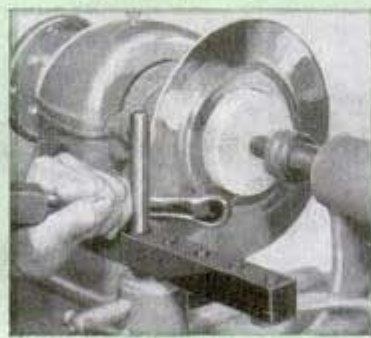

8. Best for this spinning job is—
 (a) Pewter (c) Soft brass
 (b) Aluminum (d) Mild steel

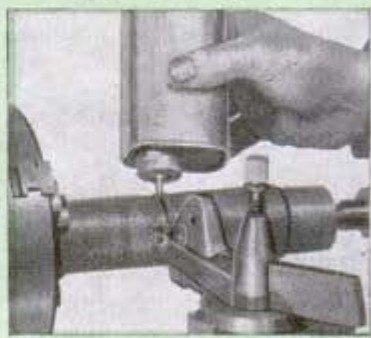

9. On this cut-off job you use—
 (a) Threading oil (c) Machine oil
 (b) Heavy oil (d) Olive oil



10. He will not need a—
 (a) Trowel (c) Straightedge
 (b) Calipers (d) Mortar

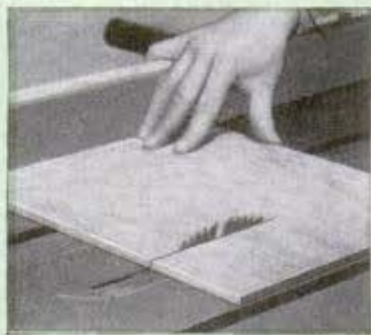

11. This sawing on plywood is—
 (a) Ripping (c) Crosscutting
 (b) Mitering (d) Chamfering

ANSWERS: 1-d; 2-b (Note wide, open grain); 3-c; 4-b; 5-a; 6-d; 7-b; 8-a; 9-a; 10-b; 11-a; (Note wood has no definite cross-grain. Here ripping is right as the work is being guided by ripping fence)



SHOP NOTES

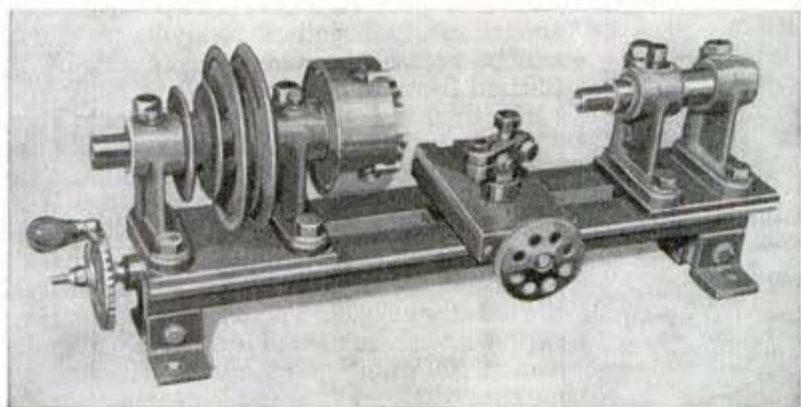

MIDGET *Metal-Turning* LATHE

by A. D. Mayo

CRAFTSMEN, modelmakers and others who need a small metal-turning lathe can make one almost entirely from scrap material available in junk or auto-wrecking yards. A chuck may have to be purchased, but many turning jobs can be done between centers or on an improvised faceplate. The lathe shown here has a swing of $4\frac{1}{2}$ in. A larger one, of course, can be made by changing the proportions.

In making the ways, Fig. 1, select straight

lengths of angle iron. These can be filed on the inner surfaces so that the slide block, Fig. 7, will travel true to within about .001 in. For finishing them smooth, a piece of fine emery cloth wrapped around a file or block is rubbed over the ways as in Fig. 2. One of the end blocks is drilled for a lead screw as shown in Figs. 6 and 7. This should not be done, however, until the carriage and slide block are positioned on the lathe, to assure locating the lead screw at the

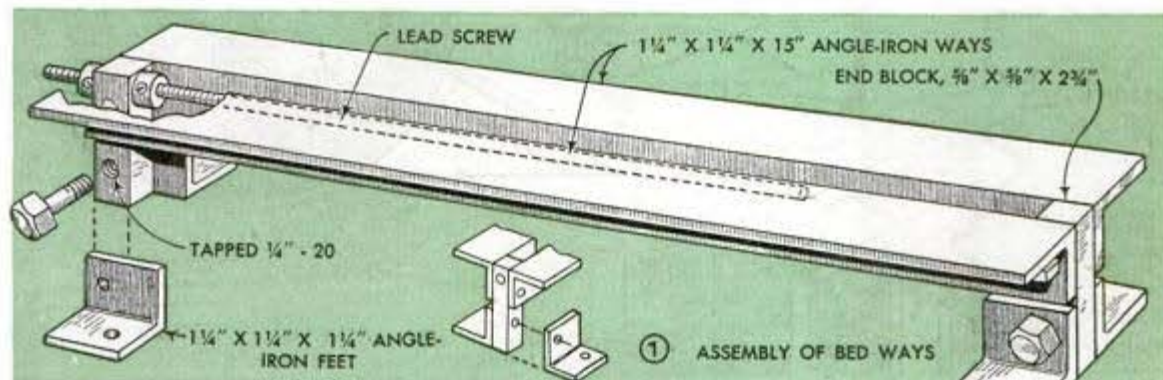



proper height. The screw is secured by collars and rotated by a gear wheel taken from a discarded hand drill. Or, almost any small crank or a wheel fitted with a knob will do. To allow maximum travel of the carriage, the screw should not be cut to length until all other working parts are in place and ready for use.

The carriage is shown in Figs. 8 and 10. For the small work done on a lathe of this size, the feed-screw thread should be fine. The tool post can be raised, lowered or turned in any direction. Even the tool itself can be rotated because it is round, being formed from an old drill bit.

For the head and tailstock, shown in Figs. 3, 9, 12 and 13, overhead-valve tappet assemblies from an auto motor are used. One of the two tailstock bearings, Figs. 8 and 13, has a stud which fits a groove in the tailstock spindle and locks it. Both headstock bearings should have oil cups as shown in the detail of Fig. 5. The two sets of bearing supports are mounted on two plates as shown, after being aligned. This is done by passing the original rocker-arm spindle through all four bearings, then locating the holes to be drilled in the mounting plates. Now, with both sets of supports in correct position on the ways, the plate on which the headstock bearings are mounted is bolted to the ways. The tailstock plate, however, is movable. It is fastened to a spacing bar as in Fig. 12; the bolts through the plate do not pass through the

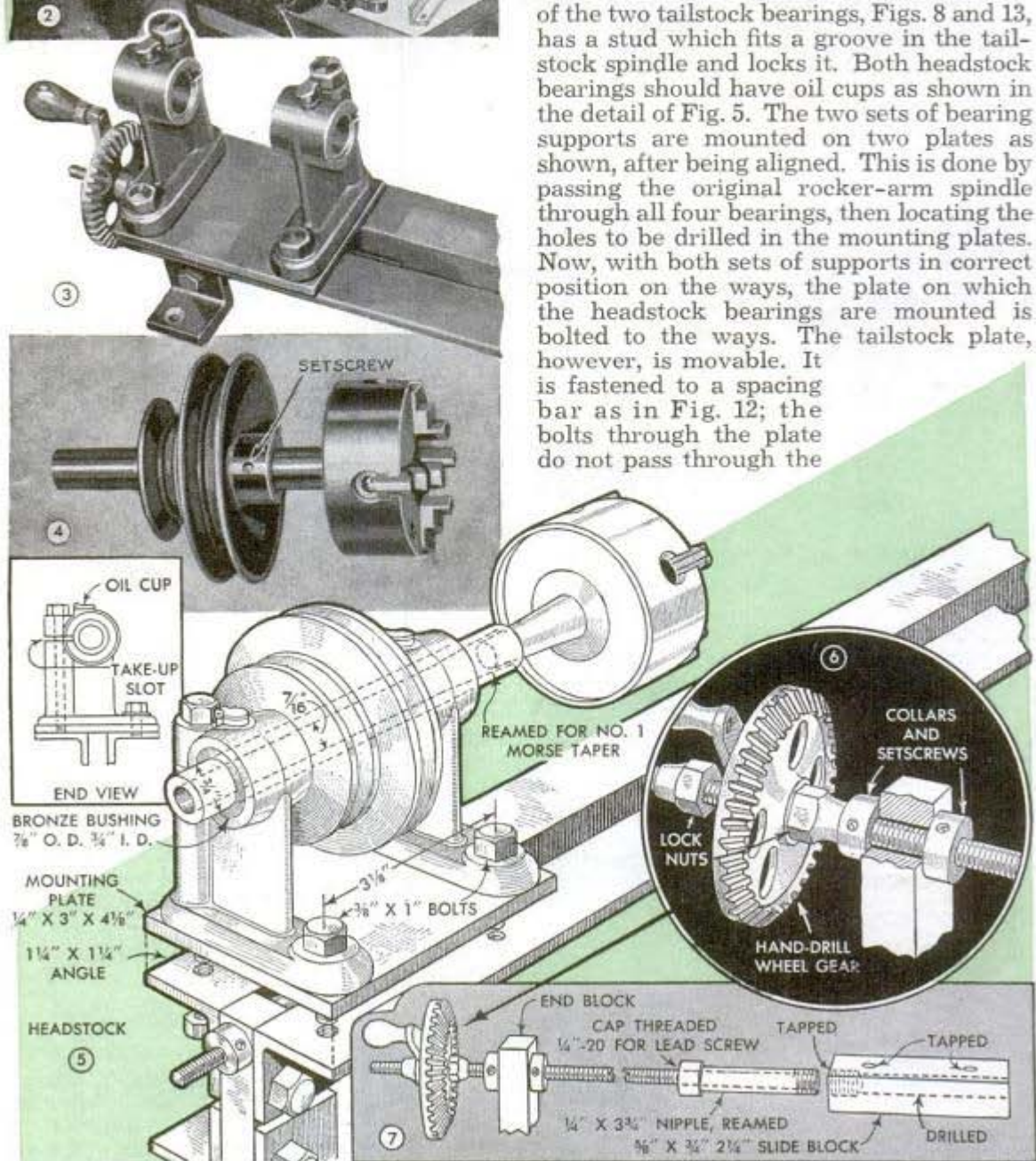

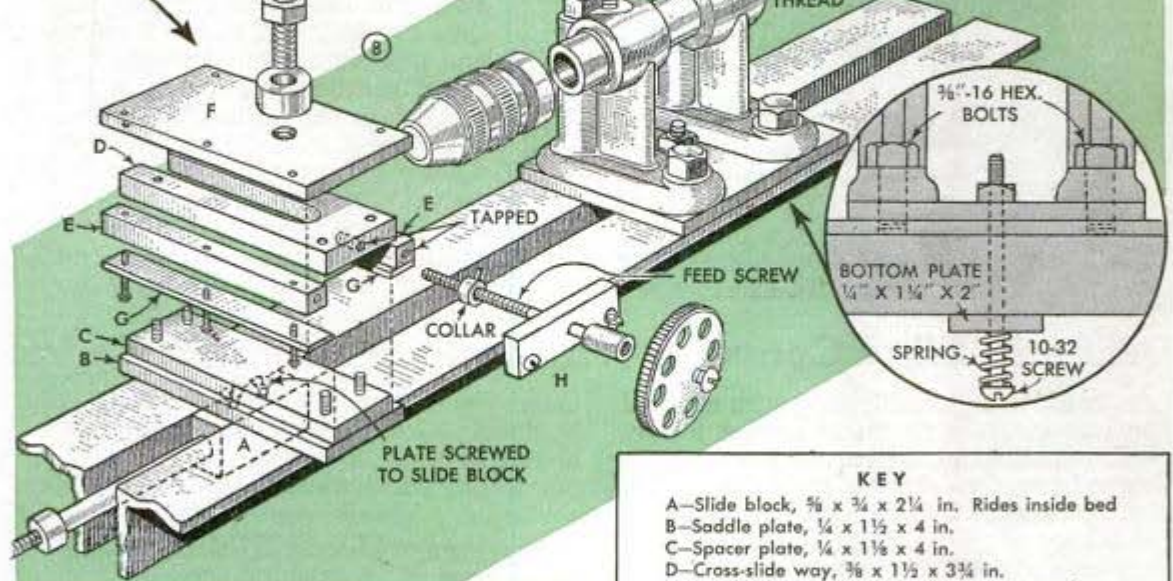
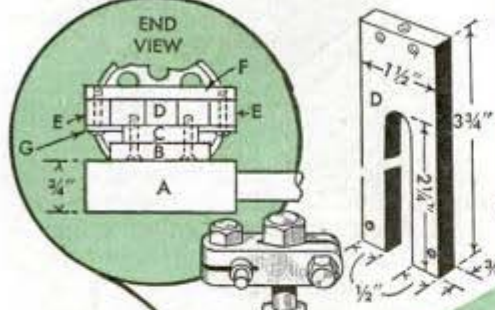
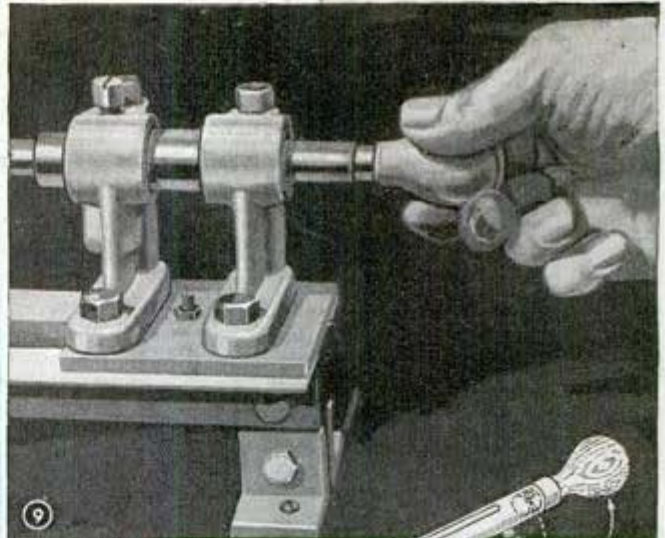
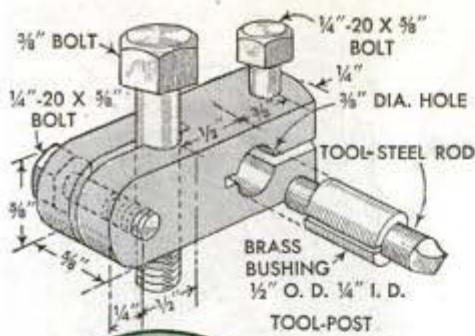

KEY

- A—Slide block, $\frac{3}{8} \times \frac{3}{4} \times 2\frac{1}{4}$ in. Rides inside bed
- B—Saddle plate, $\frac{1}{4} \times 1\frac{1}{2} \times 4$ in.
- C—Spacer plate, $\frac{1}{4} \times 1\frac{1}{2} \times 4$ in.
- D—Cross-slide way, $\frac{3}{8} \times 1\frac{1}{2} \times 3\frac{3}{4}$ in.
- E— " gib, $\frac{3}{8} \times 4$ in. key stock; 2 req'd
- F— " top plate, $\frac{1}{4} \times 2\frac{1}{4} \times 4$ in.
- G— " retainer, $\frac{1}{8} \times \frac{1}{2} \times 4$ in.
- H—Front panel for cross slide, $\frac{1}{4} \times 1\frac{1}{8} \times 2\frac{1}{4}$ in.

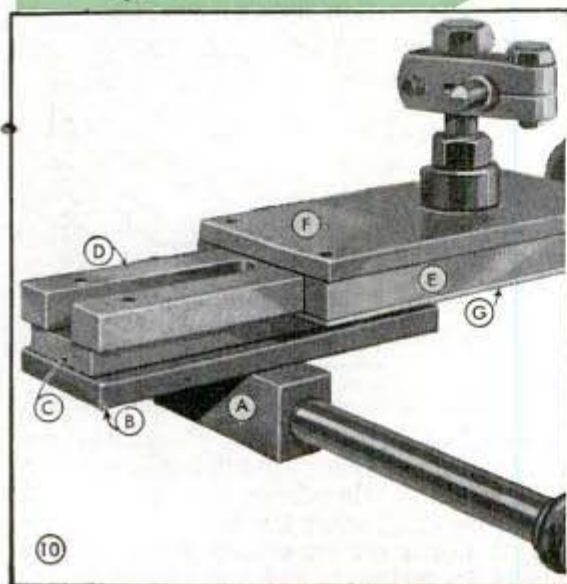

ways. The assembly can be locked by a screw through a bottom plate as shown in the circular detail of Fig. 8. To check the alignment, the carriage can be used as illustrated in Fig. 11: with the tool touching the spindle near the headstock, the carriage is moved toward the tailstock. If the bearing supports are in alignment, the tool will touch the spindle uniformly throughout its travel from end to end.

After using the rocker-arm spindle to align the bearings, suitable lengths are cut off, one for a sliding fit of the tailstock spindle, Fig. 9, and the other, for the headstock, reamed at one end to take an adapter on which the chuck is screwed. The tailstock

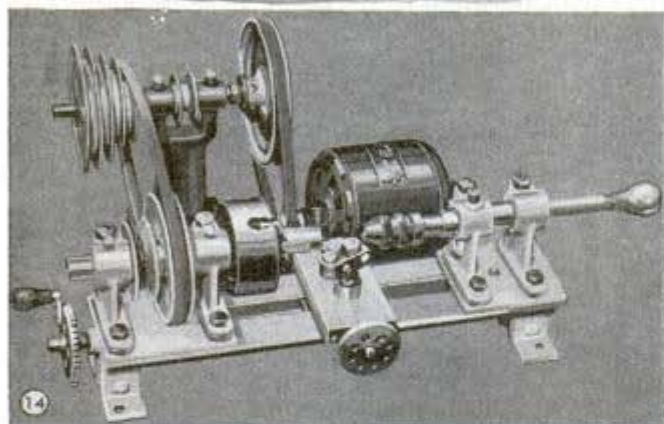
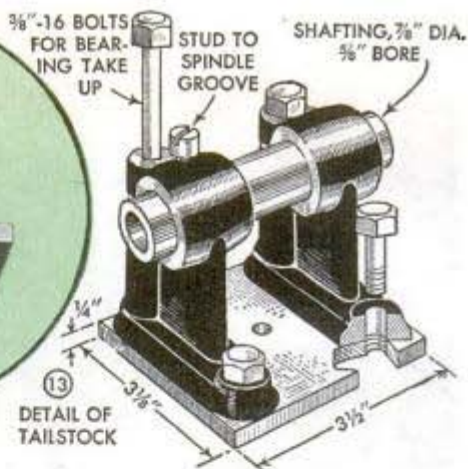
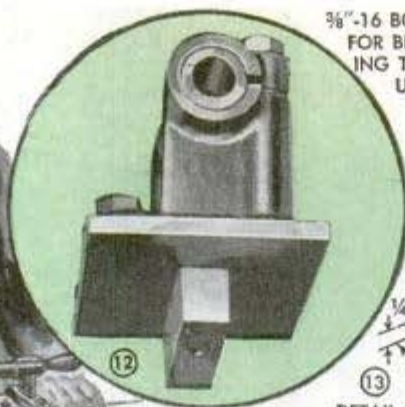

spindle is fitted with a small chuck and a wood handle. In order to use a tailstock center and other attachments having a No. 1 Morse taper, you can make an adapter which screws on the spindle. Bronze bushings are inserted in the headstock and pulleys are fitted on the headstock spindle as in Fig. 4. A countershaft as shown in Fig. 14 is necessary and may be mounted conveniently on the bench behind the lathe. With a four-step cone pulley as shown, it is possible to provide a considerable range of speed as required for various turning jobs.

Deaf and Blind Converse With Help of Alphabet Board

As an aid in communicating with a friend who was entirely deaf and almost totally blind, one man glued raised letters on a plywood board as shown. By directing his friend's hand to letters spelling the words which he wished to communicate, he could carry on a conversation even in a darkened room. The spelling board also can be used in conversing with deaf people who are not blind, as there is no need for writing out

each statement on a pad of paper as usually is done. Also, if the letters are coated heavily with zinc sulfide phosphorescent paint, they will remain visible in dim light.

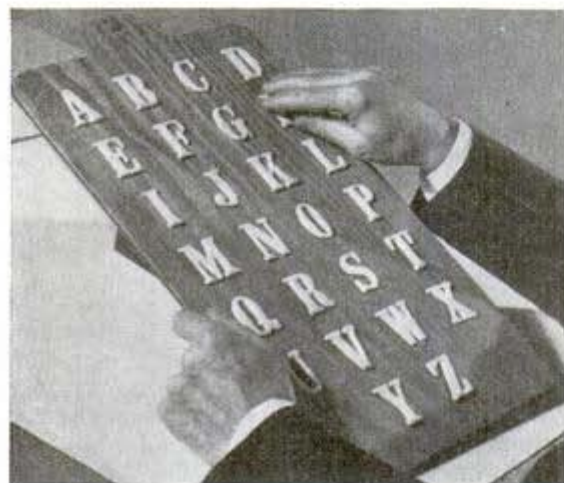

Mousetrap Holds Ribbon Badges While Lettering Them

When homemade badges or streamers are made up for a banquet or other gathering, a mousetrap will hold the ribbon for lettering. Place the work across the trap under the jaw as indicated.



Mixers From Broken Glass Rods

Instead of throwing away pieces of glass towel rods, use them for mixing liquids or stirring chemicals where metal or wood cannot be used, after the broken ends are ground down on an emery wheel. Rods having flanged ends make good pestles.

Protecting and Servicing Your Worn Grindstone



Grindstones are likely to become water-soaked and soft at spots where water is allowed to drip when they are not in use. Likewise, if a water trough is mounted under the stone, the water should be drained immediately after use, otherwise the wet portions of the stone will wear down faster than the dry portions, causing the wheel soon to become out of round as shown in Fig. 1. However, if this happens you can true up the wheel without a wheel dresser. To do this, hold one corner of an old file against the rotating stone and groove along the high portions as in Fig. 2.

Then, with a cold chisel, chip away the ridges thus formed as in Fig. 3. The roughed-out circumference can now be dressed smooth as in Fig. 4, using a sharp-edged, hard field stone.

—J. Modroch, Danbury, Conn.

Tarred Burlap Stops Leaks in Livestock-Watering Tank

Having a livestock-watering tank that had rusted so badly that several small leaks developed, and not being able to replace it, one farmer repaired it temporarily by lining it inside and out with burlap and tar. Regular road tar or asphalt was applied hot to a small area of the tank at a time,

and pieces of burlap were pressed firmly into it. After both inner and outer surfaces had been covered in this way with tar and burlap, another coating of hot tar was applied all over as a sealer coat, thus making the tank watertight.

—A. H. Waychoff, Phoenix, Ariz.



Scraper to Clean Bevel Gears

On some machines, bevel gears are operated uncovered, the gears being lubricated by regular applications of cup grease. In such cases, dirt and other foreign matter mix with the grease and form a hard gum that soon fills the spaces between the teeth. To remove this gum, you can make a scraper from a 10-in. length of clock spring. Double the spring and insert the ends into a suitable handle. This will give the spring a loop shape that will slip between the teeth easily and clean both sides.



Pipe Cleaner Picks Dust or Lint From Mimeograph Stencil



Instead of risking damage to a mimeograph stencil by picking paper lint from it with the point of a pencil or a matchstick, use a pipe cleaner. If the cleaner seems too flexible to remove some of the lint that adheres tightly, use a pointed stick, but wrap cloth around the end as shown in the detail. The cloth will prevent minute holes from being gouged into the stencil.

Leaking of Oilcan Spout Stopped With Rubber Gasket



While looking for a gasket to prevent leaking around the spout of an oilcan, I found that a rubber hose washer was just the thing. This was slipped over the threaded section of the spout base as indicated. The washer also serves as a means of hanging the can on a shelf. This was done by notching the shelf edge, the notch being slightly smaller than the diameter of the washer.

—Jule E. Koehler, Maplewood, N. J.

Cleaning Gear-Shift Air Filter

It is important to clean the air filter of the Chevrolet vacuum gear-shift cylinder every 10,000 miles. This can be done by

disconnecting the flexible hose inlet, removing the filter, washing it in kerosene, then dipping in engine oil and replacing.

—Hal Geihm, Aurora, Ill.

Ratrap Provides Safety Release For Trip Rope on Tractor

If the trip rope leading to a machine pulled by your tractor is broken often when a machine is accidentally uncoupled, or when you forget to disconnect it when unhitching the implement, this trouble can be avoided by using a ratrap as a safety release. The trap is bolted under the tractor seat and the end of the rope is held by the trap jaw. The rope end should be wrapped with twine to prevent raveling instead of the customary method of tying it in a knot, which would not let the rope slip from the trap.

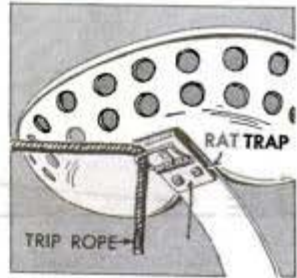

Retrieving Linotype Matrices

Retrieving a flat matrix from a linotype is easy if you wrap a rubber band around the end of the wire hook supplied with the linotype. This prevents scratching and gives a firm hold on the matrix.

Swaying of Towed Car Prevented By Stabilizing Springs

When a car is hoisted at one end for towing, a tendency to sway from side to side on the road can be prevented by using two strong springs. These are attached to the tow-truck body and are fastened to the eye of the hoist hook, or into a link of the hoist chain near the hook.

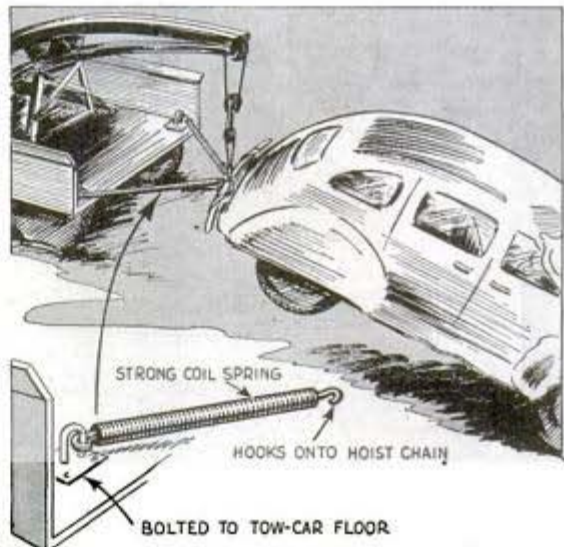

POPULAR MECHANICS

Rotating Counter Racks Save Time in Store

To avoid wasting his clerks' time while waiting for customers to make selections of small parts, and also to aid customers in determining the size and shape of the parts desired, one hardware merchant uses counter display racks of the types shown. Each has a pipe standard fastened to the counter by means of a floor flange, the racks differing only in the way the radial arms are attached to the wooden hubs. The latter on both types are screwed to floor flanges which have the threads filed off so they can rotate on the standards, pins being driven through the standards to keep the flanges in position. The rack shown in the lower right-hand detail has the arms attached to the hub by means of screws and

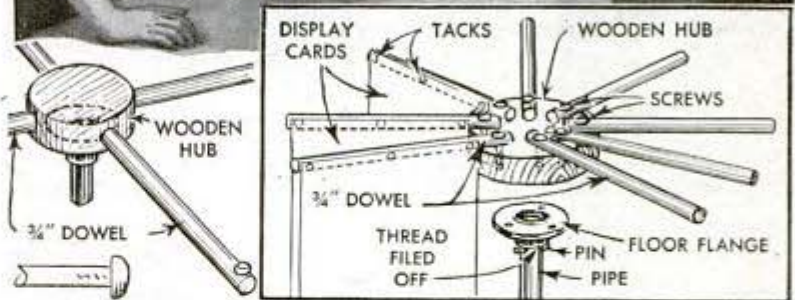

is intended to hold display cards of light items, the cards being tacked to the arms. The other rack, shown in the upper and left-hand details, has the arms glued into

holes in the hub and is used to support heavier articles, which are attached to endless pieces of canvas or other strong, heavy cloth hung over the arms.

Tilting Table Rolls and Unrolls Wallpaper for Display

Difficulty of unrolling and re-rolling wallpaper on a counter to display it in lengths sufficient to enable customers to

visualize the pattern on a wall led one merchant to devise this tilting display table. It consists of a light frame about 6 ft. long pivoted between the uprights of a supporting rack. The frame is provided with a metal trough across one end and two metal clips at the other. In use, the roll of paper to be shown is placed on the table with the free end under the clips. The frame then is tilted so that the paper rolls down to stop in the trough, thus displaying a 6-ft. length in normal, vertical position. The paper is re-rolled by tilting the table the other way. If the paper does not re-roll straight, guide strips can be added.

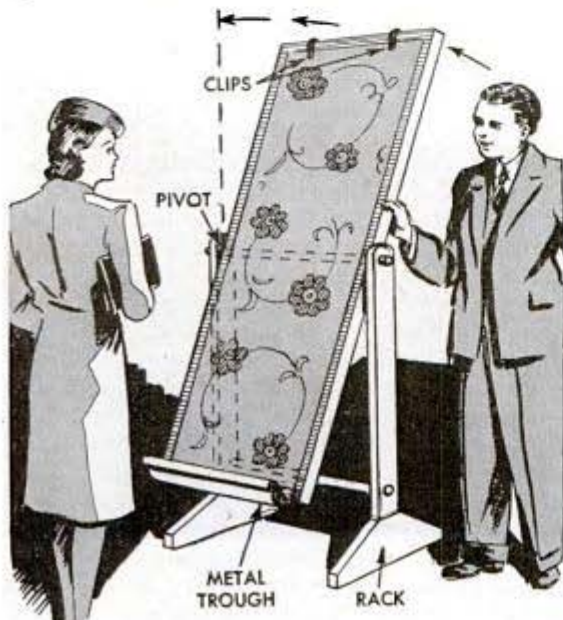

Holes at Ends of Cuts and Tears Prevent Their Spreading

A small hole punched at each end of a long cut in an inner tube before the patch is applied will prevent the cut from extending under pressure. Likewise, a tear in metal, as in fenders or aprons, will not spread beyond small holes drilled at the ends of the tear.

TIPS on TAPS

by H. J. Chamberland

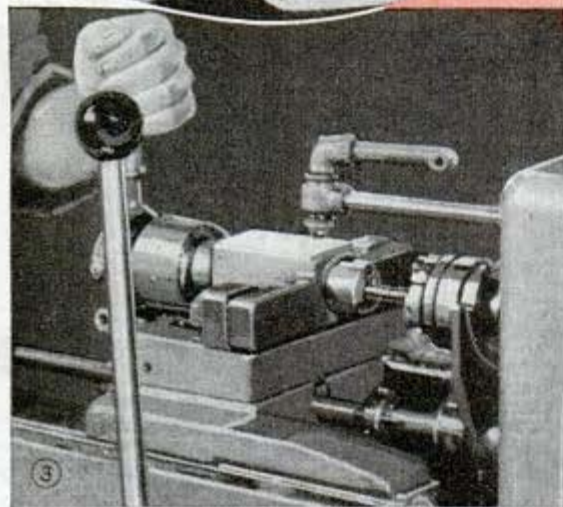
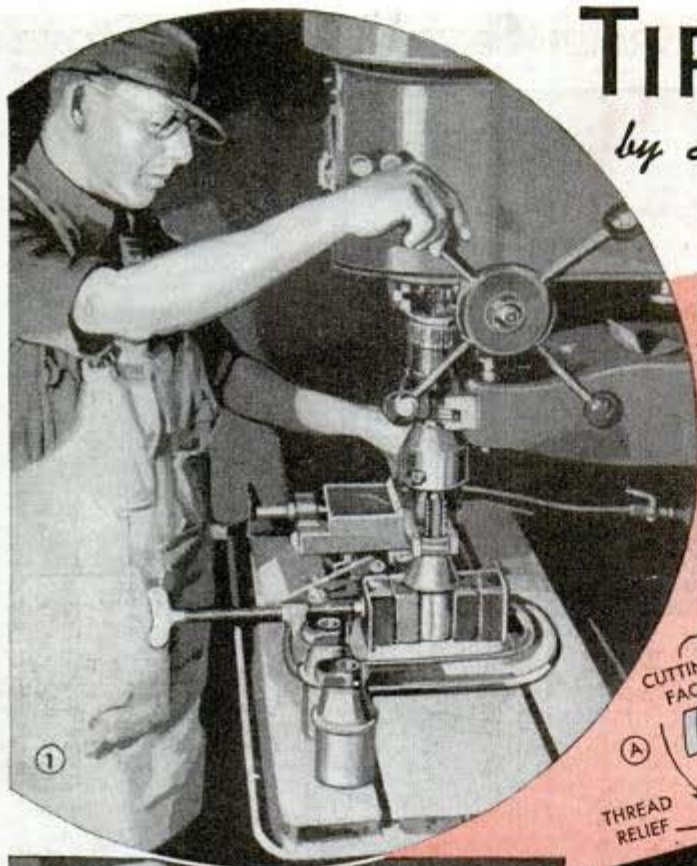

A TAP cuts a screw thread internally, in a hole, and differs from a threading die, which cuts a thread externally, as on a shaft. Taps are used more extensively than threading dies for quantity production because most external threads are produced either with automatic die heads or thread-milling machines. As shown in Fig. 2, a tap consists of a shank squared at one end and a threaded section into which flutes are milled to provide the necessary cutting action and chip passage. The shape of a flute and its relation to the cutting face varies with the material to be cut. Three standard face grinds are shown in details B, C and D of Fig. 2.

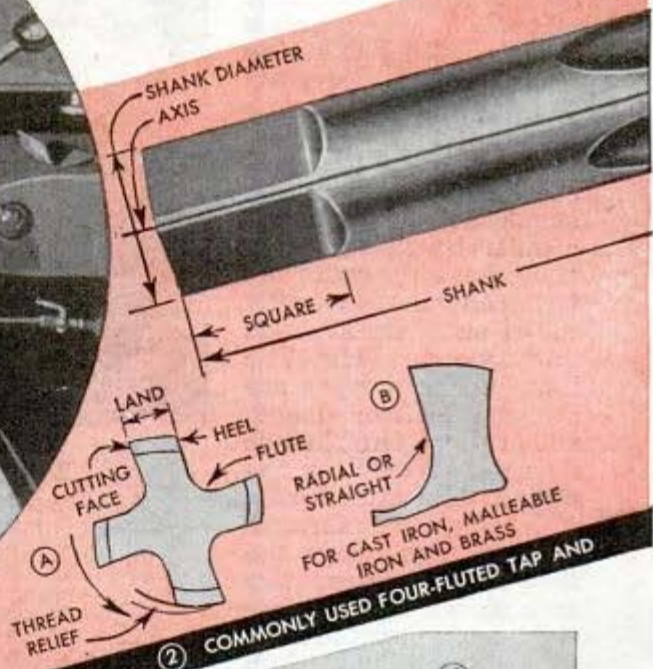

Most important are the chamfers at the entering end of a tap. These do most of the work by removing metal progressively. Very few taps have a thread relief as shown in detail A of Fig. 2 because they must be sharpened on the face and this gradually reduces the diameter of those having thread relief. Shops making their own taps in small quantities thread them in a lathe, mill the flutes and occasionally relieve the threads. However, this is too slow for production work so threading machines as shown in Figs. 1 and 3 are used. The machine in Fig. 3 has an automatic die head fitted with chasers illustrated in Fig. 4.

Taps commonly used: Types of taps used most frequently in shop practice are standard hand taps, serial hand taps, "gun" taps, adjustable chaser taps, collapsing taps, standard and stub machine-screw taps and nut taps. Standard hand taps are available in sets of three as shown in Fig. 5. The one in detail A has a long chamfer angle com-

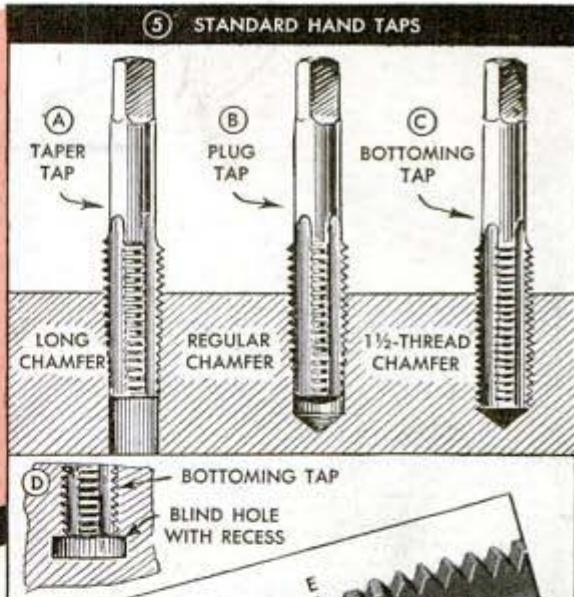
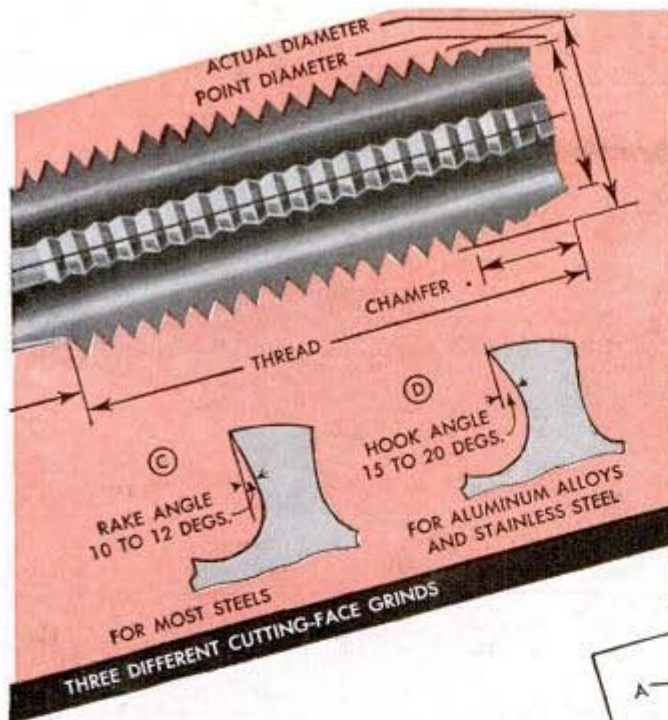

prising some seven or eight threads and is used to tap an open hole. The plug type in detail B has the regulation chamfer angle and is used to tap either an open or a blind hole. Detail C shows a tap that has only a 1½ thread chamfer and is used for a blind hole with a flat bottom or a blind hole with a recess as shown in detail D. This type is marked in fractional sizes from ¼ to 2 in. in diameter.

Serial hand taps, which come in fractional sizes up to 1 in. in diameter, are similar to the standard type but all three are necessary to obtain full thread diameter. No. 1 is undersize and is used to rough in the thread. No. 2 is a little larger and cuts a fuller thread and No. 3 finishes the thread to size. Chamfers of serial taps are shorter than those on standard hand taps.

The "gun" tap shown in Fig. 6 is a three-flute, plug type for threading open holes only. It is the strongest and most productive tap to select when it can be used. The angular cutting edge produces a long curling chip similar to that from a lathe tool. The flutes are not as deep as those of other taps,

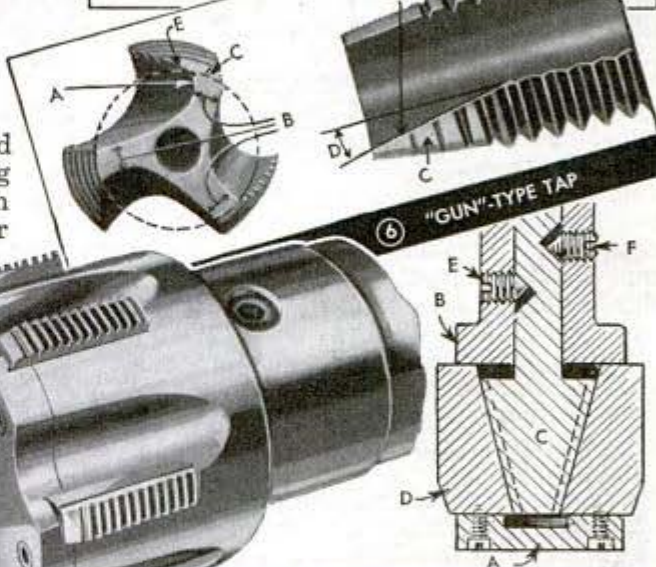

⑦ ADJUSTABLE CHASER TAP

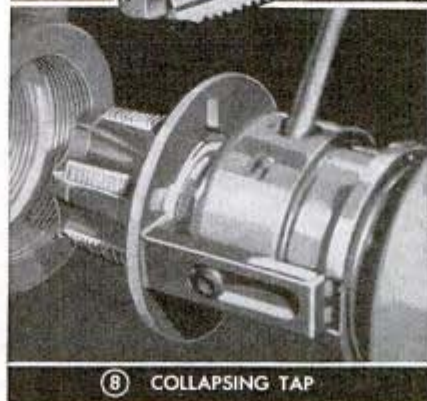

which results in greater strength. The flutes should never have to be ground if due attention is given the point.

Solid taps are seldom over 2¼ in. in diameter. Therefore, adjustable chaser taps such as shown in Fig. 7, or collapsing taps as the one in Fig. 8, are used for larger dimensions. Adjusting chaser taps is very simple.

Screws holding cap A are loosened and the body B, which is bored for steep taper plunger C, expands to contact chasers D by means of adjusting screws E and F. These screws provide ample adjustment due to vees in C and also act as a locking

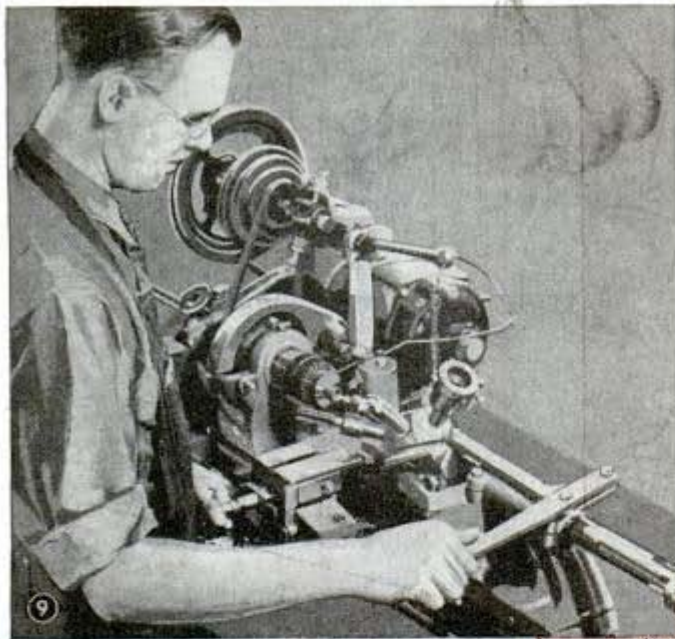

medium. A, when tightened, binds D against shoulder of B. Chasers D are interlocked with plunger C.

Standard machine-screw taps for automatic tapping are similar to standard hand taps except that the chamfer end has an external or male center. These taps are not made in sizes over $\frac{1}{4}$ in. and are listed by numbers as 3, 6, 10, etc., with their respective number of threads per inch. Stub machine-screw taps are much shorter than the standard and are used to tap thin materials. Nut taps have shanks approximately twice as long as the threaded sections and have especially long chamfer angles for angle load distribution and to make them free-cutting.

Screw-thread terms and forms: Although all terms defined in Fig. 10 are important, there are several more worth recognition. There are three classes of taps designated as follows: The "cut" tap is an ordinary one for average work and has threads polished only before hardening. Any distortion in pitch or lead due to defective heat treatment is transferred to threads produced therewith. The "commercial-ground" tap is one with threads ground to make allowance for heat-treating distortion, yet is not guaranteed to produce threads for certain classes of fit requirements. "Precision-ground" taps are finished to three varying degrees of precision to meet all demands of limits and tolerances. There are four classes of fits in connection with screw-thread assembly, Nos. 1, 2, 3 and 4, which indi-

cate, respectively, a loose, medium, free and close fit.

An "allowance" provides for variations in fits between mating threads. Maximum allowance is the difference between a minimum external and a maximum internal part; minimum allowance is the difference between a maximum external and a minimum internal part. An overlap or interference between the dimensions of mating parts is called a "negative" allowance. The term "tolerance" means the amount of variation permitted in the size of a part and is the difference between "limits," or maximum and minimum dimensions of a given part. A tolerance may be expressed also as "plus" or

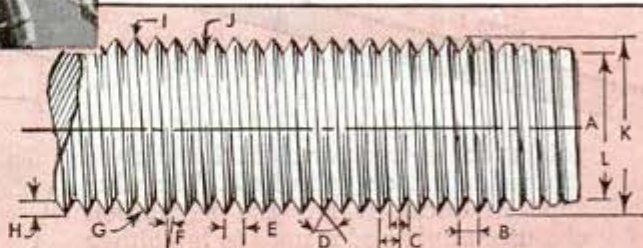

TERM	SYMBOL	DEFINITION
Axis of screw	A	Longitudinal center line.
Pitch	B	Distance from one point on thread to corresponding point on next thread. Pitch equals 1 divided by number of threads per inch.
Pitch diameter	C	Equal distance between width of thread and width of space between thread.
Angle of thread	D	Included angle, between sides of thread, measured in an axial plane.
Lead	E	Distance a screw thread advances axially in one turn. Lead E and pitch B are identical with single thread. (See note.)
Helix angle	F	Angle made by helix of thread at pitch diameter with a plane perpendicular to axis.
Side of thread	G	Surface of thread which connects crest with root.
Depth of thread	H	Distance between top and base of thread, measured normal to the axis.
Crest	I	Top surface joining the two sides of a thread.
Root	J	Bottom surface joining sides of two adjacent threads.
Major diameter	K	Commonly known as outside diameter, largest diameter on screw or nut.
Minor diameter	L	Commonly known as core or root diameter, smallest diameter of screw or nut.

Note: Single thread means a thread in which lead is equal to pitch. In a double thread the lead is equal to twice the pitch, in a triple thread the lead is equal to three times the pitch.

10

SCREW-THREAD TERMS AND THEIR DEFINITIONS

"minus." Fig. 13 shows the four thread forms covering American and European screw thread requirements. Forms A and B are widely used and form D is best where an exceptionally strong thread is required to carry substantial loads such as is the case with screw jacks. The included angle varies with all four forms. Respective formulas make it easy to compute any desired depth of thread and also the flat or radius if the pitch (1.000 in. divided by the number of teeth per inch) is known.

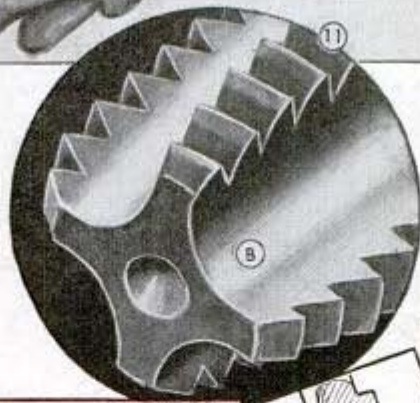
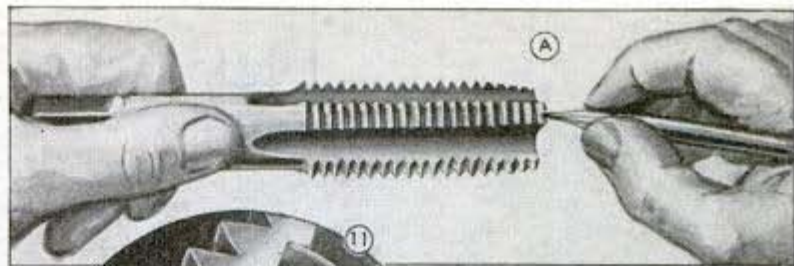

<p>Formula</p> <p>P or pitch equals 1 divided by number of threads per in.</p> <p>D or depth of thread equals P multiplied by .649 in.</p> <p>F or flat equals P divided by 8</p>	<p>(A)</p> <p>NATIONAL FORM OR FRENCH AND INTERNATIONAL STANDARD</p>
<p>Formula</p> <p>P or pitch equals 1 divided by number of threads per in.</p> <p>D or depth of thread equals P multiplied by .640 in.</p> <p>R or radius equals P multiplied by .137 in.</p>	<p>(B)</p> <p>BRITISH STANDARD OR WHITWORTH FORM</p>
<p>Formula</p> <p>P or pitch equals 1 divided by number of threads per in.</p> <p>D or depth of thread equals P multiplied by .600 in.</p> <p>R or radius equals P multiplied by 2 and product divided by 11</p>	<p>(C)</p> <p>BRITISH ASSOCIATION STANDARD</p>
<p>Formula (Approximate)</p> <p>P equals 1 divided by number of threads</p> <p>D equals major diameter of screw minus P</p> <p>F equals .370 divided by no. of threads. Minor diameter of screw equals its major diameter minus twice depth of thread</p>	<p>(D)</p> <p>AMERICAN NATIONAL ACME</p>

Drill-hole and tap sizes, lubrication, etc.: A hole to be tapped must be of correct size, clean and concentric. If the hole is undersize, the tap will break or the first full threads will be stripped when it enters the hole. If the hole is substantially oversize, rough or out of round, the thread cut will be of little value. The National thread form has a 75 percent depth of thread, meaning that the drill hole is 25 percent larger than the minor or root diameter of the tap to be used. It is well to bear in mind that a 75 percent depth of thread requires only one third the tapping power of a 100 percent depth, but has 5 percent less strength.

For maximum economy in tool cost, power and production speed, the depth of thread should be not less than 62 percent or more than 83 percent. The tougher the material and the deeper the hole, the more you must favor the diameter of the hole. Misalignment between the tap and the work results in a poor thread; the thread will be oversize and off as to

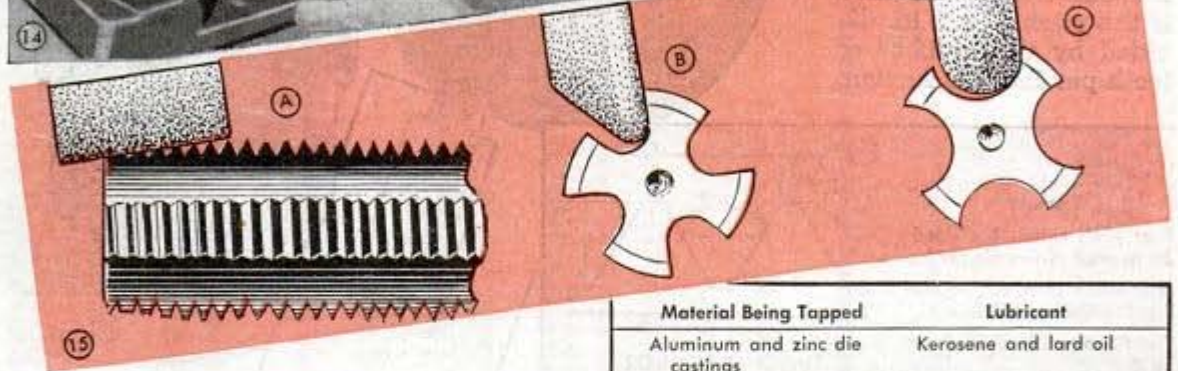
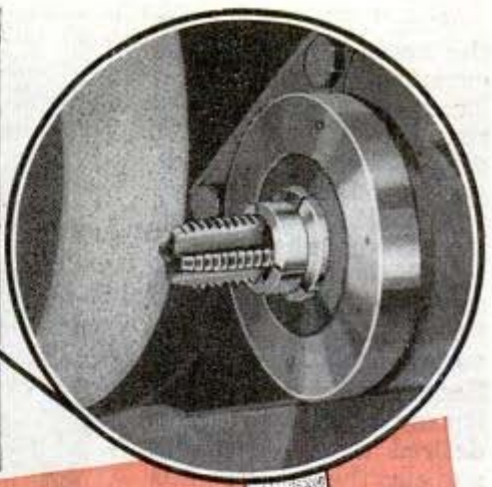
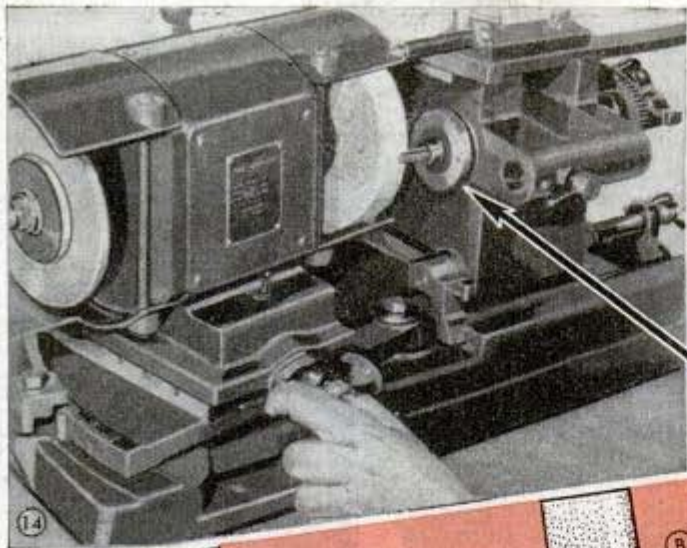

lead and pitch diameter. The correct lubricant and plenty of it is very important with threading due to the delicate cutting edges. Fig. 16 gives general recommendations.

As a tap has a positive lead and feeds itself, the operator cannot control feeding pressure. If a turret is used as in Fig. 9 it must be capable also of free horizontal movement. Tapping in a drill press requires an attachment such as shown in Fig. 12. This attachment does not rotate; the housing or shell is clamped to the drill-press quill so that the spindle itself operates the mechanism of the tapping head. The tap is driven by a friction clutch which automatically regulates tap driving power by pressure applied through the spindle. The clutch slips instantly when the tap strikes the bottom of a blind hole or sticks from loading of chips. This device permits reversing the tap at a higher speed to back it out of a threaded hole. Most manufacturers recommend a safe cutting speed but the safest method is to select a slow speed and increase it, rather than to cut down a high speed after the damage has been done.

Grinding taps: If the chamfers of a tap are kept properly ground (detail A of Fig. 11) it is seldom necessary to grind the flutes as in detail B. Special tap grinders make it possible to keep taps in perfect condition. All taps originally have an eccentric relief on the chamfers and this should be reproduced with each grind if a

Material Being Tapped	Lubricant
Aluminum and zinc die castings	Kerosene and lard-oil
Bakelite and most plastics	Dry
Brass and bronze	Good cutting compound
Duralumin or dural	Kerosene and lard oil
Cast iron	Dry or compound
Malleable iron	Compound or sulphur-base oil
Fiber	Dry
Monel metal	Sulphur-base oil or kerosene and lard oil
Manganese bronze	Light-base oil
Nickel silver	Kerosene and lard-oil
STEELS	
Cast - - - - -	Sulphur-base oil
Chromium - - - - -	" " "
Machinery - - - - -	Kerosene and paraffin
Manganese - - - - -	Sulphur-base oil
Molybdenum - - - - -	" " "
Nickel - - - - -	" " "
Stainless - - - - -	" " "
Tool - - - - -	Kerosene and lard oil
Tungsten - - - - -	Sulphur-base oil
Vanadium - - - - -	" " "

tap is to perform properly. Fig. 14 shows how a tap to be ground on chamfers is held in a split collet fitted to the work head of the tap grinder. This equipment has adjustments for left- or right-hand taps, any number of flutes, extent of angle and amount of relief. Such a grinder is also useful for producing a similar relief on countersinks, lead of reamers, step drills and three or four-fluted drills, etc.

When a dull tap needs regrinding, start at the chamfered end as in detail A of Fig. 15, using an aluminum vitrified wheel, 80-J. Grind it exactly the same angle, covering the same number of threads as is the case with an identical new tap. Grind just enough to remove the dulled edges of the threads, being sure that the point diameter is the same as the root diameter of the thread. All cutting lands must be the same height and must be equidistant. The flutes are ground only if the edges of the unchamfered teeth are dulled and nicked. A saucer-shaped grinding wheel is used if the cutting face of the flute is straight as in detail B of Fig. 15, but a formed wheel is needed if the cutting face is hooked as in detail C. An aluminum vitrified wheel, 60-R, is recommended for grinding flutes of small taps while a 46-L wheel of the same kind is best for large taps. Broken teeth of a tap should be removed by grinding as they cause damaged threads when tapping.

In grinding gun-type taps, first have a new tap of the same size at hand to help in keeping the ground tap to the same form in regard to the angle of flutes and the cutting edges. The grinding wheel is formed to exact fit for flute to keep the identical hook shape—detail E of Fig. 6. After the ends of the lands B have become thin from repeated regrinding, grind the end of the tap straight back until the lands again are of normal thickness, after which the cutting edges and flutes are ground, and the hook is reformed, keeping a straight cutting edge. When chamfer C is reground, the relief is ground carefully, leaving cutting edge A gradually receding toward the heel. See the end view of the tap in Fig. 6. Also keep the angle D for shearing.

Adjustable Safety Ground Chain For Use on Tank Trucks

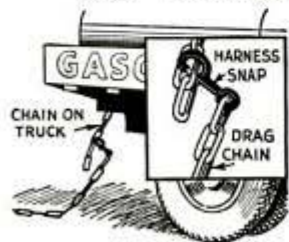

Because of the frequency with which drag chains on gasoline tank trucks have to be changed due to rapid wear, they sometimes are neglected and wear so short that they do not make good contact with the ground. To make changing the chain an easy job, one truck driver uses two lengths of chain, one being fastened to the truck to reach almost to the ground and the other being fitted with a harness snap at one end. With this arrangement, the chain is lengthened merely by dropping the snap one link on the chain.

—James H. Gosch, Scotia, N. Y.

Bar Clamps Used to Force Pulley Jammed on Shaft

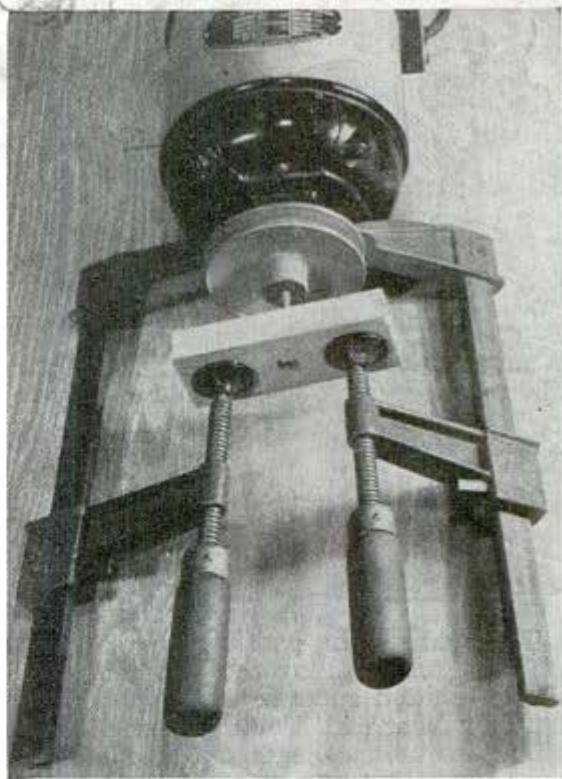

Pulleys can be removed easily, when jammed on a motor shaft, by using a pair of bar clamps as shown. With the stationary jaws placed behind the pulley, a bolt driven through a block of wood and secured with a lock nut is set against the shaft and the screws turned with equal pressure.

Water Expands Shrunken Gasket

When installing a new cork gasket on a valve cover or oil pan and the gasket has shrunk, making an oil leak likely, first place it in warm water for a few minutes. This will expand it to about normal size and assure a good fit.—C. Swope, Danville, Pa.

Several Pieces of Round Stock Faced in One Operation

Next time you want to face several short pieces of round stock, use a split bushing as shown and you can do it in one operation. When clamped in a universal chuck on a lathe, the bushing will grip the pieces firmly, even if the lengths vary.



Shield Protects Finish of a Car When Filling Fuel Tank



To avoid getting gasoline on the finish of a car when filling the fuel tank, one service-station operator uses a shield cut from a rubber mat. For cars that have the tank filler tube projecting, a hole is cut in the shield near one end to slip over the tube. For cars that have small doors covering the tube, the opening is made large enough to slip over the door when it is raised. The operator soon found that he was more than repaid in customer satisfaction for the few seconds required to attach and remove the shield.

Lacquer Protects Index Tabs



Index tabs on reference books often are soiled quickly because of frequent use, and may in time become so worn that they are totally illegible. Clear lacquer applied with a small brush on each tab will form a thin protecting film that not only will withstand wear, but can be washed repeatedly as the tabs become soiled.

Honey Boxes Secured in Beehives With Horse-Collar Pad Clips

If you have no regular springs at hand for fastening honey boxes in a beehive super, spring clips taken from an old horse-collar pad will serve the purpose. The springs are inserted at one side of the super

to press the boxes and separators together to prevent the bees from propolizing them—working wax down between them so they are difficult to separate.

—Herbert Nevesin, Rock Creek, Ohio.

Ball-End Tool Straightens Fins In Car Radiators

Straightening fins in a radiator is a simple job if you use a tool like the one shown. It consists of a $\frac{3}{8}$ -in. steel ball ground flat on one side and soldered to a length of rod, which serves as a handle.

In some cases, it may be possible to make a tool by grinding the head of a carriage bolt to suitable shape. In use, merely dip the head of the tool in oil or light grease and run it horizontally between the fins. If the fins are bent badly, it may be necessary to make several passes with the tool between the same fins to straighten them.

—H. W. Swope, Danville, Pa.

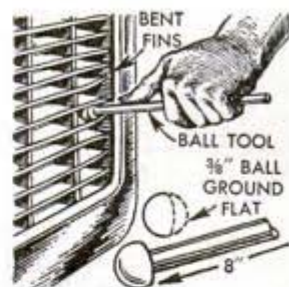

Carton Held Open for Packing By Sheet-Metal Clips

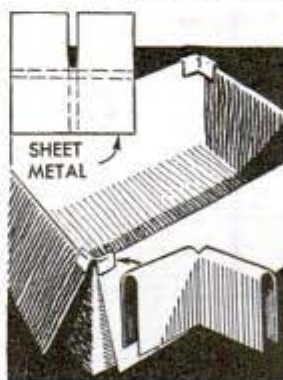

completed clip, which is shown in the lower detail, slips over the corners of the carton as indicated.

Packers and others who fill cardboard cartons will find these clips ideal for holding the carton flaps out of the way. The clips are made from light sheet metal which is slotted and bent as indicated by dotted lines in the upper detail. The

Moisture Drained From Muffler To Prevent Corrosion

Car mufflers sometimes corrode from moisture collecting as the result of incomplete combustion when the motor does not run long enough to heat sufficiently on short drives. Corrosion can be prevented by drilling a $\frac{1}{8}$ -in. hole in the bottom of the muffler to drain off the accumulating moisture.

—H. F. Rogers, North Branch, Minn.

Cordwood Held Steady on Horse By Weighted Chain



The difficulty of keeping a log steady in the sawhorse while cutting it into stove wood is eliminated by attaching one end of a chain or rope to the horse and placing a weight on the other end. After the log is placed on the horse, the weighted end is thrown over it, keeping it firmly in place.

—F. P. Schofield, Ardsley, Pa.

Number of Revolutions Counted On Lathe Thread Indicator

Having several bobbins to wind a certain number of turns, I geared the lathe for 40 threads. Then as the thread indicator passed the fifth point there were 100 turns on the bobbin. In this way any required number of turns can be figured.

—E. M. Fellows, Morrison, Ill.

Viscosity of Oil Can Be Identified With Notches on Can

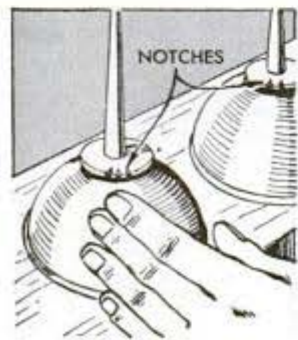

One mechanic whose work required the use of oils of various viscosities cut notches in the lower part of the oil can spouts to identify the oil. This was better than painting the cans different colors, which could not be seen when the cans became dirty. Furthermore, the notches permitted identification even when the light was poor.

Each notch indicates a viscosity of 10. A can containing oil of 10 viscosity had one notch, oil of 20 viscosity two notches and so on.—Ken Murray, Baltimore, Md.

Auger-Bit Guides Are Helpful In Reboring Holes

To enlarge a number of holes by reboring them, I used a guide like the one shown for the auger bit. The guide is made of brass or steel to a sliding fit inside the original hole and has a lead center to receive the screw point of the bit without damaging it. If you have many reboring jobs to do make up several guides in various sizes and keep them on hand.

—Louis R. Filas, Buffalo, N. Y.

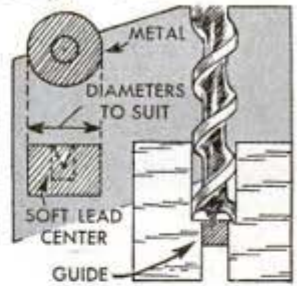

Lumber Crayon Is Strengthened By Gummed-Paper Wrapping

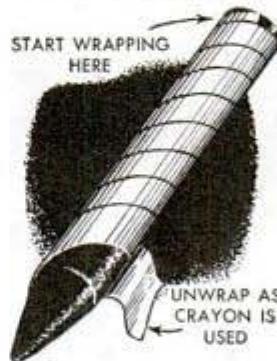

A lumber crayon is protected from breaking and chipping, and is less apt to soil the hands when given a spiral wrapping of heavy gummed paper. This may be unwrapped as necessary and torn off at the desired point.

Rubber Shield Protects Threads Of Wash-Rack Hose

Threads on the hose used at a car-washing rack often are damaged by dropping the hose on the floor, or by letting it lie without a nozzle. To prevent this trouble, one mechanic formed a cone-shaped shield from inner-tube rubber and attached it to the hose as shown to protect the threads.





Speaker Replacements

By Robert Oelrich

OBTAINING certain types of new speakers for midget and small table model receivers is proving to be quite a problem for the average radio service man. To speed up the repair of a large number of these sets, the service man can make practical substitutions with speakers of the same size but of different field impedance, and use the original output transformer.

A permanent-magnet (P.M.) speaker can be used to replace practically all 2,500- to 3,000-ohm field speakers found in a.c.-d.c. sets. These speakers are usually connected from B positive to ground; the field serves only to energize the pole piece of the speaker and does not have a choke effect; therefore, it may be removed from the circuit completely as shown in Fig. 1. P.M. speakers may also be used where a 450-ohm field was connected across the filter. Here an a.c.-d.c. choke of from 300 to 500 ohms may be used to replace the old speaker field.

Where the field resistance is higher, for example 1,000 to 1,800 ohms, the same choke may be used and a 10-watt resistor added to make up the necessary resistance, as in Fig. 2.

A P.M. speaker may be replaced with a dynamic type in practically all cases. Disconnect the filter choke and check its resistance value; then replace this choke with a field of similar value on the new speaker.

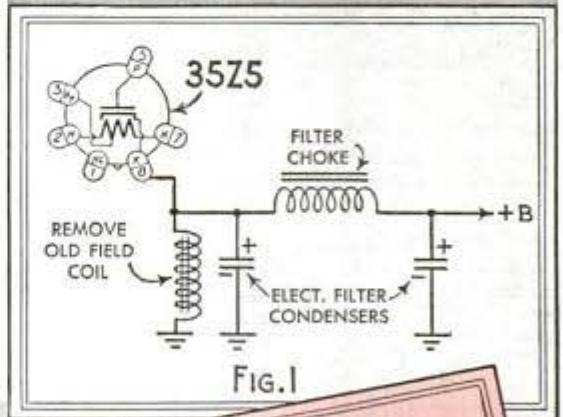

FIG. 1

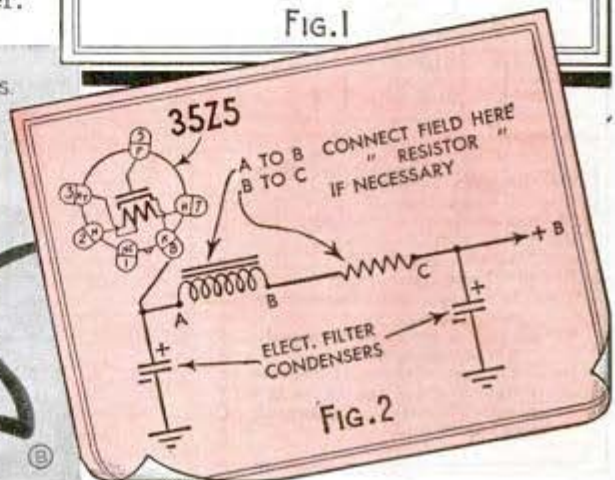
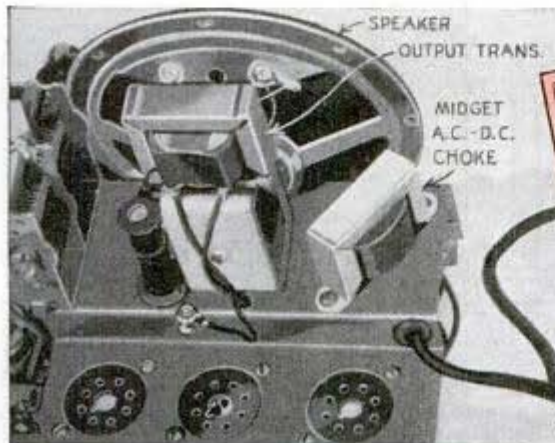

FIG. 2

"SEVEN SEAS" A.C.-D.C. SHORT-WAVE



TUNING in the cream of short-wave signals from approximately 23 to 45 meters including the popular 25 and 31 meter bands, without plug-in coils, this simple three-tube is sensitive enough to receive stations many thousands of miles away. Although made from used radio parts and a few "dime" store stock items, it is an excellent performer.

The tuning coil is wound on a bright colored plastic drinking cup $3\frac{3}{4}$ in. high and $2\frac{3}{4}$ in. wide across the top. This coil is tuned by the 2-gang condenser (C_2) with both 350 mmfd. sections in series to provide about the same low capacity as a hard-to-get midget single section variable ordinarily specified for short waves.

Designed to operate right off the 110-volt a.c. or d.c. house lighting line, a 40-watt Mazda bulb is employed to reduce the line voltage for the tubes. The bulb can be in a lamp on an extension cord, as shown in photo A, or it may be plugged directly into the baseboard receptacle as illustrated in photo D. The set consumes less than 8 watts, the remaining power going to the bulb which also serves for lighting purposes. Three type 6C5-GT (6C5 or 6C5-G) tubes are employed, or any combination of the three types. A breadboard having a bright red edge was selected to match the red plastic cup and the pointer knobs.

A schematic circuit diagram appears in Fig. 1 and the simplified wiring diagram in Fig. 2; photos B, C and E show various views of the completed set. The 2-gang condensers are mounted on the baseboard

by means of 6-32 machine screws on the underside. Cotton-covered wire is used for coils L_1 and L_2 ; wind each coil tightly and coat the turns with fingernail polish, the only household "coil dope" that seems to stick to plastic. The plastic cup may be slightly larger or

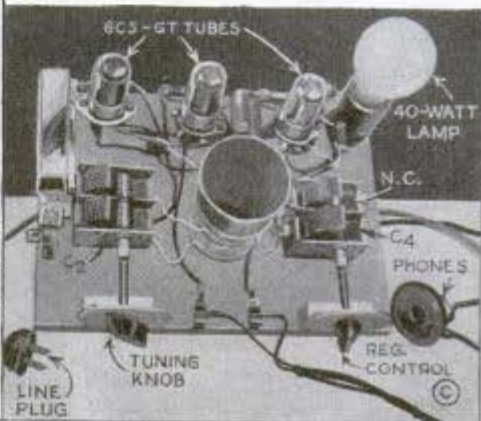
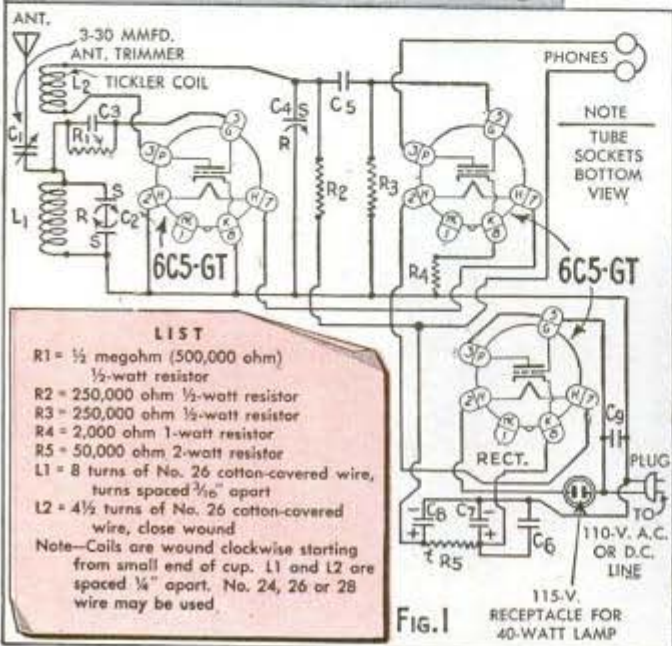
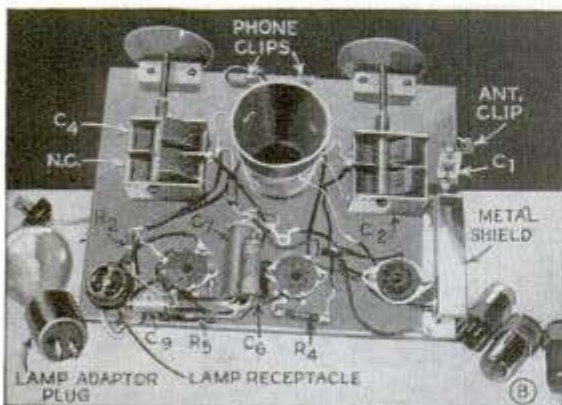

THREE TUBER

smaller than the one shown without affecting the performance of the set. A 50- or 75-ft. high and well insulated antenna should be used. The distance range will depend upon the antenna and your skill at tuning.

To tune the receiver, first adjust C_4 until the set oscillates throughout the entire tuning range of variable condenser C_2 . Then adjust condenser C_1 until "dead spots" begin to appear in the tuning range; now back off C_1 until there are no dead points, then you are ready to tune in short-wave stations. Hum is kept quite low on a.c. by means of the unmarked fixed coupling condenser C_5 . A .00025 mfd. 200 volt paper type is used here for minimum hum; however, when operating the set on d.c. line C_5 can be a .001 mfd. or larger in order to increase audio output. On a.c. try reversing the wall plug for lowest hum.

A detailed student material list, R-330, is available from Popular Mechanics radio department upon receipt of postage.

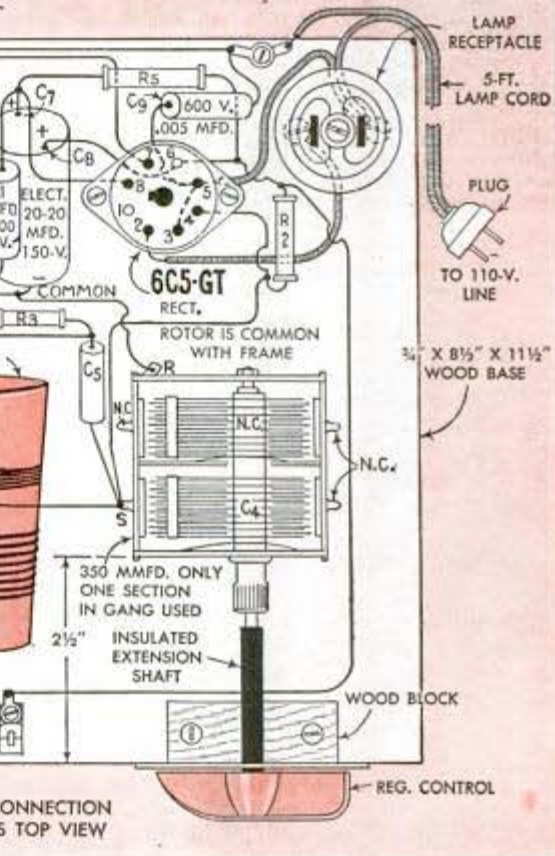

Give Your Panels That "Professional" Look

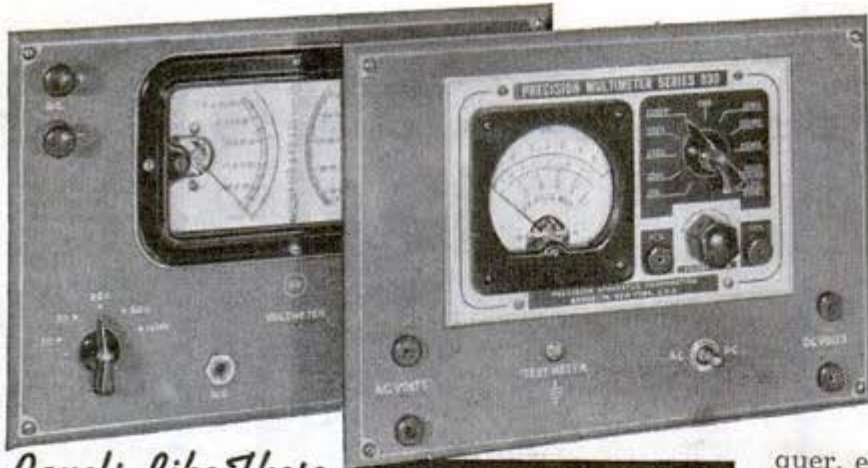

Panels Like These

can be made by any radio student, experimenter or service man who cares to spend a few dollars for lettering scales. The same method may be employed for making small receiver panels

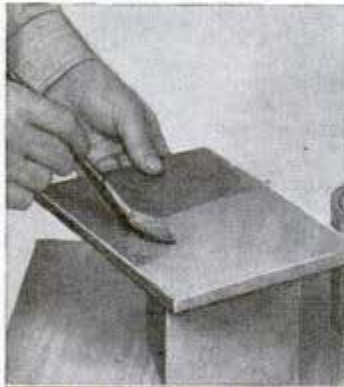

2 - PAINT WITH WRINKLE LACQUER

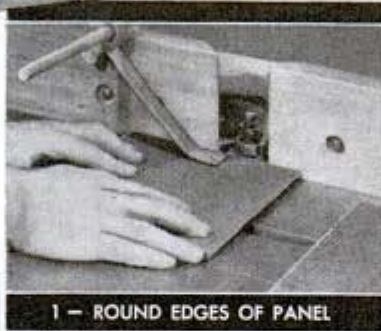

1 - ROUND EDGES OF PANEL

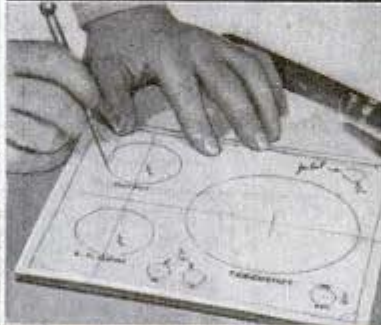

3 - TRANSFER PLAN FROM PAPER

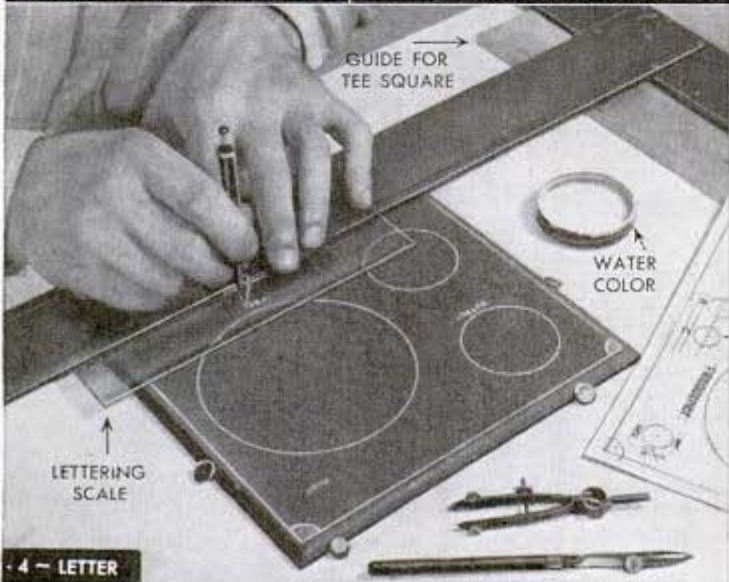

4 - LETTER

NEAT control panels for meters and electronic testing equipment can be made from $\frac{5}{16}$ -in. composition board of the hard variety. Cut the panel to size and then round the edges on a shaper as shown, or use a file and sandpaper. Second, apply one fairly wet coat of mild wrinkle lacquer, either dark gray, green or black, then place the panel in an oven and bake about 20 minutes at 125 degrees. Remove and air dry for about 6 hours.

The next step, No. 3, is to make a paper pattern of the panel and use this to transfer the necessary guide marks to the painted surface. Now the panel is ready for the final and important job of marking and lettering. Use ordinary water or poster color diluted slightly with carbon tetrachloride. Run all straight lines with a ruling pen, and circles with an inking compass. If you have much lettering to do, it is a good idea to invest about \$4.00 in a celluloid lettering scale and a special pen that will enable anyone to do good work, as illustrated in photo 4.

Use white or bright yellow water color as before, mixing the color as heavy as the pen will flow to prevent running. Dry thoroughly and then carefully spray the entire panel with a light coat of clear lacquer. If you do not have facilities for spraying, brush the water color areas with banana liquid or sizing (not banana oil) to protect the lettering and lines. It will be invisible when dry, and can be applied to the entire surface, depending upon the material. Finish by drilling and cutting the necessary holes for the meter, binding posts, jacks, switches, variable resistors and similar controls.



Tough

BUT OH SO GENTLE

● Worn-out piston rings cause needless wear *inside* your engine, where you can't see the damage. And if they're not promptly replaced, the wear grows worse and worse—until, finally, your engine may quit you for keeps.

But, fortunately, piston rings warn you when wear becomes critical. Your engine smokes, wastes oil and loses its power.

At the first sign of ring wear, it will pay you to have your motor specialist install a set of Hastings Steel-Vent piston rings. They *stop* oil-pumping, *check* cylinder wear and *restore* engine performance.

HASTINGS MANUFACTURING CO. • HASTINGS, MICH.

Hastings Mfg. of Canada, Ltd., Toronto

HASTINGS STEEL-VENT PISTON RINGS



TOUGH ON OIL-PUMPING GENTLE ON CYLINDER WALLS

★
IT'S A PRIVILEGE
TO BUY WAR BONDS



DISTINGUISHED SERVICE

Everywhere they have performed distinguished service — powered the craft of valiant flyers as they won coveted decorations. ★ They've blasted Germans and Japs, and have served the Russians and British. ★ They've been America's own liquid-cooled aircraft engines since long before Pearl Harbor. ★ Because these engines are streamlined, pilots have better visibility. Because of their dependability, they are always ready to go. Because of their smoothness, there is less pilot fatigue. Because of their economy with fuel, their range is wide. ★ These are engine qualities that will be important to you in the days of far-flung air transport to come.

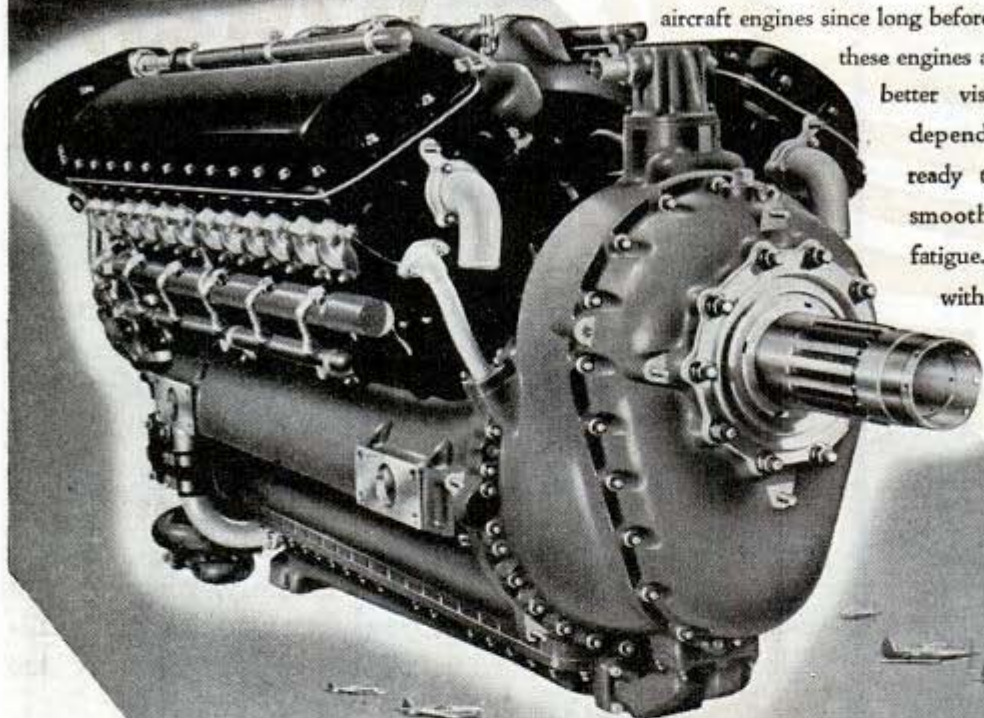

POWERED BY ALLISON

P-38—Lightning
P-39—Airacobra
P-40—Warhawk
A-36 and P-51—Mustang
P-63—Kingcobra

Allison has already furnished more than 75,000,000 H. P. for use in these planes.

LIQUID-COOLED AIRCRAFT ENGINES

Allison

DIVISION OF

Indianapolis, Indiana



**KEEP AMERICA STRONG
BUY MORE WAR BONDS**

Every Sunday Afternoon —

GENERAL MOTORS SYMPHONY OF THE AIR—NBC Network

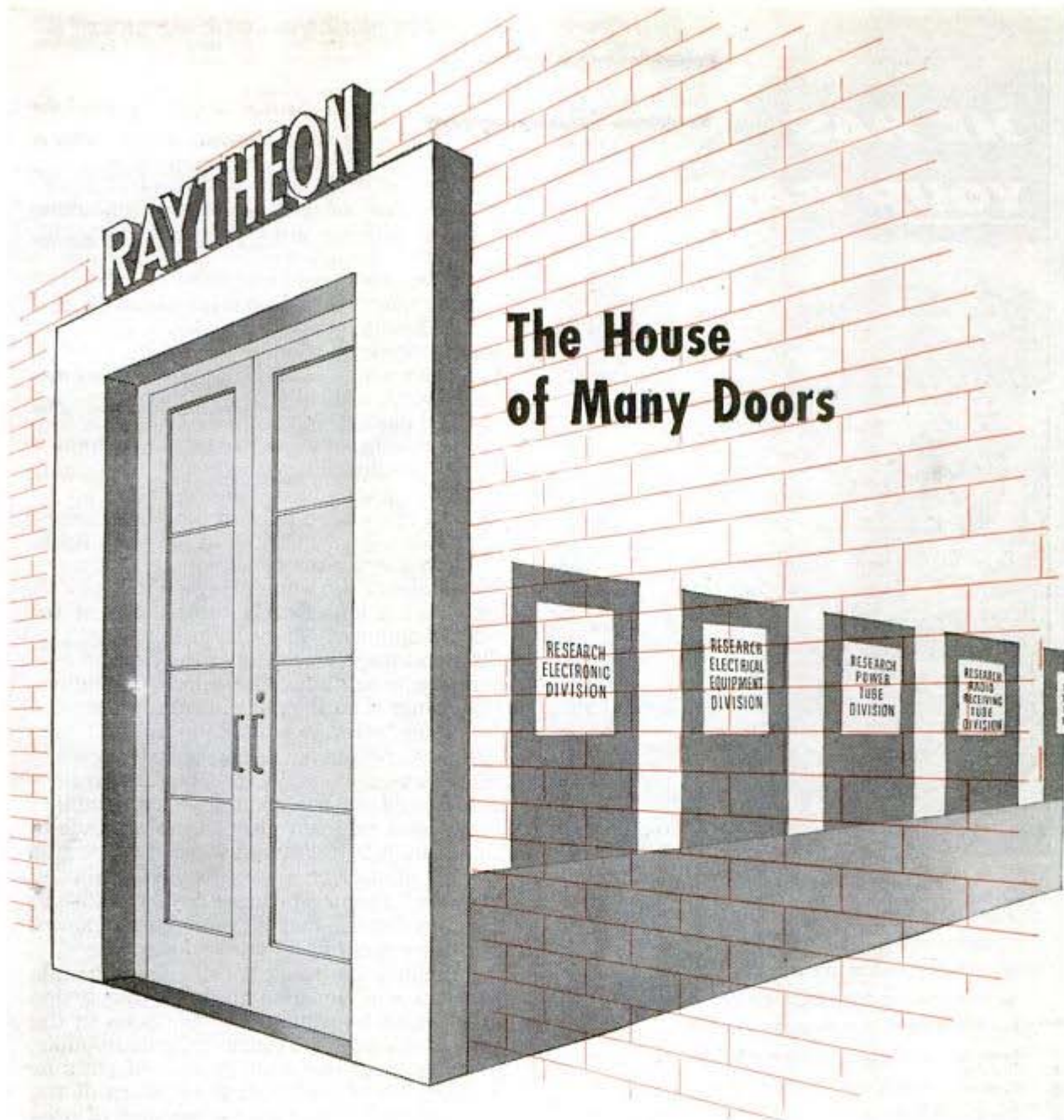

RAYTHEON is truly a house of many doors . . . doors that lead to many research, engineering, and production groups which have made great contributions to the quality and quantity of electronic equipment and receiving and transmitting tubes now helping the armed forces.

Today, behind these closed doors over 16,000 men and women are devoted to war work. Tomorrow, these doors will be wide open and through them will come new developments in all phases of electronics.

Time in the Raytheon radio program: "MEET YOUR NAVY," every Saturday night on the Blue Network. Consult your local newspaper for time and station.

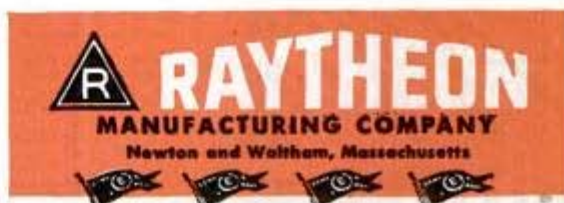

Devoted to research and manufacture of complete electronic equipment; receiving, transmitting and hearing aid tubes; transformers; and voltage stabilizers.

**HE HAS
YOUR BATTERY**



Jap pill-boxes and gun emplacements are "knocked out" fast when deadly bazookas go into action! It takes a trained two-man team and battery-power to keep these portable weapons firing. Batteries that once were made for homes and farms are now sent to serve our fighting men. Use your available Burgess Batteries sparingly... keep them cool and dry. For Free Battery Hints—Write Dept. E-5, Burgess Battery Co., Freeport, Ill.

Write to Your Serviceman Today!



**BURGESS
BATTERIES**

IN THE NATION'S SERVICE



Sharper Eyes for Stargazers

(Continued from page 85)

Red sensitive plates are important in astronomy because the space between the stars is not really empty. The emptiest cubic yard of inter-stellar space contains millions of hydrogen atoms and electrons and dozens of sodium atoms. Looking through billions and billions of such cubic yards the obscuring effect of the gas within them begins to add up.

With new fast red sensitive plates astronomers have recently been able to penetrate to the nucleus of stars around which all the stars we see and billions more are revolving. A radically new technique in infra-red photography will eventually attack the mysteries of the sun's infra-red light.

Within the last decade ordinary blue sensitive plates have been speeded up by getting more blue light to the plate and by increasing the sensitivity of the plate itself.

Take the first method of getting more blue light to the plate. Huge telescopes do not have a lens in the outer end as most people suppose. They have a 100-inch or 200-inch mirror resting at the bottom of a massive mounting. The mirror is slightly dish-shaped so that light striking the surface is reflected to a common point.

Formerly the surfaces of astronomical mirrors were coated with silver. Now they are coated with a thin layer of metallic aluminum which reflects blue and violet light much better than silver.

The plates have been speeded up by "baking" them for three days at 122° F. This produces a considerable gain in speed for exposures of an hour or longer.

Probably the most spectacular example of what can be done through purely instrumental improvements has been in the photography of the extra-galactic nebulae, lying beyond our own system of stars or galaxy. To photograph the spectra of the most distant would take exposures of prohibitive length. Astronomers either had to wait until the 200-inch was finished—or get a faster lens in their spectrograph.

By a "fast" lens is meant one with a big aperture compared to its focal length, or a small *f* value as photographers express it. Such a lens was finally designed by Dr. W. B. Rayton of the Bausch and Lomb Optical Company that gave excellent definition with a focal ratio of *f*:0.6. With this lens, exposure times on the spectra of the extra-galactic nebulae were cut by half.

One of the most remarkable features about the extra-galactic nebulae is that they all seem to be flying away from us, as

(Continued to page 150)



Here's why you get the most happiness from your homecraft hobby

..by enjoying the accuracy, dependability and safety of

Delta Homecraft Power Tools

Quality counts, in giving you the satisfaction you expect from the power tools you buy

There are lots of reasons why you have more homecraft happiness, when you're a Delta Homecraft Power Tool owner:

The Delta Power Tools you work with are *accurate*. And accuracy means you turn out parts that fit together according to plan, to form good-looking work you're proud of!

They're *dependable*, too. And dependability means the long, trouble-free, economical performance you have every right to expect!

They're *safe*. And safety means you feel free in letting other members of your family join in the fun!

They're Quality Tools!

Delta Homecraft Power Tools give you this all-around satisfaction, because of "hidden" values in construction — called *quality*.

You can't always see *quality* with your eyes, yet *quality* determines whether or not you get your

money's worth!

Quality is an important reason why Delta has become the world's largest manufacturer of power tools for home use.

"Good enough" construction isn't good enough for Delta Homecraft Power Tools—it's got to be the best for the price!

Industrial-type Construction!

Examples of the quality advantages you get in various Delta Homecraft Power Tools are:

- (1) *Double-sealed ball bearings* you don't have to worry about oiling, because they are *lubricated for life*;
- (2) *Precision-bored bearing seats* that assure accurate alignment of parts;

New Free Delta Book!

"Happiness Is In Your Hands" shows you how to get started in homecraft. Beautifully illustrated in full colors. Contains a reprint of a Reader's Digest article telling how manual hobbies aid mental health. For your free copy, fill in the coupon and mail today!



- (3) *Bearings that are preloaded* — an extra manufacturing operation that insures longer bearing life;
- (4) *Precision-ground shafts*, to assure true, accurate performance;
- (5) *Dynamically-balanced pulleys*, to cut down annoying vibration of your power tools.

Compare Before You Buy!

The care you take now *before* you buy power tools — to make sure you get real quality for your money — can mean a lot to your homecraft happiness *after*.

Right now, War Bonds are the soundest investment for you. When peace comes, reinvest your accumulated savings wisely in Delta Homecraft Power Tools—for a full measure of the fun and healthful recreation that homecraft offers you.

Tear out and mail today!

THE DELTA MANUFACTURING CO. HM-21
680A E. Vienna Avenue, Milwaukee 1, Wisconsin.

Please send me my free copy of "Happiness Is In Your Hands" picturing the ideal creative hobby and showing how to get started in it.

Name.....

Address.....

City..... (.....) State.....

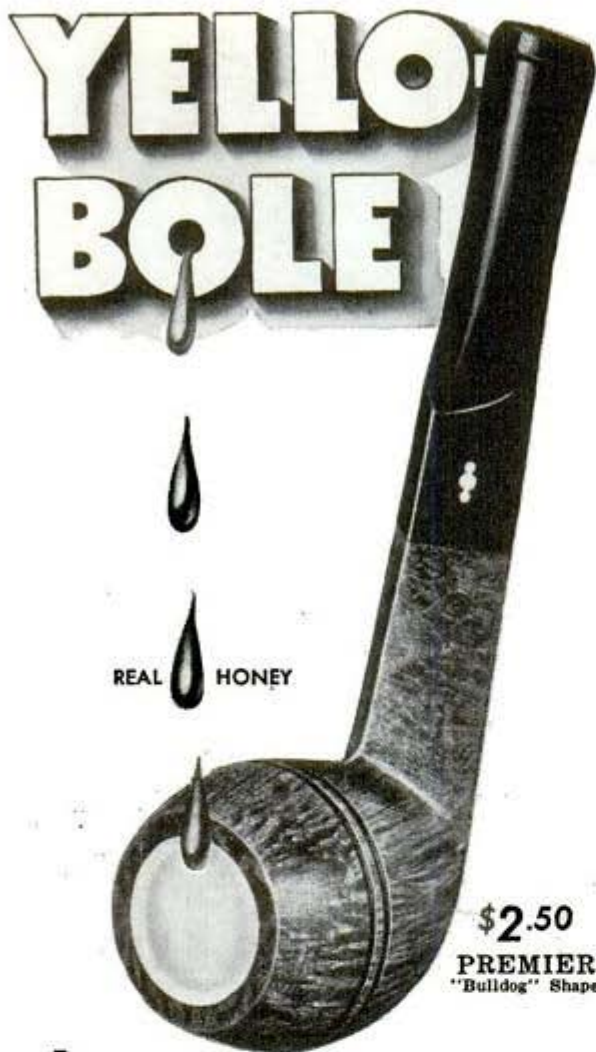

the honey-cured smoke

Real Honey, in the bowl, cures the smoke of any trace of harshness (no "breaking-in"!) and gives a fragrant character wholly different from other pipes. This has endeared these Yello-Bole Pipes for 11 years to thousands of pipe smokers. It's always mild and agreeable. The pipe-bowl itself is Nature's best burl Briar, not ordinary lumber covered with artificial painting. If you don't find Yello-Bole at your dealer's, it's because our boys on every fighting front need them, and are getting them, first. Your dealer will have your pipe soon.

YELLO-BOLE PREMIER \$2.50
YELLO-BOLE IMPERIAL \$1.50
YELLO-BOLE STANDARD \$1

YELLO-BOLE A NAME TO REMEMBER, WHEREVER YOU ARE—
 AND WHEN YOU COME HOME

if the earth were at the center of a balloon which was blowing up all around us. Nebulae close to the earth are receding at the rate of 500 miles a second. The question astronomers wanted answered was: What are the most distant nebulae doing?

With the Rayton lens the answer was soon forthcoming. Spectra of the most distant nebulae showed that they too are receding like the nearer ones, only much faster—at the rate of 12,000 miles a second, which is 43,200,000 miles per hour.

Seven Trillion Dollar Treasure

(Continued from page 53)

industry is studying various proposals for solutions of the freight problem. Pulverized coal can be carried by pipe line for distances up to a mile or so, suspended in air or liquid. Another proposal is to burn the coal right in the mine and pipe its energy away in the form of gas. Russia has six such installations in which air is pumped down one shaft and coal gas is forced to the surface by another.

In efficient utilization of coal we have a long way to go. Probably the highest efficiency in use of coal's energy is 40 percent, but since it is such a cheap source of energy the problem has never been critical. However, engineering advances in the last generation enable a locomotive to haul the same load as a World War I locomotive with 40 percent less coal; an electric utility company to generate 1 kilowatt with 1.34 pounds of coal against 3.39 pounds of coal in 1920; and a steel company to produce a ton of pig iron with 20 percent less coking coal than 25 years ago. Still, the overall efficiency of coal utilization is only about 20 percent.

It is in the field of chemistry that the most amazing strides have been taken. The coal chemicals got their start by accident. Like Columbus, who sought the Indies and

(Continued to page 152)

Model Builders Attention!

	V	V-2	V-3
Hex	1/2"	3/8"	5/16"
Thread	3/8"-24	1/4"-32	1/4"-32
Thread Length	7/32	7/32	5/32
Weight, Grams	8	3 1/2	2 1/2

Actual Size V-Plug

Champion spark plugs for model gas engines give the same dependable performance as regular Champions. Silliment sealed. Sillimanite insulator. Alloy needlepoint electrodes for easy starting. One piece construction.

CHAMPION

SPARK PLUG COMPANY • TOLEDO 1, OHIO



**WHERE MAINTENANCE OF SCHEDULES
REALLY COUNTS . . .**

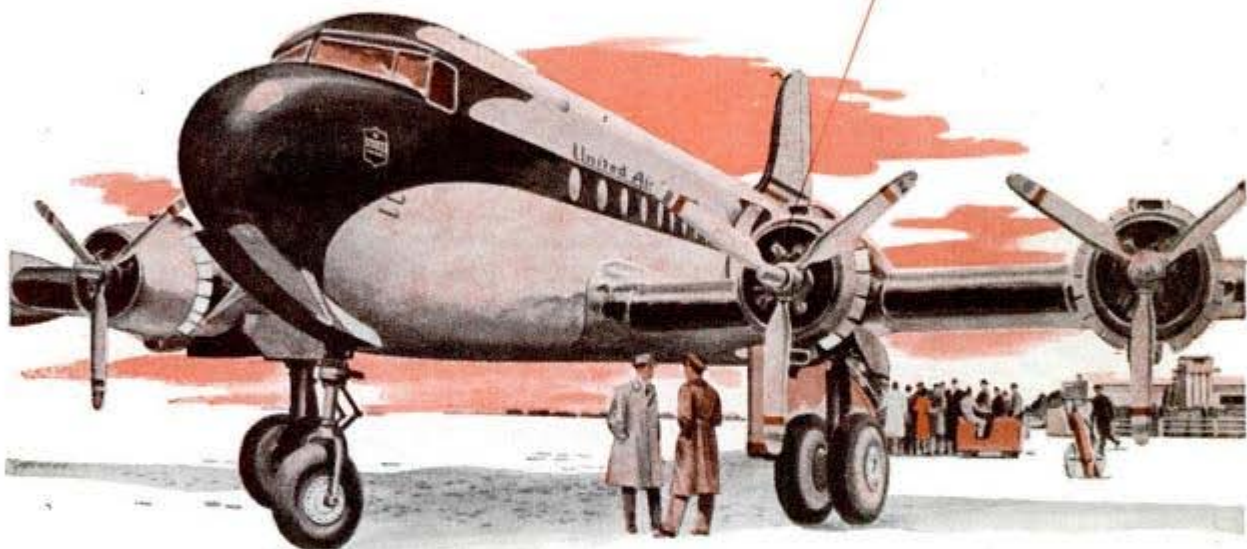

.. CHAMPION SPARK PLUGS

INSURE MAXIMUM DEPENDABILITY

Looking ahead to the days of peace, United Air Lines recently announced placement of orders for 50 four-engined Douglas luxury liners for immediate postwar use. Meantime United has set exceptional performance records in the service of the nation, both military and civilian, by operating almost 100,000 schedule miles daily with less than two-thirds the number of planes used to fly 81,000 schedule miles

in 1941. Champion Spark Plugs now used exclusively by United on its Mainliners and Cargoliners have contributed substantially to this outstanding service record. Thus once again Champion Spark Plugs demonstrate in an exceptional way the inherently high caliber of their dependability—dependability that has established Champions as the preferred spark plug for all types of service on land, water and in the air.

Buy More and More War Bonds



Until the Day of Victory

CHAMPION SPARK PLUG COMPANY, TOLEDO 1, OHIO



**TO SAVE
GASOLINE
—KEEP SPARK
PLUGS CLEAN**

A New Blade Makes a New Knife

X-ACTO... KNIFE OF A THOUSAND USES

X-ACTO knives are always sharp... for at the first sign of dullness, you instantly re-blade to re-sharpen! That is why, in

all arts and crafts, whenever it is important to have a knife with a keen, precision cutting edge, X-ACTO'S prove best by test. They are always factory-fresh... always sharp!

The new deluxe all-metal Knife Chest will give you an ease and skill in cutting you've never known before.

Get this new X-ACTO Knife Chest today. Discover the joy of working with knives that have better, sharper, surgically keen blades... with knives of a thousand uses, X-ACTO!

New! No. 83 X-ACTO deluxe all metal knife chest. The finest in knife sets complete with 3 solid aluminum handles and 12 interchangeable blades, in handy wooden chest. Price \$5.00 complete. Other knives and sets from 50c to \$2.50.

RE-BLADE TO
RE-SHARPEN

Write for 32
page Handbook
"How to Build Solid
Scale Model Warplanes"
—10 cents



On sale at Hobby and Model Dealers, Hardware and Dept.
Stores or order direct from
X-ACTO CRESCENT PRODUCTS CO.
440 Fourth Ave., New York 16, N. Y.

X-ACTO
EVERKEEN
knife



found America, an 18 year old English student, William Henry Perkin, 88 years ago sought a coal-tar substitute for quinine and found instead the aniline dyes. He never found the quinine substitute, but American chemists did, three generations later. It is atabrine, the G.I. malaria preventive obtained from coal via toluene. Only recently two Harvard chemists accomplished the synthesis of quinine itself.

Perkin missed atabrine and synthetic quinine, but he started something bigger. His aniline dye was the first of the 10,000 colors derived today from coal tar, the value of which is manifest in the single instance that indigo from India once cost \$4 a pound; the identical dye from coal costs four cents. And Perkin had started a whole family of chemicals.

Bake a ton of coal and you get about 1,520 pounds of coke and coke breeze (for briquets, etc.); 11,000 cubic feet of gas; 10 gallons of coal tar; 3.5 gallons of light oil and 28.4 pounds of chemicals. Most of the coke goes to iron and steel makers, some into home furnaces, chemicals, Carborundum and artificial graphite, fertilizers, acetylene and explosives. The brown smoke that goes up the chimney is condensed, and what does not emerge as fuel or illuminating gas is processed into cyanides, antiknock elements for motor fuel, benzene, toluene and other chemicals. Liquors precipitated from the gas become ammonia refrigerants and fertilizers.

But it is in the coal tar branch that the chemists have achieved the most fruitful results. In the field of medicine they have given us synthetic quinine and atabrine; the sulfa drugs; nicotinic acid, one of the B complex vitamins; vitamin K (for blood clotting); procaine, the anesthetic; phenobarbital and allied sleep-producers; aspirin, arsenicals, cathartics, hormones, food preservatives and such antiseptics as hexylresorcinol, phenol and creolin.

The prolific plastics family is an offshoot of the coal tar clan. Eighty-five percent of the war plastics formed into transparent blisters and noses of bombers, into shell cases and telephones, radio equipment and instrument panels, waterproof packaging, gas masks, pontoons and life rafts and lacquers, had bituminous coal as their base. From benzol come such strange relatives as explosives, phonograph records and perfumes; from xylol, inks and soaps, paints, antiseptics and depth bombs. Into every pound of neoprene synthetic rubber goes 1.1 pound of coal. Nylon, the stuff of parachutes and glider tow-ropes and, if you remember, hosiery, is descended from coal,

(Continued to page 154)



F.O.B. *Air Terminal*

Today, as an international market for our machine output looms ahead, the familiar, qualifying "F.O.B." on price lists no longer means delivery only to a freight siding or pier, but to the airport as well. Smart merchandisers will not only design and package their products for air shipment, but quote "F.O.B. Air Terminal." The establishment of an airport-to-airport rate, with allowances for pick-up and delivery, would enable large volume shippers to offer

a worth while saving and a service to their customers.

Another economy, of particular interest to the operator, comes from the weight and fuel economy of Wright Cyclones. On a four-engine transport, the basic weight saving provides a half-ton bonus — fuel economy on a ten-hour flight saves another half-ton. And Cyclone operation over billions of miles has demonstrated distinctly lower maintenance costs.

Wright Cyclones pay their way.

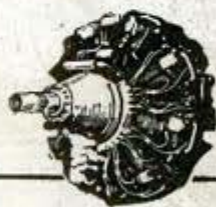

Cyclones Save 3 Ways

LESS WEIGHT—MORE PAYLOAD
LOWER FUEL CONSUMPTION
REDUCED MAINTENANCE

WRIGHT

Aircraft Engines

Wright Aeronautical Corporation
A Division of Curtiss-Wright Corp.
Paterson, New Jersey, U. S. A.

W R I G H T P O W E R S T H E T O N N A G E O F T H E A I R

A LESSON FROM THE WAR

Every engine in every tank, "Duck," truck, jeep, or other fighting vehicle, is protected by adequate oil filters. Many of these are AC Military Oil Filters.

You, too, can prolong engine efficiency and life with an AC Oil Filter or Element—retard the clogging of piston rings—check carbon formation—get more work from your engine, at less expense.

If you now have an oil filter, choose improved AC elements for replacement.



BUY WAR BONDS • BRING VICTORY QUICKER

air and water. You can protect your worldly goods against mildew or rain or moths or flame with coal chemicals, one of the youngest being DDT, the insecticide that saved Naples from the plague. Coal's toluene is the father of both TNT and saccharin, the sugar substitute, and on the same branch of the tree grow perfumes, antiseptics, dyes and solvents. And from tar and pitch the chemists give you macadam roads, insulation, floorings, paints and roofing.

We may, before we realize it, face the necessity of hydrogenating coal to obtain gasoline, as Europeans have done.

It begins to look as though Aladdin didn't rub a lamp. It was a lump of coal, packed full of power and warmth and magic.

Two Days in the Hornet's Nest

(Continued from page 31)

went to general quarters. Watching the young pilots tumble from the ready room to board their planes, I noticed that many were fidgety. A couple of the boys who lived next door to me in the officers' ward-room grinned and waved at me, as they always did, but they were plainly on edge. This was to be their first fleet combat.

Because the attack was launched at extreme range the flyers weren't due back until after sunset and we knew how the pilots felt about trying to land on carriers closely bunched at night. It was almost nine o'clock before they came back but we felt a little more optimistic when we were ordered to light up, despite the fact that we would be exposing our position dangerously. Vertical searchlight beams appeared to identify the carriers and glow lights flickered along flight decks. The flyers were told to pick any convenient carrier.

Still, it was a precarious and a nerve-racking undertaking—even for us safely aboard—because the carriers were so near one another that planes circling one flat-top often overlapped with those circling the next. Two or three planes sometimes would try to land on a flight deck at the same time; others made erratic landings in the poor visibility, skidded wildly and crashed into the island superstructure. Whenever an accident occurred, the pilot was helped out and the damaged plane shoved overboard to clear the deck.

I could make out many planes crash-landing in the sea, out of fuel. One pilot who landed near a destroyer saved himself by blowing so fiercely on a little penny whistle that he attracted the attention of the crew and was rescued. The destroyers picked up survivors for several days.

(Continued to page 156)

**POST-WAR MECHANICS WILL
WANT THESE WAR-TESTED**

Crestoloy Pliers

Representative of the better tools which American industry and Mechanics will have post-war, is this improved Crestoloy Diagonal Cutting Plier.

No. 940-6 was developed just prior to the war to meet the severe requirements of the Air Corps. It is a light-weight, heavy-duty cutter, with generous handle leverage and stubby nose, providing clean, easy cutting right at the cutter ends.

The experience we have gained in making millions of them has resulted in design perfection which normally would not be attained in many years of peacetime production.

Today the whole output of this improved tool must necessarily go to our *fighting mechanics*: tomorrow they will be available for mechanics everywhere.



CRESCENT TOOL COMPANY, JAMESTOWN, N. Y.

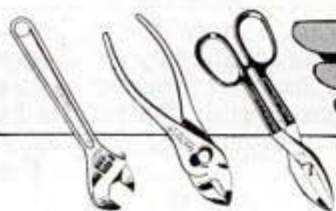
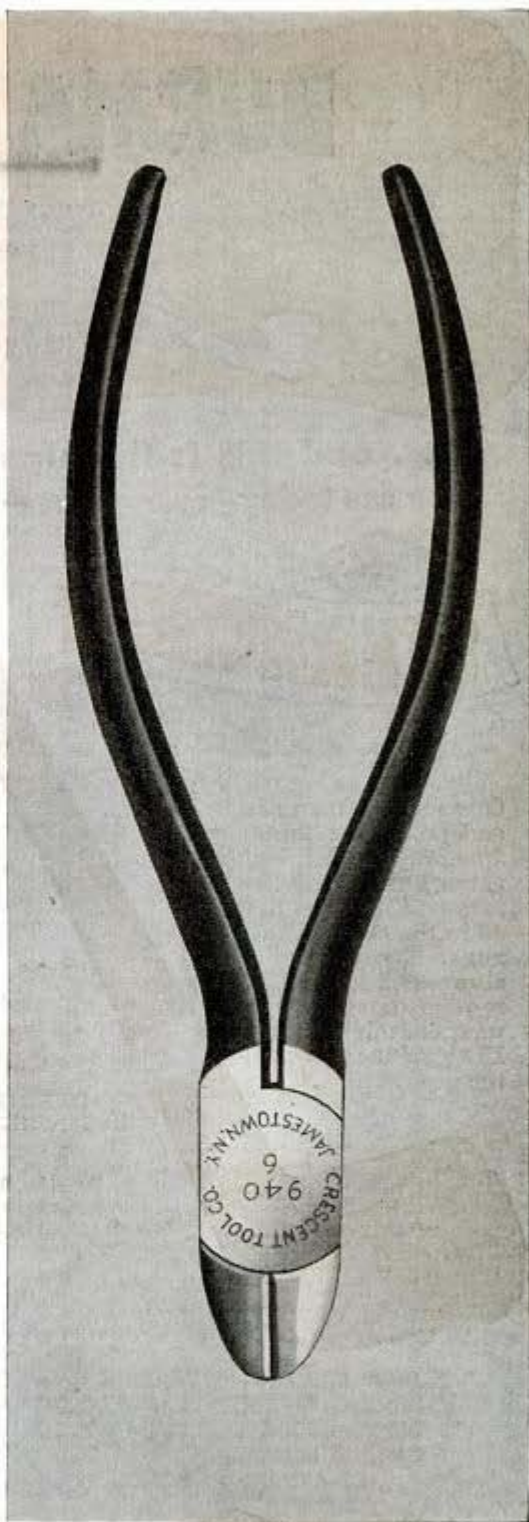

CRESCENT TOOLS
Give Wings to Work



IN BURMA

this is the pipe they
used to smoke



... and this is the pipe
you see today—everywhere—



Our service men are in Burma, and on all the far-flung battle-fronts of the world—along with them have gone the same mellow LHS pipes they puffed in the states. That's the reason you may not always find just the LHS model or style you want, but if it's an LHS, it's "the sign of the perfect pipe."



\$5

DOZENS OF
HANDSOME MODELS

Model No. 6
Antique Finish
Also Smooth Finish

IMPORTED BRIAR

Other LHS Pipes of Imported Briar
Sterncrest Ultrafine . . . **\$10.00**
Sterncrest 14K **7.50**
Certified Purex **3.50**

AT ALL GOOD DEALERS



Send for your copy of "Pointers on Pipes"—FREE
L. & H. STERN, INC., Dept. Z, 56 Pearl St., Bklyn 1, N.Y.

But the flyers had had a "field day." Three of Hirohito's largest carriers were among those hit—one sunk, one probably sunk, one damaged, while a light carrier was probably sunk and another damaged.

Proudly, we learned that one of our squadron leaders had dropped a 1,000-pound bomb squarely on the bridge of a carrier, his men following with hits on the deck. In two days we had helped ward off a mighty counterblow at Saipan, our springboard for a smash at Japan itself.

Teaching the GI Way

(Continued from page 37)

phibious training. This is a wired panel, 8 by 4 feet in size and 4½ inches deep, which demonstrates the assembly and progressive movement of small boats in a landing operation. Beneath the translucent plastic face of the panel, recurring light flashes set in motion from a control board simulate boat movements.

The U. S. Office of Education has taken the lead in the preparation of training films available to industry, and many companies have produced their own. So far the Office of Education has supervised the making of nearly 500 films. Some 33,000 prints of these films have been made and put in use, and officials estimate that they have cut 25 to 30 percent from the time required for teaching workers new skills.

But how will the new methods and techniques affect the nation's schools and colleges after the war? Will any of them be incorporated in our educational system?

Many authorities, such as E. P. Peterson, acting dean of the College of Education, University of Iowa; Dr. Samuel N. Stevens, president of Grinnell College, and Ralph W. Tyler, professor and chairman of the Department of Education, University of Chicago, answer in the affirmative.

Already several schools, including the College of the City of New York, Yale, University of Wisconsin and others, have adopted the War Department's foreign language curriculum for their civilian students. In the last year, students in the Chicago public schools have viewed more than a million showings of educational films purchased at a cost of more than \$200,000. It is estimated that 20,000 16-mm. projectors are in use in school systems.

Educators are quick to point out, however, that the results attained by the Army and Navy in their training procedures can scarcely be compared with the results in schools or colleges, because of the vastly different conditions which prevail. In the

(Continued to page 158)

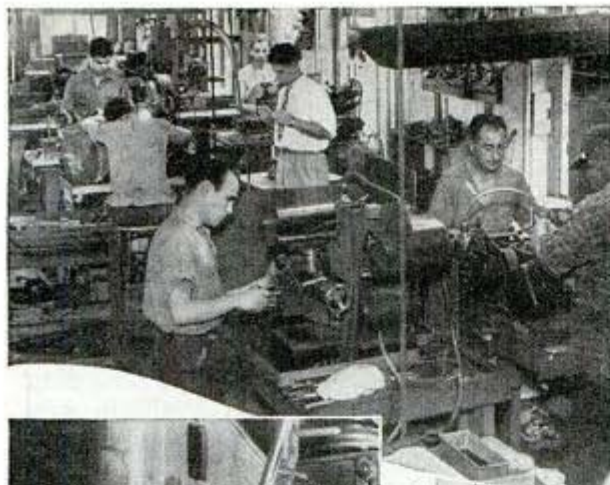

Success with Atlas

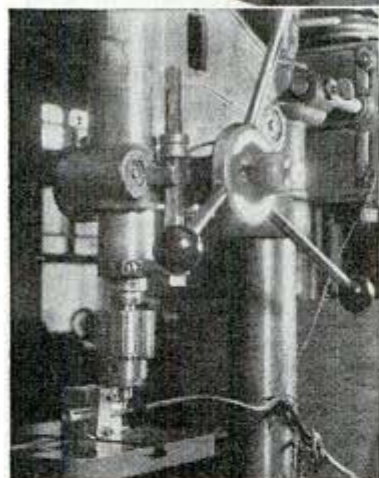

Atlas No. 63 drill press, in Triex plant, used with No. W68 Universal Vise in a vertical milling operation. Thousands of pieces have been made with this jig.



**From 2 LATHES and 1 DRILL PRESS
To 30 BUSY MACHINES**

Starting five years ago with three machines and lots of ambition, Mr. A. L. Moss and his unusual cohorts of The Triex Machine Tool Company of New York City have made an amazing precision production record. They turn out gauges within 1/10 of .001. Work in quantities from two pieces to 60,000, all within extremely fine tolerances—on over 30 Atlas lathes, drill presses, milling machines, and shapers.

There are few machinists in the shop. Most of the men come from the professions—musicians, artists, accountants, teachers—men who a few years ago didn't know the difference between a lathe and a micrometer but today work to a tolerance of half a thousandth.

The success story of Triex—typical of hundreds founded on Atlas equipment—is a hopeful sign to men of vision and ability who plan to build businesses of their own after the war. If you have such ambitions, you can build soundly on a foundation of modern Atlas tools.

SEND FOR LATEST ATLAS CATALOGS

Although all Atlas production is on high priority and will be until war needs are filled, it is not too early to start making your postwar equipment plans. Send for latest catalogs. Tell us which tools—lathes, drill presses, milling machines, shapers—interest you most.



ATLAS PRESS COMPANY

143 N. PITCHER ST., KALAMAZOO 13D, MICHIGAN

NEW ATLAS PATTERN SERVICE FOR WOOD CRAFTSMEN. See ad on page 168

fluid power



**FLOWS
THROUGH THIS VITAL LINK**

Engineered by **PARKER**

Fluid Power, the modern way to get things done, is carried wherever you want it to go through tubes, and controlled by valves.

You think of Fluid Power as a three-link chain; Source—Circuit—Utilization.

The *key link* is the Circuit—straight line, around corners, into tight places, under direct or remote control. That *key link* is vital, for the successful operation of any Fluid Power application depends on it!

It's Parker's business to engineer this vital link—to design it, build it, install it—to build the precision valves and fittings that make it function, and the tools to handle them. We've been at it for twenty years.

A Parker Fluid Power engineer will gladly discuss these interesting ideas with you. Write to The Parker Appliance Company, 17325 Euclid Avenue, Cleveland 12, Ohio.

★ ★ ★

A. A. F. SURPLUS WAR STOCKS

Parker has been selected by Metals Reserve Company to market surplus A. A. F. war stocks of valves and fittings. Immediate delivery assured. For specifications and for installation recommendations, write, wire or phone. Parker Service Agency, Division of The Parker Appliance Company, Cleveland 12, Ohio, U.S.A. Agent for Metals Reserve Co.



armed forces, the men are motivated by discipline and patriotism, and the intense desire to learn quickly. And, as one Army officer said, "The Army trains men—it does not educate them."

Flying the Power Midgets

(Continued from page 79)

The smallest engine on the market is an "Atom." It develops $\frac{1}{10}$ horsepower. This tiny power plant is smaller than your thumb and weighs two ounces, including fuel tank, propeller hub, ignition, and spark plug. It can be used in models having wing spans of up to 30 inches and gross weights of 10 ounces. Larger engines that develop up to one horsepower are also manufactured, including a $\frac{1}{2}$ horsepower twin cylinder aircooled model for heavy moderate speed models.

Some enthusiasts build their own miniature magnetos but the most commonly used sources of current are tiny dry or wet cells. One wet battery, of special materials, produces 2.8 volts from its single cell and has a gross weight of $2\frac{1}{2}$ ounces. It may be removed from its plastic case and flown as a dry cell to save weight, then replaced in its case and electrolyte for recharging from an automobile battery. Midget high tension coils for the engines weigh less than two ounces and are an inch and a half long. All the engines are fueled with a high octane menthenol racing fluid.

As in large aircraft, speed or endurance of the model aircraft depends on cleanness of design and workmanship and on the efficiency of power plants and propellers. Like professional aerodynamicists in the wind tunnels, the model builders try every new idea that might reduce drag. Factory built engines are hopped up to deliver extra power. Factory construction kits are modified to produce cleaner wing and fuselage shapes. Many speed model builders enclose their engines to reduce resistance, introducing carburetor air and cooling air by means of an air scoop. Most free flight models have fixed landing gear, but to reduce this drag some builders use one landing wheel alone. The plane lands on the one wheel and a wing skid. Eliminating the second landing wheel may add more than five miles per hour to the plane's speed.

The high speed jobs that are flown from the ends of control wires dispense with landing wheels entirely. They make their takeoff runs on wheeled dollies, then rise off the dollies when they attain flying speed. These planes skid to a stop on their bellies in landing but rarely damage a pro-

(Continued to page 160)



Bill Day, newspaper photographer, and Hank Werner got these 17 bass on Hawaiian Wigglers in Arkansas.

Hit Jack Pot with HAWAIIAN WIGGLERS

Frank Vestal, Memphis sports writer, reports the experience of Bill Day, left, and Hank Werner with Hawaiian Wigglers at Horseshoe Lake, Ark.

"They boated their way to the brush, stumps and moss beds where they cast their Hawaiian Wigglers. After a practice shot, Hank got a five-pounder on his No. 2 Hawaiian. It was Day's turn next and he landed one of equal proportions. The fun was on! The lucky anglers nabbed 17 bass, 2 to 5½ lbs., before setting out for home."

Write for Literature



No. 2
Hawaiian Wiggler \$1.10
FRED ARBOGAST, 1601 North St., Akron 3, Ohio



REPLACE "SLOW-DOWNERS" with *Snap-ons*

On any operation an inefficient or poorly adapted tool is a time killing "slow-downer" — a wasteful drag on the speed and skill of even the best mechanic. Snap-on tools help speed up the toughest jobs in production, assembly and maintenance . . . in hundreds of foremost plants they are "standard equipment", the choice of better mechanics throughout industry. Snap-on direct-to-user tool service is available through 38 factory branches located in key production centers throughout the United States and Canada.

SNAP-ON TOOLS CORPORATION
8062-A 28th Avenue, Kenosha, Wisconsin

Snap-on Tools
THE CHOICE OF BETTER MECHANICS

STOP Wasteful Leaks in your Heating System

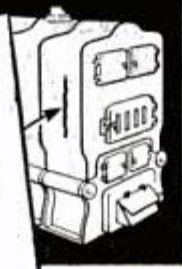

EVERY crack, every leak, every loose connection or part in your furnace, boiler, tank, radiators, piping, wastes heat, uses up fuel. Seal up those leaks quickly, easily, as professional repair men do, with Smooth-On No. 1 Iron Repair Cement—NOW.

Smooth-On is easy to use as putty, gives lasting results. Requires no dismantling, no heat, no special experience. Makes tight repairs, for it expands slightly as it sets. Has been popular for home and shop repairs the past 49 years. Get Smooth-On at your neighborhood hardware store in 1¾-oz. or 7-oz. containers or if necessary, from us. Inexpensive—does not deteriorate.

FREE HANDBOOK ON REPAIRS

40 Pages of tested, short-cut instructions for ingenious practical repairs around the home, car and shop. 170 diagrams. Pocket size. Conveniently indexed. Mail the coupon.



MAIL THIS TODAY

Smooth-On Mfg. Co., Dept. 37,
570 Communipaw Avenue, Jersey City 4, N. J.

Yes—please mail me my Smooth-On Handbook.

Name

Address

1-45

Free
Do it with SMOOTH-ON

PELLER. Some of the models have been equipped with landing gear that retracts into the wing by clockwork. One model builder retracted his landing gear by means of the centrifugal pull that develops when the plane reaches moderate speed at the end of its control lines.

Factory built wooden racing propellers, eight or nine inches long, can be turned at tip speeds of up to 45,000 feet per minute but the greatest efficiency is usually found at about 30,000 feet per minute. Contra-rotating twin propellers have been used on a few models. Slight modifications to the propeller may give a racing plane 20 or 30 miles per hour of additional speed. The model builders are ceaselessly experimenting with propellers, engines, and airfoils to fly their models faster or longer.

Giving Depth to the Movies

(Continued from page 47)

The success of all such effects lies in the art director's skill in laying out the scene. The apparent horizon line must be established ahead of time in relation to the camera position, and all parts of the scene are then planned with reference to the horizon. Usually the scene is first sketched on paper, then a realistic three-dimensional model of it is built. Errors that appear in the model are corrected, then the scenery is erected on the stage.

Skillful use of perspective helps the technicians to play many kinds of tricks on the one-eyed camera and still preserve their third-dimensional effect. A scenario may require that the interior of a vast cathedral be shown. Such a set cannot be built below a sound stage roof and yet the movie magicians have a way of creating it in spite of the stage's physical dimensions. They build the cathedral's floor and the first 10 or 15 feet of its walls, full size, inside the stage building. The upward continuation of the walls and the cathedral's ornate ceiling are then built in miniature and this small scale portion of the set is suspended in the air close to the camera, lined up to match the rest of the set. To the camera the full scale and small scale portions match exactly.

Even more ingenious is the device of joining such a combination scene with a painting. That is, it may be necessary to show the great pipes of a pipe organ against the rear wall of a cathedral. It is often best to do this by what is called the matte-shot technique, an exacting double exposure process. First the scene is filmed in the usual manner but with a small mask in front of the camera that blanks off the area

(Continued to page 162)

There's
 been a
 big change



★ Imagine going places in a horse-drawn hack, when the tempo of the times demands a modern taxi!

The ever-increasing tempo of transportation, industry and agriculture demands a tapered roller bearing with greater capacity and longer life. Tyson found the answer—developed a bearing with thirty percent more

load-carrying rollers around the raceway.

More rollers, more capacity. More rollers, longer life. More rollers, increased rigidity. The Tyson "All-Rolls" Bearing is hailed as the sturdiest and longest-lived bearing ever built for heavy-duty service.

The big name in bearings today is...TYSON!



TYSON BEARING CORPORATION • MASSILLON, OHIO

COUNT THE ROLLS - THE ROLLS COUNT



Tyson
 TODAY'S HEAVY-DUTY BEARING

★ BUY MORE WAR BONDS ★

Thousands Now Encouraged to Wear a Hearing Aid!

Thanks to the Smart New Zenith



SO INCONSPICUOUS
Another
Zenith First

Neutral-Color Earphone and Cord

• Now another great Zenith accomplishment is prompting thousands to enjoy the advantages of a hearing aid! The new Neutral-Color Earphone and Cord of the superbly performing Zenith Radionic Hearing Aid is as little noticeable as eyeglasses... brings to the hearing aid a new look of youth which enables you to wear a Zenith with poise and confidence.



A MODEL FOR EVERY
TYPE OF CORRECTABLE
HEARING LOSS

Each Complete, Ready-to-Wear

1 Model A-2-A Air Conduction. New, improved model of the famous Zenith standard hearing aid for the person of average hearing loss. Only **\$40.**

2 Model A-3-A Air Conduction. A brand new super-power instrument with tremendous volume in reserve to assure maximum clarity and tone quality even under the most difficult conditions. Only **\$50.**

3 Model B-3-A Bone Conduction. A new precision instrument created specially for the very few who cannot be helped by any air conduction aid. Only **\$50.**

BY THE MAKERS OF

ZENITH
RADIO

LONG DISTANCE
RADIONIC PRODUCTS EXCLUSIVELY
WORLD'S LEADING MANUFACTURER

PASTE ON PENNY POSTCARD AND MAIL

Zenith Radio Corporation, Dept. PM-13
P. O. Box 6940A, Chicago 1, Illinois
Please send me your Free booklet about Radionic Hearing.

Name

Address

City State

COPYRIGHT 1948, ZENITH RADIO CORP.

to be occupied by the pipe organ. Next, the same film is run through the camera again, this time shooting through a mask that blanks off everything except a painting of the pipe organ that has been lined up in front of the camera so that it exactly fills the area occupied by the original mask. With careful attention to detail and scale, matching up different elements to form one composite scene provides a convincing illusion of the interior of a cathedral.

It's All Electric but the Horses

(Continued from page 69)

tive markings on horses. These descriptions follow the horses wherever they are shipped to run on the major tracks.

The practice of stimulating horses to make them run faster has about died out, thanks to scientific methods by which stimulants may be detected in their saliva. The changing of types of horseshoes to alter the manner in which an animal runs also has been eliminated. All horses' shoes are examined before a race and the type they are wearing is posted on public boards.

Like other giant industries, race tracks have found that the more honest and scientifically efficient they can be made, the greater the profits. Everything runs with precision except the element which cannot be mechanized—the "nags" which pound hoofs around the tracks.

Gangplank to Hitler's Doorstep

(Continued from page 5)

unloading of LSTs directly onto the beaches, by the Army's amphibious ducks and the Navy's pontoon "Rhino ferries," by sunken causeways built by the Seabees, and by the sweat of thousands of GI Joes.

These hardworking Yanks set a record that must have amazed the Allied Chiefs of Staff. During the week following the storm there moved across the open beaches 50 percent more long tons and 50 percent more vehicles than had been moved ashore the week before the storm.

Although the American port came to a tragic end, it played a vital though short-lived part in moving men and supplies in the crucial early days of the invasion. Recently, at a showing of the port models in Washington, a British naval officer paid this tribute to the undertaking:

"This gigantic project which cost a hundred million dollars was worth every cent of it. Without the prefabricated ports to insure a flow of supplies over the beaches the invasion of Europe would never have been attempted."



There's a **Ford** in your future!

FORD HAS BUILT MORE THAN 30,000,000 CARS AND TRUCKS



**"MAKE MINE
Carhartt's
FOR EXTRA WEAR
AND EASY FIT"**

• A reputation is hard to get and easy to lose. That's why the Carhartt family of overall makers has jealously guarded the quality materials and workmanship of its work garments.

If you've never worn Carhartts before, ask for them by name and get the kind of comfortable fit, extra stout reinforcing, ample cut and superior wearing qualities of Carhartt sanforized Master Cloth that pay out in bed rock satisfaction and economy.



**CARHARTT
WORK CAPS**

Non-shrinking, full cut, high crowned, comfortable and cool — with exclusive eyelet ventilation.

At the Better Dealers Everywhere.

HAMILTON CARHARTT OVERALL CO.

Established 1889

Detroit
Atlanta

Dallas
Carhartt Park, Ky.

THIS LABEL IS YOUR PROTECTION

Carhartt

FOR OVER 50 YEARS A FRIEND TO ORGANIZED LABOR

LOOK FOR IT



Famous Industrial
Safeguards Since 1910

**Save Fingers
with
Steel-Grip Finger Guards**

Hundreds of factories are saving time and injuries in war production by protecting workers with Steel-Grip Finger Guards. Used for handling rough or sharp articles, for buffing, grinding, sanding, polishing, punch press work and hundreds of other jobs. Protect fingers or thumb, front or back, from cuts, abrasions or blisters. Made of durable leather with elastic web back for snug, cool, comfortable fit. Easy on and off. One size fits all, men or women. Send 10c each for samples or trial order box of 50 at 8 1/2c each, less 10%.

Catalog of Steel-Grip Safety
Apparel free on request
INDUSTRIAL GLOVES CO.
646 Garfield Blvd., Danville, Ill.
Canada: Safety Supply Co., Toronto

**HOLD-E-ZEE
AUTOMATIC GRIP
SCREWDRIVERS**



Hold-E-Zees do the job better, faster. They excel wherever screwdrivers are used. Gripper instantly released by spring action, sliding up out of way when not in use. Highest quality materials throughout. Sold at leading dealers everywhere.

UPSON BROS., INC.
86 Exchange St., Rochester 4, N. Y.

**New Designs in
FRANZITE GRIPS**

Modernize Your Gun! Improve Your Score!

Most durable grips made. Positively unbreakable! For Colt, Smith & Wesson, Hi-Standard, Ortiga, Luger & Mausers in a wide choice of beautiful designs in ivory, pearl, walnut, onyx, etc. Low prices. FREE CATALOG. Dealers Wanted.

SPORTS, INC., (Mrs.) 2850N. Clark St., Dept. P-1, Chicago 14, Ill.



MAKE MONEY! Sell Warm **LEATHER** Jackets

Hundreds of prospects near you; sportsmen, workers in lumber yards, warehouses, stock rooms, war plants, etc. Men of action demand their snug warmth, free-action comfort, sturdy construction.

COMPLETE LINE
Leather and wool jackets, work shirts, 250 shoe styles for men and women. Liberal Commissions. Write today for FREE SALES OUTFIT.

MASON SHOE MFG. CO.
Dept. M-115
Chippewa Falls, Wisc.

**"HARLEY-DAVIDSONS
UNSURPASSED"**

Sounding the keynote of thousands of letters from fighting men all over the world, Cpl. R. F. K. writes from somewhere in Germany: "Harley-Davidsons unsurpassed in all types of operations. Performance unequalled by any other American or foreign make. They wear better, last longer, are more dependable." Write today for FREE copy of "Enthusiast" magazine filled with thrilling motorcycle pictures and stories.

HARLEY-DAVIDSON MOTOR CO., Dept. P. Milwaukee 1, Wis.

**PICTURE
RING \$1.**

Exquisite Onyx-like Picture Ring—made from any photo. Send No Money! Mail photo with paper strip for ring size. Pay postman only \$1.00 plus postage. Hand tinted 25c extra. Photo returned with ring. Money back guarantee. Send photo and ring size now.

PORTRAIT RING CO., Dept. E-44. CINCINNATI, O.

Made from Any Photo or Picture! SEND NO MONEY!

**Burpee's GIANT
5 PKTS. 10c ZINNIAS**

6 best colors—Scarlet, Lavender, Yellow, Rose, White, Dahlia-Flowered, 6 inches across, 3-ft. plants, easy to grow. All 5 15c-Pkts. of seeds postpaid for 10c!

Burpee's Seed Catalog Free—all best Flowers and Vegetables.

W. ATLEE BURPEE CO.
511 Burpee Building, Philadelphia 32, Pa.
(or) 511 Burpee Building, Clinton, Iowa

SEND CATALOG FREE



*Galley on a small
U. S. warship*
(OFFICIAL U. S. NAVY PHOTO)



*This all-aluminum electric wall kitchen
has flexible metal doors which close
off the entire unit when not in use.*

Everything Shipshape

Smart, compact and shipshape as the galley of a modern warship is the inviting, space-saving pre-fabricated kitchen unit for small dwellings, portrayed above. Defoe presents this design as one of many that postwar America may expect from the pre-fabricated housing industry. The goal of this industry will be to improve living standards and provide widespread employment. Today, Defoe's only job is to build dependable fighting ships for the Navy. But after Victory, the experience, skill and ability required by this exacting work will be devoted to building quality products for peacetime America. Our postwar work will reflect the same heart and pride we put into our present crucial job.

DEFOE SHIPBUILDING COMPANY, BAY CITY, MICHIGAN

Defoe

*Four White Star Renewal Citations
now decorate the Navy "E" Award
won by Defoe workers.*

BACK THE ATTACK
—BUY WAR BONDS

SHIPS FOR VICTORY
SERVANTS FOR PEACE

YOU CAN'T BEAT this to relieve itching of SKIN and SCALP IRRITATIONS

So
Many
Druggists
Say!



Here's a Doctor's formula — Zemo — a stainless liquid which appears invisible on the skin — yet so highly medicated and soothing that the first applications promptly relieve itching, burning of Eczema, Psoriasis and similar skin and scalp irritations — due to external cause. Zemo ALSO aids healing.

Apply clean, stainless invisible Zemo any time. It won't show on skin. Buy Extra Strength Zemo for stubborn cases.

ZEMO

RADIO CABINETS — SPEAKER BAFFLES — BLANKS

Large selection for MANUFACTURERS, DEALERS, SERVICE MEN & EXPERIMENTERS. Beautiful all wood cabinets. WRITE for FREE catalog & prices to Dept. 601.

VAUGHAN CABINET CO., 3810 Clark, Chicago 13, Ill.

- SEAL OUT DRAFTS
- SAVE FUEL
- BE COMFORTABLE

KALK-KORD

THE NON-HARDENING
CAULKING AND SEALING
COMPOUND

You can quickly and easily seal loose windows against drafts with Kalk-Kord—use it around window frames, too, inside and outside.

Neat and clean to use, Kalk-Kord seals cracks without tools—just press in place with fingers. Comes packed in convenient beads or rolls. Will not stain paint or any surface. Does not harden, crack, chip, or shrink. Waterproof and unaffected by temperature changes.

For Sale by Sears, Roebuck retail stores Paint Dept. 30, or by mail from Sears

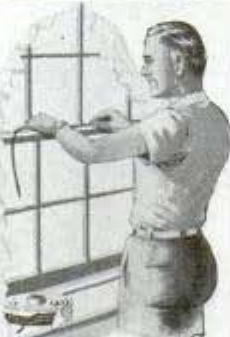

Other Household Uses

- Caulking window and door frames
- Sealing around bathtubs and sinks
- Sealing cracks in plaster, woodwork, masonry
- Sealing around baseboards

Product of

PRESSTITE ENGINEERING COMPANY
3978 CHOUTEAU AVE. • ST. LOUIS 10, MO.

SYNGRO

DROPS A BOMB!

SYNGRO Electric Jig Saws are helping to bomb the Axis by furnishing precision-made parts for bombers, tanks, submarines, guns, etc. After war, there'll be even more efficient Syncro Electric Jig Saws ready for your peacetime home workshop projects!

SYNGRO WORLD'S SAUCIEST **SAWS** Syncro Devices, Inc.
3265 Bermuda Ave. Ferndale 20, Michigan



PAINT STRIPING TOOL

Try it! See the Added Beauty

ONLY
\$1.00
POST PAID

With this NEW TOOL (not a brush) everyone can now draw lines with paint, enamel, lacquer, etc. Used on autos, models, toys, games, imitation tile walls, cabinets, furniture, linoleum floors, signs, bulletin boards, sporting goods, home workshop projects, etc. Send only \$1.00 for complete tool for painting a 1/16" wide stripe, including adjustable guide, operating instructions, etc. C.O.D. price \$1.25.

As easy to use as a pencil.



Patented

Extra interchangeable tips for making 1/64", 1/32", 3/64", 1/16", 3/32" and 1/8" wide stripe lines—.50c each.

Every Painter and Craftsman Should Own One.

Send for your tool and as many additional width tips you need today. Use it. If you are not satisfied that you can do better work, add character as well as beauty to your product or project, return the tool and we'll refund your money promptly.

Paint Dealers; Write for literature, etc.

1234-B Lincoln Ave.
WENDELL MFG. CO. CHICAGO 18, ILL.

NEVERSLIP PULLEY

Transmits more power with less belt wear; unaffected by weather. No pulley covering, no belt dressing required. Replace troublesome pulleys with NEVERSLIPS. All sizes. Money-back guarantee. Ask for NEVERSLIP Pulleys on ALL power machinery you buy. Write for folder and prices.

ROSENTHAL CORN HUSKER CO.
Box 16-145 Milwaukee, Wisconsin



DRILL-INDEX



A compact container for indexing and filing twist drills. Eliminates search. Made entirely of steel in nine sizes. Available on priority to essential users. See your dealer or write to:

HUOT MFG. CO.
Foot Schultz Bldg. St. Paul 1, Minn.

TIGHTEN LOOSE PLATES WITH GUM-TITE PLASTIC RELINER



FREE
Gum-Tite CLEANER
& APPLIER with
every tube of...
**MIRACLE ACTING
GUM-TITE**

LASTS 4 to 6 MONTHS

Keeps Food Out... Smooths Gums... Easy to Use... Rids Denture Breath Eating's a joy... Teeth won't Slip, come Loose, drop Down... Chew tough meat, chewy caramel! Gum-Tite is the original plastic reliner. Not a powder or a paste! No burning, irritation! Ends embarrassment! Rush order TODAY! Postage FREE if cash accompanies order. One Tube \$1.00 (3 for \$2.50). FREE marvelous Gum-Tite Cleaner. 100% satisfaction or DOUBLE YOUR MONEY BACK! **AGOR PRODUCTS CO.**, Dept. No. PM-2, 4554 Broadway, Chicago 40, Ill.

POPULAR MECHANICS

When it's an EXIDE ... you start



Good merchandise
and good dealers go hand in hand.
It pays to buy products and services
from the man who offers **KNOWN**
brands of high quality.

THE ELECTRIC STORAGE BATTERY COMPANY
Philadelphia 32
Exide Batteries of Canada, Limited, Toronto

BUY TO LAST

NEW *Atlas* PATTERN SERVICE

FULL SIZE PATTERNS for making furniture, household equipment, cabinets, toys are now available through Atlas. They work like templates in airplane construction to save time and insure accurate workmanship.

No. 25 PORTSMOUTH MAGAZINE RACK

This useful stand was inspired by the blacksmith tool box. Magazines take the place of hammers and files. The compartments in upper tray are very convenient for cigarettes, matches and ash trays. Truly a clever project that will bring compliments from your guests. Price 25c.



No. 15 HANDY WORKBENCH

Basic need of every shop is a good substantial workbench — and this pattern will help you make one quickly and easily — one that fits so it won't get wobbly after a few weeks use. Has

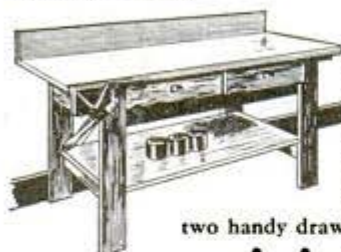

two handy drawers for tools. Price 25c.

Order patterns by number, inclosing exact cash, check or money order. Price includes mailing costs. Pattern envelopes show many other useful patterns available at low cost.

ATLAS PRESS CO. PATTERN DEPT.
Dept. A-1, P. O. Box 74, Pleasantville, N. Y.

THIS *Dustless* BRUSH REDUCES GERM LADEN DUST



Eliminates Sweeping Compound

The "Dustless" brush has a reservoir in its back which holds Arbitrin, a scientifically compounded sweeping fluid. The center row of tufts is connected to the reservoir. During the process of sweeping the Arbitrin feeds through these tufts and moistens every particle of dust it contacts. Instead of floating through the air, the dust is converted into the most efficient sweeping compound.

Tests have proved that "Dustless" sweeping reduces the number of bacteria, normally in the air between sweepings, as much as 97 per cent. The "Dustless" brush also cuts labor and material costs in half.

GUARANTEED—Dustless brushes are used in hundreds of offices, factories, schools, institutions and stores. They are unconditionally guaranteed to meet your requirements. Prompt shipment on AA-5 or higher priority rating. Write for styles, sizes and prices today.



MILWAUKEE DUSTLESS BRUSH COMPANY

528 N 22nd STREET, MILWAUKEE 3, WIS

Watch Crystals You CAN'T BREAK



PROTECT YOUR WATCH

A watch with a broken crystal is useless. Go to any jeweler—ask him for a G-S FLEXO CRYSTAL 100% BREAK-PROOF. Fitted while you wait. Any size. Any shape. *Guaranteed.* GERMANOW-SIMON MACHINE COMPANY, Rochester, N. Y.



NEW! ACCURATELY DESIGNED INSIGNIA EARRINGS

● For Wife, Mother, Sweetheart. Beautifully designed and finely made 1/10 Gold Filled Emblems. Insignia designs for Navy Crest (as shown), Marines and U.S.C.G. Specify insignia wanted.

\$6.00

No. 582. We pay Fed. Tax and postage. Per pair.

EDWIN W. LANE, Mfrs. Representative, Dept. PM, 32 W. Randolph St., Chicago 1, Ill

FREE! 40 PAGE HOBBY CATALOG

Over 1000 Items — Over 300 Photos

Our new 40-page catalog—just off the press—is the "bible" of wide-awake modelers. And what is most important, every item is in stock and ready for immediate shipment. Practically every nationally advertised model is listed and many, many hard-to-get items. Planes, engines, boats, gliders, supplies, etc.

America's Hobby Center, Dept. BC15, 40 E. 21st, N. Y. 10, N. Y.



PERFECTION

Genuine Gerstner Tool Chests are perfectly designed—perfectly made. Free catalog for Machinists and Toolmakers.

GERSTNER TOOL CHESTS
445 Columbia St. Dayton 7, Ohio

WHEN YOU BUY FLASHLIGHT BATTERIES ASK FOR

"EVEREADY" FRESH DATED BATTERIES

The word "Eveready" is the registered trade-mark of National Carbon Co., Inc.

QUICK HOME REPAIRS



Mends dishes, glassware, furniture, luggage, and toys.



DU PONT DUCO CEMENT

REG. U. S. PAT. OFF.

FREE—TO MEN AND BOYS

**WHO ARE PLANNING
TO BUILD A POST-WAR
MODEL RAILROAD**

**TELLS YOU HOW TO GET STARTED NOW
— SO YOUR LAYOUT WILL BE READY
WHEN THE WAR IS OVER**

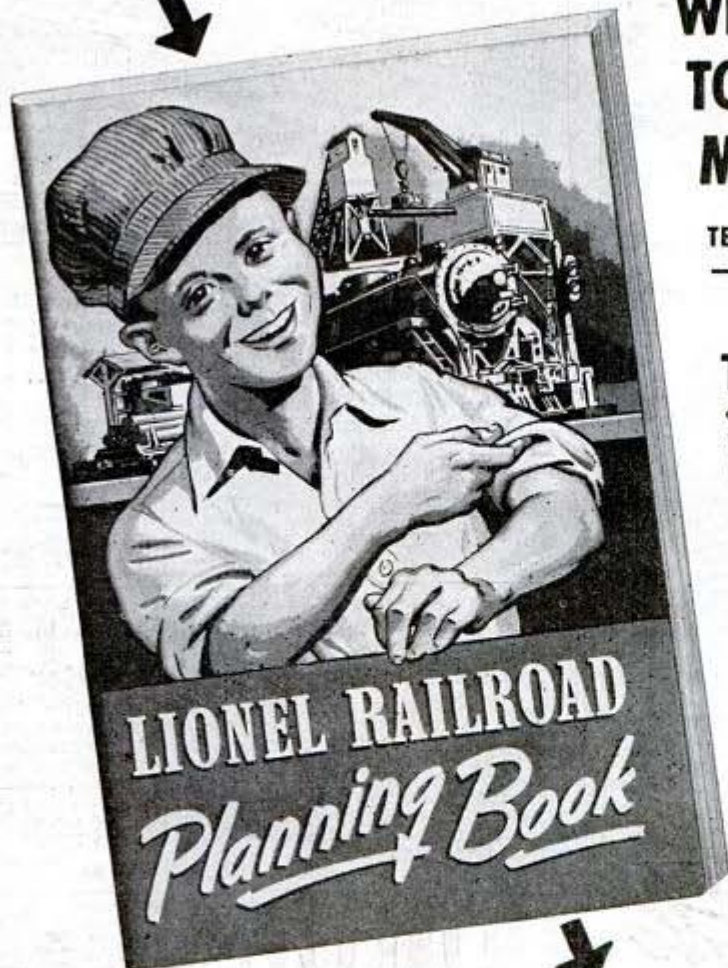

THERE are no Lionel Electric Trains for sale this year because all Lionel machinery and manpower are devoted exclusively to war work. BUT, that doesn't mean you have to wait until the war is over before beginning your post-war model railroad plans. There is in fact a great deal of preliminary work to do—and this is the best of all times to do it.

To help you get started today on your post-war model railroad, Lionel has produced a 40-page, highly illustrated Railroad Planning Book. With pictures, diagrams and complete instructions, it tells you how to design a track layout system that will embody real railroad-ing practices—with main line, sidings, engine terminals, car storage tracks and classification yards. The Planning Book tells you how to start with a simple circle of track and build it step by step into a fascinating system.

HOW TO GET YOUR COPY

You may obtain a copy of the Lionel Railroad Planning Book FREE simply by filling in the coupon below and mailing it promptly. Do it now and get started on your model railroad THIS year.

**40 PAGES OF DIAGRAMS, PICTURES,
PLANS AND CONSTRUCTION DETAILS**



The Victory Fleet Flag and Maritime "M" Pennant have been awarded to Lionel three times for "outstanding production achievement."

**LIONEL
ELECTRIC TRAINS**

The Lionel Corporation, Dept. 19
15 East 26th Street, New York 10, N. Y.

FREE

Please send me a free copy of the new Lionel Railroad Planning Book.

NAME.....

ADDRESS.....

CITY..... ZONE No..... STATE.....

If you are uncertain—
—how to make
“GOOD PICTURES”

WRITE TODAY FOR THIS 56 PAGE BOOK

IT WILL HELP YOU
SOLVE MANY PROBLEMS

- SELECTION OF FILM
- EXPOSURE
- DEVELOPING
- ENLARGING
- FLASH PICTURES
- FILTERS & COLOR

Send 25c to
ARGUS, INC.
Ann Arbor, Mich.
DEPT. H

argus

Cameras and Optical Instruments

ANN ARBOR MICHIGAN

BURN YOUR NAME ON TOOLS
WITH THE
ARKOGRAF

PROTECT YOUR TOOLS FROM THEFT

Write with electricity any name or design on the hardest and finest tools and instruments of any metal. Ink writing on paper with pen or pencil. Thousands used by mechanics, garages, machine shops.
Complete Outfit \$3.50—Prepaid Anywhere
Interesting illustrated circular free. Write today.
ARKOGRAF PEN CO., 3927 S.E. Stark, Portland 15, Ore.



Read about Motorcycling
write INDIAN MOTORCYCLE CO.
Springfield, Mass.

Indian
MOTORCYCLES

READY CUT HOMES

Order NOW

Homes \$936 and up, freight paid. Orders filled immediately in essential cases or for preferred post war delivery. Save \$500 on modern production method homes. Much more compared with builders' prices. Anyone can assemble with attention plans furnished. Complete, including paint, hardware, roofing, glass, nails, etc.

Send 25c in coin for full color catalog showing 56 modern low-priced homes and floor plans. Complete building plans ready for filing at low cost.

Dept. PM 15
INTERNATIONAL MILL & TIMBER CO.
Bay City, Mich.

NEW COLOR CATALOG FOR ONLY 25¢

PIN-UPS OF AMERICA'S BEAUTIES

Make Your Own Pictures!

ALSO, TRANSPARENCIES FOR PROJECTION AND MOVIES!

NEGATIVES, 35 MM.	6 for \$1.00—55 for \$5.00
TRANSPARENCIES, 35 MM. UNM'T'D. 10 for 1.00—55 for 4.00	
NATURAL COLOR 2" x 2" SLIDES, MTD. 2 for 1.25—10 for 5.00	
PHOTO-PRINTS, 5" x 7"	3 for 1.00—10 for 3.00
35 MM. MOVIE-STRIP, 55 TRANSPARENCIES	5.00

VENUS SERVICE (6) 140 West 42nd St., New York 18, New York

PINS 55¢ up RINGS \$1.50 up

For your class or club. Over 300 designs. Finest quality.

Write Dept. N, Metal Arts Co.
Rochester, N. Y.

FREE CATALOG

FALSE TEETH

KLUTCH holds them tighter

KLUTCH forms a comfort cushion; holds dental plates so much firmer and snugger that one can eat and talk with greater comfort and security; in many cases almost as well as with natural teeth. Klutch lessens the constant fear of a dropping, rocking, chafing plate. 25c and 50c at druggists . . . If your druggist hasn't it, don't waste money on substitutes, but send us 10c and we will mail you a generous trial box.

© I. P. INC.
KLUTCH CO., Box 4593-A, ELMIRA, N. Y.

DO YOU

WANT a permanent business profession of your own? Then BECOME A FOOT CORRECTIONIST. Earnings in this greatly needed profession run as high as \$50-\$100 weekly after a few weeks home training—not medical or chiropody—no further capital needed, no goods to buy. 47th year. Write for free booklet.

Stephenson System of Foot Correction
28 Back Bay, Boston, Mass.

do you WORRY?

Why worry and suffer any longer if we can help you? Try a Brooks Patented Air Cushion. This marvelous appliance for most forms of reducible rupture helps hold nearly every rupture securely and gently—day and night—at work and at play. Thousands made happy. Light, neat-fitting. No hard pads or stiff springs to chafe or gouge. Made for men, women and children. Durable, cheap. **Sent on trial** to prove it. Never sold in stores. Beware of imitations. Write for Free Book on Rupture, no-risk trial order plan, and proof of results. All Correspondence Confidential.



Brooks Company, 158-D State St., Marshall, Mich.

MAKE MORE MONEY sharpening lawnmowers on the IDEAL LAWNMOWER SHARPENER

BUILD A BUSINESS OF YOUR OWN

Prepare for the future. Make real money sharpening lawnmowers. Build a business of your own that will produce a steady profitable income. Lawnmowers have to be kept sharp to operate properly. You can cash in on this volume business if you start now.

The Ideal Lawnmower Sharpener makes old, dull lawnmowers cut like new. NO experience necessary. Easy to operate. Just set the mower in the sharpener, make a few simple adjustments, the machine does the rest. Sharpens like magic to perfect edge in just a few minutes. Write today for complete details and order as soon as possible to avoid disappointment.

- NO EXPERIENCE NEEDED
- EASY TO OPERATE
- KEEN EDGE IN 20 MINUTES



THE FATE-ROOT-HEATH CO.
1145 BELL ST., PLYMOUTH, OHIO

HOW TO
BUILD A
Profitable
BUSINESS
OF YOUR
OWN

SEND FOR DESCRIPTIVE LITERATURE
TELLS HOW TO BUILD A LAWNMOWER SHARPENING BUSINESS

AEROPPOINT ONE DOLLAR
"111"

AEROPPOINT

Long Life Phono Needle

AERO
NEEDLE COMPANY
208 EAST ERIE STREET
CHICAGO 11, ILLINOIS

The Needle with the Curved Spring Design

PEPSI-COLA HITS THE SPOT

BUILD AUTHENTIC SHIP MODELS



Our kits and instructions are complete to the last detail. Clear plans simplify construction.

Send \$2. today for SHIP MODELS ILLUSTRATED, WITH A GUIDE TO MODELING—the first book of its kind ever published — of ship models, of real ships, of masts, of rigging, of deck gear, covering all types from whale-boats to PT's from "Slavers" to Corvettes. Many color plates, close-up photos, detailed drawings and actual plans in addition to a salty text and glossary of nautical terms.

Catalogue included with your order.



MARINE MODEL CO.
Dept. A-4, 29 West 15th St.
New York 11, N. Y.

Mortite

UTILITY TAPE

BETWEEN YOU
and the COLD



New pliable plastic stops heat leaks—saves fuel. Weatherstrips windows, doors, baseboards, casements. Keeps out dust and dirt. Plugs cracks around drainboards, bathtubs, etc.

Use inside or outside. Can be painted.

EASY TO APPLY

Unrolls like ribbon. Just press into place and it stays put. Does not crack, chip or shrink. A roll covers about 80 feet, enough for 5 windows.

At your Dealer's \$1.25
Higher West of Rockies and Canada

Circular Free

J. W. MORTELL CO.
522 Burch St. Kankakee, Ill.



See you saw it in Popular Mechanics!



GET THIS BOOK

HOW TO BUILD

<p>TRANSFORMER WELDERS</p>	<p>WELDING GENERATORS</p>
<p>POWER TOOLS</p>	<p>ARMATURE WINDING</p>
<p>WIND PLANTS</p>	<p>ELECTRIC SCOOTER</p>
<p>LIGHT GENERATORS</p>	<p>ELECT GO BIKE</p>
<p>MOTORS</p>	<p>ELECTRIC FENCERS</p>
<p>TRACTOR LIGHTS</p>	<p>INSECT KILLERS</p>

LEJAY MANUFACTURING CO.,
47 LeJay Building, Minneapolis 8, Minn.

Gentlemen: Please send me C.O.D. your big 1945 LeJay Manual, on the understanding that if, after 3 days trial, I should return the manual, you guarantee to return the \$1.50 purchase price.
(Canada, \$1.75)

I enclose \$1.50 for the above manual, same guarantee. . .

NAME
ADDRESS
CITY STATE

The LEJAY manual

gives you plans, illustrations and instructions on how to make over
100 BUILD-YOUR-OWN ITEMS

for **FUN & PROFIT**
\$1.50
TODAY **WORTH \$12.35**
If plans bought individually

● **THERE'S LOTS OF ENJOYMENT IN THESE PROJECTS**

Making practical things that work and save money is always fascinating, especially when you can do it in spare time and with spare equipment you may have in your own garage or workshop. If you need a welder, you can make that, too. In fact, the fifty basic plans in the LeJay Manual contain instructions that will enable you to make 100 or more individual items. Think of the extra money you can earn making and repairing things for other people.

● **PLANS EASY TO FOLLOW**

These plans were made for YOU and others like you, who are not in any sense electrical experts or mechanics. They are simple, yet efficient, and do not need a lot of expensive tools to carry them out. Thousands of amateurs are having fun or making profits with the many things these plans helped them to build. The illustrations shown are only a few of the many things you can make.

LEARN HOW TO BUILD

- 200 Amp. Generator Welders
- Workshop Spot Welder
- Large Transformer Welders
- Gunsmith's Carbon Welder
- Electric Fencers
- Armature Rewinding
- Bench Grinders
- 6, 12, 32 and 110-Volt Motors
- Wind Driven Light Plant
- Insect Electrocutors
- Electric Bicycle Pusher
- and Many Other Things

MAIL COUPON
TODAY enclosing
\$1.50

● **SENT C. O. D. IF YOU PREFER**

Fill in and mail the attached coupon and we will send you the LeJay Manual C.O.D. on three days trial, guaranteeing to return your \$1.50 if you return the manual. However, you can save C.O.D. fees by sending cash in the first instance. The same return privilege applies. In Canada, send \$1.75.

LEJAY MFG. CO
47 LEJAY BLDG.
MINNEAPOLIS, MINNESOTA

Tested in a Worldwide Laboratory

On far-spread fighting fronts Ampro 16 mm. sound projectors have been subjected to the most rigorous tests ever devised. These machines have had to stand steaming, corroding humidity, congealing, sub-zero temperatures, dust storms and jarring vibrations—plus day after day operation with a minimum of service facilities.

Add to this more than a decade of pre-war experience in building 16 mm. projectors—and you will understand why Ampro provides continuous, efficient operation under the most adverse conditions.

To keep in touch with new developments in 8 mm. and 16 mm. projection—write to Ampro Corporation, Chicago 18, Illinois.



Ampro Corporation
Chicago 18

Precision
Cine
Equipment

AMPRO

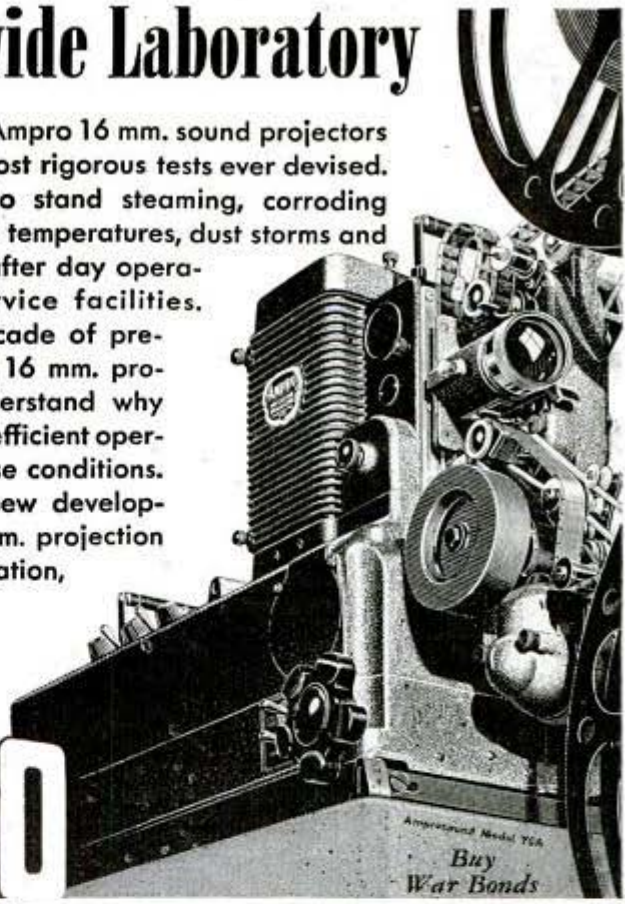

Ampro Model T66
Buy
War Bonds

TRAILER AXLES, HITCHES, AND PARTS

● If you are interested in purchasing trailer axles, hitches, and other trailer parts, contact us promptly. Complete house trailer blue prints, \$1.00. Write for free literature.

HAMMER BLOW TOOL COMPANY, Dept. 101, WAUSAU, WIS.

ELECTRIC HEATING ELEMENTS . . . NOW YOU CAN REPAIR THEM

Use Nichrocite Paste

Simply overlap ends, apply Nichrocite Paste and turn on current. Used by large utility companies. Trial order, \$1.00; 4 oz., \$2.50; 1 pound, \$8.00.

ADVANCE MFG. & DIST. CO. Box 861 Minneapolis, Minn.

5 lbs. HANDY ASSORTMENT \$1.98

FOR MECHANICS—GARAGES
—WORKSHOPS—HOME USE
SCREWS • NUTS • BOLTS • WASHERS •
RIVETS • SPRINGS • BRACKETS • MISC.

MORE THAN 1,000 PIECES

5 full pounds—a veritable treasure chest of fastening devices for every practical use. Satisfaction guaranteed. Order now. \$1.98

SPECIAL—2 assortments, over 2,000 pieces, for \$3.69.

HUDSON TRADING CORPORATION
The House of Handy Assortments
J-165 West Hubbard St., Chicago 10, Ill.

FREE! Handy List of Special Assortments: FIBER AND BAKELITE WASHERS—RUBBER WASHERS and PADS—FELT WASHERS and PADS—RADIO LUGS, CLIPS and CONNECTORS—SPRINGS—SELF-TAPPING SCREWS—etc.



★ SAVE WASTE PAPER ★

Hellcats... By Buick... are Sherrill Equipped



the SHERRILL Magnetic "Director" COMPASS

BATTLE COMPASSES TODAY!

- AUTO
- AVIATION
- AND BOAT
- COMPASSES TOMORROW!

This battle-tested big brother of the famous pre-war Sherrill Auto Compass includes new principles of compass design that will be available in the complete line of Sherrill's Magnetic "Director" Compasses and they'll sell at popular prices.

T. M. Reg. U.S. Pat. Off.

SHERRILL RESEARCH CORP., Peru, Indiana



HANDEE

Tool of 100 Uses

The original, fit-your-hand tool—today's finest. Does precision work on any metal, alloy, plastic, wood, horn, bone, glass, etc.

A WHOLE TOOLSHOP IN ONE HAND

The sky's the limit with the Handee. Its usefulness is as extensive as the number of quick-and-easy-to-change accessories you own—there are more than 300 in the Chicago line to grind, drill, polish, cut, rout, carve, engrave, sand, saw, etc.

Because it's perfectly balanced and weighs only 12 ounces the Handee is the "non-fatiguing" tool. Operates on AC or DC current at 25,000 r.p.m.

With 7 Accessories, Postpaid \$18.50 to all who have Priorities.

Free new 64 page Catalog of complete Chicago line.

CHICAGO WHEEL & MFG. CO.

1101 W. Monroe St., Dept. PM Chicago 7, Ill.



Repair FIREPLACES and BARBECUE PITS

THE EASY **Centraz** WAY

USE **Centraz** BRICK POINT



... A SPECIALLY PREPARED MIX FOR FILLING BRICK JOINTS AND FURNACE LININGS... **BETTER**

IT'S IDEAL FOR BARBECUE PITS WITHSTANDS 3100° F. HEAT!

Pint 35¢
(40¢ WEST OF ROCKIES)

See Your Hardware and Paint Dealer
CHRISTY COMPANY, Inc.
1417 PINE STREET • ST. LOUIS 3, MO.



Fuse Puller — Circuit Tester

For Home or Factory

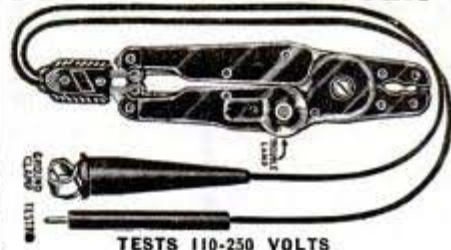

TESTS 110-250 VOLTS

When motors stop and lights go out, this tool quickly **LOCATES DEAD CIRCUITS** and safely removes blown Fuse. The Star Test Pocket Plier is made of a Transparent Plastic having in one of the legs a small lamp in series with a resistance and can be used to test 110 to 250 volts circuit. The Plier will pull fuses from 10 to 100 Amperes. Thousands of Electricians find this tool handier than Test Lamps. Price \$2.75 each without Leads, \$1.50 additional for Leads, plus 10¢ postage. Can be obtained from General Electric or Westinghouse Stores or directly from us. Order NOW. **STAR PLIER CO., 233 Canal St., New York 13, N. Y.**

AMAZING MYSTERY BUTTON



Startles Everybody. With this **Electronic Button** you can make your own Telephone—Amplifier—Detectophone. Attach this button to piece of cardboard—transmit conversation to another room. Music also transmitted to distant places. Most interesting, electrical apparatus never discovered. Enables you to perform hundreds of experiments. So tiny it can be concealed in dozens of places. A Pre-War Product. Electronic Button including 5000 word instruction booklet with 50 illustrated experiments postpaid only \$1.00.

Electronic Products Company, Saint Charles, Ill.



Titan Slide Rule

6" diameter. Easily read, clearly marked single index scales. Gives logarithms, reciprocals, squares, square roots, sines, and tangents. Continuous circular calibrations cannot go "off-scale." Invaluable in multiplication, division, proportion, conversion, all mathematical problems. Made of durable heavy pure white Vinylite. Complete with instructions, \$2.95. Leatherette case 75¢ additional. Money-back guarantee.

PRECISION INSTRUMENT CO.

Box 654, Dept. G Church St. Annex New York 7, N. Y.

NEW OTTAWA SAW

BIG FREE BOOK World's Fastest 6 H.P. EASY to MOVE Falls trees. Saws big logs, small logs, limbs. Pulley for belt work. Easy to handle, weighs less than lower powered units. FULLY GUARANTEED. Cash in on fuel shortage. Turn wood lots into cash. **OTTAWA MFG. CO. 127 PINE ST. OTTAWA, KANS.**



Tired Kidneys Often Bring Sleepless Nights

Doctors say your kidneys contain 15 miles of tiny tubes or filters which help to purify the blood and keep you healthy. When they get tired and don't work right in the daytime, many people have to get up nights. Don't neglect this condition and lose valuable, restful sleep.

When disorder of kidney function permits poisonous matter to remain in your blood, it may also cause nagging backache, rheumatic pains, leg pains, loss of pep and energy, swelling, puffiness under the eyes, headaches and dizziness.

Don't wait! Ask your druggist for Doan's Pills, used successfully by millions for over 40 years. They give happy relief and will help the 15 miles of kidney tubes flush out poisonous waste from your blood. Get Doan's Pills.

Do you know what makes this **DURO 6" Jointer** *the most efficient in its field?*

The DURO 6-inch Jointer has been acclaimed by men who use it as one of the finest jointer values on the market! Here's why: It has many exclusive features such as front and rear blade guards, extensions to increase support of work to 60", fence that eliminates dangerous gap over rear table, New Departure Ball Bearings. Cuts to 1/2" depth on material 6" wide. Has many other unusual features. Available on priority only.



SEND FOR LATEST DURO CATALOG . . .

For full details and prices on the DURO 6" Jointer send for latest DURO CATALOG using coupon below. Also lists specifications and prices of complete line of DURO single and multi-spindle Drill Presses, Circular Saws, Jointers, Routers, Shapers, Grinders, Lathes, Scroll Saws, Flexible Shaft Units and Portable Electric Drills.

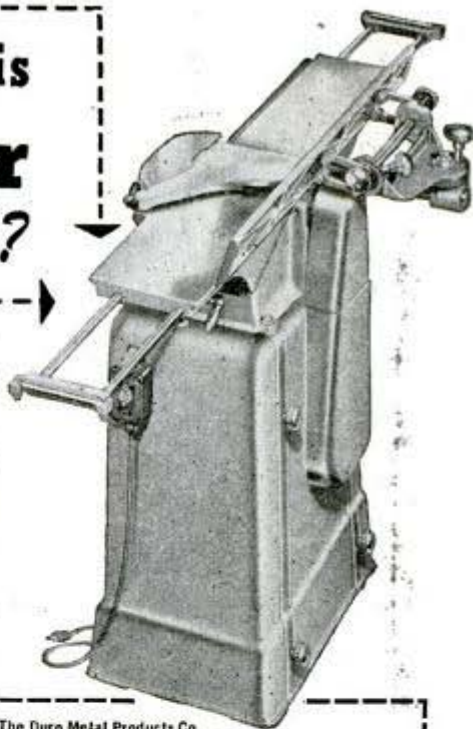

DURO TOOLS

MACHINE TOOL DIVISION
ALSO MAKERS OF **DURO HAND TOOLS**

The Duro Metal Products Co.
2053 N. Kildare Ave., Chicago 30, Illinois
Gentlemen: Please send me FREE copy of latest DURO Catalog giving full specifications on new DURO 6" Jointer and other DURO Machine Tools.
Name.....
Address.....
City..... Zone..... State.....

IT STAYS ON . . . RUST STAYS OFF

FIENDOIL

RUST INHIBITOR

Keep home tools, appliances, corrosive metal protectively coated.

35c Bottle Hdwe. — Sptg. Goods Dealers
McCambridge & McCambridge Co.
Baltimore 23, Md.



DUPOR No. 1 MINIATURE DUST MASK

Wear when sanding, grinding, paint spraying, sweeping, dusting, furnace cleaning, etc. Handy as a pair of glasses. Just keep mouth closed and breathe through nose is all you do to operate. Protects against nuisance dusts, lint, coal, cement, grain dust. Hay fever sufferers wear to keep from breathing pollen. Weighs 1 oz. Has 3 sq. in. filter. Write for Free Literature!



H. S. COVER, Dept. PM, South Bend, Ind.

"GOLDEN JUBILEE YEAR, 1894-1944"

Order Today \$1.00 POST PAID



MEN

This Horseshoe Ring, Handmade, Hand - engraved, inlaid with simulated pearl, is a **KNOCKOUT!** Shoe and shank of everlasting Monel Metal is

GUARANTEED 20 YEARS

Supply is limited . . . rush your order! SEND NO MONEY. Pay Postman only \$3.85, plus excise tax and postage. Return for refund in five days if not delighted. State size. Address:

AMERICAN JEWELRY CO., Dept. 160-H, Wheeling, W. V.

JANUARY, 1945

Start a **SAW REPAIR BUSINESS!**

MAKE A GOOD LIVING IN YOUR OWN BUSINESS—sharpening saws with the Foley Automatic Saw Filer. It makes old saws cut like new again. All hand saws, also band saws and cross-cut circular saws can be filed on this ONE machine.

THERE ARE HUNDREDS OF SAWS TO BE FILED in your own neighborhood, used by farmers, carpenters, homes, schools, factories, etc. W. L. Tarrant writes: "I left my old job last September and in 10 months have filed 2,159 saws. We have a lovely business worked up and cannot keep up with the work."

SEND FOR FREE PLAN

Shows how to start this steady cash business. No experience needed, no eye-strain, no canvassing. Send coupon today.

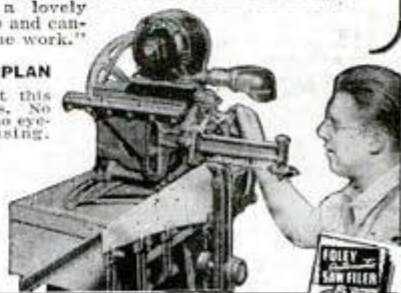

FOLEY Automatic SAW FILER

FOLEY MANUFACTURING CO.
116-5 Foley Bldg., Minneapolis 13, Minnesota
Send Free Plan on Saw Filing business, no obligation

Name.....

Address.....

★ SAVE WASTE PAPER ★

THE ONLY TOOL OF ITS KIND

Indispensable for Craftsmen

BURGESS vibro-tool

Trade Mark Reg. U.S. Pat. Off.



- WRITES ON STEEL
- ENGRAVES JEWELRY
- TOOLS' LEATHER
- CUTS STENCILS
- SLICES CARDBOARD
- CUTS RUBBER-CLOTH PATTERNS
- CARVES WOOD

AVAILABLE
NOW

Instantly, electrically, you can perform all these tasks . . . and many more . . . with Vibro-Tool: 120 vibrating strokes per sec; 110 v. 60 cycle, AC current. Anyone can use. See your dealer, or mailed postpaid on receipt of check or money order. Illustrated folder free on request.

Only
\$750
Complete
with 20 Engraving
Needles

(HANDICRAFT DIVISION)

BURGESS BATTERY COMPANY

166 N. Wabash Avenue Chicago 1, Ill.

**FRANKLIN'S
THIN GLUE LINE
HAS UNSEEN
STRENGTH**

**GLUE for KEEPS
with FRANKLIN**

Here's a genuine Hide Glue that needs no mixing, no heating. Comes ready-to-use. Eliminates chilled joints. Tests prove Franklin stronger than the wood itself.

AT YOUR HARDWARE DEALER
Or Send 30 Cents for 1/4 Pint to
The Franklin Glue Co., Columbus 3, Ohio



ELECTRICITY FOR ANY JOB ANYWHERE



Reliable, economical electric service anywhere, anytime, with an Onan Electric Generating Plant. Driven by Onan built, 4-cycle, gasoline engines, these power plants are of single-unit, compact design and sturdy construction. Suitable for all types of service.

Models range from 350 to 35,000 watts. A.C. types from 115 to 660 volts; 50, 60, 180 cycles, single or three-phase; 400, 500 and 800 cycle, single phase; also special frequencies. D.C. types range from 6 to 4000 volts. Dual voltage types available. Write for engineering assistance or detailed literature.

ONAN

D. W. ONAN & SONS, 2501 Royalston Ave., Minneapolis 5, Minn.

POCKET ADDING MACHINE

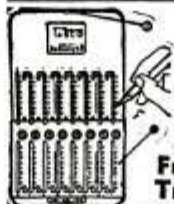

STURDY STEEL construction for lifetime use. Adds, subtracts, aids multiplication. Capacity 999,999.99. A real machine—guaranteed 5 years. Thousands of satisfied users. Send name and address. We ship immediately. On delivery, pay postman \$2.50 (plus C.O.D. and postage charges). If you send \$2.50 with order, we pay postage. Leatherette case 25c additional. Your money back after 10 days trial if not satisfied.

Free
Trial **\$2.50**

Send no money

TAVELLA SALES CO., 19AA West Broadway, New York 7, N. Y.

WOOD WORKERS

LUMBER—PLYWOOD AVAILABLE

Harold Hunt wants to send revised No. 14 catalog. 124 pages of woodworking ideas. UNEQUALED BARGAINS in imported and American woods, supplies. Those already holding this catalog—send for revised sheets.

CRAFTSMAN WOOD SERVICE CO.
2729 S. Mary St., Dept. A-53, Chicago 8, Ill.



BUILD ARC WELDER FROM OLD GENERATOR

For Light or Heavy Work. 75-200 amperes. Complete PLANS 35c. Send today and we'll include FREE our Big NEW Catalog.

LEJAY MANUFACTURING CO.
1347 LeJay Bldg., Minneapolis, Minn.



WINDOW SIGN LETTERS

For Store Fronts and Office Windows. Anyone can put them on. Samples furnished. Imitation Gold and Silver. METALLIC LETTER CO., 430 N. Clark St., Chicago 10

Burpee's BEST VEGETABLES 5 Packets 10¢

To see what a fine garden you can have with Burpee seeds, we'll send these 5 full-size 10c-Packets—Marglobe Tomato, Grand Rapids Leaf Lettuce, Crosby Egyptian Beet, Chantenay Carrot, Scarlet Globe Radish—all 5 Pkts. postpaid for only 10c. Send *now* today!

Burpee Catalog Free—all best Flowers, Vegetables; the leading American Seed Catalog.

W. Atlee Burpee Co.

512 Burpee Building, Philadelphia 32, Pa. (or) Clinton, Iowa

Send 5 Pkts. Burpee Vegetable Seeds (No. 7050) postpaid. Enclosed is 10c.

Name.....

St. or R.D.

P.O. & State.....

Send Burpee's Seed Catalog FREE.



These
Globe
products
do
precision
work

★
Compact,
Rugged Construction,
Low in Cost!

Immediate Delivery

Detailed literature
free upon request.
Address Dept. P.M.

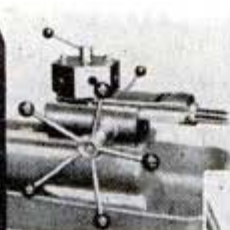

GLOBE HEAVY DUTY BED TURRETS.
Adaptable to any lathe. 4 3/4" travel. Precision built. Rugged construction.

GLOBE CROSS SLIDE. Adaptable to any lathe. 3 1/2" travel. Rugged construction.

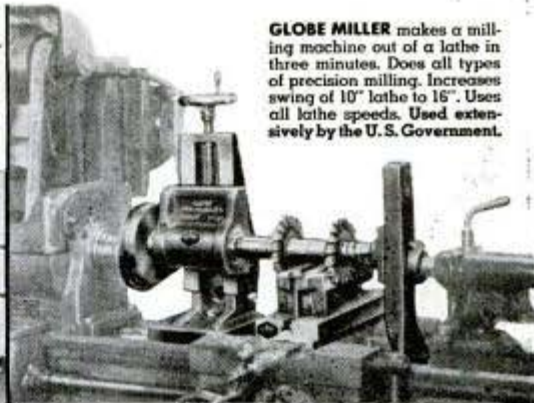
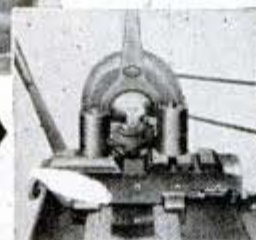

GLOBE MILLER makes a milling machine out of a lathe in three minutes. Does all types of precision milling. Increases swing of 10" lathe to 16". Uses all lathe speeds. Used extensively by the U. S. Government.

IMPORTANT! When ordering or requesting prices on above items, be sure to give: 1. Make and model of lathe. 2. Lathe swing. 3. Power or hand cross feed. 4. State if lathe is equipped with telescoping taper attachment.



GLOBE HAND SCREW MACHINE produces precision parts at high speeds, low cost. Ball Bearing Headstock. 10" swing, 1" capacity. 12 speeds up to 3126 RPM. Exceptionally rugged construction.



MILLING VISE (below) with replaceable jaw plates. Jaws 3 1/2" wide, 3" opening, 1 1/4" deep. Larger sizes available.

DIVIDING HEADS. Precision built. Various sizes available.



Milling arbors. 4", 8", and 12"



WORK HOLDING FIXTURES, hold work of various shapes for milling, drilling, shaping or grinding.

End Mill Holders. Various sizes.

GLOBE PRODUCTS MANUFACTURING CO., 3380 ROBERTSON BOULEVARD, LOS ANGELES 34, CALIFORNIA

★ **Fix Scratches, Dents, Nicks**
the Professional Way!



★ **Get This Handy Kit!**

Repair damaged furniture surfaces with new practical kit. Enables anyone to do fast, easy touch-up jobs like a professional cabinet finisher. Makes furniture and cabinets look new. Every home and shop needs this remarkable kit. Pays for itself over and over!

Amazing Results—Easy to Use

Kit includes 23 different items—scratch removers for slight scratches, assorted shades of shellac sticks for deep nicks, bottles of light and dark stains, staining lacquer, alcohol lamp with fuel, stainless steel spatula, touch-up brushes, scratch sticks, steel wool, sandpaper, rubbing liquid. Packed in handy leatherette finish case. Send for it today. Best investment of lifetime. Fully guaranteed. Detailed instructions supplied.

\$3.95

Postpaid

AMERICAN HOUSEHOLD BUREAU
Dept. F, 520 N. Michigan Ave., Chicago, Ill.

THINGS TO MAKE IN YOUR HOME WORKSHOP

16 Complete Plans — only 10c
Useful, practical, easy-to-build projects — bird houses, lazy chair, etc. Includes photos, drawings.

STANLEY TOOLS
115 Elm Street, New Britain, Conn.



AUTO ENGINE SPEED CONTROL GOVERNORS

Give constant or changeable speed to any auto or truck engine, when used for power. Guaranteed. Instructions. Oil ring bearing \$13.00. Ball bearing, constant or changeable speed, \$19.50. Prepaid. Also additional carburetor butterflies. In Montreal: 7546 Wiseman St.; Latin America: East Asiatic Co.

Agents wanted: Parts Dealers, Garages, Wreckers, Implement Dealers. General Merchants, etc. Free circulars.
CANDEE, 2641 S. Hill • Los Angeles 7, Calif.

JANUARY, 1945

★ **SAVE WASTE PAPER** ★

Quick, Easy, Lasting REPAIRS!



Cracks, holes, dents in wood, plaster, concrete, metal, etc. — loose handles, rungs, knobs, screws — mistakes in carpentry, etc. — fix them all with Savogran Crack Filler (hard as stone) or Savogran Wood Putty (easily tooled). Just mix with water, press into place. Stays put, hardens quickly, will not shrink! Can be painted, pre-colored. Ideal for models, inlays, etc. Patented! Big 1-lb. can only 30c at hardware and paint stores.

FREE CIRCULAR

Describes these and other Savogran Products: Heavy Duty Cleaner, Remover & Bleacher (renews floors), Paint Brush Cleaner, Stryp-eze (removes all finishes), Coldfoam Soapless Soap Powder.

THE SAVOGRAN CO.

Dept. 14, Boston 10, Mass.



SAVOGRAN
CRACK FILLER • WOOD PUTTY
IN EVERY WELL-EQUIPPED HOME WORKSHOP

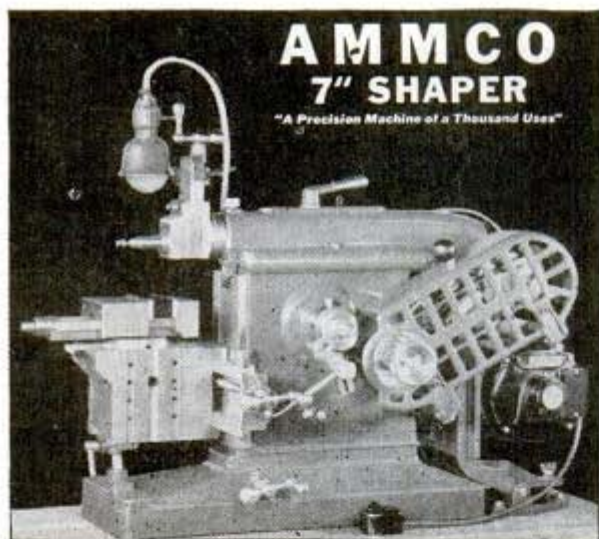

AMMCO 7" SHAPER

"A Precision Machine of a Thousand Uses"

A wide variety of jobs can be done accurately, quickly, easily, and economically on the AMMCO Shaper (7" stroke). Construction incorporates many features you would expect to find only in larger, more expensive machines... For example: WAYS of ram, tool head, and front face of the main frame are of the "VEE" type, hand scraped to insure accuracy and long life. Available for stationary installation or as portable unit.

Write today for specifications and prices

AMMCO

2140 Commonwealth Ave. North Chicago, Ill.

FREE! LATEST, MOST COMPLETE RADIO PARTS CATALOG



EVERYTHING in RADIO and
ELECTRONICS for War Training,
Maintenance or Repair

New R-F Resonance and Coil Winding CALCULATOR

Easy to use! For fast accurate determination of resonance factors and coil winding data. No. 37-955. Postpaid, 25c.

RADIO'S FINEST BOOK VALUES

Specially prepared to aid radio training in schools and industry. Full of valuable data. Send for all six!

- Radio Formulas and Data Book No. 37-752... 10c
- Dictionary of Radio Terms No. 37-751... 10c
- Radio Circuit Handbook No. 37-753... 10c
- Radio Builders' Handbook No. 37-750... 10c
- Simplified Radio Servicing No. 37-755... 10c
- Radio Data Handbook No. 37-754... 25c
- All Six Books No. 37-799... 75c

ALLIED RADIO CORP.

833 W. Jackson, Dept. 5-A-5, Chicago 7

ALLIED RADIO

PALMGREN

No. 250 MILLING ATTACHMENT VISE

A most necessary fixture for small shops and even emergency work in large ones. Fits any 8"-9"-10" South Bend, Atlas, Craftsman, Sheldon or other lathes of similar sizes. Has graduated vertical feed screw and 360 degree graduation for vertical angle adjustments. Easily mounted on cross slide and held by one T-slot bolt. Equipped with PALMGREN VISE, 2 1/2" jaws opening full 2 1/2". Vise has one plain and one grooved jaw for holding round pieces.

MAKES MILLING OPERATIONS POSSIBLE ON ANY LATHE

Width	Depth	Opening	Jaw	Jaw	Jaw	Height	Price
2 1/2"	1-7/16"	2 1/2"	10 1/2"				\$24.75

Order Direct—give priority—if dealer can't supply.

CHICAGO TOOL AND ENGINEERING CO.
8404 South Chicago Ave. CHICAGO 17, ILL.



REPAIR YOUR OWN! ELECTRIC APPLIANCES!

Trademark Reg. and Pats. Pend.

CHANITE Self-Welding ELECTRICAL HEATING ELEMENT FLUX. Generous amount; instructions enclosed. \$1.00 postpaid.

CHANITE SALES COMPANY
914 South Main Fort Worth 4, Texas



BUILD WITH CEMENT COMPOSITION

strongly reinforced with cheap wood. Several formulas. Modern stream-lined roof, walls and gutters in one. How to build a house 22x24, three rooms, as low as \$100 for materials, garage, 320, 20x50 poultry house, 450. Farm buildings for a few dollars. Home-made equipment to make wall-high building blocks with inside and outside finish. Also roof, wall and floor tile in color, and durable wallboard of wood. Labor saving. Long lasting. No painting. Make doors and windows. Sectional cabins, 100 money-saving ideas. Mixer and saw easily made from an old auto: 40 Wartime plans. Earn \$10 a day. Guaranteed, illustrated instructions, \$1.00.

MAKE FURNITURE OF COMPOSITION cement, sawdust, asbestos, paper. Some part veneer wood and metal. Illustrated instructions to make tables, cabinets, chests, racks, shelves, inlaid desks, lawn furniture and toys, 240 per cent profit, 50c.

HOW TO MAKE ACCURATE WOODWORKING MACHINES: Band, jig and circular saws; electric drills, sanding wheels, tools, electric weed cutters and many other things from old auto parts and washing machine motors. Illustrated, 50c.

HOME MFG. ENTERPRISES, 50 selected home shop projects, 50c.
Special: All of the booklets described above, \$2.00 postpaid. No C.O.D.
HOME INDUSTRIES, 1318 South 30th Ave., Dept. PM, Omaha 5, Nebr.

MASCOT SLIDE RULE

Fits the pocket. Quickly solves any problem in multiplication, division, proportion. Gives the square, the square root, logarithm and reciprocals of all numbers. Trig scales give sines and tangents of numbers. Fine black graduations on white celluloid. Complete with instructions. Price in fabricoid case \$1.00, in leather case \$1.25. Money back if not satisfied. Special offer to agents and dealers.



MONITOR SLIDE RULE—6" Dia.

Made in white Vinylite. Same scales as Mascot Slide Rule. Complete with instructions. Without case, \$2.95. Leatherette case, 75c add'l.

TAVELLA SALES CO., 19-A West Broadway, New York 7, N. Y.

SHAW and Peppy-Pal DU-ALL GARDEN TRACTORS

1 to 9 H.P. Circulars on request. War limits production—We supply repairs for all SHAW Tractors sold in our 40 years in business.

BUILD YOUR OWN RIDING TRACTOR—"WAR HORSE"

using old auto parts, powered by 2 H.P. or larger air-cooled engine; or walking type Garden Tractor 1/2 to 3 H.P. or convert truck or auto into Farm Tractor. Each with steel or rubber tires; will plow, cultivate. Plans for building, in few hours, any one of above, postpaid for \$1.00 (state which wanted) or all 3 for \$2.00. Money Back Guaranteed!

SHAW MFG. CO., 4501 Front St.
Galesburg, Kansas
668G North 4th St., Columbus, Ohio



★ SAVE WASTE PAPER ★

For Men who

... Really Know Pipes

Royalton CROWN

\$1.50

Selected Briar

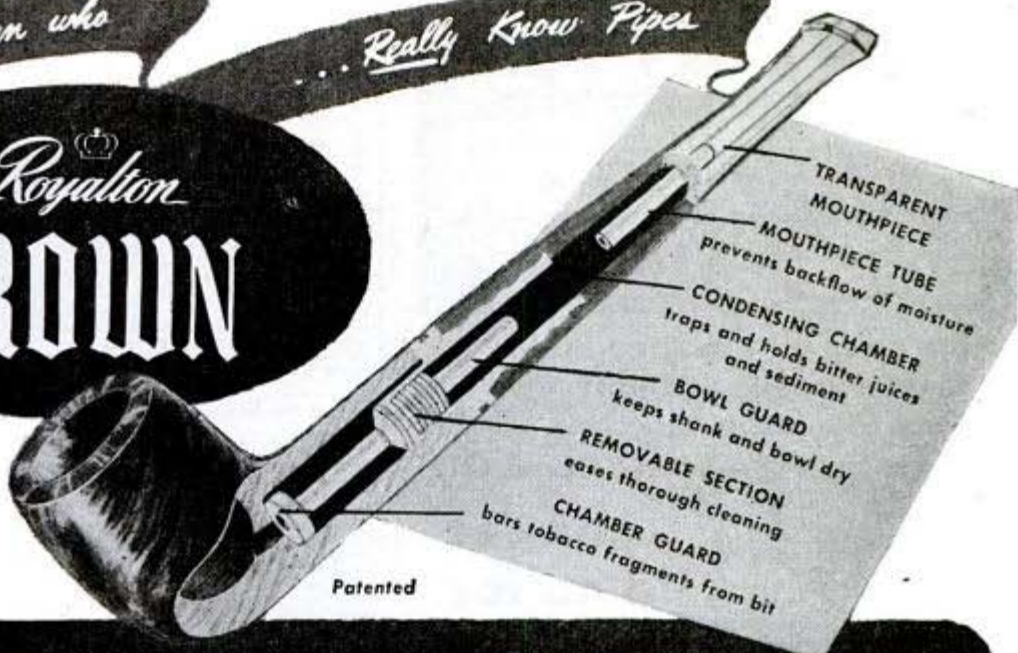

Patented

THIS IS NOT THE "PIPE DREAM" OF A GADGETEER... Fact is, the *one* amazing thing about the Royalton Crown is its ability to keep everlastingly dry. You are not annoyed by acid juices or slugs—these gremlins can't by-pass the condensing well and other patented Royalton Crown safeguards. Every pipeful gives you added dividends of smoking pleasure because bowl and stem remain sweet and dry. And it cleans in a jiffy.

HENRY LEONARD & THOMAS, INC. • OZONE PARK, NEW YORK

ANYONE CAN
DO THIS IF
THEY HAVE
OUR CHART

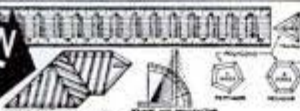

SPECIAL
OFFER
FOR
AGENTS

Blue Print 27" x 36" shows how to find length of any rafter; find any angle in degrees, frame an octagon scale, rafter tables and many other uses. Can be scaled down for model work as well as full scale framing. Also Chart changing pitches to degrees for use with Radial Saws. Send 50c in Coin or M. O. No Checks or Stamps. MASON & PARRISH ENGINEERS, 2106-B N. Burdick St., Dept. D, Kalamazoo 51, Mich.

INVENTORS, SCHOOLS, CRAFTSMEN BRONZE FOUNDRY



is again available in limited quantity without priority. Orders filled in sequence as received. INVENTORS—SCHOOLS—CRAFTSMEN use FOUNDRYETTE for making castings quickly for new inventions, for instruction, and general purpose. Order now for early delivery. Three sizes are available capable of making bronze castings of 1 1/2, 3, and 6 pounds weight, aluminum, copper, brass, etc., \$17.50, \$24.00, \$34.50, L.o.b. Kansas City. Domestic gas supply and 110 volt AC or DC energy required for operation. Write for circular.

KANSAS CITY SPECIALTIES CO.

Box 6022, Dept. P-50

Kansas City, Mo.



**SIMPLE EASY INVENTION
TRIMS HAIR AT HOME!**

SAVES
BARBER BILLS

Trims hair as it combs! Easy! Quick! Keeps men's, women's children's hair trim, neat, freshly-cut looking all the time! Trims, tapers, thins out uneven hair. Use like ordinary comb. Safe, Simple.



No experience required. Fine for legs, underarms! Sells like wild! SAMPLES FOR AGENTS Sample offer sent immediately to all who send name at once. A penny postal will do. SEND NO MONEY. Just your name. KRISTEE CO., 681 Bar St., AKRON, OHIO

SHARPEN YOUR DRILLS with the E-Z

ONLY
\$2.80
complete



WITH
NEW
PROTRACTOR
FEATURE

DRILL SHARPENER

SHARPENS ALL ROUND SHANK DRILLS
FROM THE SHORTEST TO 11" LONG—
3/32" to 1 1/16" DIAMETER

This precision fixture was developed for factory use by aircraft tool engineers. Real shop size and not a toy. Sturdily built, attaches to bench or grinder frame. Has new PROTRACTOR FEATURE which enables you to adjust quickly for different drill angles. Thousands now in use—home and repair shops, garages, factories, farm shops—wherever accurate holes are drilled. E-Z is simple to operate. Gives faster drilling, perfect hole centers and clearance. Guaranteed to do the work or money back. SAVE MONEY WITH E-Z. Comes complete with instructions, ready to sharpen your dull drills as good as new. Low price of \$2.80 because of our volume business on this wanted precision tool. The E-Z protractor gives you proper angles for cutting extra hard material, ordinary use, for soft material, wood, Plexiglas, Lucite, Plastics. Send check or money order for \$2.80. WE PAY POSTAGE AND SHIP IMMEDIATELY. Write for FREE folder giving scientific data on drilling techniques.

FRED F. TEN EYCK Dept. P2, 758 S. Irolo St.
LOS ANGELES 5, CALIF.

MODEL No. 1 is already set for 50° drill angle, no adjustment needed for 99% of drills. Sturdy shop model. Postage paid \$1.98.

So-Lo SAVES RUBBER

AND MOST ANYTHING MADE OF LEATHER AND CLOTH

- Spreads Like Butter
- Dries Hard Overnight
- Flexible—Non-Skid
- Waterproof—Won't Come Off



Longer Life for TIRES

Easy to fix cuts, bruises, worn spots in tires at home. Keeps out grit and water. Add hundreds of miles wear to your tires with SO-LO.

Re-Sole Your Own SHOES

Easy—at home. Spread on So-Lo like butter. Wears like leather. Use it for all footwear, children's and grownups'. Also use So-Lo for raincoats, boots, etc. Guaranteed to SAVE!



1,001 Repairs in the Home, Auto, Farm, Factory and Shop



Mend It with So-Lo

FOR ONLY **1¢** EACH



So-Lo

AT ANY HARDWARE AND 10c STORE

DRILL PRESS OWNERS!

HERE'S 1 TOOL WITH 5 DISTINCT USES
THE BARRON MULTI-PURPOSE ROTARY WOOD PLANER



PLANES & SURFACES • PANELS & BEADS
ROUTS & GROOVES • RABBETS • TENONS **\$7.50** COMPLETE

Converts ANY drill press into a time saving, low cost planer, paneler, tenoner, etc. Surface finishes all types of tough grained and knotty surfaces to agate smoothness. Safe! Guaranteed harmless to drill press. Thousands now in use. **SOLD ON MONEY BACK GUARANTEE.** Full refund on 5 day trial. Shipped prepaid on receipt of \$7.50—or C.O.D. YOU RISK NOTHING. Free literature.

STEEL TOP AUXILIARY DRILL PRESS TABLE

Has 300 sq. in. smooth working surface. Equipped for shaper and many other important workshop uses—a real buy at **\$95**



Barron Tool Co., 369 Architects Bldg., Detroit 1, Mich.

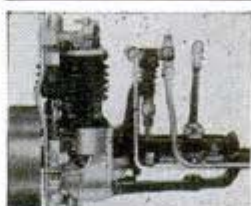

Build: STEAM ENGINE

- A precision built and engineered single cylinder, 1/4" scale marine model, with clutch or reverse.
- Send \$2.50 for 14 pages scale drawings, 2 photos, instructions.
- 2 Photos and Description... \$.25
- Rough Castings Kit..... 12.50
- Horizontal Flash Boiler Drawings and Instructions 1.00

THOMPSON ENGINEERING CO. 205 NO. DIVISION BLDG., GRAND RAPIDS 2, MICH.



"WONDER" ELECTRIC BUTTON

Most interesting electrical apparatus ever discovered. Make your own Telephone Amplifier, Detectors, Transmitters your voice or music to distant rooms. Perform hundreds of fascinating experiments. So tiny it can be concealed in dozens of places. Send \$1 now for button and free 3,000 word instruction booklet with 50 illustrated experiments. **SPECIAL OFFER 6 buttons and booklets sent post-paid for \$3.**

BUCK MFG. COMPANY, Box 124, No. Aurora, Ill.



Balance 4" x 5" Base. With either Metric or Avoirdupois Weights... **\$6.00**

Catalog with 3000 illustrations of laboratory apparatus sent for 75 cents. Catalog listing 10,000 chemicals, drugs, minerals, etc. and 1700 scientific books sent for 35 cents. **LABORATORY MATERIALS CO., 7321 Vincennes Ave., Chicago 21, Ill.**

LAW STUDY AT HOME FOR PERSONAL SUCCESS and LARGER EARNINGS. 35 years expert instruction—over 108,000 students enrolled. LL.B. Degree awarded. All texts furnished. Easy payments. Send for FREE BOOK—"Law and Executive Guidance." **AMERICAN EXTENSION SCHOOL OF LAW, Dept. 49-M, 646 N. Michigan Ave., Chicago 11, Ill.**

MAKE THIS SUIT YOURS NEW PLAN

Big CASH EARNINGS Besides!

Write at once if you want this fine tailored-to-measure suit for yourself. You can get it without paying any cash, by simply taking a few orders from friends and neighbors for Pioneer Tailoring. Also earn big cash income—up to \$10.00, \$12.00 in a day—because Pioneer's amazingly low prices help you get orders easily. Scores of choice, rich, beautiful fabrics to choose from, expertly tailored-to-measure and GUARANTEED. Also complete line of Ladies' Tailored Suits. No experience, no money needed. Be well-dressed by getting your own suit, and earn cash besides!



FREE SAMPLES Write! Mail letter or postcard today, telling about yourself—age, etc.—for big complete FREE SAMPLE OUTFIT, PERSONAL SUIT OFFER, and money-making plans. Send no money. Just write **PIONEER TAILORING CO., Congress and Throop Sts., Dept. N-1116, Chicago 7, Ill.**

★ SAVE WASTE PAPER ★



MOTO-TOOL ★ THE "POCKET-SIZE" MACHINE SHOP

PUT THIS WAR VETERAN TO WORK

Approximately
27,000 R.P.M.



MODEL 2
Illustrated

A FEW OF THE JOBS
THAT CAN BE DONE

BETTER AND FASTER
WITH A MOTO-TOOL

- | | | |
|-------------------------------------|-------------------------------------|-----------------------------------|
| <input type="checkbox"/> Sharpening | <input type="checkbox"/> Burring | <input type="checkbox"/> Cleaning |
| <input type="checkbox"/> Finishing | <input type="checkbox"/> Grinding | <input type="checkbox"/> Routing |
| <input type="checkbox"/> Touch-up | <input type="checkbox"/> Polishing | <input type="checkbox"/> Cutting |
| <input type="checkbox"/> Sanding | <input type="checkbox"/> Burnishing | <input type="checkbox"/> Rasping |
| <input type="checkbox"/> Drilling | <input type="checkbox"/> Inlaying | <input type="checkbox"/> Carving |
| <input type="checkbox"/> Mortising | <input type="checkbox"/> Sawing | <input type="checkbox"/> Brushing |
| <input type="checkbox"/> Engraving | <input type="checkbox"/> Scoring | <input type="checkbox"/> Dressing |

Moto-Tool owners are constantly discovering new jobs that these mighty little mid-gets can do more expertly in less time to speed the war effort. In fact, every new purchaser finds dozens of uses in addition to the ones for which he bought his Moto-Tool. So great is the time and labor they save, thousands of mechanics and craftsmen would find it difficult to get along without their Moto-Tools.

ONLY MOTO-TOOLS HAVE ALL
THESE FEATURES

A Model 2 Moto-Tool develops a speed of approximately 27,000 rpm. Weighs only 13 oz. Shaped to fit the hand. Sturdily built. Has shock-proof bakelite housing. Balanced for vibrationless operation. Uses 110-120 AC or DC current.

HOW TO ORDER

Ask your Dealer about Dremel Moto-Tools and accessories. If he does not handle them, send direct to factory. As long as priority ratings are required, ask your War Production Board or your employer for one.

Write for FREE CATALOG.



DREMEL MFG. CO. 115-A RACINE, WIS. U.S.A.

READ MOTO-TOOL'S

Distinguished Service Record

Long before Pearl Harbor, Dremel Moto-Tools won their spurs by tackling tough jobs in tool rooms and machine shops. Since the war began, Moto-Tools have earned the respect of every branch of the armed forces. And thousands of them helped finish production runs in plants such as General Electric, Westinghouse, Remington Arms, Ford, Nash-Kelvinator, Consolidated Aircraft, Northrup, Douglas and many other arsenals.



Kit No. 2
Illustrated

Model 1 Moto-Tool with 1 accessory \$9.85
Kit No. 1, with 23 high grade accessories and model 1 Moto-Tool, in hardwood case . . . \$17.50
Model 2 Moto-Tool with 1 accessory \$16.50
Kit No. 2, same as above, with Model 2 Moto-Tool \$23.50

SAVES TIRES and GAS

★ Don't drive extra miles by back-tracking when you can know the right direction with a **HULL STREAMLINE AUTO COMPASS**. Hull's pre-war excellence is more outstanding than ever. Limited supply available at your dealer's. Circular on request. Price \$3.50.

HULL MFG. CO., P.O. Box 246-D1, Warren, Ohio



TOMBSTONES DIRECT TO YOU \$995 UP

Genuine beautiful **ROCK-DALE** Monuments, Markers.

Satisfaction or MONEY BACK.

Freight paid. Free catalog. Compare our prices

ROCKDALE MONUMENT CO., Dept. 384, JOLIET, ILL.



MAKE BIG MONEY SAWING WOOD NOW!

350 Cuts
a Minute



OTTAWA ONE-MAN TRACTOR SAW

Turn wood lots into cash; help save other fuels to win the war. Use Ottawa—fastest cutting; easiest way. Cuts large and small logs, fells trees. Thousands in use. Built to last with special heavy stiff saw blade. Positive safety clutch control, driven from any power take-off.

OTTAWA MFG. CO., D127, Forest Ave., Ottawa, Kansas

FREE
BOOK
and
Price List

ANYONE, ANYTIME CAN MAKE PHOTO-COPIES QUICKLY



A-PE-CO
PHOTO-COPYER
\$5500

FAST, PHOTO-EXACT COPIES
IN ANY OFFICE OR SHOP

Same-size, exact photo-copies of anything up to 18"x 22". Eliminates steno-copying, tracing, proof-reading. Photo-copies direct from letters, records, pictures, blueprints, tracings, receipts, shop orders—anything written, printed, drawn, photographed. Accepted as legal evidence. Copies from magazines or books. No end to the uses of A-PE-CO. Needed by all departments. Thousands in use.

No Camera — No Darkroom — Low Cost

Any office employee quickly becomes expert. Low cost per copy, lowest investment in equipment. Saves other equipment. Simple, fast. No focusing. Conserve man-hours. Put A-PE-CO on any available desk or table. Immediate delivery. Write today, on your business letterhead, for A-PE-CO folder.

AMERICAN PHOTOCOPY EQUIPMENT CO.
2849 N. Clark St. Dept. GF-15 Chicago 14, Illinois
Representatives in Principal Cities

In Canada: Railway & Power Engineering Corp., Ltd.

★ SAVE WASTE PAPER ★

SHOP AGENTS WANTED TO SELL PRECISION TOOLS

We have an interesting proposition for individual mechanics working in plants, who want to earn extra money as shop agents selling these and other tools in the Scherr line. We can furnish micrometers, combination squares, surface gages, sine bars at prices you can afford, gage blocks and other tools required in metal-working plants. Write for details of this extra income plan.



Write for literature showing our line of GS Tool Chests. Illustrated is Solid Oak Chest 20"x9"x13 1/4" with 7 drawers and two locks for complete safety. SEND YOUR ORDER FOR QUICK DELIVERY.



This is REED No. 801 micrometer with locknut and ratchet and graduated to read to 1/10000". Fully guaranteed for accuracy. 1/10000" vernier furnished in 1, 2 and 3" sizes without extra cost. ORDER THIS ONE INCH MICROMETER TODAY for only \$6.98 plus 10 cents postage.



GS DIAL TEST INDICATORS reading to 1/1000" are widely used for machine set-up and testing. We provide a universal, ball-joint back which permits a wide range of indicator settings. WRITE FOR FOLDER No. PM12 for full details and illustrations.

SPECIAL OFFER: ALL GEORGE SCHERR COMPANY products carry a 10 day money back offer. Send us your order today. Examine the tools purchased. If they do not meet your quality standards, simply return the tools, within 10 days, and we'll refund your payment without question. SEND MONEY ORDER, CHECK, or we'll ship C.O.D.

GEORGE SCHERR CO., INC., 200A Lafayette St., New York 12, N. Y.

"Plastics, the material of the future"



PLASTIC solution

FOR TREATING WOOD and other Materials

Makes softwood hard. Improves weather resistance. Wood becomes more rigid, stronger and more durable. Easy to use. Sufficient ingredients for making One Gallon of Plastic Solution sent prepaid with instructions for mixing, for \$2.

PLASTIC CENTER COMPANY, 809 Mission St., San Francisco 3, Calif.

Name
Address

Johnson "Shur-Grip" DRILL VISE

Has 3-way use. Can hold square, rectangular or round part. A great home-shop time-saver. Price \$15.50

F. O. B. East Providence, R. I. Only cash orders accepted. Send for Bulletin 3-V.



JOHNSON TOOL CO.
L. H. COOK, Owner
EAST PROVIDENCE, R. I.



Monuments

Freight Paid Anywhere in U.S.A.

\$13.69 Up. Guaranteed Genuine Marble & Granite. Deal direct with us by mail. Save. Write for Free catalog today. U. S. MARBLE & GRANITE CO. Oneco, Fla.

A BUSINESS FOR YOU

Learn how you too can obtain a valuable, exclusive franchise for handling STAMINITE protective coatings, waterproofer, NON-SLIPPERY Floor Wax, and PLASTIC BASE speed drying, transparent coatings for wood and linoleum floors and surfaces IN or OUT. If you are qualified for local Distributorship (small stock requirement) you'll prosper greatly. Write TODAY!

THE STAMINITE CORP., DEPT. B., 109 WATER ST., NEW HAVEN, CONN.

ONE-MAN SAWMILL LESS THAN \$135.00

Easy To Turn Trees Into Money

Makes Lumber, ties, shingles, crates, bath, studding, siding.

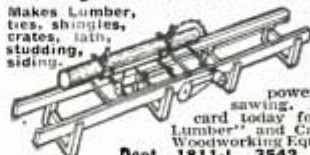

Belsaw Models in 10, 14 and 20 feet sawing lengths. Patented Mechanical Feed, accurate set works and positive dogs. Use tractor or old auto engine for low cost power. Thousands used for commercial sawing. Pays for itself quickly. Send post card today for FREE booklet, "How To Make Lumber" and Catalog of Woodworking Equipment. BELSAW MACHINERY CO. Dept. 1811-L, 3542 Main Street, Kansas City 2, Mo.

BENJAMIN H. G. PELLETS

AVAILABLE FROM FACTORY

and dealers—Cal. .22 at \$2.00 M.; Cal. .177 at \$1.80 M. Place your order now for a NEW Benjamin Air Rifle or Benjamin Air Pistol. Write today for illustrated folder of POSTWAR MODELS and POSTWAR PRIORITY PLAN. BENJAMIN AIR RIFLE CO., 812 MARION ST., ST. LOUIS 4, MO.

Say you saw it in Popular Mechanical!

Complete 520



ENGINES IN STOCK

The G. H. Q. miniature gasoline engine that really operates is still available. Over 100,000 sold to date. 1/5 H. P. Complete with flywheel and propeller, fuel, 15 accessories and full instructions. Fully bench tested and ready to run. Power for all models. \$20 complete. Send only \$1.00—Shipped Collect C.O.D. same day. Send 25c for illustrated Catalog of hundreds of hobby items and airplane identification chart.

GHQ MOTORS, Dept. BV15, P. O. Box 203, Madison Sq. Sta., New York 10, N. Y.



TURN SCRAP INTO MONEY

AUTOPOWER tells you how in plain, easy, simple, and illustrated instructions that anyone can follow. Change auto generators into useful, practical AC and DC generators and motors with voltage from 2 to 1,000 volts, for power, light, welding, radio, sound, etc. No previous experience nor special tools needed. Generators can be driven by wind, water, fan belt, etc. Already used and endorsed by thousands. Send for your copy of "AUTOPOWER." Only \$1.00 postpaid.

AUTOPOWER, INC.

2125 Pine St., St. Louis, Mo.



An Amazing Improvement In Your Pictures

—when you project on Radiant "Hy-Flect" Glass Beaded Screens—as contrasted to old, faded screens and makeshifts

The difference is almost unbelievable! Camera and home movie fans say they can scarcely recognize their old motion pictures, stills and kodachromes when they project them on this improved screen surface. Black and whites show up in brilliant contrast. Colors take on new warmth and depth. The explanation: Thousands of tiny glass optical beads firmly imbedded in the snow white plastic screen surface. Light is reflected brilliantly instead of being partially absorbed. An improved process protects screen against cracking or peeling and assures lasting whiteness.

Radiant Screens offer you many new Special Features

In addition to the "Hy-Flect" Glass Beaded Screen Surface—you will find many special conveniences and unique advantages in Radiant Tripod Screens. These include:

- 1. Automatic Clutch.** A positive device that permits instant raising and lowering of screen housing without the necessity of manipulating screws and bolts. So simple and easy to operate a child can use it.
- 2. Quick Tripod Release.** Tripod legs may be opened or closed quickly. They

support the screen in *any* position for wide or narrow spread without set screws or plungers.

3. Auto-Lock. (Pat. applied for.) Just touch convenient button for raising or lowering center extension rod and screen instantly.

4. Convertible from Square to Oblong—for movies, stills or slides, Radiant square sized screens are convertible to oblong by merely raising screen to indicated position.



The Radiant Screen here illustrated is Model DS—a portable Metal Tripod Screen—sturdy but light, compact, easily set-up, quickly adjustable. Available in sizes from 30" x 40" to 52" x 72".

RADIANT

Better Screens for Better Projection

Radiant Manufacturing Corp.
1197 W. Superior St., Chicago 22, Illinois

Please send me FREE complete Radiant Screen Bulletin giving full specifications, features, prices of complete line of Radiant Tripod, Wall, Ceiling and Table Screens for homes, clubs, etc.

Name _____
Address _____
City _____ State _____

OLD AUTOMOBILE CATALOGS WANTED



A scientific museum wants authentic automobile catalogs and sales literature issued between 1890 and 1925. Will pay reasonable prices. Write full description to Museum, Dept. PM, 140 W. Ontario St., Chicago.

SEND FOR THIS
TIME SAVING **OHMITE**
Ohm's Law Calculator



Figures Ohms,
Watts, Amperes
Volts... Quickly!
Any Ohm's Law
Problem solved
with one setting

of slide. All values direct reading. (4 1/8" x 9")
Send only 10c in coin to cover cost of handling.

OHMITE MFG. CO., 4930 Flournoy St., Chicago 44, Ill.

JANUARY, 1945

BELL



WATERPROOF

Waterproof, shockproof, anti-magnetic, radium dial and hands, unbreakable crystal, precision tested, sweep second hand.

No. MU 121
15 jewels, stainless steel back \$39.75

No. MU 212
17 jewels, stainless steel back \$42.50

No. MU 328 SELF-WINDING
17 jewels, stainless steel case \$59.75

Prices include All Federal Excise Taxes.

Postage Prepaid. Mail Orders Promptly Filled.

Write for Free Illustrated Booklet "MU"

BELL WATCH COMPANY

Time and Life Bldg., Rockefeller Center, New York 20, N. Y.

Say you saw it in Popular Mechanics!

FREE OFFER FOR FALSE TEETH
with your order

CROWN Dental CLEANER

★ Everyone who wears plates will welcome this free offer. **CROWN DENTAL CLEANER** is an especially prepared antiseptic preparation to keep your plates clean and help eliminate bad breath and foreign substances that collect and cause discomfort.

TIGHTENS FALSE TEETH or NO COST!

HERE'S new amazing mouth comfort without risking a single cent... enjoy that feeling of having your own teeth again. Satisfy your desire for food... eat what you want.

JUST 3 STEPS

- No. 1 CLEAN WELL**
- No. 2 DRY UNDER LAMP**
- No. 3 SQUEEZE CROWN FROM TUBE, PUT PLATE IN MOUTH**
- and discomfort caused by loose dental plates. Apply **CROWN RELINER**. In a jiffy your plate fits like new and stays that way up to 4 months. No old-fashioned heating to burn your mouth. Just squeeze **CROWN** from tube and put your teeth back in. They'll fit as snugly as ever. Inventor is a recognized authority in dental field. A patent has been applied for **CROWN RELINER** to protect you from imitators. After you relinse your plate with **CROWN**, take your false teeth out for cleaning without affecting the **CROWN RELINER**. **CROWN RELINER** is guaranteed... it's harmless. It's tasteless. Has that natural pink color. NOT A POWDER OR PASTE! DOES NOT BURN OR IRRITATE. If not satisfied even after 4 months, return partly used tube for full refund.

SEND NO MONEY for CROWN

MONEY BACK GUARANTEE



EATS STEAK!

J. Clements of Algonac writes: "My plates were so bad they rattled when I talked. Now I can eat steaks, corn on the cob." E. W. W., of Virginia, writes: "I found Crown Reliner to be all you claim." Many more attest to same excellent results. Reline your plates with **CROWN RELINER** today.

SEND NO MONEY You must be 100% delighted or no cost. Try four months and return for refund if not satisfied. At your druggist or order direct.

CROWN PLASTIC COMPANY, DEPT. 2401, 4358 W. Philadelphia Ave., Detroit 4, Mich.

Send your wonderful Crown Dental Plate Reliner and include the free Crown Cleaner. I will pay postman one dollar plus approximately 24c postage on arrival. If I am not satisfied after four months, I may return partly used tube for full refund.

(I am enclosing one dollar in payment, same guarantee)

Name.....

Address.....

SAVE WASTE PAPER

Just issued!
New, 16-Page Bulletin!

"Hard-to-Find Radio and Electronic Parts and Equipment"

Free for the asking

Write immediately to Dept. P-15

Now Known **LAFAYETTE RADIO CORP.**
as **CONCORD RADIO CORP.**
901 West Jackson Boulevard, Chicago 7, Illinois

BRUSH PLATING OUTFITS

for autoparts, reflectors, faucets, bicycles. No tanks necessary. Free particulars.

GUNMETAL CO., AVE. M. DECATUR, ILLINOIS

MAGI-GLO LUMINOUS PAINT

128 LIKE MAGIC—Make Anything IN THE DARK

House No.

GLOW

Earrings

Light Switch

32-L W. RANDOLPH CHICAGO 1, ILL.

101 USES: house numbers, clock dials, light switches, dark room equipment, designs on walls, toys, dash boards, costumes, scenery, jewelry, magic in the dark. It's fun, easy to use. Lasts indefinitely. Absolutely harmless.

SEND NO MONEY Complete Magi-Glo Kit only \$1.29. Send name, address, pay postman plus postal charges. Send cash, we pay postage. Satisfaction or Money Back.

Wonder-Tone NOISE ELIMINATOR

Just attach to your radio (long, short wave) and enjoy reception free from distracting noises. Send-No-Money Pay Postman 60c plus postage or send 60c and we'll send postpaid. Return in 5 days for refund if not delighted.

WONDER-TONE COMPANY, Dept 48, 7078 N. Clark St., Chicago 26, Ill.

New OTTAWA WOOD SAW

For Tractors

Makes wood sawing fast and easy. Can cut enough wood to pay for itself quickly. Easily moved while attached. Big heavy blade. FREE details.

OTTAWA MFG. CO.
W127 Oak Ave., Ottawa, Kans.

LOW PRICE

GENUINE U.S. BARGAINS ★★

O. D. WOOL BLANKETS (USED), SELECT... \$3.95
Used Late Issue GAS MASK BAGS..... .89
U. S. ARMY PUP TENTS (USED)..... 3.00
Slightly Used ARMY CAISSON WHEELS with Axles, 56" high, wt. per pair with axles, 560 lbs..... \$35.00
New CONDIMENT CANS..... .6 for \$7.75

Thousands of Other Bargains in Military, Outdoor & Sport Goods for Hunter, Farmer, Scout. Send 10c for 32-page catalog returned with first order.

A and N SUPPLY CO.
4724 LESTER ST. RICHMOND, VA.

EST. 1868

Decorative Decalcomania

Transfers Imported Designs of all Sizes & Types—Flowers, Fruits, Figures, Birds, Dogs, Horse Heads, Ships, Juvenile, Tropical, Chinese, Peasant, Colonial, Patriotic, Inlay, Borders, Initials, etc., for Furniture, Doors, Walls, Trays and what not. Catalog with 800 illustrations in color sent for 25c. Deductible on first order of \$1.00 up. L. C. WELLS, Dept. PM-51, 25 East 26th St., New York, 10

POPULAR MECHANICS

"I HAVEN'T DRIVEN ANYTHING THIS LIVELY SINCE THE TIME I PUT BURD 'GRAF-FLOX' PISTON RINGS IN MY OLD CAR!"



"Graf-Flox" PROCESS ELIMINATES SCORING—SEIZING—SCUFFING

● Burd "Graf-Flox" Piston Rings have "built-in lubrication." This is accomplished by: (1) scientifically controlled electric furnaces which produce ring iron containing evenly distributed natural graphite; (2) special cleaning methods which fully remove tenacious abrasive particles left by grinding rings to size; (3) an

exclusive "Graf-Floxing" process that applies deeply penetrating colloidal graphite. These steps in manufacture are adding to the life of engines of every sort . . . decreasing oil consumption, increasing gas mileage. Get acquainted with Burd Piston Rings . . . mail the coupon below. **BURD PISTON RING CO., Dept. PM, ROCKFORD, ILL.**



MAIL THIS COUPON FOR 2 FREE BOOKS

BURD PISTON RING CO., Dept. PM, Rockford, Ill.

Gentlemen:

I'd like a FREE copy of your "Handy Handbook," which tells how to keep my car in good working order. Also send a "Car Economy Record Book" for keeping my mileage costs.

NAME

ADDRESS

CITY..... STATE.....



ARMY & NAVY BARGAINS

NEW U. S. NAVY DOUBLE BREASTED SHIRTS & DRAWERS, 75% Wool, each.....\$2.98
 U. S. (NEW) ARMY PONCHOS (slightly imperfect) 4.95
 NEW U. S. ARMY CANTEN Collapsible cup, All Billing into cover with Shoulder Strap..... 1.49
 U. S. ARMY RAINCOAT, used, good condition 1.98
 NEW U. S. ARMY CANVAS LEGGINGS, pr..... 1.00
 NEW U. S. ARMY PISTOL BELTS..... 1.29

Send Check or Money Order. Include 30c for postage. THOUSANDS OF SATISFIED CUSTOMERS

WRITE FOR ILLUSTRATED FREE PRICE LIST
TRIANGLE Dept. Y.
 P. O. Box 156
 TIMES PLAZA STATION, BROOKLYN 17, N. Y.

OUR 25th YEAR

110-VOLTS AC from DIRECT CURRENT

with KATO KONVERTERS. Furnish standard 110-v AC from 32, 110, or 220-v. DC. Good deliveries on sizes 350 through 2500 watts on priority orders. Good deliveries on 5, 7 1/2, 15 & 25 KW AC generators. Mfrs. of motor generators, frequency changers and high frequency generators.

KATO ENGINEERING CO.
 45 Elm Street, MANKATO, MINN., USA

POST-WAR MANUFACTURING

We are interested in large or small items or special machinery, standard, patented or patentable. Established 1894.

MORGAN MACHINE CO., INC. Rochester 7, New York
 Replies to S. S. Harrington

MAGIC LIQUID MAKES PHOTOS APPEAR

On Scarfs, Ties, Stationery, Etc.

Reproduce any snapshot on cloth, leather, wood, paper. Simply apply liquid. Like magic photo appears within 2 minutes in broad daylight. Harmless to negative. Won't wash off. Pull colors included. Complete kit for 100 photos only \$1.29. Send no money, just name. Pay postman \$1.29 plus few cents postage on delivery. Or send cash with order and get postpaid. (Canada \$1.50 money order only.) Order today.

L & M Mfg. Co., Dept. 333-G, 229W. Breckenridge, Louisville 3, Ky.

Build This Authentic 3/4" CLEVELAND MODEL of the War's Most Famous Plane

77 1/4" Boeing B-17 FLYING FORTRESS C-D MFM Kit SF-100 **\$12.50**

(MFM Meant Master Flying Model-World's Finest.)

Other C-D MFM Kits of Famous War Bombers

55" B-25 MITCHELL, C-D MFM Kit SF-125, \$8.50	46" HAVOC or BOSTON, C-D MFM Kit SF-115, \$8.50
48" B-26 MARAUDER, C-D MFM Kit SF-135, \$8.50	49" HUDSON, C-D MFM Kit SF-95, \$7.50
	40" MOSQUITO, C-D MFM Kit SF-145, \$4.50

Build These \$1.00 Super Values

26 1/2" SUPER-FORTRESS, Semi-solid, Line-controlled, C-D Kit AU-200 **\$1.00**

Huge 84" Super CONDOR Sonnet. Glider, C-D Kit E-5019..... **\$1.00**

Build These 36" "T" Industrial Training Models

"BLACK WIDOW" Night Fighter, Kit T-155.... **\$1.50**

Famous "PIPER CUB," Kit T-94..... **\$1.50**

Other 36" "T" Kits are Hawker "HURRICANE," Kit T-78; "SPITFIRE," Kit T-73; "MESSERSCHMITT ME-109," Kit T-74; P-39 "AIRACOBRA," Kit T-76; "WHIRLWIND," Kit T-105; Hawker "TYPHOON," Kit T-90. Each Kit..... **\$1.50**

SEE YOUR DEALER FIRST. If ordering direct, include 30c extra for packing-postage.

CATALOG 5c (none free)

CLEVELAND MODEL & SUPPLY CO.
 4508E5 Lorain Ave. ★ ★ Cleveland 2, Ohio, U. S. A.

Say you saw it in Popular Mechanics!

4 WAYS To Be Your Own Boss!

NOW, more than ever before, is the **right** time to start a small profitable business of your own... or train yourself for a practical money-making trade in which you can be **independent**. TODAY take your first step, without cost or obligation. Just mail coupon—and by return mail you will get full information on the courses listed here.

watch and clock repairing



Learn at Home—In Your Spare Time
Prepare for a happy future of prosperity, security... and get a big-pay job now. Fascinating, high-grade occupation. You can **EARN WHILE YOU LEARN**. Excellent field for part-time work at home.

Practical Course in HOROLOGY

Thorough self-instruction training in American and Swiss watches, clocks. Special sections on alarm clock repairs. Interesting. **LEARN-BY-DOING** instruction method. Learn **QUICKLY**, easily. No previous experience necessary. **BASIC TRAINING FOR AIRCRAFT** and other scientific precision jobs.

Amazing Low Price! • Money-Back Guarantee!
Get into this fast-growing field NOW... big opportunity... don't delay. Mail coupon below for **FREE** information. No obligation.

locksmithing and key making

PRACTICAL UP-TO-DATE COURSE

How to pick locks, de-code, make master-keys, repair, install service, etc. New, self-instruction lessons for every handy man, home-owner, carpenter, mechanic, service station operator, fix-it shop, hardware dealer, gunsmith.

53 Easy Illustrated Lessons
Low Price! Satisfaction guaranteed or money back. Written now... no obligation!

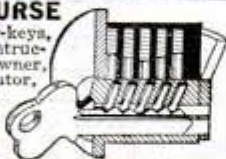

practical RADIO servicing



SELF-INSTRUCTION COURSE

Teaches you the **practical** side of radio... repair, adjustment, operation, alteration, trouble-shooting. No previous knowledge necessary. Large clear illustrations, diagrams, charts, etc. **INTERESTING STEADY WORK!** Set up a radio repair shop of your own—or prepare for booming industrial electronics. This useful, how-to-do-it course brings you all the fundamentals, including mathematics, review questions, problems, answers. Strictly up-to-date. Low price. Coupon below will bring you full information you want immediately. Mail it in today!

MAIL ORDER BUSINESS

Your Big Opportunity!

34-lesson course on proved, tested, up-to-date, **profitable** methods. Amazing treasure-house of the best mail order plans and practices. How to start your mail order business on a small one-man scale... how to keep it growing more and more profitable month after month. Money-making **FACTS**.

WRITE FOR COMPLETE DETAILS ON ANY OF THESE COURSES. Send Coupon for World-Famous Copyrighted Success-Catalog—IT'S FREE!
NELSON CO., Dept. 8A02, 321 S. Wabash Ave., Chicago 4, Ill.

FREE details... mail coupon!

NELSON CO., Dept. 8A02, 321 S. Wabash Ave., Chicago 4, Ill.
Please send me—FREE and without obligation—illustrated Success-Catalog containing information about the course (or courses) I have checked below. No salesman will call.

Watch and Clock Repairing. Locksmithing and Key Making.
 Practical Radio Servicing. Mail Order Business.

NAME _____
ADDRESS _____
CITY _____ STATE _____

in every battle... doing vital jobs... unfailingly

that's why there are just a few left for essential jobs at home



BRIGHT STAR BATTERY CO. CLIFTON, NEW JERSEY

LEPAGE'S PAPERHANGER'S PASTE

LEPAGE'S GLUE

LEPAGE'S PAPERHANGER'S WALL SIZE

BUILD YOUR OWN MACHINE TOOLS!

Blueprints \$1.00 - Catalog FREE



Detail construction Blueprints on 6 Lewis metal and wood-working tools guaranteed for \$1.00. Includes prints for Lewis 30" Shop or Milling Machine, Drill Press, Vice, 16" Band Saw, 6" Jointer, 8" Circular Saw, Plane or semi-finished castings available for these tools save up to 80% of comparable new tool cost.

Illustrated 32-page Catalog—sent free with Blueprint Order—describes 38 tools made. WRITE TODAY!

LEWIS MACHINE TOOL CO.
P. O. Box 116, Sta. A, Dept. M-13, Los Angeles 31, California

NEW Unbreakable OILERS

Modern! Streamlined!

For maintaining a constant level of oil in ring or ball bearings, pump and gear housings, etc.
Write for Bulletin No. 25

TRICO FUSE MFG. CO. Milwaukee, Wis.



WORLD'S LOWEST PRICED ADDING MACHINE

Best Pocket Size FREE TRIAL ONLY \$2.50

IDEAL FOR INCOME TAX—GUARANTEED ACCURATE. Not a toy. Operates with only a finger flick. Adds, subtracts, multiplies, divides. Counts up to ten million. Pays for itself over and over. **Ideal Gift**—for Business, Income Tax and School use. **MONEY BACK GUARANTEE.** Send name and address. Pay postman only \$2.50 plus postage. (Send full cash if outside U. S.) Money back in 10 days if not delighted. **AGENTS WRITE.**

CALCULATOR MACHINE COMPANY (Mrs.)
DEPT. 161, P. O. BOX 1118 CHICAGO, ILLINOIS

★ SAVE WASTE PAPER ★

**Handy Order List
Check and Mail!**

Little Library of USEFUL INFORMATION

Here at amazingly low cost is the practical help and information you have always wanted. Articles in previous issues of Popular Mechanics have been classified according to subject and are now available in these handy reprint booklets.

**MAKE SELECTION NOW • POSTPAID TO YOUR HOME
5 for \$1.00 12 for \$2.00 25c Each**

ELECTRICAL BOOKLETS

Rewinding & Servicing Electric Motors—75.
House Wiring—89.
Electromagnets & Solenoids—44.
Transformer Construction—41.
The Boy Electrician—43.
Soldering & Brazing—17.
Arc & Spot Welders—5.
Treasure Finders—13.

ELECTROPLATING BOOKLETS

Electroplating with Copper, Nickel, Chromium, Cadmium—86.
Plating Leather & Other Non-Metallic Objects—87.

WORKSHOP EQUIPMENT BOOKLETS

How to Use Measuring Tools—106.
Power-Driven Saws—74.
Drill Presses, Grinders—79.
Sanders—80.
Wood—Metal-Turning Lathes—81.
Filing Machine, Hacksaw, Cutoff Wheel, Shaper—82.
Lathe Tools You Can Make—101.
Workbenches—Tool Cabinets—47.
Spray Painting—94.
From Pattern to Casting—91.

BOOKLETS ON SHARPENING, USING TOOLS

Tool and Saw Sharpening—92.
Using & Sharpening Drills & Wood Bits—90.
Successful Wood Turning—32.
How to Read Blueprints—71.
Metal Turning Lathe Kinks—99.
Operating a Metal Lathe—100.
Heat Treating & Hardening—102.
Working with Glass—103.

HOME IMPROVEMENT BOOKLETS

Simple Home Improvements—104.
Building Extra Attic Rooms—23.
Attractive Basement Rooms—24.
Lower Your Fuel Cost—31.
Hanging Wallpaper—38.
Curing Leaky Basements—45.
Fitting Home Game Room—55.
Built-In Fixtures—78.
Indoor & Outdoor Fireplaces—88.
Ridding Home of Insect Pests—107.

GARDENING BOOKLETS

Backyard Gardening—39.
Lawn & Garden Novelties—72.
Trellises, Pergolas, Fences—76.
Lawn & Garden Furniture—77.
Playground Equipment—73.
Concrete Garden Furniture—6.
Bird Houses—7.
Farm & Garden Tractors—8.

CRAFT WORK—HOBBY BOOKLETS

Complete how-to-make-it instructions.
Magazine Racks—49.
Clock Cases—50.
Making Serving Trays—53.

Children's Room Furniture—51.
Book Ends—52.
Small Tables—54.
Smoking Stands—56.
Jigsawed Novelties—57.
Desks—58.
Book Cases—59.
Doll House & Doll Furniture—60.
25 Shelves You Can Make—64.
Novelties Turned on Lathe—62.
Inlay Pictures—Veneering—63.
Whittling, Wood, Soap Carving—65.
Action Toys—66.
High Flying Kites—67.
Windmills & Weathervanes—68.
Lamps in Wood, Metal—69.
Home Work Opportunities—19.
Telescopes—20.
Metal Craft—28.
Small Looms—37.
Wood Finishing—40.
Gem Cutting—42.
Working With Plastics—61.

BOAT BUILDING BOOKLETS

**Build a boat at home—
you can do it**

14 Ft. Outboard Runabout—2.
14 Ft. Sailing Dinghy—26.
21 Ft. Sloop—46.
Rowboats, Bicycle Boat, Small Dinghy—83.
Small Sail Boats—84.
Two Outboard Runabouts—85.
Build Your Own Canoe, Kayak, Surfboard—30.
Fast Class-E Ice Yacht—22.

AUTOMOBILE BOOKLETS

Auto Kinks and Shortcuts—10.
Building Trailers—27.
Motor-Driven Midget Car & Scooter—34.
Stop Auto Electrical Troubles—95.

PHOTOGRAPHY BOOKLETS

**Save Money—make your
own photo equipment**
Photo Enlargers—1.
Photo Printers & Dryer—25.
Photo Darkroom Equipment—96.
Picture Projector, Trick & Table Top Photography—97.
Photo Kinks—98.

FORMULA BOOKLETS Simple Ingredients— Make Useful Products

Cleaning Formulas—11.
Cosmetic Formulas—12.
Food Products Formulas—15.
Metal Plating & Coloring—21.
Re-Silvering Mirrors—70.

MISCELLANEOUS

Knots and Ropework—105.
Chemical Experiments—93.
Taxidermy—9.
Log Cabins, Tourists Cottages—14.
Magic for Everybody—29.
Trapping Small Animals—33.
Training Your Dog—35.
Small Furnaces—36.

If Hearing Were Visual

Here's What an Ordinary Hearing Aid Would Give You



Here's What the New Super
TELEX Will Give You



Clear, undistorted hearing, every tone, every nuance perfect in reception . . . noiseless, effortless hearing . . . far or near . . . the new super Telex gives you all this! Telex ability to reproduce sound exactly, *naturally*, will astonish you. There's only one way you can fully know how true our claims are, and that is by a free demonstration and scientific fitting, without obligation.

TELEX

Hearing Centers from Coast to Coast

Consult Your Telephone Book

FREE! Telex Hearing Report and Speech Understanding Test — thorough, helpful — whether you own a hearing aid or not. Increase your speech understanding. Mail coupon today.

TELEX PRODUCTS COMPANY
41 Telex Park - Minneapolis, Minn.

Name

Address

City State

Check and mail with this coupon!

POPULAR MECHANICS PRESS, Dept. 582, 200 E. Ontario, Chicago 11

Just check the booklets you want, clip this advertisement and mail with your remittance (U. S. bills may be mailed if carefully wrapped). Ask for big FREE catalog of helpful books.

MONEY BACK GUARANTEE

Name

Address

City State



KRW ARBOR PRESSES BENCH TYPE AND HYDRAULIC

NEEDED IN EVERY SHOP—SAVE TIME AND MONEY—DO BETTER WORK, QUICKER.

No shop is complete without a small arbor press. Pressing and squeezing operations can be done better and faster on a KRW Arbor Press. Stop using vise and sledge hammer methods—they generally deliver spoiled work in the end. KRW Factory-To-You Prices give you greater value for your money. Order today.

KRW Bench Type Arbor Presses, 3 sizes
 No. 37-P ½ Ton, \$13.25*
 No. 37-O 1 Ton, \$23.00*
 No. 37-N 3 Ton, \$33.00*
 *Prices F.O.B. Arede. N. Y. Slightly higher west of Rockies. Stand illustrated extra.



KRW Hydraulic Presses are built in 25, 50, 60 and 75 ton sizes. Prices start at \$198.00*.



K. R. WILSON, Dept. 17, 215 Main St., BUFFALO 3, N. Y.
 Builders of Shop Equipment for Ford Dealers Since 1916

Now for EVERY WORK SHOP!

NEW Invention Electroplates by BRUSH

Easy to Plate CHROMIUM GOLD, SILVER, NICKEL, COPPER . . . For Pleasure and Profit!

If you have a workshop—at home or in business—you need this new Warner Electroplater. At the stroke of an electrified brush, you can electroplate models and projects—you can replating worn articles, faucets, tools, fixtures, silverware, etc. with a durable, sparkling coat of metal . . . Gold, Silver, Chromium, Nickel, Copper or Cadmium. Method is easy, simple, quick. Everything furnished—equipment complete, ready for use. *By doing a bit of work for others, your machine can pay for itself within a week.* So make your shop complete by getting a Warner Electroplater right away. Send today for FREE SAMPLE and illustrated literature. ACT AT ONCE! Mail Coupon.

WARNER ELECTRIC CO., DEPT. A-24 360 North Michigan, Chicago 1, Illinois

FREE Details & Sample!

WARNER ELECTRIC CO., 360 N. Michigan, Chicago 1, Dept. A-24
 Gentlemen: Send Free Sample and Details to:

Name _____
 Address _____
 City _____ State _____

IRISCOPE KIT for experimental projection of BLACK-WHITE MOVIE FILMS or Slides—in NATURAL COLOR

as Described in Leading Photographic Magazines . . . Use with 8MM., 16MM., 35MM. projectors.

Particulars, stamp. Postpaid, \$5.00
H. F. JENKINS, Box 392, Elmira, New York

PRINT ANY PHOTO on Paper, Cloth, Leather or Wood

SIMPLE, EASY TO USE

Magic liquid takes only 2 minutes to reproduce any snapshot you have on to stationery, handkerchiefs, ties, scarfs, etc. Won't wash off. Won't hurt negative or fabric it's used on. Personalize your belongings! An ideal gift. Complete outfit enough to transfer 100 photos—only \$1.00 postpaid. Sent C.O.D. for \$1.21.

CHRISTY PHOTO SUPPLY, Dept. 910 2835 N. Central, Chicago 34



ITALIAN ACCORDIONS

Hand Made. Very best. Lowest prices. Buy Direct from Factory and Save Money. Send name and address for FREE catalog.
ITALIAN ACCORDION MFG. CO. 323 W. POLK ST., DEPT. PM-13, CHICAGO 7, ILL.

FIBRE ARMS AND LEGS!

Light, correctly fitted, strong and comfortable. Natural appearance. Braces for all deformities. Scientific design. Fair Terms.
BUCHSTEIN-MEDCALF 610-3rd Av. S., Minneapolis, Minn.

GET THE IMPROVED SUPER DRILL GRINDER

Grinds drill points from No. 42 to 1 ½" diameter. Grinds old drills like new. Grinds short, medium and long twist drills, up to 11".

The only drill grinder to give rounded points!

GRIND YOUR DRILLS LIKE FACTORY IN 25 SECONDS! Get a perfect center and clearance in three different drill point angles. NO MACHINE SHOP OR HOME WORKSHOP SHOULD BE WITHOUT THE SUPER DRILL GRINDER. Just mail your check or money order for only \$2.95, with your printed address—the SUPER GRINDER will come to you by return mail postage paid.

CRANDALL MFG. CO. Dept. FA-1, 1512 W. Slauson Los Angeles 44, Calif.



ONLY \$2.95 COMPLETE



\$1.85

SUPER JUNIOR!

Grinds standard 59° angle from 3/32" to 1" diameter, up to 6" long. No experience necessary to use. Will grind a rounded curve on drill point.
 ONLY \$1.85

Make Any Article GLOW IN THE DARK
with **Magic New Discovery!**

Don't pay big prices for luminous articles! Make your own! Sell at big profit or keep for your pleasure. With our complete outfit and confidential instructions, it's easy! A stroke of the brush—any article glows in the dark like magic! Lasts indefinitely. Absolutely harmless. Hundreds of uses. Use on ties, flowers, jewelry, house numbers, furniture, pictures, statues, toys, etc. Order NOW! Supply limited. Money-back guarantee.

\$1.00
Send No Money

Complete Lite-Glo Kit, \$1.00. Send name, address, pay postman \$1.00 plus postal charges. Send cash, we pay postage.

LITE-GLO, Dept. 312-LA, Topeka, Kan.

SERVICE FLAG
LIGHT SWITCH
DECORATIONS
JEWELRY
CLOCKS

MICROSCOPES SUPPLIES-ACCESSORIES-SCIENTIFIC-INSTRUMENTS

NEW & USED BOUGHT-SELL-EXCHANGED-REPAIRED
SEND FOR FREE LIST

MEDICAL INDUSTRIAL AMATEUR

NATIONAL SCIENTIFIC INSTRUMENT CO. 119 CHAMBERS ST. NY 7

Money Making Pay Raising BOOKS Catalog FREE

SEND NAME AND ADDRESS TODAY—Selected books covering all trades, office helps, home workshop, spare time work, hobbies, etc. Learn how to earn more. Write today.

Popular Mechanics Press
Dept. 588
200 E. Ontario St. Chicago, 11

LOW COST!

Make Power Tools from Auto Parts

GET THIS BOOK

Send today for new edition, featuring tools you can make of wood. Build your own lathe, drill press, sander, circular, scroll and band saw and other power tools you have always wanted, from discarded parts, at low cost. Simplified instructions, hundreds of pictures and diagrams make building easy. Order today. Only \$1.25. Money back if not satisfied.

POPULAR MECHANICS PRESS, Dept. 587, 200 E. Ontario St., Chicago, 11

Say you saw it in **POPULAR MECHANICS**

BUILD A BOAT

FOR PLEASURE OR PROFIT DESCRIBES 17 LOW COST BOATS

Got this outstanding book and build a boat at home for your own use or to sell at a profit. You can do it. Just the boat you've always wanted—power, sail or row boat—17 different kinds and sizes.

Order **BUILD A BOAT** on postal card and pay only \$1.30 plus postage on delivery. Return in 5 days if not pleased and get money back. Or send \$1.50 with order and we'll pay postage. (Outside U. S. \$1.70 with order.) Order today.

POPULAR MECHANICS PRESS
Dept. 586, 200 E. Ontario, Chicago, 11

Row Boat—12 Foot
Dinghy—8 Foot
Dinghy—14 Foot Sailing
Training Ship—6 Foot
Sea Sled—9 Foot
Outboard—12 Foot
Cruiser—13 Foot
Bicycle Boat—Kayak
Row Boat—Sectional
Dinghy—Sailing
Canoe—16 Foot
Sailing—12 Foot
Outboard—Runabout
Pontoon Ice Yacht

\$2,000
of OLD LINE LEGAL RESERVE
LIFE INSURANCE

THIS is Legal
Reserve Life Insurance offering all Standard Provisions under the New York State Insurance Laws, issued by Postal Life of New York, unique among major companies. Postal has sold Life Insurance by mail and over the counter for 40 years, has more than **\$14,000,000**, in assets and has paid out over

ONLY \$1.78
a month
at age 21

DIRECT from POSTAL LIFE of New York

MAIL THIS COUPON

\$55,000,000 to policy holders and beneficiaries. *Premiums may be reduced by dividends.* Current dividend rate **9 1/2%** of annual premium. Coupon brings full information and rates at your age. Action is vital.

** (Half Permanent Rate beginning 5th year)*

Postal Life Insurance Company
511 Fifth Ave.
Dept. M-406
New York 17, N. Y.

Mail me without obligation complete information about your low-cost Modified "4" Policy at my age.

Name.....

Occupation.....Date of Birth.....

Address.....

.....

Include P. O. District Number, if any



AMATEURS GET
"PRO" RESULTS WITH

One coat of

PLASTI-COTE AAA

the paint of tomorrow—today!

AMAZING RESIN-BASED
LIQUID PLASTIC PAINT—

WASHES
LIKE
TILE

Plasti-Cote AAA is a triumph of modern chemistry—a resin-based paint that lets you give your home, Interior and Exterior, a beautiful plastic finish that is tough, fade-proof, waterproof, and resistant to gas and fumes. This remarkably durable paint is self-leveling and leaves no brush marks. So, amateurs get the same fine results as a master painter. It's really fun to apply—and helps you cut your decorating bill almost in two.

ONE COAT of Plasti-Cote AAA covers any kind of surface—wood, wallboard, brick, stucco, plaster, even old wallpaper. It has exceptional hiding properties and does not chip, chalk, crack, or peel. Plasti-Cote AAA, being a true plastic, cannot be thinned by water. Its smooth, porcelain-like surface stands innumerable washings.

ONLY
\$7.50
PER GAL.



**MONEY-BACK
GUARANTEE**

Use 25% of this liquid plastic paint. If not delighted with results, return remainder and receive full refund. Order for cash, post-paid; or C.O.D., plus small express charge. COLORS: White, Ivory, Cream, Buff, Dusty Rose, Peach, Grey, Blue, Brown, Black, and 3 shades of Green. Specify color and whether Interior or Exterior—gloss, semi-gloss or flat. Gal. covers 300 sq. ft.

Use **PLASTI-COTE FLOOR FINISH**

New Plastic Beauty-Treatment Banishes Waxing—
Makes Floors Gleam and Sparkle

Plasti-Cote Floor Finish banishes waxing and polishing, gives hard glossy, durable finish to linoleum, rubber, concrete, asphalt, tile, cork, wood—all surfaces. Non-skid. Resists alcohol, boiling water, cigarette burns—even lye. Apply it yourself. Qt. does average kitchen. 12 colors and clear. **\$8.60 per gal.**

Let **PLASTI-COTE CAR ENAMEL**

Give Your Car a Gleaming
Factory-Fresh Lustr

Here's a car enamel that's different from any other you've ever tried—a real plastic paint that is flexible and covers better and wears longer. One coat covers the old finish. Withstands road tar, oil, sun, salt water, salt air, alcohol, boiling water, sleet, and snow. Quart does average car. Easy to apply. **\$2.95 per quart.**

DEALER INQUIRIES INVITED

CELLO-NU PRODUCTS

333 N. MICHIGAN AVE., CHICAGO 1, ILL.

PAY-RAISING — EXTRA MONEY BOOKS

Use these books to prepare for a better job—bigger pay—to start a profitable spare time or full time business of your own, improve your home, start a hobby. Popular Mechanics specializes in supplying outstanding self-help books on many subjects.

- How to Remodel a House . . . \$4.75
- Nothing is omitted
- Painting, Furniture Finishing & Repairing . . . \$1.50
- New self-help book for craftsmen, home owners
- Shop Notes for 194550c
- Now ready. For every man who uses tools
- Shop Notes Library . . . \$2.50
- 5 vols.—1945, 44, 43, 42, 41 (no dup. mat.)
- Refrigerated Locker Manual . . . \$3.00
- Plant operation, quick freeze, etc.
- How to Read Blueprints . . . \$1.50
- Welding, Brazing & Soldering . . . \$1.25
- How to build own equipment and use it effectively
- Garden Book . . . \$1.00
- Build own trellises, lawn furniture, fireplaces, ornaments, etc.
- Forty Power Tools . . . \$1.25
- Build own saw, drill, lathe, sander, etc. from scraps—save money
- Rewinding & Servicing Electric Motors (No. 75)25c
- Running a Milling Machine (new) . . . \$1.50
- Turn Scrap Into Money . . . \$1.00
- Convert old auto generators into motors, welders, etc.
- Motorcycle Speed & How to Obtain It . . . \$1.50
- House Wiring (No. 89) . . . \$2.50
- All information needed to do complete job.
- Modern Refrigeration . . . \$5.00
- Electric, gas. Be service expert
- Dyke's Auto Ency. (includes Diesels, airplanes, engines) New 20th Ed. . . \$6.00
- World's greatest book for mechanics
- Sheet Metal Work . . . \$2.50
- Self instruction in all phases
- Tool & Saw Sharpening (No. 92)25c
- Armature Winding . . . \$2.00
- Construction, winding, repairing AC & DC Motors, generators
- Build Your Own Boat . . . \$1.50
- Describes 17 popular boats—rowboats, sailboats, plywood outboard, etc. 192 pages
- Forging Practice . . . \$1.50
- Toys You Can Make of Wood . . . \$2.50
- Carpentry . . . \$2.00
- Learn modern methods
- Foundry Work . . . \$2.00
- What to Make for 194550c
- New 224 page book of handicraft projects
- What to Make Library . . . \$3.00
- 6 vols.—1945, 44, 43, 42, 41, 40 (no dup. mat.)
- Blueprint Reading . . . \$1.25
- For building trades
- Pattern Making . . . \$2.00
- Wood, metal
- Action Toys (No. 66) . . . \$2.50
- Plans for 21 easy-to-make toys
- The Young Craftsman . . . \$1.00
- over 450 things boys can make
- Five Acres and Independence . . . \$2.50
- How to make money on small farm
- New, Pocket Size MACHINE SHOP SERIES . . . \$1.50
- Drill Presses . . . \$1.50
- Engine Lathes . . . \$1.50
- Shapers . . . \$1.50
- Planers . . . \$1.50
- Millers . . . \$1.50
- Turret Lathes . . . \$1.50
- Raising . . . \$2.50
- A-B-C of Poultry . . . \$1.00
- Organ, Banjo-Uke . . . 75c
- Wooden Clock Movement . . . \$1.00
- Full-size pattern
- Silhouette Book . . . 50c
- 212 attractive silhouettes
- Deluxe Small Homes . . . \$1.00
- Selection of 210 popular designs
- Knots, Ties, Splices . . . \$1.25
- For everyone who uses rope
- Plastics . . . \$3.75
- Latest information on manufacture and use
- Workbenches & Tool Cabinets You Can Build (No. 47)25c
- Your Car . . . \$1.25
- Hundreds of simple car repairs, short cuts that will help make it last for the duration
- Concrete Handbook . . . \$1.50
- New book on using concrete around home, garden, farm
- Oil Burner Handbook . . . \$2.50
- Best methods of using
- Photo Guide . . . \$1.00
- Construct own equipment, gadgets. Make better photos
- Elementary Forge Practice . . . \$2.00
- Welding, Electric . . . \$1.25
- Welding, Oxy-Acetylene . . . \$1.25
- Fluorescent Lighting . . . \$2.50
- New manual on construction, installation, repair
- Shipbuilding Blueprint Reading . . . \$3.00
- Ropp's Calculator . . . \$50c
- Finishing made easy
- Plumbing Installation & Repair . . . \$1.50
- For those without previous training
- Complete Book of Garden Magic . . . \$3.00
- Covers all phases of gardening
- Wine Makers' Manual . . . \$1.50
- Judo, 30 Lessons in Modern Jiu-Jitsu . . . \$1.89
- Modern Core Practices & Theories . . . \$8.00
- Only book published treating completely with production and use of cores in metal casting
- Watch Repairing Simplified . . . \$3.00
- Propagation of Plants . . . \$3.50
- Covers every conceivable method
- Lessons in Ornamental Penmanship . . . \$1.00

MAIL THIS COUPON TODAY

Check the books you want, write your name and address below, and mail this advertisement with money order or check. Outside U. S. A. include 15% additional for shipping charges.

Books selected will be mailed promptly on our "money back if you're not entirely satisfied" guarantee.

Name
City State
Address

Mail to **POPULAR MECHANICS PRESS**
Dept. 581—200 East Ontario St., Chicago 11, Ill.

SPECIAL MAIL ORDER LIST

**PRACTICAL, PROFITABLE
Low Cost BOOKS**

Select and Order Now

The Young Craftsman. Over 450 easy projects. \$1.00.

How To Read Blueprints. New. Complete. Get this valuable knowledge from this one book. \$1.50.

Forty Power Tools You Can Make. All of the wanted power tools for the home workshop. Make them from old auto parts, etc., at low cost. \$1.25.

Concrete Handbook. How to use concrete around home, garden, farm. \$1.50.

Your Car. Save up to \$100 a year. Describes hundreds of simple repairs, shortcuts, etc. \$1.25.

Painting, Furniture Finishing and Repairing. Self help book for craftsmen, painters, etc. \$1.50.

Build a Boat. For pleasure or profit. Shows how to make 17 low-cost boats at home. \$1.50.

Shop Notes. Money-making, money-saving help for every man who uses tools. 1943 volume 50 cents. 5 volume Library \$2.50.

Garden Book. Build your own trellises, fences, lawn furniture, etc. \$1.00.

Welding, Brazing and Soldering. Including how to make welding equipment and use it effectively. \$1.25.

What To Make. What to make and how to make it for fun or profit. 1945 volume, 50c. 6 volume library, \$3.00.

Photo Guide. The guide to better pictures with money-saving articles on making equipment at home. \$1.25.

Money Making Formulas. \$2.00.

Books shipped anywhere in U.S.A. at listed price postpaid. Outside U.S.A. include 15% additional for shipping charges. Mail your order today.

POPULAR MECHANICS PRESS
Dept. 592 200 E. Ontario Chicago, 11

CHECK TITLES WANTED AND MAIL



THIS BOOK SHOWS
HOW TO DO IT

**STEEL SQUARE
POCKET BOOK**

Completely Revised

This concise and handy little book illustrates and describes the best methods of using the carpenter's steel square in laying out all kinds of carpentry work. It is easy to understand as a picture of the square laying directly on the work shows exactly how the various cuts are made. Its compact and handy size makes it convenient to carry in the pocket for quick reference.

Price \$1.00 Postpaid

POPULAR MECHANICS PRESS
DEPT. 594 200 E. ONTARIO, CHICAGO 11, ILL.

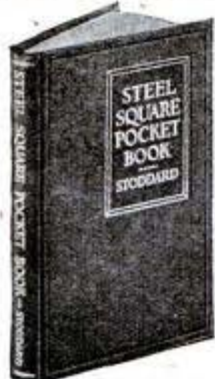

**Mathematics Made Easy by
ROPP'S CALCULATOR
AND SHORT-CUT ARITHMETIC**

Shows the Answer as Quickly as a Watch shows the Time to all Problems likely to occur in the Office, Store, Shop, Bank, Farm, or Factory.

Over 2,000,000 Sold

Explains and simplifies every principle in Arithmetic, Mechanics, and Mensuration.

PRICES POSTPAID
Desk Size, Flexible Keratol Binding \$2.00
Pocket Size, Art Leather Binding \$1.00
Pocket Size, Cloth Binding \$0.50

POPULAR MECHANICS PRESS
Dept. 595, 200 E. Ontario, Chicago, 11

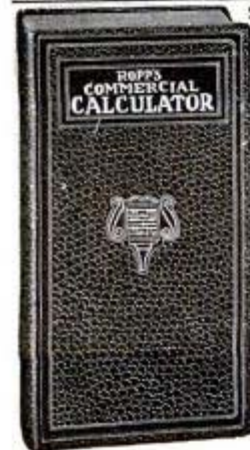

Workers arrive at the oil fields, on time — oil and gasoline are trucked to their destinations, on time — one important reason being that many oil men, like other spark plug users, have learned to have their spark plugs cleaned and regapped regularly. And when new spark plugs are necessary, a very high percentage of these "motor wise" people insist upon AC's, for utmost reliability. For your essential driving, have your plugs cleaned and adjusted every 3,000 miles, and install new AC's — of the right Heat Range for today's driving — when your old plugs are worn out.

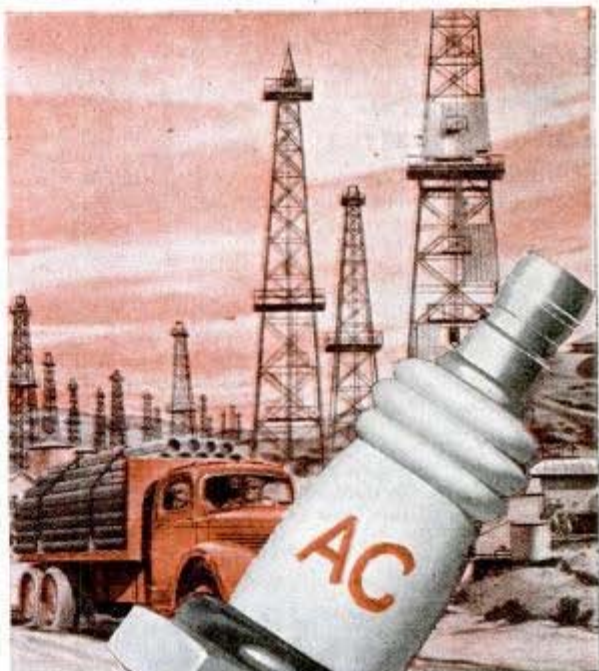

CLEAN SPARK
PLUGS SAVE UP
TO ONE GALLON
OF GAS IN TEN

**AC
SPARK PLUGS**

**DON'T LET UP NOW • KEEP BUYING WAR BONDS
LET'S FINISH THE JOB**

WYTEFACE

TRADE MARK

STEEL MEASURING
TAPES



K+E
TRADE MARK

KEUFFEL & ESSER CO.

HOBOKEN, N. J.

PALMGREN ANGLE VISES



Solve Difficult Angle Jobs

Quick, accurate setups at any angle. End makeshift methods—time loss—rejections. Ideal for tool rooms or home workshop. Accurately machined and graduated. Once set, it stays locked. Jaws hardened steel—plain or grooved. Sizes 1 1/2" to 3" Jaws. Orders filled on plant priority ratings only. You may qualify. Write.

Chicago Tool & Engineering Co.
8365 South Chicago Ave.
Chicago 17, Ill.

Send for Free Circular
"101 ANGLE OPERATIONS" describes each plate line, gives many uses.

for
Drilling
Milling
Grinding
Fitting
Filing

PRECISION WORK AT ANY ANGLE

Always write your name and full address clearly when answering advertisements.

UTICA TOOLS

ALL TYPES
FOR MORE TOOL
MILEAGE



Ask Your Dealer

U-T-I-C-A

UTICA DROP FORGE & TOOL CORP.
★ UTICA, N. Y. ★

EMPIRE LEVELS

Preferred by MASTER CRAFTSMEN . . .



EMPIRE TORPEDO LEVEL . . . Smallest and handiest accurate level made. "Cigar-shaped," no sharp corners to tear pocket. Aluminum stock. Has level, plumb and 45° vials. 9" long, only 3 oz. No. 26 . . . \$1.75. No. 151 Aluminum Level, 2 plumbs, 2 levels, 2-45° vials, 18". \$5.00; 24", \$5.50; 28", \$6.25. Order from local dealer. Write for literature.

EMPIRE LEVEL MFG. CO., Dept. P-232 717 S. Sixth St. Milwaukee 4, Wis.

SIGNS EASILY AND EXPERTLY PAINTED WITH LETTER PATTERNS AND SHOWCARDS
MANY SIZES & STYLES. WRITE FOR FOLDER.
JOHN F. RAHN
1330-31 N. Central Ave.
CHICAGO 51, ILL.

BOYS Ask Dad to Get this Great Book for You!



This big book tells and shows how to make over 450 things—useful articles for the home, toys, furniture, boats, novelties, photo equipment, electrical gadgets, etc. of the more simple, easy-to-make type. Only ordinary tools are needed. No special skill required. Tell Dad to send \$1.00 to address below NOW. We'll send Dad's money back if you and he don't think it's worth double the cost.

POPULAR MECHANICS PRESS
200 EAST ONTARIO STREET
DEPT. 572, CHICAGO 11, ILL.

★ ★ ★

MAKE YOUR OWN
POWER TOOLS
at Low Cost
from old Auto Parts, etc.



A New Edition

Featuring TOOLS OF WOOD

Now you can have a good lathe, drill press, circular and band saw and other power tools in your home workshop, at a cost of only a few dollars each. Make them yourself from old auto parts, discarded sewing machines and other odds and ends that cost little or nothing. Get this new book—"Forty Power Tools You Can Make." Costs only \$1.25 postpaid. This book gives every detail in plain language you can understand and follow. Hundreds of pictures and plans show every step to follow in making the power tools you want. Actual photographs of finished machines included. Send \$1.25 today. Money back if not satisfied.



MAKE EVERY POWER TOOL NEEDED IN YOUR HOME WORKSHOP

Some of the power tools you can make are:

2 Band Saws	2 Drill Presses
9 Sanding Machines	1 Scroll Saw
2 Circular Saws	2 Wood Turning Lathes
1 Metal Lathe	3 Grinders
1 Power Hack Saw	1 Shaper or Moulding Machine
1 Jig Shears	1 Vibrating Pencil
1 Cut-Off Wheel	and others

Information too, about pulleys, belts, motors and drive methods. Just published. No other book like it. Order today.

POPULAR MECHANICS PRESS

Dept. 583

200 E. Ontario Street, Chicago 11

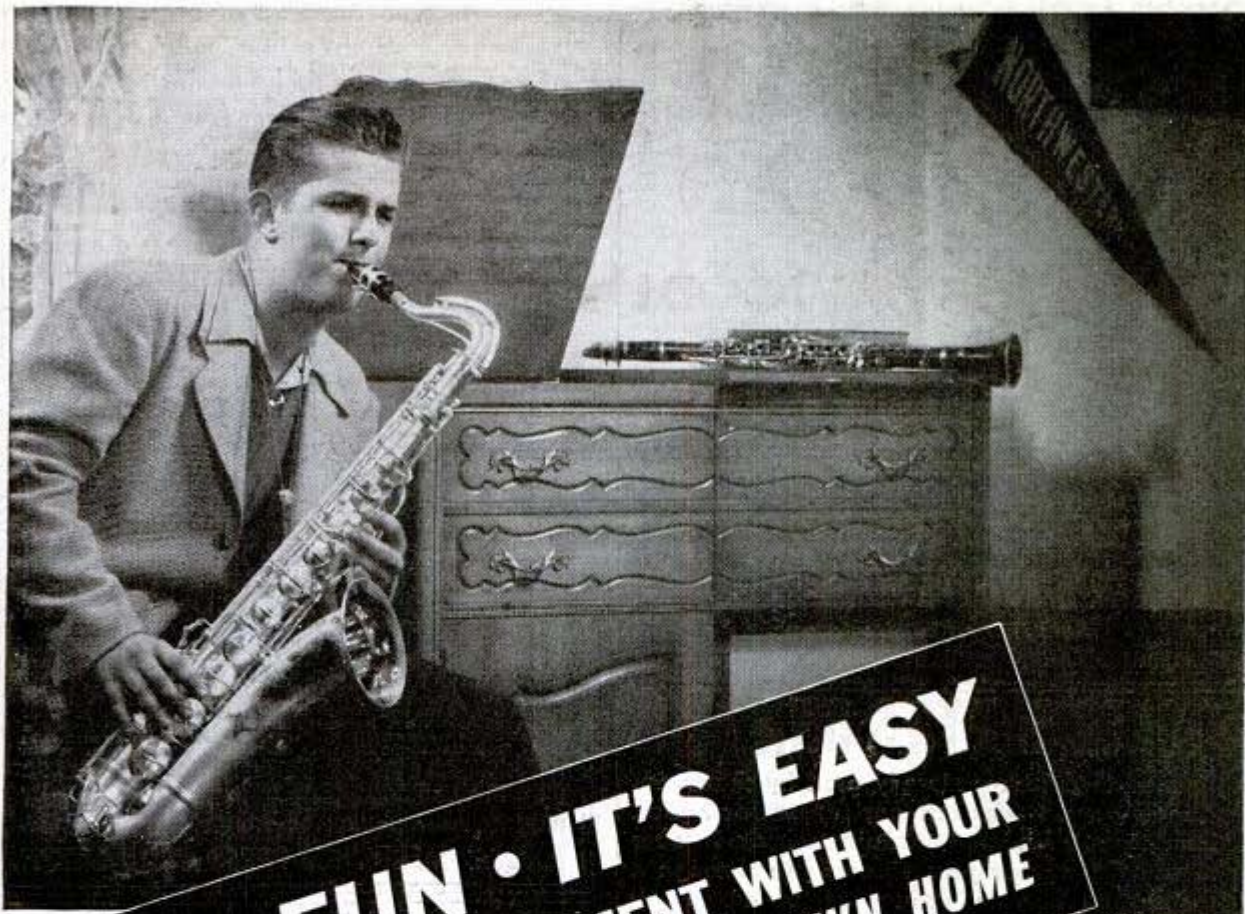

IT'S FUN • IT'S EASY
PLAY SOLO INSTRUMENT WITH YOUR
FAVORITE BAND—IN YOUR OWN HOME

Send FOR FREE
BOOKS

Parents—send for "Music, The Emotional Outlet for Youth."

Teen-agers—send for "Fun and Popularity Through Music." See your local Conn dealer, or write direct to C. G. Conn, Ltd., Dept. 131, Elkhart, Indiana.

"Swing out" on your favorite instrument. Play solo with the band of your choice... *right in your own home!* Special records are available which provide background music and leave the solo part open for you. Or you can play with regular records or by the radio with *any* band on the air. Enjoy the thrill of *making music yourself!* It's easy—and it's a lot more fun than just listening. Anyone who can whistle a tune can play a wind instrument, as there's only *one line* of notes to follow! Plan now to make music your hobby. For easier playing, better tone, insist on a genuine Conn instrument when you buy—they're "Choice of the Artists."



WORLD'S LARGEST MANUFACTURERS OF BAND INSTRUMENTS



SOLO

On WINGS of WOOD!

Thrill to the great sport of skiing . . . on championship Northland Skis! Expertly hand-crafted of super quality woods. Follow the lead of ski champions . . . choose Northlands, trademarked with the Deerhead.

★ Learn the tricks of expert skiers. Get Northland's 48 page Ski Manual FREE. Edited by Hannes Schneider. Illustrated. (Offer does not apply in Canada.)

NORTHLAND SKIS

World's Largest Ski Manufacturers

95 MERRIAM PARK • SAINT PAUL 4, MINNESOTA

STOKER EMPTIES OWN ASH!

A remarkable stoker already used by thousands of home owners—fits into any furnace or boiler. Manufactured since 1934. So automatic it takes the coal from your present coal bin through a pipe to the furnace, going around corners if necessary. Keeps house at even temperature, empties its own ash in sealed containers, no coal to shovel, no clinkers to dig, only bituminous stoker of its kind on the market. Send for full information NOW!

POCAHONTAS FUEL COMPANY INCORPORATED
344 EAST 131st STREET • CLEVELAND 8, OHIO

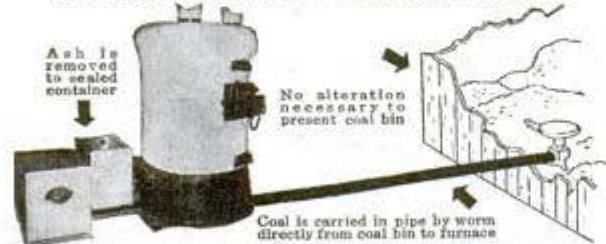

BIG PROFITS in "Simplified" ARC WELDING

PROMPT SHIPMENT on Priority

HOBART "Simplified" ARC WELDERS

HOBART - "One of the World's Largest Builders of Arc Welders."



413 Pages
Profusely Illustrated
FIVE ACRES and Independence

A PRACTICAL GUIDE TO THE SELECTION AND MANAGEMENT OF A SMALL FARM

By **M. G. Kains**

B. S., M. S., formerly Special Crop Culturist of U. S. Dept. of Agriculture.

ALL OF US long some day to OWN A SMALL FARM, whether it be for permanent residence or as a weekend haven where we may enjoy the relaxation of rural life. With war upon us, inflation, depression, strikes, high rents, high cost of food and shortages threatening, we may find the solution in a properly operated small farm where we can eat regularly and abundantly, sleep soundly, have no money worries and live a healthy outdoor life. You don't have to own a large farm, but it is important to have practical advice from one who knows all about how to farm. There are many pitfalls which may easily be avoided. And there are many tried and proved methods which can lead to success.

We have found a practical book that starts at the beginning and takes you step by step into successful farming. This book takes nothing for granted. It tells what kind of farm to buy; how to choose it; how to finance it; what and how to plant, choose and care of livestock, poultry, bees, etc.; especially essentials of fruit and vegetable growing, fertilizers, irrigation, spraying, cultivation, harvesting, storage, sale of products and by-products. Every page is packed with proved ways to make the small farm self-supporting and profitable. Whether you have a farm now or are planning to purchase one, get this book by Mr. Kains and prepare yourself. Don't miss "Five Acres and Independence"; it might change your whole life, it may bring you the independence and security you are now striving so hard to obtain!

Only \$2.50, Postpaid in U.S.A. (Outside U.S. \$2.75). Order Today

POPULAR MECHANICS PRESS Room 555 • 200 East Chicago, Chicago, 11



New 1945 SHOP NOTES Now Ready FOR EVERY MAN WHO USES TOOLS

One of these books is issued each year and is a reprint of articles published in our Shop Notes Department. It contains cream of experience of years, of hundreds of our country's most successful mechanics. Get a copy from your News Dealer, or send 50c to

POPULAR MECHANICS PRESS
Dept. 590 200 E. Ontario Chicago 11, Ill.



FUN AND PROFIT FROM YOUR HOME WORKSHOP

New 1945 "WHAT TO MAKE" is now ready. One of these books is issued each year and is a reprint of articles which have been published in our "Craftsman" Department. Hundreds of ideas that can be used around your home workshop in one handy, 224-page volume. Get book from your News Dealer or send 50c to

POPULAR MECHANICS PRESS
Dept. 585 200 E. Ontario Chicago 11

Great Demand for Welded Repair

Today, more equipment is in need of repair than ever before. Now is the time to start your job welding shop . . . to build a reputation for making the quickest repairs at lowest possible costs. This spells satisfied customers and big profits. Hobart "Simplified" Arc Welding will do this for you, so send for information today!

HOBART BROS. CO., BOX M-15, TROY, OHIO

HOBART "Simplified" ARC WELDERS



This is the Lathe you'll want...

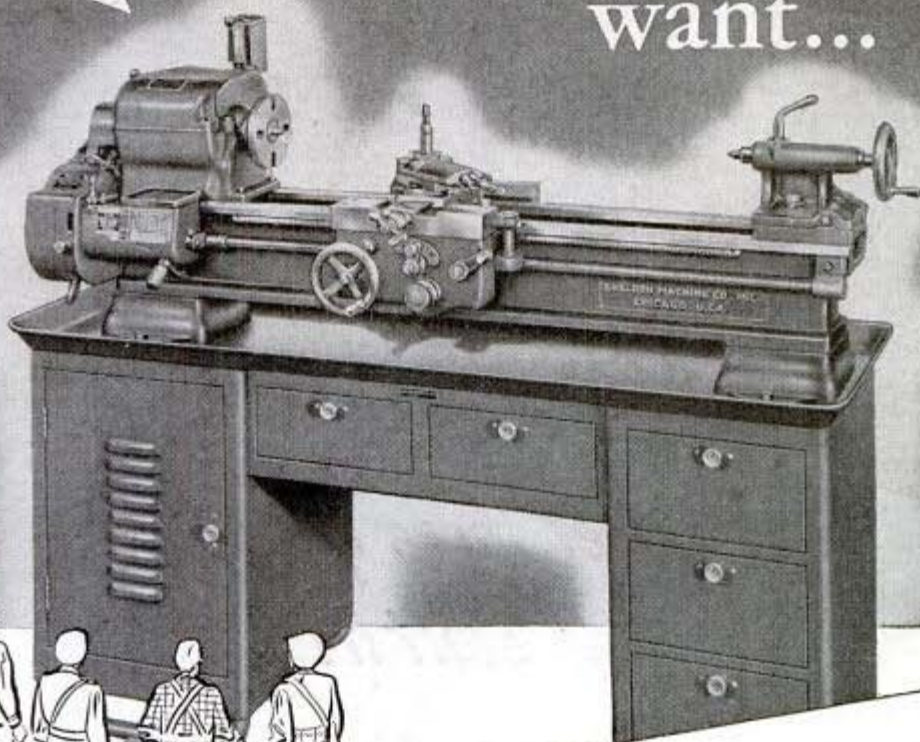

SHELDON
S-56
10-INCH SWING,
1-INCH COLLET CAPACITY

SHELDON builds a complete line of better 10", 11" and 12" precision lathes of which the SHELDON "S-56", illustrated above, is typical. This SHELDON Precision Lathe has every advanced feature, including: *extra* collet capacity, full quick-change gear box, a fully double-walled apron with spline driven power cross feed a more rigid "T"-strutted bed with *both* "V"-ways and "Flat"-ways which have been *both* precision ground and hand scraped to the closest limits of lateral and parallel alignment. It comes on a rigid steel bench which has 5 commodious drawers for tool holders, collets, etc. and houses the 4-speed, "V"-belt, underneath motor drive.

Built in great numbers for the Army, the Navy and the Marine Corps, this special lathe can now be offered as the finest lathe in the moderate priced field.

SHELDON MACHINE CO., Inc.
4266 N. Knox Ave., CHICAGO 41, U.S.A.

SEND IN THIS COUPON TODAY

Sheldon Machine Co., Inc.
Chicago 41, U.S.A.

Gentlemen:

- For preferential delivery, I wish to place a tentative order for a Sheldon Lathe; this order to be confirmed by me after I have selected the model and size lathe I desire and after I have been advised as to price and delivery date.
- Enclosed please find 50c for which please send the new edition of "Care and Operation of a Lathe" (now on the press).
- Send latest catalog sheet on lathes

For _____
Signed _____
Address _____
City _____ State _____



Official U. S.
Signal Corps Photo

*Let these guys
start it!*

There's a day coming when the enemy will be licked, beaten, whipped to a fare-thee-well—every last vestige of fight knocked out of him.

And there's a day coming when every mother's son of us will want to stand up and yell, to cheer ourselves hoarse over the greatest victory in history.

But let's not start the cheering yet.

In fact, let's not start it at all—over here. Let's leave it to the fellows who are *doing* the job—the only fellows who will *know* when it's done—to begin the celebrating.

Our leaders have told us, over and over again, that the smashing of the Axis will be a slow job, a dangerous job, a bloody job.

And they've told us what our own common sense confirms: that, if we at home start throwing our hats in the air and easing up before the job's completely done, it will be slower, more dangerous, bloodier.

Right now, it's still up to us to buy War Bonds—and to *keep on* buying War Bonds until this war is completely won. That doesn't mean victory over the Nazis *alone*. It means bringing the Japs to their knees, too.

Let's keep bearing down till we get the news of final victory from the only place such news can come: the battle-line.

If we do that, we'll have the *right* to join the cheering when the time comes.

Keep backing 'em up with War Bonds.

POPULAR MECHANICS MAGAZINE

*This is an official U.S. Treasury advertisement—prepared under auspices of
Treasury Department and War Advertising Council*



Motorists! up to 30% EXTRA MILEAGE

from EACH GAS STAMP with a

VACU-MATIC

CARBURETOR *Control*

➔ You can't change gas rationing, but you can make sure that each precious gallon of gasoline is providing you with the maximum mileage of which your car is capable. Now you can get added mileage . . . plus quicker starting and more power! Make this trial test. Install a Vacu-Matic on your car and get up to 30% extra mileage on a money-back guarantee.



AUTOMATIC SUPER-CHARGE PRINCIPLE

• Vacu-Matic is entirely different! It operates on the supercharge principle by automatically adding a charge of extra oxygen drawn free from the outer air, into the heart of the gas mixture. It is entirely automatic and allows the motor to "breathe" at the correct time, opening and closing *automatically*.

PROVEN BY TEST

• In addition to establishing new mileage records on cars in all sections of the country, the Vacu-Matic has proven itself on thousands of road tests and on dynamometer tests which duplicate road conditions and record accurate mileage and horsepower increases. Thousands of motorists now enjoy extra mileage—improved performance with Vacu-Matic.

FITS ALL CARS

• Vacu-Matic is constructed of six parts assembled and fused into one unit, adjusted and sealed at the factory. Nothing to regulate. Any motorist can install in ten minutes. The trial offer coupon will bring all the facts. Mail it today!

AGENTS TRIAL OFFER ➔

• Vacu-Matic offers a splendid opportunity for unusual sales and profits. Every car, truck, tractor and motorcycle owner a prospect. Valuable territories now open. You can obtain one for your own car if you help us introduce it to a friend. Just check and mail the coupon today.

Send this Coupon Today

THE VACU-MATIC COMPANY

7617-1132 W. State St., Wauwatosa 13, Wis.

Please send full particulars about VACU-MATIC, also how I may obtain one for trial on my car. This does not obligate me in any way.

Name

Address

City State

Check here if interested in Agency Proposition.

Now A DYNAMIC HEAVY DUTY INDUSTRIAL WELDER

TO SAVE YOU VALUABLE TIME and MONEY!

Designed to Do High-Grade Welding *Inexpensively*

Maintenance men, farmers, mechanics, machine shops, foundries, auto, general repair and job welding shops using the DYNAMIC WELDER find it so indispensable and useful that they cannot afford to be without it. If inexperienced you can easily learn to do a variety of high-grade welding jobs by following the practical, simplified operating and welding instructions furnished.

WORKS ON IRON, STEEL, BRASS, BRONZE and OTHER METALS

Has eight metallic and carbon arc welding heat stages. Does work you would think only possible with a larger, more expensive machine.

READ WHAT USERS SAY...

Repair Shop Owner says, "It will do more than you say!"

"I want to say I operate a repair garage and am more than satisfied with the welder. It will do more than you say." C. P., Butler, Ohio

It's the Greatest Portable Outfit

"Now I am equipped for all kinds of welding and I must say it's the greatest portable outfit for welding any man could ever wish to own. I wouldn't sell mine for the cost of plenty welders I have seen which were very high in cost but not in convenience. You may put me on file as a booster of your wonderful welding product." W. J. B., St. John, N. B., Canada

Better Than I Expected

"I have done quite a little welding with my welder and will say it is better than I expected. The price, convenience, and variety of work that can be done with the Dynamic are the attractive points." W. R. P., Portland, Ore.

EASY TO OPERATE!

DYNAMIC SUPERCHARGED WELDER

GET DETAILS ON OUR 10-DAY TRIAL OFFER!

Once you see a DYNAMIC in operation you won't want to be without it. Its simplicity will amaze you. In a year the DYNAMIC only costs you about 6c a day. Comes complete, ready to operate, with helmet, rods, cables, electrode holder and operating instructions, etc. Nothing else to buy. Write today for free priority assistance and particulars on how to qualify for one of these amazingly low-priced welders. Act now while they are still available.

DYNAMIC WELDER CO.

13 East 23rd Street — CA
CHICAGO 16, ILLINOIS

FOR ONLY
\$23⁵⁰
COMPLETE

AMAZINGLY SIMPLE TO OPERATE!

This portable DYNAMIC WELDER easily carried right to the job — plugs into any convenient, properly wired 110 volt light circuit.

WORKS OFF 110 VOLT ELECTRIC LIGHT CIRCUIT



FARM IMPLEMENTS



BICYCLE REPAIRS



HOME APPLIANCES



SHOP MAINTENANCE



AUTOMOBILE REPAIRS



IT'S EASY - AND FUN to build this *NEW MODERN*

FROM 5° ABOVE TO
10° BELOW ZERO

★ FAST-FREEZER

FROZEN STORAGE

*It is Not
Hard to
Build*

COMPLETE PLANS
for Building and Materials
SHOW
YOU
HOW

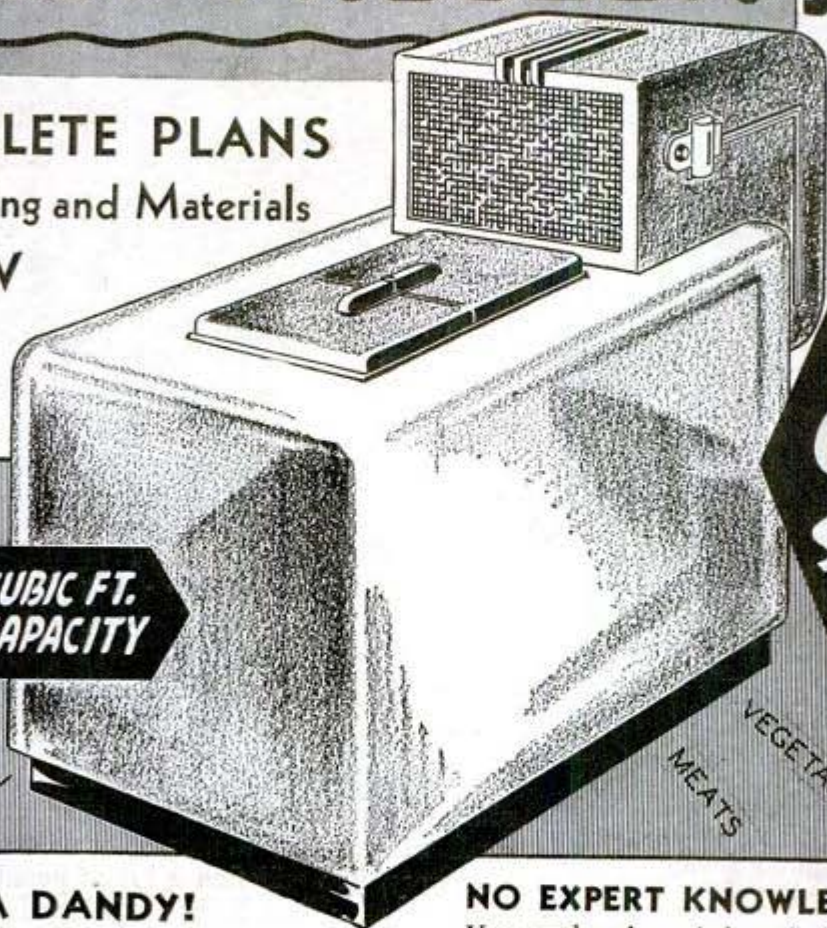

Plans
Only
\$1.00

FISH

8 CUBIC FT.
CAPACITY

FRUIT
FOWL

MEATS
VEGETABLES
BERRIES

HERE'S A DANDY!

Something every household needs and every amateur will be proud to build—saving up to 75% of the cost of a new box. Our plans show all details and it can be built from new parts or used parts you may have around. Operates electrically on any voltage available. Imagine the fun in building and the profit in using this modern equipment. It takes only a few hours of your spare time to build.

NO EXPERT KNOWLEDGE NEEDED

You need no knowledge of refrigeration or other expert experience to follow these simple plans and the necessary material is not hard to obtain. Enjoy the thrill of making this fine piece of equipment.

MAIL THE COUPON TODAY

Clip it to a \$1 bill, check or money order and slip it into an envelope. If the plans do not satisfy you, return them with this ad and you will get your money back.

LeJay Manufacturing Co., 447 LeJay Building, Minneapolis 8, Minn.
Gentlemen: Please send me complete plans of your FAST FREEZER, for which I attach \$1 bill Check Money Order .

NAME

ADDRESS

CITY..... STATE.....

LEJAY MFG. CO.

447 LEJAY BUILDING

MINNEAPOLIS 8, MINNESOTA.

9 INCH SOUTH BEND *Precision* LATHE

... FOR THE MANUFACTURE
OF SMALL ACCURATE PARTS IN
PRODUCTION SHOPS
... FOR PRECISION OPERATIONS
IN TOOLROOMS, EXPERIMENTAL
SHOPS, AND LABORATORIES

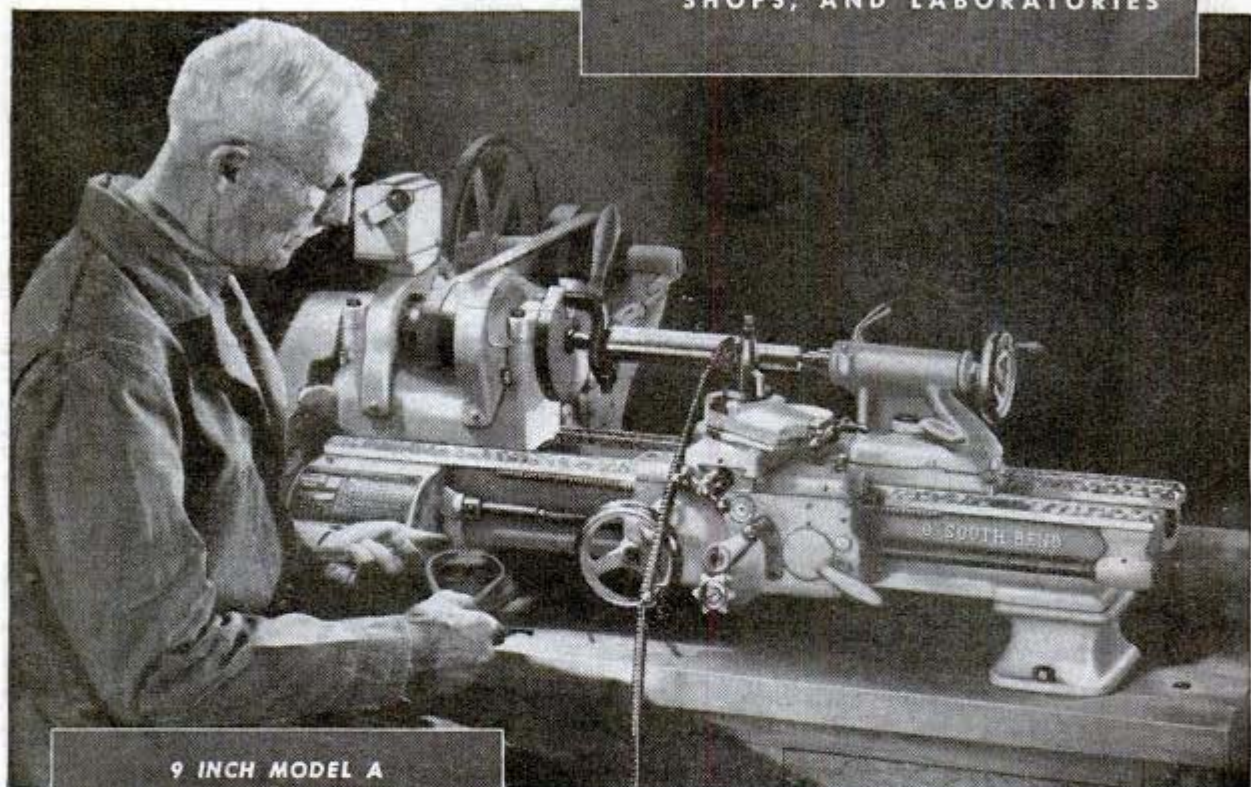

9 INCH MODEL A LATHE FEATURES

Fine workmanship by experienced machine tool craftsmen.

Superfinished spindle with large bearings.

Direct belt drive to spindle for smooth, quiet operation at high speeds.

Back-gear drive for heavy cuts and low spindle speeds.

Full quick change gear mechanism.

Thread cutting range — 4 to 224 per inch, 48 pitches.

Precision lead screw for thread cutting.

Worm drive and friction clutch for power longitudinal and cross feeds.

Whether your problem is the quantity production of small, accurate parts or the efficient machining of small work in the toolroom, experimental shop, or laboratory, you will find a lot of possibilities in the 9-inch South Bend Lathes. Modern in design, built with the same care as the larger sizes of South Bend Lathes, they are fast, accurate, and versatile. Substantial savings in capital investment, power consumption, floor space, and labor costs have often resulted from their installation.

In addition to the 9-inch Lathes, we manufacture 10", 13", 14½", and 16" lathes in Quick Change Gear and Toolroom types. Also the Series 900 and Series 1000 Precision Turret Lathes having ½" and 1" collet capacity respectively. Write for a catalog, stating the size and type of lathe you need.



SOUTH BEND LATHE WORKS
455 EAST MADISON STREET • SOUTH BEND 22, INDIANA

PRINTED BY POPULAR MECHANICS COMPANY, CHICAGO, ILL., U. S. A.



New Chris-Craft 16-ft. Special Runabout

Here is a new Chris-Craft model that will really do things for you. Drive it at speeds to 37 m.p.h. Slip your surfboard behind it and give the kids a thrill—take your friends along! Don't forget your favorite fishing haunts, the rest and relaxation it will open up for you. Colorful . . . chummy . . . complete with all needed equipment . . . high quality . . . expert workmanship. Our quantity production methods insure maximum quality at the lowest possible price to you . . . Ready after Victory. We are 100% on war work now.

Buy U.S. War Bonds Today—

Tomorrow command your own

Chris-Craft

CHRIS-CRAFT CORP., ALGONAC, MICH. ★ WORLD'S LARGEST BUILDERS OF MOTOR BOATS

Материал, законченный авторским правом



"Yeah, but who took you men to where you were going?
The Navy!"

"Okay, wise guy, but who went in and took over from there?
The Army!"

"Answer me this, chums... who's always in there pitching, land or sea?
The Marines!"

... at least they all agree on

GET a "flatfoot" (a soldier's term for a sailor), a "gravel agitator" (infantryman), and a "gyrene" (marine, to you) all together and they'll sound off about everything! But they'll agree on that pack in their pockets. Camels, first in the service from the Philippines to the Rhine. It's on the record... "With men in the Army, Navy, Marines, and Coast Guard, the favorite cigarette is Camel, based on actual sales records." Flavor and mildness make Camel a favorite wherever you go!



R. J. Reynolds
Tobacco Co.,
Winston-Salem,
N. C.



The final authority on which cigarette is best for you is your own "T:Zone"—T for Taste and Throat. Let your taste try Camel's full, rich flavor; let your throat try its cool mildness. You may find yourself agreeing with millions of smokers the world over.

Castler
Tobacco