

Cowboys of the Sea

POPULAR MECHANICS MAGAZINE

WRITTEN SO YOU CAN UNDERSTAND IT

REG. TRADE MARK, GREAT BRITAIN, NO. 40420

NOV.
25 CENTS
30c IN CANADA

SEE PAGE 82

 BUY UNITED STATES
WAR SAVINGS
BONDS AND STAMPS



BUY
WAR BONDS
TODAY
Keep America
Free

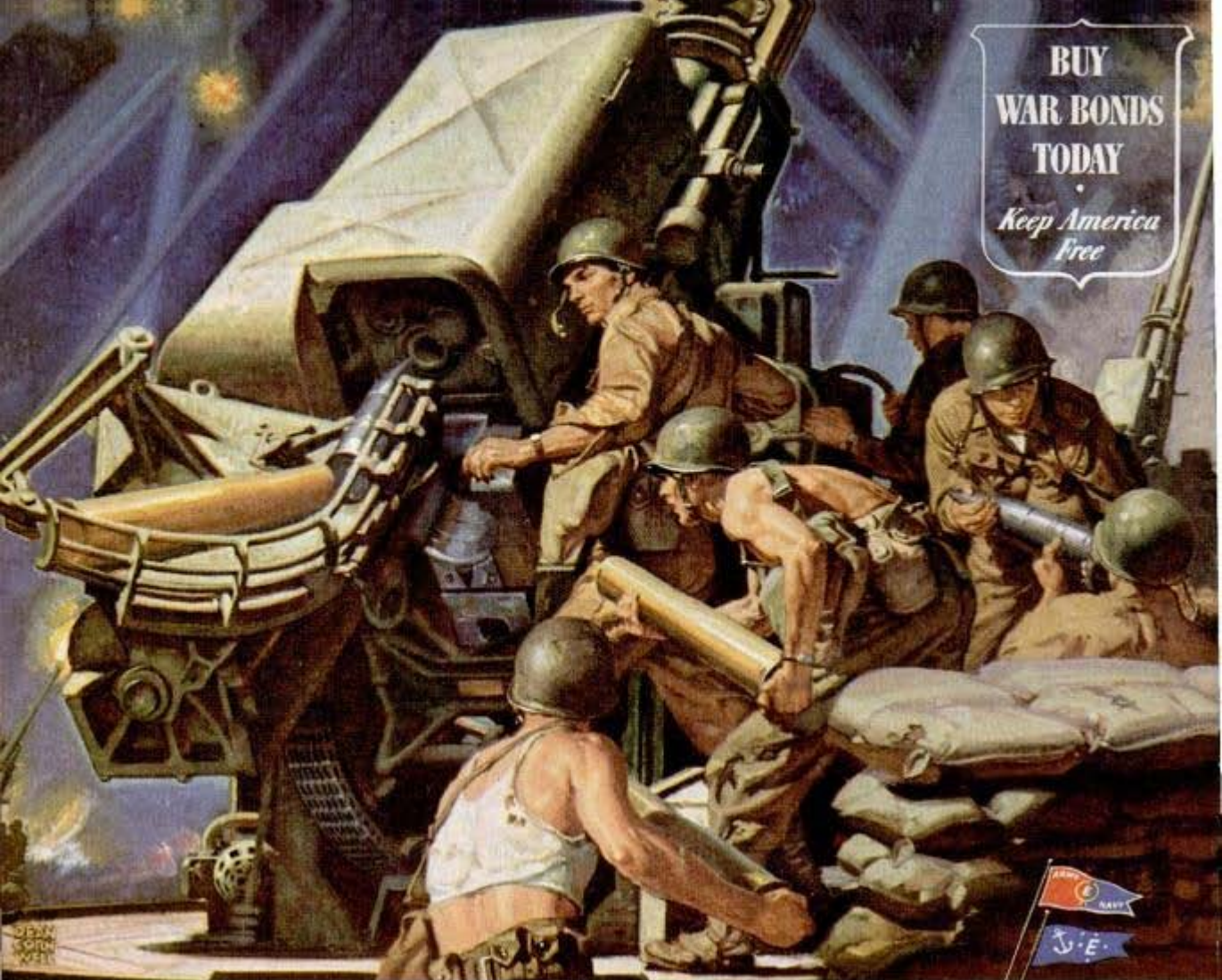

Strato-Flak *by Fisher*

The Army-Navy "E" flies above four Fisher Body plants for excellence in aircraft production and from two others for tank production, while the Navy "E," with five stars, is flown by still another Fisher Body plant for its naval ordnance work.

NO one had ever seen a gun like this three years ago.

But when bombers took to the stratosphere, Army Ordnance engineers realized the need for a 120-millimeter gun, deadly to both air and ground targets at long ranges, and capable of a high rate of fire. So they worked it out with Fisher Body.

Practically every tool, jig and machine used in production was especially designed for it. But our special pride was the automatic loader and rammer—a Fisher contribution which can set the timer before the shell is shoved home. A lot of midnight oil was burned before these black mushrooms began to burst at 60,000 feet.

Once more, we were grateful for the Fisher skills and techniques that saw us through. The

same Fisher Body craftsmanship that has turned out tanks, guns, bomber assemblies and other armament concentrated on this new puzzler—and came up with the right answers.

Our fighting men rate the best fighting tools in the world. We intend, now as always, to help give them whatever they need, and the best we know how to build.

Every Sunday Afternoon
GENERAL MOTORS SYMPHONY OF THE AIR
NBC Network



armament
BOY BY

Fisher

D I V I S I O N O F G E N E R A L M O T O R S



The tire that lights an electric bulb

An illuminating development in rubber that took the "shocks" out of flying

AN AIRPLANE in flight builds up a strong charge of static electricity, which once meant danger of sparks and fire—also danger of shock to passengers and crew.

The electricity would have passed harmlessly into the ground as soon as the plane's tires touched the earth *if* the rubber could conduct electricity. But rubber was an insulator; it *prevented* the electricity from leaving the plane. Could it be made into a conductor?

B. F. Goodrich engineers believed it could. They had already helped develop special carbon blacks to resist heat. Experiments were made with new ones to conduct electric-

ity. After many attempts, tires were built that can be placed in an electrical circuit and conduct the current into an electric bulb, as in the laboratory test shown above. And today, hundreds of airliners come to earth more safely on the new conductive tires.

B. F. Goodrich improvements in tires apply to every type of tire America uses—tires for planes, passenger cars, trucks, farm machinery. For passenger cars B. F. Goodrich made and sold tires containing synthetic rubber back in 1940, the first ever sold to American car owners and the only ones sold before the war. Their use by thousands

of people made up a road test estimated at over 80 million miles. Some of the tires are still running today, many without even being recapped.

If you can buy tires today, and if you buy B. F. Goodrich, you get tires backed by three years' extra experience; by that 80,000,000-mile road test; backed also by dozens of developments and improvements in rubber and synthetic-rubber compounds. The B. F. Goodrich Co., Akron, Ohio.



In war or peace
B.F. Goodrich
FIRST IN RUBBER

NOVEMBER, 1944

This One



WHOX-ESX-PHQ6

1A

INSIGNE OF ARMY ORDNANCE



WHERE DEPENDABLE IGNITION MEANS DEPENDABLE PERFORMANCE

"Weasel" with ski troops

... YOU'LL FIND DEPENDABLE CHAMPION SPARK PLUGS

The "Weasel," built by Studebaker, is one more of those startling developments which have characterized American inventiveness throughout the war. Specially designed, in cooperation with Army Ordnance engineers, as a cargo and personnel carrier with the ability to negotiate terrain and surfaces impassable to other wheeled or tracked vehicles, it has already proved itself unequalled at such tasks in several theaters of war. Here, as in so

many of the highly specialized vehicles of war—tanks, trucks, jeeps, half-tracks, ducks and alligators—the essence of good performance is dependability. To have dependable performance, you must have dependable ignition. This is where dependable CHAMPION SPARK PLUGS play their vital part—why Champions are used in the "Weasel" as in engines of every size and type in the service of our armed forces on land, water and in the air.

Buy an EXTRA

\$100 War Bond!



TO SAVE
GASOLINE
—KEEP SPARK
PLUGS CLEAN

CHAMPION SPARK PLUG COMPANY, TOLEDO 1, OHIO

Popular Mechanics Magazine

Registered in U. S. Patent Office and Canada

H. H. WINDSOR, Founder

H. H. WINDSOR, Jr., Editor and Publisher

November, 1944

Vol. 82, No. 5

Next Month

YOU won't have to consult a fortune teller to discover some of the things in store for your postwar home. Some of them, such as an infrared lamp for heating the bathroom or light rays for cooking, may sound revolutionary—but remember those folks who scoffed at horseless carriages and radio sets. Practical items like solar heating, frozen food lockers and parlor refrigerators (for cool drinks) will take their place alongside fluorescent lamps without wires, television sets, and germ-killing ultraviolet lamps. "Science Knocks at Your Door," in the December issue, tells all about it.

Trouble Shooters

WHEN our first long range fighters reached England their radios acted up like they were besieged by Nazi-inspired gremlins. Experts tore their hair and ripped electrical systems apart, but to no avail. An SOS was sent to the First Radio Squadron, Air Service Command, at Patterson Field. A December feature, "Radio Trouble Shooters With Wings," tells how this mystery and scores of others were solved.

Why Leave Home?

WITH the ends of the earth as close as the electronic switch at your elbow, there won't be much excuse for leaving home if radio communication engineers have their way. You can sit at home and watch Johnny running in the Olympics, send a check or photo to Zanzibar. Television, facsimile and radio-photos give you "The World at Your Elbow," a December feature.

IN THIS ISSUE

Hurricane in Harness	1
Repair Shops for Heroes	8
The Ether Patrol	14
Fitting the Gob to the Job	18
Trouble Shooting in the Sky	28
Mecca for Millions	33
Monsoon Salvage	40
Cowboys of the Sea	44
Sub-Zero Torture for Metals	50
The Battle Against Bacteria	58
Cameramen Under Fire (Part 2)	65
The World's Biggest Jigsaw Puzzle	76
Sixty-Yard Flash	82

Where-to-Buy-It Index—Page 8A

Living Test Tubes

CHANCES are you never heard of Penn State Jessie—a cow who lived in a college laboratory with a window in her stomach. She should be more famous than Elsie, for she gave the world much of its knowledge of Vitamin B. And did you know that bats have been using a supersonic device like radar for a million years so they can fly at high speed in darkness through dense foliage without brushing a leaf? Drowning ducks helped produce a liquid wetter than water, and it was a thirsty dog who helped solve the mystery of diabetes. Read the story in the December issue.

"Battling Baby Carriages"

THESE so-called "baby carriages" cost 11 million dollars apiece and are better known as baby flattops. The midget seagoing airports are today the most numerous type of large-sized warships. They fought subs in the Atlantic and their Pacific prey is the Jap torpedo or bombing plane. "Life on a Baby Flattop," as told in an outstanding article next month, is in a class by itself with a lifetime of danger packed into breath-taking 10-second intervals. Here's something new in naval warfare.

Published monthly by POPULAR MECHANICS COMPANY, 200 East Ontario Street, Chicago (11), Ill., U. S. A. Single copy in the United States, 25 cents; subscription rates in United States and possessions, and countries of the Pan-American Postal Union, 1 year, \$2.50; 2 years, \$4.50; 3 years, \$6.00. Single copy in Canada, 30 cents; subscription rates, 1 year, \$3.00; 2 years, \$5.50; 3 years, \$7.50. To all other countries add \$1.00 a year over United States prices for overseas postage. If you plan to move, notify us at least 60 days in advance so you will not miss an issue. Give both old and new addresses. Entered as Second Class Matter, September 15, 1903, at the Post Office at Chicago, Illinois, under Act of March 3, 1879. Entered as Second Class Matter at Post Office Dept. Canada. Copyright 1944, by Popular Mechanics Company. Copyright under International Copyright Union. All rights reserved under Pan American Copyright Union. Printed in the United States of America



Out of the War has come ...

This Amazing

**"NEW
"Pocket"
STOVE"**
Used by All Branches of
the Armed Forces Everywhere



**Burns the Same Fuel
Used in Your Car—
White or Leaded**

For Them Today... For YOU Tomorrow

Today, you cannot buy this new "Pocket" Stove. Originally designed by Coleman, it is exclusively built for the use of the armed forces.

When peace comes, this compact, amazing, little magic stove will double the joy and convenience of millions of picnickers and sportsmen. Easy to carry as a thermos bottle or flashlight. Only 8½ inches high, 4½ inches in diameter—yet the "hottest" little cooker

you ever touched a match to. Telescoping case makes two handy utensils. Ready in minutes for cooking, heating drinks, purifying water. It's the outdoor stove of tomorrow. Every hunter, fisherman, camper will want it. Grand for backyard picnics, too—and for hundreds of uses around the home.

FREE BOOK — Write for dramatic picture story of the Coleman "Pocket" Stove at the fighting fronts.

THE COLEMAN LAMP & STOVE COMPANY, Dept. PM-264, Wichita 1, Kans.
Chicago 11 Philadelphia 8 Los Angeles 54 Toronto, Can.



Coleman

"POCKET" STOVES—CAMP STOVES—LANTERNS—LAMPS—IRONS



MEET YOUR NEW NEIGHBOR . . .

Your new neighbor, half way around the world, will be closer than ever with improved short wave radio communications. For instance there will be new light on "darkest Africa" and descriptions by explorers of strange tribal customs as pictured above will be sent around the globe through the magic of short wave radio.

Here's a whole new world open to you. An African jungle ceremony is only one of thousands of universally important and exciting events that will be brought home through good short wave receivers. Hallicrafters' equipment reaches far

out and brings in high quality reception from the most obscure and distant points.

Famous as builders of "the radio man's radio", Hallicrafters will continue to make the finest short wave equipment available. Wherever you are . . . whatever you do, be it business, science, industry, government, teaching, you'll want to be quickly, reliably and regularly informed of fast breaking events in the post war world. For you and your particular needs there will be a Hallicrafters receiver . . . to help you meet and know your new neighbor, to help secure the peace we fight for.



Here is a Hallicrafters communications receiver with an amazing range and capacity. Right now all of Hallicrafters production goes into war communications equipment. But the time will come when you can own a set like this, a set that has been tried under fire and refined and perfected to the highest degree. Keep an eye on Hallicrafters to keep you in touch with the exciting new world to come.

BUY A WAR BOND TODAY!



hallicrafters RADIO

THE HALLICRAFTERS COMPANY • MANUFACTURERS OF RADIO AND ELECTRONIC EQUIPMENT • CHICAGO 16, U. S. A.

A Camera Fan is MADE...not born!



Photography meant nothing to Bill Brown ten years ago. His interests were boating and his daughter Diana. Once in a while he'd blow the dust off an old box-type camera and snap a stilted photo like this.



Diana finally rebelled—and one Christmas gave her dad a Universal candid-type camera and a subscription to a photo magazine. Soon Bill was taking shots like this of Diana in her first evening dress.



Bill was really bitten by the photography "bug," and fixed up this dark room in the basement. He gradually accumulated a full line of equipment—topping it off with the Universal Micrographic Enlarger.



This one won a prize at the local Photo Club exhibition. A sharp action shot, it shows how Bill had developed as a photographer. But Bill gave credit to his Mercury—one of the fastest cameras made.



OFFICIAL U. S. NAVY PHOTO

Today no new equipment is available to camera fans like Bill. All Universal's facilities go to producing fine precision optical instruments—equipping the Navy with matériel needed to win the war.



But after war needs are filled, Bill will profit from Universal's wartime experience. They'll produce superior cameras that will make good action shots easier to get. *Expect YOUR next camera to be a Universal!*

Remember: One photograph from home is worth a thousand words to a Serviceman



Peacetime Manufacturers of Mercury, Cinémaster, Corsair Cameras and Photographic Equipment

FOR YOUR POST-WAR FUTURE

INVESTIGATE ACCOUNTANCY NOW!

IN the post-war confusion and job competition, one field holds out unusual opportunity to the ambitious man or woman who is willing to prepare now.

Accounting—always a growing, good-paying profession—has expanded tremendously with the many governmental regulations and taxes. It will expand even more as civilian business resumes. And because of the war fewer people than usual have prepared for it.

If you are in earnest about your future career and willing to pay the price in earnest, sustained study, investigate Accounting. Get the facts about its requirements and its opportunities, the many different kinds of positions in it, its

place as a stepping stone to top executive positions or to a profitable business of your own, and how you can train for it.

All these facts are in an interesting 48-page booklet, "Accountancy, the Profession That Pays," which we have prepared out of 36 years of experience in helping thousands win success in this profession. It's free—without cost or obligation—and it will help you decide whether Accounting is an opportunity for you.

But ask for it *now*. Get ahead of the crowd. For by deciding and starting your training quickly, you can be ready for success when V-day comes.

LASALLE EXTENSION UNIVERSITY
A Correspondence Institution
417 South Dearborn Street
Dept. 1164-H
Chicago 5, Illinois

I am interested in knowing about Accounting as a possible career for me. Please send without cost or obligation your free booklet, "Accountancy, the Profession That Pays" and full information about your home study training for that field.

Name.....

Present Position.....

Address.....

City and State.....

Age.....



PYROIL

IMPORTANT

when your automobile was new

VITAL today!



There is many a car out of service today due to motor breakdown—and, often, it did not have to happen. A dash of Pyroil in the gasoline tank and crank case would have provided a lasting film of oil protection for the internal parts of the engine. Protection against hard carbon, gum, sludge and corrosive elements is still possible. Ask your service man for Pyroil.

Manufactured and Guaranteed by Pyroil Company, W. V. Kidder, Founder, 511 Pyroil Bldg., La Crosse, Wisconsin.

YOUR GUARANTEE

13 years' acceptance by foremost authorities—race drivers—explorers—engineers.

Keep Buying Bonds



PYROIL COMPANY

511 Pyroil Bldg., LA CROSSE, WISCONSIN

I want my car to last and run properly. Please tell me more about Pyroil and how it can accomplish this for me.

Name

Address

City or Town State

WHERE-TO-BUY-IT INDEX

Where no name and address appear directly under an item, the product is not believed by us to be commercially available

Transports for postwar travel.....	5
Chemical makes softwood hard.....	5
Blackout test for pilots.....	6
Postwar bus has bomber nose.....	6
Rocket power aids plane on takeoff.....	7
Plastic film copies surfaces.....	7
Rex D. McDill, 5109 Mayfield Rd., Cleveland 21, Ohio.	
Bomber carries 18 machine guns.....	13
Fake "ruins" fool airmen.....	13
Divers wield air-driven tools.....	17
Mechanical steeds carry riders.....	26
A. M. Bennett, 6230 Morella Ave., North Hollywood, Calif.	
B-24 gets compass check.....	26
Pickaback plane drops bomber full of TNT.....	27
Twin rotors propel helicopter.....	27
Invisible cream keeps hands clean.....	27
Turco Products, Inc., 6135 S. Central Ave., Los Angeles, Calif.	
Gunsight lamp protects flyers.....	32
Funnel to fill cartons with frozen foods.....	32
Jewett Associates, 18 Letchworth St., Buffalo 13, N. Y.	
Sound waves find metal flaws.....	32
Speery Products, Inc., Hoboken, N. J.	
Bomber drops boat to rescue flyers.....	38
Two-passenger victory buggy.....	38
Pressure cabin of B-29.....	39
"Mechanical Ant" scout car.....	39
Soil tiller does three jobs in one.....	43
Seaman Motor Co., Milwaukee, Wis.	
Dummy truck fools enemy airmen.....	43
Kites go to war.....	48
Hospital "assembly line" builds planes.....	49
Blimp propellers reversed for brakes.....	49
Rail coaches with three decks.....	55
Machine grinds metals into powder.....	56
Franklin McAllister Co., 135 S. LaSalle St., Chicago 3, Ill.	
Rubber "sandwich" keeps propeller free of ice.....	56
Self-gripping clothesline hook.....	56
The Midland Co., South Milwaukee, Wis.	
Warships float down inland canals.....	57
"Doughnut" holds flamethrower fuel.....	64
Tiny platinum wire is invisible.....	64
Pin-up flowerpot is self-watering.....	64
J. H. Mura, 1627 N. Main St., Racine, Wis.	
Flying suit has built-in tourniquets.....	64
Big crane lifts 23,000 pounds.....	70
Watertight trailer delivers supplies.....	70
Safety guard for chuck key.....	70
Safety-Specialties, 3229 N. E. 7th St., Portland, Ore.	
Tire vulcanized without removing tube.....	71
Truck body raised to load plane.....	71
Snow tractor for rescue work.....	71
A warbird lays an egg.....	72
Jigsaw span bridges stream quickly.....	74
Hydroelectric power unit for moving wing flaps.....	74
Gauge to measure relative porosity.....	74
Undersea tractor-tank.....	75
X-ray gun fights cancer.....	75
Dogs aid in locating mines.....	75
Model factories aid engineers.....	80
Oxygen generated in portable units.....	81
Germ killer found in plant.....	81
Locomotives ferried to France.....	86
Superpowered P-63 Kingcobra.....	86
Tangent-runway airport proposed.....	87
B-29 propeller is delicately balanced.....	87
Captured truck is Army postoffice.....	88
Robot bombsight finds target at night.....	88
"Magnetic tailwind" for plane.....	88

Craftsman and Shop Notes Index

AUTOMOTIVE

Battery-inspection lamp.....	92
Envelope extension for sun visor.....	96
Kerosene cleans radiator.....	106
Repair for shock-absorber bushing.....	114
Removing frost shield easily.....	115
Oil best for cleaning bearings.....	129
Preventing auto fires.....	137
Improving windshield wiper.....	138

FARM

Horseshoe protects hay rope.....	128
Wheeled feeding trough for chickens.....	129
Keep your tractor rolling.....	130
Scrub brush from cobs.....	138
Sickle sections anchor fence.....	138
Reel for barbed wire.....	140

(Continued to page 10A)



"Don't tell me you never had a chance!"

"Ten years ago you and I worked at the same machines. We were *both* discontented. Remember the noon we saw the International Correspondence Schools' advertisement? That woke me up. I realized that to get ahead I needed special training, and I decided to let the I. C. S. help me. When I marked the coupon I asked you to sign with me. You said, 'Aw, forget it!'"

"I made the most of my opportunity and have been climbing ever since. You had the same chance I had, but you turned it down. No, Jim, you can't expect promotion until you've trained yourself to handle bigger work."

There are lots of "Jims"—in war plants, offices, stores, everywhere. Are *you* one of them? Wake up! Every time you see an I. C. S. coupon, your chance is staring you in the face. Don't turn it down.

Right now over 100,000 men in industry and the Armed Forces are fitting themselves for the responsibilities and advancements of the Victory World through I. C. S. Courses.

You can join them, step up your "fire-power" on the production front, get in line for promotion in the Service, prepare for tomorrow! Mark and mail this coupon, and find out how.

SPECIAL TUITION RATES FOR MEMBERS OF THE ARMED FORCES



International Correspondence Schools

BOX 5507-K, SCRANTON 9, PENNA.

Explain fully about your course marked X:

- | | |
|--|---|
| <input type="checkbox"/> Accountancy | <input type="checkbox"/> Electrical Engineering |
| <input type="checkbox"/> Architecture | <input type="checkbox"/> High School |
| <input type="checkbox"/> Business Management | <input type="checkbox"/> Locomotive Engineer |
| <input type="checkbox"/> Chemistry | <input type="checkbox"/> Mechanical Engineering |
| <input type="checkbox"/> Civil Engineering | <input type="checkbox"/> Sheet Metal Work |
| <input type="checkbox"/> Drafting | <input type="checkbox"/> Shop Practice |

_____ (Fill in any other subject)

Name _____ Age _____

Home Address _____

City _____ State _____

Present Position _____

Working _____

Hours _____ A. M. to _____ P. M.

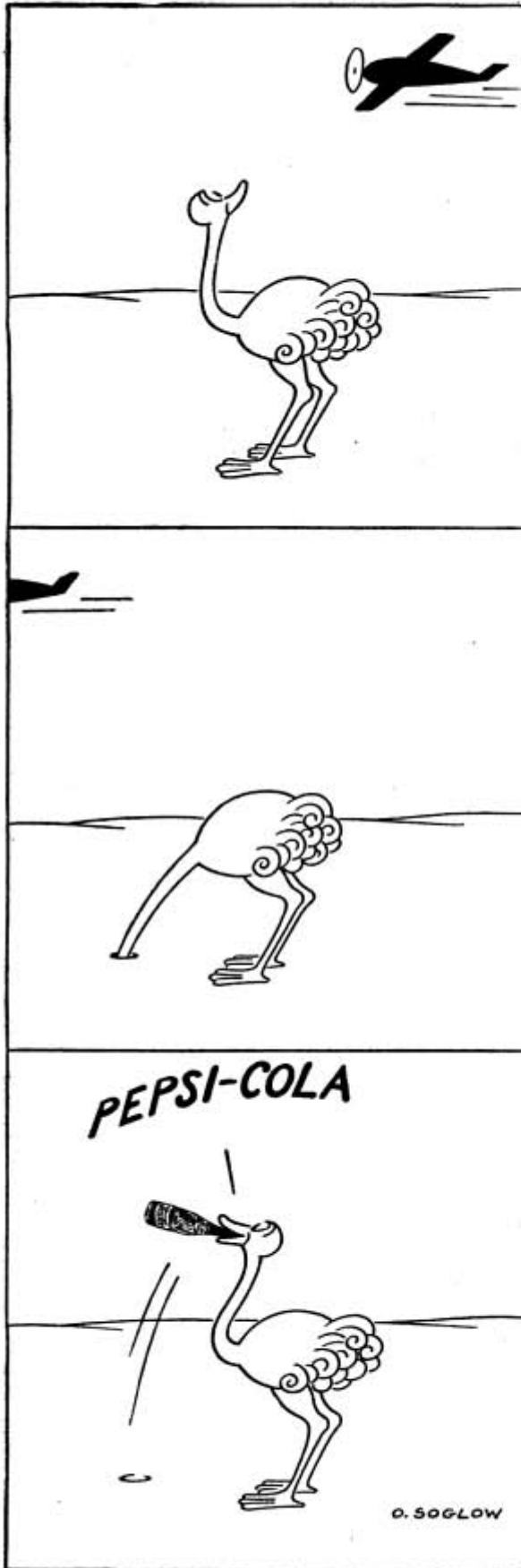

(Continued from page 8A)

FURNITURE

Desk for boy's room..... 89
 Tea cart with picture-frame tray..... 97
 Grease gun re-glues joints..... 98

HAND TOOLS

Box-opening tool from file..... 96
 Renewing pipe-wrench teeth..... 96
 Shears taped to protect hands..... 112
 Renewing pad on C-clamp..... 112
 Interchangeable soldering-iron heads..... 126
 Gauge for testing tapers..... 126
 Holder catches rods cut with chisel..... 138
 Leather holster for micrometer..... 140

HOME IMPROVEMENTS

Rack for storing storm sash..... 91
 Insulating heating plant..... 96

HOUSEHOLD

Supporting wrist watch vertically..... 92
 Aquarium-base table lamp..... 93
 Solving home problems..... 94
 Lining protects trousers from perspiration..... 98
 Sawdust makes icy walk safe..... 112
 Holder for paper napkins..... 115
 Ready-mixed paste for gravy..... 115

LAWN AND GARDEN

Wire through posts supports vines..... 92
 Killing weeds near fence posts..... 98
 Cistern made into vegetable cellar..... 99
 Fall rose care..... 114

OFFICE

Cardboard file-card holder..... 92
 Weighted tape easer to check..... 138

PHOTOGRAPHY

Photos on metal, glass, pottery..... 116
 Show-card black for lettering prints..... 119
 Photo mounts from cover paper..... 120
 Three-dimension lighting..... 121
 Prints handled with spatula..... 121

POWER TOOLS

Circular saw noise reduced..... 93
 Cutting off in lathe..... 123
 Multiple bits cut threads..... 129
 Automatic lathe switch..... 139

RADIO AND ELECTRONICS

Sergeant builds "pee-wee" radio from salvaged parts..... 141
 Short-wave "J-B three" uses old battery set tubes..... 142
 Light-bulb B-eliminator..... 144

STORE AND SHOP

Saw used to tear paper..... 112
 Oil on hands prevents rusting of tools..... 126
 Basket holds cleaning cloths..... 128
 Moving scales with hand truck..... 128
 Locked cash-register keys avoid errors..... 128
 Self-supporting display cards..... 128
 Roll covers for type cases..... 140

TOYS, GAMES AND NOVELTIES

Game boards stored under table..... 98
 What to make for Christmas..... 100
 Speedy skate sled..... 113

WOODWORKING

Spring clamps for columns..... 114
 Strip-cut drawer pulls..... 127

MISCELLANEOUS

Using warped lumber..... 91
 Beveled trap jaws cut trash..... 91
 Making model plane covering stronger..... 91
 Nail apron from handkerchief..... 92
 Nicked ruler indicates measurements..... 98
 Painting screw heads..... 98
 Midget ruler for wallet..... 99
 Bunk post holds shoe for shining..... 112
 Bolt keeps car door locked..... 113
 C-clamp handle for nail leg..... 114
 Reading luminous-dial watch..... 114
 Universal joint from clevises..... 114
 Craft quiz..... 122
 Bluing polished-steel screws..... 129
 Laboratory condenser from glass tubes..... 140
 Plastic picture hook pulls fuses..... 140

IMPORTANT NOTICE

It is the intention of this magazine to provide its readers with information regarding the latest developments in the mechanical arts. We take no responsibility as to whether the disclosures contained in our articles are covered by patents and advise readers to investigate this subject before making, using, or selling any of the products, machines, or processes described in order to avoid possible liability for patent infringement.

AUDELS REFRIGERATION & AIR CONDITIONING GUIDE....\$4

New from Cover to Cover—1280 Pages, Fully Illus. Covering basic principles, servicing, operation & repair of household, commercial & industrial refrigeration & air conditioning. A gold mine of essential important facts for engineers, servicemen, users.

AUDELS CARPENTERS & BUILDERS GUIDES—4 Vols.\$6

A practical illustrated trade assistant on modern construction for carpenters, joiners, builders, mechanics and all woodworkers. 4 vols., 1600 pages, 3700 illustrations, flexible covers. Pocket size. Each volume sold separately \$1.50 a vol.

AUDELS AUTOMOBILE GUIDE....\$4

A practical quick ready reference book for auto mechanics, service men, operators & owners. Explains theory, construction & servicing of modern motor cars, trucks, buses & auto type Diesel engines. 1540 pages, fully illustrated. 55 chapters. Indexed. A standard book for mechanics. New fluid drive covered.

AUDELS DIESEL ENGINE MANUAL.\$2

A practical, concise treatise with questions and answers on the theory, operation and maintenance of modern diesel engines including General Motors 2 cycle Diesel. 384 pages, fully illus., flexible binding, pocket size. All details plainly brought out, this book is of extreme value to engineers, operators & students.

AUDELS WIRING DIAGRAMS.....\$1

210 Pages. Illustrated. Gives practical facts on wiring of electrical apparatus. It shows clearly how to wire apparatus for practically all fields of electricity. Each diagram is complete & self-explanatory. Highly Endorsed Pocket Companion.

AUDELS PLUMBERS & STEAMFITTERS GUIDES—4 Vols.\$6

A Practical Trade Assistant & Ready Reference. Explains in plain language & by clear illustrations, diagrams, charts, graphs, pictures principles of modern plumbing practice including Marine Pipe Fitting and Air Conditioning. 4 Vols.—1670 Pages—3642 Diagrams. Pocket size. Each Vol. Sold Separately \$1.50 a Vol.

AUDELS SHEETMETAL WORKERS HANDY BOOK.....\$1

Practical inside information. Fundamentals of Sheet Metal Work. 388 pages. Illustrated. 11 sections. Clearly written. Essential & important facts, figures, pointers in everyday language. Ref. Index.

AUDELS SHEETMETAL PATTERN LAYOUTS.....\$4

Developed by Experts for Sheet Metal Workers, Layout Men & Mechanics. A Practical Encyclopedia in 10 Sections, size 7 x 10 x 2—1125 Pages—350 Layouts—1600 Illustrations. 1001 Key Facts. Fully indexed for ready reference in answering your layout problems. Covers all phases of sheet metal work including Pattern Cutting, Pattern Development & Shop Procedure.

AUDELS ANSWERS ON BLUE PRINT READING.....\$2

For Mechanics & Builders. Covers all types of blue print reading including ship & airplane. 376 pages, fully illustrated.

AUDELS NEW MACHINIST & TOOLMAKERS HANDY BOOK....\$4

Covers modern machine shop practice in all its branches. 5 practical books in 1. New from cover to cover. Tells how to set up & operate lathes, screw and milling machines, shapers, drill presses and all other machine tools. 1600 pages, fully illustrated, 5 x 6 1/2 x 2. Indexed. 5 sections. 1—Modern Machine Shop Practice. 2—Blue Print Reading & How to Draw. 3—Calculations & Mathematics for Machinists. 4—Shop Physics. 5—How to Use the Slide Rule. 60 chapters. Easy to read and understand. A shop companion that answers your questions.

AUDELS MATHEMATICS & CALCULATIONS FOR MECHANICS \$2

Mathematics for home study or reference. 700 pages, 550 illus. Practical mathematics from beginning. How to figure correctly. Easy, correct methods covering a complete review. Ill. & Indexed.

AUDELS HANDY BOOK OF PRACTICAL ELECTRICITY.....\$4

For maintenance engineers, electricians & all electrical workers. 1440 Pages, 2600 Illus. Covers important electrical information in handy form—including Marine Wiring, Radio Principles, Welding. Indexed. A Key to a practical understanding of electricity.

AUDELS RADIOMANS GUIDE.....\$4

A key to the practical understanding of radio including Frequency Modulation, Television, etc., Aircraft & Marine Radio. For radio engineers, servicemen, amateurs. 772 pages. 400 Illustrations & Diagrams. Photos. Review Questions & Answers, Reference Index. Authentic, clear, concise.

AUDELS ELECTRONIC DEVICES.....\$2

Tells What You Want to Know About Electric Eye. Easily Understood. Covers photo-electric cells & their applications. Amplifiers, illumination, frequencies, voltage, photocell, tubes, Ohm's Law, wiring diagrams, etc.

AUDELS WELDERS GUIDE.....\$1

A concise, practical text on operation & maintenance of all welding machines for all mechanics. Over 400 pages, illustrated. Covers all methods of electric and acetylene welding including airplane work.

AUDEL, Publishers, 49 W. 23 St., N. Y. 10

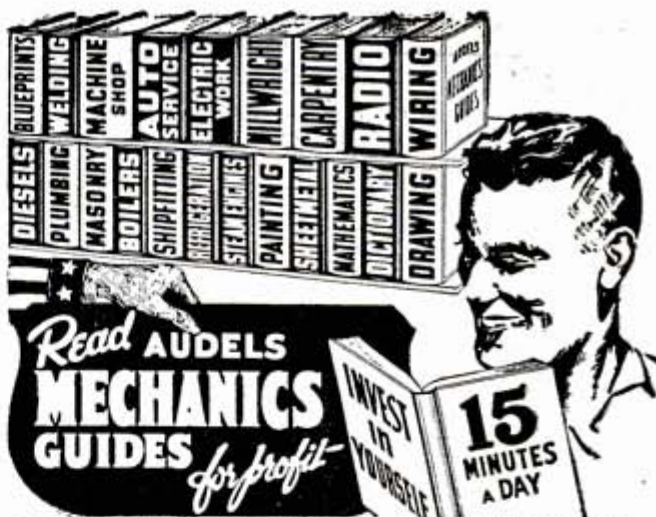

AN AUDEL GUIDE IS A GOOD FRIEND!

Use the brains and experience of others in these Guides of the Trades. Save time and money with right methods, short cuts, labor saving ideas. CHECK NOW! You can look over any Audel Guide in your home. Start the Easy Payments if satisfied.

CUT HERE MAIL ORDER

THEO. AUDEL & CO., 49 W. 23 St., New York 10, N.Y.

Please mail me for 7 days' free examination the books marked (X) below. I agree to mail \$1 in 7 days on each book or set ordered, and to further mail \$1 a month on each book or set ordered until I have paid purchase price.

If I am not satisfied with Guides I will return them.

- Audels REFRIGERATION & Air Conditioning Guide \$4.
- Audels PUMPS, HYDRAULICS & AIR COMPRESSORS 4.
- Audels WELDERS GUIDE 1.
- Audels BLUE PRINT READING 2.
- Audels SHEET METAL WORKERS Handy Book 1.
- Audels SHEET METAL PATTERN LAYOUTS 4.
- Audels AIRCRAFT WORKER 1.
- Audels MATHEMATICS and CALCULATIONS 2.
- Audels MACHINISTS & TOOLMAKERS Handy Book 4.
- Audels DIESEL ENGINE MANUAL 2.
- Audels MECHANICAL Dictionary 4.
- Audels AUTOMOBILE GUIDE 4.
- Audels MARINE ENGINEERS Handy Book 4.
- Audels SHIPFITTERS Handy Book 1.
- Gueths MECHANICAL DRAWING COURSE 1.
- Rogers DRAWING and DESIGN 2.
- Audels MILLWRIGHTS and Mechanics Guide 4.
- Audels CARPENTERS and Builders Guides (4 vols.) 6.
- Audels PLUMBERS and Steamfitters Guides (4 vols.) 6.
- Audels MASONS and Builders Guides (4 vols.) 6.
- Master PAINTER and DECORATOR 2.
- Audels GARDENERS & GROWERS GUIDES (4 vols.) 6.
- Audels ENGINEERS and Mechanics Guides Nos. 1, 2, 3, 4, 5, 6, 7 and 8 complete 12.
- Audels Answers on Practical ENGINEERING 1.
- Audels Aids to ENGINEERS EXAMINATION 2.
- Audels WIRING DIAGRAMS 1.
- Audels Handy Book of PRACTICAL ELECTRICITY 4.
- Audels ELECTRICAL POWER CALCULATIONS 2.
- Audels ELECTRICAL Guides at \$1. each 10.
- Audels ELECTRONIC DEVICES 2.
- Audels ELECTRIC Dictionary 2.
- Audels RADIOMANS GUIDE 4.
- Audels NEW ELECTRIC LIBRARY at \$1.50 a Volume Vols. I, II, III, IV, V, VI, VII, VIII, IX, X, XI, XII.

Name.....
 Address.....
 Occupation.....
 Employed by.....PM



J. E. SMITH, President
National Radio Institute
Our 30th Year of Training Men
for Success in Radio

I WILL SEND A SAMPLE to PROVE I can Train You BE A RADIO

Good Jobs Like These Go To Men I Train



\$600 Before Graduating, Kits Helped—“From your Experimental Kits I learned how electricity worked, how to connect the three stages of a Radio together, also the practical basis for the operation of different parts of a set. I made about \$600 or \$700 before I graduated.”—S. G. PIERSON, Box 71, Dry Creek, W. Va.



\$200 a Month in Own Business—“For several years I have been in business for myself making around \$200 a month. Business has steadily increased. I have N.R.I. to thank for my start.”—A. J. FROEHNER, 300 W. Texas Ave., Goose Creek, Texas.



Radio Service Manager of 4 Stores—“I was working in a garage when I enrolled with N.R.I. I am now Radio Service Manager for M—Furniture Co. for their 4 stores.”—JAMES E. RYAN, 119 Pebble Court, Fall River, Mass.



\$10 a Week in Spare Time—“I repaired some Radios when I was on my tenth lesson. I made \$600 in a year and a half, and have made an average of \$10 a week—just spare time.”—JOHN JERRY, 300 So. H. St., Exeter, California.



Chief Operator Broadcasting Station—“Before I completed your lessons, I obtained my Radio Broadcasting Operator's license and immediately joined Station WMPC where I am now Chief Operator.”—HOLLIS F. HAYES, 327 Madison St., Lapeer, Michigan.

*Get Into a Busy Field With
a Bright Peacetime Future*

BIG DEMAND NOW FOR WELL TRAINED RADIO TECHNICIANS, OPERATORS

I will send you my Lesson “Getting Acquainted with Receiver Servicing” FREE, to show you how practical it is to train for Radio at home in spare time. It's a valuable Lesson. Study it—keep it—use it—without obligation! And with this Lesson I'll send my 64-page, illustrated book, “Win Rich Rewards in Radio” FREE. It describes many fascinating jobs Radio offers, tells how N.R.I. gives you practical Radio experience at home with SIX BIG KITS OF RADIO PARTS I supply!



RADIO SERVICING (picture above) pays Technicians good money, spare or full time. **RADIO OPERATORS** (picture at right) find interesting work in U. S. Broadcasting and other types of stations.



My Radio Course Includes TELEVISION ★ ELECTRONICS FREQUENCY MODULATION

Think of the NEW jobs that Television, Frequency Modulation, Electronics, and other developments will open after the war! I will train you to be ready to cash in when Victory releases the amazing wartime developments for peacetime uses!

A TESTED WAY TO

LESSON FREE

at Home in Spare Time to

TECHNICIAN



Many Opportunities Open for Trained Radio Technicians and Operators

There's a shortage today of capable Radio Technicians and Operators. The Radio Repair Business is booming. Profits are large. After-the-war prospects are bright too. Think of the new boom in Radio Sales and Servicing that's coming when new Radios are again available—when Frequency Modulation and Electronics can be promoted—when Television starts its post-war expansion!

Broadcasting Stations, Aviation Radio, Police Radio, Loudspeaker Systems, Radio Manufacturing all offer good jobs to trained Radio men—and most of these fields have a big backlog of business that built up because of the war, plus opportunities to expand into new fields opened by war-time developments. You may never see a time again when it will be so easy to get a start in Radio!

Many Beginners Soon Make \$5, \$10 a Week EXTRA in Spare Time

The day you enroll for my Course I start sending you EXTRA MONEY JOB SHEETS that help show how to make EXTRA money fixing Radios in spare time when still learning. I send you SIX big kits of Radio parts as part of my Course. You LEARN Radio fundamentals from my illustrated, easy-to-grasp lessons—PRACTICE what you learn by building real Radio Circuits—and USE your knowledge to make EXTRA money!

Mail Coupon for FREE Lesson and Book

The opportunity war has given beginners to get started in Radio may never be repeated. So take the first step at once. Get my Lesson and 64-page illustrated book, FREE. No obligation—no salesman will call. Just mail Coupon in an envelope or pasted on a penny postal.—J. E. SMITH, President, Dept. 4MP, National Radio Institute, Washington 9, D. C.

You Build These and Other Radio Circuits with 6 Big Kits I Send



MEASURING INSTRUMENT (above) you build early in Course. Use it in practical Radio work to make EXTRA money. Vacuum tube multimeter, measures A.C., D.C. and R.F. volts, D.C. currents, resistance, receiver output.

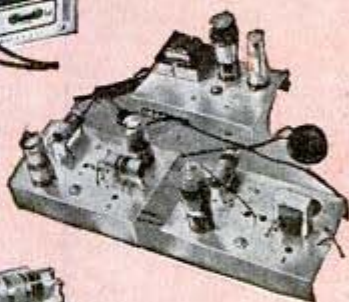

By the time you've conducted 60 sets of Experiments with Radio Parts I supply, made hundreds of measurements and adjustments, you'll have valuable PRACTICAL Radio experience for a good full or part time Radio job!

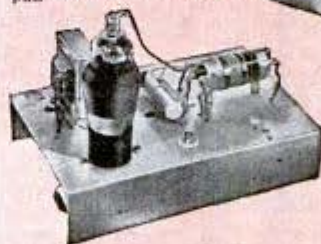

A.M. SIGNAL-GENERATOR (above) Build it yourself! Provides amplitude-modulated signals for test and experimental purposes. Gives valuable practice!

SUPERHETERODYNE CIRCUIT (above) Pre-selector, oscillator-mixer-first detector, i.f. stage, diode-detector-a.v.c. stage, audio stage. Bring in local and distant stations on this circuit you build yourself!

GOOD FOR BOTH 64 PAGE BOOK SAMPLE LESSON FREE

J. E. SMITH, President, Dept. 4MP
National Radio Institute, Washington 9, D. C.

Mail me FREE, without obligation, Sample Lesson and 64-page book, "Win Rich Rewards in Radio." (No salesman will call. Please write plainly.)

Name..... Age.....

Address.....

City..... State..... 4FR

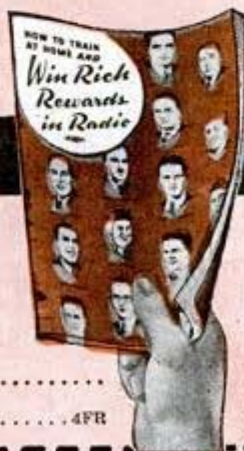

GOOD PAY

NEW BOOK *for*

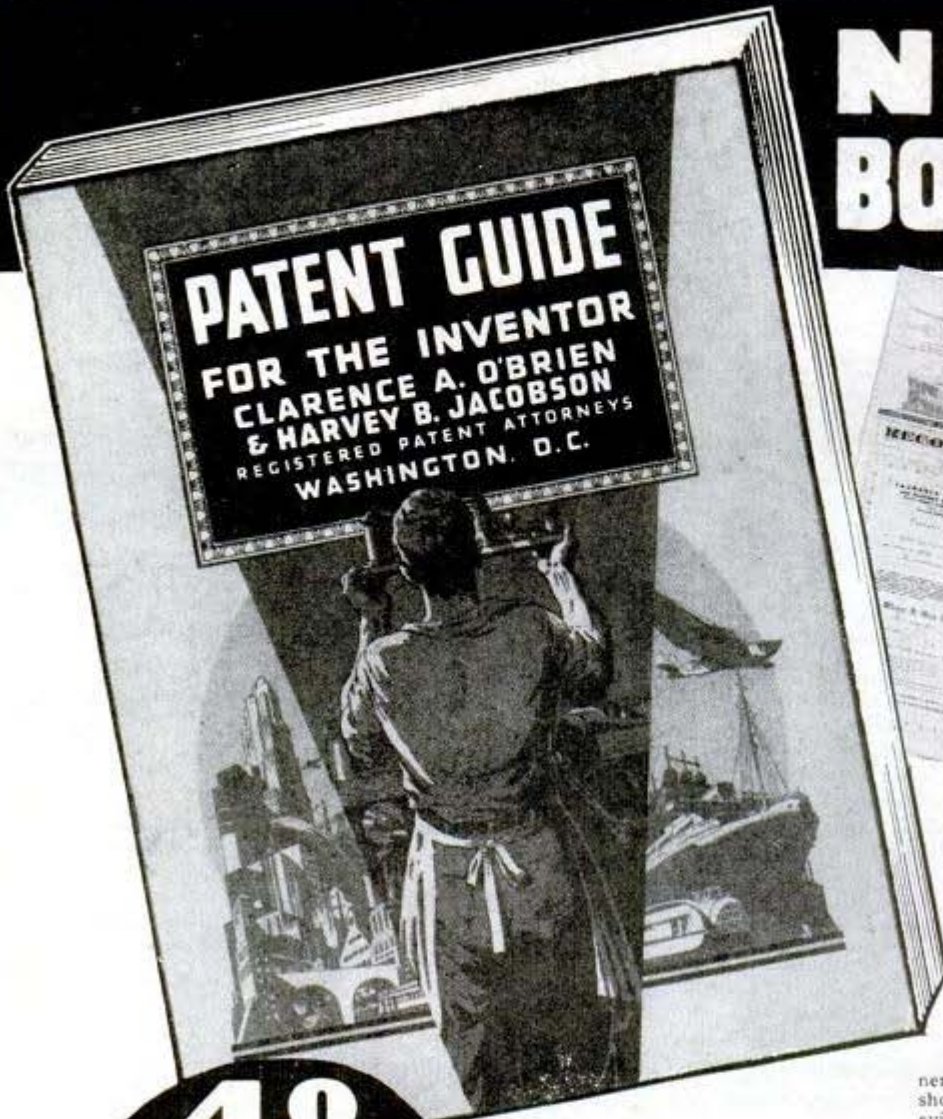

FREE RECORD OF INVENTION

This FREE Record of Invention form enables you to conveniently make a sketch of your invention and have it witnessed in a manner of value to you, should the occasion for evidence arise.

48
PAGES
Over 150
Mechanical
Movements

LATEST FACTS ON INVENTIONS

Is your invention something for the home, the farm, the factory, the store? Would you like to know whether anything like it has ever been invented, and if not, how to protect your invention? Our new 48-page book "Patent Guide for the Inventor" will show you how to proceed with your invention. You'll get a good idea of whether you "have something" or not. Would you like to know how you may judge the marketability of your invention? This book gives you several important tests prepared by authorities. Read of the experiences of Bell, Edison, Westinghouse, and other outstanding, successful inventors who patented and thereby protected their inventions. This book not only tells you how to obtain a patent, it also explains the steps that must be taken afterward to promote the success of your invention. MAIL THE COUPON TODAY to Clarence A. O'Brien & Harvey B. Jacobson, Registered Patent Attorneys, 41-L Adams Building, Washington 4, D. C.

**CLARENCE A. O'BRIEN
& HARVEY B. JACOBSON**
REGISTERED PATENT ATTORNEYS

INVENTORS

NOW Is the Time to PATENT and SELL Your Invention

Now, more than ever before, is the right time to patent your invention. Why? Because manufacturers everywhere presently engaged in war production are looking ahead to the future by buying up patent rights now, so they will have new and attractive items to make and sell for civilian consumption as soon as the war is over. This is what happened during and after the last war. Hence, the smart thing for you to do is to look ahead to the future too. Protect your invention and yourself by applying for a patent now.

Patent Guide Shows What To Do

Our "Patent Guide for the Inventor" answers many important questions concerning Patents that inventors constantly ask. It tells what facts, details, drawings, sketches, etc. are necessary to apply for a Patent; how to protect your invention through dated and witnessed disclosure; how to do this AT ONCE to safeguard your rights; how Patent Office Records can be checked to determine whether the invention is probably patentable before filing fees need be paid; discusses costs involved and a practical way these can be paid as the application progresses. It tells how some inventors secured financial backing; how many simple inventions have proved large commercial successes; how Patents covering improvements also can be profitably utilized and marketed; tells countless other facts of interest.

Why You Need Expert Assistance

The Patent Laws were enacted for your benefit—to give you protection for the features of your invention which are Patentable. But these features must be legally and concisely set forth in the form of "claims." This phase of the procedure is so complex that the Patent Office advises the Inventor to engage a competent Registered Patent Attorney. We maintain a large staff—carefully trained registered patent attorneys—expert draftsmen—experienced searchers—to serve you. We have been serving inventors for more than 20 years.

Take First Step Now

With the Patent Guide you will receive also Free a "Record of Invention" form which will enable you at once to establish the date of your invention, before you file your Patent application. This step costs you nothing yet may be vital to your success. Remember—in Patent Matters, ACTION is IMPORTANT. Delay can be costly. Mail the coupon in an envelope, or paste it on a penny postcard NOW.

*Worthy of
Your Trust*

Get

**FREE
COPY**

*Mail
Coupon
Today*

CLARENCE A. O'BRIEN & HARVEY B. JACOBSON

CLARENCE A. O'BRIEN & HARVEY B. JACOBSON
Registered Patent Attorneys before the United States Patent Office
41-L Adams Building, Washington 4, D. C.

Please send me your 48-Page "Patent Guide for the Inventor" and your specially prepared "Record of Invention" form FREE. This request does not obligate me.

Name.....

Address.....

City..... State.....

(Please write or print plainly.)

SPRAYBERRY RADIO TRAINING

Gives you Both

TECHNICAL KNOWLEDGE
SKILLED HANDS



FULL RADIO SET SUPPLIED FOR SHOP PRACTICE!

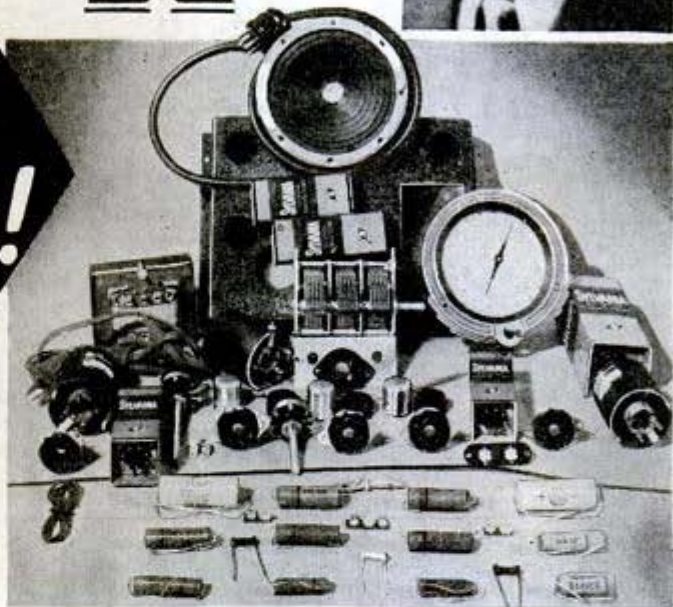

HERE'S THE ONE PRACTICAL WAY TO TRAIN FOR BIG EARNINGS AHEAD IN RADIO-ELECTRONICS & TELEVISION

JUST OUT! FREE!

"How to Read Radio Diagrams and Symbols"

... a valuable new book which explains in simple English how to read and understand any Radio Set Diagram. Provides the quick key to analyzing any Radio circuit. Includes translations of all Radio symbols. Send for this FREE book now and along with it I will send you another big FREE book describing my Radio-Electronic training.



GET FREE BOOKS

SPRAYBERRY ACADEMY OF RADIO

F. L. Sprayberry, President
Box 500RL, Pueblo, Colorado.

Please rush my FREE copies of "How to MAKE MONEY IN RADIO, ELECTRONICS and TELEVISION," and "HOW TO READ RADIO DIAGRAMS and SYMBOLS."

Name..... Age.....

Address.....

City..... State.....

(Mail in plain envelope or paste on penny postcard)

The offer I make you here is the opportunity of a lifetime. It's your big chance to get ready for a wonderful future in the swiftly expanding field of Radio-Electronics INCLUDING Radio, Television, Frequency Modulation and Industrial Electronics. Be wise! NOW'S the time to start. No previous experience is necessary. The Sprayberry Course starts right at the beginning of Radio. You can't get lost. It gets the various subjects across in such a clear, simple way that you understand and remember.

I'll Show You a New, Fast Way to Test Radio Sets Without Mfg. Equipment

The very same Radio Parts I supply with your course for gaining pre-experience in Radio Repair work may be adapted through an exclusive Sprayberry wiring procedure to serve for complete, fast, accurate Radio Receiver trouble-shooting. Thus under Sprayberry methods you do not have one cent of outlay for manufactured Test Equipment which is not only expensive but scarce.

Prepares You for a Business of Your Own or Good Radio Jobs... Civilian or Military

My training will give you the broad, fundamental principles so necessary as a background no matter which branch of Radio you wish to specialize in. I make it easy for you to learn Radio Set Repair and Installation Work. I teach you how to install and repair Electronic Equipment. If you enter the Army, Navy or Marines, my training will help you win higher rating and better pay.

HE Mailed This Coupon

J. G. O'BRIEN

Atlas Champion
Cup Winner

This is an ordinary snapshot of one of Charles Atlas' California pupils.

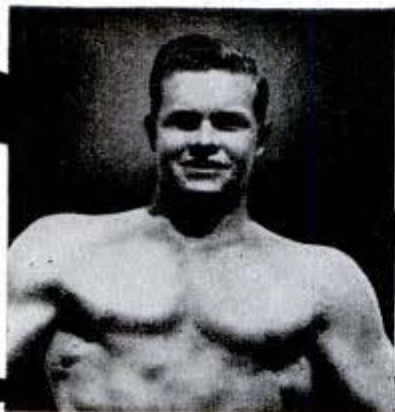

...and Here's the Handsome Prize-Winning Body I Gave Him!



CHARLES ATLAS

An untouched photo of Charles Atlas, winner and holder of the title "The World's Most Perfectly Developed Man."

J. G. O'BRIEN saw my coupon. He clipped and mailed it. He got my free book and followed my instructions. He became a New Man. NOW read what he says:

"Look at me NOW! 'Dynamic Tension' WORKS! I'm proud of the natural, easy way you have made me an 'Atlas Champion'!"

J. G. O'Brien.

"I'll Prove that YOU, too, can be a NEW MAN"—Charles Atlas

I don't care how old or young you are, or how ashamed of your present physical condition you may be. If you can simply raise your arm and flex it I can add SOLID MUSCLE to your biceps—yes, on each arm—in double-quick time! Only 15 minutes a day—right in your own home—is all the time I ask of you! And there's no cost if I fail.

I can broaden your shoulders, strengthen your back, develop your whole muscular system INSIDE and OUTSIDE; I can add inches to your chest, give you a vise-like grip, make those legs of yours lithe and powerful. I can shoot new strength into your old backbone, exercise those inner organs, help you cram your body so full of pep, vigor and red-blooded vitality that you won't feel there's even "Standing room" left for weakness and that lazy feeling! Before I get through with you I'll have your whole frame "measured" to a nice, new beautiful suit of muscle!

Only 15 Minutes a Day

"Dynamic Tension!" That's the ticket! The identical natural method that I myself developed to change my body from the scrawny, skinny-chested weakling I was at 17 to my present superman physique! Thousands of other fellows are becoming marvelous physical specimens—my way. I give you no gadgets or contraptions to fool with. You learn to develop your strength through "Dynamic Tension." You simply utilize the DORMANT muscle-power in your own God-given body—watch it increase and multiply double-quick into real, solid LIVE MUSCLE.

My method—"Dynamic Tension"—will turn the trick for you. No theory—every exercise is practical. And, man, so easy! Spend only 15 minutes a day in your own home. From the very start you'll be using my method of "Dynamic Tension" almost unconsciously every minute of the day—walking, bending over, etc.—to BUILD MUSCLE and VITALITY.

FREE BOOK "EVERLASTING HEALTH AND STRENGTH"

In it I talk to you in straight-from-the-shoulder language. Packed with inspirational pictures of myself and pupils—fellows who became NEW MEN in strength, my way. Let me show you what I helped THEM do. See what I can do for YOU! For a real thrill, send for this book today. AT ONCE. Address: CHARLES ATLAS, Dept. 8-L, 115 E. 23rd St., New York 10, N. Y.



CHARLES ATLAS, Dept. 8-L 115 E. 23rd Street, New York 10, N. Y.

I want the proof that your system of "Dynamic Tension" can help make me a New Man—give me a healthy, husky body and big muscle development. Send me your FREE book "Everlasting Health and Strength." No obligation.

Name.....
(Please print or write plainly)

Address.....

City..... Zone No. State.....
(if any)

Check here if under 16 for Booklet A

INVENTORS

LEARN HOW TO
PROTECT and SELL
YOUR INVENTION

GET NEW FREE BOOK



FREE

Invention Record
Know How Successful
Inventors Protect and
Sell Their Inventions

Our new FREE Book is a book every inventor should have. Mail the coupon today for "How to Protect, Finance and Sell Your Invention" and learn . . .

- How to know if there is a prior U. S. patent on your invention.
- How to save steps in getting patent action.
- How to prepare your application for presentation to the Patent Office.
- How you may patent an improvement on something in use now.
- How to obtain funds to patent and promote your invention.
- How to find a buyer or backer for your invention.
- How to protect yourself in making royalty agreements.

MODERN BUSINESS WANTS INVENTIONS
Practical and novel inventions are in big demand today. The opportunity for quick money is enticing. Sales sources are many if your invention has merit. But, be *sure*—before you place your device in strange hands—that it is fully protected. A United States Patent gives you this protection. *The first step toward inventive success—always is—and always has been, the application for a U. S. Patent. There is no other way to protect your invention in accordance with the laws of this country.*

MAKE THIS RECORD NOW If you have an invention, and wish to secure it for the future, act at once. Have it dated now and recorded in our office. We will send you this FREE Invention Record Form for the purpose. Fill out the Invention Record Form fully describing the nature of your invention. Make a sketch of its main features. Mail it to us and we will record the date it was received in our office. The earlier the date the better your chance of combating rival inventors who may lay claim to your idea later. *Don't delay a single minute in taking this important step. Your whole future may depend upon it. Mail the coupon for our FREE Invention Record Blank and New FREE Book today!*

HOW WE SERVE YOU AS REGISTERED PATENT ATTORNEYS

The U. S. Patent Office strongly recommends—unless the inventor is familiar with such matters—that he employ the services of a Registered Patent Attorney in the preparation of his Patent Application. We are Registered Patent Attorneys fully qualified to represent you at the Patent Office. We have had long experience in studying hundreds of types of inventions. This gives us the ability to judge your invention and to describe it accurately and convincingly in technical language. It gives us the perception to center arguments upon those details of your invention which, in our judgment, will be looked upon most favorably by the Patent Office Examiner.

Mail the coupon today for our new FREE Book, "How to Protect, Finance and Sell Your Invention," and our FREE Invention Record Form—maybe this step will pave the way to future security for you and your family. Act Today!

McMORROW & BERMAN
Patent Attorneys
1354 Albee Building, Washington 5, D. C.

McMORROW & BERMAN

PATENT ATTORNEYS

1354 ALBEE BUILDING, WASHINGTON 5, D. C.

Send me your new FREE book, "How to Protect, Finance and Sell Your Invention"—and "Invention Record" form at once. I understand that this request does not obligate me.

NAME

ADDRESS

CITY STATE

(Write or print name clearly)

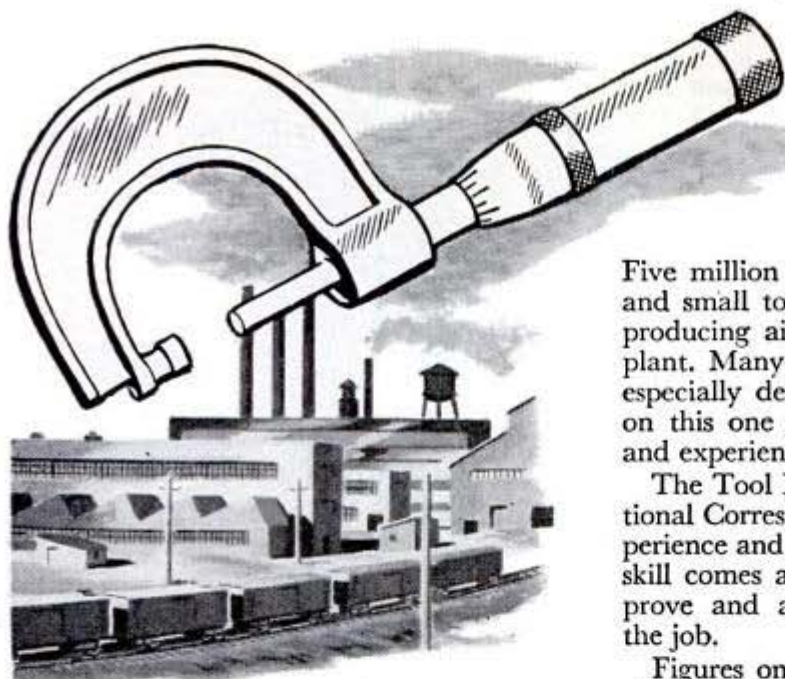

Five million tools, jigs, dies, fixtures, gauges and small tools are needed by the machines producing airplane engines in just one U.S. plant. Many of the machine tools had to be especially designed for the work to be done on this one job. That takes real knowledge and experience.

The Tool Designing Course of the International Correspondence Schools makes such experience and knowledge available to you. The skill comes as you study in your spare time, prove and apply what you learn right on the job.

Figures on the tools used in a single plant give some idea of the vast dimensions of the tool designing field. You know, too, that change and improvement is constantly going on. *All that means demand for tool engineers.*

Manufacturing conversions will make the demand even greater. Now is the time to prepare for it—and assure yourself of a *solid, well-paid future.*

You can't learn Tool Designing overnight. You *can*, by mailing the coupon, set yourself on the road to mastering this great profession.

5 million tools IN 1 PLANT!

INTERNATIONAL CORRESPONDENCE SCHOOLS



BOX 5508-K, SCRANTON 9, PENNA.

Without cost or obligation, please send me booklet and full particulars about the course *before* which I have marked X:

Air Conditioning and Plumbing Schools

- Air Conditioning
- Heating
- Refrigeration
- Plumbing
- Steam Fitting

Chemistry Schools

- Chemical Engineering
- Chemistry, Analytical
- Chemistry, Industrial
- Chemistry, Mfg. Iron & Steel
- Plastics
- Pulp and Paper Making

Civil Engineering, Architectural and Mining Schools

- Architectural Drafting
- Architecture
- Bridge and Building Foreman
- Bridge Engineering
- Building Estimating
- Civil Engineering
- Contracting and Building
- Highway Engineering
- Lumber Dealer
- Sanitary Engineering
- Structural Drafting
- Surveying and Mapping

Electrical Schools

- Electrical Drafting
- Electrical Engineering
- Power House Electrician
- Practical Electrician
- Practical Telegraphy
- Telegraph Engineering

Internal Combustion Engines School

- Auto Technician
- Diesel-Electric
- Diesel Engines
- Aviation
- Gas Engines

Mechanical Schools

- Aeronautical Engineering
- Airplane Drafting
- Flight Engineer
- Foundry Work
- Heat Treatment of Metals
- Industrial Design
- Mechanical Drafting
- Mechanical Engineering
- Mold-Loft Work
- Patternmaking
- Reading Shop Blueprints
- Sheet Metal Drafting
- Sheet Metal Worker

Ship Drafting

- Ship Drafting
- Ship Fitting
- Shop Practice
- Steel Mill Workers
- Tool Designing
- Welding, Gas and Electric

Radio School

- Electronics
- Radio, General
- Radio Operating
- Radio Servicing

Railroad School

- Air Brake
- Locomotive Engineer
- Locomotive Fireman
- Railroad Section Foreman

Steam Engineering Schools

- Boilermaking
- Combustion Engineering
- Engine Running
- Marine Engines
- Steam Electric
- Steam Engines

Textile School

- Cotton Manufacturing
- Rayon Weaving
- Textile Designing
- Woolen Manufacturing

Business and Academic Schools

- Accounting
- Arithmetic
- Business Correspondence
- Business Management
- Certified Public Accounting
- City Letter Carrier
- College Preparatory
- Commercial
- Cost Accounting
- Federal Tax
- First Year College
- Foremanship
- High School
- Higher Mathematics
- Illustrating
- Motor Traffic
- Post Office Clerk
- Railway Postal Clerk
- Salesmanship
- Secretarial
- Stenography
- Traffic Management

Language School

- Spanish
- Good English
- French

Name..... Age..... Home Address.....

City..... State..... Present Position..... Working Hours..... A.M. to..... P.M.

Canadian residents send coupon to International Correspondence Schools Canadian, Ltd., Montreal, Canada.
British residents send coupon to I. C. S., 71 Kingsway, London, W. C. 2, England.

SPECIAL TUITION RATES FOR MEMBERS OF THE ARMED FORCES

Important
PATENT
Information

FREE to SERIOUS-MINDED INVENTORS

Information you can depend upon is packed into these two big books written to help ambitious inventors like you cash-in on your ideas . . . two big books that have helped thousands of inventors by showing them what to do to secure a strong patent.



HOW to PATENT your INVENTION

Here is sound information you will need before making one move! Everything is explained in detail . . . step by step. In addition, book contains diagrams of 115 Mechanical Movements—just what you may now need to complete your invention. A valuable book . . . and FREE. Use the coupon below.



HOW TO SELL YOUR INVENTION

"When and How to Sell Your Invention" points out necessary procedures when you are ready to commercialize your invention. A book of suggestions based on our 46 years of dealing with inventors. It's FREE . . . send the coupon today.

Valuable "EVIDENCE of INVENTION" Form



This form contains space for properly submitting rough sketch and necessary details of your invention. You'll want it if you are seriously interested in patenting your idea. It's FREE for the asking.

Fill in and mail the coupon now. Read the books . . . then, if you feel you have a patentable invention, GET STARTED NOW!

GET
ALL 3
FREE . . .
Now!

VICTOR J.
EVANS & Co.

Registered Patent Attorneys for Nearly 50 years
830-M MERLIN BUILDING • WASHINGTON 6, D. C.

Please send me your books—"Patent Protection" and "When and How to Sell Your Invention"—also important "Evidence of Invention" form, without cost or obligation.

Name

Address

City and State

What Can You Read In This



FINGER PRINT?

Study it carefully. There is a secret hidden in it, just as there is in every finger print. For 28 years we have been training men to become Finger Print experts. Over 53% of all American Identification Bureaus employ I.A.S. trained men. Get into this steady-employment, good pay profession. Learn at home. Small cost. Fine opportunities.

"THE BLUE BOOK OF CRIME"

FREE This thrilling book tells all about many famous crime cases and how you can qualify for one of the fine positions in the Identification field. Write for it, stating your age.

INSTITUTE OF APPLIED SCIENCE

Dept. 1358, 1920 Sunnyside Ave., Chicago 40, Ill.

LEARN MONEY-MAKING CARTOONING

IN SPARE TIME — by Easy Picture Chart Method

Same Simplified Method that has helped train creators of "Terry & Pirates," "Freckles," "Out Our Way," "Winnie Winkle," "Regular Fellers," "Strange As It Seems," "The Neighbors," and many others. Earn while learning. Send 10c for Picture Chart (to test your ability, and full details. (State age.)



THE LONDON SCHOOL, Dept. 4411, Philadelphia 1, Penna.

In Every Shop

Men Who Can Lead are paid well..

Lincoln Extension Institute offers instructions for shop leadership. The course combines the essentials of shop engineering with the development of personal power thru knowledge and handling of the human factors present in every industry.

Men with this training are invariably marked for promotion and bigger pay. More about this important training is told in "Getting Ahead in Industry," a booklet which will be mailed upon request. Address Mr. Louis S. Vosburgh,

LINCOLN EXTENSION INSTITUTE, INC.

West 75th St. at Detroit, Cleveland, Ohio

MONEY for MEN ALL FREE

THE PLASTEX Industry needs manufacturers on small scale and for big production of Lamp and Clock Stands, Art Goods and Novelties in Plastex and Marble imitation. Experience unnecessary, 1/2c material makes regular 10c store sellers. Rubber molds furnished for speed production. Small investment brings good returns. Big chain store orders now being placed. Ambitious men have chance for real prosperity. Our Free booklet will interest and benefit you.

PLASTEX INDUSTRIES, Dept. P, 1085 Washington Ave., New York, N. Y.

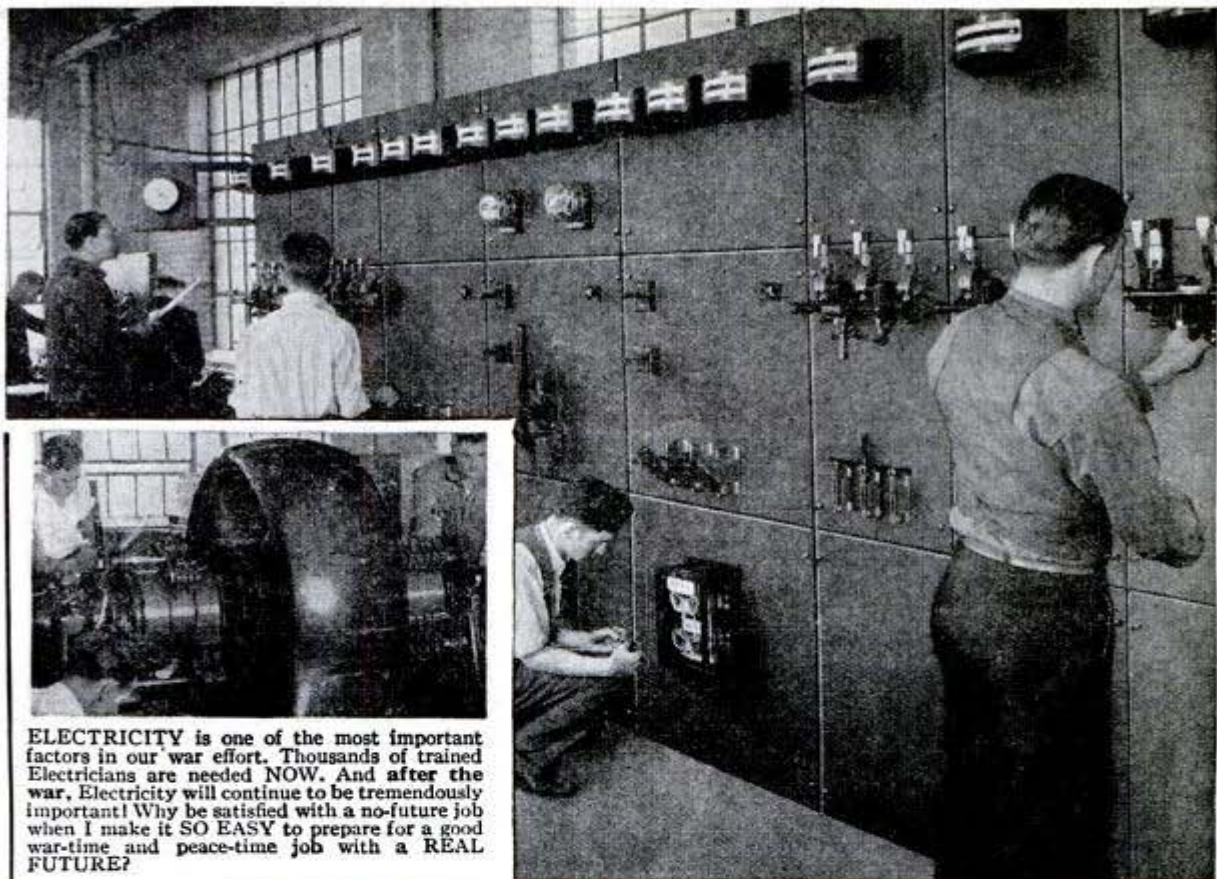

ELECTRICITY is one of the most important factors in our war effort. Thousands of trained Electricians are needed NOW. And after the war, Electricity will continue to be tremendously important! Why be satisfied with a no-future job when I make it SO EASY to prepare for a good war-time and peace-time job with a REAL FUTURE?

Learn **ELECTRICITY** 12 WEEKS TRAINING

Get into the fascinating, fast-growing, well-paid field of Electricity—a field that offers you opportunities and a future—in good times or bad times—a field that is a permanent necessity in war or peace. Here is your chance to prepare yourself for a lasting permanent future.

LEARN BY DOING

Here at Coyne—in 12 weeks, you can train for your Big Opportunity. "Learn-by-doing"—train on real electrical machinery. Not a

SPECIAL OFFER!
INDUSTRIAL ELECTRONICS
Training included at no Extra Cost.

correspondence course. Here you get all-around training in the many branches of Electricity so you are equipped for the better jobs in this field.
Coyne training is easily mastered. Many of our students have never had previous Electrical experience—many others have had experience in one or two branches but realize to advance they must have all-around Electrical training. So whether you have had electrical experience or not—you need Coyne training.



GET YOUR TRAINING NOW... PAY FOR IT LATER!

Coyne Training is EASY, PRACTICAL! You LEARN BY DOING on real, actual machinery and apparatus. Don't let lack of money stop you. You can get training first—then pay for it in easy monthly payments after you graduate. If you need part-time work to help out with living expenses, I'll help you get it.

We also have facilities for physically disabled men. Write for details.

INSURE YOUR FUTURE! *Send for Book!*

Coyne is 45 years old and has seen War and Peace—times of prosperity and times of national depression. During all these times Coyne has trained men for Good pay jobs. Coyne training is tested and proven. Mail coupon and let me send you the big free Coyne book and my complete story about how I help you get the training you need for a good Electrical job. This does not obligate you. Act at once. Just mail coupon.

H. C. LEWIS, President, COYNE ELECTRICAL SCHOOL
500 S. Paulina St. Dept. 84-72 Chicago 12, Illinois

H. C. LEWIS, President,
COYNE ELECTRICAL SCHOOL, Dept. 84-72,
500 S. Paulina St., Chicago 12, Ill.

Send me your Free Book and tell me about your plans to help me—including Pay-Tuition-after-Graduation offer and Radio-Electronics Training at no extra cost.

NAME.....
ADDRESS.....
CITY.....ZONE.....STATE.....



THE AERO TECH CAMPUS

... covers many acres and thousands of square feet of modern laboratories, shops and classrooms. Many civilians and Servicemen received their start in aviation from here.

...TO VETERANS OR SERVICEMEN

Expand your aviation knowledge by planning now to enroll in Aero Tech's special, advanced courses. This will insure your post-war opportunities in the new "aviation age," which will require trained, alert men by the thousands.

...TO CIVILIANS AND WAR WORKERS

You can do a better job in hastening victory by working in a Los Angeles essential industry and taking Aero Tech courses at the same time. The training is especially laid out for the post-war aviation era — investigate this plan.

GREATLY EXPANDED COURSES

New requirements by airlines, service depots, feeder-lines... and the need for new types of aviation trained men... has created many new courses now offered by Aero Tech. Always up-to-the-minute, Aero Tech *steps ahead* with special plans for the "aviation age of the future."



Servicing — many types of modern airplanes used for practical shop instruction.



Airport operations — Aero Tech students get actual experience on a leading Los Angeles airport.



Engineering — complete design projects are carried out by Aero Tech students.



Flying — all types of primary, secondary and blind flying instruction for men and women.



Instruments — latest type instruments, gyros, automatic pilots used for training.



Engine overhaul — all modern types of radial and in-line engines used for training.

GET COURSE BULLETINS NOW . . .

Winter classes now forming

Thousands secured their start from this institution . . . thousands more will secure a "priority" on their careers by attending Aero Tech in the near future. Send coupon for free bulletins NOW — act today.



Approved by CAA for Aircraft and Engine Mechanics Training

AERO INDUSTRIES TECHNICAL INSTITUTE

Herbert W. Hartley, President

5253 W. San Fernando Rd., Los Angeles 26



Gentlemen: Please send free bulletins, and data on courses checked below.

- | | |
|---|--|
| <input type="checkbox"/> Aircraft Mechanics | <input type="checkbox"/> Airport Operations |
| <input type="checkbox"/> Instrument Technician | <input type="checkbox"/> Flying (all licenses) |
| <input type="checkbox"/> Aeronautical Engineering | <input type="checkbox"/> Engine Mechanics |

Name _____ Age _____

Street _____

City _____ Zone _____ State _____

Civilian In Services Veteran P.11

★ SAVE WASTE PAPER ★

LEARN

Refrigeration AND Air Conditioning

★ Train now for immediate future and POST-WAR

A real opportunity for good earnings awaits reliable, ambitious, mechanically-minded men who prepare NOW and get into Refrigeration and Air Conditioning. Thousands of war-worn mechanical units need servicing RIGHT NOW; new equipment must be properly installed, intelligently serviced after the war.

A GOOD field for GOOD earnings

Start now and train in your spare time. It need not interfere with your present work. Here is a Balanced plan of practical training that offers you home-study followed by actual practice with real equipment. Since 1927 U.E.I. has been training thousands of men to get better pay in this growing field. Get this "Know How" that leads to opportunities for employment or a business of your own after the war. Write for FREE complete details TODAY.

UTILITIES ENGINEERING INSTITUTE

Dept. 1114 1314 W. Belden Ave. Chicago 14, Ill.

924 PAGE AUTHENTIC FORMULARY

10,000 Formulas, Recipes, Trade Secrets for making most any conceivable product. Prepared by experts in simple, non-technical language. Countless profitable business opportunities, supply sources. Valuable reference for home, farm or industry. \$2.00 postpaid — Canada or Foreign \$2.35, U. S. Funds. (C.O.D. orders accepted for U. S. delivery only.)



Prepare for "After-War-Business"

Especially recommended for Servicemen and War Workers planning a profitable business of their own.

ADAMS BROWN COMPANY . . Dept. 10 . . Chestnut Hill 67, Massachusetts

EVERY MARINE ENGINEER CAN USE THIS BOOK

JUST OUT! New From Cover To Cover

AUDELS MARINE ENGINEERS Handy Book

Entirely modern, Practical Treatise for Marine Engineers (all grades), Firemen, Oilers, Machinists and Students with Calculations and Questions and Answers for Examinations.

LATE INFORMATION in a Handy Form covering all branches of modern Marine Engineering with step-by-step solutions on hundreds of problems. —Tables and Data—Fully Indexed—Easy to Understand—Size 6 3/4 x 5 x 1 3/4.

Indispensable for Upgrading Examinations and Ready Reference.

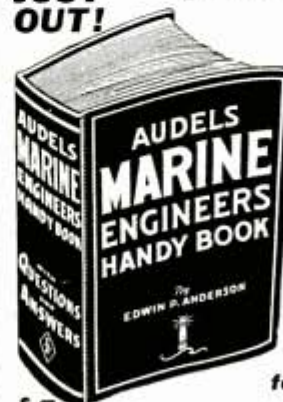

\$4 1280 PAGES—FULLY ILLUSTRATED COMPLETE ASK TO SEE IT—Get this information ONLY 1 MO. for yourself—

Clip this coupon and mail today!

AUDELS, Publishers; 49 W. 23 St., New York 10, N.Y.

Mail AUDELS MARINE ENGINEERS Handy Book (Price \$4) on 7 days free trial. If O.K., I will remit \$1 in 7 days and \$1 monthly until \$4 is paid. Otherwise, I will return it.

Name _____

Address _____

Occupation _____

Employed by _____ P.M.

PLASTICS

THE GREAT *New* FIELD OF OPPORTUNITY

PLASTICS ENGINEERS AND TECHNICIANS NEEDED
IN NOT ONE BUT MANY CLASSES OF INDUSTRY

● Leaders in science and industry have long been saying, "Keep your eye on Plastics." But now the time for action has arrived. The future of huge possibilities has already begun. Developments in Plastics for hundreds of wartime uses have set the pace for revolutionary changes in peacetime production of thousands of products.

THIS IS YOUR BIG CHANCE

Today there's a big need in vital war production for those who are trained in Plastics. From one to a hundred articles made of Plastics must be supplied for every man in our fighting forces. Start training now in Plastics Engineering, in spare time in your own home. Fit yourself for a responsible, well-paid position. Help to win Victory. And at the same time you will be preparing for even greater opportunities when the war is over.

There is scarcely an industry in which these so-called "miracle materials" will not play an important part. After the war many old materials, methods and skills will be replaced. Acquire the all-important "know how." Be in a position to step into one of the key jobs.

YOU CAN LEARN WHILE YOU EARN

Turn at least part of your leisure time into money. Qualify at home for a larger income in an interesting career. Build greater security for your future in a vocation that looms large on the horizon of the new industrial era. Hours you might otherwise waste can put you well on your way toward lasting success.

It's easy to find out about Plastics training. To get details and outline of study prepared by specialists, and about the school that has helped thousands to success during the past 46 years, write us or check and mail the coupon. Send today. The sooner you take this easy step, the sooner you will reach your goal and reap the rich rewards.

AMERICAN SCHOOL OFFERS COMPLETE TRAINING SERVICE IN MANY SUBJECTS

You who have not completed high school or have missed vocational training in college, and who cannot spare time to go away to school, can complete your education in your choice of many subjects. Several of these are listed in the coupon at right. Check the subject in which you are interested, fill in your name and address, clip and mail the coupon today.

PRACTICAL, EFFECTIVE HOME - STUDY TRAINING SINCE 1897

Take This First Easy Step

CHECK, CLIP AND MAIL COUPON NOW

AMERICAN SCHOOL, Dept. G845, Drexel at 58th, Chicago 37, Ill.
Without obligation. Please send FREE and postpaid, bulletin and details of the Subjects checked.

- | | | |
|--|---|--|
| <input type="checkbox"/> PLASTICS ENG'R | <input type="checkbox"/> Accounting and C.P.A. | <input type="checkbox"/> Drafting and Design for Men and Women |
| <input type="checkbox"/> Refrigeration | <input type="checkbox"/> Cost Accounting for Manufacturing | <input type="checkbox"/> Radio |
| <input type="checkbox"/> Architecture and Building | <input type="checkbox"/> Bookkeeping | <input type="checkbox"/> High School |
| <input type="checkbox"/> Practical Plumbing | <input type="checkbox"/> Private Secretary | <input type="checkbox"/> Air Conditioning |
| <input type="checkbox"/> Automotive Engineering | <input type="checkbox"/> Diesel Engineering | <input type="checkbox"/> Shipbuilding |
| <input type="checkbox"/> Aviation Drafting | <input type="checkbox"/> Surveying & Topographical Drafting | <input type="checkbox"/> Mechanical Eng. |
| <input type="checkbox"/> Aviation | <input type="checkbox"/> Sheet Metal | <input type="checkbox"/> Shop Management |
| <input type="checkbox"/> Business Mgmt | <input type="checkbox"/> Pattern Drafting | <input type="checkbox"/> Tool Making |
| <input type="checkbox"/> Railway Training | <input type="checkbox"/> Electrical Engineering | <input type="checkbox"/> Better Foremanship |
| | | <input type="checkbox"/> Machine Shop Operations |

Name..... Occupation.....
Address..... Age.....
City..... State.....

AMERICAN SCHOOL

Dept. G845, Drexel at 58th Street, Chicago 37



DO YOU THINK IN CIRCLES?

Do you ask yourself, "How shall I begin; what shall I do next?" Have you a confusion of ideas? Mastery in life, success in any enterprise, comes from the subtle ability to marshal your thoughts, to call to the fore, when an emergency arises, the proper mental powers. Mentally, you are an aggregate of forces. Why dissipate them because of lack of knowledge of how to properly use them? Learn to unite them, and you will have at your command, a tremendous power for accomplishment.

SEND FOR FREE BOOK

The Rosicrucians have preserved for centuries knowledge of the secret method for the development of mind power and the direction of man's unused inner faculties. This wisdom, not strange or mysterious, has changed the course of life for many men and women throughout the world. Write for the free, sealed book which explains how you may obtain this helpful information. Address: Scribe A. H. J.

The ROSICRUCIANS [AMORC]

San Jose California

— USE THIS COUPON —

Scribe A. H. J.
The Rosicrucians
San Jose, California

I am sincerely interested in an intelligent method for attaining a mastership of life. Send me without obligation, your FREE Book which explains how I may receive and use your age-old method.

Name.....
Address.....
City.....

★ SAVE WASTE PAPER ★

"The hours
that
book
saves
me!

... and the
errors it
prevents!"

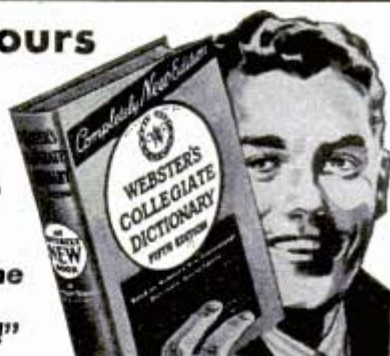

BUSINESS men, secretaries, editors, and students rely upon Webster's Collegiate because it defines all the words most commonly used. Based on and abridged from WEBSTER'S NEW INTERNATIONAL DICTIONARY, Second Edition—"The Supreme Authority," and edited with the same careful scholarship. 1,300 pages; 110,000 entries; \$4.00 to \$8.75, depending on choice of bindings.

YOU MAY HAVE TO WAIT FOR YOUR COPY of WEBSTER'S COLLEGIATE. Paper rationing, plus exceptionally heavy government needs, plus an unprecedented public demand, make it impossible to supply everyone promptly. Your bookseller will do his best to provide your copy. Also ask to see:

WEBSTER'S DICTIONARY OF SYNONYMS \$4.00
WEBSTER'S BIOGRAPHICAL DICTIONARY \$6.50
G. & C. MERRIAM CO., Springfield 2, Mass.

WEBSTER'S COLLEGIATE A Merriam-Webster



— PHOTOGRAPHY —

for
PLEASURE
or
PROFIT

Whether you are interested in photography for fun or as a sound present and postwar career—get the facts as to how America's largest, best equipped school can qualify you for success. Home study or resident training. Individual instruction by experts. Free book gives details. N. Y. INSTITUTE OF PHOTOGRAPHY, Dept. 49, 10 West 33 St., New York 1, N. Y. (Founded 1910)



Begin today. Write now for our Free Book, "How to Become a Good Penman." It contains specimens and tells how others learned to write in spare time. Enclose 10¢ for your name beautifully written and a pen point suitable for shaded writing. Write today.

THE TAMBLYN SCHOOL OF PENMANSHIP
N441 Ridge Building, Kansas City, Mo.



COMMERCIAL ART, CARTOONING, DESIGNING all in one complete course. Learn to draw step-by-step. Hundreds have profited by our practical method famous since 1914. Write today for FREE BOOK, "Art for Pleasure and Profit."

FREE BOOK gives details!

Washington School of Art, Studio 1211K
1115—15th St., N.W., Washington, D. C.

Name..... Age.....
Address.....
City..... State.....

Now You can Use.



ALL OF THESE RADIO PARTS

to help You learn

RADIO

FASTER-EASIER AT HOME

YOU CAN BUILD **133**
FASCINATING EXPERIMENTS

At home—in your spare time—you get real Radio experience with these many Radio parts and sub-assemblies. DeForest's practical equipment system (as pictured above) saves time . . . speeds experiments. You quickly build Radio Receiving Circuits that work . . . a Light Beam Transmitter, Electric Eye Devices, a Radio Telephone, and scores of other fascinating projects. Learning Radio at home is practical, effective, and fun—with DeForest's interesting "Home Laboratory."

YOU USE "LEARN-BY-SEEING"
MOVIES!

Think of the pleasure, as well as help you get from the use of this DeVRY Motion Picture Projector and exciting "movie" TRAINING FILMS. You will be surprised how much faster . . . easier . . . Home Movies help you understand Radio-Electronic fundamentals. Here's a preferred training method of tomorrow—yours today. SEE the principles of what you're learning—in motion . . . ANIMATED! See circuit actions otherwise hidden from the eye. You get this big Radio home training advantage—exclusively with DeFOREST'S. So act now! Mail coupon for complete details.



VETERANS!

The Billion Dollar Radio-Electronic Industry, with its Manufacturing, Servicing, Broadcasting, Communications, and other promising fields, invites consideration. See how DeForest's helps you prepare for a good pay job, or business of your own.

YOU GET "ALL THREE"
WITH DeFOREST'S

Where else can you get such a combination of *proved major training features* as—(1) 90 modern, loose-leaf lessons prepared under the supervision of Dr. Lee DeForest, often called the "Father of Radio," (2) the use of "Learn-by-Seeing" home training films and a genuine 16-mm. DeVRY movie projector, and (3) the use of Electronic assemblies and parts to build 133 practical experiments.

Write for DeForest's big, free book, "VICTORY FOR YOU" that has helped many to good pay jobs in essential industries—others to preferred military classifications—still others to interesting, profitable businesses of their own. See how you can prepare for a bright future now—in your spare time at home—and then get started toward a Radio-Electronics job with the help of DeForest's effective EMPLOYMENT SERVICE. Coupon below brings you illustrated "VICTORY FOR YOU" book—also colorful Kit Supplement. *You be the judge.* No obligation. Mail the coupon today.

DeForest's Training Includes Instruction in Motion Picture Sound Equipment, FM Radio and Television



DeFOREST'S TRAINING, INC., Dept. BD
2535-41 N. Ashland Ave., Chicago 14, Illinois, U.S.A.

Send—FREE and WITHOUT OBLIGATION—illustrated book, "VICTORY FOR YOU" and KIT SUPPLEMENT, showing how Home Movies and Home Laboratory can speed my preparation for a place in the Radio-Electronics industry.

Name _____ Age _____

Address _____

City _____ State _____

If under 16, check here for special information.

If a veteran of World War II, check here.

DeFOREST'S

TRAINING, INC.
CHICAGO 14, ILLINOIS

DRAFTING



GET THIS
Free
TRIAL LESSON
Send Coupon



TO PROVE TO YOU how easy it is to learn Drafting at home by the Chicago Tech method, this 40 year old technical college will send you a *Free Trial Lesson in Drafting*. No charge for this Lesson now or later.

Mail Coupon
Below

Get ready for a peacetime career. Look into the opportunities in Drafting. Read the want-ads for proof of the urgent demand for draftsmen in the aircraft, machinery, electrical and building fields. The draftsman always comes first on any new project in industry,—in peace or wartime.

The Draftsman—"The Key Man"

No new machines can be built, no airplanes constructed, no bridges or buildings erected, no ships or submarines launched until the draftsman has completed his work. Real immediate opportunities exist in Drafting—the profession upon which all construction is vitally dependent. Drafting is clean, interesting, well paid work. Investigate today what Drafting offers you.

Learn in Spare Time,—at Home!

(or at the College in Chicago)

With our easy step-by-step method (and the tools we furnish) you can learn in your spare time at home. Convenient terms—Now is the time to prepare in Drafting for peacetime opportunities. Send the coupon or a post card for the Trial Lesson and complete information,—all FREE.

CHICAGO TECHNICAL COLLEGE

P-205 Tech. Bldg., 2000 S. Michigan Ave., Chicago 16, Ill.

Yes,—please send me *FREE* Trial Lesson in *DRAFTING*.

- | | |
|---|--|
| <input type="checkbox"/> Aircraft Drafting | <input type="checkbox"/> Machine Drafting |
| <input type="checkbox"/> Electrical Drafting | <input type="checkbox"/> Structural Drafting |
| <input type="checkbox"/> Architectural Drafting | <input type="checkbox"/> Building Construction |

Name.....

Address.....

City..... State.....

Occupation..... Age.....

Show A "3-Monkey" Cartoon



Three "STARS" In Every Film
MEANY-MINY-MOE

Always "in and out" of trouble. Grand HOME ENTERTAINMENT. Show them often.

50 Ft. 8MM. . \$1.25 — 100 Ft. 16MM. . \$2.50

Free Air 1201-A | Ship Wrecked 1209-A

Beauty Shop 1202-A | The Auto Race 1213-A

See at your dealers or order direct. For catalog and prices, write to
HOLLYWOOD FILM ENTERPRISES, Inc.
6060 Sunset Blvd. Dept. 115 Hollywood 28, Calif.

Modern Wonder Plastic \$1.00

LUCITE KIT

POST PAID

Complete, supply of Lucite plastic sheets, attractive designs, instructions for cutting, shaping, bending, cementing. Make your own Lucite novelties, costume jewelry. Ideal gifts for Xmas, birthdays, etc. **EARN MONEY AT HOME.** Sell to your friends, \$15 to \$20 worth from \$1 Kit. Satisfaction guaranteed or money refunded. Get a supply of the Wonder Plastic NOW! Send your name and address with \$1 to Plastic Homecraft Co., 4617 West Washington Boulevard, Los Angeles 16, California.

ANY BOOK IN PRINT!

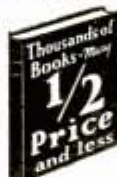

Delivered at your door. We pay postage. Standard authors, new books, popular editions, fiction, reference, medical, mechanical, children's books, etc.—all at guaranteed savings. Send card now for Clarkson's 1945 Catalog.

FREE Write for our great illustrated book catalog. A short course in literature. The buying guide of 300,000 book lovers. **FREE** if you write **NOW—TODAY!**

CLARKSON PUBLISHING COMPANY
Dept. PM4 1253 S. Wabash Ave. Chicago, Ill.

Home-Study Business Training

Your opportunity will never be bigger than your preparation. Prepare now and reap rewards of early success. **Free 48-Page Books Tell How.** Write now for book you want, or mail ad with your name, present position and address in margin today.

LASALLE Extension University
A Correspondence Institution
417 S. Dearborn Street, Dept. 1164-R Chicago 5, Illinois

RADIO ENGINEERING, Broadcasting, Servicing, Electronics, Aviation, Marine & Police Radio taught thoroughly. 48 weeks' Engineering course equivalent to 3 years' college radio work. All expenses low. Co-educational. Catalog free.

VALPARAISO TECHNICAL INSTITUTE, Dept. D, Valparaiso, Ind.

FIBRE ARMS AND LEGS!

Light, correctly fitted, strong and comfortable. Natural appearance. Braces for all deformities. Scientific design. Fair Terms.
BUCHSTEIN-MEDCALF 610-3rd Av. S., Minneapolis, Minn.

Inventions Wanted

Patented or Unpatented

Inventions can now be safely sold without patenting expense. If you have a practical, useful idea for sale, either unpatented or patented, write **Chartered Institute of American Inventors**
Dept. 4, 631 Pa. Ave., N. W. Washington, D. C.



LEARN ELECTRICAL APPLIANCE REPAIRING

NO EXPERIENCE NEEDED

If you are at all mechanically inclined—that is to say—can hold and use tools—then you have all of the qualifications required for becoming a big money-earning home appliance repairman. It does not matter if you have not had a great deal of schooling or had no previous training along these lines. Age is no barrier . . . nor is any minor physical handicap.

Read What Other Students Say

I really believe your course the best investment a mechanically minded man can make.—*Claude E. Allen, Indianapolis, Ind.*

Your course on Appliance Servicing is the most complete and up-to-date I have heard of.—*Frank Kremen, Tarentum, Penn.*

I have received your Course in Appliance Repairing and I must say I am well pleased with same. I am only sorry I did not have said Course some years ago. I have learned so much more through this course I would not part with it.—*Charles Schwarz, Hamilton, Ohio.*

The Course in Appliance Servicing arrived a few days ago. Want to take out a few minutes of my valuable time to let you know that this is just what I have been looking for ever since I opened up my Fix-It shop. I must admit that you told the truth when you said that it contains quite a bit more information than I bargained for.—*P. J. Brett, Sebring, Ohio.*

I am a mechanic for the Western Union Telegraph Co. Three days after receiving the lessons in refrigeration I earned the exact cost of the course.—*Henry S. Lee, Washington, D. C.*

PREPARE FOR THE FUTURE

If now in war work, start your home appliance repair business in your spare time and be set with a business of your own when the war is over. You don't need elaborate fixtures or expensive equipment to be a successful repairman. Operate from your garage, basement, vacant store, etc. Work as many hours as you wish . . . the home appliance repairman is his own boss. It's a profitable occupation for on many types of repairs it is usual for a repairman to charge on the basis of \$5.00 to \$6.00 an hour! *Prepare today and make sure of tomorrow's future.*

New Course Helps All

Profusely illustrated, our new course shows you in simple, easy to understand language and drawings how to make each repair on refrigerators, vacuum cleaners, washing machines, motors, etc. Explains and gives you a working knowledge of electricity, welding, nickel plating, etc. Shows you how to build the power tools you need and how to solicit and keep business coming to you. Not a theory course but an honest to goodness course written by and used by repairmen the country over. Price of course is so low that the savings on your own household appliance repairs will quickly pay for it. Act now!

Mail Coupon for
FREE LITERATURE

CHRISTY SUPPLY CO.,
2835 N. CENTRAL AVE., DEPT. D-1503,
CHICAGO 34, ILLINOIS

Please send me all the facts about America's Fastest Growing Industry—Electrical Appliance Repairing.

Name

Address

City..... State.....

Do you want

→ .. to go to College?

→ .. or to enter a Profession?

(Such as Accounting, Architecture, Nursing, Dentistry, Teaching, Social Work, Osteopathy, Beauty Culture, Optometry, Embalming, Chiropractic, Law, Medicine, etc.)

→ .. or get an Office Position?

To get anywhere, you practically **MUST** finish High School **FIRST**. You can complete our simplified High School Course in **SPARE** time at home, as **FAST** as your time and abilities permit. Equivalent to resident school work—prepares you for college, pre-professional examinations, business, industry. Standard texts furnished. Diploma. Credit for H.S. subjects already completed. Single subjects if desired. Low tuition, easy terms. American School, Chicago, est. 1897—endorsed by educators. Finish your high school education **NOW**. Write **TODAY!**

High School Course at Home

Many Finish in 2 Years

American School, Dept. H845, Drexel Ave. at 58th St., Chicago 37, Ill.

Gentlemen: Send me **FREE** information covering special training in subjects checked below. No obligation on my part.

- | | |
|--|--|
| <input type="checkbox"/> High School Course | <input type="checkbox"/> Diesel Engineering |
| <input type="checkbox"/> Cost Accounting for Mfg. | <input type="checkbox"/> Drafting and Design for men & women |
| <input type="checkbox"/> Architecture and Building | <input type="checkbox"/> Plastics |
| <input type="checkbox"/> Automotive Engineering | <input type="checkbox"/> Private Secretary |
| <input type="checkbox"/> Business Management | <input type="checkbox"/> Mechanical Engineering |
| <input type="checkbox"/> Electrical Engineering | <input type="checkbox"/> Aviation <input type="checkbox"/> Radio |
| <input type="checkbox"/> Elec. and Gas Refrigeration | <input type="checkbox"/> Salesmanship |
| <input type="checkbox"/> Air Conditioning | <input type="checkbox"/> Shipbuilding |
| <input type="checkbox"/> Railway Training | |

Name.....

Address.....

KEY TO A PRACTICAL UNDERSTANDING OF ELECTRICITY

\$1 PER MO.

AUDELS HANDY BOOK OF ELECTRICITY

\$4 HANDY SIZE

For Engineers, Electricians, Students and all interested in Electricity. A quick, simplified, ready reference, giving complete instruction and practical information. Easy to understand. A reliable authority and a handy helper that answers your questions.

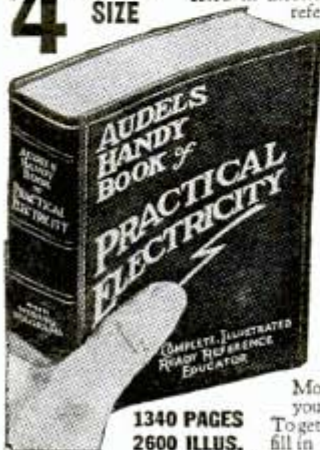

INSIDE TRADE INFORMATION ON

The Rules and Laws of Electricity—Maintenance of Machinery—A. C. and D. C. Motors—Armature Winding and Repair—Wiring Diagrams—House Lighting—Power Wiring—Cable Splicing—Meters—Batteries—Transformers—Elevators—Electric Cranes—Railways—Bells—Sign Flashers—Telephone—Ignition—Radio Principles—Refrigeration—Air Conditioning—Oil Burners—Air Compressors—Welding, and many Modern Applications explained so you can understand.

1340 PAGES To get this assistance for yourself, simply
2600 ILLUS. fill in and mail the **FREE COUPON** below.

THE O. AUDEL & CO., 49 West 23rd Street, New York
Please send me "Audels Handy Book of Practical Electricity" for free examination. If satisfactory, I will send you \$1 in 7 days, then \$1 monthly until \$4 is paid. Otherwise I will return it.



READ FOR PROFIT!

Name.....
Address.....
Occupation.....
Reference..... PM

INTRODUCING-New Victory Model HANDIWELED ELECTRIC

ARC WELDER

RETAILS ONLY \$1.95

FULLY GUARANTEED



PLUGS INTO LIGHT SOCKET

Victory Model Handiweld Arc Welder operates from 110 volts, A.C. or D.C. current same as other arc welders higher priced; generates tremendous heat to weld all metals. Not a toy welder that uses standard coated rods—sizes 1/16" and 3/32". However, due to Priorities a generous supply of 1/16" rods only are supplied with the welder. Guaranteed not to burn out. Repairs fenders, auto bodies, radiators, machinery parts, etc. Take Victory Model Handiweld anywhere to job, operate right from light socket. You'll find a thousand uses for this welder around your home, garage, workshop. Also in garages, factories, repair shops, tin shops; mechanics, inventors, plumbers, farmers, etc. Order a "Victory Model" Handiweld now.

SEND NO MONEY We'll rush one to you with rods, helmet, operating instructions, and all necessary parts with the exception of a large jar and a small piece of extension cord; these most everyone has. Pay postman only \$1.95 plus a few cents postage. If not delighted return Victory Model Handiweld in 5 days from receipt and money paid for it will be refunded promptly. Rush your order now.

KUMFY PRODUCTS, Dept. L-202, CINCINNATI 26, OHIO

AMAZING MONEY MAKING OPPORTUNITY LEARN WATCH REPAIRING

A lifetime profession regardless of age, sex or physical handicaps. Veterans with medical discharges—men, women, post 40—your opportunity! Lift yourself from a Futureless Job into a position paying Better than your Present work or that will permit you to establish your Own Shop. Our Watch Repairing, Jewelry Engraving Graduates wanted everywhere—positions \$50-\$75-\$100 per week. Write for details today.
K. C. SCHOOL OF WATCHMAKING, 113-C East 31st, Kans. City 8, Mo.



THERE'S MONEY IN CARTOONS!

RAYE BURNS will teach you HOW to CREATE ORIGINAL CARTOONS at home that you may SELL! Course contains 26 lessons and over 600 illustrations. All for Only..... \$2.85

Send name and address for free details.
RAYE BURNS SCHOOL, Dept. M, Box 3563, CLEVELAND, OHIO

LAW STUDY AT HOME for PERSONAL SUCCESS and LARGER EARNINGS. 35 years expert instruction—over 108,000 students enrolled. L.L.B. Degree awarded. All texts furnished. Easy payments. Send for FREE BOOK—"Law and Executive Guidance." AMERICAN EXTENSION SCHOOL OF LAW, Dept. 47-M, 646 N. Michigan Ave., Chicago 11, Ill.

Short-Cut Mathematics COMBINED WITH Practical Mechanics Simplified

NEW 2-in-1 reading course! Now you can learn the speedy, simplified system of calculation used by draftsmen, engineers, accountants, "master minds" on the store. Learn easy way to multiply 4 figures by 4 figures without using old-fashioned multiplication; add long and long of figures this lightning short-cut method. Learn horsepower, slide rule, micrometer, logarithms, wood measure, angles, etc. Large illustrated volume complete with answers, only \$1 postpaid. Satisfaction or refund. Amaze friends with your magic-like mental powers.

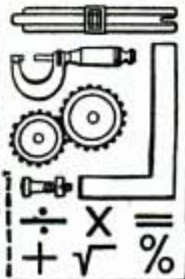

FREE Complete details... mail coupon **TODAY!**
Nelson Co., 321 S. Wabash, Dept. 3L02, Chicago 4
Please send free details about "Short-Cut Mathematics and Practical Mechanics Simplified." No obligation.
Name.....
Address.....

PLASTICS

ADVERTISING	BUSINESS MACHINES	PHONOGRAPH RECORDS	GARDEN TOOLS	BEAUTICIAN MACHINES	RAILROAD
INSTRUMENTS	DECORATING	TOYS	CLOTHING	GEARS	BOATS
PHOTOGRAPHY	HARDWARE	MUSICAL INSTRUMENTS	HOME APPLIANCES	TELEPHONES	GUNS
PRINTERS	ELECTRICAL	FURNITURE	TOOLS	PACKAGING	SHIPS
WARRANT	MODELS	REFRIGERATION	MOTORS	PRINTING	STAMPS
VEHICLE	PLUMBING	MACHINERY	FIXTURES	TEXTILES	MOVIES
WAREHOUSE	GAMES	DISPLAYS	DENTISTRY	SIGNS	PICTURES
WEAVING	AIR CONDITIONING	SURGICAL APPLIANCES	BUILDING MATERIALS	KITCHEN UTENSILS	BOOKS
WHEELS	MARINE	AUTOMOTIVE	RADIO	AIRCRAFT	NEWSPAPERS

Be a part of this Great Industry!

Plastics are playing an increasingly important part in almost every industry—improving old products and creating new ones. That is why such a brilliant future is predicted for plastics in the postwar period—offering opportunities to farsighted men and women who *know* plastics. Now is the time for you to prepare for a career in this fast-growing field.

LEARN AT HOME—You can learn plastics in your spare time at home without interrupting your present work. The Plastics Institute has developed a thorough, easy-to-understand course of training, requiring no previous technical experience. It offers complete, authoritative training based on industry requirements.

FASCINATING COURSE—The lessons are readily grasped and practical. Every step is made clear with graphs, diagrams, pictures. Actual specimens of plastics materials are furnished. A bi-weekly bulletin, "Plastics Trends," keeps you posted on new developments.

COMPREHENSIVE—Learn the various phases of plastics from this course . . . materials, designing, molding, fabricating, estimating and plant management. Acquire a basic knowledge of plastics that can be invaluable in preparing you to take your place in this great new industry.

EXCLUSIVELY PLASTICS—The Plastics Institute is America's oldest and largest plastics educational organization which devotes all of its facilities exclusively to plastics. It is held in high esteem by members of the plastics industry. Many of our graduates hold responsible positions in the plastics field.

START YOUR FUTURE—TODAY! Mail the coupon below now! We will send you an interesting booklet filled with valuable information on plastics and tell you how, at small cost, you can prepare for a career in this important industry. Don't put it off! Mail today!

Dept. PM-11, 122 E. 42nd St., New York 17—Dept. PM-11, 221 N. La Salle, Chicago 1—Dept. PM-11, 186 S. Alvarado, Los Angeles 4

SPECIAL RATES FOR SERVICE MEN

Plastics

INDUSTRIES TECHNICAL INSTITUTE

Plastics Industries Technical Institute
221 N. La Salle St., Dept. PM-11, Chicago 1

Mail in Envelope or
paste on penny postcard

Gentlemen: Please send me the booklet "World of Plastics" and information on your training program. I understand there is absolutely no obligation.

Name.....Occupation.....

Street.....Age.....

City.....Zone.....State.....

- Veterans: Check here for special information.
- If under 18: Check here for special booklet.

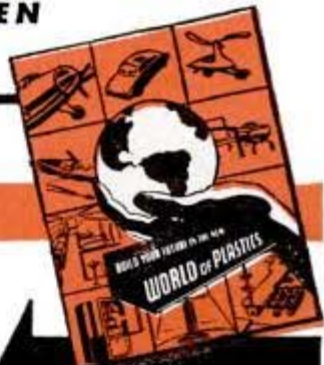

FREE BOOKLET
Send For It Today!



BUS DRIVER SELLS 8 STORIES

"Since reporting the sale of my first attempt at a magazine article, I have sold three others. Also four feature stories were accepted by the local newspaper. The credit is all yours. When you consider that I'm a driver for the local bus company, you can readily see my time is well taken up."—Herman R. Bach, Box 113, Pacific Grove, Cal.

Why Don't You Write?

It's much simpler than you think!

SO many people with the "germ" of writing in them simply can't get started. They suffer from inertia. Or they set up imaginary barriers to taking the first step.

Many are convinced the field is confined to persons gifted with a genius for writing.

Few realize that the great bulk of commercial writing is done by so-called "unknowns." Not only do these thousands of men and women produce most of the fiction published, but countless articles on business affairs, home and shop crafts, local and scientific activities, inventions, gardening, homemaking, etc., as well.

Such material is in constant demand. Every week thousands of checks for \$25, \$50 and \$100 go out to writers whose latent ability was perhaps no greater than yours.

The Practical Method

Newspaper work demonstrates that the way to learn to write is by writing! Newspaper copy desk editors waste no time on theories or ancient classics. The story is the thing. Every copy "cub" goes through the course of practical criticism—a training that turns out more successful authors than any other experience.

That is why Newspaper Institute of America bases its writing instruction on the Copy Desk Method. It starts and keeps you writing in your own home, on your own time. And upon the very same kind of actual assignments given daily to metropolitan reporters. Thus you learn by doing, not by studying the individual styles of model authors.

Each week your work is analyzed constructively by practical writers. Gradually they help to clarify your own distinctive style. Writing soon becomes easy, absorbing. Profitable, too, as you gain the "professional" touch that gets your material accepted by editors. Above all, you can see constant progress week by week as your faults are corrected and your writing ability grows.

Have You Natural Ability?

Our Writing Aptitude Test will reveal whether or not you have natural talent for writing. It will analyze your powers of observation, your imagination and dramatic instinct. You'll enjoy taking this test. There is no cost or obligation. Simply mail the coupon below, today. Newspaper Institute of America, One Park Avenue, New York 16, N. Y. (Founded 1925)

NOTICE TO CANADIANS

Newspaper Institute's operations in Canada have been approved by the Foreign Exchange Control Board, and to facilitate all financial transactions, a special permit has been assigned to their account with The Canadian Bank of Commerce, Montreal.

Newspaper Institute of America,
One Park Avenue, New York 16, N. Y.

Send me, without cost or obligation, your Writing Aptitude Test and further information about writing for profit as promised in Popular Mechanics, November.

Free
Mr. _____
Mrs. _____
Miss _____
Address _____
All correspondence confidential. No salesman will call on you. 72-8-314
Copyright 1944 Newspaper Institute of America

★ SAVE WASTE PAPER ★

LEARN



SPANISH

FRENCH, ITALIAN, GERMAN

quickly, easily, correctly, inexpensively, by

LANGUAGE-PHONE METHOD

BUSINESS MEN, professionals, engineers, Army and Navy personnel—all advance rapidly knowing Spanish, French, Italian or German. Original standard Language-Phone Method gives you the actual voice instruction of an expert native teacher right in your own home. It's as easy and pleasant as listening to music. Write for full details and easy terms. Play records on your own phonograph. Satisfaction guaranteed or money refunded.

FREE BOOKLET AND DEMONSTRATION

FREE ILLUSTRATED BOOKLET. Write today for your copy of an interesting 16-page, illustrated booklet which answers every question about Language-Phone, easy payment terms, and 7 days' free trial offer.

7 DAYS' FREE TRIAL. Try Language-Phone in your home a week before deciding. A small deposit brings you the entire course.

FREE DEMONSTRATION. Come to our New York office for free demonstration, daily except Saturday.

FUNK & WAGNALLS COMPANY

Dept. 122, 354 Fourth Avenue, New York 10, N. Y.



LEARN MEAT CUTTING At Home—In Spare Time

Get into the vital meat industry. Concise, practical Home Training based on 25 years proven instruction methods used at National's famous resident school. Prepares you for bigger pay as Meat Cutter, Supervisor, market manager or more money in your own store. Go as rapidly as your spare time permits. Diploma. Start NOW to turn your spare hours into money. Send for FREE bulletin today. No obligation.

National School of Meat Cutting, Inc., Dept. U-51, Toledo 4, Ohio

FREE BARGAIN CATALOG of BOOKS

25,000 books of all publishers listed in our 50th Annual Bargain Catalog of 320 pages. Old-time favorites—latest "best sellers." Reference, Fiction, Juvenile, History, Scientific, etc. Supplying schools, colleges, libraries and thousands of individual customers. Send postcard today for our new 1945 catalog, "Bargains in Books."

THE BOOK SUPPLY COMPANY, Dept. 130
564-566 West Monroe Street Chicago 6, Illinois

LEARN WATCH REPAIRING



AT HOME. By our modern and original system of instruction you can learn every part of the WATCH REPAIRING TRADE AT HOME. Prepare yourself for a well-paying position or start in business after completing our course of instruction. Good watch repairers are in demand and generally earn very good salaries. For particulars apply to the Wisconsin School of Watch Repairing 759 North Milwaukee St., Milwaukee 2, Wis.



★ FREE COPY ★ The World Takes Wings

Get a preview of the wonderful opportunities in post-war aviation. The world's fastest growing industry offers permanent, profitable positions of leadership to those whose training and preparation qualify them. This is yours for the asking. Write at once!

WESTERN AIR COLLEGE

198 S. Myrtle Ave. Monrovia, Calif.

POPULAR MECHANICS

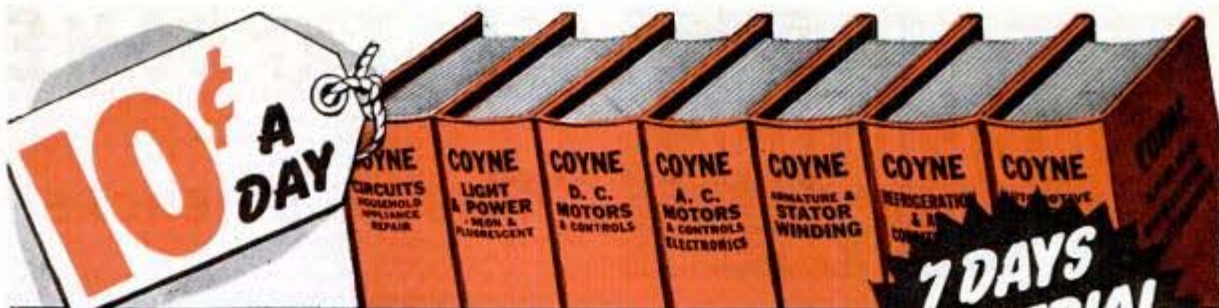

FOR THESE PAY RAISING BOOKS

ELECTRICITY

**7 DAYS
FREE TRIAL
NO MONEY
DOWN**

Costs You Nothing to See This Amazing New 7-Volume Set

Authoritative, practical, prepared by experts. Here is a set of Electrical books written in plain language for Electrical Workers Who Want to Get Ahead. Prepares you for the better Jobs in Electricity—used regularly on the job by thousands of electricians, service men, *beginners* and *old timers*.

**Coyne Applied Practical Electricity
7 Big Books — 3,000 Subjects**

Just a few of the subjects covered in this set

1. Elementary Principles and Circuits Household Appliance Repair
2. Wiring for Light and Power—Neon and Fluorescent
3. D. C. Motors and Controls
4. A. C. Motors & Controls—Electronics
5. Armature & Stator Winding & Repair
6. Refrigeration & Air Conditioning—Radio
7. Automotive, Diesel and Battery

Covers everything from house wiring to D. C. and A. C. Motors and equipment—over 3,000 subjects. New Edition—just off the press. I'll send this complete set FREE and postpaid for your examination. Look them over for 7 full days—then, either return it and owe nothing or send \$17.50 Cash (you save \$1.75) or send \$3 and \$3 per month until \$19.25 is paid. If you act NOW I'll include one year of FREE Consultation Service and Technical News Bulletins.

**COUPON IS NOT AN ORDER
JUST A REQUEST TO SEE BOOKS**



You are NOT buying these books when you send this coupon. You are merely asking to SEE them. I'll trust you and ship the entire set of 7-Volume Coyne Applied Practical Electricity or any of the other books shown on this page on 7 Days FREE TRIAL. If not 100% satisfied, ship them back and you owe nothing. If you keep them pay for them as indicated on coupon. If your order totals \$5 or more you may pay at the rate of \$3 in 7 days and \$3 a month until total is paid. Rush coupon.

COYNE ELECTRICAL SCHOOL
500 SOUTH PAULINA ST.
CHICAGO, ILL.

**3 OTHER NEW COYNE BOOKS
SEE THEM FREE**

**Be a Master Trouble Shooter
New Giant Size Manual Shows How**

New Book—just off press New Methods of trouble on electrical, radio, refrigeration, Diesel and Automotive equipment. 500 easy to follow wiring diagrams. Brand new step-by-step troubleshooting program. 612 pages. Sent on 7-day FREE trial—then either return it or send \$3 and \$3 a month until \$8.95 is paid or send \$8.00 cash. ACT NOW and I'll include 1 year FREE consultation and News Bulletins.



**LEARN ELECTRONICS—400 Pages
Just Off the Press**

AT LAST a book for Electricians, radiomen or anyone interested in PRACTICAL ELECTRONICS. Latest facts, hundred of diagrams. Includes TROUBLE SHOOTING AND INSTALLATION. Introductory price \$4.95 cash payable after 7-DAY FREE INSPECTION. ORDER NOW and I'll include one year free bulletin service.



Electrician's Handbook

400 pages of up to the minute Electrical Formulas, Tables, Charts, Rules, Methods, etc. A book every Electrician should have. JUST OFF THE PRESS. Price \$2.75 payable in 7 days.



7 DAYS FREE TRIAL COUPON

H. C. Lewis, Pres., Coyne Electrical School, Dept. 84-R6
500 S. PAULINA STREET, CHICAGO 12, ILL.

Send me the books checked below for 7 days FREE examination. I'll either return them in 7 days and owe you nothing or pay for them according to the plan I select as outlined on the left.

- COYNE APPLIED PRACTICAL ELECTRICITY: 7 big Volumes also includes Free, One year Consultation Service and Free Technical Bulletins. Price complete \$17.50 Cash—\$19.25 on time on terms of \$3 in 7 days and \$3 a month.
- COYNE ELECTRICAL & RADIO TROUBLE SHOOTING MANUAL: 1 Vol., 610 pages also includes Free consultation Service and Technical Bulletins for One Full Year. Price \$8.00 Cash or \$3.95 on time \$3 in 7 days and \$3 a month.
- COYNE MANUAL OF ELECTRONICS: 1 volume, includes Free Technical Bulletins for one full year. \$4.95 Cash payable after 7 days Free inspection.
- COYNE ELECTRICIANS HANDBOOK: 1 volume \$2.75 Cash—payable after 7 days' inspection.
- 150 COYNE SHOP PRINT AND DIAGRAM BOOK: 1 volume actual instructions in Shop Print, Reading and Circuit Tracing for "beginner or old timer." Price \$1.95 payable after 7-day inspection.
- COYNE ELECTRICAL & RADIO DICTIONARY: (1 volume, 1200 Electrical and Radio terms) Price 60c.

Name _____ Age _____
Address _____
City _____ Zone _____ State _____

Where Employed _____
 Check here if you want to pay postman cash price shown above when books are delivered. Some 7-day examination privilege and money back guarantee.

I'll Train You IN DRAFTING

until you have a
GOOD PAY JOB



All working tools FURNISHED

Professional drawing instruments, all working tools, also drawing table furnished with training. Start in right now.



With industry working feverishly—the field for Draftsmen is bigger than ever. More important—draftsmen and designers must come first in changing back to peace-time production. Get into a better job with more pay and fascinating, pleasant work. Engineer Dobe will train you at home—in your spare time, to get experience on actual work, the same kind of jobs you will do in the best paid position, and train you until you are competent, experienced, holding such a position that will mean advancement and pay raises as deserved. When competent will recommend your practical work experience as references. No need for previous training to start with me—and lack of higher education should not hold you back. You can pay monthly for your practical training from an engineer; the cost is reasonable. Write today for full illustrated details and booklet. Give your age to get reply.

GET THE FACTS NOW!

ENGINEER DOBE, Div. 337B, Libertyville, Ill. Please send me training facts on "Drafting and Industrial Designing". Also advertised list of positions for Draftsmen and Designers Wanted.

Name Age.....

Address

Town State.....

Look to ... Your Future Be an AIRCRAFT INSTRUMENT TECHNICIAN

As an Instrument Technician you're needed NOW ... and TOMORROW in the aircraft, air transport and industrial fields—where instruments are the key to efficient operations. No matter what you're doing today ... in a war plant or in the Services ... you can prepare for better service, promotions and for YOUR FUTURE through ASAI's home study course. Or, if you are free to come to Los Angeles, you can work in essential war industries here and enroll in the resident school.

Training for Veterans & Civilians NOW

Complete courses and enlarged facilities will help both Veterans and civilians increase their post-war earning power in this fast-growing field ...



Send for FREE BOOK

This 24-page book will show you the extensive resident and home study training programs of ASAI—send coupon today.

AMERICAN SCHOOL OF AIRCRAFT INSTRUMENTS
5253 W. San Fernando Road
Los Angeles 26, Calif.

American School of Aircraft Instruments
5253 W. San Fernando Road
Los Angeles 26, Calif.

Gentlemen: Please send free 24-page book and data on courses checked below, without obligation.

MASTER INSTRUMENT TECHNICIAN Home Study Instrument Course

Name Age.....

Address

City Zone..... State.....

Civilian In Services..... Veteran.....

AMERICA'S OLDEST INSTRUMENT SCHOOL

Say you saw it in Popular Mechanics!

STUDY AT HOME

With A Chartered Educational Institution

Men with specialized training win higher positions, insure larger earnings, and are bigger successes in business and public life. Opportunities NOW greater than ever before. Send for our 1944 Catalog.

ARTS AND SCIENCES

Courses in Philosophy; Education; Letters; Public Health; Medical Jurisprudence; Psychology; Sociology; Physics; Chemistry; Plastics; Geology; Political Science; Theology; Business and Commerce; Accounting; Mathematics; Statistics; Agriculture.

ENGINEERING

Courses in Electrical, Civil, Mechanical, Drafting, Architectural, Steam, Aeronautical, Radio, Structural, Mining, Industrial, Highway, Petroleum, Marine, Chemical, Diesel, Automobile and Air Conditioning Engineering.

LAW

Complete Professional Law Course includes 21 Hornbook Series college grade textbooks. Courses also in Commercial Law, Patent Law and Medical Jurisprudence.

McKinley-Roosevelt Incorporated, 4610-K, Sheridan Rd., Chicago 40, Ill.



DRAW CARTOONS BIG MONEY!

EASY ... PLEASANT WORK!

Let CHAS. H. KUHN, with 25 years actual experience in drawing a daily newspaper cartoon, teach you how to create, draw and sell your work. 52 complete lessons—one sent each week. Professional criticism on every lesson. Write today. After Jan. 1, 1945, the price of this course will advance to \$15.00.

KUHN SCHOOL OF CARTOONING

420 MURPHY BUILDING Dept. S. INDIANAPOLIS 4, INDIANA

ELECTRICITY MEN NEEDED

Electricians are needed everywhere. Demand is growing. Good pay now and bright future for trained men in this live, expanding vocation. Learn at home, in spare time, from old established school. Write for FREE Bulletin. No obligation.

AMERICAN SCHOOL

Dept. EE845 Drexel at 58th St. Chicago 37

What Every Mason Wants



We have important Masonic books for Blue Lodge, Chapter, Commandery, Scottish Rite, and Shrine.

Our Rituals Are Used the World Over. Send for free catalog of books and rituals for Masons, Odd Fellows, Knights of Pythias, Knights of Columbus, Elks, etc. EZRA A. COOK, Publisher, P. O. Box 796, PN, Chicago 90, Ill.



Write for my Free Book, "How to Become an Expert Penman," which shows what others have accomplished by taking my Course. Enclose 10c for one of my Favorite Pen Points and your name with a beautiful flourish-illustrated card. Write today.

T. M. TEVIS, Box 25K, Chillicothe, Mo.

Get into the BAKING BUSINESS

Bakers make good money! Now 7th Industry in wages! Nearly depression-proof. New home study Baking Course qualifies you. Common school education sufficient. If you're ambitious, write for FREE BOOK "Opportunities in Baking." National Baking School, 1315 Michigan, Dept. 1358, Chicago 5, Ill.



On Scarfs, Ties, Stationery, Etc.

Reproduce any snapshot on cloth, leather, wood, paper. Simply apply liquid. Like magic photo appears within 2 minutes in broad daylight. Harmless to negative. Won't wash off. Full colors included. Complete kit for 100 photos only \$1.29. Send no money, just name. Pay postman \$1.29 plus few cents postage on delivery. Or send cash with order and get postpaid. (Canada \$1.60 money order only.) Order today.

L & M Mfg. Co., Dept. 333-E, 229 W. Breckenridge, Louisville 3, Ky.

BETTER JOBS-BETTER PAY

FOR SKILLED MEN!

QUICK TRAINING BOOKS SHIPPED FREE for Examination

NOW is the time for every ambitious man to prepare for a better job at bigger pay with American Technical Society's easy-to-understand self-training books. All sets interestingly prepared by long-experienced experts and profusely illustrated. Spare time reading can give you the "know how" that brings more money. Use the jiffy index to find out what you need to know in a hurry. Any set of books sent free for examination.

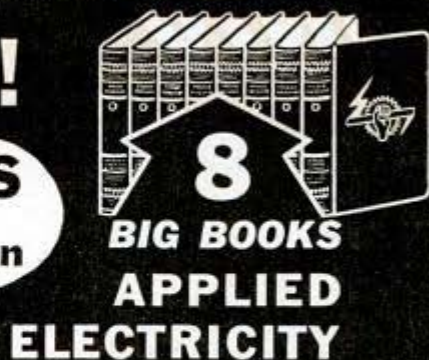

MEN who understand electricity are needed in all kinds of industries. This New 19th Edition of 8 big books contains over 3700 pages, 2700 illustrations and 134 tables. Latest subjects fully covered. Includes electronics, F.M. radio, arc welding, blueprint reading and many up-to-date subjects. Total price only \$29.80. Sent on trial.

BUILDING, ESTIMATING and CONTRACTING



9 Volumes. This big set should make it easy for any carpenter to become a contractor. Invaluable to builders. Architectural drawing and design, estimating, concrete forms, building, heating, painting, decorating and many other subjects well covered. Total price only \$29.80. Sent on trial.



MODERN SHOP PRACTICE New Edition — 8 Big Volumes

3000 pages with nearly 3000 illustrations, and a big binder of nearly 800 pages of original shop tickets and 1200 illustrations in addition to the 8 volumes. Among subjects covered are mechanical drawing, tool making, pattern making, foundry work, machine shop practice and management, and hundreds of other subjects which can fit you for a better job. Total price only \$34.80. Sent on trial.

AUTOMOBILE ENGINEERING 21st Edition — 6 Volumes

Whether you are expert or beginner, you will find great value in these books which tell, step by step, how to make repairs, and keep cars at maximum efficiency. 2800 pages, 2000 illustrations, wiring diagrams, data sheets, etc. Total price \$24.80. Sent on trial.



DIESEL ENGINEERING

6 Volumes. Over 2500 pages. Hundreds of illustrations. Total price \$24.80. Sent on trial.

PRACTICAL AVIATION 6 Volumes Prepared by Experts

The most complete and best illustrated set of Aviation instruction and reference books we have ever published. It covers whole range of subjects from first principles of flight through late types of engines, instruments, meteorology, gliding. Total price \$19.80. Sent on trial.

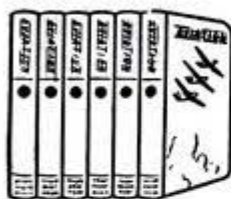

DRAFTING

For beginners or experts in machine trades, compiled by well-known engineers and written so you can understand every word. Contains hundreds of blueprints, charts and diagrams which will help you to acquire "know how" and prepare for a good job. 5 Volumes, 1600 pages. Total price only \$19.80. Sent on trial.

ANY SET SHIPPED free!

FOR EXAMINATION. All you need do to get any set for FREE examination is to fill in and mail the coupon and give required information. Read the generous offer in coupon and send today.

AMERICAN TECHNICAL SOCIETY

Vocational Publishers Since 1898

Dept. X819, Drexel at 58th Street, Chicago 37, Illinois

SEND COUPON TODAY

AMERICAN TECHNICAL SOCIETY, Dept. X 819
Drexel at 58th Street, Chicago 37, Ill.

Send for 10 days' free use, the following set of books:

I will pay the delivery charges only, and if fully satisfied, will send you \$2.00 in 10 days and then \$3.00 a month until the total price of \$..... is paid. If I return the books in 10 days I will owe you nothing. You are to include a Year's Consulting Privileges with your engineers without extra charge.

Name.....

Address.....

City.....State.....

Please attach letter stating age, occupation and name and address of employer, and at least one business man's name as reference. Men in service, also please give home address.

GET INTO RADIO



Trained Men Needed Everywhere for Hundreds of Industries and Vast New Opportunities Resulting from Electronic Developments of War. Send For FREE Lesson to Prove How Quick and Easy You Get the Basic Training and EXPERIENCE with National

SHOP METHOD HOME TRAINING

By a Long Established Technical Trade School

Here is the modern, practical, advanced way for you to get ready for F.M., TELEVISION and the wonder world of ELECTRONICS as well as the great field of Radio. Get in on the ground floor of the big industrial boom that will demand thousands of trained and experienced specialists. Get your share of the Radio Service business now. Here is a sensationally improved method—a thoroughly proved system of training whereby you study in spare time—odd hours, even minutes—and have the advantage of actual shop experience behind you.

This exclusive shop method of home training comes to you right from one of the world's greatest vocational educational centers—the resident training shops and experimental laboratories of National Schools. It is the sound, practical training based on actual experience of qualified instructors and engineers who have prepared thousands of National graduates now employed in the radio industry.

It is up-to-date—matches the progress constantly being made in modern Radio, Television and Electronics. It is time tested. National Schools has been training men for higher pay and greater opportunity for more than a third of a century. Fill out and mail the coupon below for details.

The Age of Electronics is here. Radar, Radio, Communications—other branches of electronic service have been brought to perfection during the war. These amazing improvements and advances are being turned to better living after the war. Science says the advances made are beyond imagination.

Here is a powerful force that can be put to use in industry, in commerce—in every home in the Country. America will not stand still. Americans demand the convenience, the service, the luxury that Radio and Radionics can bring them. Vast new opportunities are swinging wide open for the man who is ready.

What does this mean to YOU? Where do YOU—PERSONALLY AND INDIVIDUALLY—fit into this picture? Is there a big job waiting for YOU? IS NOW THE TIME FOR YOU TO GET INTO BUSINESS FOR YOURSELF? Don't sit back and see this chance go by. Send in the coupon and see how you can make your start right now.



Make Sure of Your Success and Security After the War

DON'T let your post-war ambitions lag after you get home and hang up your uniform. Don't let YOUR future depend on others. Carve out a career for yourself. Never in all history has the returning soldier or sailor been confronted with such a great future if he reaches out and grasps it NOW. Here is a new world opening before him. But don't YOU miff the opportunity. Get ready now while you are still in uniform. Then when you step into civvies you will be ready to take a good, well paid position or, with little capital, GET INTO BUSINESS FOR YOURSELF. It isn't a bit too soon to start now. Fill out and mail the coupon immediately and examine the NATIONAL SHOP METHOD HOME TRAINING COURSE carefully.

Join the Thousands of Successful National Graduates

National Shop Method Home Training can win a good job for you too. Step into the kind of jobs these National men are holding.



"Due to the thorough training I received at National I have been constantly employed. At present I am with an experimental department of a large aircraft factory."
—LeRoy Murray
Highlands, California.



"Due to my training at National I was selected to instruct in the laboratory work of Navy and Marines."
—R. R. Wright
Blackfoot, Idaho.



"I believe National offers the best course to be had. Keep up the good work."
—O. K. Ivey
Washington, D. C.



"My latest offer was \$5,800.00 as Radio Photo Engineer . . . but I'm doing well where I am now engaged. I am deeply indebted to National."
—Joseph Grumlich
Lake Hiawatha, New Jersey.



Radio communication has spread out to include not only aviation and marine but railroad and bus transportation—even exploration and research.



Electronic technicians are urgently needed to build and service equipment in the field of modern scientific research and agriculture.

Read what hundreds of other enthusiastic students have written about National Training. Send in your coupon today.

★ **LEARN BY DOING**

TELEVISION ELECTRONICS



Use the Actual Shop Equipment That Comes to You with Your Course

Experience is the best teacher. You learn by experience with the exclusive National Shop Method of Home Training — actually build many circuits and do experiments with the big kits of standard radio parts included in your training equipment at no extra cost to you.

Build a superheterodyne receiver. Make tests and conduct experiments that show you the why and how of electronics. Build visual testers, signal generators and other instruments with the parts and supplies included in your course.

You gain marvelous experience by this method of learning and you have valuable equipment and instruments to use on the job. Mail the coupon and learn what this means to you.

Now!



No Previous Experience Needed

You don't have to know the first thing about radio or electricity. You don't have to be handy with tools. The National SHOP METHOD HOME TRAINING is so direct, simple, practical, that it is like training directly under a skilled, experienced technician—an instructor interested in your progress and future. It is better than that in effect, because you, as a NATIONAL student, have the help and guidance of not one man but a whole staff of experienced shop instructors, ready and anxious to help you.

Get the same practical knowledge that has made possible the amazing progress of thousands of successful men—broadcast engineers, electronics experts, television specialists. Here is sound fundamental training that is based on actual experience. **LEARN BY DOING**—Working right in your own home with materials and master shop methods developed at one of the world's best equipped and most advanced RADIO TRAINING CENTERS. Get a FREE lesson and opportunity book, USE THE COUPON.

Make Extra Money Right From the Start

Your very first lesson from National is so practical and detailed that you can put your training to work for you, earning money for you, almost immediately—making radio repairs, working part time—even though you are still learning. The SHOP METHOD HOME TRAINING course encourages the outside work and does everything possible to help students with it. The big kit of parts you get with your training, plus you do get the first hand information and experience that gives a professional touch to your work. Send for the books that explain all this in detail. You are un-



der no obligation when you receive these books. You may keep them for your own and no salesman will call on you.

Be Sure—Then Go Ahead

Now, right now, is the time to grasp the great opportunity of today—a successful career for tomorrow. Get into the big money, rapid advancement, a position of importance. A **BUSINESS OF YOUR OWN**. The industry is crying for trained men everywhere. A rapidly expanding business—probably the greatest in industrial history—holds out the promise of a rich future—prosperous security. But to win it you must be ready. Well-trained men **ONLY** are wanted.

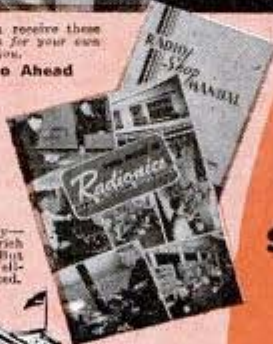

Examine the National Shop Method of Home Training carefully. Be convinced. Study the lesson we send you **FREE**. No obligation of any sort. Fill out the coupon and mail today.

Free!
GET THESE BOOKS

Left: Ellsworth K. Anderson, owner and operator of one of the country's finest radio organizations is a National graduate.

See for yourself what National Training can mean to you. Send Coupon for FREE Lesson

What about F. M.

F. M.—Frequency Modulation—one of the greatest developments in radio transmission and reception—is already in operation. The United States Government has already issued applications to 2,000 radio stations to broadcast F. M. "Farsmile," too is constantly progressing. This equipment, like every other type of radio, requires servicing, and it presents another valuable opportunity to the trained radio man. Mail the coupon here that brings you the complete story of this marvelous new system of training in Radio, Television and Electronics. It costs you nothing and may be worth a fortune.



NATIONAL SCHOOLS

Los Angeles 37, California
Established 1905

One of the Nation's Greatest Vocational Education Centers

National Schools is one of the best established and widely recognized vocational schools in the Country. Thousands of men have been trained here under the direct supervision of the U. S. Government. It is widely recognized for the type of training in which it specializes—thorough practical training based on industrial standards. Only National can provide you with SHOP METHOD HOME TRAINING for National actually has the shops—the laboratories and research departments—the experienced technicians and instructors that can develop and provide the service necessary for such a training method. Fill out and mail the coupon immediately so you can examine the evidence of the value of this course of training. **See for yourself! Decide for yourself!**

MAIL OPPORTUNITY COUPON FOR QUICK ACTION

NATIONAL SCHOOLS, Dept. 11-PMR
4000 South Figueroa Street,
Los Angeles 37, California

(Mail in envelope or paste on penny post card)

Mail me **FREE** the three books mentioned in your ad including a sample lesson of your course. I understand no salesman will call on me.

NAME..... AGE.....

ADDRESS.....

CITY..... STATE.....

Include your zone number.

JUST OUT! NEW FROM COVER TO COVER

AUDELS REFRIGERATION and AIR CONDITIONING GUIDE



4 Books in One! Covering:

- 1—Basic principles, Servicing, Operation, Repair of
- 2—Household Refrigeration
- 3—Special Refrigeration Units
- 4—Commercial & Industrial Refrigeration

4—Air Conditioning Systems
A gold mine of essential important facts for ENGINEERS, SERVICEMEN & USERS.

A Good Book is a Good Friend! Here you have at your fingers' ends a Complete Library in ONE VOLUME, the necessary data you have been looking for on: MODERN UNITS, SYSTEMS & MACHINES, REFRIGERANTS, including Freon, Lockers, Water Coolers, Quick Freezing & Air Conditioning Systems.

1280 Pages, 46 chapters all Fully Illustrated & indexed for Ready Reference.

ANSWERS YOUR QUESTIONS

Get This Information for Yourself. Mail Coupon Today. No Obligation Unless Satisfied. ASK TO SEE IT.

4 COMPLETE • PAY ONLY \$1. A MONTH

AUDELS, Publishers, 49 W. 23rd St., New York 10, N.Y.

MAIL AUDELS NEW REFRIGERATION GUIDE, for free examination. If O. K. I will send you \$1 in 7 days; then remit \$1 monthly until price of \$4 is paid. Otherwise I will return it.

Name: _____
 Address: _____
 Occupation: _____
 Employed by: _____ PM

AVIATION Career

DON'T WAIT UNTIL THE WAR IS OVER!

Since 1929 Curtiss-Wright Technical Institute has been specializing in modern, progressive training for Aeronautical Engineers and Master Aviation Mechanics (no flying involved). Prepare now for your Aviation Career. **BE READY!** The opportunities are great today and will be much greater in tomorrow's Age of Flight. **ACT!**



**CURTISS
TECHNICAL**



**WRIGHT
INSTITUTE**

GRAND CENTRAL AIR TERMINAL
 GLENDALE 1, CALIFORNIA
 (LOS ANGELES COUNTY)

MAIL THIS COUPON TODAY!

Registrar, Curtiss-Wright Technical Institute, Grand Central Air Terminal, Glendale 1, California. Please send information and profusely illustrated catalogue on Aviation Training. **FREE** ... without obligation ... Dept. PM-11.

Name _____ Birth Date _____
 Street _____
 City _____ State _____

Say you saw it in *Popular Mechanics!*

Industrial

Electronics

THE NEXT BIG OPPORTUNITY FIELD

As was electricity, the automobile and radio, in their day—Electronics is the next big opportunity field. Already at work in hundreds of war plants—it is likely to change our entire way of living and create unheard of opportunities for men who start training now as **ELECTRONIC TECHNICIANS** for industrial work.

**FREE
TWO BOOKS
Write Today**

This 28 year old school offers the practical training needed, prepared with the help of leading firms in the field, in three forms—home study—resident training in our Chicago shops—and a combination of both. Ambitious men are urged to write today for vital information.

INDUSTRIAL TRAINING INSTITUTE, Dept. 39
 2132-2158 Lawrence Ave. Chicago 25, Ill.



TRI-STATE COLLEGE

B. S. Degree in 27 Months

Distinguished for technical 2 1/2-year courses in Civil, Electrical, Mechanical, Chemical, Radio, Aeronautical Engineering; Business Administration, Accounting, and Secretarial Science. **EX-SERVICE MEN** can complete work here in shortest possible time. Special Prep. Dep't. Also **REFRESHER COURSES**, 36-Week Courses in Surveying, Drafting, Low tuition, Low living costs. Cosmopolitan student body. 61st year. Enter Jan., March, June, Sept. Catalog, 4114 College Ave. ANGOLA, INDIANA

CARTOONING



CASH IN on Big Cartoon Market. **BECOME CARTOONISTS QUICKLY** with our **NEW, EASY METHOD**. No experience necessary. Prepared by successful cartoonists. **SATISFACTION GUARANTEED**. Sample **LESSON PLATE** and interesting literature **FREE**.

NATIONAL ARTISTS BUREAU
 Dept. A, Box 4248 DALLAS 8, TEXAS



TRAIN Your VOICE! Results GUARANTEED

We build, strengthen the vocal organs—not with singing lessons—but by sound, scientifically correct silent and vocal exercises and absolutely guarantee complete satisfaction with results. Write for Voice Book, **FREE**. Sent to no one under 17 years old unless signed by parent.

PERFECT VOICE INSTITUTE, Studio 1358, 64 E. Lake St., Chicago, Ill.

LIQUID MARBLE

Make beautiful artificial Marble slabs. Pour from liquid state. Glazed or un-glazed. Mottled, veined, snow-white, or multi-colored. Unsurpassed on kitchen or bathroom walls. Easy to make and install. **PLASTIC FLOORING**. Any color. Lifetime wear. Dustproof, Soundproof, Vermin-proof. Resilient to the tread. Lay out solid or in pattern design. **FLEXIBLE MOLDS** for plaster casting. Make your own molds for few cents each. \$1.00 in raw materials will make up to \$25.00 of finished goods. We furnish names of buyers. Write now for free information.

COMPO-TEX, BOX 786-S, ST. LOUIS (1), MO.

START YOUR OWN SHOP

Men wanted now and after the war for **Plastics, Auto-Diesel, Machinist, Drafting, Refrigeration, Welding, Body & Fender, Aircraft**. Earn real money or be independent in your own business. Free booklet. Specify trade. State whether interested in Home Study or Practical Shop Training. **GREER, Dept. 2114, 2017 S. Wabash Ave., Chicago**

Learn Public Speaking

At home—in spare time. Many overcome "stage-fright," gain self-confidence and increase earning power, this easy way. Write for free booklet, *How to Work Wonders With Words* and requirements.

North American Institute, Dept. 1358 1315 Michigan Ave., Chicago 5, Ill.



Wonderful, new device, guides your hand; corrects your writing in a few days. Big improvement in three hours. No failures. **Complete outline FREE**. Write C. J. Ozment, Dept. 34, St. Louis, Mo.

POPULAR MECHANICS

Now! NO AUTO REPAIR JOB IS TOO TOUGH FOR YOU!

Let this New Short-Cut Save You Time and Work!

Used by U. S. Army and Navy



Whether you do auto repairs either as full-time or as spare-time work, no service or repair job can "throw" you when you've got MoToR's AUTO REPAIR MANUAL! Just look up make, model, and the job in the streamlined index—and you're ready to lick ANY job from carburetor to rear end, faster, easier, better!

Try it FREE for 7 Days!

MoToR's AUTO REPAIR MANUAL Shows You How to Service and Repair ANY Part of ANY Car Built Since 1935!

Nearly 200,000 service and repair facts on all 31 makes. 764 big pages; including 50 pages of carburetor text, charts, illustrations, covering all models. Over 500 charts, tables; Tune-up Chart; Valve Measurements; Compression Pressure; Torque Wrench Reading; Starting Motor; Engine Clearances; Generator; Clutch & Brake Specifications; Front End Measurements, etc.; Engines; Electric; Fuel, Cooling, Lubricating Systems; Transmissions; Universals; Front Ends; Wheels; Rear Ends, etc.

Covers All These Makes!

American	Cord	Lafayette	Oldsmobile
Bantam	Crosley	La Salle	Packard
Auburn	De Soto	Lincoln	Pierce Arrow
Austin	Dodge	Lincoln	Plymouth
Buick	Ford	Zephyr	Pontiac
Cadillac	Graham	Mercury	Reo
Chevrolet	Hudson	Nash	Studebaker
Chrysler	Hupmobile	Overland	Terreplane
			Willys

Try this great book for 7 days FREE! It's "headquarters" for 200,000 facts about service, repair, adjustment, replacement, and tune-up—on every car built from 1935 through 1942. The engineer-editors of MoToR Magazine built this Manual for YOU, by collecting and organizing all the vital information from 150 official factory shop manuals. Then they put ALL the facts into this ONE amazing work-book.

Army, Navy, trade and technical schools, thousands of auto servicemen and handymen everywhere! No wonder we're willing to have YOU try it, FREE, for 7 days! Once you use it—and see for yourself how much valuable time and hard work it saves—you'll never again want to be without it!

More Than 1,000 Pictures!

MoToR's AUTO REPAIR MANUAL not only TELLS you clearly what to do. It SHOWS you, too!—in over 1,000 cut-away photos, diagrams, drawings. 764 BIG pages (8½x11 inches) put the complete "know-how" right at your fingertips! And the fabric binding is strong, built for years of day-in-day-out service!

SEND NO MONEY

7-Day Free Examination

Don't send any cash—unless you wish to do so in order to save postage charges! Simply mail coupon NOW. When postman brings your book, pay him nothing. First make the book show you what it does for you! Unless convinced it's the greatest time-saver and work-saver you've ever seen—return book in 7 days, pay nothing. Mail coupon NOW! Address: MoToR Book Dept., Desk IN, 572 Madison Avenue, New York 22, N. Y.

No wonder it is used by the U. S.

Same FREE 7-Day Offer Applies on MoToR's TRUCK REPAIR MANUAL

For mechanics, truck specialists, service stations, fleet owners. Covers EVERY job on EVERY truck made since 1936! 1400 pictures, 914 pages, 300,000 facts. Used by Armed Forces.

All types Gasoline Engines, Diesels, Hesseiman, Fuel Systems, Governors, Lubrication Systems, Ignition Systems, Starters, Generators, Clutches, Transmissions, Axles, Torque Dividers, Transfer Cases, Brakes, Steering, etc.

ALSO SERVICES many buses, farm and industrial tractors, contractor and road building equipment, stationary power machinery, etc. (on all parts described in Manual) Check box in coupon at right.



Published by MoToR, The Leading Automotive Business Magazine. MoToR's manuals assure high standards of repair work.

MAIL COUPON NOW FOR 7-DAY FREE TRIAL

MoToR Book Dept., Desk IN, 572 Madison Ave., New York 22, N. Y.

Rush to me at once: (check box opposite book you want).

MoToR's AUTO REPAIR MANUAL (formerly "MoToR's Factory Shop Manual"). If O.K. I will remit \$1 in 7 days, \$1 monthly for 4 months, plus 35c delivery charge with final payment (\$5.35 in all). Otherwise I will return book postpaid in 7 days. (Foreign price, remit \$7 cash with order).

MoToR's TRUCK REPAIR MANUAL. (Described at left.) If O. K., I will remit \$2 in 7 days, and \$2 monthly for 3 months, plus 35c delivery charges with final payment (\$8.35 in all). Otherwise I will return book postpaid in 7 days. (Foreign price, remit \$11 cash with order).

Name _____ Age _____

Address _____

City _____ Zone No. _____ State _____

(if any)

Occupation _____

Save 35c we pay postage if you ENCLOSE full payt.

(Check, M. O.). Same 7-day return-refund privilege.

LEARN RADIO -ELECTRONICS

"LEARN BY DOING"

RIGHT HERE IN THE
SHOPS OF COYNE

**12 WEEKS
TRAINING**

**Train for a Good Job Now that
Will Also Be a Good Job
in Peace-Time**



H. C. LEWIS

Don't be caught napping. Prepare for a good essential job now that will still be a good job with a real future when the war is over. If you are not a trained man you may have to compete with millions of other untrained men. Get into a field that offers real opportunities in war times, peace-times—good-times and bad-times. Radio - Electronics trained men are needed today—they will be needed too when peace comes.

REAL OPPORTUNITIES FOR THE RADIO TRAINED MAN

Prepare for jobs as assembler, inspector and tester—Radio sales or service and installation work, electronics, television, sound work, aircraft-radio, auto-radio, etc. Many opportunities in the vast Radio-Electronics field.

LEARN BY DOING

We don't teach by book study. We train you on a great outlay of Radio, Television and Sound equipment—on scores of modern Radio Receivers, Television apparatus, Sound Reproduction equipment, etc. Whether or not you have had Radio experience you need Coyne all-around Radio-Electronics training. We give you—RIGHT HERE IN THE COYNE SHOPS IN CHICAGO—the actual practice and experience you'll need in this great field. And because we cut out all useless theory and only give that which is necessary you get a practical training in a few weeks. Right now I'm in Chicago extra training in Industrial Electronics at no extra cost. We also have facilities for physically disabled men. Write for details.

EARN WHILE LEARNING

If you need part-time work to help pay living expenses while at school, we will help you get it. After you graduate, life-time employment service will be available to you. Every Coyne graduate also receives a Life Membership, with free technical and business service and privilege of review at any time without additional tuition charge.

GET MY BIG NEW BOOK

It tells all about my big Chicago shops and my plans to help you get ahead. Packed with facts and pictures of students at work in my shops. Mail coupon for this Big New Book now! Coupon will also bring details on how I'll Finance Your Training... facts on how I help you "Earn-While-Learning"... Information on FREE EMPLOYMENT SERVICE FOR LIFE... and other plans to help you. ACT NOW TO MAKE SURE YOU GET MY GENEROUS OFFER. Sending for this interesting free book can be your first big step to success. No obligation. No salesman will call. Mail the coupon today.

H. C. LEWIS, Pres., Radio-Electronics Div., COYNE ELECTRICAL SCHOOL
500 S. Paulina St., Dept. 84-3H, Chicago 12, Ill.

Dear Mr. Lewis: Send me your Big Free Radio-Electronics Book and all the facts...also full details of your "Pay-after-Graduation" plan.

NAME.....
ADDRESS.....
CITY.....ZONE.....STATE.....

★ SAVE WASTE PAPER ★

Learn REFRIGERATION and AIR-CONDITIONING

AT
HOME
or
In Our
SHOP

START YOUR OWN REPAIR SHOP

Exceptional opportunity for men of all ages up to 60. No previous experience needed. Our practical course is easy to grasp. A common school education sufficient. Prepare now for after the war for a big pay job or start your own repair shop. The demand for service mechanics is acute.



Send for FREE BOOKLET!

Mechanics Training School

4701 W. Pico, Dept. P-11, Los Angeles 6, Cal.

Special Christmas Offer

(2 books for the price of one)

Learn Celestial Navigation at home or, if you are in Aviation, "brush up" on half-forgotten skills. Used at Hayden Planetarium.

INTRODUCTION TO CELESTIAL NAVIGATION
STEREOPIX FOR CELESTIAL NAVIGATION (printed in color with three-dimensional illustrations with viewing glasses). Descriptive folder on request.

\$1.00
ADDISON-WESLEY PRESS INC.
Kendall Sq. Bldg., Cambridge 42, Mass.

KNOW! Don't Guess

Knowledge is POWER—and you can be absolutely SURE of the things you want to KNOW, by reading the Periodicals devoted to the subjects that interest you most.

ABSOLUTELY FREE: We will send you without cost or obligation, interesting literature and price list describing over 600 Different Publications covering more than 175 fields, from which you can choose mediums that will give you the Knowledge you seek. Write today. Commercial Engraving Publishing Company, 34B North Ritter, Indianapolis 1, Indiana.

LAW STUDY AT HOME

Legally trained men win higher positions and bigger success in business and public life. Greater opportunities now than ever before. Big corporations are headed by men with legal training.

More Ability: More Prestige: More Money

We guide you step by step. You can train at home during spare time. Degree of LL.B. Successful graduates in every section of the U.S. We furnish all text material, including 16-volume Law Library. Low cost, easy terms. Get our valuable 48-page "Law Training for Leadership" and "Evidence" books FREE! Send for them NOW.
LASALLE EXTENSION UNIVERSITY, 417 South Dearborn Street
A Correspondence Institution Dept. 1164-L Chicago 5, Ill.

Good Handwriting

HELPS YOU WIN SUCCESS!

It's so important to write a good hand for business and social advancement. Poor illegible penmanship often causes costly errors and marks you for failure. Why write a poor hand? It's so easy to learn at home in spare time. Write for our new free booklet today. If you wish, send 10c for a penpoint suitable for shaded writing and your name beautifully written.
THE TAMBLYN SCHOOL OF PENMANSHIP
In Business Since 1895 M-441 Ridge Bldg., Kansas City, Mo., U. S. A.

STAMMER?

This new 128-page book, "Stammering, Its Cause and Correction," describes the Bogue Unit Method for scientific correction of stammering and stuttering—successful for 43 years. Benj. N. Bogue, Dept. 1818, Circle Tower, Indianapolis 4, Ind.

GET THIS
FREE
BOOK!

Learn PHOTOGRAPHY at Home

Splendid opportunities. Prepare in spare time. Easy plan. No previous experience needed, common school education sufficient. Send for free booklet "Opportunities in Photography", particulars and requirements.

American School of Photography
1315 Michigan Ave., Dept. 1358, Chicago 5, Ill.

BETTER SIGHT

SIGHT-TRAINING technique improved. Everybody gets results now. WRITE: Dept. P11, "USTI" 4057 Budlong Ave., Los Angeles 37, Calif.

Free
SIGHT
CHART

Please send me your FREE Sight Chart with instructions.

Name.....
Address.....

POPULAR MECHANICS

THOUSANDS NOW PLAY

who never thought they could!



Learned Quickly at Home

I didn't dream I could actually learn to play without a teacher. Now when I play for people they hardly believe that I learned to play so well in so short a time.
*H. C. S., Calif.



Plays at Dances

I have completed your course and your lessons have been most satisfactory. I can play all of the popular songs. I have also earned money playing at dances.
*E. N. J., New York.



Wouldn't Take \$1000 for Course

The lessons are so simple that anyone can understand them. I have learned to play by note in a little more than a month. I wouldn't take a thousand dollars for my course.
*S. E. A., Kansas City, Mo.



Surprised Friends

I want to say that my friends are greatly surprised at the different pieces I can already play. I am very happy to have chosen your method of learning.

*B. F., Bronx, N. Y.



You Can't Beat It

I am glad to tell anyone about the U. S. School. It is just what they say it is and they will do what they say they will. If you want to learn music you can't beat it!

*W. E. D., N. Mex.

*Actual pupils' names on request.
Pictures by professional models.

You, too, can play any instrument By this EASY A-B-C Method

YOU think it's difficult to learn music? That's what thousands of others have thought! Just like you, they long to play some instrument—the piano, violin, guitar, saxophone or other favorites. But they denied themselves the pleasure—because they thought it took months and years of tedious study to learn.

Learn in Spare Time at Home

And then they made an amazing discovery! They learned about a wonderful way to learn music at home—without a private teacher—without tedious study—and in a surprisingly short time. They wrote to the U. S. School of Music for the facts about this remarkable short-cut method. And the facts opened their eyes! They were amazed to find how easy it was to learn.

The result? Over 750,000 men and women have studied music at home this simple, A-B-C way. Now, all over the world, enthusiastic music-lovers are enjoying the thrilling satisfaction of creating their own music. They have found the key to good times, popularity and profit.

COSTS LESS THAN 7¢ A DAY

And that's what you can do, right now. Get the proof that

you, too, can learn to play your favorite instrument—quickly, easily, in spare time at home for less than seven cents a day. Never mind if you have no musical knowledge, training or talent. Just read the fascinating illustrated booklet and Print and Picture Sample that fully explain all about the famous U. S. School of Music method. If interested tear out the coupon now, before you turn the page.

U. S. School of Music,
711 Brunswick Bldg.,
New York 10, N. Y.
Largest school of its
kind in the world.

Forty-sixth year
(Est. 1898)

NOTICE

Please don't confuse the U. S. School of Music method with any system of teaching music "by ear" or by trick charts. Our method teaches you to play by actual notes—not by any trick or number system.

U. S. SCHOOL OF MUSIC, 711 Brunswick Bldg., New York 10, N. Y.

I am interested in music study, particularly in the instrument checked below. Please send me your free illustrated booklet, "How to Learn Music at Home," and your free Print and Picture Sample.

Piano	Plain Accordion	Clarinet	Modern
Guitar	Saxophone	Trombone	Elementary
Hawaiian	Trumpet, Cornet	Flute	Harmony
Guitar	Reed Organ	Piccolo	Mandolin
Violin	Tenor Banjo	Practical Finger	
Piano Accordion	Ukulele	Control	

Name..... *Have You Instrument?*.....
(Please Print)

Address.....

City..... State.....

NOTE: If you are under 16 years of age, parent must sign coupon.

SAVE 2¢ STICK COUPON ON PENNY POSTCARD

HERE'S HOW YOU CAN TRAIN NOW IN REFRIGERATION and AIR CONDITIONING and FINISH YOUR WARTIME JOB!

YOU CAN do your duty and provide for your future by training NOW with the **COMMERCIAL TRADES INSTITUTE**. Special wartime adaptations have opened up countless new fields for air conditioning and refrigeration. Future opportunities are unlimited. **NOW IS THE TIME!** Learn right where you are, in your present job, with simple, easy-to-follow, profusely illustrated lessons—where you read and SEE what to do. There is no extra charge for actual shop and laboratory training under expert instructors. Train now. Be ready for a good paying position or a business of your own.

FOR COMPLETE DETAILS—MAIL COUPON TODAY TO SCHOOL NEAREST YOU

The Commercial Trades Institute is an approved school for those who qualify for training under the "G.I. Bill of Rights."

COMMERCIAL TRADES INSTITUTE, Dept. M-4

209 W. Jackson Blvd., Chicago (6), Illinois
200 So. 20th Street, Birmingham, Alabama
300 East Grove Street, Bloomington, Illinois

Please send me the free booklet "Refrigeration and Air Conditioning"—Your Guide to a SUCCESSFUL Future.

Name
Address
City State
Occupation

DRAFTSMEN NEEDED NOW



Industry is clamoring for more draftsmen for the job can't start until plans are drawn. Buildings, airplanes, machines, guns, tanks, bridges, all start on the drafting board, so it's no wonder that every good draftsman has a fine job. Yes, more draftsmen are needed NOW. The pay is good and the opportunities for advancement great.

Learn at Home in Spare Time

Begin now to turn spare hours into money. Be a draftsman, the connecting link between a mechanic and an engineer. Enjoy the wonderful opportunities for promotion that exist now. No experience or artistic talent is needed. You don't have to leave your present job while learning. Use spare time.

American School, Dept. DD845, Drexel Ave. at 58th St., Chicago 37, Ill.

Gentlemen: Send me FREE information covering special training in subjects checked below. No obligation on my part.

- | | |
|--|--|
| <input type="checkbox"/> Drafting and Design for Men and Women | <input type="checkbox"/> Electrical Engineering |
| <input type="checkbox"/> Cost Accounting for Mfg. | <input type="checkbox"/> Diesel Engineering |
| <input type="checkbox"/> Architecture and Building | <input type="checkbox"/> High School Course |
| <input type="checkbox"/> Automotive Engineering | <input type="checkbox"/> Plastics |
| <input type="checkbox"/> Business Management | <input type="checkbox"/> Mechanical Engineering |
| <input type="checkbox"/> Railway Training | <input type="checkbox"/> Aviation <input type="checkbox"/> Radio |
| | <input type="checkbox"/> Shipbuilding |

Name
Address

Do You Make Mistakes in English?

EVERY time you speak or write you show just what you are. Mistakes in English reveal you as a person who lacks education and refinement. Lack of language power prevents you from presenting your thoughts in the strongest possible way. No matter what you do, real command of English will help you to your goal. Stop making mistakes in spelling, punctuation, pronunciation. Increase your vocabulary.



WONDERFUL INVENTION

Only 15 minutes a day with Sherwin Cody's new invention—and you can actually SEE your English improve. It teaches by HABIT—makes it easier to do the RIGHT way. Wonderful self-correcting lessons include spelling, punctuation, grammar and expression.

FREE BOOK ON ENGLISH Lack of language costing you thousands of dollars every year. See what Mr. Cody can do for you; it costs nothing to find out. Mail a postal card or letter this very minute for free book. "How You Can Master Good English in 15 Minutes a Day." It will prove a revelation to you. WRITE NOW. Address:

Sherwin Cody School of English, 511 Searle Bldg., Rochester 4, N. Y.

TRAIN for SUCCESS in the Poultry Business



YOU CAN MAKE MORE MONEY from POULTRY. Proper management means profits ANY season, for life. Get latest scientific methods that avoid losses and mistakes. Our famous system of Home Study Training has helped thousands to success. Extra profits from the start. FREE Catalog; describes courses, methods, service. Write today to Dept. 50-R. NATIONAL POULTRY INSTITUTE, Adams Center, N. Y.

FREE Music Catalog

Over 1300 Standard, Classical and Teaching Pieces for piano, violin and voice in World Famous McKinley Sheet Music and Book Editions... the teachers' standard for nearly half century. Write today for FREE catalog. Dept. 3378. MCKINLEY PUBLISHERS, Inc., 425 So. Wabash Ave., Chicago

CARTOONING PAYS WELL

Exclusive instruction by a nationally known cartoonist makes it easy to learn at home. Write for details of the course. Please state age.

NATIONAL SCHOOL OF CARTOONING
423 Penton Bldg. Cleveland 13, Ohio

INDIANA TECHNICAL COLLEGE

Engineering B.S. degree in 27 months. Aeronautical, Chemical, Civil Electrical, Mechanical and Radio Engineering. Govt. approved for G.I. bill. Prep courses, no added cost. Large industrial center. Earn living expenses. Graduates successful. Enter Dec., March, June and Sept. Catalog. 5114 E. Washington Blvd., Fort Wayne 2, Indiana.

CODE-RECEIVING SPEED

Learn to send and receive Radio Code with greater speed. Stop nervous tension. Have confidence. Be proficient. Same system used by radiotelegraph specialists. Thousands of operators needed. Rush name for FREE book.

Dept. 5-M, Box 925,
Denver 1, Colo., U. S. A.

CANDLER SYSTEM CO.

ITALIAN ACCORDIONS

Hand Made. Very best. Lowest prices. Buy Direct from Factory and Save Money. Send name and address for FREE catalog.

ITALIAN ACCORDION MFG. CO.
323 W. POLK ST., DEPT. PM-11. CHICAGO 7, ILL.

JOKE BOOKS For Adults

The kind they like. You will be both a Riot and the Life of the Party with a set of these pocket size joke books. They are full of Entertainment, Fun and Humor. A set of six books only 50c or a special assortment of 12 books all different for \$1.00. Print name and address, send cash or stamps to:

TREASURE NOVELTY CO.
72—5th Ave., Dept. 1211, N. Y. 11, N. Y.

Here is the
HELP YOU NEED
To GO PLACES
Now and After
the War!



MAKE MORE MONEY
DO ANY JOB..
EASIER.. QUICKER
in the

BIG OPPORTUNITY FIELDS

FREE TRIAL IN YOUR OWN HOME Used by Army, Navy, Other Government Depts., 200 Schools and Industrial Firms.

Get ready to meet keener job competition, now and when wartime jobs are over. Get into one of these big opportunity fields. Big money and many other advantages await you if you prepare now. Here is the help you need—EASY—QUICK—AT LOW COST. Thousands of men have already used these famous books. Beginners and experienced men alike have doubled and tripled their earnings with this help. You too, can now get the special knowledge you need for top pay, better jobs, or a business of your own. This is your GOLDEN OPPORTUNITY.

REFRIGERATION

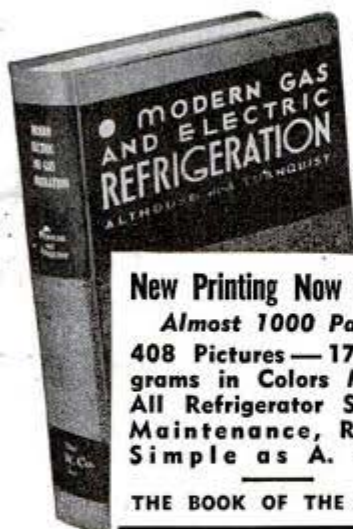

15 Million Refrigerators Need Service, Repairs

New Printing Now Ready
Almost 1000 Pages
408 Pictures—17 Diagrams in Colors Makes All Refrigerator Service Maintenance, Repairs Simple as A. B. C.
THE BOOK OF THE HOUR

No new refrigerators being made. None for years. Millions must be kept going. Owners will pay big for competent service which will be needed more and more. Get MODERN GAS AND ELECTRIC REFRIGERATION, the non-technical guide to all types of refrigerators and get your share of this new profit. Get a job or start your own service business. This book will help you make money anywhere. Price \$5.00.

HELPFUL BOOKS

Auto BODY and FENDER REPAIR
Owners will spend big money to keep cars looking new because few new cars available. Is a practical money-making guide, ideal for shop owners and every man who wants a share of the millions to be spent in keeping old cars looking new. 325 pages, 232 illustrations. Price \$3.00.

DYKE'S CARBURETOR BOOK The standard guide for a generation. New edition covers engine tune-up, ignition, carburetion, fuel pump, valves, etc. 244 pages, 549 illustrations, \$3.00.

SHEET METAL LAYOUT Makes sheet metal layout work so simple that anyone can learn. Get this new instructor and get into the easiest, cleanest and best paying part of all sheet metal work. 143 jobs worked out in drawings and carefully explained. Size of book 8½x11 inches. Price \$3.00.

ELECTRICAL WIRING Complete practical instruction on every phase of house wiring in one handy volume. Hand-book style. Gives National Electric Code. 400 pages, 669 illustrations. Electrical work will reach new heights after war. Get started now. \$2.50.

SEND NO MONEY

Select the Books YOU Need Now! We Ship C.O.D. Anywhere in U. S. and Will Refund Amount Paid if Not Satisfactory.

WELDING

AIRPLANE WELDING

New 2nd edition of this famous book by J. B. Johnson, Materials Division, Wright Field. The authoritative and practical book on Airplane welding and materials brought right up to date. 420 pages, 193 pictures. \$3.50.

MODERN WELDING PRACTICE

Newest book on all types of welding and heat treatment of metals. Written by recognized specialists in training men for production jobs. Practical and Non-Technical. Covers everything you need to know. Prepare for best pay jobs now. Price \$4.00.



430 Pages
277 Illus.
Practical and Non-Technical

AUTOMOBILE WORK

Leading Auto Book for 32 Years

★
★
★

★
★



DYKE'S AUTOMOBILE AND GASOLINE ENGINE ENCYCLOPEDIA

World's Greatest AUTO BOOK
NEW 20TH EDITION
New Material on Transmissions, Trucks, Tractors, Diesels, Aircraft and Auto Engines

Now with millions of cars needing repairs and thousands of men needed to do the work, you need the famous DYKE Auto Book more than ever before. Brand new 20th Edition covers all principles, construction, repair, adjustment, testing, troubles and remedies of all cars. World's biggest book value, \$6.00.

This big book, a complete auto library in one volume, has 1483 pages—4600 illustrations and diagrams—weighs 6 lbs.—equal to 4 ordinary books.

Mail Coupon to: Goodheart-Willcox Co., Inc.
2009 S. Michigan Ave. Dept. 19 Chicago 16, Ill.

SEND NO MONEY! Mail Coupon

GOODHEART-WILCOX CO.,
2009 S. Michigan Ave., Dept. 19, Chicago 16, Ill.

Send books checked, C.O.D. I will pay postman, plus few cents charges. If any book is not satisfactory I will return in 5 days and you will refund money paid you.

- | | |
|--|--|
| <input type="checkbox"/> Gas & Electric Refrigeration \$5.00 | <input type="checkbox"/> Sheet Metal Layout . . . \$3.00 |
| <input type="checkbox"/> Dyke's Auto Book \$6.00 | <input type="checkbox"/> Electrical Wiring \$2.50 |
| <input type="checkbox"/> Dyke's Carburetor Book . \$3.00 | <input type="checkbox"/> Body and Fender Repair . \$3.00 |
| <input type="checkbox"/> Modern Welding \$4.00 | <input type="checkbox"/> Aircraft Sheet Metal . . . \$2.50 |
| <input type="checkbox"/> Airplane Welding \$3.50 | <input type="checkbox"/> Shop Math. (2 vols.) . . . \$3.00 |

If remittance accompanies order we will pay all postage charges under same return privilege.

Name

Address

City State

This HOBART is the Arc Welder that lets you handle the **BIG PAY JOBS**

FREE!
Welder's Handy Vest Pocket Guide
Contains tables, Charts, Valuable Data. Get Yours.

You want a welder with capacity for doing all types of welding . . . that will burn down the latest developed electrodes into a sound, ductile weld. Get a Hobart and be sure that you can handle the Big Pay Jobs. Write today for complete information.

HOBART BROTHERS, Box M-114, Troy, Ohio

HOBART - "One of the World's Largest Builders of Arc Welders."

Train Now for **BEST JOBS** **REFRIGERATION AND AIR CONDITIONING**

Millions of Older Units Need Expert Service. Big After-the-War Expansion Will Create Even More Opportunities

WRITE FOR FREE BOOK

NOW is the time to get ready for a top job and good pay in this big, fast-growing field. Slowed up by the war, a serious shortage of trained men exists in all branches. Thousands of men needed now and for big expansion in post war jobs. Amazing opportunities for men up to 60. This 28 year old school—for past two years exclusively training men and women for U.S.A.—will give you the practical training you need. Train at home—in our big shops—or a combination of both. No previous experience needed. Only common schooling required. Write for **FREE** book today. No obligation.

INDUSTRIAL TRAINING INSTITUTE, Dept. 29
2132-2158 Lawrence Ave. Chicago 25, Ill.

JIU-JITSU HOW TO BECOME REAL EXPERT

Send 10c for trial lesson and details. Age must be 15 or over.

MODERN SCHOOL JIU-JITSU, 5 W. 52 St., N. Y. C. 19

PLASTICS

Resident Engineering Courses. Veterans tuition paid by Govt. (G.I. Bill). Any age. Civilians welcome. Learn in the **HEART** of the Plastics Industry—within walking distance of Bakelite, duPont, Celanese, etc. Founded 1910.

NEW YORK TECHNICAL INSTITUTE (of N. J.), 158 MARKET ST., NEWARK, N. J.

STOP RADIO STATIC

The ALL WAVE radio filter is guaranteed to help you get perfect radio reception. Eliminates all hums, clicks, crackles, etc., caused by electric razors, vacuum cleaners, motors and other electrical appliances. The ALL WAVE is a scientific and compact radio filter that can be used on any make electric radio. To connect, just put your radio plug thru the ALL WAVE's slotted opening and into any wall outlet. **15 DAY FREE TRIAL.** Sent C.O.D. for \$1.50 plus postage. Cash orders sent postpaid. Rush order—supply limited. Vogue Eliminator Co., 7759 S. Halsted, Dept. AW-802, Chicago 20, Ill.

HUNTING and FISHING

is a monthly magazine crammed full of hunting, fishing, camping, dog and boating stories and pictures, invaluable information about guns, fishing tackle, game law changes, best places to fish and hunt—countless ideas that will add more fun to your days ahead.

SPECIAL TRIAL OFFER
Send 25c in stamps or coin and we will send you Hunting & Fishing for six months.

HUNTING & FISHING MAGAZINE
251 Sportsman's Building
Boston, Massachusetts

PATENTS Protect Your Idea:

By securing **FREE** my "PROOF OF INVENTION" folder. *Exceptional Personal Service. Excellent References. Established 1906.*
E. E. VROOMAN, 871 Woodward Bldg., WASH., D. C.

PATENT YOUR IDEAS

SEND FOR FREE BOOK **NOW TO OBTAIN A PATENT**

Written by Former Member Examining Corps (1922-24) U. S. Pat. Office.

CARL MILLER, Registered Patent Attorney
Former Member Examining Corps U. S. Patent Office
Woolworth Bldg., Dept. 114-A, New York — Bond Bldg., Dept. 114-A, Washington, D. C.

BENJAMIN

H-C PELLETS ARE AVAILABLE

at dealers or direct. Cal. 22 and Cal. 177. Production of all models Benjamin Air Rifles and Benjamin Air Pistols has been suspended for the duration as our facilities are engaged in War Work. **WRITE FOR OUR ILLUSTRATED PRICE LIST OF POST WAR MODELS TODAY.**

BENJAMIN AIR RIFLE CO., 812 Marion St., St. Louis, (4) Mo.

PATENTS AND TRADE MARKS

C. A. SNOW & CO.

Registered Patent Attorneys Since 1875
Write for Free Book and "Certification of Invention" form
427 SNOW BUILDING, WASHINGTON 1, D. C.

To PROTECT YOUR INVENTION - Use this coupon, NOW

Delays are dangerous and may be very costly. My personal service assures prompt action, strict confidence, and a minimum of expense. I suggest that you send me a model or drawing, or sketch and description of your invention, and \$5.00. I will make a search and report promptly as to its patentability and send you a copy of my 72-page booklet. Or, if you prefer to read my booklet first, mail the attached coupon at once. I will also send my "Record of Invention" form. (Over 40 years experience as a Registered Patent Attorney.)

L. F. Randolph, 302-D Columbian Bldg., Washington, D. C.
Please send me at once, free of charge, your 72 page booklet and "Record of Invention" form.

Name.....
Address.....

A PERSONAL CONFIDENTIAL PATENT SERVICE

McGraw-Hill Books

help you

— do a better job

— make more money

MATHEMATICS

1. Wolfe, Mueller and Mullikin's **SIMPLIFIED INDUSTRIAL MATHEMATICS**. Gives you a quick working knowledge of the mathematics needed to handle trade and industrial problems; develops your ability to apply it to the day-to-day problems met with in shop work. Written plainly and understandably; clearly explains arithmetic, precision instruments, geometry, trigonometry, screw threads, and gearing. 281 pages.....\$2.00

MACHINE SHOP

2. Colvin's **PLANING, SHAPING AND SLOTTING**. Another practical, self-help Colvin manual explaining the starting steps in planing, shaping, and slotting, to give the beginner rapid, reliable aid in this type of machine shop work. Describes and illustrates various types of machines, their parts, types of work done, work holding methods, etc. Easy-to-follow instructions. 125 pages.....\$1.25

HOUSE REPAIR

3. Whitman's **FIRST AID FOR THE AILING HOUSE**. Big handbook of practical information on making all kinds of house repairs yourself, and on saving money in dealing with mechanics. Includes valuable material on heat conservation, use of substitute materials, making things last longer, etc. Covers everything from cellar to roof, inside and out. 359 pages....\$2.50

SCIENCE

4. White's **PRACTICAL PHYSICS**. A practical introduction to science for the industrial and technical worker. Gives a knowledge of the laws of mechanics, heat, sound, electricity, and light, emphasizing those aspects which are basic to practical use, and on which are founded so many equipments and practices in engineering, technical work, and the armed services. 365 pages.....\$3.25

SOLDERING

5. Taylor's **SUCCESSFUL SOLDERING**. Shows fully and plainly how to get good results in soldering of all types. Covers fundamentals of the process, soldering coppers, solders, and fluxes, purposes and correct uses of each, then covers the special problems of soldering various materials such as black iron, zinc, stainless steel, copper, aluminum, etc. 76 pages.....\$1.00

PLASTICS

6. Sasso's **PLASTICS FOR INDUSTRIAL USE**. Packed with clear explanations and data on plastic materials, properties, working factors—molding methods—pointers on good mold design—causes and remedies of faults in molded parts—how to machine and finish plastic parts—kinds of plastics, advantages for different uses, etc.—practical treatment of essentials of plastic design and production. 229 pages.....\$2.50

ELECTRONICS

7. Caverly's **A PRIMER OF ELECTRONICS**. An ABC book to show any electrical worker or reader concerned with application or operation of electronic devices what electronics is all about. Gives you simply, without formulas or much mathematics, just what you want to know about electronic principles and how they are applied in working devices. 235 pages.....\$2.00

CALCULUS

8. Klaf's **CALCULUS REFRESHER FOR TECHNICAL MEN**. A working tool to help in solving the great variety of practical problems involving differential and integral calculus. Entire subject present in easily understood, readily remembered question-and-answer form. Many worked-out illustrative examples, test problems, solved applications. 431 pages.....\$3.00

GAGES

9. Colvin's **GAGES AND THEIR USE IN INSPECTION**. Describes all types, from calipers, micrometers, measuring blocks, etc., up to latest electro-limit gages. Tells how constructed, how to use them, which types are best for specific jobs. Carefully defines and explains tolerances, limits, and allowances; includes many practical kinks and suggestions on inspection. 157 pages...\$1.50

WHITTLING AND CARVING

10. Tangerman's **WHITTLING AND WOODCARVING**. Clearly explains and illustrates all techniques. Goes from simple whittling through rustic, chain, and fan carving, to caricatures, ship-in-bottle, chip carving and surface decoration. Takes you successfully from choice of a knife, the right piece of wood, and a suitable subject, to the completed article. Hundreds of things to make; easy, medium-difficult, and difficult. 293 pages.....\$3.75

SEE THESE BOOKS FREE

Send coupon for books of your selection. It's worth your while to see just how clear and complete they are—how much they can give you for your money. No advance remittance, no obligation; you merely agree to pay for or return them after 10 days' examination. Start now to make these practical tools work for you; send the coupon today.

McGraw-Hill Book Co., Inc.,
330 W. 42 St., New York 18, N. Y.

Send me the books encircled below, for 10 days' examination on approval. In 10 days I will pay for books, plus few cents postage, or return them postpaid. (Postage paid on cash orders; same examination and return privilege.)

1 2 3 4 5 6 7 8 9 10

Name

Address

City and State

Position

Company PM 11-44

(Books sent on approval in United States only.)

Learn to Mount Birds

and Animals—Send Coupon for Free Book!

HELLO, SON. SPENDING THE EVENING AT YOUR WORK-BENCH AS USUAL?

COME IN, DAD. I WAS JUST READING THIS AD OF THE NORTHWESTERN SCHOOL OF TAXIDERMISTRY. IT SAYS THAT MOUNTING BIRDS AND ANIMALS IS A GREAT HOBBY FOR THE MAN WITH A WORK-BENCH—AND PROFITABLE, TOO. WHAT DO YOU THINK?

WELL, SON, I DO KNOW THAT THAT SCHOOL WAS TEACHING TAXIDERMISTRY WHEN I WAS YOUR AGE—THIRTY YEARS AGO. I OFTEN WANTED TO LEARN IT MYSELF.

IF IT'S AS INTERESTING AS IT SOUNDS, I'M AT LEAST GOING TO INVESTIGATE. AND I COULD SURE USE SOME EXTRA MONEY RIGHT NOW—ALICE WANTS A NEW DRESS AND I'D LIKE A NEW SET OF TOOLS.

NOT SO BAD FOR A BEGINNER. THERE'S A LAMP THAT WILL LOOK DANDY IN MY DEN. GUESS I'LL ASK DAD TO DROP OVER TONIGHT AND TAKE A LOOK.

THAT SQUIRREL BOXING GROUP IS ONE I MADE FOR GREEN'S SPORTING GOODS STORE FOR A WINDOW DISPLAY. SO FAR THIS MONTH I'VE BOUGHT THOSE THINGS I WANTED, AND MADE MY WORK-BENCH PAY ME AN EXTRA \$68—JUST FROM TAXIDERMISTRY.

AND I NOT ONLY MOUNT TROPHIES FOR OTHER SPORTSMEN, BUT MOUNT MY BEST ONES FOR THE DEN HERE. WHY DAD, I NOW GET TWICE AS MUCH FUN FROM MY HUNTING AS I USED TO. YOU WOULD TOO IF YOU LEARNED TAXIDERMISTRY.

WHY BOB, YOU CERTAINLY DID TAKE UP TAXIDERMISTRY IN EARNEST, DIDN'T YOU?

I SURE DID. I'VE MADE AND SOLD A BUNCH OF BOOK-ENDS, MIRRORS AND SO ON TO HUNTERS FOR THEIR DENS. AND FUN? SAY DAD, TAXIDERMISTRY'S THE GRANDEST HOBBY IN THE WORLD!

IT SOUNDS GREAT, SON. WHEN DO I START?

Fun—Fascination—Profits

Be a Taxidermist. All Secrets Revealed. Learn at Home



Save Your Hunting Trophies

Mount (stuff) expertly your valuable **game-birds, animals, fish, game-heads**. Preserve them just like **life**. That is Taxidermy. Learn at home by **mail**. Decorate home and den with nature's art. Make undreamed-of **profits** in spare time, in your shop. You can. Will you? Win fame as a taxidermist. Investigate. Mail **coupon NOW**.



Fun With a Few Loads

Yes, **war** makes shot-gun shells scarce. But just a **few** shells obtain a **few ducks**, and with **taxidermy**, you will have the grandest hunting season **ever**. Taxidermy is fine beyond description for **men and boys**. Be one of our 300,000 students. We invite **young men, boys, youths**. "Eat your Trophies and have them too!"



Mail Coupon

Or a postcard will do. No obligation on your part. The beautiful **Book**, with hundreds of entrancing **Pictures** is **Free**. Don't miss your **Only Chance** to get this remarkable book **Free and Postpaid**. Write today. State your **Age**.

Northwestern School of Taxidermy
3378 Elwood Bldg. Omaha, Neb.

Wild Game Not Needed

Use **common** specimens; squirrels, rabbits, chicks, pets, owls, pigeons—even frogs. Make useful articles like those shown here. Mount them in human and humorous positions. This is craft and novelty taxidermy. It's **fun—and profitable**. All included in our unique lessons. It's **marvelous**. Write the school this minute.

BIG PROFITS From Your Shop in Spare Time

Many students earn from \$40 to \$75 monthly in spare time. Some earn thousands of dollars each year. Sportsmen bring their trophies to be mounted. Besides you can sell your own **Novelty** groups for homes, dens and for merchants' window display.

LEARN TANNING
The lessons teach tanning harness; sole, crone leather; also furs. Expert methods. **Very profitable**.

FREE BOOK

Northwestern School of Taxidermy, 3378 Elwood Bldg., Omaha, Neb.
Gentlemen: Please send at once, your free 48-page book on Taxidermy without any obligation on my part. Tell me how I can learn Scientific Taxidermy at home.

Name..... Age.....
Address.....



**WORLD'S
BEST
WANT AD
MEDIUM**

CLASSIFIED Advertisements



Advertisements in this section, 35 cents per word, each insertion, minimum 10 words, payable in advance. To be inserted under proper classification in December issue, copy should be in our office November 4th December issue on sale December 1st

Popular Mechanics Magazine, 200 East Ontario Street, Chicago 11, Illinois

AUTOMOBILES, MIDGET CARS

GASOLINE Age. 360 pages. Wonderful book history automobile business in America. Start of Dodge Brothers, Ford, Nash, Durant, Chrysler, Willys, others described. Illustrations. Contains list of over 1500 American makes automobiles once manufactured. \$3.00 postpaid. Clymers, 2125 W. Pico, Los Angeles 6, Calif.

GARAGE Doors, all types, controlled from dashboard pushbutton. Thoroughly tested, used nation-wide. Amazingly simple, dependable. Materials inexpensive, obtainable everywhere. Complete "build yourself" plans \$1.00, refundable. Fully guaranteed. Free particulars. Kaytor Laboratories, Lynwood, Calif.

SEE Our advertisements under Motorcycles Classification. Clymers, 2125 W. Pico, Los Angeles 6, Calif.

REPAIR Your car. Do it yourself. Motor parts for all engines, chassis, parts, etc. New replacement parts. Genuine and highest quality at manufacturers' retail prices. F.O.B. Chicago. Personalized technical advice concerning your mechanical problems. \$1.50 postpaid. Send information on state registration card for proper identification of vehicle. Box 3454. Merchandise Mart, P.O. Chicago 54, Illinois.

AUTOMOBILE Books. "Racing photo album" 110 photos, exciting crashes, world's greatest race cars, drivers described. \$1.50. "Saga Roaring Road" 181 pages, 16 pictures. Starter Fred Wagner's early racing experiences with world famous drivers, cars described. Read about Rickenbacker, Murphy, Burman, DePalma, Ford "999", Oldfield's Benz \$2.50. Automobile racing book \$1.10. Prices include reprints, illustrations, drawings army Jeep and German BMW war motorcycles. All postpaid. Clymers, 2125 W. Pico, Los Angeles 6, Calif.

1944 **IGNITION** Supercharger \$3.50. Fast starting, mileage, pep. EG Sales Mfg. Co., 50 John St., New York.

POWER And Speed! World's most famous motor book. 110 large pages. 200 illustrations racing automobiles, motorcycles, airplanes. World's speed record chart, articles by world's famous speed kings Cobb, Eyeston, Campbell, Bonneville record details, photos British racers. Describes cams, compression, valves, superchargers, international racing teams, German Auto-Union, Italian, French, British racer specifications, drawings. \$2.50 postpaid. Clymers, 2125 W. Pico, Los Angeles 6, Calif.

"TIPS On Buying or Selling a Used Car." Booklet, 25c. Walters, 1291 Alameda, Detroit 3, Michigan.

MODERN Steam cars, 130 pages, 100 illustrations. Interesting, practical book on steam automobiles. Complete information early and latest makes, models. U. S., foreign makes described. Boilers, generators, engines, valves illustrated, described. Article by Stanley, early steam advertisements. How to drive and care for steam automobiles. Unusual, informative book. Postpaid \$2.00. Clymers, 2125 W. Pico, Los Angeles 6, Calif.

PROFESSIONAL Midget racers, motor-scooters, midget cars. Parts, plans. Hand-book catalog—50 illustrations, plans—20c. Midwest, 2557 Charlestown, Toledo, Ohio.

TIME Magazine said "Floyd Clymers' Motor Scrapbook is a 'must'." This unusual historical, education, humorous scrapbook illustrates early automobiles, motorcycles, airplanes. Read about "V-8" Chevrolet, 1908 Plymouth, Ford "2" and "6," three and five cylinder automobiles, Rambler, Maxwell, Metz, Knox, Sears, steamers, electrics, foreign machines, 240 others. Motorcycle section includes Pierce "4", Merkel, Pope, Thor, Emblem, Excelsior, Henderson, Ace, Cleveland, Indian, Reading, Harley, steam and front drive motorcycles. A laugh on every one of 160 pages. Postpaid \$1.50. Clymers, 2125 W. Pico, Los Angeles 6, Calif.

\$1.00 **FOR** Large photo cuts and price sheet showing racing cars, boats and speed equipment. R & R Mfg. Co., Box 546, Anderson, Indiana.

SIR Malcolm Campbell's book of famous motorists! 176 pages. 42 beautiful photographs world famous racing automobiles, drivers. Campbell describes famous race tracks, his American records, European road races, his competitors. Interesting, sensational. \$3.00 postpaid. Clymers, 2125 W. Pico, Los Angeles 6, Calif.

AUTOMOBILE Racing book, fifth edition, well illustrated. Instructions on building bodies, frames, engines. Ford A and B conversions. Plans, AAA rules, specifications. Roadster racing. Indianapolis cars. \$1.00 postpaid, \$1.30 C.O.D. Ray Kuns, Dept. 47, Madisonville, Cincinnati 27, Ohio.

INTERESTING, Educational, illustrated English "Motor" magazine on foreign automobiles. 50c postpaid. Clymers, 2125 W. Pico, Los Angeles 6, Calif.

120 **OCTANE** Fuels in your car. Most perfect fuels available. Obtainable most places throughout country. Easy to make equipment to burn them in your car. Won't harm motor. Perfect performance. Complete instructions with pictures, \$1.00. Earl Behling, Box 855, Inglewood, Calif.

STEAM Automobiles! Send 25c for literature listing names 90 different makes steamers once manufactured. Illustrations, descriptions, specifications. Stanley, White, Doble, Lane, Ross steamers, boilers, engines also photos famous White Racer "Whistling Billy" and world's record holder Stanley Racer. Interesting, educational, ancient steamer history. No cars for sale. Clymers, 2125 W. Pico, Los Angeles 6, Calif.

FAREWELL To Model "T". Humorous book with cartoons, illustrations, description car, engine, chassis, first and last Model T Fords manufactured. Folder includes page on German Jet Propulsion Opel automobile. \$1.50 complete postpaid. Clymers, 2125 W. Pico, Los Angeles 6, Calif.

AUTO SUPPLIES AND EQUIPMENT

1,000 **MOTORISTS** Needed to make gas saving test. Up to 30% savings. For trial test offer write Vacu-matic Carburetor Co., 7617-1002 W. State Street, Wauwatosa, Wis.

ATTENTION: Run your car on (natural or artificial gas.) Without alterations to carburetor or gasoline system. Build supercharged turbulence plate for more mileage. Make time shutoff control for electric appliances. Easy to install windshield defroster. Cut a five point star with one cut useful for stencil. Five above plans \$1.50. More detailed information free. Harpers Machine Shop, 218 22nd St., Dunbar, W. Va.

SHEEPSWOL Mitts, French and American chamois. Hanson's Chamois, Gloversville, N. Y.

INVENTION Uses kerosene to run motors. Circular on plans. Rush name. Houston Maupin, Tipp City 36, Ohio.

RECONDITION Motor and battery yourself with "Automobile Aids." Save fuel with more horsepower. (Salesmen wanted.) Free information. Kay Company, Stimson Bldg., Los Angeles 13.

SIX Authentic automobile racing fuel formulas 50c. Formula Research, 481 Pacific, San Luis Obispo, Calif.

WHIRLGAS Turbinator, \$3, vaporizes carburetor mixture; increases mileage and horsepower; reduces monoxide; prevents vaporlock. University and oil corporation tests. Wrench installs 15 minutes. Give auto make, year. John Hanley, 5719 Lorraine, Detroit 8, Mich.

HAVING Car trouble? Used, guaranteed auto, truck parts save money. Transmission specialists. Describe needs; immediate reply. Victory, 2439 1/2 Gunnison, Chicago 23.

ANTI-FREEZE, Noncorrosive, inexpensive, manufacture yourself. Details for stamp. Betke, Box 699, Borger, Texas.

OPERATE Cars, trucks, tractors, motors, with wood or coal gas, 1/2 cost of gasoline. Extensively used in Europe. Complete detailed instructions \$1.00. W. M. Cross, Lone Rock, Wis.

V-8 AND Mercury dual muffler sets \$20.00. Genuine steel wool packed mufflers with mellow tone. Gives less back pressure, more power and more gasoline mileage. Also single steel wool pack muffler for any car. Fits in place of regular muffler. Single V-8 Ford, Chev, Plymouth, Pontiac, etc., \$6.00. Buick, Dodge, Chrysler, etc., \$7.00. For 7 years manufacturers of California's best tone mufflers. Sandee Muffler Co., 7523 So. Western Ave., Los Angeles 44, California.

PLATING Outfits for auto parts. Connect to a battery. No tanks used. Free particulars and proofs. Gunmetal Co., Ave. J, Decatur, Ill.

AUTO TRAILERS

BUILD Your own trailer! Save money! Have every feature you want! Plans for house, sport, camp and utility trailers. Catalog describing 9 models 10c. Jim Dandy, Box 125-A, Wausau, Wisconsin.

MOTORCYCLES, BICYCLES, MOTOR-SCOOTERS AND SUPPLIES

FACTORY Built midget racer \$60; motorcycles \$50 up; gasoline motors \$5 up; motorbikes, motorscooters; unrationed 10-12-14 inch balloon tires \$1.75 to \$6.50. Send 25c for big Number Four War-Bargain catalogue just out. Mailorder only. Midget Motors Directory, Athens, Ohio.

ELECTRIC Motorbike built from your present bicycle. \$1.00 bill brings complete instructions, drawings, specifications. Mowery, Box 994, Lancaster, Pennsylvania.

PARTS, Accessories, pistons, chain for Harleys and Indians. McCann's, P.O. Box 114, El Paso, Texas.

MOTORBIKE Manual containing motorbike and scooter plans, catalog section \$1.00. Variety Enterprise Co., Dept. P.M., Station A, Box 5, Evansville, Ind.

MIDGET Car \$20, less motor; motorcycles \$50 up; motorscooters \$60 up; gasoline motors as low as \$5; unrationed 10-12-14 inch balloon tires \$1.75 to \$6.50. Mailorder only. Send 25c for big War-Bargain catalogue No. 4 listing these and hundreds of other bargains. Midget Motors Directory, Athens, Ohio.

HARLEY Davidson parts, accessories, supplies. Expert service. Cylinder reboring, generator reconditioning. 45" engines \$85.00 and up. Send \$1.85 for U. S. Army Motorcycle Instruction Book, Motorcycle Service Manual and bulletins or 25c for Service Manual and bulletin. Knuth's, 2491 Pondulac Ave., Milwaukee 6, Wis.

100 **MILES** Gallon! Motor-scooters, motorcycles, Whizzer bicycle engines, midget automobiles, gasoline engines. No priority necessary. Catalog 10c. Clymers, 2125 W. Pico, Los Angeles 6, Calif.

MOTORCYCLISTS—New and used parts, accessories, all models. Catalog 10c. Henderson catalog 10c additional. Triangle, 2157 Harrison, Chicago.

PARTS And service for most moto-scoots using Lauson or Briggs & Stratton motors. 3:50x6 and 4:00x7 tires, tubes available. Send for newest pamphlet on Amso Centrifugal Clutch usable on most moto-scoots. American Moto-Scoot Company, 1305-23 West Carroll Avenue, Chicago 7, Illinois.

FLOYD Clymers Historical Motor Scrapbook \$1.50 postpaid. This is the book Time Magazine said is a "must." 160 pages. 250 early motorcycles, automobiles illustrated, described. See our advertisements under Automobiles. Clymers, 2125 W. Pico, Los Angeles 6, Calif.

WANTED—Motorcycles, transmissions; scooters; small engines of all kinds. Name your own price. Write: Midget Motors Directory, Athens, Ohio.

BOOK "Speed—How to Obtain It." 160 pages, illustrated, instructions, cams, balance, timing, valves, pistons, racing technique. World's greatest speed tuning book. \$1.50 postpaid. Clymers, 2125 W. Pico, Los Angeles 6, Calif.

TO Highest bidder, special built three wheel, 1½ h.p. motorbike. Send stamp and 10c for photo. J. Plese, 523 N. Highland, Aurora, Ill.

CUSTOMIZE Your automobile. Illustrated new restyling ideas, instructions, suggestions, specific model changes by simple methods. \$1. Speed Wheel, Box 723-E, Arcadia, California.

U. S. Tires \$2.20, tubes \$1.10, new front wheels \$3.00, all other parts and accessories, bikes overhauled and enameled any color \$8.00. L. S. Hilaman, R.D. 2, Rising Sun, Md.

AIR SPEED indicator: Ready for your bicycle. 50c. Spargo, Miami Springs 1, Florida.

WANTED—Motorscooters, engines, motorcycles, parts, wheels and tires. Fabulous prices now being paid for this equipment regardless of condition. Write Midwest Motors, 2557 Charlestown, Toledo, O.

BOYS! All bicycle repair secrets revealed. "Bicycle Repair Manual" 65c. R. C. Klausner, Shelbyville, Ill.

PISTONS Of all kinds metallized and ground to any size desired. Stahl Machine Company, Tiffin, Ohio.

ENGLISH "Motorcycling" Magazine. Interesting, educational, foreign motorcycles, racing, new-old models, advertisements, 50c sample copy. Clymers, 2125 W. Pico, Los Angeles 6, Calif.

ATTENTION! All motorcycle owners! 1944 publication of 28 pages listing complete line first grade accessories, service and trouble saving tips and charts. 25c a copy. Copy purchase price refunded on first order of \$2.00. We carry full line of all Indian part and large supply Harley-Davidson parts. New and used. Quotation on parts and service free on request. Preston Motors, Inc., Kendallville, Ind.

BUILD Scooters, trailers, midgets, conversions. Large manual \$1.00. Illustrated circulars dime. Craftsmann Books, Box 1153-P2, Milwaukee 1, Wis.

BOOKS! "Modern Motorcycle Mechanics and Speed Tuning," 435 pages maintenance Harley, Indian, Villiers, all British motorcycles \$2.50; with drawings, specifications, illustrations U. S. Army Jeep, German BMW war motorcycles \$3.00; "Motorcyclist's Workshop," \$1.50; "Two Stroke Motorcycles," \$1.50; "Speed—How to Obtain It," \$1.50; "Historical Motorcycling Facts," \$1.00; "Automobile Racing," \$1.10; Motorcycle instruction manual "Questions—Answers," \$1.10. All postpaid. Clymers, 2125 W. Pico, Los Angeles 6, Calif.

TIRES And industrial wheels, suitable for scooters, wheelbarrows, farm equipment, etc. All sizes. Bicycles and accessories. Largest assortment in America. Send dime for list. Cycle Transport Company, 1241 So. Michigan Ave., Chicago 5, Illinois.

FLOYD Clymer's Motorcycling Manual, 144 pages, 150 illustrations. Complete information, specifications, descriptions dozens motorcycles. Engines, transmissions, carburetors, square four, two piston singles, sleeve valve engines, overhead camshafts, water cooled motorcycles, spring frames, hydraulic forks, sidescars, riding instructions. Two cycle engines and power bicycles described, illustrated. Just out \$2.00 postpaid. Clymers, 2125 W. Pico, Los Angeles 6, Calif.

SAVE Gasoline, build a motorbike now, send 25c for complete plans. Motorbike Service, 2108 McLean, New Albany, Ind.

PLANS. Scale drawings, specifications, illustrations for building attractive motor scooter complete \$2.00; plans electrically driven bicycle \$1.50. Postpaid. Clymers, 2125 W. Pico, Los Angeles 6, Calif.

AVIATION

LIGHT PLANE Manuals blueprints four new designs now ready. New illustrated circulars 2 dimes. Craftsmann Books, Box 1153-P1, Milwaukee 1, Wis.

PROPELLERS For snow sleds, air boats, catalogue free. Banks Propellers, R.F.D. 7, Ft. Worth, Texas.

CUB \$200 (Needs repainting); Curtiss Robin \$195; Fairchild \$395. Catalog over 250 listings, 25c. National Aviation, Box 1682-CS, Toledo, Ohio.

BOWLUS Sailplane, complete with trailer \$100; licenseable airplanes, \$275 up. Send 25c for big new War-bargain catalogue giving locations and owner's price of hundreds of used airplanes. Used Aircraft Directory, Athens, Ohio.

FOLLOW The progress of flying! Read Airman, fascinating new aviation magazine. Introductory offer: 12 monthly issues. \$1. Airman, Howard Street, Elmira, N. Y.

AIRPLANES, Crackups, motors, salvage, sometimes as low as \$50, located everywhere, some probably near you. Send 25c for new fall War-Bargain Directory just out, giving locations, owner's price. Used Aircraft Directory, Athens, Ohio.

USED Airplanes—Bargains at give-away prices. Ready to fly. Complete list, 20c for mailing. Joseph Jayko, Ad-Aero, Adams, Mass.

PROPELLERS—Quality, service, all sizes, including 3 blade Airliner for sleds, boats, lists free. Aircoo Ford motor conversion diagrams 50c. Standard Aircraft, Ft. Worth, Texas.

AIRPLANES—Used \$250 up. Also late models, engines, wings, parts, machinery, books. Cheap. Send 25c for list. Aircraft, 2300 West Flagler, Miami, Florida.

ELECTRICAL SUPPLIES, EQUIPMENT

ELECTRIC Hair clippers, late models rebuilt. Also new 1/40 h.p. reduction motors, 110 volts, a.c.-d.c. motor runs 15,000, shaft 5,000 r.p.m. Dremel Sales Company, 1101 Cleveland Avenue, Racine, Wisconsin.

FIBRE-BAKELITE Washers, Strips and pieces, large assortment for insulation, ideal for electricians, radio mechanics, hobby workshops. Over 1000 pieces. Satisfaction guaranteed. Special \$1.98. Order now. Hudson Trading Corp., N-169 W. Hubbard, Chicago 10.

ELECTRIC Automobile heaters! Starts cold motors quickly. Saves gasoline, operates from light current. Postpaid \$1.95. Harris Machinery, Minneapolis, Minn.

MEN—Open your own electrical appliance service shop. Complete, illustrated course covering house wiring, motor repairs, household appliance repair. Free booklet. Appliance Service, 4701 West Pico, Dept. 11-AP, Los Angeles 6.

FREE Catalog of motors, welders, generators, fencers and other electrical items. Write Le-Jay Company, Minneapolis 8, Minnesota.

ELECTRIC Iron replacement elements \$1.50. 6 ft. cords \$1.00, with switch \$1.50. Marko Supply, 2924 Logan Blvd., Chicago 47, Ill.

ATTENTION Farmers, electricians, factories, stores. Buy electrical supplies at wholesale prices. State needs. Wilson, 461 Winthrop Road, Union, N. J.

ELECTRIC Pencil: Writes—engraves all metals. \$1.00 postpaid. Beyer Mfg., 4815-H Cottage Grove, Chicago 15.

NOW—Repair your own electrical appliances with Chantite Self-welding Electrical Heating Element Flux. Instructions delivered, price \$1.00. Chantite Sales Company, 914 South Main, Fort Worth, Texas.

ELECTRIC Air heaters, electric fly traps. Gardenhour Mfg., Waynesboro, Penna.

REPAIR Electric heating elements with Nichrome paste. See our ad page 176. Advance Mfg. & Dist. Co.

BATTERIES, GENERATORS, ETC.

EDISON Batteries. Light. Power. Fifteen year life. Five year guarantee. Complete lighting plants. Free literature. See Jay Company, 321 Yonkers Avenue, Yonkers, New York.

WELDING, SOLDERING, PLATING

ARC Welders wanted by the thousands. Learn with 516 page lessons manual. Over 500 how-to-do-it photos. \$2.00 copy. Money-back guarantee. Hobartweld, Box M-1144, Troy, Ohio.

NEW Model electric welder 110 volt a.c.-d.c.; will weld all metals; easy to use; full directions. Complete with power unit, flame and metallic arc attachments, carbons, fluxes, rods, mask; all for \$19.95. Used by the navy. Magic Welder Mfg. Co., 239-MP11 Canal St., New York City.

HEAT Treating; welding metallurgy and engineering problems answered. \$2.00. Kenmore Technical Service, 64 Tulane Rd., 17, Kenmore, N. Y.

MULTIWELD 110-220 Volt production type a-c welder. Hairline control, over 200 heats. Burns 1/16" to 3/16" rods, \$82.50. Circular, Phillip Wilson, 309-E Bridge, Streator, Ill.

NEW A.C. arc welders, \$20.00 to \$100.00. Growlers \$5.00 each. Spot welder \$5.00. Electric soldering iron and tool marker combination \$1.00. Frazee Electric, Box 5086, San Francisco 1, Calif.

SILVER, Nickelplate, car parts, silverware, etc., no electricity, apparatus needed, only my formulas. Price complete \$1.00. Formula Research, 481 Pacific St., San Luis Obispo, Calif.

BUILD D.C. Arcwelder without rewinding armature. Plans \$1.00 each. 25 to 600 amperes from vehicle d.c. motors, light plant generators, automobile starter-generators. Welders Club, AB-3432 Chicago 54. For Sale: Vehicle d.c. motors.

SLIGHTLY Used arc welders. Recommended by R.E.A. Guaranteed. Forney Mfg. Co., Fort Collins, Colo.

WELDING, Cutting outfits, supplies, arc welders. Immediate delivery. Catalog 20c. Adastik Bros. Welding Supply, 1299 Michigan, Grand Rapids 6, Michigan.

WELDING, Cutting, aircraft welding and soldering equipment. Electric arc welders. Superior Oxy-Acetylene Co., Hamilton, Ohio.

SUPER Welder—For home, farm, factory. Makes even beginner an expert. Improved on type used by Navy. Fully equipped with Metallic Arc and Flame Torch handles, carbons, rods, fluxes, mask, etc. Complete directions. Operates ac-dc, 110 volts. No extra wiring needed. Guaranteed. \$19.95. Save 2%, send check with order. Super Welder Manufacturing Co., Dept. A, 23 East 20 Street, New York.

MACHINERY, TOOLS AND SUPPLIES

HARDWARE, Model makers supplies, engine castings, pulleys, belts, drills, taps, dies, saw mandrels, steel. Screwdriver with catalog 10c. Terek and Sons, 6304 Patterson, Chicago 34.

UNIVERSAL Tool set: Adjustable wrench, chisel, diagonal cutters, hammer, punch, regular plier, screwdriver. \$9.85. Remit with order. Order other tools, we'll ship c.o.d. Dealers Tool Supply, 1527 Grand, Kansas City, Mo. Dept. PM.

SANDING Cloth bargain, 100 feet assorted one inch wide, fine, medium, ruf, \$1.00 postpaid cash. Money order. None c.o.d. Thos. T. Thompson, 255 Lafayette Street, New York 12, N. Y.

SEND \$2—Receive 15 assorted wrenches 3½ pound files slightly used. Max's Mechanical Store, 150-06 Liberty, Jamaica 4, N. Y.

LATHES Attachments, chucks, indicators, mikes, millers. Machine Supply, Newfane, Vermont.

TOOLS—Micrometers, channel-vice-grip-pliers, adjustable sockets, open-box-combination sets, chests. National brands—prices. Order today. Dealers Tool Supply, Box 675, Kansas City, Mo.

USEFUL, Practical metal or woodworking tools—Mills, shapers, drill presses, vises and many others—quickly built using Lewis plain or semi-finished castings, supplied with materials and blueprints. Cost a fraction of comparable finished tools. Blueprints only available at nominal cost. Send 10c to cover cost of mailing catalog describing 23 items. Lewis Machine Tool Co., Box 116, Station A, Dept. M-46, Los Angeles 31, California.

GRIND Drills any twist in three different point angles like factory. Sold at large chain stores or factory \$2.95 prepaid. Guaranteed. 1512 West Slauson, Los Angeles 44, California.

EXPERIMENTERS—400 Valuable springs, 75 kinds, all sizes, 10,000 uses. No junk. \$2.00. Naco, 29-B Lancaster, West Hartford, Conn.

DRILL Grinder—Original patented precision sharpener. Grinds drills to factory accuracy. Calipers with direct reading scales. Circle cutters. New tool grinder. Lowest prices. Free literature. Factory, 811-B East 31st, Kansas City 3, Mo.

STEEL Beam trammels for draftsmen, engineers, mechanics. Circular free. Clair Company, Box 92M, Blythebourne Station, Brooklyn, N. Y.

INDEX Heads for sale. Very inexpensive. Sixty-two different divisions. Used on small lathes, drill press, milling machines, etc. Make gears, hobbs, cutters, etc. Very accurate, and durable. Not a toy. Used by defense schools and hobbyists. Write for free folder. Long's Index Heads, 2117 East B St., Torrington, Wyo.

BOATS, OUTBOARD MOTORS, ETC.

INDIAN Silver Arrow outboard motor parts. Indian Motorcycle Sales, Inc., 354 Columbus Avenue, Springfield 5, Mass.

FOLDING Kayak plans \$1.00. No catalog. Foldcraft, 4015 Oketo, Chicago.

SAILKITS 100 Square feet \$13.90, boat equipment, carbide lamps, army blankets, sleeping bags, etc. Alan-Clarke Co., 100 Chambers, New York 7, N. Y.

ASA Gallepe of Fort Fairfield, Maine, wishes to buy your Evinrude or Johnson.

ROWBOAT, Twelve foot, flat bottom, plan 25c. Ten plywood boat plans 50c. The Rudder, 15 Murray Street, New York.

INBOARD Marine motors, propellers, fittings, conversions. Charles Stokes, Coldwater, Michigan.

OUTBOARDS—Save 1½. Good used parts, all makes and models. Bargains rebuilt motors. Crandall Hicks Co., 959 Commonwealth, Boston, Mass.

BOAT Designers are highly paid professionals. Complete course by mail. Catalog. Westlawn, Montville, N. J.

MARINE Power—Easily convert any Ford motor (domestic and foreign) with Oco parts and kits. Complete catalogue 25c (coin). Oco Motors Corp., 2020 East Orleans Street, Dept. M, Philadelphia 34, Penna.

USED Outboard motor parts. Outboard Exchange, 1194 Remsen Ave., Brooklyn, 12, N. Y.

FULL Size, cut to shape boat patterns, blueprints. 7½ - 38 feet. Illustrated "Build a Boat" catalog, 10c (coin). "How to Build Boats" book, \$1.00. Cleveland Boat Blueprints Co., Station A-66, Cleveland, Ohio.

ENGINES, MOTORS, DYNAMOS

BARGAIN—75 H.P. twin Fairbank Morse Diesel engine; two 25 h.p. Diesel engines; good condition. F. M. Bailey, 31 David, Greenville, S. C.

TWIN-CYLINDER Air compressors \$16.75. Motors—various sizes. Hoffman, 6840 Parrish, N. College Hill 31, Ohio.

DIESEL And gasoline engines, 5 to 500 horsepower, with or without generators. Power units. New and re-conditioned "Kohler" electric systems. What are your requirements? H. Lesley Phillips, Glenmoore, Chester County, Pennsylvania.

BIG Pay jobs in welding. Complete welding lessons and reference books. 516 pages. 41 lessons. \$2.00 copy. Money-back guarantee. Hobartweld, Box 1145-M, Troy, Ohio.

MODEL Locomotives, gas, steam engines. Supplies catalogue 25c. Welding rod for aluminum, die cast, pewter. Samples and instructions 25c. Howardo, A1-2417 N. Ashland, Chicago, Ill.

SUBSTANCE Wt. and compressed air pressure (on substance) are only extra natural elements to further the usefulness of world's greatest engine, and perpetual motion. Three different separate ways to increase perpetual horsepower. \$25,000 cash and 1/3 royalty. Roy S. Johnson, Palmyra, Mo., R. 1.

"DUPLEX And simplex motors," rotary and semi-rotary fractional h.p. sizes. For water, oil, air, steam pressures—40 lbs. and up. Electric generator outfits, Duplex Motors, Burlington, Iowa.

AUTHORIZED BY W.P.B. to sell inventory of new a.c. and d.c. midgeet motors—Both geared to 4 r.p.m. Shaft speed 1250 r.p.m. 110 volts. Ideal for timing devices, displays, models. Bargain price a.c. motor \$2.00. Length 3", height 2½", width 1½", d.c. \$3.00. Length 5½", height 2½", width 3". Add 25c for postage. McLaren Products Company, 114 N.W. First Street, Evansville 8, Ind.

WINDING Data, listing 225 motors, single and three phase, \$1.00. Motor Data Co., Box 7631, Kansas City 3, Mo.

ATHLETIC EQUIPMENT, BODY BUILDING COURSES

BOXING, Jiu-jitsu. Complete course \$1.00. Joseph Dryer, 1859 Washington, Chicago 12.

BECOME Muscular! Hoist 200 pounds overhead one arm! Learn weightlifting positions, expert's secrets, "knack"! Small men—out-lift large! Show you're strongest: lift 200. Secure "Knack of Lifting," \$1.98. Anson, 619 Watson-P. Grand Rapids, Michigan.

BAR-BELLS, Exercise equipment. Courses. Special offers! Free booklet. Good Barbell Co., 3261-PM Watson Rd., St. Louis (9), Mo.

SUPER System of natural physical training. Free booklet. Harry Good, 3261-PM Watson Road, St. Louis (9), Mo.

SPORTING GOODS, GUNS, FISHING TACKLE, TRAFFING, ETC.

TRAP Fox and coyote; on bare ground or deep snow. Learn modern tricks to outwit the sly furbearers. Free illustrated circular. Q. Bunch, Welch, Minn.

CASTING Rods. Make your own with our plans and offset handle. Complete drawings \$1.00. Handle \$3.50. A. C. Bishop Co., 9535 Ohio, Detroit 4, Mich.

BOWS—Arrows for recreation, hunting, fishing. Beautiful archery instruction book, 70 pages, 50 illustrations, only 50c. Illustrated catalogue free. Archery Sales Service, 617 South State, Chicago.

AUTOMATICS, Shotguns, rifles rebuilt factory process, \$10.75. Anchor, 482, Ithaca, N. Y.

SPORT, Hunting and fishing magazines. Write for free price-list. Current single copies. Over 600 different business, vocational and diversion periodicals. Commercial Engraving Publishing Co., 34C North Ritter, Indianapolis 1, Indiana.

"I WOULD Not sell my copy at any price," declares Joseph Krajlic, Canton, Ohio, in voluntary praise of "The Gun Digest," greatest gun book value in publishing history! Magnificent, 164-page, profusely illustrated volume of 25 informative sections. Brimming with authoritative hunting, shooting techniques, secrets of the masters; plus, a reliable, comprehensive directory illustrating, describing modern rifles, shotguns, handguns, accessories. Written by 14 eminent gun experts. Paper restrictions limit quantity available. Order now. Money-back guarantee. Send \$1 (plus 10c for postage, handling.) Klein's Sporting Goods, 502-H South Halsted, Chicago 7.

CANE Fishing poles, crawfish, worms, sprouts. Bob Pace, Combs, Ark.

ELEVEN Good box traps. Complete blueprints, 30c. Wesho-Uco, Box 51, Detroit, Mich.

FISHING Pole holder, adjustable all positions, finest made, regular \$6.00, special \$3.50. Steuer, 1377 Haight, San Francisco.

HANDARMS, Rifles, shotguns—with ammunition. Colts, Smith & Wessons, Harrington Richardson's, Woodman's, Hi-Standards, Winchester, Remingtons, Browning, Springfields, etc. Decoys, luggage, hunting and pocket knives, boxing gloves, flashlights, watches. List 10c. Rudolph, Atchison, Kans.

BOY Scouts—Campers, U. S. army surplus used equipment; pup tents \$2.95; canteens with cover and cup \$1.00; messkits 75c; packs \$1.00; cartridge belts 50c. Complete set, \$5.00. Samet Sales Company, High Point, N. C.

SPORTSMAN'S Encyclopedia, 514 pages, over 1,000 illustrations. All about the outdoors! Camping, fishing, hunting, trapping, scouting. \$3.00 postpaid. Henry Schultz, Route 2, Pascagoula, Mississippi.

USED Guns, bought, sold, exchanged. List stamp. Howe Fur Company, Coopers Mills, Maine.

SHOTGUN Shells: Our 12 gauge 5 and 6 chill heavy reloads are again available. Limited supply. Shells 10c each O.P.A. established ceiling. M.O. please. Jim Clark Sportinggoods, 2029 W. Fondulac Ave., Milwaukee, Wisconsin.

NETCRAFT Kit:—Make landing nets, turtle traps, live nets, hammocks. Dollar bill brings: large, medium, small shuttles (patented), gauges, illustrated instruction booklet. Smaller kit:—Medium shuttle, gauge, booklet—50c. Netcraft, Dept. B, Toledo, Ohio.

ARCHERY Equipment: Catalogue free. Mid-West Archery, 2209-A East 75th, Chicago 49.

AMMUNITION: Hunters: Load our Rifled Lead Slugs in your own 12-gauge shotgun shells. One dozen, with wads and complete directions for loading, including postage and packing, \$2.10. Supply limited. Order today. The Kalling Company, 8026 N. Division Road, Milwaukee 9, Wis.

FIELD GLASSES, MICROSCOPES, TELESCOPES

POWERFUL Telescope lens kits—Build your own astronomical or spotting scope for fraction usual cost. Matched optical units completely finished ready to mount. Postcard brings construction plans for various types of telescopes—technical data—test chart—list outstanding optical values. Pfelegor Optical Co., P-11, Sunbury, Penna.

REAL 10 Power telescopes \$1.90. United, 2300-B Lawrence, Toledo, Ohio.

PRECISION Lenses Achromats Pyrex, 2" x 2" optical flats, \$5. 57mm diameter 142mm focus \$6. 18mm diameter 95mm focus \$2. 36mm diameter 183mm focus \$2. Lenses for Ramsden eyepieces, 1" diameter 1" focus \$1. 7mm diameter 7mm focus \$1. Send for free list. Maylor Products Corp., Kathonah, N. Y.

MAKE Your own compound microscope, lenses and instructions. 50 power \$1.00. 100 power \$1.50. 200 power \$2.00. Instructions alone 10c. Carl Jamer, Manorville, N. Y.

MICROSCOPES, Telescopes, binoculars; all scientific, chemical laboratory apparatus—bought, exchanged, repaired. Exclusively our business with a background of over 17 years of courteous, satisfactory dealing. Not get-rich-quick speculators. Trial will show we know equipment; highest prices paid. Catalog 15c. Harry Ross, 68 West Broadway, New York.

MAKE Your own powerful astronomical telescope. Perfect lenses and instructions. 100 power \$1.00. 200 power \$3.50. 400 power \$5.50. Instructions alone 10c. Carl Jamer, Manorville, N. Y.

BINOCULARS, Watches, diamonds. Buy, sell, trade. Paul Schweer, Donnellson, Iowa.

ASTRONOMICAL Telescopes, binoculars, cameras, microscopes; bought, sold, repaired. Send 10c for list of instruments wanted. Rasmussen & Reece, 41 Market, Amsterdam, N. Y.

MICROSCOPES—15 Years buying, selling, exchanging, repairing, accessories, research, industrial, amateur. National Scientific Instrument Co., 119 Chambers St., New York City 7.

ANTIQUES, RELICS, INDIAN GOODS, CURIOS

MUSEUM Supplies, Indian relics, firearms, fossils, curios, minerals, den decorations. Illustrated catalogue 25c. Museum Supplies, 6601 Oakkosh, Chicago 31, Illinois.

GUNS, Indian relics, minerals, shells, glass, china, lamps. List 5c. Guy Saulsbury, Spicer, Minn.

SWORDS, Rapiers, daggers, pistols, armor, illustrated catalog 25c. Robert Abels, 860-A Lexington Ave., New York.

20 GENUINE Indian arrowheads, \$1.00. Cat. Geo. Holder, Glenwood, Ark.

MINERALS, Coins, stamps, Indian relics, pistols, old glass. Catalogue 5c. Cowboy Lemley, Las Cruces, New Mexico.

INDIAN Relics, beadwork, coins, curios, minerals, old glass. Catalog 6c. Indian Museum, Osborne, Kansas.

DOGS, PETS, BIRDS, RABBITS

PEDIGREED White New Zealand rabbits, white mice, caviae, hamsters. Folder 10c. Fairfield Rabbit Farms, Caldwell, N. J.

WILD Geese, ducks, peafowl, pigeons, rabbits, pheasants. Prices free. Jewell Game Farm, Danville, Ill.

LEARN All about mink ranching. Send 25c for booklet. The year on a mink ranch. John Ludwig, Mohnton, Penna.

RABBITS, Most breeds. Write needs. Bay Farms, Box 59, Hayward, Calif.

RAISE Rabbits. We pay \$6.75 to \$18 each. Breeding stock furnished. Illustrated literature 10c. Hansens Rabbitry, 2744 So. State, Salt Lake City 5, Utah.

STANDARD Rabbit Journal, Milton, Pa. 3 years \$1.00. Sample dime.

RAISE Giant Chinchilla rabbits, Willow Farm, R15C, Sellersville, Penna.

CHIN-CHAMP Heavyweight Chinchillas—Profit producers. Jumbo caviae. Small investment, optional market, post-war income. Complete details, Journal, 25c. Books, 50c. Highland Fur Farms, Pearl River, New York.

RABBITS, New Zealand, reasonable. River Hill Rabbitry, Box 644, Eagle River, Wis.

LEARN All about Angora rabbits—wool brings \$9.00 pound. Book tells everything. "Angora Care-Management" regular \$1.50, special \$1.00. Catalog Angoras free. Grinsteads, Dept. 15, Edwardsville, Illinois.

CAGE Birds, interesting, profitable. Circulars 10c. Palsal's, Box 2622, Sacramento, Calif.

ST. BERNARD Pups: Champion sired beauties. Franklin Young, R4, Riverhead, Long Island, New York.

RAISE Guinea pigs. Make money at home. Big demand. Free booklet. Taylors Guinea Pig Farm, Hapeville, Georgia.

COTTONTAIL Rabbits, jumbo frogs, fishing poles. Vol Brashears, Berryville, Arkansas.

RAISE Rabbits for profit. Magazine puts you in touch with markets. Copy 10c. Booklet describing twenty breeds, and magazine for three months 25c. Address American Small Stock Farmer, Dept. 3, Pearl River, N. Y.

RAISE Money-making Angora rabbits. Wool \$9.00 pound. Plenty markets. Particulars free. White's Rabbitry, Marion, Ohio.

RAISE Your own meat—also make money raising pigeons. Booklet dime. Gebhardt Farm, Muscatine, Iowa.

RABBITS: Flemish Giants, New Zealand. Reasonably priced. Franklin Young, Riverhead, Long Island, New York.

MICE, Rabbits, pigs, pigeons. Information 10c. Jim Houck, Timn, Ohio.

FARMS, FARM LAND, REAL ESTATE

FARM Bargains. Free catalog, 7 mid-west states. Many fully equipped for convenient quick start. Many pictures. Special service to help you locate quickly, if you state requirements, payment plan and general location desired in first letter. United Farm Agency, 7-MP South Dearborn, Chicago 3, Ill.

OSARKS Guide, Lonsdale, Arkansas. Magazine for home-seekers, sportsmen. Year, \$1.00.

FLORIDA Lands on easy payments. R. W. Stewart, Inverness, Florida.

OSARK Farm bargains. 5 to 5000 acres. Frank, Mountain View, Mo.

FREE Fertile South-American lands! Fifty acre homesteads or 25,000 acre livestock ranches. Valuable illustrated information, 25c (refundable.) Valles, 395-NP Broadway, New York 13.

\$5.00 **MONTHLY** Buys 40 acres, near town; price \$175.00. Free list. Box 425-P, Carthage, Mo.

HOMESITES \$200.00, On easy payments. In California's loveliest garden spot on wooded shores of Morro Bay, midway between Los Angeles and San Francisco. Wonderful fishing, boating, hunting. Excellent soil, soft water. Grow fruits, vegetables, poultry, etc. Unusual investment opportunity. Free literature. Richard Otto, Dept. M, 6560 Hollywood Blvd., Hollywood 28, California.

GOOD Farms—Ranches. Washington, Minnesota, Montana, Idaho, Oregon, North Dakota. Dependable crops, favorable climate. Write for literature, lists describing typical farms. Specify which state. J. W. Haw, 119 Northern Pacific Ry., St. Paul, 1, Minn.

OSARK Lands for all purposes. Actual river frontages, 5 acres \$90.00 and upwards. Free list and literature. Hubbard, 216 Grossman Bldg., Kansas City, Kansas.

FARM MACHINERY AND SUPPLIES

NEW Farm machinery book. Learn your farm machinery better. A time and money saver. \$1.00 postpaid. Wirtson's, West Burlington, Iowa.

BUILD Your tractor from second-hand automobiles. Convert your horse drawn farm equipment into tractor drawn equipment. Nolan's Garage, East Wareham, Mass.

SEEDS, PLANTS, NURSERY STOCK

TREE Sprouts: Sugar tree maple, black walnut, persimmon, wild cherry, vining honeysuckle, many others. Christmas mistletoe. Bob Pace, Combs, Ark.

POULTRY AND FARM SUPPLIES

MAKE More money with poultry. Magazine with Experimental Farm explains how. Order today! Two years 50c; five years \$1.00. Poultry Tribune, Dept. 30, Mount Morris, Ill.

YOUR Greatest poultry problem will look simple when you read American Poultry Journal regularly. 500,000 poultrymen do, why not you? Only 25c year, 5 years \$1.00. American Poultry Journal, 533 South Clark, Chicago.

KNOW How to raise poultry for profit. Read Northeastern Poultryman. Every issue packed with helpful hints and practical suggestions. Latest articles on breeding, feeding, and management. Read nationally. Subscribe now. 1 year 65c; 2 years \$1.00. Northeastern Poultryman, 4M Park St., Boston 8, Mass.

RAISE Turkeys the new way. Write for free information explaining how to make up to \$3000.00 in your own back yard. Address National Turkey Institute, Dept. 3, Columbus, Kansas.

PROFITABLE OCCUPATIONS

GROW Ginseng, instructions free, seeds reasonable. Specialty Farm, Rockford, Minn.

MEN—Open your own electrical appliance service shop. Complete, illustrated course covering house wiring, motor repairs, household appliance repair. Free booklet. Appliance Service, 4701 West Pico, Dept. PA-11, Los Angeles 6.

PHOTOGRAPHY Without camera. Making photo stamps. Instructions \$1.00. Alvin, 553 William, Winnipeg, Canada.

HOMEWORKERS, Make, sell, shell novelties. Beginners samples, instructions, \$1.00. Temple, 2152 Tangerine, St. Petersburg, Fla.

MECHANICALLY Inclined men — Own and operate general appliance repair shop. Complete, illustrated course shows you how. Welding, refrigeration, motor repair, how to get business, etc., all phases covered. Free literature. Christy Supply Dept. 446, 2835 N. Central Ave., Chicago.

TYPEWRITER Repairmen urgently needed. Earn \$40 to \$50 weekly spare time. Our easy to learn home study course teaches how to repair typewriters. Write for free information. Houston Typewriter Repair Service, P.O. Box 5357C, Houston, 12, Texas.

EXCEPTIONAL Profits raising mink. Finest breeding stock available. Details furnished. Franklin Young, Riverhead, Long Island, New York.

GOLD-STAMPING. Exceptional post-war opportunity. Free booklet. Home City Specialties, Dept. 1273, Springfield, Massachusetts.

PLASTICS. Molds, plaster casting instructions 50c. Alvin, 553 William, Winnipeg, Manitoba.

MUSHROOMS Grown in boxes. Spawn instructions \$1.25. Gordon, 553 William, Winnipeg, Manitoba.

WELDING Pays. Learn with 1942 trade school text manual, 516 pages. Over 500 photos. \$2.00 copy. Money-back guarantee. Hobartweld, Box M-1143, Troy, Ohio.

MAKE Strange new plastic at 5c gallon. Sells 50c. Makes floors, walls, roofs. Sample free. Bays Laboratory, Oklahoma City 9.

ELECTRIC Clocks are every where you go, buildings, homes, parking-lots, factories. Repairs increasing. Our easy to learn course with pictures and drawings teach you how to repair these clocks. Electronic Supply Co., Dept. A, P.O. Box 2350, Houston 1, Texas.

LEARN Refrigeration mechanics. Start your own repair shop. Complete illustrated course. Free booklet. Mechanics School, Dept. 1-PM, 4703 West Pico, Los Angeles 6.

POSTWAR? Prepare now to become associated with us in an essential proven profitable profession. Universal Exterminators, 950 Margate Terrace, Chicago 40, Illinois.

\$40.00 **WEEKLY**. Made growing mushrooms, fresh, dried. Dominion patent 331583. Free spawn. North American, 169P Yonge, Toronto, Canada.

LOCKSMITHING Now made easy! New course teaches you how to pick locks, fit keys, de-code, masterkey, etc. Self-instruction lessons, Bargain price. Free details. Write Nelson Company, Dept. 7-02-2, Chicago 4.

ANNOUNCING New home study course in commercial baking. Good field. Nearly depression proof. Common school education sufficient. Send for free booklet "Opportunities in the Baking Industry" and requirements. National Baking School, 1315 Michigan, Dept. 343-B, Chicago.

STANDARD Rabbit Journal, Milton, Pa. 3 years \$1.00, sample dime.

BOOKS, PERIODICALS, PICTURES, POSTCARDS

MAGAZINES—Business, vocational, diversion. Keep posted on conditions, developments, opportunities. Write for free descriptive price-list. Current single copies. Over 600 different periodicals. Commercial Engraving Publishing Co., 34C North Ritter, Indianapolis 1, Indiana.

SAVE Money by writing for our lists of special cut-rate books, many at less than 50% of original price. Pines, Box 32, Flushing, New York.

WE Supply all technical, hobby books. Ask for free catalogs specific subjects. Modern Technical Book Co., 55 West 42nd Street, Dept. MMC, New York.

"**GOLD** Ahead," book which cures lean purses, praised by Liberty Magazine. Details free. Shirley, 1410 Linden Avenue, Baltimore 17, Maryland.

PICTURE Yourself successful—Free information. New original idea—brings more dollars to you. Write W. H. Cook, 102 Walnut, Hot Springs, Ark.

BACK Issues, magazines, mechanics, homecraft, good photography and others. Write for prices ones wanted. Morris Birge, Hinsdale, Ill.

ARTISTIC Girl pictures. Real models. 40 photos for \$1.00 postpaid. All different, postcard size. C. O. Scott, P.O. Box 343, Covington, Ky.

WHAT'S New in books? Monthly Book News, 12 months \$1.00. (Sample 25c.) Roc's, 2650K Rochester, Detroit 6, Mich.

BACK-DATED Magazines, foreign, domestic, arts. Catalog 10c (refund). Ciccone's, 863 First Ave., New York 17, N. Y.

ARTISTIC Girl pictures. Attractive models in beautiful poses. 20 to the set for \$1.00 postpaid. W. Roberts, Box 2622, Portland 3, Oregon.

BECOME Master of your own destiny, make your own breaks, don't trust everything to luck. Assure yourself of success and happiness. Wonder booklet tells how. \$1.00 postpaid. Literature free. Dorian Johnson, Box 313, Newport, Washington.

GORGEOUS Girl photos, 3x4 to 5x7, 15 for 25c. Richardson, Wyoming, Penna.

UNUSUAL Books. Catalog and sample 25c. Lefavor, Box 229, San Bernardino, Calif.

WHAT Every Mason wants. We have Masonic books for Blue Lodge, Chapter, Commandery, Scottish Rite and Shrine. Our rituals are used the world over. Send for free catalog of books and rituals for Masons, Odd Fellows, Knight of Pythias, Knights of Columbus, Elks, etc. Ezra A. Cook, Publisher, Inc. P.O. Box 796-PN, Chicago 90, Ill.

CLASSIC Pin ups, actual glossy photographs of Hollywood's glamorous film stars, full length, new fascinating poses. 20 for \$1.00, 45—\$2.00. All different, size 3 1/2 x 5 1/2. Charles Scott, P.O. Box 342, Covington, Kentucky.

HOW To get what you want. Psychology method. Unfailing book \$1.00. Booklovers Publishing Co., 28 Cassius Street, New Haven 11, Conn.

A RATIONAL View of Life \$1.00. Benjamin Seibert, Urbana, Ohio.

GOLD Ahead. Free literature. Seaman, Box 1922-D, Portland 11, Oregon.

LOCOMOTIVE, Largest steam, 8" x 10" photo, 50c. Rinehart, Engr., 332 S. Michigan, Chicago 4.

"**ALL** About Nothing." Book that helps develop intelligence. Banishes fear. Illustrated. \$1.00 postpaid. Redmont Company, P.O. Box 9264, Los Angeles 5, Calif.

FREE Catalogue, various books. Write Golden, 5730P Keith, Oakland 11, Calif.

HOW To draw from art models, 50c. Art in models, \$1.00. Photography in art, \$1.50. 3 books featuring photographic reproductions beautiful artists' models. Combination price—3 books, \$2.00. Fraser, 215A Montague Street, Brooklyn 2, N. Y.

BOOKS Full of formulas, money making ideas and Bargain Buyer's Guide. Literature free. William Powell, 618 Wallace St., York, Penna.

100,000 **POST-WAR** Jobs abroad—South America, China, India, Burma, Japan, Russia, Malaya. How and where to apply now. Post-war U. S. participation in world reconstruction and trade demands thousands of American-trained mechanics, salesmen, technicians, engineers, foremen, laborers and business representatives—every trade needed. Our 15,000-word, copyrighted forecast—compiled from business, professional and government sources—lists over 200 big U. S. firms with foreign interests, gives job information, salary brackets, contract tips, application letters, passport information, climatic conditions, etc.—everything needed for your immediate application. \$1.00. Return for refund in 7 days if not satisfied. Pacific Industrial Research Bureau, 202-E Studio Building, Portland 5, Oregon.

BOOKFINDERS! (New, used scarce books) secured promptly. Send wants, Clifton, Box 2233x Capitol Station, Austin, Tex.

BRIDGE To success. Prepare for tomorrow. Read and study today. Free list of best books on mathematics. Technicraft Book Co., Box 767A Grand Central Annex, New York 17, N. Y.

ART Pictures. Beautiful girls, 15 50c. United, 2309-C Lawrence, Toledo, Ohio.

FREE Catalog, lowest prices, domestic and foreign magazines, newspapers, professional and trade journals by subscription. Agents wanted. Sutherland Magazine Agency, Dept. M, Ringgold, Virginia.

STEAM Automobile book "The Modern Steam Car." Complete history steam cars old and new, 100 pages, 51 illustrations. Boilers, generators, engines, bodies, valves, condensers. Early models illustrated, described. Stanley's history by Mr. Stanley. Unique, interesting, historical book. \$2.00 postpaid. Clymers, 2125 W. Pico, Los Angeles 6, Calif.

WRITER'S Instruction books. World's largest collection. List free. Humanity Press, 220 West 42nd St., New York 18.

GORGEOUS Full-color pin-ups. 50 different \$1.00. 160 different \$3.00. Samples 10c. Theron Fox, 1024-B Carolyn, San Jose 10, California.

PIN-UPS. Beautiful girl models, over 200 selections. Send \$1.00 for big package. Ball Square Company, 210 5th Ave., New York City.

ART Pictures—5x7—colors. Dozen 35c. Curtis Specialties, Box 1916, Denver, Colo.

"**FOOLIES**" Contains cartoons, gags, stories. 10c. Alstone, 406, Lunenburg, Mass.

PIN-UPS. 3 1/2 x 5 1/2 Curvesome cuties in fascinating poses. 40 for \$1.00. 160—\$3.00. Samples 25c. Richardson Studios, Wyoming, Penna.

BOOKS—Tell us your wants. Chapbooks, 6 Girard, Rochester 10, N. Y.

PIN-UPS. Gorgeous girls, full color. Sample 8x10 and 3 1/2 x 5 1/2 10c. Arthur Fowler, Room 1, 697 Broadway, Somerville 43, Mass.

CHINESE Physicians, secrets, 165 pages, rare illustrations, unpublished truth, secret healing arts, peculiar custom. \$1. Write Garding Lul, Box 6227, Metropolitan Station, Los Angeles, California.

RARE, Out-of-print books located. Bookfinders, 1210N 11th Ter., Birmingham, Ala.

64 ART Cards of gorgeous beauties \$1.00. Reed Novelty, Dept. PM-5, Box 24, Queens Village 9, N. Y.

"PIN-UPS," 180 Gorgeous girl subjects! Huge bargain pack \$1.00. Clover Novelty Company, Dept. 36-DD, Hollis 7, N. Y.

SELF-EXPLAINING Bible: Illustrated circular free. Box 446-P, Minneapolis, Minn.

BOOKS. (Out-of-print, new, used) quickly supplied. Many 35c bargains. Catalogue. T. Jamkowski, 18870 Marx Ave., Detroit 3, Mich.

DRUNKENNESS Is a disease which responds to treatment. Medical skill plus human sympathy prove successful with liquor and drug cases. 60 years experience. Write for free booklet. P. M. Nelson, The Keeley Institute, Dwight, Ill.

GAMES, ENTERTAINMENT

ENDWOOD Dart board—3 regulation darts, 2 sides, 19 1/2 square, \$7 seller, \$5.00 postpaid. B. Smith, 2475-77th Ave., Philadelphia 38, Penna.

THREE Playing card games, 25c pre-paid. Box 842, Denver 1, Colo.

MAGIC TRICKS, PUZZLES, JOKER NOVELTIES

ENTERTAIN, Mystify. New, bigger magic catalog and 4 secret tricks 25c. Borinstein, P-192 N. Clark, Chicago 1.

FUN Galore! Magic races—8 for 25c, 40 for \$1.00. Russ Chaney's Hobby World, 1505 Del Norte, St. Louis 17, Mo.

MAGIC Is fun! Send \$2.00 for apparatus to perform 10 different, startling tricks. Guaranteed \$5.00 value! Free, with your order, book of "102 Tricks." Robbins Co., 152 West 42nd St., New York.

TRANSFER Liquid formula—Transfers pictures off funnies, newspapers, etc. Sample of work free. National Specialty Service, Box 216, Manassas, N. J.

ENTERTAIN Telling fortunes, Rahama's secret explained only 15c. Viking, Box 21, Hinesville, Georgia.

EIGHTY Magic and party stunts. Illustrated book. Information untold value. Regular \$1.00 now only 50c. Limited edition. Buse, 878-PM Fillmore, Buffalo 12, New York.

TRICKY Match box, it turns around! It stands up! and it opens, most weird, uncanny magic novelty trick, complete, ready to do, 25c. The Magician, 2463-M, Kensington Ave., Philadelphia, Penna.

LEARN Ventriloquism, 3c stamp brings particulars. Smith, 801 Bigelow, Peoria, Illinois.

REDHOT Comic fisherman's diploma 50c each, 4 for \$1.00. Troy Ginn, Tyler, Texas.

WORLD'S Most amazing pocket trick \$1.00 postpaid complete. Murray, 615 Main Street, Latrobe, Penna.

LEARN Ventriloquism. Book \$2.00. Gotberg, 15801 Prest, Detroit 27, Michigan.

VENTRILOQUISM! Easy method 25c; crystal gazing 25c. Parker Publications, Peterboro, Ont., Canada.

21 WAYS To overcome stage fright by MacKenzie Gant. Price one dollar. Four current catalogs 25c each. Thayer's Studio of Magic, Box 1785, Wilshire La Brea Station, Los Angeles 36, Calif.

15 DIFFERENT Professional magic tricks and puzzles. All materials, complete instructions. \$1.00. Theron Fox, 1024-B Carolyn, San Jose 10, California.

AMAZE Everyone. Answer unspoken questions. Professional "no assistant" mindreading act, \$1.00. Magical Enterprises, Box 111-P, Levering, Mich.

DISAPPEARING Key 50c. Practical Jokers kit \$1.00, 10 card tricks, magic package with each order. Lindhorst Magic Den, St. Louis 1, Mo.

SEND 25c For \$1.00 worth of magic tricks and our latest catalog. Ball Square Company, 697 Broadway, Somerville 44, Mass.

APPARATUS To perform four tricks. Dollar value 25c. Windsor Magic Mart, 2443-A E. 78th Street, Chicago 49, Illinois.

VENTRILOQUISM, Complete instructions only \$1. Lesueur, 77 Wellesley, Toronto, Canada.

NEW! Simplified card tricks! Amazing self-working bafflers 50c postpaid. James W. Roundtree, 529 Elliott St., River Rouge, Michigan.

500 TRICKS You can do! Douglas' famous catalog of 500 tricks, now only 10c. America's fastest service on magic for pocket, parlor, stage, professional, amateur. Douglas Magic Shop, Box 274, Dallas, Texas.

BE A magician. Large professional magic catalogue of latest tricks 25c. Ireland, C-109 North Dearborn, Chicago 2.

MAGIC Tricks, puzzles, books, cards, punch boards, Catalog 10c. Specialty, Box 671, St. Louis 1, Mo.

WORLD'S Largest professional magic shop keeps you in touch with latest tricks. To receive mailings send 25c for 1943 catalog. Holden, 220 W. 42nd St., New York.

NEW Vanishing key and catalog 25c. Sterling Magic, 345 John R, Detroit, Mich.

HOLLYWOOD Special! Magicians button, catalogue, ghost illusion and free trick for 25c. Magic House of Charles, Box 888, Hollywood, California.

EARN Money in any crowd. Call names of strangers, tell unspoken questions. Professional course mind reading, spirit writing, etc., \$1. Henderson, Box 341, San Bernardino, Calif.

COINS, TOKENS, CURRENCY

WE Buy Indian pennies, Lincoln pennies, and old rare coins. Highest prices paid. Indian pennies worth up to \$15.00 each. Lincoln pennies up to \$2.00 each. Other rare coins \$5.00 to \$2000.00 each. Send 10c today for new 1944 price catalogue of all wanted U. S. coins. American Rare Coin Co., Dept. 1, Transportation Bldg., Chicago.

DOLLAR Assortments, every item different. 22 paper moneys, 10 encased postage stamp money, 30 foreign coins, 25 Indian head cents; each lot \$1.00. All-Nation, 157-LP West Lake, Chicago 1, Ill.

FOREIGN Coins, 15 different \$1.00 postpaid. Stamp for price list. Frank Katon, Milford, Conn.

OLD Money wanted. Do you know that coin collectors pay up to \$100.00 for certain U. S. cents? And high premiums for all rare coins? We buy all kinds! Send 4c for large coin folder. May mean much profit to you. Numismatic Co., Dept. 20, Fort Worth, Texas.

CENTS—10 Different Indians 25c, 10 different Lincolns 8 mint 25c, 1944-5 cent nickel dime 25c, coin book 35c. Coin Shop, Box 77, Alameda, Calif.

HIGHEST Prices paid for United States gold, silver and copper coins. Catalog 25c. E. M. Shroyer, Lakeview, Ohio.

FOREIGN Coin and lists 10c. Oddehon, Box 482, St. Louis, Mo.

WILL Pay \$10.00 each for certain Lincoln pennies! Indianheads \$50.00; dimes \$1,000.00. Catalogue 10c. Federal Coin Exchange, 10-PM, Columbus, Ohio.

4 ROMAN Coins 2000 years old \$1.00, 30 different foreign coins \$1.00, 100 different \$4.00, 43 mixed Indian cents \$1.00. Lists, approvals. Delmonte, 725 West 172, New York 32.

50,000 COINS, Medals, paper money. Lists free. Nagy, 8-R South 18th, Philadelphia 3, Penna.

12 WOODEN Nickels \$1.00, 25 different Indian head cents \$1.00, Bargain lists 3c. Large retail catalogue 10c. Copyrighted buying list 6c. Beben Coin Company, 1180 East 63rd, Chicago 37, Illinois.

COMMEMORATIVE 1/16s, Columbus, Stone Mountain Texas, Cleveland, \$1.50 each, new. Illustrated catalogue 25c. Norman Shultz, Salt Lake, Utah.

FREE! Large illustrated price list of coin albums, coin books and other supplies for coin collectors. James Randall, 341 South Dearborn, Chicago 4, Illinois.

QUICK Service; reasonable prices. United States catalog 10c. Foreign catalog 10c. Ben's Coin Company, 72 West Washington, Chicago 2, Illinois.

CENTS. Large uncirculated or extra fine wanted. Give price first letter. James Peck, 1342 Carlotta, Berkeley 3, California.

10 INDIAN Head cents, different dates, also pricelists, 40c. Schultz, 1053 Richmond, Cincinnati, Ohio.

GET Profit and pleasure in collecting old coins. Send 10c for 56-page illustrated coin catalog. You'll be delighted with it. Send for it now. B. Max Mehl, 370 Mehl Bldg., Fort Worth, Texas. Largest rare coin establishment in U. S. Established 44 years.

FREE! Foreign coin, banknote and coin collectors illustrated catalog to approval service applicants. Send 3c postage. Tatham Coinco, Springfield-125, Mass.

I MAY Have just the scarce U. S. coins you want. Send me list. "Meet me by mail." William H. Kenworthy, Waterville, Maine.

STAMP COLLECTING

INTERESTED In unusual material from out of way countries not generally found in low price approvals? Kirklands, 7212 Farwell, Chicago 31, Illinois.

114 DIFFERENT Stamps from far away countries including airmail and Free Fighting French to approval applicants for 10c. Reich Stamp Co., 4647 Kenmore, Chicago 40, Dept. M9.

75 DIFFERENT United States stamps 10c to U. S. approval applicants. Davis Stamps, 172 Clinton Place, Hackensack, N. J.

FREE: Giant surprise packet. Approvals. Universe Stamp Co., 646 W. 48th Place, Chicago 9, Illinois.

UNITED States, No. 182, No. 183, No. 206, No. 248, No. 272, No. 283, No. 649, No. C27. Send 30c. Approvals accompany. Whitton-Stamps, Norwalk, Connecticut.

SPECIAL—Airmails, 21 different, including zeppelin, triangles, Latin-America, 5c with approvals. Continental Co., (Dept. B), Box 606, New Rochelle, New York.

WAR In the Pacific, 50 different from fourteen countries in the Near East 10c with approvals. Champion, Box 4725A Florence Branch, Los Angeles 1, Calif.

60 DIFFERENT United States. Includes commemoratives, higher values, airmail, 10c. Charles Stone, 3547 28th St., Astoria 1, N. Y.

BOY! Oh boy! What beautiful sets! On approval. Reasonable, Traffic Sta. Box O, Minneapolis, Minn.

POSITIVELY Greatest free offer—Latest Scott's International \$5.00 Stamp Album—covering entire world, contains 38,000 illustrated, descriptive spaces; Scott's 1944 Standard \$5.00 catalogues "Philately's Encyclopedia"—absolutely free to applicants for foreign approvals becoming customers. Bargain Stamp Service, Palm Springs, California.

FINE Approvals, freshly mounted. Fast, personal service. Tell me what countries you prefer and I'll send your stamps. Skinner, 345 East Ocean, Long Beach 2, Calif.

FIFTY Canadian, Newfoundland, including earlier, commemoratives, 10c. Approvals. Reede, 696 Gerrard, Toronto.

SPECTACULAR Approval service for collectors using International Junior or Modern albums. Loewy, Aberdeen, Maryland.

FREE Your choice of any 10 stamps from our first U. S. approval selection. List included. Cosmopolitan Stamp Company, Dept. M-11, 1457 Broadway, New York City.

AMAZING Offer! Assortment each of giant stamps, midget stamps, flag stamps, airmail stamps, Free French Colonies, U. S. commemoratives and numerous others. Everything only 10c to approval applicants. Simon, Box 214, Iraan, Texas.

CHOICE Foreign approvals, carefully selected and properly priced to bring you the most desirable stamps possible in the low price range. Good free gifts to purchasers. References please. G. E. Mitchell, Box 1357, San Antonio 6, Texas.

FREE—World's only octagonal (eight-sided) stamp and 70 year old Turkey set to approval applicants. Charles Cleaveland, 806 North Humphrey, Oak Park, Ill.

AIRMAILS! Mint! 5 free with foreign packets. 300 different 18c. M. O. Stamp Company, Route 2, New Milford, Conn.

FINE Approvals freshly mounted. Fast personal service. Filing of want lists. Phoenix Stamp, Dept. 3M, 120 West 44th, New York.

STOCKBOOK! To hold over 400 stamps 20c, 6—\$1.00. Nu-Way, 205 E. Broadway, New York City 2.

BETTER Stamps at lower prices. Pedor Stamp Service, 246 Wallington Ave., Wallington, N. J.

SPAIN, 50 Different, 10c with approval selection. Paul Rawden, Box 2920, Westville, New Haven, Conn.

FREE—Postcard will bring you our fine approvals and special gift. R. K. Holcomb, Gallaudet College, Washington 3, D. C.

WANTED—United States and foreign stamps. Highest prices paid. Groman, 306 East Hamilton, Allentown, Penna.

APPROVALS, 50% Discount on first order. S. Wooding, 1960 Las Lunas, Pasadena 8, Calif.

25 BULGARIAN Pictorials 5c to approval applicants. Walter Kotowski, 5864 St. Aubin, Detroit 11, Mich.

28 DIFF. Mint Russian 4c with approvals. Fred Mattie, No. 1610 Albert St., New Castle, Penna.

FREE Packet and 15c worth stamps free from first approval selection. 5c mailing. Osterhoudt, 260 Park, Hackensack, N. J.

FREE! Approval applicants select 10c worth free—your choice. Excel, Box 1315, Chicago 90.

EUROPE—40 Years old—15 different 10c. Elsen, Bowling Green, Ohio.

1000 MEXICO Mixed 95c. 2000 \$1.80, check, moneyorder. C. Biehl, Apartado 2887, Mexico, D. F.

GUATEMALA—25 Different 10c. Approvals. E. R. Johnson, P.O. Box 267, Morgan Hill, Calif.

EXCHANGE Your duplicate stamps. C. Bishop, Route 8, Kalamazoo 88, Mich.

BOOKS For stamp collectors. List free. Helpful Book League, 15 East 40th St., New York, N. Y.

50 FREE, Pictorial, etc., stamp dictionary, list. Bullard, Newcastle, Maine.

LIBERIA—Six different, triangles, 20c. Approvals. Dudley Hoskins, Gonzales, Texas.

PICTORIAL Malta set unused 10c with approvals. Vargo Stamps, Racine, Wis.

AUTHORITIES Buying, selling everything. Stamps, coins, currency. Levine's, Wooster, Ohio.

FREE! Choice set to approval buyers. "Ace," Box 344, Johnson City, N. Y.

FREE—30 Different U. S. with approvals. Taubers, 1755 Ocean Parkway, Brooklyn, N. Y.

ICELANDIC Stamps. Send me registered letter 1 dollar and I will send you 25 fine old and new Icelandic stamps in reg. letter. Valdemar Johannesson, Eskifjordur, Iceland.

FREE, Complete Cuba tobacco set with approvals. Seminole, Glenburnie-1, Maryland.

\$25 PARCEL New issues on approval. No references. Layne, 2660M Rochester, Detroit 6, Mich.

SOUTHERN Stamp Co., Box 70, Miami, Florida. Scarce low priced foreign approvals. Return postage paid.

105 VARIETIES Including mint British Colonials, 5c. Approvals. Rex, 39 Blackstone, Bangor, Maine.

FREE, Greenland-Iceland packet. Postage. Frits, 1699 Riverview, Decatur 45, Illinois.

PICTORIAL Approvals you will like. Oranoto Stamps, Kitchener, Ontario, Canada.

U. S. And foreign mixture packet, 3c to approval applicants. Smith, 237-A 8th Avenue, Roselle, N. J.

LOW Priced United States approvals. Steger, 1185 Downing, Denver 3, Colorado.

1c TO 10c Foreign approvals. Beaumont Stamp Exchange, 2667 McFaddin, Beaumont, Texas.

FREE! Unused Cuba Roloff commemorative to approval applicants giving references. Riedell, Greensburg, Penna.

AIRMAIL, U. S. and foreign bargain lists free. Gaydos, Kenosha, Wis.

YOU Get better stamps on approval from Kardasz & Co., 1575 W. Holt Ave., Milwaukee 7, Wis.

50c EACH—700 foreign; 1,000 Canada; 1,000 British. Seiden, 1331 Intervale Avenue, New York City 59.

UNITED States stamps on approval. Low prices. Box 488, Minneapolis.

1000 DANDY U. S. mixture 25c. Monjar, 1750 Fairmount, Cincinnati, Ohio.

U. S. Price list. Send postage. Stanley Gibbons, 38-P Park Row, New York.

34 SIAM, Canada, India, etc., 3c with approvals. Hammond, North Bellmore, New York.

LIBERIA 1937 Animal triangles, 6 different, catalog 42c, only 15c to approval applicants. Western Stamps, Box 4042, Los Angeles 24, California.

JOB Lots \$1.00, \$2.00, \$5.00. Satisfaction guaranteed. Old Quarter Stamp Shop, 706 Royal, New Orleans 18, La.

100 DIFFERENT 10c With approvals. Jacobsen, 59 Nagle Ave., New York 34, New York.

100 DIFFERENT Worldwide, 10c. Approval bargains. Edgar Meitzen, Fayetteville, Texas.

FREE! Cuban Tobacco issue to approval applicants. Wm. Thiem, 136 East 47th Street, New York City 17.

50A POPULAR MECHANICS

NAVAL Covers, price list free. Werve, Box 951, Saginaw, Mich.

COLOMBIA Packet all different 3c with approvals. Cline, Clifton, New Jersey.

VATICAN City, Eritrea, Falkland Islands, Mauritius, Nyassaland, Selangor, African airmail, Kenya, Tanganyika, South America, Asia, British Colonies. Many others. Swell packet, 5c to approval applicants only. Kenwood Stamp Co., 321-M Burchett, Glendale 3, California.

100 DIFFERENT Airmails \$1.00, 200, \$3.00. Paltra, 2664 Grand Concourse, New York 58.

SUPERB Approvals, net prices. Stamps 1/3 to 1/8 catalog. P. G. Beals, 170A Tremont St., Boston, Mass.

U. S. Flag stamps No. 909-20 complete. Mint. \$1.00. Tropical, 720 N.W. 61st Street, Miami 38, Florida.

222 DIFFERENT, 10c. Approvals. Best Stamps, Box 139, Bangor, Maine.

SENSATIONAL Offer: Abyssinia, Nyassa, Liberia, Tete, Inhambane, Congo, old and recent U. S. commemoratives, triangles and other stamps. Everything only 10c to approval applicants. Lawrence Stamp Co., Box 3507, Oklahoma City, Okla.

VALUABLE Free premiums with attractive, interesting, mounted, penny approval international. Carey Stampateria, 1304 Lansdowne, Darby, Pennsylvania.

100 DIFFERENT U. S. 35c. Verne, 6330 Oak, Kansas City 5, Missouri.

SCARCE Mongolian pictorial portraying wild horse chase, (catalog value 40c!), hard to get stamp from Transcaucasian Federated Republics, plus host of others from Russia, Tannu Touva, Latvia, Thrace, etc., only 5c to approval applicants. Big dime packet list free with each request. Methuen Stamp Service, Inc., Dept. 36, Lawrence, Mass.

EXTRAORDINARY Pictorial collection—Nigeria, Southern Rhodesia, Dutch Indies, Martinique, Newfoundland, Philippines, Porto Rico, St. Pierre and Miquelon, Djibouti, Senegal, Ceylon, Jugoslavia, Ivory Coast, Madagascar, Reunion, Wallis and Futuna. Everything only 5c. Imperial Stamps, Box 311, Yonkers 1, N. Y.

WORLD'S Largest diamond and triangle stamps, free stamp magazine, stamps from fighting Free French, 20 stamps from 20 different countries, pictorials, airmails, big bargain 5c with approvals. Capital Stamps, Dept. 2, Little Rock, Ark.

FREE Bavarian railway set. Big price list 5c. Oscar Griska, 735 North Dearborn St., Chicago, Ill.

APPROVALS 1/2c Up. Betts, 1267 Tutwiler, Memphis 7, Tenn.

FINAL Clearance—500 mixed approval remnants, etc.—\$1.00. Beacon Sales, Maynard, Mass.

LEBANON 137-38A (5) 8c With 1/4, 1/2, 1c approvals. Carroll's, 745A W. 45th, Los Angeles 37, Calif.

10 TRIANGLES Free. Mozambique airmail-commemoratives. Request details! Reuter, 611-C West 40th, Los Angeles 37.

118 DIFFERENT Stamps including commemoratives, charities, airmail sets, etc., only 3c to approval buyers. We buy collections. Badger Stamp Co., Milwaukee 3, Wis.

500 UNITED States for 10c! 500 United States—absolutely unpicked and unsorted—just as received from church missions. Many varieties, including large commemoratives, airmails, high denominations up to \$5.00! Stampdom's biggest package of fun—and you might find something really valuable! Price only 10c to serious approval service applicants. Money back if not delighted. Illustrated bargain lists with each order. Mystic Stamp Company, Department 80, Camden, New York.

FREE! The Stamp Finder! Send today for the big new edition, fully illustrated, enabling you instantly to identify all difficult stamps! Also fine packet strange, fascinating stamps from Bosnia-Herzegovina, Monaco, Patiala, Cyprus, etc., including maps, ships, animals and strange scenes. All free to approval applicants including 3c postage. Garcelon Stamp Company, Box 900, Calais, Maine.

1000 MIXED U. S. old and new 25c. 2 lbs. \$1.00. Weatherby, Medina, Ohio.

FREE! Complete "United States" stamp catalog with 1,000 illustrations! Send 10c to cover mailing. Harris & Co., 137 Transit Building, Boston, Mass.

PENNY Approvals, that satisfy. Neil Gronberg, Box 5441-P, Philadelphia 43, Penna.

U. S. Collection, all different, 50—10c; 75—25c; 100—45c; 125—95c; 200—\$1.75; 300—\$5.00; 500—\$12.00. No approvals, unless requested. S. C. Engel Co., 38 Park Row, New York 7, New York.

DEALERS—Wholesale list. Postage 3c. Frank, 5031 Queensberry, Baltimore 15, Md.

POUND Unpicked U. S. and foreign mixture containing thousands stamps \$1.00, 5 lbs. only \$4.50. Longacre Shop, 100 West 42nd, New York City.

1000 GRABBAGS 10c Each. 8 different \$1. Special bags, Free French included 25c. Zandy, 630 Bingham, Reading, Pa.

SMOKY Mountain commemorative sheet, largest U. S. stamp issued, and 33 U. S. including commemoratives, airmail, revenues, etc. Catalogs 75c—To approval applicants for 5c. Curhan Stamp Company, Gloucester, Mass.

19th CENTURY U. S. commems. Civil War revenues, battleship \$5 and 10 stamps free to U. S. approval applicants. Metropolitan Stamps, 198-C Broadway, New York.

FREE! Canadian sets, royal visit, George VI, George V, coronation, jubilee, others, to approval applicants. Ensign, Box 118-M, South Orange, N. J.

COMPLETE Mint commemorative set from Manchukuo, plus attractive Brunel pictorial—everything just 3c to approval applicants. Viking, 130 (Z) Clinton St., Brooklyn, N. Y.

WEEKLY Stamp Magazine, 26 weeks, 25c. Stamp Journal, Kalamazoo, Mich.

DANDY United States approvals. Write immediately. Sullivan, Endicott Arcade, St. Paul, Minnesota.

FREE! Western Hemisphere packet. Postage 3c. Owens, 806 Welsh, Bay City, Michigan.

FREE! British Empire packet. Postage 3c. Williams, 606 Archer, Bay City, Mich.

FREE! Pony Express set (facsimiles). Postage 3c. Roberts, 406 Building, Bay City, Michigan.

CANADA 100 Different 25c—approvals all countries. Lists. Victoria Stamp Co., London, 4, Canada.

FREE! Leeward Is., Cayman Is., Turks and Caicos plus 60 different mint Geo. VI coronation poster stamps, to approval service applicants sending 3c postage. Tatham Stampco, Springfield-30, Mass.

55 DIFFERENT United States 5c with approvals. Bookman, Box 145-M, Maplewood, N. J.

STAMPS Sent on approval, outstanding quality, low prices. Fred Herzberg, 168 Oak, Elmhurst, Ill.

UNITED States approvals complete coverage, fine quality, attractive prices. Seminole Stamps, Box 436, Coconut Grove, Florida.

MEXICO Census commemorative set free with approvals. Pladon Stamps, 1717-M Idaho, Toledo, Ohio.

WOW! \$10.00 Worth of fun for only 10c! 500 foreign stamps, unsorted and unpicked (mostly on bits of paper) just as received from the church missions and other sources. Africa, So. America, Australia, China, Philippines, Dutch Indies, and other countries are represented. Includes a few commemoratives, airmails, and stamps cataloging up to 25c or more each! The biggest package of fun in stampdom—and you might find something really valuable! Price only 10c to serious approval applicants! Money back if not delighted. Jamestown Stamp Co., Dept. No. 22, Jamestown, New York.

VICTORY Packet free—Includes stamps from Tanganyika, British Cayman Islands, animal, scarce babyhead, coronation, early Victorian, airmail, map stamps, with big catalogue—all free. Send 5c for postage. Gray Stamp Company, Dept. PM, Toronto, Canada.

60 DIFFERENT United States 10c. Pricelist free. Seidenberg, Baroda, Mich.

LATIN-AMERICA Only—65 diff., including airmails, pictorials, commems—10c with approvals. "Crescent Stamps," London, Canada.

EXCELLENT Pictorial approvals. Reasonably priced. Crown Stamp Company, Box 331, Toronto, Canada.

WE Buy collections and accumulations both United States and foreign stamps. Send by insured mail for our highest cash offer. Fort Orange Stamp Co., Albany, New York.

20 DIFFERENT—20 Different countries, 3c. approvals. A.B.C. Stamps, 2318-P Miramar, Los Angeles 4, Calif.

HOBBIES AND COLLECTIONS

ROCK And mineral sets. Greatest, most beautiful collection. Write Maplewood Rocks, Hutchinson, Minnesota.

PRESS Clippings and rare literature pertaining to your occupation, hobbies, etc. Dime brings prospectus. OrNSTEEN, Box 29, Englewood, Colorado.

CONFEDERATE \$500.00 Certificates, 75c each. Dollar size Louisiana medals, struck for Panama-Pacific Exposition, \$1.00. Costa Rica railways 50 centavos tokens, 25c. Fully illustrated U. S. rare coin value guide, 35c. Orleans Coins, 814 Royal St., New Orleans 16, La.

PATRIOTIC Envelopes, ideal assortment. Closeout 100 for \$1.00. Cheerio, Box 62, Bayside, N. Y.

COLLECTORS! Exchange duplicates. Stamp brings particulars. Box 2166, Denver 1, Colorado.

POSTCARDS, Old songs, Lists 6c. Forbes', 3151 High, Denver, Colorado.

CASH In today! Make money with your hobby. Others are doing it. Why not you? A stamp hobbyist was able to finance a \$125,000 business deal. If you want to make your hobby pay real dividends—then write, at once, for details. No obligation. Address, Grand Supply Company, Dept. M, 2506 - 52nd Street, Kenosha, Wisconsin.

100 JEWELRY Stones removed from rings, etc.—from \$2.00 to \$2.40. Lowe's, Box 311, St. Louis 1, Mo.

NEW—15 Different match covers 10c. Box 202, Rochester 1, N. Y.

UNUSED Match book covers, 100 all different \$1.00. 35 Royal Flash covers \$1.00. Free list. Charles Edelman, 1311C East 84, Cleveland 3, Ohio.

CAMERAS AND PHOTO SUPPLIES

MOVIE Camera titlers, 8mm, Eastman or Bell & Howell, \$1.95 prepaid. We buy used cameras. Gary Camera Co., 619 Washington, Gary, Indiana.

PHOTO Folders, Bargains; get list. Pan-Amer Press (PM), San Antonio 5, Texas.

"BIG Bertha" telephoto camera easily made. Objects miles away photograph close up. Ultra sharp pictures. Telephoto lens and instructions \$2.00. Instructions alone 10c. Carl Jamer, Manorville, N. Y.

FILTERS, Sunshades, filter holders—limited supply—fit any camera. Made of pre-war aluminum, filters of solid optical glass. Filters available in every color. Impossible to obtain after present supply is exhausted for the duration. Send only \$1.00 per item and lens diameter, shipped postpaid return mail. With every order for 1 holder and 2 or more filters we will ship without charge a genuine aluminum sunshade of the same size. Act immediately—this offer holds good only while present supply lasts. Absolute satisfaction guaranteed or your money immediately refunded. Order shipped same day received. V X Company, 1828 Central Avenue, Indianapolis 2, Indiana.

ENLARGERS—Build your own. Kit of parts, \$6.00. Free particulars. Crescent Engineering, Box 251-P, South Pasadena, California.

HAVE You a camera? Send ten cents for recent number of our big magazine, showing how to make better pictures and earn money. American Photography, 116 Camera House, Boston, Mass.

OIL Coloring photographs a fascinating hobby or profitable business. Learn at home. Easy simplified method. Previous experience unnecessary. Send for free information and requirements. National Art School, 1315 Michigan, Dept. 3446, Chicago 5.

MAKE Money in photography. Learn quickly at home. Easy plan. Previous experience unnecessary. Common school education sufficient. Booklet and requirements free. American School of Photography, 1315 Michigan, Dept. 3432, Chicago 5.

CASH! Spot cash for cameras, lenses, binoculars, movie or still, sound projectors. Send full description by mail, or wire for prompt cash offer. Over 30 years of dependability insures honorable dealings. Bass Camera Company, 179 West Madison Street, Chicago, Illinois.

BASS Says: War time proves Bass leadership. Amazing selection of finest still cameras—Leica, Contax, Korelle reflex. Argus, new and used still available. Write for quotations. Satisfaction guaranteed or your money refunded. Bass buys 'em, sells 'em, trades 'em. Bass Camera Company, Dept. AG, 179 W. Madison St., Chicago, Illinois.

WAR Bargains used cameras. Lists, description 25c. Used Camera Directory, 3111 West Tuscarawas, Canton 3, Ohio.

PHOTO FINISHING

ENLARGEMENTS: Eight 5x7 from negative \$1.00. Six 5x7 from photo \$1.00. Robert Renshaw, P.O. Box 478, Chester, Penna.

6-8 EXPOSURE Rolls developed and enlarged mammoth size 30c. Reprints 3c. Thrifty Photos, Box 48, South Gate, Calif.

EMBOSSER Christmas cards including envelopes from your own negative, 25 for \$1.25, 12 for 75c. Samples—4 for 25c from one negative. Film Capital Service, 840 Dewey Ave., Rochester, New York.

THIRD Dimension photo Christmas cards, 15 for \$3.00. Absolutely new. Send photo. Sanford, 215 Baum Bldg., Omaha, Nebr.

PHOTOSTAMPS 75c. Double \$1.00 hundred. Any photo. Professional enlarging from negative 8"x10"—35c. Lang, 1334 Thorndale, Chicago.

BEAUTIFUL Oil colored enlargements. Your negatives: 6x10, \$2.00; 11x14, \$2.50. From photo 50c extra. Specify color. Haynescraft, 802 20th, Washington 6, D. C.

PHOTOGRAPHS Beautifully oil colored. Any size 60c. Two for \$1.00. Snapshots tinted, 3 for 25c. Dorothy Briney, Goodell, Iowa.

FINE Finishing specials 25c. Eight exposure rolls developed with two prints of each or one enlarged print of each negative. Genuine nationally known Moentone Enamel finish. Superior quality since 1898. Moen Photo Service, 452 Moen Bldg., LaCrosse, Wis.

CHOICE Film offers—Roll developed, 8 beautiful enlarged prints (deckled if desired); or 16 brilliant "Lifetime" prints; or 8 sparkling prints plus 2 fade-proof enlargements. Pre-war quality and price—25c. Fast service. Quality guaranteed. Free mailers. Credit for unprintable negatives. Dept. 53, May Studios, LaCrosse, Wis.

8 PRINTS, All enlarged to nearly postcard size, from your roll or negative, 25c. Willard Studios, Box 3535A, Cleveland 18, Ohio.

ROLL Developed and 8 beautiful enlargements 2 to 6 times larger. Deckled edge—high gloss. Any 8 exposure roll 25c coin. 12 ex. 35c—16 ex. 50c—36 ex. \$1.00. Reprint enlargements 3c each. Aiden Photos, 94-3 Astor Sta., Boston, Mass.

SIX 8x10" Enlargements \$1.00. Three 50c—20c each. Ten 5x7" enlargements \$1.00. Four 50c—15c each. Either size oil colored 25c each extra. Ten reprints 25c. Photos copied 25c. Empire Photos, Adams Center, N. Y.

FREE! Send negative, this ad for beautiful 4x6 enlargement. (Stamp appreciated). 16 sparkling prints, 2 Hollywood enlargements from roll or negatives 25c. Lifetone Studios, Dept. A-939, Des Moines, Iowa.

SENSATIONAL Introductory offer! Send snapshot or negative, this ad, and 3c. We'll send you a beautiful 7"x5" enlargement! Or Kodak roll developed with 16 guaranteed deckled-edge Velox fadeproof prints or 8 double-size prints, 25c! Special! From your negatives, 16 regular-size or 8 double-size reprints, 25c! Candid rolls—36 exp. 35mm, developed, vapo-rated, enlarged to 3x4, \$1.00; 18 exp. 60c. Reprints 3x4, 3c each. We have new, perfect 35mm. film. Low prices. Free mailers, details on request. American Studios, Dept. 413, LaCrosse, Wis.

16 BEAUTIFUL Deckled-edge prints and enlarging coupon with each roll developed 25c. Owlphoto pm, Weatherford, Okla.

BIGGEST \$1.00 Value in 35 mm. finishing today. 36 exposure fine grain 3 1/4"x4 1/2" enlargements; deckled, embossed margin and date. Eighteen exposures 75c; 16 exposure splits 55c; 36 exposure reloads 50c. Special: return this ad with \$2.00 and we will send five 36 exposure reloads. Free mailers, 8 exposure rolls in beautiful, deckled contact finish with embossed wide margin, 25c. Mailbag Film Service, Box 5440A, Chicago 80.

WITH Every 6 or 8 exposure roll, two full sets of prints, 25c. Skyland Studios, Box 411, Dept. "M," Asheville, N. C.

YOUR Favorite kodak pictures enlarged, size 5x7, 10c; three for quarter, coin. Send best negatives (film) today. Address Gelpert Studios, Dept. 82, Des Moines, Iowa.

PHOTOGRAPHY For pleasure and profit. Prepare at home. Common school education sufficient. Write for information and requirements. American School of Photography, 1315 Michigan, Dept. 3451, Chicago 5.

BEAUTIFUL 4x6 Pictures 3 1/2c each, from 116 and 120 negatives, 3 1/4"x4 1/2" from all other sizes. All work guaranteed. Overnight service. Roll developed and 8 pictures 30c. Roll 12 pictures 45c. Roll 16 pictures 60c. Enlargements on double weight portrait paper 5x7—30c, 8x10—50c. Copies made from any picture 75c. Pacific Photo Service, Box 666, San Francisco, Calif.

EVERY Picture an enlargement! 8 sparkling deckle-edge enlargements and roll developed 25c coin; 116 size or smaller; enlarge reprints 3c. Enlarge Photo, Box 791D, Boston, Mass.

TROUP'S Photo Service, Troup Building, Toccoa, Georgia. 6 or 8 exposure roll film developed and printed 25c.

VELOX Deckle reprints 2c. Rolls developed, two deckle edged prints each negative, 25c. Two 5x7 enlargements 25c. Summers Studio, Unionville, Mo.

MOTION PICTURES AND SOUND EQUIPMENT

RENT 16 MM. sound films 50c reel. Silents 25c. Large selection; free catalog. Film Service, 128 Chestnut St., Roselle Park, N. J.

GUARANTEED Fresh movie film! Three spools double 8mm., \$3.45! Six spools single 8mm. for Univex cameras \$3.50! Dalite loading! Processing free! (Limit six each type.) Will ship c.o.d. on \$1.00 deposit. Eso-8 Pictures, 4038 Broadway, Kansas City 2, Missouri.

8-16 FILM Subjects, \$1.55 up. Lists, stamp. Fence Service, 29 Cora St., River Rouge 18, Mich.

NEW Movie films—wholesale! Free catalogue! "Surprise" samples, 10c. Superior, 126 Fourth, Paterson 4, N. J.

EXCHANGE Your 16mm. sound subjects. Top quality only. Send your list first. Bard, 1480 Meridian, Washington 10, D. C.

BETTERPIX Outdoor safety film, 100' 16mm., \$2.50. 25' double 8mm., \$1.25. Free developing. Finished subjects sold, exchanged. Sound library. Better Films, 742 New Lots, Brooklyn 7, N. Y.

IRISCOPE—For projecting black and white and slides in natural color. Complete kit for building \$5.00. Anchor Supply, 482, Ithaca, N. Y.

100' 16MM. Used sound film, \$1.00 postpaid. We buy, sell, trade. List of complete subjects upon request. Blackhawk Films, Dept. PM17, Davenport, Iowa.

MOVIE Camera film, 100' 16mm., \$2.25, 3 rolls 50.00, 25' double 8mm., \$1.25. Machine developing included. Ambassador, 479-A Quincey Street, Brooklyn, N. Y.

IRISCOPE Projects black and white films and slides in natural colors. Information free. P. Simpson, Box 201, Charleston 21, W. Va.

NEW And used 8mm., 16mm. Discounts. Sample 10c. Free lists. Paramount Film Service, Monmouth, Illinois.

LEARN Movie projection, management. Free catalog. Give age. Theatre Institute, Elmira, N. Y.

SALE—Rent 8-16mm. films. Catalogues 10c. Don Elder's, 739-A Boylston, Boston 16, Massachusetts.

NEW Pretty girl movie, "Allure," 8mm., \$2.00; 16mm., \$4.00 prepaid. Glamour lists, sample, dime. Jenkins, 392-F, Elmira, N. Y.

LARGE Variety 16-35 sound projectors, cameras, lenses, converters, power plants, films. Latest new 35mm. sound 1000 ft. newsreels, 30 titles, 50c each. Trades accepted. Mogull's, 64 W. 48th St., New York City.

35MM. Silent sound features, shorts. Bedner, 5300 So. Talman, Chicago.

GORGEOUS Girls—Sparkling new "Allure" and "Whistle Girls," 8mm.—50 ft., \$2.00; 16mm.—100 ft., \$4.00 each. Comedy, travel, adventure subjects. List for 3 cent stamp. Audet, Box 6520, Philadelphia 38, Penna.

8MM.-16MM.-35MM. Sound-silent, films, equipment. Stamp. Cinema Supply, Lakefield, Minn.

PORTABLE Holmes 35mm. sound projector, films, amplifier, etc. Suess, 5322 N. 51 St., Milwaukee 9, Wisconsin.

FREE Catalog; sample projector films, 10c. Goodwill Company, Jackson, Tenn.

SAFEGUARD Your chances of joining the Original Home Movie Film Club. Receive free subjects every month. Send three cent stamp for details and application blank today. Silver Screen, Morristown 1, New Jersey.

MOVIES: 8mm.-16mm. War, comedy, travel, glamour. Lists free. With glamour sample, dime. Keeley's, 42-PM, Corning, N. Y.

PRETTY Girl movies—8mm., 16mm. List free. Sample 10c. Americana Review, 16mm., 100 ft., \$4.75. Cavalier Camera, 1822 Center, Pittsburgh 19, Pa.

FREE Illustrated catalogs 8-16mm. Film subjects. National Film Exchange, Sta. E-Broadway, Toledo, Ohio.

MOVIE Projectors bought and sold. List 10c. United, 2309-A Lawrence, Toledo, O.

SILENT 35mm. Films! Features! Shorts! Demsey, 1613 Stewart, Youngstown, Ohio.

DELIGHTFUL, Entertaining new 1945 home movie catalog, chock full of latest hits! Yes! 425 hits for grown-ups. Sensational twenty-four page catalog with generous sample dime. Trans American Sales, Morristown 1, New Jersey.

CAMERA FILMS—100 ft. 16mm. \$2.69; panchromatic Weston 64, \$4.85; 25 ft. double 88 Weston 24, \$1.89; prices include processing. Movie accessories, chemicals, bulk film. Free circulars. Promader General, Davenport, Iowa.

WANTED: 8-16mm. Silent sound films. Movie/teat projectors, any condition. Reed, Box 209, Park Ridge, New Jersey.

I BUY, Sell, swap, rent s.o.f., 8 and 16mm. films. List free. Harvey Iris, Box 539, Brockton, Mass.

STARTLING New discovery, make your own movie screen. Free literature. Snow White Screen Company, Danville, Illinois.

"THE World's Greatest Passion Play," 8mm. 16mm. and 35mm. Specify silent or sound. Rent or purchase. Hemenway Film Co., 33-F Melrose St., Boston 16, Mass.

SPECIAL Movie film, 8mm., 25 feet double-Weston 8, \$2.00. Super double X, Pan indoor 60, outdoor 100, 16 mm., \$6.50. Super X Pan indoor 24, outdoor 50, \$5.75. Pan Weston 12, \$5.00. 16 mm. 100 feet Weston 6, \$4.00. Free developing. Exhibitors Film Exchange, 630 9th Ave., New York 19, N. Y.

BASS Says: Leadership in the cine field is apparent in war times. Here ready—your choice of 8 mm. and 16 mm. apparatus. Write for quotations. Your old equipment is worth real money in trade—describe please. Or we buy for cash and pay immediately on receipt. Write to headquarters. Bass buys 'em, sells 'em, trades 'em. Satisfaction guaranteed or your money refunded. Bass Camera Company, Dept. A, 179 W. Madison St., Chicago, Illinois.

RENTAL 16mm. Talking features \$4.95, shorts 75c. 8mm. 16mm. silent, large reel 40c. Movie accessories. Free catalogs. National Cinema, 71 Day Street, New York City.

SEND Stamp for 16mm., 8mm. catalogue. Sterling's, 679 Northampton, Easton, Pennsylvania.

8MM. Films exchanged, sold. Free catalogs. Watts, Box 941-C, Akron 9, Ohio.

MUSIC AND MUSICAL INSTRUMENTS

PIANISTS—Quickly improve technique, sightreading, accuracy, memorizing, playing through mental-muscular coordination. Free booklet. Broadwell Studios, Dept. 44L, Covina, Calif.

HARMONICA Magic. Easy new system eliminates notes. Self-instruction method includes 75 songs. Send only \$1.00. Money back guarantee. Harmonica Magic, Dept. PM, Box 3870 Merchandise Mart, Chicago 54.

LEARN Piano in 5 lessons by ear. Play any song—Easiest method known. Amazing results—Complete course \$2. ABC Piano Method, Dept. M11, Mt. Vernon, N. Y., Box 145.

ACCORDIONS—All sizes and makes. Wholesale prices. \$10.00 will hold accordion until Xmas. Free catalog. American Accordion Co., 31 S. Cicero, Chicago 44.

RECONDITIONED Band instruments, also guitars and violins. List free. Rudolph's, Atchison, Kansas.

PHONOGRAPH Records, slightly used, 20 cents each. Chas. Hoodwin Co., 4419 Broadway, Chicago, Illinois.

PLAY Swing piano in six weeks or money returned. Course \$1.00. Planow, 670A North Kenmore, Hollywood 4, California.

PHONOGRAPH Records; new and used; bought, sold. E. Hirschmann, 109 Duncan, Jersey City, New Jersey.

MUSIC Printing, composing, arranging, publishing. Complete service. Lowest rates. Auto-Litho Co., Jensen, Fla.

HOW to write and publish that song in your heart \$1.09 money order. Knight Publishing Co., Leonardtown, Maryland.

SONG Poems set to music, arranged, recorded, printed, copyrights. Free booklet. (Stamp.) Urab-P, 245 West 34th, New York 1.

SONGWRITERS: Amazing information about writing and publishing songs. P. Medary, Williamsburg, Ohio.

SONGWRITERS! Music composed, arranged. Billy Hannon, 6703 N. Oshkosh, Chicago 31.

SONGWRITERS! Amazing offer. Hibbeler, C5, 2157 N. Avers, Chicago 47.

52A POPULAR MECHANICS

SONGWRITERS. Melody, lyrics or poem made into beautiful professional song—\$3.00. Sholl, 2222 5th St., Harrisburg, Pennsylvania.

MUSIC Arranged to songs. Frank Wildt, Music Publisher, Lancaster, Pennsylvania.

EVERYBODY Can play violin. New system. No notes. Melody Masters, Box 805, Rockford, Ill.

POPULAR Piano E Z method, quick results guaranteed. Beginners advanced. Kelly School, 1781 Oak St., San Francisco 17, Calif.

SONGS Published—Liberal plan. Barnhart Publications, 1320 48th, Des Moines, Iowa.

POEMS Wanted for musical setting. Send poem for immediate consideration. Five Star Music Masters, 630 Beacon Building, Boston.

FREE Booklet song tips. Write, Melody Makers, Box 37, Hartford, Conn.

SONGWRITERS: You can arrange your songs for orchestras. 20 modern lessons \$2.00. Money back guarantee. Brokel College, 64-F East Jackson, Chicago.

SONGWRITERS: Royalty contract free. Write for details. Puritan Publishing Co., 343 S. Dearborn St., Chicago, Ill.

SONGWRITERS Are offered rare opportunity to collaborate with hit composers on percentage basis through phonograph record manufacturer. Submit poems for approval. Recola Recordings, Hollywood 28, Calif.

LEARN Piano. One hour. Free literature. Ferris, 317A So. Hartford, Bremerton, Wash.

SING Beautifully. Modern voice culture. Literature free. Ferris, 317A So. Hartford, Bremerton, Wash.

SONG Poems wanted. Free examination. McNeil, Master of Music, 510-PM South Alexandria, Los Angeles, Calif.

ACCORDIONS. New and used at wholesale prices. Save up to \$100.00. Buy direct from factory. Del Principe, 307 So. Wabash, Chicago.

SONGWRITERS Wanted; prices, details, free book. Variety, 2 Salem, Ind.

WRITE Songs. Big money and reputation. Write for information. J. Gordon Pub. Co., 201 N. Hoyne Ave., Chicago.

SONGWRITERS—Send poem for immediate examination and free rhyming dictionary. Richard Brothers, 24 Woods Building, Chicago.

SONG Poems wanted: Write for free instructive booklet, outlining opportunities. United Music Corporation, Dept. 14, Salem, Indiana.

WANTED! Lyrics, melodies for songs. We arrange, publish, sell. Superior Song Studios, Passaic, N. J.

RADIOS AND SUPPLIES

FOXHOLE Radio, amazing, no crystal, tubeless, batteryless. Serviceman's pastime gift. School boy thrill. Easy distance-getting plan \$2.00. Beachhead gadgets desk. Bible Artists, Box 28, Jackson Heights, N. Y.

TUNING Arm dial, twenty times sharper than ordinary dial. Make easily from scrap wood. "Sketch-plans" 25c. "Arts-Crafts," Blacksburg, Virginia.

TUBELESS Radio made with razor blades! Complete plans, 35c. New Radio, Lohrville, Iowa.

200 TUBE Substitutions including 50L6, 12SA7, complete instructions \$1.00. Clifford Jones, 1210F Dudley, Utica 3, N. Y.

BUILD Improved, extra-long crystal set. Easy instructions, 20c. Amorose, R-4, Hungary Road, Richmond, Va.

REVISED Plans 18 long distance crystal sets, including "Radiobuilder"—25c. Laboratories, 363-C Hampton, Hayward, Calif.

BUILD Microphones, phonographs, (crystal). Instructions 25c. Microphone or phonograph pickup kit \$5.00. R. H. Lab, 3928 Dumaine, New Orleans, La.

PLAYERS. Victrolas, phonographs (mechanical) repaired. Epstein's, 50 First St., New York 3, N. Y.

MAKE Simple, tubeless, batteryless, distance-getting crystal radios, crystal and illustrated instructions. 25c postpaid. Allen, P-427, Clinton, Missouri.

RADIO Tubes, parts, condensers. Free bargain lists. Potter, 1314 McGee, Kansas City, Mo.

PREPARE Now for tremendous opportunities in new fields of radio after the war. Training for federal licenses. Write for particulars. American Radio Institute, 62 East 23 Street, New York 10.

RADIO Service men and experimenters send for our giant radio catalogue. Save dollars. United Radio Co. (1000M), Newark, N. J.

BUSINESS OPPORTUNITIES

SELL The mail order way! Let me supply proof that my ads, letters, circulars can sell by mail any meritorious product. Tell me your problem. Gardner Advertising Service, 60 East 54th St., Kansas City 2, Mo.

START Home business making statuary, plaques, art goods, novelties, souvenirs, concrete pottery, garden furniture, artificial marble flooring, liquid marble. Make your own flexible molds. Amazing profits. Valuable folder free. Creative Publishers, (PM11), Glencoe, Illinois.

PITCHMEN. Agents, demonstrators, show people. Make money immediately. Anywhere. Complete instructions \$2.00. Mero, Box 344, Punxsutawney, Penna.

10 TRIPLE-SHAVE Double-edge razor blades in classy letter style package 1st class mail anywhere 3c. One package 30c, four packages \$1.00 prepaid. Agents wanted. Novelty Supply Co., Fremont, Ohio.

STEADY Income assured after the war if you start your own business now, part or full time. Send stamp for information. Hughes Services, Plankinton, S. Dak.

THINK Ahead. Start spare-time business now. Be secure when post-war layoff comes. Information free. Home Products Co., Redkey 1, Ind.

REMOVE Rust from guns, tools, machinery, etc. Eight guaranteed formulas 25c. Hamilton, 650 South 20th St., Newark 3, New Jersey.

UPHOLSTERING. Rebuilding furniture pays. Clean, pleasant work. 8"x11" illustrated course \$1.00. Order now or write Upholstering Institute, Dept. 232, Lombard, Illinois.

POSTWAR Planning, now is the time to start your own business and be ready for the boom. Full description free. Elite, Box 177-A, Des Moines, Iowa.

SELL By mail, limited capital. Modern inexpensive course shows how. Free consultation with noted author. A top flight mail-order specialist. Details free. J. G. Schroeder, Box 504P, Anaheim, Calif.

MAKE Colored glazed concrete pottery without molds. New, low cost, patented method. Use only sand, cement, cheap materials. No experience needed. Cemetery products, novelties, giftware, tiles, floors. Basement water-sealing. Other moneymaking projects. Booklet, color plate, details 10c. National Potteries Company, Ferguson Falls, Minnesota.

START "Soap Factory" at home. No machinery. Amazing opportunity. Literature free. Kemico, SM11, Park Ridge, Ill.

GOLDEN Opportunities for a good living after the war. Details free. Martin, Box 242, South Pasadena, Calif.

REALTY Business. How to buy, sell farms, properties, business. Gives every angle of salesmanship. Book 50c. Free particulars. Mell Specialties, DeMotte, Indiana.

GOLD. Genuine gold. Pure gold. Rated 23 to 24 karats. Valued about \$35.00 an ounce. Reclaim gold from certain commercial waste or near waste. In your home or laboratory. Apparatus costs but a few cents to make. Any amateur can do it. Begin as a hobby, prepare for profitable post war business. Not gold refining, but gold reclaiming. You have no selling problem. Gold is good as money. Mail postcard to Jay Rosten, Box 523, Dept. B, General Post Office, Brooklyn, N. Y.

PROFITABLE Item that can be manufactured. Wanted toys, or household items. Good proposition. City Machine Company, 868 East Tallmadge Avenue, Akron, Ohio.

MECHANICALLY Inclined men—Own and operate general appliance repair shop. Complete, illustrated course shows you how. Welding, refrigeration, motor repair, how to get business, etc., all phases covered. Free literature. Christy Supply, Dept. 146, 2835 N. Central Ave., Chicago.

WEBER Typewriter Mechanics School. Simplified homestudy-repairing increasing. General Delivery, Dayton, Ohio.

OPPORTUNITY Design patent 137820 for sale. Smokers humidior and blender. John Russell, Summit, N. J.

MAKE Fast selling products at home. No machinery. Wonderful profits. Literature free. Kemico, 16, Park Ridge, Illinois.

START Your own business on our capital. Always your own boss. Hundreds average \$3,000 to \$5,000 annual sales year after year. We supply stocks, equipment on credit. 200 home necessities. Selling experience unnecessary to start. Wonderful opportunity to own pleasant, profitable business backed by world wide industry. Write Rawleigh Co., Dept. K-U-PPMB, Freeport, Ill.

SELL Books and courses by mail in your spare time. Siddall, Atascadero, Calif.

RECEIVE Valuable moneymaking propositions, big mails, samples, magazines. Your name inserted in several mailing lists, 10c. Rogowski, 3413 Broadway, New York 31.

START A full or part time business in your home. Experience not essential. Literature free. Wesco Sales Co., Box 137 Fruitvale Sta., Oakland 1, Calif.

MECHANICALLY Inclined men. Prepare for the future. Vocational training books for home study—low priced. Free illustrated catalog. Lone Star Service, 1708-A First Avenue, Dallas 10, Texas.

INCORPORATE Your business. Delaware laws. Many advantages. Free details. Tax Research Bureau, Inc., Delaware Trust Building, Wilmington, Delaware.

BOOKKEEPERS—Earn \$3.00 hourly operating bookkeeping-tax service locally. Write: Thrif-T, Danville, Illinois.

OWN A mail-order paper products business. Sell envelopes, tags, labels, boxes, by mail, wholesale. Tremendous demand. Steady profits. No capital necessary. Write Omaha Envelope Service, Dept. 41, 4721 California, Omaha 3, Nebr.

PLASTICS—Made at home without equipment—perfect castings—formula 50c. Baker, 225 Symington Ave., Toronto, Can.

300 TESTED Moneymakers. 64-page book, 25c postpaid. Business secrets, formulas, wholesale supply sources galore. Book has no ads. Meant only. Money back if dissatisfied. Dulco, 324P Pitt, Pittsburgh 21, Penna.

HOW I scored tremendous mail order success from only \$100 start. By all means investigate this! Write Evans, Box 9312 Station 8, Los Angeles, Calif.

PLASTIC Wood—Make your own. Two formulas \$1.00. Box 177, Gainesville, Tex.

BIG Paying post war jobs with American firms in South America, Russia, China, Malaya, Burma, India. Complete list over 200 firms \$2.50. Wm. Addams, Chanute, Kansas.

CONCENTRATES: Cold cream, vanishing cream, shampoo, mouthwash, perfumes. Adding water makes perfect products. Big profits. Gellitabs Company, Box 633, Stamford, Conn.

MAKE Your own Flexible Molds. Statuary Art Goods, Novelties, Artificial Marble Flooring, Liquid Marble. Literature free. Kemico, 11-M, Park Ridge, Ill.

BECOME A finance man. Particulars free. George Lenhoff, Lincoln 8, Nebraska.

YOU Too can learn how to make, mold or cast real plastics. Send stamped envelope Box 498, Gainesville, Texas.

SHOWERS Of dollars, information free. S.J.T., 216½ Farr, San Angelo, Texas.

PROFITABLE Mail business. Free supervision. Stough, 250 S. Bonnie Brae, Los Angeles 4, California.

BE Prepared for after war depression. Helpful literature free. Howard Rasmussen, Boonville, Missouri.

FLEXIBLE Molds, imitation marble, granite. Details free. Dykes, 5110 Kinghill, St. Joseph, Mo.

KARAKUL Sheep are profitable. Write: Addis Kelley, Maywood, Calif.

GET Dollars by mail! Guaranteed instructions 10c. Terrill, Bogard 2, Mo.

OAKLAND, Calif., mail address. Personal-business. Reliable representation. Write Mr. Vosburgh, 4182 Emerald Street.

OPERATE Paying mail order business in your own home. Free details. Myatt's Service, Box 192, Pittsboro, N. C.

OPPORTUNITIES In Progressive Mail Trade, 10c. Moore, P.O. Box 101P, Norwood 12, Ohio.

BACKYARD Moneymakers, unique. Some good for a fortune. \$1.00. Details free. Macklyn, Box 6900, Pittsburgh 12, Penna.

CAPITAL Seekers—Interested in raising \$25,000 or more should write to Amster Leonard, Fox Bldg., Detroit 1, Mich.

RENT Books now from Victory Service, Dept. PM-2, Emmaus, Penna.

"THE Key to Wealth." Our folio (sent free) will interest you. F. A. Aisen, Box 165, Chicago 90, Ill.

GARAGE Doors dashboard controlled. Additional information under "Automobiles."

LEARN Mailorder business. Make money at home. Amazing new course. Written so you can understand it. Free details. Belfort, 225 Engineering Building, Chicago 6, Ill.

FIVE Big mailorder magazines 20c. Lewis Company, 328-M Carpenter, Oak Park, Ill.

MAKE Leather ornaments. Immediate market 15 easy-to-finish smart leather novelties \$1.00. Details free. Vogue Leathers, Box 6, Fairfield 3, Iowa.

"HORSE Lovers! Join our ass'n."—Free book "The Expert Horseman and Trainer" and information on how to start an interesting, profitable horse business. Animal Lovers Ass'n, Box K111, Tarzana, Calif.

PLAN Your post war future now. I built excellent business with automatic vending machines. Send one dollar for full story of my start and learn how you can do likewise. Vance Wallace, Box 1067, San Francisco.

SUCCESS Sure! Start own business now; insure post-war independence! 180-page volume shows way; dozens successful home-moneymaking plans detailed in big free broadside. Co-Operative Service, Box 253, Niagara Square Station, Buffalo, New York.

ENORMOUS Profits made quickly by mail right from your home. United Profit Builders, 305-West 8th, Los Angeles 14, Calif.

FORTIFY The future—Start own business home—office. No peddling, little or no investment. Folder describing "Collection of 127 Money-Making Plans" free. General Sales, Box 511-C, Burlingame, Calif.

"LIBRARY Of Business Opportunities." Set of 3 books sent postpaid \$2.00. F. L. Murray, 601 Banks St., San Francisco 10, Calif.

RAISE Giant Chinchilla rabbits. Willow Farm, R15A, Sellersville, Penna.

RUBBERFLEX—Lastex flexible mold making liquid. "The real McCoy." Sample pint with directions \$1.50. Gallon \$9.00. Agents wanted. Twentieth Century Products, 3151-N Southport, Chicago.

START Your own mail order book business. For information write to D. Foster, Box 1069, Glendale 5, California.

SIX Complete and different post card plans for starting profitable spare time business. Gordin Publishers, Box 23, Pawtucket, R. I.

AMAZING Mailorder opportunity. 10c (refundable). Cardinal, Box 48, Decatur, Illinois.

MONEY Making business of your own. Big now, with post war future. Details 25c. W.F.H., 293 Magnolia, Cranston 10, R. I.

MOLD Perfectly lettered monuments. Cost fifty cents, bring \$12.50. Cemeteries are full of business. Instructions \$1.00. Richland Gardens, Martin, Tennessee.

OPPORTUNITIES Galore. Operate top-flight plans. Details stamp. Topflight, 669 Cypress, Yeadon 3, Penna.

FORGET Canvassing! Home business, immense profits. Amazing details 3c. Service (5), Drawer 339, Butte, Montana.

PLASTICS Making, molding, processing simplified. 40 illustrated work-sheets teach you. \$1. Circular free. Plastics Digest, 3937B Tracy, Kansas City, Mo.

GET Dollars in your mail! Mail penny postcards advertising new sensational book deal. Big profits. Millions of prospects. Complete mailing instruction folio and sample cards for 10c. Elmer Swanson, Niagara, No. Dak.

STORE Owners. Enormous profits quickly. Article sells itself. Repeats. No competition. Exclusive deal. Buy direct from manufacturer. United Profit Builders, 305-West 8th, Los Angeles 14, Calif.

INFORMATION—Locating products (wholesale) etc. Rakes, Box 5931A, Chicago 80, Illinois.

WANT To make \$5,000 yearly? No bunk. Publications, Bethany 4, Oklahoma.

VITAMINS—High quality, low price, private label. Gibson Company, Harlan, Iowa.

HOW And where to obtain capital. Fully explained. Particulars free. Star Service, Wapakoneta, Ohio.

COSTS 20c. Sells \$2.00. 256 page drug-less health book. Sample book and imprints \$1.00. National Distributors, Portland 4, Oregon.

LEARN Refrigeration mechanics. Start your own repair shop. Complete illustrated course. Free booklet. Mechanics School, Dept. 2-PM, 4703 West Pico, Los Angeles 6.

MORE Money with your own products. Experience unnecessary. No machinery. Information free. B. Kinford, Wayne, Penna.

RAISING Canaries pays good profits. Valuable bird book—"Its Care, Breeding and Training." Price \$1.00. American Canary, 2839 N. Halsted, Chicago.

NO Lay offs! Dollars galore developing, printing. Full instructions 25c. National Service, 322A Union Avenue, Brooklyn 11, New York.

5000 QUARTERS From a 20-word classified ad. Send 25c and 3c stamp, for copy of ad, sample merchandise, and plan to operate by mail. Abbott, Dept-PM, 5552 Drexel, Chicago 37.

MAKE Girls novel name pins, simple, low cost. Complete instructions 25c. Melco Novelties, 323 Hayward St., Woodstock, Ill.

SELL Vitamins by mail. Big profits. Details, sample imprints, etc., 10c. B. Murphy, 4438 White Plains Ave., New York City.

OPERATE Profitable credit and collection agency business; earn \$5000-\$10000 upwards annually; interesting literature free. Write Educational Extension Service, Department 101, Wilshire-Labrae Station, Los Angeles.

SELL Exclusive books of instruction by mail. 80% profit. No bookstore competition. Snappy circulars ready. Rush name! Financial Education, 431F, 728 15th, Denver 2, Colo.

START Mailorder bookshop—Everything furnished; publisher cooperation. 25c brings booklet, exclusive setup, samples, exciting ideas. General Publications, Ossining, N. Y.

MAIL Order business course shows you how to make money, spare or fulltime. Teaches professional mail order technique—not penny-snatching schemes. New success-catalog free! Write Nelson Company, Dept. 4-02, Chicago 4.

RUBBERFORM—Plastic; waterproof elastic flexible mold making liquid. Sample pint with instructions \$1.25 postpaid. Gallon \$7.00. Plastic Products, 1410-13, Belmont, Chicago.

"HOW To Make Simple Molds and Plaster Plaques." Profit in popular novelties! Booklet 25c. Plastercraft, 1406 E. 43rd St., Cleveland 3, Ohio.

LIQUID Marble; snow-white, multi-colored. Glazed, Unglazed. Composition flooring. Lifetime wear. Any color. No priorities. Flexible molds. Plaster casting. Get into the big money now. Full information given free. Write Compo-Tex, Box 786-R, St. Louis, Mo.

COLOR Concrete with chemicals. Big money making Hollywood style pottery, birdbaths, without moulds. Wishing-wells, stucco-rock, benches. Marbling, cement water-paints. 10c brings sample, literature, pictures. Hollywood Cement-Craft, 8527 Wonderland, Hollywood 46, California.

AGENTS—To mail our literature. Good profits. Home business. Maywood, 1133 Broadway, New York.

GET Into mail selling. Prepare for future. Start sideline business now. Splendid opportunities. Interesting, profitable propositions immediately available. Progressive Magazine tells how! Free details and premium offer. Sheboygan Publishing Co., Sheboygan, Wisconsin.

CHARTERS: Delaware; best, cheapest; free forms. Colonial Charter Co., Wilmington, Del.

DRUNKENNESS Is a disease which responds to treatment. Medical skill plus human sympathy prove successful with liquor and drug cases. 60 years experience. Write for free booklet. P. M. Nelson, The Keeley Institute, Dwight, Ill.

127 WAYS To make money, in home or office, business of your own. Full particulars free. Elite Co., 214 Grand St., New York.

BRUSH Plating outfits connect to a battery. No tanks necessary. Good paying business at home plating autoparts, bathroom fixtures, bicycles, reflectors, silvering mirrors. No shop or experience required. Outfits furnished. Free booklet. Gunmetal Co., Ave. H, Decatur, Ill.

EXTRA Income—Plenty mail selling opportunities. Write Katsy, 4254 N. Kimball, Chicago.

LIQUID Marble—Colorful, glazed! Mold, brush, spray! Composition floors, rubber-lastic molds. Particulars free. Marbleizing Service, Edwardsville, Illinois.

MAKE Sell sparrow traps that will catch thousands. Complete, illustrated plans \$1.00. Money back if not satisfied. Roy Vall, Howe 20, Ind.

BE Independent. Start your own business. Any locality. Either sex. Experience unessential. Details gladly. Acme, 5521 - 36th N.E., Seattle 5, Wash.

PROFITABLE. Spare time, unusual mail business earned \$1400 monthly. Copyrighted instructions \$1.00 postpaid. W. S. Boyd, 331 Fourth, Pittsburgh 22, Penna.

FREE Subscription. Drop postal today. The Mail Order News, Somerville, New Jersey.

MONEYMAKING OPPORTUNITIES

I MAKE big money in the mail-order business. You can do the same at home with my copyrighted system. Write me, I'll tell you how. F. Little, Box 8, Glen-shaw P.O., Pittsburgh, Penna.

NATIONWIDE Syndicate mail-selling business plan, ready to start, leading mail order magazine sample copy, both 10c. Habermann (V), Box 1642 Perry Square Station, Erie, Penna.

FREE Particulars. Money making schemes. W. M. Simon, 1091 First Street, Wyandotte, Michigan.

TEN Ads that keep my mail business going. Send 25c coin. Universal, Fremont, Ohio.

MAKE With magic and make money. Entertain clubs, schools, organizations. Kit complete \$2.00. Details free. Macklyn, Box 6900, Pittsburgh 12, Penna.

"BUILD A Permanent Business" anywhere with latest, fastest money making methods. Details stamp. Gofflot Service, Alhambra, Calif.

TWELVE Practical moneymaking propositions and 52 page mail trade magazine and big mail. Romola King, 700 North Mont Clair, Dallas 11, Texas.

MOLDBAKING—Plaster Casting. Complete formulas—fully illustrated. \$1.00. Ideal Service, RM11, Park Ridge, Ill.

ADD To your present income by taking magazine subscriptions in your spare time. Liberal commissions. Send postal for information and supplies. American Readers' Service, Gwynedd, Penna.

"DOLLAR Making Tips," book of new ideas, plans, formulas, trade secrets, 25c postpaid. Joseph Royer, 17-M How St., Haverhill, Mass.

AMATEUR And semi-professional cartoonists and artists, cash in on your ability. Write, Hamilton, Box 4B, Woolsey Sta., Astoria, New York.

INVESTIGATE—Co-Operative mail promotion service for profitable opportunities. Russell Johnson, Clarksfield, Minnesota.

DISCOVER Profitable opportunities. Advance years in months. Dept. 6M, Box 5766, Philadelphia.

THOUSANDS Of articles wholesale. "Supply Source Directory" 10c. Ideal Service D-11, Park Ridge, Ill.

FREE Literature describing many profitable business plans, formulas. Herbert Boyd, Box 6081, West Asheville, N. C.

PROFIT! Publish your own magazine. Details free. Wooding, 1900 Las Lunas, Pasadena 8, Calif.

GAIN Financial independence from a city lot or a five acre plot. A new book "Security Acres" shows you how. Send for free particulars today. A. J. Shutt, Dept. 53, P.O. Box 269, New Castle, Ind.

HELP Win the war first! Then man, you'll like silvering mirrors, reflectors! Making sparkling chipped glass nameplates. Outfit prices. Sprinkle, Plaster, V80, Marion, Indiana.

MECHANICALLY Inclined men — Own and operate general appliance repair shop. Complete, illustrated course shows you how. Welding, refrigeration, motor repair, how to get business, etc., all phases covered. Free literature. Christy Supply Dept. 1146, 2835 N. Central Ave., Chicago.

PROFITS Coloring photos for yourself or others. Extremely easy pleasant work. Practically no capital needed. Even beginners get beautiful results. Instruction book \$1.00. Currie, 45A Cherry St., Quincy 69, Mass.

MAKE Colorful costume jewelry with washable plastic links! No tools or equipment needed. Excellent sideline. Free details. Beginner's outfit, \$1 (refundable). Hughes, 218 Sidell, Danville, Illinois.

SPARE-TIME Earnings—adults, school children—organizing against war, depression. Prosperity, 200C, Newfane, Vermont.

THE Novelty manufacturing business offers ambitious men in every community opportunity to start profitable business. Imports cut off—Chain stores, etc., anxious for merchandise. Start in garage or basement. No material priority. Easily learned, excellent profits—No expensive equipment needed. Particulars free. Plastex Products, 332 Balboa, San Francisco 18, California.

GET Rich. To find success find yourself and cash in on your creative ability. I've helped thousands. Dept. 7M, Box 5766, Philadelphia.

MONSTER Mail, magazine, adsheets, circulars. Opportunities. 10c. Harvey Teeple, (PM), Decatur, Indiana.

BOOK Of profitable home business plans —25c. Oscar Gaver, Jr., Middletown 1, Maryland.

TWELVE Practical moneymaking propositions, big mail and trade magazine 25c. Romola King, 700 North Mont Clair, Dallas 11, Texas.

GET Big mails, magazines. Real opportunities for success. Your name listed, 25c. Information, Box 6900, Pittsburgh 12, Penna.

"The Key to Wealth." Our folio (sent free) will interest you. Alsen Service, Box 165, Chicago 90, Ill.

REVELATION For opportunity seekers. F.L.T., Dept. 9M, Box 5766, Philadelphia.

VICTORY Day and Christmas red lycopodium. Make corsages, wreaths, sprays, decorations. Send \$1.00 for pound and manufacturing plans. Home Occupations, St. Paul 8, Minn.

SEVEN Keys to wealth, used by successful men. 63 page book, \$1.00. Free literature. Wilson, 530 West Greenfield, Milwaukee, Wisconsin.

YOUR Own business, post-war opportunities. Spare or full time. Send for booklet, Henry Schultz, Route 2, Pascagoula, Mississippi.

THOUSANDS Of alarm clocks need repairing. Jewelry stores swamped. Our simplified course teaches you how to repair these clocks. Necessary tools and supplies furnished with course. Alarm Clock Repair Service, Dept. B, P.O. Box 1983, Houston, Texas.

RAISE Giant Chinchilla rabbits. Willow Farm, R15B, Sellersville, Penna.

NEW Trust scheme plan. Big mail 10c. General Publications, Box 695-M, Indianapolis 6, Ind.

INFORMATION — Locating articles (wholesale), etc. Rakes, Box 5931B, Chicago 80, Illinois.

"ARRIVAL" Helps make your business or hobby pay. Contains: "Hobby Directory" bookfinding service for course or book you want. Market place for writers, artists, collectors, photographers, old books, swappers, job hunters, opportunity seekers, mail order men, etc. Tells where to buy wholesale. Opportunities galore. You'll like it! Subscription \$3.00 per year. Includes membership in "Association of American Writers." Beautiful certificate for framing. Press card and auto sticker. Gets you passes to shows, fairs, games, etc. Join now. Melvin C. Churchill, Secy., 319 So. Marengo, Pasadena 5, California. (Sample magazine with mammoth mail 25c). Ads 3c word.

START Business of your own. Cleaning upholstered furniture, rugs, etc. No equipment required. Secret process. Two dollars. Renovators, General P.O. Box 619, New York.

MONEY-MAKING Business. Valuable folder free. Successful Income Builders, Hollywood 28, California.

MONEY Making opportunities. Leading mailorder magazine 10c. Sign, Farmington 5, Missouri.

LEARN Refrigeration mechanics. Start your own repair shop. Complete illustrated course. Free booklet. Mechanics School, Dept. 3-PM, 4703 West Pico, Los Angeles 6.

"VARIOUS Opportunity Catalog," copy 10c. P.O. Box 1735, San Diego 12, Calif.

EARN Money evenings, copying and duplicating comic cartoons for advertisers. Adservice, Argyle, Wis.

WE Have swappers, buyers, sellers everywhere for anything you want to swap buy, sell. 25c. bring Guide. National Swappers Guide, 1100 E. Chandler, Evansville, Indiana.

BE Independent, start paying business in your home with our tested plans. Free descriptive booklet. Applied Industries, 953-M East Michigan Ave., Ypsilanti, Michigan.

CASH From your back yard, basement or bedroom. No experience necessary. Send for free details. Challenge Association, 87 Somerset, Springfield, Mass.

ESTABLISH Home business! Five volumes money making opportunities \$1.00. Des Moines Home Service, Box 855, Des Moines, Iowa.

FOUR Books—228 exciting pages on mail order work—150 ideas, plans, methods, \$1.00 postpaid. Paul A. Wilkin, 1348 N. High, Hillsboro, Ohio.

GROW Dwarfed trees few inches high for yourself or sell. Instructions 15c. Charles McGuire, P.O. Box 628, Dept. G, Seattle 11, Wash.

CATALOG Listing hundreds of opportunities 10c. (refundable). Barcus, 1001 N. 13th, Terre Haute, Indiana.

MAKE Plenty of money in spare time right from your own home. Sales made entirely by mail. No personal contact. Progressive Mail Trade Magazine tells how. Sample 10c. Edgar W. Thomas, Barnesville, Ohio.

SPECIAL Training—for entering successful business. You start small, grow big. We tell you what to start, what to pay, what to sell, who will buy. Ask for bulletin No. 12. It's free. Edgar W. Thomas, Barnesville, Ohio.

START Now, build money making mail order business. Be established after the war. Write for free particulars. Young's Industries, Kent 15, Ohio.

MONEY At home. Your own business. "Progressive Mailtrade" Magazine (15th year), prints many small capital post war opportunities. Read by thousands; you'll like it too. Copy 10c. Publishers, Box 115M, Gardenville, New York.

BOOKKEEPERS. Earn money at home posting journal entries. Ellis Business Service, Cedar Grove, North Carolina.

PUBLISH Your own magazine. Hand-some 52 page format, well edited, illustrated. Cost low as \$1.00 month. Brings you prestige, profits. 10c brings sample, details. National, Ord, Nebr.

LEARN Metascience. Remarkable drugless healing. No manipulation. No apparatus. Unbelievable simplicity and results. Inexpensive correspondence course. Write Metascience, De Land, Florida.

EARN Money at home! Thousands do "Home Worker Magazine" tells how. Sample, 25c. Sizemore, Box 7, 4917 North Kostner, Chicago.

LICK After-war layoffs! Start own business; home, office. Booklet describing "Collection of 127 Tested Plans" free. Elite Co., 214 Grand St., New York.

FORMULAS, PLANS, ETC.

EIGHT Tested formulas for fast selling products. \$1.00 bill. Make big money. Viggiano, Chemist, 6556 Ladson, Pittsburgh 6, Penna.

FORMULAS. Free lists. Research, 1233 Rathbone N. W., Grand Rapids, Mich.

"LUMINOUS Paint" shines in dark. Easily made. 100 other formulas, plans—all 25c. Soap-making course (20 formulas) \$1.00. Resilvering mirrors, formula 20c. Ideal Service, 311, Park Ridge, Ill.

10,000 MONEY Making, money saving formulas! \$1.50 postpaid. Refundable. Stehle, 330N Delphine, Philadelphia 20.

STOP. Look and listen. New bargain offer. Plastic leather and plastic wood formulas, plus 10 other guaranteed money-making formulas. All for the low price of \$1.00. Martin, 1903 Ave. U, Brooklyn, New York.

MONEY Making formulas, I tell you how. Church, 814 N. 24th St., Billings, Montana.

SURE Way to detect counterfeit coins. 10c, and 3c stamp. J. McQueen, 123 East 7th South St., Salt Lake City, Utah.

VARSOLINE! Guaranteed motor fuel! Ingredients at paint houses, drug companies, chemical companies. Formula 25c. Auto Data, Box 571, Newark 1, N. J.

FORMULAS — General cleaning, cements, waterproofing. Send for list. Frank DeVoe, Box 243, Ukiah, Calif.

OPPORTUNITIES Galore in manufacturing cosmetics, medicinal preparations, household specialties, vitamins. Specialist, 25 years experience offers gold mine of information, consultation service. Low cost. Belanger, 2623 West Third Street, Duluth, Minnesota.

GUARANTEED Formulas for sale. Our price: \$1.00 for complete information. No other charge. You name it and we'll send it or your money back. Martin, Dept. 20, 1903 Ave. U, Brooklyn, New York.

RELIABILITY. Any formula 50c. Thorough research. Excellis Products Company, P.O. Box 3198, San Francisco 19, Calif.

ANY Formula \$2.00 or money back. Case Kowal, Chemist, 1846 Cullerton, Chicago.

AUTHENTIC Formulary. 924 page illustrated book. Prepared by experts. 10,000 practical tested formulas, recipes, secrets, instructions for easily making most any product. Countless profitable business opportunities. Valuable reference for home, industry. \$2.00 post paid (c.o.d. U. S. only). Foreign \$2.35. Adams Brown Company, Dept. 11, Chestnut Hill 67, Massachusetts.

FORMULAS — Latest, best. Analysis. Literature free. Belfort, Engineering Building, Chicago.

REAL Manufacturing formulas. Lists free. Cummings, Chemist, Gordon Ave., Syracuse, N. Y.

CHEMISTRY

CHEMICAL Apparatus. Complete line of chemical glassware, apparatus and chemicals. Standard Science Supply Co., 1232 N. Paulina St., Chicago.

CHEMICALS. Ounce quantities, apparatus. Catalog 5c. Fleischer's Laboratories, Everett 49, Mass.

THE House of Winn. the home of supplies for amateur chemists. See Winn's New Idea chemical kits and apparatus outfits for home experimenting. Send 10c for retail catalog. Established 1931. John H. Winn, Dept. 511, 124 West 23 St., New York.

FREE Chemical catalogue. Enclose 3c postage. Greenwood, 398 Broadway, New York.

FREE Catalog: Chemistry, mineralogy, biology, optics. Tracey Laboratories, Evanston, Illinois.

SPECTROSCOPE For quick chemical analysis \$2.50. Kutting Sons, Campbell, California.

LABORATORY Supplies at wholesale prices: Chemistry, biology, physics. Catalogue 10c. National Scientific Co., 2204 W. North Ave., Chicago. Established 1908.

CHEMISTRY Laboratory apparatus and chemicals for industrial, analytical, and private experimental laboratories. Complete chemical laboratory supply service for correspondence school students. Send 3c for free 48-page catalog of chemicals and apparatus. Dept. M-43, Biological Supply Co., 1178 Mt. Hope Ave., Rochester, New York.

AGENTS WANTED

HOSIERY Guaranteed against everything at no extra cost! Victory sheer ladies' rayon full fashioned sells for only 94c including your profit! Also guaranteed men's hosiery. Amazing opportunity to build permanent business. No experience or money required. Simply write orders. We deliver and collect. Write today for complete free outfit. Kentcraft, Dept. L.H. 44 Court Street, Brooklyn, N. Y.

LUMINOUS Pictures that glow in the dark. Large manufacturer wants factory representatives; wonderful new item; fast seller, free sample. Madison Mills, 303 Fourth Ave., New York City.

SILVER Plating and polishing liquid. Apply with cloth. Cleans, silverplates, polishes, one rubbing. Renews silverware, jewelry, musical instruments, automobile trim, etc. like new. NuSilver, Dept. 103, Aurora, Ill.

BIG Profits taking subscriptions for all magazines. Agents' confidential catalog listing over 2500 periodicals and complete starting supplies free. Pines Subscription Agency, Flushing, New York.

SKUNKADORA Eliminates 100% all traces of skunk odors! Nothing like it. Whirlwind seller to farmers, trappers, general stores, breeders, etc. Big profits. Send \$1.00 for sample on money back guarantee or write Sparhawk, Sparkill, New York.

AMBITIOUS School seniors—We want you to sell classmates the "tops" in graduation name cards. Highest commissions! Your cards free! Cardalogs going like wildfire! Hurry! Get yours today! Craftcards, Box 235(L), Pittsburgh 30, Penna.

AGENTS—Coin money—It's new, it's hot. Everyone wants radiant "Wonderlette" colored paintings of loved ones. We deliver, collect. Condon, Box 157, Upper Darby, Penna.

GREETING Card money-makers. birthday, everyday, Christmas. Write for folder. Greenport Art Company, Dept. P., 252 - 12th Street, Brooklyn 15, New York.

EXTERMINATE Roaches, bedbugs. Formula, instructions 25c. Ross Products, Maywood, N. J.

SPARKLING Religious mottoes—\$4.00 per 100. Samples 25c. Tabernacle, 1323 High, Springfield, Ohio.

LARGE Profits in your own business. Used shoes 12c, pants 25c, coats 37c, underwear 20c, dresses 15c. Hundred other bargains. Catalog free. Established 1930. Publax, 558 Roosevelt, Chicago.

PRIZE Package deals—Joke cards. Prices quoted to distributors, jobbers, operators. Eagle Specialty Co., Akron 11, Ohio.

CASH in now—Another record breaking Christmas gift season is here! Opportunities unlimited! Send penny card for free wholesale price list today! Write McGregor Magazine Agency, Dept. PM4, Mount Morris, Illinois.

\$3 FIRE Extinguisher; quick sales, wholesale or direct; liberal profits. "Fire-Killer," 109 N. Franklin, Syracuse 4, N. Y.

STRANGE "Dry" window cleaner. Sells like wild. Replaces messy rags, liquids. Simply glide over glass. Samples sent on trial. Kristee, 136, Akron, Ohio.

START Your own business on our capital. Always your own boss. Hundreds average \$3,000 to \$5,000 annual sales year after year. We supply stocks, equipment on credit. 200 home necessities. Selling experience unnecessary to start. Wonderful opportunity to own pleasant, profitable business backed by world wide industry. Write Rawleigh Co., Dept. K-U-PPMA, Freeport, Ill.

CHRISTMAS, Birthday, patriotic and everyday greeting cards. 4154g Fifth Street, Philadelphia 40.

PROFITS Selling novelty fun cards, novelties, etc. Samples 10c. National Specialties, Box 301-M, Cincinnati 1, Ohio.

POWERFUL Mile stretcher! Increases mileage! Increases power! Increase your income! Guaranteed! Information free! Thermoxwks, Peoria 4, Ill.

MAGIC Races—At cigarette touch six horses are off. Fast seller, big profits. 40 races \$1.00. Dime brings samples, wholesale prices. Barkley Co., Dryden 11, Va.

SELL Christmas signs. Every store prospect. Huge profits. See our line tin-seled religious mottoes. Write for catalog or send dime for sample. Silvergio, 4824 Barry, Chicago 41, Ill.

MEN—Women: 4 sales day pays \$32 commission introducing our national three phase health program. Repeats regularly. Permanent work. Nutro Distributing Ass'n, Columbiana 5, Ohio.

5c WILL Make dollar profit. Free sample of product. Stanley Soaps, P.O. Box 681, Lansing, Mich.

NEEDED—5000 Agents. Week's pay in one hour at home. Free details. Martin, Dept. 25, 1903 Ave. U, Brooklyn, New York.

SELL "Personalized soap" for service men. Name imprinted. Ideal Christmas gift. Sample offer free. Dunbars, New Brunswick, N. J.

TO 400%! Fast cash sales! Free lists! Samples 35c. Sterling signs; large, sparkling, religious-patriotic mottoes. 2620 Capitol, Omaha 2, Nebraska.

BIG Bargains for big profits. Men's used pants 25c, suits \$1.00, topcoats 75c, overcoats \$1.00, shoes 12 1/2c. Over 100 sensational values. Experience unnecessary. Free wholesale catalog. Superior, 1250-CB Jefferson, Chicago 7.

FREE Mexican curiosities. Biggest line. Stupendous profits. Gallo, Apartado 9318, Mexico.

COMIC Xmas cards—25 designs, two colors, envelopes \$1.00 postpaid. Jerry's, 182 W. Bernard, St. Paul 7, Minn.

1000 BLADES, \$4.50; Dolls, dozen \$13.50; combs, gross \$3.50; aspirin, gross boxes \$1.95; payment with order. Catalogs free. Mills Sales, 901 Broadway, New York.

BOYS Make money at home spare time. Write for particulars. Roy Vail, Howe 21, Indiana.

SCHOOL Seniors—Sell classmates America's most beautiful, distinctive graduation name cards. Positively highest commission. Largest selection. Lowest prices. Free cards and free sample kit. Printcraft, 1423 East Elm Street, Scranton 5, Penna.

SELL Transparent signs, greeting cards, Christmas goods! Big profits! Catalog free! Elco, 436 North Wells, Chicago.

EXCELLENT Sideline for printing salesmen. Decalomania name plates in small quantities. Also, make money applying initials on automobiles. Free samples. "Ralco," X-164, Boston (18), Mass.

AGENTS: Stamping names on pocket-key protectors. Sample check with your name, address, 25c. Stamping outfits. Emblem checks, check-fobs, name plates. Hart Mfg. Co., 303 Degraw St., Brooklyn, N. Y.

AGENTS. Big line including food products. Fast selling premium and bargain deals. Low prices. Send card for big outfit offer with gift. Ho-Ro-Co, 2793 Dodier, St. Louis 7, Mo.

PLATING Outfits for autotparts, reflectors. Connect to a battery. No tanks necessary. Free booklet and particulars. Gunmetal Co., Ave. N, Decatur, Ill.

MAGIC Cleaner and laundry soap deal. Hotter than a firecracker. Big profits! Sample free. Bestco, 5007 Irving Park, Chicago.

GOLD Lacquered window sign, letters. New styles. Absolutely beautiful. Free samples—catalogue. Atlas, 7941 Halsted, Chicago.

WHOLESALE Sources. 500,000 articles. Free directory. Maywoode, 1133 Broadway, New York.

FREE Water and our concentrates, makes flavors, lotions, shampoos, 72 products, labels, bottles furnished. Qualco, E-20030 Russell, Detroit.

ELITE Collection contains 127 plans for starting own business; home, office. Descriptive booklet free. Elite Co., 214 Grand St., New York.

HIGH-GRADE SALESMEN

SALESMAN: Sell hardware, paint, department stores. Send one dollar for samples. Money will be refunded upon return samples or first commission check. Kittredge Company, Tunkhannock, Penna.

ADVERTISING Book matches—World's largest "direct selling" book match factory offers advance cash earnings calling on every type of business. Men or women. Experience unnecessary. Full part time. Low prices. High quality. Quick deliveries. Powerful patriotic display. Special designs for army camps and naval stations. Repeats. Sales kit free. Match Corporation of America, 9433 West 48th Pl., Dept. E-11, Chicago 32.

SALESMEN—Saleswomen. Make big money selling Colt's sensationally new Air-Foam Rubber Arch Supports. Cushions entire foot. Women buying 'em like hotcakes. Extra-large commission and bonuses. Write for free outfit. Colt Shoes, 657-L Atlantic Avenue, Boston 11, Mass.

SELL Warm leather jackets to friends, neighbors. Make money spare or full time. Also rubber raincoats, 200 styles shoes. Sample outfit free. Experience unnecessary. Consolidated Shoe System, Dept. S-67, Chippewa Falls, Wis.

300% PROFIT. Big demand. Chemical coal treatment. Government, industrial laboratories show 30% savings. \$1 brings 8 ton treatment. Sample 3 dimes. Coalal Laboratories, Waterloo, Iowa.

WONDERFUL Side line for salesmen with established line, now calling on industrial plants. Sell Permaflox Hard Mastic Industrial Flooring Compound to repair and resurface old concrete floors. Most all can use it. Repeat orders run into hundreds and thousands of dollars. Big commissions. Exclusive territory. Permaflox Products Co., Philadelphia 22, Penna.

YOURS Free! Latest Issue Opportunity Magazine—free you valuable, inspirational information on opportunities in selling. Tells you how to build business of your own quickly in post-war days. Guides you to best lines and companies. Send no money. Just send name, address, and kind of line you sold or are selling, and big, new, illustrated issue will be rushed to you at once—free! Opportunity Magazine, Dept. 15, 620 N. Michigan, Chicago 11, Ill.

ORANGE Concentrate direct from our Florida grove. One quart bottle makes 6 quarts delicious natural orange drink simply by mixing with 5 parts cold water. Groceries, food marts, roadstands, soda-fountains, resorts, camps, hotels, restaurants, hospitals, farmers, big buyers. No investment. Protected territory. Salesmen earn \$100 to \$200 repeat commission per week. Sunset Valley, 3357 Clifton, Chicago.

SOMETHING New in fire extinguishers. Red Comet Automatic Safety Sprays. Real fire killers. Low in price. Easy for you to sell. Splendid outfit furnished free. Write to Red Comet, 704 Comet Building, Littleton, Colorado.

SALESMAN: Have real money-making opening. Fits into war program. Old progressive firm. Dept. "F," Box 392, Dallas, Texas.

BLADES—Best quality, factory prices. Details free. Ace Blades, Buffalo, N. Y.

EDUCATIONAL AND INSTRUCTION

MAKE Up to \$25-\$35 a week as a trained practical nurse. Learn quickly at home, spare-time. Easy tuition payments. Earn while you learn—many earn hundreds of dollars while studying. Easy to understand lessons, endorsed by physicians. High school not required. Our 45th year. Write for free booklet and sample lesson pages. Chicago School of Nursing, Dept. K-11, Chicago.

"HOW To Break and Train Horses"—A book every farmer and horseman should have. It is free; no obligation. Simply address: Beery School of Horsemanship, Dept. 11011, Pleasant Hill, Ohio.

WHO? Me? Find success. Yes, to find success find yourself and cash in on your creative ability. I've helped thousands. Dept. 8M, Box 5766, Philadelphia.

GOOD Jobs and a sound postwar future for you in hotel and institutional field, government housing, food and recreation projects. Men and women—all ages—needed for well-paid positions that offer color, excitement, ever-new and fascinating duties. Record-breaking business in hotels, clubs, institutions means even greater opportunities. Lewis School receiving calls for managers, hostesses, executive housekeepers, purchasing agents, stewards, etc. These are not temporary jobs, but important positions in an essential business that offers splendid opportunities in war or peace, good times or bad. Previous experience proved unnecessary! No need to leave your job to qualify. A good grade school education, plus Lewis Training qualifies you, at home, in spare time. Our National Placement Bureau helps to place you and—under our amazing Certified Job Plan—actually guarantees you will "make good" when placed. Write today for free book! Lewis Hotel Training School, Room CX-368, Washington 7, D. C. (First and only school of its kind—Now in its 29th year.)

LOOK Ahead! Are you "all set" for a permanent job in the years to come? Only properly trained men will get and hold top positions with best pay. Pick air conditioning, refrigeration, heating, ventilation, welding, electricity, radio or electronics—fastest growing, most promising industries. Prepare now, train in a few months instead of years. Low tuition, liberal terms. Earn part expenses. Big book free. Milwaukee School of Engineering, Box 644, Milwaukee, Wis.

OPPORTUNITIES Through shorthand. Shorthand Institute, 211 N. 7th, Saint Louis 1.

REAL Estate. Low cost home study course for all states. Unlimited opportunities. Big earnings. Free bulletin. DeVeto Schools, 35 Vicente, San Francisco 16, Calif.

NEW Graphical system for multiplying, dividing, adding and subtracting, whole numbers, fractions, and decimals. Without figuring. Price \$2.00. Also, book of all fraction equivalents and oddities from 1/2 to 1/500. Price \$1.00. Claude Beaver, 1616 So. Westlake Ave., Los Angeles 6, California.

INCREASE Your income. Study trade magazines for business advancement. Write for free price-list. Current single copies. Over 600 different periodicals. Commercial Engraving Publishing Company, 340 North Ritter, Indianapolis 1, Indiana.

LEARN Wood carving. Instructions 25c. Karving Kraft, Box 221, Clovis, New Mex.

SHORTHAND And typing course complete 50c. Queens Sales, 30-36 49th, Astoria, New York.

DRAFTING Salaries are high. Learn now. Monroe Institute, PM-11, Alton, Ill.

WELDING—Electric arc. Learn profitable trade quickly through actual practice. Individual welder instructions at bare cost of materials. Full particulars free. Valuable welding lessons book 50c. Hobart Welding School, Box M-1142, Troy, Ohio.

PUBLICITY Pays dividends. Practical 10-lesson course in publicity and public relations. Free pamphlet, "Publicity Is Profitable." Streamlined Publicity Course, Dept. M, 1130 Sacramento Street, San Francisco 8, Calif.

BECOME A Doctor of Metaphysics (Ms. D.) Teach secret of contentment, happiness. Solve mental worries. Free book. College of Universal Truth, 5153-C North Clark, Chicago.

INVESTIGATOR Training. Phillips Secret Service, 1917-B North Kenneth, Chicago 39, Illinois.

READ Character at a glance. How to judge people by their eyes, nose, mouth, etc. May save you thousands of dollars, endless disappointment, heart break. Priceless information for everyone. Dulco, 324P Pitt, Pittsburgh 21, Penna.

USED Educational and technical books. Bought, sold, rented, exchanged. Catalog free. Educational Exchange, Henagar, Ala.

THRILLING Power of money, fascinating age-old methods for financial independence taught in our books. Inquire. Habermann (V), Box 1642 Perry Square Station, Erie, Penna.

GAGWRITING. Complete bound course, numerous entertainers material. \$2.00. C. Frankel, 3505 Adams, Chicago 24.

HOW To trisect angles. Ruler and compass only. Illustrated publication \$1.25. Pure Science Research Associates, Box 310, Moscow, Idaho.

EARN Certified Grapho-Analyst degree analyzing handwriting. Students report earnings up to \$1.00 an hour sparetime. \$75.00 weekly full time. Graduates in employment, credit agencies, police departments, courts, business and in private practice as personal problem and vocational advisors. Fully illustrated Grapho-Analyst and 3000 word illustrated lesson free. Institute, (AP), Joplin, Missouri.

REMEMBER Without effort. Easy five lesson memory course \$1.00. Amazing results. Money back guarantee. Particulars free. Mighty Midget Publications, Box A-566, Lincoln 1, Nebraska.

REFRIGERATION Mechanics. Complete home course for repair men. Booklet free. Mechanics School, Dept. 4-PM, 4703 West Pico, Los Angeles 6.

NEW Writers needed to re-write ideas in newspapers, magazines, and books. Splendid opportunity to "break into" fascinating writing field. May bring you up to \$5.00 per hour spare time. Experience unnecessary. Write today for free details. No obligation. Postcard will do. Comfort Press, Inc., 210-P South Seventh St., 2, St. Louis, Mo.

AUTO Body and fender work, including metal work, welding and spray painting. Look into it! One of the most profitable branches of tremendous auto industry offering chances for good job or your own business. Train in spare time. Write for free facts. Utilities Inst., Dept. 14X, 1316 W. Belden Ave., Chicago.

LEARN Profitable credit and collection agency business; investigate Educational Extension Service Advertisement under Business Opportunities.

RADIO Engineering, broadcasting, servicing electronics, aviation, marine and police radio taught thoroughly. All expenses low. Co-educational. Catalog free. Valparaiso Technical Institute, Dept. C, Valparaiso, Ind.

GOOD "Used" self-instruction educational books on all subjects bought, sold, rented, exchanged. Satisfaction guaranteed. Complete information and 92-page illustrated bargain catalog free. Write—Nelson Company, Dept. 2-02, Chicago 4.

CARPENTERS, We teach the square in five easy lessons by mail. Our 1/4 size practice square and simplified instructions does the work. Free information, better still send quarter for practice square and partial lesson. Builders' Topics, Medical Arts Bldg., Seattle, Washington.

USED Educational books on all subjects sold, rented, also bought and exchanged. Moneyback guarantee. Write today for free catalog and details. Lee Mountain, Pisgah, Alabama.

MEDICAL Laboratory technicians in great demand. We train you in your spare time, in your own home. You can practice while studying. Write for free catalogue. Imperial Technical Institute, Box 973-E, Austin, Texas.

DRUNKENNESS is a disease which responds to treatment. Medical skill plus human sympathy prove successful with liquor and drug cases. 60 years experience. Write for free booklet. P. M. Nelson. The Keeley Institute, Dwight, Ill.

LOCKSMITH Course. Lock picking, key fitting, etc. \$1.00 prepaid. Locksmith, Canadian, Texas.

PLAYS, STORIES, MANUSCRIPTS

WRITERS: Send for free circular P-124 with Unified Sales Plan for placing your work. Otis Adelbert Kline, Literary Agent, Established 1923, 507 Fifth Avenue, New York 17.

WRITERS Need manuscript typing insurance. Zubryn, 25 West 70th, New York City.

GHOST Writing—Technical, scientific. Sales-letters, brochures, typing, revision. Lathrop, Box 53, Manhattan, Kansas.

CARTOONING, COMMERCIAL ART, SHOWCARD WRITING, SIGN PAINTING

CARTOONING Pays well, prepare now, new, exciting, easy to learn course \$1.00 complete. Chesley Studio, 1450P Broadway, Buffalo, N. Y.

FUNNY Faces, comic faces, learn to draw them. It's simple, easy, lots of fun. Details free. Funny Faces, 3 - 924B Faust Ave., Modesto 2, California.

CARTOON Markets—10 money making plans—25c. Cartoon Studio, 1402 Charles, LaCrosse, Wis.

GUARANTEED Precision pantographs. \$2.00 postpaid. Enlarges drawings automatically. Eliminates squares. Details stamp. Pantographs, Munising, Mich.

WRITE Cartoon ideas. Nationally known magazine cartoonist booklet shows how. "Be Funny for Money, 25c." Ush Studios, 518P Wrightwood, Chicago 14.

BARGAINS — Books, courses, quick landscape painting, poster art-letting, cartooning, art studies, sign painting, etc. Write today for big illustrated list free. Art Book Shop, Kimmswick 12, Mo.

CASH For your cartoons. Details 25c. Box 71, Crawfordsville, Indiana.

REVISED, Modern poster art \$2.00, catalogue 10c. Sign, Farmington 5, Missouri.

CHALK Talks. Laugh producing program, \$1.00. Catalog 10c. Balda The Cartoonist, Oshkosh, Wisconsin.

CARTOON Advertising; also lettering, layout service. Allan K. Jensen, Audubon, Iowa.

POCKET Size cartoon course—22 easy lessons, over 200 sketches including figures and lettering. Prepared by nationally known artist. Mailed postpaid on receipt of 25c in coin. Snack-Pack Co., 34 E. Georgia St., Indianapolis 4, Ind.

ADVERTISING AGENCIES, LETTER WRITERS, FOR ADVERTISERS

PUT Over your proposition! Get more orders—increase cash returns—with Word-Master letters and sales literature. Long, successful experience assures outstanding results. Here's modern, dynamic, big-time advertising the small dealer can afford. Outline needs for free counsel. Erol Slater, 451 Mt. Carmel, Glendale 6, Calif.

24 WORDS in 90 weeklies \$4.60. H. J. Darnell, 730 Hays, Jackson, Tennessee.

ADVERTISE Profitably; \$20.00 reaches 5,000,000 Sunday newspaper readers with 24-word ad. Newspaper, magazine, mailing-list ratebook free. Chicago Advertising Agency, 20-PA West Jackson, Chicago 4.

ADVERTISING Copy prepared for all purposes. Artwork, lettering, designing. Samples 10c. 200 attractive stationery designs \$1.00. Major Service, 3510 Palmer, Chicago 47.

ADS Placed in out of town newspapers and magazines. Low rates. Catalogue free. Ideas that pay. Baker Advertising Agency, Successors Ankrum Agency, 189 W. Madison, Chicago 2.

3000 WOMEN Mail order buyers \$15.00. Our own customers. 1000—\$6.00. Woods Remnants, Bedford, Penna.

ADVERTISE: 24 Words, 149 newspapers \$6.50. Lists free. Advertising Bureau, 4615-C Cottage Grove, Chicago 15.

MAIL Order operators—Get skillfully prepared copy when placing advertising. Our "lowest" line rate plus experience gives you more profits per dollar spent. Van De Mark, Times Star Tower, Cincinnati 2.

ADVERTISING Placed, any publication, lowest rates, complete agency service. Skilled advertising—merchandising counsel. Ratelist and booklet, entitled "Advertising Results For Sale" free. Baker Agency, 3202 Dodge, Omaha, Nebraska.

FREE—New Advertisers Rate Guide. 44 pages. Includes everything. Lowest rates. E. H. Brown Advertising Agency, Merchandise Mart, Chicago.

INCH Display advertisement, 50 magazines, year \$16. Wood's Popular Services, Atlantic City, (N. J.)

BUSINESS SERVICE

SURPRISE Your wife, sweetheart or friends with cards or letters mailed from Texas. Send me cards or letters, correctly addressed, and stamped and I mail here. Will hold Christmas cards until Christmas. 10 cents each. Troy Ginn, Tyler, Texas.

OAKLAND, California, mail address. Fool friends! Business and personal letters reforwarded promptly. Monthly service \$2.00. Single letter 25c. Pacific, 4182 Emerald Street.

WANT A Washington, D. C., mail address? Complete reforwarding service, \$2.00 monthly. Hawkins, (Est. 1917), 7-c Randolph Place.

DAYTON, Ohio; home of aviation; mailing address, letters forwarded, 25c each. AAA, Pro. Co., 1340 Keowee St.

TYPEWRITERS, DUPLICATORS, OFFICE DEVICES

USED Typewriters, mimeograph machines, office appliances, supplies. Dixie-Graph, King, N. Car.

"PRINTOMATIC" Self-feeding rotary stencil post card printer, complete, \$9.50. All makes duplicator supplies. Literature free. Pittsburgh Typewriter Supply, 336-B Fourth Avenue, Pittsburgh 22, Penna.

RUBBER STAMPS, OFFICE SUPPLIES

3 LINES Cushioned, indexed, 35c. Signatures \$1.50. Stamprite, Wauwatosa, Wis.

ONE Line 20c, 2—35c, 3—50c, 4—65c. Stamp Works, Auburn, Nebraska.

PRINTING OUTFITS AND SUPPLIES

PRINTER'S Supply bargain bulletins. Send stamp. Bradshaw's, 3214-P Huron, Chicago 24.

BARGAINS—Presses, type, supplies. Send stamp. 8 Walden, Cambridge, Mass.

PRINTING Press \$12.00. Famous "Chicago" model. Ink, type, included. Details 3c. Kirlinprint, Pitman, N. J.

PRINTERS Big money makers. Samples 3c. Murico, Box 748, Dayton 1, Ohio.

INEXPENSIVE Home-made printing press. Details free. Novelty Shop, Downsville, Louisiana.

PRINTING Equipment, type and supplies. Send stamp for details or dime for complete illustrated supply book. Kelsey Inc., X-11, Meriden, Conn.

PRINTING, MULTIGRAPHING, MIMEOGRAPHING, GUMMED LABELS

SAVE Money on long runs. Have it done by offset. (A new process.) Conway, 2024 Chicago Ave., Chicago.

\$2.00 POSTPAID: 150 8 1/2 x 11 Good bond letterheads and 150 6 1/2 envelopes. 500 of each \$5.75 postpaid. Mero Products, Box 344, Punxsutawney, Penna.

200 8 1/2 x 11 BOND Letterheads \$1.25. 200 6 1/2 envelopes \$1.25. Estimates on other printing. Poster Sign & Printing Company, 4620 Cottage Grove Ave., Chicago 15, Illinois.

OFFSET Printing, planographing. Send specifications for estimates. Modern Litho-print, Jefferson City, Missouri.

\$1.00 POSTPAID 100 8 1/2 x 11 Bond letterheads and 100 envelopes. Benneville, 907 West Roosevelt, Philadelphia 40, Penna.

500 BUSINESS Cards printed \$1.50, 1000 for \$2.00 postpaid. Edward Ingewong, 1715 Russell Blvd., St. Louis, Mo.

1,000 LETTERHEADS \$3.75; 3,000 6x9 Circulars \$5.85. Lowest prices on other printing. Churchill, 2991 Washington, Roxbury 19, Mass.

500 1x2" FOUR Lines, red, white, blue stickers 25c. 350 business cards \$1.00. Postpaid. Arcraft, 97-02 Roosevelt, Corona 1, N. Y.

250 8 1/2 x 11 16 L.B. Bond letterheads, or 6 1/2 envelopes; \$1.25. Lung, Huntertown, Indiana.

MIMEOGRAPHING—Any copy. Reasonable. Mailers Service, Box 606-A, Chicago 90, Ill.

1000 8 1/2 x 11 LETTERHEADS \$2.95. Mango, 555-PM South 20th, Newark 3, N. J.

150 8 1/2 x 11 LETTERHEADS And 150 6 1/2 envelopes \$2.00 prepaid. Gago, Box P1544, Muskogee, Oklahoma.

200 8 1/2 x 11 HAMMERMILL Letterheads, \$1.00 postpaid. Envelopes, invoices, business cards same. Race Printing Company, Hudson, N. Y.

EMBOSSED Business cards 1,000 \$2.25 c.o.d. Spada, 10 Lexington, Wethersfield 9, Conn.

BETTER Grade printing reasonable. Estimates on anything. Economic Press, Leonia, N. J.

POCKET Calendars, blotters, stationery, labels, etc. Samples. Lake, 1018 Jericho Road, Aurora, Ill.

FIRST-Quality printing—reasonable. Samples. Treaster Printing, 11-44PM, Milroy, Pennsylvania.

LETTERPRESS And offset printing. Send specifications for estimate, 4154F Fifth Street, Philadelphia 40.

2500 ADVERTISING Book matches \$9.95. Otho DeWitt, Baseline, Mich.

125 LETTERHEADS And envelopes, \$1.50 postpaid. L. G. Cooper Printing, Higginville, Missouri.

600 PIECE Personalized stationery assortment consisting of 200 letterheads, 100 envelopes, 100 postcards, 100 gummed stickers, 100 calling cards printed in Beverly blue in "Hollywood script" type—only \$2.99. Beverly Printers, Dept. 250, Beverly Hills, Calif.

200 BUSINESS Envelopes with name and address \$1.00, postpaid. Excelsior Press, Hampton, Virginia.

100 PERSONAL Letterheads, 100 envelopes to match. Rippletone, \$1.25. Clarion Press, Richland, Iowa.

LET US help you in all your printing needs. State requirements. Printing Service, 7922 South Vermont Ave., Los Angeles 44, California.

CALENDARS—Post cards—of dogs, pigeons, canaries. M. Nicodemus, 2156 Ber-teau Ave., Chicago 18, Ill.

MIMEOGRAPHING And multigraphing. 14 years of fine work and fair prices. Free samples and prices. H. Allsmith, 1500 W. Nedro Avenue, Philadelphia 41, Penna.

PERSONAL Printed postals, 150, \$1.00. Harper, 7040 Woodard, Dallas 17, Texas.

QUALITY Printing moderately priced. Estimates on anything. Samples. Keystone Printing, 292 West Third Street, Williamsport 3, Penna.

\$4.00, 1,000. LETTERHEADS, Envelopes, statements, cards, etc. Dixie, Chattanooga 7, Tenn.

MIMEOGRAPHING—Letters, pricelists, formulas, instructions. Lowest prices. Lem's Letter Shop, 5710 Stanton, Detroit 8.

500 3 1/2 x 2 1/4 FOUR Line gummed stickers. 25c. Moritz Printery, Saginaw, Mich.

PATENT ATTORNEYS

PATENT Attorney since 1904; easy terms; reasonable. Sanders, 6430-A Evans, Chicago 37, Ill.

INVENTORS—First things come first. Your first move toward securing a patent on your invention is acquiring full information on what to do. Our two books "Patent Protection" and "When and How to Sell Your Invention" contain this information and other helpful data. Get them immediately, together with our "Evidence of Invention" form. They cost you nothing, you assume no obligation. Write now to Victor J. Evans & Co., Registered Patent Attorneys, 831-M Merilin Building, Washington 6, D. C.

INVENTORS: Learn now—without obligation—how to protect and sell your invention. Write for free "Record of Invention" form and complete information for making disclosure and establishing date of your invention. We also send our new free "Patent Guide for the Inventor," containing complete information about patent procedure and how to sell inventions; giving illustrations of many successful inventions; over 150 basic mechanical movements. We assure you prompt, confidential service. Delays may be dangerous. Write today for your free "Patent Guide" and "Record of Invention" form. Clarence A. O'Brien & Harvey Jacobson, Registered Patent Attorneys, 41B-L Adams Building, Washington, D. C.

INVENTORS—Industry needs your ideas now! Manufacturers are getting ready now for post-war sales and production. Factories must have products to take up the slack after war orders stop. Get our new free inventor's book today and valuable "Invention Record" form. Act now. McMorro and Berman, 134-D Albee Building, Washington, D. C.

PATENTS. Personal service, no catalogues, Washington associate. David Charney, Patent Lawyer, 606 W. Wisconsin Ave., Milwaukee 3, Wis.

"PATENT-Particulars" and blanks, free, airmailed. Sterling Buck, Park-North Avenues, Baltimore 17, Md. Government-registered 38 years.

INVENTORS—Before disclosing your invention to anyone send for form "Evidence of Conception"; "Schedule of Government and Attorneys' Fees and Instructions." Sent free. Lancaster, Allwine & Rommel, 411 Bowen Building, Washington 5, D. C.

"INVENTOR'S Guide," 100 mechanical movements, free; advises on patenting, selling inventions. Frank W. Ledermann, 154 Nassau Street, New York.

PATENTS. Promptness assured. Wilfred E. Lawson, 1524 K Street, N.W., Washington 5, D. C.

C. A. SNOW & Co., M-427 Snow Bldg., Washington 1, D. C. Registered patent attorneys. Established 1875. Literature mailed on request.

PATENTS Obtained; selling service, information, recording forms free. Labiner, World Building, New York.

L. P. RANDOLPH, 302-B Columbian Bldg., Washington, D. C. Low cost. Book and information free.

PATENTS. Protect your idea by securing free "Proof of Invention" folder. Exceptional personal service. Established 1906. E. E. Vrooman, 871 Woodard Bldg., Washington, D. C.

PATENTS—Trade marks. Preliminary advice, book and disclosure form free. Personal service. Irving L. McCathran, 315 McLachlen Bldg., Washington 1, D. C. Registered Patent Attorney.

FOR INVENTORS

INVENTORS Record ideas before patenting. Inexpensive. Write Inventors' Recording Institute, 2005 Wisconsin Tower Bldg., Milwaukee 3, Wis.

INVENTORS! Have you good patentable idea? Write Mr. Metzler, 11 West 42nd St., New York.

INVENTORS: Streamline your inventions for greater sales appeal. Industrial design service, 16 years experience. 202 Commercial Bldg., Rockford, Ill.

INVENTORS: Learn now—without obligation—how to protect and sell your invention. Write for free "Record of Invention" form and complete instructions for making disclosure and establishing date of your invention. We also send our new free "Patent Guide for the Inventor," containing complete information about patent procedure and how to sell inventions; giving illustrations of many successful inventions; over 150 basic mechanical movements. We assure you prompt, confidential service. Delays may be dangerous. Write today for your free "Patent Guide" and "Record of Invention" form. Clarence A. O'Brien & Harvey Jacobson, Registered Patent Attorneys, 41A-L Adams Building, Washington, D. C.

WHO Buys inventions? Manufacturers everywhere have written us seeking new patented inventions. Present defense program offers splendid opportunity to inventors with meritorious ideas. As Registered Patent Attorneys in Washington we have served hundreds of inventors—for full information on how to protect your invention write for free book, "How to Protect, Finance and Sell Your Invention." Also free special form "Invention Record" upon which to sketch and describe your invention. No obligation. McMorro & Berman, Registered Patent Attorneys, 134-E Albee Building, Washington, D. C.

PATENT Your ideal! Write immediately for two free illustrated books, "Patent Protection" and "When and How to Sell an Invention." 64 pages of valuable information for inventors. No obligation. Address: Victor J. Evans & Co., 832-M Merilin Bldg., Washington 6, D. C.

INVENTORS: We will turn your rough sketches into clear, readable, mechanical drawings, blueprints. All work confidential. Write for free quotation. Hamilton, 650 South 20th Street, Newark 3, New Jersey.

WILL Assist financially in designing, manufacture, marketing new or old items. Volume outlet channels for anything of merit. Give complete details in first letter. Strictly confidential. H. D. Campbell Co., Dept. PM, Rochelle, Illinois.

INVENTORS: Learn how we sell your invention. Free booklet, "Selling Your Invention." Inventors Patent Exchange, 336-B Palace Building, Hartford 3, Conn.

INVENTOR Given instruction teaching you how to become inventor. Copy 25c. Course \$1.00. Charney, P.O. Box 542, Plainfield, N. J.

INVENTORS—Get action and results on your patented, unpatented inventions. Contact purchasing manufacturers direct. Enlightening booklet, references, free. Invention Reporter, 5A-11236 So. Fairfield, Chicago.

MANUFACTURER'S Names, addresses. Any classification. Tupper, 18-A Lyman, Beverly, Mass.

INVENTORS: New military and commercial inventions urgently needed by manufacturers. Write for particulars. Chartered Institute, Dept. 4-A, Washington, D. C.

CASH For practical ideas and inventions. Mr. Ball, AB-9441 Pleasant, Chicago.

I SELL Patents. Established in 1900. Charles A. Scott, 773PM Garson Ave., Rochester, N. Y.

INVENTIONS WANTED

PATENTED, Unpatented, bought, sold, financed, no advance charges. Inventions Sales Company, Williamson Building, Cleveland, Ohio.

HAVE You practical ideas or inventions? Write Seymour, 218 South Aurora, Easton 3, Maryland.

INVENTORS: Have you good patentable idea? Write Mr. Metzler, 11 West 42nd., New York.

INVENTIONS Wanted—Patented or unpatented. Developed or undeveloped. As engineers, manufacturers and market analysts, we know what new products industry needs. If your idea is not patented write for details on your protection. Your idea may make you a fortune. Mason, Lesh and Ball, 441 No. Beverly Drive, Beverly Hills, Calif.

WE Develop your ideas, build models, necessary tools and dies for quantity production, have fully equipped plant and engineering dept. Will finance if necessary. Logan Elec Spec. Co., 214 S. Loomis, Chicago 7, Ill.

ALL Kinds. We have facilities and finances to make and sell your ideas, both mechanical and chemical. Send model, sample, details and wishes. General Sales & Supply Company, 110 East Main St., Madison 3, Wisconsin.

NOW Is the time to sell your invention for cash. 10 neat prints from your rough sketch, description. 15 manufacturer's names, addresses \$10.00. J. Weaver & Son, 2214 Tilgham St., Allentown, Penna.

WANTED—Patented, unpatented inventions having profit possibilities, all kinds. If will sell, write immediately. Descriptive booklet, references, free. Invention Reporter, EB-11236 So. Fairfield, Chicago.

CASH For inventions, patented, unpatented. Mr. Ball, A-9441 Pleasant, Chicago.

MANUFACTURER Wants sensible mechanical device or idea with quick sales possibilities in low-priced field. Write Matt, 1412-D Great Northern Building, Chicago 4.

INVENTORS: Have you a sound, practical invention for sale, patented or unpatented? If so, write Chartered Institute of American Inventors, Dept. 4-D, Washington, D. C.

PATENTS FOR SALE

LIQUID Containers for dust-laying broom. Amazing opportunity for manufacturer. Cash—royalty. Mary Dehling, 723 Scott, Wausau, Wisconsin.

ATTENTION Manufacturers! "Quick-Wa" pie set. Home bakers necessity. Flossie Noble, Gahanna, No. 1, Ohio.

VALUABLE Patentable postwar inventions for sale, 1/3 interest for patent expenses. Ben Sargent, Fort Morgan, Colo.

AMERICAN And Canadian patent, royalty or outright, for new idea which ladies can put galoshes on easily. Write H. Tamaki, 26 Glen Elm Ave., Toronto, Ont., Can.

HEADLIGHT Signal patent 2,350,599. Sell or royalty. Feldheim, Cambridge, Minnesota.

ATTENTION. Cash or royalty. Always moist antenna. Home or car. Fire claim patent. Wilbur White, 312 State Street, Salamanca, New York.

I HAVE Several excellent inventions for postwar production. Royalty basis. Inventor, Box 144, Catskill, N. Y.

MANUFACTURING

INDUSTRIAL Diamonds, 1.50 models. Products wanted. Precision machining. Production small lot. Specialty Machine Shop, 2821 Mitchell St., Racine, Wis.

MODELS, Special to order work made. Baum's Metal Specialties, Kansas City, Mo.

MODELS—Small lot manufacturing. Metals, plastics, etc. Milburn, Burlington, Kentucky.

HOME CRAFTSMEN

PLEXIGLAS—The amazing crystal-clear plastic. Saw it, drill it, bend it, twist it into hundreds useful articles that are beautifully different. Special 1 pound package assortment \$1. Postpaid; 7½ pounds \$5. Free instructions and project suggestions included! Order today! Carmen-Bronson, 160-B East Fourth Street, Mount Vernon, N. Y.

EXTRA Cash. Build and sell toy electric cannons. Accurately shoots steel shells by magnetic propulsion. 110 volts. Power tools unnecessary. Drawings, instructions, photograph \$1.00. Details free. Hamilton, 650 South 20th Street, Newark 3, New Jersey.

LUMBER. Walnut, cherry, oak, cut to order. Sample lot \$1.00. Jason E. Lyon, Harrisonburg, Va.

PATTERNS For fast selling toys. Ten for \$1.00. Homer Gabert, Eau Claire, Wis.

CHILD'S Wooden ironing board. Sells on sight. Plans 25c. Ernest Melberg, Norway, Iowa.

FLYWOOD—Beautiful nonpriority aircraft and cabinet stock. Thicknesses 1/32" through 1". Large, small panels. Fir, gum, birch, walnut, mahogany. Reasonable! Complete lists 10c. Carmen-Bronson, 160-B East Fourth Street, Mount Vernon, N. Y.

BLUEPRINTS And instructions for constructing all-weather wild bird feeding station. \$1. Alvin, 105 Overland, Peoria 5, Ill.

CORNER Cupboard: Blueprint of exclusively designed Early American press complete with details for construction in any shop; \$1.00. Penny Plans Company, Radford, Virginia.

PLANS For 30 original toys in wood. \$1.00. Winfield Hess, Dover 1, Penna.

TOYS Easily made from scrap wood, 15 patterns 25c. Novelties from scrap wood, 25 patterns 25c. Lynds, Medway, Mass.

TOY Patterns (action). Friendly puppy; peddling clown; ducky quack; man sawing wood weathervane. 25c each. Strother, Belington, W. Va.

DESIGN Smart leather ornaments. 15 easy-to-finish colorful novelties \$1.00. Guaranteed. Vogue Leather, Box 6, Fairfield 3, Iowa.

12 NEW Lawn figures (patterns) 24" to 36" high, 15c each; 10 smaller assorted new figures for 25c. All above patterns \$1.50. C. Schilder, Cresbard, S. Dak.

STAINLESS Steel scrap, generous shipment, \$1.00 postpaid. Industrial Engineering, 1155 South Kenmore, Los Angeles 6, California.

28 LAWN Ornament patterns 25c. Other patterns; 15"-20" high; Dutch girl; Dutch boy, pirate, bull terrier, Mexican girl, Mexican boy, dwarf, penguin, flower girl, 10c each; 3 for 25c. 25 novelty patterns 30c. All 62 full size patterns \$1.00 postpaid. Strother, Box 383-GF, Belington, W. Va.

TOYS—Bulldozer, power shovel, and earthmover of new design in wood. Make toys for your home town of scrap lumber with hand or power tools. Prints showing construction and details \$1.00. Earthmover Toys, East Lansing, Mich.

WHITTLE'S — Softwood subjects. 10 patterns, instructions. 25c. Cartoon Studios, 1402 Charles, LaCrosse, Wis.

NEW Plastic sheets. 1/16x8 1/2x11—\$1.50. 1/8x10x10 \$2.00. 3/16x10x10 \$2.25. 1/2x10x10 \$2.50. Manual plus free sample 25c. Complete kit for beautiful cigarette box \$1.25. Plastic Center, 3132-C West 11th, Los Angeles, Calif.

CATALOG: Large line decal transfers. Patterns for jig sawing. New designs easy to make novelty furniture, lawn ornaments, silhouettes, letters and numerals. 100 crafts and hobbies illustrated booklets. Tools. Other lines. 500 articles finely illustrated. Write Wo-Met Shop, Ashburn, Georgia.

CELLULOID — Beautiful assortment. Motifs, opaques, onyx, pearls. Used by ring makers everywhere. One pound assortment—pieces approximately 30 sq. in. each. Price \$1.00. Craft Service, 337 University Ave., Rochester, N. Y.

MODELS AND MODEL SUPPLIES

PLANES, Boats. Hundreds of hobby items. Catalog free. America's Hobby Center, Dept. B114, 40 E. 21 St., New York 10, N. Y.

SHIP Models and yacht supplies complete. Large 64 page catalogue 25c. Bill Wild's, 510 East 11 St., New York City.

RAILWAY Models, complete line, informative catalog HO and O gauge, 79 pages, 15c. Walthers, 247 Erie, Milwaukee, Wisconsin.

MANUFACTURING Dies, stampings, brass, gears and model supplies. Send 10c for catalog. Pierce Model Works, Tinley Park, Ill.

WANTED HO and O gauge scale model trains. 2 rail only. 482, Ithaca, N. Y.

CATALOG 50 Engines, model railroad supplies, 25c refunded. Simonsen Model Supply, A-3054 North Greenview, Chicago 13.

COMPLETE Kits: Ship models—coach models—covered wagon. All parts cut to fit—no shaping required—tack hammer only tool needed. Everything included, sails, wire and rigging. Send 3c for catalog. Miniature Ship Models, Dept. R, Perkaskie, Penna.

MODEL Steam and gasoline engines, castings and drawings. Literature 10c. Wayne Miller, 205 W. Wacker Drive, Chicago 6.

MODEL Steam engines, boilers. Circular M 10c. Anton Bohaboy, 2297 Price St., Rahway, New Jersey.

SHIP Model kits and fittings. Complete line Fisher model yacht equipment. All Boucher, Fisher, Marine Model and Ideal kits, fittings and blueprints at standard prices. Most complete stock in New England. James Bliss & Co., Inc., 220 State Street, Boston, Massachusetts.

MAKE IT YOURSELF

SIMPLE Plans—For own use or sell—Step ladder attachment, safety convenience 25c. Post-war built-in bed 35c. Radio-electrical test board \$1.00. Electrical questions answered 25c. Wiring diagrams 25c. Pvt. T. J. Dwyer, Jr., Det. C, BHOD, Igloo, S. D.

SURPRISINGLY Easily built lawnmower power attachment. Rejuvenates old mower. Drawings \$1.00. Dink, Dunbar, W. Va.

GARAGE Doors dashboard controlled. Additional information under "Automobiles."

SHELLWORKERS, Rehabilitation hospitals, send for wholesale price list. Plastic and metal jewelry findings, seashells and supplies. Shell Novelty Co., Box 1664, Fort Myers, Florida.

BARBECUE Plans. Build your own "vertical" barbecue with our four sheet master set of plans; 49 detail drawings, complete instructions, easy to build, inexpensive. \$1.00 postpaid. Allen Selby Associates, 1836-A Chase Ave., Chicago 26, Ill.

FLUORESCENT Lights. How to make your own 20 watt lights for less than \$1.00 each. Complete, guaranteed, detailed instructions \$1.00 M.O. or war stamp. Specialty Sales, Box 1086, Muncie, Ind.

WATCHES, OLD GOLD, JEWELRY, ETC.

GENUINE Diamonds, out-of-pawn low prices, wonderful values. Unredeemed loans and big buying power enable us to offer beautiful gems at prices far less than original cost. Shipped free for inspection, appraisal. Send for big free list showing fine diamonds at startling low prices. Lloyd J. Butler, President, Prudential Loan Association, 133-PM North Clark St., Chicago 2.

BEAUTIFUL Shell brooches hand made, latest in costume jewelry. \$3.00 postpaid. J. Gates, 840 B St., San Diego, California.

CASH. Mail today your castoff gold jewelry, diamonds, watches, bracelets. You're satisfied or no sale. Monarch Jewelers, P.O. Box 1964, Boston, Mass.

WATCH Repairing easy learned by our home study course. Watch repairers are in demand and are among the highest paid craftsmen today. Write for free information. Houston Chronometer & Watch Co., P.O. Box 5367C, Houston 12, Texas.

GUARANTEED Men's reconditioned Swiss wrist watches. Reasonably priced. Free particulars. Notlimah and Company, 407A North Broadway, St. Louis, Mo.

WANTED: Watches, diamonds, jewelry—any condition. Justice, Box 150, Chicago 90.

GOLD \$35.00 Ounce—Mail old gold teeth, diamonds, jewelry, watches—receive cash by return mail. Satisfaction guaranteed. Free information. Dr. Weisberg's Gold Refining Company, 1500-Q Hennepin, Minneapolis, Minn.

WATCH And clock repairing—complete practical course in modern horology. 66 illustrated self-instruction lessons. Just out! Low price. Information free. Write—Nelson Company, Dept. 8-02-2, Chicago 4.

WATCHES, Materials, tools, jewelry, diamonds—bought—sold. Catalogue, Gales, Box 1000, Chicago.

TOBACCO, SMOKERS' SUPPLIES

BOX Fifty fine Tampa made cigars postpaid \$5.40. Send money order or check to South Florida Sales Co., Box 5580, Tampa 5, Florida.

GENUINE Imported virgin briar pipes. Send for free catalog trial offer. Sidney Ram, 59 West Monroe, P-64, Chicago 3, Illinois.

SMOKING Cigarettes: Antiseptically decontaminated quality cigarettes that satisfy the desire while reducing the habit. Make an ideal gift. Sample pack \$1.00, cartons \$5.00. Ringel Laboratories, Box 215, Madison, Wis.

PIPES Repaired. Send for free catalog. Sidney Ram, 59 West Monroe, R-64, Chicago 3, Illinois.

FREE To pipe smokers—For a new pipe smoking thrill, write us your brand of tobacco and get free package mild, tasty, natural-flavored "Green River." Pete Moberly, Box 987, Owensboro, Kentucky.

RAZORS, BLADES, SHARPENING

MEN: Double edge razor blades \$1.50 per hundred postpaid. Write Blu-Marr Sales Co., 50 Middlesex St., Lowell, Mass.

100 DOUBLE-EDGE Blue surgical steel razor blades \$1.50 prepaid. Fully guaranteed. St. Moritz Blade Co., 321 Broadway, Dept. M, New York 7.

AGENTS — Patented "Slant-Stroke" razor and 10 "All American" blades in attractive box. \$3.00 dozen. American Sales, 1133 Broadway, New York City.

50 DOUBLE Edge razor blades \$1.00. Samples 10c. Francis Roots, 820 So. 7th, Richmond, Ind.

FOR SALE—MISCELLANEOUS

CLOSING Out sturdy self-winding extension reels manufactured on special order by Vacuum Cleaner Corporation of America. Reels equipped with 17 ft. No. 18 electric cord assuring desired length at all times. Only \$2.25 each postpaid. Radio Reel Co., 1116 Rust Building, Tacoma 2, Washington.

PRINTER'S Supplies, guitar, radios, machinery. P.O. Box 17 Sta. A, New Haven, Conn.

ARMY Goods (used). Jeep hats and caps 10c, canteens 50c, cups 15c, mess kits 35c, leggings 25c, signal flags and case 75c, pup tents \$2.50, new type helmets \$4, linens only \$1, pilot sheepskin lined leather boots \$4, raincoats \$1, ponchos \$1, canvas covers 5c per foot. All sizes. Minimum shipment \$1. Via railway express collect. N. Y. Salvage Co., 144 Chambers St., New York City.

WANTED—MISCELLANEOUS

POPCORN Machines, peanut roasters, candy floss, potato chip, caramelicorn equip. Coin operated vending machines. Northside Company, Indianapolis, Iowa.

APPRAISAL Free—Portable calculators, adders, typewriters; drafting instruments, precision tools, slide rules, stop watches, micrometers, verniers; sterling, curios, jewelry. Accept highest offers or merchandise promptly returned prepaid. Reliable, 2354B - 77th Ave., Philadelphia 38, Penna.

WANTED Item sells around one dollar for mail order. What have you? Dawson Mfg. Co., Enfield, N. C.

UNICYCLE Wanted. Orval Anderson, 864 El Centro Street, El Centro, California.

WANT To buy exclusive sales rights or patents of items that can retail \$1.00-\$3.00 in volume sales. Christy Supply, Chicago 34, Illinois.

WE Buy "anything"! Highest prices guaranteed! Justice, Box 150, Chicago 90.

MERCURY (Quicksilver) — Cadmium, blamuth, tungsten, molybdenum, cobalt, vanadium. Write for quotations stating quantity. You'll receive guaranteed prices. Metallurgical Products Co., 35th and Moore Sts., Philadelphia, Penna. Established 1909.

WATCHES Wanted—Broken or usable—all kinds, even Ingersolls. Highest prices paid for jewelry, rings, spectacles, alarm clocks, razors, cigarette lighters, gold teeth, etc. Cash mailed promptly. Lowe's, Holland Bldg., St. Louis 1, Mo.

PERSONAL

CARTOONS Drawn for your ideas by former Disney employee. Publish or frame. Ink \$3.00, colors, \$5.00. Loren Olone, 11250 Ventura Blvd., No. Hollywood, Calif.

BEAUTIFUL Penmanship—few hours. Amazing method. Write, Ozment, 9, St. Louis, Mo.

SLEEP-RITE Earplugs stop noise. Guaranteed 10c. Raymond Dowe, 13 Park Row, New York 7.

ASK Expert mechanic anything. Dollar. Gibson, 801 N. Jefferson, Peoria, Ill.

MIDGET Bible. Size of postage stamp. Only 10c; three for 25c. Delmar's, Crescent Beach, B. C. Canada.

BUY Vitamins direct. Save. Postcard. Matoska Products, White Bear, Minn.

PERSONS Located—Reward for Inaherean, Shabraska. Chaffee, 308 Washington, Chicago 6.

GREAT Fun. Pretend you are in New York. Fascinating details, evidence, souvenir 25 cts. Receiving-forwarding service. Haller, 436 New York Ave., Brooklyn 25, N. Y. Write: any year.

PSORIASIS. Write for some real facts. Stamp. Croll, Box 502, Norristown, Penna.

FALLING Hair, its cause and prevention, is fully explained in an informative and educational pamphlet entitled "How to Keep Your Hair Till Ninety." For free copy write, James Hilton, 4819 Fourth Ave., Brooklyn 20, New York.

SHOE Trouble? Make your shoes last longer. Simple directions, \$1.00. Free particulars. Grey's, Box 1151c, Vero Beach, Florida.

WANTED—I will buy nose braces. M. Trilety's make—best prices paid. A. Davidson, 305 W. 8th St., Los Angeles, Calif.

DO Your feet hurt? Don't continue suffering needlessly. Do something about it now! Amazing new information will help you overcome foot, leg troubles. Dulco, 324P Pitt, Pittsburgh 21, Penna.

PSORIASIS. Dry eczema! Rush name for amazing facts, special no risk offer. Carter-Howell Laboratory, 457 Schenectady Avenue, Dept. L-4, Brooklyn 3, N. Y.

LIVE Longer, feel better, enjoy life. Free information. Fairchild Company, Mt. Vernon, Ohio.

ATHLETE Foot. Athea helps heal. First application tests. Guaranteed. \$1.00 postpaid. Lock Box 1905, Milwaukee, Wis.

DR. RENZ Remedy for athlete foot gets results. \$1.00 a bottle. Will send c.o.d. if desired. Room 3, Chavanne Building, Lake Charles, La.

GIRL Photos, beautiful models, only \$1.00 for group. "Little Eve," Box 211, Terre Haute, Indiana.

MEXICAN Law practice. A. B. Flota, Box 240, Juarez, Mexico.

CASH By mail! Pfeiffer & Jamison, Box 4866, Washington 8, D. C.

LADIES Gift. Beautiful brooch. Genuine rolled gold on mother pearl. Initial pins \$1.39. Name pins \$2.39. Tax included. Postpaid. Mero Jewelers, Box 344A, Punxsutawney, Penna.

LIKE To see your name in newspaper headlines? Loads of fun. Any wording printed. Free particulars. Write, Horne, Box 372A, Back Bay Annex, Boston 17, Mass.

RUPTURED? Improved appliance holds in-up. Free trial. Earles Company, Flint, Michigan.

IT'S Not a dream, but your inner self, trying to exert you to take advantage of the knowledge, power and financial success that is rightfully yours. Details free. William C. Bradley, Box 2778, Kansas City, Mo.

MARRIAGE Certificate for married couple who do not have suitable license for framing. Two color. Dollar. Caswell Associates, R. No. 2 P, Altoona, Penna.

PERSONALIZED Pencils—Individual or firm name imprinted gold. Economical for school and office. Dozen 50c, 3 dozen \$1.00, gross \$3.60 cash, delivered. Pencil Market, 611 - 15th St., Knoxville 16, Tenn.

BUY Vitamins, half price. Vitamin guide free. Richardson, Wyoming, Penna.

HAIR Falling? Dandruff? Write Trichologist, 137 Lewis St., Phillipsburg, N. J.

TATTOOING Outfits, designs, colors. Write today. Zeis Studio, 728 Lesley, Rockford, Illinois.

DRUNKENNESS is a disease which responds to treatment. Medical skill plus human sympathy prove successful with liquor and drug cases. 60 years experience. Write for free booklet. F. M. Nelson. The Keeley Institute, Dwight, Ill.

MISCELLANEOUS

ORIGINAL Paintings of square rigged ships, beautifully done in oils on canvas by professional marine artist, 12x14 handsomely framed, \$5.00. Satisfaction guaranteed. Abel, 237 Chestnut St., Chelsea, Mass.

SERVICE Station driveway "service signals" again available. Free literature. Knipp, Long Beach 4, California.

INDIAN Head pennies, 25 assorted, \$1.25 prepaid. Jerry Berger, 1821 Capitol, Cheyenne, Wyo.

MEXICAN Importations. Bulletin free. Featherwork greeting and place cards. Samples 25c. Mexican Products Co., 126 N. Main, Tulsa 3, Okla.

BUILD Postwar business. Details free. Victory, Box 179C, Dowagiac 1, Mich.

BAROMETER Weather indicator free to any man or woman sending us their name and address on postal. Messenger, Box 747, Allentown, Penna.

GENUINE Italian spaghetti and ravioli sauce. Formula \$1.00. Gooeander brand. Pio, Bendinelli, Box 41 1/2, Stevensville, Mich.

UNIVERSAL Mender! "Thriftifix" securely binds any material to another. Unsurpassed for repair jobs. Shop or home. Acidproof, waterproof. Guaranteed. Trial tube 25c. Allens, 78 Beechwood, East Braintree, Massachusetts.

ALL Metal safety-fold razor blade scrapers again available. Keen edge for cutting, scraping and many uses. 25c postpaid. Alto Sales Co., 222 W. Kellogg, St. Paul 2, Minn.

BIG Mail for you. Latest moneymaking offers, opportunities, catalogs, magazines. Name listed in directory 10c. Ideal Service, 111-M, Park Ridge, Ill.

GENUINE Leather cigarette case with transparent covered picture frame for sweetheart's picture, make excellent gifts—\$1.00 postpaid, or c.o.d. plus postal charges. Corporate Case, Box 3505 Merchandise Mart, Chicago.

FOR Sale. Troemner assay balance, good condition, laboratory apparatus, chemicals, Ferrell, 5305 Harper Ave., Chicago, Ill.

AMAZE Everyone. Tell anyone's age and amount of loose change in his pocket. Call anyone by their first name. Entertaining, enlivens parties! Complete instructions 15c. Ira Smith, 153 Liberty, San Francisco 10, Calif.

SEALS (Metal) for tags to protect knots, prevent mix-ups or tag switching, locked by fingers. Your name or initials on seals. Ernest A. Dehning, 246 E. 58th St., New York 22, N. Y.

INFORMATION—How to locate most any article made in the United States. Postal brings information. Mission, 4182 Emerald, Oakland, California.

RECEIVE Free mails, valuable business opportunities, samples, magazines. Your name inserted in several mailing lists, 10c. Rogowski, 3415 Broadway, New York 31.

WORLD'S Smallest Bible no bigger than stamp, readable, 224 pages, 25c. Galen Henderson, 5440 Harold Way, Hollywood 27, Calif.

FIRE-PROOF Any garment. Complete details \$1.00. Wm. Addams, Chanute, Kansas.

MAKE Your fortune. Free, fertile South-American land, homesteading. Four crops yearly—rubber, timber, sugarcane, tropical fruits, livestock. Valuable information 10c. Valless, Box 0-115, Canal, New York 13.

UNUSUAL Novelties. Samples 10c. Modern, Box 2, Sta. B, New York 2.

GIGANTIC Mails, magazines, catalogs, samples, listing 10c. Waddell's Directory, 309 East 75th, New York 21.

RECEIVE Mails, magazines, samples. Your name in numerous mailing lists 10c. Howard, 396 Broadway, New York.

PIPING Layout and fabrication simplified: Practical manual by actual journeymen, explaining trade shortcuts for welded piping, \$1.00. 3964 So. Budlong, Los Angeles 37, California.

SMOKE Fish and sausage in your back yard. Neighbors buy readily. They are good eating. Full instructions \$1. Wm. White, P.O. Box 763, Durham, N. C.

BUILD Your new post-war home yourself. Save 1/3 to 1/2. Understandable instructions. Particulars free. William Jackson, A.B., 1713 Howard, Port Huron, Michigan.

INSPIRING Scriptural readings. Ideal gift, fifty cents. Rosetta Van Zandt, Brownwood, Texas, Box 245.

PRINT Photos on handkerchiefs, linen! Instructions 10c. Parker Publications, Peterboro, Ont., Canada.

LUMINOUS Nursery wall decorations. Fascinating cut-outs glow in darkness. Complete set 35c. Circulars, sample 3c. Luminovelties, 469 Irving, Brooklyn, N. Y.

MANUFACTURER Post-war fumigating cap, fits on paper bags, protects planting seed, clothing, furniture, rugs from ravages of insects and rodents for an indefinite period. Also to fumigate pot plants, shrubs and other plants all without dangerous effects. Cap to be made of light pressed metal. Fumigating Cap & Bag Co., P.O. Box 296, Tallulah, La.

BOYS—Girls, write for free gift. David Berg, 659 Churchill, Bridgeport 29, Conn.

POCKET Shoe cloth, 5c postpaid, 3 for 10c. Essential Products Co., Williamsburg 1, Mo.

ARTISTIC Serving tray, hand decorated, signed by artist. \$2.98 refund in 5 days. Michele Studios, Box 64, Alfenhurst, N. J.

NOW You can make your own Plastoplate printing cuts. Simple, easy process. Adayservice, Argyle, Wisconsin.

8 1/2" x 11" **BLUE** Printer, complete with blue print papers, tracing paper, chemical, \$2.75 postpaid. Best Co., Box 58022, Cleveland 1, Ohio.

BIGGEST Money in tattooing now! No experience required. Complete instructions with outfit. Send for free literature. Tatucco, 651 South State, Chicago.

INFORMATION. Any subject. Moderate rates. The Roxbys, 747 So. New Hampshire Ave., Los Angeles 5.

KEEP Eggs fresh 6-12 months without ice or mechanical refrigeration; buy them when cheap. Complete instructions 50c. Mandrake Company, 1412 Great Northern Bldg., Chicago 4.

GOOD "Used" self-instruction educational books on all subjects bought, sold, rented, exchanged. Satisfaction guaranteed. Complete information and 92-page illustrated bargain catalog free. Write—Nelson Company, Dept. 2-02-3, Chicago 4.

MEDICAL Laboratory technicians in great demand. We train you in your spare time, in your own home. You can practice while studying. Write for free catalogue. Imperial Technical Institute, Box 973-J, Austin, Texas.

FREE—Illustrated movie photo catalogue, listing movie stars, bathing suit poses, candid photos, band leaders, vocalists, etc. Send ten cents to cover handling and mailing which will be refunded with order. Irving P. Klaw, 209 East 14 St., New York City 3.

"I'll show YOU how to make yourself COMMANDO-TOUGH

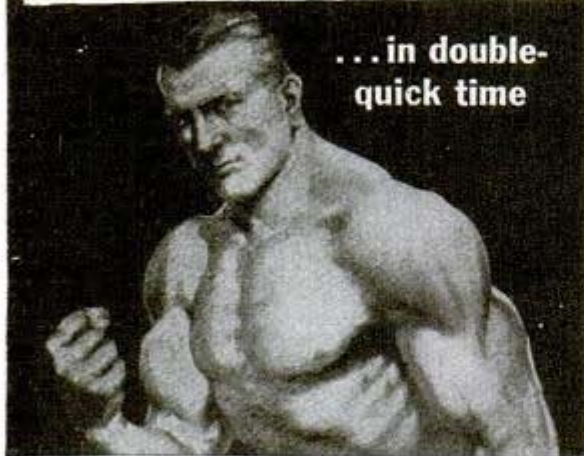

...in double-quick time

...OR IT WON'T COST YOU A CENT!"

says *George F. Jowett*

WORLD'S GREATEST BODY BUILDER

Let me prove to YOU that you can put inches of dynamic muscles on your arms! Add inches to your chest! Broaden your shoulders and power-pack the rest of your body. I can do for you what I've done for thousands the world over, including many officers and men now in the U. S. and British Armed Forces!

GIVE ME 10 MINUTES A DAY!

I'll Show You My Secrets Of Body Building

I'll help you learn the "Progressive Power Method" through which I rebuilt myself from a physical wreck to the holder of more strength records than any other living athlete or teacher! No matter how skinny or flabby you are, you can learn my methods right in your own home. Through my proved secrets I show you how to develop your power, inside and out, until YOU are fully satisfied that you are the man you want to be. "The Jowett System," says R. F. Kelly, Atlantic City, Physical Director, "is the greatest in the world!"

If you want a physique that will inspire respect from men, and admiration from women... ACT LIKE A HE-MAN! Decide at once! The famous book, "Nerves of Steel—Muscles Like Iron" will be included FREE! Priceless for the strength fan! Full of photos of marvelous power-bodied men who will show you what Jowett has done for them and how he can do the same for you. Reach out... Grasp this Special Offer today!

Jowett Institute of Physical Culture
230 Fifth Avenue
Dept. 4711
New York 1, N. Y.

PROVE TO YOURSELF IN ONE NIGHT!

Send only 25c for test Course, "Molding a Mighty Arm." Read it the evening it arrives—learn from experience the thrill you can give your muscles!

SEND FOR THESE FIVE FAMOUS COURSES IN BOOK FORM

ONLY 25c EACH
or ALL 5 for \$1.00



This Book Free!

BOOK WITH PHOTOS OF FAMOUS STRONG MEN
MAIL COUPON NOW **FREE**



Jowett Institute of Physical Culture
230 Fifth Avenue, Dept. 4711, New York 1, N. Y.

George F. Jowett: Your proposition looks good to me. Send by return mail, prepaid, the courses checked below, for which I enclose (), include FREE book of PHOTOS.

- | | |
|--|---|
| <input type="checkbox"/> All 5 courses for... \$1 | <input type="checkbox"/> Molding Mighty Legs 25c |
| <input type="checkbox"/> Molding a Mighty Arm 25c | <input type="checkbox"/> Molding a Mighty Grip 25c |
| <input type="checkbox"/> Molding a Mighty Back 25c | <input type="checkbox"/> Molding a Mighty Chest 25c |
| <input type="checkbox"/> Send all 5 C.O.D. (\$1 plus postage.) No orders less than \$1 sent C.O.D. | |

NAME.....Age.....
(Print name)

ADDRESS.....

Always write your name and full address clearly when answering advertisements.
60A

QUICK CASH for YOU

INTRODUCING AMAZING
AUTOFYRSTOP



**KILLS
FIRE
BY ITSELF**

—the remarkable new combination automatic and manual fire extinguisher and alarm that is setting records. TREMENDOUS MARKET. Sells on 2-minute demonstration to defense plants, homes, schools, stores, etc. LOW PRICED.

Big Profits. Write for FREE facts. EXPERIENCE NOT NECESSARY. **AUTOFYRSTOP CO.**, Dept. M-114, 2035 Washington Ave., Philadelphia, Pa.

PIN-UP GIRLS FOR ADULTS

(pocket size). Thrilling... breath-taking, life-like beauties that will make your heart skip a beat. The kind you like! 10 different PIN-UPS sent for 50c or 25 assorted for \$1. Shipped prepaid in plain wrapper. No C.O.D.'s. Send cash or money order. No stamps. NUDKI, Dept. P-66, Box 126, G.P.O., N.Y.C.



Store Route Plan PAYS BIG MONEY

SELL COUNTER CARD PRODUCTS

Build a good-paying business of your own! Call on dealers of all kinds; show nationally-advertised Aspirin, Vitamins, Cosmetics and 200 other necessities. Big 5c and 10c retail packages, high quality. Attractive counter displays sell goods fast. Free book gives amazing facts. Write!

World's Products Co., Dept. 10-B, Spencer, Ind.



Keep that "TICKING" Car



1588 PAGES
1500 ILLUSTRATIONS



Every operator and mechanic needs AUDELS AUTO GUIDE.

This book saves time, money and worry. Highly endorsed. It presents the whole subject of auto mechanics:

- 1—Basic principles
 - 2—Construction
 - 3—Operation
 - 4—Service
 - 5—Repair
- Handy Size, Easily understood.

NEW FLUID DRIVE, HYDRAULIC SHIFT AND DIESEL ENGINES FULLY COVERED

Over 1500 pages—1540 illustrations showing inside views of modern cars, trucks and buses with instructions for all service jobs.

4 COMPLETE • PAY ONLY \$1. A MONTH

AUDEL Publishers, 49 West 23rd St., New York
MAIL AUDELS NEW AUTO GUIDE for free examination. If O.K. I will send you \$1 in 7 days; then remit \$1 monthly until price of \$4 is paid. Otherwise I will return it.

Name.....
Address.....
Occupation.....
Employed by..... PM

POPULAR MECHANICS

Take Your Pick of 220 Little Blue Books at Bargain Price of 5c Each

THE IDEAL GIFT FOR SERVICE MEN

Add 1c per book for packing, handling and carriage. Order by number. Order at least 20 books—as many more as you like. Canada and foreign, 7c per book, prepaid. If you order every book in this ad — 220 books — remit only \$10.00 and we will prepay all carriage charges.

Self-Help Books

- 25 Rhyming Dictionary
- 75 On the Choice of Books
- 78 Hints on Public Speaking
- 82 Common Faults in Writing English
- 86 On Reading. Brandes
- 93 How to Live 100 Years
- 192 A Book of Synonyms
- 326 Hints on Writing Short Stories
- 405 Outline of Economics
- 452 Dictionary of Foreign Words
- 514 Hints on Writing Poetry
- 556 Hints on Etiquette
- 629 Hand-Book of Legal Forms
- 639 4,000 Most Essential English Words
- 681 Spelling Self Taught
- 682 Grammar Self Taught
- 683 Punctuation Self Taught
- 697 4,000 Words Often Mispronounced
- 703 Physiology Self Taught
- 734 A Book of Useful Phrases
- 759 How to Conquer Stupidity
- 815 A Book of Familiar Quotations
- 821 How to Improve Your Vocabulary
- 822 Rhetoric Self Taught
- 823 English Composition Self Taught
- 835 A Handbook of Useful Tables
- 847 Card Games
- 855 How to Write Letters
- 856 Arithmetic Self Taught Part I
- 857 Arithmetic Self Taught Part II
- 868 Hints on Self-Improvement
- 872 Manual of Parliamentary Law
- 894 Hints on How to Advertise
- 1439 How to Test Your Intelligence
- 1471 How to Become Mentally Superior
- 1743 Facts About Sleep
- 1750 Curiosities of Language

Biography

- 33 Brann: Smasher of Shams
- 123 Life of Madame du Barry
- 141 Life of Napoleon
- 142 Life of Bismarck
- 253 Heart Affairs of Henry VIII
- 324 Life of Lincoln
- 343 Diary of Columbus in 1492
- 395 Autobiography of Cellini
- 409 Great Men of Science
- 412 Life of Mahomet
- 490 Life of Michelangelo
- 506 Life of Voltaire
- 515 Louis XVI and his Court
- 522 Life of Thomas Paine
- 523 Life of Franklin
- 525 Life of Goethe

- 526 Life of Caesar
- 537 Life of Barnum
- 565 Magellan and the Pacific
- 604 Life of Roosevelt
- 713 Great Women of Antiquity
- 769 Life of Thomas Jefferson

Fiction

- 21 Carmen
- 40 House and Brain. Lytton
- 58 Tales from Decameron. Boccaccio
- 102 Sherlock Holmes Tales
- 107 The Dream Woman. Collins
- 145 Great Ghost Stories
- 151 Man Who Would Be King
- 162 Murders in the Rue Morgue
- 232 Three Strangers
- 277 Man Without a Country
- 282 The Ancient Mariner
- 288 Thrilling Tales of The Frozen North
- 352 Short Stories, William Morris
- 693 Tales of Chicago. Ben Hecht
- 699 Broken Necks. Ben Hecht
- 746 A Daughter of Eve
- 865 Main Street Tales
- 866 Untold Lie, etc.

Fine Arts

- 387 History of Painting
- 403 History of Music
- 466 History of Sculpture
- 468 History of Architecture

French Literature in English

- 3 Fourteen Little Essays. Voltaire
- 6 Love. Maupassant
- 27 Last Days of Condemned Man. Hugo
- 28 Toleration. Voltaire
- 52 Oration on Voltaire. Hugo
- 66 Crimes of Borgias. Dumas
- 85 Attack on the Mill. Zola
- 87 Love: An Essay. Montaigne
- 103 Pocket Theology. Voltaire
- 104 Battle of Waterloo. Hugo
- 178 One of Cleopatra's Nights
- 198 Majesty of Justice. France
- 199 The Tallow Ball. Maupassant

- 200 Ignorant Philosopher. Voltaire
- 221 On Women. Maeterlinck
- 292 Mademoiselle Fifé. Maupassant
- 314 Short Stories. Daudet
- 344 Don Juan. Balzac
- 886 The Piece of String and Other Stories. Maupassant
- 887 The Necklace and Other Stories. DeMaupassant
- 888 Memoirs of Madame de Staël

History

- 50 Paine's Common Sense
- 83 Marriage: Its Past, Present and Future. Annie Besant
- 126 History of Rome
- 149 Historic Crimes and Criminals
- 150 Lost Civilizations
- 214 Speeches of Lincoln
- 276 Speeches of Washington
- 558 Great Pirates. C. J. Finger
- 627 History of the Jews

Humor

- 20 Let's Laugh. Nasby
- 291 The Jumping Frog. Twain
- 382 Humor of Lincoln
- 670 Josh Billings Comical Lexicon
- 771 The Humor of "Bill" Nye

Juvenile

- 44 Aesop's Fables
- 57 Rip Van Winkle
- 156 Andersen's Fairy Tales
- 158 Alice in Wonderland
- 188 Adventures of Munchausen
- 391 Dog of Flanders, Ouida
- 516 Book of Real Adventures
- 559 Robinson Crusoe
- 716 Mother Goose
- 819 A Book of Strange Murders
- 836 Bluebeard. Cinderella

Literature

- 2 Ballad of Reading Jail
- 32 The Raven, The Bells, etc.
- 72 Color of Life and Love
- 95 Confessions of an Opium Eater
- 177 Subjection of Women. Mill
- 219 Story of Human Tragedy
- 289 Pepys' Diary
- 513 Travels of Marco Polo
- 829 Voltaire. Clarence Darrow

Philosophy

- 11 A Guide to Nietzsche
- 19 Nietzsche: Who He Was
- 96 Dialogues of Plato
- 153 Chinese Philosophy of Life
- 159 Guide to Plato
- 414 Art of Happiness. Powys
- 520 A Guide to Spinoza. Durant
- 671 Moral Discourses of Epictetus

Religion

- 4 The Age of Reason. Paine
- 61 What is Religion? Tolstoy
- 184 Primitive Beliefs
- 593 As a Man Thinketh
- 600 The Essence of the Bible
- 636 The Greatest Thing in the World
- 684 Essence of Judaism

Russian Literature (in English)

- 24 The Kiss. Chekhov
- 45 Tolstoy's Short Stories
- 100 The Red Laugh. Andreyev
- 105 Seven Hanged. Andreyev
- 239 26 Men and a Girl. Gorky

Science

- 53 Insects and Men: Instinct and Reason
- 92 Hypnotism Made Plain
- 190 Psycho-Analysis: The Key to Human Behavior
- 217 The Puzzle of Personality
- 447 Auto-Suggestion
- 491 Psychology for Beginners
- 524 Death: and Its Problems
- 555 Structure of the Earth
- 679 Chemistry for Beginners
- 727 Psychology of Affections
- 761 Food and Diet
- 876 Curiosities of Mathematics

Miscellaneous

- 651 How to Psycho-Analyze Yourself
- 654 What Young Men Should Know
- 777 Riddle of Human Behavior
- 782 Psycho-Analysis and the Mind and Body
- 784 Tests Used in Psycho-Analysis
- 986 How to Talk and Debate
- 987 The Art of Kissing
- 988 The Art of Courtship
- 1003 How to Think Logically
- 1009 Typewriting Self Taught
- 1012 Best Negro Jokes
- 1013 Best Irish Jokes
- 1014 Best American Jokes
- 1018 Humorous Limericks
- 1023 Popular Recitations
- 1063 Psychology of Laughter
- 1069 Conquest of Fear
- 1070 How to Fight Nervous Troubles
- 1078 Morals in Greece and Rome
- 1093 Amusing Puns
- 1097 Memory: How to Develop It
- 1109 Spanish Self Taught
- 1126 Eating for Health
- 1179 Funny Ghost Stories
- 1176 A Mad Love
- 1184 Book of Best Scotch Jokes
- 1207 French Self Taught
- 1221 Facts About Will Power
- 1228 Best Jokes About Drunks
- 1231 Book of Best Jokes
- 1249 Best Jokes About Lovers
- 1292 Best Short Stories
- 1320 How to Get a Husband
- 1333 Common Sense of Health
- 1340 How to Get a Job
- 1342 Typical Love-Problems
- 1354 Book of Striking Similes
- 1430 Shorthand Self Taught
- 1434 How to Think Clearly
- 1475 Book of Best Jokes
- 1562 How to Live Long
- 1710 The Magic of Numbers
- 1712 Great Dates in History
- 1714 Determinism vs. Free Will
- 1715 Funeral Services Without Theology
- 1717 Religion and Progress
- 1719 Inge's Apology for Christianity
- 1721 Gambler's Luck
- 1739 Hints on Developing Personality
- 1753 Why Many Women Are Unattractive
- 1756 Simplified Cook-Book
- 1761 America's Little Hitlers

HALDEMAN-JULIUS CO.

Dept. A-137

Girard, Kansas, U.S.A.

PLUMBERS & STEAM FITTERS

Audels Plumbers and Steamfitters Guides



4 Vols. \$6

A practical, illustrated, Reference Library and Study-Course for Master Plumbers, Journeymen and Apprentice Steamfitters, Gas Fitters and Helpers, Sheet Metal Workers, Draughtsmen, Master Builders, Engineers and all Building Trade Students. This valuable set of handy, pocket-size Guides explains in practical concise language and well-done illustrations all the principles, advances and short cuts of the Plumbing and Heating trade—based on modern practice. Contains careful, detailed instructions

on how to figure and estimate various jobs. Use FREE COUPON below to examine, without obligation, this valuable work.

INSIDE TRADE INFORMATION ON:

Soldering, tinning. Joint wiping, bending, beating. Pipe—iron—steel, threading. Mathematics, tables, physics. Materials—iron, steel, copper, brass, lead, tin, antimony, etc. Sheet metal—galvanized—plate. Sanitation, spongonage, tanks. Drainage, sewage, purification. Fixtures—bath—kitchen. Pipe fittings, soil pipe, tools. Laying out work. Roughing. Rerewed fittings, flanges, joints. Pipe bending, examples. Elbows. Heating, ventilation, air conditioning, refrigeration. Water supply, mains, wells, tanks. Gas-fittings. Sheet metal work, problems, methods. Etching, beating, lead burning. Welding, various welds, methods. Blacksmithing, forges, tools. **Air Conditioning.**

THEO. AUDEL & CO., 49 W. 23rd St., New York City

Mail Audels Plumbers Guides, 4 vols., on 7 days' free trial. If O. K. I will remit \$1 in 7 days, and \$1 monthly until \$6 is paid. Otherwise I will return them. No obligation unless I am satisfied.

Name.....
 Address.....
 Occupation.....
 Reference..... PM



BE A PLASTICS FABRICATOR



You can fabricate beautiful, modern, practical plastics gift items at home—for fun or for profits.

Dept. PM-11, 2850 W. Ave. 35, Los Angeles 41, Calif.

EASY. No special tools or training necessary. Easy, fascinating, clean, profitable.

WE SUPPLY PLASTICS. Choose items you want from our catalog. We send you crystal-clear Lucite or Plexiglas, cut to size, ready to assemble.

YOUR OWN BUSINESS. With a little experience, you can make these articles to sell at a good profit. Start your own profitable plastics busi-

ness! Earn big money!

SELL FAST. There is a big demand for beautiful, practical gift items. Sell directly to stores. Take advance orders.

CHRISTMAS GIFTS. Ideal for Christmas giving or selling—but start now!
GET CATALOG. Start yourself on this fascinating hobby or career now. Mail the coupon today for details and our catalog of many items.

PLASTICS FABRICATORS

Dept. PM-11, 2850 W. Ave. 35, Los Angeles 41, Calif.

Please send me your catalog and complete details on how I can be a plastics fabricator, no obligation.

Name.....
 Address.....
 City.....Zone.....St.....

FREE CATALOG

ELECTRICITY NEEDS YOU!

Always a BIG PAY Field—Now Bigger Than Ever.



BOOK FREE

Train Now for Post War Jobs.

Electricity is the one year 'round, all-time field of big opportunities and good pay. Get into this magnificent industry yourself. Do it now! Be ready for the tremendous boom and demand for trained men that early post war days will bring.

This 28 year old school—for the past two years exclusively training men and women for U.S.A. Services—will give you the practical training you need. You can train at home in spare time—come to our big Chicago shops—or have a combination of both. No experience or advanced schooling required. Write for FREE BOOK today. No obligation.

INDUSTRIAL TRAINING INSTITUTE, Dept. 19
 2132-2158 Lawrence Ave. Chicago 25, Ill.

PRINT ANY PHOTO on Paper, Cloth, Leather or Wood

SIMPLE, EASY TO USE

Magic liquid takes only 2 minutes to reproduce any snapshot you have on to stationery, handkerchiefs, ties, scarfs, etc. Won't wash off. Won't hurt negative or fabric it's used on. Personalize your belongings! An ideal gift. Complete outfit enough to transfer 100 photos—only \$1.00 postpaid. Sent C.O.D. for \$1.30.

CHRISTY PHOTO SUPPLY, Dept. 710
 2835 N. Central, Chicago 34



730 SHAVES FROM 1 BLADE

AMAZING NEW BLADE SHARPENER



New sharpener for all makes of double-edge razor blades performs miracles! "Not necessary to change blades," writes one user. Another says, "Have used 1 blade over 730 times." RAZOROLL really sharpens blades because it strops on leather. Gives keen, smooth shaving edges. No guess-work. Blade held at correct angle and proper pressure—automatically. Just turn crank to sharpen blade. No gears. Well made. Handsome, compact, sturdy. Weighs few ounces. Will last years. Makes ideal gift.

Only \$1.00

SEND NO MONEY! Write today. Pay postman only \$1 plus few cents postage. Use RAZOROLL for 5 days and if you're not delighted with smooth, velvet shaves you get, return RAZOROLL and we'll return your dollar. Hurry—order today. **RAZOROLL COMPANY**
 620 North Michigan Avenue, Dept. 5011, Chicago 11, Illinois

Fix Your Own ALARM CLOCKS

New, practical home course. Just out. Makes interesting hobby—profitable too. Save money by doing your own repairing at home. Easy if you know how. Price now only \$1.00. Details FREE. Send postcard.

THIES JEWELRY STORE, Genoa 3, Illinois

ARTISTS MAKE MONEY

Find out your ability. Send name, age, occupation and address for Free Vocational Art Test. **ART INSTRUCTION, INC.** (Formerly Federal Schools) 11134 Art Instruction Building, Minneapolis, Minnesota

RE-SOLE YOUR SHOES

Easy—at home. Spread on So-Lo. It wears like leather. For all footwear, children's and grownups'. Also mends tires, raincoats, boots—anything of rubber, leather, cloth.



MEND THE HOLE for SPREADS on like butter. Dries tough overnight. Flexible. Non-skid. Waterproof. Won't come off—guaranteed. **So-Lo** AT ANY HARDWARE AND 10¢ STORE **1¢**

MUSIC LESSONS

COMPLETE CONSERVATORY HOME STUDY COURSES

40 years of successful training in Piano, Violin, Cornet, Trumpet, Saxophone, Clarinet, Guitar, Mandolin—Voice, Ear Training and Sight Singing, Choral Conducting, Public School Music—History of Music, Harmony, Advanced Composition, Arranging. The only home study school teaching all courses leading to degree, Bachelor of Music.

MAIL COUPON NOW

UNIVERSITY EXTENSION CONSERVATORY 1525 E. 53rd St., Suite U70, Chicago 15, Ill.

Send for catalogue and illustrated lesson for course.
 Name
 Street
 City, State
 Give experience Age

LEARN ACCOUNTANCY BY PHONOGRAPH!

New quick simplified course—12 lessons on records! New Army "hear and see" teaching method enables you to take this fast, complete Accounting Course in your own home! Every student in school, every business man should know Accounting! This new course gives fundamental facts quick! 12 recorded lessons—plus text book of many actual examples—only \$25.00 complete! The shortest-cut for learning Accounting!

Send \$25.00 for complete course.

ACCOUNTING-BY-PHONOGRAPH CO.
 75 E. Wacker Drive — Chicago, Illinois

BE OUR PERFUME DISTRIBUTOR BIG MONEY

Year round profits. Millions in World famous essences sold annually. Complete attractive line, low prices. Stores now ordering for Xmas. **SELL STORES, JOBBERS OR DIRECT.** Perfume is scarce, but we ship promptly. Big opportunity. Get started. Write today. Free details and sample.

TOWER HALL, Dept. 423C, Manhattan Bldg., Chicago 5, Illinois

START YOUR OWN BUSINESS

GET INTO PLASTICS

SMALL CAPITAL — WORK AT HOME

New miracle Plastics industry offers you unlimited career opportunities. Get started now in your own Plastics business or prepare for postwar Plastics employment. Take your place in the new Plastics Era. Now for the first time you get practical training in your own home. This new plan gives you the fundamental technical knowledge covering all branches of the Plastics industry including all types of Plastics materials. This is not a novelty program but a real sound educational plan. The actual practical work consists of working with many different types of Plastics materials—teaching you fabrication, shaping, forming, finishing, cementing methods, mold making, casting, compounding, etc. For full information send this ad with your name in an envelope or paste on a penny postcard.—To Dept. M.

PLASTICS TECH 1845 E. 9th St., Cleveland 14, Ohio

EARN MONEY PAINTING PORTRAITS



No previous training or talent necessary. Unique Stuart System teaches you, by mail, in 11 simple, easy-to-follow lessons, to make exact charcoal and oil likenesses. Detailed guidance for your every step. Send for free book today.

STUART STUDIOS, 121 Monument Circle, Rm. 6114, Indianapolis 9, Ind. Please send me free book and outline of lessons.

Name
 Street
 City State



THAT'S WHAT I WANT FOR CHRISTMAS, DAD... A CHEMCRAFT OUTFIT!

"YOU KNOW DAD, I've been reading of all the wonderful inventions that have been made possible by chemistry. It says a lot of those inventions were used in the war, but now they will be utilized to make better things for every day living. I want to know more about chemistry."

CHEMCRAFT

REG. U. S. PAT. OFF.

No. 5—An outfit with 61 chemicals and pieces of apparatus, and manuals describing over 590 experiments. Many special features.

\$500

Other Chemcraft Outfits from \$1 to \$25. Insist on Chemcraft. You may order direct if your dealer cannot supply you.



Chemcraft has helped thousands of boys and girls understand the principles of chemistry. It will help you prepare to take advantage of the many opportunities which are being opened through chemical research.

SEND FOR FREE BOOKLET

Tells of amazing discoveries and great opportunities in chemistry for boys and girls. Also explains many mystifying experiments you can perform in your own home and describes all of the wonderful Chemcraft Outfits. Just mail coupon below.

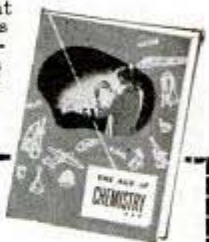

The Porter Chemical Company
 75 Prospect Ave., Hagerstown, Md.

Send me your Free Booklet, "The Age of Chemistry."

Name

Address

City State

AUDELS Carpenters and Builders Guides 4 vols. \$6



Inside Trade Information for Carpenters, Builders, Joiners, Building Mechanics and all Woodworkers. These Guides give you the short-cut instructions that you want—including new methods, ideas, solutions, plans, systems and money saving suggestions. An easy progressive course for the apprentice and student. A practical daily helper and Quick Reference for the master worker. Carpenters everywhere are using these Guides as a Helping Hand to Easier Work, Better Work and Better Pay. To get this assistance for yourself, simply fill in and mail the FREE COUPON below.

Inside Trade Information On:

How to use the steel square—How to file and set saws—How to build furniture—How to use a mitre box—How to use the chalk line—How to use rules and scales—How to make joints—Carpenters arithmetic—Solving mensuration problems—Estimating strength of timbers—How to set girders and sills—How to frame houses and roofs—How to estimate costs—How to build houses, barns, garages, bungalows, etc.—How to read and draw plans—Drawing up specifications—How to excavate—How to use settings 12, 13 and 17 on the steel square—How to build hoists and scaffolds—skylights—How to build stairs—How to put on interior trim—How to hang doors—How to lay floor—How to paint



THEO. AUDEL & CO., 49 W. 23rd St., New York City

Mail Audels Carpenters and Builders Guides, 4 vols., on 7 days' free trial. If O.K. I will remit \$1 in 7 days, and \$1 monthly until \$6 is paid. Otherwise I will return them. No obligation unless I am satisfied.

Name

Address

Occupation

Reference

Learn this Profitable Profession



IN 90 DAYS AT HOME

Money-Making Career Open to Men and Women, 18 to 50

Hundreds of men and women between 18 and 50 make \$10 to \$20 in a single day giving scientific Swedish Massage and Hydro-Therapy treatments. There is big demand from doctors, hospitals, sanatoriums and clubs. Graduates earn large full time incomes from these or in private practice in their own offices. Others make good money from home treatments given in spare time. Learn this interesting, money-making profession in your own home, through our home study course. Same instructors as in our nationally known resident school. You can win independence and prepare for future security by qualifying for your Diploma. Course can be completed in 3 to 4 months. Many earn while they learn. Begin your training at once.



Anatomy Charts & Booklet FREE

Enroll now and we will include, at no extra cost, many needed supplies. Fit yourself to help meet growing demand for massage now and after the war. Send the coupon at once for complete details, Anatomy Charts and 32-Page Illustrated Booklet, FREE, postpaid.

THE COLLEGE OF SWEDISH MASSAGE
Dept. 864, 100 East Ohio St., Chicago 11, Illinois

Please send me FREE and postpaid, Anatomy Charts, 32-page Booklet and complete details on Home Training.

Name

Address

City

State

MAN'S MASSIVE RING



A roaring lion's head, a real knockout ring with plenty of punch for a manly hand. This hand-steady, sterling silver ring is designed especially for a real HE man. Flash it among your friends, they'll admire it. A ring that is so constructed that it will give as well as take hard knocks. Send \$5 (44.17 plus \$2 tax) and ring will be sent postpaid or pay postman C. O. D. plus postage on arrival. Three sizes, large, medium and small. Send today.

JEWELRY CRAFTSMEN

Dept. P11 Providence 3, R. I.

PREPARE FOR THE FUTURE

We Supply All Kinds of TECHNICAL AND HOBBY BOOKS
Ask for FREE catalogs of SPECIFIC SUBJECTS interesting you.
MODERN TECHNICAL BOOK CO., Dept. M. M.
55 West 42nd Street, New York 18, N. Y.



MAIL ORDER MEN We Buy & Sell

We buy your ideas or plans for others to use in making gadgets, home and sports equipment to sell. We already have over 100 plans for neighborhood or mail order selling. We need hundreds more for our fast growing list of mail order clients. Get and use some of our plans. Sell us the ones you now have. Your idea may be worth many dollars. Rush name for free information.
MAIL ORDER EXCHANGE, Dept. 39, Tipp City, O.

COLOR CONCRETE WITH CHEMICALS

A business of your own. Big money making Hollywood style pottery and birdbaths without moulds. Washing-wells, stucco-rock, benches. Marbling and cement water-paints. 10c brings sample, literature, pictures.
Hollywood CementCraft, 8529 Wonderland Ave., Hollywood 46, California

WINDOW SIGN LETTERS

For Store Fronts and Office Windows. Anyone can put them on. Samples furnished. Imitation Gold and Silver.
METALLIC LETTER CO., 490 N. Clark St., Chicago 10

TRAILER AXLES, HITCHES, AND PARTS

● If you are interested in purchasing trailer axles, hitches, and other trailer parts, contact us promptly. Complete house trailer blue prints, \$1.00. Write for free literature.
HAMMER BLOW TOOL COMPANY, Dept. 111, WAUSAU, WIS.



GENUINE U.S. BARGAINS

O. D. WOOL BLANKETS (USED)..... \$2.95
USED COT MOSQUITO NETS..... 1.25
U. S. ARMY PUP TENTS (USED)..... 3.00
Slightly Used Army Caisson Wheels with Axles, 56" high, weight per pair with Axle 322 lbs. \$37.50

Thousands of Other Bargains in Military, Outdoor & Sport Goods for Hunter, Farmer, Scout Send 10¢ for 32-page catalog returned w/first order.

A and N SUPPLY CO.
4724 LESTER ST. RICHMOND, VA.

★ SAVE WASTE PAPER ★

do you WORRY?

Why worry and suffer any longer if we can help you? Try a Brooks Patented Air Cushion. This marvelous appliance for most forms of reducible rupture helps hold nearly every rupture securely and gently—day and night—at work and at play. Thousands made happy. Light, neat-fitting. No hard pads or stiff springs to chafe or gouge. Made for men, women and children. Durable, cheap. Sent on trial to prove it. Never sold in stores. Beware of imitations. Write for Free Book on Rupture, no-risk trial order plan, and proof of results. All Correspondence Confidential.



Brooks Company, 158-D State St., Marshall, Mich.

Post-War Jobs

After the war
there'll be more
of those good old



● Sealed First-Aid and Family Medicines, Spices, Champion Flavoring Extracts, Food Products, Toiletries, Soaps, Household Necessities, Insecticides, Livestock and Poultry Preparations, Brushes, Brooms, Mops.

★ Right now nearly half of our production goes to the Armed Forces with the result that we have been unable to serve thousands of our old customers.

•••— When Victory is won, we'll again be producing full time for peace and will have need for more Dealers (men and women with cars) to call on and supply farmers. If you are interested in a pleasant, good-paying steady job after the war, write us for free particulars NOW! No previous experience necessary.

Furst-McNess Company

Established 1908

Dept. A-23 Freeport, Illinois



Monuments

Freight Paid Anywhere in U.S.A.

\$13.69 Up. Guaranteed Genuine Marble & Granite. Deal direct with Us by mail. Save. Write for Free catalog today. U. S. MARBLE & GRANITE CO.

A-18

Oneco, Fla.

SENSATIONAL WAR BARGAINS IN LENSES & PRISMS

OUR ITEMS MAKE EXCELLENT CHRISTMAS GIFTS
All Neatly Packed and Marked

YOU CAN EASILY MAKE Telescopes—Periscopes—Magnifiers—Photographic Gadgets—and do Hundreds of EXPERIMENTS

All Items Finely Ground and Polished but Edges Very Slightly Chipped, which We Guarantee Will Not Interfere with their Use.



TANK PRISMS

In order that the tank driver shall not get shot in the face, two of these Silvered Prisms are used to make a periscope. They are 90-45-45 degree prisms of huge size—5³/₄" long, 2¹/₈" wide, finely ground and polished. Other uses: Experimental Optics, Optical Instruments and Gadgets, as unique gift item, unusual paper weight, desk name plate, etc. Would normally retail from about \$24 to \$30 each.

Stock No. 3004-H—SILVERED TANK PRISM—Price . . . \$2.00 each Postpaid.

Stock No. 3005-H—PLAIN TANK PRISM—Price . . . \$2.00 each Postpaid. This one is excellent for projecting all the colors of the spectrum—a beautiful sight.

Stock No. 3008-H—One Hundred Gold Letters—use to turn a silvered tank prism into a desk nameplate in 5 minutes of easy work . . . Price 5c. Make these up for Xmas gifts.

FOUR TANK PRISMS—Special . . . \$7.00 Postpaid.

. . . FREE—6 PAGE PRISM BOOKLET WITH ALL TANK PRISM ORDERS.

SPECIALS IN LENS SETS

10 Page Project Booklet Free with All Sets

Set No. 301-H "Our Advertising Special" 15 Lenses for \$1.60 Postpaid. For making your own powerful telescopes, low power microscope, strong magnifiers, drawing projector, photo cells, telephoto lens, dummy focusing camera, Kodachrome viewer, stereoscopic viewer, ground glass and enlarging focusing aids. For experimental optics, portraits of babies and small pets, copying, ultra close-up shots, and many, many other uses.

Set No. 305-H "The Gadgeteer's Delight" 35 Lenses for \$5.00 Postpaid. Contains all the lenses in the above set plus twenty more expensive lenses increasing your field of experiment and gadget making. All our lenses are neatly packed and marked.

Set No. 310-H "The Experimenter's Dream" 60 Lenses and New Complete 70 Page Booklet—\$10.00 Postpaid. Contains all the lenses in the above sets plus 25 others that makes this a sensational buy. The variety of lenses in this set will enable you to conduct countless experiments and build a wide variety of optical equipment.

70 Page Illustrated Idea Booklet "Fun With Chipped Edge Lenses" Only \$1.00. The Complete Hand Book.

FLASH!—Achromatic Objective Lenses from Government's 7X Binoculars. Use for telescopes, etc. Dia. 2 inches, f.l. 7³/₄ inches. Free Cement. Stock No. 6064. Price \$1.75.

Kellner Eye-Piece Lenses—Stock No. 6061-H . . . Price \$1.25 Postpaid. The best type eye-piece lens for telescopes and binoculars. Focal length 27.5 mms. Come uncemented, with free cement and easy directions.

Satisfaction Guaranteed • Minimum Order \$1.00

EDMUND SALVAGE CO.

27 W. CLINTON AVE., DEPT. 11, P. O. AUDUBON, N. J.

HERE'S THE
HOSPITALIZATION PLAN
YOU'VE BEEN LOOKING FOR!

ONLY **3¢** A DAY GIVES
YOU THESE REMARKABLE
BENEFITS IN CASE OF
SICKNESS OR ACCIDENT



Hospital Expenses
paid, up to
\$540
Doctor Expense paid,
up to
\$135
Loss of Wages
reimbursed, up to
\$300
Loss of Life
\$1,000
War coverage and
extra benefits

Don't wait for trouble to strike! Many a man's savings of years have been wiped out by a few weeks of misfortune. Take out your liberal hospitalization policy now and know that your doctor and hospital bills will be paid. Only 3 cents a day gives you a freedom of mind worth far more. Individuals or whole families (to age 70) are eligible, and you may go to any U. S. or Canadian hospital, under any physician's care.

MAIL COUPON TODAY. No agent will bother you.

Family Mutual Life Insurance Co.
Wilmington, Del.

PM-4

Please send, without obligation to me, complete information on your Economical Hospitalization Plan.

NAME _____

ADDRESS _____

CITY _____ STATE _____

Flash! Amazing Opportunities
NOW Open in these
practical money-making trades
watch and clock repairing



LEARN AT HOME—IN YOUR SPARETIME

Prepare for a happy future of prosperity, security... and get a big-pay job now. Fascinating, high-grade occupation. You can **EARN WHILE YOU LEARN**. Excellent field for part-time work at home.

COMPLETE COURSE in HOROLOGY

Thorough self-instruction training in American and Swiss watches, clocks. Special sections on alarm clock repairs. New, practical **LEARN-BY-DOING** instruction method. Learn **QUICKLY**, easily. No previous experience necessary. Watchmaking is basic training for aircraft instrument work, and other scientific precision jobs.

Amazing LOW PRICE • MONEY-BACK GUARANTEE
Get into this fast-growing field NOW... big opportunities... don't delay. Mail coupon below for **FREE** information. There's no obligation.

locksmithing and key making

COMPLETE UP-TO-DATE COURSE

How to pick locks, de-code, make master-keys, repair, install service, etc. New, self-instruction lessons for every handy man, homeowner, carpenter, mechanic, service station operator, fix-it shop, hardware dealer, gunsmith
53 EASY ILLUSTRATED LESSONS
Bargain Price! Satisfaction guaranteed or money back. Write now... no obligation!



Free Details—Mail Coupon Today!

NELSON CO., Dept. 8L02, 321 S. Wabash Ave., Chicago 4, Ill.

Please send me—**FREE** and without obligation—illustrated Success-Catalog containing information about the course (or courses) I have checked below. No salesman will call.

Watch and Clock Repairing. Locksmithing and Key Making.

NAME _____

ADDRESS _____

CITY _____ STATE _____

FOOT PAINS STOPPED or Your **MONEY BACK**



Air-Cooled ARCH-HEELERS

Get Quick Lasting Relief

Wear Guaranteed Proved ARCH-HEELERS in any shoes for aching feet, metatarsal pains, burning callouses, corns, weak arches. Must please you or Your Money Back. Made of selected leather, specially shaped with soft cushions to gently lift bone joints, release nerve pressure, free blood circulation, align entire foot. Springy. Air cooled. Comfortable, even in tight fitting shoes. Users praise them. "I wouldn't take \$5 for mine!" says one. Pair only \$1.

Send No Money

Send name, address and shoe size. Pay postman \$1 plus C.O.D. charge. Or please after 30 days. Send Today.

ARCH HEELER CO., Dept. Z-1, COUNCIL BLUFFS, IOWA

TIGHTEN LOOSE PLATES WITH GUM-TITE PLASTIC RELINER



FREE

Gum-Tite **CLEANER & APPLIER** with every tube of... **MIRACLE ACTING GUM-TITE**

LASTS 4 to 6 MONTHS

Keeps Food Out... Smooths Gums... Easy to Use... Rids Denture Breath
Eating's a joy...Teeth won't Slip, come Loose, drop Down... Chew tough meat, chewy caramel! Gum-Tite is the original plastic reliner. Not a powder or a paste! No burning, irritation! Ends embarrassment! Rush order TODAY! Postage **FREE** if cash accompanies order. One Tube \$1.00 (3 for \$2.50). **FREE** marvelous Gum-Tite Cleaner. 100% satisfaction or **DOUBLE YOUR MONEY BACK!** **AGOR PRODUCTS CO., Dept. No. PM-2, 4554 Broadway, Chicago 40, Ill.**



Titan Slide Rule

6" diameter. Easily read, clearly marked single index scales. Gives logarithms, reciprocals, squares, square roots, sines, and tangents. Continuous circular calibrations cannot go "off-scale." Invaluable in multiplication, division, proportion, conversion, all mathematical problems. Made of durable heavy pure white Vinylite. Complete with instructions, \$2.95. Leatherette case 75c additional. Money-back guarantee.

PRECISION INSTRUMENT CO.

Box 654, Dept. D

Church St. Annex

New York 7, N. Y.

BACKACHE, LEG PAINS MAY BE DANGER SIGN
Of Tired Kidneys

If backache and leg pains are making you miserable, don't just complain and do nothing about them. Nature may be warning you that your kidneys need attention.

The kidneys are Nature's chief way of taking excess acids and poisonous waste out of the blood. They help most people pass about 3 pints a day.

If the 15 miles of kidney tubes and filters don't work well, poisonous waste matter stays in the blood. These poisons may start nagging backaches, rheumatic pains, leg pains, loss of pep and energy, getting up nights, swelling, puffiness under the eyes, headaches and dizziness.

Don't wait! Ask your druggist for Doan's Pills, used successfully by millions for over 40 years. They give happy relief and will help the 15 miles of kidney tubes flush out poisonous waste from the blood. Get Doan's Pills.

★ REFRIGERATION

AT YOUR FINGER TIPS with Drake's NEW Manual

By means of Drake's brand new REFRIGERATION SERVICE MANUAL, you can get yourself a better job . . . earn more money. The latest developments in household and small commercial refrigeration become as simple as ABC when you study this remarkable book. More than 2,000 sold in the first 30 days . . . and none returned.

Written by leading authorities, and covering every problem in simple, easily understood language, this newest addition to Drake's Technical Library contains over 300 pages and 138 diagrams and illustrations. Included are the following:

- Installations
- Adjustment
- Testing
- Replacement
- Trouble Shooting
- Repair

The work covers practically every operation in field service, as performed where the equipment is installed, and also the shop operations which may be required. It includes domestic types of refrigeration, and fully and completely the commercial types in small and medium sizes, such as used in markets, milk depots, soda fountains, flower shops, etc., as well as in many air conditioning systems.

Use the coupon for your copy . . . today. Send only \$2.00. If you are not satisfied that this book is the answer to your expectations, return the book within 5 days, and your money will be immediately refunded.

OTHER IMPORTANT DRAKE BOOKS

1. **Practical Electricity and House Wiring:** 200 pages, 227 illustrations . . . \$1.50
2. **Cyclopedia of Radio and Electronics:** 1,000 pages, 1,178 illustrations . . . \$5.00
3. **Spray Painting, Industrial and Commercial:** 125 illustrated pages . . . \$1.50
4. **Plumbing Installation and Repair:** 200 pages, 153 illustrations . . . \$2.00

ONLY \$2.00

5. **Slide Rule and Logarithmic Tables, including Ten-Place Tables:** 200 pages, illustrated . . . \$1.50

FRED'K J. DRAKE & CO., 600 W. Van Buren St., Dept. PM-11, Chicago 7, Ill.

USE THIS COUPON FOR YOUR ORDER

FRED'K J. DRAKE & CO., 600 W. Van Buren St., Dept. PM-11, Chicago 7, Ill.

O.K. Send me postpaid the Drake books I've checked. Remittance enclosed. I understand that if the books are not entirely satisfactory, I may return them within 5 days and my money will be refunded.

Refrigeration Service Manual

1 2 3 4 5

Name

Address

City and State

Check here if you want our FREE illustrated catalog.

BROOKLYN YMCA TRADE SCHOOL



Making Plastic Molds

Learn this newest trade for post-war jobs or defense work.

Full Shop equipment. Unexcelled instruction. Fireproof dormitories. Also 2-yr. day Pre-Engineering courses.

Check your interests on coupon to receive free literature.

- Making Plastic Molds
- Aviation Mechanic
- Machinist
- Mechanical Pre-Engineering
- Diesel Pre-Engineering
- Mechanical Drafting
- Auto Mechanic
- Refrigeration
- Television and Radio Mechanic
- Architectural Drafting
- Armature Winding
- Welding
- Tool and Die Making
- Oil Burner
- Talking Pictures
- Diesel Engines
- Electrical

MAIL COUPON

1117 Bedford Ave., Dept. P.M. Brooklyn, New York City, N. Y.

Name

Address

LAW

STUDY AT HOME for PERSONAL SUCCESS and LARGER EARNINGS. 35 years expert instruction—over 108,000 students enrolled. LL. B. Degree awarded. All texts furnished. Easy payments. Send for FREE BOOK—"Law and Executive Guidance."

AMERICAN EXTENSION SCHOOL OF LAW
Dept. 47-M, 646 N. Michigan Ave., Chicago 11, Ill.

LEARN PRINTING

Top wages. Steady dignified work. Our home study course will teach you. Write for literature and free lesson. International School of Printing, Troy, Ohio.

An Au-del Guide!

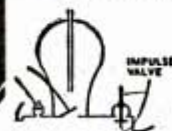

PUMPS-HYDRAULICS-AIR COMPRESSORS

JUST OUT! 3 BOOKS IN ONE—OVER 1650 PAGES, 1654 ILLUSTRATIONS, WITH QUESTIONS AND ANSWERS. COMPLETE PRACTICAL CONCISE INFORMATION FOR ALL ENGINEERS AND OPERATORS.

PART 1—PUMPS—850 Pages: All types—Centrifugal—Rotary—Reciprocating Pumps: Their Theory, Construction, Operation and Calculations. Air and Vacuum Chambers—Power Pumps—Air Pumps—Jet Condensers—Surface Condensers—Condenser Auxiliaries—Condenser Operation—Calculations—Cooling Ponds—Cooling Towers—Water Supply—Hydraulic Rams—Special Service Pumps—Automotive Fire Pumps—Dredges—Codes. 942 Illustrations.

PART 2—HYDRAULICS—320 Pages: Hydraulic Physics—Drives—Machines Control—Accumulators—Elevators—Hydraulic Airplane Control—Automobile Brakes—Shock Absorbers—Prestes—Turbines. Many new uses explained. 310 Illustrations.

PART 3—AIR COMPRESSORS—406 Pages: Compression of Air—Compressor Classification—Parts, Types—Inter and After Coolers—Regulating Devices—Installation—Lubrication—Operation—Maintenance—Blowers—Super-Chargers—Pneumatic Hand Tools—Ready Reference Index and Tables. 402 Illustrations.

Free Examination

TO GET THIS ASSISTANCE FOR \$4 COMPLETE YOURSELF SIMPLY FILL IN AND MAIL YOUR ORDER TODAY 4 ONLY \$1 MO.

AUDEL, Publishers, 49 West 23 St., New York 10, N. Y.
Send postpaid AUDEL'S PUMPS, HYDRAULICS, AIR COMPRESSORS (\$4). If I decide to keep it, I will send you \$1 within 7 days; then remit \$3 monthly until purchase price of \$4 is paid. Otherwise, I will return it promptly.

Name

Address

Occupation

Employed by

Do YOU Want the
STRENGTH, POWER
and **DEVELOPMENT** of a
CHAMP?

... then let
JOE BONOMO

Master Builder
of Men, show
YOU how to build
YOUR BODY into
MEAT and **MUS-**
CLE; and your
MUSCLES into
SPRINGS of
STRENGTH and
STEEL.



All my life I've been building big muscles and powerful bodies out of scrawny little ones. I've done it for thousands with my 'Power-Plus' Method, the most original System of Physical Development ever devised; the system that "Proves It With Results!" I'm so sure I can do it for you that I offer my **MONEY-BACK GUARANTEE!** Let me give you the build, strength, energy, vitality you want.

Send NOW for this Amazing, Complete
3 WEEKS "POWER-PLUS" SPEED COURSE
in muscular development for
ARMS, SHOULDERS, CHEST, BACK, LEGS



JACK DEMP-
SEY says:
"I consider
your course
tops for all
round phys-
ical develop-
ment".

Covers every part of your body inside and out. Gives you strength, build, speed and endurance. 18 daily work-out charts, 91 separate Photo-Instructor illustrations, 22 sheets of instructions showing how to do the proven 'Power-Plus' Muscle Builders. 3 illustrated Body Fact Lectures and more. Packed with facts about your body, including diagrams of muscles, nerves, organs. \$5.00 value, but it's yours now, complete for only 97¢ and a 3¢ stamp (or send \$1.00 cash, money-order or check), or I'll send complete course COD. Pay postman 97¢ plus postal charges. **ACT FAST!** Clip and mail coupon to me TODAY!



BERNARR
MACFADDEN
says:
"Your aston-
ishing ach-
ievements
places you at
the head of all
your compet-
itors."

FREE For Quick Action!

Strong men ACT, but as an inducement to urge you to act fast, if you send coupon at once, I'll send you my famous P.D.Q. Test Dozen. Find out how strong you really are! **RUSH COUPON TODAY.**

JOE BONOMO, Dept. 202
1841 Broadway, New York 23, N. Y.

MAIL COUPON NOW!

\$5.00
value only
97¢
and a
3¢ stamp

Joe Bonomo, personal
Bonomo Culture Institute,
1841 Broadway
New York 23, N. Y. **202**

Dear Joe: That's what I want—fast action! Rush me quick, my complete 3 weeks "Power-Plus" SPEED COURSE. Include FREE your famous P. D. Q. Test Dozen.

I enclose \$1.00 cash, money-order
 Send COD, I will pay postman 97¢ plus postal charges.

Name..... Age.....
Street.....
City..... Zone..... State.....
(Please print plainly)

Choose Your Job in These
Big Pay Fields
Send Name and Address
for Vital Facts Today

Get ready now. Meet keener job competition. Prepare for permanent success in after-war days in one of these three big opportunity fields—certain to be tops in good jobs and better pay for many years to come. This 28 year old school will train you easily and quickly in your own home or in its big Chicago shops to fill any of hundreds of different jobs. Get the facts. Write today.

INDUSTRIAL TRAINING INSTITUTE, Dept. 49
2132-2158 Lawrence Ave. Chicago 25, Ill.



A SIMPLIFIED ART ANATOMY OF THE HUMAN FIGURE

ONLY \$1 POSTPAID
by Charles Carlson. The book they're talking about! One of the most informative books of its kind for both student and professional artists. Charts, notes, and over 350 drawings show detailed studies of every part of the body, posed and in action. **HOUSE OF LITTLE BOOKS, 156-160 Fifth Ave., New York**

BOOKS FOUND FREE!

WHAT BOOKS DO YOU WANT?

We quote lowest market prices. No charge for locating Hard-to-Find Books. All books, OLD or NEW mailed POST-FREE. **SEARCHLIGHT BOOK CLUB, 22 East 17th St., New York City**

Learn to Service and Repair
ELECTRICAL APPLIANCES

Open your own electrical appliance service shop. Complete illustrated course covering house wiring, motor repairs, house appliance repair. **FREE BOOKLET.**
APPLIANCE SERVICE, 4701 W. Pico, Dept. AS-11, Los Angeles 6

BE A PERFUME DISTRIBUTOR!

Sell reproductions of world-famous, imported perfumes and get in on the now bigger than ever year around demand for this merchandise. Eye appealing packages assure you big daily cash profits. Many millions of dollars worth of perfumes sold annually. Get started at once with us—your profits are waiting! But get started! Send for free details and sample TODAY! **DUCHESS D'ANDRE, Dept. 14-F, 145 No. Clark St., Chicago 2, Ill.**

MAKE
MONEY

AT HOME!

Learn to color photos and miniatures in oil. No previous experience needed. Good demand. Send for free booklet, "Make Money at Home" and requirements.

NATIONAL ART SCHOOL
1315 Michigan Ave. Dept. 1358 Chicago 5

STATEMENT OF THE OWNERSHIP MANAGEMENT CIRCULATION, ETC. REQUIRED BY THE ACTS OF CONGRESS OF AUGUST 24, 1912, AND MARCH 3, 1933, of Popular Mechanics Magazine, published monthly at Chicago, Ill., for October 1, 1944.

Before me, a Notary Public, in and for the State and county aforesaid, personally appeared H. H. Windsor, Jr., who, having been duly sworn according to law, deposes and says that he is the Editor of the Popular Mechanics Magazine, and that the following is, to the best of his knowledge and belief, a true statement of the ownership, management (and if a daily paper, the circulation), etc. of the aforesaid publication for the date shown in the above caption, required by the Act of August 24, 1912, as amended by the Act of March 3, 1933, embodied in section 587, Postal Laws and Regulations, printed on the reverse of this form, to wit: First, That the names and addresses of the publisher, editor, managing editor, and business managers are: Publisher, Popular Mechanics Company, 200 East Ontario St., Chicago, Ill.; Editor, H. H. Windsor, Jr., 200 East Ontario St., Chicago, Ill.; Managing Editor, H. W. Magee, 200 East Ontario St., Chicago, Ill.; Business Manager, Paul H. Dunakin, 200 East Ontario St., Chicago, Ill. Second, That the owner is: (If owned by a corporation, its name and address must be stated and also immediately thereunder the names and addresses of stockholders owning or holding one per cent or more of total amount of stock. If not owned by a corporation, the names and addresses of the individual owners must be given. If owned by a firm, company, or other unincorporated concern, its name and address, as well as those of each individual member, must be given.) Popular Mechanics Company, 200 East Ontario St., Chicago, Ill.; H. H. Windsor, Jr., 200 East Ontario St., Chicago, Ill.; H. H. Windsor, Jr., Trustee for H. H. Windsor, III, and William T. Windsor, 200 East Ontario St., Chicago, Ill. Third, That the known bondholders, mortgages, and other security holders owning or holding 1 per cent or more of total amount of bonds, mortgages, or other securities are: (If there are none so state.) The Equitable Life Assurance Society of the United States, 29 S. La Salle St., Chicago, Ill. Fourth, That the two paragraphs next above, giving the names of the owners, stockholders, and security holders, if any, contain not only the list of stockholders and security holders as they appear upon the books of the company but also, in cases where the stockholder or security holder appears upon the books of the company as trustee or in any other fiduciary relation, the name of the person or corporation for whom such trustee is acting, if any; also that the said two paragraphs contain statements embracing affiant's full knowledge and belief as to the circumstances and conditions under which stockholders and security holders who do not appear upon the books of the company as trustees, hold stock and securities in a capacity other than that of bona fide owners; and this affiant has no reason to believe that any other person, association, or corporation has any interest direct or indirect in the said stock, bonds, or other securities than as so stated by him. Fifth, That the average number of copies of each issue of this publication sold or distributed, through the mails or otherwise, by paid subscribers during the twelve months preceding the date shown above is not daily publication. (This information is required from daily publications only.) H. H. Windsor, Jr., Editor. Sworn to and subscribed before me this 15th day of September, 1944. N. E. Toole, Notary Public. (My commission expires March 24, 1948.)

SIGNS EASILY AND EXPERTLY
PAINTED WITH LETTER PATTERNS

AND SHOWCARDS MANY SIZES & STYLES WRITE FOR FOLDER. **JOHN F. RAHN**
1330-31 N. Central Ave. CHICAGO 51, ILL.



Send Messages in
SECRET CODE

**THE ARME
CODE-O-GRAPH**

Creates Over
1,000,000 Different Codes

Send baffling, mysterious, secret messages! Play Spy, War, Detective, G-Men! Genuine ARME-CODE-O-GRAPH works out, decodes 1,000,000 codes. Invisible ink records it. **SEND NO MONEY.** Just name and address. We'll mail 2 Junior Secret Service CODE-O-GRAPH sets and instructions. Pay postman only \$1 plus postage. (Postage prepaid on cash orders.) After 5 days if not delighted, return for refund.

INVENTORS!
Protect Your
Ideas With
Code-O-Graph

FREE—INVISIBLE INK—FREE
Send order TO-DAY, get FREE, large supply of invisible ink.
ARME CO., Dept. 49-P, Box 1153, Chicago 90, Ill.

INDUSTRIAL RADIOGRAPHY

This amazing NEW science needs large numbers of persons trained in this NEW profession that is springing up in industry all over the world. Learn the practical and essential theory by spare time home study training. Higher education helpful, but not necessary, to become a proficient INDUSTRIAL RADIOGRAPHER. **Free Book—Rush Name.**

OHIO INSTITUTE OF TECHNOLOGY Box R-191
Greenville, Ohio

**"How to Make Money
With Simple Cartoons"**

A book everyone who likes to draw should have. It is free; no obligations. Simply address

CARTOONISTS' EXCHANGE

Dept. 911 Pleasant Hill, Ohio

**LEARN MOVIE
PROJECTION
THEATRE MANAGEMENT**

The Motion Picture Theatre Business offers big opportunities for trained men. Get into a fascinating field with a peace time future. Train at home in spare time. Free catalog. Established 17 years.

THEATRE INSTITUTE, 370 Washington St.,
Elmira, New York

FIX TYPEWRITERS

A Simplified Practical Homestudy Course. Many of our Students now have their own Business—Many Repair for others. Repair Shops Swamped. Health or Age no handicap.
WEBER TYPEWRITER MECHANICS SCHOOL
42 Hillside Road, Skyway Park, Osborn, Ohio



★ SAVE WASTE PAPER ★

**MAKE BIG MONEY SAWING
WOOD NOW!**

**350 Cuts
a Minute**



**OTTAWA ONE-MAN
TRACTOR SAW**

Turn wood lots into cash; help save other fuels to win the war. Use Ottawa—fastest cutting; easiest way. Cuts large and small logs, fells trees. Thousands in use. Built to last with special heavy stiff saw blade. Positive safety clutch control, driven from any power take-off.
OTTAWA MFG. CO., D1127, Forest Ave., Ottawa, Kansas

**FREE BOOK
and
Price List**



DANCE IN 5 DAYS . . . OR NO COST!

LEARN NEWEST STEPS—INCLUDING RHUMBA, SAMBA, CONGA and JITTERBUG, FOX TROT and WALTZ.

Let dancing open the door to Romance and Happiness for you! This sensational new book helps you learn the latest steps, quickly, easily. A revolutionary book that offers a short-cut to dancing. **MAKE THIS TEST!** Send today for Betty Lee's amazing book—it's packed full of diagrams and tells in simple language how to do the Jitterbug, Rhumba, Conga, Samba and other exciting new dances

—also the ever-popular Waltz, Fox Trot, and many old-time favorites. **SEND NO MONEY!** Act now, and we'll send you as a gift, 2 additional books FREE of any extra charge, "Tip Top Tapping," and "Swing Steps." And remember—if not satisfied with results in 5 days you may return the book and your money will be refunded.



PIONEER PUBLICATIONS, INC.
1790 Broadway, Dept. 9411H
New York 19, N. Y.

Send me by return mail, in plain wrapper "Dancing," by Betty Lee, and include 2 free books.

Ship C.O.D. I will pay on arrival, plus postage.
 I enclose \$1.95. Ship postage prepaid. If in 5 days I do not learn to dance, I may return book and you will refund purchase price.

Name.....
Address.....
City..... State.....

LIKE AVIATION?

... Then You'll Want This Book

Free! To anyone sincerely interested in Aviation as a career . . .

Let RYAN Fit You For One Of Aviation's Important Peace-Time Jobs... Be an **AIRCRAFT DRAFTSMAN**



Aviation industry leaders at Ryan have proven with direct-from-the-industry methods of instruction that they can train you thoroughly—yet quickly in part of your spare time. **Home Study You'll Enjoy . . .** You learn at home under individualized supervision. With this new "abridged" course, higher education or special experience is not necessary. Complete Aeronautical Drafting equipment included with your training at NO EXTRA COST. The low R.A.I. tuition, payable in easy monthly payments, covers everything. This illustrated book gives you full information on the most practical way to enter Aviation. Use this coupon—now—there is no obligation—it'll take but a minute—make it your first step toward a successful career in Aviation. To save time send it air mail.

RYAN
Aeronautical Institute
4211 Lindbergh Field, San Diego 1, California

Gentlemen: Please send me, without any obligation on my part, your FREE 24-page illustrated book, "New Horizons of Opportunity," and full information on R.A.I., including cost of training, and job opportunities.

NAME..... Age.....
STREET.....
CITY..... STATE.....



Be the "LIFE O'the PARTY"
 Have fun. Be the center of attraction everywhere with this easy-to-play Song Flute. Sweet Flute-like tone. Play alone, or in group, with singers, guitar or other instruments. Anyone can quickly master it.

... **EASY TO PLAY.** Yes, almost as easy as whistling a tune. Just blow for tone, finger for notes, you can't miss. Eight tone holes give full chromatic scale. Low price. Carry in pocket or purse.

Get this FREE PLAYING GUIDE

Send coupon for interesting playing guide with complete playing instructions and music. See how easy it is. Amaze your friends. Ideal Xmas gift. At all good music stores. But mail coupon today. 379

\$1



MAIL TODAY
CONTINENTAL MUSIC CO., INC. Dept. 1129
 630 So. Wabash Ave., Chicago 5, Ill.
 Please send free Song Flute playing guide and name of nearest dealer. No obligation.
 Name _____
 (Write address, town, state in margin)

AMAZING PLASTIC PAINT Gives Lasting Beauty to WALLS, WOODWORK & FURNITURE

SUPERIOR Liquid Plastic DRIES TO TOUGH, HIGH-GLOSS FINISH



Applies Easily With Brush
 • A new paint miracle perfected by Science! It's a true plastic you apply easily with a brush. Beautifies all surfaces. Dries to long-wearing, brilliant white plastic finish. Leaves no brush marks. Non-yellowing, non-scratchable. Can be washed like porcelain. It's the paint of tomorrow—yours today!

ORDER NOW ON MONEY-BACK GUARANTEE

• No. 1 for walls, woodwork. No. 2 for furniture. Pure white or can be tinted. \$5.95 per gal. with Special Thinner. Express prepaid or COD if desired.

\$5.95 PER GAL. DELIVERED

SEND YOUR ORDER OR WRITE FOR FREE ILLUSTRATED FOLDER
SUPERIOR PAINT AND VARNISH WORKS
 2256 Elston Avenue • Chicago 14, Illinois



This Plant Offers You A Post-War Opening

Veterans from overseas, as well as men from the home front, will find Fyr-Fyter doors wide open to them. Wherever you are, you can make application for a Dealer-Salesman opportunity to be filled when you are ready. Write today.

THE FYR-FYTER COMPANY
 Dept. 90 Dayton 1, Ohio

"The Book They're Talking About"

ART ANATOMY & FIGURE DRAWING

For the amateur and professional artist. Contains over 350 illustrations, charts and notes, giving detailed study of every part of the body. **POSED and IN ACTION.** **\$1**

Price Only
ENRIGHT CO., Dept. 40-C, P. O. Box 45, FOREST HILLS, NEW YORK

REFRIGERATION

Repair and improve all refrigerators. New large manual tells how. Charts and pictures to help you. Only \$1.00, postpaid. Money back guarantee. Supreme Publications, 9 South Kedzie Avenue, Chicago 12, Illinois

Correspondence Courses in RADIO and ELECTRICAL ENGINEERING **LOW AS \$25**

ELECTRICAL ENGINEERING. Get good grasp of wide electrical field. Modern. Very understandable. Theory made easy.
RADIO ENGINEERING. Extra fine course in radio, public address, photo-electric work. Trains you to be super-service man, real vacuum tube technician. Tuition ONLY \$25, either course. Deferred payment plan. Servicemen needed badly.
FREE Write for free copies of school catalogs, student magazines, etc.
LINCOLN ENGINEERING SCHOOL, Box 61-P71, Lincoln, Nebr.

Pays HOSPITAL BILLS for Whole Family
Costs 3c a Day for Adults
Only 1½c a Day for Children

It's here! The new Family Hospital and Surgical Expense Policy you need and want! One policy insures whole family—mother, father, children, anyone from 3 months to 65 years. No medical examination. Pays up to \$510.00 hospital and surgical bills for EACH and EVERY person insured. Pays up to \$100.00 doctor's fees for operations. Pays up to \$50.00 for operating room, medicines, ambulance, etc. Covers sicknesses, accidents, operations, childbirth, female disorders, and many other disabilities not covered by other policies. You select your own doctor and hospital. This full-coverage Family Hospital and Surgical Policy issued DIRECT to you at special family rates by big, strong company with over \$3,000,000.00 in assets. Investigate! SEND NO MONEY, but mail the coupon below quick for full details—sent FREE. No agent will call on you. Act today!

STERLING INSURANCE CO.
 4778 Sterling Bldg., Chicago 11, Ill.
 Send me your FREE INSPECTION Offer of LOW-COST Family Hospitalization Plan.

NAME _____
 ADDRESS _____
 CITY _____ STATE _____

Yes! NOW IT'S *Easy* TO BLAST OUT CLOGGED, DIRTY DRAINS

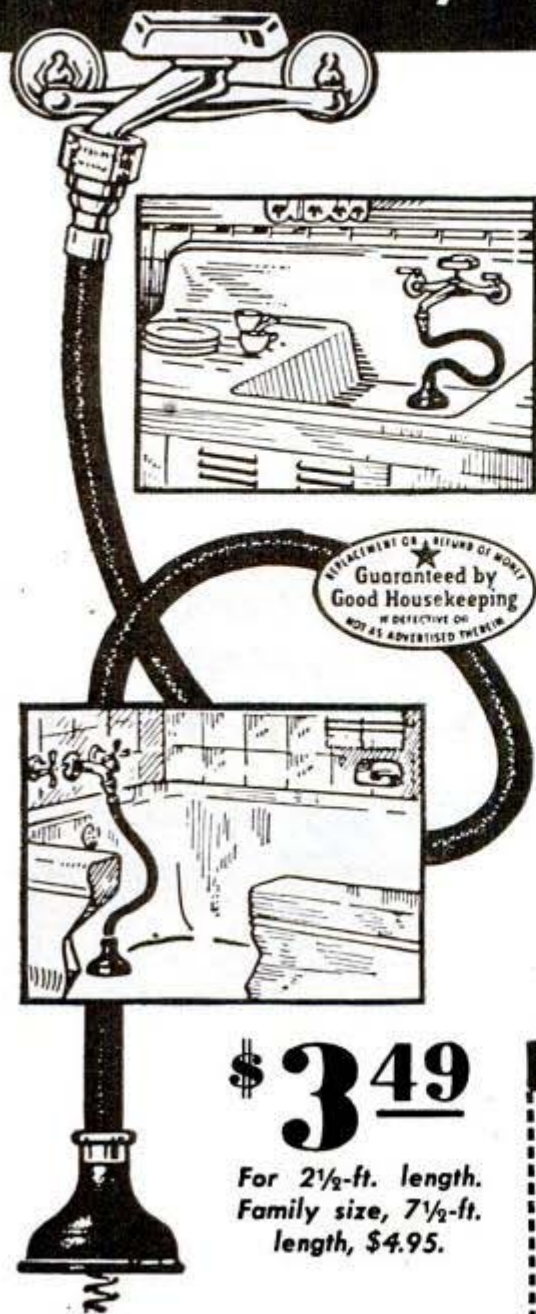

\$ 3⁴⁹

For 2½-ft. length.
Family size, 7½-ft.
length, \$4.95.

WITH THE NEW, IMPROVED CARTER

WATER PRESSURE DRAIN CLEANER

It uses the driving power of direct water pressure to force out stoppages, soap curds, and filth. It is the only mechanical water pressure drain cleaner on the market—and the Carter is now equipped with the famous Ormax Vacuum Breaker which guards against pollution. Any woman can use the Carter on lavatories, bathtubs, kitchen sinks, laundry tubs, toilets and floor drains. Whenever you have a slow-running drain simply put a Carter Water Pressure Drain Cleaner to work. Use it regularly to keep drains open and clean—to protect the health of your family. Get one today. Your local store has the Carter or can get one for you from

ONTHANK - DAVIS CO., Des Moines 9, Iowa

CARTER 
WATER PRESSURE DRAIN CLEANER

MAIL COUPON TODAY!

Onthank-Davis Co., Dept. PM-11, Des Moines 9, Iowa

- I enclose \$3.49. Send me Carter Drain Cleaner with 2½ ft. length.
 I enclose \$4.95. Send me Carter Drain Cleaner, 7½ ft. length.

Name.....

Address.....

City.....State.....



BY CONTRAST they seem worlds apart . . . the spectacular Evinrude "quads" that drive these swift assault craft . . . and the peaceful "fishing" Evinrudes that every sportsman knows. But the big motors in olive drab owe much of their great performance to the peacetime Evinrudes that came before . . . to more than 30 years of concentration on building *pleasure motors* better and better . . . lighter and more powerful . . . ruggedly reliable and trustworthy. In stepped-up measure these qualities are built into the Evinrudes that serve on battle fronts today. After Victory they will again be yours . . . in new Evinrudes designed for your greater enjoyment of every hour you spend on the water! *Evinrude Motors, Milwaukee 9, Wisconsin.*

EVINRUDE OUTBOARD MOTORS



BUY MORE WAR BONDS . . .

. . . HOLD WHAT YOU HAVE

Popular Mechanics Magazine

REGISTERED IN U. S. PATENT OFFICE AND CANADA

WRITTEN SO YOU CAN UNDERSTAND IT

Vol. 82

NOVEMBER, 1944

No. 5

Mr. Paul Healy 0-542



J. K. Salisbury, General Electric turbine engineer, indicates combustion chamber in model of marine gas turbine

WHILE many details of its recent evolution are military secrets, the gas turbine, a new and intriguing addition to the menagerie of heat engines, promises to usher in a power era of much wider scope sometime after the war. The long dreamed of rotary engine imaginative engineers have tinkered with for 150 years, it is conceded to have exciting potentialities for land, sea and air travel. Already it has been given credit for certain mechanical phenomena—propellerless, kerosene-driven airplanes capable of terrific speeds, ships which can operate without boilers, and small, economical, powerful locomotives.

The first patent on a machine using the

gas turbine principle was taken out by an Englishman as far back as 1791 but progress toward a practical unit that could vie with other forms of power on a dollar for dollar basis was slow until extensive wartime research solved the difficult requirements that had to be met from an engineering and materials point of view.

The gas turbine is a kind of multiple windmill enclosed in a steel cylinder. Compressed air and fuel—low-priced gas or oil—are forced into a chamber to provide combustion under pressure. The products then are blown through a nozzle at great speed so as to spin the “windmill,” part of whose power drives the combustion-cham-

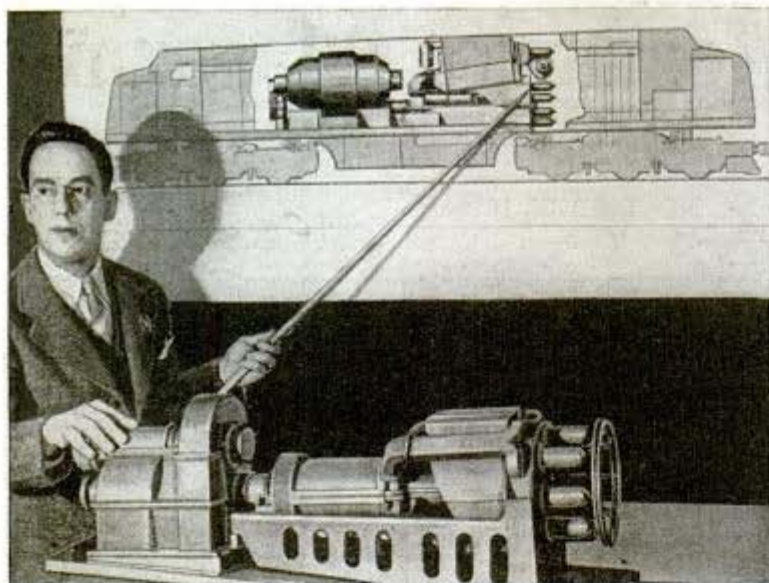

Above, phantom drawing of a locomotive and model of a marine gas turbine are shown as two promising fields for application of the engine

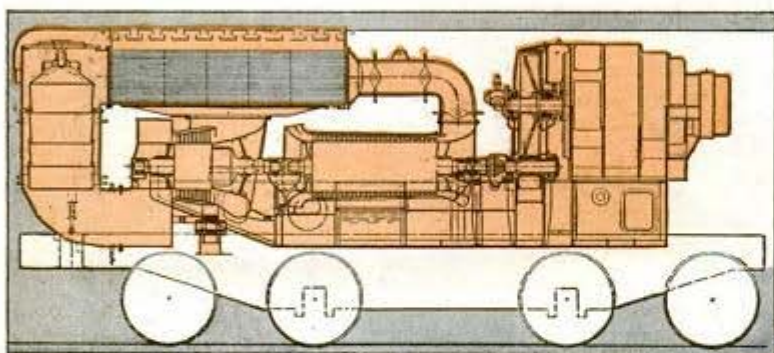

Left, diagram of locomotive shows combustion chamber at extreme left, a gas turbine above wheel at extreme left, and generator at right. Below, gas turbines and generator are lowered into a locomotive hull

Courtesy of Diesel Progress

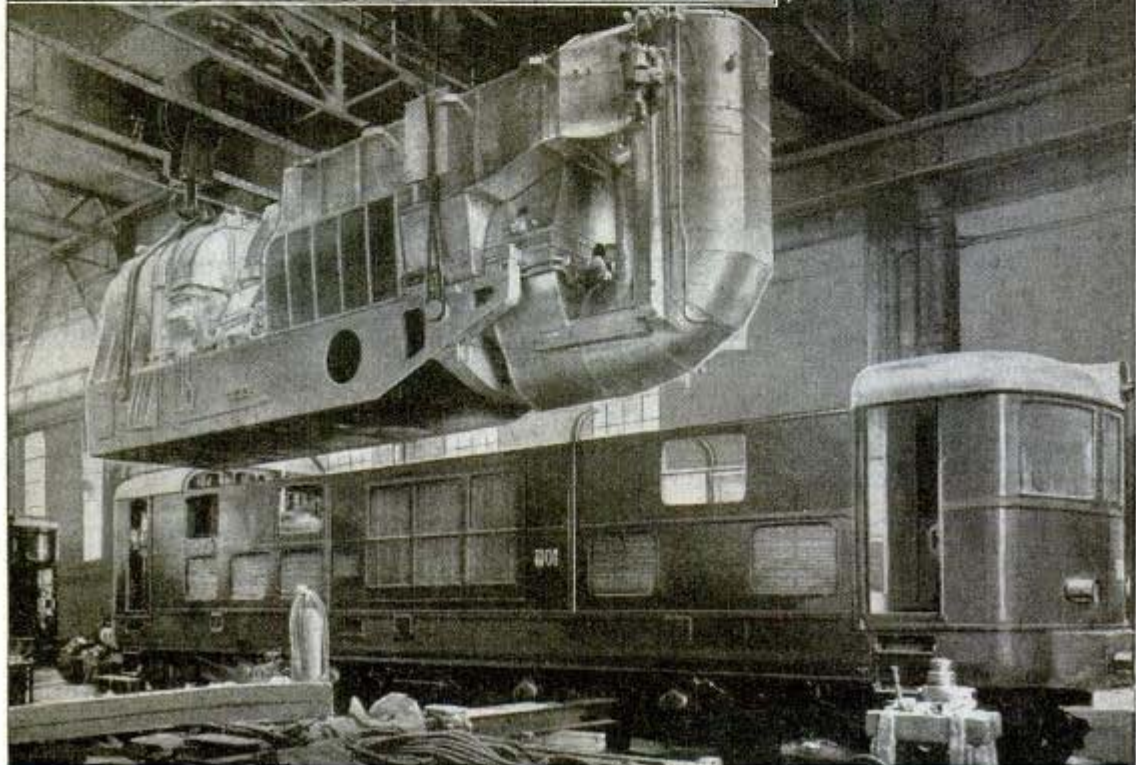

ber compressor. The remainder is the net power derived from the flaming gases. This power can be either harnessed directly to machinery or used to drive a generator for the production of electricity.

Sometimes the "hot hurricane" occurs incidentally to another process, as in the case of aircraft exhaust gases to run turbo-superchargers, which are simple gas turbines. But the important characteristic is that the turbine wheel is spun by the direct blast of the burning fuel unlike the steam turbine wheel, which is turned by steam blown from an elaborate, complicated boiler.

In its simplest form, nearly three quarters of the total power produced

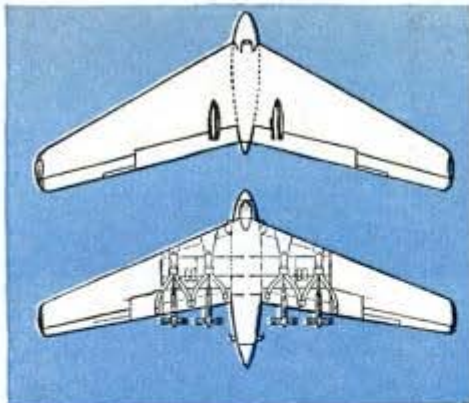

Courtesy of Aviation News and The Aeroplane
Top, sketch of a proposed jet-propelled mail plane. Bottom, plane whose gas turbines drive contra-rotating propellers (artist's conception of it is at the right)

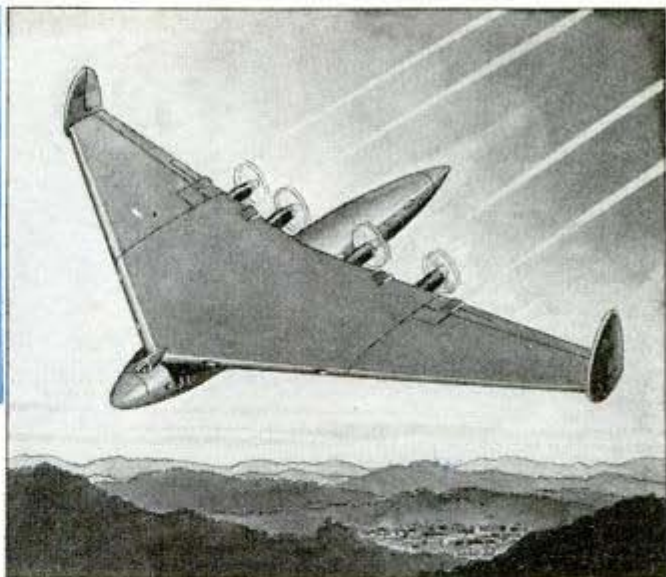

in the gas turbine is consumed by the compressor which feeds the turbine and the one quarter left as net power to do useful work is relatively less than with other forms of power-producing machinery. Both Diesel engines and ordinary gasoline engines can be made to produce even more power from the same

amount of fuel but, despite its present inefficiency, the gas turbine has advantages in weight, space, and reliability if used to drive locomotives, ships and aircraft.

On that score the gas turbine does away with the boilers and large-size condensers needed for steam turbines and the complex, heavy cooling systems and multitude of accessories required by gasoline and Diesel power plants. The type of fuel it can use also may make it much less costly.

One of the most interesting things about this prime mover is that its efficiency soars upward at a rate three times as great as for steam for each internal temperature jump. At the same time compressor efficiency improves as the external temperature drops. Think of what this means to aviation. It



Left, engineer's room of gas turbine locomotive (below) built by Brown, Boveri for Swiss railways

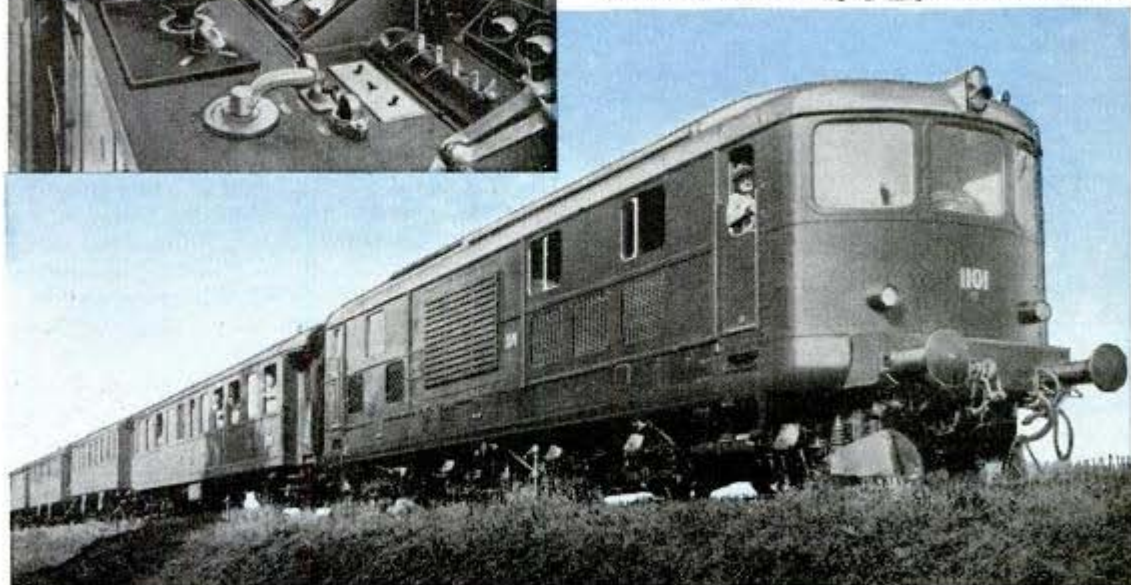

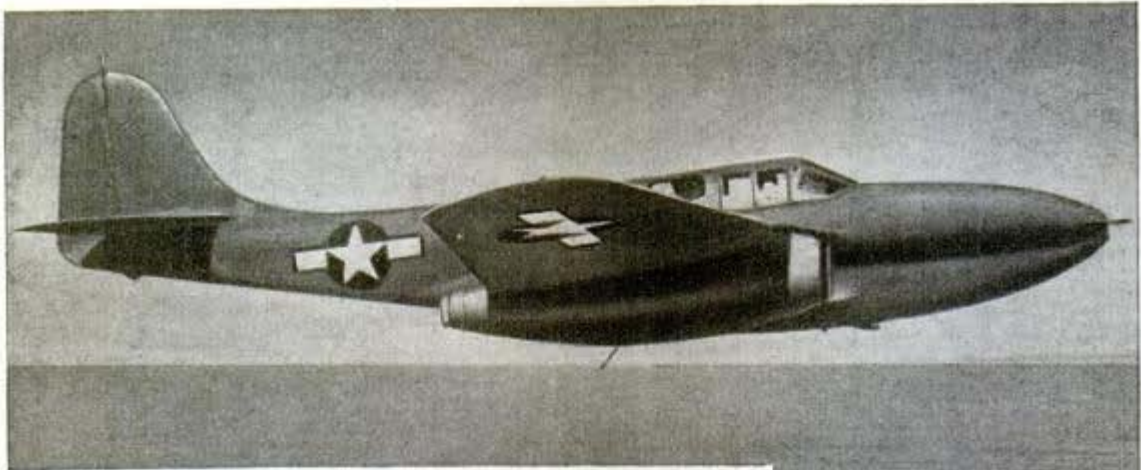

Above, the P59A Airacomet, first American jet plane. Below, the British Gloucester jet plane with intake vent in nose, propulsion vent in tail



combination of "vitamin alloys" that, added to steel, result in a material able to withstand the very high temperatures needed for efficient operation. The War Department also announced significantly that it had requested General Electric to devote 600,000 square feet of floor space to the manufacture of gas turbines.

may make possible really large and fast planes which can operate satisfactorily at 50,000 feet or more. Thus far it has been applied with apparent success in the fantastic jet propulsion plane, a propellerless craft which uses kerosene or some other cheap fuel and can travel approximately 100 miles per hour faster than any conventional aircraft. In this version the turbine wheel uses only enough power to operate the supercharger. The exhaust gas, still under pressure, jets out at high velocity through a rear nozzle. The sustained high-speed flow of exhaust gas provides the thrust that moves the plane forward.

Many engineers say the usefulness of the aircraft gas turbine will begin where the gasoline-driven engine, with its high-octane fuels, ends. The latter is now so overgrown in size and complexity that it does not seem practical to push it to much more than 2,000 horsepower; in addition, propeller efficiency falls off considerably at around 400 miles per hour, when the speed of the propeller tips begins to approach the speed of sound, and at altitudes of 35,000 to 40,000 feet.

Recently it was announced that gas-turbine-powered warplanes are already in the air, thanks to the discovery of a certain

If adapted to locomotives, the gas turbine can offer very low track wear (due to smooth power flow), low lubrication and maintenance costs, full braking power, large starting pull and longer life. Some turbine designers assert it will duplicate the desirable operating characteristics of the Diesel electric—no water stops, fast acceleration, and no track pound—while remaining as cheap, or cheaper, to run than the steam engine.

A 2,200-horsepower gas turbine locomotive built in 1939 by Brown, Boveri of Switzerland proved successful as an experimental model. In this country Allis-Chalmers, Westinghouse and General Electric are planning models which will be tried out in peacetime. General Electric is studying plans for a gas-turbine-powered locomotive with 4,500 horsepower but only 75 feet long—about half the length of a Diesel electric.

In ships, as in locomotives, the gas turbine's advantage is that it has no boiler to take up valuable cargo or passenger space and it needs no heavy condenser or bulky apparatus for distilling feed water. Including its drive mechanism, it is estimated the marine gas turbine will weigh only about

(Continued to page 162)

0544

DeLuxe Postwar Planes to Set Speed Records

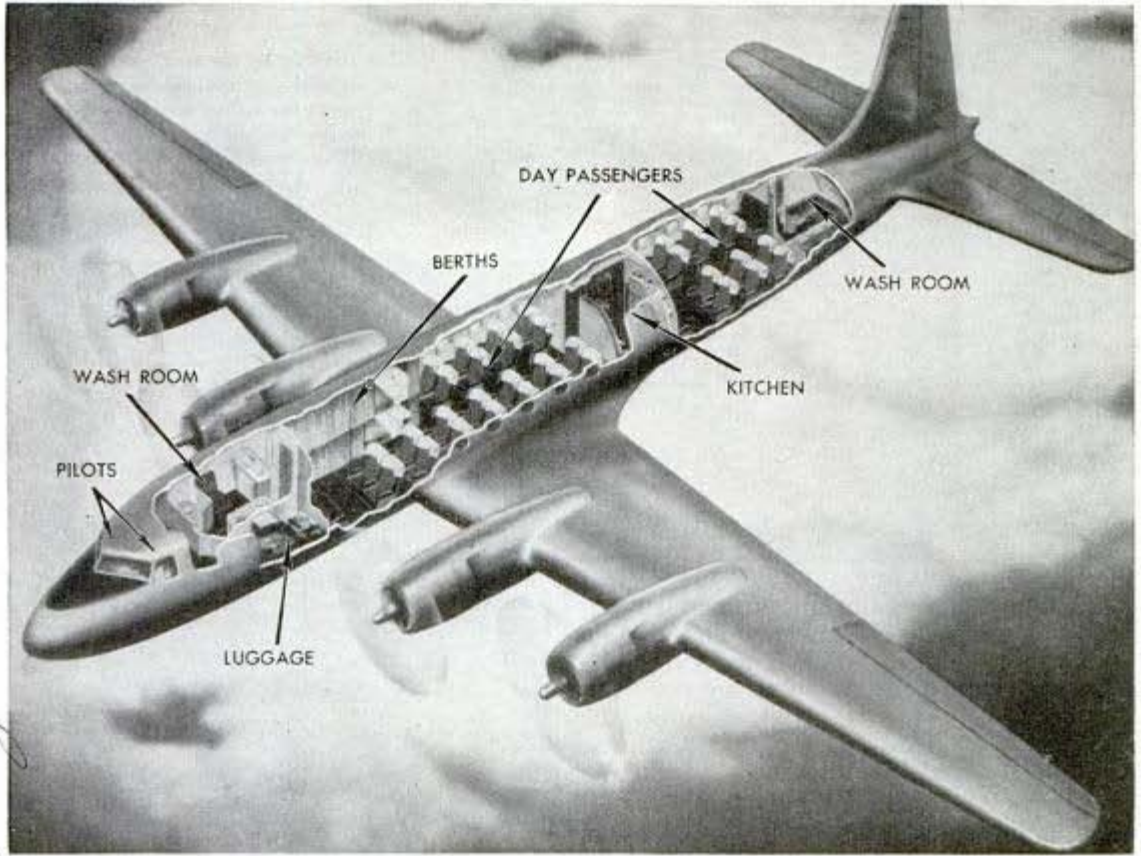

Santa Monica, Calif.

When the big sisters of the two-engine DC-3, the familiar 21-passenger prewar airliner, go into service after the war they will have an increased speed of 25 percent and nonstop range will be more than 3,000 miles. Major air lines have placed orders for more than a hundred of the new transports which will be built by the Douglas Aircraft Co. They are the DC-4, a peacetime version of the combat-transport C-54 used by the Army and Navy to fly cargo all over the world, and the DC-6. Both are four-engine planes. The DC-4 is powered by Pratt & Whitney engines of 1,450 horsepower each, and the DC-6 has 2,100-horsepower engines of the same make. The DC-4 will carry 44 passengers, the DC-6 fifty.

Both transports have a five-man crew. The DC-6 can be converted to a sleeper plane with accommodations for 24 sleeper and two sitting up passengers. This plane will also have a pressurized cabin so that it can fly "above the weather" on long hops. Maximum cruising speed of the DC-6 is 334 miles an hour at 23,800 feet with a gross weight of 63,500 pounds. At 10,000 feet the DC-6 has a cruising speed of 278 miles an hour compared with 239 for the DC-4 at the same altitude. Both have stalling speeds of only 80 miles per hour. The planes will look much alike, with identical wing span of 117 feet, six inches. The DC-6 is 100 feet, seven inches long, about seven feet longer than its sister ship.

0-202

Chemical Makes Softwoods Hard and Protects Them From Humidity

Woods are made markedly harder, stronger, stiffer and more durable by means of a chemical development at the E. I. du Pont de Nemours Co. The chemical agent, methylolurea, is obtained by compounding urea with dimethylolurea, both of which are inexpensive and available commercially. Through treatment soft woods become harder than hard maple and maple wood is made harder than ebony.

In addition, the process eliminates the natural tendency of wood to swell, shrink or warp with humidity changes. Furniture made of the transmuted wood could be shipped to any spot on the globe and still remain in condition. Color can be imparted permanently by the use of dyes in the impregnating material. The treatment also may be used to harden the outside of lumber without affecting the interior.

NOVEMBER, 1944 *Wilmington 98, Del.*

0 411

Man Spins Like Pail on a Rope in Blackout Test

Public Relations Section, AA-7 Material Command, Wright Field, Dayton, Ohio.



Left, Air Force corporal, wearing a molded brain-wave recorder, prepares for a test blackout run. Below, a technician sits next to centrifuge pivot shaft as an observer. She talks to control room



Diving blackout, the temporary loss of perception by pilots during violent flight maneuvers, is being studied by means of a special centrifuge machine in the Air Force's experimental laboratories at Wright Field, Ohio. The centrifuge, which resembles a two-arm merry-go-round with a man-carrying cab or cockpit at the end of each arm, is spun by a 250-horsepower electric motor. The volunteer test subject sits in one cab with the observer facing him. When the centrifuge is started, the cab swings outward like a pail on the end of a rope. The motion thus duplicates the force of an airplane pulling out of a dive—the maneuver which causes a black-

out. The force can be lessened or increased by varying the speed of the centrifuge. Special instruments, such as an electrocardiograph, brain wave recorder, and photo electric eye for measuring blood volume in tissues and to take pulse and respiration, record the subject's reactions.

Postwar Bus Has B-24 Nose and Airplane-Type Engine

When the first postwar bus rolls off the assembly line at a Consolidated Vultee Aircraft plant, it will bear both exterior and interior resemblance to the Liberator bomber built by that company. The driver's compartment, resembling the nose of a B-24, is almost entirely surrounded by

transparent plastics. An air cooled engine will be used in the first attempt to adapt aviation engines to highway transportation. This is one of two types of postwar buses designed for the Greyhound company. The other, of similar exterior design, will be built by General Motors and powered by Diesel engines. They will carry 50 passengers, nine more than the most modern prewar Greyhound bus, in three compartments on two levels. One compartment, which affords toilet facilities, may also include sleeping space or a smoking lounge. Engines on both types of buses may be detached easily for maintenance or repair.

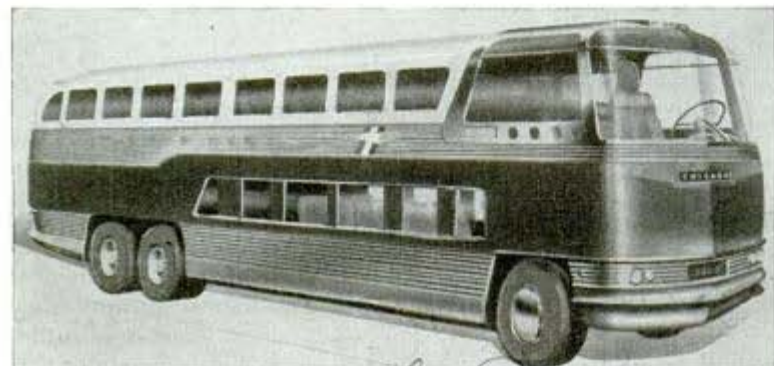

designed by: Raymond Leung

Rockets 'Shoot' Army and Navy Planes Into Air

Rocket power has been harnessed by the Army and Navy to assist bombers, carrier planes and flying boats into the air from short runways. Two types of rocket takeoff units developed at Wright Field, research center for the Army Air Forces, are the fixed and droppable. The fixed type, adaptable to combat planes, has a nozzle which emits gaseous flames from the rear of the engine nacelle. Heavier planes can be equipped with droppable rockets attached to the under side of the wings. A major problem in the development of the rocket unit was to find a nozzle that would stand the terrific heat of the ignited gas. The rocket units used by the Navy, known as "Jato," for "jet-assisted takeoff," resemble bombs and are attached to the fuselage. They are ignited by spark plugs, and the plane receives its "thrust" from an escaping stream of white gas.



Army bomber (top) takes off from a short runway with rocket units under wings. Navy plane (right) has fuselage attachment

Plastic Film "Copies" Surface to Magnify 10,000 Times



With a small projector, a strip of transparent plastic, and a special solvent, an enlargement similar to costly photomicrographic processes can be obtained in a few minutes. When the "homemade" slides are projected on a screen they produce an enlargement of 10,000 times in area with a three-dimensional effect. This non-photographic process can be used on any type of surface from a plant leaf to a metal finish. First, the surface to be studied is wet with the solvent. Then a one-inch strip of the plastic film is pressed to the surface for about a minute. The film is peeled off and inserted in a handy paper frame.

*Mr. Gen. S. McDill
5109 Mayfield Rd.
Cleveland 31, Ohio*

Mr. Allen Warren & Liatt
7 Park Avenue
N. Y., 16, N. Y.

0 485

REPAIR SHOP for HEROES

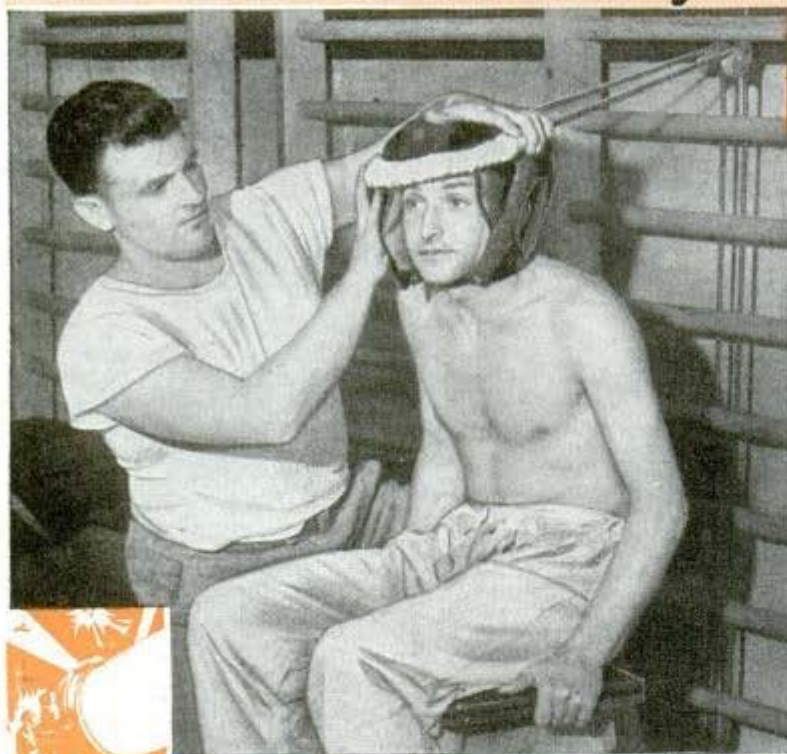

Helmet (left) protects head as patient exercises wounded neck by stretching elastic cord. Ankle exerciser below works out kinks in foot and lower leg



THOUSANDS of wounded soldiers who would have been classed as hopelessly unfit for further combat are coming back today, "fighting fit," ready and willing.

These wounded heroes are being treated by the best methods of reconditioning and the most modern apparatus American ingenuity could devise, in army hospitals that are scientific body repair shops.

Typical is the \$12,000,000 Halloran General Hospital on Staten Island, New York City; it is one of the biggest army hospitals in the world, accommodating more than 3,000 soldiers in its 100 or more buildings scattered over 383 acres of woodland.

Through the proper blend of medical treatment and hobbies—physiotherapy, hydrotherapy, electrotherapy combined with occupational and recreational therapy—the wounded soldier has an opportunity as he recuperates to do something he enjoys—something which at the same time teaches wasted

Hand-over-hand exercise turning wheel to which tension is applied helps patients learn to raise their arms again



Halloran General Hospital
Staten Island, N. Y., N. Y.



and hampered muscles and nerves to go back to work.

It starts in the great wards of the hospital when these soldier-patients are well enough along in convalescence to take an interest in something besides their physical condition.

Usually they are started off holding something with their hands. It might be a simple object which they can finger. It might be a book or a magazine. It might be an airplane recognition chart which they hold, while tiny model planes flash past the foot of their beds on wires. Some tie fishing flies. Other husky G. I.'s find themselves weaving insignia patches, camouflage tape, and liking it.

When the day comes that they can push themselves along in a wheel chair, a variety of special tools and work benches is available to them, each prescribed with a specific purpose.

Reconditioning may start in a nerve-tingling tonic shower, where a hose directed by a physical therapy aide plays alternate

Stainless steel hydrotherapy tub is used to increase circulation and warm injured parts. With weight reduced by immersion, first exercise of legs is made easier



Motor is removed from lathe and foot-power substituted to strengthen leg

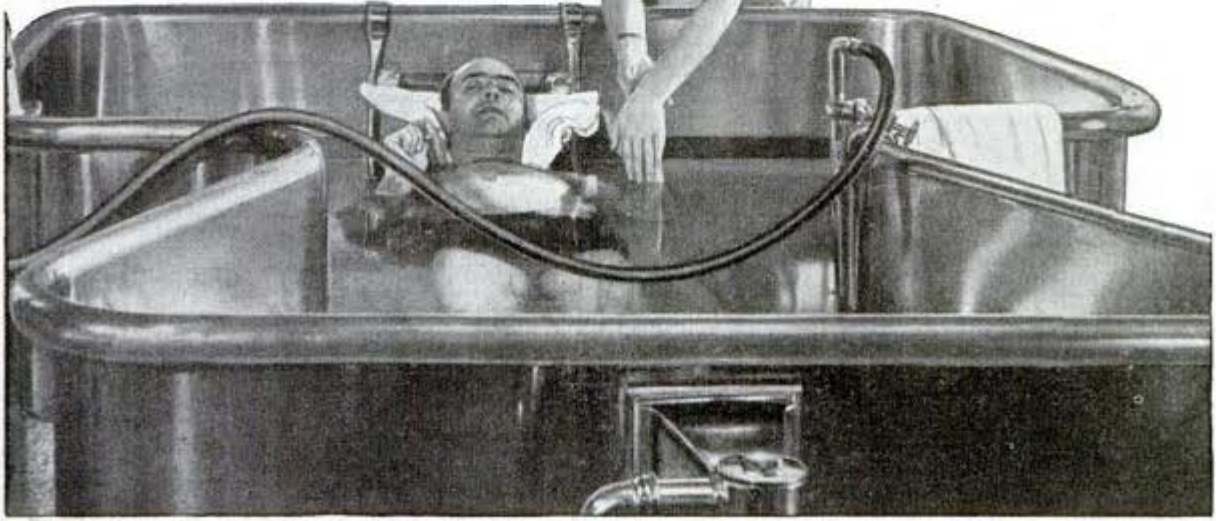

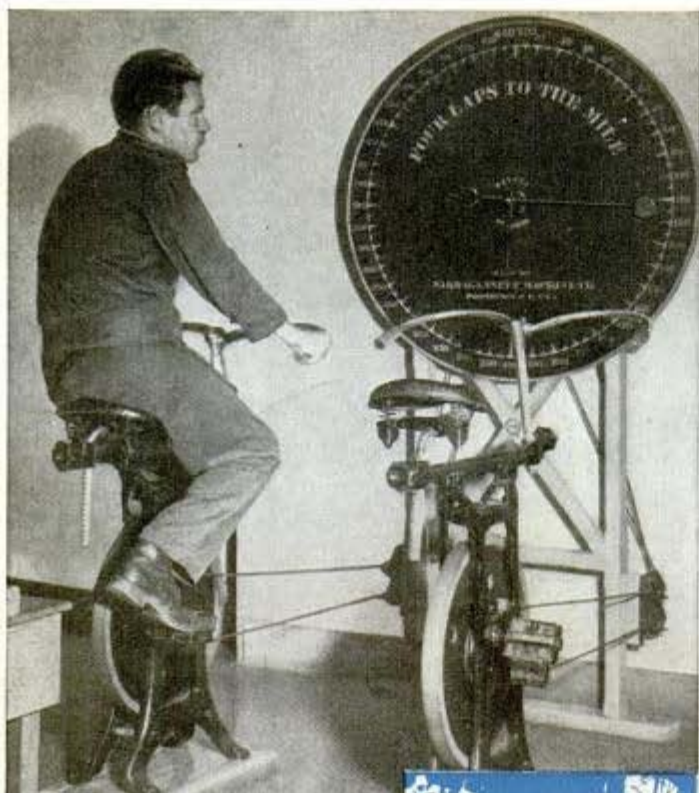

The stationary bicycle is a standard exerciser. To restore upper leg muscles to usefulness, veteran thrusts foot against a weighted cord. Weights are added as muscles gain



streams of hot and cold water against the body. Or in a fast whirlpool of hot water in which mending arms and legs can relax. Or in a shallow stainless-steel tub where the body's weight is relieved by immersion in hot water and the first exercises of incapacitated limbs can be taken with ease.

Heat and motion are the benefits of hydrotherapy. Together they restore circulation. For the same purpose diathermy, ultraviolet and heat instruments are available.

Then begins the real trip into "Therapy-land" at Halloran hospital. Adjustable "walkers" on wheels permit them to take their first steps. Stairways that lead nowhere—except to health—revive an old familiar function of the legs. "Finger ladders" with notches up which the digits climb one over another begin restoration of the use of the fingers. Molds which guide the fingers are used for the first finger movements. Ankle exercisers on springs permit feet to be rocked back and forth for the first time.

A circular, wheel-like, turning board with a single handle is rolled little by little as a tightened shoulder gradually limbers up until the day comes when the board can be turned in a complete circle. It is then that shoulder muscles are free.

A stationary bicycle with a registering dial loosens up legs as the "distance traveled" is increased by prescription. An arrangement of three mirrors helps men learn again how to swing their heads and exercise their necks.

After their muscles and nerves have "graduated" from physiotherapy, the soldier patients are often sent to occupational therapy buildings where the education of their muscles and nerves continues. The tasks here, however, are not only pleasant, but useful. Book ends, filing cabinets, tables, rugs, miniature models and a wide variety of craftsman articles flow from the shop. Men who need ankle work will rock a sewing machine treadle, others who need leg work will pedal a bicycle-gear lathe or saw.

Shoulders are educated at rug-weaving frames, fingers at rope-weaving racks, backs at cord-knotting stands. Arms are taught to raise and pull at leather presses. Wrists get limber at small sawing jobs.

Sandpapering has been found excellent for knotted fingers and hand muscles which must be retaught to grip. A wide variety of sanding

blocks provides one which will fit the needs of any disabled hand. Wads of modeling wax are manipulated in the first stage of limbering.

A bit more recreational is a game of "muscle checkers" available in the workshops. The board is larger than standard and the checkers are tapered pieces, not unlike big salt cellars. These pieces may be loaded with sand or shot until they weigh up to a pound. Since they taper toward a point, they must be grasped firmly every time a player makes a move. It's good for hands and wrists and the patient forgets he is curing a disability while interested in the game.

The next step takes the soldier into the gymnasium.

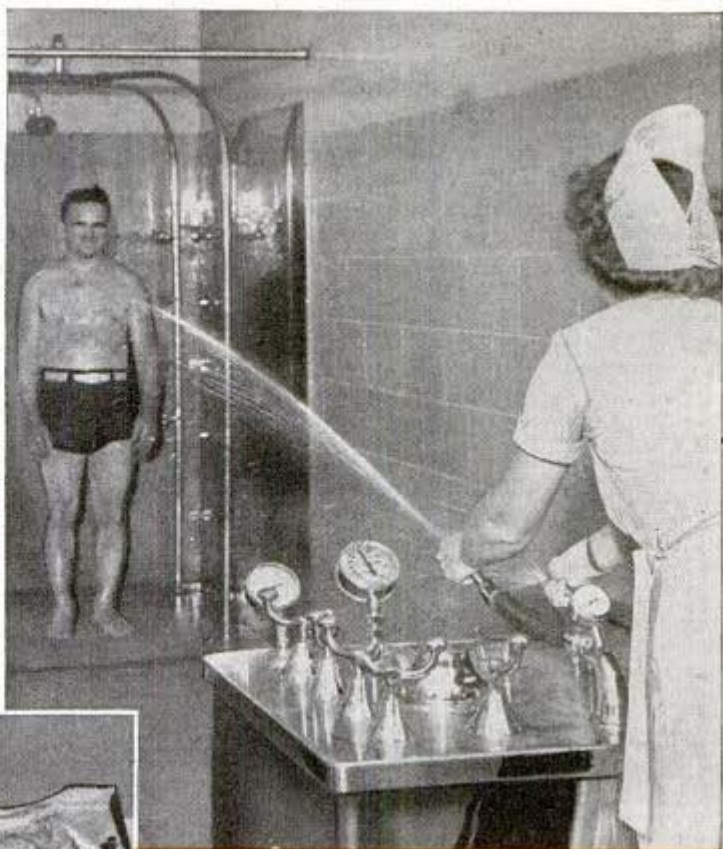

Warm water jet invigorates convalescent veteran and aids blood circulation. Molded device (left) keeps fingers spread as they learn to move and grasp. Below, tying knots and weaving cord helps raise arms, works shoulder muscles and fingers

Here is another department that can be a lot of fun, too. Great, light, air-filled punching bags can be batted back and forth by as many as four men at a time without risk of injury to wounded arms and hands. A wooden rod which can be twisted to raise weights helps the wrists. A device made of a boxing headgear and a padded elastic rope permits the muscles of an injured neck to regain strength by the mere act of bending the head forward against the resistance of the elastic.

There are curved boards on which a veteran can lie, to exercise arms while protecting a spine, perhaps broken in action, but mended now. Other effects encourage arms to raise, knees to bend, legs to walk, abdominal muscles



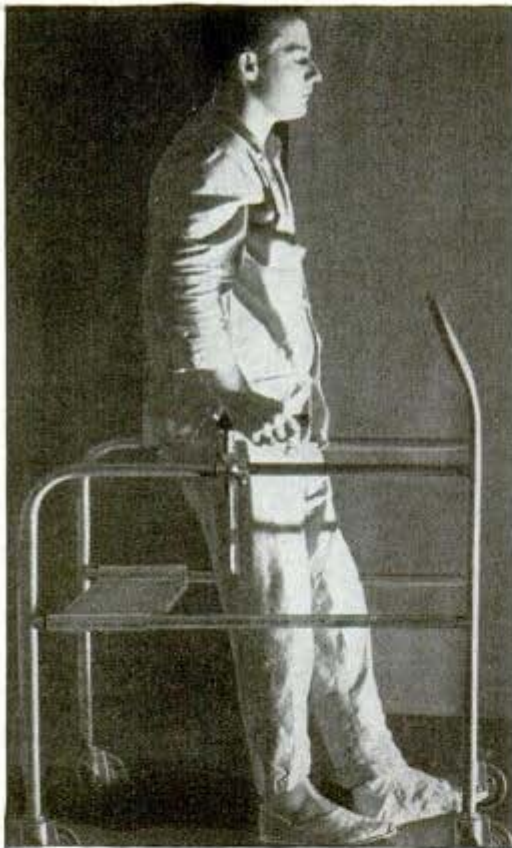

Adjustable walker on wheels helps many heroes take their first steps. Abdominal muscles are strengthened by sitting-up exercise on slanted board, right. Below, a man with fractured spine can exercise arms and shoulders on curved board



to toughen. After the gymnasium, the soldier patients move out into the open where they have all of the facilities of college or country club. They go horseback riding, play football, baseball, volleyball, softball, toss horseshoes, enjoy golf or archery.

From the time they are convalescents, the men are encouraged to make body movements which become progressively more active.

On a typical day, a half hour's exercise starts at 10 a.m., either in bed or in the open. During the next hour all ambulatory patients go to the movies. Bed patients do craft work.

At 2 p.m. exercise starts again in beds, outdoor sports fields, gymnasium, metal workshop and arts and crafts workshops. Other patients may be learning to play musical instruments, getting lessons in parlor magic or fishing in the hospital pond.

At four, regulated exercises start again for half an hour. After supper, a theatrical performance is open to walking and wheelchair patients in an auditorium. Individual ear-phones give bed patients a choice of programs.



While their muscles and nerves are being reconditioned, their minds are gradually brought around to the fact that they are still soldiers for Uncle Sam, that they are expected to continue their duties to the best of their ability. When the day comes that they are pronounced physically fit again, these lads are mentally ready to carry on the fight.

Mask That Blows Up the Lungs Permits Flying at 50,000 Feet

Air Force crews can fly at 50,000 feet without losing consciousness, thanks to a pressure mask which blows up the lungs as though inflating a balloon. Heretofore the practical limit of flyers breathing pure oxygen was 42,000 feet and then only for brief periods. Today airmen can safely fly a few minutes at 50,000 feet and about a half hour at 45,000 feet.

Dr. Cal. A. G. Gayne
POPULAR MECHANICS
Aero Medical Lab.
Wright Field, Dayton, Ohio

Bomber Packs 18 Machine Guns to Set Record

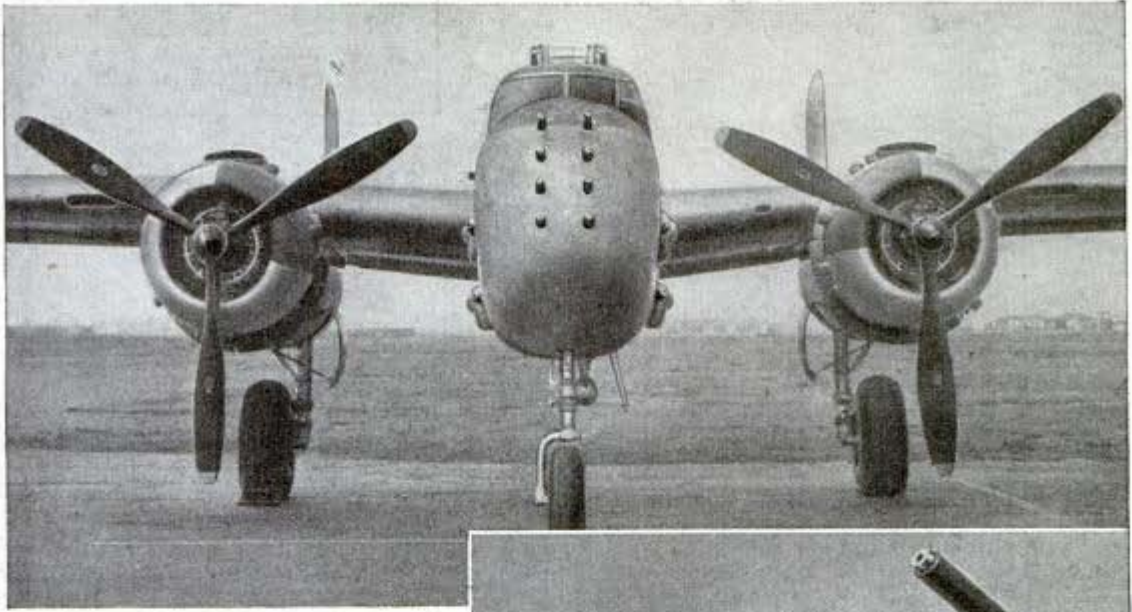

In rows of four, eight .50-caliber machine guns protrude from the nose of Mitchell B-25 bomber. It has 14 forward-firing .50-caliber guns

When the Japs get their next look at the B-25 bomber it will be a far deadlier plane than the type used in the Doolittle raid. The latest model, with 18 machine guns, is the world's most heavily armed plane. The North American Mitchell medium bomber has 14 forward-firing .50-caliber weapons, including eight in the nose. It also carries two waist guns and two tail guns along with a normal bomb load.

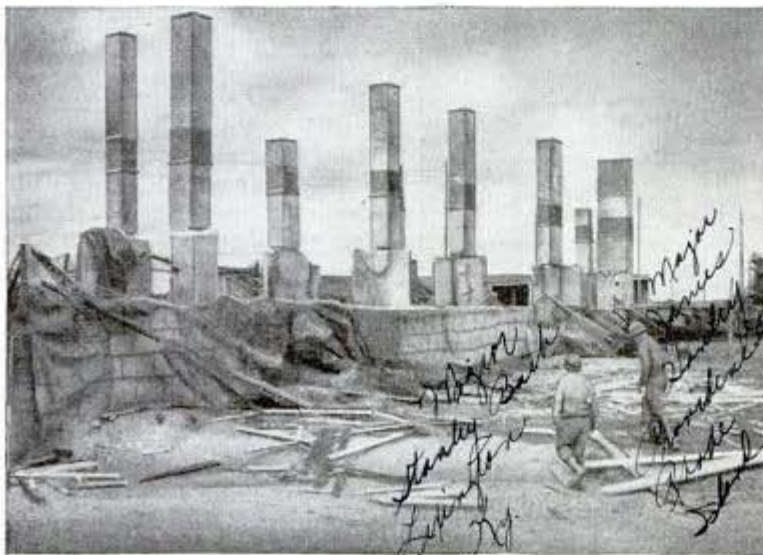
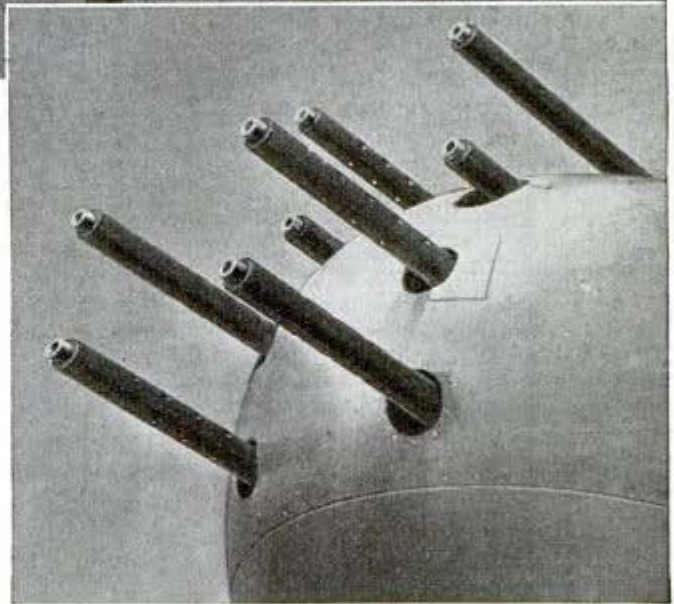

Fake Bomb Ruins Built by Germans To Fool Airmen

Phony "ruins" that resemble a bombed and burned out factory were used by the Nazis in France to conceal underground quarters. The fake bomb wreckage was made of plywood and netting, giving a realistic appearance. It is doubtful, however, if the camouflage would fool the sharp "eyes" of the aerial cameras, especially if the reconnaissance photos were made in color.

W. G. Reed, Managing Editor
Radio News, 540 N. Michigan Ave.
Chicago, Ill.

0509

The ETHER PATROL



Hunting clandestine radio transmitter, operator rotates direction finder; calibrated scale indicates bearings of hunted signal. Above at right, huge direction finder has H-shaped antenna to locate signal within one or two degrees. Below, monitoring officer exchanges data over microphone with operator at direction finder



DID YOU ever look for a needle in a haystack? Suppose your life depended upon finding a needle buried in a haystack containing 285,000 pieces of hay. To make the task more difficult, suppose the lost needle were camouflaged to resemble the hay.

Picture this tiny needle as an illegally operated radio transmitter buried under the thousands of signals which are heard as you tune the dial of your receiver. Your job is to pick out a faint signal and bring it in clearly. This will give you some idea of the problems confronting the Radio Intelligence Division (RID) of the Federal Communications Commission in locating clandestine radio transmitters.

The complete usable radio spectrum is about 300 times greater than that covered on the dial of an ordinary radio receiver. This spectrum includes more than 285,000 little spaces where radio signals



may be heard. If those stations were crowded a bit, it would be possible to include almost a million places where signals could get through. This, briefly, is the basic task confronting the "ether patrol."

The majority of personnel of the RID is made up of radio amateur operators. Their background and technical know-how made it possible to handle the maze of necessary technical equipment. The operators are faced with the job of maintaining a continuous patrol of the ether 24 hours a day. Their primary job is to recognize unlicensed



High speed recorder takes code signals at rate of 500 words per minute

1. Unknown signal is heard at one of the primary stations.
2. Other stations are alerted by Teletype.
3. Stations notify direction-finder operators over "Intercom."
4. Long range bearings are taken from several stations.
5. Bearings are sent to Washington Intelligence Center for "fix."
6. Intelligence Center notifies mobile units.
7. Mobile units take short range bearings.
8. RID men proceed on foot, guided directly to source of signal by "sniffer."

transmissions, to locate them and to direct proper authorities to the source.

They must be able to pick out those signals through heavy interference and record vital information so that identification of the station can be made.

When the United States entered the war, the demands for radio intelligence increased a hundredfold. Our government acted at once to prevent information from being sent to our

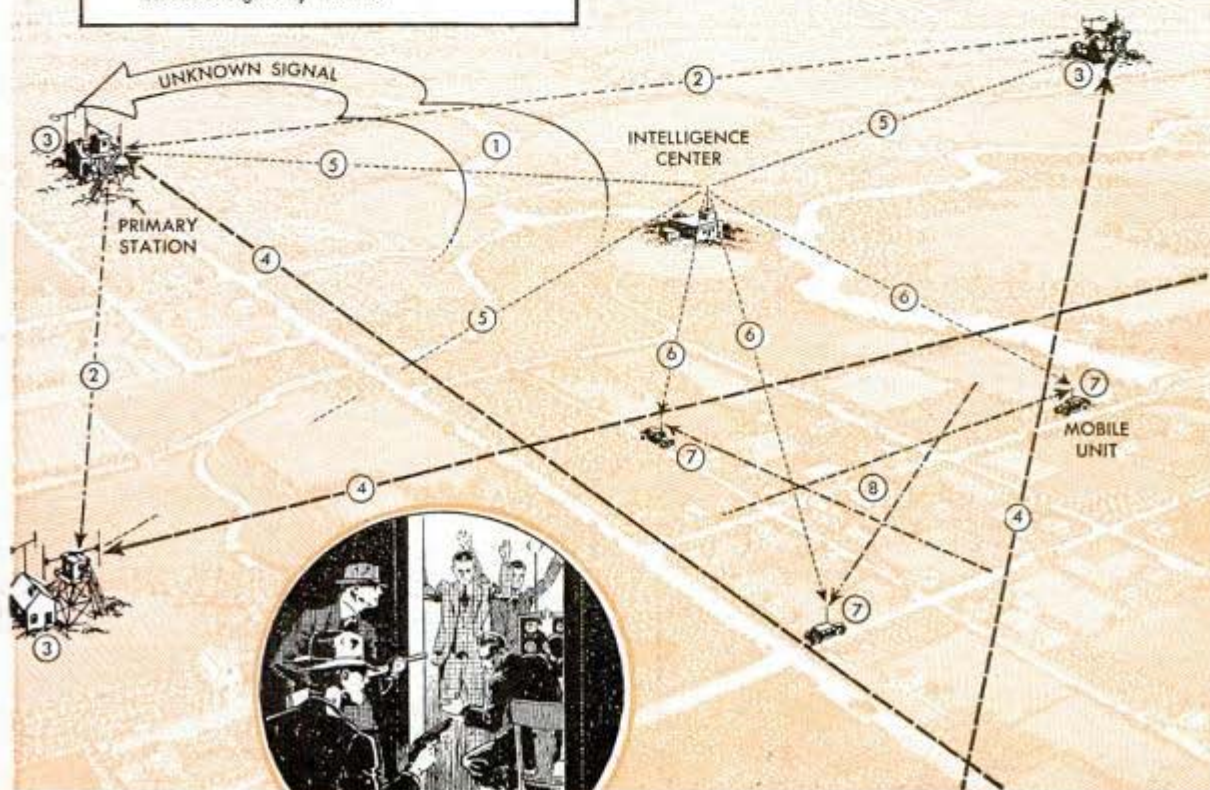



Taking close range bearing from mobile unit; note wax cylinder recorder. Right, terminus at primary station for the feeders from eight antennas

enemies. Cable service and radio telephone were stopped and the only way secret intelligence could be sent to foreign shores was by clandestine radio.

Through the efforts of the RID nearly 400 unlicensed transmitters have been located in the United States, its territories and possessions since July 1, 1940. In addition, over 9,000 cases of alleged unlicensed and subversive transmissions in this country and elsewhere have been investigated. About one-third of these were reports of subversive activities. More than 200 Axis spies have been rounded up in South America with the help of the RID operating within the United States. Thanks to the

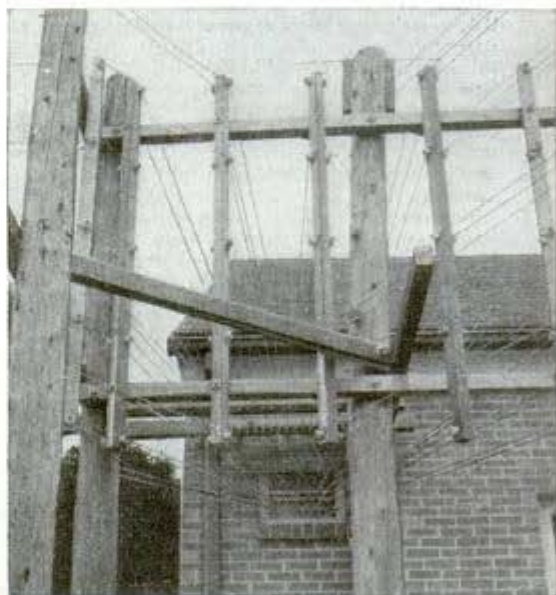

there are more than 50 radio-equipped mobile units which operate in conjunction with the various primary stations. The sites for primary stations are chosen for excellence of reception and are scattered advantageously in order to take bearings with a high degree of accuracy. The activities of these stations are directed from three radio intelligence centers located in Washington, D. C., San Leandro, Calif., and Honolulu. The secondary stations are much smaller than the primaries and their equipment is not nearly as elaborate.

One of the most important pieces of

Adjusting flexible disc to record unknown signals; new techniques give hour's recording on each side

efficiency and alertness of the RID, such clandestine stations are, in this country at least, practically nonexistent. The RID, probably the least-known government agency, is headed by George Sterling, W3DF, prominent radio engineer. The RID was set up originally to combat illegally operated radio stations used to facilitate rum running and to give out race track information. It has since expanded into one of the most important nonmilitary wartime agencies.

Scattered throughout the United States, its territories and possessions are 12 primary and 32 secondary monitoring stations. In addition,

equipment found at primary stations is the Adcock direction finder used for "long range" bearings. This peculiar-looking antenna resembles the letter H. It operates in much the same manner as a portable radio set with a built-in loop aerial. The public is familiar with the fact that by turning a portable set it is possible to discriminate between certain stations. Mobile units use a compact loop antenna for taking "short range" bearings.

The Adcock direction finder consists of vertical antenna elements and a transmission line which terminates to a Hallicrafters SX-28 communications type receiver. It is capable of determining the direction of a signal within one or two degrees. When directions from several different points are known, it is possible to establish a "fix" on a map by projecting the lines (in degrees) with respect to true north.

Let us follow a typical routine as witnessed at the primary station near Allegan, Mich. Operators are familiar with transmissions from every licensed station in the world. They know their peculiarities and even the style of the announcers. Their job is to listen continuously to signals as they tune their receivers back and forth throughout the entire radio spectrum. When a signal is heard which is not familiar to them they carefully analyze the transmission and make pertinent notes which will later serve to identify the signal. The frequency, or wave length, of the station is read directly from the receivers which have their dials calibrated. This information is immediately sent by teletype to other stations of the RID network. All stations tune to the wave length given in order to monitor the same transmission.

The operators on duty at the Adcock direction finders far out in open areas are notified over the "intercom" system, a permanent part of the installation. These operators also tune to the wave length given and exchange confirmatory data with the operators in the Cruising Room.

By means of special directional receiving antennas, it is possible to advise an operator at a direction finder as to the general direction from which the signal is emanating. This saves considerable time in establishing a bearing.

By co-ordinating the bearings taken by various primary stations, the intelligence center is able to determine the general location of the transmitter.

Mobile units near the established area are then sent to the scene in order to take short-range bearings. Operators in the mobile units are able to communicate with other units by means of two-way radio. By exchanging information they are able to

(Continued to page 158)

Divers Wield Air-Driven Tools To Salvage Sunken Ships



Lessons learned in salvaging ships sunk at Pearl Harbor and in lifting the U.S.S. Lafayette (formerly the Normandie) are expected to give divers a better chance of recovering the billions of dollars in cargo treasure sent to the bottom of the sea during the war. One example of progress made in salvaging methods will be wider use of compressed air and air-operated tools. Pneumatic tools ordinarily used only on the ground now are taken deep down in the water. Paving breakers are employed to shatter bottom formations of certain types or for freeing materials inside a flooded ship. When a ship is caught on a reef, rock drills are used to put holes in the rock so that the obstruction can be blasted away from the ship. Air-driven impact wrenches are used in backing off nuts on bolts holding gun mounts or machinery foundations so that such equipment may be reclaimed. Before the war, use of pneumatic tools in other than shallow water was complicated by the practice of leading the tool's exhaust to the surface through a connecting hose to avoid back pressure of the water against the exhaust, which causes unsatisfactory operation. At Pearl Harbor divers simply increased the air pressure at the surface to exceed the hydrostatic pressure. The same compressors which drive the tools can supply air pressure to force water out of compartments, power air lifts and operate pumps.

Mr. Ed. C. Powers, Educational Director, Compressed Air Institute, 2108 Terminal Tower

Mr. Allen Warren & Mitt
7 Park Ave.
N. Y., N. Y.

O-334



FITTING *the* GOB *to the* JOB

U. S. Navy photos

Selection of this gun crew firing salvo broadside began back at recruiting station. Below, specialists check depth of water

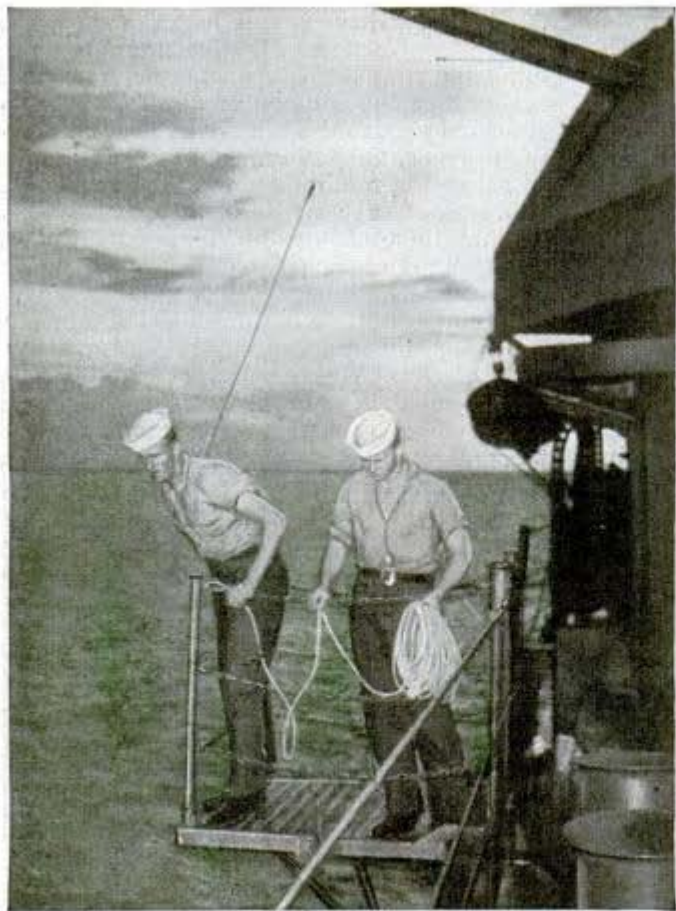

WITH an ear-shattering crash of her main batteries, one of Uncle Sam's new light cruisers reaches the climax of her shakedown cruise. The terrific shock of her own gunfire tortures the vessel's structure.

A checkup of the ship's guns and instruments follows. Suggestions are offered for repairs and possible improvements when the vessel returns to port. No man can predict exactly what a warship will do until it has been tested at sea.

But with the crew of this new light cruiser it is different. The hundreds of men aboard are as far advanced toward becoming an efficient fighting unit within one week as eight months of sea duty would have made them a few years ago.

That's what scientific testing, intensive training and card-indexing of aptitudes have done for the personnel of our expanded navy. For the first time in history, new warship crews are virtually "prefabricated" by modern methods of fitting the gob to the job.

For example, take the captain of one of the gun crews on this new cruiser. This lad's record is on file in the executive officer's

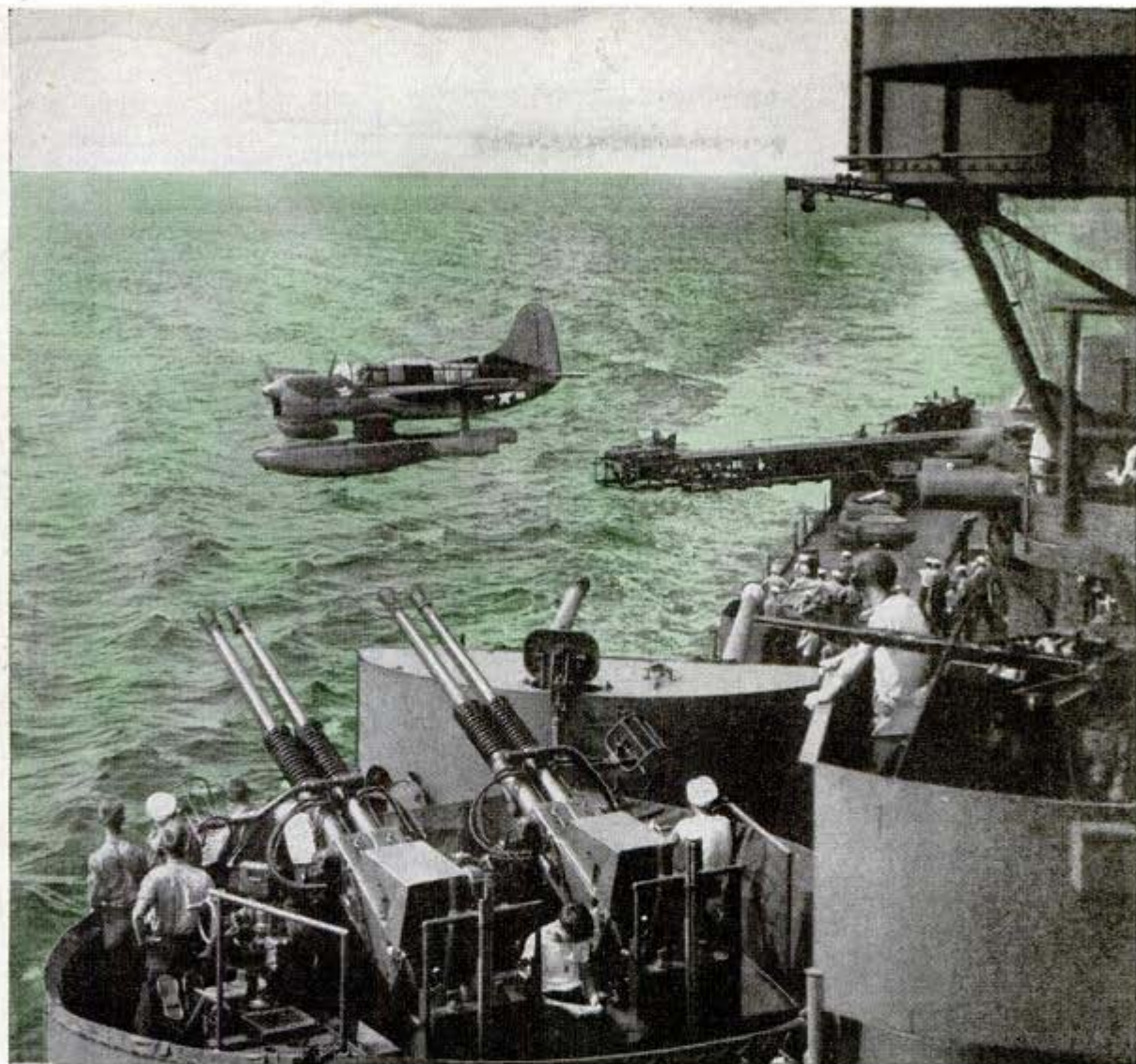

offices aboard. The record might show that he was quarterback on his high school football team. That indicates a quick mind, sharp eyes and calm nerves.

The gunner alongside him is holding his post in part because darkroom tests made with flashes of light show his eyes recover quickly from the effects of a brilliant flare. This is especially important during night fighting when the flash of a gun blinds some men for minutes.

Another man in a gun crew was chosen not only because he is husky and agile, but left-handed. This makes him more dextrous in feeding shells from the position he must occupy during action, and helps in managing the controls.

Still another man is in the gun crew because his eyes are not only

Curtiss scout leaves catapult in burst of speed for routine observation. Below, gun crew captain must have a quick mind





Pre-trained crew awaits "battle" test on shakedown trip aboard cruiser

perfect, but spaced wide apart, a prerequisite for operating a certain wide gunsight.

The records of the gun crews show that almost every man played baseball, football,

plumbers ashore, an upholsterer might be working with rope or canvas. Best of all, a cook was probably a cook in civilian life, a butcher was a butcher, a photographer a

Shakedown crew views training film on open deck after day of battle problems simulating the real thing

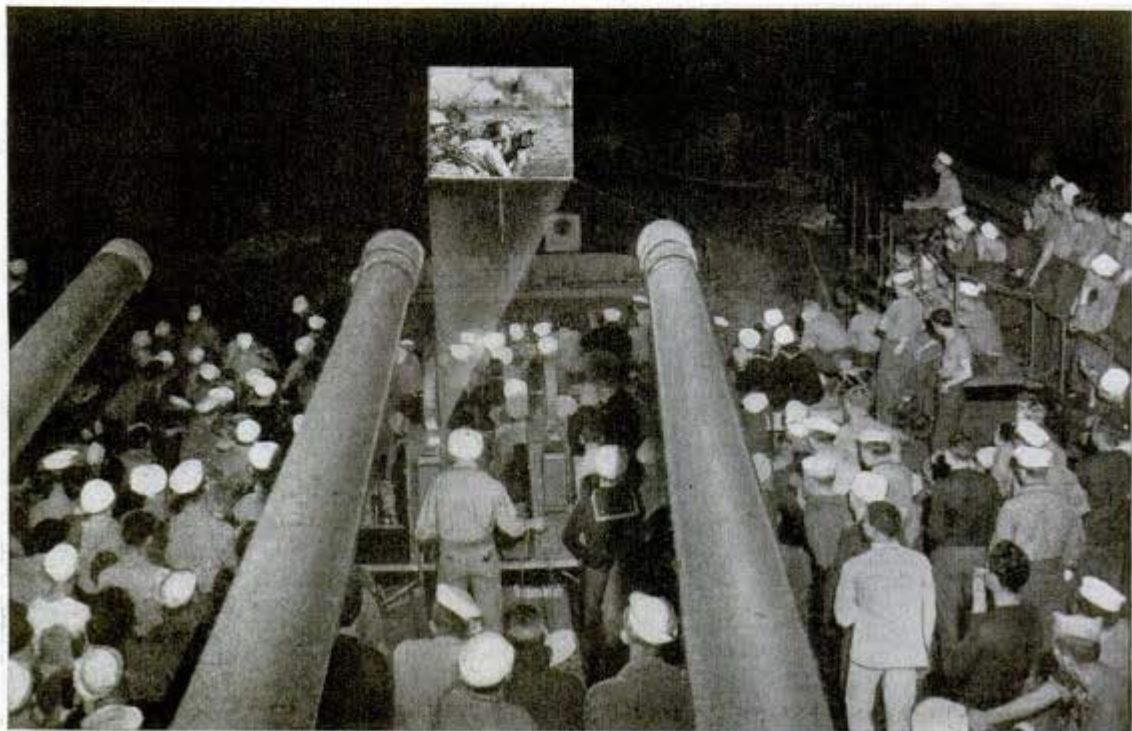

basketball or some other fast sport requiring team play. A gun crew is a team and if a man played checkers or chess for a hobby, or picked flowers in the woods, he probably would not be the type for a gun crew.

However, the best team-spirited athlete would not be likely to find himself in a turret gun crew if he were five feet nine inches tall. The reason? Not enough headroom in a turret.

A musician becomes a radio man on this new cruiser because his ears are trained for sounds. A "battle talker" or any man stationed on the telephone answered the personnel interviewer's questions in a clear concise voice. Thus he passed an aptitude test without knowing it.

Certainly some of the shipfitters on this cruiser were likely to have been

cameraman or camera fan, and even the ship's soda jerker might have done the same thing on Main Street.

The night lookout is a chap with extraordinary night vision. Here is where extensive aptitude tests in dark rooms, and others with red goggles are followed by intensive training. Even with good night vision, a night lookout must learn the tricks of the trade. For example, when the slightest object appears at night he is shown how to shake his head from side to side instead of looking directly at the barely discernable thing because the eyes function better in this manner.

Even after a lookout has passed eye tests he gets lengthy drilling in such facts as these: at the water's edge, the horizon is 2.8 miles distant; on a mast

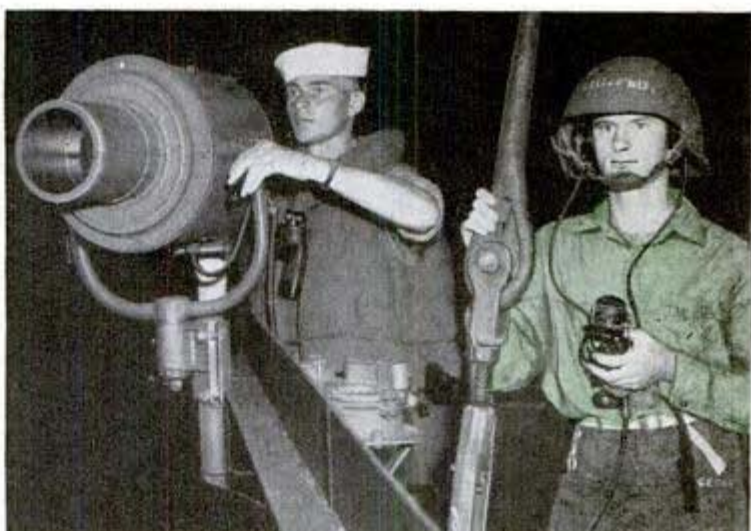

Signalman (left) needs nimble fingers; "talker" (right) a clear voice

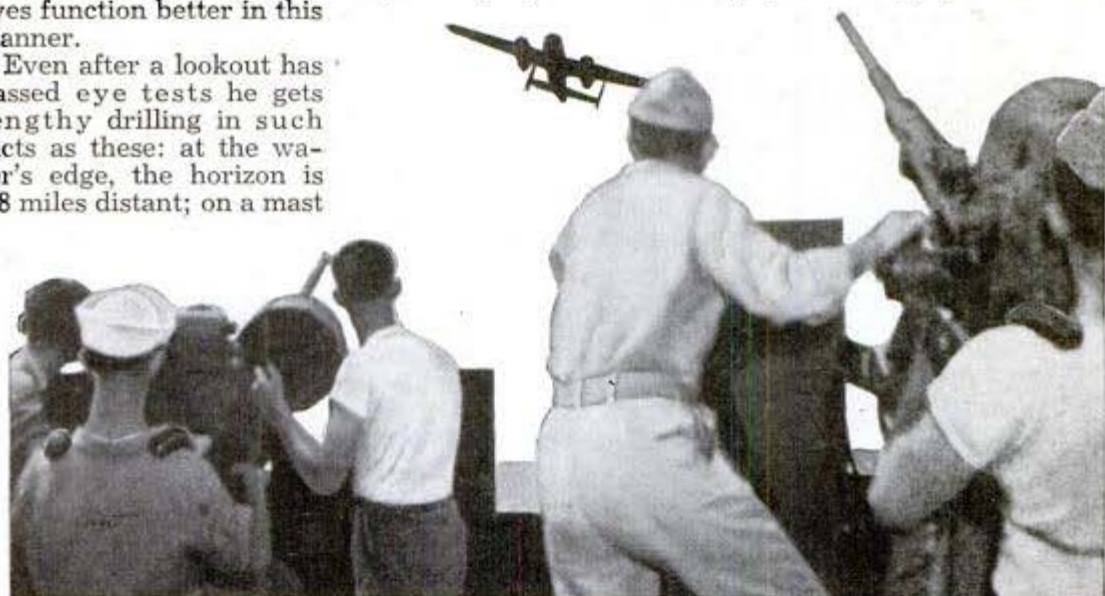

Gun crew gets sighting practice on bomber. Right, net for shell cases under turret protects deck

115 feet high it's 12.3 miles away, and so on. Time was when a man learned this aboard ships but not today.

Practically every man aboard this new cruiser received special training before he ever saw the craft. In fact, some officers, especially in the engine rooms, were assigned to the ship before the keel was laid and they saw every stage of the ship's construction.

The program of scientific selection of navy crews got under way when officers faced the fact that more



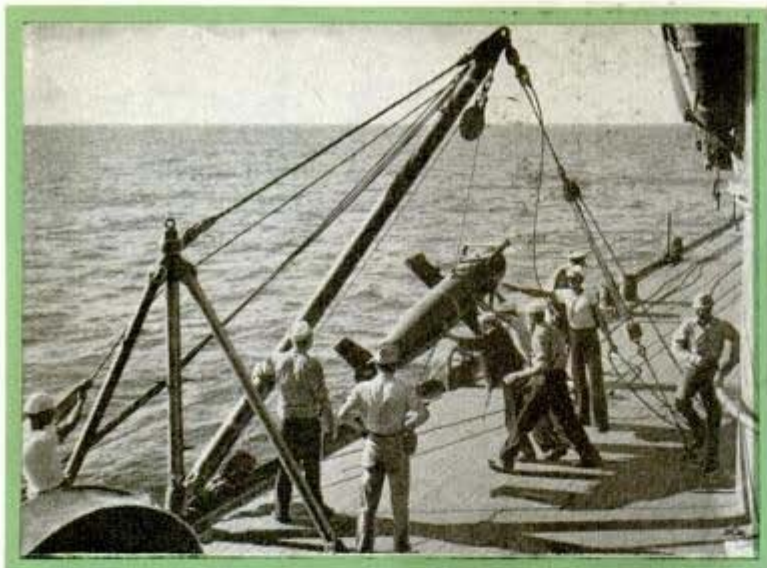

Paravane (mine clearing) gear is readied for drill. Below, bell is rung in daytime



than 2,000,000 men would be placed in navy jobs. In the leisurely past, a job was given the four years as a jack-of-all-trades to find out what he was fitted for. If he re-enlisted, something was done to shape him for his future. This was too slow for the tempo of modern war, so the system of putting the right man in his right billet begins with interviews for recruits in induction centers. These help decide where they are likely to land in the gigantic naval program.

A pool arrangement was set up in Miami for training nucleus crews, one of which was intended for our new light cruiser. The balance of the men for her crew were trained at such points as Norfolk, Va., while the new cruiser was being built. Mechanical rates from the Miami crew assigned to the cruiser were sent to the shipyard in some cases to observe the construction.

Finally, executive officers picked most of the balance of the crew from the Norfolk pool and put them into team training. Many of the future crew were trained on the cruiser while she was getting final fitting.

Now comes the great day—the day when the new cruiser shoves off. The men have been fitted

Below, launching seaplane from catapult is specialists' job

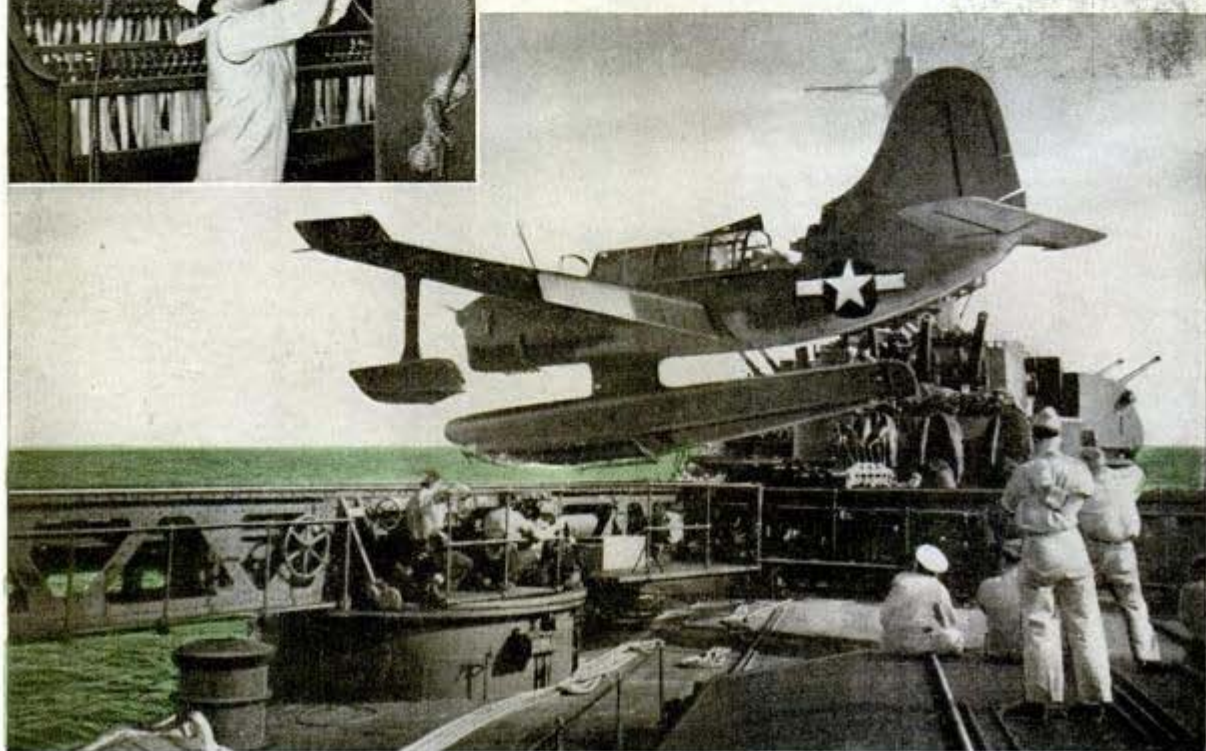

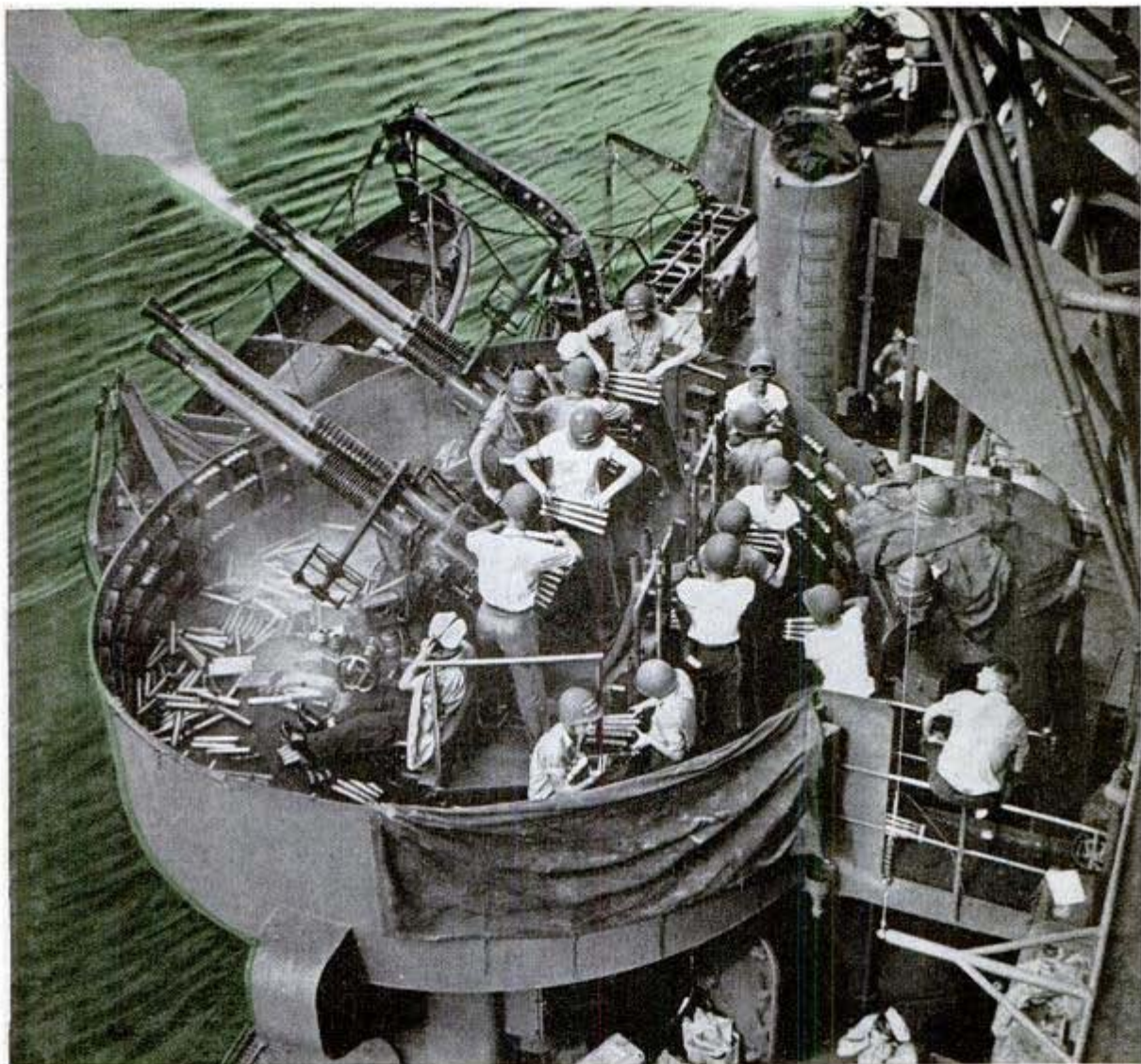

to their jobs. Now they will be fitted in their jobs. A siren blows. The propellers move.

There is a sounding of general quarters before the ship is hardly under way. Time was when this brought about indescribable pandemonium. But these men, with a minimum of confusion, scurry to their stations where they remain several hours. Division officers instruct each man once more in his duties and then in the duties of his nearby shipmates, for one must take over during battle if another is killed or wounded.

They must know the ship so thoroughly that they can find their battle stations in darkness—or the next thing to it, the feeble gleam of battle lights. They must learn every possible avenue of travel about their own parts of the ship for an enemy

Here's where teamwork counts, and every man is trained to carry on work of wounded mate. Below, even soda jerkers on new warships receive special training to man battle stations





Navy cameramen (many were photographers in civilian life) catch fire ring and fire ball from 5-inch guns

shell may close a passageway or flood several compartments.

From then on, they learn that a shake-down is no joyride. Three or four general quarters are sounded every day. Watches are posted. Additional duties are assigned. The cruiser sets a zig-zag course which keeps the navigator so busy he is away from his post only for short intervals, grabbing sleep in snatches.

Firing tests begin. Damage control par-

ties follow up with inspection of every compartment. Battle problems start. A zero hour is set. The public address system begins to chant the time periods remaining before the "battle" starts. Men are handed slips of paper containing the problem.

They are notified of hypothetical shell and torpedo hits and casualties. Remedial action must be taken quickly. Answers to the problems come: "Bulkheads shored up . . . submersible pumps started . . . counter-flooding commenced . . . manual control of communications, powder and shell-handling devices begun."

An imaginary attack comes from a group of torpedo planes and dive bombers from 40 degrees, flying at 20,000 feet. The antiaircraft guns begin throwing up a curtain of flak.

A torpedo wake is discovered. The skipper orders "left full rudder." Another imaginary torpedo crashes into the port quarter below the water line. The damage control officer estimates injury to



Racks on splinter shield of gun keep ammunition within reach

the ship. Hypothetical fires are extinguished. Repairs are ordered for damaged electrical systems. Perhaps the torpedo hit would cause a dangerous list. The answer is that compartments on the starboard side must be filled with water—and quickly.

Tugs and destroyers tow targets for firing practice. Planes tow sleeve targets. A five-inch gun will send a star shell aloft and the ack-ack gunners will tag the tiny parachute before it has a chance to get wet.



Like the gobs, trained Navy air pilots are at home as soon as they come aboard

the end of this twelve hours, the engineroom crew can relax.

After weeks of this kind of activity, interspersed with jobs such as painting, washing decks, airing bedding, washing, and the hundreds of miscellaneous tasks common in a modern warship, the crew heads the ship for home—and the "final examination." This time the battle problem is a corker and no one aboard knows what it will be.

(Continued to page 158)

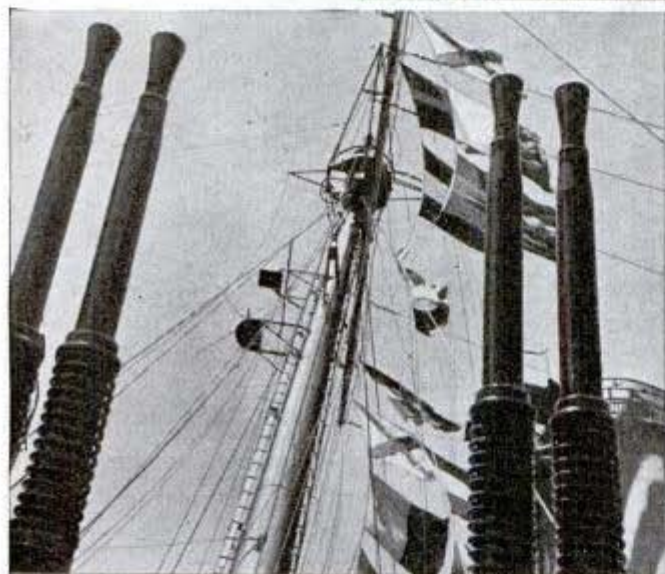

Signal flags are framed between Bofors guns. At right, "B-Day"—for airing bedding

Below decks, the engineroom crew begins the less spectacular but just as vital job of testing the cruiser's speed in a full-power run. Because new machinery cannot stand the tremendous temperatures and strains of too sudden application of full power, speed is gradually stepped up for four hours. For the next four hours they give the engines the real workout. Then for the next four the speed tapers off. At



Riders Shift Weight to Walk Mechanical Steeds

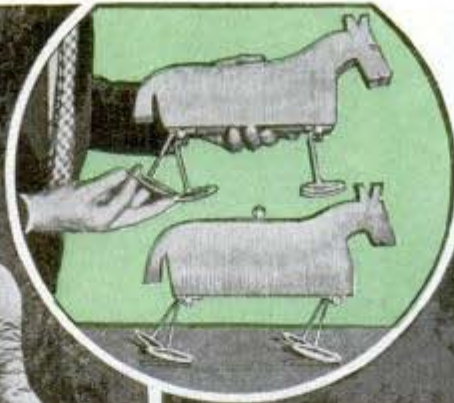

Extreme left, riding an "elephant." Left, toy models show principle by which these animals are made to walk. Below, note wide feet of "mule" and "elephant" to avoid tipping over



Mechanical animals which can be ridden at several miles per hour and guided in any direction have been patented by a California inventor. Locomotion is accomplished merely by shifting the rider's weight from side to side, rocking the apparatus so that the steed's right legs and the left legs are released alternately from the ground. Each leg is attached to the body by an offset hinge, which allows the leg to swing forward by gravity when pressure is released. A wide base under each leg prevents the animal from tipping over. Steering is accom-

plished by a handlebar between the animal's shoulders connected to both front feet. The walking animals will be placed on the market after the war.

B-24 Rides a "Merry-Go-Round" to Check Compasses

Before Liberator bombers leave the Ford Willow Run plant, they get a ride on a large wood turntable, a mechanized compass rose. While a bomber is rotated through 360 degrees, the three types of compasses

on the B-24 are checked. The turntable compass rose is believed to be the only one of its kind. Also at this station, the gun turrets and waist guns are fired with live ammunition on even numbered ships.

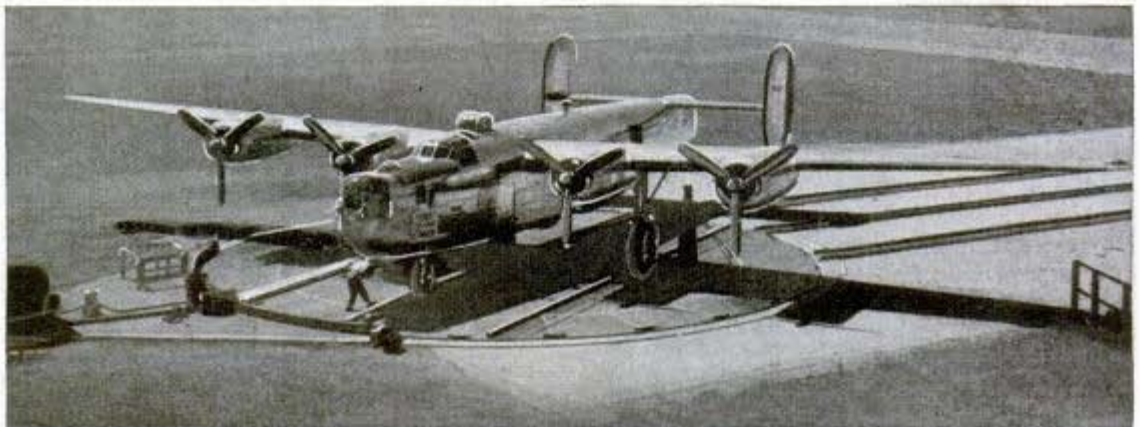

W. A. M. Bennett
6230 Wanda Ave
N. Hollywood, Calif.

Dearborn, Michigan

0448

'Pickaback Plane' Releases Junkers Full of TNT

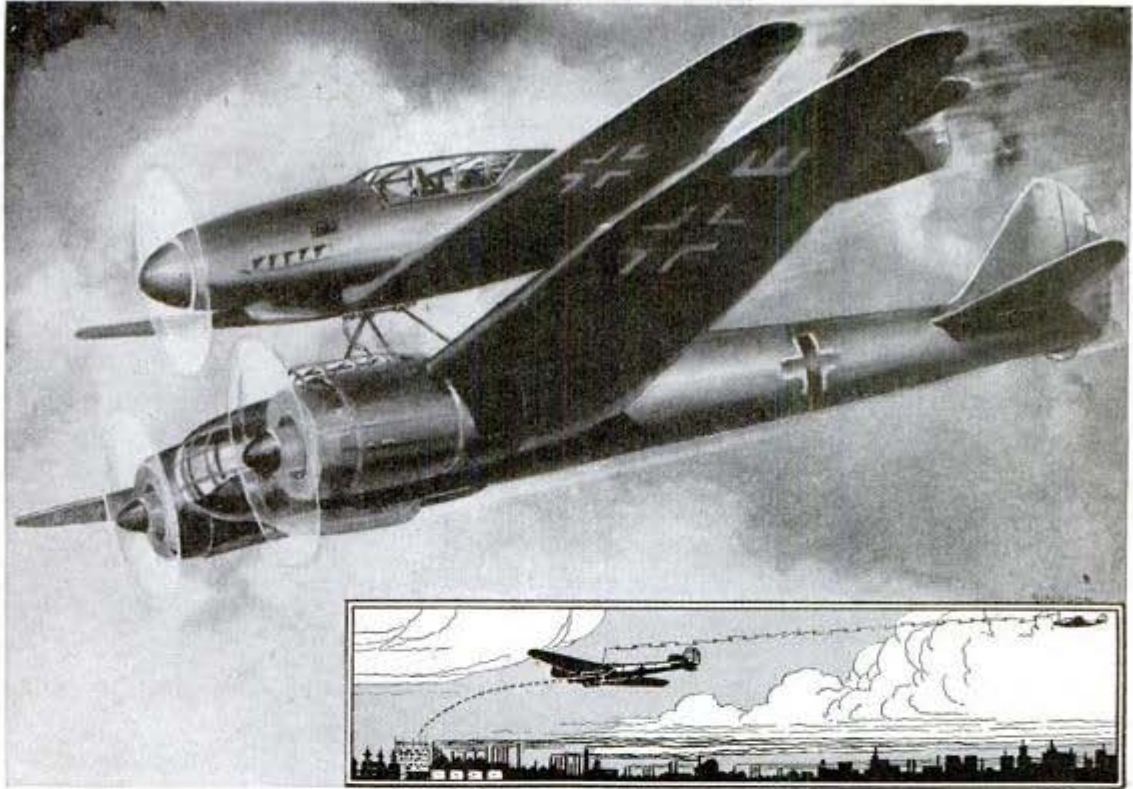

As the robot bomb-launching sites in France were captured, the Luftwaffe tried using obsolete, crewless Junkers 88's packed with TNT as glide bombs. An Me-109 was attached pickaback to the Junkers, which was stripped of its guns and other equipment and loaded with from two to four tons of explosives. Special attachments permitted all three engines to be utilized. The plan was to have the fighter

pilot fly the super "doodle-bug" to enemy territory and cut the pilotless craft loose, aiming it at some specific target. Allied flyers reported the strange contraption was a "sitting duck" target in the air, while ack-ack crews said it was almost as easy to hit it from the ground. Its speed was estimated at 150 miles per hour—less than half that of the V-1 flying bomb and its accuracy was judged to be no better.

0513

Twin Rotors Propel Helicopter Designed by 19-Year-Old

Two overhead rotary blades instead of one lift a helicopter designed and built by a 19-year-old San Francisco inventor. The machine, which has no tail rotor, took off

and landed successfully half a dozen times in a recent test. The two superimposed rotors, which turn in opposite directions, are 25 feet long; overall length of the fuselage



is 12 feet. It is powered by a 90-horsepower engine. Stanley Hiller, Jr., the inventor, has named it a "Hiller-copter." The youthful "Sikorsky" of the West Coast reports that he began work on the ship when he was 16.

☐ A smooth white cream developed by a California company forms an invisible "glove" to keep grease, paint and dirt from getting into the pores.

NOVEMBER, 1944

Hiller - Captain Air.
Kaiser Cargo, Inc.
6021 College Blvd.
Oakland 11, Calif.

277 Tunnel Rd.
Berkeley, Calif.

Turco Products Inc.
27
6135 S. Central
Los Angeles, Calif.

Meridian, Calif. 1944

Mr. Thomas C. Stinson, Jr.
3872 Franklin Ave.
Los Angeles 27, Calif.

0 417

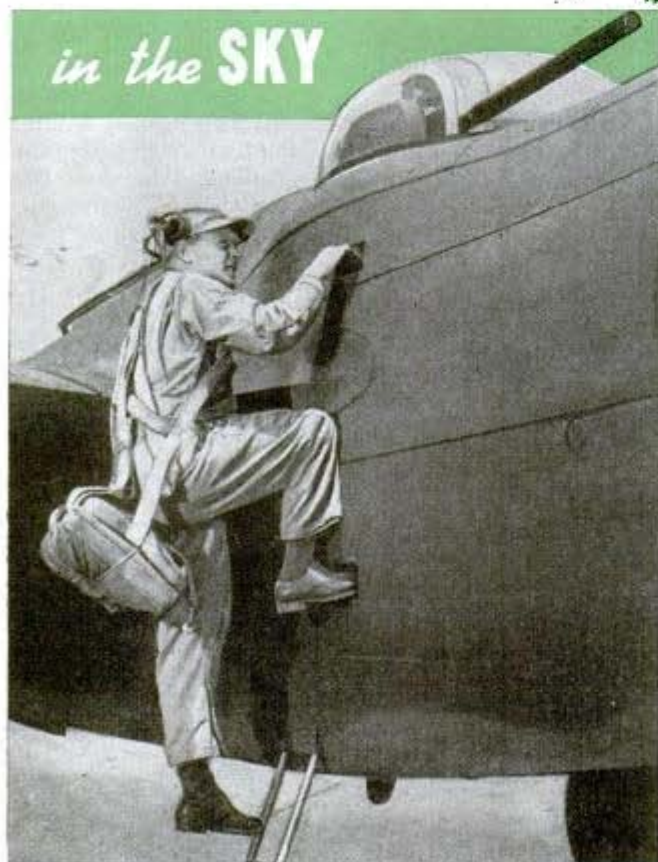
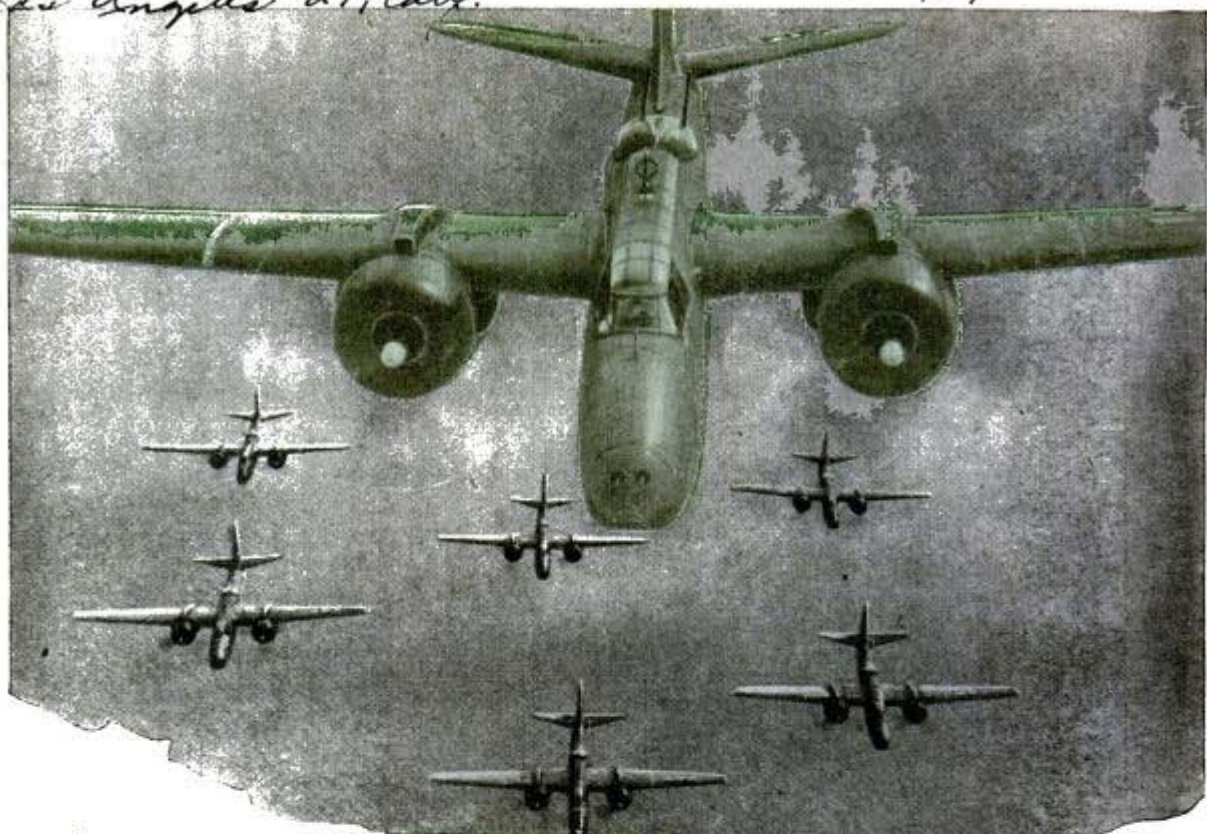

Douglas A-20 planes with gunnery noses; other A-20's have bombardier in the nose

TWENTY-FIVE tons of airplane had gone berserk in the sky. A minute ago the big four-engined "Skymaster" had been cruising smoothly at 250 miles per hour, then suddenly its whole structure began to buck and vibrate as if a giant hand was trying to shake it to pieces.

Ninety feet aft of the cockpit the huge rudder was slamming back and forth, out of control. The fuselage quivered, the wings were shuddering, and Bert Foulds and his co-pilot in the cockpit felt as if they were experiencing an aerial earthquake.

Foulds eased back on the throttles and both pilots braced their feet against the rudder pedals. That helped to stop the wild jouncing but the plane still had the shakes.

By now the two test pilots had a good idea of what was causing the trouble and they came down

One of the Douglas test pilots climbs into an A-20 "Havoc" for its No. 1 flight



Above, A-20 attack bomber lands after initial test flight. Left, test pilot makes preparations to go aloft. Below, ground inspector checks a rudder trim tab on a new plane



for a cautious landing. They found, as they expected, that the mechanism that controls the rudder trim tab had been mounted improperly. The device had worked loose, permitting the small control tab to flop the rudder itself back and forth. The rudder in turn was shaking the entire plane.

Foulds hadn't known that the airplane was going on a rampage when he took it up, but he had expected trouble of some kind. He and the 135 other pilots of the production flight testing department of Douglas Aircraft Company are professional trouble hunters. Few aircraft are perfect when they come off the assembly lines and the job of the production test pilots is to take these planes up on their first flights, hunting for irregularities so that each malfunc-

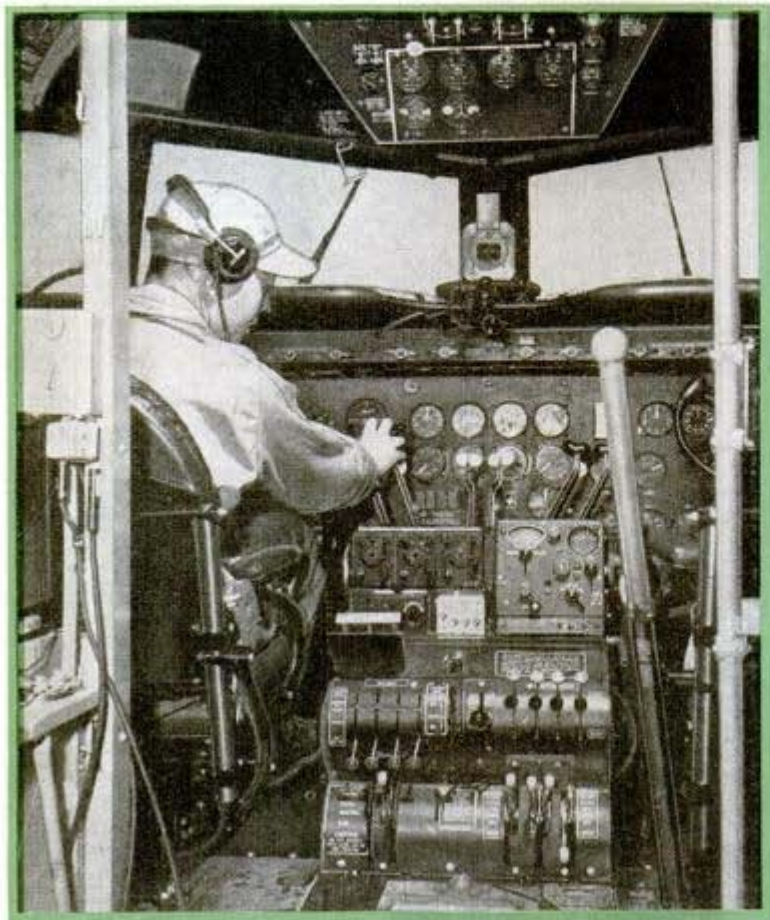

Test pilot checks instruments and controls of a C-54 Douglas Skymaster before taking it up in the air to hunt for possible kinks during flight

tion can be corrected before the plane is delivered.

Crack pilots such as Douglas "Wrong Way" Corrigan who flew to Ireland "by mistake" some years ago, Frank Fuller who won a Bendix air race, and scores of other ex-headline-makers are in the organization, headed by Jake Moxness. Each has some 3,000 hours in his log book and each is expert at diagnosing faults in the air. The group makes 40,000 flights per year from the six Douglas plants and they fly some eight million miles every 12 months. There have been no fatalities since the war

Inspector examines the auxiliary fuel tank fitted below the bomb bay

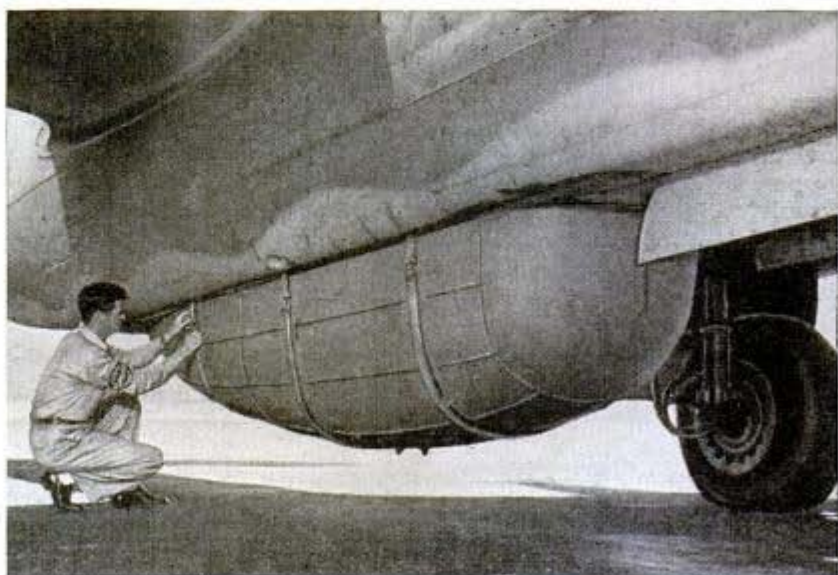

began, though pilots have landed with some or all engines dead, have slid in on the nose when the nose wheel jammed in its doors, and have brought planes down on fire.

That last occurrence can't happen again. In case of fire, each pilot has strict orders to abandon his plane over unpopulated territory and to come down by chute if he can't quench the flames. His life is more valuable than the plane. Before this rule went into effect one pilot successfully landed a flaming plane and then almost lost his life in getting away from it on the ground. The pilot was climbing out on the wing when his parachute straps caught. In the meantime a broken fuel line was pouring flaming gasoline on the ground below him. He fell part way, then hoisted himself up again. By that time his legs were badly burned. He crawled to the opposite wing tip and jumped 12 feet to the ground.

The record of no fatalities and few accidents in the Douglas test organization is due to the development of standard procedures to combat any emergency. A fire during flight is very rare, but occasionally on a first flight it happens that a plane's fire

alarm system goes haywire. The red warning light flashes on in the cockpit, indicating fire at a certain engine. The pilot can't be certain that fire actually has broken out but he takes no chances. He feathers that engine's propeller, cuts the ignition switch, and pulls the toggle that releases carbon dioxide gas in that engine nacelle. He continues to cruise until he is satisfied that the fire, if any, has been extinguished. Then he lands.

Any imperfections in construction or operation can usually be found during a plane's first flight. Most of the malfunctions are of a minor nature: "Air speed indicator registers 40 m.p.h. at wide



Above, looking for flaws in hydraulic brakeline installations. Left, the slenderness of an A-20 cockpit as seen from above



open throttle." "Plastic windshield panel distorts in flight." "Command radio not receiving on all frequencies." These are typical of the reports pilots bring back.

More serious are occasional hydraulic system failures. A pilot may be unable to extend his wheels into landing position and he may be without brakes if a hydraulic line gives way. When that happens he goes over to emergency procedure. From the cockpit he can disengage the landing gear from the retracted position. This al-

(Continued to page 160)

Fire-fighting equipment is kept handy as engine roars for the first time



Gun-Lamp Protects Flyers From Enemy in Sun



Every airman's bugaboo—attack by enemy planes diving out of the sun—has been eliminated for army and navy flyers with the installation of a brighter gunsight lamp of unique design. Using the old-type gunsight, gunners could aim within only 15 degrees of the sun, thus leaving a dreaded blind spot; with the new lamp, the sight lines or "reticle" will be visible to the flyer even against the sun's strongest glare, and gunners can aim directly into the sun with great accuracy. It no longer is necessary to use a dark filter which tends to obscure the target. The new lamp, which is about the size of a walnut, provides light from 8 to 30 times brighter than the old gunsight lamp but with the same filament wattage. Nor must the gunner "glue" his eye to an eyepiece in order to draw a deadly bead on his target. His head can move an inch or two without impairing his aim.

Funnel Helps in Filling Cartons For Quick-Freezing Foods



To simplify the packaging of foods by housewives, a wire frame and funnel are used together as a carton-filler. The frame is put into a Cellophane bag to keep it taut and unwrinkled, preventing tearing, and the bag, which is long enough to permit overlap-

ping and seal out moisture, is inserted into the carton, where it remains upright. The wire frame supports a wide-mouth funnel which prevents spilling the food when pouring it into the carton.

Sound Waves Find Metal Flaws By Timing of "Echoes"

With a machine that shoots out sound waves and records their movements, hidden flaws in metal castings are quickly located. When a sound wave strikes a flaw in the metal, it bounces back like an echo to the machine. The time that it takes the wave to get back to the machine is recorded, and from this the exact location of the flaw is determined. For example, a sound wave striking a flaw one inch from the point of entry will reflect back in eight millionths of a second. The machine, called a supersonic reflector, was invented and patented by Dr. Floyd A. Firestone, University of Michigan physicist. It will examine a piece of steel five or ten feet long in one second, which is much faster than the X-ray test now used on metals.

Ann Arbor, Mich.

Save Paper to Make Bazookas



How many bazooka barrels do you have in your attic or basement? They may be in the form of old magazines and newspapers or just waste paper, but to a hungry war industry they are the makings for the plastic barrels of flying bazookas used on Thunderbolts and other fighters. The lightweight bazooka barrels are made of a special paper plastic developed by the General Electric Co. The Scout (above) is doing his bit by delivering waste paper to make rocket launchers.

*Jewett Associates
18 Letchworth St.
Buffalo 13, N. Y.*

0397

MECCA for MILLIONS



Mr. Allen Warren Elliott, 1 Park Ave., N. Y., 16, N. Y.

ABOUT 260,000,000 pairs of feet took billions of steps in one of the most famous buildings in the world during the past year, yet few caught more than a hasty, passing glimpse of the remarkable structure which is busier than many cities.

The structure is Grand Central Terminal in New York City. The millions were hustling New York office workers and war-time travelers, part of the greatest flow of railroad traffic in history.

In a recent day more than 230,000 train passengers entered and left Grand Central Terminal. At least 600,000 other people, non-passengers, hurried through the Terminal's concourses and subterranean passages in the course of their business day.

Few of the millions who an-

Above, upper concourse of New York City's Grand Central Terminal, sometimes used by 230,000 train passengers in a single day. Below, chief operator's tower, which controls all the movements of trains

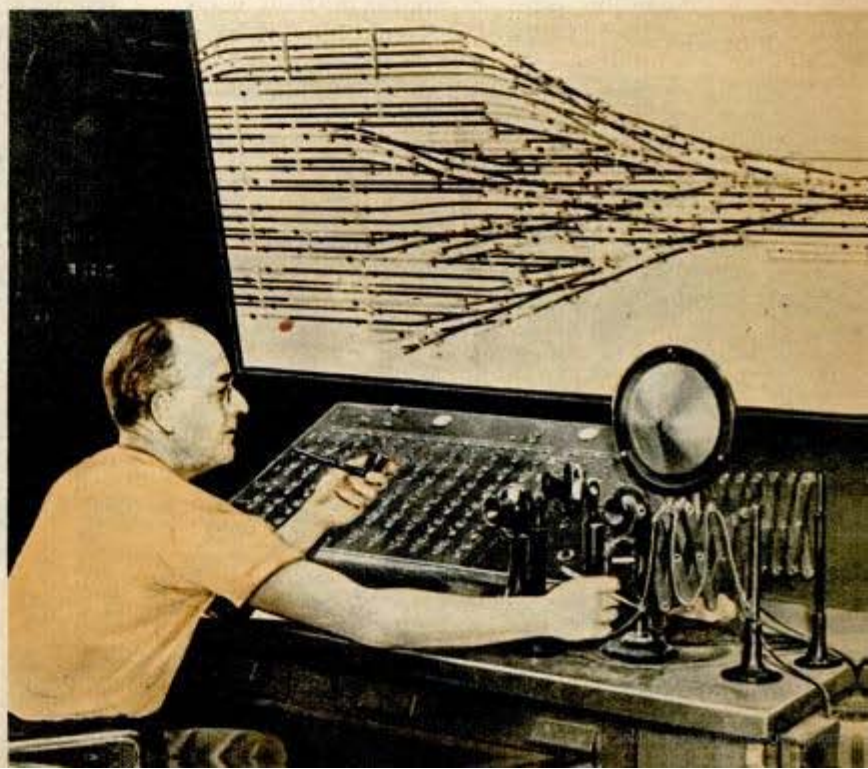



Sorting sailors' duffle bags (above) in the Terminal. Right, one of the Terminal's many gigantic windows

nually go through Grand Central Terminal see all of it because the building was designed to keep 30,000 people at a time moving to and from trains. The trains themselves, during rush hours, glide in or out at the rate of one every minute on its 67 stub tracks, a two-layer network of steel occupying some 48 acres of the most valuable real estate in the world.

Wide ramps hurry passengers to and from a concourse 272 feet long, 120 feet wide and 125 feet high. Here are ticket sellers, travel bureaus and information dispensers. Here are some of the largest windows in existence. Here is one of the biggest flags ever made, five stories tall. Most travelers see this much before other ramps, which again encourage speed, prevent accidents, help invalids and facilitate baggage handling, send passengers on their ways.

Grand Central Terminal is a city in itself



so complete that a fortune-seeking youth could arrive there and by using underground footpassages grow to old age without ever setting foot on the sidewalks of New York. Only when it came his time to die would it become necessary for him to travel on a New York street, for there is no undertaking parlor in the Grand Central Terminal.



Subways connect underground with scores of huge buildings and stores but the terminal and its subterranean passages alone enable a pedestrian to walk five blocks north and south underground. Without using streets, the visitor is able to enter and leave three hotels, the Commodore, the Roosevelt, and the Biltmore,

Left, typical wartime lines waiting to try for train reservations

POPULAR MECHANICS

and one club—the Yale. Passages connect with nine skyscrapers, one the 35-story office building owned by the New York Central System, which operates Grand Central Terminal. This structure, together with the terminal, rests on stilts of steel, since the supports are pillars between the underground tracks where trains of the company and of the New Haven Railroad enter and leave.

Subterranean and skyscraper life in "Grand Central City" embraces hotels to eat and sleep in, office buildings in which to work, seven restaurants, eight soda luncheonettes and two milk bars. The scores of shops include five book stores. Five banks are in the environs, as well as a movie theater, six bootblack stands, a liquor store, two barber shops, three parcel-checking rooms, six cigar stands, 22 newsstands, two drug stores, a printing shop, haberdasher, hairdresser, jeweler, cutlery store, candy store, bakery, art gallery and television studios. The 231 telephone booths are inadequate in wartime.

At a single terminal oyster bar, 15,000 oysters and 11,000 clams may be served in a day.

Seldom does a visitor get a chance to explore the railroad yard beneath the 722-foot roof of the main station building and the cavern of rock, steel and concrete which leads the road northward underneath Park Avenue. Beneath the main roof are two track levels. Through trains use the upper level 20 feet below the street. After these trains arrive they are hustled back out from the Terminal, through the tunnel blinking with vari-colored signals, to Mott Haven Yard, five miles north. This



Above, the handling of thousands of reservations daily involves complicated bookkeeping. To handle mere cancellation of reservations for a recent month, for example, this office used up a total of 3,341 man-hours



Above, an emergency staff is ready to combat fire or injury. Below, the Mott Haven Yard, five miles north of the station in the Bronx, where all trains are cleaned, serviced and stocked before returning to Terminal





Above, corner of sleeping deck adjacent to Traveler's Aid Service Lounge. Eight hundred men every week are given free sleeping accommodations in the station. Below, cutaway diagram showing the layout of Grand Central

open-air yard with its 23 miles of track is really an adjunct of the terminal. Here such services as car cleaning and washing, icing of water coolers, changing of linen on the pullmans and stocking of the diners is performed.

Day coaches on the shorter haul trains and the suburban trains generally use the lower level, 44 feet below the street. After arriving, they are turned around on two loop tracks, swinging in a wide arc under the terminal concourses.

Extending from the terminal to the yards is one of the busiest four-track stretches in existence, with traffic handled successfully only because the intricate signaling system permits two-way movement on any track according to the direction of the heaviest flow.

Interlocking signals which guarantee safety

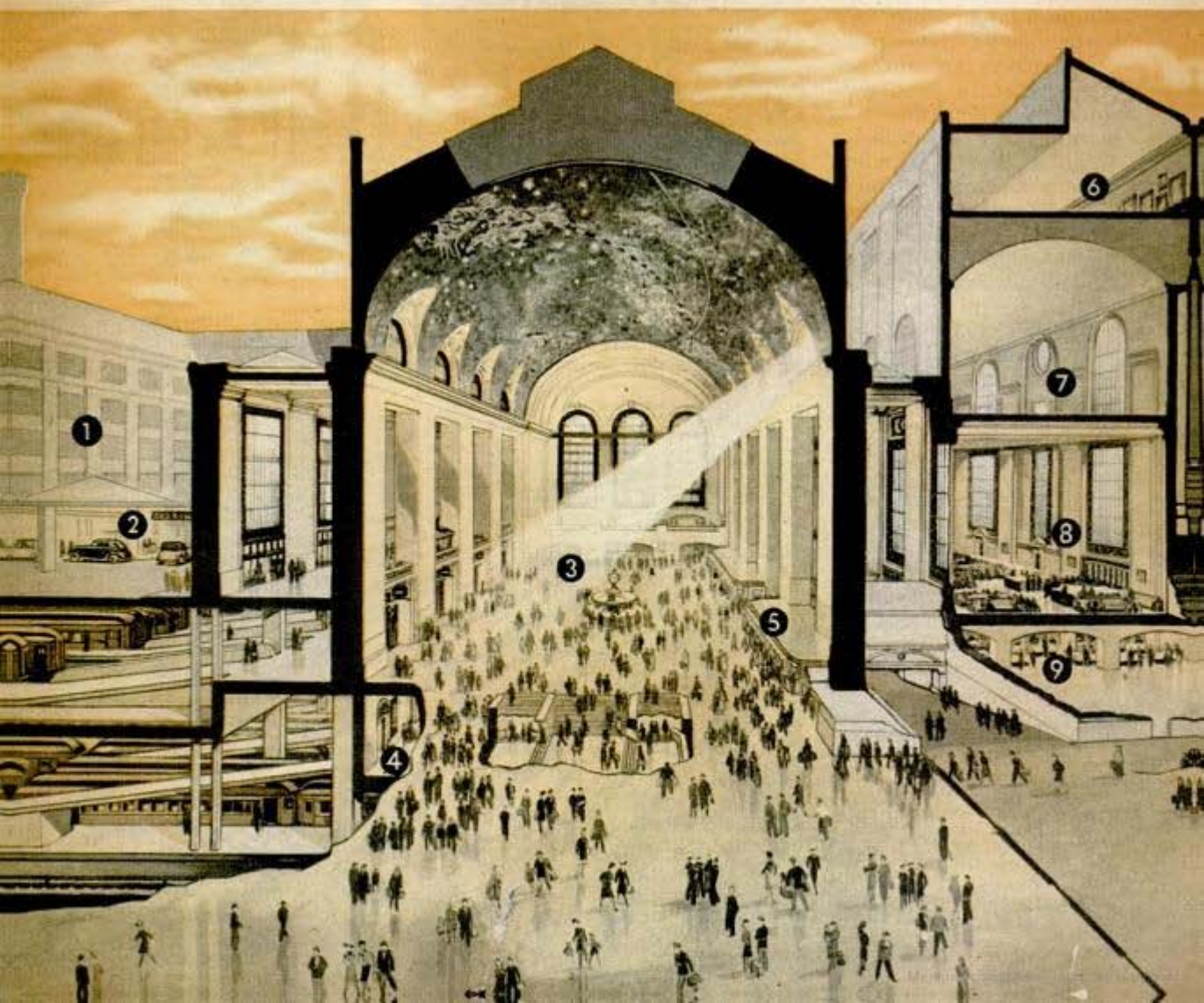

are controlled from eight towers between Grand Central and Mott Haven yard. The terminal network of tracks is governed from a four-story master tower in the middle of the underground yard, the brain center for both terminal levels.

In Grand Central Terminal the service uniform receives considerations unheard of in peacetime. In ten months more than 1,200,000 servicemen were guests of patriotic organizations active in the terminal. The Travelers Aid Society Lounge handles more than 100,000 a month. Men are given sleeping chairs, blankets and tags which state the time they are to be awakened. Cigarettes are free. Books and writing materials are furnished. Free billiard rooms are always open and entertainment includes movies and singing.



The choir provides music for servicemen and women on holiday occasions

Railroad men say that as a result of the wartime migrations, this will be the "travelingest" nation ever seen in postwar times.

Thousands of servicemen took their first long railroad trips as guests of Uncle Sam and thousands more of war workers, who had never before ridden trains, had this experience in moving to war plants. The migratory workers who used jalopies to go from job to job are now confirmed train riders because of the gasoline shortage.

Postwar travel is expected to be less than the wartime crush, but more than prewar levels. But whatever may come, one thing is sure: Grand Central can take it.

Groups of WAVES often add sparkle to station's crowd scenes
New York Central photos



GRAND CENTRAL TERMINAL

Sectional View Looking East

- | | |
|-----------------------------------|--------------------|
| 1 - Grand Central Office Building | 5 - Ticket Offices |
| 2 - Cabs | 6 - Art Galleries |
| 3 - Newsreel Theater | 7 - Offices |
| 4 - Lower Level | 8 - Waiting Room |
| | 9 - Restaurants |



Clipping: *Aug. 1944* *8/16/44*

0475

Bomber Drops Sailboat to Rescue Men at Sea

Broad & Pacific Station, 25, N. C.

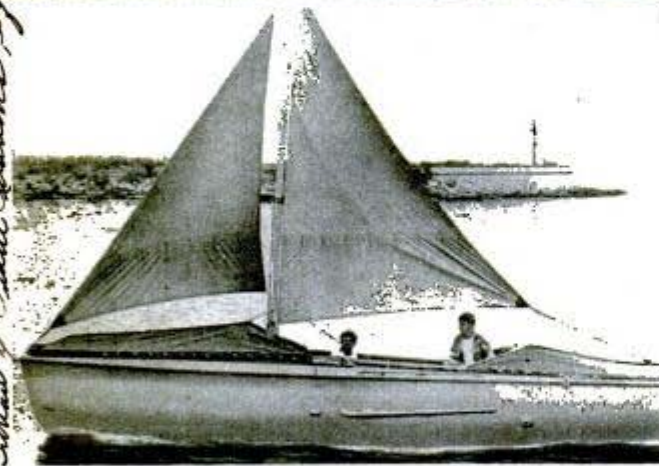
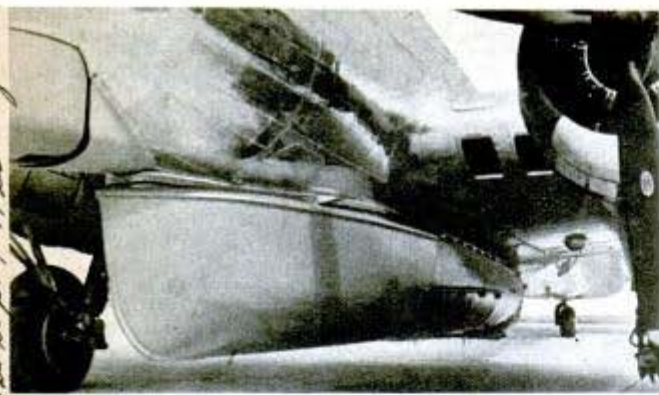

They call it the "Flying Dutchman." It is a 27-foot power boat fitted and stocked with all the necessities of life for a 1,500 mile cruise. Riding under the belly of a Flying Fortress or a B-29 or an army transport plane, it is carried to the rescue of men adrift at sea and parachuted down on three 48-foot "umbrellas" from a height of 800 feet. The one-ton craft fits the fuselage of a B-17 so snugly that it reduces the bomber's speed by only eight miles an hour. The boat is built of plywood and equipped with twin five-horsepower air-cooled gasoline engines and fuel for 400 miles, the engines also operating two salt-water stills. Their hot cylinder heads serve as stoves for cooking food. A portable 20-foot mast and 145 square feet of sail are packed aboard. Among the unique features is a smokepot that is set off by a static line as the "Flying Dutchman" parachutes to the sea, enabling the floating survivors of aircraft or shipwreck to find the rescue boat even in 30-foot waves, which the craft withstood in Air Force tests. Another innovation is a pair of 150-yard buoyant lines that are shot by rockets from each side of the boat automatically as it hits the water. These are set off by saltwater immersion switches. With the help of the two lines, the drifting men can pull themselves to the boat. Fore and aft of the open cockpit are shelters for protection against the sun. Carbon dioxide cylinders provide safety from capsizing. Other equipment includes blood plasma, medical supplies, canned foods, fishing tackle, air mattresses and blankets, warm and rain-repellent clothing, signaling and navigation instruments, cigarets and chewing gum.

At upper left the "Flying Dutchman" is fitted to the hull of a B-17; center, the boat is dropped. At bottom, it's "on its own" with motors and auxiliary sail

Two-Passenger Victory Buggy Gets 85 Miles Per Gallon

One man solved his wartime automobile worries by constructing a two-passenger Victory buggy which is a cross between a bicycle and a station wagon. The midget car weighs 225 pounds, is powered by a 1½-horsepower gasoline engine and uses regular 24-inch bicycle wheels and tires. The natural wood finish is similar to that of a station wagon. Controls on the car are of conventional type, but it is steered by a side lever. The engine is located in the rear, and the wheels are driven by bicycle chains and sprockets. The builder, Warren J. Bauman, of Lock Haven, Pa., reports that the car will travel 25 miles an hour and gets 85 miles per gallon of gasoline.

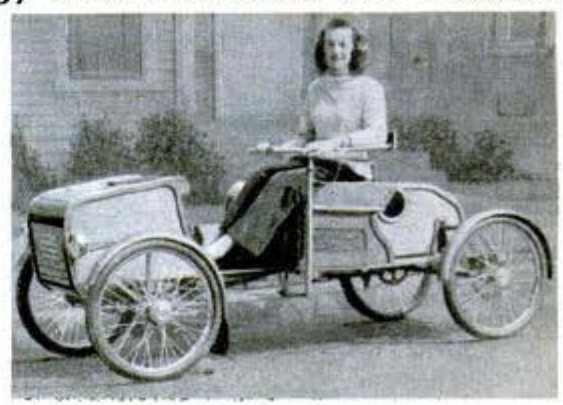

Midget car with bicycle wheels has engine in rear

38 Warren J. Bauman
116 Second St.
Lock Haven, Pa.

POPULAR MECHANICS

0478

Pressure Cabin in B-29 Is Linked by Tunnel

Superfortress crews can fly for hours in the substratosphere without the fatiguing effects of high altitude flying, due to the B-29's pressurized cabin. Details of this cabin, recently released by the War Department and the Boeing Aircraft Company, show that it is in three sections. Nose and waist sections are linked by a tunnel passing over the two bomb bays which are not pressurized. The third section in the tail is isolated from the other pressurized parts. The cabin is cylindrical in shape, rather than the usual oval, to assure even distribution of the tremendous pressure, and the bulkheads are rounded. An automatic regulator maintains interior pressure equal to about 8,000 feet regardless of altitude, and the compressed air is piped into the cabin from a supercharger on each inboard engine. Automatic air-conditioning is another feature. When heat is needed, a temperature control valve directs engine exhausts against the incoming air duct, and for cooling, air from outside is directed to the conditioning unit. All skin joints on the B-29 are sealed to guard against leakage of air, and specially designed gaskets prevent any leakage where control cables pass through bulkheads.

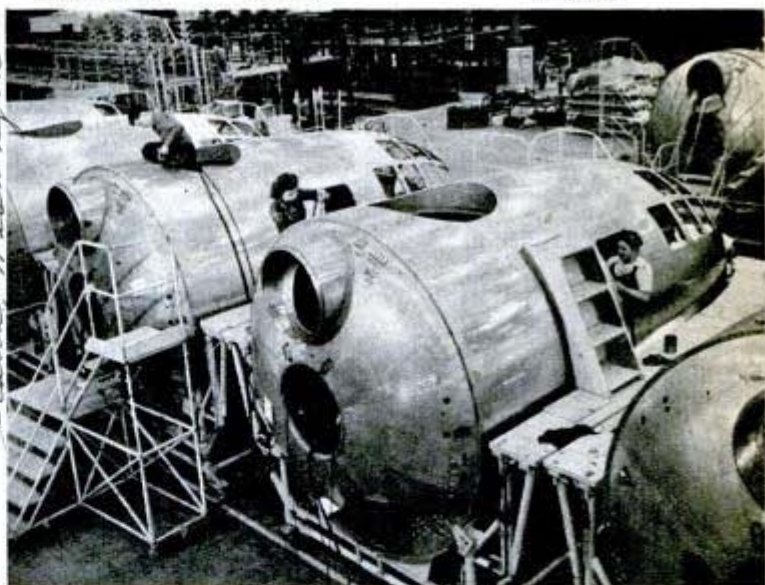
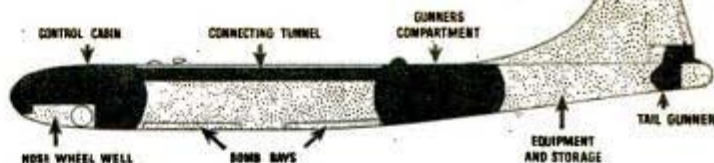

When a Superfortress crew goes into combat or is endangered by anti-aircraft fire, the men don heated flying suits and oxygen masks which can be plugged in quickly. The pressurized cabin on the B-29 is the product of thousands of hours of research by Boeing and AAF engineers. It is somewhat similar to the cabin on the Boeing-built Stratoliner, the first transport plane to have a pressure cabin.

0426

Fast-Moving "Mechanical Ant" Scout Car Steers From Either End

Heavily armed and armored, a tank-like British scout car built by Daimler engineers has five speeds both forward and in reverse and can be steered from either end. Speed, punch and mobility were emphasized in designing the car, which is used to

dash into tight corners, assault gun posts, and sometimes retreat in a hurry without turning around when the opposition gets too hot. Called the "mechanical ant," the car grips the terrain so well that it creeps over shell craters, along deep ditches and up their steep sides, and over sodden ground that only creeper track vehicles have been able to traverse. To avoid wheel spin, the vehicle is driven on all four wheels and to reduce the degree of tilt on uneven ground, it has independent spring suspension on all four wheels. It will not turn over even when tilted to an angle of 60 degrees. Weighing about 15,000 pounds, the whole mechanism sits inside a wheelbase of 8 feet, 6 inches and a track of 6 feet, 6 inches. Above is a squat, revolving turret in which is mounted a two-pounder gun, a 7.9 mm. Besa gun and a Bren gun on an anti-aircraft mounting.



British Information Service
30 Rockefeller Plaza
N. Y. N. Y.

MONSOON SALVAGE



After a belly landing in a muddy rice paddy, landing gear is let down and the P-40 is pulled out of the mire by Indian coolies. Below, the rescued plane is disassembled on river bank for barge trip



By

Maj. Thomas H. Moriarty

Air Service Command.

ON THE budget books, a P-40 is listed at \$50,000. In the air of Asia, that trusty fighter, still champion of them all for total victories against the enemy, could be listed at five hundred grand or five million dollars for that matter, depending on how many red balls of Japan were hanging in the sky over your airstrip or around your helpless transport as it flew toward the Hump.

There's one P-40 today that by ordinary figuring should be a debit of fifty grand, and it was the Air Service Command, expert in salvage, that beat the monsoon and multiplied the intrinsic value of the ship to ten or a hundred-fold.

It was late in spring when the monsoon broke unexpectedly over East Bengal, near the battlefields of Kohima. A pilot of Col. Phil

Photos by

LT. CHARLES W. DUNKIN

Air Service Command

POPULAR MECHANICS

0365



The engine removed from the P-40 is trundled over two miles of mud on a cart constructed from landing wheels of a salvaged airplane

Cochran's First Air Commando outfit was cruising in his P-40 when he ran into this fire-hose velocity rain and wind. The pilot streaked down for an emergency landing with wheels up.

In the drenching rain and violent wind, the pilot sat under his canopy for hours. Then the monsoon moved on and he saw the ship was mired in a rice paddy, more water and mud than earth. He hitched up his boots and climbed out, with the mission of reaching the nearest village and contacting the Indian police.

In a short time Col. H. M. West, Jr., Commanding Officer of an Air Service Command "service group," received a telephone call. There was a fighting ship down on some uncharted spot. In the China-Burma-India Theater it was Air Service Command's job, along with airplane maintenance and aircraft supply, to find that ship and salvage it.

The Colonel called his trigger men on jungle salvage, Capt. N. R. McMartin of Fremont, Neb., and Capt. Charles L. Davis of Lake-



What looks like a mass of junk, above, is the disassembled P-40 on a barge, ready for day and a half trip to railroad. Below, aircraft repairman at a Middle East air depot installs propeller on a P-47

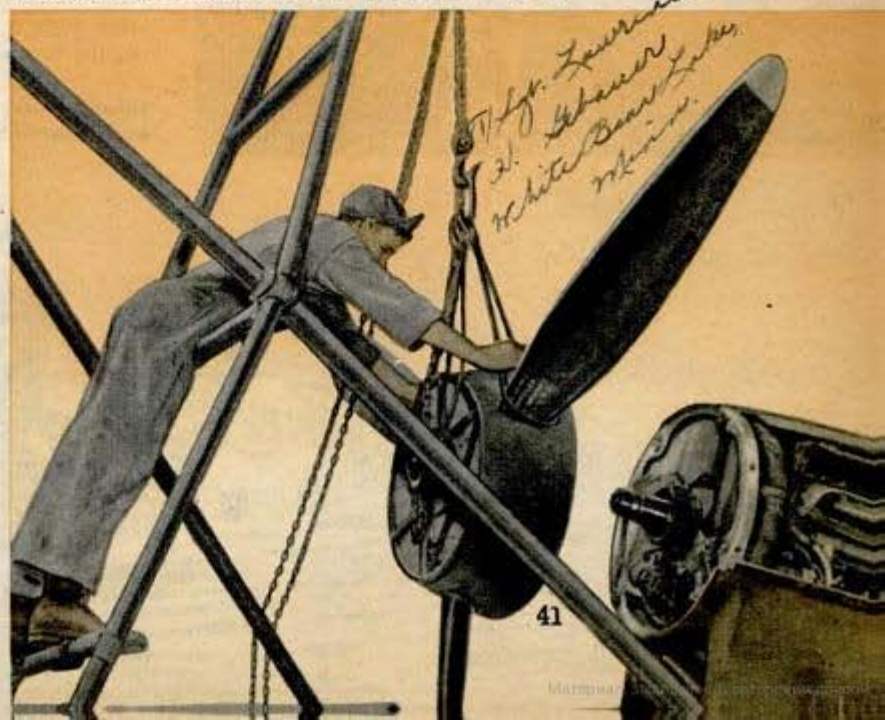



Mechanics go to work on an extensive repair job on a big bomber at a Ninth Air Service Command station



land, Fla., his assistant. The men rolled out the observation airplane and waved goodbye to Maj. Wayne L. Ramsey (Madison, Wis.), who was to follow with a detachment of ASC enlisted men. Each man a master short-cutter of precious repair time, a genius at improvisations.

From the air, McMartin and Davis saw the P-40 was sunk in the paddy. There was not a road or trail near it. However, there was a stream about two miles from the ship. The captains decided to find a fairly dry bivouac spot adjacent and then, somehow, move the airplane out of its hole. The transportation problems were a specialty of Major Ramsey and his airmen.

Returning to their field, the men found Major Ramsey with a "mechanic commando" staff that included Lieut. Billy D. Prescott of Meridian, Idaho, Finance Officer, whose pouch was fat with rupees and annas to hire Indian coolies and rent river barges. Before long, miles had been negotiated and another ASC Command Post, typical of many river and jungle and mountain salvage bivouacs, had been established "somewhere in India." Setting out across the mud with their tools, the detachment soon became a walking rescue party, knee-deep in mud and steaming. They found the plane "dug in," Cochran's pilot had been lucky, and only beautiful handling had kept the ship from bellying-over and burying him plenty deep.

"We'll take her engine out first," the major said. The ASC lads already were setting out the tools to loosen the power plant. The heavy engine offered a problem of leverage, with the soft mud not helping any. Bamboo poles, in the shape of an "A," were the answer for an engine hoist rigging.

In a little while the men heard the high-pitched chatter of natives. Their appearance was a welcome sight, for the coolies would be needed. However, the risk from

Salvage trucks and boats (left and below) are called on to save whatever is left of a wrecked airplane



curiosity was now present, so the detachment built a bamboo fence around the airplane. In addition to keeping the natives at a distance, the fence was a guard of sorts against wandering elephants, bullocks, or water buffalo.

On the first hoist-out of the engine, whacko! went the bamboo "A" frame. Too much weight. Another "A" frame was immediately constructed, reinforced, and a jack-of-all-trades cart, another ASC improvisation, was trundled over from camp. This cart was formerly the landing gear of another salvaged airplane. Its big tires are ideal for the oozy mud and long grass of India. With the cart's support, it remained only for the Indian coolies to pull on the ropes, with their leverage horizontally applied on a long bamboo pole, and work the heavy power plant across the thick mud to the river bank. A three hour job over a distance of two miles!

That night the monsoon fought back and the bunks in the swaying tent appeared ready to float out with the tired sleepers. Soon the flood roared so madly that the detachment had to retreat to a more solid windbreak.

When they took up their job at dawn, the next move was to let the landing gear down, in order to use the buoyant wheels of the airplane to roll over the mud. This was accomplished by having a squadron of coolies lift the ship on their backs for sufficient seconds to permit the release mechanism to operate. Then a rope was attached to each wheel and tied to a horizontal bamboo pole. Coolie power, about twenty to a pole, pulled the airplane the tough two miles to the river in half a day.

At the river bank, a barge was waiting. The P-40 was now taken apart, into small sections to fit the narrow barge. Wings had to be disassembled twice. Soon the detachment slung its tent, K rations, tools, and cart aboard, and settled down for the day and a half of jockeying through bamboo and banana trees and mud shoals.

At the rail head on the river, an Air Service Command truck and Service Group men were waiting. Ropes were attached to the airplane assemblies and the heavy objects winched up the slope by truck power, then hauled by truck to freight cars of the Indian railway system, to be transported back to the Service Group's headquarters.

Once at the Service Center, salvage of the P-40 became a rebuilding job for the mobile shop. From propeller lock-nut to rudder, every one of the thousands of working parts, including those of the engine, was checked, inspected, tested for battle efficiency. Through this "fourth echelon" (or heaviest) maintenance work,

(Continued to page 162)

NOVEMBER, 1944



Tiller Does Three Jobs in One Without Turning Over Ground

Plowing, disking and harrowing are performed in one operation with a tilling machine which stirs and beats the ground to a depth of about six inches. Unlike a plow, the machine does not turn the ground over in the process of preparing the soil for seeding. A blade in the middle of a revolving axle works into the ground, and curved iron arms, similar to teeth on a harrow, dig into the earth and smash clods.

Dummy Truck Is "Bomb Bait" To Fool Enemy Airmen

With wire, wood and burlap, camouflage artists of the U. S. Army can build a realistic two and a half ton truck. From a few thousand feet in the air, the dummy truck appears as a genuine target to an enemy flyer. He drops a bomb on the worthless dummy which has served to lure him away from the real target. Dummy airplanes and guns are also used to trick bombing crews.



*4th Air Force's Lemoore Airfield
Lemoore, Calif. 43*

Mr. Allen Warren Elliott
7 Park Ave.
N. Y., 16, N. Y.

0393

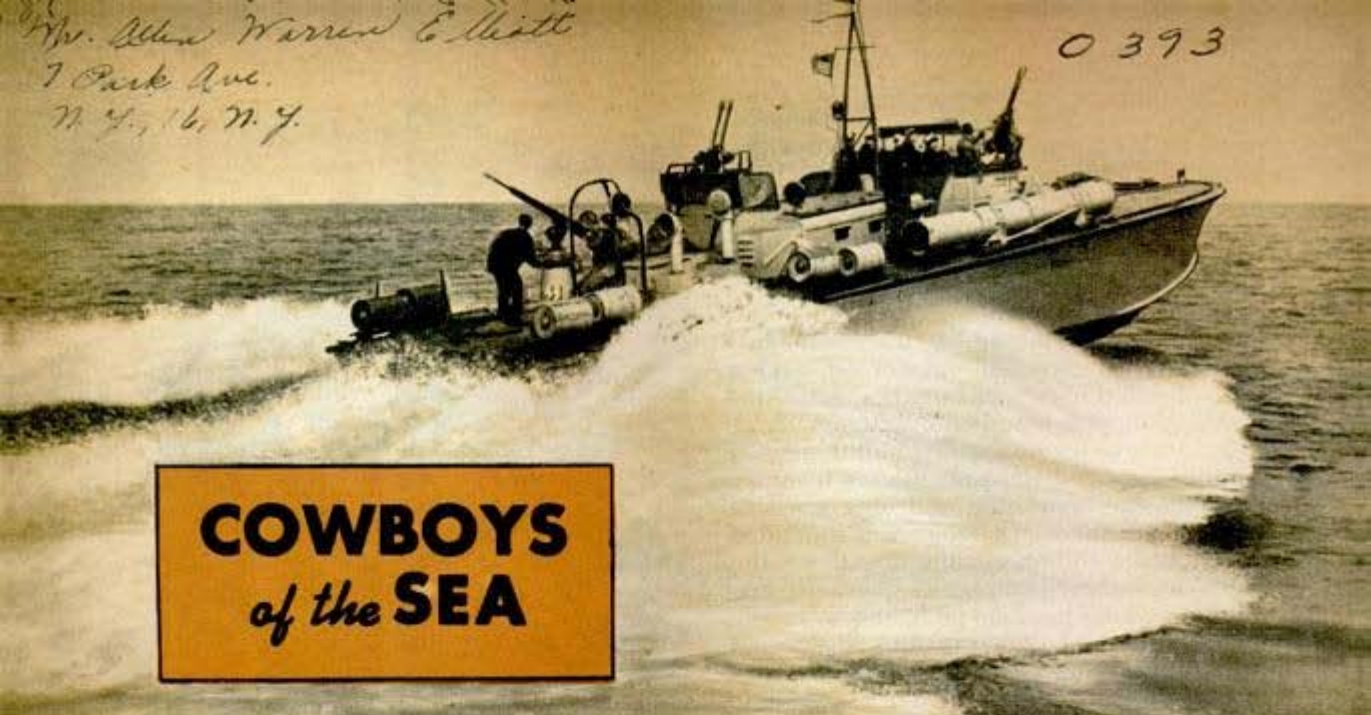

COWBOYS of the SEA



Official U. S. Navy photos
PT boat roars away on patrol at 55 m.p.h.
Left, gunners on the alert for Jap planes

the Pacific. The crews have to be tougher than bomber's crews, for the going is rougher in these 80-foot wooden cockleshells than in any bumpy air of the skies. The dangers are as numerous. The hardships are greater.

At the Annapolis of this highly-specialized branch—the Motor Torpedo Boat Training Center in Melville, R. I.—one of the first questions asked of a prospective PT commander is: "What did you do in college?" Not what did the lad study, but what were his sports. The best PT boat skippers

SOME of the riproaring spirit of the old West is being revived where you would least expect to find it—on the broad swells of the oceans. The cowboys are the crewmen aboard the navy's sharp-shootin', high-rollin' PT boats.

These riders of the bucking bronchos of the waves may not be so learned in the lore of the sea—they don't have to be—but they are genuine, trigger-quick deep-water daredevils.

The 55-mile-an-hour motor torpedo boat is helping whip Japanese air and seapower in the island-hopping war of

Studying topographical map with magnifier →



are not only college graduates, but also former wrestlers, boxers, football men, baseball, basketball, lacrosse players or members of the rowing crew. They have to be rugged to stand the strenuous life on what the Japs call "the Green Dragons." Many PT skippers are 200-pound huskies.

The crew of 11 are lean and fit as legendary riders of the purple sage. So rigorous is the life that they speak of "riding the PTs" rather than operating them. A sudden wave will toss a man several feet in the air—even into the foaming wake of the speedster. Ankles, legs and even spines have been cracked by the slap of the deck. The boats themselves are sometimes thrown clear of the water as they smack a roller.

Some men say riding a PT in a choppy sea is like operating a jeep over a rutted log road strewn with boulders. But a good man at the helm can try to smooth things out by heading into the waves obliquely. The craft gets "rhythm" and the men learn to "lean" with its motion. However, a 10-hour run on a PT is a day's work even for an athlete.

The job of the signalman is like that of a



Crewmen rolling oil drums off ramp of an LCM at PT base in New Guinea

circus bareback rider atop a horse with a greased back. Needing both hands for his wig-wag signals, he either retains his footing on a wet or icy cabin-top, depending on the climate, or he goes overboard. The engineer rides a steel saddle with stirrups over a hot engine with his controls virtually in his lap.

The crew, when it isn't being whacked by icy spray or broiled in a torrid sun, is usually looking for a comfortable spot. This is hard to find in cramped space where

Awaiting the night's call to action, deadly PTs ride four abreast at river "hitching post" of tropic isle





Even a railroad chef would be cramped in galley of a PT boat

bunkroom is at a premium and most meals, though well-prepared in a tiny kitchenette, are likely to be eaten while standing up.

Amid the South Sea Islands, where the motor torpedo boats have scored their great knockout blows against the Japs, there are compensations. Much of their deadly duty is done at night and a large part of the days are spent relaxing in lush

tropical bases with good hunting, fishing, swimming and food.

The crews are likely to be stationed on a certain island for long periods and the construction of comfortable and sanitary bases is a scientific branch of navy work. Natives are friendly and willing to work. They entertain PT crews with festivals and games. The surroundings, usually an inlet or river mouth, are likely to have the makings of a jungle paradise. These bases are usually safe from Jap bombers because camouflage is easily applied to the already dense foliage. At some bases well equipped machine and repair shops and even pontoon dry docks have been established. These docks are sunk beneath a damaged boat, the water is pumped out and the plywood hull is raised for complete overhauling. Sections are sometimes prefabricated for repairs. The damaged area is ripped out and the new section quickly fastened in its place.

Expert mechanics are trained in maintenance of the Packard aviation engines at the Rhode Island station and are shipped to PT bases along with another set of specialists, usually officers, who have been given intensive training in selection of camp sites, sanitation, the avoidance of tropical diseases and hazards.

The PT branch of the navy is building

Phosphorescent wake of speeding PT is beacon for enemy airmen; boats often creep through hostile waters



up its own tactics and battle maneuvers. Usually operating in divisions of three, they use the column, the echelon and the "V" formations, the latter being the most satisfactory for both avoiding and fighting hostile aircraft and launching torpedoes. The phosphorescent wake of a PT is a give-away even at night. The cure for this hazard is to idle the boats to prevent forming a telltale "dotted line." Many PT operations are performed by stealth. They slip from cove to cove watching for a Jap warship or merchantman. Thanks to the larger ships of our navy the latter type ship is the one they are most likely



PT "cowboys" check their shootin' by examining aerial sleeve target that caught the fire of the motor torpedo boat's machine guns. Bullets used in the tests leave painted marks on sleeve to register individual hits

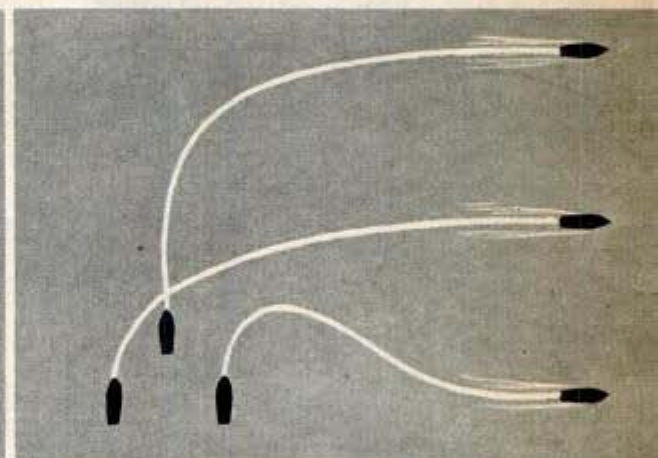
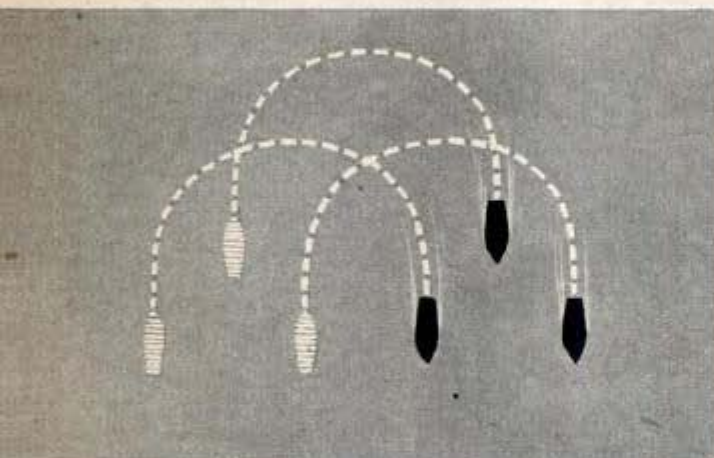

to find, but their stinging attacks on troop carriers and supply ships have left many small Jap detachments marooned on island outposts.

Any good skipper can dodge a bomb from a Jap bomber by waiting until the airplane gets set for its target run, then wheeling, but Zeros have a disconcerting way of gliding noiselessly down and strafing the boat. Its hull can be punctured fatally by a few bursts. But the men who slash the sides of wood are not the game hard way.

Training films teach basic maneuvers. Left, in counter-marching from V-formation all units turn simultaneously. Right, getting into formation to fire torpedo. Below, decks of PTs bristle with depth bombs and guns



Mr. C. N. Mason
1362 N. Dearborn
Chicago 10, Ill

0459

KITES go to WAR



Courtesy U. S. Maritime Commission

Whoever heard of going to school to learn to fly a kite? The answer: hundreds of men in the Army, Navy and Merchant Marine. The kites are used in aerial gunnery training (above), as protection against air attack over merchant ships, and on life rafts to carry "Gibson Girl" radio aerials aloft

Left, class of officers at Maritime Commission's Kite and Barrage Balloon School in New York learning construction and operating principles of large size balloon



Navy photo
Navy gunners call this one "enemy" because it has silhouettes of enemy planes painted on it. It can be used to train the loop or do figure eight. The kite, painted bright yellow, is used by Army Air Forces photo

POP



Army Hospital "Assembly Line" Builds Planes⁰⁴¹⁵



Department "99" of the Northrop Aircraft Company is located in the Army's Birmingham General Hospital, Van Nuys, Calif. This department, manned by convalescent veterans from North Africa, Italy, France and the South Pacific, is turning out parts for Northrop's Black Widow night fighter, the P-61. Equipment is adapted to the limitations of the patients. A drill press ordinarily operated by two hands is equipped with a foot pedal so a one-armed veteran can operate it. Work benches are made at wheel-chair height, and in some cases are brought right to bed patients who do sorting, inspecting or assembling of vital small parts. Special pulleys, conveyors and straps are used on this unique assembly line which is under the supervision of regular Northrop personnel. New patients who wish to engage in aircraft production work receive a preliminary training course of about a week. They learn shop nomenclature, the use of hand and bench tools, how to identify materials by color code, the use of measuring instruments and other primary skills. This experiment in physical therapy is said to produce amazing results, for the patients respond far more

Patients in Army hospital (top left) are trained by Northrop personnel. Above, special work bench designed for bed patient. Below, inspecting P-61 part



readily than they have in the past to making dolls and weaving baskets. They are not only contributing to the war effort by making thousands of P-61 parts, but are acquiring practical skills.

Navy Blimp Reverses the Pitch of Its Propellers to Serve as Air Brakes⁰⁴⁷⁴

Reversible propellers act as "air brakes" for the Navy's new M-1, anti-submarine patrol blimp which is the largest non-rigid airship built in the United States. On the takeoff the pitch of the propeller blades—

there is an engine on each side—is deepened to take a bigger "bite" of air. For landing or hovering the pitch is reversed, and by reversing only one propeller the ship can be turned as on a pivot.

W. G. W. Moore
1362 N. Dearborn St.
Chicago 10, Ill.

0382

SUB-ZERO TORTURE for METALS



Lindberg Steel Treating Co. photo
Above, testing machine gun and
ammunition in stainless-steel-
lined weather chamber at Wright
Field. Below, officer at lookout
post on ice-coated patrol boat
U. S. Navy photo

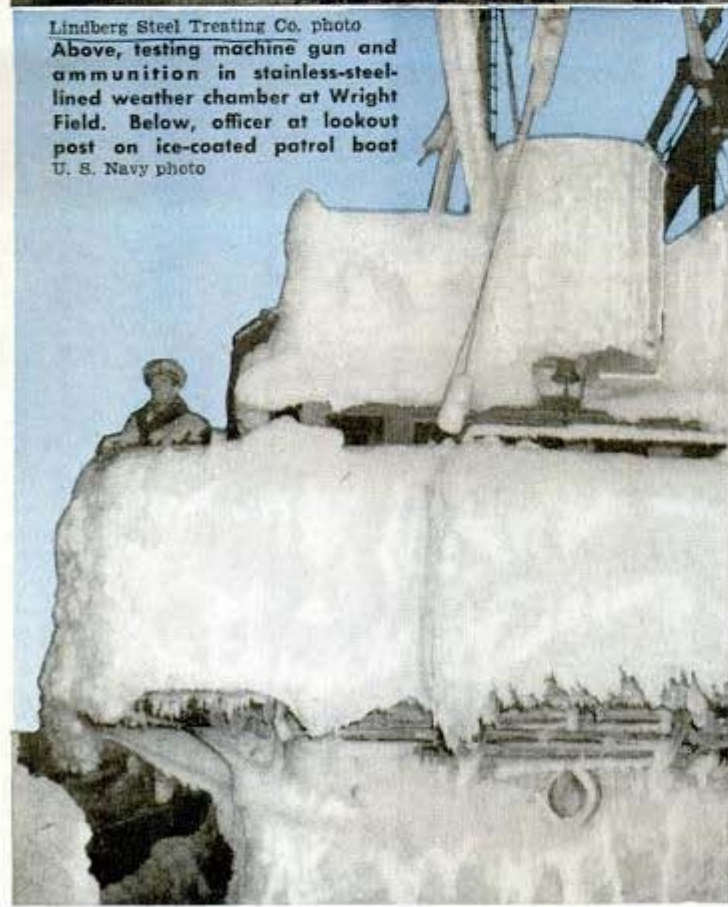

WHAT happens when the mercury plunges to 100 degrees below zero?

Arctic-clad gunners at the Frankford Arsenal who test ammunition for machine guns and small arms in a room refrigerated to 70 below might have a pretty good idea of how that temperature feels.

Men in electrically heated, fur-lined flying suits and special felt masks who work in the "world's biggest ice-box" at the AAF Materiel Command laboratories at Wright Field where 95 below can be reached might hazard an even better guess.

But the engineers who create this sub-zero cold, who know how to control it, and who are learning more and more about how to use it, are little concerned with its effect on human feelings. Their interest lies in the ways this cold affects countless different materials and how it can be used in laboratories and factories to produce better

products for war and peace.

Great strides forward have been made since the start of the war in using extreme cold both for testing war products and for treating metals and other materials. In addition, sub-zero temperatures have found many other uses in industry, boosting production and reducing costs. Experiments have utilized temperatures as low as 310 degrees below zero, Fahrenheit. It has been found, however, that it rarely is necessary to go below minus 150 degrees to accomplish desired results either in treating or testing, and a range of 80 to 130 degrees below has been found best suited to requirements of cold-treating metals.

The war, which brought demands that many products for the armed services be thoroughly tested at low temperatures for use in cold countries or at high altitudes, caused a great increase in methods and procedures of cold treatment of a seemingly endless list of materials—plastics, lubricants, leather, synthetic rubber, pharmaceuticals, chemicals, paints, vegetable oils, clothing and metals—to name only a few.

While cold treatment of metals, for example, and cold testing of materials are two entirely different processes undertaken for different purposes, the procedure is essentially the same, consisting of the use of cold cabinets, cold chambers, chilling machines and other devices ranging in size all the way from refrigerators the size of the average home unit and portable machines up to the Wright Field "icebox" which is housed in its own building, has internal dimensions of 25 by 25 by 80 feet and is large enough to accommodate the fuselage of a B-17 Flying Fortress or a full-sized fueling truck and trailer.

Rapid advances have been made in the design and construction of these chilling machines and freezing units. Some have holes sealed with arm-length gloves so that the

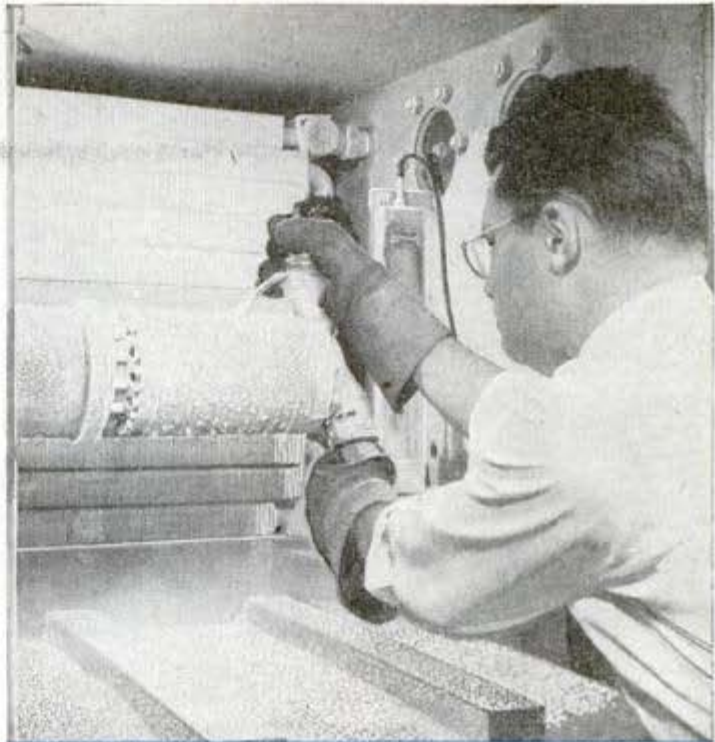

Engineer (above) removes small but powerful aircraft generator from "weather-maker" after a "flight" to 40,000 feet. Below, arctic-clad gunner tests munitions in a chamber refrigerated to 70 degrees below zero





Air Forces photo

Above, B-17's lay a carpet of vapor trails. Below, optical lenses in shell of pitch are put in a chilling machine



operators can reach inside to adjust valves or controls without interrupting the test. Many units have laminated glass windows so that behavior of products under extreme temperatures can be observed. One new type of this glass has two or more panes separated by layers of scientifically cleaned and dried air and held together with a patented metal-to-glass bond. The Wright Field chamber has eight panes of glass in observation windows to prevent frosting

and to seal in the cold air. In numerous units, openings are provided for bringing in electric power or compressed air, as might be required in various tests. In other units cold treating has been combined with features designed to reproduce exactly climate conditions encountered in all parts of the world and atmospheric conditions at high altitudes.

Both Dry Ice and mechanical refrigeration are used to produce the low temperatures required. In one unit, used by Westinghouse, half a ton of carbon dioxide Dry Ice is crushed and dropped into a tank of varsol, a low-freezing-point fluid ordinarily used in dry cleaning, in a single stratosphere test. The big Wright Field unit has five engines to provide power for the refrigerating unit.

Some of the cold tests of war materiel are both interesting and spectacular. The 70 below test of munitions at the Frankford Arsenal, for example, is described by Maj. Walter E. Monagan, Jr., public relations officer, as the most dangerous

job at the arsenal—more so than powder loading or work at the ammunition dumps.

"You can't always be sure what metal will do when the outside of the barrel is 70 below and the inside is heated by the firing of the gun, but the testers find out," he said.

At the St. Louis Ordnance Plant, 50-caliber cartridges are "soaked" for 24 hours in a chilling machine at 70 below before

test firing. Even the protective coating of ignition cables gets severe tests for flexibility at 60 below or colder.

The use of high altitude face masks worn by air gunners was not sufficient to protect the men working in the Wright Field chamber, sometimes as long as three hours at a stretch. The problem was solved by the use of felt masks, with the felt thick enough to keep body heat inside the mask circulating about the face. Since moisture does not condense readily on felt, there is less danger of moisture freezing on the masks.

What may be of more far-reaching industrial importance than cold testing, however, is the progress made in cold treating metals. As a result of "freezing," for example, some remarkable increases in service life of cutting tools have been recorded. There are instances where tool life has been extended as much as 100 percent after two to three hours treatment under a temperature of 120 degrees below zero, Fahrenheit. "Chilled" milling cutters have withstood 24 hours of continuous service instead of seven; hack saw blades, frozen at better than 100 below, have lasted up to 119 percent longer; cold treated



Above, oxygen mask is tested in low-pressure chamber at Naval Medical Research Institute. Below, cracking an ice formation with a baseball bat on a U. S. Coast Guard cutter





Coast Guard Academy cadets wear masks during bitterly cold cruise

drills, formerly cutting around 50 holes before resharpening, have cut more than 250 holes after refrigeration, and so through a long list of similar examples reported by manufacturers.

The freezing process with tool steels, as with other metals, is entirely supplementary to the usual heat treating and conventional hardening. The most common practice with high speed steel is to cool the steel directly from the heat treating quench down to 110 degrees below zero, using a continuous cycle to control the rate of cool.

Strangely enough, metallurgists do not know yet precisely what happens to metal when it is exposed to extreme cold, although there is known to be a change within the crystalline structure contributing to making the metals harder, stronger, or more ductile. This change is believed to be something of a continuance of the effect produced by heat treatment, and it is conceded that conventional heat treatment alone frequently fails to develop uniform metal structures.

One authority on the use of super cooling of hardened steels, G. B. Berlien, chief metallurgist, Lindberg Steel Treating Company, Chicago, says that with the cold treatment process all steels first are conventionally hardened. He describes one process like this:

Right, a coupling bolt pre-shrunk in a sub-zero bath of Dry Ice and alcohol is inserted into waterwheel generator hole. Bolt then expands to original diameter

"High speed steel, as an example, is given one or two preheats, whichever the practice might be, and then brought up to the regular hardening temperatures. Then it is quenched in oil, lead or salt, cooled in air to about 200 degrees F., and transferred to a refrigerating medium.

"To realize the full value from this process, the tool is cooled directly from the quench in a continuous cycle, right down to 110 degrees below zero. It would not hurt to cool the tool lower, but the advantages are not great enough to warrant additional cooling equipment. An average of 120 degrees below zero will develop the greatest degree of sub-zero martensitic decomposition, or as-quenched structure breakdown. The tempering operation then follows to reduce the high hardness to a workable range."

Mr. Berlien declares that exhaustive research has revealed that temperatures of 80 to 130 degrees produce all structural changes in steel that might be expected. Temperatures lower than 150 degrees may cause cracks, and levels higher than minus



80 degrees are relatively ineffective, he said.

In metal working, numerous other important advantages of sub-zero treatment have been developed. Shrink fitting of metal parts now utilizes cold for contraction as well as heat for expansion. Foundry castings and other metal products which are to be "aged" or "seasoned" are subjected to low temperatures to speed the process. Some foundries are substituting cold treatment for outside storage in winter, with obvious savings in time. Gauges, formerly requiring years to treat, now are aged in only a few hours, and annealed aluminum rivets and aluminum sheets are stored under low temperatures so they will remain soft after quenching and easily workable.

In the case of aluminum rivets, it was found that a difference of only 30 degrees meant the difference between success and failure of the cold treatment. If the temperature is an even zero, the rivets harden in only a few hours. But if the mercury is at minus 30 degrees, the rivets are kept in the soft quenched state for two to three weeks and thus are readily available in quantity when needed.

Production of optical lenses has been boosted considerably by several producers by freezing the pitch which holds the lenses on the blocks for final grinding and polishing. Formerly, the pitch was melted off—a slow process requiring subsequent cleaning of the lenses with a solvent. Often, too, the glass was damaged. Now the pitch is frozen and when it shrinks the lenses are lifted off easily and cleanly. About 70 per cent is saved in time alone.

With small parts, it has been found desirable in shrink fitting to use both heating and chilling, with extreme and possibly damaging temperatures being avoided in either direction. Cold cabinets with automatic feeds have been set up near production lines for mass production of motor vehicles. Here valve inserts in cylinder blocks and wrist pin bushings for pistons are chilled before fitting. In one airplane factory, output in a department was doubled with a single mechanically refrigerated unit which freezes one part of a landing strut at 70 below for shrink fitting.

The Bendix company alone uses cold testing or cold treatment in several of its plants in the production of more than 70 basic types of flight and navigational instruments and aircraft engine component parts and accessories. Tests are conducted as low as 70 degrees below zero.

(See the index to find where to buy articles described in this magazine. Say You Saw It in Popular Mechanics.

Rail Coaches With Three Decks Will Seat More Commuters

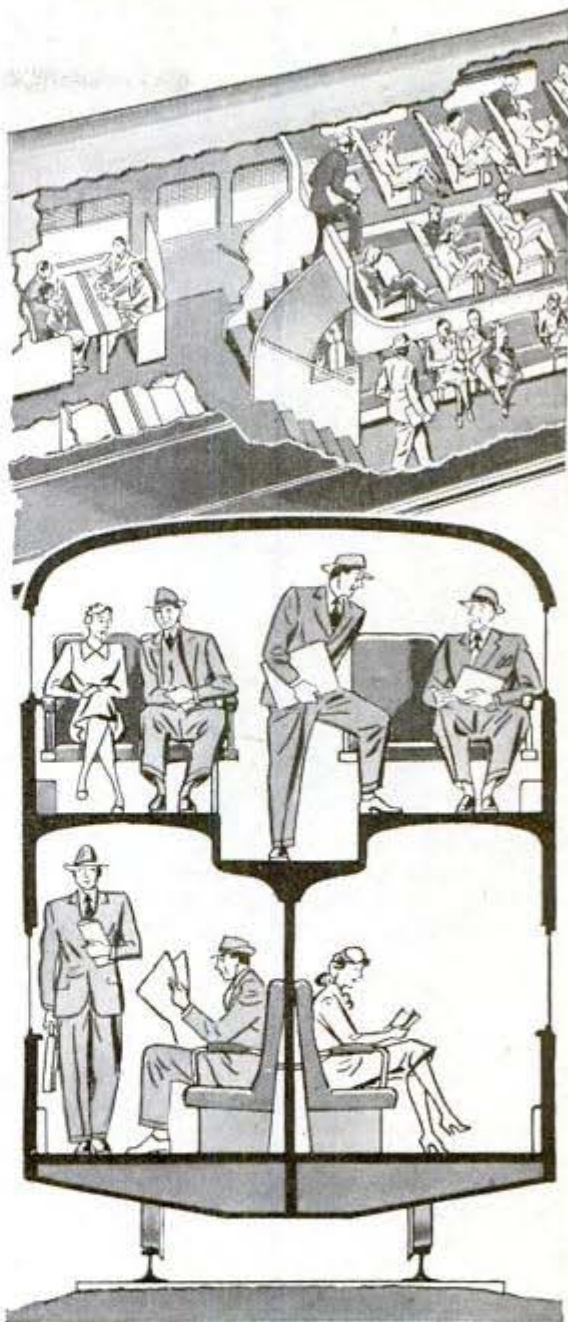

Postwar plans by Pullman-Standard call for "Threedex" railway coaches for commuter trains. The design is expected to increase capacity of the coaches to 112 passengers, one and one-third times the capacity of today's typical commuter coach. Each car will have three levels. Passengers will enter at either side on a middle level and ascend a central stairway to the top deck of seats or descend two side stairways to the lower deck. On the middle level will be four game rooms, where 16 commuters can play cards on the way to the office.

*Pullman-Standard Co.
79 E. Adams St.
Chicago, Ill.*

0436

"Disintegrator" Grinds Metals Into Powder for War Uses

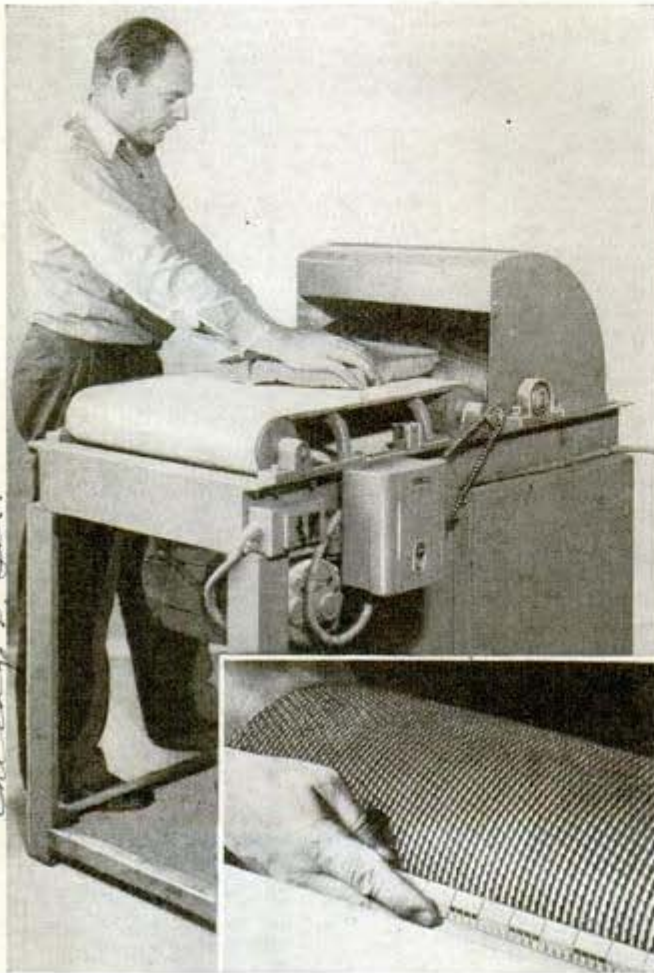

Anything a steel saw will cut—from hard metals to soft foodstuffs—can be ground or pulverized into fine powder by the thousands of teeth in a disintegrator's steel drum. The machine is equipped with a mechanism to regulate the feed and can be adjusted to various speeds and size of powder, grit or shred. Among the 41 materials the machine can handle are lead, bone, plastic, copper, wood, rubber, soap, leather, tar, chicle, cheese, horseradish, oranges and cast iron. Technological developments are widening the uses of powdered metal in such war necessities as press castings, paint pigments, and similar materials.

"Hot Sandwich" Ice Preventive Made of Conductive Rubber

Airplane propellers whirring at stratosphere levels can be kept free of ice by means of an electrical "hot sandwich" developed by the Goodyear Tire and Rubber Company. The covering consists of a rubber boot made up like a sandwich from

three layers of specially compounded synthetic rubbers which fits over the leading edge of the propeller blade. The boot, which weighs about one pound, is only a few thousandths of an inch thick. The center layer of the sandwich is of rubber that conducts electricity. It is made by forming continuous chains of electrical conducting carbon particles through a sheet of nonconducting rubber. When current is sent through this layer of the sandwich, it grows hot and melts whatever ice has formed. The upper layer protects the boot from abrasive forces of raindrops and ice particles which tear great holes in ordinary rubber, while the bottom layer is regular insulating rubber that prevents the heat from escaping into the propeller blade. The new boot also may be used to prevent ice formation on radio aerial masts, air speed indicators, wing tips not accessible to hot-air heating, tail surfaces and engine cowlings.

Self-Grip Clothesline Hook Eliminates Knots

Knots are eliminated in putting up a clothesline with a hook which can be fastened to round or flat surfaces. The hook, or clamp, holds the line in the shape of a U with the lower part consisting of a lip under which the line passes. The harder the line is pulled, the tighter it is held by the self-gripping hook. If a line breaks when held up by a series of these hooks, only the broken section would fall.

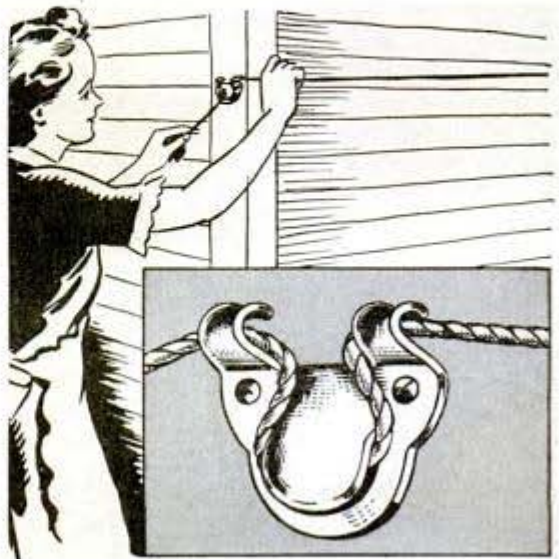

Franklin M. Alister Corp.
 130 W. La Salle St.
 Chicago 3, Ill.

0362

1144 G. Market St.
Akron, Ohio

Warships Float Down Inland Canals on Pontoons



By removing masts, attaching pontoons to the stern and shipping ballast, frigates and cargo vessels up to 338 feet long are floated down inland waterways from shipyards on the Great Lakes to New Orleans. Frigates such as the U.S.S. Peoria (above) guard convoys from submarines; the cargo vessels are used for inter-island operations. With pontoons welded and bolted on both sides (right), the stern is practically lifted out of the water and the frigate can negotiate shallow canals. Because low bridges are ahead, the U.S.S. Orlando (below) stows its mast on deck before beginning a trip to the ocean. Pusher-type tug attached aft is temporary motive power. These ships can't use the usual route through the eastern lakes to the St. Lawrence River because the canals around the rapids in the St. Lawrence can only accommodate vessels up to 259 feet in length



U. S. Maritime Commission, General Executive Office,
 310 N. Michigan Ave., Chicago 4, Ill.

Mr. Allen Warren Elliott

7 Park Ave.,

71st St. N. Y.

0378



The arrow points to Sterilamp tubes, radiating germicidal ultraviolet light, surrounding a shadowless, glareless Westinghouse surgical lamp

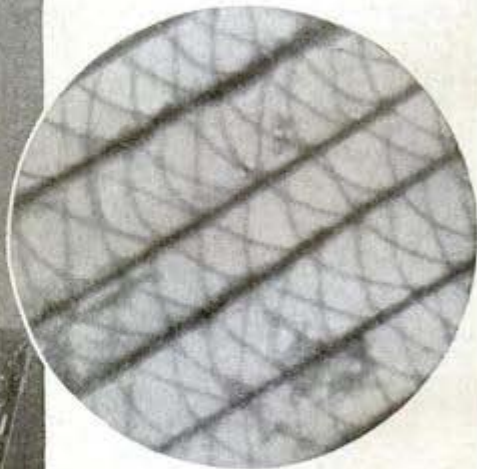

Left, RCA's electron microscope; above, electron micrograph of the scales of a malarial mosquito's wing, magnified 16,000 times

The **BATTLE** Against **BACTERIA**

IT IS a strange paradox that wartime medical discoveries will undoubtedly save more lives in future years than will be lost in this conflict.

It's as though we are fighting and winning a war within a war. This second war, a battle against bacteria, has armies numbering in uncountable billions and weapons so mysterious that no one knows how they work their magic.

Penicillin is the principal germicidal block-buster which is changing the map of disease. Science is starting to pit one friendly microscopic army of nature against destructive microscopic armies which have long and successfully attacked the human body. Penicillin is only a starter. During the next year it is likely that more of these "wonder drugs" from mold cultures will be announced.

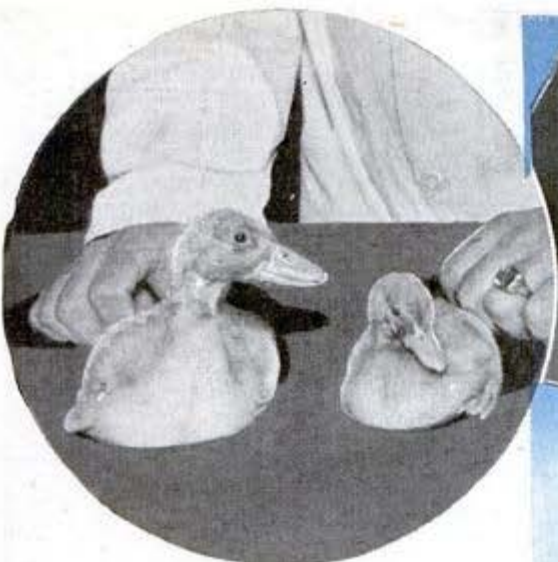

Of two ducks infected with malaria, the one at left is under atabrine treatment

Dozens are being tested. It seems likely that the very dirt in your backyard is teeming with microscopic growths like penicillin mold which provide materials poisonous to germs, but harmless to humans.

Germs from the soil, as well as molds from the soil, can be raised to kill germs. Dr. Rene J. Dubos, connected with Rockefeller Institute for Medical Research, filled three ordinary kitchen glasses with common soil. He fed the millions of organisms with cultures of laboratory germs. One day he took a pinch of the soil and dropped it into a test tube containing pneumonia germs. Through



A colony of germs growing in petrie dish at General Electric company laboratory is killed by 15 seconds exposure to ultraviolet lamp. Below, filling penicillin vials

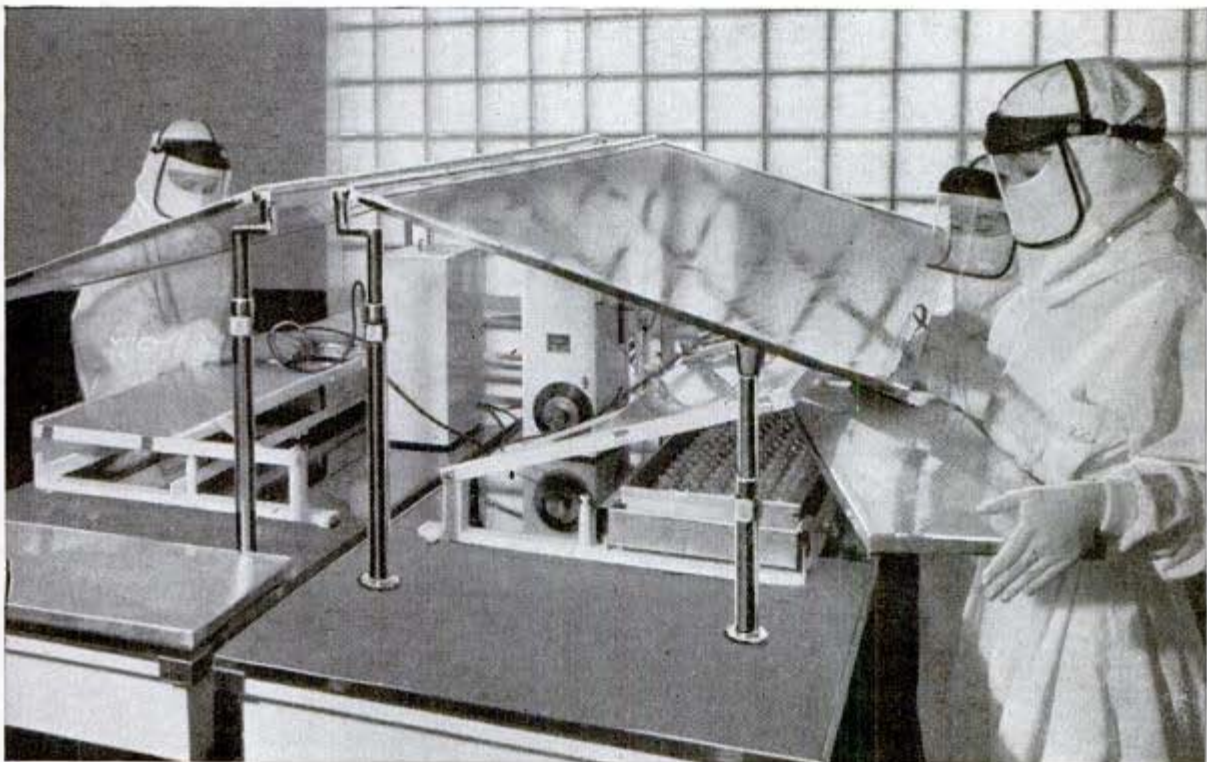



Bottles in which penicillin mold will be grown go into sterilizer at Pennsylvania State College

American pharmaceutical companies produce the drug by introducing the mold into huge vats filled with a nourishing broth. Portions are then transferred into thousands of cotton-plugged bottles where it continues to grow in another nutrient solution. It is permitted to develop for six to ten days, and during this time it grows first as a smooth, white scum on the surface of the liquid. Then it becomes coarse and wrinkled. By the fourth or fifth day, green spores begin to appear on its surface, giving the

mold a greenish gray appearance. Then tiny lemon-yellow drops may be seen on

Left, Winthrop Chemical Co. produces 800 million atabrine tablets a year. Below, workers in sterile garb make penicillin for Commercial Solvents Corp.

Perse Health, Inc.



a microscope he watched the bacteria from the soil destroy the pneumonia germs. Thus tyrothricin was added to penicillin as an ally of man. It specializes in killing germs in body cavities, such as the chest, and on skin surfaces.

University of California College of Agriculture scientists have found two tiny soil-borne organisms which secrete an unknown substance fatal to typhoid and diphtheria germs.

Mass production has only recently permitted distribution of penicillin to the public, as well as the armed forces. It is a soil-borne mold, looking like the mold which grows on bread and cheese. To protect itself against bacteria, it produces a chemical substance fatal to them. This is the remarkable drug.



the surface, drops of oily liquid rich in penicillin.

The large proportion of the penicillin is found, however, in the nutrient medium beneath the mold. This penicillin "liquor" must be poured from beneath the heavy, wrinkled mat of mold, and is the crude material from which purified and concentrated therapeutic penicillin is made.

A solution as weak as one part in 2,000,000 kills germs. Introduced into the human body or on its surface, the substance seems literally to tear the bacteria to pieces, causing their structures to crumble like a building hit by an aerial bomb.

How do scientists know this? The answer is the new, super-electron microscope, an improvement on one of the most startling inventions of the century. Here is a secret weapon in the war on germs which might be compared to a telescope in New York City which would show you what was going on in Berlin.

This new scientific "eye" has already shown 100 times greater power than a light microscope, and the peak of its usefulness has not yet been reached. Power of microscopy depends upon the length of the waves used and it is calculated that electrons may have wavelengths 100,000 times shorter than the light waves which register in your eyes. Bacteria and fungus cultures may be enlarged 50,000 to 100,000 times. An object as small as a single molecule has been photographed. Semi-portable, desk-size electron microscopes now in production will make the instrument available to more scientists.

War has not produced the long-predicted "death ray," but the war period has seen the perfection of

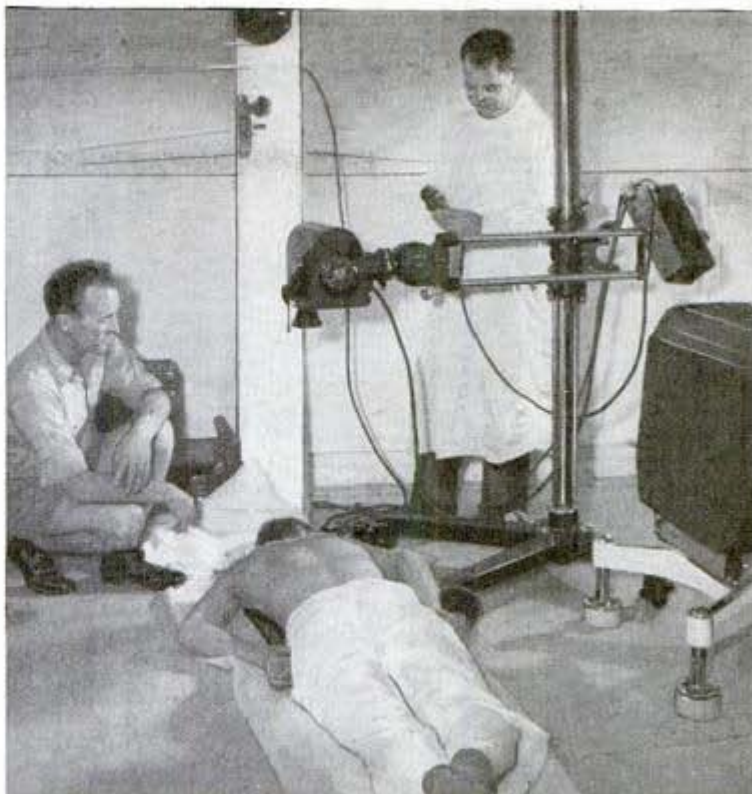

Our fighting ships have the most modern medical equipment available. Here a Medical Officer watches as X-ray picture of a patient is made

Diagram below, from American Sterilizer Co., indicates how "Hygeaire" ultraviolet lamp is placed on wall to kill germs circulating in office air

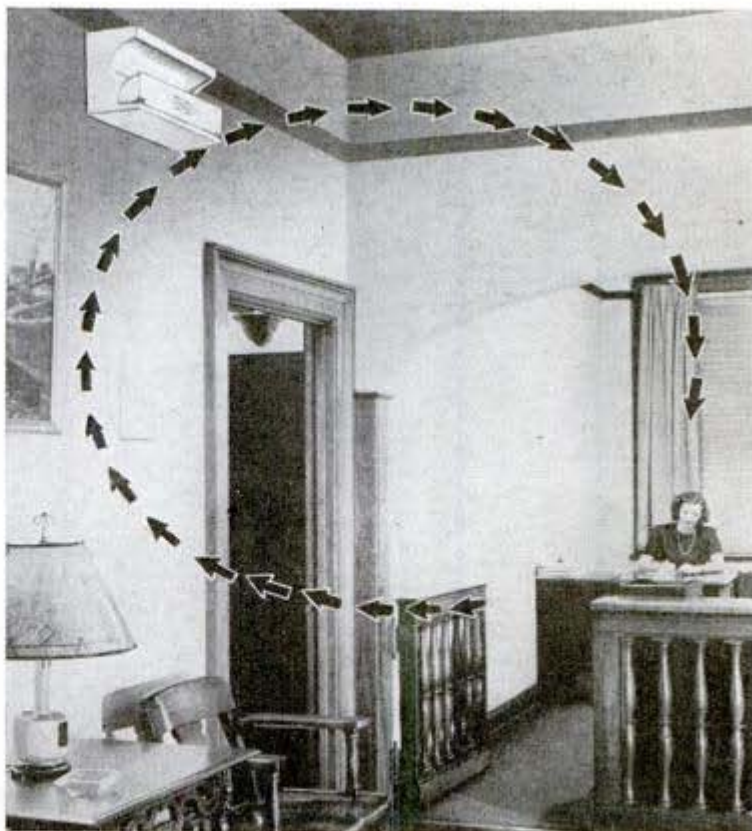



Above, portable GE ultraviolet sterilizer in doctor's office. Right, electronic heat speeds manufacture of penicillin. Below, rabbits are used for test of the fever-producing qualities of penicillin



its counterpart in the war on bacteria—ultraviolet radiation.

So important is the function of ultraviolet tubes that the government permits their manufacture during wartime to kill airborne bacteria in operating rooms, schools, offices, packing plants, pharmaceutical establishments, bottling rooms, and so on. These "bullets of ultraviolet light" have been found to kill certain types of virus which are believed to be the disease carriers responsible for wartime epidemics.

A new use for the tubes has been found in the preparation of vaccines. The preparations are spread in a thin, flowing film which passes under a powerful ultraviolet lamp, killing the germs in less than a second. Vaccines have been thus produced for sleeping sickness, rabies, and pneumonia.

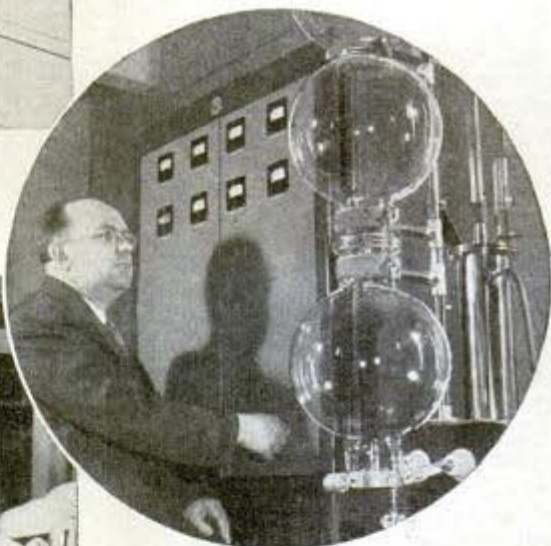

The miraculous sulfa drugs, which have been overshadowed by penicillin, have gone steadily forward saving lives by thousands. The newest in the family is sulfasuxidine, or succinylsulfathiazole, which has a special effect on intestinal bacteria, but is harmless to man.

Strangely, these sulfa drugs do not kill or destroy germs like penicillin. Pour sulfanilamide into a culture of "cocci" and they still live, but without reproducing. In the body the same "cocci" are drugged or paralyzed. The latest theory holds that sulfa drugs interfere with the germ's nutrition, inducing starvation.

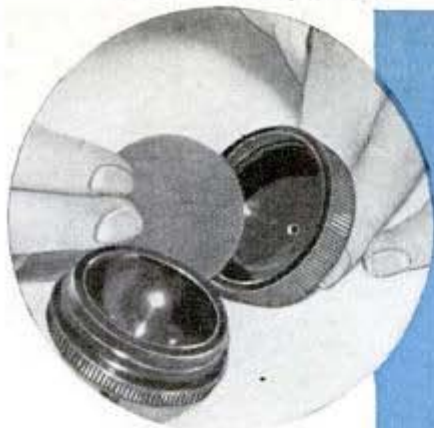

Whole blood and blood plasma are filtered through porous rubber filters (top). "Multipore" was developed by U. S. Rubber Co.

Sulfas now are injected along with penicillin, and if one does not slay the germs, the other puts them out of the fight until the body's own germ-killing troops do the lethal job.

The tremendous use of blood plasma has been accompanied by explorations in the field of blood chemistry. A derivative from blood contributed to the armed forces is becoming available through the American Red Cross for prevention or modification of measles. The gamma globulin is obtained



as a by-product in the making of serum albumin, a concentrated blood derivative, which the armed forces use in addition to blood plasma.

While the synthetics, atabrine and plasmochin were being developed in the fight against the world-wide scourge, malaria, Dr. Robert B. Woodward and Dr. William E. Doering were investigating the making of synthetic quinine. It took less than fourteen months to succeed. Their new synthetic cannot be distinguished from natural quinine. The two chemists, using common chemicals, duplicated the cinchona drug by arranging carbon, hydrogen, nitrogen, and oxygen atoms in precisely the same relationships as nature's arrangement of these atoms in the quinine molecule.

University of Chicago scientists have proved that spraying propylene glycol into the air kills airborne bacteria and will help prevent epidemics.

These new germicidal sprays can be discharged from the "health bombs" used by our servicemen to exterminate insects. The "bomb" is a dispenser loaded with liquid insecticide which is released as a fine mist.

(Continued to page 156)

Sterilizing a shoe with ultraviolet lamp to prevent spread of foot infections at a Westinghouse factory

0580

'Doughnut' on Doughboy's Back Holds Flamethrower Fuel



Paratroopers, commandos and infantrymen carried the machinery for the "Life Buoy" flamethrower onto the battlefields of Europe strapped to their backs. The "Life Buoy," a "gun" which can throw fire 50 yards, is said to be greatly superior to its German counterpart.

0248

Invisible Wire Made of Platinum Is 1/25,000th as Thick as Hair

Platinum wire so fine that it is invisible to the naked eye is used for engineering experiments in the General Electric Company laboratory. The wire is 13 millionths of an inch thick and approximately 25,000 strands would be needed to equal the cross-sectional area of a human hair. The wire cannot be seen if mounted between glass plates and held up to the light, although its shadow can be detected. One cubic foot of the wire would weigh 1,330 pounds and could circle the earth 8,000 times. It is manufactured by drawing out

64

Schenectady, N. Y.

*J. H. Mura Co.
1622 N. Main St.
Racine, Wis.*

silver wire with a platinum core to an overall thickness of two-thousandths of an inch. Then a section is placed under a microscope in a few drops of nitric acid and the silver dissolves away.

0385

Wicks in a "Pin-Up" Flowerpot Keep the Plant Watered

To facilitate hanging a flowerpot on the wall, it can be placed in an outer shell attached to the wall by a pinup. Instead of watering the flowers, the outer shell is simply filled with water and the plant draws water through the capillary action of wicks in the bottom of the pot.



0499

Four Tourniquets on Flying Suit Grip Legs or Arms of Wounded

To save the lives of flyers badly wounded in the legs or arms, two naval reserve officers designed a "tourniquet" flying suit. It has four "built-in" tourniquets on the sleeves and pants. Five-inch tabs which protrude from the tourniquet pockets can be reached by either hand or, if necessary, may be tightened by the teeth. Lightweight aluminum locks hold the tourniquets tight.



*Designed by:
POPULAR MECHANICS
Lt. Comdr. Russell G. Witter
(MC) U.S.N. Lt. Wm. F. Leach
U.S.N.*

CAMERAMEN UNDER FIRE

By Paul Healy

Part 2

IT HAPPENED on the island of New Georgia. Corp. Cyrus P. Collings, attached to a marine raider battalion spearheading an allied offensive, calmly squatted on the bank of a small river and took a picture of a Jap swimming toward the American lines. Then he put his camera back in its case, slung it around his neck, unslung his carbine, and took aim. At the crack of the gun the swimmer disappeared and the marine watched his fourth Jap of the war.

Corp. Collings is one of the dauntless and resourceful combat cameramen who make it possible for Americans to view the progress of the war in intimate closeups every day with their breakfast coffee and after dinner in the neighborhood theater. Equally expert with camera and rifle, these former portrait photographers, newspaper men, shoe clerks, truck drivers, salesmen, etc., are trained to make excellent use of both instruments wherever the fighting is fiercest. As a result of their efforts, and the equally heroic work of the civilian press photographers, every phase of World War II can be told in pictures.

For example, the battle of Tarawa, officially described as the toughest in marine corps history, also was the most photographed because marine combat cameramen were determined not to miss any of it.

The thoroughness of their job depended on men like Tech. Sgt. Norman Hatch and Sergt. Obie Newcomb. With his 35 mm. camera clutched in one hand, Hatch



Pathe News and Twentieth Century-Fox newsreel men (above) are ready to shoot action in European war theater. Below, one marine cameraman protects another from rain during New Britain campaign

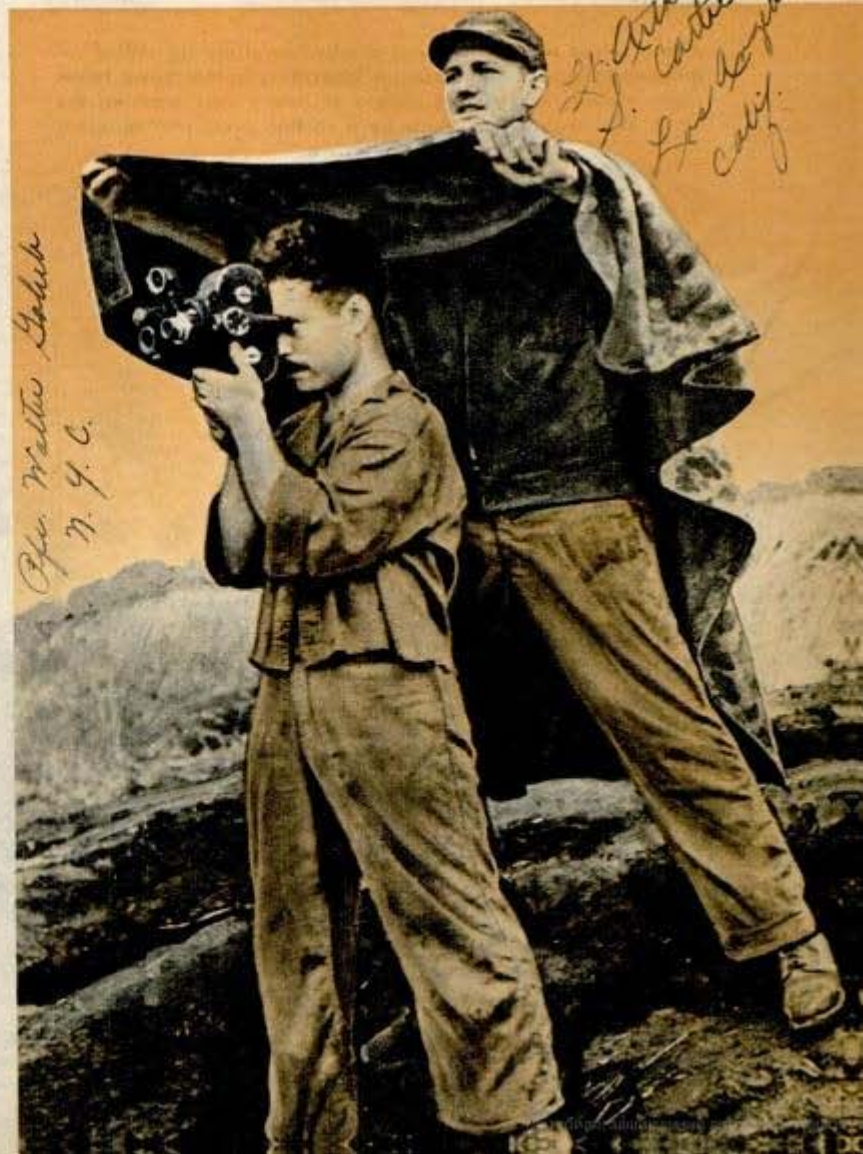

*Off. Walter Goshub
N. Y. C.*

*Off. Arthur Carter
Lt. J. G. Campbell*



Above, giant aerial camera is checked carefully by skilled repairman in Navy's photo science laboratory before being taken aloft. Below, this striking picture of heavy seas washing the decks of a cruiser was made by a civilian press photographer

rode the top of a landing craft as it raced toward the heavily fortified beaches of Tarawa. Four hundred yards from shore the ship rammed into a coral ridge and Hatch and his buddies were ordered to go over the side. With Jap bullets zipping around him, the sergeant walked those 400 yards holding his camera aloft to keep it dry.

When he reached the beach and dove for cover near the three-foot seawall, he began grinding away. Soon water, sand and flying debris jammed the camera, so he clambered into a foxhole only 20 feet behind the front lines and started reloading. He buried the rest of the film to keep the emulsion from melting, returning later when he reeled it. The fact that Hatch was not wounded was considered a minor miracle by those who saw him worming his way forward under the noses of the entrenched Japs.

Newcomb's landing craft was stopped dead by a direct hit, which killed five men, and the survivors plunged over the side. In the excitement, Newcomb forgot his camera but he was needed on the beach anyway so



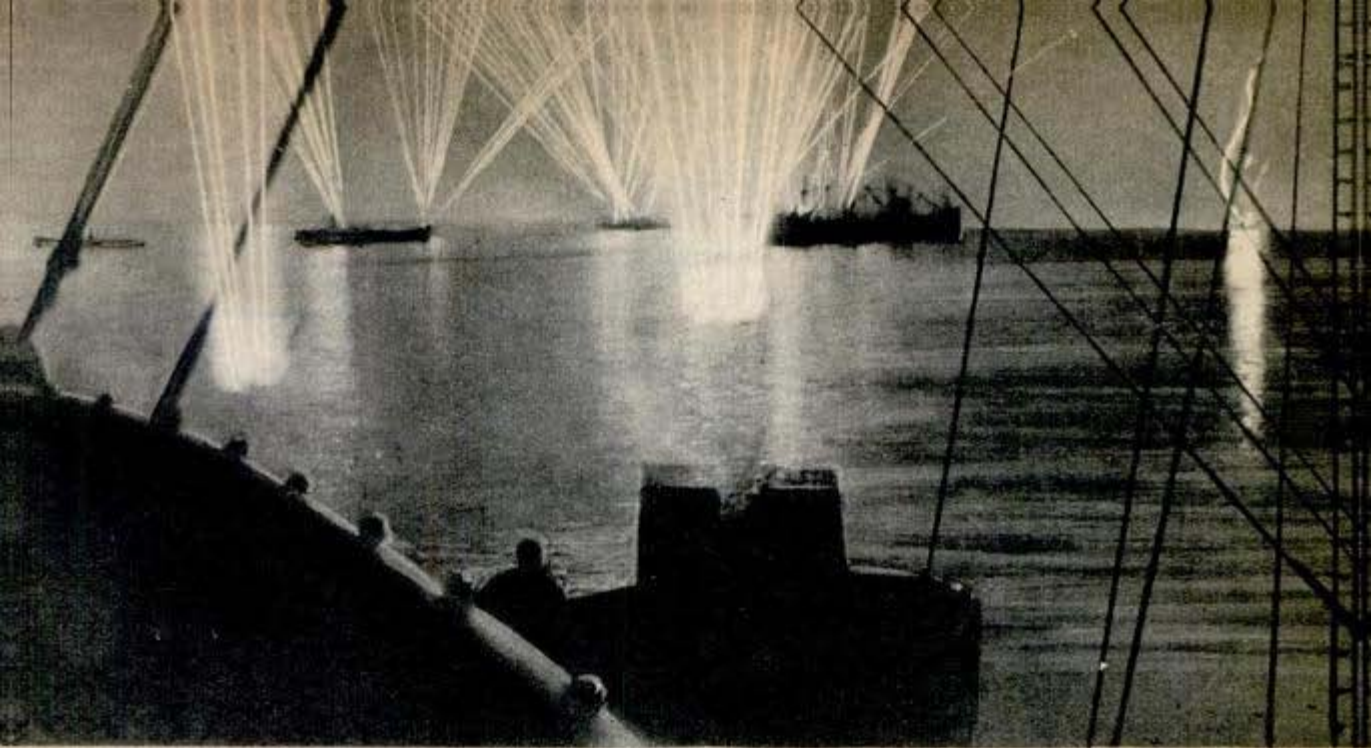

A trick picture of ack-ack fire—ship in foreground moved closer to camera during three minute exposure

he burrowed into the ground and traded shots with the enemy. Finally he crawled back to the smashed craft, found his camera, and returned to the beach, this time to take pictures of the hectic and violent scene in front of him.

Anxious for more coverage, Newcomb and Hatch obtained permission to accompany a marine flamethrower unit in assaulting a stubborn pillbox. From behind a log they photographed the attack until two men slain by Jap snipers toppled on them, temporarily putting their gear out of commission. Immediately they picked up their rifles and joined in the assault, not returning to fix their cameras until the stronghold had been demolished.

Together with the films made by 13 other marines (two of whom lost their lives), their reels made up a 5,000-foot documentary color movie which one critic said was "war in the least expurgated form Americans are likely to see it." It was so anxiously awaited that it was flown out on the first plane to leave the Gilbert Islands after the battle.

Photographer's mate trains motion picture camera on bombers in sky
U. S. Navy photo

Before going into Tarawa the marine combat photographers said their ambition was to take as realistic pictures as the Red Army cameramen, who have been responsible for some of the world's most dramatic front line photography. One Soviet film, "The People's Avengers," was made by 17 men and one woman who parachuted be-





Above, during a bombardment, Bren gunner and British Army photographer work side by side in North Africa

hind the German lines into the forest hide-outs of Russia's famous guerrilla brigades and fought with them for months, returning with a complete pictorial account of the life of the Partisans. Two of the cameramen were killed trying to make their way back to the Russian lines.



Above, photographing Nazi bombers with "Big Bertha." Left, sighting attacking planes from RAF station, then aiming camera to see if they were hit



Soldier-photographers, however, run less risks than the untrained civilian war photographers, who have no guns with which to defend themselves. Such men as Bert Brandt, of Acme, and Bede Irvin of the Associated Press, who used to photograph baseball games, chorus girls, speechmaking officials, fires, etc., face new and more hazardous problems in covering a battle. Irvin, struck by a bomb fragment, died camera-in-hand while doing close-ups of American infantry moving forward in the wake of a bomb barrage near St. Lo on the Normandy front. He had heard a shouted warning to duck but had hesitated a split second to pick up his camera before diving for a nearby ditch.

Brandt was one of the first cameramen to hit the Normandy beaches. Taking no chance with couriers, he then made three hitch-hiking boat transfers in the rough channel before getting his negatives back to England. His invasion pictures were the first to reach the United States and he would have had a scoop except for the roto picture pool, a noncompetitive wartime setup in which everyone is entitled to pictures made by everyone else, military or civilian.

Sometimes the war photographer has to develop his own films at the front. If he has nothing else in which to mix his developing solutions, he uses his steel helmet tightly covered with his raincoat to keep out the light. Sometimes he improvises entire laboratories. With their regular equipment gone, a group of marine corps photographers in the Pacific theater fashioned a makeshift darkroom. The sink was an old fuel tank from an airplane wing. The reflector on the flash equipment once had been the headlight of a steamroller. A mainspring from the bolt of a damaged Springfield rifle was broken up to function as a

(Continued to page 152)



Navy man (above) spies on activities at Jap base with a K-20 aerial camera. Below, cameraman accompanies marines at Bougainville
U. S. Marine Corps photo



*Mrs. Maurice Dent, Chief
Super. Service Staff, Tennessee
Valley Authority, Knoxville, Tenn*

'Skyscraper' Crane at Dam Lifts 23,000-Pound Load

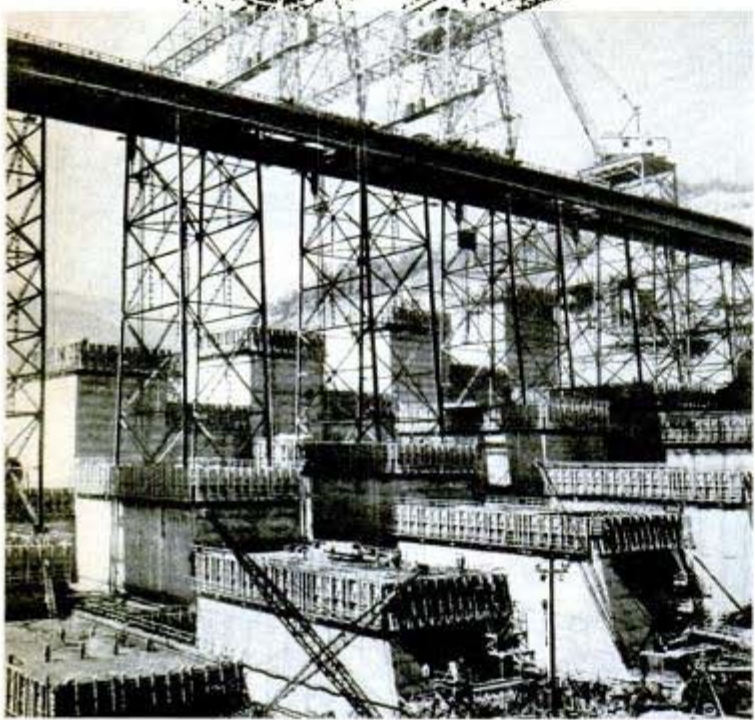

Towering above a steel construction trestle at Fontana Dam, Tennessee Valley project, are twin hammerhead cranes which operate on rails. These giant cranes are more than 400 feet above foundation rock. Each crane lifts a 23,000-pound bucket load of concrete from a flatcar and transports it to any position along the deck of the trestle. The 300-foot-long trusses are supported on gantry frames, and permit unobstructed movement of suspended loads for 150 feet either way from the centerline of the trestle. An electrical hoist installation permits the handling of great loads swiftly and smoothly. A full load is lowered at the rate of 375 feet per minute, and an empty bucket is returned at a speed of 750 feet per minute.

Twin hammerhead cranes high above trestle at Fontana Dam operate on rails and lift 11½ tons of concrete

"Amphib" Tractor Tows Watertight Trailer to Rush Supplies Ashore

Beachhead operations are speeded up with an amphibious cargo trailer with a capacity of 220 cubic feet. The watertight trailer is towed by an amphibious tractor right up on the beach during combat. In tests conducted by the Marines at Camp Lejeune, N. C., one tractor towed several trailers. Aside from insuring faster delivery of vital supplies, the amphibious trailers land materials in better condition. These trailers eliminate the need for waterproof packaging of some military items.

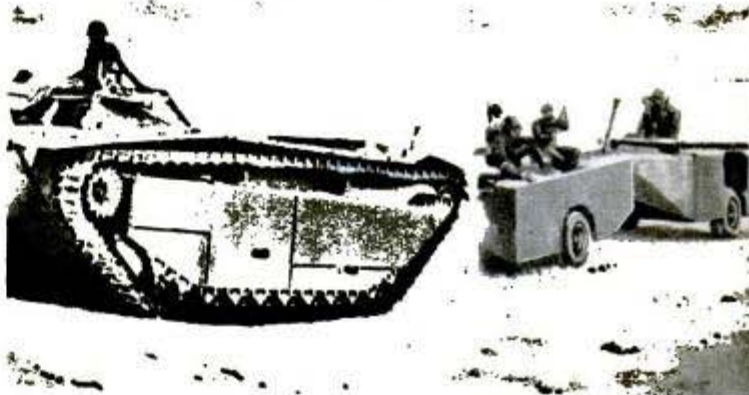

Safety Guard on Chuck Key Prevents Accidents to Lathe Workers

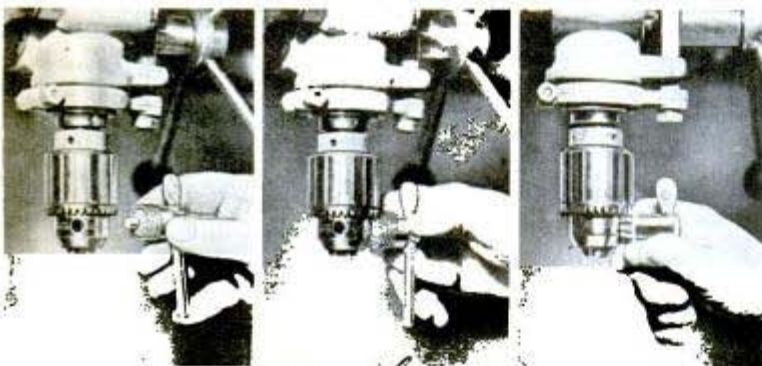

To reduce accidents among machine tool operators, a safety device called the "Kee-Jector" can be fitted as a guard on the chuck key of any size drill or lathe so that it ejects the key the moment the chuck is tightened. The fool-proof guard makes it impossible to leave a chuck key engaged in a tool chuck when power is turned on. Failure to remove the key has caused a large number of head and hand injuries to workers.

70 *Safety Specialist
3229 N. C. 7th St.
Portland, Oregon*

*Mr. John Orr Gray
14 W. 49th St.
N. Y., N. Y.*

Electric Heat Vulcanizes Tire Without Removing Tube

With an electronic device that applies "internal heat," tires are vulcanized in 10 minutes in combat zones. The process does not harm the inner tube, thus making it unnecessary to remove a tire from the rim. This vulcanizing unit, developed for the Transportation Corps, weighs only 500 pounds and replaces equipment weighing tons and requiring hours to operate. It consists of a press ram with an electrode coupled to a high-frequency generator and a press frame. Ram and frame are fitted with filler bags that adjust themselves under pressure to varied tire contours, eliminating the use of molds. After the war this process may be used for recapping to extend the life of tires to 100,000 miles. It may also be adapted to the production of new tires.



Scissors Action Raises Truck Body as High as Cargo Plane's Doors

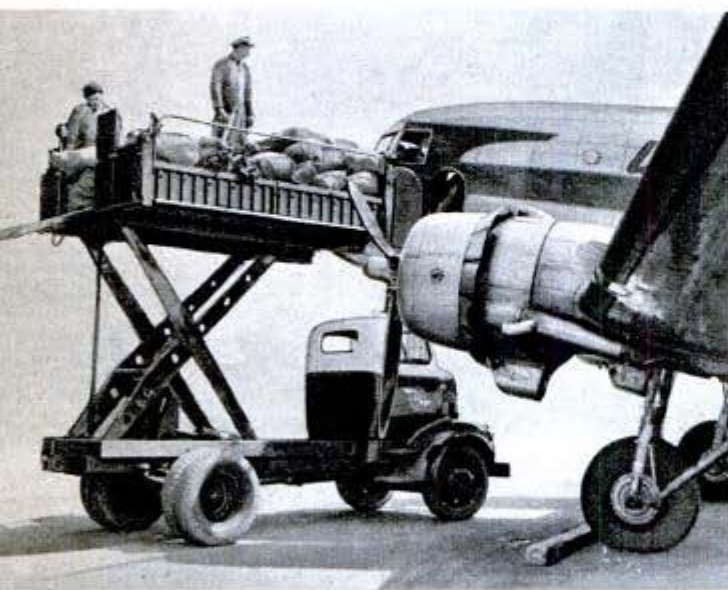

To facilitate the transferring of material between trucks and the high fuselages of cargo planes, the Air Force employs a unit built by the Heil Company, Milwaukee, Wis., which gives a standard army truck a high lift body elevated by scissors action. The mechanism consists of two hydraulic cylinders that boost the body straight up to 10 feet or any intermediate height. When the truck is backed up to the plane, the body is raised until the floor is exactly the same height as the cargo door and a specially designed tailgate is lowered for loading or unloading. Two flood lights which fit on the rear corners of the high lift body make night loading easy. The unit is built to withstand temperatures from 50 degrees below zero to 160 above.

3042 W. Milwaukee

Snow Tractor Has Sled Runners on Front for Rescue Work in Arctic

With skids on the front and treads on the sides, an Army snow tractor speeds over Arctic regions at 40 miles an hour. This light-weight vehicle, known officially as the M-7, is coupled with a snow trailer and used primarily to rescue downed fliers. It can also be used as a cargo carrier. Engine and body are covered with heavily insulated material for operation in sub-zero weather. The tractor has a four-cylinder gasoline engine with six forward and two reverse speeds.

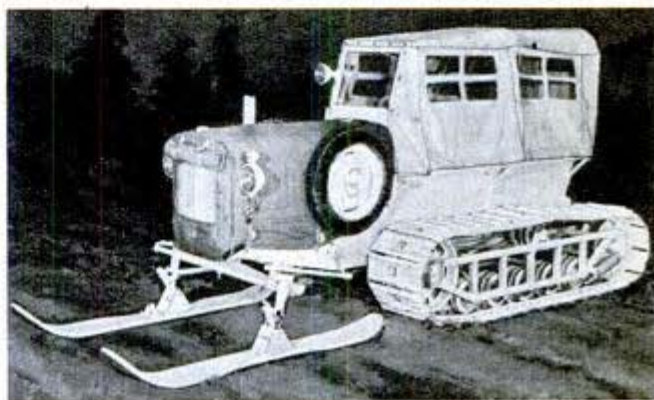

NOVEMBER, 1944 *Allis-Chalmers Mfg. Co.
Box 512, Milwaukee, Wis.*

A WARBIRD LAYS *an* EGG

Below, hauling a 2,000-pound demolition bomb on three-wheeled pneumatic-tired carrier into position under bomb bay of plane. Soldier in the rear carries a pistol to enforce rigid safety rules during the process



Official U. S. Army photos

The photographs on these pages are the first released by the Army in this country of a 2,000-pound bomb demonstration—covering all steps from careful preparation and loading to the actual "hit." Tests are conducted by experts at Army Ordnance Department Proving Ground in Aberdeen, Md., scene of photos

Attaching the tail fins to a bomb (above) is a last-minute job prior to loading, for a bent fin may mean a "miss." The fins guide the bombs on their downward flight, and because they are made of light metal must be handled with extreme care. Note red flag across bomb warning other workmen to keep safe distance



Left, electric winch inside plane lifts giant bomb through bay into its "riding" position. Flying personnel and bombardment aircraft are supplied by Air Corps for tests

POPULAR MECHANICS

Mr. G. H. Moore
1362 N. Dearborn St.
Chicago 10, Ill.

0353



One-ton demolition bomb is shown (above) an instant after its release from two-engined plane. Below, parts of the same bomb after explosion—two jagged fragments of metal. These flying fragments cause only secondary damage; the effect depends on enormous blast



Flame, smoke and dirt billow to height of 2,000 feet when bomb explodes. This photograph was taken with telescopic lens one mile away. Left, crater dug out by bomb; officer holds fragment

*Mr. D.C. Bailey of the British Ministry
of Supply, London, England. 0379*

Jig-Saw Span Joined by Pins Is Assembled Easily



Left, a Bailey span thrown over a river in Great Britain. Below, a Bailey bridge being erected across a gap in a road bridge in Italy

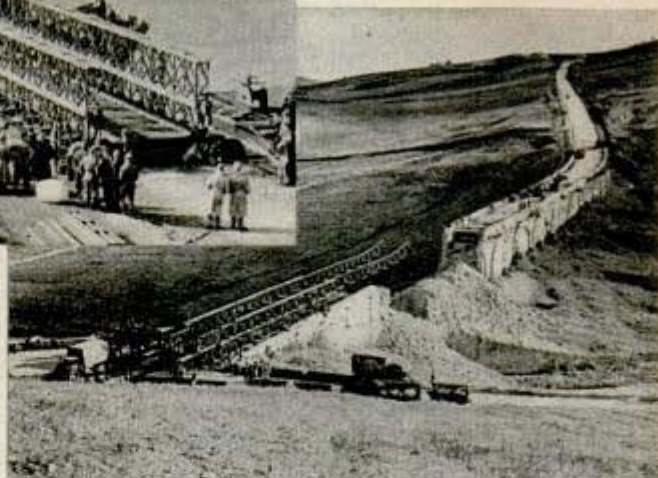

Described as the "most remarkable bridge in military history," the British-designed Bailey, which can be assembled quickly and easily, was a boon to the allies in their march through Normandy. The bridge can cross any gap up to 240 feet without pontoons and with pontoons it can span much wider gaps. In its lightest form the bridge can carry 20 tons, but its construction may be doubled or trebled to carry the heaviest tanks. Known as the "panel bridge," to Americans, it fits together like a gigantic jig-saw puzzle. There are no nuts or bolts and only one steel pin is needed for each joint. Sections are 10 feet long and are

composed of 17 parts. Nine other parts are used to make the foundation. Six men can handle the heaviest parts with ease. The bridge is built first on rollers on the bank of a gap and then pushed over by a crew with mechanical aid. With this span, sappers in Italy bridged a 300-foot gap across the Trigno river in 36 hours.

Power Unit to Move Wing Flaps Weighs Only 8 Pounds ⁰⁴¹⁴

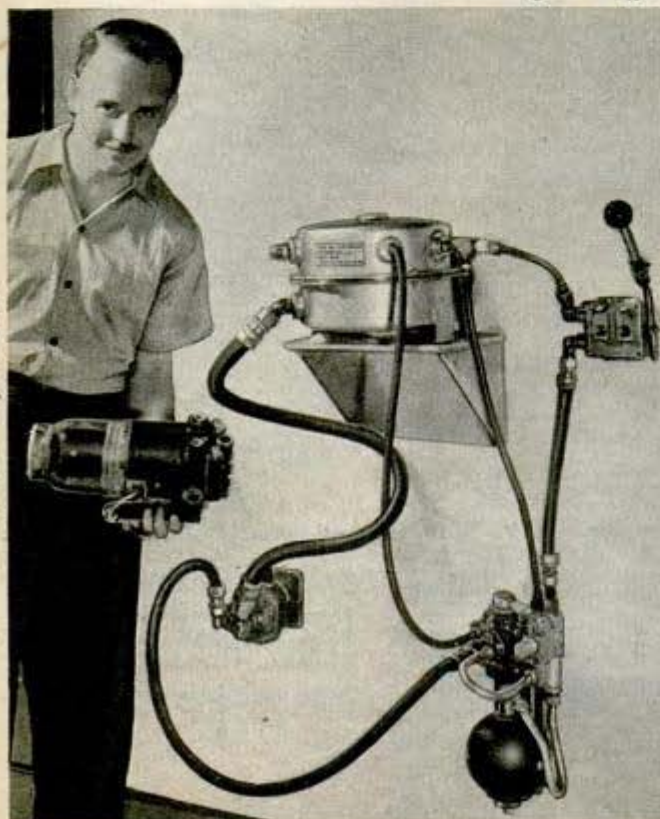

Wing flaps, landing gear and other parts of large aircraft can be operated with a pint-size hydroelectric power unit that weighs only eight pounds. The space-saving unit includes motor, pump, control valves and reservoir. It is installed at the location of the hydraulic cylinder operating the airplane parts, thus eliminating long lines of tubing.

Gauge Measures Porosity As Air Is Evacuated ⁰⁴⁹³

By measuring the rate of flow of air or gases forced out of a vacuum chamber, a small, portable apparatus determines the relative porosities of materials. The apparatus consists of a vacuum chamber placed in contact with the material to be tested, a power-driven fan for evacuating air from the chamber, and a pressure gauge to measure the degree of partial vacuum in the chamber.

POPULAR MECHANICS

B. F. Goodrich Co.

Akron, Ohio

*Press Products Co.
11610 Euclid Ave.
Cleveland 6, Ohio*

P.O. Box 312
Canaña Pk., Calif.

77 945

Undersea "Tractor-Tank" Has Sealed Compartment

Treasure hunts beneath the sea may reach new depths with an electrically driven "tractor-tank" designed to carry a crew of two in a sealed chamber. Caterpillar treads would carry the tank along the sea bottom while cranes, mounted at the corners and on top, pick up the treasure. The tractor-tank could be lowered by cable from a salvage ship to depths of 2,000 feet, according to its inventors, Charles G. Warren and Lt. Harry E. Rieseberg, who have constructed a model. They believe the crew could stay at extreme depths for 10 or 12 hours at a time. Oxygen would be carried in tanks, eliminating the usual air lines.

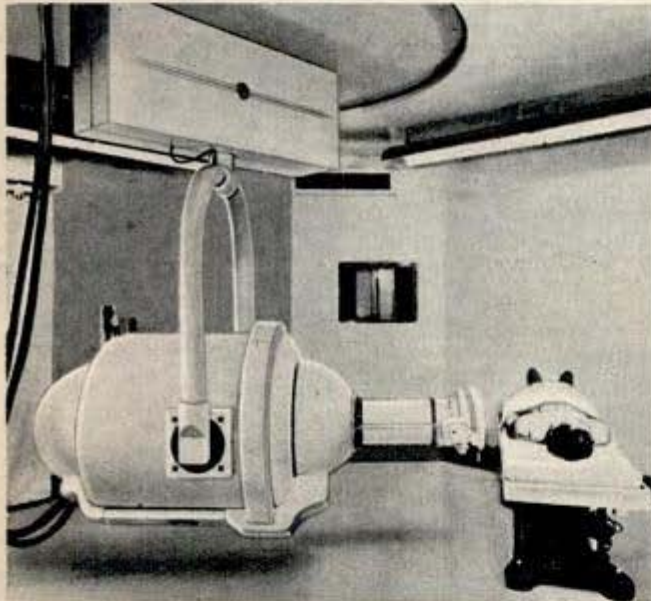

X-Ray Gun Fights Cancer With Therapy Rays

Regarded as a siege gun in the fight against cancer and other malignant diseases, a giant, million-volt X-ray machine at the Walter Reed General Hospital in Washington, D. C., can "shoot" therapeutic radiation equal to 90 million dollars worth of radium, or 12 times that of the entire supply in the United States. Pushbutton control of powerful motors lowers the unit through a concrete opening in the ceiling of the hospital's specially constructed radiation therapy section, where it can be directed at the patient. The unit was modeled after industrial units in war plants and shipyards, where they scan metal castings for flaws.

0-420
made by General Electric Co.
Schervinsky, N.Y.

Dogs Hunt Mines Defying Detectors Used by Sappers

In Normandy, dogs trained by the British helped locate the all-wooden "shoe mine" devised by the Nazis to resist mine-detecting apparatus. After the dogs locate a mine, the spot is marked so sappers can come along and dig it up. It was found that a "K-9" corps of 20 dogs can clear a lane 16 yards wide at the rate of 400 yards an hour.



The WORLD'S BIGGEST

The maze of control cables at left extends from wing root to engine compartment. Below, handy bins speed assembly of engine throttle controls of B-25

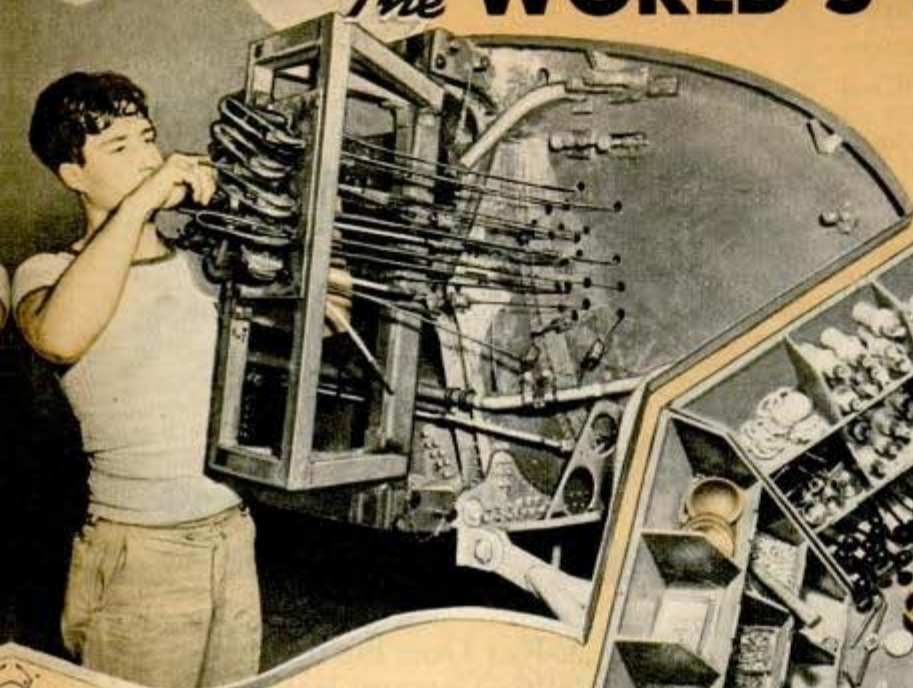

*W. Thomas C. Strivens,
3872 Franklin Avenue
Los Angeles 27, Calif.*

YOU would need nearly five acres of ground to lay out for inspection the millions of parts and pieces that go into a large modern airplane. Today's aircraft are the most complicated structures ever created by mass production methods.

Aside from our largest bombers, the first of the big ships produced on assembly line basis is the Douglas "Skymaster," the military version of which is called the C-54. This plane can carry a payload of 20,000 pounds 1,500 miles nonstop. It has flown from San Francisco to Brisbane, Australia,

in 39 hours, the time it takes a streamline train to travel from Chicago to Los Angeles. The plane has a wing span of 117 feet, take-off power of 5,400 horsepower, a top speed of 285 miles per hour, and a gross loaded weight of 32½ tons.

"Exploded" Douglas A-20 and C-54 (rear) show how sub-assemblies are joined



JIG-SAW PUZZLE

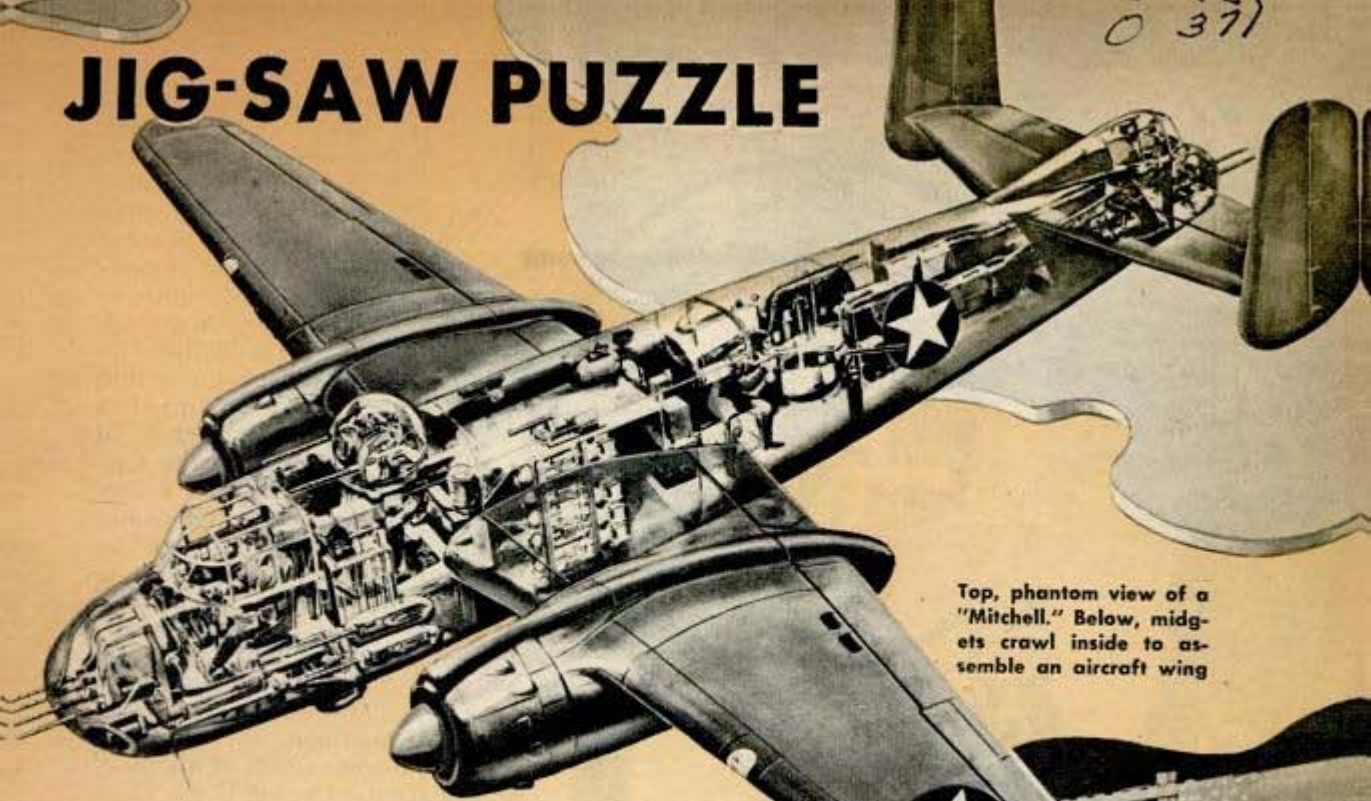

Top, phantom view of a "Mitchell." Below, midjets crawl inside to assemble an aircraft wing

As an air liner after the war it will transport 44 passengers and a crew of five in addition to mail and express. Its 55-foot cabin is of box car proportions.

Today as a military transport it is carrying cargo to all parts of the world. It can throttle down to 105 miles per hour for discharging paratroopers, but its principal job is delivering parts to bomber and fighter bases. The C-54's carry plasma and medical supplies as well, or may be loaded with food and ammunition for isolated posts. On return trips to the United States the planes carry as many as 54 wounded men, or they bring back tungsten, diamonds, tin, mica, or silk. Skymasters have carried President Roosevelt and Prime Minister Churchill on trans-oceanic flights.

The simple airplanes of the past had little more than ribs, spars, and air in their wings and fuselages. But no matter where you cross-section a C-54 you encounter an intricate maze of structural members, control gear, electric wiring, hydraulic piping, and miscellaneous equipment. Assembling the myriad parts is a real jig-saw puzzle for the engineers.

Eight tons of aluminum go into each C-54, but this tonnage is not simply aluminum metal. It consists



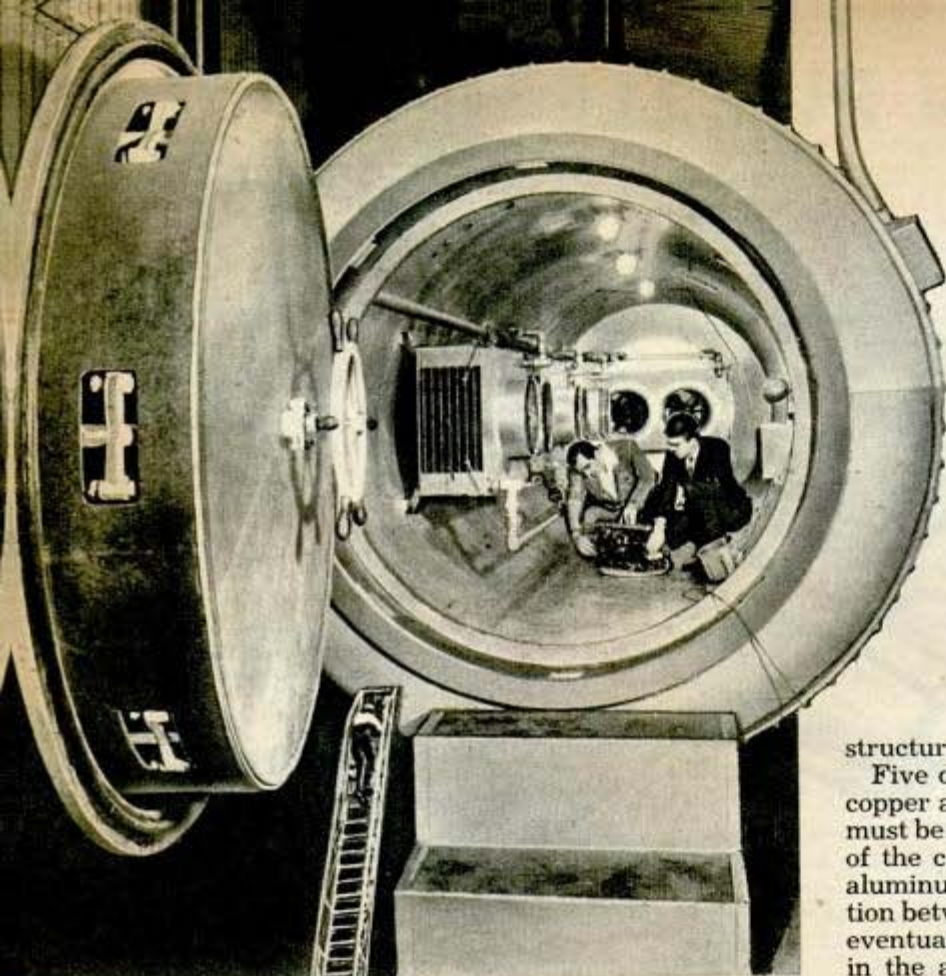

of 30 different special alloys of aluminum. Some is in sheet form and must be handled more carefully than precious jewels, some is in the form of castings, some in extruded shapes. A scratch only $7/10,000$ ths of an inch deep on a thin sheet of aluminum leads to rejection of the sheet in the factory, for such a tiny surface scratch would ultimately lower the sheet's resistance to fatigue. One special alloy is used for the more than one million lightweight rivets which fasten the

structure together.

Five different kinds of alloys of copper are used in the C-54. Care must be taken to avoid placing any of the copper in contact with the aluminum alloys; electrolytic action between the two metals would eventually destroy the aluminum in the area of this contact. Five different alloys of magnesium, having a total weight of 258 pounds, go into the plane, and more than two tons of steel of some 20 different types including stainless steel and armor plate are also

Top, Douglas altitude chamber in which conditions at 50,000 feet are duplicated. Below, photographer climbs fire ladder for shot at a C-54

used. In fact practically every metal in the alphabet from aluminum to zinc and excluding only some of the rarer elements is required in building the plane. Gold is used in some of the electrical motor contacts. Even lead, one of the heaviest metals, has a job. Lead weights are placed in the leading edges of the control surfaces to balance the surfaces statically at their hinge lines.

Most of the metal in the structure receives corrosion prevention treatment before it is assembled. In all, some 85 different solutions including cleaning baths are maintained by a staff of chemists for the anti-corrosion platings and treatments.

One hundred and twenty pounds of Plexiglas, 1,197 square feet of plywood and 108 board feet of other woods, and 102 pounds of synthetic rubber exclusive of the land-



ing tires are among the materials used in the C-54. The landing tires, incidentally, carry an appreciable weight of dead air just to keep them inflated. On such a large airplane as the B-19, larger than the C-54, the main landing wheels weigh 58 pounds more after the tires are inflated than they do before the tires are pumped up.

The retractable landing gear of a C-54 is probably more complicated than an entire airplane used to be. The two main landing units have double wheels, and the nose wheel is steerable from the cockpit. All three units have shock absorbers. The wheels are lowered and are retracted by a hydraulic system that also closes the wheel well doors when the wheels retract, completely eliminating drag. The plane's high-pressure hydraulic system is operated by



four engine-driven pumps. In addition to moving the landing gear it also operates the wheel brakes, the engine cowling flaps, and the wing flaps.

A separate complication is heating and ventilating. For the comfort of its crew a medium sized military airplane may carry gasoline-fired heaters powerful enough to warm half a dozen seven room houses. Some aircraft have hot air heaters inside their wings to prevent the formation of ice along the leading edges. Aside

(Continued to page 154)



Sand blast cleans engine fittings before treatment to prevent rusting

Left, hydraulic oil lines and fittings, pre-shaped and ready for assembly

Below, assembling giant fuselages of C-54 aircraft in Douglas plant

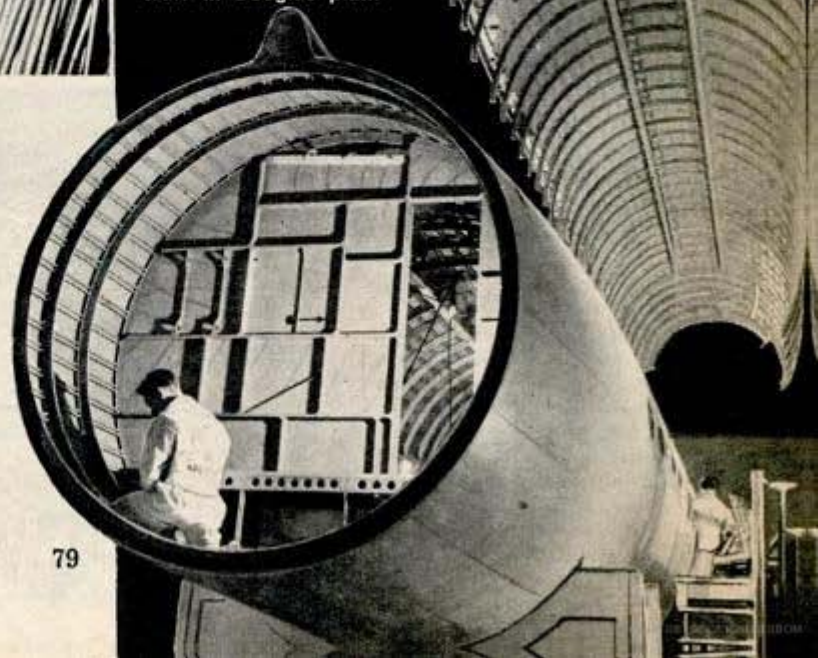

0430

0430 FACTORIES from "DOLLHOUSES"



Factory "doll houses" help layout engineers plan postwar plants with a three-dimensional preview. Left, preparing conveyor track for "doll house"

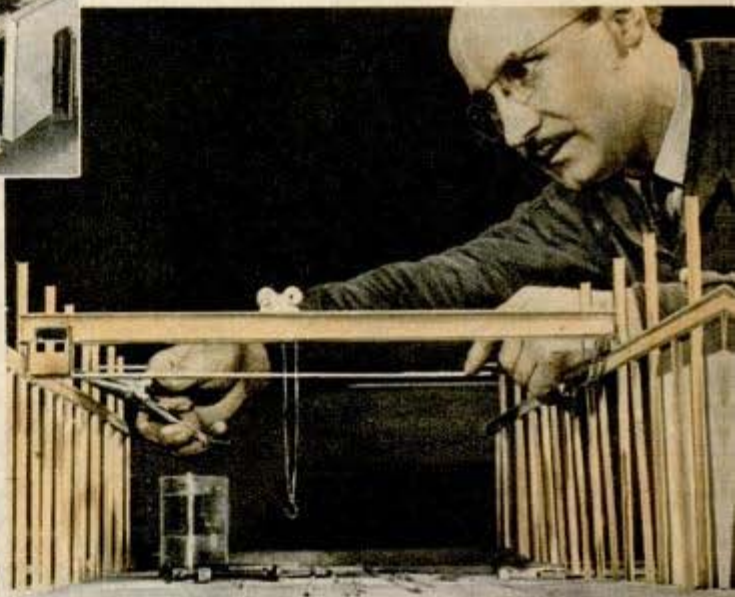
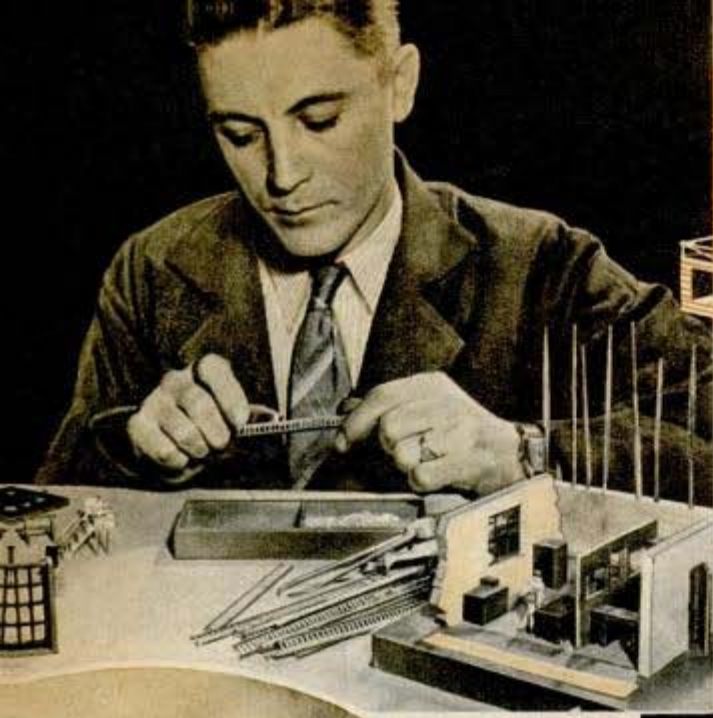

Fastening a cross-beam of "doll house" factory under construction in Westinghouse workshop. Completed model will be filled with figures of men and machines built to scale

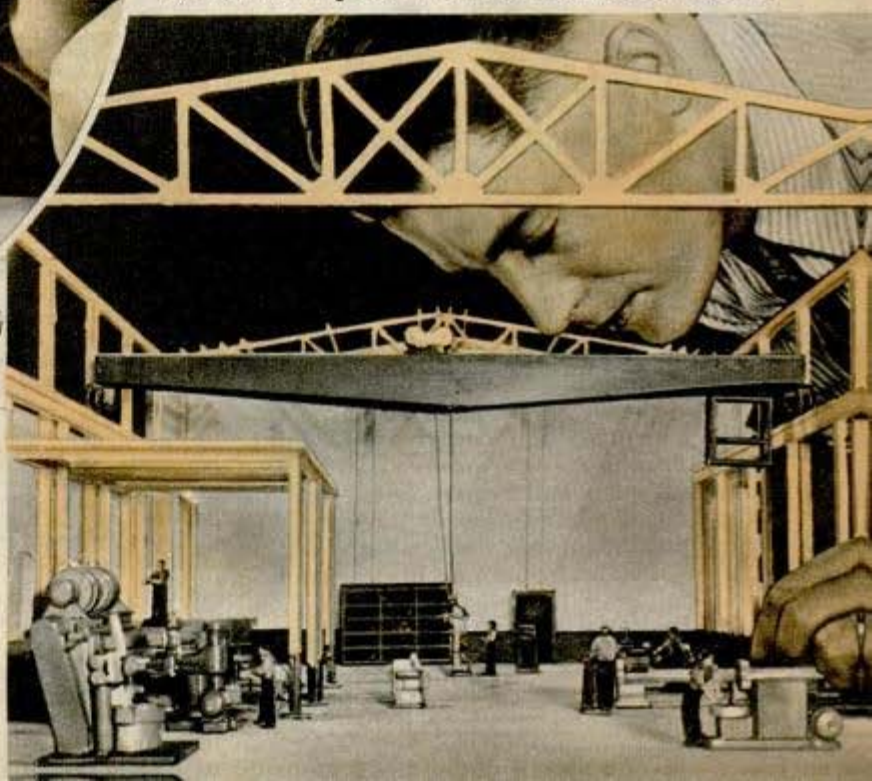
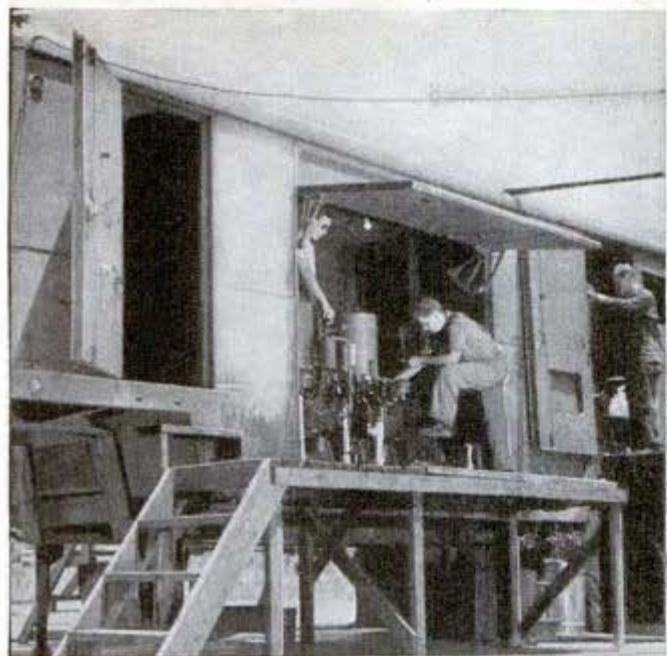

Photo by Mr. Co. Pittsburgh Pa.

Westinghouse photos
Miniature lathe (above) is so small, engineer holds a tiny piece of wood to show where part to be machined would be placed. Right, preview of how machines can be placed for greatest efficiency is provided by model

Air Force Generates Oxygen in Portable Units



Giant portable generator units are carried to overseas bases to provide the oxygen necessary to flyers who climb higher than 10,000 feet. Each of the Air Force's units, which weigh about 36,000 pounds complete, can produce up to 15,000 cubic feet of oxygen every 24 hours. Powered by 110 horsepower Hercules gasoline engines, they are hauled by a 7½ ton tractor and manned by a crew of 16. It takes only five hours to set them up for operation or dismantle them for moving. Thirteen hours are required to cool the plant down for operation and the same time is necessary for its warming up process after operation. Thus the unit is operated continuously in one location, where conditions will permit, for two or three weeks or until the chemicals used as drying and purifying agents for the air

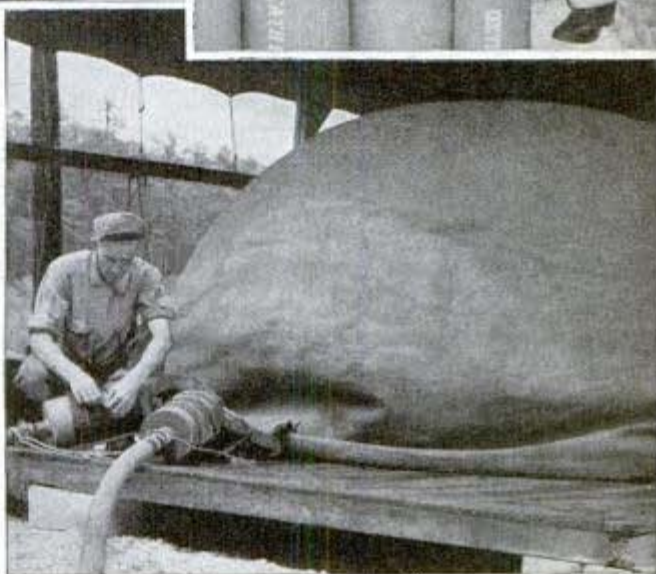

have been exhausted. The generation of oxygen is accomplished by the fractional distillation of air process.

Germ Killer Is Found in a Plant That Nourishes Itself

Chlorellin, one of the newer germ-discouraging compounds in the penicillin family, is the first of the group to be found in a green plant able to manufacture its own food out of natural raw materials. The other compounds are made by molds, soil bacteria and other plants that have to be supplied with ready-made foods in the form of glucose solutions or the like. If chlorellin is found practicable for medical purposes, all its producing plant will need

is water, a few assorted mineral salts, and a supply of carbon dioxide bubbled through the tanks in which they grow. Chlorellin, which is extracted from the chlorella plant, a common one-celled fresh water alga, checks the growth of such organisms as streptococcus and staphylococcus. In contrast to penicillin, which merely weakens germs until the white corpuscles can finish them off, however, it is believed that chlorellin may even kill bacteria.

*H. J. California, college of pharmacy
 Dept. of plant biology, labs.
 at Stanford University*

*G. G. F. Technical Center, Office of The Public Relations
 Office, Orlando, Florida.*

0237

*Signal Corps
Bureau of Public Relations
War Dept. Washington, D. C.*



SIXTY-YARD FLASH

Mass demonstration of flamethrowers at a Chemical Warfare depot. Below, flamethrower on Bougainville routs Japs who defied bazooka

By Roderick M. Grant



IT ISN'T PRETTY, fighting with flames. But nothing in war is pretty, least of all the bark of a Jap machine gun from a timbered pillbox up ahead and the spatter of bullets against the log that shields you from immediate death in a rain-filled hole in the jungle. The Marines had been pinned down long enough. It was time to clean out that nest. Two riflemen crept forward to right and left, keeping the narrow slit in the Jap pillbox covered. Between them the man with three tanks on his back and the "insect sprayer" in hand moved cautiously ahead. Now they had closed the range to 60 yards. "Start your cooker!" someone shouted. There was a hiss of escaping gas under pressure and a jet of orange shot from the flamethrower. A two-second spurt corrected

Standard Oil Company (New Jersey)
Rev. 1626, 30 Rockefeller Plaza. O 370
N.Y.C. 20, N.Y.

the aim, then a spurt of several seconds' duration arched through the jungle foliage right into the slot in the dugout. Inside, the jellied gasoline splattered and clung to the walls, flames leaped around the protective maze of timbers, and with a yell four Japs burst out of the pillbox and dropped, dying, at the exit. The rest were



Signal Corps photo

M1-A1 bores a hole through jungle on Munda, where numerous pillboxes were cleaned out. At left is the portable flamethrower

dead inside. The Marines resumed their advance.

The story was repeated at Munda and Bougainville, Tarawa and Kwajalein, Saipan and Guam. It was the same, with different settings, against the Germans in Italy. When the boys are stopped by a particularly tough pillbox that resists even direct shell hits, they call for the G. I. Hotfoot. That's Yankee for the M1-A1 flamethrower.

The "sixty-yard flash" below shows how the glowing jet of thickened gasoline can be aimed at distant target with great accuracy

Photo from Standard Oil Co. of N. J.

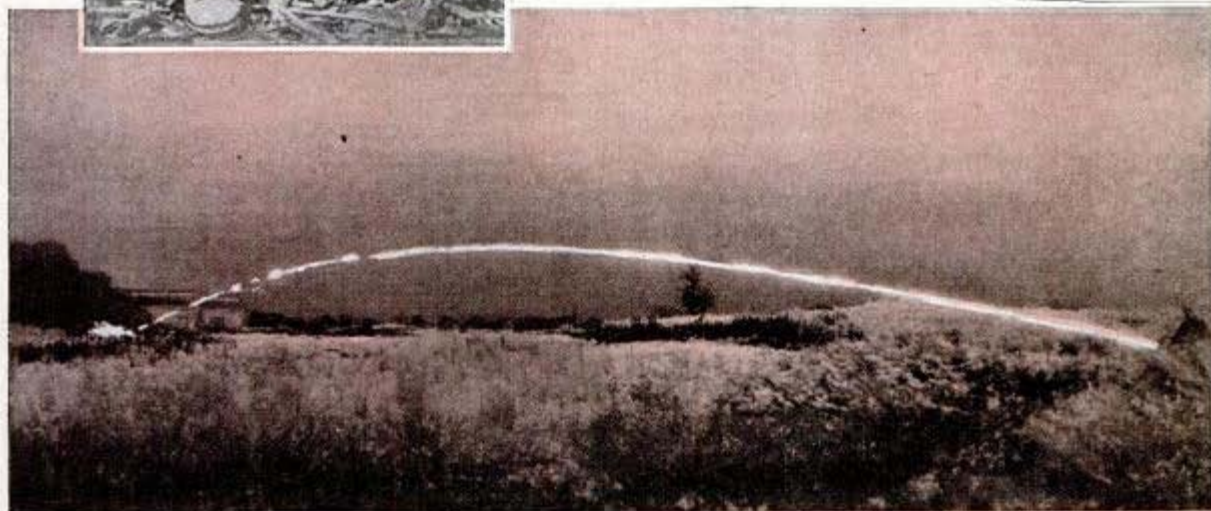



Jellied gasoline arches toward target, striking as a mass of flaming goo. In combat the trajectory is flatter

Fire has always been one of the most destructive weapons of man. The Germans introduced the modern flamethrower in 1915. It had a range of only 70 feet and its billowing flames were almost as dangerous to its operator as to the enemy except in a strong, favorable wind. We had nothing much better in 1942. The Chemical Warfare Service put the problem up to the Standard Oil Development company, already working on a gelled-gasoline incendiary bomb.

Thickened gasoline turned out to be the

answer. The remaining problem was to adapt the existing flamethrower to the new fuel. The result is the M1-A1, which throws a cohesive rod of fire with such accuracy that it can be directed into a two-inch bunker slit 60 yards away. The jet, traveling at nearly two miles a minute, does not billow out but strikes its target as a solid, glowing stream, then spatters and sticks to any object, blazing with terrific heat that destroys guns and all life within the pillbox. In the jungle a quick burst bores a clean hole through thick foliage,

A light tank of the U. S. Marine Corps turns its flamethrower on Japanese holding out in a cave on Saipan

U. S. Marine Corps photo



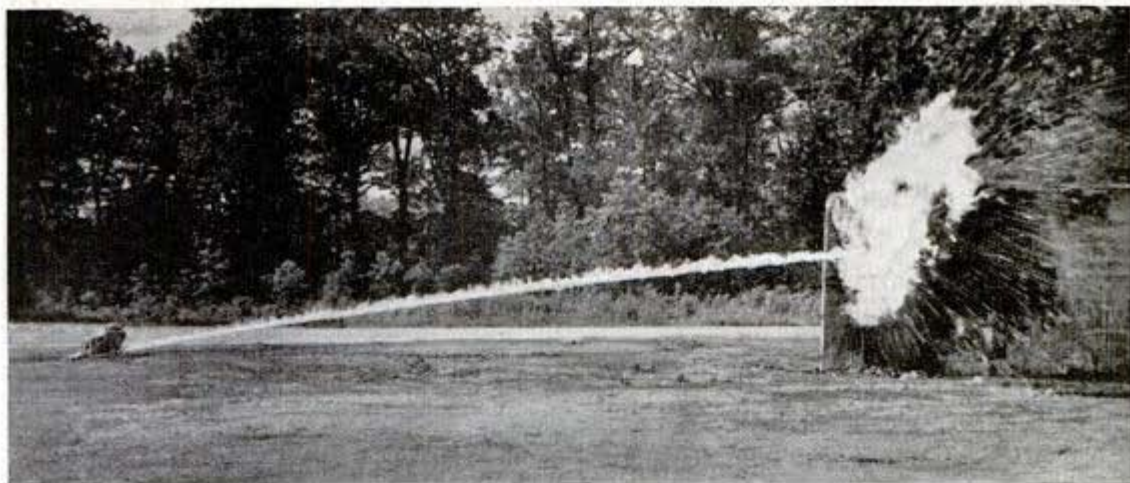

Flame jet is aimed through narrow slit of pillbox in practice

clearing a view of the target without burning away all cover in front of the attackers. Because the sticky jelly splashes around corners, the flamethrower can maneuver out of direct range of the bunker defenders and bounce gobs of fire off the side of the gun port.

The flamethrower consists of two steel fuel tanks, and a cylinder containing compressed air or nitrogen, weighing 60 pounds; and the flame gun weighing eight pounds, to which is attached a small cylinder containing hydrogen. To start his "cooker" the operator opens valves releasing the chemicals, presses a button to vent hydrogen gas from the brass nozzle, and a spark plug ignites the hydrogen which acts as a pilot light for the gel-gasoline when it is turned loose by squeezing a trigger valve.

The formula for the jelly is one

(Continued to page 150)



Gel-gas bomb fires Jap-type building; below, laying smoke



"Iron Horses" Ferried to France Haul Supplies



Normandy Beachhead

Many strange sights moved across the English channel on the backs of landing craft in the weeks following D-Day but

probably none looked more unusual than Diesel railroad engines. The "iron horse" was put to work hauling supplies.

0452

Superpowered P-63 Kingcobra Outflies Its Parent P-39

Boasting a two-stage, 1,500-horsepower Allison engine, the P-63 Kingcobra can fly higher, faster and farther than its predecessor, the P-39 Airacobra. The P-63 has an official combat radius 50 percent greater than that of the P-39, a service ceiling of 35,000 feet, and close to 400-miles-an-hour speed. The power plant, which develops 300 more horsepower than the Airacobra's,

gives higher compression through the use of a fuel supercharger geared at one speed for medium altitudes and at a higher speed for high altitude flying. Other improvements are the low-drag, laminar flow wing section designed to produce minimum drag; an automobile-type door, a big air-intake scoop beside the pilot's seat and exhaust outlets on the side of the fuselage.

*Bell Aircraft Corp.
2050 Channahon Ave.
Buffalo, N. Y.*



Profiles of Bell's two fighters—the P-63 Kingcobra (foreground) and the P-39 Airacobra—are compared in flight

Tangent-Runway Airport Would Increase Traffic

For greater efficiency, economy and safety, American Airlines officials suggest a tangent-runway airport built around a central terminal. They point out that such an airport could have runways arranged to permit simultaneous multiple take-offs away from the terminal on converging runways coincident with simultaneous multiple landings toward the terminal on converging runways. The novel layout would be notable for expandibility by logical stages, reduction of taxi distance and safety during multiple operation, they maintain. Under the plan proposed, when five adjacent runways are used simultaneously, each has a usable length of 6,000 feet but alternate runways have an actual length of 10,400 feet.

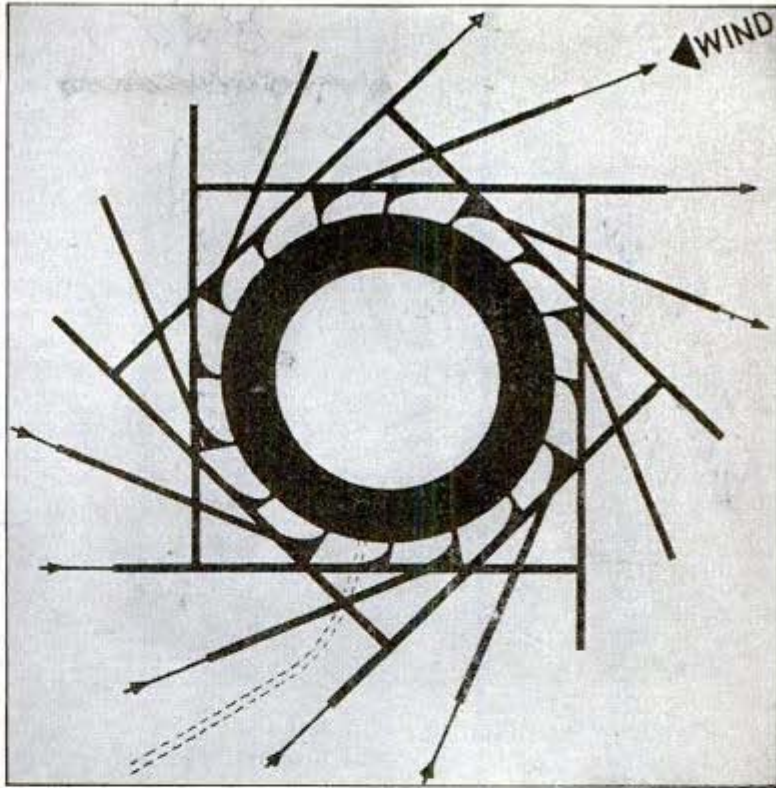

Planes land toward terminal while other flights take off away from it toward the opposite side of the area

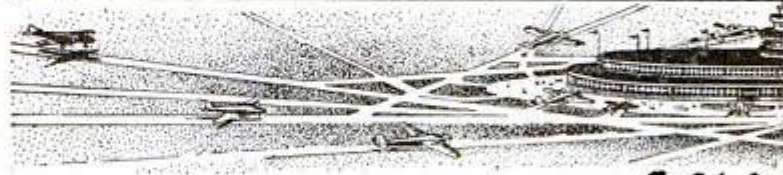

0363

Delicate Balance of B-29 'Prop' Upset by a Handkerchief

When propellers for the B-29 Superfortress are adjusted to perfect balance,

they will turn when a half-ounce handkerchief is placed on the blade, according to tests made at the Bell Bomber plant, near Marietta, Ga. Upon arrival at the plant, propeller blades are assembled and placed at different angles in a testing machine which determines which blade is heavy and which light. Particles of lead wool are added at the hub-point of the lighter blade until perfect balance is attained. A thin coating of paint along a blade sometimes is sufficient. The tests are conducted within two large pits closed off to prevent air-borne particles from striking the blades.

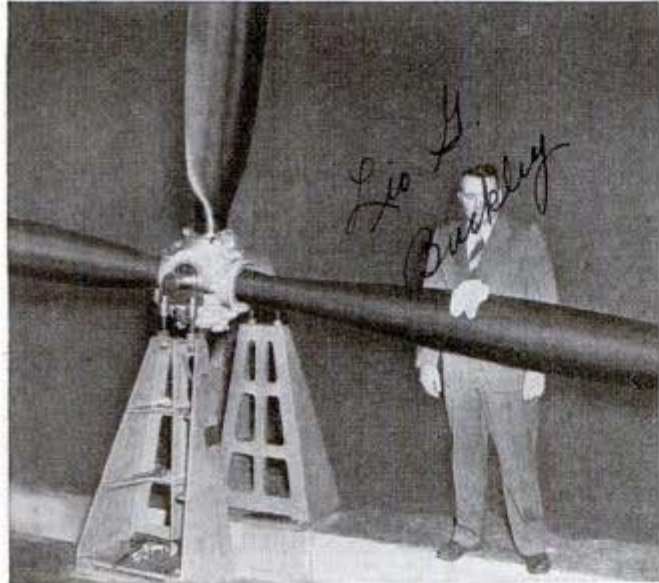

Bell Aircraft Corp.

■ In 1942 the average life span of the American people reached a high record of 64.82 years, statisticians of the Metropolitan Life Insurance company report.

0384

Captured Nazi Truck Is Mobile A.P.O. For Americans in France



Finding use for equipment captured from the Germans is a characteristic of Yankee ingenuity. In France, American troops put a captured Nazi truck to work by converting it into a portable postoffice. After rigging up a board studded with pigeonholes behind the cab, Americans near Cherbourg sorted mail and distributed it to the soldiers just as if they were in a small town.

0412

Bombsight's Robot Mind Finds Target at Night

Acting as a robot mathematician for bombardiers, the T-1 British bombsight makes possible accurate bombing during night operations and while a plane is being maneuvered at low altitude. The bombsight consists of a computer and a sighting head, which contains an optical telescopic mechanism. As the plane nears the target, the pilot sets the sight in operation and feeds information to the mechanical mind of the bombsight, which computes all variables, such as air speed, altitude, wind direction and speed, and transmits them to the sighting head. The bombardier tells the pilot how to steer the plane. Looking into the telescope, with one eye the bombardier sees the target and with the other he sees two lines of light forming cross hairs. When the cross-hairs appear to be on the target, he releases the bombs. As high as four miles above sea level the T-1 is reliable in giving the correct point in space at which the bomb must be released

88 made by AC Spark Plug Co. Plant.

to strike the target, whether the plane is climbing, diving or turning. The bombsight's moving parts are operated by high air pressure and vacuum developed by special pumps connected to the plane's fuel system.

Range of Plane Increased By "Magnetic Tailwind"

By determining accurately the power output of his engines, a bomber pilot can save enough fuel to add 100 miles or more to the range of his ship. This is done with a torquemeter, or "magnetic tailwind," which registers the "twist" of a propeller shaft on a dial. The instrument, developed by Westinghouse, measures the driving force delivered to the propeller by the engine by the amount of twist. This may be only a few thousandths of an inch for a distance of several inches along the shaft. The vital part of the torquemeter is a stationary metal sleeve

Elect. & Mfg. Co. Cambridge, Mass.

and coil assembly which encircles the propeller shaft. Projecting from rings on the shaft are two sets of gearlike teeth whose faces are a few thousandths of an inch apart. As the propeller shaft twists under the load, the distance between the teeth changes. Invisible magnetic "fingers" extending across the gap between the metal sleeve and the shaft detect this change and report it electrically to the pilot's dial.



Torquemeter registers slightest twist of the shaft



DESK and SHELVES for the boy's room

By Norbert Engels

THIS combination desk, clothes chest and shelf has a drop front which serves as a writing table and hides a pigeon-hole unit for storing pencils, ink, paste bottles, crayons and other items of stationery, and even a secret compartment for personal papers and letters. The shelf unit will hold textbooks, paper and other material too bulky for the smaller desk compartments. Moreover, though the shelf forms a pleasing counterpart to the desk, it is entirely separate and can be removed and hung on a wall in another part of the room if desired.

Ordinary white pine will do for both desk and shelf units if they are to be painted, but knotty pine left in natural finish looks especially attractive in a boy's room. Or, the

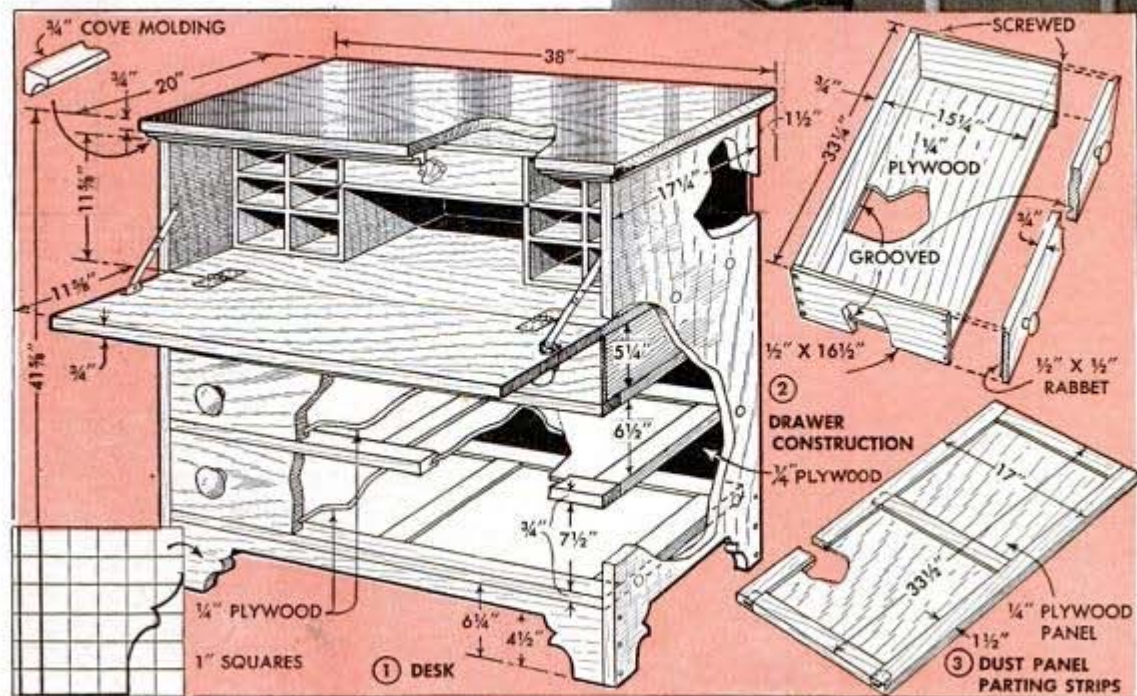



board, preferably the former if available. Next, make the dust panels between the drawers as shown in Fig. 3. The ends serve as drawer guides and the fronts as parting strips. After carefully locating the dust panels, screws are driven through the sides to hold them in place. Holes for the screws are counterbored for plugs to conceal them.

Drawer construction is shown in Fig. 2. The side, back and front panels are grooved to take a plywood bottom, the front panel is rabbeted at both ends to fit between the sides, and then all four pieces are screwed together. For drawer pulls you can use large wooden knobs about 2½ in. in diameter by 1¼ in. thick. These are used also on the drop leaf. The pigeon-hole unit, Fig. 4, is built separately

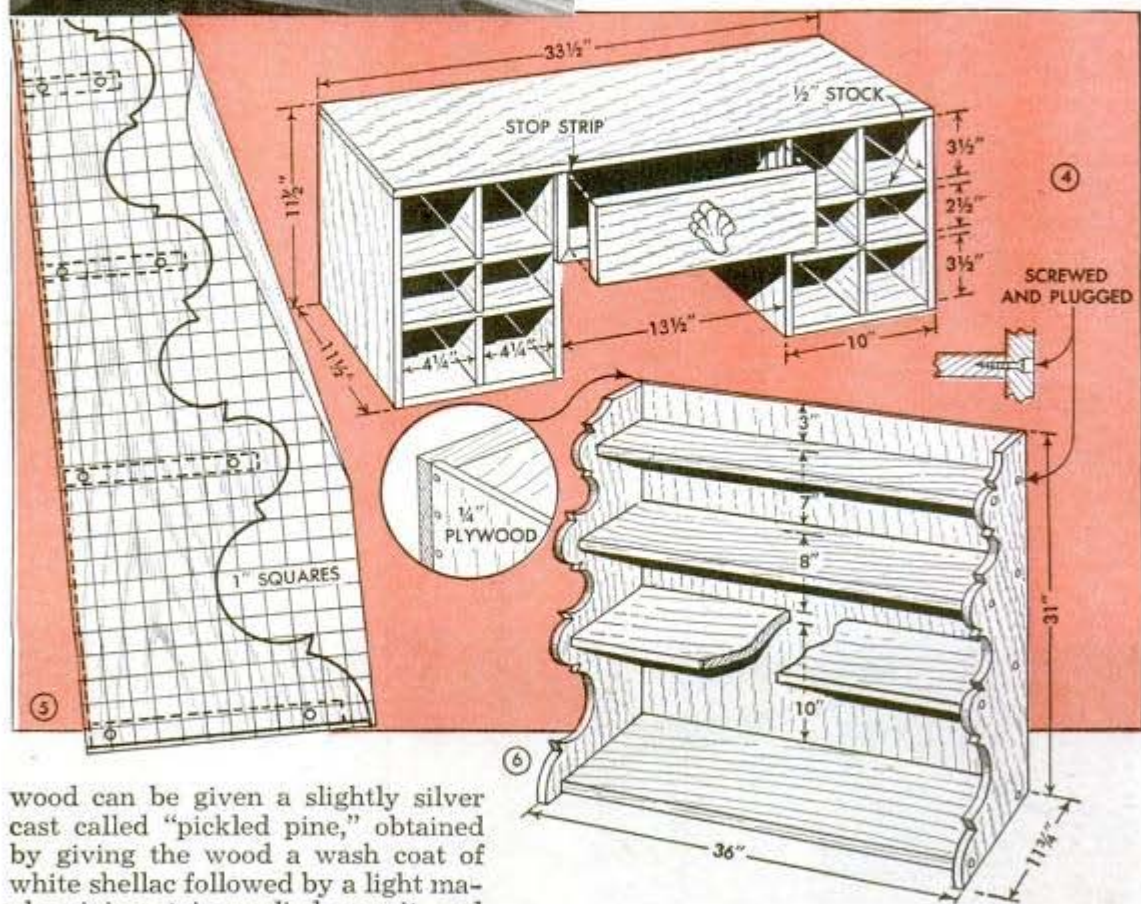

wood can be given a slightly silver cast called "pickled pine," obtained by giving the wood a wash coat of white shellac followed by a light maple wiping stain applied over it, and rubbing the entire surface with liquid wax to which some rottenstone has been added. The rottenstone will catch in the knots and bring them out clearly.

The desk top, sides and writing lid are made by gluing together several boards to the widths shown in Fig. 1. The foot pattern is cut in the two side pieces and in the front apron according to the scaled pattern, after which the sides are rabbeted for the back, which is plywood or hard-pressed

from ½-in. material, then set in place and held by strips of light molding. The secret compartment occupies the middle space, the cover being held in place against the stop strip simply by means of its snug fit. Next, the top of the desk is fastened to the sides by screws covered by concealing plugs, after which cove molding is run under the projecting edge of the top. The writing lid is hinged and the folding supports are attached. These may be taken

from an old desk or fashioned from pieces of metal. In fact, lengths of chain will serve equally well.

For the shelf unit, Fig. 6, use $\frac{3}{4}$ -in. stock to match the desk. Jigsaw the sides according to the pattern, Fig. 5, and rabbet the edge for the plywood back as shown in the circular detail. The shelves are of different widths from the wide one at the bottom to the narrow one at the top. Screws holding the shelves are covered with plugs like those in the chest. As a decoration, prints, decalcomania transfers or other colored designs of suitable size and shape can be applied to the back panel of the shelf unit.

Rack for Storing Storm Sash Safely Without Breakage

The problem of storing storm sash and window screens was solved by one man who hangs them on a rack like the one shown, where they are safe against breakage or other damage. Bolted to the ceiling joists or wall studs, the rack supports the sash and screens well above the floor in space not utilized in the average basement or garage. The rack consists of two end-pieces step-cut as indicated in the detail to receive 2 by 2-in. strips nailed to them. Hangers like those holding the sash and screens on the windows are screwed to these strips so that sash can be hung from them, each pair of hangers being numbered to correspond with the window to be hung on them. With this arrangement, each sash is hung on the rack as soon as it is removed from the window in the spring, at the same time taking down the screen from the rack and putting it up to the same window.—Edward E. Pape, New Hyde Park, Long Island, N. Y.

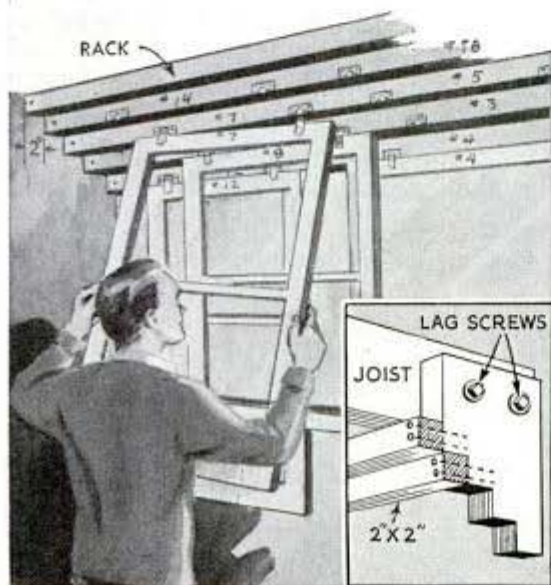

Warped Lumber Nailed Straight With Aid of Pinch Bar



Badly warped studs and joists often can be utilized by nailing them in place as shown. After nailing one end straight in place, hook a pinch bar over the edge near the other end and twist the board until the end is straight and then nail it in place.

Jaws of Steel Trap Beveled To Cut Through Trash

When the jaws of a steel trap are buried under leaves and small twigs, sawdust and similar material, it often happens that the trash will prevent the jaws from closing completely when the trap is sprung, thus allowing the animal to escape. To assure that the trap will hold under these conditions, one trapper files the lower ends of each jaw to the shape indicated, care being taken not to weaken the parts unduly. This edge will snap small twigs and will crush a thin covering of light material sufficiently to allow the jaws to close.



Model-airplane coverings will be more substantial if you cover the fuselage and wings with a layer of tissue paper before adding the final covering.

Handkerchief Knotted to Belt Substitutes for Nail Apron



A simple method of keeping nails within easy reach when you haven't a nail apron and can't keep the nails in your trousers pocket is to tie a large handkerchief or similar square piece of cloth to your belt and fill it with nails, as shown in the illustration. This method is especially practical when you are working on a roof or otherwise in a crouching position which prevents you from putting your hand into your pocket.

—Corp. Robert A. Adams, Oceanside, Cal.

Battery Lamp From Old Tester

An old battery discharge tester will make an excellent inspection light for checking the electrolyte in the cells of a storage bat-



tery. To make a lamp from the tester, attach a flashlight reflector and lamp between the legs of the tester, using two pieces of heavy brass as indicated. In use, set the legs of the tester on the positive and negative connections of the battery. A 1½-volt flashlight bulb will then illuminate the interior of the storage-battery cell when the cap has been removed.

—E. R. Gorton, Maryville, Mo.

Wire Through Posts Holds Vine

Instead of stapling supporting wires to wood posts in the ordinary way, one vineyard owner bores small holes through each post and runs the wires through them. In this way, the wires are held securely, thus preventing the damage to vines and loss of fruit caused by staples pulling loose.



File Cards Arranged Quickly In This Simple Holder

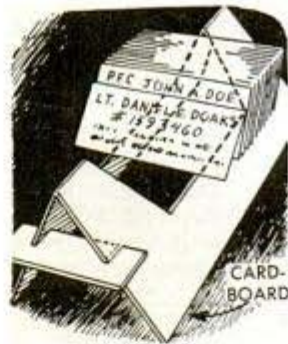

Where suitable drawers are unavailable to hold small file cards while arranging them in order, this simple cardboard holder will serve the purpose. Just fold the cardboard double and cut out a portion at the folded edge. This

should correspond in depth with the height of the cards. If the sides of the holder tend to slide apart on the desk, a slotted strip of cardboard slipped over one end will stop the trouble.

—Don Brooks, New Caledonia.

Wrist Watch Supported Upright On a Table by Paper Clip

If you do not wear your wrist watch at night, fold the strap as shown and secure it with a paper clip. It will then rest vertically on a table so that the face can be seen from your bed.

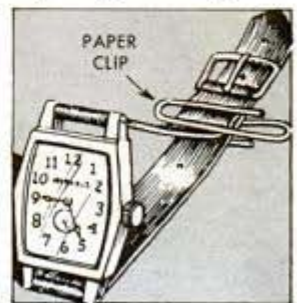

Water-Filled Table Lamp Has Illuminated Base

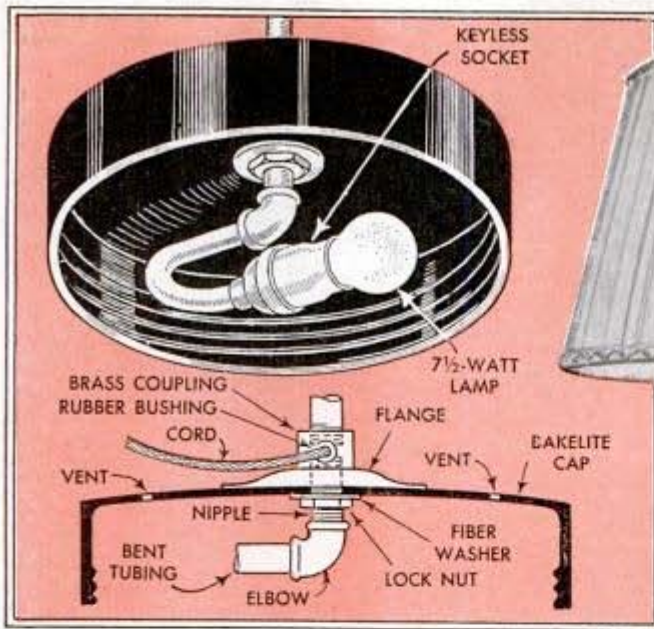

Illuminated by the soft glow of a small light, this tropical-fish aquarium forms the base of an attractive table lamp which you can assemble in a short time. First get a large-mouth bottle—about 25-lb. size—having a Bakelite screw cap at least 4 in. in diameter. A two-socket assembly from a discarded lamp is fitted to the cap, using a flange, washers and nuts as shown in the detail. A keyless socket inside the cap is fitted to a length of tubing bent to a U-shape and connected to the vertical pipe by means of an elbow. Electrical connections are made as shown in the diagram so that one of the upper sockets, fitted with a fuse, serves as a switch to control the small light in the cap. Two double-wire lamp-cords are pushed through the vertical pipe; one pair comes out of the pipe just above the flange on the cap for connection to a baseboard plug, and the other runs to the small lamp in the cap. Air vents are drilled in the cap and the metal parts inside it should be given a coat of asphaltum paint as a protection against moisture. Although the original model shown in the photo was used for tropical fish, the bottle may merely be filled with water to which pieces of coral, shells and some small water plants

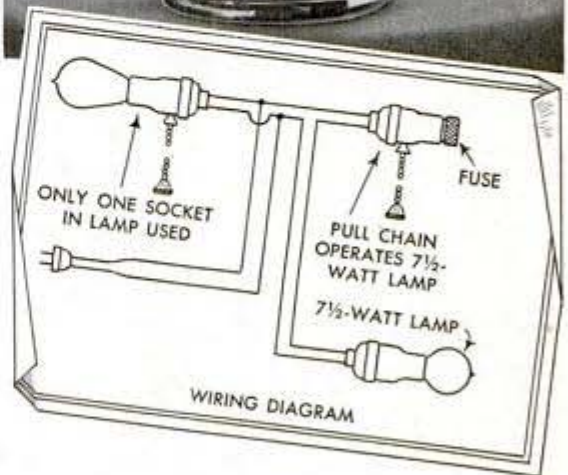

are added. However, this aquarium was not intended for goldfish, since they require more oxygen than this tank provides. The tropical fish, however, can live comfortably in the relatively small quarters.

Noise From Circular Saw Deadened by Wood Disk Placed on Arbor

I found that much of the noise of my 8-in. circular saw could be eliminated by placing a 3 1/2-in. disk of 1/4-in. plywood or hard-pressed board against the outside of the saw blade. A hole is drilled in the disk for the arbor, the disk being faced either with a sheet of thin cork or rubber. It can

be installed merely by removing the nut from the arbor, placing the faced side of the disk against the blade and screwing on the nut. It is important that the nut be drawn up tight enough to eliminate any wobble that might result.

—D. H. Johnson, Lakewood, Ohio.

Solving HOME

The annoyance of having comforters slip off the bed can be avoided by holding them with clothespins tied to elastic which is passed under the mattress corners



It's no problem to iron curtains so they will hang straight if you use two stitched lines on the ironing board and then stretch and iron the curtains so they touch the lines

Making neat buttonholes need be no trouble if you use a pair of embroidery hoops as below. With the cloth stretched taut by the hoops it is easy to stitch around the hole and produce a good job

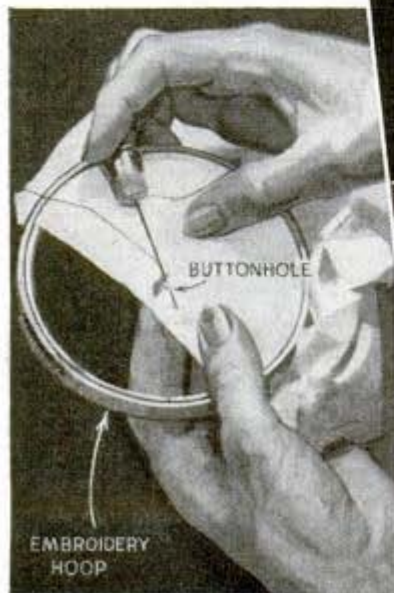

If a favorite piece of jewelry discolours your skin, clean it and then coat the back with clear nail polish

Add a novel touch to your party by painting the guests' names on the drinking glasses with nail polish, which can be taken off with polish remover



Excess fat can be removed easily from hot soup with an ice cube wrapped in a clean cloth as shown above. The fat congeals quickly on the cold surface of the cloth, which then can be washed in clean hot water

PROBLEMS

A wet chamois will not dry hard and stiff if it is hung outside in the wind, or on a line in the breeze from an electric fan so that it is kept in motion while drying

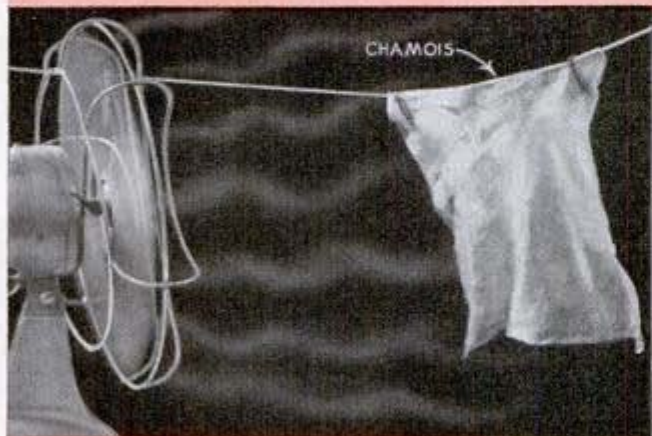

Coffee will hold its flavor longer if kept in a tightly closed container inverted on a shelf in your refrigerator

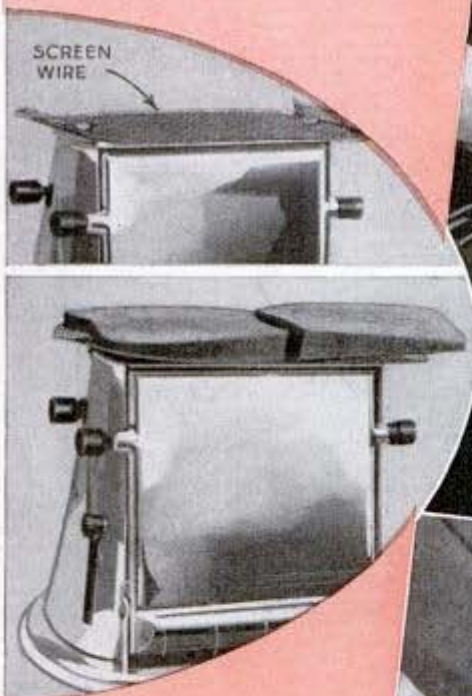

If the children have no place to store their small toys, a container made by tacking wire mesh to a plywood back and screwing it to a closet door as above solves the problem

An ordinary saltshaker provides a handy toothpick dispenser if cellulose tape is used to close all openings except the center one, which is enlarged to pass the toothpicks

Before removing a plant slip started in water, add soil gradually to replace the water. Break away the jar and the plant will grow when it is potted

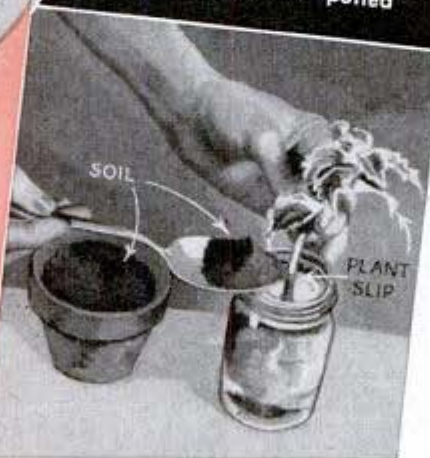

It's easy to keep toasted bread warm with a toaster of the type shown above. Simply fasten a piece of screen wire on top of the toaster to provide a shelf for the toasted bread

Home Repairs

Inexpensive Way of Insulating Your Home Heating Plant



If the boiler or furnace in your home makes too much heat in your basement, it can be insulated and this heat saved for the rooms upstairs by using batts of the mineral type of insulation, which is fire-proof. A carton of ten 15 by 24-in. batts will insulate the average small furnace or boiler and is quite inexpensive. Two people can best do the job. Start by first putting a layer of the batts around the lower part of the furnace or boiler, holding them in place with a wire or cord as indicated. After the layer is in place, stretch wire mesh or chicken wire over the batts to hold them in place permanently, attaching the ends of the mesh to the front of the furnace. Then proceed with the next layer of batts and so on until the entire surface is covered. These batts have a paper covering on one side, which should be placed outward. Care must be taken to protect the paper with asbestos paper if it comes near a fire door.—C. Lundy, Floral Park, N. Y.

Box-Opening Tool From Old File

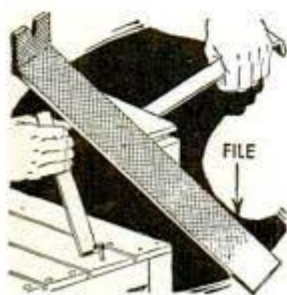

An old 12-in. file can be made into an excellent tool for opening wooden packing cases. First, grind down one end to a chisel shape and then heat the other end and bend it at right angles as in-

dicated, grinding a notch in it to provide a nail puller. In use, wedge the chisel end between boards to be parted and tap the other end with a hammer. This will loosen the nails so that they can be pulled with the notched end.

Renewing Teeth on Pipe Wrench

If the teeth of a pipe wrench have become battered and worn so that the wrench no longer grips the work securely, they can be recut easily. Since the jaws of most pipe wrenches are too hard to be recut

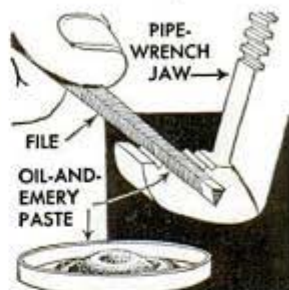

with a file alone, you will have to use some fairly coarse emery powder. Mix the powder with heavy machine oil to produce a stiff paste. Then, after clamping the wrench jaw in a vise to hold it, rub the paste over the teeth and with a slim, triangular file, preferably an old one, taking full, heavy strokes to reshape the teeth.

—W. C. Wilhite, Carlinville, Ill.

Envelope Slipped on Auto Visor Provides Handy Extension

A large envelope placed over the end of a car sun visor provides an excellent emergency extension. Many sun visors are too short to catch all the light rays, especially when driving early in the morning or late in the afternoon.



This TEA CART

has a picture-frame tray

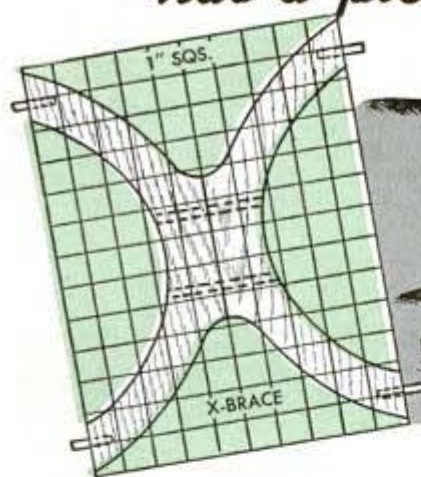

An old picture frame backed with plywood provides a removable tray for this tea cart, the sides of which are X-shaped assemblies mortised and glued together. An X-brace at the center and a $\frac{3}{4}$ -in. plywood top doweled to the sides provide rigidity. Wheels are wood disks metal bushed to rotate on heavy screw spindles. Battens recessed into the inner surfaces of the wheels prevent warping and leather tires protect the finish of polished floors

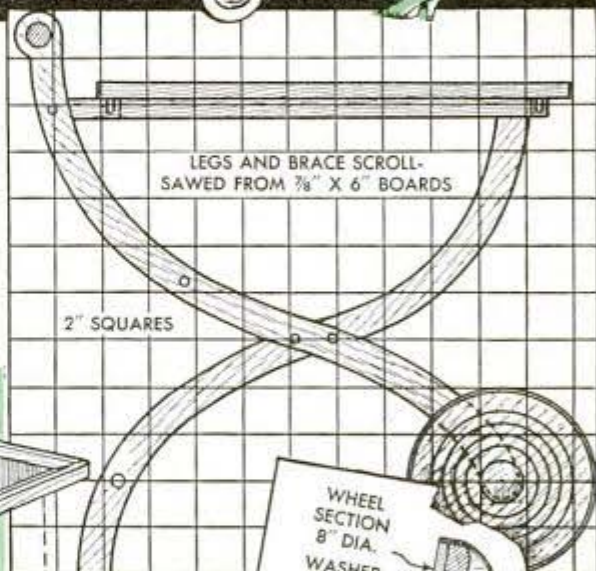

14½" X 20" PICTURE FRAME
DOWELS SERVE AS LEGS WHEN TRAY IS SET ON TABLE

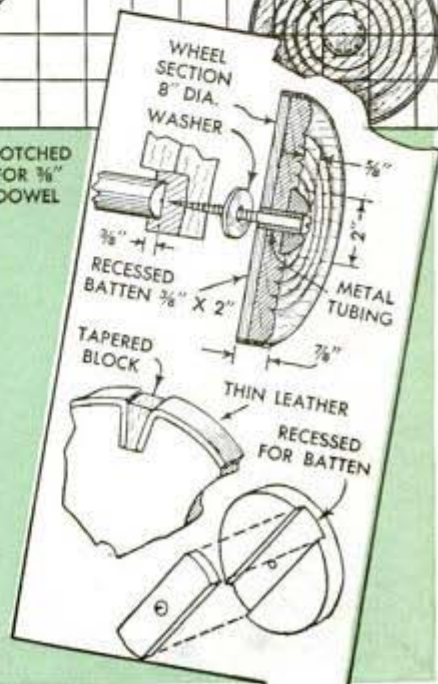
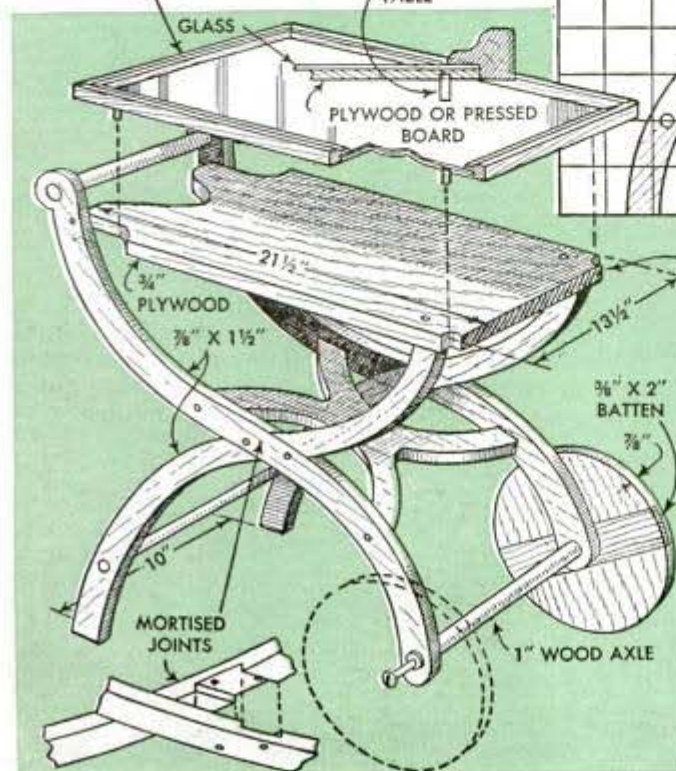

Game Boards Stored Under Table And Held in Place by Springs

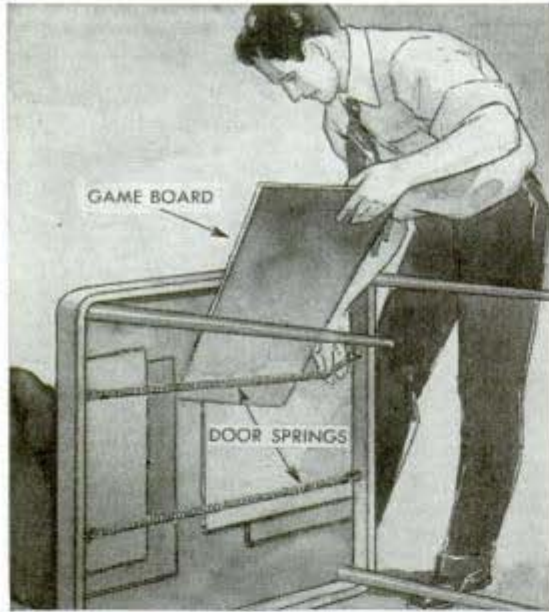

Game and playing boards of various types are kept out of the way yet ready for instant use if they are stored under a card table. Two screen-door springs stretched across the bottom of the table will hold the boards securely.

—Ronald Eyrich, Milwaukee, Wis.

Knee Linings Protect Trousers From Perspiration Rot

Ruining of woolen trousers at the knees due to perspiration is avoided if the inside of each trouser leg is lined for about 7 in. with the finest grade of oiled silk. By sewing through the seams, no stitching is visible on the sides, and the top and bottom edges are held by "whipping" over the edges with a stitch that does not go clear through the trouser fabric. This lining is not affected by cleaning and pressing.

Ruler Indicates Measurements When Drawing a Line

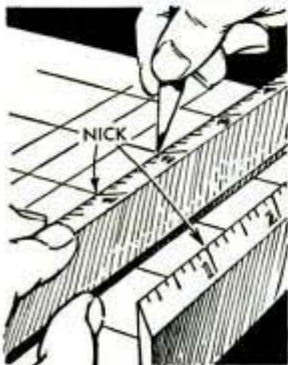

Indicating 1, $\frac{1}{2}$ and $\frac{1}{4}$ in. when drawing a line, this ruler is a handy adjunct to any drawing table. Shallow, sharp nicks are made in the ruler edge with a small triangular file, each nick being accurately placed op-

posite the marking. When using the ruler as a straightedge to draw a line the measurements are indicated by tiny jogs in the line. In addition to accurate measuring, the nicks indicate the proper spacing of cross lines when ruling is to be done.

Weed Growth Near Fence Posts Prevented by Guards

To save a lot of hand work trimming weeds and grass away from fence posts bordering a large lawn, one home owner cuts square pieces from discarded roll roofing and fits these about the posts. The roofing squares smother out any growth close to the posts.

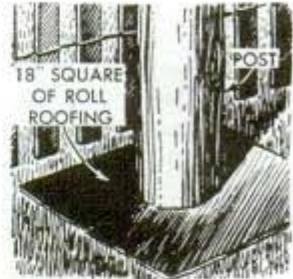

Cardboard Box Lid Holds Screws While Painting the Heads



If you wish to paint the heads of screws before using them, just drive them part way into the cover of a cardboard box. This will hold the screws so that you can paint them with a sweep of a brush.

Glue Shot Into Furniture Joint With Grease Gun

When mortise and tenon joints in furniture have loosened, and construction will not permit further loosening for insertion of waterproof glue, this can be forced in with a small grease gun. A small hole is bored in the underside of the rail and aimed to come alongside the tenon. Cabinet shops will find this idea useful for making quick repairs on loose joints of this nature.



Old Cistern Made Into Vegetable Storage Cellar

Having an old cistern that was no longer in use, one gardener converted it into an ideal vegetable storage cellar. About 12 ft. deep and 10 ft. in diameter, the cistern had two intake pipes which were disconnected at the downspouts and plugged with concrete. The opening at the top was enlarged so that large boxes and baskets of vegetables could be lowered through it, after which it was fitted with a manhole cover, obtained at a junk yard, to make the opening rain tight. Then an opening was broken through the concrete bottom of the cistern and a drainpipe installed, the pipe reaching down into a layer of sand and gravel to provide good drainage. The pipe extended about 2 ft. up inside the cistern, which was then filled with gravel almost to the top of the pipe. On top of this was poured a new concrete floor, the layer of gravel between the floors assuring dryness.

Next, two ventilator tiles were installed to extend above the ground. The inlet pipe just reached through the top of the cistern and the outlet pipe was extended to within a few inches of the floor. A small exhaust

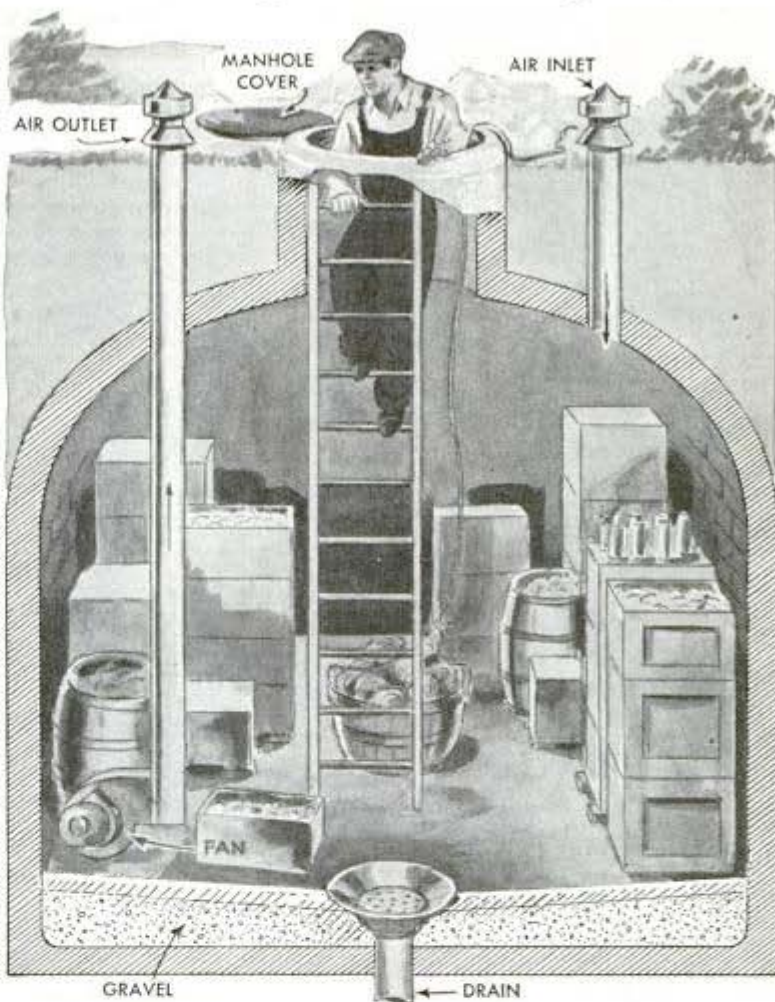

fan of the type used in kitchens was installed at the lower end of the outlet pipe. Operating the fan for a half hour two or three times a week keeps the cellar well ventilated.—Harry L. Spooner, Peoria, Ill.

Midget Ruler to Carry in Your Wallet Has Many Uses



By cutting a 6-in. ruler in two, you will have a rule that will slip into your wallet and always be handy when needed. Experience has shown that a good percentage of simple measurements are 3 in. or under. However, many 6-in. rules can be "hinged" in some manner to make them fit in a wallet or other small space.

PASSING UP AN OPPORTUNITY?

Have you ever said "That's a good idea for Popular Mechanics" but you failed to send it in? Next time, don't pass up an opportunity—write a short description, include a clear photo or drawing, and mail it to the Homecraft Editor. If your idea is accepted, a check will be sent promptly.

CHRISTMAS GIFTS

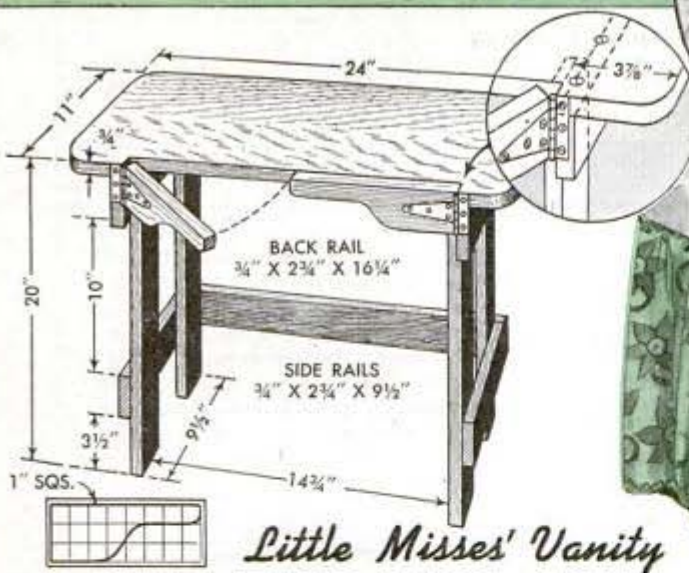

Little Misses' Vanity

Just like mother's, this little girl's cretonne-covered vanity has a stool to match. The wooden frame is sanded smooth to remove splinters before painting. Top may be painted only or covered with linoleum. The cloth skirt, which reaches the floor and goes around the front and ends to hide the framework, can be tacked to the top for easy removal when cleaning. The seat is padded before it is covered

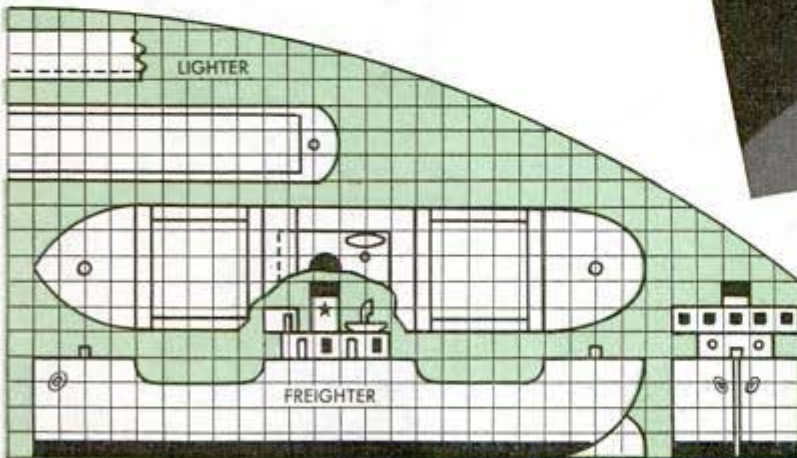
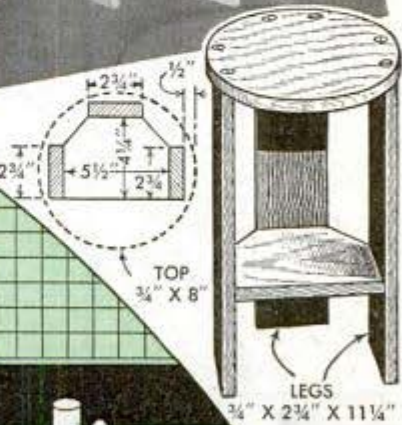

At Pier 14

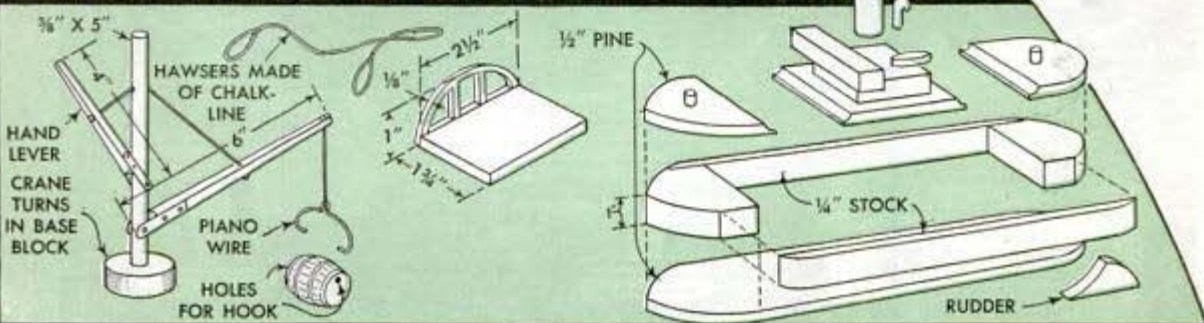

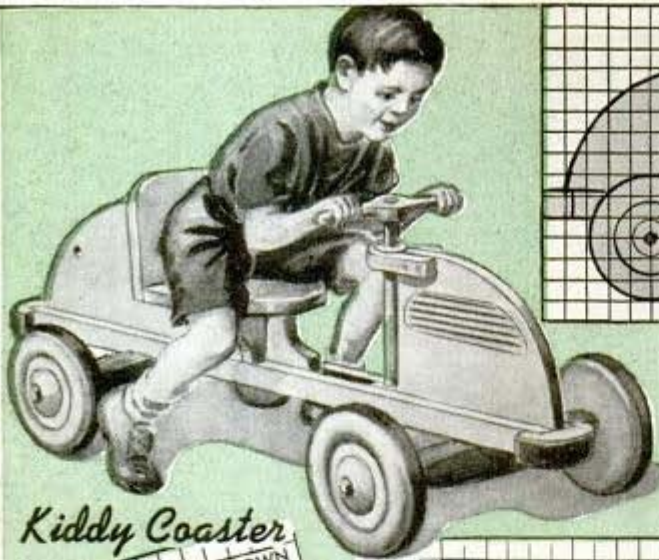

Kiddy Coaster

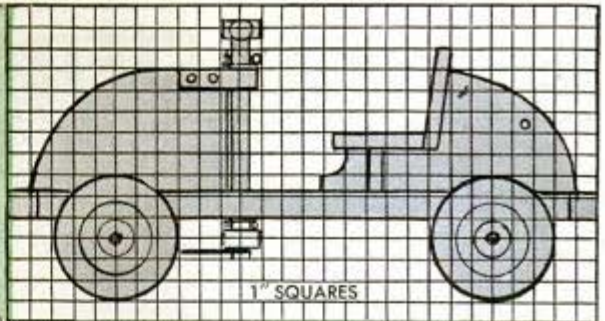

Moved by the feet or pushed by a handle, this coaster has interchangeable front ends that clamp in the frame to simulate a car, horse or locomotive. Leather-covered bumpers and tires protect furniture and woodwork, while metal-bushed wooden wheels rotating on lag-screw axle spindles assure long life

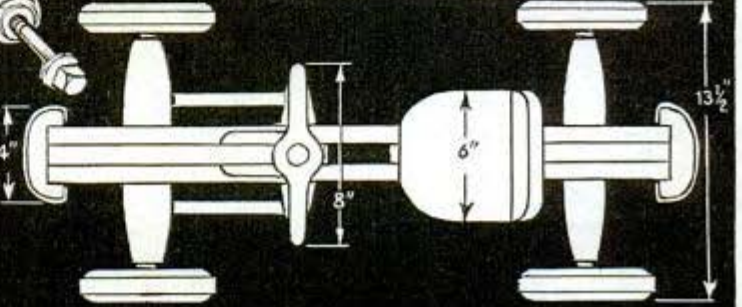
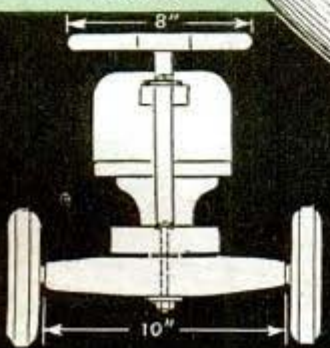
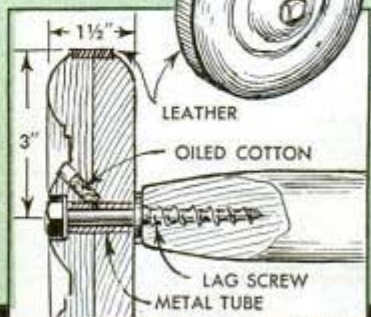
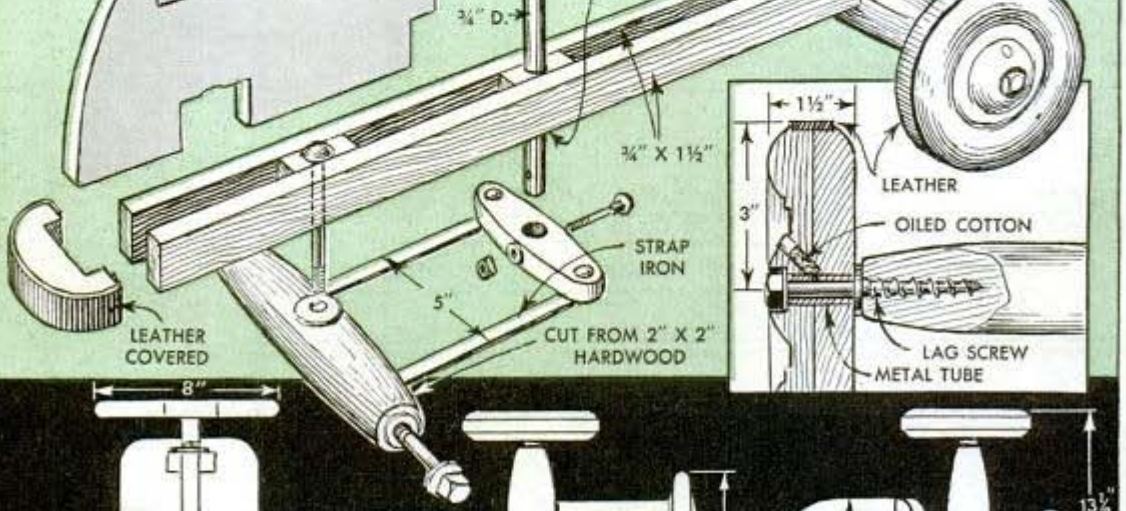
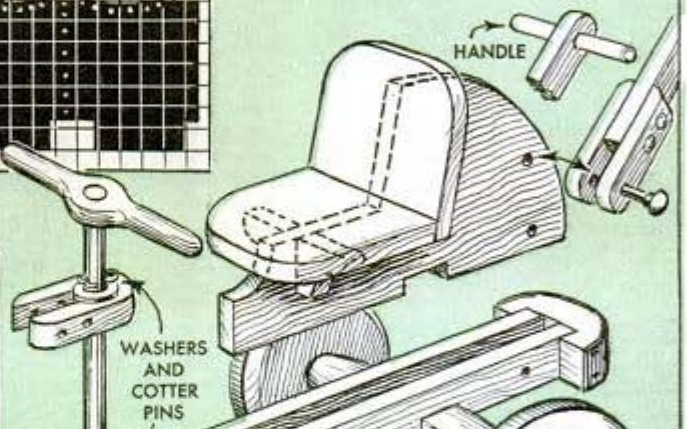
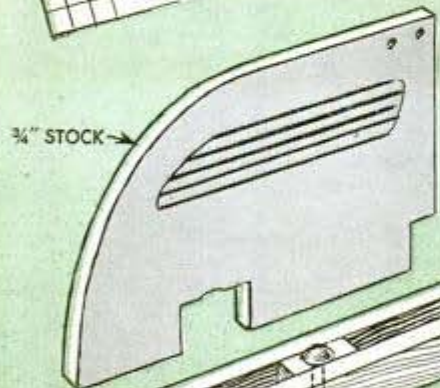
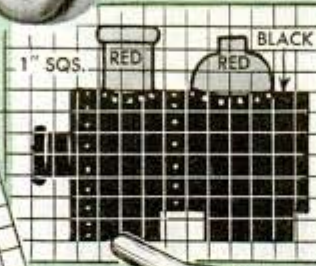
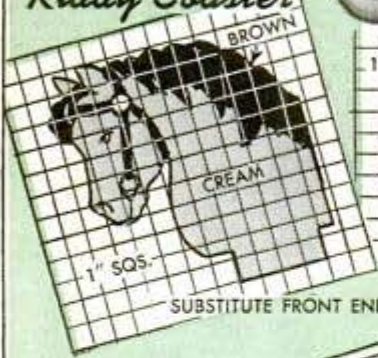

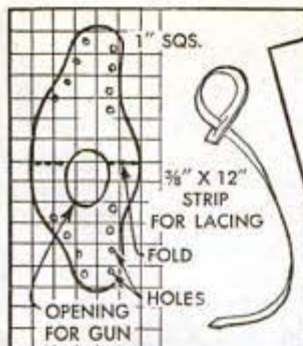

Toy-Gun Holster

The young commando will like this holster cut from rubber or fabric and bound with a colorful lacing

Turned Compact

Turned from walnut, this compact holds a mirror and puff. Bandsaw the rims so they telescope and hold together without a catch. Sand thoroughly and finish with two coats of synthetic shellac, rubbing down well with 4/0 steel wool

It's easy to make bracelets and necklaces from black walnuts. After completing the procedure below, wax and polish the slices, and then string them, using thread for the necklace and small, round elastic for the bracelet

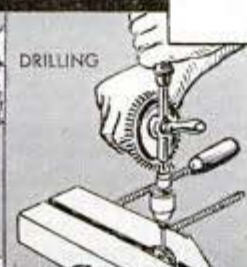
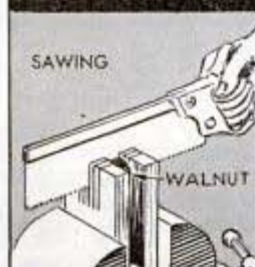

Walnut-Shell Bracelets and Necklaces



Hungry Pelican

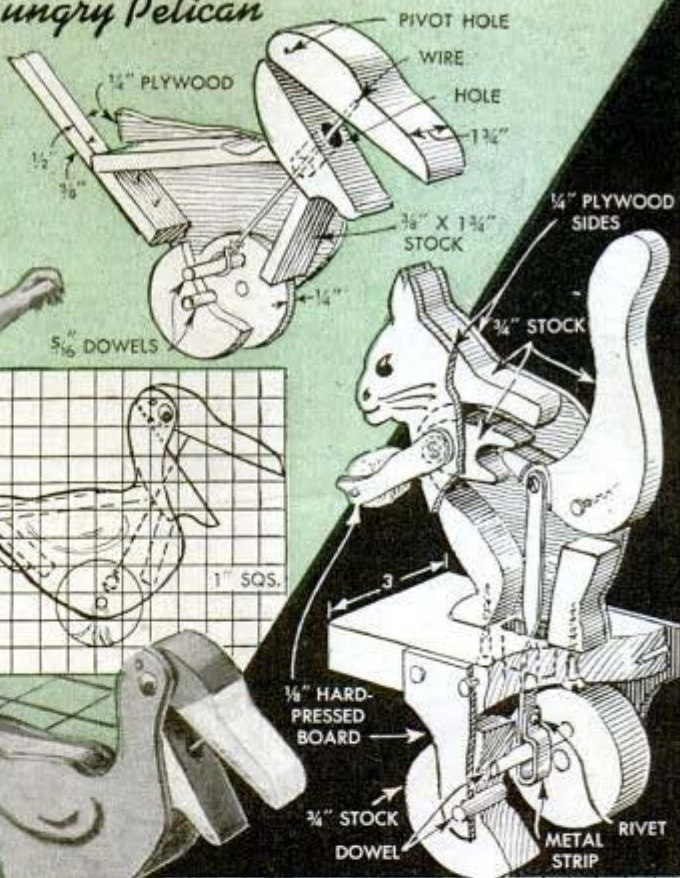

Opening and closing his beak in a realistic manner when pushed over the floor, this pelican will delight any small child. Pivoted between jigsawed sides of plywood or hard-pressed board, the upper half of the beak is actuated by a wire connecting rod, which works off a crankpin glued between the wheels which turn on stub axles

Nibbling Squirrel

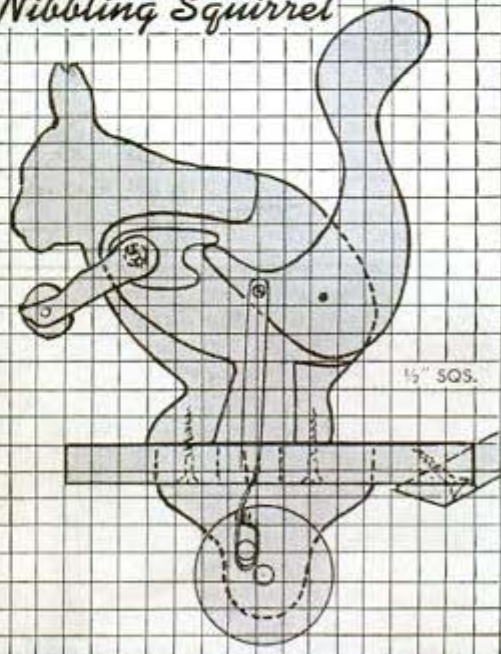

Like a real squirrel, this one flicks its tail as it nibbles on a nut. Note that the connecting rod is looped over the crankpin to impart a lifelike motion to the tail and front feet. Sand both sides of all the movable parts so that they work freely



Modern Doll Dining Set

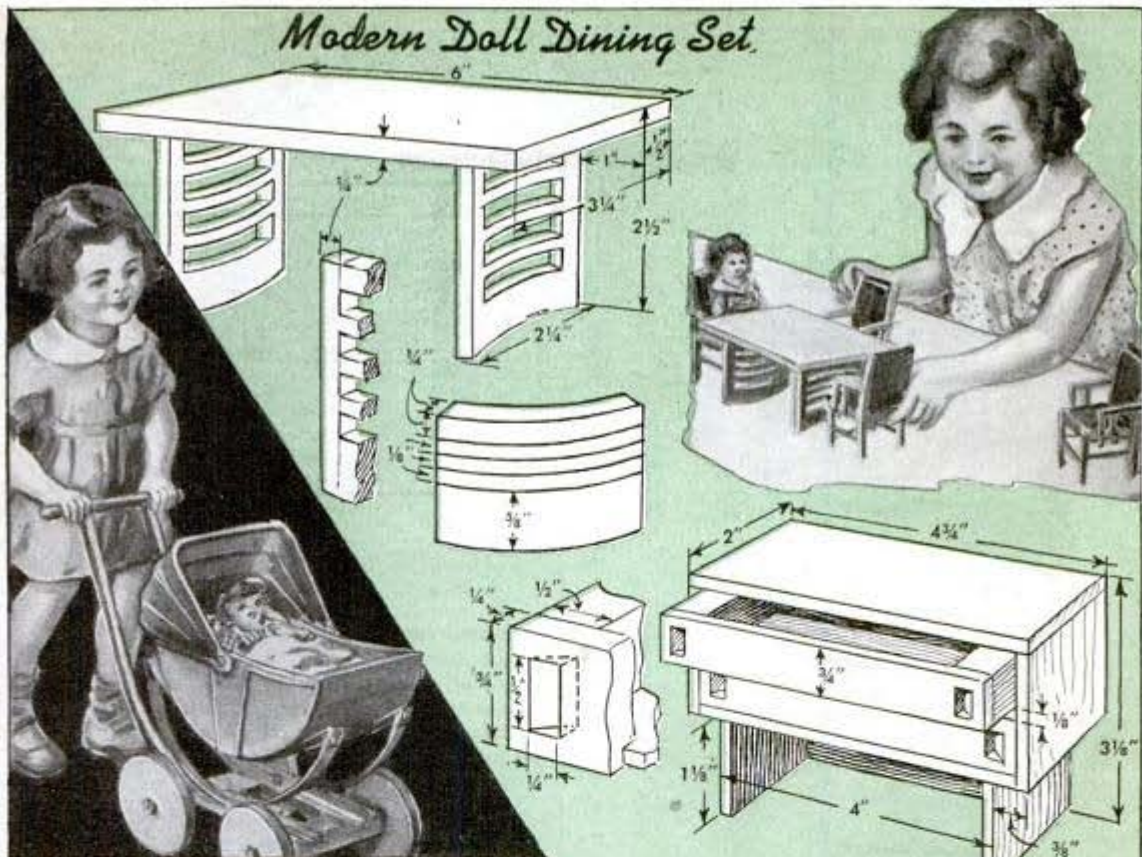

Your small daughter will be delighted with this chair, buffet and dining table for her doll house. Table legs are built-up and the top is glued and bradded to them. The buffet can also be used as a bedroom dresser and the chairs will serve anywhere

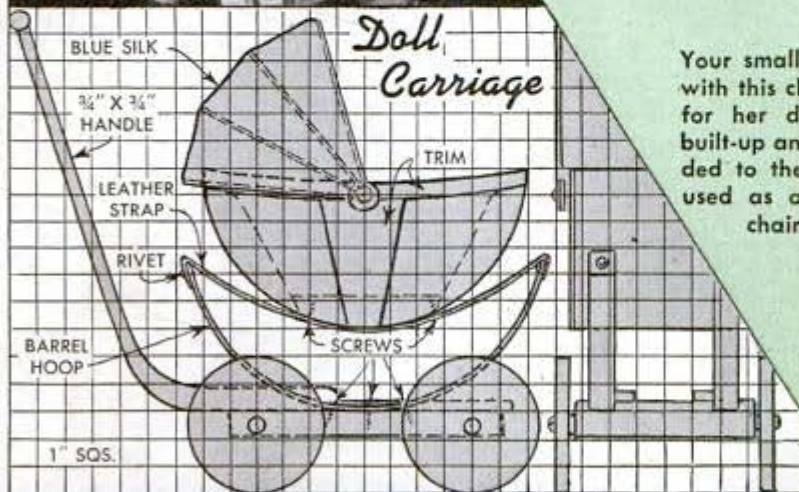

This doll carriage has a fabric shade stretched over a piano-wire frame. The springs are formed from barrel hoops cut in two and held to shape by straps

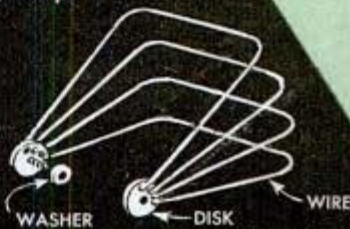
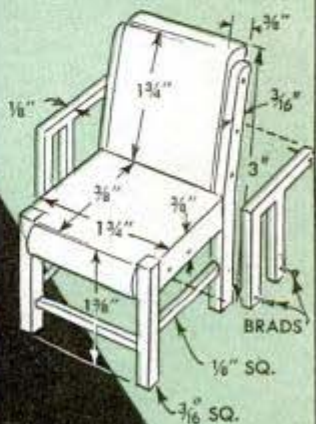
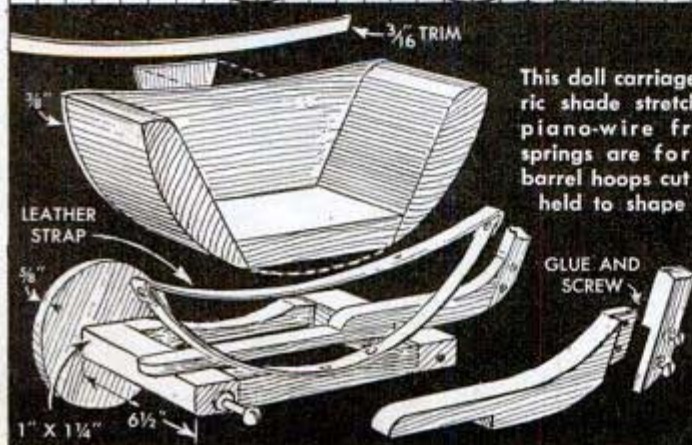



"Book" Magazine Basket

Walnut sides contrasting with maple ends make this unusual basket suitable in any room

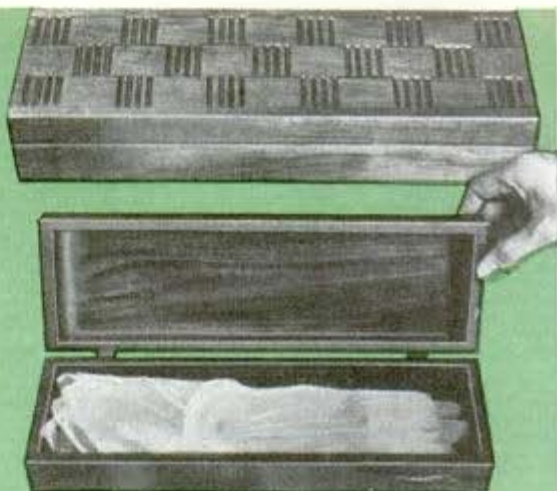
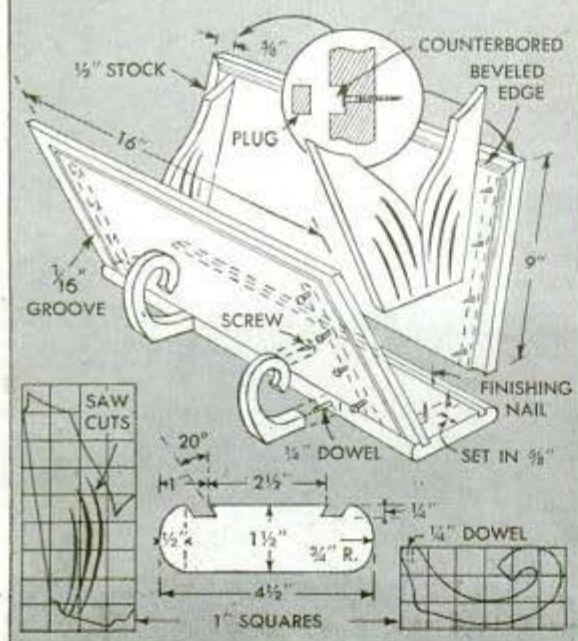

"Woven-Lid" Glove Box

Unusual construction of this box eliminates the usual box corner joint. The novel woven effect on the lid is achieved by first grooving the solid stock and then ripping it into strips. These are staggered, doweled and glued together, and then band-sawed to correct thickness

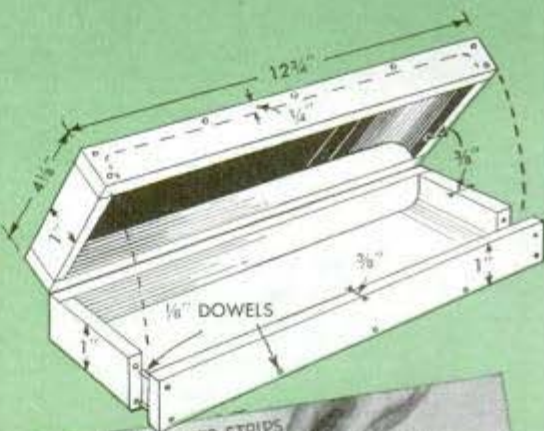

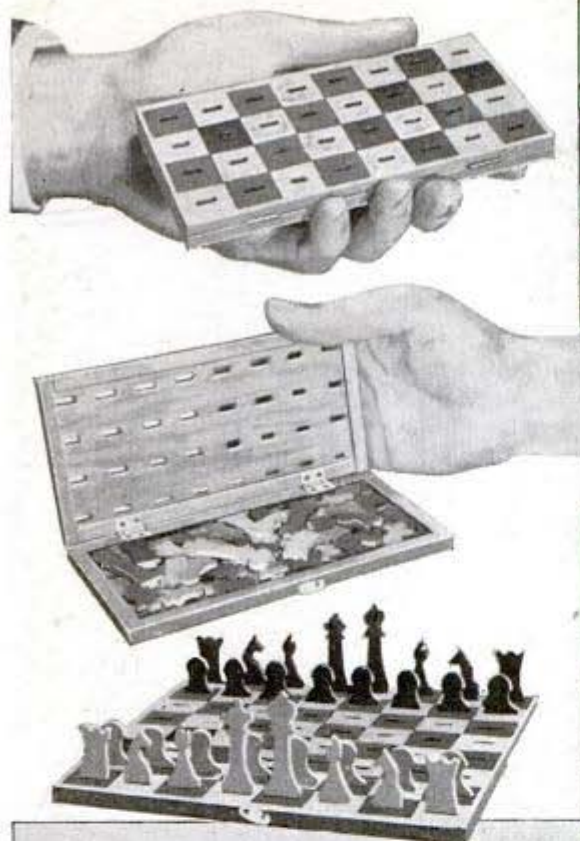

Pocket Chess Set

This pocket chess set is a welcome gift for service men because it folds compactly with the chessmen inside. Chessmen are flat and are jigsawed from $\frac{1}{8}$ -in. stock, each having a tab extending at the bottom to fit slots in the squares of the board to support them vertically

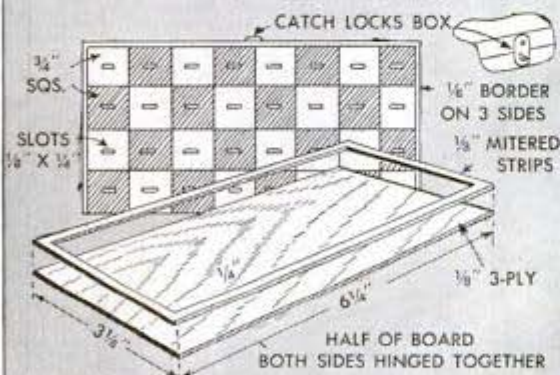

KING 1 WHITE 1 WHITE 2 WHITE 2 WHITE 2 WHITE 8 WHITE
 1 BLACK 1 BLACK 2 BLACK 2 BLACK 2 BLACK 8 BLACK

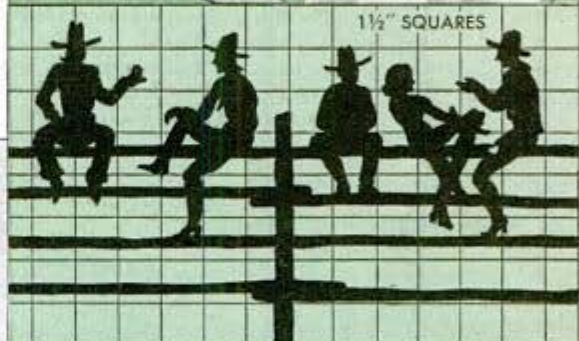

Hat Racks for the Outdoor Man

A scrollwork of "fence sitters" gives the rack above a pleasing western atmosphere, while an edging of rope and anchors topped by a ship's wheel makes the rack below distinctively nautical

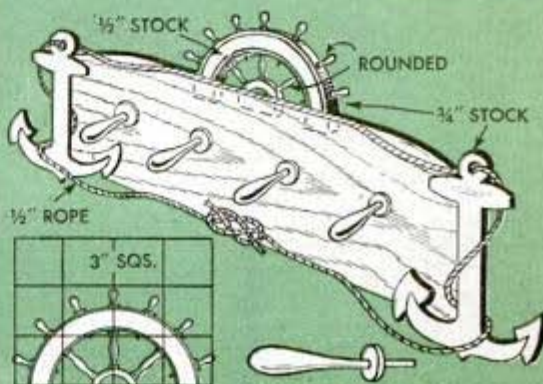
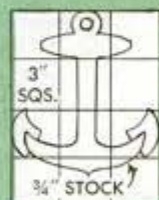

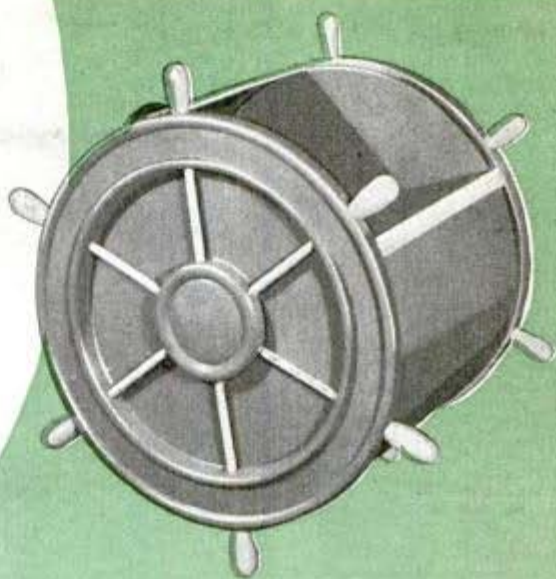
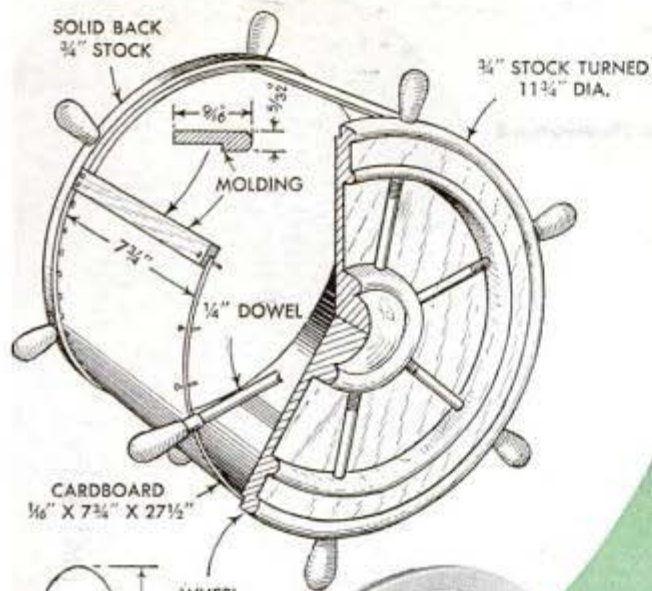

Unusual in design, these two wastebaskets look well in any room. The ship's wheel basket above consists of two turnings drilled as below for insertion of the spokes. Cardboard edged by molding strips at the basket opening and nailed in the rabbeted edges of the turnings hold assembly together

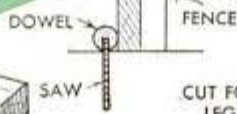
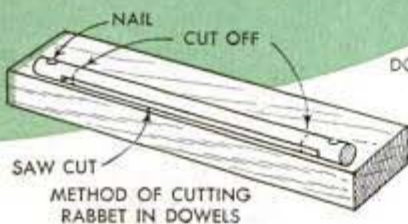
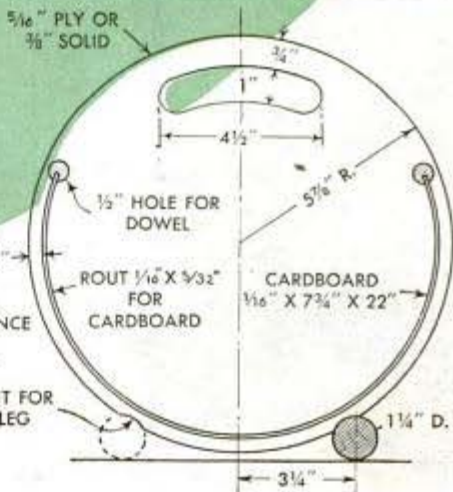
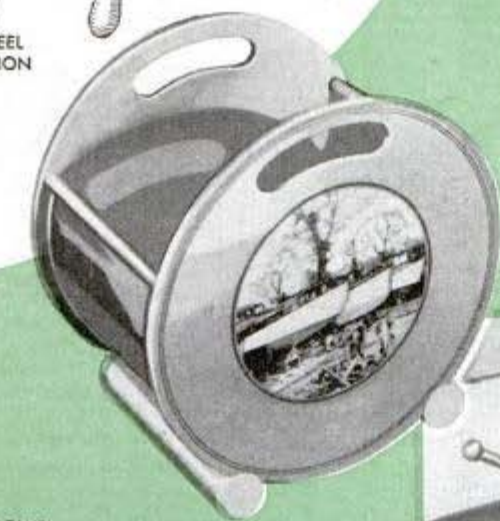
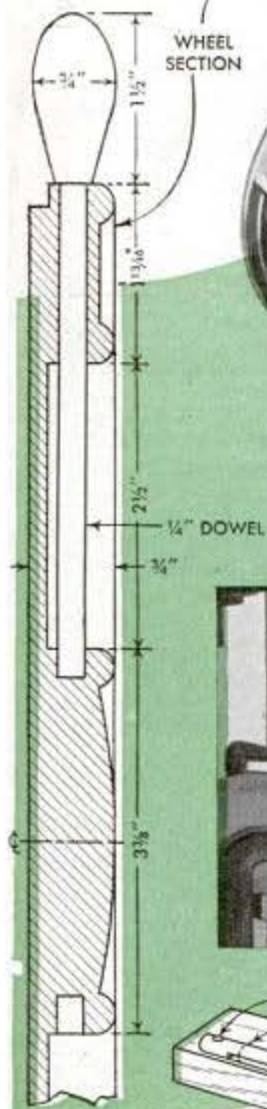

Picture Frames



Holders for your snapshots are easy to make without troublesome framing. Just saw out an easel or a star-shaped base as above, place the picture between two pieces of glass, the edges of which have been filed smooth, insert the assembly in the holder and the job is done

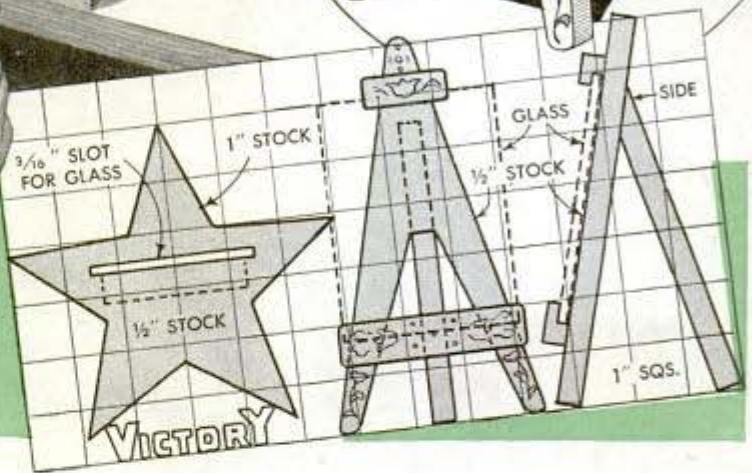

Pictures and glass are inserted through the bottom of this unusual picture frame and are held in place by a wooden insert, which in turn is secured by a hickory splint, the latter making it easy to dismantle and pack the assembly flat for convenient packaging or mailing. The splint, of course, projects through holes in the standard into blind holes in the base

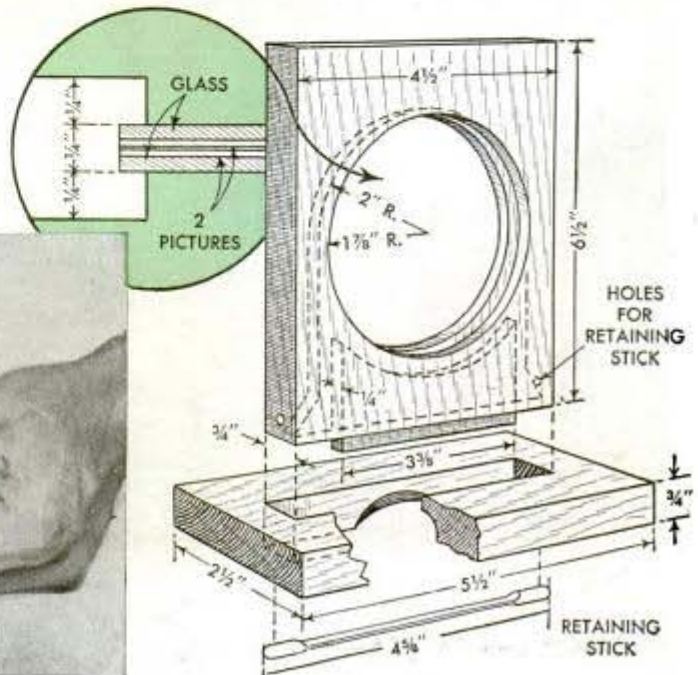

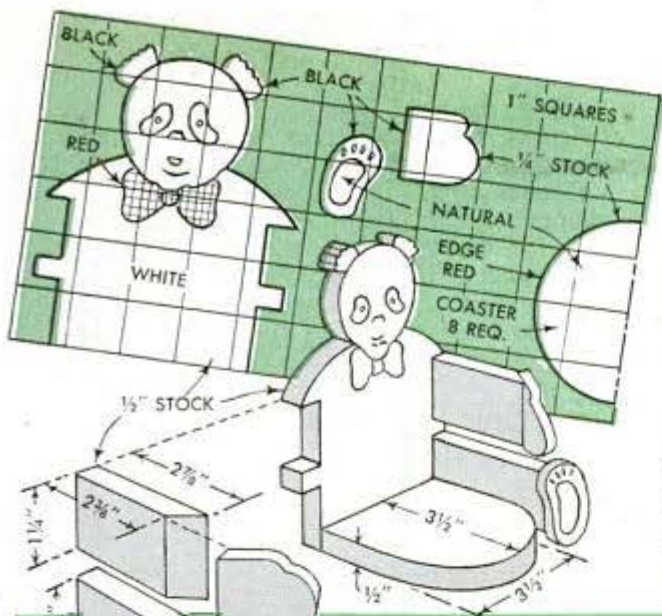

Panda Coaster Set

Patently holding eight 3-in. coasters cut from 1/4-in. plywood, this little figure has a body cut from 1/2-in. stock and feet and hands jigsawed from 1/4-in. plywood. Painting suggestion is given in the upper detail

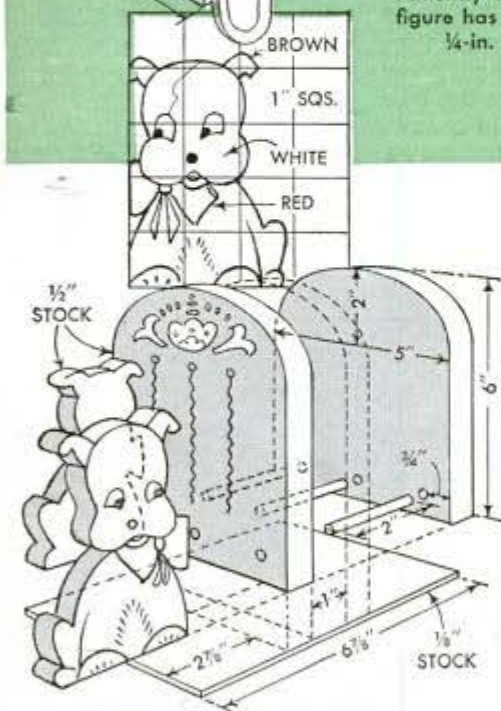

Book Ends and Watch Holder

The problem of storing children's books of various sizes is solved with these book ends. Large books are placed between them and small ones are set at each end. There also is a place for pamphlets and papers. The novel holder at the right converts your old pocket watch into a useful dresser "clock." Note that the one-piece foot and leg is notched into the body

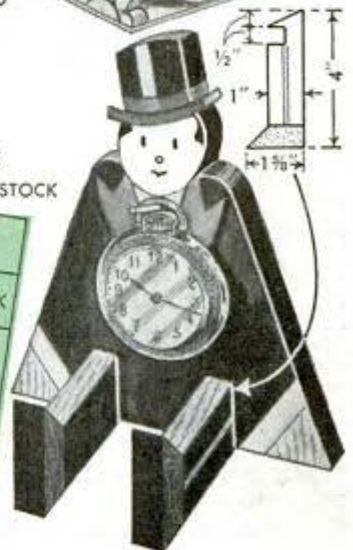
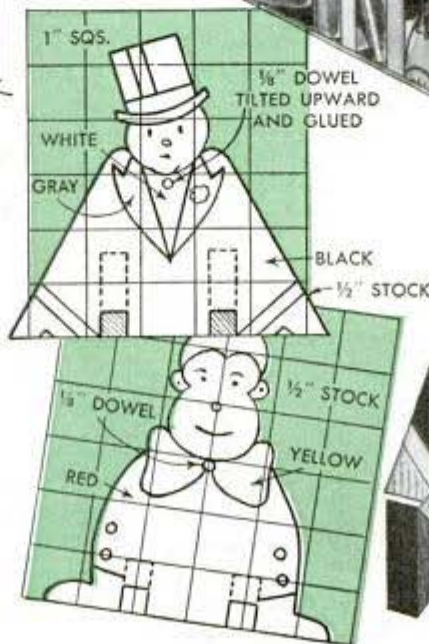
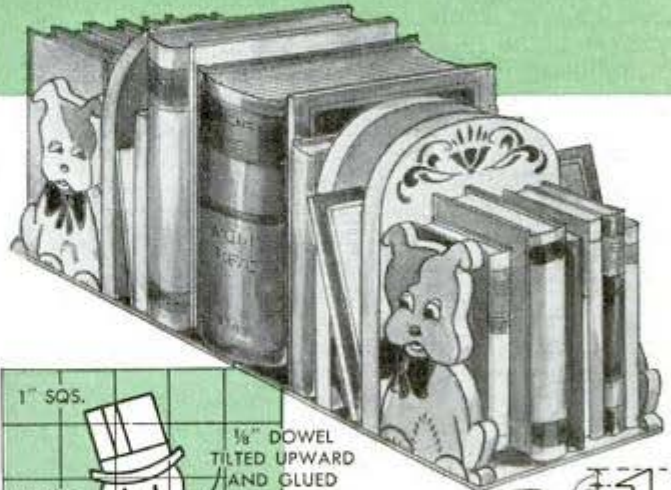

Corner Post of Barracks Bunk Holds Shoe for Polishing



Here's a suggestion for the boys in the barracks who sometimes grow weary of trying to shine their shoes without having a suitable support to keep them steady under a vigorously applied brush or a flapping cloth. As shown in the illustration, a shoe can be held fast between the corner posts of double-deck bunk beds with the heel placed on top of the lower post and the upper post set into the shoe. To avoid marking the heel or inside leather by the tenon which holds the posts together, a metal or plastic jar cover or a piece of wood or cardboard can be inserted in the shoe before it is placed under the post.

—Pfc. R. F. Crocker, Camp Campbell, Ky.

Shears Taped to Protect Hands

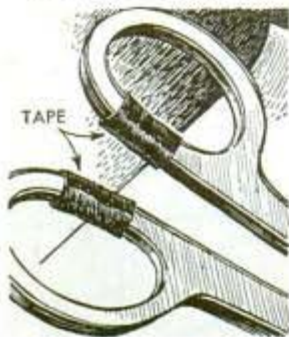

The fleshy part of your hand can be pinched severely in using tin shears, the flesh being caught unexpectedly between the handles. To avoid this, merely wrap a short length of tape around each handle as shown.

Sprinkle Sawdust on Icy Walks

The next time your sidewalk is covered with ice, sprinkle sawdust on it instead of the customary ashes, sand, or cinders.

Sawdust is superior to these materials because when the ice melts sand, ashes and cinders settle to the bottom and leave a slick surface when water freezes again, while sawdust floats. It may cling to the soles of one's shoes almost as tenaciously as ashes and sand but it does not ruin carpets or hardwood floors if tracked into the house. Also it absorbs moisture more efficiently and adheres to the ice just as well or better. After the ice has melted and the moisture dried, the sawdust remains but is easily swept or washed away.

Renewing Pad on the Screw End Of Broken C-Clamp

If you are unfortunate enough to break the pivoted pad on the screw end of a C-clamp, the pad can be replaced with one built up from iron washers. To do this, first slot a washer that will not pass over the bead on the end of the screw, slip it over screw back of the bead and close the slot with a hammer. Then, apply three washers that will slip over the bead, and lastly a solid piece of metal at the end of these and weld or braze the assembly together.—Louis Coia, Tullystown, Pa.

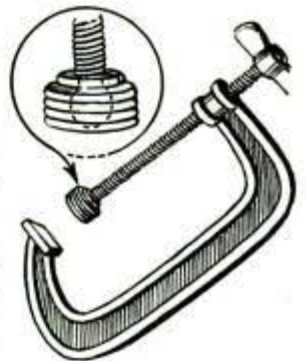

Tearing Paper Against Saw Blade Gives Neat, Uniform Edge

When it is necessary to tear wrapping paper, press a saw blade lightly against the paper and tear along the saw. This makes a uniform and neat tear either with or across the grain, and is especially useful if a number of narrow strips are needed.

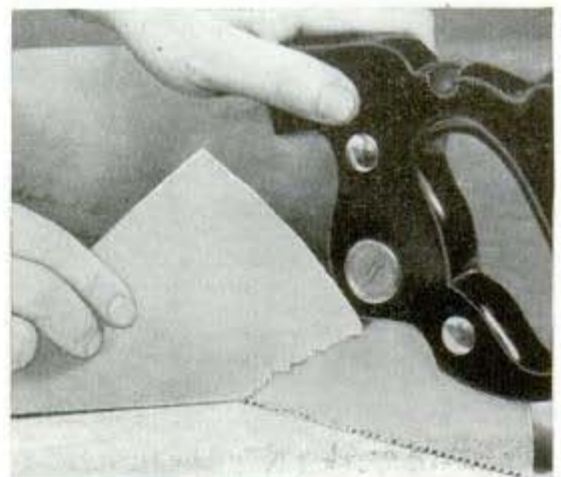

Fun on the Ice With This Speedy Skate Sled

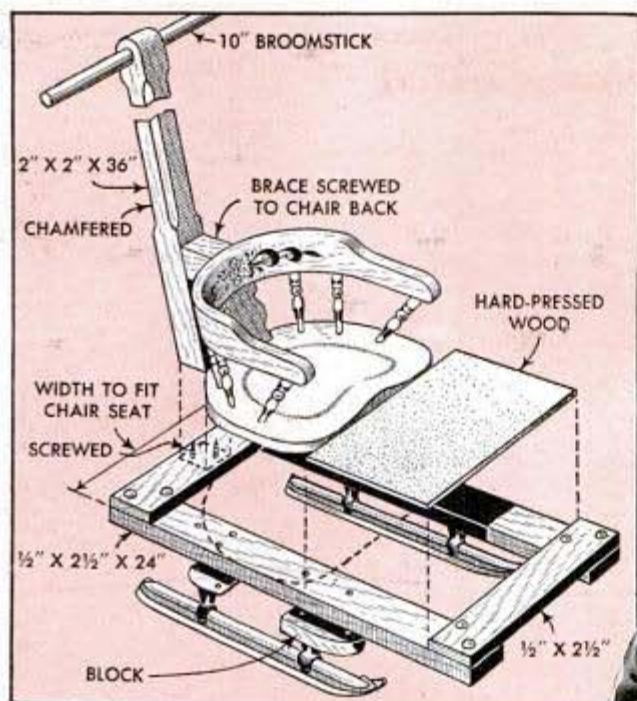

A pair of ice skates—an old pair will do—a few pieces of wood and the seat and back of a child's chair assembled as shown are all you need to make this push-type skate sled that will skim over the ice with ease. Use just the runners and foot plates of the skates, with a filler block on the front plate to raise it even with the rear one, and fasten the skates to the frame with screws. A brace reinforces the

handle as shown, and a piece of hard-pressed wood supplies a place for the rider's feet.—Harold Gluck, Bronx, N. Y.

Bolt in Car Door Partition Keeps the Rear Door Locked

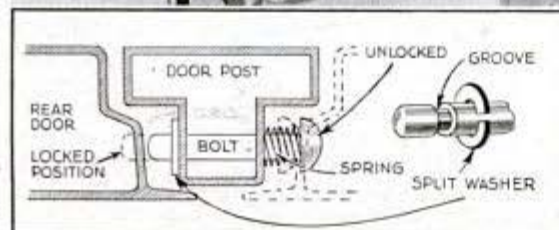
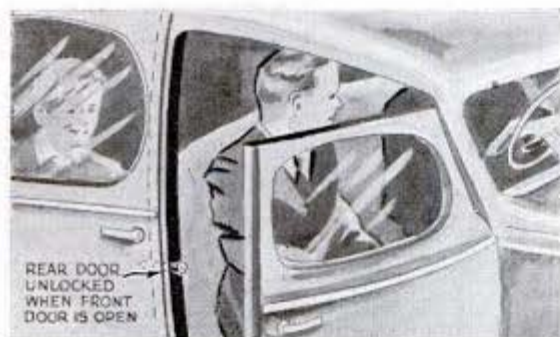

A sure way to keep children from falling out of a moving automobile by accidentally opening the rear door is to install a simple rear-door lock made by inserting a round-head bolt through the upright partition so that the front door, in closing, forces it through a hole drilled in the metal edge of the rear door to lock it securely. A coil spring slipped over the bolt forces it out of the catch when the front door is opened, and a split washer set in a groove near the end keeps the bolt from dropping out.

Kerosene Cleans Auto Radiator

A solution that will remove grease and grime from inside auto radiators can be made by mixing kerosene, 1 part, with water, 2 parts. Place this in the radiator, run the motor until the solution is boiling, then drain and fill with clean water.

C-Clamp Used as Carrying Handle For Small Keg of Nails

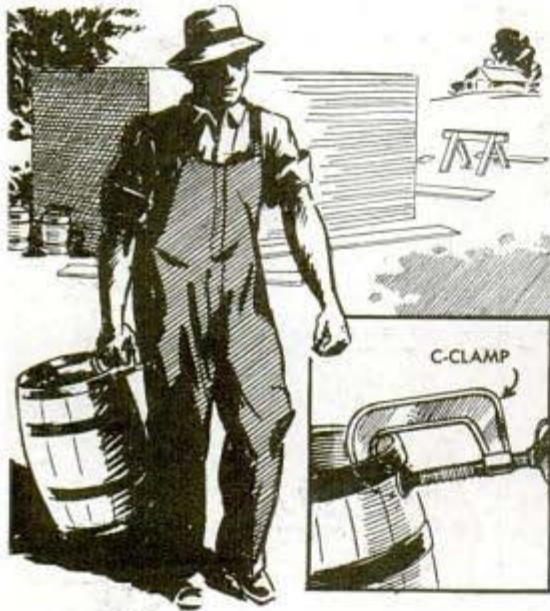

The difficulty of carrying a small keg of nails because of the lack of a handle can be overcome by improvising a handle from a large C-clamp. Just attach the clamp to the keg as indicated. This idea can be used on only small kegs as the weight of larger ones likely would bend the clamp.

Silencing Worn Shock Absorber With Rubber Bands

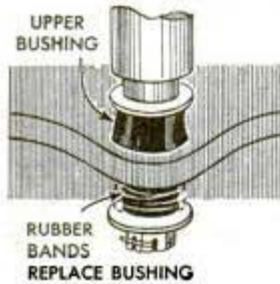

When a rubber bushing in the linkages of some car shock absorbers wears or rots away and allows an annoying rattle to develop, it can be repaired temporarily with rubber bands until a replacement can be made. Just wind several bands tightly around the exposed shaft as indicated. On ball-and-socket types of linkages, pieces of old inner tube can be used instead of the bands.

Fall Covering Saves Roses

Roses are in less danger of winter killing if the base of each plant is covered with soil or peat moss to a height of about 6 in. A covering of hay, straw, or leaves should be added after the ground has frozen. Another common practice is to tie the tops together and cut them off about 18 in. above the ground. Climbers generally should be removed from their supports and placed

along the ground, covered lightly with burlap or straw, while in very cold climates the climbers should have a dirt covering. Uncovering the plants a little at a time in the spring makes damage from late frosts less likely.

Column Clamp Made From Cord And Screen-Door Spring

The next time you are building up a column or half column and there are no suitable clamps at hand, try some screen-door springs. Use as many as necessary and tie them around the work with strong cords as shown. Clamps of this type exert uniform pressure on all joints of the column regardless of its contour.

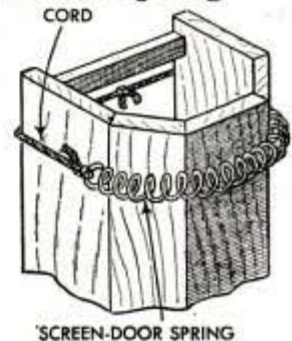

Reading Luminous Watches

To read a luminous-dial watch at night, which often is difficult because the minute and the hour hand cannot be distinguished from one another, I simply note the position of both hands in relation to the stem and then move them. In doing this, the minute hand is recognized because it moves the most. Then, I can return the hands to their approximate former positions and note the time. This method is not altogether accurate but works well enough in most situations.—Pfc. Andrew Vena, U. S. Army.

Universal Joint for Light Work Made From Brake-Rod Clevises

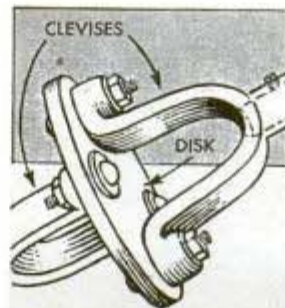

Flexible or universal joints for use in light machine drives can be made inexpensively from clevises taken off the ends of old car brake rods. The clevises are heated and bent at right angles at the ends as indicated, after which they are bolted to a disk of leather taken from an old shoe sole or heavy belt. Usually the shanks of these clevises are threaded to screw onto the rod where they are held by locknuts. They can be attached to your drive shafts in the same way or they can be drilled and tapped for setscrews to lock them in place.

Holder Keeps Paper Napkins Neatly on Table

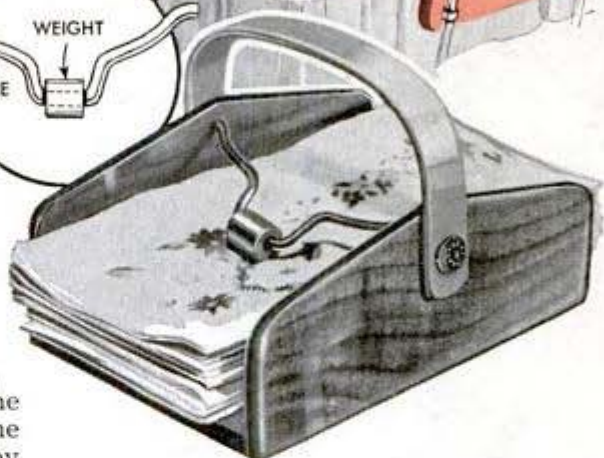
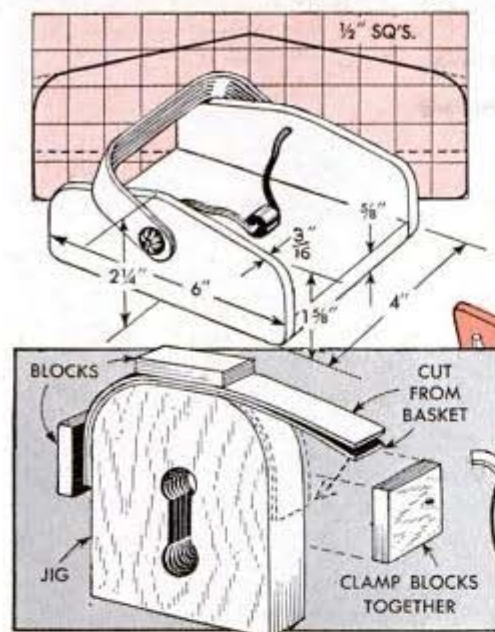

This little holder solves the problem of keeping a supply of paper napkins on the table so that they will be neatly arranged and cannot be blown or scattered about. Made from three pieces of wood cut to the size and shape shown in the upper left-hand detail, the holder is the right size for standard napkins that come folded into squares slightly less than 7 by 7 in. When the squares again are folded in half they will slip nicely into the holder. It can be nailed or glued together, using nails with ornamental heads to pivot the handle. The latter is made from two splints, each $\frac{5}{8}$ by 8 in., cut from the thin sides of a fruit basket. To shape the splints, soak them in water for a few minutes and then clamp them over a jig made as shown in the lower detail. The jig is cut from a block of wood and has an opening in the center to

take one jaw of a C-clamp. You can use the latter on the upper clamping block and a short bar clamp on the two side blocks. A weight, which rests on the napkins, is held by means of a wire support shaped as shown in the circular detail. The ends of the wire are inserted into holes in the sides of the holder and should fit loosely. Finishing the holder is a matter of choice, using either a wax, varnish or paint.—Charles and Bertram Brownold, Woodmere, N. Y.

Frost Shield Removed Quickly by Using Piece of Thread

Removing automobile frost shields without tearing them or scratching the glass is easy if a piece of strong thread or wire is

worked under them as shown. The corner of the shield is the best place to start the thread under the shield.



Ready-Mixed Paste for Gravies

When cream gravies or sauces are needed, they can be made more quickly and will be much smoother if the flour-and-water thickening has been prepared beforehand. After the desired quantity of water is placed in a fruit jar, drop the flour in, cover the jar and shake until the paste is smooth.

—Mrs. Kathryn Geihm, Aurora, Ill.

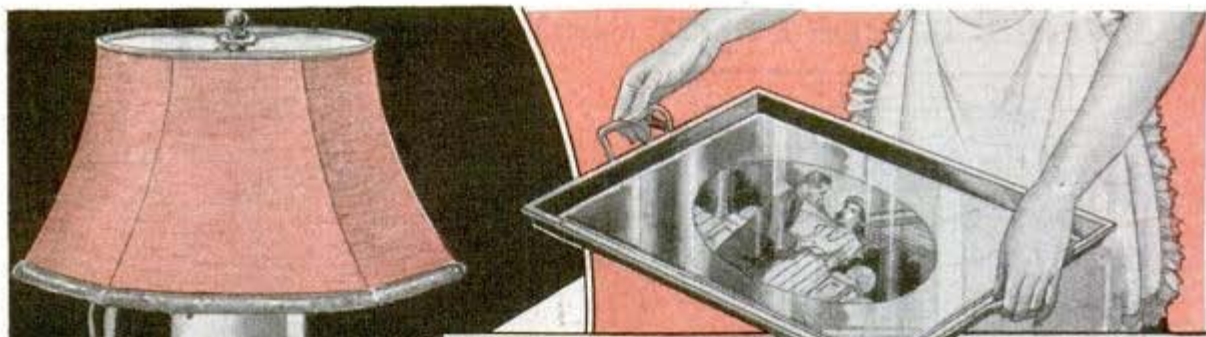

PHOTOS *on* METAL,

is fixed, washed, dried and coated with transparent lacquer. Doing the work is comparatively simple but it is highly important that you follow all details of the process carefully as described in this article. Photos can be applied to any flat surface and also to surfaces having a one-way curve, but not to surfaces having compound curves such as is the case with many vases and lamp bases, since the negative cannot be curved in two directions at the same time to contact the entire surface.

Cleaning the surface: The first



① METAL SURFACES THOROUGHLY CLEANED



② STIR WHILE ADDING LIQUID ACID DIP FOR BRASS AND COPPER

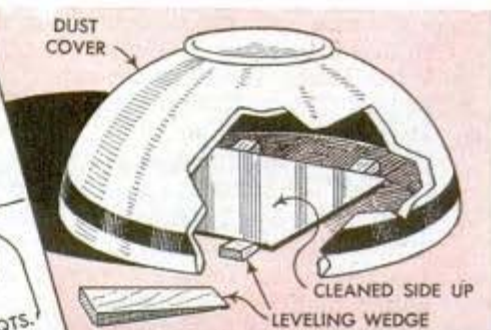

③ DRYING UNDER COVER

By C. A. Crowley

FOR a lasting and novel display, your favorite photos can be printed on lamp bases, serving trays, beverage glasses, plates, mirrors, wastebaskets and many other items made of non-porous materials. The work can be a fascinating hobby and has possibilities as a profitable spare-time business. All you need is a good negative, preferably one having considerable contrast. This is held in contact with the surface of the material which you have previously cleaned and coated with a gelatin base and a sensitizing solution. Then the exposure is made and the exposed surface

step is to prepare the surface, making it perfectly clean and free from dirt, grease and corrosion. Metals should be scrubbed in hot soap water containing a few ounces of washing soda per gallon, as shown in Fig. 1. Fine steel wool or other abrasives can be used to aid in cleaning the work while washing it, but these too should be washed off the work with soap and water. The soap water is rinsed away in hot and cold running water. Following this, if there is any rust or corrosion, it must be removed. Brass and copper can be freed from tarnish by dipping in a solution of nitric acid, 1 lb., and hydrochloric acid, $\frac{1}{2}$ oz., in water, 3 qts.,



GLASS and POTTERY

as shown in Fig. 2. The solution is prepared by slowly adding the acid to the water in a stoneware crock, stirring with a glass rod or a wooden paddle while mixing. Aluminum is dipped in a solution of 50 percent hydrofluoric acid, 1 part, and water, 9 parts. A lead or wax-lined container must be used for this solution as hydrofluoric acid attacks glass or stoneware. Or, aluminum can be dipped in a solution of sulphuric acid, 1 lb., and water, 1 qt., to which is added sodium dichromate, 1 oz.

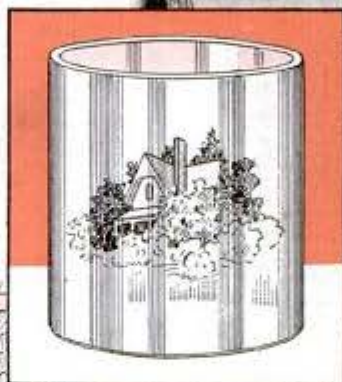

1st—ADD CHROME ALUM
3 GRAINS, IN WARM
WATER, ½ OZ., MIX
WELL

GELATIN, 40
GRAINS,
IN WATER,
1 OZ., HEATED
TO DISSOLVE
GELATIN AFTER
SOAKING

2nd—ADD 10 DROPS
OF A 10% SOLUTION
OF PHENOL

4 PREPARING THE GELATIN MIXTURE

The sulphuric acid is added slowly to the water in a stoneware crock, stirring while adding and, after mixing, the sodium dichromate is added. The metal is dipped in the solution for a few seconds and then rinsed in hot and cold running water. Then it is permitted to dry in air, protected against dust as shown in Fig. 3.

Mixing the gelatin: The surface on which the print is to be made is first coated with a gelatin mixture and later with the sensitizing solution. The gelatin mixture is prepared in two parts. First, put gelatin, 40 grains, in an enameled pan with water, 1 oz., allowing it to soak for about 15 min. While the gelatin is soaking, dissolve in a separate container chrome alum, 3 grains,



GELATIN-CHROME-
ALUM
MIXTURE

5 GELATIN MIXTURE DROPPED
ON CLEAN DRY SURFACE

6 SPREAD EVENLY WITH
SOFT BRUSH

in warm water, ½ oz. When the gelatin has soaked, place the pan on a stove and heat gently until the gelatin has dissolved. With the pan still on the burner, add the solution of chrome alum, a few drops at a time, as shown in Fig. 4, while stirring vigorously. When mixing is completed, add about 10 drops of a 10-percent solution of phenol (carbolic acid) and stir. To coat the work, place it face up on a level surface and pour a few drops of the gelatin-chrome-alum mixture on it as shown in Fig. 5. If the surface is not level, wedges should be used as in Fig. 3. The gelatin



7 MASKING PICTURE BEFORE PRINTING

spots or exposed metal. Solution A is prepared, as shown in Fig. 8, by dissolving silver nitrate, 1 oz., in distilled water, about 12 oz., and adding to this solution part of the ammonium hydroxide, drop by drop, until the precipitate which forms at first has redissolved. Solution B is prepared as shown in Fig. 9, by dissolving in a separate container citric acid, 1 oz., and tartaric acid, $\frac{1}{2}$ oz., in distilled water, about 12 fl. oz. When this has dissolved, ferric ammonium citrate (green scales) $\frac{1}{2}$ oz., is added, and when that has been dissolved, the remainder of the ammonium hydroxide is added to this solution and mixed in.

The sensitizer is ready for use after solution A has been added to solution B, and stirred to mix well. This must be done in a subdued light. Enough distilled water is added to bring the total volume of sensitizer to 1 qt., and it should be stored in a brown bottle, tightly corked.



8 SENSITIZER SOLUTION A

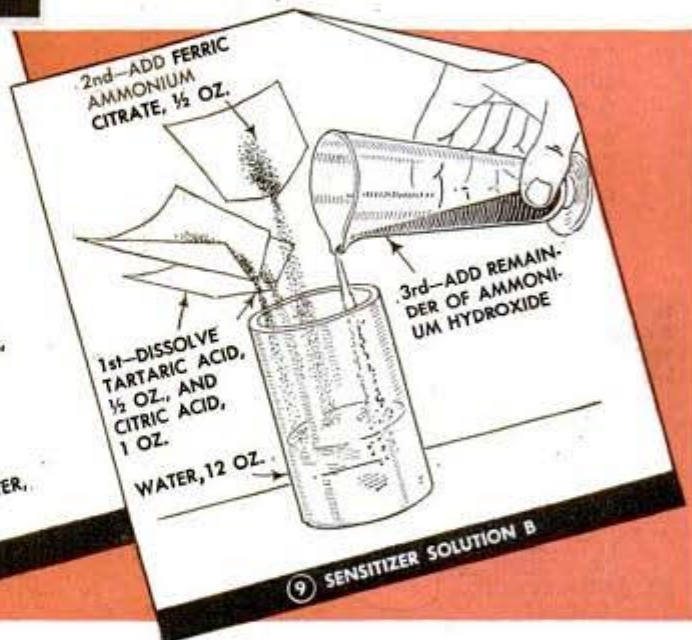

9 SENSITIZER SOLUTION B

solution should be spread evenly over the surface, using a clean, soft brush as in Fig. 6. The layer of gelatin should be uniform and quite thin. It should be left for at least half an hour or until dry, protected from dust.

Preparing the sensitizer: While the gelatin is drying, the sensitizing solution is prepared in two parts, solution A and solution B. First measure out $2\frac{3}{4}$ fl. oz. of 26-percent ammonium hydroxide, which is the total amount required for both solutions A and B. Chemically pure (C.P.) chemicals and distilled water should be used in preparing the sensitizer. All mixing should be done in glass jars, beakers, or enameled vessels free from chipped

Sensitizing the gelatin: When the gelatin film on the work has hardened you are ready to sensitize it. Lay it, gelatin side up, on a level surface, or level it with wedges, and pour on a few drops of the sensitizing solution. Then brush the solution over the entire surface evenly with a soft camel's-hair brush. In working with the sensitizer avoid exposing it to sunlight or artificial light—keep it in subdued, reflected light although it is not necessary to use a photographic darkroom. The sensitized sheet should be set away, protected against dust and light, until it has had time to dry, which will take at least half an hour.

Exposure: Prints can be made from any good negative, although a contrasty negative will give the best results. The negative

should be placed with its dull or emulsion side in contact with the sensitized surface (working in subdued light) and a suitable mask placed around the part to be printed as shown in Fig. 7. All or any part of the negative can be used. Masks can be cut in any desired size and shape from lightproof paper or cardboard. A clean piece of glass or celluloid should be placed over the mask to hold the negative in contact with the sensitized surface, Fig. 12. On flexible material, the glass is clamped to it with paper clips or spring-type clothespins as in Fig. 11, a flat, rigid backing being provided. On curved surfaces, the mask and negative are placed under a piece of celluloid, or Cellophane, which is held on the work by rubber bands or cellulose tape as in Fig. 10.

The exposure can be made either by direct sunlight or a photoflood lamp. Usually exposure requires from 2 to 5 min., de-

10
HOW TO PRINT
ON CURVED
SURFACES

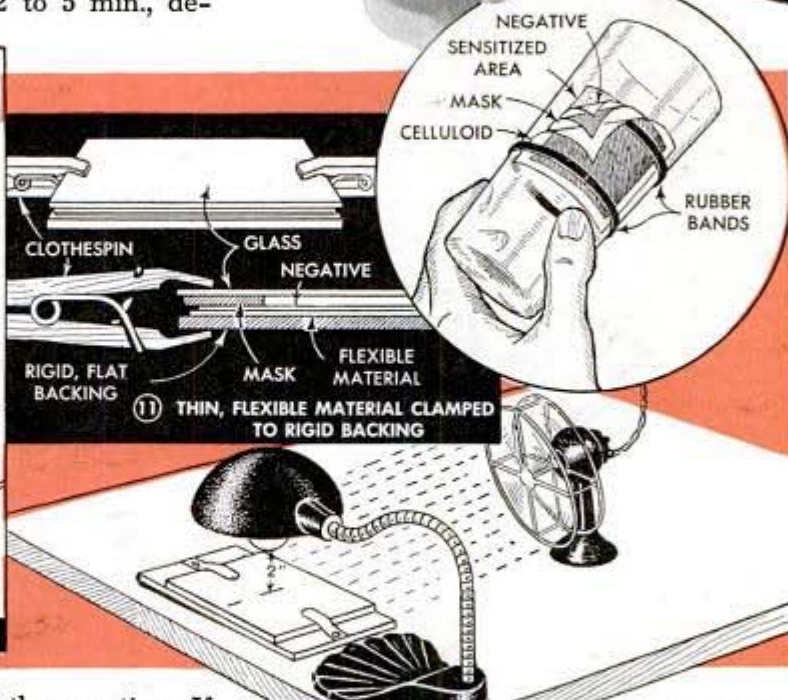
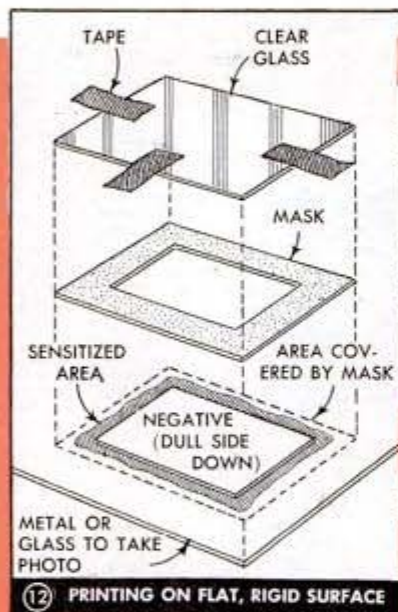

13 EXPOSING BY PHOTOFLOOD LAMP

not over 65 deg. F. The finished print is rinsed again in cold water and allowed to dry. Transparent lacquer applied on the finished work protects it from scratches.

Show-Card Black for Lettering On Glossy Prints

For lettering captions or other notations on glossy prints, show-card black is better than waterproof ink, which eventually will crack off. Mix the show-card black with a little very soapy water which acts as a binder, and load the pen with a brush. This mixture will adhere also to china and glass, and may be wiped off with a damp swab.

pending on the density of the negative. If you use a photoflood lamp it can be put in a standard reflector or in a desk lamp as in Fig. 13. On small negatives, the lamp should be placed about 2 in. from the glass. For larger negatives the lamp should be raised so all parts of the negative are about the same distance from the lamp. A fan is placed as shown to prevent overheating.

Fixing and finishing: No development is required, but the print must be fixed for 30 sec. in a solution of sodium thiosulphate (hypo), 2 oz., in water, 1 qt., used at a temperature not over 65 deg. F. After fixing the print it is rinsed in cold water. Then the gelatin should be given a final hardening by immersing the print for 30 sec. in a solution of 40-percent formaldehyde, 1 part, and water, 10 parts, at a temperature

PHOTO MOUNTS from Cover Papers



IN THE absence of suitable photo mounts, you can make your own from cover paper, usually obtainable at printers, or other heavy paper purchased from artists' supply houses. Type A is made from a single sheet of stock which is stiff enough to support photos up to 4 by 5 in. It is scored at the center for folding and diagonal corner slits are cut to hold the photo in place. A cardboard template the same size as the photo facilitates making the cuts the right size in the correct position. Type B consists of a large sheet of cover paper folded twice to provide a back and two wings. Fold the left wing so it will overlap the other when closed. With this mount, art corners are used to hold the photo. They are pasted to a sheet of contrasting paper cut $\frac{1}{4}$ in. larger than the photo to form an underlay and to help stiffen the mount. For large photos, use a mount such as type C. Besides the folded back and a flyleaf, it has two masks over the photo, one of dark and the other of light paper. The opening in the dark mask is cut slightly smaller than the one in the light mask. The top mask should match the flyleaf. To assemble the mount, first glue in the flyleaf and then the photo, following with the masks, which first are glued together and then attached over the photo.

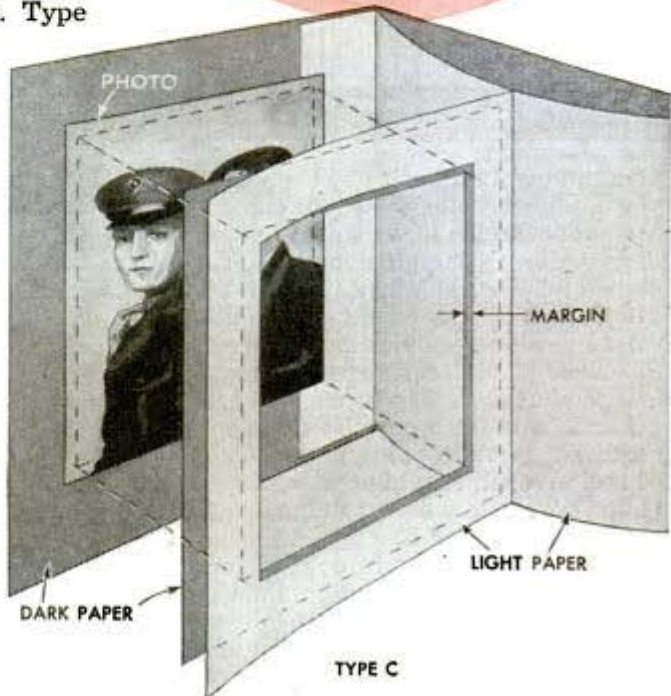
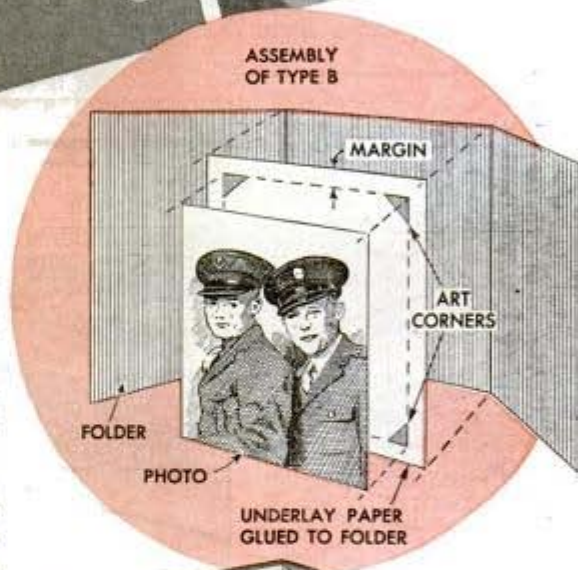

Side-and-Back Lighting Gives Portraits Depth

With this arrangement of side lighting you get just the opposite light-and-shadow effects from those obtained with the usual setup of lights directed at the subject from the front. Well rounded contours that result are especially pleasing for portrait work as they have a three-dimensional effect. Sides of the face receding farthest from the camera are lighted, the outline of the head and shoulders is brought out to separate the subject from the background and the parts of the face closest to the camera are slightly toned down in shadow. Also, the hair is highlighted, which gives it life and snap. Three photofloods of equal intensity are used. Two are set at equal distances from the subject, one on each side and slightly behind it so that the light is directed downward at about a 45-deg. angle. The third lamp is placed slightly on one side, ahead of and a little above the camera. Its distance from the subject should be about one-third greater than that of the other two lamps, or at a point where the face shadow is softened sufficiently. By moving it farther away you can deepen the "tone" or "mood" of the picture for special effect, but if you place it too far away the shadow on the face will be too dark. Moving it too close, however, will tend to "flat-



ten" the picture by equalizing all three lights. Always use a lens shade, of course, to avoid direct glare into the lens. This arrangement of lamps can be used for home movies because no matter where the actors are, the light will reach all surfaces in about the same proportions.

—Skippy Adelman, New York.

Handle Small Prints With Spatula to Avoid Fingerprints

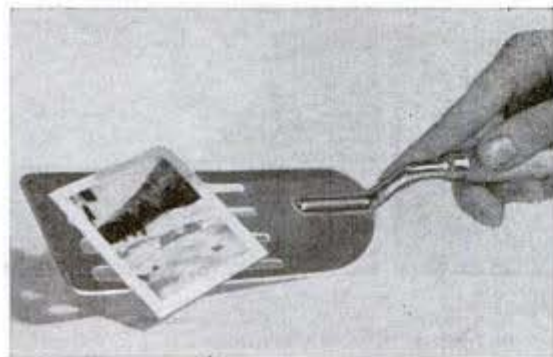

Use of a kitchen spatula for handling small prints while developing eliminates the danger of fingerprints and other handling stains. It is also handy to lift the print closer to the safelight for inspection. If a stainless steel spatula is used, there will be no danger of corrosion.

We pay cash for ideas showing simpler and better ways to do daily tasks, shortcuts in shop work, dark-room aids, household hints, auto kinks, etc. Send a good photo or sketch and a concise but full explanation of your ideas to the Homecraft Editor, Popular Mechanics, 200 East Ontario Street, Chicago 11, Ill.

CRAFT QUIZ

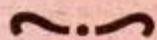

1. Bolts on wood trailer bed are—
 (a) Hanger bolts (c) Toggle bolts
 (b) Bed bolts (d) Carriage bolts



2. This wood turner is using a—
 (a) Gauge (c) Parting tool
 (b) Skew (d) Spear



3. This wall finish is known as—
 (a) Hen tracks (c) Tiffany
 (b) Antique (d) Sponge mottle

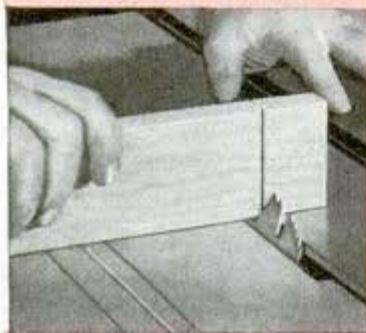

4. You can see this saw has a—
 (a) Swing cut-off (c) Rip fence
 (b) Tilting arbor (d) Dado head



5. Good wood to plank this boat is—
 (a) Red gum (c) Red oak
 (b) White pine (d) Chestnut



6. For glass grinding you use—
 (a) Garnet (c) Pumice
 (b) Silicon carbide (d) Flint



7. Wood is being prepared for a—
 (a) Dowel joint (c) Butt joint
 (b) Miter joint (d) Scarf joint

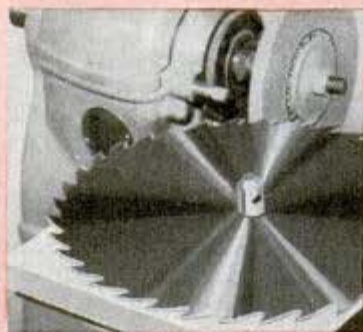

8. This circular saw is a—
 (a) Planer (c) Miter
 (b) Crosscut (d) Rip

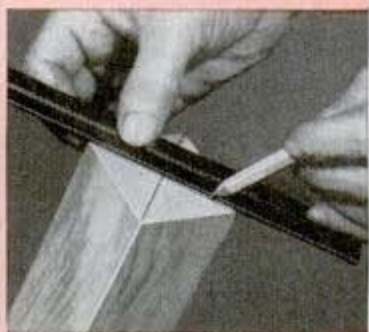

9. Getting ready to use a—
 (a) Band saw (c) Sander
 (b) Jointer (d) Lathe

ANSWERS: 1-d, 2-b, 3-d, 4-b (table is level, blade tilted—hence tilting arbor); 5-b (white pine warps or rots least of these woods); 6-b; 7-c (jointer used to get straight and square edges); 8-d; 9-d (end of wood is being center marked); 10-c (4-penny nails, 1 1/2 in. long, are right size—others too long); 11-a



10. Size nails for this job are—
 (a) 10-penny (c) 4-penny
 (b) 6-penny (d) 7-penny

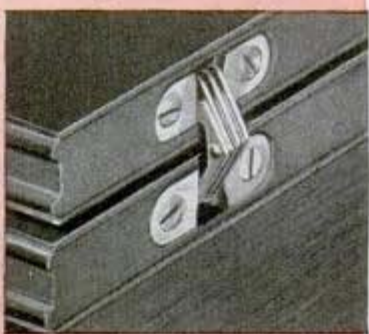

11. This hinge is—
 (a) Invisible (c) Rule joint
 (b) Friction (d) Fall leaf



SHOP NOTES

Tricks of CUTTING-OFF in the lathe

By Sam Brown

THE cut-off tool is a narrow, ready-shaped blade which requires only grinding of end clearance to keep it sharp and ready for work. It is held in a cut-off tool holder. There are two common types of tool holders—rigid and spring. The rigid type is always used with the blade set on the centerline of the work as shown in Fig. 2. With the spring type the blade is set slightly above the center of the work as in Fig. 3. Of the two, the spring type is slightly more expensive, but it is far superior for all general cutting and it is the only type that works well with a power feed. Both rigid and spring types of tool holders can be obtained in straight, right offset and left offset pat-



OIL IS NEEDED ONLY WHEN CUTTING TOUGH, HARD STEEL. MILD STEEL AND ALL OTHER MATERIALS CAN BE CUT DRY

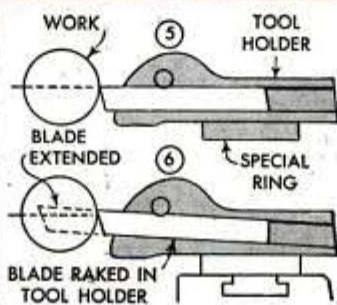
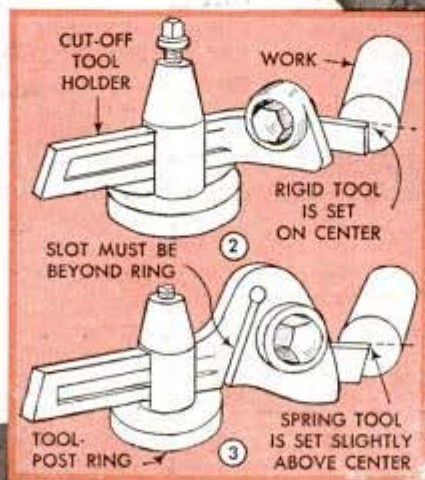

terns. The right offset pattern is most generally used as it can work closer to the chuck than either of the others. Since the tool is always used in a fixed relation to the centerline of the work it is a good idea to use a special toolpost ring as shown in Fig. 4, to automatically support the blade at the right height. This arrangement works with the blade at any extension if the blade is parallel with the tool holder, as shown in Fig. 5. If the blade is set at an angle or "raked" in the tool holder as in Fig. 6, the ring should be made up for a 1-in. extension

What speeds and feeds are best?

The table at the right shows what will happen when the cut-off tool is used on medium hard steel at various speed-feed combinations

CUTTING IS POSSIBLE IN THIS RANGE
 BEST FEEDS AND SPEEDS FOR GENERAL WORK
 NOT SATISFACTORY CUT CANNOT BE MADE
 TIME IN MINUTES TO CUT 1-IN. DIAMETER BAR

Feed Per Rev.	SPINDLE SPEED				
	50 R.P.M. 13 S.F.M.	100 R.P.M. 13 S.F.M.	150 R.P.M. 40 S.F.M.	300 R.P.M. 80 S.F.M.	500 R.P.M. 130 S.F.M.
.0002	Rub .50	Rub .25	Squeal -	Squeal -	Squeal -
.0004	Too Slow .25	Slow .12.5	Slow .8.3	Squeal -	Squeal -
.0005	Slow .20	Slow .10	Slow .6.6	Squeal -	Squeal -
.0010	Slow .10	Slow .5	.3.3	Chatter -	Squeal -
.0014	Slow .7.1	.3.5	Good .2.4	Light Chatter .1.2	Squeal and Chatter -
.0018	Slow .5.5	.2.7	Good .1.8	Light Chatter .9	Squeal and Chatter -
.0021	Slow .4.7	Good .2.4	Good .1.6	.8	Chatter -
.0024	Slow .4.2	Good .2.1	Good .1.4	Good .7	Chatter -
.0027	.3.7	Good .1.8	Good .1.2	Good .6	Near Max. .3
.0031	.3.2	Good .1.6	Good .1.1	.5	Stall -
.0036	.2.8	Good .1.4	.9	Near Max. .5	Stall -
.0043	.2.3	Good .1.2	.8	Near Max. .4	Stall -
.0050	.2.0	.1.0	Grunt .7	Stall -	Stall -
.0072	.1.4	Near Max. .7	Near Max. .5	Stall -	Stall -
.0100	Near Max. 1.0	Near Stall .5	Stall -	Stall -	Stall -

7

IF YOUR LATHE DOES NOT HAVE POWER FEED, APPLY THIS FORMULA:

$$6 \div (\text{WORK SPEED IN R.P.M. TIMES FEED})$$

THE RESULT IS TIME IN SECONDS FOR ONE COMPLETE REVOLUTION OF FEED HANDLE

EXAMPLE:
 WORK SPEED = 150 R.P.M.
 FEED PER REV. = .002 IN.
 $150 \times .002 = .3$
 $6 \div .3 = 20$ SECONDS

O.K. BUT SLOW AND ROUGH CUTTING

GOOD RANGE. EXCELLENT SPEED FOR HARD STEEL

BEST CONSTANT SPEED FOR GENERAL WORK

FASTEST. BLADE CUTS BEST WITH BACK RAKE

VERY CRITICAL AS TO FEED AT THIS SPEED

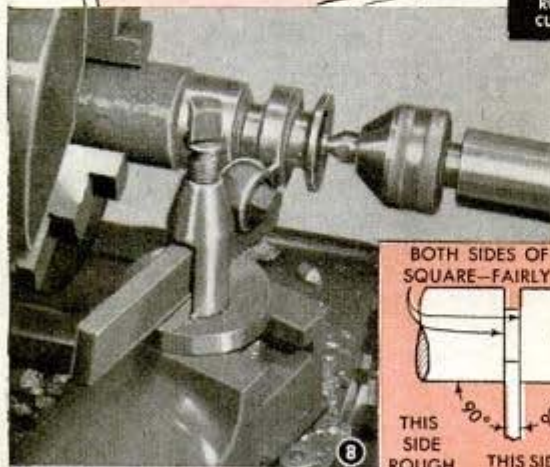

of the blade in which case the the blade always should be used at this extension. It can be seen from Fig. 6 that if the blade is pushed out farther it will be above the centerline of the work.

Speed and feed: By a careful study of Table No. 1 on test cuts in medium hard steel, you can determine what will happen when the cut-off tool is used at various speed-feed combinations. Note that as the spindle speed is increased, the feed rate becomes more critical. Hence, if you use the hand feed, the lower speeds are best. However, at the very low speed of 50 r.p.m., the operation is slower than hack-sawing. Picking up a chip and holding it with a steady feed is the secret of cutting-off. General fault is too slow a feed, which should be at least .0015 in. per rev. in order to hold a chip in steel with a straight blade as shown in Fig. 13. If your lathe does not have a power crossfeed, use the formula given in Fig. 7 to determine time required. This will tell you how fast to turn the cross-

The blade will cut rough or smooth, depending on angle it is fed to work

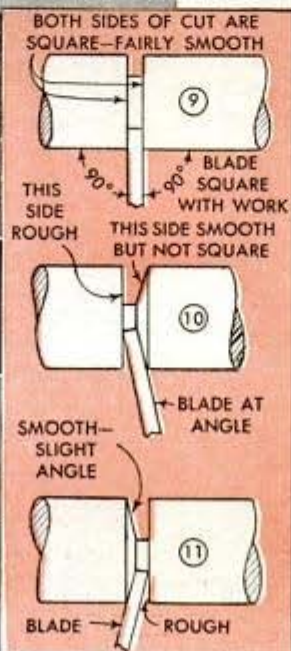
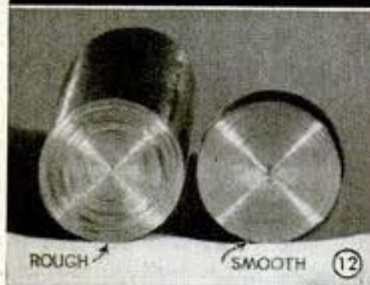

slide handle to get a specific feed per rev. A little practice with a watch in view will enable you to approximate any given feed.

Feed angle of blade: This should be straight in as shown in Fig. 9. If you are making a cut at an angle, as for example in making a pulley, the tool holder must be mounted perfectly square with the compound and fed with the compound handle as in Fig. 8. If the blade is not square with the work, it will cut one side rough and the other side smooth, as shown in Figs. 10, 11 and 12. In cases where a slight angle does not matter, this kind of cut can be used to advantage occasionally in order to produce a smooth surface.

Chatter and "hogging"; Chatter is caused by the inability of the cutter to penetrate

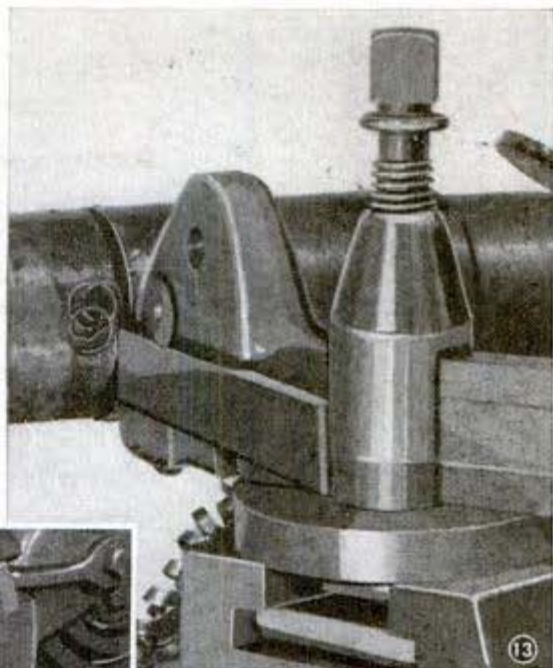
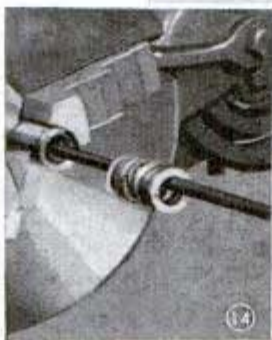
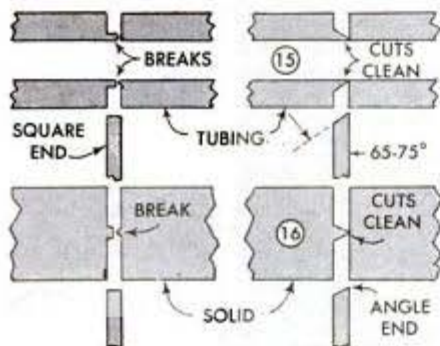

Picking up a chip and holding it with steady feed is secret of cutting-off. Most turners feed too slow—it takes at least .0015 in.-per-rev. feed to hold a chip in steel with straight blade

the work and hold the chip. A fine feed will cause chatter because the blade does not penetrate. If the blade does not have back rake, it takes a minimum of about .015 in. to pick up and hold a chip. On hard steel and hard brass, chatter is present at all feeds if a straight blade is used. Therefore the remedy here is to use a blade with back rake. This permits easier penetration and holds a chip at a slower feed rate than is the case with a straight blade. "Hogging" occurs when the feed is too heavy—when you try to take a chip that is too much for the lathe or the tool—with the result that the lathe stalls, the work twists out of the chuck, or the tool breaks.

Large work: Maximum diameter for cut-off work on a small lathe is about 3 in. Do not project the blade the full distance at the start, but work it out gradually, a quarter of an inch at a time. Cutting a double groove in order to obtain more clearance is good practice generally followed in making deep cuts. All cuts made in hard and also in mild steel that has a diameter greater than 1 in. should be given a lib-

RECOMMENDATIONS FOR CUT-OFF WORK Table No. 2				
Material	Nature of Chip	Work Speed in R.P.M.*	Tool Feed Per Rev.	Blade
Mild Steel	Short Curl	250	.0025	A or B
Medium Steel	Medium Curl	150	.0025	A or B
Hard Steel	Stringy	100**	.002	B or C
Yellow Brass	Short-Brittle	500	.0015	A
Hard Brass	Stringy	300	.002	B or C
Bronze (Phosphor)	Stringy	300	.002	C
Cast Iron	Short Chips	150	.002	A or B
Cast Plastics	Long Ribbon	500	.002	A or B
Copper	Stringy	300	.0015	B or C
Aluminum	Medium Curl	500	.0015	C

* Constant speed—Use for all work up to 1½" diameter ** Use cutting oil (lard oil) especially on diameters over 1"

eral application of cutting oil as in Fig. 1.

Special setups: When you are cutting washers it is a good idea to fit a small rod inside the hole to catch the finished work as it is cut free, as shown in Fig. 14. When cutting-off in the center of a bar, always support the work at the point of cutting with a steady rest as in Fig. 17, and cradle the free end in your hand. All cuts over 3 in. from the chuck should be supported

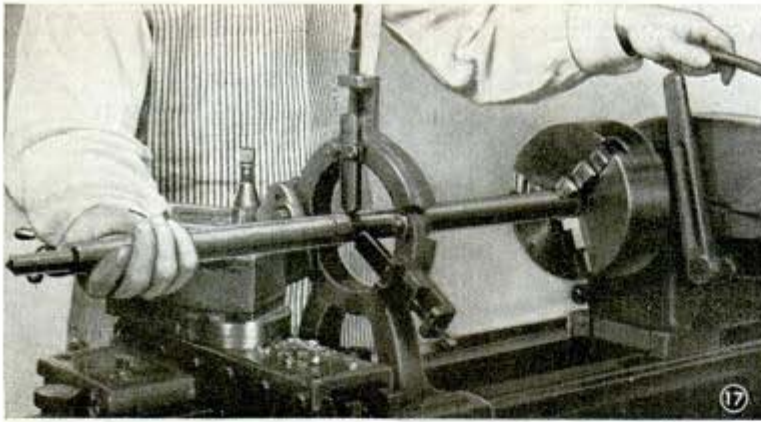

a hacksaw. If you want to eliminate the small nib, which forms when work is cut off with a standard straight-end blade, use a blade ground at 65 to 75° angle as shown in Figs. 15 and 16.

Various metals: Recommendations for cutting off various metals are given in Table No. 2. Use the constant speed system specified and you will quickly get the feel of the work. You should have

by bringing up the tail center; after which the stock is turned to not less than 1/4 in. diameter. Then the work is removed from the lathe and the 1/4-in. neck is parted with

three cut-off blades, as shown in details A, B and C below Table 2. When you have trouble with any cut, reduce the spindle speed but maintain the feed.

Interchangeable Soldering-Iron Heads Shaped to Suit Job

Anyone who has considerable light soldering work to do, such as radio repairing, will find interchangeable soldering-iron heads of copper like the ones shown very convenient. Besides these heads, others can be made to suit your particular needs. They can be of irregular shape to get into hard-to-reach places, or they can have two soldering points for soldering in two positions at the same time. However, the heads should not be too long or too slender if a soldering temperature is to be maintained at the ends. In preparing a soldering iron for the interchangeable heads, unscrew the original head and slot it as indicated. Then drill and tap a hole through the head from opposite sides of the slot for a retaining screw to hold the interchangeable heads in place. If possible, it is a good idea to obtain another head like the original one for the iron so that it can be used for heavy work whenever necessary.



Adjustable Gauge for Testing Tapers Has Many Uses in the Shop

Machinists will find this gauge a time-saver when making or checking tapers, drills, reamers, etc. Also, auto mechanics will find it handy as a go-and-not-go gauge for straight cylindrical work. The gauge

consists of two adjustable straightedges mounted on a cast-iron base, which has a rib on one side for holding or clamping the gauge when in use. The straightedges are made of tool steel hardened and ground, and their testing faces are lapped flat and straight to very close limits. They can be adjusted to any standard taper. An opening milled in the base admits light.

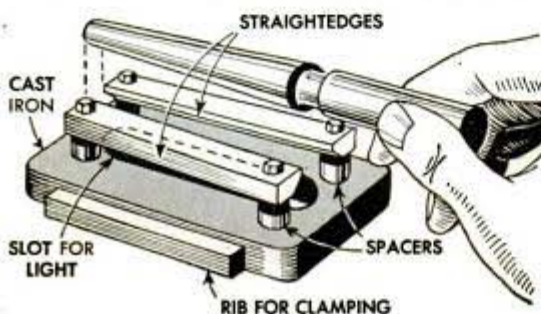

Often slight perspiration on the hands will cause rusting of polished steel. If you experience this trouble, rub your fingers lightly on the back of your hand before handling precision steel tools. Natural oils transferred to the fingers in this manner will prevent the trouble.

Strip-Cut DRAWER PULLS

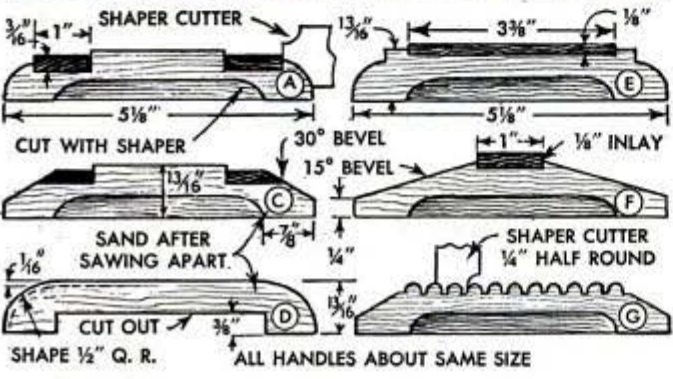
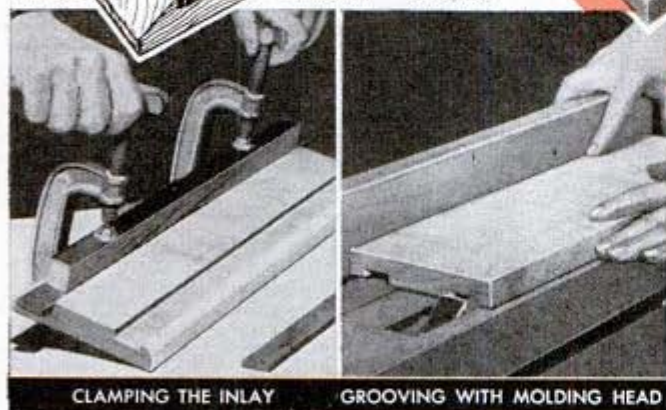
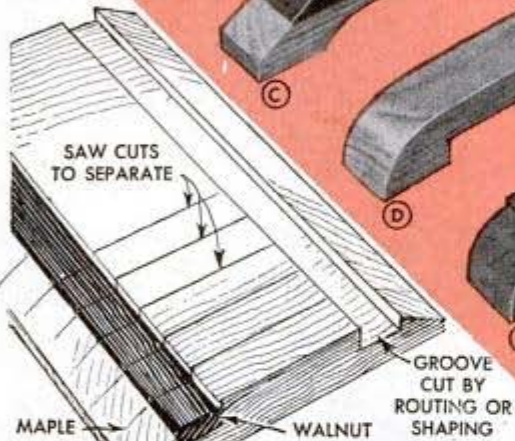
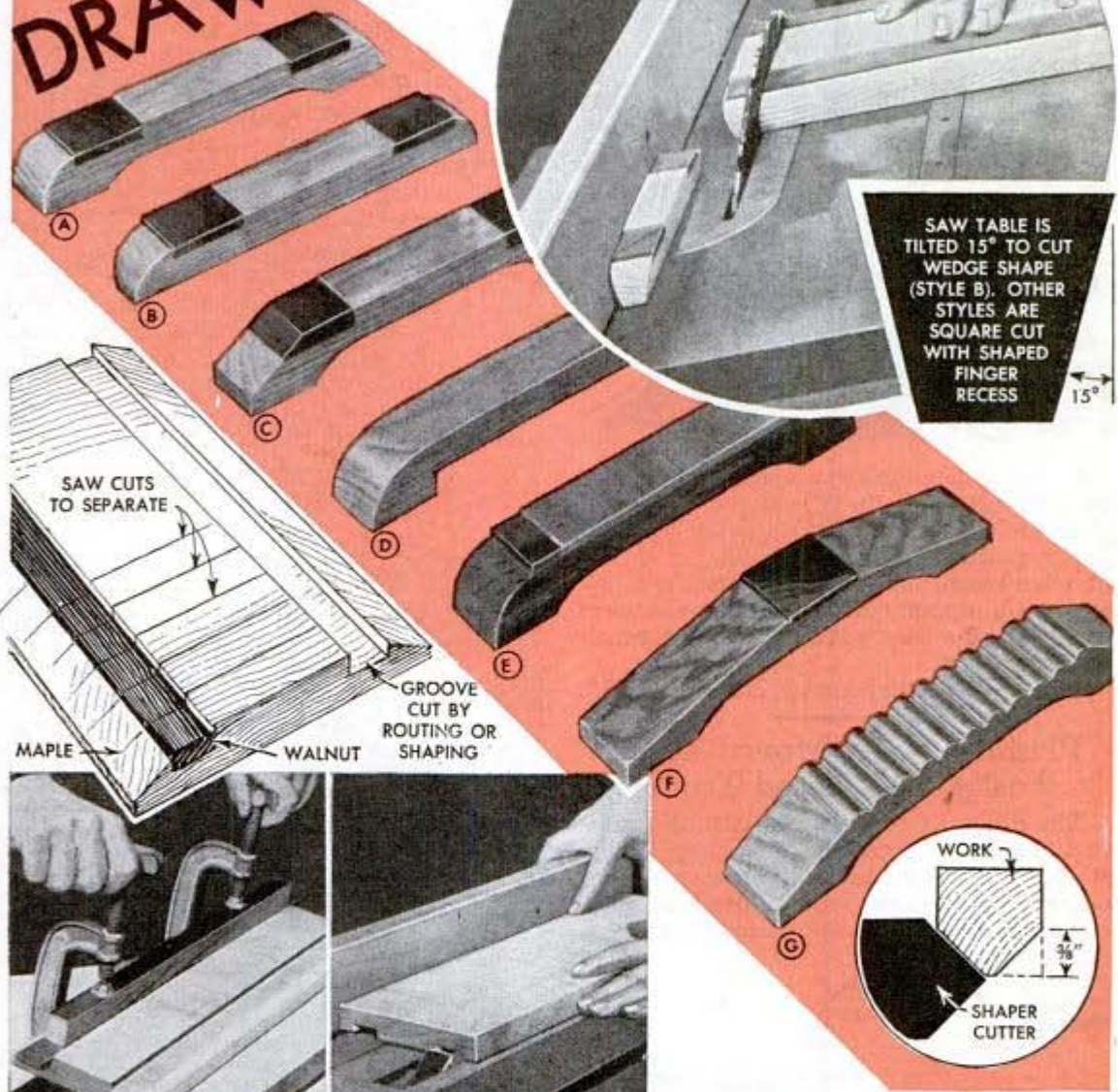
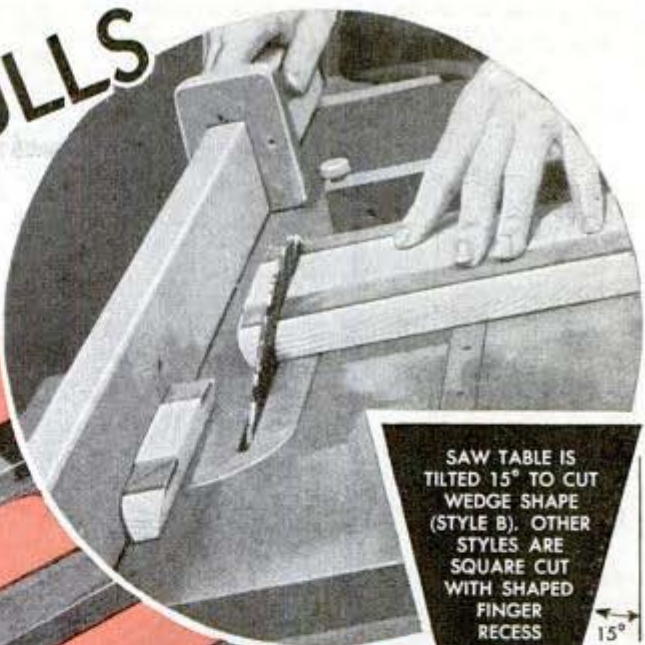

INSTEAD of making drawer pulls individually, when several identical ones are required, use the strip-cut method in which one strip of wood is machined to shape and then cut into strips representing completed pulls. This assures uniformity in shape and saves time by eliminating repeated machine operations. Designs other than those shown can be devised to suit individual requirements. Waterproof glue should be used to secure the inlays, otherwise they may loosen when exposed to dampness.

Basket Under Inspector's Stool Keeps Cleaning Cloths Handy



In the inspection department of one war plant it was found that a basket-like receptacle under the inspector's stool provided a handy place to keep cleaning cloths. Made of wire mesh, the basket is attached between the upper rungs of the stool where it is out of the way, yet is within easy reach of the worker.

—Kenneth Murray, Baltimore, Md.

Platform Scales Moved About Easily With Hand Truck

The difficulty of moving platform scales to the various locations necessary in his store, especially through narrow spaces and around corners, led one produce buyer to attach a hook to the front end of the

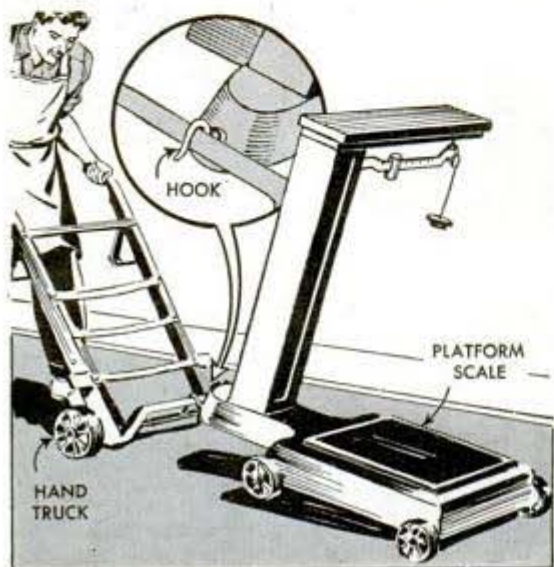

scales as shown. With this arrangement, the beak of a hand truck could be used to lift the front of the scales and tow them wherever needed.

Hay-Rope Hole in Wall of Barn Reinforced With Horseshoe

Splitting and damaging of boards on a barn where an opening is cut for the passage of a hay rope may be avoided by reinforcing the opening with a horseshoe. In this way, wear caused by the rope swinging to one side or the other will be taken by the metal shoe, which also will prevent the board from splitting under strain of the rope pressing against it. Edges of the shoe should be rounded where they touch the rope.



Avoiding Errors on Cash Register



In one drug store where inexperienced clerks at the fountain often made errors by pressing the keys denoting one dollar or more, these keys were locked by pushing small corks between them as indicated.

Since individual purchases rarely amounted to a dollar, use of these keys was not required, and locking them made it impossible for errors of more than a dollar to be made.

Self-Supporting Display Cards

To avoid the use of special blocks or stands to support large display cards on the floor, one card writer uses double cards as indicated. The cards are bent to a slight arc and stapled together with a piece of cardboard between them. The cardboard holds the cards in the bowed position, thus spreading them at the bottom so that they will stand alone.



Multiple Tool Bits Cut Threads in One Operation

With this tool, much time can be saved when threading large nuts as the thread can be completed in one operation. The tool consists of a holder shaped as shown and slotted at one end to hold four $\frac{1}{2}$ -in. tool bits. After the slot has been milled, the flattened portion of the holder is drilled and tapped for eight setscrews which hold the tool bits in position. As a further aid in keeping the bits in correct alignment, the slot is plugged with a piece welded in place and fitted with a setscrew to exert end pressure against the bits. These are adjusted so that the cutting ends project .020 in. progressively toward the back.

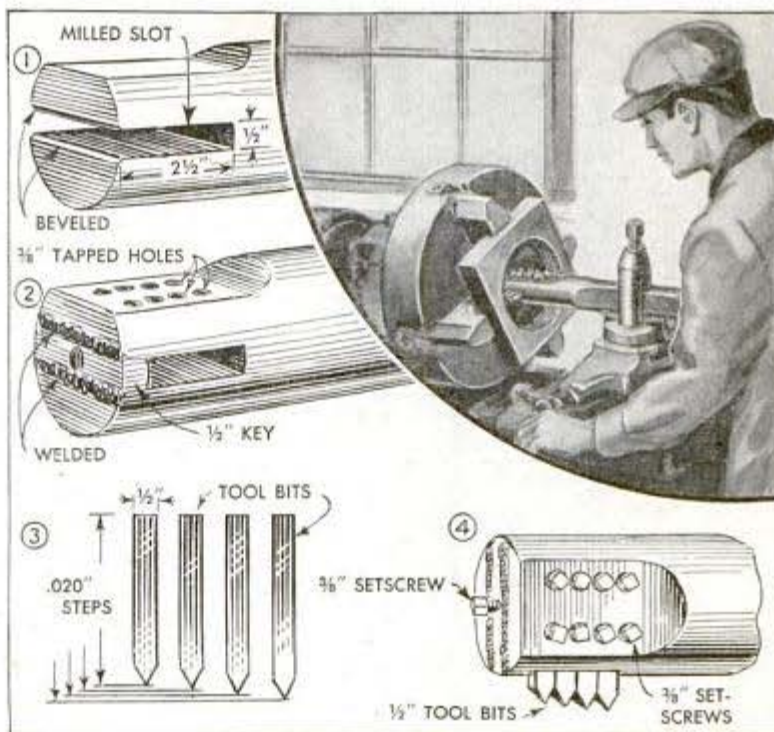

Wheeled Feed Boxes Simplify Care of Housed Chickens

Caring for chickens housed in coops is simplified with feed boxes like the one shown. It has small wheels at one end and can be pulled out for filling without opening a door through which chickens might escape. The boxes are made like drawers with the front ends projecting beyond the

sides so they cannot be accidentally pushed beyond the openings in the coop sides. Wheels 2 in. in diameter are attached to the rear ends on nail axles and rest on the bottoms of the coops.

—L. D. Mooty, San Antonio, Tex.

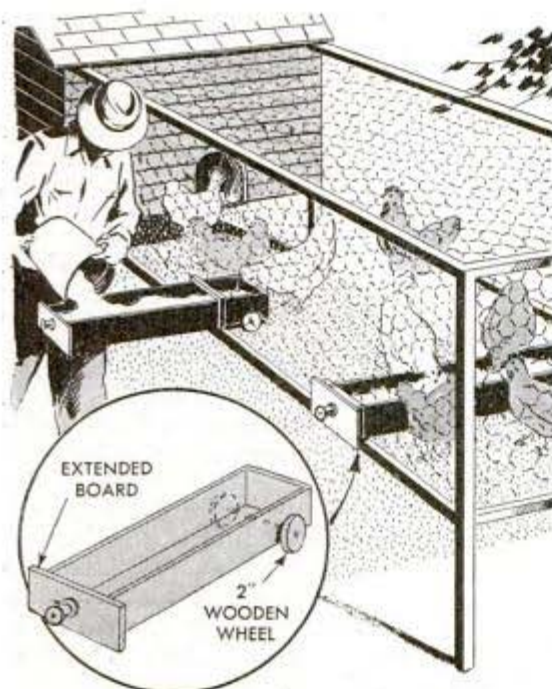

Bluing Polished Steel Screws

For bluing polished steel screws, heat them in sand until they take on the characteristic oxide blue due to temperature, after which they are quenched in linseed or mineral oil. To obtain a deeper blue shade, dip the screws in lubricating oil and burn the oil off by placing the screws on a thin steel plate over a gas flame. When the first coating of oil has been burned off, more can be sprayed on giving an even deeper color, while still more oil should be applied as the screws are cooling.

Clean Bearings in Light Oil

Bearings are cleaned best by soaking them in a light oil heated to about 175° F. If time is limited, a commercial cleaning fluid may be used if care is taken to lubricate the bearings thoroughly after cleaning. Although gasoline often is used for the purpose, most of the gasolines carry anti-knock compounds which are injurious to bearings.



Keep Your

To keep a tractor in good condition, it's the daily service routine that counts. Careful attention to the simplest service details helps to cut down the big repair bills and is certain to result in much longer periods of peak efficiency and trouble-free service

RULES FOR SAFE TRACTOR OPERATION

1. Be sure the gear shift lever is in neutral before cranking the engine.
 2. Always engage the clutch gently, especially when going up a hill or pulling out of a ditch.
 3. When driving on highways, or to and from fields, be sure that both wheels are braked simultaneously when making an emergency stop.
 4. Always ride on seat or stand on platform of tractor. Never ride on drawbar of tractor or drawn implement.
 5. When tractor is hitched to a stump or heavy load, always hitch to drawbar and never take up the slack of chain with a jerk.
 6. Be extra careful when working on hillsides. Watch out for holes or ditches into which a wheel may drop and cause tractor to overturn.
 7. Always keep tractor in gear when going down steep hills or grades.
 8. Always drive tractor at speeds slow enough to insure safety, especially over rough ground or near ditches.
 9. Reduce speed before making a turn or applying brakes. The hazard of overturning the tractor increases four times when speed is doubled.
 10. Always stop power take-off before dismounting from tractor.
 11. Never dismount from tractor when it is in motion. Wait until it stops.
 12. Never permit persons other than the driver to ride on tractor when it is in operation.
 13. Never stand between tractor and drawn implement when hitching. Use an iron hook to handle drawbar.
 14. Do not put on or remove belt from belt pulley while the pulley is in motion.
 15. Should motor overheat, be careful when refilling radiator.
 16. Never refuel tractor while motor is running or extremely hot.
 17. When tractor is attached to a power implement be sure that all power-line shielding is in place.
- (Prepared by the Farm Safety Committee of the Farm Equipment Institute and approved by the National Safety Council)



By W. Clyde Lammey

YOU DON'T have to be an experienced mechanic to do the simple service jobs recommended by the manufacturer of your tractor. The important thing is to make sure that a maintenance schedule is carried out day in and day out. This schedule must include all parts that require periodic attention. It won't do to check fuel, oil, water, air pressure in the tires, grease daily, and then, for example, neglect to service the air cleaner or check the level of the battery solution at the proper time. It's a good idea to keep written records of service on those parts that require attention over longer periods of time.

Fig. 1 gives a maintenance schedule, which, of course, does not agree in every detail with recommendations by various manufacturers, due to the varying designs of tractors and parts, but it does show the importance of attention at regular intervals. Equal in importance to the regular schedule of maintenance is periodic attention to the proper condition of the six parts shown in Fig. 2. Neglect of any one of these will cause a waste of fuel and oil, which will result in undue wear and unsatisfactory operation of the tractor within a comparatively short time. The operator who fails to clean and grease the magneto or distributor at the proper time, add distilled

Tractor Rolling

- ① **EVERY 10 HOURS**
1. **Air Cleaner**—wash and refill oil reservoir. Clean top screen.
 2. **Lubricate**—grease fittings.
 3. **Crankcase**—check oil level.
 4. **Cooling System**—check water and antifreeze.
 5. **Breather Cap**—wash in gasoline or clean as recommended in instruction manual.
 6. **Fuel Filter**—inspect and clean if necessary.
 7. **Tire Pressures**—inflate to proper pressure.

- EVERY 20 TO 60 HOURS**
1. **Battery**—wipe away dust, check solution level, add distilled water when required. Coat terminals with vaseline if necessary.
 2. **Front Wheel Bearings**—lubricate with grease gun if provided with pressure grease fittings.
 3. **Bolts and Nuts**—check with wrench every 60 hours for tightness.
 4. **Radiator**—inspect and clean out dirt and chaff.

- EVERY 100 TO 600 HOURS**
1. **Transmission and Differential**—change gear oil in new tractor after 200 hours; then every 600 hours. Use oil of recommended viscosity.
 2. **Crankcase Oil**—change at 200 hours or under if oil shows dark on dipstick. Use oil of recommended viscosity.
 3. **Oil Filter**—renew cartridge when oil is changed.
 4. **Front-Wheel Bearings**—(not equipped with grease fittings) pack with proper grease and adjust bearings.
 5. **Generator**—few drops of light oil in bearings every 100 to 300 hours as recommended in instruction manual.
 6. **Air Cleaner**—remove whole assembly and clean thoroughly including element. When working in continued dusty conditions, every 100 hours.
 7. **Cooling System**—drain and flush every 100 to 200 hours, or twice a season.
 8. **Sparkplugs**—clean and check gap every 200 hrs.
 9. **Distributor and Magneto**—inspect every 200 hours. Clean breaker-point chamber and check clearance of points. Dress points if necessary.
 10. **Pneumatic Tires**—wash, clean and inspect treads for cuts and other defects. Repair if necessary.



water to the battery, re-gap spark plugs or replace them if necessary, change the oil filter and keep tires inflated to proper working pressures, is heading for trouble as several of these parts, such as battery, tires, and spark plugs deteriorate very rapidly with neglect. Improperly adjusted distributor and magneto points, wiring fouled with an accumulation of oil and dirt, a weak coil and dirty plugs not only result in a loss of power and more rapid wear in the engine but cause it to use an excessive amount of fuel.

Carburetors on most tractors have two adjustments, the idling adjustment and the main-jet or "load" adjustment. To obtain maximum fuel economy it's important that the carburetor be adjusted properly. Fig. 3 pictures a carburetor typical of those on tractor engines. Usually the approximately correct adjust-

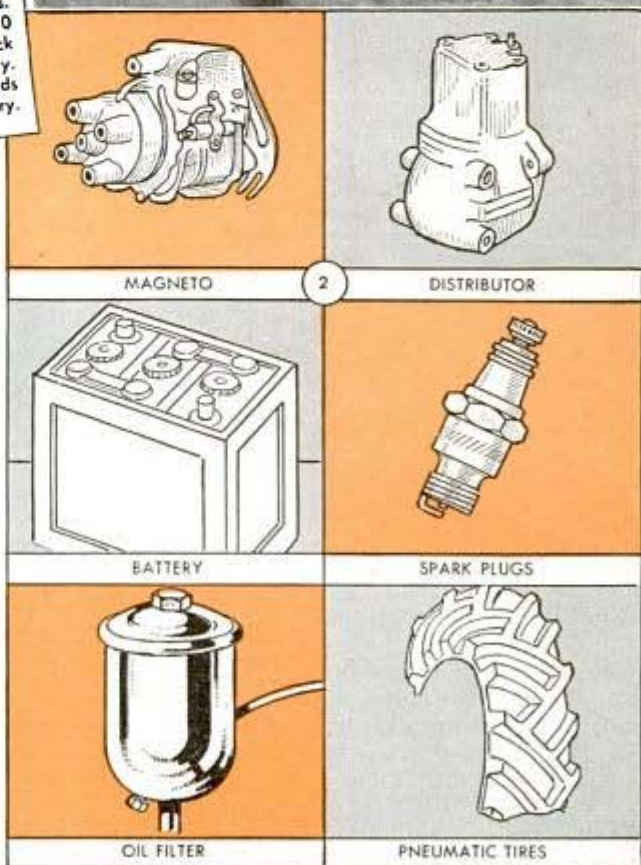

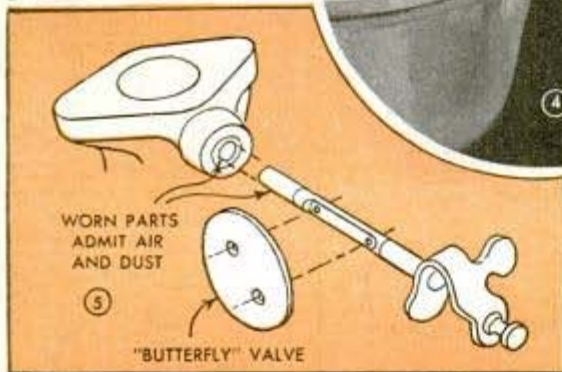
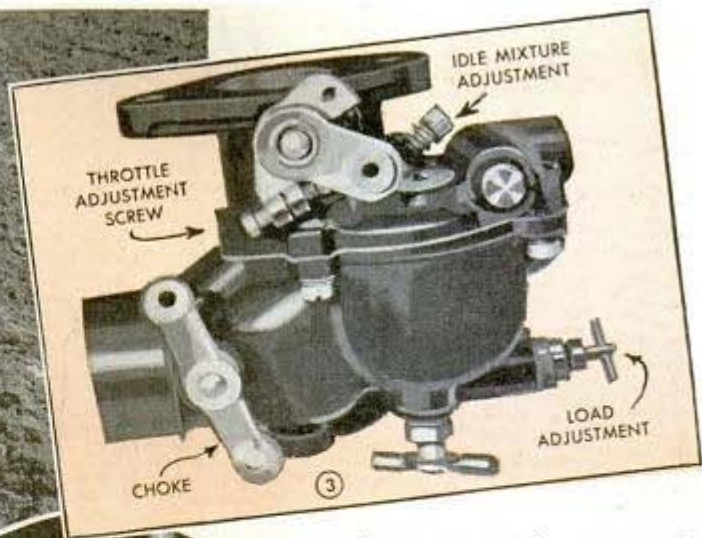

the engine picks up speed quickly and uniformly the adjustment is probably correct. But if the engine "skips" or "coughs," open the screw $\frac{1}{8}$ of a turn at a time until it picks up smoothly when the hand throttle is opened. To adjust for smooth idling, warm the engine to operating temperature, close the throttle and turn the idle-adjusting screw in until the engine begins to

run irregularly, and the exhaust sounds "rough." Then open the screw slowly, noting operation of the engine. By slow adjustment of the screw you'll find the point where the engine "smooths out," provided of course, all other parts are in proper condition. At regular intervals during the more seasonal service periods, drain the fuel tank through the carburetor and clean the fuel-filter sediment bowl and also the tiny screen at the fuel inlet to the carburetor, Fig. 4. This screen should be cleaned carefully with gasoline. While going over the carburetor, especially on older tractors, examine the throttle and choke linkage. If the small shafts carrying the "butterfly" choke and throttle valves are worn badly there may be openings large enough to admit air and dirt directly into the carburetor and intake manifold, Fig. 5.

ment for the main jet will be given as $1\frac{1}{4}$ turns of the screw from the closed position. Consult the instruction manual for the correct number of turns, as this may vary. In any case, if the mixture is too lean it tends to cut down power, which causes overheating. Although not conclusive, a simple field test for proper carburetor adjustment is to suddenly pull the hand throttle wide open when the engine is under load. If

As dirt and dust are enemies of all machinery, manufacturers have made every effort to keep it out of differential and transmission housings and particularly the engine. That's why frequent servicing of the air cleaner, Fig. 6, is so important. Under extremely dirty conditions it is advisable to service the cleaner at least twice daily. This means a thorough washing in distillate, or the so-called "white" gasoline,

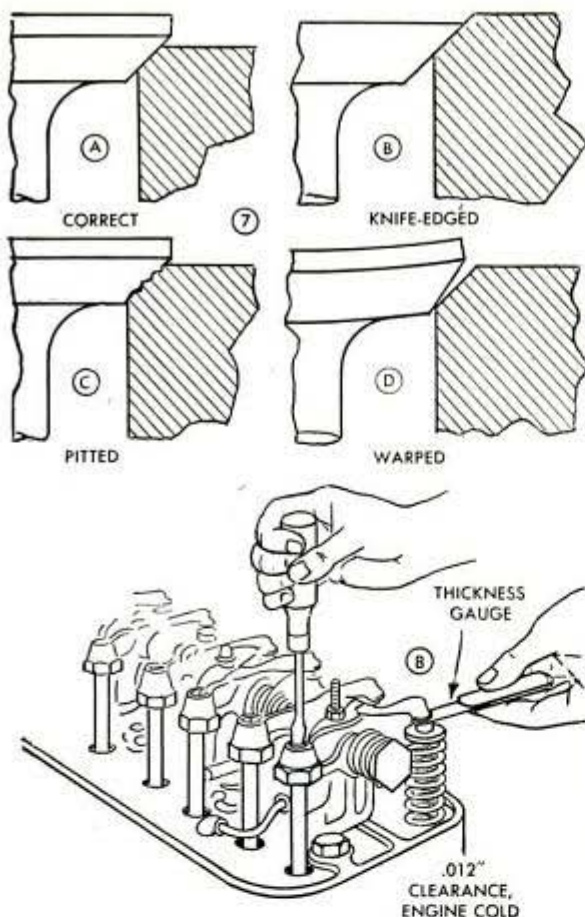

and filling with clean, unused oil of the viscosity recommended by the manufacturer of your tractor. Check frequently to see that there are no air leaks in the tube leading from the air cleaner to the carburetor.

In Fig. 7, detail A shows how a valve should seat, and details B, C, and D show three common defects. For purposes of illustration, the details are exaggerated and, of course, a badly burned and pitted valve body does not always appear as in detail C. Valves ground to a knife edge as in detail B are sure to burn and pit in a very short time. Warped, pitted and knife-edged valves should be replaced. In later-type tractor engines fitted with valve-seat inserts the valves are usually refaced on special equipment when service is necessary. However, in older engines the valves are generally ground with hand equipment as in Fig. 9. Fig. 8 details the common method of setting clearances on engines having "overhead" valves. When setting valves after grinding them, it is necessary to set the clearance twice, as it generally is recommended that the cylinder head be tightened in two stages, the second time after some hours of operation. Therefore, it is necessary to reset the valve clearances after this second tightening of the cylinder head. The .012-in. clearance given in Fig. 8



⑩ SCRAPE AWAY CARBON



⑪ TIGHTEN HEAD UNIFORMLY

justing of the breaker points. Figs. 18 and 19 show this type magneto partly disassembled. It's important to keep the breaker-arm chamber clean, as an accumulation of oil and dirt causes rapid wear. The chamber should be inspected at regular intervals and the points checked with a thickness gauge as in Fig. 19. In dressing breaker points, use a sharp, fine file and crown one of the points as in Fig. 20. When you remove the distributor body, be sure not to crank the engine or it may be necessary to re-time the magneto. When it is necessary to remove the magneto, re-time and re-wire it according to the instruction manual. On later-type magnetos this usually is a simple operation, but you will have to know the firing order of the cylinders, Fig. 21. However, the firing order given is not universal. Lastly, be sure that Cable A in Fig. 22, is pushed firmly into the sockets and that the ventilator holes in the distributor cap are open. Usually it is best to take old-type magnetos to a skilled mechanic for service and repair.

On tractors equipped with battery ignition or with separate battery for starting and lighting, it is necessary to keep the generator-charging rate at the minimum which will assure a fully charged battery at all times. Adjusting the charging rate on most generators is done by changing the position of the third brush, some generators being equipped with a screw adjustment as in Fig. 23. By trial adjustment of the generator at the average engine speed you use in field work and frequent checks with a battery hydrometer, Fig. 25, you can determine the rate that will maintain a full charge without "boiling" the battery solution. Usually this will be

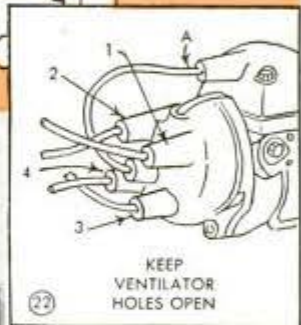
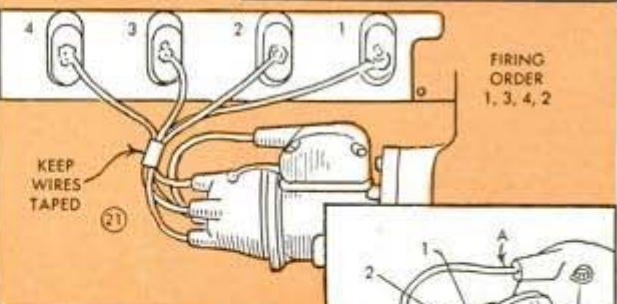
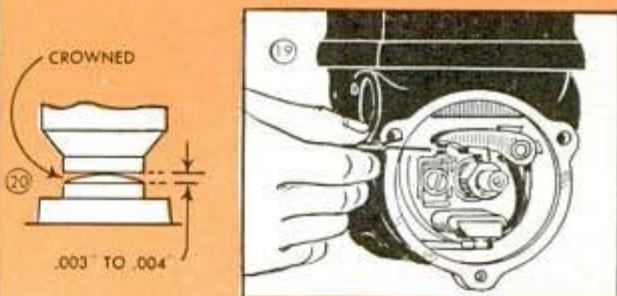
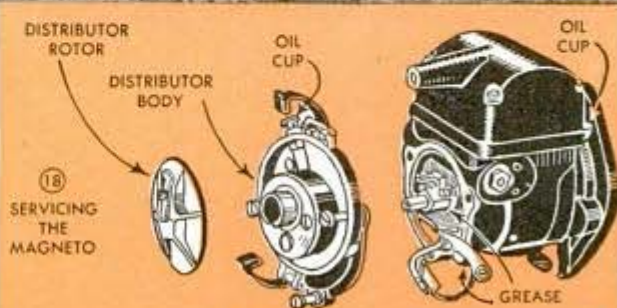

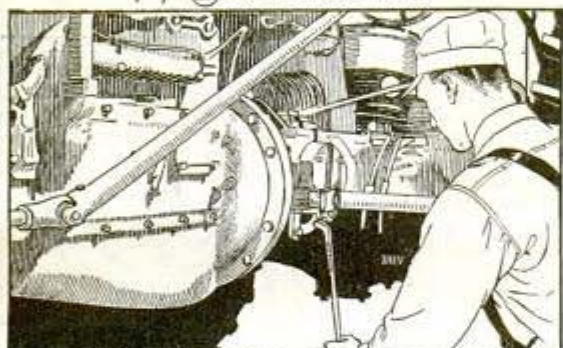
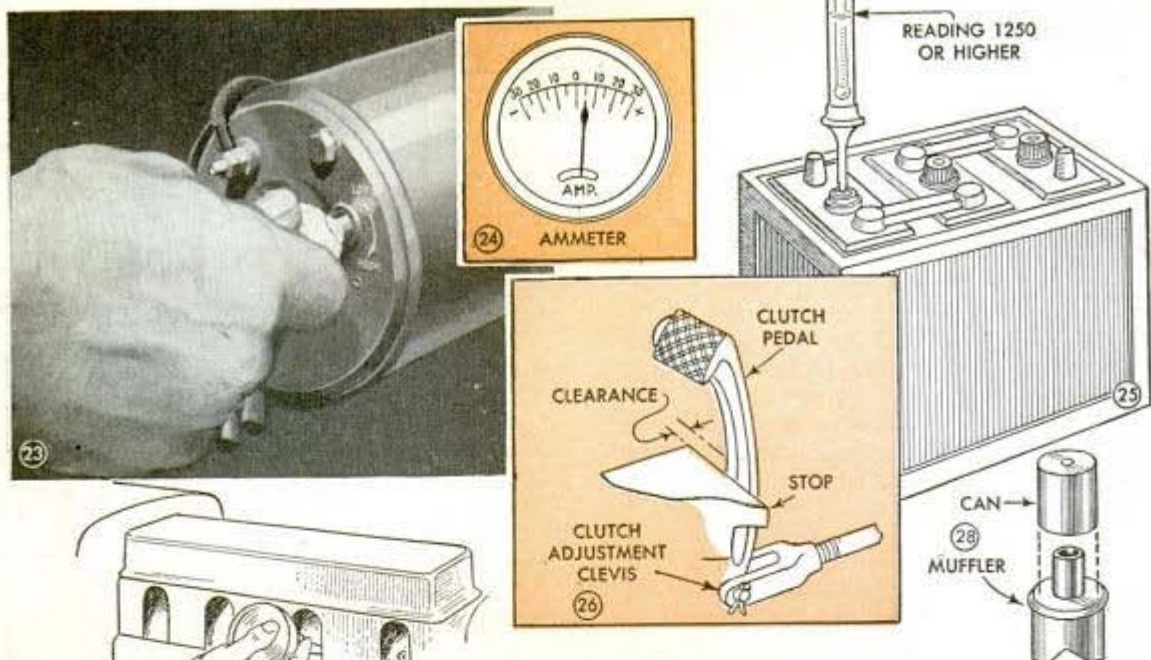

ger of freezing, drain the cooling system and flush it out with clean, soft water. Wash out the air cleaner and add fresh oil. This will prevent any accumulation of dirt settling and "caking" in the oil receptacle. Drain crankcase and oil filter, and if necessary, the transmission. Add fresh oil. Remove the battery and have it charged at regular intervals. Also remove the spark plugs and pour $\frac{1}{8}$ to $\frac{1}{4}$ pint of medium crankcase oil in each cylinder as in Fig. 27. Crank engine 40 to 50 turns, to distribute oil to all moving parts. Then remove the valve cover and "paint" the valve stems and springs with medium oil. Press a clean rag into the exhaust pipe or muffler and the breather pipe to prevent moisture entering the engine. Cover upright mufflers with a small can as in Fig. 28. Wash all mud and dirt from the tires and inflate to full recommended pressures and keep pressures up during the storage period. Fill any small cuts or breaks in the tire treads with a prepared cut filler. Before putting the tractor in service, re-oil the cylinders and valves as described, check tires, and don't forget to remove the rag plugs from exhaust and breather pipes. Where pneumatic-tired tractors must stand idle more than 30 days it will pay well to use wood supports, as in Fig. 30. These should be high enough to support the tractor with the tires clear of the floor. The front support can be made from 4 by 4-in. stock in the same way as an ordinary sawhorse. Usually, a single length of 4 by 4-in. stock will do for each rear support. Saw triangular-shaped wing braces and nail to opposite sides of one support as shown. Then when the tractor is jacked up, place the

under 5 amps. as in Fig. 24, when the electrical system is in good condition.

An important periodic adjustment which should not be overlooked is clutch-pedal clearance shown in Fig. 26. An adjustment also is provided on tractors equipped with a hand-operated clutch. In either case the purpose of providing proper clearance is to prevent slippage due to the clutch not being fully engaged. On the foot-operated type of clutch the pedal-to-stop distance varies in the recommendations of different manufacturers. Refer to your instruction manual. And don't forget to grease the clutch-release bearing, as in Fig. 29, on tractors provided with an outside pressure-grease fitting. On some tractors this is a ball bearing of the grease-sealed type which requires no lubrication.

When the tractor is stored or must stand unused for more than 30 days, several precautions should be taken. Drain all fuel through the carburetor and if there is dan-

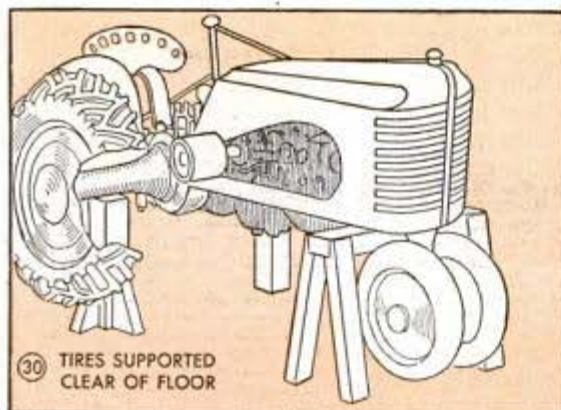

supports in the position indicated. This arrangement will prevent tipping. After a tractor has stood for some time unused it's a good idea to loosen transmission and differential drain plugs so that any moisture which has collected in the housings can drain out. Be sure to tighten the plugs after draining. Also, it's a good idea to check them occasionally during the work season. Even though it may be necessary to partially replenish the solution several times during the season, continued use of a rust inhibitor will avoid a lot of trouble with the cooling system. Bugs, dirt, and chaff will collect in the radiator fins and must be washed out occasionally with a hose.

It's a good practice to keep a tractor reasonably clean. Scrape off accumulations of oily dirt and mud with a putty knife and wire brush, Fig. 31, and then wipe off with rags or a paintbrush soaked in gasoline, distillate, or kerosene. Always have tractor in the open while cleaning. If you use gasoline, don't scrub metal parts with a wire brush. Strike a spark from metal with the brush and you may have a serious fire. Many owners paint their tractors regularly, Fig. 32. It's a good practice and it pays to do a thorough job.

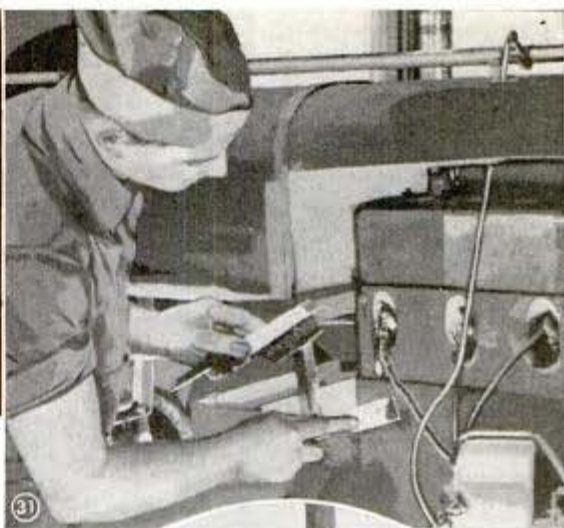

Photos and some details in this article by courtesy of Allis-Chalmers Co.—Caterpillar Tractor Co.—Harry Ferguson, Inc.—International Harvester Co.—J. I. Case Co.—John Deere Tractor Co.—Massey-Harris Co., Inc.—Minneapolis-Moline Power Implement Co.—Oliver Farm Equipment Co.

Simple Precautions That Help Avoid Fires in Automobiles

In many cases, a fire that destroyed or seriously damaged a car could have been avoided by a few simple precautions. Practically all wiring in a car is "hot" with relation to the metal of the frame or body. Consequently, should the insulation on a wire wear through, a short circuit and a fire may result. When parked with lights off, the wiring that is "hot" includes only that from the battery to the switches, plus the lead to the generator or regulator. Therefore, check these wires to see that they cannot vibrate against sharp metal edges. Tape all worn spots. When the car is running, the amount of "hot" wire is increased accord-

ing to the switches that are turned on. The addition of accessories frequently results in extra lengths of wire which often are wound around any convenient object in order to take up the slack. Sometimes fires are started by heater wires wrapped around a gas line, or taillight wires are allowed to ride loose across gas tanks or gas lines. Another cause of fire is an overheated motor in which an alcohol coolant is used. Here the fumes resulting from overheating may explode or burn with disastrous results. Consequently, checking hose connections, radiator coolant level, and fan belt condition is also important.

Suspended Pipe Catches Rod End When Cut Off With Chisel

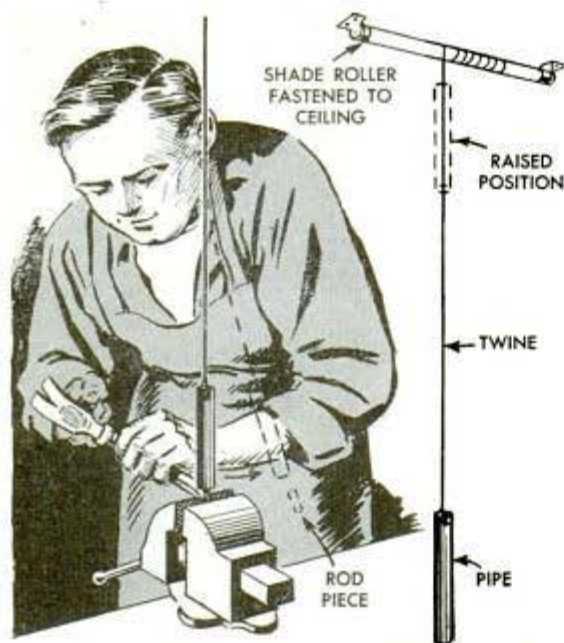

One mechanic, who frequently had to cut off the ends of rods with a cold chisel, rigged up this holder to prevent the severed ends of the rods from flying about and possibly injuring someone. The holder consists of a short piece of pipe which is suspended from the ceiling by means of a window-shade roller. In use, the pipe is slipped over the end of the rod before cutting it off. When not in use, the pipe is raised up out of the way.

Adding-Machine Tape Weighted To Hold It for Checking

The difficulty of holding a strip of adding-machine tape on the typewriter or machine table for checking or typing may



138

be overcome by attaching paper clamps to the ends of the tape to serve as weights. The clamps are applied or removed easily, provide just enough weight to hold the tape in position, and permit it to be moved over the edge of a table as the checking progresses.—G. E. Hendrickson, Argyle, Wis.

Scrubbing Brush of Corncobs

Difficulty of obtaining scrub brushes to use in scouring vats and tubs in his dairy led one farmer to improvise some from corncobs. Each brush consists of a block of wood having spikes driven through it to project about $\frac{3}{4}$ in. The clean cobs are impaled on the spikes and are rough enough to do a thorough job of scouring. The cobs may be turned to present new cleaning surfaces, and complete replacement costs no more than the few minutes time involved to install new ones.



Fence Anchors on Rough Ground Made From Sickle Sections

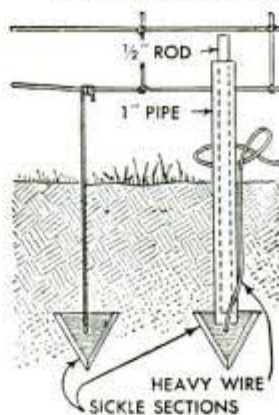

wires with lengths of anchor wire. To drive the sections we use a length of 1-in. pipe, which is notched at the lower end to fit over the sections. If these tend to stick in the slot when pulling the pipe from the ground, a length of rod can be inserted inside the pipe to knock them loose.

—E. R. Gorton, Maryville, Mo.

☐The annoyance of short or uneven strokes of an old windshield wiper often can be overcome and the wiper adjusted to clean a larger area by changing the position of the arm hub on the serrated shaft.

Stop Switch Provides Automatic Lathe Control

Long cuts on a lathe often require several minutes for completion, during which time the operator must remain at the machine. The lathe can be stopped automatically at the end of the cut by using a simple stop switch clamped to the lathe bed as in Fig. 1 or to the carriage as in Fig. 2 to control spindle and faceplate cuts. While almost any type of snap-action switch that breaks contact by pressure on a button can be used, the precision type of micro switch

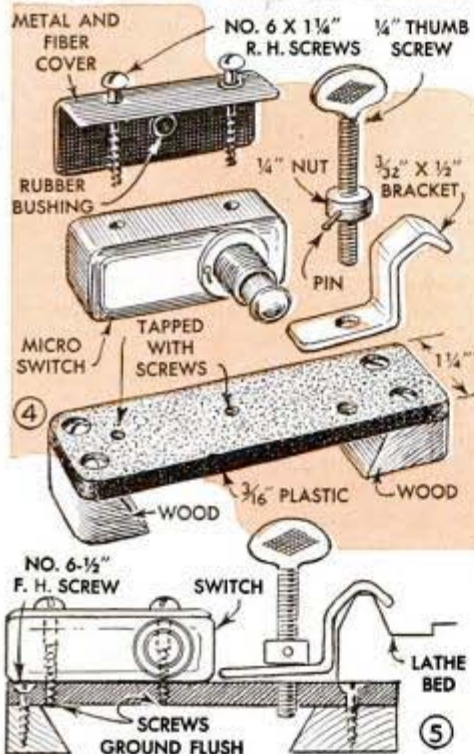
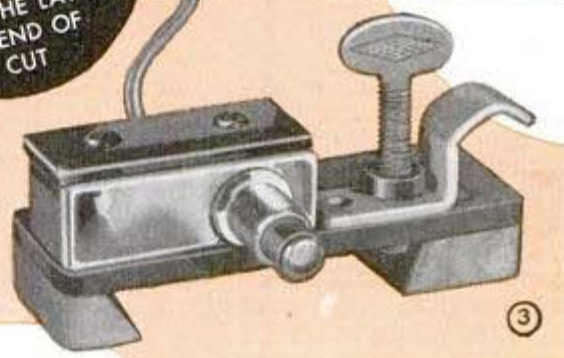
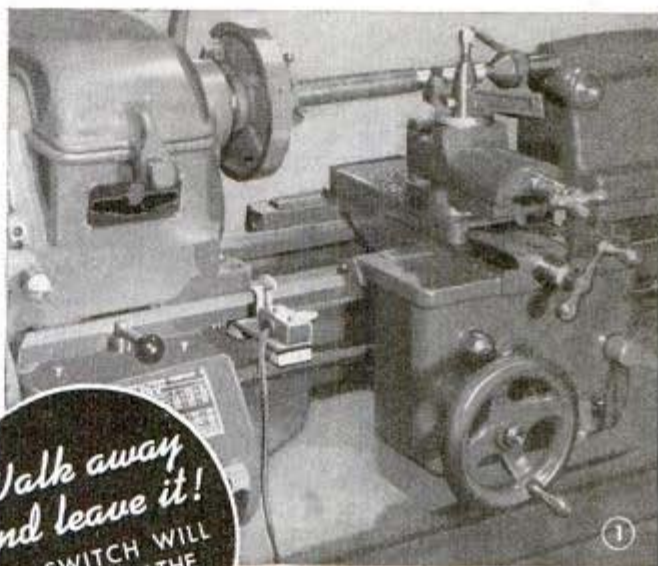

shown in Fig. 3 is recommended. This switch is a snap-action, pin-plunger type that makes positive contact with less than .0005 in. travel, and can be obtained at most electrical supply houses. Actual construction of the switch mounting is simple. As indicated in Fig. 4, a metal bracket clamps to the lathe bed at any point, while a V-bottom piece permits mounting on the cross slide, a thumb screw providing clamping action in either position. Wiring is simply a matter of breaking one of the power leads at the lathe switch. In use, the lathe carriage is moved to the point where the cut is to end, after which the switch is clamped to the lathe bed so that the pushbutton is touching the side of the carriage. Then the carriage is backed off and the cut started. When the side of the carriage contacts the switch, the lathe stops. There is a matter of coasting action to be considered. The switch has an overtravel to take care of this. As far as the work itself is concerned, the coasting action of the average lathe is less than two revolutions, which is negligible at average feed rates. When not in use, the switch is pushed to the headstock end of the bed where it is out of the way. In this position, it is useful as a thumb switch for momentarily stopping the lathe.

Emergency Laboratory Condenser Made From Glass Tubing

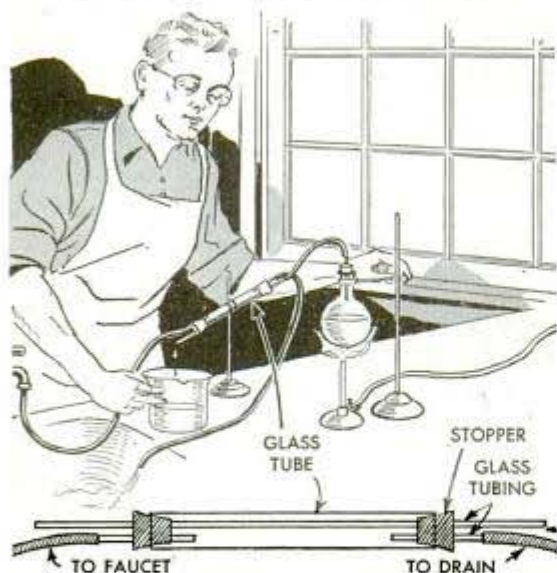

It's a simple job to make an emergency condenser for use in a laboratory. All you need is one long and two short lengths of small glass tubing and one length of large glass tubing, such as a tube that contained photo developer. Assemble the tubing as indicated, using two rubber stoppers to plug the ends of the large tube. The stoppers must be drilled for the insertion of the smaller tubes. By means of rubber tubing, connect one short tube to a cold-water faucet and the other to a drain. The long tube, of course, is connected to your apparatus to carry the vapor that is to be condensed.—W. C. Roher, Jr., Vernon, N. J.

Dust Kept Out of Type Case By Window-Shade Cover

Type cases that are left on top of the racks in a print shop soon gather so much dust that setting type is a messy and unpleasant task. To avoid much of this dust

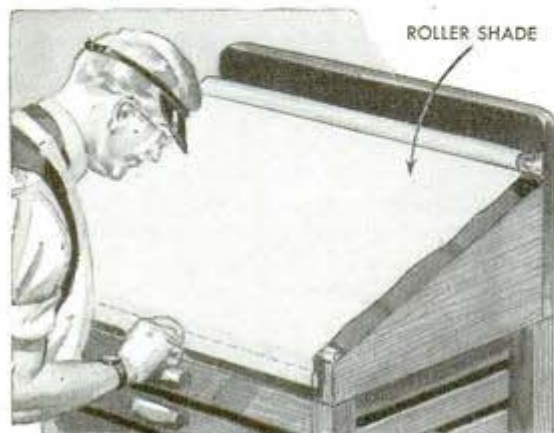

accumulation, one printer obtained window shades of a width to fit across the cases and attached them to the back of the racks so they could be pulled over the type or removed in a jiffy.

Large Cartridge Fuses Pulled With Plastic Picture Hook

Large cartridge fuses often become corroded in their holders so that they are difficult to pull out. To do this safely, one electrician found that a plastic picture hook was ideal. The hook being non-metallic, there was no possibility of an electrical shock if the hook accidentally touched the holders.

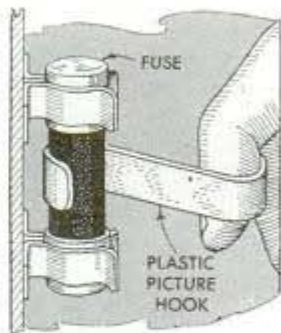

Simple Holster Keeps Micrometer Within Easy Reach of Worker



One worker who had to use a micrometer in his inspector's job in a factory used a holster like the one shown. The holster kept the micrometer where it was easy to reach at all times, and also helped to keep the instrument from rusting due to contact

with his hands. The holster is made from a leather cigarette case, the flap of which is folded over the rear side of the case and sewed to it to form a loop for insertion of the trouser belt.—Allen Fiske, Chicago.

Handy Reel for Barbed Wire

The next time you have short lengths of barbed wire to roll up for future use, nail three pieces of wood together to provide a good portable reel. In use, grasp the reel by the center arm and shift slightly to hook the wire over the ends.

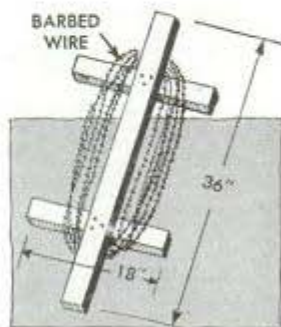



Radio

Sergeant Builds 'Pee-Wee' Radio From Salvaged Parts

"THEY wanted a young fortune for an old beat up piece of tin," says Sergeant Donald L. De Velder of Rochester, N. Y., a member of a mobile chronograph crew in the Panama Coast Artillery Command, after spending fruitless months in search of a radio. Deciding to solve the problem for themselves Sergeant De Velder and Staff Sergeant Emmet Ellis, of Niagara Falls, N. Y., assembled this three-pound "pee-wee" radio receiver from spare parts retrieved from junk heaps. Plugged into a wall socket, with a short antenna trailing down De Velder's foot locker he can now tune in the local Armed Forces Radio Station and other Panama wavelengths. Sergeant De Velder's broad grin testifies to satisfactory results as he is shown getting an earful of the latest news.

The tiny set is a 2-tube, 6 in. wide, 6 in. long and 3 in. deep, and housed in a simple cabinet made of plywood. The list of parts, and schematic circuit diagram, Fig. 1, were prepared from data supplied by De Velder. The coils have to match the tuning condenser used; a small magnetic speaker was employed. The only expense involved in the undertaking was for the 32L7 tube the Sergeant is pointing out in the lower photo, which cost him \$2.00. "Back in the States," Sergeant De Velder says, "I could have bought the same tube for 69 cents."

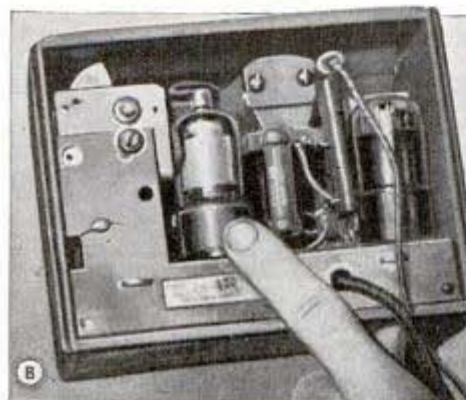

LIST

R1—.5 megohm 1/2 watt	C1—.05 mfd. 200 v. (paper type)
R2—10 " 1/2 watt	C2—.01 mfd. " " " "
R3—1000 ohms 1/2 watt	C3—.2 mfd. " " " "
R4—.5 megohm 1/2 watt	C4—.1 mfd. " " " "
R5—200 ohms 10 watts	C5—.02 mfd. 600 v. " "
R6—300 ohms 10 watts	C6 & C7—20 mfd. elect. 150 V.
R7—10,000 ohm midget	C8 & C9—365 mmfd. (ganged) var. cond.
	C10—.02 mfd. 200 v. (paper type)
	C11—.002 mfd. 600 v. " "

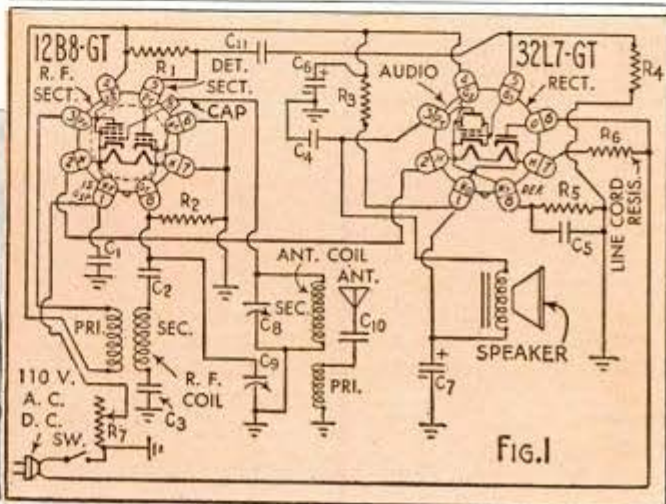

SHORT-WAVE "J-B THREE"

By L. B. Robbins



NOW you can use those old discarded battery set tubes to make a good short-wave receiver. Strictly "junk box" down to the very last nut and screw, this experimenter's 3-tuber will operate with either type-30, 199 or 201-A tubes by merely changing the "A" battery, either dry cell or storage type, to suit the filament requirements of the tubes used. Do not use a.c. on the filaments of battery-type tubes.

Designed for either headphones or a small speaker, it covers the short-wave bands from 10 to 160 meters by means of hand-wound plug-in coils wound on bases removed from discarded 4-prong tubes. Winding (L_1) on the 10 and 20-meter coils is space-wound, the turns being about $\frac{1}{8}$ of an inch apart. Duco cement holds the windings on the coil forms. The schematic circuit diagram is Fig. 1, and all coils are detailed in Fig. 2; the pictorial wiring diagram appears in Fig. 3. Ordinary bell wire is used for connections; the wire for the coils can be either cotton, silk or enamel covered.

The bottom of the wood base

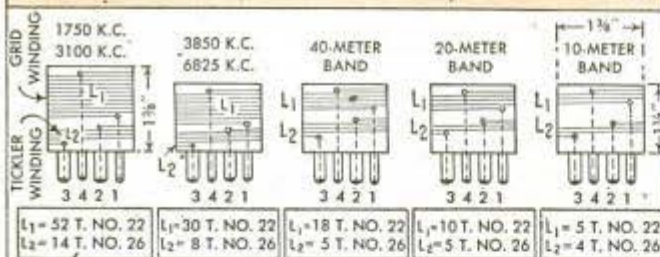
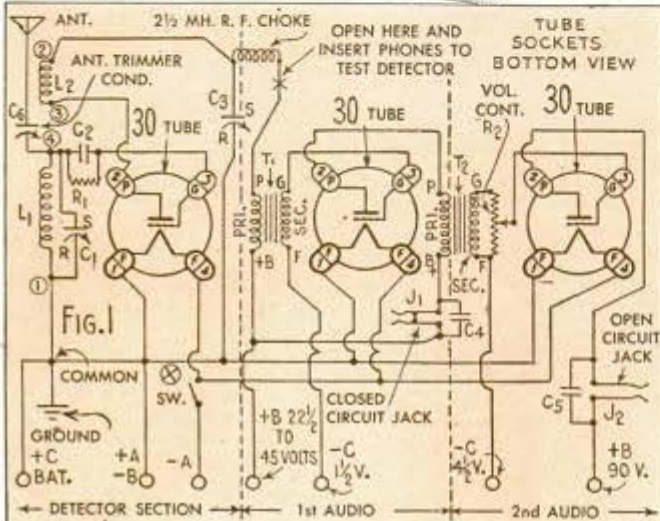

T = Turns. Coils L_1 and L_2 are spaced $\frac{1}{8}$ " apart. Note—All coils are close wound except L_1 on the 10 and 20 meter coils. These are space wound (see text). Wire size may vary slightly.

FIG. 2

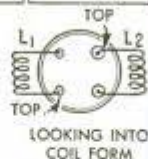

- LIST -

- C_1 & C_3 = 100 mmfd. (.0001 mfd.) variable condensers
- C_2 & C_4 = .0001 mfd. fixed condensers (any type) (Note— C_2 can be .00025 mfd.)
- C_5 = .002 mfd. fixed condenser (any type)
- C_6 = 3-35 mmfd. trimmer or padding condenser (any type) (not critical)
- R_1 = 5 to 8 megohm fixed resistor (grid leak)
- R_2 = 500,000 ohm variable resistor (volume control)
- T_1 & T_2 = 3-1, or 3 $\frac{1}{2}$ -1 ratio, audio transformers (any type)

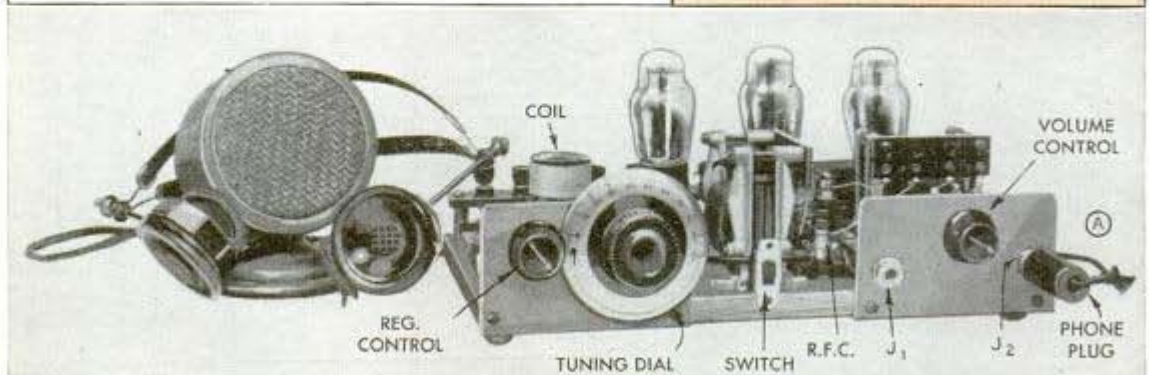

USES OLD BATTERY TUBES

board is covered with a piece of metal held with four rubber feet. Two soldered connections are made to this metal sheet on the underside. The hard pressed wood control panels are $\frac{1}{8}$ by $2\frac{1}{2}$ by $4\frac{1}{4}$ in.

Try various detector B-voltages to find the value for best reception. Detailed student material list R-329 is available from Popular Mechanics radio department, upon receipt of postage. The B-power supply can be two 45-volt B-batteries or a simple power pack of the type described in this issue on the following page. When this B-supply unit is used, no direct ground connection can be made on the receiver. If an external ground is needed, connect a .1 mfd. 600-volt paper-type fixed condenser in series with the ground lead to prevent shorting the power line. Use a 50 ft. antenna and adjust C_6 for best results. Tune slowly and clear the signals with regeneration control C_3 . A 10 ft. antenna will be best on the very short waves; readjust C_6 when changing antennas. Refer to short-wave logs for best listening hours.

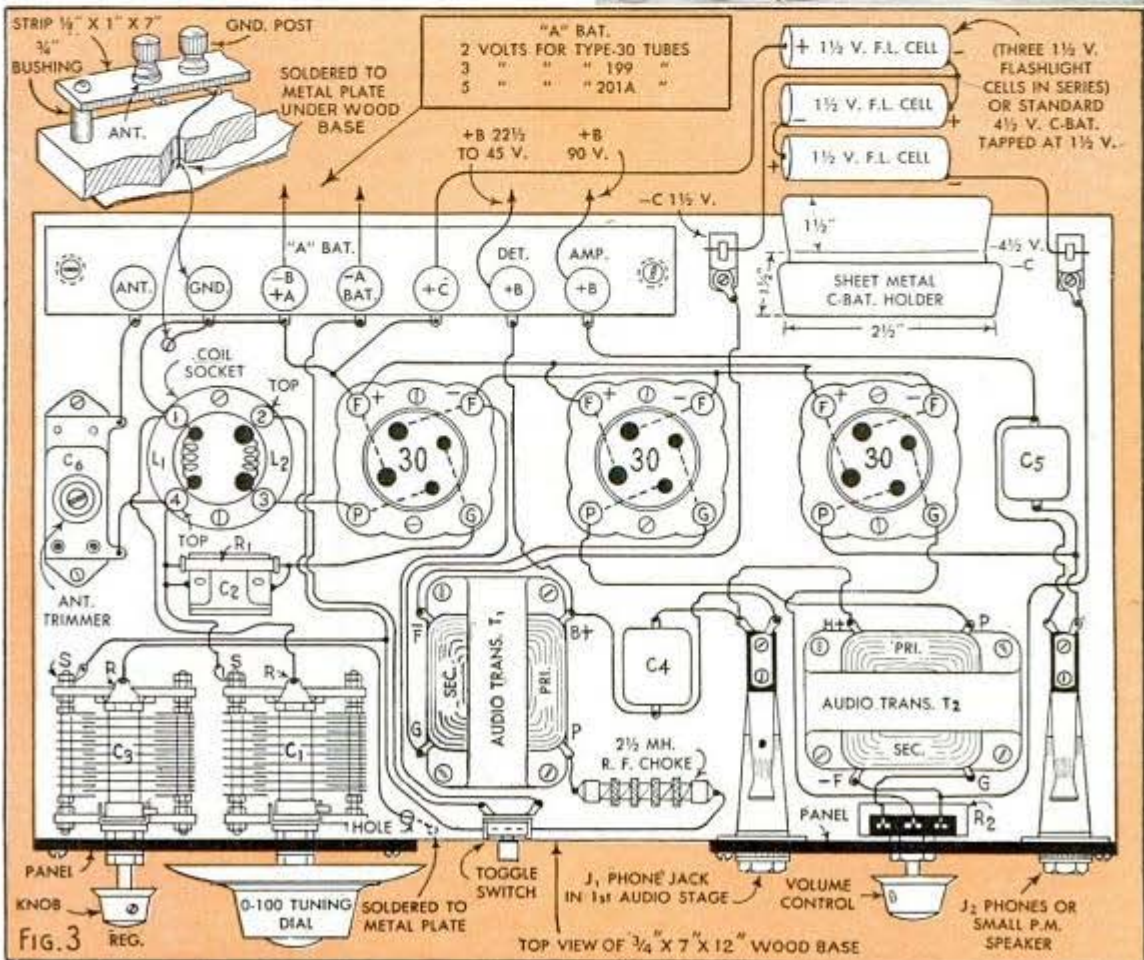
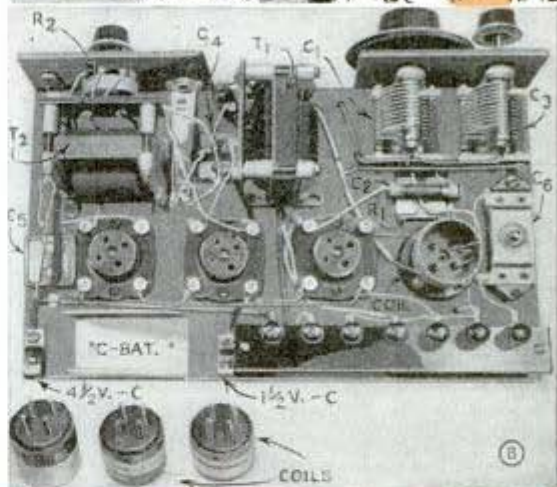

Here's how your car FEELS...

... after

MARFAK

*chassis
lubrication!*

Now's the time for MARFAK chassis lubrication. Keeps your car *limber* despite freezing weather, makes winter driving smooth and effortless. MARFAK is extra tough and long-lasting. And your Texaco Dealer applies it by chart . . . never by chance! Every point of wear, every point of adjustment gets a going over . . . from tie rods to spring shackles. But don't wait. Colder weather's just around the corner. Ask your Texaco Dealer to give your car that "MARFAK feeling" today!

THE TEXAS COMPANY



Let us
MARFAK
your car



TUNE IN the TEXACO STAR THEATRE starring James Melton every Sunday night. See your local newspaper for time and station.

NOVEMBER, 1944

145

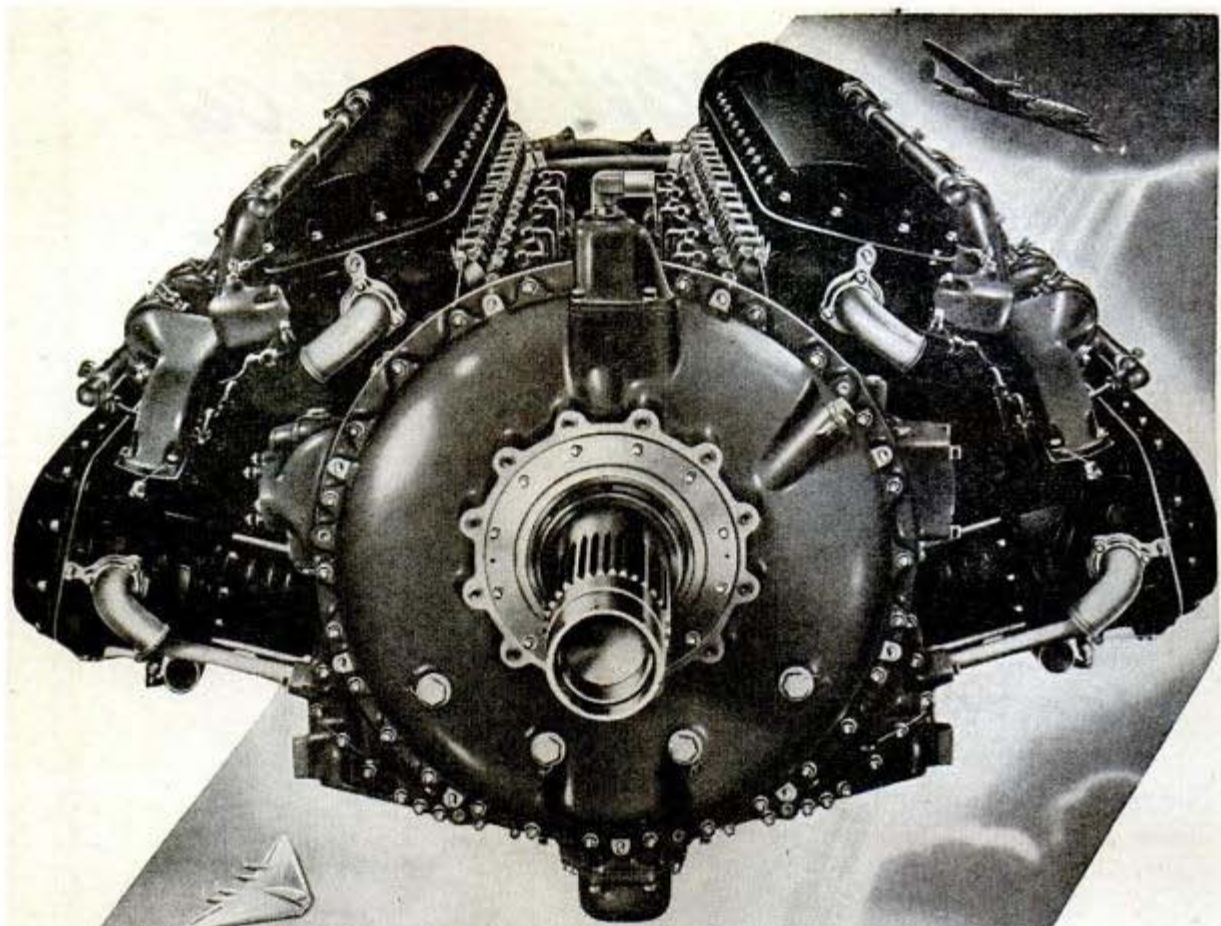

A LIQUID-COOLED GIANT — THE WORLD'S MOST POWERFUL

Going into America's new planes is the most powerful liquid-cooled aircraft engine in the world. ★ It is an Allison engine — of approximately 3,000 horsepower. It is more powerful by hundreds of horsepower — gives our pilots over a third more power to work with than the huskiest engine they had before. ★ Virtually all its parts are the same as in other Allison's. So plane crews around the world can service it right now. ★ Its high power, long range, smoothness and dependability are qualities vital in the days of war, and equally important in the planes in which you will fly when peace returns.

**KEEP AMERICA STRONG
BUY MORE WAR BONDS**

POWERED BY ALLISON

P-38—Lightning
P-39—Airacobra
P-40—Warhawk
A-36 and P-51—Mustang
P-63—Kingcobra

The more-than-50,000 Allison engines built for the U. S. Army Air Forces power the above planes.

LIQUID-COOLED AIRCRAFT ENGINES

Allison
DIVISION OF

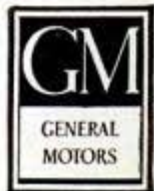

Indianapolis, Indiana

Every Sunday Afternoon

GENERAL MOTORS SYMPHONY OF THE AIR — NBC Network

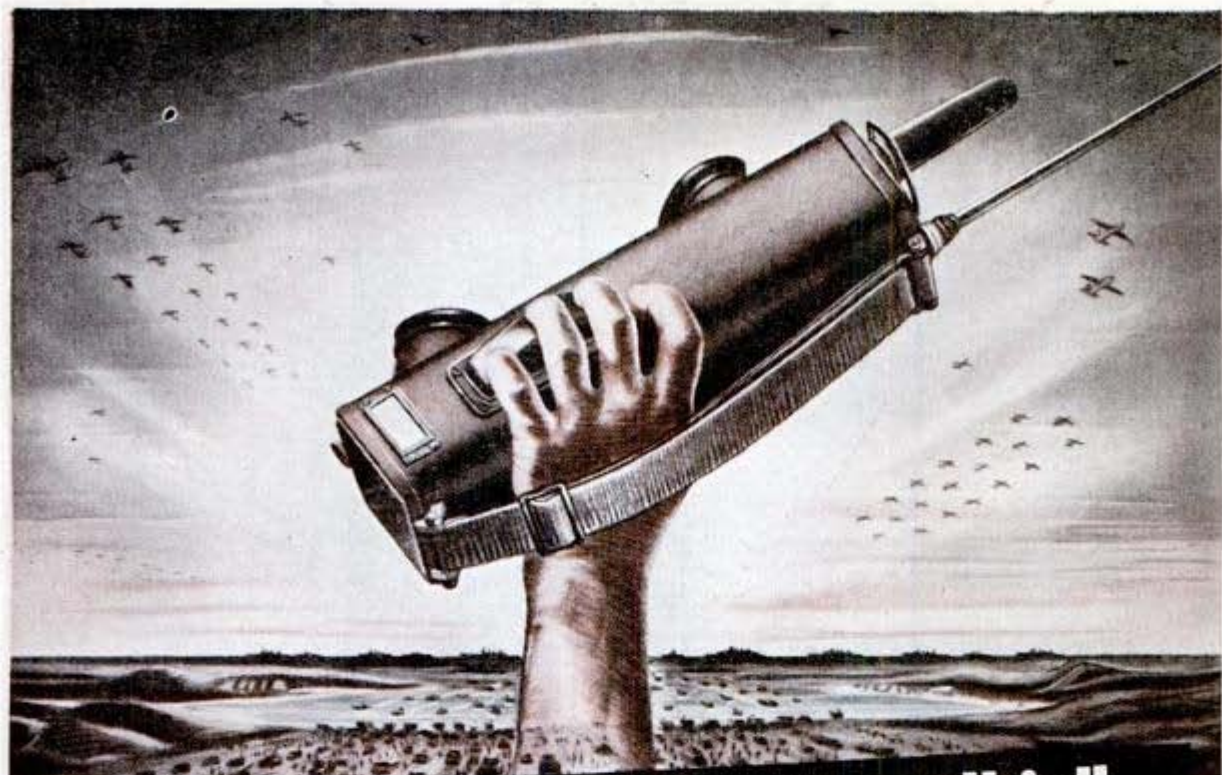

Motorola Radio "Handie Talkie" co-ordinating our march to Victory



The story of every great Victory of our armed forces has been a story of teamwork . . . split-second timing and miraculously unified attack. Radio ties all combat arms together.

Motorola Radio Engineers have developed, built and delivered in great quantity such battle-famous radios as the Walkie-Talkie, the "Handie Talkie," the Cavalry Guidon Set, and the power-

ful two-way unit that moves on wheels.

Much of this equipment has been of the F-M (Frequency Modulation) type. This is the static-less, noiseless radio you will enjoy when Victory restores peace and normal living to our America.

There will be Motorola Radios soon again for your Home and Car. F-M, Television, other Electronic developments? You bet! Motorola will have them all!

Like the "Handie Talkie" this Tiny Portable is a notable Motorola Radio First!

Thousands know the Motorola "Playboy" as the smallest, most powerful personal portable radio on the market. It plays richly, beautifully, on planes, trains . . . in steel constructed buildings. The marvelous thing about the Motorola "Playboy" is its size . . . no larger than a snapshot camera . . . just a mighty little handful of radio pleasure. Watch for the new post-war Motorola "Playboy". It will be a "Honey"! Buy more war bonds!



GALVIN MFG. CORPORATION • CHICAGO 51



Motorola Radio

F-M HOME & CAR RADIO ★ PHONOGRAPHS ★ RADAR ★ TELEVISION ★ F-M POLICE RADIO ★ MILITARY RADIO COMMUNICATIONS

Crown of

steel for a queen

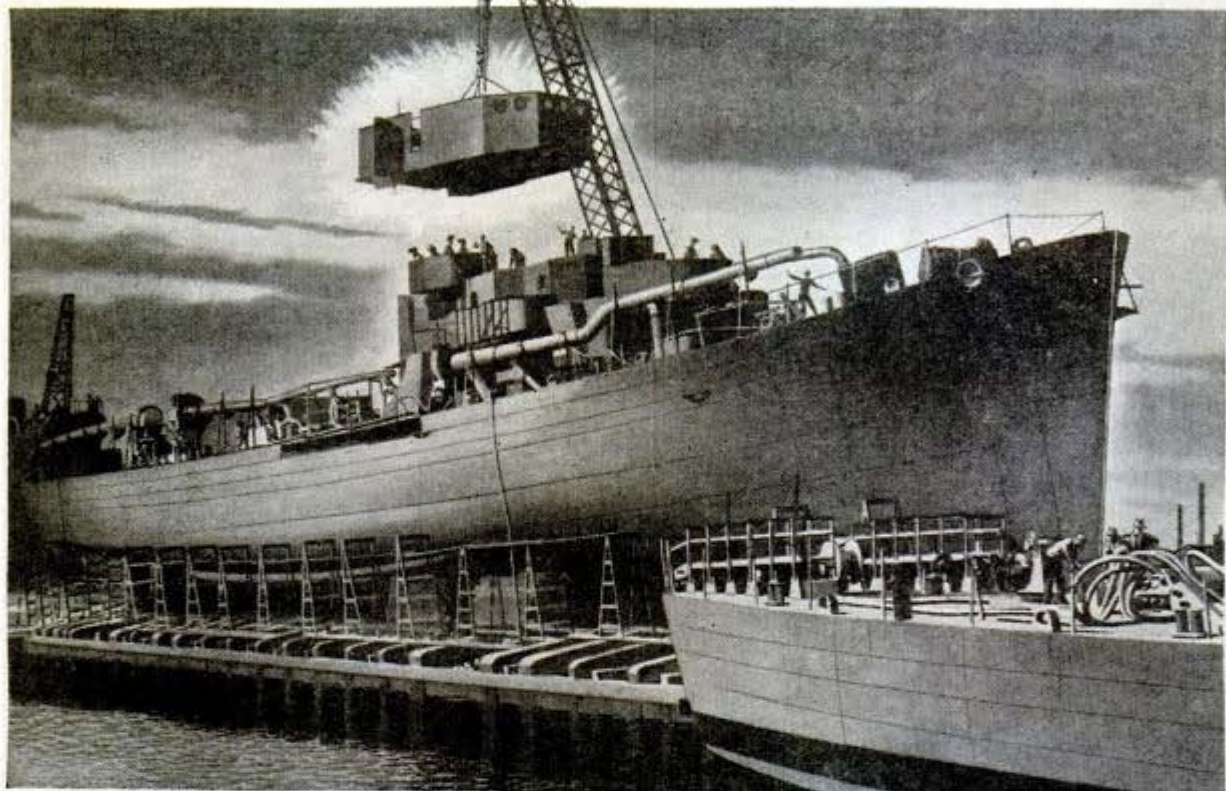

As significant in its way as the coronation of an earthly monarch, is the placing of the steel superstructure that crowns a queen of the sea. ☆ And surely a fine ship is queenlike, for she possesses regal beauty, proudly defies the wind, the weather and the sea and gives royal guardianship to the men who sail her. ☆ These qualities are imparted to a vessel by the shipbuilders—men who build with their hearts as well as their arms. Theirs is both an art and an industry—a craft and a science. ☆ For nearly forty years, Defoe has been building and *crowning* queens of the sea. Yesterday, beautiful yachts and hardy small craft came from the Defoe ways. Today, fighting ships for the Navy. Tomorrow, for peacetime America, Defoe will build private vessels and industrial products that reflect the skill and devotion typical of the shipbuilder's art. This is the only way we know how to build.

DEFOE SHIPBUILDING COMPANY, BAY CITY, MICHIGAN

Defoe

*Four White Star Renewal Citations
now decorate the Navy "E" Award
won by Defoe workers.*

**BACK THE ATTACK
—BUY WAR BONDS**

**SHIPS FOR VICTORY
SERVANTS FOR PEACE**



ENGINES WEAR OUT, TOO...

 The life of an engine depends largely on the care it gets. This life can be shortened by neglect, or greatly extended by proper attention.

Today millions of engines are operating efficiently, long beyond their normal span . . . because they have been watched closely, checked frequently . . . and serviced at the first indication

of trouble. Every engine is a trust in its owner's hands. Take no chances . . . protect your vital transportation . . . replace worn parts before undue wear occurs! Consult your motor specialist regularly and often.

TOUGH BUT OH SO GENTLE

HASTINGS MANUFACTURING COMPANY • HASTINGS, MICHIGAN

Hastings Mfg. of Canada, Ltd., Toronto

★ *It's a privilege to buy War Bonds*



HASTINGS STEEL-VENT PISTON RINGS



TOUGH on oil-pumping • GENTLE on cylinder walls

Sixty-Yard Flash

Continued from page 85

of our pet secrets, but essentially it is ordinary motor gasoline almost solidified. Its relatively short range has limited the flamethrower's usefulness. But the M1-A1's sixty-yard flash has already been surpassed by tank-mounted flamethrowers that hurl a 150-yard jet. These were used on Saipan and against the Siegfried Line.

The British 41-ton Churchill "Crocodile" tank carries what they claim as the most powerful flamethrower in the world, throwing a geyser of fire over 450 feet. It tows its own fuel in an armored trailer.

The G. I. Hotfoot is a first cousin of the oil incendiary bombs we have showered over Nazi Europe and the Japanese isles. Both are loaded with the same gasoline jelly. The new jelly bomb is not so hot as the German magnesium bomb which flares briefly at a temperature of 3,000 degrees Fahrenheit and is harder to extinguish, but the total heat content of the gel-gasoline is almost twice as great and it burns longer.

That was proved when the new incendiaries destroyed whole Japanese and German cities on a desert in Utah. Under supervision of Standard Oil Development research men, entire cities were built secretly in a remote section of Utah. Architects familiar with Jap and German structural design and materials were employed. One had worked 18 years in Japan, another was a German refugee architect. Not only were roofing and insulation materials and joist construction duplicated as closely as possible, but the buildings were furnished in the German and Japanese manner down to the oriental tea table and the rice-straw mats, hundreds of which were rounded up from Japanese settlements along the west coast and throughout the Hawaiian islands. The job was complete in two months. Then Fortresses and Liberators and Mitchells swarmed over the cities to bomb them out of existence. All types of incendiaries and explosive bombs were used. The cities were destroyed, rebuilt and destroyed again. The gasoline-jelly bomb proved its effectiveness above all others. An interesting sidelight was the fact that, in pure destructive power, the bombs carried on Doolittle's Tokyo raid were the least effective of all. We have progressed a long way since.

The oil incendiary is devilishly ingenious. It looks like a piece of hexagonal pipe, so shaped in order that it can be packed in clusters of as many as 60, which break into individual bombs as they fall, covering a wide area. Each carries 2½ pounds of gel

(Continued to page 152)

HE HAS YOUR BATTERY



Vital cargoes must get through to our fighting men overseas! For emergency communication the Merchant Marine depends upon portable, battery-powered megaphones. We're short of batteries on the homefront now because they're needed to power countless time-saving, life-saving instruments on land and sea. Use your available Burgess Batteries sparingly . . . keep them cool and dry. For Free Battery Hints—Write Dept. E-3, Burgess Battery Company, Freeport, Illinois

The War Chest Helps Here and Overseas!



BURGESS BATTERIES

IN THE NATION'S SERVICE





... WISH I OWNED IT, DAD

"Gee, Dad, I sure get a kick out of just holding your Savage rifle. Bet I can put 'em in the bull's-eye same as you do. When am I going to have a Savage of my own?"

"Can't blame you for liking this rifle, son. A Savage has always been my favorite ... and that goes for shotguns, too.

"It won't be long now before you'll have your Savage .22. Then you and I will do some target shooting, and later on we'll go on some real hunting trips. I've got a feeling I'll be wanting a new shotgun, too."

Savage Arms Corporation

Plants in Utica, N.Y. and Chicopee Falls, Mass.

Manufacturer of SAVAGE, STEVENS, FOX Sporting Arms

SAVAGE

YOU'LL WANT ONE, TOO

As soon as war restrictions are lifted, there'll be a great variety of Savage rifles and shotguns for every shooting requirement. All the skill and precision manufacturing facilities that enabled Savage to produce huge quantities of Victory arms will assure supremely fine quality and outstanding value in every Savage model.



TOP . . . Savage Model 4
.22 Cal. Repeating Rifle
CENTER . Savage Model 220
Single Barrel Shotgun
LOWER . Savage Model 720
Automatic Shotgun





Where the job is important
... files must be right

Filing nicks out of propeller blade of Budd-built RB-1 transport plane.

EVERY detail in the maintenance of a costly giant of the air is important. Taking nicks out of a plane's propeller blade *could* be done—after a fashion—with a randomly selected file; but modern shop practice says, "No! Use the *right file for the job.*" With Nicholson Files, that admonition can be obeyed. For smooth-filing aluminum and aluminum alloys (like airplane propellers), the specially designed Nicholson "Aluminum Type A" usually does the job best.

Hundreds of other filing jobs present similar situations. "Know your files and get ahead" is today's advice to the forward-looking mechanic. Know Nicholson Files and your knowledge of file types will be up to the minute.

FREE BOOK, "FILE PHILOSOPHY." It can give you more information about file kinds, use and care in half an hour's reading than months of "apprenticing." . . . 48 interesting illustrated pages.

NICHOLSON FILE CO., 22 Acorn St., Providence 1, R. I., U. S. A.
(Also Canadian Plant, Port Hope, Ont.)

NICHOLSON
FILES FOR EVERY
PURPOSE

NICHOLSON
U.S.A.
MADE IN U.S.A.

gas. As it breaks from the cluster, a cloth streamer emerges from the tail and slows its fall just enough to let the bomb penetrate an enemy roof without damaging the bomb's own mechanism. Impact sets off a fuse which ignites a three to five second powder train; then an explosion of black powder and magnesium shoots out of the bomb case a flaming cheesecloth sock filled with the gel gas. Flung with enough force to send it nearly 100 yards, the sock splatters gobs of flaming goo wherever it hits.

The gel-gas incendiary bomb had one of its first combat tests over Ponape. First the bombers went over the Jap-held island and sowed blockbusters, then the "rec" planes made an inspection tour and brought back photographs of the results. A day or two later the bombers returned with a load of incendiaries, and the cameras followed up for a recheck. The gel-gas treatment had accomplished about 150 times as much destruction as an equal weight of blockbusters. The high explosives dug enormous craters and had a terrific blast effect, but the damage was more localized. The incendiaries spread over a wide territory and started innumerable destructive fires.

Heavy explosives were in favor during the early part of the war, but the Air Force has put more weight in fire bombs during recent months. At one time incendiaries formed only about five percent of our total bomb loads. Lately the proportion has been 35 to 50 percent incendiaries. In one mass raid 350,000 fire bombs were dumped on Berlin. A favorite technique is to send over first a shower of high-explosive bombs, then a second wave of planes to drop a deluge of gasoline-jelly fire bombs, and finally another wave of explosives which intensify the fires by scattering combustible debris and interfering with the fire fighters and their equipment.

Fire is a ruthless weapon, but we fight ruthless enemies. The gel-gas incendiary bomb and the flamethrower are answers to the fire-bomb attacks that in 22 days and nights set 10,000 major fires in London. In one such attack on English shipyard workers' cottages less than a dozen out of 12,000 were left undamaged.

We learned about fire from the Germans. Now the pupil is the teacher.

Cameramen Under Fire

Continued from page 69

pressure spring on the contact printer. The developing tank was an old Vienna sausage can, coated with a clear lacquer. The print and negative washer was made from

(Continued to page 154)

DON'T BE *Side tracked*

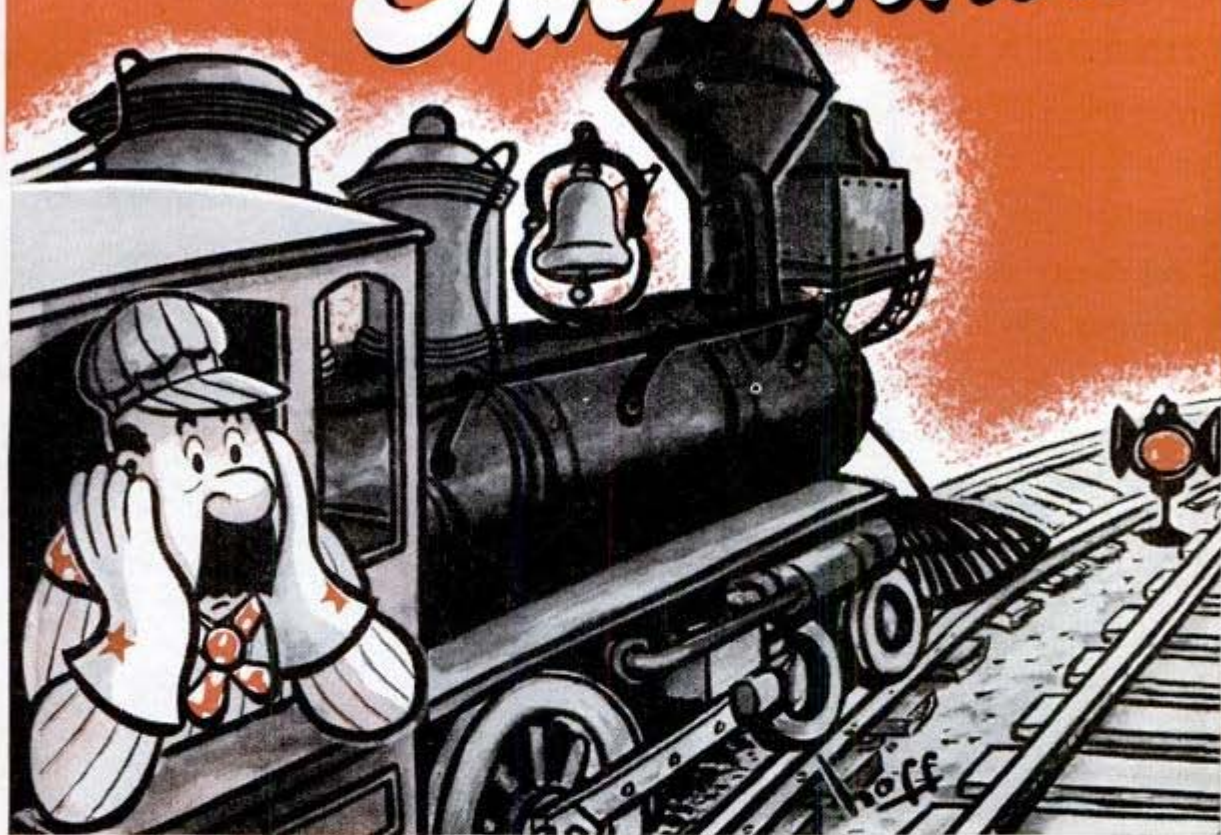

Switch to Auto-Lite Batteries

Be guided by the experts who choose batteries for the world's toughest transportation services. For example, the million-mile trans-ocean flying record was established by a Pan-American Clipper equipped with Auto-Lite batteries.

Auto-Lites, too, are specified for service with our

fighting forces in tanks, half-tracks, jeeps . . . wherever dependable power counts.

Get the long life . . . the extra power you need. Buy an Auto-Lite battery—specified as original equipment by leading automotive engineers.

Auto-Lite
means
Auto-Life

AUTO-LITE BATTERY CORPORATION • TOLEDO, 1, OHIO

Manufacturing Plants at:

Niagara Falls • Atlanta • Indianapolis • Oakland • Oklahoma City • Toronto

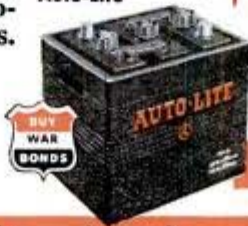

Tune in 
AUTO-LITE'S
GREAT RADIO SHOW
STARRING
DICK HAYMES
IN
"Everything for the Boys"
Every Tuesday Night . . . NBC Network
Featuring stars of stage, screen and radio and men and women at the fighting fronts

AUTO-LITE BATTERIES

Will Your Car Outlast the War?

As a special wartime service to owners of **ALL MAKES** of cars, General Motors offers a new edition of **The Automobile User's Guide**, containing 196 practical suggestions on such subjects as *how to get better gasoline economy, how to prolong tire life, how to keep your car in the best operating condition, how to preserve exterior finish, etc.*



You can get your **FREE COPY** from any General Motors dealer or by using the coupon below.



Customer Research Dept., Room 1763
GENERAL MOTORS, DETROIT 2, MICH.

Please send **FREE COPY** of new 64-page
"AUTOMOBILE USER'S GUIDE"

Name.....
please print

Address.....
please print

City.....
State

Make & Model
of Car Owned.....

the tin that once covered a crate of matches and the serrated rubber cushion of a ping pong paddle lined the handle depressor of a contact printer.

In the air, combat cameramen must be able to earn their way on a bombing mission by manning a machine gun in an emergency. Lt. James Bray, former Pathe cameraman with the 9th Air Force, who has the distinguished flying cross and the air medal with two clusters, took over when the waist gunner beside him was killed and shot down two Messerschmitts. Two Air Force cameramen were killed in filming the "Memphis Belle," a documentary color movie which showed civilians graphically what 8th Air Force crews go through on a routine mission.

The story of Sergt. Johnny Bushemi, photographer for the service magazine Yank, symbolizes the characteristic industry and bravery of American cameramen. When the American forces were about to attack Makin and Tarawa simultaneously, Bushemi chose to go to Makin but soon found he had made a mistake, for the fighting on Makin was comparatively tame. So he hitched a plane ride to Tarawa and arrived just in time to see the last stages of the great slaughter. Later he fractured his hand on Kwajalein Island and it was all he could do to operate his camera with one arm in a sling. However, he insisted on landing with the marines in the invasion of Eniwetok, where a knee mortar shell severely injured him in the cheek, neck and left leg. He died three hours later aboard a Navy transport offshore as the surgeons were tying the arteries in his neck. His last words were, "Be sure to get those pictures back to the office."

World's Biggest Jig-Saw Puzzle

Continued from page 79

from the main cockpit and cabin heating plant that the C-54 carries, a special heater is located in its nose wheel well just to provide hot air that keeps the cockpit windshield defrosted.

Even a propeller assembly, which was quite a simple unit ten years ago, is now an intricate mechanism of 1,200 different parts, balanced so delicately that a splash of paint on the tip of one blade might cause unbalance and dangerous vibration.

The jigs in which large aircraft are assembled are lined up by surveying instruments and are sighted in to an exactness of 1/10,000th of an inch to help make each airplane identical with the others of its type. Nevertheless, minute manufacturing

(Continued to page 156)

LIGHTER MOMENTS with **fresh Eveready Batteries**



"It never fails . . . the minute I get in the bath, there goes the telephone!"

"Keep your eye on the Infantry—the doughboy does it!" The doughboys are in every front line drive. Are you in on every War Bond drive?

MILITARY FIELD TELEPHONE EQUIPMENT calls for the kind of dependable power found in "Eveready" No. 6 Dry Cells.

That's why much of our production goes to the Armed Forces. The civilian supply is limited, so use yours wisely. However, after the war, there will be new and finer "Eveready" batteries...giving better service, longer life.

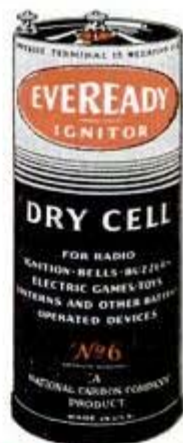

EVEREADY

TRADE-MARK

The words "Eveready" and "Ignitor" are registered trade-marks of National Carbon Company, Inc.



- GENUINE IMPORTED BRIAR**
- ◆ Sterncrest Ultrafine . . . \$10.00
 - ◆ Sterncrest 14K 7.50
 - ◆ Sterncrest Sterling 5.00
 - ◆ Certified Purex 3.50
- CHOICE AMERICAN BRIAR**
- ◆ Select Grain \$2.50
 - ◆ Silvercrest 2.00
 - ◆ Superfine Purex 1.50
 - ◆ Sculptured Purex 1.50

Many styles, dozens of handsome models, plain or antique finish—and all are of LHS craftsmanship

FREE—write for our new booklet, "Pointers on Pipes", chock full of pipe lore and pipe do's and don'ts

L. & H. STERN, INC., 56 Pearl Street, Brooklyn 1, N. Y. (STERN BUILDING)

irregularities may produce slight differences in the flight characteristics of each plane. These are compensated for during the test flights by means of special trim tabs on the left wing aileron and the tail group, which are adjusted and then set permanently so that each airplane will maintain level flight with a balanced load. One item of equipment that goes with each plane is a balance computer that resembles a slide rule, by which a pilot can determine the plane's center of gravity under different load conditions.

Fuel and oil for its engine and air for the tires were about all a plane once needed. Now the servicing also includes replenishment of the hydraulic oil, fresh bottles of oxygen for the high altitude breathing apparatus and, on some aircraft, the addition of water to the plane's water tank. This water provides "war emergency power" to the engines. It spurts into the carburetor at the rate of one gallon per minute when the pilot pushes a button, supplying moisture to the carburetor air. This increases the power output and temporarily steps up the plane's speed.

The Battle Against Bacteria

(Continued from page 63)

In the 12 to 14 minutes required for complete discharge, one dispenser will fumigate 150,000 cubic feet of space, the equivalent of 240 army pup tents, or 50 giant bombers. But the spray can be turned on and off as necessary. Only three seconds are required to fumigate one pup tent.

Even sound waves have been found effective as bacteria killers. An American naval officer has invented a magnetic device which produces 9,300 vibrations a second, fatal to all bacteria within six inches.

Another group has found that chlorophyll, which gives green coloring to plants, can be dissolved in water and applied to wounds and burns as an antiseptic.

How all these discoveries are working out on the field of battle is illustrated by an incident when 561 wounded men were moved from France to England and not one of them died. In some types of wounds, the death rate would have reached 90 percent in the last war.

How the wartime developments will affect the world is likely to be startling indeed. Scientists say that people will live so much longer that countries like ours will be "old peoples' nations and our habits, politics and international relations will change as viewpoints of more elders prevail. Thus the war within a war will affect our lives in many generations to come.

AUTO-LITE SPARK PLUGS

IN SERVICE ON EVERY FRONT



"Dang it, Maw . . . Ah tol' you to let go the crank when she back-fires."

DO YOUR CAR A GOOD TURN WITH "PLUG-CHEK"

"Plug-Chek" Inspection Service is the quick and accurate way of finding the spark plugs that are wasting gas . . . it puts the finger on faulty or improper plugs, may add as much as 12% to the mileage you are now getting from your coupons, according to tests by the American Automobile Association.

Possibly all your present plugs need is cleaning or regapping—a "Plug-Chek" can give you the answer. But if new ones are needed, install ignition engineered Auto-Lites.

THE ELECTRIC AUTO-LITE COMPANY
TOLEDO, 1 • Merchandising Division • OHIO
BACK THE ATTACK—BUY WAR BONDS

Tune in
AUTO-LITE'S

GREAT RADIO SHOW

STARRING

DICK HAYMES

AND GORDON JENKINS' ORCHESTRA IN

**"Everything For
The Boys"**

Tuesday Night—NBC Network

Featuring men and women at
the fighting fronts



WORKSHOP WISDOM

How to make linoleum stay down



IT'S EASY to make an excellent linoleum cement with Casco Glue. Simply mix $1\frac{1}{4}$ measures of Casco with 1 measure of water.

Apply this mixture liberally to the clean floor with a heavy brush. Roll linoleum carefully over this space and place sandbags or weights on top surface to assure even pressure. Keep weights on for 12 hours or overnight.

Casco Glue wins on 4 counts

Unusual strength. Casco Glue hardens and sets chemically to form a bond of remarkable strength and toughness.

Greater durability. This glue is highly resistant to dampness, heat, and age.

Easy to mix. Casco Glue mixes easily with cold water—no heating problems.

Economical. A little Casco goes a long way. Mix it as you need it. The powder, if tightly covered, lasts indefinitely.

For special outdoor jobs and water projects, ask for Cascamite—the waterproof plastic adhesive.

You can get both Casco Glue and Cascamite in 10¢, 25¢, and larger sizes at all hardware stores.



Send for free Casco Project Booklets and free Gluing Guide containing 80 household gluing hints. Just address a post card to Casein Company of America, Dept. P2, 350 Madison Avenue, New York 17, N. Y.

CASCO Powdered Casein GLUE

"Sets chemically—hardens permanently"

Fitting the Gob to the Job

(Continued from page 25)

It is certain to be a battle and a grim one. To make it more complicated a group of inspecting officers runs about the ship, like expert gremlins, pulling switches and disconnecting oil lines to gum things up for the sweating crew.

An inspecting officer suddenly points at a telephone talker. "You're dead," he says. The man sits down, leaving his phone unattended. Another man grabs the telephone.

Communication between the bridge and engineroom is severed. A human chain transmits orders. A key officer is a "casualty." Another steps up.

The shakedown cruise gives every man aboard something that he can get only while operating the ship. A navy officer, just back from the shakedown of a light cruiser tells what it is:

"The one big idea you get is that the Navy is a team. You know your job—and see its importance to the team. Sure, you learned a lot in training camp. You learn more at sea. One lesson that is burned into your mind is your place on the team."

The Ether Patrol

(Continued from page 17)

locate the hidden transmitter which they now know to be in a certain small area, perhaps an apartment building.

RID operators then proceed on foot carrying a small gadget known as a "snifter." The indicator on this device tells the operator when he is approaching the source of the signal. Authorities are then summoned.

There are many instances where signals are received in the form of high speed code. It is not possible to type the contents at a speed greater than approximately 40 words per minute. In such cases, operators in the Intercept Room make a complete recording of the transmission on a device known as a Boehme ink recorder. The speed of the tape going through the machine is adjustable. A special receiver and an electronic clipping device make it possible to record signals directly onto the tape at any speed up to 500 words per minute. The tape is then removed and placed before another operator trained to decode the contents.

In other cases, certain aural intelligence must be recorded for study and observation. Several elaborate recorders are available and are known as Memovox disk recorders. They make use of a paper-based flexible disk which is capable of holding more than an hour's recording on each side.

(Continued to page 160)

America's Number One Manufacturer of Warm Air Heating Plants Announces

A NEW KIND OF FURNACE DESTINED TO SWEEP AMERICA!

COSTS LESS!...MORE EFFICIENT!...AMAZINGLY COMPACT!

ALREADY PROVED IN THOUSANDS OF HOMES!

FLOOR-LEVEL AIR DRAWN OFF HERE—QUICKLY WARMED—MEANS WARM FLOORS.

AIR INTAKE CHAMBER SPREADS AIR INTO HEATING CHAMBER.

AIR IS WARMED AND CIRCULATED 3 TO 5 TIMES AN HOUR IN AN AVERAGE 5-ROOM HOUSE.

STREAMLINED BOTTOM MAKES AIR "FLY" 35% FASTER THROUGH THE FURNACE!

80% OPEN REGISTER SPEEDS WARMTH TO EVERY CORNER OF YOUR HOME.

COMPLETELY AUTOMATIC! NO DIRT, ASHES, SHOVELING OR WORK.

NEEDS NO BASEMENT—NO DUCTS. AIR-FLOW PRINCIPLE GIVES BETTER COMFORT.

GET THE WHOLE STORY OF THIS "HEAT OF TOMORROW" FROM THIS FREE BOOK!

FREE!

The "INSIDE STORY" about this and other "magic" heat plants.

**IT'S CALLED A "FLOOR FURNACE"—
BECAUSE IT IS SET IN THE FLOOR!**

Here is some of the practical Coleman heat-magic you can have after the war. New "warm-floor" comfort—automatic effortless ease—surprisingly low fuel cost. One of a group of advanced heating plants, perfected by Coleman engineering genius. Gas, oil, butane models will be available.

A book of solid facts about the different type of heating that will be available when production is resumed. Mail coupon for your copy, to Coleman Lamp and Stove Co., Dept. PO-626, Wichita 1, Kansas.



Coleman

**THE "HOT" NAME
IN HOME HEATING**

THE COLEMAN LAMP AND STOVE COMPANY
WICHITA 1 • CHICAGO 11 • PHILADELPHIA 8 • LOS ANGELES 54

THE COLEMAN LAMP & STOVE CO.,
Dept. PO-626, Wichita 1, Kansas.

Without obligation, send me your FREE illustrated book,
"The Inside Story of Tomorrow's Home Heating."

Name _____

Address _____

Town _____ State _____

Night shift or day shift, the steelworker's car must be always ready. Thousands of those "front line" workers insure utmost reliability in spark plug performance by having their plugs cleaned and adjusted every 3,000 miles, and by replacing worn plugs with new AC's. That's a good rule for everybody, because it saves gas, oil, and vital materials for an earlier Victory.



CLEAN SPARK PLUGS
SAVE UP TO ONE GAL-
LON OF GAS IN TEN

AC
SPARK PLUGS

BRING YOUR FIGHTING MAN HOME SOONER
BUY ANOTHER WAR BOND THIS MONTH

Another often used device is a Telecord wax cylinder recorder. RID mobile units carry them so they may record transmissions which they have under observation.

One of the most important wartime functions of the RID is the locating of lost aircraft. Requests are made daily to search for both private and military craft, and hundreds of them have been located and guided to landing fields. In peacetime, the RID will continue this important function.

America can well be proud of her amateur radio hobbyists. Without this trained personnel it is doubtful such an efficient organization could have been set up almost overnight.

Trouble Shooting in the Sky

(Continued from page 31)

lows the wheels to fall by gravity into landing positions, where they lock in place. Now he is able to land but he still has the problem of bringing the plane to a stop, possibly on a short runway. First he tries to pump up the hydraulic pressure in the brake system by means of an auxiliary booster pump. If this doesn't work he lands anyway and then, at the point on the ground at which he wants to apply the brakes, he pulls a toggle that releases compressed air into the braking system's hydraulic lines. The air slams on the brakes and stops the plane.

The testing of a new plane is a methodical job. First comes a complete pre-flight check by the ground crew. When any apparent troubles have been remedied, the plane gets a personal inspection by a pilot. Satisfied, he starts the engines, checks his instruments, and begins writing answers to the scores of questions on his check sheets. Instrument readings during the takeoff must be remembered and written down as soon as he gains a comfortable altitude. Then he cruises at slow speed because the engines are new and must be broken in gradually.

Any malfunctions are remedied after he lands and then the plane gets a second test flight to make certain that the reworked items are operating properly. Soon after, the plane makes its third flight, the acceptance flight on which it is turned over to the military service that will use it.

Included in the production flight test department is a special corps of flyers who roam over much of the world, doing trouble shooting for the armed forces and teaching military pilots how to get the best performance out of the Douglas planes.

Chief among these traveling pilots is

(Continued to page 162)

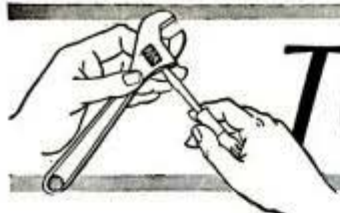

TOOL NOTES

Maintenance
and Repair
Suggestions to
Prolong Tool Life

No. 19 PICKING THE PROPER TOOL FOR THE JOB

A few simple rules will help in selecting the proper cold chisel or punch. In making your selection, remember this basic rule: cold chisels are designed to cut only metals softer than the tool itself. Use a heavy hammer; a light hammer won't transmit the force of the blow to the cutting edge.

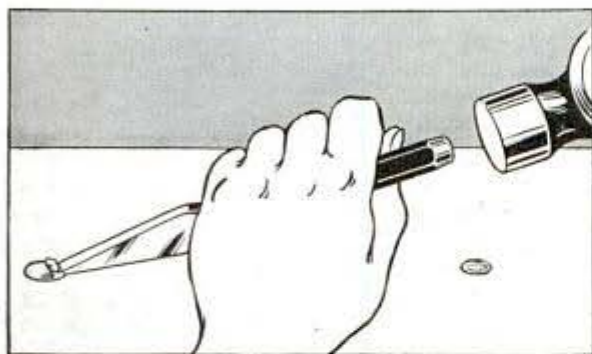

Probably the easiest way to remove a rivet head is to use a Crescent Cape Chisel, as illustrated. Cut through center section first, then knock off the two side wings.

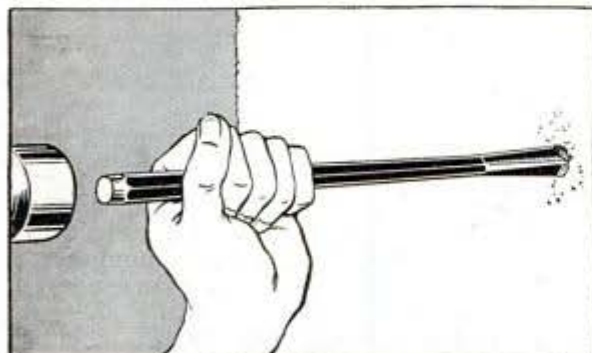

A Crescent Star Drill is the proper tool for making holes in concrete or other masonry. Give the drill a quarter turn after each blow with a heavy hammer. In a pinch, a cold chisel will suffice but work is slower.

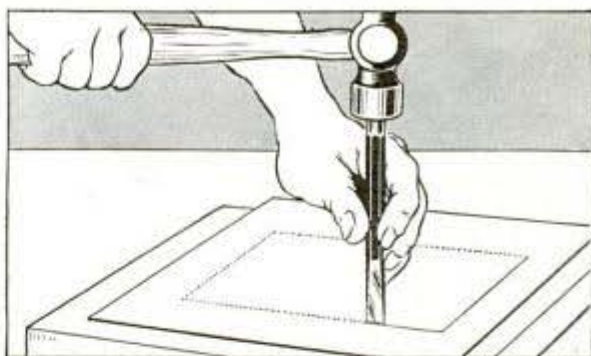

Use a Crescent Cold Chisel to cut sheet metal with a back plate. First scribe the line or design and with sheet laid on back plate, cut as illustrated. Finish edges with a file.

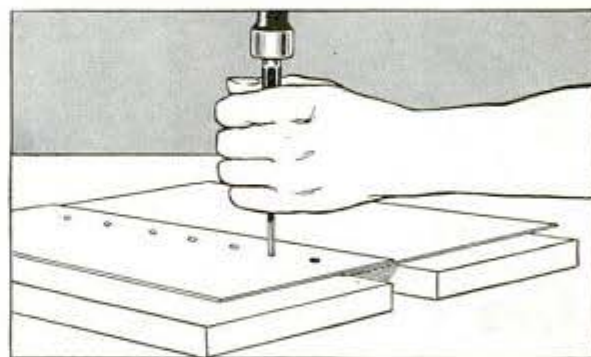

Use a Crescent Pin Punch to drive out a rivet or pin. Select a punch having a diameter slightly less than that of the rivet. A point too small may upset the end of a soft rivet and make it seize.

MAIL THE COUPON FOR FREE REPRINTS



This is No. 19, in Crescent's TOOL NOTES Series. These informative advertisements provide practical information for users of hand tools.

CRESCENT TOOL COMPANY, JAMESTOWN, N. Y.

.....
Crescent Tool Co., Jamestown, N. Y. I-6

Please send your "Tool Notes" Series

for Bulletins for 3-ring binder

Name _____

Address _____

City _____ State _____

CRESCENT TOOLS

Give Wings to Work



the honey-cured smoke

There's a truly wonderful flavor and aroma from the honey, as it blends gently (just enough) with your tobacco. It took years of patient work to get this flavor right, and ever since 1933 Yello-Bole has been among the most popular and favored, of pipes. Agreeable, and *mild*, even the first pipeful. The pipe-bowls are made from real burls, not lumber. If your dealer doesn't have Yello-Boles now, he should have them soon. Men in service all over the world, are getting Yello-Boles first. But yours will be there shortly.

- YELLO-BOLE IMPERIAL \$1.50
- YELLO-BOLE PREMIER \$2.50
- YELLO-BOLE STANDARD \$1

YELLO-BOLE A NAME TO REMEMBER, WHEREVER YOU ARE—
AND WHEN YOU COME HOME

Benny Howard, who averages more than 10,000 miles in the air per month. On one trip he flew from the United States to Australia in 40 hours, made a side trip to New Guinea to deliver spare parts, and was back in California one week from the time he started. Howard jumps to Scotland for a conference, makes a side trip to Casablanca to show Army pilots how to carry heavier loads in their C-54's, and yet spends more than half of his time at the main Douglas plant. During the last few years he has traveled half a million miles by air.

Monsoon Salvage

(Continued from page 43)

the P-40 took shape rapidly and one rainy morning, an ASC took her up. Diving her, split-S-ing her, throwing in a few chandelles, he satisfied himself that this fighter was "as good as new." A radio went to Col. Cochran's executive officer: "Mission accomplished."

"We like to get 'em in good enough condition to make 'em flyable again," Colonel West commented. "Some are just too inaccessible to pull out like this one. If that happens, or if it's a wreck, we go in anyway with coolies and pack out all salvageable parts. Our boys are mighty proud of their 'keep 'em flying' job. They deserve all the praise in the world, and the fighter and bomber pilots are the first to give it to them. Air Service Command is part of a wonderful team, a real American team that guarantees victory."

Hurricane in Harness

(Continued from page 4)

40 to 50 pounds per horsepower, compared to a weight range of 100 to 300 pounds per horsepower on conventional ship engines. Accordingly, a Liberty ship could carry 1,000 tons more cargo, if gas turbine powered, and attain more speed. Construction of several marine gas turbines for cargo ships and tankers has started in the United States.

Its lightness and compactness make the gas turbine ideal for use as a fairly small stationary power plant. For example, Brown, Boveri's 4,000-kilowatt, bombproof standby generating plant occupies only 34 percent of the space a comparable steam turbine would, with at least equal efficiency. Twenty-seven gas turbines have been installed in this country to assist in the Houdry catalytic cracking process of making 100-octane gasoline for the nation's warplanes. Without this "boxed hurri-

(Continued to page 164)

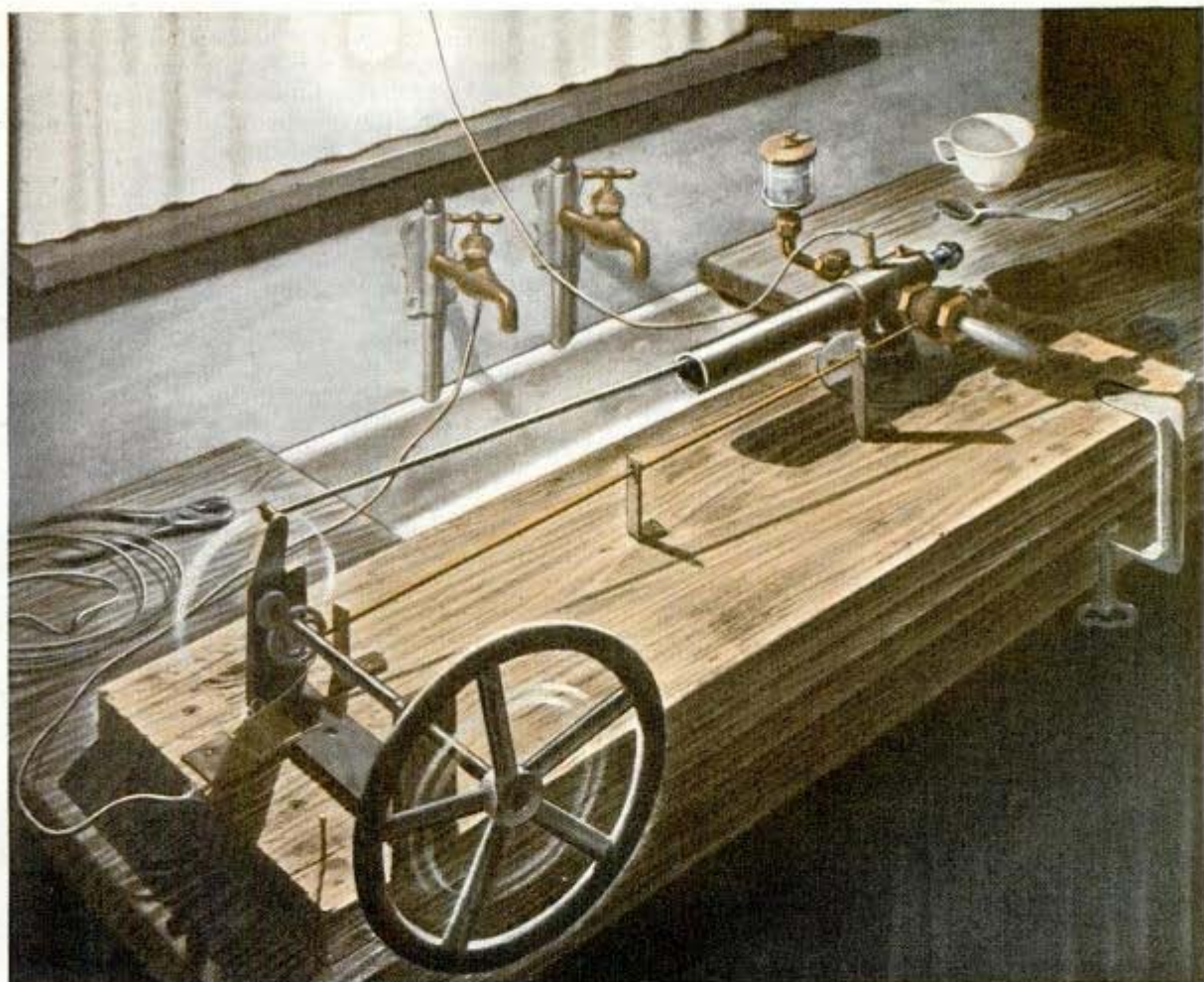

In the Ford kitchen . . . this little trial engine sputtered into life

IT HAPPENED far back—in the very early 1890's. In the kitchen of his Detroit home, a young engineer, named Henry Ford, was testing a principle of the internal combustion engine.

His apparatus, clamped to the kitchen sink, was a piece of one-inch gas pipe, reamed out for a cylinder—the flywheel, a hand-wheel from a lathe. Gasoline was fed from an oil cup. A wire connected to the kitchen light furnished the spark.

He spun the flywheel. Flame came from the exhaust, the sink shook and the trial engine was running under its own power. Mr.

Ford was satisfied. He put the engine aside. It had served its purpose. His idea was proved.

But he did not stop to applaud himself. "The man who thinks he has done something," Mr. Ford once said, "hasn't even started." His mind was already stirring with thoughts of a new and larger engine for transportation use.

Just ahead lay the pioneering which was to produce the Ford automobile of world-wide use. Ahead lay the creation of the first industrial assembly line, hundreds of inventions and improvements, the building of 30,900,000 low-cost motor cars and trucks to

serve the needs of *all* the people.

Today, at Ford Motor Company the pioneering still goes forward. New methods, new materials, new devices are continually being developed. You don't hear about many of them, because Ford assignments now are military.

But one day the story of this modern pioneering *can* be told. It will be told, you may be sure, through the medium of Ford, Mercury and Lincoln cars so advanced in both style and engineering that new millions will seek to own them—for comfort, for smartness, for reliability, and for economy.

FORD MOTOR COMPANY 



POOR RICHARD wrote a good hand!

Benj. Franklin won fame with his Almanac . . . in later life was twice ambassador to England, once to France. A clear thinker, he took pride in his clear penmanship. In his Autobiography, he said, "I learned to write a good hand."

Our present foreign envoys in the AUS—hundreds of thousands of them—may write poorer hands, but have better pens . . . Many treasure an Inkograph . . . the precision instrument of penmanship. Sturdy and speedy-acting, with smooth flow of ink, it is built to write millions of words.

The needs of service men come first, so if your dealer is out of stock—keep trying. Sorry, no mail orders—only dealers can supply you.

Use any pen to sign up for more
WAR BONDS!

INK-O-GRAPH²
Inkograph Co., Inc., 200 Hudson St., N. Y. C. 13



cane," a motor requiring 5,000 to 6,000 extra horsepower would be needed to power the compressor in the Houdry process.

Many problems, however, remain to be solved in the development of gas turbines for heavy, continuous-duty jobs. Problem No. 1 is finding materials which will remain stable even at glowing temperatures.

"Gas turbine engineers foresee the time, as temperatures go higher and higher, when the only suitable materials for the task may be both too hard to machine and too brittle to forge," says J. K. Salisbury, General Electric turbine engineer. "That will require new ways to form and shape metals. A possible solution can be borrowed from dentistry—in which minute gold fillings must be cast to intricate shapes with virtually no dimensional error.

"Use of such methods—direct casting of turbine parts to their ultimate shapes and dimensions, so that they require no further shaping or forming—will enable use of the metals needed to withstand high temperatures that will give high gas turbine efficiencies."

Another shortcoming is the fact that the turbine seems limited to power plants requiring from 1,000 to 10,000 horsepower. Because of the large volume of air needed, Salisbury sees it as a reliable prime mover of intermediate capacity for the present, rather than as competition for large steam turbines used in central power stations. Also, while it will be powerful enough to drive airplanes, ships and locomotives, it probably would be delicate, costly and inefficient if it were built small enough to power automobiles.

Oil and Coal Made From Plants By Pressure-Heat Process

Sugar cane, potatoes, and even weeds are transformed into crude oil and coal by a pressure and temperature process. This shortcut, which does the work it takes nature some millions of years to perform, was developed in the laboratories of the Carnegie Institute of Technology by Prof. E. Berl. The process, which may solve the world's fuel problem for all time, involves the use of alkalis derived from limestone, dolomite and zeolites. In the natural conversion of carbohydrates to crude petroleum, Prof. Berl believes these alkalis were present in large amounts. It would take only 2.1 percent of the land available to grow sufficient starchy or fiber crops to provide gasoline and oil for America's automobiles, according to Prof. Berl. This would amount to 55,600,000 tons of liquid fuel a year.

*American Chemical Society
in Cleveland, Ohio*
POPULAR MECHANICS

This is the Time TO PLAN YOUR MODEL RAILROAD

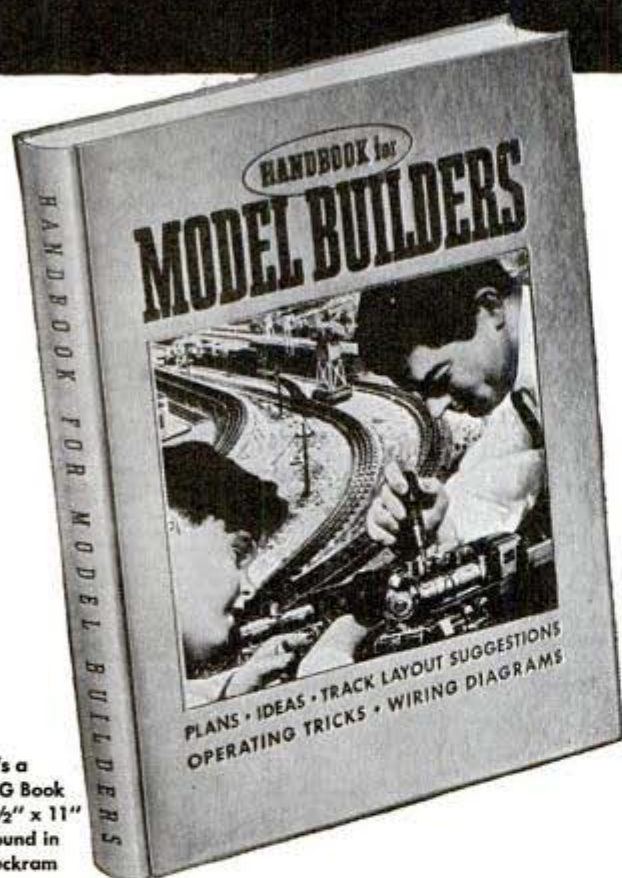

**AND THIS IS THE BOOK
THAT WILL HELP YOU**

HANDBOOK FOR Model Builders

PUBLISHED BY LIONEL

**When Lionel Trains Are Made
Again, You'll Be Ready for Them**

24 EXCITING CHAPTERS. 192 PAGES IN ALL

How to Begin. Planning the Layout. Looking Ahead. Layout Suggestions. Giant Railroads. Layout Blueprints. Tables and Benches. Cuts and Fills. Grades and Elevations. Lakes and Waterways. Bridges, Trestles. Trackwork, Signals. Scenery. Stations. Yards. Engine Terminals. Real Estate Improvements. Landscapes. Motive Power. Rolling Stock.

Pictures, plans, blueprints, facts, figures and instructions that tell the complete story of model railroading from the ground up—show you what to do to build a train set into an extensive operating system—how to plan a layout that will look like a real railroad—how to build an elevated division, a miniature lake, river or waterfall—how to ballast the roadbed—how to operate trains accord-

ing to real railroad practices and make them duplicate everything that real trains do. **BEST OF ALL**, the Handbook shows you what you can do **NOW** so that you will be ready when the war is over and Lionel Trains are again being made. Clip and mail the coupon below, enclosing One Dollar in check or money order. A copy of the Handbook will be sent to you by return mail.

LIONEL TRAINS

The Lionel Corporation, Dept. A,
15 East 26th Street, New York 10, N. Y.

Enclosed is \$1. Please send a copy of the Handbook to:

Name _____
Please Print

Address _____

City _____ Zone No. _____ State _____

Both FREE

THIS USEFUL PROTRACTOR RULE

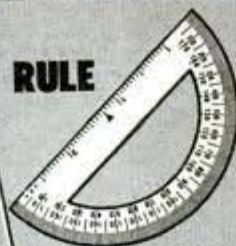

THIS HANDY REPAIR HANDBOOK

• All you have to do is sign and mail the coupon. You'll receive, without any expense whatsoever:

1. An accurate metal protractor, clearly marked, with angles reading in both directions and the straight side scaled in inches. Indispensable for the home craftsman.
2. The 40-page, pocket size Smooth-On Handbook, showing how to make dozens of necessary home repairs, with Smooth-On Iron Cements. 170 diagrams. Clear, concise directions. Conveniently indexed.

What the Handbook Shows

This repair handbook shows how you can SEAL CRACKS in furnace, boiler, stove, water heater, radiators, piping, auto crank and gear cases, water jackets, etc. . . . STOP LEAKS at seams, threaded or flanged joints, bolts, rivets, etc. . . . TIGHTEN loose screws, bolts, handles, pulls, casters, fixtures, etc. on tools, utensils, furniture . . . WATERPROOF wet cellars, concrete, brick or stone floors, walls, cisterns, troughs, tanks, pools, etc.

Your neighborhood hardware store handles Smooth-On Cements. Easy to use. Require no heat. Make durable repairs. Get a can of Smooth-On

Get Smooth-On No. 1 in 1 $\frac{3}{4}$ -oz., 7-oz., 1-lb. or 5-lb. container from your dealer, or if necessary from us. For your protection, insist on SMOOTH-ON, used by mechanics and repair men since 1895.

today. And be sure to mail the coupon before our limited supply of protractors is gone.

—FREE—Send Today—

SMOOTH-ON MFG. CO., Dept. 37
570 Communipaw Ave., Jersey City 4, N. J.

Please mail me my Protractor and the Smooth-On Handbook.

Name
Address
11-44



Do it with SMOOTH-ON

★ SAVE WASTE PAPER ★

WOULDN'T IT LOOK BETTER WITH *CLOPAY WINDOW SHADES?

*Women are amazed when they discover beautiful Clopay Window Shades are economical fiber instead of costly linen. In plain finish only 15c. In washable finish only 29c. Full 36 in. x 6 ft. size, ready to attach. At 5c & 10c and Neighborhood Stores everywhere.

BUILD AUTHENTIC SHIP MODELS



Our kits and instructions are complete to the last detail. Clear plans simplify construction. Send \$2. today for SHIP MODELS ILLUSTRATED, WITH A GUIDE TO MODELING—the first book of its kind ever published — of ship models, of real ships, of masts, of rigging, of deck gear, covering all types from whale-boats to PT's from "Slavers" to Corvettes. Many color plates, close-up photos, detailed drawings and actual plans in addition to a salty text and glossary of nautical terms.

Catalogue included with your order.

MARINE MODEL CO.
Dept. A-2, 29 West 15th St.
New York 11, N. Y.



ANYONE CAN DO THIS IF THEY HAVE OUR CHART

SPECIAL OFFER FOR AGENTS

Blue Print 27" x 36" shows how to find length of any rafter; find any angle in degrees, frame any polygon 3 to 16 sides, read board foot and brace tables, octagon scale, rafter tables and many other uses. Can be scaled down for model work as well as full scale framing. Also Chart changing pitches to degrees for use with Radial Saws. Send 50c in Coin or M. O. No Checks or Stamps. MASON & PARRISH ENGINEERS, 2106-B N. Burdick St., Dept. D. Kalamazoo 81, Mich.

MILWAUKEE SURFACE PLATES ANGLES AND BOX PARALLELS

MODERN TOOL ROOM NECESSITIES

Indispensable in this day of modern production. Ideal for tool and jig building. Available on Priority only.

J. C. BUSCH CO. 158 S. Ferry St. Milwaukee, Wis. Since 1907

NEW OTTAWA SAW

BIG FREE BOOK World's Fastest 6 H.P. EASY to MOVE

Fells trees. Saws big logs, small logs, limbs. Pulley for belt work. Easy to handle, weighs less than lower powered units. FULLY GUARANTEED. Cash in on fuel shortage. Turn wood into cash.

OTTAWA MFG. CO. 1127 PINE ST. OTTAWA, KANS. POPULAR MECHANICS

"It's miraculous how these **HARLEY-DAVIDSONS** stand up"

One of the finest tributes Harley-Davidson Motorcycles ever received is in this letter from T/Cpl. E. J. E., in the Pacific area:

"It's miraculous how Harley-Davidsons stand up under combat conditions. We have a stretch of road 35 miles inland and there isn't a road in the states that could be half as bad. Dust about 6 inches deep, and hills so steep that locked wheels won't hold when we stop. That's where power is needed and a good sturdy machine. I even forded streams where the water was swirling around the air cleaner — and she kept running. It's a new deluxe Harley-Davidson for me after the war. It's a great motorcycle!"

No more need be said after that except — Buy War Bonds NOW for your own Harley-Davidson after Victory!



HARLEY-DAVIDSON MOTORCYCLES

HARLEY-DAVIDSON MOTOR CO.
Dept. P, Milwaukee 1, Wisconsin

Please send at once free copy of 24-page
ENTHUSIAST MAGAZINE, filled with motor-
cycle action pictures and thrilling stories.

Name.....

Address.....

City..... State.....



**A Pipe Cleaner
in the Stem**
keeps the smoke
passage clean
and free of
moisture



A fresh
sweet
DRY
SMOKE
all the time

Briarcraft
Smokemaster

With SMOKEMASTER, you get the full enjoyment of fine tobacco, for you never draw through rank, biting moisture. No tricky gadgets. A fresh pipe cleaner can be inserted in a jiffy. Try it for a really new experience in smoking pleasure.

Smokemaster Custom-made \$1.50
Smokemaster Standard \$1.00

At leading dealers

If your dealer is temporarily out of Smokemaster, it's because so many are going to the Armed Forces. He'll have more shortly.

BRIARCRAFT, INC.

347 Fifth Avenue, New York 16, N. Y.

★ SAVE WASTE PAPER ★

SAVE
Valuable
Paint
Brushes!



RESTORE OLD BRUSHES. Use Dic-A-Doo Paint Brush Bath. Bring valuable bristles back to useful work. Remove every trace of old, hard paint. SAVE NEW BRUSHES, hard to buy. Keep bristles soft—clean—flexible. Buy 5¢ package... good for several baths, or 10¢ box, at Paint—Hardware—Five & Ten Cent Stores, The Patent Cereals Co., Geneva, N. Y., makers of Dic-A-Doo Paint Cleaners.

DIC-A-DOO
PAINT BRUSH
BATH



FOR AMATEUR OR "PRO"
COMPASS-DIVIDER

PRECISION MADE—both a compass and divider. Holds rigid at ¼ to 7 inches. Replaceable guide points, scribing needle and standard pencil. Perfect for linoleum, tile, sheet metal and workshop use. 10 DAY MONEY BACK GUARANTEE. Send cash or money order \$2.00 (N.O. C.O.D.'s) We pay postage



WALTER E. SELCK & CO.

223 W. HUNNARD ST., DEPT. 8, CHICAGO 10, ILL.



CRAFTSMEN Get this
BOOK OF MATERIAL, SUPPLIES
& TOOLS... STILL AVAILABLE

NEWEST ISSUE. Full of valuable hints and short cuts plus complete list of materials, tools and supplies. Simplified charts to figure lumber needs at big savings. Features Identification Panel and Charts of over 60 Rare Woods in Natural Color, full color showing of 83 inlay borders in natural color, new 8 page insert of 55 different inlays in full color. Send only 25¢ stamp or coin.
ALBERT CONSTANTINE & SON, Inc.
791W, East 135th St. New York 54, New York

WYTEFACE

TRADE MARK

STEEL MEASURING
TAPES



K+E
TRADE MARK

KEUFFEL & ESSER CO.

HOBOKEN, N. J.



"WE'D RATHER
SAY *YES*"

We don't like to tell people that they'll have to wait to get a home telephone. We'd much rather say "yes" to requests for service. That's the way it always used to be.

But the needs of war still have first claim on available telephone

equipment and on telephone manufacturing facilities and manpower. Delays in filling civilian orders just can't be helped.

All of us telephone people sincerely appreciate your patience and understanding in this war emergency.



BELL TELEPHONE SYSTEM

"Make it last!" This wartime lesson

Surely should be memorized.—

Any lighter will serve longer

If you keep it

Ronson-ized



Avoid
inferior
imitations



For Better Service

USE
EXTRA-LENGTH

RONSON REDSKIN 'FLINTS'

RONSONOL quick-lighting **FUEL**

RONSON high-absorption **WICKS**

In demand on all fighting fronts

If your **RONSON** needs attention
send it to Ronson (Dept. Newark 2,
N. J.) for servicing at minimum cost.

FOR ALL LIGHTERS

RONSON

LIGHTER ACCESSORIES

BY **RONSON** • WORLD'S GREATEST LIGHTER

MAKE YOUR DOLLARS FIGHT—BUY WAR BONDS!

**RESET
DRAWER
PULLS!**

Loose drawer pulls can be quickly and easily reset with **PLASTIC WOOD**. Handles like putty; hardens into wood. At Paint, Hardware, and 10¢ Stores.



**PLASTIC
WOOD**

NEW! IDEAL NAVY GIFTS!

Grand "Sweetheart" Combination Gift!

... the pin for HER ... the ring for HIM



No. 3121—Men's heavy ring in 10K Solid Gold, only \$16.50, in Sterling Silver, \$7.50. Lady's pin (No. 541) in solid sterling, 24K gold plate anchor, \$3.00. Pictures actual size. Prices include postage and Federal Tax. Satisfaction guaranteed. Send for free Jewelry Circular.



E. W. LANE, Mfrs. Representative

HERFF-JONES Mfg. Jewelers, Dept. PM, 32 W. Randolph, Chicago 1, Ill.

DIXON'S SLIPSTIK THE ALL-PURPOSE GRAPHITE LUBRICANT

... in handy stick form ... lubricates sticking windows, drawer slides, automobile doors, fire arms, bicycles, and everything that sticks, squeaks or wears. With SlipStik, there's no fuss—no muss.



AT YOUR
DEALER
15¢

JOSEPH DIXON CRUCIBLE CO. • JERSEY CITY 3, N. J.

Build a **STURDY WORK BENCH** from complete working plan in Stanley Set No. 11. Includes 4 other good plans. Now 14 Sets to choose from.

EACH
SET OF
5 PLANS
ONLY
10¢

STANLEY TOOLS Division of The Stanley Works
1114 Elm St., New Britain, Conn.

END TOOL RUST WORRIES



RIG—Universal stops rust when others fail. Used by Mfrs., Labs., Unexcelled for TOOLS, dies, hinges, locks, chrome, battery terminals or anything that rusts! The finest known rust preventive for firearms. 1 lb. \$1.50. Write ...

RIG, 5646 LAKE PARK AVE., CHICAGO 37, ILL.



GERSTNER CHESTS

AMERICA'S Finest for the best Mechanics. Free Catalog for Toolmakers and Machinists.

GERSTNER TOOL CHESTS

444 Columbia St. Dayton 7, Ohio

KRW ARBOR PRESSES BENCH TYPE AND HYDRAULIC

NEEDED IN EVERY SHOP—SAVE TIME AND MONEY—DO BETTER WORK, QUICKER.

No shop is complete without a small arbor press. Pressing and squeezing operations can be done better and faster on a KRW Arbor Press. Stop using vise and sledge hammer methods—they generally deliver spoiled work in the end. KRW Factory-To-You Prices give you greater value for your money. Order today.

KRW Bench Type Arbor Presses, 3 sizes

- No. 37-P 1/2 Ton, \$13.25*
- No. 37-O 1 Ton, \$23.00*
- No. 37-N 3 Ton, \$33.00*

*Prices F.O.B. Arcade, N. Y. Slightly higher west of Rockies. Stand illustrated extra.



KRW Hydraulic Presses are built in 25, 50, 60 and 75 ton sizes. Prices start at \$198.00*.



K. R. WILSON, 17 Lock St., BUFFALO 2, N. Y.

Builders of Shop Equipment for Ford Dealers Since 1916



INDUSTRY'S NEW SOURCE OF CONTROLLED POWER

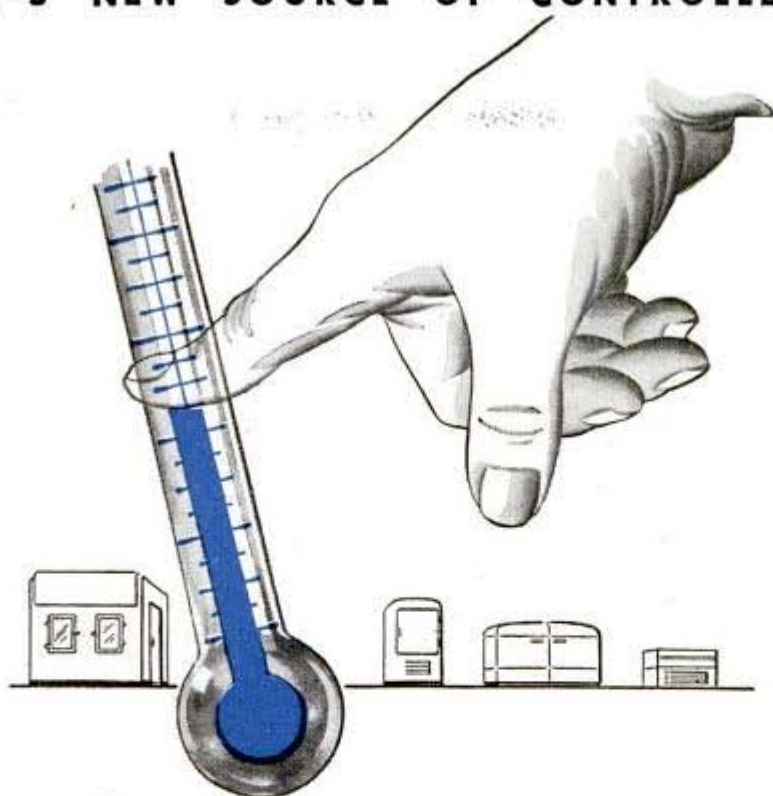

Fluid Power DRIVES THE MERCURY DOWN

When the mercury in the thermometer rises too high, many things spoil—including tempers. But Fluid Power forces the temperature down, makes synthetic cold one of man's most useful servants.

Your electrical refrigerator is a good example of this type of Fluid Power. In a closed system of tubing, liquids change into gases and back again to liquids in a repeated cycle. Heat is extracted, carried away, then dissipated into the air.

Applications of this type of Fluid Power are expanding rapidly. Industry uses below-zero cabinets to obtain shrink fits. Home freezers may revolutionize the food storage problem of the future. Air cooling and conditioning may eventually become a standard in every home.

If you are considering product development using this type of Fluid Power, ask a Parker engineer. He is familiar with the new advances and applications in this field.

Ask a
Parker Engineer about
Fluid Power

Today, you'll find Parker-engineered Fluid Power Systems in locomotives and bombers, in ships, machine tools and chemical plants. If you need FLUID POWER for control or drive, talk the matter over with a Parker engineer. He has the kind of "know-how" you'll find most valuable. Write direct to The Parker Appliance Company, 17325 Euclid Avenue, Cleveland 12, Ohio.

★

THE
PARKER
APPLIANCE COMPANY
CLEVELAND • LOS ANGELES
FLUID POWER ENGINEERING

'INVISIBLE' LIQUID

proves great success for

SKIN and SCALP IRRITATIONS

**Promptly
Relieves
Itching—
Aids
Healing!**



Here's a Doctor's formula—Zemo—a remarkable liquid which appears invisible on your skin—yet so highly medicated that first applications relieve itching, burning of Eczema, Psoriasis, and similar skin and scalp irritations due to external cause. Zemo also aids healing.

Zemo positively won't show on skin all the time it is helping it. Apply any time. First trial convinces! 3 sizes. Buy Extra Strength Zemo for stubborn cases.

ZEMO

OUTDOOR MEN!

Don't suffer from

CHAPPED LIPS!



**SEND
FOR
YOURS
NOW**

Get LYP SYL Now!

When lips are chapped, cracked, painful, just rub on this colorless pomade. Lyp syl soothes and promotes healing. Equally good for dry, parched lips. Helps cracked, broken skin to heal. Applies in a jiffy. Get a tube for every member of the family. Costs only 25c. If your druggist is out of Lyp syl, send 25c and coupon below for prepaid tube.

LYP SYL Pronounced "LIP-SIL"

I ever Brothers Co., 50 Memorial Drive, Dept. 2
Cambridge 39, Mass.

No chapped lips for me. Rush along my Lyp syl, prepaid, 25c for each tube.

Send me _____ tubes. (PRINT PLAINLY)

Name _____

Address _____

City _____ State _____

Always write your name and full address clearly when answering advertisements.

172

Watch Crystals You CANT BREAK



PROTECT YOUR WATCH

A watch with a broken crystal is useless. Go to any jeweler—ask him for a G-S FLEXO CRYSTAL 100% BREAK-PROOF. Fitted while you wait. Any size. Any shape. *Guaranteed.* GERMANOW-SIMON MACHINE COMPANY, Rochester, N. Y.

LEPAGE'S GLUE

**LEPAGE'S
MODEL
AEROPLANE
GLUE**

**LEPAGE'S
LIQUID
SOLDER**



**REPAIR YOUR OWN
ELECTRIC APPLIANCES!**

Trademark Reg. and Pats. Pend.

CHANITE Self-Welding ELECTRICAL HEATING ELEMENT FLUX. Generous amount, instructions enclosed. \$1.00 postpaid.

CHANITE SALES COMPANY
914 South Main Fort Worth 4, Texas

A BUSINESS FOR YOU

Learn how you too can obtain a valuable, exclusive franchise for handling STAMINITE protective coatings, waterproofers, NON-SLIPPERY Floor Wax, and PLASTIC BASE speed drying, transparent coatings for wood and linoleum floors and surfaces IN or OUT. If you can qualify for local Distributorship (small stock requirement) you'll prosper greatly. Write TODAY!

THE STAMINITE CORP., DEPT. B., 109 WATER ST., NEW HAVEN, CONN.

10c NEW BOOK OF LATHE AND DRILL PRESS SET-UPS
Practical, unusual uses, contains 49 illustrations.
Post- Send 10c to cover handling and postage.
Paid JACOBS MFG. CO. 154 Jacobs Rd. Hartford 1, Conn.

SEND FOR THIS
TIME SAVING **OHMITE**
Ohm's Law Calculator



Figures Ohms,
Watts, Amperes
Volts... Quickly!
Any Ohm's Law
Problem solved
with one setting

of slide. All values direct reading. (4 1/8" x 9")
Send only 10c in coin to cover cost of handling.

OHMITE MFG. CO., 4931 Flournoy St., Chicago 44, Ill.

POPULAR MECHANICS

SCREWBALL IDEAS ON BATTERY CARE



Gideon P. Shorthaul is puzzled. Several nights each week, he has been driving his car around the block to keep his battery charged. But it didn't work. Actually, his starter and lights used more juice than his generator could replace on these short hops. You were only wasting precious gasoline, Gideon!

...THE WISE WAY IS PERIODIC RECHARGES!

GAS rationing means restricted driving . . . and that's bad for your battery. But don't let your battery go "dead." Drive in to your Exide Dealer occasionally for a **FREE CHECK UP!** When necessary, he'll advise a recharge which will keep your battery strong. **PERIODIC RECHARGES** cost little, but they postpone the day when you'll need a new battery. When you *must* buy, get a dependable, long-lasting Exide. Buy to Last—Save to Win.

THE ELECTRIC STORAGE BATTERY CO.
Philadelphia 32
Exide Batteries of Canada, Limited, Toronto

**EXIDES ARE USED IN MORE THAN 100
APPLICATIONS BY OUR ARMED FORCES**



- 1 Don't buy *anything* you can do without.
 - 2 If you **MUST** buy, insist on dependable, long-lasting merchandise.
 - 3 Take care of the things you have. *Make them last!*
- These conservation rules save materials for war production, help curb inflation, give you more money to invest in War Bonds.



SPEECH UNDERSTANDING TEST

FOR THE HARD OF HEARING



There's a big difference between hearing and understanding! Try this test, with and without your hearing aid. Have sentences read aloud, speaker 12 feet away, lips concealed. Check your scores:

RIGHT WRONG
✓ ✓

1. Is the sun larger than the earth?		
2. Name the tree on which bananas grow		
3. Explain the purpose of fire drills		
4. Name a state which has no seacoast		
5. Explain why a corked bottle floats		

If you score less than 80%—you need the new super Telex hearing aid to give you complete hearing. Telex gives you noiseless, effortless hearing, under all conditions. Test a new super Telex. It will be fitted scientifically. The complete speech test will prove our claims. No obligation.

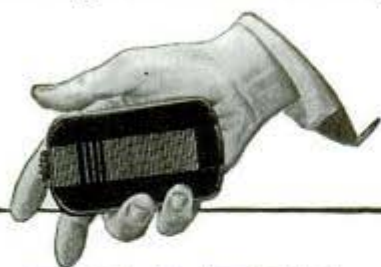

TELEX

Hearing Centers From Coast to Coast
Consult Your Telephone Book

TELEX LABORATORIES . 42 Telex Park . Minneapolis, Minnesota

I would like to receive your complete speech understanding test and free hearing report, without obligation.

Name.....

Address.....

City..... State.....

Always write your name and full address clearly when answering advertisements.

174

NAMECHAIN

Personalized
KEY CHAIN
Spells
YOUR NAME
in full

DURABLY CONSTRUCTED
IN GOLD PLATE

The Perfect Gift

Each Namechain made to your order . . . up to 16 letters allowed. Individually packed in Gift Box. Orders filled in one day. Sent Postpaid for \$3.50.

Namechain Mfg. Co.
19 E. Pearson St., Dept. P, Chicago 11, ILL.

Guide for ALL Drivers

☆ Some drivers appreciate directional help on mountain roads, others in the desert, others in strange cities. The HULL AUTO COMPASS acts as a guide everywhere. New model available after the war at your dealer's.

HULL MFG. CO., P.O. Box 246-D11, Warren, Ohio



INDOOR GARDENING through SOILLESS GROWTH

NEW SIMPLE METHOD

No solutions to make; no measuring, weighing nor stock bottles. Spread U-C Formula on bed of sand in which seeds or plants are supported and use regular tap water. Allow for drainage. You will be astounded at the luxurious vegetables, fruits or flowers which can be grown under controlled conditions. This method assures a balanced diet, freedom from bacteria and enormous development in small spaces. Use a closet, window, basement or outdoors. Formula contains magnesium, calcium, iron, boron, manganese, zinc, copper, vitamin B1, nitrate, phosphate, potash, sulfates, all in proper proportions.

YEAR'S SUPPLY OF CHEMICALS

Full year's supply of U-C Formula for many plants, and instructions only \$2.50. FREE with each order—quantity of filter material to assist drainage. Send to

UTILITY CHEMICALS, 7524 S. Racine Avenue, Chicago 20, Illinois

Class Pins and Rings ★

Artistic pins, rings and emblems.
Finest quality. Reasonable prices
from 55c up. Write today. Dept. N.

FREE
Catalog

Metal Arts Co., Rochester 5, N. Y.

BROKEN CHINA REPAIRED EASILY

Mends furniture,
dishes, glassware,
luggage and toys.



DU PONT DU CO CEMENT

REG. U. S. PAT. OFF.

POPULAR MECHANICS

For Men who *Really* Know Pipes



Selected Briar \$1.50



Royalton
CROWN

THIS IS NOT A MIRACLE-PERFORMING PIPE . . . Royalton Crown has no mystic gadgets—no secret elements to make a poor tobacco taste wondrously fragrant . . . But it *does* have SIX PATENTED FEATURES that make it the only pipe of its kind—a pipe that STAYS EVERLASTINGLY DRY . . . Condensing well traps bitter slugs and juices, assuring an ever-dry bowl and an ever-dry mouthpiece. Special construction permits efficient cleaning.

HENRY LEONARD & THOMAS, INC., OZONE PARK, N. Y.

Avoid those Cold Wave Jitters



ASSURE MORE HOME COMFORT WITH BALSAM-WOOL ATTIC INSULATION



When the weather man says "continued cold," will you groan as you watch your fuel dwindle? There's an easy, inexpensive way to keep your home more comfortable—while you make fuel savings as high as 20%. Just install Balsam-Wool Insulation in your attic!

Balsam-Wool—the famous Blanket Insulation now bringing comfort and savings to thousands—is easy to apply in your attic. And Balsam-Wool is designed to give you lasting service because it is windproof, moisture-proof and fire resistant . . . high in efficiency. No wonder Balsam-Wool is sold under a Money-Back guarantee of complete satisfaction! This is a job you can do now—see your lumber dealer, or mail the coupon.

Balsam-Wool

SEALED ATTIC INSULATION

Balsam-Wool . . . Products of Weyerhaeuser . . . Nu-Wool

WOOD CONVERSION COMPANY
Dept. 210-11, First National Bank Bldg.
St. Paul 1, Minnesota

Gentlemen: I want to know more about Balsam-Wool Double-Value Attic Insulation.

To assist us in giving you special information, please check: I am a homeowner
renter architect contractor
student postwar planner

Name

Address

City State



Say you saw it in Popular Mechanics!

NOW IS THE TIME TO KILL RATS!

Rats are now destroying millions in precious food and property. And spreading disease nation-wide! Kill rats quickly and easily with improved K-R-O Ready Mixed, in Bis-Kit form.

Safe to use around livestock, pets and poultry. No mess. No trouble. No mixing.

Each package contains a variety of highly toxic red squill baits. 35¢ for small size—\$1 for large size. At drug, seed and hardware stores. The K-R-O Company, Springfield, Ohio.



Build: STEAM ENGINE

● A precision built and engineered single cylinder, 1/4" scale marine model, with clutch or reverse.

● Send \$2.50 for 14 pages scale drawings, 2 photos, instructions.

● 2 Photos and Description.....\$.25

● Rough Castings Kit..... 12.50

● Horizontal Flash Boiler Drawings and Instructions 1.00

THOMPSON ENGINEERING CO. 206 NO. DIVISION BLDG., GRAND RAPIDS 2, MICH.

FALSE TEETH

KLUTCH holds them tighter

KLUTCH forms a comfort cushion; holds dental plates so much firmer and snugger that one can eat and talk with greater comfort and security; in many cases almost as well as with natural teeth. Klutch lessens the constant fear of a dropping, rocking, chafing plate. 25c and 50c at druggists . . . If your druggist hasn't it, don't waste money on substitutes, but send us 10c and we will mail you a generous trial box.

KLUTCH CO., Box 3193-K, ELMIRA, N. Y.

ELECTRIC HEATING APPLIANCE ELEMENTS REPAIRED... Use NICHROCITE PASTE

Simply overlap ends, apply Nichrocite Paste and turn on circuit. Used by large utility companies. Trial order, \$1.00; 4 oz., \$2.50; 1 pound, \$8.00. Advance Mfg. & Dist. Co. Box 861 Minneapolis, Minn.

Balance 4" x 9" Base. With either 5¢.00 Metric or Avordupois Weights... 6.00

Catalog with 2000 illustrations of laboratory apparatus sent for 75 cents. Catalog listing 10,000 chemicals, drugs, minerals, etc., and 1700 scientific books sent for 25 cents.

LABORATORY MATERIALS CO., 7321 Vincennes Ave., Chicago, Ill.

BUILD WITH CEMENT COMPOSITION

strongly reinforced with cheap wood. Several formulas. Modern stream-lined roof, walls and gutters in one. How to build a house 22x24, three rooms, as low as \$100 for materials, garage, \$20, 30x60 poultry house, \$50. Farm buildings for a few dollars. Homemade equipment to make wall-high building blocks with inside and outside finish. Also roof, wall and floor tile in color, and durable railroad of wood. Labor saving. Long lasting. No painting. Make doors and windows. Sectional cabins, 100 money-saving ideas. Mixer and saw easily made from an old auto. 40 Warming plans. Earn \$10 a day. Guaranteed, illustrated instructions, \$1.00.

MAKE FURNITURE OF COMPOSITION cement, sawdust, asbestos, paper. Home-made elements. Some part scrap wood and metal. Illustrated instructions to make tables, cabinets, chests, racks, shelves, inclosed sinks, lawn novelties and toys. Over 500 per cent profit. 50c.

HOW TO MAKE 50 ACCURATE WOODWORKING MACHINES: Band, jig and circular saws; electric drills, sanding wheels, tools, electric weed cutters and many other things from old auto parts and washing machine motors. Illustrated, 50c.

HOME MFG. ENTERPRISES, 60 selected home-shop projects, 50c.

Special: All of the books described above, \$2.00 postpaid. No C.O.D.

HOME INDUSTRIES, 1318 South 30th Ave., Dept. PM, Omaha 5, Nebr

POPULAR MECHANICS

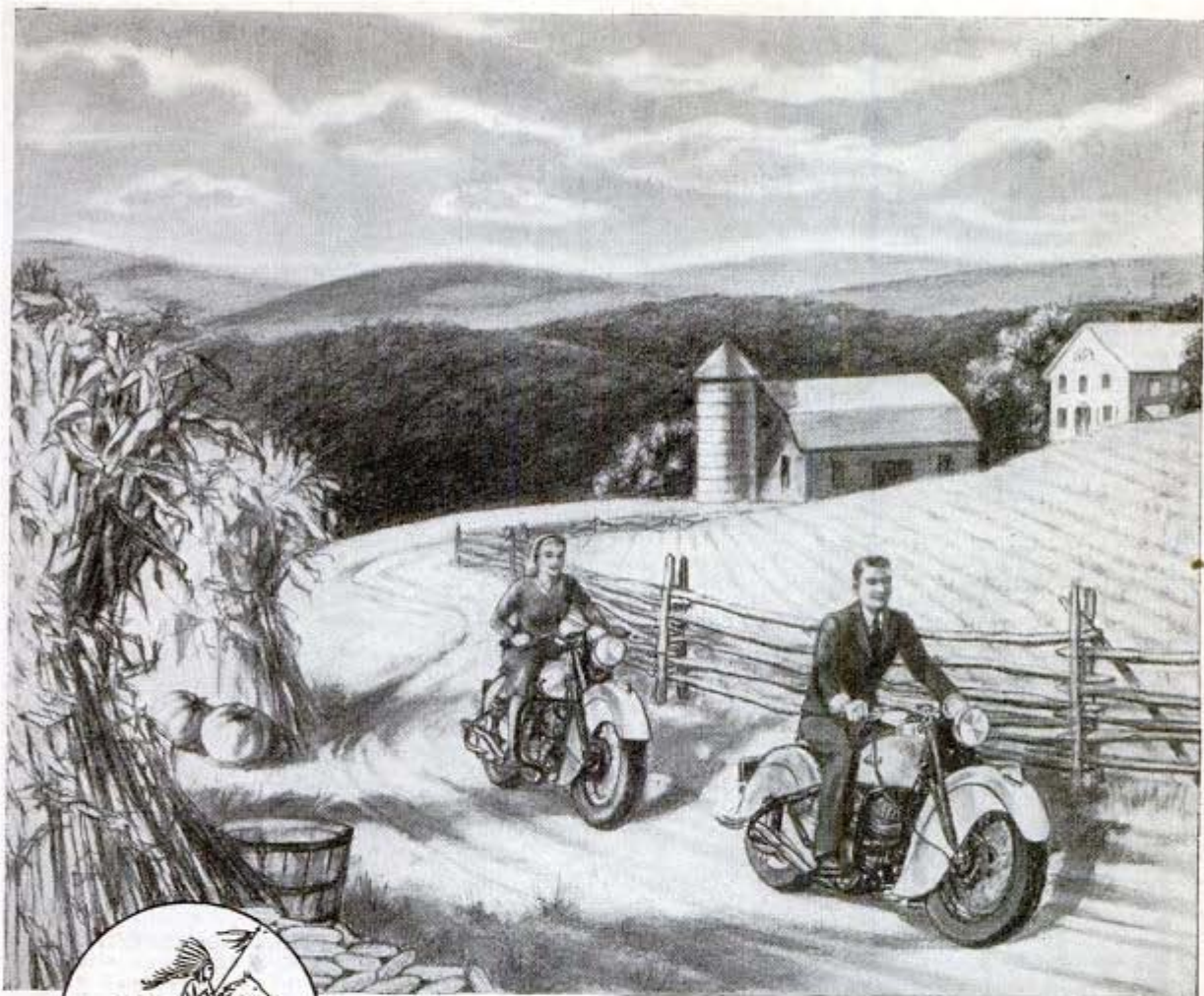

Head for the Open Road

JUST a moment from America's Main Street await the thrills of the open road . . . thrills we have put aside as we strive for the Victory days ahead.

For the open road holds an allure known to motorcyclists everywhere. Riding along . . . up and down hill . . . the cool breezes always in your face . . . and a feeling of elation, of sure control over the power waiting only the twist of your wrist to leap into action. If you've never known the real thrill of the open road . . . of riding an Indian motorcycle . . . you'll want to in the days ahead when the motorcycle sport gets back into full swing.

Indian, with its exclusive Spring Frame comfort, bril-

liantly powerful engines and streamlined design offers motorcycling at its very best. To head for the open road now on an Indian . . . or in postwar days on one of the Indians designed to make motorcycling an even greater and more economical travel pleasure than ever before . . . is a pleasure you can make your own.

Find out about motorcycling and about Indian, now! Put your coupon in the mail . . . Today.

**BUY WAR BONDS NOW
TO BUY AN INDIAN LATER**

Indian Motorcycle Company
Dept. PM-11 Springfield, Mass.



*Read
about
Motorcycling*

Please send me *Indian News* . . . and put my name down to receive any new Indian announcements.

Name.....

Address.....

City..... State.....

Indian

MOTORCYCLES

**NOW AVAILABLE
WITHOUT LIMITATIONS**

PLASTI-COTE

AAA

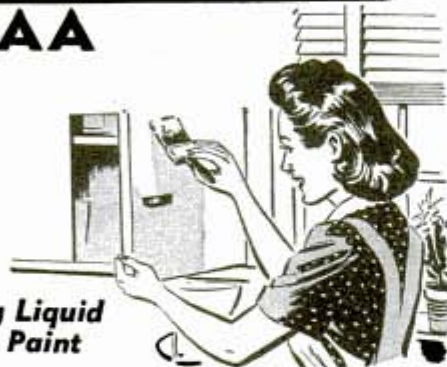

**Amazing Liquid
Plastic Paint**

ONE COAT COVERS

No priorities or other limitations on this remarkable liquid plastic paint. You can now order all you want. PLASTI-COTE AAA is one of the major marvels of modern chemistry—a true resin-based liquid plastic that lets you give your home, EXTERIOR OR INTERIOR, a beautiful lustrous finish of tile-like smoothness that is fadeproof, water-proof, and unaffected by smoke, gas, or fumes. PLASTI-COTE AAA is amazingly tough, tenacious, and resilient. You can apply it yourself. It leaves no brush marks. Being a true plastic, it cannot be thinned with water.

ONE COAT COVERS Yes, just one coat of PLASTI-COTE AAA covers any surface—wood, stucco, brick, concrete, metal, plasterboard, even old wallpaper.

**\$7.50
PER
GAL.**



AAA

**Make Your Floors Gleam and Sparkle
Banish Waxing, Polishing, with
PLASTI-COTE FLOOR FINISH**

Non-skid. Ideal for all surfaces, wood, cork, linoleum, asphalt tile, rubber. Gives hard, glossy, durable finish. Resistant to alcohol, boiling water, cigarette burns—even lye. Apply it yourself. 12 colors and clear.....\$8.60 per gal.

**Give Your Car a Gleaming Plastic
Finish—Repaint with
PLASTI-COTE CAR ENAMEL**

One coat covers the old finish, gives factory-like lustre, durable new beauty. PLASTI-COTE is a real plastic—covers better, wears longer, resists sun, alcohol, road tar, oil, salt air, snow, sleet, rain. Quart does average car. Apply it yourself.....\$2.95 quart.

DEALER INQUIRIES INVITED

CELLO-NU PRODUCTS

333 N. Michigan Ave., Dept 2, Chicago 1, Ill.

Fuse Puller—Circuit Tester

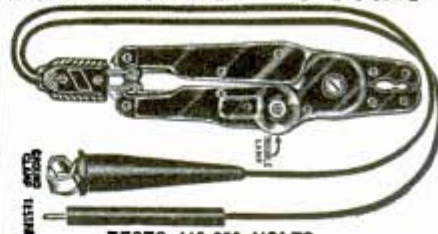

**For
Home
or
Factory**

TESTS 110-250 VOLTS

When motors stop and lights go out, this tool quickly **LOCATES DEAD CIRCUITS** and safely removes blown Fuse. The Star Test Pocket Plier is made of a Transparent Plastic having in one of the legs a small lamp in series with a resistance and can be used to test 110 to 250 volts circuit. The Plier will pull fuses from 10 to 100 Amperes. Thousands of Electricians find this tool handier than Test Lamps. Price \$2.75 each without Leads, \$1.50 additional for Leads, plus 10¢ postage. Can be obtained from General Electric or Westinghouse Stores or directly from us. Order NOW. **STAR PLIER CO., 233 Canal St., New York 13, N. Y.**

**Save Fingers
with
Steel-Grip Finger Guards**



Hundreds of factories are saving time and injuries in war production by protecting workers with Steel-Grip Finger Guards. Used for handling rough or sharp articles, for buffing, grinding, sanding, polishing, punch press work and hundreds of other jobs. Protect fingers or thumb, front or back, from cuts, abrasions or blisters. Made of durable leather with elastic web back for snug, cool, comfortable fit. Easy on and off. One size fits all, men or women. Send 10¢ each for samples or trial order box of 50 at 85¢ each, less 10%.



INDUSTRIAL GLOVES COMPANY
Famous Industrial 651 Garfield, Danville, Illinois
Safeguards Since 1910 (In Canada: Safety Supply Co., Toronto)

IT STAYS ON . . . RUST STAYS OFF

**FIENDOIL
RUST INHIBITOR**



Keep home tools, appliances, corrosive metal protectively coated.

35c Botl & Hdwe.—Spng. Goods Dealers
McCambridge & McCambridge Co.
Baltimore 23, Md.

EMPIRE 'TORPEDO' LEVELS

Available in ALUMINUM Now!

Smallest, handiest, accurate level. "Cigar-shaped," can't tear pockets. Polished ALUMINUM. 9" long, with level, plumb and 40° vials. Light weight, strong. No. 26, only \$1.75. Limited number. Order from dealer or write direct.

EMPIRE LEVEL MFG. CO., DEPT. P 131 112 SOUTH SIXTH STREET MILWAUKEE 2, WISCONSIN

BUILD-ARC WELDER FROM OLD GENERATOR

For Light or Heavy Work. 30-200 amperes. Complete PLANS 35c. Send today and we'll include FREE our Big NEW Catalog.

LEJAY MANUFACTURING CO.
1347 LeJay Bldg., Minneapolis, Minn.



DO YOU

WANT a permanent business profession of your own? Then **BECOME A FOOT CORRECTIONIST.** Earnings in this greatly needed profession run as high as \$50-\$100 weekly after a few weeks home training—not medical or chiropody—no further capital needed, no goods to buy. 47th year. Write for free booklet.

Stephenson System of Foot Correction
28 Back Bay, Boston, Mass.

★ **SAVE WASTE PAPER** ★

POPULAR MECHANICS



Let Aeronca show YOU how to get ready to do
BIG BUSINESS with a SMALL AIRPORT!

Do you want to get into the real money making end of aviation, the coming new industry—in business for yourself? You can be independent—your own boss—running your OWN AIRPORT.

Now—today—you can start getting ready to make big profits in aviation! You need no fancy set-up, no big cash outlay. But you *do* need the "know how", and *only* Aeronca offers its dealers a complete profit-making program! Tells you things you must know to make money with a

small airport; to whom and how to sell Aeronca planes, how to make your field "flying headquarters" and many other things you'll want to know.

Aeronca's complete dealer program is based on more than 16 years experience in leadership of the personal plane field. It can start you, as it has started others, on the road to success and profits through small airport operation!

Ask Aeronca for the facts—now. Send for illustrated booklet today. Use the coupon.



MAIL THIS COUPON! GET THIS BOOKLET NOW!

 The Only Light Aircraft Company to Receive the Army and Navy "E".

AERONCA
 AIRCRAFT CORPORATION
 MIDDLETOWN, OHIO

Al Bennett, Director of Sales,
 Aeronca Aircraft Corporation, Middletown, Ohio.
 Send me your valuable booklet on "Why You Should Be An Aeronca Dealer". I enclose 10c.

Name.....
 Address.....
 City and State..... K-11

BETTER PROTECTION
with
Carhartt
WORK CLOTHES
Built for Work
Comfort

WHETHER you handle the throttle of a locomotive—the wheel of a truck—wield a paint brush or torch—work at lathe, screw machine, miller, drop forge, or grinder you'll find greater work satisfaction, better protection, more solid work comfort in Carhartt Work Clothes. They're designed and built with the skill and experienced workmanship assured by three generations of the Carhartt family. That's a record we're proud of—one family making overalls for over fifty years! Your guarantee of greater satisfaction.

HAMILTON CARHARTT OVERALL CO.
Established 1889
Detroit, Mich. Carhartt Park, Ky.
Atlanta, Ga. Dallas, Texas
On sale at your local dealers

Carhartt
UNION MADE WORK CLOTHES
50 Years a Friend to Organized Labor

10 POWER TELESCOPE
Look What Only 98¢ Buys
Here's America's biggest 10-Power Telescope value. Don't confuse it with small "weak-vision" telescopes. It's precision made and measures full 16 inches. Focuses instantly on stationary or moving objects. Brings far away objects 10 times closer. Clear—sharp—BIG as Life. You'd expect to pay up to \$10 for such power. Everyone should own a Powerful Telescope. Spot airplanes—identify distant objects, people, animals, etc. Valuable for Air Wardens, Boy Scouts, Sailors, Sportsmen. Ideal for fights, ball games, races and outdoor events. Enjoy front row seats from way back.

CLIP AD AND MAIL
Just clip this ad and mail with 98¢ (plus 10¢ for the packing and postage). Use the Telescope for 10 days without risk. If you aren't positively thrilled, return in 10 days and we will refund your money in full. Supply is limited due to priorities. So rush your order today.

BRINGS OBJECTS 10 TIMES CLOSER

Only 98¢

FREE Valuable Airplane CHART FREE if you order promptly

ILLINOIS MERCHANDISE MART, Dept. 322-C, 500 N. DEARBORN ST., CHICAGO 10, ILL.

DRILL-INDEX A compact container for indexing and filing twist drills. Eliminates search. Made entirely of steel in nine sizes. Available on priority to essential users. See your dealer or write to
HUOT MFG. CO.
Foot Schultz Bldg. St. Paul 1, Minn.

GRAY HAIR VITAMIN NOW **\$1.95**
PAY NO MORE

No dyes—No drugs—Hair grew out in Natural Color in almost nine out of ten test cases just taking one tablet Calcium Pantothenate Vitamin each day.

Why pay \$3.50 to \$5.00 for the famous "Gray Hair Vitamin"? **SEND NO MONEY.** Just send name and address. We will ship 100 10-mg. tablets (100 days' supply) genuine standard quality Calcium Pantothenate Vitamin C.O.D. for \$1.95 plus few cents postage. Guaranteed same quality as used in National Tests or money back.

HYGEA VITAMIN CO., 2017 S. Michigan Ave., Dept. 911, Chicago, Ill.

You Can EARN MORE with a HOBART "SIMPLIFIED" ARC WELDER

IMMEDIATE DELIVERY
to Priority holders
Check your rating and send it with your order.

You can depend on Hobart "Simplified" Arc Welding to do those "Big Pay" welding jobs, for it has the capacity for doing all types of arc welding. Get a Hobart and turn into cash that business you were turning down because your equipment wasn't capable.

HOBART BROS. CO., Box M-1141, Troy, Ohio

FREE! Vest Pocket Guide for Arc Welders. Contains Tables, Charts and Valuable Reference Material—Ask for Yours

A.C. or D.C. Arc Welders
Portable Electric
Gas Drive

"One of the World's Largest Builders of Arc Welders."

Материал, защищенный авторскими правами

Ingenious New Technical Methods

Presented in the hope that they will
prove interesting and useful to you.



Now—Air Operated Collet Chuck Relieves Second Operation Work on Screw Machines

Work formerly requiring automatic or hand screw machines can now be done at much less cost through the combination of this new air chuck and any drill press. The Redmer Air Chuck is a collet air chuck using standard Brown & Sharpe type screw machine collets. The collet remains stationary, the opening and closing controlled by a sleeve action.

By using a collet as the chucking means, slight variations in the diameter of the work as frequently experienced with automatic and hand screw machine products can be permitted without sacrificing accuracy or concentricity. Thus accomplishing an important saving in time and cost.

The air chuck is an ideal tool for holding parts for drilling, milling, slotting, burring, chamfering, boring, counterboring, tapping, threading, reaming and other work where the machine operation should be concentric with the chucking surface. It is adaptable to many different jobs merely by changing collet and stop. This results in saving of valuable production metals and materials. The chuck will take any type work whether round, hex, square or rectangular, and permits full efficiency of the operator, as it is operated by a foot operated valve thus leaving hands free to load and unload—reducing fatigue and cutting unproductive time to a minimum.

Wrigley's Spearmint Gum, too, is a help on the job. For chewing gum helps relieve dry throat, and helps ease fatigue brought on by the strain of work. And at the same time you are chewing and getting the benefits of swell tasting Wrigley's Spearmint, both hands are free and you need not take a "time out." The Army and Navy have recognized these benefits and are now shipping overseas *only*, all of the limited production of Wrigley's Spearmint. When Wrigley's Spearmint can again be produced in sufficient quantity for all, the valuable benefits of Wrigley's Spearmint Gum now being proven on the battlefield will apply to industry here at home.

*You can get complete information from Redmer Air Devices
Corp., 601 West Washington Blvd., Chicago 6, Ill.*

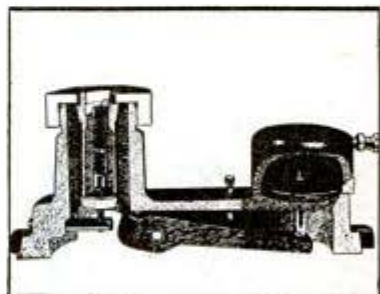

An air operated collet holding
fixture for precision chucking
or machine tools

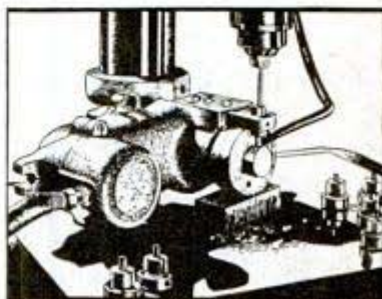

Chuck can be mounted on angle
for angle milling job

Y-154

Amazing Handy ADDING MACHINE

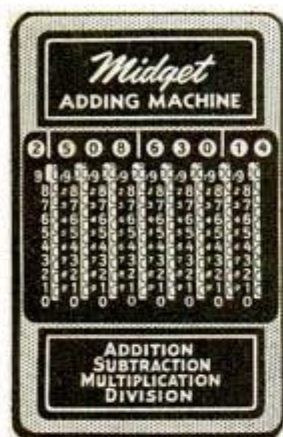

Can Be Carried
in Vest Pocket

ONLY
\$2.50
POSTPAID

**ABSOLUTELY
ACCURATE**

Yet Weighs Only 5 Ounces

- Handles Totals up to \$10,000,000.00.
- Totals appear instantly—as fast as you put the figures down.
- Can be used to subtract, multiply and divide, as well as add.
- Metal construction for years of service.

Haven't you often wished for a handy little device like this . . . that you could take with you ANYWHERE . . . on the road, in the office, at home or in the shop? You can get one now . . . Business man, student, housewife—everyone finds this handy, guaranteed-accurate little machine useful . . . ORDER YOURS TODAY.

SEND NO MONEY

Just send name and address. Then pay postman \$2.50 plus postal charges on delivery. Or send \$2.50 with order and we pay all charges—saving you about 50 cents at the new postal rates.

LEE SPECIALTY CO., Dept. PM-6
Box 3620, Mdse. Mart, Chicago 54, Ill.

MAIL COUPON TODAY

LEE'S SPECIALTY CO., Dept. PM-6,
Box 3620 Mdse. Mart, Chicago 54, Ill.
Please send me one of your MIDGET ADDING MACHINES.

I am enclosing \$2.50 Send C.O.D. plus postage

NAME

ADDRESS

CITY & STATE.....
PLEASE PRINT PLAINLY

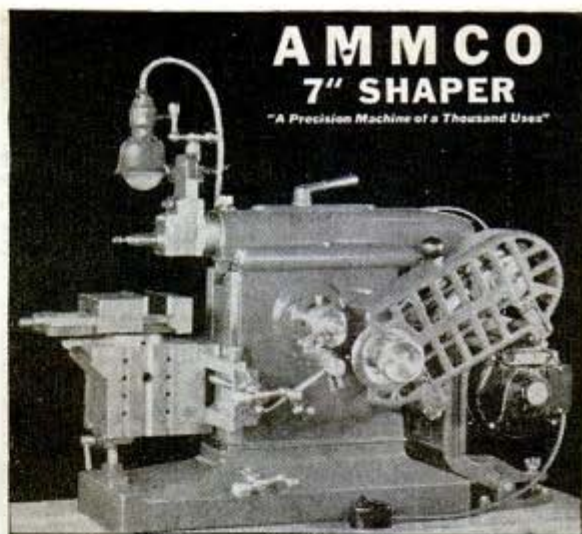

AMMCO 7" SHAPER

"A Precision Machine of a Thousand Uses"

A wide variety of jobs can be done accurately, quickly, easily, and economically on the AMMCO Shaper (7" stroke). Construction incorporates many features you would expect to find only in larger, more expensive machines . . . For example: WAYS of ram, tool head, and front face of the main frame are of the "VEE" type, hand scraped to insure accuracy and long life. Available for stationary installation or as portable unit.

Write today for specifications and prices

AMMCO

2140 Commonwealth Ave. North Chicago, Ill.

WOOD WORKERS

AMAZING BOOK FOR YOU

Harold Hunt wants to send revised No. 14 catalog. 124 pages of woodworking ideas, UNEQUALED BARGAINS in imported and American woods, supplies. Those already holding this catalog—send for revised sheets.

CRAFTSMAN WOOD SERVICE CO.
2729 S. Mary St., Dept. A-51, Chicago 8, Ill.

only **10¢**

New OTTAWA WOOD SAW

For Tractors

—Makes wood sawing fast and easy. Can cut enough wood to pay for itself quickly. Easily moved while attached. Big heavy blade. FREE details.

OTTAWA MFG. CO.
W1127 Oak Ave., Ottawa, Kans.

LOW PRICE

AUTO ENGINE SPEED CONTROL GOVERNORS

CANDEE-SMITH GOVERNOR

Give constant or changeable speed to any auto or truck engine, when used for power. Guaranteed. Instructions. Oil ring bearing \$13.00. Ball bearing, constant or changeable speed, \$19.50. Prepaid. Also additional carburetor butterflies. In Montreal: 7546 Wiseman St.; Latin America: East Asiatic Co.

Agents wanted: Parts Dealers, Garages, Wreckers, Implement Dealers, General Merchants. Free circulars.

CANDEE, 2641 S. Hill • Los Angeles-7

THERE'S
 BEEN A
 BIG CHANGE

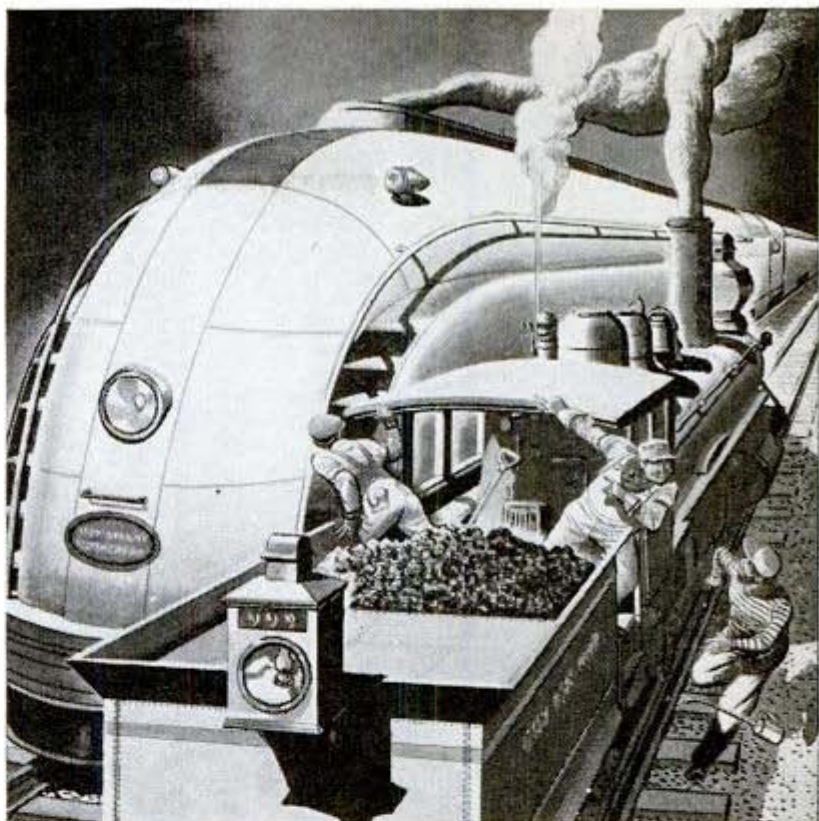

★ For years old "999" was undisputed champion of locomotive design and performance. But she couldn't keep up with progress.

For years nobody challenged the efficiency of the conventional tapered roller bearing, either—until transportation and industry heaped increasing burdens on bearing service.

It's the rollers that carry the load. And Tyson

found the way to add more load-carrying rollers around the raceway. Result: a sturdier, longer-lasting heavy-duty bearing.

The Tyson "All-Rolls" design is leading the progress parade by doing many tough jobs better—and lasting longer—than bearings with fewer rollers. The big name in bearings today is . . . TYSON!



TYSON BEARING CORPORATION • MASSILLON, OHIO

COUNT THE ROLLS - THE ROLLS COUNT



Tyson
 TODAY'S HEAVY-DUTY BEARING

★ BUY MORE WAR BONDS ★

»» MARXMAN »»

FOR MEN OF ACTION



MARXMAN PIPES ease the tension... the strain of battle, the breakneck pace in the office and factory. Men of action everywhere depend on MARXMAN PIPES to relax... to lighten the load!

Enjoy the smoothness, the mellowness, the cool and satisfying sweetness of a MARXMAN. Every pipe is bench-made by expert craftsmen from thoroughly aged, selected briars. There's a MARXMAN PIPE for every taste—all the popular styles and also many exclusive shapes. Look for »»MARXMAN»» on the next pipe you buy.

MOROCCO
Featherweight at
\$250



MEL-O BRIAR
Famous Pipes at
\$350



SUPER BRIAR
Rare Grains at
\$500

AT FINE STORES—EVERYWHERE

»» MARXMAN »»

27 W. 24th Street, New York City

FOR THE DURATION

Worth looking for — dealers' stocks are limited. Worth waiting for — if you can't find them. Worth caring for — if you own them.



WEEJUNS



SKI BOOTS

BASS

THE IMPORTANT NAME IN
OUTDOOR FOOTWEAR



SPORTCASINS



QUAIL HUNTERS

FREE

Write for booklet. You'll want to know all about famous Bass Footwear, even though some models are temporarily unavailable. G. H. Bass & Co., 611 Main St., Wilton, Maine.



OVERWORK IS DRIVING ME MAD!

Let Memindex Do "Half Your Work"

Busy people everywhere claim Memindex "does half their work" by relieving mind and memory of a tremendous amount of detail. Memindex, the "Automatic Memory," keeps all data on hand, cleverly indexed and dated cards—today's always visible. Fine leather POCKET CASE organizes your daily memos; handsome DESK TRAY keeps permanent records for you. No transferring! Worth 1000 times its small cost to business men, salesmen, professional men, comm. & non-comm. officers, Gov't workers, etc. **Outfits \$4.35 and up. Write for Folders and details.**

Free DATED CARDS
for remainder of '44 with orders for '45 Memindex.
Order early and get this bonus!



WILSON MEMINDEX CO.
149 Carter St., Dept. G, Rochester 5, N. Y.



MEN

This Horseshoe Ring, Handmade, Hand-engraved, inlaid with simulated pearl, is a **KNOCKOUT!** Shoe and shank of everlasting Monel Metal is

GUARANTEED 20 YEARS

Supply is limited... rush your order! SEND NO MONEY. Pay Postman only \$3.85, plus excise tax and postage. Return for refund in five days if not delighted. State size. Address:

Dept. 103H,
AMERICAN JEWELRY CO., Wheeling, W. Va.

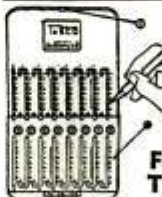

POCKET ADDING MACHINE

STURDY STEEL construction for lifetime use. Adds, subtracts, aids multiplication. Capacity 999,999.99. A real machine—guaranteed 5 years. Thousands of satisfied users. Send name and address. We ship immediately. On delivery, pay postman \$2.50 (plus C.O.D. and postage charges). If you send \$2.50 with order, we pay postage. Leatherette case 25c additional. Your money back after 10 days trial if not satisfied.

Free Trial **\$2.50**

Send no money

TAVELLA SALES CO., 19-PA West Broadway, New York 7, N. Y.

New Designs in

FRANZITE GRIPS



Modernize Your Gun! Improve Your Score!

Most durable grips made. Positively unbreakable! For Colt, Smith & Wesson, Hi-Standard, Ortgie, Luger & Mausers in a wide choice of beautiful designs in ivory, pearl, walnut, onyx, etc. Low prices. **FREE CATALOG.** Dealers Wanted.

SPORTS, INC., (Mrs.) 2850N. Clark St., Dept. P-11, Chicago 14, ILL.

Delta's New, Illustrated Power Tool Buying Guide

helps you make
a wise selection

Tells you what to look
for, to assure yourself
of satisfaction

Tells you what to look
out for, to avoid dis-
appointment



Sent to YOU

free!

HM-19

"How to Get More for Your Money When Buying Homecraft Power Tools" is a new, timely Delta book packed with information it pays you to know before you buy *any* power tools (when they are again available).

There are several makes of power tools. Generally, they *look* alike. And most salesmen's arguments *sound* alike. But, actually, there are *differences*.

So here Delta offers you a "yardstick" which you can use to compare one make of power tools with another. And thus learn the advantages and disadvantages of each.

24 Pages of Helpful Information
The *quality* of power tools is a hard thing to detect. It can't always be seen with the eyes.

Yet, it's what you *can't* see that counts in giving you your money's worth: The patented, exclusive features that mean accuracy, ease of operation.

The pages of this book give you a look *inside* Delta Homecraft Power Tools, so that you can *see* Delta quality. And give you a basis for comparison that you can use to do a shrewd job of looking at other makes of power tools...ask the right ques-

tions... and avoid being misled to buy on price alone.

You See for Yourself

This valuable book provides you with sheets that you can use to actually "score" any make of power tools for accuracy, dependability, safety.

That way, you don't have to take our word for it, but can see for yourself that popular Delta Homecraft Power Tools give you the most for your money.

How to Get Your Free Copy

There's a free copy of "How to Get More for Your Money When Buying Homecraft Power Tools" ready for mailing to you. No charge — no obligation.

Send for it. Fill in the coupon below. Then mail it today.

Tear out coupon and mail today!

DELTA
MILWAUKEE
Power Tools

THE DELTA MANUFACTURING COMPANY
681M E. Vienna Avenue, Milwaukee 1, Wisconsin

Please send me my free copy of Delta's new
buying guide, "How to Get More for Your
Money When Buying Homecraft Power Tools."

Name.....
Address.....
City..... (.....) State.....

HM-18

The Sharper the Knife, the Better the Train!

Every modeller knows the difference between a sharp or dull knife. And the great difference between X-ACTO and other knives is that X-ACTO, with blades made of fine surgical steel, is always sharp. For when the cutting edge dulls, with a twist of the wrist, a new blade is inserted.

New! No. 83 X-ACTO deluxe all metal knife chest. The finest in knife sets complete with 3 solid aluminum handles and 12 interchangeable blades, in handy wooden chest. Price \$5.00 complete. Other knives and sets from 50c to \$3.50.

RE-BLADE TO
RE-SHARPEN



But even more than that, each of the eight different blades in X-ACTO Kits is designed for specific cutting jobs. Each is a "specialist" in its own right.

Only with X-ACTO, the refillable blade knife, can you derive the greater satisfaction from your hobbies that comes from using the right knife with the right blades, that are always sharp, that always cut with precision.

For better results . . . order your X-ACTO set today!

Write for 32 page Handbook "How to Build Solid Scale Model Warplanes!" —10 cents

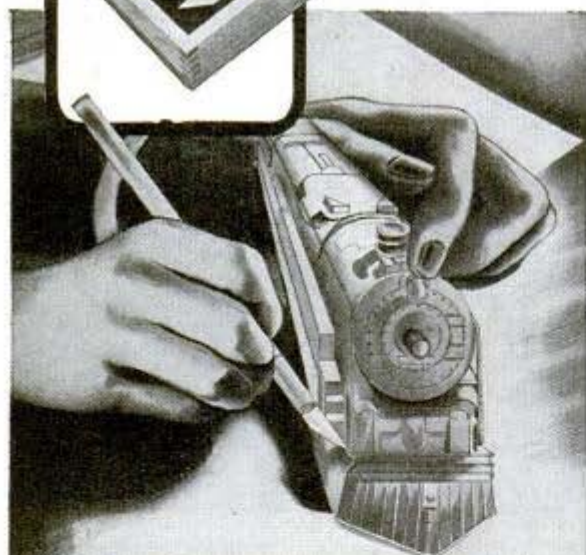

On sale at Hobby and Model Dealers, Hardware and Dept. Stores or order direct from
X-ACTO CRESCENT PRODUCTS CO.
402 Fourth Ave., New York 14, N. Y.

X-ACTO

EVERKEEN knife

Say you saw it in Popular Mechanics!

STOKER EMPTIES OWN ASH!

A remarkable stoker already used by thousands of home owners—fits into any furnace or boiler. Manufactured since 1934. So automatic it takes the coal from your present coal bin through a pipe to the furnace, going around corners if necessary. Keeps house at even temperature, empties its own ash in sealed containers, no coal to shovel, no clinkers to dig, only bituminous stoker of its kind on the market. Send for full information NOW!

POCAHONTAS FUEL COMPANY INCORPORATED
344 EAST 131st STREET • CLEVELAND 8, OHIO



GS TOOL CHESTS

GS Tool Chests are used by thousands of mechanics to safeguard their valuable precision tools. Illustrated is Solid Oak Chest 20"x9"x13 1/4" with 7 drawers and TWO LOCKS for complete safety. Price \$13.50 plus shipping charges. QUICK DELIVERY to workers in war plants. Extra discounts on quantity orders. INQUIRE. SEND YOUR ORDER IN TODAY.

Write for four page folder.

Geo. Scherr Co.

200-A LAFAYETTE ST., NEW YORK 12, N. Y.



SAVE THAT MOTOR!

Give electric tools longer life with Heavy Body 3-IN-ONE Oil! Right for electric refrigerators and washing machines, too. Lubricates, cleans, polishes, prevents rust. At Hardware, Drug, Grocery, 10¢ Stores.



**HEAVY
BODY**

"3-IN-ONE" OIL

POPULAR MECHANICS

**The Stirring Drama of the Men
who Built America...**

Here is a story wrought from
the muscle and sinews of our
nation! The thrill-filled romance
of a man who fought his way
to power and riches... and the
girl who believed in his dreams!

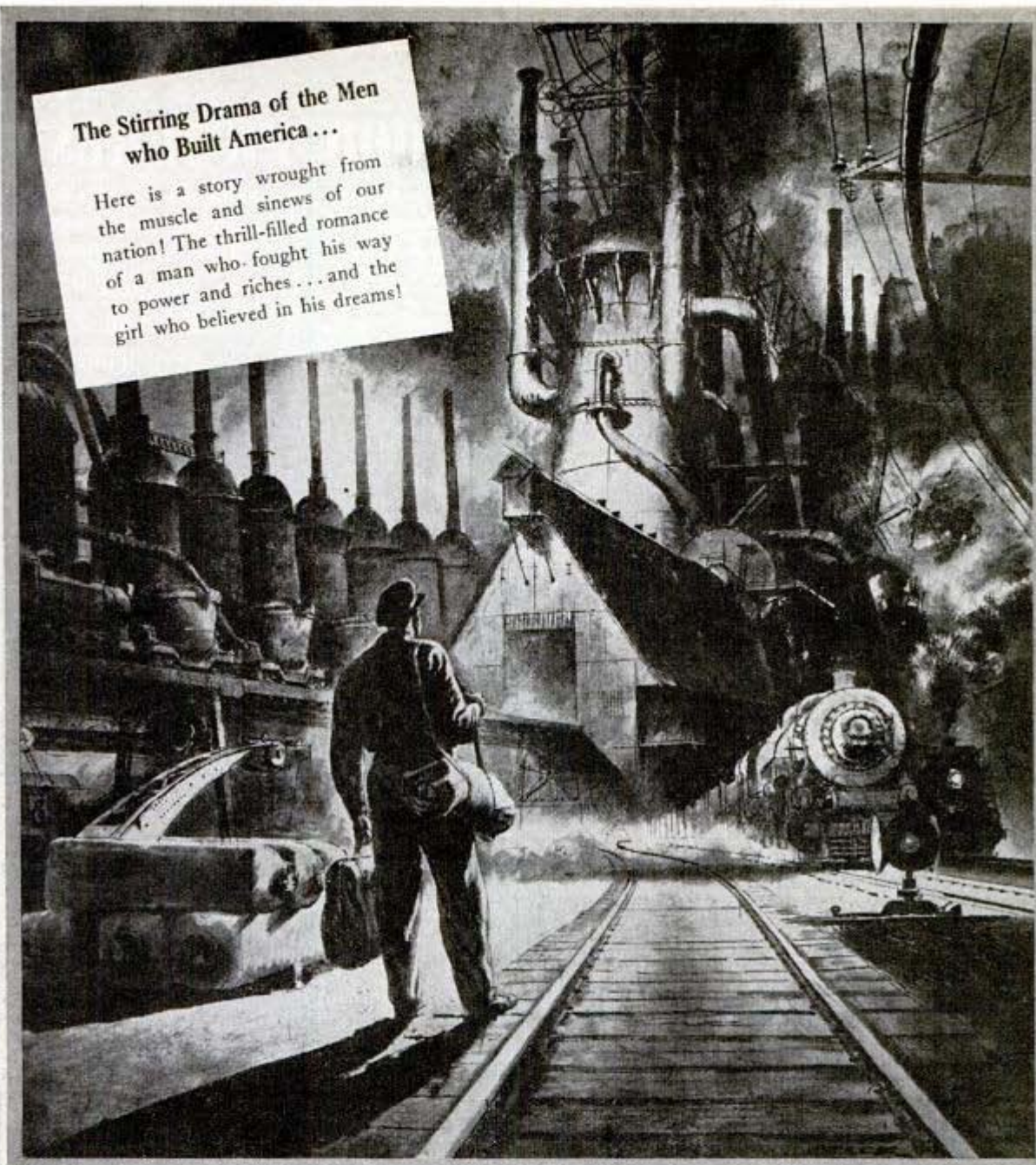

Drawing by Peter Helck

M-G-M PRESENTS KING VIDOR'S PRODUCTION IN TECHNICOLOR



AN American Romance

starring

BRIAN DONLEVY

with ANN RICHARDS • WALTER ABEL
JOHN QUALEN • HORACE McNALLY

Screen Play by Herbert Dalmas and William Ludwig

Produced and Directed by KING VIDOR • A Metro-Goldwyn-Mayer Picture



NOVEMBER, 1944

187

Mortite

UTILITY TAPE

**BETWEEN YOU
and the COLD**



New pliable plastic stops heat leaks—saves fuel. Weatherstrips windows, doors, baseboards, casements. Keeps out dust and dirt. Plugs cracks around drainboards, bathtubs, etc.

Use inside or outside. Can be painted.

EASY TO APPLY

Unrolls like ribbon. Just press into place and it stays put. Does not crack, chip or shrink. A roll covers about 80 feet, enough for 5 windows.

At your Dealer's \$1.25

Higher West of Rockies and Canada

Circular Free

J. W. MORTELL CO.

522 Burch St.

Kankakee, Ill.



If you are uncertain—
—how to make
“GOOD PICTURES”

WRITE TODAY FOR THIS 56 PAGE BOOK

IT WILL HELP YOU
SOLVE MANY PROBLEMS

- SELECTION OF FILM
- EXPOSURE
- DEVELOPING
- ENLARGING
- FLASH PICTURES
- FILTERS & COLOR

Send 25c to
ARGUS, INC.
Ann Arbor, Mich.
DEPT. H



★ SAVE WASTE PAPER ★

Build the B-29 “SUPERFORTRESS”

Build this realistic 26 1/2" line-controlled gas model of the greatest of all bombers. Kit UA-200,

\$1.00

This is one model every model builder should build. Be sure to get your kit today.

Another Cleveland Model
“SUPERVALUE”



36" PIPER CUB

Well known U. S. plane that is doing a grand war job. Kit T-04.

\$1.50

9 Other Big 36" Industrial Training Models. Each Kit only..... **\$1.50**



Famous U. S. “BLACK WIDOW”

Big 30" model of the super night fighter that has all the world agog. This is another of the C-D popular Industrial Training Models. Build them all. Kit T-155.

\$1.50

See your dealer first. If ordering direct, include 20c extra for packing-postage.

Biggest \$1.00 Model in U.S. 84" Super Condor Soarer. Kit E-5010.....

\$1.00

CATALOG 5c
(none free)

CLEVELAND MODEL & SUPPLY CO.

4508D105 Lorain Ave.

Cleveland 2, Ohio, U. S. A.

POPULAR MECHANICS

FREE BOOKLET EDITED BY DU PONT ENGINEERS



*gives latest methods
for care of car cooling
systems!*

This clear, concise booklet—“Take Care of Your Cooling System”—is a guide every car owner should have. Photographs and diagrams show exactly what to do to keep your cooling system in tiptop condition. Tells how to find, cure and prevent mechanical troubles . . . how to clean out rust and scale . . . how to get the most heat from car heaters. Compares different types of anti-freeze. It's free—no obligation whatsoever. Just mail coupon today.

E. I. du Pont de Nemours & Co. (Inc.)
2496-M Nemours Bldg.
Wilmington 98, Del.



Please send me a free copy of “Take Care of Your Cooling System.”

Name _____

Address _____

City _____ State _____

Success WITH Atlas

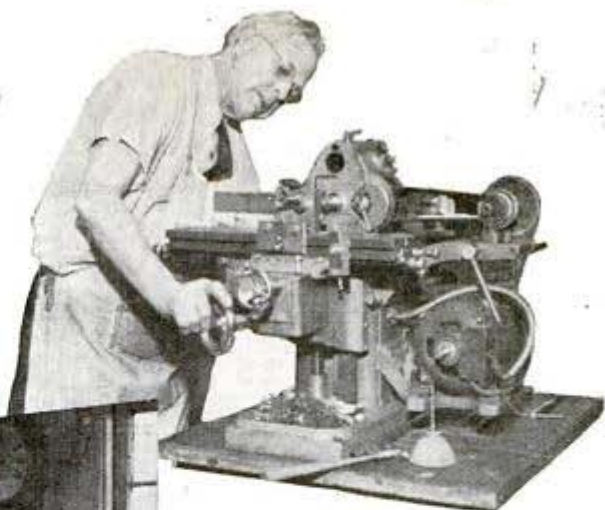

There are many jobs for the Atlas milling machine in the ABC Tool and Die Co.

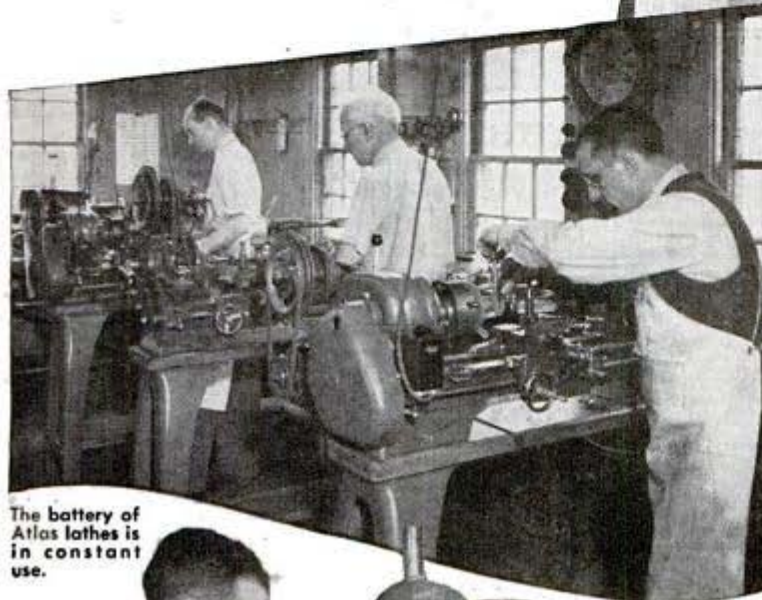

The battery of Atlas lathes is in constant use.



There is plenty of precision drilling for the Atlas floor model drill press.

HOME WORKSHOP BASIS OF SMALL BUT VITAL WAR PLANT

One day's work a day wasn't enough for Mac Milligan and Jack Ryan, Rochester, N. Y., when the Axis took on Uncle Sam. So the two veteran machinists pooled their home shop resources . . . an Atlas lathe, milling machine, shaper, and drill press . . . and began making tools and dies in their spare time.

Soon Mac and Jack had to spend full-time on their business which they named the ABC Tool and Die Company — and one by one retired machinist friends offered to pitch in and help. More machines were purchased . . . including four more Atlas lathes . . . and the plant force grew to sixteen men with thousands of vital precision products to their credit.

What these two patriotic Americans did is typical of the efforts of many hundreds. In small shops and home workshops, Atlas tools pointed the way to profitable after-hours work that grew into a thriving business. Be sure to find out about low-cost, compact Atlas tools for your postwar shop!

"NEW
PATTERN
SERVICE
for WOOD
CRAFTS-
MEN . . .
see Atlas
ad page
202"

ATLAS PRESS COMPANY
1143 N. PITCHER ST., KALAMAZOO 13D, MICHIGAN

I Built This "AA" GUN Myself!

Realistic, super-detailed model. Barrel swivels and elevates, lowers, etc. Pre-fabricated wood parts. 3 1/4" scale. Complete with plans. Del. in U.S.A.

\$3 25

POLK'S
Nation's Leading Hobby House!
314 5th Ave. New York City 1
Open daily til 6 PM
Thurs. til 9 PM

Many interesting working features in finished model!

MODELS of WEAPONS THAT Scale ARE BRINGING Victory!

B-29 SUPER FLYING FORT

Exciting scale model of New Giant (3 1/2" to ft.). ALL BALSAs. Many finished parts in kit; shaped fuselage, wings, tail, rudder. Plastic turret blisters. Large 2 1/2" scale. Del. in U.S.A. . . . \$2.75

KITS Solid, flying, 'U' Control models. Ideal Gifts! to \$10

DeLuxo Detailed Army JEEP

Lifelike miniature, precise 1" scale. Plastic & wood pre-formed parts. No carving.

\$2.75

Kit, plans. Del. in U.S.A.

AMPHIBIAN JEEP, 1" scale \$1.20

ARMY TRUCK KIT, Del. U.S.A. . . . \$1.65

10 FT. SOARING GLIDER

ALBATROSS, giant BALSa model. Cut parts, liquids, 1 issue, illus. \$3.75

Condor, Super 7 ft. soarer, \$1.30

Thermic 70", super kit, . . . \$3.75

Thermic '18' & '20' . . . both 60c

Finished PLASTIC Models NOT KITS

EXACTLY AS USED IN PRE-COMBAT TRAINING OF FIGHTER-BOMBER PILOTS!

JUST RELEASED FOR CIVILIAN OWNERSHIP! Dramatic mementos of World War II. Cast from same molds which produced official, military models. Every detail, every design characteristic of original plane is in the finished ARISTO-CRAFT Ebony Plastic! Official 1/72nd Identification Scale.

Planes of All Types — All Powers

Mariner . . . \$5.00	Well III . . . \$4.00	Junkers 57B . . . \$2.25
Vengeance 2.00	Well II . . . 4.00	Junkers 90 . . . 5.75
Commando 8.00	Hotspur GI . . . 2.75	Heinkel 113 . . . 1.75
Liberator . . . 5.00	Black Pkua . . . 1.75	Heinkel 115 . . . 5.25
Vindicator 2.00	Manchester . . . 4.00	DFR Glider . . . 4.00
Lodestar . . . 3.50	Lerwick . . . 5.00	Bf-109E . . . 6.25
Skytrain . . . 6.75	IL-2 . . . 2.00	Hulkdiver . . . 2.25
Waco GI . . . 5.75	Kawasaki 97 . . . 2.25	Whitley . . . 3.75
Catalina . . . 8.00	Mitsu 97 . . . 4.00	Focke-W. 187 . . . 4.00
Boe . . . 1.75	His . . . 1.75	Buconner . . . 2.00

ILLUS. BROCHURE of all ARISTO-CRAFT Plastic Plane-Models 25c; refundable with 2 model order.

X-acto Modellers Knife Sets

Everkeen knife with interchangeable blades. No. 82—Fitted Wooden Chest, 3 knives, 12 assorted blades. \$3.50; No. 82—Double Set, 2 knives, 12 asstd. blades, \$2.00. (By mail, add 25c)

128 Page, Illustrated Boat Book

Ship kits, fittings (over 10,000) accessories, supplies. 25c. RAILROADS (HO) 128 Pgs., illus. 25c. PLANES (solids), 10c.

POLK'S Model Craft HOBBIES
314 (M) 5th Ave., N. Y. C1

FRANKLIN'S THIN GLUE LINE HAS UNSEEN STRENGTH

MAKE BIG ONES OUT OF LITTLE ONES

WITH FRANKLIN Liquid Hide GLUE

Use the small pieces by putting them together with Franklin, a genuine hide glue, ready-to-use. No mixing or heating means no chilled joints.

EVERY DROP WORKS™

AT YOUR HARDWARE DEALER or send 30 cents for 1/4 pint to The Franklin Glue Co., Columbus 3, Ohio

FREE! LATEST, MOST COMPLETE RADIO PARTS CATALOG

EVERYTHING in RADIO and ELECTRONICS for War Training, Maintenance or Repair

New R-F Resonance and Coil Winding CALCULATOR

Easy to use! For fast accurate determination of resonance factors and coil winding data. No. 37-955. Postpaid, 25c.

RADIO'S FINEST BOOK VALUES

Specially prepared to aid radio training in schools and industry. Full of valuable data. Send for all six!

Radio Formulas and Data Book No. 37-752 . . . 10c

Dictionary of Radio Terms No. 37-751 . . . 10c

Radio Circuit Handbook No. 37-753 . . . 10c

Radio Builders' Handbook No. 37-750 . . . 10c

Simplified Radio Servicing No. 37-754 . . . 10c

Radio Data Handbook No. 37-755 . . . 25c

All Six Books No. 37-799 . . . 75c

ALLIED RADIO CORP.
833 W. Jackson, Dept. 5-L-4, Chicago 7

ALLIED RADIO



How to enjoy starched collar neatness & soft collar comfort

The answer is SPIFFY—the invisible collar stay with the self-adjusting springs. Smooths away wrinkles and collar curl—holds down the points—keeps a fellow looking neat, smart and trim the whole day long.

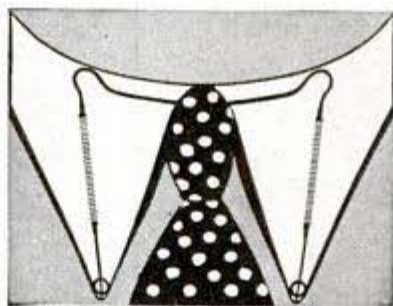

INVISIBLE UNDER COLLAR

19 Million Sold To Servicemen!

It's a "Must" with the boys in khaki... they're easy to mail. Why not send three or four to your man in the service.

Every man should have three or four—25c and more at men's stores everywhere.

SPIFFY COLLAR STAYS

CREST SPECIALTY CO., 663 W. Washington St., Chicago 6, Ill.

Home repairs can be handled at the drop of a hat with Weldwood Glue.

Mixed just by adding tap water to the powder, it can be used at once, sets fast (jobs can be light-worked in a few hours) and it makes a *permanent* bond.

Used and accepted by the Army, Navy, Civil Aeronautics Authority and Maritime Commission (in the manufacture of war products from PT boats to airplanes) this plastic resin adhesive actually welds woods together.

Your hardware store or lumber dealer has handy packages of Weldwood Glue in 10c, 25c, 50c and 85c (1 lb.) sizes. Get a can today or send 25c and your dealer's name for a trial 3½ oz. sample.

UNITED STATES PLYWOOD CORPORATION
Weldwood Glue Dept. 108
55 West 44th St., New York 18, N. Y.
"Makes the glue line the SAFETY line"



Weldwood Glue Has Everything!

1. Tremendous strength. 2. Waterproof, bacteria- and rot-proof. 3. Quick and easy to use. No heating. No waiting. 4. Economical. 5. Applied cold, quick setting. 6. Stain-free. Supply limited due to Uncle Sam's war needs.



WELDWOOD
PLASTIC RESIN
WATERPROOF GLUE





HANDKERCHIEF TEST



PROVES VITAL ZONE SPOTLESS AND FREE FROM "GOO"—no matter how often you smoke it!



HESSON GUARD MILANO

BURN YOUR NAME ON TOOLS WITH THE

ARKOGRAF

PROTECT YOUR TOOLS FROM THEFT Write with electricity any name or design on the hardest and finest tools and instruments or any metal, like writing on paper with pen or pencil. Thousands used by mechanics, garages, machine shops. **Complete Outfit \$3.50—Prepaid Anywhere** Interesting illustrated circular free. Write today. **ARKOGRAF PEN CO., 3927 S.E. Stark, Portland 15, Ore.**



TURN SCRAP INTO MONEY

AUTOPOWER tells you how in plain, easy, simple, and illustrated instructions that anyone can follow. Change auto generators into useful, practical AC and DC generators and motors with voltage from 2 to 1,000 volts, for power, light, welding, radio, sound, etc. No previous experience nor special tools needed. Generators can be driven by wind, water, fan belt, etc. Already used and endorsed by thousands. Send for your copy of "AUTOPOWER." Only \$1.00 postpaid.

AUTOPOWER, INC.

2125 Pine St., St. Louis, Mo.



DRILL PRESS OWNERS!

HERE'S 1 TOOL WITH 5 DISTINCT USES THE BARRON MULTI-PURPOSE ROTARY WOOD PLANER



PLANES & SURFACES • PANELS & BEADS \$7.50 COMPLETE ROUTS & GROOVES • RABBETS • TENONS

Converts ANY drill press into a time saving, low cost planer, paneler, tenoner, etc. Surface finishes all types of tough grained and knotty surfaces to agree smoothness. Safe! Guaranteed harmless to drill press. Thousands now in use. **SOLD ON MONEY BACK GUARANTEE.** Full refund on 5 day trial. Shipped prepaid on receipt of \$7.50—or C.O.D. **YOU RISK NOTHING.** Free literature.

STEEL TOP AUXILIARY DRILL PRESS TABLE

Has 300 sq. in. smooth working surface. Equipped for shaper and many other important workshop uses—a real buy at **\$9.95**



Barron Tool Co., 369 Architects Bldg., Detroit 1, Mich.

INVENTORS, SCHOOLS, CRAFTSMEN BRONZE FOUNDRY



is again available in limited quantity without priority. Orders filled in sequence as received. **INVENTORS—SCHOOLS—CRAFTSMEN** use **FOUNDRYETTE** for making castings quickly for new inventions, for instruction, and general purpose. Order now for early delivery. Three sizes are available capable of making bronze castings of 1½, 3, and 6 pounds weight, aluminum, copper, brass, etc., \$17.50, \$24.00, \$34.50, f.o.b. Kansas City. Domestic gas supply and 110 volt AC or DC energy required for operation. Write for circular.

KANSAS CITY SPECIALTIES CO.
Box 6022, Dept. P-48 Kansas City, Mo.

Say you saw it in Popular Mechanics!

PAINT STRIPING TOOL

ONLY \$1.00 POST PAID

Try it! See the Added Beauty

With this **NEW TOOL** (not a brush) everyone can now draw lines with paint, enamel, lacquer, etc. Used on autos, models, toys, games, imitation tile walls, cabinets, furniture, linoleum floors, signs, bulletin boards, sporting goods, home workshop projects, etc. Send only \$1.00 for complete tool for painting a 1/16" wide stripe, including adjustable guide, operating instructions, etc. C.O.D. price \$1.25.

As easy to use as a pencil.



Patented

Extra interchangeable tips for making 1/64", 1/32", 3/64", 1/16", 3/32" and 1/8" wide stripe lines—.50c each.

Every Painter and Craftsman Should Own One.

Send for your tool and as many additional width tips you need today. Use it. If you are not satisfied that you can do better work, add character as well as beauty to your product or project, return the tool and we'll refund your money promptly.

Paint Dealers; Write for literature, etc.

WENDELL MFG. CO. CHICAGO 18, ILL.



BLOWERS BUILD YOUR OWN

Warm your home by **AIR CIRCULATION.** Live up the old heating plant with modern methods. Controls for heating units, Steel Blowers, Exhaust Fans, Steam and Gas fired UNITS, GAS RANGER \$39.00. **ELECTRIC DAMPER CONTROL FOR COAL FURNACES \$14.00.** See literature. Free literature.

PEERLESS SALES, Dept. M.-C. V. Stn. Lincoln 6, Nebr.



BUILD YOUR OWN MACHINE TOOLS!

Blueprints \$1.00 - Catalog FREE

Detail construction Blueprints on 6 Lewis metal and wood-working tools postpaid for \$1.00. Includes prints for Lewis 10" Shaper or Milling Machine, Drill Press, Vice, 16" Band Saw, 6" Jointer, 8" Circular Saw. Plain or semi-finished castings available for these tools save up to 80% of comparable new tool cost.

Illustrated 32-page Catalog—our free with Blueprint Order—describes 29 Lewis tools. WRITE TODAY!

LEWIS MACHINE TOOL CO.
P.O. Box 116, Sta. A, Dept. M-11, Los Angeles 31, California



WAITING..

With 12 million red-blooded men busy in the armed services, lots of fine fish are growing fat (and careless). The "good spots" are better than they ever were—just *waiting* to be fished. Beautiful fishing models of Johnson Sea-Horse outboard motors will be waiting too, when the right day comes.



WAITING..

We have been making lots of outboard motors right along. For war. It will take some time, when materials and manpower are released, to stock up on the deluxe models you want. But we will do our best to see that they are ready when Johnny (and Jane) come marching home.

JOHNSON MOTORS, WAUKEGAN, ILLINOIS

THERE IS NO SUBSTITUTE
FOR EXPERIENCE



JOHNSON SEA-HORSES for DEPENDability



*You've had to wait
because lives had to be saved!*

Ta-Pat-Co life-vests—that even bullets could not sink—have been in the war.



Before long, Stay-A-Float will again make swimming and boating safe for Johnny and Jane.



Safe sleep went into the jungle with this specially designed hammock. To be yours with peace.



On the sea . . . in the jungle . . . in the Arctic . . . were those who *could not wait*. Navy and Coast Guard men . . . marines . . . merchant sailors . . . soldiers . . . airmen. To these boys the slender margin between life and death might be the safety of a life-vest or the security of a sleeping bag.

Because such tasks could not wait, you have had to. But when all is over, you will be well repaid for waiting.

The spur of war's necessities has led to many new improvements and innovations in Ta-Pat-Co Outdoor Sports Equipment. These will be yours when Ta-Pat-Co soon greets its multitude of sportsman friends again.

This book is as entertaining to you who know the answers as it is helpful to those who don't. How to call wild ducks without a call—hunt rabbits without a gun—and 100 other do's and don'ts. New post-war edition now ready for the press. Put your name in now for a first copy. No charge. Just write.



Tapatco
TRADE MARK REGISTERED U.S. PAT. OFF.
THE AMERICAN PAD & TEXTILE CO.
GREENFIELD, OHIO

THE AMERICAN PAD & TEXTILE CO.
GREENFIELD OHIO

How to learn to shoot

The Guidebook to Rifle
MARKSMANSHIP



O.F. Mossberg

Send for this Free Booklet

Take advantage of the Government-approved program, sponsored by the National Rifle Association of Washington, D. C., to train citizens in the use of small arms. Write today for the above Free booklet: "The Guidebook to Rifle Marksmanship" and details on how to get rifle training.

O.F. Mossberg
& SONS, INC.

46511 ST. JOHN ST., NEW HAVEN 5, CONN.

Today, 100% in war work. In normal times, manufacturers of 22 cal. RIFLES, SHOTGUNS, TELESCOPE SIGHTS, TARGO GUNS AND EQUIPMENT

Now for EVERY WORK SHOP!

NEW Invention **Electroplates** by BRUSH



Easy to Plate CHROMIUM GOLD, SILVER, NICKEL, COPPER . . . For Pleasure and Profit!

If you have a workshop—at home or in business—you need this new Warner Electroplater. At the stroke of an electrified brush, you can electroplate models and projects—you can replate worn articles, faucets, tools, fixtures, silverware, etc. with a durable, sparkling coat of metal . . . Gold, Silver, Chromium, Nickel, Copper or Cadmium. Method is easy, simple, quick. Everything furnished—equipment complete, ready for use. *By doing a bit of work for others, your machine can pay for itself within a week.* So make your shop complete by getting a Warner Electroplater right away. Send today for FREE SAMPLE and illustrated literature. ACT AT ONCE! Mail Coupon. WARNER ELECTRIC CO., DEPT. 319 360 North Michigan, Chicago 3, Illinois

FREE Details & Sample!

WARNER ELECTRIC CO., 360 N. Michigan, Chicago 3, Dept. 319
Gentlemen: Send Free Sample and Details to:

Name _____
Address _____
City _____ State _____

Say you saw it in Popular Mechanics!



Convenient, comfortable, hospitable—that's Cleveland's favorite hotel

Hotel Cleveland

Cleveland, Ohio

Directly connected with Union Passenger Terminal

HOLD-E-ZEE

AUTOMATIC GRIP SCREWDRIVERS

Hold-E-Zees do the job better, faster. They excel wherever screwdrivers are used. Gripper instantly released by spring action, sliding up out of way when not in use. *High-quality materials throughout.*

Upson Bros., Inc.
86 Exchange St.
Rochester 4,
N. Y.



At Leading Dealers Everywhere

SHAW and "Peppy-Pal" "DU-ALL" GARDEN TRACTORS

• 1 to 9 H.P. Circulars on request. War limits production—We supply repairs for all SHAW Tractors sold in our 40 years in business.

BUILD YOUR OWN RIDING TRACTOR—"WAR HORSE"

using old auto parts, powered by 2 H.P. or larger air-cooled engine; or walking type Garden Tractor 1/2 to 3 H.P. or convert truck or auto into Farm Tractor. Each with steel or rubber tires; will plow, cultivate. Plans for building, in few hours, any one of above, postpaid for \$1.00 (state which wanted) or all 3 for \$2.00. Money Back Guaranteed!

SHAW MFG. CO., 4511 Front St.
Galesburg, Kansas
668G North 4th St., Columbus, Ohio



POPULAR MECHANICS



*Signet of Quality
in Pipes*



VanRoy

Men treasure the VanRoy Pipe for the trail of memories it leaves of past enjoyments—and for its unfailing promise of new pleasures still to come. Give yourself the justly proud satisfaction of owning a VanRoy—the pipe that proclaims the exacting smoker . . .



Pipes Illustrated:
VanRoy Dumont \$10

VAN ROY COMPANY, INC.
EMPIRE STATE BUILDING
NEW YORK 1, N. Y.

VanRoy Pipe Family—ARISTA 3.50 • BARD 5.00 • COURIER 7.50 • DUMONT 10.00



THEIR'S TODAY.....YOURS
FOR PEACETIME GUIDANCE

the SHERRILL COMPASS

New battle-tested principles of design will be available in your Sherrill precision compass at war's end. They're "miracles" in modern plastic. All models will sell at popular prices.

BATTLE
COMPASSES TODAY!

- * AUTO
- * AVIATION
- * AND BOAT

COMPASSES
TOMORROW!

SHERRILL
RESEARCH CORP.
PERU, INDIANA



Customer: "That's a beautiful job, Pete."

Pete: "Yes, you can't beat the Foley for turning out a perfect cutting saw."

**SAW
FILING**

is a Good Business

With the Foley Automatic Saw Filer you can put yourself into a fine cash business with steady customers and make a good living. The Foley automatically joints the saw, making all teeth even in size, shape, spacing. The Foley is the only machine that files all hand saws, also hand and cross-cut circular saws.

SEND FOR FREE PLAN—Shows how to start a saw repair shop. No canvassing. Send coupon today.

FOLEY Automatic SAW FILER

FOLEY MANUFACTURING CO.

1116-4 Foley Bldg., Minneapolis 13, Minnesota

Send Free Plan on Saw Filing business, no obligation

Name _____

Address _____



5 lbs. HANDY ASSORTMENT \$1.98
FOR MECHANICS—GARAGES
—WORKSHOPS—HOME USE

SCREWS • NUTS • BOLTS • WASHERS •
RIVETS • SPRINGS • BRACKETS • MISC.

MORE THAN 1,000 PIECES

5 full pounds—a veritable treasure chest of fastening devices for every practical use. Satisfaction guaranteed. Order now..... **\$1.98**

SPECIAL—2 assortments, over 2,000 pieces, for \$3.69.

HUDSON TRADING CORPORATION

The House of Handy Assortments
N-165 West Hubbard St., Chicago 10, Ill.

FREE! Handy List of Special Assortments: FIBER AND BAKELITE WASHERS—RUBBER WASHERS and PADS—FELT WASHERS and PADS—RADIO LUGS, CLIPS and CONNECTORS—SPRINGS—SELF-TAPPING SCREWS—etc.



Just issued!

New, 16-Page Bulletin!

"Hard-to-Find
Radio and Electronic
Parts and Equipment"

Free for the asking



Write immediately to Dept. P-11

Now Known **LAFAYETTE RADIO CORP.**
as **CONCORD RADIO CORP.**
901 West Jackson Boulevard, Chicago 7, Illinois

Wonder-Tone NOISE ELIMINATOR

Just attach to your radio (long, short wave) and enjoy reception free from distracting noises. Send-No-Money Pay Postman 60c plus postage or send 60c and we'll send postpaid. Return in 5 days for refund if not delighted.

WONDER-TONE COMPANY, Dept. 46, 7078 N. Clark St., Chicago 26, Ill.



Say you saw it in Popular Mechanics!

WRITE FOR
OUR
TOOL DATA
SHEETS

WILLIAMS
SUPERIOR DROP-FORGED TOOLS

J. H. WILLIAMS & CO., BUFFALO, N. Y.

**ELECTRICITY FOR ANY JOB
ANYWHERE**



Reliable, economical electric service anywhere, anytime, with an Onan Electric Generating Plant. Driven by Onan built, 4-cycle, gasoline engines, these power plants are of single-unit, compact design and sturdy construction. Suitable for all types of service.

Over 65 models, in sizes from 350 to 35,000 watts. A.C. types 50 to 800 cycles, 115 to 660 volts, single or three phase; D.C. types 6 to 4000 volts. Dual A.C.-D.C. combinations available. Write for details.

ONAN

D. W. ONAN & SONS, 1099 Royalston Ave., Minneapolis 5, Minn.

For Every nut turning operation there is a Snap-on wrench engineered to do the job better, easier, with greater accuracy and safety. Standout for precision is the Snap-on Torqometer illustrated. The Torqometer is widely used wherever accurate bolt tension is essential — both in factory assembly and servicing operations. The worker sees the pressure as he turns the nut . . . as easily as reading a watch . . . and confidently tightens to the correct inch-pound or foot-pound. Snap-on Torqometers are available in 15 models, capacities up to 2000 ft. pounds.

SNAP-ON TOOLS CORPORATION
8062-K 28th Avenue, Kenosha, Wisconsin

THE CHOICE OF BETTER MECHANICS



*"A guy with a Marlin Rifle
just scared the spots off me!"*

THE MARLIN FIREARMS CO., NEW HAVEN, CONN.

YOU CAN DO A BETTER JOB WITH A MOTO-TOOL

No. 1 Moto-Tool with 1 accessory . . . \$9.85
 Kit No. 1 with 23 high grade accessories and Model 1 Moto-Tool in hardwood case . . . \$17.50
 No. 2 Moto-Tool, with 1 accessory . . . \$16.50
 Kit No. 2, same as below with Master Model Moto-Tool . . . \$23.50



10 DAY TRIAL

DREMEL MANUFACTURING CO.,

Dremel Moto-Tools have been the means of speeding up hundreds of jobs in the Armed Forces and in war plants, training schools and repair shops. Good mechanics and tool makers have found them indispensable. They've proven great time and labor savers even in the hands of inexperienced operators. See how handy Moto-Tools are . . . how well they're built.

A FEW OF THE JOBS MOTO-TOOLS CAN DO BETTER

- | | | | |
|-------------------------------------|--------------------------------------|-------------------------------------|------------------------------------|
| <input type="checkbox"/> Sharpening | <input type="checkbox"/> Burring | <input type="checkbox"/> Burnishing | <input type="checkbox"/> Rasping |
| <input type="checkbox"/> Cleaning | <input type="checkbox"/> Finishing | <input type="checkbox"/> Drilling | <input type="checkbox"/> Inlaying |
| <input type="checkbox"/> Grinding | <input type="checkbox"/> Routing | <input type="checkbox"/> Carving | <input type="checkbox"/> Mortising |
| <input type="checkbox"/> Polishing | <input type="checkbox"/> Touching-Up | <input type="checkbox"/> Sawing | <input type="checkbox"/> Brushing |
| <input type="checkbox"/> Cutting | <input type="checkbox"/> Sanding | <input type="checkbox"/> Engraving | <input type="checkbox"/> Dressing |

ONLY MOTO-TOOLS HAVE ALL THESE FEATURES

About 27,000 rpm—the proper speed for better work and longer life from cutters. * Weight only 13 ounces. * Shaped to fit the hand for easy operation. * Sturdily built with shock-proof Bakelite housing. * Oil-less (oil-sealed) bearings. * Fan cooled motor. * Vibrationless (has dynamically balanced armature). * Operates equally well on AC or DC current.

Order Moto-Tools and Dremel accessories from your dealer, if he does not handle them, order direct from factory on 10-day trial. Money-back guarantee. If you do not have a priority ask your employer for it.

OUR PART IN THE WAR

Dremel Moto-Tools are proving indispensable in the Armed Forces and at General Electric, Westinghouse Electric, Remington Arms, Ford, Nash-Kelvinator, Consolidated Aircraft, Douglas Aircraft and Northrop Aircraft and many other important war plants.



CATALOG of Dremel Moto-Tools, Kits, Accessories, etc., sent **FREE**

Dept. T114-L,

RACINE, WISCONSIN

LYTE-CRAFT



LUMINESCENT PIGMENTS THAT GLOW IN THE DARK!

AVAILABLE NOW!

At long last, those amazing Luminescent and Fluorescent Pigments that glow so brilliantly in the dark, are now available for the first time in this practical Kit.

Beautifully packaged, the Kit contains a very generous supply of six different pigments, including the color pigments, luminescent adhesive tape, carrying agents for mixing paint, the ultra violet ray "black-light" bulb, mixing trays, brush, glass stirring rods and an illustrated manual giving the scientific picture of this new amazing field, its many practical uses and applications.

SEND FOR YOURS TODAY! Price \$9.15 Money Back Guarantee

Lynch Corporation, Lyte-Craft Division
 86 Weybasset St. Dept. M11
 Providence 3, R. I.

Please send me the LYTE-CRAFT Kit of Luminescent Pigments

NAME _____

ADDRESS _____

CITY _____ ZONE _____ STATE _____

- Enclosed find Check or Money Order. Ship postage paid.
 Send Lyte-Craft Kit C. O. D. plus postage.

PALMGREN

No. 250 MILLING ATTACHMENT VISE



A most necessary fixture for small shops and even emergency work in large ones. Fits any 8"-9"-10" South Bend, Atlas, Craftsman, Sheldon or other lathes of similar sizes. Has graduated vertical feed screw and 360 degree graduation for vertical angle adjustments. Easily mounted on cross slide and held by one T-slot bolt. Equipped with PALMGREN VISE, 2 1/2" jaws opening full 2 1/2". Vise has one plain and one grooved jaw for holding round pieces.

MAKES MILLING OPERATIONS POSSIBLE ON ANY LATHE

Width	Depth	Opening	Jaw	Jaw	Height	Price
2 1/2"	1-7/16"	2 1/2"	10 1/2"			\$24.75

Order Direct—give priority—if dealer can't supply.

CHICAGO TOOL AND ENGINEERING CO.
 8365 South Chicago Ave. CHICAGO 17, ILL.

AUTHENTIC FLYING MODEL AIRPLANES

Sensational Time-Saving Construction!

Enjoy the thrill of building and flying a model built on a tube. 45 fine kits to choose from—15 cents to \$3.00. Big 32 inch wing span kits—fighters and bombers—only 50 cents. All kits include cement.

★

Joe Ott

AIRPLANE KITS

415 West Superior Street - CHICAGO, 10

OTT-O-FORMER AND OTT-O-TUBE CONSTRUCTION

At Your Dealer

★

CAN VITAMINS RESTORE NATURAL COLOR TO YOUR GRAY OR STREAKED HAIR?



FREE BOOKLET
"Vitamins and Gray Hair"

Here's How You Can Test the Amazing Panates Anti-Gray Hair Vitamins that Combine "Anti-Gray Hair" Vitamins with Wheat Germ Oil, Staff of Life (E) Vitamins

You've read and heard about the latest miracle of vitamin science—the anti-gray hair vitamins. Panates give not only the anti-gray hair vitamin, but the wheat germ oil (vitamin E) activator as well. Panates actually is a healthful food supplement. It works by restoring to your system the hair color vitamins that may be lacking in your daily diet and, if so, should literally feed natural color through the hair roots to check gray spread, to give the hair new lively lustre, and to bring new hope for restoration of normal hair color once again. While too new to guar-

antee 100% results, we can and do make this fair money back trial offer. Send for either the \$1.79 (30 day) or \$4.79 (90 day) Panates Anti-Gray Hair and Wheat Germ Oil (E) Vitamins. Send no money. Pay postman on arrival on the positive guarantee results must please you or money back. Send remittance with your order and we pay postage. Or, write for a free booklet which tells much about Anti-Gray Hair Vitamins. Don't let another day pass without taking steps to see what Panates two-way Vitamin Treatment may do for you.

THE PANATE COMPANY, Dept. H-240, 116 So. Michigan Avenue, Chicago 3

To dad or brother, hubby or lover
 ...your gift of a fine pipe will mark
 you as a "solid sender." The Biltmore
 Blue Ribbon is a sweet-smoker, light
 in the teeth, cool on the draw... a life-
 time of pleasure. Many models...
 choice century-old American bejar...
 rich-grained, with a craftsman finish.
 Biltmore Pipe Co., 220 Fifth Ave., N.Y.

The "BULLDOG"
 \$3.50

For a super special gift
 choose a Biltmore of in-
 period Algonquin Bjar, at
 \$5 \$7.50 \$10

Biltmore
 "BLUE
 RIBBON"
 PIPES

A Great WATCH... PROVED
 IN ACTION

17 Jewels

**The PIERCE
 Parashock**
 REG. U. S. PAT. OFF.

WATERPROOFED
 SHOCKPROOFED
 ANTI-MAGNETIC

\$49.75

Price indicated is suggested
 retail price and includes
 Federal tax.

No other watch has such features
 for service! By laboratory test... by
 test of men and women in industry
 ... by test in battle on land, sea
 and in the air... the PIERCE
 PARASHOCK has proved its ability
 to withstand strain and remain
 dependable. And this same quality
 is built into all PIERCE watches...
 renowned for distinctive styling.
 Ask your jeweler for PIERCE...
 "Watchword of the Airways"...
 The Pierce Watch Co., 22 West
 48th St., N. Y.

KNOWN AND SERVICED THE WORLD OVER

"GRAF-FLOX" TREATED PISTON RING

Microphoto shows evenly distrib-
 uted natural graphite in Burd
 electric furnace iron... that
 abrasive particles are eliminated
 ... penetrating colloidal graphite
 applied.

OLD TYPE PISTON RING

This photo shows poor distribu-
 tion of carbon in ordinary cupola-
 iron rings. Note harmful metal
 particles on ring surface which
 loosen in cylinders and cause
 trouble.

SEE HOW "Graf-Flox" ELIMINATES "RUN-IN"

★ SEE why Burd "Graf-Flox" Piston Rings
 are self-lubricating, quicker seating. Inde-
 pendent research laboratory photos, above,
 prove Burd electric furnace iron scientifically
 assures uniform distribution of natural
 graphite... that abrasive grinding particles
 are eliminated and deeply penetrating col-
 loidal graphite applied. That's why you can
 drive a Burd "Graf-Flox" Piston Ring
 equipped car or truck right from the shop
 under full load and speed... why they do
 not score, seize, scuff or stick in grooves
 ... why they add miles of life to your
 motor. Send in the coupon today and get
 your free copies of the Burd "Graf-Flox"
 Handy Handbook and Car Economy Record
 book.

BURD PISTON RING CO., ROCKFORD, ILL.



THIS COUPON BRINGS 2 FREE BOOKS

BURD PISTON RING CO., DEPT. PM

Rockford, Ill.

Gentlemen:

Please send me your Handy Handbook on how to
 keep my car in good working order. Also Car
 Economy Record Book to keep mileage costs and
 gas coupons safely.

Name

Address

City..... State.....



Tomorrow's Miracle

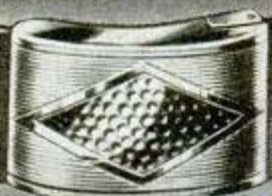

ELASTI-GLASS*

Belts & Braces

Available now . . . in limited quantities at many dealers . . . smartly fashioned Elasti-Glass braces, with yielding 100% full stretching comfort in wide range of sport tones. Clip or button ends . . . \$1 . . . Also Elasti-Glass "Stratton" Belt in Tan, Grey or Brown with handsome Giant Grip buckle . . . 100% stretching comfort . . . \$1.

*Elasti-Glass is an ORGANIC GLASS and although of almost living elasticity contains no silica or rubber. (Trade Mark Registered U. S. Pat. Off. Made from Vinylite[®] Brand Resins. [†] Trade Mark Reg. C. & C. C. Co.) Covered by U. S. Pat. No. 2,288,313.

Buchbaum & Co.

MANUFACTURERS SINCE 1888 · CHICAGO

Dealer's Note: Limited stocks on hand at our New York, Chicago, Los Angeles and Honolulu Offices.

THIS Dustless BRUSH REDUCES GERM LADEN DUST



Eliminates
Sweeping Compound

The "Dustless" brush has a reservoir in its back which holds Arbitrin, a scientifically compounded sweeping fluid. The center row of tufts is connected to the reservoir. During the process of sweeping the Arbitrin feeds through these tufts and moistens every particle of dust it contacts. Instead of floating through the air, the dust is converted into the most efficient sweeping compound.

Tests have proved that "Dustless" sweeping reduces the number of bacteria, normally in the air between sweepings, as much as 97 per cent. The "Dustless" brush also cuts labor and material costs in half.

GUARANTEED—Dustless brushes are used in hundreds of offices, factories, schools, institutions and stores. They are unconditionally guaranteed to meet your requirements. Prompt shipment on AA-5 or higher priority rating. Write for styles, sizes and prices today.



**MILWAUKEE DUSTLESS
BRUSH COMPANY**

528 N 22nd STREET, MILWAUKEE 3, WIS

THE BOND with a PEDIGREE



Chicago **FV**

A thousand test formulas—hundreds of bonds of various kinds—fifty years experience making bonds for the world's best grinding wheels—this is the Pedigree behind the new FV Bond.

FOR THAT PERFECT FINISH—Chicago Wheels made with FV Bond hold their shapes even when run at high speed—produce a satin-like finish that is so accurate it passes any surface analyzer test hands down.

Chicago Mounted Wheels are tough, long lived, dependable. Over 300 sizes, styles and grains.

Chicago Grinding Wheels—Only sizes up to 3" in diameter for the duration, with full WPB approval.



Handee Tool of 1001 Uses and Hi-Power Grinders are still available to all who have priorities.

Send for Free Catalog

CHICAGO WHEEL & MFG. CO.

1101 W. Monroe St., Dept. PM, Chicago 7, Ill.

Decorative Decalomania

Transfers Imported Designs of all Sizes and Types—Flowers, Fruits, Figures, Birds, Dogs, Horse Heads, Ships, Juvenile, Tropical, Chinese, Peasant, Colonial, Patriotic, Inlay, Borders, Initials, etc., for Furniture, Doors, Walls, Trays and what not. **Catalog with 800 illustrations in Color sent for 25c.** Deductible on first order of \$1.00 up. **L. C. WELLS, Dept. PM-411, 25 East 26th St., New York, 10**



BALL BEARINGS

Set in flawless steel rings, assuring precision operation due to friction-free rotation. All Standard makes—New Departure, S. K. F., Norma-Hoffman, Fafnir, etc. We can supply promptly any quantity needed from our large stock of the **MOST POPULAR SIZES.** And you **SAVE 50 to 60%** on the Manufacturer's List. All Ball **FULLY GUARANTEED** Bearings.

Write **TODAY** for Bulletin B

M-E-T EXCHANGE, Dept. PM, 323 Canal St., New York 13, N. Y.

140 PIECE ARBOR SET \$3.95

Hard To Get Items



We only have 100 of these sets. Boxed as illustrated, to keep neat and easy to use. A good \$5.95 value for only \$3.95.

Set contains—1 circular saw on mandrel; 5 assorted flat stones on demountable mandrels; 10 additional ass't stones to fit mandrels; 3 mounted polishing brushes, one each round, cup and flat; 2 felt polishing discs, (one mounted); 1 sanding disc, 5 ass't bits, 1 carborundum disc—all on demountable mandrels; also 8 ass't burrs of high speed steel; 2 carborundum cutoff discs; and over a hundred assorted sand paper discs.

Orders filled in order received. Send check or money order. Shipped prepaid in U.S.A.

GENERAL AIRE CO. 4648 Penhurst St. Philadelphia 24, Pa.

BELL



WATERPROOF

Waterproof, shockproof, anti-magnetic, radium dial and hands, unbreakable crystal, precision tested, sweep second hand.

- No. EX 121
15 jewels, stainless steel back \$39.75
- No. EX 212
17 jewels, stainless steel back \$42.50
- No. EX 330
17 jewels, all stainless steel case \$59.75

Prices Include All Federal Excise Taxes.
Postage Prepaid. Mail Orders Promptly Filled.

Write for Free Illustrated Booklet "EX"

BELL WATCH COMPANY

Time and Life Bldg., Rockefeller Center, New York 20, N. Y.

DUPOR No. 1 MINIATURE DUST MASK

Wear when sanding, grinding, paint spraying, sweeping, dusting, furnace cleaning, etc. Handy as a pair of glasses. Just keep mouth closed and breathe through nose is all you do to operate. Protects against nuisance dusts, hot, cool, cement, grain dust. May fever sufferers wear to keep from breathing pollen. Weighs 1 oz. Has 9 sq. in. filter. Write for Free Literature!



H. S. COVER, Dept. PM, South Bend, Ind.
"GOLDEN JUBILEE YEAR, 1894-1944"

Order Today \$1.00 POST PAID

in every battle... doing vital jobs... unflinching

that's why there are just a few left for essential jobs at home



BRIGHT STAR BATTERY CO., CLIFTON, NEW JERSEY

NOVEMBER, 1944



AC

FUEL PUMPS

You have enjoyed such good service and long life from your AC Fuel Pump because of the quality that is built in, from design to finished pump.

You will continue that performance and quality if you insist on an AC when you need a new, or a rebuilt, fuel pump.

BUY WAR BONDS • BRING VICTORY QUICKER

Say you saw it in Popular Mechanics!

201

NEW *Atlas* PATTERN SERVICE

FULL SIZE PATTERNS for making furniture, household equipment, cabinets, toys are now available through Atlas. They work like templates in airplane construction to save time and insure accurate workmanship.

No. 42 MODERN 4 PIECE BOOKCASE

A beautiful, modern piece of furniture for any home. Pattern includes shop-tested "templates" for each wood piece and time-saving numbered assembly instructions. Price 50c.



No. 15 HANDY WORKBENCH



Basic need of every shop is a good substantial workbench — and this pattern will help you make one quickly and easily — one that fits so it won't get wobbly after a few weeks use. Has two handy drawers for tools. Price 25c.

Order patterns by number, inclosing exact cash, check or money order. Price includes mailing costs. Pattern envelopes show many other useful patterns available at low cost.

ATLAS PRESS PATTERN DEPT.
Dept. A-11, P. O. Box 74, Pleasantville, N. Y.

NUT DRIVERS THAT ARE *Truly* DIFFERENT

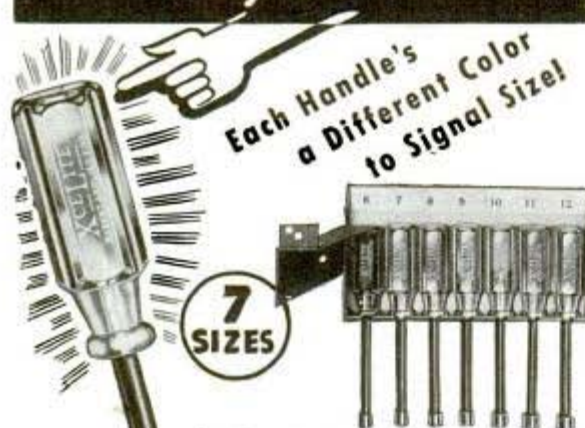

Each Handle's a Different Color to Signal Size!

7 SIZES

In Lockable Metal Holder

You can't really call your outfit of tools complete without this newest ideal in nut drivers. They are indispensable for electrical and radio work. Each size of nut driver has a different colored handle, made of special shock-proof, fire resistant plastic. Just spot the color, and you have the desired size. Sockets are precision formed, deep enough to handle two nuts. Seven sizes (in 32nds) for nuts from 1/8" to 3/4". Supplied in sturdy metal holder which can be wall mounted and locked. Ask your radio, electrical or hardware dealer—or write, Dept. J.

Quality TOOLS Preferred BY THE EXPERTS

XCELITE

Park Metalware Co., Inc.
Orchard Park, New York

Seal Windows and Doors— Cut Heat Losses

KALK-KORD

Seals Cracks Quickly, Easily, Without Tools!



Kalk-Kord, the original non-hardening caulking compound in soft rope-like form, enables you to seal window and door frames against cold and dirt, fills cracks in wood or plaster anywhere, inside and out.

You simply press Kalk-Kord in place with fingers alone, no guns or other tools needed. It is non-oxidizing and will not check, crack, or harden. Kalk-Kord seals tightly and it stays tight.

Use Kalk-Kord now. Lower your heating bills and avoid soiled walls and drapes due to drafts. Use it also to seal unsightly cracks or nail holes in woodwork or plaster. Kalk-Kord is waterproof and can be painted over immediately if desired.

Kalk-Kord is packed in convenient rolls, ready for use. It is neat and clean to work with, cannot stain. Users everywhere are enthusiastic about Kalk-Kord. Try it yourself, now.

Buy Kalk-Kord at your nearest SEARS, ROEBUCK retail store or order from Sears by mail.

PRESSTITE ENGINEERING COMPANY
3978 Chouteau Avenue St. Louis 10, Missouri

MASCOT SLIDE RULE

Fits the pocket. Quickly solves any problem in multiplication, division, proportion. Gives the square, the square root, logarithm and reciprocals of all numbers. Trig scales give sines and tangents of numbers. Fine black graduations on white celluloid. Complete with instructions. Price in fabricoid case \$1.00, in leather case \$1.25. Money back if not satisfied. Special offer to agents and dealers.



MONITOR SLIDE RULE—6" Dia.

Made in white Vinylite. Same scales as Mascot Slide Rule. Complete with instructions. Without case, \$2.95. Leatherette case, 75c add'n'l.

TAVELLA SALES CO., 19-P West Broadway, New York 7, N. Y.

UP TO 100 PERFECT SHAVES from every blade

SATISFACTION GUARANTEED OR YOUR MONEY BACK

MASTER HONE puts a perfect edge on used blades in a few seconds. Made of special composition — the original safety razor hone — no other like it — over a million sold.



50c each postpaid in U.S. and Canada, or send \$1.00 for 3 (No COD's). Write for quantity prices.

WISCONSIN ABRASIVE COMPANY, 854, Milwaukee 11, Wisconsin

ONE-MAN SAWMILL LESS THAN \$135.00

Easy To Turn Trees Into Money



Makes Lumber, ties, shingles, crates, lath, studding, siding.

Belsaw Models in 10, 14 and 20 feet sawing lengths. Patented Mechanical Feed, accurate set works and positive dogs. Use tractor or old auto engine for low cost power. Thousands used for commercial sawing. Pays for itself quickly. Send post card today for FREE booklet, "How To Make Lumber" and Catalog of Woodworking Equipment. **BELSAW MACHINERY CO.** Dept. 1811-J, 3542 Main Street, Kansas City 2, Mo.

THIS

Portable Electric Driven Bilge and Refueling Pump

may be
your

ANSWER

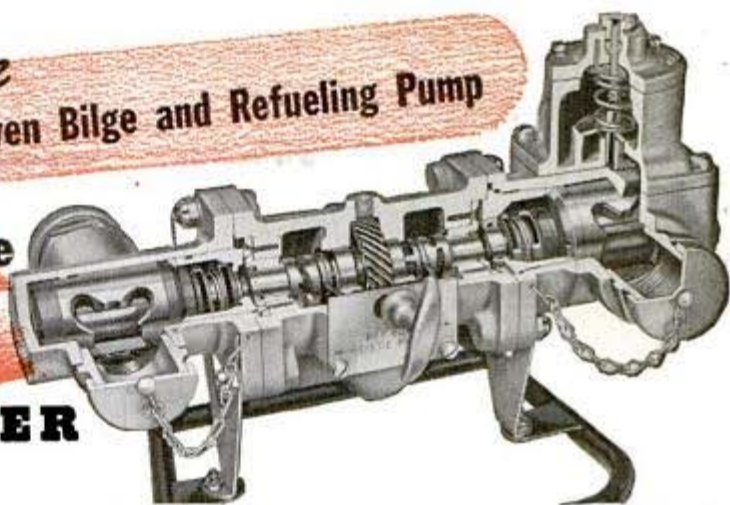
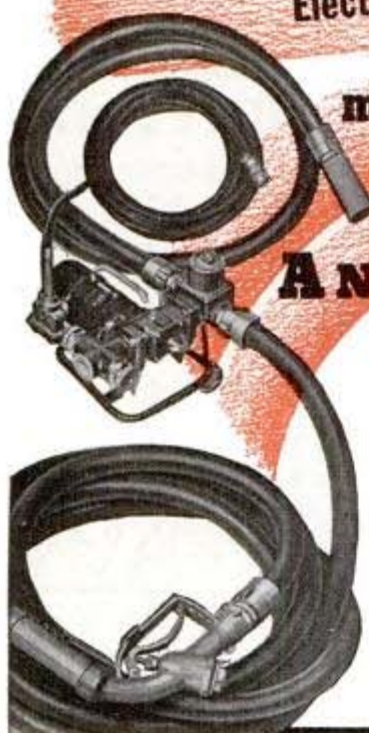

This is the dual purpose pump for siphoning as well as filling tanks, vats, drums, etc. Ideal for quicker transfer of water, gasoline, oil, chemicals, etc. Suction capacity is 840 gal. per hr. Filling speed is 1500 gal.

per hr. and more. G. E. electric motor, a 10 ft. suction hose, and a 30 ft. discharge hose. Wt. 64 lbs. Built by the pioneers of the famous **ROME C AIR-CRAFT PUMPS**. Write for literature.

THE ROME C PUMP COMPANY
130 Abbey Road, Elyria, O.



Step up AND MEET



"THE GENERAL" ☆☆☆☆

The New H. & R. Reising .22 Caliber Automatic Rifle

Here's the automatic rifle that every boy has been waiting for! Yes, sir! "The General," patterned after the famous H. & R. Reising .22 Caliber U. S. Marine Corps training rifle, is the most accurate, perfectly balanced, durable automatic .22 caliber rifle on the market. It's a thrill to shoot "The General," and it fires ten shots, exactly where you aim, as fast as you can squeeze the trigger! See it, try it today at your local dealer's—it's the rifle for you!

Quality Arms
since 1871

HARRINGTON & RICHARDSON ARMS CO.

331 PARK AVENUE, WORCESTER 2, MASS.

HEARING AID

with New "Look of Youth"

*Brings New Poise, Confidence
to Hard of Hearing*



NEW ZENITH RADIONIC with Neutral-Color Earphone and Cord

Described in FREE Booklet! Mail coupon below today for your copy. Tells how thousands of hard of hearing now feel casual and at ease with Zenith's smartly styled plastic earphone and cord which complements any complexion. Contains valuable information for all hard-of-hearing.

\$40 Complete, Ready to Wear

Model A-2-A

FREE BOOKLET tells how Zenith combines its leadership in "Radionics Exclusively" with precision mass production to bring you at \$40 an even finer hearing aid than Zenith's first \$50,000 hand-made model. Also describes many other Zenith advantages. Send coupon below at once!

Also available—New Bone Conduction and Bone-Air Zeniths for the few whose physicians recommend these types. Each only \$10 more, complete.

BY THE MAKERS OF

ZENITH

LONG DISTANCE RADIO

RADIONIC PRODUCTS EXCLUSIVELY—
WORLD'S LEADING MANUFACTURER

PASTE ON PENNY POSTCARD AND MAIL

ZENITH RADIO CORPORATION, Dept. PM-11
P. O. Box 6940A, Chicago 1, Illinois

Please send me your Free booklet about Radionic Hearing.

Name _____
Address _____
City _____
State _____

COPYRIGHT 1944, ZENITH RADIO CORP.

REPAIR TILE

THE EASY Centraz WAY

Centraz TILE POINT



Repairs cracks over bathtubs, around kitchen sinks, pipes and plumbing fixtures. Dries Pure White. Pint.....35¢

(40¢ West of Rockies)

WATERPROOF ADHESIVE

Sets loose tile and linoleum. Prevents screws, bolts and pipe joints from working loose. ¼ Pint...25¢

(30¢ West of Rockies)



For Sale at Your Hardware
and Paint Dealer

CHRISTY COMPANY, Inc.

1417 Pine Street

St. Louis 3, Mo.

UTICA TOOLS



ALL TYPES
FOR MORE TOOL
MILEAGE

Ask Your Dealer



UTICA DROP FORGE & TOOL CORP.
★ UTICA, N. Y. ★

LAW

STUDY AT HOME for PERSONAL SUCCESS and LARGER EARNINGS. 35 years expert instruction—over 108,000 students enrolled. L.L.B. Degree awarded. All texts furnished. Easy payments. Send for FREE BOOK—"Law and Executive Guidance."

AMERICAN EXTENSION SCHOOL OF LAW
Dept. 47-M, 646 N. Michigan Ave., Chicago 11, Ill.

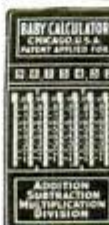

WORLD'S LOWEST PRICED ADDING MACHINE

IDEAL XMAS GIFT—GUARANTEED ACCURATE. Not a toy. Operates with only a finger flick. Adds, subtracts, multiplies, divides. Counts up to ten million. Pays for itself over and over. Ideal Gift for Business, Income Tax and School use. MONEY BACK GUARANTEE. Send name and address. Pay postman only \$2.50 plus postage. (Send full cash if outside U. S.) Money back in 10 days if not delighted.

AGENTS WRITE:
CALCULATOR MACHINE COMPANY (Mrs.)
DEPT. 159, P. O. BOX 1118 CHICAGO, ILLINOIS



Motorists! up to 30% EXTRA MILEAGE

from **EACH GAS STAMP** with a

VACU-MATIC CARBURETOR *Control*

➔ You can't change gas rationing, but you can make sure that each precious gallon of gasoline is providing you with the maximum mileage of which your car is capable. Now you can get added mileage . . . plus quicker starting and more power! Make this trial test. Install a Vacu-Matic on your car and get up to 30% extra mileage on a money-back guarantee.



AUTOMATIC SUPER-CHARGE PRINCIPLE

• Vacu-Matic is entirely different! It operates on the supercharge principle by automatically adding a charge of extra oxygen drawn free from the outer air, into the heart of the gas mixture. It is entirely automatic and allows the motor to "breathe" at the correct time, opening and closing *automatically*.

PROVEN BY TEST

• In addition to establishing new mileage records on cars in all sections of the country, the Vacu-Matic has proven itself on thousands of road tests and on dynamometer tests which duplicate road conditions and record accurate mileage and horsepower increases. Thousands of motorists now enjoy extra mileage—improved performance with Vacu-Matic.

FITS ALL CARS

• Vacu-Matic is constructed of six parts assembled and fused into one unit, adjusted and sealed at the factory. Nothing to regulate. Any motorist can install in ten minutes. The trial offer coupon will bring all the facts. Mail it today!

AGENTS TRIAL OFFER ➔

• Vacu-Matic offers a splendid opportunity for unusual sales and profits. Every car, truck, tractor and motorcycle owner a prospect. Valuable territories now open. You can obtain one for your own car if you help us introduce it to a friend. Just check and mail the coupon today.

Send this Coupon Today

THE VACU-MATIC COMPANY
7617-999 W. State St., Wauwatosa 13, Wis.

Please send full particulars about VACU-MATIC, also how I may obtain one for trial on my car. This does not obligate me in any way.

Name

Address

City State

Check here if interested in Agency Proposition.



MEDICO

FILTERED

SMOKING

REMOVABLE FILTER

(famous in pipes)

A SENSATION IN CIGARETTE AND CIGAR HOLDERS

\$1
WITH BOX OF FILTERS FREE!

The patented filter is the heart of Medico Filtered Smoking. Its 66 mesh-screen baffles whirlcool smoke—retain flakes—and absorb moisture. When filter is discolored, it has done its job. Discard it and put in a fresh one—costs only ONE CENT. Enjoy the benefits of Frank Medico Pipes, Cigarette and Cigar Holders.



GENUINE FILTERS FOR MEDICO PACKED ONLY IN THIS RED & BLACK BOX



A Complete Line of 10", 11" and 12" PRECISION LATHES

Quality Lathes built to industrial machine tool standards. Used by Army, Navy, and Marines. Manual 50c. Catalog free.

SHELDON MACHINE CO., Inc.
4266 N. Knox Ave., Chicago 41, USA

The Care and Operation of a Lathe

AMAZING MYSTERY BUTTON



Startles Everybody. With this Electronic Button you can make your own Telephone—Amplifier—Detectophone. Attach this button to piece of cardboard—transmit conversation to another room. Music also transmitted to distant places. Most interesting, electrical apparatus ever discovered. Enables you to perform hundreds of experiments. So tiny it can be concealed in dozens of places. A Pre-War Product. Supply Limited. Electronic Button including 5000 word instruction booklet with 50 illustrated experiments postpaid only \$1.00. **Electronic Products Company, Saint Charles, Ill.**

See you saw it in Popular Mechanics!

Complete \$20

ENGINES IN STOCK



The G. H. Q. miniature gasoline engine that really operates is still available. Over 100,000 sold to date. 1/5 H. P. Complete with flywheel and propeller, fuel, 15 accessories and full instructions. Fully bench tested and ready to run. Power for all models. \$20 complete. Send only \$1.00—Shipped Collect C.O.D. same day. Send 25c for illustrated Catalog of hundreds of hobby items.

GHQ MOTORS, Dept. BV114, 40 East 21 St., New York 10, N. Y.

BRUSH PLATING OUTFITS

for autoparts, reflectors, faucets, bicycles. No tanks necessary. Free particulars. **GUNMETAL CO., AVE. M. DECATUR, ILLINOIS**



NOW a DYNAMIC HEAVY DUTY INDUSTRIAL WELDER

Saves VALUABLE TIME and MONEY!

AMAZINGLY SIMPLE & EASY TO OPERATE

This portable Dynamic Welder—easily carried right to the job—plugs into any convenient, properly wired 110 volt light circuit—works on Iron, Steel, Brass, Bronze and other metals—has eight metallic and carbon arc welding heat stages—does work you would think only possible with a larger, more expensive machine.

for Only \$23.50 COMPLETE

DESIGNED TO DO HIGH GRADE WELDING INEXPENSIVELY

Maintenance Men; Farmers; Mechanics; Machine Shops; Foundries; Auto, General Repair and Job Welding Shops; using the Dynamic find it so indispensable and useful that they cannot afford to be without it.

If inexperienced, you can easily learn to do a variety of high grade welding jobs by following the practical, simplified operating and welding instructions furnished.

DYNAMIC WELDER CO., 13 East 23rd St., BN, Chicago 16, Ill.

Once you see a Dynamic in operation you won't be without it. Its simplicity will amaze you. In a year the Dynamic only costs you about 6c a day.

Comes complete with helmet, rods, cables, electrode holder and operating instructions, etc.

Write today for free priority assistance and particulars on how to qualify for one of these amazingly low-priced welders. Act now while they are still available. Get details on our 10-day trial offer.

HAVE FUN PROFITABLY

WITH THIS
BOOK OF
50 PLANS

A Fine Xmas
Gift of over 100
"Build Your Own"
items

only
\$1.50

WELDING
GENERATORS



TRACTOR
LIGHTS



TRANSFORMER
WELDERS



BUILT FROM OLD AUTO GENERATORS AND PARTS—

these fascinating and practical projects are inexpensive to make and require no special tools or experience to carry them through. The different types of welding equipment are given particular attention, for your instruction and profit.

WITH THESE PLANS YOU CAN MAKE:

200 Amp. Generator Welder
Workshop Spot Welder
Large Transformer Welders
Gunsmith's Carbon Welder
Electric Fencers
Bench Grinders
Armature Rewinding
6, 12, 32 and 110-Volt
Motors
Wind Driven Light Plant
Insect Electrocutors
Electric Bicycle Pusher
and Many Other Things.

YOU NEED NOT SEND MONEY—

Fill in and mail the coupon below and we will send you the LeJay Manual C.O.D. and packed in a **SPECIALLY COLORED CHRISTMAS WRAPPER**, which will make your gift much more appreciated by the receiver. Bear in mind, however, that C.O.D. fees have been considerably increased, so if you prefer to save this expense, send \$1.50 now, same guarantee. Canada \$1.75.

ELECTRIC
SCOOTER



INSECT
KILLERS



ELECTRIC
FENCERS



MOTORS



WIND PLANTS



LIGHT GENERATORS



ARMATURE WINDING



POWER
TOOLS



ELECT. GO-BIKE



ELECTRIC
OUTBOARD



Worth
\$12.50 if
Plans Bought
Individually!



LEJAY MFG. CO.

47 LEJAY BUILDING

MINNEAPOLIS 8, MINNESOTA.

MAIL COUPON TODAY with only \$1.50

LeJay Manufacturing Co.,
47 LeJay Building, Minneapolis 8, Minn.

Gentlemen: Please send me C.O.D. your big 1944 LeJay Manual, on the understanding that if, after 3 days trial, I should return the Manual, you guarantee to return the \$1.50 purchase price.
(Canada, \$1.75)
I enclose \$1.50 for the above Manual, same guarantee.

NAME
ADDRESS
CITY STATE

Versatility for Precision Toolroom Work

The ease with which South Bend Toolroom Lathes can be changed from one set-up to another for an almost unlimited variety of precision operations is one of the reasons for their popularity in the busy toolrooms of war-rushed essential industries.

Convenient, well placed controls; easy reading graduated dials; and smooth operation save time and reduce operator fatigue to a minimum. A wide range of spindle speeds permits machining various kinds of metals with maximum cutting tool efficiency. Threads and



power feeds for all requirements are instantly available through a full quick change gear mechanism. A complete line of attachments and accessories simplifies tooling the lathe for many special and unusual classes of toolroom work.

South Bend Toolroom Lathes and Engine Lathes are made in five sizes: 9", 10", 13", 14½", and 16" swing respectively. Precision Turret Lathes are available in two sizes: Series 900 with 9" swing and ½" collet capacity and Series 1000 with 10" swing and 1" collet capacity. Write today for catalog.

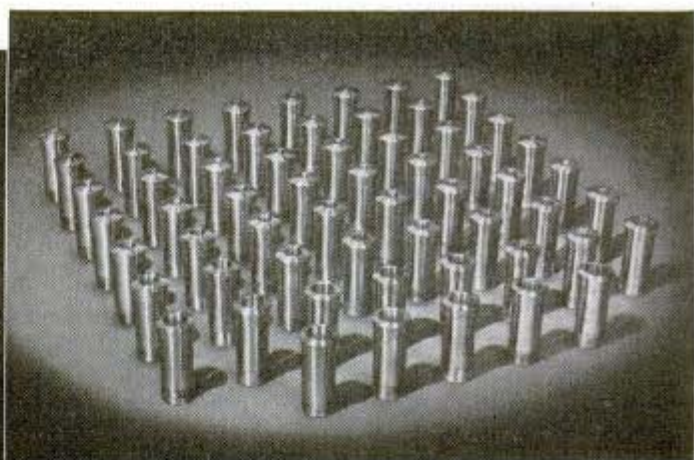
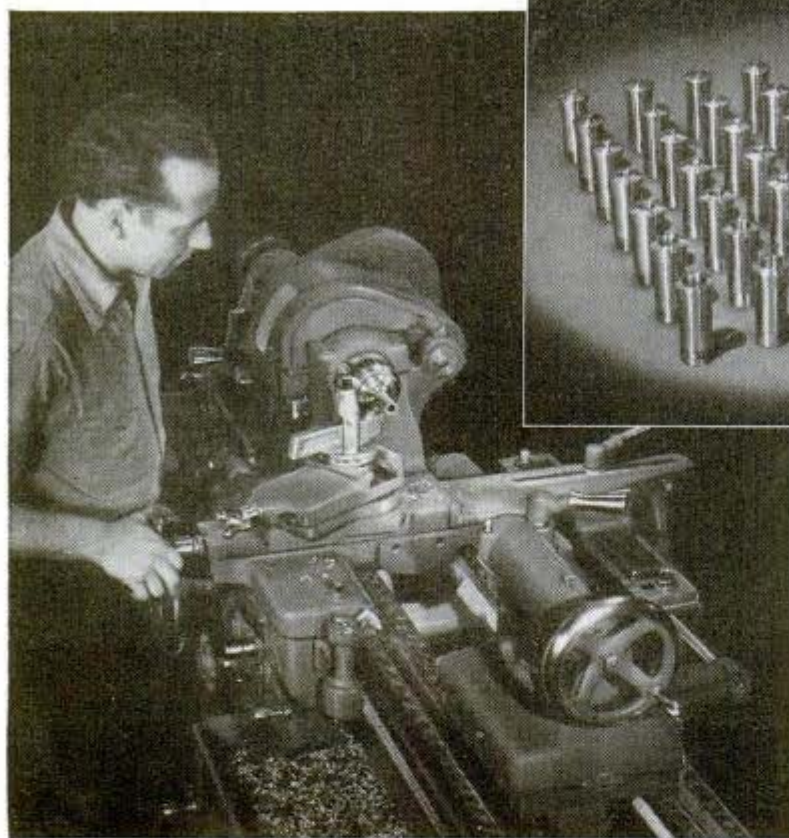

COLLETS

Collets for all sizes and types of South Bend Lathes are now being shipped directly from stock. All sizes from 1/16" to 1" diameter in steps of 1/64" are available.

A complete set of collets is especially helpful in toolroom and maintenance work. Often the time saved by having on hand the right size collet for a single rush job will more than compensate for the cost of a full set of these fine collets.

Check your collet requirements today—for toolroom, maintenance, and production work—and order all you need. Specify size and serial number of lathe.



BUY WAR BONDS — SAVE FOR LATHES

SOUTH BEND LATHE WORKS
SOUTH BEND 22, INDIANA • LATHE BUILDERS FOR 37 YEARS

PRINTED BY POPULAR MECHANICS COMPANY, CHICAGO, ILL., U. S. A.

Here's the latest on the anti-freeze situation

BECAUSE of the tremendous demands of our Armed Forces and Lend-Lease for "Prestone" anti-freeze, there has been a reduced supply available for civilian use this season.

The War Production Board, with the assistance of the Anti-Freeze Industry Advisory Committee, worked out a state allocation distribution plan for all types of anti-freeze this year. Under this arrangement there should be a sufficient supply of anti-freeze to go around. Yet, there may be many localities where "Prestone" brand anti-freeze is unavailable.

"Prestone" anti-freeze has been the favored anti-freeze of motorists for year after year. One shot lasts all winter. It won't evaporate, boil away, or lose effectiveness through "foaming." Protects against corrosion.

NATIONAL CARBON COMPANY, INC.

Unit of Union Carbide and Carbon Corporation



The registered trade-marks "Eveready" and "Prestone" distinguish products of National Carbon Company, Inc.

*Keep your eye on the Infantry
— THE DOUBTIFY DOES IT!*

U. S. A. RETAIL
CEILING PRICE
\$ 2.65
PER
GALLON



...YOU'RE SAFE. AND YOU KNOW IT WITH

PRESTONE

TRADE-MARK

Anti-Freeze



R. J. Reynolds Tobacco Co., Winston-Salem, N. C.

"I'd walk a mile for a CAMEL!"



March 50 min. . . . rest 10!

Hour after hour, mile after mile, that's Johnny Doughboy's marching routine. And when that 10-minute rest period comes along, well, that's when Camels come into the picture. For Camels and uniforms have been constant companions from way back—they were in '18, and they are today, the soldier's favorite cigarette.

The "soldier's pack"

That's Camels! Cool, extra-mild—with a full-flavored appeal that never wears out its welcome. No matter how many you smoke, Camels don't go flat. Camels always taste fresh . . . good! If you're not already a Camel smoker, try them today. Let your own taste tell you the meaning of the words, "I'd walk a mile for a Camel."



FIRST IN THE SERVICE

With men in the Army, Navy, Marine Corps, and the Coast Guard, the favorite cigarette is Camel. (Based on actual sales records.)