

Camerasmen Under Fire

POPULAR MECHANICS

★

MAGAZINE

WRITTEN SO YOU CAN UNDERSTAND IT

OCT.
25 CENTS
30c IN CANADA



 BUY UNITED STATES
WAR SAVINGS
BONDS AND STAMPS

SEE PAGE 26



Remember when . . .

You could buy a pre-war tire like this?

It was made of natural rubber by top-flight Seiberling craftsmen. It was good to look at, and good to ride on because it delivered many an extra mile of safe, comfortable driving-per-dollar. Both those who rode on it and those who sold it recognized it as America's FINEST Tire.

AND NOW AGAIN

in the new Seiberling Tire made from synthetic rubber . . . you get that "something extra" you've learned to expect from Seiberling. Rich experience, engineering skill and manufacturing craftsmanship have transformed wartime synthetic rubber into handsome, durable Seiberling Tires. They are the latest achievement of "Experts in Rubber" devoted to building the best.

And when you get your new Seiberling Synthetic Tires, you get still another "best." You get a personal, "interested in you" service that's extra valuable now. Your Seiberling Dealer is an *Independent Dealer*—a self-reliant man who has had the initiative to build his own business

—the kind of man who has helped create freedom and opportunity in America. *He has the strongest of all incentives to serve you well . . . his success and his future depend upon it.*

Although tires are more plentiful than they have been for a long, long time, please remember this: *We still cannot risk creating another severe tire shortage through abusing the tires we have. This is especially important now because synthetic rubber is a new material that requires extra care.* Don't drive your synthetic tires either under or over inflated, and be sure to have small cuts and bruises repaired promptly. There's where your Seiberling Dealer can help you. He is an "Expert in Rubber."

SEIBERLING *Experts in Rubber*



Wartime manufacturers of Bullet-Sealed Tubes and Military Tires for our armed forces • Bullet-Sealing Gasoline Tanks • Rubber Floats, Boats and Pontons • Rubber Parts for Gas Masks, Airplanes and Tanks. Also makers of Tires and Tubes for passenger cars and trucks • Sealed Air Tubes • Rubber Heels, Soles and Mechanical Goods.

Here's how your car FEELS...

...after
MARFAK
chassis
lubrication!

It drives so smooth and effortlessly, fairly soars along — after a MARFAK job. Yes, Texaco MARFAK chassis lubrication is great at making life easy for your car. Because MARFAK is extra tough and longer-lasting, it helps your car *live longer* too! MARFAK is applied by chart, never by chance. From king pins to rear shackles, every point of wear, every point of adjustment is checked when you ask your Texaco Dealer to give your car that "MARFAK feeling." Ask him today!

THE TEXAS COMPANY



Let us
MARFAK
your car



TUNE IN the TEXACO STAR THEATRE starring James Melton every Sunday night. See your local newspaper for time and station.

OCTOBER, 1944

This One



KXCP-NHW-B8FN

1A



Camouflaged Communications Center of American Command Post during heavy fighting

Front Line Telephone Post

TELEPHONE lines are life-lines wherever our men fight. The lines lengthen with every mile of advance.

Bell System manufacturing facilities have had to be devoted almost exclusively to keeping the armed forces supplied with communication and electronic equipment. As a result, we are

short of telephones, switchboards and other equipment needed to meet civilian requirements.

We're sorry if you've had to wait for home telephone service. But you can be sure that every effort is being made to take care of your needs just as soon as the war allows.

BELL TELEPHONE SYSTEM



• Please give the service men and women first chance at Long Distance between 7 and 10 each night.

Popular Mechanics Magazine

Registered in U. S. Patent Office and Canada

H. H. WINDSOR, Founder

H. H. WINDSOR, Jr., Editor and Publisher

October, 1944

Vol. 82, No. 4

Next Month

G. I. HOTFOOT is not what you get from a 30-mile forced march. It's Yankee for the new squirt gun that throws a rope-like flame straight through the two-inch slit in a Jap pillbox 180 feet away. When it hits, the jellied gasoline spatters gobs of flaming goo that literally cook everything within the bunker. A sockful of that same deadly fuel comes shooting out of the new incendiary bombs that are 150 times as destructive as blockbusters. "Sixty-Yard Flash," a November feature, tells how we learned about flamethrowing from the Germans—then improved on our teacher.

Mecca for Millions

MOST of the hundreds of thousands who hurry through New York's Grand Central Terminal daily are not interested in the trains that come and go at a rate of one a minute. Some 230,000 rail travelers passed through the station one day recently, but 600,000 more, non-passengers, hustled through its concourses and underground passages. "Mecca for Millions," a November article, takes you through Grand Central, where everybody meets in wartime.

Wartime Test Pilots

SINCE the last test pilot brought his flaming plane safely to land and then was badly burned getting out of it, the strict rule at Douglas is to jump. Pilots are worth more than planes. So, despite an occasional thrill as when a Skymaster started shaking to pieces, there have been no fatalities among the wartime test pilots at Douglas. Read about them next month.

IN THIS ISSUE

Springboard for Victory	1
The Army's Handy-Andy Ships	8
Twin-Threat Man in a Dive Bomber	18
Football—Tougher But Safer	28
"Glass Eyes" for G. I.'s	33
Secrets of Super-Speed	44
The New Age of Steel	50
Cracking Davy Jones's Locker	56
Cameramen Under Fire, Part I	65
Shooting Birds With a Camera	72
Our New West	76
Television After V-Day	82

Where-to-Buy-It Index—Page 8A

Cowboys of the Sea

THERE is something of the spirit of the wild west in the "cowboys" who ride our bucking PT boats on nightly hunts for Jap ships in the South Pacific. You have to be tough just to stay aboard one of the ornery critters, and you have to be smart to stay alive when a Zero glides down your phosphorescent wake to strafe you. But there are compensations in the satisfying blast of a torpedo made in U.S.A. cutting an enemy ship in two, and in daytime fishing, hunting and swimming parties at a base in the South Sea islands that would be Paradise in peacetime. Read the story of the PT cowboys in the next issue.

The Battle Against Bacteria

FEW moments in the world's history have encompassed as many great medical discoveries and developments as this war period. Staggering as the war's cost in life will be, it is undoubtedly true that far more lives will be saved by advances in medical science hastened by the emergency. Lifesaving germs from the soil, penicillin and the sulfas, the electron microscope, germ-killing sound waves and sun rays, these and other developments are discussed in an important article in November.

Published monthly by POPULAR MECHANICS COMPANY, 200 East Ontario Street, Chicago (11), Ill., U. S. A. Single copy in the United States, 25 cents; subscription rates in United States and possessions, and countries of the Pan-American Postal Union, 1 year, \$2.50; 2 years, \$4.50; 3 years, \$6.00. Single copy in Canada, 30 cents; subscription rates, 1 year, \$3.00; 2 years, \$5.50; 3 years, \$7.50. To all other countries add \$1.00 a year over United States prices for overseas postage. If you plan to move, notify us at least 60 days in advance so you will not miss an issue. Give both old and new addresses. Entered as Second Class Matter, September 15, 1903, at the Post Office at Chicago, Illinois, under Act of March 3, 1879. Entered as Second Class Matter at Post Office Dept. Canada. Copyright 1944, by Popular Mechanics Company. Copyright under International Copyright Union. All rights reserved under Pan American Copyright Union. Printed in the United States of America.

Moduflow

HONEYWELL'S Amazing New Control System will Revolutionize Home Heating

NOW you can end the discomfort of ordinary "on and off" heating systems. No longer need you swelter, then freeze . . . For Minneapolis-Honeywell engineers have perfected a marvelous new system of heat-

ing controls. It is called MODUFLOW — heat *modulated* to just the right degree with a uniform, continuous *flow*. It is the exact opposite of the intermittent heat supply of conventional heating systems.

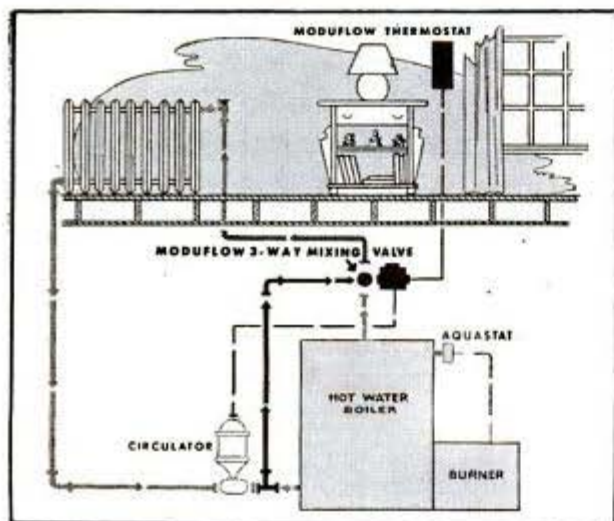

HERE'S HOW *Moduflow* WORKS

Moduflow is a simple, but ingenious, arrangement of controls that operates on an entirely new principle. It can be used with any type heating plant, hot water, warm air or steam, and with any kind of fuel. The diagram illustrates a hot water system. The solid black lines show the simple changes required. The hot water or steam is tempered at the boiler by means of a "by pass" line and mixing valve, to just the degree required by outside weather conditions. Heat is furnished *continuously* at the command of the modulating thermostat. Room temperatures vary only a fraction of a degree from high to low, and are uniform from floor to ceiling.

LISTEN . . . *The Blue Jacket Chair with Donny O'Neil every Sunday 11:05 to 11:30 A. M., Eastern War Time over Columbia Broadcasting System.*

MINNEAPOLIS
Honeywell
TEMPERATURE CONTROLS

Makers of the famous M-H Electronic Autopilot, used on AAF 4-engined bombers

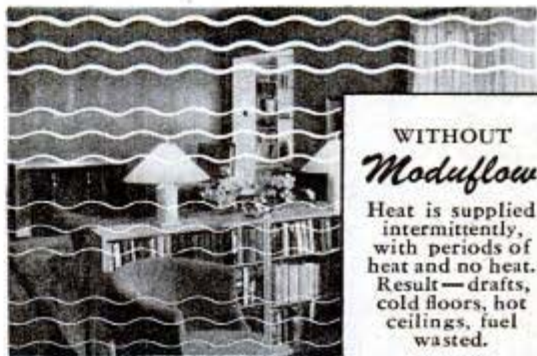

WITHOUT *Moduflow*

Heat is supplied intermittently, with periods of heat and no heat. Result — drafts, cold floors, hot ceilings, fuel wasted.

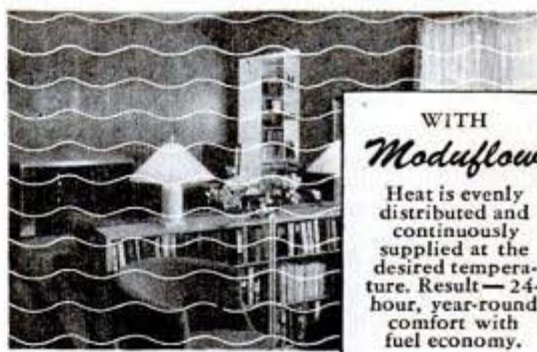

WITH *Moduflow*

Heat is evenly distributed and continuously supplied at the desired temperature. Result — 24-hour, year-round comfort with fuel economy.

MODUFLOW IS NOW AVAILABLE for only a limited number of homes. Before you make plans to build or remodel, be sure to investigate Moduflow. Send for the illustrated Booklet: "Heating and Air Conditioning the Postwar Home." Just mail the coupon.



Free! SEND FOR THIS BOOKLET

Minneapolis-Honeywell Regulator Co.
2907 Fourth Avenue South
Minneapolis 8, Minnesota

Please send my free copy of "Heating and Air Conditioning the Postwar Home"

Name

Address

City State

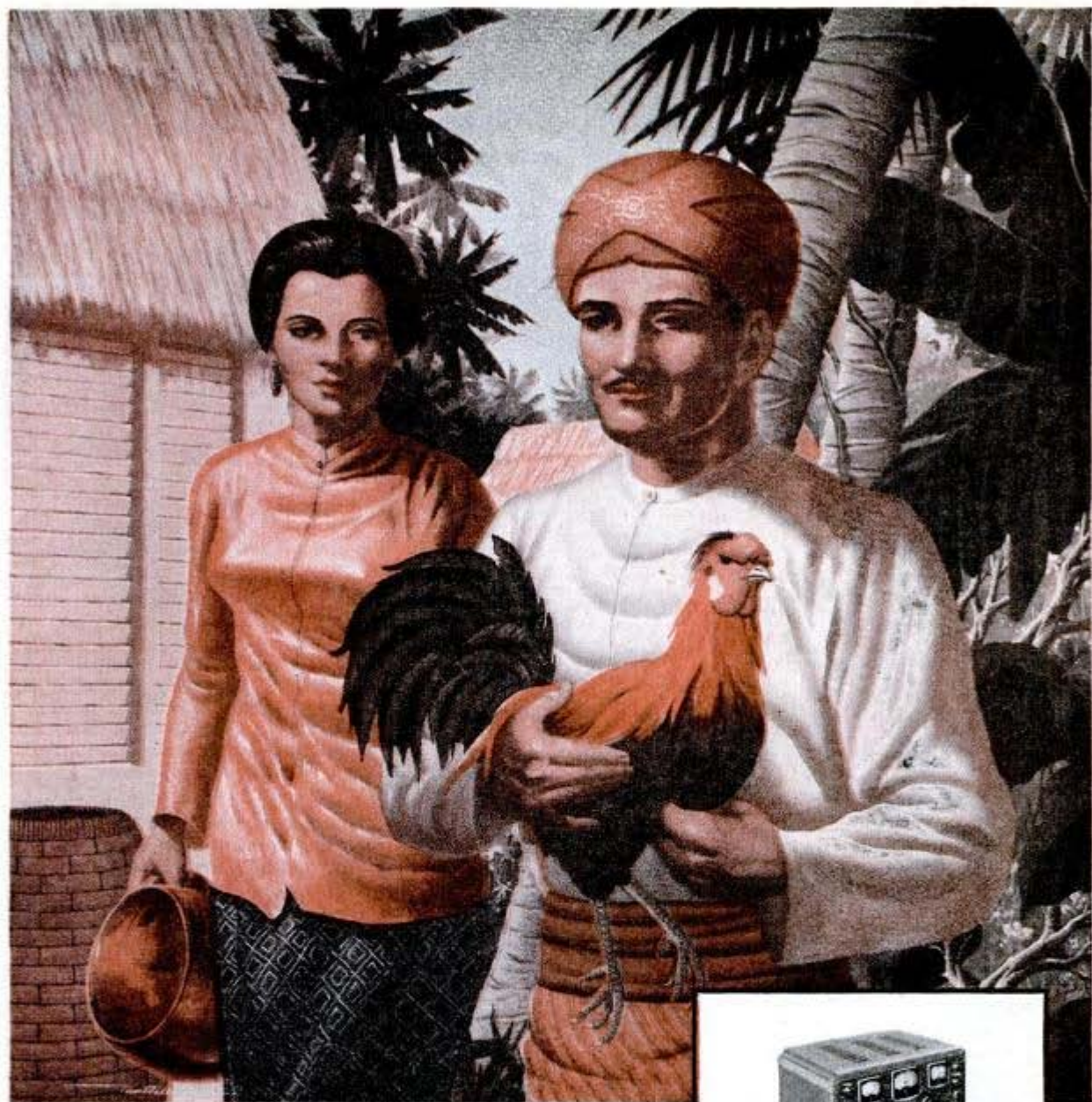

MEET YOUR NEW NEIGHBOR...

Java is one of the string of important stepping stones to Asia and the East—steps that include the magic sounding islands of Madura, Sumatra, Borneo and the Celebes. Today Java is Jap held. Tomorrow the Japs will be blasted out of there. Hallicrafters short wave radio equipment in the first assault wave will help do the job. The day after tomorrow Hallicrafters will help introduce Java into the widening circle of new, world neighbors. Hallicrafters radios, constantly refined under fire of war, will be ready for the peace with the finest short wave radio equipment available.



Here is a Hallicrafters 15 tube, six band communications receiver with an amazing range and capacity. Right now all of Hallicrafters production goes into war communications equipment. But the time will come when you can own a set like this. Keep an eye on Hallicrafters to keep you in touch with the exciting new world to come. THE HALLICRAFTERS COMPANY, Manufacturers of Radio and Electronic Equipment, Chicago 16, U. S. A.

BUY A WAR BOND TODAY!

hallicrafters RADIO



The lamp that DOES NOT GROW DIM!

SEE WHY

it means safer night driving for you



LIGHT OUTPUT



G-E MAZDA SEALED BEAM WHEN NEW 100%



G-E MAZDA SEALED BEAM AT END OF LIFE 99%

Here's a picture of the performance of an average G-E Mazda Sealed Beam lamp, based on years of road and laboratory tests. Up to the very end of life, it gives you 99% of original light!



STURDY, ONE-PIECE, "ALL-GLASS" UNIT...NO DIRT OR MOISTURE CAN SEEP IN.

2 FIXED-FOCUS FILAMENTS ACCURATELY LOCATED

MIRROR-LIKE REFLECTING SURFACE OF VAPORIZED ALUMINUM

LOOK FOR G-E HERE

THE WHOLE THING IS A BULB

BUY WAR BONDS AND HOLD THEM

SAFETY from start to finish! That's what General Electric Lamp Research has given you in the amazing G-E "All-Glass" Sealed Beam lamp...*the lamp that does not grow dim!* The whole thing is a rugged, hermetically sealed bulb which air, dust and dirt cannot penetrate. The reflector *never* tarnishes.

Play safe! When a headlamp burns out, replace it with a G-E "All-Glass" Sealed Beam lamp. You can use G-E Sealed Beam lamps in *any* car that has a "sealed beam" headlighting system. *And for most pre-1940 cars* sealed beam adaptors are available. Ask your service station, garage or dealer for G-E Sealed Beam lamps...the lamps that do not grow dim!

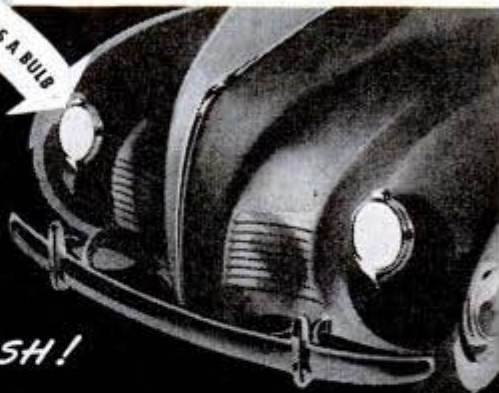

SAFETY FROM START TO FINISH!

G-E MAZDA SEALED BEAM LAMPS

GENERAL  ELECTRIC

Hear the General Electric radio programs: "The G-E All-Girl Orchestra", Sunday 10 p. m., EWT, NBC; . . . "The World Today" news every weekday 6:45 p. m. EWT, CBS.

TO THE MAN WHO WANTS SUCCESS

after the WAR!

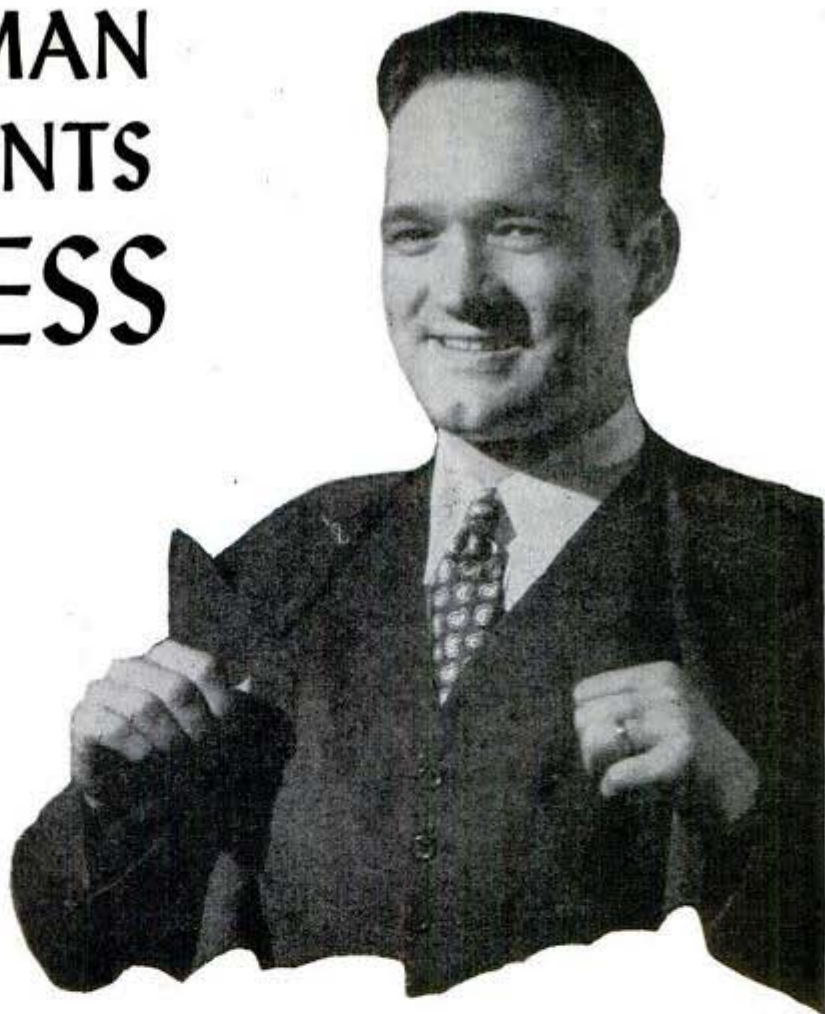

If you want success and security when peace comes, prepare for it now. Make sure that you have the trained ability that employers will want and pay for in the post-war adjustment.

As business converts back to civilian goods, there will be urgent call for accountants, bookkeepers, salesmen, sales and credit correspondents, traffic managers, marketing men, secretaries, office managers and legally trained executives.

For 36 years, LaSalle has been training adults in their spare time for such positions.

It knows how. It can train you—quickly, thoroughly, at moderate cost, without interruption to your present work.

Mark the coupon below for our free booklet about the field of your interest. It costs nothing to get the facts and they may lead you to larger security and success—now and after the armistice whistles blow.

LASALLE EXTENSION UNIVERSITY

A Correspondence Institution

417 SOUTH DEARBORN STREET, DEPT. 1064-R, CHICAGO 5, ILLINOIS

I am interested in knowing what your training is and how it can help me in the post-war adjustment. Please send me your free booklet on the field I have marked at right.

- Accounting
- Bookkeeping
- Salesmanship
- Business English

- Law: LL.B. Degree
- Business Law
- Office Management
- Business Correspondence
- Stenotypy: machine shorthand

- Traffic Management
- Executive Management
- Foremanship
- Industrial Management

Name.....Age.....

Position.....Address.....

City and State.....

AVAILABLE

*...more mileage
for your car!*

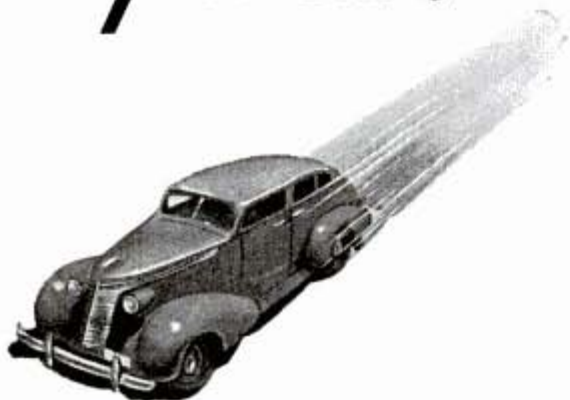

IT ISN'T gas rationing that determines how many miles you are going to drive your car during the next year—it's the ability of your car to keep rolling. That's why mechanically-wise car owners are using Pyroil to reduce to the minimum possible breakdown due to piston and cylinder wear and corrosion. A 3-Ounce Bottle of Pyroil added to your gas tank every 250 or 300 miles of driving—a pint of Pyroil poured into your crankcase will make more mileage available to you. Simply ask the gas station attendant for Pyroil.

Manufactured and Guaranteed by Pyroil Company, W. V. Kidder, Founder, 510 Pyroil Bldg., La Crosse, Wisconsin.

YOUR GUARANTEE

13 years' acceptance by foremost authorities—race drivers—explorers—engineers.

**THREE OUNCE SIZE
Keep Buying Bonds**



PYROIL COMPANY

510 Pyroil Building, La Crosse, Wisconsin

I want my car to last and run properly. Please tell me more about Pyroil and how it can accomplish this for me.

Name

Address

City or Town..... State.....

WHERE-TO-BUY-IT INDEX

Where no name and address appear directly under an item, the product is not believed by us to be commercially available

Tiny furnace heats house.....	6
Jeep used as fire truck.....	6
Speed camera catches rockets.....	7
Remote-control Nazi tank.....	7
Nearly odorless insect spray.....	7
Radio made of razor blade.....	11
B-29 has twin bomb bay doors.....	12
Aluminum fins for plane engine.....	12
Mathematical calculating machine.....	13
Concrete afloat.....	14
Sand-blasted built from scrap.....	16
Gas bottles fight shipyard fires.....	16
Men on wings guide Thunderbolt pilot.....	16
50-seat postwar skyliner.....	17
Panel checks radio broadcasts.....	17
Air force wants "Buck Rogers" ideas.....	17
"Weasel" can be steered with reins.....	26
Magnetic detector for planes.....	27
Scale model of roller coaster.....	27
Rubber lines big storage tank.....	27
U. S. Rubber Co., 1230 6th Ave., New York 20, N. Y.....	32
Machine measures highway roughness.....	32
Magnetic current made visible.....	32
"Soap bubble" plastic cockpit cover.....	32
Canopy protects lift truck driver.....	38
Shadow compass in Flying Fortress.....	38
Automatic anti-aircraft gun.....	38
Magnetic brake for motor.....	38
Spanker paddles riflemen.....	39
"Balloon" splint for broken leg.....	39
Dr. G. J. Curry, Hurley Hospital, Flint, Mich.....	39
"Skybus" for feeder lines.....	39
Dehydrator fits in oven.....	39
Hammacher Schlemmer, 145 E. 57th St., New York 22, N. Y.....	40
Portable home fits on truck.....	42
Hitch-hiker on a parachute.....	42
Color film processed at home.....	42
Rivet guns stored in holsters.....	42
Rocket-propelled model.....	43
Sacred scene etched on leaf.....	43
Fish change color to match seabottom.....	43
Sub-chaser is floating hospital.....	48
Mobile factory workshop.....	49
New helicopter models.....	49
Robot pilot for rider.....	49
Expansion bits drill 1-foot hole.....	55
Freezing kills pain of dentist's drill.....	55
Erection rig for linemen.....	60
Six-motor Nazi bomber.....	60
Glass-plastic "sandwich" fabric.....	60
Owens-Corning Fiberglas Corp., Nicholas Tower, Toledo, Ohio.....	61
Plastic raincoat protects plane.....	61
Trailer hauls liquid gas.....	61
Repairing the tools of war.....	62
Self-rising lightweight plastic.....	64
Simple clamp for rubber hose.....	64
Tinnerman Products, 2023 Fulton Rd., Cleveland 13, Ohio.....	64
Chemists produce synthetic sugar.....	64
Drill-grinding attachment.....	64
Crandall Mfg. Co., 1512 W. Slauson, Los Angeles 44, Calif.....	70
Polarized light tests lenses.....	70
Electric finger locates needle in heart.....	70
Stretcher folds into pack.....	70
E. D. Bullard Co., 275 E. 8th St., San Francisco 3, Calif.....	70
Bombs start "tidal waves".....	71
Electric grid dries paint.....	71
Harper J. Ransburg Co., Indianapolis 7, Ind.....	75
Lighted lens locates slivers.....	75
Radio waves sterilize food.....	75
Safety machine for blind workers.....	81
J. O. Kleber, Am. Assn. for Blind, 15 W. 16th St., New York.....	11
Cellulose sponge acts as fire guard.....	87
Plastic domes look like bombs.....	87
Gas pumped back into ground.....	88
Plastic models help plane designers.....	88
Seven tasks for scientists.....	88
Propeller drive has 10,000 parts.....	88
Morse Chain Co., Ithaca, N. Y.....	

Craftsman and Shop Notes Index

ART AND ARTIST	
Music sheet used as lettering guide.....	98
Rule makes dot-dash lines.....	137
Ruler tacked to T-square.....	139
AUTOMOTIVE	
Cornstarch adds luster to car wax.....	103
Short wiper blade removes snow.....	113
Loose fan belt causes overheating.....	130
Cutter removes battery straps.....	130
Cover protects gas-tank cap.....	137
Pitch prevents battery corrosion.....	139
Easier tappet adjustment.....	140
FARM	
Jig to straighten baling wire.....	102
Stop prevents drafts under door.....	130
Easy way to clean poultry house.....	138
Setscrew lock prevents loss of implement parts.....	138
Shields protect seed corn.....	140
FURNITURE	
Full-up chair.....	89
Western fireplace accessories.....	100

Continued to page 10A

"This is a partnership agreement with my son"

"ENROLLING for a course with International Correspondence Schools, I'm making two pledges to that boy in the Service.

"One is that I'm stepping up my own 'fire power' on the industrial front—producing as only a *trained* man can.

"The other is that I'll be helping him win *after* the war. My son and the other boys coming home to jobs in the world of thousands of new industrial developments are going to need the help and counsel of *trained* men who know that world. I'm going to be one of them!"

• You believe we are going to win this war. You know that Victory will usher in an era of tremendous industrial expansion. Prepare for the Victory World of Tomorrow while you help win the war *now*. The coupon will bring you full information on I. C. S. training. Mail it *today!*

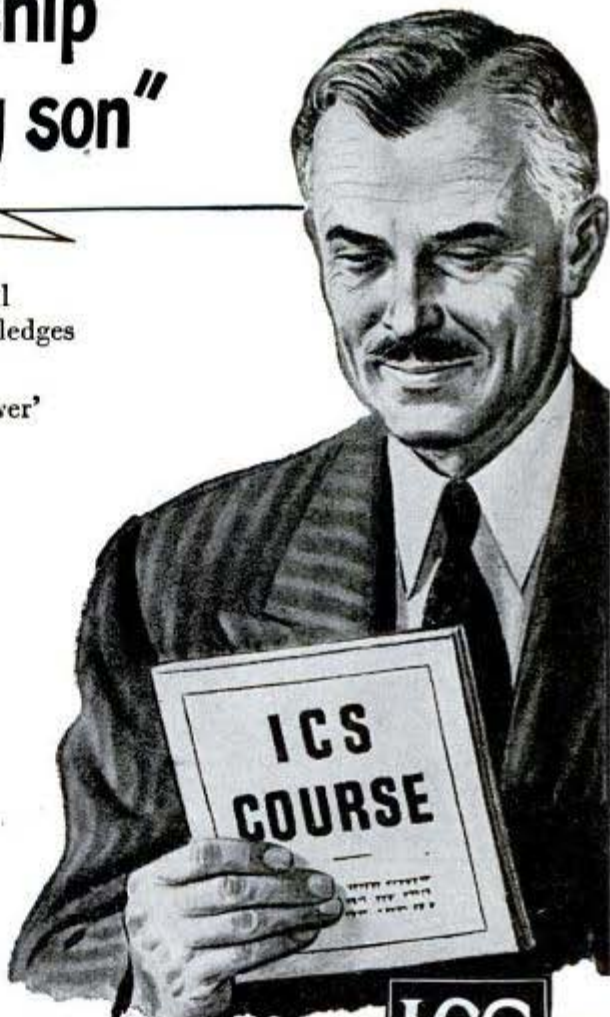

INTERNATIONAL CORRESPONDENCE SCHOOLS



BOX 5505-K, SCRANTON 9, PENNA.

Without cost or obligation, please send me booklet and full particulars about the course *before* which I have marked X:

- Air Conditioning and Plumbing Schools**
- Air Conditioning
- Heating Plumbing
- Refrigeration Steam Fitting
- Chemistry Schools**
- Chemical Engineering
- Chemistry, Analytical
- Chemistry, Industrial
- Chemistry, Mfg. Iron & Steel
- Plastics
- Pulp and Paper Making
- Civil, Architectural and Structural Engin'g Schools**
- Architectural Drafting
- Architecture
- Bridge and Building Foreman
- Bridge Engineering
- Building Estimating
- Civil Engineering
- Contracting and Building
- Highway Engineering
- Lumber Dealer
- Sanitary Engineering
- Structural Drafting
- Surveying and Mapping

- Electrical Schools**
- Electrical Drafting
- Electrical Engineering
- Power House Electrician
- Practical Electrician
- Practical Telegraphy
- Telegraph Engineering
- Internal Combustion Engines School**
- Auto Technician Aviation
- Diesel-Electric
- Diesel Engines Gas Engines
- Mechanical Schools**
- Aeronautical Engineering
- Airplane Drafting
- Flight Engineer
- Foundry Work
- Heat Treatment of Metals
- Industrial Design
- Mechanical Drafting
- Mechanical Engineering
- Mold-Loft Work
- Patternmaking
- Reading Shop Blueprints
- Sheet Metal Drafting
- Sheet Metal Worker

- Ship Drafting Ship Fitting
- Shop Practice
- Steel Mill Workers
- Tool Designing
- Welding, Gas and Electric
- Radio School**
- Electronics Radio, General
- Radio Operating
- Radio Servicing
- Railroad School**
- Air Brake Car Inspector
- Locomotive Engineer
- Locomotive Fireman
- Railroad Section Foreman
- Steam Engineering Schools**
- Boilermaking
- Combustion Engineering
- Engine Running
- Marine Engines
- Steam Electric
- Steam Engines
- Textile School**
- Cotton Manufacturing
- Rayon Weaving
- Textile Designing
- Woolen Manufacturing

- Business and Academic Schools**
- Accounting Advertising
- Arithmetic Bookkeeping
- Business Correspondence
- Business Management
- Certified Public Accounting
- City Letter Carrier
- College Preparatory
- Commercial
- Cost Accounting
- Federal Tax
- First Year College
- Foremanship
- High School
- Higher Mathematics
- Illustrating
- Motor Traffic
- Post Office Clerk
- Railway Postal Clerk
- Salesmanship Secretarial
- Stenography
- Traffic Management
- Language School**
- Spanish French
- Good English

Name..... Age..... Home Address..... Working Hours..... A.M. to..... P.M.

City..... State..... Present Position.....

Canadian residents send coupon to International Correspondence Schools Canadian, Ltd., Montreal, Canada.
British residents send coupon to I. C. S., 71 Kingsway, London, W. C. 2, England.

SPECIAL TUITION RATES FOR MEMBERS OF THE ARMED FORCES

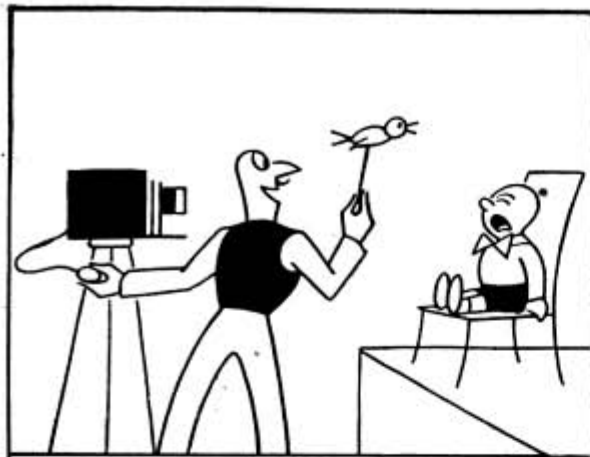

O. SOGLOW

Continued from page 8A

HAND TOOLS

Knobs cast from babbitt metal.....	96
Try square used as marking gauge.....	98
Avoiding squeaks when filing saw.....	98
How to use broken twist drills.....	104
Level to plumb vertical shafts.....	137
Tweezers for ball bearings.....	139
Pointer on wire gauge avoids errors.....	140

HOUSEHOLD

Ration tokens kept in spectacle case.....	92
Winter air cools vegetable room.....	93
Solving home problems.....	94
Plumber's snake from wire cable.....	96
Lard removes tar spots from clothing.....	97
Heat guard for barbecue fork handle.....	98
Locking cotter keys on baby carriages.....	98
Locking clothesline prop in place.....	102
Calking saves fuel.....	103
Screen attached with office stapler.....	104
Folding quilting frame.....	109
Storage bins under garage roof.....	110
Using textile colors.....	111
Fireplace grate from auto crankcase.....	113

LAWN AND GARDEN

Bird feeders.....	99
Ant-poison dispenser.....	102

OFFICE

Cane tips as typewriter feet.....	96
Cutting lines on mimeograph stencils.....	110
Table to address mailing tubes.....	130

PAINT AND PAINTING

Keeping dust off new paint.....	99
Glue keeps stain from penetrating.....	123

PHOTOGRAPHY

Getting good composition.....	114
Oil on ground glass aids in focusing.....	119
Sand tips of flash bulbs.....	119
Removing dust from negatives.....	120
Photomicrograms without a camera.....	120
Diffusion enlarger effects with opal glass.....	120
Keeping shutter from freezing.....	120

POWER TOOLS

Removing pin from band saw table.....	92
Glass liner for grinder water cup.....	93
Tft rod holds taper shank lathe attachments.....	96
Cutting wedges on circular saw.....	99
Lamp for jigsaw.....	104
Extension table for band saw miter.....	123
Chuck key taped to drill cord.....	130
Longer life for scrollsaw blades.....	131
Lapping machines.....	132
Boring tool holder.....	139
V-block centers work under drill.....	140

RADIO AND ELECTRONICS

Tube substitutions for battery portables.....	141
Desk lamp "dx-er" for boy's room.....	142
"Camera" tube for television.....	144

STORE AND SHOP

Small hydraulic press.....	121
Portable shelf for inventory.....	130
Tubing joined without solder.....	131
Reflector locates window pull socket.....	138
Ball bearing holds end of twine.....	138
Holder for shipping tags.....	140

TOYS, GAMES AND NOVELTIES

"Battlewagons" game.....	97
Sidewalk jeep.....	105

WOODWORKING

Making slender cut on circular saw.....	93
Using a parting tool.....	113
Adjustable stop holds work for planing.....	123
How to make inlays.....	124
Scored guide lines aid in sanding.....	129
Boring shotgun stocks.....	131

MISCELLANEOUS

Fixture to saw insulating board.....	96
Newspapers displayed on towel rack.....	102
Sewing machine perforates patterns.....	104
Section of comb rules music staff.....	104
Adjustable bench stop.....	108
Retaining wall of concrete blocks.....	110
Pencil holds cigarettes in pocket.....	110
Holder for marking dies.....	122
Clothespin holds test tube.....	138

IMPORTANT NOTICE

It is the intention of this magazine to provide its readers with information regarding the latest developments in the mechanical arts. We take no responsibility as to whether the disclosures contained in our articles are covered by patents and advise readers to investigate this subject before making, using, or selling any of the products, machines, or processes described in order to avoid possible liability for patent infringement.

AUDELS REFRIGERATION & AIR CONDITIONING GUIDE....\$4

New from Cover to Cover—1280 Pages, Fully Illus. Covering basic principles, servicing, operation & repair of household, commercial & industrial refrigeration & air conditioning. A gold mine of essential important facts for engineers, servicemen, users.

AUDELS CARPENTERS & BUILDERS GUIDES—4 Vols.\$6

A practical illustrated trade assistant on modern construction for carpenters, joiners, builders, mechanics and all woodworkers. 4 vols., 1600 pages, 3700 illustrations, flexible covers. Pocket size. Each volume sold separately \$1.50 a vol.

AUDELS AUTOMOBILE GUIDE....\$4

A practical quick ready reference book for auto mechanics, service men, operators & owners. Explains theory, construction & servicing of modern motor cars, trucks, buses & auto type Diesel engines. 1540 pages, fully illustrated, 53 chapters. Indexed. A standard book for mechanics. New fluid drive covered.

AUDELS DIESEL ENGINE MANUAL.\$2

A practical, concise treatise with questions and answers on the theory, operation and maintenance of modern diesel engines including General Motors 2 cycle Diesel. 384 pages, fully illus., flexible binding, pocket size. All details plainly brought out, this book is of extreme value to engineers, operators & students.

AUDELS WIRING DIAGRAMS.....\$1

210 Pages. Illustrated. Gives practical facts on wiring of electrical apparatus. It shows clearly how to wire apparatus for practically all fields of electricity. Each diagram is complete & self-explanatory. Highly Endorsed Pocket Companion.

AUDELS PLUMBERS & STEAMFITTERS GUIDES—4 Vols.\$6

A Practical Trade Assistant & Handy Reference. Explains in plain language & by clear illustrations, diagrams, charts, graphs, pictures principles of modern plumbing practice including Marine Pipe Fitting and Air Conditioning. 4 Vols.—1670 Pages—3612 Diagrams. Pocket size. Each Vol. Sold Separately \$1.50 a Vol.

AUDELS SHEETMETAL WORKERS HANDY BOOK.....\$1

Practical inside information. Fundamentals of Sheet Metal Work. 388 pages, illustrated, 11 sections. Clearly written. Essential & important facts, figures, pointers in everyday language. Ref. Index.

AUDELS SHEETMETAL PATTERN LAYOUTS.....\$4

Developed by Experts for Sheet Metal Workers, Layout Men & Mechanics. A Practical Encyclopedia in 10 Sections, size 7 x 10 x 2—1125 Pages—350 Layouts—1600 Illustrations, 1001 Key Facts. Fully indexed for ready reference in answering your layout problems. Covers all phases of sheet metal work including Pattern Cutting, Pattern Development & Shop Procedure.

AUDELS ANSWERS ON BLUE PRINT READING.....\$2

For Mechanics & Builders. Covers all types of blue print reading including ship & airplane. 376 pages, fully illustrated.

AUDELS NEW MACHINIST & TOOLMAKERS HANDY BOOK...\$4

Covers modern machine shop practice in all its branches. 5 practical books in 1. New from cover to cover. Tells how to set up & operate lathes, screw and milling machines, shapers, drill presses and all other machine tools. 1600 pages, fully illustrated, 5 x 6 1/2 x 2. Indexed. 5 sections. 1—Modern Machine Shop Practice. 2—Blue Print Reading & How to Draw. 3—Calculations & Mathematics for Machinists. 4—Shop Physics. 5—How to Use the Slide Rule. 60 chapters. Easy to read and understand. A shop companion that answers your questions.

AUDELS MATHEMATICS & CALCULATIONS FOR MECHANICS \$2

Mathematics for home study or reference. 700 pages, 550 illus. Practical mathematics from beginning. How to figure correctly. Easy, correct methods covering a complete review. Ill. & Indexed.

AUDELS HANDY BOOK OF PRACTICAL ELECTRICITY.....\$4

For maintenance engineers, electricians & all electrical workers. 1440 Pages, 2600 Illus. Covers important electrical information in handy form—including Marine Wiring, Radio Principles, Welding. Indexed. A Key to a practical understanding of electricity.

AUDELS RADIOMANS GUIDE.....\$4

A key to the practical understanding of radio including Frequency Modulation, Television, etc., Aircraft & Marine Radio. For radio engineers, servicemen, amateurs. 772 pages. 400 Illustrations & Diagrams. Photos. Review Questions & Answers, Reference Index. Authentic, clear, concise.

AUDELS ELECTRONIC DEVICES...\$2

Tells What You Want to Know About Electric Eye. Easily Understood. Covers photo-electric cells & their applications. Amplifiers, illumination, frequencies, voltage, photocell, tubes, Ohm's Law, wiring diagrams, etc.

AUDELS WELDERS GUIDE.....\$1

A concise, practical text on operation & maintenance of all welding machines for all mechanics. Over 400 pages, illustrated. Covers all methods of electric and acetylene welding including airplane work.



AN AUDEL GUIDE IS A GOOD FRIEND!

Use the brains and experience of others in these Guides of the Trades. Save time and money with right methods, short cuts, labor saving ideas. CHECK NOW! You can look over any Audel Guide in your home. Start the Easy Payments if satisfied.

CUT HERE MAIL ORDER

THEO. AUDEL & CO., 49 W. 23 St., New York 10, N.Y.

Please mail me for 7 days' free examination the books marked (X) below. I agree to mail \$1 in 7 days on each book or set ordered, and to further mail \$1 a month on each book or set ordered until I have paid purchase price.

If I am not satisfied with Guides I will return them.

- Audels REFRIGERATION & Air Conditioning Guide \$4.
- Audels PUMPS, HYDRAULICS & AIR COMPRESSORS 4.
- Audels WELDERS GUIDE 1.
- Audels BLUE PRINT READING 2.
- Audels SHEET METAL WORKERS Handy Book 1.
- Audels SHEET METAL PATTERN LAYOUTS 4.
- Audels AIRCRAFT WORKER 1.
- Audels MATHEMATICS and CALCULATIONS 2.
- Audels MACHINISTS & TOOLMAKERS Handy Book 4.
- Audels DIESEL ENGINE MANUAL 2.
- Audels MECHANICAL Dictionary 4.
- Audels AUTOMOBILE GUIDE 4.
- Audels MARINE ENGINEERS Handy Book 4.
- Audels SHIPFITTERS Handy Book 1.
- Gueths MECHANICAL DRAWING COURSE 1.
- Rogers DRAWING and DESIGN 2.
- Audels MILLWRIGHTS and Mechanics Guide 4.
- Audels CARPENTERS and Builders Guides (4 vols.) 6.
- Audels PLUMBERS and Steamfitters Guides (4 vols.) 6.
- Audels MASONS and Builders Guides (4 vols.) 6.
- Master PAINTER and DECORATOR 2.
- Audels GARDENERS & GROWERS GUIDES (4 vols.) 6.
- Audels ENGINEERS and Mechanics Guides Nos. 1, 2, 3, 4, 5, 6, 7 and 8 complete 12.
- Audels Answers on Practical ENGINEERING 1.
- Hawkins Aids to ENGINEERS EXAMINATION 2.
- Audels WIRING DIAGRAMS 1.
- Audels Handy Book of PRACTICAL ELECTRICITY 4.
- Audels ELECTRICAL POWER CALCULATIONS 2.
- Hawkins ELECTRICAL Guides at \$1. each 10.
- Audels ELECTRONIC DEVICES 2.
- Audels ELECTRIC Dictionary 2.
- Audels RADIOMANS GUIDE 4.
- Audels NEW ELECTRIC LIBRARY at \$1.50 a Volume Vols. I, II, III, IV, V, VI, VII, VIII, IX, X, XI, XII.

Name -----
 Address -----
 Occupation -----
 Employed by ----- PM

AUDEL, Publishers, 49 W. 23 St., N. Y. 10



Be a Radio

Win Success in a Busy Field

J. E. SMITH
President
National
Radio
Institute

I Train BEGINNERS at Home for Good Spare Time and Full Time Radio Jobs

MEN I TRAINED AT HOME GET JOBS LIKE THESE



Communications Station Operator
"Am with the Civil Aeronautics Administration as Aircraft Communicator at the Shreveport Airways Communication station. Have a lifetime position with pension after retirement."—

JESSE N. ROBERTS, Box 1079, Shreveport, La.



Chief Operator Broadcasting Station

"Before I completed your lessons, I obtained my Radio Broadcast Operator's license and immediately joined Station WMPC where I am now Chief Operator."—

HOLLIS F. HAYES, 327 Madison St., Lapeer, Michigan.



\$200 a month in Own Business

"For several years I have been in business for myself making around \$200 a month. Business has steadily increased. I have N.R.I. to thank for my start in this field."—

ALBIE J. FROBER, 300 West Texas Avenue, Goose Creek, Texas.



Salary increased \$1,500 Year in Radio

"I have been regularly employed in Radio since my graduation. Am Chief Engineer of WDDO. My salary has increased \$1,500 per year since entering Radio."—

JULIUS C. VESSELLS, Station WDDO, Chattanooga, Tenn.



\$5 to \$10 a Week in Spare Time

"I am engaged in spare time Radio work. I average from \$5 to \$10 a week. I often wished that I had enrolled sooner because all this extra money sure does come in handy."—

THEODORE K. DUBIREK, Hershey, Pa.



Radio Service Manager of 4 stores

"I was working in a garage when I enrolled with N. R. I. I am now Radio Service Manager for M. . . . Furniture Co. for their 4 stores."—

RYAN, 110 River, Mass.

Here's your opportunity to get a good job in a busy field with a bright peacetime future! Today there is a shortage of trained Radio Technicians and Operators. So mail the Coupon for a FREE copy of my 64-page, illustrated book, "Win Rich Rewards in Radio." It describes many fascinating types of Radio jobs, tells how N.R.I. trains you at home in spare time—how you get *practical* experience building and testing Radio Circuits with SIX BIG KITS OF RADIO PARTS I send!

Big Demand Now for Well Trained Radio Technicians, Operators

Keeping old Radios working is booming the Radio Repair business. Profits are large; after-the-war prospects are bright, too. Think of the *new* boom in Radio Sales and Servicing that's coming when new Radios are again available—when Frequency Modulation and Electronics can be promoted—when Television starts its postwar expansion!

Broadcasting Stations, Aviation Radio, Police Radio, Loudspeaker Systems, Radio Manufacturing all offer good jobs now to qualified Radio men—and most of these fields have a *big backlog* of business that is building up during the war, *plus* opportunities to expand into *new*

You Build These and Other Radio Circuits with 6 Big Kits I Send!



SUPERHETERODYNE CIRCUIT (above) Preselector, oscillator-mixer-first detector, i.f. stage, diode detector-a.v.c. stage, audio stage. Bring in local and distant stations on this circuit you build yourself!

MEASURING INSTRUMENT (below) You build early in course. Use it in Practical Radio work to make *EXTRA* money. Vacuum tube multimeter, measures A.C., D.C. and R.F. volts, D.C. currents, resistance, receiver output.



A.M. SIGNAL-GENERATOR (above) Build it yourself! Provides amplitude-modulated signals for test and experimental purposes. Gives valuable practice!

By the time you've conducted 60 sets of Experiments with Radio Parts I supply, have made hundreds of measurements and adjustments, you'll have valuable **PRACTICAL** Radio experience for a good full or part time Radio job!

FIND OUT ABOUT THIS TESTED WAY

Technician

with a Bright Future

fields opened by wartime developments. You may never again see a time when it will be so easy to get a start in Radio!

Many Beginners Soon Make \$5, \$10 a week EXTRA in Spare Time

The day you enroll for my Course I start sending you EXTRA MONEY JOB SHEETS that help show how to make EXTRA money fixing Radios in spare time while still learning. I send you SIX big kits of Radio parts as part of my Course. You LEARN Radio fundamentals from my illustrated, easy-to-grasp lessons—PRACTICE what you learn by building real Radio Circuits—and USE your knowledge to make EXTRA money!



My Course includes training in TELEVISION & ELECTRONICS FREQUENCY MODULATION

Find Out What N.R.I. Can Do For You

MAIL THE COUPON for your FREE copy of my 64-page book. It's packed with facts—things you never knew about opportunities in Broadcasting, Radio Servicing, Aviation Radio, other Radio fields. Read the details about my Course—"50-50 Training Method"—6 Experimental Kits—EXTRA MONEY JOB SHEETS. See the fascinating jobs Radio offers you and how you can train at home. Read many letters from men I trained telling what they are doing, earning. No obligation. Just MAIL COUPON in an envelope or pasted on a penny postal!—**J. E. SMITH, President, Dept. 4KP, National Radio Institute, Washington 9, D. C.**

Broadcasting Stations employ N.R.I. trained Radio Technicians as operators, installation, maintenance men and in other capacities and pay well.



THIS Free Book HAS HELPED HUNDREDS OF MEN MAKE MORE MONEY

Our 30th Year of Training Men for Success in Radio

Mail this to get 64 page book FREE

**J. E. SMITH, President, Dept. 4KP
National Radio Institute, Washington 9, D. C.**

Dear Mr. Smith: Please mail me FREE, without obligation, your 64-page book, "Win Rich Rewards in Radio," which points out Radio's opportunities and tells how you train men at home to be Radio Technicians and Operators. (No salesman will call. Please write or print plainly.)

Age.....

Name.....

Address.....

City..... State.....



Set Servicing pays many N.R.I. trained Radio Technicians well. Others hold their regular jobs and make \$5 to \$10 EXTRA a week fixing Radios in spare time.

TO BETTER PAY

NEW BOOK *for*

PATENT GUIDE

FOR THE INVENTOR

CLARENCE A. O'BRIEN
& HARVEY B. JACOBSON

REGISTERED PATENT ATTORNEYS
WASHINGTON, D. C.



FREE RECORD OF INVENTION

This FREE Record of Invention form enables you to conveniently make a sketch of your invention and have it witnessed in a manner of value to you, should the occasion for evidence arise.

48
PAGES
Over 150
Mechanical
Movements

LATEST FACTS ON INVENTIONS

Is your invention something for the home, the farm, the factory, the store? Would you like to know whether anything like it has ever been invented, and if not, how to protect your invention? Our new 48-page book "Patent Guide for the Inventor" will show you how to proceed with your invention. You'll get a good idea of whether you "have something" or not. Would you like to know how you may judge the marketability of your invention? This book gives you several important tests prepared by authorities. Read of the experiences of Bell, Edison, Westinghouse, and other outstanding, successful inventors who patented and thereby protected their inventions. This book not only tells you how to obtain a patent, it also explains the steps that must be taken afterward to promote the success of your invention. MAIL THE COUPON TODAY.

CLARENCE A. O'BRIEN & HARVEY B. JACOBSON

REGISTERED PATENT ATTORNEYS

INVENTORS

NOW Is the Time to PATENT and SELL Your Invention

Now, more than ever before, is the right time to patent your invention. Why? Because manufacturers everywhere presently engaged in war production are looking ahead to the future by buying up patent rights now, so they will have new and attractive items to make and sell for civilian consumption as soon as the war is over. This is what happened during and after the last war. Hence, the smart thing for you to do is to look ahead to the future too. Protect your invention and yourself by applying for a patent now.

Patent Guide Shows What To Do

Our "Patent Guide for the Inventor" answers many important questions concerning Patents that inventors constantly ask. It tells what facts, details, drawings, sketches, etc. are necessary to apply for a Patent; how to protect your invention through dated and witnessed disclosure; how to do this AT ONCE to safeguard your rights; how Patent Office Records can be checked to determine whether the invention is probably patentable before filing fees need be paid; discusses costs involved and a practical way these can be paid as the application progresses. It tells how some inventors secured financial backing; how many simple inventions have proved large commercial successes; how Patents covering improvements also can be profitably utilized and marketed; tells countless other facts of interest.

Why You Need Expert Assistance

The Patent Laws were enacted for your benefit—to give you protection for the features of your invention which are Patentable. But these features must be legally and concisely set forth in the form of "claims." This phase of the procedure is so complex that the Patent Office advises the Inventor to engage a competent Registered Patent Attorney. We maintain a large staff—carefully trained registered patent attorneys—expert draftsmen—experienced searchers—to serve you. We have been serving inventors for more than 20 years.

Take First Step Now

With the Patent Guide you will receive also Free a "Record of Invention" form which will enable you at once to establish the date of your invention, before you file your Patent application. This step costs you nothing yet may be vital to your success. Remember—in Patent Matters, ACTION is IMPORTANT. Delay can be costly. Mail the coupon in an envelope, or paste it on a penny postcard NOW.

*Worthy of
Your Trust*

Get

**FREE
COPY**

*Mail
Coupon
Today*

CLARENCE A. O'BRIEN & HARVEY B. JACOBSON

CLARENCE A. O'BRIEN & HARVEY B. JACOBSON
Registered Patent Attorneys before the United States Patent Office
41-K Adams Building, Washington 4, D. C.

Please send me your 48-Page "Patent Guide for the Inventor" and your specially prepared "Record of Invention" form FREE. This request does not obligate me.

Name.....

Address.....

City..... State.....

(Please write or print plainly.)

SPRAYBERRY RADIO TRAINING

Gives you Both



**FULL RADIO SET
SUPPLIED FOR
SHOP PRACTICE!**

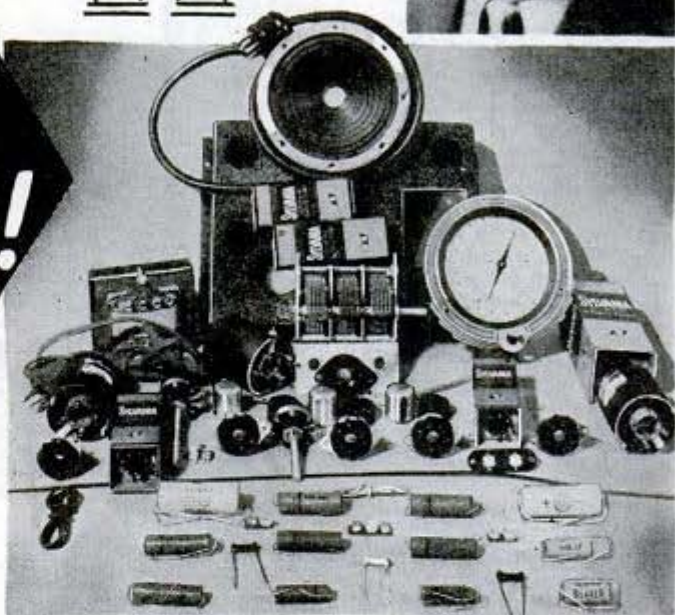

**HERE'S THE ONE PRACTICAL WAY TO TRAIN FOR
BIG EARNINGS AHEAD IN RADIO-ELECTRONICS & TELEVISION**

JUST OUT! FREE!

"How to Read Radio Diagrams and Symbols"

... a valuable new book which explains in simple English how to read and understand any Radio Set Diagram. Provides the quick key to analyzing any Radio circuit. Includes translations of all Radio symbols. Send for this FREE book now and along with it I will send you another big FREE book describing my Radio-Electronic training.



GET FREE BOOKS

SPRAYBERRY ACADEMY OF RADIO

F. L. Sprayberry, President
Box 500RK, Pueblo, Colorado.

Please rush my FREE copies of "How to MAKE MONEY in RADIO, ELECTRONICS and TELEVISION," and "HOW TO READ RADIO DIAGRAMS and SYMBOLS."

Name..... Age.....

Address.....

City..... State.....

(Mail in plain envelope or paste on penny postcard)

The offer I make you here is the opportunity of a lifetime. It's your big chance to get ready for a wonderful future in the swiftly expanding field of Radio-Electronics INCLUDING Radio, Television, Frequency Modulation and Industrial Electronics. Be wise! NOW'S the time to start. No previous experience is necessary. The Sprayberry Course starts right at the beginning of Radio. You can't get lost. It gets the various subjects across in such a clear, simple way that you understand and remember.

I'll Show You a New, Fast Way to Test Radio Sets Without Mfg. Equipment

The very same Radio Parts I supply with your course for gaining pre-experience in Radio Repair work may be adapted through an exclusive Sprayberry wiring procedure to serve for complete, fast, accurate Radio Receiver trouble-shooting. Thus under Sprayberry methods you do not have one cent of outlay for manufactured Test Equipment which is not only expensive but scarce.

Prepares You for a Business of Your Own or Good Radio Jobs... Civilian or Military

My training will give you the broad, fundamental principles so necessary as a background no matter which branch of Radio you wish to specialize in. I make it easy for you to learn Radio Set Repair and Installation Work. I teach you how to install and repair Electronic Equipment. If you enter the Army, Navy or Marines, my training will help you win higher rating and better pay.

Are You Satisfied with

YOUR BODY?

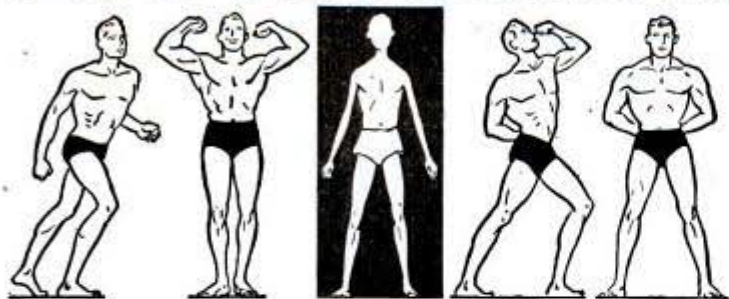

**Let Me PROVE I Can
Make You a NEW MAN in
Only 15 Minutes a Day!**

HOW do YOU look *stripped*—in locker-room or gym?
Skinny, scrawny, sparrow-chested, self-conscious,
HALF ALIVE?

How do you feel when people notice *your* physique? Can you stand their gaze? If you're not satisfied with your present physical development, let me prove I can make you a New Man—in only 15 minutes a day, right in the privacy of your own home! I'll give you biceps like iron and a fine, deep chest. I'll broaden your shoulders, add ridges of solid muscle to your stomach, fill out your arms and legs. If you are fat and flabby, I'll streamline you into a picture of radiant manhood.

What *Dynamic Tension* Can Do

How? *Dynamic Tension!* That's the secret that changed me from a flat-chested 97-lb. weakling into the red-blooded HE-MAN that I am today. That's how I'm turning thousands of fellows like yourself into New Men—with husky, handsome body and tireless endurance. I can do the same for you. Let me PROVE it!

Dynamic Tension is a PRACTICAL and NATURAL method. You use no tiring apparatus, no muscle-straining gadgets. My method is actually FUN! In only 15 minutes a day, you will actually see your muscles increase into powerful bulges of brawn and strength. You'll enjoy new stamina, a glad-to-be-alive feeling. Before you know it, you'll have a rugged, handsome body, a rough-and-ready ambition surging out of you that the world can't lick! I'll show you how it really feels to LIVE!

SEND FOR FREE BOOK

All I ask is that you mail the coupon NOW for my illustrated FREE book, "*Everlasting Health and Strength*." It shows actual photos of pupils I've changed from weaklings into remarkable specimens of manhood. If you want a body that men respect and women admire, then get this coupon into the mails as fast as you can. Address me personally. CHARLES ATLAS, Dept. 8K, 115 E. 23rd St., New York 10, N. Y.

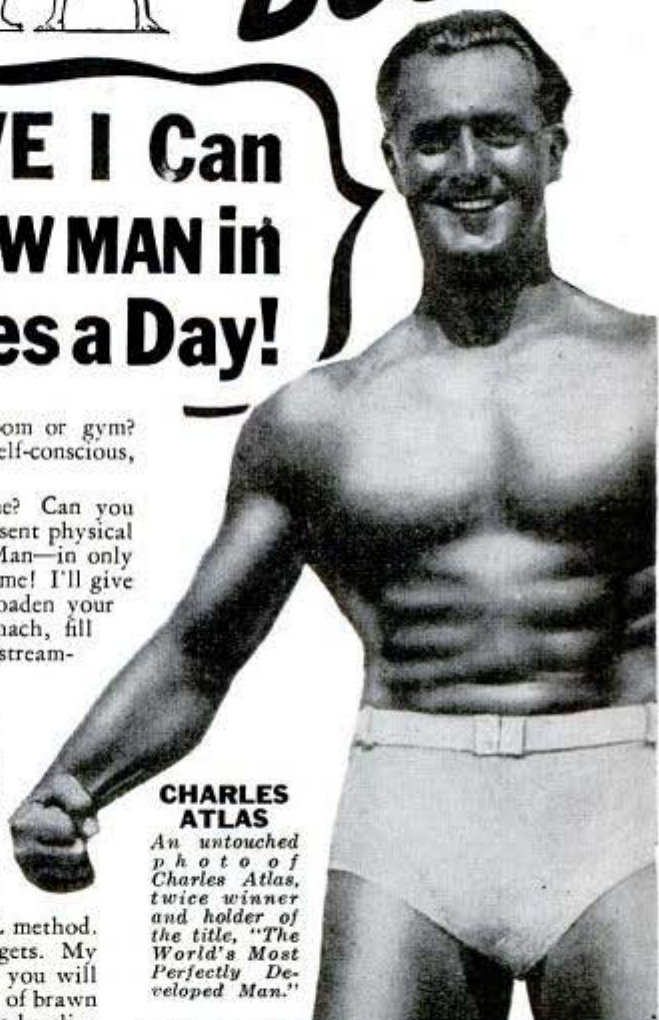

CHARLES ATLAS

An untouched photo of Charles Atlas, twice winner and holder of the title, "The World's Most Perfectly Developed Man."

**CHARLES ATLAS, Dept. 8K,
115 East 23rd Street, New York 10, N. Y.**

I want the proof that your system of "*Dynamic Tension*" will help make a New Man of me—give me a healthy, husky body and big muscle development. Send me your free book, "*Everlasting Health and Strength*."

Name

(Please print or write plainly)

Address

City

State

Check here if under 16 for Booklet A

INVENTORS

LEARN HOW TO
PROTECT and SELL
YOUR INVENTION

GET NEW FREE BOOK



FREE

Invention Record

**Know How Successful
Inventors Protect and
Sell Their Inventions**

Our new FREE Book is a book every inventor should have. Mail the coupon today for "How to Protect, Finance and Sell Your Invention" and learn . . .

- How to know if there is a prior U. S. patent on your invention.
- How to save steps in getting patent action.
- How to prepare your application for presentation to the Patent Office.
- How you may patent an improvement on something in use now.
- How to obtain funds to patent and promote your invention.
- How to find a buyer or backer for your invention.
- How to protect yourself in making royalty agreements.

MODERN BUSINESS WANTS INVENTIONS

Practical and novel inventions are in big demand today. The opportunity for quick money is enticing. Sales sources are many if your invention has merit. But, be sure—before you place your device in strange hands—that it is fully protected. A United States Patent gives you this protection. *The first step toward inventive success—always is—and always has been, the application for a U. S. Patent. There is no other way to protect your invention in accordance with the laws of this country.*

MAKE THIS RECORD NOW

If you have an invention, and wish to secure it for the future, act at once. Have it dated now and recorded in our office. We will send you this FREE Invention Record Form for the purpose. Fill out the Invention Record Form fully describing the nature of your invention. Make a sketch of its main features. Mail it to us and we will record the date it was received in our office. The earlier the date the better your chance of combating rival inventors who may lay claim to your idea later. *Don't delay a single minute in taking this important step. Your whole future may depend upon it. Mail the coupon for our FREE Invention Record Blank and New FREE Book today!*

HOW WE SERVE YOU AS REGISTERED PATENT ATTORNEYS

The U. S. Patent Office strongly recommends—unless the inventor is familiar with such matters—that he employ the services of a Registered Patent Attorney in the preparation of his Patent Application. We are Registered Patent Attorneys fully qualified to represent you at the Patent Office. We have had long experience in studying hundreds of types of inventions. This gives us the ability to judge your invention and to describe it accurately and convincingly in technical language. It gives us the perception to center arguments upon those details of your invention which, in our judgment, will be looked upon most favorably by the Patent Office Examiner.

Mail the coupon today for our new FREE Book, "How to Protect, Finance and Sell Your Invention," and our FREE Invention Record Form—maybe this step will pave the way to future security for you and your family. Act Today!

McMORROW & BERMAN
Patent Attorneys
1353 Albee Building, Washington 5, D. C.

McMORROW & BERMAN

PATENT ATTORNEYS

1353 ALBEE BUILDING, WASHINGTON 5, D. C.

Send me your new FREE book, "How to Protect, Finance and Sell Your Invention"—and "Invention Record" form at once. I understand that this request does not obligate me.

NAME

ADDRESS

CITY..... STATE.....

(Write or print name clearly)

Train for **SUCCESS** with **I.C.S.**

AIR CONDITIONING AND PLUMBING SCHOOLS
Air Conditioning
Heating Refrigeration
Plumbing Steam Fitting

CHEMISTRY SCHOOLS
Chemical Engineering
Chemistry, Analytical
Chemistry, Industrial
Chemistry, Mfg. Iron and Steel
Plastics Pulp and Paper Making

CIVIL ENGINEERING, ARCHITECTURAL AND MINING SCHOOLS
Architecture Contracting and Building
Architectural Civil Engineering
Drawing Highway Engineering
Bridge and Lumber Dealer
Building Foreman Sanitary Engineering
Bridge Engineering Structural Drafting
Building Estimating Structural Engineering
Coal Mining Surveying and Mapping

ELECTRICAL SCHOOLS
Electrical Drafting Power House
Electrical Engineering Electrician
Electric Utilities Practical Telephony
Practical Electrician Telegraph Engineering

AVIATION AND INTERNAL COMBUSTION ENGINES SCHOOLS
Aircraft and Aviation
Engine Mechanic Diesel—Electric
Automobile Diesel Engines
Technician Gas Engines

MECHANICAL SCHOOLS
Aeronautical Engineer's, Junior
Airplane Drafting
Flight Engineer's Foundry Work
Heat Treatment of Metals
Industrial Engineering
Inventing and Patenting
Machine Shop Practice
Mechanical Drafting
Mechanical Engineering
Mold-Loft Work
Patternmaking
Reading Shop Blueprints
Sheet Metal Drafting
Sheet Metal Worker Ship Drafting
Shipfitting Shop Practice
Steel Mill Workers Tool Designing
Weather Observing
Welding, Gas and Electric

TEXTILE SCHOOL
Cotton Mfg. Textile Designing
Rayon Weaving Woolen Mfg.

ACADEMIC SCHOOLS
Arithmetic First Year College
College High School
Preparatory Higher
Commercial Mathematics
High School Illustrating

RADIO SCHOOLS
Electronics Radio Operating
Radio, General Radio Servicing

BUSINESS SCHOOLS
Accounting
Advertising
Bookkeeping
Business Correspondence
Business Management
Certified Public Accounting
City Letter Carrier
Commercial
Cost Accounting
Federal Tax Course
Foremanship
Motor Traffic Management
Post Office Clerk
Railway Postal Clerk
Salesmanship
Secretarial
Stenography
Traffic Management

RAILROAD SCHOOL
Air Brake Car Inspector
Locomotive Engineer
Locomotive Fireman
Railroad Rate Clerk
Railroad Section Foreman

MARINE AND STEAM ENGINEERING SCHOOLS
Boilmaking Navigation
Combustion Petroleum
Engineering Refining Plant
Engine Running Steam Electric
Marine Engines Steam Engines

LANGUAGE SCHOOL
French
Good English
Spanish

True for 53 years:
TODAY'S I.C.S. STUDENT
IS TOMORROW'S LEADER!
—and never truer than today

• *The Future belongs to the Trained Men!*

ACT NOW TO JOIN THEM

Thousands of America's business and industrial leaders began their climb to success by mailing this coupon!
Special Tuition Rates for Members of the Armed Forces.

INTERNATIONAL CORRESPONDENCE SCHOOLS
BOX 5506-K, SCRANTON 9, PENNA.

Please send me complete information on the following subjects:

_____ (Write above the subject in which you are interested.)

Name _____ Age _____

Home Address _____

City _____ State _____

Employed by _____ Working _____
Present _____ Hours _____ A.M. to _____ P.M.
Position _____

INVENTORS

**YOU CAN HELP SHORTEN THE WAR—
HELP AMERICA WIN THE PEACE!**

TODAY'S INVENTIONS ARE KEYS TO THE FUTURE

Your IDEAS have a place in TODAY'S thinking—of war planners and peace planners. For it is to you that industry will turn for the time and labor saving devices—the new and improved products—that are NEEDED to bring about the marvels of tomorrow's world.

No matter what your idea is—don't delay in developing your invention. Once your patent is granted, it is yours, for 17 years—to sell or to license as you see fit. Many inventors are selling their patents NOW—to forward-thinking manufacturers who want to get into peacetime production as soon as the war ends.

**WE'VE HELPED MEN
LIKE YOU FOR NEARLY
HALF A CENTURY**

Nearly all inventors take advantage of specialized Patent Attorney service. A competent staff is at your disposal—your application is pushed to a speedy conclusion—saving you time, money and trouble.

**These
FREE BOOKS
tell you
WHAT TO DO**

These two books give you all the information you need. They have helped many successful inventors—they can help you. Profusely illustrated, they outline clearly every step you must take—give you valuable tips on how to make your invention practical; show details of 115 fundamental mechanical movements. Also included with these two books—you get the "Evidence of Invention" form that will help establish your claim.



★
**SEND FOR THEM
TODAY—
JUST MAIL THIS COUPON**

VICTOR J. EVANS & Co.

REGISTERED PATENT ATTORNEYS FOR NEARLY 50 YEARS
830-L Merlin Building, Washington 6, D. C.

Please send me your books, "Patent Protection" and "When and How to Sell Your Invention"—also important "Evidence of Invention" form, without cost or obligation.

Name.....
Address.....
City and State.....

**INTRODUCING-New Victory Model
HANDIWELD ELECTRIC
ARC WELDER**

RETAILS ONLY \$1.95

FULLY GUARANTEED

PLUGS INTO LIGHT SOCKET

Victory Model Handiweld Arc Welder operates from 110 volts, A.C. or D.C. current same as other arc welders higher priced; generates tremendous heat to weld all metals. Not a toy welder that uses carbons, but actually uses standard coated rods—sizes 1/16" and 3/32". However, due to Priorities a generous supply of 1/16" rods only are supplied with the welder. Guaranteed not to burn out. Repairs fenders, auto bodies, radiators, machinery parts, etc. Take Victory Model Handiweld anywhere to job, operate right from light socket. You'll find a thousand uses for this welder around your home, garage, workshop, etc. Also in garages, factories, repair shops, tin shops; mechanics, inventors, plumbers, farmers, etc. Order a "Victory Model" Handiweld now.

We'll rush one to you with rods, helmet, operating instructions, and all necessary parts with the exception of a large jar and a small piece of extension cord; these most everyone has. Pay postman only \$1.95 plus a few cents postage. If not delighted return Victory Model Handiweld in 5 days from receipt and money paid for it will be refunded promptly. Rush your order now.

KUMFY PRODUCTS, Dept. K-202, CINCINNATI 26, OHIO

MUSIC LESSONS

COMPLETE CONSERVATORY HOME STUDY COURSES

Piano, Harmony, History of Music, Advanced Composition, Voice, Public School Music, Violin, Cornet, Trumpet, Guitar, Mandolin, Saxophone, Clarinet, Dance Band Arranging, Ear Training and Sight Singing, Choral Conducting. The only correspondence school teaching all the courses leading to the Degree of Bachelor of Music. Ask for illustrated lessons and catalog.

Give experience.....
UNIVERSITY EXTENSION CONSERVATORY 1525 E. 53rd St. Dept. U-60, Chicago 15, Ill.

LEARN MONEY-MAKING CARTOONING

IN SPARE TIME — by Easy Picture Chart Method

Same Simplified Method that has helped train creators of "Terry & Pirates," "Freckles," "Out Our Way," "Winnie Winkle," "Bog'lar Fellers," "Strange As It Seems," "The Neighbors," and many others. Earn while learning. Send 10c for Picture Chart (to test your ability), and full details. (State age).

THE LANDON SCHOOL, Dept. 4410, Philadelphia 1, Penna.

LEARN MEAT CUTTING

At Home — In Spare Time

Get into the vital meat industry. Concise, practical Home Training based on 25 years proven instruction methods used at National's famous resident school. Prepares you for bigger pay as Meat Cuts, Supervisor, market manager or more money in your own store. Go as rapidly as your spare time permits. Diploma. Start NOW to turn your spare hours into money. Send for FREE bulletin today. No obligation.

National School of Meat Cutting, Inc., Dept. U-50, Toledo 4, Ohio

**SIMPLE EASY INVENTION
TRIMS HAIR AT HOME!**

SAVES BARBER BILLS

Trims hair as it combs! Easy! Quick! Keeps men's, women's children's hair trim, neat, freshly-cut looking all the time! Trims, tapers, thins out uneven hair. Use like ordinary comb. Safe. Simple. No experience required. Fine for legs, underarms! Sells like wild!

SAMPLES FOR AGENTS Sample offer sent immediately to all who send name at once. A penny postal will do. **SEND NO MONEY.** Just your name.

KRISTEE CO., 679 Bar St., AKRON, OHIO

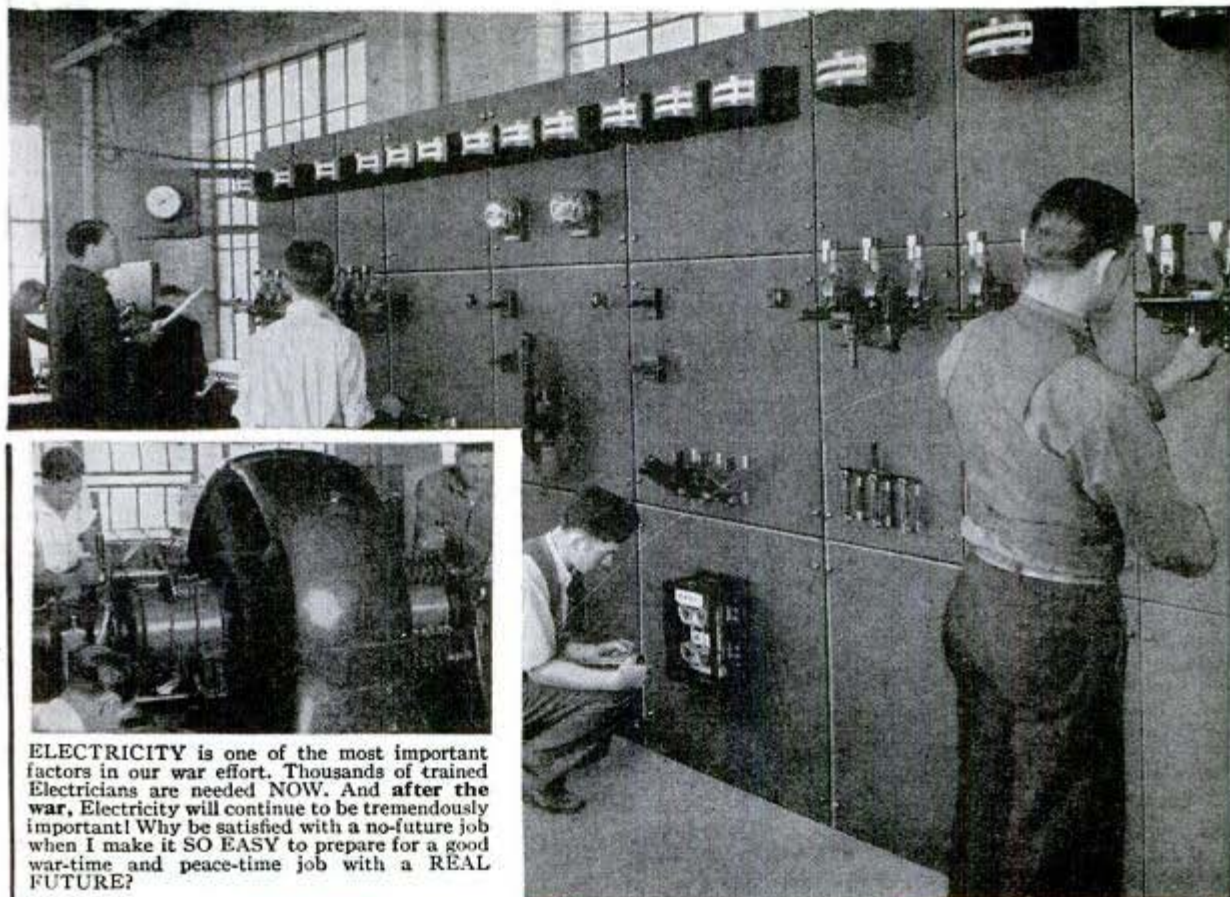

ELECTRICITY is one of the most important factors in our war effort. Thousands of trained Electricians are needed NOW. And after the war, Electricity will continue to be tremendously important! Why be satisfied with a no-future job when I make it SO EASY to prepare for a good war-time and peace-time job with a REAL FUTURE?

Learn **ELECTRICITY**

12 WEEKS TRAINING

Get into the fascinating, fast-growing, well-paid field of Electricity—a field that offers you opportunities and a future—in good times or bad times—a field that is a permanent necessity in war or peace. Here is your chance to prepare yourself for a lasting permanent future.

LEARN BY DOING

Here at Coyne—in 12 weeks, you can train for your Big Opportunity. "Learn-by-doing"—train on real electrical machinery. Not a

SPECIAL OFFER!

INDUSTRIAL ELECTRONICS

Training included at no Extra Cost.



correspondence course. Here you get all-around training in the many branches of Electricity so you are equipped for the better jobs in this field.

Coyne training is easily mastered. Many of our students have never had previous Electrical experience—many others have had experience in one or two branches but realize to advance they must have all-around Electrical training. So whether you have had electrical experience or not—you need Coyne training.



H. C. Lewis

GET YOUR TRAINING NOW... PAY FOR IT LATER!

We also have facilities for physically disabled men. Write for details.

Coyne Training is EASY, PRACTICAL! You LEARN BY DOING on real, actual machinery and apparatus. Don't let lack of money stop you. You can get training first—then pay for it in easy monthly payments after you graduate. If you need part-time work to help out with living expenses, I'll help you get it.

INSURE YOUR FUTURE! Send for Book!

Coyne is 45 years old and has seen War and Peace—times of prosperity and times of national depression. During all these times Coyne has trained men for Good pay jobs. Coyne training is tested and proven. Mail coupon and let me send you the big free Coyne book and my complete story about how I help you get the training you need for a good Electrical job. This does not obligate you. Act at once. **Just mail coupon.**

H. C. LEWIS, President
COYNE ELECTRICAL SCHOOL
 500 S. Paulina St. Dept. 74-72 Chicago 12, Illinois

H. C. LEWIS, President
 COYNE ELECTRICAL SCHOOL, Dept. 74-72
 500 S. Paulina St., Chicago 12, Ill.

Send me your Free Book and tell me about your plans to help me—including Pay-Tuition-after-Graduation offer and Radio-Electronics Training at no extra cost.

NAME.....
 ADDRESS.....
 CITY.....ZONE.....STATE.....

MAN-*The Mortal God*

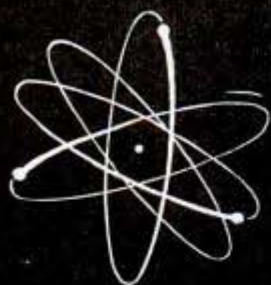

Unseen Worlds At *Your* Command!

Possibly there are universes beyond this one to be realized. Perhaps within the nucleus of each atom is the energy of a thousand dynamos—awaiting man's command. But for all of this outward conquest, are you still at the mercy of mysterious *indwelling* forces? No man is a master who has not explored self—to whom the worlds of *inspiration, mental creating, and intuition* remain dark continents of the mind. Would you like to shatter the illusions of time and space—know what is real and what are the oppressing limitations in life? Would you like to *know* the true purpose of your conscious existence—and experience the Cosmic forces which influences it?

ACCEPT THIS *Free* BOOK

Now is the time to discard obsolete, traditional thought. We are on the horizon of a new era. Learn how nature was intended to obey your commands. Write the Rosicrucians, a world-wide fraternity (not a religion), for their fascinating free book, "The Mastery of Life." It will throw new and searching *light* upon you and your universe.

Address SCRIBE: V. G. L.

THE ROSICRUCIANS (A. M. O. R. C.)

SAN JOSE, CALIFORNIA, U. S. A.

PLASTICS

THE GREAT *New* FIELD OF OPPORTUNITY
PLASTICS ENGINEERS AND TECHNICIANS NEEDED
IN NOT ONE BUT MANY CLASSES OF INDUSTRY

● Leaders in science and industry have long been saying, "Keep your eye on Plastics." But now the time for action has arrived. The future of huge possibilities has already begun. Developments in Plastics for hundreds of wartime uses have set the pace for revolutionary changes in peacetime production of thousands of products.

**THIS IS YOUR
BIG CHANCE**

Today there's a big need in vital war production for those who are trained in Plastics. From one to a hundred articles made of Plastics must be supplied for every man in our fighting forces. Start training now in Plastics Engineering, in spare time in your own home. Fit yourself for a responsible, well-paid position. Help to win Victory. And at the same time you will be preparing for even greater opportunities when the war is over.

There is scarcely an industry in which these so-called "miracle materials" will not play an important part. After the war many old materials, methods and skills will be replaced. Acquire the all-important "know how." Be in a position to step into one of the key jobs.

**'YOU CAN LEARN
WHILE YOU EARN**

Turn at least part of your leisure time into money. Qualify at home for a larger income in an interesting career. Build greater security for your future in a vocation that looms large on the horizon of the new industrial era. Hours you might otherwise waste can put you well on your way toward lasting success.

It's easy to find out about Plastics training. To get details and outline of study prepared by specialists, and about the school that has helped thousands to success during the past 46 years, write us or check and mail the coupon. Send today. The sooner you take this easy step, the sooner you will reach your goal and reap the rich rewards.

**AMERICAN SCHOOL OFFERS
COMPLETE TRAINING SERVICE
IN MANY SUBJECTS**

You who have not completed high school or have missed vocational training in college, and who cannot spare time to go away to school, can complete your education in your choice of many subjects. Several of these are listed in the coupon at right. Check the subject in which you are interested, fill in your name and address, clip and mail the coupon today.

PRACTICAL, EFFECTIVE HOME - STUDY TRAINING SINCE 1897

Take This First Easy Step

CHECK, CLIP AND MAIL COUPON NOW

AMERICAN SCHOOL, Dept. G745, Drexel at 58th, Chicago 37, Ill.
Without obligation. Please send FREE and postpaid, bulletin and details of the Subjects checked.

- | | | |
|--|---|--|
| <input type="checkbox"/> PLASTICS ENG'R | <input type="checkbox"/> Accounting and C.P.A. | <input type="checkbox"/> Drafting and Design for Men and Women |
| <input type="checkbox"/> Refrigeration | <input type="checkbox"/> Cost Accounting for Manufacturing | <input type="checkbox"/> Radio |
| <input type="checkbox"/> Architecture and Building | <input type="checkbox"/> Bookkeeping | <input type="checkbox"/> High School |
| <input type="checkbox"/> Practical Plumbing | <input type="checkbox"/> Private Secretary | <input type="checkbox"/> Air Conditioning |
| <input type="checkbox"/> Automotive Engineering | <input type="checkbox"/> Diesel Engineering | <input type="checkbox"/> Shipbuilding |
| <input type="checkbox"/> Aviation Drafting | <input type="checkbox"/> Surveying & Topographical Drafting | <input type="checkbox"/> Mechanical Eng. |
| <input type="checkbox"/> Aviation | <input type="checkbox"/> Sheet Metal | <input type="checkbox"/> Shop Management |
| <input type="checkbox"/> Business Mgmt | <input type="checkbox"/> Pattern Drafting | <input type="checkbox"/> Tool Making |
| <input type="checkbox"/> Railway Training | <input type="checkbox"/> Electrical Engineering | <input type="checkbox"/> Better Foremanship |
| | | <input type="checkbox"/> Machine Shop Operations |

Name..... Occupation.....
Address..... Age.....
City..... State.....

AMERICAN SCHOOL

Dept. G745, Drexel at 58th Street, Chicago 37

"I'll show YOU how to make yourself COMMANDO-TOUGH



...in double-quick time

...OR IT WON'T COST YOU A CENT!"

says *George F. Jowett*

WORLD'S GREATEST BODY BUILDER

Let me prove to YOU that you can put inches of dynamic muscles on your arms! Add inches to your chest! Broaden your shoulders and power-pack the rest of your body. I can do for you what I've done for thousands the world over, including many officers and men now in the U.S. and British Armed Forces!

GIVE ME 10 MINUTES A DAY!

I'll Show You My Secrets Of Body Building

I'll help you learn the "Progressive Power Method" through which I rebuilt myself from a physical wreck to the holder of more strength records than any other living athlete or teacher! No matter how skinny or flabby you are, you can learn my methods right in your own home. Through my proved secrets I show you how to develop your power, inside and out, until YOU are fully satisfied that you are the man you want to be. "The Jowett System," says R. F. Kelly, Physical Director of the YMCA, Atlantic City, "is the greatest in the world!"

PROVE TO YOURSELF IN ONE NIGHT!

Send only 25c for test Course, "Molding a Mighty Arm." Read it the evening it arrives—learn from experience the thrill you can give your muscles!

SEND FOR THESE FIVE FAMOUS COURSES IN BOOK FORM

ONLY 25c EACH
or ALL 5 for \$1.00

BOOK WITH PHOTOS OF FAMOUS STRONG MEN

MAIL COUPON NOW

FREE



Jowett Institute of Physical Culture
230 Fifth Avenue, Dept. 4710, New York 1, N.Y.

George F. Jowett: Your proposition looks good to me. Send by return mail, prepaid, the courses checked below, for which I enclose (). Include FREE book of PHOTOS.

- George F. Jowett
Champion of
Champions
- All 5 courses for . . . \$1
 - Molding a Mighty Arm 25c
 - Molding a Mighty Grip 25c
 - Molding a Mighty Back 25c
 - Molding a Mighty Chest 25c
 - Send all 5 C.O.D. (\$1 plus postage.) No orders less than \$1 sent C.O.D.

NAME _____ Age _____
(Print name)

ADDRESS _____

STUDY AT HOME

With A Chartered Educational Institution

Men with specialized training win higher positions, insure larger earnings, and are bigger successes in business and public life. Opportunities NOW greater than ever before. Send for our 1944 Catalog.

ARTS AND SCIENCES

Courses in Philosophy; Education; Letters; Public Health; Medical Jurisprudence; Psychology; Sociology; Physics; Chemistry; Plastics; Geology; Political Science; Theology; Business and Commerce; Accounting; Mathematics; Statistics; Agriculture.

ENGINEERING

Courses in Electrical, Civil, Mechanical, Drafting, Architectural, Steam, Aeronautical, Radio, Structural, Mining, Industrial, Highway, Petroleum, Marine, Chemical, Diesel, Automobile and Air Conditioning Engineering.

LAW

Complete Professional Law Course includes 21 Hornbook Series college grade textbooks. Courses also in Commercial Law, Patent Law and Medical Jurisprudence.

McKinley-Roosevelt Incorporated, 4610-K, Sheridan Rd., Chicago 40, Ill.



DRAW CARTOONS BIG MONEY!

EASY . . . PLEASANT WORK!

Let CHAS. H. KUHN, with 25 years actual experience in drawing a daily newspaper cartoon, teach you how to create, draw and sell your work. 52 complete lessons—one sent each week. Professional criticism on every lesson. Write today.

After Jan. 1, 1945, the price of this course will advance to \$13.00

KUHN SCHOOL OF CARTOONING

420 MURPHY BUILDING Dept. 5. INDIANAPOLIS 4, INDIANA

ELECTRICITY MEN NEEDED

Electricians are needed everywhere. Demand is growing. Good pay now and bright future for trained men in this live, expanding vocation. Learn at home, in spare time, from old established school. Write for FREE Bulletin. No obligation.

AMERICAN SCHOOL

Dept. EE745

Drexel at 58th St.

Chicago 37

LEARN WATCH REPAIRING



AT HOME. By our modern and original system of instruction you can learn every part of the WATCH REPAIRING TRADE AT HOME. Prepare yourself for a well-paying position or start in business after completing our course of instruction. Good watch repairers are in demand and generally earn very good salaries. For particulars apply to the Wisconsin School of Watch Repairing 524 E. Mason St., MILWAUKEE 2, WIS.

LAW

STUDY AT HOME FOR PERSONAL SUCCESS and LARGER EARNINGS. 35 years expert instruction—over 108,000 students enrolled. LL.B. Degree awarded. All texts furnished. Easy payments. Send for FREE BOOK—"Law and Executive Guidance."

AMERICAN EXTENSION SCHOOL OF LAW
Dept. 46-M, 646 N. Michigan Ave., Chicago 11, Ill.

MONEY for MEN ALL FREE

THE PLASTEX Industry needs manufacturers on small scale and for big production of Lamp and Clock Stands, Art Goods and Novelties in Plastex and Marble imitation. Experience unnecessary. 1/2c material makes regular 10c store sellers. Rubber molds furnished for speed production. Small investment brings good returns. Big chain store orders now being placed. Ambitious men have chance for real prosperity. Our Free booklet will interest and benefit you.

PLASTEX INDUSTRIES, Dept. P, 1085 Washington Ave., New York, N. Y.

You can become a practical

RADIO

ELECTRONICS MAN

DEFOREST'S MODERN A·B·C WAY
.. at Home

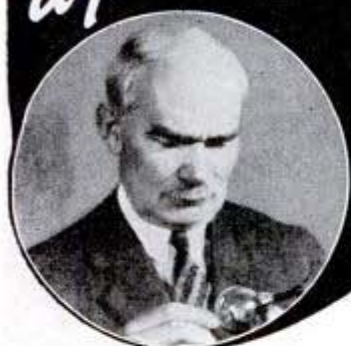

Radio-Electronics authority, Dr. Lee DeForest, under whose supervision DeForest's Training was prepared.

DeFOREST'S TRAINING INCLUDES INSTRUCTION IN MOTION PICTURE SOUND EQUIPMENT, FM RADIO, AND TELEVISION.

See how you may readily—in spare time at home—start toward a bright career in one of America's most interesting, fast-growing fields—RADIO and ELECTRONICS. We don't mean "Radio Servicing" only—but also a wide variety of other good-pay, NEWER opportunities in this BILLION-DOLLAR FIELD that seeks many trained men NOW, and promises such a bright POSTWAR future. Investigate these many profitable opportunities. See how you can prepare and GET STARTED with DeFOREST'S. Mail coupon below for big, free book, "VICTORY FOR YOU!" No obligation. You be the judge.

TRAINED RADIO-ELECTRONICS MEN Needed NOW and in the FUTURE

Only from DeFOREST'S do you get this modern combination of movies, radio parts and helpfully illustrated text-lessons to speed you to a practical working knowledge of Radio-Electronics—in your spare time—at home.



You get 90 up-to-date, well-illustrated, loose-leaf lessons—presented so you can readily understand them—prepared under the supervision of Dr. Lee DeForest, inventor of the Audion tube—a man recognized as one of the world's foremost Radio-Electronics authorities.



You work out 133 interesting, practical Radio-Electronics experiments, with 8 big kits of Radio Parts and Assemblies. You build and operate six different radio receiving circuits—a public address system—"Electric-Eye" control devices—light beam transmitter, etc. You put your training to work in your home... speed your preparation for a start in the Radio-Electronics field... in your spare time.



You get the use of a 16mm. DeVRY Movie Projector and special training films which show and explain visually the action that takes place in various Radio circuits and parts—help you understand the principles and the "reason-why" of Radio—make it easier to grasp the fundamentals of Radio-Electronics.

YOU GET VALUABLE EMPLOYMENT SERVICE.

DeFOREST'S actually helps you get started in the Radio-Electronics field—or in a Radio Business of Your Own. We have long-established contacts with many employers using large numbers of Radio-Electronics men.

Why not get more complete facts about DeFOREST'S Training at once—and about the interesting, good-pay jobs—opportunities now ahead in Radio and Electronics. Send for your free copy of "VICTORY FOR YOU" and the "KIT FOLDER."

YOU "LEARN-BY-DOING"

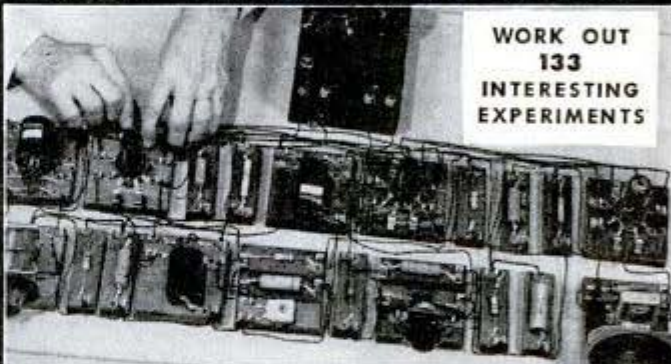

WORK OUT 133 INTERESTING EXPERIMENTS

YOU "LEARN-BY-SEEING"



DeFOREST'S MOVIES HELP YOU LEARN FASTER-EASIER

See Radio Circuits in Action—Electrons on the March!

Mail the Coupon TODAY!

DeFOREST'S TRAINING, INC.
2533 North Ashland Ave., Dept. BB
Chicago 14, Illinois

Please send me "VICTORY FOR YOU" book and "KIT FOLDER," FREE and without obligation.

NAME _____ AGE _____

ADDRESS _____

CITY _____ STATE _____

Check here, if under 16, for Special Information.



DEFOREST'S TRAINING, INC.
CHICAGO 14, ILLINOIS

DRAFTING



GET THIS
Free
TRIAL LESSON
Send Coupon



TO PROVE TO YOU how easy it is to learn Drafting at home by the Chicago Tech method, this 40 year old technical college will send you a *Free Trial Lesson in Drafting*. No charge for this Lesson now or later.

Mail Coupon Below

Get ready for a peacetime career. Look into the opportunities in Drafting. Read the want-ads for proof of the urgent demand for draftsmen in the aircraft, machinery, electrical and building fields. The draftsman always comes first on any new project in industry,—in peace or wartime.

The Draftsman—"The Key Man"

No new machines can be built, no airplanes constructed, no bridges or buildings erected, no ships or submarines launched until the draftsman has completed his work. Real immediate opportunities exist in Drafting—the profession upon which all construction is vitally dependent. Drafting is clean, interesting, well paid work. Investigate today what Drafting offers you.

Learn in Spare Time,—at Home! (or at the College in Chicago)

With our easy step-by-step method (and the tools we furnish) you can learn in your spare time at home. Convenient terms. Now is the time to prepare in Drafting for peacetime opportunities. Send the coupon or a post card for the Trial Lesson and complete information,—all FREE.

CHICAGO TECHNICAL COLLEGE
N-205 Tech. Bldg., 2000 S. Michigan Ave., Chicago 16, Ill.

Yes,—please send me **FREE** Trial Lesson in **DRAFTING**.

<input type="checkbox"/> Aircraft Drafting	<input type="checkbox"/> Machine Drafting
<input type="checkbox"/> Electrical Drafting	<input type="checkbox"/> Structural Drafting
<input type="checkbox"/> Architectural Drafting	<input type="checkbox"/> Building Construction

Name.....

Address.....

City.....State.....

Occupation.....Age.....

★ SAVE WASTE PAPER ★

Learn REFRIGERATION and AIR-CONDITIONING

At HOME or In Our SHOP

START YOUR OWN REPAIR SHOP

Exceptional opportunity for men of all ages up to 60. No previous experience needed. Our practical course is easy to grasp. A common school education sufficient. Prepare now for after the war for a big pay job or start your own repair shop. The demand for service mechanics is acute.



Send for **FREE** BOOKLET!

Mechanics Training School
4701 W. Pico, Dept. P-10, Los Angeles 6, Cal.

AMAZING MONEY MAKING OPPORTUNITY LEARN WATCH REPAIRING

A lifetime profession regardless of age, sex or physical handicaps. Veterans with medical discharges—men, women, past 40—your opportunity! Lift yourself from a Futureless Job into a position paying Better than your Present work or that will permit you to establish your Own Shop. Our Watch Repairing, Jewelry Engraving Graduates wanted everywhere—positions \$50-\$75-\$100 per week. Write for details today.



K. C. SCHOOL OF WATCHMAKING, 113-B East 31st, Kans. City 8, Mo.



Nationwide opportunities. sound postwar career waiting. Photographers needed by newspapers, advertisers, in business, industry, science. N.Y.I. graduates winning success from coast to coast. Qualify at America's largest, oldest school. Resident or home study courses. **FREE** catalog gives details.

N. Y. INSTITUTE OF PHOTOGRAPHY, Dept. 49, 10 W. 33 St., New York 1, N. Y.

CARTOONING



CASH IN on Big Cartoon Market. BECOME CARTOONISTS QUICKLY with our **NEW, EASY METHOD**. No experience necessary. Prepared by successful cartoonists. **SATISFACTION GUARANTEED**. Sample LESSON PLATE and interesting literature **FREE**.

NATIONAL ARTISTS BUREAU
Dept. A, Box 4248 DALLAS 8, TEXAS

HOW TO GET A BIG PAY JOB IN Real Estate



Tremendous real estate boom predicted. Big-pay, permanent jobs or your own 6-profit business. Salaries up to \$2,500 to \$10,000 a year in property management, insurance, building. Many make fortunes selling real estate. Thousands of trained men, women, required yearly by real estate firms, insurance companies, banks, Federal agencies. Rush post-card for 32-page **QUIZ BOOK**—mailed **FREE** with full details on new and only Evolve Library. **MODERN REAL ESTATE PRACTICE!** Lane Books, Dept. B-10, 100 East Ohio St., Chicago 11, Illinois.

RADIO ENGINEERING, Broadcasting, Servicing, Electronics, Aviation, Marine & Police Radio taught thoroughly. 48 weeks' Engineering course equivalent to 3 years' college radio work. All expenses low. Co-educational. Catalog free.

VALPARAISO TECHNICAL INSTITUTE, Dept. D, Valparaiso, Ind.

Inventions Wanted Patented or Unpatented

Inventions can now be safely sold without patenting expense. If you have a practical, useful idea for sale, either unpatented or patented, write **Chartered Institute of American Inventors**
Dept. 4, 631 Pa. Ave., N. W. Washington, D. C.



**ESTABLISH
YOURSELF IN
A PROFITABLE
LIFETIME
BUSINESS
- BIG MONEY
- INDEPENDENCE**

LEARN ELECTRICAL APPLIANCE REPAIRING

NO EXPERIENCE NEEDED

If you are at all mechanically inclined—that is to say—can hold and use tools—then you have all of the qualifications required for becoming a big money-earning home appliance repairman. It does not matter if you have not had a great deal of schooling or had no previous training along these lines. Age is no barrier . . . nor is any minor physical handicap.

Read What Other Students Say

I really believe your course the best investment a mechanically minded man can make.—*Claude E. Allen, Indianapolis, Ind.*

Your course on Appliance Servicing is the most complete and up-to-date I have heard of.—*Frank Kremen, Tarentum, Penn.*

I have received your Course in Appliance Repairing and I must say I am well pleased with same. I am only sorry I did not have said Course some years ago. I have learned so much more through this course I would not part with it.—*Charles Schwarz, Hamilton, Ohio.*

The Course in Appliance Servicing arrived a few days ago. Want to take out a few minutes of my valuable time to let you know that this is just what I have been looking for ever since I opened up my Fix-It shop. I must admit that you told the truth when you said that it contains quite a bit more information than I bargained for.—*P. J. Brel, Sebring, Ohio.*

I am a mechanic for the Western Union Telegraph Co. Three days after receiving the lessons in refrigeration I earned the exact cost of the course.—*Henry S. Lee, Washington, D. C.*

PREPARE FOR THE FUTURE

If now in war work, start your home appliance repair business in your spare time and be set with a business of your own when the war is over. You don't need elaborate fixtures or expensive equipment to be a successful repairman. Operate from your garage, basement, vacant store, etc. Work as many hours as you wish . . . the home appliance repairman is his own boss. It's a profitable occupation for on many types of repairs it is usual for a repairman to charge on the basis of \$5.00 to \$6.00 an hour! *Prepare today and make sure of tomorrow's future.*

New Course Helps All

Profusely illustrated, our new course shows you in simple, easy to understand language and drawings how to make each repair on refrigerators, vacuum cleaners, washing machines, motors, etc. Explains and gives you a working knowledge of electricity, welding, nickel plating, etc. Shows you how to build the power tools you need and how to solicit and keep business coming to you. Not a theory course but an honest to goodness course written by and used by repairmen the country over. Price of course is so low that the savings on your own household appliance repairs will quickly pay for it. Act now!

Mail Coupon for
FREE LITERATURE

CHRISTY SUPPLY CO.,
2835 N. CENTRAL AVE., DEPT. D-1403,
CHICAGO 34, ILLINOIS

Please send me all the facts about America's Fastest Growing Industry—Electrical Appliance Repairing.

Name

Address

City..... State.....

The set of
books
that makes



MASTER MACHINISTS and leads to bigger pay!

This big home-study and reference course gives you the practical facts on machines and methods you need to advance in machine shop work. Take advantage of the other man's experience as found in books, to solve your problems, increase your efficiency, with

The AMERICAN MACHINISTS' LIBRARY

6 volumes—2368 pages—2516 illustrations

(A combined home-study course and reference library)

This library of machine shop practice was written for practical men. It gives you the best methods for every kind of machine shop work. It fully explains lathes, drills, and other machine tools and their operation, automatic screw machines, speeds and feeds, gear design and production, jigs and fixtures, punch and die work, metal surfacing, etc., etc. Plainly written—completely illustrated—the best kind of help to the machine shop man who wants to advance himself.

No money down—special price—easy payments.

EXAMINATION COUPON

McGRAW-HILL BOOK CO., 330 W. 42nd St., N. Y. 18

Send me for ten days' examination the American Machinists' Library. If satisfactory I will send you \$1.50 in 10 days and \$3.00 monthly until the price of \$19.50 is paid. If not wanted, I will return the books postpaid. (To insure prompt shipment write plainly and fill in all lines.)

Name

Home Address

City and State

Position

Name of Company

PM-10-44

Do you want

→ .. to go to College?

→ .. or to enter a Profession?

(Such as Accounting, Architecture, Nursing, Dentistry, Teaching, Social Work, Osteopathy, Beauty Culture, Optometry, Embalming, Chiropractic, Law, Medicine, etc.)

→ .. or get an Office Position?

To get anywhere, you practically MUST finish High School FIRST. You can complete our simplified High School Course in SPARE time at home, as FAST as your time and abilities permit. Equivalent to resident school work—prepares you for college, pre-professional examinations, business, industry. Standard texts furnished. Diploma. Credit for H.S. subjects already completed. Single subjects if desired. Low tuition, easy terms. American School, Chicago, est. 1897—endorsed by educators. Finish your high school education NOW. Write TODAY!

High School Course at Home

Many Finish in 2 Years

American School, Dept. H745, Drexel Ave. at 58th St., Chicago 37, Ill.

Gentlemen: Send me FREE information covering special training in subjects checked below. No obligation on my part.

- | | |
|--|--|
| <input type="checkbox"/> High School Course | <input type="checkbox"/> Diesel Engineering |
| <input type="checkbox"/> Cost Accounting for Mfg. | <input type="checkbox"/> Drafting and Design for men & women |
| <input type="checkbox"/> Architecture and Building | <input type="checkbox"/> Plastics |
| <input type="checkbox"/> Automotive Engineering | <input type="checkbox"/> Private Secretary |
| <input type="checkbox"/> Business Management | <input type="checkbox"/> Mechanical Engineering |
| <input type="checkbox"/> Electrical Engineering | <input type="checkbox"/> Aviation |
| <input type="checkbox"/> Elec. and Gas Refrigeration | <input type="checkbox"/> Salesmanship |
| <input type="checkbox"/> Air Conditioning | <input type="checkbox"/> Shipbuilding |
| <input type="checkbox"/> Railway Training | |

Name

Address

★ TRAIN for SUCCESS in the Poultry Business



Study at home in spare time. Earn extra while learning.

YOU CAN MAKE MORE MONEY from POULTRY. Proper management means profits ANY season, for life. Get latest scientific methods that avoid losses and mistakes. Our famous system of Home Study Training has helped thousands to success. Extra profits from the start. FREE Catalog; describes courses, methods, service. Write today to Dept. 50-Q, NATIONAL POULTRY INSTITUTE, Adams Center, N. Y.



JOKE BOOKS For Adults

The kind they like. You will be both a Riot and the Life of the Party with a set of these pocket size joke books. They are full of Entertainment, Fun and Humor. A set of six books only 50c or a special assortment of 12 books all different for \$1.00. Print name and address, send cash or stamps to:

TREASURE NOVELTY CO.,
72—5th Ave., Dept. 1210, N. Y. 11, N. Y.

MAGIC LIQUID MAKES PHOTOS APPEAR

On Scarfs, Ties, Stationery, Etc.

Reproduce any snapshot on cloth, leather, wood, paper. Simply apply liquid. Like magic photo appears within 2 minutes in broad daylight. Harmless to negative. Won't wash off. Full colors included. Complete kit for 100 photos only \$1.29. Send no money, just name. Pay postman \$1.29 plus few cents postage on delivery. Or send cash with order and get postpaid. (Canada \$1.50 mfg. order only.) Order today.

L & M Mfg. Co., Dept. 363-D, 229 W. Breckenridge, Louisville 3, Ky.



What Every Mason Wants



We have important Masonic books for Blue Lodge, Chapter, Commandery, Scottish Rite, and Shrine.

Our Rituals Are Used the World Over. Send for free catalog of books and rituals for Masons, Odd Fellows, Knights of Pythias, Knights of Columbus, Elks, etc.

EZRA A. COOK, Publisher, P. O. Box 796, PO, Chicago 90, Ill.



Write for my Free Book, "How to Become an Expert Penman," which shows what others have accomplished by taking my Course. Enclose 10c for one of my Favorite Pen Points and your name with a beautiful flourished bird written on a card. Write today.

T. M. TEVIS, Box 25K, Chillicothe, Mo.

REFRIGERATION

Repair and improve all refrigerators. New large manual texts how. Charts and pictures to help you. Only \$1.00, postpaid. Money back guarantee. Supreme Publications, 328 S. Jefferson St., Chicago 6, Illinois

Get into the BAKING BUSINESS

Bakers make good money! Now 7th Industry in wages! Nearly depression-proof. New home study Baking Course qualifies you. Common school education sufficient. If you're ambitious, write for FREE BOOK "Opportunities in Baking." National Baking School, 1315 Michigan, Dept. 1357, Chicago 5, Ill.



MAKE MONEY AT HOME!

Learn to color photos and miniatures in oil. No previous experience needed. Good demand. Send for free booklet, "Make Money at Home" and requirements. NATIONAL ART SCHOOL, 1315 Michigan Ave. Dept. 1357 Chicago 5

Externally
Caused

PIMPLES

ACNE, BLACKHEADS, OILY SKIN, RED PATCHES Discouraged by soaps and salves? SEBOLINE applied nightly often shows improvement in a week. Money Back if not completely satisfied after 2 weeks. Skin Specialist Prescription. SENT ON TRIAL. You risk nothing. FREE Send for Free Booklet at Once. Don't suffer embarrassment any longer. WRITE TODAY. Seboline Lab., Dept. H-5, P. O. Box 350, Independence, Mo.

GET INTO RADIO ELECTRONICS & TELEVISION NOW!

Hundreds of Industries Need Radio and Television Men Now and for Great Future Demands

The man trained in electronics is wanted not only in Radio and Television, but in Aviation, Transportation, Communications, ... in the designing, engineering and operation of hundreds of industries today and for years to come. Learn how great the field is for YOU... How you may GET INTO BUSINESS FOR YOURSELF. Mail the coupon now.



Send for FREE Lesson and Prove to Yourself How Quick and Easy You Get Ahead in Radio by the NEW

SHOP METHOD HOME TRAINING



Learn by Doing!
Use real Radio Equipment Furnished with your Course

Experience is the best teacher. You learn by experience with the exclusive National Shop Method of Home Training—actually build many circuits and do experiments with the big kits of standard radio parts included in your training equipment at no extra cost to you.

Build a superheterodyne receiver. Make tests and conduct experiments that show you the why and how of electronics. Build an audio oscillator, signal generators and other instruments with the parts and supplies included in your course.

"F.M." Means Future Money
Frequency Modulation (F.M.) is here to stay. Thousands of F.M. licenses have been granted by the government F.C.C. all over the country. Learn what this means to you.

Get ready for TELEVISION. Get your share of the RADIO SERVICE Business. Here is a sensational improved way for you to get the right training—a thoroughly proved system whereby you study in spare time—odd hours, even minutes—and have the advantage of actual shop experience behind you.

This exclusive shop method of home training comes to you right from one of the world's greatest vocational educational centers—the resident training shops and experimental laboratories of National Schools. It is the sound, practical training based on actual experience of qualified instructors and engineers who have prepared thousands of National graduates now employed in the radio industry.

It is up-to-date—matches the progress constantly being made in modern radio, television and electronics. It is time tested. National Schools has been training men for higher pay and greater opportunity for more than a third of a century. Fill out and mail the coupon below for details.

Shop Method Training Wins Good Jobs

Joseph Grunich, Lake Hiawatha, New Jersey.
"My latest offer was \$5,800.00 as Radio Photo Engineer... but I'm doing well where I am now engaged. I am deeply indebted to National."

R. R. Wright, Blackfoot, Idaho.
"Due to my training at National I was selected to instruct in the laboratory work of Navy and Marines."

O. K. Ivey, Washington, D. C.
"I believe National offers the best course to be had. Keep up the good work." Read what hundreds of other enthusiastic students have written about National Training. Send in your coupon today.

Be Sure in Post-War

Now, right now, is the time to prepare for SUCCESS AND SECURITY in the great expansion after the war. The field is wide open. Trained men will get the preference in the broadcasting stations—in industry—will make quick progress with small capital in their own business. Soldiers, sailors and marines make use of your free time to get ready for the future. Study while still in uniform. Thousands of men in the armed forces have trained at National Schools under U. S. Government sponsorship.

See for Yourself
Now, right now, is the time to grasp the great opportunity of today—a successful career for tomorrow. Get into the big money, rapid advancement, a position of importance. A BUSINESS OF YOUR OWN. The industry is crying for trained men everywhere. A rapidly expanding business—probably the greatest in industrial history—holds out the promise of a rich future—prosperous security. But to win it you must be ready. Well-trained men ONLY are wanted.

NATIONAL SCHOOLS

LOS ANGELES 37, CALIFORNIA EST. 1905

MAIL OPPORTUNITY COUPON FOR QUICK ACTION

National Schools, Dept. 10 PMR
4000 South Figueroa Street, Los Angeles 37, California
(Mail in envelope or paste on penny post card)

Mail me FREE the three books mentioned in your ad including a sample lesson of your course. I understand no salesman will call on me.

NAME..... AGE.....
ADDRESS.....
CITY..... STATE.....
Include your zone number

Examine the National Shop Method of Home Training carefully. Be convinced. Study the lesson we will send you FREE. No obligation of any sort. Fill out the coupon and mail it today.



**If You Have Had to Wait
for Your Copy of
WEBSTER'S NEW INTERNATIONAL
DICTIONARY, Second Edition**

This Is the Reason:

THE rationing of paper has made unavoidable a restriction in production and heavy government needs must be supplied—all in the face of the greatest civilian demand for the Merriam-Webster in our history. Naturally there are not enough copies to make possible prompt delivery to everyone. Please wait as patiently as you can for your bookseller to supply you.

GET THE BEST — Even If You Have To Wait For It

The Merriam-Webster is the standard of schools and colleges; State Supreme Courts; the Government Printing Office; professional and business offices everywhere. Contains 600,000 Entries —122,000 more than in any other dictionary. 12,000 terms illustrated. 3,350 Pages. G. & C. MERRIAM CO., Publishers, Springfield 2, Mass.

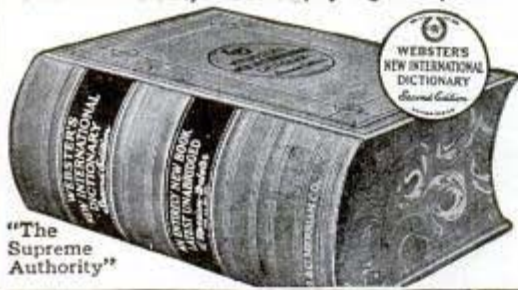

**MEN NEEDED FOR
GOOD PAY WORK**

**IN
Air Conditioning
AND
Refrigeration**

**TRAIN NOW
FOR POST-WAR**

A real opportunity for good income awaits those men who prepare NOW for an interesting and successful career in Air Conditioning and Refrigeration. Thousands of Mechanical Units need servicing right NOW; additional NEW equipment must be installed and serviced after the War.

Enter This Field For Good Earnings

Start now and learn in your spare time. Get set for bigger income possibilities. Here is a balanced plan of practical training that offers you home-study instruction and actual shop-work experience. Since 1927, U.E.I. has been training thousands of ambitious men to get better pay in this interesting, important, pleasant work. You, too, can get this "Know How" that can lead to the golden opportunities that await you after the War. This balanced instruction will not interfere with your present work. Write for FREE complete details TODAY.

UTILITIES ENGINEERING INSTITUTE
Dept. 1104, 1314 W. Selden Ave., Chicago (14), Ill.



*** FREE COPY *
The World Takes Wings**

Get a preview of the wonderful opportunities in post-war aviation. The world's fastest growing industry offers permanent, profitable positions of leadership to those whose training and preparation qualify them. This is yours for the asking. Write at once!

WESTERN AIR COLLEGE
198 S. Myrtle Ave. Monrovia, Calif.

**THERE'S MONEY IN
CARTOONS!**

RAYE BURNS will teach you HOW to CREATE ORIGINAL CARTOONS at home that you may SELL! Course contains 26 lessons and over 600 illustrations. All for Only... **\$2.85**

Send name and address for free details.
RAYE BURNS SCHOOL, Dept. M, Box 3583, CLEVELAND, OHIO



Begin today. Write now for our Free Book, "How to Become a Good Penman." It contains specimens and tells how others learned to write in spare time. Enclose 10¢ for your name beautifully written and a pen point suitable for shaded writing. Write today.

THE TAMBLYN SCHOOL OF PENMANSHIP
N441 Ridge Building, Kansas City, Mo.

STAMMER?

This new 128-page book, "Stammering, Its Cause and Correction," describes the Bogue Unit Method for scientific correction of stammering and stuttering—successful for 43 years. Benj. N. Bogue, Dept. 1817, Circle Tower, Indianapolis 4, Ind.



**Short-Cut Mathematics
COMBINED WITH
Practical Mechanics Simplified**

NEW 2-in-1 reading course! Now you can learn the speedy, simplified system of calculation used by draftsmen, engineers, accountants, "master minds" on the stock. Learn easy way to multiply 4 figures by 4 figures without using old-fashioned multiplication; add long columns of figures this lightning short-cut method. Learn horsepower, slide rule, micrometer, logarithms, wood measure, puzzles, etc., etc. Large illustrated volume complete with answers, only \$1 postpaid. Satisfaction or refund.

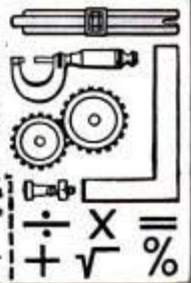

FREE Complete details... mail coupon TODAY!

Nelson Co., 321 S. Wabash, Dept. 3K02, Chicago 4
Please send free details about "Short-Cut Mathematics and Practical Mechanics Simplified." No obligation.

Name.....
Address.....

**BE A
DIESEL
EXPERT**
Training Books
FREE
for Examination



Prepare NOW for the BIG opportunities in Diesel Power—revolutionary power for railway trains, trucks, buses, tractors, boats, power plants, construction equipment, etc. Fit yourself for a better, more permanent job.

Latest 6 Volume Edition

is packed full of up-to-date and easy-to-learn facts about Diesel design, manufacture, operation and repairing. Written in simple language by prominent Diesel authorities. Over 2500 pages. Hundreds of illustrations and diagrams. Durable bound. Start at once to master this New, Big-Pay Profession. Send the coupon. Examine the books. If you are not thoroughly satisfied, return them and you'll not owe us a cent. Don't delay. Send today.

AMERICAN TECHNICAL SOCIETY, Vocational Publishers Since 1898
Dept. 0719, Drexel at 58th Street, Chicago 37, Ill.

Send for 10 days' free trial, 6 volumes on Diesel Engineering. I will pay delivery charges only. If I decide to keep them I will send \$2.00 in 10 days, then only \$3.00 a month until \$24.80, total price, is paid. If not satisfied, I will return books in 10 days and owe you nothing. Include Consulting Service Privilege.

Name.....
Address.....
Please attach letter stating age, occupation, employer's name and address, and name of at least one business man as reference. Men in service, also please give home address.

Win WAR BONDS

A GRAND TOTAL OF

\$1,000.00

IN PRIZES *for Your Ideas*

Midwest Radio Corporation—since 1920, famous for fine radios, and their factory-to-you selling plan with savings up to 50%—looks to the post-war future. To build the kind of radio you want, they ask you now to submit a letter on the subject: "What I Want In My Post-War Radio." For the 11 best letters, Midwest will give \$1,000.00 in War Bonds. Letters must not exceed 200 words and you may send as many entries as you wish. Letters will be judged on the practical value of the ideas contained therein and the decision of the judges will be final. In case of ties, duplicate prizes will be awarded. All entries must be postmarked not later than midnight Dec. 31, 1944. Contest open to all except employees of Midwest Radio Corporation, their advertising agency, and members of their families. Winners will be notified on Jan. 31, 1945. Prizes will be awarded as follows:

First Prize . . . \$500 in War Bonds

Second Prize . . \$200 in War Bonds

Third Prize . . . \$100 in War Bonds

and eight prizes of a \$25 War Bond each.

Send your entry to Contest Editor at

MIDWEST RADIO CORP., Dept. 15-J, Cincinnati 2, O.



MIDWEST RADIO

KEY TO A PRACTICAL UNDERSTANDING OF ELECTRICITY

\$1 PER MO.

• AUDELS HANDY BOOK OF ELECTRICITY

\$4 HANDY SIZE

For Engineers, Electricians, Students and all interested in Electricity. A quick, simplified, ready reference, giving complete instruction and practical information. Easy to understand. A reliable authority and a handy helper that answers your questions.

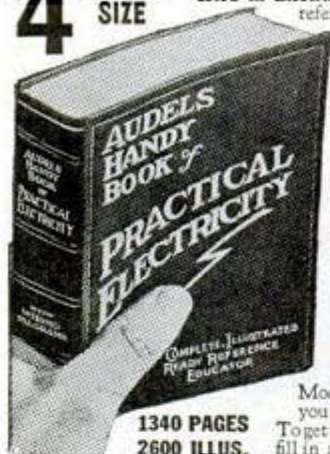

• INSIDE TRADE INFORMATION ON

The Rules and Laws of Electricity—Maintenance of Machinery—A. C. and D. C. Motors—Armature Winding and Repair—Wiring Diagrams—House Lighting—Power Wiring—Cable Splicing—Meters—Batteries—Transformers—Elevators—Electric Cranes—Railways—Bells—Sign Flashers—Telephone—Ignition—Radio Principles—Refrigeration—Air Conditioning—Oil Burners—Air Compressors—Welding, and many Modern Applications explained so you can understand.

1340 PAGES
2600 ILLUS.

To get this assistance for yourself, simply fill in and mail the FREE COUPON below.

THEO. AUDEL & CO., 49 West 23rd Street, New York
Please send me "Audels Handy Book of Practical Electricity" for free examination. If satisfactory, I will send you \$1 in 7 days, then \$1 monthly until \$4 is paid. Otherwise I will return it.



READ FOR PROFIT!

Name _____
Address _____
Occupation _____
Reference _____ PM

AVIATION Career

DON'T WAIT UNTIL THE WAR IS OVER!

Since 1929 Curtiss-Wright Technical Institute has been specializing in modern, progressive training for Aeronautical Engineers and Master Aviation Mechanics (no flying involved). Prepare now for your Aviation Career. BE READY! The opportunities are great today and will be much greater in tomorrow's Age of Flight. ACT!



CURTISS TECHNICAL WRIGHT INSTITUTE

GRAND CENTRAL AIR TERMINAL
GLENDALE 1, CALIFORNIA
(LOS ANGELES COUNTY)

MAIL THIS COUPON TODAY!

Registrar, Curtiss-Wright Technical Institute, Grand Central Air Terminal, Glendale (1), California. Please send information and profusely illustrated catalogue on Aviation Training. FREE... without obligation... Dept. PM-10

Name _____ Birth Date _____
Street _____
City _____ State _____

OSWALD RABBIT Cartoon Home Movies! Are ALWAYS Funny!



Feature an OSWALD film next time you entertain family and friends with a HOME MOVIE show. Screen also a Mickey Mouse—3 Monkeys—Donald Duck cartoon. All packed with laughs.

GET THESE FEATURES
50 FT., 8MM. \$1.25
100 FT., 16MM. 2.50

The Duck's Birthday.....6-A
Doctor Oswald.....9-A
Sniffs and Sniffles.....10-A
Fairlyland Express.....11-A

See At Your Dealers or Order Direct
For Catalog and Prices, Write to—

HOLLYWOOD FILM ENTERPRISES, Inc.
6060 Sunset Blvd. Dept. 115 Hollywood 28, Calif.

ACCOUNTANT BECOME AN EXPERT

Executive Accountants and C. P. A.'s earn \$2,000 to \$10,000 a year. Thousands of firms need them. We train you thoroughly at home in spare time for C. P. A. examinations or executive accounting positions. Previous experience unnecessary. Personal training under supervision of staff of C. P. A.'s. Placement counsel and help. Write for free book, "Accountancy, the Profession That Pays."
LASALLE Extension University, 417 So. Dearborn St.
A Correspondence Institution Dept. 1064-H Chicago 5, Ill.

PLAY GUITAR LIKE THE COWBOYS DO... 8 LESSONS

Just out—very latest guaranteed, simple, easy method. Play cowboy songs the Western way in a few minutes by ear. Surprise and amaze your friends. Be in big demand at parties, camps, public entertainments, on the radio, etc. 12 Complete Lessons. SEND NO MONEY. Pay postman only \$1.00 plus postage and P.O.D. charges, or send \$1.00 and get EXTRA SONGS all postpaid. (Canada, \$1.25 money order only.) Nothing else to buy. Positive money back guarantee. Rush order today.
WESTERN RANGER STUDIOS, Dept. 1510, Hutchinson, Kans.

FIX TYPEWRITERS

A Simplified Practical Homestudy Course. Many of our Students now have their own Business—Many Repair for others. Repair Shops Swamped. Health or Age no handicap.
WEBER TYPEWRITER MECHANICS SCHOOL
5417 Santa Monica Blvd., Hollywood 27, Calif.



Learn Public Speaking

At home—in spare time. Many overcome "stage-fright," gain self-confidence and increase earning power, this easy way. Write for free booklet, *How to Work Wonders With Words* and requirements.
North American School, Dept. 1357
1315 Michigan Ave., Chicago 5, Ill.

DRAW for MONEY BE AN ARTIST!

Trained Artists are Capable of Earning \$30, \$50, \$75 a week

Use Your Spare Time to Prepare for a Profitable Art Career! COMMERCIAL ART, DESIGNING and CARTOONING—all in ONE complete home study course. No previous ART experience necessary—we teach you step by step—hundreds have profited by our practical method. TWO ART OUTFITS FURNISHED. Full information in colorful, FREE BOOK, "Art for Pleasure & Profit"—tells all about our course, service, what our graduates say—and commercial opportunities for you in Art.

FREE BOOK gives details!

WASHINGTON SCHOOL OF ART
Studio 1210K, 1115 15th St., N.W., Wash. 5, D.C.
Send me your booklet and full particulars about your course.

Name _____ AGE _____
Address _____
City _____ State _____

AUTO REPAIR MEN!

Are You Short-Handed for Mechanics?

Are You LOSING MONEY on Work You Can't Handle? — LOSING TIME on Hard-to-Do Jobs?

SEE HOW THIS AMAZING MANUAL IS "WORTH 2 EXTRA MEN" IN YOUR SHOP!



You Can Do ANY Basic Repair Job on ANY Car Built Since 1935!

No need to keep on losing money on jobs you just don't have time, or enough hands, to do! It's like adding "2 mechanics" to your shop when you put MoToR's AUTO REPAIR MANUAL on the job!

With this book on hand you can repair anything from carburetor to rear end — more quickly and easily! Just look up make, model, and job in the quick index in this great book — and go to work! Clear, illustrated instructions lead you step by step.

To make such an amazing book possible, engineers, editors of MoToR Magazine collected and "broke down" 150 official factory shop manuals for you, spotted all vital repair information you need, dove-tailed it all into ONE handy, easy-to-understand book.

No Other Manual Like It!

This BIG book — over 764 pages, 8 1/2 x 11 inches, bound in sturdy fabric — brings you nearly 200,000 service, repair, adjustment, replacement, tune-up facts on every car built from 1935 to 1942. More than 1,000 cut-away photos, diagrams, drawings show you exactly WHAT to do, HOW

to do it! Used by U. S. Army, trade, technical schools, thousands of auto servicemen.

The PARTIAL Table of Contents shown here can only give you an idea of all the thousands of jobs this book covers. Hundreds of "war-timely" pointers on maximum mileage and performance with minimum fuel consumption. Full wheel alignment data to prevent tire waste and wear.

SEND NO MONEY

Just mail coupon below — without money! When postman brings book, pay him nothing. First make it show you what it's got! Actually try it out on a few extra-tough jobs. See for yourself how its quick index, easy instructions, and clear pictures can save you time, trouble and money — how the book can pay for itself the first few days you use it!

Unless you agree this is the greatest time and work-saver you've ever seen — return book in 7 days and pay nothing. Mail coupon today! MoToR Book Dept., Desk 1M, 572 Madison Avenue, New York 22, N. Y.

Nearly 200,000 Service and Repair Facts on All These Makes:

American	Ford	Oldsmobile
Bantam	Graham	Overland
Auburn	Hudson	Packard
Austin	Hupmobile	Pierce
Buick	Lafayette	Arrow
Cadillac	La Salle	Plymouth
Chevrolet	Lincoln	Pontiac
Chrysler	Lincoln	Reo
Cord	Zephyr	Studebaker
Crosley	Mercury	Terraplane
De Soto	Nash	Willys
Dodge		

764 pages; 50 pages of carburetor text, charts, illustrations, covering all models.

Over 500 charts, tables covering important specifications, clearances, measurements, arranged in handy form, including: Tune-up Chart; Valve Measurements; Compression Pressure; Torque Wrench Readings; Starting Motor; Engine Clearances; Main & Rod Bearing Journal Dimensions; Generators; Clutch & Brake Specifications; Front End Measurements, etc.

Detailed, pictured instructions on Engines; Electric, Fuel, Cooling, Lubricating Systems; Transmissions; Wheels; Front Ends; Universals; Rear Ends, etc., etc.



FREE 7-DAY OFFER

MoToR Book Department, Desk 1M, 572 Madison Ave., New York 22, N. Y. Rush to me at once: (check box opposite book you want).

MoToR's AUTO REPAIR MANUAL (formerly "MoToR's Factory Shop Manual"). If O.K. I will remit \$1 in 7 days, and \$1 monthly for 4 months, plus 35c delivery charge with final payment (\$5.35 in all). Otherwise I will return book postpaid in 7 days. (Foreign price, remit \$7 in cash with order).

MoToR's TRUCK REPAIR MANUAL. (Described at left in the box.) If O.K. I will remit \$2 in 7 days, and \$2 monthly for 3 months, plus 35c delivery charges with final payment (\$8.35 in all). Otherwise I will return book postpaid in 7 days. (Foreign price, remit \$11 cash with order).

Name _____ Age _____

Address _____

City _____ Zone No. (if any) _____ State _____

SAVE 35c! Check here if enclosing full payment (check or money-order) WITH coupon. We pay 35c shipping costs. Same 7-day return privilege, for full refund.



Same FREE 7-Day Offer Applies on MoToR's

TRUCK REPAIR MANUAL

Covers all types Gasoline Engines; Diesels, Hesselmans, Fuel Systems, Governors, Lubrication, Ignition Systems, Starters, Generators, Clutches, Transmissions, Axles, Torque Dividers, Transfer Cases, Brakes, Steering, etc. Check box in coupon at right.

Published by MoToR, The Leading Automotive Business Magazine. MoToR's manuals assure high standards of repair work.

Listen to this Record!



SPEAK SPANISH

FRENCH, GERMAN, OR ITALIAN

Big opportunities awaiting Americans who speak Spanish. Learn as a child learns—"by listening" to these brand-new CORTINA recordings.

Only 15 Minutes a Day

Cortinaphone Method famous for 60 years. THOUSANDS have found it the most fascinating, most satisfactory method. Here is the quick, easy way to learn Spanish for PLEASURE AND BUSINESS. INVESTIGATE!

Sent on 5 Days Approval



"The Cortinaphone Short-Cut"—tells just what you want to know. Interesting. Get it!

Write Today-NOW!

CORTINA Academy (Language Specialists for 60 Yrs.)
Suite 6410, 105 W. 40th St., New York 18, N. Y.

Please send me—without obligation—your free booklet. I am interested in (mark):

SPANISH French Italian German

Name

Address

JUST OUT! NEW FROM COVER TO COVER

AUDELS REFRIGERATION and AIR CONDITIONING GUIDE



4 Books in One! Covering:
Basic principles, Servicing, Operation, Repair of
1—Household Refrigeration
2—Special Refrigeration Units
3—Commercial & Industrial Refrigeration
4—Air Conditioning Systems
A gold mine of essential important facts for ENGINEERS, SERVICEMEN & USERS.

A Good Book is a Good Friend! Here you have at your fingers' ends a Complete Library in ONE VOLUME, the necessary data you have been looking for on: MODERN UNITS, SYSTEMS & MACHINES, REFRIGERANTS, including Freon, Lockers, Water Coolers, Quick Freezing & Air Conditioning Systems. 1280 Pages, 44 chapters all Fully Illustrated & indexed for Ready Reference.

ANSWERS YOUR QUESTIONS
Get This Information for Yourself. Mail Coupon Today. No Obligation Unless Satisfied. ASK TO SEE IT.

4 COMPLETE • PAY ONLY \$1. A MONTH ←

AUDELS, Publishers, 49 W. 23rd St., New York 10, N. Y.
MAIL AUDELS NEW REFRIGERATION GUIDE for free examination. If O. K. I will send you \$1 in 7 days; then remit \$1 monthly until price of \$4 is paid. Otherwise I will return it.

Name

Address

Occupation

Employed by PM

Industrial

Electronics

THE NEXT BIG OPPORTUNITY FIELD

As was electricity, the automobile and radio, in their day—Electronics is the next big opportunity field. Already at work in hundreds of war plants—it is likely to change our entire way of living and create unheard of opportunities for men who start training now as ELECTRONIC TECHNICIANS for industrial work.

This 28 year old school offers the practical training needed, prepared with the help of leading firms in the field, in three forms—home study—resident training in our Chicago shops—and a combination of both. Ambitious men are urged to write today for vital information.

FREE TWO BOOKS Write Today

INDUSTRIAL TRAINING INSTITUTE, Dept. 38
2132-2158 Lawrence Ave. Chicago 25, Ill.

TRAIN



Your VOICE!

Results GUARANTEED

We build, strengthen the vocal organs—not with singing lessons—but by sound, scientifically correct silent and vocal exercises and absolutely guarantee complete satisfaction with results. Write for Voice Book, FREE. Sent to no one under 17 years old unless signed by parent.

PERFECT VOICE INSTITUTE, Studio 1357, 64 E. Laka St., Chicago, Ill.

924 PAGE AUTHENTIC FORMULARY



10,000 Formulas, Recipes, Trade Secrets for making most any conceivable product. Prepared by experts in simple, non-technical language. Countless profitable business opportunities, supply sources. Valuable reference for home, farm or industry. \$2.00 postpaid—Canada or Foreign \$2.35, U. S. Funds. (C.O.D. orders accepted for U. S. delivery only.)

Prepare for "After-War-Business"

Especially recommended for Servicemen and War Workers planning a profitable business of their own.

ADAMS BROWN COMPANY . . Dept. 10 . . Chestnut Hill 67, Massachusetts



Wonderful, new device, guides your hand; corrects your writing in a few days. Big improvement in three hours. No failures. Complete outline FREE. Write C. J. Osment, Dept. 34, St. Louis, Mo.

INDIANA TECHNICAL COLLEGE

Engineering B.S. degree in 27 months. Aeronautical, Chemical, Civil Electrical, Mechanical and Radio Engineering. Govt. approved for G.I. bill. Prep courses, no added cost. Large industrial center. Earn living expenses. Graduates successful. Enter Dec., March, June and Sept. Catalog. 5104 E. Washington Blvd., Fort Wayne 2, Indiana.

LAW STUDY AT HOME

Legally trained men win higher positions and bigger success in business and public life. Greater opportunities now than ever before. Big corporations are headed by men with legal training. More Ability: More Prestige: More Money. We guide you step by step. You can train at home during spare time. Degree of LL. B. Successful graduates in every section of the U. S. We furnish all text material, including 14-volume Law Library, Law code, essay forms. Get our valuable 48-page "Law Training for Leaders" and "Evidence" books FREE. Send for them NOW. LASALLE EXTENSION UNIVERSITY, 417 South Dearborn Street A Correspondence Institution Dept. 1064-L, Chicago 5, Ill.



LEARN PORTRAIT PAINTING AT HOME

• Previous art training or talent NOT necessary. This new Stuart System teaches you, in 11 simple, easy-to-follow lessons, to make exact charcoal and oil likenesses. Guidance for your every step. Send for free book today.

STUART STUDIOS,

121 Monument Circle, Room 6104, Indianapolis 9, Ind.

Please send me free book and outline of lessons.

Name

Street

City

PLASTICS

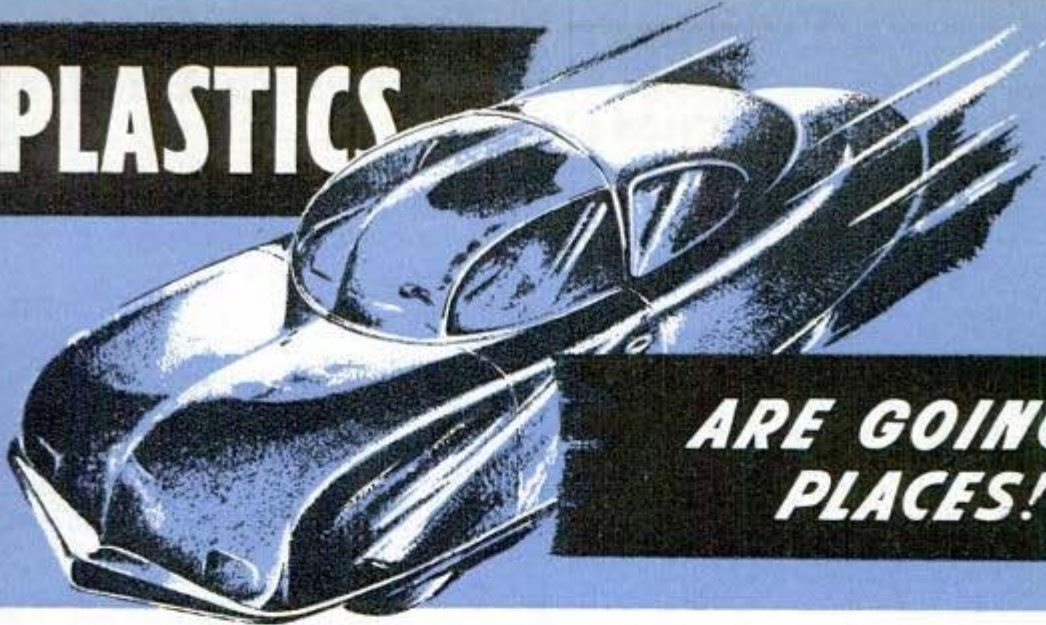

ARE GOING PLACES!

PREPARE **NOW** TO GO ALONG!

Plastics, already proved in war, demonstrate their many advantages and varied uses. Now the plastics industry looks forward to the postwar period when they will be used in countless new ways . . . improving old products, creating new ones. A growing industry needs men to grow with it. That's why plastics offer remarkable opportunities to persons of ambition and foresight.

LEARN AT HOME—You can learn plastics in your spare time at home without interrupting your present work. The Plastics Institute has developed a thorough, easy-to-understand course of training, requiring no previous technical experience. It offers complete, authoritative training based on industry requirements.

FASCINATING COURSE—The lessons are readily grasped and practical. Every step is made clear with graphs, diagrams, pictures. Actual specimens of plastics materials are furnished. A bi-weekly bulletin, "Plastics Trends," keeps you posted on new developments.

Dept. PM-10, 122 E. 42nd St., New York 17—Dept. PM-10, 221 N. La Salle, Chicago 1—Dept. PM-10, 186 S. Alvarado, Los Angeles 4

COMPREHENSIVE—Learn the various phases of plastics from this course . . . materials, designing, molding, fabricating, estimating and plant management. Acquire a basic knowledge of plastics that can be invaluable in preparing you to take your place in this great new industry.

EXCLUSIVELY PLASTICS—The Plastics Institute is America's oldest and largest plastics educational organization which devotes all of its facilities exclusively to plastics. It is held in high esteem by members of the plastics industry. Many of our graduates hold responsible positions in the plastics field.

START YOUR FUTURE—TODAY! Mail the coupon below now! We will send you an interesting booklet filled with valuable information on plastics and tell you how, at small cost, you can prepare for a career in this important industry. Don't put it off! Mail today!

SPECIAL RATES FOR SERVICE MEN

FREE BOOKLET

Send For It Today!



Plastics

INDUSTRIES TECHNICAL INSTITUTE

Plastics Industries Technical Institute

221 N. La Salle St., Dept. PM-10, Chicago 1

Mail in Envelope or
paste on penny postcard

Gentlemen: Please send me the booklet "World of Plastics" and information on your training program. I understand there is absolutely no obligation.

Name.....Occupation.....

Street.....Age.....

City.....Zone.....State.....

Veterans: Check here for special information.

If under 18: Check here for special booklet.

The Steady Pay Profession Good Times or Bad!

SCIENTIFIC CRIME DETECTION

FOLLOW
THIS MAN

Operator
No. 38



It Is Easy to Learn!

I will teach you this fascinating science during your spare time at home. It pays to be an expert in Finger Printing, Firearms Identification, Police Photography and Secret Service Methods. I have trained hundreds of men and women now successfully serving in identification bureaus throughout America. You, too, may quickly prepare yourself to become a well-paid valued officer of the law, often sharing in the generous rewards offered for wanted criminals.

FREE! 53 PER CENT

"BLUE BOOK OF CRIME"

This book is full of exciting information on scientific crimedetection. It will show how you can get started in a grand career. Now, at amazingly low cost. Clip coupon now... Mail it today.

of all Identification Bureaus in the U. S. employ students and graduates of I. A. S. A majority of these men are heads of Bureaus. Many of them knew nothing about crime detection before training with me. Now they have steady jobs, good salaries and a fine future. Write today for full particulars and free book. Give age.

INSTITUTE OF APPLIED SCIENCE

1920 Sunnyside Ave., Dept. 1357 Chicago 40, Ill.

INSTITUTE OF APPLIED SCIENCE

1920 Sunnyside Ave., Dept. 1357, Chicago 40

Gentlemen: Without any obligation on my part, send me the "Blue Book of Crime," and complete list of Identification Bureaus employing your students or graduates, together with your low prices and Easy Terms Offer. (Literature will be sent ONLY to persons stating their age.)

Name.....

Address.....

Age.....



SAVE WASTE PAPER



DRAFTSMEN NEEDED

Now



Industry is clamoring for more draftsmen for the job can't start until plans are drawn. Buildings, airplanes, machines, guns, tanks, bridges, all start on the drafting board, so it's no wonder that every good draftsman has a fine job. Yes, more draftsmen are needed NOW. The pay is good and the opportunities for advancement great.

Learn at Home in Spare Time

Begin now to turn spare hours into money. Be a draftsman, the connecting link between a mechanic and an engineer. Enjoy the wonderful opportunities for promotion that exist now. No experience or artistic talent is needed. You don't have to leave your present job while learning. Use spare time.

American School, Dept. DD745, Drexel Ave. at 58th St., Chicago 37, Ill.

Gentlemen: Send me FREE information covering special training in subjects checked below. No obligation on my part.

- | | |
|--|--|
| <input type="checkbox"/> Drafting and Design for Men and Women | <input type="checkbox"/> Electrical Engineering |
| <input type="checkbox"/> Cost Accounting for Mfg. | <input type="checkbox"/> Diesel Engineering |
| <input type="checkbox"/> Architecture and Building | <input type="checkbox"/> High School Course |
| <input type="checkbox"/> Automotive Engineering | <input type="checkbox"/> Plastics |
| <input type="checkbox"/> Business Management | <input type="checkbox"/> Mechanical Engineering |
| <input type="checkbox"/> Railway Training | <input type="checkbox"/> Aviation <input type="checkbox"/> Radio |
| | <input type="checkbox"/> Shipbuilding |

Name.....

Address.....

Do You Make Mistakes in English?

EVERY time you speak or write you show just what you are. Mistakes in English reveal you as a person who lacks education and refinement. Lack of language power prevents you from presenting your thoughts in the strongest possible way. No matter what you do, real command of English will help you to your goal. Stop making mistakes in spelling, punctuation, pronunciation. Increase your vocabulary.



WONDERFUL INVENTION

Only 15 minutes a day with Sherwin Cody's new invention—and you can actually SEE your English improve. It teaches by HABIT—makes it easier to do the RIGHT way. Wonderful self-correcting lessons include spelling, punctuation, grammar and expression.

FREE BOOK ON ENGLISH Lack of language power may easily be costing you thousands of dollars every year. See what Mr. Cody can do for you: it costs nothing to find out. Mail a postal card or letter this very minute for free book. "How You Can Master Good English in 15 Minutes a Day." It will prove a revelation to you. WRITE NOW. Address:

Sherwin Cody School of English, 510 Searle Bldg., Rochester 4, N. Y.

In Every Shop

Men Who Can Lead are paid well..

Lincoln Extension Institute offers instructions for shop leadership. The course combines the essentials of shop engineering with the development of personal power thru knowledge and handling of the human factors present in every industry.

Men with this training are invariably marked for promotion and bigger pay. More about this important training is told in "Getting Ahead in Industry," a booklet which will be mailed upon request. Address Mr. Louis S. Vostburgh,

LINCOLN EXTENSION INSTITUTE, INC.
West 75th St. at Detroit, Cleveland, Ohio



CODE-SENDING-RECEIVING-SPEED

Learn to send and receive Radio Code with greater speed. Stop nervous tension. Have confidence. Be proficient. Same system used by radiotelegraph specialists. Thousands of operators needed. Rush name for FREE book.

CANDLER SYSTEM CO., Dept. S-L, Box 328, Denver 1, Colo., U. S. A.

CARTOONING PAYS WELL

Exclusive instruction by a nationally known cartoonist makes it easy to learn at home. Write for details of the course. Please state age.

NATIONAL SCHOOL OF CARTOONING
423 Penton Bldg. Cleveland 13, Ohio

FREE Music Catalog

Over 1300 Standard, Classical and Teaching Pieces for piano, violin and voice in World Famous McKinley Sheet Music and Book Editions... the teachers' standard for nearly half century. Write today for FREE catalog. Dept. 3376. **McKINLEY PUBLISHERS, Inc., 1507 E. 55th St., Chicago**

WRITERS Your story or book, typed and revised as you desire it. Submit your manuscript in part for 500-word example copy and estimate of charge. No obligation. **TINNEY, 237 Centre St., Dallas, Tex.**

Learn PHOTOGRAPHY at Home

Splendid opportunities. Prepare in spare time. Easy plan. No previous experience needed, common school education sufficient. Send for free booklet "Opportunities in Photography", particulars and requirements.

American School of Photography
1315 Michigan Ave., Dept. 1357, Chicago 5, Ill.

START YOUR OWN SHOP

Men wanted now and after the war for Plastics, Auto-Diesel, Machinist, Drafting, Refrigeration, Welding, Body & Fender, Aircraft. Earn real money or be independent in your own business. Free booklet. Specify trade. State whether interested in Home Study or Practical Shop Training. **GREER, Dept. 2104, 2017 S. Wabash Ave., Chicago**

BETTER SIGHT

SIGHT-TRAINING technique improved. Everybody gets results now. WRITE: Dept. P-10 "USTI" 4057 Budlong Ave., Los Angeles 37, Calif.



Please send me your FREE Sight Chart with instructions.

Name.....

Address.....

**DO ANY JOB..
EASIER.. QUICKER**

MAKE MORE MONEY

in the **FIELDS of**

BIG OPPORTUNITIES

Here is the HELP YOU NEED . . . Now and After the War!

FREE TRIAL IN YOUR OWN HOME

Used by Army, Navy, Other Government
Depts., 200 Schools and Industrial Firms.

Get ready to meet keener job competition, now and when wartime jobs are over. Get into one of these big opportunity fields. Big money and many other advantages await you if you prepare now. Here is the help you need—EASY—QUICK—AT LOW COST. Thousands of men have already used these famous books. Beginners and experienced men alike have doubled and tripled their earnings with this help. You too, can now get the special knowledge you need for top pay, better jobs, or a business of your own. This is your GOLDEN OPPORTUNITY.

REFRIGERATION

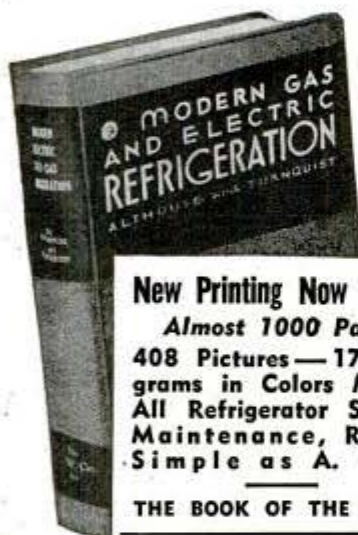

15 Million Refrigerators Need Service, Repairs

**New Printing Now Ready
Almost 1000 Pages
408 Pictures — 17 Diagrams in Colors Makes All Refrigerator Service Maintenance, Repairs Simple as A. B. C.**

THE BOOK OF THE HOUR

No new refrigerators being made. None for years. Millions must be kept going. Owners will pay big for competent service which will be needed more and more. Get MODERN GAS AND ELECTRIC REFRIGERATION, the non-technical guide to all types of refrigerators and get your share of this new profit. Get a job or start your own service business. This book will help you make money anywhere. Price \$5.00.

SEND NO MONEY

Select the Books YOU Need Now! We Ship C.O.D. Anywhere in U. S. and Will Refund Amount Paid if Not Satisfactory.

WELDING

AIRPLANE WELDING

New 2nd edition of this famous book by J. B. Johnson, Materials Division, Wright Field. The authoritative and practical book on Airplane welding and materials brought right up to date, 420 pages, 193 pictures. \$3.50.

MODERN WELDING PRACTICE

Newest book on all types of welding and heat treatment of metals. Written by recognized specialists in training men for production jobs. Practical and Non-Technical. Covers everything you need to know. Prepare for best pay jobs now. Price \$4.00.



430 Pages
277 Illus.
Practical and Non-Technical

HELPFUL BOOKS

Auto BODY and FENDER REPAIR

Owners will spend big money to keep cars looking new because few new cars available. Is a practical money-making guide, ideal for shop owners and every man who wants a share of the millions to be spent in keeping old cars looking new. 325 pages, 232 illustrations. Price \$3.00.

DYKE'S CARBURETOR BOOK

The standard guide for a generation. New edition covers engine tune-up, ignition, carburetion, fuel pump, valves, etc. 244 pages, 549 illustrations, \$3.00.

SHEET METAL LAYOUT

Makes sheet metal layout work so simple that anyone can learn. Get this new instructor and get into the easiest, cleanest and best paying part of all sheet metal work. 143 jobs worked out in drawings and carefully explained. Size of book 8 1/2 x 11 inches. Price \$3.00.

ELECTRICAL WIRING

Complete practical instruction on every phase of house wiring in one handy volume. Hand-book style. Gives National Electric Code, 400 pages, 669 illustrations. Electrical work will reach new heights after war. Get started now. \$2.50.

AUTOMOBILE WORK

Leading Auto Book for 32 Years

★ ★ ★

★ ★



World's Greatest AUTO BOOK

NEW 20TH EDITION
New Material on Transmissions, Trucks, Tractors, Diesels, Aircraft and Auto Engines

Over a half million copies of 20 editions of Dyke's have been sold. Gives specifications of old and newer cars.

Now with millions of cars needing repairs and thousands of men needed to do the work, you need the famous DYKE Auto Book more than ever before. Brand new 20th Edition covers all principles, construction, repair, adjustment, testing, troubles and remedies of all cars. World's biggest book value, \$6.00.

This big book, a complete auto library in one volume, has 1483 pages—4600 illustrations and diagrams—weighs 6 lbs.—equal to 4 ordinary books.

Mail Coupon to: Goodheart-Willcox Co., Inc.
2009 S. Michigan Ave. Dept. 18 Chicago 16, Ill.

SEND NO MONEY! Mail Coupon

GOODHEART-WILCOX CO.,
2009 S. Michigan Ave., Dept. 18, Chicago 16, Ill.
Send books checked, C.O.D. I will pay postman, plus few cents charges. If any book is not satisfactory I will return in 5 days and you will refund money paid you.

<input type="checkbox"/> Gas & Electric Refrigeration . . . \$5.00	<input type="checkbox"/> Sheet Metal Layout . . . \$3.00
<input type="checkbox"/> Dyke's Auto Book . . . \$6.00	<input type="checkbox"/> Electrical Wiring . . . \$2.50
<input type="checkbox"/> Dyke's Carburetor Book . \$3.00	<input type="checkbox"/> Body and Fender Repair . \$3.00
<input type="checkbox"/> Modern Welding . . . \$4.00	<input type="checkbox"/> NOT LISTED
<input type="checkbox"/> Airplane Welding . . . \$3.50	<input type="checkbox"/> Aircraft Sheet Metal . . \$2.50
	<input type="checkbox"/> Shop Math. (2 vols.) . . \$3.00

If remittance accompanies order we will pay all postage charges under same return privilege.

Name
Address
City State

AN INFANT INDUSTRY ... SUDDENLY MATURED PLASTICS

Get In at the Start—and Grow

Plastics is a new industry which the nation's war needs is forcing to quick maturity. Already Plastics are indispensable in practically every branch of the Service—Aircraft, Ordnance, Chemical, Marine, Signal Corps, etc. Opportunities? Nearly everything, from homes to clothing, from gadgets to tools, will be affected by Plastics.

Spare Time Training Now Ready

The time to get started is now. You can prepare at home, in your spare time, to take your place in an infant industry that even now is leaping into prominence. A new, practical training plan is now ready to help you realize your ambitions and build your future security. Act now. Don't delay. Mail this coupon today.

AMERICAN SCHOOL, Dept. P745
Drexel Ave. at 58th St., Chicago 37, Ill.

Send me FREE information covering special training in subjects checked below. No obligation on my part.

- | | |
|--|---|
| <input type="checkbox"/> Plastics | <input type="checkbox"/> Cost Accounting for Mfg. |
| <input type="checkbox"/> Electrical Engineering | <input type="checkbox"/> Automotive Engineering |
| <input type="checkbox"/> Drafting and Design for Men and Women | <input type="checkbox"/> Architecture & Building |
| <input type="checkbox"/> Diesel Engineering | <input type="checkbox"/> Shipbuilding |
| <input type="checkbox"/> Mechanical Engineering | <input type="checkbox"/> Business Management |
| <input type="checkbox"/> Aviation | <input type="checkbox"/> High School Course |
| <input type="checkbox"/> Radio | <input type="checkbox"/> Railway Training |

Name.....

Address.....

Flash! Amazing Opportunities NOW Open in these practical money-making trades watch and clock repairing



LEARN AT HOME—IN YOUR SPARETIME

Prepare for a happy future of prosperity, security...and get a big-pay job now. Fascinating, high-grade occupation. You can EARN WHILE YOU LEARN. Excellent field for part-time work at home.

COMPLETE COURSE in HOROLOGY

Thorough self-instruction training in American and Swiss watches, clocks. Special sections on alarm clock repairs. New, practical LEARN-BY-DOING instruction method. Learn QUICKLY, easily. No previous experience necessary. Watchmaking is basic

training for aircraft instrument work, and other scientific precision jobs.
Amazing LOW PRICE • MONEY-BACK GUARANTEE
Get into this fast-growing field NOW...big opportunities...don't delay. Mail coupon below for FREE information. There's no obligation.

locksmithing and key making

COMPLETE UP-TO-DATE COURSE

How to pick locks, de-code, make master-keys, repair, install service, etc. New, self-instruction lessons for every handy man, home-owner, carpenter, mechanic, service station operator, fix-it shop, hardware dealer, gunsmith.

53 EASY ILLUSTRATED LESSONS
Bargain Price! Satisfaction guaranteed or money back. Write now...no obligation!

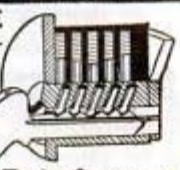

Free Details—Mail Coupon Today!

NELSON CO., Dept. 8K02, 321 S. Wabash Ave., Chicago 4, Ill.

Please send me—FREE and without obligation—illustrated Success-Catalog containing information about the course (or courses) I have checked below. No salesman will call.

Watch and Clock Repairing. Locksmithing and Key Making.

NAME.....

ADDRESS.....

CITY.....

STATE.....

Train Now
for **BEST
JOBS**

**REFRIGERATION
AND
AIR CONDITIONING**

Millions of Older Units Need Expert Service. Big After-the-War Expansion Will Create Even More Opportunities

WRITE FOR
FREE BOOK

NOW is the time to get ready for a top job and good pay in this big, fast-growing field. Slowed up by the war, a serious shortage of trained men exists in all branches. Thousands of men needed now and for big expansion in post war jobs. Amazing opportunities for men up to 60. This 28 year old school—for past two years exclusively training men and women for U.S.A.—will give you the practical training you need. Train at home—in our big shops—or a combination of both. No previous experience needed. Only common schooling required. Write for FREE book today. No obligation.

INDUSTRIAL TRAINING INSTITUTE, Dept. 28
2132-2158 Lawrence Ave. • Chicago 25, Ill.

LIQUID MARBLE Make beautiful artificial Marble slabs. Pour from liquid state. Glazed or un-glazed. Mottled, veined, snow-white, or multi-colored. Unsurpassed on kitchen or bathroom walls. Easy to make and install. **PLASTIC FLOORING.** Any color. Lifetime wear. Dustproof, Soundproof, Vermin-proof. Resilient to the tread. Lay out solid or in pattern design. **FLEXIBLE MOLDS** for plaster casting. Make your own molds for few cents each. \$1.00 in raw materials will make up to \$25.00 of finished goods. We furnish names of buyers. Write now for free information.
COMPO-TEX, BOX 786-S, ST. LOUIS (1), MO.

Good Handwriting
HELPS YOU WIN SUCCESS

It's so important to write a good hand for business and social advancement. Poor illegible penmanship often causes costly errors and marks you for failure. Why write a poor hand? It's so easy to learn at home in spare time. Write for our new free booklet today. If you wish, send 10c for a penpoint suitable for shaded writing and your name beautifully written.
THE TAMBLYN SCHOOL OF PENMANSHIP
In Business Since 1895 H-441 Ridge Bldg., Kansas City, Mo., U. S. A.

Correspondence Courses In **RADIO and ELECTRICAL ENGINEERING** **LOW AS \$25**

ELECTRICAL ENGINEERING. Get good grasp of wide electrical field. Modern. Very understandable. Theory made easy.
RADIO ENGINEERING. Extra fine course in radio, public address, photo-electric work. Trains you to be super-service man, real vacuum tube technician. Tuition ONLY \$25, either course. Deferred payment plan. Servicemen needed badly. Write for free copies of school catalogs, student magazines, etc.

FREE LINCOLN ENGINEERING SCHOOL, Box 61—P 70
LINCOLN, NEBR. (Formerly of Washington, D. C.)

ARTISTS MAKE MONEY

Find out your ability. Send name, age, occupation and address for Free Vocational Art Test.

ART INSTRUCTION, INC. (Formerly Federal Schools)
10134 Art Instruction Building, Minneapolis, Minnesota

ITALIAN ACCORDIONS

Hand Made. Very best. Lowest prices. Buy Direct from Factory and Save Money. Send name and address for FREE catalog.

ITALIAN ACCORDION MFG. CO.
323 W. POLK ST., DEPT. PM-10, CHICAGO 7, ILL.

BOOKS FOUND FREE!

WHAT BOOKS DO YOU WANT?
We quote lowest market prices. No charge for locating Hard-to-Find Books. All books. OLD or NEW mailed POST-FREE.
SEARCHLIGHT BOOK CLUB, 22 East 17th St., New York City

Become a Doctor of PSYCHOLOGY

Win the degree of Ps.D. Teach the secret of contentment, happiness. Solve mental worries. Experience the revelation of truth. Chartered college. Individual help. Write for FREE book. **COLLEGE OF UNIVERSAL TRUTH, 5153-B North Clark St., Chicago.**

Store Route Plan PAYS BIG MONEY

SELL COUNTER CARD PRODUCTS
Build a good-paying business of your own. Call on dealers of all kinds; show nationally-advertised Aspirin, Vitamins, Cosmetics and 200 other necessities. Big 5c and 10c retail packages, high quality. Attractive counter displays sell goods fast. Free book gives amazing facts. Write!
World's Products Co., Dept. 10-A, Spencer, Ind.





Have You Heard About My "HAVE-MORE" PLAN?

"A little land and a lot of living"

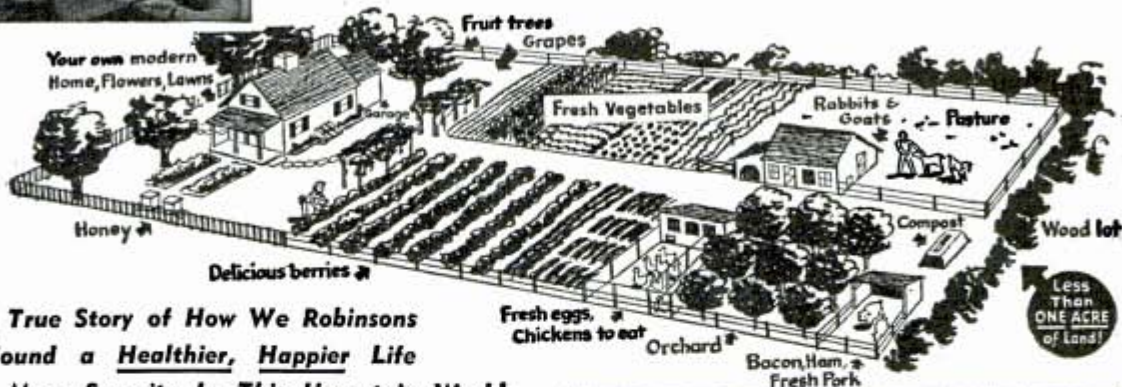

It's the True Story of How We Robinsons Have Found a Healthier, Happier Life ...and More Security In This Uncertain World

HOW YOU CAN DO IT, TOO!

The "Have-More" Plan is the story of our family and our place. It tells how we moved to the outskirts of town, how I've kept a regular, full-time job—how we grow most of our own food in part of our spare time—have fun doing it—have better health—more sunshine and fresh air—more peace and quiet—more security and independence—in fact more of just about everything that really counts in life!

IF YOU FOLLOW OUR PLAN HERE'S HOW YOU'LL BE SITUATED

You'll have a lovely home and an acre or so of land within a few miles of where you work. Your place will pay for itself as you go along—you will own it free and clear.

You'll have hardly any weekly grocery, meat and milk bills. With the small scale, modern, labor-saving methods we'll show you, you can raise up to 75% of all your family food—do it all in about one hour of chore time a day—and find real pleasure in doing it!

Your family can become truly self-reliant. You can be healthier and happier. You need never worry very much about losing your job. You can retire years sooner, if you want to, and if you will put away enough to be assured of just a small regular income!

OUR PLAN IS \$1.00

We'll send you our Plan if you write us and send one dollar. We wish we didn't have to charge anything for our Plan—but it does cost money to get things printed, mailed, etc.

Anyway, we've kept the price just as low as we possibly could.



Mrs. Robinson and our son, Jack. The home-raised goose I'm holding weighed 10 1/2 lbs. at 10 weeks of age. All the food it ate was stale bread and grass growing around our place.

If, after you look over the Plan, you aren't pleased and delighted, we'll gladly send your money back.

A GRAND WAY TO LIVE! If You Have a Full-Time Job:

You can easily work out the "Have-More" Plan in an hour or so of spare time a day. You can have a beautiful little place near your job. (There are hundreds of such places near every city.) If you work long hours and don't have time to do the whole Plan at present, you can do part of it in as little as 15 or 30 minutes a day. Even so you can have all the health, happiness and security of this kind of living. You can have a fine garden, beautiful flowers—get your fruit trees, berries, asparagus and rhubarb started, perhaps even have a few chickens.

This way of living is especially good for children. You can get your place all paid for and have that wonderful sense of security and independence knowing that you and your family have your place to fall back on—that you could get by with very little cash income if you ever had to.

If You Have a Part-Time Job:

If you work short hours, such as 40 hours a week or less, you can get all the more benefit out of the Plan. Perhaps in your work you have several days a week free or perhaps several weeks or months a year free. If you have a place like ours you can invest that free time in your own future security.

If You Are Planning to Retire:

Or if you are already retired, you can see that this Plan is a very practical way to stretch your retirement income and to help keep yourself in better health. This way, if you are going to receive Social Security benefits, or with just a small pension or annuity, you can look forward to many years of happiness and security. We've heard from lots of folks from Vermont to California who are doing just this right now!

If Your Income Is Limited:

This Plan is all the more for you if your income is limited. You can start with as little as \$50 cash.

Honestly, this Plan can be the way for you to have more of the really worthwhile things in life—if you'll just turn loose and get started! So sit down this minute and write me. Just put a dollar bill in an envelope with your name and address.

Right now is not only a good time to get started, it's an excellent time to make your plans for the future.

Yours for "a little land and a lot of living."

Ed and Carolyn Robinson
Box 2710, Noroton, Conn.

OUR PLAN TELLS HOW

Over 50,000 Words; 73 Illustrations

My "HAVE-MORE" Plan is clear-cut diagrams, pictures, easy-to-understand directions, tables, charts, etc. It shows just how we have applied the most modern, easy, practical labor-saving methods at our place—how you can easily do the same:

FINDING A PLACE

How to rent or buy the right kind, near your job, for as low as \$30, \$40 a month. (If you don't already have a place.)

FRESH VEGETABLES

A wonderfully bountiful garden with a lot less work.

TASTY CHICKEN

Broilers and roasters at 16¢ a pound. It's simple to raise chickens—using the new, easy methods.

FRESH EGGS

All you want with only 7 minutes a day care of the hens.

DELICIOUS RABBIT MEAT

At only 8¢ a pound even if you buy much of their feed instead of raising it yourself.

MILK, BUTTER, CREAM

Goat's milk tastes better and is worth twice what Grade A homogenized cow's milk costs. Yet a goat costs only one-seventh as much as keeping a cow.

PIGS ARE EASY

It is easy to turn surplus vegetables, etc., into 150 pounds of luscious ham, pork chops, bacon, sausage!

GEESE, TURKEYS, SQUABS, DUCKS

Easy, interesting and mighty good eating!

LOVELY FLOWERS

For mother.

EASIER PRESERVING

How to preserve and quick freeze vegetables, fruits, meats and dairy products with new, amazing methods—that taste far better, too!

HONEY BEES

75 pounds of delicious honey—from only one hive and only 10 minutes' work per week.

EXTRA INCOME

Selling your surplus crops. (If you ever have to or want to, you can go right on from my "Have More" Plan to full-time farming.)

FRUIT TREES

How to choose and care for them so that they will bear years sooner.

GRAPES, BERRIES

Your investment back each year—and they are awful good eating!

LOT'S MORE

There isn't room to tell all about here. It's how you can have more—more security, better food, better rest, more fun, more of just about everything that makes life worth living!

If You Already Have a Place

Maybe you'd like to "compare notes" with us. Our Plan is laid out step-by-step, subject-by-subject, with lots of actual photographs of our place, diagrams, charts, tables, drawings. It shows how we do things the easiest, latest, most practical and scientific ways we can find. Who knows, maybe we can show you some short cuts, new methods, help you get better results. Just one new, good idea would be worth a lot more than the price of the whole Plan—and you'll have a lot of fun comparing your methods with the way we do things!

Do You Want To See Our Plan?

If you do, just put a dollar bill or dollar money order (if bank check, \$1.05) in an envelope with your name and address and turn it over to Uncle Sam's mailman. We'll send you our copy of our Plan by return mail. If for any reason you aren't pleased with it, let us know and we'll refund your money without delay and without question. Address:

ED ROBINSON, BOX 2710, NOROTON, CONN.

Your name

Address

Keep that "TICKING" Car



858 PAGES
1500 ILLUSTRATIONS



Every operator and mechanic needs AUDELS AUTO GUIDE.

This book saves time, money and worry. Highly endorsed. It presents the whole subject of auto mechanics:

- 1—Basic principles
 - 2—Construction
 - 3—Operation
 - 4—Service
 - 5—Repair
- Handy Size, Easily understood.

NEW FLUID DRIVE, HYDRAULIC SHIFT AND DIESEL ENGINES FULLY COVERED

Over 1500 pages—1540 illustrations showing inside views of modern cars, trucks and buses with instructions for all service jobs.

4 ASK TO SEE IT!—To Get This Assistance for Yourself Simply Fill in and Mail Coupon Today.

COMPLETE • PAY ONLY \$1. A MONTH

AUDEL Publishers, 49 West 23rd St., New York MAIL AUDELS NEW AUTO GUIDE for free examination. If O.K. I will send you \$1 in 7 days; then remit \$1 monthly until price of \$4 is paid. Otherwise I will return it.

Name.....

Address.....

Occupation.....

Employed by..... P.M.

Learn this Profitable Profession



IN 90 DAYS AT HOME

Money-Making Career Open to Men and Women, 18 to 50

Hundreds of men and women between 18 and 50 make \$10 to \$20 in a single day giving scientific Swedish Massage and Hydro-Therapy treatments. There is big demand from doctors, hospitals, sanatoriums and clubs. Graduates earn large full time incomes from these or in private practice in their own offices. Others make good money from home treatments given in spare time. Learn this interesting, money-making profession in your own home, through our home study course. Same instructors as in our nationally known resident school. You can win independence and prepare for future security by qualifying for your Diploma. Course can be completed in 3 to 4 months. Many earn while they learn. Begin your training at once.

Anatomy Charts & Booklet FREE

Enroll now and we will include, at no extra cost, many needed supplies. Fit yourself to help meet growing demand for massage now and after the war. Send the coupon at once for complete details, Anatomy Charts and 32-Page Illustrated Booklet, FREE, postpaid.



THE COLLEGE OF SWEDISH MASSAGE
Dept. 764, 100 East Ohio St., Chicago 11, Illinois

Please send me FREE and postpaid, Anatomy Charts, 32-page Booklet and complete details on Home Training.

Name.....

Address.....

City..... State.....

WANTED

SUB-CONTRACTS FOR THE MANUFACTURE OF HIGH-PRECISION PRODUCTS

This Company, with 2 modern factories, and 1,300 employees, at present engaged in the most exacting type of high-precision war production, is interested in products or units requiring high-precision and skill for post-war production.

Write New Products Division, Dept. PM10

THE MB MANUFACTURING CO., INC.
NEW HAVEN, CONN.

PRINT ANY PHOTO

on Paper, Cloth, Leather or Wood

SIMPLE, EASY TO USE

Magic liquid takes only 2 minutes to reproduce any snapshot you have on to stationery, handkerchiefs, ties, scarfs, etc. Won't wash off. Won't hurt negative or fabric it's used on. Personalize your belongings! An ideal gift. Complete outfit enough to transfer 100 photos—only \$1.00 postpaid. Sent C.O.D. for \$1.30.

CHRISTY PHOTO SUPPLY, Dept. 610
2835 N. Central, Chicago 34



"The Book They're Talking About"



ART ANATOMY & FIGURE DRAWING

For the amateur and professional artist. Contains over 350 illustrations, charts and notes, giving detailed study of every part of the body. POSED and IN ACTION. CANADA, \$1.25 Price Only \$1
ENRIGHT CO., Dept. 40-B, P. O. Box 45, FOREST HILLS, NEW YORK

YOUR BOY

May be another Edison, Ford or Luther Burbank. Help him start a laboratory today. Edison worked with crude home-made apparatus. Your boy can get the finest materials available, at low cost. Send 10c for catalogue for Chemistry, Physics and Biology Supplies.

NATIONAL SCIENTIFIC CO.

2204 W. North Ave. Dept. 11 Chicago 47, Ill.

JIU-JITSU HOW TO BECOME REAL EXPERT

Send 10c for trial lesson and details. Age must be 15 or over.

MODERN SCHOOL JIU-JITSU, 5 W. 52 St., N. Y. C. 19

PLASTICS

Resident Engineering Courses, VET-GRANTS free if qualified, 2000 hours, 50 weeks, tuition \$900. Study in the HEART of the Plastics Industry—within walking distance of Bakelite, duPont, Celanese, etc. Founded 1910.

NEW YORK TECHNICAL INSTITUTE (of N. J.), 150 MARKET ST., NEWARK, N. J.

FIBRE ARMS AND LEGS!



Light, correctly fitted, strong and comfortable. Natural appearance. Braces for all deformities. Scientific design. Fair Terms.

BUCHSTEIN-MEDCALF

610-3rd Av. S., Minneapolis, Minn.

Now... OPPORTUNITY KNOCKS



... the right kind of
"know-how" will
OPEN THE DOOR

Get ready now! When jobs are being re-shuffled for peace-time production, new opportunities will open up for men who have the right training. The books described below are written by practical experts in their field to help you get ahead and make more money.

TURRET LATHES: This book simplifies a seemingly complicated machine so that a beginner can learn much about it quickly. Detailed descriptions illustrated with many photos show clearly the necessary tool set-ups for specific jobs. Cutting tools, sharpening methods for them and precision measuring tools are thoroughly covered. 75 illustrations.Price \$1.50

ENGINE LATHES: This is a book that will help you to understand and operate this universally used machine tool. In simple, understandable language it gives you all the essential elementary steps, describes the necessary cutting tools used and tells you how to sharpen them. Micrometers, verniers and other precision measuring tools are covered. Set-up work is explained. Over 200 photos and drawings.Price \$1.50

SHAPERS: Both apprentice and seasoned worker can benefit by reading this book. It explains the various types of shapers, the different shaper cutting tools, their place in modern machine shop practice and tells how to grind them for specific types of work. Over 100 illustrations.Price \$1.50

PLANERS: Expert planer hands are among the highest paid mechanics in any machine shop. Here is a book that will be of great value to either beginners on this machine or to the skilled machine shop operator who wishes to advance by learning the operation of another machine tool. 206 pages. Over 100 illustrations.Price \$1.50

MILLERS: Operators for these machines are always in demand. This book covers every important phase of the work on these machines. It is of great value to anyone who is either a specialist in the operation of this machine or wishes to become one. 405 pages. Over 150 illustrations.Price \$1.50

AIRCRAFT ENGINES: Here's a book that gets to the point quickly . . . helps you to understand the intricate mechanism of aircraft engines without getting you all tangled up with engineering technicalities. Contents include: principles of internal combustion engine, types of engines, their requirements, construction, cooling and lubrication systems, fuels, carburetors, ignition, servicing and propellers. 392 pages, over 200 illustrations.Price \$1.50

DRILL PRESSES: In this new book, the principles in design and operation of drill presses are fully explained. Various types of sensitive, multiple spindle and radial type drill presses are covered. Also the selection of proper drills for any job, proper methods of drill grinding, correct speeds and feeds for drilling various kinds of metal, plastics and other materials. Many valuable tables. Over 75 photographs and drawings.Price \$1.50

MICROFILMING: This modern method of compressing bulky papers and vital records on tiny strips of film, offers dazzling opportunities for profitable employment. The author is the technical director of a nationally known microfilming organization. He writes about the subject clearly, completely and in an interesting manner. Over 100 illustrations.Price \$1.50

YOUR WORLD TOMORROW: New materials, new products, new ways of doing things . . . these are some of the things that will make your world tomorrow totally different from the one you know now. This book shows you clearly with words and pictures how the shape of things to come will effect your life. It tells you how to fit into this new world and how you can prepare yourself for a better job in it. 252 pages and close to 100 beautiful illustrations.Price \$2.50

ESSENTIALS OF ARITHMETIC: Here, in compact, easy-to-understand form, are the common, everyday problems that meet the needs of the working man. It thoroughly covers shop arithmetic and is designed for the man who has to meet practical problems. This book will give you the basic key to successful shop work.Price \$1.50

SEND NO MONEY!

Essential Books, Dept. 321
270 Madison Ave., New York 16, N. Y.

Please ship the books I have checked below. I agree to pay the postman the price listed below, plus a few cents postage. I MUST BE SATISFIED or I will return the books within 5 days and you will refund the purchase price.

- | | | | |
|--|--------|---|--------|
| <input type="checkbox"/> Turret Lathes | \$1.50 | <input type="checkbox"/> Aircraft Engines | \$1.50 |
| <input type="checkbox"/> Engine Lathes | 1.50 | <input type="checkbox"/> Drill Presses | 1.50 |
| <input type="checkbox"/> Shapers | 1.50 | <input type="checkbox"/> Microfilming | 1.50 |
| <input type="checkbox"/> Planers | 1.50 | <input type="checkbox"/> Your World Tomorrow | 2.50 |
| <input type="checkbox"/> Millers | 1.50 | <input type="checkbox"/> Essentials of Arithmetic | 1.50 |

NAME
(please print)

ADDRESS

Check Here if you wish to enclose your check or money order for each book ordered, thus saving delivery charges. (Same money-back guarantee, of course.)



ORDER NOW!



You Can Do "BIG PAY" Welding Jobs with this HOBART

Wide Range
of 1000
Welding Steps
Remote Control
Polarity Control

It's Simplified! Why wait until after the war to start that job welding shop you have been planning on for so long? Get your Hobart "Simplified" Arc Welder today and cash in on some of those "BIG PAY" welding jobs now open. You can have an established business ready for that post-war period.

HOBART
"Simplified"
ARC WELDERS

Write today for best possible delivery, priority you will need, and special Hobart Plan.
HOBART BROS., CO., Box M-104, Troy, O.

"One of the World's Largest Builders of Arc Welders."

HUNTING and FISHING

is a monthly magazine crammed full of hunting, fishing, camping, dog and boating stories and pictures, invaluable information about guns, fishing tackle, game law changes, best places to fish and hunt—countless ideas that will add more fun to your days afield.

SPECIAL TRIAL OFFER
Send 25c in stamps or coin and we will send you *Hunting & Fishing* for six months.

HUNTING & FISHING MAGAZINE
251 Sportsman's Building
Boston, Massachusetts



Choose Your Job in These
Big Pay Fields
Send Name and Address
for Vital Facts Today

Get ready now. Meet keener job competition. Prepare for permanent success in after-war days in one of these three big opportunity fields—certain to be tops in good jobs and better pay for many years to come. This 28 year old school will train you easily and quickly in your own home or in its big Chicago shops to fill any of hundreds of different jobs. Get the facts. Write today.

INDUSTRIAL TRAINING INSTITUTE, Dept. 48
2132-2158 Lawrence Ave. Chicago 25, Ill.

Always write your name and full address clearly when answering advertisements.

BENJAMIN

H-C PELLETS ARE AVAILABLE
at dealers or direct. Cal. 22 and Cal. 177. Production of all models Benjamin Air Rifles and Benjamin Air Pistols has been suspended for the duration as our facilities are engaged in War Work. **WRITE FOR OUR ILLUSTRATED PRICE LIST OF POST WAR MODELS TODAY.**
BENJAMIN AIR RIFLE CO., 812 Marion St., St. Louis, (4) Mo.

ELECTRICITY
Year 'round, all-time good pay field. Dozens of different branches.

REFRIGERATION
Serious shortage of trained men now. Thousands more to be needed.

ELECTRONICS
The newest field of big opportunities. Vital and exciting.

"730 SHAVES FROM 1 BLADE" AMAZING NEW BLADE SHARPENER



New sharpener for all makes of double-edge razor blades performs miracles! "Not necessary to change blades," writes one user. Another says, "I have used 1 blade over 700 times." **HAZOROLL** really sharpens blades because it strops on leather. Gives keen, smooth shaving edges. No guesswork. Blade held at correct angle and proper pressure—automatically. Just turn crank to sharpen blade. No gears. Well made. Handsome, compact, sturdy. Weighs few ounces. Will last years. Makes ideal gift.

Only \$1.00

SEND NO MONEY! Write today. Pay postman only \$1 plus few cents postage. Use **HAZOROLL** for 5 days and if you're not delighted with smooth, velvet shaves you get, return **HAZOROLL** and we'll return your dollar. **Harry—order today. RAZOROLL COMPANY, 620 North Michigan Avenue, Dept. 5010, Chicago 11, Illinois**

WE MEND MEN BY AUTO-MATIC FIBRE-LITE ARMS & LEGS
With Soft, Adjustable COMFORT SOCKETS. TRUSSES, BRACES, BOX, SUPPORTS. **WORMAN CO., 310-P, THIRD AV. SO. MINNEAPOLIS-15, MINN. U.S.A.**

BE A PERFUME DISTRIBUTOR!
Sell reproductions of world-famous, imported perfumes and get in on the now bigger than ever year around demand for this merchandise. Eye appealing packages assure you big daily cash profits. Many millions of dollars worth of perfumes sold annually. Get started at once with us—your profits are waiting! But get started! Send for free details and sample TODAY! **DUCHES D'ANDRE, Dept. 14-D, 145 No. Clark St., Chicago 2, Ill.**

Learn to Service and Repair ELECTRICAL APPLIANCES
Open your own electrical appliance service shop. Complete illustrated course covering house wiring, motor repairs, house appliance repair. **FREE BOOKLET. APPLIANCE SERVICE, 4701 W. Pico, Dept. AS-10, Los Angeles 6**

PATENTS AND TRADE MARKS C.A. SNOW & CO.
Registered Patent Attorneys Since 1875
Write for Free Book and "Certification of Invention" form
427 SNOW BUILDING, WASHINGTON 1, D. C.

PATENT YOUR IDEAS NOW TO OBTAIN A PATENT
SEND FOR FREE BOOK
Written by Former Member Examining Corps (1923-34) U. S. Pat. Office.
CARL MILLER, Registered Patent Attorney
Former Member Examining Corps U. S. Patent Office
Woolworth Bldg., Dept. 104-A, New York — Bond Bldg., Dept. 104-A, Washington, D. C.

To PROTECT YOUR INVENTION Use this coupon, NOW

Delays are dangerous and may be very costly. My personal service assures prompt action, strict confidence, and a minimum of expense. I suggest that you send me a model or drawing, or sketch and description of your invention, and \$5.00. I will make a search and report

promptly as to its patentability and send you a copy of my 72-page booklet. Or, if you prefer to read my booklet first, mail the attached coupon at once. I will also send my "Record of Invention" form. (Over 40 years experience as a Registered Patent Attorney.)

L. F. Randolph, 302-D Columbian Bldg., Washington, D. C.
Please send me at once, free of charge, your 72-page booklet and "Record of Invention" form.

Name.....
Address.....

A PERSONAL CONFIDENTIAL PATENT SERVICE

It's Fun to Draw

A COMPLETE SELF-INSTRUCTION COURSE AND REFERENCE BOOK
with over 1000 "How-to-do-it" SKETCHES AND DRAWINGS
9 Sections—a \$9 Value All for only \$1.00



ANYONE WHO HAS LEARNED TO WRITE, can learn to draw! This helpful book removes the mysticism that has surrounded art. By reducing the elements of drawing to its simple steps, it teaches THE BEGINNER to draw, and then takes him by easy instructions, into advanced subjects.

AS YOU CAN SEE from the above illustrations—this complete course covers 9 BRANCHES OF PRACTICAL ART. No previous knowledge on your part is expected. Within a few days you will be drawing with an ease and enjoyment you never thought possible. For the professional artist, it is a REFERENCE BOOK and veritable mine of information.

THIS BOOK GUIDES YOU from the first stroke on paper to selling the finished art work. Includes specific instruction, advice, tricks, time-savers, special effects, on: Still Life, Animals, Anatomy, Human Figure, Faces and Portraits, Lettering, Advertising, Cartooning, Animated Cartooning, Commercial Art, Illustrations for Newspapers, Magazines, Books, Book Jackets, The Use of Color, etc. Teaches you by sketches and instructions, how to draw:

—hands, feet, heads, bodies, ears, noses, mouths, eyes—in different positions, of different sexes and ages, and with different perspectives. Shows you how to attain and indicate:—action, proportion, balance, composition, shading; and how to express:—laughter, anger, terror, grief, surprise, and other emotions. Also how to originate and draw caricatures, cartoons and comic drawings. Also how to letter, with 37 COMPLETE ALPHABETS shown. Includes a glossary of Art Terms, Types of Work, etc. Profusely illustrated with over ONE THOUSAND Instructive and Example Drawings, Sketches and Pictures.

Ordinarily a course of this scope costs much more money, but to make it available to everyone seeking a practical knowledge and enjoyment of Art, we have disregarded costs and precedents, and have established the special low price of **ONLY \$1.00 FOR THE COMPLETE COURSE. NOTHING ELSE TO PAY!** "IT'S FUN TO DRAW" is undoubtedly the greatest bargain in the art world today!

You take absolutely no risk —
so mail coupon NOW!

EXAMINE IT FREE! MAIL COUPON NOW!

ONLY
\$1
for the
complete
course!

Merely mail the coupon below. When your copy of *It's Fun To Draw* arrives — read and test it for 5 days. If, after this examination, it hasn't opened up new paths of

fun and artistic ability for you — return it, and it won't cost you a single penny. If you decide to keep it, the FULL PRICE is only \$1.00.

**KNICKERBOCKER PUB. CO., Dept. X702
120 Greenwich St., New York 6, N. Y.**

**KNICKERBOCKER PUB. CO., Dept. X702
120 Greenwich St., New York 6, N. Y.**

Rush me a copy of "IT'S FUN TO DRAW". If it hasn't opened up new paths of fun and artistic ability for me, I may return book and get my money back.

I enclose \$1.00 in full payment. Send postage.

Send C.O.D. I will pay postman \$1.00 plus postage.

Name.....

Address.....

City & State.....



HUNTERS! LEARN NOW AT HOME to MOUNT BIRDS



Animals, Game-heads, Fish, Pets and to Tan Skins. Save your valuable trophies. Kill only a FEW game birds but **DOUBLE** your interest and pleasure in hunting.

MEN, BOYS! Be an expert taxidermist! Learn quickly **BY MAIL**, from our simple lessons. A wonderful, profitable hobby for expert hunters and **ALSO FOR BOYS** and **YOUTHS** on farm or in city.

FUN • FASCINATION • PROFIT

Have a Home Museum

SPORTSMEN, YOUNG AND OLD. Here is the **grandest hobby** in the world for Hunters, Anglers. If you **EVER** hunt or fish, even seldom, **YOU** will be delighted with **taxidermy**. Save those wonderful trophies; mount them just like life, and create a **home museum** that will amaze family and friends and make you **well known and popular**.

Help Save the Game

Shoot fewer specimens, **yet double your fun**. Help save the disappearing wild-game. Join **"DUCKS UNLIMITED"** in wild-game preservation. Shoot only a **FEW** wild-ducks, mount them for your den or home and have **MORE PLEASURE** than you ever had by killing the bag limit. Help keep wild-game **forever**. **"Eat your trophy and have it too."**

WHAT YOU LEARN

Our simple lessons teach you **QUICKLY**, right in your own home in your spare time, to **MOUNT**—beautifully and permanently, **BIRDS, ANIMALS, GAME-HEADS, FISH**, just like museum exhibits. You will also learn the wonderful **KROME-TANNING**. You can then **TAN** fine furs for garments, also skins into real leather. Write today.

LESSONS WORTH \$1,000.00

E. J. Riordan says: "I am more than delighted. My friends are amazed and urge me to mount their specimens. I think your course is worth a thousand dollars, yet it is **priceless to sportsmen**. I am known everywhere as a **"taxidermist"**, and earn fine profits in my spare time mounting for other sportsmen. All thanks to your great school."



HE AND PARTNER SUCCEED

John M. Sizsle writes: "I and Bob, my partner, who is only 14 years of age have mounted more than 50 specimens. I shall send you a picture of our "museum" which is becoming famous. We learned quickly from your simple lessons, in spare time. Your great school is doing a wonderful job. All sportsmen should join it."



MEN, BOYS, Send Today! Don't delay. Obtain your **FREE BOOK** before the supply is exhausted. . . nothing like it in the entire world. **Write Now. A Postal will do.**

NORTHWESTERN SCHOOL OF TAXIDERMYS
3377 Elwood Bldg. Omaha 8, Nebraska

300,000 STUDENTS

This vast number of **MEN, BOYS AND WOMEN** are delighted members of the famous, reliable 35 year old sportsmen's school. Think of that! They are located all over the world. **YOU are invited** to join this grand throng. **Send for the FREE BOOK** this very minute.

Sportsmen, Boys

All hunters OF COURSE save their trophies now-a-days. The school **INVITES THE BOYS TOO**; boys as young as 12 or 13 years succeed in Taxidermy. **Get the FREE BOOK**, join the school.

BIG, EASY PROFITS

Mount and Tan for others. Work comes from far and near. Many students earn fine **PROFITS** from spare time. **SO CAN YOU. RUSH THE COUPON.**

Wild-Game Not Needed

Mount squirrels, rabbits, pigeons, frogs, chicks, crows, hawks. Make craft-work: book-ends, door-stops, gun-racks hundreds of valuable and delightful creations. **What a Hobby for you!**

FREE BOOK!

Yes, **FREE**, 44 pages, with 100 unique pictures of taxidermy work. No other book in the world like this. It will thrill and amaze you. **Ask today for your free copy. State your AGE.**

Send the Coupon!

Write name plainly in coupon or margin, or a post card will do. **Rush** your request, as **free books** may be exhausted quickly. **Decide now.** Don't wait a moment. **State your age.**

FREE BOOK

Northwestern School of Taxidermy, 3377 Elwood Bldg., Omaha, Neb. Send me your free illustrated book "How to Mount Game". Also tell me how I may learn this fascinating art easily and quickly by mail. No obligation. State your age.

Name _____ Age _____
Address _____



**WORLD'S
BEST
WANT AD
MEDIUM**

CLASSIFIED Advertisements



Advertisements in this section, 35 cents per word, each insertion, minimum 10 words, payable in advance
To be inserted under proper classification in November issue, copy should be in our office October 4th
November issue on sale November 1st
Popular Mechanics Magazine, 200 East Ontario Street, Chicago 11, Illinois

AUTOMOBILES—MIDGET CARS

STREAM Automobile book "The Modern Steam Car." Complete history steam cars old and new, 100 pages, 51 illustrations. Boilers, generators, engines, bodies, valves, condensers. Early models illustrated, described. Stanley's history by Mr. Stanley. Unique, interesting, historical book. \$2.00 postpaid. Clymers, 2125 W. Pico, Los Angeles 6, Calif.

"AUTOS Of Yesterday," neat packet 20 genuine photographs of 1900 to 1915 model automobiles. 25c each packet, 5 for \$1, postpaid. Lloyd, 1411-G Northwest 17th, Oklahoma City 6.

GASOLINE Age. 360 pages. Wonderful book history automobile business in America. Start of Dodge Brothers, Ford, Nash, Durant, Chrysler, Willys, others described, illustrations. Contains list of over 1500 American makes automobiles once manufactured. \$3.00 postpaid. Clymers, 2125 W. Pico, Los Angeles 6, Calif.

SEE Our advertisements under Motorcycles Classification. Clymers, 2125 W. Pico, Los Angeles 6, Calif.

CUSTOMIZE Your automobile. Illustrated new restyling ideas, instructions, suggestions, specific model changes by simple methods. \$1. Speed Wheel, Box 723-0, Arcadia, Calif.

AUTOMOBILE Books. "Racing photo album" 110 photos, exciting crashes, world's greatest race cars, drivers described. \$1.50. "Saga Roaring Road" 181 pages, 16 pictures. Starter Fred Wagner's early racing experiences with world famous drivers, cars described. Read about Rickenbacker, Murphy, Burman, DePalma, Ford "999", Oldfield's Benz \$2.50. Automobile racing book \$1.10. Prices include reprints, illustrations, drawings army Jeep and German BMW war motorcycles. All postpaid. Clymers, 2125 W. Pico, Los Angeles 6, Calif.

PROFESSIONAL Midget racers, motor-scooters, midget cars. Parts, plans. Handbook catalog—50 illustrations, plans—20c. Midwest, 2557 Charlestown, Toledo, Ohio.

POWER And Speed! World's most famous motor book. 110 large pages. 200 illustrations racing automobiles, motorcycles, airplanes. World's speed record chart, articles by world's famous speed kings Cobb, Eyeston, Campbell, Bonneville record details, photos British racers. Describes cams, compression, valves, superchargers, international racing teams, German Auto-Union, Italian, French, British racer specifications, drawings. \$2.50 postpaid. Clymers, 2125 W. Pico, Los Angeles 6, Calif.

"TIPS On buying or selling a used car" booklet 25c. Walters, 1291 Alameda, Detroit 3, Michigan.

TIME Magazine said "Floyd Clymers's Motor Scrapbook is a 'must'." This unusual historical, education, humorous scrapbook illustrates early automobiles, motorcycles, airplanes. Read about "V-8" Chevrolet, 1908 Plymouth, Ford "2" and "6," three and five cylinder automobiles, Rambler, Maxwell, Metz, Knox, Sears, steamers, electric, foreign machines, 240 others. Motorcycle section includes Pierce "4", Merkel, Pope, Thor, Emblem, Excelsior, Henderson, Ace, Cleveland, Indian, Reading, Harley, steam and front drive motorcycles. A laugh on every one of 160 pages. Postpaid \$1.50. Clymers, 2125 W. Pico, Los Angeles 6, Calif.

AUTOMOBILE Racing book, fifth edition, well illustrated. Instructions on building bodies, frames, engines. Ford A and B conversions. Plans. AAA rules, specifications. Roadster racing, Indianapolis cars. \$1.00 postpaid, \$1.30 C.O.D. Ray Kuns, Dept. 47, Madisonville, Cincinnati 27, Ohio.

SIR Malcolm Campbell's book of famous motorists! 176 pages. 42 beautiful photographs world famous racing automobiles, drivers. Campbell describes famous race tracks, his American records, European road races, his competitors. Interesting, sensational. \$3.00 postpaid. Clymers, 2125 W. Pico, Los Angeles 6, Calif.

INTERESTING, Educational, illustrated English "Motor" magazine on foreign automobiles. 50c postpaid. Clymers, 2125 W. Pico, Los Angeles 6, Calif.

STEAM Automobiles! Send 25c for literature listing names 90 different makes steamers once manufactured. Illustrations, descriptions, specifications, Stanley, White, Doble, Lane, Ross steamers, boilers, engines also photos famous White Racer "Whistling Billy" and world's record holder Stanley Racer. Interesting, educational, ancient steamer history. No cars for sale. Clymers, 2125 W. Pico, Los Angeles 6, Calif.

FAREWELL To Model "T". Humorous book with cartoons, illustrations, description car, engine, chassis, first and last Model T Fords manufactured. Folder includes page on German Jet Propulsion Opel automobile. \$1.50 complete postpaid. Clymers, 2125 W. Pico, Los Angeles 6, Calif.

1944 **IGNITION** Supercharger \$3.50. Fast starting, mileage, pep. EG Sales Mfg. Co., 60 John St., New York.

AUTO SUPPLIES AND EQUIPMENT

V-8 AND Mercury dual muffler sets \$20.00. Genuine steel wool packed mufflers with mellow tone. Gives less back pressure, more power and more gasoline mileage. Also single steel wool pack muffler for any car. Fits in place of regular muffler. Single V-8 Ford, Chev, Plymouth, Pontiac, etc., \$5.00. Buick, Dodge, Chrysler, etc., \$7.00. For 7 years manufacturers of California's best tone mufflers. Sandee Muffler Co., 7523 So. Western Ave., Los Angeles 44, California.

INVENTION Uses kerosene to run motors. Circular on plans. Rush name. Houston Maupin, Tipp City 30, Ohio.

USED New and rebuilt parts for all cars, transmission, rear end, mufflers, etc. Write for prices. Marshall Auto Parts, 5421 W. Diversey, Chicago.

1,000 **MOTORISTS** Needed to make gas saving test. Up to 30% savings. For trial test offer write Vacu-Matic Carburetor Co., 7617-989 W. State Street, Wauwatosa, Wis.

FIVE Cents worth of natural gas will run your car 25 miles. Photos, blueprints and instructions \$1.25. Harper's Machine Shop, 218 -22nd Street, Dunbar, W. Va.

HEAVY Duty Truck tires frozen to rim easily removed. Instantly adjusted to any size tire. "Tiretool" made by anyone in few minutes. Complete plans 50c. No stamps. A. E. Silva, 534 - 12th St., Oakland, Calif.

TIRED Of gas rationing shortages, excessive carbon ping, knock, poor mileage, high operating costs? Then get straight facts about butane, not rationed, plentiful, cannot form carbon, 120 octane, no ping, no knock, half price, plus more mileage. Butane is the perfect fuel, beware of other harmful and impractical schemes. Get complete information, sketches, list of necessary equipment, etc. by sending one dollar to Alberts, Dept. 16, Box 492, Alhambra, Calif.

WHIRL Gas Turbinator, \$3, vaporizes carburetor mixture; increases mileage and horsepower; reduces monoxide; prevents vaporlock. University and oil corporation tests. Wrench installs 15 minutes. Give auto make, year. John Hanley, 5719 Lorraine, Detroit 8, Mich.

HAVING Car trouble? Used, guaranteed auto, truck parts save money. Transmission specialists. Describe needs; immediate reply. Victory, 2439 1/2 Gunnison, Chicago 28.

DUAL Mufflers. California style fit Ford V-8, Mercury. Saves gasoline, increases power, beautiful deep tone. All attachments, pipes, etc. Easy installation. \$20.00 complete. Clymers, 2125 W. Pico, Los Angeles 6, Calif.

EXTRA Miles. Easily drive 50 miles for each gallon gas used. Equip car yourself inexpensively. New simplified diagrams and instructions \$1.00 cash or money order. Mechanic's Special, Box 54, San Bruno, Calif.

BURN 120 Octane—the perfect fuel in your car (not gasoline). Superb performance. Complete easily followed instructions to make your own unit. \$1.00. Earl Behling, Box 956, Inglewood, Calif.

ANTI-FREEZE, Noncorrosive, inexpensive, manufacture yourself. Details for stamp. Betke, Box 699, Borger, Texas.

CLYMER DeLuxe chromed spotlight for automobiles, motorcycles, boats, hunters. Trigger switch, pistol grip handle, powerful beam, 32 cp., operates off any 6-8 automobile battery. Only few left, hurry. \$8.50 postpaid. Clymers, 2125 W. Pico, Los Angeles 6, Calif.

OPERATE Cars, trucks, tractors, motors, with wood or coal gas, 1/2 cost of gasoline. Extensively used in Europe. Complete detailed instructions \$1.00. W. M. Cross, Lone Rock, Wis.

PRESERVE Your tires with plastic, and puncture proof your tires. Details for stamp. Betke, Box 699, Borger, Texas.

PLATING Outfits for auto parts. Connect to a battery. No tanks used. Free particulars and proofs. Gunmetal Co., Ave. J, Decatur, Ill.

AUTO TRAILERS

BUILD Your own trailer! Save money! Have every feature you want! Plans for house, sport, camp and utility trailers. Catalog describing 9 models 10c. Jim Dandy, Box 125-A, Wausau, Wisconsin.

MOTORCYCLES, BICYCLES, MOTOR-SCOOTERS AND SUPPLIES

THE Entire first edition of "Modern Motorcycle Mechanics" book has been sold out. Revised and enlarged second edition, 500 pages, 250 illustrations, covering design, operation and servicing American and British motorcycles now being published. Watch advertised announcement of date, new edition will be available. Publishers, Nicholson Brothers, Saskatoon, Canada.

MOTORSCOOTERS \$50 Up, motorcycles \$50 up; Briggs-Stratton, Lauson, Maytag motors, some as low as \$8; unrated 10-12-14 inch balloon tires, \$1.75 up. Send 25c for war-bargain directory No. 3 of over 200 items, located everywhere. Midget Motors Directory, Athens, Ohio.

HARLEY Davidson parts, accessories, supplies. Expert service. Cylinder reboring, generator reconditioning, 45" engines \$85.00 and up. Send \$1.85 for U. S. Army Motorcycle Instruction Book. Motorcycle Service Manual and bulletins or 25c for Service Manual and bulletin. Knuth's, 2491 Fondulac Ave., Milwaukee 6, Wis.

PISTONS Of all kinds metallized and ground to any size desired. Stahl Machine Company, Tiffin, Ohio.

MOTORCYCLE Engines for ice boats. Storms, 199 Broadway, Asheville, N. C.

PARTS, Accessories, pistons, chain for Harleys and Indians. McCann's, P.O. Box 114, El Paso, Texas.

WANTED—Motor-scooters, motorcycles, motors, transmissions, parts, etc. Name your own price. Write: Midget Motors Directory, Athens, Ohio.

ENGLISH "Motorcycling" Magazine. Interesting, educational, foreign motorcycles. Racing, new-old models, advertisements. 50c sample copy. Clymers, 2125 W. Pico, Los Angeles 6, Calif.

ATTENTION: All motorcycle owners! 1944 publication of 28 pages listing complete line first grade accessories, service and trouble saving tips and charts. 25c a copy. Copy purchase price refunded on first order of \$2.00. We carry full line of all Indian part and large supply Harley-Davidson parts. New and used. Quotation on parts and service free on request. Preston Motors, Inc., Kendallville, Ind.

BUILD Scooters, trailers, midgets, conversions. Large manual \$1.00. Illustrated circulars dime. Craftsmann Books, Box 1153-P2, Milwaukee 1, Wis.

NEW Book just out. English Motorcycle Manual. 68 large pages complete authentic factory servicing information. British war and civilian motorcycles. 140 illustrations, diagrams, drawings, engines, transmissions. Enfield, Norton, Triumph, B.S.A., Matchless, Ariel, Velocette, Birman, Lucas ignition, B.T.H. Magneto, Miller lighting sets, hydraulic forks. Wonderful book British owners, interesting, educational any motorcyclist. \$1.50 postpaid. Clymers, 2125 W. Pico, Los Angeles 6, Calif.

BOOK "Speed—How to Obtain It." 160 pages, illustrated. Instructions, cams, balance, timing, valves, pistons, racing technique. World's greatest speed tuning book. \$1.50 postpaid. Clymers, 2125 W. Pico, Los Angeles 6, Calif.

TIRES And industrial wheels, suitable for scooters, wheelbarrows, farm equipment, etc. All sizes. Bicycles and accessories. Largest assortment in America. Send time for list. Cycle Transport Company, 1241 So. Michigan Ave., Chicago 5, Illinois.

BOOKS! "Modern Motorcycle Mechanics and Speed Tuning," 435 pages maintenance Harley, Indian, Villiers, all British motorcycles \$2.50; with drawings, specifications, illustrations U. S. Army Jeep, German BMW was motorcycle \$3.00; "Motorcyclist's Workshop" \$1.50; "Two Stroke Motorcycles" \$1.50; "Speed—How to Obtain It" \$1.50; "Historical Motorcycling Facts" \$1.00; "Automobile Racing" \$1.10; Motorcycle instruction manual "Questions—Answers" \$1.10. All postpaid. Clymers, 2125 W. Pico, Los Angeles 6, Calif.

SAVE Gasoline, build a motorbike now, send 25c for complete plans. Motorbike Service, 2108 McLean, New Albany, Ind.

FLOYD Clymers's Motorcycling Manual. 144 pages, 120 illustrations. Complete information, specifications, descriptions dozens motorcycles. Engines, transmissions, carburetors, square four, two piston singles, sleeve valve engines, overhead camshafts, water cooled motorcycles, spring frames, hydraulic forks, sidecars, riding instructions. Two cycle engines and power bicycles described, illustrated. Just out \$2.00 postpaid. Clymers, 2125 W. Pico, Los Angeles 6, Calif.

MOTORCYCLE Parts, new and used. List 10c. Ballak, 811 N. 9th, St. Louis 1, Mo.

100 MILES Gallon! Motor-scooters, motorcycles, Whizzer bicycle engines, midgeet automobiles, gasoline engines. No priority necessary. Catalog 10c. Clymers, 2125 W. Pico, Los Angeles 6, Calif.

MOTORBIKE Manual. Containing plans for easy to build motorbike and scooter, and catalog section. \$1.00. Variety Enterprise Co., Dept. PM, Box 5, Station A, Evansville, Ind.

FLOYD Clymers Historical Motor Scrapbook \$1.50 postpaid. This is the book Time Magazine said is a "must." 160 pages. 250 early motorcycles, automobiles illustrated, described. See our advertisements under Automobiles. Clymers, 2125 W. Pico, Los Angeles 6, Calif.

PLANS, Scale drawings, specifications, illustrations for building attractive motor scooter complete \$2.00; plans electrically driven bicycle \$1.50. Postpaid. Clymers, 2125 W. Pico, Los Angeles 6, Calif.

AVIATION

MODELS! Ready built free flight and control line gas models equipped with new motors, \$45 to \$150. P-40 with new O.K. motor only \$69. Large stock of used motors on hand. Write: Blazek Models, Lidgerwood, No. Dak.

TAYLORCRAFT \$375; Aeronca \$325; Piper Cub \$225. Send 25c for catalogue listing these and over 200 other buys, located everywhere. Used Aircraft Directory, Athens, Ohio.

PROPELLERS — Quality, service, any size, lists free. 3 blade Airliner for sleds, boats. Ford motor conversion diagrams 50c. Standard Aircraft, Ft. Worth, Tex.

LIGHTPLANE Manuals blueprints four new designs now ready. New illustrated circulars 2 dimes. Craftsmann Books, Box 1153-F1, Milwaukee 1, Wis.

ELECTRICAL SUPPLIES, EQUIPMENT

A NEW manual "Know Your Multispeed Motors." Explains in every detail this type of motor. 193 pages of the most vital information on the subject. Price \$2.00 or descriptive literature sent free. Electric Generator Mfg. Co., 1333 No. Dale St., St. Paul 3, Minnesota.

USED D.C. motors \$4.00 up. Growlers \$5.00. Frazee Electric, Box 5086, San Francisco 1.

FIBRE-BAKELITE Washers, Strips and pieces, large assortment for insulation. Ideal for electricians, radio mechanics, hobby workshops. Over 1000 pieces. Satisfaction guaranteed. Special \$1.98. Order now. Hudson Trading Corp., C-169 W. Hubbard, Chicago 10.

MAKE Your own electric hammer. No gears. No coils to wind. Plans. Free details. Rush. Houston Maupin, Tipp City, 27, Ohio.

RELIGHT And use burned-out fluorescent tubes indefinitely. Easy to do. Complete information \$1.00. Research Lab., 2414-S-8th St., Council Bluffs, Ia.

ELECTRIC Pencil; Writes-engraves all metals. \$1.00 postpaid. Beyer Mfg., 4515-H Cottage Grove, Chicago 15.

NOW—Repair your own electrical appliances with Chanite Self-welding Electrical Heating Element Flux. Instructions delivered, price \$1.00. Chanite Sales Company, 914 South Main, Fort Worth, Texas.

ELECTRIC Air heaters, electric fly traps. Gardenhour Mfg., Waynesboro, Penna.

REPAIR Electric heating elements with Nichrome paste. See our ad page 184. Advance Mfg. & Dist. Co.

WESTINGHOUSE Irons \$7.95 c.o.d. Lamberson, 302 West Broad, Hazleton, Pa.

BATTERIES, GENERATORS, ETC.

EDISON Batteries. Light. Power. Fifteen year life. Five year guarantee. Complete lighting plants. Free literature. See Jay Company, 321 Yonkers Avenue, Yonkers, New York.

WELDING, SOLDERING, PLATING

NEW Model electric welder 110 volt a.c.-d.c.; will weld all metals; easy to use; full directions. Complete with power unit, flame and metallic arc attachments, carbons, fluxes, rods, mask; all for \$19.95. Used by the navy. Magic Welder Mfg. Co., 239-MP10 Canal St., New York City.

ARC Welders wanted by the thousands. Learn with 516 page lessons manual. Over 500 how-to-do-it photos. \$2.00 copy. Money-back guarantee. Hobartweld, Box M-1044, Troy, Ohio.

FARMERS, Garagemen, repairmen, manufacturers: Guaranteed 110/220 volt a.c. welder, 20 to 160 amperes continuous output, complete supplies, \$135.00 f.o.b. Chicago. Welds heavy production, light maintenance, repairs. Others, \$68.00 to \$245.00. Circulars, supplies. Williams Sales Company, Box 4100, Portland 8, Ore.

NEW A.C. arc welders in stock. \$20 to \$100. Catalog. Frazee Electric, Box 5086, San Francisco 1.

WELDING. Cutting outfits, supplies, arc welders. Immediate delivery. Catalog 20c. Adastik Bros. Welding Supply, 1299 Michigan, Grand Rapids 6, Michigan.

MAKE Electric welder—information free. "International," 6347 Parnell-G, Chicago 21.

ACETYLENE Welding outfit like new; arcwelder 80 amp. \$40.00. Eagle Welding, 5085 Broadway, Chicago 40, Ill.

A.C.-D.C. 1/4" Welding rods. Coated mild steel (without priority). 50 pound cartons \$5.00 f.o.b. Welders Club, AB-3432, Chicago 54.

AC And DC welding rod—all sizes—1/16", 5/64", 3/32", 1/8", 5/32", 3/16", 1/4"—No priority—Any quantity one pound up. Send 25c for trial package, literature and price list. Western Welding Wire Company, 125 So. Santa Fe Ave., Los Angeles 12, Calif.

BUILD A.C. arcwelder. 100, 200, 300 amperes. Plans \$1.00 each. Welders Club, AB-3432, Chicago 54.

WELDING. Cutting, aircraft welding and soldering equipment. Electric arc welders. Superior Oxy-Acetylene Co., Hamilton, Ohio.

SLIGHTLY Used arc welders. Recommended by R.E.A. Guaranteed. Forney Mfg. Co., Fort Collins, Colo.

SUPER Welder—For home, farm, factory. Makes even beginner an expert. Improved on type used by Navy. Fully equipped with Metallic Arc and Flame Torch handles, carbons, rods, fluxes, mask, etc. Complete directions. Operates ac-dc, 110 volts. No extra wiring needed. Guaranteed. \$19.95. Save 2%, send check with order. Super Welder Manufacturing Co., Dept. A, 23 East 20 Street, New York.

MACHINERY, TOOLS AND SUPPLIES

CONCRETE Building block machines and molds. Easy payments. Catalog free. Concrete Machine Co., 5129 South Compton Ave., St. Louis 11, Mo.

EXPERIMENTS — 400 Valuable springs, 75 kinds, all sizes, 10,000 uses. No junk. \$2.00. Naco, 29-B Lancaster, West Hartford, Conn.

CARBOLOY Tipped lathe tools 1/4 sq. x 2 1/2 lg., right, left and straight to steel—right, left and straight to cut cast iron—set of 6 tools postpaid and guaranteed \$8.00. Kwik Kut Tool Co., 13414 Fenkell, Detroit 27, Mich.

LEWIS Castings, materials and blueprints are the ideal means of equipping home, school or commercial machine shops—at unbelievably low cost! Mills, shapers, vices, drill presses and many other tools are quickly and easily built from Lewis Supplies—right in your own shop. Send 10c to cover mailing of descriptive catalog listing 23 items. Lewis Machine Tool Co., Box 116, Station A, Dept. P-45, Los Angeles 31, California.

SCREWS, Nuts, bolts, washers, rivets, brackets, etc. Handy assortment for mechanics, garages, household use, workshops. Over 1000 pieces, 5 full pounds. Satisfaction guaranteed. Special \$1.98. Order now. Hudson Trading Corp., C-167 W. Hubbard, Chicago 10.

FOLEY Retoother with 5 bars \$35.00, one with 10 bars \$55.00. 3329 1/2 Bagley, Los Angeles 34, Calif.

DECIMAL Equivalent chart, 12x18, 25c. Fay, 8 Ardsley Court, Newark 2, N. J.

DRILL Grinder—Original patented precision sharpener. Grinds drills to factory accuracy. Calipers with direct reading scales. Circle cutters. New tool grinder. Lowest prices. Free literature. Factory, 811-B East 31st, Kansas City 3, Mo.

STEEL Beam trammels for draftsmen, engineers, mechanics. Circular free. Clair Company, Box 92M, Blythebourne Station, Brooklyn, N. Y.

GRIND Drills any twist in three different drill point angles like factory, \$2.95 prepaid. Guaranteed. Factory, 1512 West Slauson, Los Angeles 44, Calif.

INDEX Heads for sale. Very inexpensive. Sixty-two different divisions. Used on small lathes, drill press, milling machines, etc. Make gears, hobs, cutters, etc. Very accurate, and durable. Not a toy. Used by defense schools and hobbyists. Write for free folder. Long's Index Heads, 2117 East B St., Torrington, Wyo.

BOATS, OUTBOARD MOTORS, ETC.

ASA Galleup of Fort Fairfield, Maine, wishes to buy your Evinrude or Johnson.

ROWBOAT, Twelve foot, flat bottom, plan 25c. Ten plywood boat plans 50c. The Rudder, 15 Murray Street, New York.

INBOARD Marine motors, propellers, fittings, conversions. Charles Stokes, Coldwater, Michigan.

BOAT Designers are highly paid professionals. Complete course by mail. Catalog. Westlawn, Montville, N. J.

MARINE Power—Easily convert any Ford motor (domestic and foreign) with Osco parts and kits. Complete catalogue 25c (coin). Osco Motors Corp., 2020 East Orleans Street, Dept. M, Philadelphia 34, Penna.

USED Outboard motor parts. Outboard Exchange, 1194 Remsen Ave., Brooklyn, 12, N. Y.

FULL Size, cut to shape boat patterns, blueprints. 1 1/2 - 38 feet. Illustrated "Build a Boat" catalog, 10c (coin). "How to Build Boats" book, \$1.00. Cleveland Boat Blueprints Co., Station A-66, Cleveland, Ohio.

OUTBOARDS — Save 1/2. Good used parts, all makes and models. Bargains re-built motors. Crandall Hicks Co., 959 Commonwealth, Boston, Mass.

ENGINES, MOTORS, DYNAMOS

REBUILT Electric motors. Guaranteed. 1/2 h.p., 3550 r.p.m., 110 volt, 60 cycles, a.c. \$24.95 f.o.b. No priority. No c.o.d. Other sizes. Flint Fix-All Shop, G-1085 East Carpenter, Flint 5, Mich.

"DUPLEX And simplex motors," rotary and semi-rotary fractional h.p. sizes. For water, oil, air, steam pressures—40 lbs. and up. Electric generator outfits. Duplex Motors, Burlington, Iowa.

AUTHORIZED By W.P.B. to sell inventory of new a.c. and d.c. midgeet motors—Both geared to 4 r.p.m. Shaft speed 1250 r.p.m. 110 volts. Ideal for timing devices, displays, models. Bargain price a.c. motor \$2.00. Length 3", height 2 1/2", width 2 1/2", d.c. \$3.00. Length 5 1/2", height 2 1/2", width 3". Add 25c for postage. McLaren Products Company, 114 N.W. First Street, Evansville 6, Ind.

WINDING Data, listing 225 motors, single and three phase, \$1.00. Motor Data Co., Box 7631, Kansas City 3, Mo.

BIG Pay jobs in welding. Complete welding lessons and reference books. 516 pages. 41 lessons. \$2.00 copy. Money-back guarantee. Hobartweld, Box 1045-M, Troy, Ohio.

CATALOG 50 Engines. Model railroad supplies. 25c. New welding rod for aluminum. Pewter, die cast. Generous sample and instructions 25c. Surplus tools—send stamp for list. Howard, A-2417 N. Ashland Ave., Chicago, Ill.

FOR Sale: 400 brand new precision Universal motors, 1/4 h.p., 7000 r.p.m., \$34.50 each. No priorities required while these last. Anzak, 180 W. Washington, Chicago.

ATHLETIC EQUIPMENT, BODY BUILDING COURSES

BECOME Muscular! Hoist 200 pounds overhead one arm! Learn weightlifting positions, expert's secrets, "knack"! Small men out-lift large! Show you're strong, eat: lift 200. Secure "Knack of Lifting," \$1.98. Ansoorge, 619 Watson-P, Grand Rapids, Michigan.

LEARN Guerilla self-defense. Beats Jiu-Jitsu. Circular free. Crown Books, Charlotte 4, Mich.

BAR-BELLS. Exercise equipment. Courses. Special offers! Free booklet. Good Barbell Co., 3261-PM Watson Rd., St. Louis (9), Mo.

SUPER System of natural physical training. Free booklet. Harry Good, 3261-PM Watson Road, St. Louis (9), Mo.

SPORTING GOODS, GUNS, FISHING TACKLE, ETC.

BOY Scouts, campers, U. S. army surplus used equipment. Pup tents \$2.95, mess-kits 75c. Canteens with cover and cup \$1. Cartridge belts 50c. Complete set \$5. Samet Sales Co., High Point, N. C.

\$50,000.00 CASH Available for your guns, ammunition! Top prices paid for rifles, shotguns, handguns. No red tape! Write today describing make, model, caliber (gauge), condition. Receive generous cash offer by return mail. Or trade. Send 25c (refunded with first order) for full "guaranteed bargain catalog." Klein's Sporting Goods, 5017H South Halsted, Chicago 7.

"PLAN For plenty" ammunition. Gun-ammunition list 25c. Frank Parish, Vicksburg, Mississippi.

"AUTOMATICS," "Shotguns," "rifles," with ammunition. "Golf balls," "tennis balls," "hunting and pocket knives," "flashlights," "luggage," "watches." List 10c. Rudolph's, Atchison, Kansas.

NEW Style fishpole holder. Full sized plans \$1.00. Kits with parts formed \$3.00. Harold Grabitske, 413 North Bluff St., Janesville, Wis.

SHOTGUN Shells: Our 12 gauge 5 and 6 shell heavy reloads are again available. Limited supply. Shells 10c each O.P.A. established ceiling. M.O. please. Jim Clark Sportsgoods, 2029 W. Fondulac Ave., Milwaukee, Wisconsin.

USED Guns, bought, sold, exchanged. List, stamp. Howe Fur Company, Coopers Mills, Maine.

NETCRAFT Kit:—Make landing nets, turtle traps, live nets, hammocks. Dollar bill brings: large, medium, small shuttles (patented), gauges, illustrated instruction booklet. Smaller kit:—Medium shuttle, gauge, booklet—50c. Netcraft, Dept. B, Toledo, Ohio.

WANTED 45 Colt Automatics in good shape. Griffin, 482, Ithaca, N. Y.

ARCHERY Equipment: Catalogue free. Mid-West Archery, 2309-A East 75th, Chicago 49.

AMMUNITION: Hunters: Load our Rifled Lead Slugs in your own 12-gauge shotgun shells. One dozen, with wads and complete directions for loading, including postage and packing, \$2.10. Supply limited. Order today. The Kalling Company, 8026 N. Division Road, Milwaukee 9, Wis.

"HOW To Mount Fish as a Hobby," \$1.00. Lewis Enholm, 19 Newfield St., Wollaston, Mass.

BOWS—Arrows for recreation, hunting, fishing. Beautiful archery instruction book, 90 pages, 50 illustrations, only 50c. Illustrated catalogue free. Archery Sales Service, 617 South State, Chicago.

FIELD GLASSES, MICROSCOPES, TELESCOPES

PRECISION Lenses Achromats Pyrex, 2" x2" optical flats, \$5. 57mm diameter 142mm focus \$6. 18mm diameter 95mm focus \$2. 36mm diameter 182mm focus \$2. Lenses for Ramsden eyepieces, 1" diameter 1" focus \$1. 7mm diameter 7mm focus \$1. Send for free list. Mayflor Products Corp., Katonah, N. Y.

REAL 10 Power telescopes \$1.90. United, 2309-T Lawrence, Toledo, Ohio.

MAKE Your own compound microscope, lenses and instructions. 50 power \$1.00, 100 power \$1.50, 200 power \$2.00. Instructions alone 10c. Carl Jamer, Manorville, N. Y.

MICROSCOPES, Telescopes, binoculars; all scientific, chemical laboratory apparatus—bought, exchanged, repaired. Exclusively our business with a background of over 17 years of courteous, satisfactory dealing. Not get-rich-quick speculators. Trial will show we know equipment; highest prices paid. Catalog 15c. Harry Ross, 68 West Broadway, New York.

POWERFUL Telescope lens kit—Consists 3" diameter 75" objective—50X and 100X astronomical eyepiece. Builds six foot refracting telescope. Guaranteed show moon's craters inside craters, ringed Saturn, moons Jupiter, double stars, etc. While they last \$1.95 postpaid. With 50X terrestrial eyepiece \$2.95. Experimenters 16 piece optical kit \$1.00. Postcard brings our literature of world's best optical values, telescope construction plans, optical test chart, etc. Pfeegor Optical Company, P-10, Sunbury, Pennsylvania.

BINOCULARS, Watches, diamonds, Buy, sell, trade. Paul Schweer, Donnellson, Iowa.

MAKE Your own powerful astronomical telescope. Perfect lenses and instructions. 100 power \$1.00, 200 power \$3.50, 400 power \$5.50. Instructions alone 10c. Carl Jamer, Manorville, N. Y.

ASTRONOMICAL Telescopes, binoculars, cameras, microscopes; bought, sold, repaired. Send 10c for list of instruments wanted. Rasmussen & Reece, 41 Market, Amsterdam, N. Y.

MICROSCOPES—15 Years buying, selling, exchanging, repairing, accessories, research, industrial, amateur. National Scientific Instrument Co., 119 Chambers St., New York City 7.

ANTIQUES, RELICS, INDIAN GOODS, CURIOS

GUNS, Relics, curios, antiques. List of 1000 items 10c. Guy Saulsbury, Spicer, Minn.

20 GENUINE Indian arrowheads, \$1.00. Cat. Geo. Holder, Glenwood, Ark.

FIVE Stoneage Indian tools 50c. Catalog 5c. Sistersshop, Northbranch, Kansas.

KENTUCKY Rifles, pistols, swords, daggers, powderhorns, flasks. Lists free. Antique Shop 8-A South 18th, Philadelphia 3, Penna.

PACIFIC Islands souvenirs. Complete hula skirt outfit, \$10.00 cash. Also free list: Shell beads necklaces, pearl-shell ornaments, woodwork, mats, etc. Enterprise, Inc., Box 51, Rarotonga, Cook Islands, South Pacific.

INDIAN Relics, coins, bills, gems, crystals, curios, etc. Illustrated catalog 5c. 100 ancient arrowheads \$3.00. H. Daniel, Hot Springs, Ark.

MINERALS, Coins, stamps, Indian relics, pistols, old glass. Catalogue 5c. Cowboy Lemley, Las Cruces, New Mexico.

INDIAN Relics, beadwork, coins, curios, minerals, old glass. Catalog 6c. Indian Museum, Osborne, Kansas.

DOGS, PETS, BIRDS, RABBITS

TROPICAL Fish—write for free sample new Lik-A-Live Food. Highly nutritional; always available; will not spoil nor pollute water. Lik-A-Live Fish Food Co., Box 86, Midwood Station, Brooklyn 30, N. Y.

LEARN All about Angora rabbits—wool brings \$9.00 pound. Book tells everything. "Angora Care-Management" regular \$1.50, special \$1.00. Catalog Angoras free. Grinsteads, Dept. 15, Edwardsville, Illinois.

CAGE Birds, interesting, profitable. Circulars 10c. Palsal's, Box 2622, Sacramento, Calif.

RAISE Rabbits. Profitable pleasure. Write for information today. Prices reasonable. Pedigreed stock. Tunstall Rabbitry, Greenville, N. C.

ST. BERNARD Pups: Champion sired beauties, Franklin Young, R4, Riverhead, Long Island, New York.

MAMMOTH Chinchilla rabbits—Complete information portfolio, Rabbit Journal, fur samples, 25c. Illustrated book 50c. Melv. Behrens, Pearl River, N. Y.

RABBITS—New Zealand Whites. Pedigreed stock. Information. Hugh Williford, 512 S. Wilson, Dunn, N. C.

ST. BERNARD Puppies. Unusual beauties. Registered. Franklin Young, R. 4, Riverhead, Long Island, New York.

RAISE Guinea pigs. Make money at home. Big demand. Free booklet. Taylors Guinea Pig Farm, Hapeville, Georgia.

COTTONTAIL Rabbits, jumbo frogs, fishing poles. Vol Brashears, Berryville, Arkansas.

RABBIT Skins wanted, send for high price list, shipping tags, instructions. Rabbit Products of America, 1113 So. Walnut, San Gabriel, Calif.

RAISE Rabbits for profit. Magazine puts you in touch with markets. Copy 10c. Booklet describing twenty breeds, and magazine for three months 25c. Address American Small Stock Farmer, Dept. 3, Pearl River, N. Y.

RAISE Money-making Angora rabbits. Wool \$9.00 pound. Plenty markets. Particulars free. White's Rabbitry, Marion, Ohio.

MOST Beautiful fur. Small investment. Large profit. Free illustrated booklet. Willow Brook Farm, R. D. 15, Sellersville, Penna.

RAISE Your own meat—also make money raising pigeons. Booklet dime. Gebhardt Farm, Muscatine, Iowa.

RABBITS: Flemish Giants, New Zealand. Reasonably priced. Franklin Young, Riverhead, Long Island, New York.

MICE, Rabbits, pigs, pigeons. Information 10c. Jim Houck, Tiffin, Ohio.

SEEDS, PLANTS, NURSERY STOCK

4 YEAR Old Colorado Blue Spruce, 6 to 10 inches tall, 15 for \$1 or 35 for \$2 or 100 for \$3.95. Postage, planting instructions. Cash with order. Fischer Nursery, Box 36, Bakerstown, Penna.

20 DIFFERENT Perennial flowering plants—\$1.00. Fregoe's, 28 Park, Massena, N. Y.

FARMS, FARM LANDS, REAL ESTATE

RAYBURN'S Ozark Guide, Lonsdale, Arkansas. For homeseekers, sportsmen. Year, \$1.00.

GOOD Farms—Ranches. Washington, Minnesota, Montana, Idaho, Oregon, North Dakota. Dependable crops, favorable climate. Write for literature, lists describing typical farms. Specify which state. J. W. Haw, 119 Northern Pacific Ry., St. Paul, 1, Minn.

144-ACRE Going highway farm, on good fish stream, only \$2,500! Milk route, only 3 1/2 miles village; 35 cultivated, spring-watered woods pasture, woven wire, merchantable firewood, part-bearing orchard 135 peaches, 100 apples; new 6-room house, spring water piped in, shady yard, fair barn, spring for barnlot, good 400-hen poultry house, smokehouse; owner now in gov't service, bargain at \$2,500 including crops time of sale, 12 head stock, farming equipment, some household goods, \$2,000 down. Free Fall catalog. United Farm Agency, 7-MP South Dearborn, Chicago 3, Ill.

OZARK Lands for all purposes. Actual river frontages, 5 acres \$90.00 and upwards. Free list and literature. Hubbard, 216 Grossman Bldg., Kansas City, Kansas.

OZARK Farms. Large, small. Bargain prices. List free. Frank, Mountain View, Missouri.

FARM MACHINERY AND SUPPLIES

NEW Farm machinery book. Learn your farm machinery better. A time and money saver. \$1.00 postpaid. Wirtson's, West Burlington, Iowa.

BUILD Your tractor from second-hand automobiles. Convert your horse drawn farm equipment into tractor drawn equipment. Nolan's Garage, East Wareham, Mass.

POULTRY AND FARM SUPPLIES

KNOW How to raise poultry for profit. Read Northeastern Poultryman. Every issue packed with helpful hints and practical suggestions. Latest articles on breeding, feeding, and management. Read nationally. Subscribe now. 1 year 65c; 2 years \$1.00. Northeastern Poultryman, 4M Park St., Boston 8, Mass.

RAISE Turkeys the new way. Write for free information explaining how to make up to \$3000.00 in your own back yard. Address National Turkey Institute, Dept. 3, Columbus, Kansas.

PROFITABLE OCCUPATIONS

MEN—Open your own electrical appliance service shop. Complete, illustrated course covering house wiring, motor repairs, household appliance repair. Free booklet. Appliance Service, 4701 West Pico, Los Angeles 6.

MECHANICALLY Inclined men—Own and operate general appliance repair shop. Complete, illustrated course shows you how. Welding, refrigeration, motor repair, how to get business, etc., all phases covered. Free literature. Christy Supply Dept. 445, 2835 N. Central Ave., Chicago.

LEARN Refrigeration mechanics. Start your own repair shop. Complete illustrated course. Free booklet. Mechanics School, Dept. 1-PM, 4703 West Pico, Los Angeles 6.

GINSENG. Planting instructions free, seeds for sale. Specialty Farm, Rockford, Minn.

HOMEWORKERS. Make, sell, shell novelties. Beginners samples, instructions, \$1.00. "Temple," Box 533 Station A, St. Petersburg, Fla.

EXCEPTIONAL Peacetime opportunity. Operate a collection agency-credit bureau. Quickly learned. Many make \$5000 yearly up. Write Cole Associates, Syracuse, N. Y.

WELDING Pays. Learn with 1942 trade school text manual. 516 pages. Over 500 photos. \$2.00 copy. Money-back guarantee. Hobartweid, Box M-1043, Troy, Ohio.

GOLD Panning for vacation expenses or occupation. New 160 page book for beginners. Blueprints on modern equipment. Free literature. Old Prospector, Box 878-K34, Oakland 4, Calif.

MUSHROOMS Grown in boxes. Instructions 25c. Spawn \$1.00. Gordons, 553 William, Winnipeg, Manitoba.

POSTWAR? Prepare now to become associated with us in an essential proven profitable profession. Universal Exterminators, 950 Margate Terrace, Chicago 40, Illinois.

MAKE Your hobby pay! 25c brings magazine. Tells how. Writers, swappers, collectors, opportunity seekers, etc. You'll like it. Ads 3c word. "Arrival," 319 So. Marengo, Pasadena, Calif.

AFTER Victory what? Details postcard. Bay State Service, 16 Bulfinch, Boston 14, Mass.

20 COMPLETE Moneymaking plans. Book 25c. Lucas, 8704 St. Aubin, Hamtramck 12, Michigan.

MONEYMAKING Plans—68 pages, not ads. 25c. Worth dollars. Victory, Box 179f, Dowagiac 2, Mich.

TYPEWRITER Repairsmen urgently needed. Earn \$40 to \$50 weekly spare time. Our easy to learn home study course teaches how to repair typewriters. Write for free information. Houston Typewriter Repair Service, P.O. Box 5357C, Houston, 12, Texas.

"FROG Raising" profitable—Interesting. New book tells how! Free literature. Write today! Marlboro House, 1035-P Marlborough, Detroit 15, Mich.

GOLD-STAMPING. Exceptional postwar opportunity. Free booklet. Home City Specialties, Dept. 1273, Springfield, Massachusetts.

\$40.00 WEEKLY. Made growing mushrooms, fresh, dried. Dominion patent 331583. Free spawn. North American, 189P Yonge, Toronto, Canada.

LOCKSMITHING Now made easy! New course teaches you how to pick locks, fit keys, de-code, masterkey etc. Self-instruction lessons. Bargain price. Free details. Write Nelson Company, Dept. 7-02-2, Chicago 4.

ANNOUNCING New home study course in commercial baking. Good field. Nearly depression proof. Common school education sufficient. Send for free booklet "Opportunities in the Baking Industry" and requirements. National Baking School, 1315 Michigan, Dept. 343-B, Chicago.

STANDARD Rabbit Journal, Milton, Pa. 3 years \$1.00, sample dime.

BOOKS, PERIODICALS, PICTURES, POSTCARDS

BLUE Plan booklet. Illustrating 10 apartment cottages. Now just 10c postpaid. Model Service, 308 E. 51 St., Kansas City 2, Mo.

10 BEAUTIFUL Postcard views of historic Philadelphia 25c. Address, stamp, return, mailed free. Walter Arnold, 122 N. Dearborn St., Philadelphia 39, Penna.

SAVE Money by writing for our lists of special cut-rate books, many at less than 50% of original price. Pines, Box 32, Flushing, New York.

MAGAZINES—Business, vocational, diversion. Keep posted on conditions, developments and opportunities in your line through periodicals devoted to it. Write for our free price-list of over 600 different publications, covering more than 175 fields, from which to choose current copies. Commercial Engraving Publishing Company, 340 North Ritter, Indianapolis 1, Indiana.

FREE Catalog, lowest prices, domestic and foreign magazines, newspapers, professional and trade journals by subscription. Agents wanted. Sutherland Magazine Agency, Dept. M, Ringgold, Virginia.

COLORADO Scenic views—75, \$1.00; twenty 30c. George Bryant, 3709-D High, Denver 5, Colo.

WRITER'S Instruction books. World's largest collection. List free. Humanity Press, 220 West 42nd St., New York 18.

GORGEOUS Full-color pin-ups. 50 different \$1.00. 160 different \$3.00. Samples 10c. Theron Fox, 1024-B Carolyn, San Jose 10, California.

WANT To get ahead? List of self-help books free. Write Sweeper, 141-A West St., Newark, N. J.

WHAT Every Mason wants. We have Masonic books for Blue Lodge, Chapter, Commandery, Scottish Rite and Shrine. Our rituals are used the world over. Send for free catalog of books and rituals for Masons, Odd Fellows, Knight of Pythias, Knights of Columbus, Elks, etc. Esra A. Cook, Publisher, Inc. P.O. Box 796-PO, Chicago 90, Ill.

SPECIAL Day gift exclusive scenic post card collection representing national parks, noted cities. Free literature. 10 samples 25c—250 cards \$5.00. Satisfaction guaranteed. V. Reasor, Medical Lake, Washington.

25 ARTISTIC Pictures 50c. Illustrated lists 10c. Western Sales, Hillstreet Bldg., Los Angeles 14.

PIN-UPS. Beautiful girl models, over 200 selections. Send \$1.00 for big package. Ball Square Company, 210 5th Ave., New York City.

ART Pictures—5x7—colors. Dozen 35c. Curtis Specialties, Box 1916, Denver, Colo.

ARTISTIC Pin up's, actual glossy photographs of Hollywood's glamorous film stars, full length, new fascinating poses, 4 for 35c. 20—\$1.00. 45—\$2.00. All different, size 3 1/2 x 5 1/2. Charles Scott, P.O. Box 342, Covington, Kentucky.

A RATIONAL View of Life—\$1.00. Benjamin Selbert, Urbana, Ohio.

INVASION! 15 Actual scenes, official pictures, American armed forces, worldwide battlefronts, contained neat packet. 25c each, 5 for \$1, postpaid. Lloyd, 1411-H Northwest 17th, Oklahoma City 6.

"FOOLIES" Contains cartoons, gags, stories. 10c. Alstone, 406, Lunenburg, Mass.

PIN-UPS. 3 1/2 x 5 1/2 Curvesome cuties in fascinating poses. 40 for \$1.00. 180—\$3.00. Samples 25c. Richardson Studios, Wyoming, Penna.

BOOKFINDERS. 319 So. Marengo, Pasadena, Calif. Books, courses, wanted. For sale.

PIN-UP Girls—"Brand new" set 10 actual photographs, gorgeous lovelies interesting poses. Size 2 1/2" x 3 1/2", neat packet. 25c each packet, 5—\$1, postpaid. Lloyd, 1411-J Northwest 17th, Oklahoma City 6.

BOOKS—Tell us your wants. Chapbooks, 6 Girard, Rochester 10, N. Y.

BRIDGE To success. Prepare for tomorrow—read and study today. Free literature on books on radio, electronics, television—a choice selection—biggest values. Technicraft Book Co., Box 787A, Grand Central Annex, New York 17, N. Y.

BEAUTIFUL 8x10 Pin ups. Different and original. 5 for \$1.00. Wineholt, Woodbine 45, Penna.

50 COLORED Canadian post cards \$1.00, 10 for 25c. Dionne quintuplets photo free with \$1.00 order. Wilkins Post Cards, 417 Hill, London, Canada.

BOOKFINDERS! (New, used, scarce books) secured promptly. Send wants. Clifton, Box 2233, Capitol Station, Austin, Texas.

12 "PIN-UP" Girls in full color. Size 8x10 in portfolio, \$1.00 postpaid. 4 different portfolios \$2.50. Novelty Sales, 301B Eldred, Battle Creek 21, Michigan.

RENT Books now. Save dollars. Victory Service, Dept. PM-2, Emmaus, Penna.

BEAUTIFUL Pin up girl pictures. Attractive poses. 24 for \$1. United Arts, 2309-P Lawrence, Toledo, Ohio.

SPECIAL Sale of books. Technical, fiction, art, juvenile books. Write for interesting folder describing many titles. Hatch Press, 1526 Hanover, Meriden, Conn.

DIXIE Flyer, mail order magazine. Sample 10c. Dixie, Chattanooga 7, Tenn.

PIN-UPS. Gorgeous girls, full color. Sample 8x10 and 3 1/2 x 5 1/2 10c. Arthur Fowler, Room 1, 697 Broadway, Somerville 43, Mass.

HAWAIIAN Post cards. 5 beautiful cards for 25 cents. Write message, address, stamp and return for free remailing. Hawaii Shopping Service, Box 753, Honolulu, T. H.

CHINESE Physicians, secrets, 165 pages, rare illustrations, unpublished truth, secret healing arts, peculiar custom. \$1. Write Garding Lui, Box 6227, Metropolitan Station, Los Angeles, California.

RARE. Out-of-print books located. Bookfinders, 1210N 11th Ter., Birmingham, Ala.

64 ART Cards of gorgeous beauties \$1.00. Reed Novelty, Dept. PM-5, Box 24, Queens Village 9, N. Y.

"PIN-UPS," 160 Gorgeous girl subjects! Huge bargain pack \$1.00. Clover Novelty Company, Dept. 39-DD, Hollis 7, N. Y.

REBINDING: We bind magazines, old books, Bibles, hymnals. Heckman Bindery, Dept. D, North Manchester, Indiana.

MAGAZINES (Back-dated) — Foreign, domestic, arts. All publishers. Bargain prices. Also books, booklets, pin-ups, subscriptions. Catalogs 10c (stamps accepted). Cicerone's, 863 First Avenue, New York 17.

SELF-EXPLAINING Bible: Illustrated circular free. Box 446-P, Minneapolis, Minn.

BOOKS. (Out-of-print, new, used) quickly supplied. Many 35c bargains. Catalogue. T. Jankowski, 18870 Marx Ave., Detroit 3, Mich.

DRUNKENNESS Is a disease which responds to treatment. Medical skill plus human sympathy prove successful with liquor and drug cases. 60 years experience. Write for free booklet. P. M. Nelson, The Keeley Institute, Dwight, Ill.

GAMES, ENTERTAINMENT

"MAGIC Tricks and Party Stunts," by professional magician. Illustrated. Mystifying, entertaining. Postpaid \$1.00. Grover Publications, 390 Bartlett, San Francisco 10, California.

COMEDIAN'S Sure fire scripts. Kleinman, 25-31-B 30th Road, Long Island City 2, New York.

MAGIC TRICKS, PUZZLES, JOKER NOVELTIES

AMAZING Value! Only \$2.00 buys apparatus for 10 different, startling tricks, and book of "102 Easy Tricks." Remit cash or money order. Satisfaction guaranteed. Robbins Co., 152-P West 42nd St., New York.

21 WAYS To overcome stage fright by MacKenzie Gant. Price one dollar. Four current catalogs 25c each. Thayer's Studio of Magic, Box 1785, Wilshire La Brea Station, Los Angeles 36, Calif.

FAMOUS Magicians' tricks. Sawing a woman in half, packing box escape, mind reading, sword proof girl, spirit seance and thirty eight other tricks in one book, fully illustrated. Amaze, mystify and amuse \$1.00 postpaid. Order now. Interstate Sales, Dept. P.M., Box 1868, Fort Worth, Texas.

15 DIFFERENT Professional magic tricks and puzzles. All materials, complete instructions. \$1.00. Theron Fox, 1024-B Carolyn, San Jose 10, California.

CARD Tossed in air vanishes. Can be produced again. Send dime. Eastwood, Box 623, Parkersburg, W. Va.

FINEST Pocket trick made simply amazing, \$1.00 complete. Murray, 615 Main St., Latrobe, Penna.

MAGIC Jokers puzzles. Illustrated lists. Dime refundable. Jokerhammel, Lehighton, Penna.

SHOOTING Of Dan McGrew! Told with playing cards. Entertaining, mystifying! Lots of fun, baffles everyone. Easy, self working. Quarter brings patter, instructions. Debee Specialties (P.M.), P.O. Box 951, San Jose, California.

TRICKY Match box, it turns around! It stands up! and it opens, most weird, uncanny magic novelty trick, complete, ready to do. 25c. Magic Shop, 2463-M, Kensington Ave., Philadelphia, Penna.

AMAZE Everyone. Answer unspoken questions. Professional "no assistant" mindreading act, \$1.00. Magical Enterprises, Box 111-F, Levering, Mich.

BEAUTIFUL Pinup girl (in motion) dime. Ferguson Toys, 231 East Olive, Springfield, Mo.

NEW Vanishing coin 50c. Lists. Carlo, 436 Superior, Toledo, Ohio.

HITLER'S Last will, testament 10c. Parker Publications, Peterboro, Ont., Can.

NINETY Magic trick booklet. Anyone can do them, mystifying, amusing. Sample 15c, dozen \$1.00. Auerbach, 14 East 34th, New York.

MAGIC Packet 25c. O. Kocher, 805 W. Indiana Ave., Philadelphia, Penna. (33).

DISAPPEARING Key 50c. Practical Jokers kit \$1.00, 10 card tricks, magic package with each order. Lindhorst Magic Den, St. Louis 1, Mo.

SEND 25c For \$1.00 worth of magic tricks and our latest catalog. Ball Square Company, 697 Broadway, Somerville 44, Mass.

APPARATUS To perform four tricks. Dollar value 25c. Windsor Magic Mart, 2443-A E. 75th Street, Chicago 49, Illinois.

VENTRILOQUISM. Complete instructions only \$1. Lesueur, 77 Wellesley, Toronto, Canada.

500 TRICKS You can do! Douglas' famous catalog of 500 tricks, now only 10c. America's fastest service on magic for pocket, parlor, stage, professional, amateur. Douglas Magic Shop, Box 274, Dallas, Texas.

ENTERTAIN. Mystify with popular magic. Four secret tricks and catalog 10c. Borinstein, P-7520 Cornell, Chicago.

NEW! Simplified card tricks! Amazing self-working bafflers 50c postpaid. James W. Roundtree, 529 Elliott St., River Rouge, Michigan.

BE A magician. Large professional magic catalogue of latest tricks 25c. Ireland, C-109 North Dearborn, Chicago 2.

MAGIC Tricks, puzzles, books, cards, punch boards. Catalog 10c. Specialty, Box 671, St. Louis 1, Mo.

WORLD'S Largest professional magic shop keeps you in touch with latest tricks. To receive mailings send 25c for 1943 catalog. Holden, 220 W. 42nd St., New York.

NEW Vanishing key and catalog 25c. Sterling Magic, 345 John R, Detroit, Mich.

HOLLYWOOD Special! Magicians button, catalogue, ghost illusion and free trick for 25c. Magic House of Charles, Box 888, Hollywood, California.

EARN Money in any crowd. Call names of strangers, tell unspoken questions. Professional course mind reading, spirit writing, etc., \$1. Henderson, Box 341, San Bernardino, Calif.

COINS, TOKENS, CURRENCY

COMMEMORATIVE \$15c. Columbus, Stone Mountain, Texas, Cleveland, \$1.50 each, new. Illustrated catalogue 25c. Norman Shultz, Salt Lake, Utah.

OLD Money wanted. Will pay fifty dollars for nickel of 1913 with Liberty head (no buffalo). We pay cash premiums for all rare coins. Send 4c for large coin folder. May mean much profit to you. Numismatic Co., Dept. 20, Fort Worth, Texas.

30 DIFFERENT Foreign coins \$1. 100 different \$4. 43 mixed Indian cents \$1. Delmonte, 725 West 172, New York 32.

WILL Pay \$10.00 each for certain Lincoln pennies! Indianheads \$50.00; dimes \$1,000.00. Catalogue 10c. Federal Coin Exchange, 9-PM, Columbus, Ohio.

RARE Collection contains: large cent over 85 years old, flying eagle cent, white Indian cent, 2c piece, 3c silver, 3c nickel, half dime, dime before 1840, Civil War cent, Confederate bill, foreign coin, foreign bill and our latest buying and selling catalogue all for \$3.00. 28 different dates Indian cents \$1.00. 25 different foreign coins \$1.00. Know the real value of old coins. Send 25c for our complete catalogue showing the price that we buy and sell coins for. 25c refunded after you have sold or bought \$5.00 worth. We will pay for 1916 Liberty standing quarter \$15.00, 1909-S.V.D.B. cent \$4.50, 1871 nickel \$8.00 to \$40.00, 1877-\$52.50, 1878-\$22.50, 1885-\$35.00 to \$20.00, 1916-D dime \$2.75, 1901-S quarter \$12.00, 1913-S-\$4.00, 1921-\$1.50 to \$25.00 and hundreds of others, large cents, Indian cents, half dollars, silver dollars, gold coins, paper money, etc. Worthy Coin Corporation, 23-A1 Cornhill, Boston, Mass.

DOLLAR Assortments paper money, Every item different. "7 Russian"; "7 Poland"; "9 Austria-Hungary"; "15 Germany"; any lot \$1.00. See former ads. All-Nation, 157-HP West Lake, Chicago 1, Ill.

FREE! Large illustrated price list of coin albums, coin books and other supplies for coin collectors. James Randall, 341 South Dearborn, Chicago 4, Illinois.

INTERESTING Foreign coin and lists 3c. Oliver Arnold, Macon, Mo.

QUICK Service; reasonable prices. United States catalog 10c. Foreign catalog 10c. Ben's Coin Company, 72 West Washington, Chicago 2, Illinois.

50,000 COINS, Medals, paper money. Lists free. Nagy, 8-D South 18th, Philadelphia 3, Penna.

12 WOODEN Nickels \$1.00. 25 different Indian head cents \$1.00. Bargain lists 3c. Large retail catalog 10c. We pay highest prices all rare coins. For example, 1909-SVDB cents \$4.50, complete set Pan-Pacific coins in frame \$687.50, commemorative 1/2, up to \$35.00. Copyrighted buying list 6c. Bebee Coin Company, 1180 East 63rd, Chicago 37, Ill.

CENTS. Large uncluttered or extra fine wanted. Give price first letter. James Peck, 1342 Carlotta, Berkeley 3, California.

FOREIGN Coin and lists 10c. Oddehon, Box 482, St. Louis, Mo.

10 INDIAN Head cents, different dates, also price lists, 40c. Schultz, 1053 Richmond, Cincinnati, Ohio.

GET Profit and pleasure in collecting old coins. Send 10c for 56-page illustrated coin catalog. You'll be delighted with it. Send for it now. B. Max Mehl, 370 Mehl Bldg., Fort Worth, Texas. Largest rare coin establishment in U. S. Established 44 years.

FREE! Foreign coin, banknote and coin collectors illustrated catalog to approval service applicants. Send 3c postage. Tatham Coinco, Springfield-125, Mass.

I MAY Have just the scarce U. S. coins you want. Send me list. "Meet me by mail." William H. Kenworthy, Waterville, Maine.

STAMP COLLECTING

SCARCE Mongolian pictorial portraying wild horse chase, (catalog value 40c!), hard to get stamp from Transcaucasian Federated Republics, plus host of others from Russia, Tannu Touva, Latvia, Thrace, etc., only 5c to approval applicants. Big dime packet list free with each request. Methuen Stamp Service, Inc., Dept. 36, Lawrence, Mass.

EXTRAORDINARY Pictorial collection—Nigeria, Southern Rhodesia, Dutch Indies, Martinique, Newfoundland, Philippines, Porto Rico, St. Pierre and Miquelon, Djibouti, Senegal, Ceylon, Jugoslavia, Ivory Coast, Madagascar, Reunion, Wallis and Futuna. Everything only 5c. Imperial Stamps, Box 311, Yonkers 1, N. Y.

AIRMAILS Triangle with 24 others, 10c with approvals. Padlez, Box 288, South River, New Jersey.

STAMPS From 20 different countries free. Quality penny approvals included. Harding Stamp Co., 5031 No. Harding, Chicago 25, Ill.

STAMPS Seldom seen on beginners approvals. Request your selection today. Suburban Stamp Sales, 1224 Grant Drive, St. Louis 14, Mo.

SPECIAL Album free. The United States flag series for twelve overrun nations is the most unique, remarkable, impressive, and beautiful set of stamps ever issued. It fairly cries for a special album worthy of it, such as we have published. It's a very fine album of 34 pages. Cover designed by a famous artist. Arrangement artistic and practical, telling the history of each honored nation.—It is free to sincere approval applicants. Just send 10c for mailing expenses, and state whether you desire approvals of the United States or foreign stamps or both. Approval Headquarters, Globus Stamp Company, 268 Fourth Ave., New York City 10, Dept. 201.

UNUSUALLY Good approvals on request. Miller, 384 (16) Highland, Malden 48, Massachusetts.

GRAND Bargain approvals! Unusual U. S.! Fascinating foreign! Close-out prices to serious collectors giving references. Traffic Sta., Box 0, Minneapolis.

DIFFERENT Stamps cataloging \$4.04-25c. Burtis, 725 Greenwood, Trenton 9, N. J.

WORLD'S Largest diamond and triangle stamps, free stamp magazine, stamps from fighting Free French, 20 stamps from 20 different countries, pictorials, airmails, big bargain 5c with approvals. Capital Stamps, Dept. 2, Little Rock, Ark.

APPROVALS—Frewar prices, references please. Crawford, 5043 Woodland, Kansas City, Missouri.

PACKET Of stamps with approvals 5c. Edward Hefflon, St. Albans, Vermont.

FREE Your choice of any 10 stamps from our first U. S. approval selection. List included. Cosmopolitan Stamp Company, Dept. M-10, 1457 Broadway, New York City.

PITCAIRN Islands! 1/2d, 1d, 1 1/2d mint. Colorful "Mutiny on the Bounty" stamps only 10c to serious approval applicants. William Thiem, Cape Vincent, New York.

FINE Approvals, freshly mounted. Fast, personal service. Tell me what countries you prefer and I'll send them stamps. Skinner, 345 East Ocean, Long Beach 2, Calif.

STOP And look. Perforation gaffe and bargain list 10c. G. T. Cooper, 856 Tod Avenue, Youngstown, Ohio.

200 DIFFERENT Foreign, 30c. Many countries. Jem Stamps, Port Jefferson, N. Y.

BRITISH Colonies packet, only 3c to approval applicants. Smith, 237-A 8th Avenue, Roselle, N. J.

FREE—Seven Argentine officials to serious approval applicants. Garfield, 501 Garfield, Cadillac, Michigan.

50 FREE, Pictorial, etc., stamp dictionary, list. Bullard, Newcastle, Maine.

MALTA Set war printing 10c with approvals. Vargo Stamps, Racine, Wis.

STAMP Trading Post, 5 issues 5c. Station A, Box 14, Pasadena 3, Calif.

FREE Bavarian railway set. Big price list 5c. Oscar Griska, 735 North Dearborn St., Chicago, Ill.

\$10.00 WORTH New issues sent regularly on approval. No references. Stamporium, 2660-M Rochester, Detroit 6, Mich.

UNITED States. All different, 10 airmails 20c. 21 famous Americans 20c. 30 commems 20c. Donald Stopp, Pen Argy, Penna.

EXCHANGE Your duplicate stamps. C. Bishop, Route 8, Kalamazoo 88, Mich.

FIVE Mint sets, 55c value—10c. Approvals. Barton, Box 321, Elizabeth, N. J.

300 MIXED Stamps 25c. Liberty Stamp Co., 5846 Frontenac, Apt. 28, Detroit 11, Mich.

2 CENT Washington. Schermach perforation. Postage. Approvals. Gobrecht, 205 Anderson, Joliet, Ill.

105 VARIETIES Including Bavaria, China, Latvia, Russia, 5c. Approvals. Rex, 39 Blackstone, Bangor, Maine.

100 DIFFERENT Belgium or British Colonies 49c or both for 89c. Richard Smith, 216 No. Main, Dunkirk, Indiana.

1c TO 10c Foreign approvals. Beaumont Stamp Exchange, 2667 McFaddin, Beaumont, Texas.

50 DIFFERENT U. S., many commemoratives, 5c. Gerhardt, 2804 Rio Grande, Austin, Texas.

300 STAMPS From 75 countries—\$1.00. Liberty Stamp Co., Dept. P, Kirkwood 22, Mo.

BARGAIN! 100 Different Paraguay \$1.00. Monjar, 1750 Fairmount, Cincinnati, Ohio.

EXCHANGE Your duplicates. Particulars, stamp. Kurtz, Box 1051, Allentown, Pennsylvania.

100 DIFFERENT U. S. 35c. Allen, 6330 Oak, Kansas City 5, Mo.

80 PAGE United States catalogue free. Postage 3c. Spencer Anderson, 65 Nassau, New York City 7.

APPROVALS 1/2c Up. Betts, 1267 Tutwiler, Memphis 7, Tenn.

FINAL Clearance—500 mixed approval remnants, etc.—\$1.00. Beacon Sales, Maynard, Mass.

FREE! See my advertisements, "Autos of Yesterday," "Invasion," "Pin-up Girls," other classifications, this issue. Any \$2 order receives premium of genuine Mexican Revolutionary five peso banknote; \$3 order receives both five and ten peso banknotes. Lloyd of Oklahoma City.

LEBANON 137-38A (5) 8c With 1/4, 1/2, 1c approvals. Carroll's, 745A W. 45th, Los Angeles 37, Calif.

JUNGLELAND Flying fish triangle, tiny "amputated" triangle, enormous American flag stamp printed in six colors, Siberia, Arabia, Spice Islands, 50 year old colonial stamp, others. Only 5c with approvals. H. Fenny, Rowayton, Conn.

ALASKA Embossed air mail cover with photo stamp. Attractive. Unique. Send 15c stamps or coin. Arctic Cachet Company, Box 118, Ketchikan, Alaska.

CHINA—25 Different, 5c with general approvals. Fox Stamps, Box 573-A, Pasaic, N. J.

100 U. S. Commemoratives, obsoletes, etc., 10c. Howell, 1198 Webster, Hamilton, Ohio.

10 TRIANGLES Free. Mozambique airmail-commemoratives. Request details! Reuter, 611-C West 40th, Los Angeles 37.

100 DIFFERENT 10c With approvals. Jacobsen, 59 Nagle Ave., New York 34, N. Y.

EXOTIC Solomons, gorgeous Gilberts, etc.—3c with approvals! Saxon, Valley Stream, N. Y.

MEDIUM And cheap approvals 10% bonus. Calaveras Stamp Co., Floresville, Texas.

DIFFERENT U. S. commemoratives: 50 mint \$2.00; 100 used \$1.00. Tate, 5619 Anunciation, 15, New Orleans.

NEW Issues—Complete sets "Cav-Lee Approvals," 511 North Second Street, Dep't 4, Phoenix, Arizona.

AUSTRALIA "MacArthur", Canal Zone, Curacao! Others from Antipodes, Caribbean, Africa, Asia. Given for 3c with splendid approvals. Reo Stamps, 2271 So. Howell, Milwaukee 7, Wis.

EUROPEANS, British and French Colonials, South and Central America on approval. Henry Zimmer, 722 Culver Road, Rochester 9, N. Y.

118 DIFFERENT Stamps including commemoratives, charities, airmail sets, etc., only 3c to approval buyers. We buy collections. Badger Stamp Co., Milwaukee 3, Wis.

500 UNITED States for 10c! 500 United States—absolutely unpicked and unsorted—just as received from church missions. Many varieties, including large commemoratives, airmails, high denominations up to \$5.00! Stampdom's biggest package of fun—and you might find something really valuable! Price only 10c to serious approval service applicants. Money back if not delighted. Illustrated bargain lists with each order. Mystic Stamp Company, Department 80, Camden, New York.

FREE! The Stamp Finder! Send today for the big new edition, fully illustrated, enabling you instantly to identify all difficult stamps! Also fine packet strange, fascinating stamps from Bosnia-Herzegovina, Monaco, Patiala, Cyprus, etc., including maps, ships, animals and strange scenes. All free to approval applicants including 3c postage. Garcelon Stamp Company, Box 900, Calais, Maine.

1000 MIXED U. S. old and new 25c. 2 lbs. \$1.00. Weatherby, Medina, Ohio.

FREE! Complete "United States" stamp catalog with 1,000 illustrations! Send 10c to cover mailing. Harris & Co., 137 Transit Building, Boston, Mass.

U. S. Mixture, 5 lbs. \$1.75. U. S. price list. Send postage. Stanley Gibbons, 38-P Park Row, New York.

PENNY Approvals, that satisfy. Neil Gronberg, Box 5441-P, Philadelphia 43, Penna.

DEALERS—Wholesale list. Postage 3c. Frank, 5031 Queensberry, Baltimore 15, Md.

SMOKY Mountain sheet 8c. Western, British Colonials. Approvals. Guy Freese, R.R. 6, South Bend, Ind.

FOUND Unpicked U. S. and foreign mixture containing thousands stamps \$1.00. 5 lbs. only \$4.50. Longacre Shop, 100 West 42nd, New York City.

U. S. Collection, all different, 50—10c; 75—25c; 100—45c; 125—95c; 200—\$1.75; 300—\$5.00; 500—\$12.00. No approvals, unless requested. S. C. Engel Co., 38 Park Row, New York 7, New York.

100 DIFFERENT Airmails \$1. 200 \$3. Paltra, 2664 Grand Concourse, New York 58.

S.P.A. Miniature sheet 5c. Approvals, Bargain lists. Gaydos, Kenosha, Wis.

1000 GRABBAGS 15c Each. 8 different \$1. Special bags. Free French included 25c. Zandy, 630 Bingham, Reading, Pa.

SPOT Cash paid for stamp collections. PKEigwin Company, Vineland, N. J.

SMOKY Mountain commemorative sheet, largest U. S. stamp issued, and 33 U. S. including commemoratives, airmail, revenues, etc. Catalogs 75c—To approval applicants for 3c. Curhan Stamp Company, Gloucester, Mass.

19th CENTURY U. S. commems. Civil War revenues, battleship \$5 and \$10 stamps free to U. S. approval applicants. Metropolitan Stamps, 198-C Broadway, New York.

FREE! Canadian sets, royal visit, George VI, George V, coronation, jubilee, others, to approval applicants. Ensign, Box 118-M, South Orange, N. J.

COMPLETE Mint commemorative set from Manchukuo, plus attractive Brunel pictorial—everything just 3c to approval applicants. Viking, 130 (Z) Clinton St., Brooklyn, N. Y.

WEEKLY Stamp Magazine, 26 weeks, 25c. Stamp Journal, Kalamazoo, Mich.

DANDY United States approvals. Write immediately. Sullivan, Endicott Arcade, St. Paul, Minnesota.

FREE! Western Hemisphere packet. Postage 3c. Owens, 806 Welsh, Bay City, Michigan.

FREE! British Empire packet. Postage 3c. Williams, 606 Archer, Bay City, Mich.

FREE! Pony Express set (facsimiles). Postage 3c. Roberts, 406 Building, Bay City, Michigan.

CANADA 100 Different 25c—approvals all countries. Lists. Victoria Stamp Co., London, 4, Canada.

FREE! Leeward Is., Cayman Is., Turks and Caicos plus 60 different mint Geo. VI coronation poster stamps, to approval service applicants sending 3c postage. Tatham Stampco, Springfield-30, Mass.

WOW! \$10.00 Worth of fun for only 10c! 500 foreign stamps, unsorted and unpicked (mostly on bits of paper) just as received from the church missions and other sources. Africa, So. America, Australia, China, Philippines, Dutch Indies, and other countries are represented. Includes a few commemoratives, airmails, and stamps cataloging up to 25c or more each! The biggest package of fun in stampdom—and you might find something really valuable! Price only 10c to serious approval applicants! Money back if not delighted. Jamestown Stamp Co., Dept. No. 22, Jamestown, New York.

VICTORY Packet free—Includes stamps from Tanganyika, British Cayman Islands, animal, scarce babyhead, coronation, early Victorian, airmail, map stamps, with big catalogue—all free. Send 5c for postage. Gray Stamp Company, Dept. PM, Toronto, Canada.

55 DIFFERENT United States 5c with approvals. Bookman, Box 145-M, Maplewood, N. J.

STAMPS Sent on approval, outstanding quality, low prices. Fred Herzberg, 168 Oak, Elmhurst, Ill.

UNITED States approvals complete coverage, fine quality, attractive prices. Seminole Stamps, Box 436, Coconut Grove, Florida.

MEXICO Census commemorative set free with approvals. Fladon Stamps, 1717-M Idaho, Toledo, Ohio.

3,000 U. S. Foreign \$2; Approvals: Griest; 409 Oak, Davenport, Iowa.

FREE, Complete Cuba tobacco set with approvals. Seminole, Glenburnie-1, Md.

UNITED States No. 114, No. 209, No. 226, No. 272, No. 283, No. 518, No. 537. Send 50c. Approvals accompany. Whiton-Stamps, Norwalk, Connecticut.

60 DIFFERENT United States 10c. Pricelist free. Seidenberg, Baroda, Mich.

ATTENTION Collectors! 25 Latin American stamps for 5c to approval applicants featuring the best stamps obtainable, at reasonable prices, in sets and singles for beginners and advanced collectors. Lawrence Stamp Company, P.O. Box 3507, Oklahoma City, Oklahoma.

FOREIGN Approvals for beginners and intermediate collectors. Raymond P. Schwarting, South Amara, Iowa.

BRITISH Colonies—Sets on approval. Want lists filled. Zampino, 2022 West Ninth, Brooklyn 23.

LATIN-AMERICA Only—65 diff., including airmails, pictorials, commems—10c with approvals. "Crescent Stamps," London, Canada.

LIBERIAN Triangle set 20c. Approvals foreign sets 5c to \$1.00. Yokums, Box 1327, San Antonio 6, Texas.

COVERS. Hundreds U. S. before 1910. \$1.00. Approvals. Bates, Wardsboro, Vt.

EXCELLENT Pictorial approvals. Reasonably priced. Crown Stamp Company, Box 331, Toronto, Canada.

TRIANGLES, Airmails, complete (ten) Mozambique Co 28c. Pricelist free. Hermes Stamps, Box 276, Hempstead, N. Y.

SIX Beautiful foreign sets 5c! Serious approval applicants only. Masco, Manchester, Connecticut.

UNITED States only. Approval services. Price list. Box 488, Minneapolis.

FREE—World wide packet with approvals. Regent Stampco, 330 Flatbush Ave., Brooklyn 17, New York.

LOOK! U. S. Italian occupation overprint, highest value! (Scarce "Naples issue") 10c with approvals! Ramapo Stampco, Ramsey 5, N. J.

U. S.—55 diff. airmails, commemoratives, etc. 3c. Approvals. Mosley, 4515a Laclade, St. Louis, Mo.

60 DIFFERENT U. S. commemoratives including famous Americans, Columbian, Army, Navy, hinges, approvals, all 25c. Ray Bovard, 309 East 3d Ave., Cheyenne, Wyoming.

GOYA Nudes, (2 vs.) 10c. Approvals. Millhiser, 724 Abbott, Pittsburgh, Penna.

15 WEST Indies, 3c with approvals. Super Stamp Shop, 2 S. Madison, Greencastle, Indiana.

60 UNITED States commemoratives, old, new issues, etc., all different, 10c. Charles Stone, 3547 26th St., Astoria 1, N. Y.

CANADA War set, 10 var. 10c with interesting approvals. Rheume, 8949 Routhier, Montreal, Canada.

POPULAR Equatorial set 3c with approvals. Sullivan's, Fairport 1, New York.

PENNY Approvals for general collectors my speciality. Premiums. Chas. Creek, Canoga Park, Calif.

1000 MIXED U. S. old and new 25c. Kolona, Troy 3, Ohio.

WE Buy collections and accumulations both United States and foreign stamps. Send by insured mail for our highest cash offer. Fort Orange Stamp Co., Albany, New York.

AIRMAIL, Tank, Canada, war issue, free with approvals. Saturn Stamp Co., 617 Main, Buffalo, N. Y.

FIGHTING Yugoslavia, 25 different 5c to approval applicants. Charles Mangels, 19413A 111th Road, St. Albans, N. Y.

QUEER Country packet—Includes Albania (catalogs 20c alone), Lourence Marques, St. Thomas, Prince Islands, Siberia, Mozambique, Far Eastern Republic, Kouang Tchou, Iceland, Charkhari, Italian Ethiopia, Gwalior, Ireland (George Washington stamp), Travancore, Thailand, Kenya, Uganda, Tanganyika, Victoria, names stamp (50 yrs. old), Queensland and world's tiniest triangle. Everything 5c to approval applicants. Woodlawn Stamp Company, 1923 W. Mulberry, San Antonio 1, Texas.

20 DIFFERENT—20 Different countries, 3c, approvals. A.B.C. Stamps, 2318-P Miramar, Los Angeles 4, Calif.

HOBBIES AND COLLECTIONS

TWO Genuine Texas cotton bolls. Novelty corsage or hobby collectors. 50c postpaid. Jack Smith, Box 991, Wichita Falls, Texas.

GENUINE Arizona rubies (garnets) and desert sapphires. Send quarter for packet. Mineral Specimens, Box 2651, Phoenix, Arizona.

PIANO As hobby, no instruction. I taught myself. 3c stamp for details. Leming, 900 Battery, Little Rock, Ark.

THE Most fascinating and fastest growing hobby in America, collecting embroidered (military insignia). Send 10c for price list and application and other details. Torrent Hobby Club, 52 Goodwin Pl., Brooklyn, N. Y.

WANTED: Old cigarette cards. Write Charles Bray, East Bangor, Penna.

COLLECTORS! Get our assortment of real state money. Only 25c. Maniss Photo Co., Colorado City, Texas.

MEMBERSHIP Free. National Hobby Club, Box 523-A, Rochester 2, N. Y.

"PROFITABLE Avocations," post-war opportunities, 10c. Gerard, Publisher, Gaston, Fairmont, W. Va.

CASH In today! Make money with your hobby. Others are doing it. Why not you? A stamp hobbyist was able to finance a \$125,000 business deal. If you want to make your hobby pay real dividends—then write, at once, for details. No obligation. Address, Grand Supply Company, Dept. M, 2506 - 52nd Street, Kenosha, Wisconsin.

100 JEWELRY Stones removed from rings, etc.—from \$2.00 to \$2.40. Lowe's, Box 311, St. Louis 1, Mo.

NEW—15 Different match covers 10c. Box 202, Rochester 1, N. Y.

UNUSED Match book covers. 100 all different \$1.00. 35 Royal Flash covers \$1.00. Free list. Charles Edelman, 13110 East 84, Cleveland 3, Ohio.

CAMERAS AND PHOTO SUPPLIES

BELLOWS Installed, box camera shutters repaired. Horton, 81 Campbell, West Haven, Conn.

FILTERS, Sunshades, filter holders—limited supply—fit any camera. Made of pre-war aluminum, filters of solid optical glass. Filters available in every color. Impossible to obtain after present supply is exhausted for the duration. Send only \$1.00 per item and lens diameter, shipped postpaid return mail. With every order for 1 holder and 2 or more filters we will ship without charge a genuine aluminum sunshade of the same size. Act immediately—this offer holds good only while present supply lasts. Absolute satisfaction guaranteed or your money immediately refunded. Order shipped same day received. V X Company, 1828 Central Avenue, Indianapolis 2, Indiana.

AMER-A-CINE Camera film—unlimited supply. 25' double 8mm: Weston 8—\$1.20, Weston 24—\$2.25, Weston 60—\$2.75. 100' 16mm; Weston 8—\$2.45, Weston 24—\$3.25, Weston 60—\$6.00. Free developing. Immediate delivery. Minimum two to customer. Lenses, filters, all sizes, colors, portrait-telephoto. American Art Service, 15, P.O. Box 53, Station O, New York.

ENLARGERS—Build your own. Kit of parts \$6.00. Free particulars. Crescent Engineering, Box 251-P, South Pasadena, California.

HAVE You a camera? Send ten cents for recent number of our big magazine, showing how to make better pictures and earn money. American Photography, 116 Camera House, Boston, Mass.

"BIG Bertha" telephoto camera easily made. Trifling cost. Objects miles away photograph close up. Ultra sharp pictures. Telephoto lens and instructions \$2.00. Instructions alone 10c. Carl Jamer, Manorville, N. Y.

OIL Coloring photographs a fascinating hobby or profitable business. Learn at home. Easy simplified method. Previous experience unnecessary. Send for free information and requirements. National Art School, 1315 Michigan, Dept. 3446, Chicago 5.

MAKE Money in photography. Learn quickly at home. Easy plan. Previous experience unnecessary. Common school education sufficient. Booklet and requirements free. American School of Photography, 1315 Michigan, Dept. 3432, Chicago 5.

CASH! Spot cash for cameras, lenses, binoculars, movie or still, sound projectors. Send full description by mail, or wire for prompt cash offer. Over 30 years of dependability insures honorable dealings. Bass Camera Company, 179 West Madison Street, Chicago, Illinois.

BASS Says: War time proves Bass leadership. Amazing selection of finest still cameras—Leica, Contax, Korable reflex, Argus, new and used still available. Write for quotations. Satisfaction guaranteed or your money refunded. Bass buys 'em, sells 'em, trades 'em. Bass Camera Company, Dept. AG, 179 W. Madison St., Chicago, Illinois.

WAR Bargains used cameras. Lists, description 25c. Used Camera Directory, 3111 West Tuscarawas, Canton 3, Ohio.

DON'T Cut your 35 mm. film strips. Store the rolls in Maraflex—neat dust-proof fibre boxes with hinged lids and sections for 25 rolls. Complete with index. Two boxes \$1.00 postpaid. Marathon Photo Supply Co., Box 415-A, Wausau, Wisconsin.

PHOTO FINISHING

FINER Finishing specials 25c. Eight exposure rolls developed with two prints of each or one enlarged print of each negative. Genuine nationally known Moentone Enamel finish. Superior quality since 1898. Moen Photo Service, 452 Moen Bldg., LaCrosse, Wis.

35MM. Argus, Leica, etc. (except "Mercury") 36 exposure rolls, fine grain developed (Eastman DK-20) and beautifully enlarged to 3"x4" glossy prints, 90c. Cartridge reloaded, 35c. 18 exposure rolls, 55c, reload 20c. 24-hour service. Satisfaction guaranteed. Free mailing bags, sample print. Technifinish Laboratory, 38-42 Scio St., Rochester 4, N. Y.

CHOICE Film offers—Roll developed, 8 beautiful enlarged prints (deckled if desired); or 16 brilliant "Lifetime" prints; or 8 sparkling prints plus 2 fade-proof enlargements. Pre-war quality and price—25c. Fast service. Quality guaranteed. Free mailers. Credit for unprintable negatives, Dept. 53, May Studios, LaCrosse, Wis.

EMBOSSSED Christmas cards including envelopes from your own negative, 25 for \$1.25. 12 for 75c. Samples—4 for 25c from one negative. Film Capital Service, 840 Dewey Ave., Rochester, New York.

8 PRINTS. All enlarged to nearly postcard size, from your roll or negative, 25c. Willard Studios, Box 3535A, Cleveland 18, Ohio.

FREE Photo Christmas card! Rush negative today for free card! Amazing offers. Mosher Studios, Vineyard Haven, Mass.

8x10 MATT Or silk enlargement, any negative 25c. Lang, 1334 Thorndale, Chicago.

ENLARGEMENTS: Eight 5x7 from negative \$1.00. Six 5x7 from photo \$1.00. Robert Renshaw, P.O. Box 478, Chester, Penna.

ROLL Developed and 8 beautiful enlargements 2 to 6 times larger. Deckled edge—high gloss. Any 8 exposure roll 25c coin. 12 ex. 35c—16 ex. 50c—36 ex. \$1.00. Reprint enlargements 3c each. Alden Photos, 94-3 Astor Sta., Boston, Mass.

EMBOSSSED Christmas cards including envelopes from your own negative, 25 for \$1.25. 12 for 75c. Samples—4 for 25c from one negative. Film Capital Service, 840 Dewey Ave., Rochester, New York.

SIX 8x10" Enlargements \$1.00. Three 50c—20c each. Ten 5x7" enlargements \$1.00. Four 50c—15c each. Either size oil colored 25c each extra. Ten reprints 25c. Photos copied 25c. Empire Photos, Adams Center, N. Y.

6-8 EXPOSURE Film. Film developed and printed, 5x7 enlargement free, 25c. Reprints 3c. Hubold Studio, 1414 W. Minnehaha, 4, St. Paul, Minn.

16 BEAUTIFUL Deckled prints and enlarging coupon with each roll developed 25c. Owlphoto pm, Weatherford, Okla.

SENSATIONAL Introductory offer! Send snapshot or negative, this ad, and 3c. We'll send you a beautiful 7"x5" enlargement! Or, Kodak roll developed with 16 guaranteed deckled-edge Velox fadeproof prints or 8 double-size prints, 25c! Special! From your negatives, 16 regular-size or 8 double-size reprints, 25c! Candid rolls—36 exp. 35mm. developed, vaporated, enlarged to 3x4, \$1.00! 18 exp. 60c. Reprints, 3x4, 3c each. We have new, perfect 35mm. film. Low prices. Free mailers, details on request, American Studios, Dept. 413, LaCrosse, Wis.

FREE! Send negative, this ad for beautiful 4x6 enlargement. (Stamp appreciated). 16 sparkling prints, 2 Hollywood enlargements from roll or negatives 25c. Lifetone Studios, Dept. A-939, Des Moines, Iowa.

PROFESSIONAL Enlargements made of your favorite picture on double weight portrait paper, 5x7, 25c; 8x10, 50c. Send negative and coin to Highland Studio, Box 134, Sioux Falls, South Dakota.

FILM Developed, 8 album size enlargements or 16 sparkling prints, 25c; 8 snappy 4x6 enlargements, 30c. Reprints each: Contact prints, 2c; album enlargements, 3c; 4x6 enlargements, 4c. Crystal Studios, 159-F, Rushford, Minn.

BIGGEST \$1.00 Value in 35 mm. finishing today. 36 exposure fine grain 3 1/4 x 4 1/2 enlargements; deckled, embossed margin and date. Eighteen exposures 75c; 16 exposure splits 50c; 36 exposure reloads 50c. Special: return this ad with \$2.00 and we will send five 36 exposure reloads. Free mailers. 8 exposure rolls in beautiful, deckled contact finish with embossed wide margin, 25c. Mailbag Film Service, Box 5440A, Chicago 80.

12 BEAUTIFUL Enlargements—from roll or negatives—only 25c! Six 5x7 enlargements, 25c; six 8x10's, 50c—from negative. Free—send negative for one free enlargement, mailers, literature! Immediate service guaranteed. Photo Research Laboratories, Blackstone 11, Mass.

WITH Every 6 or 8 exposure roll, two full sets of prints, 25c. Skyland Studios, Box 411, Dept. "M," Asheville, N. C.

BEAUTIFUL Oil colored enlargements. Your negatives: 8x10, \$2.00; 11x14, \$2.50. From photo 50c extra. Specify colors. Haynescraft, 802 20th, Washington 6, D. C.

YOUR Favorite kodak pictures enlarged, size 5x7, 10c; three for quarter, coin. Send best negatives (film) today. Address Gert Studios, Dept. 82, Des Moines, Iowa.

PHOTOGRAPHY For pleasure and profit. Prepare at home. Common school education sufficient. Write for information and requirements. American School of Photography, 1315 Michigan, Dept. 3451, Chicago 5.

TROUP'S Photo Service, Troup Building, Toccoa, Georgia. 6 or 8 exposure roll film developed and printed 25c.

8 BEAUTIFUL Enlarged prints (nearly postcard size) or 16 regular prints 25c. 35mm. rolls enlarged 3 1/4 x 4 1/2, \$1.00. Burton Studios, 55-M, Roscoe, New York.

BEAUTIFUL 4x6 Pictures 3 1/2c each, from 116 and 120 negatives, 3 1/4 x 4 1/2 from all other sizes. All work guaranteed. Overnight service. Roll developed and 8 pictures 30c. Roll 12 pictures 45c. Roll 16 pictures 60c. Enlargements on double weight portrait paper 5x7—30c, 8x10—50c. Copies made from any picture 75c. Pacific Photo Service, Box 666, San Francisco, Calif.

VELOX Deckle reprints 2c. Rolls developed, two deckle edged prints each negative, 25c. Two 5x7 enlargements 25c. Summers Studio, Unionville, Mo.

EVERY Picture an enlargement! 8 sparkling deckle-edge enlargements and roll developed 25c coin; 116 size or smaller; enlarge reprints 3c. Enlarge Photo, Box 791D, Boston, Mass.

MOTION PICTURES AND SOUND EQUIPMENT

CAMERA Films—100 ft. 16mm. \$2.69; panchromatic Weston 64, \$4.85; 25 ft. double 88 Weston 24, \$1.89; prices include processing. Movie accessories, chemicals, bulk film. Free circulars. Fromader Genera, Davenport, Iowa.

CHRISTMAS Holiday movies—"Merry Christmas" and "Christmas Cartoon"—two films to gladden the hearts of young and old. 8mm. 50 ft. \$1.75; 16mm. 100 ft. \$2.75 each. List for 3c stamp. Audet, Box 6520-BC, Philadelphia, Penna.

MOVIE Subjects, sample, list 10c. Midwest Cine Shop, Hannibal, Missouri.

8MM.-16MM. Films. Free catalogue (sample film 10c). Parkway Exchange, 1593 Union Street, Brooklyn, New York.

8MM. 180' PARAMOUNT Christie hilarious comedy "Dizzy Sights" \$4 postpaid. LeMoine Films, Nevada, Missouri.

100' 16MM. Used sound film, \$1.00 postpaid. We buy, sell, trade. List of complete subjects upon request. Blackhawk Films, Dept. PM16, Davenport, Iowa.

8-16 MM. Film-subjects—Black and white and color; sound or silent. Largest selection ever compiled; 75c to \$100. Write for new, deluxe 1945 catalog—profusely illustrated! 25c (coin) refunded first purchase. Hollywood Movie Supply, Hollywood, Calif.

35MM. Sound features and shorts. A. Savarese, Woodcliff Lake, New Jersey.

WANTED: 8-16mm. Silent sound films, Moviemite projectors, any condition. Reed, Box 209, Park Ridge, New Jersey.

FRESH Movie film, 100' 16mm. \$2.25. 25' double 8mm. \$1.25, developing included. Ambassador, 479-A Quincy Street, Brooklyn, N. Y.

I BUY, Sell, swap, rent s.o.f., 8 and 16mm. films. List free. Harvey Iris, Box 539, Brockton, Mass.

SILENT 35mm. Films! Features! Shorts! Demsey, 1613 Stewart, Youngstown, Ohio.

8MM-16MM. Silent-sound films. Complete rental library. All latest subjects. Free catalogue, (sample film 10c). Garden Film, 317 West 50th, New York 19.

SARONG Girls, 8mm., 50 ft., \$2.00; 16mm., 100 ft., \$4.00. Complete glamour, thrill lists, glamour sample, dime. Kodachrome subjects, also. Jenkins, 392-F, Elmira, N. Y.

MOVIE Owners join Motion Picture Educational Society. Free particulars. Box 875, Reading, Penna.

GORGEOUS Girls—"Lorelei," "Sarong Girls," "Diversion" and "Beauty Brevities"—four glittering films, 8mm., 50 ft. \$2.00; 16mm., 100 ft. \$4.00 each. Travel, comedy, thrill and glamour newsreels. Reels, cans and screens. List for 3c stamp. Audet, Box 6520-BG, Philadelphia, Penna.

MOVIE Projectors bought and sold. List 10c. United, 2309-N Lawrence, Toledo, O.

8MM. Home movies our specialty. Bought, sold, exchanged. Free bargain list. Values, Woodbury, Conn.

8MM. Films exchanged, sold. Free details. Watts, Box 941-A, Akron 9, Ohio.

SILENT 35MM. films! Features! Shorts! Demsey, 1613 Stewart, Youngstown, Ohio.

FREE, Projector film catalog; samples 10c. Goodwill Company, Jackson, Tenn.

MOVIES: 8mm.-16mm. War, comedy, travel, glamour. Lists free. With glamour sample, dime. Keeley's, 42-PM, Corning, N. Y.

16MM. Rental sound films, dime brings list. Sound projectors sold. Anchor, 482 Ithaca, N. Y.

LATEST European invasion films, etc. Lists, 3c. Roger Felton, Winthrop Terrace, Meriden, Conn.

COMEDIES, Glamour, sample, dime. Zientek, 1129 Monroe Circle, Baltimore 25, Maryland.

\$1 BRINGS "Surprise" assortment 8mm. colorful titles! Guaranteed. LeMoine Films, Nevada, Missouri.

STARTLING New discovery, make your own movie screen. Free literature. Snow White Screen Company, Danville, Illinois.

"THE World's Greatest Passion Play." 8mm., 16mm. and 35mm. Specify silent or sound. Rent or purchase. Hemenway Film Co., 33-F Melrose St., Boston 16, Mass.

SPECIAL Movie film, 8mm., 25 feet double-Weston 8, \$2.00. Super double X, Pan indoor 60, outdoor 100, 16 mm.—\$6.50. Super X Pan indoor 24, outdoor 50, \$5.75. Pan Weston 12, \$5.00. 16 mm. 100 feet Weston 6, \$4.00. Free developing. Exhibitors Film Exchange, 630 9th Ave., New York 19, N. Y.

BASS Says: Leadership in the cine field is apparent in war times. Here ready—your choice of 8 mm. and 16 mm. apparatus. Write for quotations. Your old equipment is worth real money in trade—describe please. Or we buy for cash and pay immediately on receipt. Write to headquarters. Bass buys 'em, sells 'em, trades 'em. Satisfaction guaranteed or your money refunded. Bass Camera Company, Dept. A, 179 W. Madison St., Chicago, Illinois.

SEND Stamp fr.: 16mm., 8mm. catalogue. Sterling's, 679 Northampton, Easton, Pennsylvania.

LEARN Movie projection, management. Free catalog. Give age. Theatre Institute, Elmira, N. Y.

I BUY, Sell, swap, rent s.o.f., 8 and 16mm. films. List free. Harvey Iris, Box 539, Brockton, Mass.

RENTAL 16mm. Talking features \$4.95, shorts 75c. 8mm.-16mm. silent, large reel 40c. Movie accessories. Free catalogs. National Cinema, 71 Dey Street, New York City.

BETTERPIX Outdoor safety film, 100 feet 16mm., \$2.50. 25 feet double 8mm., \$1.25. Free developing. Finished subjects sold, exchanged. Sound library. Better Films, 742 New Lots, Brooklyn 7, N. Y.

MUSIC AND MUSICAL INSTRUMENTS

PIANISTS—Send for free booklet showing how you may greatly improve technique, accuracy, memorizing, sight-reading, playing through mental-muscular co-ordination. Quick results. Used by famous pianists, teachers and students. Broadwell Studios, Dept. 44-K, Covina, Calif.

NEW! Transposition at a glance. Get this handy pocket size book now! Learn transposition of orchestral instruments, 50c (coin). MacGregor, P.O. Box 828, Hollywood 28, Calif.

I TAUGHT MYSELF piano, no instruction, no charts. 3c stamp for details. Leming, 900 Battery, Little Rock, Ark.

EVERYBODY Can play violin. New system. No notes. Melody Masters, Box 805, Rockford, Ill.

POPULAR Piano E Z method, quick results guaranteed. Beginners advanced. Kelly School, 1781 Oak St., San Francisco 17, Calif.

RECONDITIONED Band instruments, also guitars and violins. List free. Rudolph's, Atchison, Kansas.

SONGS Published—Liberal plan. Barnhart Publications, 1320 48th, Des Moines, Iowa.

SONGWRITERS! Amazing offer. Hibbler, C5, 2157 N. Avers, Chicago 47.

POEMS Wanted for musical setting. Send poem for immediate consideration. Five Star Music Masters, 630 Beacon Building, Boston.

SONGS Published. Radio license. National Songwriters, 6603 Sunset, Hollywood, Calif.

PROFESSIONAL Melody to your words. \$2. Professionals, 339 Mill Valley, Calif.

NEW Songs and lyrics wanted for popular radio program and professional promotion. Free examination. Transradio Music, Inc., Dept. P, 1650 Broadway, New York. (Affiliate of B.M.I.)

FREE Booklet song tips. Write, Melody Makers, Box 37, Hartford, Conn.

SONGWRITERS: You can arrange your songs for orchestras. 20 modern lessons \$2.00. Money back guarantee. Brokel College, 64-P East Jackson, Chicago.

SONGS: Poems published free. Royalities. Hollywood Song Guild, Box 2230, Hollywood 28, California.

MUSIC Arranged to songs. Frank Wildt, Music Publisher, Lancaster, Pennsylvania.

SONGWRITERS, Professional offer. Edward Madden, 1300 Lodi, Syracuse, N. Y.

RECORDING Discs 1/2c. Easily made. Excellent quality. Special equipment unnecessary. Material available everywhere. Instructions, including sample disc, \$1.00. Free details. Kaytor Laboratories, Lwnwood, Calif.

SONGWRITERS: Would you like to know what to do with your song? I'll tell you. Gray, Woodcliff Lake, New Jersey.

HAWAIIAN Guitar orchestrations. Five for \$1.00. List on request. Golden Gate Publications, 5472 Foothill Blvd., Oakland 1, California.

WANTED Songs for folio edition, also selling agency. Southern Music Agency, Knoxville 15, Tenn.

SONGWRITERS: Royalty contract free. Write for details. Puritan Publishing Co., 343 S. Dearborn St., Chicago, Ill.

BECOME Music writer, at home. All instruments. Harmony Instructors, 2348 Foothill, Oakland 1, Calif.

LEARN Piano faking! Fascinating negro harmony. Irresistible chords. Rare modulations. Don't murder harmony! Write the man who knows! "Piano Bill," 207 Ossington, Toronto, Ontario.

MUSIC Printing by music type method. Music composed. Reginald Belcher, Chatham, New Jersey. Established 1910.

PLAY Hot! Play by ear. Compose. Harmony. Chords. New system. Endorsed by famous musicians. Price \$1.00. Driscoll-Cherrey Studios, Leadmine, Wis.

HARMONICA Magic. Easy new system eliminates notes. Self instruction method includes 75 songs. Send \$1.00. Money back if not satisfied. Harmonica Magic, Box 3870 Merchandise Mart, Chicago 54.

ACCORDIONS—All sizes and makes. Special discount. Free catalog. American Accordion Co., 31 S. Cicero, Chicago.

SONGWRITERS Are offered rare opportunity to collaborate with hit composers on percentage basis through phonograph record manufacturer. Submit poems for approval. Recola Recordings, Hollywood 28, Calif.

SONGWRITERS—Free booklet "Getting Ahead in Songwriting." Write today. Song Service, 331-C West 46th, New York.

LEARN Piano. One hour. Free literature. Ferris, 317A So. Hartford, Bremerton, Wash.

SING Beautifully. Modern voice culture. Literature free. Ferris, 317A So. Hartford, Bremerton, Wash.

SONG Poems wanted. Free examination. McNeil, Master of Music, 510-PM South Alexandria, Los Angeles, Calif.

ACCORDIONS. New and used at wholesale prices. Save up to \$100.00. Buy direct from factory. Del Principe, 307 So. Wabash, Chicago.

SONGWRITERS Wanted; prices details, free book. Variety, 2 Salem, Ind.

WRITE Songs. Big money and reputation. Write for information. J. Gordon Pub Co., 201 N. Hoyne Ave., Chicago.

SONGWRITERS—Send poem for immediate examination and free rhyming dictionary. Richard Brothers, 24 Woods Building, Chicago.

SONG Poems wanted: Write for free instructive booklet, outlining opportunities. United Music Corporation, Dept. 14, Salem, Indiana.

WANTED! Lyrics, melodies for songs. We arrange, publish, sell. Superior Song Studios, Passaic, N. J.

RADIOS AND SUPPLIES

PLAYERS, Victrolas, phonographs (mechanical) repaired. Epstein's, 50 First St., New York 3, N. Y.

RADIO Parts. Surprise packages. 100 pieces \$2.00. R. H. Lab, 3928 Dumaine, New Orleans, La.

TUBELESS Radio made with razor blades! Complete plans, 35c. N.W.A. Radio, Lohrville, Iowa.

BUILD Improved, extra-loud crystal set. Easy instructions, 20c. Amorose, R-4, Hungary Road, Richmond, Va.

REVISED Plans 18 long distance crystal sets, including "Radiobuilder"—25c. Laboratories, 363-C Hampton, Hayward, Calif.

BUILD Crystal microphones, phonographs. 2 crystals \$2.00. Kit of essential parts, phono or mike \$5.00. R. H. Lab, 3928 Dumaine, New Orleans, La.

SUBSTITUTION Instructions. 200 critical tubes \$1.00. Jones, 1210F Dudley, Utica 3, N. Y.

LEARN Radio code; make simple, inexpensive practice outfits, send 50c for complete plans and large self instruction code manual. Eticu, Box 712, Pittsburgh, Pa.

MAKE Simple, tubeless, batteryless, distance-getting crystal radios, crystal and illustrated instructions. 25c postpaid. Allen, P-427, Clinton, Missouri.

RADIO Tubes, parts, condensers. Free bargain lists. Potter, 1314 McGee, Kansas City, Mo.

PREPARE Now for tremendous opportunities in new fields of radio after the war. Training for federal licenses. Write for particulars. American Radio Institute, 52 East 23 Street, New York 10.

RADIO Service men and experimenters send for our giant radio catalogue. Save dollars. United Radio Co. (1000M), Newark, N. J.

BUSINESS OPPORTUNITIES

START Your own business on our capital. Always your own boss. Hundreds average \$3,000 to \$5,000 annual sales year after year. We supply stocks, equipment on credit. 200 home necessities. Selling experience unnecessary to start. Wonderful opportunity to own pleasant, profitable business backed by world wide industry. Write Rawleigh Co., Dept. J-U-PPMB, Freeport, Ill.

MECHANICALLY Inclined men—Own and operate general appliance repair shop. Complete, illustrated course shows you how. Welding, refrigeration, motor repair, how to get business, etc., all phases covered. Free literature. Christy Supply, Dept. 145, 2835 N. Central Ave., Chicago.

TYPEWRITER Ribbons renewed. 5 cents each. Renewer, the magic ribbon renewer makes them almost like new. Regular dollar size sample 50 cents. Moneyback guarantee. Immense profits. Exclusive territory. Particulars for stamp. United Profit Builders, 305-West 8th St., Los Angeles 14, Calif.

START Home business making statuary, plaques, art goods, novelties, souvenirs, concrete pottery, garden furniture, artificial marble flooring, liquid marble. Make your own flexible molds. Amazing profits. Valuable free. Creative Publishers, (PM10), Glencoe, Illinois.

UPHOLSTERING Pays. Do own. Start business. Practical 8 1/2 x 11 illustrated course \$1.00 prepaid. Upholstering Institute, Dept. 228, Lombard, Illinois.

NO Matter what you have to offer, a personal office in New York, under your own name, (no care-of required) is bound to increase your business. Rates \$1.00 monthly or \$7.30 yearly. Co-Operative Offices, 128 Lexington Avenue, New York.

VITAMINS—High quality, low price, private label. Gibson Company, Harlan, Iowa.

"749 HOME Business Opportunities," magazines; 25c. Hirsch Enterprises, Spring Valley, N. Y.

WESTERN Trading Post offers you opportunity to earn money. Write for particulars today! 1355 Cedar Avenue, San Bernardino, Calif.

MAKE Fast selling products at home. No machinery. Wonderful profits. Literature free. Kernico, 16, Park Ridge, Illinois.

RABBITS Make money. Stamp for circular. Bonnies Bunnyland, Mastic, New York.

AFTER The war what? We have the answer for you now! Shoes Co., M-3, 45 Astor Place, New York 3, N. Y.

HOW And where to obtain capital. Fully explained. Particulars free. Star Service, Wapakoneta, Ohio.

SELL Books and courses by mail in your spare time. Siddall, Atascadero, Calif.

PINKLE Writes powerful mailorder letters, literature, complete campaigns. Famous for famous results! Long, successful experience! Reasonable! Pinkle Advertising, 1201 1/2 South Ogden, Los Angeles.

1000 LIVE Names of opportunity seekers 50c. All late cash buyers. Joseph Royer, 17-M How Street, Haverhill, Mass.

MAKE Money at home. Free booklet. William R. Todd, Box 872, Lubbock, Tex.

MAKE Your own Flexible Molds. Statuary, Art Goods, Novelties, Artificial Marble Flooring, Liquid Marble. Literature free. Kernico, 10-M, Park Ridge, Ill.

START Home or office business, spare or full time. Experience not essential. Literature free. Herbert Boyd, Box 6081, West Asheville, N. C.

COSTS 20c. Sells \$2.00. 256 page drugless health book. Sample book and imprints \$1.00. National Distributors, Portland 4, Oregon.

LEARN Refrigeration mechanics. Start your own repair shop. Complete illustrated course. Free booklet. Mechanics School, Dept. 2-PM, 4703 West Pico, Los Angeles 6.

MEN, Women: Investigate Golden Magic Embossing Ink. No canvassing. Purple stamp please. Joseph Mail Service, Keene, N. H.

PERMANENT Substantial income manufacturing newest, badly needed civilian goods. Investment small. Profits immense! Stamp brings "Messenger" listing modern analyses and certified formulas. Miller, Chemist, Tampa 6, Florida.

WANTED—Mail order dealers, beginners, read my new letter—Mail Selling is Money Business. Boom beginning now. Rush name, Houston Maupin, Tipp City 33, Ohio.

WHY Work for others—Be your own boss. Details free. No obligation. W. M. Simon, 1091 First Street, Wyandotte, Michigan.

EARN Money in your backyard. Free details. George Gundrum, LeRoy, Mich.

GIANT Mail, big mail order magazine included. Opportunities galore! 10c. The Old Commander, Box 302, Chillicothe, O.

BECOME An "Attritionist Masseur." First improvement over Swedish massage in 100 years! Results unbelievable! Dr. Swearingen, 9128M, Station 8, Los Angeles.

PLASTICS—Made at home without equipment—perfect castings—formula 50c. Baker, 225 Symington Ave., Toronto, Can.

MORE Money with your own products. Experience unnecessary. No machinery. Information free. B. Kinford, Wayne, Penna.

FIVE Big mailorder magazines 20c. Lewis Company, 828M Carpenter, Oak Park, Ill.

RAISING Canaries pays good profits. Valuable bird book—"Its Care, Breeding and Training." Price \$1.00. American Canary, 2839 N. Halsted, Chicago.

MAKE Colored glazed concrete pottery, cemetery products, tiles, novelties. Basement waterproofing. Other projects. Booklet, colorplate 10c. National Potteries, Ferguson Falls, Minnesota.

300 MONEY Making plans 25c. Sinder, Box 888-C, Haverhill, Mass.

WANTED Partner with capital for food manufacturing business. Robert Arthur, 914 Pike Street, Seattle 1, Washington.

START Your own mail order book business. For information write to D. Foster, Box 1069, Glendale 5, California.

300 TESTED Money-makers. 64-page book, 20c postpaid. Business secrets, formulas, wholesale supply sources galore. Book has no ads, meat only. Money back if dissatisfied. Dulco, 324P Pitt, Pittsburgh 21, Penna.

BECOME A finance man. Particulars free. George Lenhoff, Lincoln 8, Nebraska.

ADVERTISE Your business in my papers and magazines. Low prices. Guaranteed large circulation. Dr. G. Anthony, 210 5th Ave., New York.

FOR Reputable manufacturers a tremendous fortune can be made in a new household necessity. Post war item. Plastic molding, or metal stamping. Box 827, St. Louis 1, Mo.

HOW I scored tremendous mail order business success from only \$100 start. Write George Evans, Box 9312, Station S, Los Angeles, California.

NO Lay off! Dollars galore developing, printing. Full instructions 25c. National Service, 322A Union Avenue, Brooklyn 11, New York.

5000 QUARTERS From a 20-word classified ad. Send 25c and 3c stamp, for copy of ad, sample merchandise, and plan to operate by mail. Abbott, Dept-PM, 5552 Drexel, Chicago 37.

INFORMATION—Locating most any article. (Quarter). Rakes, E-35 So. Halsted, Chicago 6.

PLAN Now for a successful postwar business of your own. We tell you how to start, what will pay, what to sell, who will buy. Information free. Great Lakes Distributors, Box 97, Flint, Mich.

MAKE And mold genuine plastics. Forty illustrated work sheets explain methods, processes. Authentic—simplified. \$1. Free circular. Research, 3937B Tracy, Kansas City, Mo.

MAKE Girls novel name pins, simple, low cost. Complete instructions 25c. Melco Novelties, 323 Hayward St., Woodstock, Ill.

FREE Details how to co-publish your own magazine. Sample dime. Victory, 106 Penn, Dowagiac 1, Mich.

GET into victory and prosperity. Local or mail business. Make 300% profit. Dime brings proof. Central, Simpson 1, Kansas.

REPAIR Home appliances: Learn to repair appliances with simplified instructions. Send 50c, stamps, coins or will send c.o.d. plus post. Acme Press, Box 182, Chicago 17, Ill.

SELL By mail. No waiting. We help you start making big profits immediately. Send \$1.00 only. Satisfaction assured. Moneyback guarantee. United Profit Builders, 305 West 8th St., Los Angeles 14, California.

"INVENTION" Simple to build. Great demand. 300% profit. Small capital. Saves customers thousands. Plans, instructions, permission to manufacture \$25.00. Information 25c. Cash Inventor, Box 416, Chula Vista, Calif.

SELL Vitamins by mail. Big profits. Details, sample imprints, etc., 10c. B. Murphy, 4438 White Plains Ave., New York City.

FITCHMEN, Agents, demonstrators, show people. Make money immediately. Anywhere. Complete instructions \$2.00. Mero, 100 Morrison Ave., Funxutawney, Penna.

LEARN Auto painting. Earn \$100 per week working for yourself. 2,000,000 autos must be painted each year at \$50 to \$100 each. Complete up to date 5,000 word copyrighted instructions for \$100. Terms, Clinton C. Davidson, 636 "C" Street, San Diego 1, California.

10 TRIPLE-SHAVE Double-edge razor blades in classy letter style package. 1st class mail anywhere 3c. Send 30c one package or \$1.00 four packages prepaid. Agents wanted. Novelty Supply & Mfg. Co., Fremont, Ohio.

FOR Well paying position, with peace time future, prepare now. Details free. Lone Star Service, 1708 First Ave., Dallas 10, Texas.

START Home Mailorder Business. New course tells how. Literature free. Kemico, 179, Park Ridge, Ill.

OPERATE Profitable credit and collection agency business; earn \$5000-\$10000 upwards annually; interesting literature free. Write Educational Extension Service, Department 101, Wilshire-Labrae Station, Los Angeles.

ELECTRIC Clocks are every where you go, buildings, homes, parking-lots, factories. Repairs increasing. Our easy to learn course with pictures and drawings teach you how to repair these clocks. Electronic Supply Co., Dept. A, P.O. Box 2350, Houston 1, Texas.

SELL Exclusive books of instruction by mail. 80% profit. No bookstore competition. Snappy circulars ready. Rush name! Financial Education, 431P, 728 15th, Denver 2, Colo.

READY To go mail business 25c. One small ad gets you going. Send 25c for Quarters Galore. Rennolett, 830 - 9 St., Rock Island, Ill.

WIN Business success and wealth. Avoid mistakes. Get experienced business advice. 20 years experience in sales, advertising, manufacturing, purchasing, engineering and finance. Write, Drake, P.O. Box 1135, Columbus, Ohio.

START Mailorder bookshop—Everything furnished; publisher cooperation. 25c brings booklet, exclusive setup, samples, exciting ideas. General Publications, Ossining, N. Y.

MAIL Order business course shows you how to make money, spare or fulltime. Teaches professional mail order technique—not penny-snatching schemes. New success-catalog free! Write Nelson Company, Dept. 4-02, Chicago 4.

SELL By mail. Modern course shows how. Free consultation with noted author. Details free. J. G. Schroeder, Box 504-P, Anaheim, Calif.

BIG Opportunities in Latin America with U. S. firms and pay. Develop your own hacienda or business idea on side. Send \$1.00 for information and big list of American firms doing business in beautiful Latin America. Latin American Research Bureau, 305 W. 8 St., Los Angeles 14, Calif.

NEW Ever-repeating profit plan. Particulars free. Lynch, 402-M Hazlett, Baltimore 29, Md.

ADVERTISE In Progressive Mail Trade for big positive, powerful results. Best puller for checks, inquiries, orders! Lowest rates. Pewitt Publications, 605 Clayton, San Francisco, California.

INDIA! Country of four hundred millions. Vast field. Wanted agencies for any marketable goods. Can export any Indian manufactured goods. Jhaveri & Co., Jhaveri Building, Forbandar, India.

FOR Cash without canvassing, write Poulsen & Company, Zion, Illinois.

SIX New and complete post card plans for starting your own profitable business. Gordin Publishers, Box 23, Pawtucket, R. I.

FREE Literature explains profitable home mailorder. Cutler Publications, Reading, Penna.

YOU Can make fancy profits selling flavoring extracts. Make your own. Send two dollars for each formula. Your Service, Box 643, Warren, Ohio.

RUBBERFORM—Plastic; waterproof elastic flexible mold making liquid. Sample pint with instructions \$1.25 postpaid. Gallon \$7.00. Plastic Products, 1410-13, Belmont, Chicago.

HOW And where to obtain capital. Fully explained, particulars free. Star Service, Wapakoneta, Ohio.

LIQUID Marble; snow-white, multi-colored. Glazed. Unglazed. Composition flooring. Lifetime wear. Any color. No priorities. Flexible molds. Plaster casting. Get into the big money now. Full information given free. Write Compo-Tex, Box 786-R, St. Louis, Mo.

COLOR Concrete with chemicals. Big money making Hollywood style pottery, birdbaths, without moulds. Wishings, stucco-rock, benches. Marbling, cement water-paints. 10c brings sample, literature, pictures. Hollywood Cement-Craft, 8527 Wonderland, Hollywood 46, California.

AGENTS—To mail our literature. Good profits. Home business. Maywood, 1133 Broadway, New York.

ADVERTISE In Progressive Mail Trade, famous for famous results. There's a reason why advertisers stay in year after year. Best puller. Lowest rates. Pewitt Publications, 605 Clayton, San Francisco 17, Calif.

"HOW To Make Simple Molds and Plaster Plaques." Profit in popular novelties! Booklet 25c. Plastercraft, 1406 E. 43rd St., Cleveland 3, Ohio.

WEBER Typewriter Mechanics School. Simplified homestudy-repairing increasing. Hollywood 27, California.

GET into mail selling. Prepare for future. Start sideline business now. Splendid opportunities. Interesting, profitable propositions immediately available. Progressive Magazine tells how! Free details and premium offer. Sheboygan Publishing Co., Sheboygan, Wisconsin.

CHARTERS: Delaware: best, cheapest; free forms. Colonial Charter Co., Wilmington, Del.

DRUNKENNESS is a disease which responds to treatment. Medical skill plus human sympathy prove successful with liquor and drug cases. 60 years experience. Write for free booklet. P. M. Nelson, The Keeley Institute, Dwight, Ill.

127 WAYS To make money, in home or office, business of your own. Full particulars free. Elite Co., 214 Grand St., New York.

BRUSH Plating outfits connect to a battery. No tanks necessary. Good paying business at home plating autoparts, bathroom fixtures, bicycles, reflectors, silvering mirrors. No shop or experience required. Outfits furnished. Free booklet. Guntra Co., Ave. H, Decatur, Ill.

EXTRA Income—Plenty mail selling opportunities. Write Katz, 4254 N. Kimball, Chicago.

PLASTIC—Liquid "Cellophane", clear, transparent. Covers, protects, wood, plaster art objects, etc. Sample print \$1.25. Twentieth Century Products, 3151-N, Southport, Chicago.

5 MOST Read mail order magazines 20c. Armand Cartier, 695A North, Pittsfield, Mass.

LIQUID Marble—Colorful, glazed! Mold, brush, spray! Composition floors, rubber-lastic molds. Particulars free. Marbleizing Service, Edwardsville, Illinois.

PRINT Your license number on gas coupons. Send 25c coin for own number and state stamp. Box 157, Williamsburg, Ohio. Sell your friends, order six for \$1.00.

START Your own business. Latest automatic fire extinguisher. Low price. Liberal profits. General Machine Co., Dept. 88-P, Camden, New Jersey.

MAKE, Sell sparrow traps that will catch thousands. Complete, illustrated plans \$1.00. Money back if not satisfied. Roy Vall, Howe 20, Ind.

OPPORTUNITIES, Big mails. Your name listed. 25c. Wilson, 105 Penn, Dowagiac 2, Mich.

BUSINESSMEN! New method saves bookkeeping expense. Details free. Anderson Sales, 101 Park Ave., New York.

BE Independent. Start your own business. Any locality. Either sex. Experience unessential. Details gladly. Acme, 5521 - 36th N.E., Seattle 5, Wash.

"ROYAL Mail" opportunities. Surprise! Dime. Rowanna, Box 553-PM, Kannapolis, N. C.

20 TESTED Money-making plans. Book only 25c postpaid. Lucas, 8704 St. Aubin, Hamtramck 12, Michigan.

FORGET Canvassing! Home business, immense profits. Amazing details 3c. Service (5) Drawer 339, Butte, Montana.

MONEYMAKING Opportunities, business secrets, plans, tips, formulas. Mack, Box 1278-H, San Francisco 1.

PROFITABLE, Spare time, unusual mail business earned \$1400 monthly. Copyrighted instructions \$1.00 postpaid. W. S. Boyd, 331 Fourth, Pittsburgh 22, Penna.

MEN—Women, sell Penmanship Correctors. No competition. Exclusive territory. Ozment, St. Louis, Mo.

DO This at once! It's the simplest plan on earth, you start with one small ad. No stock to carry. Returns should pyramid amazingly. 25c for outline, choice of ad copy, complete details, fully guaranteed. Messenger, Box 747, Allentown, Penna.

MONEY Making opportunities. Leading mailorder magazine, 10c. Sign, Farmington, Missouri.

OWN A mail-order paper products business. Sell envelopes, tags, labels, boxes, by mail, wholesale. Tremendous demand. Steady profits. No capital necessary. Write Omaha Envelope Service, Dept. 34, 4721 California, Omaha 3, Nebr.

FREE Subscription. Drop postal today. The Mail Order News, Somerville, New Jersey.

RUBBERFLEX—Latex flexible mold making liquid "The Real McCoy." Sample pint with directions \$1.50. Gallon \$9.00. Agents wanted. Twentieth Century Products, 3151-N, Southport, Chicago.

MONEYMAKING OPPORTUNITIES

MOLDMAKING—Plaster Casting. Complete formulas—fully illustrated. \$1.00. Ideal Service, RM10, Park Ridge, Ill.

STEADY Income assured after the war if you start your own business now, part or full time. Send stamp for information. Hughes Services, Plankinton, S. Dak.

START Profitable horse business. Learn to break colts; gait show horses; teach circus tricks; train stock horses. Become expert. Doctor book free. Write Animal Lovers Assn., Bx K111, Tarzana, Calif.

MECHANICALLY Inclined men — Own and operate general appliance repair shop. Complete, illustrated course shows you how. Welding, refrigeration, motor repair, how to get business, etc., all phases covered. Free literature. Christy Supply Dept. 1145, 2835 N. Central Ave., Chicago.

MAKE Colorful costume jewelry with washable plastic links! Profitable sideline. Free details. Beginner's outfit, \$1 (refundable). Hughes, 218 Sidell, Danville, Illinois.

MAKE Money home or room. Send 25 cents coin and 3 cents stamps for two 25 cent plans and details other excellent opportunities. Specialty Company, Box 635, Modesto, California.

HAVING Retired at 46 with a yearly gross income in excess of \$20,000, I am not unwilling to make available to other men and women with little education and capital the basic information that they may do even better than I. My 24 page, 8 1/4" x 10 1/2" illustrated, copyrighted booklet "How to Operate Concessions, Shows and Thrill Rides on Midways" sent postage prepaid U.S.A. or Canada on receipt of \$3.00 money order. Harry McQuiston, P.O. Box 4624, Sellwood Station, Portland, Oregon.

YOUR Own business, spare or full time. Information stamp. Henry Schultz, Route 2, Pascagoula, Mississippi.

MAKE Sell, cosmetics, perfumes, household specialties. 110 formulas—50c. Hanson, 380 Third Ave., New York City.

LEARN Refrigeration mechanics. Start your own repair shop. Complete illustrated course. Free booklet. Mechanics School, Dept. 3-PM, 4703 West Pico, Los Angeles 6.

"VARIOUS Opportunity Catalog," copy 10c. P.O. Box 1735, San Diego 12, Calif.

START "Soap Factory" at home. No machinery. Amazing opportunity. Literature free. Kemico, SM-10, Park Ridge, Ill.

EARN Money evenings, copying and duplicating comic cartoons for advertisers. Adservice, Argyle, Wis.

12 PRACTICAL Money-making propositions and big mail 25c. Romola King, 700-A North Mont Clair, Dallas 11, Texas.

GAIN Financial independence from a city lot or a five acre plot. A new book "Security Acres" shows you how. Send for free particulars today. A. J. Shutt, Dept. S-1, P.O. Box 269, New Castle, Ind.

HELP Win the war first! Then man, you'll like silvering mirrors, reflectors! Making sparkling chipped glass nameplates. Outfit prices. Sprinkle, Plater, V60, Marion, Indiana.

THOUSANDS Of articles wholesale. "Supply Source Directory" 10c. Ideal Service D-10, Park Ridge, Ill.

WE Have swappers, buyers, sellers everywhere for anything you want to swap, buy, sell. 25c brings Guide. National Swappers Guide, 1100 E. Chandler, Evansville, Indiana.

SCHOOL Seniors—Sell classmates America's most beautiful, distinctive graduation name cards. Positively highest commission. Largest selection. Lowest prices. Free cards and free sample kit. Printcraft, 1423 East Elm Street, Scranton 5, Penna.

BE Independent, start paying business in your home with our tested plans. Free descriptive booklet. Applied Industries, 953-M East Michigan Ave., Ypsilanti, Michigan.

DUGAN'S Hamburger spread — Home manufacturing—Hot seller. Formula 25c. "LaPlant," Menominee, Michigan.

OPPORTUNITIES Galore. Operate top-flight plans. Details stamp. Topflight, 699 Cypress, Yendon 3, Penna.

JOIN First \$1,000 Club. 20 items. Formula, ads, magazines, etc., starts bringing you money. Years service mammoth mails, all 13c. Melvin Churchill, 319 So. Maringo, Pasadena, Calif.

MAKE Big money at home by mail. Write for free details. H. G. Smith, Dept. M-10, Mt. Vernon, N. Y., Box 145.

INFORMATION — Locating articles wholesale, etc. (Quarter). Rakes, M-35 So. Halsted, Chicago 6.

CASH From your back yard, basement or bedroom. No experience necessary. Send for free details. Challenge Association, 87 Somerset, Springfield, Mass.

I MAKE Big money in the mail-order business. You can do the same at home with my copyrighted system. Write me. I'll tell you how. F. Little, Box 8, Glenshaw P. O., Pittsburgh, Penna.

OPPORTUNITY Seekers packet big mail 10c. Worrock, Room 438-X, 2051 Telegraph Ave., Oakland 12, Calif.

ESTABLISH Home business! Five volumes money making opportunities \$1.00. Des Moines Home Service, Box 855, Des Moines, Iowa.

247 GOOD Genuine opportunities. Not penny snatching scheme. 20 quick cash new tested plans. Book of 20 complete layouts only 25c postpaid. Lucas, 8704 St. Aubin, Hamtramck 12, Michigan.

MONEY By mail. Dime brings proof, Giant mail. Lee Wilson, Niles 2, Mich.

GET Rich. To find success, find yourself and cash in on your creative ability. F.L.T. Ph. D., Dept. 88A, 185 Godfrey, Philadelphia 20.

FOUR Books—228 exciting pages on mail order work—150 ideas, plans, methods, \$1.00 postpaid. Paul A. Wilkin, 1348 N. High, Hillsboro, Ohio.

TEN Ads that keep my mail business going. Send 25c coin. Universal, Fremont, Ohio.

START Today profitable repeat M.O. business. 25c coin brings proven details. B. Benson, 8940 Rindge, Venice, Calif.

127 WAYS To build your own business at home, or small office. Details free. Victory Publications, Box 179E, Dowagiac 1, Mich.

FREE "Mail Order Trade Directory," given with, "If It's Wealth You Desire," book with a guide to financial independence, \$1. Morgan, 114 Callaghan, San Antonio 3, Texas.

THOUSANDS Of alarm clocks need repairing. Jewelry stores swamped. Our simplified course teaches you how to repair these clocks. Necessary tools and supplies furnished with course. Alarm Clock Repair Service, Dept. B, P.O. Box 1983, Houston, Texas.

GROW Dwarfed trees few inches high for yourself or sell. Instructions 15c. Charles McGuire, P.O. Box 628, Dept. G, Seattle 11, Wash.

EASILY Made gasoline gas machines as well as other types (septic, reformed gas, etc.), 5,000 word booklet \$1.00. Gas rate for heating and cooking as low as 30 cents. Ideal Spec., Lakewood 5, Rhode Island.

MONSTER Mail, magazine, adsheets, circulars. Opportunities, 10c. Harvey Teeple, (PM) Decatur, Indiana.

CATALOG Listing hundreds of opportunities 10c. (refundable). Barcus, 1001 N. 13th, Terre Haute, Indiana.

GET Big mails, magazines, samples. Name listed, 10c. American Directory, 1420 Mistena, Corpus Christi, Texas.

MAKE Plenty of money in spare time right from your own home. Sales made entirely by mail. No personal contact. Progressive Mail Trade Magazine tells how. Sample 10c. Edgar W. Thomas, Barnesville, Ohio.

SPECIAL Training—for entering successful business. You start small, grow big. We tell you what to start, what to pay, what to sell, who will buy. Ask for bulletin No. 12. It's free. Edgar W. Thomas, Barnesville, Ohio.

BIG Profits, make and fit arch supports. Particulars. Jul Corssen, 2638 Geyer, St. Louis 4, Missouri.

START Now, build money making mail order business. Be established after the war. Write for free particulars. Young's Industries, Kent 15, Ohio.

MONEY At home. Your own business. "Progressive Mailtrade" Magazine (15th year), prints many small capital post war opportunities. Read by thousands; you'll like it too. Copy 10c. Publishers, Box 115M, Gardenville, New York.

PERFUME Instructions furnished. Start mail order or local business. Particulars free. Dr. Abell, Parkway Bldg., Pasadena, Calif.

BOOKKEEPERS. Earn money at home posting journal entries. Ellis Business Service, Cedar Grove, North Carolina.

PUBLISH Your own magazine. Handsome 52 page format, well edited, illustrated. Cost low as \$1.00 month. Brings you prestige, profits, 10c brings sample, details. National Ord. Nebr.

LEARN Metascience. Remarkable drugless healing. No manipulation. No apparatus. Unbelievable simplicity and results. Inexpensive correspondence course. Write Metascience, De Land, Florida.

EARN Money at home! "Thousands do!" "Home Worker Magazine" tells how. Sample, 25c. Sizemore, Box 7, 4917 North Kostner, Chicago.

LICK After-war layoffs! Start own business; home, office. Booklet describing "Collection of 127 Tested Plans" free. Elite Co., 214 Grand St., New York.

FORMULAS, PLANS, ETC.

BUILD Your own crack proof concrete walls for anything. Plans \$1.00, or money order. W. Denham, Box 1362, Durham, N. C.

MAKE Glass etching fluid at home in your spare time. A real money maker. Instructions and formula 50c. Forrest Easley, Delano, Calif.

"LUMINOUS Paint" shines in dark. Easily made. 100 other formulas, plans—all 25c. Soap-making course (20 formulas) \$1.00. Resilvering mirrors, formula 20c. Ideal Service, 310, Park Ridge, Ill.

MAKE Floor covering using wall paper. Directions 50c. Pierce, 302 Kiefaber, Dayton 9, Ohio.

FORMULAS—Make your own products. Use your own head. Write DeVor, Box 243, Ukiah, Calif.

RELIABILITY. Any formula 50c. Thorough research. Excellis Products Company, P.O. Box 3198, San Francisco 19, Calif.

ANY Formula \$2.00 or money back. Case Kowal, Chemist, 1846 Cullerton, Chicago.

FORMULAS—Latest, best. Analysis. Literature free. Belfort, Engineering Building, Chicago.

AUTHENTIC Formulary, 924 page illustrated book. Prepared by experts. 10,000 practical tested formulas, recipes, secrets, instructions for easily making most any product. Countless profitable business opportunities. Valuable reference for home, industry. \$2.00 post paid (c.o.d. U. S. only). Foreign \$2.35. Adams Brown Company, Dept. 11, Chestnut Hill 67, Massachusetts.

REAL Manufacturing formulas. Lists free. Cummings, Chemist, Gordon Ave., Syracuse, N. Y.

CHEMISTRY

LUMINOUS Paints, ready-mixed, five colors phosphorescent \$1.00. Five colors fluorescent \$1.00. Each color covers six to ten square inches. Card showing the ten colors on inch squares 25c. Catalog of electroscopes, spectroscopes, radium paint, U. V. lamps, etc., free with above. Catalog alone 10c. Hammer Laboratories, Denver 7, Colorado.

THE House of Winn, the home of supplies for amateur chemists. See Winn's New Idea chemical kits and apparatus outfits for home experimenting. Send 10c for retail catalog. Established 1931. John H. Winn, Dept. 510, 124 West 23 St., New York.

CHEMICALS, Ounce quantities, apparatus, catalog 5c. Fleischers Laboratories, Everet 49, Mass.

FREE Catalog: Chemistry, mineralogy, biology, optics. Tracey Laboratories, Evanston, Illinois.

HANDBOOK For chemical experimenters, hundreds of experiments, illustrated, 50c. Experiment booklet 15c. Chemical catalogue 5c. Reading Scientific Company, Reading, Penna.

SPECTROSCOPE For quick chemical analysis \$2.50. Kutting Sons, Campbell, California.

LABORATORY Supplies at wholesale prices: Chemistry, biology, physics. Catalogue 10c. National Scientific Co., 2204 W. North Ave., Chicago. Established 1908.

CHEMISTRY Laboratory apparatus and chemicals for industrial, analytical, and private experimental laboratories. Complete chemical laboratory supply service for correspondence school students. Send 3c for free 48-page catalog of chemicals and apparatus. Dept. M-43, Biological Supply Co., 1176 Mt. Hope Ave., Rochester, New York.

HELP WANTED

EARN Profits in spare time by recommending technical books to fellow workers. Write for details to E. M. Kask, 330 W. 42nd Street, New York 18, New York.

AGENTS WANTED

SALESMEN—Agents. Big profits selling home remedies, vitamins, cosmetics, extracts, household necessities. Fast selling combination deals. 200 items. Midwest Drug Company, 232 North High Street, Columbus 15, Ohio.

SKUNKADORA Eliminates 100% all traces of skunk odors! Nothing like it. Whirlwind seller to farmers, trappers, general stores, breeders, etc. Big profits. Send \$1.00 for sample on money back guarantee or write Sparhawk, Sparkill, New York.

AMBITIOUS School seniors—We want you to sell classmates the "tops" in graduation name cards. Highest commissions. Your cards free. Catalogs going like wildfire. Hurry! Get yours today! Craft-cards, Box 235-L, Pittsburgh 30, Penna.

EXTRA Dollars in selling magazines of all kinds. Attractive Christmas gift offers. Pleasant and profitable, full or part-time work. Now is the time to get new and renewal orders. Write for full particulars and selling kit. The Instructor Subscription Agency, Dansville, New York, Dept. PM.

PIGSNIKERS Needed by every hog raiser. Full information on request. Agents sample 25c. Honeastrop, Winona, Minn.

START Your own business on our capital. Always your own boss. Hundreds average \$3,000 to \$5,000 annual sales year after year. We supply stocks, equipment on credit. 200 home necessities. Selling experience unnecessary to start. Wonderful opportunity to own pleasant, profitable business backed by world wide industry. Write Rawleigh Co., Dept. J-U-PPMA, Freeport, Ill.

BIG Profits taking subscriptions for all magazines. Agents' confidential catalog listing over 2500 periodicals and complete starting supplies free. Pines Subscription Agency, Flushing, New York.

SELL "Personalized Soap" for service men. Name imprinted. Ideal Christmas gift. Sample offer free. Dunbars, New Brunswick, N. J.

MAGIC Races—At cigarette touch six horses are off. Fast seller, big profits. 40 races \$1.00, quantity prices, sample free. Barkley Co., Dryden 11, Va.

ONE Man can kill 300 trees or sprouts with Boko of Jonestown, Miss., in one day.

HANDY Hair trimmer. Sells like wild. Trims as you comb. Saves barber bills. Samples sent on trial. Kristee, 135, Akron, Ohio.

BIG Bargains for big profits. Men's used pants 25c, suits \$1.00, topcoats 75c, overcoats \$1.00, shoes 12½c. Over 100 sensational values. Experience unnecessary. Free wholesale catalog. Superior 1250-CB Jefferson, Chicago 7.

FREE Mexican curiosities. Biggest line. Stupendous profits. Gallo, Apartado 9318, Mexico.

AGENTS—Coin money—it's new, it's hot. Everyone wants radiant "Master-lette" colored paintings of loved ones. We deliver, collect. Condon, Box 157, Upper Darby, Penna.

AGENTS—Big profit in Christmas gift subscriptions! Prepare now to earn extra money. Easy sales. Get free wholesale price list today! Write to McGregor Magazine Agency, Dept. PM4, Mount Morris, Illinois.

COMIC Xmas cards—25 designs, two colors envelopes, \$1.00 postpaid. Jerry's, 182 W. Bernard, St. Paul 7, Minn.

DOUBLE Your money selling our hair dressings for colored people. Write for samples and particulars. Dawson Manufacturing Co., Enfield, N. Car.

POWERFUL Mile stretcher! Increases mileage! Increases power! Increase your income! Guaranteed! Information free! Thermoxwks, Peoria 4, Ill.

YOUR Opportunity Xmas card agents. Sell 50 for \$1.00. Samples on approval. Henry-Neil Card Co., 400 So. Orange Ave., Newark 3, N. J.

TODAY'S Leading moneymaker! Full or part time. Write immediately. Knickerbocker, 126-33 Lexington, New York 16.

1000 BLADES, \$4.50; Dolls, dozen \$13.50; combs, gross \$3.50; aspirin, gross boxes \$1.95; payment with order. Catalogs free. Mills Sales, 901 Broadway, New York.

SELL Glutted mending fluid. Exclusive territory. Repeat business. Money maker. Trial order \$1.00. Barnorall Industry, 19338 Griggs, Detroit 21, Michigan.

LUMINOUS Paint (shines in dark). Profitable seller to thousands of homes, stores, offices, and factories. Details. Write, Lite-Saver, 97C, Saybrook, Conn.

"WONDER-PASTE" Cleans everything. Sensational demonstrator. Solvex Products, Monticello, Iowa.

SILVERWARE Made like new again. Right in your own home, or place of business, by yourself or any employee, simply by rubbing the worn or tarnished piece with a soft cloth, saturated with NuSilver, the 17-year-old trademark patented Silver Plating and Polishing Liquid. Simple, quite inexpensive, anyone can do it. Follow simple directions on each bottle. Contains and deposits genuine 1000 fine silver on Silverware, Sterling Silver, Brass, Copper, Bronze and Zinc metal surfaces, leaving a brilliant silver-color finish that lasts for a year or more. Won't wash off. Does not adhere to iron and steel metal surfaces. Guaranteed non-injurious to the finest ware, jewelry, etc. Unsurpassed for cleaning diamonds, rings, brooches, all precious stones and jewelry. Does not change color of gold. Used and endorsed by jewelers, musical instrument makers, antique hardware and automotive trade. A miracle silverware-renewing product for Eating Places, large and small. Excellent to clean and fill in scratches on nickel and chrome plating. Removes rust quickly no matter how old. Wonderful for all automobile trim and headlight reflectors. Works miracles on electriclight, bathroom, kitchen fixtures, doorknobs, etc. Has a thousand wonderful uses besides renewing worn-through and tarnished silverware. Sold successfully in stores and by agents with an unqualified money-back guarantee on every bottle. To introduce to more users, one bottle will be sent postpaid for \$1.00. Representatives are wanted to sell wholesale and retail by a most astounding personal demonstration on their own ware to Eating Places, Dealers and Homes, for fulltime, sparetime or sideline. Confidential prices and full details will be sent with one bottle to try out fully postpaid for \$1.00. NuProcess Products, Aurora, Ill.

HOSIERY Guaranteed against everything at no extra cost! Victory sheer ladies' rayon full fashioned sells for only 94c including your profit! Also guaranteed men's hosiery. Amazing opportunity to build permanent business. No experience or money required. Simply write orders. We deliver and collect. Write today for complete free outfit. Kentcraft, Dept. KH, 44 Court Street, Brooklyn, N. Y.

BOYS Make money at home spare time. Write for particulars. Roy Vall, Howe 21, Indiana.

EARN Big money selling Loeb Patented Neckties. Handsome new tie line sells on sight. No investment necessary. Send today for big new selling outfit free! The Loeb Company, 99 Chauncy St., Boston 11, Mass. Dept. PM.

SCHOOL Seniors—Sell classmates America's most beautiful, distinctive graduation name cards. Positively highest commission. Largest selection. Lowest prices. Free cards and free sample kit. Printcraft, 1423 East Elm Street, Scranton 5, Penna.

CALL On friends with easy to sell personalized stationery with name in raised type. Big profits. Free samples. Mers Printery, 135 Lenox Street, Rochester 11, N. Y.

SELL Transparent signs, greeting cards, Christmas goods! Big profits! Catalog free! Elfoe, 436 North Wells, Chicago.

"MAIL Order Trade Directory" tells you where to buy wholesale. 25c brings 1944 edition. Box 693-PM, Canton 1, Ohio.

GET Dollars by mail! 90c profit. Instructions 10c. Terrill, Bogard 2, Mo.

SELL New-used clothing from home, auto, store. Men's suits 99c. Leather jackets 73c. Overcoats 43c. Dresses 12c. Ladies' coats 38c. Other bargains. Catalog free. S & N, 565A Roosevelt, Chicago.

PROFITS Selling novelty fun cards. Samples 10c. National Specialty, Box 301-M, Cincinnati.

CHRISTMAS Card agents. We undersell everybody. Box assortments—name printed. Free cards with orders. Samples quarter (refunded). Klayer, 2219 Crane, Cincinnati, Ohio.

EXCELLENT Sideline for printing salesmen. Decalcomania name plates in small quantities. Also, make money applying initials on automobiles. Free samples. "Ralco," X-164, Boston (18), Mass.

EXCLUSIVE Territory. Fire extinguishers. \$2.75 retail. Old concern. Firstaid, 1824 Fourth Avenue, Los Angeles 6, Calif.

BIG Money taking orders; shirts, ties, socks, pants, jackets, sweaters, shoes, uniforms, etc. Sales equipment free. Experience unnecessary. Nimrod, 4922-AN Lincoln, Chicago.

AGENTS: Stamping names on pocket-key protectors. Sample check with your name, address, 25c. Stamping outfits, Emblem checks, check-fobs, name plates. Hart Mfg. Co., 303 Degray St., Brooklyn, N. Y.

AGENTS. Big line including food products. Fast selling premium and bargain deals. Low prices. Send card for big outfit offer with gift. Ho-Ro-Co, 2793 Dodier, St. Louis 7, Mo.

WHOLESALE Sources. 500,000 articles. Free directory. Maywood, 1133 Broadway, New York.

PLATING Outfits for autopaarts, reflectors. Connect to a battery. No tanks necessary. Free booklet and particulars. Gunmetal Co., Ave. N, Decatur, Ill.

MAGIC Cleaner and laundry soap deal. Hotter than a firecracker. Big profit! Sample free. Bestco, 5007 Irving Park, Chicago.

PLAYING Card game. 250% profit. Sample game 25c. Box 842, Denver 1, Colo.

GOLD Lacquered window sign, letters. New styles. Absolutely beautiful. Free samples—catalogue. Atlas, 7941 Halsted, Chicago.

FREE Water and our concentrates, makes flavors, lotions, shampoos, 72 products, labels, bottles furnished. Qualco, E-20030 Russell, Detroit.

ELITE Collection contains 127 plans for starting own business; home, office. Descriptive booklet free. Elite Co., 214 Grand St., New York.

HIGH-GRADE SALESMEN

POCKET \$1.50 On every order for new gold bronze "In the Service" patriotic embossed frame with 8x10 enlargement from snap shot photo. Mothers, fathers, sisters, everyone with friends in service buy fast. Sample outfit offer. Al Peterson, Box 822, Providence 1, Rhode Island.

SALESMEN Exclusive territory extraordinary calendars, patriotic, international and tricolor designs. Show line, sale made. Commissions paid receipt of order. Dission Co., Bond Bldg., Washington 5, D. C.

ORANGE Concentrate direct from our Florida grove. One quart bottle makes 6 quarts delicious natural orange drink simply by mixing with 5 parts cold water. Groceries, food marts, roadstands, soda-fountains, resorts, camps, hotels, restaurants, hospitals, farmers big buyers. No investment. Protected territory. Salesmen earn \$100 to \$200 repeat commission per week. Sunset Valley, 3357 Clifton, Chicago.

SELL Warm leather jackets to friends, neighbors. Make money spare or full time. Also rubber raincoats, 200 styles shoes. Sample outfit free. Experience unnecessary. Consolidated Shoe System, Dept. S-66, Chippewa Falls, Wis.

SIDE Line, salesman line custom jewelry. Mission, 2328W Pico, Los Angeles 6, Calif.

TO Sell Dr. Chas. Mendenhall's Wonder of the World Liniment to dealers and agents. Complete details free. Mendenhall, 106 So. Main St., Dayton 2, Ohio.

NOW Available for civilian use. New, profitable, different. Non-competitive field with unusual possibilities. Investigate now! Union Company, Box 523, Lynn, Massachusetts.

SALESMAN Wanted: A good salesman can get set for life with a wide-awake progressive nationally known firm; unusual chance for self-betterment to the man who can do a real selling job. Line consists of top quality lubricants and maintenance materials. Liberal drawing account after production record is established. Write Box 392, Dallas, Texas.

SOMETHING New in fire extinguishers, Red Comet Automatic Safety Sprays. Real fire killers. Low in price. Easy for you to sell. Splendid outfit furnished free. Write to Red Comet, 704 Comet Building, Littleton, Colorado.

SALESMAN: Have real money-making opening. Fits into war program. Old progressive firm. Dept. "P," Box 392, Dallas, Texas.

BLADES—Best quality, factory prices. Details free. Ace Blades, Buffalo, N. Y.

EDUCATIONAL AND INSTRUCTION

PLAY Directing is profitable. Amateur groups in every community need people to direct them in dramatics. This book tells you how to proceed; "Producing the Play" by Gassner and Barber, with chapters by leading professional Broadway experts. Over 200 illustrations, 750 pages, complete with easy-to-follow working drawings for making stage sets and producing sound effects. This book is widely used in schools, colleges, and little theatre groups throughout the country. Price \$3.75. Zinnsmith Press, 161 Grand St., New York 13, N. Y.

STUDY Broadcasting-television spare time at home. Writing, announcing, newscasting, management, traffic. Qualify for good paying jobs. Course prepared by network executives. Write Chicago Institute Broadcasting and Television, Suite M18, 32 West Randolph, Chicago.

MAKE UP to \$25-\$35 a week as a trained practical nurse. Learn quickly at home, spare-time. Easy tuition payments. Earn while you learn—many earn hundreds of dollars while studying. Easy to understand lessons, endorsed by physicians. High school not required. Our 45th year. Write for free booklet and sample lesson pages. Chicago School of Nursing, Dept. K-10, Chicago.

GOOD Jobs and a sound postwar future for you in hotel and institutional field, government housing, food and recreation projects. Men and women—all ages—needed for well-paid positions that offer color, excitement, ever-new and fascinating duties. Record-breaking business in hotels, clubs, institutions means even greater opportunities. Lewis School receiving calls for managers, hostesses, executive housekeepers, purchasing agents, stewards, etc. These are not temporary jobs, but important positions in an essential business that offers splendid opportunities in war or peace, good times or bad. Previous experience proved unnecessary! No need to leave your job to qualify. A good grade school education, plus Lewis Training qualifies you, at home, in spare time. Our National Placement Bureau helps to place you and—under our amazing Certified Job Plan—actually guarantees you will "make good" when placed. Write today for free book! Lewis Hotel Training School, Room CW-368, Washington 7, D. C. (First and only school of its kind—Now in its 29th year.)

SHORTHAND In 6 weeks at home. Famous Speedwriting system, no signs or symbols. Easy to learn; easy to write and transcribe. Fast preparation for a job. Surprisingly low cost. 100,000 taught by mail. Used in leading offices and civil service. Write for free booklet. Speedwriting, Dept. 1510, 274 Madison Ave., New York 16.

FOR A lifetime of pleasure and profit be a treecraft expert. Do all types of budding and grafting. Grow different varieties of fruit or flowers on one tree. For details write Treecraft Publications, Dept. 3, P.O. Box 5, South Charleston 3, W. Va.

EARN Certified Grapho-Analyst degree analyzing handwriting. Students report earnings up to \$1.00 an hour sparetime. \$75.00 weekly full time. Graduates in employment, credit agencies, police departments, courts, business and in private practice as personal problems and vocational advisors. Fully illustrated Grapho-Analyst and 3000 word illustrated lesson free. Institute, (AP) Joplin, Missouri.

REMEMBER Without effort. Easy five lesson memory course \$1.00. Amazing results. Money back guarantee. Particulars free. Mighty Midget Publications, Box A-566, Lincoln 1, Nebraska.

WHY Don't you write? Writing short stories, articles, etc., will enable you to earn extra money. In your spare time we teach you to write your newspaper men learn—by writing. Free "Writing Aptitude Test" tells whether you possess the fundamental qualities essential to successful writing. Write today! Newspaper Institute of America, Suite 570-P, One Park Avenue, New York 16, N. Y.

MEASURE Your mind! Learn the truth with self-conducted, standard intelligence test (in plain wrapper)—only 50c; three tests—dollar. Limited supply. Psychotest Service, Box 3243-L, Atlanta, Ga.

"HOW To Break and Train Horses"—A book every farmer and horseman should have. It is free; no obligation. Simply address Beery School of Horsemanship, Dept. 1110C, Pleasant Hill, Ohio.

WELDING—Electric arc. Learn profitable trade quickly through actual practice. Individual welder instructions at bare cost of materials. Full particulars free. Valuable welding lessons book 50c. Hobart Welding School, Box M-1042, Troy, Ohio.

USED Educational books bought, sold, rented. Free catalogs. (2500 books wanted.) Educational Exchange, Henagar, Ala.

DISCOVER Your best abilities through scientific aptitude tests. Information 10c. Testing Service, 202N Commercial Building, Rockford, Illinois.

FASCINATING Age-old methods, that may well start you on the road to wealth! Inquire. Habermann, Box 1642-Y Perry Square Station, Erie, Penna.

GET Dignified position, learn drafting. Monroe Institute, PM-10, Alton, Illinois.

INVESTIGATOR Training. Phillips Secret Service, 1917-B North Kenneth, Chicago 39, Illinois.

REFRIGERATION Mechanics. Complete home course for repair men. Booklet free. Mechanics School, Dept. 4-PM, 4703 West Pico, Los Angeles 6.

GET "Set now!" When the war-time job boom ends, only properly trained men will get and hold permanent positions with top pay. Pick air conditioning, refrigeration, heating, ventilating, welding, electricity, radio or electronics—fastest growing, most promising industries. Prepare now, train in a few months instead of years. Low tuition, liberal terms. Earn part expenses. Big book free. Milwaukee School of Engineering, Box 644, Milwaukee, Wis.

TRISECTION Solution—Divide any angle into three equal parts. Ruler and compass only. Send \$1.25 for your copy of this publication now! Author invented world's only universal focus lens. Pure Science Research Associates, Box 310, Moscow, Idaho.

MATHEMATICS, Drafting, building, surveyor's, engineer's licenses. Mondell Institute, 230 West 41st, New York.

READ Character at a glance. How to judge people by their eyes, nose, mouth, etc. May save you thousands of dollars, endless disappointment, heart break. Priceless information for everyone. Dulco, P324 Pitt, Pittsburgh 21, Penna.

TOOL Designing pays big. Home study course. Low cost. Easy terms. Free booklet. Ohio Institute of Technology, Box 188, Greenfield, Ohio.

WRITE Short stories at home for pleasure and profit. Fame, riches and happiness of achievement are rewards to be realized by students who acquire tested technique. Get free booklet from home study school with 50 years experience. Write today! Blackstone-Sprague, Dept. 110, 307 North Michigan, Chicago 1.

PSYCHOLOGY That works turns "ordinary" ability into "extraordinary" achievement. F.L.T. Ph. D., Dept. 89A, 185 Godfrey, Philadelphia 20.

"SUREHAND" Legible shorthand easily gets every word. Swiftest numerals. Textbook 25c. Jesse L. Cook, Bartow, Fla.

INCREASE Your income—Study magazines covering subject that interests you. Our list covers 175 fields—616 periodicals. It's free. Write today. Commercial Engraving Publishing Co., 34E North Ritter, Indianapolis 1, Indiana.

NEW Writers needed to re-write ideas in newspapers, magazines, and books. Splendid opportunity to "break into" fascinating writing field. May bring you up to \$5.00 per hour spare time. Experience unnecessary. Write today for free details. No obligation. Postcard will do. Comfort Press, Inc., 210-P South Seventh St., 2, St. Louis, Mo.

AUTO Body and fender work, including metal work, welding and spray painting. Look into it! One of the most profitable branches of tremendous auto industry offering chances for good job or your own business. Train in spare time. Write for free facts. Utilities Inst., Dept. 14X, 1316 W. Belden Ave., Chicago.

LEARN Profitable credit and collection agency business; investigate Educational Extension Service Advertisement under Business Opportunities.

HOME Study course, drugless therapy. Free literature. Inst. of Drugless Therapy, Tama, Iowa.

LIST of "Home Study" books free. (New, used.) Buy, sell, rent, exchange. Bargains! Dalton, Box 3363, Seattle 14, Wash.

RADIO Engineering, broadcasting, servicing electronics, aviation, marine and police radio taught thoroughly. All expenses low. Co-educational. Catalog free. Valparaiso Technical Institute, Dept. C, Valparaiso, Ind.

GOOD "Used" self-instruction educational books on all subjects bought, sold, rented, exchanged. Satisfaction guaranteed. Complete information and 92-page illustrated bargain catalog free. Write—Nelson Company, Dept. 2-02, Chicago 4.

CARPENTERS, We teach the square in five easy lessons by mail. Our 1/2 size practice square and simplified instructions does the work. Free information, better still send quarter for practice square and partial lesson. Builders' Topics, Medical Arts Bldg., Seattle, Washington.

USED Educational books on all subjects sold, rented, also bought and exchanged. Moneyback guarantee. Write today for free catalog and details. Lee Mountain, Pisgah, Alabama.

SECRET Investigation. Experience unnecessary. Investigators particulars free. George Wagner, M 125 West 86th, New York.

MEDICAL Laboratory technicians in great demand. We train you in your spare time, in your own home. You can practice while studying. Write for free catalogue. Imperial Technical Institute, Box 973-E, Austin, Texas.

DRUNKENNESS Is a disease which responds to treatment. Medical skill plus human sympathy prove successful with liquor and drug cases. 60 years experience. Write for free booklet. P. M. Nelson, The Keeley Institute, Dwight, Ill.

LOCKSMITH Course. Lock picking, key fitting, etc. \$1.00 prepaid. Locksmith, Canadian, Texas.

PLAYS, STORIES, MANUSCRIPTS

\$1.00-\$10.00 FOR Poems. Specialized market. Sample, 35c. Study before contributing. Strict regulations. Embers, E. Batavia, N. Y.

CARTOONING, COMMERCIAL ART, SHOWCARD WRITING, SIGN PAINTING

CARTOONING Course—30 illustrated lessons, over 500 sketches, complete \$1.00. Rex Cartoon Studio, Box 892, Pasadena, Calif.

STUDY Cartooning, make money. Complete course \$1.00. Chesley Studio, 1450 Broadway, Buffalo 12, N. Y.

FIGURE Drawing, 20 colored photographs, 8 1/2 x 11, \$2.00. Catalogue 10c. Sign, Farmington, Missouri.

CASH For humorous ideas! Details, dime. Gerard, Gaston, Fairmount, W. Va.

PEN Drawings from objects or photographs. Sanden, 716 - 21st, Bellingham, Wash.

WRITE Cartoon ideas. Nationally known magazine cartoonist booklet shows how. "Be Funny for Money, 25c." Uish Studios, 518P Wrightwood, Chicago 14.

CARTOONISTS—Sell work, 10 money making plans, 25c. Cartoon Studio, 1462 Charles, Lacrosse, Wis.

CHALK Talks. Laugh producing program, \$1.00. Catalog 10c. Balda The Cartoonist, Oshkosh, Wisconsin.

CARTOON Advertising; also lettering, layout service. Allan K. Jensen, Audubon, Iowa.

POCKET Size cartoon course—22 easy lessons, over 200 sketches including figures and lettering. Prepared by nationally known artist. Mailed postpaid on receipt of 25c in coin. Snack-Pack Co., 34 E. Georgia St., Indianapolis 4, Ind.

ADVERTISING AGENCIES, LETTER WRITERS, FOR ADVERTISERS

STRONG Letters—Mailorder, goodwill, promotional! Exceptionally experienced! Reasonable! Satisfaction guaranteed! Compare! Jenkins, 306 So. 25th St., Billings, Montana.

ADVERTISING Placed everywhere lowest rates. Reliable guidance on publications, expert assistance on ads without charge. Newspaper, magazine, mailing-list ratebook free. Chicago Advertising Agency, 20-P West Jackson, Chicago 4.

ADS Placed in out of town newspapers and magazines. Low rates. Catalogue free. Ideas that pay. Baker Advertising Agency, Successors Ankrum Agency, 189 W. Madison, Chicago 2.

3000 WOMEN Mail order buyers \$15.00. Our own customers. 1000—\$6.00. Woods Remnants, Bedford, Penna.

AFTER The war then what? Go in business, sell by mail, big profit, fully guaranteed. Dr. G. Anthony, 210 5th Ave., New York.

20 WORDS, 30 Newspapers, \$2.00. Goodall, 37 Gardner, Vallejo, California.

ADVERTISING, Promotional copy writing. Artwork, stationery designing. Attractive samples 10c. 150 designs \$1.00. Major Service, 3510 Palmer, Chicago 47, Ill.

ADVERTISE: 24 Words, 149 newspapers \$6.50. Lists free. Advertising Bureau, 4515-C Cottage Grove, Chicago 15.

18 WORDS In 100 weeklies \$4.32. H. J. Darnell, 730 Hays, Jackson, Tennessee.

MAIL Order operators—Get skillfully prepared copy when placing advertising. Our "lowest" line rate plus experience gives you more profits per dollar spent. Van De Mark, Times Star Tower, Cincinnati 2.

ADVERTISING Placed, any publication, lowest rates, complete agency service. Skilled advertising—merchandising counsel. Ratelist and booklet, entitled "Advertising Results For Sale" free. Baker Agency, 3302 Dodge, Omaha, Nebraska.

FREE—New Advertisers Rate Guide. 44 pages. Includes everything. Lowest rates. E. H. Brown Advertising Agency, Merchandise Mart, Chicago.

INCH Display advertisement, 50 magazines, year \$16. Wood's Popular Services, Atlantic City, (N. J.)

BUSINESS SERVICE

RECEIVING And re-forwarding mail. For further particulars write to Dunn Mail System, 216 West 69th Street, Box 42, New York 23, N. Y.

CHICAGO Mail address. \$1 monthly. Confidential. Representation. Faultog. 3439 Michigan, Chicago.

WANT A Washington, D. C. mail address? Complete reforwarding service, \$2.00 monthly. Hawkins, (Est. 1917), 7-b Randolph Place.

FOOL Friends, pretend you're visiting Washington, 3 view cards, send 25c (7-50c), you write message, address. I remain in Washington. Letters 15c. National, Box 6741, Fort Davis Station, Washington 20, D. C.

WANT A Washington, D. C. mail address? Complete reforwarding service, \$2.00 monthly. Hawkins, (Est. 1917), 7-c Randolph Place.

CHICAGO Mail address: Personal use—3 months \$3; business purposes—3 months \$5; mail received here forwarded to you same day. General Business Service, 30 W. Washington, Chicago 2, (Established 1919.)

BUSINESS Mail service—Send 25c for three Hollywood scenic post cards, write message, address, stamp and return to us for mailing from Hollywood. Letters mailed, 15c. Adele's Novelty Shop, P.O. Box 3535, Terminal Annex, Los Angeles 54, Calif.

INSECTS. Consult us on the extermination and control of annoying, destructive and disease carrying insects. Universal Exterminators, 960 Margate Terrace, Chicago 40, Illinois.

MIAMI, Florida, mailing address. Letters reforwarded promptly, 25c each, 5 for \$1.00 cash (no stamps). Send postage with letters properly addressed. Hamaco Service, P.O. Box 1445 Riverside Sta., Miami 35, Fla.

TYPEWRITERS, DUPLICATORS, OFFICE DEVICES

REBUILT Typewriters, mimeograph machines, office supplies, appliances. Dixie-graph, King, N. Car.

"PRINTOMATIC" Self-feeding rotary stencil post card printer, complete, \$9.50. All makes duplicator supplies. Literature free. Pittsburgh Typewriter Supply, 336-R Fourth Avenue, Pittsburgh 22, Penna.

RUBBER STAMPS, OFFICE SUPPLIES

3 LINES, Cushioned, indexed, knob handle, 50c guaranteed. Rubber stamp ink 25c. Pad 25c. Ideal Rubber Stamp Co., Box 83, Detroit 8, Mich.

NAME—Address (2 lines) self-inking pocket stamps \$1.00. Circular. Press, Warrmsprings, Ga.

ONE Line 20c, 2—35c, 3—50c, 4—65c. Stamp Works, Auburn, Nebraska.

3 LINES 30c; Cushioned, indexed, 35c. Signatures \$1.50. Stamprite, Wauwatosa, Wis.

PRINTING, MULTIGRAPHING, MIMEOGRAPHING, GUMMED LABELS

LETTERHEADS, Envelopes, 500 \$2.85, 1000 \$3.85. Billheads, noteheads, 1000 \$3.25. Free samples, quotations. Studio Press, 1728 Monroe, Madison 5, Wisconsin.

\$2.00 POSTPAID: 150 8½x11 good bond letterheads and 150 6¼ envelopes. 500 of each \$5.75 postpaid. Mero Products, Box 344, Punxsutawney, Penna.

CIRCULARS, Folders, postcards, typewriter letters, stationery—all printing—promptly at low prices. Samples. Goodprint, Harrisonburg, Va.

FREE Samples. Printing, multigraphing. Mango, 555-PM South 20th, Newark 3, N. J.

DISTINCTIVE Printing, rubber stamps, office supplies. Particulars free. Treaster Printing, Milroy, Penna.

500 TWO-COLORED Letterheads \$3.80. 500 6¼ envelopes \$1.80. Bowman Printing, Roxana, Illinois.

500 ¾x2¼ FOUR Line gum stickers 30c. Cliff's Print Shop, Dept. G, 926 Philadelphia Street, Covington, Ky.

200—8½x11 HAMMERMILL Letterheads distinctively printed \$1.00 postpaid. Envelopes same. Race Printing Company, Hudson, N. Y.

SERVICE Men's personal stationery. Ideal gift. Samples free. Walker Printing Service, Box 1298, Amarillo, Texas.

PERSONAL Printed postals, 150, \$1.00. Harper, 7940 Woodard, Dallas 17, Texas.

GENUINE Engraved letterheads, \$15 thousand. Samples. Faultless, 3439-P Michigan, Chicago.

ENVELOPES, Letterheads, mimeographed forms, 500, \$2.00; 1000, \$3.75; 5000, \$14.95. Victory, 3708-PM Cranston, Baltimore 29, Md.

BEST Printing! Letterheads or envelopes. 200—\$1.25; 500—\$2.50; 1000—\$3.85. Appas, Box 391, Charlotte 1, N. C.

150—8½x11 LETTERHEADS And 150 6¼ envelopes \$2.00 prepaid. Gago, Box P1544, Muskogee, Okla.

LET Us help you in all your printing needs. Lowest prices. State requirements. Printing Service, 7922 So. Vermont Ave., Los Angeles 44, Calif.

PRINTING That pleases, low prices. Quick service, samples. Schmitt Press, 2950 Stafford, Pittsburgh 4, Penna.

YOUR Name, address on de luxe cushion mount rubber stamp, \$1.00, pad 25c. Name and address neatly printed on 500 gummed stickers ¾x2" 30c coin (no stamps). Write plain. Printing pricelist free. Edgewood Press, Box A-1, Edgewood, Maryland.

MIMEOGRAPHING And multigraphing. 14 years of fine work and fair prices. Free samples and prices. H. Allsmith, 1500 W. Nedro Avenue, Philadelphia 41, Penna.

QUALITY Printing moderately priced. Estimates on anything. Samples. Keystone Printing, 292 West Third Street, Williamsport 3, Penna.

\$1.00 POSTPAID: 100 8½x11 Bond letterheads and 100 6¼ envelopes. Benneville, 907 West Roosevelt, Philadelphia 40, Penna.

MIMEOGRAPHING—Any copy. Reasonable. Mailers Service, Box 606-A, Chicago 90, Ill.

CALENDARS—Post cards—of dogs, pigeons, canaries. M. Nicodemus, 2156 Beaufort Ave., Chicago 18, Ill.

ENGRAVING Cuts—engravings 10c per square inch—(minimum \$1.00). 1 column halftones \$1.00 each, postpaid. List and samples free. Superior Engraving Co., Parkersburg, W. Va.

LOW Prices, quick service. Free samples, estimates. Wilson Printing, Dowagiac 3, Mich.

\$2.00 POSTPAID: 150 8½x11 Good bond letterheads and 150 6¼ envelopes. 500 of each \$5.75 postpaid. Mero Products, Box 344, Punxsutawney, Penna.

100 LETTERHEADS, 100 Envelopes to match, beautiful Rippletone \$1.25. Clarion Press, Richland, Iowa.

DISTINCTIVE Printing: 500 8½x11 bond letterheads or 500 6¼ envelopes, \$2.75 prepaid. Neat work. Fast service. Victor Chicke, Harvey, Illinois.

\$4.00, 1,000. LETTERHEADS, Envelopes, statements, cards, etc. Dixie, Chattanooga 7, Tenn.

3000—6x9 CIRCULARS \$5.85 postpaid to 4th zone. Education Publishers, Pittsfield, Mass.

MIMEOGRAPHING—Letters, pricelists, formulas, instructions. Lowest prices. Lem's Letter Shop, 5710 Stanton, Detroit 8.

500 ¾x2¼ FOUR Line gummed stickers, 25c. Moritz Printery, Saginaw, Mich.

BETTER Grade printing reasonable. Estimates on anything. Economic Press, Leonia, N. J.

PRINTING OUTFITS AND SUPPLIES

TYPE 25c, Cases 25c, used presses. Mureico, Box 748, Dayton 1, Ohio.

INEXPENSIVE Home-made printing press. Details free. Novelty Shop, Downs-ville, Louisiana.

PRINTING Equipment, type and supplies. Send stamp for details or dime for complete illustrated supply book. Kelsey Inc., X-11, Meriden, Conn.

PRINT At home. 10c will bring a complete catalog of presses, type and supplies. P. Peiffer & Company, 6 Columbia St., Newark, N. J.

USED Presses, type, supplies. Lists 3c. Turnbaugh Service, Laysville, Penna.

PATENT ATTORNEYS

INVENTORS—First things come first. Your first move toward securing a patent on your invention is acquiring full information on what to do. Our two books "Patent Protection" and "When and How to Sell Your Invention" contain this information and other helpful data. Get them immediately, together with our "Evidence of Invention" form. They cost you nothing, you assume no obligation. Write now to Victor J. Evans & Co., Registered Patent Attorneys, 831-L Merlin Building, Washington 6, D. C.

INVENTORS: Learn now—without obligation—how to protect and sell your invention. Write for free "Record of Invention" form and complete information for making disclosure and establishing date of your invention. We also send our new free "Patent Guide for the Inventor," containing complete information about patent procedure and how to sell inventions; giving illustrations of many successful inventions; over 150 basic mechanical movements. We assure you prompt, confidential service. Delays may be dangerous. Write today for your free "Patent Guide" and "Record of Invention" form. Clarence A. O'Brien & Harvey Jacobson, Registered Patent Attorneys, 41B-K Adams Building, Washington, D. C.

PATENT Attorney since 1904: easy terms; reasonable. Sanders, 6430-A Evans, Chicago 37, Illinois.

PATENTS. Personal service, no catalogues. Washington associate. David Charnes, Patent Lawyer, 606 W. Wisconsin Ave., Milwaukee 3, Wis.

"PATENT-Particulars" and blanks, free. airmailed. Sterling Buck, Park-North Avenues, Baltimore 17, Md. Government-registered 38 years.

INVENTORS—Before disclosing your invention to anyone send for form "Evidence of Conception"; "Schedule of Government and Attorneys' Fees and Instructions. Sent free. Lancaster, Allwine & Rommel, 411 Bowen Building, Washington 5, D. C.

INVENTORS—Industry needs your ideas now! Manufacturers are getting ready now for post-war sales and production. Factories must have products to take up the slack after war orders stop. Get our new free inventor's book today and valuable "Invention Record" form. Act now. McMorro and Berman, 134-C Albee Building, Washington, D. C.

"INVENTOR'S Guide," 100 mechanical movements, free; advises on patenting, selling inventions. Frank W. Ledermann, 154 Nassau Street, New York.

PATENTS. Promptness assured. Wilfred E. Lawson, 1524 K Street, N.W., Washington 5, D. C.

C. A. SNOW & Co., M-427 Snow Bldg., Washington 1, D. C. Registered patent attorneys. Established 1875. Literature mailed on request.

PATENTS Obtained; selling service, information, recording forms free. Labiner, World Building, New York.

L. F. RANDOLPH, 302-B Columbian Bldg., Washington, D. C. Low cost. Book and information free.

PATENTS. Protect your idea by securing free "Proof of Invention" folder. Exceptional personal service. Established 1906. E. E. Vrooman, 871 Woodard Bldg., Washington, D. C.

PATENTS—Trade marks, Preliminary advice, book and disclosure form free. Personal service. Irving L. McCathran, 315 McLachlen Bldg., Washington 1, D. C. Registered Patent Attorney.

FOR INVENTORS

YOUR Product idea—is wanted. Leading manufacturers are eagerly seeking sound, practical, new product ideas. If you have one, investigate what this organization can do for you as special counsel to a group of prominent companies located in the very heart of war-time production. Remember, the best idea in the hands of the wrong manufacturer cannot produce maximum profit. Investigation costs nothing—incurs no obligation. Write or wire for immediate action. The Howard Crawford Company, 2015 Book Tower, Detroit 26, Michigan.

PATENT Your Ideal Write immediately for two free illustrated books, "Patent Protection" and "When and How to Sell an Invention," 64 pages of valuable information for inventors. No obligation. Address: Victor J. Evans & Co., 832-L Merlin Bldg., Washington 6, D. C.

INVENTORS: Learn now—without obligation—how to protect and sell your invention. Write for free "Record of Invention" form and complete instructions for making disclosure and establishing date of your invention. We also send our new free "Patent Guide for the Inventor," containing complete information about patent procedure and how to sell inventions; giving illustrations of many successful inventions; over 150 basic mechanical movements. We assure you prompt, confidential service. Delays may be dangerous. Write today for your free "Patent Guide" and "Record of Invention" form. Clarence A. O'Brien & Harvey Jacobson, Registered Patent Attorneys, 41A-K Adams Building, Washington, D. C.

SMALL Rubber factory is looking for new items to manufacture postwar. Do you have a patent or a good idea? Perhaps we can help you with design or financing. Reliance Rubber Company, 1515 Powell Street, Oakland 8, California.

ALLIED Patent Enterprises, world-wide services, established 1928, 4854 Santa Monica Blvd., Hollywood 27, Calif., inventions patented, promoted, engineering, complete services for inventors and manufacturers.

INVENTORS—Get action and results on your patented, unpatented inventions. Contact purchasing manufacturers direct. Enlightening booklet, references, free. Invention Reporter, 5A-11236 So. Fairfield, Chicago.

INVENTORS! Have you good patentable ideas? Write Mr. Metzler, 11 West 42nd, N.W. York.

MANUFACTURERS And inventors—Ask us for an estimate for consulting on your manufacturing problems, developing your ideas or refinements on your products for postwar production. We are equipped with a staff of graduate engineers with many years of product design experience. Have your ideas witnessed for your protection. Engineering Associates, 543 Parkview Ave., Westfield, N. J.

INVENTOR Given instruction. Teaching you how to become inventor. Copy 25c. Course \$1.00. Charney, P.O. Box 542, Plainfield, N. J.

WE Protect, commercialize unpatented ideas; sell patented inventions; low cost. Parker, Box 702-p, Chicago 90.

"NOTARIZED Blueprints"—The perfect prepatent protection for unpatented inventions or ideas. Mail rough sketches, detailed description or model, \$15.00 maximum or less for 24"x30" tracing. Send for sample copy today. Write Draftsmen Associates, 299 Madison Ave., New York 17, N. Y.

MANUFACTURER'S Names, addresses. Any classification. Tupper, 18-A Lyman, Beverly, Mass.

INVENTORS—Your patented, unpatented inventions, gadgets, ideas, have a brilliant future if made of plastic. Send drawings and description for technical advice pertaining to your invention. Plastic Engineer, 1603 Linden Ave., Long Beach 6, Calif.

INVENTORS: New military and commercial inventions urgently needed by manufacturers. Write for particulars. Chartered Institute, Dept. 4-A, Washington, D. C.

CASH For practical ideas and inventions. Mr. Ball, AB-9441 Pleasant, Chicago.

I SELL Patents. Established in 1900. Charles A. Scott, 773PM Garson Ave., Rochester, N. Y.

INVENTIONS WANTED

WANTED—Patented, unpatented inventions having profit possibilities, all kinds. If will sell, write immediately. Descriptive booklet, references, free. Invention Reporter, 5B-11236 So. Fairfield, Chicago.

CASH For postwar product ideas, patented or unpatented, urgently needed. Write Industrial Engineering, 1155 South Kenmore, Los Angeles, California.

INVENTORS! Have you good patentable ideas? Write Mr. Metzler, 11 West 42nd, New York.

INVENTIONS Urgently needed for industry. Write Seymour, 218 Aurora, Easton, Maryland.

INVENTORS: Learn how we sell your invention. Free booklet, "Selling Your Invention." Inventors Patent Exchange, 336-B Palace Building, Hartford 3, Conn.

WE Develop your ideas, build models, necessary tools and dies for quantity production, have fully equipped plant and engineering dept. Will finance if necessary. Logan Elec Spec. Co., 214 S. Loomis, Chicago 7, Ill.

RELIABLE Advice on your ideas for inventions, processes and methods. Our certificate entitles you to one year's service on any number of your ideas. Recommendations on engineering, development, patenting and marketing. Complete protection—registered engineers. International Inventors Service, 619 Corbett Bldg., Portland 4, Oregon.

CASH For inventions, patented, unpatented. Mr. Ball, A-9441 Pleasant, Chicago.

MANUFACTURER Wants sensible mechanical device or idea with quick sales possibilities in low-priced field. Write Matt, 1412-D Great Northern Building, Chicago 4.

WANTED — Patented or unpatented ideas for postwar manufacture. Submit plans and proposition. Sierra Mfg. Co., 610 So. Arroyo Pky., Pasadena 2, Calif.

ALL Kinds. We have facilities and finances to make and sell your ideas, both mechanical and chemical. Send model, sample, details and wishes. General Sales & Supply Company, 110 East Main St., Madison 3, Wisconsin.

INVENTORS: Have you a sound, practical invention for sale, patented or unpatented? If so, write Chartered Institute of American Inventors, Dept. 4-D, Washington, D. C.

PATENTS FOR SALE

BIG Fortune for someone. Marvelous invention. Split rim auto wheel. Fully patented. Child can change tire in few seconds. Thoroughly tested over 10,000 miles, all roads. Will send part interest; form company, or sell outright. William B. Crane, 305 West 8th St., Los Angeles 14, Calif.

WAR Novelty for sale. Allan Browne, 4715 Michigan Ave., Chicago.

METAL Adjustable weather stripping. Simple to install. Big item for chain stores. Apt. B11, 5101 39th Ave., Long Island City 4, N. Y.

SAFER Men's collar clips, royalties, patent pending. Joseph Palagonia, 1724 Putnam Ave., Brooklyn, N. Y.

COFFEE Sack drainer. Patent No. 1681786, with improvements. Samuel Rickles, 718 1/2 23rd, Seattle 22, Wash.

OUTRIGHT OR royalty, patented collapsible head crowbar and pinch bar, good for building and wrecking jobs. Clarence Chaddock, 1243 W. 22 St., Los Angeles, Calif.

ADVERTISING Sign, animated attention compelling for display window or billboard. Motor, fan or breeze powered. Patent 2,093,710. P. R. Conley, 8415 Roosevelt, Seattle, Wash.

I HAVE Several excellent inventions for postwar production. Royalty basis. Inventor, Box 144, Catskill, N. Y.

MANUFACTURING

INDUSTRIAL Diamonds, precision machining. Products wanted. Models production small lot. Specialty Machine Shop, 2821 Mitchell St., Racine, Wis.

MODELS. Special to order work made. Baum's Metal Specialties, Kansas City, Mo.

MODELS—Small lot manufacturing. Metals, plastics, etc. Milburn, Burlington, Kentucky.

HOME CRAFTSMEN

EXTRA Cash. Build and sell toy electric cannons. Loads like real cannon. Accurately shoots steel shells by magnetic propulsion. 110 volts. Power tools unnecessary. Drawings, instructions, photograph \$1.00. Details free. Hamilton, 650-A South 20th Street, Newark 3, New Jersey.

TOYS—Bulldozer, power shovel, and earthmover of new design in wood. Make toys for your home town of scrap lumber with hand or power tools. Prints showing construction and details \$1.00. Earthmover Toys, East Lansing, Mich.

TOYS Easily made from scrap wood. 15 patterns 25c. Novelties from scrap wood, 25 patterns 25c. Lynde, Medway, Mass.

WHITTAKER'S — Softwood subjects, 10 patterns, instructions, 25c. Cartoon Studios, 1402 Charles, LaCrosse, Wis.

NEW Plastic sheets, 1/16x8 1/2x11—\$1.50. 1/4x10x10 \$2.00. 3/16x10x10 \$2.25. 1/2x10x10 \$2.50. Manual plus free sample 25c. Complete kit for beautiful cigarette box \$1.25. Plastic Center, 3132-C West 11th, Los Angeles, Calif.

FIFTEEN Fast selling novelty and toy patterns \$1.00. Winokur, 4815 Locust St., Philadelphia, Penna.

RENOVATE Your own Venetian blinds. We supply new tape, cord, hardware. Send 10c for illustrated instructions on cleaning renovating. Venetian Blind Supply Co., 1612 Farwell, Chicago 26.

CATALOG: Large line decal transfers. Patterns for jig sawing. New designs easy to make novelty furniture, lawn ornaments, silhouettes, letters and numerals. 100 crafts and hobbies illustrated booklets. Tools. Other lines. 500 articles finely illustrated. Write Wo-Met Shop, Ashburn, Georgia.

28 LAWN Ornament patterns 25c. Other patterns; 15"-20" high; Dutch girl; Dutch boy, pirate, bull terrier, Mexican girl, Mexican boy, dwarf, penguin, flower girl, 10c each; 3 for 25c. 35 novelty patterns 30c. All 62 full size patterns \$1.00 postpaid. Strother, Box 383-GC, Belington, W. Va.

CELLULOID — Beautiful assortment. Mottles, opaques, onyx, pearls. Used by ring makers everywhere. One pound assortment—pieces approximately 30 sq. in. each. Price \$1.00. Craft Service, 337 University Ave., Rochester, N. Y.

THE Shebel Piler files all saws. Send for circular. A. P. Shebel, 730 S. 2nd St., Milwaukee 4, Wis.

PLYWOOD—Beautiful non priority aircraft stock. Thickness 1/32" through 1/4"; large, small panels. Fir, gum, birch, mahogany. Reasonable. Lists 10c. Carmen-Bronson, 160-B East Fourth Street, Mount Vernon, N. Y.

MODELS AND MODEL SUPPLIES

PLANES, Boats, hundreds of hobby items. Catalog 6c. America's Hobby Center, Dept. B104, 40 E. 21 St., New York 10, N. Y.

COMPLETE Kits: Ship models—coach models—covered wagon. All parts cut to fit—no shaping required—tack hammer only tool needed. Everything included, sails, wire and rigging. Send 3c for catalog. Miniature Ship Models, Dept. R, Perkasie, Penna.

MODEL Steam and gasoline engines, castings and drawings. Literature 10c. Wayne Miller, 205 W. Wacker Drive, Chicago 6.

RAILWAY Models, complete line, informative catalog HO and O gauge. 79 pages, 15c. Walthers, 247 Erie, Milwaukee, Wisconsin.

MODEL Steam engines, boilers. Circular M 10c. Anton Bohaboy, 2297 Price St., Rahway, New Jersey.

SHIP Model kits and fittings. Complete line Fisher model yacht equipment. All Boucher, Fisher, Marine Model and Ideal kits, fittings and blueprints at standard prices. Most complete stock in New England. James Bliss & Co., Inc., 220 State Street, Boston, Massachusetts.

MAKE IT YOURSELF

BARBECUE Plans. Build your own "vertical" barbecue with our four sheet master set of plans; 49 detail drawings, complete instructions, easy to build, inexpensive. \$1.00 postpaid. Allen Selby Associates, 1836-A Chase Ave., Chicago 26, Ill.

BUILD A proven long life regular size storage flash light battery easy. No technical knowledge needed. Material secured anywhere cheap. No priorities. Recharge from car battery, little current used. Instructions one dollar. B. Wayland, Red Bluff, Calif.

BUILD It yourself. Automatic overhead garage doors operated from drivers seat. Used auto parts and other material available everywhere cheap. Use 1/4 h.p. motor. Tried and tested. Be first in your neighborhood to build one. Complete plans \$1.00. McIntosh Projects, 2479 Coolidge Ave., Oakland 1, Calif.

FLOURESCENT Lights. How to make your own 20 watt lights for less than \$1.00 each. Complete, guaranteed, detailed instructions \$1.00 M.O. or war stamp. Specialty Sales, Box 1086, Muncie, Ind.

WATCHES, OLD GOLD, JEWELRY, ETC.

GENUINE Diamonds, out-of-pawn low prices, wonderful values. Unredeemed loans and big buying power enable us to offer beautiful gems at prices far less than original cost. Shipped free for inspection, appraisal. Send for big free list showing fine diamonds at startling low prices. Lloyd J. Butler, President, Prudential Loan Association, 133-PL North Clark St., Chicago 2.

GUARANTEED Men's reconditioned Swiss wrist watches. Reasonably priced. Free particulars. Notlimah and Company, 407A North Broadway, St. Louis, Mo.

WANTED: Watches, diamonds, jewelry—any condition. Justice, Box 150, Chicago 90.

GOLD \$35.00 Ounce—Mail old gold teeth, diamonds, jewelry, watches—receive cash by return mail. Satisfaction guaranteed. Free information. Dr. Weisberg's Gold Refining Company, 1500-Q Hennepin, Minneapolis, Minn.

WATCH Repairing easy learned by our home study course. Watch repairers are in demand and are among the highest paid craftsmen today. Write for free information. Houston Chronometer & Watch Co., P.O. Box 5367C, Houston 12, Texas.

WATCH And clock repairing—complete practical course in modern horology. 66 illustrated self-instruction lessons. Just out! Low price. Information free. Write —Nelson Company, Dept. 8-02-2, Chicago 4.

OPALS. Sample packet \$5.00. Catalogue free. Norman Seward, Melbourne, Australia.

WATCHES. Materials, tools, jewelry, diamonds — bought — sold. Catalogue, Gales, Box 1000, Chicago.

TOBACCO, SMOKERS' SUPPLIES

FINE Six cent cigars available soon. Be first on list for first shipments. Act now. Send no money, only name and address to P.O. Box 776, Dept. F-64, Chicago 90, Ill.

PIPES Repaired. Send for free catalog. Sidney Ram, 59 West Monroe, R-64, Chicago 3, Illinois.

MAKE Smoking pipes, briar blocks 30c. Stems 15c. Michelson & Sternberg, 67 West 44th St., New York 18.

FREE To pipe smokers—For a new pipe smoking thrill, write us your brand of tobacco and get free package mild, tasty, natural-flavored "Green River." Pete Moberly, Box 987, Owensboro, Kentucky.

RAZORS, BLADES, SHARPENING

AGENTS — Patented "Slant-Stroke" razor and 10 "All American" blades in attractive box. \$3.00 dozen. American Sales, 1133 Broadway, New York City.

SURVEYING INSTRUMENTS

GUARANTEED Factory rebuilt transits and levels for sale (cash or terms) or rent (with purchase option). We will repair, trade, or buy old instruments. Ship prepaid for estimate and valuation. For complete information, write for list M910, Warren-Knight Co. (Manufacturers of Transits and Levels), 136 N. 12th St., Philadelphia 7, Penna.

FOR SALE—MISCELLANEOUS

ARMY Gun slings, used, 39c. musette bags \$2.95, messkits 60c, canteens, carbide lamps, carbide, sleeping bags, wool blankets, pup tents, canvas, cement, airplane dope, boat supplies, Alan-Clarke, 100 Chambers, New York City.

WANTED—MISCELLANEOUS

SWAP. Buy, hobby-collectors items wanted for "Western Trading Post." Valuable list 20c postpaid. Your ad sent all over U.S.A. Write today, 1355 Cedar Avenue, San Bernardino, California.

TYPING. Manuscripts or envelopes. Write, Mag, 2385 Castle, Cleveland 13, Ohio.

OLD Music bought. Particulars stamp. Drake, 3151 High, Denver 5, Colorado.

WANTED: Distribution rights for meritorious product. Bob Pace, Combs, Ark.

MANUFACTURERS Experienced salesman, past middle age, desires representation with reliable company, in this or other desirable territory, for post-war selling. What have you? Benson, 3423 East Douglas, Wichita, Kas.

WANT Coin operated machines — all kinds. Describe. Adair Company, Box 166F, Oak Park, Illinois.

WANT To buy: Old time music boxes. North Side News, Sheboygan, Wis.

WE Buy "anything"! Highest prices guaranteed! Justice, Box 150, Chicago 90.

MERCURY (Quicksilver) — Cadmium, bismuth, tungsten, molybdenum, cobalt, vanadium. Write for quotations stating quantity. You'll receive guaranteed prices. Metallurgical Products Co., 35th and Moore Sts., Philadelphia, Penna. Established 1909.

WATCHES Wanted—Broken or usable—all kinds, even Ingersolls. Highest prices paid for jewelry, rings, spectacles, alarm clocks, razors, cigarette lighters, gold teeth, etc. Cash mailed promptly. Lowe's, Holland Bldg., St. Louis 1, Mo.

GOLD Coins wanted. Will pay 50% above face value. Ralph Shaw, 707 So. Broadway, Los Angeles, California.

PERSONAL

GROOVED Letters correct poor penmanship—few hours—guaranteed. Ozment, 9, St. Louis, Mo.

FOR Only 25c I'll send you identification key tag with your name, address, phone number, social security number. Stamping machine Operator, P.O. Box 681, Lansing, Mich.

CHRISTMAS Coming, save money, buy Lucite giftware from manufacturer. Literature free. Art Plastics of California, 1350 82 Ave., Oakland 3, California.

HAND Balancing quickly learned. Write, W. Power, 923 W. Vine, Kalamazoo, Mich.

FALLING Hair, its cause and prevention, is fully explained in an informative and educational pamphlet entitled "How to Keep Your Hair Till Ninety." For free copy write James Hilton, 4819 Fourth Ave., Brooklyn 20, N. Y.

HANDWRITING Character analysis 25c. Irene, 33 Mountain St., Hartford 6, Conn.

EVERYONE Should make a will, complete booklet, \$1.00. Hendrix Studio, 411 Madison, Wilmington, Delaware.

SEE Your name in newspaper headlines. Startle your friends. Fun galore. Any wording printed. Free particulars. Write Horne, Box 372Y, Back Bay Annex, Boston 17, Mass.

SLEEPING Or hunting—you need Sleep-Rite, soft waxen earstoppers that stop noise. Users say,—"sleep like a babe,—health improved,—great,—wonderful,—blessing." Guaranteed package 10c. Four months supply \$1.00. Free "Sleep" literature. Raymond Dow, 15 Park Row (12150), New York 7.

SCREEN Summary digests leading critical opinion on current films. Trial subscription—5 weeks, \$1.00. Zubryn, 25 West 70, New York 23, N. Y.

MISSING Persons located. Birth certificates obtained. Chaffee, 308 Washington, Chicago 6.

RUPTURED? Improved appliance helps many. Free trial. Write Earles Co., Flint, Michigan.

BURNING Feet, stinging callouses quickly relieved, particulars free. Lunco Products, Kimball, Nebr.

IT'S Not a dream, but your inner self, trying to exert you to take advantage of the knowledge, power and financial success that is rightfully yours. Details free. William C. Bradley, Box 2778, Kansas City, Mo.

PSORIASIS Sufferers: Pixacol has brought relief when everything else failed. Use only as directed. Apply externally, dries quickly, convenient. 1 1/2 regular \$1 bottle without investing a cent! Write: Pixacol, Box 3583, Cleveland, Ohio.

MARRIAGE Certificate for married couple who do not have suitable license for framing. Two color. Dollar. Caswell Associates, R. No. 2 P, Altoona, Penna.

PERSONALIZED Pencils—Individual or firm name imprinted gold. Economical for school and office. Dozen 50c, 3 dozen \$1.00, gross \$3.60 cash, delivered. Pencil Market, 611 - 15th St., Knoxville 16, Tenn.

BUY Vitamins, half price. Vitamin guide free. Richardson, Wyoming, Penna.

HAIR Falling? Dandruff? Write Trichologist, 137 Lewis St., Phillipsburg, N. J.

TATTOOING Outfits, designs, colors. Write today. Zels Studio, 728 Lesley, Rockford, Illinois.

GIRL Photos, beautiful models, only \$1.00 for group. "Little Eve," Box 211, Terre Haute, Indiana.

DRUNKENNESS Is a disease which responds to treatment. Medical skill plus human sympathy prove successful with liquor and drug cases. 60 years experience. Write for free booklet. P. M. Nelson. The Keeley Institute, Dwight, Ill.

MISCELLANEOUS

TAILORED Homes, Sixty plans one-story houses with selection beautiful colonial, English, Spanish, moderne exteriors—making hundreds of combinations! Price \$1. Prepare for rationing and higher building site prices. Avoid rush, plan now! H. P. Jones, 486K Brandeis Bldg., Omaha, Nebr.

BOYS—Girls, write for free gift. David Berg, 659 Churchill, Bridgeport 29, Conn.

ROACH-PROOF: "Permanenteur" rids all roaches; non-poison. \$5.00 only answer, satisfaction guaranteed. Old Colony Wax, Davenport, Iowa.

YOUR New post-war home! Save 1/3 to 1/2 by building it yourself. Let us show you how. Circular free. Address: William H. Jackson, A.B., 1713 Howard Street, Port Huron, Michigan.

POCKET Shoe cloth, 5c postpaid, 3 for 10c. Essential Products Co., Williamsburg 1, Mo.

"CUT Your Own" hair 7 1/2" long, \$1.00 prepaid. Bulk Company, Aurora, Illinois.

BIG Mail for you. Latest moneymaking offers, opportunities, catalogs, magazines. Name listed in directory 10c. Ideal Service, 110-M, Park Ridge, Ill.

UNPAINTED Wall plaques 2 1/2c up. Write Oman, 642 1/2 Broadway, St. Paul 1, Minn.

CORPORATION Prospectus prepared. Financial advertising literature written. Charters secured. Lists. Faultless Organization, 3430-B Michigan, Chicago.

HOW To drill glass, no special tools needed, full particulars, how to make money hints. Send one dollar bill to: Harry O. Shoots, 326 E. Liberty St., Charlestown, W. Va.

ARTISTIC Serving tray, hand decorated, signed by artist, \$2.98 refund in 5 days. Michele Studios, Box 64, Allenhurst, N. J.

NOW You can make your own Plasto-plate printing cuts. Simple, easy process. Adayservice, Argyle, Wisconsin.

8 1/2" x 11" BLUE Printer, complete with blue print papers, tracing papers, chemical, \$2.75 postpaid. Best Co., Box 5802F, Cleveland 1, Ohio.

MEXICAN Jumping bean season closes November. Dozen 25c, hundred \$1.00. Mexican Products Co., 126 N. Main, Tulsa, Ok, Oklahoma.

BIGGEST Money in tattooing now! No experience required. Complete instructions with outfits. Send for free literature. Tatuco, 681 South State, Chicago.

PENCILS—Individual or firm name imprinted gold. Dozen 50c, 3 dozen \$1.00, gross \$3.60. Pencil Market, 611 - 15th St., Knoxville, Tenn.

INFORMATION. Any subject. Moderate rates. The Roxbys, 747 So. New Hampshire Ave., Los Angeles 5.

IDENTIFICATION Necklaces, lodge tags, 25c each. Moyer, B-252, Milton, Penna.

10 BEAUTIFUL Novelties from "The North Woods." Balsam pillows, sweet grass baskets, beautiful plaques, everlasting moss, flowers in novelty vases, ash trays, etc. Ten for only \$1.00 plus 35c postage. Wingfield, Medicine Lake, Tenstrike, Minn.

TRIMRITE Combs trims family's hair; 60c postpaid, guaranteed. Park, 501 West 145, Dept. 5, New York 31.

HITLER'S Last resting place. (A wow) and others. Sample 25c. Gregor's 79 Cortlandt Street, Belleville 9, N. J.

PRESS Clippings; miscellaneous literature. All subjects. Particulars free. Box 29, Englewood, Colorado.

A THOUSAND Laughs—Unique Jackass cigarette dispenser. Holds 10 cigarettes. Simply press donkey's head down, tail rises—presto—out slips cigarette. Satisfaction guaranteed. Sent postpaid for \$1.00 with order or \$1.10 c.o.d. Sanimo Industries, Dept. C-8, Spencer, Indiana.

PRINT Photographs on handkerchiefs, linen, etc. Directions 10c. Parker Publications, Peterboro, Ont., Canada.

KEEP Eggs fresh 6-12 months without ice or mechanical refrigeration; buy them when cheap. Complete instructions 50c. Mandrake Company, 1412 Great Northern Bldg., Chicago 4.

MEXICAN Importations, bulletin free. Featherwork greeting and place cards. Samples 25c. Mexican Products Co., 126 N. Main St., Tulsa 3, Okla.

FOOL Your friends. Pretend you are in San Francisco. 3 postcards sent 25c (20—\$1.00.) You write message, address, return. I remail in San Francisco. Letters mailed 15c. Your friends will think you're traveling. Ira Smith, 153 Liberty St., San Francisco 10, Calif.

INK Powder 25c (pint). Park, 501 West 145, Dept. 5, New York 31.

POST-WAR Fumigating cap, fits on paper bags, protects planting seed, clothing, furniture, rugs from ravages of insects and rodents for an indefinite period. Also to fumigate pot plants, shrubs and other plants all without dangerous effects. Cap to be made of light pressed metal. Fumigating Cap & Bag Co., P.O. Box 296, Tallulah, La.

GOOD "Used" self-instruction educational books on all subjects bought, sold, rented, exchanged. Satisfaction guaranteed. Complete information and 92-page illustrated bargain catalog free. Write—Nelson Company, Dept. 2-02-3, Chicago 4.

MEDICAL Laboratory technicians in great demand. We train you in your spare time, in your own home. You can practice while studying. Write for free catalogue. Imperial Technical Institute, Box 973-J, Austin, Texas.

MAGAZINES Covering 175 vocations—616 different periodicals. Learn more—earn more. Literature free. Commercial Engraving Publishing Co., 34D North Ritter, Indianapolis 1, Indiana.

HULA Skirts—Largest supply U. S. \$1.75—\$7.50. Write for catalog. Oahu Publishing Company, 802 Film Building, Cleveland 14, Ohio.

FREE—Illustrated movie photo catalogue, listing movie stars, bathing suit poses, candid photos, band leaders, vocalists, etc. Send ten cents to cover handling and mailing which will be refunded with order. Irving P. Klaw, 209 East 14 St., New York City 3.

FLORIDA Cocoanuts for souvenirs. Only \$1.35 each. No stamps. Tropical Service, Box 85, Little River Sta., Miami, Fla.

ELECTRICAL BOOKS

shipped
FREE



8 BIG BOOKS

FOR EXAMINATION
**MODERN
ELECTRICITY
INCLUDING RADIO
AND REFRIGERATION**

Here's great news for anyone interested in Electricity. NEW, up-to-date 19th Edition of Applied Electricity with new subjects fully covered, including blueprint reading, electronics, F. M. radio, fluorescent lighting, 8 Big Books FREE for examination!

NEW Edition for
Beginners and
Experts

Over 3700 pages, 2700 illustrations and 134 tables in most complete electrical work we have published. Dynamos, motors, direct plants, power stations, transmission—everything explained for easy understanding.

**BIG FIELD! Big Demand!
Big Pay!**

Men who understand electricity are needed now in all kinds of industries, and will be needed when war production has ended. Practically every business depends on electrical knowledge, and men who know this subject make big money. Learn easily with these new, interesting books. Send coupon for a set for FREE examination. See how they will help you to get ahead faster.

SEND NOW [A year's consulting privileges with our engineers now given to all buyers of this famous Cyclopaedia of Electricity.]

AMERICAN TECHNICAL SOCIETY
Vocational Publishers Since 1898

American Technical Society, Dept. E-719, Drexel at 58th St., Chicago 37
Send for 10 days' free use, 8 volume set of New 19th Edition, Applied Electricity, including a certificate entitling me to consulting privileges for one year. I will pay the delivery charges only on the books. If I wish I may return them in 10 days and owe you nothing, but if I keep them, I will send \$2.00 after 10 days, then \$3.00 a month until the total price of only \$29.80 is paid.

NAME

ADDRESS

CITY STATE

Please attach letter stating age, occupation and name and address of employer and have at least one business man as reference. Men in service, also please give home address.

Quick! Right Now Get into DRAFTING



**I'll train you until you
have a GOOD PAY JOB**

With industry working feverishly—the field for Draftsmen is bigger than ever. More important—draftsmen and designers must come first in changing back to peace-time production. Get into a better job with more pay and fascinating, pleasant work. Engineer Dobe will train you at home—in your spare time, to get experience on actual work, the same kind of jobs you will do in the best paid position, and train you until you are competent, experienced, holding such a position that will mean advancement and pay raises as deserved. When competent will recommend your practical work experience as references. No need for previous training to start with me—and lack of higher education should not hold you back. You can pay monthly for your practical training from an engineer; the cost is reasonable. Write today for full illustrated details and booklet. Give your age to get reply.

**All working tools
FURNISHED**

Professional drawing instruments, all working tools, also drawing table furnished with training. Start in right Now.



GET THE FACTS TODAY!

ENGINEER DOBE, Div. 3377, Libertyville, Ill.
Please send me training facts on "Drafting and Industrial Designing". Also advertised list of positions for Draftsmen and Designers Wanted.

Name.....Age.....

Address.....

Town.....State.....

PREVENT LARGE FIRES

SMALL FIRES from becoming



A recent frightful increase in fire hazards has stepped up the demand for fire protection equipment to a new high. FYR-FYTERS have a very high rating in the fire equipment field, while the demand exceeds the supply just now. This backlog of business will necessitate a greatly increased sales force for our coming sales program expansion. If you want a postwar selling job, write us today. Tell us about yourself in confidence. We may have just the money-making opportunity you are seeking.

ARMY & NAVY
WAR BONDS

THE FYR-FYTER CO.
Dept. 90 Dayton 1, Ohio

Fyr-Fyter

PIN-UP GIRLS FOR ADULTS
(pocket size). Thrilling . . . breath-taking, life-like beauties that will make your heart skip a beat. The kind you like! 10 different PIN-UPS sent for 50c or 25 assorted for \$1. Shipped prepaid in plain wrapper. No C.O.D.'s. Send cash or money order. No stamps. NUDKI, Dept. P-23 Box 126, G.P.O., N.Y.C.



Fix Your Own



ALARM CLOCKS

New, practical home course. Just out. Makes interesting hobby—profitable too. Save money by doing your own repairing at home. Easy if you know how. Price now only \$1.00. Details FREE. Send postcard.

THIES JEWELRY STORE, Genoa 3, Illinois

AUDELS Carpenters and Builders Guides

4 vols. \$6



Inside Trade Information for Carpenters, Builders, Joiners, Building Mechanics and all Woodworkers. These Guides give you the short-cut instructions that you want—including new methods, ideas, solutions, plans, systems and money saving suggestions. An easy progressive course for the apprentice and student. A practical daily helper and Quick Reference for the master worker. Carpenters everywhere are using these Guides as a Helping Hand to Ease Work, Better Work and Better Pay. To get this assistance for yourself, simply fill in and mail the FREE COUPON below.

Inside Trade Information On:

- How to use the steel square—How to file and set saws—How to build furniture—How to use a mitre box—How to use the chalk line—How to use rules and scales—How to make joints—Carpenters arithmetic—Solving mensuration problems—Estimating strength of timbers—How to set girders and sills—How to frame houses and roofs—How to estimate costs—How to build houses, barns, garages, bungalows, etc.—How to read and draw plans—Drawing up specifications—How to excavate—How to use settings 12, 13 and 17 on the steel square—How to build hoists and scaffolds—skylights—How to build stairs—How to put on interior trim—How to hang doors—How to lay floor—How to paint



THEO. AUDEL & CO., 49 W. 23rd St., New York City

Mail Audels Carpenters and Builders Guides, 4 vols., on 7 days' free trial. If O.K. I will remit \$1 in 7 days, and \$1 monthly until \$6 is paid. Otherwise I will return them. No obligation unless I am satisfied.

Name

Address

Occupation

Reference

★ SAVE WASTE PAPER ★



American Business Offers CASH FOR YOUR USEFUL IDEAS!

Now You Can Reach Prospective Buyers of Your Ideas and Inventions At Absolutely No Cost To You!

Hundreds of people like yourself have already taken advantage of this offer made by the Nation-Wide Bureau of Ideas. It's an amazingly simple way for anyone with a new, useful gadget, mechanical device, process or method to cash in on his ideas.

Here's How It Works

You simply send a brief description of your idea, accompanied by the form printed below, to the Nation-Wide Bureau of Ideas. The Bureau then prepares digests of the ideas received and sends this material to its subscribers. These include well-rated companies in all types of business. They are constantly seeking new, worthwhile ideas and are willing to pay well for those they can use.

You Pay No Fees

When a company becomes interested in your idea, the Bureau of Ideas arranges contact with you. From that point on, you personally handle all details with the prospective buyer of your idea. The Nation-Wide Bureau of Ideas charges

you nothing—now or later—for this valuable service. It functions purely as a clearing-house for ideas and neither buys nor sells.

You Are Fully Protected

The Bureau asks only for descriptions of your ideas, not actual details. If you believe your idea is patentable, it may be wise to disclose details in a sketch or in writing to some other person, (not the Nation-Wide Bureau of Ideas). Date this record so you will have proof that you had the idea on a certain date. Patent application may be filed if your idea proves worthwhile.

Time Is Money—Act Now

Don't delay in sending in any ideas you have now. The sooner they are placed before prospective buyers, the quicker you will realize benefits.

If you are not quite ready to send ideas, then use the coupon below to get free folder on "Ideas That Pay." Also keep this ad for future reference and send in as many ideas as you wish, anytime.

NATION-WIDE BUREAU OF IDEAS

Morton Manufacturing Company, 353 N. Leamington Ave., Chicago 44, Illinois

Use Either or Both of These Coupons TODAY!

MORTON MANUFACTURING COMPANY
Nation-Wide Bureau of Ideas
353 N. Leamington Avenue
Chicago 44, Illinois

Please submit attached idea (or ideas) to your subscribers without cost to me. If such submission brings about the use of my idea, and unless or until I have patent protection, I agree to accept whatever amount the user, or users, offer, provided that the sum is not less than \$25.00. I reserve to myself the right to negotiate with anyone for sale of, or license under, any patent which has been or may be issued to me.

I fully understand that you make no representations whatsoever that a patent can or will be issued to me or that a user for my idea(s) will be found. In consideration of your services, I release you from liability of any kind or nature.

This certificate will signify my willingness to use your free service on the above basis in connection with any ideas which I may elect to submit to you at any future date.

Morton Manufacturing Company
Nation-Wide Bureau of Ideas
353 N. Leamington Avenue
Chicago 44, Illinois

Please send me your free folder, "Ideas That Pay—How to Produce Them—How to Sell Them," which tells about the kind of ideas that find a ready market. This request does not obligate me in any way.



SIGN NAME AND FULL ADDRESS IN MARGIN BELOW



Know Electricity as Experts Know It—and Get an Expert's Pay!

What about your future? Who is safe today? Surely not the man who is contented to stand still! Know your job thoroughly—prepare yourself for jobs ahead. To do just this thousands of men have used

The Croft Library of Practical Electricity

The Croft Library is a complete electrical educator. It is founded on practice—on 20 years of shirt-sleeve experience—on work as it is actually done. It is jammed from cover to cover with the kind of hard-headed facts you want. Written so that the beginner can easily understand it, yet so sound, so thorough, that it is the daily guide of 50,000 highly paid electrical workers and engineers. Croft tells you the things you need to know about motors, generators, armatures, commutators, transformers, circuits, switchboards, distribution systems—electrical machinery of every type—wiring for light and power—wiring of finished buildings—underwriters and municipal requirements—illumination in its every phase—the most improved methods of lighting—lamps and lamp effects, etc.—how to do a complete job, from planning it, to completion.

No money down — easy payments

Fill in and mail the coupon attached and we will send you the entire set of seven volumes for ten days' examination on approval. We take all the risk—you assume no obligation. If you decide to keep the books, send \$3.00 in ten days and the balance at the rate of \$1.00 a month. Send the coupon NOW and see the books for yourself.

EXAMINATION COUPON

McGraw-Hill Book Co., 330 W. 42nd St., N. Y. 18

Send me for ten days' examination on approval the Croft Library of Practical Electricity, 7 vols. If satisfactory I will send you \$3.00 in 10 days and \$1.00 monthly until the price of \$18.00 is paid. If not wanted, I will return the books postpaid. (To insure prompt shipment write plainly and fill in all lines.)

Name.....
Home Address.....
City and State.....
Position.....
Name of Company..... PM-10-44

★ SAVE WASTE PAPER ★

A Magic Eye THAT CAN SEE through STEEL

INDUSTRIAL RADIOGRAPHY Now Made Plain

This amazing NEW science needs large numbers of persons trained in this NEW profession that is springing up in industry all over the world.

Learn the practical and essential theory by spare time home study training. Higher education helpful, but not necessary to become a proficient INDUSTRIAL RADIOGRAPHER.

O.I.T. gives the world another FIRST. You can't afford to pass up this OPPORTUNITY. RUSH YOUR NAME for FREE CATALOG. Check below for your free copy of this Amazing New Bulletin.

OHIO INSTITUTE OF TECHNOLOGY Box R-185
Greenville, Ohio

CHECK BELOW - MAIL TODAY

Ohio Institute of Technology, Box R-185, Greenville, Ohio.
Send me complete free information on the drafting or design engineering subjects checked below.

- | | | |
|--|---|--|
| <input type="checkbox"/> Industrial Radiography | <input type="checkbox"/> Air Conditioning | <input type="checkbox"/> Mechanical |
| <input type="checkbox"/> Plastics | <input type="checkbox"/> Bridge | <input type="checkbox"/> Machine Design |
| <input type="checkbox"/> Plastics with Design Engineering | <input type="checkbox"/> Concrete | <input type="checkbox"/> Highway |
| <input type="checkbox"/> Aircraft Drafting | <input type="checkbox"/> Communications | <input type="checkbox"/> Railroad |
| <input type="checkbox"/> Aircraft and Layout and Detail Design | <input type="checkbox"/> Diesel | <input type="checkbox"/> Structural |
| <input type="checkbox"/> Automotive | <input type="checkbox"/> Sheet Metal | <input type="checkbox"/> Tool Design |
| <input type="checkbox"/> Architectural | <input type="checkbox"/> Electrical | <input type="checkbox"/> Production Engineering with Tool Design |
| | <input type="checkbox"/> Estimating | |
| | <input type="checkbox"/> General | |
| | <input type="checkbox"/> Marine | |

Name..... Age.....
Address.....
City..... State.....

Save Time and Money SHORT METHOD MATHEMATICS AND SIMPLIFIED MECHANICAL CALCULATIONS

Get valuable illustrated book for home study or reference... contains methods used by foremost experts. Solves everyday problems... useful at home, office, shop or in armed services. Learn to figure quickly and accurately; rapid methods of proving problems in arithmetic; calculate interest; trade discounts, square root by inspection; measures of angles and area. Describes How to use Slide Rule; How to read Micrometer and Vernier.

Only
50¢
Postpaid

THE CHARLES T. POWNER CO.,
P.O. Box 796, Dept. PO, Chicago 90

Please send free details about "Short Method Mathematics"; also list of other technical books. No obligation.

Name.....
Address.....

Send Stamp, Cash or Money Order for your copy today. Only 50¢ postpaid. Send for list of other practical Mathematics, Technical, Seamanship books. Mail coupon today.

LEARN PRINTING

Top wages. Steady dignified work. Our home study course will teach you. Write for literature and free lesson. International School of Printing, Troy, Ohio.



RE-SOLE YOUR SHOES

Easy—at home. Spread on So-Lo. It wears like leather. For all footwear, children's and grownups'. Also mends tires, raincoats, boots—anything of rubber, leather, cloth.



MEND THE HOLE for SPREADS on like butter. Dries tough overnight. Flexible. Non-skid. Waterproof. Won't come off—guaranteed. **1¢** So-Lo AT ANY HARDWARE AND 10¢ STORE

SPECIAL TRAINING is ESSENTIAL to SUCCESS

Train NOW in Air Conditioning and Refrigeration

WARTIME production has opened up scores of new applications in these fields which mean unlimited opportunities for the future. Today's demand for men qualified to sell, install, operate and service refrigeration and air conditioning systems far exceeds the number available. Train now with the COMMERCIAL TRADES INSTITUTE. Learn while on your present job. Fundamentals are given in simple, easy-to-follow lessons—where you read and SEE what to do. Actual shop and laboratory experience, working with expert instructors, is provided at no extra cost. Here is the ideal course for the man who wants a career—not just a job.

FOR COMPLETE DETAILS—MAIL COUPON TODAY TO SCHOOL NEAREST YOU

COMMERCIAL TRADES INSTITUTE Dept. M-3

209 West Jackson Street, Chicago, Illinois
200 South 20th Street, Birmingham, Alabama
300 East Grove Street, Bloomington, Illinois

Please send me the free booklet "Refrigeration and Air Conditioning"—Your Guide to a SUCCESSFUL Future.

Name.....
Address.....
City..... State.....
Occupation.....

IMAGINE THEIR JOY WHEN THEY FOUND THEY COULD PLAY



LEARNED QUICKLY AT HOME

"I didn't dream I could actually learn to play without a teacher. Now, when I play for people they hardly believe that I learned to play so well in so short a time."
*H. C. S., Calif.



PLAYS AT DANCES

"Your lessons have been most satisfactory. I can play all of the popular songs. I have earned money playing at dances."
*E. N. J., New York



PLAYS ON RADIO

"I can't keep from telling you that I have a good position playing from KTBS, Hot Springs, Ark., every morning."
*J. S., Okla.

What Instrument Would You Like to Play?

JUST name your instrument and we'll show you how you can learn to play it—quickly, easily, in spare time at home. Never mind if you don't know one note of music from another—don't worry about "special talent." And forget all you've ever heard about music's being hard to learn.

The truth of the matter is that *thousands now play who never thought they could!* Yes, men and women everywhere have discovered this amazingly easy way to learn music at home. Now they are enjoying the thrilling satisfaction of playing the piano, violin, guitar, saxophone or other favorite instruments. Some of them are playing in orchestras and over the radio; others are teaching music, making money in spare or full time. And thousands are having the time of their lives playing for their own enjoyment and the entertainment of their friends.

LEARN TO PLAY BY NOTE
Piano Guitar
Violin Saxophone
Organ Mandolin
Tenor Banjo
Hawaiian Guitar
Piano Accordion
Or Any Other Instrument

No tedious study and practice, no tiresome exercises. You learn to play by *playing*—start right in with the melody of a simple tune! It takes only a few minutes a day; the cost is trifling. Does it sound too good to be true? Mail the coupon and get the FREE PROOF!

FREE PRINT AND PICTURE SAMPLE

Our fascinating illustrated booklet answers all your questions—the free Print and Picture Sample shows how you can learn to play any instrument. If interested, just mail coupon below. U. S. School of Music, 710 Brunswick Bldg., New York 10, N. Y.

*Actual pupils' names on request. Pictures by professional models.

U. S. SCHOOL OF MUSIC

710 Brunswick Bldg., New York 10, N. Y.

I am interested in music study, particularly in the instrument indicated. Please send me your free illustrated booklet, "How to Learn Music at Home" and the Free Print and Picture Sample.

Name..... (PLEASE PRINT)
Address.....
Instrument..... Have you Instrument?.....

Let RYAN Fit You For An Important Post-War Job in Aviation

Get into **AIRCRAFT DRAFTING**
DESIGNING & ENGINEERING

Aircraft Draftsmen at work creating a plane of the Future

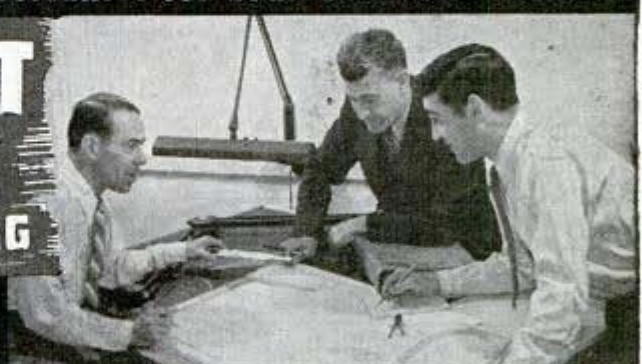

Direct-From-Industry Training in Your Own Home

The Aircraft Industry needs Draftsmen and Engineers NOW—and for the Big Tomorrow in Aviation. Be ready to cash in on the reconversion. As a trained Draftsman you can be an important figure in Peace-time Aviation. Remember—everything new starts on the drafting boards. Ambitious high school students—and service men, too—are now choosing this RYAN method of leisure-time training—planning for a successful future.

RYAN Trains You In Spare Time

Aviation Industry leaders at Ryan have proven with direct-from-the-industry methods of instruction that they can train you thoroughly—yet quickly, in your spare time. The lessons are so interesting many students earn a coveted Ryan diploma far ahead of schedule. Higher education or previous experience not necessary. Included with your training, you get complete Aeronautical Drafting equipment at NO EXTRA COST. The low R.A.I. tuition covers everything.

Free! Interesting 24-page Illustrated Book, Full Information and Costs

Do This—Then Judge for Yourself

Your time is the most valuable thing you have. You owe it to yourself to see that the study course on which you spend your time is the finest—the most practical. So use below coupon—now! It'll take but a minute—and it may easily be your passport to a successful career in aviation. Save time, send it Air Mail.

RYAN Aeronautical Institute
4210 Lindbergh Field, San Diego 1, California

Please send me your FREE 24-page illustrated book, "New Horizons of Opportunity," and full information on R.A.I., including cost of training and job opportunities.

NAME..... AGE.....
STREET.....
CITY..... STATE.....



Bernarr Macfadden, founder and originator of Physical Culture Magazine—now again on sale in a new format at all newstands.

LET

Bernarr Macfadden

HELP YOU

SAVE YOUR HAIR

The NATURAL Way

No "Magic" Tonics—No Cure-All—Just Plain Common Sense!

If your hair is beginning to thin, fall out—if dandruff and ugly scales are causing you concern—DO SOMETHING ABOUT IT! Don't wait until it's too late! You don't have to resign yourself to being bald, old looking, unattractive!

40 years ago Bernarr Macfadden started to become bald. But today his wavy handsome head of hair is the envy of men and women half his age. He learned what to do—how to check this ailment through the use of natural methods. Now you can get the full benefit of his experience through his really remarkable 210 page book "Hair Culture". Recommending no cure-alls, no "magic" salves, no overnight remedies—but merely applying principles of natural healthy living, this remarkable book may help you as it has helped thousands with down to earth common sense based on an intimate knowledge of the natural bodily functions which Mr. Macfadden has gained over the past many years. Remember, you don't have to be bald! Get a copy of HAIR CULTURE today! Clip the coupon now! You may be amazed at the results!

SEND NO MONEY!

Send no money for your copy of HAIR CULTURE unless you wish to do so! Simply deposit \$3.00 with the postman when you receive your book. We pay all postage charges! Keep the book for five days. Read it. Apply the methods Bernarr Macfadden recommends. Then and only then, decide whether you want to keep the book. You have nothing to lose—a great deal to gain.

MONEY BACK GUARANTEE!

Your money will be refunded in full without any questions asked if HAIR CULTURE does not live up to your every expectation. All you have to do is send the book back within five days. Clip the coupon today!

Macfadden Foundation, Inc., Dept. 7310
535 Fifth Avenue, New York 17, N. Y.

Please send me HAIR CULTURE by Bernarr Macfadden. I will deposit \$3.00 with the postman. I understand that if I am not completely satisfied I may return the book within five days and my money will be refunded at once.

Name

Address

City..... State.....

★ SAVE WASTE PAPER ★

GET INTO PLASTICS

START YOUR OWN BUSINESS
SMALL CAPITAL—WORK AT HOME

● Be your own boss. Get into new plastics business today. Start in your own home. Small capital needed. As you increase your knowledge and skill, you grow with this big industry. This opportunity is yours today, so get started now in what may mean a big paying Plastics business of your own.

● Now for the first time you can start by preparing in your own spare time — in your own home. This new plan gives you the sound fundamental knowledge you need to be a success in Plastics. Included are actual working projects and plastics materials to teach you, in your own home, how to do fabrication, shaping, forming, finishing, cementing, mold making, casting, etc. Mail coupon for free information.

PLASTICS TECH., 1845 E. 9th St., Cleveland 14, Ohio

NAME AGE

ADDRESS..... P.O. ZONE.....

CITY..... STATE.....

Handy Mail Order List

Little Library of Useful INFORMATION

5 for \$1.00
12 for \$2.00
25¢ Each

Here at amazingly low cost is the practical help and information you have always wanted. Articles in previous issues of Popular Mechanics have been classified according to subject and are now available in these handy reprint booklets.

- How to Use Measuring Tools—Micrometers, Calipers, etc.—106.
- Power Driven Saws—74.
- Drill Presses, Grinders, Etc.—79.
- Wood, Metal Turning—Lathes—81.
- Filing Machine, Hack Saw, Cutoff Wheel, Shaper—82.
- Lathe Tools You Can Make—101.
- Workbenches—Tool Cabinets—47.
- Spray Painting—94.
- From Pattern to Casting—91.
- Tool and Saw Sharpening—92.
- Sharpening Drills, Wood Bits—90.
- Successful Wood Turning—32.
- How to Read Blueprint—71.
- Metal Turning Lathe Kinks—99.
- Operating a Metal Lathe—100.
- Heat Treating, Hardening—102.
- Working With Glass—103.
- Servicing Elec. Motors—75.
- Electromagnets & Solenoids—44.
- Transformer Construction—41.
- The Boy Electrician—43.
- Soldering and Brazing—17.
- Arc and Spot Welders—5.
- Electroplating With Nickel, Chromium, Cadmium, Etc.—86.
- Plating Leather, Wood, etc.—87.
- Lower Your Fuel Costs—31.
- Curing Leaky Basements—45.
- Fitting Home Game Room—55.
- Indoor & Outdoor Fireplaces—88.
- Backyard Gardening—39.
- Lawn and Garden Novelties—72.
- Trellises, Pergolas, Fences—76.
- Lawn and Garden Furniture—77.
- Playground Equipment—73.
- Concrete Garden Furniture—6.
- Making Serving Trays—53.
- Sanders—80.
- House Wiring—89.
- Treasure Finders—13.
- Hanging Wallpaper
- Built-in Fixtures—78.
- Bird Houses—7.
- Magazine Racks—49.
- Clock Cases—50.
- Book Ends—52.
- Small Tables—54.
- Smoking Stands—56.
- Desks—58.
- Book Cases—59.
- Action Toys—66.
- High Flying Kites
- Telescopes—20.
- Metal Craft—28.
- Knots and Ropework—105.
- Working With Plastics—61.
- Simple Home Improvements—104.
- Ridding Home of Insect Pests—107.
- Children's Room Furniture—51.
- Jigsawed Novelties—57.
- Doll House & Doll Furniture—60.
- 25 Shelves You Can Make—64.
- Novelties Turned on Lathe—62.
- Inlay Pictures—Veneering—63.
- Wood, Soap Carving—65.
- Windmills & Weather-vanes—68.
- Lamps from Wood, Metal—69.
- Home Work Opportunities—19.
- Wood Finishing—40.
- Boats—14 ft. Outboard—2.
- Boats—14 ft. Sail Dinghy—26.
- Boats—21 ft. Sloop—46.
- Rowboats, Small Dinghy—83.
- Small Sail Boats—84.
- Two Outboard Runabouts—85.
- Build Own Canoe, Kayak—30.
- Build Class-E Ice Yacht—22.
- Auto Kinks—Shortcuts—10.
- Building Trailers—27.
- Motor-Driven Midget Cars—34.
- Stop Auto Elect. Troubles—95.
- Photo Printers and Dryers—25.
- Home Dark Room Equipment—96.
- Trick and Table Top Photos—97.
- Cosmetic Formulas—12.
- Food Products Formulas—15.
- Metal Plating and Coloring—21.
- Re-Silvering Mirrors—70.
- Chemical Experiments—93.
- Log Cabins, Tourist Houses—14.
- Trapping Small Animals—33.
- Farm and Garden Tractors—95.
- Building Extra Attic Rooms—23.
- Attractive Basement Rooms—24.
- Small Looms—37.
- Den Cutting—42.
- Photo Enlargers—1.
- Photo Kinks—98.
- Cleaning Formulas—11.
- Taxidermy—9.
- Mats—29.
- Training Dogs—35.
- Small Furnaces—36.

Check Titles Wanted, Clip, Mail with Remittance to
POPULAR MECHANICS PRESS, Dept. 575, 200 E. Ontario, Chicago, 11

Always write your name and full address clearly when answering advertisements.



FUN AND PROFIT FROM YOUR HOME WORKSHOP

New 1945 "WHAT TO MAKE" is now ready. One of these books is issued each year and is a reprint of articles which have been published in our "Craftsman" Department. Hundreds of ideas that can be used around your home workshop in one handy, 224-page volume. Get book from your News Dealer or send 50c to

POPULAR MECHANICS PRESS
Dept. 571 200 E. Ontario Chicago 11

YOU NEED THIS AMAZING NEW WAY TO GET AHEAD IN ELECTRICITY

A. T. Dozier earned 6 pay raises. C. E. Jackson more than doubled his salary. "I am now Foreman," says R. Loebhaugh. These men, and hundreds of others, say my remarkable method of getting Practical Electrical "Know-How" quickly and easily brought them Success—job security—and pay increases. Write TODAY for details of this great plan for beginners or experienced Electricians to get ahead in the world's biggest Opportunity field—ELECTRICITY, at trifling cost—without leaving your job. Find out how you can get EXTRA EARNINGS. Just paste coupon on penny post card and mail.
H. C. Lewis, Pres., 500 S. Paulina St., Dept. 74-R5, Chicago 12, Ill.

H. C. Lewis, Pres., 500 S. Paulina St., Dept. 74-R5, Chicago 12, Ill.
Rush me FREE information about your new plan for me to get ahead in ELECTRICITY. Send everything FREE and without obligation.

Name..... Age.....

Address.....

Town..... Zone..... State.....

★ REFRIGERATION

AT YOUR FINGER TIPS with Drake's **NEW** Manual

By means of Drake's brand new REFRIGERATION SERVICE MANUAL you can get yourself a better job . . . earn more money. The latest developments in household and small commercial refrigeration become as simple as A B C when you study this remarkable book.

Written by leading authorities, and covering every problem in simple, easily understood language, this newest addition to Drake's Technical Library contains over 300 pages and 138 diagrams and illustrations. Included are the following:

- Installations
- Adjustment
- Testing
- Replacement
- Trouble Shooting
- Repair

The work covers practically every operation in field service, as performed where the equipment is installed, and also the shop operations which may be required. It includes domestic types of refrigeration, and fully and completely the commercial types in small and medium sizes, such as used in markets, milk depots, soda fountains, flower shops, etc., as well as in many air conditioning systems.

Use the coupon for your copy . . . today. Send only \$2.00. If you are not satisfied that this book is the answer to your expectations, return the book within 5 days, and your money will immediately be refunded.

OTHER IMPORTANT DRAKE BOOKS

1. Practical Electricity and House Wiring: 200 pages, 227 illustrations \$1.50
2. Cyclopedia of Radio and Electronics: 1,000 pages, 1,178 illustrations \$5.00
3. Armature and Magnet Winding: 270 pages, illustrated . . \$1.50
4. Carpentry (Craft Problems): 302 pages, 700 illustrations . \$2.00
5. Building—Forms, Stairs, Roofs: 210 pages, 495 illustrations \$2.00

ONLY \$2.00

6. Modern Homecraft: 240 pages, illustrated \$3.00
7. Spray Painting, Industrial and Commercial: 125 illustrated pages \$1.50
8. Plumbing Installation and Repair: 200 pages, 153 illustrations \$1.50

FRED'K J. DRAKE & CO., 600 W. Van Buren St., Dept. PM-10, Chicago 7, Ill.

USE THIS COUPON FOR YOUR ORDER

FRED'K J. DRAKE & CO., 600 W. Van Buren St., Dept. PM-10, Chicago 7, Ill.

O.K. Send me postpaid the Drake books I've checked. Remittance enclosed. I understand that if the books are not entirely satisfactory, I may return them within 5 days and my money will be refunded.

Refrigeration Service Manual

1 2 3 4 5 6 7 8

Name

Address

City and State

Check here if you want our FREE illustrated catalog.

NEW PRODUCTS—NEW IDEAS

● A large manufacturer now engaged exclusively in defense work, wants large production items for post-war development.

We can furnish Engineering, Financing, Manufacturing, Selling.

Many sound products or ideas never get past the model stage, due to a lack of one or more of the above essentials. Why not contact a strong company able to supply all of the above facilities within the one organization. If your proposition meets the requirements of soundness and practicability, we would like to discuss it

with you. Before sending your drawings to us or anyone else, protect yourself by having copies of them witnessed and the originals retained in your possession. The date of witnessing should be kept confidential by you, as this is the date on which you can prove priority.

AERO SUPPLY MFG. CO., INC., Corry, Pa.

A SIMPLIFIED ART ANATOMY OF THE HUMAN FIGURE
 ONLY \$1 POSTPAID
 by Charles Carlson. The book they're talking about! One of the most informative books of its kind for both student and professional artists. Charts, notes, and over 350 drawings show detailed studies of every part of the body, posed and in action.
 HOUSE OF LITTLE BOOKS, 156-160 Fifth Ave., New York

LAW
 STUDY AT HOME for PERSONAL SUCCESS and LARGER EARNINGS. 35 years expert instruction—over 108,000 students enrolled. LL.B. Degree awarded. All texts furnished. Easy payments. Send for FREE BOOK—"Law and Executive Guidance."
AMERICAN EXTENSION SCHOOL OF LAW
 Dept. 46-M, 646 N. Michigan Ave., Chicago 11, Ill.

BROOKLYN YMCA TRADE SCHOOL



Making Plastic Molds

Learn this newest trade for post-war jobs or defense work.

Full Shop equipment. Unexcelled instruction. Fireproof dormitories. Also 2-yr. day Pre-Engineering courses.

Check your interests on coupon to receive free literature.

- Making Plastic Molds
- Aviation Mechanic
- Welding
- Machinist
- Tool and Die Making
- Mechanical Pre-Engineering
- Diesel Pre-Engineering
- Mechanical Drafting
- Oil Burner
- Auto Mechanic
- Talking Pictures
- Refrigeration
- Diesel Engines
- Television and Radio Mechanic
- Architectural Drafting
- Armature Winding
- Electrical

MAIL COUPON

1117 Bedford Ave., Dept. P.M. Brooklyn, New York City, N. Y.

Name

Address

.....

FREE OFFER FOR FALSE TEETH
with your order.

CROWN Dental CLEANER

★ Everyone who wears plates will welcome this free offer. CROWN DENTAL CLEANER is an especially prepared antiseptic preparation to keep your plates clean and help eliminate bad breath and foreign substances that collect and cause discomfort.

TIGHTENS FALSE TEETH or NO COST!

HERE'S new amazing mouth comfort without risking a single cent... enjoy that feeling of having your own teeth again. Satisfy your desire for food... eat what you want. CROWN RELINER TIGHTENS FALSE TEETH OR NO COST. PERFECT FOR PARTIALS, LOWERS AND UPPERS. Don't suffer embarrassment and discomfort caused by loose dental plates. Apply CROWN RELINER. In a jiffy your plate fits like new and stays that way up to 4 months. No old-fashioned heating to burn your mouth. Just squeeze CROWN from tube and put your teeth back in. They'll fit as snugly as ever. Inventor is a recognized authority in dental field. A patent has been applied for CROWN RELINER to protect you from imitators. After you reline your plate with CROWN, take your false teeth out for cleaning without affecting the CROWN RELINER. CROWN RELINER is guaranteed... it's harmless. It's tasteless. Has that natural pink color. NOT A POWDER OR PASTE! DOES NOT BURN OR IRRITATE. If not satisfied even after 4 months, return partly used tube for full refund.

JUST 3 STEPS

- No.1 CLEAN WELL** 
- No.2 DRY UNDER LAMP** 
- No.3 SQUEEZE CROWN FROM TUBE, PUT PLATE IN MOUTH** 

SEND NO MONEY for CROWN

MONEY BACK GUARANTEE

CROWN Dental PLATE RELINER

RUSH COUPON

EATS STEAK!

J. Clements of Algonac writes: "My plates were so bad they rattled when I talked. Now I can eat steaks, corn on the cob." E.W.W., of Virginia, writes: "I found Crown Reliner to be all you claim." Many more attest to same excellent results. Reline your plates with CROWN RELINER today.

SEND NO MONEY

You must be 100% debt-free or no cost. Try four months and return for refund if not satisfied. At your druggist or order direct.

CROWN PLASTIC COMPANY, DEPT. 2410, 4358 W. Philadelphia Ave., Detroit 4, Mich.

Send your wonderful Crown Dental Plate Reliner and include the free Crown Cleaner. I will pay postman one dollar plus approximately 24c postage on arrival. If I am not satisfied after four months, I may return partly used tube for full refund.

(I am enclosing one dollar in payment, same guarantee)

Name.....

Address.....

BUILD a BOAT

FOR PLEASURE OR PROFIT DESCRIBES 17 LOW COST BOATS

Get this outstanding book and build a boat at home for your own use or to sell at a profit. You can do it. Just the boat you've always wanted—power, sail or row boat—17 different kinds and sizes.

Order BUILD A BOAT on postal card and pay only \$1.50 plus postage on delivery. Return in 5 days if not pleased and get money back. Or send \$1.50 with order and we'll pay postage. (Outside U. S. \$1.70 with order.) Order today.

POPULAR MECHANICS PRESS
Dept. 573, 208 E. Ontario, Chicago, Ill.

Money Making Pay Raising BOOKS Catalog FREE

SEND NAME AND ADDRESS TODAY—Selected books covering all trades, office helps, home workshop, spare time work, hobbies, etc. Learn how to earn more. Write today.

Popular Mechanics Press
Dept. 569
200 E. Ontario St. Chicago, Ill.

Say you saw it in **POPULAR MECHANICS**

"How to Make Money With Simple Cartoons"

A book everyone who likes to draw should have. It is free; no obligations. Simply address **CARTOONISTS' EXCHANGE**

Dept. 910 Pleasant Hill, Ohio

Pays HOSPITAL BILLS for Whole Family

Costs 3c a Day for Adults Only 1½c a Day for Children

It's here! The new Family Hospital and Surgical Expense Policy you need and want! One policy insures whole family—mother, father, children, anyone from 3 months to 65 years. No medical examination. Pays up to \$510.00 hospital and surgical bills for EACH and EVERY person insured. Pays up to \$100.00 doctor's fees for operations. Pays up to \$50.00 for operating room, medicines, ambulance, etc. Covers sicknesses, accidents, operations, childbirth, female disorders, and many other disabilities not covered by other policies. You select your own doctor and hospital. This full-coverage Family Hospital and Surgical Policy issued DIRECT to you at special family rates by big, strong company with over \$3,000,000.00 in assets. Investigate! SEND NO MONEY, but mail the coupon below quick for full details—sent FREE. No agent will call on you. Act today!

STERLING INSURANCE CO.
4777 Sterling Bldg., Chicago 11, Ill.

Send me your FREE INSPECTION Offer of **LOW-COST** Family Hospitalization Plan.

NAME.....

ADDRESS.....

CITY..... STATE.....

THIS GREAT BOOK

HOW to BREAK and TRAIN HORSES

FREE!

Every farmer, every lover of horseflesh should have a copy of it. This amazing book tells how to know horses—how to break them—how to train them—how to make money as a master horseman. Write for it today—FREE, together with my special offer of a course in Animal Breeding without cost to you. If you are interested in Gaiting and Riding the saddle horse, check here Do it today—now. You'll never regret it.

BEERY SCHOOL OF HORSEMANSHIP
Dept. 11010 - - Pleasant Hill, Ohio

LEARN MOVIE PROJECTION THEATRE MANAGEMENT

The Motion Picture Theatre Business offers big opportunities for trained men. Get into a fascinating field with a peace time future. Train at home in spare time. Free catalog. Established 17 years.

THEATRE INSTITUTE, 370 Washington St., Elmira, New York

MAIL ORDER MEN We Buy & Sell

We buy your ideas or plans for others to use in making gadgets, home and sports equipment to sell. We already have over 100 plans for neighborhood or mail order selling. We need hundreds more for our fast growing list of mail order clients. Get and use some of our plans. Sell us the ones you now have. Your idea may be worth many dollars. Rush name for free information.

MAIL ORDER EXCHANGE, Dept. 35, Tipp City, O.

AUTO BOOKS SENT FREE

ON APPROVAL. Just mail the coupon and we'll send you a complete set of Six Big Auto Books, 20th Edition. Whether you are a mechanic or helper, expert or apprentice, auto owner or driver, take immediate advantage of this FREE EXAMINATION OFFER.

MAKE GOOD MONEY NOW HOLD A PERMANENT JOB

America's autos must be kept in service, now and after the war. Men with "know how" are in demand, at big pay. These books will help you get and hold an important job, or give you a chance to go into business for yourself now or later. Any man who half tries to improve himself can learn auto servicing and repairing by this quick reference method. Use the JIPFY INDEX to find easily understood answer to any auto problem. These wonder books prepared by eleven of America's great automobile engineers. Many hundreds of valuable illustrations. Send the coupon TODAY.

A year's consulting privileges with our engineers now given with these books without extra charge.

Vocational Publishers Since 1898

CAN YOU FIX IT?

These wonder books tell step by step HOW to make difficult repairs and adjustments, how to keep a car at maximum efficiency, including latest improvements in car design and operation, Engine troubles and how to correct them well covered.

6 BIG VOLUMES
2800 pages, 2000 illustrations, wiring diagrams, etc., including Diesel engines. Beautiful, modernistic, washable cloth binding.

AMERICAN TECHNICAL SOCIETY, Dept. A719
Orexel Ave., at 58th St., Chicago 37, Ill.

I would like to examine your Six-Volume Set of Auto Books. I will pay the delivery charges only, but if I choose I may return them express collect. If after 10 days use I prefer to keep them, I will send you \$2 and pay the balance at the rate of only \$3 a month until \$24.80 has been paid. Please include consulting service as offered above.

Name

Address

City

State

Please attach letter stating age, occupation and address of employer and of at least one business man as reference. Men in service, also please give home address.

GET INTO RADIO-ELECTRONICS

Get Ready Now for a Good Pay Job
with a Peace-Time Future

12 WEEKS TRAINING

Here in Coyne Shops "Learn-by-Doing"



Don't be caught napping. Prepare for a good essential job now that will still be a good job with a real future when the war is over. If you are not a trained man you may have to compete with millions of other untrained men. Get into a field that offers real opportunities in war times, peace-times—good-times and bad-times. Radio-Electronics trained men are needed today—they will be needed too when peace comes.

REAL OPPORTUNITIES FOR THE RADIO TRAINED MAN

Prepare for jobs as assembler, inspector and tester—Radio sales or service and installation work, electronics, television, sound work, aircraft-radio, auto-radio, etc. Many opportunities in the vast Radio-Electronics field.

LEARN BY DOING

Here "you learn while doing". We train you on a great outlay of Radio, Television and Sound equipment—on scores of modern Radio Receivers, Television apparatus, Sound Reproduction equipment, etc. Whether or not you have had Radio experience you need Coyne all-around Radio-Electronics training. We give you—RIGHT HERE IN THE COYNE SHOPS IN CHICAGO—the actual practice and experience you'll need in this great field. And because we cut out all useless theory and only give that which is necessary you get a practical training in a few weeks. Right now I'm including extra training in Industrial Electronics at no extra cost. We also have facilities for physically disabled men.

EARN WHILE LEARNING

If you need part-time work to help pay living expenses while at school, we will help you get it. After you graduate, lifetime employment service will be available to you. Every Coyne graduate also receives a Life Membership, with free technical and business service and privilege of review at any time without additional tuition charge.

GET MY BIG NEW BOOK

It tells all about my big Chicago shops and my plans to help you get ahead. Packed with facts and pictures of students at work in my shops. Mail coupon for this Big New Book now! Coupon will also bring details on how I'll Finance Your Training... facts on how I help you "Earn-While-Learning"... information on FREE EMPLOYMENT SERVICE FOR LIFE... and other plans to help you. ACT NOW TO MAKE SURE YOU GET MY GENEROUS OFFER. Sending for this interesting free book can be your first big step to success. No obligation. No salesman will call. Mail the coupon today.

We have facilities for men with physical disabilities. If you have a physical disability write me when you mail the coupon.

H. C. LEWIS, Pres., Radio-Electronics Div. COYNE ELECTRICAL SCHOOL
500 S. Paulina St., Dept. 74-3H, Chicago 12, Ill.

Dear Mr. Lewis: Send me your Big Free Radio-Electronics Book and all the facts...also full details of your "Pay-after-Graduation" plan.

NAME

ADDRESS

CITY.....ZONE.....STATE.....

★ SAVE WASTE PAPER ★

Amazing PLASTIC That Flows!
SUPERIOR LIQUID PLASTIC
 APPLY WITH BRUSH TO BEAUTIFY
 WALLS, FURNITURE AND WOODWORK

- ★ TOUGH FINISH
- ★ WASHABLE-SCRUBBABLE
- ★ NON-SCRATCHABLE
- ★ NON-YELLOWING
- ★ NO BRUSH MARKS

Use this true liquid plastic to renew furniture, walls and woodwork. Easy to apply with brush, dries to long-wearing, high-gloss, brilliant white finish. Made of same ingredients as science's new plastic articles. *Beware:* don't accept substitutes. Buy SUPERIOR, the true liquid plastic!

ORDER NOW ON MONEY-BACK GUARANTEE

No. 1 for walls, woodwork. No. 2 for furniture. Pure white or can be tinted. \$5.95 per gal. with Special Thinner. Express prepaid or COD if desired.

SEND YOUR ORDER OR WRITE FOR
 FREE ILLUSTRATED CIRCULAR

SUPERIOR PAINT AND VARNISH WORKS
 2256 NORTH ELSTON AVENUE • CHICAGO 14



5.95
 PER GALLON
 DELIVERED

ELECTRICITY NEEDS YOU!

Always a BIG
 PAY Field—
 Now Bigger
 Than Ever.



Train Now for Post War Jobs.

Electricity is the one year 'round, all-time field of big opportunities and good pay. Get into this magnificent industry yourself. Do it now! Be ready for the tremendous boom and demand for trained men that early post war days will bring. This 28 year old school—for the past two years exclusively training men and women for U.S.A. Services—will give you the practical training you need. You can train at home in spare time—come to our big Chicago shops—or have a combination of both. No experience or advanced schooling required. Write for FREE BOOK today. No obligation.

BOOK FREE

INDUSTRIAL TRAINING INSTITUTE, Dept. 18
 2132-2158 Lawrence Ave. • Chicago 25, Ill.

TELEVISION

Resident school, 35 weeks. Tuition \$495. VETERANS free if qualified. Each student builds a Television set to keep. Learn in the BIRTHPLACE of the Television industry. Founded 1910. Conveniently located in R.C.A., C.B.S., DuMont, Western Electric, Westinghouse, etc.

NEW YORK TECHNICAL INSTITUTE (of N. J.), 158 MARKET ST., NEWARK, N. J.

STOP RADIO STATIC



The ALL WAVE radio filter is guaranteed to help you get perfect radio reception. Eliminates all hums, clicks, crackles, etc., caused by electric razors, vacuum cleaners, motors and other electrical appliances. The ALL WAVE is a scientific and compact radio filter that can be used on any make electric radio. To connect, just put your radio plug thru the ALL WAVE's slotted opening and into any wall outlet. 15 DAY FREE TRIAL. Sent C.O.D. for \$1.50 plus postage. Cash orders sent postpaid. Rush order—supply limited. Vogue Eliminator Co., 7759 S. Halsted, Dept. AW-702, Chicago 20, Ill.

★ SAVE WASTE PAPER ★

It's Easy to Master

REFRIGERATION

and AIR CONDITIONING

SERVICING

—with diversified equipment, good instructors, well-planned lessons. Use the facilities that have trained over 30,000 students for good-paying positions in leading technical fields. Complete refrigeration course in 3 months designed especially for the man who wants to have a business of his own. Six month course includes Air Conditioning. Moderate tuition—send coupon NOW.

President Oscar Werwath, PM 1044, North Broadway and East State, Milwaukee, Wisconsin

Please send Free Booklet—and give me complete information on—

- () REFRIGERATION SERVICING..... 3 months
- () REFRIGERATION & AIR CONDITIONING..... 6 months
- () TECHNICIAN'S COURSE..... 1 year

also Electronics—Arc Welding—Aircraft Welding Drafting Electrical Engineering (B.S. Degree)

Name..... Address.....

City and State..... Age..... PM-1044

Milwaukee School of Engineering 40th year

BE A PLASTICS FABRICATOR



You can fabricate beautiful, modern, practical plastics gift items at home — for fun or for profits.

EASY. No special tools or training necessary. Easy, fascinating, clean, profitable.

WE SUPPLY PLASTICS. Choose items you want from our catalog. We send you crystal-clear Lucite or Plexiglas, cut to size, ready to assemble.

YOUR OWN BUSINESS. With a little experience, you can make these articles to sell at a good profit. Start your own profitable plastics business!

ness! Earn big money!

SELL FAST. There is a big demand for beautiful, practical gift items. Sell directly to stores. Take advance orders.

CHRISTMAS GIFTS. Ideal for Christmas giving or selling—but start now!

GET CATALOG. Start yourself on this fascinating hobby or career now. Mail the coupon today for details and our catalog of many items.

PLASTICS FABRICATORS

Dept. PM-10, 2850 W. Ave. 35, Los Angeles 41, Calif.

Please send me your catalog and complete details on how I can be a plastics fabricator, no obligation.

Name.....
 Address.....
 City.....Zone.....St.....

FREE CATALOG

Learn to LETTER

For FUN or PROFIT

This amazing Self-Teaching "30 MINUTE DRAWING GUIDE IN LETTERING" Complete with Kit of working materials is a New, Modern and Practical Method for learning to letter. Anyone can learn the principles in 30 minutes—then "Practice makes Perfect." It's fascinating, loads of fun and mighty profitable. Contains over 40 different styles, each step simply illustrated plus many facts and short cuts used by professional artists.

No Talent or Experience Necessary. Earn While You Learn at Home

Teaches you to letter for POSTERS, COVER-DESIGNS, TRADE MARKS, TITLE PAGES, etc., for school, personal or commercial use.

Send for this Lettering Guide complete with Kit and put it to work at once. All for only 98c. Postpaid while this special offer lasts. Money refunded in 5 days if not satisfied.

The HERLENE CO.,
402 S. Market St.,
Chicago 7, Illinois.
Enclosed find 98c for "30 MINUTE DRAWING GUIDE IN LETTERING" & KIT.

Name

Address

City..... State.....

Complete Kit with 30 MINUTE Drawing Guide for Lettering
Drawing Pad and Pencils
Complete For Only 98c

RADIO: FEDERAL EXAMINATION PREPARATION

Many Airtel and Broadcast station positions now open to holders of **FEDERAL RESTRICTED RADIOTELEPHONE OPERATOR PERMITS.** ETICO'S SIMPLIFIED PREPARATION MANUAL enables persons with no technical knowledge or previous experience in radio to quickly prepare themselves to pass this examination. Available to those entering military service or in civilian life desiring **DOCUMENTARY EVIDENCE OF QUALIFICATION IN RADIO.** Send only \$1.00 today for this SIMPLIFIED PREPARATION MANUAL, prepaid. **ETICO A TO Z SELF INSTRUCTION CODE MANUAL:** For learning Radio Code at home, with pictorial diagrams of easily constructed, inexpensive practice outfits, only 50c. prepaid. Order today.

ETICO PUBLISHING CO., BOX 712, PITTSBURGH, PA.

Lovely DALE EVANS Says:
"IT'S EASY TO LEARN DANCING!"

DALE EVANS, Republic star of "Yellow Rose of Texas"

DANCE IN 5 DAYS . . . OR NO COST!

LEARN NEWEST STEPS—INCLUDING RHUMBA, SAMBA, CONGA and JITTERBUG, FOX TROT and WALTZ.

Let dancing open the door to Romance and Happiness for you! This sensational new book helps you learn the latest steps, quickly, easily. A revolutionary book that offers a shortcut to dancing. **MAKE THIS TEST!** Send today for Betty Lee's amazing book—it's packed full of diagrams and tells in simple language how to do the Jitterbug, Rhumba, Conga, Samba and other exciting new dances

—also the ever-popular Waltz, Fox Trot, and many old-time favorites. **SEND NO MONEY!** Act now, and we'll send you as a gift, 2 additional books FREE of any extra charge, "Tip Top Tapping," and "Swing Steps." And remember—if not satisfied with results in 5 days you may return the book and your money will be refunded.

PIONEER PUBLICATIONS, INC.
1790 Broadway, Dept. P9410H
New York 19, N. Y.

Send me by return mail, in plain wrapper "Dancing," by Betty Lee, and include 2 free books.

Ship C.O.D. I will pay on arrival, plus postage.

I enclose \$1.08. Ship postage prepaid. If in 5 days I do not learn to dance, I may return book and you will refund purchase price.

Name

Address

City..... State.....

TWO BOOKS Included FREE

OCTOBER, 1944

SENSATIONAL WAR BARGAINS IN LENSES & PRISMS

YOU CAN EASILY MAKE Telescopes—Periscopes—Magnifiers—Photographic Gadgets—and do Hundreds of EXPERIMENTS

All Items Finely Ground and Polished but Edges Very Slightly Chipped, which We Guarantee Will Not Interfere with their Use.



TANK PRISMS

In order that the tank driver shall not get shot in the face, two of these Silvered Prisms are used to make a periscope. They are 90-45-45 degree prisms of huge size—5 3/4" long, 2 7/8" wide, finely ground and polished. Other uses: Experimental Optics, Optical Instruments and Gadgets, as unique gift item, unusual paper weight, desk name plate, etc. Would normally retail from about \$24 to \$30 each.

Stock No. 3004-H—SILVERED TANK PRISM—Price . . . \$2.00 each Postpaid.

Stock No. 3005-H—PLAIN TANK PRISM—Price . . . \$2.00 each Postpaid. This one is excellent for projecting all the colors of the spectrum—a beautiful sight.

FOUR TANK PRISMS—Special . . . \$7.00 Postpaid.

. . . This is the most sensational bargain we have ever been able to offer.

SPECIALS IN LENS SETS

10 Page Project Booklet Free with All Sets

Set No. 301-H "Our Advertising Special" 15 Lenses for \$1.60 Postpaid. For making your own powerful telescopes, low power microscope, strong magnifiers, drawing projector, photo cells, telephoto lens, dummy focusing camera, Kodachrome viewer, stereoscopic viewer, ground glass and enlarging focusing aids. For experimental optics, portraits of babies and small pets, copying, ultra close-up shots, and many, many other uses.

Set No. 305-H "The Gadgeteer's Delight" 35 Lenses for \$5.00 Postpaid. Contains all the lenses in the above set plus twenty more expensive lenses increasing your field of experiment and gadget making. All our lenses are neatly packed and marked.

Set No. 310-H "The Experimenter's Dream" 60 Lenses and New Complete 50 Page Booklet—\$10.00 Postpaid. Contains all the lenses in the above sets plus 25 others that makes this a sensational buy. The variety of lenses in this set will enable you to conduct countless experiments and build a wide variety of optical equipment.

50 Page Illustrated Idea Booklet "Fun With Chipped Edge Lenses" Only \$1.00. The Complete Hand Book.

35mm Slide Projecting Lens Set—No. 4004-H . . . \$1.50 Postpaid. (May also be used for enlarging 35mm to 2 1/4 x 2 1/4 Film) Consists of 2 uncemented achromats 1 1/4 inches in diam. Mounting directions and cement supplied Free.

Make Your Own RIFLESCOPE. Complete set 5 matched Achromatic Lenses, originally produced for U. S. Navy gunscoops—3 1/2" Power. Order No. 2000-H . . . \$11.00 Postpaid.

16MM. Achromatic Projecting Lenses. Set No. 4002-H . . . consists of 2 cemented achromats, 18.5 MM. diameter with effective focal length of 2". Originally mfg. for U. S. Government . . . \$4.00 Postpaid.

Satisfaction Guaranteed • Minimum Order \$1.00

EDMUND SALVAGE CO.

27 W. CLINTON AVE., DEPT. 11, P. O. AUDUBON, N. J.

★ SAVE WASTE PAPER ★

New Booklet Shows You HOW TO FLY!

"HOW TO FLY A PIPER CUB" SHOWS YOU WITH OVER 50 STEP-BY-STEP PICTURES AND DESCRIPTIONS!



SEE HOW TO TAKE OFF, CLIMB, FLY STRAIGHT AND LEVEL, GLIDE, LAND AND MUCH MORE.



GET YOUR COPY NOW—STUDY IT, THEN TAKE LESSONS.



For booklet send 10c in stamps or coin for postage-handling. Piper Aircraft Corporation, Department PM104, Lock Haven, Pennsylvania.

16mm. SOUND FILM—"The Construction of a Light Airplane." For distribution points, write: Supervisor, Audio-Visual Aid, Extension Services, Pennsylvania State College, State College, Pennsylvania.



PIPER CUB

POINTS THE WAY TO WINGS FOR ALL AMERICANS



A Technique for Producing Ideas

Where do the money-making ideas come from—those ideas that make successful novels, radio programs, moving pictures, advertising campaigns, and businesses? James Webb Young, one of the highest paid idea men in the advertising business,

set out to answer this question for his students at the University of Chicago. The result is a little book that you can read in an hour but will remember the rest of your life. In the simplest and clearest of language Mr. Young has succeeded in describing the way the mind works in all creative people. He gives you the FORMULA which they consciously or unconsciously follow in producing ideas. He shows you how to train your mind so that idea production is, as he says, "as definite as the process by which motor cars are produced." Enthusiastically endorsed by editors, college professors, poets, advertising men, salesmen, and business executives who have read it. Send for your copy of **A TECHNIQUE FOR PRODUCING IDEAS** now. Only \$1 postpaid. Money back if you don't say it is worth \$10 to you. Advertising Publications, Inc., 115 E. Ohio St., Chicago, Ill.

Always write your name and full address clearly when answering advertisements.



ELECTRICITY

SEE THESE 7 GREAT BOOKS FREE

Know electricity the way experts know it. Use these books to "get set" for bigger pay job NOW and after war. Here's set of Electrical books that's DIFFERENT. Just off press, this 7-volume set covers everything from house wiring to D.C. and A.C. Motors and equipment. Over 3,000 subjects—10,000 facts—thousands new methods, diagrams, photos. Up-to-minute information and data on new developments for "on the job" use. Coyne Electrical School, with 45 years of training experience, has written these books for "beginner" or "old timer" who wants to get ahead in Electricity.

SEND NO MONEY I'll send this entire 7-volume set and any other new books listed for 7-day FREE examination. If not satisfied return them and you owe nothing. If you keep them pay as indicated. If order totals \$5.00 or more, send just \$3.00 in 7 days and \$3.00 per month. Offer limited. RUSH Coupon Now!

H. C. Lewis, President **COYNE ELECTRICAL SCHOOL, Dept. 74-R6**
500 S. PAULINA STREET, CHICAGO 12, ILLINOIS

- H. C. Lewis, Pres., Coyne Electrical School, Dept. 74-R6
500 S. PAULINA STREET, CHICAGO 12, ILL.
- Send me books checked below. I'll either return them in 7 days and owe nothing, or pay according to plan I select as outlined above.
- COYNE PRACTICAL APPLIED ELECTRICITY:** 7 volumes, includes 2 years free consultation service and bulletins. Price complete \$19.50 Cash — or \$21.00 on time payable \$3.00 in 7 days and \$3.00 monthly.
 - COYNE ELECTRICAL & RADIO TROUBLE SHOOTING MANUAL:** 1 volume—610 pages—500 large wiring diagrams—new step-by-step trouble shooting course — 4 books in one. Price \$8.00 Cash — or \$8.95 on time, payable \$3.00 in 7 days and \$3.00 monthly. One year consultation and bulletins FREE.
 - COYNE ELECTRICIANS HANDBOOK:** 1 vol.—400 pages—latest electrical laws, rules, formulas, methods; book every electrical worker should have. Price \$2.75 payable after 7-day Free trial.
 - ELECTRONICS FOR RADIO MEN & ELECTRICIANS:** 1 volume—400 pages. Newest facts, diagrams and developments—includes installation and trouble shooting—includes 1 year FREE technical bulletins. Price \$4.95 after 7-day trial.
 - 150 SHOP PRINTS & DIAGRAMS:** 1 vol.—150 large electrical wiring diagrams—a real buy. Price \$1.95 after 7-day Free trial.

Name _____ Age _____

Address _____

Town _____ Zone _____ State _____

If you prefer to pay postman cash price shown above, check here. Same FREE examination and money back guarantee of satisfaction.



"You'll Go Places On This Team!"

1st Lt. Richard J. Niederriter, pilot, 1st Lt. Richard A. Carocari, navigator, Sgt. Richard W. Evans, tail-gunner, and 1st Lt. Lester A. Darst, bombardier, (left to right in foreground above) have hit most of Germany's "hot spots" in their Flying Fortress, the "Winsome Winn." Asked which was their most exciting mission, their answer was unanimous: "Anklam!"

"You probably never heard of Anklam," Lt. Carocari said. "Before the war it was just a little jerk-water town a hundred miles or so from Berlin. But the Nazis built a Focke-Wulf assembly plant there. And our assignment was to flatten it."

"I plotted my course for Berlin, to make Jerry think that was where we were heading. And we hadn't any more than crossed Denmark until the reception committee buzzed out to meet us. At least 300 German fighters hit our flight. They'd come barreling in from all directions at once . . . the fire from their cannons and machine guns making a solid sheet of flame along their wings. The going was hot and heavy for awhile."

"Hot and heavy is right," Lt. Niederriter said. "We were under fire for 3½ hours. But our gunners were too smart—and too good—for them. Evans here had his tail-gun knocked out, so he came up and fired the flexible gun in the nose. When the ball-turret got fouled up with oil from a damaged line, the ball-gunner adjusted it so it would keep revolving—to fool the fighters—and then he climbed out and lent a hand at the waist-guns. It was the prettiest piece of teamwork I've ever seen."

"That's what really licked 'em," Sgt. Evans said. "Teamwork! Lt. Niederriter had his hands full keeping the Winsome

Winn on her course . . . yet all the time, he sat up there and called the shots for us gunners. We sure did work those German fighters over. We saw two blow up in mid-air."

"Finally," Lt. Darst said, "we changed our course and cut for Anklam. The F-W's gave us a breathing spell as we swung in over the town and we made a nice, smooth bombing run. I saw our eggs land square on that factory. And, brother, did we plaster it! They won't make fighter planes there very soon again!"

Lt. Niederriter grinned. "Sure," he said, "you go plenty of places in the AAF. And it's not exactly joy-riding, either. But we've got a job to do. And we work together to do it."

"And I think that's the important thing for any young fellow—who wants to win his wings as Gunner, Bombardier, Navigator, or Pilot—to remember . . .

"You're on a team in the AAF—from the time you step into your first training plane until you get up there in action. And it's a winning team . . . an unbeatable team . . . the 'greatest team in the world!'"

U. S. ARMY RECRUITING SERVICE



"They came barreling in from all directions."

MEN OF 17...



If you want to fly on the "greatest team in the world," an AAF air combat crew . . . go to your nearest AAF Examining Board . . . see if you can qualify for the Air Corps Enlisted Reserve. If you qualify, you will receive this insignia . . . but will not be called for training until you are 18 or over.

When called, you will be given further tests to determine the type of training you will receive. If you are trained as a gunner or technician gunner, you will go into actual combat as a non-commissioned officer. If

your aptitudes are outstandingly high, you will be trained as a bombardier, navigator or pilot, and upon successful completion of training, will be graduated as a Flight Officer or Second Lieutenant.

For pre-aviation training, see your local Civil Air Patrol officers. Also see your High School principal or adviser about recommended courses in the Air Service Division of the High School Victory Corps. Ask about the opportunities for college training through the Army Specialized Training Reserve Program.

For information on Naval Aviation Training, apply at nearest Office of Naval Officer Procurement. This advertisement has the approval of the Joint Army Navy Personnel Board.

FLY AND FIGHT WITH THE

GREATEST TEAM IN THE WORLD

Fix these words in your mind:

Zenith Specializes in “RADIONICS EXCLUSIVELY”

★

**This Zenith Policy
is your assurance of the World's Finest
in your coming New Radio**

SAY THAT WORD, "RADIONICS" out loud. It sounds just like what it means... a compound of radio and electronics which includes many new, secret developments born in the heat of wartime necessity.

It's a broad field, RADIONICS. A field so revolutionary and fast-moving that it requires complete concentration to remain its master. That's why Zenith specializes in "RADIONICS EXCLUSIVELY." No spreading out into unrelated fields like refrigerators, washers, electric irons, cooking ranges and vacuum cleaners. Zenith has no intention of competing with lifelong specialists in those fields.

This policy of "RADIONICS EXCLUSIVELY" has made Zenith one of the largest Radio manufacturers in the world.

It is the reason why millions of owners of pre-war Zeniths are still enjoying top radio performance with least service expense.

And it is the reason why today, down vast Zenith production lines, flow record numbers of superbly performing Radionic devices for the armed services—many of them so "hush-hush" they can only be hinted at. They are not only helping to save lives and win battles but they are also doing their jobs un-

der the most severe fighting and weather conditions.

SO, OUT OF WAR'S proving ground—out of Zenith's background of "RADIONICS EXCLUSIVELY"—will come the finest in radio for you. For through unrivaled war work and years of experience in "RADIONICS EXCLUSIVELY" Zenith has won unquestioned leadership in High Frequency—the basis of FM Radio, Television and Short Wave. Remember—it was Zenith that years ago introduced short wave communication into the U. S. Navy.

MARK these words... the Zenith Radionic Revolution is on its way! Watch for it in the coming new Zenith Radionic Radios, Radio-Phonographs, and Global Portables. It's an exclusively Zenith revolution that will begin a new era of engineering advancement and precision quality at low cost... a revolution that assures you greatest value per dollar in the coming new radio for your home!

Keep your eye on Zenith for the best in radio... and see Zenith first.

ZENITH RADIO CORPORATION, Chicago 39, Ill.
All Production Now for War or Rehabilitation

COPYRIGHT 1944, ZENITH RADIO CORP.

Keep Your Eye on **ZENITH** for the Best in Radio!

LONG DISTANCE RADIO

RADIONIC PRODUCTS EXCLUSIVELY—
WORLD'S LEADING MANUFACTURER

RADIO · FM · TELEVISION · RADAR · SHORT WAVE · RADIO-PHONOGRAPHS · HEARING AIDS

Popular Mechanics Magazine

REGISTERED IN U. S. PATENT OFFICE AND CANADA

WRITTEN SO YOU CAN UNDERSTAND IT

0422

Vol. 82

OCTOBER, 1944

No. 4



By Rear Admiral
Clark H. Woodward

U. S. Navy

SPRINGBOARD for VICTORY

THE AMERICAN conquest of Saipan, because of its position in the strategic Marianas group of islands, was the greatest victory won by the Allies in the Pacific war. By the opposite token it was Japan's greatest defeat.

That the effect on Japan was paralyzing was proved by the overthrow of Premier Tojo and his cabinet, following closely upon changes of the Chief of Staff and Ministers of the Army and Navy. Such a shake-up in Japan's High Command was a public acknowledgment that the

Douglas Dauntless dive bombers of a task force that hit Rabaul crowd deck of Saratoga



OCTOBER, 1944

1

*Industrial Inventive Rev. N. W.
2118 Massachusetts Ave.
Washington 25, D. C.*



U. S. Navy photo

Grumman Avenger torpedo bombers (top) and Dauntless dive bombers roar above the ships of Task Force 58, that deadly combination of sea and air power that is sweeping the Pacific clean

previous cautious defensive policy of the Tokyo war lords was bringing ruin to the empire.

This was virtually admitted by Tojo when, upon reporting the loss of Saipan, by broadcast, he stated that "Imperial Japan has come to face an unprecedentedly great national crisis."

This was, by no means, an overstatement.

The loss or neutralization of the Marianas, the bombing of Japan's industrial centers by our Superfortresses, and the continuous loss and damage to enemy shipping inflicted by our planes and submarines have kept the Japanese public in a constant state of jitters.

A glance at the map shows how the conquest of the Marianas, planted firmly in Japan's inner defense area, 4,000 miles west of Pearl Harbor and directly on the road to the Philippines, fits into Allied strategy. These is-

lands, as intimated by Secretary of the Navy Forrestal, are the springboards for attacks by land-based and carrier-borne aircraft on the mainland of Japan, the Philippines and the major part of the Dutch East Indies. Also, they are the advance sea-air bases for reconquest of the Philippines and establishment of operational bases on Formosa, or the China coast, for air attacks

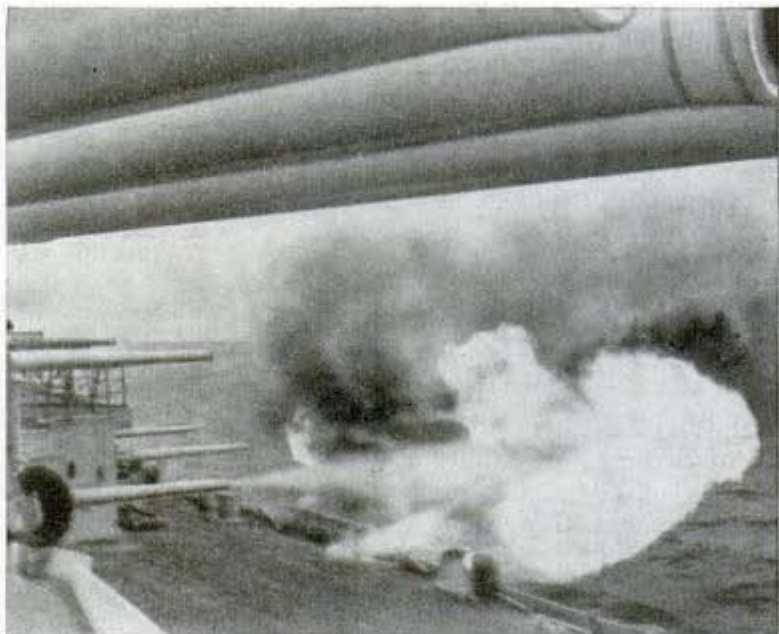

Beneath the big guns of a U. S. battleship the secondary battery lashes at Jap positions ashore

on Japan. From them Japan's sea communications to Malaya, the Dutch Indies and the Indian Ocean are directly menaced.

The map on page one shows five significant points:

1. About two-thirds of Japan, half of Formosa and all of the Philippines are inside the range of fleet air operations;

2. The same area, plus Borneo, is in the "possible radius of operations from Pacific bases of the newest U. S. bombers;"

U. S. Marines dig in on the beach of Saipan on the morning they established their first toehold

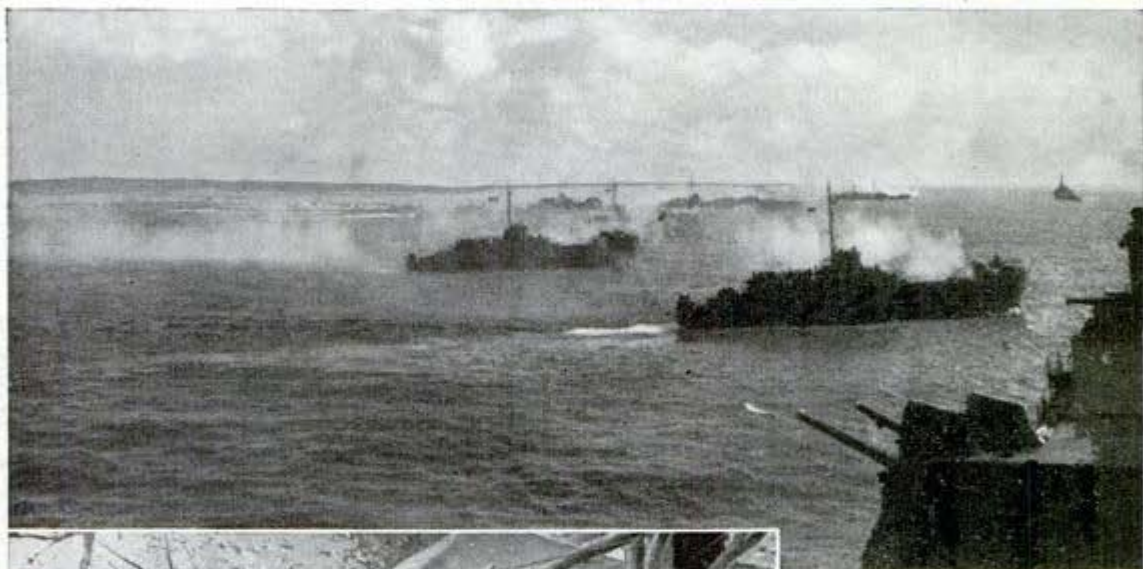

Above, continuous broadsides hit the Japs on Saipan during landing operations. Left, Navy chaplain conducts services for Marines who died in the assault

3. Additional area of Allied air operations as result of New Guinea advances and invasion of the Marianas, includes the Bonin and Volcano Islands and half of the Philippines;

4. Air control of the northern half of the Kurile Islands from Aleutian bases; and

5. Isolated pockets in the Central, South and Southwest Pacific containing 200,000 Japanese

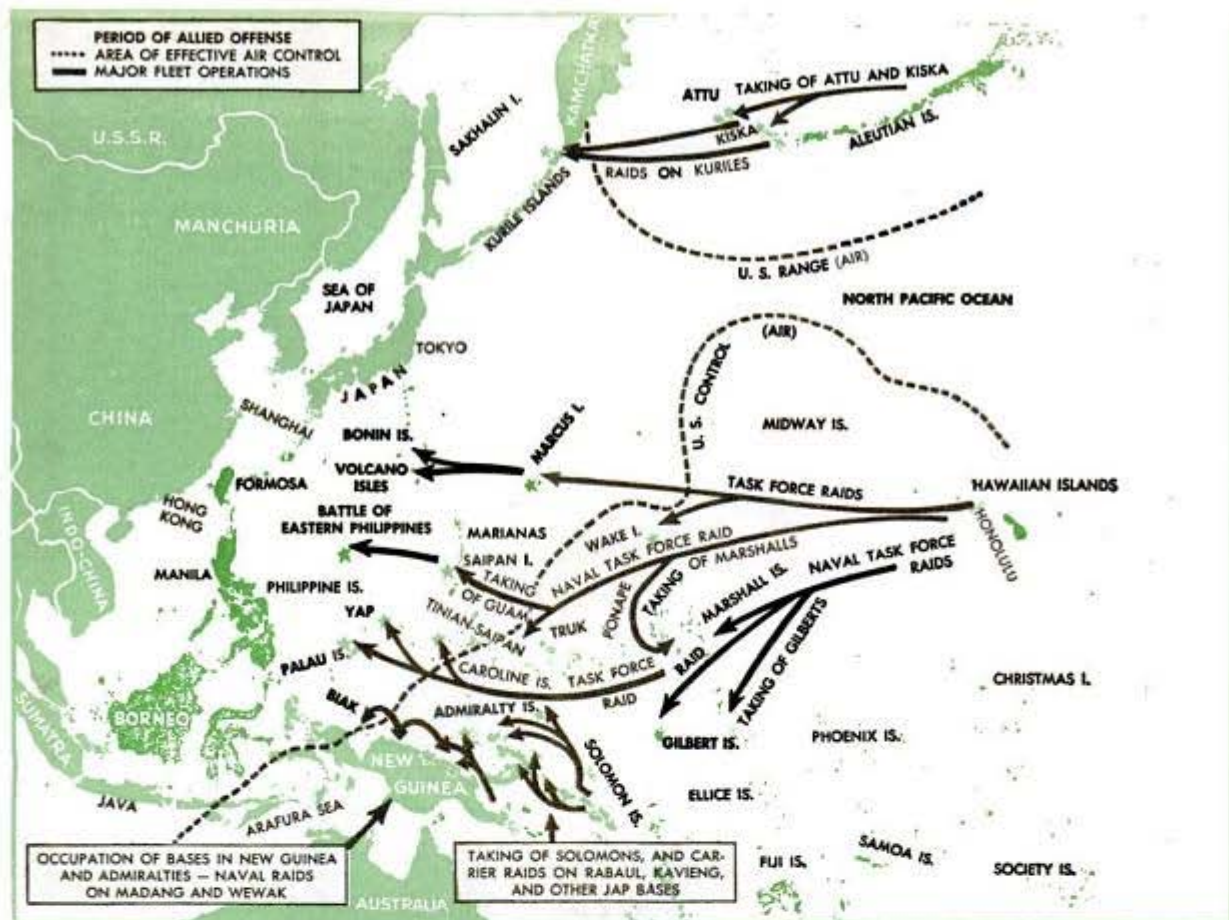

The Navy map shows our task force raids and landing operations. Below, just out of range of Jap shore batteries, a U. S. destroyer transfers men wounded on Saipan by breeches buoy to a larger ship

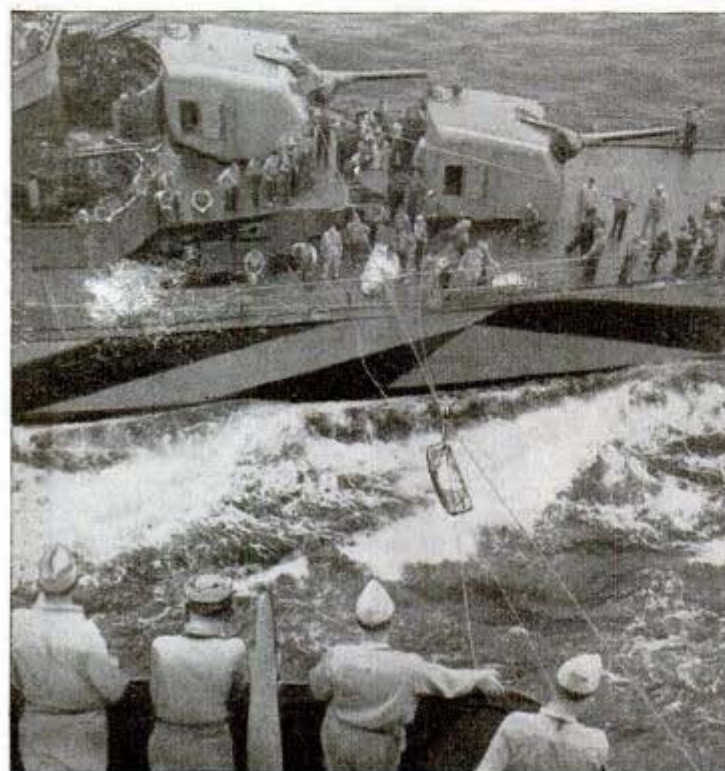

“out of range of help from the homeland.”

Since the Battle of Midway the face of the war in the Pacific, particularly in the central theater, has been transformed by the American navy. Its offensive strategy adheres to the tried principles of employing concentrated forces, with surprise tactics, against weak positions of the enemy. This has made possible the seizure of base after base from which our forces could press forward toward Japan's inner defense ring while neutralizing or bypassing other strongpoints no longer of great importance.

By this means our fleet, in less than a year, has gained more and more control of the Pacific until now it is at Japan's front door where her main battle fleet, hiding in home waters, can remain unchallenged by surface craft, and within protective range of her land-based planes.

The development of aircraft carriers has enabled our navy, by using its sea-air strength as a team, to conduct the offensive on a great scale and with unprecedented speed. The problem of waging war at vast distances in the Pacific has been solved by the Navy's self-sufficient task forces. Because of their accompanying floating bases—supply and ammunition ships, oilers, hospital



U. S. Marine Corps photo

Tojo doesn't answer any more. Members of a Marine communications unit put to work a captured phone

ships, repair ships and other auxiliaries—task forces no longer depend upon shore bases.

Beginning with captured bases in the Gilberts, last November, successful operations and leap-frog jumps have carried our forces more than 4,000 miles from our main base at Pearl Harbor, and through the enemy's outer defense perimeter to less than 1,000 miles from Tokyo.

Continued to page 160

Left, crew of a flattop in Task Force 58 marks up another "rising sun" plane downed. Below, Marines clean guns and dig foxholes for first night on Saipan

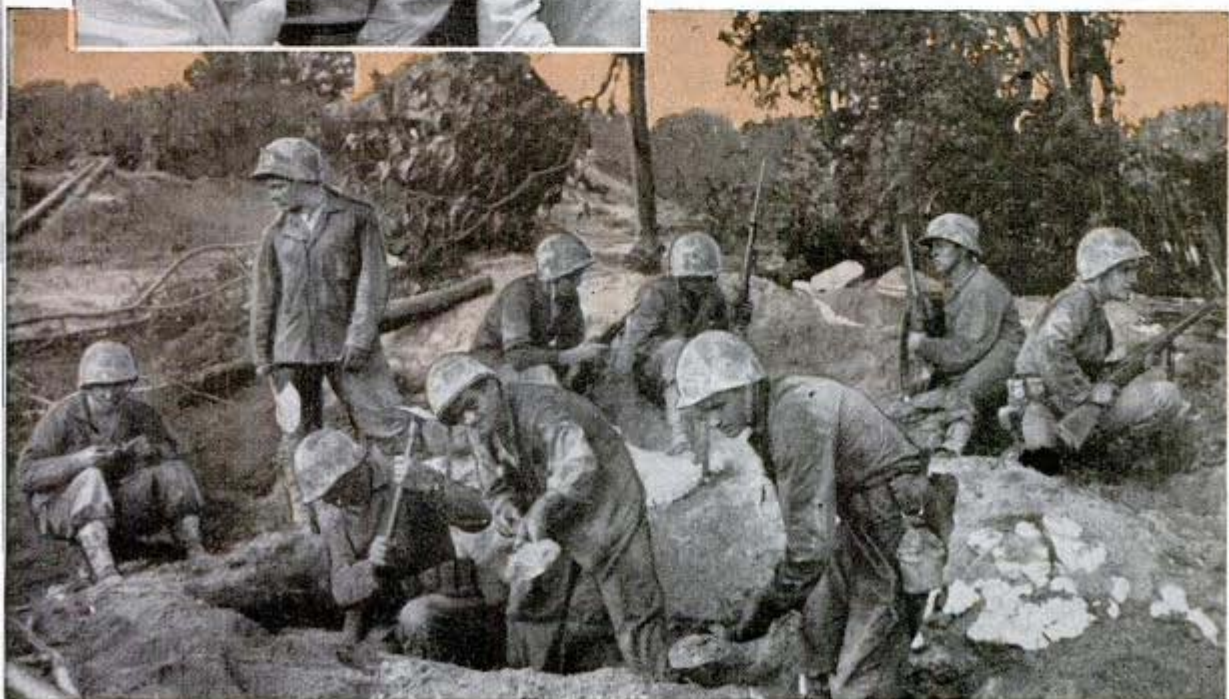
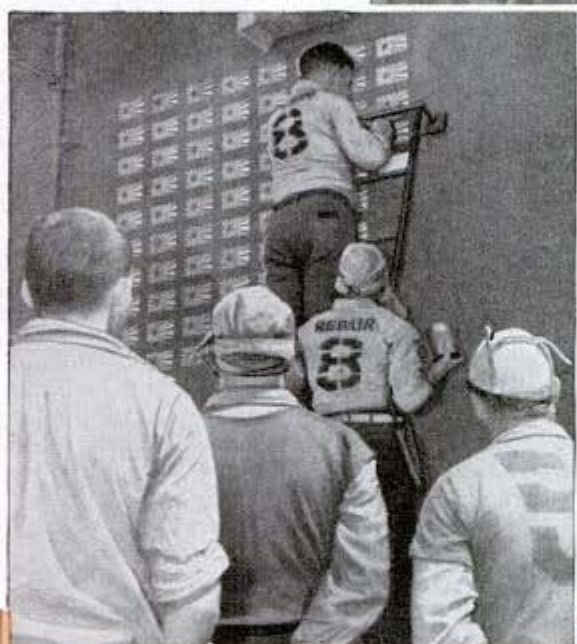

*N. W. Geyer & Son, Inc.
30 Rockefeller Plaza, N. Y., 20, N. Y. 0484*

Tiny Tube-Like Furnace Heats House in a Jiffy



The 75-pound tubular burner is dwarfed by conventional furnace. Right, conducting ash tests on two units. Below, cutaway of tube

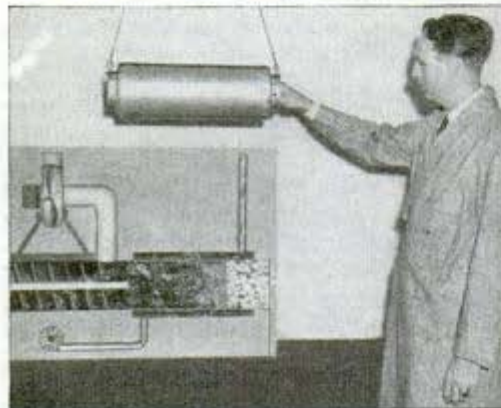
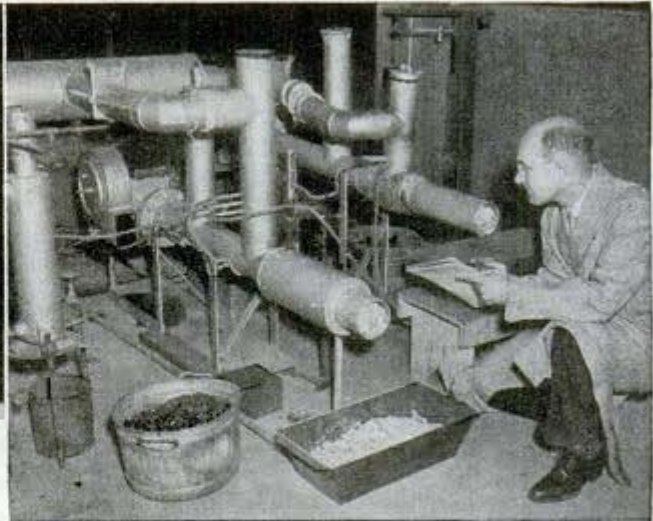

Enclosed in space two feet square and three feet long, a revolutionary heating unit of tubular design burns anthracite to heat an average size home in 15 minutes. The burner weighs only 75 pounds. Coal is pushed

automatically through the tube, which is six or eight inches in diameter, with a screw-like worm. It is ignited in the center of the tube and the ash is discharged at the other end into a dustproof container. Air for the burner is supplied by a suction fan. Water or air, depending on the type of heating system desired, is circulated around the hot part of the tube in a compact jacket. This "capsule" furnace, which is said to do the work of a half-ton unit, was developed by Anthracite Industries, Inc., as a postwar project and no furnaces have been built for sale. The tubular design is possible for an anthracite burner, according to its inventors, because hard coal under proper condition can be made to burn within its own area. This eliminates the need for secondary combustion space. Less heat is said to be wasted in the midget furnace, and more of it goes into the water or air to be circulated.

Primer R.

Junior Jeep Becomes 'Fire Peep' to Replace \$10,000 Truck 0383



Under the label "fire peep," a \$600 junior jeep was remodeled by the fire department of the Indianapolis Naval Ordnance plant to replace a \$10,000 regulation fire truck, which was transferred to another naval authority. The hose reel and extinguisher cabinet were placed on a small trailer, while the peep itself was equipped with ladder racks, gas masks, electric lantern, mounting plates for nozzle tips and a cabinet for complete asbestos suit kit.

U. S. Navy photo *Mr. G. N. Moore
1362 N. Dearborn St.
Chicago 10, Ill.*

Camera Catches Rocket Fired From Thunderbolt

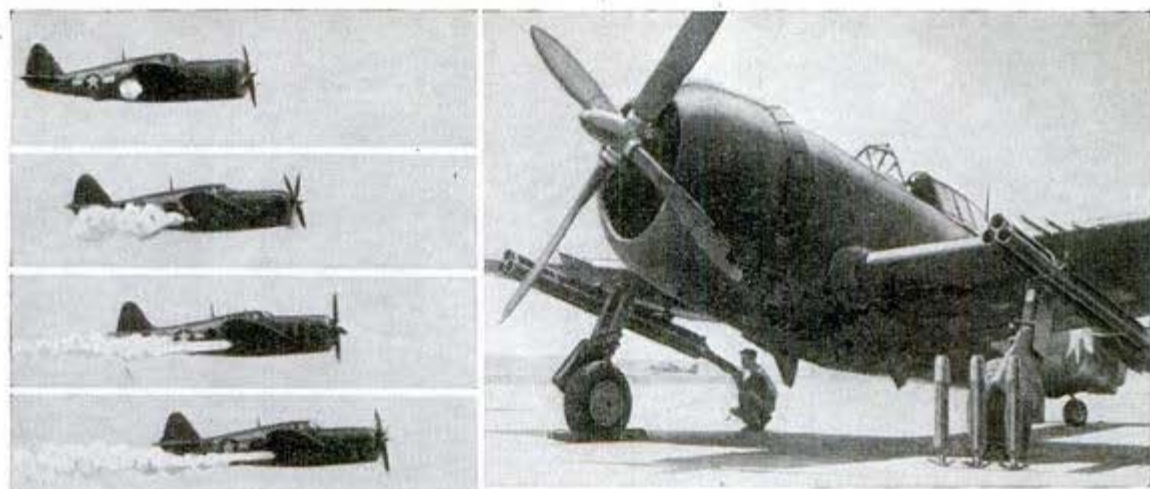

Left, camera snaps rocket being fired. Above, crew loads rocket tubes before take-off

Complementing the vicious fire power of its eight .50 caliber machine guns, the P-47 now packs rocket armament. Three long thin tubes grouped underneath each wing are loaded with projectiles just before the Thunderbolt takes off for enemy territory. Other details of their operation remain secret.

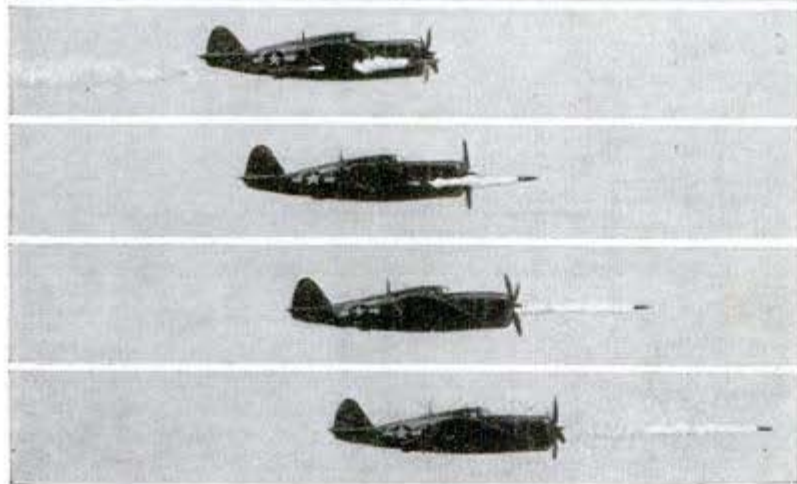

Nazi Tank Loaded With TNT Aimed by Remote Control

Captured intact in Normandy, a German remote control vehicle "B4," which looks like a small tank, carries on its front a detachable steel box container with a big

charge of high explosive inside. The box could be released from the vehicle, which is driven by a man to a safe spot, then guided by a remote control device to its target.



An allied soldier inspects a remote-control "tank" used by Nazis

Near-Odorless Fly "Dope" Can Be Sprayed on Clothes

Used by the Army at the rate of thousands of gallons a month, an insect repellent that has little odor can be sprayed on clothes or applied directly to the skin. Clothing sprayed with two or three ounces of the water-like liquid keeps mosquitoes, flies, fleas, gnats, sandflies or chiggers away for about five days. On the skin, it is effective for one to six hours. The repellent, called dimethyl phthalate, was developed by the Dupont Company from a compound used in making synthetic resin. It is hailed as a successor to citronella.

Mr. John La Coda
227 Pilgrim Lane, Drexel Hill, Pa.
0 278

U. S. Army's Port Repair Ship

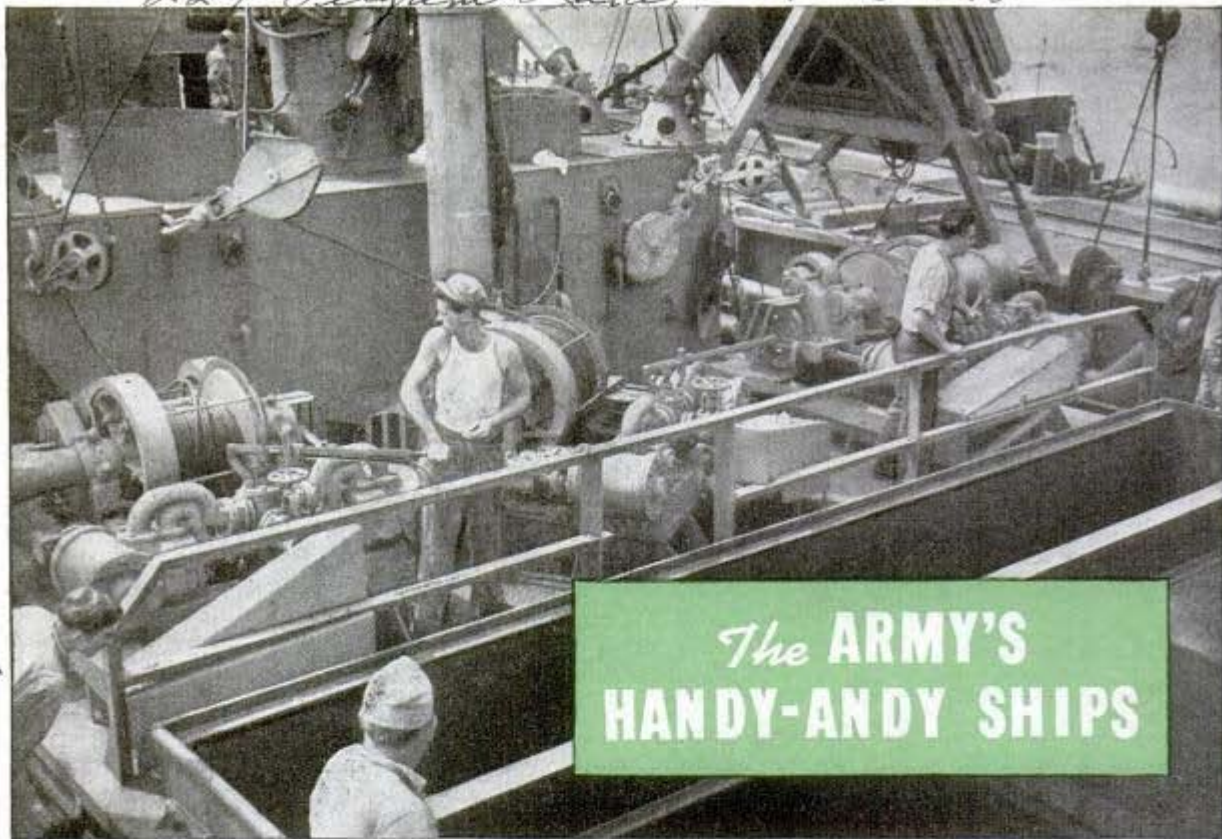

The **ARMY'S
HANDY-ANDY SHIPS**

A soldier (above, left) mans a donkey engine while a crewmate lowers a steel pump over the side of a harbor repair ship. Below, a radio operator climbs up the "king post" to repair an aerial on the ship

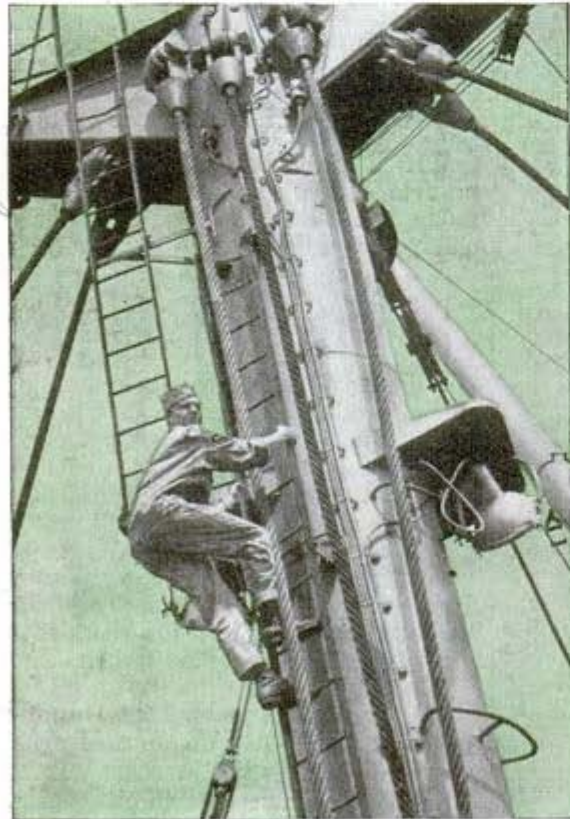

THE Army's seagoing soldiers—"sail-jers," they call themselves—are ready to hornpipe their way into bomb-broken harbors the world around.

With lathes and tackle and cutting torches they are at work wherever the enemy, in his desperation, has ravaged docks and cluttered shipping channels.

To get the G. I. gobs there and enable them to do their job, the Army is acquiring a fleet of tough oceangoing craft. When the first of the vessels was unveiled at Philadelphia, it looked like a mechanic's dream ship, jammed to the gunwales with lathes, drill presses, forges, planers, pipe threaders, generators and whatnot.

The ship, at one time a lumber freighter, was christened the Junior N. Van Noy in honor of a 19-year-old Idaho boy who gave his life on a New Guinea beachhead and became the first Service Forces soldier to receive the Congressional Medal of Honor in this war.

While the Van Noy is a madeover craft, other ships—bigger and faster and with additional features—are being built to specification for the harbor-clearing task.

The Van Noy was virtually rebuilt inside and out. Everywhere there are reinforcing girders and double-riveted plates. At her bow is a steel cathead capable of lifting 40 tons. Mounted on her massive foremast are five booms, four of them 10-tonners, the other a 30-ton heavyweight.

The ship carries a complete 21-unit ponton system. When bolted together the pontoons have a lifting capacity of 50 tons. Obviously there will be need for such equipment in the postwar period, when the raising of ships torpedoed along America's coasts will in itself be a job of colossal dimensions.

The Van Noy has five divers. If they happen to be under water when an enemy attack begins, they can be rushed to the surface and placed in a recompression chamber.

Right, a diver comes up with pipe removed from harbor bottom. Debris-clearing is one of ship's jobs



Above, a soldier crewman wields a fire hose. Right, divers' recompression chamber to prevent the "bends"

chamber. Thus they will escape the double danger of bends and concussion.

The jack-of-all-trades vessel can fight fires too. She carries four motor-driven pumps, each with a capacity of 3,000 gallons per minute. An eight-inch fire main is looped around the main deck. Eight hydrants are spaced handily throughout the ship.

If the Van Noy encounters harbor impediments which cannot be cut down or dragged away, her dynamite experts will take over. If she is attacked, her deck rifles and antiaircraft guns will sound defiance.

So many generators does she carry that if a town's electrical system were smashed the Van Noy could plug into the power



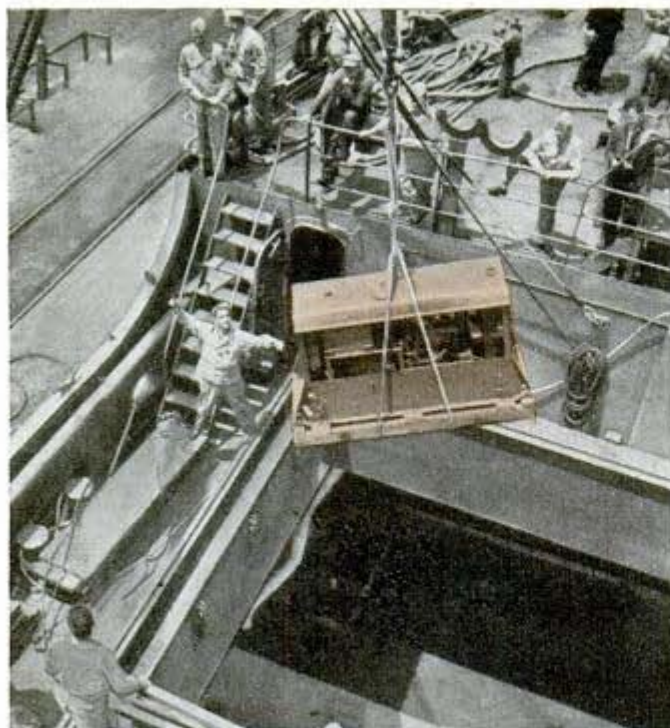

Generator being loaded aboard a "handy-andy" ship. The Van Noy carries enough generators to supply electricity to a town

lines and supply current until regular facilities were restored.

The men who sail this remarkable ship have backgrounds packed with adventure. Take the tough-skinned skipper, 50-year-

old Thomas J. Allison, for example. For 20 years he commanded everything from tankers to river scows. Between times he was a coal heaver, an actor and a newspaperman. In 1930 he quit the sea for a quiet shore berth at the Ryan Aeronautical Corporation in San Diego, California.

When the Army Engineers, having observed the devastation at Bengasi and Tobruk and elsewhere, decided on the handy-andy ships, they asked Allison to lend a hand. When they told him he would have charge of the Van Noy, which in years past he had known as the Covena, he came out of retirement.

Allison was permitted to hand-pick his officers. From Trinidad he signed up Ralph R. Buscell, who as a Navy civilian employe had charge of 17,000 men and was earning \$1,000 a month. Now Buscell wears a captain's bars and is the ship's salvage wrecking officer.

Allison also lured into uniform, and a captaincy, George L. White, of Brooklyn, who was making \$700 a week with the Standard Oil Company of Venezuela. White became chief engineer.

From the salvaging of the liner Normandie came white-haired Austin George. He

Below, four of the Van Noy's hose lines in operation. She can pump 12,000 gallons of water a minute

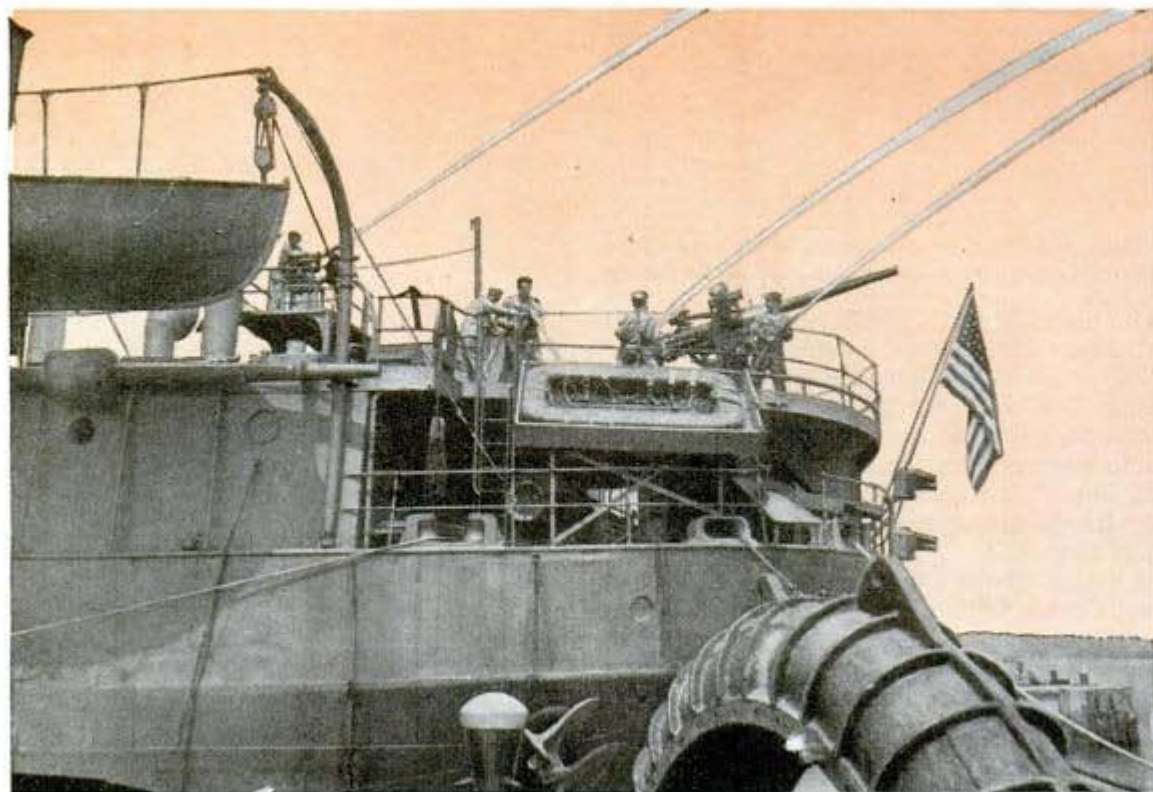

sacrificed something, too: \$300 a week. Now, at 44, he is a warrant officer junior grade and the ship's chief diver.

Army specialist schools supplied most of the crew. All have undergone Army basic training and could hold their own with the best of infantry-drilled troops. They went through the Service Forces course at Camp Gordon Johnson, Fla., where units comparable to the Navy's Seabees are trained. Today only seven of the 56 enlisted men aboard are privates; most are technical sergeants.

During the calm-water shakedown cruise from Mobile, Ala., to Philadelphia, 49 of the "sailjers" became seasick. Gradually, however, they got the hang of things. Advice from the ship's Navy gun crew helps. No longer do the soldiers refer to a deck as a floor or to a companionway as a stair.

The men like to call themselves "Allison's Raiders." Although they wear regular Army uniforms, they occasionally don sailor hats just to add a nautical touch. Like all good ships, the Van Noy has a mascot, a puppy named Salty. He, too, has acquired his sea legs.

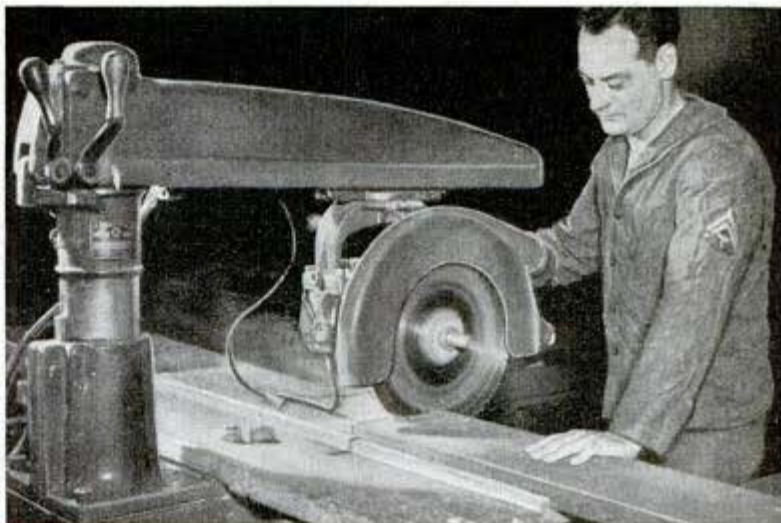

Above, the carpenter has plenty to do aboard this "mechanic's dream ship"



Two "Sailjers" team up for some electric welding on an emergency job

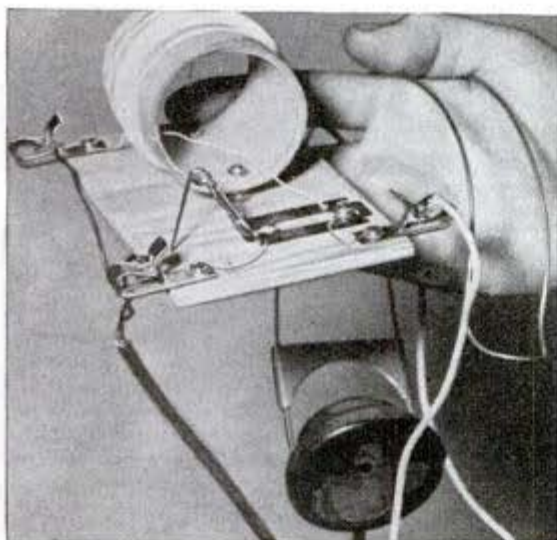

OCTOBER, 1944

0318

Radio Made Out of Razor Blade

Instead of discarding their used razor blades, American soldiers on the Italian front added a safety pin, a pair of ear-phones and a coil of wire with 120 turns and rigged up a radio receiving set to provide entertainment in their foxholes. The blued steel surface on a double-edged Marlin blade gave the rectifying action for detection of strong signals without crystals or tubes. The blade is tacked to a piece of wood with a wire taped to it and going to one side of the coil. The other side goes to ground and to one side of the headset. From the other side of the headset a wire goes to the safety pin, which is driven into the wood base at one end so the pin may be moved across the unground part of the blade to find your station.

*Markie Ferrarone Co.
17 E. 42nd St.
N. Y., N. Y.*

Twin Bomb Bays of B-29 Keep Load Balanced ⁰⁴²⁵

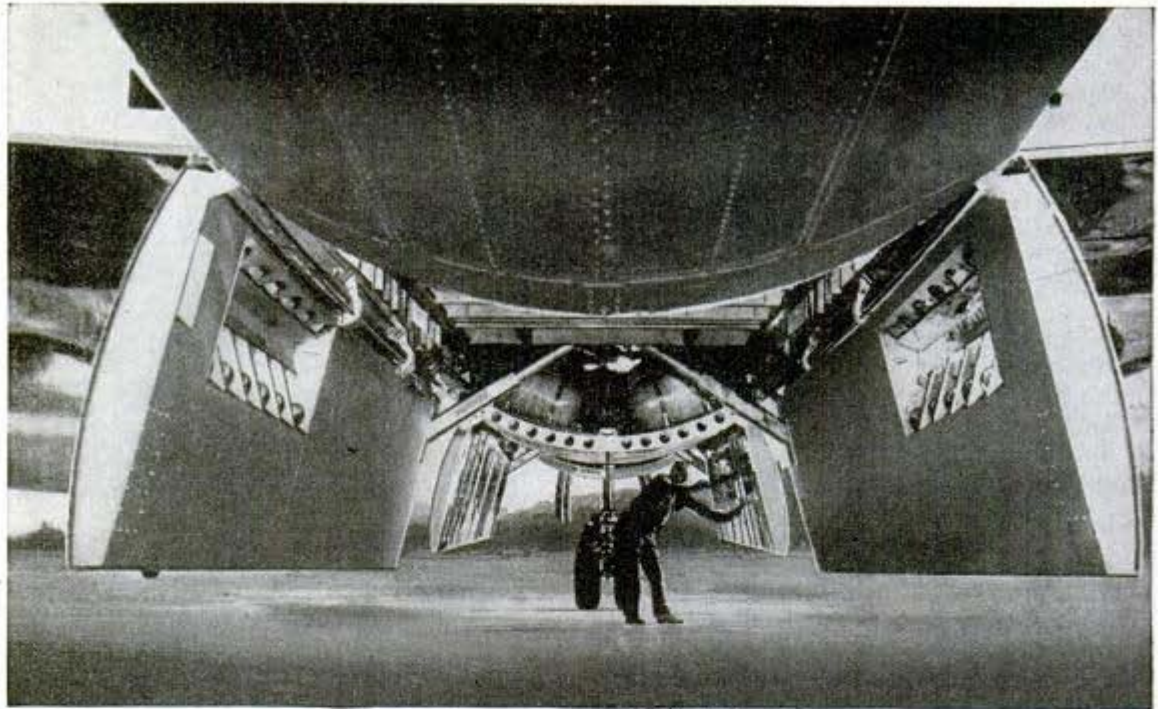

So big are the bomb loads that Superfortresses drop on the Axis that two bomb bays are necessary to carry them. A mechanism releases the bombs alternately from the double bays. Since one bay is forward

Balancing
of the wing and one aft, the center of gravity is maintained and the flight of the huge ship is unaffected. The bomb capacity of the B-29 is still a secret but it is conceded to be larger than that of any other plane.

Aluminum Fins Add Horsepower to Aircraft Engines ⁰⁴⁰⁴

Using aluminum cooling fins on the steel cylinder barrels of Cyclone engines has enabled the Wright Aeronautical Corp. to add horsepower and at the same time save an estimated 24,000,000 pounds of highly critical alloy steel annually. Sixty fins are mounted on a barrel in the same space formerly required for 40 steel fins machined from the barrel wall. The combination of

steel and aluminum gives almost twice the cooling area of the all-steel fin. This advantage, plus the fact that aluminum dissipates heat more rapidly than steel, results in cooler operation, permits more power to be taken from the engine and adds life to piston rings. Known as the "W" fin, the device eliminates the difficult machining operation which used to be necessary to cut 40 narrow grooves into a solid steel barrel. It is produced by folding a strip of sheet aluminum into the shape of an extremely exaggerated letter "W." While this barrel reduced the overall weight of the engine by only one pound per cylinder, the saving in raw material is considerable.



Worker compares the new fins (right) to the old type

Paper Is Ammunition—Save It!

Any staff officer of the Army or Navy will tell you that fighting a war is a lot of paper work. That is a gigantic understatement. Paper is one of the most vital materials. Vast tonnages of paperboard are required for packing the guns and ammunition and rations for ten million fighting men. Paperboard is made from scrap: yesterday's newspaper, the contents of your wastebasket. Save your old paper for the salvage drive!

30 Rocky Mountain Airways N. Y. N. Y.

Robot Works Problems Never Before Solved

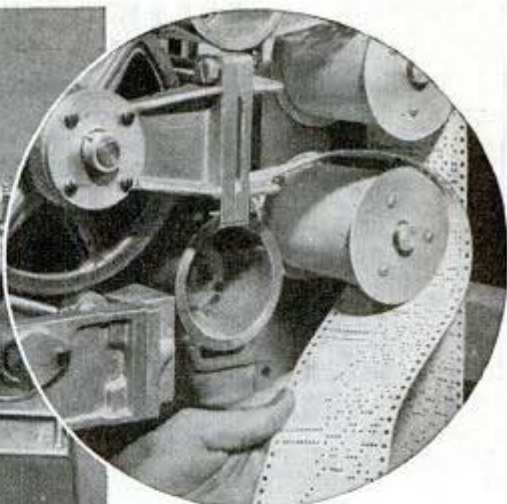

Solving problems which stumped mathematicians throughout history, is all in the day's work to the "world's greatest calculating machine" which gives accurate answers in 23 figures. Above, preparing a problem for the machine on manual tape punch which dictates operation of the "superbrain" with coded perforations. Center, system of holders on which tape moves

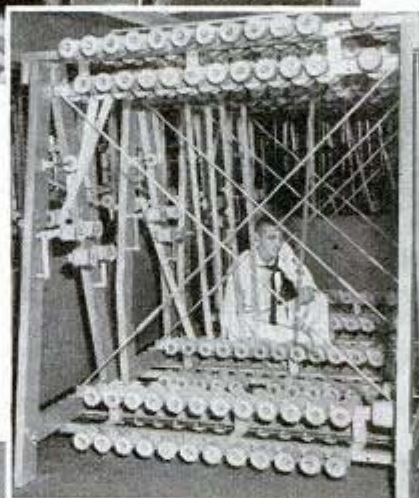

Above, tape entering sequence control mechanism shows how problem looks in "punch code." Below, general view of robot which is 51 feet long, 8 feet high. It has 500 miles of wire, 3,000,000 connections, tiers of 72 adding machines. Invented by Cmdr. H. H. Aiken, U.S.N.R., it was built by International Business Machines and presented to Harvard University for use by the Navy. After the war it will solve problems of star movements and algebraic equations hitherto unsolved

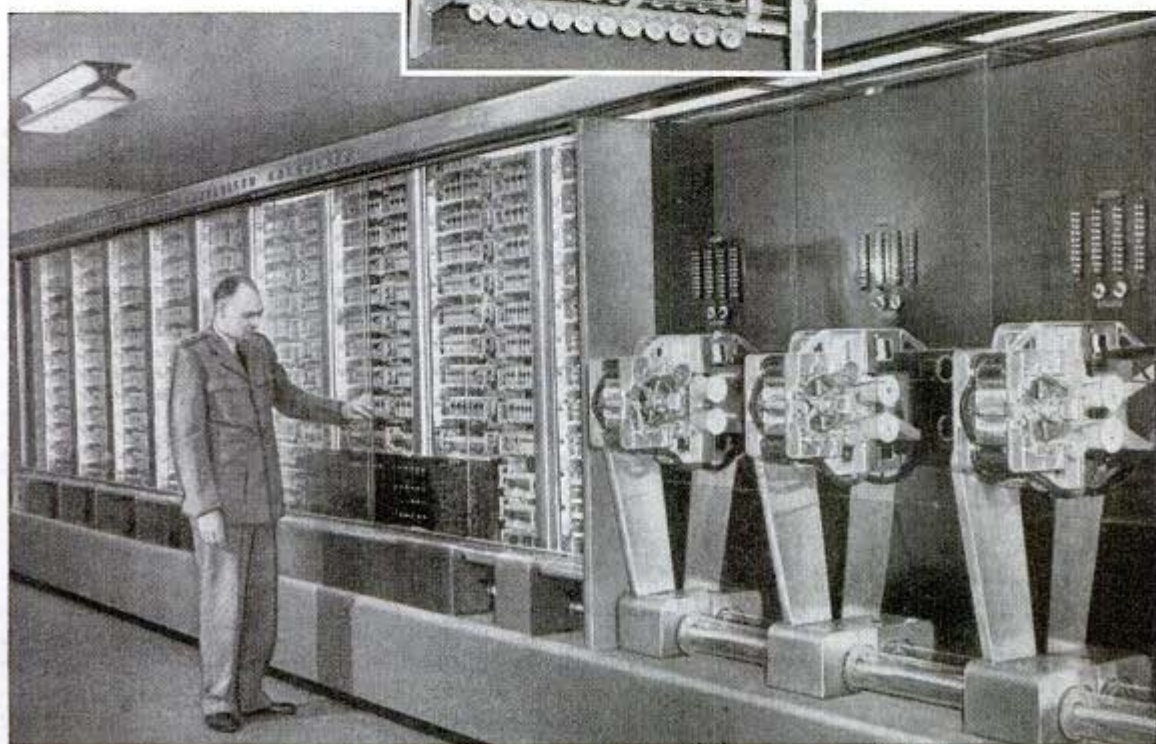

CONCRETE AFLOAT

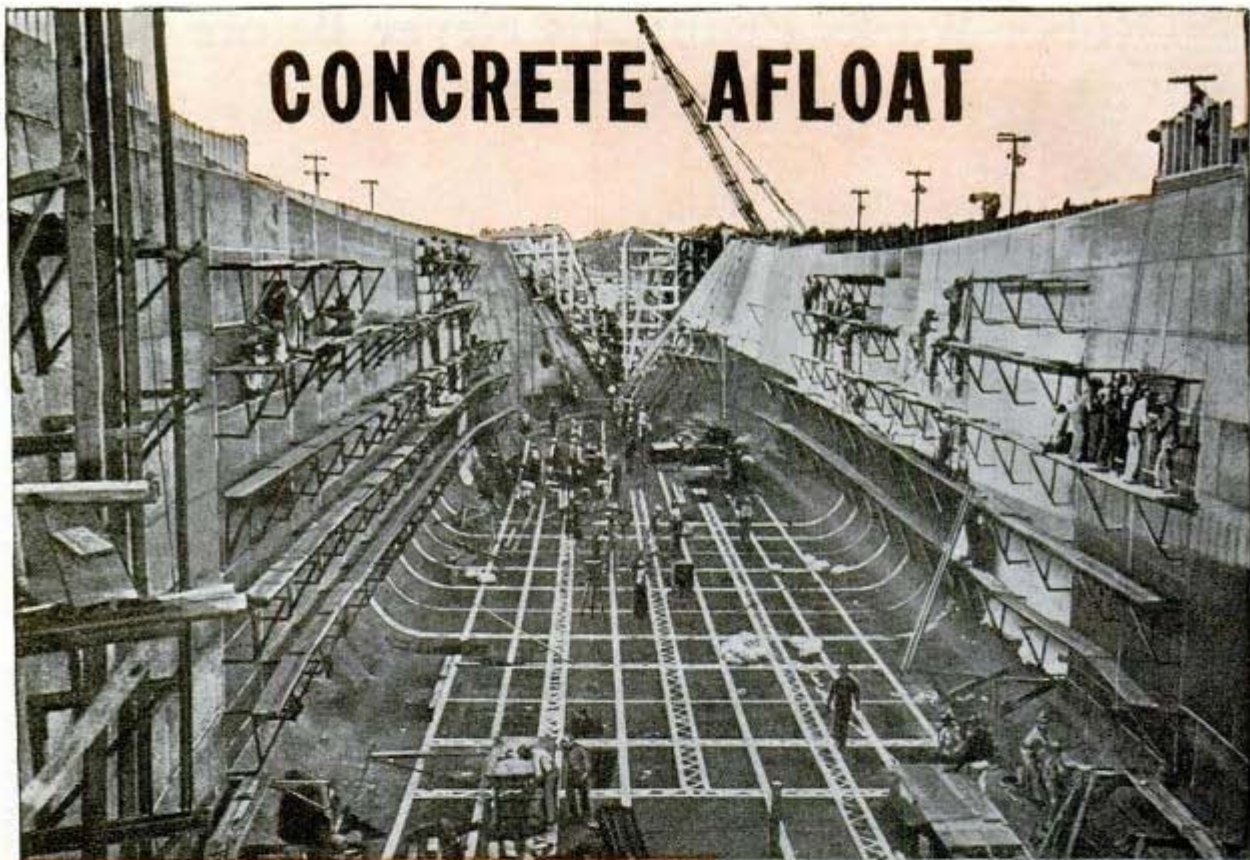

Plywood forms (above) are set for the construction of a concrete ship, once considered an impossibility. Steel rods will be woven around the bottom and sides of the structure and when the web is complete concrete (below, left) will be poured around the rods. Reinforcing steel forms 80 percent of the ship's weight, to give resilience, but most of the steel plate ordinarily used is left out. Concrete ships are used in the U. S. merchant fleet

*McCloskey, Tampa,
Florida*

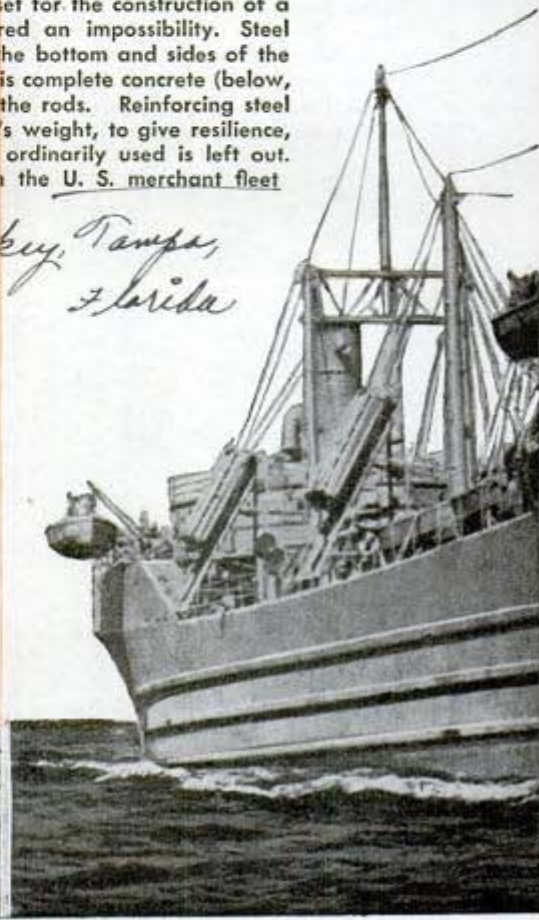
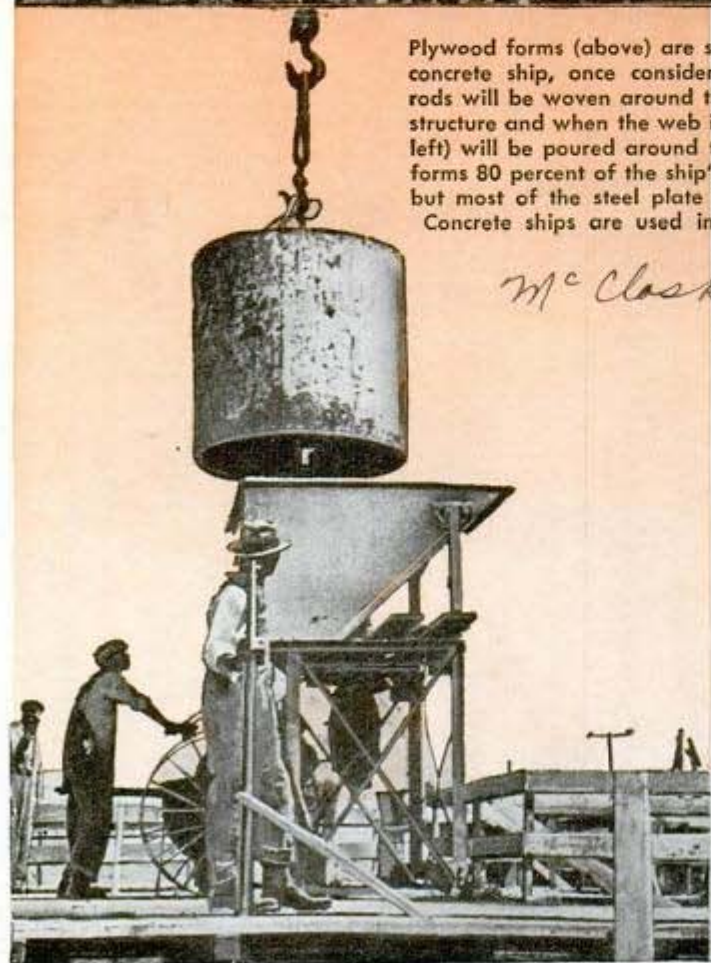



Above, a huge basin is excavated where the bottoms of concrete ships will be laid. There are three such basins in McCloskey & Co.'s shipyards at Tampa, Fla. Length of the ships is 366 feet



Above, a wooden form resembling the skeleton of a prehistoric monster is built to set the ship's contours and hold the reinforcing steel in place

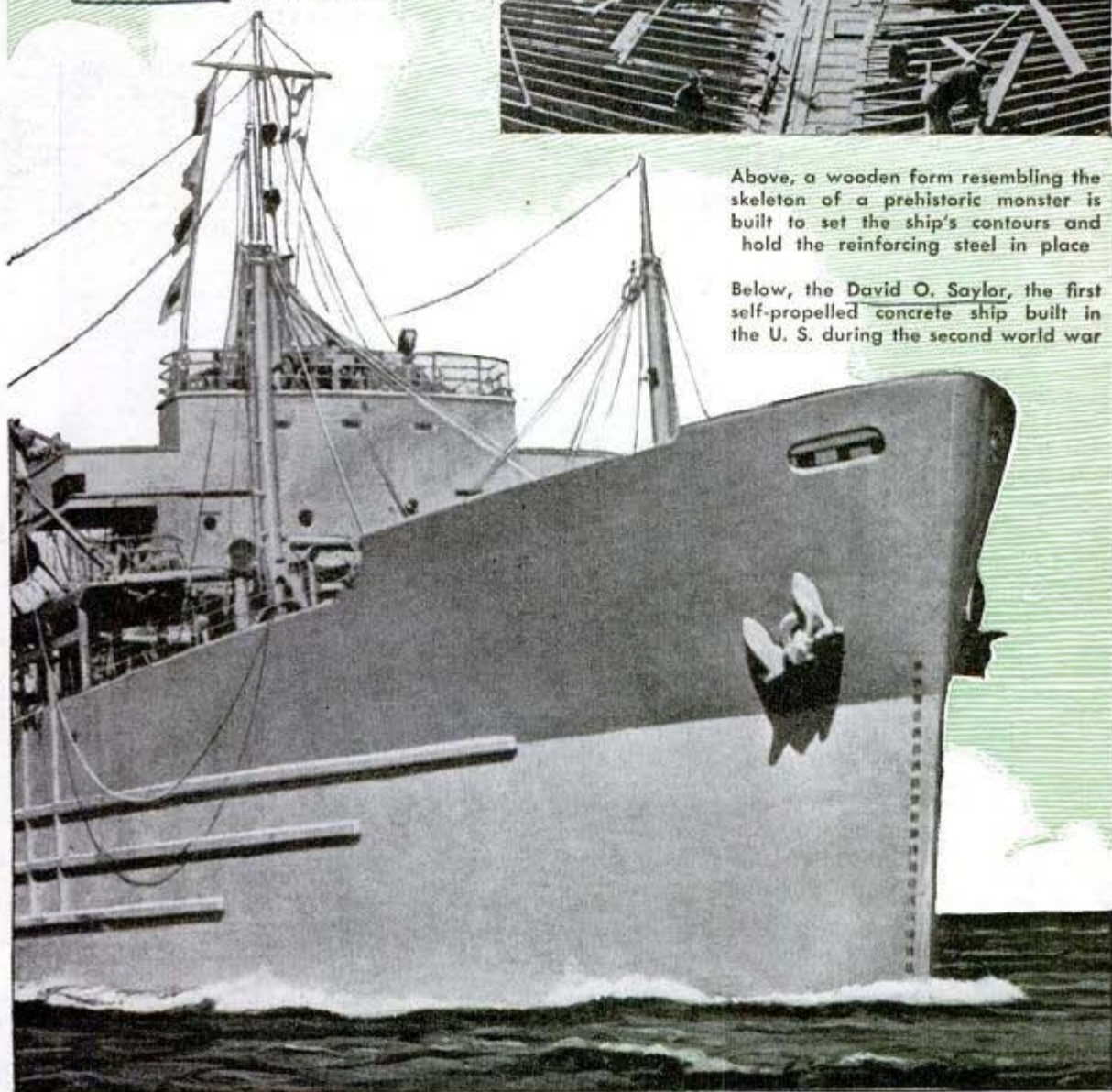

Below, the David O. Saylor, the first self-propelled concrete ship built in the U. S. during the second world war

*M. F. J. Stame, Com. 2415 Navy Bldg.
Navy Dept., Washington 25, D.C.*

0432

Makeshift Sand-Blaster Blows Coral Tornado



Navy Seabees on Espiritu Santo saved valuable time by improvising a sand-blasting machine from scrap and salvaged parts for cleaning old equipment. Unable to obtain the silica sand ordinarily used for the purpose, they successfully employed coral sand, dried and screened through an ordinary window screen. The machine holds enough sand to operate 30 minutes. Cleaning a salvaged motor, which took 7 hours, requires only 20 minutes with the sand-blaster.

Crane Lifts Gas Cylinders To Fight Shipyard Fires

As protection against fire breaking out in the shipyards of the Electric Boat Company, Groton, Conn., where submarines are built, 1,200 pounds of carbon dioxide fitted onto a platform can be swung overhead by crane to any point, leaping hurdles that would obstruct a fire truck. The gas is bottled in 24 50-pound cylinders arranged in four banks of six manifold cylinders each, with hose reel and nozzle attached. Each bank can be used independently, if necessary. Released, the gas expands to 450 times its compressed volume, driving out the fire-feeding oxygen and snuffing out the flames in seconds.



0410

Men Ride Wings of P-47 To Guide It to Runway

Mechanics riding on the wings act as the "eyes" of P-47 pilots in France, where ships at more than one field must be maneuvered carefully from their parking places through groves of trees onto a narrow taxi strip. Because of the bubble canopy on Thunderbolts the pilots have no direct forward vision when the plane's nose is up.

☐ There are 5,000 pounds of rubber in a B-29 Superfortress, of which nearly two tons go into the 30 bullet-sealing fuel tanks.



*Model by: Walter Kiddle & Co.
88 West St. Syracuse, N.Y.*

50-Seat Sky Liner Ready to Fly World Routes

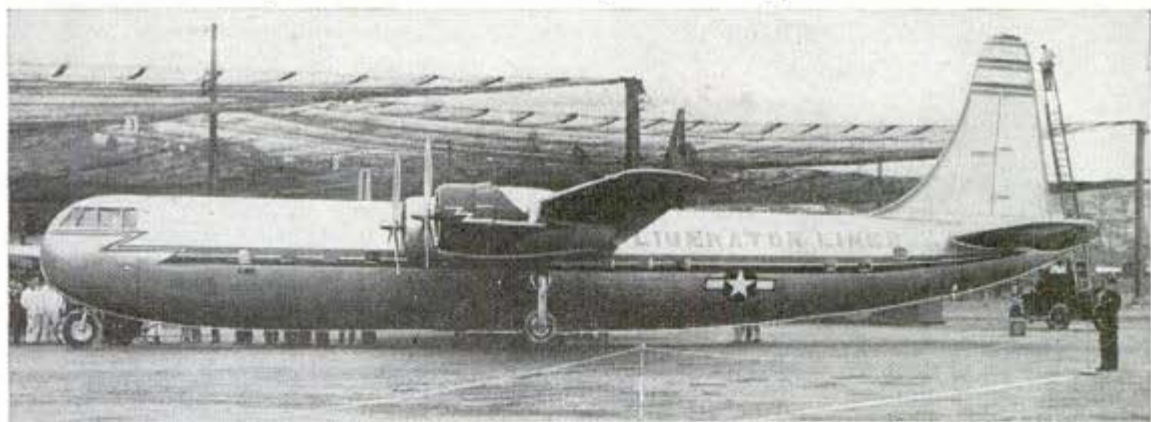

Consolidated-Vultee Corporation introduced recently its postwar transport plane, the "Liberator Liner," designed to carry 50 passengers at a cruising speed of 240 miles per hour. Powered by four Pratt &

Whitney engines, the craft has a long nose, boatlike fuselage and stubby wing. Although it has a single tail fin, the ship has many parts which are identical with those of the famous B-24 Liberator bomber.

Panel Links Newsmen Abroad With Radio Control Desk

A special panel for checking accurately on the quality of broadcasts originating

overseas and for keeping in touch with branch stations in other countries is used



in the CBS world news headquarters in New York City. The panel includes three rows of lights, marked "good," "fair" and "poor," by which the engineers signal the quality of broadcasts to the executives; a row of buttons marked with such outlying points as Anzio, London, Algiers, etc., for signaling the announcers and production men to go ahead. By pushing other buttons, Paul White, CBS director of news broadcasts, can hear overseas signals himself and can talk with correspondents.

*Columbia Broadcasting System
485 Madison Ave.*

Air Force Seeks "Buck Rogers" Ideas for Long Range Experiments

Working on radical, apparently impractical ideas is the sole function of the "little group of dreamers" who comprise the engineering division of Air Force Materiel Command, according to Brig. Gen. Franklin O. Carroll, chief of the division. The general said he has given his group of young scientists and engineers orders never to have a practical idea, but to look ahead and concentrate on projects which cannot be realized for years. He pointed out that many features of aircraft which

are standard today once were considered "Buck Rogers" dreams of the future—for example, the internally braced wing, which eliminated exterior struts and wires; the supercharger, which enables planes to operate at high altitudes; the jet-propulsion plane and remote controlled guns. In their efforts to keep American airpower from three to five years in advance of the rest of the world, he said the engineers delve into every science from astronomy to chemistry and from physics to physiology.



Torpedo bomber over Jap-held Wake Island heads for "home" on completion of mission; radio-gunner will see plenty of action

Ordnance mates help radio-gunner install machine gun on his plane; turret guns protect bomber on dangerous homeward trip

Official U. S. Navy photos



THE PILOT had flown his Navy Dauntless dive bomber straight to the target, a Jap destroyer. His dive had been perfect. The bombs had hit the spot, and the quarry was listing badly. The offensive job was complete and now the plane was pointed toward "home," the deck of a U. S. aircraft carrier, hundreds of miles away.

Then came the Zeros. They came from behind, from above, from various angles that made it impossible for the pilot, with his fixed guns in the wings which fire only straight ahead, to defend his plane. It was up to the man in the rear turret—a man who spends 99 percent of his time in the air taking care of the routine duties of a flying radioman, and only one percent shooting at the enemy.

But the radioman was a gunner, too—an aerial radio-gunner, to be exact. A good deal more than one percent of his training had been spent in shooting instruction, and he knew all about deflection firing, the art of judging the range, angle of flight and speed of opposing planes so he could aim his guns at just the distance and just the angle ahead for top effectiveness.

That knowledge came in handy

*Mr. G. N. Moore
1362 N. Dearborn St.
Chicago 10, Ill.*



Aerial gunner on carrier-borne fighter plane checks the swing of his gun before taking off to blast foe

as the plane sped home. The pilot did his part by flying a deceptive, zig-zag course. Attack after attack of Zeros failed. Some of them gave up the chase; others went down in flames. The radio-gunner had his part, also, in "bringing 'em back alive" from what might have been a disastrous mission.

Incidents like that one are becoming more and more frequent in the war against

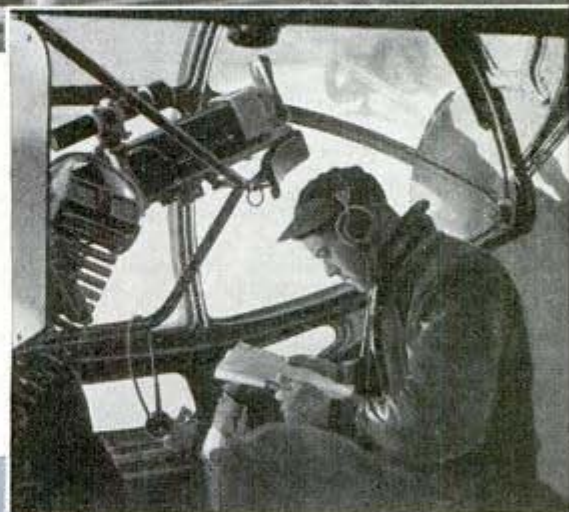

Delayed by weather, gunner reads in blister turret. Left, radioman ready to fire



the Japs as the Navy's aircrewmembers, a large part of whom are aerial radio-gunners, at last are getting the recognition they deserve in the fighting done by every type of Navy plane except single-seat combat ships.

Pilots long have been the focal point in descriptions of air combat and in honors and achievements. And their importance is by no means minimized in giving their crewmen a full share of the credit in what is perhaps the greatest combat team in the air—the Navy pilot and his gunner, whether the latter be radioman, ordnanceman or mechanic "on the side."



Student in power-operated turret mount works with his instructor



Gunnery students firing from power-operated turrets on trucks. Below, ensign on grotesque-looking turret-trainer tests marksmanship



Navy records, in fact, are packed with information about the individual accomplishments of aerial gunners. Many of them have been decorated, like John Liska who holds the Air Medal, three commendations and two Presidential Unit Citations and has four Jap planes to his credit, two in the battle of the Coral Sea, and two more at Santa Cruz. Another crewman, Harry Ferrier, received the Distinguished Flying Cross, Air Medal and two Presidential Citations

after three years of action in which he participated in almost every major Pacific battle. Some of them have well over 2,000 hours of flying time; others are brand new on the job. All of them know what it is to meet the Japs, plane to plane.

So vital is the task of these air crewmen that the Navy is making a special effort to augment their ranks from volunteer inductees at "boot camp." Because the requirements, mental and physical, are rigid, no direct recruiting appeal can be made since no advance guarantee can be given that any man entering the Navy will be qualified.

Once selected to be an air-crewman, however, an in-

ductee is given one of the world's finest training courses, covering nearly nine months, which includes instruction expected to be of unusual value after the war in electronics, radio, automotive or aviation fields.

An aerial gunner, first of all, is a technician. If he is a machinist's mate, he is taught airplanes inside out and how to keep them flying—he must know the job well because he will fly in the same plane he must repair. If he is a radioman, he learns to operate radio devices. Or he may be an ordnanceman, specialist in guns. Then, all three ratings are trained to be expert gunners to defend planes during attack.

Special emphasis now is being placed on radio gunners since the Navy needs these men to help man the Dauntless, Hell-diver and Avenger—dive and torpedo bombers.

After eight weeks at boot camp, the aircrewman attends technical training school for five weeks, then the Naval Air Gunners' School for another five weeks. In the last 16 weeks of his instruction, he spends half in operational training and half in squadron formation flying. Upon completion of Naval Air Gunnery School the crewman receives the gunner's sleeve badge and may be provisionally rated third class at that time. When graduated from operational training he receives his wings, flight pay, leave, and is finally rated third class.

Formerly, wings were awarded only to men who had three months' experience with a combat unit. Now, the wings may be retained for a probationary period of 12 months as soon as the operational course is fin-



In "clay pigeon" test, student gunners practice with turret fixed with shotgun mount, learning to swing their bodies with the gun. Below, reloading twin .30-caliber guns on Navy Dauntless dive bomber on carrier





This flying photographer mans a machine gun as well as camera. Below, hits or misses are registered on screen showing plane

ished, and during that time may be awarded permanently.

Probably never before in the history of the Navy has the idea of teamwork between pilot and gunner been stressed as much as it is in training aerial gunners. During the final part of his training, the gunner teams up with the pilot with whom he will fly and when the training period is ended, he knows, almost instinctively, which way the pilot will turn and bank, and just how he will fly. The gunner, in fact, becomes what amounts to eyes in the back of the pilot's head, so closely do the two work together.

Having remarkable value in combat and in other critical periods when the plane is in the air, this teamwork likewise is reflected in many other tasks a pilot and his radio-gunner must perform in the countless emergencies arising in the battle for the Pacific.

It was the co-operation of pilot and gunner, for example, that helped write one of the most thrilling rescue chapters of the war in a recent attack on the Jap stronghold of Truk. The two, in a tiny Kingfisher catapult plane—a standing joke in the fleet be-

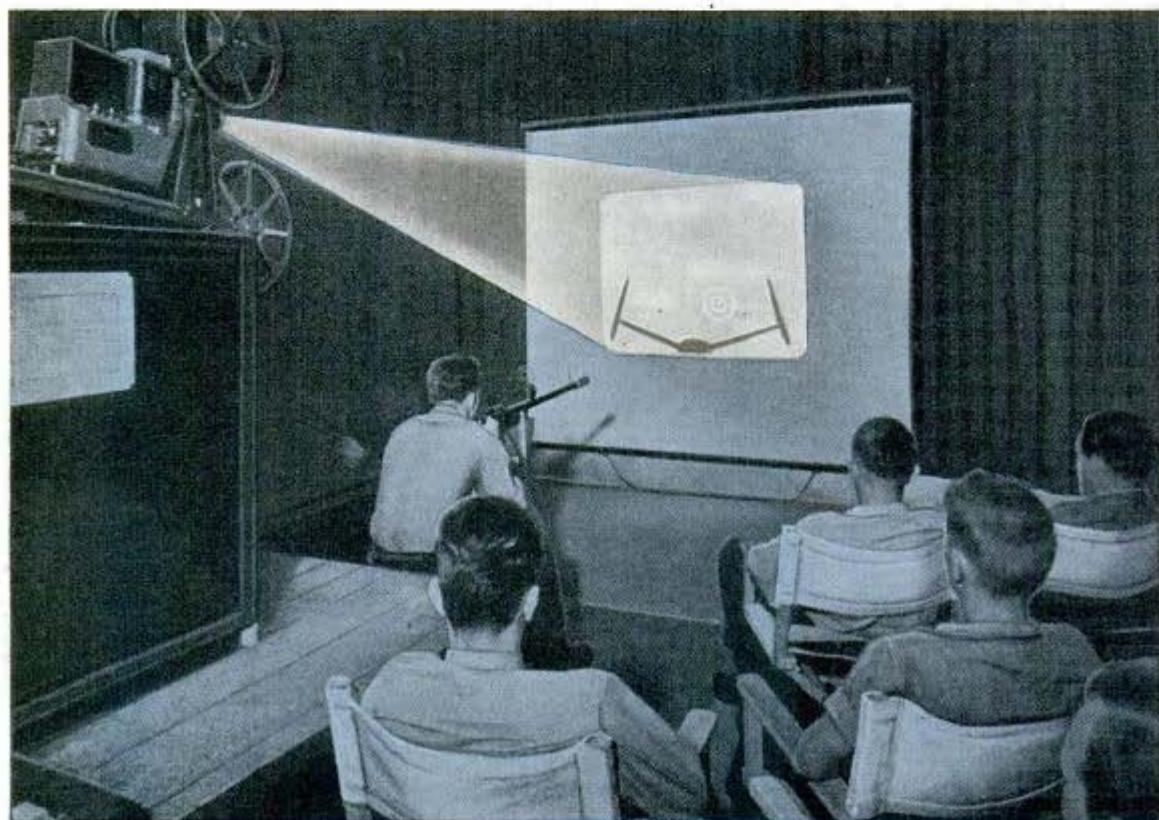

cause of its size—were sent to the rescue of the crews of two torpedo planes, a dive bomber and two fighter planes which had been shot down by Jap guns.

There were fourteen men in rubber rafts in the sea off the eastern reef of Truk atoll when the Kingfisher arrived. Since the plane can hold, at the most, three men, there was a single empty seat, the other two being occupied by the pilot and gunner. Taking on 14 extra passengers was out of the question, but the drift was toward the land and Jap guns, and something had to be done, quickly.

"Grab ahold, and hold on, boys!" called the pilot, while the radioman leaned over to give assistance in making the rafts fast to the pontoons of the plane. The plane went forward, slowly—on the water, not over the water. For nearly three hours, the Kingfisher plodded ahead, with the radioman half in and half out of his seat, helping his comrades. Finally, a rescue ship was sighted, and when it reached the plane, airmen were on the wings, the fuselage and the pontoons. All

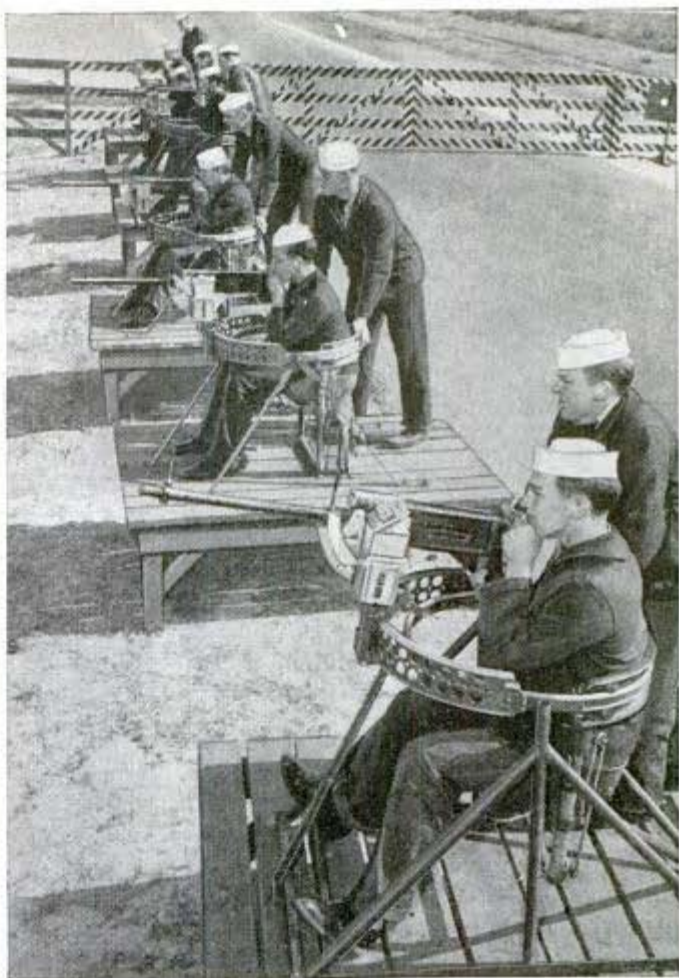

Bucket seats are used by students on firing range at training station. Below, turret gunner in Navy PBY bomber keeps sharp watch for Zeros on patrol

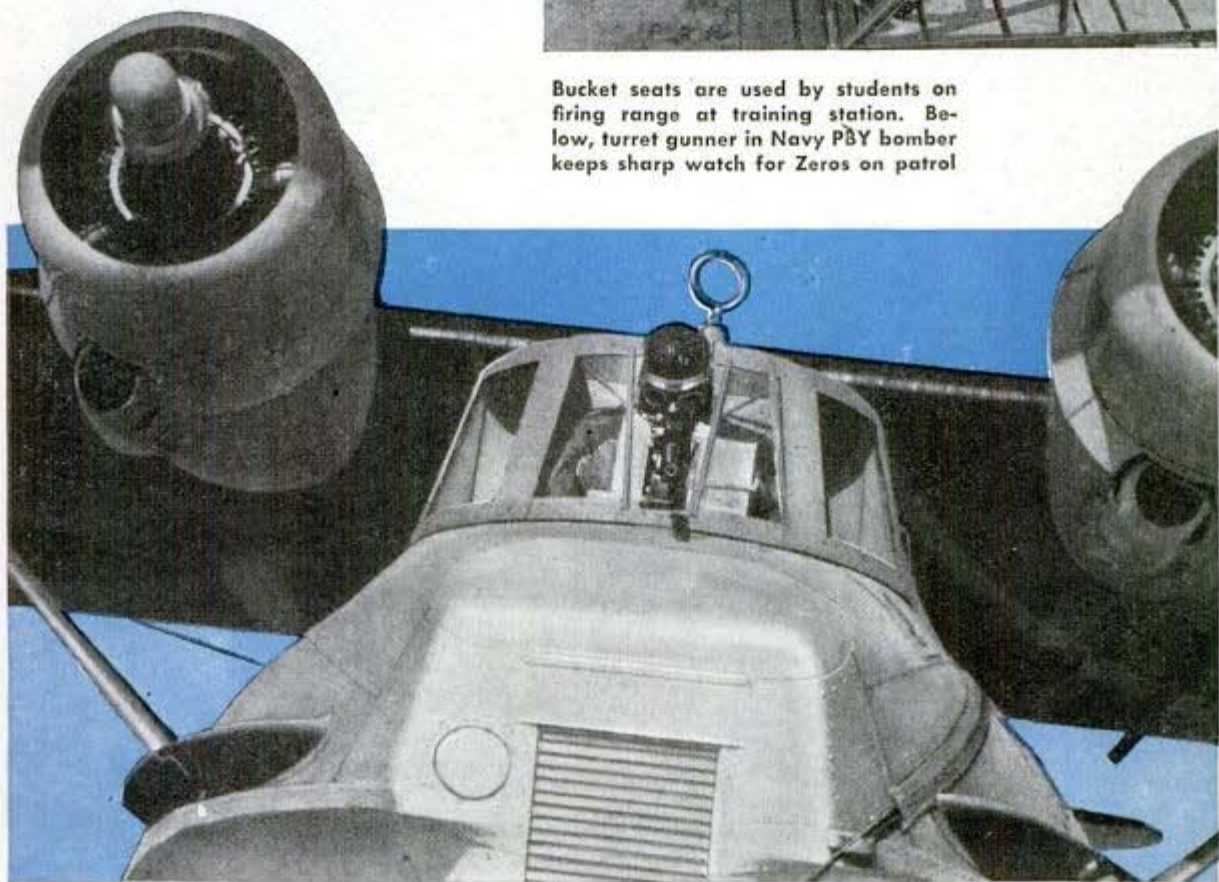

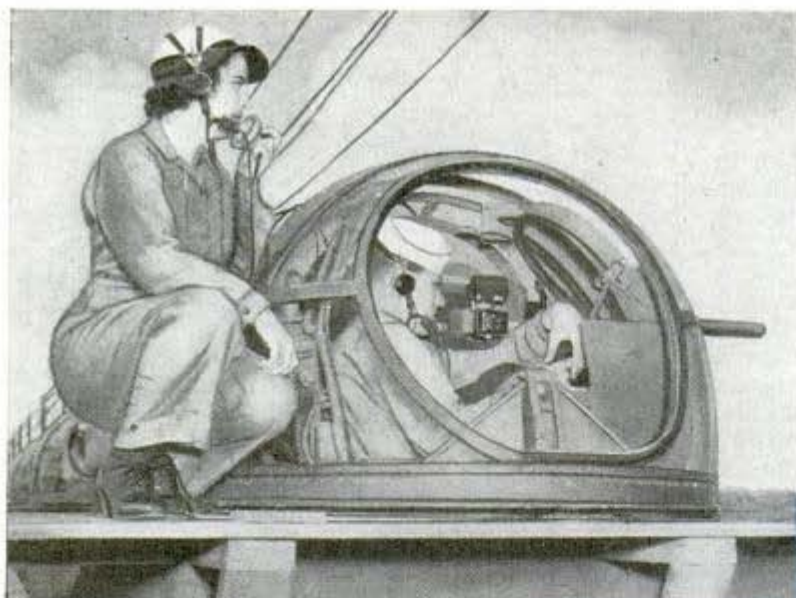

Wave gives instructions to student in turret at Naval Air Gunners School, Hollywood, Fla.

hands were safe, though one pontoon had sprung a leak and some of the rubber rafts had been lost. Here again, the radio-gunner had helped "bring 'em back alive."

Had it not been for the teamwork of the pilot, Lt. John Burns of Wynnewood, Pa., and the radio-gunner, Aubrey James Gill, of San Francisco, the rescue could not have been completed with success, according to eyewitness reports of the heroism of both during the last lap of the exploit.

In the gunnery phase of the training period, one of the first things the men are told is that bringing down Jap planes is a whole lot like shooting ducks—"You can't aim where they used to be and get results—you must

learn to aim where the target will be by the time the bullet gets there." The Navy has its own special device for doing just that. It is called a ring sight.

The theory of duck shooting and the theory of aerial gun sighting are combined at the Naval Gunners' School. Trainees do their first shooting with shotguns at clay pigeons. At the start, there is trap-

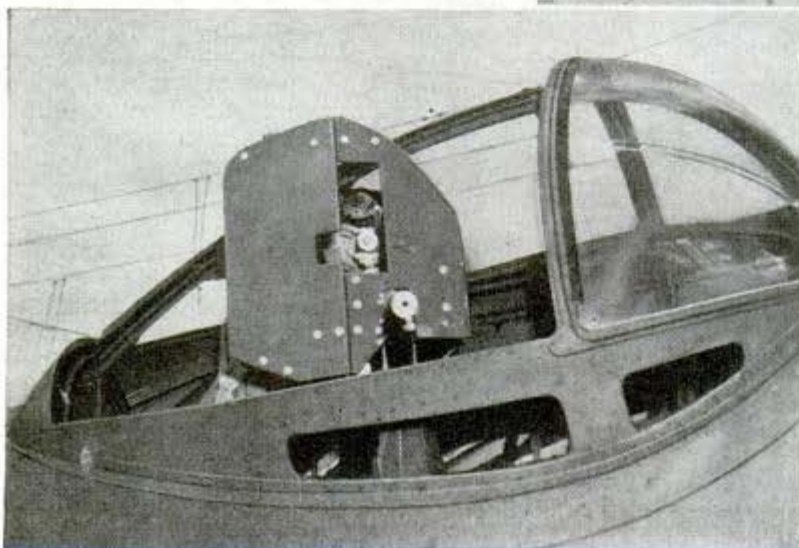

Navy gunner (above) in waist "blister" of Catalina patrol bomber checks the sights of his .50-caliber machine gun. At left, heavy armor plane is protection for gunner as he squints through telescopic sight of machine gun mounted in the blister turret of PBV patrol bomber

shooting at "birds" flying away from the shooter in the same direction. Next is deflection shooting with a ring-sight equipped shotgun on a skeet range. Trainees are taught to shoot with both eyes open as F.B.I. experts do, and to keep the "bead" and "peep" always lined up while swinging with a fast moving target.

The next step is learning to shoot with a shotgun in a machine gun pivot mount, like waist gunners in Flying Fortresses. The shotgun has spade grips and a ring sight, and the men learn to swing their bodies with the gun when the clay pigeons are shot at difficult angles.

Before long, the trainee moves to a shotgun in a machine-gun mounting on a bucket seat, just like the seats in combat planes. Last of all, on the shotgun range, he climbs into a plane turret and learns how to manipulate the guns so they blast the "target" almost before it leaves a 40-foot tower.

When the trainee graduates to real machine guns, he is at the beginning of a



Jap flag by the rear-seat gun position is for a Zero shot down over Truk

course that takes him clear through the alphabet of air gunnery and includes everything from tracer ammunition to making patterns with multi-gun mounts to create "hot" areas through which no enemy plane can survive. Actual combat films, many of them restricted, electric-eye machine guns, electrical apparatus, all are tied in together to make the course one of the most fascinating in the Navy.

Navy Helldiver is all set for takeoff from deck of a carrier; note exposed position of the radio-gunner



Army's "Weasel" Can Be Steered With Reins



Making "tracks" through deep snow, Weasels wear camouflage on boxlike tops. Left, car takes a steep slope

carrier is its simplified controls which permit the driver to steer with reins while he walks behind the car. Thus, if the Weasel should plunge into a snow-filled crevasse the driver would be saved. The vehicle has a demountable canvas top and is powered by a six-cylinder Studebaker engine and can be turned in a 12-foot radius.

Steering Weasel with reins protects driver if car drops into a crevasse

Deep snow, sand, mud or swamp land is no obstacle to the Army's new cargo and personnel carrier, the M-29. This low-slung, square-faced vehicle has been nicknamed the "Weasel" for its ability to strike swiftly and stealthily. The Weasel's broad tracks are rubber padded, and its light weight makes it ideal for reconnaissance, commando raids, or negotiating nearly-impassable terrain. Pressure on the ground exerted by the Weasel is only one-fourth that of a fully equipped infantryman. One feature of the



Studebaker factory in South Bend, Ind. for army

Magnetic Detector Locates Aircraft For Germans

Aircraft spotting by a magnetic detector was one of Hitler's secret weapons, according to a German report coming through neutral channels. It is claimed that a huge mysterious-looking instrument throws out magnetic rays of great power which locate approaching planes long before they can be heard.

Photo of weird looking contraption used by Germans to detect approaching planes was received through neutral sources. The detector is said to send out magnetic ray

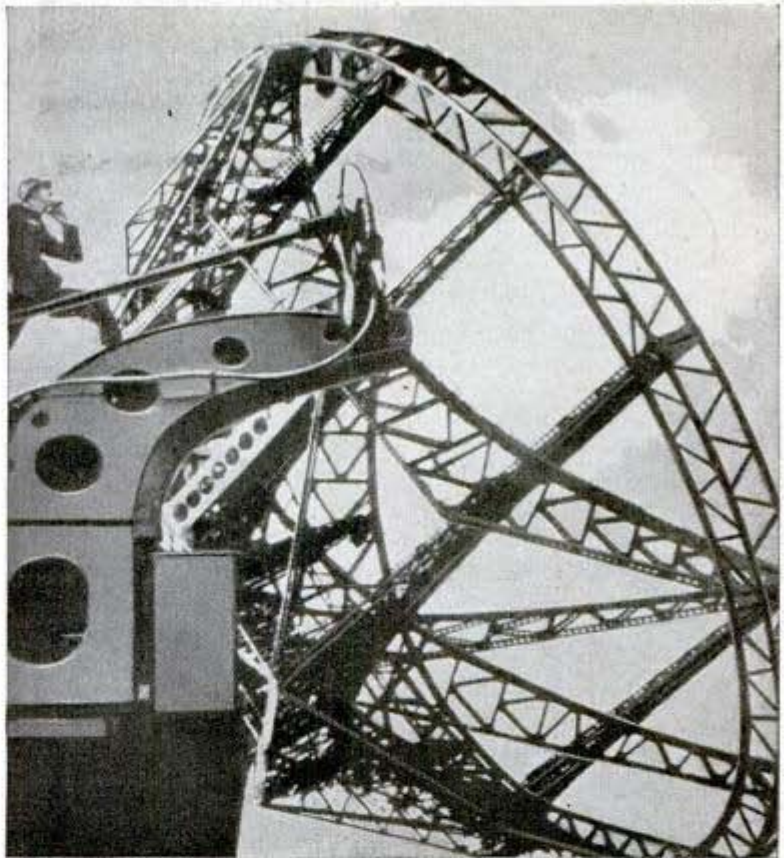

0316

Model of Coney Island's Roller Coaster Built in a Week for Movies

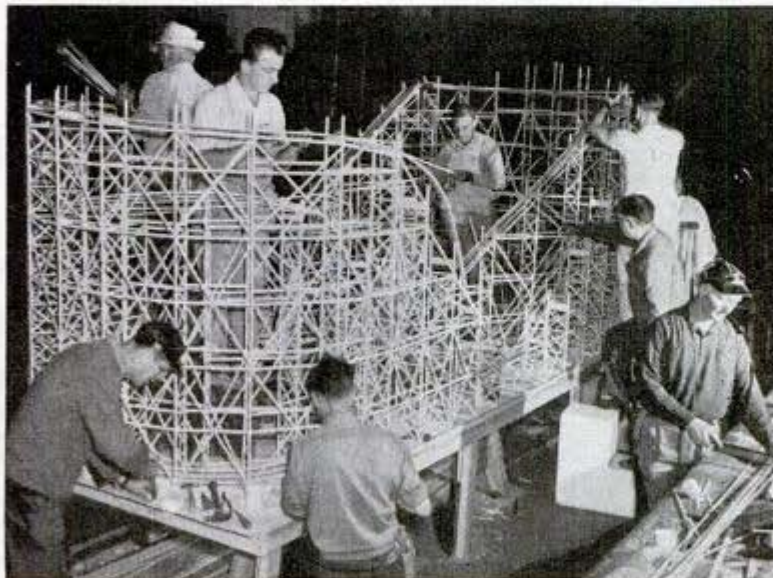

Coney Island's famous roller coaster was reproduced in a scale model in one week by the Universal Studios, Culver City, Calif., as a prop for a musical show. The replica, one of the largest scale models in the history of the movie industry, is complete with lights, turns, cars, and dizzy glides. The model was constructed with the assistance of Fred Knoth, who formerly built real roller coasters. In order to finish the model on schedule, Knoth and his crew of workmen labored 24 hours a day.

0322

Rubber Lining in Huge Steel Storage Tank Protects Purified Water

From five to seven tons of rubber line a 43,000-gallon steel storage tank to prevent corrosion from contaminating highly purified water used in the manufacture of high explosives, nitroglycerine and rocket powder. The lining consists of long strips of rubber nearly a quarter of an inch thick.

They are bonded to the inside of the tank with rubber cement, the seams being stitched by a machine to insure perfect bonding. The Army, Navy and Marine Corps and some industrial companies are using rubber linings in concrete storage tanks for holding high-octane gasoline.

OCTOBER, 1944

*U. S. Rubber Co.
1230 - Sixth Ave.
N. Y. 20, N. Y.*

27

0408

FOOTBALL--TOUGHER

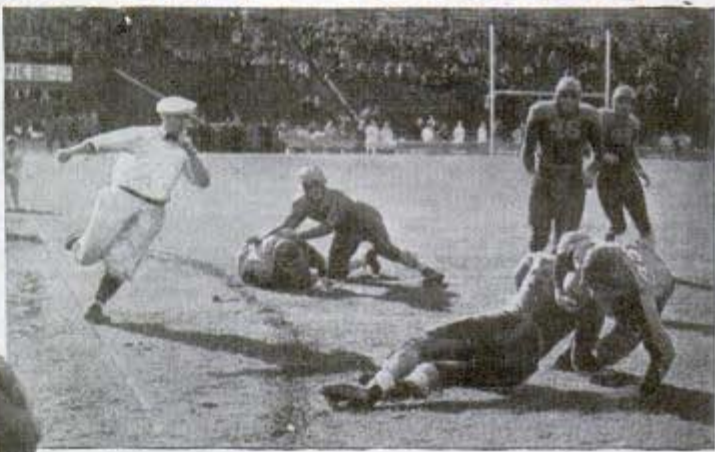
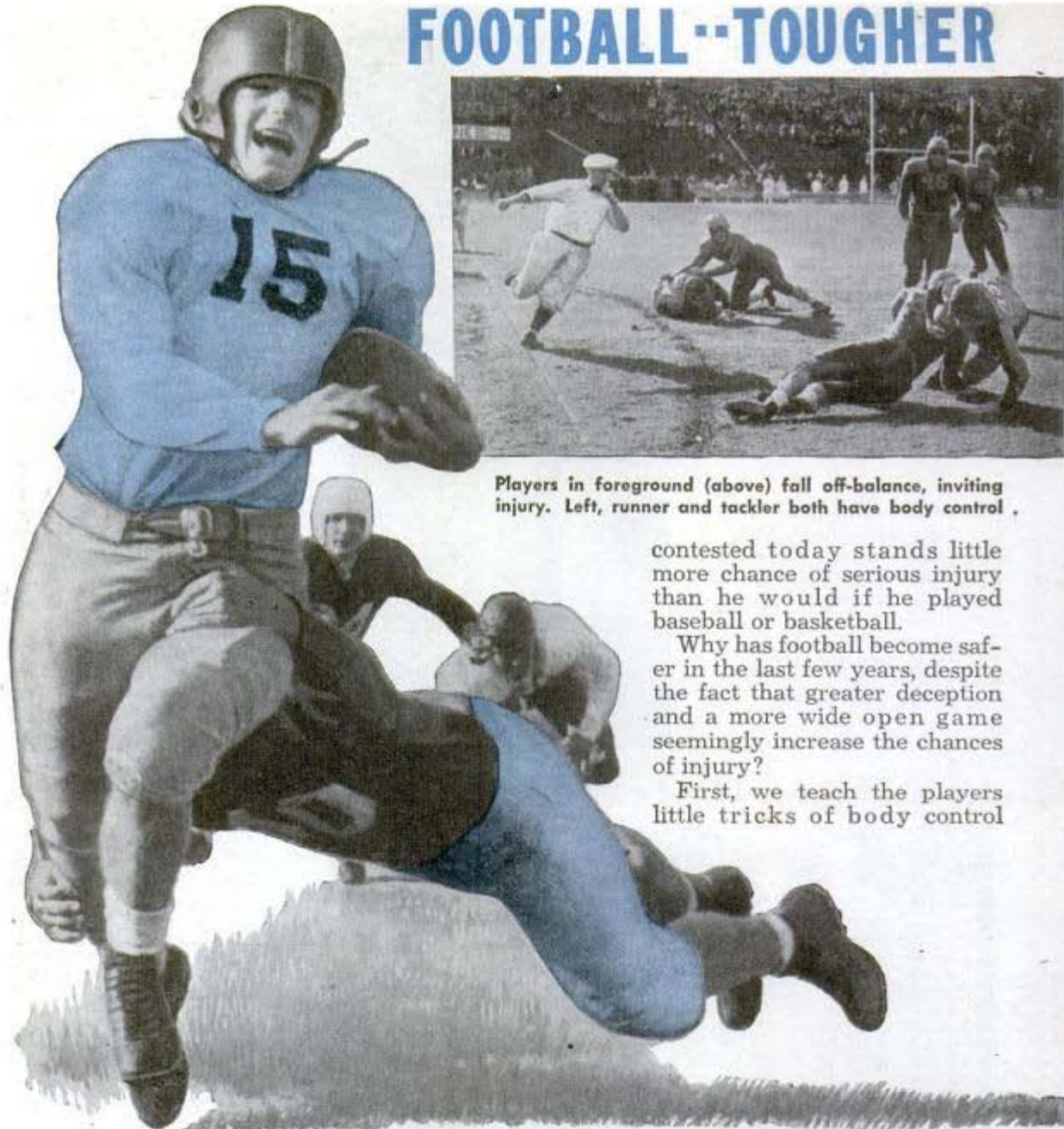

Players in foreground (above) fall off-balance, inviting injury. Left, runner and tackler both have body control.

contested today stands little more chance of serious injury than he would if he played baseball or basketball.

Why has football become safer in the last few years, despite the fact that greater deception and a more wide open game seemingly increase the chances of injury?

First, we teach the players little tricks of body control

By Lou Little

Football Coach, Columbia University

NOT so long ago the end of every football season brought with it a list of casualties among college players which frequently ran into the hundreds. Yet today, when college football is much faster and has sharper body contact than ever before, the game has become so safe that a serious injury is unusual and a death is news. In fact, a boy playing college football as hard as it is

Right, would-be tackler on ground lost control of his body and could easily get hurt

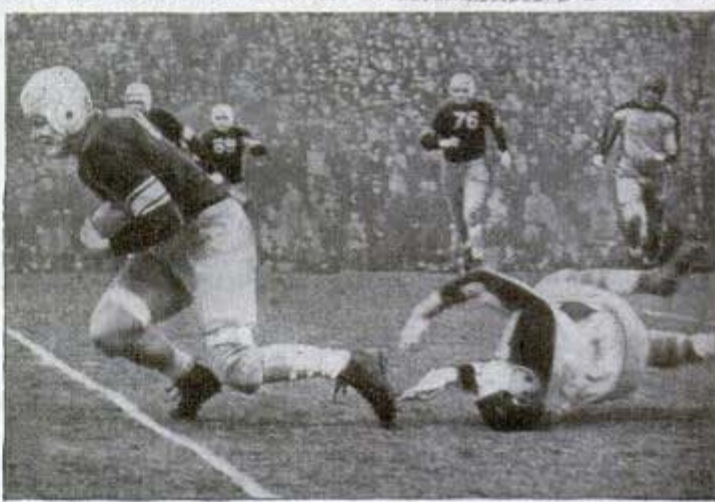

BUT SAFER

which probably are not noticeable to the spectators up in the stands but which reduce to a minimum the chances of getting hurt. In blocking, tackling, or simply falling down, there is a safe way and a dangerous way of doing each, and we drill every player in the all-important difference between the two. The difference is having control of the body upon making contact. When he has body control, a player executes the maneuver more effectively as well as more safely, even though it may not look so spectacular.

In the old days a player with a flair for dramatics would make a diving block or a flying tackle in an apparently heroic effort to get his man. That type of do-or-die stuff looks good in the newsreels but it is dangerous and usually ineffective. Nine times out of ten the player soaring through the air not only fails in his purpose but loses control of his body and lands on his shoulder, spraining it, or on his hip, tearing a muscle. Sometimes he lands on his head.

Currently players are taught to do things more sensibly. We tell a boy not to tackle or block until he is in such a position as to be able to complete the action, having full control of his body all the while. The player

Below, two players in foreground were off-balance and thus missed their assignments



Above, safe way to block—head up with feet solid underneath, shoulders squared. Below, dangerous way to block

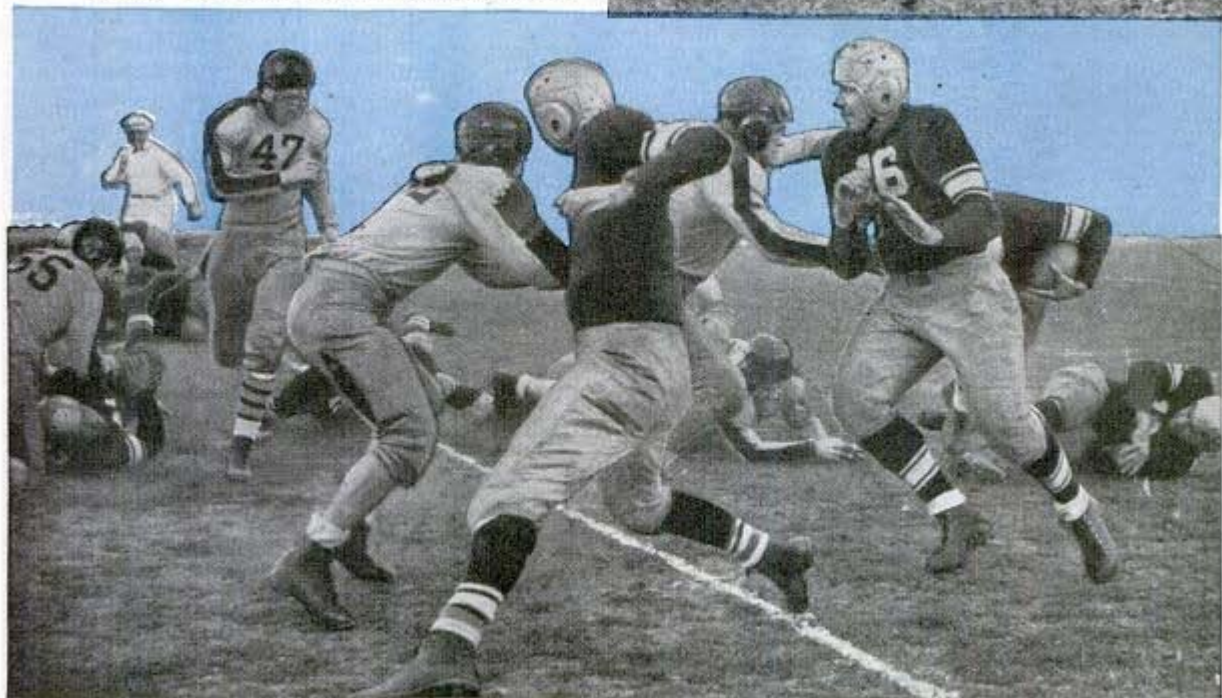



Football today is fast and wide open. Below, blocker stops tackler and falls straightened out



learns that when he makes a tackle he should be close to his target and driving ahead with his legs solidly under him, instead of reaching forward off balance. His head must always be up, and his shoulders squared. He looks at his target—nothing else! The same principles apply to blocking.

In practice sessions coaches pound these rules into their boys constantly. Great stress must be laid on them today because the more frequent and more imaginative use of the forward pass and other deceptive formations has opened the game up so much that there is harder, more violent contact between teams.

Nevertheless, there are fewer head and neck injuries than ever before. Why? Again—body control! A boy protects his neck and shoulders if he doesn't drop his head when he blocks or tackles. I tell the boys at Columbia to keep themselves as straight and rigid as a ramrod from the top of their heads to the base of their spines when making contact. Otherwise, they are likely to buckle up.

To my sorrow I gave a vivid—and painful—illustration of this point myself several years ago. I was working with an end and wingback, trying to teach them the proper way to handle the defensive tackle. After explaining the maneuvers in detail, I decided

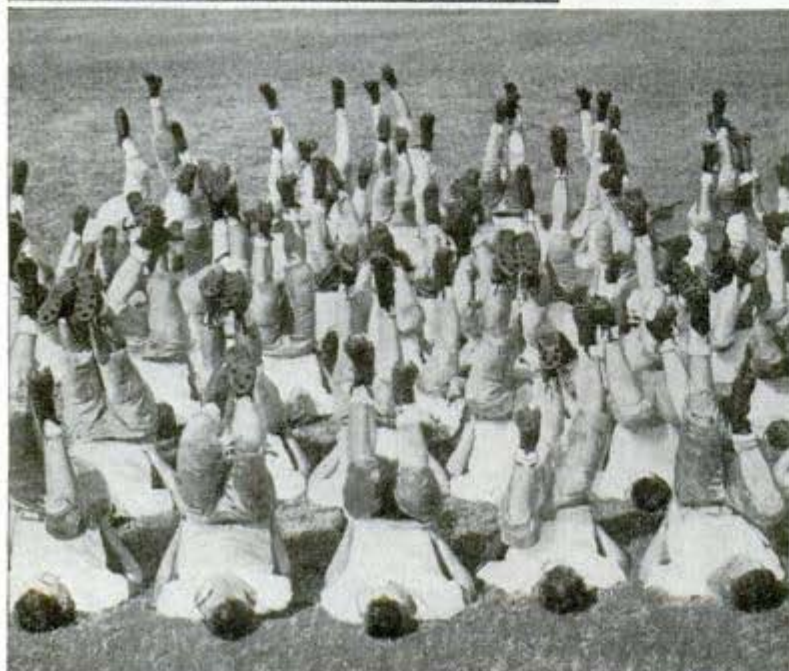

←Limbering up before practice

the best way to show them was to do it myself. I put on a pair of shoulder pads and a head guard and started to scrimmage. Acting as the defensive tackle, I tried to outwit and out-charge the two players in a different way every time they flung themselves against me. After about 15 minutes of this, I got tired—and it happened. As I surged into them, I dropped my head and turned my shoulders a bit. Unfortunately they hit me with a shoulder block that had plenty of driving power behind it. In other words, they had perfect control of their bodies and I didn't. I felt something snap inside me and later discovered that I had fractured a transverse process of one of my cervical vertebrae. It meant two weeks in the hospital in a plaster cast, then for the rest of the season wearing a combination leather and steel brace which prevented me from turning my head and shoulder. It was an unforgettable lesson for the players but one which I hope I never have to repeat.

If he develops his neck and shoulders, a player has a much better chance of attaining perfect body control. For this reason I have every member of the squad bring a foot-square rubber mat with him to practice. On it before scrimmaging he is obliged to do "bridging" exercises, as if he were a wrestler. By twisting and turning every possible way he can put pressure on the neck and shoulders and strengthen them enormously.

Next time you go to a college game no-

tice the way a good player falls: he will always fall forward. His head will be up, his shoulders straight and his legs out behind him, so that there is no chance of another player piling on and injuring him.

To keep their faces from getting kicked I warn my players not to turn their heads away from impact. As long as they are driving on through their tackle, they won't

Continued to page 152

Safe and dangerous ways of tackling. Flying tackle is considered foolhardy as well as inefficient

Posed by Northwestern University players



0 346

"Bump-O-Graph" Road Scooter Measures Highway Roughness



Every bump or uneven stretch on a highway is measured and recorded with a 16-wheel machine that looks like a big scooter. Any inequality on the road surface that might interfere with the smooth rolling of an automobile is recorded by graphs. The machine, designed and tested by the California division of highways, has revealed highway surfaces are affected by seasonal changes and sudden variations of temperature or moisture. The "scooter" showed that a highway may be rougher at certain times of day than at others.

0 361

Magnetic Current Is Visible As It Sets Droplet Spinning

To prove the existence of nature's third force—the electric action of magnetic currents, Prof. Felix Ehrenhaft recently demonstrated what he called the first magnetic motor operating purely on magnetic current supplied by a permanent magnet. With an eye-dropper, the professor deposited a drop of ferric chloride, which carries natural electric charges, between the two poles of

a permanent Alnico magnet and adjusted the poles in such a way that both of them touched the droplet. Then he invited members of the American Physical Society to view the results through a microscope. The scientists saw something they had never seen before—the droplet was revolving between the two poles of the magnet without evidence of loss of energy, the direction of its motion being counter-clockwise from observation of the face of the south pole. Prof. Ehrenhaft explained the energy was supplied by the current flowing between the poles of the magnet, acting on the natural charges of the iron-chlorine ions.

0 337

"Soap Bubble" Plastic Forms Cockpit Cover

Blown like a soap bubble with "air-forming" technique, single sheets of transparent plastic are shaped into cockpit canopies for fighter planes. The Plexiglas "bubble," used on the Thunderbolt P-47, enables the pilot to see in all directions, and also reduces weight and wind resistance. The process by which the Plexiglas is actually blown to shape eliminates struts and frames, such as were used in earlier canopies.



Rehm & Haas
POPULAR MECHANICS
Bristol, Pa.

*F. N. Doremus
Inventor*

Wayne W. Pittard 0 356

'GLASS EYES' for G.I.'S



Signal Corps photo
Yanks at an Arctic base take readings on big range finder, one of the most precise optical instruments in the world. Below, seaman on lookout duty aboard ship of a task force Navy photo

NATURE may have endowed Annie Oakley and Daniel Boone with telescopic vision and instinctive range finders, but the G. I. Joes and gobs of World War II make them look like pikers when it comes to finding the target. America's optical industry has furnished them with the "glass eyes" to do the job.

"You can't hit 'em where they ain't," is an old slogan aptly applied to fast-moving modern warfare on the ground, at sea, and in the skies. In order to "hit 'em where they are," our fighting men are equipped with thousands of precision instruments that include deadly accurate range and height finders, aircraft gunsights, tank sights, telescopes, telephoto lenses, bomb sights, periscopes, binoculars by the carload, and even ordinary spectacles which are worn by two million men in uniform. Mobile optical shops, equipped with cutters and drills, follow close behind the front lines.





Aerial machine gunner wears nonglare goggles—one of millions of pairs made by the American Optical Company

One company alone, the American Optical, produces more than 100 different products for the Army and Navy, ranging from sun glasses and safety goggles (2,500,000 pairs were shipped in one seven-month period) to field charting instruments: The Bausch & Lomb Optical Company, which pioneered the industry in this country in 1912, recently produced its 3,600,000th pound of optical glass since Pearl Harbor. Today, one of America's youngest industries has not only challenged but probably surpassed the century-old supremacy of Germany in the optical field.

The headlines that tell of German fortresses



Above, operating range finder on escort carrier. Left, eye-examining instrument used by Navy

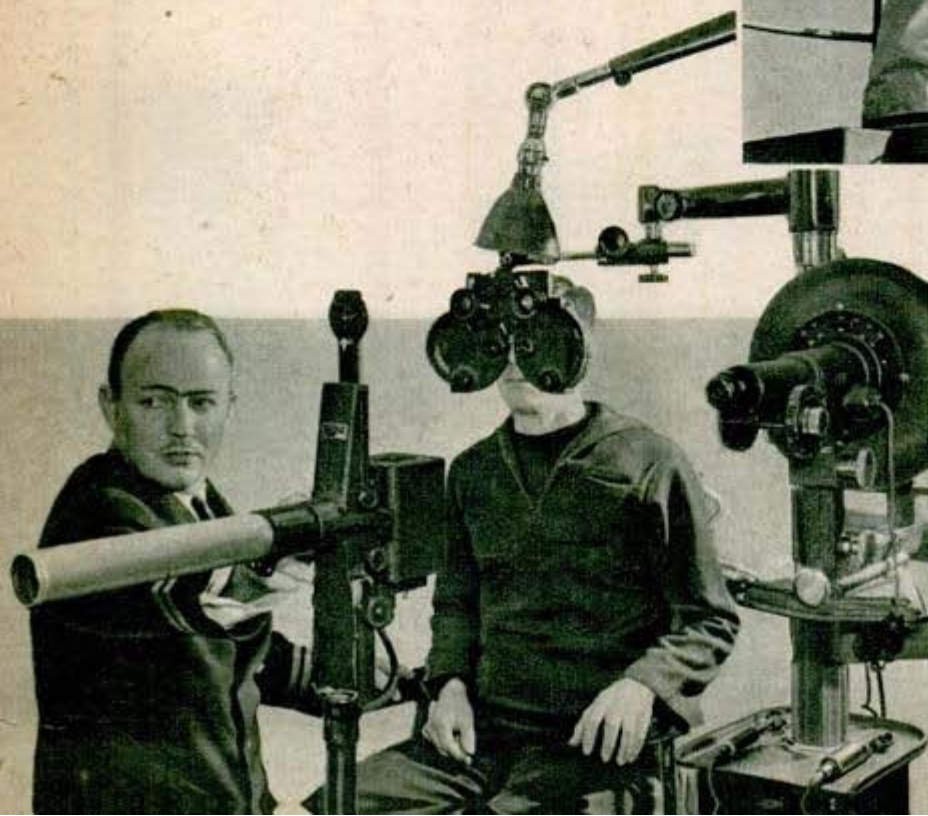

help provide this information.

The largest type of range finder used on battleships almost fills a freight car, and when installed protrudes from either side of the ship's gun turret. These range finders may have more than 100 lenses and prisms

ground to tolerances measured in millionths of an inch. Deviation of one-half second of arc, according to Bausch and Lomb technicians, would make a difference of only an inch on a target six and a half miles away. That is why the first shell to be fired is often "on target."

Two types of modern range finders are the coincidence and stereoscopic. The former type brings two partial images of the target, whether an enemy pillbox or a smudge of smoke on the horizon at sea, into coincidence to determine the range. The common form of range finder consists of a metal tube within which is a bar and frame for the suspension of the optical system. At the end of the tube are windows behind which are reflecting prisms which receive light from the target. This light is directed along the axis of the instrument on which are arranged telescopic objectives, deflecting prisms, and the eyepiece assembly.

These range finders are so sensitive that it is possible to use them at night against a target that is only a pinpoint of light. In cases like this, an "astigmatiser" is used to make the point of light appear as two vertical streaks which can be brought into coincidence more accurately than a couple of split pinpoints.

The stereoscopic type of range finder



Navy photo
With eyes glued to periscope, a sub commander gives estimate of "enemy" ship's speed at training center

brings the complete image of the target into the same plane with a range mark.

This range mark consists of a piece of glass with markings to divide the field of view into equal squares which appear superimposed on the target.

Aerial height finders for antiaircraft fire control are stereoscopic instruments. During World War I, the altitude for antiaircraft fire was determined by the two-station altimeter. The modern self-contained instrument not only determines the altitude of the target but its range. This is believed to be the most complicated type of optical instrument known, and it can be used to gauge the distance of an approaching tank as well as a plane.

Another optical product of major importance on the battlefield is the telephoto lens used in aerial cameras. This photographic Big Bertha covers a nine-inch square of film, and the camera on which it is used takes pictures of amazing accuracy from 30,000 to 40,000 feet.

Another type of camera, widely used

Gunner of field artillery battalion in Italy adjusting aim in panoramic sight. The result: direct hit





After optical instruments help find target, squeeze of triggers sends forth stream of bullets from a PT

for mapping and reconnaissance, is the Bausch & Lomb metrogon. Its wide-angle lens is so free from distortion that equal areas from any part of the negative represent equal areas on the ground. Thus, a plane can accurately and safely photograph a target which is horizontally three to five miles away. Two of the metrogon's deep-curved lenses are paper-thin at the center and two are paper-thin at the edge.

Precision lenses have made it possible for the Army and Navy to make thousands of contour maps in a hurry. An intricate system, known as Multiplex, converts overlapping aerial photographs into accurate maps.

Another lens, which is at the opposite extreme from the giant metrogon or telephoto, is the 16 mm. movie camera lens used by aerial gunners. When the gunner presses the trigger, the camera takes pictures of each burst.

One camera, built by Eastman Kodak,



Left, aerial camera is precision-built instrument which takes 220 exposures on one roll of film. Below, sighting into a glaring sun



photographs the stars around the zenith of the sky. This makes it possible for navigators to calculate their exact position at the time of exposure.

Optical instruments have been a boon in training programs. They provide our Army and Navy gunners with synthetic targets under conditions simulating the real thing. An aircraft training gunsight, developed by the American Optical Company and installed in the Special Devices Section of the Navy Bureau of Aeronautics, makes it possible to go through all the motions of an air battle without leaving the ground.

The number of optical instruments used on a modern battleship, such as the South Dakota, mounts into the hundreds. Without these instruments to supply vital information during navigation and attack, the ship which attained fame as the Battleship X would have been powerless. They include range and height finders, periscopes for the turrets and towers so that the men inside will be able to obtain a clear view of any action while protected by steel armor, alidades (cross-hair telescopes) mounted above the compass and used to keep the ships in line or in proper formation during attack, telescopic gunsights, binoculars, and even sun glasses.

Aside from helping G. I. Joe find the target, prisms and lenses are guarding his health and improving the weapons with which he fights.

Thousands of microscopes in Army and Navy medical laboratories are helping find new ways to safeguard health. In war plants, stereoscopic microscopes are used to ex-

Continued to page 154

OCTOBER, 1944



Courtesy American Optical Company

Lookout using Polaroid goggles which have control button to admit or exclude light as desired. Below, gun director (foreground) 'scope in rear Signal Corps photo



0-401



Canopy Over Lift Truck Driver Catches Falling Crates

Drivers of small gasoline lift trucks who used to sprout bumps on their heads as souvenirs of falling crates don't have that hazard any more at the Douglas Aircraft plant in Long Beach, Calif. Company engineers rigged up safety canopies over the trucks and now drivers can load and unload their cargoes without dodging.

Shadow Compass in Flying Fort Gives Craft's True Heading 0395

To check variations on the plane's other compasses, a shadow compass has been installed in the astrodome of Flying For-

resses. Working on the same principle as a sun dial, a shadow pin mounted in the center of the compass throws a shadow which is interpreted to give the plane's true heading.

0-396

Automatically Fed Ack-Ack Gun Is Allied Secret Weapon

Less publicized than Hitler's robot bombs but highly destructive to German aircraft, a giant 120 mm. antiaircraft gun was regarded as one of the United States' major



secret weapons when the invasion of France began. Most of the gun's new features, including the principle of automatic feeding, were unknown to the enemy.

0282

Quick-Acting Magnetic Brake Stops Motor in Six Turns

Force which can stop a one-eighth horsepower motor traveling at 16,000 revolutions per minute in less than six turns is contained in a magnetic brake developed by Chester I. Hall, General Electric engineer. According to Hall, the force is accomplished by a cork shoe and friction, although magnetism releases it, once the need for braking is removed. The motor is braked at all times, except when current is applied. The brake, which is expected to be used widely for equipment in the armed services, consists of 15 parts, compared to 51 parts in the model previously used for this purpose.



developed by: Boeing Aircraft Co. Seattle 14, Wash.

0375

Spanker Paddles Riflemen Who Pull Hard on Trigger

Automatic spanking by a complicated contraption is the humiliation suffered by soldiers who don't follow instructions in correct trigger squeezing at Fort Custer, Mich. If the soldier pulls the trigger hard instead of gently squeezing it, the trigger releases a skate wheel, tripping a hammer. This pulls another wheel on the spanking machine which drops a weight into a box, releasing a spring and causing the crude but effective paddle to make contact with the seat of the erring soldier's trousers.

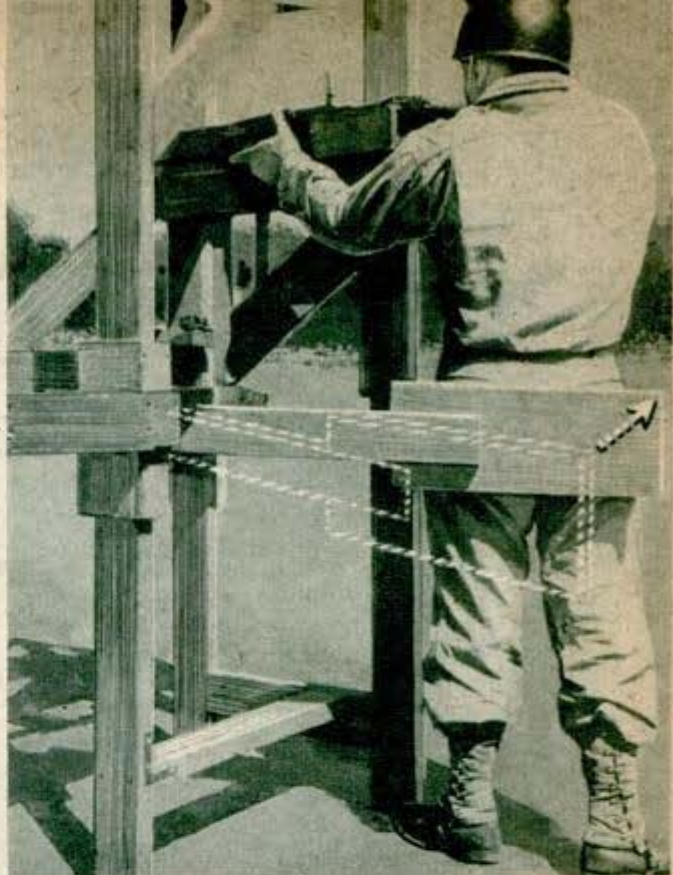

"Balloon" Splint Grips Fracture

0451

For use primarily in emergencies, a pneumatic splint, consisting of a flat, rubber-surfaced sack with hooks along its edges so that it can be laced like a boot around a broken leg, has been devised by a doctor in Flint, Mich. After the splint is laced on, air is pumped in, or it can be blown in by ordinary human lung pressure.

Dr. G. J. Curry, Hurley Hospital



"Skybus" for Feeder Lines To Carry 24 Passengers

0376

Dubbed the "Skybus," a high-wing, twin-engine, all-metal monoplane with tricycle landing gear has been designed by Douglas Aircraft Company engineers as the ideal postwar plane for feeder lines. The ship will carry 24 passengers, who will get full downward vision because of the high-wing effect. Two wide, truck-bed-level doors, an adjustable bulkhead in the cabin, and large baggage racks will assure quick and easy loading and will make it possible for the craft to be used for both passenger and cargo work. Extremely maneuverable on the ground and in the air, the "Skybus" will be powered with two 700 horsepower engines.

Santa Monica, Calif.

Dehydrator That Fits Into Oven Conserves Food at Home

0390

Making home food conservation simple and scientific, a compact dehydrator made of hardwood can be fitted into the majority of ovens, whether they use gas, oil, coal or electricity. The dehydrator, which has three drying trays, is used in a partially open oven at low heat. It is easy to assemble and complete instructions for preparing foods go with it.



OCTOBER, 1944
Hammacher Schlemmer
145 East 57th St.
N. Y. 22, N. Y.
39

EXPANDING HOME MOVED



Expanding portable homes moved by highway truck or freight car may answer the post-war need for millions of homes in a hurry. While being shipped, the houses are 8 feet wide but expand to 15 feet when the bedrooms are rolled out. Standard length is 26 feet. Front and back demountable porches (example above) are included. Heating equipment, cupboards, kitchen appliances and most of the furniture are built in to save space. The central room is divided into livingroom (shown at left), diningroom and kitchen sections. An expanding house, minus the doors and windows, is shown on a truck below

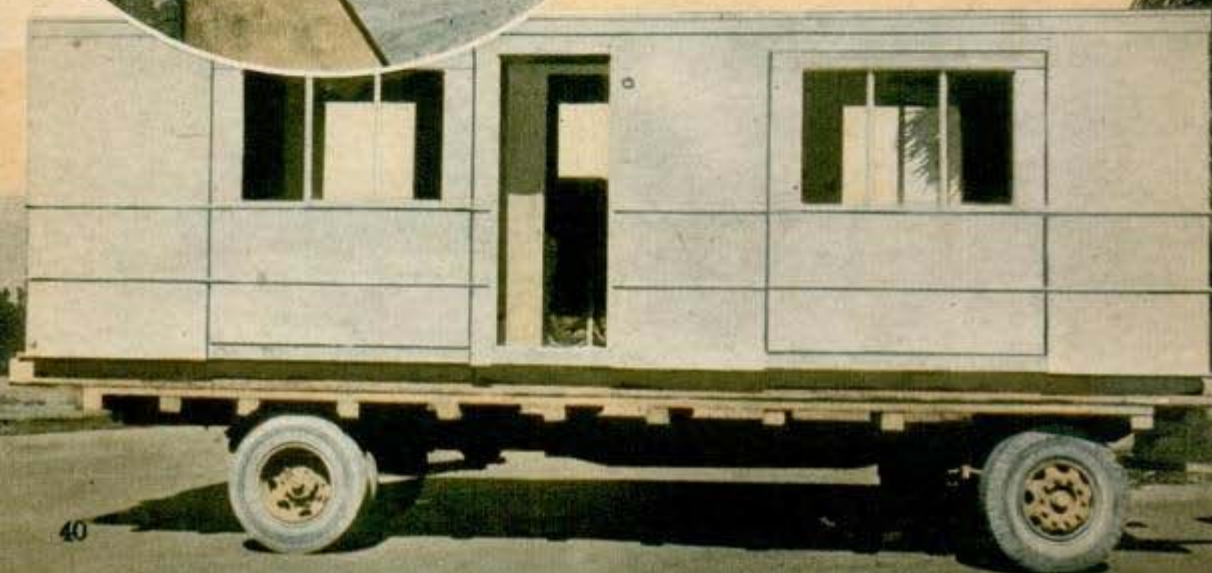

by TRUCK



Another view (above) of the large combination room, with the kitchen stove, sink and cupboard visible in the background. Scores of these homes already are sheltering war workers where housing is scarce



In the master bedroom (above) the double bunks provide sleeping space for a family of four

1144 G. Market St.

An expanding house (above) is in use at Litchfield Park, Ariz. Designed by Wingfoot Homes, Inc., of Akron, O., the houses vary in type, according to the climate in which they will stand. Some can be bought for \$2,000, plus utilities

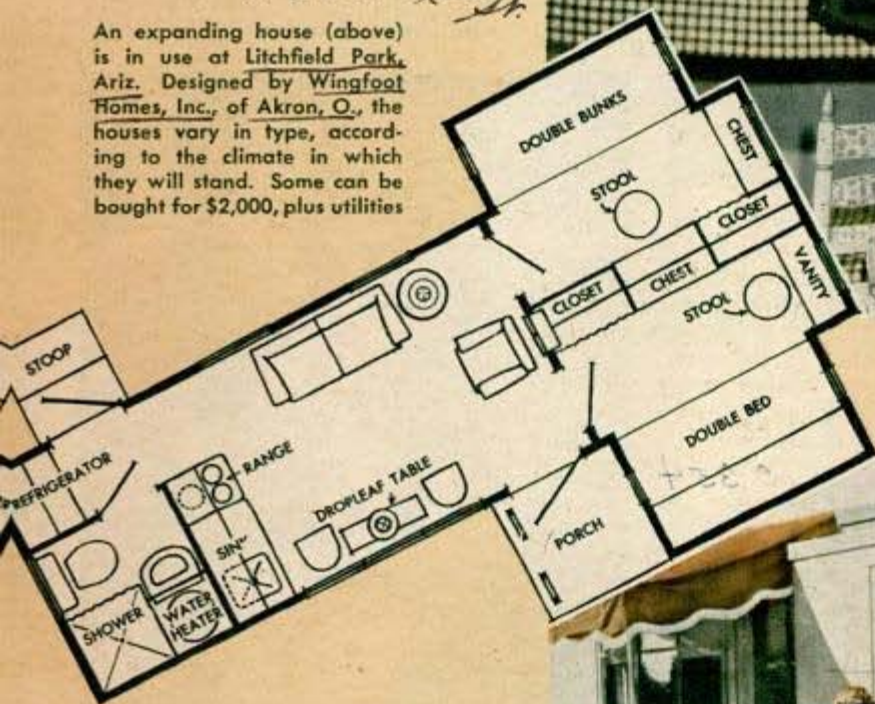

Above, portable house's floor plan. At right, bedroom wing of the house is collapsed to bring the house within the 8-foot limit for traveling on the highway. The wing, moving on a roller, is easy to collapse. The homes are popular as garden apartments and vacation shacks All Wingfoot Homes, Inc., photos



Hitch-Hiker on Parachute Rides Safely to Ground



When a paratrooper ^{L. J., N. Y.} on maneuvers at Camp McArthur, N. Y., found himself falling through space with a parachute which wouldn't open, he grabbed onto the billowing 'chute of a fellow paratrooper without waiting for an invitation. They descended together safely. Before they landed, the embarrassed jumper's emergency 'chute opened, but too late to be of assistance.

Color Film Processed at Home In Only Ninety Minutes

Amateur photographers can process their own color film at home in only 90 minutes, using the new color film developed by the AnSCO Corporation, Binghamton, N. Y. Until recently the film, which comes in 16 mm. movie film as well as sheet film, was made exclusively for the armed forces and war industries. The film reproduces color images through "subtractive color synthesis," which is based on the theory that almost all colors can be reproduced by re-establishing a proper

ratio of the blue, green and red rays reflected from the object photographed. The film is composed of three layers of emulsion, the top layer of silver halide crystals recording the blue light reflected by the object, the middle layer recording blue and green, and the bottom layer recording blue and red. A yellow filter layer between the first and second layers stops the blue rays from progressing further. Thus the green rays reflected from the object are recorded on the middle emulsion and the red rays on the lower without the blue interfering. Using the special color developer the photographer then brings out the positive color images in the three emulsions. Prints are made by the usual three-color separation method. Another advantage of the process is that after the first 15 minutes of the developing period the film may be stored or shipped, leaving completion of the process to some future time.

0 394

Idle Rivet Guns Put in Holsters To Reduce Accident Hazard

Canvas and leather holsters large enough to hold idle rivet guns are supplied to riveters at a General Motors aircraft plant. Each holster has a hook in its back so that it can be hung on any convenient pipe or rack. Besides saving much stooping, the holsters prevent the risk of rivet guns left lying on the floor, a former accident hazard.



POPULAR MECHANICS

*Eastern Aircraft Div.
Linden, N. J.*

Duke Fah
1234 N. Parisholt. 0373
Burbank Calif.

Rocket-Propelled Model Has Wings Near Tail

While German rocket bombs soared into England, youthful model builders in the United States were matching their rocket planes in exhibitions. One rocket plane model at the Los Angeles Aero Modelers contest recently had its wings near the rear of its fuselage, next to a large tail fin. The horizontal stabilizer was in the front of the fuselage. The model builders launched their planes by lighting a rocket fuse.



Scene Is "Etched" on Leaf By Scraping Surface

By means of a novel and elaborately painstaking technique, "etchings" are made on leaves by Brother Adrian Lewis, of Manhattan College, New York City, as a hobby. Using a simple, sharp-pointed instrument, he makes the "etching" or drawing by scraping away portions of a leaf's green surface in varying depths, depending on the shading desired. The art form was suggested by insects' habit of eating away the green matter of leaves. Since 1914 the brother has turned out hundreds of leaf "etchings," most of them dealing with a religious theme. Each takes from two to six hours to produce.

Fish Change Color Camouflage as Their Eyes React to the Seabottom

Quick-change artist of camouflage is the winter flounder whose eyes control its color. Impressions received through the eye and relayed through the fish's nervous system cause the flounder to take on the color of the seabottom on which the head lies. Eye control of color in the flounder and other fishes of its type was proved by placing the fish against a variety of natural and artificial backgrounds, according to Karl P. Schmidt, curator of the department of zoology at the Chicago Natural History Museum, formerly the Field Museum. If the fish is blind, no change in color takes place. Some fish also

change color due to nervous stimuli, such as fright, causing a secretion of the pituitary gland at the base of the brain. Both sets of color controls may be combined in the same fish.

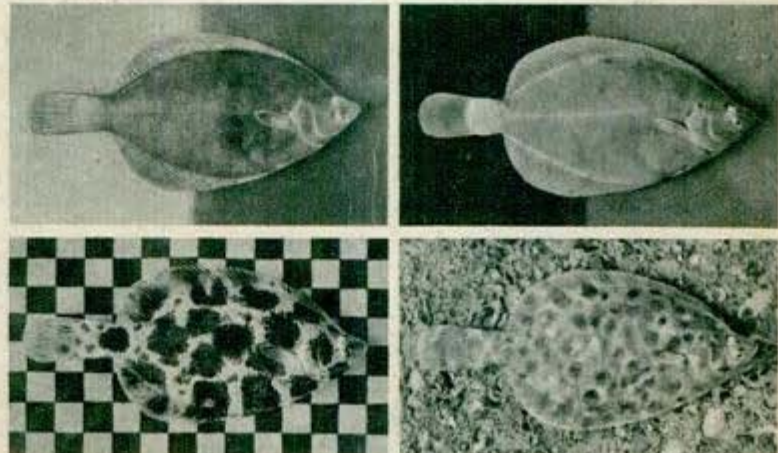

OCTOBER, 1944

Mr. Orr Goodson, Chicago Natural History Museum
Roosevelt Rd + Field Dr.
Chicago 5 Ill.

SECRETS *of* SUPER-SPEED

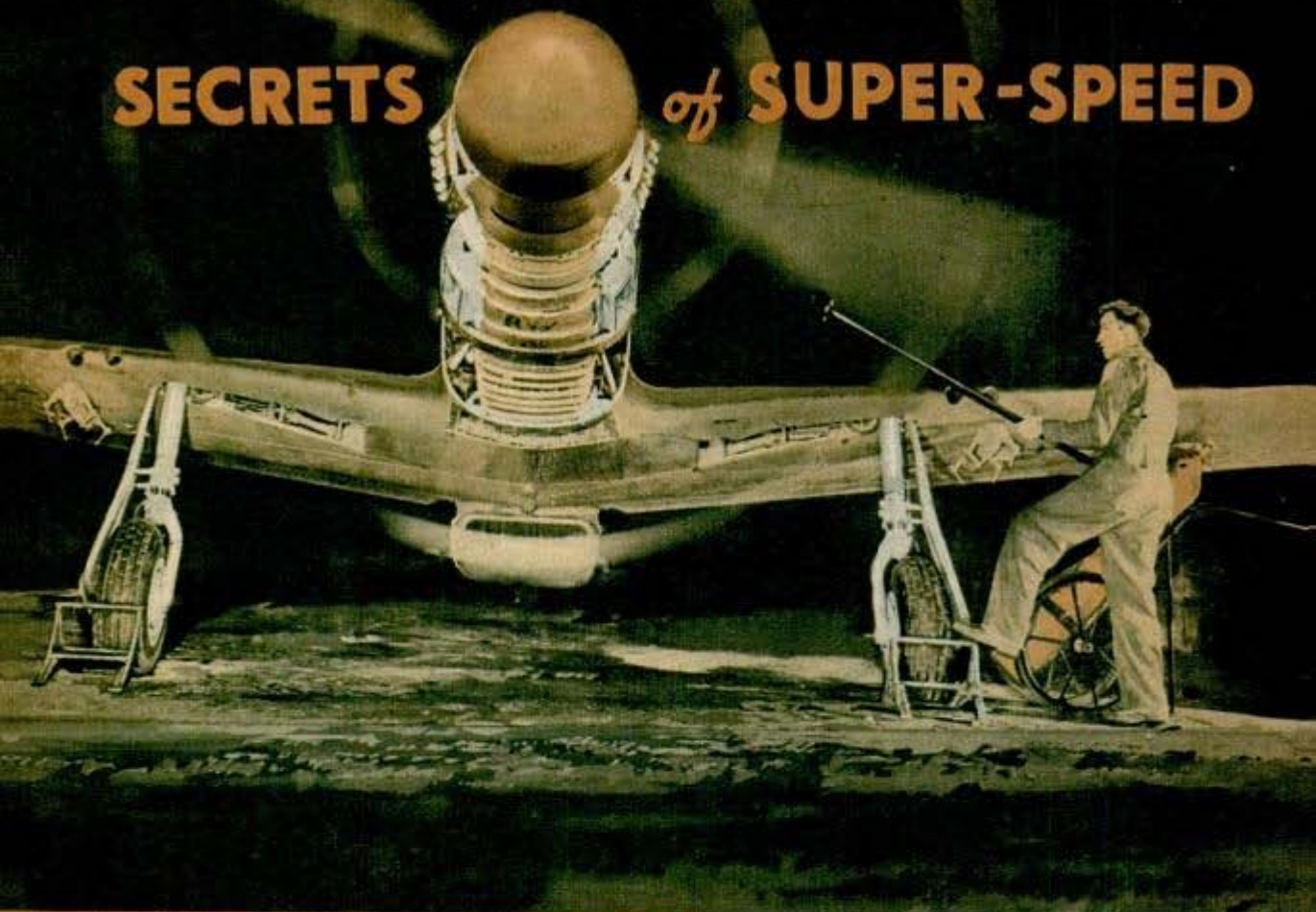

With "throat" bared, engine of new P-51 gets a final test. Note jet propulsion exhaust stacks on sides. Below, four-blade "prop" boosts speed



ORDINARY air, so familiar to us that we hardly ever think about it, is a temperamental mysterious substance to the men who design our high speed aircraft.

Airplanes couldn't fly if there was no air, and yet it is air that impedes aircraft from flying faster than they do. Air will do one thing under certain circumstances; it may behave quite differently if the circumstances are changed in the slightest degree.

On a hot day we stir air into a breeze to keep us cool, but one of the problems in aviation is to find a way to keep a pursuit pilot from becoming overheated by the cold breeze that is admitted to his cockpit for ventilation. The incoming air slows down in the cockpit and as a result becomes compressed. Compression causes heating. The rise in air temperature may amount to 30 degrees in the case of a pursuit plane of the 400-miles-per-hour class. This heat plus warmth from the engine often makes the cockpit uncomfortably warm even when the outside temperature is unpleasantly cold.

One might suppose that an airplane tends to be compressed or squeezed together at extremely high speed because of the pressure of the air through which

O 340

Thomas C. Stinson, Jr.
3872 Franklin Ave.
Los Angeles 27, Calif.

Convex rear-view mirror in P-51 cockpit (right) gives the pilot wide angle of vision. Below, cutaway drawing of North American Aviation's fighter reveals ingenuity of engineers. Note how the retractable tail wheel is housed inside tail. Front view (inset) shows why the P-51 has slight wind resistance

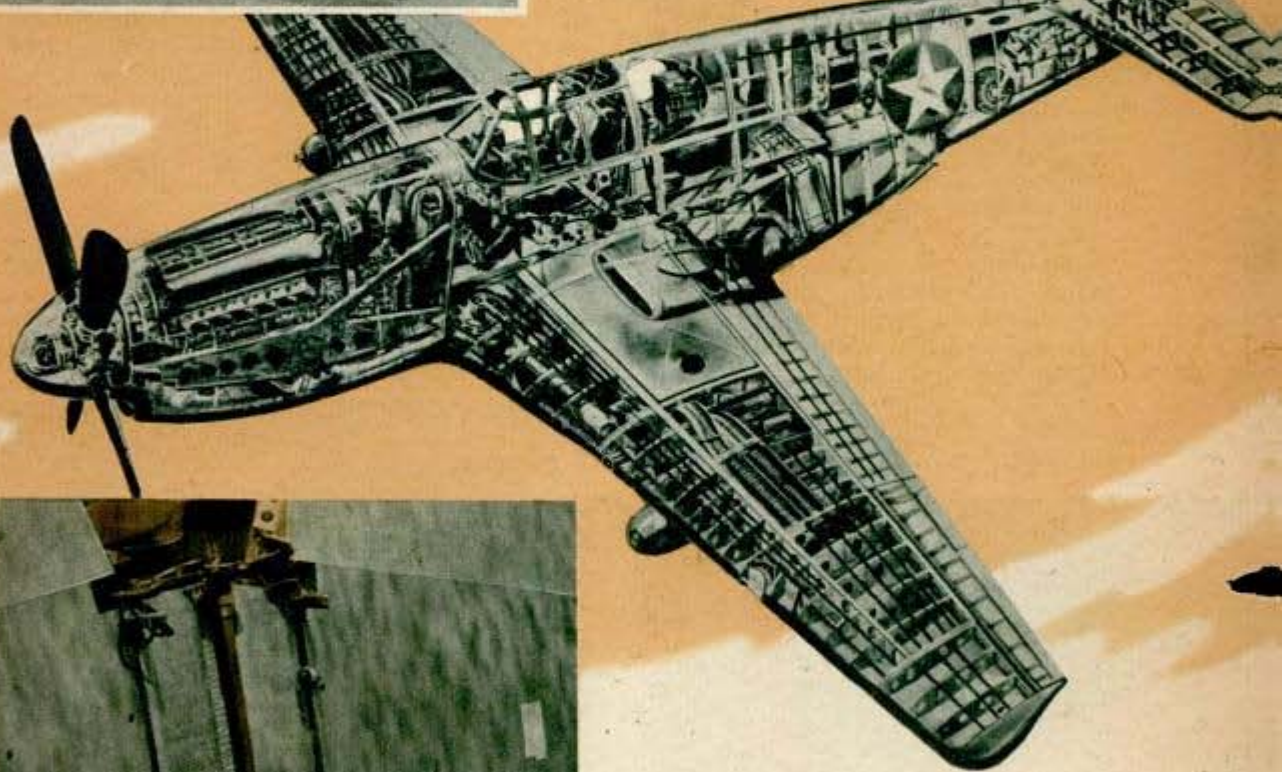

it moves. The truth is just the opposite. At high speed an airplane tends to burst. The skin tries to pull away from the main structure. Doors fly open if they are not securely fastened. The reason is that the plane's leading edges force some of the atmosphere away just as the bow of a moving boat

Pilot's control stick on Mustang P-51 fighter is attached directly to wing for maneuverability



Sealed-beam type of landing light on P-51 retracts and folds into wheel well when wheels are retracted

pushes water from the hull. An area of reduced pressure is produced around the airplane. At high speed the plane literally flies in a partial vacuum and it tends to expand. The structure must be built to resist this outward pull.

Air packs a hefty wallop when you move through it at high speed, as you can tell by putting your head out of the window of a fast automobile. But the push that your face receives at 70 or 80 miles per

hour is negligible compared to the force imposed on an airplane that flies in excess of 400 miles per hour, or that builds up to a speed of 600 miles per hour in a dive. Power alone is not enough to push an airplane against such tremendous headwinds. The structure must be cunningly streamlined to lower its resistance to the air.

An outstanding example of how aerodynamicists and engineers are building speed into the design of a plane is North American Aviation's P-51 Mustang fighter. This plane has an announced ceiling of 40,000 feet and a top speed of around 425 miles per hour. It is a large, heavy airplane and yet it offers no more resistance to the air than would a flat plate three and a half square feet in area. To the air, the P-51 is smaller than nine pages of this magazine laid side by side.

To achieve this startling effect the North American Aviation aerodynamic staff did more than simply design a clean and streamlined plane. In half a dozen different ways they tricked the atmosphere into helping boost the plane along instead of retarding its flight.

They designed the air intake duct that leads to the carburetor in such a way that the air rams itself in. This supercharging effect is so pronounced that at 30,000 feet the engine breathes air that is equal in density to the atmosphere a full mile below.

It is standard practice to obtain a slight amount of forward thrust from the discharge of engine exhaust gases. For the Mustang the engineers experimented with



Inspecting non-drag air intake scoop. It leads cold air to radiator and expels it without the loss of speed

Radiator unit of Mustang is slung beneath fuselage in a 10-foot streamlined tunnel that is open at either end

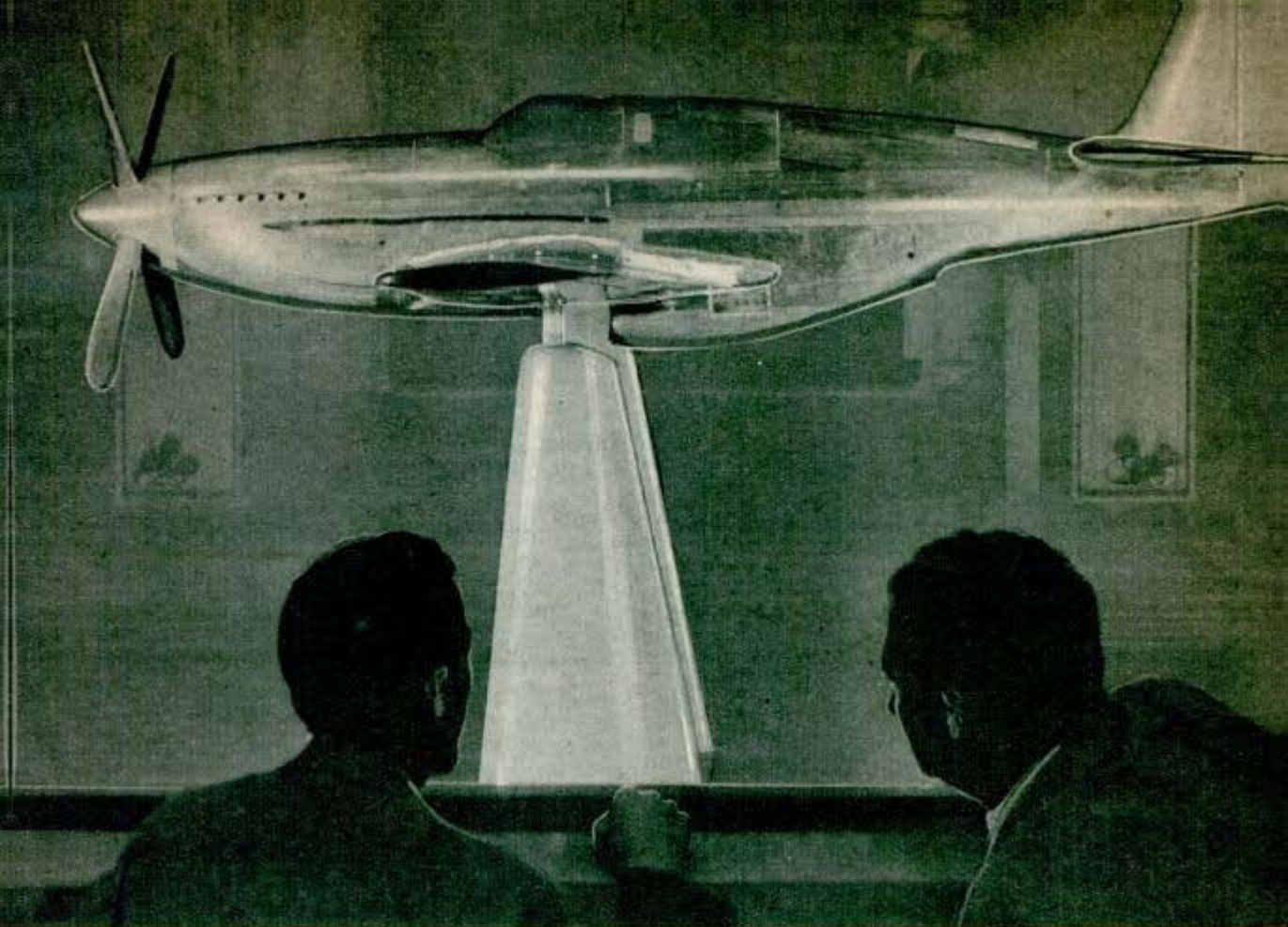

Wind tunnel test on P-51 model reveals air resistance equal to flat plate about three square feet in area

different designs of exhaust stacks until they found a shape that provides true jet propulsion. These stacks boost the total useful horsepower by some 200 h.p. and contribute 25 miles per hour to the plane's top speed.

The designers lost half of this increase in speed when they were asked to attach bomb racks under the plane's wing. Protruding only a few inches, these racks cost 15 miles per hour because of their interference with the flow of air.

If such bomb racks cost 15 miles per hour, what would the drop in speed amount to when you stick a radiator that has a cross section of 400 square inches out in the wind? Theoretically this radiator would cut the top speed of the plane by 100 miles per hour. Actually, in the case of the P-51, the loss is less than one mile per hour.

This radiator is needed for cooling the water and ethylene glycol solution used as the engine coolant. North American Aviation's thermodynamic staff worked on the radiator prob-

lem until they got something for nothing. They placed the radiator out in the air where it would set up a terrific drag, then they enclosed the radiator in a tunnel that is 10 feet long, as deep as 15 inches below the fuselage, and open at each end. This duct under the P-51 looks like a long scoop. Bulky as it is, the duct is the secret of how the radiator gets a free ride.

At the plane's top speed, the forward end of the duct scoops in air at about 300 miles per hour. The air slows down to about 50 miles per hour by the time it moves aft to

Continued to page 156

Attaching jet exhaust stacks to engine that add 30 m.p.h. to speed of Mustang



0 341

Sub-Chaser Is Convoy's Rescue Boat-Hospital

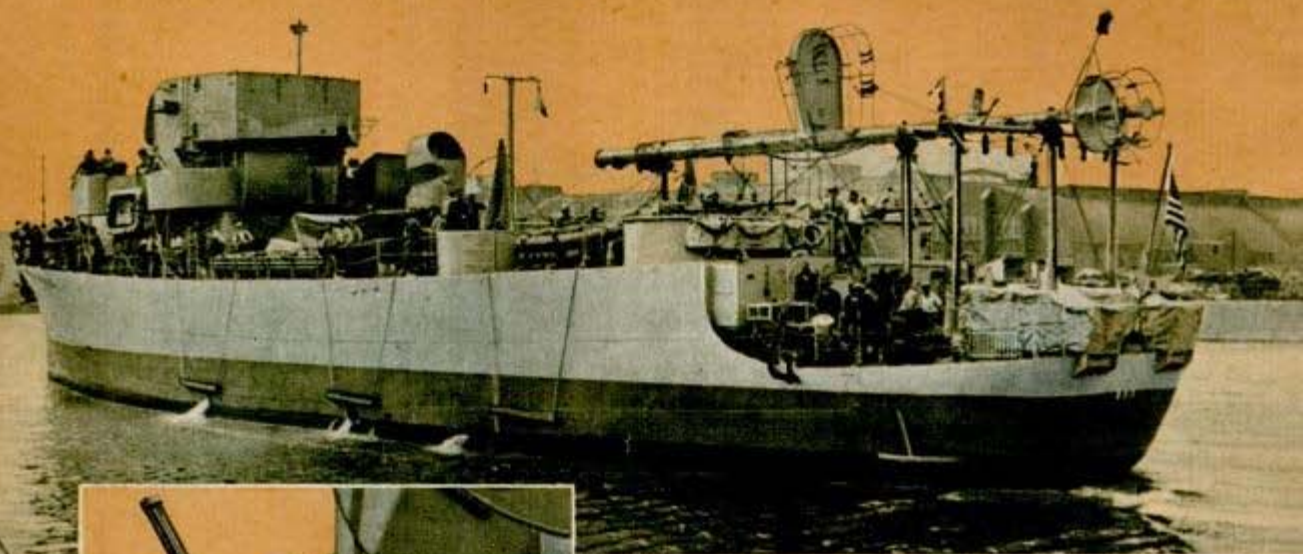

*Putnam-Standard Oil Co.
Chicago, Ill.*



Sub-chasers, officially known as PCE-R (patrol craft escort, rescue) boats, have been converted into "floating hospitals" so that adequate medical attention will be available in convoys. Each ship contains bunks for 57 passengers and has a doctor, operating table, dispensary and X-ray machines in addition to other standard hospital equipment. Like other PCE boats, they are manned by seven officers and 100 men. PCE's are Diesel-powered, 180 feet long, and are equipped with big guns, several anti-aircraft rifles and depth charge tracks and throwers. They displace more than 800 tons and can be used to follow up landing craft in an invasion. Almost as self-contained as a battleship, a PCE is able to remain at sea for extended periods.

0 357

Mobile Factory Workshop Has Outlets for Power Tools

To save a mechanic trips back and forth to his workshop for more tools, a portable tool crib has been mounted on casters by the Hubert Creeper Company, Ashtabula, O. By taking his mobile workshop with him anywhere in a large plant, the mechanic can keep handy all the tools he needs to complete the job he is working on. A panel made of half-inch plywood can be made to lock over the front of the crib while not in use. Electric tools plug into outlets on the side of the cabinet and a 75-watt bulb is located in the top section. It required only 12 manhours to make the crib at a cost of \$7.50, exclusive of casters. By slightly altering the design, it can be adapted to the needs of electricians, plumbers, or carpenters.



48 *Hubert Creeper Co.
Ashtabula, Ohio*

Helicopter Is Ambulance and Courier at Front



Greater power, speed and range are characteristics of three helicopters built by the Sikorsky Company at the request of the Army and Navy. For example, the XR-5 model, in which the pilot sits in a Plexiglas compartment in the nose, has a speed in excess of 120 miles per hour, can operate efficiently more than a mile above the earth, can take off or land over a 50-foot obstacle at zero-forward speed, and can remain in the air for more than three hours. Its maximum load is more than 1,100 pounds, including pilot and observer, and its rotor is the largest ever used on a helicopter. It also has a tail rotor.

Because the R-5 may be converted into a hospital craft, provision has been made for carrying four litters, two on each side. Tasks for which the new helicopter models can be used are rescuing of personnel from



areas that are inaccessible to ground crews or other types of aircraft; liaison and messenger service within combat areas and behind the lines; and observation and fire control in forest areas.

0 261

Robot Glider Pilot Holds Course If Tow Plane Is Invisible

As a result of the installation of an automatic pilot, gliders can be set to follow the tow plane at a given altitude on a true course, even when the tow plane is hidden by bad weather. Formerly it was necessary for the pilot at the manual controls to see the tow plane in order to follow the course. The auto-pilot, which also pre-

vents the pilot from becoming overfatigued on long trips, has an instrument panel similar to that in an airplane. A small propeller, located in the outlet of an air-driven pump in the glider's nose, furnishes power for hydraulic and vacuum pumps, which operate the gyro units. The latter mechanisms, in turn, operate the controls.

W. C. N. Maull
1362 N. Dearborn
Chicago, Ill.

0381



The NEW AGE of STEEL

Above, molten steel from open hearth furnace is poured into ingot molds. Below, arc welder wears Voodoo mask to protect himself
Lincoln Electric Co.



BACK in the days when knights fought in suits of armor with heavy spears and shields on mail-clad horses, every man and his steed carried around 200 pounds of iron and steel—a healthy load.

Today the U. S. steel industry has become so huge it could produce enough to equip around 2,500,000 such knights per day, and take the job right in its stride.

Every half hour U. S. steel mills produce enough to build and completely equip one new destroyer, and every 24 hours the total is sufficient for two



giant battleships and more than 1,000 heavy bombers thrown in for good measure.

As most people know, the amazing growth of the steel industry since the start of the war is one of the great wonders of the industrial world. Right now, close to 95 million tons of steel ingots and castings can be turned out annually, which is nearly twice as much as in the first world war and far ahead of the biggest peacetime output of 63 million tons in 1929. The added capacity built in the last few years alone is nearly two-thirds as big as the entire industry in England.

No one will dispute that the steel industry has been one of the biggest single factors in win-

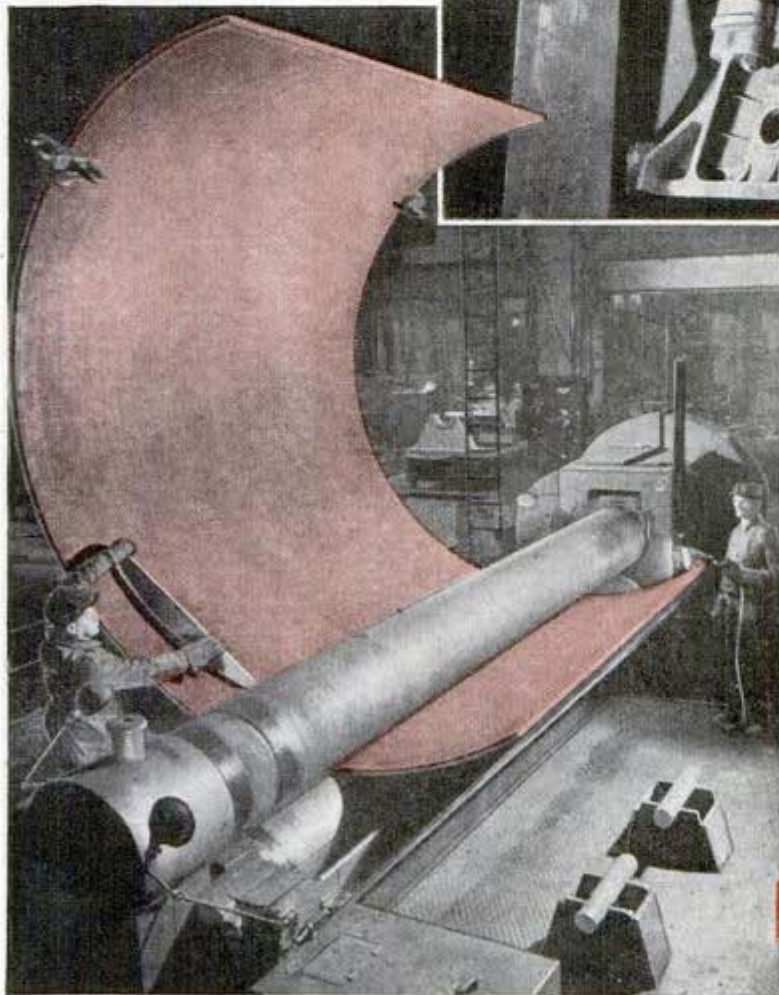
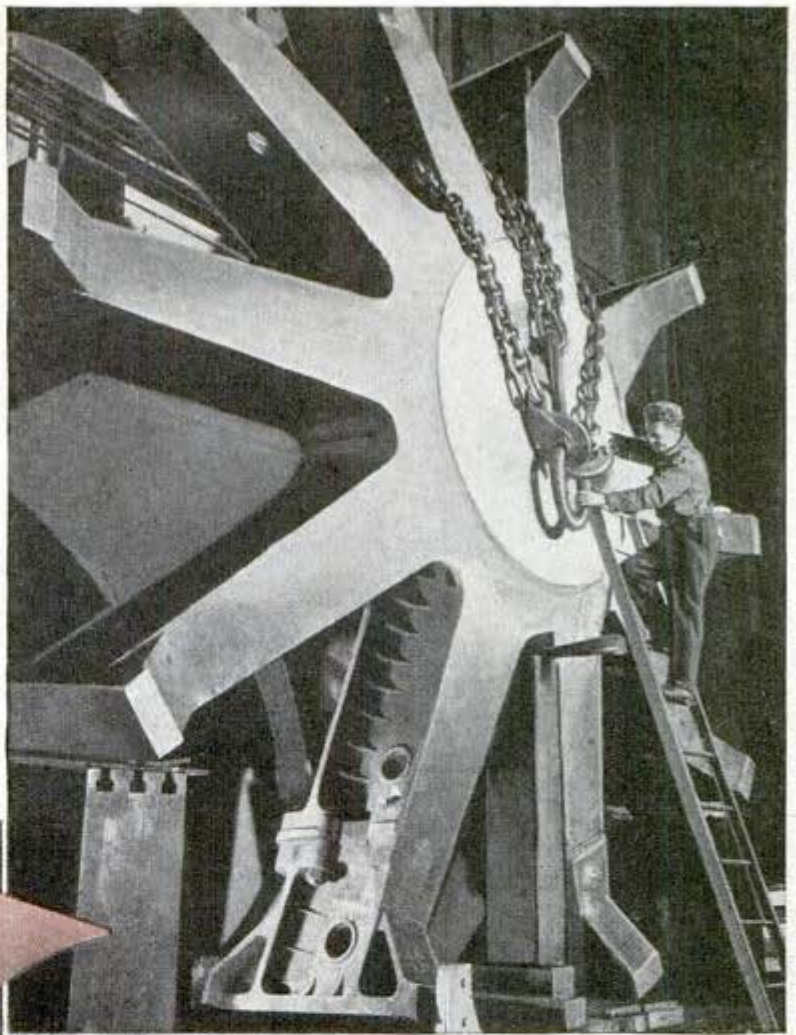

Above, 27 tons of steel went into skeleton of a waterwheel generator. Left, a giant "wringer" curves steel frame of turbine generator through cold rolling
Westinghouse photo

ning the war, but many wonder how this giant new steel-making capacity will be used after the war is over. Where will all the steel go? What new uses of steel will be found? What about competition from plastics, glass, synthetic rubber, the light metals, aluminum and magnesium, and other materials?

Some of these questions are more easily answered when it is considered that steel continues as the world's basic engi-



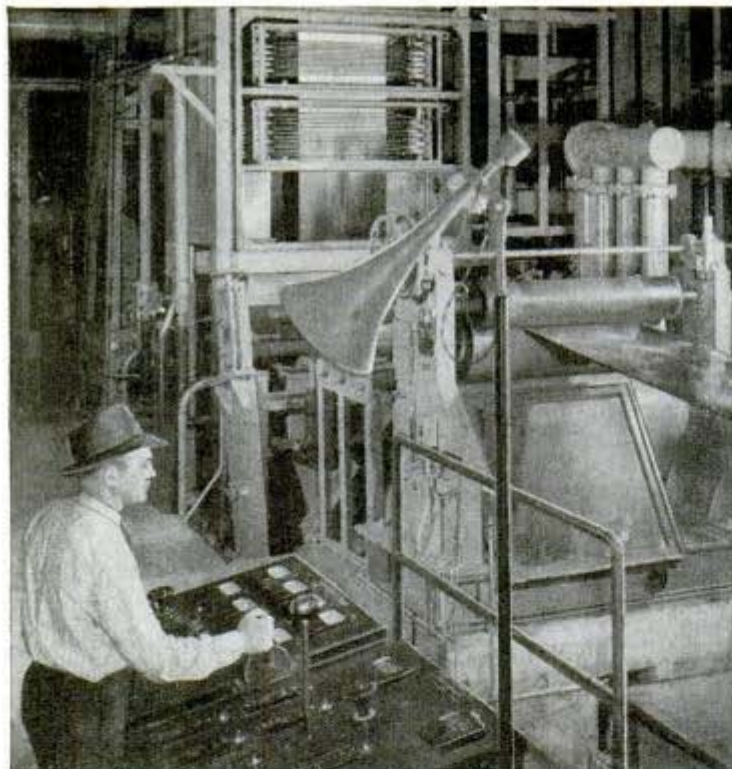

Republic Steel Corp.

Induction unit melting tin and fusing it to a steel strip base

neering material, and will be just that for years to come unless productive capacities of other materials are increased to far beyond present levels.

It has been estimated that America will be able to produce 96,000,000 tons of steel every year after the war compared to only 6,000,000 tons of glass; 1,500,000 tons of copper; 1,500,000 tons of aluminum and magnesium; 1,000,000 tons of zinc; 1,000,000 tons of lead;

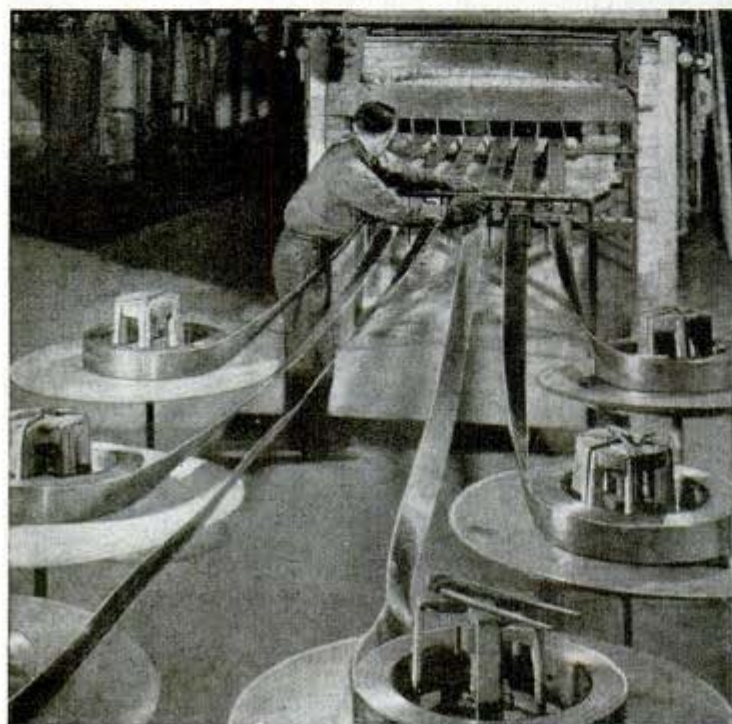

1,000,000 tons of plywood; 1,000,000 tons of synthetic rubber, and only 200,000 tons of all types of plastics. Steel comprises 85 percent of all materials and 95 percent of all metals.

But even though there will be far more steel available than all other materials combined, the steel industry is making rapid progress in finding new uses for steel, developing new alloys, and working closely with other

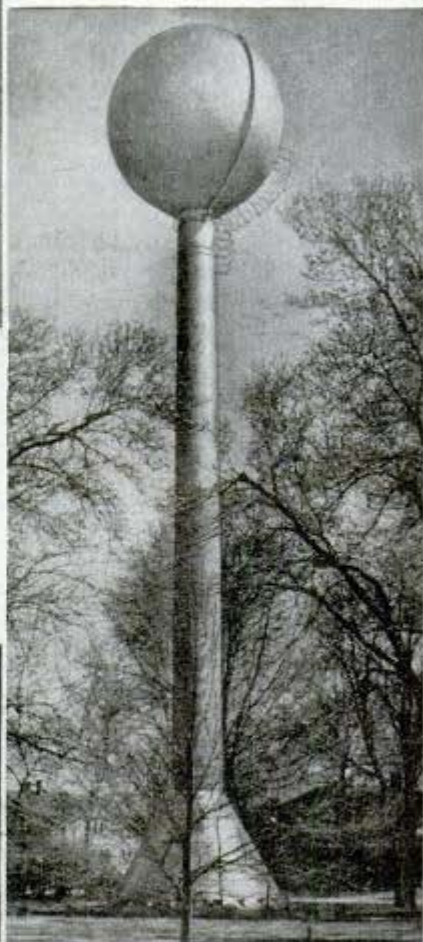

Above, 50,000-gallon watersphere is built entirely of welded steel. Left, stainless steel strips leave "payoff" reels to enter the annealing furnace
Photo from U. S. Steel Corp. Subsidiaries

industries in finding ways that steel can be used along with other metals, glass, plastics and rubber to produce new peacetime products ranging all the way from home appliances and personal items to huge buildings, bridges and important public works proj-

ects badly needed throughout the world.

Many of the new alloys used in war materiel still are closely guarded military secrets. It is known, however, that they have improved toughness, hardness and strength and given greater resistance to heat, corrosion, abrasion and impact shock. In one instance, cobalt was added to a low-tungsten molybdenum steel analysis to give a high speed steel of maximum hardness for heavy duty work. In other cases, steels requiring smaller amounts of alloys have found widespread use, and the alloy-saving NE (National Emergency) steels developed since the beginning of the war now are used in practically every piece of Army equipment specifying alloy steel.

Steel also is being plated far more effectively and with far more speed as a result of new electroplating methods using cadmium, one of the best coatings to prevent corrosion, and tin for containers. A new DuPont development makes it possible



Above, inspecting surface of tin plate. Below, the 150-ton shaft which is part of the first Grand Coulee Dam's waterwheel generator, largest in the world

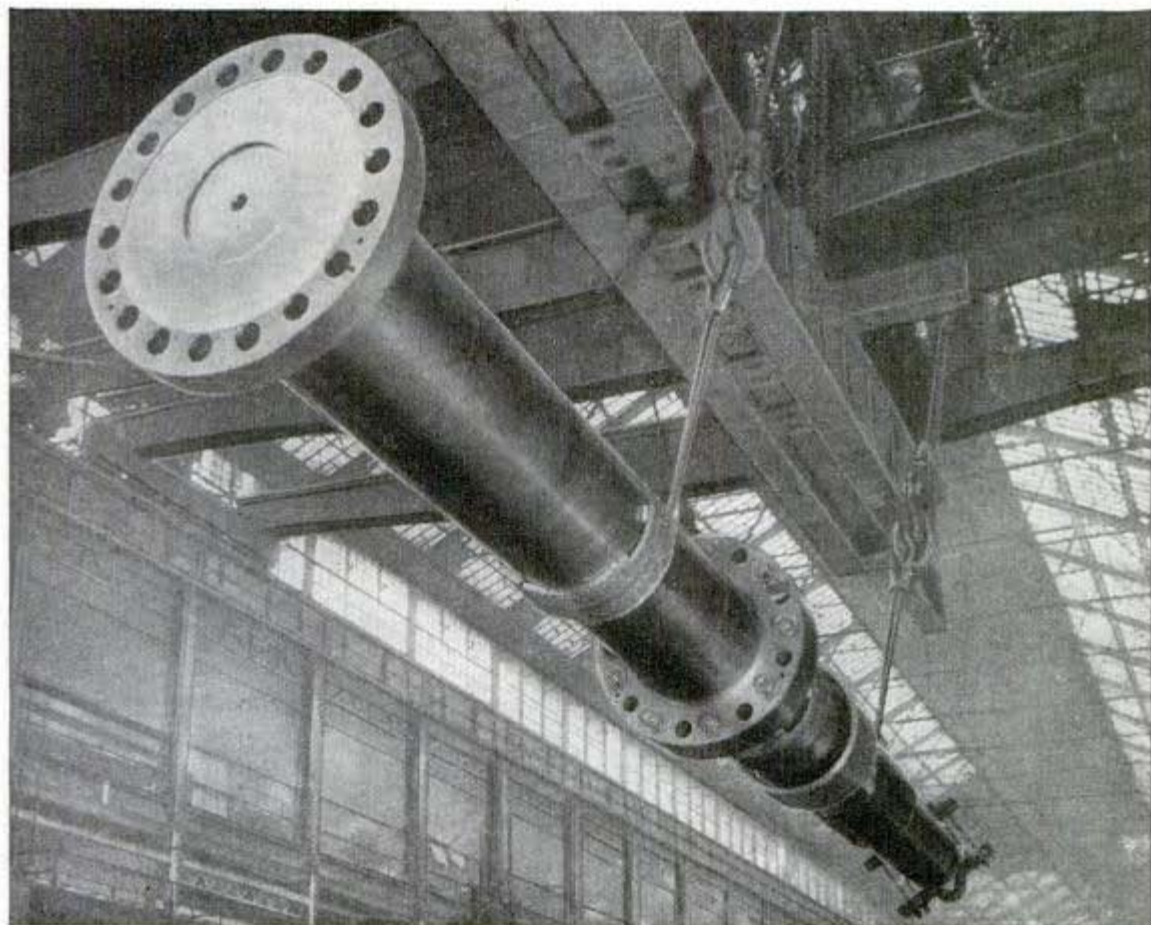

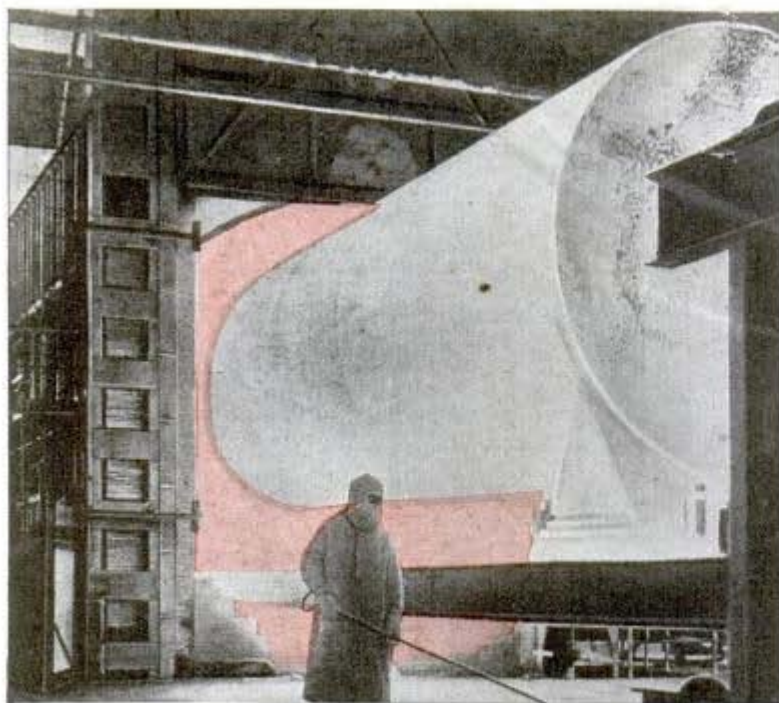

Worker wears special suit as stainless steel tank emerges from furnace

to use cadmium in coats 50 times thicker, and thus give greater protection to the steel surface. A recently introduced electroplating process puts steel strips through a maze of machinery and chemical baths at 1,000 feet a minute with a better and more uniform coating of tin than ever before and saving more than 4,000,000 pounds of tin a year.

In working out ways to use steel instead of other metals for war products, metallurgists have developed metals that will be of great peacetime value. The type of steel used in cartridge cases, which saved in one year more than half a billion pounds of copper, undoubtedly will have many post-war uses. Many things also have been learned about making cold rolled strip steel. One instance involved exacting spec-

Right, giant wind turbine near Rutland, Vt., is capable of generating 1,000 kilowatts. Below, one of its huge stainless steel blades is trucked to the site

Electro Metallurgical Co. photo

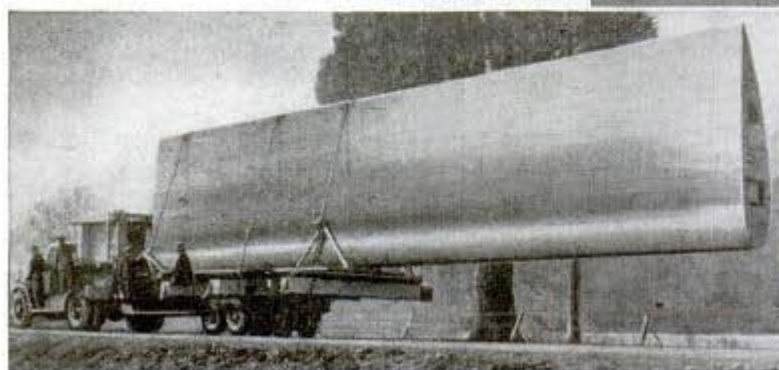

units and by greater use of welding in all forms of construction.

While the prefabricated home of the future is likely to contain numerous structural materials besides steel, its basis probably will be a steel framework. New production processes may bring thin copper or brass layers rolled onto steel sheets, offering the strength of steel plus the surface beauty of copper or alloy at small cost. Similar arrangements with plastics as ve-



ifications for cartridge belt links that tie bullets together as they race through .50 caliber machine guns at 800 shots a minute without jamming. To impart perfect workability in these links, the steel is bright annealed in furnaces of special and improved design so that the fabricator can set dies and machinery for top-speed production with full confidence that he will get precise results.

In addition to great quantities of steel needed after the war for automobiles, farm implements, refrigerators and other high production items, the steel needed for structural purposes is expected to be increased by advances made in pre-fabrication of housing

neers over steel may be even more popular because of the variety of surface colors and effects that can be obtained. Combinations of plywoods and steels also are said to have possibilities. Steel framing systems for housing have been developed in a range that includes industrial and municipal buildings, multiple dwellings, group housing projects, cottages, boat houses, plane hangars, cabinets, summer houses and many others. The light-gauge steel now used has characteristics which serve equally well in all types of construction, forming a rigid framework which will not sag, gives resistance to termites and rot, and is light enough to handle easily.

In prefabricating and welding larger structures, much has been learned from war experiences in shipbuilding. At least one prominent welding authority—J. F. Lincoln, president of the Lincoln Electric Company—believes that eventually the use of rivets will disappear entirely.

"There is endless opportunity in the direction of finding new uses for steel," he says. "Uses in place of castings, forgings, malleable iron and wood are apparent and have been urged for years in some parts of the industry. The steel industry must, of necessity, force these uses if it is to keep operating at highest capacity. This means steel houses, fabricated steel parts and new alloy steels for new purposes which will enormously increase the places where steel would economically be applied."

There is said to be a full potential market of more than 25 million refrigerators, nearly 20 million washing machines, and 21 million cooking ranges from now until 1950. If the potentials are realized, around 5,000,000 tons of steel will be needed.

Far greater use of stainless steel is forecast. New methods are said to increase the flow-ability of stainless steel and make it more workable in press dies. If stainless steel does come into greater use, it will become one of industry's most useful metals, since already it has more strength for weight than any other material in common use and does not rust or corrode. Providing lighter sections in structural assemblies without sacrifice of strength, stainless steel likewise gives resistance to heat.

In connection with a statement by C. F. Kettering, director of research of General Motors, that the all-steel airplane will come before the aluminum automobile, it is notable that the first stainless steel commercial airplanes give excellent service.

Steel parts also are being made in huge quantities with the utmost precision. Millions of lustrous, mirror-finish steel balls for frictionless bearings now approach absolute roundness. Made of electric furnace

Continued to page 150

Expansion Bits of Different Sizes Drill Hole a Foot Wide



By means of a series of various-sized expansion bits made up for the purpose, a power tool can drill holes up to a foot in diameter. A guide hole is drilled first with a one-inch bit. A three-inch expansion bit, mounted on a piece of one-inch stock that fits into the guide hole, is then used to increase the width of the hole to three inches. A six-inch expansion bit, mounted on a three-inch guide, enlarges the hole again and the process is repeated with nine and 12-inch bits. Countersinking also may be done with the bits.

Dentists Freeze Patient's Jaw To Kill Pain From Drilling

Experiments by the United States Naval Medical Research Center presage refrigeration of jaws in place of the use of drugs by dentists to kill the pain, according to the Journal of the American Dental Association. Sixteen sailors and Waves volunteered for the experiments, in which 22 cavities were filled under local refrigeration at the freezing temperature of one or two degrees Centigrade. Complete anesthesia or loss of sensation was obtained in 15 instances, while in seven a mild degree of pain was felt.

Lt. Comdr. J. S. Gostarowski 55

0226

Bethesda, Md.

CRACKING DAVY JONES'S LOCKER

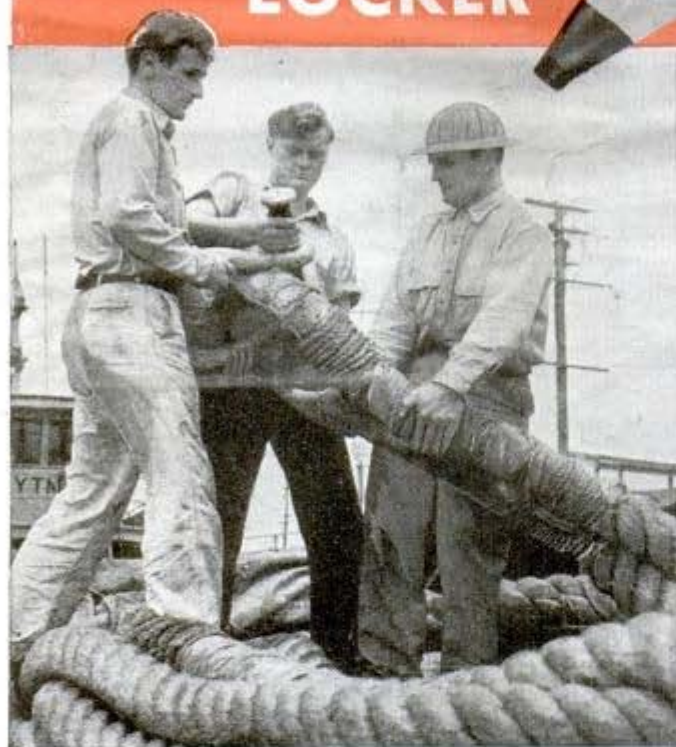

Above, right, diver inspects underwater suit and helmet. Above, attaching shackle to end of 12-inch towing line on rescue ship. Below, LCI high above high tide, ready to make half-mile overland "cruise" to beach for refloating



AFTER the war, you might suppose, will come the giant task of raising from the sea the hundreds of ships that have been sunk by military action. Millions and possibly billions of dollars worth of ships and cargoes are lying on the ocean bottoms.

Yet the opinion of deep sea salvors is that most of these ships will remain where they are for all time. Most torpedoed vessels sank well offshore and lie at depths where they can't be reached. Even ships that lie in the comparatively shallow waters of the continental shelves won't be touched. We will have more good ships than we will know what to do with when the war is over, and prices for scrap metal will be too low to warrant raising ships for their value as scrap. Only in isolated cases will salvage operations be worthwhile.

But wrecks that will be literally worthless tomorrow are infinitely precious today if they can be salvaged, for right now America needs every cargo carrier that it can obtain. Raising, patching, and repairing a wrecked ship is the same as building a new one without expenditure of materials.

Ship salvage men now are busier than ever before. They have gone out into the middle of the

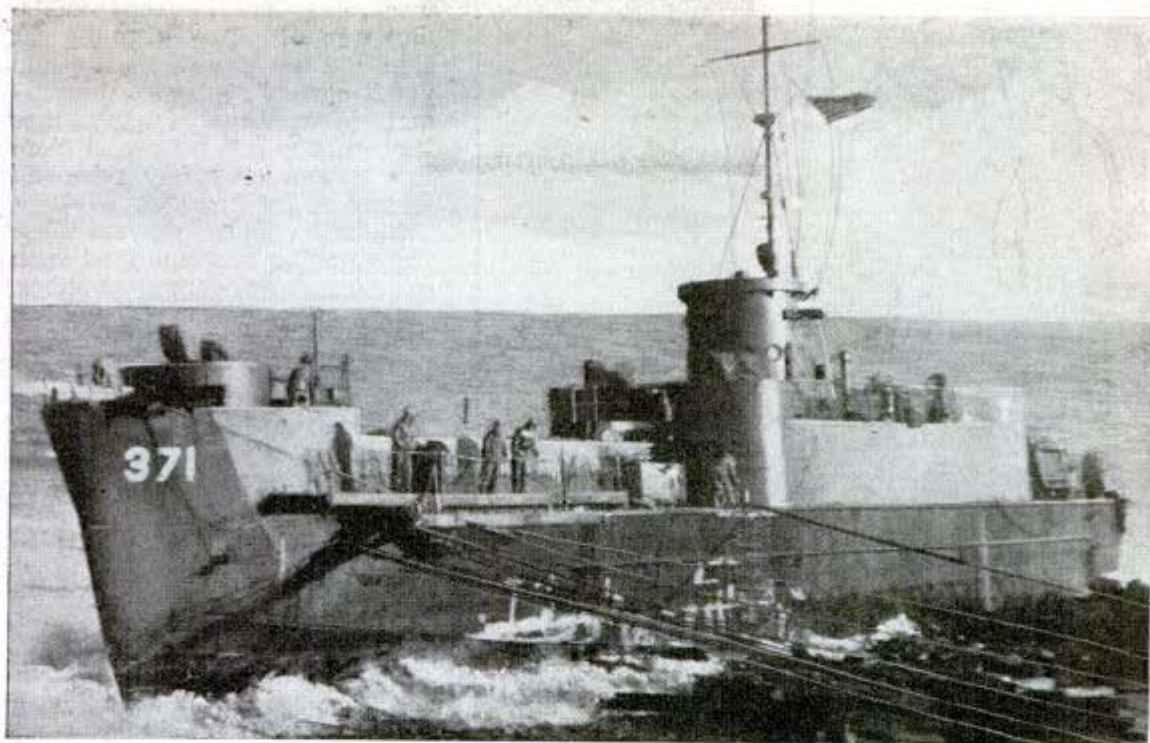

Atlantic to tow back vessels that were crippled but not sunk by submarines and they have raised and repaired German, Japanese and Italian vessels that were sunk. Many of their jobs are done in active war zones and they sometimes work behind the protection of warships, screened overhead by blimps or airplanes.

Salvage operations are performed either by trained Navy crews or by crews of civilian experts who work under contract with the Navy. Navy salvors alone have been credited with recovering some 6,000 tons of lead, copper, rubber, and other vital materials from the sea, in addition to sufficient iron and steel to build two heavy cruisers.

Salvage men tackle big jobs like the raising of the "Normandie," but they are just as concerned with recovering and putting back to work little ships that literally could be placed on the "Normandie's" deck. An odd example of salvaging a small ship occurred when an LCI troop carrier went ashore broadside to the beach on an island off the west coast. Subsequent tides put the vessel up on the rocks.

LCI after it had gone ashore broadside to beach. Cables hold it in place as tide pushes it farther up the beach. Below, preparing to fire hand line from rescue ship so that a larger line can be attached. It in turn will be used to pull heavy cable to ship being salvaged





Radio man (above) on rescue ship converses by walkie-talkie with salvage crew. Below, tiny salvage tug next to sinking steamer

Salvage men decided that it would be too risky to drag the ship back down to the water at that point and so they made the vessel cruise for half a mile overland under her own power to a beach from which she could be re-launched with safety.

A roadway was built, timber tracks were laid on the road, rollers were put under the ship, and then the LCI dragged herself forward by means of her own anchor winches, hauling on lines attached to sand anchors up ahead. The troop carrier moved overland and down to the beach, dragging herself into the sand at low tide so that she was partially afloat when the tide came in. Then a salvage vessel pulled her safely into deeper water.

When the war turned ship salvage from an occasional episode to a steady occupation, the Navy developed a special rescue vessel known as the ARS type. This is a large ocean-going tug especially designed for salvage

work. One of them seems ridiculously small compared to a great ship that it may be assisting, and yet it carries specialized equipment by which ships many times its own size can be raised from the bottom or safely removed from a rocky shore.

Steam or Diesel driven, these rescue ships are equipped with machine shops, carpenter shops, and blacksmith shops. They have hoisting winches capable of pulling 10-ton loads, they have large capacity air compressors and they carry elaborate fire fighting equipment. On deck are 12-inch Manila hawsers for towing, and 8,000-pound kedge anchors of special design. At least one diver is a member of each crew.

Coils of chicken wire, walkie-talkie radio sets, hand shovels, and ordinary building lath are among the important odds and ends of equipment that the rescue ships need and always carry with them. The chicken wire is handy when pumping out a ship, for it can be fashioned into a



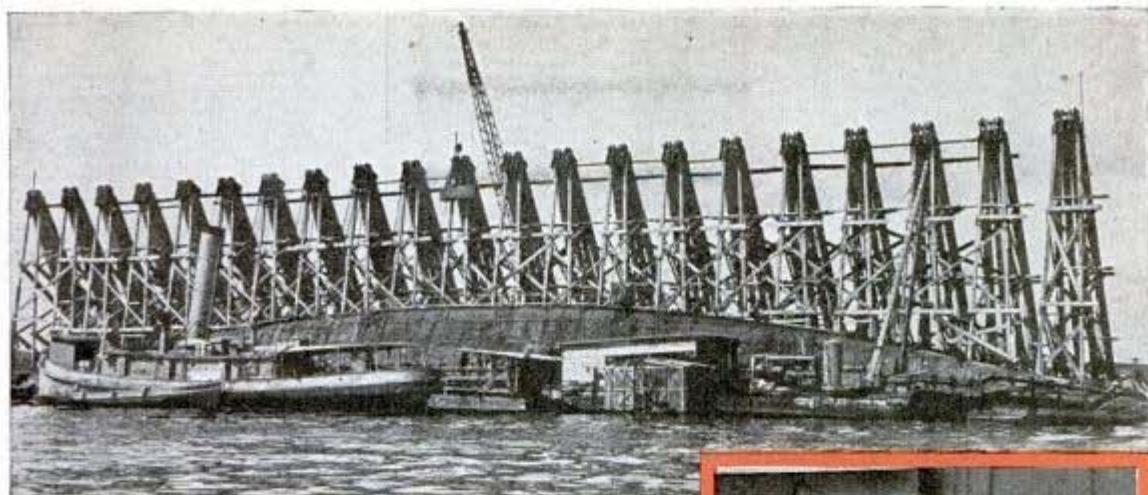

Above, U.S.S. Oklahoma, sunk at Pearl Harbor, is raised with help of timber frames. Right, rescue ship's kedge anchor which is dropped and pulled against in hauling vessels off shore
U. S. Navy photo

strainer that prevents debris from clogging the pumps. Walkie-talkies speed up communication between the rescue vessel and the salvage crew at work on the wreck. Shovels are needed when the salvage men bury "dead men" ashore as anchorages. The lath is used to help hold in place the large felt blankets that serve to temporarily patch a hole in a ship's side.

Every salvage job is different although salvage men say that they merely "patch 'em, pump 'em out, and tow 'em in." Usually the patching is an

Continued to page 150

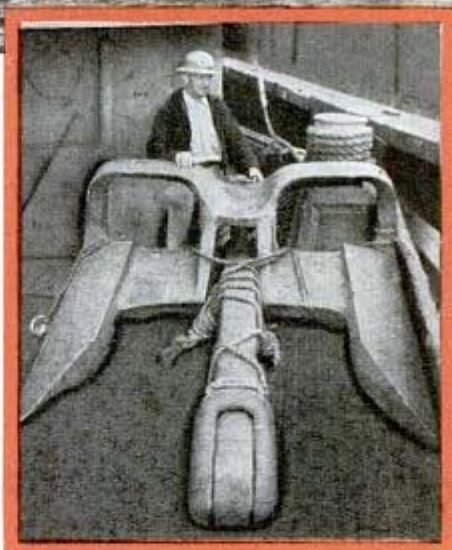

Below, lifting bow of U.S.S. Turner, ripped apart by explosion

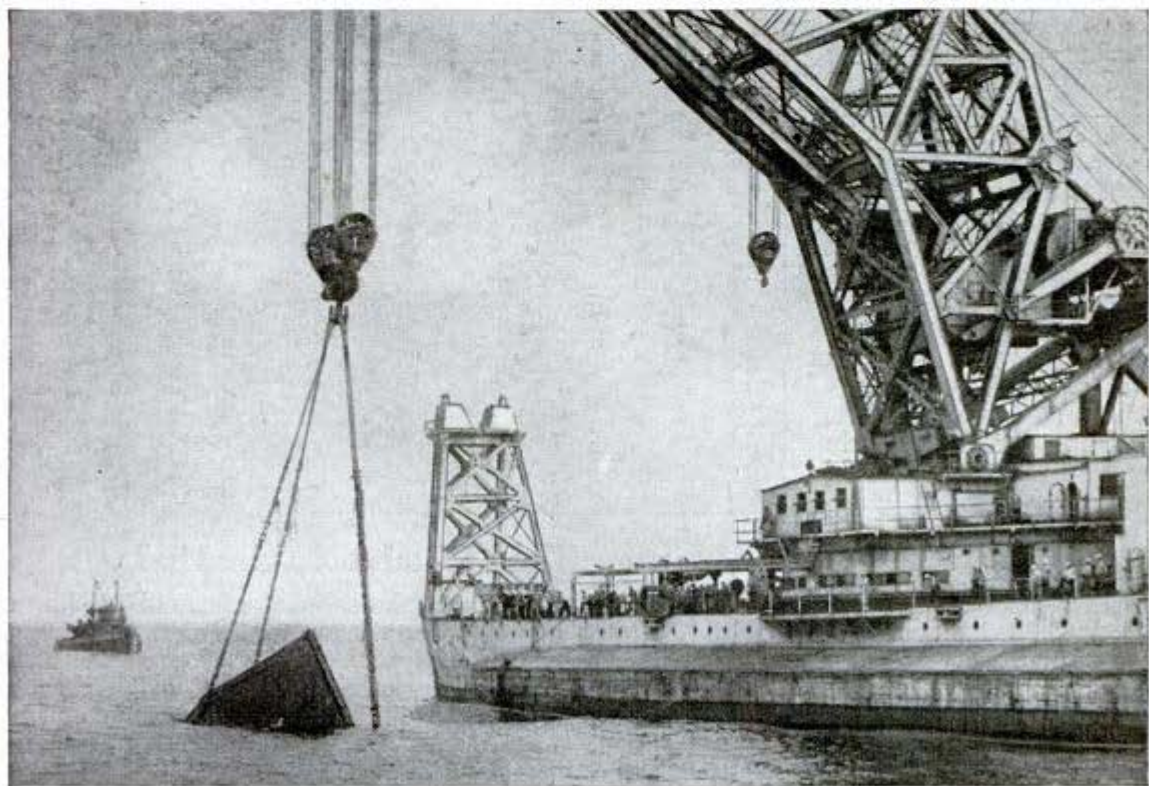

'Sky-Ride' Platform On Erection Rig Holds Linemen

An erection rig topped by a high platform speeds the work of power linemen on the Shasta Dam-Oroville transmission line in northern California. The rig is moved by a Caterpillar tractor and enables workmen to do a two-hour job in 45 minutes. The "clipping" operation for which the platform is used consists of removing the conductor from a cable sheave, wrapping it with armor rods, placing suspension clips and securing them to insulator units. The new method for "clipping" was developed by U. S. Bureau of Reclamation engineers. Formerly, linemen used ladders and safety belts—a more spectacular, but slower method.

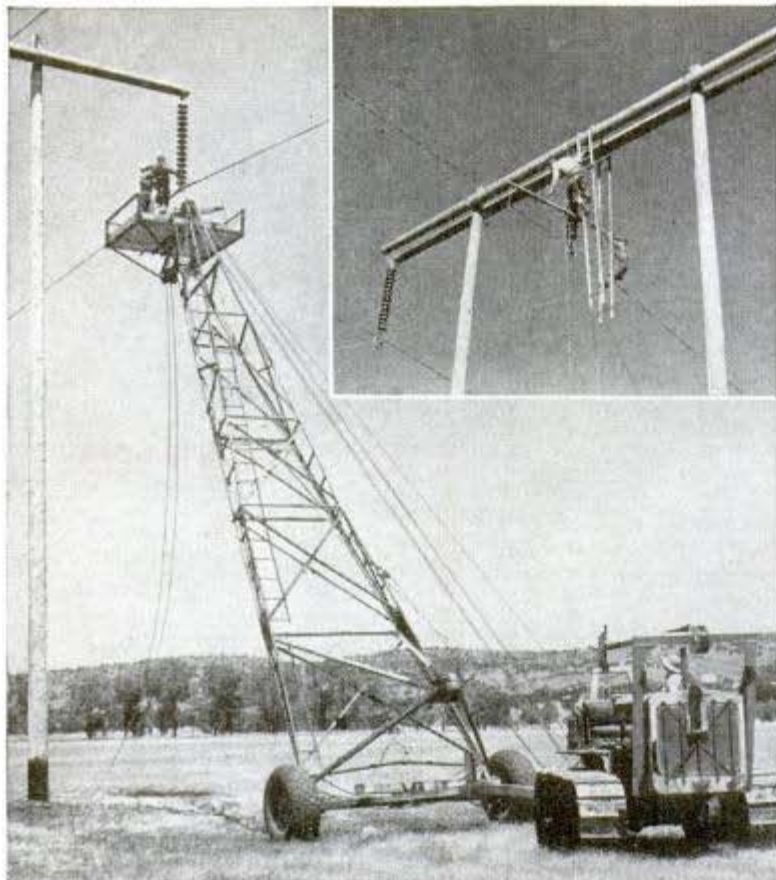

Six-Motor Bomber Unveiled by Nazis As Their "B-29"

Germany's largest bomber is the six-motor BV222 Viking, according to a report from Stockholm, Sweden. Hoping the plane will offset the U. S. Army's B-29, the Nazis announced that the Viking has a length of 111 feet, which is 13 feet longer than the B-29, and has a wing span of 138 feet, slightly smaller than that of the Superfortress. It was said the giant has machine guns facing in every direction. No other details were given.



Glass-Plastic "Sandwich" Stronger Than Metal to Be Used in Luggage

Glass-plastic "sandwiches" which are stronger than metals will be available for use as lightweight luggage, molded office and home furniture, and prefabricated kitchen and bath units after the war. The new material, developed by the Army Air Forces to fabricate fuselage and tail sec-

tions for airplanes, can be formed into large intricate shapes at low pressure without using costly molds. It is a combination of glass fibers and special plastic resins. Strength-weight tests show the "sandwich" is 50 percent stronger than aluminum and 80 percent stronger than wood.

Plastic "Raincoat" Sprayed on Planes Like Paint

Right, plane with a "plastic raincoat," which won't crack at 30 below zero or 180 degrees above. Below, a plane is sealed by plastic spray

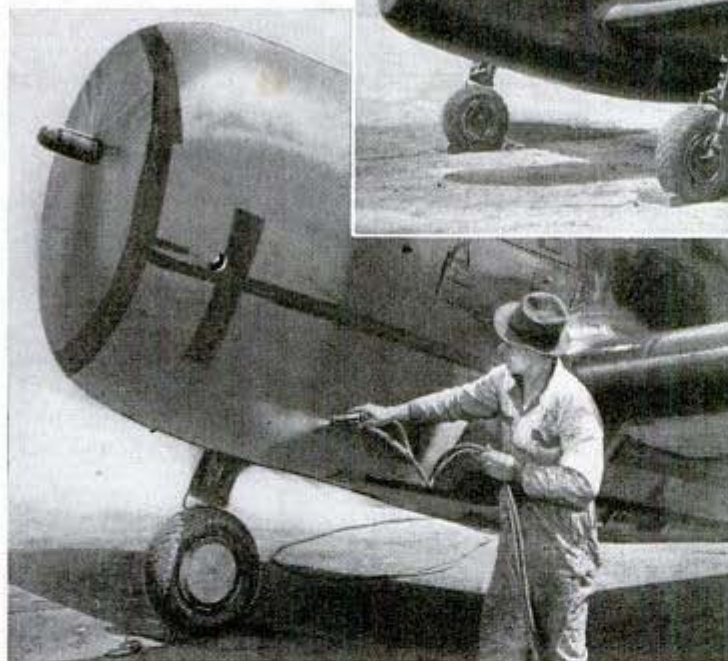

War planes, which are often shipped overseas on open decks, are protected against corrosion with a plastic "raincoat" that is sprayed on. The liquid spray dries in less than 30 minutes, forming a paper-thin coating which seals the entire plane. When the plane arrives at an advanced base, it takes only half an hour to peel off the plastic coat. The peelings can be ground up and used again.

"Bottle" Trailer That Hugs Road Hauls Liquid Gas Safely 0.343

To add safety and economy to the transportation of liquefied petroleum gases, the Heil Company, of Milwaukee, Wis., uses low-slung "trailerized" units. The gas tank is suspended between the axles of the trailer and the tractor so that, fully loaded, the tank is only 18 inches above the ground, providing a center of gravity lower than that of conventional tank-hauling units. The advantages are a safer, more compact highway carrier, which is easier pulling, has less side sway and reduced wear and

tear on the tires. One of the unit's unique features is that the payload's center of gravity can be moved forward or backward to maintain desired axle or king pin loadings. Maximum payload is 4,000 gallons and the tank is equipped with safety valves which blow at 225 pounds pressure in emergencies to release the load in the form of gas. The unit transports butane, propane and other liquefied gases which are used extensively in the production of synthetic rubber and high-octane gasoline.

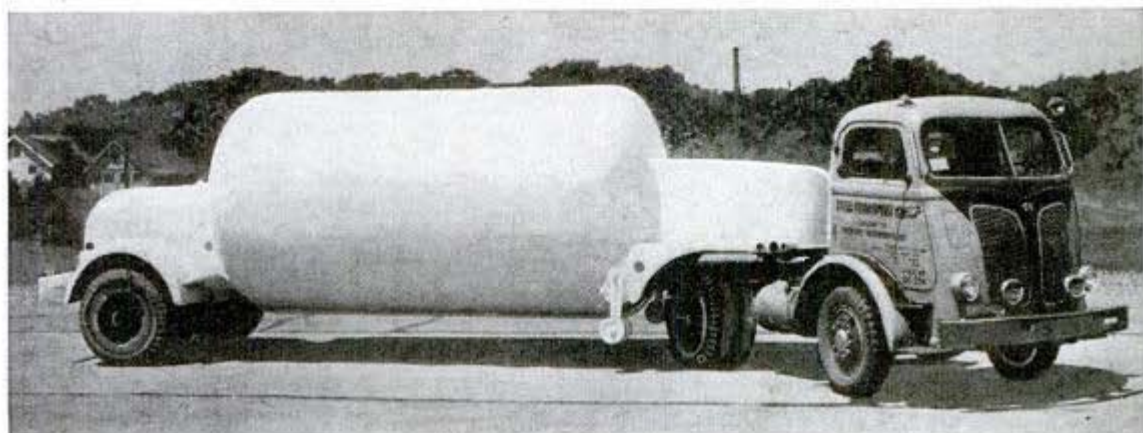

Suspending the payload between the axles has eliminated over a ton of dead weight in this "trailerized tank"

REPAIRING *the* TOOLS of WAR ☆ ☆

Putting the "fight" back in military equipment damaged in battle is one of the big jobs now being performed in Army arsenals in the United States. Giant 155 mm. howitzer (left) is made new again at Benicia Arsenal in California, one of the largest repair depots in the world. Everything in ordnance, from field guns to revolver (below) is repaired and tested at the depot

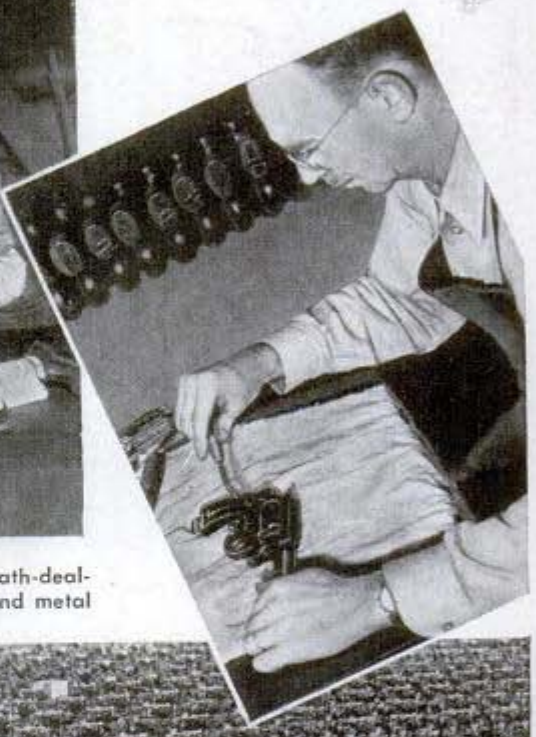

The 40 mm. antiaircraft gun tubes (below) get a new lease on death-dealing for enemy planes in arsenal shops. Repair job saves time and metal

*Benicia Arsenal,
Calif*

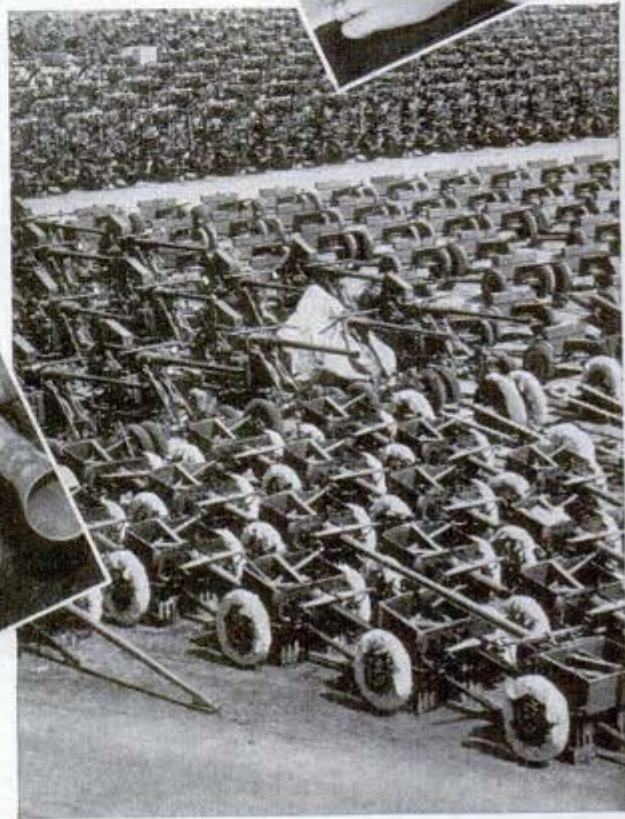

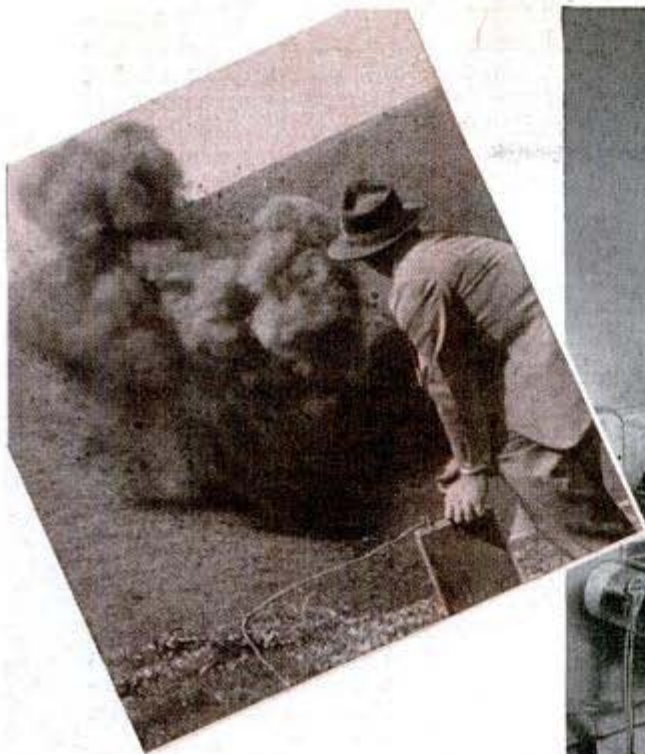

Exploding defective shells or explosives is all in the day's work at arsenal. Above, an electric exploder blows up a defective bangalore torpedo. Below, an imposing array of rebuilt equipment ready for re-shipment abroad to battle zones. Here are limbers, air borne howitzers, antitank guns, antiaircraft guns—all good as new



With his thumb on switch that cocks and fires weapon, an ordnance expert tests .30-caliber gun in an underground gallery

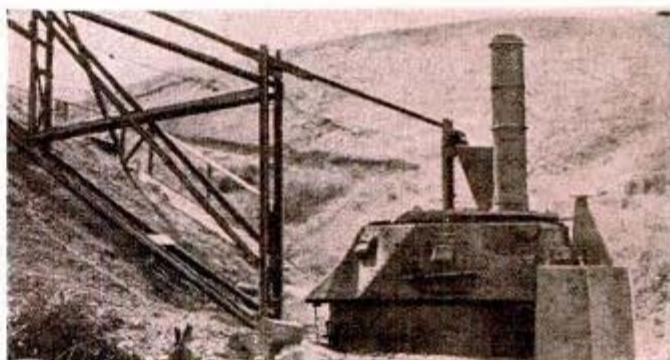

Salvaged M-3 tank with smokestack on top serves as exploding chamber for defective primers and fuses carried on an endless belt. Below, test firing carbine in the underground gallery



Self-Rising Lightweight Plastic Forms Non-Heat Insulation



With a versatility surpassing that of the Army jeep, plastic materials have entered a new field—insulation. Foam plastic, developed by General Electric engineers, is said to have a lower heat conductivity than cork or rock wool insulation. A unique characteristic of this lightweight plastic is that it is self-rising, no heat being required in the manufacturing process. The material begins to foam and expand two minutes after it is stirred. Foam plastic weighs only 1½ to 2 pounds per cubic foot.

Simple Clamp for Rubber Hose Locks With Ordinary Pliers

Using no gears, thumb screws, or intricate locking means, a one-piece hose clamp

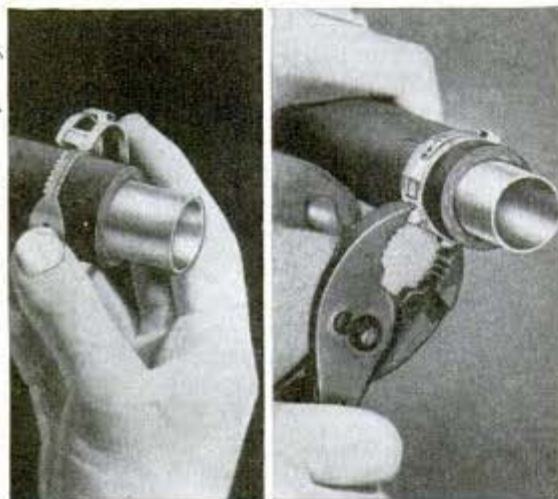

may be snapped over the hose into a pre-latched position by hand. The final lock is made with ordinary pliers. The clamp, which is made for lower pressure connections and has a lower profile, is light in weight and exerts an even pressure around the circumference of the hose.

Synthetic Sugar Solves Puzzle Of How Nature Makes It

After 50 years of experiments, synthetic sugar which is identical with ordinary commercial sugar has been produced by chemists. Two grams of pure crystalline sucrose—the sugar which is formed naturally in sugar cane, sugar beets and other plants—were recently produced by three University of California chemists. Fructose, or fruit sugar, and phosphorylated glucose were used in the process with a bacterial enzyme as reagent. Too expensive for practical production, the process shows the chemical mechanism by which nature forms sugar, and may lead to obtaining greater yields from beets or cane.

Handy Attachment Grinds Drills At Three Different Angles



Old drills can be quickly and accurately ground by an untrained workman with an adjustable grinding attachment. It grinds drills at three different drill point angles, and can be used on those ranging from 3/32 inch up to 1 1/16 inch in diameter. The drill is placed in a swinging trough mounted on a tilted post. An adjustable rod can be lifted out and screwed in the bottom end of the trough to accommodate drills 11 inches long. The device can be used with a bench grinder or with a floor grinder if a bracket is provided.

*Patfield Plastics, Inc.
Pittsfield, Mass.
Temmerman Products, Inc.
2023 Fulton Rd., Cleveland 13, Ohio*

Berkley Calif.

J-303

O-288

O-279

CAMERAMEN UNDER FIRE

By Paul Healy

Part I

THE dramatic war pictures you take for granted in your daily newspaper and in the weekly newsreel often were made under almost impossible conditions and in the teeth of enemy gunfire. They were taken by the unpublicized heroes who are willing to go anywhere and risk any hazard to obtain for the folks at home vivid close-ups of the hard facts of combat. Some of these cameramen are soldiers, sailors and marines trained to defend themselves, while the others are unarmed civilians who must dodge snipers and machine gunners as best they can.

The life of a front line photographer is considered

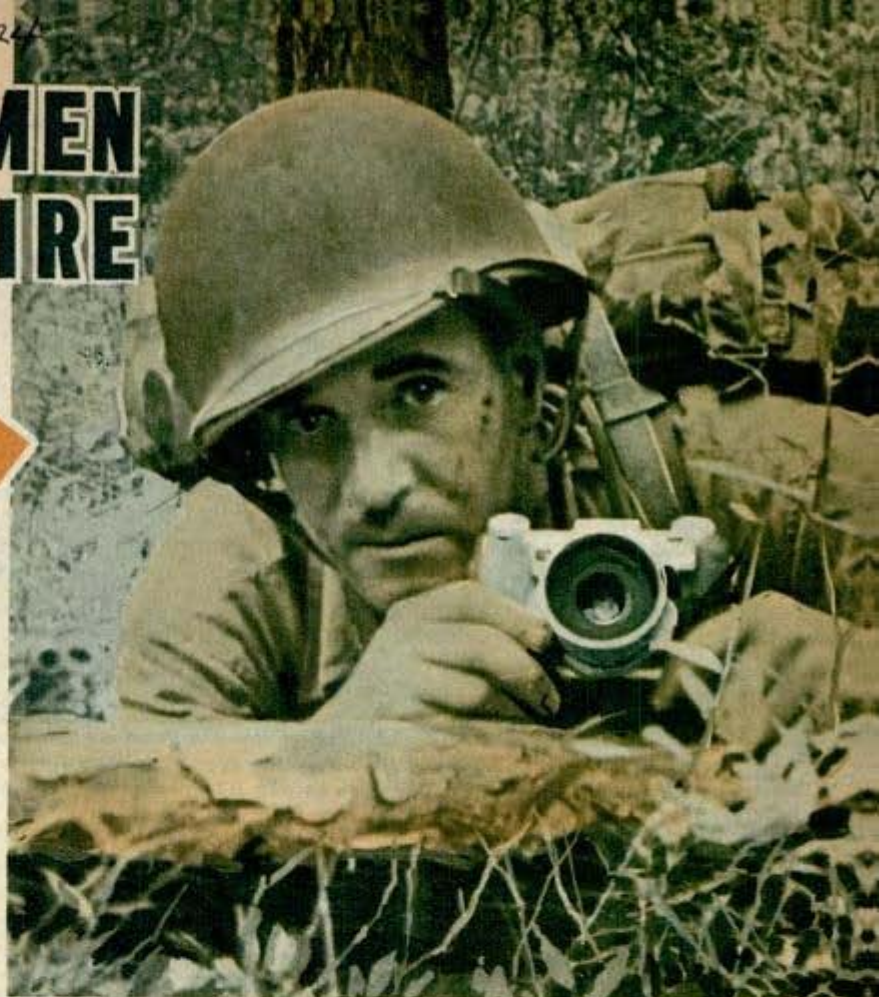

Above, marine combat cameraman inches forward on his stomach to get close-ups of a battle. Below, marines stooping low in the face of a deadly barrage charge in single file across a beachhead on Tarawa. The cameraman who took this picture followed right along with them
U. S. Marine Corps photos





Above, dressed in sheepskin and high-altitude oxygen mask, an Air Force combat cameraman looks like this when he puts a bombing mission on film

so rugged that Martin Barnett, Paramount News cameraman, says he frequently discovered veterans in the New Guinea area staring at him in perplexed amazement. They wanted to know why he, as a civilian, was obliged to suffer the rigors of combat in the tropics.

"It's my job—I asked for it," Barnett always replied.

"You mean you like this kind of work?" they exclaimed. "You mean you could go

home where it's safe and comfortable and you don't want to?"

Nevertheless, Barnett found that the troops were always glad to see him coming, for it meant that millions of American citizens were going to get a realistic picture story of what the Allies were up against in the Pacific. Like other cameramen, Barnett insisted on going wherever the fighting men went, loaded as he was with heavy photographic equipment. During the Buna campaign early in the war he lived in quarters which were bombed and strafed every evening for 12 consecutive days.

Barnett suffered such a serious injury while making his complete movie record of the first assault on Lae that it caused him to be shipped home. Aiming his camera from the "conning tower" of an LCI (landing craft, infantry), Barnett was riding into the beach with the first wave of Australian forces when three Jap bombers broke through the air umbrella and scored a near miss. The concussion flung him to the deck of the ship, injuring his spine.

Navy photographer caught this explosive action from deck of a carrier during a task force raid on Saipan





U. S. Air Forces photo
Air Force cameramen shoot a movie record of air action off Munda Point in the South Pacific

Heroics which win a writer a by-line rarely win similar recognition for a cameraman, yet several war photographers have become nationally known through their individual exploits. One is Frank Filan, of the Associated Press, who won the Pulitzer Prize for the best war news photo of 1943. The picture, made during the battle of Tarawa, showed marines examining the remains of what once had been a Japanese stronghold, with the bodies of dead Japs strewn grotesquely among the rubble.

Filan's job had not been easy. When the assault boat in which he was being carried ashore sank, he seized his heavy pack and started bucking the shoulder-high surf, then turned back to assist a wounded marine. Together they covered the perilous 600 yards to the beach but several times the cameraman slipped and went in over his head, ruining his cameras. That night Filan filled in as a stretcher bearer carrying wounded marines from No Man's Land to the doctors behind the lines. Then he borrowed a camera from a Coast Guard photog-

rapher and made his award-winning photo. He was commended by Adm. Chester Nimitz for his "inspiring devotion to duty."

The first famous World War II combat pictures were made on Dec. 12, 1937, by Norman Alley, a veteran newsreel man, standing on the deck of the United States gunboat Panay as Jap bombs exploded all around him. Alley's reels were considered so valuable as a historic



Left, press "fotog" shares a foxhole with a doughboy

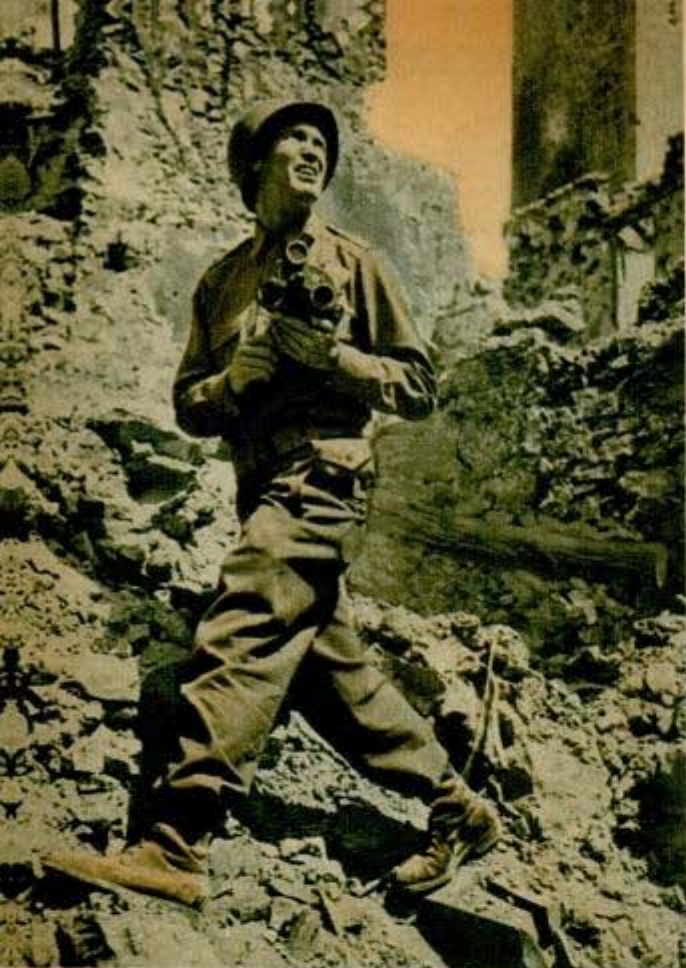

Above, Lewis Cass, Paramount newsreel man, keeps a sharp lookout for snipers as he prowls among ruins at Castelforte, Italy. Below, the camera captures fountain-like effect as an allied ammunition ship blows up after air attack in Gela, Sicily, harbor

document of the unprovoked sinking of the ship that they were insured for \$350,000 and convoyed under armed guard all the way to Washington, where they were studied in the White House. The cameraman was given a medal by Congress for his work in aiding the Panay wounded and an award from the National Headliners club for making the best photos of 1937.

Since then Alley, who learned his job as an army signal corps photographer in France during the first world war, continued to set the pace for front-line cameramen. He covered the Russian war in Finland and was present when the German army marched into Norway, Holland and Dunkirk, later smuggling out the only picture of the bombing of civilians made in Nazi-held Europe; when America went to war, he followed the shooting from the Marshalls, to New Guinea, to Guadalcanal, to Sicily, and to Italy. Watching the invasion of Salerno from a destroyer, he stayed within 15 feet of the bridge for 72 hours and shot 7,000 feet of film, including the first picture of a German glider bomb exploding.

Eugene Smith, a magazine photographer who flew over the islands of Tarawa, Truk, Kwajalein, Eniwetok and Tinian, also contrived to be at the right spot on many occasions. One day, returning from a bombing run over a Jap atoll, Smith heard an excited pilot's voice in his ear phones: "Mid-air collision! Mid-air collision!" As his plane banked and turned,



Smith raised his camera to the hole in the Plexiglas in time to catch two big puffs of smoke on the water. It was the only picture of the death of Raymond Clapper, newspaper columnist, and was widely published in newspapers and magazines.

The primary job of the great numbers of combat cameramen trained by the army, navy and marine corps is to act as the "eyes" of the tacticians and the strategists but a good share of their work is released to the public through the roto picture pool, a noncompetitive wartime set-up in which every publication and every newsreel company is entitled to use any picture made by any cameraman, military or civilian.

Servicemen-photographers, who are equipped to fight if they have the opportunity, shot their pictures and dispatched them to the laboratory so fast during the invasion of Normandy last June that the United States received the first still photos just 36 hours after the battle of France had started. The first invasion motion pictures arrived 28 hours after that.

Continued to page 158



Top, huge aerial camera in action. Center, bearded marine cameraman in action during battle of Tarawa. Below, photo-trailers for developing pictures on Guadalcanal
U. S. Navy photo

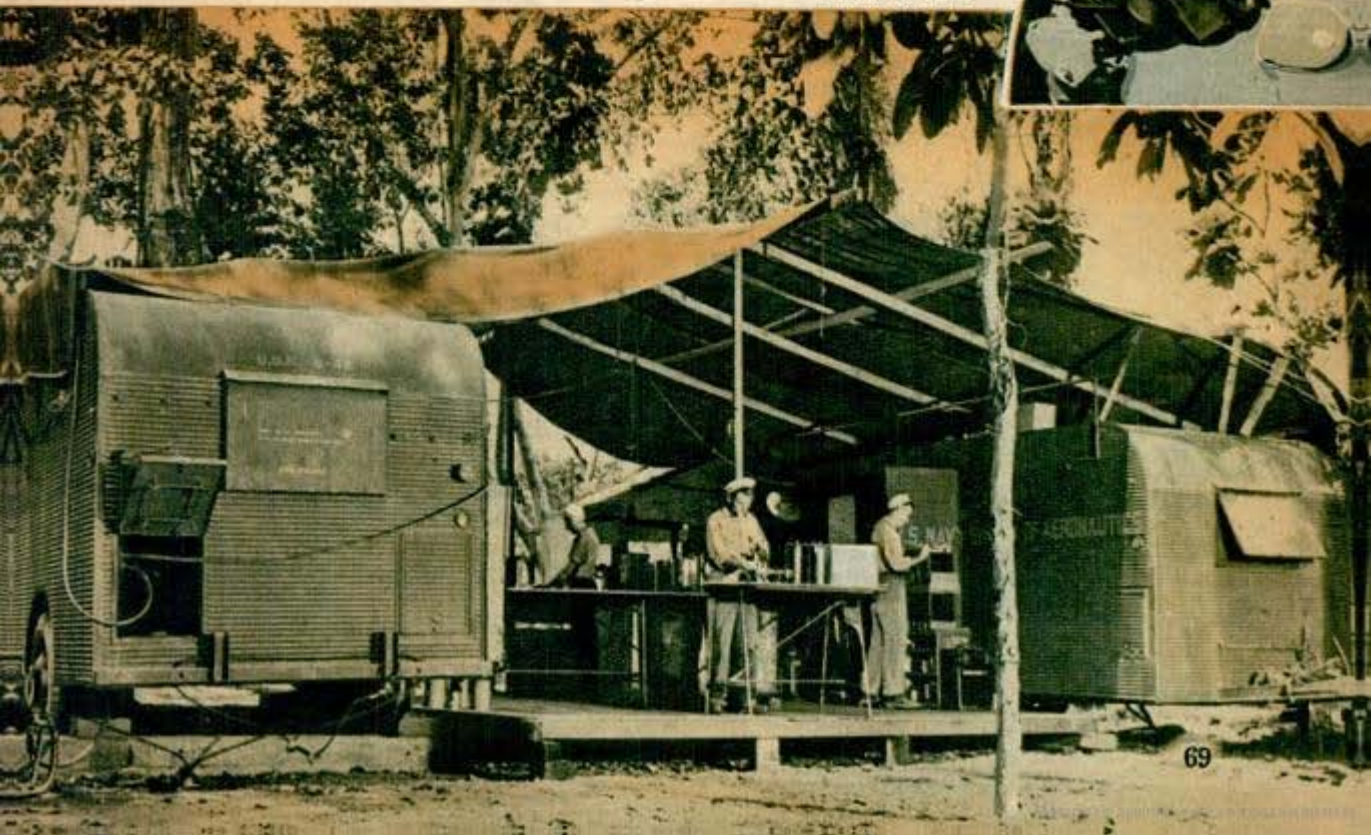

Saunders Eye, Mass.



Polarized Light Tests Lenses Toughened by Heat Process

0-251

You can look inside a piece of glass with polarized light to determine its degree of toughness. This method is being used by the American Optical Company to inspect lenses for safety goggles. The black pattern which shows up under polarized light reveals the strength of the shatterproof glass. Finished lenses are toughened by reheating and then cooling by compressed air. This increases resistance to the impact of flying particles by 400 percent.

Electric Finger Finds Needle Inside Woman's Heart

0-127

In a delicate operation which lasted more than two hours, a two and a half inch sewing needle was extracted from the ventricle of a woman's heart in New York City, the first such case in medical history, according to the New York Surgical Society. The instrument which made the feat possible was an electronic finger, surfaced with



*Samuel Bernan
N. Y., N. Y.*

stainless steel, and about as large as a human finger, though longer. A cord connects the finger to a meter whose dials show the presence of any metal near the finger tip. First the finger indicated the needle was in the back of the heart, then it guided the doctor to a line directly under which the metal lay. If the finger had been in error by as much as a hair's breadth, it would have necessitated two incisions—more than the heart could stand.

Stretcher That Folds Into Pack Makes Ambulance of Sedan

0-252

Because it may be doubled up and carried in the trunk when not in use, a folding stretcher can convert an ordinary sedan into an emergency ambulance. In addition,



the stretcher can be carried like a pack on the back, and folded at right angles it can be used to remove injured persons in nearly upright positions from manholes and other confined places. When carried as a pack, the leg straps are used as a

harness. The stretcher also provides a means of securing the head with a bandage to immobilize neck fracture cases and an L-shaped attachment for traction splinting on either leg. Seventy-four inches long, it weighs only 16 pounds but can support 1,000 pounds.

0 387

6-Ton Bombs Start 'Tidal Waves'

Six-ton blockbuster bombs are used by the Allies to start "tidal waves" which engulf German shipping in harbors and boat pens along the coast of Europe. The bombs, which are capable of making craters in the earth 40 feet deep and 110 feet in diameter, stir up such colossal waves that E-boats, the counterparts of our PT-boats, are lifted out of the water and concrete boat pens are undermined. Boats up to 200 feet long have been badly damaged.

*Harpur J. Ransburg Co. 234 Barth Ave.
Indianapolis 7, Ind. 0 257*

Electric Grid Dries "Tears" Left After Dip in Paint

Excess paint which collects at the drain-off points on dipped objects is removed with a high voltage grid. Formerly, these "fatty edges" or "tears" had to be corrected by hand. Grounded articles passed over the grid are de-teared by electrostatic attraction in 15 seconds to one minute. In coating steel cartridges, this method not only produces a smoother finish but saves thousands of gallons of scarce finishing material. The same principle, with a reverse application, is applied to spraying. The part is carried by a conveyor into an electric field where paint particles acquire a charge which causes them to be attracted to the article. This saves paint and produces a uniform coating.



Navy Spots "Cat's Eye" Vision With Luminous Dial Test

Normal night vision, vital for night flyers, ship's pilots and lookouts, is detected in a few minutes with a portable instrument developed by the Navy's Bureau of

Medicine and Surgery and the American Optical Company. The test consists of the subject's ability to see an object silhouetted against a luminous radium dial in a darkened room. The dial is in the lower part of the instrument's front panel, and a small red cross above it serves as a beacon. If the man being tested has normal night sight, he will be able to name the position of the opaque letter "T" on the dial as it is rotated. The dial is made of two pieces of glass between which is sandwiched a radium-activated luminous material. A neutral-colored filter before the glass reduces the light to an infinitesimal three one hundred-millionths of a lambert. Before taking the test, sailors and flyers wear special dark-adaptation goggles fitted with red lenses.



Southbridge, Mass.

Gasoline-Powered "Can Opener" Cuts the Ends Out of Oil Drums

By rigging what may be world's largest "can opener," the Navy Seabees in the South Pacific are able to cut the top and bottom out of a discarded steel oil drum in a single operation in less than two minutes. The same job done by three men by hand takes an hour. The cutting is done by a cone-shaped blade powered by a 60 horsepower gasoline motor. The drum cutter was given mobility by installing it on a trailer. After the drums have been cut open the Seabees use them as airfield and road drainage pipe, roofing shingles (after they have been rolled out straight), stoves, sinks, furniture, showers and toilets.

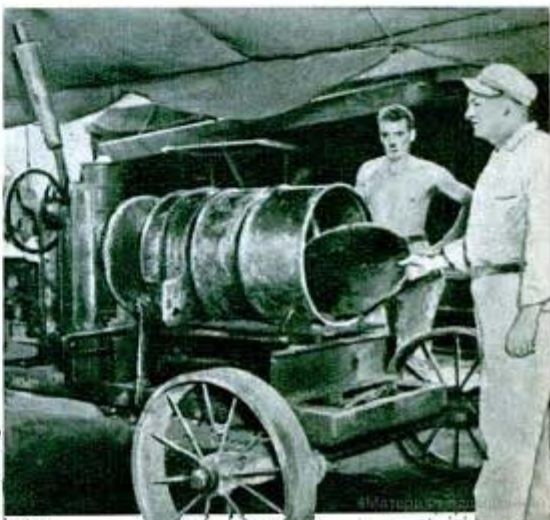

0 292

OCTOBER, 1944

*W. H. Hudson
Baltimore, Md.*

SHOOTING BIRDS *with a* CAMERA



photography; that could mean any one of innumerable methods, even the crude boyhood trick of tying a thread to the camera shutter release and pulling it from a distance.

But after experimenting with many remote control plans (including the thread stunt), I decided the most practical and dependable system is a battery-operated solenoid—the magnetic coil device that operates your doorbell.

Why is remote control necessary in bird photography? The beginner often learns the answer the hard way. He learns that birds are frightened by any

Camera two feet from nest, controlled from blind 30 feet away, caught cardinal feeding its baby

By **Hal H. Harrison**

President, Audubon Society of Western Pennsylvania

HOW in the world do you get so close to those birds?"

That question is part of the routine of my work as a wild bird photographer. I can expect it almost every day, just as I can expect my interrogator to look a bit startled when I answer:

"I don't!"

Mine is a remote control method of bird



The shy Virginia rail above took an hour and ten minutes to decide the camera three feet from its nest was harmless. When it returned at last, the photographer hidden in a distant tent blind (at left) shot the picture

Write to Mr. Harrison
% Camera Club

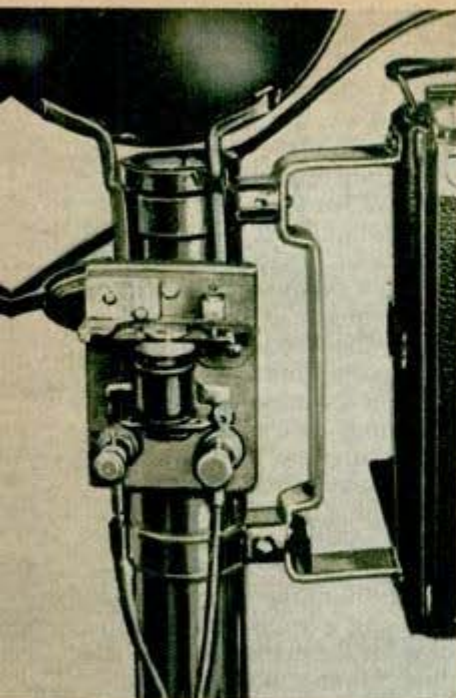

0392

Camera Club
19 N. + +ok. St.
N.Y., 18, N.Y.

Above, the magnet used in remote-control system. Synchronized photoflash and shutter are fired at any distance by closing circuit. Right, robin family poses for photographer sitting in auto



strange thing that moves, but generally will come to accept that is inanimate. Thus, a bird would never approach a photographer, but in most cases it will ignore a camera provided the operator is not in sight.

If the photographer has a telephoto lens, and if his subject is in good light where the shutter may be operated at a speed fast enough to stop movement, a bird blind may be used to hide both the camera and the operator. But since this method is not possible for the majority of amateurs, the remote control system is more practical.

When the photographer operates his apparatus at a distance, the picture must be planned. The bird must be decoyed to appear in a satisfactory pose in front of the lens. The nest is the most commonly used decoy, for the bird instinctively returns to its nest, especially when there are

Camera is mounted on post secured to ladder, with holes every few inches to permit adjusting height of camera to focus on nest

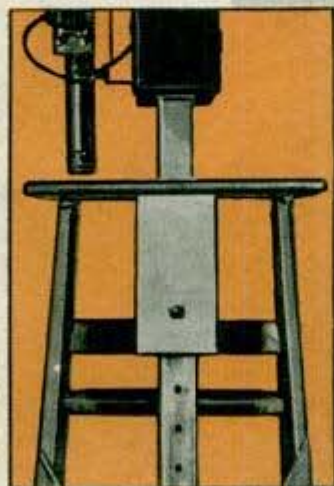



mote control outlet, 50 to 100 feet of insulated wire, and a dry cell battery or two.

The battery is carried with the photographer to his hiding place some distance from the camera. I often use a tent-blind for concealment. One end of the wire is connected to the battery in such a way that the circuit is open. When the picture is to be taken, the circuit is closed. The other end of the wire is connected to the magnetic coil. Mine is a home-made affair mounted on a small board. On the other side of the board are the two prongs of the plug that fit the remote control outlet in the battery case on the camera.

The camera, mounted on a tripod, is focused on the spot where the bird is to be photographed. All apparatus is set up exactly as when a photoflash picture is to be taken and operated in the usual method of pressing the button on the battery case. When all is ready, the magnetic coil is plugged in and the long wire attached to it. The wire is strung to the dry cell battery, under the control of the photographer.

Tree swallow at left was caught by camera mounted on ladder. Cameraman trips shutter and flash by closing contact on terminal of dry cell, shown below

young to be fed. But an ingenious photographer will find other decoys that add variety: feeding stations, bird baths, singing perches, routes traversed when returning to a nest, nesting material racks, etc.

Very often, especially when nests are in heavy shade, the photographer is compelled to work in poor light. It is here that a battery-operated remote control is most useful. Synchronized photoflash is the solution to the lighting problem, and a remote-control outlet in the battery case is the ideal set-up.

The apparatus is quite simple. There are only three necessary pieces besides the camera and the ordinary flash gun with a remote control outlet: the magnetic coil that plugs into the re-



Camera is trained on spotted sandpiper's nest; wire connects it with battery in car



When the bird is in position, the circuit is closed, and the solenoid principle operates the synchronized photoflash in the same manner as it rings a doorbell.

It is helpful, but not necessary, to use binoculars or field glasses to watch the subject from a distance. In the case of small birds that are very active, these glasses are particularly desirable in determining the exact second when the circuit should be closed to shoot the picture.

To reach tree-nesting birds above the range of the ordinary tripod, I have constructed "tripod tops" on four different size ladders. A square hole was made in the top of each ladder. A square box with the center the exact size of this hole was placed under each ladder top. One hole was drilled completely through the sides of each box. A three-foot post was made to fit snugly through the hole in each ladder top and to slide through the box underneath. At intervals of three inches, holes were bored through the post, matching in size and position, the holes in the boxes. A bolt slipped through the box and the post fastened the post at the desired height. On top of the post is a standard tripod screw that fits the camera. By using ladders of different height, and by adjusting the post, a convenient "tripod" is available for reaching nests 15 feet or more high. The fact that stepladders are used makes the camera easily accessible for focusing, changing film and bulbs, and cocking the shutter.

An efficiently operated remote control system is not a guarantee for perfect pictures of wild birds, but it is certainly a means of eliminating some of the heartaches in the hobby.

Although many cameras can be used, it is well to own one particularly suited for this work. I have found that ground glass focusing gives more assurance of good composition and sharp focus.

A thorough knowledge of bird behavior will save the photographer hours, even days of wasted effort. It will also assure him that his work around nesting birds will not jeopardize the lives of his subjects.

Finally, there is the all-important matter of patience. I know of no way to eliminate the need for an ability to wait and wait and wait for the picture which on some occasions never comes. Birds are so unpredictable that there is no sure way of knowing that they will assume a satisfactory pose in front of the camera.

But perhaps it is this challenge to sportsmanship, possessed by almost every man, that makes the hobby of bird photography so intriguing. And perhaps that is why annually more and more hunters lay down their guns to take up a more difficult sport of hunting wildlife with a camera.



Lighted Magnifying Lens Is Aid In Locating Splinters

Old-fashioned methods for removing splinters in fingers or toes are outmoded with a scientific instrument which has a lighted magnifying lens. A splinter is quickly located under the lens and can be removed with a sterilized scalpel. This instrument, used in first aid departments of industrial plants, is especially useful in detecting fine splinters of "invisible" wire.

Radio Waves Sterilize Foods After They Are Packaged

High frequency radio waves, which are providing the heat for many intricate processes in war plants, also serve to sterilize packaged foods to prevent spoilage. The packages of food, such as flour or raisins, move on a conveyor belt through a "radio heat" machine called a megatherm. High frequency waves have a uniform heat penetration. With these waves it is possible to cook a steak rare in two seconds.



Federal Telephone & Radio Corp.
252 South St.
Newark, N. J.

*Chippewa River Plant
Bordov Guitler Corp
Peterboro, N. J.*

0298

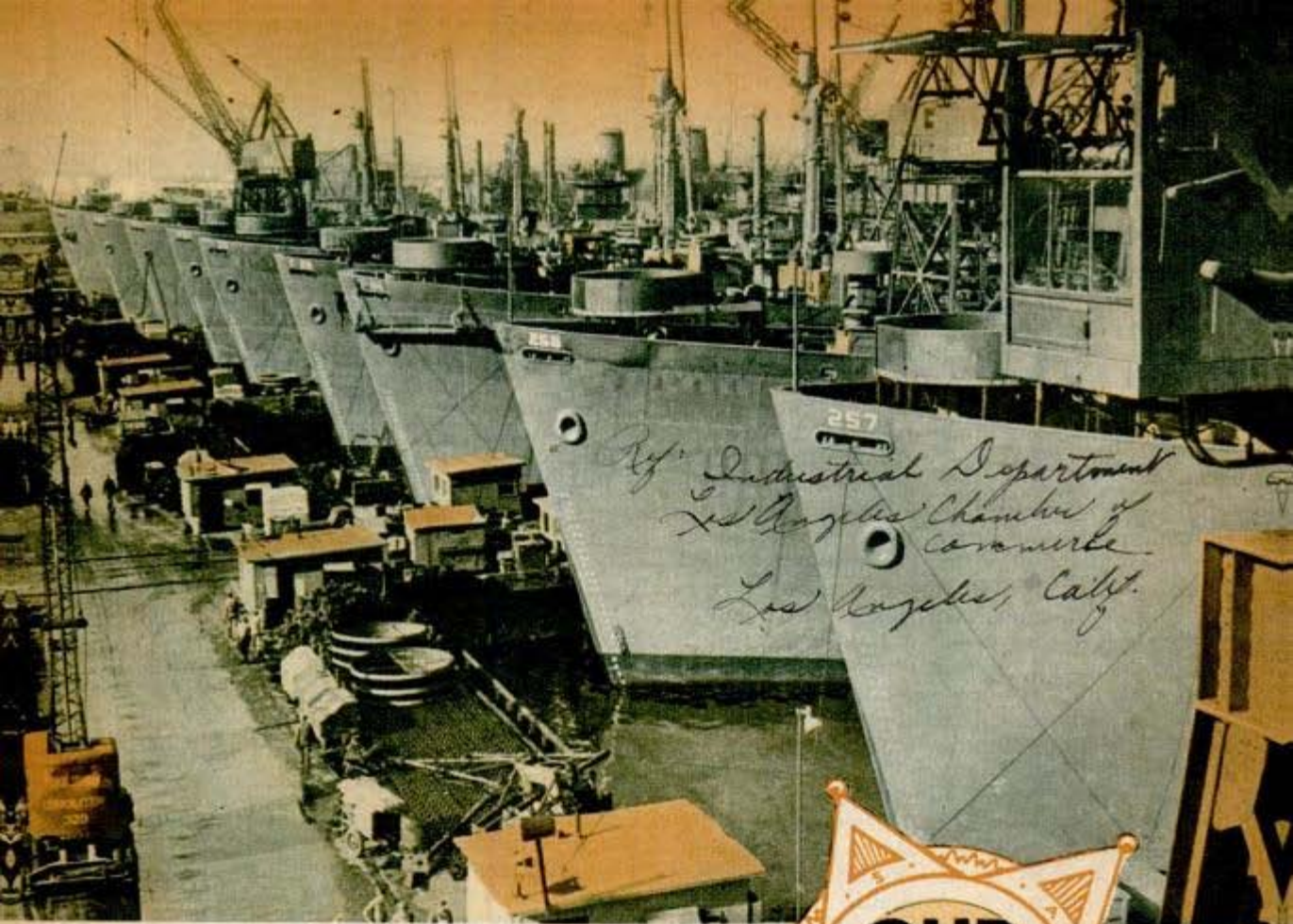

Above, nine Liberty ships get finishing touches at Calship docks, Los Angeles. So many ships are being built on the Coast that putting ribbons on bottles (below) for launchings ranks as a war job



TO A lot of people the West means wide open spaces, cow punching, and gold mining. Mention Los Angeles and they think of oranges and motion pictures.

Such ideas are old fashioned today.

With hydro-electric power from its great dams and fuel oil from its oil fields the West is changing itself into an industrial empire.

Right now the states west of the Rockies, with not much more than 10 percent of the nation's population, are turning out a big part of our war production. Two-thirds of our heavy bombers in addition to large percentages of other aircraft are built there. About half of the nation's ships are launched on the West Coast. The West is producing a third of the country's aluminum and important percentages of our magnesium and synthetic rubber. Landing craft, tanks, guns,

Mr. Stinson: 0268

and armament of all descriptions are manufactured in the West. Los Angeles city by itself is second only to Detroit in the value of war contracts being handled.

Because of these war industries the westward surge of population has resembled another gold rush, with new arrivals estimated at about 1,000 per day. Towns that didn't exist four or five years ago are now teeming, busy communities. Men and women who had never seen an ocean are building flying boats in San Diego today. People who left their middlewestern homes a couple

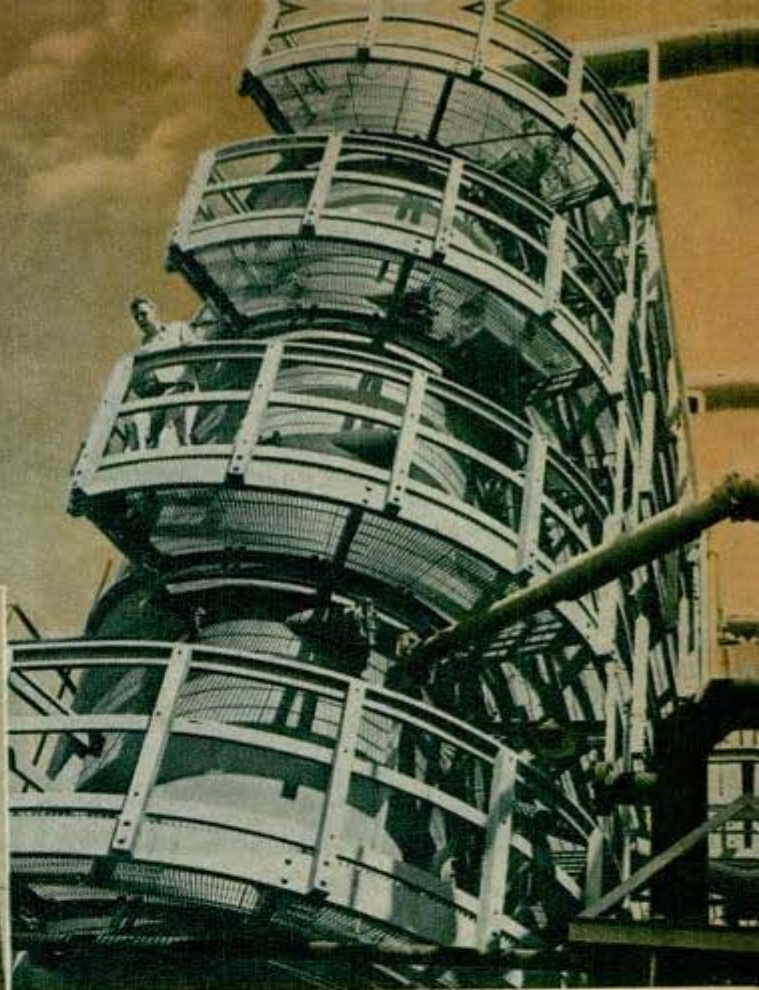
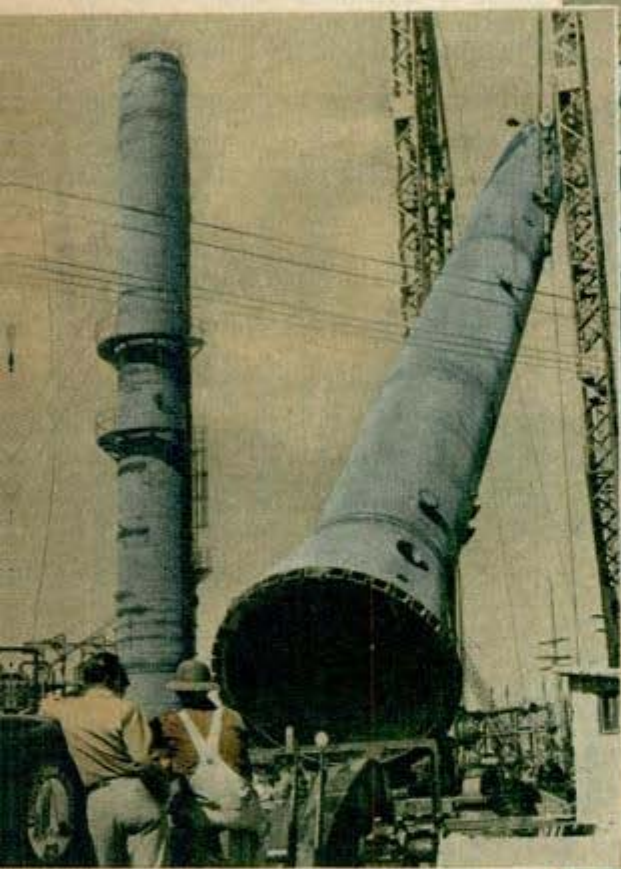

Above, a styrene extraction tower at a synthetic rubber plant. Left, raising a distillation tower. Below, box kites to lift radio antennas on rafts

of weeks ago are making aluminum in Portland or are building ships in Seattle this week. Two thirds of these new arrivals, surveys indicate, will make their permanent homes on the Coast.

The war rushed western industry to the level that it was expected to reach twenty years from now. The fact is that the West was rapidly becoming industrialized before the war began. Important percentages of the country's food, lumber, petroleum, and minerals, from gold to clay, come from the western part of the United States.



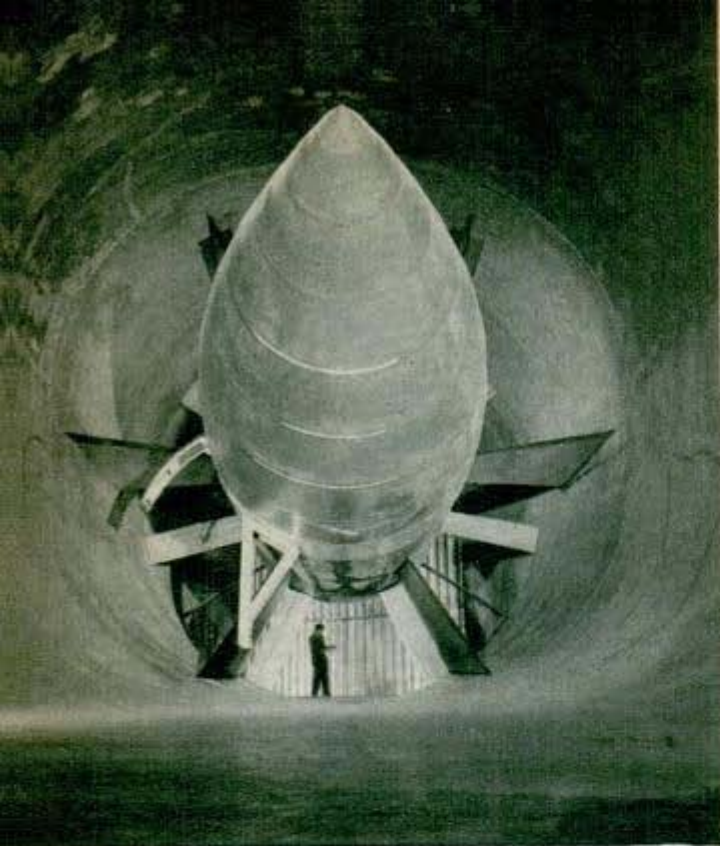

Above, a power nacelle in wind tunnel of aircraft plant in Los Angeles. Right, plywood glider wings in a western glider factory. Below, assembling the "ditty bag" of a ship's life raft, which includes blankets, awning, fishing gear, signal lamps and flares, first aid kit, oils and even magazines and games, besides the necessary food and water

Los Angeles, all by itself, is industrially more important than are some small European countries. The city has been second only to Detroit in the assembly of automobiles, second only to Akron in making tires and rubber goods, and among the top three areas in petroleum refining. It leads the nation in aircraft, motion pictures, sports-wear, and oil well tools. It is the fourth largest furniture manufacturing center in the country. It ranks fifth in the nation in number of factories, number of wage earners, and value of manufactured products.

In spite of such statistics, western economy has been lopsided because the West manufactures only a small fraction of all the goods it consumes. The 11 western states normally buy about 15 percent of the goods manufactured in the country, all but



a small fraction of which is shipped west with the western buyers paying the freight. "Prices higher west of the Rockies" has been a familiar line in many national advertisements. It is estimated that if rugs, for instance, were manufactured on the Coast the average western purchaser would pay shipping charges of half a dollar per hundred pounds instead of more than two dollars per hundred pounds that it now costs to transport rugs across country. The 11 western states purchase 13 percent of the nation's radios and phonographs while producing only two percent of them. Sales of electrical and gas appliances in the West amount to 15 percent of the nation's total,

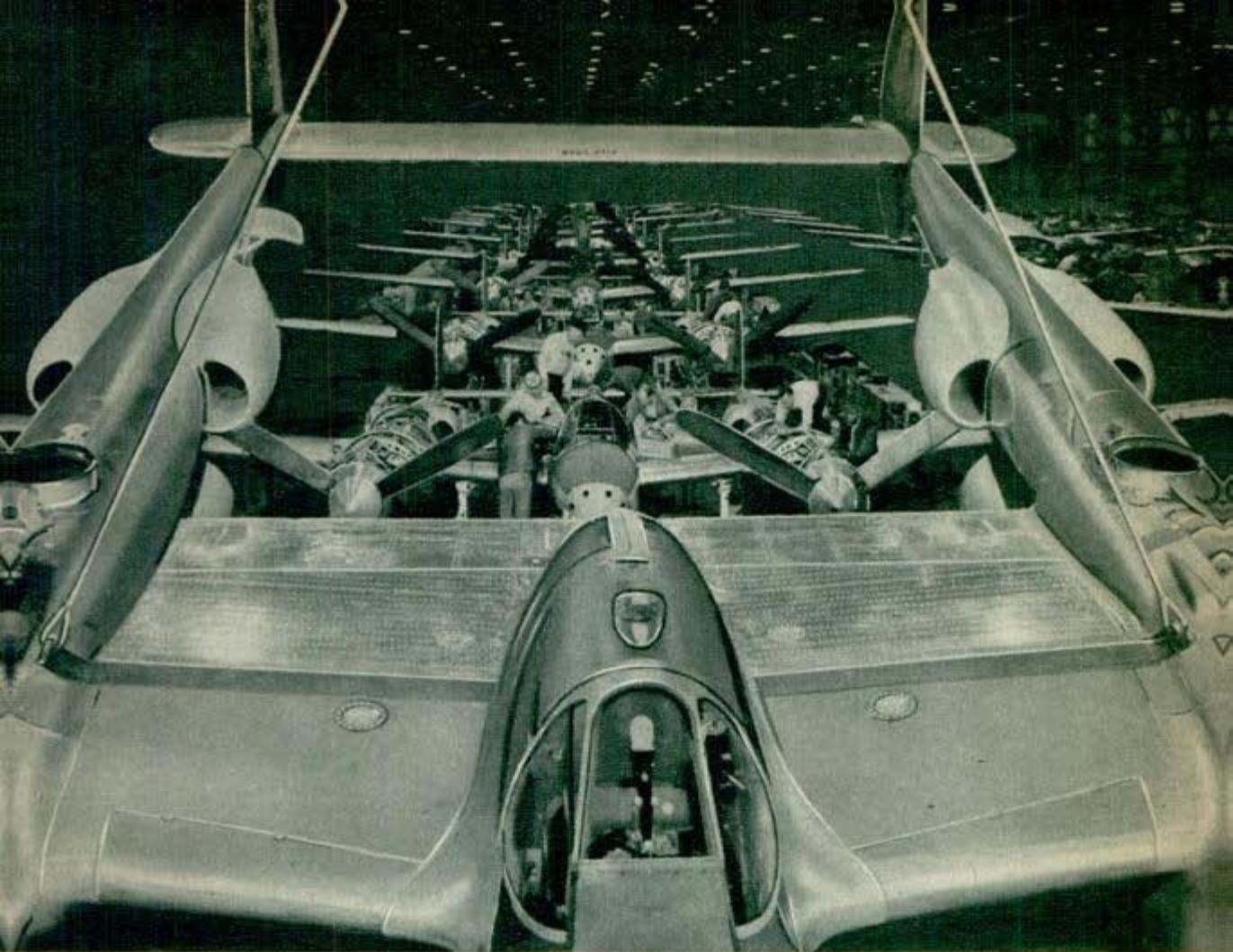

Above, Lockheed "Lightnings" come off assembly line. Manhours required to build a P-38 were halved in the last year. Below, girls make parachutes, an important industry on the war-stimulated West Coast

though only 2.6 percent are manufactured in the West. This explains in part why the West has been building up its own industry.

For a long time, too, the West has wanted to make iron and steel from local ores instead of hauling it from eastern mills at cost plus freight. Deposits of iron ores, coking coal, and limestone are scattered all through the West.

Today, at Fontana in Los Angeles county the Henry J. Kaiser Company is operating the Coast's first fully integrated steel plant, consisting of blast furnaces, open hearth furnaces, rolling mills, structural, plate, and merchant mills. Kaiser's is a \$90,000,000 project. At Geneva, Utah, an integrated steel plant costing twice that much and correspondingly larger, is just getting into production. Both plants are of the latest design, are government-financed, and are currently making ship's plate. They are "war babies" in the sense that they were built to meet the demands of war but western industry hopes to keep them busy after the war is over.

Up and down the coast the capacities of smaller mills for processing steel have been increased and in the Northwest attention is being paid to the possibility of producing electric furnace pig iron. Much of the elec-



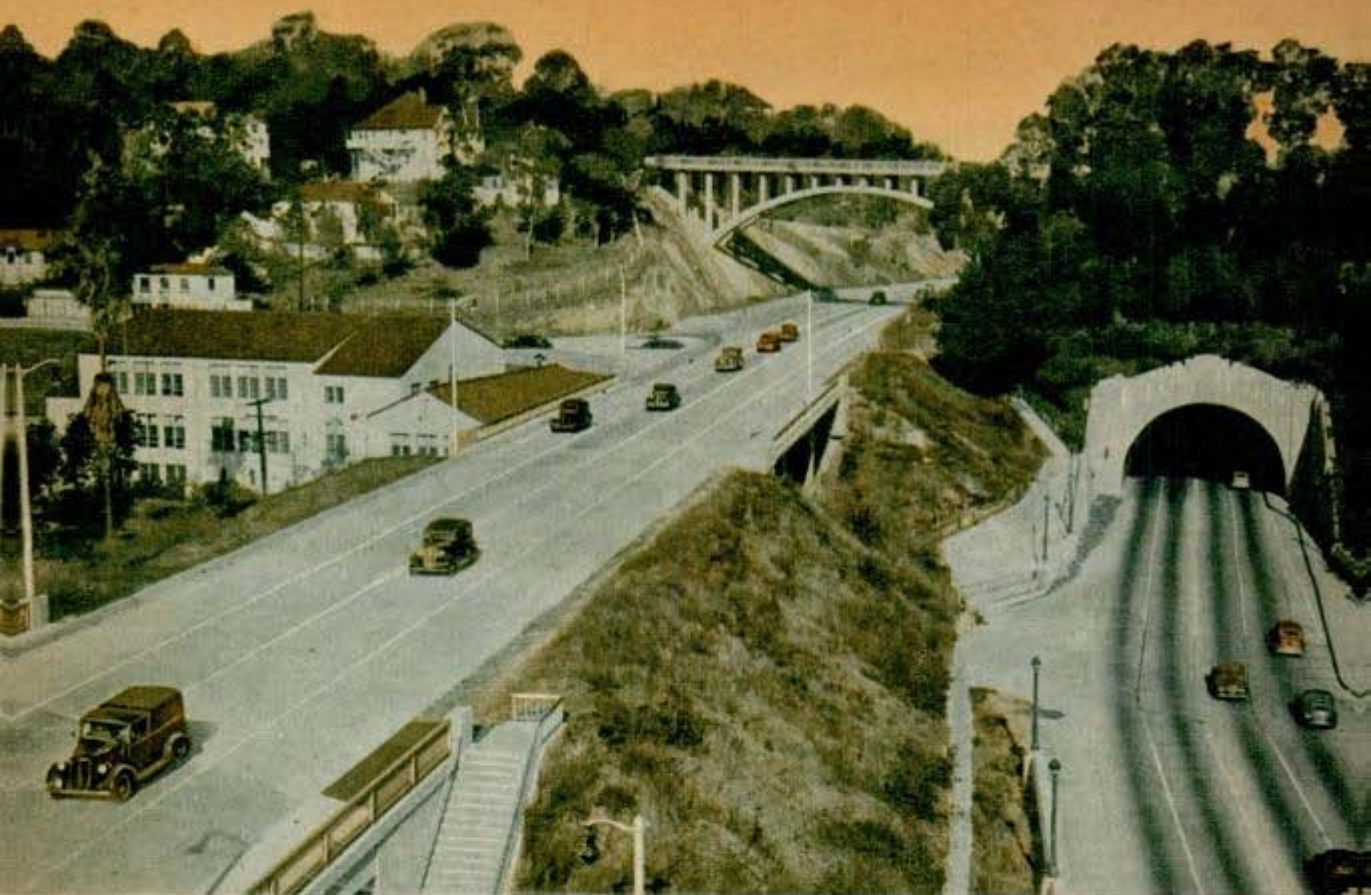

Bridges, tunnels, and roadways provide three levels for automotive travel approaching Los Angeles

tric energy from the Bonneville-Grand Coulee power circuits in the Northwest is currently used to operate five great aluminum plants that have an annual capacity of 500,000,000 pounds of metal.

Magnesium, lighter than aluminum, is being produced in a vast plant near Las Vegas and in a Kaiser plant in California. Six big synthetic rubber plants near Los Angeles are creating rubber at the rate of 90,000 tons per year.

Being new, all the big plants in the West were designed to use modern techniques and to take advantage of the latest ideas. Thus the new synthetic rubber plants manufacture rubber almost without human aid. Automatic instrumentation in the form of a few electric control boards does most of the actual work. Measured amounts of

chemicals are poured into the right vats at the right times, temperatures are automatically maintained, mixing machinery goes to work, and the vats dump themselves when mixing is complete. A handful of men instead of several hundred keep such a plant going.

Another example of modern practice is the Permanente cement plant near San Francisco, called the world's largest. This plant practically runs itself for it generates its own electricity, free, and the electricity in turn performs most of the work. Conveyor belts traveling down a mountain are kept in motion by the weight of the cement ore that they carry, and generators that are rotated by the belts supply current that operates the digging shovels, crushes and grinds the rock, and lights the plant.

Manpower efficiency has gone hand in hand with efficiently designed plants and factories. A heavy bomber that required 37,000 manhours of labor to produce in a typical western plant in 1943 is now built in only 16,000

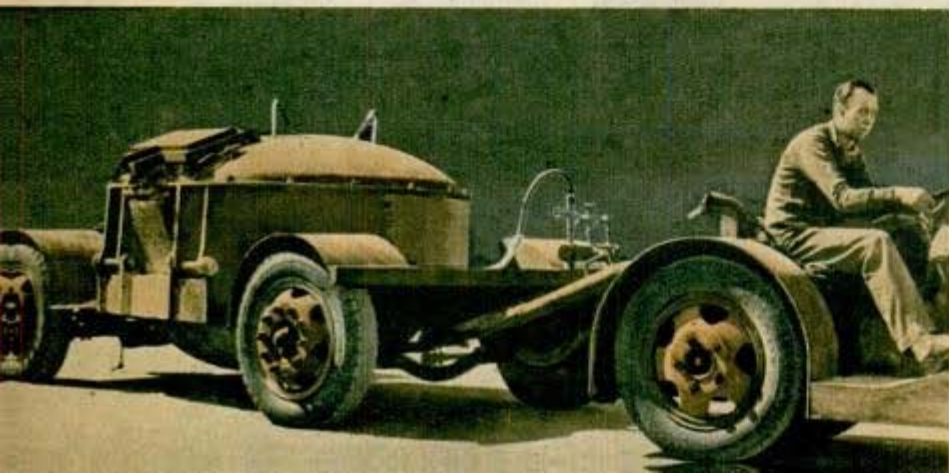

Left, molten metal is carried in pot to Basic Magnesium plant in Nevada for final processing

Beam of Light Protects the Blind On Speedy Sewing Machine

manhours of work, with comparable reductions in cost. Similarly the cost of light bombers was reduced from \$11 per pound in 1941 to \$5 per pound in 1944. Fighter planes cost \$6 per pound this year, half of what they cost two years ago. Mass production methods aren't the only reason, for this year's airplanes are heavier and more complicated than last year's, and have greater range and fire power.

The West is larger than might be realized. Los Angeles city, on the Pacific but still east of Reno, Nevada, covers 451 square miles. Los Angeles county is about as wide as is the distance from New York to Philadelphia. It is roughly the same distance from Los Angeles to San Francisco as it is from Washington, D. C., to Toronto, Canada. San Diego and Seattle are about as far apart as are New York and Kansas City. Most of the West, of course, is sparsely populated. New Bedford, Mass., has a greater population than has the entire state of Nevada, an area that is roughly the size of New England.

Vast areas in the West appear to be utterly useless and yet there is hardly a region from which minerals may not be extracted or that fail to produce good crops when supplied with water. Tungsten, manganese, copper, potash, and other industrial materials are found in the deserts. Millions of acres of arid desertland have been supplied with water from the mountains and are now under cultivation. Millions of additional acres will be available for farming when present water development programs are completed.

These back-log natural resources are reasons why the West anticipates a greater industrial expansion than ever when peace comes. The war brought on the establishment of basic industries that were needed in the West, plus an increase in population that has stepped up the West's industrial needs.

In 1943 the steel industry consumed electricity enough to supply 17,178,000 families for twelve months and fuel oil sufficient to heat 1,406,000 homes for a year—a record-breaking schedule.

OCTOBER, 1944

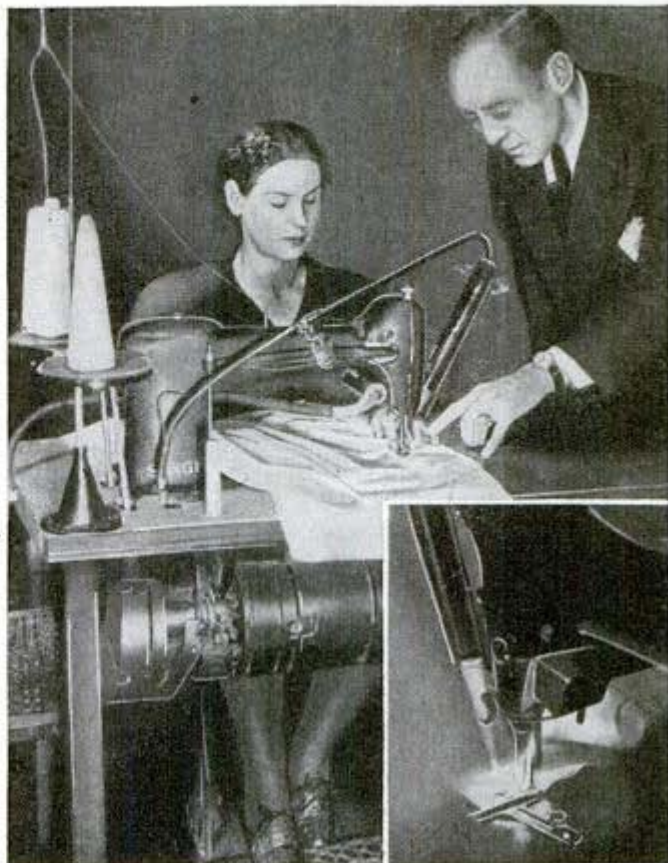

Dr. O. A. K. K. K. American Foundation for the Blind

Blind workers can operate safety sewing machines with needles that move at 4,500 strokes a minute. The machines are equipped with photoelectric cells which cast a protective circle of light around the needle. When the light beam is broken the machine is brought to an instantaneous stop. Attaching the magic eye to the sewing machine was accomplished in the engineering laboratory of the American Foundation for the Blind.

0162

Cellulose Sponge Acts as "Fire Guard" If Flak Hits Bomber's Gas Tanks

Because of the rubber shortage, cellulose sponge has been perfected as a substitute for sponge rubber, or latex foam, in keeping bomber wings as fire-proof as possible. The cellulose sponge, a handyman in millions of prewar households, is inserted in the wing spaces around the self-sealing gasoline tanks to soak up the fuel which usually escapes before the rubber swells to close the holes made by enemy bullets. If allowed to flow into open wing spaces around the tanks, the gasoline would form a highly flammable and explosive mixture with the air. So that the sponge won't absorb water, which would add unduly to the weight of the plane, the "fire guard" is treated with a water repellent. Untreated cellulose sponges are used by the armed forces in large quantities for washing and cleaning jobs.

*C. I. du Pont de Nemours & Co. Inc.
Wilmington 98, Del.*

TELEVISION *after* V-DAY

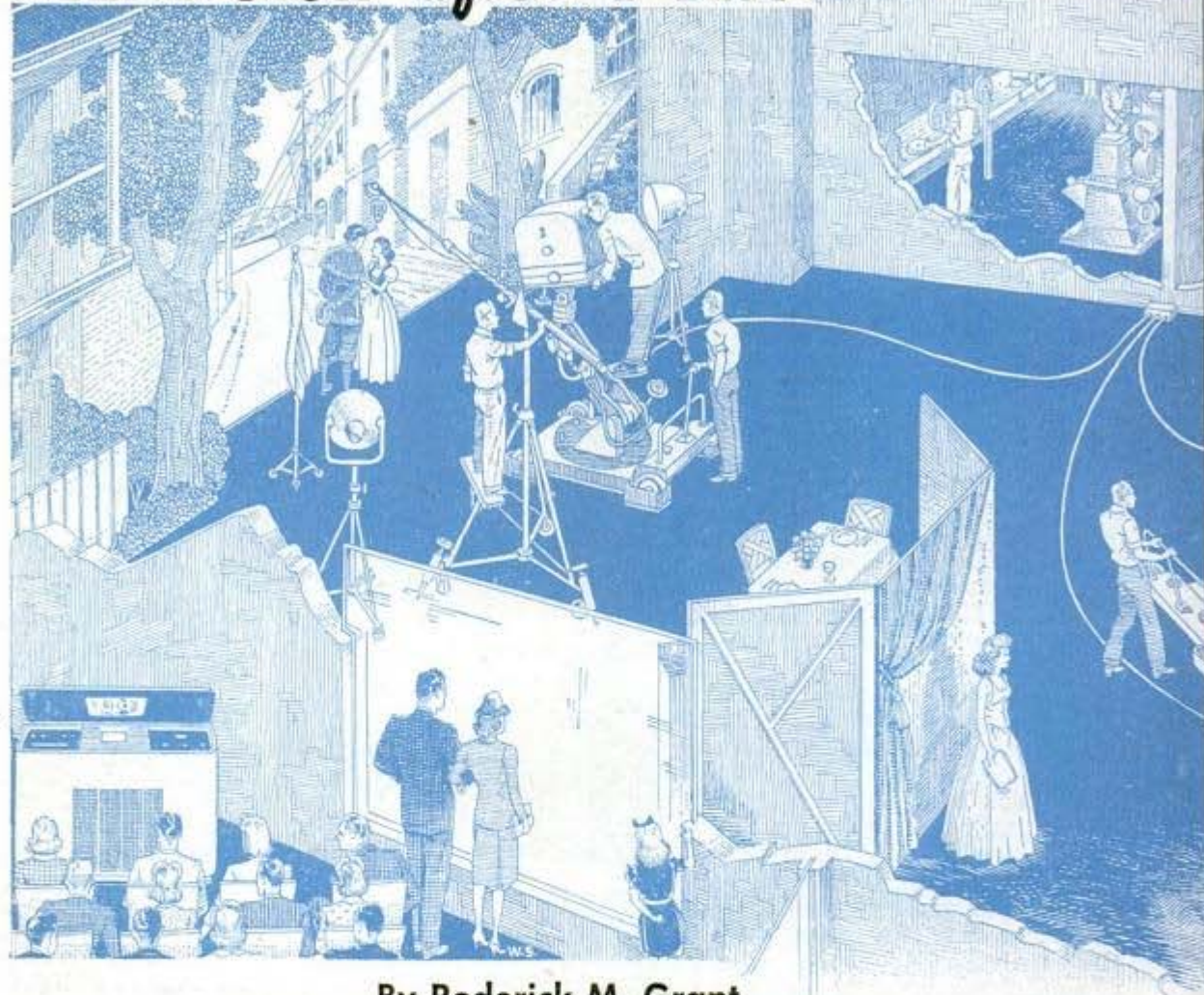

By Roderick M. Grant

THE time is tomorrow. In a certain busy factory the production manager presses a button on his desk and there flashes on the television screen before him a scene at

a strategic spot on the sub-assembly line. He watches the moving line for a moment, then his finger touches another button: the scene shifts to reveal a giant hydraulic press pounding out great metal forms.

That is television at work. Television useful as well as ornamental.

Now look a bit farther into the future. On your living room wall a televised Hollywood movie plays for a roomful of guests. It is televised in full color, and you are boasting that any day now there'll be "airborne" movies in three dimensions.

One of your guests is ready to go home, and you telephone for a taxicab. In a few min-



Quality of picture is controlled at "shading desk" in television studio

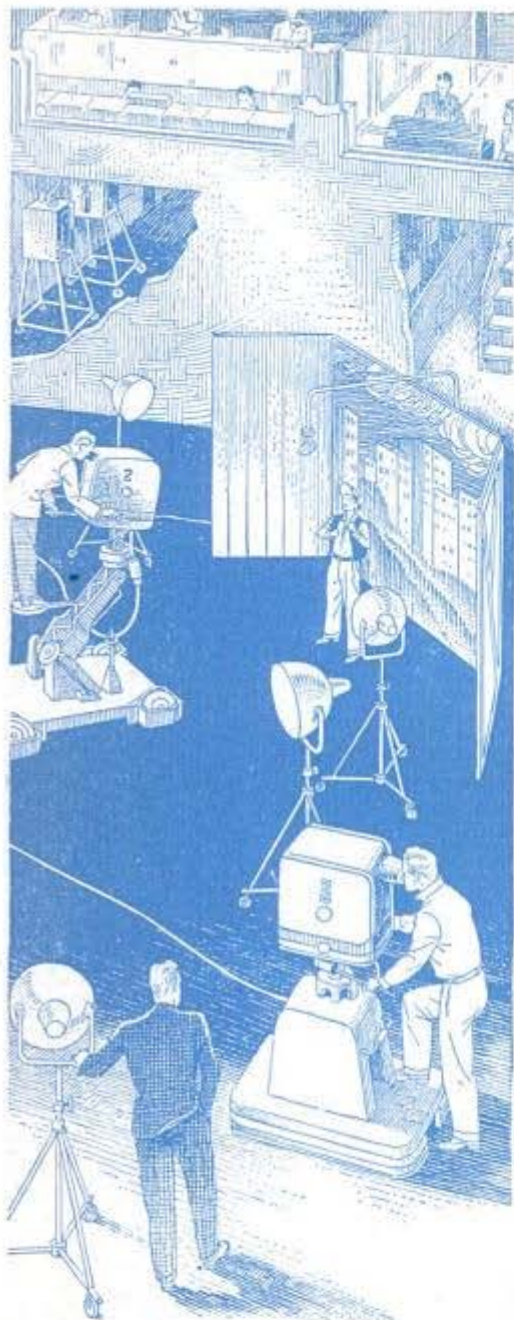

Home television screen on RCA experimental set retracts into the cabinet. Image is reflected to the 13½ by 18-inch screen

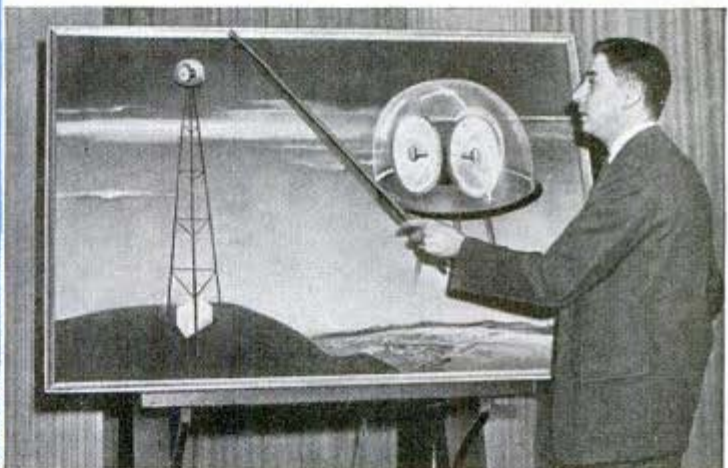

Courtesy General Electric Company

Artist's sketch of television relay station with closeup of receiver and transmitter. Below "televising" a puppet show

utes it arrives, summoned by shortwave radio while cruising. Before retiring you turn on your facsimile set to record the morning news while you sleep; and suddenly your FM receiver automatically comes alive with an important news flash from a master transmitting station that can call in your set without your own help. And when you are out, the magnetic wire recorder takes over as "home secretary" to record any phone calls during your absence.



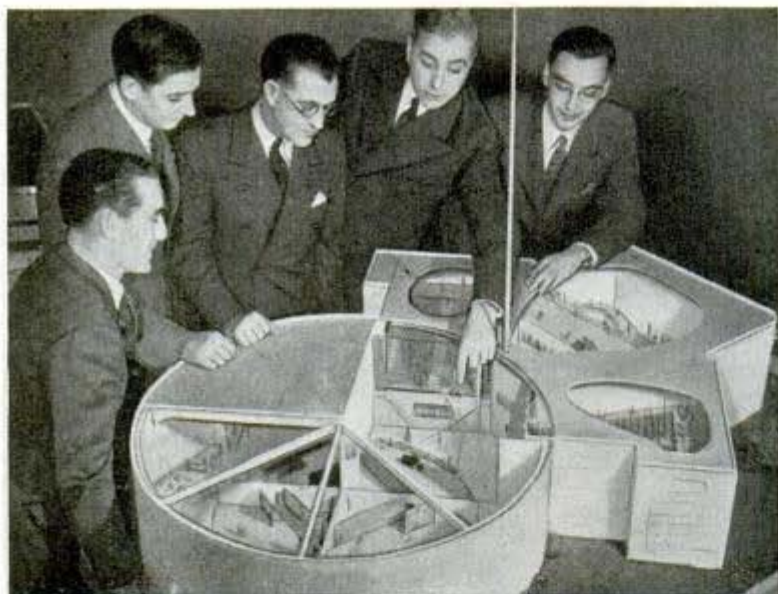

Inspecting model of postwar television building designed by the Austin Company engineers

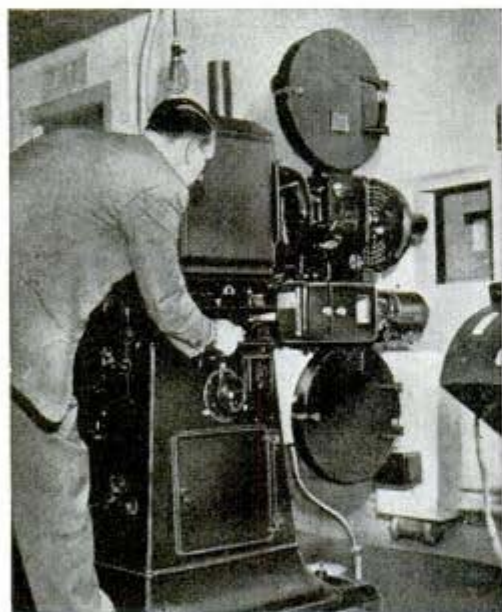

ing, so far as you personally were concerned, to a state of suspended animation. But FM is ready for the boom. It has learned to talk in tanks and fighter planes and landing boats; it is the voice of the walkie-talkie on the Normandy beachhead. It is also the voice of television. It has the multiple advantage of static-free, high-fidelity reproduction through the full range audible to the human ear; high-frequency transmission on a band sufficient to provide channels for upward of 3,000 American FM stations without interference, contrasted with the 912 AM stations occupying only 106 channels today; and FM operates at lower power cost. With amplitude modulation the broadcast signal must be 100 times as strong as any interfering noise on the same wave; with FM, only twice as strong. Translated into

Left, GE movie projector. Below, NBC class watches television show reflected in the mirrored top of the cabinet

A very beautiful dream. And some of it is not so far from realization. After the new rules of peace are posted on the remains of the mikado's palace you will go shopping for an alarm clock, an automobile with 100,000-mile tires, and a radio-television set that does everything but read your mind. You'll hunt through the second-hand stores for an army walkie-talkie to take along on that fishing trip, and you'll learn that your doctor already carries one to keep



in touch with his office at all times for emergency calls; and that truck drivers, ranchers, miners, construction engineers and locomotive crews are wondering how they ever got along without the walkie-talkie.

The makings of that beautiful dream are here—but don't expect too much too soon. We don't say you can't have what you ask for, but it will take time.

Staticless frequency-modulation radio was only a child prodigy and commercial television a babe when the war reduced radio manufactur-

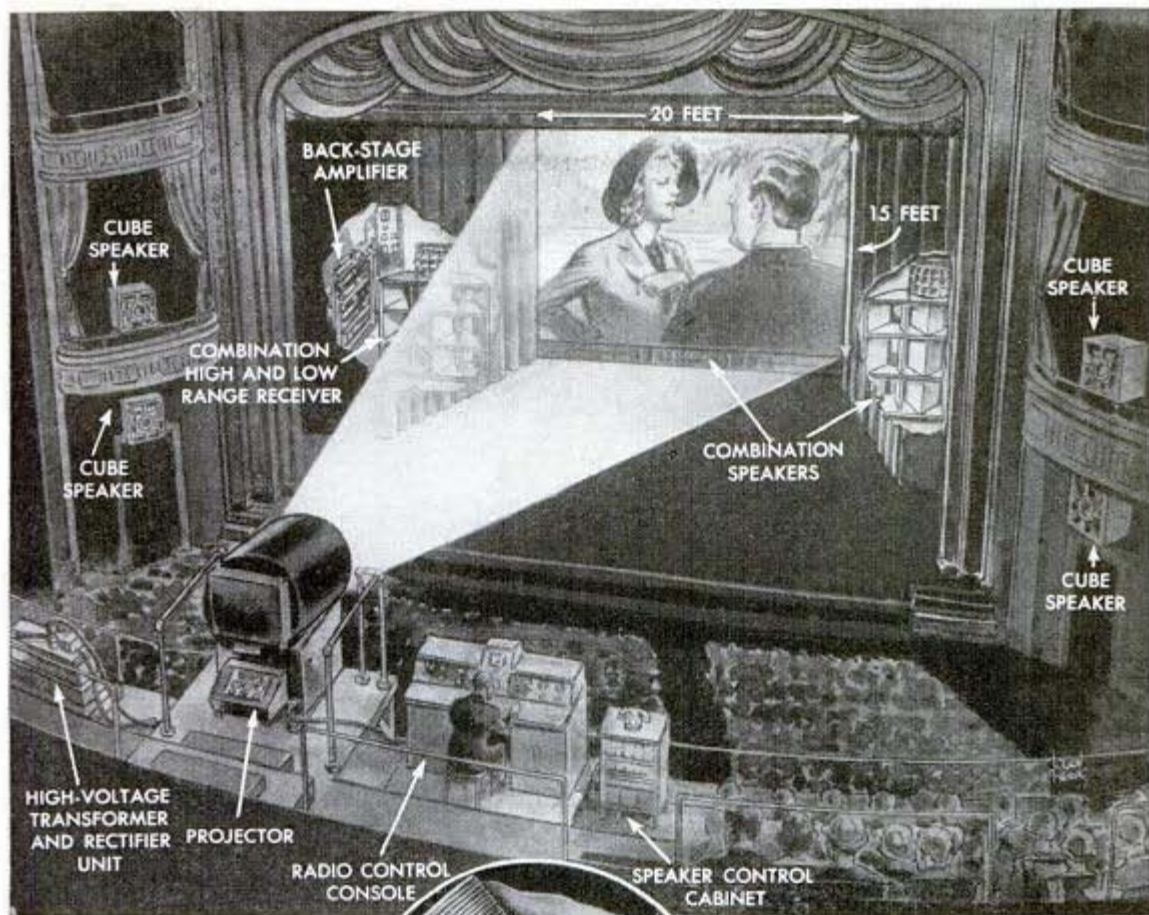

transmitting power requirements, this means that, with respect to elimination of interference, a 200-watt FM station is equal to a 500,000-watt AM station on the same channel.

This all adds up to the confident assertion by the industry that you will be switching from AM to FM after the war. For a time, radio stations probably will broadcast the same programs on both AM and FM. But as FM receivers in American homes (now 600,000) swell to an expected 5,000,000 in the year after Victory and 15,000,000 in five years, standard broadcasting will dwindle, hundreds of FM transmitters will be operating and AM stations will shrink from the present 912 to around 750. Those are the figures of a General Electric company executive.

And what of television?

Its growth stunted by the war, television is enduring a painful



Sketch shows setup for the projection of television in a theater. The tube (left) makes ultra-high frequency relaying possible. Below, using television cameras in studio

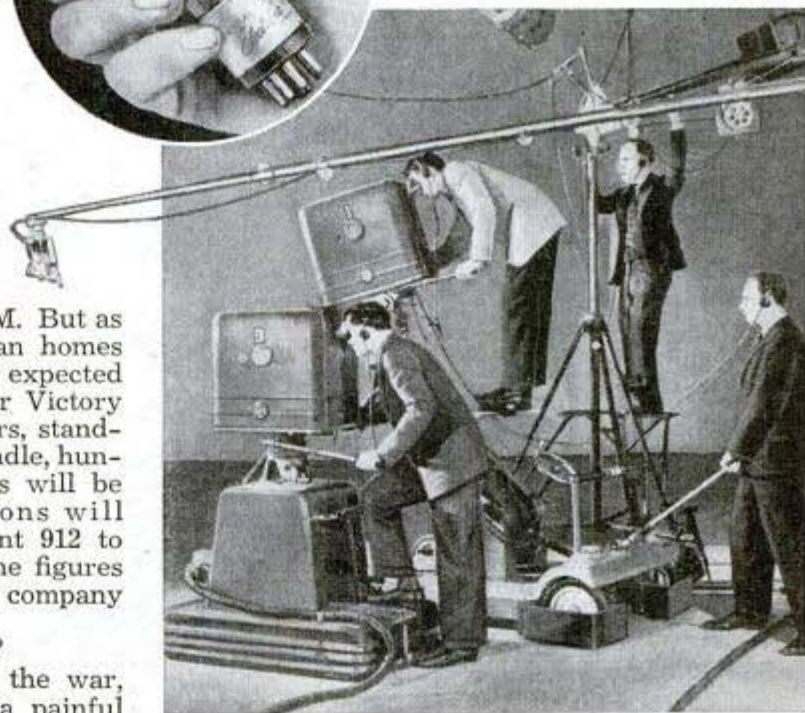



Television transmitter — its range is only to the horizon

adolescence. What's ready, if Victory Day were tomorrow, is the promising if primitive marvel that went on the air to the New York, Schenectady and Hollywood neighborhoods five years ago: airborne talking pictures mirrored to you from a 12-inch cathode ray tube, at times flickering and lightstruck and distorted like a 1910 nickel show. What's ahead is—super.

Television engineers promise you that true color television can be produced 10 years after you relieve them of the burden of war research. A mechanical method of televising color with whirling disks synchronized to a related mechanism in the home receiver has been tried; but electronic color is what the broadcasters order, and it will come.

Experimentally, RCA has projected television on a 15 by 20 foot theater screen. RCA laboratories have built experimentally sets with an 18 by 24-inch translucent television screen for home use, the picture being mirrored to the back of the vertical screen from the cathode



Six-foot home screen for television is a postwar prediction. Below, an early NBC television studio showing camera men working under banks of hot lamps

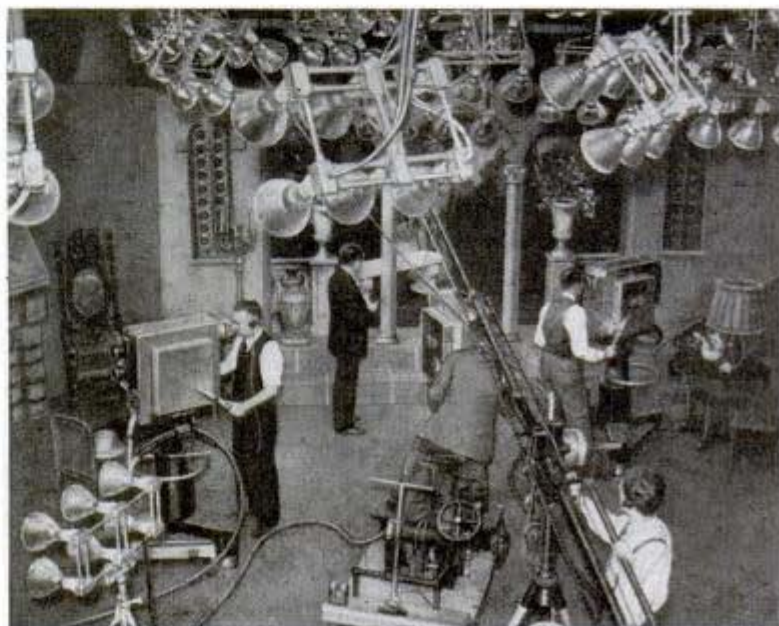

ray bulb. There is also an experimental projector using a 6 by 6-foot screen. The American appetite wants nothing less than today's ball game thrown on the playroom screen as large as life and as noisy. Give them a few years and the magicians of RCA and General Electric and DuMont and the rest will produce a television projector matching today's movies in clarity on a six-foot home screen or a 15 by 20 foot theater screen. In fact RCA is confident that theater television is "practically ready for commercialization immediately after the war."

One of the more painful symptoms of television's growing up is the dispute over postwar standards. The Columbia Broadcasting System brought the issue into sharp focus by calling for a moratorium in the manufacture of television receivers of pre-war type for a year or more after the war, until the industry can develop higher-frequency equipment capable of producing more brilliant, detailed pictures. This would mean the eventual

scrapping of the 7,000 television receivers now privately owned and the \$20,000,000 investment of the broadcasters; but Columbia argues that it would protect the public from further investment in a low-standard television system that would soon be obsolete.

CBS backed its declaration of policy with an order for an experimental transmitter which would operate on frequencies above 400 megacycles, compared with the present CBS television station's 60-66 megacycles. The standard 441-line television image adopted in 1938 contains some 250,000 tiny picture elements, comparable to the dots of a newspaper engraving. The proposed 40-mc picture would contain up to 585,000 elements; the anticipated result, larger and clearer images.

Secrecy surrounds the discoveries of wartime electronic research, but CBS asserts: "Enough has already been done—developed, tested, proved and put to work—to strike off the technical shackles that held pre-war television to a relatively coarse-screen picture. Enough to free television from the straightjacket of narrow-band, black-and-white transmission. Enough to promise pictures twice as large and twice as rich in detail, as well as pictures in full and brilliant color. Enough, in sum, to make the 'good-enough' pictures of pre-war vintage seem not good enough at all, in terms of post-war possibilities."

On the other side of the question, the National Broadcasting Company advocates continued use of prewar standards after the war while research goes on. Niles Trammell, president of NBC, has said: "Television should not be held from the American public while experimenters deal in theory and supposition."

The Radio Technical Planning Board, representing the industry, is studying the problem and its recommendation will be considered by the Federal Communications Commission in deciding whether the folks in Tallahassee, Topeka and Tucson will see television soon after the war, or not until television betters itself.

Many tough technical problems remain. Many are being solved in wartime research. General Elec-

Giant "Bombs" to Protect Radio Are Molded Plastic Domes



Three different-shaped plastic domes which, when stacked one on top of the other, resemble a block buster bomb, are used to protect wartime radio equipment built by General Electric. The largest of the three domes, painted black, measures 35 inches in diameter and 43 inches in height and is one of the largest single pieces of plastics molded by General Electric at its Pittsfield, Mass., plant.

tric has introduced a tube not much bigger than your thumb, generating frequencies beyond 1,000 megacycles; it may be the heart of nation-wide television networks. The early difficulties of providing highly intense studio lights by which the Iconoscope can pick up nearly 6,000,000 picture elements per second are being eased; actors who once perspired and wilted under the heat of multiple banks of lamps now perform coolly under water-cooled mercury lamps. RCA has a new supersensitive tube that "sees what the eye sees."

Continued to page 148

Plastic "Ghosts" of Women Pilots Studied by Plane Designers



a sixth of the possible efficiency (100 lumens per watt). 2—How to get two colors from the same electrical discharge in a gas or vapor. 3—How to combine fluorescence with phosphorescence and prolong the rate of decay of the latter. 4—How to conserve fuel by placing radiant heat directly onto the body rather than heating the air. 5—How to develop indoor sunshine for a vegetable garden in the basement. 6—How to develop walls and ceilings as glowing light sources. 7—How to use visible light as a glorifying medium, sometimes described as "mood conditioning," rather than the elementary job of utilitarian seeing.

Tug's Big Propeller Drive Includes 10,000 Parts

More than 10,000 parts went into the enormous marine propeller drive used on the Navy's new 110-foot harbor tugs. The largest roller chain application of its kind, it couples two direct-reversing Diesel engines of 635 horsepower each to a single propeller with 3 to 1 reduction and provides outstanding advantages in efficiency, economy and flexibility.

Life-size manikins made of plastics are used by the Air Forces to enable designers to adjust plane interiors and equipment to the comfort of women Air Force service pilots. The "ghosts" were sculptured to the composite dimensions of three average WASP types—large, medium and small—after 35 measurements had been taken of each WASP. The manikins are made in sections and the mechanical action of each human joint is reproduced by means of elastic "tendons," making possible more natural studies of operating space requirements. While they are seated or standing in the plane, the manikins' transparency gives the designers a clear view of points of contact.

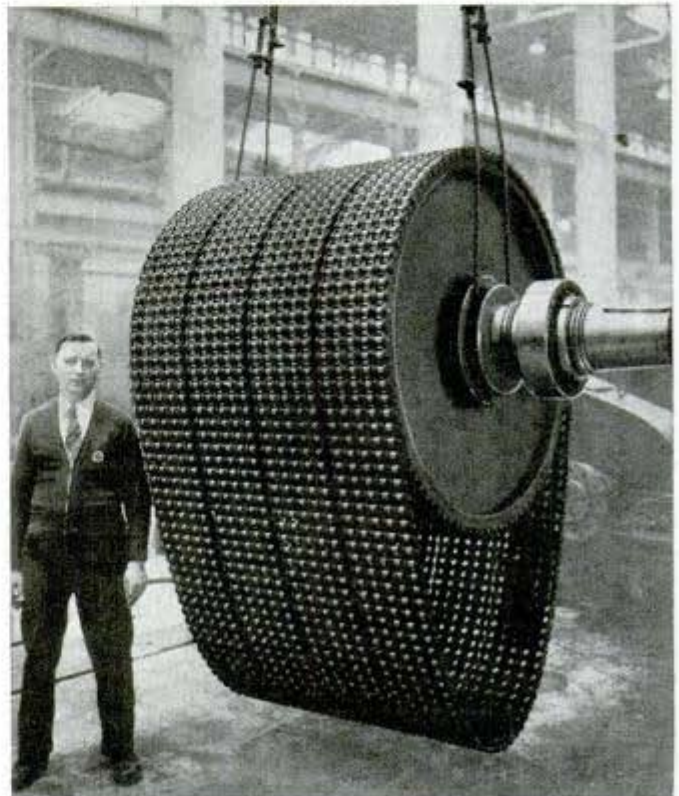

The enormous propeller drive dwarfs man standing next to it

Seven Tasks for Scientists Listed by Research Man

Seven unsolved problems awaiting the answer of future research men were listed recently by a Westinghouse engineer. They are:

1—How to make electric lamps of

*C. S. du Pont de Nemours & Co., Inc.
Wilmington, Del.*

*Dr. S. G. Hobbes, director of Applied Lighting, Westinghouse Electric & Mfg. Co.
Pittsburgh, Pa.*

POPULAR MECHANICS
*Morse Chain Co.
Ithaca, N. Y.*



Sturdy **PULL-UP CHAIR** *has graceful lines*

By Benjamin Nielsen

WITH its sturdy double-tenoned and doweled construction, this pull-up chair is not only designed to give long service, but it also has simple, graceful lines that are becoming to any living room. Walnut always is a good choice of wood for a chair of this type, but any other hardwood will do equally well as all of the frame is covered except the legs and arms, which should, of course, be made of a tough hardwood that has an attractive grain.

The rear legs and back support, Fig. 6, are sawed from 1 $\frac{3}{4}$ -in. stock 5 in. wide, and mortised for the top and bottom rail tenons as shown in Fig. 2. Top and front rails are band-sawed according to the pattern in Fig. 1, each having tenons $\frac{5}{8}$ in. thick and $\frac{7}{8}$ in. wide at the ends. For the top rail, use a piece 1 $\frac{1}{4}$ in. thick. Because of the bulge in the center of the front rail, a piece of 2-in. stock is required for it. Since the back rail is 3 $\frac{3}{4}$ in. shorter than the front to allow for the outward spread of the chair, the side rails should be beveled at one end as shown in the detail of Fig. 2, to fit snugly against the back support and conform to the spread. All mortise-and-tenon joints in the legs are reinforced with dowels as indicated in Fig. 9 to assure unusually rigid construction. The dowel holes are drilled from the inside surfaces of the legs, and can be drilled



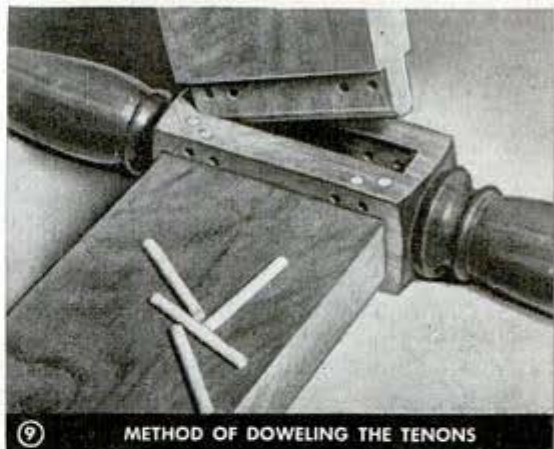
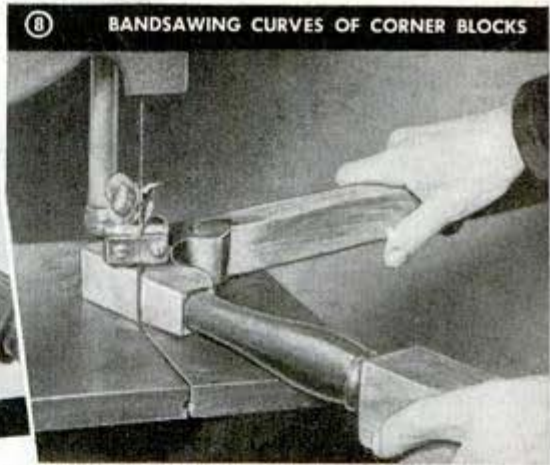
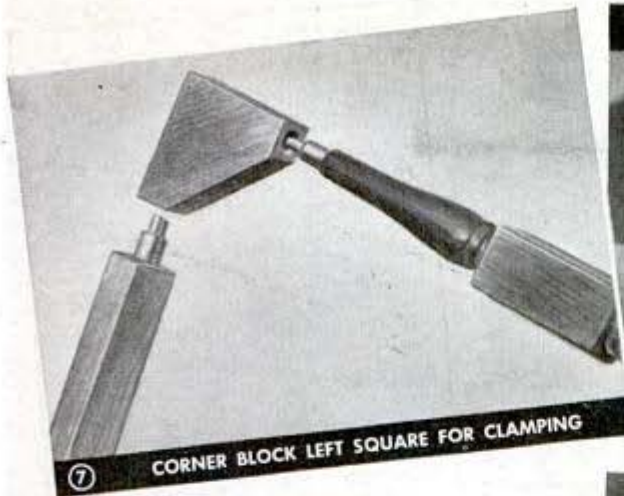

clear through the front legs as they are covered with veneer at these points. However, if veneer is not used, the holes should be stopped before the drill breaks through the outer surfaces, otherwise the dowel ends will show in the finished chair. Also, the dowel holes in the rear legs must be stopped, as the legs are not covered at these points. Front legs are turned to the dimensions given in Fig. 3. Note that the tenon at the upper end which fits into the hand rest is stepped to reduce the diameter so that it may be extended farther into the hand rest, Fig. 4, than would be possible otherwise. If the tenon were turned to the same diameter for its entire length, its end likely would be exposed when the hand rest was shaped to size. Therefore, to provide sufficient diameter to resist breakage of the tenon under strain and to allow the tenon to be inserted into the rest far enough to afford a good glued joint, it is turned to two diameters.

The front legs are mortised for the side-rail tenons and burl veneer is applied to front and sides as shown in Fig. 5. Arm rests are cut to fit. These also are step-tenoned at the front ends and taper slightly from front to back as illustrated in the upper detail of Fig. 2. They are notched at the rear ends to fit over the back support to which they are doweled and glued, using dowels as large as possible without the dowel hole weakening the arm.

Fig. 4 shows the construction of the corner block from which the curved hand rest is cut. The shape of the upper curve is found by locating a common point 4 in. from diagonal corners of a 4½-in.-square piece of wood. Measure off 1¼ in. from these corners and from these points locate a common center of 5½ in. radius from which to scribe the inner curve. If you wish to carve the sides as indicated, the design should be marked off now, after which the block is sawed to the shape

shown in Fig. 7 to facilitate clamping the pieces tightly when they are glued. Following this, holes are drilled for the tenons. Then the legs and arms are glued in place in the corner block and, when thoroughly dry, the curves are band-sawed, Fig. 8, after which the design may be carved on the sides and the corners rounded by sanding. Do this carefully to avoid ruining the piece and thus waste a lot of meticulous work already done. Assemble the members with glue and clamp all corners tightly until dry. Apply a filler and rub it into the grain thoroughly, after which the frame is varnished.

After completing the framework, you are ready for the upholstering job. If suitable springs are not at hand for the seat, you may be able to use some of the pocket type taken from an old automobile cushion. These should be sewed into pockets of new material, preferably muslin, and installed as shown in the illustration opposite Fig. 1. If coil springs are available, webbing may be used to support them in the seat frame, or plywood nailed to the lower edges of the side rails as suggested in Fig. 11. If webbing is used, the springs should be sewed tightly to the strips as shown in the circular detail of Fig. 12. Upholsterers' cord is

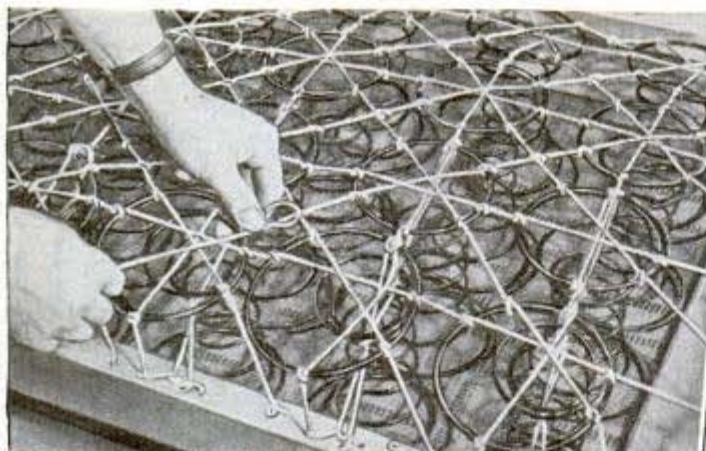

10 HOW SPRINGS ARE TIED

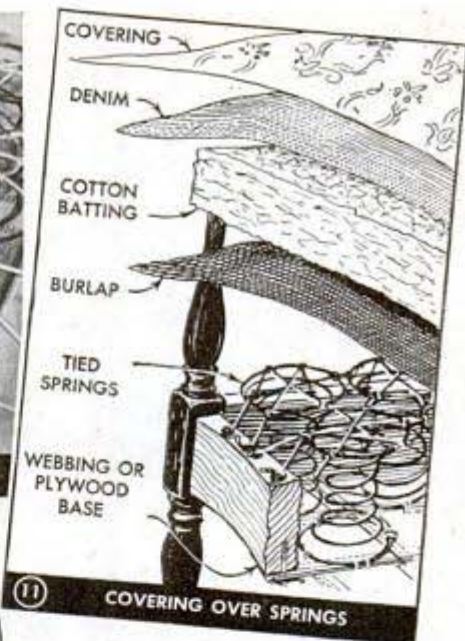

11 COVERING OVER SPRINGS

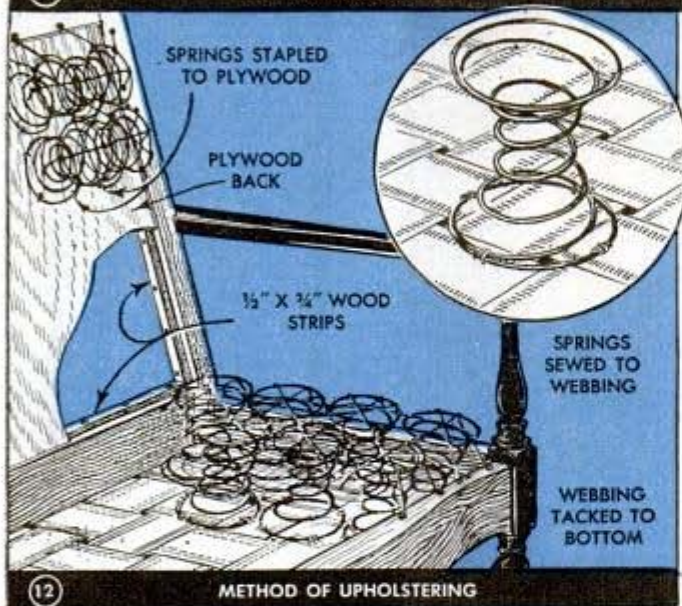

12 METHOD OF UPHOLSTERING

wood, supported by and bradded to wood strips or narrow molding, will give firmer support to the occupant's back than the more resilient webbing. The springs are attached by staples driven into the wood and clinched on the back.

To upholster the seat and back, cover the springs with a layer of heavy burlap pulled down tightly and tacked to the side rails. Place over the burlap a generous padding of cotton batting. Curled hair or kapok is, of course, superior to cotton but may not be available.

Over the padding, denim or some equally strong fabric is laid and nailed smoothly in place, and finally the tapestry cover is tacked in place. Gimp may be fastened by upholsterers' tacks around the lower edge of the seat, along the edges of the legs and around the back to give a finished appearance to the job.

tied to each spring to brace it in all directions, and nailed to the side-rail edges as in Fig. 10. If the cords are not pulled tight before tying, the springs will tend to loosen and cause bulges and depressions in the covering to spoil the appearance of your work. For the back, a sheet of $\frac{1}{4}$ -in. ply-

equally strong fabric is laid and nailed smoothly in place, and finally the tapestry cover is tacked in place. Gimp may be fastened by upholsterers' tacks around the lower edge of the seat, along the edges of the legs and around the back to give a finished appearance to the job.

Band-Saw Table Pin Removed With a Claw Hammer

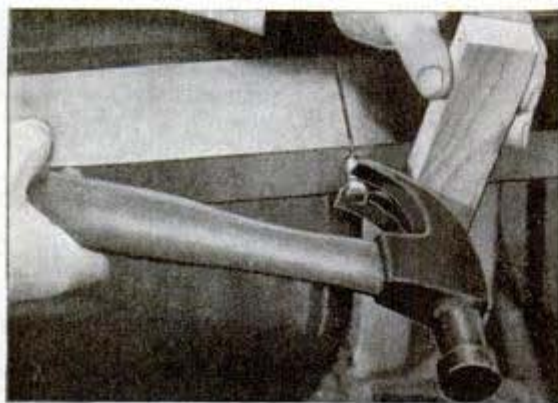

The next time you change band-saw blades, try the simple claw hammer-and-block method of removing the table pin. As shown in the photo, the pin can be pulled straight out. This method eliminates ugly scratch marks which invariably result when pliers are used.

Spectacle Case Holds Tokens

You can keep ration tokens conveniently in a discarded spectacle case. Such a holder is large enough for all the tokens of the average family, and it is flat enough to be kept easily with the ration books.

Winter Air Refrigerates Vegetable Storage Room

Safe storage of vegetables in a basement requires that the storage room be kept as cool as possible, and that proper ventilation and humidity be maintained. To approximate this condition in the average home, the owner can bring cool air in from the outside by means of a 3-in. sheet-metal heater pipe as shown. The pipe should extend down to within 6 to 8 in. of the floor, and a short outlet pipe should be provided as indicated to permit air circulation. A damper in the inlet pipe permits regulation of the incoming air to prevent freezing inside the storage room during extremely cold weather. As the storage room should be dark inside, a shade is fitted over the ends of the pipes where they pass through the outside wall. This is merely a triangular box having the underside open. Screen wire over the ends of the pipes keeps out insects. Of course, the storage room should be tight to

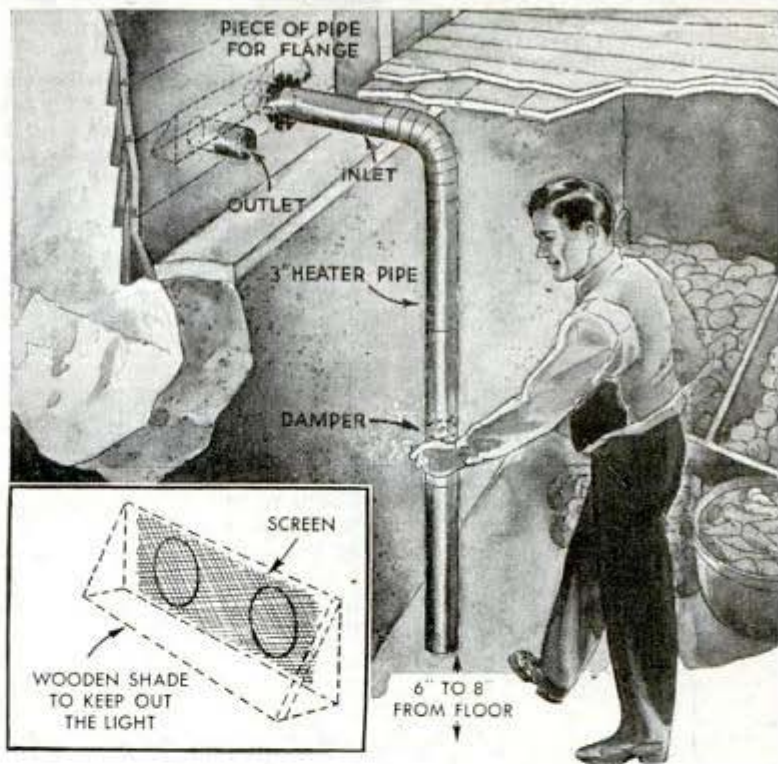

keep cold air from entering the rest of the basement. If possible, the room should be insulated. This can be done inexpensively by lining it with 1/2-in. insulating board, which is available at your lumber yard.

keep cold air from entering the rest of the basement. If possible, the room should be insulated. This can be done inexpensively by lining it with 1/2-in. insulating board, which is available at your lumber yard.

Glass Lining Inside Grinder Cup Prevents Rusty Water

Water poured directly into the grinder water cup quickly becomes rusty and dirty because the water attacks the metal. Clean water and easy changing are provided by fitting the cup with a glass jar or tumbler.



Slender Cut Made on Circular Saw With Aid of Wood Strip

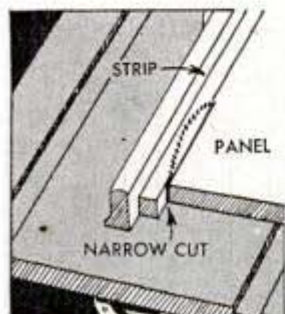

Lacking the use of a jointer, or when the fence on the power saw is not equipped with a wooden side, a saw cut equal to, or less than, the thickness of the saw blade can be shaved off a panel with the help of a

1-in. strip of wood. The fence is set 1 in., plus the thickness of the ripping desired, away from the outer teeth of the saw, after which the strip and the panel are worked through the saw simultaneously.

Solving HOME



Instead of storing long candles in a drawer when not in use, suspend them by their wicks. This keeps them straight and prevents accidental breakage

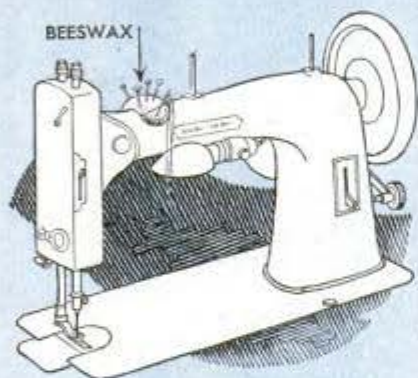

You can keep pins and needles conveniently at hand at your sewing machine if they are pushed into a piece of beeswax stuck to the machine

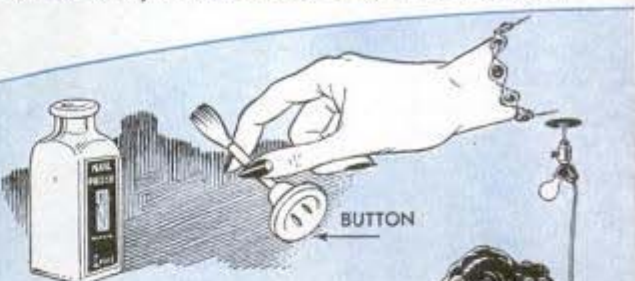

Cement a large button to the stopper end of your nail-polish brush and you can stand it on end when you want to set it down. This prevents getting polish on the vanity and makes the brush easy to pick up

When ironing long articles, such as curtains, use of a holder like the one below will keep them from touching the floor. It folds for storage and consists of X-shaped end pieces joined by dowels and covered with cloth



Supporting small laundered pieces near a radiator to dry them is no problem if a coat hanger is hooked over a cork wedged between two radiator sections

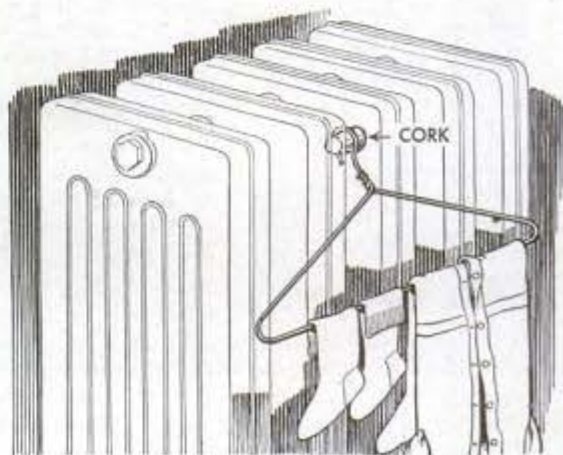

When the refrigerator is crowded, carrots will keep fresh and crisp outside of it, if placed in glass jars. Wash the carrots and, while still wet, place them in jars, screwing the lids tightly to retain moisture

PROBLEMS

To remove a cork that has been pushed inside a bottle bend a narrow piece of screen wire to a trough shape and insert it into the bottle under the cork, which then can be pulled through the bottle neck

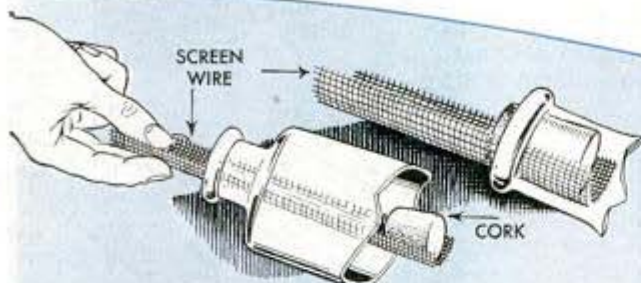

Depressed spots in the gasket of a refrigerator door that permit air leaks often can be repaired simply by placing strips of adhesive tape behind the spots to bring them out flush with the edge of the gasket

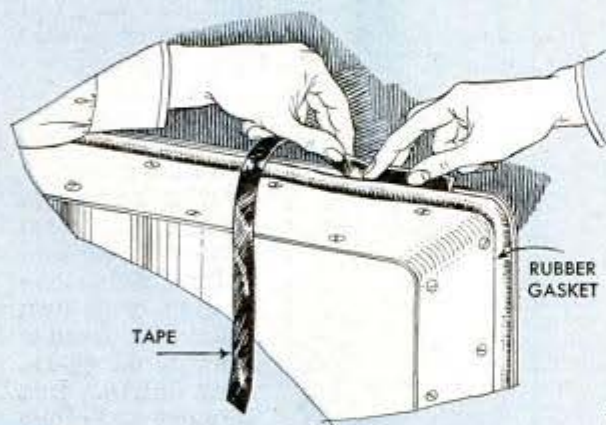

If a hose is unavailable for wetting ashes to keep down dust while removing them from a furnace, a garden sprayer of the tank type will do

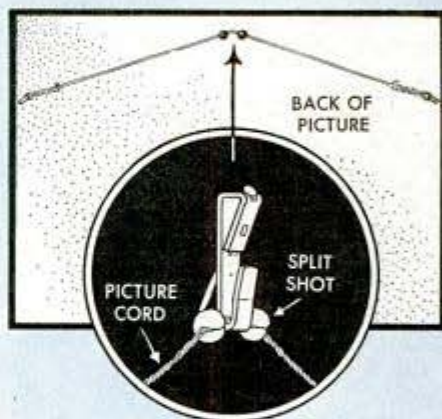

Wall pictures will not slip and hang at a slant if a lead-shot fishline sinker is pressed over the picture wire at each side of the hook that holds it

With this frame in a soap dish, soap dries more quickly and less is wasted. The frame is made of $\frac{3}{4}$ -in. stock, the V-cuts being formed on a circular saw

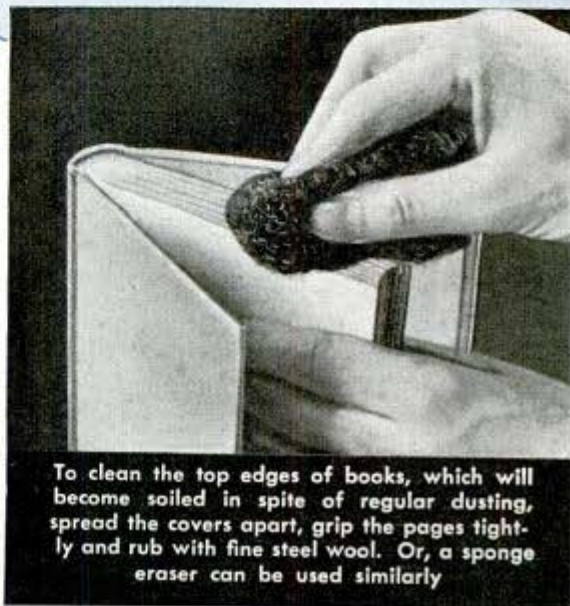
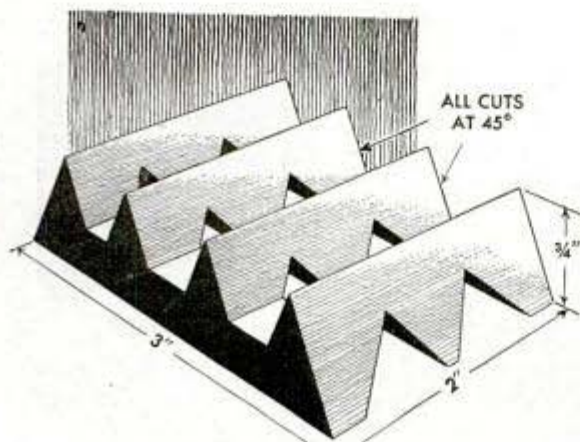

To clean the top edges of books, which will become soiled in spite of regular dusting, spread the covers apart, grip the pages tightly and rub with fine steel wool. Or, a sponge eraser can be used similarly

Fixture Stiffens Insulating Board To Saw It Lengthwise

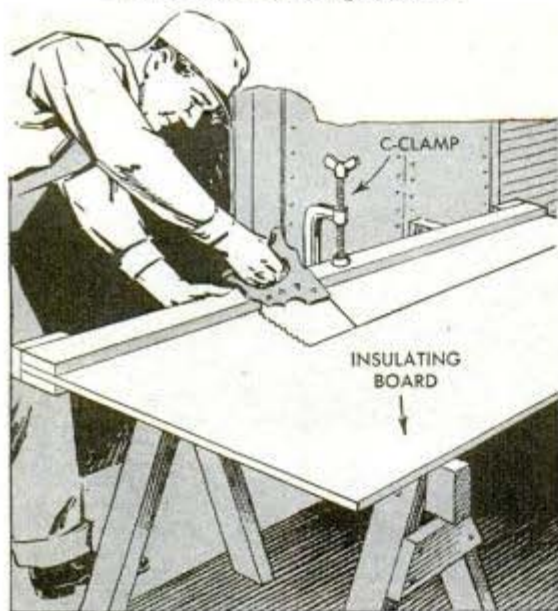

Difficulty often experienced in sawing long panels of insulating board because of its flexibility can be overcome by using a fixture to stiffen the panel. The fixture consists of a couple of wood strips, which are spaced to slip over the edge of the panel and then cleated together in this position. In use, the fixture is merely slipped over the edge of the panel to be sawed as shown, using a C-clamp at the center to hold the fixture in place.

Taper-Shank Lathe Attachments Held Securely by Tie Rod

Unless held in by end pressure, taper-shank fittings used in a lathe may work loose. This annoyance can be prevented by using a $\frac{1}{4}$ -in. tie rod of sufficient length to pass through the lathe spindle. Most shanks are already tapped with a $\frac{1}{4}$ -20 hole for this purpose, but if not, it is a simple matter to drill a hole and then tap it to take the tie rod. A positive mounting of

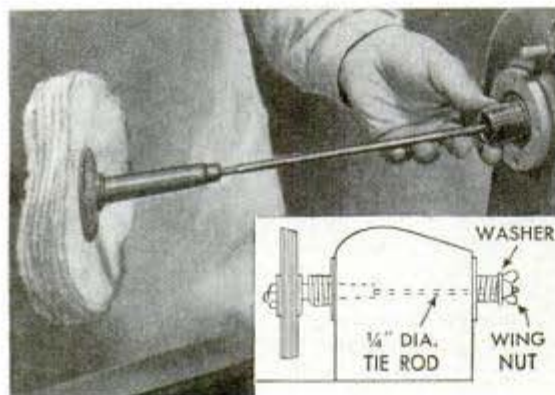

this kind always should be used when working buffing wheels, grinding wheels or drum sanders at high speed.

Replacement Knobs Cast Easily From Babbitt Metal

If you break a corrugated knob of glass, plastic or metal on some machine or instrument and a new one is unavailable, one can be cast from babbitt metal. Just bore a hole of suitable size in a hardwood block, and then make the corrugations with a three-cornered file. Set the mold on a board, which then serves as a bottom for the mold, and pour in the molten babbitt metal, first inserting the spindle or arm from which the knob was broken.—O. W. Nolen, Odem, Tex.

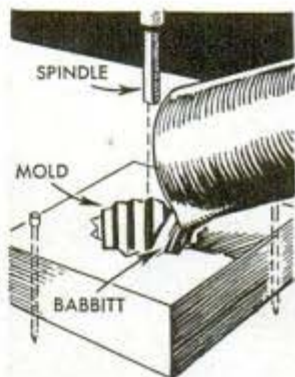

Plumber's "Snake" From a Cable

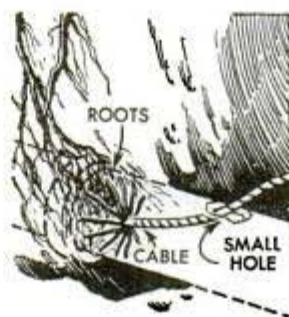

When a sewer drain becomes clogged and there is no suitable tool at hand for cleaning it, you can make one from a length of $\frac{1}{2}$ -in. wire cable. Just fray one end of the cable as indicated.

It was found that the wires were flexible enough to be pushed through a small hole made in the sewer pipe near the obstruction, yet stiff enough to clear a stoppage of hairlike tree roots.—Kendrick Martin, Oakland, Calif.

Cane Tips as Typewriter Feet

Rubber cane tips provide good replacements for worn or lost typewriter feet that are no longer available. The tips are cut down to about half their original length and then slipped over the legs of the machine. If the typewriter does not stand level, adjust the legs or place small washers inside the tips.

—W. H. McClay, Pasadena, Calif.

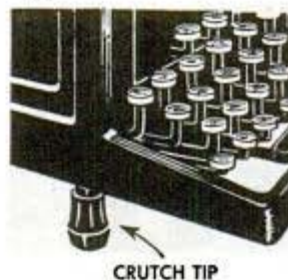

Heat Guard on Barbecue Fork Protects Your Hands



Heat often not only reddens the hands, but sometimes actually burns them when using a barbecue fork over an open fire. This trouble can be avoided by fitting the fork with a shield near the handle. The shield is nothing more than a wooden bowl drilled in the center to slip tightly over the handle. The bowl can be purchased or turned on a lathe, and if you do not mind the appearance, just an ordinary turned wooden disk will serve the purpose.

—Kendrick Martin, Oakland, Calif.

Hook Ground on End of Square Marks Spindle for Turning

Instead of using the usual pencil-and-ruler method of laying off lathe spindle work, try this simple marking gauge. It is made from an ordinary try square, and requires only the grinding of a point at the

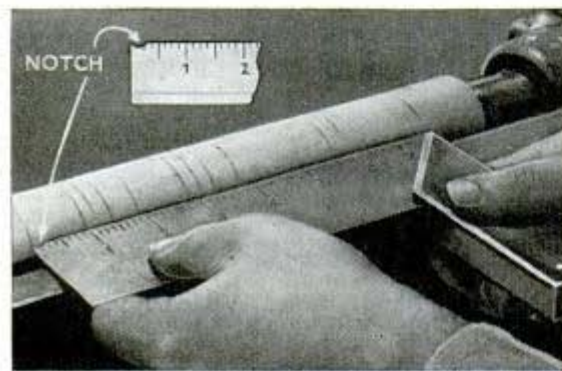

extreme end as shown. In setting off a 1-in. space on the spindle, for example, the gauge is held with the 1-in. mark over the starting line. A slight twist of the gauge enters the hook point into the spindle. Setting-off in this manner is quick and accurate, and can be used for any location point except the centerline on beads.

Music Blank Serves as Guide In Lettering Drawings

When writing on unruled, light-weight paper, or when lettering on transparent drafting paper, blank music sheets prove useful as a guide to better lettering and writing. The blanks are slipped under the paper and provide readymade lines. In drafting, the music blank can be moved where needed and helps to make all lettering of uniform size.—Michael Ligoeki, Gary, Ind.

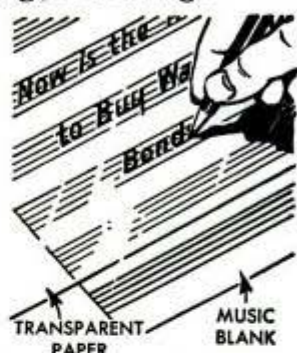

Putty Prevents Annoying Squeaks When Filing Handsaw



To muffle the squeaking noises that come from a saw when it is being filed, just stick a wad of putty or modeling clay to the outer end of the saw. This reduces the vibrations that are set up in the saw

blade by the file and so prevents squeaks.

How to Lock Cotter Keys Safely In Baby-Carriage Wheels

Many of the wheels on victory baby carriages are held on by cotter keys which, if locked in the usual manner, will snag ladies' stockings and catch on furniture. However, all of this damage can be avoided if the keys are cut off and the legs bent as shown.

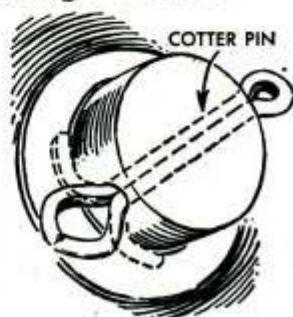

—C. Lundy, Floral Park, N. Y.

Bird Feeders Hold Grain or Vegetable Scraps

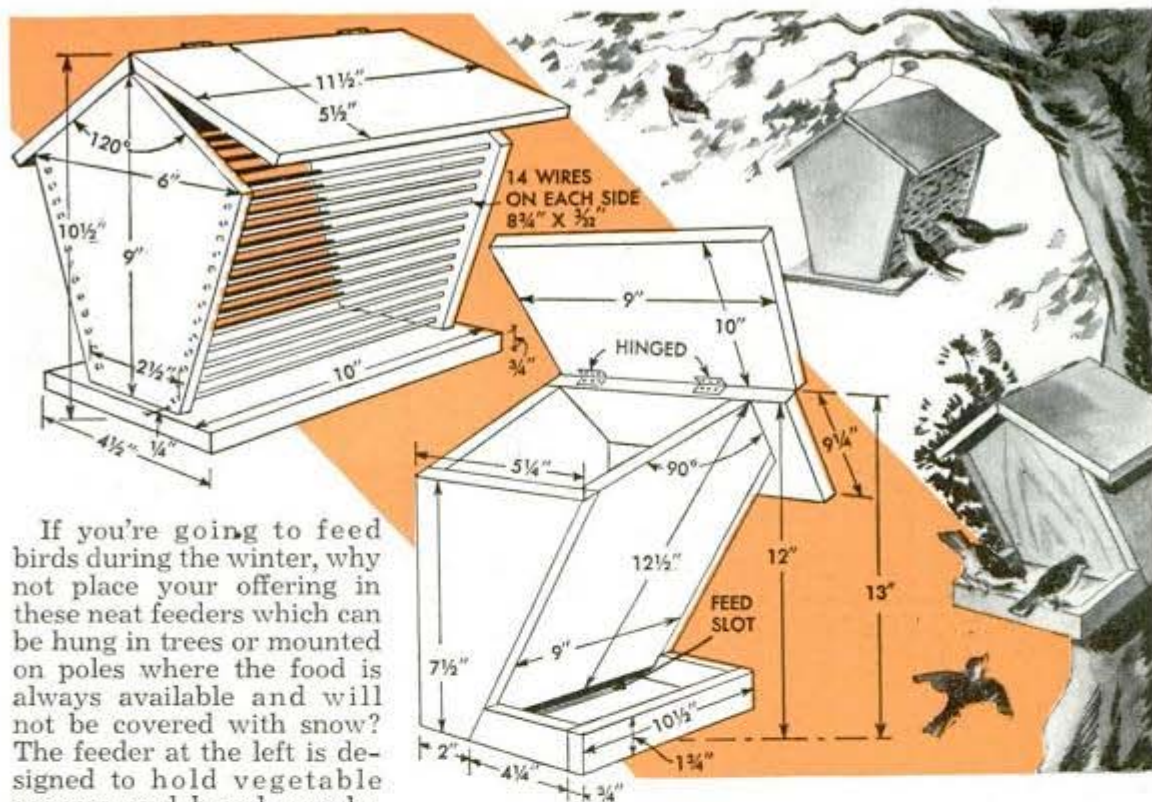

If you're going to feed birds during the winter, why not place your offering in these neat feeders which can be hung in trees or mounted on poles where the food is always available and will not be covered with snow? The feeder at the left is designed to hold vegetable scraps and bread crumbs, and the one on the right is for grain. The roof of the vegetable feeder is mitered at the peak, but on the grain feeder one side overlaps the other for hinging and therefore must be slightly wider. As only one side need open for filling the hopper, the other is nailed or screwed in place per-

manently. Although either type of feeder may be mounted on a post, the vegetable feeder can be hung from the branches of a tree by hooking a wire through the gable ends, allowing birds to feed from both sides at once.

—James J. Frys, Chagrin Falls, O.

Short Wedges Cut on Circular Saw With Aid of Simple Jig

Wedges of from $\frac{1}{4}$ to $1\frac{1}{2}$ in. taper in 6 in. can be cut on a circular saw by using this adjustable jig. An adjusting screw at the rear of the jig slides against the saw fence as a wedge is being cut and thus determines its taper. The screw has a nut on either side to hold it fast after setting at the desired angle. The clearance hole for the screw is bored through the jig from side to side to permit turning the screw in for adjustment. The saw cuts a narrow wedge when the screw is extended and a wide one when it is turned in.

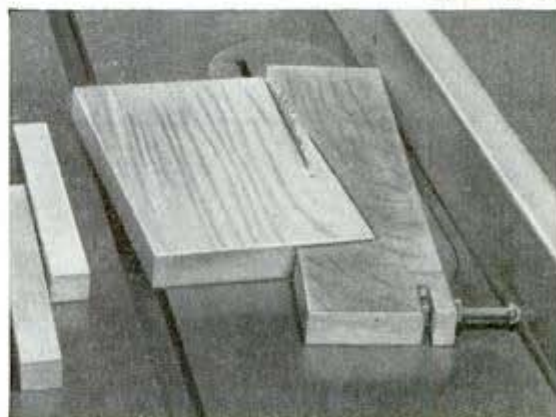

Dust Kept Off Fresh Finishes

You can keep dust particles off newly painted or varnished articles by drying them inside dustproof bags of the type used to store clothing. The hanger inside the bag provides a handy holder for suspending them in the sack with thread or wire.—Robert Price, Springfield, Mass.

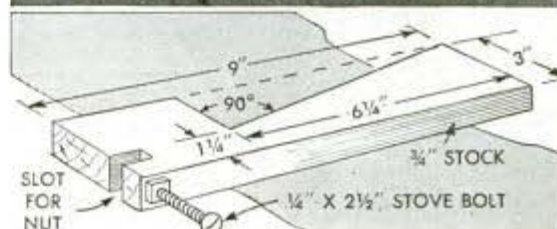

DRESS YOUR FIREPLACE

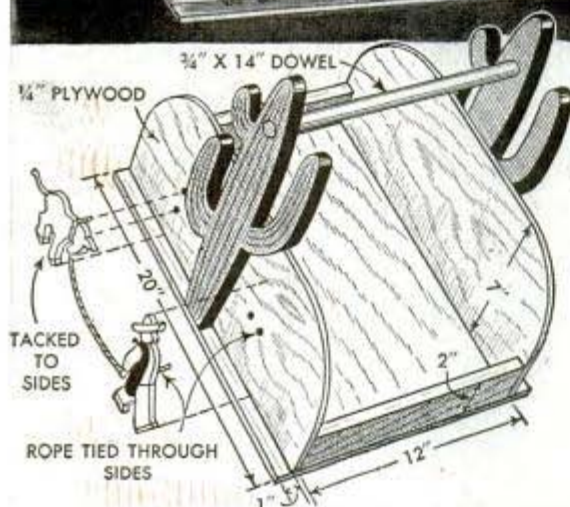
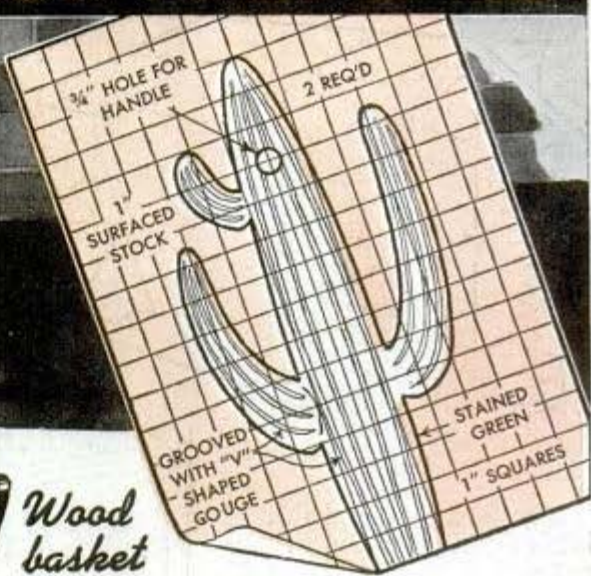
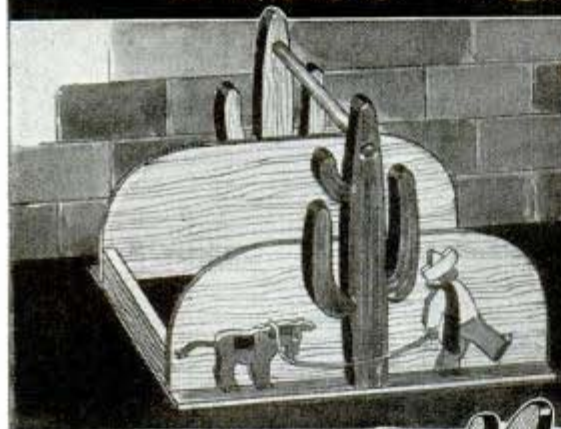

Wood basket

By Roberta L. Fairall

THESE fireplace accessories, touched up with the bright colors and gay figures of the old southwest, add charm to cool autumn evenings spent around the fireplace. For the wood basket, any scrap lumber will do, but plywood or tempered hard-pressed board is preferable for sides and bottom, with two pieces of 1/2-in. wood for the ends. The handle supports are jigsawed from 1-in. stock. They should be grooved with a V-gouge to resemble cacti, drilled for the dowel and nailed in place. A short piece of rope serves for the donkey's tail, and a rope halter passes behind the man's hand through two holes in the side, knots at the ends of the rope keeping it in place.

Sides and back of the dust pan are 1/4-in. stock nailed together with a 9-in. strip of molding at the front edge of the bottom, which should be 1/8-in. hard-pressed board. A slot is cut in the lower end of the handle to fit over the back. The upper end of the handle is coated with glue and wrapped with rope tacked at the ends. Green and red cactus designs may be stenciled on the sides, and the handle left a natural finish except for notches painted red. For the nut bowl, an ordinary kitchen mixing bowl will serve. It is

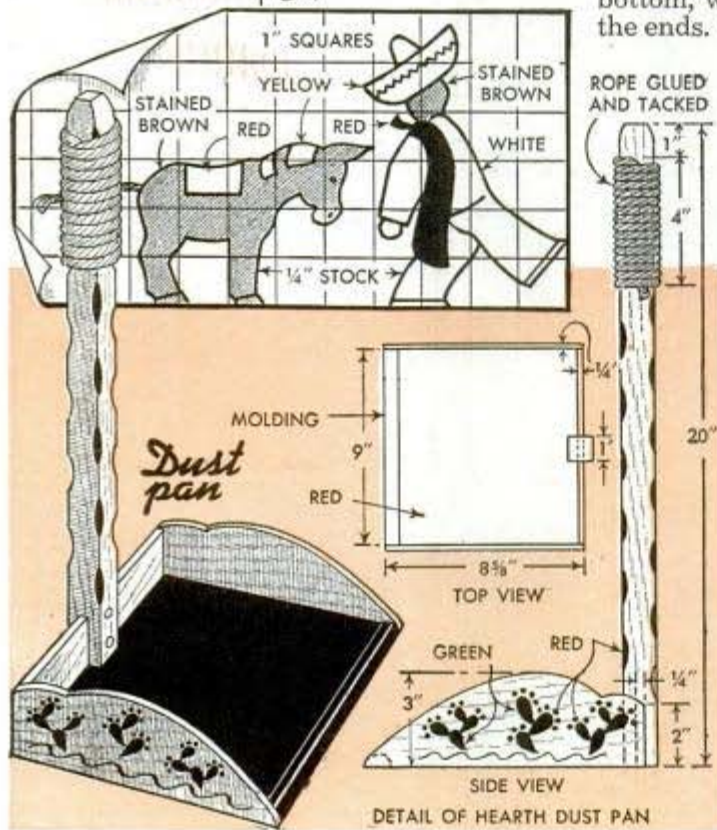

IN WESTERN TOGS



drilled for three legs which are glued in at an 80-degree angle. These are braced at the lower ends with two sticks as shown. Then rope is glued and tacked around the lower ends. The bowl will look best if left in natural finish. It can be shellacked or varnished and have a design painted around it for a border. The leg notches, like those on the dust-pan handle, should be painted red.

The tiny cricket stool, shaped like the ace of spades, is sawed from 1-in. stock. The narrow front leg and wide back leg are wedge-shaped and are notched along the edges like the legs of the nut bowl. A brace is nailed between them just under the top. Since the other pieces are predominantly red and green, the top of the footstool should be enameled black for contrast with a design left unpainted on the surface as shown. Leg notches, of course, may be painted red as they are on the other pieces.

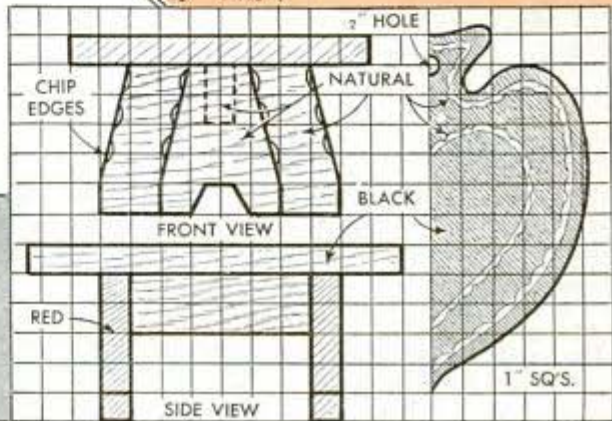
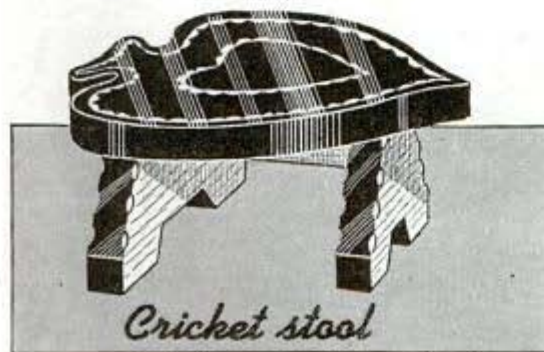
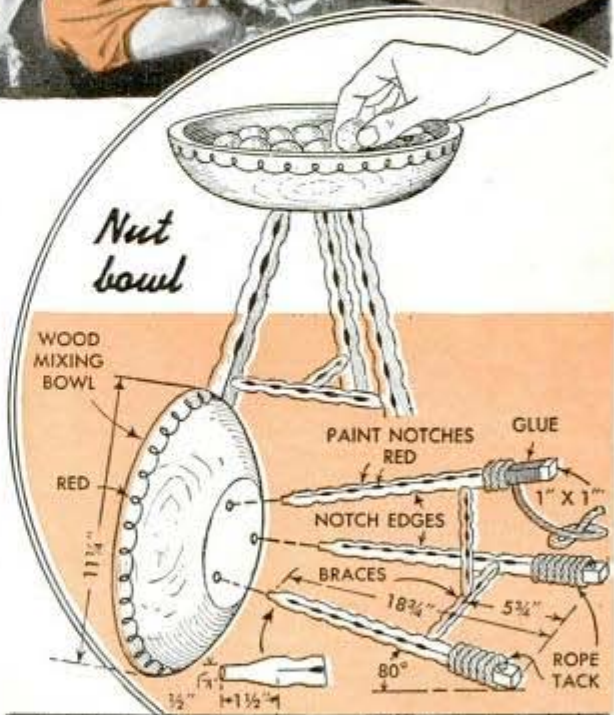

Used Baling Wire Straightened With Simple Stretcher

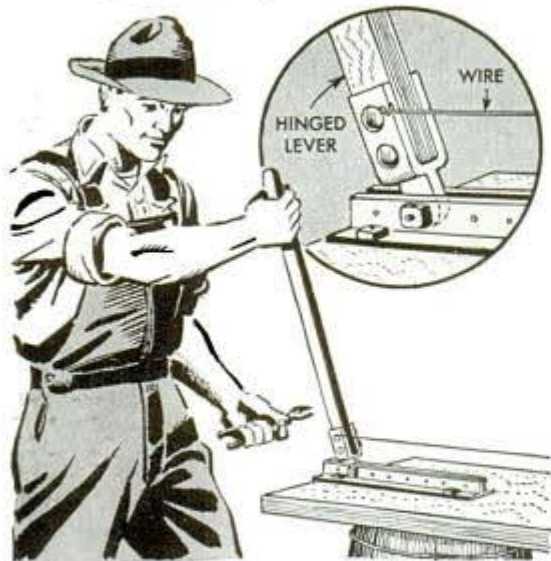

Most farmers find many uses for wire after it has been removed from bales of hay, straw, etc. To straighten the wire, one farmer uses a simple hand stretcher, as shown. It consists of a long plank having a lever mounted at one end and a hook at the other, between which the wire is stretched. The circular detail shows how the lever is pivoted between two pieces of angle iron, which are drilled at several places so that the spacing between the hook and lever can be adjusted to suit the length of the wire. Although not shown, a hook on the lever to receive the wire instead of twisting it under a bolt head as indicated would simplify the job.

Poisoned Ant-Bait Container Made From Small Box



A discarded salve or pill container of metal makes a good ant-poison dispenser because, though it readily admits ants, it keeps the poison effectively hidden from pet animals and inaccessible to the prying fingers of young children. Furthermore, being flat, it cannot easily be tipped over to spill its contents on lawns or carpets. To provide entrances for the ants, three slits, $\frac{1}{8}$ in. wide, are cut in the sides to within $\frac{1}{8}$ in. from the bottom, and a piece of blotting paper, fitted into the bottom, is soaked with a poisonous solution made by dissolving sugar, 4 oz. and tartar emetic, $\frac{1}{2}$ oz. (obtainable at drug stores), in a quart of

water. A piece of cloth or small sponge soaked in the liquid is placed over the blotter, and the cover replaced. Due to evaporation of the liquid, the dispenser will need frequent refillings during warm weather.—John K. Karlovic, Chicago.

Clothesline Prop Locked in Place Against Dislodgement by Wind

If the wind sometimes dislodges your clothesline prop, here is a simple way to prevent this trouble. About an inch or so from the upper end, drill a hole for the line and make a slot from the hole to the end of the prop for in-

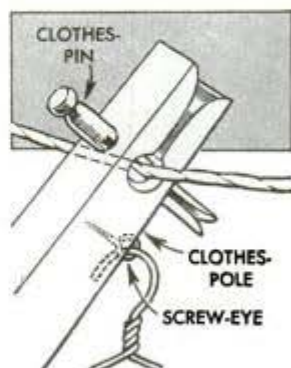

sertion of the line. Then drill a smaller hole through the edge of the prop to break through the larger one so that a clothespin can be inserted to keep the line in place. When a prop is fixed in this way, it is handy for supporting a garment on a hanger, which can be hooked into a screw eye driven into the prop just below the hole for the line as indicated.

Towel Rack Holds Newspapers Handy on Stand

To display an assortment of newspapers, one newsstand operator uses a couple of folding towel racks attached to the wall above the counter. The prospective purchaser can thus swing the papers into view to make a selection without much handling or possibility of soiling them.



SAVE FUEL *by Calking*

IN MOST houses, slight settling of foundations and shrinkage of materials cause cracks around doors and windows. Sometimes there will be cracks in mortar joints of masonry or stucco walls. As such cracks are heat wasters, and wall cracks in masonry may weaken the structure, all of them should be made wind and weatherproof as soon as they are noticed.

Cracks around doors and windows can be sealed best with calking compound, a material elastic enough to compensate for the movements of settling. It sticks tightly to all materials, becomes dry on the surface but remains semi-plastic underneath, and is water and weatherproof. It can be bought in several colors and in two consistencies; a soft grade that can be pressed through a calking gun, and a heavier grade that can be applied with a knife.

Application of calking compound is done most easily with a gun which pushes a ribbon of material into the cracks. Used in this way, the compound must be free from skins and lumps which might clog the nozzle. Around hinges and in some corners, it may be necessary to force down the compound and smooth it with a wooden paddle about $\frac{1}{2}$ in. wide, which has been soaked in oil to prevent the compound from adhering.

Before filling cracks, see that they are dry, and clean out all loose dirt, mortar and paint scales. Metal framework should be scraped or wire-brushed to remove rust, and given a coat of paint before calking. Wide cracks should be painted before applying the compound, but if they are more than $\frac{1}{4}$ in. wide they should be filled with oakum forced in with a blunt chisel, putty knife or calking iron and packed down by tapping the iron with a hammer until the filling comes up to $\frac{1}{4}$ in. of the surface. Cracks in masonry or stucco should be filled with cement mortar consisting of portland cement, 1 part, hydrated lime, 1 part, and clean sand, 2 or 3 parts. Wet the cracks before filling with cement, using a small putty knife or tuckpointer's trowel. When the cement is dry, cover it with a ribbon of calking compound to keep out the water.

—F. N. Vanderwalker, Flossmoor, Ill.

☛ When polishing your car, you can obtain a more lustrous finish with less work if you apply dry cornstarch with a piece of cheesecloth just after waxing.

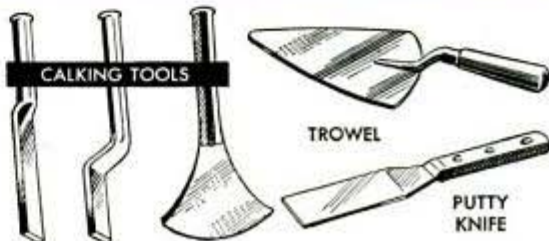
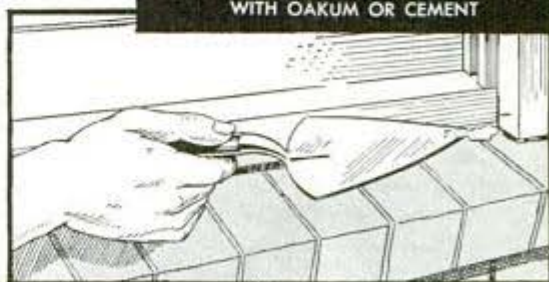
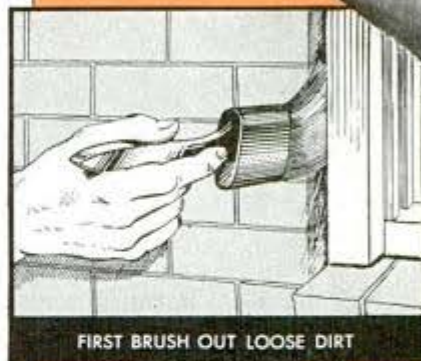

Lamp Added to Jigsaw Is Made From Tin Can and Wood



If you have an old type jigsaw that has no lamp for lighting the work, you can make one from a piece of wood and a tin can. Cut the wood to a shape somewhat like the figure 8 and jigsaw a hole in each section, one to slip over the blower case and the other to fit a lamp socket. Remove top and bottom of the tin can, slit it up the seam and nail it to the wood as shown. The socket will be held in place when the lamp is screwed into it. The fixture may be swung aside, as it pivots on the blower case.

—Arthur F. Tuckwell, Merriton, Ont.

Sewing Machine Punches Pattern For Transferring Design

In perforating paper patterns for use with a pounce bag, I find it is convenient



to use the sewing machine, following the design just as in sewing. It is necessary, of course, to remove the thread from the needle. Needles of any desired thickness can be used, and the stitch length can be altered as necessary.

—A. H. Waychoff, Phoenix, Ariz.

Piece of Comb Rules Music Staves Quickly and Accurately

To rule staves quickly, one music teacher breaks off a piece of common pocket comb and from this breaks out as many teeth as necessary to remove all but five, equally spaced as desired. Used over carbon paper with a ruler for a guide, this comb section makes accurate staves. Two sections of this type with a suitable blank space broken out between them also rule good double staves.

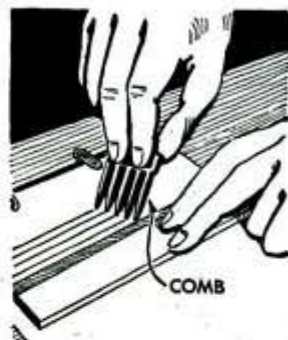

Using Broken Twist Drills

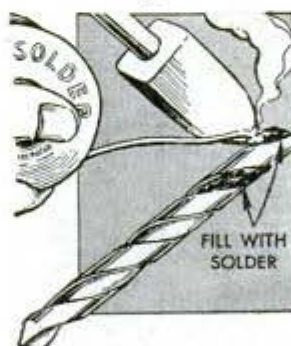

Instead of discarding a broken twist drill because it will not run true when clamped in a chuck, fill the flutes with solder for a distance of about $\frac{3}{4}$ in. from the broken end. Then file down any unevenness in the solder. This

will enable you to chuck the drill accurately so that it can be used.

—Ralph S. Wilkes, Elbridge, N. Y.

Wire Stapled to Window Screens

An inexpensive office stapler is a timesaver for fastening wire to window-screen frames. Also, the stapler is ideal for attaching felt weatherstripping and blanket insulation. To use the stapler, just remove the base and use the upper half as indicated.

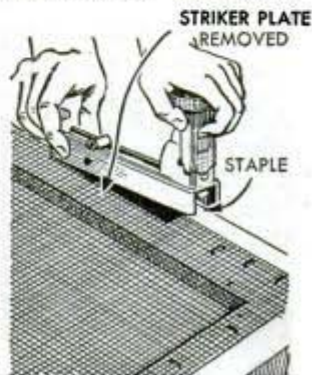

—Geo. W. Snell, Wichita, Kas.

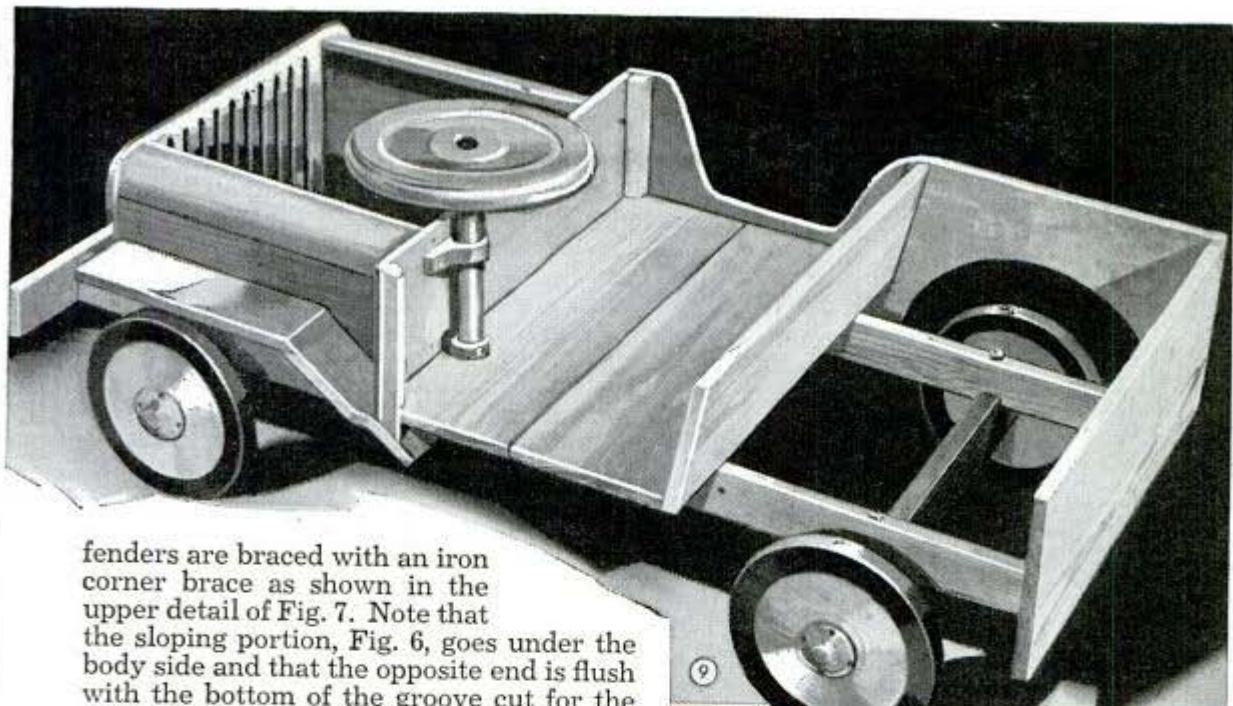

fenders are braced with an iron corner brace as shown in the upper detail of Fig. 7. Note that the sloping portion, Fig. 6, goes under the body side and that the opposite end is flush with the bottom of the groove cut for the top section of the fender as shown in Fig. 9. The horizontal section of the fender is glued into the hood groove and is screwed and glued to the sloping piece.

The grill, dashboard and back are installed as illustrated in Figs. 2 and 9. The grill is laid out according to the pattern in Fig. 1, jigsawed as shown, attached to the frame by dowels. Both the grill and the dash are screwed to the ends of the hood and the back is fastened to the frame with countersunk screws. The floor is cut from $\frac{1}{2}$ -in. stock, the pieces being butted against the dashboard and nailed to the top of the frame. Before nailing the floor down, however, drill a $\frac{1}{4}$ -in. hole in the piece adjoining the dashboard, $\frac{1}{4}$ in. on center

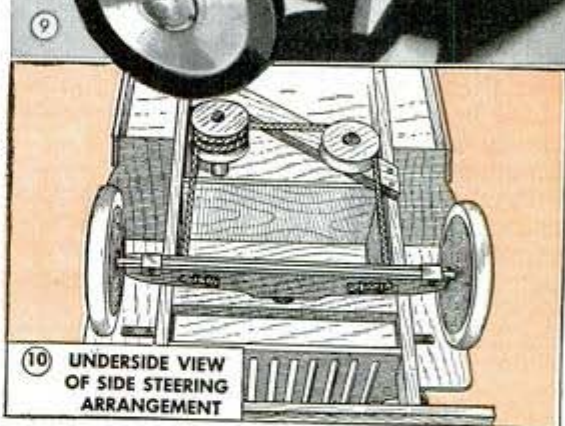

10 UNDERSIDE VIEW OF SIDE STEERING ARRANGEMENT

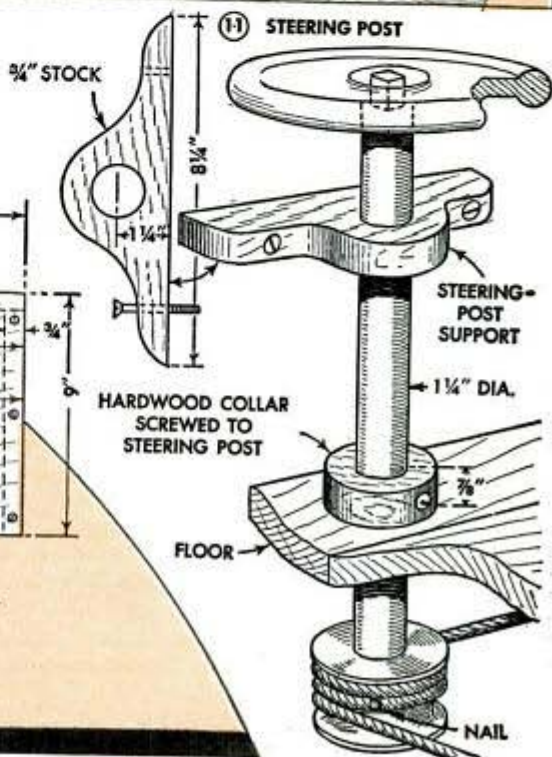

11 STEERING POST

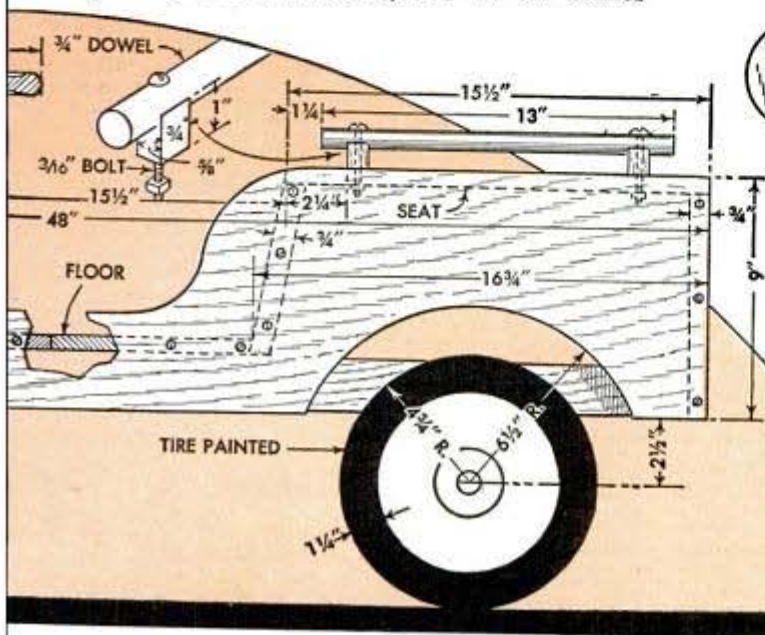

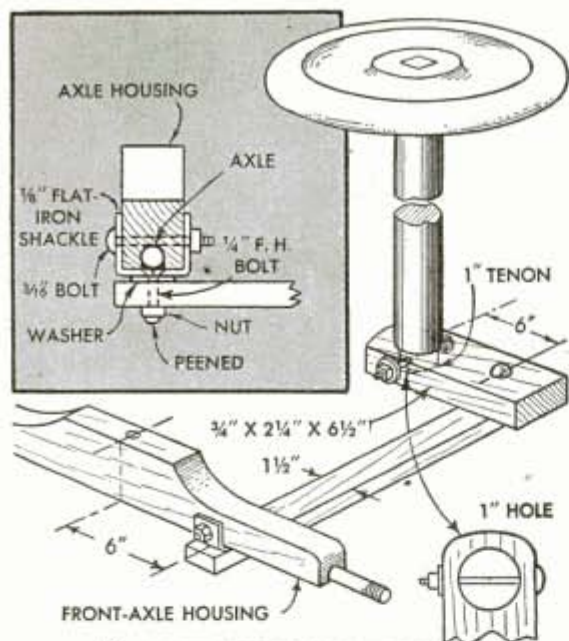

12 CENTER STEERING ARRANGEMENT

from the front edge, for the steering post.

The body sides are $9\frac{3}{4}$ in. high at the front and 9 in. high at the back, Fig. 8, with the lower front corner cut off at an angle flush with the fender. The two sides should be tacked together and the curves bandsawed in one operation to assure identical pieces. They are screwed to the back, dashboard, floor and back rest. The back rest fits behind the floor and extends at an angle to within $\frac{1}{2}$ in. of the top of the sides, both edges being beveled to fit the floor and seat respectively. To make the quarter round used on the sides of the hood, glue four pieces of 2 by 2 by 17-in. wood together, using paper between all joints. Turn this unit to a diameter of $3\frac{1}{2}$ in. and then split into four quarter-rounds with a chisel. Cut the false engine sides and end blocks shown in Fig. 7. Making and installing the seat rails will complete the body.

In turning the wheels, a circle 3 in. in diameter should be marked on the wheel with pencil to locate the hub which will be turned separately. Note that the hole for the bearing is cut part way through the wheel to a point which will allow the bearing to run in the center, as shown in the circular detail, Fig. 4. Be sure the hole is cut in straight so that the bearing will be tight when it is driven to the center. After the bearing is driven in, it is followed by a tight-fitting wooden collar, glued on. If, however, velocipede bearings are not available, you can turn 1-in. spindles on the ends of an oak axle and drill the wheels to rotate with a snug rather than a binding fit. With this arrangement, spindles must be kept thoroughly lubricated with graphite. To avoid any season cracks, it is well

to give the wheel a coat of shellac or sanding sealer immediately after it is finished and sanded. The tire is then painted on with slate-gray porch or deck paint.

A wooden chuck is necessary for turning the hubs. It is merely a 5-in. wooden disk screwed to a 3-in. faceplate. The work is fastened to the chuck with wood screws inserted through the chuck into the work outside the area to be turned.

The steering wheel and cross arm are glued to their respective ends of the steering post after the support and collar are slipped on and the post is inserted through the floor as in Fig. 11. The support is bolted through the dashboard, all bolts being bradded to prevent their working loose. If an all-wood front axle is used, the flat-iron shackles shown in Fig. 4 may be eliminated and the steering rods bolted through both axle and housing as in Fig. 12. It is necessary that the steering rods pivot at a point directly beneath the front axle and that they be an equal distance from the center on both the housing and the steering cross-arm, otherwise the mechanism will bind when the wheels are turned. It is better to locate these pivot points when the parts are being assembled to avoid any discrepancies. If two or more youngsters are to ride on the Jeep, the steering wheel may be placed on the left side to allow more than one to ride at the same time. In this case, the steering mechanism will consist of one pulley wide enough to take three turns of sash cord with a nail through the second turn, and a second pulley over which the cord runs to connect to the axle, as shown in Figs. 10 and 11. The cord should form perfect right angles when the front axle is square with the frame.

Four sash lifts make the steps on the side of the seat. A floor mat, electric horn, and spare wheel are suitable accessories. Paint the body a dull green, and use aluminum paint for the headlamps and the star in the middle of the hood.

Turning Bolt Adjusts Bench Stop

Your workbench stop can be raised and lowered by turning a bolt which runs through a nut soldered to a $1\frac{1}{2}$ by 3-in. angle bracket attached to the bench leg. A metal cup fastened to the bottom of the stop by a countersunk screw provides a solid surface against which the bolt turns to force the block up.

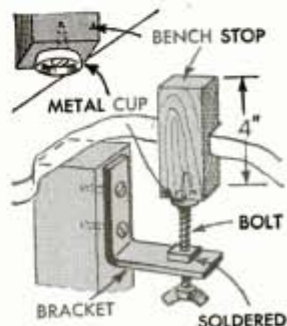

QUILTING FRAME

folds flat for storage

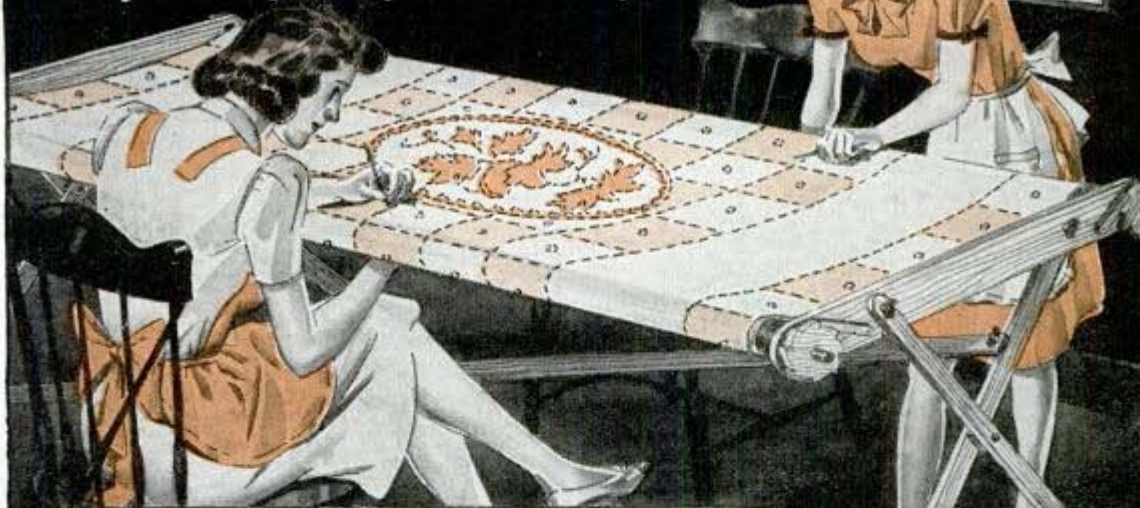

By removing eight wing nuts, the cross braces and legs can be folded flat against the frame for storage. The legs and braces may be of common pine, but hardwood should be used for the frame rails and ratchet wheels. The tenoned ends of the rails can be formed by gluing short dowels in centered holes, or the stock itself may be rounded at the ends with a wood rasp. Fasten quilt by sewing tape to two edges and tying to the rails

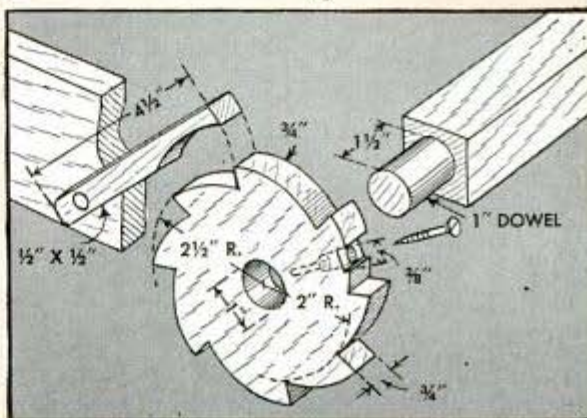
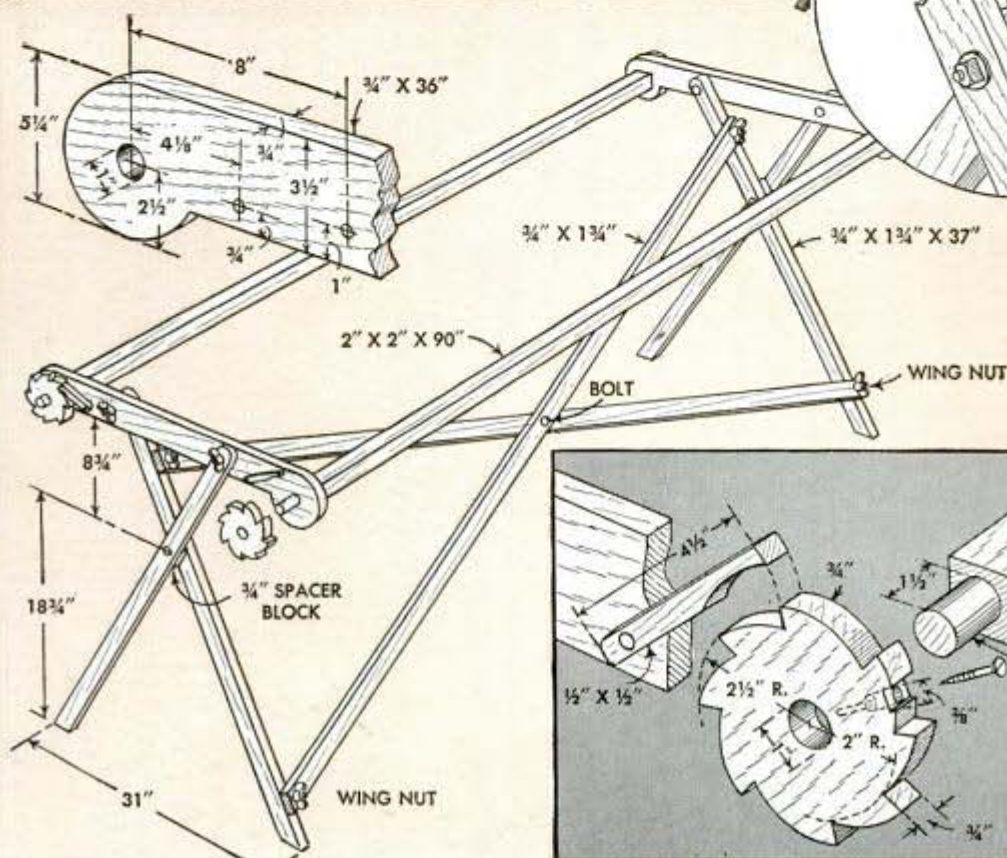
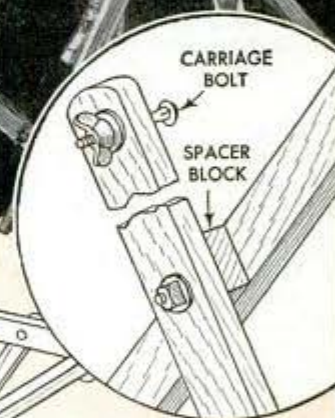

Bins Under the Garage Ceiling Store Needed Articles



The only space generally not used in a one-car garage is the area just under the roof at the top of the walls. But this space is suitable for hanging removable storage bins in which automobile parts, tools, polishes, cleaning cloths and other miscellaneous articles can be kept. The bins are made of plywood or hard-pressed board and are attached by hardwood cleats which slide in grooved wooden strips screwed to the ceiling. A pair of handles attached as shown make removing the bin easy, and a paper label glued or tacked to the front identifies the contents.

—Opie Read, Jr., Chicago.

Temporary Concrete-Block Wall Is Easy to Build

Since no mortar is used in constructing this temporary cement-block retaining wall, future usefulness of the blocks is not impaired. The blocks can be used for regular building work after the temporary wall has served its purpose. To build the wall, lay the blocks in the usual offset fashion to the height desired, tilting the wall slightly inward to give it retaining strength. Then as a means of locking the blocks together, insert 2 by 4-in. stakes down through their holes, driving

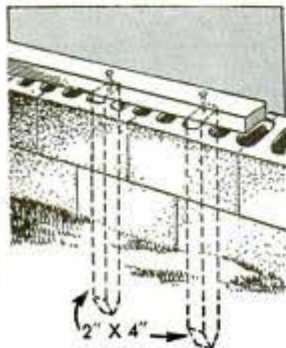

W.T.M. Concrete

each stake about a foot into the ground. Saw off the extending ends and join them together by nailing a rail across their tops. If the wall is to remain standing for a considerable length of time, paint the stakes with creosote beforehand.

—J. Modroch, Danbury, Conn.

Pencil Holds Cigarette Pack In Shirt Pocket

A shirt pocket is not a very secure place for a package of cigarettes, as it is apt to drop out when stooping. A pencil that can be clipped to the pocket will hold the package in place if the point of the pencil is slipped down into it.

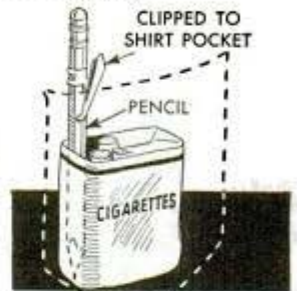

Parallel Lines Cut on Stencils With These Simple Styluses

Cutting parallel lines on a mimeograph stencil is simplified with this stylus, which is made by driving two needles into the ferrule of a pencil as shown. Another type of stylus for ruling double lines close together for border and other effects is made by grinding the eye of a common darning needle to provide two prongs, the size depending on the space needed between the lines. After forming the prongs, rub the ends smooth on an oil stone and push the needle into a wooden holder or the end of a pencil.—A. H. Waychoff, Phoenix, Ariz.

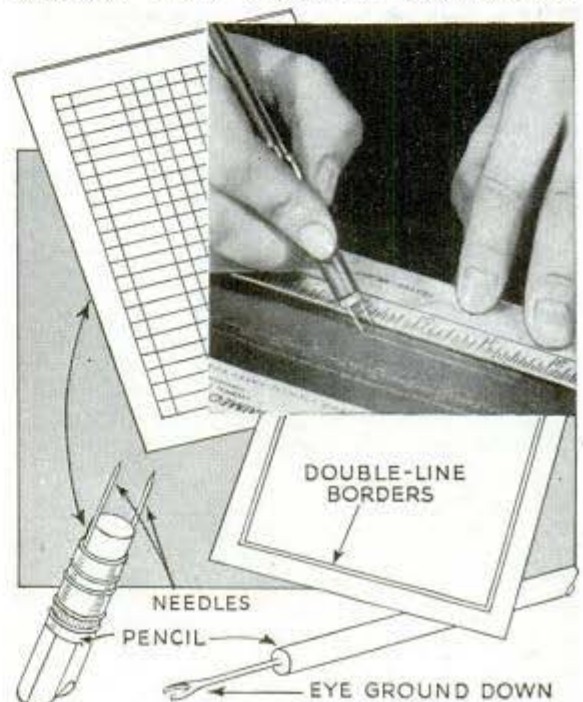

What You Can Do With TEXTILE COLORS



By Grant A. Waddle

WITH the new textile colors now available for stenciling on cloth, you can decorate with designs of your own making such articles of home furnishing as tablecloths, towels, napkins, pillows, and drapes as well as dresses, scarfs and other items of clothing. Or, if you prefer, you may select a readymade stencil from the many now available in sizes and patterns to suit varying tastes and requirements. The colors, which are fast, can be applied to any kind of fabric—even oilcloth.

One advantage of this method of decorating cloth is that the same design may be reproduced on all your pieces, or combined with other figures to form combinations or patterns. Then, too, you can use the same figure in several places in different colors, thereby varying the effect with the same stencil. And, best of all, you can produce

in quantity for gifts and yet have sets of finished articles for your own use.

As examples of figure-combinations, one of the photos shows the effect of combining several different figures on a tablecloth. The same design, reduced in size, can be repeated on the napkins if you wish, or a single figure may be centered on the napkins and towels. For pillows, all-over designs are attractive, or merely flowered borders used. Large flower patterns are effective on drapes, dresses and scarfs. Men's furnishings, too, can be individualized by monograms or simple figures applied to the pockets of shirts or to the cor-

Photos courtesy American Crayon Co.



WASH THE CLOTH THOROUGHLY

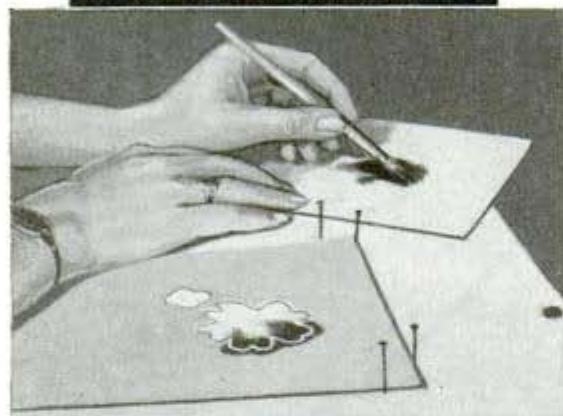

APPLY COLOR THROUGH STENCIL

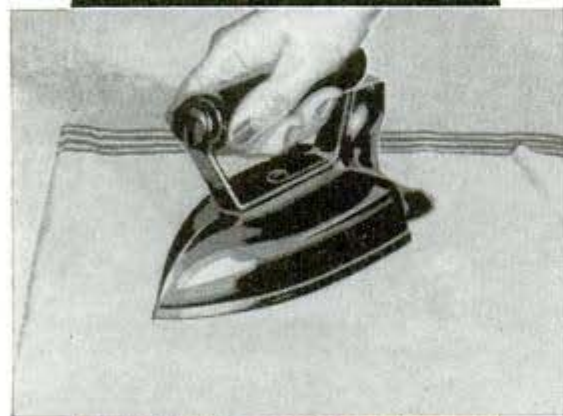

"SET" THE COLOR WITH HOT IRON

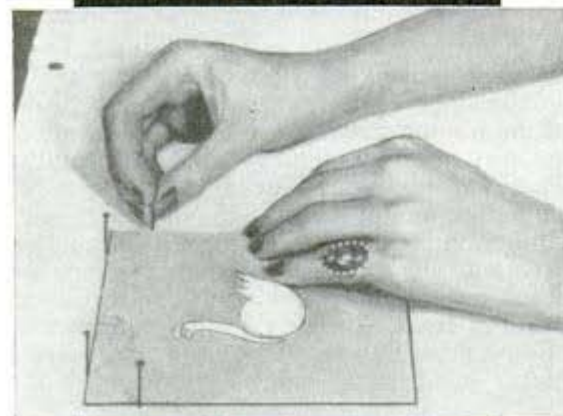

GUIDE PINS TO ALIGN STENCILS

ner of a tie or handkerchief. Umbrellas, bags and sweaters may be similarly decorated.

Textile colors are easy to use—there are just four steps to take in producing a finished piece of work. First wash the cloth thoroughly in order to remove the starch and sizing with which most new materials are filled. Warm, soapy water is best for this purpose. Then rinse well to remove all traces of soap, and press to dry the cloth. Stretch the cloth tightly on a drawing board or other suitable backing such as heavy cardboard that will not buckle or allow the fabric to wrinkle, and fasten the cloth with tape or thumbtacks. Put the stencil over the area you wish to color and fasten it in place with pins or thumbtacks so that it cannot move out of place. Also, be sure that the edges of the stencil are pressed tightly to the cloth, otherwise the color will seep under them and blur the outline. Apply the color with the brush which comes with the kit, using light, sweeping strokes. It is better to apply several light coats than it is to put on a single thick one. Work the color into the fabric, occasionally stippling with the end of the brush to obtain a uniform penetration. Then remove the stencil carefully, taking care not to let any part of it come in contact with the wet color to streak it. Allow the work to dry thoroughly for at least 12 hrs., although leaving it for 24 hrs. is better. Now you are ready to "set" the color. Place a damp cloth over the back of the design and iron it for at least a full minute with the iron heat at 350 degrees. For rayons, use a moderately hot iron at about 200 to 230 degrees. By dampening the pressing cloth with white vinegar instead of water you will increase the "fastness" of the color.

If the design you use calls for a combination of several colors applied to the same area with the use of several stencils, be sure to align each stencil properly so that the colors will be placed in the correct relation to each other. To do this, lay the main stencil—the one containing the major portion of the design—over the spot to be colored and set four guide pins to hold it and the other stencils (all same size) in position.

To make your own stencils, draw on a piece of stencil paper the pattern you wish to reproduce, or copy the design directly by means of carbon paper, and cut around the lines with a stencil knife. The stencil paper and knife may be purchased at an artists' supply house or large department store. Wall paper or magazines often supply patterns that can be used, although, of course, you can originate patterns of your own.

How to Use a Woodworking-Lathe Parting Tool

Instead of making a narrow cut with a woodworking parting tool, make a wide cut as shown at C. The narrow cut indicated at A often causes the tool to heat, and there also is a possibility that the tool may be jerked out of your hands. Besides this, the narrow cut, if deep, makes it harder to caliper the work accurately, and makes caliper necessary more frequently because it is difficult to judge when the desired diameter of the work is being approached. The wide cut is easy to make, the work being done by pivoting the tool back and forth on the tool rest. If it is desired to have a square shoulder on one end of the parted work, it can be done by making

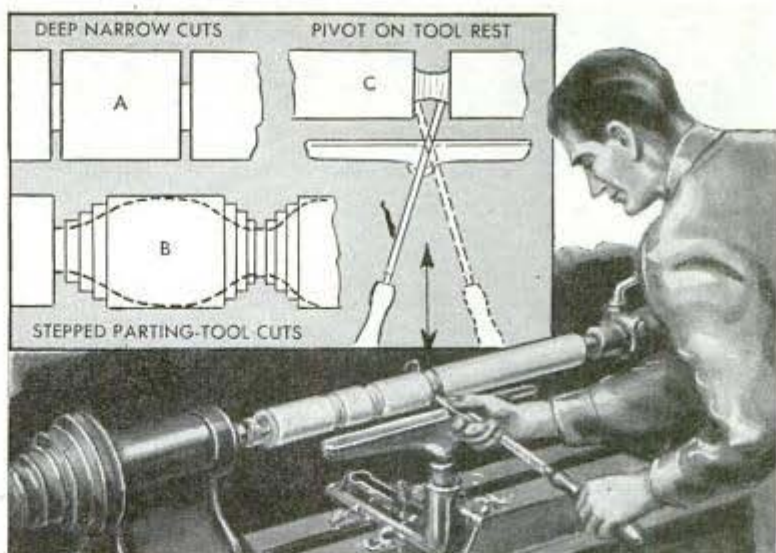

stepped cuts as shown at the left end of illustration B. Stepped cuts also can be used to make wide parting cuts as indicated at the right side of B.

Coal Fireplace Grate Improvised From Auto Crankcase

A fireplace grate that will give good service can be made easily from an old auto crankcase. One from any four-cylinder motor will fit most fireplaces, and can be obtained from a wrecking yard at a small cost. A model-A Ford crankcase is easy to alter for the purpose. Merely pry out the inner pan or partition containing the bearing troughs and punch a number of holes in it as indicated to permit entrance of air under the fuel. Replace the pan and remove the plate over the oil pump, which will permit air to enter the crankcase un-

der the perforated pan when the case is set on the andirons. Before using the grate, however, it is a good idea to burn off all the oil and grease so that there will be no odor when the fireplace is put into use. If another type of crankcase not having an inner pan is used, it may be necessary to punch holes through the sides to provide a draft. You can do this with a cold chisel, making the holes about an inch square. Be sure to provide good support under the metal when punching the holes, otherwise you likely will dent and misshape the grate.

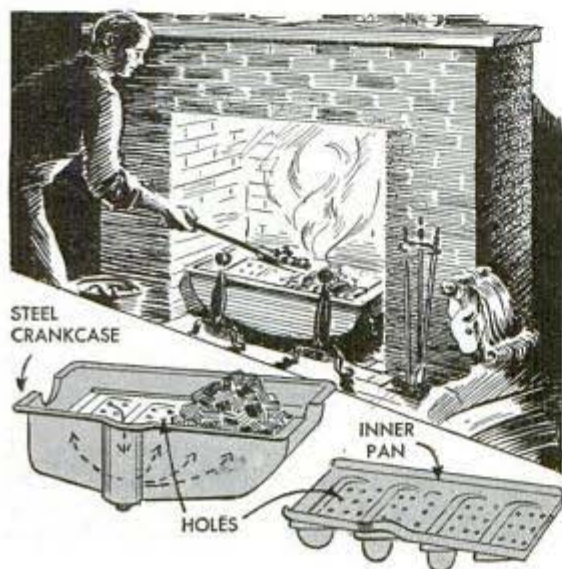

Windshield Wiper Shortened To Remove Heavy Snow

During the winter, an extra windshield wiper blade cut to about $\frac{2}{3}$ its former length and substituted for the regular long blade, will clear snow and sleet from your windshield without becoming so heavily weighted with snow that it freezes to the glass. Although the area of vision will be somewhat reduced, at least this portion of the glass will be cleared.



—R. E. Buck, East Lynn, Mass.



Getting **GOOD**

by Fred G. Korth

GOOD composition is the factor that makes a picture out of just a photograph. In trying to get good composition in your black-and-white photos, the do's and don'ts as given in this article are not absolutely hard and fast rules that cannot be broken. However, they have been formulated by studying accepted masterpieces of art, and keeping them in mind will pay dividends in better photography.

Most people looking at pictures have a hard time in explaining just why they like or dislike certain ones—even those that they have taken themselves. Often they are surprised when some of their shots turn out better than expected and vice versa. For instance, the finest autumn scene of colored foliage may be very drab in black and white, and it may contain too many unimportant elements. Generally, beginners get too much into photographs. Tele-

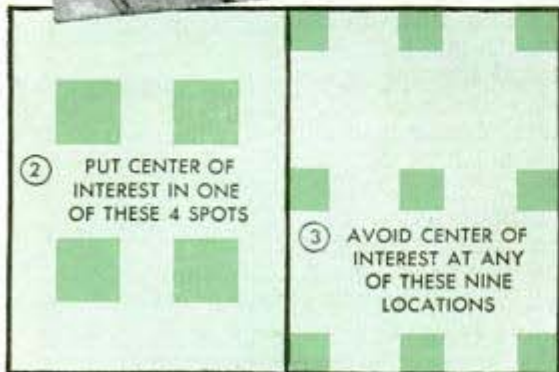

Right ⑤

④ Wrong



COMPOSITION in Your Photos

⑦ Right

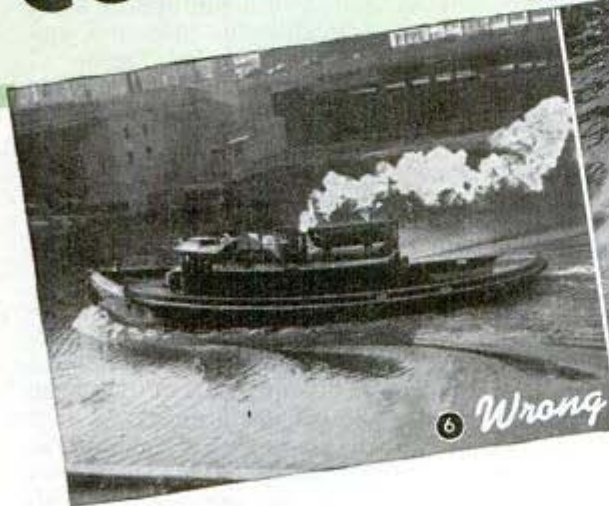

⑥ Wrong

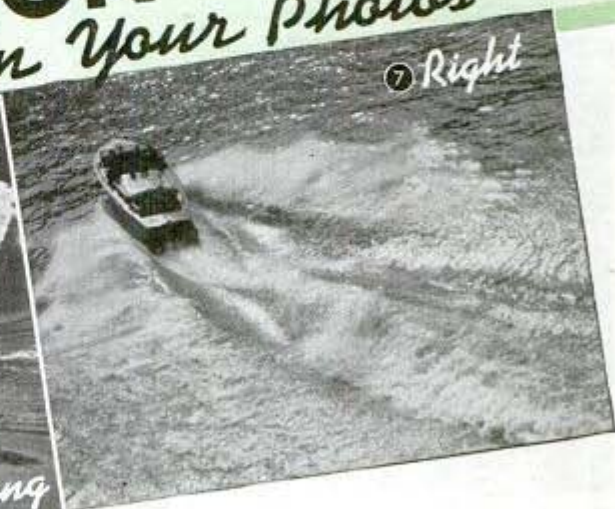

phone poles and wires, tree trunks, advertising signs, door and window frames, ceiling lamps and many other objects have a tendency of creeping into the negative, surprising the unwary photographer and ruining the composition of his otherwise well chosen subject matter. A good way to eliminate the vast space outside of the camera angle and to reduce colors to a one-color effect is to look at the subject matter through a small piece of blue glass of the same proportions as the negative. By keeping the glass at a certain distance from your

eye, which you can determine by experiment, the area observed through it will be the same as that included on the negative.

Good composition and the concentration on as little subject matter as possible may turn the simplest scene into an exhibition picture. The first thing to watch is the division of the picture space. Don't divide a picture horizontally, vertically or diagonally into two fields of equal size. As soon as the area of division is about in the proportion of three to five parts, a picture begins to become acceptable. But a proportion of two to five or even one to five parts can result in a masterpiece. Division of a picture into separate areas is occasioned by

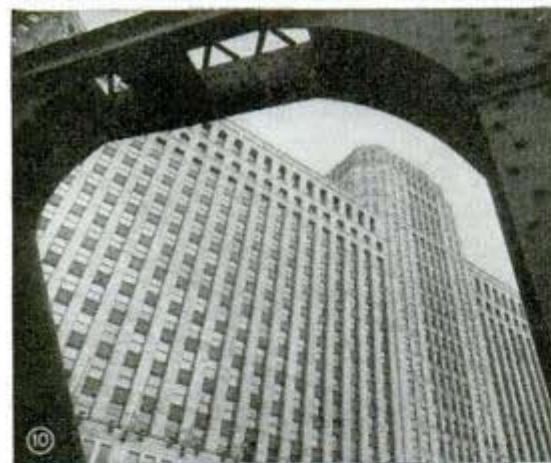
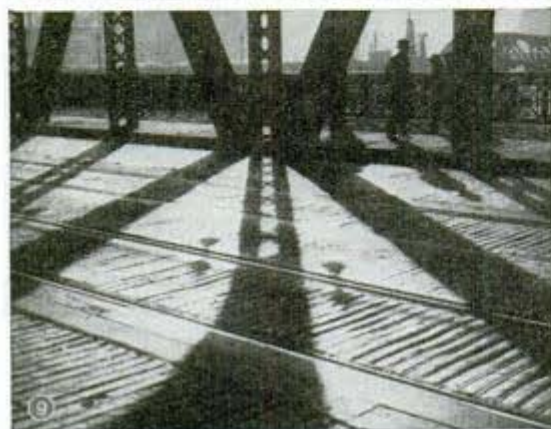

lines and masses such as horizons, trees, buildings, water lines, shadows and so forth. Often other lines or masses subdivide the main divisions of a picture. Sometimes it is desired to divide a picture into a number of repeating identical shapes of increasing or decreasing size or tonal value as, for example, a row of columns, a line of trees or a range of mountains. There are fast lines and interrupted lines, straight lines and curves of all kinds as well as suggested lines. Fast, unbroken lines lead the eye of the observer quickly in a given direction, while broken or less distinguishable lines give the observer time to linger on the way. Straight lines generally indicate strength, drama and punch, while curves suggest peaceful leisure and beauty. Suggested lines sometimes influence the pattern as much as visible ones. A person looking at something suggests a line from his eye to the object. A moving car or boat or a running child suggests a line of movement which should be considered in arranging a picture. Try to avoid having a subject or main line run toward the edge of the picture. Likewise, avoid having only one dominant curve which tends to lead the eye in an endless circle. A good picture provides an easy "entrance," a pleasant "stay" and a happy "exit" for the eye.

After these few preliminary observations, let's analyze the photographs shown in this article. Fig. 1 is a picture of slate shingles. Stacks of shingles afforded opportunities for many so-called "pattern" pictures. All-over pattern photos are those in which the theme is repeated over and over again. Pictures of this sort provide no center of interest and usually no rest for the eye. However, in Fig. 1, one stack of shingles, laid horizontally in the foreground and slightly toward the left interrupts the all-over pattern effect.

Fig. 2 illustrates where a center of interest may be placed for good composition, and Fig. 3 shows locations where it should not be placed. The application of these illustrations leads to Figs. 6 and 7. A fast moving boat needs plenty of water and, in a picture, it needs plenty of space. If you place it too close to the borders on both sides as in Fig. 6, the lack of sufficient space is noticeable. Also, you should eliminate as many of the undesired objects from the background as possible and avoid putting the center of interest in the center of the picture. In Fig. 7, the boat has been given plenty of water and the picture does not include miscellaneous elements in the background. The sweeping diagonal curve produced by the boat's wake, and the placement of the subject itself make this picture much more pleasing than the one in Fig. 6.

Often you will need more space for the center of interest than is suggested in Fig. 2. The waterfall in Fig. 4 is located in the exact center of the picture and nothing in the background or elsewhere alters this poor arrangement. Fig. 5, a photo of Old Faithful, shows how a similar subject was handled with better results. The mass of water is placed well to the left side. Clouds, groups of people, lines of foreground, forest and sky all help to balance the masses in a harmonious way. Not a single line divides the picture at the center.

Simple, everyday material makes just as good photographs as do distant beauty spots. But composition will determine how successful each shot is. Figs. 8 to 11 show what can be done. These photos are all patterns with deep shadows and bright highlights. They are bold and masculine in undertone, and include strong lines of steel girders to arrest attention. Yet, not all of them are good. Fig. 8 is poor because its lines, which crisscross the picture, scatter attention and give no rest to the eye. Fig. 9 makes a little better use of dominant diagonal lines but lacks a worthwhile center of interest. Fig. 10 is good as it has a satisfactory center of interest. This shot makes use of the old shortcut to success—getting a picture within a picture. The steel beams serve nicely to frame the building. Here is a pattern with an apparent purpose behind it. But, best of all is Fig. 11. The strong diagonal of the bridge girder cuts daringly across the building without leading the observer out of the picture. The upper edge of the dark steel is interrupted by a corner of the building while the lower edge combines curves with straight lines. Enough detail remains in the shadows of the steel and in the highlights of the sky and building to avoid the effect of so called "soot and whitewash."

According to psychologists, people involuntarily begin to look at a picture in the upper left corner from which the eye



travels gradually toward the lower right corner—perhaps a habit formed by reading. Although diagonal lines help to create strong photographs, one running from the upper left to the lower right aids the tendency of most people to follow this path naturally, and quickly leads the eye right out of the picture. Such diagonals, therefore, should be avoided. On the contrary, it is better to place strong diagonals from the lower left to the upper right, as shown in Fig. 11, as they stop the eye that tends to move from upper left to lower right. If a subject is such that you cannot avoid getting a wrong diagonal, it is possible to save the situation by turning the negative over when making a projection print, thus reversing it.

Not every picture is designed to stop the observer. Many photos are intended to focus attention on the beauty of Nature and her seasons. Everybody feels a desire to go out and get some fine scenes of newly



fallen snow settling on trees and houses, which may be particularly true because of the rareness of the occasion. Such snow scenes are shown in Figs. 12 and 13. Although they have much in common, the one in Fig. 13 shows the better composition. The streets cut across Fig. 13 at a greater angle than in Fig. 12. Also, human interest has been added to Fig. 13 in a good location. Painters call the human element of this kind "staffage." It not only adds life, but proportion as well. It should not dominate the scene and become the center of interest.

Fig. 15 is a typical example of the folly of trying to get too much into a photo. There is a skyline of buildings, a ship, water, sky and an advertising sign. The division is horizontally across the photo and the shot, judged from the angle of composition, belongs in the wastebasket. Fewer similar elements grouped pleasingly are shown in Fig. 14. Note the suppression of unnecessary details in the shadows. Buildings, lamp posts and foreground lines suggest a diagonal alignment, although most of the visible lines are vertical.

The same general ideas also apply to photos of people. When taking one merely as a record shot or for identification, little

thought is given to composition, but to produce a pleasing effect, lines and masses must be taken into consideration. Examples of such photos are Figs. 17, 18 and 19. In Fig. 17, the subject assumed the usual pose for having a picture taken, but the result, compositionally, was a failure. The Indian, shoulders squarely facing the camera, stands against a wall while the black windows and the design of stones detract from the subject. Figs. 18 and 19 avoid these pitfalls. In Fig. 18 the bow and arrow lend interest. All lines with the exception of those of the bow are pointing toward the head. In Fig. 19, sand was chosen as a background instead of sky. Here a Pueblo medicine man is making a sand painting. His arms, leg and body, the trays of sand and the painting fit into a composition of diagonals. None of these lines dominates

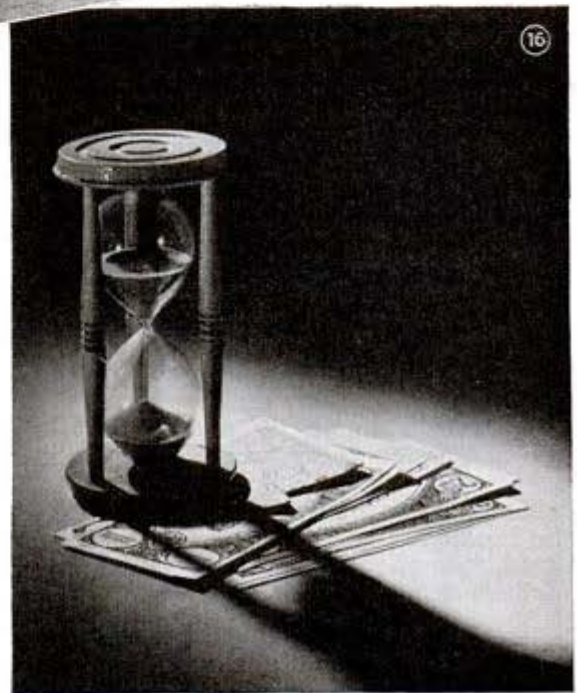
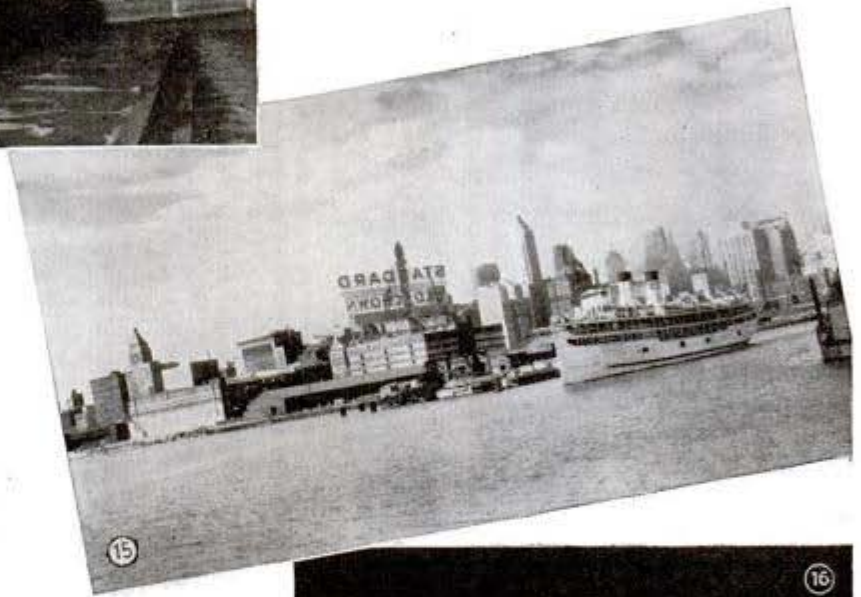



everything else, though the painting is emphasized most. All elements follow each other in a circular movement that forms a harmonious whole.

Fig. 16 shows a still-life photo which has a pleasing composition. This would not have been the case if the hourglass had been set in the center with the money directly underneath and the foreground had been allowed to blend into white. With the hourglass far to the side, its shadow a suppressed diagonal, and with the money forming another diagonal, an interesting result was obtained. A picture of this type has simple lines, yet is bold enough to catch the eye and demand attention.

Focusing in Poor Light Easier When Ground Glass Is Oiled

The image will appear much brighter when you are focusing under poor light conditions if you apply a small amount of machine oil to the etched side of the ground glass. The oil should be very light and need only be applied to a small area of the glass.—Wm. Swallow, Brooklyn, N. Y.

Flash of Photo Bulb More Certain If Tip Is Sanded Before Use

Sanding the tips of flash bulbs removes any possible tarnish, insuring a better connection which makes the flash more certain. A small square of fine sandpaper glued to the side or back of the camera will serve the purpose and act as a reminder before use.—Phil Lance, Philadelphia, Pa.



Dust Removed From Negatives By Statically Charged Rod



In enlarging and printing, dust particles that are usually so hard to remove from the negative will come off easily, especially in cold weather, when a statically charged glass rod is passed along both sides close to the surfaces. Rubbing the rod briskly for a few seconds on a scrap piece of fur or silk will charge it.

How to Make Photomicrograms Without Using a Camera

You can make photomicrograms satisfactory for most purposes without the use of elaborate equipment, even without a camera, by merely projecting the image from a microscope directly onto photographic printing paper, which then is developed in the usual way. The drawing

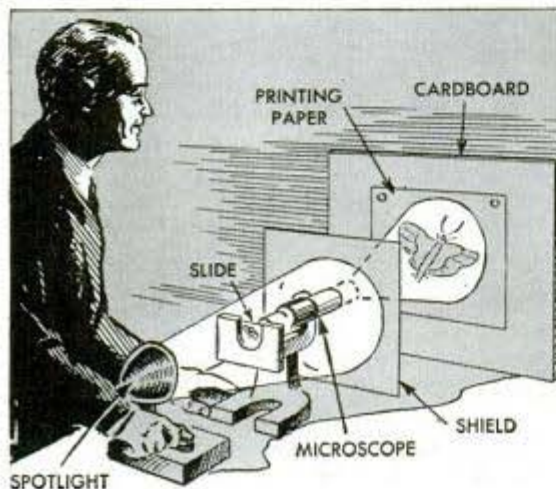

shows the setup. The microscope is used in a horizontal position with a strong spotlight directed on the specimen slide so that the image is projected onto a cardboard easel placed about 1 ft. in front of the eyepiece. A large shield, through which the eyepiece projects, prevents direct illumination from reaching the easel. After focusing the microscope, a piece of printing paper is put on the easel and given an exposure of about 6 seconds, depending on the strength of your light source. Of course, the exposure must be made in a dark room.—Ira Laufer, New York City.

Effect of Diffusion Enlarger Gained With Opal Glass

Improved tone value and detail possible with diffusion enlargers often can be obtained with condenser enlargers by placing a piece of flashed opal glass on the top of the negative carrier and inserting the com-



bination into the condenser enlarger. If your enlarger uses a glass "sandwich" carrier, substitute the sheet of opal glass for the top glass, with the rough surface always toward the light source.

Keeping Shutters From Freezing

To keep camera shutters from slowing up or stopping due to cold weather, miniature cameras and others which are small enough should be carried beneath the outer clothing. This will warm the shutter lubricant sufficiently so that it will not congeal.—Pfc. Bernie Aumuller Minneapolis, Minn.



SHOP NOTES

Make Your Own HYDRAULIC PRESS

By E. S. Harris

FOR fitting bushings into connecting rods, forcing gears on shafts, removing axles from small wheels and similar work in the garage, service station or shop, a hydraulic press like the one illustrated will do the job quickly and efficiently. It consists of a hydraulic auto jack, some pipe and pipe fittings and a frame made from odds and ends of scrap iron usual-

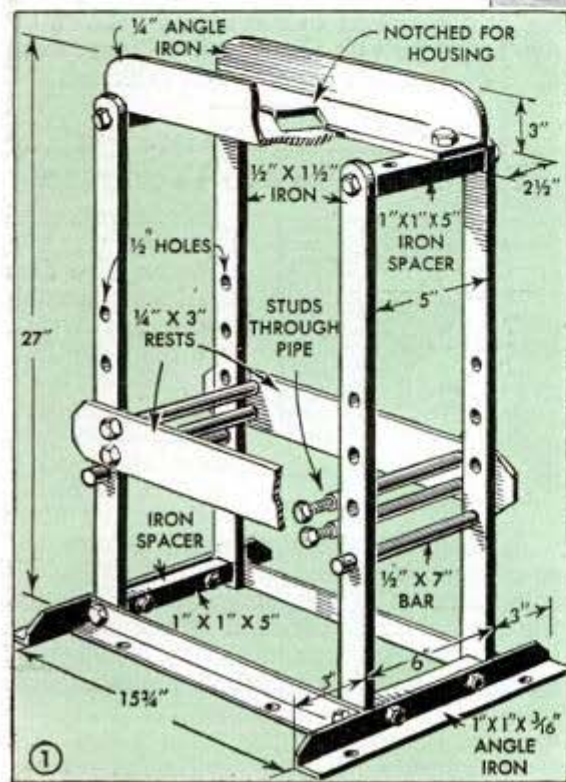
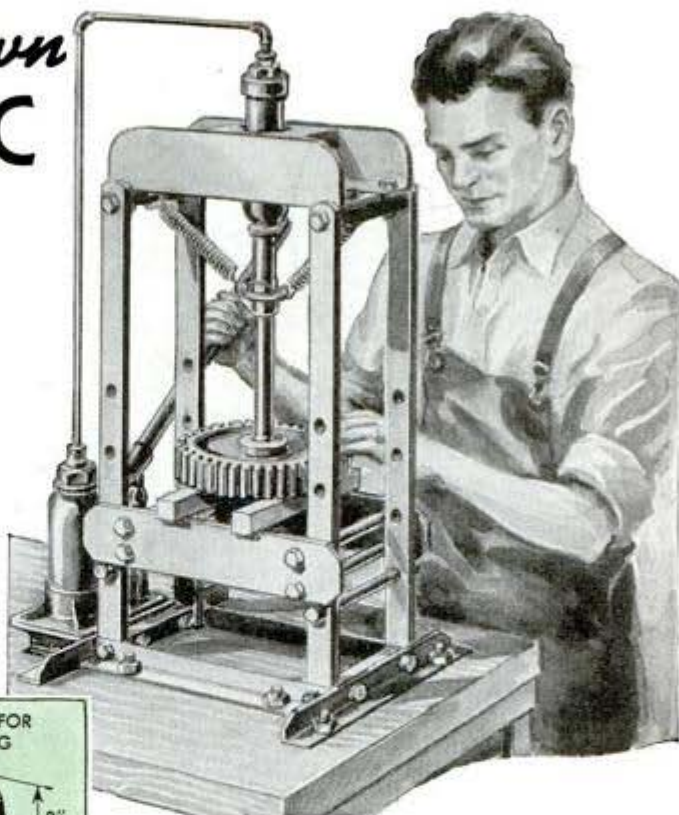

ly available at garages and machine shops.

Four pieces of angle iron forming the base are bolted to the workbench, and the uprights are attached with 1/2-in. bolts. Four spacers, shown in Fig. 1, are drilled and tapped for 1/2-in. bolts which hold them to the uprights. The top of the press is made from two lengths of angle iron which are bolted to the spacers. A notch is cut in each piece of angle iron through which the jack will be inserted later, and two steel retaining blocks, similarly notched as shown in the circular detail of Fig. 2, are drilled and tapped for two 1/2-in. bolts on each side and on the underside to receive a similar bolt extending through the slot where the pieces of angle iron butt together. The adjustable rests are supported at any one of four positions by bars placed through 1/2-in. holes spaced at 3-in. intervals in the uprights, and are held together tightly by four studs running through sections of iron pipe.

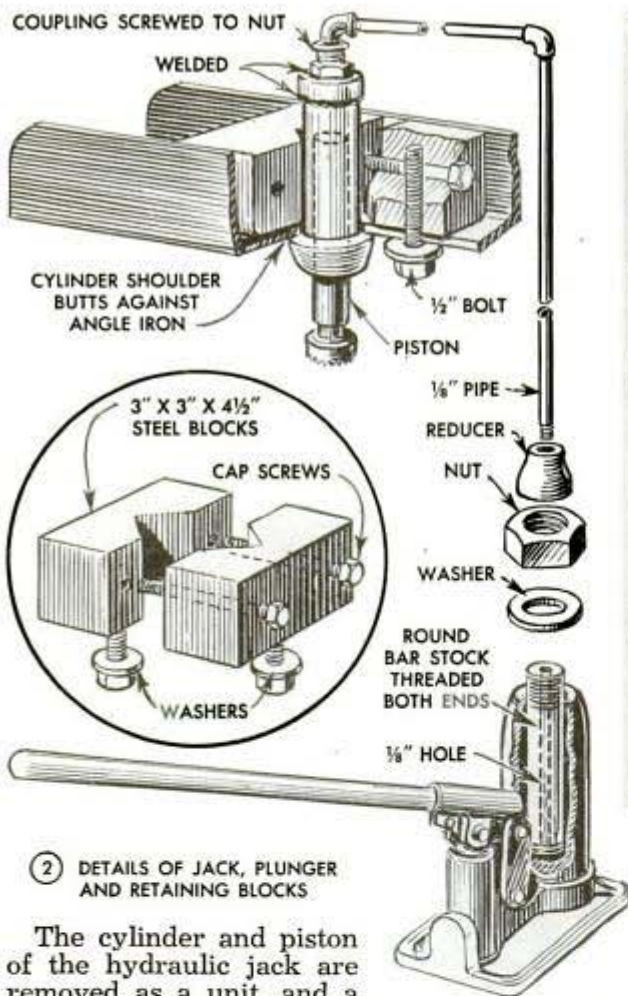

② DETAILS OF JACK, PLUNGER AND RETAINING BLOCKS

The cylinder and piston of the hydraulic jack are removed as a unit, and a piece of round bar stock of the same diameter and length as the cylinder is substituted. A hole is drilled through it lengthwise for the passage of fluid, and the ends are threaded, one end to screw into the base of the jack housing, the other to take a nut and pipe reducer into which the feed pipe is to be fitted. After the bar is screwed into the housing, a washer is placed over it and the nut turned down tightly to prevent loss of fluid. It may be necessary to put a gasket under the washer as a seal. Instead of using a reducer, the feed pipe can be threaded and fitted into a counter-bored, tapped hole in the bar.

Next, make a housing for the cylinder and piston. This is made from a length of 1 3/4-in. iron pipe about half as long as the cylinder, welded to a metal base which is threaded like the jack housing to receive the cylinder, and is drilled for the passage of fluid. A nut is welded to the base and a feed-pipe coupling screwed into it. The cylinder and piston in the substitute housing are mounted on the frame as shown in the upper detail of Fig. 2, with the end of the housing resting on the angle iron and the cylinder shoulder butting up against the underside of the angle iron. The hous-

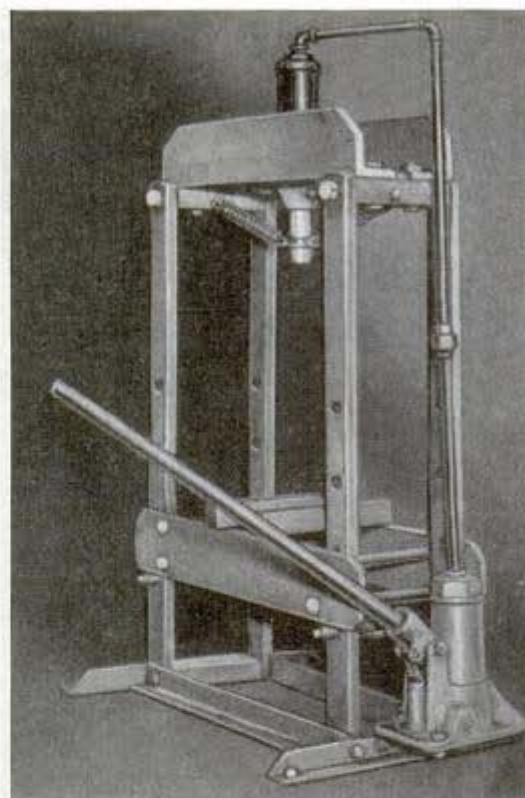

ing is clamped securely between the retaining blocks. In this position, the piston will press down on the work when fluid is pumped into the cylinder. The feed pipe is attached by couplings and elbows, and the jack is supported by a brace at the side of the frame. Coil springs, attached to the frame spacers by eye bolts, pull up the piston and force the fluid back when the valve is released.

Holding Marking Die in Pipe Tee Prevents Injury to Workman

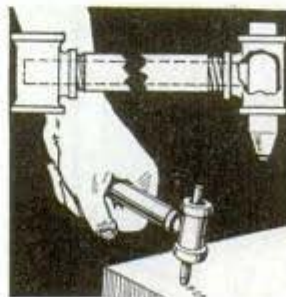

After repeated pounding with a hammer, the dies used in stamping numbers, initials, or other identifying marks on metal parts become rounded on top, permitting the hammer to strike a glancing blow which may hit the workman's fingers and so cause damage and loss of time. To avoid this threat of injury, one worker designed the die holder illustrated. It is made from two 3/8-in. pipe tees joined by a length of 3/8-in. pipe within which a 1/4-in. pipe is inserted. With the die slipped in place, the tees are turned to tighten the inside pipe against it, thus holding it firmly.

Adjustable Stop Holds Work Upright for Planing

Accommodating work from $\frac{1}{8}$ to $1\frac{1}{4}$ -in. thickness, this handy bench stop holds the work in an upright position for planing and other operations. The stop is made from two pieces of hardwood, about 1 in. thick, to the dimensions given in the sketch. The two pieces are right and left hand, the miter half-lap being on the top on one piece and on the bottom on the other. The stop is mounted parallel with the side of the workbench, with about $\frac{1}{16}$ in. separation between the two pieces. A 2-in. No. 10 round-head wood screw driven through each half of the stop into the bench top anchors the stop, the screws being located at midlength as shown in the detail.

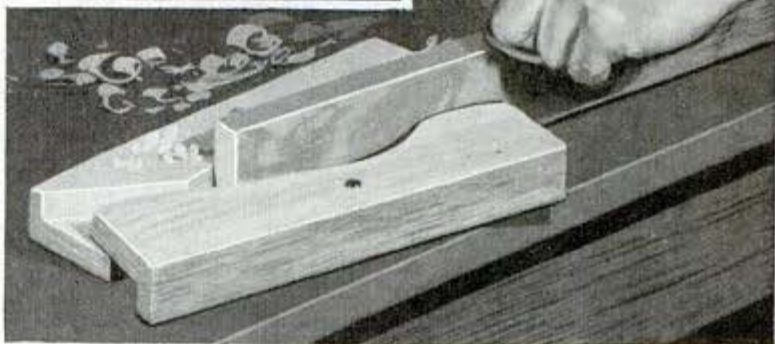
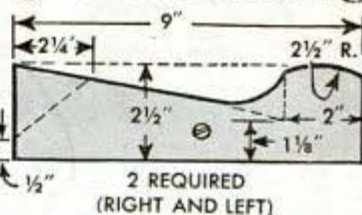
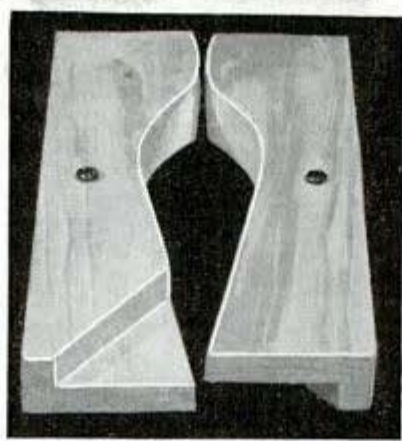

Extension Table Permits Use of Miter Gauge on Band Saw

It is frequently helpful to use a miter gauge on the band saw for cut-off work. If your saw does not have this feature, make an extension table of wood, and fasten it in place by means of guide pins into

the band-saw table, plus two screws which fit slots cut in the ends of fence guide rails. If your saw does not have fence guide rails, the extension table can be fitted to short angle-iron arms. The miter-gauge groove

in the wood table should be made the proper size to take the circular-saw miter gauge. The gauge can be fitted with a wood backstop for supporting the work when cutting off close to the blade. The wood table should be exactly flush with the top of the regular band-saw table, and need not be removed except when it is necessary to change the blades.

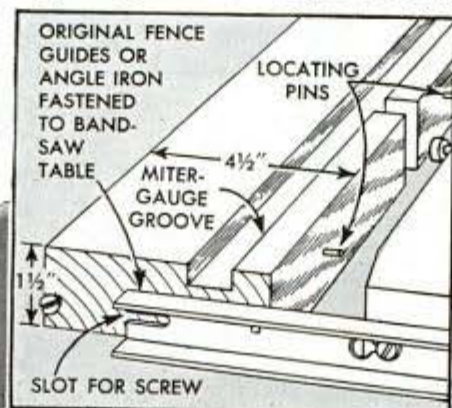
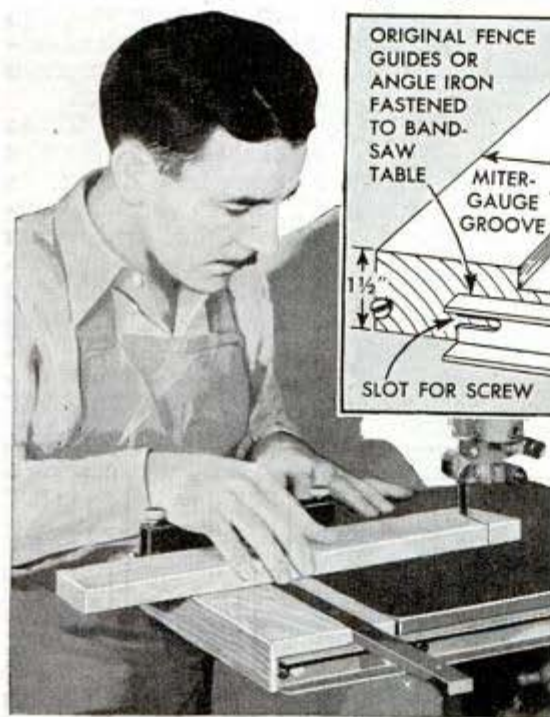

Glue Stops Stain Penetration

Stains will not "bleed" through paint if the stained surface is well sanded then covered with waterproof glue mixed to the consistency of cream. Two coats should be applied, allowing the first to dry thoroughly before applying the second. A priming coat of paint also makes better results.

—C. L. Cronk, Washington, D. C.

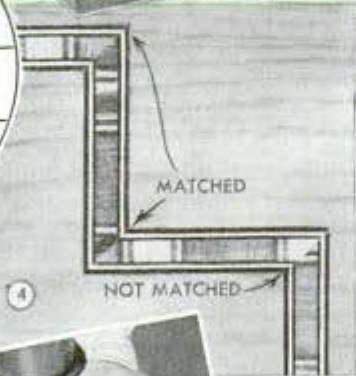
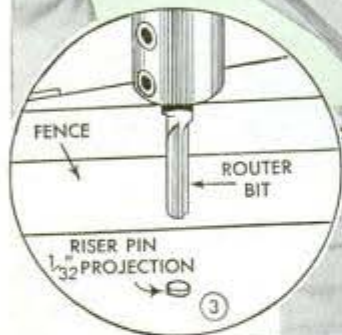
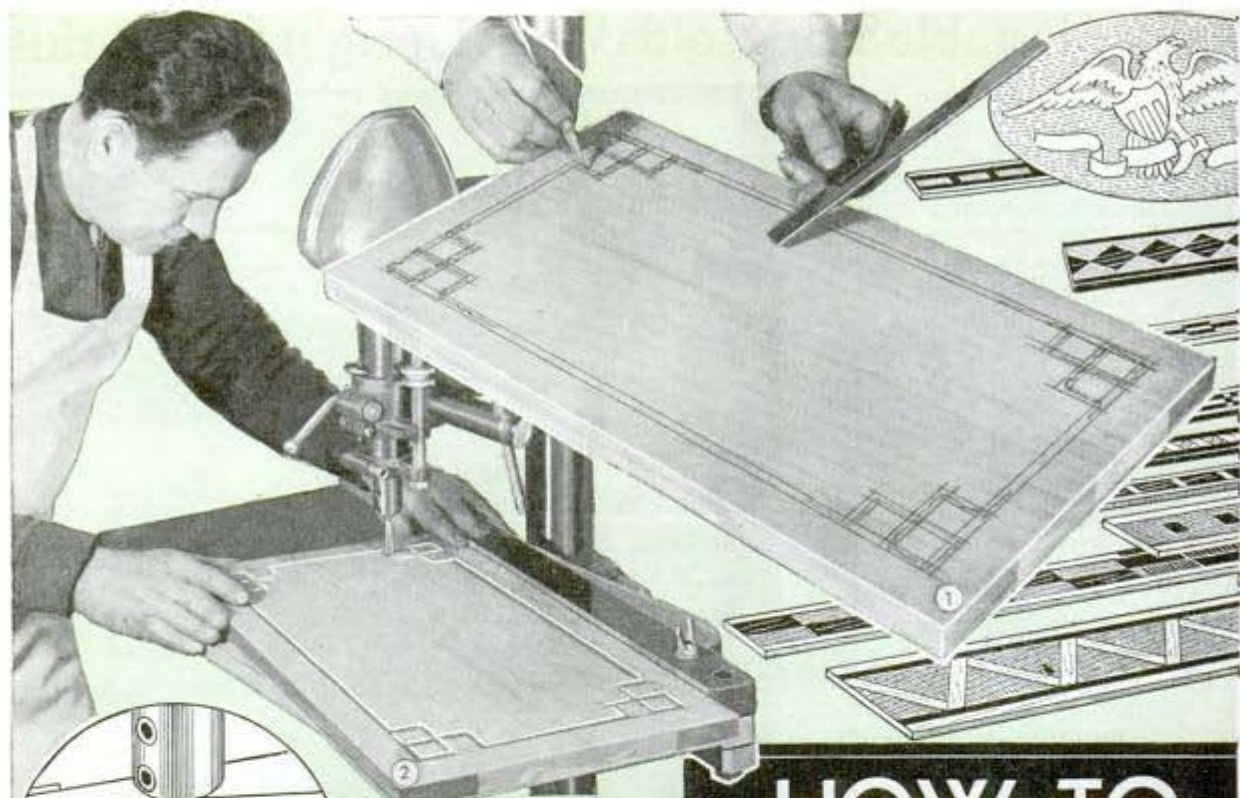

BLOCK TO CUT INLAY BANDS AT 45° ANGLE

HOW TO

INLAY bands and designs offer an attractive and easy-to-work medium for the enrichment of small boxes, table tops, drawer fronts, book ends and many other craft projects. Of course, such decorating can be overdone but, judiciously applied, a touch of colorful inlay will improve almost any project.

Inlay bands: These are sold in yard lengths ranging in widths from $\frac{1}{8}$ to 1 in., and the design itself embraces about a hundred standard patterns. The first step in inlaying a band or border is to mark off the design on the work, Fig. 1. The necessary

INLAY BANDS, obtainable in many different patterns, add color to any project. Routing of recess is done on the drill press at a speed of 5,000 r.p.m., using a fence to guide the cuts. Grooves across the grain of the work should be cut first. Various corner designs for tables and boxes are shown at right

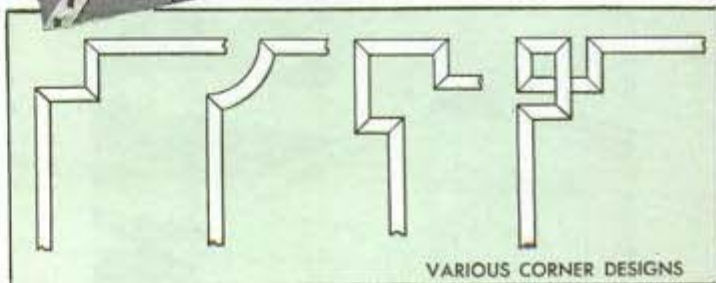

VARIOUS CORNER DESIGNS



WORK *with* INLAYS

STRINGS are inlay bands, cut from solid veneer or thin plastic, which can be purchased, or can be sawed from sheet veneer by using the simple set-up shown above

recessing then is done with a single or double-flute router bit of the same diameter as the width of the band. Cuts across the grain should be run in first, after which with-the-grain cuts at the same fence setting can be made, Fig. 2. This method of working will avoid tearing the wood at the end of the cut. The depth of the recess should be a little less than the thickness of the inlay band. If the work is slightly warped, it is advisable to work over a riser pin, as shown in Fig. 3, to assure a groove of uniform depth. The drill speed should be no less than 5,000 r.p.m. After routing, it is necessary to clean the corners with a sharp chisel as in Fig. 5. The inlay band itself can be cut with chisel and guide block, Fig. 6, or the miters can be rough-cut and then sanded smooth, Fig. 7.

Miter joints should be matched

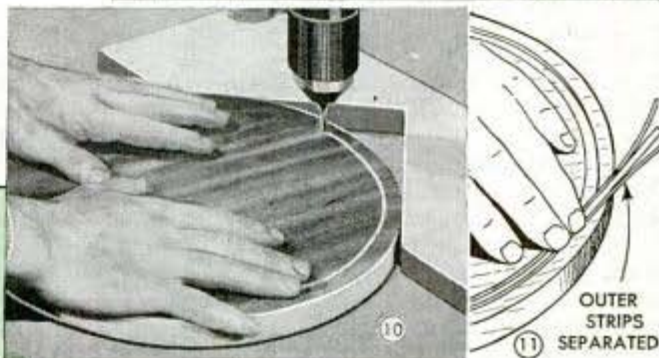
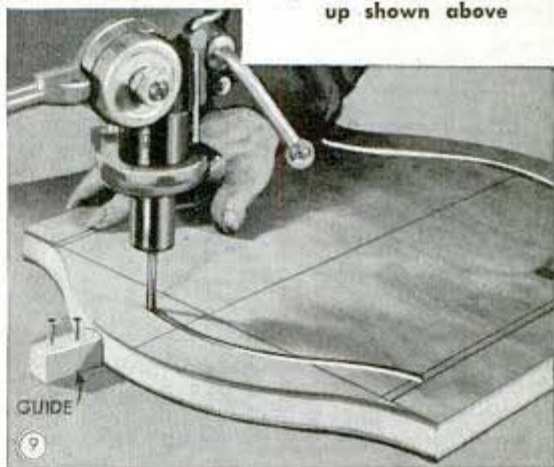

CURVES are routed by using a guide pin or, if the work is circular, a V-block or pivot pin

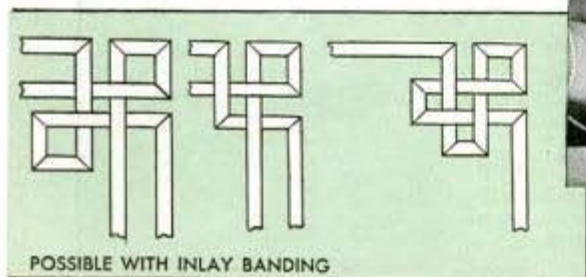

POSSIBLE WITH INLAY BANDING

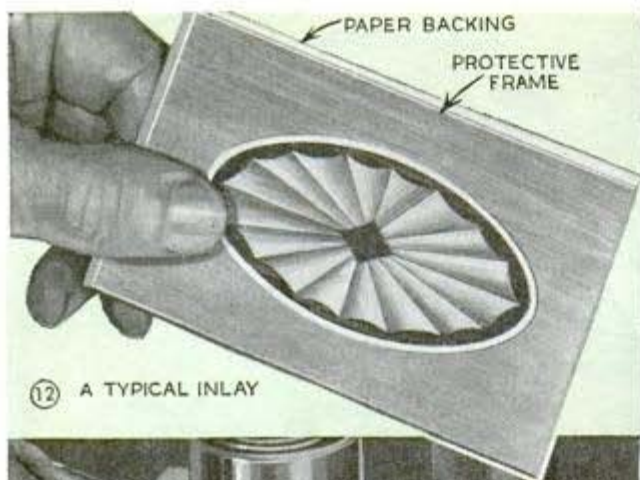

12 A TYPICAL INLAY

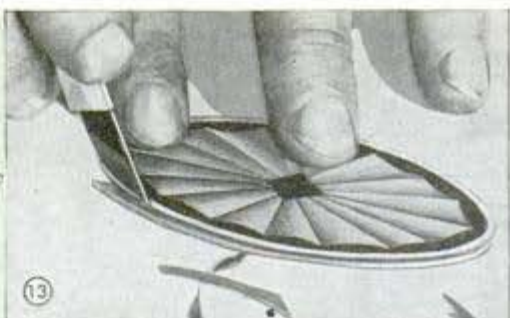

13

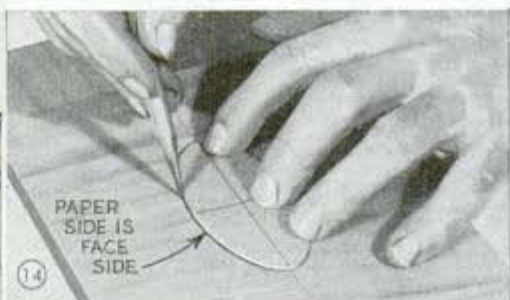

14

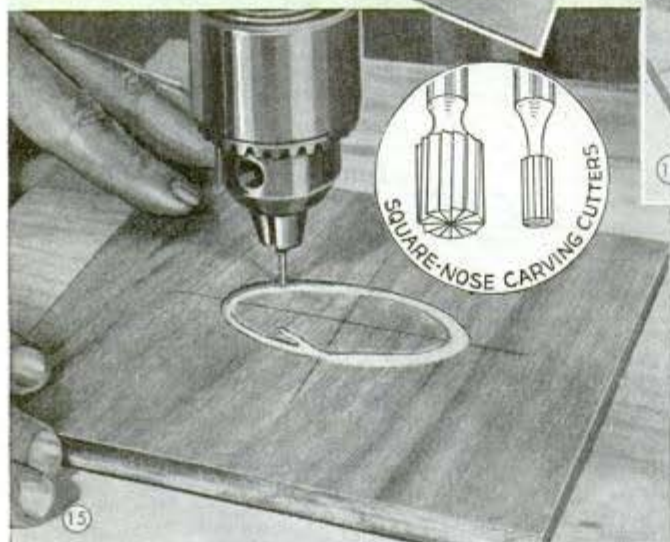

15

INLAYS are purchased ready-made and are fitted by routing them freehand on a drill press or with rotary hand tool

(see Fig. 4). If you use the chisel method of cutting, trimming to the exact miter line, perfect matching, Fig. 4, will be obtained by simply turning one of the pieces over. If the miter is not correct, it should be sanded down until the design comes to the proper repeat position for matching. Some borders permit mismatching; others expose a mismatch like the proverbial sore thumb.

Strings: Strings are inlay bands cut from solid veneer, celluloid or thin plastic. The method of cutting shown in Fig. 8 permits ripping of strings as narrow as $\frac{1}{16}$ in. with perfect accuracy. The application is the same as for ornamental banding. Another method of making strings is to use veneer of a thickness



16

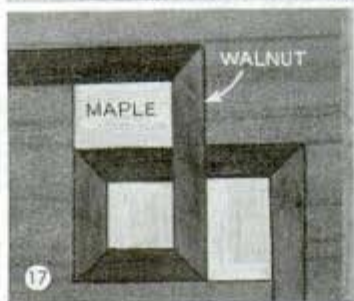

17

SOLID CORNERS, built up from lumber stock, have many advantages in production work. The design is completed with veneer strings

equal to the width of the banding required.

Banding of curves: The average inlay banding will take moderate curves. Cutting the recess requires a pin guide as shown in Fig. 9 or, if the work is circular, a V-shaped guide or pivot pin, Fig. 10. Curves should not be attempted with banding over $\frac{5}{16}$ in. wide. Fitting on abrupt turns is easier if the banding is heated. If this does not turn the trick, the banding can be wetted to permit peeling the outer strips free as in Fig. 11. In this condition, the various separated strips will slide past each other, permitting abrupt turns.

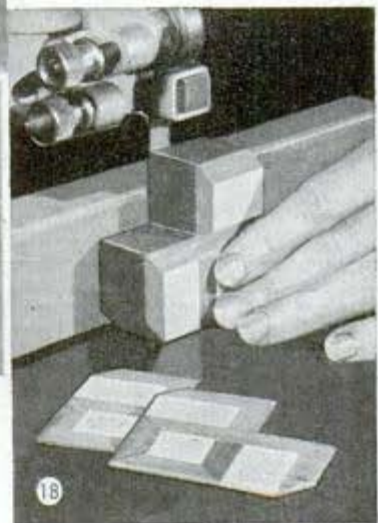

18

Inlays: This word in itself indicates a built-up pattern design as shown in Fig. 12. The design is surrounded with a protecting veneer frame, and the whole thing is backed with paper, the paper side being the face side. Band-saw around the design and then trim to the joint line with a knife, as in Fig. 13. Using the inlay as a pattern, mark around it onto the work, Fig. 14. Note that the paper side is up. Cut the recess free-hand, using a square-nose carving cutter mounted in a drill press, Fig. 15, or a rotary hand tool, Fig. 16. The carving cutter does not

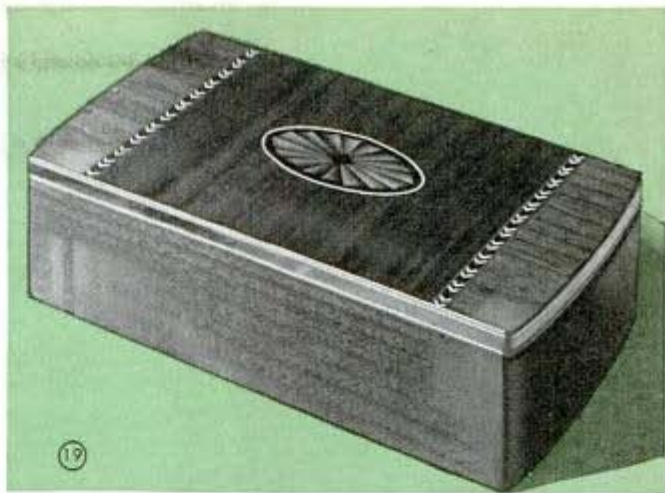

Fit inlay on 3/16-in. plywood and saw; then sand pattern, taking off a little of the inlay to assure pattern of exact size

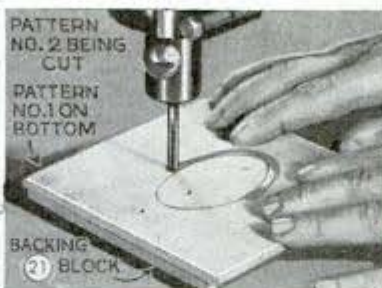

Fit pattern on underside of backing block and rout pattern No. 2, using 1/4-in. router bit and 1/4-in. guide pin. Rout in 2 bites

DOUBLE PATTERNS provide a good working method of inlaying the same design in production work, such as the box shown above

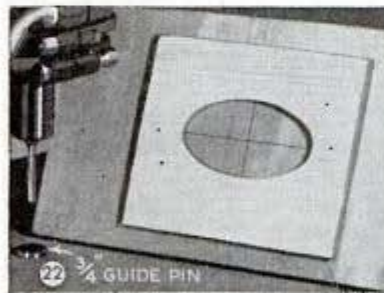
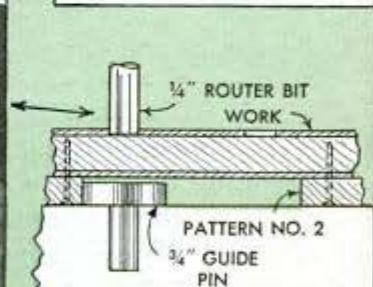
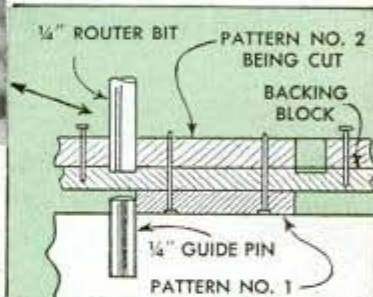

Center pattern No. 2 on underside of work. Be sure face side is up. Fit 3/4-in. guide pin. Do not change setup of router bit



Rout the recess, cutting to a depth a little less than thickness of inlay. This part is easy since pattern supplies positive control

kick like a single or double-flute router bit, and it is quite simple to trim the recess exactly to the pencil line. Freehand cutting of this kind is recommended for all jobs where a single inlay is to be fitted; other methods using patterns are best for production work, as will be described later.

Solid corners: A type of inlay border using a solid built-up corner is illustrated in Fig. 17. The work is built up in a thickness of about 1 in., which, when ripped on

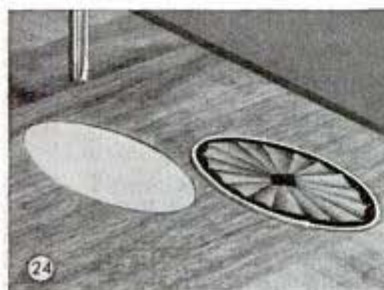

Leave pattern in place and rout out freehand the wood in center of recess. Go around the outside again to assure a full cut

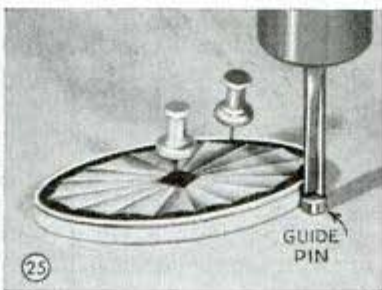

Other inlays of same pattern are shaved to exact size by using pattern No. 1 with 1/4-in. guide pin and 1/4-in. router bit

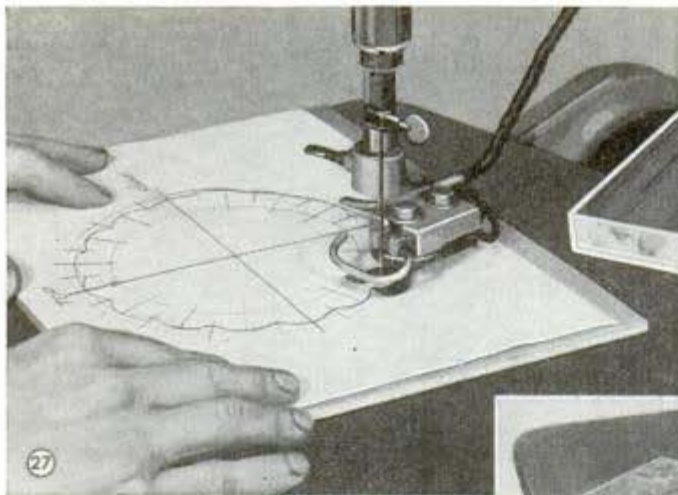

27

VENEER INLAYS are cut from solid veneer of contrasting color. One pattern is used for cutting both the inlay and the recess

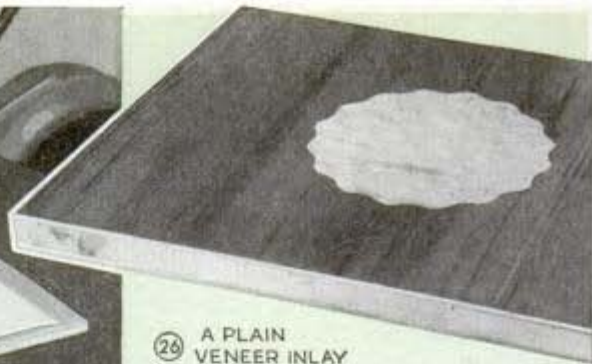

26 A PLAIN VENEER INLAY

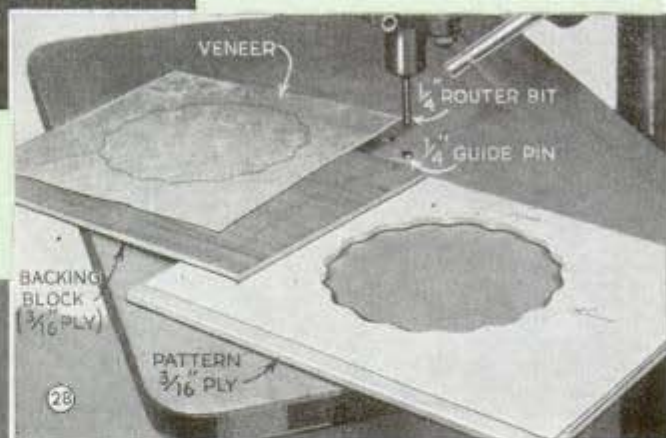

28

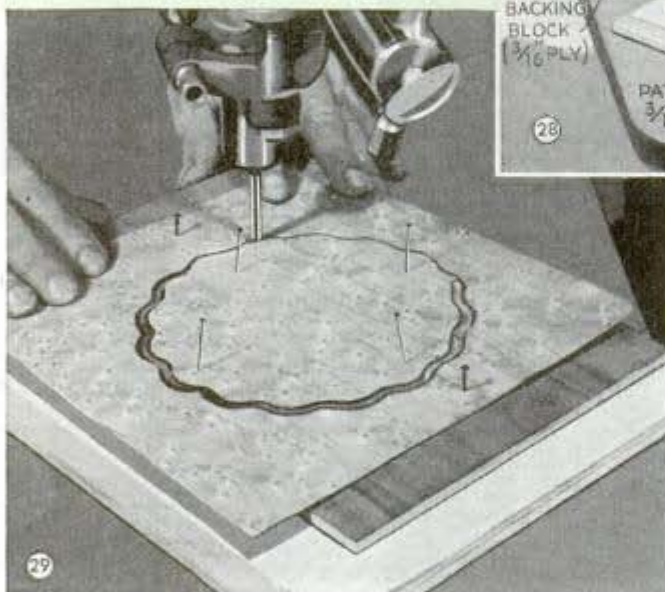

29

and a tight fit for the pins. Keep in mind which side of each pattern is the face and work accordingly. In the popular oval designs, it is not at once apparent that the design has a right and left side. This feature is at once apparent when working an inlay like the inlay letter B shown in Fig. 30. Work all symmetrical designs the same way.

Veneer inlays: Single or production work on plain veneer inlays, Fig. 26, is best done with a pattern, the pattern serving as a guide for both inlay and recess.

the band saw, Fig. 18, supplies several corner pieces. Joining strips are plain veneer, ripped to the required width.

Double patterns: This method is useful when the same stock design is to be inlaid several times, such as production work on a box like the one shown in Fig. 19. Start by sawing and sanding a pattern of the same size as the inlay, Fig. 20. Follow the successive operations as described in the captions of Figs. 20 to 25. A 1/4-in. double-flute router bit is used in these operations and is the best size for average work. Two guide pins are used, one being the same diameter as the router bit; the other, three times the diameter of the bit, less about .005 in. These should be turned from metal and must be exact. The fitting hole in the table must be exactly under the router bit

With slight variations, this is the same as the system already described. The pattern is scrollsawed as in Fig. 27, using a fine blade to get a smooth, regular outline. No particular dimensions need be followed, except it should be remembered that the inlay will be smaller than the pattern by the size of the router bit. Fig. 28 shows the setup for cutting the veneer, using 1/4-in. router bit and 1/4-in. guide pin. Fig. 29 shows the veneer being cut. The pattern must be kept tight against the pin to avoid cutting the veneer undersize. As a visual guide, it is good practice to center and mark the design with pencil on the veneer before starting the routing operation. After the veneer inlay has been cut, the same pattern is fitted on the underside of the work, and the recess is cut, using the same



router bit but with the $\frac{3}{4}$ -in. minus guide pin. Cutting the recess is the simpler of the two operations since the pattern in this case supplies a positive guide so that overcutting is impossible. Go around the work twice to make sure that you are out to the full limits of the pattern.

Inside cuts: These, such as the letter B, Fig. 30, are worked the same as solid veneer inlays except that the pattern is a bit more complicated. The design should be drawn actual size, after which the actual lines of the pattern are set off outside the inlay, Fig. 32. The setup recommended is the $\frac{1}{8}$ -in. router bit. This requires a $\frac{1}{8}$ -in. guide pin for cutting the inlay, and a $\frac{3}{8}$ -in. (minus) pin for cutting the recess. Fig. 31 shows the work finished and the pattern turned over. It will be apparent that the size of the work is limited by the inside cuts, which must be large enough to permit taking-off and still leave wood enough for handling and mounting. Do not destroy the paper design when doing work of this kind since it will be needed in properly positioning the inside parts of the pattern. Obviously, this method is useful only for production work; if the job is a single piece it can be inlaid much quicker by using the freehand method of cutting the recess.

Finishing: Use cold resin or hot glue for mounting, applying glue to recess only. Avoid using any kind of glue which stains. Banding will usually stick without clamping; inlay designs should be clamped under a board with paper between. Allow the glue to dry thoroughly, then sand the inlay flush, finishing with no coarser than 4/0 paper. The best finish is French polish. The fastest and clearest finish is clear lacquer or varnish, about three coats, without filler. If filler is used, it should be natural. If a very dark filler is used, the inlay

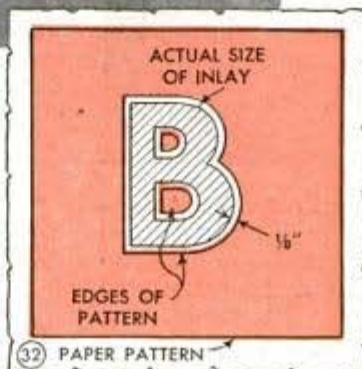

INLAYS WITH INSIDE CUTS are worked with a single pattern. The work is limited by the size of the inside cuts which cannot be smaller than about $\frac{1}{2}$ in. For single pieces, use the freehand method of cutting

must be protected with masking tape or by giving it a coat of shellac. If this is not done, the inlay will pick up some color from the filler and lose brilliancy. However, some types of inlays, such as Holly banding or other close-grain wood, will wipe clean with just the right amount of contrast. The use of stain on the ground work should be avoided. This positively requires masking the inlay and even then there is danger of the stain striking into the edges of the inlay and spoiling the effect.

Scored Line Aids in Sanding Work on a Disk Sander



make it readily visible. The scoring establishes a definite parting line to which you can sand more accurately than is possible when sanding to a pencil line.

Sanding work accurately to line on a disk sander is easy if you follow a stunt used by pattern makers. First the line of cut (sanding line) is scored with the point of a knife, after which a chisel-edge pencil is run in the score to

Mailing Tubes Addressed Easily On This Simple "Table"



Having a number of mailing tubes to address in longhand each month, one office worker made a simple table on the top drawer of his desk to hold the tubes and support his arm to reduce wrist strain. The table is made by notching the sides of the drawer to hold a tube in position, after which an armrest is provided by laying a piece of sheet metal or hard-pressed board over the drawer as indicated, the armrest being cut out at the rear end to expose the portion of the tube to be addressed.

Loose Belt Causes Overheating

When a car is overheating, a loose fan belt which slips and will not allow the water pump to function properly often causes the trouble, although the fuel pump or some other factor may be blamed wrongly as the cause. Trimming the frayed edges of the fan belt and reinstalling it at the proper tension generally will eliminate the trouble.—Hal Gheim, Aurora, Ill.

Hinged Stop Prevents Drafts Under Large Sliding Doors

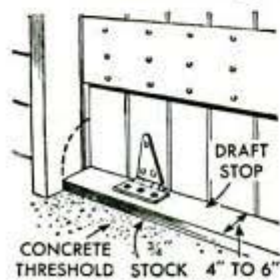

To prevent drafts and to stop rain and snow from blowing under large sliding doors on barns and outbuildings, one farmer fitted a hinged stop to the bottoms of the doors as shown.

The stop can be made of $\frac{3}{4}$ -in. stock 4 to 6 in. wide cut to fit loosely between the door jambs. Before attaching, the hinge-

pivots are nicked with a cold chisel to stiffen them so that the stop will stay in a raised position when the door is opened.

Chuck Key Taped to Electric Cord Is Accessible for Instant Use

To avoid time lost in searching for a chuck key, which is sometimes mislaid when separated from the hand drill, one mechanic tapes it to the electric cord of the drill so that it will be always available. Attached in this manner, the key can be turned freely in the chuck merely by slacking the cord slightly.

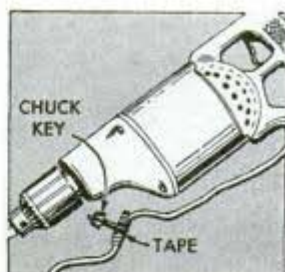

Portable Shelf Unit Is Handy When Inventorying Stock

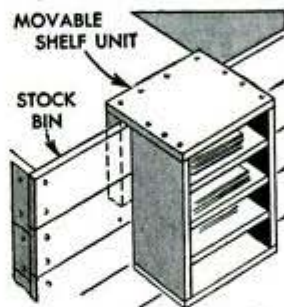

In order to have labels, envelopes, data sheets and other necessary supplies at hand when working in a stock room, one inventory clerk uses a portable shelf unit which hooks over the side of a stock bin.

Consisting of a small box with shelves, the unit can be sanded smooth on top to serve as a writing surface.

Cutter Removes Battery Straps Without Damaging Elements

Instead of sawing off the posts to remove the connecting straps of a storage battery, use a hole saw to cut the strap from the post. To make the saw, file teeth in one end of a piece of thin wall pipe or tubing and drill a hole at the other end for a handle. To use, press the cutter down on the strap where it fits over the terminal post and turn the cutter back and forth until the ring is cut through. The straps can then be lifted off, and may be placed over the posts of a new cell and soldered tight.

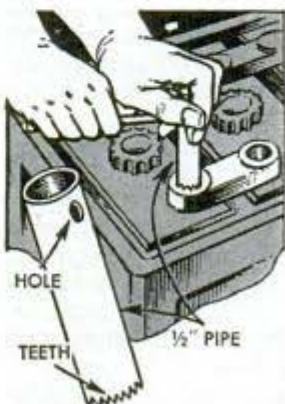

Accurate Method of Boring a Shotgun Stock

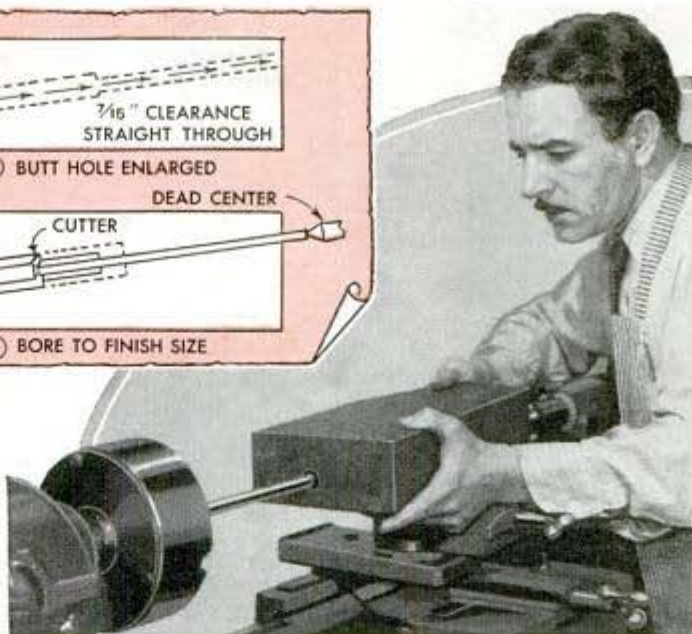
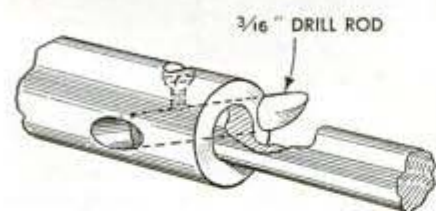
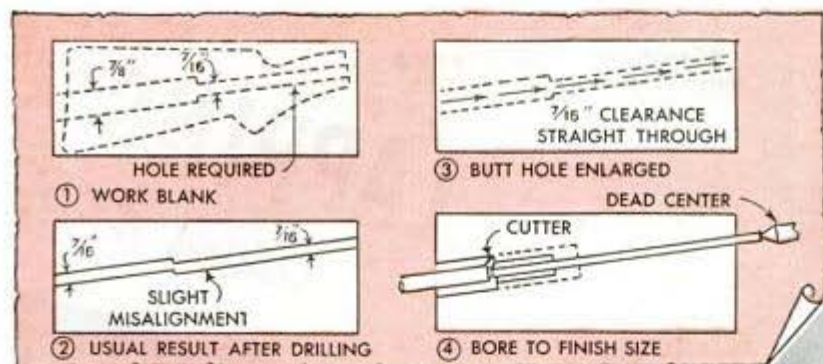

When you are making a shotgun stock and want to bore the stock bolt accurately, try this method: The job requires a specially made tool—a boring bar with a pilot—but results are well worth the time taken to make it. Fig. 1 shows a typical blank and the hole required for the bolt. Follow the usual method of centering the work in the lathe, drilling from both ends. Usually the holes will be out of alignment from $\frac{1}{16}$ to $\frac{1}{8}$ in., as shown in Fig. 2. With a larger drill, bore out the butt end, Fig. 3. This will not correct the misalignment, but it will provide a straight passage for the boring-bar pilot. Do not bore the hole any larger

than necessary to clear the pilot. The final operation, which is done with the special boring bar, is shown in Fig. 4. Make the pilot end of the bar about 1 in. longer than the work, and the part behind the cutter a little longer than the depth of the hole. A piece of $\frac{3}{16}$ -in. drill rod held in place with a setscrew is the cutter, as shown in the lower detail. The boring bar is under power while the work is pushed forward by the lathe compound. Although the cut will be a little rough at the start, it will quickly smooth out and will be a perfect concentric fit at the shoulder, which is the important part.

Water-Tight Joints Made in Tubing Without Using Solder

Where pieces of tubing are to be joined in a tight seam, much time can be saved by rolling shallow grooves in the tubing with

a dull tube cutter to form rings which will interlock when the tubes are joined and hold the parts tightly. This method is especially valuable at present because it eliminates the use of solder.

—D. H. Loosli, Chicago.



Long Life for Scrollsaw Blades

I have doubled the life of the blades on my electro-magnetic scrollsaw by using an extra table top which I cut from $\frac{1}{2}$ -in. plywood. I drilled holes in the corners of the metal table top and countersunk corresponding holes in the plywood top, leaving a small hole in the plywood for the blade. Now after I have dulled several blades I merely screw on the plywood top, which raises the work so that a new portion of each blade comes into use.

—O. A. Smith, White Plains, N. Y.

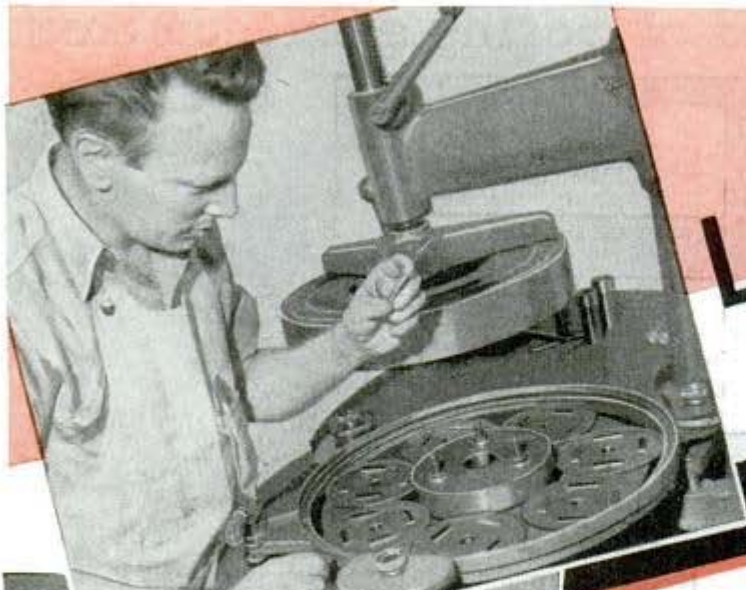

LAPPING

Gives Metal

By H. J. CHAMBERLAND

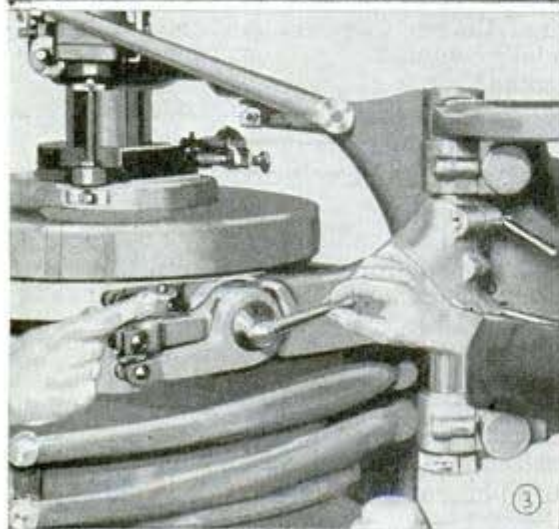

TREMENDOUS airplane speeds of today would be impossible if the motor parts were finished only with metal-cutting tools. Where accurate fit and surface-to-surface contact of moving parts are involved, as in airplane or automobile motors, the initial wear must be removed by lapping the parts to "micro-precision" dimensions before assembling them. Dimensional accuracy is impossible without surface accuracy. This article includes methods of mechanically lapping a number of similar parts for fine external finish, either cylindrical or flat.

Types of lapping machines: There are two distinct types of external lapping machines. The one shown in Figs. 1 and 5 is the original design, having two metal disks or laps the diameter of which varies to suit individual requirements. Only the bottom lap revolves and on it the parts to be finished are supported by means of retainers, spiders and other work-holding devices. The top lap, which does not rotate, does an equal share of the work and provides the necessary light pressure. This lap is made to "float" because it must be dismounted often for reconditioning. Without this floating action of the upper lap, the parts would not be finished parallel nor straight. Fig. 1 shows the lapping of gauge blocks while Fig. 5 shows the lapping of six plug gauges mounted on a retainer which allows them to rotate on their centers.

The machine shown in Fig. 2 is more modern. In this case both laps consist of fine-grit grinding wheels that rotate horizontally in opposite directions, the upper one clockwise and the lower one counter-clockwise. The upper one is lowered to contact the work, and the feed is hydraulically operated. To keep the surfaces of the wheels in perfect parallelism, a twin

"Micro-Precision" Finish

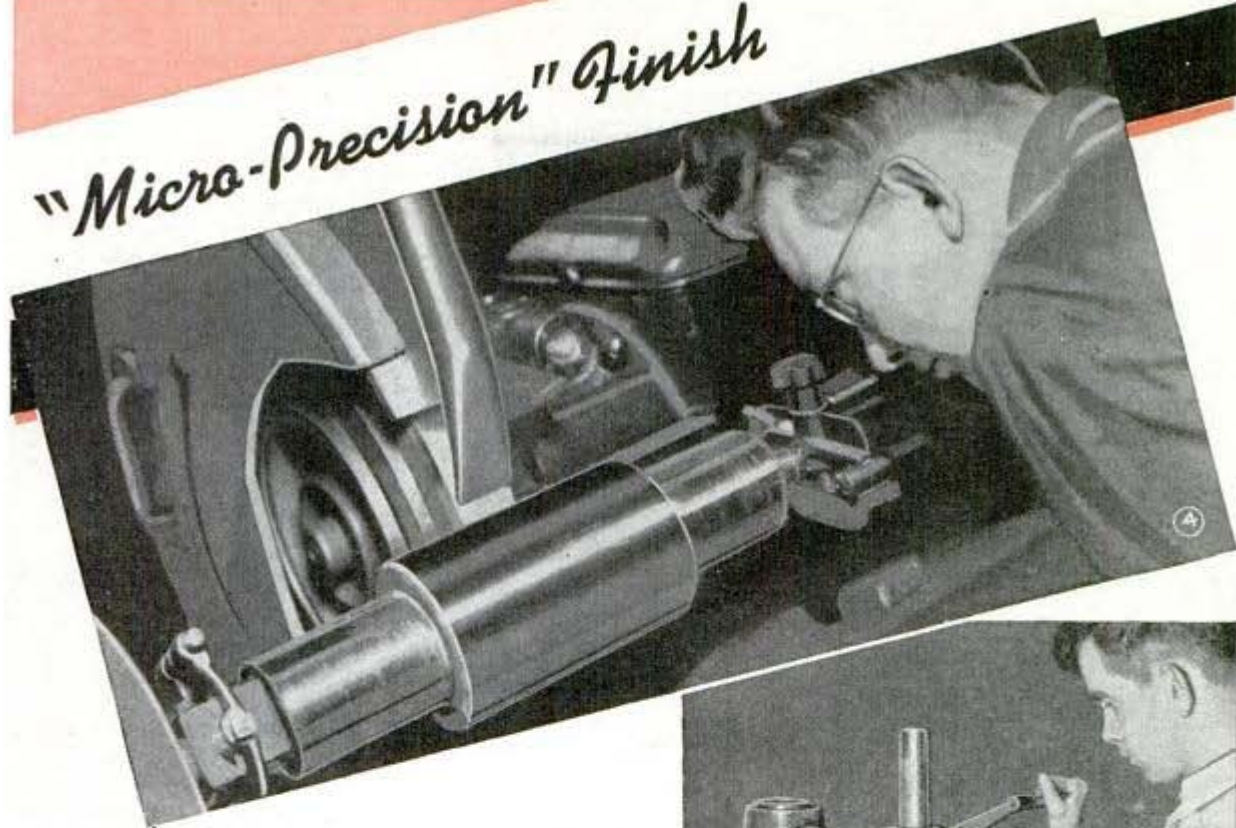

diamond dressing arm, shown in Fig. 3 is provided. This also is hydraulically controlled. With these facilities and an electrical gauge showing how the lapping operation is progressing, very little training is required to operate this machine. Besides the common types of lapping machines already described, there are some that have been specially designed for certain jobs. Fig. 6 shows such a machine which laps all bearings on a crankshaft simultaneously.

"Break-up" motion: On lapping machines a variety of work-holding devices forms the basis of the equipment. The machine itself is of relatively simple construction. The metal or grinding-wheel laps rotate at less than one-tenth of the peripheral speed of regular grinding wheels. The retainer, spider or work holder, which serves as a chuck, provides the proper travel for the work during the cycle for each piece to cover the entire abrading surface of the lapping members. The primary motion given to the work is a rolling one produced by movement of one lap with regard to the other with the work in frictional contact between them. The secondary motion is produced by the eccentric drive pin driven by a train of gears from the lower lap spindle. This single motion however, is not sufficient for a perfectly flat, parallel or straight finish. The retainer or spider is not concentric with the bottom lap but it is fixed to the spindle of the bot-

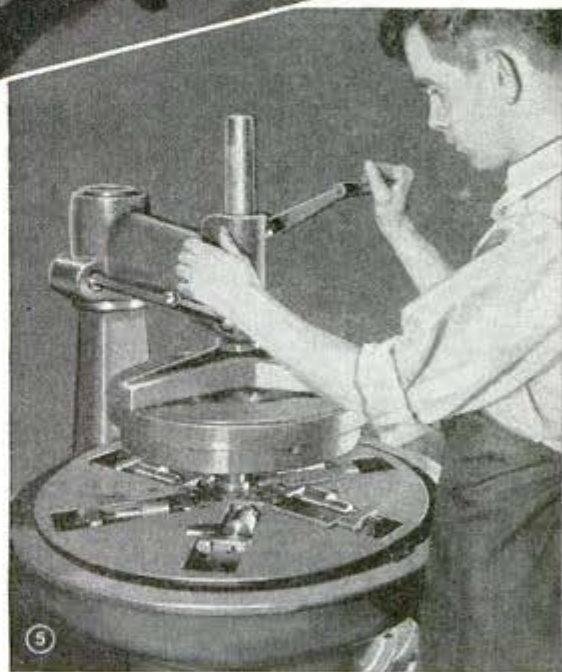

tom lap and a secondary motion for the retainer is provided by a drive pin from a train of gears assembled on the lower drive shaft. Thus during the operating cycle the movement of the retainer is somewhat similar to the throw of a crankshaft. The combined motions between the abrading surfaces of both laps provide the "break-up" action, which corrects defects to assure both surface and dimensional accuracy.

Hand lapping: As lapping machines are effective and economical for production runs only, manual lapping must be resorted to when there are just a few pieces. Fig. 7 shows an example of short-run external lapping by hand, on a lathe. One end of a go-and-no-go plug gauge, which is being

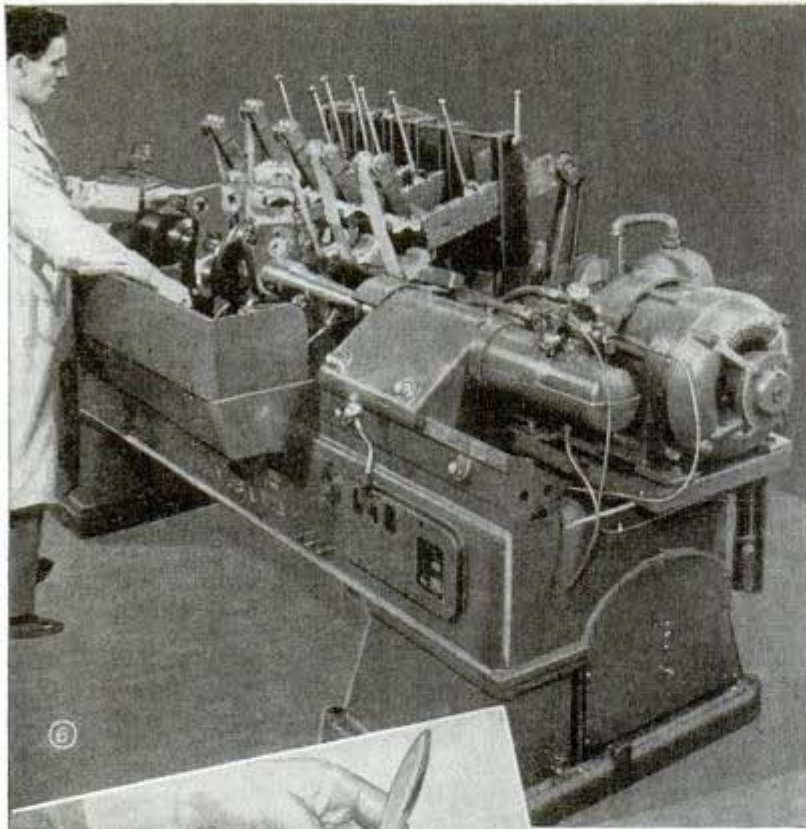

lapped in this case, is held in a three-jaw chuck and the other end is centered on the tailstock. The working surface of the lap is bored eccentric to provide space for two socket-type screws which are used for adjustment. The lap is slit after the holes have been tapped. The lap shown in Fig. 8 consists of a piece of slit tubing and lapping pressure is provided by a lathe dog. For flat lapping manually, one must still resort to a lapping plate as shown in Fig. 10.

Rolling axis and transposition: Cylindrical lapping is done on wrist pins, valve stems, tappet rollers, roller bearings and other similar parts. In the construction of retainers for cylindrical parts, the rolling axis of

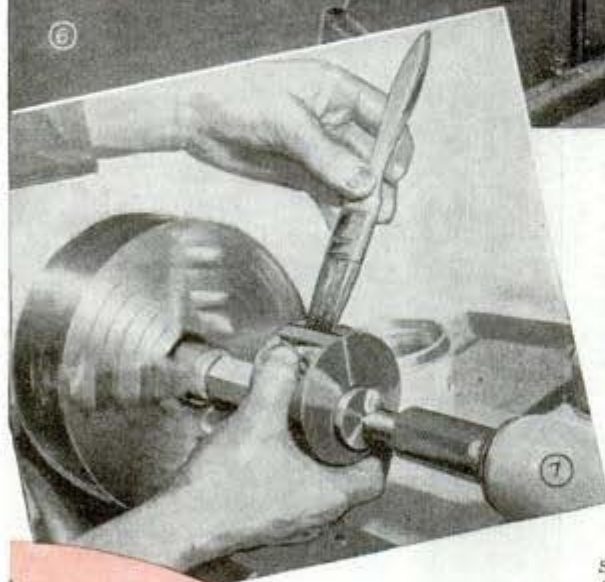

the work is not in line or radial with that of the laps. For free rolling action, the work must be positioned at the greatest angle possible, which varies from 10 to 22 degrees, depending on the nature of the work. This angular position of the work is necessary to introduce a slippage as the work is rolled on the face of the laps. Mechanical flat lapping requires a particular technique, called transposition, to assure precision of parallelism. After some lapping has been done, the machine is stopped and the parts are exchanged with the corresponding parts diametrically opposite them for the next lapping cycle.



Metal laps and lapping compounds: Fine-grit lapping wheels introduce no maintenance problems as they remain permanently located and automatically wear themselves down uniformly, from repeated dressings and surface-to-surface contact. However, the face of metal laps must be reconditioned regularly. Preparation of the surface to be flat-lapped is highly important; it must be machined accurately, the part must be stabilized by heating and freezing alternately several times to eliminate internal strains, and the surface to be lapped is finally hand-scraped. Two surfaces of square or rectangular shape are made precisely flat by lapping them into each other with reciprocal movement. Disk laps are finished similarly by circular or

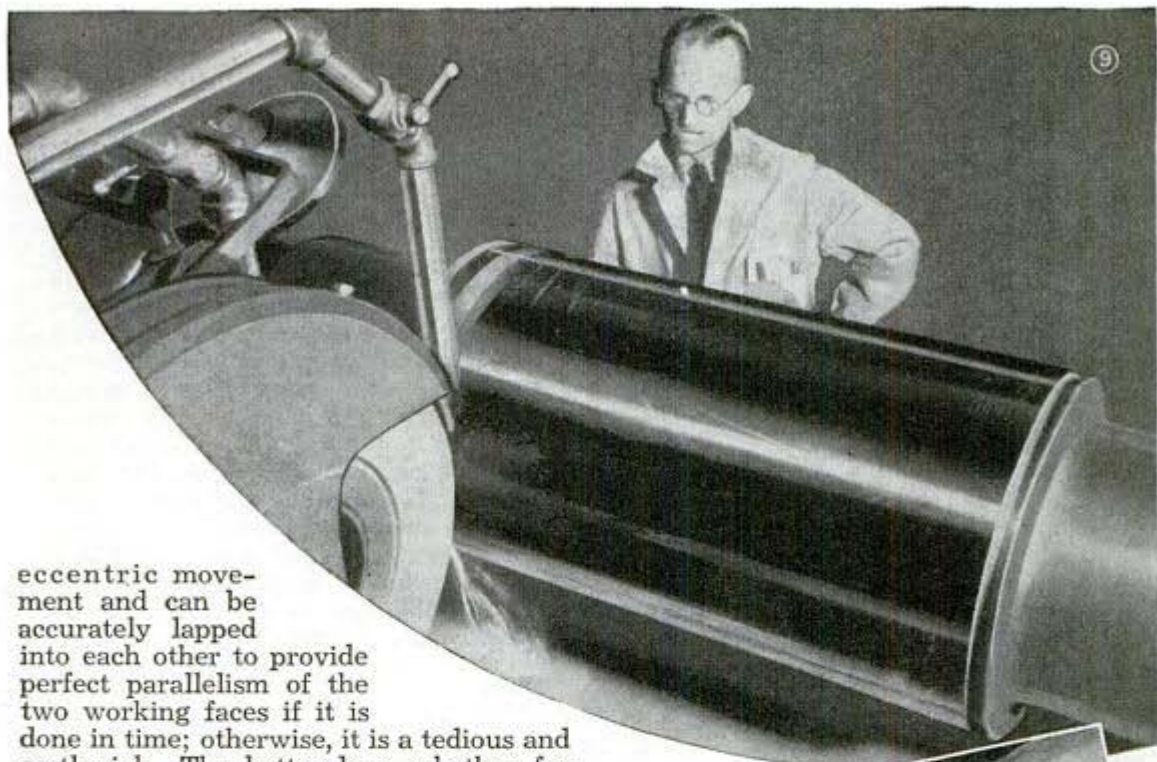

eccentric movement and can be accurately lapped into each other to provide perfect parallelism of the two working faces if it is done in time; otherwise, it is a tedious and costly job. The better laps, whether for machine or bench work, are made from castings of soft and close-grain gray iron, which must be free from alloy. The softer and finer the grain, the better will be the surface of the laps and the quality of work they will do. On lapping machines, it has been found economical to make the laps interchangeable so that they can be transposed each time they are removed for re-surfacing. This practice is said to help the surfaces wear more evenly and thus prevent a concave-convex condition, which cannot be remedied simply by lapping.

Proper selection and use of lapping compound is highly important. The abrasive grain should mix well with the vehicle or lubricant so that the mixture will adhere readily to the surface of the laps. Fine silicon carbide of 400 or 500-grain size is excellent for general lapping requirements. Rouge and lavigated alumina are particularly recommended for extra fine finishes. Kerosene, with a little machine oil added, makes a fine vehicle for the grain, but sperm oil has no equal and olive oil is a close second. The excessive use of the compound is worse than using too little. The compound should be spread uniformly but sparingly on the entire surface of the still member and then lapping should be carried on for 2 min., after which both surfaces should be cleaned with naphtha and wiped dry.

Mirror-like finishes: External lapping includes finishes produced by fine grinding. What correct grinding technique can do is shown in Figs. 4 and 9, which show

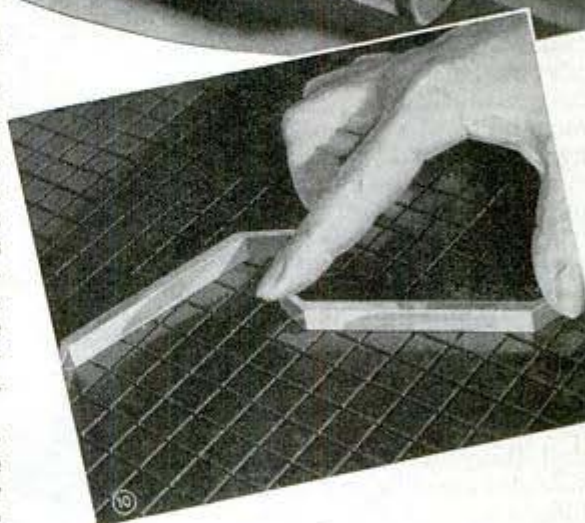

lapped finishes on rolls such as used in sheet-metal rolling mills and also in textile and paper mills. This kind of work requires the use of several wheels varying in grit size. As the diameter of the roll increases, the diameter of the wheel should decrease in order to obtain a small arc of contact between the wheel and the work. To obtain mirror-like finishes, four different wheels are used generally on hardened steel rolls. A 46-L5B is used first for roughing off the greatest amount of stock. It is followed with a 150-J5B for a second roughing cut. Both wheels are vitrified aluminum oxide. Then the rolls are finish-ground with a silicon-carbide shellac-bonded wheel, 320-I8L. The fourth wheel, also of silicon carbide, 500L9L, removes no stock but imparts the mirror-like finish.

The choice of coolant in connection with



the bonded abrasive laps and roll grinding is important and so are the means of filtration. The most efficient solution for lapping consists of just enough soap in water to produce a lather but not a heavy suds. For the ground reflective finish, a solution consisting of a good grade of soluble oil gives good results and even sal soda can be used. The use of a dirty coolant has most serious effects and therefore the abrasive and metallic particles must be removed systematically. Many filtering devices have been tried but the most effective is centrifugal clarification. In large plants all lapping operations are performed in air-conditioned rooms.

Measuring surface finish with light waves: The apparatus shown in Figs. 11 and 12, consisting of a monochromatic (one-color) light and two optical flats, is a natural micrometer to measure accuracy of flatness by means of light waves. The surface to be inspected should have an accuracy of at least fifty-millionths inch. Fig. 12 shows the finish of a plug gauge being checked against that of a precision gauge block. Light waves have crests and troughs which usually equal each other and a wave length is measured from where it begins to where it begins to repeat itself. The length

of the wave remains constant but its width varies with the intensity of the light. With incandescent helium, used in this case, the light wave has a length of 23.2 millionths inch. When the waves cross each other they blank each other out at the point of crossing. The blank spots are called black interference bands and they occur at every wave length or every 11.6 millionths inch. When the light is turned on the work, the waves are reflected from the top surfaces of the parts and the bottom surface of the top optical flat. The waves are produced by a wedge of air between the two, and the width of the air wedge determines the spacing of the bands. These always run at right angles to the wedge of air. So, what the observer sees are the two patterns shown in Fig. 13. The surface at the left is flat within four-millionths inch because the dark bands are all parallel to the edge of contact. The surface at the right is not nearly as flat because the dark bands curve; the more the curvature the greater is the inaccuracy of the surface finish.



Level Saves Time in Plumbing Vertical Shafts

Used in a large ordinance plant to plumb hundreds of vertical shafts, this level saved time and assured accuracy. Once it is attached to the shaft by means of a snubbing chain, which takes only a few seconds, the level can be swung around the shaft to check it quickly in all directions. Another advantage is that it permits use of a graduated vial instead of having to depend on a tiny ungraduated one. The frame is welded together and is assembled from conduit, angle and channel iron as shown. The two large V-shaped pieces, which contact the shaft to be plumbed, are tied together with a piece of small angle iron $13\frac{1}{2}$ in. long to give the frame rigidity, the two curved pieces of the frame being conduit bent to shape and welded in place. Two iron plates welded to the top of the frame are provided with adjusting screws which support

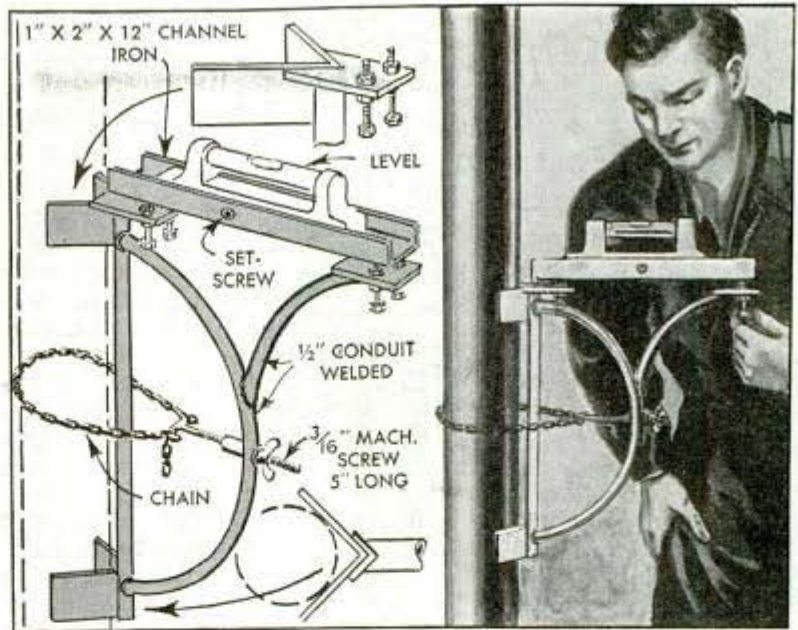

the channel-iron level holder and permit the level to be adjusted to a true right angle with the V-shaped contact pieces. Once the adjustment is obtained it is only necessary to check occasionally to see that a true right angle is maintained.

—V. C. Lovegreen, St. Paul, Minn.

Altering a Ruler to Make Dot-Dash Lines on Drawings

To add a neat and precise touch to your drawings, convert your regular brass-edged ruler into a dot-and-dash ruler by removing the brass strip, sawing a flat section along the edge of the ruler from which

the strip has been taken and grinding the brass strip so that it has two projecting points every $\frac{1}{2}$ in. as shown. Next drill countersunk holes in the brass strip and nail it to the edge of the ruler, making sure that the nails do not project, since they would interfere with the stroke of the pen, which is fitted with a small heart-shaped metal piece, soldered at a slight angle to contact the points on the brass strip.



Cover Protects Gas Tank Lock

Dirt and moisture are less apt to enter the lock on a gasoline tank cap if it is kept covered with a small Cellophane or wax-paper cup of the type sold in most stores to protect food in the refrigerator.

—Spencer A. Pease, Wauwatosa, Wis.

CASH FOR UNUSUAL IDEAS

If you have an idea that might be used for a short article in these pages, send it to the Home-craft Editor. Enclose a snapshot or drawing and give all the necessary information in as few words as possible. To be accepted, material must be of general interest and different from any we have published previously.

Panels in Front of Poultry Roosts Keep Chickens Out of Litter



Instead of installing dropping boards under chicken roosts in the usual way, one farmer eliminates the boards and puts panels of hard-pressed board in front of the roosts as shown. This makes it easy to clean under the roosts and keeps the chickens from scratching the litter over the poultry-house floor.

Flasher Button Locates Socket In Upper Sash of Window

In lowering the upper sash of a high window in a school or office, the glass often is cracked in trying to locate the pull socket

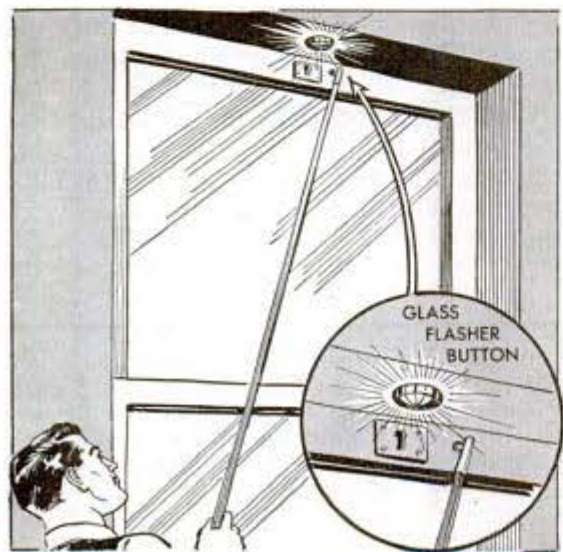

with the long window hook. If a glass reflector or flasher button is attached to the window casing directly above the socket, it will be easy to insert the hook of the pull pole into the socket.

Clothespin Serves as Clamp To Hold Test Tube

An ordinary spring-type clothespin is just the thing for holding test tubes up to $\frac{1}{2}$ in. in diameter. The curved recess cut in the inner surfaces of the jaws for gripping the clothesline are just right for fitting around the test tube. For tubes larger than $\frac{1}{2}$ in. in diameter, it may be necessary to enlarge the recesses.

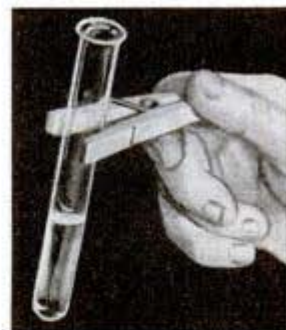

—Herman Klein, Pittsburgh, Pa.

Ball Bearing in a Tapered Hole Holds End of Wrapping Twine

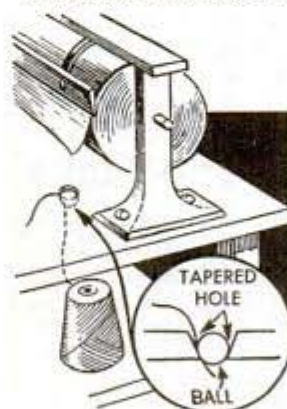

To prevent the loose end of wrapping twine from tangling, and yet have it at hand for instant use without an overhead fixture, run it through a small hole in the counter. Taper the hole from the top so that a ball bearing will fit snugly into it. The ball will

prevent the twine from falling back through the hole and will allow the twine to be pulled up as needed.

Setscrew Prevents Loss of Parts If They Loosen on Machinery

Adjustable parts of farm machinery and other equipment which are held in place with setscrews often work loose and are lost. To prevent this, file a tapering flat on the removable part, leaving a shoulder as shown. The setscrew tightens on the flattened portion. Should the setscrew loosen, the part cannot drop entirely free of the holder.

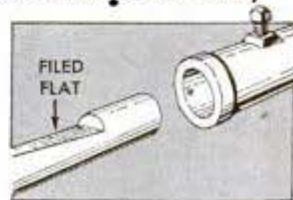

Holder Supports Boring Tool Close to Work

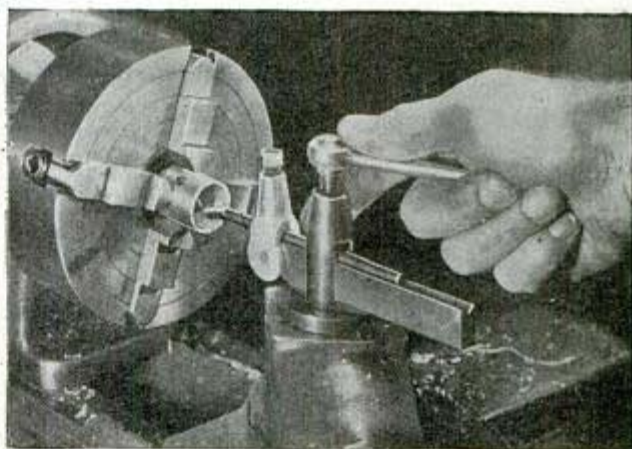
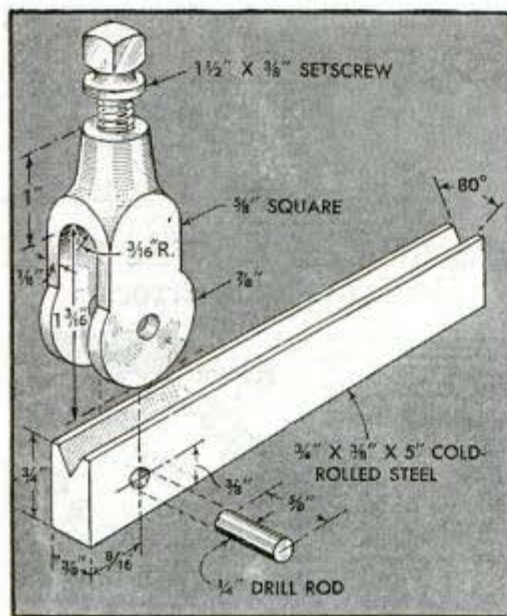

For boring and threading work of small internal diameter, this boring tool holder, made from scrap steel, will prove a worthwhile addition to your lathe equipment. To slot the yoke, drill a hole near the center and make two saw cuts down to it from one end. Then the slot is brought to finish

size and the circular part rounded by hand filing. A hole is drilled through the slot to take a piece of 1/4-in. drill rod, which holds the yoke to the shank. The tapered end is turned to size and, while the yoke is still in the chuck, the hole for the setscrew is drilled and tapped. An ordinary setscrew can be used, or you can make up one to fit. The shank of the holder is grooved in a shaper to hold the boring tool, and a hole is drilled in one end for the drill rod, which is a press fit.

—C. W. Woodson, East Aurora, N. Y.

Sliding Ruler on T-Square Permits Quick Measurements

An 18-in. straightedge with slots cut at each end through which thumbtacks fasten it to the T-square, will enable you to make horizontal measurements anywhere on the board without sliding the T-square out of the way. The slots allow moving the straightedge to either side to bring the calibrations even with the point of measure-

ment. Also, by calibrating a 60-degree triangle along its 90-degree edge, you can measure vertically without removing the triangle from the square.

—Jack N. Gunter, High Point, N. C.

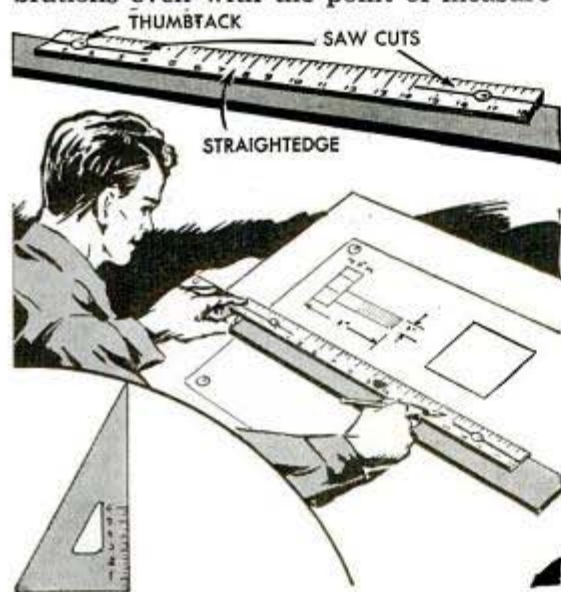

Ball Bearings Easy to Handle With Improvised Tweezers

When taking small bearings apart, a pair of tweezers like the ones shown will simplify handling the small balls. The tweezers can be made from a medium size safety pin by cutting off the head and pointed end and forming small eyes on them, the size of the eyes depending on the size of the bearings.

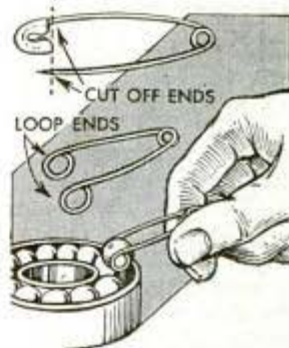

Corrosive action on battery boxes, cables and terminals can be avoided by coating them with battery pitch dissolved in a small amount of gasoline.

Tenon on V-Block Centers Work On Drill-Press Table

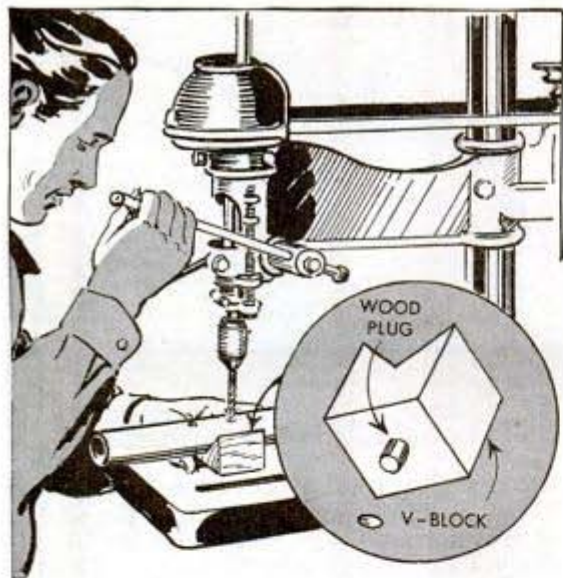

When drilling duplicate pieces of round work, this V-block will automatically center the work under the drill, once the table is adjusted correctly for the job. The block is made of wood and has a tenon or plug on the underside to fit snugly in the center hole of the drill-press table. Thus when the block is in place the work will be centered under the drill when placed in the block.

Adjustable Shipping-Tag Holder

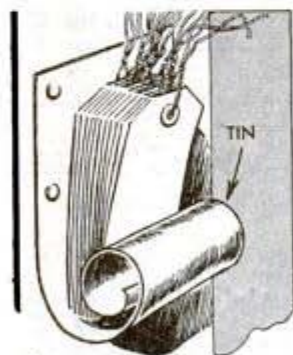

Nailed to a wall or table within easy reach, this simple holder will permit rapid removal of one or more shipping tags without disturbing those remaining in the holder. It is made by simply rolling one end of a piece

of tin or light sheet metal so that the tags can be slipped behind the rolled section.

Adjusting Tappets More Easily

You can save considerable trouble in removing the engine head and making adjustments on the tappets of your car simply by unscrewing the spark plugs from the engine head and then reconnecting them to the proper leads from the distributor. Turn on the ignition and crank the engine slowly by hand. When a spark plug "fires," that indicates that the piston of the corresponding cylinder is in the firing posi-

tion. Leave the crank in approximately the same position as when the spark plug fired and make the necessary adjustments on the tappets of the "firing" cylinder. After you have adjusted all the tappets in this manner and bolted the valve plates back on, simply screw the spark plugs back into the engine head and reconnect the leads from the distributor.

—R. H. Brown, Wellesley Hills, Mass.

Spring Indicator on Wire Gauge Helps to Avoid Errors

When using a wire gauge to make duplicate measurements, any possibility of error in using the wrong slot in the gauge can be avoided by using an adjustable



pointer like this one. It is made from a piece of clock spring and is pivoted to the center of the gauge by means of a small rivet, making the pivot a fairly snug fit so that the position of the pointer cannot be changed accidentally when laying down the gauge or by brushing it against your clothing.

Shields From Discarded Linoleum Keep Mice Out of Seed Corn

To protect seed corn strung on wires in the barn for drying, one farmer uses shields made from discarded linoleum. These pieces, about 8 by 12 in. in size, were slit through the center to the depth of 7 in. or more so that they could be slipped over the line, as shown.

—G. E. Hendrickson, Argyle, Wis.

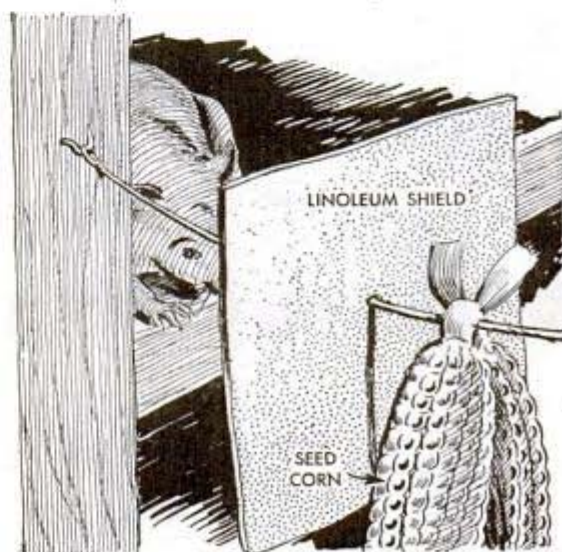

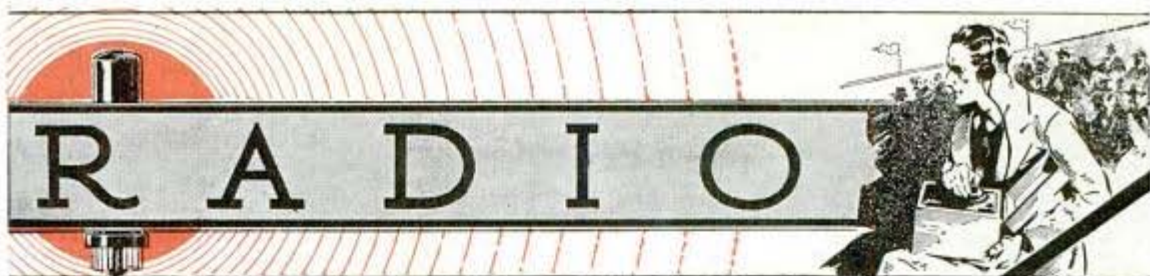

Tube Substitutions for Battery Portables

By ROBERT OELRICH

IF YOUR battery portable receiver is temporarily laid up because you are unable to purchase a 1A7-GT, 1N5-GT, or a 1Q5-GT tube, you can substitute miniature type tubes such as the 1R5, 1T4 and 1S4 which are easier to find.

Although these miniature-type tubes are of different base design and require a tiny socket, there is nothing difficult about assembling an adaptor by means of which the substitution may be made without any changes in the wiring of the set.

A miniature-type socket is wired to the base of a discarded metal type tube as illustrated. The base of a metal tube, such as a 6F6, 6K7 or similar type, is removed by straightening the crimped edges of the outside shell and unsoldering the wires in the pins. This base is then used as the male end of the adaptor. Solder 4-in. lengths of No. 18 bare solid copper wire to each pin terminal of the miniature tube socket according to the accompanying chart specifications; all pin numbers refer to bottom view. Thread the leads on the miniature tube socket through the empty pins of the base and pull the wires through the base evenly so that the miniature tube socket stands level and rigid just above the base, and solder the wires in the base pins. Spread the miniature socket prongs slightly to make the compact adaptor unit shown in the photos. Make certain that none of the wires in the adaptor are touching each other; insulate if necessary. Where a grid cap must be provided, bring out a fairly stiff 3¼-in. insulated lead from the grid pin terminal on the miniature tube socket. The grid cap is then removed from the old GT tube and soldered to the end of the grid lead. GT tubes 1C5, 1A5, 1Q5 and 1T5 may be substituted indiscriminately without adaptors if the set uses a 1½-volt "A" battery.

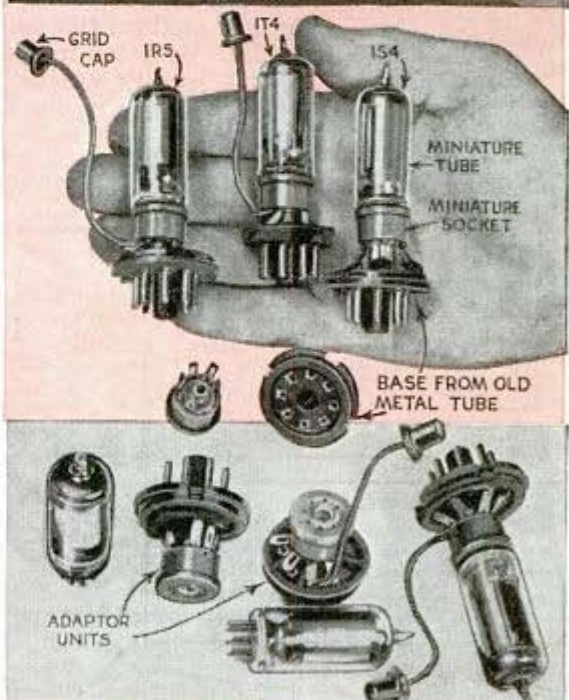
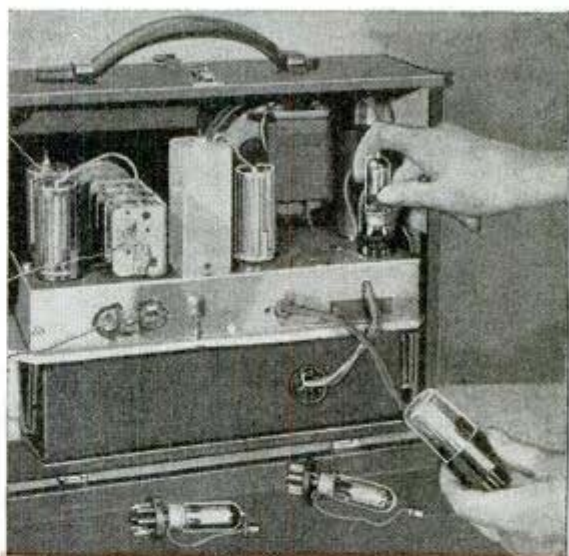

Substitute	Type	Substitute	Type	Substitute	Type
1R5	1A7GT	1T4	1N5	1S4	1Q5
Pin No. 1	7	Pin No. 1	2	Pin No. 1	7
2	3	2	3	2	3
3	6	3	4	3	5
4	5	4	N. C.	4	4
5	N. C.	5	N. C.	5	N. C.
6 - Grid Cap		6 - Grid Cap		6	N. C.
7	2	7	7	7	2

DESK LAMP

By S. A. Johnson

BUILT into a wood card-filing case, this simple 2-tube student set also serves as a desk light, as the 40-watt lamp bulb is part of the radio circuit. No batteries are required as the lamp bulb drops the line voltage for the tubes and the set works on any 110-volt a.c. or d.c. supply line.

This ultra simple broadcast receiver employs two type-37 tubes which are a common older type usually found in old sets, or a radio student's junk box. One is used as a detector and the other for a rectifier as shown in the schematic circuit diagram Fig. 1; type-76 tubes may be substituted without change. The file box which serves as a cabinet for the set, is a standard type designed for 5 by 8-in. cards. Assembled on a 1/8-in. hard-pressed wood base the

chassis is supported by two small blocks of wood resting on the bottom of the case. All base and case details are clearly shown in Fig. 2, and photos A, B, C, D and E.

The coil is hand wound clockwise on a cardboard tube and the windings are spaced 1/4 in. apart. Suitable wire can be obtained from any old filter choke or audio transformer. The coil is fitted with a small angle bracket for mounting as will be noted in the simplified wiring diagram Fig. 3. All of the circuit wiring is completed before the chassis base is installed in the file box.

The light socket, which is a Bakelite variety commonly found in the "dime" store, supports the bulb and shade and is mounted on a 5 1/2-in. length of hollow round curtain rod. This rod is simply forced into the bottom of the lamp socket, and the other end is mounted on the case in a 3/4 by 1 3/4 by 1 3/4-in. wood block, drilled and fastened to the underside of the box lid by means of two wood screws. China cement keeps the rod from sliding down into the box. The antenna connection is made to a

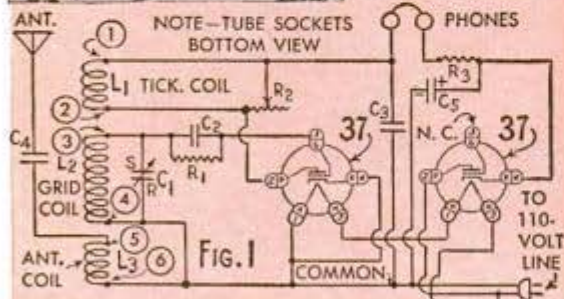
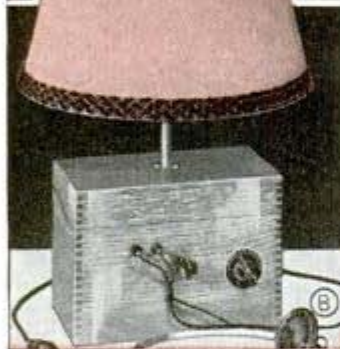

- R₁ = 2 MEG. 1/2 WATT RESISTOR
- R₂ = 5,000-OHM VAR. RESISTOR
- R₃ = 100,000-OHM 1 OR 2-WATT RESISTOR
- L₁ = 40 TURNS OF NO. 28, 30, OR 32 ENAMELED WIRE
- L₂ = 73 TURNS OF NO. 28, 30, OR 32 ENAMELED WIRE
- L₃ = 55 TURNS OF NO. 28, 30, OR 32 ENAMELED WIRE

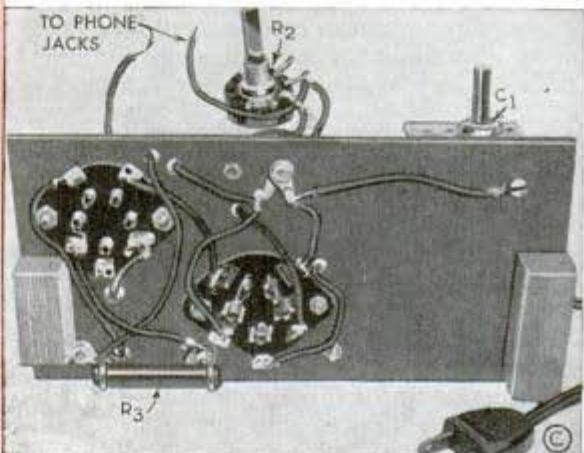
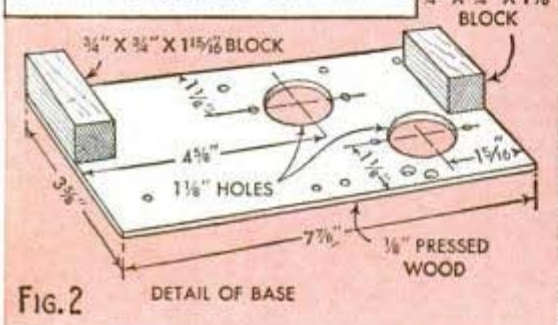

"DX-ER" FOR BOY'S ROOM

Fahnestock clip mounted directly on the rear of the case by means of a soldering lug and a machine screw. Detailed student material list R-328 is available from Popular Mechanics radio department, upon receipt of postage. The lamp shade is an inexpensive type which has a spring clip that clamps over the light bulb. Best selectivity on local stations in crowded localities is obtained by using a 15 ft. indoor antenna. A long and high outdoor antenna is best for "DX" stations. No external ground is used on this set. The receiver is turned on and off by means of the line switch on the lamp socket.

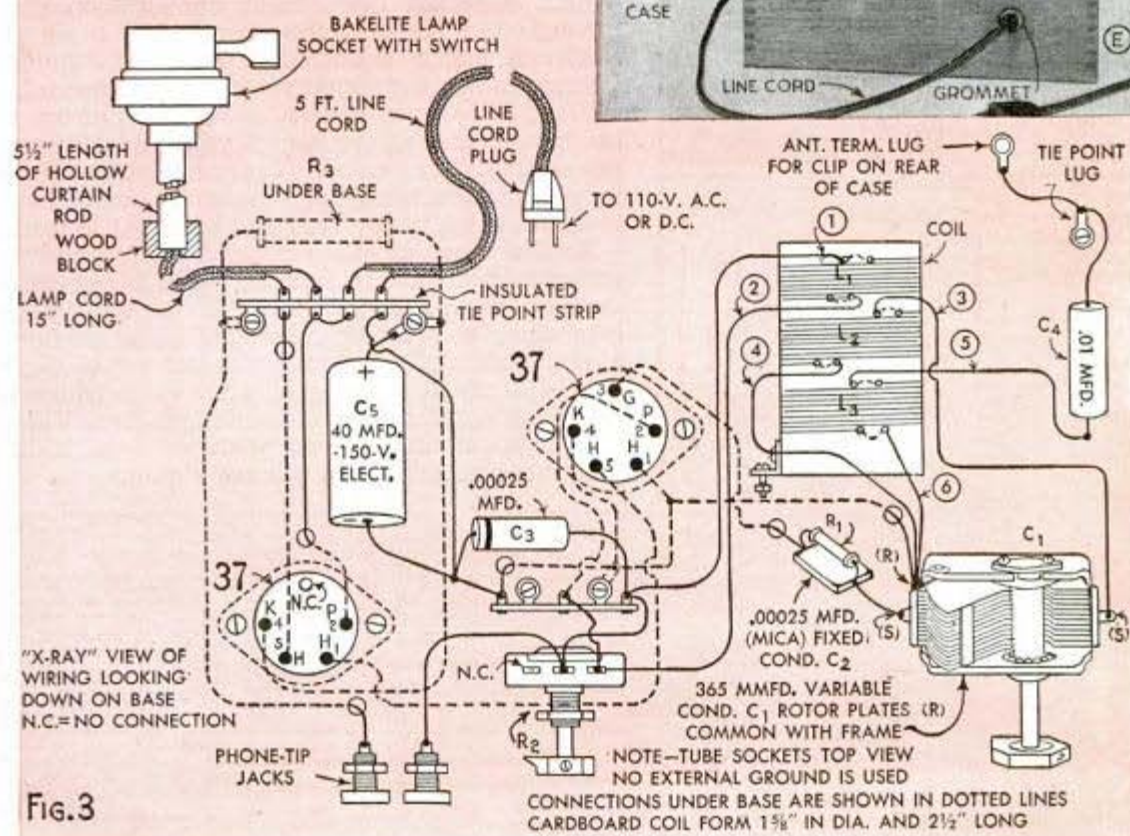
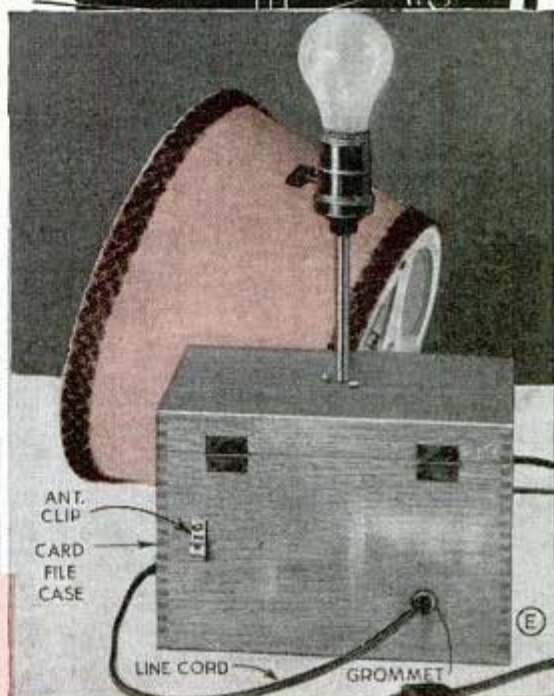
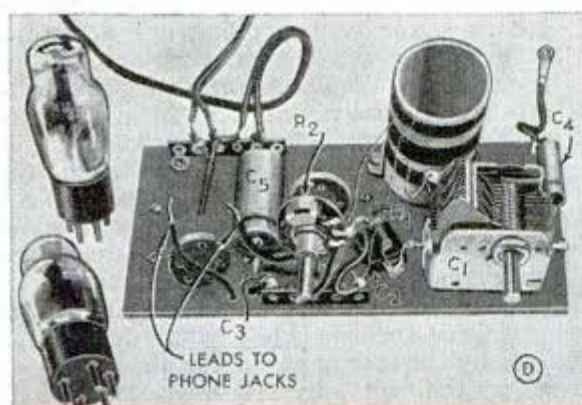

Fig. 3

"CAMERA" TUBE for Television

By F. L. Brittin

PICKING up the scene and converting it into an electrical signal, the electromagnetic deflection type Iconoscope "camera" tube is a special cathode-ray tube that makes modern television transmission practical. As in many advanced developments in sight and sound engineering the inventor makes good use of tips provided by nature, and in this case the eyes have it. The "camera" tube "looks" at individual points on the object at different intervals of time and the impulse received from each point is transmitted separately.

The tube contains a mosaic plate covered with miniature photoelectric cells. These individual cells consist of cesium-oxide-coated silver particles that are deposited on a mica sheet which is mounted on a metal plate. Each tiny particle, mica dielectric and the metal plate, form a miniature condenser. When this mosaic plate is mounted in the vacuum tube these tiny condensers are charged by the photoelectric effect when the tube is connected in the pickup "camera" as shown in the conventional circuit diagram Fig. 1. Pictorially exaggerated in Fig. 2, these individual cells are charged in varying degree according to the amount of light picked up by the mosaic elements; these are discharged by the vertically and horizontally controlled sweeping beam from the electron gun, through the resistor, thus producing a signal. Each cell recharges instantly. A view of the electron gun assembly appears in Fig. 3. A good television picture may consist of 240 lines of top to bottom "looks" at the object repeated 20 times per second. For example, to form a single 3 by 4 in. picture the television "camera" would have to look at this young lady in about 76,000 spots.

As the result of photoemission and secondary emission from the mosaic, the tube generates a current which is proportional to the image brightness of the particular spot being scanned at any instant. The flow of this current through the load impedance produces a voltage which is the video signal for the television picture. Video will be a commonly used postwar word which identifies the television picture signal.

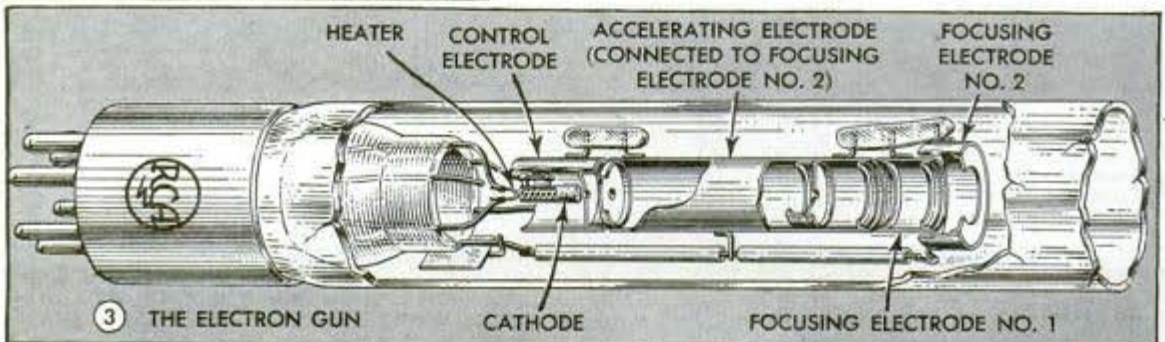
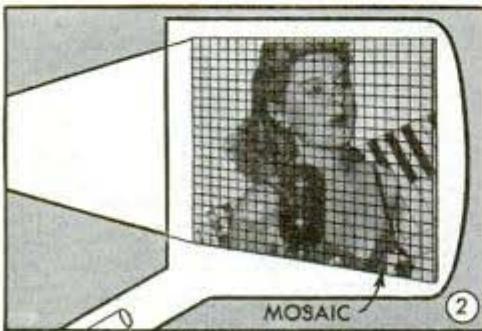
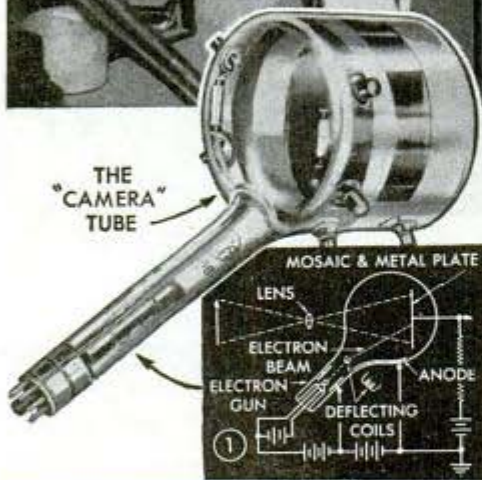



WHAT'S A NUT FOR?

A nut is an important type of fastening.

It draws things together. It holds them. It is removable and replaceable.

But its chief job is to hold. If it ever loosens and lets go, it's not a good nut.

An Elastic Stop Nut always stays put. It grips fast without extra locking pins or gadgets. It locks anywhere on the bolt. And even severe vibration won't break its hold. Until you want to take it off it's on for good.

The reason is the elastic collar in the top. This collar squeezes between and around the bolt threads. It hugs them with an unyielding grip. Since it is elastic you can use the nut over and over again.

Today Elastic Stop Nuts are used by billions in building airplanes. A single bomber uses more than 50,000. That is because they are so secure and safe. After a while you'll see these, Esna nuts on many of the things you buy. You can tell them by their red collar.

And you'll know that the car, refrigerator, radio or whatever it is, will be safer, last longer, and need less service.



OK'D FOR THE RESPONSIBLE JOBS

When Pan American's great Boeing Clippers come home, they get a thorough going over. A swarm of skilled mechanics in 8-hour shifts have the Clipper ready to go again in 60 hours. The many thousands of Elastic Stop Nuts that fasten these ships cut inspection and servicing time and contribute greatly to their quick "turn-around."



ESNA

TRADE MARK OF
ELASTIC STOP NUT CORPORATION OF AMERICA

ELASTIC STOP NUTS

Lock fast to make things last
UNION, NEW JERSEY AND LINCOLN, NEBRASKA

THEY MUST BE GOOD

The battle record of American fighter pilots plainly says, "They must be good!" ★ Here at home, our firm resolve is that the engines we supply them must be good too — the best that care and precision and long experience can produce. Allison has built and delivered more than 50,000 such engines to the U. S. Army Air Forces. ★ In service that covers every front, planes powered by these engines have helped to run up an impressive score against enemy aircraft. ★ This is an indication of qualities useful not only in war but in engines to power the planes in which you will travel when peace has been won.

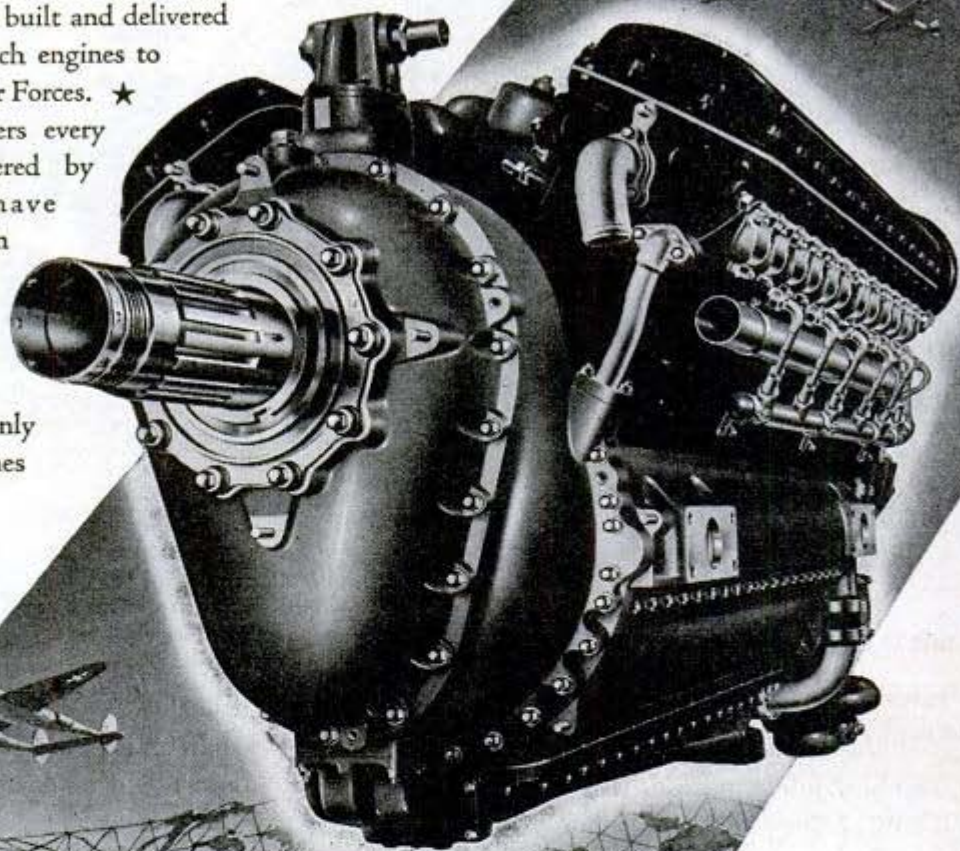

POWERED BY ALLISON

P-38—Lightning
P-39—Airacobra
P-40—Warhawk
A-36 and P-51—Mustang
P-63—Kingcobra

More than 50,000 Allison engines built for the U. S. Army Air Forces power the above planes.

LIQUID-COOLED AIRCRAFT ENGINES

Allison

DIVISION OF
Indianapolis, Indiana



Every Sunday Afternoon
GENERAL MOTORS SYMPHONY OF THE AIR—NBC Network

**KEEP AMERICA STRONG
BUY MORE WAR BONDS**

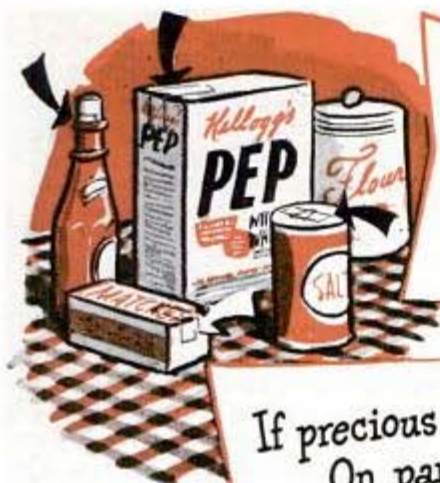

On moving day, a thousand things
Must be wrapped securely;
But Texcel Tape will seal them all,
Quickly, neatly, surely!

If precious stockings should get caught
On parts of desks or chairs,
Just shield rough spots with Texcel Tape-
No snags, no runs, no tears.



For keeping licenses unsoiled,
For keeping passes sealed,
You'll find in sturdy Texcel Tape
A safe, transparent shield.



For Texcel is an improved tape
Whose "stick-um's" bonded on.
It won't come off, it won't dry out,
It's one, like grass and lawn.



Since all the Texcel Tape that's made
Is being used for war,
Buy Bonds and Stamps 'til Victory
Returns it to your store.

Made by
Industrial Tape Corporation
A Division of
Johnson & Johnson
New Brunswick, N.J.

Texcel Tape

CELLOPHANE TAPE - STICKS WITH A TOUCH

FORMULA for GOOD WORK

"How do you mix your paints?" inquired an admirer of the work of a famous painter. "With brains," was the crisp reply.

The combination of "know how" and good tools is an equally effective formula for shop work. His years of experience have enabled the veteran machinist pictured here to recognize the best in files—and to "weed out" the inferior ones. For the exacting work he is doing, he uses Nicholson brands. His production is high, his work precise, his rejects few.

Nicholson Files will aid any mechanic's skill. Precision-shaped, precision-cut, precision-hardened, these world-famous files come through the factory in such uniformly high quality that Nicholson can safely guarantee *Twelve perfect files in every dozen.*

NICHOLSON FILE CO., 22 Acorn Street
Providence 1, R. I., U. S. A.
(Also Canadian Plant, Port Hope, Ont.)

FREE BOOK

"FILE PHILOSOPHY"

48 interesting illustrated pages on the manufacture, kinds, use and care of files.



NICHOLSON
FILES FOR EVERY PURPOSE

NICHOLSON
U.S.A.
MADE IN U.S.A.

Television After V-Day

Continued from page 87

Problems of cost will solve themselves when television goes commercial. National chains will make possible high-grade programs; television may go into the movie theaters; department stores are already planning to put style shows and store scenes on home screens to lure housewives away from the kitchen sink.

An expensive problem remains: the transmission of FM sound and television image beyond the horizon. The short waves don't follow the earth's curve. A nationwide hookup involves transmission from city to city by coaxial cable or by radio relays. Either method is costly. The American Telephone and Telegraph Company considers as a definite possibility the investment of up to \$100,000,000 in construction of 6,000 to 7,000 miles of coaxial cables which could carry television images as well as hundreds of telephone conversations. Even that mileage would serve only metropolitan cities, and television transmitters can broadcast no farther than they can see: 100 miles is a limit seldom reached.

The best solution may be a system of radio relay stations 20 miles apart on the level plains, perhaps 60 miles apart between mountain peaks. Each station, unattended, would pick up the signals from the last station in the chain with parabolic reflectors and beam the program on to the next. Larger cities would have their own television studios and local programs. Smaller communities would have satellite stations picking up the broadcasts from the radio relay chain. The A. T. & T. plans a beginning of such a network with a series of relay stations between New York and Boston, which will cost \$2,000,000 and take two years to complete. That would average \$10,000 a mile; figure out for yourself the cost of a radio relay system reaching into every small town in America.

Nevertheless, television will come to your home. Figures do not stagger the men who believe theirs is the great new industry of tomorrow. NBC looks for 1,000 television stations in the decade after Victory, representing an investment of \$250,000,000; and for public investment of \$3,000,000,000 in 25,000,000 receivers.

The frontier once was measured by acres, valleys, states. Today it is measured by opportunities. Television is one of our greatest frontiers. When the brains that developed radar and all its secret electronic affinities are turned loose on FM and AM and television, that new frontier will be wide open.

In $\frac{1}{50}$ of a second it stops stock-still



WHEN a plane pilot presses the button to adjust control flaps, he wants just so much motion and no more.

But electric motors take time to stop. They overrun.

So while electric controls were desirable because they were less vulnerable and didn't freeze up, they had the disadvantage of overcontrolling.

What you see in the picture is the Lear solution. It is the Fastop Clutch.

With this clutch, controls stop instantly. For it stops stock-still in about $\frac{1}{50}$ of a second.

There is nothing else like this Fastop Clutch. It is built right into the Lear electric motor as a unit.

As with all aircraft equipment, this unit had to meet unusual and rigid requirements of space and weight. It had to have rare power

for its size. In fact the requirements were so severe, old-timers said it couldn't be done.

There will be many new conveniences and devices in the coming days of peace. Perhaps you are already planning one.

And perhaps you would welcome a motor like this and the Fastop Clutch — or some of the other 250 Lear products.

That is why we are telling you about them now. We want you to know that products like these are being made, and that there is available the kind of engineering that made them possible.

PLANTS: Piqua, O., and Grand Rapids, Mich. BRANCHES AT: New York, Los Angeles, Chicago, Detroit, Cleveland, Providence.



you can **SAVE**
your **SAW**
where you **SEE**
this **SIGN**



● To help conserve tools during wartime, many hardware stores and saw repair shops are offering expert saw sharpening service . . . and displaying this sign in their windows or on their counters.

If you *must* have a new saw, for *essential* work, your Disston dealer will do his best to meet your needs. However, Disston saws and other quality brands are made to give long service and your hardware man knows how to keep them in good condition.

Remember—a sharp saw saves time, trouble and lumber—and gives you a better looking job. See your Hardware Dealer or Saw Repairman today!



HENRY DISSTON & SONS, INC.

1011 Tacony, Philadelphia 35, Pa., U. S. A.

FREE BOOK ON SAWS AND OTHER TOOLS !

Ask your Hardware Retailer—or write us—for your copy of the Disston Saw, Tool and File Manual. Shows right way to use and care for tools.



The New Age of Steel

Continued from page 55

steel, they are accurate to one two hundred thousandth of an inch.

Advances in powder metallurgy, and new subzero treatments to increase the toughness, hardness and ductility of steels, presage new applications of steel.

Big figures, of course, are the order of the day in forecasts of steel requirements for such uses as public works program, rehabilitation of war torn countries abroad, and expansion of such successful projects as petroleum pipe lines. At least 28 states have started engineering plans involving great quantities of steel for buildings, bridges, elevated highways, subways or subway stations, and other needs.

With all the advances made in steel uses and fabrication, the large postwar demand that is sure to exist, and the scientific progress that will be unfolded after the war, it appears that the people who called the period before the war "the age of steel," will have to revise the term or think up a new one when the war is over.

Cracking Davy Jones's Locker

Continued from page 59

underwater task that must be performed by divers. A ship that has been torpedoed has extra complications and hazards, for the inward bursting of the explosive charge that sank the ship leaves jagged edges of metal that must be trimmed away with underwater cutting torches before the hole itself can be patched. Cracks and open seams in a sunken ship are welded closed by the divers.

Sometimes a ship can be raised from the bottom by closing most of the holes in her hull and then feeding compressed air through hose lines to her sealed-off compartments, forcing out the water and giving the ship enough buoyancy to float again.

A small vessel such as a submarine that may be resting on the bottom can sometimes be raised without preliminary patching, by submerging huge pontoons, attaching them to the hull, and then pumping them out so that their buoyancy raises the vessel to the surface. On such a job as this the divers use a hydraulic lance to tunnel under the ship's bottom, washing open a channel with water power, so that chains can be passed underneath and fastened to pontoons at each side.

Deep sea salvors believe that their profession will practically die after the present flurry in salvaging ships comes to an

Continued to page 152

Going round in Circles

ABOUT WHAT BATTERY TO BUY ?



Buy the Battery Experts Choose

Be guided by the experts who choose batteries for the world's toughest transportation services. For example, the million-mile trans-ocean flying record was established by a Pan-American Clipper equipped with Auto-Lite batteries.

Auto-Lites, too, are specified for service with our

fighting forces in tanks, half-trucks, jeeps . . . wherever dependable power counts.

Get the long life . . . the extra power you need. Buy an Auto-Lite battery—specified as original equipment by leading automotive engineers.

AUTO-LITE BATTERY CORPORATION • TOLEDO, 1, OHIO

Manufacturing Plants at: Niagara Falls, Atlanta, Indianapolis, Oakland, Oklahoma City, Toronto



Tune in 
AUTO-LITE'S
GREAT RADIO SHOW
STARRING
DICK HAYMES
IN
"Everything for the Boys"
Every Tuesday Night . . . NBC Network
Featuring stars of stage, screen and radio and men and women at the fighting fronts

AUTO-LITE BATTERIES



Patriot, President —and penman!

General Washington, in dark days, led his country toward light. This peerless patriot was also a potent penman—wrote fiats and commands, ledgers, memorable memoranda, with quills of geese.

TODAY, the pen behind the sword is Inkograph—chosen by many generals, and hundreds of thousands of men in service. Easy flowing, precision-built, pointed to fit pressure of any hand, light yet durable, it is as dependable in the field as in the office and home.

If your dealer is out of stock, please keep trying!

Sorry, no mail orders; only dealers can supply you.

*Use any pen to sign up for more
WAR BONDS!*

INK-O-GRAPH²

Inkograph Co., Inc., 200 Hudson St., N. Y. C. 13



end. After the war, they think, fewer ships than ever will get into trouble. Sea safety will be increased by new scientific aids, the most important of which is radar. This instrument locates distant objects and measures the distance to them by radio waves. Ship captains can expect to use simplified radar equipment to locate ships or coastal points they are approaching in fog or darkness.

Even accidental collisions when entering or leaving port in dense fog may come to an end after the war because of the probability that short wave radio beams will be used, just as they are used now on domestic airways, to guide ships safely to the entrance of a harbor and then guide them along their side of the channel.

Football—Tougher But Safer

Continued from page 31

get more than a scratch or two, while if a player is knocked back as he turns his body, he falls in an awkward position, inviting serious injury.

As a matter of fact, a smart college player who knows how to fall can take an amazing amount of punishment. He doesn't need the protection of the rule that if any part of the ball-carrier's body, other than the hands or feet, touches the ground his advance is automatically stopped and the play ended. For instance, a year before this rule went into effect "Red" Cagle, Army's immortal halfback, played his first professional game with the New York Giants against the Green Bay Packers in the Polo Grounds. Red gained many yards because whenever he was partly tackled and knocked to the ground he would slip from the tackler's grasp, jump up and plunge on a few yards. Red was still a sophomore at heart and every yard gained was sacred ground to him, but by the time the game was over he was pretty well used up by those big Green Bay players.

The next day he told me his body was very sore from the pounding he had taken but the important thing was he had not been hurt because he knew how to fall.

Of course there are other factors which contribute to safety in modern college football. For one thing, equipment is tailor-made for each player. Even the papier-mache thigh guards are made to fit properly to prevent the possibility of a "Charley Horse." Head guards are lined with foam rubber and are constructed so as to distribute the effects of a hard blow, reducing chances of concussion, and shoulder pads are fixed so they stay in position re-

Continued to page 154

THE RECORD BREAKER DOES

A BETTER JOB TODAY



Once they crowded the shoreline, watched him out-distance all challengers—spurt past the final buoy. Now, in time of war, his ability and skill are put to a more difficult, desperate task. He looks different. But his character is unchanged. Plumb, too, has donned a service uniform. Some of the fine finish is gone for the duration—by Government Order.

But the quality of each Plumb tool is the same. The expertly-shaped hickory handle, the one-piece steel head—tempered with exactness and skill. The hang. The perfect balance. For over eighty years master craftsmen have made Plumb tools—and zealously guarded these features.

Yes, appearance has changed slightly—but Plumb is proud of its service uniform. Fayette R. Plumb, Inc., 4837 James Street, Philadelphia, 37, Pa.

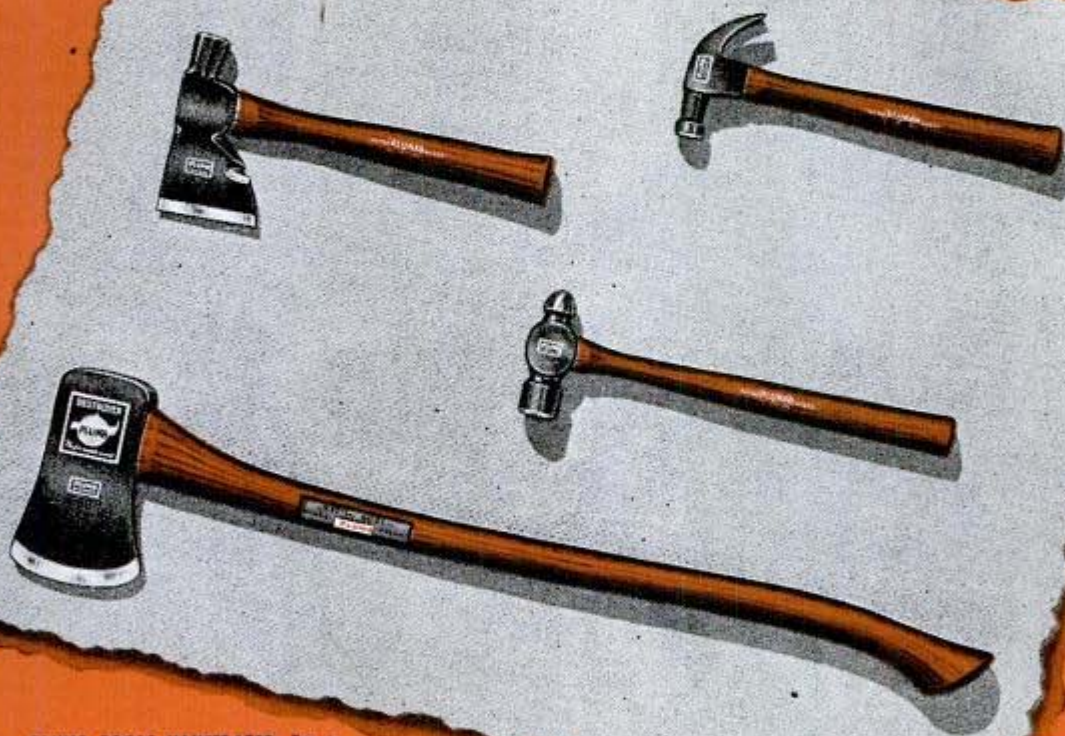

PLUMB TOOLS ILLUSTRATED, Top to Bottom: Nail Hammer, Half Hatchet, Ball Peen Hammer, Single Bit Michigan Axe.

Quality Comes **FIRST**
PLUMB
is **FIRST** in Quality

PLUMB

HAMMERS • HATCHETS • AXES • SLEDGES

IF YOU CAN'T ALWAYS FIND
THE **LHS** OF YOUR CHOICE

Remember

A MAN IN SERVICE MAY
BE SMOKING YOUR PIPE



Besides ever-increasing civilian demand, a tremendous percentage of our production is going to men in the armed services. So, if your dealer hasn't just the LHS you want, model or brand, REMEMBER, ANY LHS IS THE BEST PIPE IN ITS PRICE CLASS.

Model #6

This is an **STERNCREST** pipe \$5

YOU HAVE ALL THESE TO CHOOSE FROM—AND ALL ARE AT ALL GOOD DEALERS

LHS

GENUINE IMPORTED BRIAR

- ◆ Sterncrest Ultrafine . . . \$10.00
- ◆ Sterncrest 14K 7.50
- ◆ Sterncrest Sterling 5.00
- ◆ Certified Purex 3.50

CHOICE AMERICAN BRIAR

- ◆ Select Grain \$2.50
- ◆ Silvercrest 2.00
- ◆ Superfine Purex 1.50
- ◆ Sculptured Purex 1.50

Many styles, dozens of handsome models, plain or antique finish—and all are of LHS craftsmanship

FREE—write for our new booklet, "Pointers on Pipes", chock full of pipe lore and pipe do's and don'ts

L. & H. STERN, INC., 56 Pearl Street, Brooklyn 1, N. Y.
(STERN BUILDING)

ardless of how wild the action becomes. Foot injuries are avoided by scientific fitting of shoes and bandaging ankles.

Also whatever injuries do occur are much better treated than they used to be. For example, only in recent years have injuries been treated with physical therapy and whirlpool baths; formerly the only thing done for many injuries was to apply hot towels. Medical attendants have learned to be more cautious in examining players; now if a doctor thinks there is even a remote chance of concussion the player is taken off the field at once on a stretcher.

But the big factor in promoting safety in college football is the attitude of the players. They know that once they master the coordination of muscles football can be one of the toughest and at the same time one of the safest games in the world.

"Glass Eyes" for G. I.'s

Continued from page 37

amine cutting tools. Metallurgical microscopes helped solve difficult problems involved in welding oxygen cylinders for high altitude planes. Microscopes are indispensable to modern chemical research which gave us synthetic rubber and many other strategic items. Microscopes and photomicrographic equipment prevent the jamming of machine guns by testing the metal in the links of cartridge belts.

Many different kinds of optical glass are required to produce these instruments. Each glass is made from a different formula, and requires its own melting, fining, and annealing technique.

One development, which has improved the quality of wartime optical instruments, is a process for applying to glass a microscopic film of magnesium fluoride which reduces surface reflection. Transmission of light through binoculars with uncoated glass surfaces is about 55 percent, but the coated optics increase this to 78 percent.

By combining optical instruments with electronic and mechanical devices, the Bell & Howell Company predicts a new field for development in what it terms "Optonics." These so-called opti-onical instruments of the future will enable you to view a caller at the front door when you are in the workshop in the basement. They may also bring about amazing improvements on airplane and automobile instrument panels.

But whatever develops in the optical field, G. I. Joe will have the edge on civilians for it will most likely be old stuff to him. Don't expect him to gasp in awe, for he's the guy who has been finding targets from one to 20 miles away.

**"THANKS FOR THE
LEAKPROOF BATTERIES!"**



THE FLASHLIGHT BATTERY THAT

STAYS FRESH FOR YEARS

BECAUSE IT'S LEAKPROOF

Here is a battery that our fighters stake their very lives upon. It powers Flashlights, Field Telephones, Flame-throwers, and many other vital war weapons. You can't have LEAKPROOFS for your flashlights now, but millions of our men at the front thank you for your sacrifice.



Ray-O-Vac LEAKPROOF is the battery that stays fresh! Its patented, sealed-in-steel construction holds the power in. Laboratory tests show Ray-O-Vac LEAKPROOFS still alive with power after four years. It's the only battery guaranteed never to cause corrosion damage in your flashlight. After Victory, this is the battery you will surely want.

FLASHLIGHTS  BATTERIES

RAY-O-VAC COMPANY, MADISON 4, WIS., Other Factories at CLINTON, MASS., LANCASTER, OHIO, SIOUX CITY, IA., FOND DU LAC, WIS., MILWAUKEE, WIS.

Reliability is the very life of the great public utilities. The public demands reliability from them. They, in turn, must have it in all their equipment.

Like millions of motorists, many utilities get the utmost in reliability from AC Spark Plugs, which help to keep their maintenance vehicles ready and efficient,—day and night, in rain, or snow, or summer heat. And to insure top performance, and long life, they clean and adjust those spark plugs every 3,000 miles.

Profit by the example of these experts. Have your spark plugs cleaned and adjusted every 3,000-5,000 miles. When badly worn, and only then, replace them with new AC's. If you do this, you'll get the maximum of spark plug efficiency, besides conserving valuable materials, gasoline, and oil for our fighting forces.

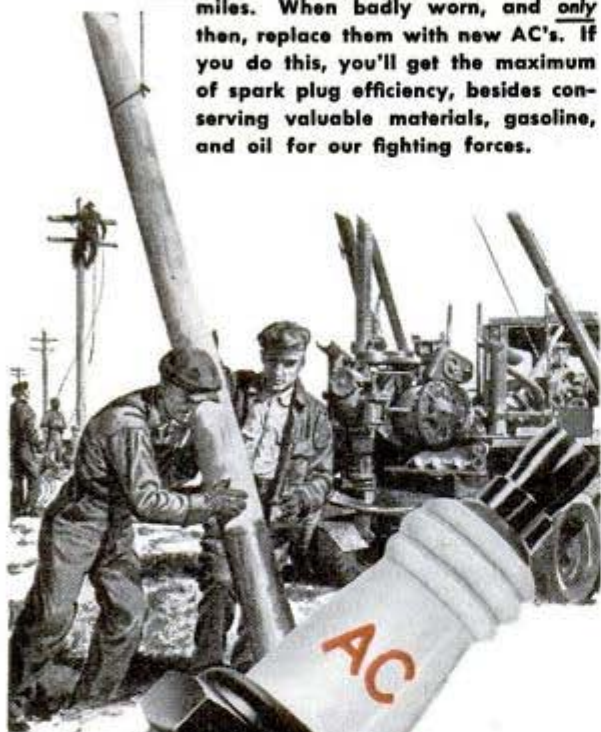

CLEAN SPARK PLUGS
SAVE UP TO ONE GAL-
LON OF GAS IN TEN

AC
SPARK PLUGS

BRING YOUR SOLDIER HOME SOONER
BUY ANOTHER WAR BOND

Secrets of Super-Speed

Continued from page 47

the radiator. There it does two things. It picks up heat, thus cooling the engine coolant efficiently, and it expands considerably.

The exhaust end of this duct is shaped to squeeze the air into smaller volume again, the result being that the increased volume of air has to speed up, so much so that it blows out of the exhaust end of the duct at a slightly higher velocity than the speed with which it entered the front end. The resulting jet propulsion or thrust makes up for the drag of the duct and radiator.

No one knows how fast a speed can be attained by a modern pursuit plane. None of these aircraft can be dived to terminal velocity because they can't climb high enough to reach an altitude from which a dive to terminal velocity must begin. Reports that some planes have reached speeds in excess of 800 miles per hour in dives have been published but many engineers doubt that any aircraft has yet been dived at even 700 miles per hour.

The differences of opinion rest on the lack of a positive way of measuring aircraft speeds. High speeds, especially in dives, are determined by calculations that are based on indicated air speed, which is often less than the true speed through the air, and variables that include the pressure, temperature, and compressibility of the air.

Even so, aircraft have already been dived at speeds at which normal methods of control are ineffective. That is, at high altitude a plane that is placed in a diving attitude tends to increase the sharpness of its dive no matter what the pilot does to try to bring it out of the dive. Not until the plane reaches warmer, denser air at lower altitudes does it respond to the controls. Because of this, fighting planes carry warning notices on their instrument boards that set speed limits beyond which the aircraft must not be dived.

This control complication is due to shock waves of compressed air that act on the control surfaces at speeds in the neighborhood of the speed of sound. These shock waves resist efforts to move the controls. Since the speed of sound drops from about 750 miles per hour at sea level to around 680 miles per hour at 30,000 feet, the effect is first observed at high altitude. Not much is yet understood about these effects of air compressibility but it seems now that if and when practical aircraft that can fly in the range of the speed of sound are built they will need to be provided with some method of control that is quite different from the present system of control surfaces.

IT'S HEADS DOWN AND THROTTLES WIDE

—when the Storm Boats
hit the beach!



BELLY-flat and heads down, nearly a ton of rugged fighting men and their battle gear cover the bottom of each racing Storm Boat when it slashes for the beach — hits the shore — leaps bodily from the water and disgorges its crew!

High speed, and the darting maneuverability of an angry hornet are the Storm Boats' defense against hostile fire. The great Evinrude "storm boat motors" provide both, make the Storm Boat one of the most spectacular of small assault craft.

1 The speedy Storm Boat is useful for many other tasks! Here one is shown tearing over the water loaded with a 37-mm antitank gun, together with two-man gun crew, ammunition, and the operator. Machine gun squads and mortar squads are among other standard storm boat "cargoes"



2 Storm Boat on patrol. The hull draft is only a few inches, and like all other Evinrudes the big motor tilts readily over obstructions, making the storm boat adaptable for operation in the shoalest of waters. The bottom is well compartmented to make the boat practically nonsinkable.

3 The high efficiency of the storm boat motor has won for it other important assignments. Here are storm boat motor power heads specially built to power high-capacity portable pumps . . . "last-ditch" fire fighters for use when a ship's main fire-fighting equipment has been blasted out of action!



All of Evinrude's facilities are now devoted to production for Victory. With peace there will be sparkling new Evinrudes for all to enjoy. EVINRUDE MOTORS, Milwaukee 9, Wisconsin



Every Dollar You Invest Helps Speed Victory — Buy More Bonds

EVINRUDE

OUTBOARD MOTORS

WORKSHOP WISDOM

How to make windows slide easily

To end the annoyance of sticking windows and drawers, follow these easy directions:—



1. Clean off any excess paint . . . sandpaper smooth all sliding surfaces.

2. Apply a thin coat of Cascamite to these surfaces. Let dry and sandpaper again lightly.

3. Rub frames with paraffin or wax candle.

Cascamite will sink into the wood pores, harden, and help prevent future swelling or sticking.

Cascamite for scores of wood-gluing jobs because:

It's Waterproof. Ideal for jobs exposed to weather, water, or excessive dampness.

It's Stronger. By actual tests, joints made with Cascamite are as strong as the wood itself.

It's Economical. Comes as a dry powder which keeps well, doesn't "dry up." Mix (in cold water) only the amount you need for the job.

You can get Cascamite Plastic Adhesive—as well as Casco, the all-purpose household glue—in 10¢, 25¢, and larger sizes at all hardware stores.

Send for free Casco Project Booklets and free Gluing Guide containing 80 household gluing hints. Drop a post card to Casein Company of America, Dept. P1, 350 Madison Avenue, New York 17, N. Y.



CASCAMITE

Plastic Adhesive

Cameramen Under Fire

Continued from page 69

The first combat films were brought back by a sergeant who stepped off a boat and into a minefield in three feet of water at H-hour. Thirty seconds later shrapnel wounded him in the upper left arm. The sergeant stumbled, but held his camera above water as machine gun bullets swept the surf and the shore. Wading onto the beach, the sergeant shot hundreds of feet of film before he consented to return to a hospital in England.

Another signal corps hero was a youth who was carried off the beach across the channel to a field hospital. His left foot had been blown off and there were wounds in his arm and thigh. But as he was hoisted on the operating table he said, "Please, doc, I've got some film in my camera and it's important. Please call headquarters."

Naval photographers, too, "performed wonders" in making historical records of the initial landings. At the start of the war the Navy had 300 photographers' mates; now it has more than 3,300.

Ducking bullets is only part of a war cameraman's worries. Usually he grumbles far more about the photographic problems brought about by extreme climatic conditions. Filan complained that at Vella Lavella, where it was particularly wet and warm, the cardboard boxes containing his film came apart and the pasted ends of the film rolls opened by themselves.

"Aside from the abundance of moisture," he said, "the biggest handicap is the lack of light. I believe if we had an exposure meter we'd go crazy as I'm sure it would indicate that daylight pictures were impossible. I got thin negatives even shooting with the lens wide open at a tenth of a second on the fastest film obtainable."

Ants and rats ate holes in the equipment bags of Tom Shafer, Acme photographer in the South Pacific, but that was the least of his troubles.

"The rains here are terrible and the camera equipment just cannot take it," he wrote to the home office. "Every time I make a landing it seems to pour cats and dogs and I have to get my cameras rebuilt. It causes moisture condensation between the lenses and I can't get them apart for cleaning because of the rust. The film packs are ruined by every rain."

Accompanying the first assault wave on landing operations is no set-up for picture-taking, according to Shafer. He said he always was so busy digging a foxhole that he had little time left for his camera.

(To be concluded next month)

Why This Kind Of Oil Heater HEATS YOUR HOME LIKE A FURNACE

... And Brings You 3-Way Comfort From One Appliance

50% More Heating Area—and 50% longer flame travel—means more heat delivered into home, less heat lost up the chimney. Note heat-radiator fins—they help increase warm air circulation 25%!

Quick-Warm-Up Radiant Heat—the penetrating, "bone-warming" kind, floods out when you open these heat-reflector doors.

High-Efficiency Coleman Burner—For extremely clean-burning flame; low carbon, maximum heat from fuel. Low-flame fuel saver allows 50% lower adjustment for cool days.

Directed Warm Air-Flow Along Floors. Coleman Power Blower draws warm air from Hot Tube Radiator (upper right). Adjustable louvers direct this warmth where you want it!

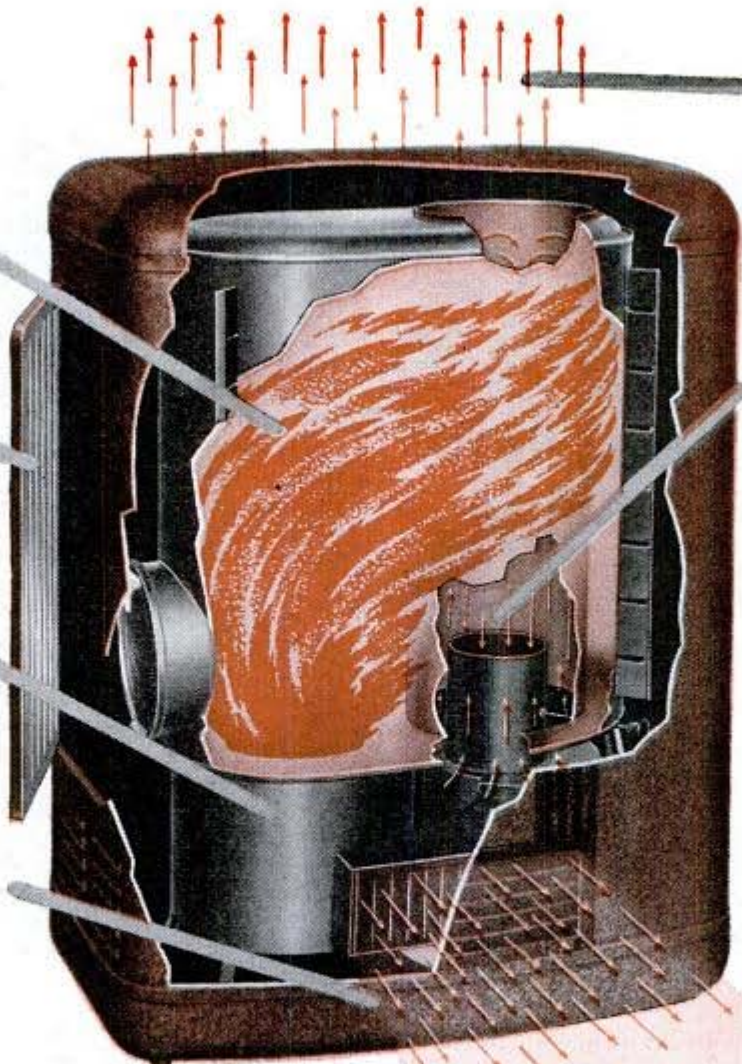

Billows of Warm Air—through big open grill top. Outer casing is built to pull air like a chimney. Pulls in floor-level air for heating by big heat unit. Actually gives forced warm air without moving parts! Keeps floors warm; circulates freshly warmed air 3 to 5 times an hour!

Hot-Tube Radiator does two jobs!—Provides extra heating surface for warming more air—a bigger warm-air flow; supplies warm air for directed heat along floor through Power Blower.

All This, Plus Automatic Ease! Burns clean, low-cost oil. No fuel dust, dirt, soot or ashes. Automatic controls available, so you "tend the fire from an armchair," and get warm floors, even heat from floor to ceiling, and warmth that circulates through the house—not just one room!

FREE! The "Inside Story" of this and other "magic" heat plants, now being prepared for you by Coleman—oil heaters, floor furnaces, central plants, water heaters! They will be ready to provide new comfort in your home after the war. Write for it today!

THE COLEMAN LAMP & STOVE CO.
Wichita 1 • Chicago 11 • Philadelphia 8
Los Angeles 54 • Toronto, Canada



The Coleman Lamp & Stove Co.,
Dept. PO 620-A Wichita 1, Kans.
Without obligation, send me your FREE illustrated book, "The Inside Story of Tomorrow's Home Heating!"

Name _____
Address _____
Town _____ State _____

THE "HOT" NAME
IN HOME HEATING



NAVAL AVIATION



WHERE PERFORMANCE REALLY COUNTS



COUNT ON DEPENDABLE CHAMPION SPARK PLUGS

Full throttle, the jarring, explosive push of the giant catapult, and a Navy scout plane is airborne to search the seas ahead for lurking submarine or other enemy craft. In the few seconds after launching, the plane actually drops slightly, then the full power of the engine takes hold. This is no place for spark plug failure. Dependable Champion Spark Plugs, true to their more than thirty-year-old heritage, are designed to meet extreme as well as normal service. The records of our armed forces in the air, on the land and on the sea provide dramatic daily evidence that where performance really counts, you can count on dependable Champion Spark Plugs.



BACK THE ATTACK WITH WAR BONDS
BUY MORE THAN BEFORE

Springboard for Victory

Continued from page 5

This war against mileage as well as against the Japs not only tops the record of any previous war but demonstrates the utter failure of Japan's defensive strategy. Some of the most powerful Japanese bases in the Central Pacific were overwhelmed even faster than less powerful ones in the Southwest Pacific.

Japan's failure to use, effectively, her land-based planes to beat off attacking American fleet units and her naval strength in repulsing landings on vital bases was due, in large measure, to her limited sea and air power. More particularly, however, it was due to the growing strength of the American navy, especially in aircraft carriers, of which nearly 100 are now in the Pacific. Each task force is capable of putting 1,000 planes in the air at once.

The tremendous losses sustained by the enemy at Saipan and Guam, and his failure to stop the advance to the Marianas not only show that we can take anything Japan holds, but also portend her ultimate defeat. Continuous blows on Japan's inner defense line will prevent her from concentrating a superior naval force at any particular point.

In the coming campaigns the American navy will have freedom of decision and of action. The decisive battle will start with blows on the Eastern front, combined with blows from the north, south and west.

Though the enemy's main fleet is still strong, it has failed, not only in its main mission of preventing the American fleet from operating close to Japan's home islands, but also in protecting Jap troop convoys and supply ships. Japan's navy has been whittled down considerably by American surface vessels, aircraft and submarines. The most effective threat of Japan's sea power, therefore, lies in the existence of her "fleet-in-being," for that, as a con-

Continued to page 162

**Model Builders
Attention!**

	V	V-2	V-3
Hex	1/2"	3/8"	3/16"
Thread	3/8"-24	1/4"-32	1/4"-32
Thread Length	7/32	7/32	3/32
Weight, Grams	8	3 1/2	2 1/2

Actual Size V-Plug

Champion spark plugs for model gas engines give the same dependable performance as regular Champions. Sillimanite sealed. Sillimanite insulator. Alloy needlepoint electrodes for easy starting. One piece construction.

CHAMPION

SPARK PLUG COMPANY • TOLEDO 1, OHIO

HYCON

3000 p.s.i. Hydraulic Power Unit

3 HP Motor • 8 cylinder Pump

Unloading Valve • Accumulator & Reservoir

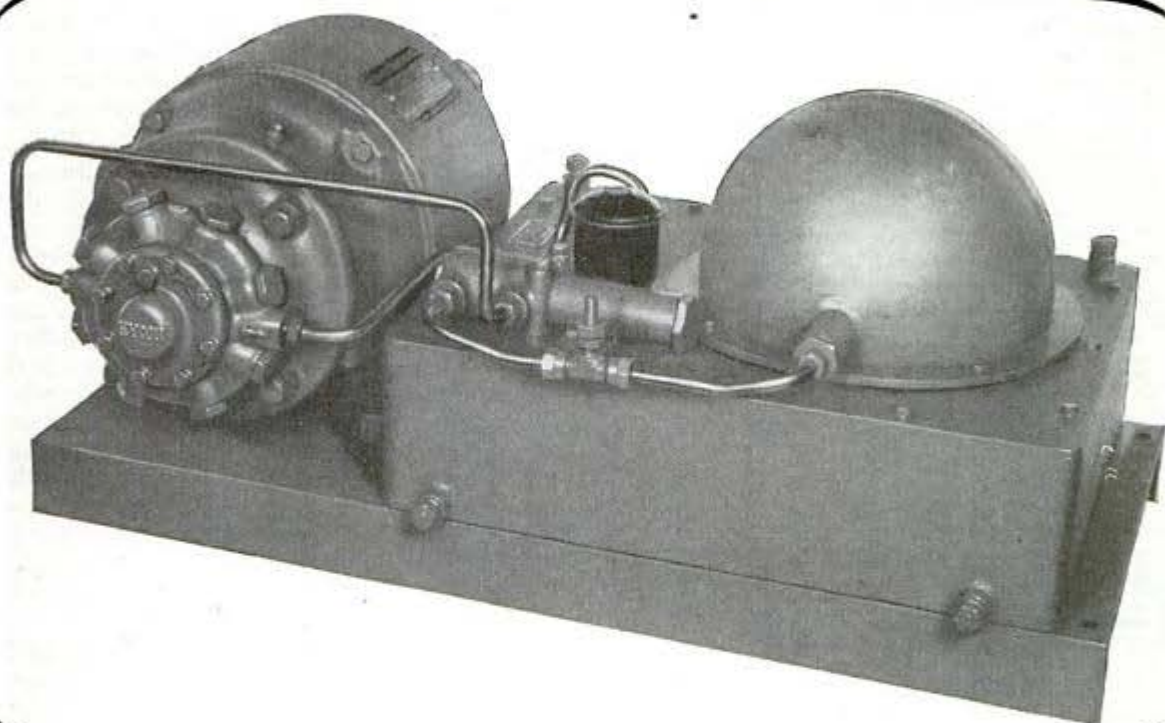

A small compact unit for machine tools,
hydraulic presses and test equipment



Quickly and easily installed for smooth,
reliable hydraulic operations up to 3000 p.s.i.

Specifications and Engineering Data on Request

THE NEW YORK AIR BRAKE COMPANY

Hydraulic Division

420 LEXINGTON AVENUE, NEW YORK 17, N. Y.

RED-ITCHY SKIN?

watch out—it's often

ECZEMA

**Home
Treatment
Promptly
Relieves
Torture!**



First applications of wonderful soothing medicated *liquid Zemo*—a Doctor's formula—quickly relieve the intense itching burning of Eczema, Psoriasis and similar annoying skin and scalp irritations due to external cause. Zemo also aids healing. Amazingly successful for over 35 years! Apply anytime—doesn't show on skin. First trial of clean, stainless *liquid Zemo* convinces! 3 different sizes. Buy Extra Strength Zemo for stubborn cases. All drugstores.

ZEMO

BURN YOUR NAME ON TOOLS

**WITH THE
ARKOGRAF**

PROTECT YOUR TOOLS FROM THEFT

Write with electricity any name or design on the hardest and finest tools and instruments or any metal, like writing on paper with pen or pencil. Thousands used by mechanics, garages, machine shops.

Complete Outfit \$3.50—Prepaid Anywhere

Interesting illustrated circular free. Write today.

ARKOGRAF PEN CO., 3927 S.E. Stark, Portland 15, Ore.



UP TO 100 PERFECT SHAVES from every blade
SATISFACTION GUARANTEED OR YOUR MONEY BACK

MASTER HONE puts a perfect edge on used blades in a few seconds. Made of special composition—the original safety razor hone—no other like it—over a million sold.

50c each postpaid in U.S. and Canada, or send \$1.00 for 3 (No COD's). Write for quantity prices.

WISCONSIN ABRASIVE COMPANY, 654, Milwaukee 11, Wisconsin



**SAVE THAT
BIKE!**

Heavy Body 3-IN-ONE Oil lubricates and protects bicycle bearings and coaster-brakes—cleans and polishes frames and other exposed metal parts—protects from rust and tarnish! At Hardware, Drug, Grocery, 10¢ stores.



"3-IN-ONE" OIL

tinuous menace, influences the disposition of American naval forces. Japan has kept her "fleet-in-being" only by avoiding action, and at a great price—the abandonment of the outer defense perimeter.

As the Tokyo war lords know full well the war is lost, their sole object is to delay defeat in hope of a negotiated peace.

At sea Japan has neither the forces nor the strategic ability for a protracted defense. Had her strategy been different, in the earlier stages of the war, she might have been able to stave off invasion of the Gilberts and Marshalls by concentrating her fleet in the Central Pacific instead of having it run to cover. Even later, she could have gathered her main forces off Saipan instead of sending a boy to do a man's job in an attempt to interfere with the American invasion, and thereby losing a battle which not only disrupted her aircraft carrier force protecting the Philippines, but started Japan on the last lap to disaster.

Prior to the Saipan campaign Japan's principal chain of island defenses extended from the mainland to the Carolines through the Bonins and the Marianas. Reinforcements, supplies and planes were sent by this route to garrisons in the South and Southwest Pacific. Occupation of the Marianas, however, changed this procedure. Vital supplies to Japanese forces in outlying bases are blockaded, leaving the garrisons to die or surrender. With the Marianas in American hands and the isolation of the once formidable bases in the Carolines—Truk, Ponape, Yap and Palau—the road to the Philippines and Japan lies open. Both of these targets are within range of land-based planes on the Marianas.

Paralleling the fleet's westward march in the Central Pacific, is General MacArthur's campaign in the Southwest, which is making similar progress toward the Philippines, thus securing Admiral Nimitz's left flank. These offensives form a coordinated pincers toward the Philippines. Reconquest of the Philippines, however, is only a step toward domination of the China coast.

Once these islands are under American control, Japan's communications to the Dutch Indies and other southern outposts could be cut, leaving her garrisons to perish for lack of supplies and curtailing her oil supply, on which both fleet and plane operations depend. With her lifelines thus severed, Japan's ability to fight would suffer a heavy blow, and her whole "Co-prosperity Sphere" be doomed to collapse.

(Note: The opinions expressed and the assertions made herein are my own and are not to be construed as official or reflecting in any way the views of the Navy Department or Naval Service at large.)



“Young man — you have it!” said the Wizard of Menlo Park

IT IS A warm August evening in 1896. Around a banquet table on Long Island sit Thomas A. Edison and the country's leading men of the electrical industry.

The talk swings naturally to politics, to Bryan and McKinley and the Cuban situation—then back again to business. There is high discussion about storage batteries to drive America's “horseless carriages”. Someone points to young Henry Ford, Chief Engineer of the Detroit Edison Company, and says: “There's a man who has built a *gas* car!”

At once, Edison eagerly begins to ask questions—and to listen. “How do you explode the gas in

the cylinder? Do you do it by contact or a spark?”

On the back of a menu, Henry Ford sketches the details of his engine. Edison thumps the table so hard the glassware tinkles.

“Young man, that's the thing—you have it. Keep at it. Your car is self-contained—carries its own power plant—no fire, no boiler, no smoke, and no steam. *Keep at it!*”

Here was just the challenge and encouragement which Henry Ford needed most. It was something he never forgot. And through the years, keeping-at-it has remained a firm tradition of the Ford Motor Company as it has

moved forward in the creation of 30 million reliable cars and trucks.

It is this keeping-at-it in research, in engineering and production, that has made the Ford name a synonym for smart, comfortable, economical transportation, priced to serve the needs of the greatest number.

In peaceful days ahead, the new Ford, Mercury and Lincoln cars will reflect all the established Ford skills and inventiveness. Their advanced styling will match their quality leadership, and they will benefit by the newer knowledge of materials and techniques being achieved as Ford *keeps at it* in making the tools of victory.

FORD MOTOR COMPANY





Fluid Power

MAKES MOLECULES BOUNCE!

In synthetic rubber plants, Fluid Power helps pry the molecules apart and squeeze them into new combinations. Liquids and gases are measured, mixed and transformed to meet the exacting standards of chemical formulas.

Fluid Power is transmitted through tubes. It helps to drive, control and regulate... all the way through from the raw ingredients to the bouncing tire.

Fluid Power is simple, dependable. And that's an essential in the complex operations of rubber and chemical plants and modern oil refineries. Whether the job calls for precision timing or powerful, remote control, Fluid Power does it efficiently—and without coddling!

Where and how can Fluid Power be put to work for you? The applications are limitless. A Parker engineer will be glad to discuss your problem with you.

THE
PARKER
APPLIANCE COMPANY
CLEVELAND • LOS ANGELES
FLUID POWER ENGINEERING

VICTORY DELUXE Plan NOW to Own a **MOTO-SCOOT** for PLEASURE or PROFIT

● We expect civilian production of Moto-Scoots to be resumed soon. This amazingly efficient, all-purpose motor scooter is the world's greatest economy in motorized transportation—up to 80 MILES PER GALLON, 35 MILES PER HOUR. For utility and sport. Large package compartment for merchant delivery. Side panels for billboard space. "Victory" Model features many new improvements. Inquire today!

DEALERSHIPS OPEN NOW!

Plan to enter this profitable Moto-Scoot selling field. Franchised territory available for dealerships. Write for details.

AMERICAN MOTO-SCOOT CO., Dept. 19P
1305-23 W. Carroll Ave., Chicago 7, Ill.

On the Open Road Again

☆ Driving in unrestricted times, you'll need a HULL AUTO COMPASS to guide you. A new model, improved in performance and design, will be available at your dealer's.

HULL MFG. CO., P. O. Box 245-D10, WARREN, OHIO

ARMSTRONG TOOL HOLDERS

enabled American Industry to change to war production "over night." For they are the permanent, multi-purpose tools used by 95 per cent of the machine shops and tool rooms, on lathes, planers and shapers—the tools used to make dies and jigs, to build production machines. They are the tools you will want for your own shop after the war—ARMSTRONG TOOL HOLDERS for industry, ACE Tool Holders for home work shops.

ARMSTRONG BROS. TOOL CO.
"The Tool Holder People"
368 N. Francisco Ave., Chicago, U.S.A.

New OTTAWA WOOD SAW

For Tractors

—Makes wood sawing fast and easy. Can cut enough wood to pay for itself quickly. Easily moved while attached. Big heavy blade. FREE details.

LOW PRICE

OTTAWA MFG. CO.
W1027 Oak Ave., Ottawa, Kans.

FREE CATALOG Pins and Rings

Finest quality. Over 300 artistic designs. Write for our attractive free catalog and select a beautiful pin or ring for your class or club.

Dept. N, Metal Arts Co., Rochester 5, N. Y.

FOR AMATEUR COMPASS OR "PRO"... DIVIDER

2 Tools in one—Precision steel. Rigidly holds 1/4 to 7 inch openings—replaceable guide points, scribing needle and standard pencil. Unexcelled for linoleum, tile, sheet metal and workshop use.

Complete including postage **\$2.00**

10-DAY MONEY BACK GUARANTEE. Send cash or money order (No C.O.D.'s)

WALTER 223 W. HUBBARD ST.,
E. DEPT. 7,
SELCK & CO. CHICAGO 10, ILL.

Sailing into the pages of history

Fast PC ships and Destroyer Escorts clearing the U-Boat wolfpacks from the convoy lanes . . . husky LCI (L) Landing Craft smashing through to the landing beaches! These are new immortals of the sea . . . sailing into history with the Constitution, the Monitor and the Oregon! Making history, too, are the people who build these modern warcraft. Here at Defoe, record-breaking construction methods are saving priceless days in delivery time. Only craftsmen who build well can measure up to the shipbuilder's standards. They must work with plenty of heart and pride. So you may be sure whatever this organization produces after the war will embody exceptional quality and value for peacetime America

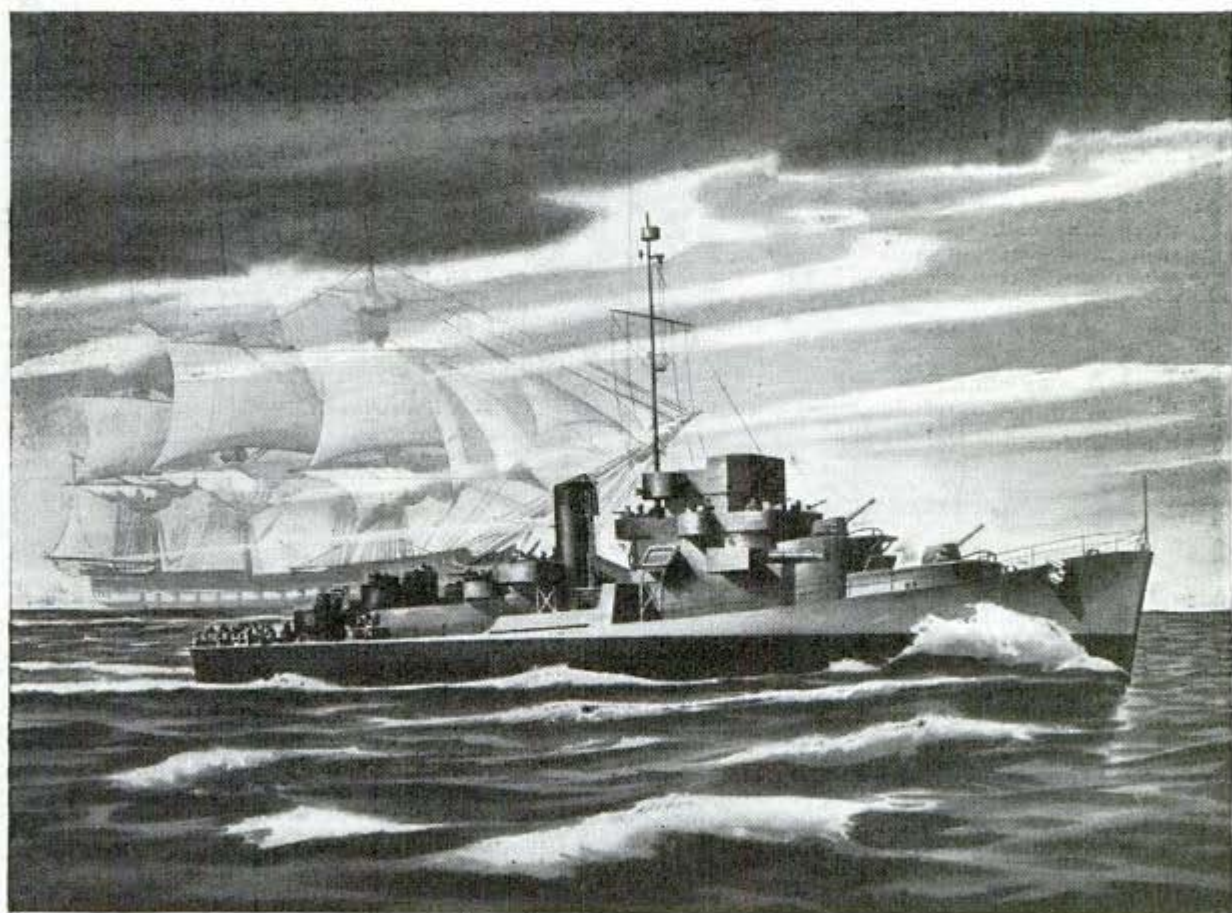

DEFOE SHIPBUILDING COMPANY, BAY CITY, MICHIGAN

Defoe

*Four White Star Renewal Citations
now decorate the Navy "E" Award
won by Defoe workers.*

*INVEST IN INVASION
— BUY WAR BONDS*

*SHIPS FOR VICTORY
SERVANTS FOR PEACE*

*Sidetracks
moisture*



An exclusive
Smokemaster
feature

When you smoke this fine pipe, you never draw through rank, biting moisture. A pipe cleaner, extending practically the full length of the stem, absorbs moisture as fast as it forms. Smokemaster literally keeps itself clean!

The striking improvement which this exclusive feature makes in smoking pleasure accounts for the ever-growing popularity of Smokemaster. Try it, and you too will be a Smokemaster booster.

At leading dealers

Smokemaster Custom-made \$1.50
Smokemaster Standard \$1.00

Pat. No.
2,166,537



Briarcraft Smokemaster

Many Smokemasters are going to the Armed Forces. If your dealer's stock is temporarily depleted, he'll be glad to set aside the model you want, when he receives another shipment.

BRIARCRAFT, INC., NEW YORK 16, N. Y.

MENDS FURNITURE

Also dishes,
glassware,
toys and
luggage.
Good for
models
too.



DU PONT DUCO CEMENT

New Designs in

FRANZITE GRIPS

Modernize Your Gun! Improve Your Score!

Most durable grips made. Positively unbreakable! For Colt, Smith & Wesson, Hi-Standard, Ortgies, Luger & Mausers in a wide choice of beautiful designs in ivory, pearl, walnut, onyx, etc. Low prices. FREE CATALOG. Dealers Wanted.

SPORTS, INC., (Mrs.) 2850N. Clark St., Dept. P-10, Chicago 14, Ill.



SOILLESS GROWTH of Plants

The Story of
Botanical Wonders

A NEW SCIENCE
OFFERING NEW
CAREERS

FASCINATING

GET
STORY OF SOILLESS
GROWTH. ILLUSTR.

ALSO

10-Gal. Chemicals
& Silica Sand
Pad. All Only... 60c

Send to
UTILITY CHEMICALS
7524 S. Racine Avenue,
CHICAGO 20, ILLINOIS

CRESCENT TOOLS

Give Wings to Work

ASK YOUR
HARDWARE
DEALER



Balance 4" x 9" Base. With either \$6.00
Metric or Avoirdupois Weights ... 6.00

Catalog with 2000 Illustrations of Laboratory Apparatus sent for 75 cents. Catalog listing 10,000 chemicals, drugs, minerals, etc. and 1700 scientific books sent for 25 cents.

LABORATORY MATERIALS CO.,
7321 Vincennes Ave., Chicago, Ill.

You'll Get MORE GOOD WELDS per Hour with a HOBART Arc Welder

"Simplified"
DUAL CONTROL

REMOTE CONTROL

POLARITY CONTROL

IN-BUILT EXCITER
& COOL OPERATION

LOOK AT THESE EXCLUSIVE FEATURES... that make HOBART the outstanding welding machine buy for more quality welding per hour and continuous operation without shutdowns.

IT'S SIMPLIFIED...

for ease in operation, yet built to give years of dependable service on all types of welding jobs.

HOBART BROTHERS CO.
BOX M-1041 Troy, Ohio

Write Today
for Catalog
and Special
HOBART PLAN
For Immediate
Deliveries, proper
Priority necessary



HOBART "One of the World's Largest Builders of Arc Welders and Equipment."

SCREWBALL IDEAS

ON BATTERY CARE

It shouldn't happen even to a camel! But Ardvard Sluff won't keep water in his battery because he thinks the water will dilute the electrolyte. He'll be sorry—when he has to buy a new one.

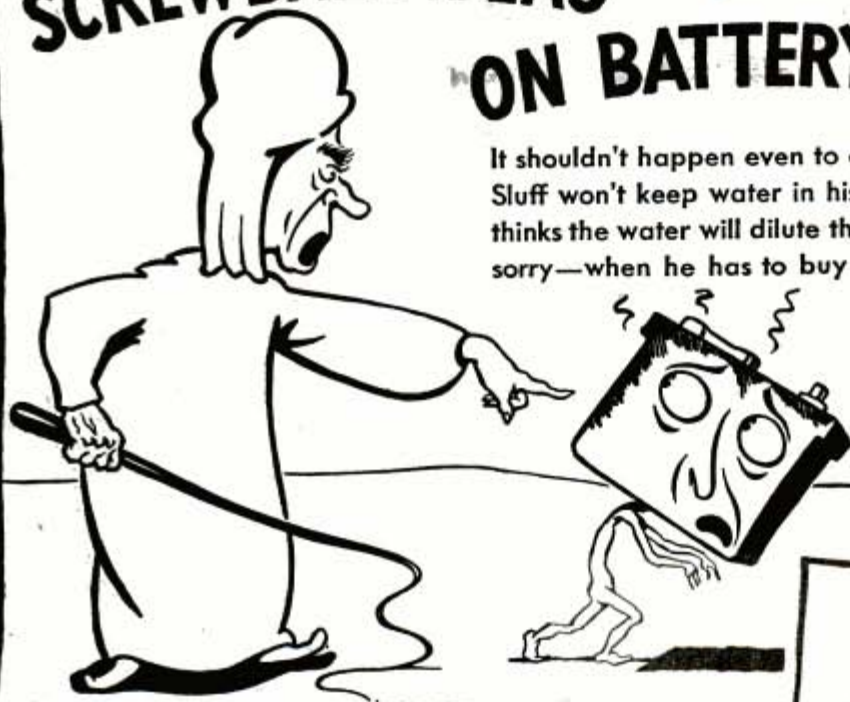

... EVERY BATTERY NEEDS A LITTLE EXTRA CARE THESE DAYS

WAR TIME is no time to neglect your battery! If restricted driving keeps your battery from getting its normal charge, see your Exide Dealer for an occasional **FREE CHECK UP!**

When necessary, he'll advise a recharge. At little cost, periodic recharges keep your battery strong and postpone the day when you'll need a new one. When you *must* buy, get a dependable, long-lasting Exide. Buy to Last—Save to Win.

THE ELECTRIC STORAGE BATTERY CO.
Philadelphia 32
Exide Batteries of Canada, Limited, Toronto

EXIDES ARE USED IN MORE THAN 100
APPLICATIONS BY OUR ARMED FORCES



- 1 Don't buy *anything* you can do without.
 - 2 When you **MUST** buy, insist on dependable, long-lasting merchandise.
 - 3 Take care of the things you have. *Make them last!*
- These conservation rules save materials for war production, help curb inflation, give you more money to invest in War Bonds.



Tool Tips by STANLEY

Use of Ball Pein Hammer

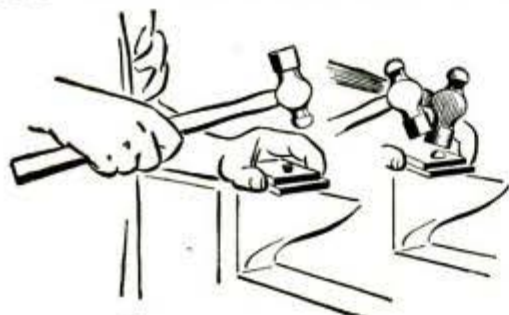

To rivet with a ball peen hammer, place the parts together with the holes in line and insert the rivet. Support the head of the rivet on a solid object, such as a vise anvil, and strike straight down on the rivet with the ball peen; head the rivet over with the ball peen or with the hammer face.

To raise a curved or bowl-shaped form in malleable metal, hold the work over a suitable hardwood form and beat it out with the ball peen.

The Stanley Tool Guide Shows Proved Tool Methods Galore!

More than 200 illustrations, with practical instructions covering the use of boring tools, doweling jig, spoke shaves, scrapers, planes, marking gauge, chisels, and other commonly-used hand tools are included in this one book. Send for your copy today, 25c postpaid.

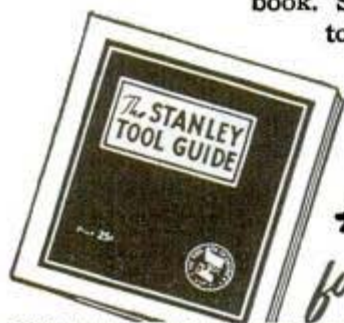

A Big Value for only 25¢

STANLEY TOOLS

1104 Elm St., New Britain, Conn.

Enclosed find 25c. Please send me the Stanley Tool Guide, postpaid. (In Canada: Send coin or stamps to Stanley Tool Co. of Canada, Roxton Pond, Quebec.)

Name.....
Address.....
City..... State.....

★ SAVE WASTE PAPER ★

AEROPoint "88"
AEROPoint
AERO NEEDLE COMPANY
208 EAST ERIE STREET
CHICAGO 11, ILLINOIS
"The Needle with the Plastic" Silencer"

The Dennison Handy Helper says:
Don't Just Think About It—Write!
Send It V-Mail, Keep It Light

AND ON THEIR PACKAGES USE

Dennison
SERVICEMEN'S LABELS
At Stationery Departments Everywhere



Titan Slide Rule

6" diameter. Easily read, clearly marked single index scales. Gives logarithms, reciprocals, squares, square roots, sines, and tangents. Continuous circular calibrations cannot go "off-scale." Invaluable in multiplication, division, proportion, conversion, all mathematical problems. Made of durable heavy pure white Vinylite. Complete with instructions, \$2.95. Leatherette case 75c additional. Money-back guarantee.

PRECISION INSTRUMENT CO.

Box 654, Dept. C Church St. Annex New York 7, N. Y.

COLD PIPE, CONDUIT and TUBE BENDING MACHINES

15 Sizes and Types Available

Free printed matter on request

AMERICAN PIPE BENDING MACHINE CO., INC.
World's Largest Manufacturers
77 Pearl St., Boston, Mass.



WOOD WORKERS

AMAZING BOOK FOR YOU

Harold Hunt wants to send revised No. 14 catalog. 124 pages of woodworking ideas. UNEQUALLED BARGAINS in imported and American woods, supplies. Those already holding this catalog—send for revised sheets. CRAFTSMAN WOOD SERVICE CO. 2729 S. Mary St., Dept. A-50, Chicago 8, Ill.

only 10¢



OTTAWA LOG SAW

Write for FREE BOOK



PUT THIS OTTAWA to work for you. MAKE MONEY! Wood is valuable. Does more than 10 men. Easily operated. Falls trees—and saws limbs. Use 5-hp. engine for other work.

SAW 10 to 20 CORDS A DAY

OTTAWA MFG. CO. 1027 Wood St. Ottawa, Kans.



PULVEX FLEA POWDER

Kills fleas
100% SATISFACTION
...OR MONEY BACK

25¢ AND 50¢

POPULAR MECHANICS

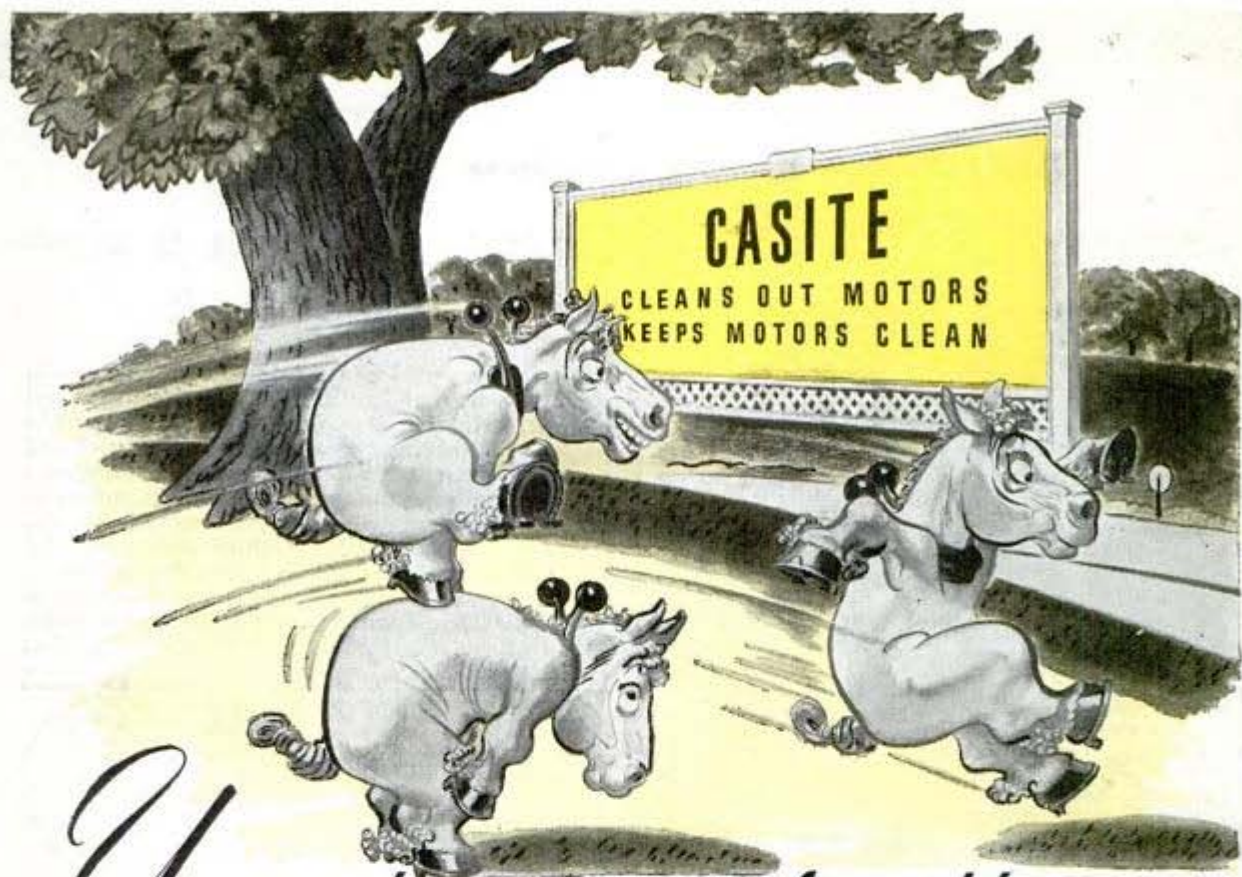

Young horsepower for old cars

Ever see the inside of your motor? Well, it's a maze of little pipes and passages that choke up with power-destroying sludge and gum. You can clean these out, and keep them clean, with Casite.

**Better and Smoother Performance
or Double-Your-Money-Back**

It's as simple as that. Either your motor

runs better and smoother, or you get back *twice* what you paid. Used through the carburetor, Casite gives an effective tune-up at low cost. Added to the crankcase oil, it stays on the job from one oil change to another.

Sold by service stations, garages and car dealers coast-to-coast at 65¢ a pint.

THE CASITE CORPORATION • HASTINGS, MICH.

Guarantee

Add Casite to crankcase and run through carburetor according to instructions, then drive your car 100 miles or for 60 days, whichever is first. If not convinced that Casite gives you better and smoother performance, you get double your money back by filling out guarantee certificate and mailing it to The Casite Corporation, Hastings, Michigan. Maximum refund is \$1.30 per pint, twice the nationally advertised price of Casite.



WHE-E-E-E GET CASITE AND GO!



IT'S A PRIVILEGE

TO BUY WAR BONDS



**HE HAS
YOUR BATTERY**

Today flasher signal lights and invasion-barge search-lights are more important than battery-powered lights on the home front. Burgess Batteries go *first* to the men who need them most, so we'll all have to take better care of what batteries we may have. Keep them cool and dry . . . use them as little as possible and rest them as *often* as possible. For Free Battery Hints—Write Dept. E-2, Burgess Battery Company, Freeport, Ill.

Paper Packs a War Punch—Save It!



**BURGESS
BATTERIES**

IN THE NATION'S SERVICE



How to live with a pipe —and like it

Pipe-smokers who wander along tobacco roads in search of deep and abiding satisfaction are urged to send for their free copy of "The Choice of Experience." Here, in narrative form, is a brief and readable history of Walnut . . . John Middleton's master-blend of the world's 7 finest tobaccos . . . mild, fragrant, friendly, *naturally* aromatic. It starts in a little tobacco-shop along the old Philadelphia water-front in 1856. And it brings, in addition to the booklet, an ample sample of Walnut. All for a penny postal addressed to John Middleton, 1201 Walnut (Tobacco) St., Philadelphia 7, Pa.

MASCOT SLIDE RULE

● Fits the pocket. Quickly solves any problem in multiplication, division, proportion. Gives the square, the square root, logarithm and reciprocals of all numbers. Trig scales give sines and tangents of numbers. Fine black graduations on white celluloid. Complete with instructions. Price in fabricoid case \$1.00, in leather case \$1.25. Money back if not satisfied. Special offer to agents and dealers.



MONITOR SLIDE RULE—6" Dia.

Made in white Vinylite. Same scales as Mascot Slide Rule. Complete with instructions. Without case, \$2.95. Leatherette case, 75c addn'l.

TAVELLA SALES CO., 19-N West Broadway, New York 7, N. Y.

IT STAYS ON . . . RUST STAYS OFF

FIENDOIL

RUST INHIBITOR



Keep home tools, appliances, corrosive metal protectively coated.

35c Bottle Hdwe.—Sptg. Goods Dealers
McCambridge & McCambridge Co.
Baltimore 23, Md.

BUILD A WELDER FROM OLD GENERATOR

For Light or Heavy Work. 30-200 amperes. Complete PLANS 35c. Send today and we'll include FREE our Big NEW Catalog.

LEJAY MANUFACTURING CO.
1347 LeJay Bldg., Minneapolis, Minn.



SHAW and "Peppy-Pal" GARDEN TRACTORS

● 1 to 9 H.P. Circulars on request. War limits production—We supply repairs for all SHAW Tractors sold in our 40 years in business.

BUILD YOUR OWN RIDING TRACTOR—"WAR HORSE"

using old auto parts, powered by 2 H.P. or larger air-cooled engine; or walking type Garden Tractor 1/2 to 3 H.P. or convert truck or auto into Farm Tractor. Each with steel or rubber tires; will plow, cultivate. Plans for building; in few hours, any one of above, postpaid for \$1.00 (state which wanted) or all 3 for \$2.00. Money Back Guaranteed!

SHAW MFG. CO., 4510 Front St.
Galesburg, Kansas
668G North 4th St., Columbus, Ohio





\$1,000.00

(Retail value)

in Delta equipment for a Homecraft Shop

199 Other Prizes Given Away **FREE** in Delta Post-War Shop Planning Contest!

Useful Prizes that bring happiness to you

★ **1st Prize** ★

Your choice of
\$1,000.00 in Delta Equipment
(retail value)

★ **2nd Prize** ★

Your choice of
\$500.00 in Delta Equipment
(retail value)

★ **3rd Prize** ★

Your choice of
\$250.00 in Delta Equipment
(retail value)

★ **4th to 8th Prizes** ★

Your choice of
\$75.00 in Delta Equipment
(retail value)

★ **9th to 20th Prizes** ★

\$10.00 worth of Delta
Accessories and/or Supplies!
(retail value)

(Merchandise certificates will be awarded to winners entitling them to prizes when materials required for making Delta equipment are released by the government.)

★ **21st to 40th Prizes** ★

Set of 27 Delta-Craft Project Books and Manuals! \$4.50 value! A complete education in modern shop practice.

★ **41st to 60th Prizes** ★

Set of 6 Delta Tool Manuals — Value \$1.50! Shows how to master tools and operations.

★ **61st to 200th Prizes** ★

1 Year's Subscription to The Deltagram! Value \$0.50. The popular, plan-packed homecrafter's magazine.

Nothing to buy! No entry fee! You don't have to be an expert to win!

Think of it—you have a chance to get \$1,000.00 worth of famous Delta equipment (post-war delivery), or one of 199 other valuable Delta prizes, *absolutely free!*

What a swell opportunity to have a complete Delta-equipped homecraft shop you can really be proud of—and where you and all the family can enjoy fun and healthful recreation!

Here's What to Do

All you have to do to become eligible for these big prizes is simply
HM-16

tell us in your own words your idea of a practical homecraft shop. Maybe it's that shop you've been dreaming about — or perhaps it's an improvement on the one you now have.

Whatever it is, simply send us a sketch of the floor plan (we don't expect a finished drawing) — together with a statement covering the points listed in the rules below. Include any ideas you think can put you among the winners.

You've Got to Start Now!

This exciting contest closes Tuesday, October 31, 1944. Your entry must be postmarked not later than midnight of that day.

So don't delay. Start your plan right now. And be sure to mail it on time.



Be Sure to Read these Rules!

1 The contest is open to any person of any age (male or female) residing in the United States or Canada, except employees of The Delta Manufacturing Co., dealers and distributors of Delta products and their employees, employees of Delta's advertising agency, and members of the immediate families of any of the above.

2 Entries are to consist of a floor plan or layout of the entrant's proposed post-war homecraft shop showing position of power tools, workbenches, and other major equipment, together with a statement giving the following information:

- A. Reasons for adopting layout and equipment shown in floor plan.
- B. List of power equipment now owned.
- C. List of power equipment planned for purchase after the war, the prices you would pay, and name of store where purchase would be made.
- D. List of hand tools and other accessories now owned.
- E. General type of work to be done in the shop.

3 Entries will be judged on their suitability to the type of work to be done, efficiency and ingenuity of arrangement, and use of space available. Neatness and clearness will count, but not costliness or elaborateness of the proposed shop, or elaborateness of the presentation.

4 All entries must be postmarked not later than midnight Tuesday, October 31, 1944. They are to be mailed to Contest Editor, The Delta Mfg. Co. 681L E. Vienna Ave., Milwaukee Co. 681L E. Vienna Ave., Milwaukee 1, Wis. Entries become the property of The Delta Mfg. Co. to be used as they see fit, and none can be returned.

5 Decisions of the judges will be final. In case of ties, duplicate prizes will be awarded.

6 Contestants are limited to one entry. If more than one entry is submitted by a contestant, only the first one received will be considered.

7 Final judging will be done by: William Bachrach, Regional Coordinator of Engineering, Science and Management, War Training; E. R. Haan, Technical Editor, Popular Mechanics; Harry Walton, Home and Workshop Editor, Popular Science.

NEW! "SLIDE RULE" for Woodworkers



Special wartime offer by the makers of famous GREENLEE tools for craftsmen.

ONLY **10¢**

You just set the dial and . . .

- ▶ Convert linear to board feet
 - ▶ Determine slope per foot in degrees
 - ▶ Compare hardness, weights, shrinkage, warping, ease of working of various woods
 - ▶ Find bit sizes for head, body and thread of standard screws
 - ▶ Determine nail specifications
 - ▶ Get helpful tool sharpening tips
- Heavy varnished cardboard . . . soil-proof . . . 6 inches in diameter . . . fits tool kit.



Send for yours now!

GREENLEE TOOL COMPANY, 2110 COLUMBIA AVENUE
ROCKFORD • ILLINOIS

Enclosed is 10c. Send your "Handy Calculator" by return mail.

Name _____

Address _____

City _____ State _____

DRILL PRESS OWNERS!

HERE'S 1 TOOL WITH 5 DISTINCT USES
**THE BARRON MULTI-PURPOSE
ROTARY WOOD PLANNER**



PLANES & SURFACES • PANELS & BEADS
ROUFS & GROOVES • RABBETS • TENONS **\$750** COMPLETE

Converts ANY drill press into a time saving, low cost planer, paneler, tenoner, etc. Surface finishes all types of tough grained and knotty surfaces to agree smoothness. Safe! Guaranteed harmless to drill press. Thousands now in use. **SOLD ON MONEY BACK GUARANTEE.** Full refund on 5 day trial. Shipped prepaid on receipt of \$7.50—or C.O.D. **YOU RISK NOTHING.** Free literature.

**STEEL TOP AUXILIARY
DRILL PRESS TABLE**
Has 200 sq. in. smooth working surface. Equipped for shaper and many other important workshop uses—a real buy at **\$5.95**



Barron Tool Co., 369 Architects Bldg., Detroit 1, Mich.

Free! TO PIPE SMOKERS SAVES YOU MONEY



FREE! Six Months' subscription to PIPE LORE . . . crammed full . . . illustrations, helpful hints ("How To Keep Your Pipe Sweet"—"How To Blend Tobaccos"); pipe-news about new styles, inventions, and collections; pipe and tobacco bargains, pouches, racks, humidors, and pipe gadgets. We cater to pipe-smokers EXCLUSIVELY . . . as specialists we save you money. Get the next six issues of Pipe Lore FREE, no obligation, of course. Act Now! Send this ad and your name and address to **WALLY FRANK, Ltd.,**

10 E. 45th ST., NEW YORK 17, N. Y., DEPT. 108

PAINT STRIPING TOOL

ONLY **\$1.00** POST PAID

Try it! See the Added Beauty

With this NEW TOOL, (not a brush) everyone can now draw lines with paint, enamel, lacquer, etc. Used on autos, models, toys, games, imitation tile walls, cabinets, furniture, linoleum floors, signs, bulletin boards, sporting goods, home workshop projects, etc. Send only \$1.00 for complete tool for painting a 1/16" wide stripe, including adjustable guide, operating instructions, etc. C.O.D. price \$1.25.



Patented

As easy to use as a pencil.
Extra interchangeable tips for making 1/64", 1/32", 3/64", 1/16", 3/32" and 1/8" wide stripe lines—.50¢ each.
Every Painter and Craftsman Should Own One.
Send for your tool and as many additional width tips you need today. Use it. If you are not satisfied that you can do better work, add character as well as beauty to your product or project, return the tool and we'll refund your money promptly.

Point Dealers: Write for literature, etc.
WENDELL MFG. CO., CHICAGO 18, ILL.

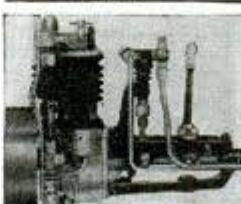

Build: STEAM ENGINE

- A precision built and engineered single cylinder, 1/4" scale marine model, with clutch or reverse.
- Send \$2.50 for 14 pages scale drawings, 2 photos, instructions.
- 2 Photos and Description . . . \$.25
- Rough Castings Kit . . . 12.50
- Horizontal Flash Boiler Drawings and Instructions 1.00

THOMPSON ENGINEERING CO. 206 NO. DIVISION BLDG., GRAND RAPIDS 2, MICH.

★ **NEW! Sell Popular** ★
ALL WOOL Buffalo Check Shirt ★
BIG PROFITS FOR YOU!

Every Outdoor man a prospect. Smartest color and style combined with warm snug comfort. Genuine ALL WOOL Buffalo Check Shirts. Full cut, patented storm cuffs. Amazingly low priced, with generous profit for you.
COMPLETE LINE—Leather and wool jackets, raincoats, 200 fast selling shoe styles for men and women. Our salesmen making biggest profits in this field, using Actual Samples we furnish FREE. Write today for FREE SAMPLE OUTFIT.

MASON SHOE MFG. CO., Dept. M-144, Chippewa Falls, Wis.

**"WITH THE WIND BLOWING MY HAIR
AND SINGING A SONG IN MY EARS"**

"I was in Alaska over a year — am now somewhere in the Aleutians. The Harley-Davidsons here are doing praiseworthy work and giving faithful service. It's good your machines are made to stand hard punishment. I long to be back in the saddle of my own faithful Harley-Davidson again — *with the wind blowing my hair and singing a song in my ears.*"

The story is always the same. Thousands of letters tell of Harley-Davidsons' superior performance under severest war action. And thousands of riders tell how eager they are "to get this thing over with so we can have a new HARLEY-DAVIDSON for the thrilling motorcycling days to come." **BUY WAR BONDS NOW**, to make those days come soon!



**HARLEY-DAVIDSON
MOTORCYCLES**

HARLEY-DAVIDSON MOTOR CO.
Dept. P, Milwaukee 1, Wisconsin

Please send at once free copy of 24-page "Enthusiast" Magazine, filled with motorcycle action pictures and thrilling stories.

Name.....

Address.....

City..... State.....



YELLO-BOLE

REAL HONEY



\$1.00
STANDARD
"Dublin" Shape

the honey-cured smoke

A mellowing and curing agent, of the proper thickness, the honey lining has endeared these Yello-Bole Pipes to thousands of men since 1933. For there's no "breaking-in," with a Yello-Bole. It smokes like a seasoned, trusted pipe, from the beginning. Honey does it (it's in that yellow bowl). Fine pipe-bowls, with Nature's markings. If your dealer hasn't got them, it's because we're supplying the men in ships and fox-holes, first, and your dealer will have your Yello-Bole soon.

YELLO-BOLE STANDARD \$1
YELLO-BOLE IMPERIAL \$1.50
YELLO-BOLE PREMIER \$2.50

YELLO-BOLE A NAME TO REMEMBER, WHEREVER YOU ARE—
AND WHEN YOU COME HOME

Say you saw it in Popular Mechanics!

FILLS FLOOR CRACKS!

Holes and cracks in floors can be quickly repaired with PLASTIC WOOD! Handles like putty; hardens into wood. At Paint, Hardware, and 10¢ Stores.



TAPE WORMS
ROUND WORMS
(Ascarids)
HOOK WORMS
WHIP WORMS



...you can free your dog of all these worms

with **PULVEX**
COMBINATION TREATMENT **WORM CAPSULES**

Used by leading breeders. At leading pet, drug, department stores, 50¢ a package (double size, 75¢). Packed two ways: for puppies, for dogs.

ONE-MAN SAWMILL LESS THAN \$135.00

Easy To Turn Trees Into Money

Makes Lumber, ties, shingles, crates, lath, studding, siding.



Belsaw Models in 10, 14 and 20 feet sawing lengths. Patented Mechanical Feed, accurate set works and positive dogs. Use tractor or old auto engine for low cost power. Thousands used for commercial sawing. Pays for itself quickly. Send post card today for FREE booklet, "How To Make Lumber" and Catalog of Woodworking Equipment. BELSAW MACHINERY CO. Dept. 1811-H, 3542 Main Street, Kansas City 2, Mo.

in every battle...
doing vital jobs...
unfailingly...



that's why there are just a few left for essential jobs at home

BRIGHT STAR BATTERY CO., CLIFTON, NEW JERSEY

POPULAR MECHANICS

vest pocket power



Why put an air-cooled aircraft engine in a tank? Because no other engine packs as much power into such small size. Tanks and gun carriers slog into battle on caterpillar treads, but they are similar to aircraft in that they require an engine high in power, small in size, and light in weight. Other engines of equal power are massive, creating a vicious circle in which large size demands more armor plate, in turn adding weight and calling for more power to maintain speed.

Seasoned by years of operation in transport, private, and trainer planes, the Wright

Whirlwind was the logical choice for the Army's medium tanks and gun carriers. This engine, weighing but a scant 1% of the M-4 tank's 30 tons, packs 400 HP plus in its 45" diameter.

Enlisted in our armored divisions, the Whirlwind was assigned to combat duty with virtually all medium tanks and heavy gun carriers to reach the fighting fronts. In no sense a competitor to the air tonnage hauling Cyclone, the Whirlwind has nonetheless lived up to the Wright tradition for light, compact power, adaptable to many purposes.

Cyclones and Whirlwinds · Light · Compact · Powerful **WRIGHT** *Aircraft Engines*

WRIGHT POWERS THE TONNAGE OF THE AIR

GLAMORIZE AND WINTERPROOF YOUR HOME WITH

PLASTI-COTE



AMAZING LIQUID
PLASTIC PAINT

ONE
COAT
COVERS

EXTERIOR

THE PAINT OF TOMORROW—TODAY! Imagine cosying and beautifying your home, inside and out, with a film of real plastic, tough, tenacious, deeply beautiful... which neither sun, rain, fumes, or smoke affects. That's PLASTI-COTE, the amazingly durable plastic paint, which anybody can apply.

EXTERIOR—One Coat Covers clapboard, shingle, stucco, brick, plasterboard, concrete, metal. Fills cracks and imperfections. Leaves no brush marks. Does not chip, chalk, or peel.

INTERIOR—Gloss, semi-gloss or flat, for walls and woodwork, even old wallpaper. Washes like tile. Cannot be thinned with water.

MONEY BACK GUARANTEE

Use 25% of this resin-based liquid plastic paint. If not delighted, return remainder and receive full refund. Order for cash, post-paid; or C. O. D. plus small express charge. Colors: White, Ivory, Cream, Buff, Dusty Rose, Peach, Grey, Blue, Brown, Black, and Green, 3 shades. A gallon covers 300 square feet.



INTERIOR

\$5.95

PER
GAL.



Say Good-Bye to Wax and Polish Slavery—Use **PLASTI-CLEAR FLOOR FINISH** Banishes waxing and polishing. Resists alcohol, cigarette burns, boiling water—even lye. Ideal for wood, concrete, linoleum, tile. Non-skid. 10 colors and clear. Per Gal. \$6.75.

Cosify Your Damp Basement with **PLASTI-BASE WATERPROOF FINISH** Seals and beautifies brick, concrete, masonry, mortar. Stops seepage and moisture. No costly undercoats necessary. Make your basement dry, colorful playroom. 6 colors. Gal. \$7.50.

DEALER INQUIRIES INVITED

CELLO-NU PRODUCTS

333 N. MICHIGAN AVE., DEPT. 2, CHICAGO 1, ILL.

★ SAVE WASTE PAPER ★

AUTHENTIC FLYING MODEL AIRPLANES Sensational Time-Saving Construction!

Enjoy the thrill of building and flying a model built on a tube. 45 fine kits to choose from—15 cents to \$3.00. Big 32 inch wing span kits—fighters and bombers—only 50 cents. All kits include cement.

Joe Ott
AIRPLANE KITS
JOE OTT MANUFACTURING CO.
415 West Superior Street - CHICAGO, ILL.

OTT-O-FORMER
AND OTT-O-TUBE
CONSTRUCTION

At
Your
Dealer

LEPAGE'S GRIPSREADER MUCILAGE

LEPAGE'S WHITE PASTE

LEPAGE'S GLUE

GRAY HAIR VITAMIN NOW \$1.95

No dyes—No drugs—Hair grew out in Natural Color in almost nine out of ten test cases just taking one tablet Calcium Pantothenate Vitamin each day.

Why pay \$3.50 to \$5.00 for the famous "Gray Hair Vitamin"? SEND NO MONEY. Just send name and address. We will ship 100 10-mg. tablets (100 days' supply) genuine standard quality Calcium Pantothenate Vitamin C.O.D. for \$1.95 plus few cents postage. Guaranteed same quality as used in National Tests or money back. HYGEE VITAMIN CO., 2017 S. Michigan Ave., Dept. 910, Chicago, Ill.

MAKE MONEY CASTING AT HOME FREE FACTS SENT

Make hundreds of Plastic Casts, quick, easy. Sell output to stores, novelty shops, etc. Enormous profits. No experience. Very little capital needed. Start in basement, garage or workshop. Complete, simple instructions anyone can follow. Start now while merchants are begging for merchandise to sell. Rush. PLASTIC ARTS STUDIOS, R.R. 4, Dept. 210, Muncie, Ind.

MEN

This Horseshoe Ring, Handmade, Hand - engraved, inlaid with simulated pearl, is a **KNOCKOUT!** Shoe and shank of everlasting Monel Metal is

GUARANTEED 20 YEARS
Supply is limited . . . act now! SEND NO MONEY with order, just name and ring size. Pay on arrival, 20% tax included, ONLY \$3.98, NOT one cent extra for anything! Return in five days for refund if not delighted. Address: Dept. 333-H AMERICAN JEWELRY CO., Wheeling, W. Va.
POPULAR MECHANICS

Ingenious New Technical Methods

Presented in the hope that they will
prove interesting and useful to you.

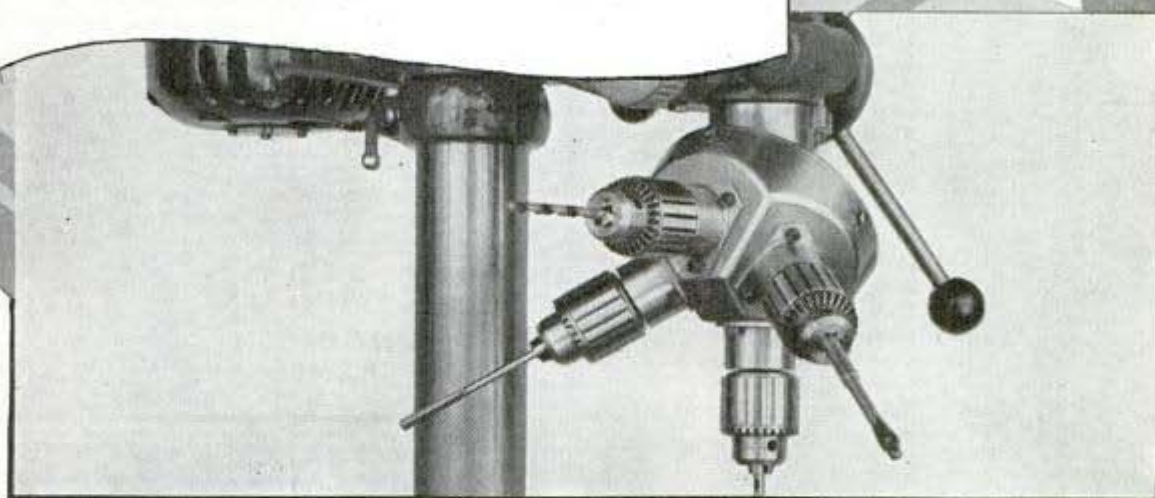

Amazing New Four Spindle Turret Attachment for Drill Press!

Now one drill press can do the work of four and, at the same time, effect a savings of up to 75% in floor space, with the "Quadri-ll" attachment. This rotary device will accommodate four boring or cutting tools at the same time, yet one tool *only* is in motion when the head is in operating position.

The entire unit is assembled to the quill of the drill press and is driven from the drill press spindle. Accuracy and rigidity of alignment of the "Quadri-ll" are assured by the special construction of the driver and spindles, thus efficiency is only limited by the accuracy and power of the drill press itself.

Foolproofing in indexing is accomplished by visual markings and by the relationship of the index pointers on the index disc, as well as the extension of the spring retainer. Four hardened and ground spindles are fitted for No. 32 Jacobs chucks or their equivalent. To provide correct positioning at all times, the entire spindle assembly is located by means of an accurate fitting of recess and undercut, between turret and bearing housings. The hardened friction starter and driver have been so constructed that at any speed proper synchronization of the driver teeth is accomplished without clashing.

It goes without saying that our fighting men must have the finest possible quality materials home industry can produce. So, although the stock of quality raw materials from which Wrigley's Spearmint chewing gum is made is growing steadily smaller, they are still maintaining pre-war standards. However, they can now make only a portion of their former output, so all of this limited production is going to our fighting men and women overseas only . . . where it is an "on-duty" need.

You can get complete information from Chicago Drillet Corporation, 919 North Michigan Avenue, Chicago 11, Illinois



Quick and positive indexing assured
by pointers on index disc



Quadri-ll assembly complete ready
for attachment to drill press

Y-143

**"I'VE WORN
Carhartt
OVERALLS
FOR OVER 50 YEARS"**



When you're giving something extra in your war job you should expect something extra in comfort, fit and wear from your work clothes. You can get these extras by wearing Carhartt Work Clothes. Made from stout Sanforized Carhartt Master Cloth—their better tailoring and workmanship, their experienced design and stronger reinforcing and lock stitching make Carhartts America's outstanding work uniforms. Carhartt has always gone slogs length in giving you the best that money can buy with its famous 50 year old money back guarantee.

Carhartt washable work caps are skillfully tailored, full cut for lasting wear, comfort, fit and neat appearance.

On sale at your local dealers

HAMILTON CARHARTT OVERALL CO.
Established 1889

Detroit, Mich.
Atlanta, Ga.

Carhartt Park, Ky.
Dallas, Texas



Carhartt
UNION MADE WORK CLOTHES
50 Years a Friend to Organized Labor

How to SAVE PAINT BRUSHES

BEFORE—Bristles caked, stiff, useless. **AFTER**—Bristles silky-soft and flexible—ready for easier—faster—better painting. **DIC-A-DOO** Paint Brush Bath makes the difference. Restores old brushes. Saves new brushes. Buy 5¢ package, 10¢ box at **PAINT, HARDWARE, FIVE & TEN CENT STORES.**—The Patent Cereals Co., Geneva, N. Y.—makers of **DIC-A-DOO** Paint Cleaners.

DIC-A-DOO
PAINT BRUSH BATH

AMAZING MYSTERY BUTTON

Startles Everybody. With this **Electronic Button** you can make your own Telephone—Amplifier—Detectophone. Attach this button to piece of cardboard—transmit conversation to another room. Also transmitted to distant places. Most interesting, electrical apparatus ever discovered. Enables you to perform hundreds of experiments. So tiny it can be concealed in dozens of places. A Pre-War Product. Supply Limited. **Electronic Button** including 5000 word instruction booklet with 50 illustrated experiments postpaid only \$1.00. **Electronic Products Company, Saint Charles, Ill.**

POCKET ADDING MACHINE

STURDY STEEL construction for lifetime use. Adds, subtracts, aids multiplication. Capacity 999,999.99. A real machine—guaranteed 5 years. Thousands of satisfied users. Send name and address. We ship immediately. On delivery, pay postman \$2.50 (plus C.O.D. and postage charges). If you send \$2.50 with order, we pay postage. Leatherette case 25c additional. Your money back after 10 days trial if not satisfied.

Free Trial \$2.50
Send no money

TAVELLA SALES CO., 19-NA West Broadway, New York 7, N. Y.

KRW ARBOR PRESSES BENCH TYPE AND HYDRAULIC

NEEDED IN EVERY SHOP—SAVE TIME AND MONEY—DO BETTER WORK, QUICKER.

No shop is complete without a small arbor press. Pressing and squeezing operations can be done better and faster on a KRW Arbor Press. Stop using vise and sledge hammer methods—they generally deliver spoiled work in the end. KRW Factory-To-You Prices give you greater value for your money. Order today.

KRW Bench Type Arbor Presses, 3 sizes

No. 37-P	1/2 Ton,	\$13.25*
No. 37-O	1 Ton,	\$23.00*
No. 37-N	3 Ton,	\$33.00*

*Prices F.O.B. Arcade, N. Y. Slightly higher west of Rockies. Stand illustrated extra.

KRW Hydraulic Presses are built in 25, 50, 60 and 75 ton sizes. Prices start at \$198.00*.

K. R. WILSON, 17 Lock St., BUFFALO 2, N. Y.
Builders of Shop Equipment for Ford Dealers Since 1916

VanRoy



*Signet of Quality
in Pipes*

No casual smoker is a VanRoy owner. Each pipeful brings moments of rare enjoyment — from the luxurious first puff to the last reluctant draw. Moments like these are priceless, yet easily within reach. Discover for yourself the uncommon satisfaction of possessing a VanRoy Pipe.



2 Pipes
Illustrated:
VanRoy
DUMONT
\$10

VANROY COMPANY, INC., EMPIRE STATE BUILDING,
NEW YORK 1, N. Y.

VanRoy Pipe Family

VanRoy ARISTA . . . 3.50
VanRoy BARD 5.00
VanRoy COURIER . . 7.50
VanRoy DUMONT . . 10.00



A *Great* WATCH...PROVED
IN ACTION

17 Jewels

The PIERCE Parashock

REG. U. S. PAT. OFF.

WATERPROOFED
SHOCKPROOFED
ANTI-MAGNETIC

\$49.75

Price indicated is suggested
retail price and includes
Federal tax.

No other watch has such features for service! By laboratory test... by test of men and women in industry... by test in battle on land, sea and in the air... the PIERCE PARASHOCK has proved its ability to withstand strain and remain dependable. And this same quality is built into all PIERCE watches... renowned for distinctive styling. Ask your jeweler for PIERCE... "Watchword of the Airways"... The Pierce Watch Co., 22 West 48th St., N. Y.

KNOWN AND SERVICED THE WORLD OVER

How to learn to shoot

The Guidebook
to Rifle
MARKSMANSHIP



O.F. Mossberg
& SONS, INC.

Send for
this Free
Booklet

Take advantage of the Government-approved program, sponsored by the National Rifle Association of Washington, D. C., to train citizens in the use of small arms. Write today for the above Free booklet: "The Guidebook to Rifle Marksmanship" and details on how to get rifle training.

O.F. Mossberg
& SONS, INC.

46510 ST. JOHN ST., NEW HAVEN 5, CONN.

Today, 100% in war work. In normal times, manufacturers of .22 cal. RIFLES, SHOTGUNS, TELESCOPE SIGHTS, TARGO GUNS AND EQUIPMENT

Test-O-Lite

the MODERN
TROUBLE SHOOTER



THE NEON GLOW

... LOCATES TROUBLE INSTANTLY in electric circuits, fuses, cut-outs, motors, radios, appliances. Tests everything electrical from 100 to 550 volts. Indicates hot or grounded wires. Tells AC from DC. Far superior to ordinary clumsy test bulb.

PUTS "FINGER" ON THE TROUBLE SPOT -- QUICKLY

Saves precious time. Indispensable in shop or home. Has patented safety features. Vest pocket size with clip. Lifetime guarantee. List \$1.50 (Priority A7 required) Purchase through regular electrical dealers.

L. S. BRACH MFG. CORP.
55 Dickerson St. Newark, N. J.



FUSES



MOTORS



OUTLETS

110-VOLTS AC from DIRECT CURRENT

with KATO KONVERTERS. Furnish standard 110-v AC from 32, 110, or 220-v. DC. Good deliveries on sizes 850 through 1500 watts on priority orders.

Good deliveries on 5, 7½, 15 & 25 KW AC generators. Mfg.'s of motor generators, frequency changers and high frequency generators.

KATO ENGINEERING CO.
43 Elm Street, MANKATO, MINN., USA



Complete Plans and
Building Instructions, 85c

TRAILER BUILDERS' PARTS CATALOG

We'll save you money on everything. Largest and most complete trailer builders' supply house in the United States. Member TRAILER COACH MFRS.' ASSOC. Send 10c for parts catalog. NATIONAL TRAILER EQUIPMENT CO. Milwaukee 3, Wis.



BLOWERS PLANS FOR BUILDING a blower for your furnace.

Gas & oil burners. Controls and repairs for stokers, oil & gas burners. ELECTRIC DAMPER CONTROL FOR COAL FURNACES \$15.60. Stokers for apartments & stores. Sump pumps. Automatic gas water heaters. GAS RANGES \$39.00. Gas & oil circulating heaters. PEERLESS SALES, Dept. M. C. V. Stn. Box 122, Lincoln 8, Nebr.



10c NEW BOOK OF LATHE AND DRILL PRESS SET-UPS
Practical, unusual uses, contains 49 illustrations.
Post- Send 10c to cover handling and postage.
Paid JACOBS MFG. CO. 154 Jacobs Rd. Hartford 1, Conn.

MAKE BIG MONEY SAWING WOOD NOW!

350 Cuts
a Minute

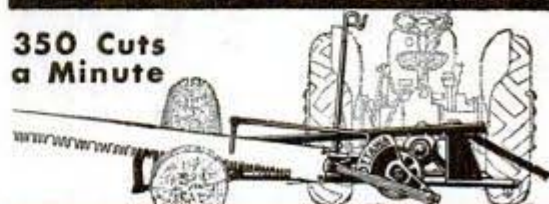

OTTAWA ONE-MAN TRACTOR SAW

Turn wood lots into cash; help save other fuels to win the war. Use Ottawa—fastest cutting; easiest way. Cuts large and small logs, fells trees. Thousands in use. Built to last with special heavy stiff saw blade. Positive safety clutch control, driven from any power take-off.

OTTAWA MFG. CO., D1027, Forest Ave., Ottawa, Kansas

FREE BOOK
and
Price List

★ SAVE WASTE PAPER ★

POPULAR MECHANICS

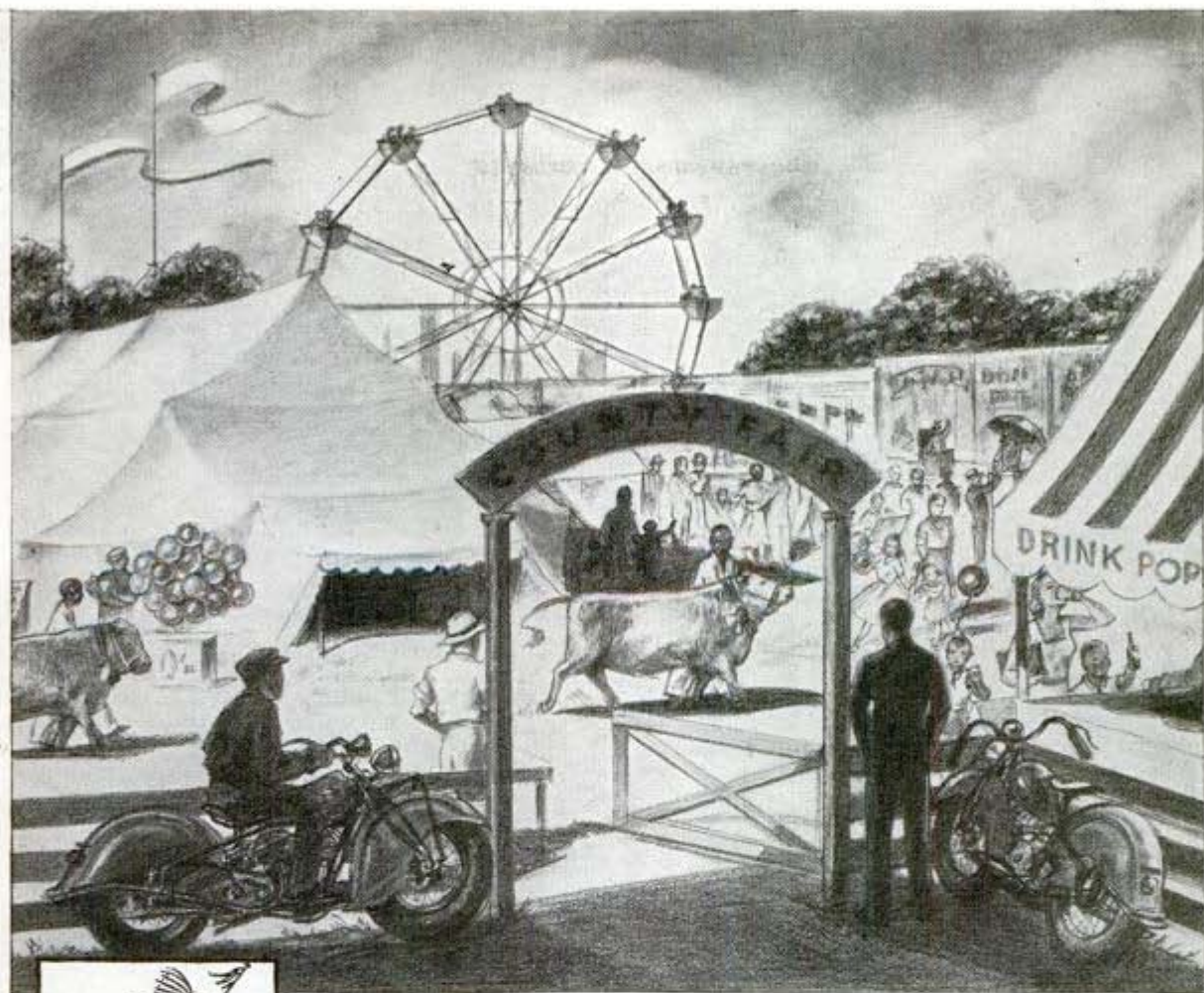

What a Champion

FOR MORE than 43 years Indian has held the lead for speed, endurance, instant ease of handling, unmatched power . . . and for every other factor that assures safety, comfort and all 'round dependability.

Indian's perfection and performance have earned the plaudits of motorcycle owners and riders everywhere . . . sports-lovers and safety officials alike, thanks to Indian's engineering leadership, better materials throughout its entire construction, superior principles of design . . . and constant improvement.

No matter where the road may lead . . . or what the demands may be . . . you will get there quicker, with lots more pleasure, at much less cost if your choice is the safer, better Indian . . . "The Champion of Them All."

Indian Motorcycle Company, Springfield, Massachusetts

New thousands will thrill to the joys of motorcycling when Indian surprises America with postwar improvements. Send us your name and address on the coupon below . . . so you will get the good news just as soon as it's announced.

Mail the coupon today.

BUY WAR BONDS NOW TO BUY AN INDIAN LATER

Indian Motorcycle Co., Springfield, Mass.

Please send me *Indian News* . . . and put my name down to receive any new Indian announcements. PM-10

Name.....

Address.....

City..... State.....

Indian

MOTORCYCLES

Read about Motorcycling



HANDKERCHIEF TEST



**PROVES VITAL ZONE SPOTLESS
AND FREE FROM "GOO"—no matter
how often you smoke it!**



HESSON GUARD MILANO

★ **SAVE WASTE PAPER** ★



TOOL and DIE MAKERS

Your good tools deserve the care that only a Gerstner Chest can give. Free Catalog.
GERSTNER TOOL CHESTS
444 Columbia St. Dayton 7, Ohio

STOKER EMPTIES OWN ASH!

A remarkable stoker already used by thousands of home owners—fits into any furnace or boiler. Manufactured since 1934. So automatic it takes the coal from your present coal bin through a pipe to the furnace, going around corners if necessary. Keeps house at even temperature, empties its own ash in sealed containers, no coal to shovel, no clinkers to dig, only bituminous stoker of its kind on the market. Send for full information NOW!

POCAHONTAS FUEL COMPANY INCORPORATED
344 EAST 131st STREET • CLEVELAND 8, OHIO

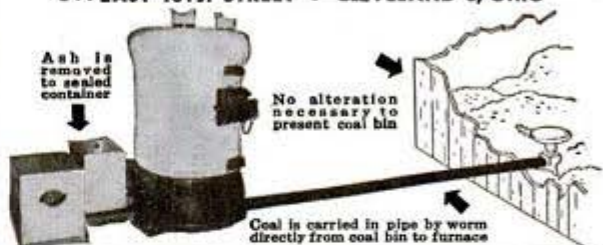

Ash is removed to sealed container

No alteration necessary to present coal bin

Coal is carried in pipe by worm directly from coal bin to furnace



BUILD WITH CEMENT COMPOSITION

strongly reinforced with cheap wood. Several formulas. Modern stram-line roof, walls and gutters in one. How to build a house 22x24, three rooms, as low as \$100 for materials, garage, \$20, 20x50 poultry house, \$50. Farm buildings for a few dollars. Homemade equipment to make wall-high building blocks with inside and outside finish. Also roof, wall and floor tile in color, and durable wallboard of sawdust. Labor saving. Long lasting. No painting. Make doors and windows. Sectional cabins, 100 money-saving ideas. Mixer and saw easily made from an old auto. 40 Wartime plans. Earn \$10 a day. Guaranteed, illustrated instructions, \$1.00.

MAKE FURNITURE OF COMPOSITION cement, sawdust, asbestos, paper. Homemade elements. Some part scrap wood and metal. Illustrated instructions to make tables, cabinets, chests, racks, shelves, inlaid sinks, lawn novelties and toys. Over 500 per cent profit. 50c.

HOW TO MAKE 50 ACCURATE WOODWORKING MACHINES: Band, jig and circular saws, electric drills, sanding wheels, tools, electric weed cutters and many other things from old auto parts and washing machine motors. Illustrated, 50c.

HOME MFG. ENTERPRISES, 50 selected home shop projects, 50c.

Special: All of the books described above, \$2.00 postpaid. No C.O.D.

HOME INDUSTRIES, 1318 South 39th Ave., Dept. PM, Omaha 5, Nebr.

Wonder-Tone NOISE ELIMINATOR

Just attach to your radio (long, short wave) and enjoy reception free from distracting noises. Send-No-Money Pay Postman 60c plus postage or send 60c and we'll send postpaid. Return in 5 days for refund if not delighted.
WONDER-TONE COMPANY, Dept. 45, 7078 N. Clark St., Chicago 26, Ill.

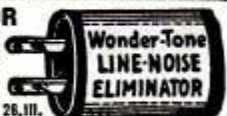

LAW

STUDY AT HOME FOR PERSONAL SUCCESS and LARGER EARNINGS, 35 years expert instruction—over 108,000 students enrolled. LL.B. Degree awarded. All texts furnished. Easy payments. Send for FREE BOOK—"Law and Executive Guidance."

AMERICAN EXTENSION SCHOOL OF LAW
Dept. 46-M, 646 N. Michigan Ave., Chicago 11, Ill.



BUILD THESE PROJECTS

For garden or lawn. Easy to build. Easy to sell. Detailed Blueprints Model B-25 Dutch Windmill 50c; Model DM-60 Old Mill, 85c. Lawn Figs. Patterns—Bunbonnet Girl, Dutch Boy, Tulip Girl, Holland Fair, 35c each, all 4—\$1.00. Catalog illustrating many models, send 10c, today.

CRAFTSMAN'S MODEL CO., Dept. P-79, 2030 N. 41st St., Milwaukee, Wis.

TRAILER AXLES, HITCHES, AND PARTS

● If you are interested in purchasing trailer axles, hitches, and other trailer parts, contact us promptly. Complete house trailer blue prints, \$1.00. Write for free literature.
HAMMER BLOW TOOL COMPANY, Dept. 110, WAUSAU, WIS.



Com- 520
plete

ENGINES IN STOCK



The G. H. Q. miniature gasoline engine that really operates is still available. Over 100,000 sold to date. 1/5 H. P. Complete with flywheel and propeller, fuel, 15 accessories and full instructions. Fully bench tested and ready to run. Power for all models. \$20 complete. Send only \$1.00—Shipped Collect C.O.D. same day. Send 25c for illustrated Catalog of hundreds of hobby items and airplane identification chart.

GHQ MOTORS, Dept. BV104, P. O. Box 203, Madison Sq. Sta., New York 10, N. Y.

Success with Atlas



Compact Atlas milling machines handle all types of milling work.

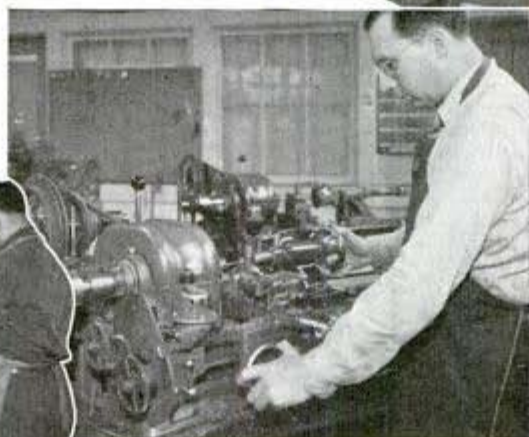

Atlas 10" lathes are the basic machine tool in thousands of shops.



An Atlas multiple spindle drill press was secured to handle series of drilling and tapping operations.

AUTO SERVICE MAN BUILDS THRIVING BUSINESS PRODUCING VITAL WAR PARTS

Shortly after Pearl Harbor, Hugh Leaming decided he could do more for his country as a machinist than as service manager of a Rochester, N. Y. automobile agency. His first shop was just large enough to house his original equipment — an Atlas lathe, drill press, bench grinder, and shaper.

Working alone eighteen hours a day he finished his first contract for close tolerance gun parts on time and with such accurate workmanship that he obtained additional contracts quickly from prominent Rochester war producers.

Today, Leaming employs 21 men who work fourteen Atlas lathes, a milling machine, shaper and several Atlas drill presses.

Hugh Leaming's success story is typical of hundreds of men who have put Atlas precision tools to good use — in small shops — in basements — wherever space was available — making useful, profitable articles. Remember Atlas machine tools for YOUR postwar shop!



ATLAS PRESS COMPANY

1043 N. PITCHER ST., KALAMAZOO 13D, MICHIGAN

Tomorrow's Miracle



ELASTI-GLASS*

Belts & Braces

Available now . . . in limited quantities at many dealers . . . smartly fashioned Elasti-Glass braces, with yielding 100% full stretching comfort in wide range of sport tones. Clip or button ends . . . \$1 . . . Also Elasti-Glass "Stratton" Belt in Tan, Grey or Brown with handsome Giant Grip buckle . . . 100% stretching comfort . . . \$1.

*Elasti-Glass is an **ORGANIC GLASS** and although of almost living elasticity contains no silica or rubber. (Trade Mark Registered U. S. Pat. Off. Made from Vynylite® Brand Resins. †Trade Mark Reg. C. & C. C. Covered by U. S. Pat. No. 2,228,313.)

Buchbaum & Co.

MANUFACTURERS SINCE 1888 · CHICAGO

Dealer's Note: Limited stocks on hand at our New York, Chicago, Los Angeles and Honolulu Offices.

Seal Windows and Doors—
Cut Heat Losses

KALK-KORD

Seals Cracks Quickly,
Easily, Without Tools!

Kalk-Kord, the original non-hardening caulking compound in soft rope-like form, enables you to seal window and door frames against cold and dirt, fills cracks in wood or plaster anywhere, inside and out.

You simply press Kalk-Kord in place with fingers alone, no guns or other tools needed. It is non-oxidizing and will not

check, crack, or harden. Kalk-Kord seals tightly, and it stays tight.

Use Kalk-Kord now. Lower your heating bills and avoid soiled walls and drapes due to drafts. Use it also to seal unsightly cracks or nail holes in woodwork or plaster. Kalk-Kord is waterproof and can be painted over immediately if desired.

Kalk-Kord is packed in convenient rolls, ready for use. It is neat and clean to work with, cannot stain. Users everywhere are enthusiastic about Kalk-Kord. Try it yourself, now.

Buy Kalk-Kord at your nearest SEARS, ROEBUCK retail store or order from Sears by mail.

PRESSTITE ENGINEERING COMPANY
3978 Chouteau Avenue St. Louis 10, Missouri

Fuse Puller—Circuit Tester



For
Home
or
Factory

TESTS 110-250 VOLTS

When motors stop and lights go out, this tool quickly **LOCATES DEAD CIRCUITS** and safely removes blown Fuse. The Star Test Pocket Plier is made of a Transparent Plastic having in one of the legs a small lamp in series with a resistance and can be used to test 110 to 250 volts circuit. The Plier will pull fuses from 10 to 100 Amperes. Thousands of Electricians find this tool handier than Test Lamps. Price \$2.75 each without Leads, \$1.50 additional for Leads, plus 10c postage. Can be obtained from General Electric or Westinghouse Stores or directly from us. Order NOW. **STAR PLIER CO., 233 Canal St., New York 13, N. Y.**



BALL BEARINGS

Set in flawless steel rings, assuring precision operation due to friction-free rotation. All Standard makes—New Departure, S. K. F., Norma-Hoffman, Fafnir, etc. We can supply promptly any quantity needed from our large stock of the MOST POPULAR SIZES. And you SAVE 50 to 60% on the Manufacturer's List. All Ball **FULLY GUARANTEED** Bearings

Write **TODAY** for Bulletin B
M-E-T EXCHANGE, Dept. PM, 323 Canal St., New York 13, N. Y.

ELECTRIC HEATING APPLIANCE ELEMENTS REPAIRED . . .

Use NICHROCITE PASTE



Simply overlap ends, apply Nichrocite Paste and turn on current. Used by large utility companies. Trial order, \$1.00; 4 oz., \$2.50; 1 pound, \$8.00. Advance Mfg. & Dist. Co. Box 861 Minneapolis, Minn.

FALSE TEETH
FIT TIGHT
with **Dentyte**



Soften **DENTYTE** by warming—spread it on your plate—put in mouth and bite to make a perfect impression. Remove plate—and allow few minutes to "set". You get an absolutely perfect fit. Sore gums vanish—no more slipping or loose teeth. **DENTYTE** is firm but resilient. Each lining lasts for months, immediately removable with fingers. Full size jar—(a year's undreamed of comfort per plate); postpaid only \$1. Send dollar bill at our risk. Easy to order. Easy to use. Unconditionally Guaranteed.

Dental Products Corp. Dept. PM-20 Manheim, Pa.

BRUSH PLATING OUTFITS

for autoparts, reflectors, faucets, bicycles.
No tanks necessary. Free particulars.
GUNMETAL CO., AVE. M, DECATUR, ILLINOIS
SAVE WASTE PAPER



AUTO ENGINE SPEED CONTROL GOVERNORS

Give constant or changeable speed to any auto or truck engine, when used



for power. Guaranteed. Instructions. Oil ring bearing \$13.00. Ball bearing, constant or changeable speed, \$19.50. Prepaid. Also additional carburetor butterflies. In Montreal: 7546 Wiseman St.; Latin America: East Asiatic Co.

Agents wanted: Parts Dealers, Garages, Wreckers, Importment Dealers. General Merchants. Free circulars.
CANDEE, 2641 S. Hill • Los Angeles-7

POPULAR MECHANICS

There's
 been a
 big change



★ Football is still a matter of touchdowns—but time has developed a more skillful game with many technical improvements.

The duties of a tapered roller bearing are the same, too. Tyson, however, has introduced the *All-Rolls* design which has vastly increased its efficiency.

With the addition of *thirty percent more rolls*, Tyson has almost doubled ordinary roller bearing life. Size for size, the Tyson "All-Rolls" bearing has greater load capacity—more strength and rigidity. It's a heavy-duty bearing for heavy-duty jobs. *The big name in bearings today is... TYSON!*



TYSON BEARING CORPORATION • MASSILLON, OHIO

COUNT THE ROLLS - THE ROLLS COUNT



Tyson
 TODAY'S HEAVY-DUTY BEARING

★ BUY MORE WAR BONDS ★

Are you singing the "TIME CLOCK BLUES"?



● Thousands of otherwise healthy men feel all fagged out long before the end of the day. Often this early fatigue can be directly traced to the constant strain and drag on delicate muscles in "the vital zone." Bauer & Black Suspensories help relieve these dangerous strains for thousands.

THIS FREE BOOK TELLS THE STORY

It tells how men claim to have found new energy and pep . . . how they get more out of life . . . feel younger . . . when they have the comfortable support of a Bauer & Black Suspensory. It tells how a suspensory may help you banish "quitting time fatigue."



DON'T FEEL FAGGED OUT—SEND THE COUPON

BAUER & BLACK

Suspensories

Division of The Kendall Company

Dept. S-310
2500 South Dearborn St., Chicago 16, Ill.

I'm tired of being tired. Send me "What Every Man Should Know."

Name.....

Address.....

City..... State.....

★ SAVE WASTE PAPER ★

IT'S YOUR DUTY TO KILL RATS!

Enemies to your crops, health and profits

Rats are destroying food and property; and spreading disease to humans and livestock.

Kill rats quickly and easily with improved K-R-O Ready Mixed in Bis-Kit form. Variety of baits containing highly toxic red squill. Safe to use around livestock or poultry. No mixing. No muss. No trouble. Household size 35¢. Large farm size \$1. At drugstore, seed or hardware dealer. The K-R-O Company, Springfield, Ohio.



KILLS RATS ONLY
READY MIXED BIS-KIT FORM

SAVE 1/2 ON MUSIC STRINGS!

For VIOLIN
UKELELE
GUITAR
BANJO



Now you can save about 50% on genuine Aristocrat quality GUT music strings! Buy these sweet-toned, factory-fresh strings DIRECT from manufacturer—to save Jobber-Dealer commissions! **DOLLAR BARGAINS** for Violin, Guitar, Ukelele or Banjo: 8 E's for \$1 or 10¢ each—4 A's for \$1 or 25¢ each—4 D's for \$1 or 35¢ each. **EVERY STRING** full 22" length! Table below shows type string used for each instrument:

VIOLIN	UKELELE	BANJO	GUITAR
E.....	same as 1st & 4th	1st.....	E.....
A.....	same as 2nd & 3rd	2nd.....	B.....
D.....	same as.....	3rd.....	G.....

We pay postage! No orders filled under \$1. No Canadian orders. Satisfaction and Quality **GUARANTEED** or money back. **Order Now, H. E. WILLS CO., 1047 W. 47th St., Dept. B 104, Chicago 9, Ill.**

DO YOU

WANT a permanent business profession of your own? Then **BECOME A FOOT CORRECTIONIST!** Earnings in this greatly needed profession run as high as \$50-\$100 weekly after a few weeks home training—not medical or chiropody—no further capital needed, no goods to buy. 47th year. Write for free booklet.

Stephenson System of Foot Correction

28 Back Bay, Boston, Mass.

REED MICROMETERS 1", 2" and 3" READING to 1/10000"

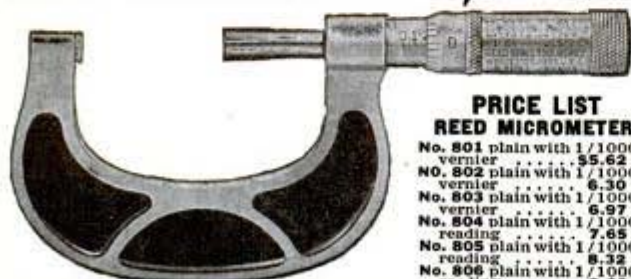

PRICE LIST REED MICROMETERS
No. 801 plain with 1/10000" vernier \$5.62 net
No. 802 plain with 1/10000" vernier 6.30 net
No. 803 plain with 1/10000" vernier 6.97 net
No. 804 plain with 1/1000" reading 7.65 net
No. 805 plain with 1/1000" reading 8.32 net
No. 806 plain with 1/1000" reading 9.00 net
Add 10¢ for postage.
Write for new free eight-page folder "MEASURE TO 1/10000" AT NO EXTRA COST."

Illustrated is Reed No. 802 1 to 2" micrometer, graduated to 1/10000". Here is a fine all around micrometer for general shop use with extremely high quality workmanship. Other sizes listed have same type frame, construction.

SHOP AGENTS WANTED. We have a very interesting proposition for individual mechanics who want to earn extra money as shop agents selling Reed Micrometers, Tool Chests, Dial Indicators & other Machinists' Tools. Write for full details today.

You can now obtain Reed Micrometers immediately without priority. This precision tool has been made in the U.S.A. for over thirty years. Fully guaranteed, must pass rigid tests for accuracy.

We now furnish Reed Micrometers in the 1", 2" and 3" sizes with a vernier reading to 1/10000" AT NO EXTRA COST. Compare our net prices shown below. Tolerances are closer. More and more blueprints call for tenths of thousandths and every good mechanic needs a 1", 2" and 3" micrometer graduated to 1/10000". Here is your opportunity to purchase these tools at today's low prices. Send your order to us for quick delivery.

GEORGE SCHERR CO., INC., 200A Lafayette St., New York 12, N. Y.

THE BOND with a PEDIGREE



Chicago **FV**

A thousand test formulas—hundreds of bonds of various kinds—fifty years experience making bonds for the world's best grinding wheels—this is the Pedigree behind the new FV Bond.

FOR THAT PERFECT FINISH—Chicago Wheels made with FV Bond hold their shapes even when run at high speed—produce a satin-like finish that is so accurate it passes any surface analyzer test hands down.

Chicago Mounted Wheels are tough, long lived, dependable. Over 300 sizes, styles and grains.

Chicago Grinding Wheels—Only sizes up to 3" in diameter for the duration, with full WPB approval.



Handee Tool of 1001 Uses and Hi-Power Grinders are still available to all who have priorities.

Send for Free Catalog

CHICAGO WHEEL & MFG. CO.

1101 W. Monroe St., Dept. PM, Chicago 7, Ill.

Mortite

YEAR AROUND PLUGGER-UPPER

A pliable Plastic that plugs holes in and around screens, casements, drainboards, sinks, bathtubs, etc. Stops rattles.

In winter weatherstrips windows.

MANY USES IN THE HOME

Keeps out dust and dirt, mosquitoes, flies, ants and other insects.

Easy to apply. Unrolls like ribbon. Adheres to any clean, dry surface. Just press into place and it stays put. Does not shrink, crack or chip.

About 80 feet to a roll. At your Dealer's or \$1.25 postpaid.

Send for Circular

J. W. MORTELL CO.

522 Burch St.

Kankakee, Ill.



AC

FUEL PUMPS

You have enjoyed such good service and long life from your AC Fuel Pump because of the quality that is built in, from design to finished pump.

You will continue that performance and quality if you insist on an AC when you need a new, or a rebuilt, fuel pump.

BUY WAR BONDS • BRING VICTORY QUICKER

A New Craft! decorate fabrics with **PRANG TEXTILE COLORS**
REG. U. S. PAT. OFF.

You can make beautiful gifts with the new Prang Textile Colors—gifts that have all the distinctive qualities of exclusive, expensive merchandise.

Prang Textile Colors are easy to use—and fast! No artistic ability is required.

Ties, bridge sets, linens, drapes, towels, handkerchiefs and scarfs are just a FEW of the gifts you can decorate with Prang Textile Colors. They do not fade or run—can be washed or dry cleaned.

Send for the booklet "DO IT YOURSELF"—full of ideas, and will tell you just how to do it. 25c POSTPAID.

Complete Prang Textile Color Kit—everything you need to decorate fabrics, including booklet—\$3.50 Postpaid.

Dept. PM-1

THE AMERICAN CRAYON COMPANY • SANDUSKY, OHIO •

Make Gifts for Christmas or any time

RONSON
 WORLD'S GREATEST **LIGHTER**

STURDY, BUILT-IN QUALITY INSURES LONG SERVICE

Ronson Whirlwind with disappearing windshield

PRESS... IT'S LIT
 RELEASE... IT'S OUT

RONSONS made today are supplied only to our Government for our Armed Forces overseas. Individual orders cannot be filled.

Ronson, Newark 2, N. J.
 MAKE YOUR DOLLARS FIGHT—BUY WAR BONDS!

5 lbs. HANDY ASSORTMENT \$1.98
 FOR MECHANICS—GARAGES
 —WORKSHOPS—HOME USE

SCREWS • NUTS • BOLTS • WASHERS • RIVETS • SPRINGS • BRACKETS • MISC.

MORE THAN 1,000 PIECES

5 full pounds—a veritable treasure chest of fastening devices for every practical use. Satisfaction guaranteed. Order now. **\$1.98**

SPECIAL—2 assortments, over 2,000 pieces, for \$3.69.

HUDSON TRADING CORPORATION
 The House of Handy Assortments
 C-165 West Hubbard St., Chicago 10, Ill.

FREE! Handy List of Special Assortments: FIBER AND BAKELITE WASHERS—RUBBER WASHERS and PADS—FELT WASHERS and PADS—RADIO LUGS, CLIPS and CONNECTORS—SPRINGS—SELF-TAPPING SCREWS—etc.

★ SAVE WASTE PAPER ★

Your Future
IN RADAR-RADIO

If you are a Radio Engineer, Layout Draftsman, Laboratory Assistant, Quality Tester, Analyser, Phaser, find out what Motorola offers you in future security, rapid advancement, recognition and salary increases. We'll send details. Write today.

Motorola GALVIN MANUFACTURING CORPORATION
 4545 W. Augusta Blvd. • Chicago 51, Ill.

COLOR CONCRETE WITH CHEMICALS

A business of your own. Big money making Hollywood style pottery and birdbaths without moulds. Washing-wells, stucco-rock, benches. Marbling and cement water-paints. 10c brings sample, literature, pictures. Hollywood CementCraft, 8529 Wonderland Ave., Hollywood 46, California

WRITE FOR OUR TOOL DATA SHEETS

WILLIAMS
 SUPERIOR DROP-FORGED TOOLS
 J. H. WILLIAMS & CO., BUFFALO, N. Y.



Waterproof, shockproof, anti-magnetic, radium dial and hands, unbreakable crystal, precision tested, sweep second hand.

- No. LX 121
15 jewels, stainless steel back \$39.75
- No. LX 212
17 jewels, stainless steel back \$42.50
- No. LX 330
17 jewels, all stainless steel case \$59.75

Prices include All Federal Excise Taxes.
Postage Prepaid. Mail Orders Promptly Filled.

Write for Free Illustrated Booklet "LX"

BELL WATCH COMPANY
Time and Life Bldg., Rockefeller Center, New York 20, N. Y.

FREE! LATEST, MOST COMPLETE RADIO PARTS CATALOG



EVERYTHING in RADIO and ELECTRONICS for War Training, Maintenance or Repair

New R-F Resonance and Coil Winding CALCULATOR
Easy to use! For fast accurate determination of resonance factors and coil winding data. No. 37-955. Postpaid, 25c.

RADIO'S FINEST BOOK VALUES
Specially prepared to aid radio training in schools and industry. Full of valuable data. Send for all six!

- Radio Formulas and Data Book No. 37-752... 10c
- Dictionary of Radio Terms No. 37-751... 10c
- Radio Circuit Handbook No. 37-753... 10c
- Radio Builders' Handbook No. 37-750... 10c
- Simplified Radio Servicing No. 37-755... 10c
- Radio Data Handbook No. 37-754... 25c
- All Six Books No. 37-799... 75c

ALLIED RADIO CORP.
833 W. Jackson, Dept. 5-K-4, Chicago 7

6 BOOKS FOR 75c

ALLIED RADIO

BUILT WITH PRECISION
—for Precision



At home, in the repair shop, or right on the production line — a good tool is like a good right hand. Being so important, it must have the qualities that produce a product worthy of a craftsman. That's where Millers Falls comes in. For we build with Precision — for Precision. At the beginning of our National Crisis, we pledged ourselves to keep the quality of Millers Falls Tools at the highest level possible. There were some pretty tough obstacles to overcome, but they were taken in stride. Today, we are happy to say that our tools are still the kind that the good craftsman wants.

MILLERS FALLS COMPANY
MILLERS FALLS TOOLS
SINCE 1868
GREENFIELD MASSACHUSETTS

If Hearing Were Visual

Here's What an Ordinary Hearing Aid Would Give You



Here's What the New Super
TELEX Will Give You



Clear, undistorted hearing, every tone, every nuance perfect in reception . . . noiseless, effortless hearing . . . far or near . . . the new super Telex gives you all this! Telex ability to reproduce sound exactly, *naturally*, will astonish you. There's only one way you can fully know how true our claims are, and that is by a free demonstration and scientific fitting, without obligation.

TELEX

Hearing Centers from Coast to Coast

Consult Your Telephone Book

FREE! Telex Hearing Report and Speech Understanding Test — thorough, helpful — whether you own a hearing aid or not. Increase your speech understanding. Mail coupon today.

TELEX PRODUCTS COMPANY
41 Telex Park - Minneapolis, Minn.

Name

Address

City State



Build It At Home . . . From SCRAP! THE WORLD'S SMALLEST 5-CYLINDER AIRPLANE ENGINE! 5/8" Bore and .600" Stroke

You can be the proud owner of this amazing 5-cylinder, 4 stroke cycle airplane engine, built to 1/8th scale of its big brother. Right now we are working all out for Uncle Sam but when our facilities can be released for peace time production, this engine can be purchased from us complete, factory tested, guaranteed, and ready to run, also raw casting kits and completely machined kits. MEANWHILE . . . START BUILDING IT, YOURSELF, NOW. You can build this fascinating motor in your own work shop—all of it or any part—using easily procurable, non-essential metal scrap. Any parts you may not wish to make you can buy from us later, at a reasonable price.

COMPLETE SET OF BLUEPRINTS AND INSTRUCTIONS are now available; understandable and easy to follow.

A COURSE IN MACHINIST TRAINING AND A FASCINATING HOBBY . . .

Anyone building this engine will avail himself of a machinist and a mechanical training, comparable to any training available anywhere, and will gain practical experience in all phases of engine building. Complete set of blueprints and instructions sent post-paid for \$4.95. Send check or money order for \$4.95 to

MORTON AIRCRAFT CORP., Dept. 6

3227 HARNEY STREET

OMAHA 2, NEBRASKA

ARMY & NAVY BARGAINS

GENUINE U. S. PUP TENTS (used) good cond.	\$2.98
U. S. (NEW) ARMY PONCHOS (slightly imperfect)	4.95
NEW U. S. ARMY CANTEEN Collapsible cup.	1.89
All Bibles into cover with Shoulder Strap . . .	3.39
NEW NAVY TYPE CANVAS HAMMOCKS	1.00
NEW U. S. ARMY CANVAS LEGGINGS, pr.	1.29
NEW U. S. ARMY PISTOL BELTS	1.29

Send Check or Money Order. Include 30c for postage.
THOUSANDS OF SATISFIED CUSTOMERS

WRITE FOR ILLUSTRATED FREE PRICE LIST

TRIANGLE

Dept. M
P. O. Box 156
TIMES PLAZA STATION, BROOKLYN 17, N. Y.

OUR
25th
YEAR

• SAVE WASTE PAPER •

KIDNEYS MUST REMOVE EXCESS ACIDS

Help 15 Miles of Kidney Tubes Flush Out Poisonous Waste

If you have an excess of acids in your blood, your 15 miles of kidney tubes may be over-worked. These tiny filters and tubes are working day and night to help Nature rid your system of excess acids and poisonous waste.

When disorder of kidney function permits poisonous matter to remain in your blood, it may cause nagging backache, rheumatic pains, leg pains, loss of pep and energy, getting up nights, swelling, puffiness under the eyes, headaches and dizziness.

Kidneys may need help the same as bowels, so ask your druggist for Doan's Pills, used successfully by millions for over 40 years. They give happy relief and will help the 15 miles of kidney tubes flush out poisonous waste from your blood. Get Doan's Pills.

FOR MEN
WHO REALLY
KNOW PIPES

Royalton

CROWN

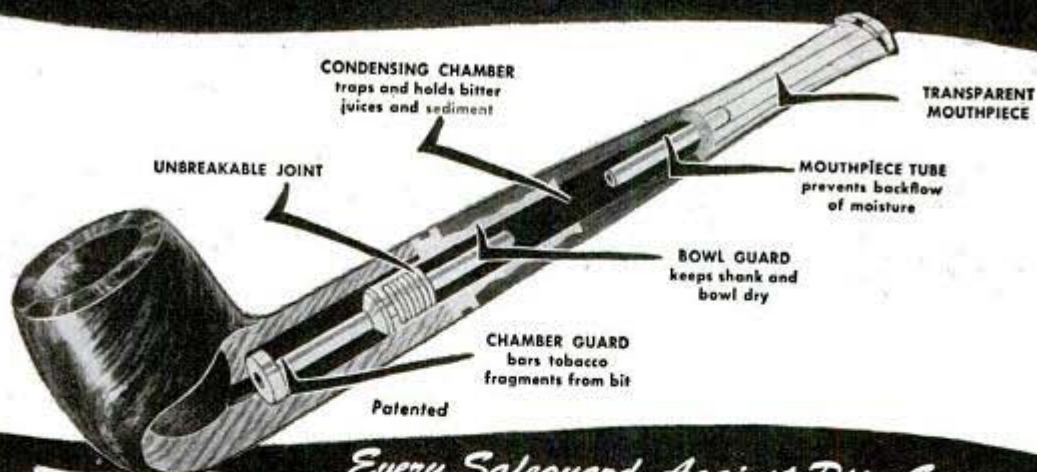

\$150

Selected Briar

Every Safeguard Against Pipe Gripe

Your first puff will tell you that Royalton Crown is the most satisfying pipe you could own. Patented features guard the smoke-stream all the way from bowl to bit. Each performs its special function, contributing to the guarantee of mellow, cooler smoking in a clean, ever-dry pipe.
HENRY LEONARD & THOMAS, INC., OZONE PARK, N. Y.



Don't let your home be a Frozen Asset



... FUEL GOES FURTHER WITH BALSAM-WOOL ATTIC INSULATION!



Even though fuel must be saved—even though icy winds howl outside—your home need not be chilly and cheerless! Balsam-Wool Insulation, laid in your attic, will conserve what heat you have... will keep you warmer and more comfortable this winter, and for all the winters to come!

Because it saves up to 20% in fuel costs... because it keeps precious heat from escaping through your roof, Balsam-Wool insulation is a gilt-edged investment. Remember, too, that Balsam-Wool is scientifically designed to give lasting protection—windproof, moistureproof and fire resistant. Because it meets every insulation need and requirement, your lumber dealer sells it under a money-back guarantee of complete satisfaction. See him now about getting this better insulation... tried and proved in thousands of homes—or mail the coupon.

Balsam-Wool

SEALED ATTIC INSULATION

Balsam-Wool... Products of Weyerhaeuser... Nu-Wood

WOOD CONVERSION COMPANY
Dept. 210-10, First National Bank Bldg.
St. Paul 1, Minnesota

Gentlemen: I want to know more about Balsam-Wool Double-Value Attic Insulation.

To assist us in giving you special information, please check: I am a homeowner
renter architect contractor
student postwar planner

Name.....

Address.....

City..... State.....



SYNGRO

Torpedoes the Axis!

Syncro Electric Jig Saws are busy torpedoing the Axis in the shape of SYNCRO-machined parts for submarines, bombers, tanks, guns, etc. Meanwhile Syncro research guarantees better Syncro Saws for you after Victory!

SYNGRO WORLDS SAIGEST SAWS



SYNGRO DEVICES, INC.
3265 Bermuda Ave.
Ferndale 20, Michigan

MAGI-GLO IDEAL FOR HALLOWE'EN



LIKE MAGIC—Make Anything IN THE DARK

Use on Costumes, Pumpkins, Party Favors for a really "different" Halloween. Wonderful for house numbers, toys, holiday ornaments.

A stroke of the brush—it glows like magic in the dark. It's fun, easy, 101 uses. Lasts indefinitely. Absolutely harmless. Complete Magi-Glo Kit only \$1.29. Send name, address, pay postman plus postal charges. Send cash, we pay postage. Satisfaction or Money Back.

MAGI-GLO—32-A W. RANDOLPH CHICAGO 1, ILL.

END GUN RUST WORRIES

RIG-Universal stops rust when others fail. Protects even in moist tropical climates and salt sea air. Eliminates frequent cleaning. Unexcelled for TOOLS, chrome, battery terminals or anything that rusts. 1 lb. \$1.50. Write RIG, 5646 Lake Park Ave., Chicago 37, Ill.

GENUINE U.S. BARGAINS

G. D. WOOL BLANKETS (USED)... \$2.95
USED COY MOSQUITO NETS... 1.25
U. S. ARMY PUP TENTS (USED)... 3.00
Slightly Used Army Caisson Wheels with Axles, 56" high, weight per pair with Axle, 322 lbs. \$37.50

Thousands of Other Bargains in Military, Outdoor & Sport Goods for Hunter, Farmer, Scout Send 10¢ for 32-page catalog returned with first order.

A and N SUPPLY CO.
EST. 1868 4724 LESTER ST. RICHMOND, VA.

★ SAVE WASTE PAPER ★ do you WORRY?

Why worry and suffer any longer if we can help you? Try a Brooks Patented Air Cushion. This marvelous appliance for most forms of reducible rupture helps hold nearly every rupture securely and gently—day and night—at work and at play. Thousands made happy. Light, neat-fitting. No hard pads or stiff springs to chafe or gouge. Made for men, women and children. Durable, cheap. Sent on trial to prove it. Never sold in stores. Beware of imitations. Write for Free Book on Rupture, no-risk trial order plan, and proof of results. All Correspondence Confidential.



Brooks Company, 158-D State St., Marshall, Mich.

**FRANKLIN'S
THIN GLUE LINE
HAS UNSEEN
STRENGTH**

**MAKE BIG ONES
OUT OF LITTLE ONES**

WITH **FRANKLIN** *Liquid Hide* **GLUE**

Use the small pieces by putting them together with Franklin, a genuine hide glue, ready-to-use. No mixing or heating means no chilled joints.

AT YOUR HARDWARE DEALER
or send 30 cents for 1/4 pint to The
Franklin Glue Co., Columbus 3, Ohio



★ **SAVE WASTE PAPER** ★

**DUPOR No. 1 MINIATURE
DUST MASK**

Wear when sanding, grinding, paint spraying, sweeping, dusting, furnace cleaning, etc. Handy as a pair of glasses. Just keep mouth closed and breathe through nose is all you do to operate. Protects against nuisance dusts, hot, coal, cement, grain dust. May fever sufferers wear to keep from breathing pollen. Weighs 1 oz. Has 3 sq. in. filter. Write for Free Literature!

H. S. COVER, Dept. PM, South Bend, Ind.
"GOLDEN JUBILEE YEAR, 1894-1944"

Order Today \$1.00
POST PAID

OPEN GARAGE FROM CAR

Dashboard button opens overhead, swinging or sliding doors. No radio, photo electric cells or imbedded coils. Entirely new principle. Used nation wide. Complete plans \$2. Details FREE. Kaytor Labs., Lynwood, Calif.

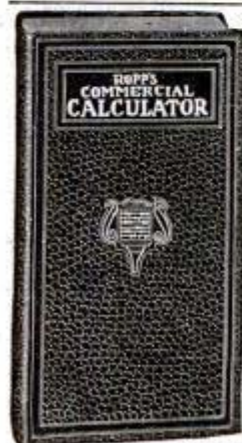

**Mathematics Made Easy by
ROPP'S CALCULATOR
AND SHORT-CUT ARITHMETIC**

Shows the Answer as Quickly as a Watch shows the Time to all Problems likely to occur in the Office, Store, Shop, Bank, Farm, or Factory.

Over 2,000,000 Sold

Explains and simplifies every principle in Arithmetic, Mechanics, and Mensuration.

PRICES POSTPAID

Desk Size, Flexible Keratol Binding.....\$2.00

Pocket Size, Art Leather Binding.....\$1.00

Pocket Size, Cloth Binding \$0.50

POPULAR MECHANICS PRESS
Dept. 576, 200 E. Ontario, Chicago, 11



**NOW YOU CAN
ACTUALLY SEE
THE DIFFERENCE
IN PISTON RINGS**

★ Compare the above independent research laboratory microphotos. SEE how Burd electric furnace iron assures scientifically controlled tension and uniform distribution of natural graphite in Burd "Graf-Flox" Piston Rings. Note that exclusive Burd methods completely eliminate abrasive metal particles from ring surfaces and apply deeply penetrating colloidal graphite. Here you SEE why Burd "Graf-Flox" Piston Rings are self-lubricating, non-abrasive . . . do not score, seize or scuff . . . why you can drive your Burd equipped engine right from the shop under full load and speed without run-in . . . why they will add miles of motor life to your car or truck. Use the coupon and get free copies of the Burd "Graf-Flox" Handy Handbook and Car Economy Record Book.

BURD PISTON RING CO., ROCKFORD, ILL.



BURD "Graf-Flox"
PISTON RINGS

THIS COUPON BRINGS 2 FREE BOOKS

BURD PISTON RING CO., DEPT. PM

Rockford, Ill.

Gentlemen:

Please send me your Handy Handbook on how to keep my car in good working order. Also Car Economy Record Book to keep mileage costs and gas coupons safely.

Name

Address

City..... State.....



LYTE-CRAFT



LUMINESCENT
PIGMENTS
THAT
GLOW
IN THE
DARK!

AVAILABLE NOW!

At long last, those amazing Luminescent and Fluorescent Pigments that glow so brilliantly in the dark, are now available for the first time in this practical Kit.

Beautifully packaged, the Kit contains a very generous supply of six different pigments, including the color pigments, luminescent adhesive tape, carrying agents for mixing paint, the ultra violet ray "black-light" bulb, mixing trays, brush, glass stirring rods and an illustrated manual giving the scientific picture of this new amazing field, its many practical uses and applications.

SEND FOR YOURS TODAY! Price \$9.75 Money Back Guarantee

Lynch Corporation, Lyte-Craft Division
86 Weybosset St. Dept. M-10
Providence 3, R. I.

Please send me the LYTE-CRAFT Kit of Luminescent Pigments

NAME _____

ADDRESS _____

CITY _____ ZONE _____ STATE _____

- Enclosed find Check or Money Order. Ship postage paid,
 Send Lyte-Craft Kit C. O. D. plus postage.

STOP SWEARING AT DULL BLADES

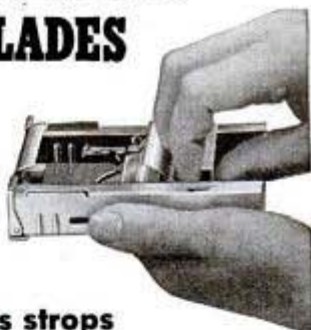

Allegro

HONES as well as strops

Stropping alone won't put a new edge on a razor blade. First you have to do what a barber does—*hones* it. Allegro both hones and strops double-edge blades. You simply slip the blade into the holder and stroke it a few times on the honing stone, then on the stropping device. It takes but 30 seconds. The blade cuts your beard with new ease, because it has a truly professional edge.

\$6.50 at leading cutlery stores. If not available locally, we send postpaid on receipt of \$6.50.

Graf & Schmidt, Inc., Dept. 1A, 381 4th Ave., New York 16, N. Y.

Always write your name and full address clearly when answering advertisements.

RADIO CABINETS—SPEAKER BAFFLES—BLANKS



Large selection for MANUFACTURERS, DEALERS, SERVICE MEN & EXPERIMENTERS. Beautiful all wood cabinets. **WRITE FOR FREE catalog & prices.** Immediate delivery.

L. Vaughan Cabinet Co., 3810 Clark, Chicago 13, Ill.

MAKE YOUR OWN
POWER TOOLS
at Low Cost
from old Auto Parts, etc.



A New Edition Featuring TOOLS of WOOD

Now you can have a good lathe, drill press, circular and band saw and other power tools in your home workshop, at a cost of only a few dollars each. Make them yourself from old auto parts, discarded sewing machines and other odds and ends that cost little or nothing. Get this new book—"Forty Power Tools You Can Make." Costs only \$1.25 postpaid. This book gives every detail in plain language you can understand and follow. Hundreds of pictures and plans show every step to follow in making the power tools you want. Actual photographs of finished machines included. Send \$1.25 today. Money back if not satisfied.



MAKE EVERY POWER TOOL NEEDED IN YOUR HOME WORKSHOP

- Some of the power tools you can make are:
- | | |
|--------------------|------------------------------|
| 2 Hand Saws | 2 Drill Presses |
| 9 Sanding Machines | 1 Scroll Saw |
| 2 Circular Saws | 2 Wood Turning Lathes |
| 1 Metal Lathe | 3 Grinders |
| 1 Power Hack Saw | 1 Shaper or Moulding Machine |
| 1 Jig Shears | 1 Vibrating Pencil |
| 1 Cut-Off Wheel | and others |

Information too, about pulleys, belts, motors and drive methods. Just published. No other book like it. Order today.

POPULAR MECHANICS PRESS

Dept. 574 • 200 E. Ontario Street, Chicago 11



ANYONE, ANYTIME
CAN MAKE PHOTO-COPIES
QUICKLY

A-PE-CO
PHOTO-COPYER

\$5500

**FAST, PHOTO-EXACT COPIES
IN ANY OFFICE OR SHOP**

Same-size, exact photo-copies of anything up to 18" x 22". Eliminates steno-copying, tracing, proof-reading. Photo-copies direct from letters, records, pictures, blueprints, tracings, receipts, shop orders—anything written, printed, drawn, photographed. Accepted as legal evidence. Copies from magazines or books. No end to the uses of A-PE-CO. Needed by all departments. Thousands in use.

No Camera—No Film—Low Cost

Any office employee quickly becomes expert. Low cost per copy, lowest investment in equipment. Saves other equipment. Simple, fast. No focusing. Conserve man-hours. Put A-PE-CO on any available desk or table. Immediate delivery. Write for A-PE-CO folder.

AMERICAN PHOTOCOPY EQUIPMENT CO.

2849 N. Clark St. Dept. GF-104 Chicago 14, Illinois

Representatives in Principal Cities

In Canada: Railway & Power Engineering Corp., Ltd.

FIGHT WITH WAR BONDS

SHARE YOUR FUN!

If you own an outboard motor, share your fun. When you go "fishin'", TAKE A FRIEND. Invite someone who hasn't fished and introduce him to the restful, healing sport of an afternoon on the water. You, your friend and the daily work of both, will all be better for it.

You'll have more fishin' time, of course—and more fun all around—if the third party on your trip is a Sea-Horse. The Sea-Horse is a born fishin' friend!

DO YOUR DUTY—BUY WAR BONDS

DEALERSHIPS: All of the many thousands of Sea-Horse outboard motors being manufactured are for the armed services and essential needs. But if you are interested in selling and servicing outboard motors after the war, write us now—no matter what your location may be.

JOHNSON MOTORS, WAUKEGAN, ILL.



THERE IS NO SUBSTITUTE FOR EXPERIENCE



JOHNSON SEA-HORSES for DEPENDability

Weldwood Glue Has Everything:

1. Tremendous strength. 2. Waterproof, bacteria- and rot-proof. 3. Quick and easy to use. No heating. No waiting. Mixed just by adding water to powder.
4. Economical. 5. Applied cold, quick-setting. 6. Stain-free. *Supply limited due to Uncle Sam's war needs.*

Scientific shear tests prove that Weldwood Glue "makes the glue line the Safety line." It is actually stronger than the wood it joins!

Wherever wood meets wood, this modern plastic resin adhesive does a quick and permanent "welding" job. It's one of the handiest "tools" a home hobbyist or repairman ever had.

Your hardware store or lumber dealer has packages of Weldwood Glue in 10c, 25c, 50c and 85c (1 lb.) sizes and 5 lb. cans. Get a can today or send 25c and your dealer's name for a trial 3½ oz. sample.

UNITED STATES PLYWOOD CORPORATION
Weldwood Glue Dept. 107, 55 W. 44th St., N. Y. 18, N. Y.
"Makes the glue line the SAFETY line"

WELDWOOD

PLASTIC RESIN

WATERPROOF GLUE

Amazing Handy ADDING MACHINE

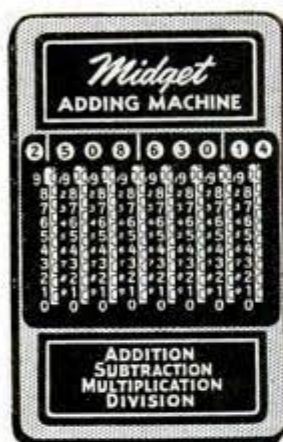

Can Be Carried
in Vest Pocket

ONLY
\$2.50

POSTPAID

**ABSOLUTELY
ACCURATE**

Yet Weighs Only 5 Ounces

- Handles Totals up to \$10,000,000.00.
- Totals appear instantly—as fast as you put the figures down.
- Can be used to subtract, multiply and divide, as well as add.
- Metal construction for years of service.

Haven't you often wished for a handy little device like this . . . that you could take with you ANYWHERE . . . on the road, in the office, at home or in the shop? You can get one now . . . Business man, student, housewife—everyone finds this handy, guaranteed-accurate little machine useful . . . ORDER YOURS TODAY.

SEND NO MONEY

Just send name and address. Then pay postman \$2.50 plus postal charges on delivery. Or send \$2.50 with order and we pay all charges—saving you about 50 cents at the new postal rates.

LEE SPECIALTY CO., Dept. PM-5,
Box 3620, Mdse. Mart, Chicago 54, Ill.

MAIL COUPON TODAY

LEE'S SPECIALTY CO., Dept. PM-5,
Box 3620 Mdse. Mart, Chicago 54, Ill.
Please send me one of your MIDGET ADDING MACHINES.

I am enclosing \$2.50 Send C.O.D. plus postage

NAME

ADDRESS

CITY & STATE.....

PLEASE PRINT PLAINLY

★ SAVE WASTE PAPER ★



Cleveland's most friendly
hotel is its most convenient one, too.

Hotel Cleveland

CLEVELAND, OHIO

Directly connected with
Union Passenger Terminal



**SHIP
MODELS
ILLUSTRATED**
with a guide to
modeling



\$2
POSTPAID

is the first book of its kind ever published — of ship models, of real ships, of masts, of rigging, of furniture, of deck gear — covering many types of vessels from whale-boats to PT's from "Slavers" to Corvettes. It incorporates many color plates, closeup photos, detailed drawings and actual construction plans, in addition to a salty text covering ship model building and a glossary of nautical terms. Send for it today. We'll include our catalogue of ship model kits and supplies.

MARINE MODEL CO. DEPT. A-1 29 WEST 15th STREET
NEW YORK CITY



Now Ready!
NEW! FREE! CATALOG
RADIO AND ELECTRONIC COMPONENTS AND EQUIPMENT
... last-minute listings ... hundreds of items ... for schools, government and military services, war plants, laboratories, etc. **MAIL COUPON TODAY.**

LAFAYETTE RADIO CORP.
901 W. JACKSON BLVD., CHICAGO 7, ILL., DEPT. P-10
Please send me a FREE copy of the new Lafayette Radio Corporation Catalog No. 94.

NAME

ADDRESS

CITY..... STATE.....

**A WONDERFUL
LITTLE IDEA!**



PLUS



Spiffy
Collar
Stay



**Starched collar neatness
Soft collar comfort**



Invisible Under Collar

Here is an idea that works wonders for your appearance and comfort. Simply hide a SPIFFY under your soft collar and see the miraculous change. It's invisible—has self-adjusting spring—makes wrinkles disappear—upturned collar points lie flat. SPIFFY adds many months to the life of your shirts.

19 Million Sold to Servicemen!

It's a "Must" with the boys in khaki... they're easy to mail. Why not send two or three to your man in the service!

Every man should have three or four—25c and more at all men's stores, P. X.'s and Army stores everywhere.



Spiffy COLLAR STAYS

CREST SPECIALTY CO., 663 W. Washington St., Chicago 6, Ill.

LOOK AT THIS TOOL BOX



**ALL STEEL
Cantilever
4 TRAYS**

Built
Like a
Battleship

**NO
PRIORITY
NEEDED**

**ONLY
\$7.95
PREPAID**

THOUSANDS PURCHASED BY THE
U. S. AIR CORPS AND ARMY ENGINEERS

Amazing value in this Super-De Luxe Tool Box Kit. Limited supply for civilian use. Has 4 roomy cantilever trays with handy opening action on attached hinges. Note divided compartments for screws, nuts, bolts, small tools, etc.—each tray easily accessible. Sturdily built of 18-gauge steel for years of service. Closed size 18" x 10" x 13". Cover lids close in hip roof design for handy carrying. Has metal snap locks and stout steel handle. Olive drab baked enamel wrinkle finish with matching trays.

RUSH YOUR ORDER Just send \$1 deposit and pay balance of \$6.95, plus express charges on delivery. Or enclose \$7.95 with order for prepaid delivery. You save express charges and recently increased C.O.D. fee. If not delighted return in 5 days for refund. No risk!

ANDREW A ROBE WAREHOUSE 1716 S. Michigan Ave. Dept. 14, Chicago, Ill.



**GET
MACHINE-SHOP
ACCURACY
at home**

\$2.65
each
complete with
spare blade

Every home workshop needs a MASTER Streamline steel tape rule. Easy to handle, this versatile tool simplifies measuring and performs many workbench jobs—in addition to its use demonstrated here as a scribe. You can make inside measurements, outside caliper measurements—you can use it as a height gauge, arc scribe or for bench layout work. • Time-saving Streamline comes equipped with a lever-lock and spare blade. Numerals and markings are clearly etched on both sides and all edges of blade.

Branch: 541 S. Spring St.
Los Angeles, Calif.

MASTER
WOOD AND TAPE RULES

Master Rule Mfg. Co., Inc.
815 E. 136th St., N. Y. C., Dept. F10
Enclosed please find \$2.65 for
6 ft. Streamline with spare blade.

Name _____
Address _____
City _____ State _____

"YANKEE" TOOLS

Standard of Dependability

Standard the world over for more than half a century, "Yankee" Fine Mechanics' Tools—Spiral Screw Drivers, Tap Wrenches, Automatic Drills, Bit Braces—are saving vital man-hours on every conceivable sort of wartime production. They'll work at reconversion one of these days, and then again on production of the peacetime goods of private enterprise. They save man-hours by being deliberately and ingeniously designed to do precisely that. So remember "Yankee" Tools as time, trouble, and money savers when they are again readily available after Victory has been won.

"YANKEE" SPIRAL SCREW DRIVER No. 130A
A Size for Every Purpose



"YANKEE" TOOLS

make good mechanics better

North Bros. Mfg. Co., Phila. 33, U.S.A.
Established 1880

Makers, also, of "Yankee-Handyman" Tools

ELECTRICITY FOR ANY JOB ANYWHERE



ONAN GASOLINE DRIVEN ELECTRIC PLANTS provide electricity in locations where it is not otherwise available, and for emergency standby service. Thousands of units are doing a winning job in the war.

Sizes from 350 to 35,000 watts. A.C. 50 to 800 cycles, 115 to 660 volts, D.C. 6 to 4000 volts. Also dual A.C. and D.C. output models. D. W. ONAN & SONS, 1098 Royalston Ave., Minneapolis 5, Minn. Details gladly furnished

ONAN

PAY-RAISING—EXTRA MONEY BOOKS

Use these books to prepare for a better job—bigger pay—to start a profitable spare time or full time business of your own, improve your home, start a hobby. Popular Mechanics specializes in supplying outstanding self-help books on many subjects.

- How to Remodel a House Nothing is omitted. \$4.75
- Painting, Furniture Finishing & Repairing New self-help book for craftsmen, home owners. \$1.50
- Shop Notes for 1945 Now ready. For every man who uses tools. .50c
- Shop Notes Library 5 vols.—1945, 44, 43, 42, 41 (no dup. mat.) \$2.50
- Refrigerated Locker Manual Plant operation, quick freeze, etc. \$3.00
- How to Read Blueprints \$1.50
- Welding, Brazing & Soldering How to build own equipment and use it effectively. \$1.25
- Garden Book Build own trellises, lawn furniture, fireplaces, ornaments, etc. \$1.00
- Forty Power Tools Build own saw, drill, lathe, sander, etc. from scraps—save money. \$1.25
- Rewinding & Servicing Electric Motors (No. 75) .25c
- Running a Milling Machine (new) \$1.50
- Turn Scrap Into Money Convert old auto generators into motors. \$1.00
- Motorcycle Speed & How to Obtain It. \$1.50
- House Wiring (No. 89) All information needed to do complete job. .25c
- Modern Refrigeration Electric, gas. Be service expert. \$5.00
- Dyke's Auto Ency. (includes Diesels, airplane engines) New 20th Ed. World's greatest book for mechanics. \$6.00
- Sheet Metal Work Self instruction in all phases. \$2.50
- Tool & Saw Sharpening (No. 92) .25c
- Armature Winding Construction, winding, repairing AC & DC Motors, generators. \$2.00
- Build Your Own Boat Describes 17 popular boats—rowboats, sailboats, plywood outboard, etc. 192 pages \$1.50
- Forging Practice. \$1.50
- Toys You Can Make of Wood. \$2.50
- Carpentry Learn modern methods. \$2.00
- Foundry Work. \$2.00
- What to Make for 1945 New 224 page book of handicraft projects. .50c
- What to Make Library 6 vols.—1945, 44, 43, 42, 41, 40 (no dup. mat.) \$3.00
- Blueprint Reading For building trades. \$1.25
- Pattern Making Wood, metal. \$2.00
- Action Toys (No. 66) Plans for 21 easy-to-make toys. .25c
- The Young Craftsman over 450 things boys can make. \$1.00
- Five Acres and Independence How to make money on small farm. \$2.50

- New, Pocket Size MACHINE SHOP SERIES
- Drill Presses \$1.50
- Engine Lathes 1.50
- Shapers 1.50
- Planers 1.50
- Millers 1.50
- Turret Lathes 1.50
- A-B-C of Poultry Raising \$2.50
- How to Build Violin, Pipe Organ, Banjo-Uke \$1.00
- Wooden Clock Movement Full-size pattern 75c
- Silhouette Book 212 attractive silhouettes. 50c
- Deluxe Small Homes Selection of 210 popular designs. \$1.00
- Knots, Ties, Splices For everyone who uses rope. \$1.25
- Plastics Latest information on manufacture and use. \$3.75
- Workbenches & Tool Cabinets You Can Build (No. 47) .25c
- Your Car Hundreds of simple car repairs, short cuts that will help make it last for its duration. \$1.25
- Concrete Handbook New book on using concrete around home, garden, farm. \$1.50
- Oil Burner Handbook. \$2.50
- Steel Square Pocket Book Best methods of using. \$1.00
- Photo Guide Construct own equipment, gadgets. Make better photos. \$1.25
- Elementary Forge Practice \$2.00
- Welding, Electric. \$1.25
- Welding, Oxy-Acetylene Welding, cutting. \$1.25
- Metallurgy \$2.50
- Fluorescent Lighting New manual on construction, installation, repair. \$3.00
- Shipbuilding Blueprint Reading \$3.00
- Ropp's Calculator Figuring made easy. .50c
- Plumbing Installation & Repair For those without previous training. \$1.50
- Complete Book of Garden Magic Covers all phases of gardening. \$3.00
- Wine Makers' Manual. \$1.50
- Judo. 30 Lessons in Modern Jiu-Jitsu \$1.89
- Modern Core Practices Theories Only book published treating completely with production and use of cores in metal casting. \$8.00
- Watch Repairing Simplified \$3.00
- Propagation of Plants Covers every conceivable method. \$3.50
- Lessons in Ornamental Penmanship \$1.00



MAIL THIS COUPON TODAY

Check the books you want, write your name and address below, and mail this advertisement with money order or check. Outside U. S. A. include 15% additional for shipping charges. Books selected will be mailed promptly on our "money back if you're not entirely satisfied" guarantee.

Name

City..... State.....

Address

Mail to POPULAR MECHANICS PRESS
Dept. 577—200 East Ontario St., Chicago 11, Ill.

THIS **Dustless** BRUSH REDUCES GERM LADEN DUST



*Eliminates
Sweeping Compound*

The "Dustless" brush has a reservoir in its back which holds Arbitrin, a scientifically compounded sweeping fluid. The center row of tufts is connected to the reservoir. During the process of sweeping the Arbitrin feeds through these tufts and moistens every particle of dust it contacts. Instead of floating through the air, the dust is converted into the most efficient sweeping compound.

Tests have proved that "Dustless" sweeping reduces the number of bacteria, normally in the air between sweepings, as much as 97 per cent. The "Dustless" brush also cuts labor and material costs in half.

GUARANTEED—Dustless brushes are used in hundreds of offices, factories, schools, institutions and stores. They are unconditionally guaranteed to meet your requirements. Prompt shipment on AA-5 or higher priority rating. Write for styles, sizes and prices today.



**MILWAUKEE DUSTLESS
BRUSH COMPANY**

528 N 22nd STREET, MILWAUKEE 3, WIS

Now
for **EVERY WORK SHOP!**

**NEW
Invention** **Electroplates
by BRUSH**



**Easy to Plate CHROMIUM
GOLD, SILVER, NICKEL, COPPER**

... For Pleasure and Profit!

If you have a workshop—at home or in business—you need this new Warner Electroplater. At the stroke of an electrified brush, you can electroplate models and projects—you can replate worn articles, faucets, tools, fixtures, silverware, etc. with a durable, sparkling coat of metal... Gold, Silver, Chromium, Nickel, Copper or Cadmium. Method is easy, simple, quick. Everything furnished—equipment complete, ready for use. *By doing a bit of work for others, your machine can pay for itself within a week.* So make your shop complete by getting a Warner Electroplater right away. Send today for **FREE SAMPLE** and illustrated literature. **ACT AT ONCE!** Mail Coupon.

**WARNER ELECTRIC CO., DEPT. 318
360 North Michigan, Chicago 1, Illinois**

FREE Details & Sample!

WARNER ELECTRIC CO., 360 N. Michigan, Chicago 1, Dept. 318
Gentlemen: Send Free Sample and Details to:

Name _____
Address _____
City _____ State _____

Look How Many
Jobs You Can Do
With This Can



TRY THIS on your next day off... stop in at your neighborhood hardware store and get an inexpensive can of Smooth-On No. 1 Iron Cement. Then line up all those postponed little repair jobs around the house and garage... that leaking pipe in the cellar—the crack in the furnace—those wobbly door hinges—that loose caster—the cabinet knob that is always coming off—the shaky hammer head—the loose hose connection and rattly door handle on your car... then get busy with Smooth-On.

You'll be surprised to find how little time and trouble it takes—how little Smooth-On you need—what professional-looking, durable repairs you make without previous experience. No heat required. Just mix with water and apply like putty. Obtainable in 1 3/4-oz., 7-oz., and larger containers from your hardware store, or if necessary, from us.



FREE REPAIR HANDBOOK

Practical, tested, money-and-time-saving directions for making

metal repairs of countless kinds. 40 pages. 170 diagrams. Send coupon for your copy.



---MAIL THIS TODAY---

Smooth-On Mfg. Co., Dept. 37
570 Communipaw Ave., Jersey City 4, N. J.
Please mail me the Smooth-On Repair Handbook.

Name

Address

10-44

Free

Do it with **SMOOTH-ON**

Say you saw it in *Popular Mechanics!*

It's the patented filter with its 66 mesh-screen baffles, that whirlcools the smoke—retains flakes and slugs—absorbs moisture—minimizes raw mouth and tongue bite. When filter is discolored, it has done its job. Discard it and put in a fresh one—costs only ONE CENT. Enjoy the benefits of Frank Medico Pipe, Cigarette and Cigar Holders.



\$1 WITH BOX OF FILTERS **FREE!**

X-RAY VIEW

GENUINE FILTERS FOR MEDICO
PACKED ONLY IN THIS RED & BLACK BOX



RATIONED MOTORISTS

Now Get **EXTRA GASOLINE MILEAGE**



Now you can get up to 30% extra gasoline mileage with a Vacu-matic on your car. Quicker pick-up, smoother running, added power and precious gasoline savings guaranteed.

Automatic Supercharge Principle
Vacu-matic is entirely different! Operates on the Supercharge principle. Saves gas. Automatically provides a better gas mixture. Guaranteed to give up to 30% extra gas mileage, more power and better performance.

FITS ALL CARS

Constructed of six parts, fused into a single unit. Adjusted and sealed at the factory. Very quickly installed by anyone.

AGENTS TRIAL OFFER

Every car, truck, tractor a prospect. Send name, address on postcard for big money-making offer and how you get yours for introducing.

Vacu-matic Co., 7617-986 W. State St., Wauwatosa 13, Wis.

NEW...MULTIPLYING WHEEL SIMPLE

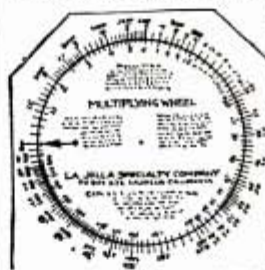

For Multiplying, Dividing, Finding Areas, Circumferences and everyday figuring. No instruction book needed.

All information on wheel. Just turn the wheel for the answer.

If you cannot operate it in five minutes, send back in ten days and we will refund your money.

Fits pocket or tool box. Size about 4x5" in leatherette case. Send 50c in coin (not stamps).

LA JOLLA SPECIALTY COMPANY, Box 272, La Jolla, Calif.

\$ WINDOW SIGN LETTERS

For Store Fronts and Office Windows. Anyone can put them on. Free Samples. Imitation Gold and Silver. METALLIC LETTER CO., 430 N. Clark St., Chicago 10



NOW a DYNAMIC HEAVY DUTY INDUSTRIAL WELDER

Saves VALUABLE TIME and MONEY!

AMAZINGLY SIMPLE & EASY TO OPERATE

This portable Dynamic Welder—easily carried right to the job—plugs into any convenient, properly wired 110 volt light circuit—works on Iron, Steel, Brass, Bronze and other metals—has eight metallic and carbon arc welding heat stages—does work you would think only possible with a larger, more expensive machine.

DESIGNED TO DO HIGH GRADE WELDING INEXPENSIVELY
Maintenance Men; Farmers; Mechanics; Machine Shops; Foundries; Auto, General Repair and Job Welding Shops; using the Dynamic find it so indispensable and useful that they cannot afford to be without it.

If inexperienced, you can easily learn to do a variety of high grade welding jobs by following the practical, simplified operating and welding instructions furnished.

DYNAMIC WELDER CO., 13 East 23rd St., BK, Chicago 16, Ill.

for Only **\$23⁵⁰**
COMPLETE

Once you see a Dynamic in operation you won't be without it. Its simplicity will amaze you. In a year the Dynamic only costs you about 6c a day.

Comes complete with helmet, rods, cables, electrode holder and operating instructions, etc.

Write today for free priority assistance and particulars on how to qualify for one of these amazingly low-priced welders. Act now while they are still available. Get details on our 10-day trial offer.

After Victory



S C ELECTRIC OUTBOARD MOTORS

Plan on owning a modern S C Electric Outboard Motor. Quiet, dependable, efficient, these motors are ideal for trolling with boats up to 16 foot.



S C BOAT & LUGGAGE TRAILERS

A dual-purpose trailer for any flat, vee or round-bottom boat up to 18 foot . . . or with utility body in place, a 1000-pound luggage and equipment carrier.

S C products will be available as soon as civilian production can be resumed. Orders accepted now for early post-war delivery.

SILVER CREEK PRECISION CORP.
SILVER CREEK, NEW YORK



Awarded the Army-Navy "E" for excellence in war production. Now building precision parts for 30 cal. Carbine and Springfield Rifles; 30 and 50 cal. Browning Machine Guns; 20 mm Oerlikon Anti-Aircraft Guns; Curtiss P-40 and P-46 Aircraft; Aircraft generators and Sterling Admiralty Engines.

IT'S FREE Don't Miss This NEW BOOKLET

"The Age of Chemistry"

New 1944 Chemcraft Chemistry Booklet describes many amazing experiments you can perform; and tells of the big opportunities, both now and in the future, for boys with a knowledge of chemistry . . . Send Today.

THE PORTER CHEMICAL COMPANY
55 Prospect Ave. Hagerstown, Md.



TOMBSTONES \$13.69
Freight Paid.

Interested! Write us now for Free Catalog. Made of best Marble & Granite. Service direct to you by mail. Why wait. U. S. MARBLE & GRANITE CO.
A-18 Oneco, Fla.

A BUSINESS FOR YOU

Learn how you too can obtain a valuable, exclusive franchise for handling STAMINITE protective coatings, waterproofer, NON-SLIPPERY Floor Wax, and PLASTIC BASE speed drying, transparent coatings for wood and linoleum floors and surfaces IN or OUT. If you can qualify for local Distributorship (small stock requirements) you'll prosper greatly. Write TODAY!

THE STAMINITE CORP., DEPT. B., 109 WATER ST., NEW HAVEN, CONN.

SIGNS EASILY AND EXPERTLY PAINTED WITH LETTER PATTERNS
AND SHOWCARDS MANY SIZES & STYLES WRITE FOR FOLDER!
JOHN F. RAHN
1230-31 N. Central Ave.
CHICAGO 51, ILL.

HEARING AID with New "Look of Youth"

Brings New Poise, Confidence to Hard of Hearing



NEW ZENITH RADIONIC with Neutral-Color Earphone and Cord

Described in FREE Booklet! Mail coupon below today for your copy. Tells how thousands of hard of hearing now feel casual and at ease with Zenith's smartly styled plastic earphone and cord which complements any complexion. Contains valuable information for all hard-of-hearing.

\$40 Complete, Ready to Wear

Model A-2-A



FREE BOOKLET tells how Zenith combines its leadership in "Radionics Exclusively" with precision mass production to bring you at \$40 an even finer hearing aid than Zenith's first \$50,000 hand-made model. Also describes many other Zenith advantages. Send coupon below at once!

Also available - New Bone Conduction and Bone-Air Zeniths for the few whose physicians recommend these types. Each only \$10 more, complete.

BY THE MAKERS OF

ZENITH
"LONG DISTANCE" RADIO

RADIONIC PRODUCTS EXCLUSIVELY -
WORLD'S LEADING MANUFACTURER

PASTE ON PENNY POSTCARD AND MAIL

ZENITH RADIO CORPORATION, Dept. PM-10
P. O. Box 6940A, Chicago 1, Illinois
Please send me your Free booklet about Radionic Hearing.

Name _____

Address _____

City _____

State _____

COPYRIGHT 1944, ZENITH RADIO CORP.



SAVE WASTE PAPER



Anyone Can Build.. ARC WELDERS with these Plans

WE SHOW YOU HOW

Here are six plans that will enable you to save money on your own welding and to make money on outside jobs. On top of that, a knowledge of welding is a valuable asset anywhere.

- Plan 8:** Arc Welder from old auto generator. Single or dual hook up. Output 75 to 200 amps.
- Plan 29:** Portable transformer Arc Welder for use on 110 or 220 A.C. Output 80 to 125 amps.
- Plan 50:** Transformer Arc Welder for use on 110 or 220 A.C. Has 16 different heats, 75-85 amperes. No rewinding necessary. Uses coils taken from old auto generator.
- Plan 30:** Spot Welder capable of welding up to $\frac{1}{8}$ " for operations on 110 A.C.
- Plan 32:** Spot Welder for handling light sheet metals. Operates on car battery. Simple to build.
- Plan 46:** Carbon electrode welder for light welding, brazing and soldering. Operates on car battery.

PLANS SIMPLE— NO EXPERIENCE NEEDED

All details clearly shown and described; no hard work or previous experience required for a perfect job. Our valuable Catalog of 1,000 Electrical Supply Bargains will be sent FREE with plans.

Send only 98c for complete set of 6 Plans and get started on a fascinating and money-making project.

Total value of plans, if purchased separately, \$1.85.

**6
PLANS
Only
98c**

**LEJAY
MANUFACTURING COMP.**

2347 LeJay Building
MINNEAPOLIS 8, MINN.



Build These NEW Cleveland Models!

The Famous U. S. "BLACK WIDOW"

A super night fighter that has proved the sensation its designers intended it to be. Span 36". Kit T-155..... \$1.50

Cleveland Tether "SUPERFORTRESS"

A line-controlled gas model of the "big fellow" that is bombing Japan. Span 26 $\frac{1}{2}$ ". Kit UA-200 (less hdwc.)..... \$1.00

Cleveland Tether "SHARPIE"

21" Line controlled gas model suitable for Class A, B, C. Kit GPL-5023 (less hdwc.)..... \$1.00

11 Big 36" Industrial Training WAR MODELS

Great for learning design, construction and flight theory. Kit T-73. "SPITFIRE"; Kit T-74 "MESSERSCHMITT ME-109"; Kit T-76 "AIR-COBBRA"; Kit T-77 "WARHAWK"; Kit T-78 "HURRICANE"; Kit T-85 "LIGHTNING"; Kit T-91 "MUSTANG"; Kit T-94 PIPER "CUB"; Kit T-99 "TYPHOON"; Kit T-105 "WHIRLWIND"; \$1.50 Each Kit.....

At your dealers. If ordering direct, add 20c pack-post. chge. Send 5c for complete catalog.

CLEVELAND MODEL & SUPPLY COMPANY
Cleveland 2, Ohio
4508D 95 Lorain Ave.,

Say you saw it in POPULAR MECHANICS

BOYS Ask Dad to Get this Great Book for You!



This big book tells and shows how to make over 450 things—useful articles for the home, toys, furniture, boats, novelties, photo equipment, electrical gadgets, etc. of the more simple, easy-to-make type. Only ordinary tools are needed. No special skill required. Tell Dad to send \$1.00 to address below NOW. We'll send Dad's money back if you and he don't think it's worth double the cost.

POPULAR MECHANICS PRESS
200 EAST ONTARIO STREET
DEPT. 572, CHICAGO 11, ILL.



New 1945 SHOP NOTES Now Ready
FOR EVERY MAN WHO USES TOOLS

One of these books is issued each year and is a reprint of articles published in our Shop Notes Department. It contains cream of experience of years, of hundreds of our country's most successful mechanics. Get a copy from your News Dealer, or send 50c to
POPULAR MECHANICS PRESS
Dept. 570 200 E. Ontario Chicago 11, Ill.

GET THE IMPROVED SUPER DRILL GRINDING ATTACHMENT

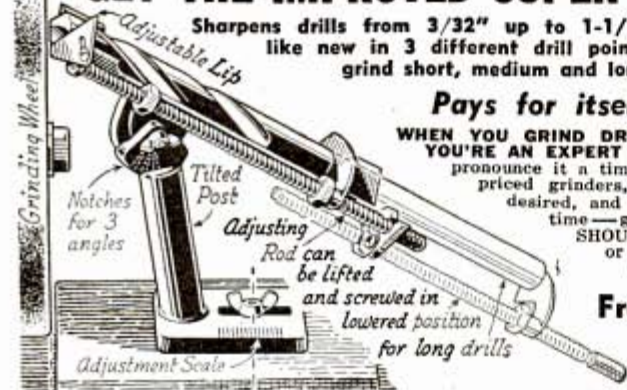

Sharpens drills from $\frac{3}{32}$ " up to 1- $\frac{1}{16}$ " diameter. Grinds old drills like new in 3 different drill point angles—59°—69°—88°. Will grind short, medium and long twist drills up to 11".

Pays for itself the first week

WHEN YOU GRIND DRILLS WITH THE SUPER GRINDER YOU'RE AN EXPERT FROM THE START. Machine shops pronounce it a time saver, does work like the highest priced grinders, gives a perfect center, clearance desired, and three different point tapers. Saves time—grinds drill perfectly in 25 seconds. NO MACHINE SHOP SHOULD BE WITHOUT THE SUPER GRINDER. Just mail your check or money order for \$2.95, complete, and your address—the SUPER GRINDER will come to you quickly, postage paid.

Fred F. Ten Eyck, Distributor
Dept. C, 758 S. Irolo St.
Los Angeles 5, California

**ONLY
\$2.95
COMPLETE!**

**MONEY
BACK
GUARANTEE**

REPAIR TILE

THE *Centraz* WAY

Centraz TILE POINT



Repairs cracks over bathtubs, around kitchen sinks, pipes and plumbing fixtures. Dries Pure White.

Pint **35¢**

(40¢ West of Rockies)

WATERPROOF ADHESIVE

Sets loose tile and linoleum. Prevents screws, bolts and pipe joints from working loose. 1/4 Pint . . . **25¢**

(30¢ West of Rockies)



For Sale at Your Hardware and Paint Dealer

CHRISTY COMPANY, Inc.

1417 Pine Street

St. Louis 3, Mo.

AMMCO 7" SHAPER

"A Precision Machine of a Thousand Uses"

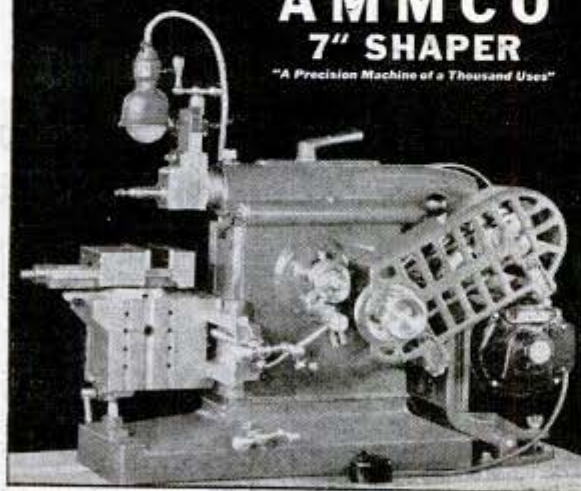

A wide variety of jobs can be done accurately, quickly, easily, and economically on the AMMCO Shaper (7" stroke). Construction incorporates many features you would expect to find only in larger, more expensive machines . . . For example: WAYS of ram, tool head, and front face of the main frame are of the "VEE" type, hand scraped to insure accuracy and long life. Available for stationary installation or as portable unit.

Write today for specifications and prices

AMMCO

2140 Commonwealth Ave. North Chicago, Ill.



Ask the Man who has seen it in Action!

Men who have operated Ampro 16mm. sound projectors the world over will tell you almost unanimously that Ampro projectors have come through the grueling tests of war with the highest record of performance.

This fact is important to you when you are selecting the 8mm. and 16mm. equipment for bringing into your home the vast libraries of educational and entertainment films.

Write today for the Ampro catalog of 8mm. silent and 16mm. silent and sound projectors.

Buy War Bonds

AMPRO

Ampro Corporation
Chicago 18, Illinois
Precision Ciné Equipment



SAVE WASTE PAPER



Greater Pleasure from Your Hobbies with Knives that Respond to Your Touch... X-ACTO

New! No. 83 X-ACTO deluxe all metal knife chest. The finest in knife sets complete with 3 solid aluminum handles and 12 interchangeable blades, in handy wooden chest. Price \$5.00 complete. Other knives and sets from 50c to \$2.50.

RE-BLADE IN RE-SHARPEN

Men at work with X-ACTO knives know the joy of using finest surgical steel blades that are always sharp—that always make precision cuts with ease.

No matter what the carving or cutting job, be it a frisket, a model airplane, or a piece of 16 ply cardboard, get to know the satisfaction of using X-ACTO for with a twist of the wrist you insert a new blade. Result? A knife that is factory-fresh!

For greater pleasure in your work or arts and crafts, get an X-ACTO Knife Chest.

Write for 32 page Handbook "How to Build Solid Scale Model Warplanes!" —19 cents



On sale at Hobby and Model Dealers, Hardware and Dept. Stores or order direct from X-ACTO CRESCENT PRODUCTS CO. 440 Fourth Ave., New York 16, N. Y.

X-ACTO

EVERKEEN knife

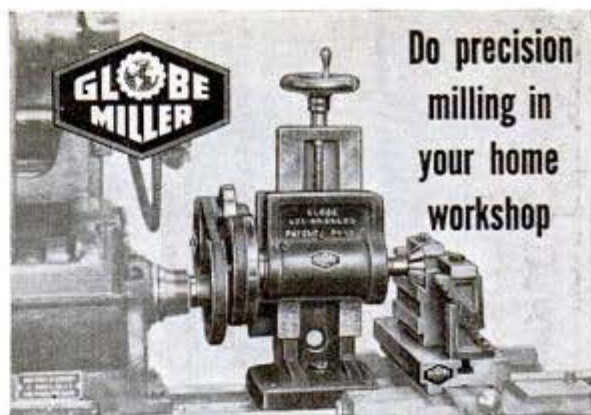
Do precision milling in your home workshop

Globe Miller attaches to standard lathe in 3 minutes, does all precision milling operations, but costs only a fraction as much as milling machine. With headstock as power source, it uses all lathe speeds and feeds, and increases lathe swing 5 to 10 inches.



Accessories: Precision-made arbors, end mill holders, stop blocks, dogs, chuck adapters, work holding fixtures and other machine tool accessories available.

Write for Free Literature giving Make and Size of Lathe.

GLOBE PRODUCTS MFG. CO.
3380 Robertson Boulevard, Los Angeles 34, California

Try Anti-Gray Hair Vitamins Plus Wheat Germ Oil (E) Vitamins ON THIS MONEY BACK OFFER

RESTORING COLOR TO GRAY HAIR WITHOUT DYES IS SCIENCE'S LATEST MIRACLE

If your hair is gray, graying, streaked, faded or off-color, modern science offers new hope without dyeing. A lack of certain vitamins in your daily diet can cause hair to turn gray. Improve your diet, get extra supplies of these "anti gray hair" vitamins by simply taking the original 2-way Panate Vitamin treatment. You too may be amazed and delighted to see the gray spread stopped, restoration of normal natural original color to the hair at roots, temples, parting, a great improvement in your hair beauty. You can now test Panates yourself on an iron clad guarantee that leaves no room for doubt.

PANATES is different—it not only contains a powerful supply of "Anti-Gray Hair" Vitamins but "staff-of-life" Vitamin (E) Wheat Germ Oil as well. Panates is not a hair dye. You have nothing to fear... no fuss, no fuss. You can test safe, beautiful Panates whether you now dye your hair or not, because Panates Vitamins work from within to check gray spread and literally feed natural color back into the hair roots.

When the blood does not provide the proper elements, the tiny laboratory that manufactures color shuts down and the hair grows gray. Perhaps you may need the vitamins in Panates. Make this test today.

SEND FOR THIS INTRODUCTORY TRIAL OFFER TODAY



The 30 day trial of the regular \$4.79 (90 day) Panates double action Vitamins is only \$2.79 if you act at once! SEND NO MONEY pay postman plus C.O.D. postage on arrival on guarantee of full satisfaction or money back. Send \$2.79 and we pay all postage. (Or, if you want more of the amazing Panates Anti Gray Hair Vitamin story, write for FREE Valuable Booklet, "Vitamins and Gray Hair." No cost, no obligation. Whatever you send for put your letter or postcard in the mail today while Special Offer is available. Who knows perhaps the 2 vitamins in Panates may be the wonderful way-way answer to your hair color worries! Not in stores. Write

The Panate Co., Dept. G-240, 116 S. Michigan, Chicago 3, Illinois



Honeywell
Heat
Regulating
Thermostat



Damper Motor

Act Quick! Enjoy Automatic Heat This Winter... Install It Yourself... USE WITH ANY HAND FIRED FURNACE OR BOILER

ONLY
\$23⁰⁰

Latest model of the famous Minneapolis Honeywell "Electric Janitor." They've been unobtainable for two years. Now WPB has released a limited number to help save coal this winter.

A flick of your finger sets the dial at the temperature you want. The "Electric Janitor" does the rest. Saves countless steps, conserves health, gives undreamed of comfort. Owners report savings up to 30% on their coal bills.

The "Electric Janitor" will pay for itself the first season. Nothing will give you more pleasure and satisfaction. Scores of thousands are in use. Made and guaranteed by the largest maker of heating controls in America—Minneapolis Honeywell.

Don't delay. Supply is limited. Your ordinary house tools are all you need to install it. Send check or money order for \$23.00. We'll ship immediately, P. P. prepaid, anywhere in U. S.

If you prefer, we'll ship, small cash down payment, Balance C.O.D. Parcel Post Collect.

COMPLETE... Ready to Install "ELECTRIC JANITOR"

Includes the famous Honeywell Thermostat, electric damper motor (115 volt, 60 cycle), transformer, chain, pulleys, cable and all needed accessories, together with full instructions.

W. F. HANN & SONS CO., Heating Specialists
15505 Euclid Avenue • Established 1907 • Cleveland 12, Ohio

IF YOU WANT TO MAKE "Good Pictures"

USE YOUR CAMERA—SEND 25c

for this 56-page book. It will help solve many of your problems. Write to Argus, Inc., Ann Arbor, Michigan, Dept. H.



argus — ann arbor
incorporated — michigan



Customer: "That's a beautiful job, Pete."

Pete: "Yes, you can't beat the Foley for turning out a perfect cutting saw."

SAW FILING

is a Good Business

With the Foley Automatic Saw Filer you can put yourself into a fine cash business with steady customers and make a good living. The Foley automatically joints the saw, making all teeth even in size, shape, spacing. The Foley is the only machine that files all hand saws, also band and cross-cut circular saws.

SEND FOR FREE PLAN—Shows how to start a saw repair shop. No canvassing. Send coupon today.

FOLEY Automatic SAW FILER

FOLEY MANUFACTURING CO.
1016-4 Foley Bldg., Minneapolis 13, Minnesota
Send Free Plan on Saw Filing business, no obligation

Name _____
Address _____





\$4.90
complete

"SERVICE PAL" DELUXE KIT

The answer to your serviceman's "pipe dream". A grand gift—a welcome companion. All three at one special price!

PIPE Imported MEERSCHAUM set in fine, aged Briar of exquisite beauty. Para rubber stem. Mellow, cool-smoking. Cannot burn out.

POUCH Genuine Leather (choice blue or brown), with slide fastener. Waterproof lining. Holds full pack of tobacco.

TOBACCO Honey Briar Mixture. Mild, aromatic, sweet-smoking. ¼ lb. package.

Packed ready to ship.
No overseas request needed.
Shipped direct if desired.

Note: For \$1.00 additional, we will include Windproof Lighter.

SACHS PIPES, 5435 Myrtle Ave., Brooklyn 27, N. Y. Est. 1887



Decorative Decalcomania

Transfers Imported Designs of all Sizes and Types—Flowers, Fruits, Figures, Birds, Dogs, Horse Heads, Ships, Juvenile, Tropical, Chinese, Peasant, Colonial, Patriotic, Inlay, Borders, Initials, etc., for Furniture, Doors, Walls, Trays and what not. **Catalog with 800 illustrations in Color sent for 25c.** Deductible on first order of \$1.00 up. **L. C. WELLS, Dept. PM-410, 25 East 26th St., New York, 10**



It's the new .22 automatic H&R Reising automatic rifle — kid brother to the Reising sub machine gun used so effectively by the U. S. Marines.

This military model precision rifle snaps out ten shots right where you point it and as fast as you can squeeze the trigger.

Ask your sporting goods dealer about it. Send now for descriptive folder.

Quality Arms since 1871

HARRINGTON & RICHARDSON ARMS CO.

331 PARK AVE., WORCESTER 2, MASS.

\$100 MOTOR-GENERATOR for \$17.95 MADE FOR U.S. ARMY TANKS BY WESTINGHOUSE

Make \$5.00 Per Hour

and more in spare time by developing this Westinghouse Motor-Generator into:

- 1½ HP. D-C Motors
- AC-DC Motors
- Arc Welders
- Home Generators
- Wind Chargers
- School Equipment
- Farm Applications
- Experimental Units for Special Uses



Cost over \$100.00. Brand new, 1½ HP. 24-V. 7.5 amp. 3600 RPM. D-C motor direct connected to 1-K.W. 4.5 amp. 230-V. D-C Generator in same housing, 85° C. Ball-bearing. Totally enclosed. ½" shaft (adapter 95c extra). Wt., 125 lbs. Converted into D-C motor by changing and rewinding two 1-lb. coils No. 31 wire. Instructions furnished for D-C motor and welder only. Invest \$17.95 and get priceless experience reworking unit for other uses and make easy profits selling your developments.

Shipped Prepaid for \$17.95 (Cash) or C.O.D. on \$3.00 Deposit.
MIDLAND MOTORS, P-744 W. ADAMS ST., CHICAGO 7, ILL.

INVENTORS, SCHOOLS, CRAFTSMEN BRONZE FOUNDRY



is again available in limited quantity without priority. Orders filled in sequence as received. **INVENTORS—SCHOOLS—CRAFTSMEN** use FOUNDRYETTE for making castings quickly for new inventions, for instruction, and general purpose. Order now for early delivery. Three sizes are available capable of making bronze castings of 1½, 3, and 6 pounds weight, aluminum, copper, brass, etc., \$17.50, \$24.00, \$34.50, L.O.B. Kansas City. Domestic gas supply and 110 volt AC or DC energy required for operation. Write for circular.

KANSAS CITY SPECIALTIES CO.
Box 6022, Dept. P-47 Kansas City, Mo.

WORLD'S LOWEST PRICED ADDING MACHINE

Best Pocket Size FREE TRIAL ONLY \$2.50

IDEAL FOR BUSINESS OR PERSONAL USE. GUARANTEED ACCURATE. TOTAL COST SEND NO MONEY

Not a toy. Operates with only a finger flick. Adds, subtracts, multiplies, divides. Counts up to ten million. Pays for itself over and over. Ideal Gift—for Business, Income Tax and School use. **MONEY BACK GUARANTEE.** Send name and address. Pay postman only \$2.50 plus postage. (Send full cash if outside U. S.) Money back in 10 days if not delighted. **AGENTS WRITE.**

CALCULATOR MACHINE COMPANY (Mrs.)
DEPT. 158, P. O. BOX 1118 CHICAGO, ILLINOIS

POPULAR MECHANICS

NOTED PEN ENGINEER INVENTS
AN AMAZING NEW KIND OF



S. M. Sager—famous designer of the INKMAKER and outstanding fountain pen improvements in use the world over.

FOUNTAIN PEN *that* MAKES ITS OWN INK



**READ WHAT
THEY SAY!**

The INKMAKER Pen the PERFECT GIFT for Service Men

A Corporal in New Guinea writes: "A pen like this is truly a service man's dream come true. We are on the move at a moment's notice and ink bottles get lost or broken. The remarkable feature of the Ink-maker is no moving parts of metal to rust or wear out. Metal rusts here over-nite."

A Soldier in Italy writes: "I am a battery clerk with U. S. forces in Italy. Before I had the Inkmaker pen, my supply of ink became exhausted and my work was at a standstill. With ink withheld for indefinite periods, you see how valuable the "Ink-maker Pen" is to me."

Another Yank writes: "The Inkmaker Pen comes in so handy here overseas as one can carry dry ink batteries in bilfold, liquid ink is so hard to get over here. Merely filling with water makes it one of the most valuable pieces of my equipment."

AND NO WONDER. Miles from the nearest ink bottle—perhaps weeks before more ink is available—yet a few ounces of water—any kind of water—and your service man has a penfull of lustrous, easy-flowing, quick-drying ink, ideal for V-Mail.

LIMITED QUANTITY AVAILABLE
Order at Once for Overseas Shipment

The number of INKMAKERS available is limited. We want these to go to the men who need them most. Civilians have easier access to a supply of ink for their pens. Service men haven't. Order one or more of these INKMAKER Pens; mail it to a man or woman in service. They will appreciate your thoughtfulness.

Thousands in Use the World Over

Do not confuse the INKMAKER with ordinary pens. The INKMAKER Pen is a high quality product displayed by some of the nation's finest shops. Thousands of these fine pens are now in use in the U.S.A. and the many fighting fronts throughout the world. We will ship INKMAKER Pens direct to give you an opportunity to send this fine military pen, which carries a LIFELONG SERVICE GUARANTEE, as a gift to our boys in the armed services.

The INKMAKER has the sparkling quality of a jewel. It is streamlined in and out—made of durable plastics—feather light—perfectly balanced—leakproof for use in high altitudes, equipped with a velvety smooth-writing 14K gold point.

This is a lifetime gift. Right now it is the most appropriate gift you can send a service man—overseas especially, where ink is hard to get. Rush your order in the next mail. Mark the coupon and get it in the mail at once. We will ship promptly as long as stocks last.

HOW TO ORDER: As long as our stock lasts we will fill orders—use the attached coupon-order blank. The retail price of the INKMAKER Pen is \$8.75. You may send remittance with order and we will ship with postage prepaid. Or you may send a deposit of only \$1.00 and we will ship C.O.D. for the balance, plus C.O.D. charges. Each pen includes four Ink Batteries (two in pen, plus two extra). Re-fills always available, 2 for 25c. Do not delay.

Dealers Write!

40 South Clinton Street,
Dept. 210, Chicago 6, Illinois



Price
\$8.75



INKMAKER Pens are equipped with the INK-O-GUARD. This patent protects against leaking. An exclusive feature in INKMAKER Pens.

FILLS ITSELF

by natural air pressure! Simply follow easy filling directions that accompany each pen.

With "Spare" Ink Battery in the pen you never run out of Ink!



Concentrated Ink Battery writes for MONTHS without replacement. Simply add water. Generates fresh, lustrous, quick drying ink as you write!

Without rubber sacs, gadgets, plungers, etc., space in pen-barrel provides mammoth ink capacity!

WHEN ORDERING specify Color and Points: Khaki, Navy Blue, Hospital White, Burgundy, Black. POINTS: Fine, Medium, Heavy. Due to wartime conditions, it is advisable to give two color choices when ordering.

INKMAKER PENS 40 S. Clinton St., Dept. 210, Chicago 6, Ill.

Please ship me.....

.....

.....

I enclose.....in full. Ship prepaid.

I enclose \$1.00 per pen and will pay postman balance \$7.75 per pen plus C.O.D. charges.

Name.....

Please Print Plainly

Address.....

City.....Zone.....State.....

INKMAKER PENS,

Close Limits and Fine Finish-

FOR EFFICIENT PRODUCTION

Close limits and a fine finish are essential for efficient production on many important metal working operations. Maximum output at minimum cost can be attained only when the methods and machines are such that close tolerances and the best possible finish can be maintained on piece after piece, indefinitely.

It is on this type of work—exacting toolroom jobs or production operations that call for toolroom accuracy—that the high precision and dependable performance of South Bend Lathes pay real dividends. Their smooth operation through a wide range of spindle speeds produces surprisingly fine finishes. In fact, when South Bend Lathes are installed, subsequent finishing operations can often be eliminated.

Today South Bend Lathes are better in every way. Our entire plant is devoted to lathe production—we manufacture no other products. There has been no lowering of standards because of war-time restrictions or shortages and the use of substitute materials is negligible, limited to non-essential parts such as name plates, paint, etc. Improvements have been accelerated to meet war production needs.

South Bend Engine Lathes and Toolroom Lathes are made in five sizes: 9", 10", 13", 14½", and 16" swing. Precision Turret Lathes are available in two sizes: Series 900 having 9" swing with ½" collet capacity, and Series 1000 having 10" swing with 1" collet capacity. Write for Catalog No. 100-C.

BUY WAR BONDS NOW... SAVE FOR LATHES

SOUTH BEND LATHE WORKS

Lathe Builders For 37 Years • South Bend 22, Indiana

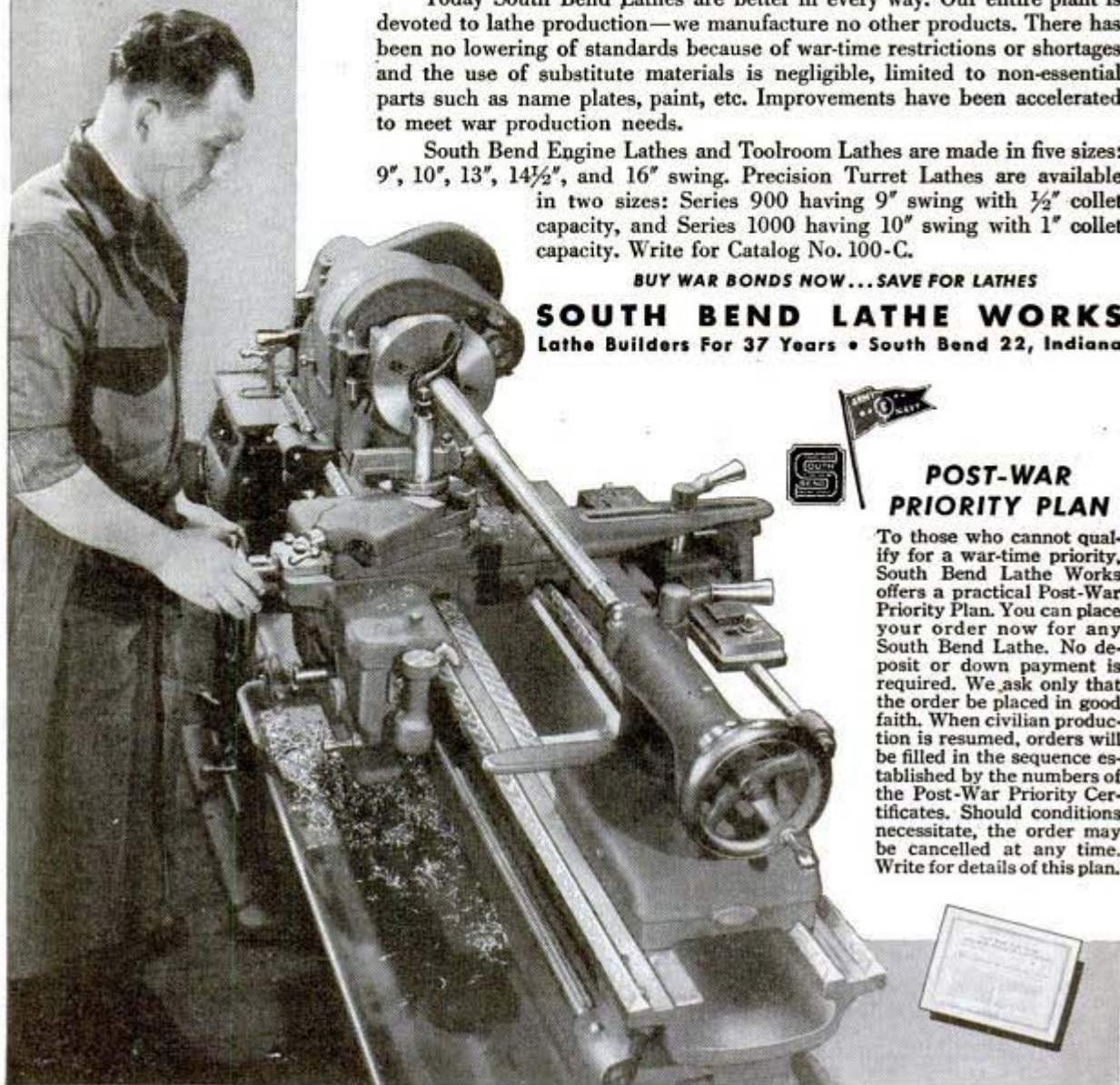

POST-WAR PRIORITY PLAN

To those who cannot qualify for a war-time priority, South Bend Lathe Works offers a practical Post-War Priority Plan. You can place your order now for any South Bend Lathe. No deposit or down payment is required. We ask only that the order be placed in good faith. When civilian production is resumed, orders will be filled in the sequence established by the numbers of the Post-War Priority Certificates. Should conditions necessitate, the order may be cancelled at any time. Write for details of this plan.

ANTI-FREEZE USERS

"PRESTONE" Anti-Freeze

is being distributed under W.P.B. Plan

THE ARMY, NAVY, AND LEND-LEASE are taking millions of gallons of "Prestone" anti-freeze. This leaves a reduced supply for civilian consumption.

The War Production Board, assisted by the Anti-Freeze Industry Advisory Committee, has worked out a plan of distribution of the available supply of all types of anti-freeze based upon a state allocation system. Under this plan there is every reason to expect that there should be enough anti-freeze to keep the nation's motor vehicles running this winter.

However, the chances are that "Prestone" brand anti-freeze will be rather scarce in many localities. Yours may be one of them. So, see your dealer early. Have that feeling of security that comes when you have the world's finest anti-freeze in the radiator of your car. One shot lasts all winter. It doesn't boil away, evaporate or lose effectiveness through "foaming." Protects against rust and corrosion.

NATIONAL CARBON COMPANY, INC.
Unit of Union Carbide and Carbon Corporation



The words "Eveready" and "Prestone" are registered trade-marks of National Carbon Company, Inc.

*Keep your eye on the Infantry
— THE DOUGHBOY DOES IT!*

U. S. A. RETAIL
CEILING PRICE
265
PER
GALLON



...YOU'RE SAFE. AND YOU KNOW IT WITH

PRESTONE

TRADE-MARK

Anti-Freeze



FOR YOUR FIGHTING MAN

BUY MORE BONDS

Head and Shoulders

OVER OTHERS

FOR MILDNESS... FOR BETTER TASTE

And as sure as night follows day... Chesterfield's definitely Milder Better Taste is the result of their...

RIGHT COMBINATION
WORLD'S BEST TOBACCOS

Make these 5 Key-words the key to your Smoking
Pleasure, as they are for millions everywhere.

ASK FOR - **CHESTERFIELD**